

# Electronic Design

FOR ENGINEERS AND ENGINEERING MANAGERS.

VOL. 16 NO.

1

JAN. 4, 1968

**Cities are turning to electronics** to solve their pressing problems. Rugged, reliable sensors, meters and transceivers will help fight air pollution, sewage backups,

transit snarls and rising crime. Microwave links to traffic-light controllers, such as in this New York City unit, are a first step. For the full picture, see page 65.





**NEW**

# DO-T200™ SERIES

**ULTRAMINIATURE TRANSISTOR TYPE  
AUDIO TRANSFORMERS**

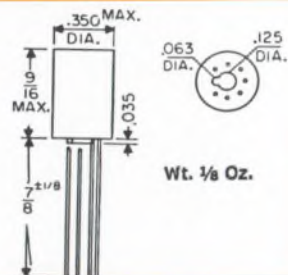

Wt. 1/8 Oz.

U. S. PAT. NO. 2,949,591; others pending.

This DO-T200 series of transistor transformers and inductors has been newly added to the UTC lines of stock items available for immediate delivery. These transformers provide the unprecedented power handling capabilities and the inherent reliability found only in the basic structural design of the UTC DO-T Family of miniature transformers. This reliability has been dramatically proven in the field.

Leads are 7/8" long, .016 Dumet wire, gold plated, and may be either welded or soldered. They are uninsulated and are spaced on a .1" radius circle, conforming to the termination pattern of the "TO-5" cased semiconductors and micrologic elements.

DO-T200 series of transformers are designed for Class R application. On special order they may be designed to Class S Specifications. No additional life expectancy is gained by using Class S insulation systems at Class R temperatures.

In pulse coupling impedance matching applications, (when measured with a 30 microsecond input pulse voltage wave), typical values for these transformers are: 5% or less droop, zero overshoot, and less than 10% backswing.

Special unit modifications, such as additions and deletions of leads, changed lead lengths, different impedance ratios and incorporation of electrostatic shields, etc., are available in these constructions.

• Manufactured and successfully tested to complete environmental requirements of MIL-T-27B

- Most Ruggedized MIL Structure, Grade 4, Metal Encased
- Hermetically Sealed
- Immediate Delivery From Stock
- Straight Pin Terminals
- Full Conformance to MIL Mounting Requirements
- Excellent Response
- Solderable and Weldable Leads
- High Efficiency
- Low Distortion

Type No.	MIL Type	Pri. Imp.	D. C. mat <sup>†</sup> in Pri.	Sec. Imp.	Pri. Res.	Mw Level	Application
DO-T255	TF4RX13YY	1K/1.2K CT	3	50/60	115	100	Output or matching
DO-T275	TF4RX13YY	10K/12K CT	1	1.5K/1.8K CT	780	100	Interstage
DO-T277	TF4RX13YY	10K/12K CT	1	2K/2.4K split	560	100	Interstage
DO-T278	TF4RX13YY	10K/12.5K	1	2K/2.5K CT	780	100	Driver
DO-T283	TF4RX13YY	10K/12K CT	1	10K/12K CT	975	100	Isol. or Interstage or Pulse
DO-T288	TF4RX13YY	20K/30K CT	.5	.8K/1.2K CT	830	50	Interstage
DO-T297	TF4RX16YY	200,000 CT	0	1000 CT	8500	25	Input and Chopper
DO-T200SH	Drawn Hipermalloy shield provides 15 to 20 db shielding through side of case						

†DCma shown is for single ended useage. For push pull, DCma can be any balanced value taken by .5W transistors. Where windings are listed as split, 1/4 of the listed impedance is available by paralleling the winding.

## THE DO-T FAMILY OF COMPONENTS



These items manufactured and successfully tested to complete environmental requirements of MIL-T-27B, Grade 4, Class R, Life X. Except PIP: to MIL-T-21038B, Grade 6, Class R, Life X. Grades 4 and Grades 6 of MIL-T-27B & MIL-T-21038B respectively, are identical.

DO-T Flexible leads. Freq range 300 CPS—10KC & up. Power up to 1/2 W. Size 3/16 dia x 1 1/2" h. Wt approx 1/10 oz.

DI-T Flexible leads. Freq range 400 CPS—10KC & up. Power up to 1/2 W. Size 3/16 dia x 1/4" h. Wt approx 1/15 oz.

DO-T200 Series. See above

DI-T200 Series Straight pin gold plated. Dumet leads. Freq range 400 CPS—100KC. Power up to 500 mw. Size 3/16 d x 3/4" h. Wt approx 1/15 oz.

PIL Inductors range from .025 hy to .8 hy, DC 0 to 10 ma. Transformers from 500 ohms to 10,000 ohms impedance. Freq range 800 cps—250 KC; power up to 100 MW. Size 3/16 dia x 3/16" h. Wt 1/20 oz.

PIP (Pulse) Flexible leads. Wide application pulse transformers, to MIL-T-21038B specifications. Size 3/16 dia x 3/16". Wt 1/20 oz.

DO-T400 (Power) Flexible leads, power transformer. Power output 400 mw @ 400 cycles. Size 3/16 dia x 1 1/2". Wt 1/10 oz.

**AND SPECIAL, CUSTOM BUILT COMPONENTS TO YOUR SPECIFICATIONS**

Write for catalog of over 1,000 STOCK ITEMS with UTC High Reliability IMMEDIATELY AVAILABLE from YOUR Local Distributor



**UNITED TRANSFORMER CO. TRW**

DIVISION OF TRW INC. • 150 VARICK STREET, NEW YORK, N. Y. 10013

ON READER-SERVICE CARD CIRCLE 242

# FOUR DECADES IN ONE SWEEP

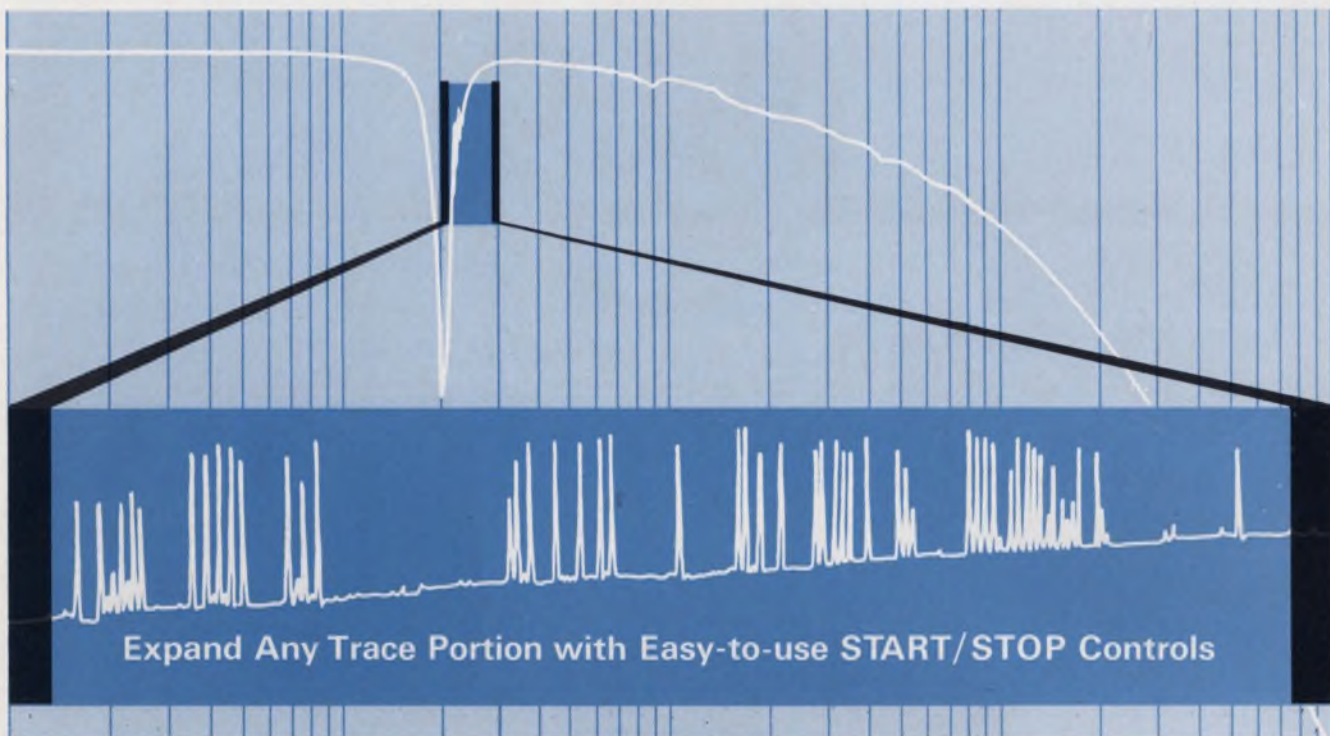

For the first time, you can sweep four decades without switching ranges. The new hp 3305A Plug-In with the hp 3300A Function Generator sweeps logarithmically in any of three ranges from 0.1 Hz to 100 kHz for narrow or wide band testing.

Easy-to-set calibrated START and STOP frequency controls establish sweep end points with  $\pm 10\%$  accuracy. The manual sweep can be used for close inspection of any point on the trace. It can also be used for accurate frequency identification.

You can adjust START/STOP controls to bracket any portion of the response curve, without readjusting the X-axis of the oscilloscope or X-Y recorder.

Continuously adjustable sweep time of 0.01 sec to 100 seconds is slow enough for accurate response testing of high-Q devices and fast enough for good visual displays of wide band responses. For flicker-free viewing of slow sweeps, use the hp 141A Variable Persis-

tence Oscilloscope. The hp 7562A Logarithmic Converter can be used as a detector (narrow band sweep can have as much as 80 dB dynamic range).

For ease of automated testing, frequency can be externally programmed and the sweep trigger also externally controlled.

For the complete story on the new hp 3305A Sweep Plug-In and the hp 3300A Function Generator, call your hp field engineer. Or, write to Hewlett-Packard, Palo Alto, California 94304. Europe: 54 Route des Acacias, Geneva. Price: hp 3300A Function Generator, \$625; hp 3305A Sweep Plug-In, \$975.

097/18

**HEWLETT  PACKARD**  
SIGNAL SOURCES

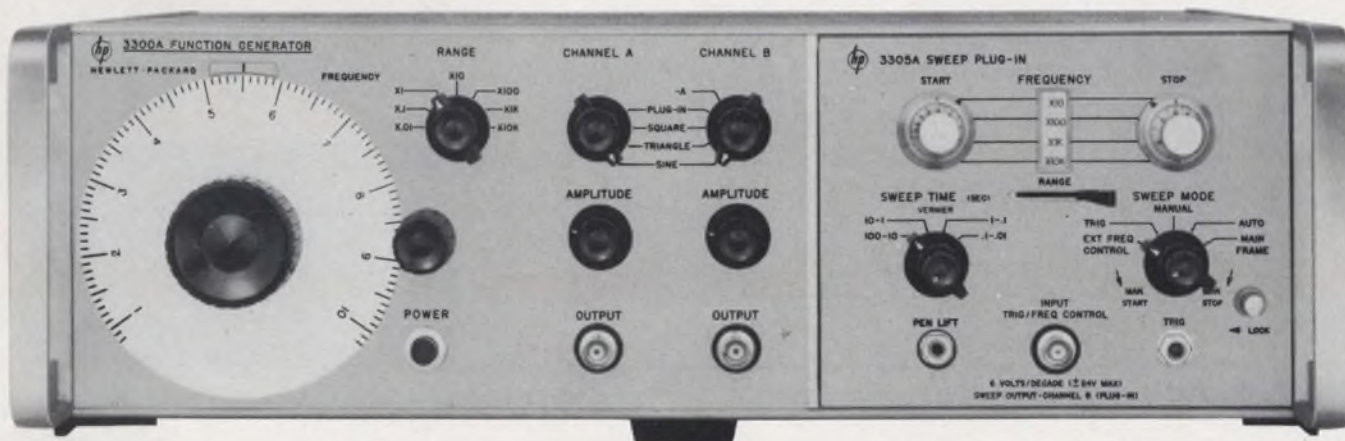

ON READER-SERVICE CARD CIRCLE 2



# NEW

## 110B Pulse Generator

More for the Money!

The Datapulse 110A was a great pulse generator — about the best general purpose instrument money could buy. The 110B is better!

Why? Some of the reasons are easy to spot: the attractive new cabinet styling, the new front panel design with streamlined controls, and the completely new internal packaging. Other reasons are less obvious — until you look at some 110B pulses. Then you see faster rep rates, improved dc baseline offset, and the cleanest pulses ever to come down the pike. The 110B also gives you both synchronous and asynchronous gating, and there's a triggered indicator on the front panel. You'll discover many more reasons why you'd want to own a 110B when you've seen the data sheet and a demonstration.

Datapulse welcomes technical employment inquiries.

Datapulse is the leading producer of solid state pulse instrumentation. 48 technical sales offices and 7 field service centers in 18 countries.

So, if you've recently ordered a Datapulse 110A, don't be concerned if you receive a 110B. It won't cost you a penny more and you'll get everything you expected and then some.

### Fully Controllable Fast Pulses

*Ask for a demonstration of the 110B's fully controllable fast pulses: linear rise times to 4 ns, rep rates to 50 MHz, 10V regulated dc baseline offset,  $\pm 10V$  simultaneous outputs, single or double pulses, 10 ns to 5 ms pulse widths, 10 ns advance to 50 ms delay. Price: Still only \$1250.00.*

*Write for complete specifications and applications information!*

**DATAPULSE**®



Datapulse Incorporated — A Subsidiary of Systron-Donner Corporation, 10150 West Jefferson Blvd., Culver City, California 90230. Telephone: (213) 836-6100, 871-0410. TWX: 910-340-6766. CABLE: Datapulse • Microwave Division: DeMornay-Bonardi.

---

## NEWS

- 21 News Scope
- 25 **Electronic sales still rise, but at a slower rate**  
EIA sees a 5% increase in output, a leveling-off of the defense budget.
- 31 **LSI will demand new computer architecture**  
Performance will improve but no significant cost reduction is foreseen.
- 35 **'Fence' in sky keeps an eye on space objects**  
Phased arrays in new radar set up scanning pattern over equator.
- 36 **'Reborn' oil tanker to help track spacecraft on Apollo missions.**
- 38 **'Peace Pipe' locates troops in the field.**
- 43 Washington Report
- 58 Sidelights of the Issue
- 61 **Editorial: Can advanced technology be applied to urban needs?**

---

## TECHNOLOGY

- 65 **Special Report: Electronics starts solving the problems of the cities.**
- 66 Crisis in the megalopolis demands new electronics.
- 86 **Urban hardware grounds the aerospace experts.**
- 96 **Boost class-D rf amplifier efficiency** but beware of antenna impedance changes that can reduce the device's power output.
- 102 **Draw your network's impedance** instead of bothering with complex algebra. The graphics are accurate and yield the impedance at one frequency.
- 106 **Smooth reflections with TDR** in pulsed active devices. Time-domain reflectometry helps preserve the 50-ohm continuum.
- 114 **Don't fool with gold plate selection.** The choice of solution can spell success or failure in joining plated components.
- 122 Test your IC IQ
- 126 **Money is not the only motivator.** There are personal satisfactions that every engineer must get, and the wise manager makes them available.
- 136 NASA Tech Briefs
- 138 Ideas for Design

---

## PRODUCTS

- 150 **Semiconductors:** Unijunction transistors are programable.
- 154 10-to-150-kV rectifiers are surge-compensated.
- 166 **Test Equipment:** Sweep synthesizer has 100-MHz sweep width.
- 168 Voltage-level detector has multiple applications.
- 182 **Systems:** Fourier transform computer—a mathematical whiz.
- 192 **Materials:** Glass puts muscle into moldable nylon.
- 200 Microwaves
- 206 Production Equipment
- 208 Components

---

## DEPARTMENTS

- 14 Designer's Datebook
  - 134 Book Reviews
  - 212 Design Aids
  - 213 Application Notes
  - 214 New Literature
  - 218 Reprints
  - 221 Advertisers' Index
  - 223 Information Retrieval Services
- Reader Service card inside back cover

**INTROD**

**KEMET<sup>®</sup> CERAMIC  
CAPACITORS**

**Brand Spanking New!**

# DUCCING

*(CK05, CK06, CK12... and others)*

Now from Union Carbide's Electronics Division you can get the finest quality ceramic capacitors available. Including those being manufactured to MIL-C-11015C.

Electrically, environmentally and mechanically, these capacitors are of the quality which you have come to expect of the KEMET Brand. And this puts us up in front . . . right in the beginning!

Every KEMET ceramic capacitor is manufactured to exceed the demanding BX characteristics of MIL-C-11015C and MIL-C-39014 . . . whether you need it or not! This single benefit is just one of many that helps us prove that with KEMET capacitors, *quality comes first*.

End use products are Computers, Industrial

Controls, Ordnance Devices, Instruments and other Industrial or Military Electronic Equipment.

Interested?

We answer many of your questions in our new product catalog. Write to P.O. Box 5928, Greenville, South Carolina, 29606, or simply call your local KEMET Representative.

From Union Carbide, The Discovery Company.



# Now you can put long-term reliability into precision resistor applications.

Because Corning made a production of precision.

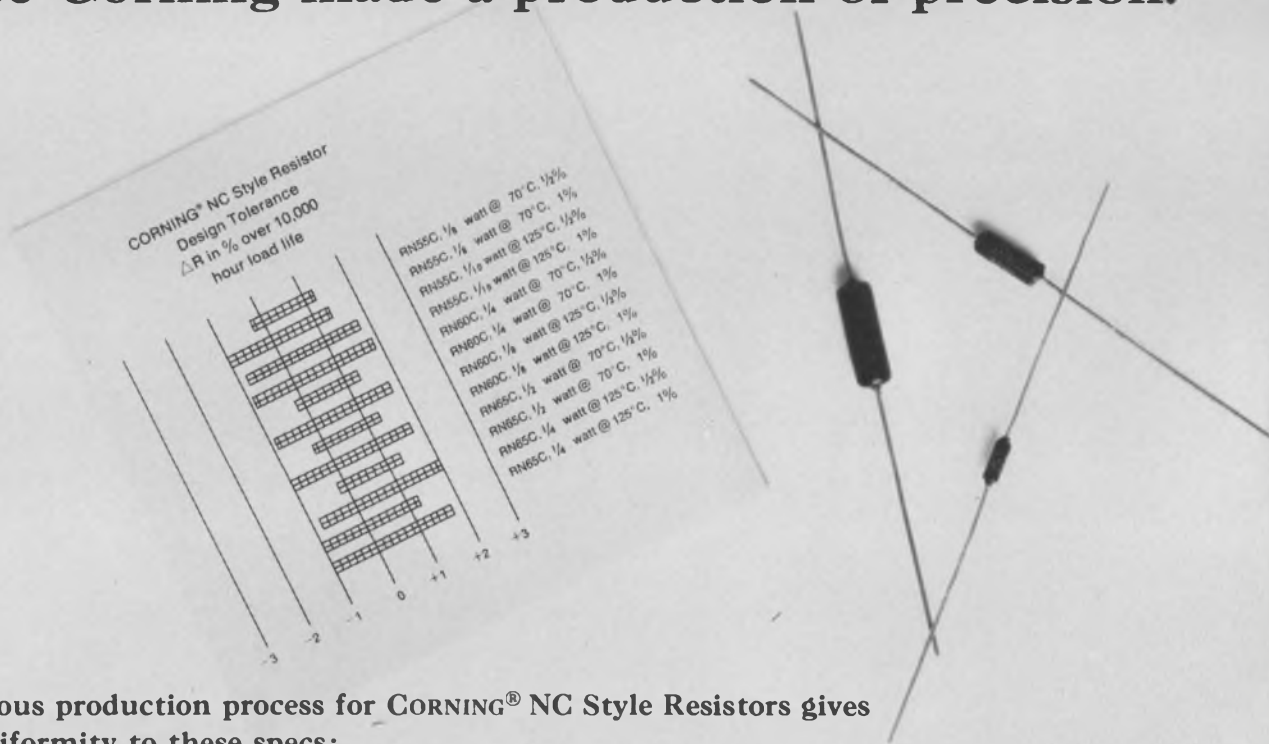

The continuous production process for CORNING® NC Style Resistors gives you total uniformity to these specs:

- Predictable end-of-life design tolerances from +1.8% to -1.0%
- Molecular bonding of metal oxide film and glass substrate.
- Matching TC's of film and glass.
- <1/2% load life  $\Delta R$ .
- Overall TC of  $\pm 50$  ppm.
- Mil-R-10509E, Char. C conformance.

Get this precision again and again. Specify CORNING NC Style Resistors. In three sizes, with these ratings at 125°C.: 1/10 watt in 49.9 ohms to 301K, 1/8 watt in 49.9 ohms to 1 meg, and 1/4 watt in 49.9 ohms to 2 meg. Precise data is yours for the asking from your Corning distributor, or by writing to: Corning Glass Works, 3913 Electronics Drive, Raleigh, N. C. 27602.

**CORNING**  
ELECTRONICS



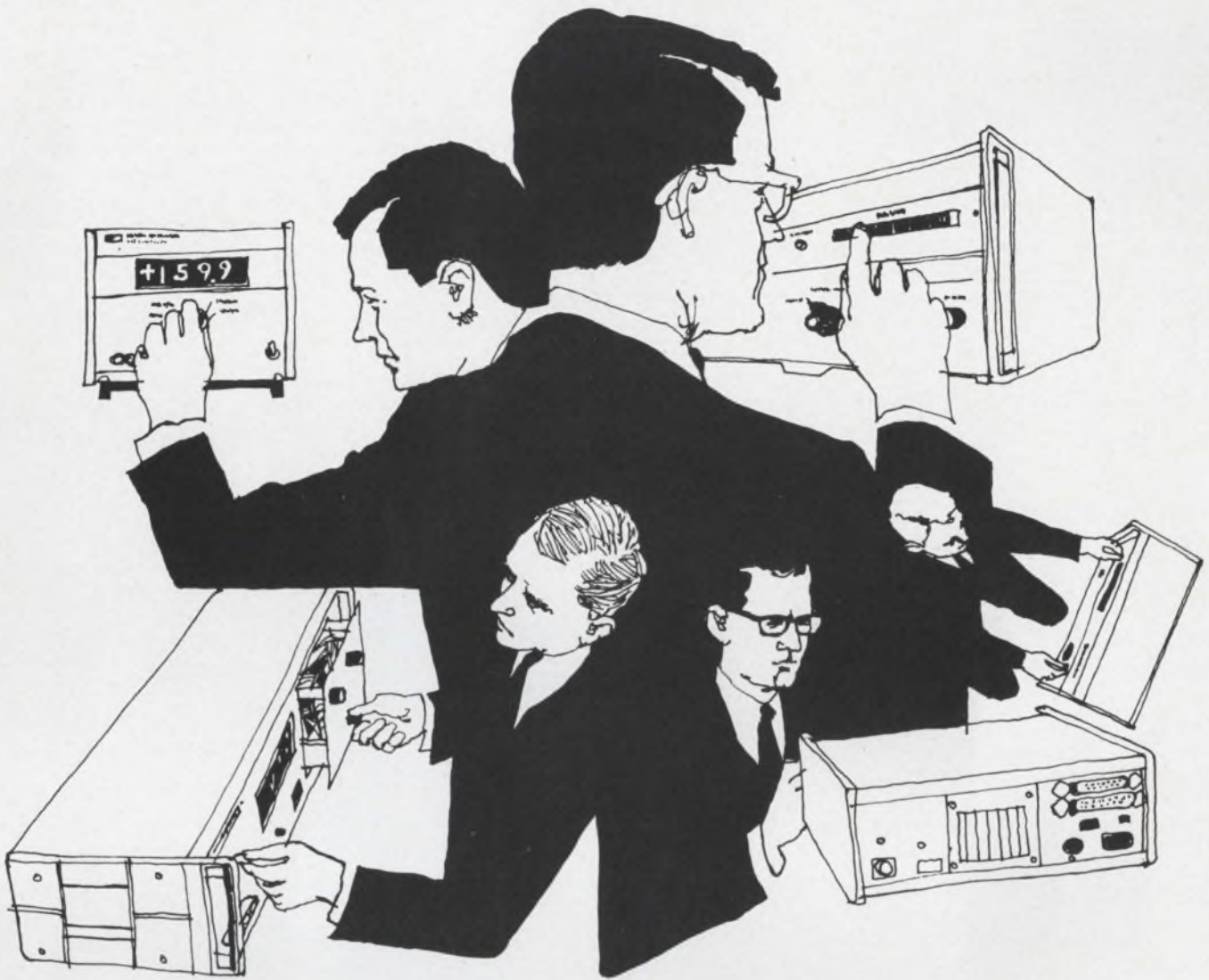

## LOOKING FOR MORE RETURN ON YOUR DVM DOLLAR?

Hewlett-Packard gives you more capability per measurement dollar with the widest choice of DVM's in the industry! Choose from 3, 4, 5, and 6-digit instruments with a variety of accuracies, sensitivities, functions and prices.

+ 159.9

**Looking for Economy?**

There's the three-digit hp 3430A for measurements within  $\pm(0.1\% + 1 \text{ digit})$  and a sensitivity of  $100 \mu\text{V}$ , with up to 60% overranging capability indicated by a fourth digit. Low price of only \$595.

+ 9999

**Looking for Plug-In Capability?**

It's yours with the four-digit hp 3440A. Six plug-ins give ac volts, dc volts, dc current and ohms. Basic dc accuracy is  $\pm 0.05\%$  of reading  $\pm 1 \text{ digit}$ . The 3440A has BCD printer output and rear terminals in parallel. Price: hp 3440A, \$1160; plug-ins, \$40 to \$575. For bench use, get lower-priced hp 3439A (no BCD outputs), \$950.

+ 1.19999

**Looking for Accuracy and Speed?**

For laboratory precision and systems speed, try the five-digit (plus a sixth digit for 20% overranging) hp 3460B. It has  $\pm 0.004\%$  of reading  $\pm 0.002\%$  full scale accuracy. The 3460B

has  $10 \mu\text{V}$  sensitivity and makes automatic and remote-controlled dc measurements at up to 15 readings per second. The guarded 3460B has high common mode rejection, and  $>10^{10}\Omega$  input resistance at balance on the 1 V and 10 V ranges (minimum  $10 \text{ M}\Omega$ ). On the 100 V and 1000 V ranges, input resistance is  $10 \text{ M}\Omega$ . Price: hp 3460B, \$3600; hp 3459A, (no BCD outputs), \$2975.

+ 1.999999

**Looking for Highest Accuracy and Sensitivity?**

hp H04-3460A gives resolution of 1 part in  $1.2 \times 10^6$ , sensitivity of  $1 \mu\text{V}$ , accuracy of  $\pm 0.005\%$  of reading or  $\pm 0.0005\%$  of full scale . . . with six-digit readout and seventh digit for 20% overranging. The guarded H04-3460A has 160 dB effective common mode rejection at dc, and uses integration to reduce effect of superimposed noise. Automatic, manual or remote operation is possible. Instrument has BCD printer output. Price: hp H04-3460A, \$4600.

For full details on the hp DVM that fits your needs—contact your nearest hp field engineer. Or, write to Hewlett-Packard, Palo Alto, California 94304. In Europe: 54 Route des Acacias, Geneva.

097/17

**HEWLETT**  **PACKARD**

ON READER-SERVICE CARD CIRCLE 6

◀ ON READER-SERVICE CARD CIRCLE 5

7



It is rare indeed for a components company to develop an expertise in more than one technology. But when it happens, the products which result are usually impressive. Wedding

the superb advantages of solid state electronics to those of electro-mechanical switches has already improved performance in several industries where precise timing is required.

Consider a missile launch program, aircraft

check-out equipment, an automotive test stand, or an industrial manufacturing process. All have one thing in common — a need for accurate control, either sequentially or simultaneously, of multiple events.

A newly-developed programmer provides that kind of control. It combines the functions of high current electro-mechanical relays with an appropriate network of solid state electronics which coordinates a memory unit and an automatic timer.

**How the Programmer Works:** Each basic control function or event is represented by an independent channel in the electronic

system. Timing data for each event is key punched on cards or tape and fed into a reader. The data is then stored in a volatile memory (magnetostrictive delay line) and held there until a fresh set of cards is entered with different data or until the timer is shut off. The contents of the memory are examined every second and compared with the elapsed time for each program which is also stored in the memory. When an exact comparison is made between a program's elapsed running time and the pre-programmed instruction for a specific channel, the output relay for that channel switches instantly.



As many as eight on/off operations can be programmed in for each channel and held in the circulating memory until used. The unused portion of the memory makes it possible to extend the cycle time for any channel to practically any length needed. This is accomplished by punching the correct data on new cards and plugging them into the reader. However, the total size of the memory determines the maximum operating period, the maximum number of controlled channels and the maximum number of operations per channel.

**Reliable Performance:** This programming system is far more reliable than any of the

hundreds of purely mechanical systems in use today. Consistent performance at high switching accuracies to a few milliseconds can be obtained in contrast to the minimum resolution of several seconds delivered by conventional systems.

It is more economical and flexible than an entirely solid state unit. Semiconductors provide accurate logic while the use of relays for the higher current output minimizes heating and provides isolation.

Performance is enhanced still further by the use of relays with 100,000 cycle or more life capability. Literally, this means years

of faultless operation free of the expense of scheduled maintenance.

Whatever the application, the basic benefits will always be there: operation is simple and flexible because the timing cycle is established by punched cards or tape. Starting times and sequencing are always under precise control. Programming is so uncomplicated that downtime during change-over is minutes. Maintenance costs are minimized.

**Write for a copy of our Brochure on Electronic Programmed Timers.** Leach Corporation,

**LEACH**

Relay Division, 5915  
Avalon Blvd., Los Angeles,  
California 90003.

# Just Married!

**Oh, no! Not another "revolutionary new breakthrough in electronic science." Just what in the world is a "Glo-Annunciator"??\***

It may not be as important as the invention of the transistor, but in it's own way, in it's own application, it's a pretty revolutionary product.

The Switchcraft "Glo-Annunciator" is a miniature, electromagnetically operated annunciator that appears to glow without the use of a lamp. A magnet-



indicator panel simply slides back and forth behind a display screen, alternately exposing and hiding the reflective indi-

# SWITCHCRAFT FORUM

cator as the device is actuated. The highly reflective material appears to glow, just as though there was a lamp behind it.

No power is needed to burn a lamp. In fact, the only power needed is a pulse signal to activate the slide magnet.

**Sounds ingenious. But what does all this mean in terms of improved electrical efficiency? An annunciator board isn't all that complicated.**

Oh, no? Add up the power consumption on a big board. And the heat. Not only from lamps. Buzzers or ring-down devices also use a lot of power and generate heat. What we have is a real cool device. The pulse signal feeds the annunciator coil which consumes only 0.7 watts at rated voltage. Even if you had an application where the annunciator coil must operate continuously, 0.7 watts is still a lot less than required for many indicator lamps.

And for extended life, we use a highly efficient ceramic magnet. Just for comparison, a ceramic magnet has 5 to 6 times greater magnetic retention than Alnico.

**I'm used to lamps. At least with a lamp, when it's "on," you know it. Can your reflective material match the intensity of a lamp?**

In the dark, no. It takes ambient light to reflect. But, here's one big advantage: the brighter the ambient light, the less a lamp appears to glow, by contrast. With our material, the brighter the ambient light, the brighter our reflected signal. And here's another big advan-

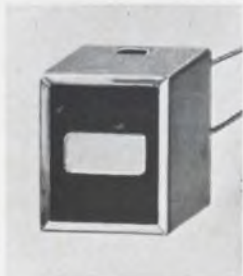

tage of the "Glo-Annunciator". A lamp is either "on" or "off". When a lamp is out, how do you know it isn't just burned out? Ours is a two-way signal. In one position it can glow green, in the other it can glow red . . . or many other combinations of colors. It is a positive signal in either position, and nomenclature may be imprinted on the indicator.

"Burn-out" brings us to another point. Lamps are relatively cheap, but how about the labor costs and down-time to replace them?

**You claim infinite life characteristics. Just how long will the "Glo-Annunciator" continue to operate?**

Practically forever. Here's why. The only moving part is the ceramic magnet slider. No pins, no bearings or latches to wear out. Secondly, the coil can't wear out and will continue to function electrically under the proper operating conditions. Finally, unlike

lamps, the flourescent material just keeps on glowing as long as there is light to reflect.

The simplified operation of the "Glo-Annunciator" bears this out:

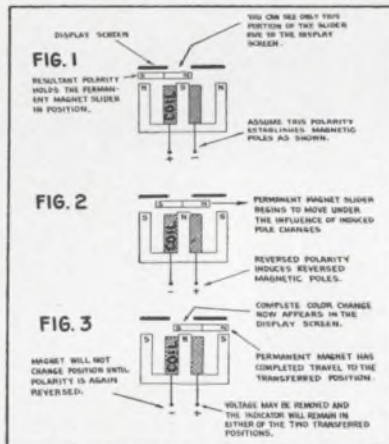

**Sounds pretty exciting. How do I get complete details on mounting dimensions, circuit applications, etc? By the way, I've got some comments on your FORUM, too.**

Good, just circle the Reader Service No. below. And, drop us a line on your company letterhead with your comments on any of our FORUM projects. We're anxious to have a lively exchange of ideas.

Also, we'll print the most interesting comments in our TECH-TOPICS engineering magazine, which you'll receive every other month. TECH-TOPICS features technical articles on switches and related products. Ten-thousand engineers already receive this Switchcraft publication and find the application stories useful in solving similar switching problems.

\*Patents pending.

**SWITCHCRAFT**  
INC.

5529 North Elston Avenue • Chicago, Illinois 60630

ON READER-SERVICE CARD CIRCLE 9

ELECTRONIC DESIGN 1, January 4, 1968

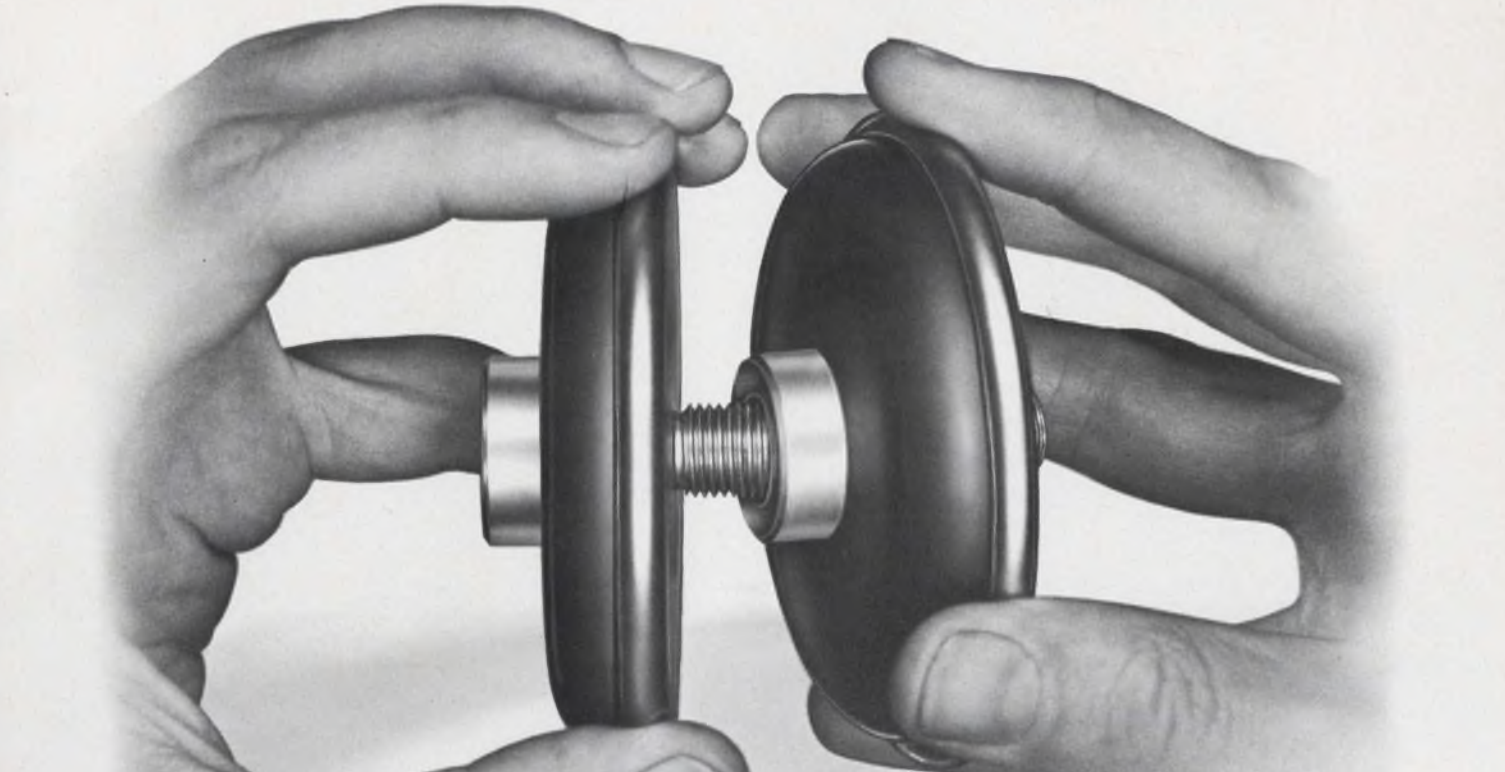

## These hands are designing a 50 KV–5 amp rectifier that is virtually fail-proof.

It's no oversimplification. They do work, they don't fail, and you can screw together almost any assembly you need up to 600 KV from the 14 stackable modules we have on the shelf. PIV's from 2.5 KV to 15 KV and currents to 10 amps. The men who designed these modules were high-voltage engineers. They knew the high-voltage engineering had to be done in the module before you started stacking. That's why they built in protection against transient surges. That's why they built in things like an anti-corona ring, shunt capacitance and controlled gradients. And that's why we haven't seen a legitimate failure of one of these devices in 3 years. Look . . .



THE DOORBELL RECTIFIER MODULE BY

# UNITRODE

580 Pleasant St., Watertown, Mass. 02172, (617) 926-0404



Get yourself a complete set of specs that give you all kinds of information too detailed to put in this ad. Circle the reply card number now.



# **T**est these new high-strength silicone resins before you specify!

Send for a cured sample of Sylgard® 186 or Sylgard® 187 silicone resin and test your own strength! These resins are *tough . . . flexible . . .* and highly tear resistant, even after being nicked.

Yet, they cure without danger of exothermic damage to delicate electronic parts . . . without damage due to stresses caused by shrinkage during cure. They are ideally suited for encapsulating, potting, filling, coating and embedding.

Sylgard 186 resin is transparent while Sylgard 187 resin is black. Both cure at room temperature . . . provide deep section cure . . . and have a service temperature range from -65 to 250 C with no post cure.

We will be happy to send you a sample of either Sylgard 186 or 187 silicone resin; plus complete technical data on both.

For the name of the Dow Corning representative in your area, write to: Dept. A7432, Electronic Products Division, Dow Corning Corporation, Midland, Michigan 48640.

**DOW CORNING**



*We're a materials producer exclusively. Let us tailor a material to your need.*

Circle No. 851

# Who Built the Converter Used on the Army's Minigun?



*Abbott did.* Out of 931 converters delivered during 14 months, only two were returned for repair. Maybe that's the reason, Abbott's Model BL5D-11A converter was selected as a power supply for installation in the SUU-11A/A minigun system, used on helicopters in Vietnam. This system employs a 7.62 millimeter minigun pod with firing rates of 6000 rounds per minute and therefore demands high reliability. This Abbott converter has an MTBF (mean time between failures) of 129,379 hours as calculated from the MIL-HDBK-217 handbook.

Abbott power modules use only the highest quality semiconductors and MIL-T-27B transformers in their construction to obtain the high degree of reliability under tough environments demanded by today's military requirements. To withstand heat sink temperatures of 100°C all silicon semiconductors are used exclusively.

High density electronics packaging, coupled with good design, give Abbott power modules a minimum size and weight for their rated power

output. One group of Abbott's DC to DC converter line, for example, the Model B05D, is smaller than a package of cigarettes, weighs less than a pound and produces five watts of regulated output voltage. All of the models described in the Abbott Catalog have correspondingly small sizes and weights.

If you have a need for a reliable converter, inverter or modular power supply, take a look at Abbott's. There are over 3000 models listed in their new catalog. They are built to operate in military environment of MIL-E-5272C at 100°C. They include output voltages from 5 volts to 10,000 volts DC with output currents from 2 milliamperes to 20 amperes. A wide range of different types of input power is available:

60 $\phi$  to DC, Regulated  
400 $\phi$  to DC, Regulated  
28 VDC to DC, Regulated  
28 VDC to 400 $\phi$ , 1 $\phi$  or 3 $\phi$   
60 $\phi$  to 400 $\phi$ , 1 $\phi$  or 3 $\phi$

Please write for your FREE copy of this new catalog or see **EEM** (1967-68 ELECTRONIC ENGINEERS MASTER Directory), Pages 1665 to 1678.

**abbott transistor**  
LABORATORIES, INCORPORATED

5200 W. Jefferson Blvd./ Los Angeles 90016  
(213) WEBster 6-8185 Cable ABTLABS

TO: Abbott Transistor Labs., Inc., Dept. 07  
5200 West Jefferson Blvd.  
Los Angeles, California 90016

Sir:  
Please send me your latest catalog on power supply modules:

NAME \_\_\_\_\_ DEPT. \_\_\_\_\_  
COMPANY \_\_\_\_\_  
ADDRESS \_\_\_\_\_  
CITY & STATE \_\_\_\_\_

ON READER-SERVICE CARD CIRCLE 12

## Designer's Datebook

JANUARY						
Sun	Mon	Tue	Wed	Thu	Fri	Sat
	1	2	3	4	5	6
7	8	9	10	11	12	13
14	15	16	17	18	19	20
21	22	23	24	25	26	27
28	29	30	31			

FEBRUARY						
Sun	Mon	Tue	Wed	Thu	Fri	Sat
				1	2	3
4	5	6	7	8	9	10
11	12	13	14	15	16	17
18	19	20	21	22	23	24
25	26	27	28	29		

For further information on meetings, use Reader Service card.

Jan. 11-12

Symposium on Photographic Systems for Engineers (Los Angeles)  
Sponsor: SPSE; S. A. Feigenbaum, Houston Fearless Corp., 11801 West Olympic Blvd., Los Angeles, Calif. 90064.

CIRCLE NO. 244

Jan. 16-18

Reliability Symposium (Boston)  
Sponsor: IEEE; L. J. Blumenthal, Melpar, Inc., 7700 Arlington Blvd., Falls Church, Va. 22042.

CIRCLE NO. 245

Jan. 17-18

Cybernetics Symposium (Chicago)  
Sponsor: American Society for Cybernetics; G. T. Jacobi, IIT Research Institute, 10 West 35 St., Chicago, Ill. 60616.

CIRCLE NO. 246

Jan. 16-19

Dynamic Measurements in Ocean Sciences (Cocoa Beach, Fla.)  
Sponsor: ISA; Ocean Sciences Short Course, ISA Headquarters, 530 William Penn Place, Pittsburgh, Pa. 15219.

CIRCLE NO. 247

Jan. 22-26

Marine Sciences Instrumentation Symposium (Cocoa Beach, Fla.)  
Sponsor: Instrument Society of America; M. Reed, Meetings Coordinator, Instrument Society of America, 530 William Penn Place, Pittsburgh, Pa. 15219

CIRCLE NO. 248

Jan. 27

Quality Control Conference (Pomona, Calif.) Sponsor: San Bernardino Section of the American Society for Quality Control; W. J. Willey, 327 Cimmaron Trail, Glendora, Calif. 91740.

CIRCLE NO. 249



# ***Better Silicon Power Switch/Amplifier Ideas Are Available— Take It From The Authority!***

All about designing with silicon power transistors with proven basic circuits acting as springboards for the designer's own requirements!

Chock-full of practical, comprehensive information every consumer and industrial circuit designer needs to know when using silicon power transistors, the just-released volume is highlighted by easy-to-understand, "how-to-do-it" topics like using direct coupling to eliminate amplifier transformers, outguessing the effects of damaging, secondary-breakdown transients, square wave forms and intermittent, irregular pulses, an exhaustive examination of AC to DC inverters, FET's and HV silicon in entertainment designs, and designing short-circuit-proof voltage regulators, to name a few.

Specific titled selections are:

- Low-Cost, High-Voltage Servo Amplifiers
- Complementary, Solid-State Audio Amplifiers
- Thermal Response of Semiconductors
- The ABC's of DC to AC Inverters
- A Method of Predicting Thermal Stability
- Solid-State Video Amplifiers
- New Solutions to Voltage Control Problems

... and much, much more that will  
make this a most-used design aid!

This more-than-120-page, 65-circuit edition is the latest Motorola-authored technical reference tool devoted to saving you time in design. It also incorporates the new Silicon Power Selector Guide . . . over 100 types — including the state-of-the-art Thermopad plastic devices — spanning collector currents from 30 mA to 30 A, collector-emitter voltages to 400 V, power dissipation ratings from 3.75 to 200 W and  $f_T$ 's from 1 to 60 MHz.

***Your technical library isn't complete  
without it and it's yours for the asking.  
Resolve to get it today!***

Write on your company letterhead to Box 955, Phoenix, Arizona 85001.



**MOTOROLA**  
**Semiconductors**

*—where the priceless ingredient is care!*

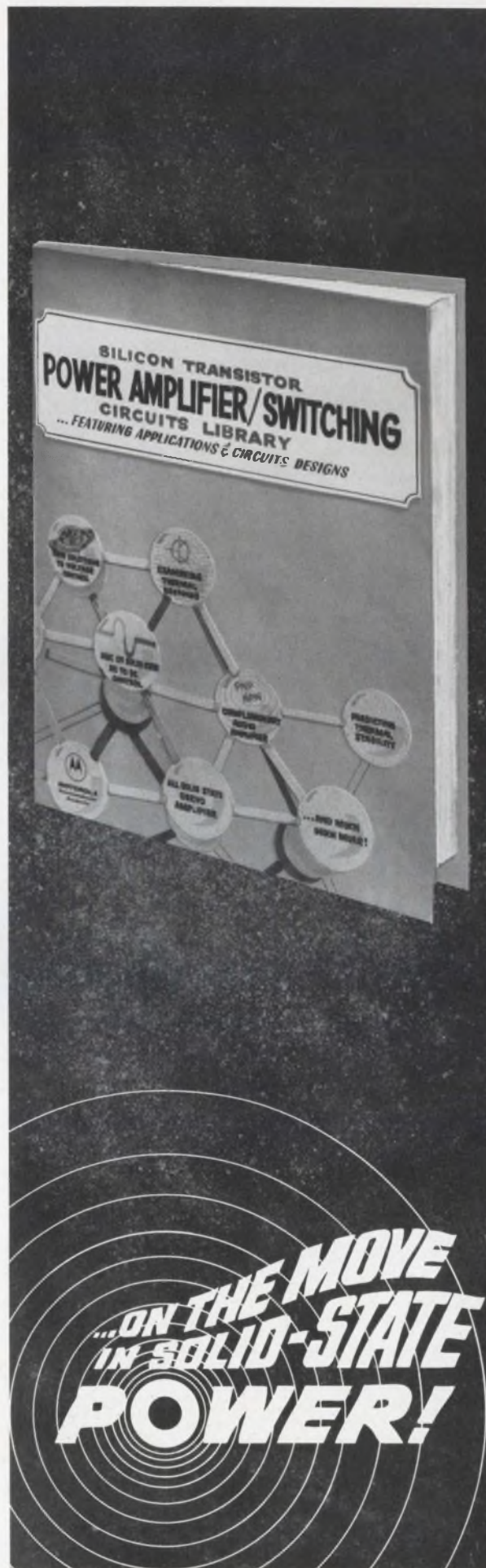

# Air variables from JFD solve your high Q high frequency problems

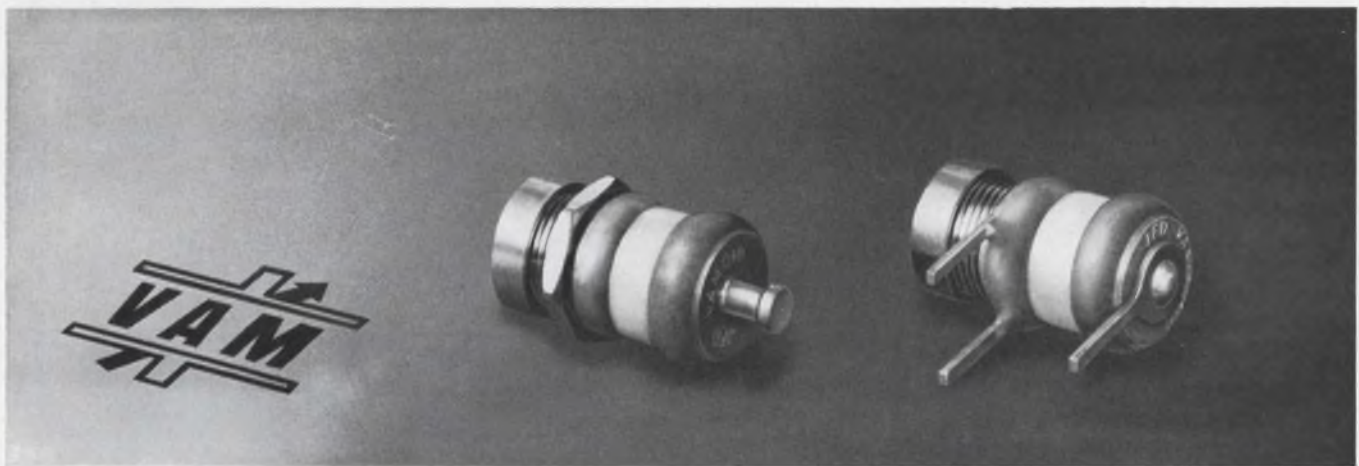

Capacitors shown enlarged 120%

The JFD air variable miniature capacitor series—VAM—is specifically designed for high frequency applications that demand extreme stability, small size and high Q (greater than 2,000 measured at 10 pf and 100 MHz) VAM's have rugged construction, measure approx. ½" in length and are completely interchangeable with competitive devices.

## ELECTRICAL DATA — ALL VAM MODELS

Cap. Range at 1 MHz ... 0.8 to 10.0 pf

Q at 10 pf & 100 MHz ... >2,000

Insulation Res. at 25°C ... 10<sup>6</sup> megs.  
at 500 VDC

Temp. Coeff. of Cap. (–55°C to  
+125°C) ... 0 ±20 PPM/°C

WVDC ... 250 VDC

Test Voltage ... 500 VDC

## ACTUAL SIZES

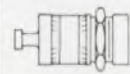

**VAM 010\***  
Panel Mount w/Turret Terminal

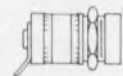

**VAM 010M**  
Panel Mount w/Lug Terminal



**VAM 010W**  
Printed Circuit

\*VAM 010 also available as VAM 010H with 4-40 threaded stud replacing turret terminal.

Write for catalog VAM-67-B

*"TODAY'S COMPONENTS BUILT FOR TOMORROW'S CHALLENGES"*

**JFD**

JFD ELECTRONICS CO. / COMPONENTS DIVISION / 15th Avenue at 62nd Street / Brooklyn, New York 11219 / Phone 212-331-1000  
Offices and subsidiaries in principal cities, world-wide.

ON READER-SERVICE CARD CIRCLE 14

# Soliton

announces High Reliability  
Small Signal Transistors for  
**IMMEDIATE DELIVERY!**



**NPN SILICON  
DIFFUSED  
TO-18  
2N930A**

$h_{FE}$  100 min @ 10  $\mu$ A  
 $I_{CBO}$  < 1 nA @ 45V  
NF 3db max @ 10  $\mu$ A  
 $f_T$  45 MC @ 500  $\mu$ A  
 $C_{OB}$  6 pf @ 5V



**NPN DIFFERENTIAL  
AMPLIFIER  
TO-78  
2N2642**

$h_{FE}$  100 min @ 10  $\mu$ A  
 $I_{CBO}$  < 1 nA @ 45V  
 $h_{FE1}/h_{FE2}$  .9 @ 100  $\mu$ A  
 $V_{BE1}-V_{BE2}$  5mV @ 10  $\mu$ A  
 $\Delta(V_{BE1}-V_{BE2})$  10  $\mu$ V/ $^{\circ}$ C  
 $\Delta T$



**PNP SILICON ALLOY  
AMPLIFIER  
COAXIAL  
2N1244**

$BV_{CBO}$  > 110V  
 $BV_{CEO}$  > 110V  
 $BV_{EBO}$  > 110V  
 $I_{CBO}$  < 10 nA @ 90V  
 $h_{FE}$  14-32 @ 1mA, 1KC



**PNP SILICON  
DIFFUSED  
TO-46  
2N2603**

$h_{FE}$  150 TYP @ 1mA  
 $I_{CBO}$  < 1 nA @ 45V  
NF 3db max @ 10  $\mu$ A  
 $f_T$  45 MC @ 500  $\mu$ A  
 $C_{OB}$  6 pf @ 5V



**PNP DIFFERENTIAL  
AMPLIFIER  
TO-78  
2N2805**

$h_{FE}$  100 TYP @ 1mA  
 $I_{CBO}$  < 1 nA @ 45V  
 $h_{FE1}/h_{FE2}$  .9 @ 100  $\mu$ A  
 $V_{BE1}-V_{BE2}$  5 mV @ 100  $\mu$ A  
 $\Delta(V_{BE1}-V_{BE2})$  10  $\mu$ V/ $^{\circ}$ C  
 $\Delta T$



**PNP SILICON ALLOY  
CHOPPER  
TO-5  
SSS1004**

$BV_{CEO}$  > 160V  
 $BV_{CBO}$  > 160V  
 $BV_{EBO}$  > 160V  
 $V_O$  < 2mV @ 750  $\mu$ A  
 $I_{P1}$  < 3nA @ 10V

Now, Soliton offers one of the industry's largest selections of high reliability small signal transistors. And, with the addition of new production facilities, they are immediately available from stock. These units include Differential and Darlington Amplifiers and Silicon Transistors manufactured by alloy and diffused techniques. Some typical devices — just a few of Soliton's wide selection — are shown here.

DIAL 1-800-327-3243 FOR A "NO CHARGE" TELEPHONE CALL AND FURTHER INFORMATION

*When you think of semiconductors...think Soliton!*

**Soliton** DEVICES, INC.

1177 BLUE HERON BLVD. / RIVIERA BEACH, FLORIDA / (305) 848-4311 / TWX: (510) 952-6676

ON READER-SERVICE CARD CIRCLE 15

# 60 MHz flip-flops, 5 nsec gates

## Sprague SSL\* is the fastest TTL

(Super-Speed Logic)



and they're pin compatible with series 8000

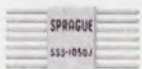

for maximum systems speed, check out  
Sprague SSL Super-Speed Logic

PROPAGATION DELAY .....	5 nsec
POWER DISSIPATION .....	25 mW
NOISE IMMUNITY .....	1.0 V
FANOUT .....	11
FLIP-FLOP TOGGLE FREQUENCY .....	60 MHz

For additional information  
write to:  
Semiconductor Division  
Sprague Electric Company  
115 Northeast Cutoff  
Worcester, Mass. 01606

\*Trademark

SPRAGUE WORCESTER... the world's finest microcircuit facility



'Sprague' and '®' are registered trademarks of the Sprague Electric Co.

# News

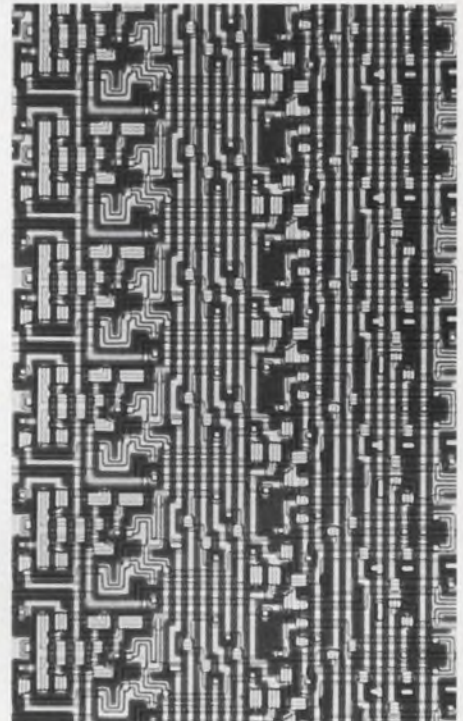
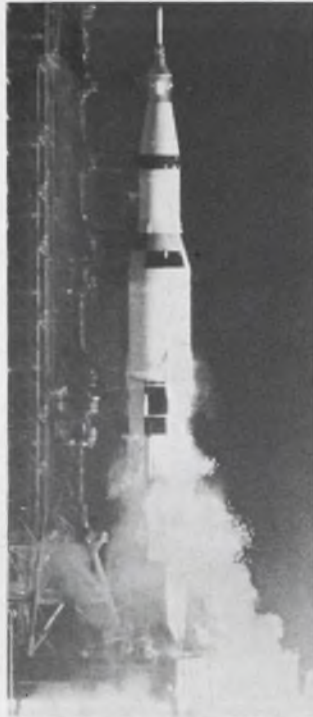

**Business prospects for 1968** are favorable in most areas, but Vietnam is the key to the course of events. Page 25

**LSI demands new design** to up computer efficiency. Page 31



**Former oil tanker has been rebuilt** to become the best equipped of five Apollo vessels that

form part of the communications and tracking system for moon missions. Page 36

## Also in this section:

Phased-array radar scans over the equator for space objects. Page 35

'Peace Pipe' permits aircraft to pinpoint troops at all times. Page 38

News Scope, Page 21 . . . Washington Report, Page 43 . . . Editorial, Page 61

**Only from Sprague Electric!**

# TYPE 137D TANTALEX<sup>®</sup> SINTERED-ANODE TANTALUM CAPACITORS

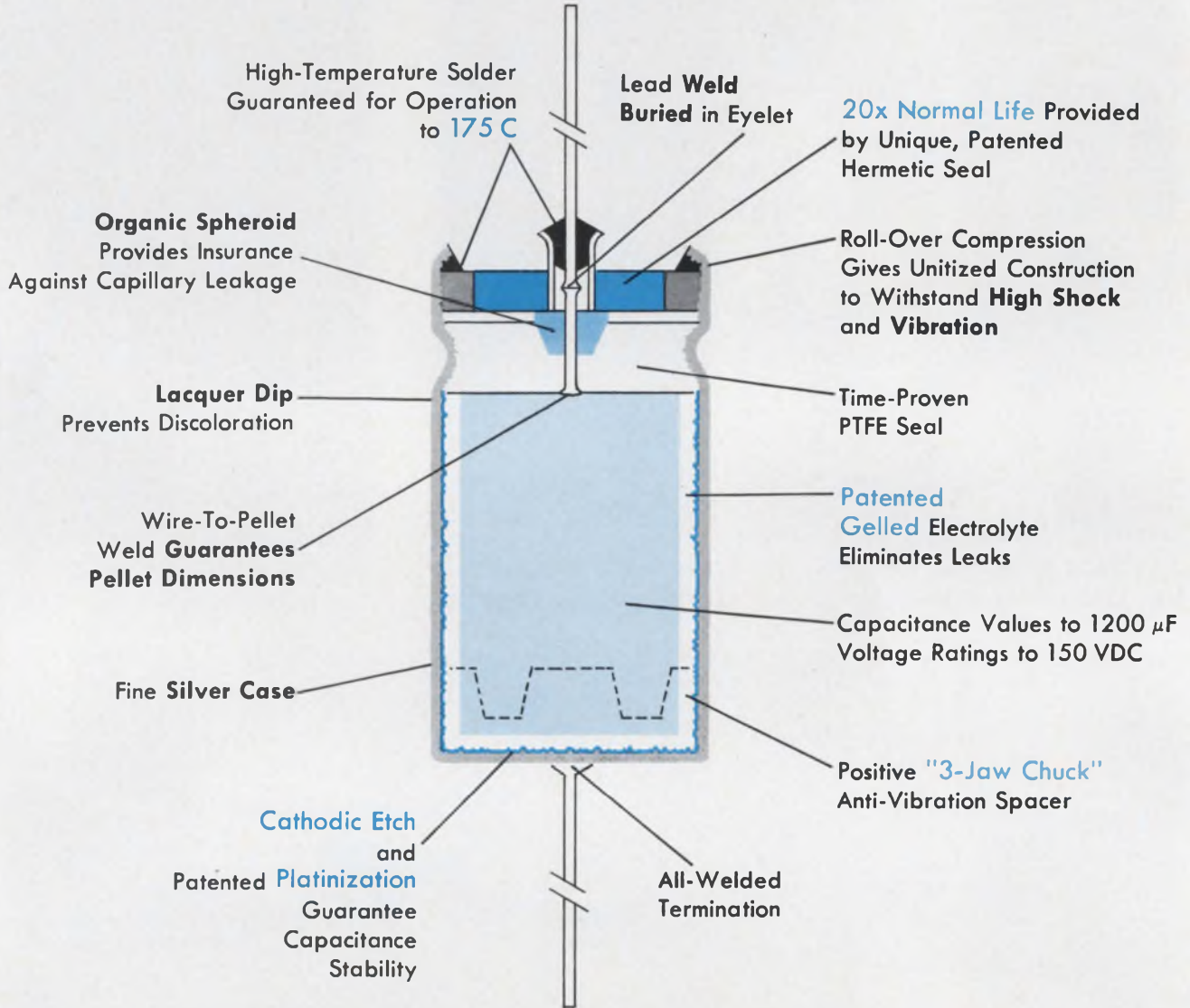

## WHY SETTLE FOR LESS?

For complete technical data, write for Engineering Bulletin  
3703A to Technical Literature Service, Sprague Electric Co.,  
347 Marshall St., North Adams, Massachusetts 01247.

### SPRAGUE COMPONENTS

CAPACITORS  
TRANSISTORS  
RESISTORS  
INTEGRATED CIRCUITS  
THIN-FILM MICROCIRCUITS

PULSE TRANSFORMERS  
INTERFERENCE FILTERS  
PULSE-FORMING NETWORKS  
TOROIDAL INDUCTORS  
ELECTRIC WAVE FILTERS

CERAMIC-BASE PRINTED NETWORKS  
PACKAGED COMPONENT ASSEMBLIES  
BOBBIN and TAPE WOUND MAGNETIC CORES  
SILICON RECTIFIER GATE CONTROLS  
FUNCTIONAL DIGITAL CIRCUITS

**SPRAGUE<sup>®</sup>**  
THE MARK OF RELIABILITY

Sprague<sup>®</sup> and <sup>®</sup> are registered trademarks of the Sprague Electric Co.

## Back to the drawing board for Vietnam air missiles

Air Force fighter pilots who now tangle almost daily with Soviet-built MIGs over North Vietnam have found that the guidance systems for their tactical air-to-air missiles were not designed for the tactics they are forced to use.

Built for firing at enemy bombers from a comfortable distance of 5000 feet — or from a minimum of 2000 feet — the missiles are useless to an F-4 or F-105 pilot whose fast closing speed often puts him on a MIG tail at a helpless range of 200 feet.

The Air Force Tactical Air Warfare Center at Eglin Air Force Base, Fla., has recently tested three solutions and come up with promising results:

The Falcon infrared-seeking missile has been modified to operate at close range through changes in its cooling system. Rather than cooling the heat-seeking element briefly before each launching, the system now keeps the element cool for longer periods, so the missiles can be fired without delay.

Also rebuilt for quicker response has been the Sparrow missile's semiactive radar guidance—a system that uses a receiver in the missile's nose to home on echoes from the target produced by radar in the mother plane.

Another approach has been to put the Army's man-carried, anti-aircraft Redeye heat-seeker in the gunless F-4C fighter plane. Built for very short range to begin with, the missile turned out to be a very effective airborne "gun" for use at close quarters.

U.S. countermeasures against North Vietnamese ground missile sites are also being improved to fight SAM, the Soviet-built surface-to-air missile radar sites, 250-pound, five-foot pods carried on U.S. fighter planes have been highly successful in putting six or more false blips on the enemy radar screen. Or, if enough planes are working together, they can fill the offending radar screen with brute-force noise.

After the enemy learns to counter

these tactics, the Tactical Air Warfare Center is testing three newer units that deceive more convincingly and are more reliable and lighter because of integrated circuit design.

Another way being developed to foil SAM is to detect and jam radio warning communications from remote search radars to the SAM sites. These messages, which alert the SAMs to approaching U.S. planes, are sent by vhf, uhf, ssb and microwave. The EB-66 electronic countermeasures planes that prowl the skies will look for these signals and jam them.

The Air Force will soon have a missile with a memory to enable it to home on turned-off radars. It will get the Navy-sponsored Standard Arm anti-radar missile built by the General Dynamics Corp.'s Pomona Div. in California.

## 50-mi/h electric car due with 150-mile range

A compact three-passenger electric car, with a top cruising speed of 50 mi/h and a range of 150 miles between charging cycles, represents American Motors' and Gulton Industries' entry into the electric auto race. Road-testing of the prototype, called the Amitron, is slated within the year, according to Roy D. Chapin, Jr., chairman of American Motors.

Power will be supplied by two lithium-nickel fluoride battery packs, each weighing 75 pounds and occupying about two cubic feet. The lithium package is rated at 150 watt-hours per pound, ten times the capacity of conventional lead-acid batteries. Also included for powering the car will be two 25-pound nickel-cadmium batteries to provide high-energy output for rapid acceleration. The nickel-cadmium batteries will be charged from the lithium batteries during normal cruising periods.

A regenerative braking scheme has been designed to use the energy normally lost in slowing and stopping a car to recharge the battery system. This design feature, coupled with the use of the lightweight lithium battery approach, is claimed to provide a range of 150 electric cars announced in the past miles before recharging.



SAM sites like these are being outwitted by U. S. in North Vietnam.

## R&D spending to rise while growth rate sags

A declining growth rate in research and development expenditures for 1968 in the United States has been forecast by economists of the Battelle Memorial Institute, Columbus, O.

While the total figure predicted for this year is \$26.5 billion, an increase of \$700 million over the 1967 estimate, the growth rate is only 3.3. This is considerably less than the growth rate during the decade from 1955 to 1965, when R&D spending increased by an average of 14 per cent annually.

The underlying factor in this decline, according to the Battelle specialists, is a "sharply reduced rate of growth of military, space and atomic-energy research programs."

## Radar specs come with built-in headache

Three companies just awarded contract-definition-phase contracts for the Air Force AN/TPN-19 ground-controlled-approach radar systems are going to have a rough time solving the design headache written into the specifications.

The precision-approach radar portion of the system must be able to lock onto a plane 20 miles away, through a storm 5 miles in diameter with rain falling at a rate of 2 inches an hour. Since the ground operator uses this radar to watch the approaching aircraft and talk the pilot down to a fog-bound runway, the reliability must be nearly 100 per cent.

Unfortunately, radio waves allocated by the Office of the Director of Telecommunications Management for this kind of radar—9100 to 9200 MHz (X band)—are just about the length of a raindrop and so bounce back from rain rather than pass through it.

"Getting frequencies for the TRN-19 in another band would be a real problem," Director of Frequency Management William E.

Plummer said, when asked how his agency would meet the problem. "Also," he added, "a lower frequency, such as L band, wouldn't provide the range accuracy that X band does."

The search radar used to acquire the aircraft before the precision radar is needed will operate in the S band (2700 to 2900 MHz) and should present no problem.

The AN/TPN-19, which will be used by both the Air Force and the Marine Corps, will be part of the Air Force's 407L tactical air control system, a gigantic assortment of modularized shelters containing all the communications and ground electronic equipment needed to fight a brushfire war. The system is air-transportable and can be set up in hours. The landing field portion of the system will convert a bare field into an instrumented airport capable of controlling and landing all types of aircraft under all weather conditions. The system is being designed for aircraft operational now and for those of the post-1970 period.

The winning companies are ITT Gilfillan Inc., a subsidiary of International Telephone and Telegraph Corp.; Raytheon Co.; and Westinghouse Electric Corp.'s Surface Div.

The definition phase will last six months, then one of the three contractors will be chosen to build 25 prototypes.

## Anticollision tests set

Collision-avoidance equipment built to meet long-standing requirements of the airlines will undergo flight tests this year. The first phase of the two-year test program will start under a \$150,000 grant. The Air Transport Association, representing scheduled U.S. and airlines, says that it hopes to have equipment flying by 1974. Research has been going on for more than 12 years (see CAS:Aid) to traffic safety in crowded skies," ED 10, May 10 1967, pp. 17-23).

## Urban engineer in focus

The engineer's role in urban problems will be explored in a special Jan. 11 symposium during the

winter meeting of NSPE in Washington, D.C. Speakers will include Gene R. Schaefer, director of Westinghouse Air Brake Co.'s Mass Transit Center, and John F. Kincaid, Assistant Secretary of Commerce for Science and Technology.

## Supreme Court rules some bugs are okay

The door has been opened a crack wider to the use of electronic eavesdropping, or bugging, devices in law enforcement in the U.S.

A U.S. Supreme Court ruling has made it clear that the court's interpretation of the Fourth Amendment does not preclude all use of bugging to fight crime. But the court stated that rigid legal restrictions must be applied. Court-issued warrants could fulfill that requirement.

New York State already has a draft law on these lines ready for submission to the Legislature.

## Japanese TVs on rise

More than 500,000 Japanese color television sets are expected to arrive in the United States in 1968—a big jump over the 330,000 receivers that came in from Japan last year, according to Junji Hiraga, executive vice-president of the Tokyo Shibaura Electric Co. More than 60 per cent of the new sets will be sold under U.S. manufacturers' labels, Hiraga added.

## Communications studied

It will be politicians rather than engineers who work out the "mix" of undersea cables and communications satellites that will handle international communications.

This seems clear from the situation that has developed over the American Telegraph and Telephone Co.'s plan for a new undersea cable between Rhode Island and Spain. A definite stop order was made by the State Dept., sources in the communications field said. A special commission appointed by President Johnson is studying a plan to establish a "super-organization" to merge international carriers so that they may share satellites and cables.



# 24 hours after we hear from you, you'll hear from us.

Name \_\_\_\_\_

Address \_\_\_\_\_

City \_\_\_\_\_ State \_\_\_\_\_ Zip \_\_\_\_\_

College \_\_\_\_\_

Degree \_\_\_\_\_ Year \_\_\_\_\_

I am interested in the following type of assignment:

\_\_\_\_\_  
\_\_\_\_\_  
\_\_\_\_\_  
\_\_\_\_\_  
\_\_\_\_\_

I have had professional experience in the following area(s):

\_\_\_\_\_  
\_\_\_\_\_  
\_\_\_\_\_  
\_\_\_\_\_  
\_\_\_\_\_

I have had a total of \_\_\_\_\_ years' experience.

AIRMAIL COUPON NOW TO:

Mr. Robert A. Martin  
Head of Employment, Dept. 57  
Hughes Aerospace Divisions,  
11940 W. Jefferson Blvd.,  
Culver City, California 90230

## Hughes— where the hiring action is

*300 aerospace engineers needed.*

Electro-Optical Engineers  
Aeronautical System Engineers  
High-Frequency Design Engineers  
Space Systems Engineers  
Guidance and Control Engineers  
Missile Systems Engineers  
Component Engineers and  
many other disciplines.

*Current projects include:*

PHOENIX, TOW,  
AIM-47A / AIM-4E Missile  
Systems • VATE  
Automatic Checkout Equipment  
• CORDS • COMMUNICA-  
TIONS SATELLITES like Lani  
Bird • APPLICATIONS  
TECHNOLOGY SATELLITES  
• and dozens of other important  
programs and projects.

**HUGHES**

HUGHES AIRCRAFT COMPANY  
AEROSPACE DIVISIONS

*An equal-opportunity employer  
(U.S. citizenship required)*

# CLIFTON HAS A WHOLE RAFT OF QUALITY AMPLIFIERS



Clifton is rapidly becoming known as an amplifier house. And why not, since we are designing and building a wide variety of amplifiers—and here's the best part—to stringent Clifton QUALITY standards.

For instance, Clifton has a new state of the art, low cost, high reliability servo amplifier for position

Our booster amplifier-resolver chains are another area in which Clifton excels. The amplifiers (single or dual channel) are built to MIL-E-5400 (as are all our amplifiers) and feature an overall loop gain of 66db. min. They are completely interchangeable within a system.

Additional Clifton amplifiers include frequency modulator isolation amps, summing isolation amps, resolver buffer amps and many more servo types.

Clifton also builds a number of power supplies and related servo system components. Look to Clifton for all your electronic module needs.

Contact Clifton Division of Litton Industries, Clifton Heights, Pa., 215 622-1000, TWX 510 669-8217, or our local Sales Offices.

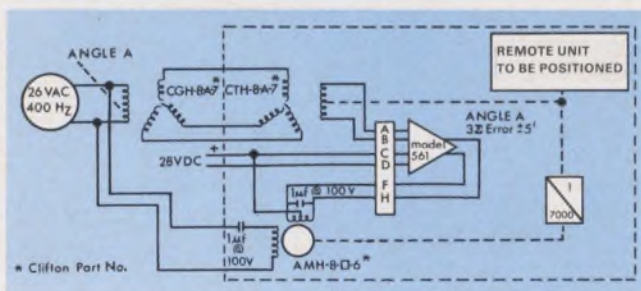

servo systems. It is Model 561. See the typical diagram above. Note also that Clifton rotating components are recommended in this system for their excellent matching qualities with our servo amplifiers (and vice versa).

**CLIFTON**   
DIVISION OF LITTON INDUSTRIES

# Electronic sales still rise, but at slower rate

**EIA sees a 5% increase in output to \$24 billion, with defense budget leveling and NASA's falling**

**Ralph Dobriner**  
Chief News Editor

Despite unexpected slowdowns in some sectors of the electronics market last year, industry sales, according to the Electronic Industries Association, reached a record high of about \$23 billion—up 10 per cent from 1966.

This growth rate, though substantial, nevertheless represents a decline from the 1964-1966 boom years in which the industry growth averaged more than 13 per cent each year.

Robert Galvin, president of the EIA and board chairman of Motor-

ola, Inc., envisions a further slowing of growth in the electronics market in 1968 to a level of \$24 billion, up about 5 per cent from last year.

Industry spokesmen generally attribute the braking effect to three factors:

- An initially rapid Vietnam War buildup that has now leveled off.
- A recent slowdown in industrial investment expenditures.
- The rise and fall of consumer demand for color television sets.

The Vietnam War continues to be the biggest question mark in the industry outlook for 1968.

The largest increase in electronic sales in 1967 was in the Government market, which rose about \$1.5 billion, largely due to military requirements. The EIA foresees a more modest rise in 1968 to \$12.7 billion, up nearly 4 per cent from last year's level. This figure represents about 60 per cent of the total electronics market.

Electronics spending by the Defense Dept. rose from \$9 billion

during 1966 to about \$10.5 billion in 1967, with a further climb predicted to some \$11 billion in 1968—a 22 per cent increase in two years.

Galvin expects expenditures for electronics by the National Aeronautics and Space Administration and the Federal Aviation Administration to remain essentially unchanged during the next two years, despite Congressional threats to curtail space programs.

Representative George P. Miller (D-Calif.), chairman of the House Committee on Science and Astronautics, gave *ELECTRONIC DESIGN* a somewhat more pessimistic picture: "We'll be lucky if we get \$4 billion for NASA in 1968 [compared with \$4.85 billion in 1967]."

Miller said that he hoped to get the bill that provides for NASA out of committee fairly rapidly. "It's a political year, which makes it hard," he acknowledged. "We hope to get it out as soon as possible, before Congress gets in an angry election-year mood."

A survey on the long-term outlook for the defense and space markets after cessation of the Viet-

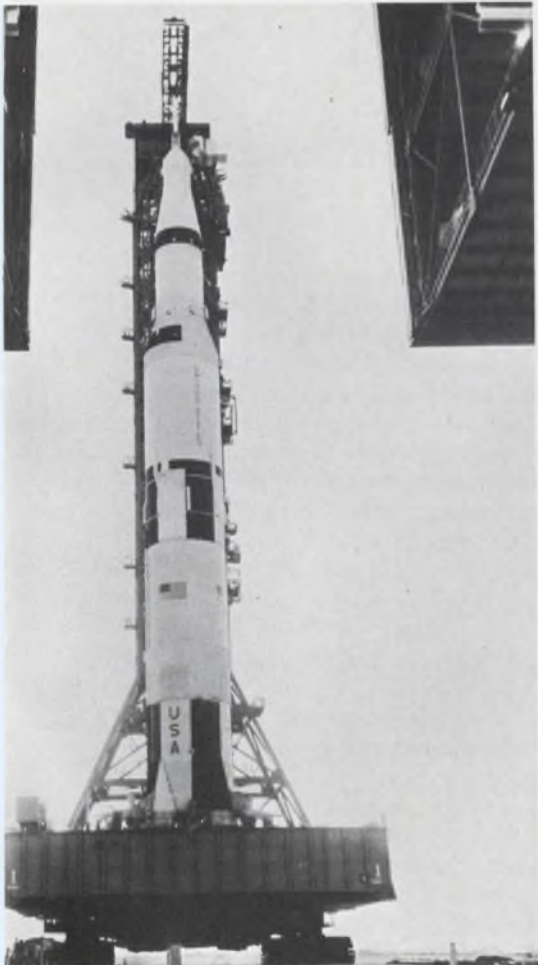

Non-Apollo space programs have been severely curtailed because of the cost of fighting the Vietnam war.

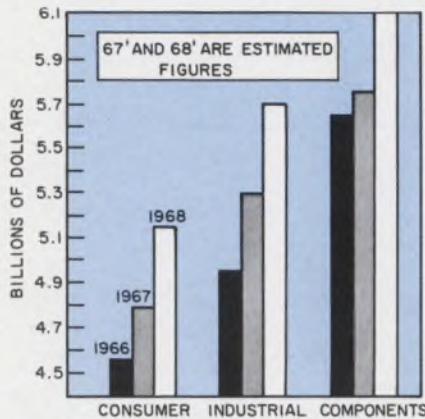

After the Vietnam war ends, the probability of other "brush-fire conflicts," plus the need for a continued presence in Southeast Asia, will keep defense expenditures at a relatively high level.

('68 forecast, *continued*)

Growth in all areas of the electronics market is predicted for this year, particularly in the consumer and components sectors, which suffered slowdowns in 1967.

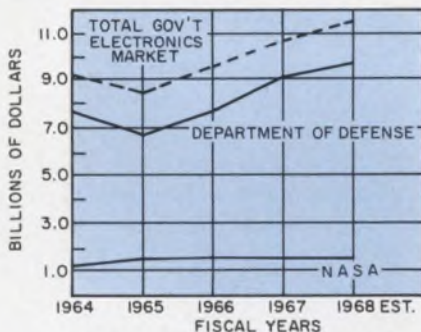

The Government market registered the largest increase in electronic sales in 1967, due largely to military requirements. NASA spending remained at a steady level.

## Predictions for 1968

**Government:** A modest 4 per cent increase in electronic sales—to \$12.7 billion, about 60 per cent of the total electronics market.

**Consumer:** Color TV still the leader. Other areas to watch: video and audio tape recorders and home-entertainment products.

**Components:** A modest increase after a disappointing year. Recovery in semiconductors and tubes.

**Industrial:** Continued rapid growth. Computing and data-processing equipment alone will represent about half the market.

nam conflict was made recently by the EIA. The report revealed that most respondents, while predicting a halt to the Vietnam War during 1969 or 1970, felt that the probability of other "brush-fire" wars, plus the need for a continued U.S. presence in Southeast Asia, would keep Defense Dept. expenditures relatively high.

### A leveling-off seen

The predictions show defense budgets declining by about \$6 billion following a Vietnam settlement, to a low of \$67.6 billion in fiscal 1973, then gradually increasing to \$74.3 billion in 1976.

The drop, it is expected, would affect primarily "general-purpose forces" expenditures. The subsequent increase would occur in the strategic area to finance a new generation of manned bombers and intercontinental ballistic missiles and to deploy an antiballistic-missile system, probably in 1970-71.

The results of the survey indicated that space activities may be constrained so long as the Vietnam War lasts. The longer the delay in ending the war, the less likely NASA will be able to follow a coherent program, the survey respondents believed. Furthermore continued success of the Apollo program was deemed critical to the future of NASA.

NASA was considered particularly susceptible to budget cuts because its financial commitment to Apollo has been completed and there is no new national space goal.

### CONSUMER PRODUCTS

Production of consumer electronic products, the Electronic Industries Association says, should reach \$5.2 billion this year, up 7 per cent from the estimated \$4.8 billion of 1967.

The hottest single product in the consumer market continues to be color television. Factory sales this year, according to industry spokesmen, are expected to total more than six million sets—worth about \$2.5 billion—compared with an estimated 5.5 million sets sold in 1967. The growth of consumer demand for color sets last year was more than offset by declines in sales

of monochrome sets, some models of radios and larger console phonograph sets, according to the EIA.

William Lee, general manager of electronic components at the General Electric Co., Oak Brook, Ill., attributes the downturn in some consumer items to "consumer purchase reluctance and industry inventory adjustment." Lee sees the fourth-quarter pickup in 1967 extending into this year. "Areas to watch are color TV, tape recorders, fm radio and stereo sets," he said.

This year should see an expanding market for two closely related products—video tape recorders and tape-cartridge player systems for both the home and automobiles. A trend to lower-priced monochrome TV sets is also expected to continue.

Other electronic devices that may find increasing use by consumers, the EIA observers, include such items as citizens' band walkie-talkie transceivers, electronic organs and other musical instruments, entertainment kits, home intercommunications equipment, window and garage-door controls, and automotive devices.

### COMPONENT MARKET

Component sales, which declined early last year as equipment manufacturers encountered slowdowns, rose during the final quarter to total some \$5.75 billion in 1967, up moderately from the \$5.64 billion of 1966. A \$6-billion market is forecast this year.

Several factors caused sales of electronic components to fall short of expected levels in 1967. Among them were these:

- A large expansion in component inventory in 1966, in anticipation of electronic-equipment growth comparable with preceding years.

- A slowdown in the growth rate of consumer products, particularly in sales of monochrome TV and radio sets and phonographs.

Tube sales of all types are expected to increase about 5 per cent over the estimated \$1.3 billion volume of 1967. This compares with a decline of approximately 4 per cent last year.

In the TV market, the rate of transition to solid-state devices is

# Super Zener

**\$4.50**

Who would be mad enough to come into the market with a four-dollar-and-fifty-cent Zener when you can buy some cheaper than aspirin.

We would. And did.

Our new LM-103, Super Zener, has the sharpest low-current knee there is. It's a monolith, packaged in a two-lead TO-46 header.

Impressively, breakdown voltage changes less than 150 mV when the current is varied between 10  $\mu$ A and 10 mA or only 15 mV between 100  $\mu$ A and 1 mA. This is true for any of the 10 voltages available from 5.6V down to 2.4V.

The only way to get our \$4.50 Zener any cheaper is to buy them at \$3.00 for 100 or more. O.K. now, let's hear from the big spenders. National Semiconductor Corporation, 2975 San Ysidro Way, Santa Clara, California 95051 (408) 245-4320.

**National Semiconductor**

('68 forecast, *continued*)

continuing, but at a slower pace as manufacturers pause to reevaluate over-all costs.

This reevaluation, according to Leonard Maier, Jr., general manager of General Electric's Electronic Components Div., has "resulted in a push for more reliable tubes for the tough functions associated with color TV, rather than increased rate of transition to solid-state devices."

**'Tribridization' trend forecast**

Maier sees a trend towards hybridization and even "tribridization" of television—that is the use of tubes, discrete devices and integrated circuits.

The shift to purchases of portable sets and the smaller, low-priced screen sizes has slowed the dramatic growth of television picture tubes from 1964 to 1966.

Power, microwave special-purpose tubes, including industrial thyratrons, planar and pickup tubes, should be worth about \$350 million to domestic manufacturers in 1968, up slightly over 1967.

The military is expected to be a continued strong buyer of power tubes because they permit the use of proven designs when higher power and frequency are required.

**A dip for semiconductors**

Semiconductor sales, which rose rapidly from 1964 through 1966, showed a slight 4 per cent decline in 1967. This is attributed to across-the-board price erosion, manufacturers' reduction of excessive inventories and a softening in the consumer electronic market.

While sales of several types of the older semiconductor devices declined, rising sales of integrated circuits, field-effect transistors, thyristors, high-voltage series rectifiers and microwave diodes somewhat offset the losses.

In 1968 over-all semiconductor sales are expected to rise about 8 per cent to nearly \$1.2 billion. Sales of semiconductor integrated circuits alone may rise 30 per cent, to about \$310 million, according to the EIA.

A survey of the major semicon-

ductor manufacturers reveals unhesitating optimism for 1968 in three product areas: integrated circuits, large-scale integration and plastics.

Thomas Connors, vice president of Motorola Semiconductors, Phoenix, Ariz., predicted:

"Discrete semiconductors will gain 10 per cent and ICs will gain 50 per cent in 1968. This compares with a 10 per cent drop in sales for the discretos and a 50 per cent rise in ICs in 1967."

Will the prices of semiconductors stabilize this year? Connors believes not. "Prices will continue to go down in the older as well as the newer devices," he said. "There are still many markets for semiconductors to penetrate, such as TV, automotive and appliances. These are high-volume areas, and we must pass these low prices on to the customer."

**Plastic devices gaining**

Connors predicts further that by 1971 the total "free world" market for semiconductors will equal that of the U.S. He sees it as a potential \$3-billion market.

Keith Sueker, marketing manager of Westinghouse Semiconductor Div., Youngwood, Pa., predicts that by 1969 all devices under 50 amperes will be plastic.

Military acceptance of plastic devices will take another year, Connors said. "The biggest stumbling block here is generating a specification."

**INDUSTRIAL AREA**

The industrial electronics market has expanded at an average annual rate of more than 15 per cent in the past decade, according to EIA figures. In 1967 it was more than five times the size it was in 1957.

Sales of industrial electronic products reached an estimated total of \$5.3 billion in 1967, up 8 per cent over sales of \$4.9 billion in 1966. A further gain of 7.5 per cent is predicted this year.

The swift expansion of the industrial market is primarily attributed to the remarkable rise in computer activities. In addition to widespread domestic use of data-

processing equipment, shipments to foreign markets have grown substantially in recent years.

The output of computer equipment currently represents about one-half of the total industrial market.

**Automation demand expected**

General Electric is even more optimistic than the EIA; it expects an 8 per cent growth rate in 1968. The company sees the dual problems of soaring labor costs and a need for greater productivity as spurring the demand for automation equipment.

According to GE's components manager, William Lee: "Half of American industry alone is still working toward the mechanization stage and has not yet moved toward optimum automation." Time sharing, reductions in the size and costs of processing equipment, the increasing importance of software, advances in information retrieval and optical scanning techniques—all reflect current trends in the computer market.

Also, technical gains in peripheral equipment may include the use of more electronic equipment, higher-speed tapes with increased packing densities, and non-impact printers.

**Process-control expansion**

The process-control computer market has expanded rapidly in recent years and is expected to continue to enlarge at about a 30 per cent annual rate over the next five years.

In testing and measuring equipment, product innovations—including development of instruments of greater accuracy and reliability, smaller size and increased sensitivity—we're expected to continue to be the principal area of advancing technology.

The continuing incorporation of integrated circuits into many testing devices, particularly counters, is expected to stimulate sales this year.

GE's Lee predicts a 6 per cent rate of growth in communications equipment this year.

"We can expect to see increases in the broadcast area, in color telecasting and fm broadcasting

# The one-up op amp.

Since we announced the LM-101 op amp, our improvement on the 709, we've had great response: fan letters, purchase orders, and a new idea.

So now we have two 101's. The original LM-101 and the LH-101 which goes it one better by putting all required frequency compensation inside the package.

Operation guaranteed for supply voltages from  $\pm 5V$  to  $\pm 20V$ .

Low current drain—even with the output saturated. No latch-up when common-mode range is exceeded. Continuous short-circuit protection.

Input transistors protected from excessive input voltage.

Available now from our stocking distributors.

Prices (100 pcs.): LH-101, \$48.00. LH-201 (commercial unit), \$11.40. Write for details: National Semiconductor Corporation, 2975 San Ysidro Way, Santa Clara, California 95051, (408) 245-4320.

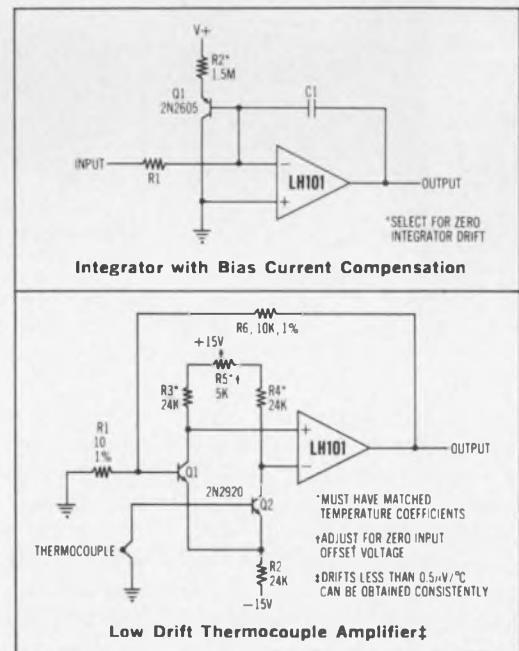

## National Semiconductor

ON READER-SERVICE CARD CIRCLE 21

('68 forecast, *continued*)

equipment, in two-way mobile communications and in land, airborne and marine applications."

Lee also foresees advances in industrial, utility and transportation areas. "Growth should occur in closed-circuit television in industrial, utility and transportation areas and in community antenna television," he says.

Another area of increasing importance is the market for nuclear electronic equipment. Performing radiation detection, measuring and control functions, these instruments are applied in nuclear-reactor operations, with radioisotope systems by industrial and food-processing firms, and in the medical, scientific and educational fields.

Sales of such equipment totaled \$50 million in 1966 and registered an increase during the last year.

Increased use is being made of nuclear techniques, such as those in oil-well exploration, thickness and density measurement with nuclear gauges, measurement of ground, air and water contamination and nondestructive testing with isotopes.

Current trends are toward more complex multipurpose instruments, greater miniaturization, increasing precision and an increased demand for integrated control systems.

### Materials costs going up

New developments, such as those currently taking place in X-ray emission and detection instruments, are expected to open additional markets.

If you are designing with silver, copper or brass, 1968 will probably mean that you will have to dig a bit deeper into the corporate pockets to get materials.

Designers and users of switches, relays, contacts and connectors will feel the pinch. Strikes and spiraling materials costs are being felt by the electronics industry. And industry is passing along its woes in the form of price increases.

So look for trouble in these areas:

Even higher prices and much more difficulty in procuring copper. And higher prices for brass and silver. ■■

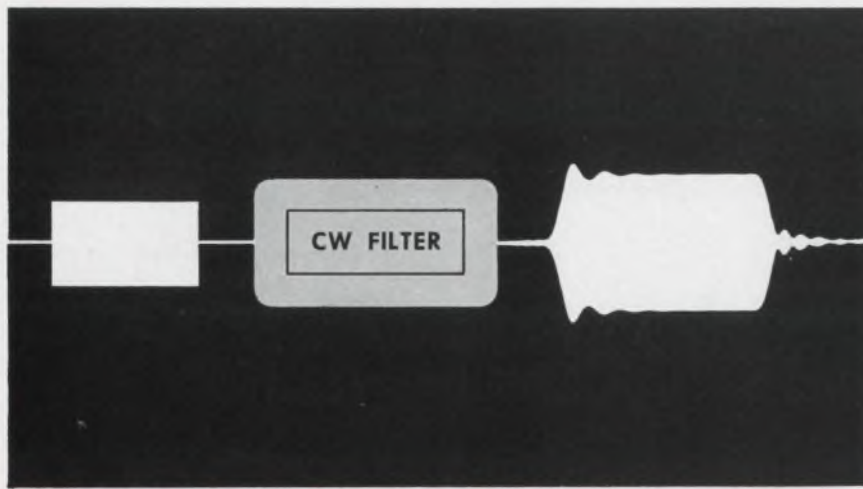

# SUPERIOR PULSE RESPONSE

with Matched Crystal  
Filters by DAMON



Matched Crystal Filter Model 5399A  
Center Frequency: Every 10 KHz  
from 5000 KHz to 5150 KHz  
Size: 3" L x 1" H x 7/8" W

Optimization of the signal-to-noise ratio of a pulse receiver is now possible with the Damon Matched Crystal Filter.

The illustration, above, compares the response of a conventional crystal filter with that of a Damon Matched Crystal Filter. The Damon Matched Crystal Filter not only minimizes overshoot and ringing, but since the filter is matched to the transform of the input pulse, maximum signal-to-noise ratio is also achieved.

Solutions to complex pulse modulation crystal filter designs cannot be "picked from a chart". Consultations between circuit designers and Damon engineers are the best route to proper filter selection. As a starter, may we invite you to write for our Technical Bulletin on Matched Crystal Filters. Damon Engineering, Inc., 115 Fourth Avenue, Needham Hts., Mass. 02194 (617) 449-0800.

## DAMON

ON READER-SERVICE CARD CIRCLE 22



# LSI will demand new computer architecture

**Performance will be improved, but specialists see no significant cost reductions for the user**

**Jeffrey N. Bairstow**  
Computer Editor

Now that large scale integration (LSI) appears to be practical by 1970, three trends in computer design are shaping up:

- New computer system designs, or computer architectures, are needed to make the best use of LSI. Large scale integrated circuits will be complex arrays of gates and memory elements. Thus LSI computers will need array-type parallel organizations, whereas most of today's second- and third-generation computers are serially organized.

The costs of complete computer systems are unlikely to be reduced much by LSI, because the logic cost of a computer is only a few percentage points of the total system cost. If some of the software functions, such as compilation, can be handled by LSI, then some cost reductions may be expected.

- Both speed and capacity will

be increased by using LSI. Gate speeds of 1 ns may be expected from MOS devices. Full-slice technology may result in memories of 10,000 bits on a single chip.

These conclusions were agreed upon by engineers and scientists at the Fall Joint Computer Conference in Anaheim, Calif.

## LSI and system architecture

By its nature, LSI means arrays of circuit elements that, unless each element is to have separate external connections, must be interconnected in an identical regular fashion. In a computer only the logic associated with the data path is regular. For example, each gate in an accumulator appears to be connected in the same way as its neighbors. Perhaps 40 per cent of computer logic is associated with the data path.

The remaining 60 per cent is used for the control functions in

the computer, and these functions are unlikely to be regular. Thus it might seem that only 40 per cent of the computer logic will be able to use LSI. However, scientists at RCA Laboratories, Princeton, N.J., have found that much of the control logic can be regularized. Henry S. Miiller, project manager of a computer design group at RCA Laboratories, has described two types of computer architecture that will reduce the irregular functions of a computer to less than 30 per cent of the total logic.

Miiller terms the first of his machines "a register machine," because it uses registers to interface a series of individual, but similar, modules (Fig. 1a). These modules, or instruction execution units, each perform one machine instruction or a very similar set of machine instructions. A five-part bus is used for communications between the instruction execution units and the main memory. Miiller notes that "not only is the quantity of equipment devoted to control considerably reduced," but also "this decentralized control eliminates many

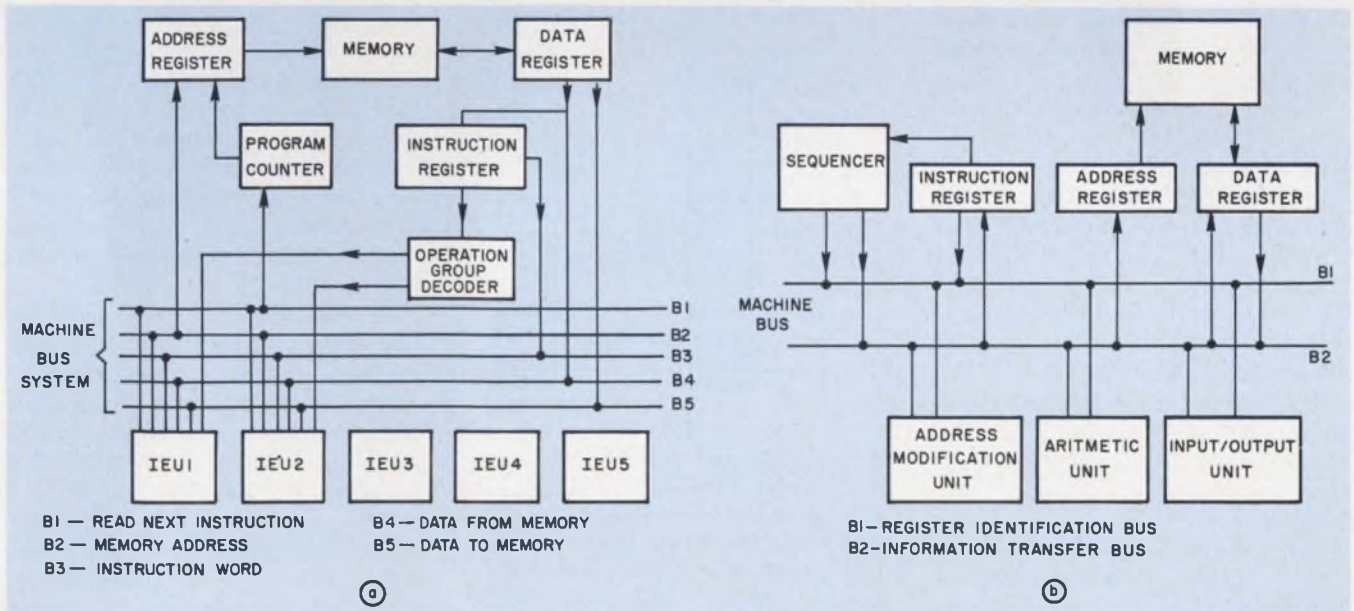

1. The register machine concept of computer system design (a) uses registers to interface between instruction execution units which perform sets of machine instructions. A further development, the functionally partitioned

machine, divides its control into information transfers and data-processing executions. The latter are processed by independent function execution units. Each unit is a small computer operating in an asynchronous mode.

(LSI, continued)

of the long lines which emanate from a centralized control unit."

Miiller regards his second machine as a further development of the instruction-execution-unit principle. The machine control is further decentralized into processing modules, called function execution units (Fig. 1b). An instruction is executed by a set of control words, where each word corresponds to a single step. This procedure is often referred to as microprogramming. Thus a functional execution unit is responsible for data-processing execution control, while the information transfer control is common to all processing modules.

**Little cut in costs due**

Cost reductions of less than a few percentage points may be expected in the over-all system by the user of one that incorporates LSI. Martin G. Smith, a member of the research staff at IBM's Watson Research Center, Yorktown Heights, N.Y., feels that even an order-of-magnitude reduction in silicon processing costs will result in less than a 7 per cent reduction in the over-all cost of a system.

In fact, Smith thinks that this may be an optimistic estimate and that systems using a high proportion of peripheral equipment, with sophisticated software, may show even lower cost savings through the use of LSI.

Taking a hypothetical intermediate-sized computer system and assuming that LSI is used for logic and special memory, but not for the main memory, Smith contends that the cost of a central processing unit will be reduced by 30 per cent (Fig. 2a). When peripheral equipment is added, this cost reduction falls to 18 per cent (Fig. 2b).

If the cost of software, operation and maintenance are also brought into the picture (Fig. 2c), then the reduction in cost is only 7 per cent.

Even if the introduction of LSI fails to reduce costs materially, it will mean that extra circuits may be added for little or no increase in over-all system costs. Simply adding more logic will mean that sophisticated functions will be

available on inexpensive computers.

For example, multiple addressing and instruction look-ahead could be easily provided.

However, although silicon processing costs may be reduced, the manufacturing cost of an LSI part will be high for small quantities. For example, the mask set of a 100-circuit device will cost \$5,000, according to Smith. "At present costs," says Smith, "the very-small-volume machine would require more just for the LSI masks than for implementing the logic by other means. Under these circumstances the small-volume users will

have to be motivated by something other than cost if he uses LSI."

In addition, errors in LSI will be more expensive to correct. Some systems designers have speculated that the development of LSI machines would take 50 to 100 per cent longer than the development of today's machines.

**Improved performance expected**

The four lines of LSI development at present are the bipolar chip, full-slice, MOS and hybrid technologies. Of these, the hybrid offers advantages in speed, according to Dr. Richard L. Petritz, director of research for Texas Instruments, Dallas. Gate speeds of less than 2 ns are now possible and may be expected to increase.

To obtain these high speeds, the level of integration is held at 25 circuits per chip to obtain a reasonable yield. Dr. Petritz hopes that thin-film interconnection technology will lead to circuit densities of 100 circuits per inch<sup>2</sup>. Four or five chips will be interconnected for this density.

In the MOS area more moderate speeds are likely. Although the theoretical cut-off of a voltage-controlled device, such as the MOS-FET, would suggest a bandwidth of 1 GHz, today's limit appears to be about 10 MHz, Dr. Petritz says. The advantage of MOS lies in the area of silicon needed for each device. MOS devices typically use about half the silicon needed for a bipolar device. Thus large memory functions, of say 10-K bits, are thought to be possible with MOS.

"Such a memory could compete very favorably against magnetic-core technology for moderate speed (1-2  $\mu$ s) main frame memory," Dr. Petritz says.

In addition to improvement in component performance and size, gains in over-all system performance may be expected with LSI. These improvements will stem from the ability of LSI to provide more functions per hardware dollar.

For computer system input-output, LSI might provide more channels, interlacing of input-output operations and more pre-processing and post-processing of data and instructions to relieve the central processor of these tasks, says Smith of IBM. ■■

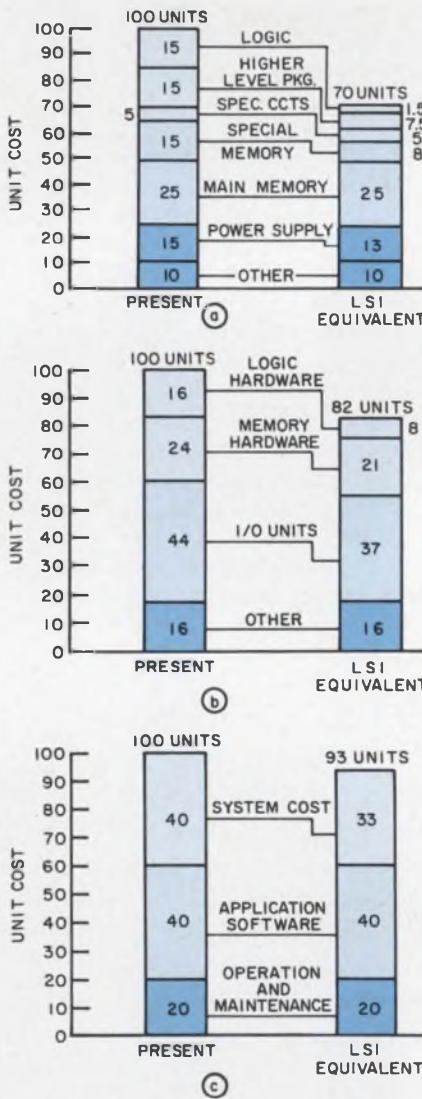

2. A tenfold cost reduction in silicon processing will result in a 30 per cent reduction in central-processing-unit costs (a). When this unit is incorporated in a system with input-output devices and other peripheral units, the saving drops to 18 per cent (b). Finally, when software and operating costs are taken into account, then the savings to the user is only 7 per cent or less (c).

## IDEAS/CRTs

### Instantaneous display of computer-generated data, plus hard-copy prints in seconds.

How a Sylvania CRT lets you select and view computer data . . . and print out only the parts you want within seconds.

Here's another imaginative use for a Sylvania CRT: one-step viewing of computer-generated data and simultaneous hard-copy recording of it on Dry-Silver paper. The 3M "129" Display/Print Module also provides ready access, at many remote locations, to a single computer-memory storage bank.

In addition to electronic data processing applications, these CRT Display/Print Modules record medical data such as ECGs VCGs, and EEGs . . . duplicates sustained TV facsimile displays . . . and reproduces repeating waveforms displayed on CRT instrumentation recorders.

This is just one IDEA for use of a Sylvania CRT. (And we have dozens of different types—each for a specific application.)

Below are specifications for the CRT used in this 3M "129" Display/Print Module. How many ways can you use it?

#### SYLVANIA SC 4639 CRT

Focusing Method	Electrostatic
Deflection Method	Electromagnetic
Deflection Angle	.50 degrees
Phosphor	P1
Fluorescence	Green
Persistence	Short to medium
Faceplate	7-inch diameter, flat (6-inch useful screen diameter)
Length	.14 inches
Trace Width	Better than 0.008 inch with light output in excess of 1,000 foot-lamberts
Anode Voltage	20,000 VDC

CIRCLE NUMBER 300

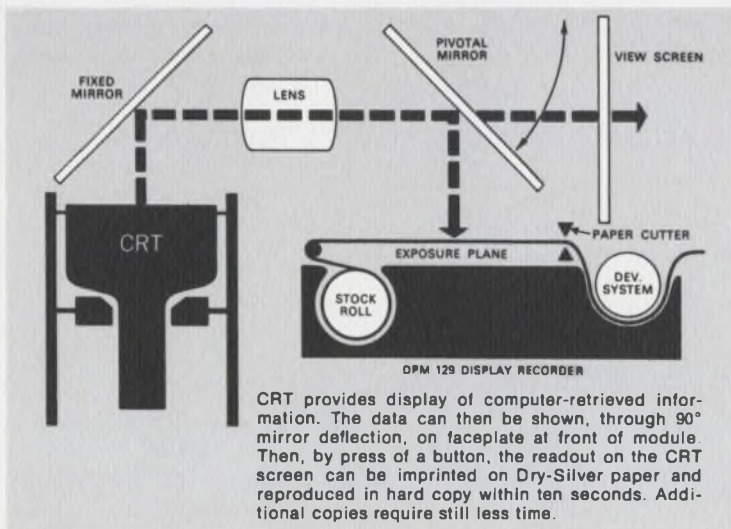

CRT provides display of computer-retrieved information. The data can then be shown, through 90° mirror deflection, on faceplate at front of module. Then, by press of a button, the readout on the CRT screen can be imprinted on Dry-Silver paper and reproduced in hard copy within ten seconds. Additional copies require still less time.



3M "129" Display CRT Print Module. Information retrieved from computer memory bank is displayed on screen at top. Press "print" button and information on screen will be reproduced on dry paper, below, within 10 seconds.

### This Issue in capsule

#### Diodes

PIN microwave switching diodes with assured Quality ("Q") Factor

#### Rectifiers

1-amp glass rectifiers absorb 1000-watt reverse transients

#### Circuit Boards

Low-cost, laminated SYL-PAC boards increase IC switching speeds by 60%

#### B&W Picture Tubes

A black-and-white picture for less than 12¢ a square inch

#### Integrated Circuits

Designing a low-cost serial adder-subtractor subsystem

#### IC Systems

A 131,072-bit memory weighing less than 7 pounds

#### Manager's Corner

Why U.S.-made B&W TV receivers are still very much alive

## New PIN microwave switching diodes with assured R-C product (Quality or "Q" Factor).

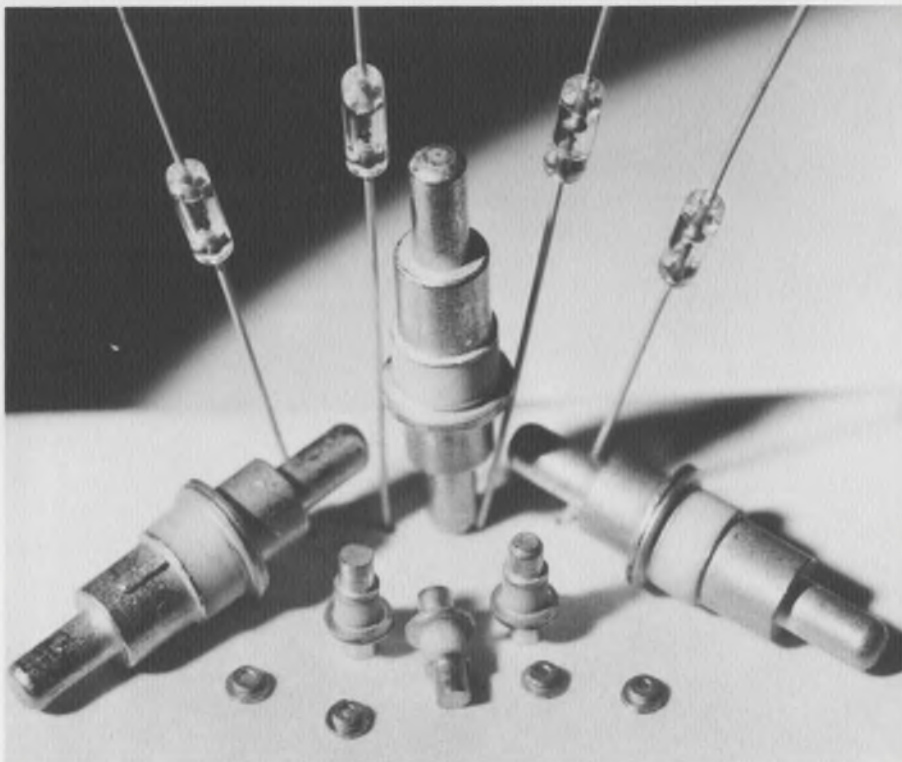

Available in a variety of package styles, both glass and ceramic-and-metal.

R-C curve for Sylvania PIN diodes. Broken line shows Q factor for standard units, solid line for premium units having slightly lower Q factor at slightly higher cost.

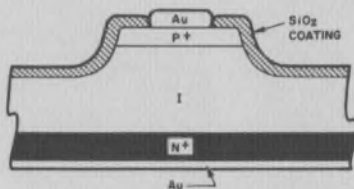
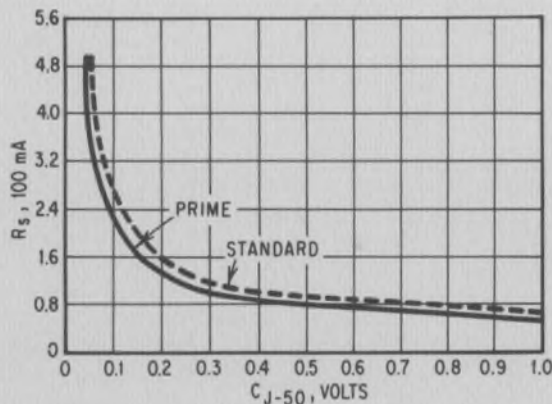

Diodes consist of a P+ type and N+ type region separated by an intrinsic layer, gold leads and a passivating layer of silicon dioxide which completely covers the junction area. Mesa construction provides high-voltage capability without sacrificing high-frequency switching performance.

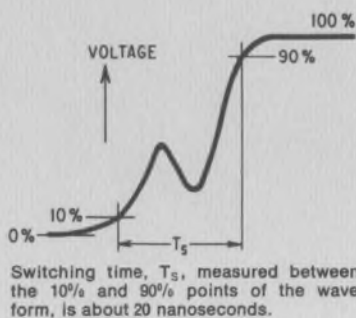

Now, PIN configuration assures customer-specified Resistance/Capacitance product—or Quality ("Q") Factor—in microwave switching diodes.

Sylvania now offers a line of PIN microwave switching diodes with an assured R-C (Quality Factor) product. In other words, you specify the maximum junction capacitance ( $C_J$ ) and the series resistance ( $R_s$ ) you want, and we'll provide that combination of characteristics on a unit-to-unit, lot-to-lot basis. Diodes are specified in two categories: low-cost standard and slightly higher-cost premium units so that you can obtain high performance when you need it, but don't have to pay extra for it when you don't.

Sylvania PIN microwave switching diodes are essentially voltage-dependent variable resistors, so that even at microwave frequencies they are capable of switching, limiting and controlling power from microwatts to kilowatts in cw or pulsed operation. To assure the most efficient device for operation at various power levels, these units are offered in voltage range of from 200-1000 volts.

A typical forward current bias of 50 to 100 ma is required for turn-on in switching applications. Zero bias is all that is necessary to "turn off" the diode in many applications. Under a reversed bias condition, the PIN diode exhibits a gradual decrease of series resistance because of the widening of depletion layer. This process continues until the reverse breakdown voltage of the device is reached and heavy conduction starts again.

### We recommend them for:

- Low power switching
- Higher power switching and multiplexing
- Limiting
- Voltage-controlled attenuators
- AGC systems
- High-frequency switching
- Phase shifters

And we assure the R-C performance capability you specify.

CIRCLE NUMBER 301

# One-amp glass rectifiers that absorb 1000-watt reverse transients.

Sylvania double-diffused silicon glass-encapsulated rectifiers meet all applicable commercial, industrial and military specifications within their performance range.

Our 1-amp glass-encapsulated silicon rectifiers easily take 50-amp forward surges and 1000-volt reverse transients in stride. They have extremely low reverse leakage current: 10 nA at 25°C. Sylvania's advanced glass-to-metal sealing techniques assure virtually complete hermetic seals: Radiflo leakage rates of less than  $1 \times 10^{-10}$  cc/sec typical. They operate over a temperature range of from -65°C to +175°C and exceed all standard life and design requirements of MIL-S-19500.

Heat dissipation in the units is increased by welding a solid, high-conduction power lead to an oversized heat conduction stud. This increases power handling capability, makes the device last longer and keeps it cooler. The glass package is electrically neutral and smaller than most metal rectifier cases, thus permitting greater stacking and card densities. The glass body also helps improve in-process quality control by allowing visual inspection during production.

CIRCLE NUMBER 302

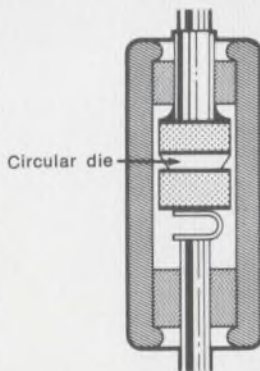

Sylvania's circular die with its truncated cross section provides better, more reliable breakdown characteristics than a straight-sided square die. This results from a uniform spreading of the field around the circular die as opposed to concentration at the corners of square ones. The truncated junction eliminates surface breakdown phenomena by controlling depletion-layer exposure at the die sides and its angle to the exposed edge. These units handle reverse power transients well over normal ratings with high immunity to catastrophic failure.

### Typical Characteristics

ABSOLUTE MAXIMUM RATINGS AT 25°C:	IN4383	IN4384	IN4385	IN4585	IN4586	
Breakdown Voltage, BV	200	400	600	800	1000	volts
Average Forward Current, $I_o$ (+50°C)	1.0	1.0	1.0	1.0	1.0	amp
Average Forward Current, $I_o$ (+100°C)	1.0	1.0	1.0	0.6	0.6	amp
Average Forward Current, $I_o$ (+150°C)	0.3	0.3	0.3	0.2	0.2	amp
Forward Surge Current, $I_F$ (surge) 1 cycle, F=60 cps	50	50	50	50	50	amps
Forward Surge Current, $I_F$ (surge) recurrent, F=60 cps	6	6	6	6	6	amps
Operating Temperature, $T_j$	(-65°C to +175°C, all types)					

ELECTRICAL CHARACTERISTICS:	TYPES	MAX.	UNIT
<b>Forward Voltage Drop, <math>V_F</math> (25°C)</b> $I_F=1.0$ amp	All	1.0	volt
<b>Reverse Current, <math>I_R</math> (25°C)</b>			
$V_R=200v$ ,	1N4383	10	ua
$V_R=400v$ ,	1N4384	10	ua
$V_R=600v$ ,	1N4385	10	ua
$V_R=800v$ ,	1N4585	10	ua
$V_R=1000v$ ,	1N4586	10	ua
<b>Reverse Current, <math>I_R</math> (+175°C)</b>			
$V_R=200v$ ,	1N4383	500	ua
$V_R=400v$ ,	1N4384	500	ua
$V_R=600v$ ,	1N4385	500	ua
$V_R=800v$ ,	1N4585	500	ua
$V_R=1000v$ ,	1N4586	500	ua
<b>Dynamic Reverse Current, <math>I_R</math> (full cycle average):</b>			
$I_o=1000ma$ , $V_R=200v$ , $T=100°C$	1N4383	275	ua
$I_o=1000ma$ , $V_R=400v$ , $T=100°C$	1N4384	250	ua
$I_o=1000ma$ , $V_R=600v$ , $T=100°C$	1N4385	225	ua
$I_o=1000ma$ , $V_R=800v$ , $T=50°C$	1N4585	200	ua
$I_o=1000ma$ , $V_R=1000v$ , $T=50°C$	1N4586	200	ua
<b>Dynamic Forward Voltage Drop, <math>V_F</math> (full cycle average):</b>			
$I_o=1000ma$ , $V_R=200v$ , $T=100°C$	1N4383	1.3	v(pk)
$I_o=1000ma$ , $V_R=400v$ , $T=100°C$	1N4384	1.3	v(pk)
$I_o=1000ma$ , $V_R=600v$ , $T=100°C$	1N4385	1.3	v(pk)
$I_o=1000ma$ , $V_R=800v$ , $T=50°C$	1N4585	1.3	v(pk)
$I_o=1000ma$ , $V_R=1000v$ , $T=50°C$	1N4586	1.3	v(pk)

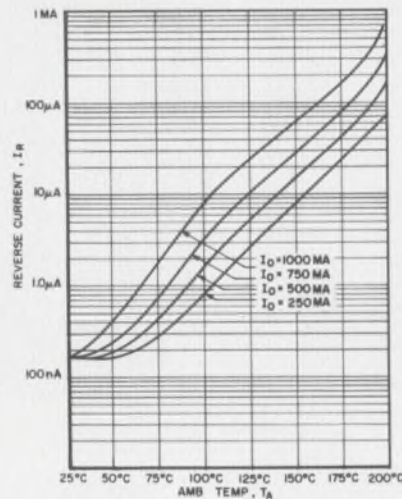

Reverse current vs ambient temperature.

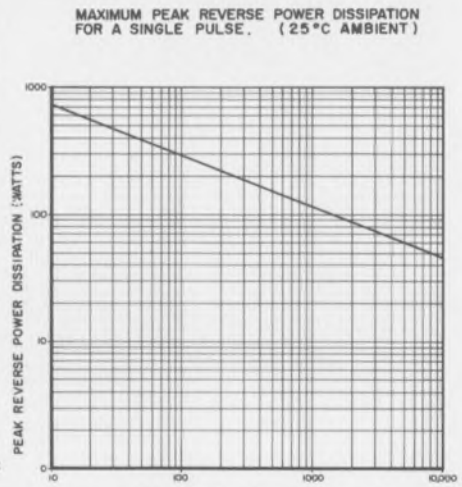

PEAK REVERSE POWER DISSIPATION (WATTS)  
PULSE TIME DURATION (MICROSECONDS)

# SYL-PAC: The circuit boards that are finally catching up to high-speed IC capabilities.

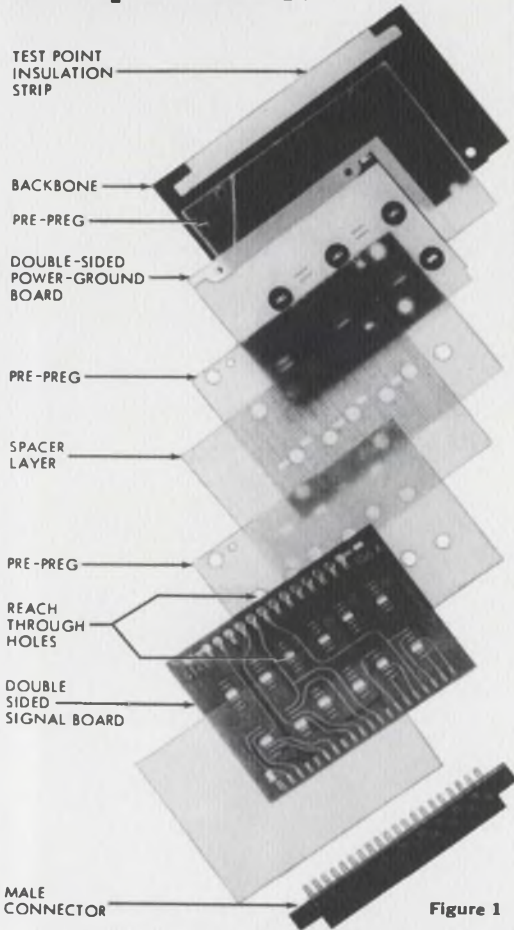

Figure 1

Exploded view, SYL-PAC laminated circuit board. Consists of a double-sided signal board, with two signal layers connected by plated reach-through holes, and a double-sided power-ground board. Any connection on either side of the board is always within 1/64" of the power-ground source.

How SYL-PAC circuit boards minimize  $L \frac{\Delta i}{\Delta t}$  noise at high-switching speeds.

Until now, high-speed integrated circuits mounted on conventional circuit boards have tended to be "noisy"...or to generate spurious signals...in direct proportion to the speed of operation and the length of the current paths connecting the terminals.

In fact, it had become almost pointless to design faster ICs since, up until now, circuit-board design had not kept pace with IC speeds. Heretofore, our 50 MHz SUHL™ II TTL ICs have been limited to about 20 MHz switching speed; anything faster on available boards would result in

extremely high noise levels.

But our new SYL-PAC circuit boards allow the same components to operate at about 33 MHz...and with  $L \frac{\Delta i}{\Delta t}$  noise levels as much as 8 times lower than other circuit boards...a 60% improvement.

### SYL-PAC board construction

SYL-PAC multi-plane laminated circuit boards are made up of two double-sided signal layers on either side of a "backbone." Signal layers are connected by plated reach-through holes, which allow the mounted ICs to contact a common power-ground plane, which carries the B+ voltage to all parts of the board (Fig. 1). With this construction, every IC lead is always within 1/64" of the power-ground source.

Such extremely short current

Adaptable to all forms of component mounting

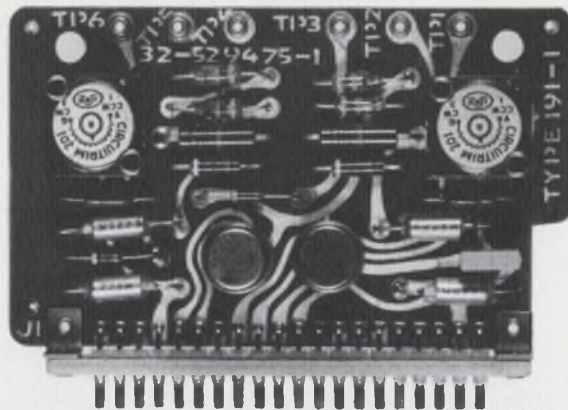

Discrete-component circuit logic card. This package uses the same male connector and configuration as the IC package; both types may be freely intermixed at chassis level.

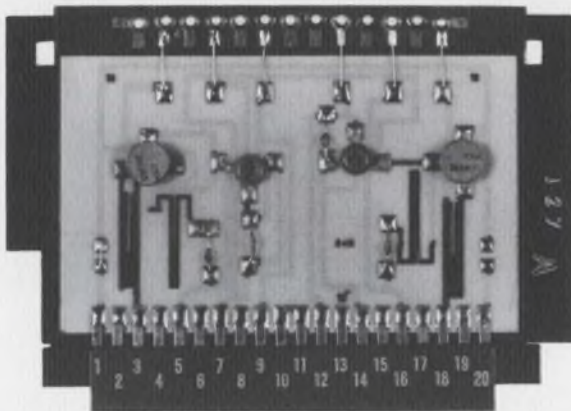

Thick-film/ceramic logic card. Here discrete components are mounted with thick-film/micro-electronic substrate components. Connectors are again the same as for the standard IC package.

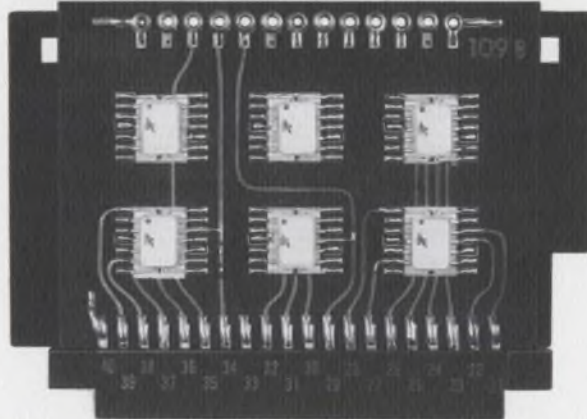

Integrated-circuit logic card. Double-sided board contains up to 12 IC flatpacks or dual in-line plug-in packs. Standard board has a 40-pin double-row male connector mounted at lower edge.

connections reduce noise sufficiently to let you approach the theoretical switching-speed limits of even the fastest ICs available today, such as SUHL II units.

**Reduce circuit noise**

Noise, or spurious signals in a high-speed switching circuit, can originate from four primary sources:

*Inherent IC noise.* For this problem, start out by using Sylvania SUHL TTL logic elements and monolithic arrays, the lowest-noise units available.

*Power-supply decoupling.* Problem is minimized by use of controlled distributed capacitance from the power-ground planes within the SYL-PAC board. This is achieved by precise control of the quality and thickness of the dielectric elements and the parallelism of the conductive layers. In our SYL-PAC boards, the capacitance between the power and ground layers, 1500 pF per package, provides adequate decoupling for any circuit configuration.

*Crosstalk, or intermodulation.* Directly proportional to switching circuit speed and number of interconnecting crossovers. The SYL-PAC common power-ground plane distributes power and ground voltages evenly, eliminates excess wiring and crossovers on the signal plane, and at the same time acts as an overall capacitor between connections.

*Self-induced noise.* Also known as  $L \frac{\Delta i}{\Delta t}$  noise, where L= inductance;  $\Delta i$  = pulse height, or change in current from "0" to "1" condition; and  $\Delta t$  = the rise time of the pulse.

This type of noise is *directly and linearly proportional* to the length of the circuit connection into which the signal is introduced. The extremely short connections characteristic of our SYL-PAC boards—particularly to the power-ground plane—can reduce  $L \frac{\Delta i}{\Delta t}$  noise by as much as 8 times in comparison with other board designs.

**Faster operating speed**

Because SYL-PAC boards with SUHL low-noise IC components reduce circuits noise so significantly, they let you operate your high-speed switching circuits at much higher speeds without fear of spurious signal interference.

CIRCLE NUMBER 303

## How about a 12-inch B&W picture tube for less than 12¢\* a square inch.

Modifications in basic design are one of the factors which can increase the cost of picture tubes. This new 12" B&W standard tube is designed to sell for an extremely low price, in large quantities and without modifications.

Black-and-white TV set manufacturers—particularly of small-sized sets—have run into increasing price competition in recent years from low-cost imported sets.

To meet the challenge, Sylvania has designed a new low-cost 12" picture tube which allows U.S. set manufacturers to be competitive again in the small-size B&W set market. Our new 12DEP4 incorporates all the quality components and engineering advances found in every Sylvania CRT. No performance characteristic is sacrificed... yet the tube costs less.

Sylvania has developed the tube to sell in OEM quantities for about \$9.00\*. We can deliver any changes you wish, of course, but each one will increase the cost per unit.

**Why was the 12" size selected?**

From the glassmaking standpoint, a major picture-tube bulb manufacturer recently conducted a survey to determine the most acceptable tube size for the small-screen, low-cost B&W set market. The survey solidly established the 12" size as the most popular.

From the electronics standpoint, Sylvania has determined just which focus and deflection voltages, gun-mount configurations, anode-button location and other design considerations are most desirable.

The result is a picture tube which incorporates all the most popular features manufacturers have requested in the past... in a single 12" size which we can now deliver in volume. Custom variations on the basic model... and other sizes such as 6", 9", 11" and 13"... will cost more, naturally.

But design this tube into your next portable model and you can market a "MADE IN U.S.A." TV set that's competitive in price with foreign imports of the same size. And you get all the service and delivery benefits that only a domestic manufacturer can offer.

We feel that you'll make up in unit volume what you miss in "uniqueness of screen size".

\*Determined in accordance with standard terms and conditions of sale.

CIRCLE NUMBER 304

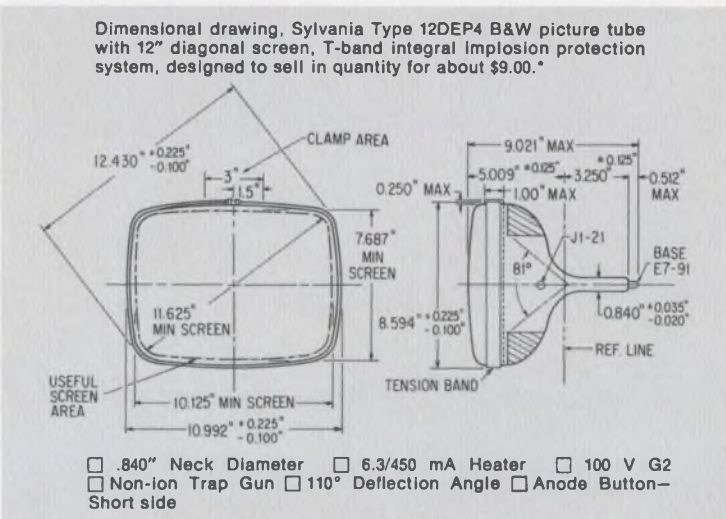

# How to make a low-cost TTL serial adder-subtractor.

Serial adder-subtractor subsystems are simpler than parallel subsystems to design and construct, and require fewer components. They cost less, and are ideal for medium-speed computers.

These diagrams (Figs. 1 and 2) indicate the packaging and interconnection economies permitted by serial adder subsystems.

In a *parallel* adder subsystem, the number of SM-10 adders must equal the number of bits being

processed simultaneously, i.e., a 64-bit storage register would require 64 full adders.

But in a *serial* adder subsystem, only one SM-10 adder is required regardless of the capacity of the storage register. A 64-bit serial system would require 64 storage registers but only one single SM-10 adder, greatly simplifying wiring and reducing component costs.

Such subsystems are recommended for what, today, we call "medium-speed computers." But today's SUHL and monolithic-array TTL ICs are so fast that these low-cost *serial* subsystems actually operate at speeds comparable to many *parallel* adder subsystems presently in operation: about 200 ns/bit. That means our serial adders can process a 24-bit number in 3 to 4 ms. If that's fast enough for you, systems like these can save you money.

The first subsystem (Fig. 1) will add or subtract two 4-digit binary numbers, depending on the logic levels applied to the mode control. A logic "0" level applied to the subtract control will produce a difference; to the add control it will produce a sum. For a sum or difference, the contents of the A and B registers are clocked into the SM-10 full adder, one bit at a time, and the result is stored in the B register.

If adding, the result in the B register is the sum. If subtracting, the Most Significant Digit (MSD) must be checked for "1" or "0". If the MSD is "1", the B register is complemented to obtain the difference, which will be a positive number. If the MSD is "0", the B register is shifted right four times to facilitate end-around carry and provide the difference, which in this case would be a negative number.

The second subsystem (Fig. 2) performs addition only, in the same manner as the first, with the final sum appearing in the B register. Both subsystems are open-ended, and can be expanded to handle numbers of any size merely by increasing the number of flip-flops in the A and B registers. No additional SM-10 fast adders would be required in either case.

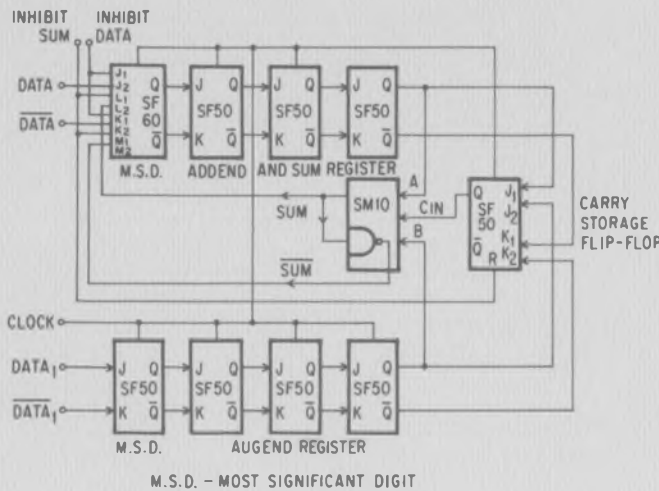

Fig. 1. Serial adder-subtractor subsystem uses SM-10 full adders, SF-60 OR J-K flip-flops, SK-50 AND J-K flip-flops, an SG-110 AND-NOR gate and SG-140 NAND-NOR gates. The full adders are monolithic arrays; the gates and flip-flops are standard SUHL integrated circuits.

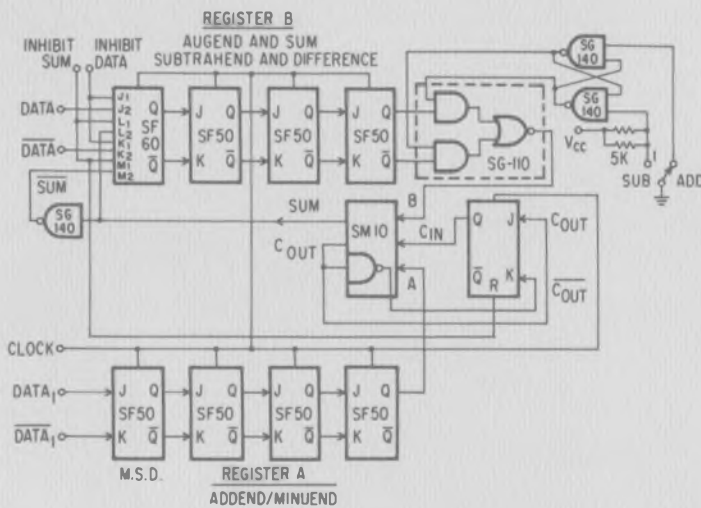

Fig. 2. Simpler subsystem performs addition only. Both subsystems can easily be expanded to handle larger numbers simply by increasing the number of flip-flops in the A and B registers.



# SUHL™ TTL ICs help create a 131,072-bit airborne memory weighing less than 7 pounds.

The new SEMS 5™—Severe Environment Memory System—to be demonstrated at April JCC. Miniature militarized unit was designed by Electronic Memories, Inc., of Hawthorne, California.

SEMS 5 is designed for aerospace applications where small size, low weight, high reliability, high speed and minimum power requirements are demanded. It can withstand 10G vibration, 30G shock over a temperature range from -55° to +85° C. It weighs 6.9 pounds and has a volume of only 132 cubic inches. It has a cycle time of 2 microseconds and an access time of 700 nanoseconds.

It can be built to custom specifications, with memory storage capacities of from 256 to 16,384 words from 8 to 32 bits each. Voltage requirements are +15 v, +5 v and -5 v.

The system uses SUHL TTL integrated circuits for logic, sense amplifiers, address decoders, data and address registers. Logic interface is TTL positive true. Both clear/write and read/restore are standard modes. Optional modes include split cycle (read/modify/write) and buffer cycle. Memory access is by initiate and read/write mode lines or by read/write pulse lines.

Use of SUHL ICs simplifies wiring to increase reliability. Each coincident-current memory plane contains eight bits instead of the usual one. Only three wires instead of the normal four are used, with a common line performing both sense and inhibit functions.

This eliminates a large number of electrical interconnections where many memory-stack failures can occur.

The unit uses approximately 50 Sylvania ICs: SG-40 and SG-140 dual 4-input NAND-NOR gates. Both are monolithic epitaxial saturated high-speed logic elements.

Electronic Memories naturally turned to SUHL TTL ICs to get the performance they wanted into the space available. They also inform us that: "Unfortunately, no failure data is available on the performance of your circuits, nor do (we) know when this would be available."

Because, obviously, none have failed yet . . . and none are likely to.

CIRCLE NUMBER 306

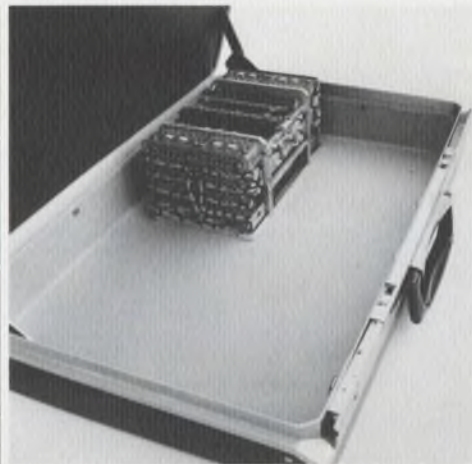

Tiny, rugged SEMS 5 militarized airborne memory system has memory storage capacity of 4096 words of 32 bits each. This extremely high packaging density is made possible by use of Sylvania SUHL TTL ICs.

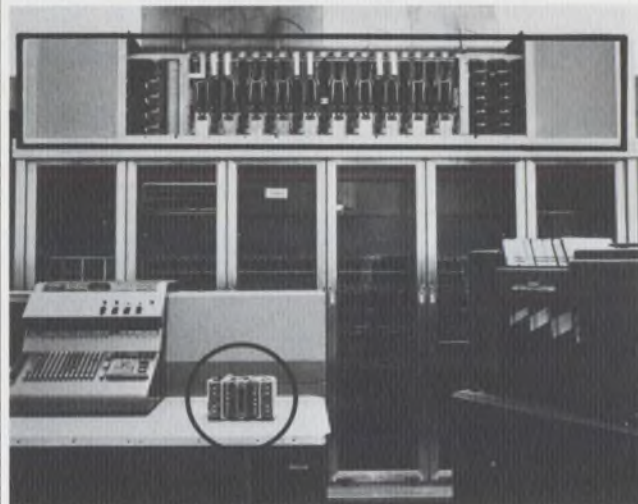

SEMS 5 (circled), on table in foreground, compared with an older, discrete-component memory system of comparable memory capacity (in rectangle). SEMS 5 was designed and produced by Electronic Memories, Inc., of Hawthorne, California.



Use Sylvania's "Hot Line" inquiry service, especially if you require full particulars on any item in a hurry. It's easy and it's free. Circle the reader service number(s) you're most interested in; then fill in your name, title, company and address. We'll do the rest and see you get further information by return mail.

**BUSINESS REPLY MAIL**

No Postage Stamp Necessary if Mailed in the United States

FIRST CLASS  
Permit No. 2833  
Buffalo, N.Y.

POSTAGE WILL BE PAID BY

Sylvania Electric Products Inc.  
Sylvania Electronic Components  
1100 Main Street  
Buffalo, New York 14209

Dept. C111

---

---

---

---

---

---

---

---

---

---

## "Black and white TV receivers are dead."

How often have you heard this said?

Sylvania has a more positive approach. To paraphrase Mark Twain, we think that reports of the B&W set demise have been grossly exaggerated.

At present there are about 66 million B&W TV receivers in use in the United States, and about 7½ million were sold here in 1966. Hardly a dead market. People are still buying them for many reasons: low cost, small size and weight, portability, brightness, contrast, resolution and ease of servicing, just to name a few.

So the question is not whether to revive a dead market. It's to recapture a bigger share of a very "live" market which has been increasingly lost to foreign competition.

People buy foreign B&W sets—as opposed to domestic—on price. So to start with, you have to get the price down to compete.

One way is standardization. A decision to go with, and stick with, a standardized line of picture tubes, receiving tubes, circuitry and related components in a set that's standard except for external styling. Once this decision has been made, components can be designed into a marketable set at a very low cost.

As a start, we've developed a standard 12" B&W picture tube—the most expensive single component in a TV set—and designed it to sell, without variation, in OEM quantities for around \$9.00\*. (See article elsewhere in this issue.) Together with other standardization economies, this makes it possible to assemble, distribute and market a 12" set at a very low retail price.

\*Determined in accordance with standard terms and conditions of sale.

We didn't settle on the 12" size arbitrarily. As the companion article indicates, a recent survey conducted by a major picture-tube bulb manufacturer on consumer preferences in portable TV sets shows the 12" size to be the overwhelming favorite.

In deciding upon a standardized picture tube at such a low cost, you can offer the most popular features ever built into one picture tube without sacrificing any of the engineering leadership and quality assurance measures that have made Sylvania B&W picture tubes number one in the industry.

Our design and field-engineering staff still provide the full range of services and technical assistance you expect from Sylvania—and which you've probably learned *not* to expect from overseas manufacturers. With exception of the glass bulb, we still manufacture and process every component that goes into these tubes—and to our own unmatched quality standards.

The reason we can bring you a picture tube at such an extremely low price is volume production. That can be achieved only through wide acceptance of a standardized product.

Work with us and we'll help to show you that a market you may have considered "dead" is still very much "alive."

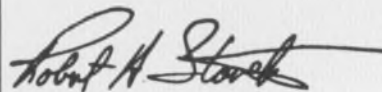

Robert A. Starek  
Product Marketing Manager  
Picture Tubes

This information in Sylvania Ideas is furnished without assuming any obligations.

# SYLVANIA

A SUBSIDIARY OF  
GENERAL TELEPHONE & ELECTRONICS

NEW CAPABILITIES IN: ELECTRONIC TUBES • SEMICONDUCTORS • MICROWAVE DEVICES • SPECIAL COMPONENTS • DISPLAY DEVICES

C1

NAME \_\_\_\_\_

TITLE \_\_\_\_\_

COMPANY \_\_\_\_\_

ADDRESS \_\_\_\_\_

CITY \_\_\_\_\_ STATE \_\_\_\_\_ ZIP \_\_\_\_\_

Circle Numbers Corresponding to Product Item

300	301	302	303	304
305	306			

Please have a Sales Engineer call



### HOT LINE INQUIRY SERVICE

Need information in a hurry? Clip the card and mail it. Be sure to fill in all information requested. We'll rush you full particulars on any item indicated.

You can also get information using the publication's card elsewhere in this issue. Use of the card shown here will simplify handling and save time.

# 'Fence' in sky keeps an eye on space objects

## Phased arrays in new Air Force radar set up scanning pattern over equator to count targets

Neil Sclater  
East Coast Editor

A satellite, rising 1000 miles away out of the southern hemisphere, arcs northeast across the Atlantic Ocean. Simultaneously a green line edges slowly up the face of a scope on a radar control console in a block-long building at Eglin Air Force Base, Fla. The green trace, advancing on a grid marked with spherical coordinates, indicates the satellite's position.

Scenes like this took place last month as operators tested and demonstrated for newsmen the Air Force's new big eye on the sky—a \$62 million, electronically scanned phased-array system called the AN/FPS-85. The radar tracker, housed in a tent-shaped structure, looks south toward the equator from a point near the Gulf of Mexico. It is the latest and most effective sensor in the nation's defensive satellite tracking network (see "News Scope," ED 26, Dec. 20, 1967, p. 21).

"You are watching an analog display of the passage of the satellite as if you were standing outside a transparent globe and it was leav-

ing a trace on the surface," explained George H. Harlan, the program director of the AN/FPS-85.

Because of the way satellites move, Harlan said, all orbiting objects will pass through the "fence," or field, scanned by the array at least twice daily. During a 12-hour period, one can expect to see all the objects that man has hurled into an orbit in space as they pass over the equator.

The display that shows the radar as a spot in the center of the sphere gives the operator a "warm feeling" for satellite-tracking, Harlan said, but the real job of processing, storing and presenting data on the more than 1200 objects in space is done by computers.

The radar scans electronically instead of with a rotating antenna. Under computer control, signals are directed to individual antenna elements. The time-phasing of the elements produces the scanning beam that traces out the "fence" in the sky. By varying the time-phasing of the receiving elements, the receiving "beam" is directed through the fence in nanoseconds.

The system is programed so that it can divide its capability

among the many targets that may be within range, Harlan said.

The transmitter modules (see photo) are driven by 16 master oscillators through a divider system. The modules are also fed steering signals and power by a distribution scheme.

The receiver array contains 4660 modules arranged in an optimum pattern and connected to active dipoles. Fully transistorized, each of the 12-pound units has two channels for receiving vertical and horizontal signals.

There are 19,500 dipoles in the receiving array, but only the 4660 are connected. The modules are connected to a power divider, and they feed four subarrays to form nine receiver beams. The nine beams are then fed into a beam processor.

A signal processor converts the intermediate-frequency signals from the beam-forming subsystem into digital information for use by the radar computer.

The radar interface and control equipment is a special-purpose group of digital units designed to link the real-time world of the radar to the computer. It performs such functions as the generation of timing and control signals; the buffering and structuring of data; recording of identification data, and elimination of false signals.

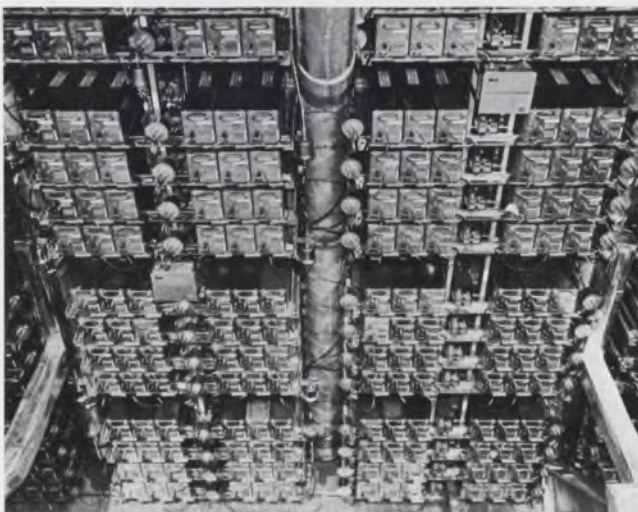

Transmitter modules are arranged like drawers in a file cabinet in a 72 x 72 square pattern behind the sloping transmitter array. Each of the identical 50-pound modules can be replaced without shutting down the array.

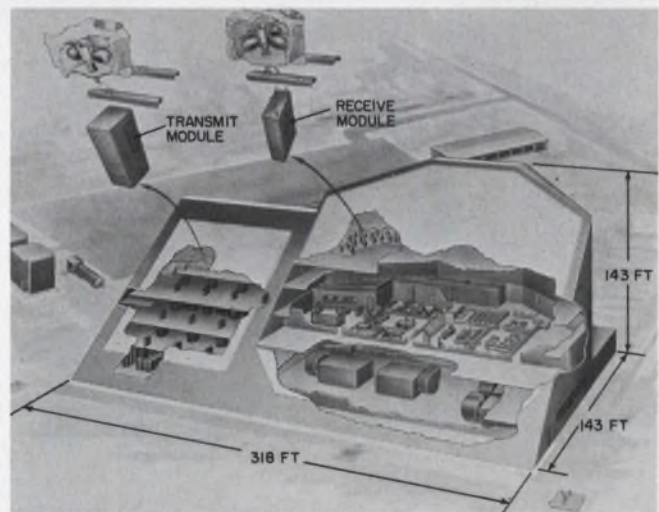

FPS-85 phased-array radar is housed in a 13-story-high, air-conditioned building containing computers, control and operations rooms, offices and shops. Square array (left) is transmitter. Octagonal receiving array is at right.

# For a clear picture of Centralab...

...keep an eye on our ripples

In our years of manufacturing miniature and subminiature components, we've made many ripples, and a few splashes, in the electronics industry:

**Centralab designed** and produced the world's first carbon composition potentiometer and for more than 40 years has been an industry leader. In 1936 we introduced the first temperature-compensating ceramic capacitor in America. We were first to offer dual controls and to add integral line switches to variable resistors. Our exclusive  integrated circuits have been key elements in the miniaturization of electronic equipment. During World War II days Centralab developed the ceramic disc capacitor design for military requirements. And our Ultra-Kap<sup>®</sup> ceramic disc capacitor has replaced millions of larger, more costly devices.

**Centralab sales** have increased substantially every year and our services have grown proportionately. Our products are sold, by separate sales groups and from separate warehouses, to original equipment and distributor markets.

**Centralab's tested and proven** products include capacitors, packaged circuits, rotary switches, potentiometers and technical ceramics. In October, 1966, we erected a push button switch manufacturing plant and in May, 1967, we acquired solar devices and semiconductor facilities.

Innovation, growth and stirring the waters are nothing new at Centralab; and we don't intend to stop. As technology advances and components become smaller, more complex and more sophisticated, we'll keep our feet wet.

To help keep abreast of Centralab developments, we'll be happy to send you complete product literature.



**CENTRALAB**

Electronics Division

GLOBE-UNION INC.

5757 NORTH GREEN BAY AVENUE  
MILWAUKEE, WISCONSIN 53201



ON READER-SERVICE CARD CIRCLE 24

## NEWS

(sky fence, continued)

A master control room contains display and control consoles to monitor beam-steering, receivers, transmitters, master oscillators, power supplies, air-conditioning and fire stations.

A tactical operations room contains the video display that shows the passage of satellites. Two input-output situation display consoles are also there, as well as radar operators.

Harlan reported that the use of the relatively simple receiving and transmitting modules and the large amount of built-in test equipment would permit the operation and maintenance of the system to be taken over by uniformed Air Force personnel next April. Civilian programmers, technicians and electronic engineers will fill advisory roles.

### Three computers used

The FPS-85 uses three IBM 360 central data processors: two Model 65-Is for data control (one a standby) and a Model 40-H to coordinate peripheral equipment for data input and output, printed readouts and the recording of information on punched cards.

Each Model 65-I stores 512,000 characters of information in magnetic cores. Auxiliary storage of 65.3 million characters on magnetic disks and of more than 20 million characters on magnetic tape is also provided.

The computers monitor radar sightings and classify them as known or unknown in virtually real time by comparing them with a list stored in a memory. The memory list has data on 300 operating satellites plus 900 orbiting objects that aerospace specialists call "space junk"—abandoned rocket booster stages, space probes and satellites.

If a sighting is classified as unknown, the computers, using the radar data, calculate the vehicle's track over the earth. The information displayed to space-surveillance officers and technicians is transmitted to the Space Defense Center at the North American Air Defense Command in Colorado Springs, Colo. ■■

# control/alarm cost-cut

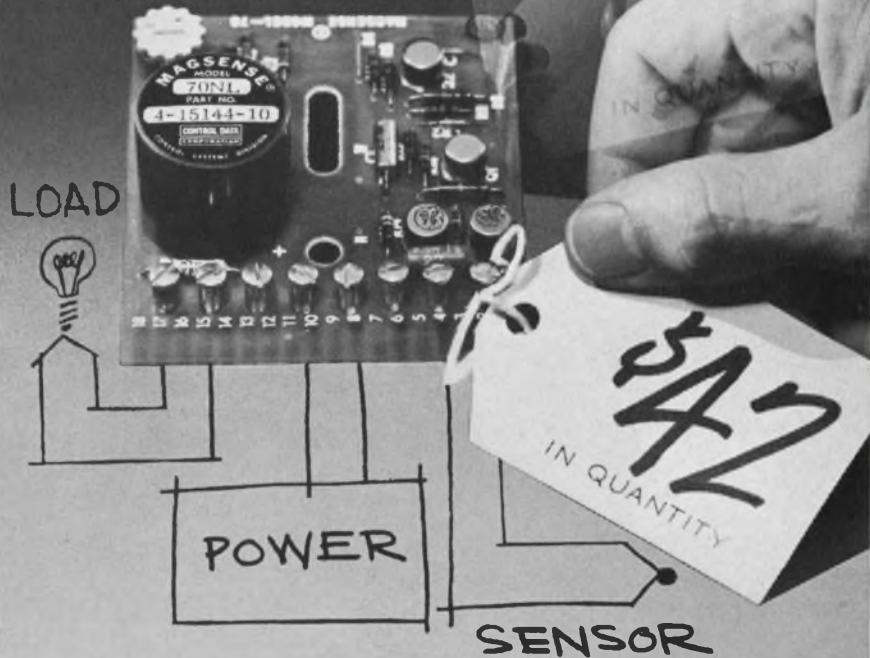

## MAGSENSE

control/alarm for temperature, pressure, speed, flow

**Here's the low-cost way** to solve your control/alarm problem. Hook up sensor, load and power source to a MAGSENSE® control/alarm module and adjust the setpoint. That's it. No time wasted designing and debugging a circuit. And while you're saving time you'll be saving money, getting *proven-in-service* performance.

**Capabilities?** All MAGSENSE modules offer 100-billion power gain, accept inputs as low as 10 microvolts or 1 microamp *directly* without preamplification. Completely isolated inputs are unaffected by common mode voltages as high as 110vac, 60Hz, or overloads as large as 1000-times full scale input. Typical accuracy is  $\pm 0.5\%$  full scale. And they all

operate from a *single* DC power source (either 28v or 12v).

**Options?** The list includes remote and dual setpoints, adjustable hysteresis, choice of output action, transducer excitation voltage and cold junction and copper compensation on thermocouple models. There's a MAGSENSE model for your application.

**Price?** Get the MAGSENSE control/alarm module shown for as little as \$42 in quantity, others as low as \$35. Compare that with the cost of developing and building your own circuit.

**More information?** Write or call, or circle the reader service number and we'll send you complete specifications and prices.

**CONTROL DATA**

**CORPORATION**

4455 Eastgate Mall, La Jolla, Calif.

MAGSENSE Sales, Dept. 230  
Analog-Digital Systems Division  
Control Data Corporation  
4455 Eastgate Mall  
La Jolla, Calif. 92037  
Phone 714/453-2500

ON READER-SERVICE CARD CIRCLE 23

A former World War II oil tanker was recently rebuilt as the best equipped of five Apollo instrumentation ships that will be part of the communication and tracking network during this country's manned mission to the moon.

The Redstone, one of three large vessels being used for this purpose, is one up on her mates. She was the first to receive a seagoing satellite-communications receiver.

Along with two sister ships, Mercury and Vanguard, the Redstone was converted by removal of her tanker midsection. This was replaced by a longer, wider midbody. Two smaller ships, the Huntsville and the Watertown, were formerly Victory-class ships.

Redstone is 595 feet long, with a 75-foot beam. The new midbody contains 455 tons of electronic equipment and living quarters for a crew of 88 and 106 technicians.

The conversion was performed by the General Dynamics Corp., Quincy, Mass.

Starting with preliminary Apollo missions next year, the shipboard instrumentation will function as a single system. Data on the spacecraft's projected trajectory will be sent from the Manned Spacecraft Center in Houston to the Redstone for feeding into a central data-processing system. The data will be used to help aim the antennas of the ship's tracking radar system, the unified S-band and telemetry systems for initial acquisition.

The ship's position and attitude measurement system, timing system, and acquisition and stabilization network will be the other main antenna-aiming computer input.

Personnel in the vessel's mission control center will monitor the spacecraft with the instrumentation, telemetry and flight displays. It will be possible to send command signals directly to the spacecraft.

Redstone will be operated in the Pacific Ocean by the Navy's Military Sea Transportation Service under orders from the U.S. Air Force.

The operation and maintenance of the ship's electronic equipment are performed by technicians from the Federal Electric Corp., Paramus, N.J. ■ ■

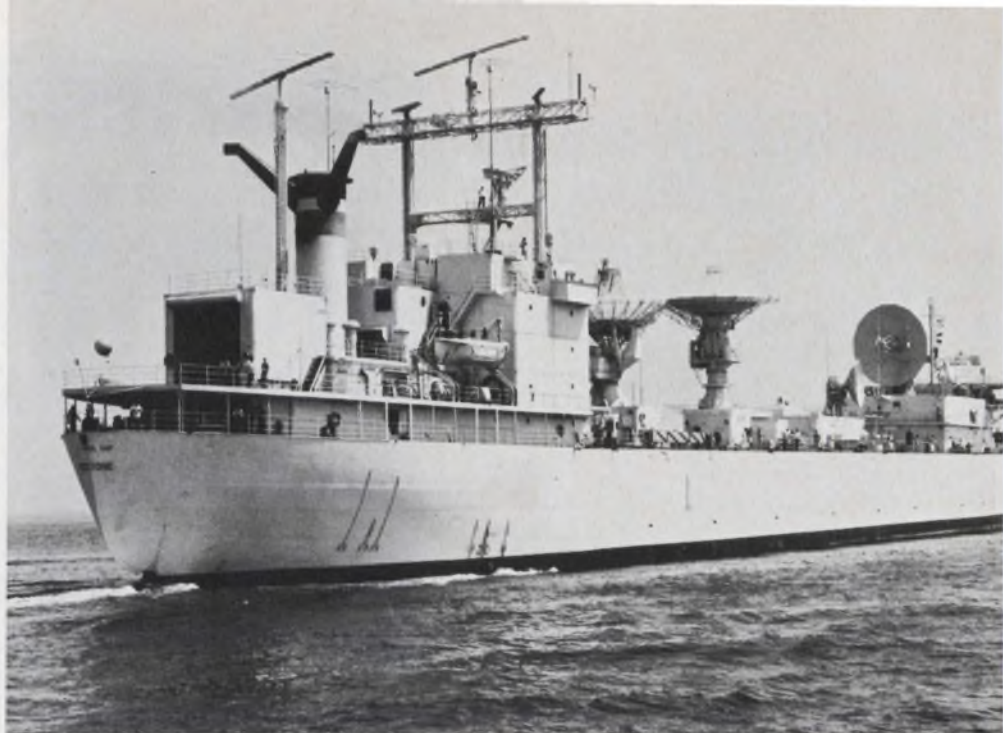

**\$30 million worth of electronics** make the Redstone as well equipped as most land-based tracking stations. A satellite-communications system with antenna (far right), makes this ship the best equipped of the five in the Apollo program.

## 'Reborn' oil tanker to help track spacecraft on Apollo missions

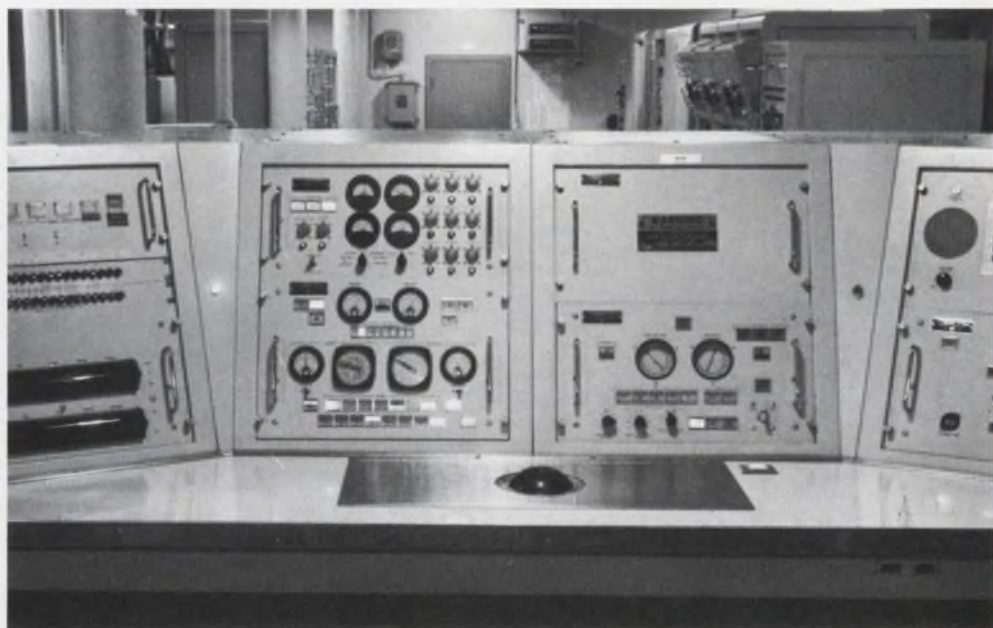

A "bowling-ball" manual control in the console desk top (center) positions the 30-foot parabolic antenna reflector of the ship's unified S-band system. The system can track a spacecraft as well as transmit data to and from the craft.

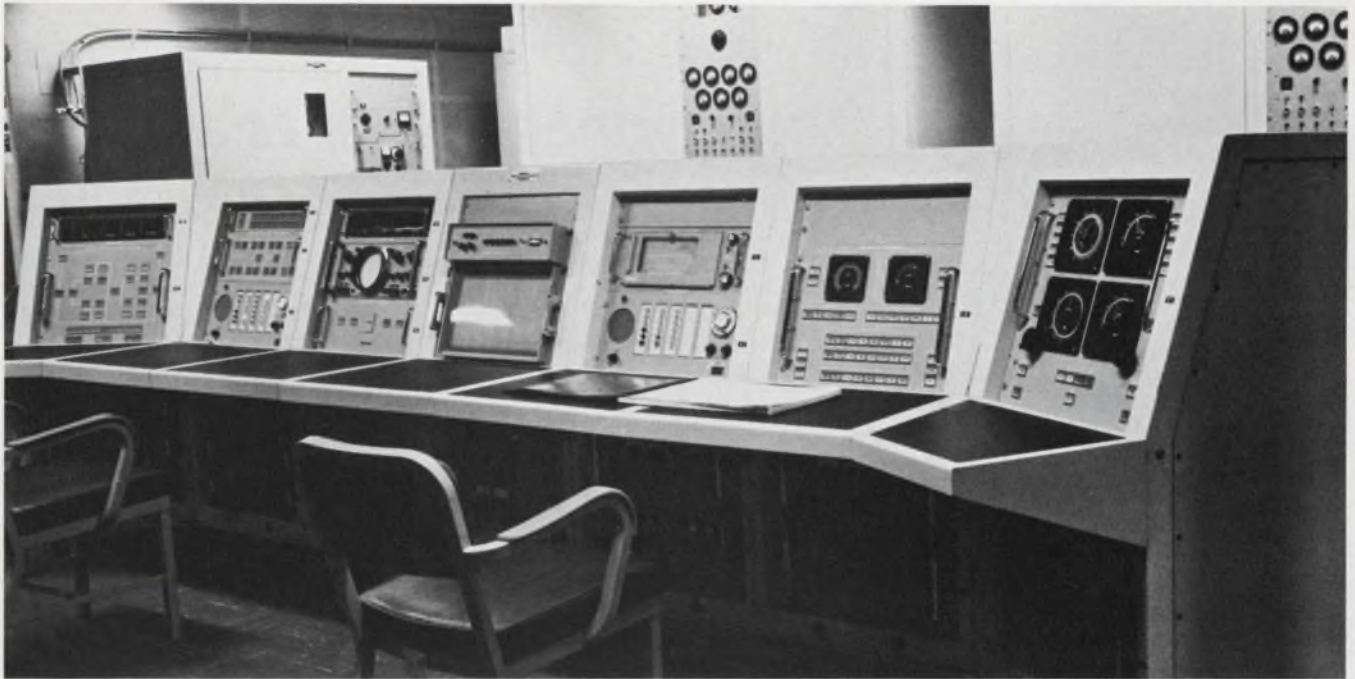

Command signals to the Apollo spacecraft can be sent through the vessel's command control system. The panel displays are used to monitor and control communica-

tions. Vhf/uhf spacecraft voice communications are transmitted through the command-control helix array; commands are sent over the unified S-band system.

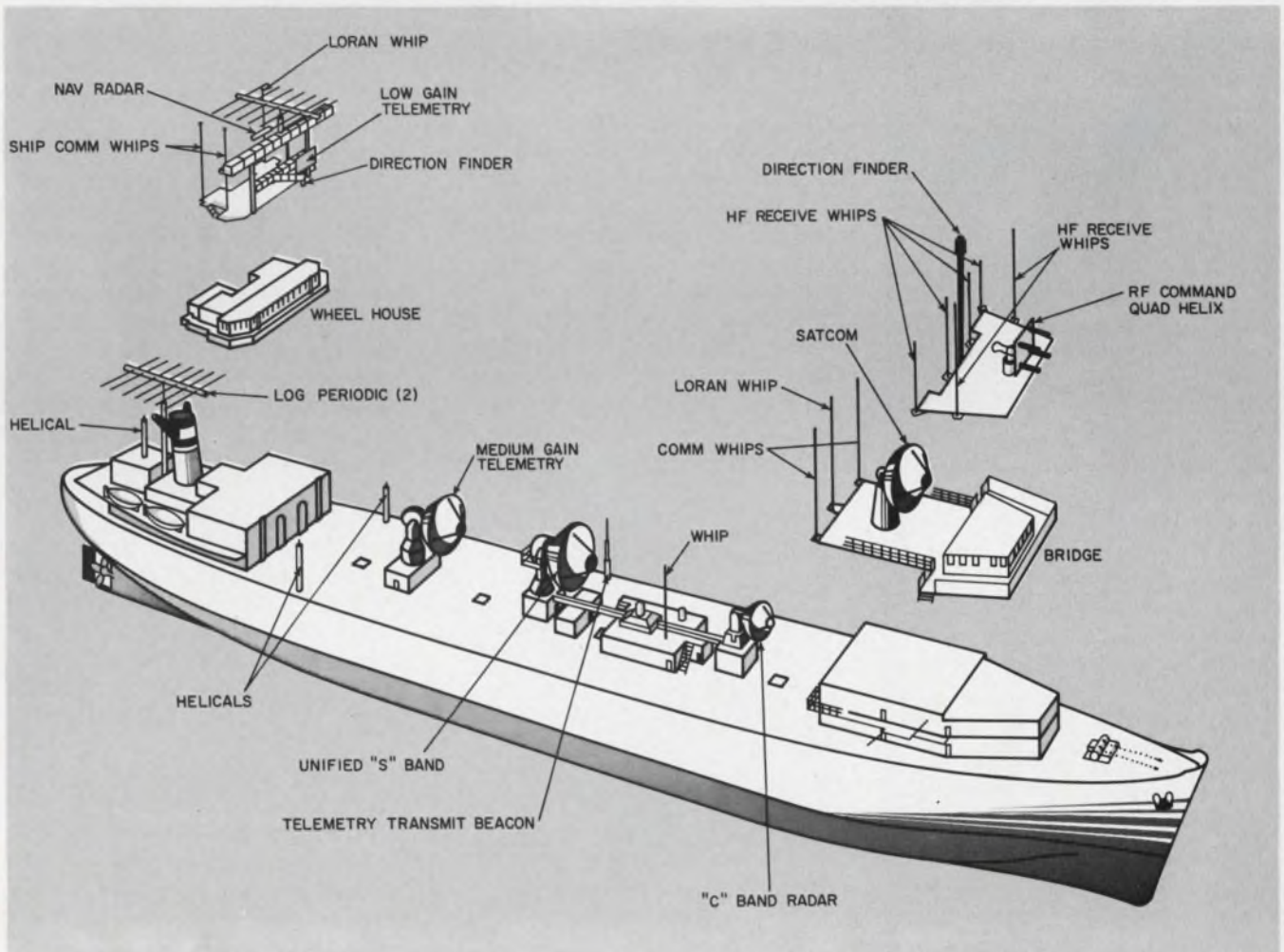

A forest of antennas gives a hint of the variety of electronics on the Redstone. The largest antennas (from left to right) are the 30-foot medium gain telemetry; 30-foot

unified S-band; 16-foot modified FPS-16 radar, and 30-foot satellite-communication units. Computers process data from the spacecraft and compute its exact position.

## 'Peace Pipe' pinpoints air drop

The Air Force is evaluating a miniaturized communication and location system that will permit airborne supplies to be dropped more accurately under conditions of low visibility and at night.

The system, called Peace Pipe, can pinpoint ground locations to within 25 yards with the aircraft as much as 50 miles from the drop zone. The name "Peace Pipe" is another in a series of Indian names being given to tactical ranging and homing systems.

In operation, a transponder resembling a walkie-talkie radio carried by the field soldier automatically responds to an interrogating signal from the aircraft by transmitting a series of pulses. The pulses received by the special antennas aboard the aircraft provide the pilot with the slant-range distance and bearing from the aircraft to the ground unit.

Range is measured by a clock installed in the aircraft that counts from the trailing edge of the interrogating pulse to the beginning of the ground beacon's return pulse. Since the turnaround time in the beacon (the time delay between receipt of the interrogating signal and transmission of the reply) could cause errors in range accuracy, a precision 10 microsecond delay is

built into the beacon. This delay is then subtracted out by the clock. A phased-array antenna installed on the nose of the aircraft measures the received signal from two slightly different angles to provide bearing information.

To minimize detection by the enemy, the ground beacon operates as a semipassive device, transmitting only when interrogated and only when the interrogation signal is at the correct frequency and pulse width. In addition, the pilot may select any one of five available carrier frequencies for interrogating the beacon. An additional module that plugs into the bottom of the transponder provides a two-way communication link between the ground and aircraft. The entire system operates in the vhf region (142 to 148 MHz). One set of batteries provides two full weeks of beacon operation.

Harold Sefton, manager of the microwave and antenna department at Bunker-Ramo Corp. of Canoga Park, Calif., developer of the Peace Pipe, said the system will provide greatly improved performance over aircraft homing systems presently in use. Present systems operating at microwave frequencies provide good range accuracies, but their range is severely restricted because the signals cannot easily penetrate thick jungle foliage. Earlier systems were rather large; the ground unit being half a cubic foot in volume or larger and weighing 15 to 30 pounds. The Peace Pipe volume is 50 cubic inches including the detachable voice module and weighs 3-1/2 pounds, Sefton noted.

The airborne portion of the system containing an interrogator/receiver, range indicator, control panel and phased-array antenna system, weighs approximately 75 pounds and is adaptable to a variety of aircraft.

The system is being evaluated by the Tactical Air Command at Eglin, AFB, Fla. ■■



Transponder portion of Peace Pipe is designed to fit into a soldier's fatigue pocket. The detachable module on the bottom provides two-way voice communication with the aircraft.

Get  
"PLUS  
FEATURES"

That  
Count . . .

### PLASTIC DIELECTRIC CAPACITORS TYPE "OF" GLASS CAP

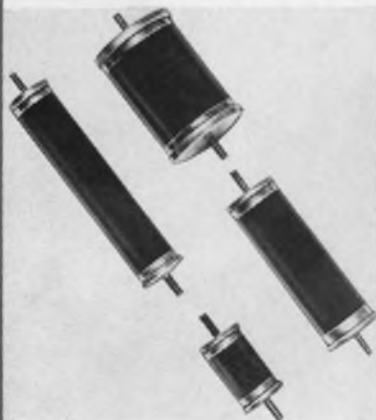

- ★ Continuous operation for 10,000 hours at ambient temperature of 85°C.
- ★ Adaptable to all DC filter applications
- ★ Complete mounting versatility
- ★ Hermetically sealed construction
- ★ Available 2KV to 60KV—capacitance range .0001 mfd. to .5 mfd

Built to precise specifications, Type "OF" capacitors give you more "plus features" that count when quality can and does make the difference. Best of all, most sizes are available in stock to meet your immediate needs.

Write for complete list of Standard High Voltage Capacitors in stock—or, send specifications for custom quotations.



Plastic Capacitors, Inc.

2620 N. Clybourn • Chicago 14, Ill.  
DI 8-3735



# Computer conscious...

... means the Drake Bi-Pin Cartridge lamp has plenty of savvy when it comes to sophisticated computer, data processing equipment and instrumentation applications.

Born of computer needs and seasoned under years of military and commercial use, the Bi-Pin Cartridge offers instant replaceability ... right from the front of the panel. Speedy legend line-up too, because it's indexed to the pins.

Versatility? Select any of five colors and an entire range of voltages in neon or incandescents. Use the new 120 V. incandescent cartridge for maximum brightness and add a variety of lenses for style or color interchangeability.

These are sturdy lampholders made of aluminum and phenolic, that adapt to any Drake or other standard Bi-Pin Cartridge lamp.

One more special feature ... Drake product and service dependability, personalized to your needs of today through more than 35 years of application problem-solving. Ask your local authorized Drake distributor for a brochure, or write.



**DRAKE**

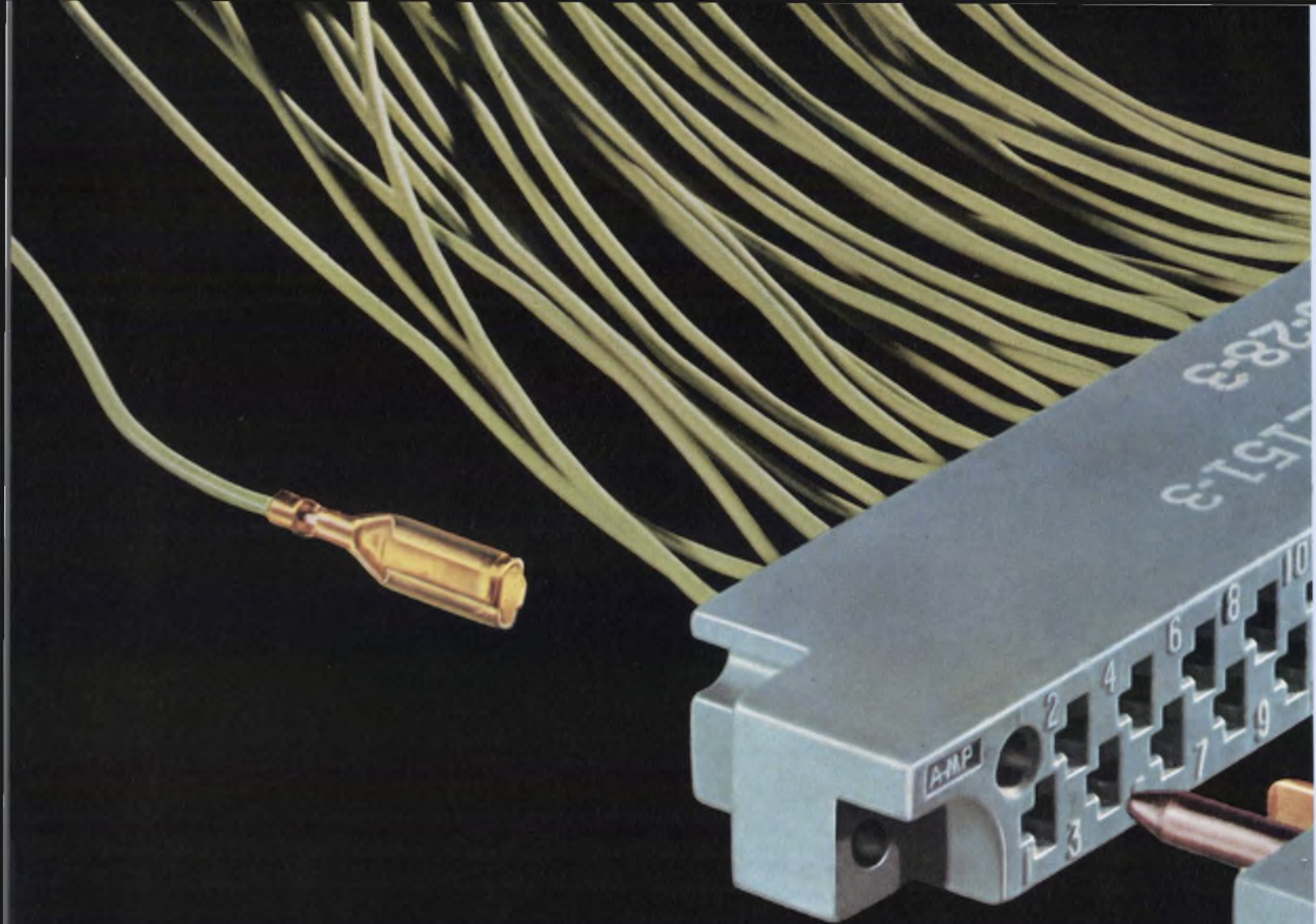

**MIL-C-21097**  
**Crimp.**  
**Snap in.**  
**Stake down.**

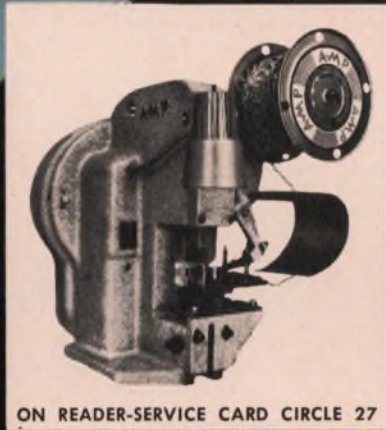
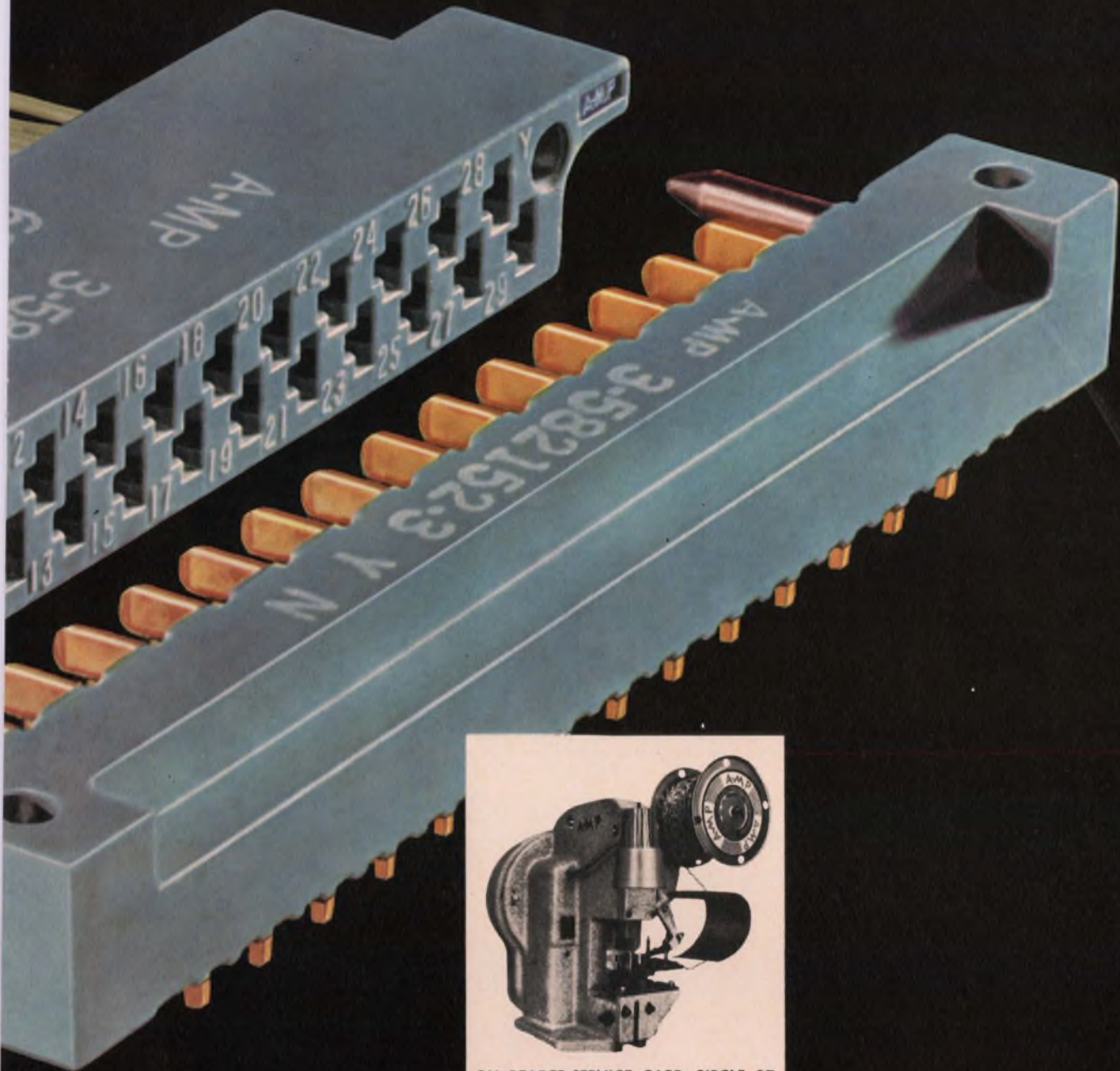

ON READER-SERVICE CARD CIRCLE 27

The AMP-BLADE\* Printed Circuit Connector. Male housing: staked to board, prevents warping; encapsulated tabs, polarizing guide pins. Female housing: snap-in receptacles, easy keying. Large contact areas, gold over nickel plating, wiping action. Famous AMP reliability. Automatically crimp 3,000 receptacles an hour with the AMP-O-LECTRIC\* machine. Lowest installed cost. Available in 17, 23, 29, 35, 41 and 47 contact positions. Send for full information today.

\*Trademark of AMP Incorporated

**AMP**  
**INCORPORATED**  
 Harrisburg, Pennsylvania

*This is only one of a full line of printed circuit connectors available from AMP... Worldwide.*



## At .0008" dia., Craftsmanship is paramount

LEAD-BONDING CAPILLARY TUBES OF TUNGSTEN CARBIDE, with bore sizes as small as .0008", are made possible by Tempress' unique ability to machine and polish ultra-hard materials in microdimensions. This has brought a new efficiency to semiconductor manufacturing. Bonding tips are held in shank by a magnetic system, permitting instant replacement, even while heated. Heated shank maintains constant tube temperature from 0° to 350°C. This unique system for thermal compression

bonding of leads to semiconductors has brought important savings in time, tools, and materials to the nation's leading semiconductor manufacturers. Equally fine craftsmanship is applied to the Tempress line of diamond scribes, lead-bonding wedges, diamond lapping points, and other miniature semiconductor manufacturing tools.



# TEMPRESS

Tempress Research Co., 566 San Xavier Ave., Sunnyvale, California



### Mobile-missile advantages cited

The disclosure of the Soviet Union's newly operational mobile strategic missiles will doubtless arouse a clamor for the U.S. to resume development of an equally potent mobile ballistic missile. The U.S. once had such a program, called the Mobile Mid-Range Ballistic Missile (MMRBM), and spent nearly \$200 million in the early Sixties on R&D before the Dept. of Defense killed the program.

The first voice has already been raised. Sen. Wallace F. Bennett (R-Utah) has once again called on the Pentagon to reinstate the MMRBM program. The weapon, he said, could be carried on railroad cars or trucks and could be used in both NATO and SEATO as a supplemental offensive system, something that is now lacking. In citing advantages of the MMRBM, Sen. Bennett reiterated all the arguments that had been heard previously when work on the MMRBM first began. The principal contentions are that mobility increases chances of survival, that a mid-range system could fill the gap now existing between the 400-mile-range Pershing missile and the 5000-mile-plus Minuteman, and that air transportability guarantees rapid global deployment to meet changing international political or tactical situations. Bennett added the argument that available technology could raise the cost effectiveness of such a weapon system. He urged the Dept. of Defense seriously to consider renewing the mobile-missile program and to look at the possibility of both medium- and long-range systems.

Meanwhile, John S. Foster, Jr., Director of Defense Research and Engineering, announced that the U.S. is developing a spacecraft that can drop off thermonuclear warheads city by city as it flies over enemy territory. One of the craft, referred to as a "space bus," could be fired into orbit by a single Minuteman III or Poseidon

# Washington Report

CHARLES D. LAFOND  
WASHINGTON BUREAU

missile. It could carry "many individual reentry vehicles with thermonuclear warheads," Foster said. Observers believe that the disclosures were intended to offset, at least in part, criticism of the Administration for refusing to deploy a full-scale antiballistic-missile system to counter the Soviet threat.

### Satellite rehearses space team

For the first time NASA is able to put its global manned-space-flight network ground equipment and station personnel through their paces with the aid of an orbital spacecraft. Launched successfully Dec. 13 from Cape Kennedy, Fla., the Test and Training Satellite (TTS-1) was carried piggyback into space together with a Pioneer 8 spacecraft. The Pioneer is the third in a series of interplanetary probes of the environment and hazards of space. Its main task is to garner data that will help in the reliable prediction of intense solar storms.

En route to outer space, the Pioneer dropped the TTS-1 off into an orbit similar to that of future manned orbital craft. The actual orbit measures 182 by 304 statute miles. The 40-pound octahedral TTS and the Pioneer 8 were ejected into space from a cannister installed on the side of the launch vehicle, a thrust-augmented Thor-Delta.

The TTS-1 was designed by TRW, Inc., of Redondo Beach, Calif. Its key element is an S-band transponder that both receives and transmits data from the Apollo unified S-band system. Signals from the ground to the vehicle are at 2101.8 MHz; the down link is at 2282.5 MHz. The signals will closely simulate all the types of transmission normally encountered in manned orbital flights. A vhf telemetry transmitter is included to permit accurate range and

range-rate determination by ground stations so that they can establish the spacecraft's ephemeris. The S-band transponder will simulate normal-voice, emergency-voice, PCM telemetry and an emergency AMT. A second TTS is slated to be launched in about 6 months, NASA disclosed.

## Frequency congestion critical, police say

Pressure is expected to build in Congress to force the Federal Communications Commission (FCC) into assigning new frequencies for mobile land stations quickly. The need has become critical, particularly for small businesses and for police networks throughout the country. The urgency of the present situation was forcefully described to the House by Rep. John D. Dingell (D-Mich.), who has received a mass of correspondence from top police officials all over the nation.

Dingell's subcommittee on the activities of the regulatory agencies, of the Select Committee on Small Business, has been collecting testimony on the "almost unbelievable congestion" resulting from the FCC's failure to update its frequency allocations. The FCC has for a very long time been studying the feasibility of shared use of vhf television channels and the possibility of reallocating some uhf TV channels for public safety. No new assignments, however, have yet been made.

Typical of the plight of law enforcement agencies is the City of Los Angeles, where the police have installed new four-frequency radios in their patrol cars but are unable to activate a citywide emergency net because of the FCC's delay. New York City has an equally vexing problem. It has 2200 police vehicles, 15 harbor launches and five helicopters all equipped with radio but operating on only eight frequencies. The Police Dept. also has 550 radios for foot patrolmen which operate on six 15-kHz split frequencies and the city has budgeted for

1700 more units. A prerequisite of procurement, however, is additional radio channels and repeater systems to accommodate the extended coverage.

Dingell assured Congress and the FCC that he and his subcommittee intend to press the matter until a satisfactory solution is forthcoming.

## Nuclear test ban safeguards satisfactory

The nuclear test ban treaty has been in effect for four years. During that time the U.S. has continued development within the treaty limits of nuclear systems and has monitored the global environment to assure itself that other signatories have lived up to the agreement. For the fourth year a review of treaty safeguards and their implementation was presented to the Senate by Sen. Henry M. Jackson (D-Wash.).

In describing the present atomic energy detection system, he said existing facilities represent an investment of about \$85 million. In fiscal year 1968, \$16 million will be spent for modernization of equipment. Eight Vela satellites, designed to detect nuclear detonations in the atmosphere, have been launched into near-circular Earth orbits. All have been successful and all continue to operate and provide mission data.

Two more vehicles will be launched simultaneously this year employing similar but upgraded monitoring systems and with an added capability for optical and electromagnetic pulse-measuring systems. The cost to the U.S. of carrying out treaty safeguards will run about \$750 million in fiscal 1968, he said.

The senator pointed out that Communist China did not subscribe to the treaty and that its nuclear development poses an increasing threat. He reported that U.S. experts on Sino-Soviet affairs predict that China and the Soviet Union will probably renew cooperation within two to five years following either the death or removal of Mao Tse-tung. To compensate for this expanded strategic nuclear capability, the U.S. will need another generation of land-based ICBMs, nuclear submarines with larger missiles, and the best antiballistic missile defense that science and technology can provide.

# if your meter problem is . . .

## space . . .

**Small Panel Area Meters**—Miniature, stackable, edgewise meters—and Simpson's new minimum-height Designer Series.

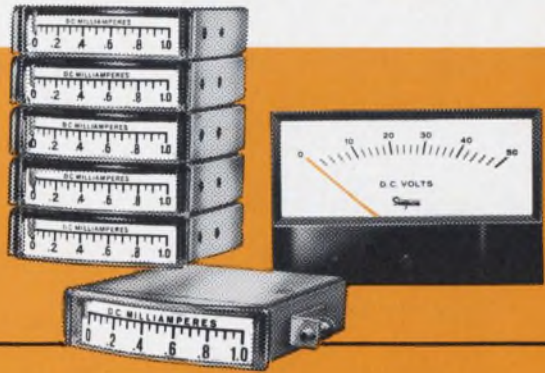

## time . . .

**Elapsed Time Meters**—Matching panel meter styles, in 110 and 220 volt stock models.

## control . . .

**Meter Relays**—Contactless and contact types, one and two control point models.



## environment . . .

**"Rugged Seal" Construction**—Sealed from dust and moisture.

# SIMPSON HAS THE ANSWER . . .

and it's probably available from stock.

Simpson makes more ranges, more special types, and in more sizes—as regular stock items. Over 1,325 different panel meters are stocked. If you have a meter problem, Simpson can usually solve it faster. Check your electronics distributor for immediate delivery . . . or write for a "problem solver" quotation on special order models.

Write for bulletin 2077 which gives complete information.

# Simpson

## ELECTRIC COMPANY

5200 W. Kinzie Street, Chicago, Illinois 60644 • Phone: (312) 379-1121

Export Dept: 400 W. Madison Street, Chicago, Illinois 60606, Cable, Simelco

IN CANADA: Bach-Simpson Ltd., London, Ontario

IN INDIA: Ruttonsha-Simpson Private Ltd., International House, Bombay-Agra Road, Vikhroli, Bombay



DIVISION

ON READER-SERVICE CARD CIRCLE 29

# BOBBINS

...if you need them,  
**PERMACOR®**  
has them!



Name your size . . . select your shape . . . if it's Bobbins you want, we have them. As the world's largest maker of cores, we have the designers and production facilities to answer your every need, be it Bobbins or any other standard or special powdered iron cores.

IRON CORES... Plain, Hollow, Threaded, Insert, Tuning, Cup, and Toroidal Iron Cores, Iron Coil Forms, Sleeves, Flexible Magnetic Shielding, Bobbins and special shapes.

**PERMACOR®**

A Division of Radio Cores, Inc.

9540 Tully Ave., Oak Lawn, Ill. 60454  
Phone: 312-422-3353

ON READER-SERVICE CARD CIRCLE 30

# Letters

## Current source measures MOS gate threshold

Sir:

I was interested in the Idea for Design "Simple Zener-diode tester uses single transistor," presented in ED 22 (October 25, 1967, p. 140). I have used a similar current source in measuring gate threshold characteristics of n- and p-channel MOS enhancement devices.

The gate turn-on characteristics are measured by connecting the gate to the drain with a constant current through the drain to source. The drain-to-source voltage or the gate-to-source voltage is measured with a high-impedance voltmeter. The schematics in Fig. 1 show the necessary connections for  $V_{Th}$  measurements on both n- (Fig. 1a) and p-channel (Fig. 1b) devices. This method accurately and rapidly characterizes the MOS turn-on voltages. While Pallottino's simple circuit would suffice for the above measurements except at low current levels, a few modifications make the current source more versatile for MOS gate threshold measurements. For gate threshold measurements, currents of  $0.1 \mu A$

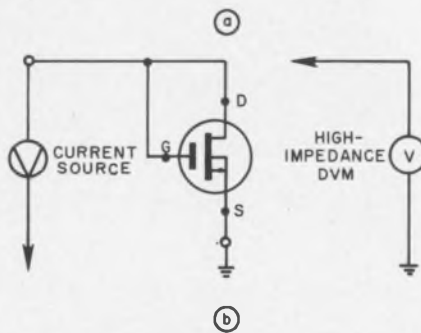
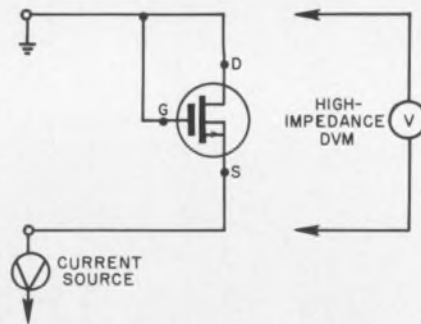

1. Threshold voltage of MOS devices can be measured with this simple setup. n-channel devices are connected up as in (a); p-channel units are connected as shown in (b).

to 1 mA with decade increases are useful. Gate stability problems associated with the oxide are easily detected at these currents.

In the schematic of the current source (Fig. 2), the emitter resistors were selected to give the desired decade current levels. The biasing network, composed of  $R_1$ ,  $D_1$ ,  $R_2$ ,  $R_3$  and  $R_4$ , determines the voltage across the emitter resistors. The potentiometer ( $R_4$ ) in the biasing network adjusts the

(continued on p. 48)

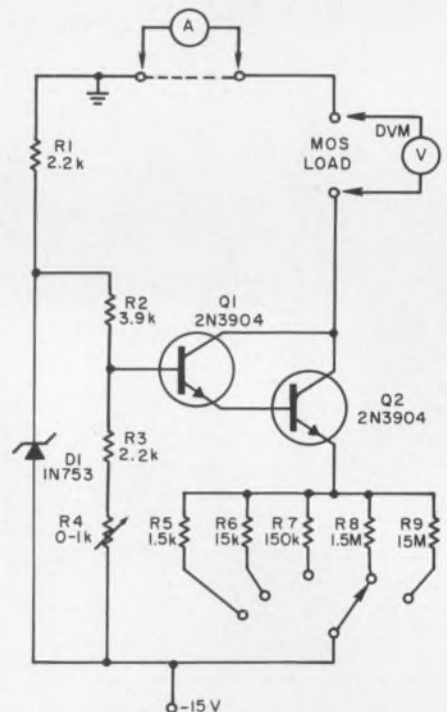

2. Modified current source is more versatile means of making MOS gate threshold measurements.

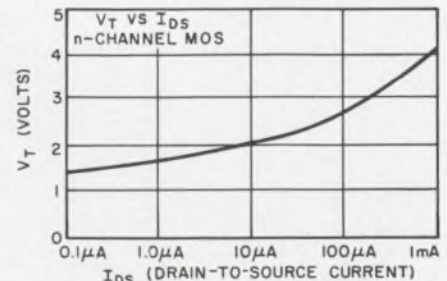

3. Typical measurements made for a n-channel device with the modified current source.

ON READER-SERVICE CARD CIRCLE 31



**Environment Proof  
is what we call it.**



## **Tough New Arrival**

The Stackpole Series 100 miniature rotary switch is here! New, compact 1 1/8" diameter body size. Totally enclosed to protect against exposure, contact contamination and production damage. Explosion-proof. Ideally suited for today's rugged demands and space applications.

Reliability and long life are assured by Stackpole's unique mode of switching—field proven

in the larger Series 600 switch. Internal intermixing of electrical functions and interconnection of decks and terminals provide unprecedented switching versatility. Inherently economical — Stackpole enclosed rotaries are competitively priced with open deck, clip type switches. This new versatility and economy encourage complete freedom of design and afford the use of enclosed rotary switches for all applications.

Sample switches, made to your exact specifications, are shipped in 2 to 3 days and production quantities in 2 to 3 weeks. For prompt quotations and samples, send your wiring diagrams or specifications to: Stackpole Components Company, P. O. Box 14466, Raleigh, North Carolina 27610. Telephone: 919-828-6201. TWX: 510-928-0520.

Now in two sizes



**STACKPOLE**  
COMPONENTS COMPANY

# 25 AMPS OF REGULATED DC FOR INTEGRATED CIRCUITS

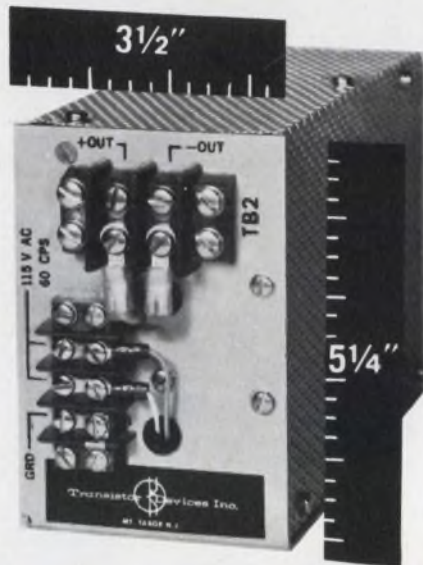

**INPUT:** 105-120 VAC at 50, 60 or 400 Hz  
**WEIGHT:** Only six pounds

Here's a new series of high efficiency power supplies specifically designed to meet the regulation, ripple, noise and RFI requirements of all commonly available integrated circuits, and deliver more watts of regulated power per cubic inch than previously available from any module of its size.

For example, Model IC5-25 measuring only 5 1/4" x 3 1/2" x 7 1/2" and weighing only six pounds, delivers 5 VDC at 25 AMPS with regulation of 125 MV and RMS ripple of 15 MV.

This high efficiency and package density creates new design flexibility and capability for applications where space is at a premium, or power distribution a problem. Low RFI and noise add to the suitability of this series for Integrated Circuits and similar applications.

All models have full isolation between line and load, automatic short circuit protection and operate in ambient temperatures between 0 and 55°C. Higher temperature operation is available with forced air cooling or derating. Military Grade and other units are available on special order.

Model	Output Adj. Range	Load Current	Regulation Line & Load	Ripple RMS
1C4-25	3-4 V	0-25 A	± 125 MV	15 MV
1C5-25	4-5 V	0-25 A	± 125 MV	15 MV
1C6-20	5-6 V	0-20 A	± 125 MV	15 MV
1C10-13	6-10 V	0-13 A	± 200 MV	20 MV

For complete technical data write to:

**Transistor  
Devices Inc.**

ROUTE 53, MT. TABOR, N. J. 07878  
TELEPHONE (201) 625-0250

ON READER-SERVICE CARD CIRCLE 32

## LETTERS

(continued from p. 46)

current through each of the emitter resistors while the decade current ratios remain the same. A Darlington transistor arrangement is necessary for low base current, so that the collector current is very nearly equal to the emitter current at low currents. The Zener diode in the biasing network stabilizes the current source with respect to  $B+$  settings or changes.

The graph in Fig. 3 shows the measurements made for a n-channel MOS device with this current source.

Wesley A. Vincent  
Electronics Engineer  
Telecommunications Laboratory  
Motorola, Inc.  
Scottsdale, Ariz.

## Idea for Design is not original

Sir:

The life of a circuit designer is difficult at best. He may toil for hours or days over a concept, only to find it has been done before. This is the case of an Idea for Design, "Get sharp edges from an astable multivibrator waveform," by T. M. Jarvis, ED 19, 13 Sept., 1967 [p. 128]. I published this idea under the title "A linear voltage-variable one-shot with fast retrigger time" in *EEE*, May 1965.

Unfortunately we circuit designers seldom remember articles from two or three years past.

Jarvis has missed one important point, however: The waveform

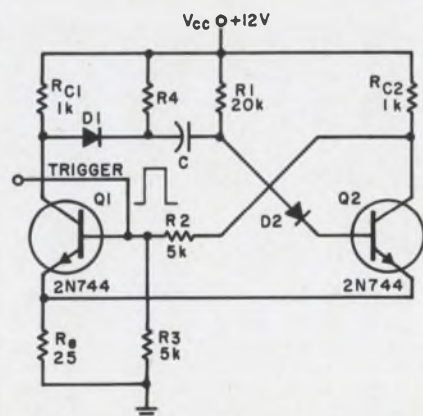

1. Astable multi waveform is sharpened when  $R_4$  and  $D_1$  are added to a standard configuration.

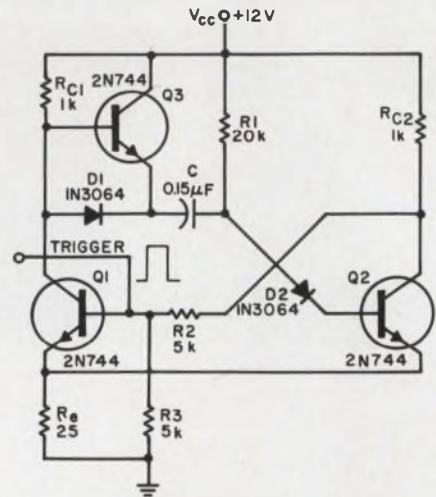

2. Retrigger time is shortened from 150  $\mu$ s to 14  $\mu$ s by the addition of transistor  $Q_3$ .

may be "sharpened" by the use of a diode and resistor (see Fig. 1). When  $Q_1$  turns back off, the collector is dc-isolated from timing capacitor  $C_1$  by diode  $D_1$ . The capacitor now charges through  $R_4$ . The use of the transistor does offer one distinct advantage, retrigger time. The retrigger time for a one-shot (or free-running multivibrator) is dependent on the  $R_{C1}$  time constant. The addition of  $Q_3$  in Fig. 2 charges  $C_1$  through the low impedance of  $Q_3$ . The retrigger time for this amplifier is 14  $\mu$ s (for a period of 500  $\mu$ s); without  $Q_3$  the retrigger time is greater than 150  $\mu$ s.

Richard S. Hughes  
Senior Electronic Engineer  
Naval Weapons Center  
China Lake, Calif.

## Author concurs

Sir:

I am grateful to Richard Hughes for his comments on this very useful technique. I had not seen his article previously but have now had an opportunity to read it. The wealth of available information and the resulting difficulty in locating particular articles are something of an occupational hazard for us would-be authors. Very few people are lucky enough to have a truly original idea.

It had not occurred to me merely to use an isolation diode ( $D_1$  in Hughes' circuit) and then to recharge the timing capacitor with a resistor ( $R_4$ ). My application, an astable multivibrator, clearly re-

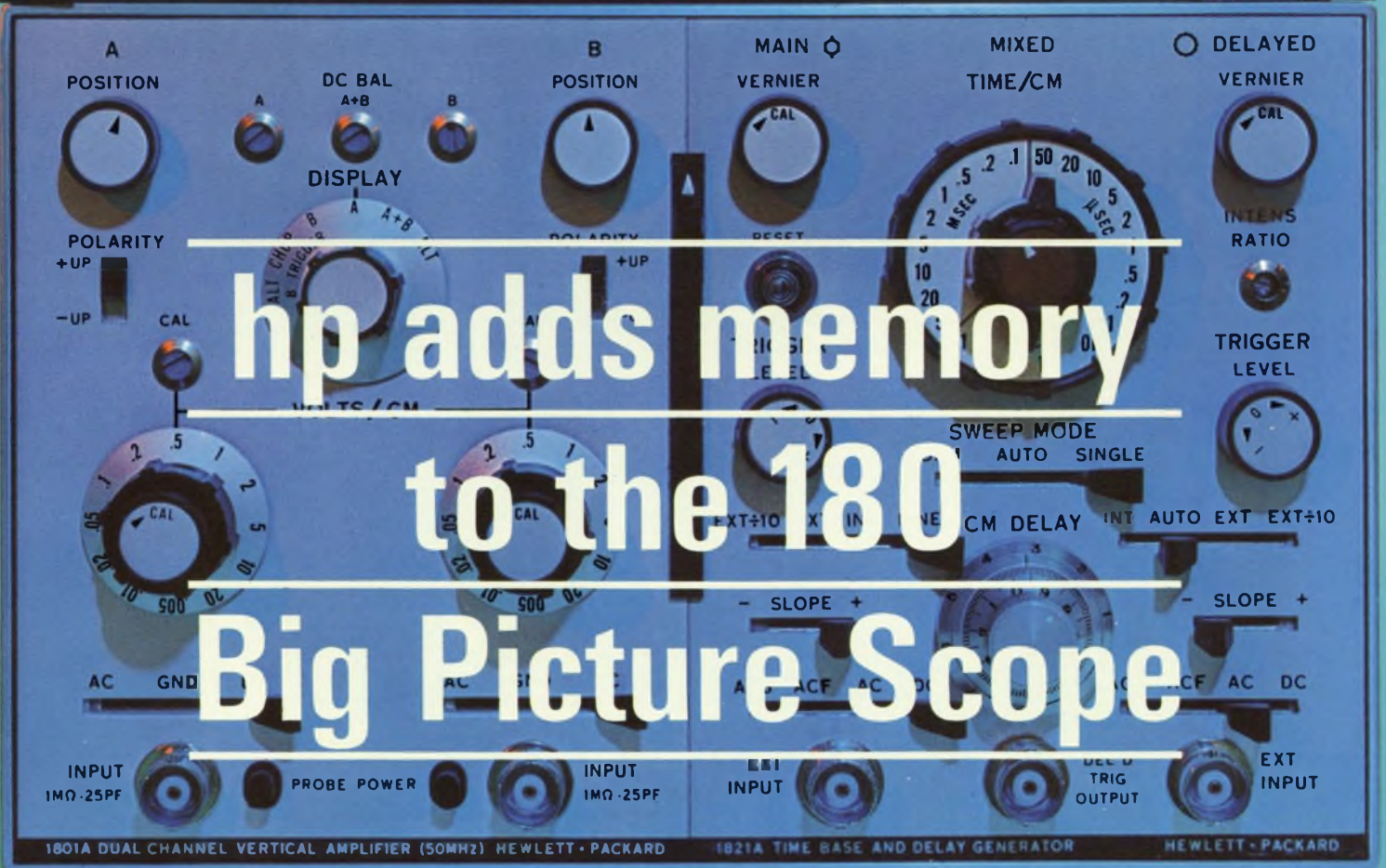
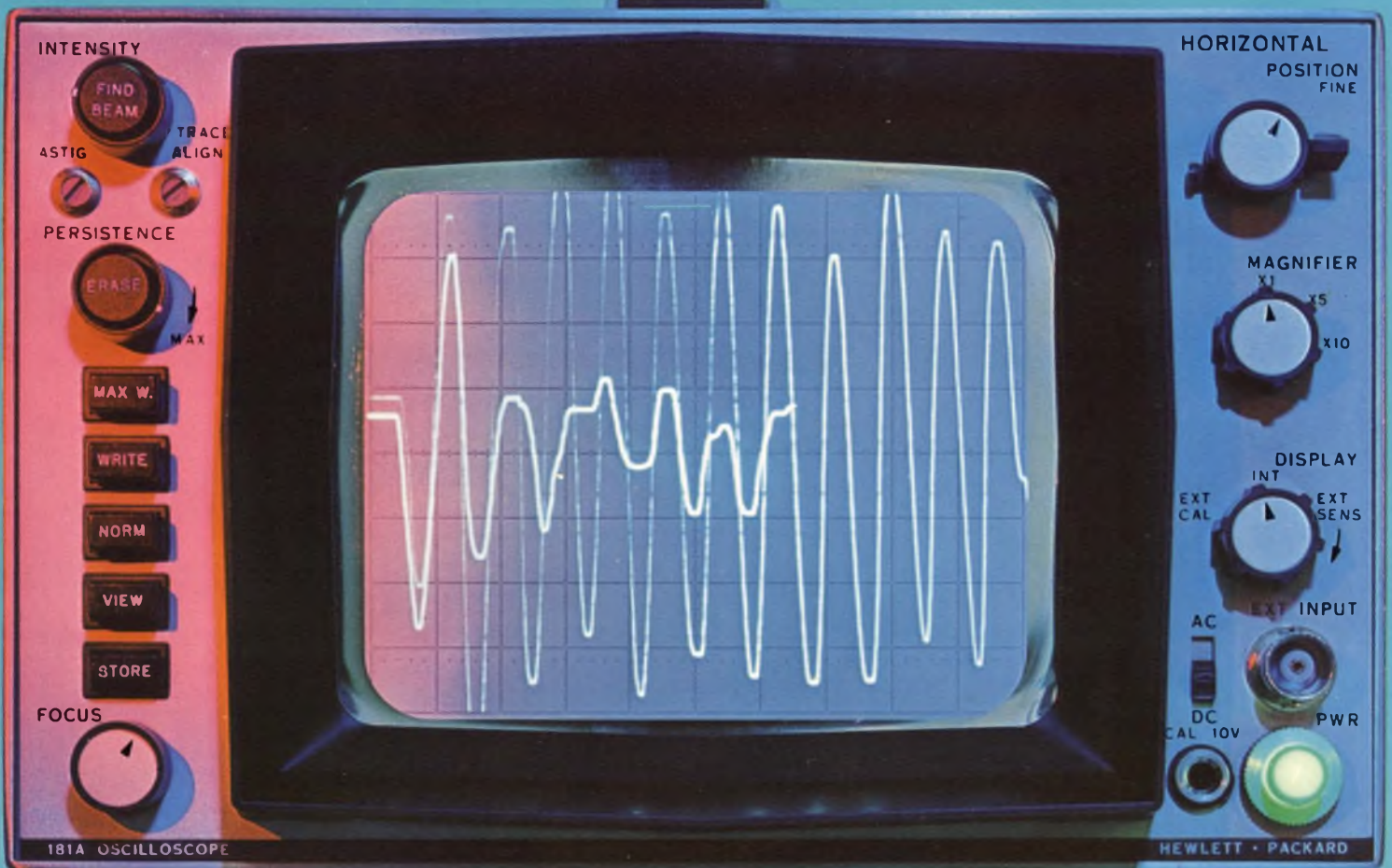

ACTUAL SIZE

# PERSISTENCE



MAX



YOU  
CONTROL CRT  
PERSISTENCE!

# STOP • STORE •



## VARIABLE PERSISTENCE

See more with the new 181A's variable persistence—made possible by the special rectangular CRT using hp's exclusive mesh storage design! At the twist of a knob you can adjust the memory span from 0.2 second to more than a minute.

See clear, flicker-free displays of fast 7 ns rise time, low rep rate pulses. See signal trends while making circuit adjustments by simply adjusting persistence so several traces appear on the screen simultaneously. See slow traces such as transducer or biomedical waveforms by adjusting persistence so the old trace fades as the new one is being written.



## STORAGE

Do more with the new 181A's storage capabilities! Catch and store single-shot transients with the 181A's fast writing rate of 1 cm/ $\mu$ sec. Store traces side by side for later comparison. Hold traces intact for later viewing for more than an hour. With the trace stored and the scope turned off, store as much as a full minute of information for days—or even weeks! Use this feature to get a graphic display of critical parameters prior to system failure, the activation of a safety device, or excursion beyond some predetermined limit.



**New hp 181A Oscilloscope with Variable Persistence and Storage . . .**

For the first time you get the added dimension of variable persistence and storage in a high frequency scope—50 MHz bandwidth at 5 mV sensitivity now, and mainframe capabilities for 100 MHz.

With the 181A, you also have big picture displays, plug-in versatility, 100% solid-state circuitry, 30-pound portability, and superior performance for field, laboratory and production applications.

Get the complete story on the new hp 181A from your nearest hp field engineer. Or, write to Hewlett-Packard, Palo Alto, California 94304. Europe: 54 Route des Acacias, Geneva. Price: \$1,850.00 plus plug-ins.

# VARY DISPLAY TIME!



## CONVENTIONAL USE

Use the new 181A as a conventional scope. You get the same high-frequency and high-sensitivity performance found in the other scopes in the hp 180 Series—50 MHz bandwidth at 5 mV sensitivity now, and mainframe capability for 100 MHz. All the hp 180 Series plug-ins give full performance in the 181A mainframe.

Use it anywhere. All-solid-state circuitry and aircraft frame construction give maximum ruggedness with minimum weight. Scope with plug-ins operates in temperatures from  $-28$  to  $+65^{\circ}\text{C}$ —and at altitudes up to 15,000 feet. It operates in a steaming 95% relative humidity up to  $40^{\circ}\text{C}$ !

It's rugged enough to take rough treatment in field, laboratory or production area without affecting electrical performance!



**HEWLETT  PACKARD**

**OSCILLOSCOPE SYSTEMS**

# SEE MORE... DO MORE!

*with a scope from the growing, versatile hp 180 system.*

The hp 180 plug-in scope system has set the trend—for today and years to come. With an hp 180 scope, you get versatility previously possible only with a benchful of special purpose scopes. Hewlett-Packard now offers three mainframes—the 180A, 180E and the new 181A—plus three versatile plug-

ins with more to come, soon! You buy a scope to see with, so get the hp 180 mainframe with the *big picture* that meets your present requirements. It will continue to meet your growing requirements with new, fully compatible plug-ins in the future!



**Lab/Field 180A Oscilloscope**—First in the hp 180 Scope System, this scope has capability beyond 100 MHz, has horizontal amplifier sensitivity of 0.1 V/cm. X1, X5, X10 magnified sweep, accuracy  $\pm 5\%$ . Beam finder brings trace on CRT regardless of setting of horizontal, vertical or intensity controls. Power supplies and large 8 x 10 cm CRT are capable of handling existing and future plug-ins. Price: hp 180A, \$825; hp 180AR (rack mount), \$900.



**Variable Persistence and Storage 181A Oscilloscope**—The new all-solid-state 181A scope expands the versatility of the 180 Scope System. The 181A operates as a conventional scope, or as a variable persistence scope, or as a storage scope. Persistence variable from 0.2 sec to more than a minute. Single shot writing rate is 1 cm/ $\mu$ sec. Standard 180 System plug-ins give full electrical performance in the 181A mainframe. Price: hp 181A, \$1850.



**Military Version 180E Oscilloscope**—Ruggedized version of hp 180A scope meets military requirements. Has same electrical performance specifications as 180A under such extreme environmental conditions as 95% humidity at 65°C. Passes MIL-S-910C for shock. Only 30 pounds including plug-ins for easy portability. Has proven MTBF of 5000 hours in accordance with MIL Hdbk. 217. Price: hp 180E, \$1215; hp 180ER (rack mount), \$1205.



**1801A Dual Channel Vertical Amplifier**—Has dc to 50 MHz bandwidth (all ranges), 7 ns rise time, 5 mV/cm sensitivity, A + B and A - B operation, internal trigger on Channel B in ALT and CHOP modes. Price: hp 1801A, \$650; ruggedized hp 1801E with X5 amplifier for use with the 180E, \$800.



**1821A Time Base and Delay Generator**—Triggers to beyond 100 MHz, sweeps from 1 sec/cm to 10 ns/cm. Mixed sweep is provided for slow/fast sweep display. Delayed sweep is easy to use. Price: hp 1821A, \$800; ruggedized hp 1821E with added 2 sec/cm sweep to be used with the 180E, \$920.



**1820A Time Base**—Triggers to beyond 100 MHz, sweeps from 2 sec/cm to 5 ns/cm. Variable holdoff locks-in complex waveforms. Has bright line automatic triggering. Gives you economy without sacrificing performance. Price: hp 1820A, \$475; ruggedized hp 1820E for use with the 180E, \$570.

HEWLETT  PACKARD

OSCILLOSCOPE SYSTEMS

quired the equivalent of fast re-trigger capability in Hughes' monostable so a transistor was essential.

T. M. Jarvis

Products & Instruments  
Bell Aerosystems  
Buffalo, N.Y.

## Reader finds slip in least-squares method

Sir:

In the process of reading the article "Profit by learning cost analysis" written by Lawrence M. Matthews [ED 23, Nov. 8, 1967, pp. 96-101], I reviewed the mathematical calculations of the suggested least-square method. I confirm your printed differentiations and concur with the algebraic conclusions. However, in the final substitution, I arrive at  $b = 1.5$  instead of  $b = 1-1/3$ . Please advise me if I am correct in my findings, which would therefore yield the best equation for the best straight line for the set of points:

$$y = x/2 + 1.5.$$

Norbert D. Ostrowski

Engineering Dept.  
U.S. Plastic Molding Corp.  
Wallingford, Conn.

(Mr. Ostrowski is correct:  $b$  does indeed equal 1.5—Ed.)

## Management article is characterized as ironic

Sir:

Your October 25 feature, "Let's smooth the path to management," [ED 22, pp. 114-118] is ironic, perhaps unconsciously. It quotes engineering managers as complaining that engineering societies have done too little to educate and inform engineers and engineering students.

These managers are complaining about themselves. Look at the list of officers of any engineering society—the IEEE, ASME, ASCE, or any of the dozens of them: all the officers are either professors or officials of companies that employ engineers. Never is there a mere practicing engineer.

An officer of a prominent engineering society once told me pri-

re Technipower's  
CM-95 Series  
power modules...  
**they're  
loaded!**



Technipower's miniature DC-DC power modules are packed with extras not found in other point-of-load regulators.

E.g.:

- Full 1.5 ampere capability with simple chassis mount or specially designed heat sink;
- Fully operational without adding external components;
- Complete line of output voltages, with either positive-common or negative-common versions;
- Easily mounted — input and output terminals are insulated from case;
- Protected against output shorts;
- \$30 each — much less in quantity!

Specifications include  $\cong 200:1$  input ripple attenuation,  $\pm 0.5\%$  regulation for a full 30% input or full load change, output voltage adjustment  $\pm 5\%$ , and operation to  $95^\circ\text{C}$  case temperature.

Write or call for information.



# TECHNIPOWER

A BENRUS Subsidiary

Benrus Center, Ridgefield, Connecticut 06877

Phone: (203) 438-0333 TWX: 710-450-3631

ON READER-SERVICE CARD CIRCLE 33

# Wheelock QUALIFIES...

## Again...

Lunar Excursion  
Module ALSEP

## And Again...

Nimbus Satellite

vately: "What we need is engineers trained to do their jobs but not to ask questions. We need docile employees. We cannot use engineering employees who are apt to think beyond the specific areas that we assign to them. We try to influence engineering education to give us this type of man."

What are the managers complaining about?

Lawrence Fleming

President

Innes Instruments

Pasadena, Calif.

### Government agencies should fire deadwood

Sir:

A Hoover-type Congressional investigating commission, such as the one proposed in your editorial "The great American brain drain: It's time to stop" [ED 22, Oct. 25, 1967, p. 61], could undoubtedly also find some overstaffing in Federal agencies. Due to the present budgetary pressure, some government manpower reductions are already in progress.

I would like to warn against manpower reduction by normal attrition, which is the method presently used by the government. Normal attrition is largely the result of the best talents leaving for better jobs. The consequences of this policy should be obvious. The most constructive action for government agencies would be the selective firing of their deadwood.

Ernst F. Germann

Houston

### Accuracy is our policy

In "IC and four resistors compose inexpensive voltage regulator," ED 10, May 10, 1967, pp. 96 & 98, the second sentence in paragraph two should read: "A stable reference element can be obtained by taking advantage of the negative temperature coefficient of the

(continued on p. 52)

## Here are Three Good Reasons Why...

#### ULTRA MINIATURE REED RELAY



Series 442

- Smallest multi-pole relays in industry (1-4 poles Form A)
- PC Board Mount
- Operates on 90 mw
- Contacts rated at a full 7 watts
- Occupies 0.055 cu. in. per pole

#### MINIATURE REED RELAY

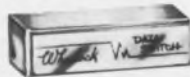

Series 262

- Meets crystal can relay standards for shock & vibration
- Single pole unit weighs only .2 oz.
- Coil ratings: 125 to 600 mw
- Contact rating: 10 watts
- Coil voltages: 6 to 48 VDC

#### STANDARD REED RELAYS

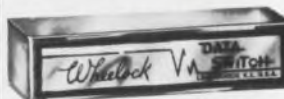

Series 3002

- 100% tested
- Coil ratings: 60 to 1500 mw
- Contact ratings: to 50 watts inductive
- Operating time: 2 ms. (typical)
- Coil voltages: 6 to 120 VDC

# Wheelock

WHEELOCK SIGNALS, INC.  
273 Branchport Avenue  
Long Branch, N. J.  
(201) 222-6880

ON READER-SERVICE CARD CIRCLE 34



Maybe it seems so.

In our thrifty, Scottish way, we've brought out a Honeywell taut-band meter that costs even less than a pivot-and-jewel meter. (About 10% less, on the average.)

Does that make you think we might be short-changing you? We are: We left all the unnecessary parts out of our taut-band meter. (Fewer parts: fewer things to go wrong.)

It's simple. Which is the whole idea.

It's self-shielded.

There's no friction in its moving parts. Which gives you better readout accuracy, better repeatability.

And it comes in just about any style you'd like.

Obviously, the low-cost taut-band meter from Honeywell has a brilliant future ahead of it.

But the question is: Will it ever replace the pivot-and-jewel meter?

We doubt it. We believe there are some sensitivities and applications that will always be

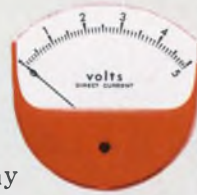

handled best by our good, old pivot-and-jewel meter.

But if you like the idea of our low-cost taut-band meter, by all means write us for our brochure. It'll tell you all the sizes, styles and prices.

Honeywell Precision Meter Division, Manchester, N.H. 03105.



**Honeywell**

**Is the pivot-and-jewel meter  
going out of the picture?**



# SOLID delivery capability



**Transistor Amplifiers for VHF/UHF: ATI launched its engineering effort in low-noise all solid-state amplifiers in 1962. Using computer-aided design and receiver systems know-how, we solved problems that continue to perplex competitors.**

Today, our low-noise, all-silicon amplifiers from HF to microwave are well past the lab curiosity stage. Thousands of ATI production units designed specifically for systems applications have been delivered.

We've consolidated five years experience into a new low-price line of all-printed circuit amplifiers available with any bandwidth up to an octave. Our new silicon L-Band amplifier extends production capabilities up to 2 GHz.

Both commercial and military product lines carry comprehensive specs — noise figure, dynamic range, VSWR, temperature, vibration, shock, and RFI. Your system can't afford less.

True production quantities available 60–90 days—sample quantities stocked on the shelf.

If you have volume requirement, call us — we've done it before.

## APPLIED TECHNOLOGY A Division of Itek Corporation



3410 Hillview Avenue  
Stanford Industrial Park  
Palo Alto, California 94304  
Microwave Laboratory  
Telephone (415) 321-2461

Equal opportunity positions available for experienced research and development personnel

ELECTRONIC WARFARE SYSTEMS • MICROWAVE COMPONENTS • SPECIAL COMMUNICATIONS • AIRCRAFT MODIFICATION

## LETTERS

(continued from p. 50)

collector-to-base junction . . ." (not collector-to-emitter junction, as printed).

In the schematic,  $R_3$  should be connected between the unregulated side (pins 11 or 12) and pin 9 (not between pins 1 and 9, as shown).

In "Use single printed circuit for several logic card types," in the Ideas for Design section of ED 21, Oct. 11, 1967, pp. 106 and 108, in the right-hand column of p. 108, second paragraph, the fourth line should read: ". . . gates with an output of  $F = A + B$  (not  $F = AB$ , as printed), Fig. 1c is one etc. . . ." In Fig. 1b, the label should read  $F = A + B$ .

In "Build complementary-symmetry amplifiers," ED 21, Oct. 11, 1967, pp. 52-55, author Prabodh Shah has drawn attention to the following inaccuracies:

In the first paragraph of the article and in Fig. 1, it should state: "Each output transistor . . . sees a maximum of only the supply voltage" (not a maximum of only one-half the supply voltage, as printed).

On p. 52, right-hand column, fourth paragraph, the first equation should read:

$$I_{B1(max)} = (V_{CC}/2 - V_{BE1})/R_1,$$

inserting the omitted division bar.

The equation immediately preceding Eq. 1 should read:

$$h_{FE1(min)} = [R_1/(V_{CC}/2 - V_{BE1})] \times [(2P_o/R_L)^{1/2}],$$

where the second element in the equation was incorrectly printed as:

$$[(R_L/2P_o)^{1/2}].$$

In Eq. 1, the third element should be:

$$(R_L/2P_o)^{1/2},$$

not  $(2P_o/R_L)^{1/2}$ , as printed.

In Fig. 1, capacitor  $C_2$  should be shown connected to the emitters of  $Q_1$  and  $Q_2$ . The solder dot was omitted.

In "Low-pass filter cuts from 20 to 10 GHz," in the Microwaves listing of the New Products section of ED 25, Dec. 6, 1967, p. 168, the headline should read: "Low-pass filter cuts from 2 to 10 GHz."

# EMI FILTER *BREAKTHROUGH*

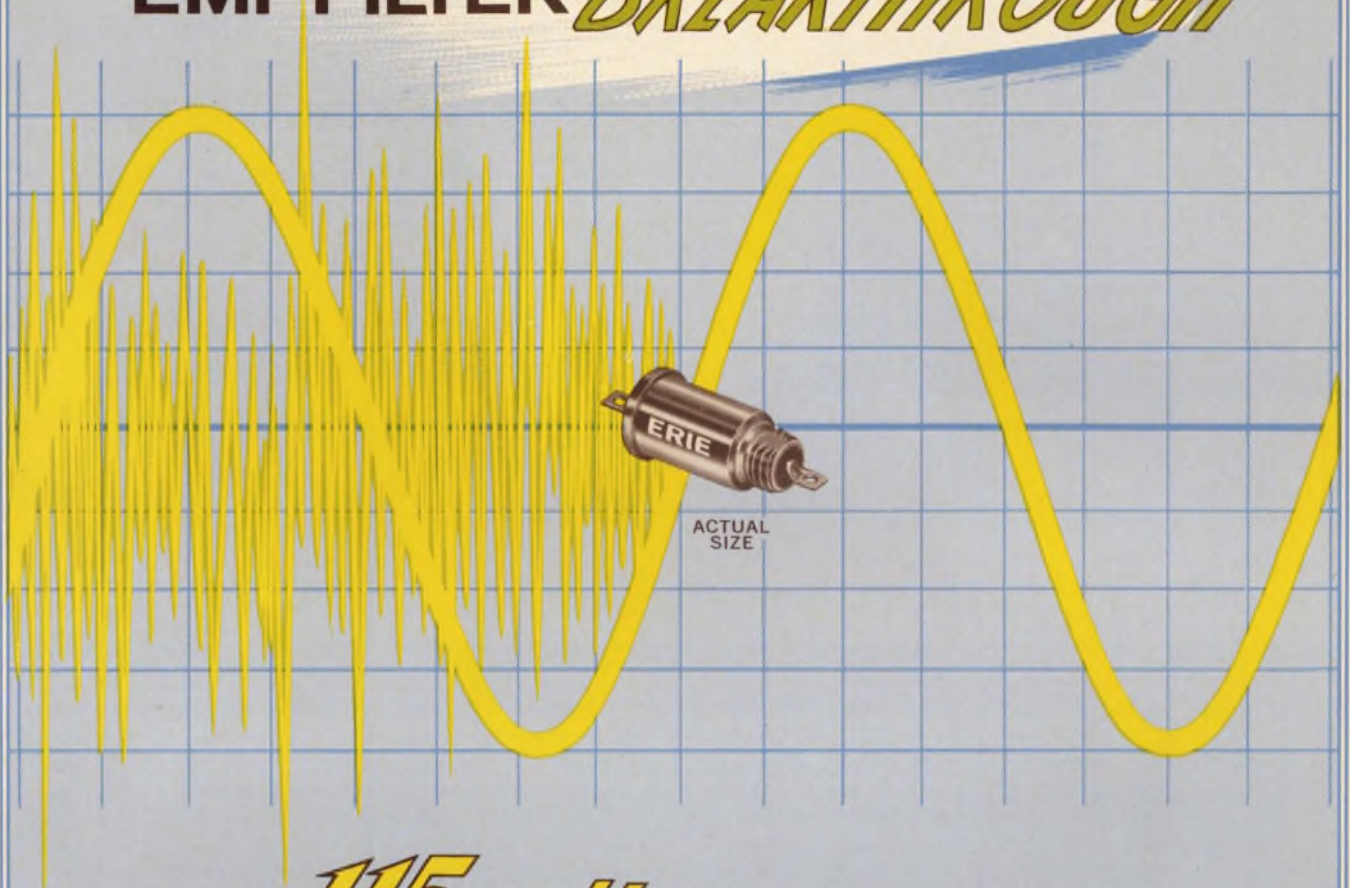

## ERIE *115 volt ac* LINE FILTERS

**SMALLER and LIGHTER THAN ANY OTHER  
LINE FILTER AVAILABLE!**

- **DESIGNED FOR OPERATION IN . . .**  
400 Hz lines @ 85°C  
60 Hz lines @ 125°C
- **INSERTION LOSS GUARANTEED FROM . . .**  
-55°C to +125°C @ rated current
- **TYPICAL INSERTION LOSS . . .**  
30 db @ 150 kHz  
80 db @ 1 MHz and up



These hermetically sealed ERIE EMI Power Line Filters represent a substantial reduction in size and weight without sacrifice in performance through the use of a sophisticated state of the art dielectric. Most measure less than 1 inch long and weigh less than 10 grams, making these tiny Filters perfect for power supply applications where reliability, size, and weight are design considerations.

The broad line of ERIE EMI Filters economically provides optimum performance for virtually any environment. For detailed specs see your local ERIE applications engineer or write for Catalog 9000.

ERIE

TECHNOLOGICAL

PRODUCTS, INC.



Erie, Pennsylvania

ON READER-SERVICE CARD CIRCLE 37



## When the Chips are down...

# IC's Don't Provide High Impedance and Low Bias Current Like this NEW LOW COST FET Op. Amp!

- Bias Current, max. — 50pA
- Input Impedance —  $10^{11}$  ohms
- Price (1-9) — \$25.00

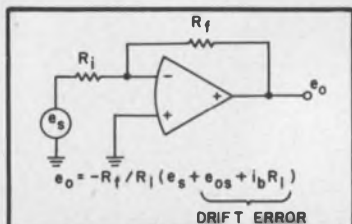

### HIGH IMPEDANCE INVERTING CIRCUITS

Curve shows that the 141 gives low drift errors even for summing resistors ( $R_i$ ) up to 15 M ohms. Curve at right applies using  $R_i$ . Applications include long term integration, picoamp current measurements, D-A converters and high Z summation or subtraction.

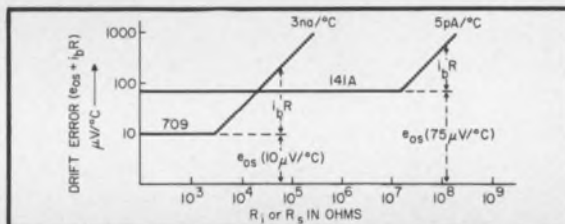

### DRIFT OF 709 vs. 141A

Curve compares total drift error of 709 type ICs to the 141A. Total drift error consists of voltage drift error ( $e_{os}$ ) and voltage errors caused by the current drift component ( $i_b R$ ). For low resistances, drift error is constant since it is due primarily to voltage offset drift ( $e_{os}$ ). For high resistances, drift increases rapidly due to the effect of bias current drift ( $i_b$ ). For resistances above  $10^4$  ohms drift error of the 709 exceeds that of the 141 due to the effect of larger bias current drift.

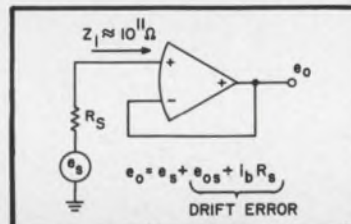

### HIGH IMPEDANCE NONINVERTING CIRCUITS

When connected as a follower the 141 gives  $10^{11}$  ohms input impedance ( $Z_i$ ) and low drift errors for sources ( $R_s$ ) up to 15 M ohms. Curve at left applies to using  $R_s$ . Applications include pot unloading, sample and hold circuits, A-D converters and ph meters.

IC op amps, like the 709, are small and inexpensive and for many applications they are quite satisfactory. But when you need high input impedance or low bias current IC's are no match for FET's. That's why we have worked so hard to produce the industries lowest priced FET op amp. In large quantities the Model 141 is priced lower than your cost for a 709 with an FET input stage and our performance is better too. Moreover, the 141 offers guaranteed specs and is 100% tested from  $-25^\circ\text{C}$  to  $+85^\circ\text{C}$  which is not usually the case for home brewed circuits.

Write or call collect for an evaluation amplifier today. Circle inquiry number to receive 141 data sheet and our new 32 page op amp catalog.

### Specifications

Open Loop Gain, min.	—	20,000
Rated Output, min.	—	$\pm 10\text{V}$ @ 2mA
Unity Gain Bandwidth	—	3MHz
Full Power Response, min.	—	50kHz
Slewing Rate, min.	—	$3\text{V}/\mu\text{sec}$ .
Common Mode Voltage, min.	—	$\pm 7\text{V}$
Common Mode Rejection	—	1000
Input Impedance, C.M.	—	$10^{11}\Omega$
Supply Voltage Rejection	—	$150\mu\text{V}/\%$

Bias Current, $25^\circ\text{C}$ , max.*	50pA	30pA	30pA
Bias Current Drift, $25^\circ\text{C}$ *	$5\text{pA}/^\circ\text{C}$	$3\text{pA}/^\circ\text{C}$	$3\text{pA}/^\circ\text{C}$
Voltage Drift, max.**	$75\mu\text{V}/^\circ\text{C}$	$40\mu\text{V}/^\circ\text{C}$	$25\mu\text{V}/^\circ\text{C}$
Price (1-9)	\$25.00	\$30.00	\$35.00
*double each $10^\circ\text{C}$			**avg. from $-25$ to $+85^\circ\text{C}$

Model A	Model B	Model C
50pA	30pA	30pA
$5\text{pA}/^\circ\text{C}$	$3\text{pA}/^\circ\text{C}$	$3\text{pA}/^\circ\text{C}$
$75\mu\text{V}/^\circ\text{C}$	$40\mu\text{V}/^\circ\text{C}$	$25\mu\text{V}/^\circ\text{C}$
\$25.00	\$30.00	\$35.00
		**avg. from $-25$ to $+85^\circ\text{C}$



ANALOG DEVICES INC. 221 FIFTH STREET, CAMBRIDGE, MASS. — 617/492-6000

# DON'T SPEC A SINGLE TURN UNTIL YOU'VE SEEN THE SIX NEW CONDUCTIVE PLASTIC INFINITRON® ELEMENT PRECISION POTENTIOMETERS FROM BOURNS

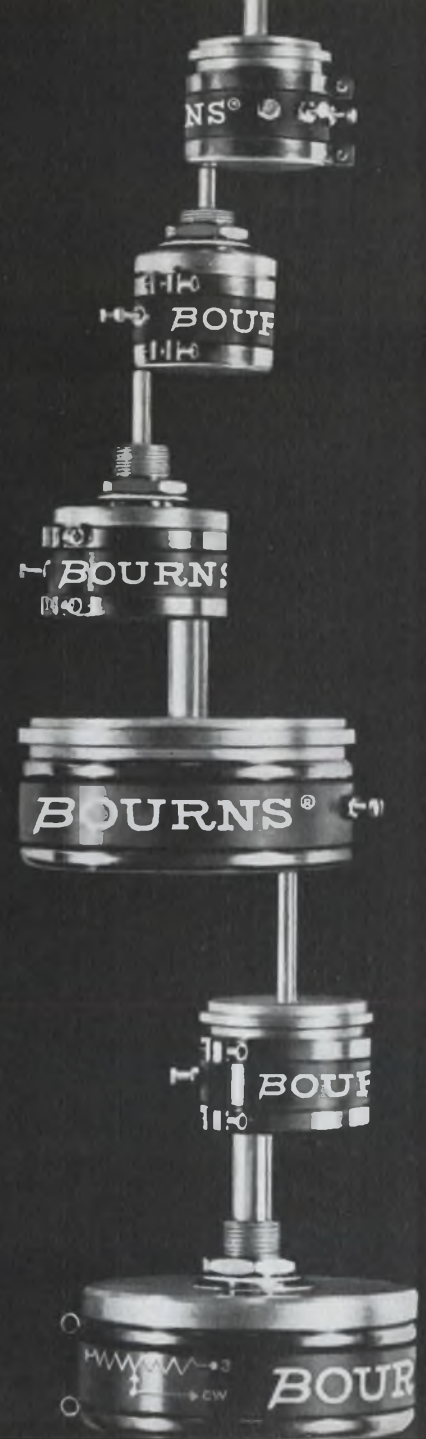

The new Bourns units are available in  $\frac{7}{8}$ ",  $1\frac{1}{16}$ " and 2" diameters with either bushing or servo-mount lids. Standard linearity is 0.5% with special linearities on request. Rotational life of the new conductive plastic units is 50,000,000 shaft revolutions and temperature range is  $-55^{\circ}\text{C}$  to  $+125^{\circ}\text{C}$ . All have outstanding resistance to humidity and exceed the moisture resistant requirement of MIL-R-39023. Most are available in ranges of 100 to 1,000,000 ohms. All models are manufactured to the stringent quality specifications you have come to expect from a Bourns product line. As with all products manufactured by Bourns, every single INFINITRON unit is guaranteed by the Bourns Reliability Assurance Program,

which includes individual inspection to published electrical and physical characteristics. Standard units are ready to ship off-the-shelf to fit your production or engineering requirements. . . special resistance values, taps, electrical angles and mechanical stops are available upon request.

Don't gamble in down-time, extended deliveries, etc., and don't speculate on quality and specifications! Investigate all the outstanding specs offered by the six new INFINITRON conductive plastic precision potentiometers from Bourns! For complete technical data contact your nearest Bourns office, representative or write the factory direct.



BOURNS, INC., TRIMPOT DIVISION • 1200 COLUMBIA AVE., RIVERSIDE, CALIF.  
TELEPHONE (714) 684-1700 • TWX: 910 332-1252 • CABLE: BOURNSINC.

TRIMPOT® and Precision Potentiometers - Miniature Relays - Electronic Modules - Microcomponents

# Buy the Generation IC

Here's your Engineering Data Sheet; tear out and keep. 

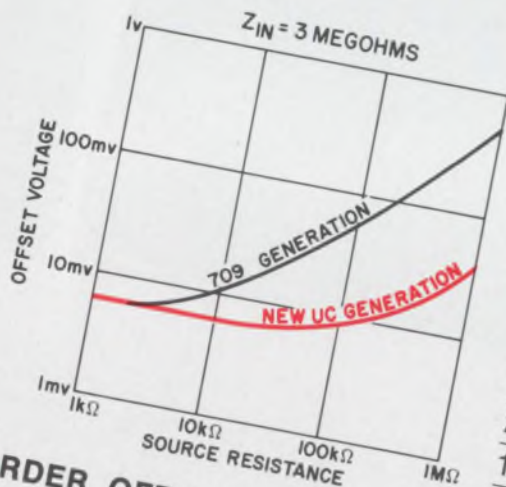

## UC4200 and UC709

**CHECK THE SPECIFICATIONS:**   
**USE THEM IN:** infra-red sensors, PM sensors, piezoelectric transducers, ionization gauges, EEG and EKG preamplifiers, analog integrators, and electrometric type voltage followers.

### PRICES:

	UC 4200	UC 709
1-24	\$34.00	\$15.00
25-99	28.00	12.75
100-249	22.50	9.50

ORDER OFF THE SHELF FROM UNION CARBIDE ELECTRONICS DISTRIBUTORS.



Semiconductor Department / 365 Middlefield Road / Mountain View, California 94040 / Telephone: (415) 961-3300 / TWX: 910-379-6942

# New



# op amps now!

## MONOLITHIC OPERATIONAL AMPLIFIERS

## LINEAR INTEGRATED CIRCUITS

## UC4200

The UC4200 operational amplifier is constructed on a single silicon chip. The amplifier has the following features:

- $\pm 24$  V operation for aerospace and airframe application
- High input impedance of 3 meg  $\Omega$
- Output is short-circuit proof
- TC of input offset voltage is 6  $\mu\text{V}$  per  $^{\circ}\text{C}$  typical
- Operating temperature range  $-55^{\circ}\text{C}$  to  $+125^{\circ}\text{C}$

### MAXIMUM RATINGS

$T_A = 25^{\circ}\text{C}$  (UNLESS OTHERWISE NOTED)

Supply Voltage	$\pm 26$ V
Power Dissipation (125 $^{\circ}\text{C}$ Free Air)	300 mW
Differential Input Voltage	$\pm 5$ V
Total Input Voltage	$\pm 15$ V
Output Short Ckt. Duration	Indefinite
Op. Temp. Range	$-55^{\circ}\text{C}$ to $+125^{\circ}\text{C}$
Storage Temp. Range	$-65^{\circ}\text{C}$ to $+200^{\circ}\text{C}$

### ELECTRICAL CHARACTERISTICS

@ 25 $^{\circ}\text{C}$  and  $\pm 24$  V supply (UNLESS OTHERWISE NOTED)

SPECIFICATION	Sym.	Min.	Typ.	Max.	Units	CONDITIONS
Open Loop Voltage Gain	$A_{VOL}$	50K				$R_L = 5$ K
Differential Input Impedance	$Z_{in}$	1	3		Meg Ohm	$f = 1$ KHz
Output Impedance	$Z_{out}$		150		Ohms	$f = 1$ KHz
Input Bias Current	$I_B$		30	100	nA	$V_{out} = 0$
Input Offset Current	$I_{OS}$		5	35	nA	$V_{out} = 0$
Input Offset Voltage	$V_{OS}$			8	mV	$R_s = 10$ K $\Omega$
Power Dissipation	$P_D$		110	180	mW	$V_{out} = 0$
Supply Current (each supply)	$I_{SS}$		2.3		mA	$V_{out} = 0$
Com-Mode Rejection Ratio	CMR		90		dB	$V_{out} = 0$ VDC, $f = 1$ KHz
Transient Response						
Risetime	$t_r$			1.0	$\mu\text{sec}$	(See Fig. 1)
Overshoot				30	%	(See Fig. 1)
						(See Fig. 1)
						(See Fig. 1)

## ELECTRICAL CHARACTERISTICS

@ -55 to +125°C (UNLESS OTHERWISE NOTED)

SPECIFICATION	Sym.	Min.	Typ.	Max.	Units	CONDITIONS
Open Loop Voltage Gain	$A_{VOL}$	50K				$R_L = 5\text{ K}$
Differential Input Impedance	$Z_{in}$	500K			Ohms	$f = 1\text{ KHz}$
Input Bias Current	$I_B$		80	300	nA	$V_{out} = 0$
Input Offset Current	$I_{OS}$		20	100	nA	$V_{out} = 0$
Av T.C. of Input Offset Voltage	$\Delta V_{OS(av)}$		6		$\mu\text{V}/^\circ\text{C}$	$R_n = 10\text{ K}\Omega$
Input Offset Voltage	$V_{OS}$			10	mV	$R_n = 10\text{ K}\Omega$
Com-Mode Voltage Range	CMV	$\pm 15$			Volts	$V_{out} = (0\text{ VDC}), f = 1\text{ KHz}$
Com-Mode Rejection Ratio	CMR	70	90		dB	$R_n = 10\text{ K}\Omega$
Output Voltage Swing	$V_{out}$	$\pm 20$			Volts	$R_L = 5\text{ K}\Omega$
Supply Sensitivity				150	$\mu\text{V}/\text{V}$	$R_n = 10\text{ K}\Omega$

## MECHANICAL DATA

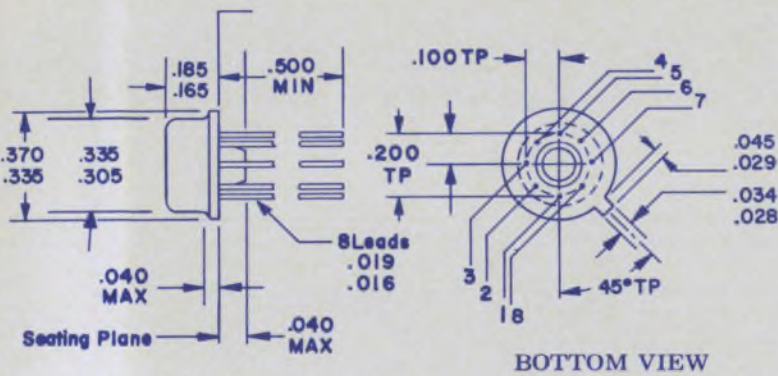

- (1) INPUT FREQUENCY COMPENSATION
- (2) INVERTING INPUT
- (3) NON-INVERTING INPUT
- (4) V- (PIN 4 CONNECTED TO CASE)
- (5) OUTPUT FREQUENCY COMPENSATION
- (6) OUTPUT
- (7) V+
- (8) INPUT FREQUENCY COMPENSATION

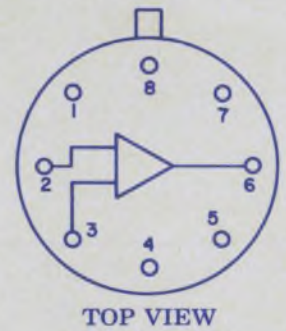

## RECOMMENDED COMPENSATION

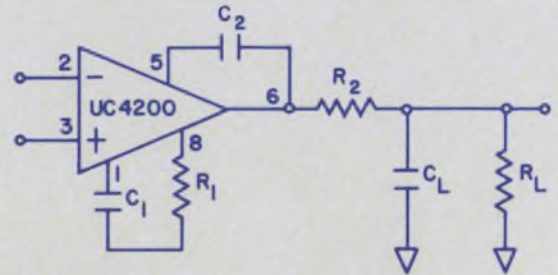

Use  $R_2 = 50\ \Omega$  when the amplifier is operated with heavy capacitive loading. A minimum value of 100 pF for  $C_L$  may be required for low values of  $R_L$ .

	$C_1$	$C_2$	$R_1$	$R_2$	$C_L$
$A_v = 1$	5000 pF	300 pF	750 $\Omega$	$\infty$	$\infty$
$A_v = 10$	3500 pF	50 pF	1.5K $\Omega$	$\infty$	$\infty$
$A_v = 100$	1000 pF	0	0	$\infty$	$\infty$
$A_v = 1000$	300 pF	0	0	$\infty$	$\infty$

## TRANSIENT RESPONSE TEST

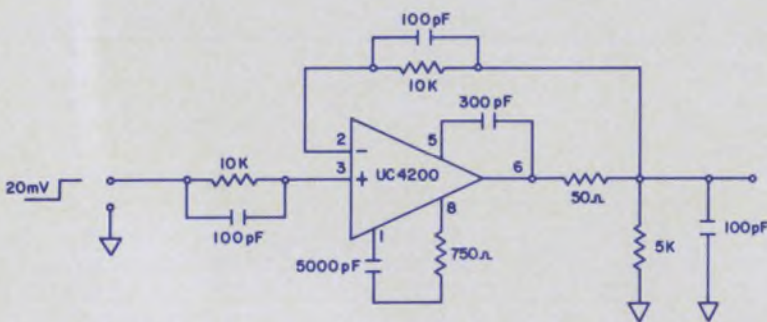

FIGURE 1



**ELECTRONICS**





**ELECTRONICS**

# MONOLITHIC OPERATIONAL AMPLIFIERS LINEAR INTEGRATED CIRCUITS UC709

The UC709 operational amplifier is constructed on a single silicon chip. The amplifier has the following features:

- Low power dissipation of 48 mW • High input impedance of 3 meg  $\Omega$  • Output is short-circuit proof • TC of input offset voltage is 6  $\mu$ V per  $^{\circ}$ C typical • Operating temperature range  $-55^{\circ}$ C to  $+125^{\circ}$ C

## MAXIMUM RATINGS

@  $25^{\circ}$ C (UNLESS OTHERWISE NOTED)

Supply Voltage	$\pm 18$ V
Power Dissipation (125 $^{\circ}$ C Free Air)	300 mW
Differential Input Voltage	$\pm 5$ V
Total Input Voltage	$\pm 10$ V
Output Short Ckt. Duration	Indefinite
Op. Temp. Range	$-55^{\circ}$ C to $+125^{\circ}$ C
Storage Temp. Range	$-65^{\circ}$ C to $+200^{\circ}$ C

## ELECTRICAL CHARACTERISTICS

@  $25^{\circ}$ C and  $\pm 15$  V supply (UNLESS OTHERWISE NOTED)

SPECIFICATION	Sym.	Min.	Typ.	Max.	Units	CONDITIONS
Open Loop Voltage Gain	$A_{VOL}$	25K		70K		$R_L = 2$ K
Differential Input Impedance	$Z_{in}$	1	3		Meg Ohms	$f = 1$ KHz
Output Impedance	$Z_{out}$		150		Ohms	$f = 1$ KHz
Input Bias Current	$I_B$		25	75	nA	$V_{out} = 0$
Input Offset Current	$I_{OS}$		5	25	nA	$V_{out} = 0$
Input Offset Voltage	$V_{OS}$			5	mV	$R_n = 10$ K $\Omega$
Power Dissipation	$P_D$		48	80	mW	$V_{out} = 0$
Supply Current (each supply)	$I_{SS}$		1.6		mA	$V_{out} = 0$
Com-Mode Rejection Ratio	CMR		90		dB	$V_{out} = 0$ VDC, $f = 1$ KHz
Transient Response						
Risetime	$t_r$			1.0	$\mu$ sec	(See Fig. 1)
Overshoot				30	%	(See Fig. 1)

## ELECTRICAL CHARACTERISTICS

@ -55 to +125°C (UNLESS OTHERWISE NOTED)

SPECIFICATION	Sym.	Min.	Typ.	Max.	Units	CONDITIONS
Open Loop Voltage Gain	$A_{VOL}$	25K		70K		$R_L = 2\text{ K}$
Differential Input Impedance	$Z_{in}$	500K			Ohms	$f = 1\text{ KHz}$
Input Bias Current	$I_B$		75	225	nA	$V_{out} = 0$
Input Offset Current	$I_{OS}$		15	75	nA	$V_{out} = 0$
Av T.C. of Input Offset Voltage	$\Delta V_{OS(av)}$		6		$\mu\text{V}/^\circ\text{C}$	$R_s = 10\text{ K}\Omega$
Input Offset Voltage	$V_{OS}$			6	mV	$R_s = 10\text{ K}\Omega$
Com-Mode Voltage Range	CMV	$\pm 8$			Volts	$V_{out} = (0\text{ VDC}), f = 1\text{ KHz}$
Com-Mode Rejection Ratio	CMR	70	90		dB	$R_s = 10\text{ K}\Omega$
Output Voltage Swing	$V_{out}$	$\pm 12$			Volts p-p	$R_L = 10\text{ K}\Omega$
	$V_{out}$	$\pm 10$			Volts p-p	$R_L = 2\text{ K}\Omega$
Supply Sensitivity				150	$\mu\text{V}/\text{V}$	$R_s = 10\text{ K}\Omega$

## MECHANICAL DATA

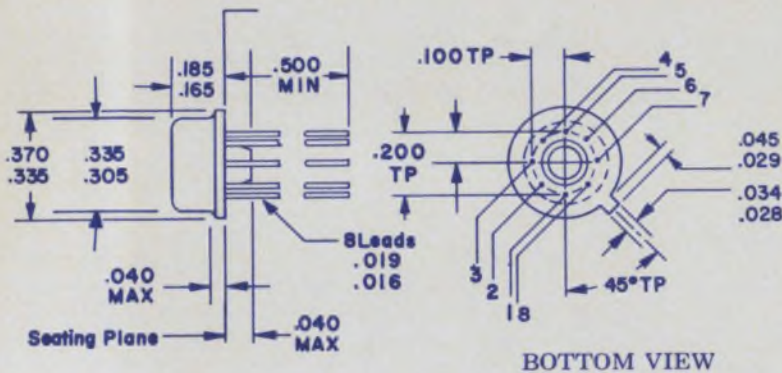

- (1) INPUT FREQUENCY COMPENSATION
- (2) INVERTING INPUT
- (3) NON-INVERTING INPUT
- (4) V- (PIN 4 CONNECTED TO CASE)
- (5) OUTPUT FREQUENCY COMPENSATION
- (6) OUTPUT
- (7) V+
- (8) INPUT FREQUENCY COMPENSATION

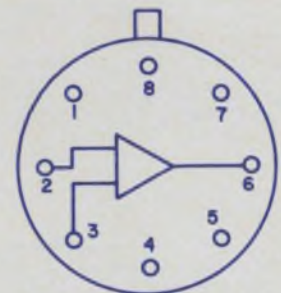

TOP VIEW

### TRANSIENT RESPONSE TEST

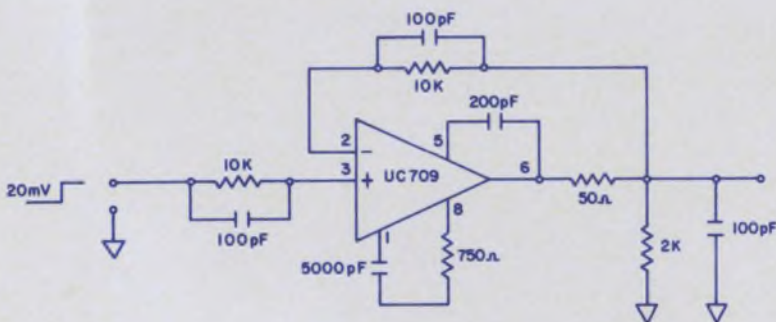
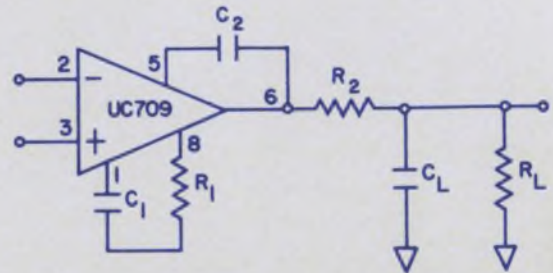

FIGURE 1

### RECOMMENDED COMPENSATION



\*Use  $R_2 = 50\ \Omega$  when the amplifier is operated with heavy capacitive loading. A minimum value of 100 pF for  $C_1$  may be required for low values of  $R_L$ .

$A_V = 1$	$C_1$	$C_2$	$R_1$	$R_2$	$C_L$
$A_V = 10$	5000 pF	200 pF	750 $\Omega$	$\infty$	$\infty$
$A_V = 100$	2500 pF	50 pF	3 K	$\infty$	$\infty$
$A_V = 1000$	500 pF	0	0	$\infty$	$\infty$
	150 pF	0	0	$\infty$	$\infty$



# New - Order samples by phone

FOR 3%  
DISCOUNT,  
SEE BELOW

## DISTRIBUTORS / EASTERN

**ALABAMA, Huntsville**  
Hall-Mark Electronics • (205) 536-9627

**ALABAMA, Huntsville**  
Schweber Electronics • (205) 539-2756

**FLORIDA, Orlando**  
Hall-Mark Electronics • (305) 855-4020

**MARYLAND, Silver Springs**  
Schweber Electronics • (301) 587-2900

**MASSACHUSETTS, Burlington**  
Avnet Electronics • (617) 272-3060

**MASSACHUSETTS, Waltham**  
Schweber Electronics • (617) 891-8484

**NEW JERSEY, Clifton**  
Eastern Radio • (201) 471-6600

**NEW YORK, Binghamton**  
Federal Electronics • (607) 748-8211

**NEW YORK, Buffalo**  
Summit Electronics • (716) 884-3450

**NEW YORK, New York**  
Eastern Radio • (212) 244-8930

**NEW YORK, Westbury, L.I.**  
Schweber Electronics • (516) 334-7474

**NORTH CAROLINA, Winston-Salem**  
Electronic Wholesalers  
(919) 725-8711

## CENTRAL

**ILLINOIS, Elk Grove Village**  
Arco Electronics • (312) 439-8100

**ILLINOIS, Schiller Park**  
Pace-Avnet • (312) 678-6310

**MINNESOTA, Minneapolis**  
Avnet Electronics • (612) 920-5866

**MISSOURI, St. Louis**  
Electronic Components for Industry  
(314) 647-5505

**OHIO, Cleveland**  
Schweber Electronics • (216) 333-7020

**OKLAHOMA, Tulsa**  
Hall-Mark Electronics • (918) 835-8458

**TEXAS, Dallas**  
Hall-Mark Electronics • (214) 231-6111

**TEXAS, Dallas**  
Sterling Electronics, Inc. • (214) FL 7-9131

**TEXAS, Houston**  
Hall-Mark Electronics • (713) SU 1-0011

**TEXAS, Houston**  
Sterling Electronics • (713) 666-3811

## WESTERN

**ARIZONA, Phoenix**  
Avnet Electronics • (602) 272-6821

**CALIFORNIA, Culver City**  
Avnet Electronics • (213) 870-6141

**CALIFORNIA, Los Angeles**  
K-Tronics • (213) 685-5888

**CALIFORNIA, Mountain View**  
Avnet Electronics • (415) 961-7700

**CALIFORNIA, Newport Beach**  
Western Electronic Components  
(714) 540-1322 • (213) 631-6119

**CALIFORNIA, Redwood City**  
Fortune Electronics • (415) 365-4000

**CALIFORNIA, San Diego**  
Avnet Electronics • (714) 279-1550

**CALIFORNIA, San Diego**  
Kierulff Electronics • (714) 278-2112

**COLORADO, Denver**  
Newark-Denver Electronics  
(303) 757-3351

**OREGON, Portland**  
Washington Electronics  
(206) 682-8981

**WASHINGTON, Seattle**  
Washington Electronics  
(206) 682-8981

## CANADA

**MONTREAL, Quebec**  
Avnet Electronics of Canada  
(514) 381-9126

**TORONTO, Ontario**  
Avnet Electronics of Canada  
(416) 789-2621

## FACTORY SALES ENGINEERS

**CALIFORNIA 92633, Fullerton**  
Fred Vogel, Fred Yingling  
(213) 691-0958 • (714) 871-5073  
TWX: 910-592-1255

**CALIFORNIA, Mountain View**  
Bill Geist  
(415) 969-9390 • TWX: 910-379-6444

**ILLINOIS 60068, Park Ridge**  
Buzz Potter, Dick Kolander  
(312) 825-7181 • TWX: 910-253-4081

**NEW YORK 11753, Jericho**  
Phil Cancelliere, Jim Blanchard  
(516) 433-8441 • TWX: 510-221-1840



Engineering Data Sheets: (If somebody beat you to them, circle No. 121  
For Applications Data, circle No. 122 ; Reliability Data, No. 123)

## DISCOUNT REGISTRATION

Name of Buyer \_\_\_\_\_

Company \_\_\_\_\_

Address \_\_\_\_\_

City \_\_\_\_\_ State \_\_\_\_\_ Zip \_\_\_\_\_

Phone Number \_\_\_\_\_

Please have sales engineer call

\* Discount offer expires midnight, February 15, 1968.

# 30% DISCOUNT

Register now for your 30-day 3%  
discount, good on all UC4200  
and/or UC709 purchases from  
Union Carbide distributors.

Simply complete this form and drop it in the  
mail to be registered for your 3% distributor  
discount.

**Address: Distributor Manager  
Union Carbide Electronics  
365 Middlefield Road  
Mountain View, Calif. 94040**



**HIGH** STYLE FOR  
**HIGH** PERFORMANCE



**THE NEW  
CENTURION  
LINE...**

**with  
the Proven  
Beede  
Taut Band  
Movement...**

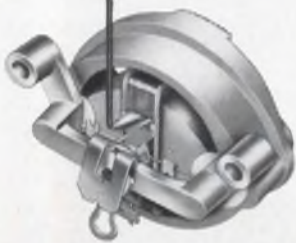

The clean custom appearance of the new "CENTURION" line will contribute to the quality appearance of any fine instrument. A durable compression molded phenolic construction permits rugged handling and lasting design appearance. Also available in a behind-the-panel model.

This new "CENTURION" line employs the high performance Beede Taut Band movement with  $\pm 1\%$  or  $\pm 2\%$  tracking, excellent balance, good damping and response, and no drift.

Send for our complete meter catalog today.

**BUY VALUE / BUY BEEDE**



ON READER-SERVICE CARD CIRCLE 41

## SIDELIGHTS OF THE ISSUE

### Paris is the prize

What better way to start the New Year than by winning a free trip for two to Paris? Or failing that, an electronic organ or a color television set?

In the first issue of each year, **ELECTRONIC DESIGN** runs its "Top Ten" contest. All you have to do is choose which ten advertisements in the issue are going to be best remembered by readers. Does it seem unfair that engineers should have to compete against the "experts" in advertising and marketing? Don't worry! A separate contest is run for them with the same prizes. Entries are judged against the advertisements that come top in Reader Recall, **ELECTRONIC DESIGN**'s method of measuring readership. Sixty-one prizes are offered in both contests, so your chances are good.

Does it sound exciting? Why don't you enter, then? The entry blank and contest rules are on the last page of the magazine, opposite the Reader Service card.

### A new year dawns for electronics

"What's going to happen this year?" This question must be in the minds of many as an old year dies and a new year is born. News Chief Ralph Dobriner has scanned the electronics industry for signs of what 1968 holds for it. He has surveyed the consumer, industrial, components and government fields, and has weighed the effects of the Vietnam war. For his findings and forecasts, see p. 25.



News Chief Ralph Dobriner looks into electronics' future.

### A new aid to readers

As another service to help readers get the most out of **ELECTRONIC DESIGN**, the magazine has revived its Information Retrieval Services. (p. 223). All products written up in each issue will be listed alphabetically in 20 main categories at the back of the book. To help track down products of interest, each entry will give both the page number of the write-up and its Reader Service number.

ON READER-SERVICE CARD CIRCLE 42 ►

**NOW...**

a miniature 4PDT 3 amp plug-in relay that's

**QUALITY**

all the way

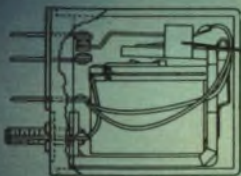
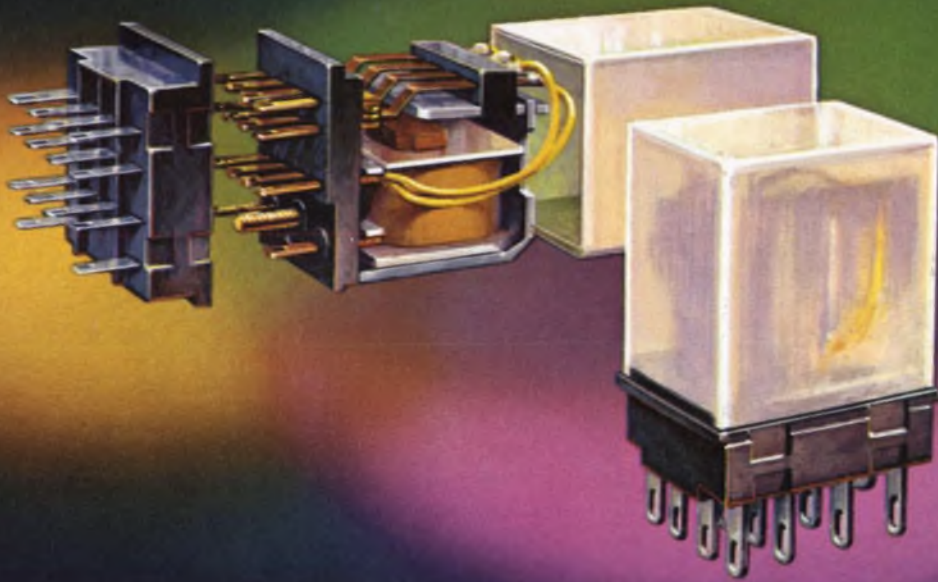

**QUALITY**—Heat-resistant LEXAN cover is standard on 1300 series.

**QUALITY**—Molded parts are glass-filled polyester for higher arc resistance.

**QUALITY**—Expected life in excess of 100,000,000 operations.

**QUALITY**—Rated at 250,000 operations at rated load AC.

This is Guardian's new 4PDT 3 amp plug-in relay. Designed and built for maximum endurance and reliability, it is especially suitable for computers, data processing, logic systems, business machines, or any other application that requires uncompromising quality. The new 1300 Series is available AC or DC, plug-in or quick-disconnect, 6 to 115 VAC and 6 to 110 VDC. Contact rating 3 amps at 30 VDC or 115 VAC resistive. WRITE TODAY for descriptive brochure.

**GUARDIAN**  **ELECTRIC**

Guardian Electric Manufacturing Company 1550 W. Carroll Ave. Chicago, Ill. 60607

## TRW METALLIZED POLYCARBONATE CAPACITORS



... small enough to fit!

TRW 50-volt Metallized Polycarbonate Capacitors are made to squeeze into tight places. Imagine 10 microfarads measuring .547" x 1¼" long... the smallest wound capacitor on the market!

Short on size and long on reliability, the X463UW series meets all requirements of MIL-C-27287.  
**VOLTAGE**—50V, 100V, 200V, 400V  
**CAPACITANCE**—.001 through 10 mfd  
**TOLERANCE**—available to  $\pm 1\%$ .

ON READER-SERVICE CARD CIRCLE 43

For data, write TRW Capacitor Div., Ogallala, Neb. Phone (308) 284-3611. TWX 910-620-0321.

# TRW®

ELECTRONIC DESIGN 1, January 4, 1968

**Co-Publishers**

James S. Mulholland, Jr.  
Hugh R. Roome

**Editor**

Howard Bierman

**Managing Editor**

Robert C. Haavind

**Technical Editors**

Jeffrey N. Bairstow  
Peter N. Budzilovich  
David H. Sorgan

**Management and Careers Editor**

Howard S. Ravis

**News Editors**

Ralph Dobriner, Chief  
Richard N. Einhorn

**Washington News Bureau**

Charles D. LaFond, Chief

**Military/Aerospace Editor**

John F. Mason

**East Coast Editor**

Neil Sclater

**West Coast Editor**

Ron Gechman

**New Products Editor**

Steven B. Futterman

**Copy Editor**

Peter Beales

**Editorial Production**

Dollie S. Viebig  
Phyllis Gura

**Art Director**

Clifford M. Gardiner

**Art Assistant**

William Kelly

**Technical Illustrators**

Cheh Nam Low  
Sheila F. Ward  
William Alvarez

**Production Manager**

Thomas V. Sedita

**Asst. Production Manager**

Helen De Polo

**Production Assistants**

Bernard Wolinsky  
Gregory A. Bannon

**Circulation Manager**

Nancy L. Merritt

**Reader Service**

Diane Mandell

## EDITORIAL



## Can advanced technology be applied to urban needs?

Can today's aerospace technology be put to work to help solve the problems of the cities?

There are no "major and direct applications" of aerospace technology to urban problems, stated Thomas F. Rogers, director of the Office of Urban Technology and Research in the Dept. of Housing and Urban Development, at a recent Washington meeting.

Further discussion after the meeting with Al Weinstein, an assistant to Mr. Rogers, clarified the intent of his remarks. Using the space program as an example, Mr. Weinstein explained that Atlas and Titan boosters and the Huntsville, Ala., rocket facility were "major and direct applications" of military technology to the space program. No such transfer of technology appears possible to help our cities' problems, he said, but there are smaller ways in which technology is already helping, and more will be found.

How difficult are the design problems involved?

This is one of the questions ELECTRONIC DESIGN set out to answer when it began work this past summer on the comprehensive report, "Electronics in the cities," beginning on page 65. Roger Kenneth Field toured sewage plants, police departments, traffic control centers, municipal buildings and systems companies from coast to coast to gather his facts.

He found that some companies bold enough to tackle this redesign problem ran into plenty of trouble. The report spells out the specific design defects of an electronic sewage disposal monitoring system built by Honeywell's Industrial Div. for a California sewage plant.

Yet such problems are not insurmountable. Honeywell has since designed quite successful automated sewage disposal systems. Many highly competent urban managers are seeking technical solutions to needs in transportation, pollution monitoring, communications and many other areas.

They face an overwhelming problem—lack of money. Big cities today are struggling with mammoth financial burdens. Much of the money that is available must be spent just trying to keep pace with growing social problems. Aerospace manufacturers will not devote the heavy initial investment and their best engineering talent to urban design unless they see a developing market.

Is the Federal Government backing the efforts that are being made? Al Weinstein pinpointed the answer to this by citing comparative R&D figures for 1968: for defense: \$7 billion; for space: \$4.6 billion; for urban needs: \$10 million.

There are signs that this situation may be changing. President Johnson has just formed the Institute for Urban Development, which will begin to develop plans for urban progress.

Designers have built electronic systems that will operate deep in space or far beneath the oceans. They can help our overcrowded, inefficient, smoggy cities, too, if given the kind of support they've had in space and defense programs.

ROBERT HAAVIND

# 150 MHz, 2.4 ns

New performance from probe tip to CRT!

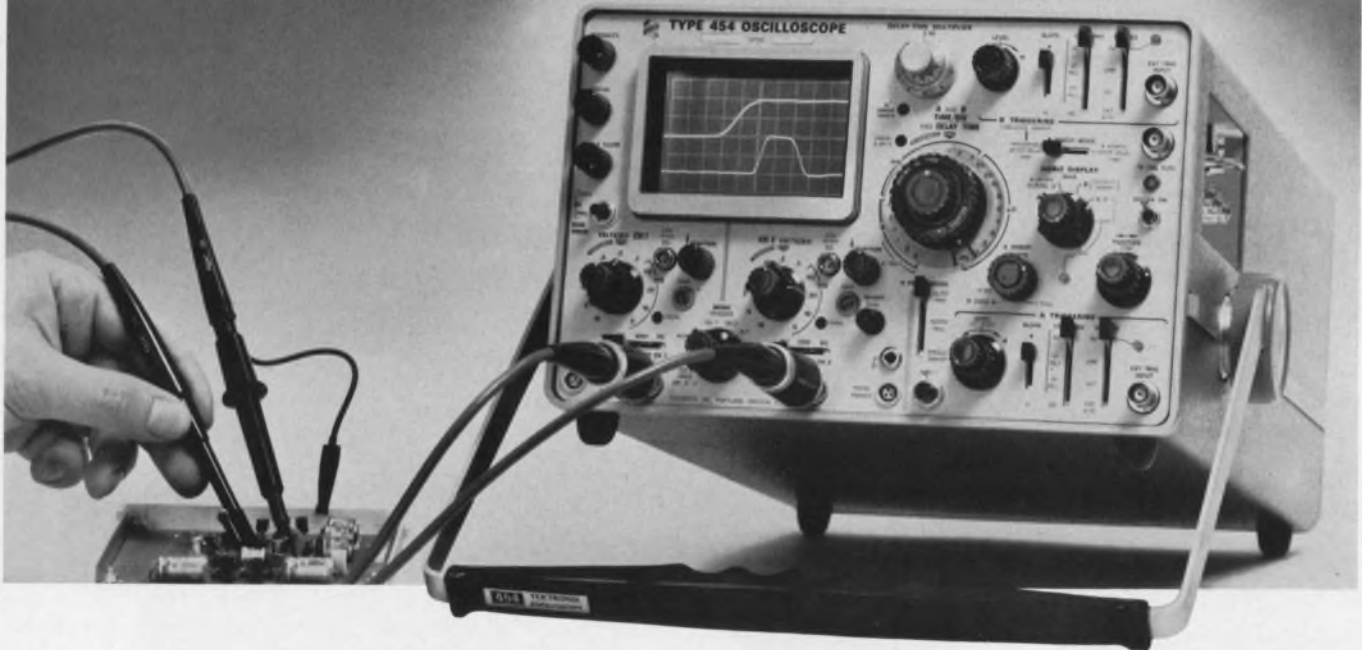

The Tektronix Type 454 is an advanced new portable oscilloscope with DC-to-150 MHz bandwidth and 2.4-ns risetime performance where you use it — at the probe tip. It is designed to solve your measurement needs with a dual-trace vertical, high performance triggering, 5-ns/div delayed sweep and solid state design. You also can make 1 mV/div single-trace measurements and 5 mV/div X-Y measurements.

The vertical system provides the following dual-trace performance, either with or without the new miniature P6047 10X Attenuator Probes:

Deflection Factor*	Risetime	Bandwidth
20 mV/div to 10 V/div	2.4 ns	DC to 150 MHz
10 mV/div	3.5 ns	DC to 100 MHz
5 mV/div	5.9 ns	DC to 60 MHz

\*Front panel reading. With P6047 deflection factor is 10X panel reading.

The Type 454 can trigger internally to above 150 MHz. Its calibrated sweep range is from 50 ns/div to 5 s/div, extending to 5 ns/div with the X10 magnifier on both the normal and delayed sweeps. The delayed sweep has a calibrated delay range from 1  $\mu$ s to 50 seconds.

For a demonstration, contact your nearby Tektronix field engineer, or write: Tektronix, Inc., P. O. Box 500, Beaverton, Oregon 97005.

Type 454 (complete with 2 P6047 and accessories) . . . . . \$2600  
 Rackmount Type R454 (complete with 2 P6047 and accessories) \$2685  
 New Type 200-1 Scope-Mobile® Cart . . . . . \$ 75

U. S. Sales Prices FOB Beaverton, Oregon

## Pulse fidelity

This double-exposure photograph shows the same 12-ns-wide pulse displayed on the Type 454 (upper display) and on a 7-ns, 50-MHz oscilloscope (lower display). Note the difference in detail of the pulse characteristics displayed on the Type 454 with its 2.4-ns risetime performance.

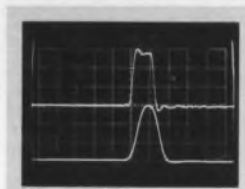

10 ns/div

## 5 ns/div delayed sweep

The delayed sweep is used to measure individual pulses in digital pulse trains. The Type 454 with its 1  $\mu$ s-to-50 s calibrated delay time, 5-ns/div sweep speed and 2.4-ns risetime permits high resolution measurements to be made. Upper trace is 1  $\mu$ s/div; lower trace is 5 ns/div.

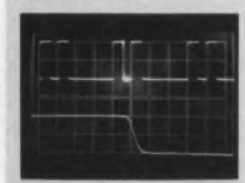

Double Exposure

## X-Y

The upper display is a 150-MHz signal that is 50% modulated by a 2 kHz signal. The lower display is an X-Y trapezoidal modulation pattern showing the 150-MHz AM signal vertically (Y) and the 2kHz modulation signal horizontally (X). Straight vertical line is the unmodulated carrier. Multiple exposure.

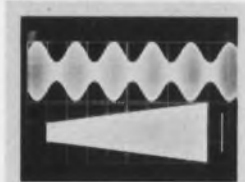

150 MHz AM



Coordinated research,  
design and manufacturing



... part of the Tektronix commitment  
to progress in the measurement sciences



# Technology

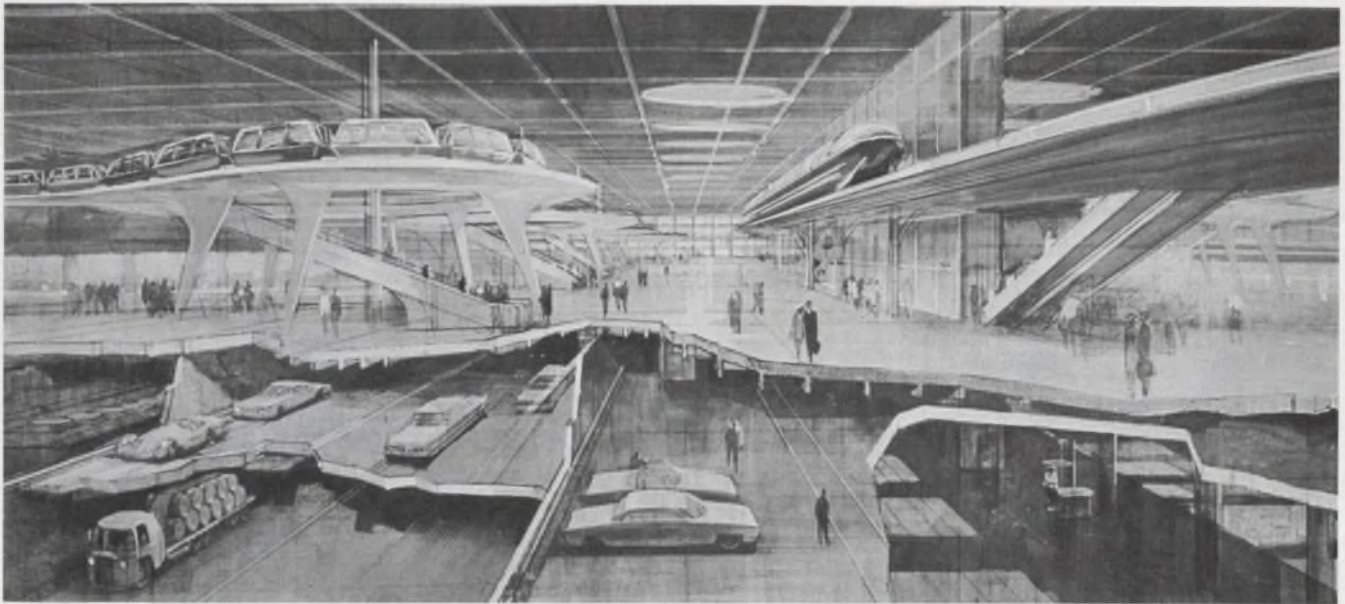

**Electronics in the cities** is a special report on the problems that beset all city dwellers and

on how electronics aims to make the cities more habitable in future. It begins on p. 65

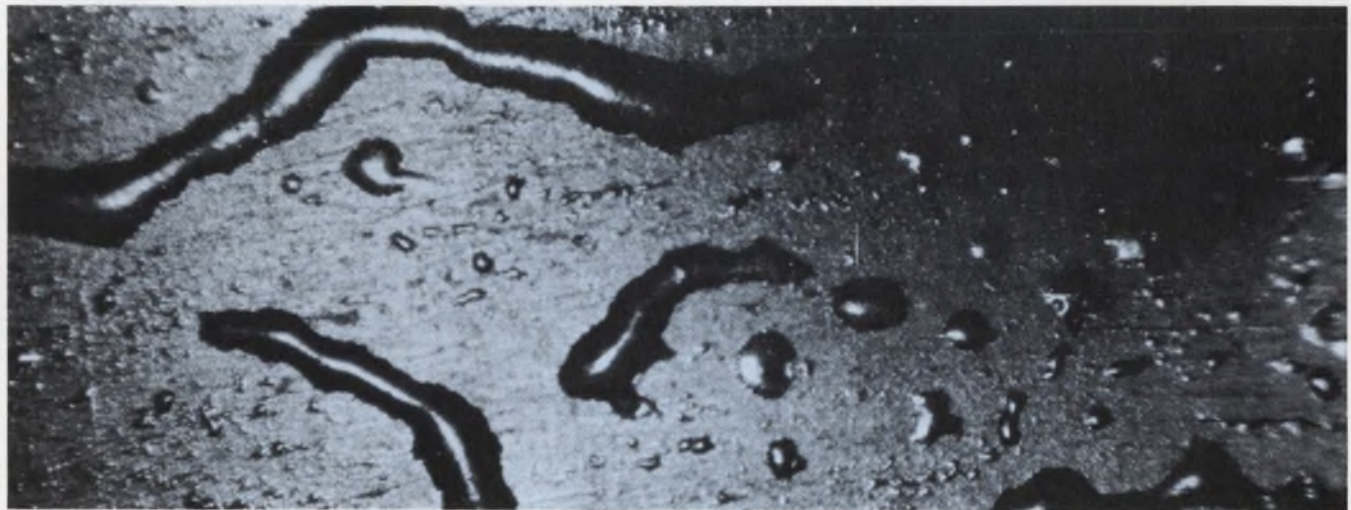

**Selection of the right gold plate** for a specific application can be a key to success or failure

in joining components. A guide to choosing the best solution for plating opens on p. 114

## Also in this section:

**Class-D rf amplifier design** can be speeded with a simple test setup. Page 96

**Network impedances** are easier to calculate geometrically than algebraically. Page 102

**Time-domain reflectometry** helps design with pulsed active devices. Page 106

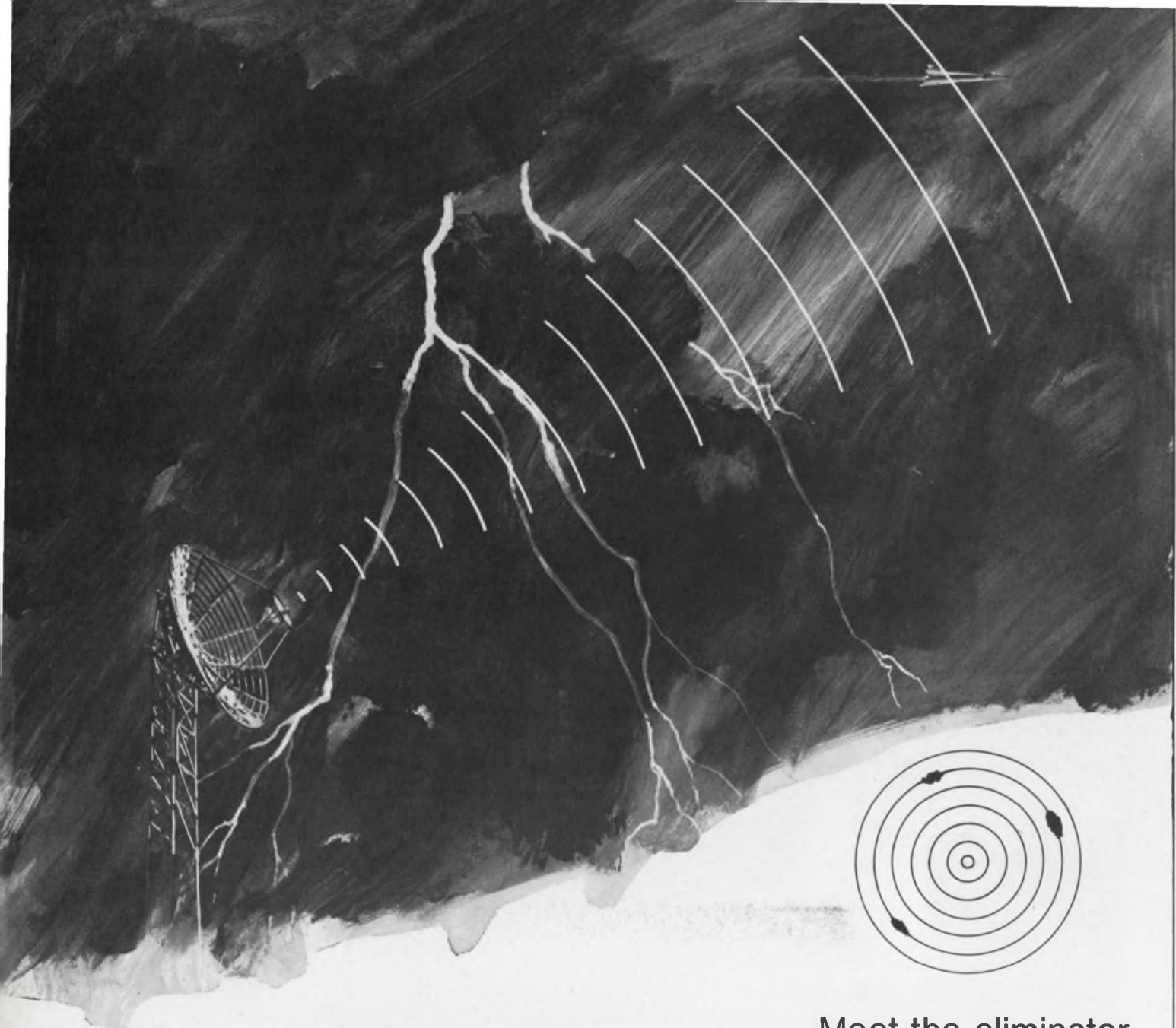

## Meet the eliminator. Make a clean sweep of RFI problems with our filter pin contacts.

When RFI started giving trouble, we did something about it. ITT Cannon developed filter pin contacts to achieve optimum RFI rejection in the connector assembly. And because our filters are an integral part of the connector — and terminated like standard contacts — they also eliminate filter boards and all the attendant expenses of engineering, assembly, wiring, inspection and testing of separate filter units.

Even crowded corners are no longer an obstacle to RFI filtering. CANNON®

Plugs with filter pin contacts are up to 75% *smaller* and 62% *lighter* than connectors with separate clusters of filters — and up to 500 times more effective.

This better idea in RFI-resistant connectors is available in many shapes and



sizes: miniature circular connectors designed to MIL-C-26482 and NAS1599 specifications, miniature and sub-miniature rectangular rack and panel, and RF coaxial connectors.

For further information and literature, write to ITT Cannon Electric, 3208 Humboldt Street, Los Angeles, California 90031.

A division of International Telephone and Telegraph Corporation.



AN ELECTRONIC DESIGN SPECIAL REPORT

# Electronics starts solving the problems of the cities

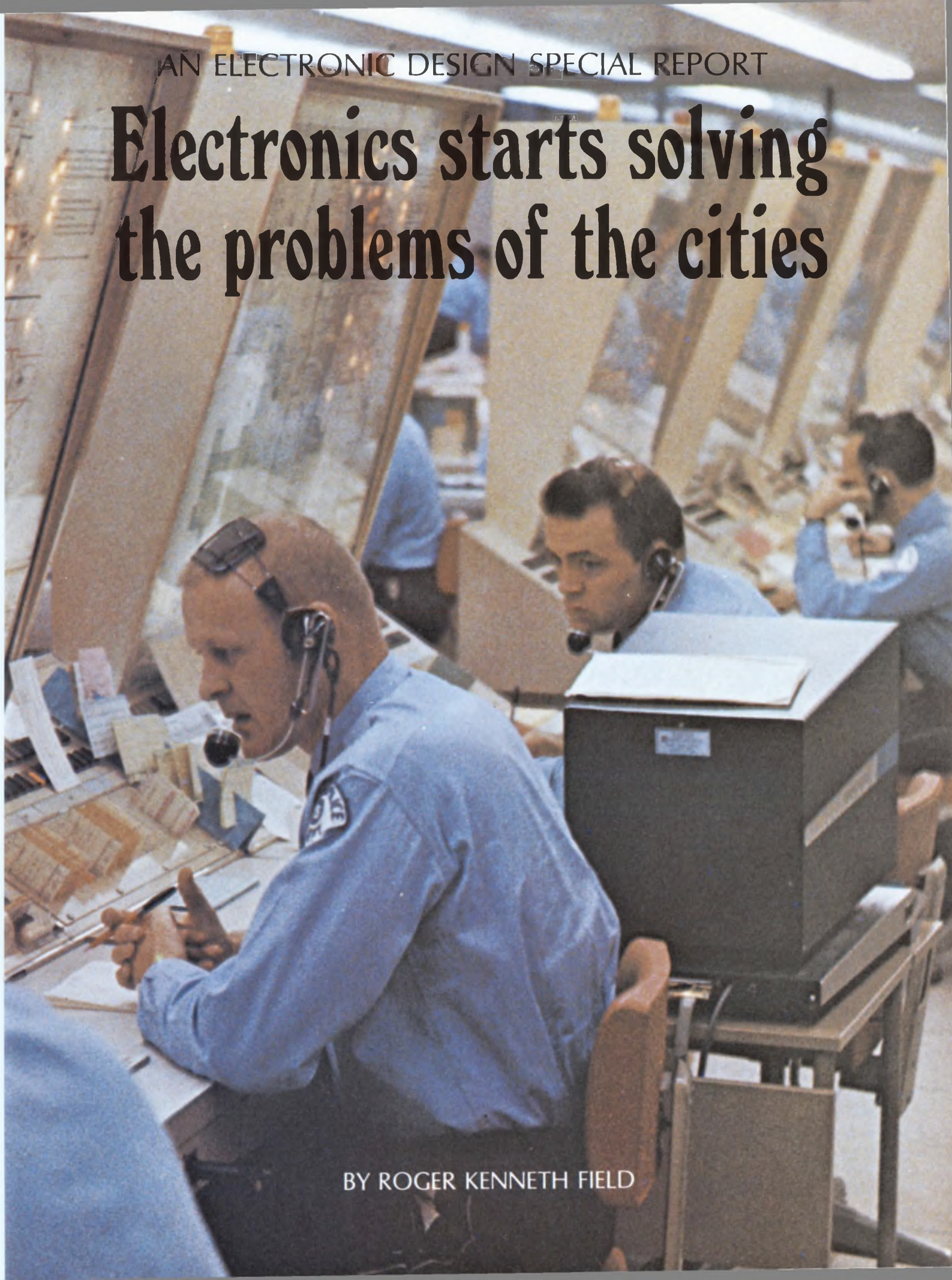

BY ROGER KENNETH FIELD

# Crisis in the megalopolis demands new electronics



Photographs by Roger Kenneth Field

The cities are beset by many, many problems: air pollution makes the eyes of the urban public smart and tear; water pollution renders surrounding streams, rivers, bays and lakes unfit for drinking and, in some cases, swimming; noise pollution prevents city dwellers from getting a decent night's sleep and permanently impairs the hearing of older citizens; and during rush hour, traffic chokes the city streets and clogs the highways.

It is a popular misconception that technology, particularly electronic technology, can solve these problems. It cannot. To effect anything that even resembles a solution, urban problems require vigorous legislation, bold architecture and civil engineering, enormously improved programs of education, and a variety of economic adjustments. But these depend, in turn, on proper pollution abatement, traffic control, efficient rapid transit and effective law enforcement. In short, for the cities to have a ghost of a chance of improving the lot of their inhabitants, they must first enthusiastically and abundantly provide the services to which they have only lazily tipped their hat in the past, and the only way they can do much of this economically is with electronics.

The present urban paradox is clear: Though electronics cannot solve the problems of the cities, the cities cannot solve their problems without electronics.

The popular misconception assumes that adequate electronic technology exists to help the megalopolis out of its dilemma. In fact, it doesn't. And cities are not in the habit of underwriting research and development programs to create it. Even when they try, as New York City found with Sperry and Chicago found with Illinois Institute of Technology Research Institute, the R&D they buy may not bring them perceptibly closer to an improved urban environment. "We have been pretty inept in the purchase of electronics R&D," observes the assistant mayor of one big city. "We haven't had the billions of dollars of experience NASA has had. But we're learning."

On the other hand, the electronics industry doesn't seem to appreciate the problems of the cities: it solves the wrong problem, or it attempts to solve the right problem with the wrong designs.

There is, of course, some basis for optimism. A large body of electronic technology, originally designed for military, industrial, and aerospace markets, can be adapted for the cities. Such adaptation is taking place, but it seems to be successful only when it is undertaken by unusually bright people who are intimately familiar with both the problems of the cities and the traditional solutions to these problems. Such individuals are rare and widely scattered—which explains why San Jose, Calif., has the best computer-controlled traffic system; Los Angeles, the most extensive air-pollution monitoring and water reclamation programs; Sacramento, Calif., the most modern water distribution and sewer maintenance system; New York City, the most up-to-date communication and routing equipment for a complex rapid-transit system; and Chicago, the most technologically advanced police department.

There is considerable communication between the creators of these

---

**This workman is giving instructions to the operator of a crane located atop a New York skyscraper. Their headsets are connected by a long wire that runs all the way up the side of the building and across its roof. Not very exotic? That's the point! These men communicate with rugged, reliable equipment that almost never requires maintenance and can be quickly repaired with the most rudimentary tools. They have tried radios, but they cannot successfully perform their jobs if interference garbles some transmissions and equipment occasionally fails. Their needs, like those of municipal governments, will only be satisfied by the new design philosophy embodied in "man in the street" electronics, which stresses utter reliability and simplicity.**

systems and their colleagues in other cities. News of a breakthrough travels like wildfire, as does news of a flop. Thus progress is rapid provided it is judged in the context of the time scale of governmental activity rather than the far more compressed time scale of, say the semiconductor industry.

Sometimes, manufacturers claim, city officials seem reluctant to buy new equipment. As a rule, this is not so. Government employees used to ask only, "Will it work?" and then, "What will it do for the people I serve?" Now they are offered more sophisticated equipment and in turn they ask more specific questions: "Is my present staff incapable of maintaining your equipment? Will it add to my noise pollution or air pollution problems? Is it easily damaged by vandals? Will it

be an additional burden on my already overcrowded radio communication channels? Will it look awful on my sidewalks? Will it be affected by smoke, oily soot or rainstorms? Will the information it provides my law enforcement people fail to stand up in court?"

The fact is that the only acceptable answer to these questions is: "No, Mr. Mayor."

Answering these questions is not enough. Each urban problem entails its own set of additional design rules—in fact, each city needs special thinking. The best urban designer is the one who combines sensitivity to the problem to be solved with acute awareness of the environment in which his solution must operate. Here designers may profit more from the design philosophy of the automobile industry than that of the aerospace industry: if Detroit has given the design community anything at all, it is the inspiration to design a machine that can be built by uncaring workers, maintained by ill-trained mechanics and driven by an oblivious public—and that performs every day in spite of all this. Likewise in urban electronics, as the following examples will show, simplicity is tantamount to elegance.

#### What you'll find in sewage

The municipal function that lends itself most readily to electronic instrumentation is waste disposal.

With the present population and technology explosions, the U.S. in the next decade will roughly double the number of the nearly 8000 sewage plants presently in operation. They will have to remove polymers, insecticides, and industrial chemicals that have yet to be invented from the waste materials they process.

Though treatment techniques will need further refinement to handle the exotic wastes of the future, modern sewage plants return a remarkably clear, deodorized effluent to nearby watercourses usually without adding any chemicals.

There are two distinctions that separate sewage treatment from any other industrial process. With sewage, what comes in the front conduit has to be dealt with as soon as and in whatever quantity it flows. And the process is essentially biological, rather than chemical. Before electronics can be designed for water treatment control, sewage processing must be understood



This man is lighting a methane burner with a high-voltage wand at Philadelphia's old N.E. Sewage Treatment Plant. A thermocouple used to be used to ensure ignition of the flame, but heat damaged the sensitive junction. Nine years ago the plant replaced the thermocouples with ultraviolet sensors housed in the purple cylinders (lower right corner of photograph). Should the gas fail to ignite, the sensor triggers a valve, which prevents the flow of raw methane.

in the light of these two distinctions. The two most usual methods of treatment are anaerobic, in which bacteria consume organic waste in heated (96°F), covered tanks called digesters, and aerobic, in which different bacteria perform a similar operation in aerated, open tanks that require no heat.

After a preliminary filtering, skimming and settling, the effluent is aerated by mechanical means and pumped into treatment tanks. There, activated sludge—sludge that is alive with hungry bacteria that congregate on the solid, suspended particles—is introduced into the effluent. Its organic waste is attacked by the bacteria and after a certain length of time, the activated sludge is allowed to settle before being siphoned off for reuse.

The goal of all this is to remove such diverse ingredients as suspended particles, grease, bacteria, offensive chemicals and organic matter from the raw sewage and to return a clear, odorless, chemically neutral liquid either to the ground or to some nearby body of water that may well be used for recreational activities such as swimming or boating, or even drinking.

During the process, the effluent is tested for acidity or basicity, turbidity (clarity) and the presence of such dissolved gases as carbon dioxide, nitrogen, oxygen, and methane, which is produced by the bacteria. The methane in the anaerobic process is pumped off and burned to heat the activated sludge, the effluent in the digesters and the plant buildings themselves. And the latest plants use methane-powered motors to run the aeration pumps and even to generate the plant's electricity.

Stewart Cameron, a city-employed mechanical engineer, is working on the modernization of Philadelphia's old Northeast Sewage Plant. "We need three things before we can stop running this plant on historical records and start some real-time, on-line, process control," says Cameron. "An in-stream turbidity meter, a sampling device that will automatically divert small samples of effluent into refrigerated jars, and a sensor that will continuously monitor BOD, which stands for biological oxygen demand." You can pollute a river, explains Cameron, simply by introducing into it large volumes of water that lack dissolved oxygen, even if the bacterial and organic content is not offensive. "You see, the

bacteria will use up the river's dissolved oxygen as they eat the organic matter. And aquatic life cannot remain alive for long in water that has insufficient oxygen." From the point of conservation, the responsibility for killing fish by denying them oxygen is as great as if a deadly chemical had been dumped into the water. And, from a practical point of view, once the fish are gone, the river's natural balance is upset and it can no longer accept any sewage, treated or untreated.

BOD, then, is a measure of how much oxygen the effluent requires to satisfy thoroughly the appetites of its bacteria; it is desirable to minimize BOD in treated sewage. Every effluent also contains inorganic chemicals that tend to form compounds with oxygen. These chemicals similarly reduce the oxygen available to the aquatic



**Sewage plant operators must resort** to crude sampling techniques until on-stream, electronic BOD sensors are developed. Here, at the Whittier-Narrows Water Reclamation Plant in Los Angeles, an ordinary kitchen refrigerator receives effluent samples, which are diverted by an electromechanically controlled fin into the pipe that enters on the left. A small sample enters the pail every 15 minutes; an empty pail is rotated into place under the pipe every four hours.

community and a comparable measure, called COD (chemical oxygen demand), indicates potential inorganic oxygen losses. "We can chemically measure both BOD and COD," says Martin Loganoff, a chemist at the Philadelphia plant. But it takes hours for the bacteria to consume the organic matter in a sample and to see how much oxygen they use. By that time a completely different mix of raw sewage may be present in the plant. "If we could read the BOD in real time, we could optimize our mix on a minute-to-minute basis, and free our lab personnel for other tasks," Loganoff declares.

The same settling, skimming and bacterial decomposition that reduces BOD also reduces COD, and considering the rather random content of raw sewage, the two demands track each other quite well.

Unfortunately COD is almost as hard to measure on stream as BOD, and instrument manufacturers are forced to resort to fairly imprecise correlations to arrive at approximate indications of either BOD or COD. The Beckman 915 Total Organic Analyzer, for example, uses high- and low-temperature furnaces with a Beckman IR-215A Infrared Analyzer to ascertain a sample's total carbon and its total inorganic carbon. It then subtracts the latter from the former to arrive at the sample's total organic carbon, which is recorded on a strip-chart recorder. The total organic content can be related to the biodegradable carbon content. This in turn gives an indication of the biological oxygen demand that will be made on the sample when the organic matter that contains the biodegradable carbon is attack-

ed by bacteria in the sludge.

Because the bacteria in the activated sludge need oxygen, the effluent is always aerated before they are added to it. Excessive aeration hinders sedimentation; insufficient aeration prevents the bacteria from doing their job—it may even make the tank "go sour," the waterman's term for cessation of bacterial activity. Should this go unnoticed, slightly decanted raw sewage would be discharged into the river. This, however, is against the law.

Beckman has now evolved a dissolved-oxygen sensor, which consists of two plates, one gold and the other silver, separated by an electrolyte of potassium chloride. The sensor, developed to operate in any position for an aerospace application, originally used a jellied electrolyte, which had to be changed every week or two. For sewage applications, Beckman substituted a liquid, which needs replenishment only every half year. The sensor is self-cleaning, a very important feature for sewage sensing, where it is common for millions of gallons of liquid to flow past a sensor each day.

In the design of water-quality instrumentation, it is a little odd that, while there are no valid standards for such basic measurements as turbidity and BOD, there are several for the analog, direct-current levels that travel from the sensors to the meters, and strip-chart and circular recorders. Several firms, including Fischer and Porter, of Warminster, Pa., use 4 to 20 mA to indicate zero to full-scale-deflection. Another popular range (used by Foxboro, of Van Nuys, Calif., among others) is 10 to 50 mA. One company uses 1 to 5 mA.

No one has yet designed a recording device that is ideal for water-pollution work. "All the industrial firms offer us strip-chart recorders that display the last few hours of sampling," notes Chuck Sutfin, a civil engineer at the Whittier-Narrows Water Reclamation Plant in Los Angeles. "What we need is a strip recorder that displays about a week of data. And you shouldn't have to grapple with the paper roll if you want to go back earlier than that. You should be able to just roll it right back without removing the take-up spindle. One firm, Robert Shaw, of St. Louis, Mo., makes a strip chart with a drive-release button. You can push it and spin the chart back. But the chart really ought to display a week at a time." Though circular recorders that display a week's data are available, Sutfin points out that the electronic versions are too costly for water plants, which won't pay for the 1%-2% accuracy they offer. "Just what do they think we're measuring here?" asks Sutfin, who notes that 5% is sufficient accuracy for almost all measurements with the exception of activated sludge and raw sewage flow, which may require 1% accuracy.

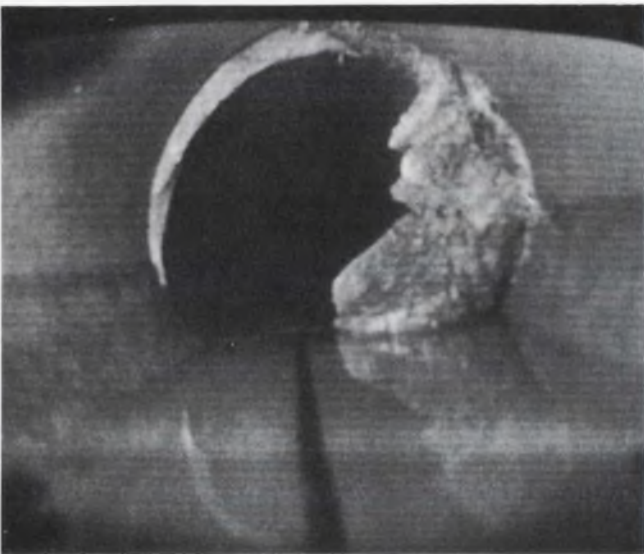

When a waterproof TV camera peers down a pipe it can see construction flaws as well as cracks due to age. Here, it discloses an error made when the pipe was installed: Concrete seeped through an open seam and hardened, blocking the flow of sewage and debris through the pipe.



There is, of course, the possibility of over-instrumenting water measurements, particularly once the effluent is discharged into a waterway. Such is the case all over the northeast of the United States.

Until three years ago the Trenton (N.J.) Board of Health took samples of the Delaware River from a bridge with a weighted cup on the end of a string. And New York City used to send a man with a pail out into Jamaica Bay in a row-boat. "Now," says Douglas Clark of Trenton's Water Pollution Department, "the U.S. Geological survey operates several monitoring stations in New Jersey. Each station monitors the river at three separate depths every half hour for solar radiation, turbidity, conductivity, oxidation-reduction potential, dissolved oxygen and temperature. They send us all these raw data, along with the wind speed and direction, on a computer print-out. We have absolutely no idea what to do with it. We've asked them several times not to send it here. Where do they expect us to put all

this stuff? We haven't got room for it."

### Electronics looks down the pipe

Water treatment plants are certainly in need of electronic help, but the network of underground pipes and conduits that distribute fresh water and collect sewage are even more essential to a city's wellbeing and can also use electronics, to implement effective maintenance programs. In California, Walt Driggs, Sacramento County's maintenance superintendent, no longer sends men out to make the rounds of pumping stations. Should the water back up, water level sensors feed analog signals from simple potentiometers to solid-state level (current) detectors, which then feed go/no-go signals to one of several multiplexers located at regional substations. The signals are transmitted over telephone data lines, which are rented for \$1.00 per quarter mile from the Sacramento Telephone Co. The multiplexer combines the go/no-go signals from a number of pumping stations and produces an analog signal, which is transmitted over "tone-quality" telephone lines rented for \$2.00 for the first quarter mile and \$1.00 per quarter mile thereafter. Since most of the pumping-station-to-substation lines are short and carry one go/no-go signal, and the substation-to-central lines are long and carry many signals on each line, it was appropriate to divide up the system into analog and digital segments. The cost of the multiplexers and the added dollar for the analog lines were more than offset by the many long lines eliminated by the analog multiplexing.

There is a current fad in the marketplace that equates digital data transmission with modernity and accuracy and analog transmission with obsolescence and inaccuracy. The people like Driggs who run the municipal departments and specify the equipment they purchase, however, seem quite unmoved by this digital hoopla. When they discuss the needs of their system, they pick pragmatically whichever offers them the best long-range economy. They generally have no fear about mixing data modes in one system, or about calling a manufacturer to task should a unit fail to perform. Driggs likes to tell of the time when a multiplexer did not work and he demanded that the company, which was located in the east, send a man out to Sacramento to fix it.

"He got here on the very next plane and he spent a week looking over the unit and talking to New York on the phone," Driggs recalls. "I told him he was going to stay right here until it was fixed. I have a right to demand that. After all, I reshuffled and laid off a whole crew of men who used to do what the equipment was supposed to do and, by golly, it's going to do it. I didn't care if he had to work on it right through Sunday.



Walt Driggs fought 12 years to get his pumping station alarm system. Now when water at a station backs up, its corresponding bulb on this detailed wall map lights up.

Those water lines must work on Sundays, too.”

Driggs measures his department's performance in “homes per gripe.” “We've actually reduced the total number of gripes over the past decade while the number of homes we serve has nearly doubled,” he declares. “And we've held the line on manpower.”

To do this, Driggs relies heavily on electronics for preventive maintenance. Every morning he dispatches a crew with an unusual television camera, which is pulled through Sacramento's sewer and water pipes. The camera, made by the Halliburton Co., Duncan, Okla., is waterproof. It is supplied with power for its circuits and front-mounted light by a single coaxial cable, which also carries the image signal back to the crew's van. Coaxial is a lot less susceptible to damage than earlier five-wire cables. A Sony television set displays an image of the sewer. By measuring the cable, the men can locate any cracks, roots or construction flaws without getting their hands dirty. “Now what we need,” says Driggs, “is a little transmitter that can be embedded in a steel weight. You see, we could fit a heavy, round weight into the pipe and let the water push it through to dislodge any material that blocks it. But if the weight were to get stuck in the pipe, we'd have to dig up half of Sacramento to find it.” Driggs is hoping someone will design a little transmitter that can be inserted into a steel weight, to keep his men informed of its whereabouts. But the device will have to produce a detectable signal that can penetrate iron pipe walls up to three inches thick. “Right now we don't have the guts to use a solid plug,” says Driggs, “so we use a block of ice. It doesn't have the weight or hardness, but at least if it gets stuck, it melts.

“Incidentally, while you're at it, tell them I also need a paging system that operates on 453 MHz and will beep a receiver in a workman's pocket, and I'll pay \$125 each for 100 of them. Right now I use a Motorola system that blows the crew truck's horn. I'll bet it would really pay for the designers to stop wasting their time on space shots and design me some of this stuff. There's only one NASA in this country, but there are a lot of maintenance crews.”

### The lofty problems of air pollution

The municipal function that is the most difficult to instrument has even attracted the attention of NASA. Air pollution is so dense in some areas that it shows up on photographs taken from satellites, which also monitor cloud conditions indicative of high-pollution atmospheric conditions.

Man has battled against contamination of his air longer than any other pollution. In 1273, King

Edward I of England, passed the first smoke abatement law. Apparently it didn't help. By 1306 the burning of bituminous coal was forbidden by parliamentary proclamation and a violator was executed for flouting it.

Twentieth-century air-pollution control laws aren't quite so strict as Edward's nor are they so effectively enforced.

Because much air pollution emanates from private vehicles, furnaces, and incinerators, observes one official, “air pollution is a far tougher can of worms than water pollution. With water pollution, the blame goes mainly to collective sources—municipalities and industries—and cleanup costs fall on them.

“When a cleanup program threatens to hit [individuals] directly and change the way they're doing things, and cost a little bit, they back off.

“And if the pressure isn't there, the politician isn't going to do anything. He can think of 26 other ways of spending public money that will be more popular.”

In spite of the apparent unpopularity of the pursuit, many municipalites—over 100—have installed fairly elaborate air-pollution monitoring equipment. These cities mean to learn what pollutants can be harmful, and to determine when the concentrations of these pollutants rise above the danger point. This is a little like playing the stock market, for it is impossible to predict with certainty a sharp, fast rise in concentration that will last long enough to be of danger to the community. (The deleterious effects of air pollution on health seem to be closely related to both the level and the length of exposure.)

Air pollution is best sampled from many sites in a given area and electronic sensors, multiplexers, telemetering equipment and instrumentation are needed to do this effectively. Five serious problems complicate design of equipment for air-pollution monitoring:

- No one can know in advance, particularly in a new locality, what to test for. Thus air pollution people monitor what they can. But it is hard to tell what else should be watched, or whether they are watching the right pollutants.

- No standard methods have been established. Consequently, test results arrived at by different methods are hard to relate to one another, and a regional data bank is impossible to establish. Successful air pollution control, however, must be done on at least a regional basis.

- Standard pollutant samples to calibrate different methods (or even new designs based on old methods) are not available.

**Single copies of this report** “Electronics starts solving the problems of the cities” will be mailed to readers who circle number **250** on the Reader-Service card at the back of this issue.

■ There is absolutely no way of positively identifying the source of pollutants, except the particulates, for all gas molecules look alike.

■ Except for the suggestions on sulfur dioxide levels from the Federal Dept. of Health, Education and Welfare, no one knows for sure the effects of various exposures to the different pollutants.

One enthusiast, B. Garland, chief of industrial sanitation, Atlanta, Ga., solved the first problem in a remarkably practical, economical way. Garland received a \$25,000 Federal grant under the Clean Air Act of 1965, but he didn't know which pollutants should be monitored.

He decided to forego expensive electronic equipment and instead bought a truck and trailer and filled it with standard laboratory flasks, beakers and test tubes. Then he air-conditioned the trailer and hired students to man it. The truck and trailer have traveled all over Georgia's Fulton County for a year, making over 11,000 tests, which included SO<sub>2</sub>, NO, NO<sub>2</sub>, CO, COH, oxidants, particulate matter and even pollen. The students also measured temperature, relative humidity, wind speed and direction, visibility and sky conditions. The whole project cost less than the \$25,000 and the students got an education that would be hard to duplicate. Now Garland is prepared to measure electronically just those pollutants that require watching.

Garland described his unusual approach in a paper at a recent air pollution conference. Snickers came from the audience, which was composed of people who collectively monitored air pollution with many millions of dollars' worth of equipment. But Robert Chapman, principal applications engineer at Beckman, and other important people in the air pollution field, were impressed

by Garland's approach and thought it ingenious and highly commendable.

The second problem may eventually be solved. Recently, a small group of East Coast air pollutionists met at Lake Mohonk, N.Y., to decide upon standard methods for measuring various pollutants. They could agree on only one, sulfur dioxide. For it, they agreed to use a wet-chemical technique known as the Wes-Gaeke method. They also agreed that when sulfur dioxide reached a steady concentration of 0.3 parts per million, the public should be alerted.

The National Bureau of Standards, Gaithersburg, Md., may have an answer to the third problem. The bureau hopes to offer cylinders containing precise traces of pollutants to the pollution community sometime in 1969, provided funds are assigned for that purpose. At present, the bureau offers only known traces of carbon dioxide in nitrogen, which it bottles for the convenience of meteorologists tracking the worldwide increase in carbon dioxide.

To solve the fourth problem, one firm, Advanced Metals Research, Burlington, Vt., is collaborating with scientists at Massachusetts Institute of Technology to categorize particulate matter from various combustion processes. Advanced Metal's director, Dr. Sheldon Moll, is using a hybrid machine that combines the ability of an electron microprobe, which can identify the composition of small particles, with an electron microscope, which can produce an image of them. Thus particulate matter will eventually divulge its source to this scanning electron probe.

The fifth problem seems to defy solution, for the question, "What levels of which pollutants are dangerous?" presses on the forefronts of

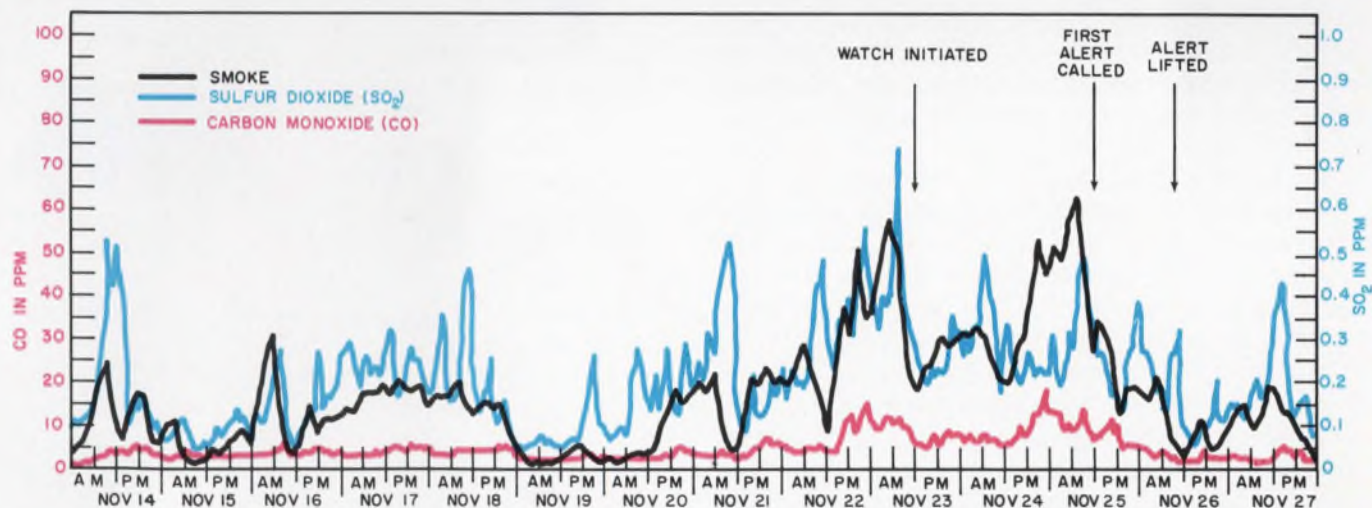

**Monitoring air pollution is like playing the stock market:** Air pollutionists watch the levels of several pollutants to detect and even anticipate high concentrations. The latter are usually attributable to a layer of warm air that blankets the area and prevents automobile and industrial fumes from escaping into the upper atmosphere or being

dispersed by breezes. During the Thanksgiving holiday of 1966, New Jersey citizens were asked to reduce automobile use and not to incinerate garbage when the state's monitoring equipment indicated that pollution levels were zooming during one such temperature inversion, which trapped industrial and vehicular emissions.

present medical knowledge.

This puts even more responsibility on the design community. Accurate sensors and instrumentation, precisely calibrated, can garner data that may well suggest to medical researchers the nature of the biological mechanisms that translate certain pollution concentrations and certain mélanges of pollutions into human deaths and diseases.

New Jersey is one of the states that has undertaken a program to acquire this much-needed data with electronic sensors and instrumentation.

Roland Yunghans, who is responsible for the state's air pollution instrumentation, monitors three constituents of New Jersey's air pollution—SO<sub>2</sub>, CO, and particulates.

### The popular air-pollution sensors

Yunghans measures sulfur dioxide by the conductometric method: the gas dissolves in distilled water, increasing its conductivity. One problem with conductometric tests is that the tester is never quite sure it is SO<sub>2</sub>, and not some other water-soluble gas, that he is measuring. So Yunghans also monitors SO<sub>2</sub> with the Wes-Gaeke method, a colorimetric technique.

This technique is well suited to automatic testing machines, such as Technicon and the Robot Chemist. In this test, sulfur dioxide in the air is trapped in a chemical, sodium tetrachloro mercury. This is then added to a mixture of perarosaline hydrochloride and formaldehyde, which turns blue in the presence of sulfur dioxide. The degree of blue is measured by a light-and-photocell combination. Yunghans, in fact, uses the Technicon to perform this test in three mobile stations in New Jersey.

He uses a nondispersive, infrared technique to detect the presence of carbon monoxide. The light shines through a sample of air, which attenuates certain frequencies if it contains the unwanted monoxide. This light is pulsed by a light chopper, filtered, and then compared with a reference beam passing through a known sample of the gas.

Particulate matter is measured by a method that arrives at a "soiling index" for these airborne particles. Air is drawn through a clean, white filter paper at a steady rate for an hour. As the paper catches the particles, it blackens. Light reflected from the blackened area is measured by a photocell. The darker the filter paper; the higher the soiling index.

One interesting method that Yunghans does not yet use is a coulometric technique recently developed by Beckman. This method can now be used for detection of ozone and sulfur dioxide, and the basic principle should be applicable to a number of other gases.

In the coulometric test for ozone, for example,

air is bubbled through chromic acid, which removes sulfur dioxide and oxides of nitrogen. The air is passed into a solution of potassium iodide, which is oxidized by the ozone to form potassium oxide and free iodine. In the presence of a catalyst, namely a platinum electrode, the free iodine goes back into solution, leaving free electrons on the electrode. To find out how much ozone was in the original sample, the tester need only monitor the current coming from this electrode.

Each of these air pollution sensing methods has its drawbacks.

The conductometric method may appear to measure the presence of a slight amount of highly soluble gas, when in fact it is measuring a high concentration of a completely different gas that is only slightly soluble.

The colorimetric method is a wet-chemical technique that uses chemicals, which have to be replenished. (It must be pointed out, though, that this method is widely applicable to the sensing of dozens of air and water pollutants, and for this reason is very popular.)

The infrared technique depends on mechanical gadgets for light chopping and is useful with very few gases.

The test for "soiling index" produces different readings for the same amount of particulate matter if the samples contain matter of different colors. And it takes at least half an hour to accumulate enough matter to make a reading.

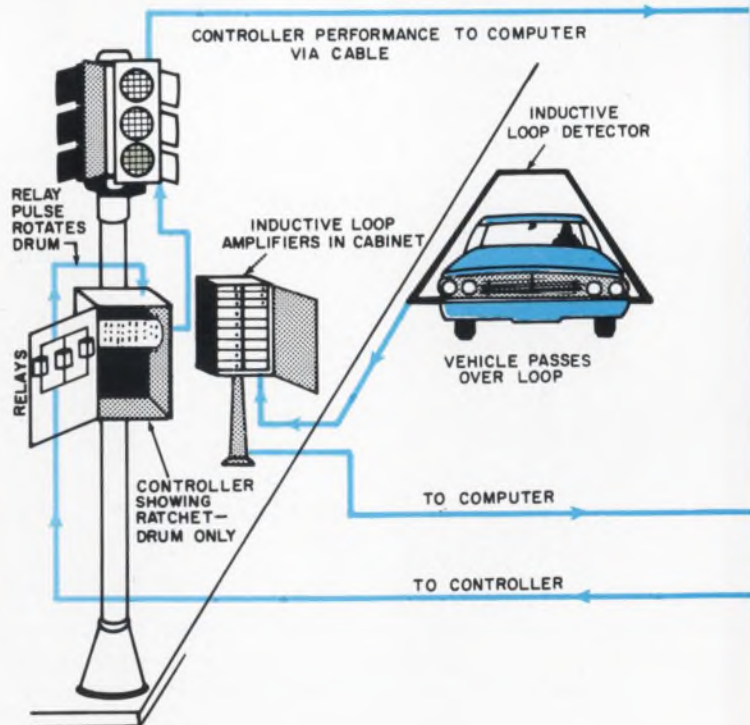

When a car passes over a buried loop detector, its metal increases the loop's inductance much like the insertion

The coulometric method seems to be the most sensitive to slight traces of pollutants, but few air pollutionists have yet given it serious, lengthy tests. At this point it can measure only ozone and oxides of nitrogen.

All these methods have one drawback in common—they all measure absolute amounts of pollutant, but it is pollutant concentration that is of interest. Thus the accuracy of each method is ultimately limited by how accurately the tester can gauge how much air was sampled.

Monitoring air pollution is one thing; controlling it is quite another. The best way to control air pollution, of course, is to stop it at its source. The millions of vehicle exhausts and residential and industrial smokestacks represent a staggering market for sensors, recorders and electrostatic precipitators, should local laws ever require them. At least two companies, Bristol and Beckman, feel that they will be required, and that industry will tend to choose the same instrumentation to check its stacks and vehicle exhausts as the agencies that will regulate emissions. Furthermore, as nitric acid manufacturers discovered, the pollutants that go up a smokestack represent wasted money. In many cases, the combination of pollution monitoring equipment with on-line process control may well be a good investment, regardless of the legal status of the matter.

Industry is certainly a big contributor to air pollution, but smog and smaze, both euphemisms

for foul urban air, are chiefly attributed to the automobile, which emits carbon monoxide, hydrocarbons, lead and oxides of nitrogen through its crankcase vent as well as its exhaust. In fact, the internal combustion engine has been blamed for as much as 50% of all big-city air pollution.

Los Angeles' smog, for example, is formed by the reaction of unsaturated hydrocarbons and oxides of nitrogen in the presence of sunlight. This reaction forms ozone, aldehydes, and the photochemical pollutant, peroxyacetyl nitrate (sometimes called PAN), and these three along with particulate matter are the smog's chief ingredients.

One electronic solution, recently announced by Volkswagen, will sense the density of exhaust fumes and automatically adjust carburetor controls and timing to minimize it. This may work well on the small, relatively low-compression VW engine, but it is unlikely to be so effective in a more typical high-compression engine. Why?

Any internal combustion engine, for example, emits a certain amount of unburned gasoline, a hydrocarbon. To reduce the hydrocarbon emission, the engine must be operated at higher efficiency—in other words, at higher compression ratios and temperature. At elevated temperature and pressure, however, the engine fixates nitrogen—that is, nitrogen and oxygen, both present in the air in its cylinders, combine to form oxides of nitrogen. Until recently, nitrogen oxides were not considered particularly

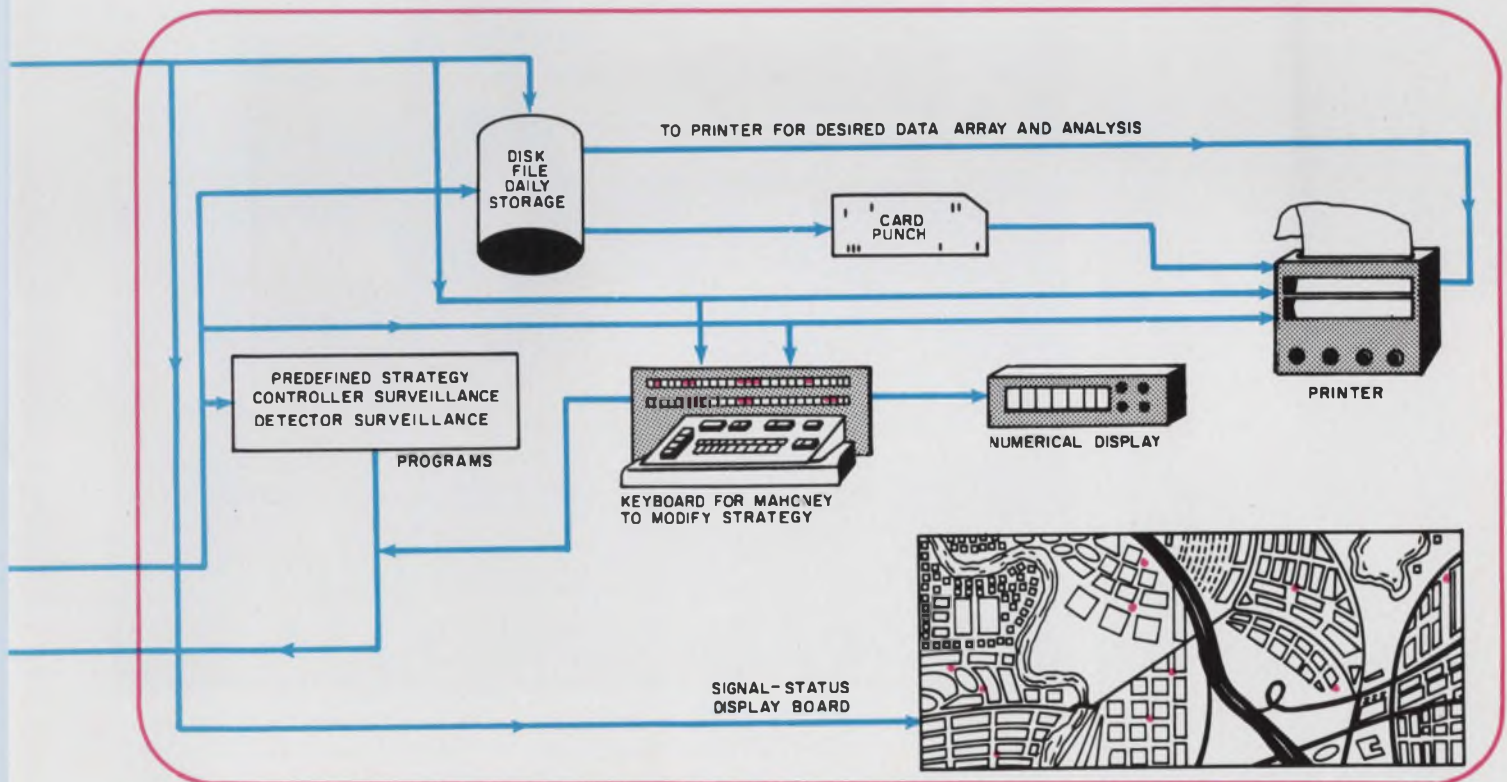

of a ferrite core in an electromagnet. Changes in the inductance are amplified right at the intersection and

travel by cable to the central computer. In Gene Mahoney's San Jose system, the strategy can be altered.

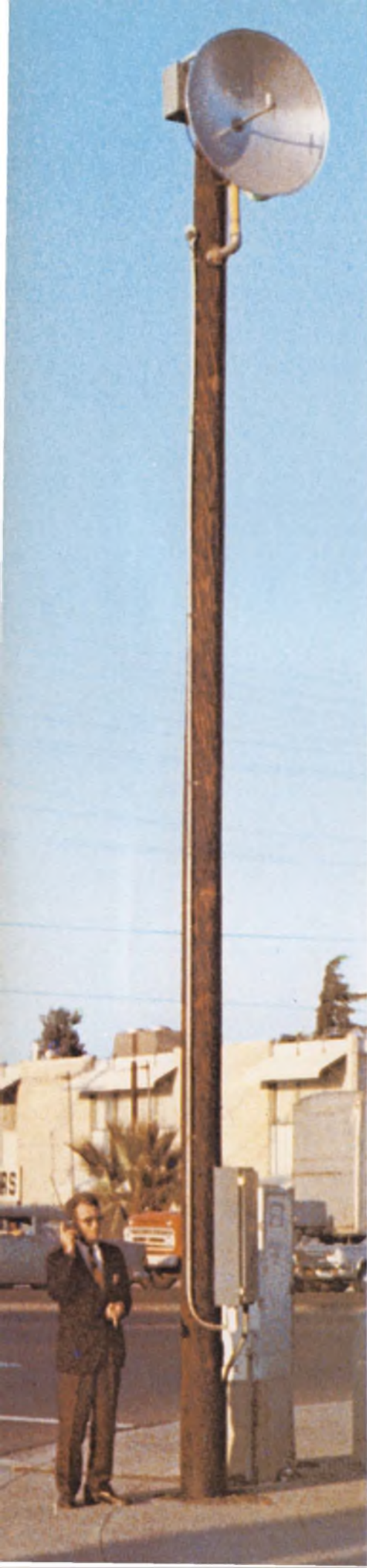

dangerous, but this view is being revised. This month, the Federal Dept. of Health, Education and Welfare plans to publish a book on the unhealthy effects of nitrogen oxides—a book that will be comparable to its report on the effects of sulfur dioxide that caused such a furor over the sulfur in crude fuel oils. Nitrogen oxides begin to form in an engine when its compression ratio exceeds five or six to one. Modern engines already have compression ratios somewhat above 8:1, and it is unlikely that Detroit's horsepower race will be reversed.

#### Noise pollution defies enforcement

Even when a pollution can be accurately monitored, its effects are largely known, its source is easily identified, and its control is the subject of proper legislation, cities can still have trouble enforcing the spirit of the law, even if they succeed in enforcing the letter of it. This is the case with noise pollution.

In 1961 New York's Port Authority, for example, set noise limits of 112 dBs and installed automatic, noise-monitoring equipment around airports in the metropolitan area.

According to a report in *The New York Times*, Pan American World Airways simply stationed a man in a truck a few dozen feet from the Port Authority monitoring station. As a Pan Am jet takes off, the man, Gerald C. Hall, Jr., watches a decibel meter. When it reaches 110 dB, Hall radios the plane's pilot to reduce throttle and stop climbing. For ten seconds (as the plane passes over the authority's sensor, according to a NASA test) its noise level drops to around 100 dB on the ground. Then the plane resumes its climb. Noise proceeds to jump even higher than before since the plane's power was reduced, but the plane is no longer over the sensor: it is now over the residential community, the complaints of which caused the authority to install the noise monitoring equipment in the first place.



**Gene Mahoney tries out a palm-size transceiver on a street corner in San Jose, Calif.** The unit, made by Sylvania for use in Vietnam, can help Mahoney check his loop detectors. Mahoney decided where detectors should be buried by monitoring traffic with temporary detectors and beaming the information back to headquarters with a microwave antenna mounted atop a pole (left). This unit, like that on the cover, was made by Motorola for the use of traffic engineers.

Traffic control does not involve such touchy legal problems: a simple red light will almost inevitably bring cars to a halt. The problem is to figure out what to do with traffic signals to keep cars rolling along smoothly, especially in congested areas. In fact, each traffic engineer has his own method. Before building effective hardware, then, it is important to understand what considerations the software is based on.

### Traffic control hardware for soft theories

Until the last few years, traffic engineers have had to rely on their own observations and extremely crude counting techniques to provide a data base to test their theories. These theories have been at once mechanistic and deterministic: cars behave like fluid particles as they flow through constrictions, states a macroscopic theory of traffic flow. Its complement, the microscopic theory, holds that the acceleration of a car is proportional to the difference in velocity between it and the car it follows. Though either view appears to model actual movement correctly under certain circumstances, such determinism almost inevitably produces misleading results by overlooking the single factor that really determines actual traffic patterns under all circumstances: the driver. "He may do anything he damn well pleases, and usually does!" exclaims one harried traffic engineer. This explains why some traffic theorists have attempted to describe unpredictable, seemingly random driving maneuvers with probabilistic theories. But again, Poisson distributions seem to work best when cars are not close enough to interact, and traffic is so light that it moves easily—that is, when involved theories and intricate hardware are least needed.

Still, the failure of the three main deterministic theories does not mean that traffic control engineers have given up in despair. Even with a skimpy theoretical foundation, digital computers are milking simple sensors for information to help improve the flow of traffic.

In traffic circles, it is now almost universally believed that traffic should control the signals, rather than the signals the traffic. To this end, engineers install systems that sense traffic movement, compute directives for moving vehicles according to a preprogrammed strategy, and then manipulate signal lights at street intersections.

It is conceivable that sensors could be designed to detect everything from a vehicle's precise speed to the color of its paintwork, and computers to control painstakingly every signal at every moment in time. As one might expect, however, this is not the case.

Most traffic sensors in use today simply detect the presence of a vehicle. The computers control how we do it," says Gene Mahoney, the man who

only three parameters of a signal light. "This is installed San Jose's traffic control system.

"We bury a wire loop under the roadway a few hundred feet from the corner. As a car passes over the loop, the inductance added to the loop is sensed by a bridge circuit that is nulled for capacitance and resistance effects. So when the inductance changes, we know a car's there. There might be two cars there, but that's life.

"The circuit is powered by line current, which checks for the presence of a car 60 times a second. So you might say the loop detector measures the car's speed. You might say that, but you'd be wrong. It guesses the car's speed, because what passes might be a slow Volkswagen or a fast truck. Now, depending on what's coming at it from four directions, the light tries to please everybody. It can't if traffic is at all heavy, but here's how it tries.

"The computer checks its strategy and selects the optimum offset, split and cycle. 'Offset' is the time-lapse between the appearance of a green signal at one intersection, and its appearance at the next. This determines how fast a car must go to keep up with the lights. 'Cycle' is the total length of time from the appearance of a green to its reappearance. And 'split' is the ratio of red to green.

"Now all day the computer manipulates Mahoney's traffic," says Mahoney himself, as if the man responsible for the computer had just left the room. "And at the end of the day it prints out what Mahoney wants to know."

A fat wad of printout showed the activity at every single intersection in San Jose. "At my age, this is too much data for the eyes," proclaims Mahoney. "So I ask the computer to do a little figuring here." A single line displays the day's total volume, total stops, total delay, delay per car, stops per car and delay per stop. These are the parameters that interest Mahoney.

"Now, that's better. But look here. You can't do much about the 'total volume,' but you can use strategy to minimize any one of the other parameters. You reduce 'total stops' by extending cycle time, but then 'total delay' goes up, because when a car does stop he sits there for the afternoon. You can reduce 'delay per car' with very short cycles, but then up goes the next column, 'stops per car.' Or you can make every car stop at every light for a second and reduce 'delay per car.' But up goes driver frustration, because every time he approaches a light, it turns red. The idea is to reduce all of these. You know what would help me do it?

"I need a detector—it could be a loop, it could be ultrasonic, it could be a tin can—that tells me how many cars are waiting in each lane for a light. I'd like to count them back to 600 feet from the corner. But I can be bargained with. If

a man comes to me with one that counts them for 300 feet, we'll talk. If my computer knows how many cars are waiting, it can control the light more intelligently, and I also get better data to figure out better strategy.

"I could really cut those figures if I had a controller I could afford that would skip phases. If there's no one in the left lane, let's skip the left-turn signal. All I've got to sell is green time. Let's give it to a lane that needs it. There is a phase-skipping controller out for \$2500. But who can afford it? Let's get one for \$400 to \$500. Also, I could save running 12 wires back from the detectors at each intersection if someone came up with a dependable 12-signal multiplexer. But again, for \$3000 I can run 12 wires back to the computer; for \$400 I can't. And someone should invent a good paste-down detector, so Mahoney doesn't have to rip up the street every time he wants to put one in."

Mahoney contends that the real goal of traffic engineering should not be to speed up traffic, but rather to reduce driver frustration, which he considers the principal cause of automobile accidents.

For this reason he advocates the development of new kinds of traffic signal lights. By blinking

in his face, the old green-red and even green-yellow-red signals irritate the driver, and may goad him into an accident farther up the road, Mahoney believes. He feels, however, that a numerical display like the recently introduced "countdown" signal (see "Traffic light uses numerical display," ED 3, 1967, p. 36.) is not the answer. "The driver makes scores of decisions as he approaches an intersection—he watches the light, the traffic, the children and maybe a pretty blonde. And he presses the brake, the gas and turns the wheel maybe left, maybe right. And he's in no hurry to get home because his wife nags him. Or he's dying to drop his tongue into a waiting martini," he says.

"We don't want him to count digits. Traffic equipment designers should start exploring more symbolic aides. How about a green bull's-eye that starts from a dot in the center and expands until it hits an outer green ring. Then the light turns red. We should try to make it pleasant for a driver to stop at a red light, or easy for him to time his arrival so he doesn't have to. After all, we just trip a relay to light a red light; a driver has to bring a 3000-pound machine to a halt. He doesn't have to, either. Its not an iron bar; its only a little red light."

**Walter Key checks one of the many tape decks** at Chicago Police headquarters that keeps a record of instructions issued by dispatchers (see page 65) to the policemen who man the department's patrol cars. Key

will soon let a contract for the development of a personal communications transceiver to be carried by each policeman. The unit, to cost between \$500 and \$1000, will be the modern electronic replacement for the police whistle.





Mahoney's ideas may sound a little unusual, but he's given them a great deal of thought. Dedicated to the automobile flow in and around San Jose, Mahoney lives with traffic day and night. He knows all the theories and then some, and when he says, "We'll talk," he means it. "Mahoney," again referring to himself in the third person, "doesn't care if you have ten degrees—if you're not interested in Mahoney's traffic, Mahoney's not interested in you. If you're interested in Mahoney's traffic, Mahoney doesn't care if all you have is a driver's license."

Recently, two men arrived in San Jose to see Gene Mahoney: New York's traffic commissioner Henry Barnes, and his chief of signals and communications, E. Vinson Hoddinott. They spent three days watching Mahoney's system operate.

Barnes and Hoddinott were so impressed by it, they returned to New York City with an unusual request for its Board of Estimate. In a letter to the board, Barnes and Hoddinott recommended that New York purchase, without bids, an IBM system just like the one in San Jose, to control all the intersections on Manhattan's Upper East Side. Mahoney's system, adapted for New York, can put the city's lagging traffic modernization program back on schedule, says Hoddinott.

#### **Officer Krupke needs a small partner**

Unlike the traffic engineers and the pollution controllers, police departments all over the United States have one common, fundamental problem, and it can be largely solved with a single electronic device: The police need a good, small, personal radio transceiver.

"I'm proposing a two-piece unit," says Walter Key, director of communications of the Chicago police, and if Superintendent of Police James Conliss approves the idea, the department will let out an R&D contract for bid.

"The lower half of the new radio, worn at chest or waist level, should contain all the electronics and the battery," Key explains. "It would weigh approximately 20 ounces and occupy less than 20 cubic inches. Its only control would be a channel selector knob. The other part, worn near the shoulder, would be a five-cubic-inch, combination speaker-microphone-antenna, and it would have a transmit switch and a volume control. The antenna should be at shoulder level so the patrolman's body doesn't attenuate its transmission. It should be a short, very flexible stub—perhaps about seven inches long. The microphone should be up there too, so his hands are free. After all, the very time he needs this radio most, he usually also needs the use of his hands. The speaker, also at shoulder level, is near his ear so he can receive messages without using his hands, even in a noisy environment. Speaker placement near the ear offers another advantage: the unit need

dissipate less power while it is receiving, and that represents at least 80% of the duty cycle. Hence, the policeman can hear clearly, yet save his batteries for when he really needs them. Isn't it a bit absurd that present units are mounted on his belt with the speaker facing away from his ear?" (Wasted power can be expensive. Detroit already has personal-radio-equipped police: the system is called PREP. Battery costs reportedly run to around \$300 a year per radio.) But power consumption is not the only problem that inclines Key toward the development of a new radio.

"Right now, two large companies make two-way radios, but neither solves the communications problem of the policeman on the big-city beat," says Key.

"One unit is much too heavy (over 32 ounces) and the other unit isn't as stable as it could be and it is virtually unrepairable: should it fail, it must be returned to the factory."

"The components for the almost ideal personal radio system are available," observes Key. "The object of the design, the safety of the policeman, must be kept in mind.

#### **The role of the little transceiver**

"Put yourself in the shoes of a policeman. You walk into a dark basement where you hear suspicious sounds, and sure enough, you find a burglary in progress. You want your radio to get your message to headquarters for sure. Your life depends on its signal getting past obstacles that may include a bunch of water pipes and perhaps several layers of concrete. Also, you want a radio that can't be used as a weapon against you."

Like the present units, the new unit would operate on narrow-band fm. There are three bands reserved for nationwide police use: a low band between 30 and 50 MHz, a high band between 150 and 160 MHz, and a very high band up near 450 MHz. The low band is too long a wavelength for urban use: the signal should be able to pass easily through windows and doors. And both the low and the high bands are already overcrowded. So Key will use the 450-MHz band.

Overcrowding is a very serious problem for all urban communications. To alleviate the problem, the Federal Communications Commission has announced that present channels on the 450-MHz band, which are presently spaced 50 kHz apart, will be placed at 25 kHz from center to center. The new rule, to go into effect by mid-1968, will place stringent demands on the frequency stability of the small receivers. "That is one thing that the manufacturers are doing well," says Key. "One unit, for example, offers a frequency stability of 0.0002% over a temperature range of from  $-30^{\circ}\text{C}$  to  $+60^{\circ}\text{C}$ ," exclaims Key. "That's a stability of two parts per million."

Key doesn't expect a radio of this description, which puts out about a watt or two, to penetrate clear back to police headquarters. He has considered two possible systems: One puts repeaters in the patrol car to transmit the patrolman's signal back to headquarters over another frequency; the other places satellites on tall buildings and other large, stationary structures. These satellites would pick up the policeman's signal and relay it over telephone lines to headquarters.

Key is inclined to the latter method. For one thing, it would leave free a portion of the radio spectrum for other police purposes, such as a mobile, hard-copy, computer printout-keyboard. For another, satellite concentration could be heavier near big buildings, such as Chicago's Merchandise Mart, which might otherwise pose reception problems. And thirdly, the stationary satellites could operate, protected from the elements, vibration and vandalism, for years with very little maintenance. But it is the conservation of radio channels that is by far the most compelling reason.

#### The misplaced confidence in single-sideband

There has been a spate of renewed interest in single-sideband techniques to ease the airwave traffic headache. Key explains that single sidebands would not, however, open up usable, new channels for police communications. He points out that, even with, say, 60-dB attenuation of the unwanted channel at the receiver, the signal it is supposed to reject would be clearly audible to a patrolman in the vicinity of the central, high-power transmitter. Also, ssb would require frequency stability on the order of one part in  $10^7$ . Stability for present portable units is already quite impressive at 2-5 parts in  $10^6$ : It's unlikely that it can be improved by an order of magnitude in a lighter unit. And with ssb, the FCC would probably not be able to effect its pending channel-tightening.

It is clear that the crowded urban airways preclude transmitting devices that are of only limited application. Car locators fall into this category. Key says, for example, that Chicago uses a saturation approach in the use of patrol cars: "If they're just within their zone," he observes, "we already know their location more accurately than a locating system.

"On the other hand, a modern police force would be more than willing to set aside radio spectrum for a mobile, computer-address system, which could check license plates for stolen vehicles and robbery suspects. It could have a teletypewriter keyboard and hard-copy output, but it should have some kind of a buffer storage. Otherwise, a slow keyboard operator could tie



Rapid-transit systems require electronic routing and communications equipment that can withstand steel dust, explains Charles Kalkhof. They should be accompanied by two sets of blueprints: one "black-box" set (above) for use in the field, shows connections and test points for coded leads; a detailed schematic, for shop use, shows every component and every connection.

up the computer while urgent requests for information must stand by. And policemen aren't hired for their typing ability.

"Another valuable idea I believe worth pursuing would complement the Teletype: a dual-mode, mobile, closed-circuit television. Operating as a normal television, it could bring photographs of wanted criminals right into the patrol car. In its slow-scanning, high-resolution mode (1000-2000 lines), it could reproduce documents, fingerprints and, indeed, any printed matter that requires fine detail."

With all the information police place and plan to place on the airwaves, it might be expected that there will be a good market for countermeasures equipment. In general, however, the police are reluctant to buy such gear. Police pragmatically insist that someone will always be willing to supply the civilian and criminal populace with descramblers as quickly as the police develop scramblers, and in light of their limited budgets for technology they are unwilling to embark on what they believe will inevitably be a



The speaker mike at the right of this motorman connects to a transceiver that plugs into a dc outlet aboard the train. The unit is as portable as it need be: the motorman can carry it easily to the train. And it must transmit over its outboarded antenna only to a nearby wire that runs parallel to the tracks. The Transit Authority Police, however, need a unit much like that of the Chicago police.

continual and costly one-upmanship.

There exists a striking parallel between the new communications goals of the Chicago police and those New York City's Transit Authority had a few years ago. The authority, too, wished to equip its motormen, police, and maintenance personnel with personal walkie-talkies and was confronted by such problems as signal penetration of tunnels and a noisy environment. Here, however, the constraints were slightly different and the two men who designed the authority's system fully exploited these differences and avoided the problems peculiar to rapid transit.

#### Steel dust settles on rapid-transit gear

Like Walter Key, the authority's superintendent of maintenance, Charles Kalkhof, and his assistant signal circuit engineer, Val Alster, chose a satellite repeater system. Unlike the Chicago police, however, Kalkhof and Alster were able to substantially reduce the number of satellites by the fact that all the remote units were to be used in the vicinity of the authority's subway tracks.

They ran antenna wire from each wayside satellite along these tracks. The maximum length of each antenna, which consisted of two parallel solid wires separated by about an inch of low-dielectric foam, was determined by its attenuation characteristics. Kalkhof and Alster found that it paid to design special wire that would provide minimum attenuation for their assigned frequency of 44.6 MHz.

Kalkhof and Alster specified a foam dielectric rather than air because they feared that steel dust, which, according to Alster, "settles on any equipment located near rapid-transit tracks in a matter of minutes," would creep into any hair-line cracks that might develop in the wire's insulation and increase its attenuation.

The Authority insists that any wayside equipment be protected from steel dust either by encapsulation or, where that impairs service of the equipment, by foam gasketing.

"For rapid transit systems," says Kalkhof, "you have to design according to railroad rules. All electronic circuits must be well protected against steel dust, humidity and vibration. And all that malfunction for any reason must be instantly identifiable and instantly replaceable." For this reason, Kalkhof strongly urges that each printed-circuit board should contain a small neon light that glows or blinks if the circuit is defective. "Keep in mind our worst case," he urges. "Think of your circuits failing out there on the tracks on a dark, rainy night during rush hour. If our man can open the box, locate the faulty card, slide it out, and replace it all in a matter of seconds, your design is a success. Otherwise, thousands of commuters would have to wait in stalled cars while the maintenance man nervously searches for the cause of the trouble."

One easy way to preempt failure of electronic equipment, particularly failure due to vibration, is to keep circuits that contain active components off the rolling stock. This may seem awkward, but an example in New York produced an extremely rugged, reliable train-sorting system.

For many years the authority's trains were routed by dispatchers, who sat in little green towers by the tracks. As a train passed the tower, they noted its destination and switched the track. When the authority set out to centralize its dispatching operation, the single most important piece of equipment was the one that would have to switch the trains automatically.

Though the obvious solution would have placed a coded transmitter on the train, the system chosen required the train to carry only a coil and three-position switch-capacitor combination.

Solid-state equipment at the wayside senses the LC circuit's resonant frequency as the train slides past, then operates electromechanical

switches, which shunt the train along the tracks that correspond to the capacitor setting.

The desire to keep the trains completely free of active components is realistic for the New York City system, where all trains are presently operated by motormen. It is impossible, however, for the modern, fully automatic trains now under development, which must have fairly complex electronics to control speed, bring the train to a stop at the correct point along the platform, open and close doors, and detect failures and malfunctions.

Nevertheless, when Westinghouse designed its Sky-Bus, a rapid-transit vehicle with rubber tires that runs on concrete rails, it put the bulk of the electronics in wayside computers and only a "dumb" receiver aboard the train (see "Westinghouse puts electronics in the driver's seat," ED 6, 1966, pp. 40-41). These computers transmit instructions to the trains by means of a wire antenna, which, like the New York communications wire, runs right along the tracks.

### The exciting challenge of high-speed trains

The real challenge for the electronics industry will come when high-speed rapid-transit designs make radical departures from those of the nineteenth century. These departures will take place in every basic function of the vehicles: suspension, guidance, control and propulsion.

The only major project in this country that embodies design concepts wholly developed since the turn of this century is the high-speed ground transportation system planned for the Northeast Corridor.

In this ambitious plan, the Federal Government's new Dept. of Transportation (DOT) hopes ultimately to operate trains from Boston to Washington, D.C., at speeds that would compete with the jet airplane in door-to-door travel times, namely about 300 mi/h.

At such speeds, the train is completely dependent on electronics that have yet to be developed. An absolute necessity, according to DOT's consultant Paul Larsen, is an electronic sensor that detects the presence of small rocks along the track. The support system for the high-speed train will probably not be wheels—at 300 mi/h a half-inch sag in a mile of track can seriously jar the passengers. DOT will turn to air-cushion suspension and trains will hurtle along with about half-an-inch clearance between the chassis and the roadbed. A rock, a small bird or an animal could cause havoc at that speed.

Another problem for the high-speed train is its communication system. One distinct advantage it will have over aircraft is telephone service for passengers. In the 150-mi/h trains made by United Aircraft (for the New York-to-Boston run) and the Budd Co. (for the New York-to-

Philadelphia run), which will test public acceptance of the plan, a total of 30 cars will carry telephones. At present the telephones transmit to wayside radio equipment, but on the full-scale, 300-mi/h units, a communications system that does not propagate waves into space is absolutely essential. (DOT, having no assigned frequencies of its own, "borrowed" the use of 16 frequencies for the 150-mi/h test from four cooperative agencies.)

"We're thinking along the lines of three closed systems," says Larsen. "One would use 2-4-GHz signals in a leaky waveguide—a copper tube, two to four inches in diameter, with a one-eighth-inch wall that has slots in it, each a few inches long and about one-quarter inch wide. But this method would require many microwave repeaters along the guide.

"Another solution would use the principle of surface-wave conduction in which the same 1-2-GHz frequencies skim along the surface of a wire. These signals are picked up by a similar, parallel wire aboard the train. But here, a bird alighting on the wire would interfere with signals on it.

"Yet another method would use lasers, which would have to be of very low power so they don't blind people. Semiconductor devices would seem to fill the bill except that they are primarily infrared sources and long optical waves are affected by haze, fog and rain."

Though the present 150-mi/h trains use gas turbine (United Aircraft) and electric (Budd) drives, the need for a no-contact suspension dictates that the 300-mi/h trains go to a linear-induction motor for propulsion, if for no other reason than to provide a method of braking the vehicle. According to Larsen, DOT has contracted with the AiResearch Co. Div. of Garrett Corp., Torrance, Calif., for the development of a 2500-hp linear motor. The giant motor's first test will be conducted with a wheeled vehicle; when the air-cushion suspension is ready, it will be tried on that.

From a systems point of view, the linear-induction motor opens exciting possibilities in a ground transportation system. For one thing it can be used for braking as well as forward thrust. For another, the vehicle it powers can pass through long tunnels unlike those powered by gas turbines, which would quickly fill a tunnel with exhaust. The most refreshing possibility, however, is that for the first time it would allow a vehicle to use a single medium (in this case magnetic flux) to accomplish guidance, suspension and propulsion.

"The force that attracts the linear motor to the passive rail is about ten times the forward thrust developed by the motor," says Howard Ross, a transportation analyst at Stanford Re-

search Institute, "and if we could design it to lift the vehicle, the motor would provide its suspension."

Ross points out that it may be possible to shape the motor's flux so that it makes the vehicle follow the rail. "It may not be too many years up the road," hopes Ross, "when magnetic flux supports the vehicle, guides it, moves it forward and brakes it." Then, he observes, all you need is some super electronic sensors and controls to make sure it does all this without hitting other trains or obstacles and, finally, stops where it is supposed to stop. At 300 mi/h, it can pass through a mile-long station in about one second.

#### A 'test city' comes to Florida

One important instrument to encourage and test new technology for the cities is lacking—the city itself. Right now, industry's few innovations are tested in two ways: they are embodied in marketable devices and sold to cities, which often get burned for taking a chance; or



In case of failure, neon lights tell a rapid-transit repairman which printed-circuit card malfunctioned. Here, a technician checks the repaired card in a "working" simulation. A foam-gasketed lucite plate covers the front.

they are installed on an informal basis and tested by the city.

Many scientists and engineers hope that some day a futuristic city may be built just to try out new ideas and so hasten the flow of technology from the laboratory and drawing boards into people's lives.

There is one spankily new city on the drawing boards that promises to fulfill this dream. It incorporates some highly ambitious but believable concepts in urban planning, rapid transit and communications. And suprisingly, its creator was neither an aerospace firm, a conglomerate, nor an electric giant. It was the master fantasy realizer, the late Walt Disney. Like the others, Disney embarked on his new city project with all kinds of technological innovations in mind. He had already come to see the chief stumbling block to the truly new city (the one that has kept Litton and General Electric and many others out of the new-city business in this country) and had already conquered it with Disneyland at Anaheim, Calif.: No one can build an advanced city or even an advanced amusement park without taking drastic liberties with local building codes. "There just isn't a building code for a Matador mountain," mused one Disney official.

Two days before Walt Disney entered the hospital for the last time, he completed a film that was to present EPCOT—Experimental Prototype Community Of Tomorrow—to the Florida legislature. It may well be the most important film Disney ever made. The lawmakers voted to allow him to set his own building codes.

Disney's organization, WED Enterprises in Glendale, Calif., is proceeding full-steam-ahead under the direction of his brother, Roy Disney, with the entire project called Disney World.

Present plans call for the creation of an amusement area much like Disneyland by 1971. And by 1976, EPCOT expects to open its doors. The land area in central Florida occupied by Disney World is 45,000 acres—more than twice the size of the island of Manhattan.

EPCOT will be a radial city with four concentric parts: a downtown business district at the center, high-rise dwellings on its edge, a greenbelt beyond that, and finally, low-density private housing on the periphery.

The downtown business district occupies 50 acres, which will be completely enclosed and climate-controlled. Vehicles will enter and leave on three levels: the enclosed streets will be served by high-speed monorail and a medium-speed system its designers call the Wedway people mover. Both will be powered by electricity and the people mover will be entirely automatic. Its cars never actually come to a full halt—people stand on a moving belt on its station platforms, the cars bunch up, pull alongside in groups

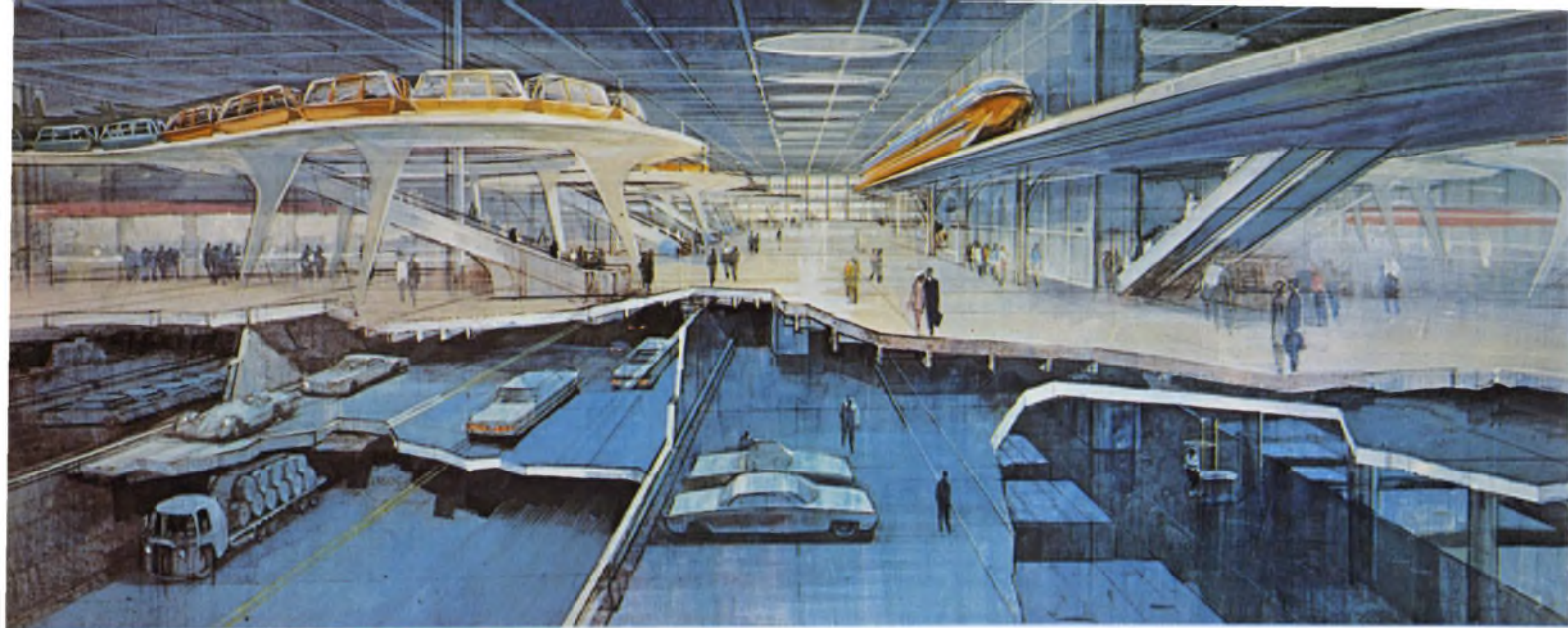

Vehicles arrive in downtown EPCOT on one of three levels: electric-powered monorail and Wedway vehicles deliver people to the enclosed business district; automobiles pull in and park on the second level; and trucks make deliveries on the lowest level. Thus the sources

of air pollution will not enter the climate-controlled business district on the upper level. The primary purpose of the city, which was conceived by film-maker Walt Disney, will be to prove out new urban technology. EPCOT will open in 1976, according to its director, Marvin Davis.

of four and move along synchronously, allowing people to step in. Once the Wedway cars leave the central city, each group of four cars picks up speed. And as they approach their destination, they slow down to match the speed of the walkway and bunch together again. Thus passengers will find a continuous flow of cars in the station, and speedy transport to their destinations.

At present WED is operating its people mover at Disneyland. The cars are now propelled by motor-driven wheels embedded in the roadbed, but WED hopes to use a linear induction motor at EPCOT.

The spark of EPCOT has caught the imagination of the scientific and industrial community as well as the Florida lawmakers. The research and development laboratories of a number of large companies, including Bell, RCA, General Electric, Westinghouse, DuPont, IBM and Monsanto, have opened their doors to give the Disney team the opportunity to plan developments for EPCOT in 1976.

EPCOT's creators, who bill themselves as "imagineers," are designing the city so that it will always be able to assimilate new technology as it is developed. Even now they are planning to incorporate advanced features which, like the linear induction motor, may still be fresh when EPCOT opens to the public.

Coaxial cables, for instance, will be imbedded in the walls of homes, which will then become complete communication centers. Each center will include such facilities as closed-circuit televised information, a "print-out" newspaper that is updated right to the moment its start button is

pushed, electroluminescent walls, perhaps some rooms in which the air itself is ionized for illumination, and, of course, picturephones and the standard roster of audio-visual communication equipment, including a time-sharing computer terminal.

From a municipal point of view, its waste system will be most interesting. EPCOT will discard its waste by burning it under conditions of extremely low pressure and high temperature. Thus, the residue will be utterly neutral, and will occupy one-twentieth the volume of the trash that comprised it.

The heat from the combustion of the garbage will provide energy to generate electricity. EPCOT will also maintain a "spinning reserve" of mechanical power in the angular momentum of several inertial systems, to keep the trash-driven generators going, whenever necessary, until reserve power generators can be started up.

Noise will be no problem at EPCOT. WED will use a wall material that offers the acoustical isolation of an 18-inch cement-block wall but is only 2-3/4 inches thick.

It may seem a bit odd that a man with a background in animated cartooning should outperform all the highly touted masters of technology in the creation of an advanced city. The secret of Disney's success as film maker, amusement park operator and ultimately as designer of the first urban proving ground, is a secret fundamental to good urban design, but it's something the aerospace and electronics industry has yet to learn: "Please people," pleaded Disney, "you've got to please people. . . ." ■■

**This new memory may not  
do everything better.  
But it does everything.  
And it takes up  
less space doing it.**



All together, the specs on our medium capacity memory systems are unsurpassed. Some systems may have slightly faster cycle times, but they don't offer speeds of 650 nanoseconds in a unit that's so small you'll be surprised to find a power supply and tester also included—just like the I.C. electronics and 2½ D magnetics. All are contained in only 2½ cubic feet (7"x19"x21.5").

Capacities range up to 295,000 bits per unit. Multiple module capability is available for larger capacity requirements.

Compact as it is, the design doesn't get in the way of maintenance. The systems are extremely easy to repair. Stacks, electronics and tester are on plug-in modules—all are accessible and slip in and out easily.

Information on both the Nanomemory 2650 (650 nsecs cycle time) and Nanomemory 2900 (900 nsecs) are in our compact (8½x11") brochure. Write for Litpak 200.

**EM electronic memories**

12621 Chadron Aveune, Hawthorne, California 90250  
(213) 772-5201

# Urban hardware grounds the aerospace experts

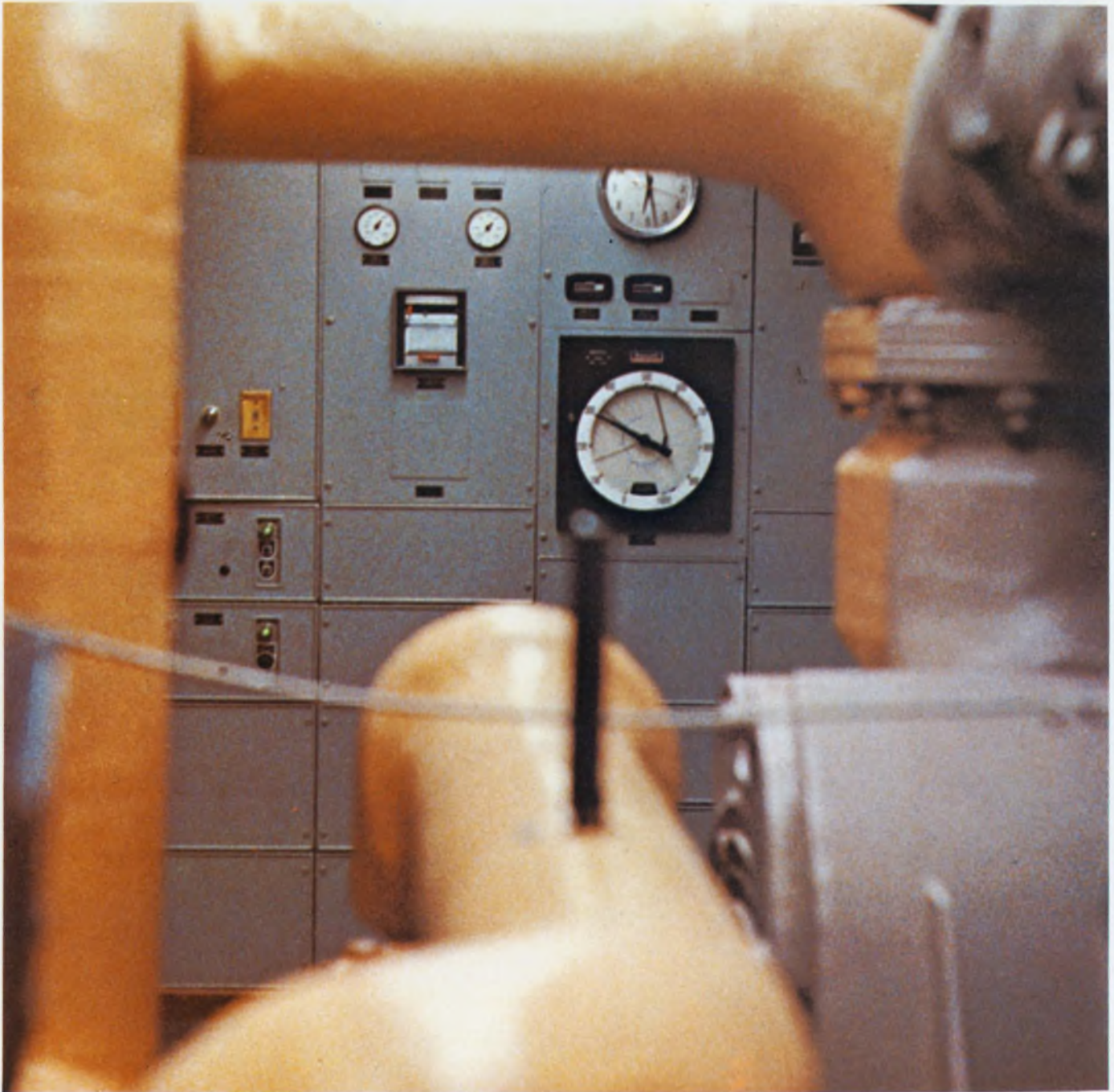



For some strange reason, which relates to the peculiar tendency of the U.S. public to ascribe near-divine omnipotence to such collections of mortals as the FBI, the Rough Riders and IBM, this country is permeated by the belief that somehow the aerospace industry can save the megalopolis. The missile machine, along with its systems analysis, its dazzling technological expertise and its whiz kinds, is miraculously to turn every rat-infested, smelly, ugly, noisy city into a kind of paradise.

There is no doubt that if the cities could afford the financial burden of their own Apollo-sized programs to improve the lot of their inhabitants, aerospace organizational and management techniques might well work wonders. There is, however, considerable doubt in the minds of some city planners that the big aerospace and systems houses can successfully design urban systems and urban hardware.

Paul Goodman, author of *Communitas* (a radically new plan for New York City) questions the intent of those firms that have been feeding at the NASA/DOD trough: "These goals [which include urban development, education, and improvement of the quality of man's environment] indeed require research and experimentation of the highest sophistication, but not by you," he told the members of The National Security Industrial Association. "You people are unfitted by your commitments, your experience, your customary methods, your recruitment, and your moral disposition. You are the military industrial of the United States, the most dangerous body of men at the present in the world, for you not only implement our disastrous policies but are an overwhelming lobby for them, and you expand and rigidify the wrong use of brains, resources, and labor so that change becomes difficult."

Even if the heads of the military industrial companies to whom Goodman addressed these remarks were guilty as charged, there is no particular reason to believe that the engineers and scientists who actually develop the technology can be so glibly set aside. Goodman may be right about the inability of the NASA/DOD firms to supply technology to the cities, but he is right for the wrong reasons.

The style of urban design is not only unlike that of aerospace and industrial design; it is its very antithesis! Whereas aerospace designs can be as complex as necessary to achieve specific, well-defined goals (for instance, "put a man in orbit"), urban designs must be supremely simple, so that they function unattended for weeks or years yet accomplish goals that still cannot be clearly enunciated, (for instance, "monitor air pollution" or "improve the flow of traffic"). This important distinction can be overlooked only with disastrous consequences when the designer gets down to urban hardware.

### Sperry goes out to play in traffic

The most famous example of a troubled urban hardware project is the \$5.3 million contract New York City's Traffic Dept. awarded to the Sperry Gyroscope Div. of Sperry Rand, Great Neck, N.Y. The reason the Sperry program became famous is simple: New York Traffic Commissioner Henry Barnes is a colorful, outspoken official who would just as soon communicate with Sperry's management through the front page of a morning newspaper as by telephone or private letter. But Barnes had

---

**The zero drifts all over the place** on this circular-chart recorder installed by Honeywell in a sewage treatment plant at Sacramento, California, according to the plant's supervisor, John Brady. Honeywell sporadically tried for a year to solve this and other instrumentation malfunctions, says Brady, but to no avail. It has been suggested that the reasons for Honeywell's difficulties were that the company purchased some of the equipment it installed there from other manufacturers; its service personnel didn't fully understand how to set up this unfamiliar equipment; and that in its anxiety to land the contract, Honeywell didn't leave itself enough money for the initial setup.

good reason. Three years ago Sperry thought the city an attractive alternative customer to the Dept. of Defense, which seemed likely to peter out as a source of contracts. When the Vietnam conflict ensured more defense spending, not less, Sperry was reported to have pulled its best engineers off the traffic project and put them into "high priority" programs. When Sperry failed to meet its first delivery in May, 1966, and showed no signs of catching up, Barnes blew his top.

Sperry apparently needed only four basic pieces of equipment to help New York's frustrated motorists: a detector that would indicate the presence of a car; a sensor to measure its velocity; a computer to manipulate the information from these detectors and sensors; and a controller that connects with the computer and operates the signal light. "We wanted positive information on automobile presence and velocities," says E. Vinson Hoddinott, chief of signals and communications of New York's Traffic Dept., "and we wanted all detectors and sensors to be mounted above street level. You don't improve traffic in New York by ripping up its streets to put in buried loop detectors."

All four items had been successfully manufactured for years by a number of companies and computers had been a product of Sperry's Univac Div. almost since the inception of computers themselves. It was natural, then, for Sperry to use a stripped-down version of its own Univac for traffic control. But the company had not made the peripheral hardware, and its difficulties with these deceptively uninspiring gadgets caused it to increase its design team from less than eight to 60 as the project fell further and further behind schedule. Three years have passed but Hoddinott estimates that it will still take nearly two and one-half years for delivery. Until it fell so far behind schedule, Sperry was bent on designing radically new sensors and detectors.

Before Sperry entered the picture, the basic design for an ultrasonic automobile detection device used a 20-kHz tweeter to generate a pulsed sensing signal.

The tweeter was supplied by the audio firm of J. B. Lansing in Los Angeles, but unlike the company's regular line, this tweeter was specially designed with a sharp peak at 20 kHz. Crude as it seemed, it did have one tremendous advantage: used as microphone as well as a speaker, the tweeter could detect its own pulsed signal.

Sperry decided to pursue a slicker, more compact design. It pushed the emitted frequency up to 40 kHz; to do it, it developed a crystal transducer to replace the tweeter. Although the prototype worked, bringing Sperry contract approval, the production units didn't, according to Hoddinott. They operated at a very low signal-to-

noise ratio, which worked fine on a lightly trafficked street in Great Neck, but not in the congested city with lots of cars and noise. It was so sensitive to its environment that even a stiff breeze confused it.

There was also a problem in the circuitry. The device was to be installed high above the street and its gain had to be set so that the device would detect the presence of any object more than 18 inches above the pavements. When the gain drifted up, it would continuously detect the mere presence of the road surface; when it

**Sperry put the first of its traffic controllers on New York's Third Avenue at 26th Street. Unfamiliar with the techniques of urban design, the Sperry engineering team used underrated relays and overrated its ability to come up with radically new speed-sensing radar and ultrasonic detection equipment for New York's Traffic Department.**



drifted down, automobiles would pass unnoticed beneath its effective level.

Plagued by inadequate signal-to-noise ratio and gain drift, the device, reportedly, would sometimes count cars, sometimes overlook cars, and sometimes indicate the presence of imaginary cars, eliciting from Commissioner Barnes the memorable comment that "they [Sperry] could build one that sends signals to the moon and Mars, but they can't seem to build a system that sends signals 17 feet to the pavement."

Sperry had no better luck with its 2455-MHz, speed-sensing radar. Again, the prototype unit worked, but the production units, with a solid-state transmitter and receiver in the same housing, had severe feedback problems. "The use of microwave transistor oscillators instead of klystron tubes in this equipment could have saved the city millions of dollars in maintenance costs," explains Hoddinott. "That's why the department was anxious to see Sperry succeed and did not exercise its right to cancel the contract after Sperry's failure to deliver." Solid-state equipment that doesn't work, however, saves the city nothing, and it refused to pay a penny until it took delivery of working equipment.

Though the ultrasonic detector and the microwave sensor were Sperry's biggest headaches, they were far from its only problems. The electro-mechanical relays in the controller that turned the signal lights on and off were carrying more current than the limit specified by their manufacturer, Hart Advance Relay, of Elkhart, Ind. Consequently, their contacts either fused together or eroded away, leaving the traffic lights on or off, as the case might be. Used within their limit, the relays were guaranteed for millions of cycles. But they seldom lasted more than a few months in the Sperry controller, says Hoddinott.

A spokesman for Sperry says its management now refuses to talk about these problems, claiming that at great expense they have finally overcome them and that in so doing they have developed a proprietary klystron tube, the details of which they prefer not to discuss. In fact, says Hoddinott, Sperry plans to buy the klystron from either Raytheon or Varian for about \$40. The tube, Sperry hopes, should last three to four years at 10 GHz. The radar unit that ultimately holds this klystron probably will not be designed by Sperry at all. The company discovered that its French subsidiary was already using a suitable unit on the roads of Europe. The New York City Traffic Dept. will accept it if it works, says Hoddinott, provided it is built completely with parts obtainable in the United States (hence, the American klystron).

Sperry also plans to purchase all its ultrasonic detectors from one of three firms that success-

fully make them with the 20-kHz tweeter: Crouse-Hinds, of Syracuse, N.Y.; General Railway Signal Co.; or the Automatic Signal Co. Div., Laboratory For Electronics, of East Norwalk, Conn.

In its controller, Sperry had no difficulty using bigger relays, but another small problem is still unsolved. Should the computer fail, each controller has a small, synchronous, electric motor that drives the signal's switching circuit in synchronization with the other controllers on the same street. This provides a kind of fail-safe mechanism. These motors work fine for a while, but then they fall out of synchronization. This problem is so annoying that Hoddinott's men will soon start removing the few Sperry controllers that they installed on Third Avenue. Sperry management also refuses to comment on this problem. A small sign on the inside of the controller's door informs maintenance crews:

*The standby timer in this controller is a modified experimental model.*

*If this controller is changed, please give a detailed account of the failure and expedite through normal channels.* —Sperry Gyro. Co.

Seasoned observers of public-works bidding feel that Commissioner Barnes might have been too slick a horsetrader for Sperry.

To be sure, Sperry is not the first company to encounter difficulties with a Barnes-inspired contract. Sperry's experience with the commissioner remarkably parallels General Electric's dealings with him in Baltimore. There in 1957, General Electric, interested in the municipal market, contracted to install a computer-controlled system. After similar ups and downs with its own system, General Electric bought equipment from Automatic Signal Co., and washed its hands of the traffic-control field by selling its division to Econolite. To this day, the streets of Baltimore sport GE control boxes filled with Automatic Signal Co. equipment.

Have Barnes' tribulations in two cities dimmed his hopes of using electronics to ease New York's traffic jam? On the contrary, Barnes and Hoddinott plan to plunge ahead with phase two of the department's \$100 million plan to automate the city's antiquated traffic system.

These problems are not limited to Sperry Gyroscope or even to the field of traffic control. Look what happened to another systems firm in a West Coast sewage plant.

A few years before Sperry took an interest in New York's traffic, Honeywell looked into a sew-

**Single copies of this report** "Electronics starts solving the problems of the cities" will be mailed to readers who circle number **250** on the Reader-Service card at the back of this issue.

age control system at the Northeast Water Quality Control Plant in Sacramento County, Calif. From its painful experiences, Honeywell learned a great deal and has now overcome all its difficulties.

Nevertheless, in 1961, Honeywell's Brown Instrument Div., Philadelphia, anxious to do business with municipal governments, underbid the competition and installed instrumentation at the plant. Monitoring sewage can be terribly tricky—it can never be known what is going to hit the sensors—but Honeywell approached the job as it would any process control system. It installed a full complement of flow meters, sensors, recorders, integrators and even a large display panel to pinpoint the location of any troubles that might crop up.

### Honeywell takes a bath in sewage

Troubles cropped up all right, but it was in the instruments, not the sewage or the heavy machinery. "We checked out one electronic integrator that tells us how much raw sewage flows into this plant," says John Brady, the plant's maintenance manager, "and it was losing between half a million and one million gallons of sewage daily out of a total flow of six million gallons. And it still doesn't work." The question of the misplaced million gallons was hardly Brady's



Brady brought his Beckman dissolved-oxygen meter right to his aeration tank, dropped its sensor into the effluent, and plugged it in. The instrument worked so well, it turned up a testing flaw: bacteria used the oxygen.

only problem.

He is still plagued by these malfunctions: two electronic strip chart recorders, one measuring raw sewage flow, the other temperature, fail to record because their paper drives do not pull the chart paper past their pens; a waste sludge meter records data, but its zero drifts between 50 and 150 gallons/minute out of 1000 within a week of calibration; the indicator light bulbs on a panel display burn out after a few days' use—the panel consumed over 150 banana bulbs at \$1.00 apiece during the first six months of plant operation. All this instrumentation, says Brady, was purchased from and installed by Honeywell. What did Honeywell do?

The contract specified vendor installation and set up—Honeywell was to install, calibrate, and maintain the equipment for a period of one month. In addition, the instrumentation was warranted against failure for a year.

Honeywell installed the instruments and attempted to get the system working. "Every time I'd show them what was wrong," explains Brady, "they would throw up their hands and tell me they couldn't do any better. On one occasion, an air pressure sensor blew its element—a sensitive membrane. The Honeywell representative promptly ordered three. But when they arrived, with a bill for \$125 each, he returned them. Finally, I asked them to leave."

On and off, Honeywell struggled with the instrumentation over a whole year, says Brady. When the year was up, their tinkering started to cost the plant \$100 a day for each man and still the equipment would not run.

At that point Brady flew off the handle. He called Honeywell's local factory representative, who had a team of men come out to the plant, remove all the equipment and take it back for overhaul. They did, but when they brought it back and reinstalled it, it still didn't work. They were not called in again. So there Brady sits. His men pull the paper through a chart recorder by hand every hour, his sludge meter's zero still drifts, and he's given up trying to replace the banana bulbs in the indicator panel: when the horn sounds, his men scurry around the plant trying to locate the problem. Does this experience leave Brady bitter about electronic instrumentation?

"Hell, no," exclaims Brady, "I just got a new Beckman 710 dissolved oxygen meter and it works great! It saves us making a 20-minute wet chemical test every two hours—a test that used to cost us over \$10,000 a year in lab time."

Brady could hardly wait to get the dissolved oxygen meter into service. He has been using it for weeks right at the aeration tank and he has not even taken it out of its packing crate. He was particularly elated when the meter turned up a



This differential-pressure sensor blew its diaphragm. A Honeywell representative was said to have ordered three replacements but when they arrived with a bill for \$375, he returned them to their manufacturer.

This strip-chart recorder is supposed to measure sewage flow. Its rollers, however, fail to pull paper past the pen. Below it, an electronic integrator records total sewage. Unfortunately, it loses about a million gallons a day out of about six million that the plant processes.



John Brady mourns the loss of yet another banana bulb. The bulbs apparently get overheated inside their colored buttons. Brady long ago gave up replacing banana bulbs, and the panel behind him, installed by Honeywell, is now

essentially a decorative piece. It was intended to pinpoint the location of equipment failure in Brady's sewage plant. The bulbs, says Brady, cost a dollar apiece. Cheaper bulbs that consumed fewer watts should have been used.

minor flaw in his chemical test method—his technician was not adding quite enough chemical to inhibit the bacteria, which continued to use up dissolved oxygen while the sample was being transported back to the laboratory. The sensor's only drawback is that its electrolyte needs replenishment about once a week, but now Beckman is marketing a dissolved oxygen sensor that needs attention only every six months. Brady may yet come to regard his Honeywell equipment as highly. Within 48 hours of this magazine's inquiry into the matter, Honeywell arranged with the County of Sacramento to go over the malfunctioning equipment piece by piece and control loop by control loop. A Honeywell spokesman feels that Brady's difficulties may be due to subsequent modifications of the equipment, improper use, or inadequate maintenance. The firm plans to submit to county officials a complete analysis of its difficulties, a proposal for proper remedial action, and an estimate of the approximate costs of this action.

The Brady-Honeywell and the Barnes-Sperry tales have an element in common: both firms offered extremely low bids to get into the business. Honeywell subsequently dipped into two more water-quality installations on the West Coast, but it stayed with the instrumentation problems and solved them. Thus, it finally learned the needs of its municipal customers. It also learned to bid more realistically. "On our last three contracts," says a consulting engineer on the West Coast, "Honeywell bid only one, and they were a good deal higher than the lowest bidder. Unfortunately, however, there seems to be an endless supply of newcomers who underestimate the design problems and offer unrealistically low bids for municipal facilities."

Municipal governments, like the Federal government, almost invariably take the proposal of the low bidder (Honeywell's bid of \$30,804 on Brady's panel and electronic instrumentation, for example, only saved Sacramento a bit more than \$1000 over Foxboro's next-to-lowest bid of \$31,853). One manifestation of the municipalities' lack of purchasing expertise is that their qualifications for an acceptable bidder are not nearly as well defined or as stringent as those of, say, NASA or DOD.

Both Sperry and Honeywell encountered difficulties because they failed properly to appreciate the peculiar nature of the urban problems they addressed. When an established company thoroughly understands the problem, however, it can design highly marketable, highly sophisticated urban electronics, even if it has never done so before. This is precisely what happened at the Neptune Meter Co., Long Island City, N.Y., when it hired Tom Clark, a Princeton University physicist, to design an electronic water-meter reader

for millions of meters all over the United States.

The water meter in most homes is located indoors, usually in the basement, and there are two problems in reading it—the meter reader must have access to the meter and he records the reading on a handwritten form that cannot be read by the computers that municipalities use for billing purposes.

### Neptune starts updating water meters

Neptune realized that water-meter reading needed to be updated, but it also realized that cities are reluctant to rip out the existing meters in each home. So the company decided upon the following system. The meter reader plugs a portable digital tape recorder into a special outlet on the side of the house. The recorder's input circuitry scans the plug for its fixed house number and the meter reading, both of which are recorded on magnetic tape. At the end of the day the tape cartridge is slid into a digital tape scanner, which drives a computer's peripheral equipment, translating the information on to punch cards, punched tape or whatever form the computer uses for billing. This unit that is fixed inside the home readily fits existing water meters.

Clark immediately decided that Neptune needed a digital tape-recorder that electronically scans the plug mounted on the house. The available electromechanical scanners, Clark felt, were prone to failure and any attempt to cut costs would further decrease reliability.

"I knew we had to scan the plug electronically to avoid an electromechanical unit," Clark recalls, "but I had never designed a logic circuit. Furthermore, I knew we'd have to use microcircuits for this thing, since it has to be portable, and I had never designed anything with microcircuits. So I fired off some letters to microcircuit manufacturers and started to design the prototype with discrete transistors."

Clark's discrete prototype worked. But he used 38 printed-circuit cards and the "portable" unit tipped the scales at 100 pounds. The scanning circuit was simply a binary counter that continuously cycled from one to 18 and fed these binary numbers to a decoder.

Meanwhile, the literature he had requested had arrived, and, to his amazement, Clark found he could buy NAND gates. "I didn't even know what a NAND gate was when I started this project, but I suddenly realized that the microcircuit manufacturers had presolved a lot of the hardware problems. I decided to make better use of these packaged 'solutions' and I discarded the binary counter in favor of a shift register."

Clark hit on quite a clever scheme for implementing his scanner. Rather than the

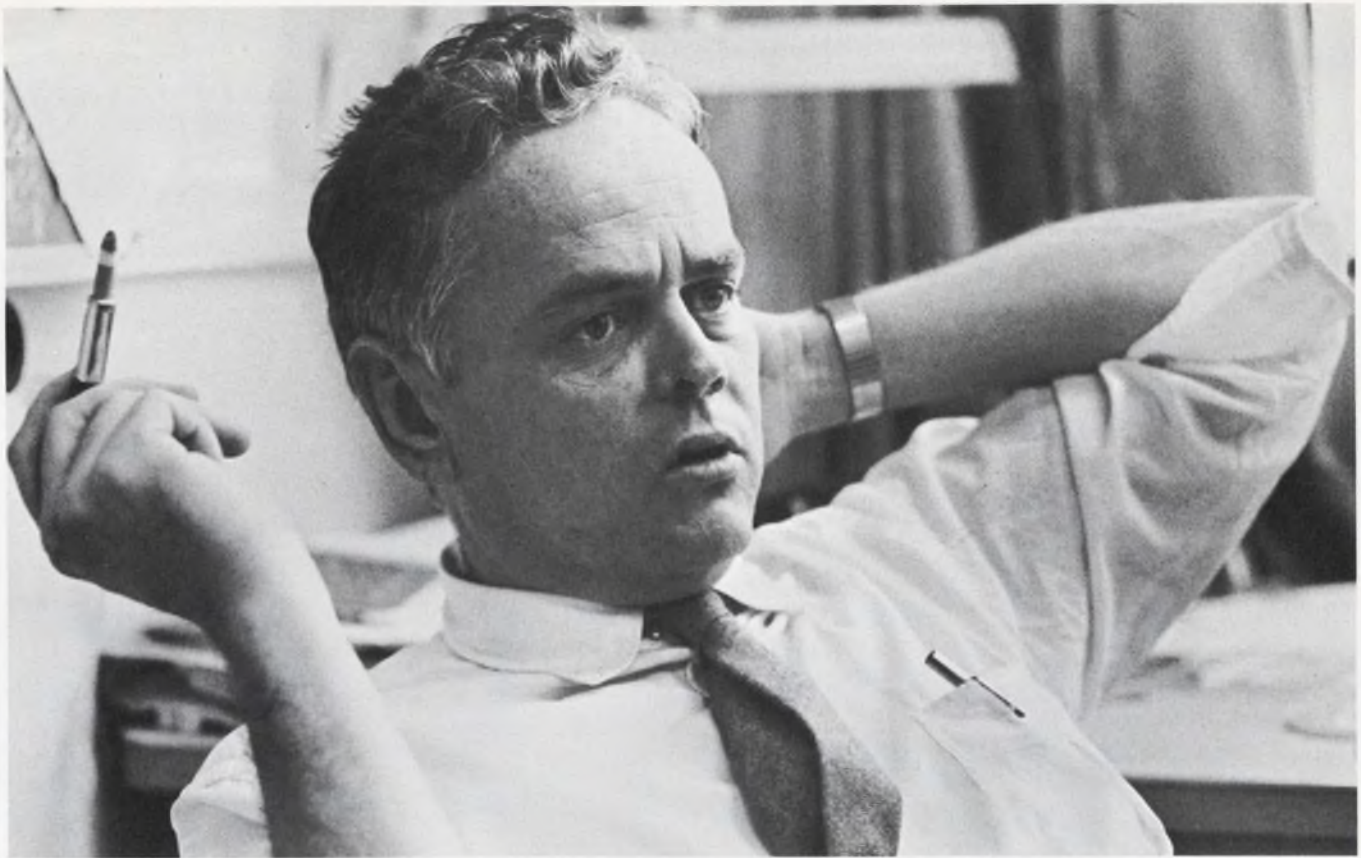

**Tom Clark** contemplates the design of his digital water-meter reading equipment.

counter and decoder, he simply uses a microcircuit multivibrator to load a bit into the front end of a shift register. As the bit is clocked through the shift register, it pulses the pick-off of each stage. The multivibrator cycles at a rate computer designers would find laughable—5 Hz. But Clark picked this speed to ensure a low bit density on the slow-moving tape. A meter reader, Clark figured, could only get to 300-400 houses a day and he felt there was no point in trying to cram enough data for thousands of homes on a standard tape reel.

Clark modestly explains his elegant solutions in terms of his own lack of experience: "I guess I was unhampered by any prior knowledge." But his final design is loaded with circuit tricks that help him get the logic he needs while dissipating the least amount of heat in the circuit.

He drives the tape head, for example, with current from a NAND gate directly. "The TTL gate's output impedance was 70 ohms, says Clark, and since it could sink 57 mA and we needed only ten, I threw a few hundred ohms in series with its output to drive the tape head. I did the same thing with an error warning: I used a gate to drive a solenoid that moves a flag indicator."

In the end, Clark was able to contain all the circuitry on three printed-circuit cards instead of 30. The recorder was a smashing success and the

system is presently being installed in 500 homes in Kansas City, Mo.

Clark points out that Texas Instruments' complete characterization of its TTL logic helped him think up some of the circuit tricks he used successfully. "We need more than just the logic and pin connections," he exclaims. "We had to know exactly what components are on the chip. We examined Texas Instruments' schematic of its NAND gate, for example, and noted that its output is a 70- $\Omega$  emitter-follower circuit, so we were able to use it to drive the record head without a write-amplifier."

Tom Clark's cleverness is, however, hardly as dependent on the specification sheets as his modesty would lead one to believe. Clark thinks differently from most designers, but so do people like Walt Driggs in Sacramento, Gene Mahoney in San Jose, Walter Key in Chicago and Val Alster in New York.

These men, in a sense, are the humble heroes of our urban saga. They are confronting the problems of the cities, the problems that history may come to call the crucial and most exciting of the twentieth century.

Will electronics start providing some of the urgently needed solutions to these urban problems?

Will you start designing the systems and hardware that are so desperately needed? ■■

**Is there an AC digital voltmeter anywhere that can measure this waveform accurately?**

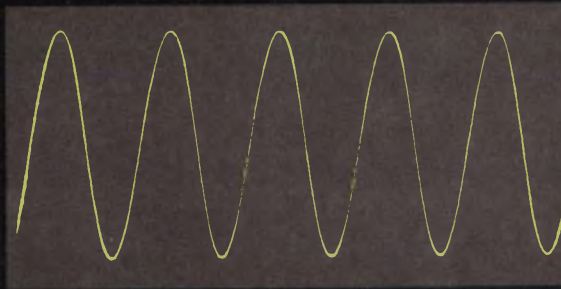

**And this one too?**





# **There is now! The new Fluke 9500A true rms automatic digital voltmeter reads these complex waveforms to an absolute accuracy of $\pm 0.05\%$ . And, if you know your AC's, that's progress.**

Another DVM on the market? Usually that's good for a ho-hum. But as we've said above, if you know your ac's, that's not the case with the new Fluke 9500A. It's the first automatic ac voltmeter capable of reading and digitally presenting the true rms value of any input—regardless of waveform—to 0.05% absolute accuracy (50 Hz to 10 KHz).  Frequency response is broad, 20 Hz to 700 KHz. Accepts voltage from 0.001 to 1100 volts rms in five ranges, each with 20% overranging. Range selection is automatic or manual. Crest factor of 10 virtually eliminates effects from voltage spikes or pulse trains. Low capacitance, high resistance input minimizes loading effects.  Self-calibration is automatic whenever instrument is turned on. On-line self-calibration is either automatic or manual, selectable by front panel switching. All controls and indicators, conveniently located on the front panel, are easy to use and understand. Complete control of the 9500A is possible from a remote facility if desired.  Price of the Model 9500A, including rack adapter, is \$2,485. Extra cost options include a probe input (\$75), rear panel BNC input (\$50), and 1-2-4-8 or 1-2-2-4 BCD digital outputs (\$195). For complete information, please call your full service Fluke sales engineer (see EEM), or write directly to us here at the factory.

Fluke, Box 7428, Seattle, Washington  
98133. Phone: (206) 774-2211.  
TWX: (910) 449-2850.



In Europe, address Fluke International Corporation, P. O. Box 5053, Ledeborstraat 27, Tilburg, Holland. Telex: 844-50237. In U.K., address Fluke International Corporation, P.O. Box 102, Watford Herts, England.

# Boost class-D rf amplifier efficiency

but beware of antenna impedance changes that can reduce the device's output power.

No sooner did the efficient rf switched amplifier become available than the high-frequency designer had to face a host of new problems: How can its source impedance be measured, how much power will reach the antenna, what load variations are acceptable with a specified range of radiated power?

A simple test setup answers these questions. With the aid of a variable-length line between the antenna and a class-D<sup>1,2,3,4,5</sup> switching amplifier, the test yields a set of curves that can be used in most design problems.

## Antenna mismatch may be necessary

A simple switched-type amplifier is shown in Fig. 1. Switches 1 and 2 are coupled so that if switch 1 is turned off, switch 2 is on, and vice versa. The switches are operated by the rf signal to be amplified. It can be seen that the internal impedance of this source is zero, or in practice close to zero.

The antenna that is usually connected to the amplifier's output terminals has a nominal impedance of 50 ohms, but it has been practical to accept variations in small transmit antennas up to a VSWR of 3. In terms of the actual impedance level of the antenna, this change in VSWR means 150 and 16.7 ohms, which may be read off at the real points on a Smith chart. This swing in VSWR would reduce the radiated power by about 25%, provided that the internal impedance of the source is 50 ohms also.

But this is not the case for class-D switching amplifiers, as the equivalent circuit in Fig. 1 shows. Its source resistance is practically zero, and this mismatch is necessary for maximum power transfer from the amplifier to the antenna. Were they matched, the dc-to-rf efficiency would never exceed 50 per cent, because at least half the power delivered by the battery would be consumed in the internal impedance of the source. This difference

in impedance level has a drawback. It makes the power delivered to the antenna very sensitive to changes in the antenna impedance level so that a VSWR swing to 3 is no longer tolerable.

To find the exact amount of source impedance, an extensible length of transmission line is added at the end of the amplifier, as shown in Fig. 2. The internal impedance of the amplifier is then measured at the cable's output terminals. In Fig. 2,  $E$  is the emf of the source,  $R_0$  is the characteristic generator resistance and  $L$  is the length of the cable, which has characteristic impedance of  $Z_0$ .

If the length of the internal cable is varied, the internal impedance at the output terminals of the amplifier moves along a circle of constant VSWR, as shown in Fig. 3.

The power delivered to the load when  $Z_0$  is equal to the nominal load resistance  $R_{L0}$  is:<sup>6</sup>

$$P = P_o (1+K)^2 / [m(1+K/m)^2 + (m - 1/m) (K^2 - 1) \sin^2 x], \quad (1)$$

where:

- $P$  = output power delivered to load,
- $P_o$  = output power delivered to nominal load resistance  $R_{L0}$ ,
- $K = R_0/Z_0$ ,
- $R_0$  = characteristic generator resistance,
- $Z_0$  = characteristic impedance of transmission line in the equivalent circuit of Fig. 2, chosen to be equal to  $R_{L0}$ ,
- $m = 1/\text{VSWR}$  of load, when  $R_{L0} = Z_0$ ,
- $x = 2\pi L/\lambda$ ,
- $L$  = cable length.

The plot of Eq. 1 is shown in Fig. 4.

## Output power swings with mismatch

Figure 4 shows that the output power delivered to the load varies much more for a given VSWR, or mismatch of the load, if the characteristic generator resistance,  $R_0$ , is much less than  $Z_0$  or  $R_{L0}$ —that is, if  $K \ll 1$ .

In an actual circuit, the parameters  $R_0$ ,  $E$  and  $L$  are measured by the following procedure:

The amplifier operating at, say, 35 MHz is connected to a real load,  $R_2$ , of known mismatch (e.g.,  $\text{VSWR} = 1/m = 3 \therefore R_2 = 16.7 \Omega$ ) over a trans-

Dieter R. Lohrmann, Development Engineer, Comm/ADP Laboratory, U.S. Army Electronics Command, Fort Monmouth, N.J.

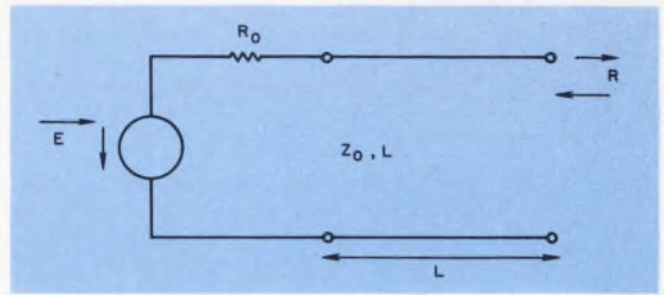
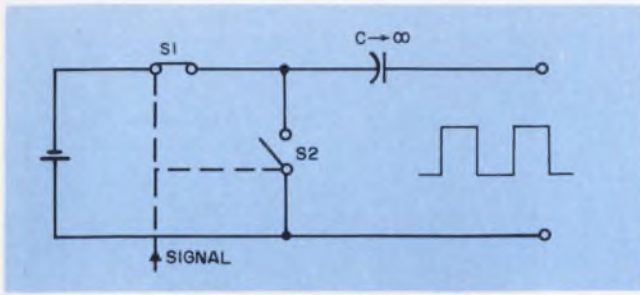

1. Simple switched-type rf amplifier is very efficient—up to 80%. The switches are operated by the rf signal that alternately turns  $S_1$  and  $S_2$ . The amplifier's internal impedance is ideally zero, which is well approximated by the actual device.

2. Transmission line between source and output terminals of the amplifier is used in practical systems as a filter. The antenna is connected at the end of the line, which has a characteristic impedance  $Z_0$  and length  $L$ . The source has a characteristic resistance of  $R_0$  and an emf of  $E$ .

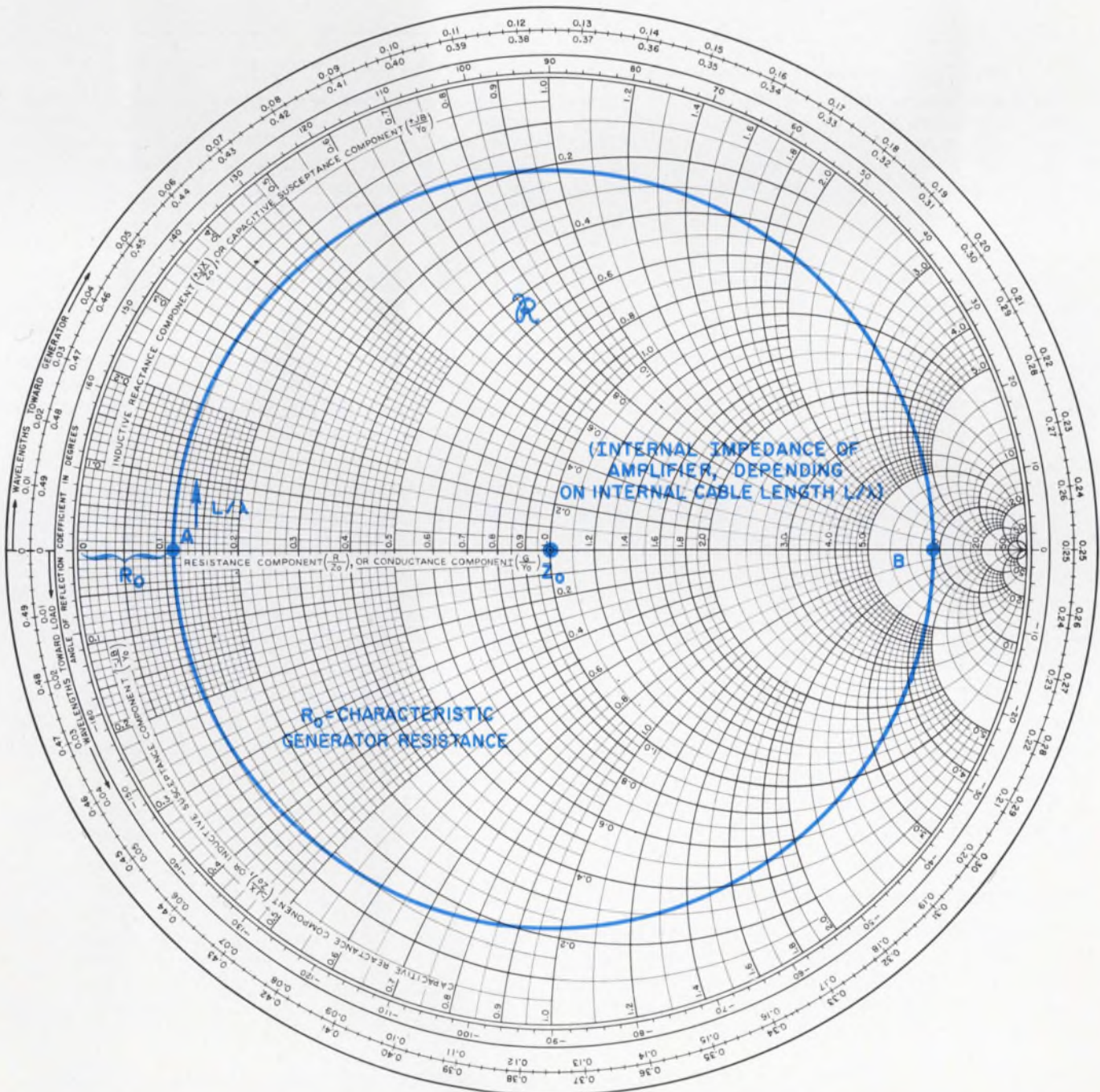

3. Impedance of amplifier moves along a circle of constant VSWR as the cable length is varied.

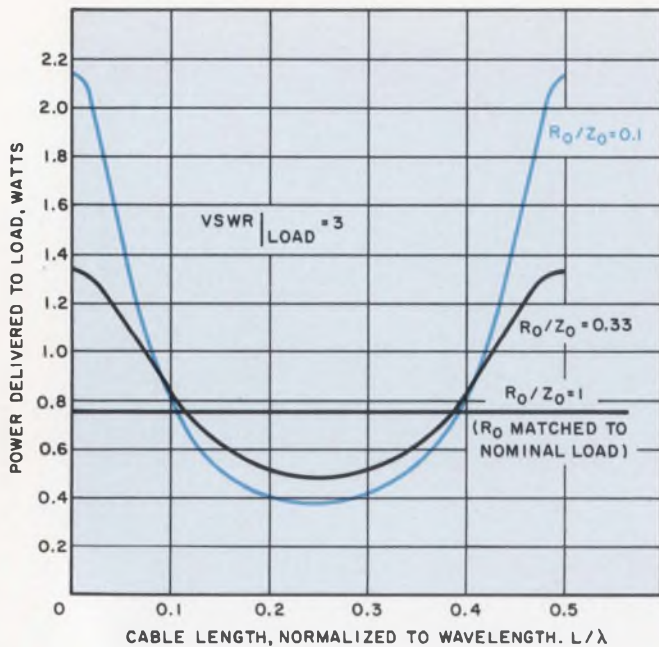

4. The power delivered to the load depends on the cable length,  $L$  and on the ratio,  $R_0/Z_0$ . The VSWR of the load is kept constant, at 3. The curve in color indicates the situation with a switched class-D amplifier, with an internal resistance that is about 10% of the usual 50-ohm load value.

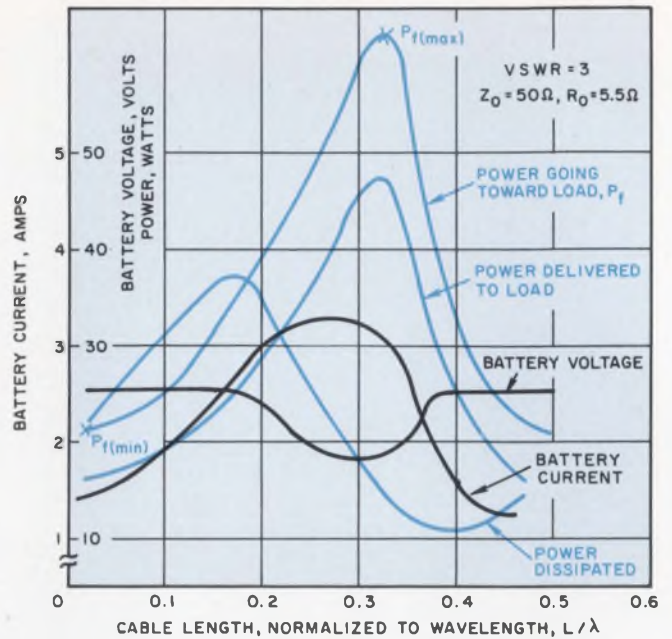

5. The plot of power going toward the load vs the cable length yields the maximum and minimum available powers,  $P_{f(max)}$  and  $P_{f(min)}$ . These values are needed to calculate the source resistance of the amplifier. The dip in the battery voltage shows the action of overload protectors in the practical circuit.

mission line with a characteristic impedance of 50 ohms and a variable length,  $L$ . Between the source and the line of variable length a through-line wattmeter is inserted to measure the power going on the line in a forward direction toward the load. This forward-going power,  $P_f$ , is plotted against the length of the extensible line in Fig. 5. From this plot, a maximum forward-going power,  $P_{f(max)}$ , and a minimum-forward going power,  $P_{f(min)}$ , are found. These values are inserted into Eq. 2, which gives the value of  $R_0$  in the equivalent circuit:<sup>7</sup>

$$R_0 = Z_0 \frac{1 - R_2/Z_0 [P_{f(max)}/P_{f(min)}]^{1/2}}{[P_{f(max)}/P_{f(min)}]^{1/2} - R_2/Z_0} \quad (2)$$

The source emf voltage,  $E$ , is given by:

$$E = 2[(R_0 + R_2)/(Z_0 + R_2)][Z_0 P_{f(max)}]^{1/2} \quad (3)$$

A dip in the battery voltage, plotted in Fig. 5, signals the starting point of the dc overload protectors, which are built into the practical circuit. But the value of  $P_{f(max)}$  has to be referenced to the full battery voltage.

#### Maximum power occurs with capacitive load

To evaluate Eqs. 2 and 3, Fig. 5 is used to find  $P_{f(max)}$  and  $P_{f(min)}$ . Equations 2 and 3 yield  $R_0 = 5.5 \Omega$  and  $E = 50 \text{ V}$ ; therefore  $K = 0.11$ . This gives an output power of 40 watts, if the coaxial line is matched with the nominal load impedance of  $R_{L0} = Z_0 = 50 \Omega$ , since:

$$P_o = Z_0 \{ E[Z_0/(R_0 + Z_0)] \}^2 \approx 40 \text{ W.}$$

The maximum power dissipation in the transistor does not occur at the minimum load resistance, as might have been expected, but at a capacitive complex load. Figure 5 makes this clear. The projection of the  $P_{f(max)}$  on the abscissa represents a line length at which the amplifier collector "sees" the minimum real load impedance. To the left of the point, the load appears capacitive; to the right, inductive. Since maximum power dissipation occurs to the left of this point, the load there is capacitive.

A general set of curves (plotted in Fig. 6) relates the power delivered to the load, the VSWR of the load and the  $K$  factor. The maximum available power is shown in color, the minimum power in solid black. Therefore, if the amplifier is specified and its source resistance and the required power at the antenna are known, the allowable variations in the load can be read off. Or, for a given output power and known load changes, the designer can select the optimum amplifier. ■ ■

#### References:

1. M. L. Stephens and J. P. Wittmaun, "Switched-Mode Transistor Amplifiers," *Communications and Electronics*, No. 68 (Sept. 1963), pp. 470-472.
2. D. F. Page, W. D. Hindson and W. J. Chudobiab, "On Solid-State Class-D Systems," *Proc. IEEE (Correspondence)*, LIII, No. 4 (April 1965), 423-424.
3. Peter Senak, Jr., "Amplitude Modulation of the Switched-Mode Tuned Power Amplifier," *Proc. IEEE (Correspondence)*, LIII, No. 10 (Oct. 1965), 1658-1659.
4. D. Lohrmann, "Amplifier has 85% efficiency," *ELECTRONIC DESIGN*, XIV, No. 5 (March 1, 1966), 38-43.
5. *High-Efficiency Transistor cw rf Power Amplifier* (Fort Monmouth, N. J.: U.S. Army R&D Report ECOM 2836).
6. H. P. Westman (ed.), *Reference Data for Radio Engineers* (4th ed.; New York: International Telephone and Telegraph Corp., 1956), p. 549 ff.
7. *Ibid.*

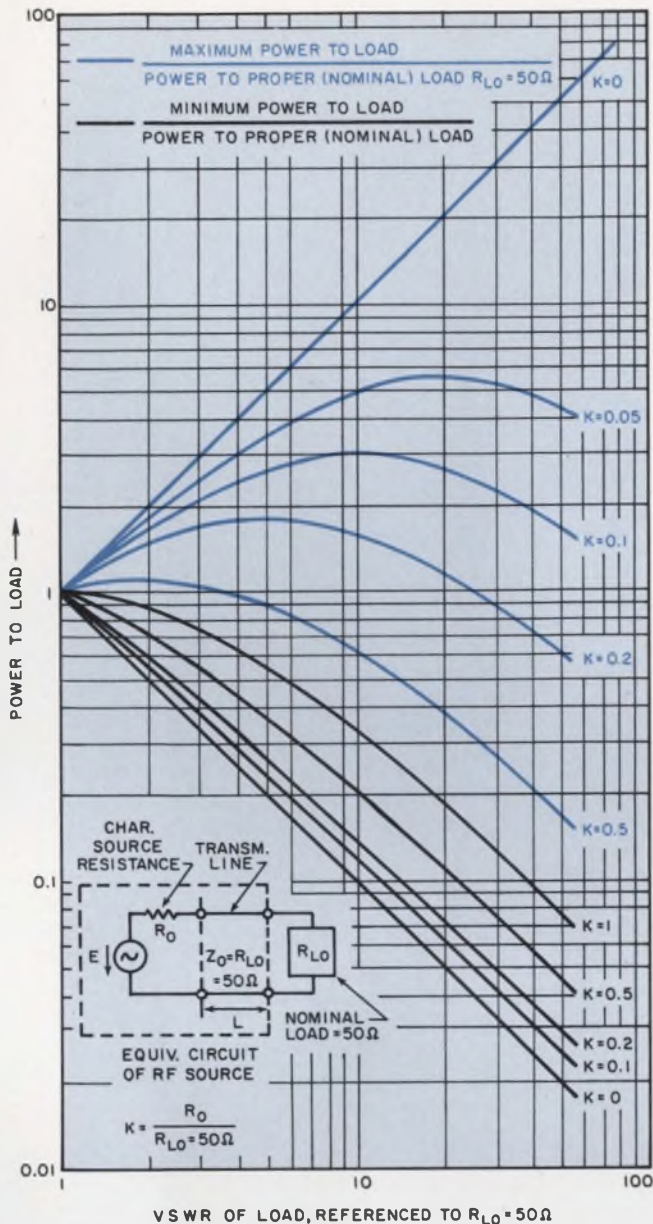

VSWR OF LOAD, REFERENCED TO  $R_{L0} = 50\Omega$

6. A set of curves relates the power delivered to the load, the relative magnitudes of the source and load impedances, and variations in the load, expressed in terms of VSWR. The curves in color show the maximum available power, the others, the minimum power.

### Test your retention

Here are questions based on the main points of this article. They are to help you see if you have overlooked any important ideas. You'll find the answers in the article.

1. There is a mismatch between the source impedance of the class-D switched amplifier and the antenna. Why?

2. What is the source impedance of the class-D amplifier?

3. VSWR of up to three is tolerable in simple switched amplifiers. This is not the case with the class-D. Why?

4. Maximum power dissipation in the transistor does not occur at minimum load resistance. Where does it occur? Why?

# METALIZED MYLAR CAPACITORS



to your exact specifications...  
at stock prices

### METALIZED MYLAR CAPACITORS

Unique, self-healing units that remain in circuit during voltage surges with little or no loss of electrical properties. Use the M2W's where size and weight are limiting factors and long life and dependability are required. The units utilize metalized Mylar\* Dielectric with film wrap and custom formulated epoxy resin end fill. Available in round and flat styles.

\*Du Pont Trademark for Polyester Film

Samples available on your letterhead request

**Standard** CONDENSER CORPORATION

DEPT. ED-1, 1065 WEST ADDISON STREET, CHICAGO, ILLINOIS 60613

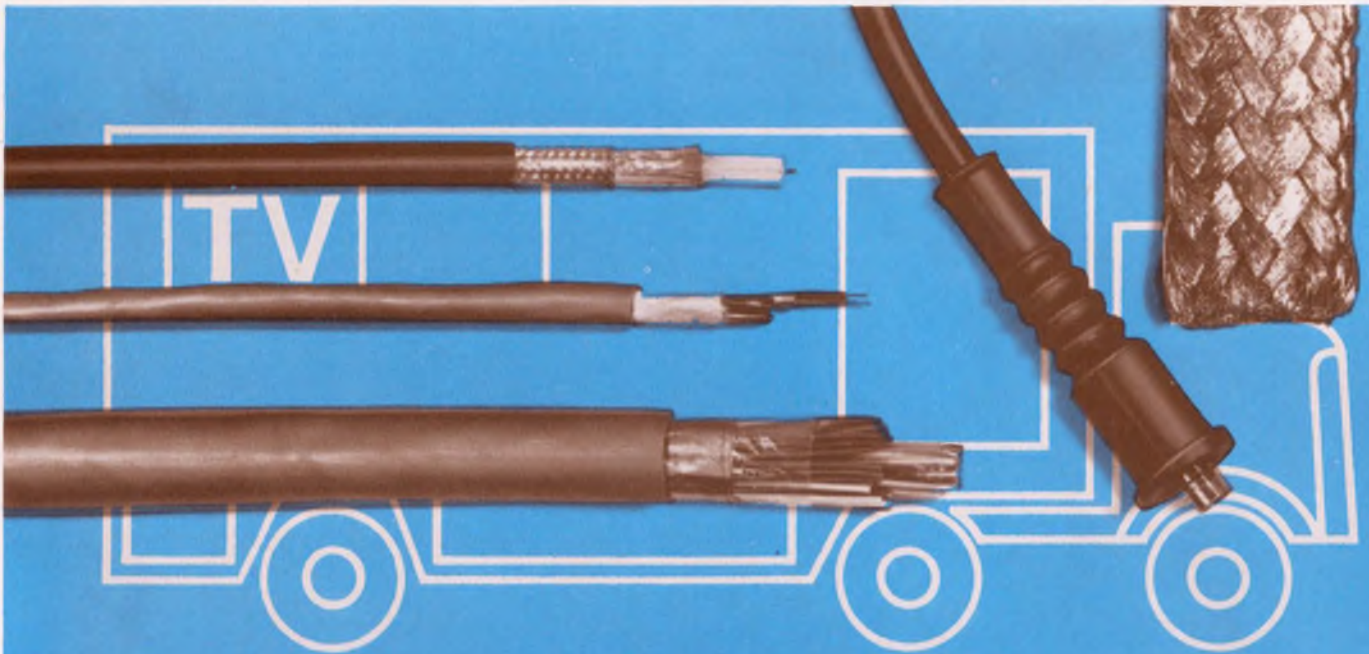

**talk about systems...**



keeping new ideas for electrical energy moving

G-2-7

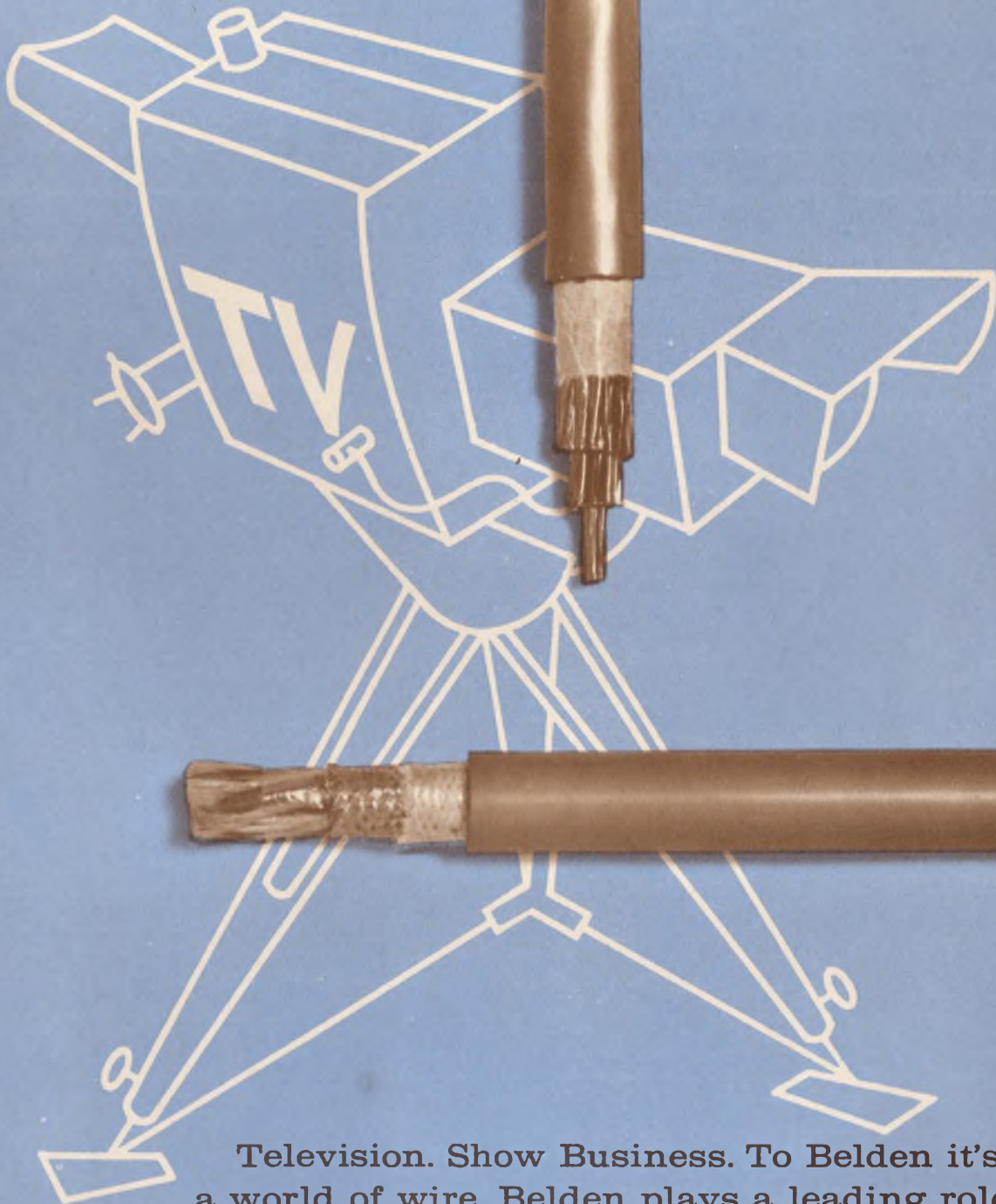

Television. Show Business. To Belden it's all a world of wire. Belden plays a leading role in many complex systems of sight and sound communication. By delving into design, processing, packaging and a host of factors, Belden's team of wire specialists have helped many people wring out hidden costs. Success takes a supplier that is really perceptive — one who makes all kinds of wire for all kinds of systems. Want to join us in wringing out values and costs? Just call us in . . . Belden Corporation, P.O. Box 5070-A, Chicago, Illinois 60680.

**Belden**

# Draw your network's impedance

instead of bothering with complex algebra. The graphics are accurate and yield the impedance at one frequency.

Geometry comes to the engineer's rescue again. Instead of going through complex algebra when trying to find the impedance of networks, he can now plot out the values quickly and accurately. The technique works with all types of elements: resistive, inductive and capacitive.

Although the values are found at discrete frequencies, it often takes less time to plot frequency response data by this method than to solve the complex algebra and plot the resulting equation. The procedure is not based on any approximations, so the results can be as accurate as one cares to construct the plots. The limitation of this technique is that all impedances involved must be uncoupled and linear.

The problem of solving for the impedance of networks by geometric techniques can be divided into two lesser problems:

- How does one geometrically parallel two resistances, two capacitive reactances, or two inductive reactances?

- How does one geometrically parallel a resistance and a reactance and then determine the resultant series impedance, and how does one series a resistance and a reactance and then determine what equivalent parallel combination will give the same impedance?

Many engineers are familiar with the answer to the first of these problems. Although seldom taught in standard engineering courses, if one attends enough engineering "bull sessions" he will usually find someone familiar with the paralleling of resistances or reactances by the "leaning-ladder" technique. This procedure is best illustrated with an example. The problem is to find the resistance of two resistors in parallel, say,  $R_1$  and  $R_2$  in Fig. 1. Start with a line of arbitrary length,  $AB$ , and then draw two lines perpendicular to it,  $AC$  and  $BD$ , making their lengths proportional to the resistance of  $R_1$  and  $R_2$ , respectively. Then drawing lines  $AD$  and  $CB$ , enables line  $EP$  to be drawn perpendicular to  $AB$ , which is proportional to the resistance of

$R_1$  and  $R_2$  in parallel. Since the length of the base line,  $AB$ , is arbitrary, three or more resistors can be paralleled on the same geometric figure by simply treating  $EP$ , the resistances of  $R_1$  and  $R_2$  in parallel, as a single resistor and continuing the same process with the additional resistors, marked off on either  $AC$  or  $BD$ .

Unfortunately, one cannot parallel a capacitive reactance with an inductive reactance in this manner, but these problems are easily done on a slide rule by using the simple quotient:

$$X_p = -X_L X_C / (X_L - X_C), \quad (1)$$

where  $X_p$  is the equivalent parallel reactance,  $X_L$  is the inductive reactance to be paralleled and  $X_C$  is the capacitive reactance to be paralleled.

## Combine resistances and reactances

This technique has been extended to combine resistances and reactances. The procedure of paralleling a resistance with a reactance and finding the equivalent series impedance is illustrated in Fig. 2. Although the example uses an inductive reactance, capacitive reactances can be handled similarly.

Let  $X_p$  and  $R_p$  be the impedances to be paralleled. Draw a line  $OB$  proportional to  $X_p$ , and a perpendicular line,  $OD$ , proportional to  $R_p$ . The right triangle  $OBD$  results. The line  $OC$ , perpendicular

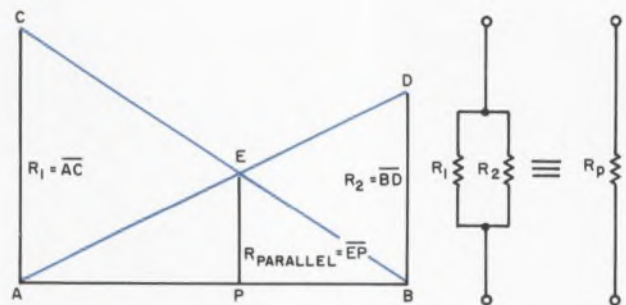

1. Leaning-ladder plotting method finds parallel values of two resistances, or two capacitive or two inductive reactances.

Richard E. Johnson, Sylvania Electric Products, Warren, Pa.



to the hypotenuse  $\overline{BD}$ , and the line  $\overline{CA}$  perpendicular to the leg  $\overline{OD}$ , form the necessary solutions. The equivalent series resistance  $R_s$  and reactance  $X_s$  are given by the lines  $\overline{OA}$  and  $\overline{AC}$  respectively, and the complex equivalent impedance of the combination,  $Z_s$ , is given by  $\overline{OC}$ . In essence these lines solve the transform equations:

$$R_p = R_s + X_s^2/R_s; \quad (2)$$

$$X_p = X_s + R_s^2/X_s; \quad (3)$$

$$R_s = R_p X_p^2 / (X_p^2 + R_p^2); \quad (4)$$

$$X_s = X_p R_p^2 / (X_p^2 + R_p^2). \quad (5)$$

The construction in Fig. 2 shows that  $X_p$  and  $R_p$  could have been determined just as easily if  $X_s$  and  $R_s$  were given.

### Combine two methods

The resistive and reactive plotting methods (Figs. 1 and 2) can now be combined to solve networks like the one in Fig. 3.

This network is broken down into simpler equivalent circuits, step-by-step. The parallel resulting series inductance and resistance are converted into their equivalent series form and combined with the 30-ohm inductor (Fig. 3a). The resulting series inductance and resistance are re-converted to their parallel equivalent (Fig. 3b). The "leaning-ladder" technique on the resistances and Eq. 1 on the parallel inductance and capacitance yields the simple two-element network of Fig. 3c. This is then easily converted to the equivalent series impedance shown in 3d.

This technique can be put to good use in a variety of engineering applications. It will not, of course, always eliminate the need for mathematics, but in a great many instances will save time and, even more important, relieve the engineer from unnecessary drudgery. ■ ■

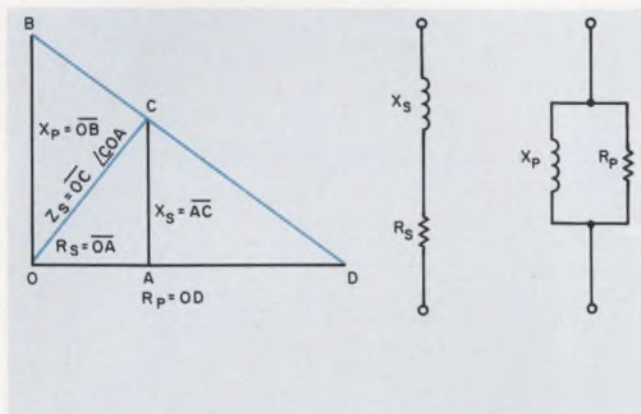

2. Combine resistance with a reactance with this triangular plot. From parallel to series, or vice versa, the transformation is equally simple.

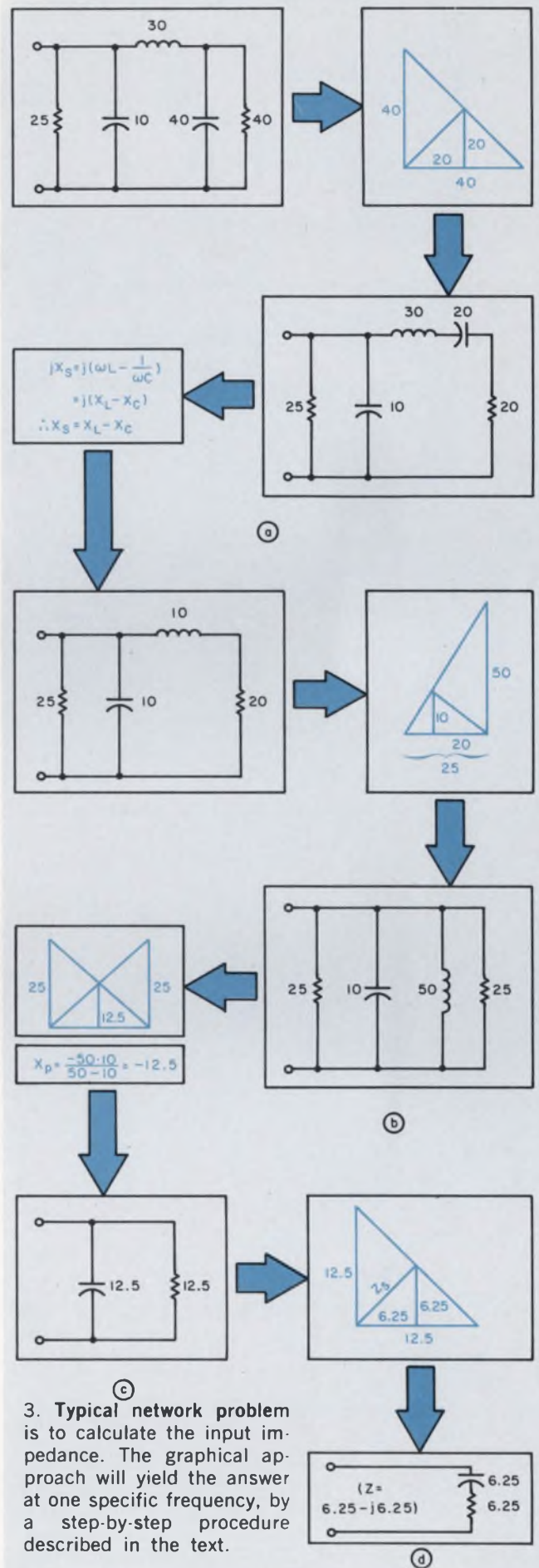

3. Typical network problem is to calculate the input impedance. The graphical approach will yield the answer at one specific frequency, by a step-by-step procedure described in the text.

# NEW *FROM Signalite*

## FAST RAMP GENERATOR

### 10 kv in 50 ns



Now for the first time . . . you have available 10 kv in 50 ns . . . with the new Signalite Fast Ramp Generator, Type TS-211. This unique, portable instrument is ideal for circuit testing, component evaluation and other high voltage applications. **Typical examples include: close proximity leads, solid state rectifiers, capacitors, transformer insulation, cables, etc.** All controls of the TS-211 are conveniently located on the front panel.

#### SPECIFICATIONS

- Input . . . . . 115 Vac, 60 Hz, 1 amp maximum
- Output . . . . . 3 to 10 kv peak, variable
- Risetime (10%-90%) 50 ns constant\*
- Energy, approximately .5 joule maximum
- Dimensions . . . 11" Height, 11 $\frac{1}{8}$ " Wide, 18" Deep
- Weight . . . . . 25 lbs.

\*Both slower and faster rise times can be provided to meet specific customer applications.

*Signalite*  
 SUBSIDIARY OF  
 GENERAL  
 INSTRUMENT  
 CORPORATION  
 INCORPORATED

1933 HECK AVENUE, NEPTUNE  
 NEW JERSEY 07753 • (201) 775-2490

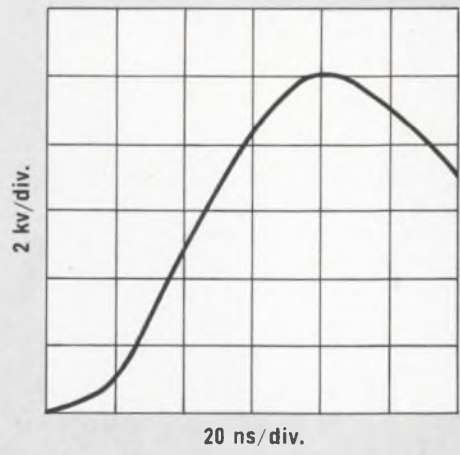

Typical Voltage Ramp From TS-211

A single output pulse rising, 10% to 90%, to 10 kv in 50 ns. (Measured on a Tektronix scope, Model 556, with 6015 probe and 1A2 plug-in.)



SIEMENS

# FILTER COMPONENTS

## FERRITE "SIFERRIT®" POT CORES

**PRECISION-ENGINEERED:** Each assembly has unique built-in advantages consisting of easy adjustment to a precise inductance, high stability with time and temperature, high Q, low distortion as well as self-shielding that allows compact component density without regeneration or cross-talk problems. Their uniform electrical characteristics month after month allow them to meet the most critical requirements for filters used in multiplex and other filter applications.

**WIDE RANGE OF MATERIALS:** Ten different types of material provide optimum properties for frequencies ranging from audio up to 40 mc/s for oscillator and filter coils—up to 400 mc/s for transformers.

**WIDE RANGE OF SIZES:** Diameters range from 0.22" to over 2.75" including all International I.E.C. Standard Sizes.

**MOUNTING ASSEMBLIES AND BOBBINS:** All cups are available with a variety of printed circuit, rivet or bayonet style mounting assemblies complete with a variety of bobbin configurations.

**TEMPERATURE COEFFICIENTS:** Closely controlled to match the values for compensating capacitors such as polystyrene.

**HIGH Q AND INDUCTANCE VALUE:** An international size 26 x 16mm cup assembly with an inductance of 315 mh per thousand turns at 100 kc has a Q value in excess of 1000 at 100 kc/s.

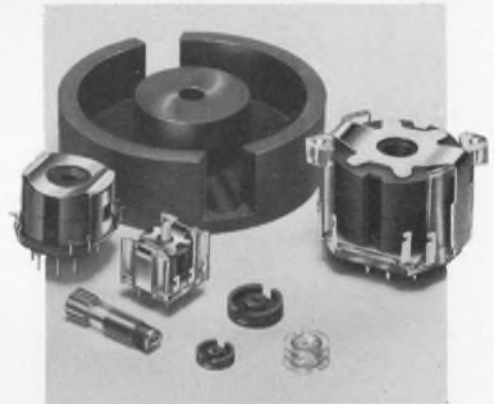

## POLYSTYRENE "STYROFLEX®" CAPACITORS

**UNIQUE PROPERTIES:** The method of manufacturing developed by Siemens has resulted in LOW COST polystyrene "Styroflex" capacitors offering:

**RELIABILITY:** Each unit is tested at 3.3 times its rated voltage to prevent voltage breakdown. Positive welded contacts between foil and leads assures operation in the microvolt range.

**STABILITY:** The special Siemens manufacturing process has assured maximum stability of capacitance over long periods of time, temperature and voltage conditions.

**LOW SELF-INDUCTANCE:** Values as low as extended foil construction.

**LOW DISSIPATION FACTOR:** Lower than mica capacitors making them especially suitable for LC filter circuits.

**HIGH RESISTANCE TO HUMIDITY:** Polystyrene has the lowest water absorption coefficient of all capacitor dielectric materials.

**HIGHEST INSULATION RESISTANCE:** Higher than for any other kind of dielectric material.

Should you require any additional engineering information concerning the above mentioned products as well as other Siemens components such as METALIZED PAPER, PLASTIC LACQUER, METALIZED MYLAR and ELECTROLYTIC CAPACITORS, a variety of MAGNET WIRE, SEMI-CONDUCTORS, DIODES, RECTIFIERS, ELECTRONIC and MICROWAVE TUBES, please contact:

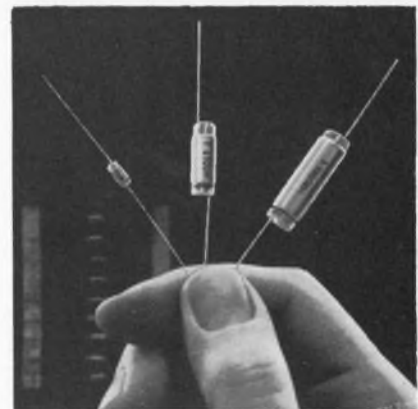

SIEMENS AMERICA INCORPORATED

Components Division • 230 Ferris Avenue, White Plains, N.Y. 10603

ON READER-SERVICE CARD CIRCLE 51

# Smooth reflections with TDR

in pulse active devices. Time-domain reflectometry helps preserve the 50-ohm continuum.

All the world is a transmission line—at least to the designer who must generate and deliver step-switching in hundreds of picoseconds. He is, however, limited to low-impedance transmission lines, so that jigs, switches, resistors, transistors, and so forth are obstacles to his 50-ohm continuum. His major design objective is therefore to minimize these obstacles and this, he can achieve with time-domain reflectometry (TDR).

Time-domain reflectometry<sup>1</sup> allows the designer to see a complex network exactly as it appears to its drive circuit. The technique will be illustrated first by using it to examine transistors and then to design a test jig for active devices.

## Look at nonlinear devices with TDR

Many active devices have characteristics that are so time-variant and nonlinear over the required operating range that it is impossible to define an impedance or construct an equivalent circuit with fixed elements. A case in point is a transistor's input characteristic: In a grounded-emitter configuration what does the driving circuitry see, and how does it vary with changes in circuit parameters?

Equivalent circuits<sup>2,3,4</sup> suffer from a fundamental limitation—they are like two-dimensional representations of a three-dimensional system—that is, they are set up with fixed, lumped elements, while in the actual device, parameters are time-dependent, bias-dependent and distributed. In particular, in fast pulse work requiring extreme bandpass and large-signal capability, predictions from an equivalent circuit are likely to be wide of the mark, and data from the model must be checked and supplemented by data from the bench.

To illustrate the working of time-domain reflectometry, take a simple problem—to deliver a fast, clean current step into the base of a 2N2369 npn silicon switch. The device is to be saturated with a 20-mA step, switching in 1 ns or less. With a given collector load and supply voltage, what does the

base-emitter junction look like to the drive system? What happens if the supply voltage, quiescent bias level, or collector load is changed?

The TDR method is to inject a fast step into the transistor base from a low-impedance transmission line and to read off the nature of the base-emitter characteristic from the reflections sent back up the line.

To interpret the output, it is essential to know what to expect from elementary  $R$ ,  $L$  and  $C$  discontinuities in a line. The reflections from ideal  $R$ ,  $L$  and  $C$  terminations are given in Fig. 1. A step reflection up or down indicates an essentially re-

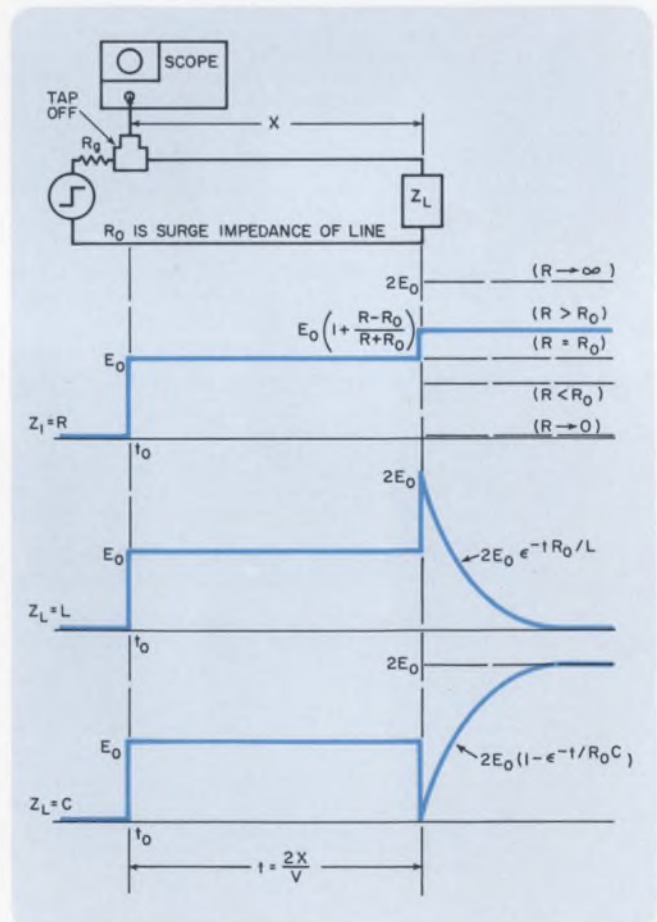

1. Basic shapes of reflections from ideal resistive, inductive, and capacitive terminations. A length of test cable is inserted between device under test and tap-off point.

Thad Dreher, Consultant, E-H Research Laboratories, Oakland, Calif.

sistive discontinuity above or below the line's surge impedance,  $R_o$ , with a reflection coefficient,  $(R - R_o)/(R + R_o)$ .

An open line will reflect all the incident step in additive phase, so that when the reflection arrives back at the tap-off observation point, the display shows an amplitude twice that of the incident step. A shorted line sends the incident step back in subtractive phase, so that the tap-off sees the step abruptly returned to base line after an interval that is twice the transit time to the short. A positive-going spike with a time-constant decay indicates a series inductance, and a similar spike in the opposite direction to the incident step is the signature of a shunt capacitance.

### Stepping into the practical world

In the real world, of course, these ideal concepts become blurred. It is very difficult to generate a clean, fast step, and it is even more difficult to display it on a scope without including some contributions from the scope. There are no pure resistances, inductances or capacitances. The deviations from the ideal create reflections that look like those in Fig. 2. The combined pulse-and-scope characteristic produces a step that is far from the ideal step,  $u(t)$ , with some fine-structure aberration and a pronounced dribble up to the full step height of 5 cm. There is also no easy way to get into a coaxial cable to add a shunt capacitance without introducing some series inductance. This is shown in the capacitive reflection, where small positive (i.e., inductive) excursions occur before and after the capacitive dip. Furthermore, when a system has several discontinuities, these can generate reflection, like the 'birdie' following the capacitive dip in Fig. 2b. And the effect of the finite speeds of the pulser and scope are clearly seen in the difference between photos of a 200-ps step (Fig. 2b) and a 1-ns step (Fig. 2c).

How would a transistor show up? The mechanics of the test are simple. Solder the transistor, say a 2N2369, on the end of a short coaxial test cable. The cable has a large diameter and a characteristic impedance of 50 ohms. The cable with the transistor is inserted between the tap-off and termination points in the system of Fig. 1. The configuration appears in Fig. 3a; the typical reflection patterns on the scope are in Fig. 3b. The three traces show variations of input characteristic as a function of collector supply for a low collector load of 50 ohms. There is a fixed inductive spike, presumably due to the short transition to the higher-impedance line of the transistor leads; there is a variable time constant of about 2 ns, which is a function of collector supply,  $V_{cc}$ ; and the steady-state impedance level varies over a narrow range of about 40 to 75 ohms, depending also on  $V_{cc}$ .

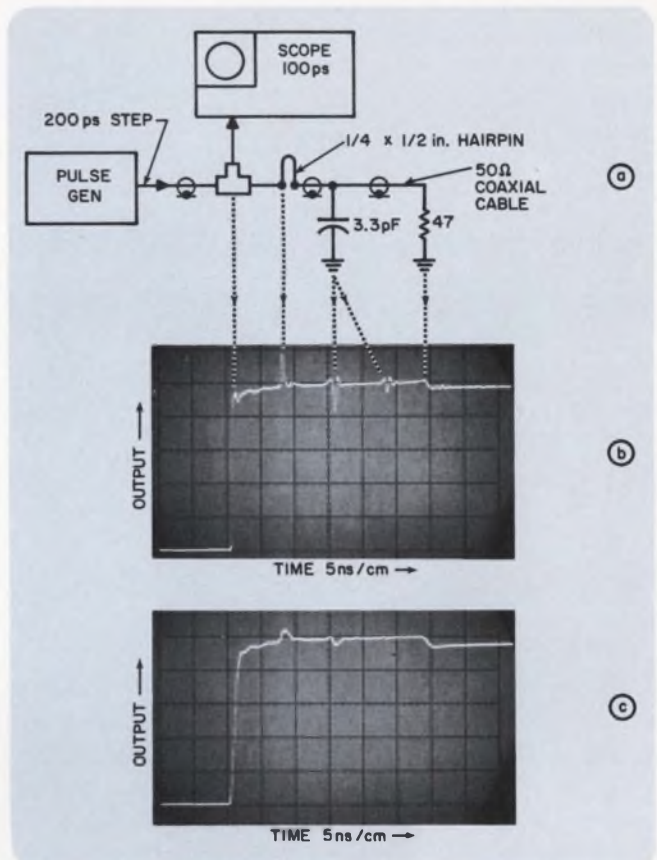

2. Actual reflectometer patterns associated with typical discontinuities in a 50-ohm transmission system (a) With 200-ps excitation (b), there is a "birdie" exactly the same distance after the shunt capacitor as the hairpin inductor is before it. This means that some of the reflection from the capacitor going toward the generator is returned back toward the load by the inductor. A 1-ns excitation (c) shows the effect of the change in the speed of the input step: the sharply defined reflections appear as lumps.

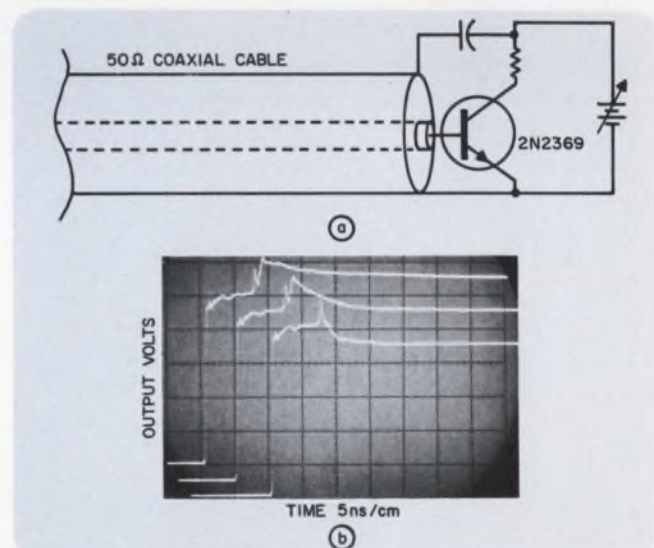

3. A fast silicon switch is attached to large-diameter, 50-ohm coaxial cable (a). The reflectometer display (b) of its base-emitter characteristics shows changes due to three different collector supply levels. Drive is a 1-volt step at zero bias.  $V_{cc}$  is 8 V for top trace, 2 V for second trace and 0 V for the last one.

The steady-state impedance level is easily determined. A transition to an impedance  $R$  from a line of surge impedance  $R_0$  gives a reflection which has an amplitude of:

$$e = E_0 [1 - (R - R_0) / (R + R_0)]$$

Solve for the unknown  $R$  in terms of the displayed amplitude  $e$ :

$$R = [(e/E_0) / (2 - e/E_0)] R_0.$$

Hence, for the top trace in Fig. 3b (for  $V_{cc} = 8$  V), the display climbs to approximately 6 cm after transients, and the ratio  $e/E_0$  becomes 6/5. The impedance is:

$$R = [(6/5) / (2 - 6/5)] 50 = 75 \Omega.$$

For the third trace (for  $V_{cc} = 0$ ),  $R$  becomes:

$$R = [(4.5/5) / (2 - 4.5/5)] 50 = 41 \Omega.$$

It is immediately apparent why the device needs to be driven from a current source, that is, from an impedance level that is at least several times higher than the 50-ohm level used here—the variations between the 40- and 75-ohm levels will be swamped out by the relatively large source impedance.

Now that the limits of impedance variation are known, calculating the resultant drive current variations for any chosen source impedance is straightforward. With a 950-ohm resistor in series with the 50-ohm line, a 20-volt step would deliver the required 20 mA into a nominal 50-ohm load. At the upper limit of 75 ohms, the delivered current is:

$$i_b = 20 / (950 + 75) = 19.5 \text{ mA},$$

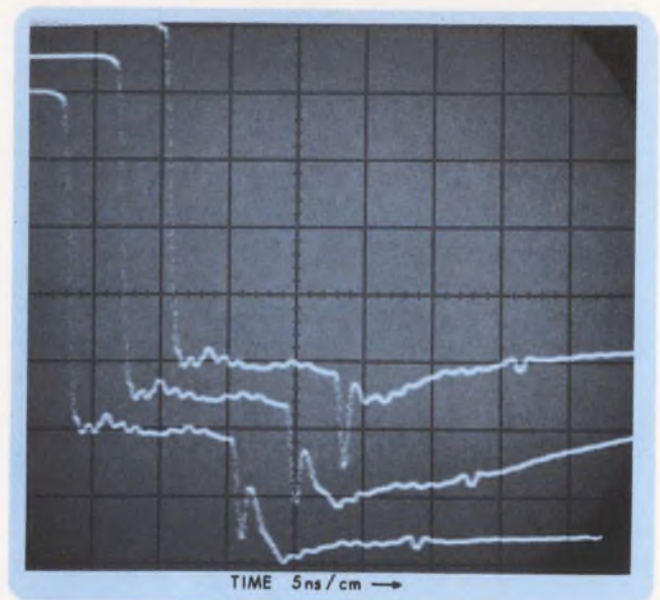

4. 0.5-V step into the base of a germanium pnp amplifier produces these reflections for  $V_{cc} = 8$  V (top), 2 V (middle), 0 V (bottom). Zero bias,  $R_c = 100 \Omega$ .

which is a deviation of 5 parts in 200, or 2.5% from the nominal value. It can now be safely assumed that a series resistor of 1000 ohms, if it is made a pure resistance over the band of interest, will swamp the variation in device characteristic and deliver a clean current step to the base.

#### Some other examples of TDR

Generalizing from a single experiment is risky. It is entirely possible that other transistor types may show very different behavior. So figures for

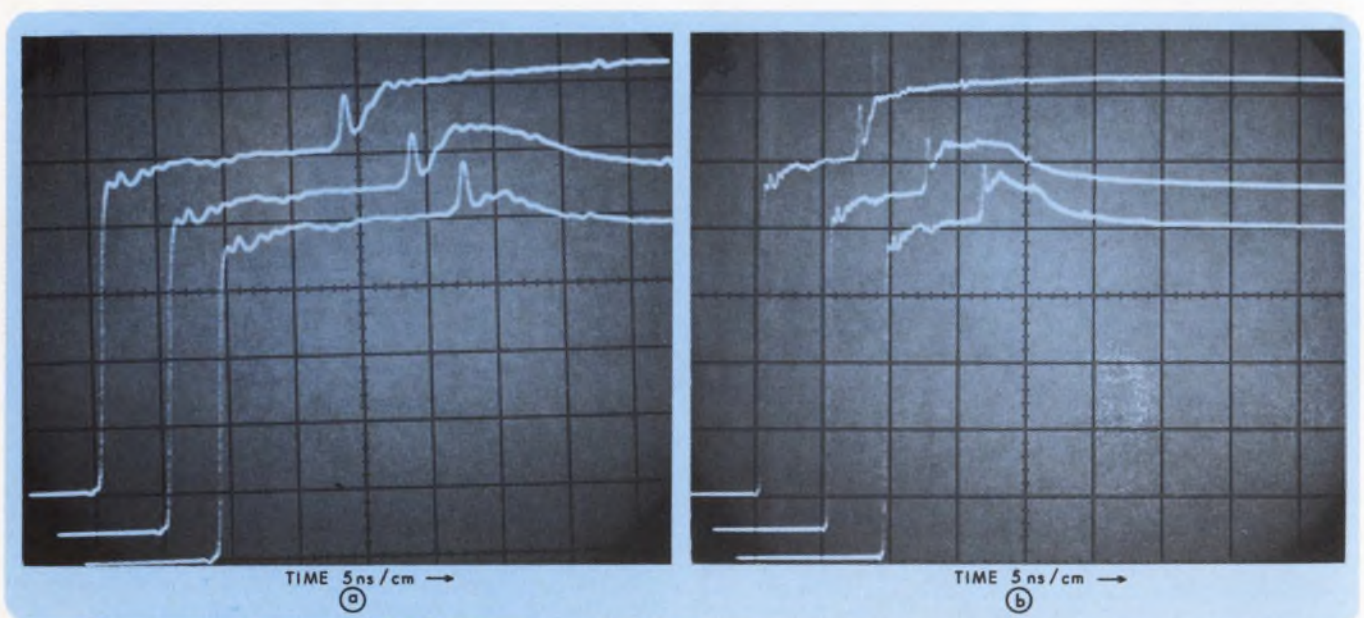

5. Variations in input impedance of a 2N706B silicon switch: As a function of collector supply (a), the curves are similar to Fig. 3b, except at 2 ns/cm. From top to

bottom,  $V_{cc} = 8$  V, 2 V and 0 V. As a function of collector load (b), from top to bottom,  $R_c = 51 \Omega$ , 200  $\Omega$  and 560  $\Omega$ ;  $V_{cc} = 8$  V.

an amplifier and a switch have been worked out.

Figure 4 shows a negative-going step into the base of a 2N1143 germanium high-performance wide-band amplifier. The leads were left about 3/8 inch long, and the increased amplitude of the initial inductive spike is evident. The low-voltage steady-state impedance level is almost exactly 50 ohms, while the highest point reached is:

$$R = [(7/5) / (2 - 7/5)] 50 = 117 \Omega,$$

so that deviation from nominal current with a 1-k $\Omega$  source impedance would be 60 parts in a thousand, of 6%.

Figure 5 has photographs of two sets of characteristics for a 2N706B, a silicon switch used in pulse work. The upper set of traces is comparable to those for the 2N2369 in Fig. 3; it shows variations as a function of collector supply. The lower set shows the effect of changing collector loads with all other parameters held constant. It shows again that, while there are quite distinct and meaningful variations in input characteristic as a function of collector load, the total variation in impedance level for this type of device lies in the narrow range from 40 to 75 ohms.

Another conclusion can be drawn from the reflection patterns of Figs. 3, 4 and 5—lead inductance limits the goal of extreme speed and bandpass capability in a transistor amplifier in a TO-5 or TO-18 case. The inductive spike returned toward the generator means that some of the higher frequencies making up the fast edge of the incident pulse have been stripped off and returned back up the line, so the chip base region receives a degraded, slowed drive pulse.

### TDR helps design jigs for transistors

Once the interpretation of reflections from transistors is understood, the task is to design a test jig that will not affect the tests. Test jigs must be flexible, convenient and accurate—quite exacting requirements with fast switching speeds. TDR again helps the designer.

**Table: Direct-readout errors**

Actual $t_r$ of device under test	System $t_r$	Ratio $t_{r(\text{dev})} : t_{r(\text{sys})}$	Direct-readout error
1 ns	1 ns	1:1	41%
1 ns	500 ps	2:1	14%
1 ns	333 ps	3:1	6%
1 ns	250 ps	4:1	3%
1 ns	100 ps	5:1	2%

$$t_{r(\text{readout})} \approx [t_{r(\text{device})}^2 + t_{r(\text{system})}^2]^{1/2}$$

A typical set of specifications might look like this:

- Measure transistor switching times in the range 1 to 10 ns over a collector voltage ( $V_{cc}$ ) range of 5 to 20 volts.
- Have variable bias provision for both linear and saturated modes of operation.
- Have built-in provision for monitoring the base ( $i_b$ ) and collector currents ( $i_c$ ).
- Make measurements repeatable at several stations.
- Be accurate to 1%.

To drive a 1-ns device, the driving function should switch at 200 ps or less. This fact is often glossed over, yet the wrong drive signal can ruin all attempts at accuracy. For example, to drive a 1-ns linear device with a 1-ns step means that operations begin with an error of more than 40% designed into the system (see table). There are two choices for a 200-ps excitation: an all-electronic pulser that permits sampling or averaging read-out, or a mercury pulser in conjunction with a single-shot read-out system.

The requirement that measurements are to be repeatable at widely separated locations presents another problem. At 200 ps, differences in cables, connectors and pads may cause considerable variation in waveshape, even if the generators are identical. The fastest standardizing filter available has a nominal rise time,  $t_{r1}$ , of 200 ps. When this is added to the generator rise time,  $t_{r2}$ , the over-all rise time becomes:

$$t_{ro} \approx (t_{r1}^2 + t_{r2}^2)^{1/2} = (200^2 + 200^2)^{1/2} = 283 \text{ ps.}$$

With all but the fastest devices it might be worth slowing the drive by 83 ps for the sake of uniform gain. For devices slower than 200 ns, a 500-ps filter is recommended. If the filters are reasonably matched, individual variations in generators and cables will simply be swamped out of sight.

### Secure high drive-source impedance

Now that a fast step is being delivered to the input port of the fixture by large-diameter 50-ohm coaxial cable, the next step is to ensure a clean current step into the transistor base. Since the transistor base is a reactive, time-varying, nondefinable impedance,<sup>5,6</sup> the drive-source impedance must be quite high (several hundred ohms), so that variations in base impedance have little or no effect on the current. This may be done with a series resistor of about 1 k $\Omega$  terminating the drive line and a shunt resistor across the input port.

Some provision must be made to inject the dc bias and to sample the base current. This could be done by building a scope probe into the jig at the 50-ohm level of the sampling scope inputs, but a single-shot read-out system gets round this. The

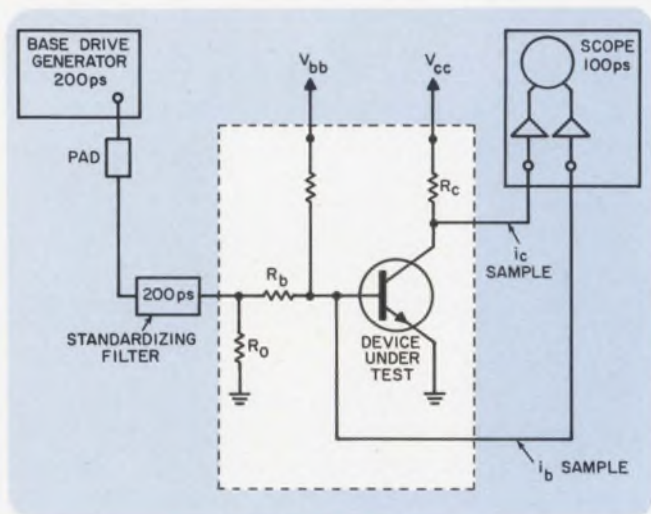

6. Tentative system elements of a test jig for fast switching transistors include sampling outlets.

50-ohm feedthrough arrangement of such a system's start discriminator enables the bias to be connected in series with the drive line at the input port of the jig.

In the collector circuitry there is again the problem of probing down to 50 ohms to sample the collector current. In the absence of any specified collector load, this problem may be minimized by choosing  $R_c$  to be 50 ohms. This would ensure that the transistor is tested at the top of its intrinsic speed capability. In general, however, the collector load will be specified.<sup>7</sup>

The system elements as developed to this point are blocked out in Fig. 6. The considerations are:

- Terminate the input line.
- Deliver a clean  $i_b$  step.
- Monitor  $i_b$ .
- Inject base bias.
- Monitor  $i_c$ .

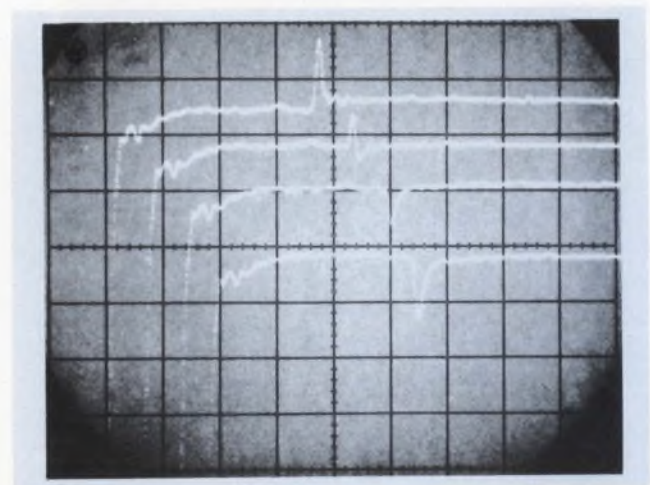

7. Reflectometer patterns for terminations using one, two, three and four carbon resistors show the progression from excess inductance (top, single resistor) to excess capacitance (bottom, four 200-ohm resistors in parallel.)

- Prepare the mechanical layout

Each of these steps can be accomplished easier and faster with a time-domain reflectometer.

### Check carbon resistors with TDR

The reflectometer simplifies the evaluation of the performance of terminations formed with ordinary carbon resistors. Terminating the test cable with a single, 50-ohm, 0.25-watt resistor results in a serious inductive reflection (Fig. 7), which will slow the drive pulse considerably. Two 100-ohm resistors in parallel leave the termination slightly inductive. The addition of one series resistor,  $R_b$ , will add shunt capacitance to the junction.

In mock-up of the jig input, with an  $R_b$  of 1 k $\Omega$  and two 100-ohm, 0.25-watt resistors as the test-cable termination, the total reflection of a 200-ps step was reduced to less than 1%. The continuous reflectometer display permits the designer to watch while he tunes for best geometry.

The conversion of the input voltage step into the desired base drive current step is complicated by the base input characteristic. Typical base-emitter junctions show inductive, time-varying, nonlinear effects that are also functions of supply voltage, collector loads, and bias levels. The maximum impedance variations of the 2N2369 have already been shown to be about 25 ohms on either side of a nominal 50-ohm level. Therefore a 1000-ohm series resistor (provided it is a resistance and not a complex network) will make the waveform of  $i_b$  follow the input voltage waveform closely.

The problem then is to make a carbon resistor look resistive at gigahertz frequencies. This is simplified by the fact that the nominal impedance level at the transistor end of  $R_b$  is near the 50-ohm level of the scope input, so the scope has little effect on the display. In evaluating the tuning of the input network, substitute the scope cable for the transistor input junction and observe the delivered current step directly.

The way to minimize the reactances associated with the ordinary axial-lead resistor is shown in Fig. 8a. A metal plate is screwed to the connector to make the resistor a conductor-between-ground-planes line. The plate is adjusted to optimize step transmission, that is, to find the best compromise between series inductive and shunt capacitive effects. The peaking effect of the end-to-end capacitance of the resistor is controlled by mounting it through a hole in a thin plate.

With the resistor in position, observe the transmitted step and adjust the ground plane for slight overpeaking, then fill the gap around  $R_b$  between the two planes with Eccosorb\* blocks placed to

\*Eccosorb is a trade name for the rf-absorbing material manufactured by Emerson & Cuming, Inc., Canton, Mass.



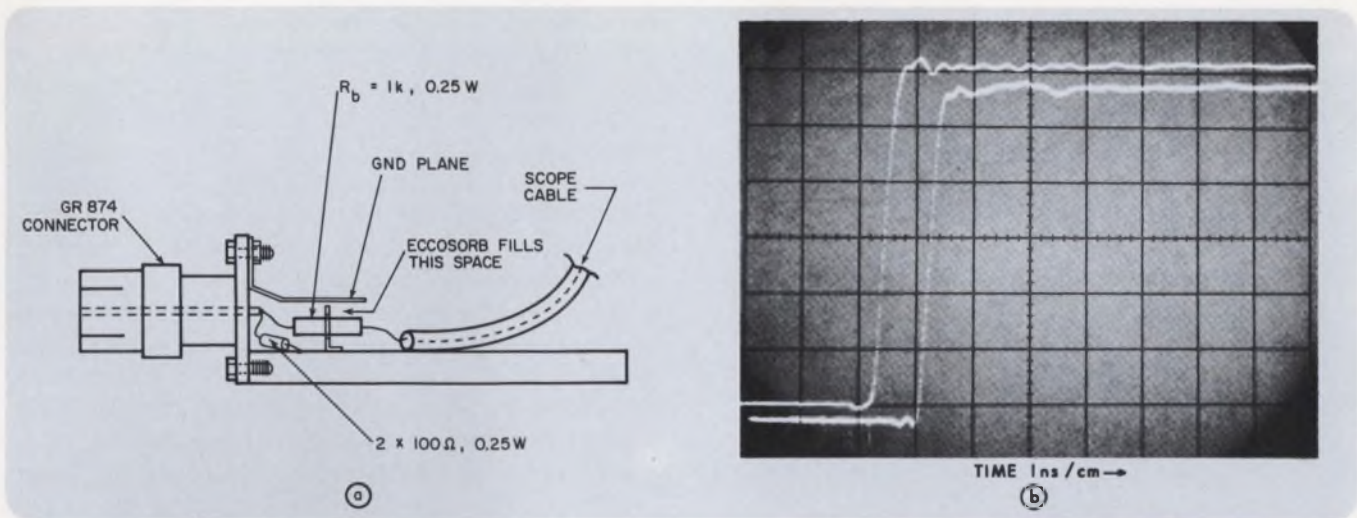

8. Mock-up for base drive circuitry (a). Top trace (b) shows a 200-ps step going directly into the scope; bot-

tom trace is going through the jig as in (a). Reasonably good steps result.

tom trace is going through the jig as in (a). Reasonably good steps result.

obtain the best waveform. The result is shown in Fig. 8b, where a reasonably good step is delivered to the 50-ohm resistive input of the scope cable.

### Two methods for $i_b$ sampling

Two alternatives exist for monitoring base drive: a small sampling resistor may be inserted directly at the base socket pin, or a built-in current transformer may be used at the same point. It is also possible simply to monitor the voltage waveform at the input terminal if the current source is resistive enough to act as a true current source over the range of transistor input variation.

Current sampling directly at the base socket pin is attractive since no assumptions need to be made, but both sampling resistors and transformers require extra circuit length at a critical point. Neither method gives good baseline reference on the display.

If the input voltage waveform gives reasonable indication of base current (Fig. 8), a voltage probe may be built into one leg of the input termination as in Fig. 9a. Tuning with TDR can keep the reflections below 1%, with waveforms as in Fig. 9b.

### Where should the bias go?

The bias may be injected directly at the base pin, or into the input junction.

Biasing the base terminal directly is quite difficult since the bias source impedance is in parallel with the critical drive point. Therefore the bias source should be made into a broad-band current source. For a 200-ps capability, it involves a series  $RL$  network, beginning with a length of fine wire (i.e., the excess inductance of a 600-ohm line), and progressing to lower-frequency chokes in series.

The simpler way to inject the bias is to feed the dc voltage into the lower end of one leg of the input

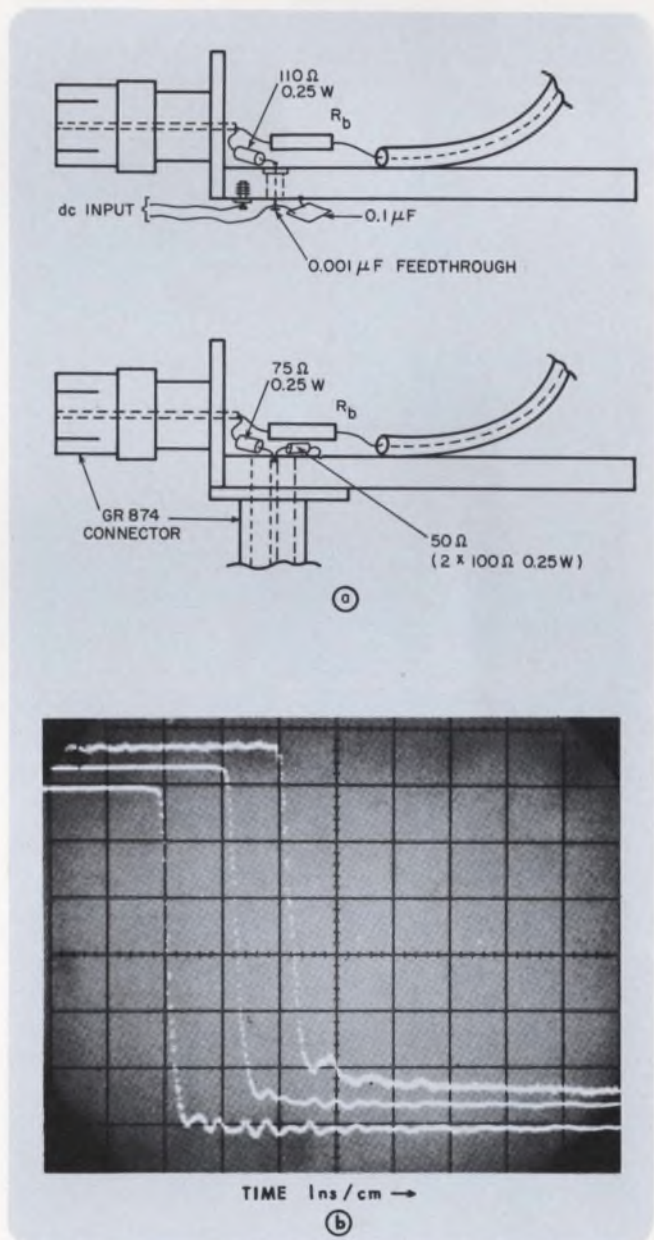

9. Add dc offset through one leg and 4:1 probe in the other (a). Photo (b) shows input, output, and tap-off.

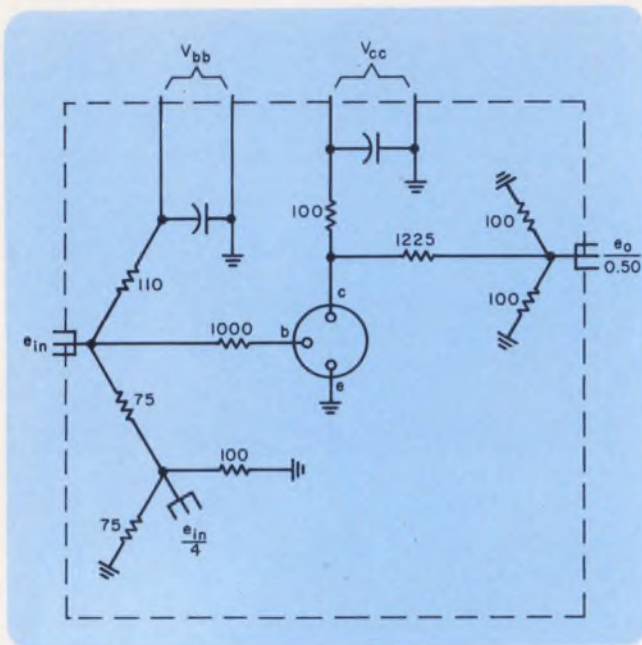

10. Schematic of a jig designed for 200-ps excitation. It tests transistors with switching times which range from 1 to 10 nanoseconds.

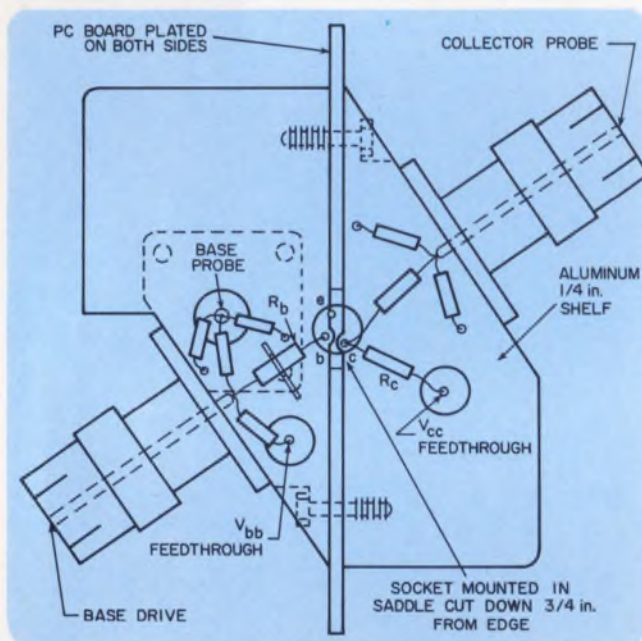

11. Input and output circuitry is mounted on opposite sides of a double-sided PC board. Connectors are screwed to heavy aluminum shelves.



12. The finished jig. Input and output circuitry are mounted on opposite sides of a 2-sided PC board.

termination. With a feedthrough capacitor that leaves the lower end of the second terminating resistor at signal ground, reflection on the drive line is still less than 2%, with a slight degradation of drive  $di/dt$ , as shown in Fig. 9b. This arrangement gives direct indication of base-line level at the input junction. So with the 1-k $\Omega$  series resistor, the base-line voltage on the scope display may be read off directly in milliamperes.

The collector current may be checked directly with a current transformer or with a sampling resistor. If  $R_c$  is essentially resistive, the voltage waveform at the collector is proportional to  $i_c$ ; the voltage may then be monitored, as in the case of  $i_b$ . This approach needs a terminated 50:1 probe, which creates essentially the same problem as the input current source. So use exactly the same technique of construction and testing as before; that is, inject a fast step into the sampling terminal and tune for best waveform into the scope cable at the collector terminal.

The circuitry for the completed jig appears in Fig. 10, the layout in Fig. 11 and the finished jig in Fig. 12. The ground planes over the components are omitted for clarity. For best shielding, the input and output circuitry are mounted on opposite sides of a double-sided printed-circuit board ground plane. The socket is edge-mounted in a saddle, cut down from the top of the PC board. To withstand the torque of large-diameter coaxial cable, the connectors are screwed to heavy aluminum shelves. ■ ■

#### References:

1. Oliver, "Time Domain Reflectometry," *H/P Journal*, XV, No. 6 (Feb. 1964).
2. Roehr (ed.), *Switching Transistor Handbook* (Phoenix, Ariz.: Motorola Semiconductor Products Div., 1963).
3. Pritchard, "Electric-Network Representation of Transistors: A Survey," *IRE Trans. on Circuit Theory*, Vol. CT-3, March 1956.
4. Pritchard, "Transistor Equivalent Circuits," *Proc. IEE*, Vol. CVI, May 1959, Part B, Supplement No. 17.
5. Oliver, *op. cit.*
6. Roehr, *op. cit.*, Chap. 5.
7. *Ibid.*, p. 103.

#### Test your retention

Here are questions based on the main points of this article. They are to help you see if you have overlooked any important ideas. You'll find the answers in the article.

1. Where do equivalent circuits fail in the description of such active devices as transistors?
2. What does a step reflection indicate?
3. To drive a 1-ns device, the driving function should switch at less than 200 ps. Why?
4. What are the two methods for  $i_c$  sampling?
5. What is the best way to inject the dc bias into the jig?

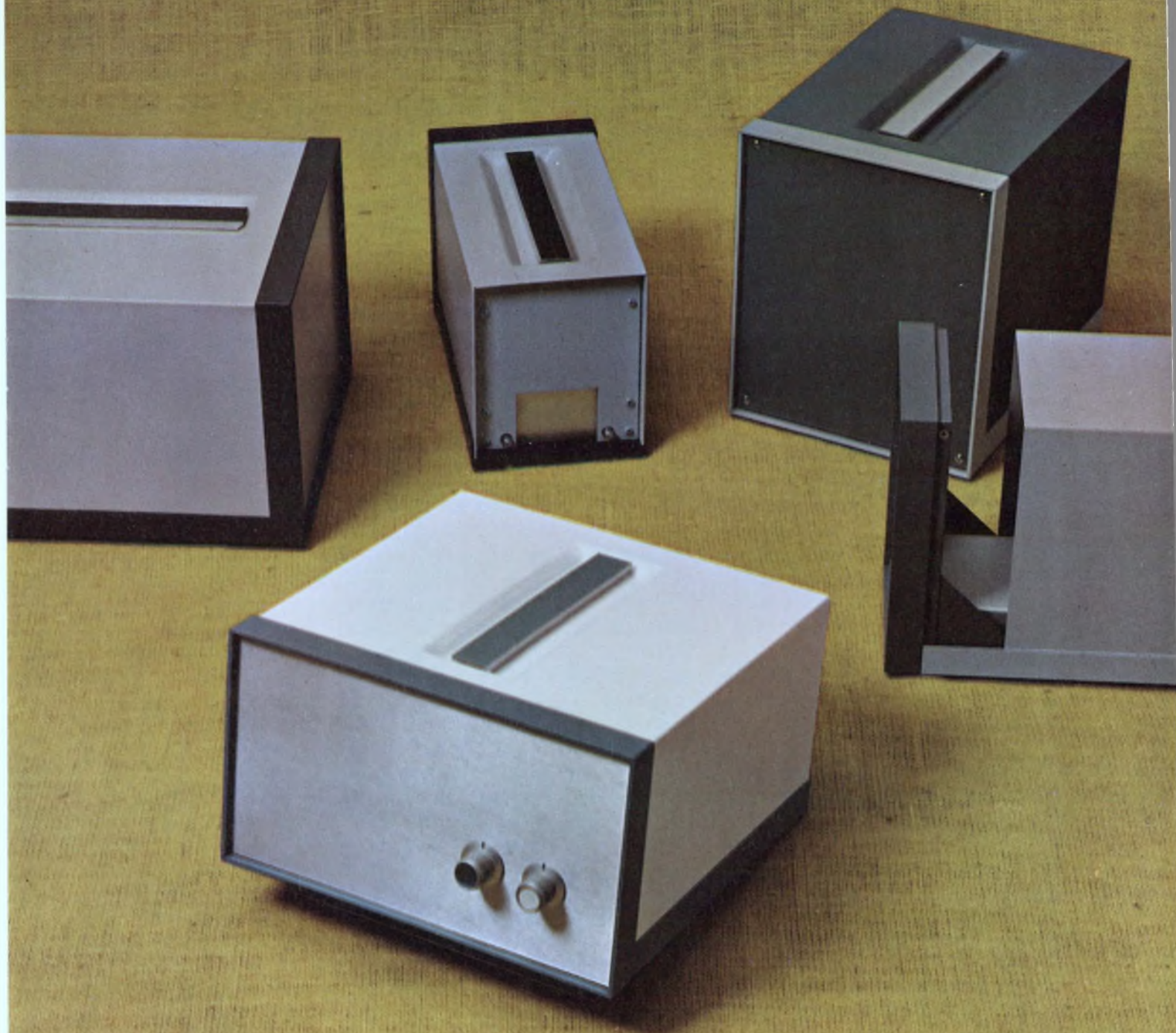

**...and in this case  
your small instruments will look great.**

**Nine sizes, eight colors, all aluminum, vinyl finish, award-winning Optima style.  
Designed for instruments that hate to look average.**

**Call Marty Bethune, Marketing Manager**

**OPTIMA®**

**a product of Scientific-Atlanta, Inc.**

**Box 13654, Atlanta, Ga. 30324**

**Tel. 404-938-2930**

# Don't fool with gold plate selection.

The choice of solution can spell success or failure in joining plated components.

From flat packs to connectors and relays, gold-plating is used extensively in electronics. And with good reason. Gold provides excellent electrical properties, and it resists corrosion and abrasion. It is highly malleable. Gold also provides a reliable, low-resistance contact.

Inevitably, gold-plated components must be joined to each other. Gold is excellent for this; it can be welded, soldered or die-bonded. But improper plate can wreck an otherwise successful joint. Achieving good joints between gold-plated parts requires more than good plating and joining practices; it requires good gold plate to start with. The selection of the type of gold for a specific application is the all-important first step.

If you fail to act wisely at the outset, contact resistance may be affected adversely, or a weak joint may result. Use an improper solution or an improper plating practice, and you risk occlusion of some of the electrolyte in the gold deposit, thereby producing an inferior joint when the plated component is soldered. Any occluded cyanide or other breakdown product in the gold deposit may react with the basis metal or plate to form oxides or other films.

## All that glitters is not good

To determine the best gold solution to use when plating electronic components, consider a variety of requirements. Component shelf life, operating life, hardness of deposit, end-use temperature, brightness and purity are a few factors. The suitability of the gold deposit for joining to other components is obviously a vital factor. If a particular gold solution produces a deposit that has poor joining characteristics, it must be rejected, even if it is perfectly suited for all other requirements. For example, say that the component is to be soldered. The gold plate normally completely alloys with the tin (photo, right, opposite page) and goes into solution in the solder layer. In effect, soldering is done to the basis metal or the plate that lies under the gold. The gold

must alloy completely with the tin in the solder layer. A gold that alloys incompletely will result in a poor joint (lower left).

Three types of gold are recommended:

**1. Neutral 24-karat gold solutions.** These are the best for joining because of their extreme purity (99.99%). Pure gold has perfect properties to alloy and join with other metals. It gives the greatest range of flexibility for a good joint. Neutral (pH of 5 to 7) 24-K golds are classed as "electronic grade" golds that meet even the stringent requirements of space and missile applications for high-temperature resistance and extremely low porosity. They have a mixture of laminar and columnar crystalline structure which, combined with their extreme purity, is excellent for die bonding.

**2. Acid bright and hard 24-karat golds.** These are recommended for connectors, printed circuits and switches, reed relays and some headers. Their purity almost equals the neutral 24-K baths (99.8% plus). At the same time they have a mostly laminar crystalline structure that provides excellent corrosion resistance and never becomes passive to soldering. They are of the proper hardness (150 to 250 Knoop) for the majority of electronic applications, are mirror bright and exhibit good leveling action.

**3. Alkaline alloy golds.** These are the most economical bright golds. They are suitable for printed circuits, barrel-plated contacts, stepping switches and reed relays. They have excellent wear resistance and generally good solderability. The bath itself has good corrosion resistance, excellent salt-spray resistance and high brightness. A cyanide-free alkaline alloy bath can be operated over a pH range of 8 to 10 to minimize attack on masks or printed-circuit resists. Without cyanide occlusions, there is no tendency to bleed out or stain, and leaching operations are not needed.

Two types of gold are *not* generally recommended:

**1. High-cyanide bright alloy golds.** They are not in widespread use. If a plating solution contains free cyanide, decomposed free cyanide will be occluded in the deposit, unless it is continuously purified. Under action of a soldering temperature, occluded free cyanide will carbonize and oxidize, causing blistering. Cyanide golds are not recommended for applications where heat will be applied in joining.

---

**Hrant Shoushanian**, Director of Laboratories, Technic, Inc., Providence, R.I.

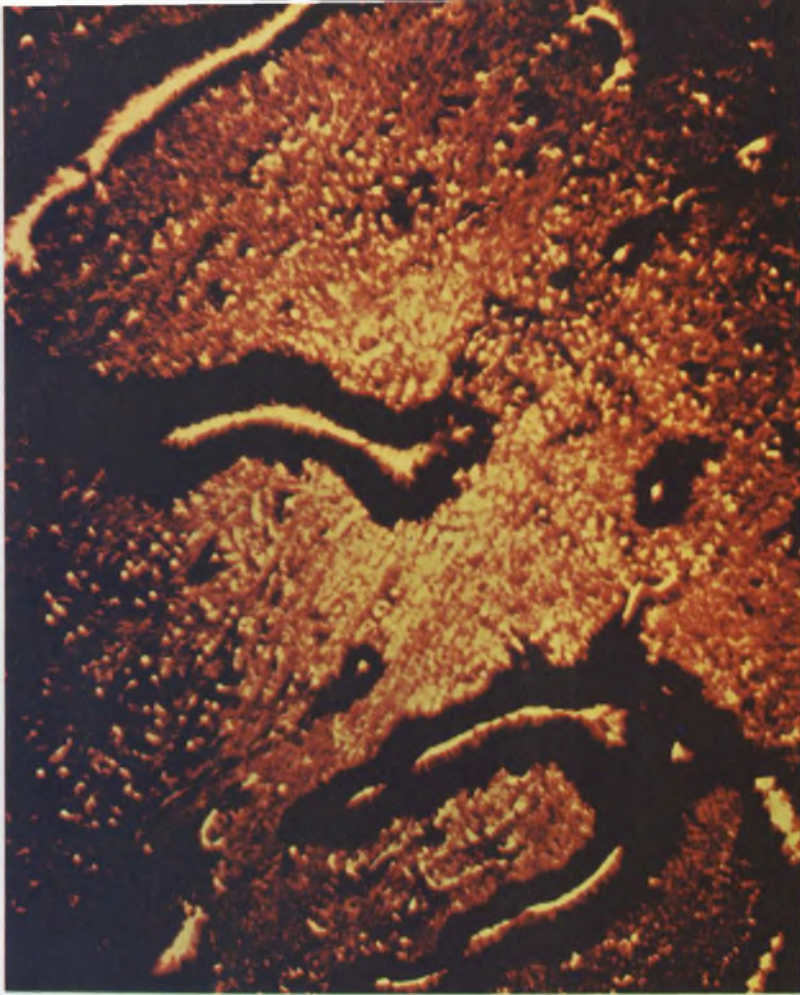

**A dewetted surface was wetted initially but has pulled together upon solidifying to form the isolated globules.**

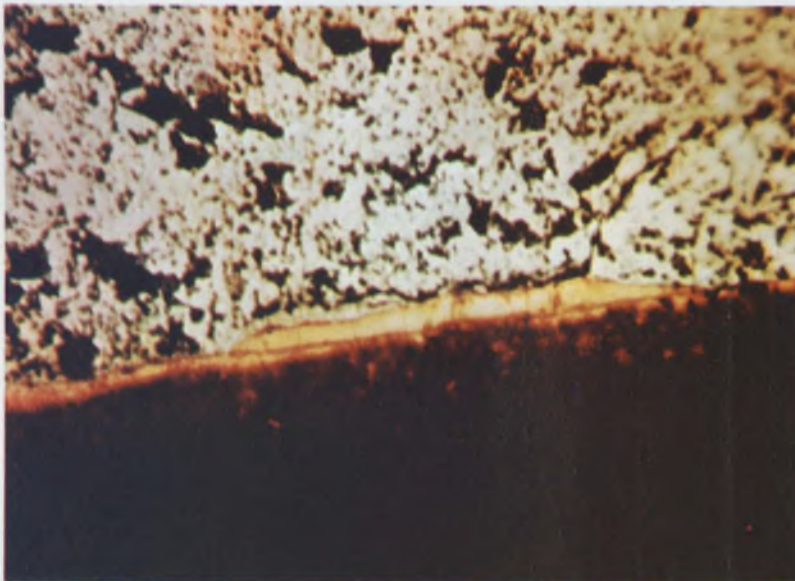

**A weak joint results when gold doesn't alloy completely with tin. In this cross-section of a soldered gold-plated metal, some gold which did not alloy still remains on base metal.**

**Needle-like crystals form when gold alloys with tin in molten solder. With thicknesses to 150 mils, pure gold completely dissolves in solder.**



2. **Acid bright alloy golds.** They are also rarely used. They require longer soldering time when intentionally alloyed with nickel, cobalt or indium.

In general, the purer the gold deposit, the easier, faster, and more homogeneous the alloying with the tin in the solder layer. Any additive to gold, metallic or organic, that may co-deposit or be occluded in the deposit will hinder the ease with which the alloying takes place.

In the case of acid golds that are intentionally alloyed with nickel, cobalt or indium in excess of 0.5%, wetting or alloying is more difficult and requires longer times (upper left, p. 115). Often, alloying with tin is not even homogeneous. Sometimes the gold seems to float in chunks on the solder layer, and sometimes, in the case of cobalt and indium alloys, it even remains in contact with the surface in isolated areas.

#### Plating procedure also important

Whenever two metals are put into close proximity (as in plating), they interdiffuse at a rate determined by the nature of the metals, the ambient temperature and the length of time they are in contact. Diffusion may be minimized (never completely

eliminated) by plating on as perfect a base metal surface as possible and by plating on a slow, diffusing base metal, or by introducing a barrier plate between the base metal and the gold.

Organic films on the surface of the base metal—such as the brighteners used in bright nickel, silver and copper solutions—must be removed or the metal will not solder well. Removal of these brighteners is not easy, and simple rinsing in cold water merely “freezes” them on surface. More severe cleaning methods must be used, such as deburring, chemical cleaning, activating, and often acid etching.

The type and thickness of the barrier plate used are important in determining the thickness of the gold plate. The best barrier plate to prevent diffusion between the base metal and gold is platinum, but palladium or nickel are generally used, since they are less expensive.

While it is possible to solder to any thickness of gold, too much gold (over 150 millionths of an inch) alloying with the solder produces a brittle joint. On the other hand, very thin gold deposits over nickel (less than 10 millionths of an inch) dewet excessively on soldering. With increasing gold thickness, however, soldering is performed with no dewetting.

**Table. The choice of a plating solution**

Solution	Advantages	Applications	Remarks
Neutral 24 K	Highest purity, excellent high-temperature-resistance, excellent solderability, tight grain, very low porosity, excellent die bonding with silicon and germanium, lowest contact resistance.	All semiconductor components, transistors, diodes, flat packs, reed relays.	Contains no additives or organic brighteners. Semi-bright, lemon-yellow color.
24 K acid bright and hard	Minimum purity of 99.8%, excellent corrosion-resistance, good solderability, smooth, mirror bright, low contact-resistance, optimum hardnesses for wear-resistance (150-250 Knoop).	Connectors, printed circuits, switches, reed relays, rectifier bases.	These baths are the best for general electronic use. Some can be used for high-temperature components.
Alkaline alloy (cyanide-free)	Good solderability, good wear-resistance, good corrosion-and-salt-spray-resistance, low cost.	Connectors, printed circuits.	95-99% purity. Does not withstand high temperatures.
Alkaline alloy (high-cyanide)	Good wear-resistance, good corrosion and salt-spray-resistance.	Connectors.	95-99% purity. Does not withstand high temperatures. Often requires leaching. Free cyanide is troublesome to solderability.
High-cyanide bright alloy	Lowest cost (but more difficult to control).	Semiconductors, transistors.	Poor solderability. Occluded cyanide by-products in the plate are troublesome. Often requires leaching.
Acid bright alloy	Extremely hard, lower karat (20-22 K), high contact-resistance.	Jewelry and decorative items.	Not recommended for electronic applications. Cost savings are illusionary.

Alloyed golds require greater thicknesses than purer gold to achieve the same results. Over copper, on the other hand, the opposite is true. Thinner gold coatings solder very well. Only thicker coatings show any signs of dewetting, and this usually takes place with the alloyed golds.

Even a good gold bath for the intended application may not produce acceptable results, unless the plater maintains the proper temperature, current density, and pH, and keeps the bath free of all contaminants, both organic or inorganic. All are important in obtaining the type of plate that will produce proper joints.

For example, when using a neutral 24-karat gold bath, the temperature should be maintained above 140°F. If the temperature of a plating bath is decreased appreciably below that limit, some of the electrolyte might be occluded, and blistering will result at the time the plated component is joined to

another. Occluded materials should be leached out of the plate immediately after plating, to eliminate or minimize their effects on the basis metal.

In plating, the current density (the ratio of current to area of the metal being plated) should not be higher than 10 A/ft<sup>2</sup>. If the current density is allowed to go above this level, porosity may result, and the properties gained by plating with gold will be lost.

### Consider the joining technique, too

Three techniques are commonly used to join gold-plated components:

**1. Soldering.** In its simplest form this is joining or bonding two metal parts with a third metal—the solder. This bond between the solder and each of the metal parts is a metallurgical surface reaction. The reaction, or alloying, takes place between the

## Glossary

<b>Activating</b>	Chemically treating a basis metal to remove oxides and other passive films to make it more receptive to electroplating.	Upon solidification, however, the solder pulled together to form isolated solder globules.
<b>Barrier plate</b>	A layer of slow-diffusing metal placed between two fast-diffusing materials to prevent, or slow, their interdiffusion. Palladium and nickel are good barrier plates.	<b>Diffusion</b>
<b>Bleedout</b>	The tendency of occluded electrolytes, impurities, base materials and preplates, such as silver, to diffuse to the surface of the gold plate.	The process whereby one metal migrates through another.
<b>Blistering</b>	The process whereby a plate separates from another or from the base material in the form of bubbles. It commonly occurs during heating, as a result of poor adhesion caused by improper cleaning and activation cycles.	<b>Eutectic alloy</b>
<b>Columnar structure</b>	Crystalline formation that tends to be mostly vertical with the plating surface.	The ratio of alloy components having the lowest possible melting point. For example, eutectic solder is 63-37 tin-lead alloy. This ratio has the lowest melting point.
<b>Current density</b>	The ratio of current to surface area, applied to either electrode in a plating solution.	<b>Laminar structure</b>
<b>Deburring</b>	Mechanical or chemical treatment to remove burrs prior to plating.	Crystal formation that tends to be mostly horizontal with the plating surface.
<b>Dewetted surface</b>	A surface that was initially wetted—that is, one on which the solder flowed uniformly.	<b>Leaching</b>
		The process of dissolving and removing impurities and soluble components from plated items, tank materials and the like.
		<b>Leveling action</b>
		The ability of a plating solution to produce a surface smoother than that of the basis metal.
		<b>Occlusion</b>
		The embedment within the plate layer of a small particle or impurity from the plating solution or cleaning cycle.
		<b>Stain</b>
		The discoloration of a plated surface due to bleedout or improper cleaning and drying procedures.
		<b>Wetted surface</b>
		A surface on which the solder flows uniformly, forming a smooth, continuous and adherent layer.



**Occlusions in a gold deposit** result when some electrolyte is trapped or embedded in the plate as shown in this cross-

section. Occlusions will cause a poor joint if solder is applied at this point.

solder and the metals involved. The amount of alloy formed depends on the solubility of the metals in solder, the temperature of the solder, and the length of time the soldered component is held at this temperature. In soldering, gold plate forms an alloy with the tin in the solder. The best joints result when the gold disperses uniformly into the solder. In effect, we are soldering to the basis metal, or the plate that lies under the gold. Therefore the purer the gold plate, the better the chance for a satisfactory soldered joint (photo, above).

**2. Welding.** This technique joins two metals by melting both and fusing them together. Welding usually takes place at about 900°C, when an alloy is formed between the metals being welded. In the welding of small gold-plated components, only 3 to 4 seconds are required to melt, make the joint and start cooling.

**3. Die bonding.** This refers to the bonding of a germanium or silicon wafer to a gold-plated surface. The wafer and the gold are heated to about 500°C, until a eutectic alloy is formed between the germanium or silicon and the gold. The eutectic alloy adheres to both. In most cases a pure, 24-karat deposit is a necessity for satisfactory die bonding. However, slight alloying of the gold with antimony is often used to achieve electrical properties, with no effect on the formation of the eutectic alloy. Ideally die bonding requires a slightly rough surface on the gold.

Finally, to achieve satisfactory joints between gold-plated components, it is necessary to have a combination of the proper solution for gold-plating, proper plating techniques, and proper joining.

- In selecting a solution, the most important factor is purity.

- Plating solutions containing any free cyanide are unsatisfactory.

- Proper plating requires thorough preparation of the base metal to be plated, maintaining the recommended operating limits of the solution, and

good housekeeping to maintain the uncontaminated plating bath.

### **Beware use of the wrong gold**

What happens if you don't choose your gold carefully? Here is one example:

Contact resistance of pure 24-K gold, plated for the proper thickness over a reed switch, for example, has a very low contact resistance—about 0.2 to 0.4 mΩ. If this part is subjected to high temperature, intentionally or on use, contact resistance will change very little—possibly up to 0.6 to 0.8 mΩ, depending on the temperature, time, and thickness of gold directly over the base material. If, however, the wrong gold is used—such as an acid alloy gold with cobalt—contact resistance initially will be on the order of 0.6 to 1 mΩ with a 0.002-inch gold plate. If this is subjected to 250° to 300°C for 10 hours, the contact resistance increases to 60 to 100 mΩ. At 450°C for 30 minutes, the contact resistance is up to 1 to 2 Ω. ■ ■

### **Test your retention**

*Here are questions based on the main points of this article. They are to help you see if you have overlooked any important ideas. You'll find the answers in the article.*

1. *Why are cyanide golds least desirable?*

2. *If a barrier plate is needed to prevent diffusion between the base metal and the gold plate, should we use a barrier plate of gold itself? Why?*

3. *Which desirable properties of gold would be destroyed if the plating current density exceeded 10 A/ft<sup>2</sup>? Why?*





Products designed to save your productive time

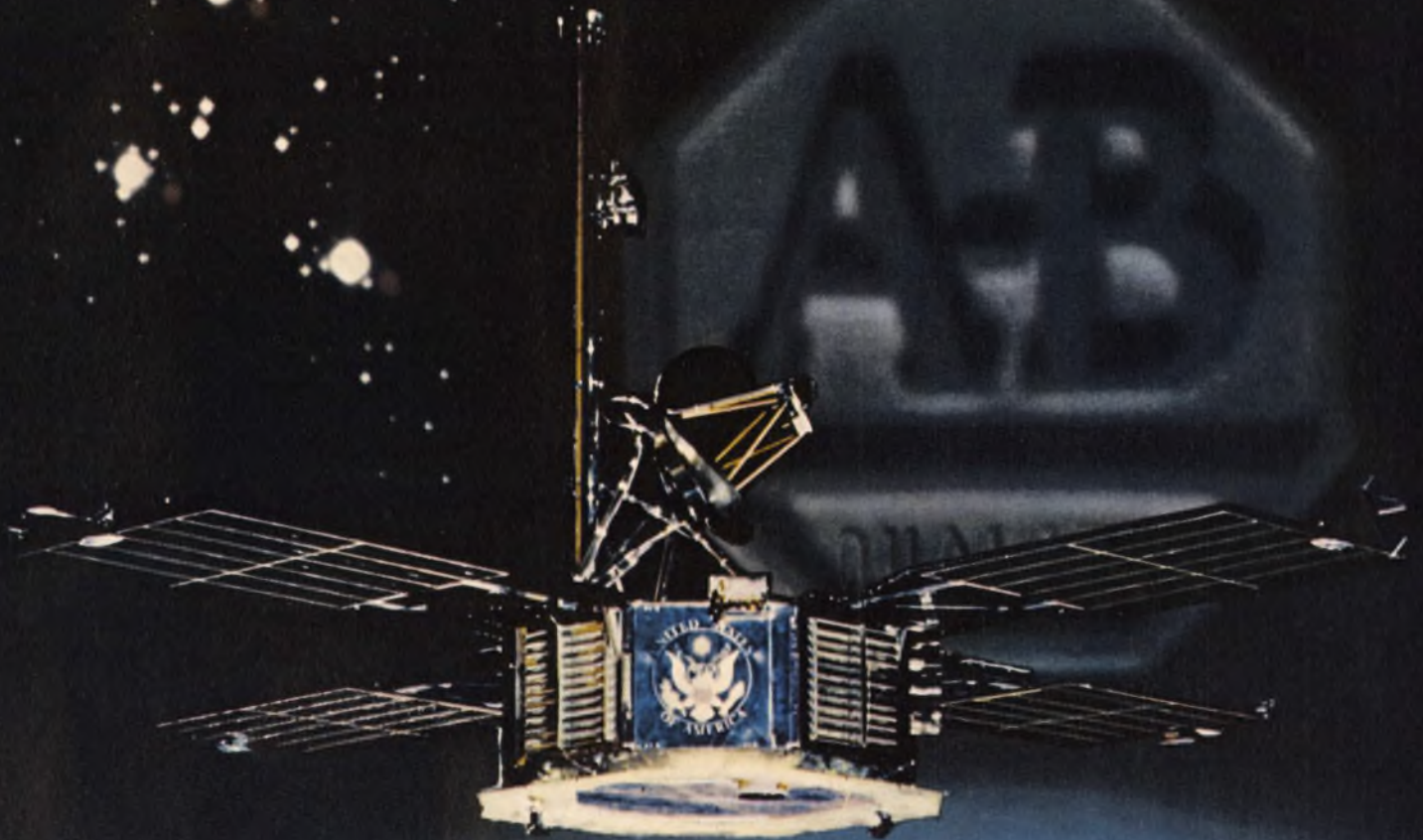

## “on time” in space

Allen-Bradley hot-molded fixed resistors were an integral part of the “happenings” that made the Mariner V Venus flight so successful. On a one-way trip of over 200 million miles there is no room for compromise. No time for mistakes. This is why Allen-Bradley resistors have been aboard every major U. S. space probe. Their functional integrity is incomparable.

A single moment may not be critical in *your* specific resistor application, but every minute, hour, and day has to be. And this is why you should insist on Allen-Bradley quality. Measured in precise, accurate, reliable performance day-in and day-out, Allen-Bradley resistors save you valuable production time. Since time is your most priceless asset, let Allen-Bradley help you make the most of it. For complete specifications, write: Allen-Bradley Co., 1315 S. First St., Milwaukee, Wis. 53204. In Canada: Allen-Bradley Canada Ltd. Export Office: 630 Third Ave., New York, N. Y., U.S.A. 10017.



A-B hot-molded fixed resistors are available in all standard resistance values and tolerances, plus values above and below standard limits. **A-B hot-molded resistors meet or exceed all applicable military specifications including the new Established Reliability Specification.** Shown actual size. Type HB 2-watt not used on Mariner V.

**ALLEN - BRADLEY**  
QUALITY ELECTRONIC COMPONENTS

# Allen-Bradley hot-molded trimmers

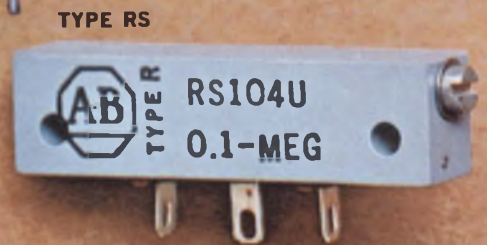
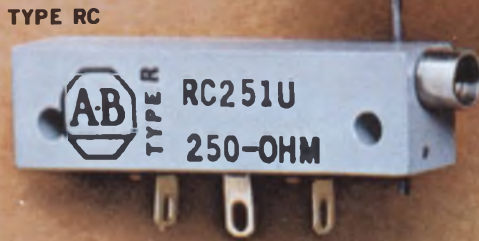
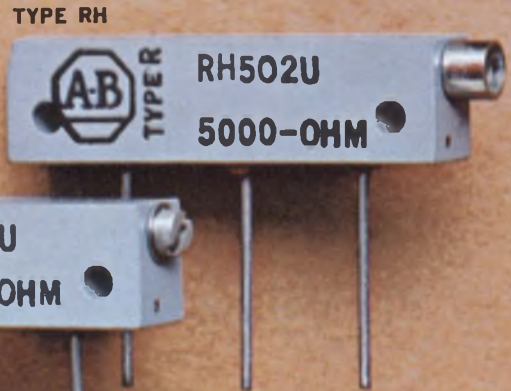
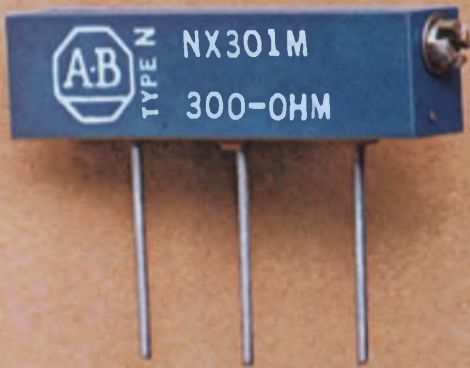
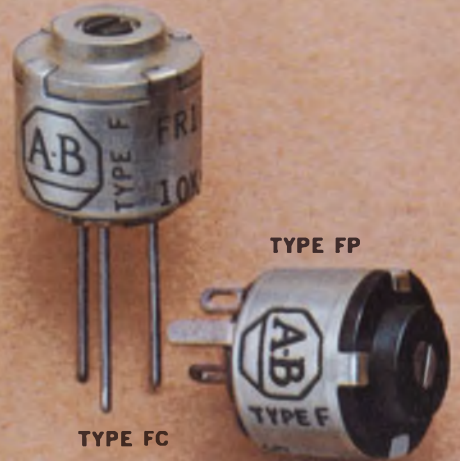

1167E-2

TYPE YH



TYPE YS

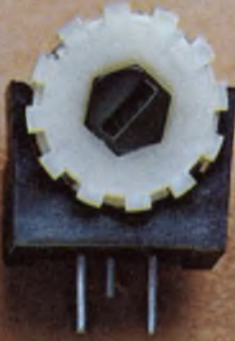

TYPE YR



TYPE YC



TYPE YN



## best in "set" ability... best in "hold" ability

This family of Allen-Bradley trimmers features a solid resistance track made by A-B's exclusive hot-molding technique. This solid resistance element assures smooth adjustment at all times. It approaches infinite resolution—there are never any of the abrupt changes in resistance which introduce transients as is characteristic of wirewound controls.

When Allen-Bradley hot-molded trimmers are once set, they will remain stable during severe

mechanical shock and vibration. In addition, A-B trimmers have low distributed capacitance and are essentially noninductive, permitting their use at high frequencies where wirewound units are totally useless.

For complete specifications on these high performance trimmers, please write: Allen-Bradley Co., 1344 S. Second St., Milwaukee, Wis. 53204. In Canada: Allen-Bradley Canada Ltd. Export Office: 630 Third Ave., N.Y., N.Y., U.S.A. 10017.



**Type R** trimmers are ruggedly built to maintain their settings under severe shock and vibration. Continuous resistance change is provided over 25 turns of the adjustment screw. Enclosures are dust-tight and watertight. Long operational life—accelerated tests produce less than 5% resistance change after 500 complete cycles (25,000 turns of the actuator). Rated  $\frac{1}{4}$  watt at 70°C, and can be applied in temperatures from  $-55^{\circ}\text{C}$  to  $+125^{\circ}\text{C}$ . Available in resistance values from 100 ohms to 2.5 megohms. Write for Technical Bulletin B5205.



**Type F** trimmers are single turn controls built to withstand severe environmental condition. They are  $\frac{1}{2}$ " in diameter and are rated  $\frac{1}{4}$  watt at 70°C. Can be used from  $-55^{\circ}\text{C}$  to  $+120^{\circ}\text{C}$ . Enclosure is nonmagnetic, corrosion-resistant, and watertight. Available in resistance values from 100 ohms to 5.0 megohms. Various tapers can be furnished. Send for Technical Bulletin B5201.



**Type N** trimmers are similar to the Type R units, and provide substantial economies where environmental conditions are not excessively severe. The 25-turn adjustment screw permits precise settings. The operational life is the same as the Type R. The enclosure is dust-tight and immersion-proof. The rating is  $\frac{1}{3}$  watt at 50°C and can operate in ambient temperatures from  $-55^{\circ}\text{C}$  to  $+100^{\circ}\text{C}$ . Available in resistance values from 100 ohms to 2.5 megohms. Please write for Technical Bulletin B5206.



**Type Y** trimmers are economical single-turn units designed for use where environmental conditions are not particularly severe. The low profile construction allows them to fit easily within the commonly used  $\frac{3}{8}$ " stacking. Options for the Type Y include thumb wheel and mount for horizontal installation. Type Y is also made with snap-in mount for panel mounting, as shown in drawing. Rated  $\frac{1}{4}$  watt at 70°C. Resistances from 100 ohms to 5.0 megohms. Please write for technical literature.



**ALLEN-BRADLEY**  
QUALITY ELECTRONIC COMPONENTS

ON READER-SERVICE CARD CIRCLE 54

# Test your IC IQ

## To what extent can passive components and functions be integrated onto a monolithic chip?

In monolithic design it is always desirable to simulate large-value capacitors with a combination of a small capacitor and a transistor, (Miller effect), which take up far less room. In MOS integrated circuits, almost all resistors are obtained by dc-biased MOS transistors with the gate tied to the drain. Large-value capacitors (above a few hundred picofarads) are outboarded; they take far too much area to be designed onto the chip economically. Inductors are still out of the question.

Some passive circuit functions, such as certain types of RC filters, can already be integrated. At frequencies near 1 GHz, stripline techniques can provide usable amounts of inductance for filters. The most workable arrangements for most applications, however, use thin- or thick-film passive components on substrates to which monolithic chips are bonded.

## How can a user ensure interchangeability between microcircuits made by different suppliers?

Unless the circuits are made with identical mask sets, similar starting materials and precisely the same processing sequence, there can be no guarantee of interchangeability. One of the major second-source problems facing the industry today is the absence of electrical interchangeability of all parameters that might affect the operation of a particular system. Many users have received circuits that meet the specifications set by other suppliers who use different layouts or fabrication techniques, only to find that these circuits will not work in their systems.

A particularly insidious example of this problem occurred when a supplier improved the performance of his circuits with modified layout and

improved material. Though the circuits were improved by the changes, these very changes led to instability and oscillation in certain applications. Even manufacturers' licensees make "identical" microcircuits that are far from interchangeable in some systems.

At present, then, there can be no substitution. Extensive tests and evaluation under a variety of environmental conditions must be conducted to ensure that integrated circuits made by different processing techniques will satisfy the requirements of a given system.

## Can the ultrasonic bonder wire chips as consistently as thermal-compressional binders?

Certain users get equally consistent results with ultrasonic and thermal-compressional bonders. The adjustment of the ultrasonic energy generator, however, is critical. Small variations in the height of posts and headers and in the posts' mass and moment of inertia can cause the inconsistencies implied by the question. The thermal-compression bonder requires a heated tip or substrate, but it is far less susceptible to these variations.

## Which are more reliable: flip-chip, thermal-compression, or ultrasonically bonded leads?

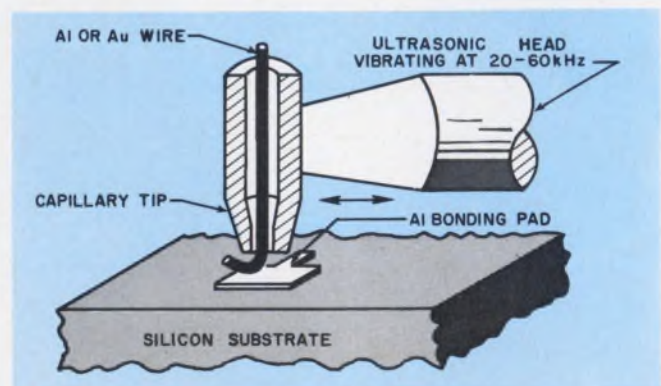

The ultrasonic bonding head moves the capillary tip back and forth, local heating due to friction makes the bond.

---

**Test your IC IQ** is a collaboration between the staff of ICE (Integrated Circuit Engineering Corp.) Phoenix, Ariz., and the editors of ELECTRONIC DESIGN. Readers are invited to submit questions to Test your IC IQ, Electronic Design Magazine, 850 Third Ave., New York, N.Y. 10022.

At the present time, there are insufficient data on the relative reliability of these three assembly techniques. On a theoretical basis, however, it seems that in the long-run flip-chip bonding techniques will prove more reliable than individual wire bonding.

To date, more than half the reported integrated-circuit failures have occurred with wire bonds. These failures occur in both gold and aluminum wire and in both the ultrasonic and thermal-compression bonding techniques. Aluminum wires bonded to aluminum pads have the problem of breaking through the thin tenacious aluminum oxide that forms on both surfaces. Ultrasonic scrubbing action usually prevents this, but variations in the ultrasonic energy transmission due to fluctuations in the thermal mass and the ultrasonic generator's pressure setting have occasionally produced inadequate bonds, which cause failures. On the other hand, gold wire connected to aluminum metalization has the potential problem of intermetallic compound formation. Given the name "purple plague," this problem is often overstated. The undesirable gold-aluminum intermetallic compounds do form at an accelerated rate at higher temperatures, but, if the assembly procedure can be accomplished without subjecting these bonds to high temperatures and so long as the circuits are not held at high temperatures for long periods of time, the problem is not extremely serious. Some of the intermetallic gold compounds are hard and brittle, or flaky; the latter can cause the leads eventually to fall off.

Flip-chip assembly eliminates the wires that are bonded one at a time and so may solve the reliability problem. Flip-chip-assembled systems, however, have not been long enough in the field to provide proof of this higher reliability.

**Why concentrate on such small integrated-circuit chips when the terminal connections are all spread out? Wouldn't bigger microcircuits be cheaper to test and easier to build?**

There are many reasons why it would be undesirable to spread out an integrated circuit and use a larger chip for a given circuit function, even though such an arrangement would be cheaper to test and assemble into its package. One of the basic economic rules of integrated-circuit processing is that the smaller the integrated-circuit die can be made for a given amount of electronics, the cheaper it is (within the limits of mask resolution). Thus, suppliers usually attempt to place the maximum possible amount of electronic circuitry on the smallest possible chip. The cost of the silicon die is approximately constant per unit of area.

As a matter of fact, the cost of additional components fabricated by the same process is meas-

ured only by the amount of additional area they occupy. This results in the unusual situation where high-frequency integrated circuits that use smaller sizes of resistors are cheaper to build than larger-size units that operate at a lower frequency. There is, however, no reason why a circuit capable of high-frequency operation cannot be used for intermediate and audio applications. By the same token, it is frequently desirable to replace one large component by a number of smaller components, for instance, a large-value capacitor might be replaced by a much smaller capacitor operated in combination with a transistor used as a capacitive multiplier. Also, to reduce the number of processing steps, certain types of components have been eliminated by use of a larger number of smaller components made by a less complicated process. One major supplier, for example, replaced a pair of capacitors by a combination of twelve transistors and improved his yield because the transistors were compatible with the process required for the remainder of the circuit. The elimination of the capacitors enabled him to employ a smaller die size and to eliminate one critical processing step in the fabrication procedure.

**Can one design pnp transistors on a chip that already has npns?**

One can, but it is impossible to optimize the characteristics of both in one processing sequence. To make both npn and pnp transistors requires either an additional p or n diffusion, which in turn, requires the previous diffusion to be rather light. With the standard npn process, pnps can be made with no additional process steps: the lateral pnp can be formed by placing two p regions near each other during the base diffusion; the substrate pnp can be formed between the p diffusion at the surface of the chip and the p substrate. These two methods produce relatively poor pnp transistors—the former has a  $\beta$  between 1 and 30; the latter between 0.01 and 10.

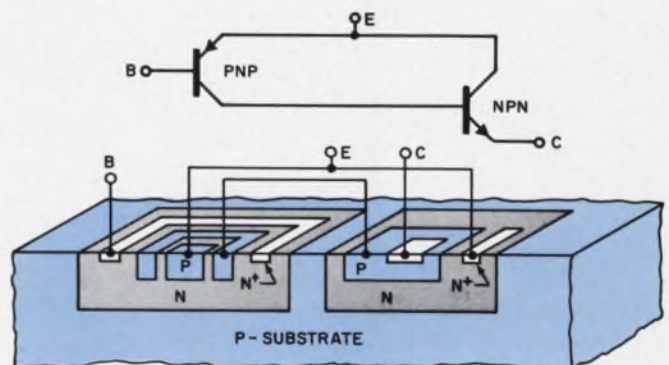

**The lateral pnp (left) almost inevitably has poorer gain than the npn transistor (right) in monolithic circuits.**



Company of Analog Engineers  
**NON-LINEAR SYSTEMS, INC.**  
DEL MAR, CALIFORNIA 92014  
[714] 755-1134/TWX: 910-322-1132

VALUE THROUGH INNOVATION

**It's worth waiting for!**



# Get in on the backlog!

## Solid State Multipurpose Digital Voltmeter with VTVM Capabilities

### FEATURES:

DC Volts: 10 Microvolts to 10,000 volts @ 100 Meg  $\Omega$  Input Impedance

AC Volts: 10 Millivolts to 300 Volts 20 Hz to 500 MHz

Ohms: 10 Milliohms to 200 Megohms

Current: 10 Pico amps to 200 Milliamps

Accuracy: .1%  $\pm$  1 digit

100% Over-range .05% Resolution

3 Readings per second most ranges

Floating Input

Unique Low, Medium, High Range Selector

Overload Indicator

Analog Output

Auxiliary Power Supply Output

Dual Ohms Protection

Automatic Polarity

Polarity Indication

Display Storage

Optional Adjustable 20 volts, 150 ma regulated plug-in supply

Quantity	Price
1- 9	\$695.00 (including probes)
10- 24	675.00
25- 49	635.00
50- 99	615.00
100-250	595.00
250 and above,	consult factory

F.O.B. your plant



The NLS X-3 is the first digitally indicating multifunction instrument designed to fill those requirements where .005% and .01% accuracies are not required. The X-3 eliminates the operator training required by inaccurate, difficult-to-read moving pointer meter displays.

Parallax is completely eliminated; the unique Hi-Lo-Medium range switch makes the X-3 a pleasure to use; especially in production line testing.

All the features in the X-3 are standard, includ-

ing the probes. A unique and long awaited innovation in the X-3 is PS-1 Power Supply Option. The Standard X-3 provides a filtered 40 volt, 200 ma power supply. When the PS-1 is used, it directly plugs into the front panel terminals on the X-3. Now, besides having the measuring capabilities provided by the X-3, you have an adjustable, regulated 0-20 volt, 150 milliamperere supply. By simply turning a switch on the supply, you can monitor both supply voltage and supply current and still use all the measuring capability of the X-3.

circle # 148 for immediate action

## Money is not the only motivator.

There are personal satisfactions that every engineer must get at work, and the wise manager makes them available.

If you think that money is the only incentive that motivates people to do a good job, your career as a manager is not likely to be successful. Money is a strong motivator, but it's only the beginning.

When an engineer doesn't work to his peak performance, it is because he isn't motivated to do so. He has no incentive to do his best—no matter how generous your company's salary policy may be.

Practical motivating incentives help people to satisfy their basic social, psychological and self-fulfillment needs. And such incentives are things that you, the manager, have control over.

Nonmonetary incentives get people ego-involved in their jobs and are the cornerstone of a positive approach to managing engineers.

These incentives represent nothing new or different; the challenge lies in adapting them to your managerial policies and then putting them to use on a consistent basis.

It's significant that these incentives were drawn up by men from all levels of management, not by a group of psychologists.

### Inform him where he fits in

If an engineer doesn't know where he and his department "fit in," he can't have any sense of importance or identification. If a maximum contribution is to be made, everyone must have a clear picture of what the department's objectives are and how these objectives relate to the rest of the company.

*Involve your engineers actively in the determination of departmental objectives, as well as in tying these goals to over-all company progress. This process of involvement creates a sense of identification in the individual.*

Another successful practice is to let the engineer coordinate the job or project on which he is working with other departments, such as production or sales. In this way, he is exposed to the rest of the organization, and his job takes on significantly

more practical meaning. In turn, you, the manager, can devote more effort to coaching, counseling, coordinating and over-all controlling, rather than to doing the detailed work.

### Explain why his job is important

Closely related to, and an extension of, this point is the need to emphasize the importance of the job. Every engineer should have a clear picture of exactly *what will happen if his job is not done adequately.*

The engineer should know why the project is being undertaken, the relationship of the project to potential sales and other projects, and the specific conditions that led to its inclusion in the work schedule.

Managers should take the engineer beyond the simply physical accomplishment of his work and show him how and why his job is vital to the total company operation, especially succeeding operations.

Emphasize the problems that will arise if the job is done wrong or is late, and let the engineer meet some of the coworkers who are depending on his performance.

### Let him know what is expected

People will generally perform at the level demanded of them only if it is within reason. Unless you have clearly outlined *what you expect and the specific standards by which performance will be judged,* you cannot reasonably expect any more than you get. Letting them know explicitly gives them something to work for. It gives direction to their efforts and they can see tangible results in terms of accomplishment.

Managers, who take the time to sit down with their engineers, reach a common agreement on the key elements of the job and set specific performance standards for each element, get significantly im-

---

Dr. Burt Scanlan, Associate Professor, University of Wisconsin Management Institute, Madison, Wis.

David Westermann, president of Hazeltine Corp., Little Neck, N.Y., discusses technology-based corporate strategy with his engineers and engineering managers.



LEVERAGE STRATEGY		
EFFORT & COMPANY CASH APPLIED	PRODUCTS & CASH RETURN	
COMPANY FUNDED R&D FOR PRODUCT DEVELOPMENT	GOVERNMENT FUNDED R & D	PRODUCTS FOR HC MFG & MKTG
COMPANY FUNDED PROPOSALS AND R&D IN ANTICIPATION OF GOVERNMENT FUNDING	LIMITS CO. - COST - RISK	NET PROFIT & THEREFORE GROWTH
	INCIDENTAL PROFIT OPPORTUNITY	



*"Involve your engineers actively in determining goals and objectives."*

proved results. In fact, when engineers are actively involved in this process, they often will set standards higher than you will.

It is not uncommon for an engineer to spend considerable time and effort to complete a project, only to find that the results don't coincide with what his boss had in mind. The supervisor, another engineer or the man himself starts backtracking. Additions, subtractions, rework and revisions are needed to get the effort into the desired shape. The outcome then is wasted time, duplication of effort, strained relations, frustration and, perhaps most unfortunate, a demoralizing effect on the engineer who did the work.

Usually all this could have been avoided if the manager had only looked before he leaped — if he had initially determined specifically what results he was looking for and outlined and discussed these with the engineer before he began, not after the job was done.

### Offer the engineer a challenge

Not only do people generally perform at the level demanded of them, but they also respond more

favorably when there is a real challenge. One of the strongest needs people have is a *sense of achievement*. If there is no challenge, this need cannot be satisfied.

Make the challenge reasonable and have it represent attainable goals. When, as a manager, you set goals for your staff that are far above what can reasonably be accomplished and beyond what you really expect, there are severe long-range repercussions:

- Staff members become frustrated, because they can never reach the goals.
- There is no sense of achievement.
- Employees are constantly on the defensive, trying to justify their unrealistic performance levels.
- Padding of budgets, schedules, etc., takes place.
- The superior-subordinate relationship breaks down in antagonism.

A manager should pause periodically to analyze the strength of his staff. Review the work of each man and ask the questions: "Am I using his talents fully? Does he have something to work for, something to stimulate his mind?"

Too often managers view the challenge for their staff members solely in terms of how much work each man can do in a physical sense. What is needed is work that stretches the mind, that leads to new learning, new growth and development on the job. When the work of an engineer becomes boring and routine, motivation disappears. A formal program, with the objective of progressively moving professional people up to higher levels of work as they exhibit the required abilities, can go a long way toward motivating these people.

### Tell him where he stands

How many times have you heard a manager complain about an engineer's performance, only to learn that not only has the manager never let the engineer know what was expected of him but also never informed him of his progress on the job? The idea behind this incentive goes back to the basic philosophy that, if given the opportunity, most people want to work and do a good job. If they don't know where they stand or if they find out only after the situation has deteriorated substantially, the manager cannot expect improvement. *The relationship between the manager and the engineer must be a continuing one in terms of what is being accomplished.*

When problems arise in this area, the cause may well be that the manager has not done a good job of defining key areas of accountability, establishing meaningful measures of performance, setting objectives and standards, and evaluating people on



'Where do I fit in?' Every engineer should know where he and his department fit into the total company.



Give bouquets for a good job. Engineers, like everyone else, like to receive praise for a job well done.

the basis of results achieved.

These performance measures can be established for any job, either by a specific yardstick or a series of statements that describe the conditions that will exist when a given phase of the work is done adequately.

### Delegate authority, responsibility

Every manager should consciously assess both his own and the department's activities with this question in mind: "What jobs am I doing and what decisions am I making that might just as well be done by one of my engineers?" The result could be to relieve the manager of some activities and decisions while, at the same time, to make a subordinate's work more meaningful.

Another point: When subordinates come to you with questions or problems, it might be advantageous to get their ideas on how to handle the situation. This shows respect for the subordinates' judgment, fosters their initiative and confidence and makes them feel more important. Instead, many managers are prone to express "their ways" and never give the subordinate a chance to express his views.



The written word is powerful. A letter of praise in an engineer's personnel folder is a strong motivator.

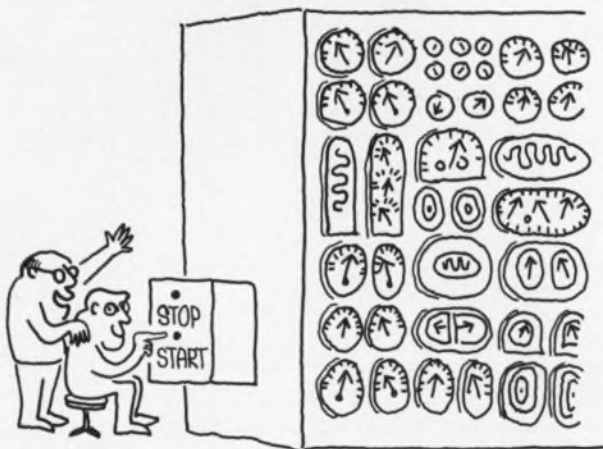

Every job is important. A wise manager ensures that every engineer knows why his specific job is important.

Make a commitment to give your staff members freedom to work in their own ways toward agreed-on goals. By doing this, you'll achieve a higher level of departmental achievement, higher morale and a less hectic schedule for yourself.

Delegation of authority can be destroyed by always detailing the "how to" or by overcontrolling on a day-to-day basis. The man who usually knows a job best is the one who does it every day. He is more sensitive to the problems that hinder accomplishment and is more likely to have ideas and suggestions on how to overcome them.

### Give credit where credit's due

How often have you taken stock at the end of the day or a week and asked yourself: "Who in the department did a particularly good job or accomplished something that deserves a pat on the back?"

*Good performance happens more often than you realize.* Too often the manager is vocal when things go wrong or when he exerts pressure to get results, but never acknowledges the achievements of the department and the individuals who contributed to them. A positive approach in a sincere and meaningful climate tends to beget positive results. When you accentuate the positive rather than the negative, the chances are that your engineers will follow the example.

Sometimes it means giving credit in the form of written recognition. Often there is a need to formalize credit in this manner, because it means much more to the individual being praised.

A recent company study of the personnel folders of 3974 employees revealed that there were 3241 cases of written memos of discipline and warning compared with only 338 cases of written recognition in a four-year period. This imbalance exists in a great many companies.

The written word is a powerful motivator when used properly. It can be the little extra that makes the difference.

### Show a personal interest in him

Somewhere along the line, the manager has to establish a personal relationship with his staff members that goes beyond the purely technical or job relationship.

This does not necessarily mean socializing with them. Rather it means that, if you are going to get maximum performance from your people, you must relate to them as individuals in a sincere way. You must develop a genuine interest in them in terms of things that are important to them.

Most of us have had the experience of meeting someone for the first time and walking away with a very favorable impression. In analyzing why that person impressed us, we very often find it was because he showed sincere and keen interest in us.



**Offer him a challenge.** Give the engineer an opportunity to put his abilities to work on a challenging assignment.

In short, our ego received a boost. Engineers are no different.

When an employee feels that his boss is sincerely interested in him, his problems, his future and his wellbeing, he is more likely to be a high producer. Every manager should ask himself: "How much time do I spend interacting with and giving support to my subordinates, so they can conceive to their highest level of capability?"

Support means helping your subordinates overcome problems that hinder accomplishment, working to diminish interdepartmental barriers and coaching and counseling your engineers.

#### **Allow your engineer to participate**

Participation plays a large part in gaining commitment. When people participate, *they become mentally and emotionally, as well as physically, involved.* Their role is active rather than just passive. Participation involves actively seeking the ideas and suggestions of people, encouraging them to voice their opinions and to get involved, and allowing them to contribute with their minds as well as their skills. Here again, it is worthwhile to ask if there are areas of your operation where it would be possible for employees to take a more active role.

A manager can take a problem to his staff, seek their ideas and suggestions, and come up with a list of specific actions that could be taken. Such lists often contain suggestions that the manager was oblivious of.

#### **Bridge the communications gap**

Failure to communicate is one of the most frequently cited complaints that subordinates have of their bosses. And the problem may not be a lack of knowledge of how to communicate effectively;

rather it may be one of not *realizing the importance of communication and how people feel when communication is lacking.*

A useful experiment in communications is to sit down with a group of your peers and build a list of all types of information that your staff absolutely must know to do their jobs. After listing from 5 to 10 points of information, each man evaluates himself on how effectively he is communicating these essentials to his staff. Some managers have their subordinates do the evaluation and, by so doing, add to the list areas that the manager may have overlooked. A similar procedure can be used to identify the types of information people would like to know.

#### **Provide opportunity for growth**

A man is never fully satisfied until he is working toward or has reached that level of the job that is consistent with his ability. What a man can be, he must be. This self-fulfillment need is strong and can be satisfied only when the employee is provided with the opportunity to grow. If these opportunities are not forthcoming in his present job, he will most certainly look elsewhere.

Potential for growth is a very important consideration in engineering. There is a big need for companies to examine and classify the engineering work that they are doing. This work must be categorized according to degrees of difficulty, challenge and abilities required. After this is done, a program of continual personnel evaluation must be established, to identify the engineers who have met the requirements and are ready to move to the next level of work. A formal program for the growth and development of the professional engineer must be established. ■ ■

*There is another side to the "motivation coin," that of motivating your superiors. This will be the subject of an article in ED 2.*

#### **Test your retention**

*Here are questions based on the main points of this article. They are to help you see if you have overlooked any important ideas. You'll find the answers in the article.*

1. *Why is it important for the engineer to know exactly where he and his department fit into the total company structure and how important their functions are?*
2. *What are the dangers of setting unrealistic and unattainable goals for your engineers?*
3. *Are effective communications and participation between engineer and manager necessary in providing each of the incentives?*

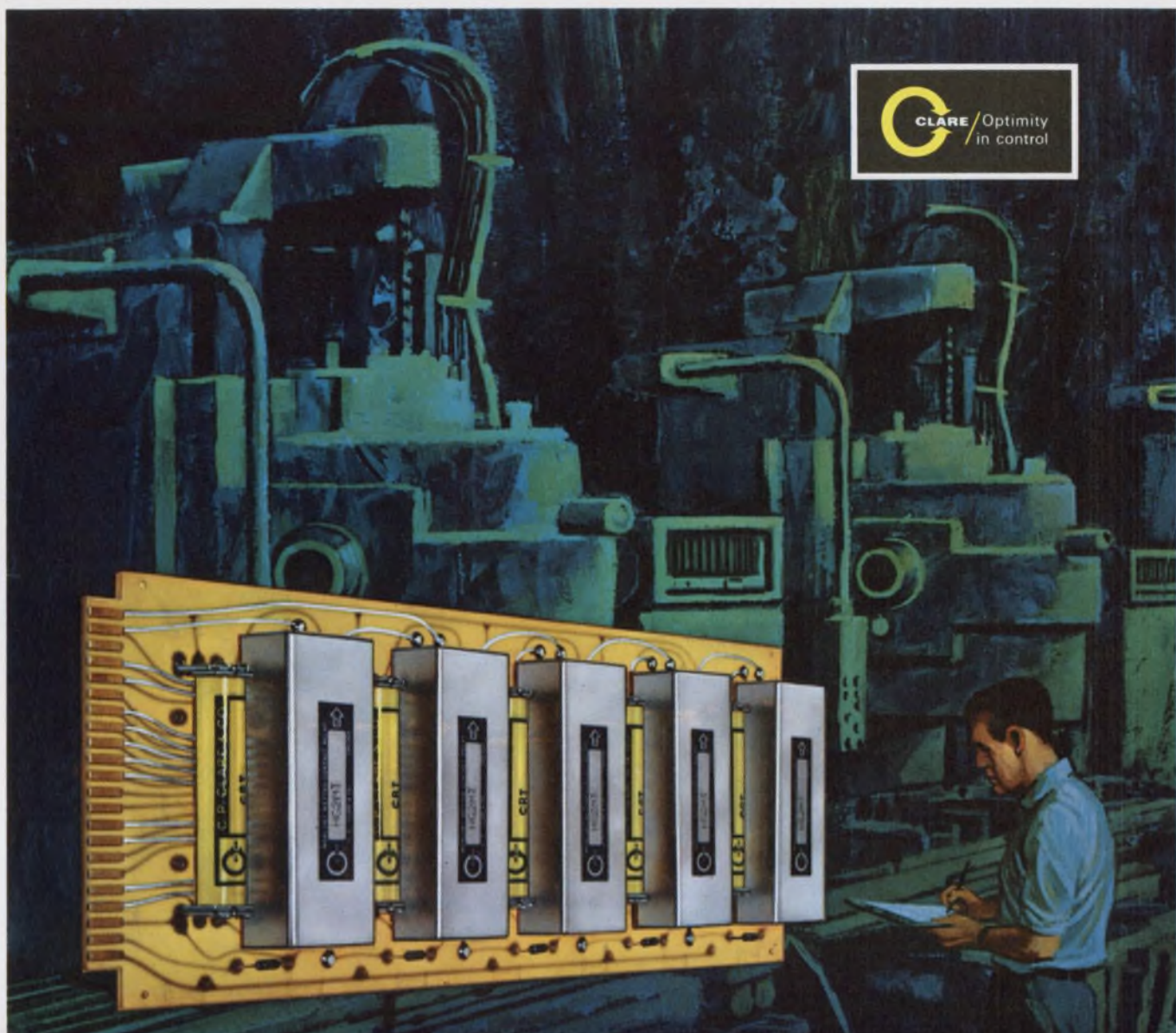

# In industrial process systems Clare puts you in control

In any sector of industrial/electronic applications, Clare capability can put you in control. In cost-conscious industrial process control, or high-speed data processing systems. In demanding communications networks, or instruments of utmost accuracy. In aerospace or ground support systems, where perfection is expected—and delivered.

Everywhere contact switching can optimize control systems—wherever long life, high reliability, advanced capability, and maximum economy are needed—let Clare put you in control.



C. P. Clare & Co.—worldwide.

a GENERAL INSTRUMENT company

Clare contact switching... for optimity in

Industrial Process Control   Electronic Data Processing   Aerospace and Ground Support   Communications   Instrumentation



*"The secret of success in life...  
is for a man to be ready for  
his opportunity when it comes." — Disraeli.*

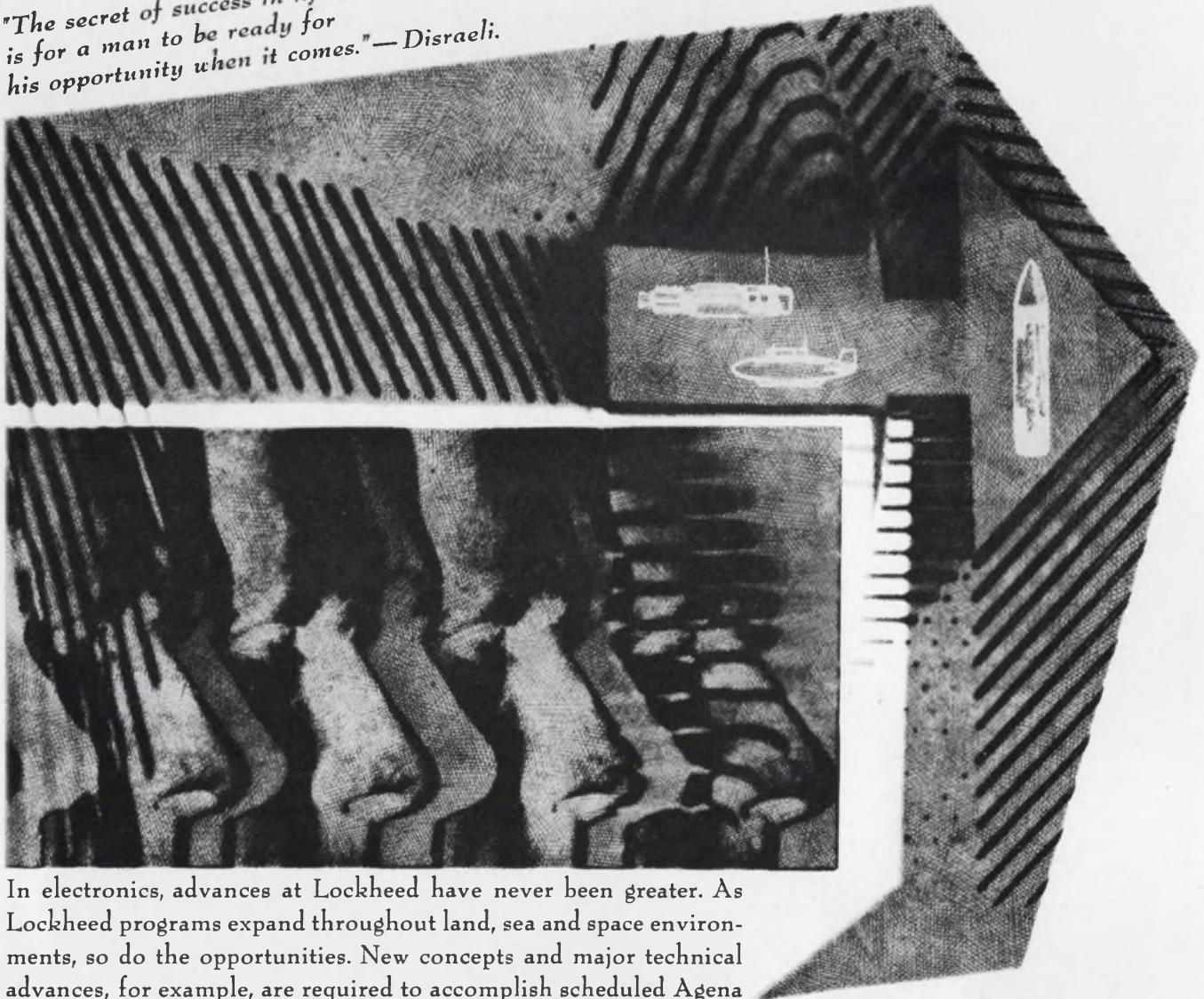

In electronics, advances at Lockheed have never been greater. As Lockheed programs expand throughout land, sea and space environments, so do the opportunities. New concepts and major technical advances, for example, are required to accomplish scheduled Agena flights in years to come—new approaches in digital communication systems for data transmission and command, optical and infrared sensors, solar power panels, power conditioning, digital and analog flight control systems. The number one deterrent force of the future—the Poseidon fleet ballistic missile—requires advances in postulation, establishing requirements, integration, design and use of electronics test and checkout equipment. While on land, advanced vehicle systems and hospital information systems pose unique problems. Undersea, Lockheed offers programs like the Deep Submergence Rescue Vehicle and ocean mining with fresh opportunities in such areas as undersea instrumentation. For more information, write Mr. R. C. Birdsall, P.O. Box 504, Sunnyvale, California 94088. Lockheed is an equal opportunity employer.

**LOCKHEED**  
**MISSILES & SPACE COMPANY**  
A GROUP DIVISION OF LOCKHEED AIRCRAFT CORPORATION

# PROJECT LEADERS

(present & future):

---

## Look at your capabilities. Then look at ours. As a catalyst.

A catalyst in terms of significant projects, with important contributions yet to be made. A catalyst in terms of environment, with solid technological competence in a wide variety of areas, both to draw upon and to grow into. And, equally important, a catalyst in terms of your future development with an in-writing 'people development' plan that charges each supervisor with developing his own replacement before he moves up the ladder.

### Anti-Submarine Warfare Laboratory

ASW activities are concentrated in three separate departments: Hydroacoustics, Electroacoustics, and Special Development—each with its own technical facilities and staff. Among the newest and most intriguing programs you might work on are the advanced marker/launcher system for USW; an advanced integrated sonar system for surface ships, and the use of special hydroacoustics sources for deep submergence sonar. Special facilities support these projects in design and testing: a fully instrumented, 48-ft. diameter sonar tank; a nearby lake—600-ft. deep and ice-free; and a completely instrumented, 165-ft. self-propelled barge capable of testing transducers weighing up to 35 tons.

### Data Communications Laboratory

Data Communications is currently designing at the state-of-the-art in hardware and systems for digital communications equipment. Two strong areas of current R&D interest are (1) the application of modulation and coding theory to data communications for transmission via many different media (2) development of frequency—differential signaling for high-speed data transmission in the high frequency band, studies of propagation and polarization phenomena at high frequency, and frequency measurement in the microwave band. The subscriber terminal equipment for AUTODIN, a world-wide digital communication network, is just one of the current programs in the data lab.

### Communications & Avionics Laboratory

The RF Group is involved in ground and air communications hardware and systems. Their interest involves all frequencies ranging from HF through UHF. Included are secure communications pack sets, receiver design utilizing micro min techniques, and advance communication systems integrating black box design and techniques into mobile or shelter installations. Currently avionics design work is being concentrated on the micro min of the F106

TACAN. This involves complex design utilizing the state-of-the-art in integrated circuits and solid state devices.

### Aerospace Ground Equipment Laboratory

The F-111 places heavy demands on an AGE engineer. This most complex and advanced combat aircraft in the U.S. arsenal must be tested with even more complex simulation equipment in order to test the diversified types of the F-111 for its various missions and their respective avionics. The magnitude of the systems and design problems to be encountered are illustrated by the following intricacies of this ground support equipment: It's a highly automated test and fault-location system which includes a video station, radar receiver/transmitter modulation station, indicator/controls station, central air data computer station, radar servo and indicator station, UHF—HF and TACAN stations, HF flightline tester, IR digital station—each sophisticated enough to test the state-of-the-art. And to create responsible positions in engineering and management within this laboratory.

### Microelectronics Application Laboratory

This technical service laboratory is now in its embryo stages of development. Its purpose will be to provide the above product labs with the most advanced designs in micro min techniques for the development of their individual needs. This task involves a close partnership with the product development laboratory, aiding in the design of circuits and utilizing thin and thick film techniques. At present positions are available at both Junior and Senior salary levels for those who have experience in circuit design using integrated circuits and/or the actual design of ICS and micro-miniaturization techniques.

### Your Opportunities:

If you have background/interest in one or more of the above areas, we'd like to tell you more about the year-round creative climate we offer. Send a resume to Mr. J. P. O'Reilly, Dept. 147.

## **GENERAL DYNAMICS**

### *Electronics Division*

1400 N. Goodman St., Rochester, N.Y. 14601 *An Equal Opportunity Employer (M&F)*

# Whatever your specialty, chances are TI has the opening.



Now all we need  
is your name.

We'll shoot the photo later. So just send us your name on the coupon.

Add anything you want about yourself.

Things like what your degree is. What you've been doing for the past two to five years. What you'd like to be doing for the next five or ten.

The adjoining column lists some of our current openings.

We can assure you of this.

*Whatever* your specialty, chances are we have an important job. Important to the company. Important to you as an individual. And when you look at our growth record, plus what we have planned for the future, you'll see why.

Since World War II, TI has grown 200-fold to a \$580-million annual billings level. Our present growth

goal is to reach \$3-billion in annual sales in the next decade.

Even though TI is a big, diversified company, with plans to get bigger, you won't get lost here.

One of the things that management is accomplishing is that you retain your individuality and can relate your own personal goals to those of the company.

How we achieve this retention of individuality is told in a comprehensive brochure. It's yours by return mail for the asking.

It gives you a look at what we do. It shows why we can offer you meaningful growth opportunities in a wide range of disciplines.

Don't be surprised to find that we have an opening with your name on it.

Tom Dudley  
P. O. Box 5474  
Dallas, Texas 75222

E.D.

Please send me the story of TI.

Name \_\_\_\_\_

Address \_\_\_\_\_

City \_\_\_\_\_

State \_\_\_\_\_ Zip \_\_\_\_\_

My degree is: \_\_\_\_\_

My area of interest is: \_\_\_\_\_



An Equal  
Opportunity Employer

**TEXAS INSTRUMENTS**  
INCORPORATED

ON READER-SERVICE CARD CIRCLE 892



# TI openings

**SYSTEMS ENGINEER**  
Specifications and customer liaison for cryogenic cooler test equipment. BSME, EE, or Physics.

**QA ENGINEER**  
Develop and implement QA disciplines. BS plus experience in quality engineering or design.

**CHEMICAL ENGINEER**  
Control quality and process of chemical handling facility. BS plus related experience.

**COMPUTER ANALYST**  
Experience in systems analysis, programming, diagnostic programming of monitors and arithmetic routines.

**MECHANICAL ENGINEER**  
Design hydraulic test equipment. BSME plus experience in aircraft hydraulic design.

**DESIGN ENGINEER**  
Engineer design and packaging for power sources. BSEE plus 3-5 years' design on low frequency power supplies.

**MANAGEMENT SYSTEMS MANAGER**  
Direct implementation of advanced management information system. Broad operating and supervisory experience.

**ELECTRICAL ENGINEER**  
Design circuits for space instrumentation. MS plus 1-5 years' experience.

**TEST ENGINEER**  
Build radar systems. Experience in pulse compression and phased array.

**PATENT ATTORNEY**  
LLB plus BSEE, Physics or Chemical Engineering. 3-5 years' electronic experience.

**MARKETING ENGINEER**  
Manage marketing for product line. BSEE or equivalent technical marketing experience.

**COMPUTING SYSTEM ANALYST**  
Design and execute programs for IBM 7074, 1401, 1440, 1460 and 360. BS plus 2-4 years' experience.

**ELECTRICAL ENGINEER**  
Design and develop proximity fuse circuits and special test equipment. BS or MSEE plus 5 years' experience.

**TECHNICAL WRITER**  
Write and edit technical manuals and reports. Coordinate print production. BSEE or Physics, plus 3-5 years' experience.

**LOGISTICS ENGINEER**  
Prepare data relative to TI equipments. BA plus 3 years' logistics or related experience.

**R&E ADMINISTRATOR**  
Help administer cost control, reporting, plans, and implementation of projects. Business and technical background.

**WRITE FOR COMPLETE LIST OF CURRENT OPENINGS**

An Equal Opportunity Employer



**TEXAS INSTRUMENTS**  
INCORPORATED

## Book Reviews

Theory and  
Applications  
of

### HOLOGRAPHY

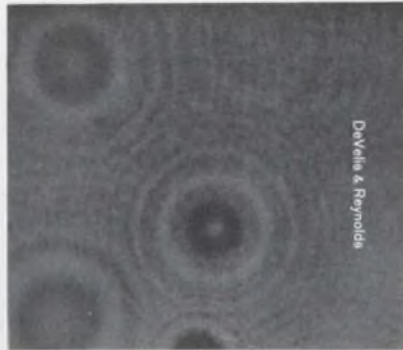

#### Holography

*Theory and Applications of Holography*, John B. DeVelis and George O. Reynolds (Addison-Wesley Publishing Co., Reading, Mass.), 196 pp. \$12.95

The major purpose of this monograph is to develop a unified treatment of holography. The first two chapters will serve less mathematically inclined readers. A more rigorous mathematical analysis is also included, to emphasize the nature of the general hologram process as a problem in the classical theory of partial coherence. The pertinent properties of each system are discussed in detail. Many of the experimental results presented here were made available specifically for this book. The final chapter considers such present-day applications as holographic microscopy, data storage and processing and optical computing.

CIRCLE NO. 251

#### Humor handbook

*The Modern Handbook of Humor*, Ralph L. Woods (ed.) (McGraw-Hill, New York), 618 pp. \$8.95.

This handy thesaurus of humor is specifically designed for professional people called on to deliver or prepare public addresses. With more than 6000 entries, it contains the "right" one for almost any situation. It is well indexed.

CIRCLE NO. 252

# Lockheed's electronics engineers have a lot of fingers in the...



*It figures. The scope of production, development and study programs now under way at Lockheed-California range from "A" (ASW)...to "V" (V/STOL); with many stops in between, such as Military Rotary Wing Aircraft; Commercial Aircraft; Fighter/Bombers and Hypersonic Aircraft. They all have one thing in common: sophisticated electronic systems...and you can help to provide them.*

*The variety of projects at Lockheed have created openings for Electronics Engineers in the areas of Sensors; Data Processing; Navigation; Communications; Armament and Electrical Installation. □ If you're an electronics engineer equally at home with a formula or an idea...look into Lockheed-California. Send your resume to Mr. E. W. Des Lauriers, Professional Placement Manager, Department 1308 2402 North Hollywood Way, Burbank, California 91503. Lockheed is an equal opportunity employer.*

## LOCKHEED- CALIFORNIA COMPANY

A group division of  
Lockheed Aircraft Corporation

ON READER-SERVICE CARD CIRCLE 893

## Wide-band optical modulator requires only 10-W drive power

**Problem:** Develop an optical modulation system capable of operation over a 100-MHz video bandwidth with less than 10-watt modulator drive power. Previously up to 500 volts rms and 270 watts were required for operation over a video bandwidth of only 50 MHz.

**Solution:** An optical modulation system, consisting of an optical modulator and transistorized driver, that combines small cross-section potassium dideuterium phosphate crystals with laser beam-condensing optics.

A laser beam condenser is used at the modulator input to reduce and collimate the beam. The modulator cell employs equal-length crystals on each side of a half-wave plate with their optical axes opposite in sense, to balance the natural birefringence of the electro-optic element that is a function of temperature. When a voltage is applied across the cell, generating an  $E$  field along the optical ( $Z$ ) axis of the crystals, a phase retardation is imparted to the  $X$  component of a light beam propagating along the  $Y$  axis. The result of the retardation imparted to the  $X$  component of the light beam is a conversion of linearly polarized input light to an elliptically

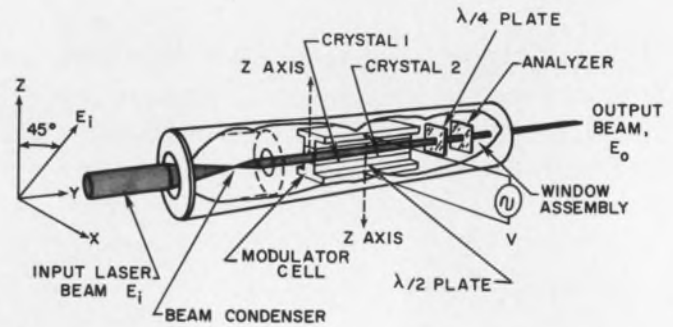

polarized output. The analyzer in the output window converts the polarization-modulated beam to intensity modulation. The quarter-wave plate biases the system to align the peak modulated-polarization vector with the analyzer axis, eliminating the need for a dc bias component in the applied modulation voltage.

Complete details are contained in: *Wide-Band High-Efficiency Optical Modulator*, by W. J. Rattman, B. K. Yap, and W. E. Becknell, Final Report, 15 Feb. 1966 to 15 March 1967, Sylvania Electronic Systems, Waltham, Mass. Copies are available from: Technology Utilization Officer, Marshall Space Flight Center, Huntsville, Ala. 35812. Reference B67-10289.

Inquiries about obtaining rights for the commercial use of this invention may be made to NASA, Code GP, Washington, D.C. 20546.

## You might be better off working in a small company you never heard of, than working in a big company that never heard of you.

And Loral Electronic Systems is a small company, compared to some of the more familiar giants in the electronics field.

But we have the same facilities as the giants. On a smaller scale: We have a modern, technologically-up-to-date plant in the East Bronx, New York.

And an engineering staff of only 300, leaves you plenty of growing room. With less wasted time and red tape.

We're a state-of-the-art company. And work on things like: electronic counter measures, reconnaissance, navigation, information and display systems.

And we're looking for engineers in the following disciplines who would like to grow with us:

**ELECTRONIC SYSTEMS:** Microwave & Phased Array Antennas; Electronic Warfare—ECM; Reconnaissance; Electro-Optics.

**ELECTRONIC DESIGN:** IF Hardware & Circuitry; Digital-Special Purpose Computers; Video Control Circuitry; Microwave Receivers; Display Circuitry; Test Equipment—RF & Pulse.

**MECHANICAL:** Project; Board Design—Black Box.

**OTHER:** Technical Writing—RF Microwave; Test Engineering—Digital & Logic; Test Engineering—Procedures; Reliability—Component Evaluation; Engineering Program Estimating; Engineering Administration.

We also have openings for electrical engineer graduates with one or two years' experience.

Send your résumé to Mr. John Means, Department D. Loral Electronic Systems, 825 Bronx River Avenue, Bronx, New York 10472.

And we'll continue to grow. Together.

### Loral Electronic Systems

A Division of Loral Corporation. An Equal Opportunity Employer.

ON READER-SERVICE CARD CIRCLE 894

No need! Nearly twenty years of flight time on aircraft from the B-29 to the C-5A have proven the dependability of wiring insulated with TEFLON fluorocarbon resins. Lab tests are O.K.; we've got hundreds on record, but nothing tops the proof of use . . . and TEFLON has the proof

of millions of flying hours in scores of aircraft.

Ask for our brochure explaining in detail why there are no test flights for TEFLON. It may help you eliminate one unnecessary variable from *your* next test flight. Write Du Pont Company, Room 5617E, Wilmington, Delaware 19898.

\*Reg. U.S. Pat. Off. for Du Pont fluorocarbon resins and films.

**There are no test flights for Teflon\***



Better things for better living  
... through chemistry

TEFLON... the proven performer

## Logic controls measurements

**Problem:** Devise an average and reject system that provides an average of the output signals of up to ten transducers measuring such critical parameters as temperature and pressure.

**Solution:** A circuit that compares each signal against an average, rejects any signal that departs significantly from the average, and supplies an average of the acceptable signals.

The system is a 0-10-volt system employing ten input channels. Two averaging amplifiers operate redundantly to average the channel inputs and feed the resultant signal into ten channel-reject networks. Each channel-reject network compares its signal with the average signal. If the channel output varies by a predetermined amount from the

average, the channel-reject network generates a reject signal that disconnects this channel from the circuit. It is also possible to reject any channel manually. The selected outputs of the individual reject networks are then fed into a "total reject network" where they are compared against a manually selected limit. When the number of channels rejected is equal to the manually selected limit, a lock-down signal is generated to prevent automatically the rejection of any additional channels. Visual indication can be provided to show the number of channels rejected before lock-down.

The output of each averaging amplifier is fed to an "average reject network" for comparison with the highest signal coming from the ten channels. If the output of either averaging amplifier exceeds the value of the highest

signal, then the network disconnects that amplifier from the load by turning off the transistor in series with it. An indicator light is activated to show that the amplifier is disconnected.

*Inquiries concerning this innovation may be directed to: Technology Utilization Officer, AEC-NASA Space Nuclear Propulsion Office, U.S. Atomic Energy Commission, Washington, D.C. 20545 Reference B67-10262.*

## Subroutines simplify plotter operation

**Problem:** To devise an easy means of plotting data on a CALCOMP 566 digital incremental plotter. To provide the plotter with instructions for graphically displaying data points with the proper scaling of axes, numbering, lettering, tic marking, is often time consuming.

**Solution:** Fortran language subroutines that make possible the production of a tape for a 360-30 tape unit that controls the CALCOMP plotter.

During execution of a Fortran IV program, the subroutines are called on when it is desired to construct a plot tape. The plot tape is physically removed from the computer and placed on the 360-30 tape unit driving the plotter.

GEORGE is a Fortran IV subroutine that checks, supplies, or calculates graph dimensions, and then calls DRASTC, another subroutine, to draw, scale, tic-mark, and number the axes. GEORGE also labels the axes, titles the graph, and plots the data array providing a complete graphic display.

The subroutines are programmed in Fortran IV for the IBM 7094 computer, but with minor adjustments will operate on other computers.

*Inquiries concerning this program may be directed to: COSMIC Computer Center, University of Georgia, Athens, Ga. 30601. Reference: B67-10222.*

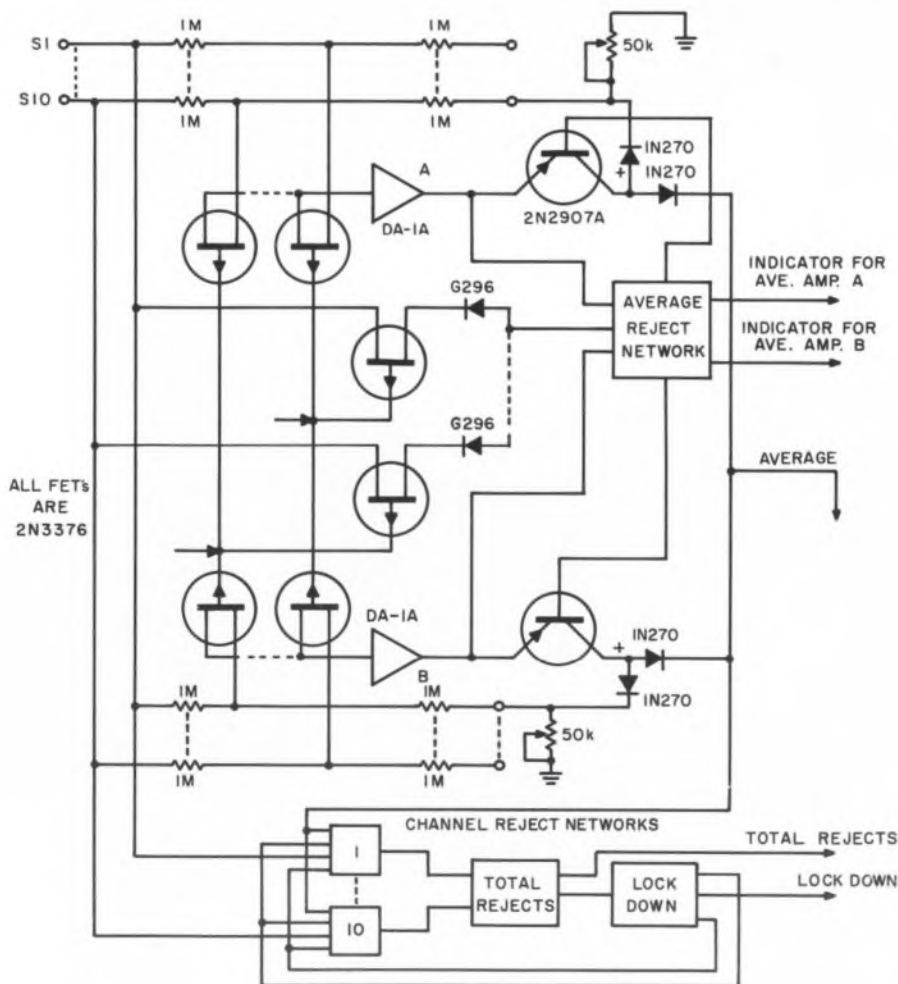

# Move With Advanced Computer Technology At NCR Electronics Division

## SYSTEMS FORMULATION

Analysis and development of advanced systems specifications; consultation on systems design, hardware configuration, software trade-offs; analysis of competitive systems. Applicant should have familiarity with very high speed memories, large-scale integration, disc files, drum files, communications and time sharing plus related BS degree and 3 to 5 years' experience in one or more areas mentioned.

## SOFTWARE SYSTEMS

Programmers to develop executive and operating systems for third-generation computer systems. Desire experience with medium- and large-scale general-purpose systems employing high speed peripheral units, tapes, random-access files, disc files, drum files, on-line, time sharing and multi-programming. Requires related BS degree and 3 to 5 years' directly related experience. Positions also open for hardware-oriented programmers to do systems diagnostic work.

## EDP ANALYST/PROGRAMMERS

Analyst position entails systems analysis in financial and administrative areas. One year of EDP experience required, degree desirable. Programming positions involve accounting and manufacturing systems. Degree and recent experience on medium- to large-scale systems desired.

## OPTICAL SYSTEMS

To do computer-aided design of specific elements in complex optical systems, such as field and condenser, as well as image-forming elements.

Activity includes optical-electronic lab work, systems layout and design, technical liaison. Involves geometrical and physical optics. Requires BS in physics or optics plus 2-5 years' directly related experience.

## MEMORIES RESEARCH

To design high-speed magnetic memory circuits. Requires knowledge of nanosecond pulse techniques and magnetic memory organization. Familiarity with plated-wire and mass-storage memory concepts desirable. Requires BSEE plus five years' experience.

## SYSTEMS ENGINEER

For systems design on advanced computers. Requires extensive knowledge of memory technology, systems logic and large-scale integration as applied to medium- to large-scale general-purpose computing systems. Minimum of BSEE and five years' direct experience required.

## LOGIC DESIGN

Several positions available for EE's with 2-5 years' experience in logic design on either special- or general-purpose equipment. Positions require thorough knowledge of logic as related to real-time hardware development or automatic test equipment.

## CIRCUIT DESIGN

Positions for both systems- and device-oriented circuits men to work either in developmental projects or standard circuits group. BSEE required plus 3-5 years' design experience and thorough understanding of IC technology. Knowledge of large-scale integration concepts and

ramifications desirable. Projects include thin-film memories, IC utilization and development, project/vendor liaison, systems applications.

## FACILITIES/LAYOUT

Work entails projecting needs of expanding division, development of proposals, program implementation. Requires three years of facilities and layout experience, preferably in electronics industry; BSIE or equivalent; ability to deal effectively with all levels of personnel. Knowledge of safety codes desirable.

## MACHINE DESIGN

Creative mechanical engineer capable of designing sophisticated manufacturing hardware and of developing machines to do jobs which heretofore have not been encountered. Requires BSME and minimum of two years' experience.

## CHEMICAL PROCESSES

Positions in both engineering and manufacturing for man with BSChE and 2-5 years' experience in electroplating and electrodeposition in thin and thick films. Thorough knowledge of related materials, pre-plating surfaces, plating equipment required. Work entails development of advanced processes and techniques for computer development and production.

## QUALITY ASSURANCE ENGINEERS

Q.C. assignments include process capability, studies, failure analysis, design reviews, establishment of inspection standards. Position requires 2-3 years' experience with EDP equipment, knowledge of magnetic materials, BSME degree. Reliability positions involve planning, conducting and reporting reliability tests of electronic components, assemblies and units. BSEE required plus experience with reliability mathematics, computer circuitry. Positions also available in systems test.

TO ARRANGE A CONFIDENTIAL INTERVIEW send resume including salary history to: STEVE WILLIAMS

NCR Electronics Division is the largest commercial computer manufacturing facility in Southern California and one of the most advanced in the world. The Los Angeles plant and laboratories have recently been doubled, and an additional manufacturing facility is now under construction in San Diego. At NCR you will enjoy stable, non-defense activity in a

thoroughly professional environment. Your job and your future: the creation of advanced business automation for NCR markets in 121 countries.

Challenge, opportunity and Southern California are waiting for you. Look into these opportunities now.



The National Cash Register Company<sup>®</sup>  
ELECTRONICS DIVISION  
2817 W. El Segundo Blvd., Hawthorne, Calif.  
Telephone: (213) 777-7344  
An equal-opportunity employer



ON READER-SERVICE CARD CIRCLE 895

# Match antenna impedance with series Q-sections

The radiation resistance of most antenna arrays is considerably lower than the transmission line to which the array must be connected. The Yagi-Uda parasitic array usually exhibits a radiation resistance at the center of the driven element of from 20 to 25 ohms, while most standard cables have impedances of 50 ohms. To get matching, linear, quarter-wavelength transmission, line transformers (or Q-sections) can be used.

An electrical quarter-wavelength (or odd multiple thereof) of linear transmission line will transform an impedance at the input to the line into another impedance at the output of the line. The numerical impedance of the Q-section is the geometric mean of the input and output impedances and is given by:

$$Z_Q = (Z_{in} Z_{out})^{1/2} \quad (1)$$

The length of the Q-section is:

$$L_Q = 75 V_p N / f, \quad (2)$$

where:

- $L_Q$  = length of the Q-section in meters,
- $V_p$  = velocity factor of the transmission line,
- $N$  = an odd integer (usually one),
- $f$  = frequency in MHz.

In applying the Q-section matching system to this antenna array, assume an array radiation resistance of 22.5 ohms and a coaxial transmission line impedance of 50 ohms. By Eq. 1, the impedance of the Q-section must be:

$$Z_Q = (22.5 \times 50)^{1/2} = 33.5 \text{ ohms.}$$

A table of standard coaxial transmission lines

shows that the only cables with an impedance in the range required are RG-83/U, which have an impedance of 35 ohms.

The 35-ohm Q-section transformer has two drawbacks: RG-83/U and RG-100/U coaxial cables are very seldom used and therefore very difficult to obtain; power capability is limited. What is needed is a system that uses standard cables of nominal 50- and/or 75-ohm impedance with high power capability. This can be accomplished with two separate Q-sections in series.

Again assume an antenna array with a radiation resistance of 22.5 ohms. The first Q-section will be constructed from 50-ohm transmission line (any type). From Eq. 1:

$$Z_{out} = Z_Q^2 / Z_{in} = 50^2 / 22.5 = 111.2 \text{ ohms.}$$

This means that a 50-ohm Q-section connected to the feedpoint of the array will have an output impedance of 111.2 ohms at the end of the section. To transform this output impedance into 50 ohms (nominal), another Q-section of 75-ohm cable is employed. From Eq. 3 the output of the second section is calculated:

$$Z_{out} = 75^2 / 111.2 = 50.6 \text{ ohms}$$

The output of the second Q-section is thus an excellent match for standard 50-ohm coaxial transmission cable.

*Ronald J. Finger, Field Engineer, Lockheed Electronics Co., Plainfield, N.J.*

VOTE FOR 311

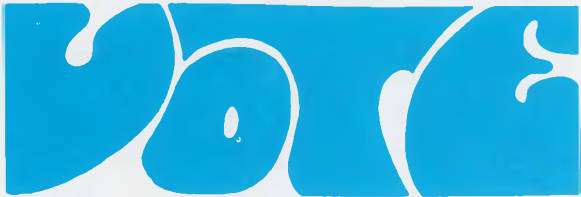

**VOTE!** Go through all Idea-for-Design entries, select the best, and circle the appropriate number on the Reader-Service-Card.

**SEND US YOUR IDEAS FOR DESIGN.** You may win a grand total of \$1050 (cash)! Here's how. Submit your IFD describing a new or important circuit or design technique, the clever use of a new component or test equipment, packaging tips, cost-saving ideas to our Ideas-for-Design editor. You will receive \$20 for each accepted idea, \$30 more if it is voted best-of-issue by our readers. The best-of-issue winners become eligible for the Idea Of the Year award of \$1000.

## Low-current SCR separates digital data from carrier

Digital information can be separated from its carrier with the simple circuit shown in the accompanying schematic. The SCR triggers only not fast enough to respond to the carrier and, in addition, is biased to let through only the peaks.

The SCR load resistor  $R1$  is made large enough to limit the SCR current below its holding value and capacitor  $C1$  large enough to supply holding current between gate drive.

The input circuit is biased heavily, so that the negative swing of the input signal generates the positive gate trigger pulse. The output buffer serves

# Small wonder:



Our new "4th-generation" 12.5 MHz universal counter/timer. Wonderful versatility in a wonderfully small package — at an even more wonderfully small price.

With the new Model 100A you can measure average frequency, frequency ratio, single period or time interval, or count total events. It has a crystal-controlled clock, Monsanto integrated circuit construction, and built-in compatibility with a rapidly growing assemblage of accessory modules.

With its \$575\* price tag (accessory modules are pegged at comparably modest rates) you can have big-league counter/timer performance at

costs never before possible. Small wonder we are selling (and delivering) Model 100A's just as fast as we can build them.

Call your local Monsanto field engineering representative for full technical details, or contact us directly at: Monsanto Electronics Technical Ctr., 620 Passaic Avenue, West Caldwell, New Jersey 07006. Phone (201) 228-3800; TWX 710-734-4334.

\*U.S. Price. FOB West Caldwell, New Jersey

**Monsanto**  
ELECTRONICS®

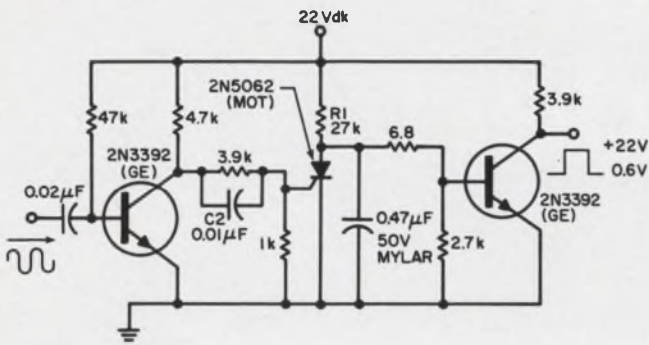

RESISTORS 1/2 WATT

Sharp pulses are obtained when an SCR is triggered by the input waveform peaks. SCR turn-off is caused by large load resistor R1.

a dual purpose: It cleans up the waveform, since there is some ripple present, and inverts the output to a true positive level. Capacitor C2 should be small but still provide a negative swamping pulse to the gate in order to provide a fast trailing edge.

Frank Mounts and Doug Moore, Project Managers, Rheem Manufacturing Co., Califone-Roberts Electronics Div., Los Angeles.

VOTE FOR 312

## Gated amplifier uses FET in feedback loop

Because of its relatively high on resistance, the plastic economy field-effect transistor is generally not too useful as a video switch or gate. If, however, the channel resistance,  $R_{on}$ , is used to short a much higher-feedback resistance around an ac amplifier this disadvantage can be overcome (Fig. 1a).

A practical example of this technique is shown in Fig. 1b. Q1 and Q2 comprise a feedback pair, Q1 providing the voltage gain and Q2 the current gain and low impedance. If the network of Q3, C2 and R4 is neglected for the moment, the closed-loop voltage gain will be essentially  $R_f/R_{in}$ , or  $150\text{ k}\Omega/10\text{ k}\Omega = 15$ . When Q3's channel resistance is lowered by a positive gating signal, the closed-loop voltage gain is lowered by the shunting effect of  $R_{on}$ . With  $R_{on} = 1/g_m$ , and worst-case  $g_m = 2000\ \mu\text{mhos}$ , the highest  $R_{on}$  is  $5\text{ k}\Omega$ . The new voltage gain is then  $5\text{ k}\Omega/10\text{ k}\Omega$ , or 1/2. Thus a voltage gain reduction of 30 to 1 has been effected.

Additional virtues of the circuit include:

- A low output impedance from Q3's emitter under all signal conditions—an advantage not possessed by conventional series or shunt choppers.
- Constant input impedance,  $R_{in}$ , under all sig-

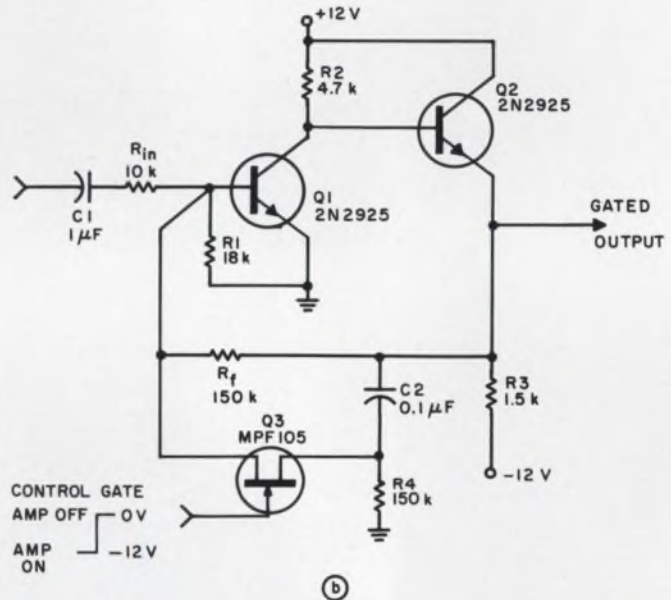
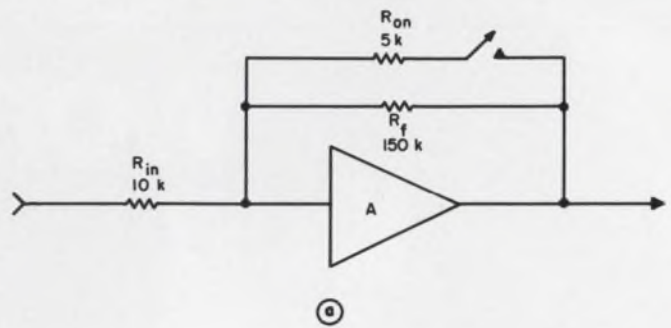

High-speed switching is possible with a FET connected as shown (b). Simplified schematic is in (a).

nal conditions—also not characteristic of series or shunt choppers.

■ Reduction of high-frequency spikes from the differentiating action of FET capacity, because Q3 drives directly into a low-impedance point, Q1's base in one direction and Q2's emitter impedance in the other direction.

Walter G. Jung, Associate Engineer, Electronics Dept., Maryland Telecommunications, Inc., Cockeysville, Md.

VOTE FOR 313

## Stepper uses thyristors as switching elements

This stepping chain may contain any number of stages. Stepping the chain may be carried out by means of any contact function, for instance, a transistor. External loads, such as a relay, may be connected to the output of every stage. If the output



**MOST  
RESISTORS ARE  
PRETTY MUCH  
ALIKE  
IT'S THE NAME  
BEHIND THEM  
THAT COUNTS**

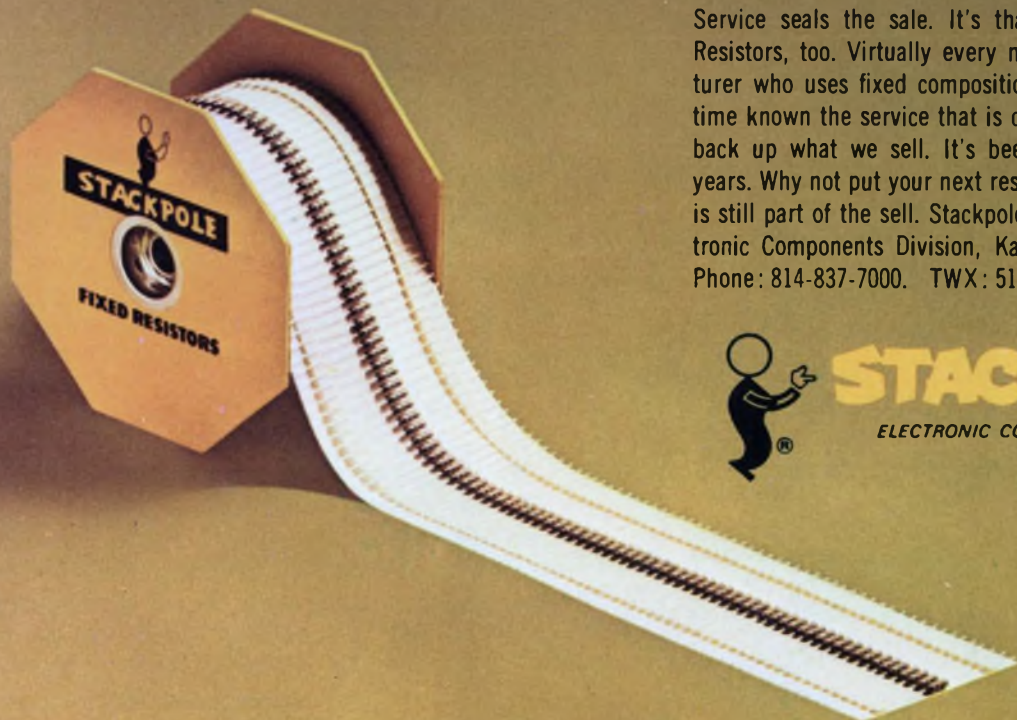

Service seals the sale. It's that way with everything. Resistors, too. Virtually every major domestic manufacturer who uses fixed composition resistors has at some time known the service that is distinctly Stackpole's. We back up what we sell. It's been that way for over 35 years. Why not put your next resistor order where service is still part of the sell. Stackpole Carbon Company, Electronic Components Division, Kane, Pennsylvania 16735. Phone: 814-837-7000. TWX: 510-695-8404.



**STACKPOLE**

ELECTRONIC COMPONENTS DIVISION

of the last stage is connected to the input of the first, the chain will be of the ring type.

Assume that the loads are connected to the respective outputs *G, H, . . . , Q*, and the positive supply voltage is connected to the loads as shown in the figure. The negative side of the supply is connected to point *C*. In this state none of the thyristors will be conducting.

Zero setting of the chain is accomplished by applying a positive pulse at *A* and making the first thyristor, *T1*, conduct. In this state, current is flowing from plus through the load, thyristor *T1* and resistor *R4* to minus at *C*. The pulse across *R4* will charge capacitor *C11* by way of diode *D3* and resistor *R5*, and the capacitor will maintain this charge until the first trigger pulse is applied at *F*. Capacitor *C1* is charged through load 2 and the conducting thyristor *T1*.

After connecting minus to point *F*, *C11* will discharge through *D4, D6, R6*, the gate-cathode diode of thyristor *T2* and *D5*. Discharging current will thus fire *T2*, so that the voltage at the anode of *T2* will be abruptly reduced. The negative voltage step at the anode of *T2* will be transmitted to the anode of *T1* by way of *C1*. *T1* will therefore be cut off, disconnecting load 1.

In this new state, thyristor *T2* will be conducting and all other thyristors cut off. Minus is now removed from point *F*.

*C12* and *C2* will now be charged in the same way

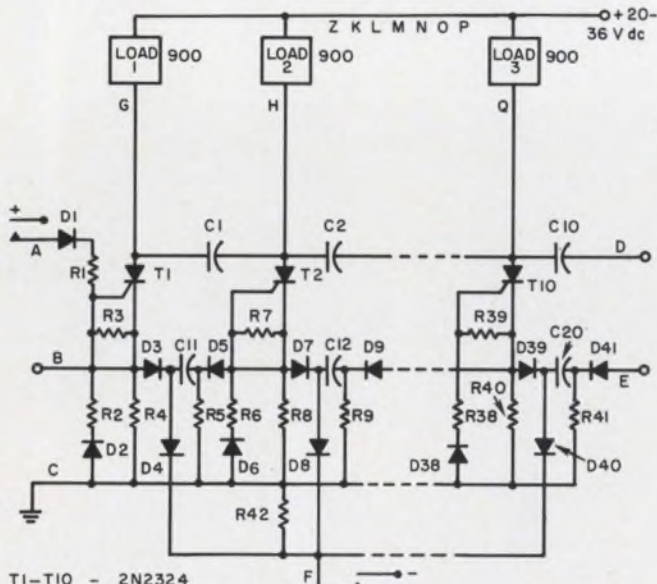

- T1-T10 - 2N2324
- D1-D41 - IN 645
- C1-C20 - 0.22 μF
- R1 - 5.6 k
- R2,R6 --- R34,R36 - 27
- R5,R9 --- R37,R41 - 15 k
- R3,R4,R7,R8 --- R35,R36,R39,R40 - 220

**600-Hz ring stepper** for any number of loads uses thyristors as switching elements.

as *C11* and *C1*, respectively, when thyristor *T1* was conducting. When minus is once more connected to point *F*, the next thyristor will fire and so on.

When the last thyristor in the stage *T<sub>n</sub>* of the chain is conducting, any further trigger pulses at *F* will offset the stage. If, however, connections are made between points *E* and *B* and between points *D* and *A*, the result of applying minus at *F* when *T<sub>n</sub>* is conducting will be that *T1* fires and *T<sub>n</sub>* cuts off. Hence a ring type of chain is established. The maximum frequency possible with this circuit is 600 Hz.

*O. Tedenstig, Laboratory Engineer, L M Ericsson a.-b., Stockholm, Sweden.*

VOTE FOR 314

## High-voltage quick-disconnect can be made for about 25 cents

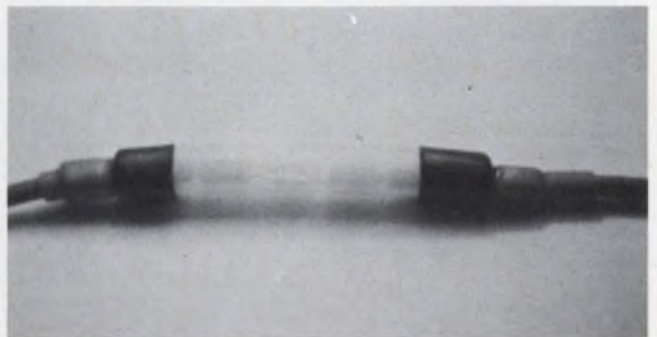
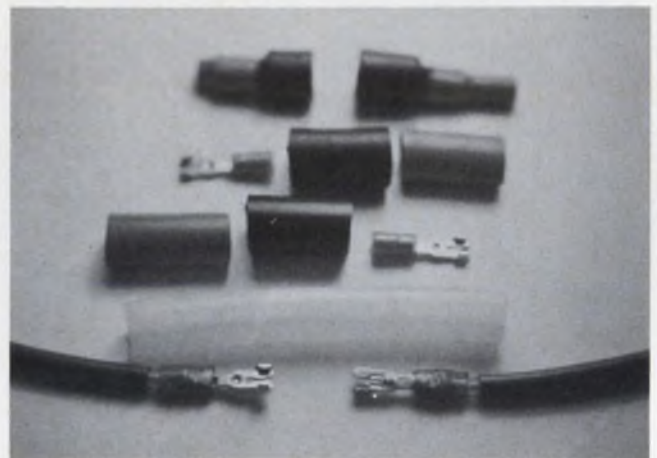

Safe high-voltage quick-disconnect (a) is a snap to build with the parts shown in (b).

By crimping on a standard quick-disconnect (Thomas & Betts Co., Elizabeth, N.J.; \$1.00/doz.), then snugging a 30-mil-wall Teflon tube over the joint with heat-shrink tubing, a 20 kV visual inspection joint can be made. The Teflon will not stick to the melted heat-shrink, but TV anode wire or



## Nearly everything that flies... flies with Cutler-Hammer power relays!

You've made us Number One. And we thank you.

For years, you've been buying more Cutler-Hammer power relays for your airborne projects than anybody else's.

Probably because our relays combine the utmost in small size, light weight and resistance to severe environmental conditions.

Now, we'd like to tactfully remind you that more and more of your fellow engineers are using our relays in ground support as well. And in ordnance and shipboard electronics, too.

Like in the tank above, and in trucks, radar, power systems and fire-control systems.

We're delighted. But not surprised. Because the relays are very much the same.

Same proved reliability under severe environmental conditions. Same in-process inspection and rigid quality control.

On your next project—ground, marine or airborne—specify Cutler-Hammer power relays. Call our local stocking distributor, or write for new Catalog **LL-292-A217**



Typical of Cutler-Hammer's full line are these 25-, 50-, and 100-amp hermetically sealed power relays (front), our new 175-amp hermetically sealed generator contactor, and a 400-amp environmentally sealed relay.

**Switch**  
**to No. 1**

More than just products:  
prompt availability,  
field help, innovation,  
quality assurance too.

ON READER-SERVICE CARD CIRCLE 58

  
**CUTLER-HAMMER**  
Milwaukee, Wisconsin 53201

nylon high-voltage cable might. To avoid sticking, make up a batch of heat-shrink endcaps using a drill bit as a mandrel. Rotate the bit while heat-shrinking over it. When the bit begins to seize, douse it and the hot tubing in a cup of water. This will set the inside diameter.

At about 700 volts per mil, the Teflon tubing (Pennsylvania Fluorocarbon Corp., Clifton Hts., Pa.; 0.375-by-0.30-in. neutral flexible TFE) remains fairly transparent while insulating up to 20 kV or more.

David M. Allburn, Senior Research Engineer, Technology Inc., Dayton, Ohio.

VOTE FOR 315

## IC makes a Schmitt trigger and a single-shot circuit

An IC dual two-input NAND gate connected as in Fig. 1a makes a stable, inexpensive Schmitt trigger. Incorporating a  $\mu\text{L}914$  and the components shown, the circuit triggers at about 1.4 volts with an on-off differential of 10 to 20 mV. It will trigger on pulses of 200 ns or longer. The output voltage swings from less than 1 volt in the off condition to over 3 volts in the on condition. The circuit will operate at a repetition rate close to 1 MHz, depending on the pulse width.

By adding the resistor and switch as shown in Fig. 1b, the Schmitt trigger can be made into a latching circuit.

By addition of the capacitor and potentiometer

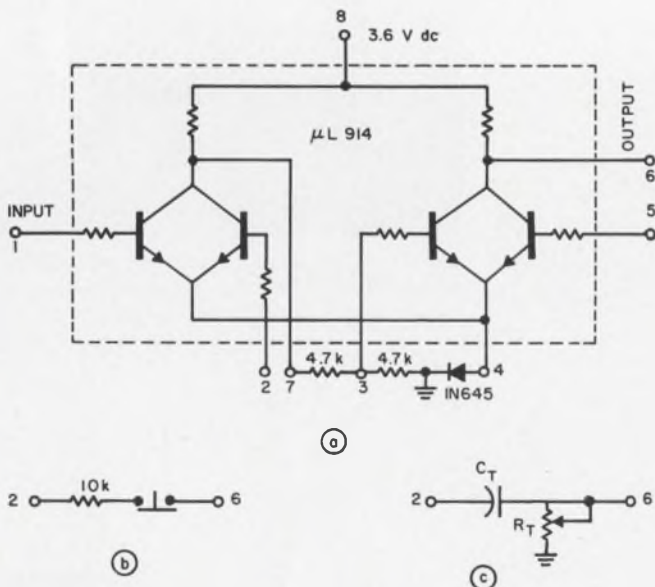

A Schmitt trigger is the result when an inexpensive IC is connected as shown (a). With modification (b) it becomes a latching circuit. In (c) a single-shot circuit is the outcome.

(Fig. 1c), a very useful pulse stretcher or single-shot circuit is achieved. With  $R_T$  of 100 k $\Omega$  and  $C_T$  of 0.01  $\mu\text{F}$ , a pulse width of nearly 500  $\mu\text{s}$  can be obtained.

The rise and fall times of the output pulse are less than 100 ns; the repetition rate is a function of the pulse width. The pulse width is approximately 0.6 RC, owing to the triggering level of the circuits. It can be as narrow as the triggering pulse and as long as several milliseconds. The longest time obtained, however, has been about 100  $\mu\text{s}$ . As in most single-shot circuits, the stability depends on the quality of the timing components  $R_T$  and  $C_T$ .

R. E. Adams, Product Tester Design Div., Sandia Laboratory, Albuquerque, N.M.

VOTE FOR 316

## Zero-crossing detector needs no supply voltage

Zero-crossing detectors are often needed when precise synchronization with the line frequency is required, as in SCR firing circuits. This one (Fig. 1a) is inexpensive, has few components, needs no supply voltage or center-tapped transformer, and can be used with any waveform.

A signal from the secondary of transformer  $T1$  is full-wave rectified by  $D1$  through  $D4$ , then applied to the base of  $Q1$  through  $R2$ . When the signal level drops below conduction in the vicinity of zero crossing, the normally on  $Q1$  cuts off, and a positive-going pulse appears at the collector.

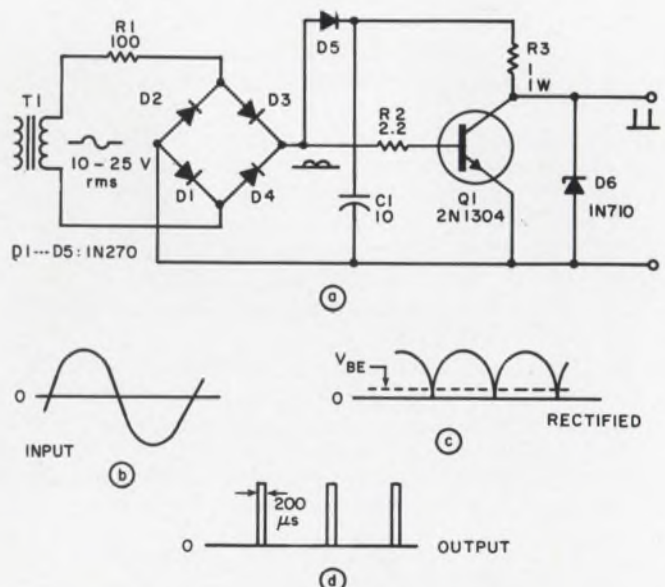

Zero crossovers are detected by a simple circuit (a). Waveforms occurring in the circuit are in (b), (c) and (d).



*In days of old, when swains were bold,  
 Before the electronic computer;  
 The "electric kiss" was a test of love  
 To match a lass and suitor.*

*One of a series of...*

**Vignettes in Electronic History**

The "electric kiss" was a romantic 18th Century fad, but it produced no practical results even for that early period. Today, ardor and zeal alone are even less likely to produce significant technological innovation. Now, only the companies with the most modern facilities and the best people and machines can maintain technical leadership. That's why a visit to Spectrol's new facility in the City of Industry has turned many a skeptic into a fervent customer. Quote from a large user of potentiometers: "What impressed me most wasn't just the large, modern, R&D, fabrication, and assembly areas; but also the orderly

**Better Components for Better Systems:** precision potentiometers • trimming potentiometers • turns-counting dials • miniature switches

*A limited number of full-color reproductions of the "electric kiss" painting, along with the story of the experiment, are available upon request.*

layout and the efficient way people went about their jobs. It looked to me like good management as well as a fine facility —and that's what makes for reliable products." But why not? Spectrol designed and built this plant from the ground up for the sole purpose of producing the quality components you need, at competitive prices. Of course, we're not perfect yet but we're working at it! (Perhaps you'd like to be working with us.)

**Spectrol Electronics Corporation**

*A subsidiary of the Carrier Corporation  
 17070 E. Gale Ave., City of Industry, Calif. 91745  
 Copyright ©1967*

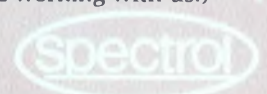

Supply voltage is provided by charging  $C1$  through  $D5$ .

$R1$  prevents current surge through  $D1-D4$  when  $C1$  is being charged.  $R2$  provides sufficient base current to drive  $Q1$  into saturation. Zener diode  $D6$  clips the output pulse to the desired amplitude and makes it independent of collector voltage and ripple.

Figures 1b through 1d show the pertinent waveforms. With germanium semiconductors the output pulse is about  $200 \mu s$  in duration and has a rise time of  $20 \mu s$ . Silicon semiconductors would provide a  $500\text{-}\mu s$  output pulse, because of their higher forward voltage drop.

Robert Billon, Design Engineer, UNITEC, Grenoble, France.

VOTE FOR 317

## Unijunction and flip-flop improve pulse generator

Conventional unijunction pulse generators are limited in their ability to produce variable pulse widths. With the circuit shown, a pulse-repetition-frequency (PRF)-to-pulse-width ratio of 50 is easy to obtain.

When the flip-flop is in the state shown, the logical 1 output causes capacitor  $C$  to be charged through resistor  $R1$  and diode  $CR1$ . After the voltage on capacitor  $C$  has exceeded the unijunction threshold, the unijunction produces an output and causes the flip-flop to complement. Capacitor  $C$  then charges through  $R2$  and  $CR2$ . The ratio of

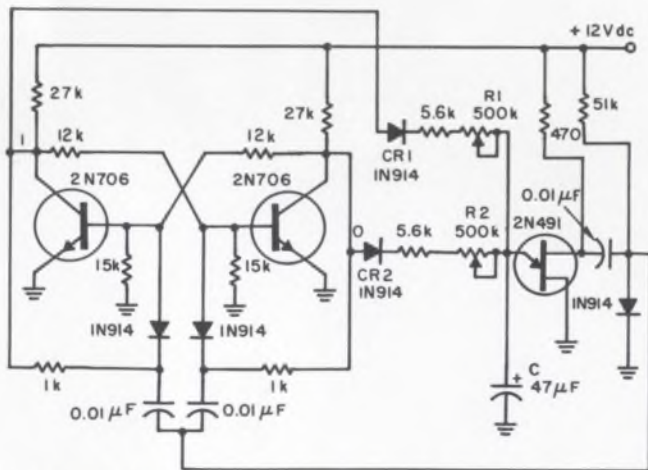

WITH COMPONENT VALUES SHOWN:  
PULSE WIDTH IS VARIABLE FROM 800 ms TO 35 s AND PERIOD FROM 1 s TO 35 s

800-ms to 35-s pulses with periods from 1 to 35 s result when a flip-flop drives a unijunction. Ratio of  $R1$  to  $R2$  determines the PRF-to-pulse-width ratio.

$R1$  to  $R2$  determines the PRF-to-pulse-width ratio. With this circuit, pulse width can be varied from 800 ms to 35 s and the period from 1 to 35 s.

For proper operation of the unijunction, the flip-flop should be operated from a positive supply of greater than 12 volts.

J. T. Shaul and A. Mall, Design Engineers, Bendix Corp., Bendix Radio Div., Baltimore.

VOTE FOR 318

## Single-pulse synthesizer uses single flip-flop

In digital systems a common problem is to obtain a simple pulse synchronized with a master clock—in other words, to send one and only one output pulse every time an enabling signal (gate) arrives. This operation may be represented by a state diagram (Fig. 1).

In the absence of an input signal ( $W = 0$ ), the system goes to or remains in the initial state (state 1). No output pulse is sent ( $Y = 0$ ). When an output signal arrives ( $W = 1$ ), a change to state 2 occurs and an output pulse is sent ( $Y = 1$ ). If the input signal stays at the logical level 1, each clock pulse will keep the circuit in state 2 without delivering an output pulse. When the input signal drops to the logical level 0, the first clock pulse will bring the circuit to state 1 (Table 1).

The states must now be given a corresponding binary number. In this case the problem is simple because the choice is between two similar assignments, both of which result in almost identical solutions. If state 1 is assigned the logical level 0

Table 1. Transition table

Actual State	Input	Next State	Output
$X_n$	$W$	$X_{n+1}$	$Y$
1	0	1	0
1	1	2	1
2	1	2	0
2	0	1	0

Table 2. Transition table

Actual State	Input	Next State	Output
$X_n$	$W$	$X_{n+1}$	$Y$
0	0	0	0
0	1	1	1
1	1	1	0
1	0	0	0

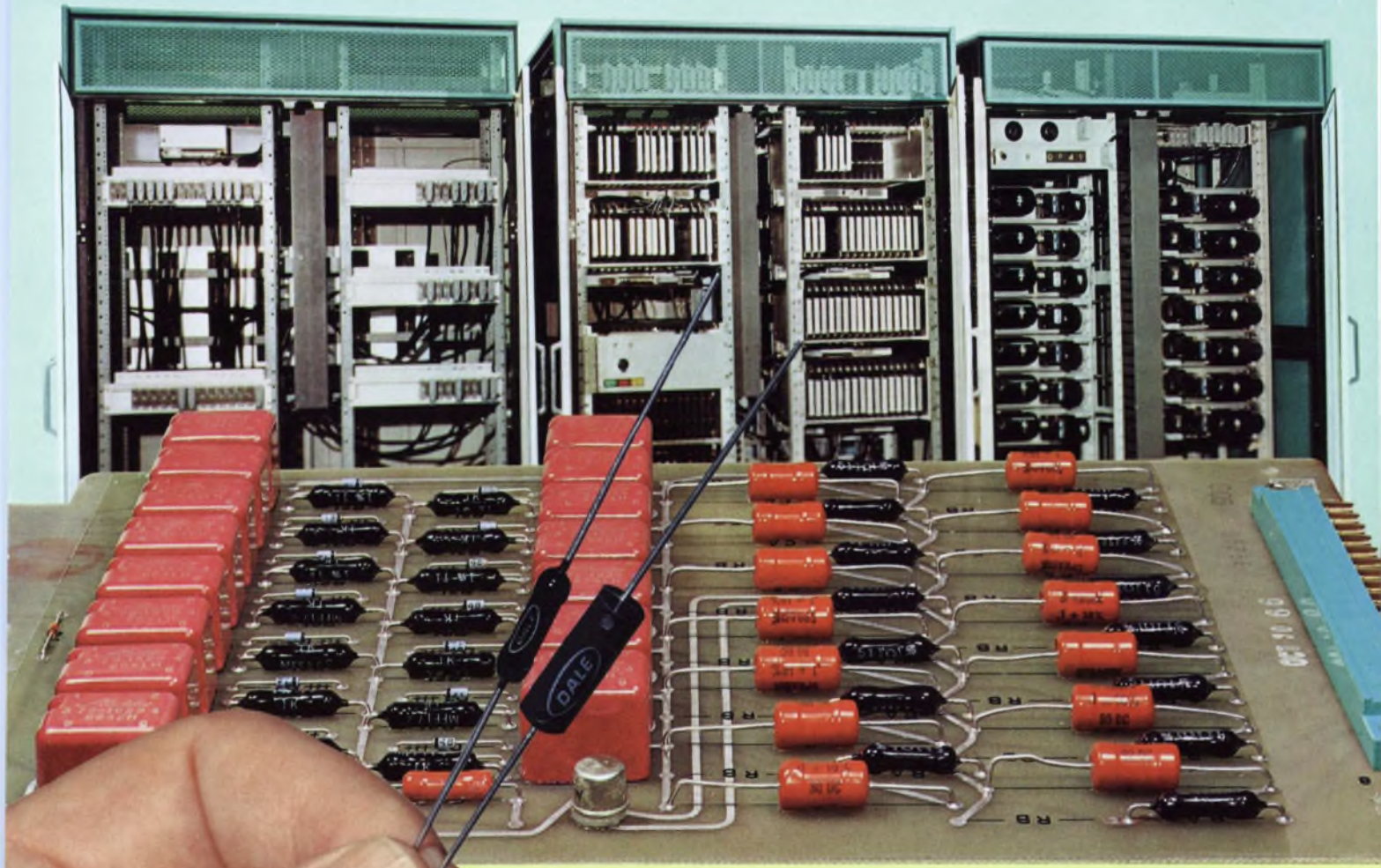

**DALE**

## Metal Film Resistors

...chosen for long life in the  
Westinghouse PRODAC System

### GENERAL SPECIFICATIONS TYPE MF\* MIL-R-10509F

DALE TYPE	MIL. TYPE	125° C RATING (Char. C & E)	70° C RATING (Char. D)	RESISTANCE RANGE (Ohms)
MF50	RN-50	1/20 w	1/10 w	30.1 to 80.6K
MF-1/10	RN-55	1/10 w	1/8 w	30.1 to 301K
MF-1/8	RN-60	1/8 w	1/4 w	10 to 1MΩ
MF-1/4	RN-65	1/4 w	1/2 w	10 to 1 MΩ
MFS-1/2	RN-70	1/2 w	3/4 w	10 to 1.5 MΩ
MF-1	RN-75	1 w	-	25 to 2.6 MΩ
MF-2	RN-80	-	2 w†	100 to 10 MΩ

\*Also available in conformal coated (MFF) styles. †Char. B  
Tolerance: ±1%, ±5%, ±25%, ±10% standard.  
Characteristics D, C, or E apply depending on T.C. required

Computers for industrial process control demand long resistor life. To insure this, Dale Metal Film resistors are used extensively in the versatile Westinghouse PRODAC System. Value analysis dictated the choice—with the long life characteristics of metal film winning over the lower price of carbon and carbon composition types. Dale verifies this reliability with long-term load life tests (see below). Delivery is reliable, too. Expanded production facilities can put quantities up to 50,000 in your plant in 2 weeks (1% tolerance units). We'll prove it—call 402-564-3131 today.

### NEW METAL FILM LOAD LIFE DATA

Dale MF resistors have undergone 16,320,000 hours of load life testing without a failure (100% rated power, 70°C; failure defined as  $\Delta R > 1\%$ ). Based on these tests, the MF resistor has a proven failure rate of .004% per 1,000 hours (60% confidence at 50% power, 70°C ambient). Write Dale for complete test data.

FOR COMPLETE INFORMATION CIRCLE NO. 181

**DALE**

for optimum value in industrial resistors

DALE ELECTRONICS, INC., 1300 28th Ave., Columbus, Nebr. 68601 In Canada: Dale Electronics Canada, Ltd.

**DALE****G resistors need less space in outer space.***(and in down-to-earth circuits, too)*

Dale G resistors give you precision power in the smallest packages available. Test them with equivalent size wirewounds and you get 1.4 to 4 times more power. Run them at mil power levels and you get stability that can't be challenged. Dale's silicone-coated G Series combines the superior conductivity of beryllium oxide cores with the exclusive wire and wire-winding techniques perfected in the Minuteman High Reliability Development Program. When you need more precision power in less space, or more stability without increasing size—call Dale. Only the G Series gives you this freedom of choice.

#### SURVEYOR RELIABILITY

*demands are met by AGS wirewounds — the established reliability version of Dale's G Series. Supplied to Hughes Aircraft Company, builder of the Surveyor, AGS resistors have a proven failure rate of .000113% per thousand hours (60% confidence level, 50% rated power at 25° C ambient). They are the world's most reliable wirewounds.*

#### G SERIES SPECIFICATIONS

DALE TYPE	MIL-R 26D TYPE	DALE RATING		RESISTANCE RANGES (OHMS)		
		U	V	.05%, .1%, .25%	.5%, 1%, 3%	
G-1	RW-81	1.0 W	—	10 to 950	1 to 3.4K	
G-2	—	1.5 W	—	10 to 1.3K	1 to 4.9K	
G-3	RW-80	2.25 W	—	1 to 2.7K	.1 to 10.4K	
G-5	—	4.0 W	5 W	1 to 6.5K	1 to 24.5K	
G-5A	—	4.5 W	6.5 W	1 to 11.4K	.1 to 42.1K	
G-5C	—	5 W	7 W	1 to 8.6K	.1 to 32.3K	
G-6	—	6 W	8 W	1 to 12.7K	1 to 47.1K	
G-10	—	7 W	10 W	5 to 25.7K	1 to 95.2K	
G-12	—	10 W	12 W	5 to 41.4K	1 to 154K	
G-15	—	15 W	18 W	5 to 73.4K	.1 to 273K	

**MIL SPEC:** G Series resistors meet the requirements of MIL-R-26D as well as the older MIL-R-26C and MIL-R-23379 specifications.

**STABILITY:** G Series resistance shift is less than 50% than that of conventional wirewounds of equivalent size (Dale RS) operated at the same ratings.

**STANDARD VARIATIONS:** G Series resistors are available with radial leads (Type GL) and with non-inductive (Aryton-Perry) winding (Types GN and GNL).

**COMPARATIVE SIZE:**



Dale G-5C resistance element (left) rated at 5 watts compared with conventional RS-5 watt wirewound element.

**For action, call Dale: 402-564-3131. For information, circle 181 for Catalog A.**

**DALE ELECTRONICS, INC.**

1300 28th Ave., Columbus, Nebraska 68601  
In Canada: Dale Electronics Canada, Ltd.

**DALE**

Printed in U.S.A.



# What does the CD-65 have that all other 2½D memory systems don't?

MORE STRINGENT DESIGN CRITERIA + HIGHER RELIABILITY + GREATER USER VERSATILITY.

The CD-65 is designed with the demanding user in mind. Operating margins in this unit are significantly greater than accepted industry standards. Mechanical packaging of key circuits and magnetics in the CD-65 provides a system organization easily adapted to custom application. All circuits are worst case designed and are verified by customer examination. □ Featuring a newer 2½ D packaging concept, the CD-65, with a 650 nanosecond cycle time, permits faster speeds and definite economies for larger word systems. The CD-65 is available in sizes from 8K to 65K words—each containing from 16 to 144 bits. □ Speaking of words, may we have some with you? We'd like to tell you more about the CD-65. For more information, write: Lockheed Electronics Company, Memory Products, 6201 East Randolph Street, Los Angeles, Calif. 90022. Or phone (213) 722-6810.

Visit Lockheed  
Memory Land  
FJCC Booth 148-151

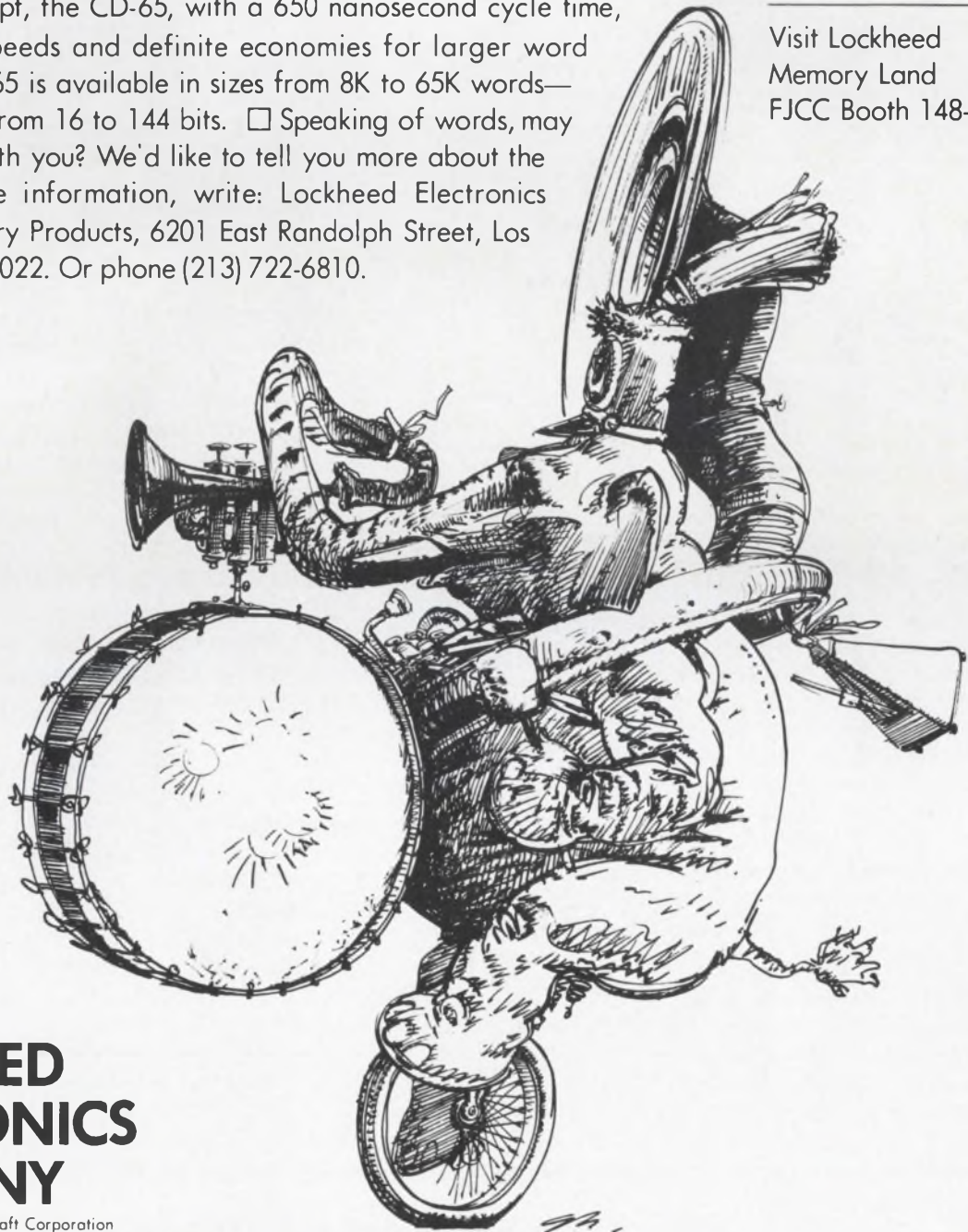

**LOCKHEED  
ELECTRONICS  
COMPANY**

A Division of Lockheed Aircraft Corporation

ON READER-SERVICE CARD CIRCLE 59

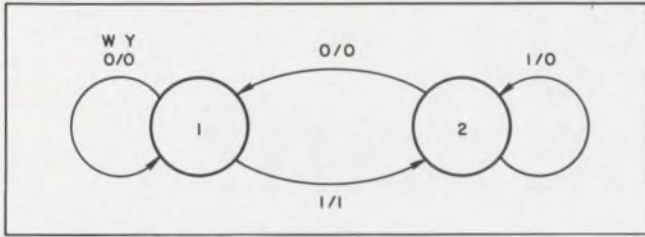

1. **Sequential circuit synthesis** starts with a state diagram showing all the desired system states and the transitions from one state to another.

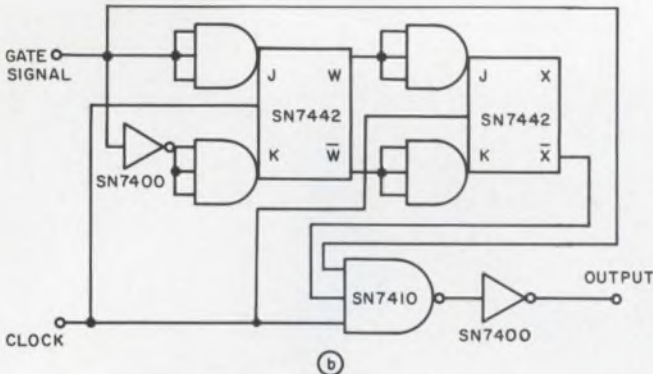
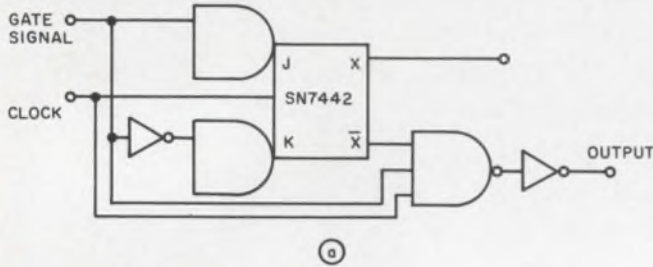

2. **The simplest form of single-pulse generator** uses a single J-K master-slave flip-flop (a). To prevent gate signals from altering the length of the output pulse, a second flip-flop is used that will change state only during clock intervals (b).

and state 2 the logical level 1 then Table 2 results. Table 2 gives the following logical expressions:

$$X_n + 1 = \bar{X}_n W + X_n \bar{W} = W$$

$$Y = \bar{X}_n W$$

$$\bar{X}_n + 1 = \bar{W}$$

The final circuit is easily synthesized with a J-K master-slave flip-flop (Fig. 2a).

This particular configuration has the disadvantage that the input signal may arrive during a clock pulse so that the length of the output pulse is not constant. A simple way of avoiding this is to synchronize the input signal with the clock, that is, to employ another flip-flop that will change state on the envelope peaks because the input circuit is only during clock intervals (Fig. 2b).

Nicola Cajano, Doctor of Engineering, N.P.A. Div., CERN, Geneva.

VOTE FOR 319

## Simple hookup eliminates problems in using $\mu 710$

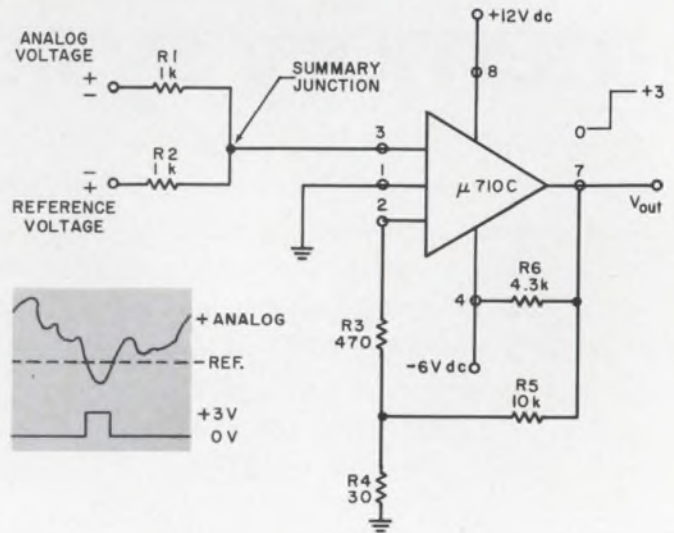

Problems are eliminated in the use of the  $\mu 710$  by connecting it as shown. See text for details.

This circuit does away with several problems in using the  $\mu 710$  IC differential comparator or equivalent device:

- The summing junction technique of  $R_1$  and  $R_2$  alleviates the problem of  $\mu 710$ 's input impedance swinging about its transition point.
- For minimum offset voltage, the impedance load on pins 2 and 3 can be matched. For low source resistances:

$$R_3 + R_4 = R_1 || R_2.$$

- Positive feedback from voltage divider  $R_4$  and  $R_5$  eliminates the  $\mu 710$ 's tendency to oscillate in its linear region. This hysteresis should be above about 6 mV for the gain of the  $\mu 710$ . For the values shown:

$$\text{hysteresis} = +V_{out} R_4 / (R_4 + R_5) = 9 \text{ mV.}$$

- Finally  $R_6$  is added to sink more current than the worst case of 0.5 mA at the zero-volt level (negative state). This permits sinking 2 mA at -0 volts which is compatible with today's TTL logic families.

David Weigand, Design Engineer, Burroughs Corp., Paoli, Pa.

VOTE FOR 320

## IFD Winner for September 27, 1967

W. F. Ball, AURA, Inc., Tucson, Ariz.

His Idea, "Ultrawide-range VCO uses op amp and UJT," has been voted the \$50 Most Valuable of Issue Award.

Cast Your Vote for the Best Idea in this Issue.



## Do your problems start here?

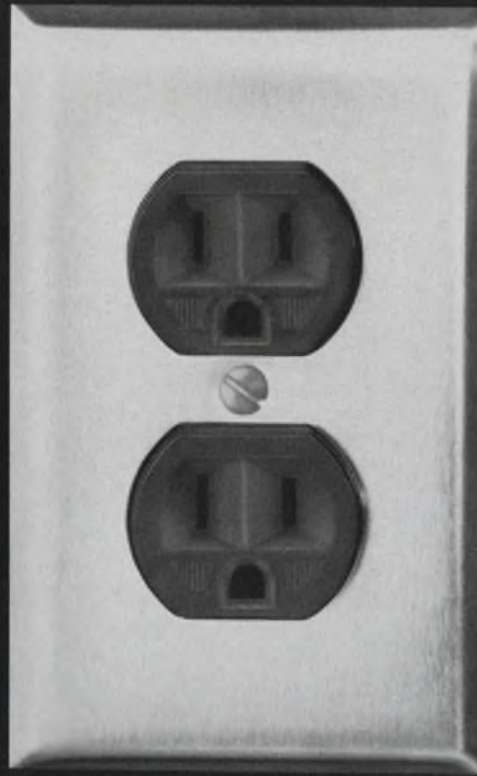

Line-voltage variations are seldom blamed for the insidious little problems that plague us daily. Usually we blame the equipment. So, as a public service to protect electrical equipment from kicks, fists, cuss words, and other abuses, we would like to list a number of troubles that are directly attributable to off-normal line voltage.

**Motors . . .** Low voltage increases starting time, reduces starting torque (at 10% undervoltage, a squirrel-cage motor has 19% less starting torque); efficiency of portable tools such as hand grinders will drop as much as 10%. Overvoltage may stress shafts, gears and belts; with a 10% increase in line voltage, starting current is up 12%, power factor is down 5%, and motor noise increases.

**Lighting . . .** Low voltage reduces lamp efficiency; a 10% line drop reduces light in incandescent lamps by 30%. Tungsten-halogen lamps blacken; color temperature of photographic lamps drops by 100°K. Overvoltage reduces lamp life; a 4% increase halves the life of incandescent lamps. A 10% increase produces a 20% increase in heat of infrared lamps — enough to scorch sensitive surfaces.

**Electrical Equipment . . .** At 10% undervoltage unprotected thyratrons and other gas-filled tubes can fail in minutes.

Output of unregulated oscillators and generators will vary, stability will be impaired, and calibration will be questionable. Varying voltage will seriously distort the accuracy of data obtained during life testing. A 10% increase in voltage will cut tube life by 75%.

**Industrial Equipment . . .** At 10% undervoltage ultrasonic cleaner and induction-heater output is off 20%; plating deposition rate drops 10 to 20%; precipitator cleaning power drops 20%; solenoid holding power is reduced; electrical heating time is increased by 20 to 25%. Varying line voltage impairs weld consistency produced by energy-storage spot welders used for fabricating aluminum and exotic metals. Heat sealing processes are seriously hampered by voltage fluctuation. At 10% overvoltage, metallic rectifiers become overstressed and their ability to withstand transient surges is reduced by 50%. Idling losses in electrical distribution equipment is increased; transformer core losses increase approximately as the square of the applied voltage.

**The SOLUTION . . .** These and many other voltage ills can be handled simply and effectively with Variac® automatic voltage regulators. They are designed for fast (up to 80-volts-per-second correc-

tion on 115-V lines), accurate ( $\frac{1}{4}\%$  or  $\frac{1}{2}\%$ ), and distortionless control of line voltage. Overloads as much as 10 times rated current can be accommodated.



These all-solid-state regulators are available in 31 electrically-different models, rated at 2- to 20-kVA for industrial use and 2- to 9.2-kVA for military applications. Models are available for line frequencies of 50 to 60 Hz or 350 to 450 Hz, single- or three-phase operation, and nominal line voltages of 115, 230, and 460 volts. Prices start at \$530 in U.S.A.

For complete information, write General Radio Company, W. Concord, Massachusetts 01781; telephone (617) 646-0550; TWX (710) 347-1051.

## GENERAL RADIO

# Helipot rings up the twelve dollar C.P. pot.



The new Model 3351 conductive plastic potentiometer is our twelve dollar solution to your age-old budget problem. It's a new low price for a non-wirewound precision potentiometer, and yet performance and quality have not been sacrificed. This new model excels wherever high precision and long, trouble-free life are needed at minimum cost.

If you like the \$12.00 price, then check these specs. ■ Essentially infinite resolution. ■ Standard resistance range; 1K to 75K ohms. ■ Long life. ■ Linearity;  $\pm 0.5\%$ .

■ Power rating; 0.75 watts at 70°C. ■ Resistance tolerance;  $\pm 10\%$ . ■ Operating temperature range;  $-65^{\circ}\text{C}$  to  $+125^{\circ}\text{C}$ . ■ Factory stocked.

Also, Helipot has other all-new non-wirewound pots to satisfy most every application. Standard servo mount models with either conductive plastic or cermet resistance elements are available in 7/8" and 1-1/16" diameter. And they are priced under \$25.00.

Ask your local Helipot sales representative for the complete non-wirewound pot story... now.

**Beckman**

INSTRUMENTS, INC.

HELIPOT DIVISION

FULLERTON, CALIFORNIA • 92634

INTERNATIONAL SUBSIDIARIES: GENEVA; MUNICH; GLENROTHES, SCOTLAND; TOKYO; PARIS; CAPETOWN; LONDON; MEXICO CITY



ON READER-SERVICE CARD CIRCLE 62

# Products

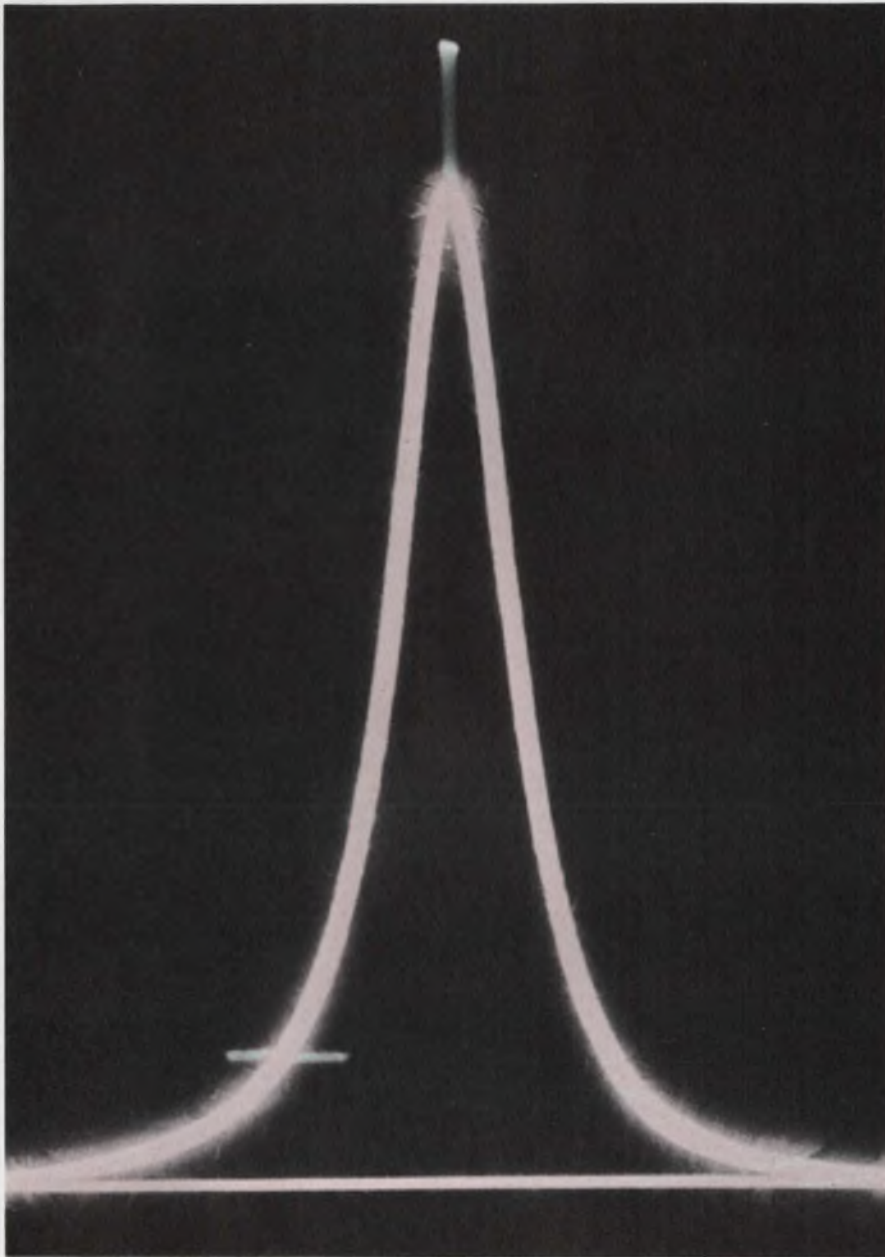

**Sweep and marker generator** covers 50 kHz to 100 MHz using plug-ins with an accuracy of 0.05%. Page 166

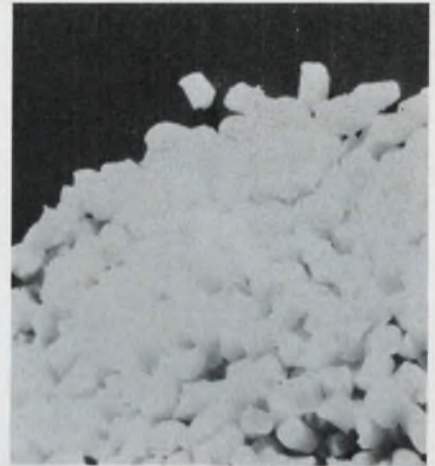

**Glass spheres + nylon = a mighty material.** Page 192



**Unijunction transistor** spans from 2 to 40 V. Page 150

## Also in this section:

**Packaging innovation decreases** capacitors needed in rectifiers. Page 154

**Digital-Fourier-transform computer** provides mathematical versatility. Page 182

Design Aids, Page 212 . . . Application Notes, Page 213 . . . New Literature, Page 214

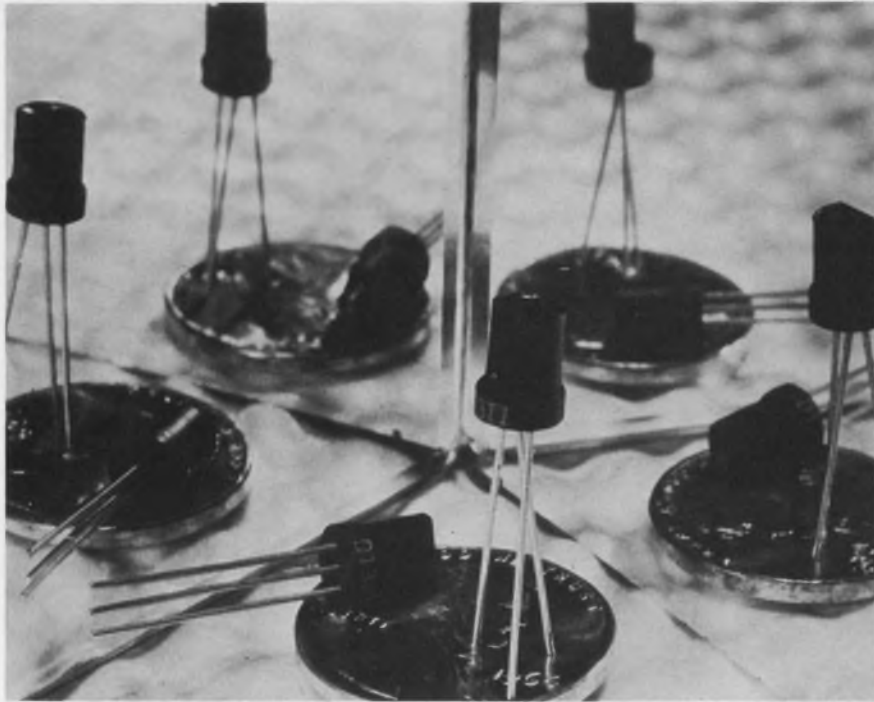

## Unijunction transistors are programmable

General Electric Co., Schenectady, N.Y. Phone: (518) 374-2211. Price: D13T1 39¢ (10,000 lots); D13T2 90¢ (10,000 lots).

Two solid-state devices known as programmable unijunction transistors that operate from 2 to 40 V have been put on the market.

The D13T1 can be used for ordinary thyristor applications and SCR trigger timers. The schematic shows a unijunction circuit using the D13T1 and resistors *R1* and

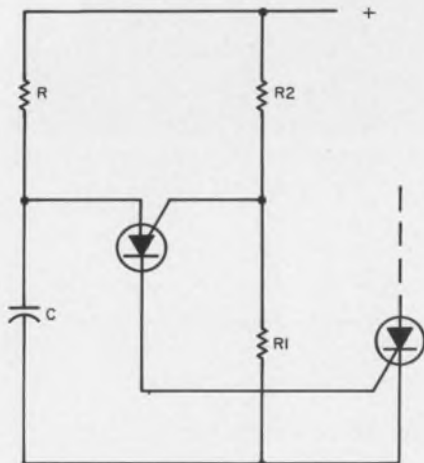

• Programmable unijunction transistor in a typical PUT configuration.

*R2*. *R1* and *R2* are equivalent to the interbase resistance of a conventional unijunction. For anode voltages less than the gate potential which is established by *R1* and *R2*, the D13T1 is in a nonconducting state. As the anode voltage is raised above the gate potential, it turns on, producing a negative resistance region determined by the parallel combination of the resistors. The lower the gate resistance, the higher the valley current. Peak-point current drops with increasing gate resistance, and is less than 2  $\mu$ A with an anode-gate-to-anode leakage current of 10 nA.

The pulse voltage rise rate is 80 ns with pulse output voltage of 6 V. Total average power is 300 mW. Major breakdown voltage is 40 V. Peak anode recurrent forward current is 1 A at 100- $\mu$ s pulse width, 1% duty cycle. Dc anode current is 150 mA. Operating ambient temperature range is  $-50^{\circ}$  to  $100^{\circ}$ C.

General Electric is also introducing the D13T2, intended primarily for applications that require low leakage and peak-point current. It offers an ultralow peak-point current of 0.15  $\mu$ A.

CIRCLE NO. 253

## Integrated gate protects MOSFET

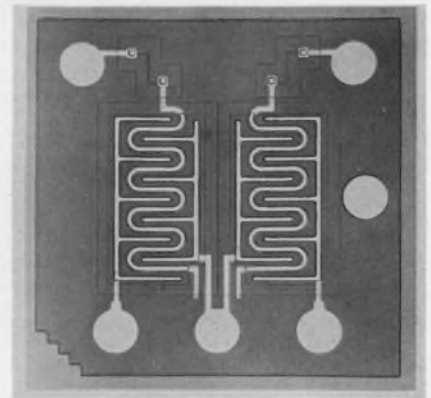

Fairchild Semiconductor, 313 Fairchild Drive, Mountain View, Calif. Phone: (415) 962-2530. P&A: FT704 \$4.50, FT701 \$10.00

The p-Channel FT704 and its companion, the dual p-Channel FT701, have an integrated-gate protection circuit, consisting of a diffused resistor-diode network that protects the gate of the MOSFETs from accidental damage by voltage transients. The FT704 is available in a TO-72 package and the FT701 comes in a TO-76 package.

CIRCLE NO. 260

## Tiered diodes withstand 7000 V



Solitron Devices, Inc., 256 Oak Tree Road, Tappan, N.Y. Phone: (800) 431-1850.

Hi-Pac process has been applied to a tiered modular assembly by void-free monolithic diodes mounted on an insulated aluminum base. This application results in a modular rectifier with an electrical capability of 7000-V PIV, at 3 A dc. Because the devices are individually compensated with RC networks, assemblies can be constructed without further external compensation up to 90-kV PIV, yet maintain their high current rating.

CIRCLE NO. 261



**YOU'LL JUMP  
FOR JOY...**

**when you see the complete specs  
and prices on our new**

**“PIXIEPOT”<sup>TM</sup>  
POTENTIOMETER!**

Never before in the history of the pot industry have you been able to get a TEN-TURN, WIRE-WOUND PRECISION potentiometer at prices like these. The Duncan Model 3253 “PIXIEPOT” is yours for as low as **\$3.97** each in production quantities and only **\$5.95** each for 1-24 units.

Match the following “PIXIEPOT” features with any other similar pot on the market.

- Length: **ONLY ¾”**
- Diameter: **ONLY ⅞”**
- Linearity: **±0.25%**
- Resistance Range: **100 ohms to 100K ohms**
- Power Rating: **2 watts @ +20°C**
- Temperature Range: **-25°C to +85°C**
- Resolution: **Better than ANY wirewound pot TWICE its size!**
- Slotted Stainless Steel Shaft

A Duncan “PIXIEPOT” can save you dollars on your instrument and system requirements. If you want to know just how many, call or write us today. The full story on the “PIXIEPOT” will be in the mail to you within 24 hours. And when it arrives, be prepared to jump for joy!



**DUNCAN electronics, inc.**

A DIVISION OF SYSTRON-DONNER CORPORATION

2865 FAIRVIEW ROAD, COSTA MESA, CALIFORNIA 92626



ON READER-SERVICE CARD CIRCLE 63

## This was the result of an IMC reducing plan.

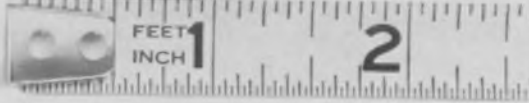

Moves more than 11,000 times its own volume of air each minute.

For spot cooling of miniaturized equipment.

Cools micro-circuits, transistor heat sinks, airborne computers and instrumentation . . . de-fogs radomes and optical equipment.

Delivers 6.5 cubic feet of cooling air per minute, yet this precision engineered vaneaxial fan weighs only 1 ounce and measures just 1 inch on a side.

Meets demanding environmental,

performance, and reliability specifications, operating efficiently for 1000 hours at 125° C, much longer at lower temperature ranges.

Standardized, for low cost and easy mounting, IMCube fans are readily placed throughout a system, whether it's already completed, or still in design stage.

IMCube fans with cylindrical housing optionally available.



IMC Magnetics Corp., Eastern Division, 570 Main St., Westbury, N.Y. 11591  
Phone (516) 334-7070 or TWX 510 222-4469

ON READER-SERVICE CARD CIRCLE 64

**Push-pull, push-pull, push-pull, push-pull,  
push-pull, push-pull, push-pull, push-pull,  
push-pull, push-pull, push-pull, push-pull,  
push-pull, push-pull, push-pull, push-pull,  
push-pull, push-pull, push-pull, push-pull,  
push-pull, push-pull, push-pull, push-pull.  
That's the monotony of reliability.**

Monotonous reliability characterizes IMC's solenoids, even at 4 millisecond speeds. There's a whole catalog of them in stock at IMC's Western Division, in sizes and configurations for avionics, instrumentation, computer peripherals and other systems.

If you need to push-pull, or to Indicate, Measure, and Control using steppers, synchros, resolvers, flag indicators or solenoids, contact the Applications Section at 6058 Walker Ave., Maywood, Calif., 90270. Phone (213) 583-4785 or TWX 910 321 3089.

For the catalog or data sheets contact the Marketing Div., 570 Main St., Westbury, N.Y. 11591 or circle the inquiry number.



ON READER-SERVICE CARD CIRCLE 65

## SEMICONDUCTORS

### Rectifier devices handle 5 kV PIV

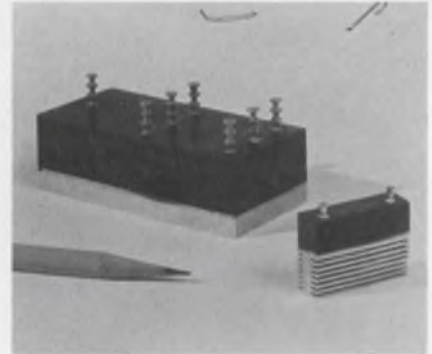

Solitron Devices, Inc., 256 Oak Tree Rd., Tappan, N.Y. Phone: (914) 359-5050.

A process named Hi-Pac has been applied to two series of rectifier assemblies. The devices are stackable on insulated boards or stands. The G865 devices have a 5-kV PIV and an output rating of 3 A. The G850 series combines two rectifier configurations in one package. One is a three-phase bridge with a 20-A output and the other is a single-phase center tap with a 20-A output.

CIRCLE NO. 257

### Dual-gate MOSFET sustains vhf use

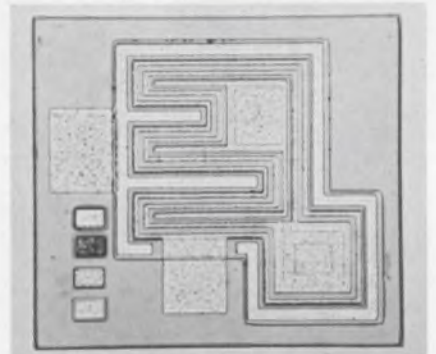

General Instrument Corp., 600 W. John, Hicksville, New York. Phone: (516) 681-8000.

An n-channel dual gate enhancement-depletion-mode MTOS transistor, known as Type MEM 554, is designed for use in rf amplifiers, mixers and i-f applications in communications to vhf frequencies. The features of the device include the following typical characteristics:  $g_m$ —12,000  $\mu$ mhos,  $C_{iss}$ —5pF,  $C_{oss}$ —0.02 pF. The power gain and noise figure at 200 MHz are 18 dB and 3.5 dB, respectively.

CIRCLE NO. 258

ON READER-SERVICE CARD CIRCLE 66 ►  
ELECTRONIC DESIGN 1, January 4, 1968





# *Small Wonder* the

Burroughs miniature rectangular NIXIE® tube is so well accepted! It is the smallest electronic readout available. For space-saving applications, excellent readability, greatest reliability and long life, the Burroughs Type B-4998 is the only answer. Now, because of its great popularity, Burroughs has effected production economies to reduce the price in quantities of 1000 to only \$13.95. For more detailed information on this NIXIE tube, associated driver modules and assemblies, contact Burroughs Corporation, Electronic Components Division, P.O. Box 1226, Department N5, Plainfield, New Jersey 07061 Telephone (201) 757-5000.

Tube photograph is actual size.



**Burroughs Corporation**

*Only Burroughs manufactures NIXIE Tubes.*

# Monolithic capacitors

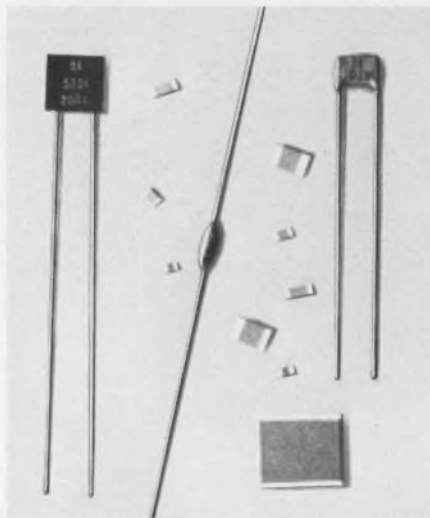

components and chips shown actual size

**If you need microminiature size and the ultimate in reliability—you need SKottie monolithic capacitors.**

SKottie monolithics provide the highest capacitance per unit volume available. And monolithic construction makes these capacitors practically immune to their environment. They offer the double protection of fused ceramic plus epoxy or phenolic encapsulation.

Both capacitors and chips are available in values ranging from 1.0 pf to 1.0 Mfd and higher in three dielectric materials. The chips are ideally suited for hybrid integrated circuits and can be soldered directly to the substrate. They can be supplied either tinned or untinned and also in special terminations other than silver. SKottie monolithic capacitors are available molded, dipped, or unencapsulated in both axial and radial lead configurations.

Write on your company letterhead for test samples. Ask for bulletin 6801 for more detailed information.

## SKOTTIE

**ELECTRONICS, INC.**

Subsidiary of Renwell Industries, Inc.  
Line St., Archbald, Penna. 18403  
Ph: 717-876-1686 TWX: 510-656-2979

ON READER-SERVICE CARD CIRCLE 67



## 10-to-150-kV rectifiers are surge-compensated

*Atlantic Semiconductor, 905 Mattison Ave., Asbury Park, N.J. Phone: (201) 775-1827. P&A: \$89 (150 kV unit in 1000 lots); stock.*

A packaging trick in making high-voltage silicon rectifier strings has led to smaller, surge-compensated rectifiers. Conventional voltage-surge compensation is achieved by placing a small ceramic capacitor across each junction. The capacitors store the energy during high-voltage surges to equalize the voltage drops across each junction. In the case of a 150-kV string (assuming 150 junctions of 1000 V each), 150 capacitors are required. The over-all capacitance (assuming equal capacitors) is then one-one-

hundred-fiftieth of this value. This consequently limits the unit's ability to absorb high-voltage transients.

In the new device, six 1000-V junctions are packed into one enclosure. Placing one capacitor across this whole rectifier unit then reduces the number of series capacitors required for a given voltage. This in turn results in larger over-all capacitance and increased ability to sustain voltage surges. Each 6000-V module of this type is packaged in a 0.75-in.-dia, 0.250-in.-high plastic encapsulated cylinder. Any multiple of 6000 V can be obtained by stacking the required number of cells.

The units available are rated from 10 to 150 kV, all at 100 mA continuous rectified current.

They are useful in dielectric testing, corona tests, insulation tests and other equipment where a requirement to rectify high voltage at low current exists.

In conclusion, it should be mentioned that each junction, when operated at the rated 100 mA, has a forward voltage drop of about 1 V. The reverse leakage current is about 1  $\mu$ A. The recovery time is about 5  $\mu$ s.



OLD

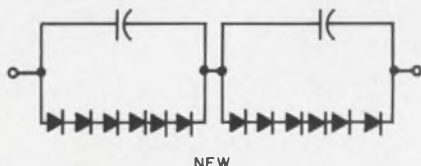

NEW

**Only one** compensating capacitor is used, as opposed to the old method.

CIRCLE NO. 256

# ANNOUNCING

## Varian's new TWT Division

<b>Low-noise TWT's</b>	<b>High-reliability Satellite TWTA's</b>	<b>Medium-power CW TWT's</b>	<b>High-power CW TWT's</b>	<b>High-power Pulse TWT's</b>
----------------------------	--	----------------------------------	--------------------------------	-----------------------------------

We've concentrated our efforts on TWT's by reorganizing, streamlining, and centralizing. We've taken the best from all our tube divisions and melded them into a new Traveling Wave Tube Division.

This new division offers you superior products all along the spectrum from low-noise TWT's through high-power pulse TWT's. It offers you *better engineering, better service, and better delivery* of the *best* traveling wave tubes available in the industry today.

For information, write the Traveling Wave Tube Division, 611 Hansen Way, Palo Alto, California. In Europe: Varian A.G., Zug, Switzerland. In Canada: Varian Associates of Canada, Ltd., Georgetown, Ontario, Canada. In Australia: Varian Pty., Sydney, Australia.



traveling wave tube division

611 Hansen Way • Palo Alto, California

ON READER-SERVICE CARD CIRCLE 68

It's "Top Ten" time again for Electronic Design readers, with that fabulous first prize of

# 2 ROUND-TRIP TICKETS AND PARIS...

But, if you don't come in first, there are 60 additional prizes to be won.

2nd prize

**Deluxe Heathkit/Thomas "Paramount" Transistor Theatre Organ.** Kit comes complete with 19 organ voices, 200 watts peak power, chimes, rotating Leslie speaker, horseshoe shaped console (retail value \$995.00).

3rd prize

**Deluxe Heathkit 23" Color TV.** Kit comes with all parts including walnut cabinet, chassis, tubes, mask, UHF, VHF tuners, mounting kit and special limited-field 4" x 6" speaker (retail price \$349.95).

4th through 11th prizes

**EICO "Cortina" 3070 All Solid State 70 Watt Stereo Amplifier (Kit).** Extremely compact "low silhouette" design ideally suited for bookshelf or cabinet installations. Versatile enough for the audiophile, simple enough for the beginner (retail value \$89.95).

Plus 50 additional prizes

**"Microelectronic Design",** containing nearly 90 outstanding articles providing a thorough overview of the field. Edited by Howard Bierman. (retail value \$11.50).

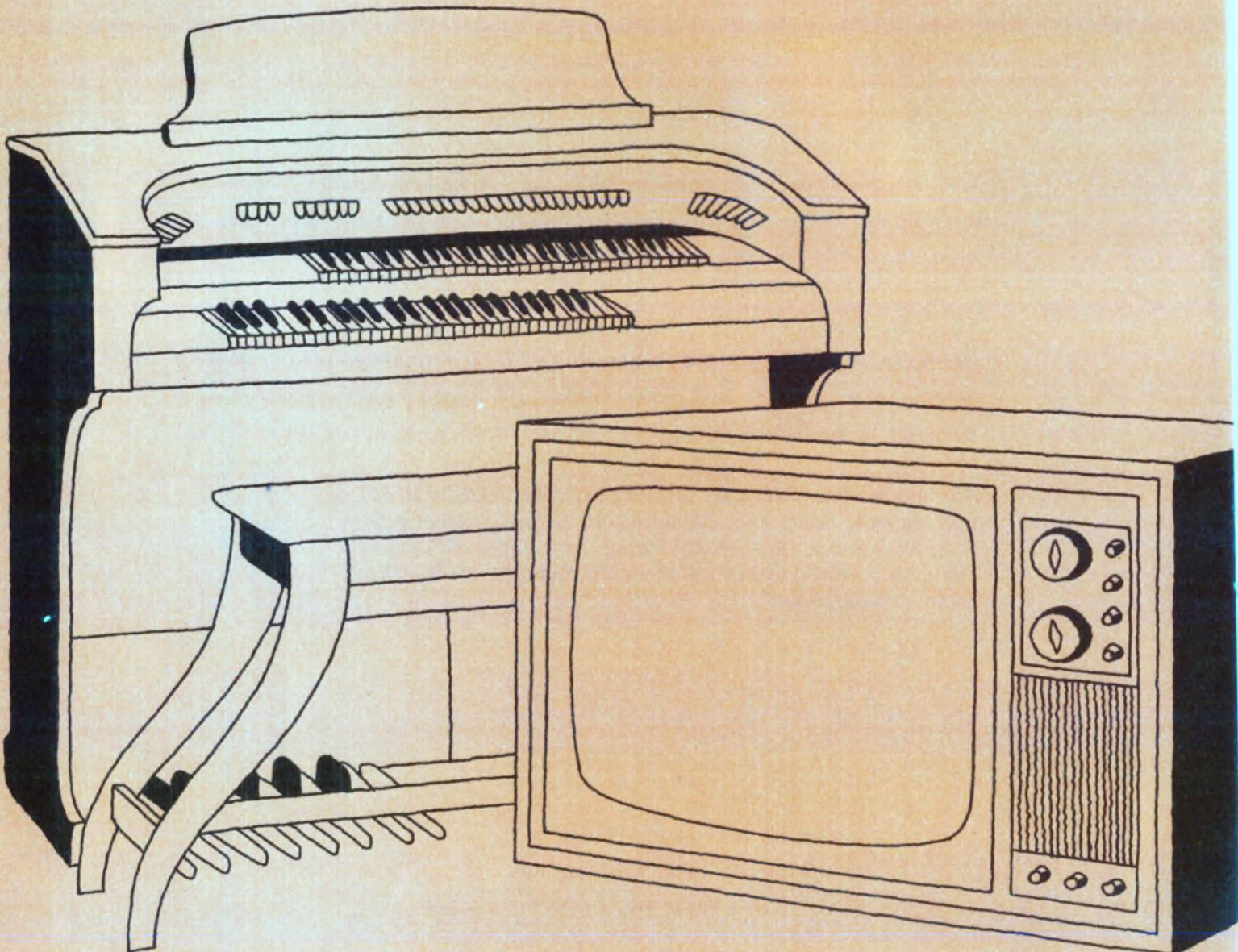

# BETWEEN NEW YORK VIA AIR FRANCE

## Easy to enter...

Simply pick the ten ads in this issue that you feel will be best remembered by your fellow readers. Your selections will be measured against the ten ads ranking highest in the "Recall Seen" category of Reader Recall, Electronic Design's method of measuring readership. Remember, in selecting the top ten ads, consider not only your own tastes and interest in the subject matter of each particular advertisement, but also those of the other engineers and engineering managers who read Electronic Design.

Use the entry blank (it's part of the Reader Service card) inside the back cover and get it in the mail today! Don't miss your opportunity to cash in on the

"Top Ten" action in '68...be it a trip to Paris or one of the 60 exciting prizes that will go to runners up. For contest rules see the page opposite the Reader Service cards (in this issue).

## Marketing people! Ad people!

There's a separate contest open to personnel at companies and agencies. Use the entry blank which appears inside the front cover of advertiser copies of this issue...or the Reader Service card (or contact your nearest Electronic Design representative and he'll be happy to supply you with one). Make your "Top Ten" selections today. In addition to valuable prizes, you may win free advertising for your company.

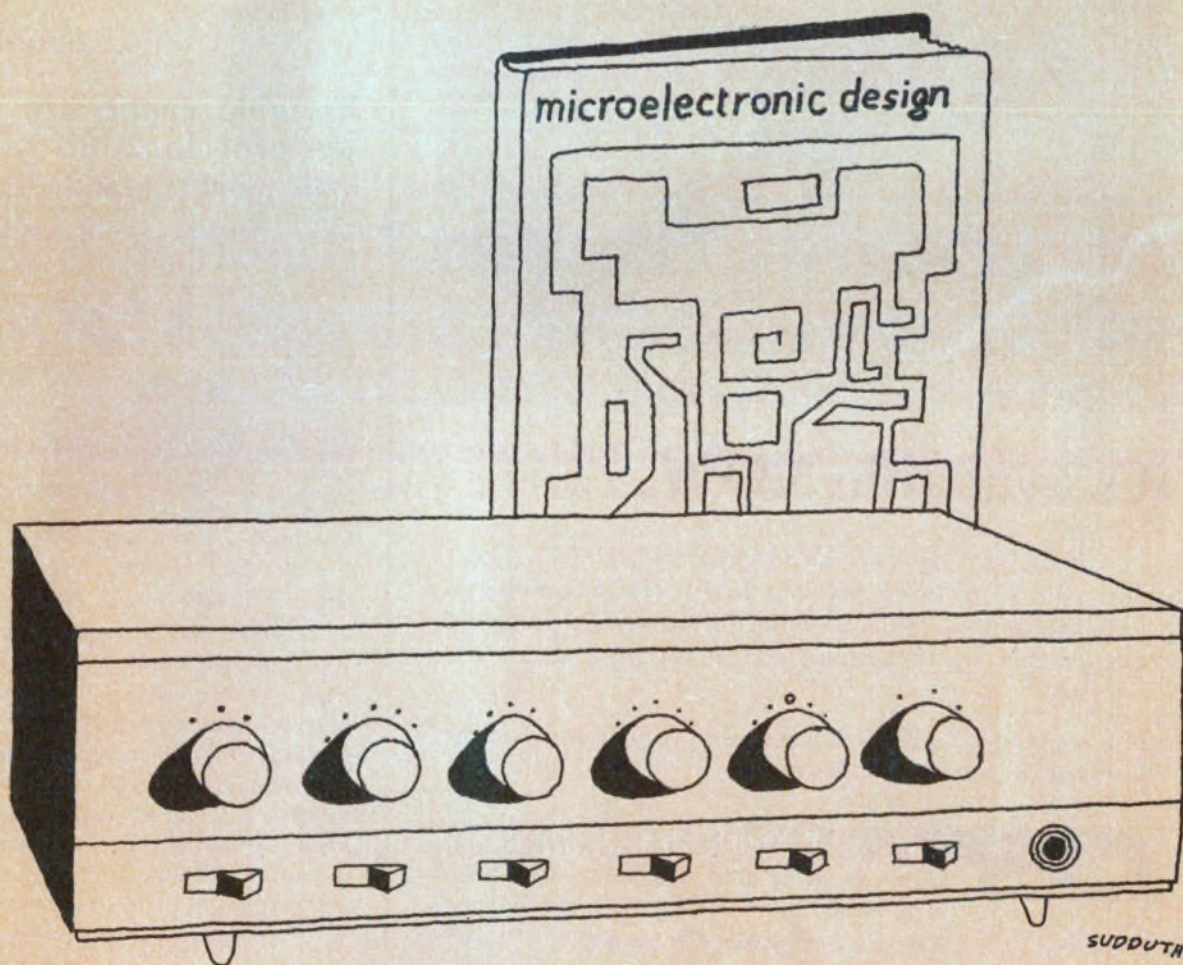

does an overall bandwidth of 400 kHz at an input frequency of 700 kHz sound rather wide to you?

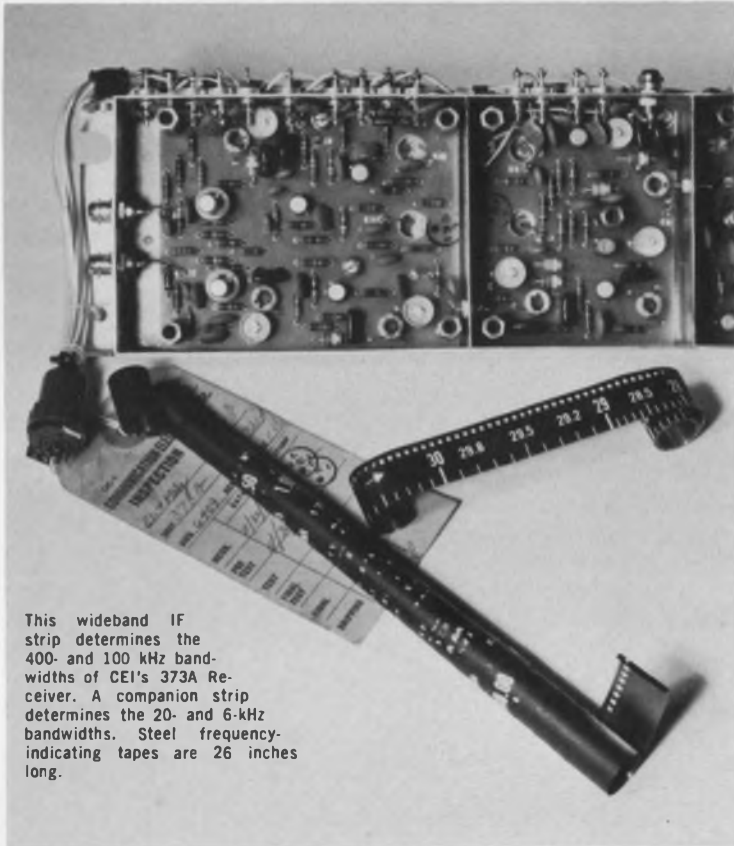

This wideband IF strip determines the 400- and 100 kHz bandwidths of CEI's 373A Receiver. A companion strip determines the 20- and 6-kHz bandwidths. Steel frequency-indicating tapes are 26 inches long.

## it's available NOW...

... in CEI's 373A Receiver designed for RFI/EMI detection. The 373A covers 500 kHz to 10 MHz in one band, from 10 to 30 MHz in the other. IF bandwidths include the 400 kHz mentioned plus 100, 20, and 6 kHz, switch-selectable.

Call or write for specifications and information on modifications for your particular needs.



**COMMUNICATION ELECTRONICS INC.**  
6006 Executive Blvd., Rockville, Md. 20852  
301/881-3300 • TWX: 710-824-9603

A SUBSIDIARY OF WATKINS JOHNSON



ON READER-SERVICE CARD CIRCLE 69

## SEMICONDUCTORS

### Transducer amplifier has 1 to 1000 gain

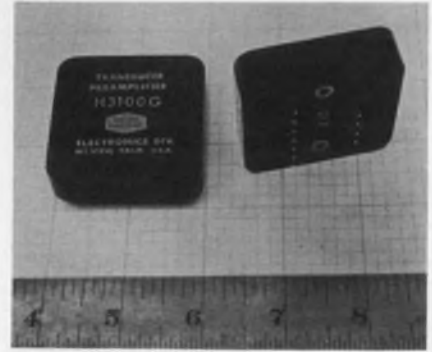

*Union Carbide Electronics, 365 Middlefield Rd., Mountain View, Calif. Phone: (415) 961-3300.*

The H3100G amplifies dc signals by a fixed gain of 1 to 1000, adjustable by one external resistor. Gain stability and linearity are 0.5% over the gain range. The bandwidth is 1 MHz at a gain of 1, and the output is  $\pm 10$  V at  $\pm 2$  mA. The amplifier operates from  $\pm 18$  V dc. It is suitable for use with both low-impedance transducers, such as strain gauges and thermocouples, and high-impedance transducers.

CIRCLE NO. 254

### Variable capacitors perform to 1000 pF

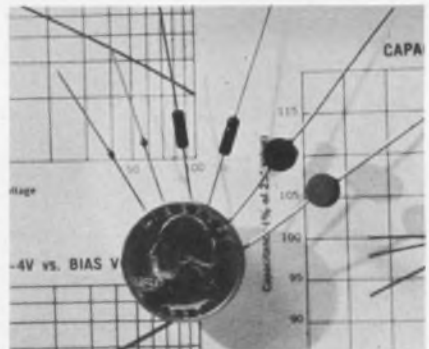

*Computer Diode Corp., Pollitt Drive South, Fair Lawn, N.J. Phone: (201) 797-3900.*

Voltage-variable capacitors with junction capacitance ratings as high as 1000 pF and  $Q$  values as high as 500 at 50 MHz and  $-4$  V are available. Working inverse voltage ratings up to 150 V can be provided. All these capacitors are abrupt junction diodes whose capacitance varies inversely as the square root of the applied voltage ( $1/V^{1/2}$ ).

CIRCLE NO. 255

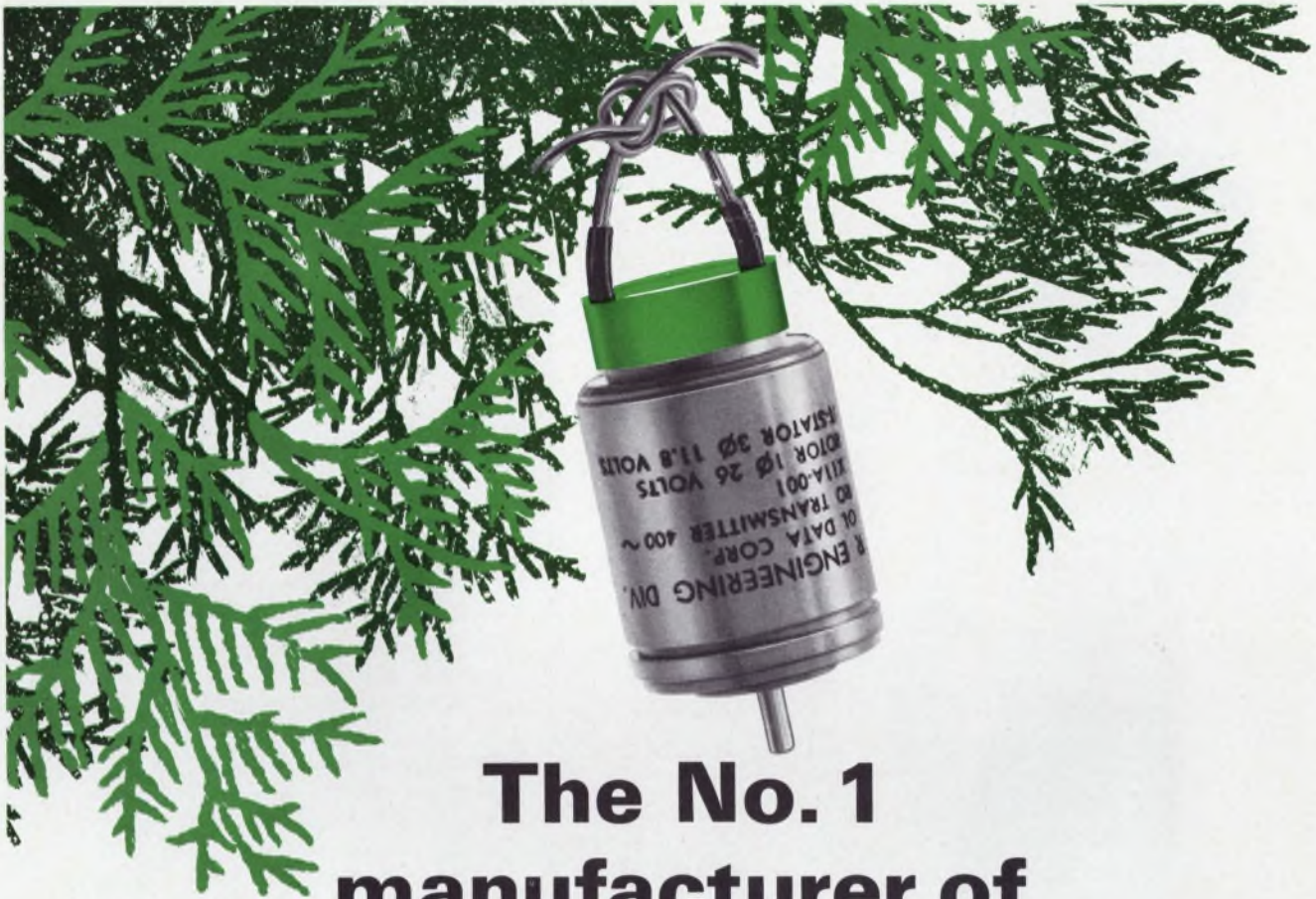

# The No. 1 manufacturer of servo motors is branching out into **SYNCHROS**

■ Cedar has long been a leader in the manufacture of precision servomotors, motor-tachometers and stepper motors. Through the years, Cedar has built a reputation for quality and economy.

Now Cedar brings its experience to bear on the manufacture of synchros. The first entry into this field is a Size 11 synchro transmitter available in a variety of winding and shaft configurations. Other types and sizes are soon to be announced.

Cedar's first synchro has been carefully developed and tested to assure conformance to strict specifications. It has already been qualified and government certified.

When you need Size 11 synchro transmitters write or give us a call. When it's made by Cedar, you know it's a quality product.

**CEDAR** **CONTROL DATA**  
ENGINEERING DIVISION CORPORATION

5806 West 36th Street, Minneapolis, Minn. 55416 • Phone (612) 929-1681

ON READER-SERVICE CARD CIRCLE 70

REJECTED? YES... BUT ONLY ONCE IN TEN YEARS!



## waldom solderless terminals & connectors

Our pretty miss should never be rejected . . . but, it may comfort her to know it also happened to us. Waldom Solderless Terminals and Connectors have been distributed for more than ten years, have been used in millions of circuits and installations and we, too have had a rejection. Just once. That's quality. But there are other good reasons for you to specify Waldom . . .

- \* Broad selection including Quick Disconnects
- \* All constructions styles
- \* Absolute dependability
- \* Saves time and labor
- \* Easier servicing
- \* All types made to military specs.

Fast delivery from your electronics or electrical distributor. Write for FREE Waldom catalog listing more than 3000 electronic hardware items.



**waldom**  
ELECTRONICS, INC.

4643 West 53rd Street, Chicago, Illinois 60632

ON READER-SERVICE CARD CIRCLE 105

## SEMICONDUCTORS

### Power recovery diodes resist radiation

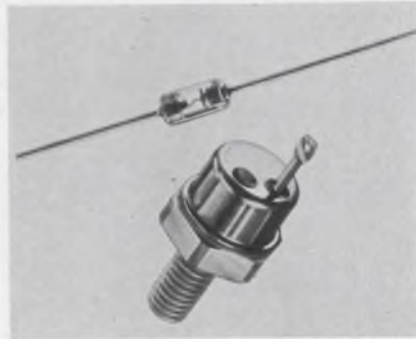

*Continental Device Corp., 12515 Chadron Ave., Hawthorne, Calif. Phone: (213) 772-4551.*

Two radiation-resistant power recovery diodes have come onto the market. The 1-W version is packaged in glass with 6.030-in. leads. It is 0.265 in. max length and 0.135 in body dia. The 10-W version is packaged in a modified TO-59 stud package. These devices are relatively low-voltage units with breakdowns of approximately 100 V and working voltages of 70 V. They have recovery times of less than 100 ns.

CIRCLE NO. 262

### Reference diodes accurate to $\pm 2\%$

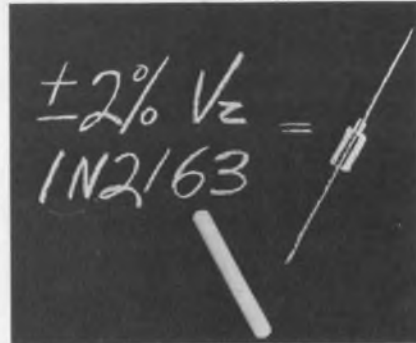

*Motorola Semiconductor Products, Inc., P.O. Box 955, Phoenix, Ariz. Phone: (602) 273-6900. Price: \$2.50 (100 up).*

This 9.4-V (nominal) IN2163 to IN2171 series of temperature-compensated reference diodes can be specified in voltage tolerances of either  $\pm 0.2$  V (A type,  $\pm 2\%$ ) or  $\pm 0.4$  V (nonsuffix,  $\pm 4\%$ ) over the nominal rating with temperature coefficients to 0.0005%/°C. They are designed for voltage stability under severe environmental stress.

CIRCLE NO. 263



**PAKTRON**  
**THE**

**BIGGEST  
NAME  
IN FILM  
CAPACITORS  
★ PRESENTS ★**

THE FIRST

# PAKTRON FILM

INTRODUCING  
**LOLITA**  
IN METALIZED MYLAR



**SEE  
THE  
GREATEST  
COLLECTION  
OF FILM  
CAPACITORS  
EVER  
ASSEMBLED  
FOR A  
SINGLE  
PRODUCTION.**

Thrill as they match or exceed their guaranteed ratings. Chill as they find themselves in a maze of electronic equipment. Marvel as they slip into high reliability military applications.

THEY MAY SHOCK YOU.

THEY MAY STARTLE YOU.

BUT THEY'LL NEVER FAIL YOU.

"AN ELECTRIFYING PRODUCTION"  
... Chronicle Gazette  
"HIGH VOLTAGE PERFORMANCE"  
... Globe Examiner

"...electrifying...totally new...a brilliant performance." Globe Gazette

You'll be dazzled by her resistance. Charmed by her size. Thrilled by her durability. You'll tremble at her volumetric efficiency. And you'll want to witness her tireless performance on the boards. Remember, Lolita is from Paktron, the company that brought you Theda and Greta—the biggest names in the radial capacitor biz. And, if you want to be alone with Lolita, just give us the word. Any capacitor named Lolita can't be all bad.

**LOLITA**  
ALL NEW RADIAL LEAD METALIZED  
MYLAR FILM CAPACITOR

Lolita—a character study:  
Working Voltage: 100, 200, and 400 WVDC  
Tolerance: ±5%, ±10%, ±20% Standard  
Capacitance Values: .1 mfd.—10.0 mfd.  
Lead crimps to fit your printed  
circuit board applications

ANNUAL

# FILM FESTIVAL

INTRODUCING  
**URSULA**  
IN WRAP AND FILL



"...a really new film star...this one is destined for greatness." Chronicle Examiner

You'll thrill to her high performance. You'll quiver as this trim little lovely exhibits her form in a skin type wrap. Your blood will run cold as she resists shock and vibration. Your palms will sweat when you see her axial leads in a point to point configuration. And remember, Ursula is from Paktron, the company that made radial lead capacitors the biggest hit of our time. Once you've seen Ursula in action, you'll have to see her in person. She's available for demonstrations. Just ask. Be honest with yourself. Would anyone name a capacitor Ursula if he didn't think it could stand the shock?

**URSULA**  
ALL NEW WRAP & FILL  
CAPACITOR

Here's how the critics describe Ursula:  
Capacitance Values: .001 mfd.-1.0 mfd.  
Tolerances:  $\pm 5\%$ ,  $\pm 10\%$ ,  $\pm 20\%$  Standard  
Working Voltage: 80, 100, 200, 400, and 600 WVDC

## COMING ATTRactions

In the months to come you'll see:

- One of the industry's brightest stars, Bridgette in **THE BATTLE OF CIRCUIT CITY**.
- Rhonda, darling of the circuit, in **SHELL SHOCK**.
- **RETURN TO PAKTRON PLACE** in which factory workers follow Sophia's Leads.

You won't want to miss a single one of these film capacitors.

★ **SEND** ★  
**FOR A FREE  
PIN-UP  
CALENDAR.**

See all your film favorites, posed the way you like them, in shocking color. Write on your letterhead to:

**FLO ZIGFIELD**  
Paktron Division  
Illinois Tool Works Inc.  
1321 Leslie Avenue  
Alexandria, Virginia 22301

# EVER POPULAR FAVORITES

THRILL AS TINY **THEDA** STRUGGLES TO PROTECT HER CAPACITY.



Ultra thin Mylar Film/Foil—the MW-50  
Capacitance Values: up to 0.47 mfd.  
Working Voltage: 50WVDC  
Tolerances:  $\pm 5\%$   $\pm 10\%$   $\pm 20\%$   
Operating Temperature Range:  
-55°C to +125°C

THE GORGEOUS **GRETA** SEE THIS PROUD BEAUTY RESIST THE ADVANCES OF AGE.



Hi-Blu™ Mylar Film/Foil Epoxy Dip-coated  
Capacitance Values: to 0.5 mfd.  
Working Voltages: 100 to 600 WVDC  
Tolerance:  $\pm 5\%$  to  $\pm 20\%$   
Operating Temperature Range: -55°C to +125°C

MEET **SOPHIA** MOLDED MYLAR CAPACITOR. GET TO KNOW HER BY HER FIRST NAME.



Working Voltage: 50WVDC  
Tolerance:  $\pm 1\%$ ,  $\pm 2\%$ ,  $\pm 5\%$ ,  $\pm 10\%$  Standard  
Capacitance Value: 220 mmfd.—.1 mfd.

THE BEWITCHING **BRIGITTE** WILL LURE YOU WITH HER PRECISION FORM.



Classic molded polycarbonate  
Capacitance Values: 470 mmfd.—.056 mfd.  
Working Voltage: 50WVDC  
Tolerances:  $\pm 1\%$ ,  $\pm 2\%$ ,  $\pm 5\%$   $\pm 10\%$  Standard  
Operating Temperature Range: -65°C to 105°C  
(no Voltage derating)

LEARN WHY **CLARA** ISOLATED HERSELF FROM THE REST OF THE CIRCUIT.



Flat Line—Mylar Film/Foil  
Capacitance Values: .01 mfd.—.5 mfd.  
Working Voltage: 100WVDC  
Tolerance:  $\pm 5\%$ ,  $\pm 10\%$ ,  $\pm 20\%$  Standard  
Operating Temperature Range:  
-55°C to +125°C

THE TEMPTING **RHONDA** SAYS "WHY DON'T YOU PICK ME UP AND TRY ME SOMETIME?"

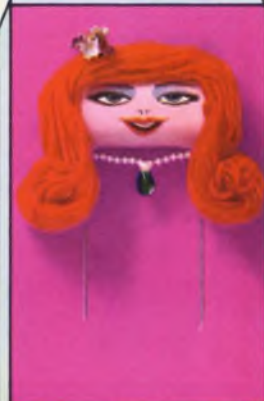

Epoxy dip coated Metalized Polycarbonate  
Capacitance Values: .068 mfd.—2.5 mfd.  
Working Voltage: 100 WVDC  
Tolerance:  $\pm 5\%$ ,  $\pm 10\%$ ,  $\pm 20\%$  Standard  
Operating Temperature Range: -55°C to +125°C (no Voltage derating)

**PAKTRON**  
Division Illinois Tool Works Inc.  
**itw**

These Paktron film stars are distributed exclusively by COMPAR.

# Tips on cooling off hot transistors

See how circuit designers use IERC heat dissipators to protect semiconductors...improve circuit performance and life.

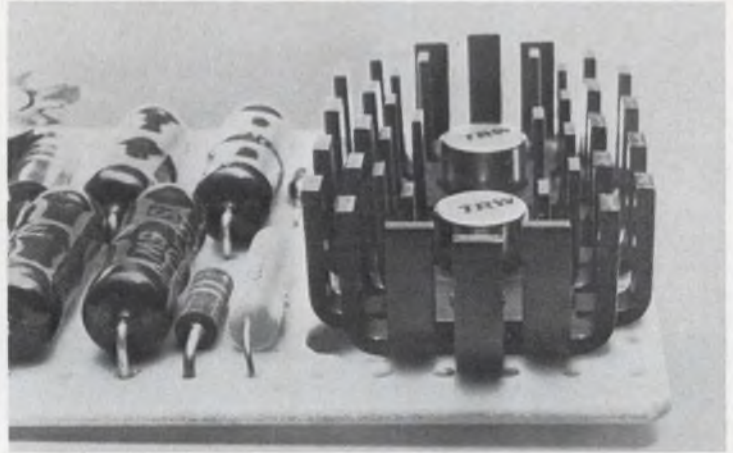
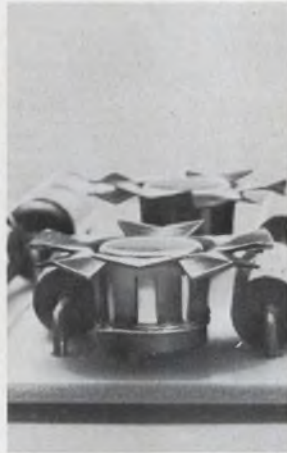
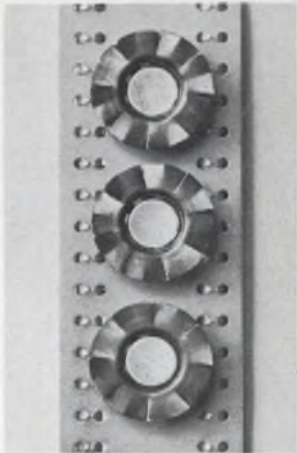

**Fan-top dissipators for TO-5 and TO-18 cases drop temperatures dramatically; cost just pennies.** T-shape adds almost nothing to board height; allows components to snuggle close to transistors. Spring fingers provide fast, press-on installation.

**To cool off low-to-medium power transistors in TO-5 and TO-18 cases, use IERC's efficient LP's.** Patented, staggered-finger design maximizes radiation and convection efficiency, radiates heat directly to ambient. Available in single or dual mounting for thermal mating of matched transistors.

**IERC Therma-Link Retainers provide efficient thermal links between transistors and chassis or heat sinks.** (Also, excellent dissipation when used on p-c boards.) Integral BeO washers reduce capacitance up to 2/3. Fast, no-snap installation; transistors are firmly held.

**New! Dissipators and retainers for plastic and epoxy transistors.** 3 new series for RO-97A, RO-97 and X-20's. Permit a jump of 10% to 33% in operating power.

**Free 8-page short form catalog** discusses IERC's complete line of dissipators, retainers and tube shields. Gives specifications, prices, how to order. Send for your copy today.

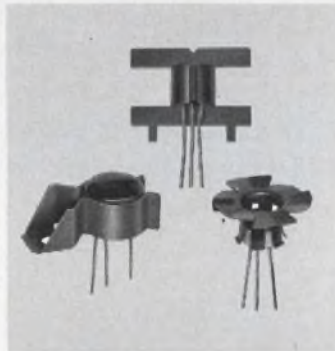
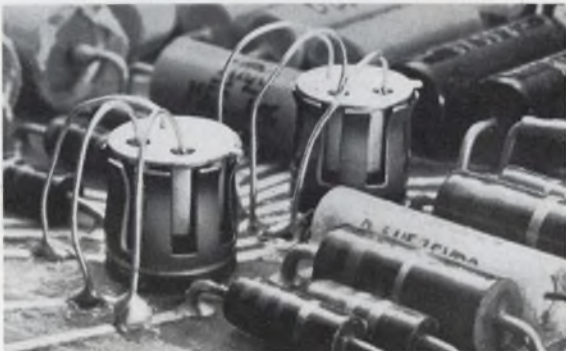

**Special insulating coating** — Insulube 448, a special non-hygroscopic finish developed by IERC, combines excellent dielectric properties, 50 K megs insulation resistance, and high heat emissivity. Also protects against salt spray, fungus, etc.

**Tough heat dissipating problem?** IERC engineers welcome your letter-head inquiry for specific information or assistance in selecting heat dissipators.

**ierc**  
SEMICONDUCTOR  
HEAT DISSIPATORS

INTERNATIONAL ELECTRONIC RESEARCH CORPORATION • A corporate division of Dynamics Corporation of America  135 West Magnolia Ave. • Burbank, Calif. 91502

ON READER-SERVICE CARD CIRCLE 71

◀ ON READER-SERVICE CARD CIRCLE 140

161

**ENGINEERED PLASTIC PUMPS AND FILTERS**  
**For Virtually any Chemical or Corrosive Fluid Application**

**CHEM-GARD HEAVY DUTY PLASTIC CENTRIFUGAL PUMPS . . .**

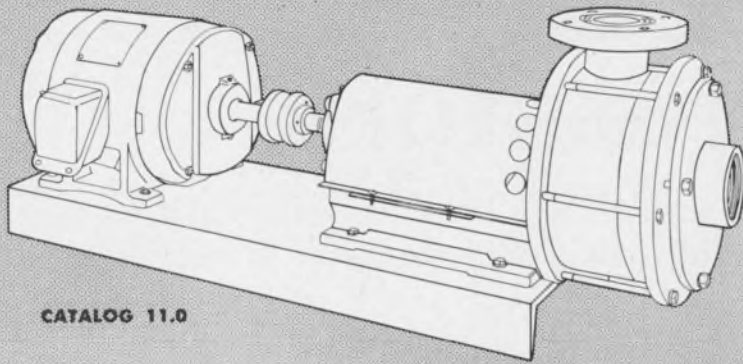

CATALOG 11.0

. . . embody the basic design and physical configurations dictated for efficient heavy duty fluid transfer pumps. In addition, these pumps utilize highly corrosion resistant Polypropylene and/or PVC materials for the fluid end. The result is a series of pumps of unique material utilization and design characteristics unlike any other centrifugal pumping equipment now in use for the conveyance of chemicals, pharmaceuticals and other fluids which require protection from metallic corrosion and contamination.

Models range in size from 5GPM to 300GPM at discharge heads to 170 feet.

**FLEXI-I-LINER PLASTIC SEALLESS ROTARY PUMPS . . .**

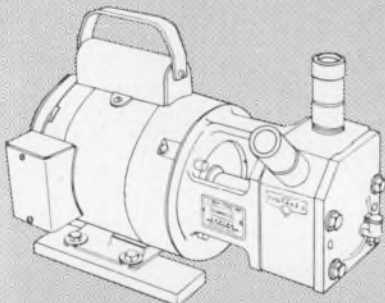

CATALOG 10.0

. . . resolve the single biggest problem in the transfer of corrosive or abrasive fluids by eliminating entirely the need for shaft seals or stuffing boxes of any sort. Flex-i-Liner pumps are self-priming, will operate wet or dry, and will handle a wide variety of acids, alkalis, abrasive slurries, viscous fluids and corrosive gases. The only parts in contact with the fluid are the body block and flexible liner. These are available in over sixty combinations of plastic and synthetic materials including Teflon, Viton A, Kel F, etc. Capacities from 1/3 to 40 GPM at heads to 50 psig.

**CHEM-GARD ALL PLASTIC PUMP-FILTER SYSTEMS . . .**

. . . provide a self priming filtration cycle totally free of metallic elements thus assuring a contamination and corrosion free course for even the most corrosive and sensitive solutions.

Filtration units in either PVC, PVDC, or lucite and furnished with polypropylene cartridges allow for depth filtration from 1 to 200 microns. Flow systems up to 1200 GPH are available.

CATALOG 12.0

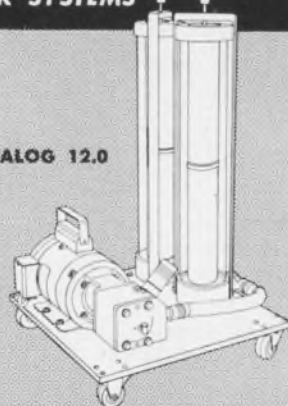

**ENGINEERED PLASTIC PRODUCTS FOR FLUID HANDLING**  
**VANTON PUMP & EQUIPMENT CORP.**

201 Sweetland Avenue, Hillside, New Jersey • Area Code 201 - WA 6-2435

ON READER-SERVICE CARD CIRCLE 72

**SEMICONDUCTORS**

**Plastic transistors offer 50% space savings**

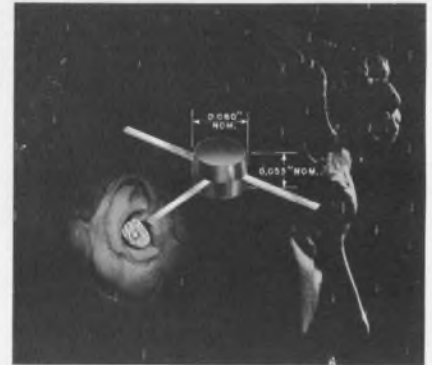

*Motorola Semiconductor Products, Inc., P.O. Box 955, Phoenix, Ariz. Phone: (602) 273-6900. Price: \$1.60 to \$2 ea (100 up).*

Because the new devices occupy approximately one-tenth the volume of comparable performance transistors in standard TO-18 and TO-92 packages, the user achieves a 20% to 50% reduction in design space. A total of 144 individual devices will fit comfortably on a 2-1/2-in.-square printed-circuit board.

CIRCLE NO. 264

**Bridge rectifier handles 120-A surge**

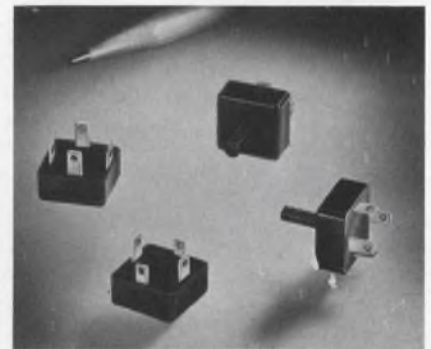

*Sarkes Tarzian, Inc., Semiconductor Div., 415 N. College Ave., Bloomington, Ind. Phone: (812) 332-1435.*

This 2-A silicon bridge rectifier is 1/4 in. high and 9/16 in. square and can resist a power surge of 120 A at 25°C. It is available in PIV ratings from 200 to 1000. Max ambient operating temperature is 140°C with heat sink conduction. The S 6230 series can be supplied with a nylon mounting stud where lead or printed-circuit board mounting is not desired.

CIRCLE NO. 265

# POLY-SIL PLASTIC MIL RECTIFIER AT HALF THE COST OF GLASS



Popular  
1N3611 series  
now available  
from IRC...  
off-the-shelf.

Up to now these units were available only from one source and at nearly twice the cost. Now, IRC (the resistor people) offers a Poly-Sil rectifier that's a real money saver for all your low-power MIL applications. Check these prices.

TYPE	1-99	100-999
JAN 1N3611	\$1.49	\$ .99
JAN 1N3612	1.95	1.30
JAN 1N3613	2.70	1.85

Commercial versions at lower cost

**These units have a single-cycle surge rating of 20 amps.**

Tough and durable, Poly-Sil completely surrounds all internal parts. This solid construction is stronger than comparable glass packages.

A great combination of low cost and superior performance, the 1N3611 series is available off-the-shelf in production quantities. See your IRC representative or write for data. IRC, Inc., Semiconductor Division, 727 Lynnway, Lynn, Mass. 01905.

## SPECIFICATIONS



ACTUAL SIZE

MIL.....	Meets MIL-S-19500/228D
RATINGS.....	2A @ 25° C
	1A @ 100° C
	0.3A @ 150° C
VOLTAGE.....	200, 400, 600
TEMP. RANGE	
operating.....	-65° C to 150° C
storage.....	-65° C to 175° C



**SEMICONDUCTOR DIVISION**

ON READER-SERVICE CARD CIRCLE 73

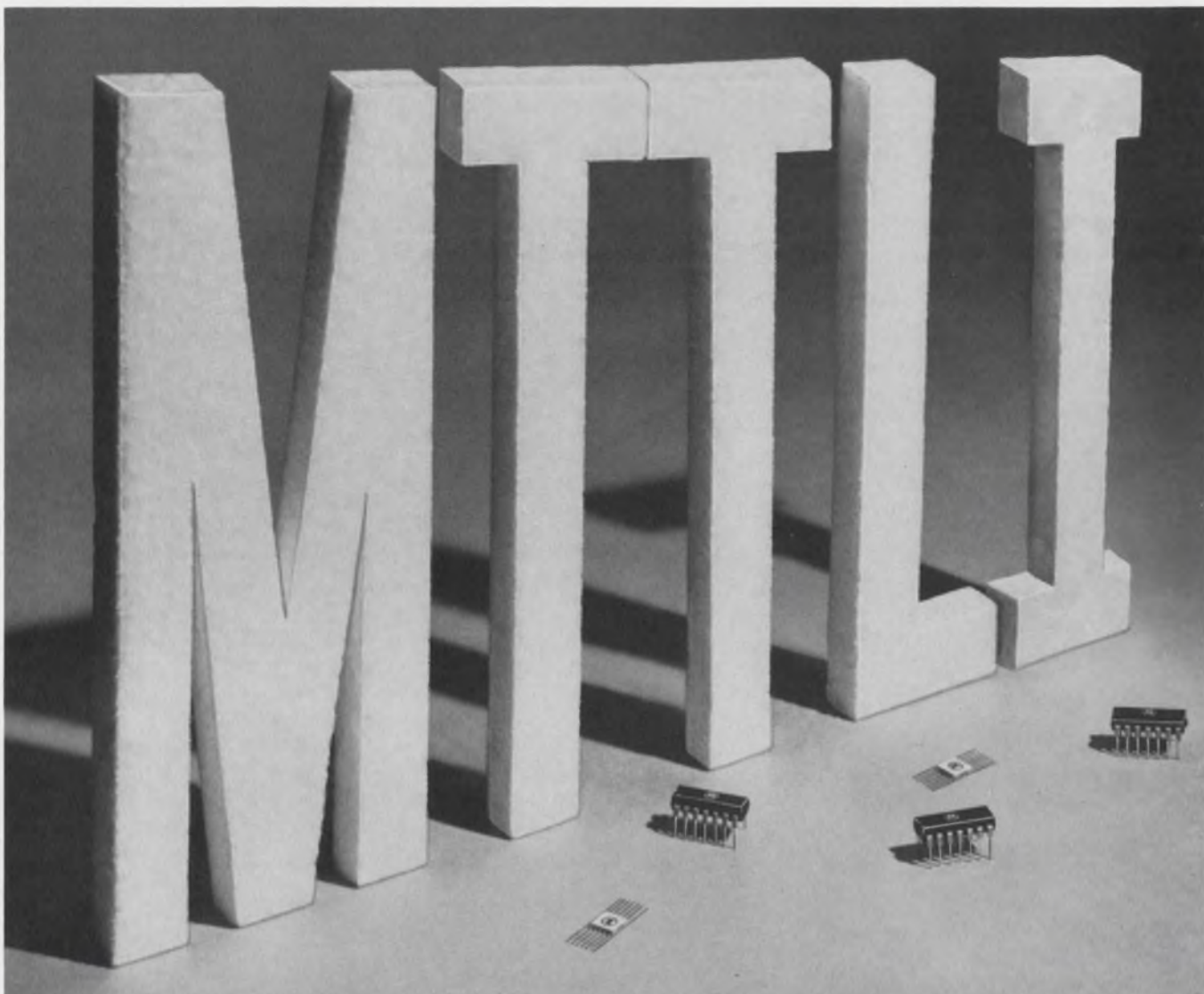

## MOTOROLA'S MTTL I SERIES INTEGRATED CIRCUITS SOLVE THE T<sup>2</sup>L "AVAILABILITY" PROBLEM

### MOTOROLA'S MTTL I SERIES PROVIDES OPTIMUM SELECTION & DESIGN FLEXIBILITY!

Motorola has production quantities immediately available of all circuit functions in the MTTL I (some call it SUHL\* I) T<sup>2</sup>L circuit series! Even the "hard-to-get" J-K Flip-Flops (SF50 & SF60) are readily available from Motorola. Just ask for MC515 or MC516 . . . or, any of the others shown at the right.

So, for systems now in production — or for new designs — you'll want to choose from our MC400/500 series (flat-packs or plastic) to fit all of your application needs. Don't wait on that important order that you're holding. Call Motorola, today! For complete technical details on these two popular series, write: P.O. Box 955, Phoenix, Arizona 85001.

MTTL is a trademark of Motorola Inc.  
\*Trademark of Sylvania

DESCRIPTION	-55 to +125°C F.O. = 15	-55 to +125°C F.O. = 7	0 to +75°C F.O. = 12	0 to +75°C F.O. = 6
Dual 4-Input NAND/NOR Gate	MC500 (SG40)	MC550 (SG41)	MC400 (SG42)	MC450 (SG43)
Expandable Quad 2-Input AND-OR-INVERT Gate	MC501 (SG50)	MC551 (SG51)	MC401 (SG52)	MC451 (SG53)
Single 8-Input NAND/NOR Gate	MC502 (SG60)	MG552 (SG61)	MC402 (SG62)	MC452 (SG63)
Dual 3-Input AND-OR-INVERT Gate (with complement)	MC503 (SG90)	MC553 (SG91)	MC403 (SG92)	MC453 (SG93)
Expandable Triple 3-Input AND-OR-INVERT Gate	MC504 (SG100)	MC554 (SG101)	MC404 (SG102)	MC454 (SG103)
Expandable Dual 4-Input AND-OR-INVERT Gate	MC505 (SG110)	MC555 (SG111)	MC405 (SG112)	MC455 (SG113)
Expandable Single 8-Input NAND/NOR Gate	MC506 (SG120)	MC556 (SG121)	MC406 (SG122)	MC456 (SG123)
Quad 2-Input NAND/NOR Gate	MC508 (SG140)	MC558 (SG141)	MC408 (SG142)	MC458 (SG143)
Quad 2-Input AND/OR Expander	MC509 (SG150)	MC559 (SG151)	MC409 (SG152)	MC459 (SG153)
Dual 4-Input AND/OR Expander	MC510 (SG170)	MC560 (SG171)	MC410 (SG172)	MC460 (SG173)
Dual 4-Input AND Expander	MC511 (SG180)	MC561 (SG181)	MC411 (SG182)	MC461 (SG183)
Triple 3-Input NAND/NOR Gate	MC512 (SG190)	MC562 (SG191)	MC412 (SG192)	MC462 (SG193)
Set-Reset Flip-Flop	MC513 (SF10)	MC563 (SF11)	MC413 (SF12)	MC463 (SF13)
J-K Flip-Flop (AND Inputs)	MC515 (SF50)	MC565 (SF51)	MC415 (SF52)	MC465 (SF53)
J-K Flip-Flops (OR Inputs)	MC516 (SF60)	MC566 (SF61)	MC416 (SF62)	MC466 (SF63)

All MTTL I circuits are available in the TO-86, 14-lead flat package ("F" suffix). Types MC400 thru MC466 are also available in the 14-lead, dual in-line plastic package ("P" suffix).

*-where the priceless ingredient is care!*



**MOTOROLA Semiconductors**

ON READER-SERVICE CARD CIRCLE 81



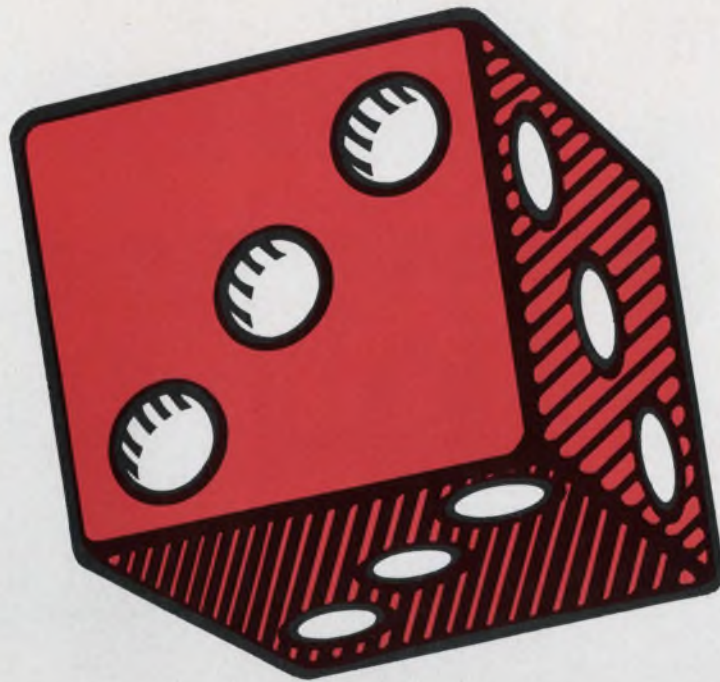

**LIKE A SURE THING ?**

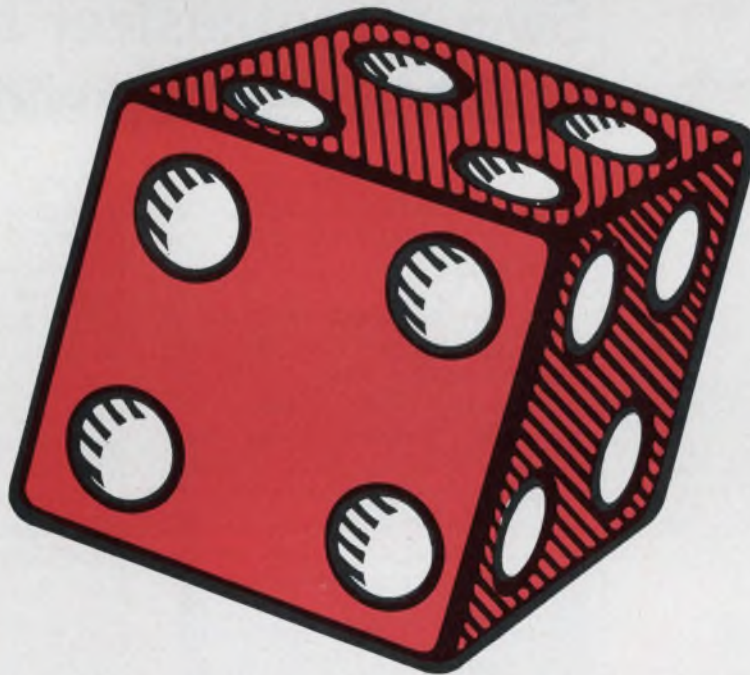

**THE ODDS ARE 36,000 TO ONE COHU HAS THE RIGHT TV SYSTEM FOR YOU!** A pioneer in TV, Cohu today is the largest producer of standard, off-the-shelf TV systems in the industry. Take the standard lenses, camera controls, pick-up tubes (both vidicons and Plumbicons®) and video monitors—put these together with Cohu's various camera housings, remote controls and lens drives and you have over 36,000 possible TV system combinations. And this does not include Cohu's wide variety of quality TV accessories and switching systems.

**ONE IS RIGHT FOR YOU!** Whether your needs be industrial, educational or military, one of Cohu's TV combinations is right for you. Let Cohu engineering know-how design for you a custom TV system from standard, off-the-shelf components.

For details on the industry's most complete TV line, contact your nearest Cohu representative or call Bob Boulio direct at 714-277-6700 in San Diego. The odds are in your favor.

Box 623, San Diego, California 92112. TWX 910-335-1244.

® Reg. T.M. of N.V. Philips Co., Holland  
ELECTRONIC DESIGN 1, January 4, 1968

ON READER-SERVICE CARD CIRCLE 82

**COHU**  
ELECTRONICS, INC  
SAN DIEGO DIVISION

# Bulova can supply the crystal you need



to match your specs!

Many years of supplying crystal control units for the most advanced military and space programs enable Bulova to offer a full line encompassing virtually the entire frequency spectrum—2 kc to 125 Mc for oscillator and filter applications. We can supply every type of packaging—including koldweld and glass sealed. Our military crystals meet latest MIL-C-3098D specifications. All reasons why you should make Bulova your single source of supply.

**HIGH PRECISION GLASS SEALED CRYSTALS** 1 Mc to 125Mc. Available in vacuum sealed, glass enclosures of the HC-26/U and HC-27/U type.

**Example: Precision SSB Crystals**

Frequency: 1 Mc to 5 Mc  
Holder: HC-27/U  
Tolerance:  $\pm .0025\%$  from  $-55^{\circ}\text{C}$  to  $+90^{\circ}\text{C}$ , or to specification  
Aging:  $3 \times 10^{-8}$  per week after one week stabilization at  $75^{\circ}\text{C}$



**KOLDWELD SEALED CRYSTALS**—low aging, high reliability, 1 Mc to 125 Mc. Now available in TO-5, HC-6/U and HC-18/U type cans sealed by the koldweld process to eliminate effects of heat and to reduce contamination.

**Example: TO-5**

Frequency: 15 Mc to 125 Mc  
Tolerance:  $\pm .0025\%$  from  $-55^{\circ}\text{C}$  to  $+105^{\circ}\text{C}$ , or to specification  
Aging:  $1 \times 10^{-7}$  per week after one week stabilization at  $75^{\circ}\text{C}$



Write or call for specifications on Bulova's complete line of crystals. Address: Dept. ED-17

## BULOVA

FREQUENCY CONTROL PRODUCTS

ELECTRONICS DIVISION OF BULOVA WATCH COMPANY, INC.

61-20 WOODSIDE AVENUE WOODSIDE, N.Y. 11377, (212) DE 5-6000

ON READER-SERVICE CARD CIRCLE 75



## Sweep synthesizer has 100-MHz sweep width

*Kay Electric Co., Maple Ave., Pine Brook, N.J. Phone: (201) 227-2000. Price: \$2475; plug-ins are \$35 to \$595.*

The Syntha-Sweep 101-A is a sweep and marker generator that offers sweeps 100 MHz wide. Front panel controls select stabilized cw operation, stabilized swept frequency operation with sweep widths variable from a controlled residual fm to a max of 4% of center frequency, stabilized swept

frequency operation with sweep widths variable from a controlled residual fm to a max of 4% of center frequency, or swept frequency operation with sweep widths variable from a proportionately low residual fm to the full sweep width.

The circuits are arranged to permit free-running sweep generator performance from 50 kHz to 100 MHz, and stabilized sweep and cw performance from 100 kHz to 70 MHz. The stabilized frequency output is controlled by a direct-reading 3-place digital switch arrangement and a calibrated digital vernier dial. A two-step calibration at 1 MHz provides a max error of 0.05% at all frequency settings; a zero adjustment at the selected setting cuts the max error to 0.01%. The full 50-kHz-to-100-MHz range (includes stabilized 100 kHz to 70 MHz) is covered by a single voltage-controlled oscillator module, constructed as a plug-in assembly fitted in place from the rear of the instrument.

In addition a series of somewhat more limited-range plug-in oscillators covers one or more octaves and provides typical residuals as low as 5 Hz.

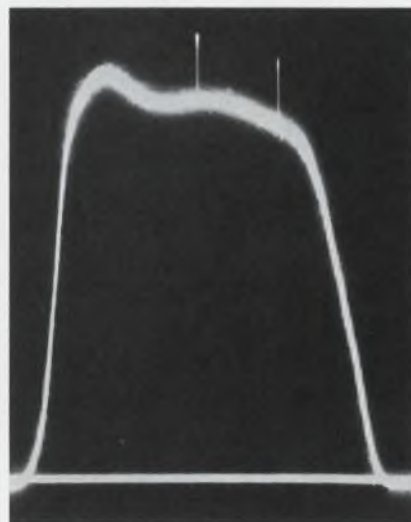

Two markers show amplitude of 9-MHz filter, accuracy is  $\pm 0.05\%$ .

CIRCLE NO. 269

## TEST EQUIPMENT

### Digital ohmmeter records to 1000ΩM



Hickok Electrical Instrument Co., Cleveland, Ohio. Phone: (216) 541-8060. P&A: \$560; stock.

Digital display of resistance measurements is provided in a digital ohmmeter, designated model DMS-3200/DP-170. It provides digital readout of resistance measurements from 0.001 Ω to 1000 MΩ in ten ranges from accuracy capability of ±0.1% full-scale, ±0.1% of reading. Of special interest is the low power applied to the resistor under measurement — it is 1 mW max.

CIRCLE NO. 267

### Sweep generator stable to 50 Hz/min



Telonic Instruments, 60 N. First Ave., Beech Grove, Indiana. Phone: (317) 787-3231.

This sweep signal generator is capable of maintaining its set frequency within 50 Hz over a 1-minute operating period and within 5 kHz for an hour's operation. The generator, Model 1013, operates from 2 kHz to 25 MHz with variable sweep width from 200 Hz to 25 MHz. The unit supplies 1 V rms into 5 Ω with a sweep rate from 0.01 to 60 Hz, cw and modulated cw.

CIRCLE NO. 268

# Ballantine low-cost DVM's are small, easy-to-use... permit fast, highly accurate measurements in production with unskilled personnel... are ideal, too, for the lab and quality control. Compare their many useful features.



## BALLANTINE DC DVM

### Model 353

Designed to replace multi-knob manual vm's for speed and accuracy ■ 0 to 1100 V ■ High accuracy ±0.02% of reading ±0.01% f.s. ■ 4 digit with overranging to 5, plus interpolation of last digit ■ Resolution 0.002% ■ Reading retention or continuous observation of varying signals ■ All solid state ■ 10 megohms input resistance ■ Isolated signal ground with high common mode rejection ■ Small size (½ rack module) and low weight (7.7 lbs.) ■ Power requirement 115/230 V, 50 to 60 Hz ■ Price: \$490

## BALLANTINE AC-DC DVM

### Model 355

Designed to increase accuracy and speed up readings compared to those made with analog instruments ■ 0 to 1000 V ac, 30 Hz to 250 kHz ■ 0 to 1000 V dc ■ Accuracy 0.25% f.s. ■ Full scale sensitivity of 10 mV on ac; 100 mV on dc ■ 3 digits with overranging to 4, plus interpolation of last digit ■ Single economical package ■ Small size (½ rack module) ■ Reading retention, or continuous observation of varying signals ■ Isolated signal ground, with high common mode rejection ■ DC output for connection to recorder ■ Amplifier output, 60 dB gain ■ Zener reference ■ Power requirement 115/230 V, 50 to 60 Hz ■ Price: \$620

Write for brochures giving complete details



**BALLANTINE LABORATORIES INC.**  
Boonton, New Jersey

CHECK WITH BALLANTINE FIRST FOR DC AND AC ELECTRONIC VOLTMETERS/AMMETERS/OHMMETERS, REGARDLESS OF YOUR REQUIREMENTS. WE HAVE A LARGE LINE, WITH ADDITIONS EACH YEAR. ALSO AC/DC LINEAR CONVERTERS, AC/DC CALIBRATORS, WIDE BAND AMPLIFIERS, DIRECT-READING CAPACITANCE METERS, AND A LINE OF LABORATORY VOLTAGE STANDARDS FOR 0 TO 1,000 MHZ.

ON READER-SERVICE CARD CIRCLE 76

**These new Keithley mos fet op-amps are just the ticket for researchers and designers who like to write their own.**

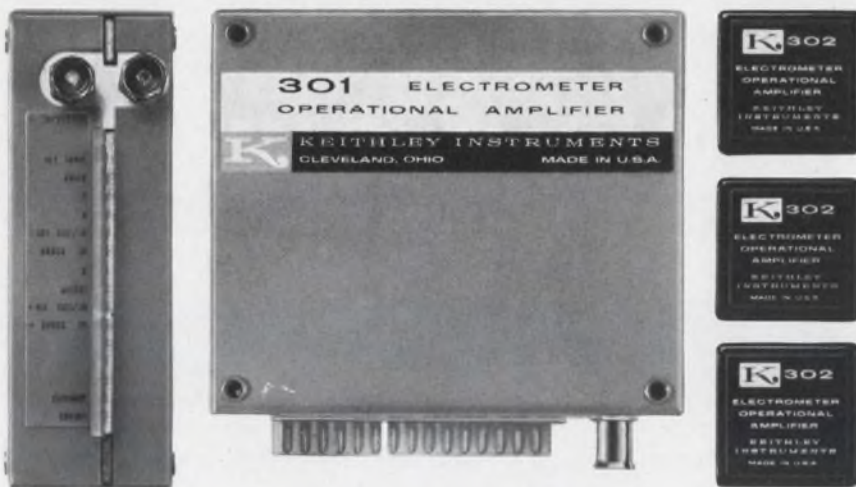

**Each is a true high performance electrometer op-amp, with unsurpassed 2mv/week stability and  $10^{-14}$  ampere offset current.**

Now choose, rather than chance, performance characteristics needed in operational amplifiers. Keithley's new Models 301 and 302 are excellent voltage amplifiers and exceptional current amplifiers for linear, logarithmic, integrating or charge measuring applications.

As a group, these solid state amplifiers share common characteristics like mos fet inputs, voltage stability of 2 millivolts/week or  $150 \mu\text{V}/^\circ\text{C}$ ,  $10^{-12}$  ohms input impedance and  $10^{-15}$  ampere/day current stability.

Individually, each has its own uncommonly fine features:

**Keithley's 301** is fully shielded—accommodating feedback elements. It has a built-in voltage regulator, operates to specs on unregulated supplies from  $\pm 19$  to  $\pm 30$  volts, at  $+35$  ma or  $-5$  ma. And—this differential input model features open loop dc voltage gain of 50,000—an output of  $\pm 11$  volts

at 11 ma. The 301 sells for \$200 in single units. The 301K, identical, but without voltage regulator, is \$175. Prices lower on both, in quantity orders.

**Keithley's 302** is a single-ended low cost OEM type unit. A compact little performer, it fits easily on pc boards. It operates on  $\pm 15$  volt regulated supplies, features open loop dc voltage gain of 12,000—an output of 10 volts at 5 ma. The 302 is economy priced, in single units, at a low \$150. Much lower in quantities.

To check them out, call your experienced Keithley Sales Engineer. Get our engineering notes on operational amplifiers, too. Keithley Instruments, Inc., 28775 Aurora Road, Cleveland, Ohio 44139. In Europe: 14 Ave. Villardin, 1009 Pully, Suisse. Prices slightly higher outside the U.S.A. and Canada.



**KEITHLEY**  
ON READER-SERVICE CARD CIRCLE 77

TEST EQUIPMENT

**Voltage-level detector has multiple applications**



Preston Scientific Inc., 805 E. Cerritos Ave., Anaheim, Calif. Phone: (714) 776-6400. P&A: \$585; 60 days.

This gated output-voltage level detector consists of an input amplifier, an adjustable precision voltage source, an output amplifier, an output commutator and an output zero-crossover detector. The input amplifier provides three calibrated switch-selected gains of 1, 10, and 100 with a corresponding input full-scale voltage range of 100, 10 and 1 V respectively.

The versatility of the X-MOD 703 enables it to be used as a voltage amplifier with 21 calibrated, switch-selected gains ranging from 1 to 10,000, with a bandwidth of 10 MHz min at unity gain decreasing to 10 kHz at a gain of 10,000. The gain accuracy is  $\pm 1\%$  over the entire range. The input impedance is  $1 \text{ M}\Omega$  shunted by 22 pF for all input ranges, with a direct output capability of  $\pm 10 \text{ V}$  or  $\pm 100 \text{ mA}$ .

It may be used as a voltmeter with three switch-selected full-scale ranges of 1, 10 and 100 V. With an accuracy of  $\pm 0.1\%$ , the voltmeter provides both a metered indication and an amplifier output.

A rear patchboard connector provides an additional input and direct output, and furnishes all other outputs and control inputs. This allows the unit to be used as either a single test instrument or incorporated with other X-MODS to form an instrumentation system.

CIRCLE NO. 266

# THE COMPLETE LINE OF MODERN SWEEP SIGNAL GENERATORS

## 1968 CATALOGUE

Send for the complete 64-page Catalogue and Technical Brochure of Texscan products. Includes information on all four series of sweep/signal generators Plus:

- Definition of Specifications
- Interpretation of Specifications
- How Hidden Specifications Affect Measurements
- Application Techniques
- 24-page Section on RF Attenuators
- Oscilloscopes



### RS SERIES—Range from 1 MHz to 2000 MHz

An extremely sophisticated, solid state line of instruments. Includes all features of the VS series plus additional features such as triggered sweep, start-stop frequency indicator, dual trace sweep width, dual trace sweep time, logarithmic detection and internal AM modulation.



### VS SERIES—Range from 200 Hz to 2500 MHz

A solid state instrument line which features variable sweep rates, low distortion and high stability. Many options are available to increase the capabilities of this instrument line.



### LS SERIES—Range from 1 MHz to 1000 MHz

A low priced, line rate sweep generator designed for specific test situations not requiring the versatility of the VS and RS lines. This series is most competitive for production, broad sweep requirements.



### HS SERIES—Range from 20 MHz to 1000 MHz

High power sweep/signal generators providing up to 8 watts swept RF output. These instruments are line rate sweep generators with CW and amplitude modulation capabilities.

Tescan's complete line of sweep/signal generators offer the modern electronic engineer the widest choice of generators in the industry. The instrument you want, with the features you need, at a price you can afford, are now available in the four basic series of solid state generators by Texscan.

Contact your nearest Texscan Field Application Engineer . . . a specialist in electronic instrumentation.



2446 North Shadeland Avenue Indianapolis, Indiana 46219  
Tel. 317-357-8781 • TWX. 810-341-3184

ON READER-SERVICE CARD CIRCLE 78

# If You're Still Using A V.T.V.M. It's Time To Change ...Go Solid-State!



**A** Kit  
IM-16  
**\$44.95**  
Wired  
IMW-16  
**\$64.95**



**B** Kit  
IM-25  
**\$80.00**  
Wired  
IMW-25  
**\$115.00**

## These New Heathkit® Solid-State Meters Feature State-Of-The-Art Performance At Prices You Can Afford

- Modern, stable, long-life solid-state circuitry
- New low-voltage ranges to accurately analyze modern transistor circuits
- Full capability to go "out on the job" . . . instant selection of internal battery power or 120/240 v. 50-60 Hz AC operation
- Exceptional accuracy . . . 3% on DC volts, plus a large, easy-to-read 6" meter face
- High impedance F.E.T. input for minimum circuit loading

**A** **New! Deluxe Solid-State Volt-Ohm Meter**  
Features 8 DC and 8 AC voltage ranges from 0.5 v to 1500 v full scale; 7 ohmmeter ranges (10 ohms center scale) x1, x10, x100, x1k, x10k, x100k, & x1 megohm; 11 megohm input on DC ranges; 1 megohm on AC ranges; internal battery or 120/240 v 50-60 Hz AC power for portable or "in shop" use; large readable-across-the-bench 6" meter; separate switches for individual functions; single test probe for all measurements; modern, stable solid-state circuit-board construction.

Kit IM-16, 10 lbs. . . . . \$44.95; Wired IMW-16, 10 lbs. . . . . \$64.95

**B** **New! Deluxe Solid-State Volt-Ohm-Milliammeter**  
All silicon transistors plus FET's. Features 9 AC and 9 DC voltage ranges from 150 mV to 1500 volts full scale; 7 ohmmeter ranges (10 ohms center scale) x1, x10, x100, x1k, x10k, x100k, & x1 megohm; 11 current ranges from 15 uA to 1.5 Amperes full scale; 11 megohm input on DC voltage ranges; 10 megohm input on AC voltage ranges; internal battery power or 120/240 v 50-60 Hz AC power for maximum versatility; easily readable 6" meter face; ± 3% accuracy on DC volts; ± 4% on DC current; ± 5% accuracy on AC voltage and current; separate range switches "human engineered" for efficiency in actual use; modern circuit board construction; all solid-state components; easy to assemble.

Kit IM-25, 10 lbs. . . . . \$80.00  
Wired IMW-25, 10 lbs. . . . . \$115.00

**HEATH COMPANY,**  
Benton Harbor, Mich. 49022 Dept. 520-26  
*In Canada, Daystrom Ltd.*

Please send my FREE 1968 Heathkit Catalog.

Enclosed is \$ \_\_\_\_\_, plus postage.

Please send model(s) \_\_\_\_\_

Name \_\_\_\_\_

Address \_\_\_\_\_

City \_\_\_\_\_ State \_\_\_\_\_ Zip \_\_\_\_\_

Prices & Specifications subject to change without notice. TE-165

ON READER-SERVICE CARD CIRCLE 79

## TEST EQUIPMENT

### Signal generators use fixed frequency



Metric Engineering, 5235 E. Simpson Road, Mechanicsburg, Pa. Phone: (717) 766-0741. P&A: \$265; 2 weeks.

A fixed-frequency signal generator is suited for repetitious alignment of communications, video or radar receivers. Metric Engineering will provide any output (signal) frequency between 200 kHz and 80 MHz. It operates from 105 to 130 V rms, 60 Hz. Its output power from 200 kHz to 1 MHz is 1 mW into 600 Ω, from 1 to 80 MHz it is 1 mW into 50 Ω. Its stability is 0.005%/day.

CIRCLE NO. 272

### Current measurer spans 1 pA to 10 μA



EG&G, Inc., Las Vegas Division, P.O. Box 1912, Las Vegas, Nevada. Phone: (702) 736-8111. P&A: ME-1035 \$3945, ME-1036 \$4530; 90 days.

The Model ME-1035 picoammeter has solid-state design, including MOSFET input, and has a range of 1 pA full-scale to 10 μA full-scale in 7 decades. The accuracy of the unit is from ±0.05% of reading ±1 count at 10 μA to ±0.5% of reading ±1 count at 1 pA. The instrument was developed as a standard and calibration laboratory tool. A current suppression option is available.

CIRCLE NO. 273

# Only NJE offers this



# 10 YEAR WARRANTY

**NJE CORPORATION**  
Electronic Development & Manufacturing

A subsidiary of  Corporation

## on DC power supplies

Our 10-year warranty is a revolutionary first that no other power supply manufacturer offers. We could lose our shirt on this warranty if we didn't build reliable power supplies. But we do. Our records show that our power supplies operate without failure for at least 10 years. This includes operation in some of the most severe commercial and

military environments. So there's no risk for us in a 10-year warranty. No risk for you in ordering NJE power supplies. Warranty applies for 1 year on high-voltage supplies.

NJE Corporation, Kenilworth, N.J. 07033/(201) 272-6000  
Telefax: FFP, TWX: (710) 996-5967. A subsidiary of Condec Corporation.

**our adaptable  
conformist.**

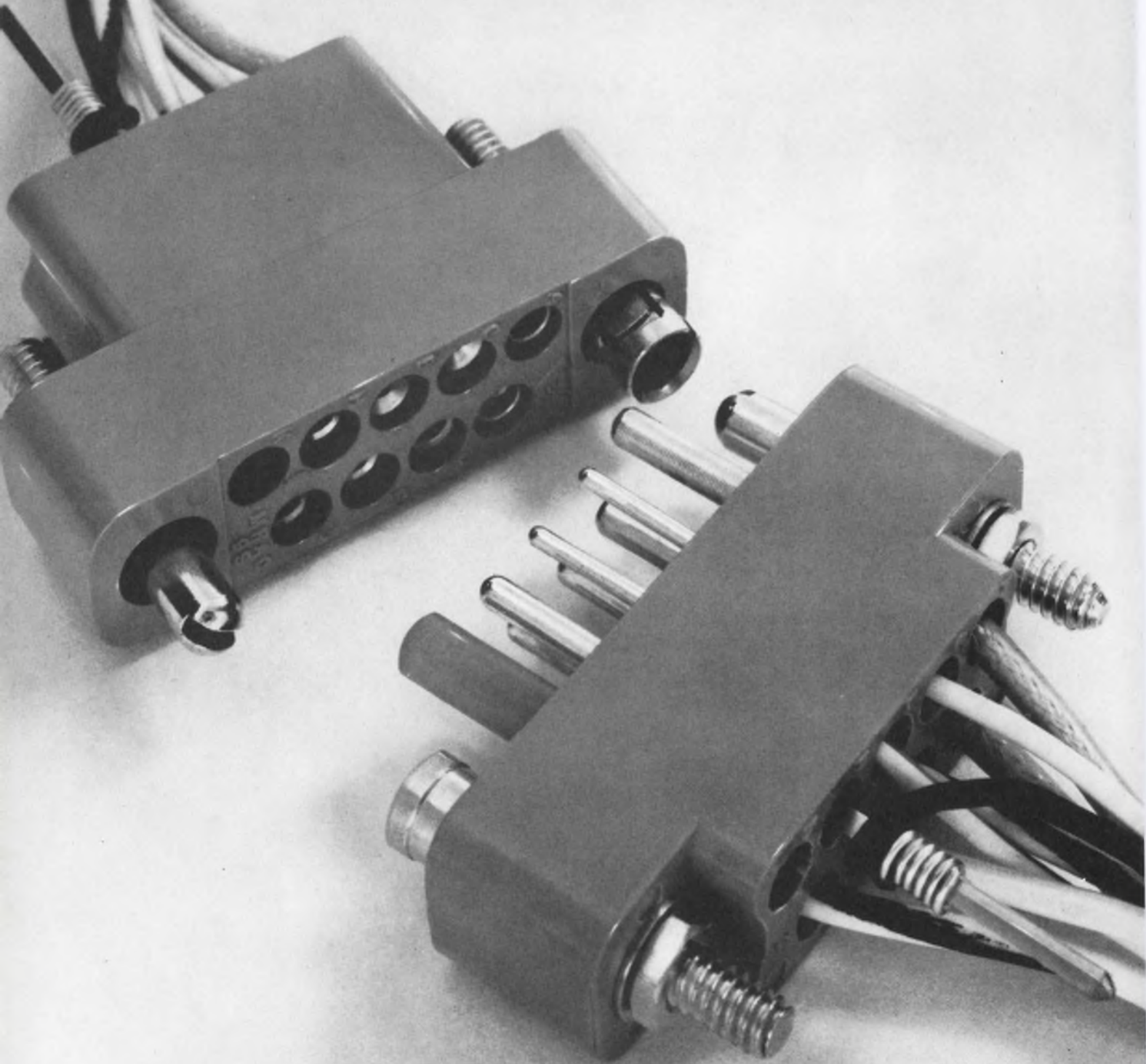



## TEST EQUIPMENT

### Surveillance system plots its own signals



*Fairchild Electro Metrics Corp., 88 Church St., Amsterdam, N.Y. Phone: (518) 843-2600.*

A spectrum surveillance system is designed to sweep the spectrum from 20 Hz to 1000 MHz and plot simultaneously both the average and peak readings of received signals. Designed for automated RFI/EMC testing, it is built around interference analyzers Models EMC-10 and EMC-25. A selection of antennas and accessory devices are available for the frequency range of 20 Hz to 1 GHz.

CIRCLE NO. 274

### Direct-writing recorder makes colored traces

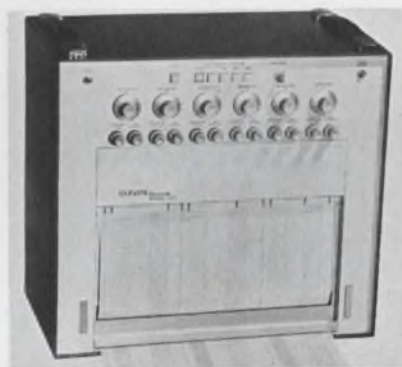

*Clevite Corp., 37 & Perkins, Cleveland. Phone: (216) 361-3315. Price: \$4500.*

This direct-writing recorder makes traces in two colors, red and blue, to simplify interpretation of data. The Mark 260 offers six 40-mm analog recording channels, four event marker channels, a 1-s timer, a servo-controlled accuracy of 99.5% and a built-in solid-state amplifier that provides a usable measurement range from 1 mV to 500 V and eight push-button chart speeds.

CIRCLE NO. 275

### Conductivity bridge accurate to 0.05%

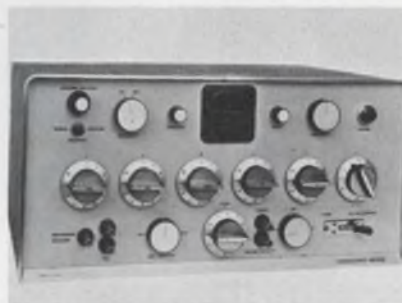

*Beckman Instruments, Inc., 2500 Harbor Blvd., Fullerton, Calif. Phone: (714) 871-4848. Price: \$990.*

A conductivity bridge that permits measurement of electrolytic conductivity has an absolute accuracy of better than 0.05%. Overall instrument range is 0 to 100,000  $\Omega$  in steps of 0.1  $\Omega$ , and 0 to 10,000  $\mu\text{mho}$  in steps of 0.01  $\mu\text{mho}$ . Power requirements are 40 W, 115/230 V, 50/60 Hz.

CIRCLE NO. 276

### Solid-state clock has 6 or 9 digits

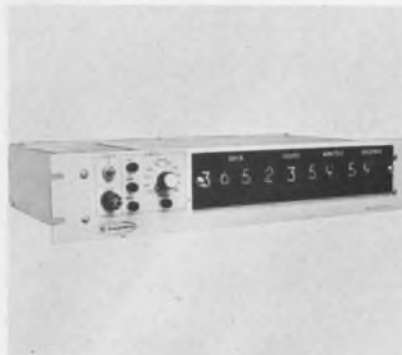

*Datatron, Inc., 1636 East Edinger Avenue, Santa Ana, Calif. 92705 Phone: (714) 835-2121. Price: \$850.*

Solid-state digital clock furnishes accumulation of real or elapsed time for display purposes and/or the time tagging of digital data. The Model 3350 utilizes from six to nine Nixie indicator tubes for visual output. Digital output consists of binary-coded decimal information with resolution available down to one ms.

CIRCLE NO. 277

The Winchester MRAC Series conforms to MIL-C-22857. Hoods, block and contacts are all certified. And *only* our MRAC connectors can make that claim!

Or provide such adaptability. Easily installed, readily removed contacts are ordered separately. So you can design your own circuitry — at substantial savings in time and labor. And our removable contacts are available in crimp, solder or shielded types. Or wire-wrap. Plus polarizing pins too.

More adaptability. You can intermix power, shielded signal and signal circuits in the same connector. With everything certified to MIL-C-22857.

We recommend the MRAC Series for applications such as computers, shipboard equipment, radar and ground support hardware. For details, and prototype quantities, check your local Winchester Distributor. Or write to: Winchester Electronics, Main St. and Hillside Avenue, Oakville, Connecticut 06779.

#### Specifications:

#### Current rating:

Up to 13 amps

#### No. of contacts:

9, 14, 18, 20, 26, 34, 41,  
42, 50, 66, 75, 104

#### Contact Specifications:

MIL-C-23216 No.	Catalog No.
MS17803-16-16	100B-1016P95
MS17803-16-20	100R-1020P95
MS17804-16-16	100B-51016S95
MS17804-16-20	100R-51020S95

**WINCHESTER ELECTRONICS**  
LITTON INDUSTRIES

# Waters INDUSTRIAL TRIMMER PT 3/4C

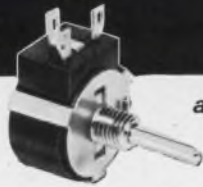

actual size

**When a lot in a little  
is a must..!**

Because so much potentiometer performance must so often be packed into small space, we developed the PT 3/4C Trimmer to do this job for you. And to do it well . . . all half-ounce of it!

Conforming to Waters exacting standards, you can depend on the PT 3/4C to deliver stable resistance control with military reliability over a long operational life. And at commercial cost level.

You'll want the whole story on this versatile potentiometer. We'd like to send it to you.

### NEED A PARTICULAR POT . . . ?

If you have a worthwhile need for the potentiometer that doesn't exist . . . could be Waters has the engineering know-how to do something about it.



**WATERS**  
MANUFACTURING INC.  
WAYLAND, MASSACHUSETTS

EXPORT: Charles H. Reed, Export Director, Waters Manufacturing, Inc.,  
Wayland, Mass. 01778 U. S. A.

ON READER-SERVICE CARD CIRCLE 83

## TEST EQUIPMENT

### Temperature probe digitally settable

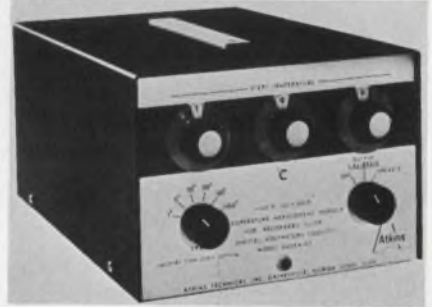

Atkins Technical Inc., Mail Box  
14405, University of Florida Station,  
Gainesville, Fla. Phone: (904)  
372-3518.

Potentiometric recorders are converted into universal temperature systems by adding "T into V" probes and modules. The temperature start point can be set digitally at any temperature between  $-100^{\circ}\text{C}$  and  $+200^{\circ}$  (or  $-150^{\circ}\text{F}$  and  $+400^{\circ}\text{F}$ ), then the desired span is set above the start point. Spans can be  $100^{\circ}$ ,  $50^{\circ}$ ,  $20^{\circ}$ ,  $10^{\circ}$ , or  $5^{\circ}\text{C}$ . A linear mV output is generated over the span which has been set.

CIRCLE NO. 270

### Vhf signal generator covers 10 to 420 MHz



Winslow Teletronics, Inc., 1005  
First Ave., Asbury Park, N.J.  
Phone: (201) 775-6100.

The Model SG-44 vhf signal generator covers 10 to 420 MHz in five bands with a calibration accuracy of  $\pm 0.5\%$  full-range. Frequency drift is less than  $0.002\%$  ten minutes after warm-up. A built-in crystal calibrator provides frequency markers at every 1 and 5 MHz. The output voltage is adjustable from 0.1 mV to 0.5 V into a  $50\text{-}\Omega$  load. The output attenuator is calibrated in microvolts and dBm. Voltage accuracy is  $\pm 1$  dB.

CIRCLE NO. 271

ON READER-SERVICE CARD CIRCLE 84 ►

What's the biggest problem plaguing RFI filter designers? Well, poor attenuation from available filter components has to be one of the most troublesome. Optimum attenuation leaves a lot to be desired. Our engineers tackled the problem and found we already had a solution.

It's a ferrite material we call Ferramic® O-5. This material has established an outstanding reputation for use in chokes, inductors, and transformers operating over the frequency range from audio to the broadcast band. But it does an about face

and its attenuation climbs like a rocket from 10 KHz up through the megacycle range. And it exhibits extremely high permeability and dielectric constant throughout this range.

In short, our O-5 ferrite is about the finest RFI filter material made anywhere and is available as a standard production item. In addition, we have other materials, like H and Q-1 ferrites that do an excellent job for similar applications. This is just one more example of the new uses of ferrites in a widening range of industries.

Because of our demonstrated ability to handle RFI filtering problems we now have various new materials and applications under development for both the military and commercial markets. You'll be hearing about them soon. So if you have an RFI filtering problem, you ought to find out what we've got. Just write Mr. K. S. Talbot, Manager of Sales, Indiana General Corporation, Electronics Division/Ferrites, Keasbey, N. J.

**INDIANA GENERAL** 

**When it comes to filtering radio frequency interference  
Indiana General has what it takes.**





**Couch**  
ROTARY  
RELAYS

## Cramped for space?

### Use Couch 1/7-size Relays

Space/weight problem? The new Couch 2X 1/7-size crystal can relay gives you tremendous savings in space and weight. 0.1" grid — plus many outstanding specs — all in microminiature. Thoroughly field-proven in electronics and space applications.

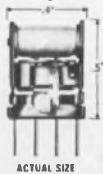

	2X	1X
Size	0.2" x .4" x .5"	same
Terminal Spacing	1/10" grid	same
Rating	0.5 amp @ 30 VDC	same
Coil Operating Power	150 mw	70 mw
Coil Resistance	60 to 4000 ohms	125 to 4000 ohms
Temperature	-65°C to +125°C	same
Vibration	20 G	same
Shock	75 G	same

Meets MIL-R-5757D

Broad choice of terminals, coil resistances, mounting styles. Write for detailed data sheets.

RUGGED ROTARY RELAYS  Dynamically and Statically Balanced

## COUCH ORDNANCE INC.

3 Arlington St., North Quincy, Mass. 02171, Area Code 617.  
Cypress 8-4147 • A subsidiary of S. H. COUCH COMPANY, INC.

ON READER-SERVICE CARD CIRCLE 85

## TEST EQUIPMENT

### Transducer indicator supplies 5 V dc



General Transducer Co., Santa Clara, Calif. Phone: (408) 245-5501. P&A: \$89.50; stock.

Providing excitation and readout facilities suitable for use with any four-arm strain-gauge sensor, this transducer indicator has two operating controls. Operating from 115 V, 50 to 60-Hz power, the unit includes supply delivering a fixed 5-V dc excitation into a 350-Ω bridge.

CIRCLE NO. 278

### Pulse generators require single dc supply



Trump Ross Industrial Controls, Inc., 265 Boston Rd., Billerica, Mass. Phone: (617) 667-9679. P&A: \$192.50; 3 wks.

Rotary-pulse generators that produce two-output channels of quadrature square waves are fully compatible with standard DTL, RTL, TTL, DEC, and other common logic. Each requires a single dc power supply to operate lamps and amplifiers: +5 to +7 V for series 11, and -5 to -7 V for series 10. Output signal amplitude is within 0.2 V of amplifier supply voltage.

CIRCLE NO. 279

### Digitally tuned filter ranges to 100 kHz



Krohn Hite Corp., 580 Massachusetts Ave., Cambridge, Mass. Phone: (617) 491-3211. Price: \$775 to \$2215.

This solid-state multifunction digitally tuned, variable filter has switch-selected 20-dB amplifiers in each channel and line or battery operation. Available in either single- or two-channel versions (and with 24 or 48 dB/octave slopes), the series 3300 spans the frequency range of 0.001 Hz to 99.9 kHz with rotary selector switches.

CIRCLE NO. 280

### Component test chamber gives 1°F gradient



Associated Testing Labs., Inc., 200 Route 46, Wayne, N.J. Phone: (201) 256-2800. Price: \$1000 up.

A component test chamber is designed for those component test requirements where extremely low temperature gradients across the component tray are required. Testing of the model TP 1100 has shown a 1°F max gradient across all test positions. The chamber has a temperature range of -100°F to +400°F.

CIRCLE NO. 281



**The key reason  
why the front plug-in  
Alfred model 650 is the finest  
microwave sweep  
oscillator ever made:  
front panel usability.**

(over please)

# And here are the rest of the reasons:



**Complete coverage.** For frequency ranges not included above, ask about special range units such as 1 to 2.6, 2 to 4.5 and 2.6 to 5.2 GHz.

**Complete independence of control.** Set the broadband sweep  $F_1 \rightarrow F_2$ , the symmetrical sweep  $F_0 \pm \Delta F$  and 3 frequency markers with controls which are independent of each other. You can change sweep and display modes without changing frequency settings.

**Unique  $F_0$  control.** Serves as frequency marker, the center of the symmetrical sweep, and as a single frequency.

**Choice of leveling.** Internal or external leveling . . . PIN diode or grid leveling.

**Choice of stable single frequencies.** Five single CW or squarewave modulated signals may be pre-set with convenient front panel controls.

## 650 and 650A Oscillator plug-in units.

Frequency GHz	Grid Levelled				Pin Diode Levelled			
	Model	Power Output mw	Power Variation leveled db	Price	Model	Power Output mw	Power Variation leveled db	Price
0.25 to 0.5					651A-S2	25	—	\$1875
					651AK-S2	20	$\pm 0.3$	2350
0.5 to 1.0					651A-S3	50	—	1875
					651AK-S3	40	$\pm 0.3$	2350
1 to 2	651	80	—	\$1800	651A	60	—	2025
	651K	70	$\pm 0.3$	2090	651AK	60	$\pm 0.3$	2300
1.4 to 2.5	651-S1	80	—	2050	651A-S1	60	—	2325
	651K-S1	70	$\pm 0.3$	2350	651AK-S1	60	$\pm 0.3$	2625
2 to 4	652	60	—	1600	652A	40	—	1850
	652K	50	$\pm 0.3$	1875	652AK	40	$\pm 0.3$	2130
1.7 to 4.2	652-S5	35	—	1925	652A-S5	15	—	2150
	652K-S5	30	$\pm 0.5$	2275	652AK-S5	15	$\pm 0.5$	2525
3.5 to 6.75	653-S1	40	—	1990	653A-S1	20	—	2200
	653K-S1	30	$\pm 0.4$	2500	653AK-S1	20	$\pm 0.4$	2700
4 to 8	653	30	—	1550	653A	20	—	1800
	653K	25	$\pm 0.5$	1900	653AK	20	$\pm 0.5$	2150
3.7 to 8.3	653-S2	10	—	1850	653A-S2	5	—	2100
	653K-S2	10	$\pm 0.5$	2225	653AK-S2	5	$\pm 0.5$	2450
7 to 11	654	20	—	1600	654A	10	—	1900
	654K	15	$\pm 0.5$	1975	654AK	10	$\pm 0.5$	2300
7 to 12.4	654-S1	20	—	1750	654A-S1	10	—	2050
	654K-S1	15	$\pm 0.75$	2150	654AK-S1	10	$\pm 0.75$	2450
8 to 12.4	655	60	—	1550	655A	20	—	1825
	655K	50	$\pm 0.5^*$	1950	655AK	20	$\pm 0.5^*$	2200
10 to 15.5	656	35	—	2300				
12.4 to 18	657	40	—	1650				
	657K	25	$\pm 0.8$	2175				
18 to 26.5	658	10	—	2400				
26.5 to 40	659	5	—	4100				

**Model 650 and 650K Series.** Every model 650 and 650K unit includes a leveler-amplifier connected for grid leveling. The Model 650 Series requires an external rf sampler for leveling rf power. The Model 650K Series includes the rf sampler mounted internally.

**Model 650A and 650AK Series.** Every Model 650A and 650AK unit includes a leveler-amplifier connected to an internal PIN diode leveler. Model 650A Series requires an external rf sampler for leveling the output power. The Model 650AK Series includes the rf sampler mounted internally.

**Price: Sweep Oscillator Model 650, \$1,550.**

**New data file available.** For more information, ask your full service Alfred sales engineer for our new data file, or write Alfred Electronics, 3176 Porter Drive, Palo Alto, California 94304. Phone (415) 326-6496.

Project responsibility opportunities exist for qualified engineers on Alfred's growing technical staff.

# ALFRED ELECTRONICS

Circle 95 for more information.

See us at IEEE  
#2C12-2C14

# Do you have a "special" photocell problem?

## Clairex probably has a "standard" answer with the industry's widest line.

## If not, we can design a photoconductive cell to meet your needs.

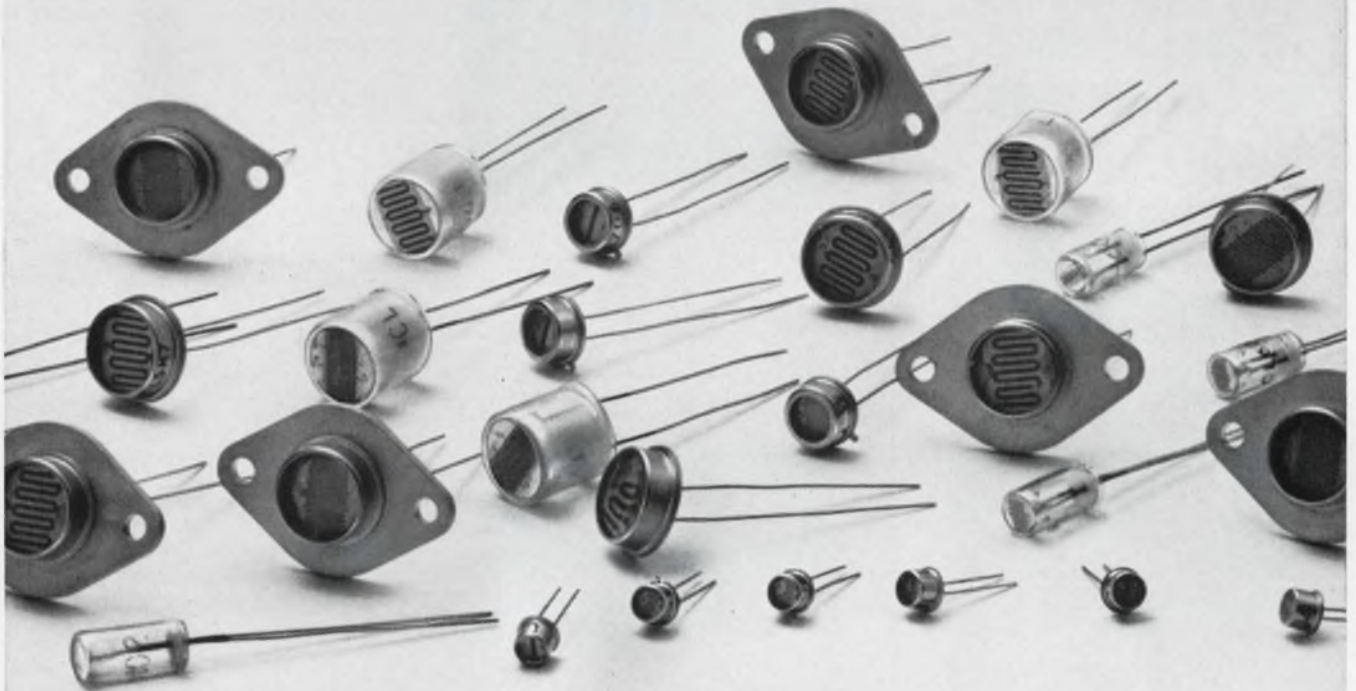

Helping industry solve problems involving light control has been Clairex's only business since 1953. To provide creative engineering to the country's leading companies, we have developed the industry's widest line of photoconductive cells . . . over 80 standard types of CdS and CdSe units.

Standard Clairex cells provide combinations of features that you need to meet most needs . . . high speed, low temperature coefficients, low memory, high linearity, uniform color temperature response, small size, high stability. They come in 6 hermetically sealed packages from TO-18 to TO-3.

If a special photocell is required, Clairex can

design one to meet your requirements. And don't hesitate to call on us for help in setting up your specifications. We are frequently able to save time and money for customers who consult us before establishing detailed cell designs.

If you'd like more information, remember, we wrote the book. Send for your copy of the Clairex Photoconductive Cell Design Manual.



INC. ■ 1239 BROADWAY, NEW YORK, N. Y. 10001

ON READER-SERVICE CARD CIRCLE 86

**One company  
makes a  
blower  
that really  
does do more,  
in less space,  
and costs less  
too!**



**The  
Cool Cube  
from**

**Electronic Enclosures Inc**

225 South Aviation Boulevard  
El Segundo, California 90245  
(213) 679-0181

7825 Airport Highway  
Pennsauken, New Jersey  
(609) 665-6810

WRITE FOR COMPLETE INFORMATION  
ON READER-SERVICE CARD CIRCLE 87

## TEST EQUIPMENT

### Eight-channel monitor permits 50-ns recording



*Micro Instrument Co., 12901 Crenshaw Blvd., Hawthorne, Calif. Phone: (213) 772-1275. P&A: \$3500; 4 wks.*

A transient-voltage-monitoring system has eight channels that allow continuous and simultaneous 16-channel strip-chart recording of positive and negative transients from 50 ns to dc and from 0 to 1000 V. The system employs pulse stretchers in each channel to provide sufficient memory for readouts.

CIRCLE NO. 282

### X-Y oscilloscope sensitive to 1 mV/cm



*Texscan Technical Products Division, 4610 North Franklin Road, Indianapolis. Phone: (317) 545-6481. P&A: \$1495; 30 days.*

An X-Y display oscilloscope permits the display and resolution of frequency response curves and can be used in conjunction with a sweep generator of almost any frequency. A scanning system and three identical, directly coupled Y amplifiers with 1 mV/cm sensitivity permit the simultaneous display of three frequency response curves.

CIRCLE NO. 283

### Power supplies span 0.5 to 50 V dc

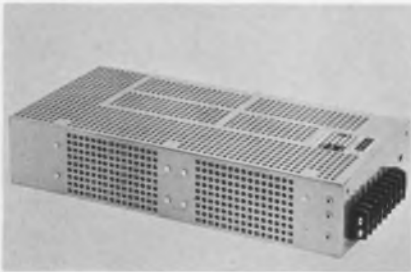

*Dynage, Inc., 1331 Blue Hills Ave., Bloomfield, Conn. Phone: (203) 243-0315. P&A: \$265; 3 days.*

A selection of power supplies have voltage outputs from 0.5 to 50 V dc, with voltages up to 252 V dc furnished on request. Typical amperage levels for the low-voltage ratings go as high as 23 A at 50°. Features include a stability of  $\pm 0.001\%$  or  $\pm 120 \mu\text{V}$ . A built-in overvoltage protection is included.

CIRCLE NO. 284

### Ionization detector senses smoke and gas



*E. W. Bliss Co., 209 W. Central St., Natick, Mass. Phone: (617) 655-3200.*

Before a fire breaks out, invisible particles are released from the area of the potential blaze and become airborne. The particles are present long before smoke or heat is evident. This ionization detector notes the presence of such airborne particles and sets off an alarm.

CIRCLE NO. 259



**MINIATURE SIZE RELAY** □ **CONTACT RATINGS:** Contact Material: Rhodium. Maximum Voltage (Volts): 50 VDC, 150 VAC. Maximum Current: Switch, .500 amp. Carry, 2.5 amps. Maximum Power (Watts, DC): 6 Watts. Resistive or properly suppressed (VA, AC): 10 VA. Maximum Resistance Initial: 100 milliohms. End-of-life: 2 ohms. **Peak Breakdown Voltage:** 300 volts rms. **Life & Reliability At Rated Load:** 20 x 10<sup>6</sup> operations. **Dry Circuit:** 500 x 10<sup>6</sup> operations. **OPERATING PARAMETERS:** Speed: Depending on sensitivity and number of poles, the speed for miniature size relays is from 1 msec to 2½ msec, including contact bounce and coil time. **Insulation Resistance:** Coil to ground: 50 megohms (min). Coil to contact: 500 megohms (min). **Temperature Range:** -50°C to +105°C. **Vibration:** 10G @ 10-55 cycles/sec (open or closed). **Shock:** 15G (min).

**STANDARD SIZE RELAY** □ **CONTACT RATINGS:** Contact material: Rhodium. Maximum Voltage (volts): 150 VDC, 250 VAC. Maximum Current: Switch, 1.5 amps. Carry, 6 amps. Maximum Power (Watts, DC): 25 watts. Resistive or properly suppressed (VA, AC): 40 VA. Maximum Resistance Initial: 50 milliohms. End-of-life: 2 ohms. **Peak Breakdown Voltage:** 500 volts rms. **Life & Reliability, At Rated Load:** 20 x 10<sup>6</sup> operations. **Dry Circuit:** 500 x 10<sup>6</sup> operations. **OPERATING PARAMETERS:** Speed: Depending upon sensitivity and number of poles, the speed for standard size relays, including contact bounce and coil time, is: 2½ msec to 6 msec. **Insulation Resistance, Coil to ground:** 100 megohms (min). Coil to contact: 2000 megohms (min). **Temperature Range:** -50°C to +105°C. **Vibration:** 10G @ 10-55 cycles/sec (open or closed). **Shock:** 15G (min).

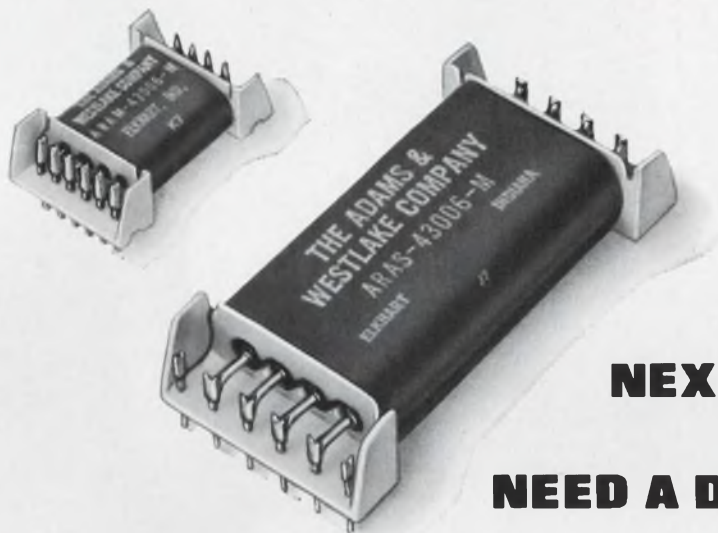

**NEXT TIME YOU**

**NEED A DRY REED RELAY**

**THERE'S A BRAND NEW SOURCE**

**WHERE YOU CAN GET IT FASTER**

It's Adlake—the company you call on for mercury relays. We now supply dry reed relays in standard and miniature sizes; single, double, and 4-pole. And we promise you the same fast delivery that made us the leader in mercury-displacement and mercury-wetted relays.

There's no compromise with quality. Our dry reed relays have the most accurately-wound coils and the most reliable switches you can find anywhere. They are specially recommended for such applications as automatic numerical machine controls, telephone and telegraph switchgear, and data processing.

Write today for our new catalog. And don't forget that at Adlake we always stand ready to assist you with design and engineering.



**THE ADAMS & WESTLAKE COMPANY**

A SUBSIDIARY OF **ALLIED** PRODUCTS CORPORATION

Elkhart, Indiana 46514 • 219 264-1141 • TWX 219 522 3102 • TELEX 25-8458 • CABLE ADLAKE

ON READER-SERVICE CARD CIRCLE 88

**Circuit continuity tested audibly**

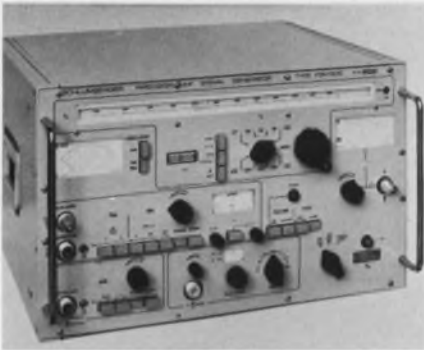

*Circon Component Corp., Santa Barbara Municipal Airport, Goleta, Calif. Phone: (805) 967-1113.*

The latest sound in test equipment is a device with an audible signal for testing circuit continuity. The Humdicator was developed for safe testing of microcircuits, thin-film circuits, integrated circuits and circuit continuity anywhere. The current across the probes is less than 10  $\mu$ A.

CIRCLE NO. 288

**Temperature indicators cover -100 to +1100°C**

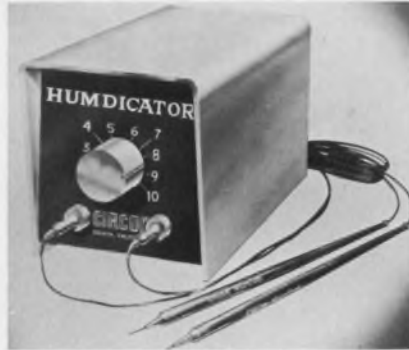

*Harrel, Inc., 16 Fitch St., E. Norwalk, Conn. Phone: (203) 866-2573.*

Digital readout of temperature in 7/16-in.-high numerals is a feature of these indicators. The absolute accuracy is 0.4°C or better over a 200°C range. Sensors are available in a wide range of shapes and forms for any measuring need from -100°C to 1100°C.

CIRCLE NO. 289

**Frequency synthesizer ranges to 470 MHz**



*E. F. Associates, Inc., P.O. Box 361, Scotch Plains, N.J. Phone: (201) 322-6471. P&A: FSM 500 \$4925; FS 30 \$250; stock.*

Frequency synthesizer FSM 500 generates a spectrally pure frequency from 300 Hz to 470 MHz. The device offers a spectrally pure signal of at least 85 dB below the selected output. In combination with the basic unit, type FS 30, which is used as the driver, generates a signal with an accuracy of three parts in 10<sup>9</sup> per day.

CIRCLE NO. 290

**Smallest 3-Phase Electronic Frequency Converters Ever Made!**



Now, from CML, comes a series of the smallest 3-phase Electronic Frequency Converters ever made... featuring fixed or adjustable plug-in oscillators at frequencies ranging from 45 to 6,000 cycles. Write today for details on Models T500A through T2500A!

Model	3 $\phi$ Output VA	Dimensions (For standard 19" relay rack mounting)
T500A	500	8 $\frac{3}{4}$ " h x 21" d
T750A	750	14" h x 21" d
T1200A	1200	14" h x 21" d
T1750A	1750	14" h x 21" d
T2500A	2500	14" h x 21" d



**CML, Inc.**  
A Subsidiary of Tenney Engineering, Inc.  
350 Leland Avenue • Plainfield, New Jersey  
Telephone (201) 754-5502 • TWX: 201-756-2064

ON READER-SERVICE CARD CIRCLE 89

**NEW and Unique**

**The Lundey Clinch-Loc<sup>®</sup> HERMETIC TEFLON<sup>®</sup> TERMINAL**

*the ultimate in simplicity*

**IT'S DUAL-PURPOSE**  
... and economical

\* Dupont Trademark

Use it as a moisture-proof terminal or a conventional panel feed-thru and get *low initial cost, fast and economical assembly, ruggedness and mechanical reliability* — plus the excellent thermal and electrical values of Teflon.

U.S. Patent 3,166,634  
Canadian Patent 727,204  
Other Foreign Patents Applied For

Designed to meet Mil-T-27B requirements



**WRITE NOW FOR SAMPLE KIT**  
includes product samples and literature

another quality product in THE LUNDEY LINE

**LUNDEY ASSOCIATES, INC.**  
694 Main St. Waltham, Mass. 02154

ON READER-SERVICE CARD CIRCLE 90

ELECTRONIC DESIGN 1, January 4, 1968



# The biggest filter news is the smallest!

## Hybrid I.C. Active Filters

This little filter has big muscles. As a matter of fact, it performs identically to the standard unit, and is just as reliable.

Some of the features of our little giant are:

- 0.06 cubic inch per pole pair
- Frequency ranges between 10Hz and 200KHz
- Maximum Q: 500
- Q stability is 0.1% per °C (independent of Q)
- Center frequency stability is .005% per °C

If you've ever been faced with filter packaging problems, we now have the solution. And our standard line of Active Filters will meet all of your conventional requirements.

Write, phone or TWX for complete information.



### Western Microwave Laboratories, Inc.

1045 DiGiulio Avenue, Santa Clara, California 95050  
Telephone (408) 246-4500 / TWX 910-338-0032

ON READER-SERVICE CARD CIRCLE 91



# KEPCO OPERATIONAL POWER

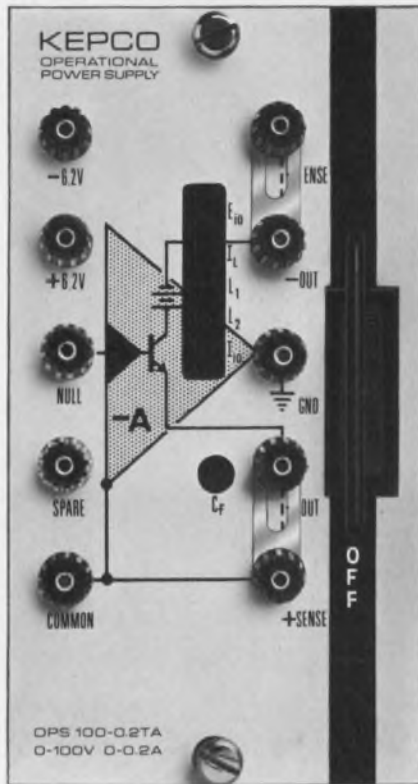

Model OPS 100-0.2TA Panel

## PATCHBOARD ACCESSIBILITY

Now you can order operational power supplies (amplifiers) with a convenient patch board access. Not only are both references, the null, output and common terminal made readily available, but all operating controls are brought to the front in a convenient recessed slot. They include offset voltage nulling ( $E_{io}$ ), offset current nulling ( $I_{io}$ ), the current limit adjustment (10% - 110% range) and two AC stabilizing adjustments.

Amplifier characteristics include: 500,000 V/sec slewing speed, 80db open loop gain. Six models from 0-7V at 2A to 0-100V at 0.2A.

FOR COMPLETE SPECIFICATIONS AND APPLICATIONS NOTES, WRITE DEPT. O-5



131-38 SANFORD AVE. • FLUSHING, N.Y. 11352  
(212) 461-7000 • TWX # 710-582-2631

ON READER-SERVICE CARD CIRCLE 92

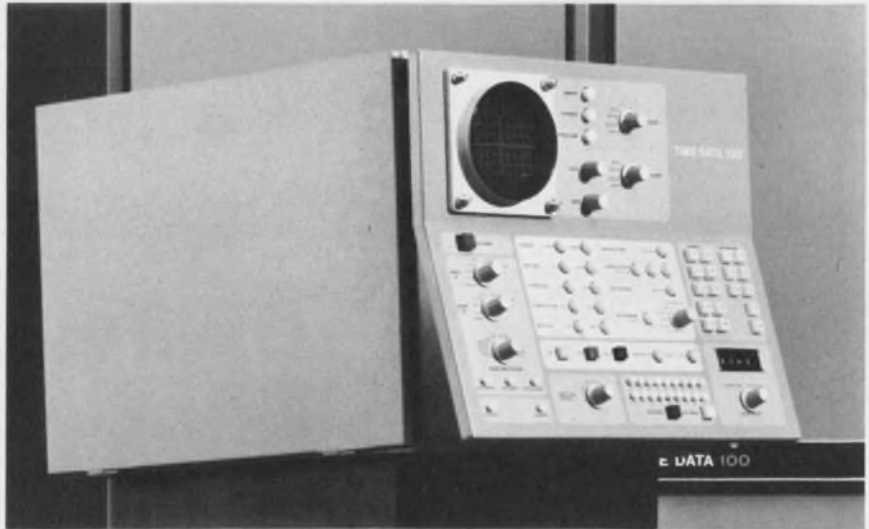

## Fourier transform computer: a mathematical whiz

*Time/Data Corp., 490 San Antonio Road, Palo Alto, Calif. Phone: (415) 327-8322. Price: \$63,425.*

This "rapid Fourier transform" digital computer can turn 1000 waveform samples into 1000 Fourier spectral coefficients in one second.

This provides virtually real-time computation for all sorts of scientific experiments and system development work. Numerous other important mathematical operations can be done in real time with this digital analyzer.

The Time/Data 100 is reported to be the first computer capable of doing discrete Fourier transforms in real-time applications. Other experimental machines, such as those built by Bell Telephone Laboratories and Sylvania Electronic Systems Div. (see "The FFT computer: Designer's 'missing link'," ED 25, Dec. 6, 1967, pp. 25-30), are faster, but this machine is a compromise between cost and speed.

In addition to transforms, the machine can perform functions such as cross spectrum, autospectrum, autocorrelation or cross-correlation, convolution, and ensemble averaging. It can also devise histograms.

An output CRT can display single or double traces. A marker band can be moved to a portion of interest on a displayed waveform and then that portion can be mag-

nified eight times.

Logic is performed by DTL microcircuits driven by a 400-ns clock. The memory is a Fabritek 2- $\mu$ s cycle-time unit. It is divided into zones with the function of each zone dependent on the particular algorithm the machine is implementing.

The machine was designed for all types of time series research, such as biomedical, geophysical and vibration analyses. However, there has been growing interest in the use of the computer for analyzing audio signals such as those in antisubmarine warfare and vocoder development, meteorology—determining propagation paths and detecting severe storms—and other types of systems work.

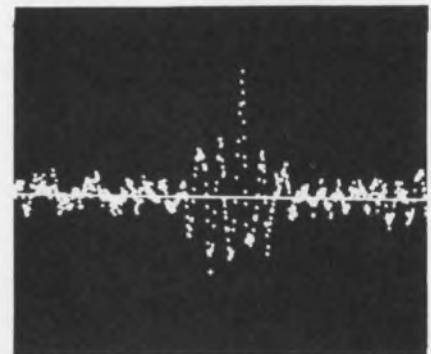

Matched filter detection of a signal buried in noise is provided by convolving the signal and noise with a mirror image of the original signal. Peak indicates the position of the signal at match.

CIRCLE NO. 285

ON READER-SERVICE CARD CIRCLE 93 ►  
ELECTRONIC DESIGN 1, January 4, 1968



## THE GREAT HERMETIC SEAL

Every part of every Deutsch hermetic seal is made and assembled in our own plants. All glass-to-metal sealing and brazing is done in the most modern automatic furnaces in the world. Every seal is checked for leakage; and every hermetic connector checked for contact positioning, polarization, high voltage capacity and precise dimensions.

This rigid quality assurance program, and 100% inspection, guarantee performance to and beyond specifications.

And this performance—and on-time delivery—is available on the widest range of hermetically sealed connectors in the industry.

Push-pull, bayonet, threaded, and specials of every description are available in a variety of insert arrangements and mounting styles. You can order them with high temperature brazed bussing strips to

provide internal circuitry; and with special shell materials or platings to meet exotic environments.

Recently developed Deutsch rear release hermetics are compatible with the Deutsch Integrated Termination System. Here, crimped rear release contacts eliminate costly soldering and increase reliability.

Rear release hermetics are available that intermate and interchange with existing Mil C 26482, NAS 1599 or Deutsch subminiature connectors.

Get all the details on the full line of Deutsch hermetic connectors by writing Deutsch, Electronics Components Division, Municipal Airport, Banning, California 92220.

**DEUTSCH**   
HERMETIC CONNECTORS

# Big performance in small space

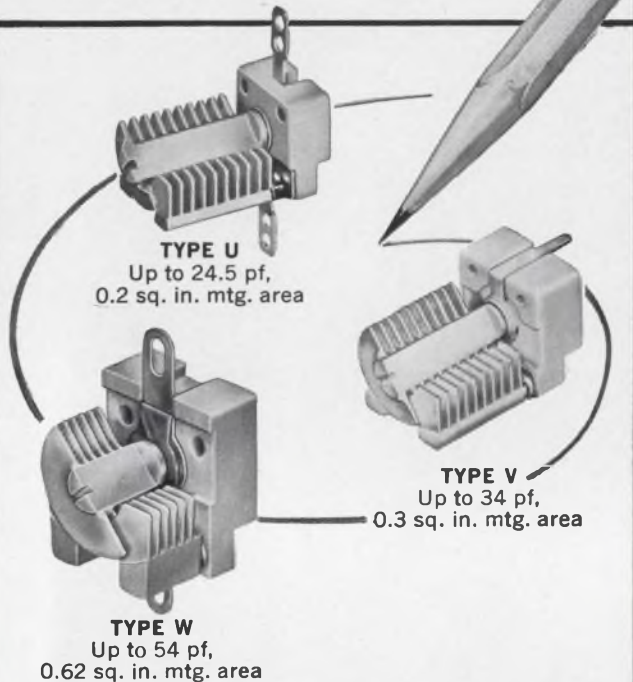

## Johnson increases U capacitor plate area, keeps same overall dimensions

Sub-miniature Type U capacitors now provide 28% more capacitance in the same compact package that takes less than 0.2 square inches of mounting area. Type V miniature and Type W capacitors, available in higher capacities, are also unusually compact.

Unique Johnson milling technique permits machining each rotor and stator from a single piece of solid brass. This provides exceptional uniformity and stability, both mechanically and electrically. "Q" is greater than 1500 at 1 MHz. Temperature coefficients are typically plus  $45 \pm 15$  PPM/ $^{\circ}$ C. Breakdown ratings 650 volts DC.

Johnson Type U, V, and W capacitors are available from stock in a wide range of sizes. Type U single section in PC, panel, or two-hole mounting. Type U butterfly and differential in PC mounting. U-LC tuners in PC or panel. Type V and Type W single section in PC or panel mounting.

**FREE CATALOG** includes complete information on these and other Johnson quality electronic components. See your Johnson representative or write for your copy today.



## E. F. JOHNSON COMPANY

3317 Tenth Ave. S.W., Waseca, Minn. 56093

Providing nearly a half-century of communications leadership

ON READER-SERVICE CARD CIRCLE 94

## SYSTEMS

### 90-kHz converter handles 10 bits



AIC Corp., 6214 Royalton St., Houston, Tex. Phone: (713) 774-0353. P&A: \$1500; 45 days.

An A-to-D converter converts bipolar inputs over a  $\pm 5$ -V range to a nine-bit-plus-sign binary output in 11  $\mu$ s. Max conversion rate is 90,000 words/s with an accuracy of  $\pm 0.1\%$ . The binary output is available at a rear connector and is displayed on the front panel. Input resistance is a min of 2000  $\Omega$ . Silicon transistors are used throughout; ICs are used in the logic circuitry.

CIRCLE NO. 286

### Infrared detector aids quality control

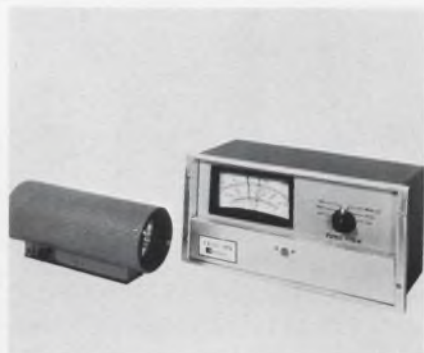

Industrial Electro-Optical Systems Group of Ovitron Corp., 1425 Milldale Road, Cheshire, Conn.

This infrared detection system is designed for use in automated industrial processing or quality control. It consists of a sensor head and a control instrument. Solid-state throughout, the system is available in several models covering overlapping sensing temperatures ranges from  $-60^{\circ}$  to  $700^{\circ}$ F.

CIRCLE NO. 287

**MEAN DISTANCE: 238,857 MILES.**  
**HIGH-RELIABILITY, QUALITY PRODUCTS NEEDED**  
**EVERY MILE OF THE WAY**



The Model 2600 Push-Button Rotary Switch is designed for only those applications requiring the highest of reliability and quality.

**UNIQUE**

Several interesting engineering accomplishments have made this push-button switch unique.

It is totally enclosed . . . and explosion proof.

It has a readout that can display numbers, symbols, color, and binary codes.

It even has its own light.

No other push-button switch has had so much designed into so little a package.



The Model 2600 is so small it has been nicknamed the "Space-Saver."

And a Space-Saver it is . . . Only .350 wide x 1.00 high. This adds up to panel space savings.

**APPLICATIONS**

The Space-Saver represents tomorrow's push-button state of the art today.

It was designed for only those applications needing the finest

quality push-button switch. *It was designed for applications where function and performance outweigh all other criteria.*

When your project calls for nothing but the finest, high-reliability, push-button rotary switch manufactured, you can rest assured that it is available at Janco Corporation.

And we mean available . . . even for the mean distance and back!

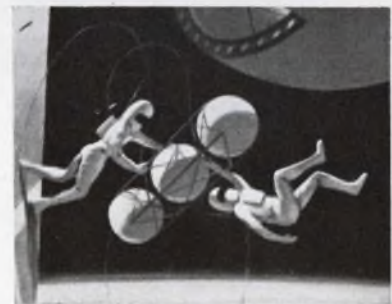

**JANCO**  
CORPORATION

3111 Winona Avenue, Burbank, California 91504

ON READER-SERVICE CARD CIRCLE 96



## NEW / FROM NORTRONICS

### EXTENDED POLE PIECE TAPE HEADS

### FOR READING SOUND FROM FILM



Nortronics extended pole piece record/play heads read sound from 8 mm or 16 mm film without touching the film's optical or sprocket areas. This avoids scratching of the optical surfaces and eliminates possible picture bounce or sound flutter from sprocket hole-to-head contact. The extended tip on these heads is available with Alfenol laminations for long wear or Mu-metal laminations for maximum sensitivity.

These heads are also appropriate for a variety of other applications requiring a projecting track, such as card readers, drums and discs.

As small as a 1/4 inch cube, the heads can be supplied with track widths from .006" to .070", with a choice of sizes and case styles. Complete technical data is available upon request.



Like all Nortronics tape heads, the extended pole piece type has a fine laminated, precision lapped core structure for low loss, a deposited quartz gap for optimum high frequency resolution, and superb shielding for protection from external magnetic fields. The world's largest manufacturer of tape heads and pace-setter for the industry, Nortronics offers a complete line of heads, including many for replacement and prototype applications off-the-shelf from your local distributor.

**Nortronics**  
COMPANY, INC.

8101 Tenth Avenue North  
Minneapolis, Minnesota 55427

ON READER-SERVICE CARD CIRCLE 97

## SYSTEMS

### Core-memory system holds 8192 words

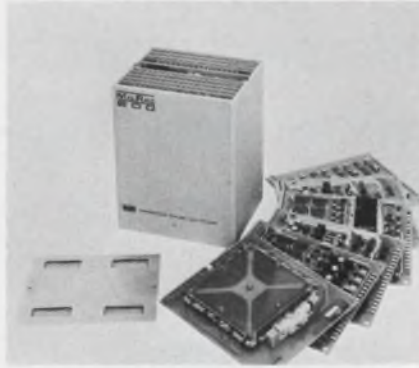

Information Control Corp., 1320 E. Franklin Ave., El Segundo, Calif. Phone: (213) 322-6930.

Military random-access core-memory systems designed specifically for operational shipboard, ground-based, vehicle-based and airborne weapons systems are designated the MilRac-200 series. The memory is organized to be expansible up to 8192 words and up to 16 bits. The memory is organized as a four-wire coincident-current system and employs 22-mil lithium ferrite cores.

CIRCLE NO. 294

### BCD attenuator gives 1% accuracy



Canoga Electronics Corp., 8966 Comanche Ave., Chatsworth, Calif. Phone: (213) 341-3010.

This attenuator is capable of remote control and automatic programming. The value of attenuation in dB is determined by 1248 BCD input signals. Other features include up to 143-dB attenuation in 1-dB steps; temperature stability 0.001 dB/dB/°C through the use of metal-film elements; 1% accuracy, and operation up to 1000 MHz.

CIRCLE NO. 295

### Data storage unit aids 370 calculator

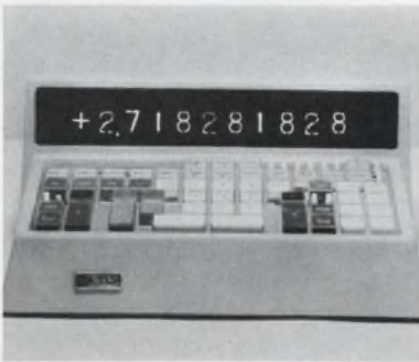

Wang Laboratories, Inc., 836 North Street, Tewksbury, Mass. Phone: (617) 857-7311.

A new option has been added to the 360 calculating system. It is the 373 data-storage unit, a 64-register core storage device. Each register consists of a 10-digit decimal number with algebraic sign and decimal point. A total of 64 registers is available. The operation of the 373 allows a 370 calculating system to solve simultaneous equations with only two card readers (160 program steps).

CIRCLE NO. 296

### Laser interferometers perform calibration



DoAll Co., Des Plaines, Ill. Phone: (312) 824-1122.

Laser interferometers and high-speed bidirectional counters are being developed for calibrating. The Model 121, in a 16-in.-long tube is a double-path interferometer with self-contained laser and power supply, designed for machine-tool calibration. The Model 127, in 8-in.-long tube, is a single-path interferometer, operating with an external single-mode helium-neon laser.

CIRCLE NO. 297



# MSC Series 10E ...the lighted pushbutton switch for reliable answers to your toughest design problems!

The MSC Series 10E Twist-Lite® Switch can provide an answer to virtually every functional or environmental design requirement you might encounter. Standard and optional features range from a positive hardmount, achieved without special brackets or extraneous hardware, to the optional drip-proof seal for equipment destined for duty in severe environments. Four-lamp operation provides unlimited flexibility in color selection and control for performance under any ambient light condition. The front lens provides maximum legend area per panel space occupied, with optional configurations ranging from full to 4-way splits. Ease of maintenance is assured by the twist/lock principle for quick lamp, legend or color filter change from the panel front without tools of any kind. These are the features that have made the Series 10E the preferred illuminated switch for critical aerospace and industrial control systems. Investigate the advantages the Series 10E holds for you. Contact your nearest MSC regional office or write and ask for an operating demonstration, **SEND FOR CATALOG NUMBER 2000.**

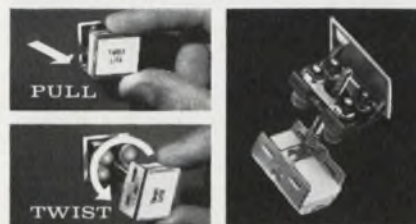

**EXCLUSIVE TWIST/LOCK RELAMPING WITHOUT TOOLS**  
Easily done without fear of accidental switch actuation. Lamp/Lens assembly remains connected to the housing during relamping to prevent transposing with adjacent units.

**OPTIONAL DRIP-PROOF SEAL**  
blocks passage of foreign matter through panel cutout.

**OPTIONAL RFI SCREEN**  
inhibits radiated and conducted RFI passage through panel cutout.

**OPTIONAL SWITCH-GUARD**  
prevents accidental switch actuation.

**INTEGRATED MOUNTING SLEEVE**  
Produces a positive hardmount without brackets or hardware.

**SNAP-ON 2PDT or 4PDT SWITCH MODULES**  
Precision snap-action alternate or momentary modules rated to 5 amps/ 125 or 250VAC.

**SNAP-ON MASTER TEST CONTROL CAPSULES**  
Permits lamp verification tests without external circuitry.

**INTERNALLY BUSSED COMMON GROUND LAMP CIRCUITS**  
... reduces wiring time.

**FULL TO 4-WAY SPLIT LENS CONFIGURATIONS**  
4-Lamp projected color with individual lamp color control.

# Master Specialties Company



25 YEARS IN INFORMATION DISPLAY AND CONTROL DEVICES



**MASTER SPECIALTIES COMPANY** 1640 MONROVIA • COSTA MESA • CALIFORNIA 92627 • (714) 642-2427 • TELEX 6-78433.

**Regional Offices:** Huntsville, Ala. (205) 536-7415 • Costa Mesa, Calif. (714) 642-0114 • Sunnyvale, Calif. (408) 245-9292 • Winter Park, Florida (305) 647-0100 • Chicago, Ill. (312) 282-7112 • Waltham, Mass. (617) 893-1020 • Haddonfield, N.J. (609) 428-0701 • Syracuse, N.Y. (315) 479-9191 • Valley Stream, L.I., N.Y. (516) 561-2334 • Cleveland, Ohio (216) 851-9700 • Dallas, Texas (214) 357-9459 • Houston, Texas (713) 228-2294 • Seattle, Wash. (206) 546-5161.

**Also available from distributor stock at AVNET ELECTRONICS**

WESTBURY, LONG ISLAND, NEW YORK • (516) 333-5800

**A-to-D converter works in 12.5  $\mu$ s**

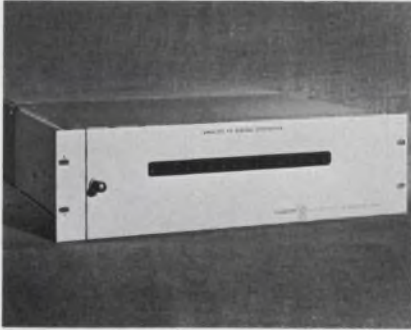

*Preston Scientific Inc., Marketing Dept., 805 East Cerritos Ave., Anaheim, Calif. Phone: (714) 776-6400. P&A: \$3545; 60 days.*

Analog-to-digital converter Model 8500-MS provides up to 14 bits plus sign resolution, and has a total conversion time of less than 12.5  $\mu$ s at an accuracy of  $\pm 0.01\%$ . The unit is intended for medium-speed applications (up to 80,000 readings/s). It is designed to operate in an ambient temperature from 0° to 50°C. Either positive true or negative true logic voltage levels are available.

CIRCLE NO. 291

**Tape converter packs 200 bits/in.**



*Instrumentation Technology Corp., 15336 Roscoe Blvd., Van Nuys, Calif. Phone: (213) 780-0744. Price: \$4837 up.*

Punched - tape - to - magnetic - tape converter is designed to operate at 150 characters/s at a packing density of 200 bits/in. The series 7925 accept 5-, 7-, or 8-level punched-tape formats and generate an equivalent 7-level NRZL IBM compatible magnetic tape, including automatic interrecord gap verification, parity verification, and all necessary code conversions.

CIRCLE NO. 292

**Signal simulator for telemetry codes**



*Stellarmetrics, Inc., 416 E. Cota St., Santa Barbara, Calif. Phone: (805) 963-3566. P&A: \$10,000; 60 days.*

A signal simulator with an optional add-on capability for phase-shift keying telemetry codes, is designated the DDS-30. The signal simulator provides the following output codes: NRZ-L, NRZ-M, NRZ-s, RZ, Bi-phase L, Bi-phase M, Bi-phase S, and RZ Bi-level. Output level is variable from 0 to + 12 V pk-pk in all models. Bit rate is 2 Hz to 2 MHz variable in six ranges plus manual.

CIRCLE NO. 293

**DELAY TIMERS**



Any mounting style; voltage specification; time cycle; operational method. No special engineering required. Good delivery schedules. Our stock is ample.

**INDUSTRIAL  
TIMER CORPORATION**

U.S. Highway 305, Parsippany, N. J.

Subsidiary of  General Precision Equipment Corporation

ON READER-SERVICE CARD CIRCLE 99

**"IT'S GOOD BUSINESS  
TO HIRE THE HANDICAPPED."**

**ISN'T THAT A GREAT IDEA, SNOOPY?**



**THE PRESIDENT'S COMMITTEE ON EMPLOYMENT  
OF THE HANDICAPPED, WASHINGTON, D. C.**

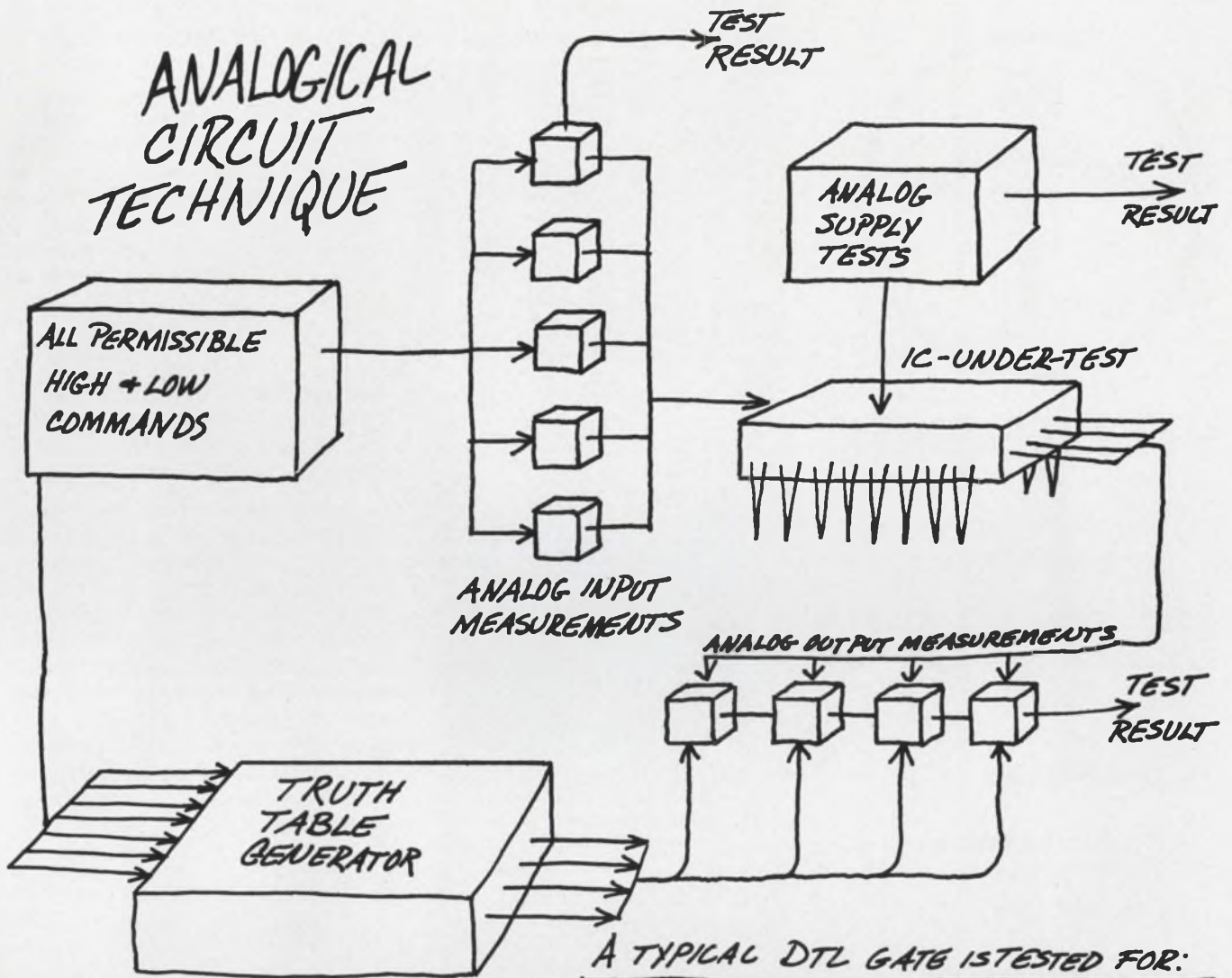

A TYPICAL DTL GATE IS TESTED FOR:

$I_{IN HI}$	5.1 mA MAX @ 4.1 V
$I_{IN LO}$	1.1 mA MAX @ 1.1 V
$V_{OUT HI}$	2.6 V MIN @ 0.12 mA
$V_{OUT LO}$	0.45 V MAX @ 12.0 mA
$I_{CC}$	16 mA MAX @ 5.0 V

Intriguing, isn't it, this new way of testing digital integrated circuits?

Now you can make sure ALL of your ic's will work — because you can make both parameter and functional tests simultaneously, and for all permissible combinations of inputs. □ It's done by exercising all the LOGICAL inputs on the ic-under-test and selecting the appropriate ANALOG measurements that should be made. 5,000 such measurements are made in 1/100 of a second.



□ Even more exciting, our Analogical Circuit Technique is available on a little machine that weighs only 25 lbs. It's a cinch to program, and costs only about \$5,000. □ We call it ACT 1 (because of the fortunate acronym). □ To learn more about analogical testing, just write: ACT 1, Teradyne, 183 Essex Street, Boston, Massachusetts 02111.



## MEASUREMENTS

.....

Designers and manufacturers of precision electronic test equipment for more than 25 years.

- Signal Generators
- Frequency Synthesizers
- Pulse Generators
- Square Wave Generators
- Frequency Meters
- Deviation Meters
- Megacycle (Grid-Dip) Meters
- Crystal Calibrators
- Vacuum Tube Voltmeters
- Standard Bolometer Bridges

Laboratory Standards



## MEASUREMENTS

A McGraw-Edison Division

P.O. Box 180, Boonton, N. J. 07005

Phone: 201-334-2131

ON READER-SERVICE CARD CIRCLE 101

## SYSTEMS

### Memory system has random access

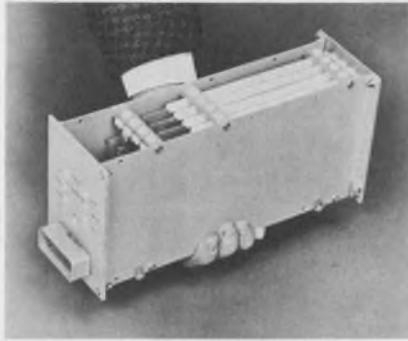

*Ferroxcube Corp., 5455 S. Valentia Way, Englewood, Colo. Phone: (303) 771-2000.*

This compact 1024 word by one-bit coincident memory occupies only 214 in.<sup>3</sup>. Read or write cycle time for the memory is 1  $\mu$ s and the access time is 900 ns. Power requirements are plus and minus 6 V and the output for logic 0 is 0 V to +0.45 V at 30 mA, for logic 1 it is +3.5 to +7 V. It measures 3-11/16 x 11-1/8 x 5-7/32 in.

CIRCLE NO. 298

### Molded memory plane has 32 terminals

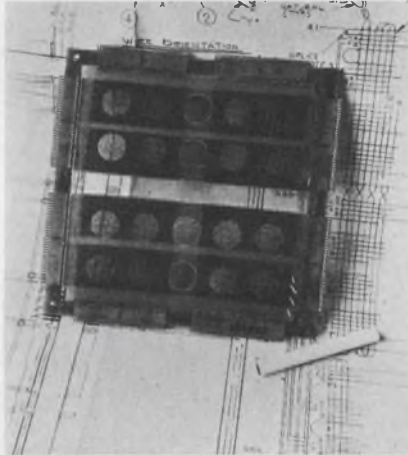

*Indiana General Corp., Electronics Div./Memory Prod., Crows Mill Rd., Keasbey, N.J. Phone: (201) 826-5100.*

A memory plane for coincident-current applications in commercial, military and industrial computers is available. Named Cor-Gard, the plane includes supporting plates to prevent core mat sag, encapsulating compound over solder connections and an optional foam pad over the cores, resulting in high resistance to shock and vibration. Flexibility in design is made possible by a variety of winding configurations.

CIRCLE NO. 299

### Alignment system laser-controlled

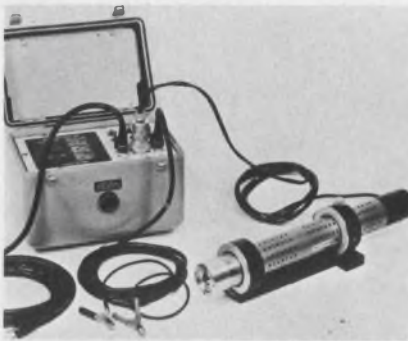

*Perkin Elmer Corp., Laser Product Dept., 131 Danbury Rd., Wilton, Conn. Phone: (203) 762-6972.*

Laser alignment system is designed for field use in construction, tunneling and mining operations. The system consists of a model 5205 battery-operated field power supply. Suitable for any alignment application requiring a precise straight line, the device emits a continuous 0.8-in.-dia. collimated red laser beam.

CIRCLE NO. 321

### Synchronous converter provides sine and cosine



*Natel Engineering Co., Inc., 7129 Gerald Ave., Van Nuys, Calif. Phone: (213) 782-4161. P&A: \$250; 4 wks.*

Synchronous - to - sine - and - cosine converter provides  $\pm 5$  minute accuracy. Called the Model 401, it will accept the input of a standard 3-wire ungrounded synchronous stator and provide dc voltage outputs corresponding to the sine and cosine of rotor shaft angle. It has a tracking speed of 9000°/s and resolution of  $\pm 3$  minutes.

CIRCLE NO. 322

ON READER-SERVICE CARD CIRCLE 102 ►

# Giant Killers

Second in the series.



International road racing had long been dominated by foreign automotive dynasties... until 1965, when the old regimes were toppled from the world racing throne by a bold Texan, Carroll Shelby, with his Cobra sports cars. In '66 and '67 Shelby Fords swept Le Mans — another American first — and a clear indication the giant was no longer king of the hill!



In the fast recovery power diode field, we knock heads with some industry giants, too. Take an example.

Our 251UL silicon diode boasts a 250-ampere forward current with recovery time of  $1.5\mu\text{s}$ , 600 to 1000 PRV,  $2.0\mu\text{s}$  to 1300 PRV. These recovery times are tested at 785 amps peak  $I_F$  ( $\frac{1}{\pi}$  times the FCA rating) as recommended by JEDEC. You get microsecond recovery at operational currents.

The giants can't come near it. Brands G, W and M publish recovery times tested at  $I_F$  levels well below specified capacities—usually 1 to 5 amps or so. Try their diodes in a circuit and see how fast they recover.

If you have inverters with critical high frequency requirements, talk to the giant killer—IR—developers of the 200 ampere power logic triac. Send for 251UL bulletin plus test procedures. Or just send your order. We've been delivering them for over a year.



**INTERNATIONAL RECTIFIER**

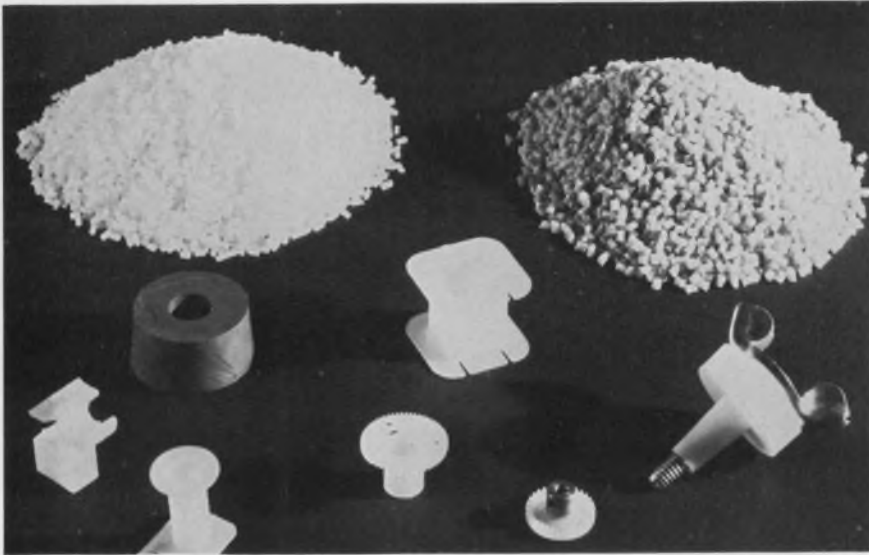

## Glass puts muscle into moldable nylon

*Nichols & Co., Inc., Boston. Phone: (617) 482-0102. Price: Well-Sphere 73¢/lb, Well-A-Mold 81¢/lb, Well-Fibe 87¢/lb (in 10-ton lots).*

Tougher thermoplastic molding materials have been compounded of glass and nylon. Two grades of solid-glass-sphere-filled nylon are available. Well-Sphere is a compound of 60% Wellamid nylon resin and 40% glass spheres. Well-A-Meld is a combination of 60% nylon resin, 25% glass spheres and 15% short glass fiber. A third material, Well-Fibe, is 60% nylon and 40% glass fiber. All three materials are stocked in four colors—natural, white, blue and black.

Well-Sphere compared with regular nylon improves tensile strength by 10% and greatly reduces ultimate elongation. Flexural modulus is improved by 42% and compressive strength is more than eight times as great. Deformation under load, tested at 4000 lb/in.<sup>2</sup>, was less than for unfilled nylon tested at 2000 lb/in.<sup>2</sup>.

Well-A-Meld bridges the gap between the sphere-filled and the fiber-glass-filled materials. It has the flow properties and surface smoothness that the spheres give, as well as the good mechanical properties of the straight fiber-reinforced compounds. Tensile strength is double that of unrein-

forced resin and 62% higher than Well-Sphere. Compared with other compounds with 20% and 30% short-glass-fiber reinforcement, tensile strength is higher and elongation is lower. Well-A-Meld's flexural modulus is nearly thrice that of unfilled nylon, is 75% greater than that of sphere-filled material and 54% higher than 20% glass fiber compound. Compressive strength is six times that of nylon resin alone and just over 20% higher than glass fiber materials. It is, however, less than that of a sphere-filled compound. Water absorption is 43% less than that of unreinforced nylon, and the coefficient of thermal expansion is 58% better than plain nylon. Impact resistance equals that of unfilled resin and betters that of sphere-filled material and 20% glass fiber compound. Mold shrinkage is only 0.005 in./in., which is one-quarter that of unfilled resin. The melt index is higher than that of any fiber-glass-reinforced nylon and second only to glass-sphere-filled material.

Well-Fibe has twice the tensile strength of sphere-filled material and 30% more than sphere-fibre material. Flexural modulus is more than double sphere-filled material and one-third more than that of sphere-fiber material.

CIRCLE NO. 323

## Acrylic resin makes glossy coating

*S. C. Johnson & Son, Inc., 1525 Howe St., Racine, Wis. Phone: (414) 632-1611.*

This water-base acrylic resin air-dries to a clear, glossy protective coating on metal, glass, paper, leather and rubber. Called CDX 77-1, the new coating is intended to improve appearance and protect all metals, including aluminum, brass, stainless steel and phosphate-coated metals, against rust, corrosion or tarnishing. Its dielectric characteristics (in excess of 2500 V/mil) make it suitable for use with transformers, printed circuits, electric busbars and other electrical components requiring an insulating coating. The coating can be removed easily.

CIRCLE NO. 324

## Gold conductive paste bonds to substrates

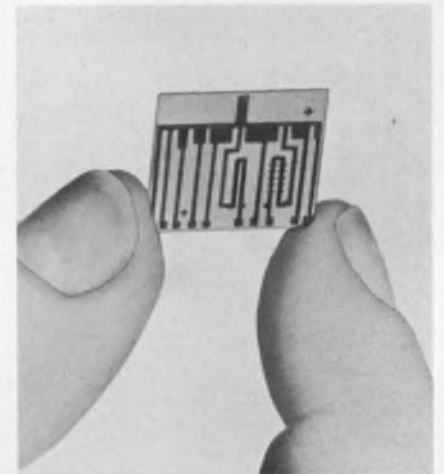

*Electro Materials Corp. of America, 605 Center Ave., Mamaroneck, N.Y. Phone: (914) 698-8434.*

A gold conductive composition for screened thick-film micro-circuits can be bonded directly to ceramic substrates without the use of intermediate alloys. Bonding of the gold is done at 300° to 500°F, in an air, nitrogen or forming gas cover. Final firing temperature is from 1700° to 1900°F. The fired film is over 90% gold and has excellent adhesion to alumina, steatite and beryllia.

CIRCLE NO. 325



**Application:** Shirt pocket size 1-watt FM transceiver.

**Problem:** How to fit a precision two channel, 1-watt FM transceiver into a 7" x 2 3/8" x 7/8" package weighing 18 ounces and still not sacrifice performance or reliability.

**Solution:** Ultra high density packaging utilizing Minitan subminiature solid tantalum capacitors.

The pocket sized transceivers carried by policemen, the beacon-transceivers in aircrew survival packs, and the tape recorders in our latest space shots have at least one thing in common — Minitan subminiature solid tantalum capacitors. Wherever large value capacitors are needed for by-passing, coupling, or filtering, there is really no substitute for electrolytics. And among electrolytics, none offers greater capacitance to volume ratios or greater reliability than Minitan subminiatures.

Minitans are up to 75% smaller than equivalent CS13 styles and up to 90% smaller than "miniature" aluminum electrolytics. They are even smaller than monolithic chip ceramics and miniature Mylars beginning at about 0.5 mfd. Minitans don't sacrifice performance and reliability for size, however. This is why they are designed into a growing number of portable and miniature communications equipments.

Minitans operate reliably to 125°C, handle 130% voltage surges, withstand Method 106 moisture testing, and have excellent TC's. Standard tolerances are  $\pm 20\%$ ,  $\pm 10\%$ , and  $\pm 5\%$ . DC leakage is typically less than .01uA per mfd-volt. Impedance is typically below 10 ohms between 1MHz and 10MHz.

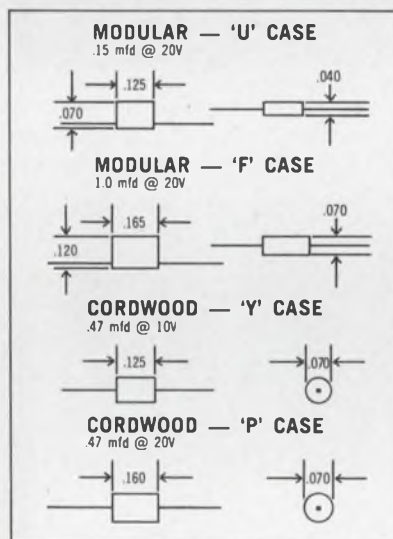

Will equipment give thousands of hours of trouble-free life even after being stored for months or years? We can't guarantee the equipment, but we can the capacitors which never require re-forming, never leak or dry out, and have normal life expectancies measured in the tens of thousands of operational hours.

## how to save space in subminiature communications gear...

What about voltage derating for even greater reliability and longer life. Don't try this with capacitors whose dielectric conforms with less than rated applied voltage. But with Minitan solid tantalums, voltage derating not only substantially reduces leakage values but materially increases reliability and life as well.

Minitans are available in 11 case sizes, working voltages to 35 volts, and capacitance values from .001 to 220 mfd. A full line of non-polar styles is offered for severe reverse DC bias applications.

Both axial and radial leads are available in both tubular and rectangular case styles. For maximum IC compatibility, gold plated ribbon leads are a standard option.

Components, Inc. offers more subminiature case styles and ratings than anyone else. **Our products are designed in, not added on.** So we welcome requests for samples, performance and reliability data, and applications aid. Almost every catalog part can be shipped in prototype quantities within 24 hours.

... with  
**Minitan<sup>®</sup>**  
**solid tantalum  
capacitors**

**COMPONENTS, INC.**  
SMITH STREET / BIDDEFORD, MAINE 04005  
TEL. 207-284-5956 / TWX-710-229-1553

# Service...Engineering...Experience

MAKE THE **BIG** DIFFERENCE  
BETWEEN A YOKE SPECIALIST  
AND A YOKE SUPPLIER



1" ID 12 oz. Single Gap  
Shielded Dynamic/Static  
Focus Coil

Syntronic Yoke Specialists have more yoke knowledge and provide more engineering assistance than anyone else in the field.

The most extensive line of deflection yokes available is offered by Syntronic... in production quantities or custom designed to special requirements. See the BIG Difference for yourself the next time you specify a yoke.

*Syntronic* **INSTRUMENTS, INC.**  
100 Industrial Road, Addison, Illinois Phone 312, 543-6444

ON READER-SERVICE CARD CIRCLE 153

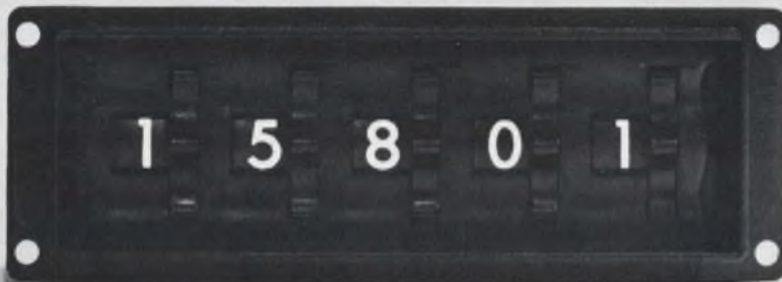

## What's black and white and read all over?

Old joke, great product. Digiswitch® and Miniswitch® are the industry's standard in thumbwheel switches. You'd almost think we'd pioneered the thumbwheel switch. (We did.)

Digitran switches set quickly. Read clearly. Save you up to 50% in panel space over old fashioned rotary switches. Absolute simplicity means absolute reliability. A million counts guaranteed.

As the world's largest manufacturer

of thumbwheel switches we happen to have the world's largest library of thumbwheel switch applications. Want more information about how Digitran can help with your switching problems? Send for our catalog, and we'll give it to you in black and white.

**THE DIGITRAN COMPANY**  
Subsidiary of Becton, Dickinson and Company   
855 S. Arroyo Pkwy./Pasadena, Cal. 91105  
Tel: (213) 449-3110/TWX 910-588-3794

ON READER-SERVICE CARD CIRCLE 154

## MATERIALS

### Card holders offer rigid mounting

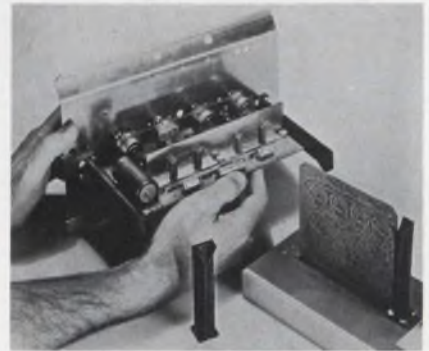

Gibson-Egan Co., 34 La Porte St., Arcadia, Calif. Phone: (213) 681-7301.

A high-strength printed-circuit card holder doubles as a chassis bracket. This Model 500 guide, molded of 20,000-lb/in.<sup>2</sup> fiber glass reinforced nylon, is suited for applications where strength and rigidity are important. Four hold-down holes provide means to secure the base to an instrument panel. Special sizes can be custom-molded up to 9 in.

CIRCLE NO. 326

### Fused quartz is bubble-free

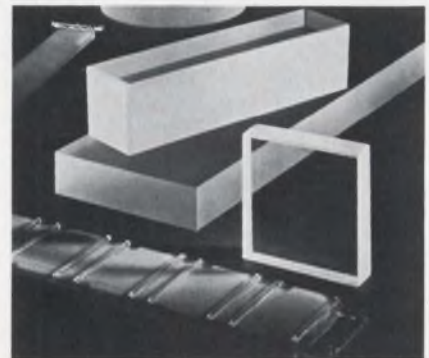

General Electric Co., Lamp Glass Dept., 24400 Highland Rd., Highland Heights, Ohio. Phone: (216) 266-2121.

A fused quartz that is free of large bubbles is available in five optical grades of infrared, ultraviolet and full-spectrum types. Also available is a schlieren-grade fused silica for critical ultraviolet and optical applications. Tests indicate a maximum birefringence of 20 nm/cm, although it is stated that the majority of the material will fall below 10 nm/cm.

CIRCLE NO. 327



# When you're little you have to think fast or play dirty.

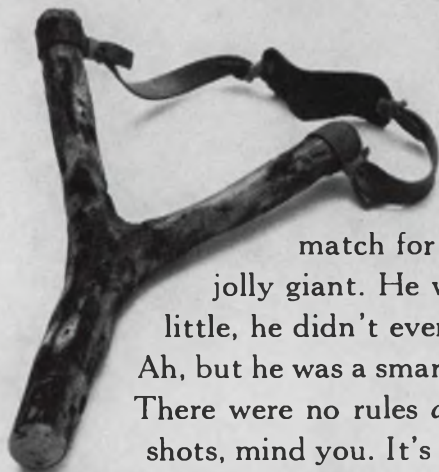

Take David, for instance. He was no match for that not-so-jolly giant. He was not only little, he didn't even play dirty! Ah, but he was a smart little devil! There were no rules *against* slingshots, mind you. It's just that our large friend had been getting by on his size so long that he turned into sort of a clumsy thinker.

David took an existing device, applied it to a new situation and bingo! One dead giant.

At MIDTEX/AEMCO we call that creative thinking. And we do a lot of it for our customers, because believe us, we don't get by on our size. Compared to some of the giants in the relay and time delay business

... we're a David.

But we think quick. And creatively. We've solved an unusually difficult time delay problem for Xerox, dozens of relay problems for Collins Radio and given solid assistance to RCA, Bruning, E. F. Johnson Co., and many more.

But we're not going to sit here and crow about what we did for somebody else yesterday, it's what we can do for you tomorrow that's important.

So, if you have a giant relay problem, or giant timing problem, remember little MIDTEX/AEMCO.

We're smart little devils ... specializing in dead giants.

How can anybody forget a ridiculous story like that?



AEMCO DIVISION  
10 STATE STREET  
MANKATO, MINNESOTA 56001

PROGRAMMERS/TIME DELAY RELAYS/MINIATURE COAXIAL RELAYS/INDUSTRIAL RELAYS/MERCURY-WETTED CONTACT RELAYS



Netic & Co-Netic  
Magnetic Shielding



Copycat

*They may look alike  
...but the similarity  
ends there!*

**This is what  
MSD  
gives  
you.**



**Permanently  
Effective  
Shielding**

Netic & Co-Netic shields do not require periodic re-annealing, are insensitive to ordinary shock and have minimal retentivity.

**Technical  
Assistance**

Ask our design and engineering departments to assist in solving your shielding problems. MSD = Service.

**Price**

MSD's vast experience (over 80% of current shield designs originated here) gets you the most shielding for the money.

**Delivery**

Immediate on stock items. 2-4 weeks on many items. 6 weeks on complex items.

For additional information on magnetic shielding write for EMC catalog.

**MAGNETIC SHIELD DIVISION**



*Perfection Mica Company*  
1322 North Elston Avenue  
Chicago, Illinois 60622  
Phone: 312, EV 4-2122

ON READER-SERVICE CARD CIRCLE 156

**MATERIALS**

**Resin fiber tape stretches 20%**

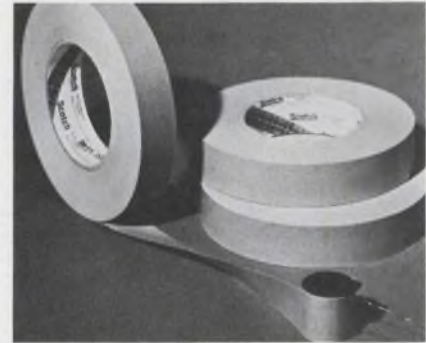

3M Co., 2501 Hudson Rd., St. Paul, Minn. Phone: (612) 733-4033. P&A: 58¢ (60 yd. by 1/4 in. roll); stock.

Resin-fiber, conformable, stretchable electrical tape has a thermosetting, pressure-sensitive adhesive. Properties include a tensile strength of 45 lb/in., 20% elongation, electric strength of 2400 V, insulation resistance of 75 MΩ and adhesion of 45 oz/in. Recommended cure cycle for the thermosetting adhesive is 1 hour at 300°F.

CIRCLE NO. 328

**Shielding material cuts magnetic loss**

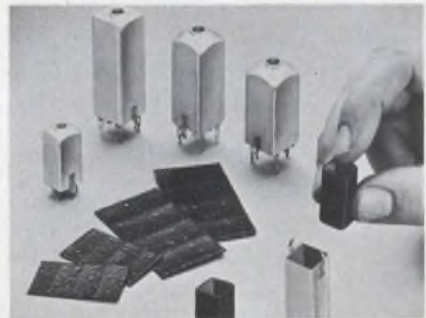

Arnold Engineering Company, Box G, Marketing Dept., Marengo, Ill. Phone: (815) 568-2000.

Flexible shielding material is designed for use as liners in miniature transformer cans to reduce magnetic losses in the transformer coil by as much as 20% to 50%. The shielding liner material is 0.040 in. ±0.005 in. thick and comes with a 0.0005-in. acid-free thin kraft paper backing. The thinness and flexibility of the material permits it to be cut easily to fit requirements.

CIRCLE NO. 329

ON READER-SERVICE CARD CIRCLE 157 ►  
ELECTRONIC DESIGN 1, January 4, 1968

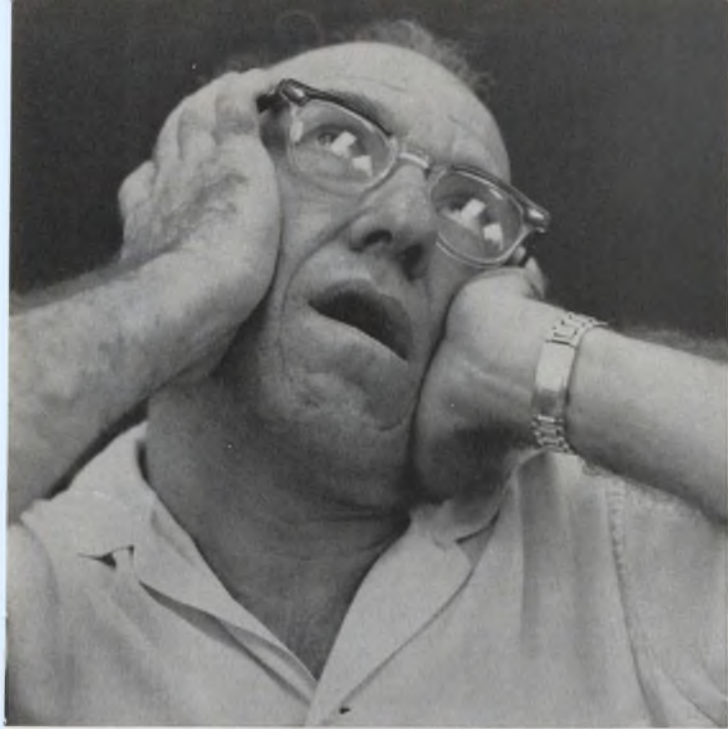

"I was in terrible trouble. The additional circuitry changed my power supply requirements."

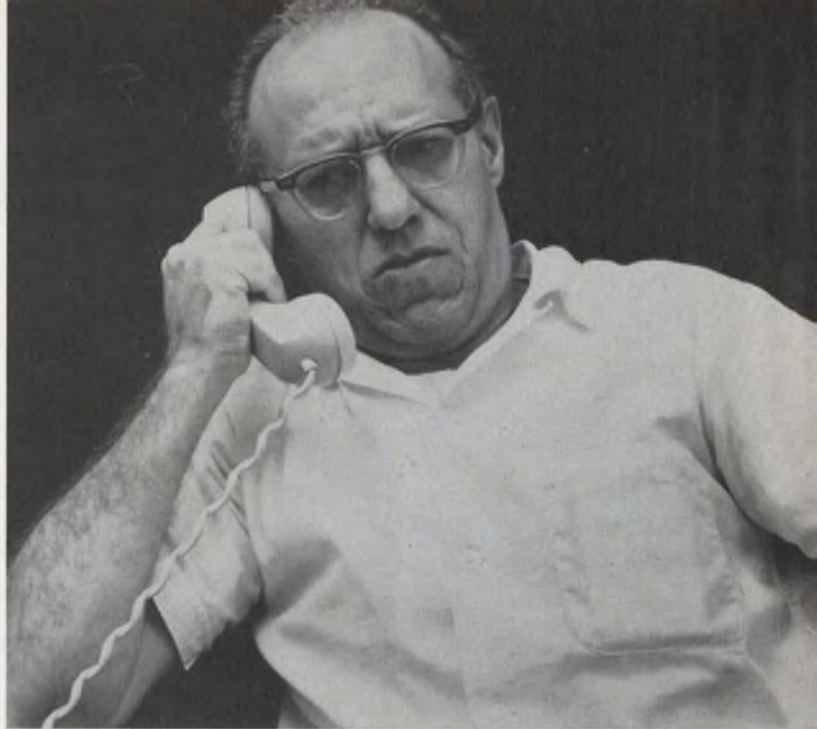

"More trouble . . . my usual source of supply said, 'Six weeks to get power supplies with the new ratings'."



"I had heard about Acopian's incredible 3-day shipment guarantee on their 62,000 different types of AC to DC plug-in power supplies, and decided to give them a try."



"Imagine my glee . . . when a few days later . . ."

Next time you're in trouble with power supply delivery, contact Acopian. If you do not have a copy of our latest catalog, by all means, request one. It lists 62,000 different AC to DC plug-in power supplies, any of which will be shipped to you in just three days! For particulars, contact your local Acopian rep., call us at (215) 258-5441, or write to Acopian Corp., Easton, Penna. 18042.

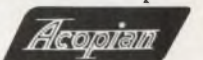

### Bifurcated contact will carry 5 A

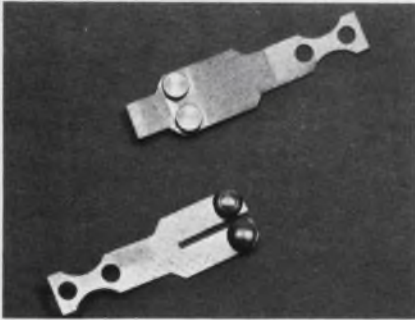

Parelco, Inc. 26181 Avenida Aero-  
puerto, San Juan Capistrano, Calif.  
Phone: (714) 493-4507.

This M contact has the inherent reliability of bifurcation for heavy-duty loads. The contact is available on relays in up to an 8-form-C configuration. A typical application is switching a 5-A solenoid in a computer card handler where reliability on a high-current inductive load is required. Pricing depends on the number of poles.

CIRCLE NO. 330

### Teflon laminate uses aluminum

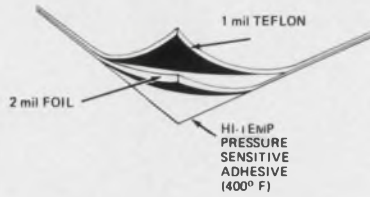

Lamart Corp., 16 Richmond St.,  
Clifton, N.J. Phone: (201) 772-  
6262.

The laminate is composed of 1-mil Teflon laminated to 2 mils of aluminum foil and pressure-sensitized with a temperature adhesive capable of withstanding 400°F. Applications are in the manufacturing and processing lines demanding surfaces with antifriction, nonstick and chemically inert characteristics. It is available in 1- and 2-in.-wide rolls.

CIRCLE NO. 331

### Powdered resin withstands 180°C

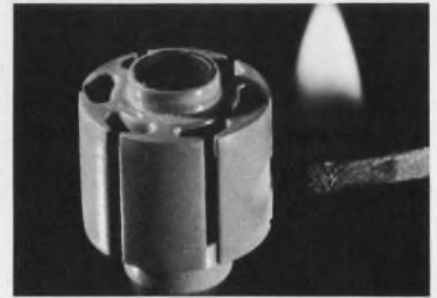

3M Co., 2501 Hudson Rd., St. Paul,  
Minn. Phone: (612) 733-4033.

High-temperature resin will withstand continuous operation in the cured state in excess of 180°C temperatures. It has an adhesion to steel of 2000 to 3000 lb/in.<sup>2</sup>. It is chemically inert, with a resistance to a wide range of chemicals and corrosive substances. Its dielectric constant is 100 Hz at 23°C, its dissipation factor is 0.005 and its volume resistivity is 10<sup>16</sup> Ω/cm.

CIRCLE NO. 332

**When Only Excellent is Adequate TURN to Grayhill**

for EXCELLENCE IN  
MINIATURE... SUB-MINIATURE...  
ULTRA-MINIATURE  
ELECTRONIC COMPONENTS

... the Difference Between  
Excellent and Adequate

Grayhill Components are only fabricated from select materials . . . in designs long proven to fully satisfy applications demanding long life and high reliability under extreme environmental and operating conditions. Here is Excellence, competitively priced.

Ask for Catalog G-304-A for full details

000 Hillgrove Avenue  
LaGrange, Illinois 60525  
Area Code 312, Phone 354-1040  
"PIONEERS IN MINIATURIZATION"

ON READER-SERVICE CARD CIRCLE 158

### SYNCHRO-TO-DC CONVERTERS



Here's a new complete line of Synchro-to-DC Converters which accept the output of a standard 3-wire, ungrounded synchro stator and provide DC voltage outputs corresponding to sine and cosine, arc-tangent, or linear DC output proportional to shaft angle.

**Performance** — Natel's synchro converters provide accuracies consistent with present sophisticated system requirements, ±3 minutes of arc (typical).

**Flexibility** — DC voltage or current outputs are available to operate

with virtually all digital conversion or direct reading equipment.

**Reliability** — Solid state design. Minimum component complement by eliminating unnecessary logic. Units comply with MIL-E-5272, E-5400 and T-21200.

**Price** — Elimination of digital data conversion components significantly reduces unit cost. Units are designed and priced for direct coupling to synchro.

**Input:** 11.8 vrms line to line or 90 vrms line to line 400 hz ±20 hz.

**Input Impedance:** 100 K line to line.

**Output:** 0 to ±5 or ±10 VDC.  
**Frequency Response:** 20 hz (flat).

**NATEL ENGINEERING CO., INC.**  
7129 Gerald Ave. • Van Nuys, California 91406 • (213) 782-4161

ON READER-SERVICE CARD CIRCLE 159

# If it's so great, how come it's so cheap?

It's only \$5,000 because you said that's what it ought to cost. Our market research boys told us there was a tremendous need for an IC tester specifically designed for QC, QA, reliability testing, and everyday engineering evaluation. They also told us we could sell four times as many at \$5,000 as we could at \$7,500.

So we gave our design department a list of functions, a \$5,000 pricetag, and locked the door. Here's what came out: A \$5,000 IC tester that:

- Performs both pulse and dc parameter tests as well as functional tests without external equipment.
- Has a measurement accuracy of 1% (0.1% with an optional digital readout DMM.)
- Can be operated by a bright girl with half-a-day's training.
- Programs with thumbwheels in less than 60 seconds for most IC's.
- Has power supply accuracy of 0.1%  $\pm$ 1mv. (All supplies have adjustable current or voltage limiting and will both source or sink current.)

- Has Kelvin connections to the device under test.
- Has self powered, line-isolated modules.
- Has a complete line of device adaptors available.

How were we able to deliver so much machine per dollar? It was a snap. All we did was make every damn penny do a dime's work. We did it by committing to an annual agreement wherever there was a price advantage.

We did it by cutting out the fat. If a function was non-essential, it went. (This is one ungilded lily.)

We did it with painstaking project engineering. For example, the loads module: We could have made 1% capacitive loads. But it would have cost three times as much, and no one knows what to do with capacitive accuracy of better than 5% anyhow. Another example: the thumb-wheel switches. We found a great one, but discovered the price included \$2 each for a pair of stainless-steel screws. We bought them knocked-down,

assembled them ourselves and used 6¢ screws instead.

Or the pulse generator. Ours is equivalent to two single-channel output units like the ones that Datapulse sells for \$775. They're great, but by sacrificing separate control and adjustment (which isn't necessary in our tester anyway) and the fancy case cut the price in half.

We found a terrific \$15 digital switch. But we didn't use it. We built one without superfluous extras for a buck and a half apiece.

We're handling the AC-switching with 32 controlled planar devices. This saves 192 reed relays, that is to say, greenbacks.

One thing we did was hardest of all. We cut the profit margin. We're honest-to-gosh taking only  $\frac{3}{4}$  the typical profit.

One more thing. The 990 turns out to cost \$4,950 instead of \$5,000. Use the extra \$50 to take the little woman out to a show and dinner.

Write for complete technical data, or if you're in a hurry, call us collect.

## Redcor's 990 IC tester



Redcor Corporation/7800 Deering Avenue/Canoga Park, California/(213) 348-5892/TWX 910-494-1228

ON READER-SERVICE CARD CIRCLE 160

# FREE!

## VECO HANDBOOK OF THERMISTORS



- Applications
- Characteristics
- Circuitry

The practical range of applications of the temperature sensitive resistor — the Thermistor — is limited only by the creativity of the circuit designer. The VECO HANDBOOK of Thermistor Applications, Characteristics and Circuitry . . . written for Electronic Engineers, Scientists and Physicists . . . can be a valuable addition to your reference library, just as the VECO Thermistor can be a valuable addition to your personal bag of circuit design tools. Regularly priced at \$2.00, the HANDBOOK is available to you **Free of Charge** for a limited time only.

THERMISTORS • VARISTORS

VECO First in Progress • First in Service

**VECO** VICTORY ENGINEERING CORP  
136 Springfield Ave., Springfield, N. J. 07801  
Tel: 201 • 379-5900 TWX: 710-983-4430

ON READER-SERVICE CARD CIRCLE 161

### MICROWAVES

## Junction diodes span 2 to 5 GHz

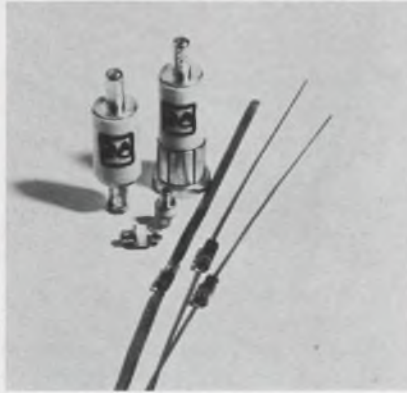

*Microwave Associates, Burlington, Mass. Phone: (617) 272-3000.*

Schottky-barrier junction diodes cover the frequency range from 2 to 5 GHz with a max noise figure of 9 dB and have a cw burnout of 1 W. The diodes have been designed for use as broad-band mixers. They are mounted in low-loss microwave packages and are rf-characterized at 3060 MHz. They operate across a temperature range of  $-65^{\circ}$  to  $150^{\circ}\text{C}$ . The metal-silicon junction is encapsulated in a hermetic glass seal.

CIRCLE NO. 342

## Airborne antenna rated to Mach 2



*Andrew Corp., P.O. Box 807, Chicago. Phone: (312) 349-3300.*

This airborne antenna provides a linearly polarized beam. It is constructed of aluminum and has a max air speed rating of Mach 2 and max altitude rating of 80,000 feet. The flush-mounted aircraft antenna operates in the 4.2- to 4.4-GHz range with 13-dB gain. Its max VSWR is 1.35. Antenna characteristics, MIL specifications and mounting details are available.

CIRCLE NO. 343

## Traveling-wave tube covers X-band

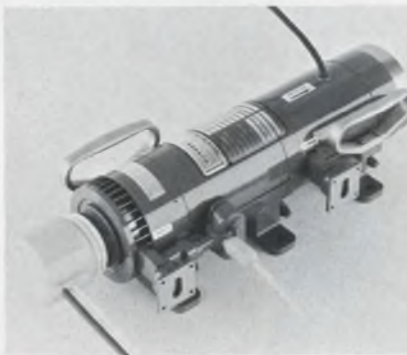

*Hughes Electron Dynamics Div., 3100 W. Lomita Blvd., Torrance, Calif. Phone: (213) 670-1515.*

Broad-band high-power pulsed traveling-wave tube has 40% efficiency at the 25-30-kW level in X band. The model 750 H has a gain of 45 dB. The tube, designed to meet MIL-E-5400 Class-1A specifications, measures less than 20 in. in length and weighs less than 27 lb. It utilizes alnico permanent-magnet focusing and air cooling.

CIRCLE NO. 344

## 500-W tetrode is air-cooled



*Varian, 301 Industrial Way, San Carlos, Calif. Phone: (415) 595-1221.*

This 500-W tetrode is air-cooled and warms up to half-power in 250 ms without using booster or stand-by circuits. The tetrode is designed for use with push-to-talk mobile and airborne communication systems. The tube is also compatible with solid-state circuitry and can be used with a low-level solid-state driver. It has ceramic metal construction.

CIRCLE NO. 345



# EE'S

with military communications  
equipment experience

## call us collect

area code 317/459-2808

Rapid expansion of our ground based and airborne military communications capability has created urgent requirements for electrical engineers (B.S. or M.S.) at Delco Radio.

Opportunities at all levels—beginning, through supervisory, with 2-10 years experience—in the following areas:

Digital communications in the HF, VHF, and UHF bands

Single side band design, HF, and VHF

Frequency synthesizer techniques in all frequency ranges

Wide range electronic tuning

Retransmission techniques

Secure communications techniques

Man-portable and vehicular battle area communications equipment

Acoustic transducers, antennas, and micro-electronics applications.

Call us collect for an interview or more information. Area Code 317/459-2808. Ask for C. D. Longshore. Or send your resume to Mr. Longshore, Supervisor, Salaried Employment, Dept. 203, Delco Radio Division of General Motors, Kokomo, Indiana.



MARK OF EXCELLENCE

## **DELCO RADIO**

DIVISION OF GENERAL MOTORS • KOKOMO, INDIANA

An equal opportunity employer

# Eliminate Manual I.C. Testing



**NOW! TEST FLAT-PACKS AND DUAL-IN-LINES FAST WITH BARNES HIGH-SPEED, AUTOMATIC TEST HANDLER**

Are you still hand-feeding your expensive I.C. parameter test equipment? Now you can handle flat-packs ( $\frac{1}{8}$ " x  $\frac{1}{4}$ " to  $\frac{3}{8}$ " x  $\frac{3}{8}$ ") with up to 14 leads and standard 14 or 16 lead dual-in-lines in Barnes 029 Carriers at speeds up to 4000 test cycles per hour. For production test, QC and incoming inspection, the Barnes TH037-B02 handler is fast, foolproof and flexible . . . featuring automatic magazine or manual input and go-no go sorting. Write for full data.



Lansdowne, Pa. 19050 • 215/MA2-1525

**barnes** / THE FIRST WORD IN CARRIERS, CONTACTORS & SOCKETS FOR I.C.'S

ON READER-SERVICE CARD CIRCLE 163

## SOLID-**PRECISION** STATE

### ADJUSTABLE-SPEED DRIVES

ALL MOTORS TOTALLY ENCLOSED, FAN-COOLED

**SPEED RANGE** Infinitely adjustable from less than 24 rpm to more than 3600 rpm (150:1) while delivering full rated torque. Continuous duty rating at all speeds.

**REGULATION** Temperature-compensated tachometer feedback provides both line and load regulation of better than  $\frac{1}{2}$  of 1% of rated speed.

**MAINTENANCE** Design eliminates vacuum tubes, selenium rectifiers, and time delays. Utilizes silicon diodes, transistors and a magnetic amplifier for exceptionally long service life. Modular plug-in construction requires only a screwdriver for servicing.

1 HP AS ILLUSTRATED

**\$687<sup>00</sup>**

Other models from  $\frac{1}{8}$  hp to  $\frac{1}{2}$  hp proportionately priced.

Write for 500/600 series catalog:

#### **SERVO-TEK PRODUCTS**

**COMPANY** 1086 ED Goffle Road, Hawthorne, N.J. 07506 • or call 201 427-3100



ON READER-SERVICE CARD CIRCLE 164

## MICROWAVES

### Telemetry system interrogates 400 sites

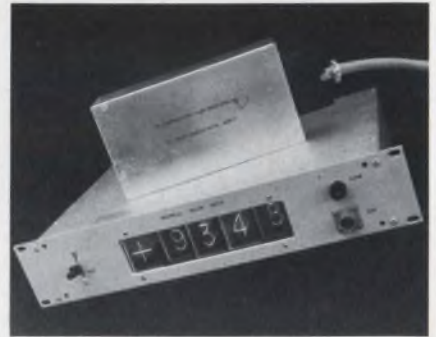

HB Engineering Corp., 1101 Ripley St., Silver Springs, Md. Phone: (301) 589-0670.

A sequential multiple-decade telemetry system is capable of interrogating as many as 400 locations over a common-wire line or radio link. The unit is a tone system, capable of displaying up to 10 decades of data telemetered from a remote site that employs a wire- or radio-transmission circuit. In addition to the display, the system also provides a recorder output.

CIRCLE NO. 340

### L-band transmitter delivers 20 W

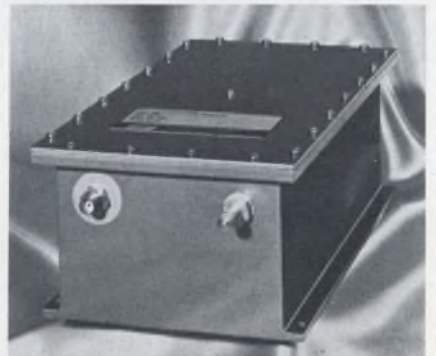

Electro-Mechanical Research, Inc., Box 3041, Sarasota, Fla. Phone: (813) 958-0811.

Fm transmitters capable of delivering 20 W min at L-band frequencies are intended primarily for transmitting telemetry data in the 1435 - 1540-MHz uhf range. This band is one of two allocations for aerospace telemetry use after 1970. It performs within specifications during 55-g shock, at any altitude, and in a temperature range of  $-20^{\circ}$  to  $+75^{\circ}$ C.

CIRCLE NO. 341



For Capacitors with **GREATER RELIABILITY . . .**

Choose  
**EL-Menco**

*The Capacitors You  
Find Wherever  
There's Electronics!*

**EL-MENCO DUR-MICA CAPACITORS**

**Only 1 Failure Per 43,000,000 Unit-Hours!**

- It has been computed that "debugged" DM30, 10,000 MMF units, when subjected to 257,000 hours of life at 85°C with 100% of the rated DC voltage applied, will yield only 1 FAILURE PER 43,000,000 UNIT-HOURS!
- DM15, DM16, DM19, DM20 . . . perfect for miniaturization and for new designs using printed wiring circuits. Also available in DM30, DM42 and DM43.
- New "hairpin" parallel leads insure easy application. Exceed all electrical requirements of military specification MIL-C-5A.

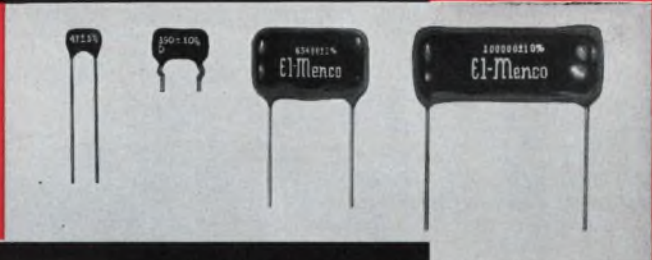

**EL-MENCO TRIMMERS & PADDERS**

**Design Versatility!**

- Available in 350 VDC and 500 VDC as well as other test voltages.
- All bases are of low-loss steatite.
- Special lugs are obtainable for printed circuitry.
- Miniature units are available.
- Solder Lugs can be bent in any position without affecting the capacity setting due to the rigid construction.
- Various types of mounting brackets are available for all trimmers.
- Units can be constructed for special applications.

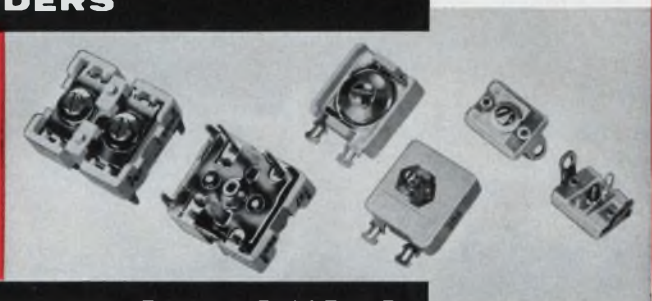

**EL-MENCO \*MYLAR-PAPER DIPPED CAPACITORS**

**Only 1 Failure in 14,336,000 Unit-Hours!**

- Life tests at 105°C with rated voltage applied have yielded only 1 FAILURE PER 1,433,600 UNIT-HOURS for 1 MFD. Since the number of unit-hours for these capacitors is inversely proportional to the capacitance, 0.1 MFD Mylar-Paper Dipped capacitors will yield only 1 FAILURE PER 14,336,000 UNIT-HOURS!
- Working volts DC: 200, 400, 600, 1000 and 1600.
- Durez phenolic resin impregnated.
- Tolerances:  $\pm 10\%$  and  $\pm 20\%$  (closer tolerances available).
- Dielectric strength: 2 or 2 1/2 times rated voltage, depending upon working voltage.
- Exceed all electrical requirements of E.I.A. specification RS-164 and military specifications MIL-C-91A and MIL-C-25A.

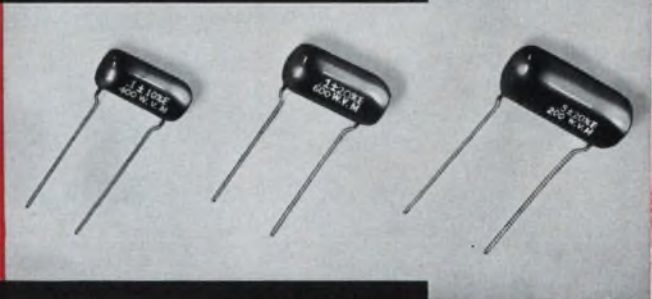

\*Registered Trademark of DuPont Co.

**EL-MENCO MOLDED MICA CAPACITORS**

**Superior Performance!**

- Unmatched for excellent stability, dielectric strength, high insulation resistance, extremely high "Q" and correspondingly low power factor.
- Units can be subjected to a short "debugging" life test at elevated voltage and temperature for removal of early life failures and for improved reliability.

*Write for Free Samples and Booklets  
on Any of The Above Capacitors*

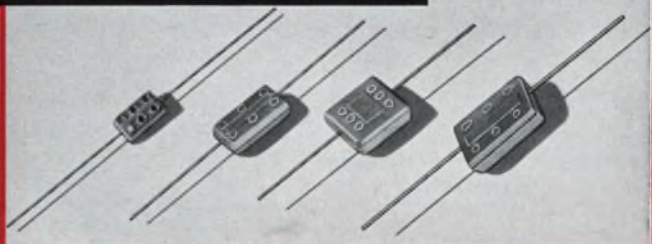

EL-MENCO OFFERS A COMPLETE LINE OF CAPACITORS . . . STANDS READY TO SERVE ALL YOUR CAPACITOR NEEDS

**THE ELECTRO MOTIVE MFG. CO., INC.**  
**WILLIMANTIC, CONNECTICUT**

*Dipped Mica • Molded Mica • Silvered Mica Films • Mica Trimmers & Padders  
Mylar-Paper Dipped • Paper Dipped • Mylar Dipped • Tubular Paper*

MANUFACTURERS OF

**EL-Menco**  
*Capacitors*

**ARCO ELECTRONICS, INC.**, Community Drive,  
Great Neck, L. I., New York  
*Exclusive Supplier to Jobbers and Distributors  
in the U. S. and Canada*

*West Coast Manufacturers Contact:*  
**COLLINS & HYDE CO.**, 900 N. San Antonio Road  
Los Altos, California  
11880 Whittier Boulevard, Los Angeles, California

ON READER-SERVICE CARD CIRCLE 165

# VCR FET

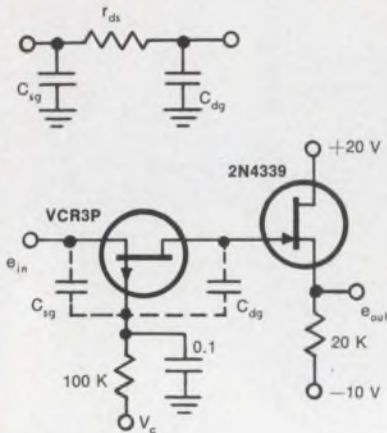

## TUNABLE LOW PASS FILTER

SILICONIX ASSUMES NO RESPONSIBILITY FOR THE CIRCUIT SHOWN, OR DO THEY REPRESENT OR WARRANT THAT IT DOES NOT INFRINGE ANY PATENTS.

Corner frequency of this RC pi-filter is voltage tunable over a 100:1 range. A Siliconix VCR\* has the equivalent circuit—drain resistance and gate capacitances form the pi.  $V_c$  controls the variation by changing  $r_{ds}$ . To change the frequency range . . . shunt the gate and source with fixed capacitors.

Build this or other circuits with the VCR FET Designer's Kit "DK6"—includes 6 VCR FETs worth \$30—available from your distributor for \$19.50. Check inquiry card or write . . . we'll be happy to send literature.

\* VCRs are voltage controlled resistors—a new family of FET devices—featuring a variable resistance range of typically 10,000 to 1.



**Siliconix incorporated**

1140 W. Evelyn Avenue,  
Sunnyvale, California 94086  
Telephone (408) 245-1000  
TWX: 910-339-9216

## MICROWAVES

### Hot reference loads aid calibration

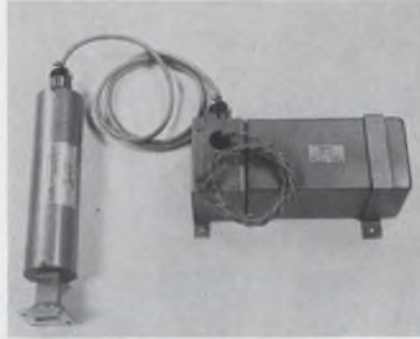

Advanced Technology Corp., Timonium, Md. Phone: (301) 252-1400.

Hot loads were developed to supplement the liquid nitrogen load series that have been in existence for several years for the calibration of microwave receivers and radiometers. Consisting of a waveguide termination in a thermostatically controlled oven, these loads can be furnished for any temperature in the range of ambient to 60°C with  $\pm 0.3^\circ\text{C}$  stability.

CIRCLE NO. 336

### Diode modulator controls 2 W cw

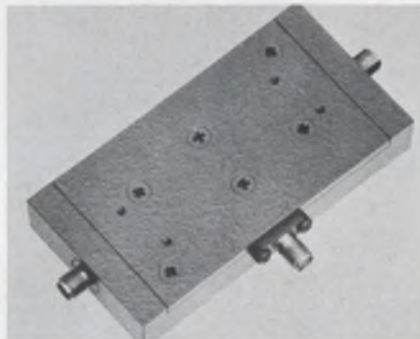

Hewlett Packard, 1501 Page Mill Rd., Palo Alto, Calif. Phone: (415) 326-7000. P&A: \$395; stock.

A pin-diode absorptive modulator can modulate, switch or attenuate cw microwave power up to 2 W. It can handle up to 100 W peak from pulsed sources (1  $\mu\text{s}$  pulse width, 0.001 duty factor). The frequency range of the modulator extends from 8 to 18 GHz. Response time is 50 ns. The modulator operates over a temperature range of  $-55^\circ$  to  $+95^\circ\text{C}$ .

CIRCLE NO. 337

### S-band transmitters produce 0.2 to 2 W

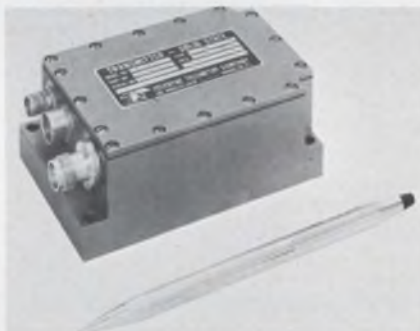

Teledyne Telemetry, 9320 Lincoln Blvd., Los Angeles. Phone: (213) 776-4360. P&A: \$4200; 90 days.

S-band transmitters offer a full spectrum of rf output at power levels from 0.2 to 2 W in less than 13 in.<sup>3</sup> The TR-2300 transmitters are capable of frequency stabilities exceeding the requirements of IRIG 106-66. Additional features include carrier deviation to  $\pm 10$  MHz and high broadband modulation frequency response of dc to MHz.

CIRCLE NO. 338

### Microstrip transition mates 3-mm connectors

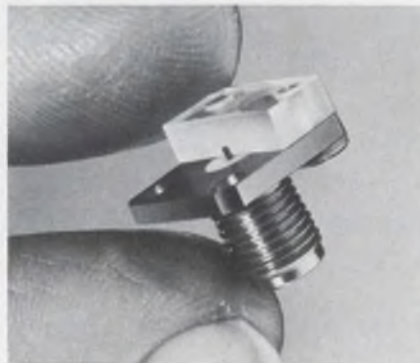

Tek-Wave, Inc., Raymond Rd., Princeton, N.J. Phone: (609) 921-8910.

High-dielectric constant microstrip-to-coaxial transition is a compensated 50- $\Omega$  device designed for 0.020- to 0.025-line widths on 0.025-in.-thick ceramic substrates and for dielectric constants from 9 to 10. The body of the unit is stainless steel. The center conductor is made of gold-plated beryllium copper. The VSWR from dc to 12 GHz is 1.10 max.

CIRCLE NO. 339

$\pm 0.003$

$\pm 0.0015$

$\pm 0.0005$

$\pm 0.001$

**Large helpings? *precisely!***

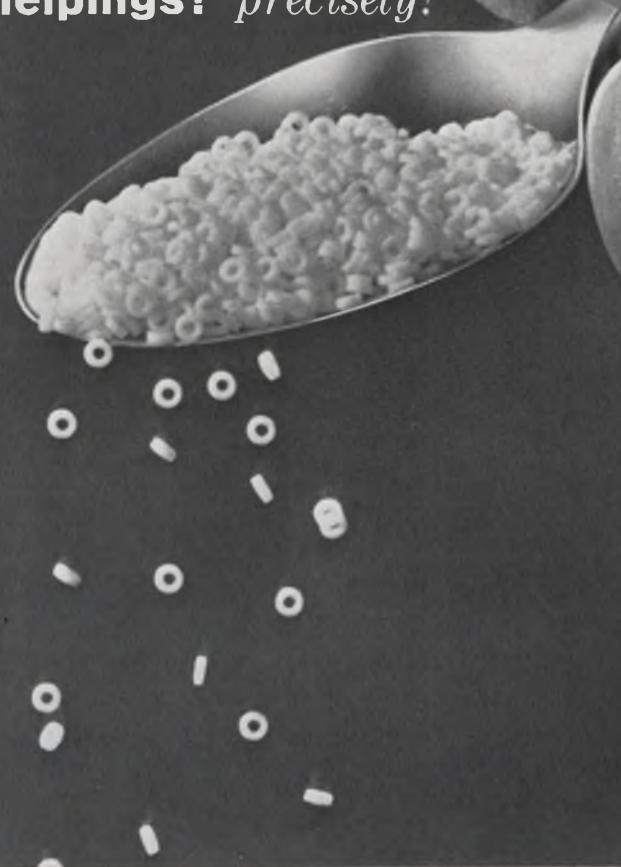

Smaller and smaller and smaller parts...tighter and tighter tolerances...in larger and larger quantities...this is the story of microceramics. Regular production includes substrates so tiny that a teaspoon holds more than 8,000 parts! Coors offers a complete facility for creating small, consistent, ceramic substrates - in several Coors Alumina and Beryllia ceramics, metallized or unmetallized. To assure economy, "as-fired" parts are produced in quantity, to extremely close tolerances (as shown at right). Let Coors provide the special help you need. Write for Data Sheet No. 7002. Get on-the-spot answers. Dial Coors-303/279-6565, Ext. 361. For complete design criteria, write for Coors Alumina and Beryllia Properties Handbook No. 952.

# Coors

## CERAMICS

ALUMINAS • BERYLLIAS • MAGNESIAS • SPECIAL OXIDES  
Coors Porcelain Co., Golden, Colo.

### EXAMPLES OF AS-FIRED TOLERANCES HELD BY COORS IN REGULAR PRODUCTION

- HOLE PATTERN DIA. .200  $\pm .0005$  .205 x .257 x .030 LOCATION OF .016 DIA. HOLES HELD WITHIN .001
- .060 DIA. .030 I.D. .001 CON-CENTRICITY .097 x .222 .007 THICK-NESS  $\pm .0005$  .001 CAMBER
- .143 DIA. .013 THICK-NESS  $\pm .0005$  .001 CAMBER .186 DIA. .013 THICK-NESS  $\pm .0005$  .001 CAMBER
- .268 DIA. .002 FLAT-NESS .008 SLOT WIDTH
- .010 THICK-NESS  $\pm .001$  .001 MAX. CAMBER .015 THICK-NESS  $\pm .001$  .001 MAX. CAMBER .230 I.D.

### Automatic sorter feeds 3000 an hour

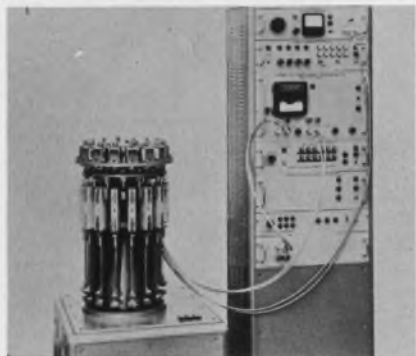

B. Freudenberg, Inc., 50 Rockefeller Plaza, New York. Phone: (212) 757-9130.

An automatic sorter for mica plates or chip capacitors will feed, test, sort and restock them in magazines at the rate of 3000 an hour according to high-voltage flash, 10 capacitance groups and dissipation factor. The sorting mechanism consists of a horizontally rotating wheel with 16 suction contacts arranged in a circle underneath it.

CIRCLE NO. 333

### Laser welder achieves 4 J



Korad Corp., 2520 Colorado Ave., Santa Monica, Calif. Phone: (213) 393-6737.

A laser system for welding very small metal wires and parts includes the necessary optics and has an energy output of 4 J. It is designed for precise positioning and welding of units that range in dia from 0.015 to 0.001 in. Special interlocks screen the operator from laser radiation. The laser uses a neodymium-doped glass rod. Emission is at 1.06  $\mu\text{m}$  in the infrared.

CIRCLE NO. 334

### Wire stripper uses compressed air



Eubanks Engineering Co., 225 W. Duarte Rd., Monrovia, Calif. Phone: (213) 358-4531.

This machine is powered by compressed air and is electrically controlled. A pneumatic clamp grips the wire and feeds it into the cut-and-strip mechanism. Wire length is determined by clamp travel and is changed by altering the stroke of the air cylinder by means of a micrometer. The unit will cut and strip insulated wire as small as 37 AWG.

CIRCLE NO. 335

## MOTORS, MOTOR SPEED

Bodine fractional horsepower motors, many full horsepower

## CONTROLS, GEARMOTORS,

motors, Superior Electric Co., Inc. Slo-Syn Motors, B & B

## VARIABLE SPEED DRIVES,

Synchronous Motors, General Electric Motors, Geartronics

## STEPPING MOTORS

Apcor Multi-Speed Gearmotors and Reducers, Zero Max Variable

## TIMERS, CHRONOMETERS,

Speed Drives, Helland Mechanical Overload Couplings, Miller

## SPEED INDICATING

Rectifiers and Transformers, A.T.C. Timers and Counters,

## SYSTEMS • ONE SOURCE

Chronometric Speed Counters, Vis-count Tachometer Speed

## IMMEDIATE DELIVERY

Indicating Systems, Heller Speed Controls. All in our new

## FACTORY LOW PRICES

64 page catalog No. 14-67. Write for your copy.

## TECHNICAL ASSISTANCE

**B&B MOTOR AND CONTROL CORP.**  
96 SPRING STREET  
NEW YORK, N.Y. 10012 (212) 966-5777

ON READER-SERVICE CARD CIRCLE 167



# TERMINAL BLOCKS

CURTIS

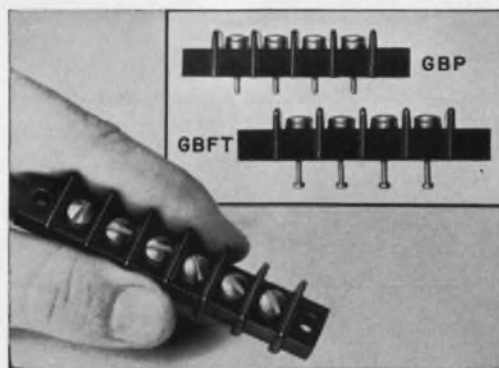

### FEED-THRU GB-SERIES

Versatile flat base feed-thru terminal blocks with choice of interior turret-type solder terminals or .062 dia. printed circuit pins. Inserts are bright tin plated for excellent solderability, conductivity, and long shelf life. Rated — 20 amps, 300 volts. Available — 1 to 18 terminals,  $\frac{1}{16}$ " center-to-center terminal spacing. #6-32 screw connections accept up to #12 AWG wire.

**FREE!** Full details, descriptions and prices in new Curtis 24-page illustrated catalog.



**CURTIS DEVELOPMENT & MFG. CO.**  
3236 N. 33rd St. • Milwaukee, Wis. 53216



ON READER-SERVICE CARD CIRCLE 168

ELECTRONIC DESIGN 1, January 4, 1968

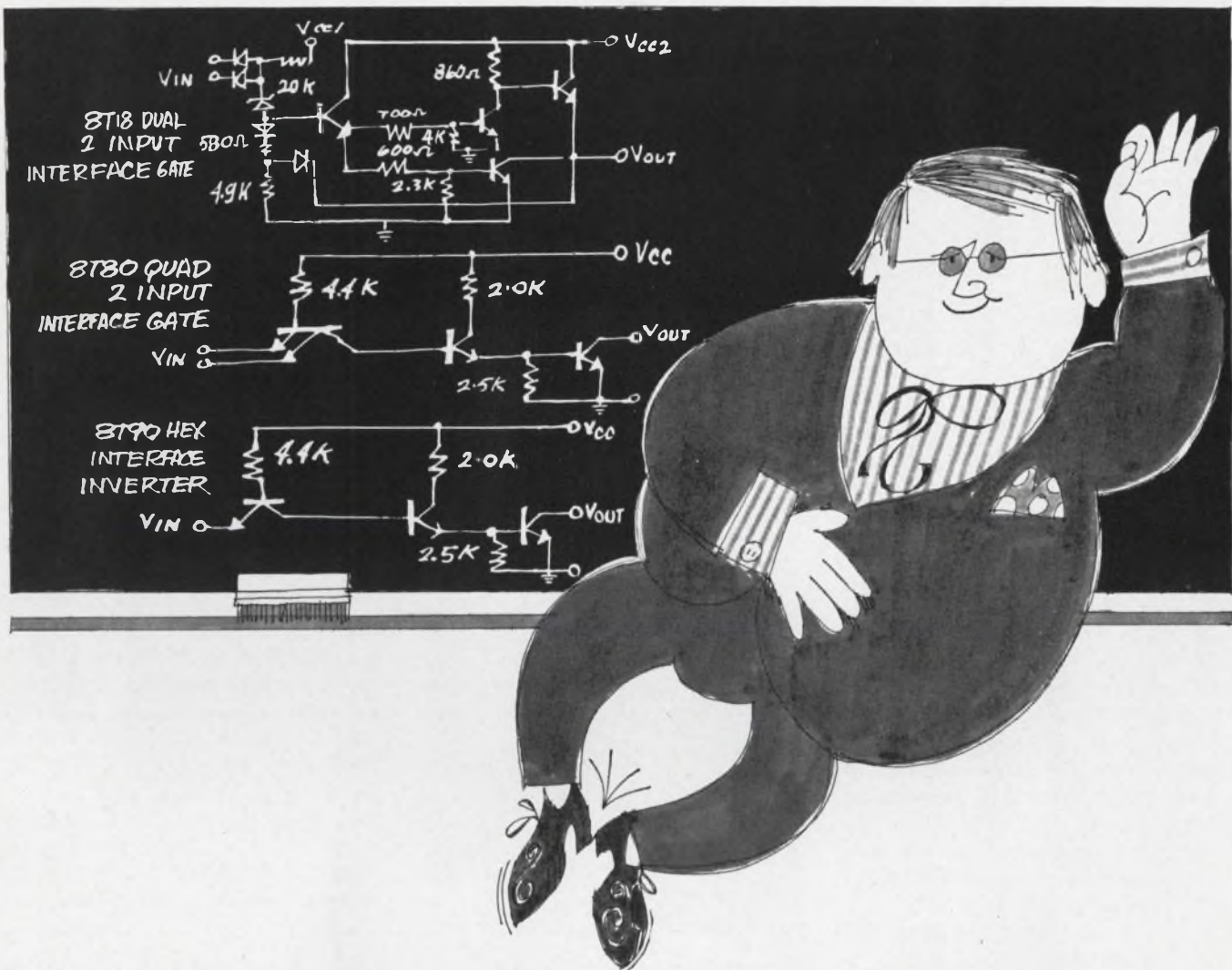

## EUREKA! Signetics solves the IC interface problem.

We've just saved you time and money and simplified your system design procedures. There are three new interface elements in the DCL series. They are designed specifically to match system levels of up to 30 volts with DCL levels of 5 volts. In addition to their obvious application in level translation and buffering, they may be used as lamp, relay and line drivers.

Hooray! No more special discrete component designs at interfaces. Signetics has done it again! Just circle the number on the bingo card, or write, and we'll be happy to send you the data sheets on the 8T18 Dual 2-Input Interface Gate, 8T80 Quad 2-Input Interface Gate, 8T90 Hex Interface Inverter.

**SIGNETICS  
INTEGRATED  
CIRCUITS**

A SUBSIDIARY OF CORNING GLASS WORKS  
811 EAST ARQUES, SUNNYVALE, CALIFORNIA 94086

**SIGNETICS SALES OFFICES:** Metropolitan New York (201) 992-3980; Upper New York State (315) 469-1072; Southwestern (214) 231-6344; Western Regional (213) 272-9421; Orange County (714) 636-4260; Eastern Regional (617) 245-8200; Washington Baltimore (301) 946-6030; Mid Atlantic (609) 858-2864; Southeastern (813) 726-3734; Midwestern Regional (312) 259-8300; Northwestern (408) 738-2710

**DISTRIBUTORS:** Compar at all locations listed below; Semiconductor Specialists, Inc. (312) 279-1000; Terminal Hudson Electronics (212) 243-5200; Wesco Electronics (213) 684-0880; Wesco Electronics (405) 968-3475; Hammond Electronics (305) 241-6601; Avnet Electronics Corp. of Massachusetts (617) 272-3060; Pioneer Standard Electronics Inc. (301) 427-3300; Kieruluff Electronics (206) 763-1711

**DOMESTIC REPRESENTATIVES:** Jack Pyle Company (415) 349-1266; Compar Corporation at the following locations: Alabama (205) 539-8476; Arizona (602) 947-4336; California (213) 245-1172; California (415) 697-6244; Colorado (303) 781-0912; Connecticut (203) 288-9276; Florida (305) 855-3964; Illinois (312) 692-4125; Maryland (301) 484-5400; Massachusetts (617) 969-7140; Michigan (313) 357-5369; Minnesota (612) 922-7011; Missouri (314) 542-3399; New Jersey (609) 429-1526; New Mexico (505) 265-1020; New York (518) 436-8536; New York (607) 723-8743; New York (516) 921-9393; North Carolina (919) 724-0750; Ohio (216) 333-4120; Ohio (513) 878-2631; Texas (214) EM 3-1526; Texas (713) 667-3420; Washington (206) 763-1711

**INTERNATIONAL SALES:** France, Germany, Italy, Belgium, Holland, Luxemburg, Spain - Sovcor Electronique, 11, Chemin de Ronde, Le Vesinet, (S. & D.) France, United Kingdom, Ireland, Sweden, Denmark, Norway, Switzerland, Austria, Portugal - Electrosil Ltd., Lakeside Estate, Coinbrook By-Pass Slough, Buckinghamshire, Great Britain; Australia - Corning, 1202 Plaza Building, Australia Square, Sydney, N.S.W. 27 4318; Canada - Corning Glass Works of Canada, Ltd., Leaside Plant, Ontario, Canada (416) 421-1500; Israel - Optronix, P.O. Box 195, Ramat Gan, Israel 724-437; Japan - ASAHI Glass Co., Ltd., Corning Products Sales Dept. No. 2, 3 Chome Marunouchi, Chiyoda ku, Tokyo, Japan.

ON READER-SERVICE CARD CIRCLE 169

### Fluidic op amp operates to 30 lb/in.<sup>2</sup>

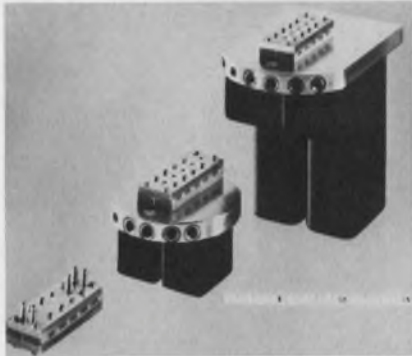

General Electric, Research and Development Center, P.O. Box 8, Schenectady, N.Y. Phone: (518) 346-8771.

In GE's new family of operational amplifiers, signal amplification is performed by a multistage amplifier "block" that provides the necessary high gain. The block develops a forward gain of 1500 or more, and can operate on a supply pressure of up to 30 lb/in.<sup>2</sup>. Signal to noise ratios exceed 200:1. The block also has high input impedance and low output impedance, which minimize circuit interactions.

CIRCLE NO. 346

### Differential op amp drifts only 3 $\mu\text{V}/^\circ\text{C}$



Analog Devices, Inc., 221 Fifth St., Cambridge, Mass. Phone: (617) 491-1650. P&A: model 183 A, \$30 (1 to 9), model 183 B, \$40 (1 to 9); stock.

A compact differential operational amplifier shows a maximum drift in voltage of only  $3\mu\text{V}/^\circ\text{C}$  and an offset current of  $50\text{ pA}/^\circ\text{C}$ . A companion amplifier, model 183A, is identical except for a  $6\mu\text{V}/^\circ\text{C}$  max drift figure.

The key to the 183 series' stability specifications is a dual-transistor input circuit, which replaces the two separate input transistors used in conventional operational amplifiers.

CIRCLE NO. 347

### Silent relay free of linkage



### Impact switch closes to 2000 g

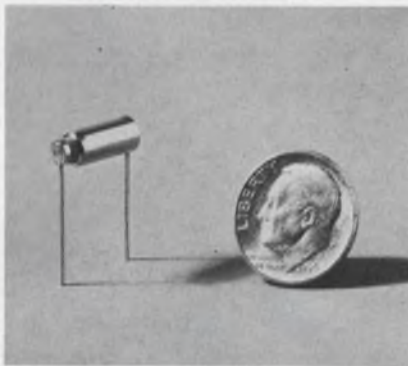

### Miniature microphone responds to 5000 Hz

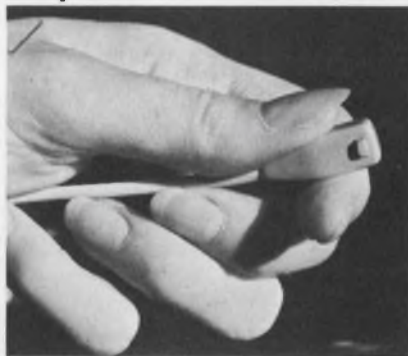

### 8-digit counter cycles 60 pulses/s

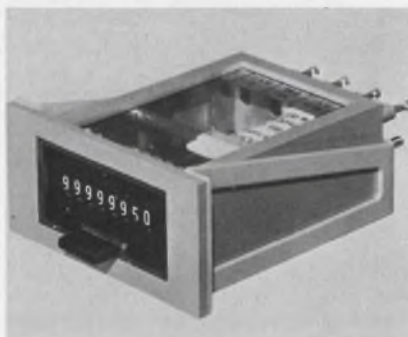

Lectrocon Corp., 25 Legion Dr., Bergenfield, N.J. Phone: (201) 385-9494

This relay is completely free of mechanical linkage and the maintenance of a perfectly joined electrical path does not depend on the strength of the magnetic field in the unit's solenoid. Use of soft metallic compounds, called Merkalloys, is said to eliminate pitting and wear. The metals constantly recoat the tips of the electrodes, in effect renewing their surfaces after each cycle.

CIRCLE NO. 348

Raymond Engineering Inc., Middletown, Conn. Phone: (203) 347-5611.

Simple in design, the switch is actuated by lateral impact in a selected range from less than 300 g to 1000 g and longitudinal impact in one direction from 1000 to 2000 g. It measures less than 1/2 in. long, withstands severe vibration levels without closing, and operates over a wide temperature range up to 250°F, exceeding applicable military specifications.

CIRCLE NO. 349

Unex Labs., Hawthorne, Mass. Phone: (617) 774-3300

A subminiature push-to-talk microphone is designed for either close or remote pickup applications. The device is self-shielded against external fields and has a nominal impedance of 5000  $\Omega$  at 1 kHz. Its useful response is from 400 to 5000 Hz and its typical sensitivity is 80 dB below 1 V per dyne/cm<sup>2</sup> rms pressure. It measures 1 in. long by 0.365 in. wide and 0.285 in. thick.

CIRCLE NO. 232

Landis & Gyr, Inc., 45 West 45th St., New York. Phone: (212) 586-4644.

Impulse counter with 8-digit capacity is capable of counting speeds up to 60 impulses/s. This device's size is 1.89 × 0.95 × 2.84 in. It operates on 24 V dc with other voltages available on special order. These counters are designed for either flush-panel or surface mounting. They can be used for many counting and totalizing functions.

CIRCLE NO. 233

# where will you be in 1973?

Five years at Sanders will make you immeasurably more accomplished.

Here you will work on new things, designing and building systems to answer yet unsolved problems — significant problems that can change the way we live, perhaps the course of history. To carry out such an assignment you are going to have to find new answers.

Answers in turn raise further questions.

This is progress — cutting a path to what is meaningful through the choking flow of random data that all too often is a substitute for thought.

This is the opportunity at Sanders. Here your role can be personally and professionally rewarding.

**WRITE to Mr. T.J. Auger today for career information. The address: Sanders Associates, Inc., Dept. 296 ED, 95 Canal Street, Nashua, New Hampshire 03060.**

**SYSTEM DESIGN ENGINEERS ■ ECM SYSTEM ENGINEERS ■ DIGITAL DESIGN ENGINEERS ■ ELECTRO-OPTICAL ENGINEERS ■ ANTENNA ENGINEERS ■ ELECTRONIC ENGINEERS**

CREATING NEW DIRECTIONS IN ELECTRONICS



\* T. H. SANDERS ASSOCIATES, INC. An Equal Opportunity Employer M/F





## Don't Shoot the Librarian...

(She's doing the best she can.)

Besides, even if she could find the catalogs you wanted, chances are that 60% of them would be obsolete. After all, she has to try and keep track of some 20,000 different electronic products, in forty-seven different categories, and from over 500 companies selling off-the-shelf equipment! Why not make life easier for her...and yourself? Get all of the information, every spec of it (electrical/mechanical/price/features), in our 6-volume STANDARD REFERENCE FILE. It contains everything a technical library should have...and

most likely a lot more. Best of all, it is continuously updated (on a monthly basis) so you know the information is accurate, the prices are current.

Try the STANDARD REFERENCE FILE free, for 30 days. No obligation, of course.



## **SPEC-DATA SYSTEMS**

TECHNICAL INFORMATION CORP.

P.O. BOX 514, SMITHTOWN, NEW YORK 11787

516 234-0100

ON READER-SERVICE CARD CIRCLE 184



COMPONENTS

**Dual photoconductors aid resistor output**

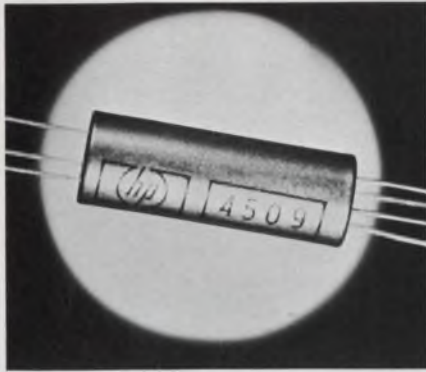

*Hewlett Packard, 1501 Page Mill Rd., Palo Alto, Calif. Phone: (415) 326-7000. P&A: \$11; stock.*

Two photoconductors controlled simultaneously by one light source allow this photocontrolled resistor to control two isolated, independent circuits. Each of the two independent photocell elements has a resistance range extending from greater than 100 MΩ with the lamp dark, to less than 10 kΩ with the lamp excited at the 10-V level. The two cells track within 10% of each other.

CIRCLE NO. 234

**Urethane coupling corrects alignment**

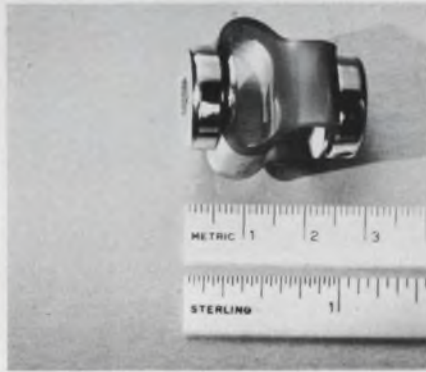

*Acushnet Process Co., Rubber Div. New Bedford, Mass. Phone: (617) 993-1711.*

Flexible urethane K-couplings measuring 1-1/8 by 1-1/8 in. are available for low-horsepower, high-speed drives. They withstand up to 6 in.-lb of torque and accept shaft misalignments up to 10° angular and 3/32 in. parallel, under continuous operating conditions. Produced from a custom-compounded urethane, they are formed to a cross-catenary loop and assembled to zinc-plated bores.

CIRCLE NO. 235

**Pressure transmitter responds to 2000 psi**



*Electro Development Corp., Box 100, 16700 13th Ave. W., Lynnwood, Wash. Phone: (206) 743-1313.*

The model 7-1113 pressure transmitter, a complete measurement system in a single case, has pressure units of 50 to 2000 psia or psig. This sealed transmitter performs in an aerospace environment at -35° to +165°F. It will withstand up to 30 g pk vibration with a total error of less than 1%.

CIRCLE NO. 236

**Passive delay line rises in 0.1 μs**

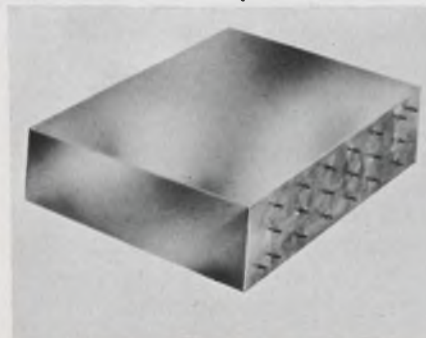

*Allen Avionics, Inc., 255 E. 2nd St., Mineola, N.Y. Phone: (516) 747-5450.*

Precise lumped-constant passive delay line is designed to be used for encoding and decoding. The unit features a max rise time of 0.1 μs with a delay of 24.65 μs. This device is tapped at every 1.45 μs and all taps have a delay tolerance of ±0.05 μs. It is supplied with a 50-Ω impedance and an 18-dB max attenuation.

CIRCLE NO. 237

From Sigmund Cohn Corp. **LR**®

**Low Resistivity Gold Alloy Potentiometer Wire**

LR Alloy	Resistivity	Tensile Strength
LR 29*	29Ω/cmft	150,000 PSI
LR 45*	45Ω/cmft	160,000 PSI
LR 65*	65Ω/cmft	160,000 PSI
LR 80	80Ω/cmft	160,000 PSI

The LR series includes four noble metal alloys for wire-wound potentiometers developed in the Sigmund Cohn plant . . . They are noteworthy for their extremely low noise, excellent corrosion resistance and long shelf-life.

Write for engineering data



**Sigmund Cohn Corp.**

121 So. Columbus Ave., Mount Vernon, N. Y. 10553

# GCC makes every type of Teflon coated wire you need today. And some you may need tomorrow.

Everyone agrees Teflon® insulated wire is more than a match for outer space. But, can you depend on getting it to your plant on time to meet your production schedule?

GCC is ready to meet your needs, wherever your plant happens to be. 51 GCC distributing centers and a nationwide network of manufacturing facilities are ready, willing and able to back up every order. GCC's delivery

policy goes one step further; tell us your needs and we'll be sure to stock your most popular items, so you'll always have a readily available source close by.

For specific data on the scope of our Teflon insulated product capabilities, drop us a line.

**General Cable Corporation,  
730 Third Avenue,  
New York, New York 10017.**

## GCC



**WE'RE IN THE TEFLON  
INSULATED WIRE BUSINESS.  
AND WE'RE IN IT BIG.**

Teflon® is a DuPont trademark

ON READER-SERVICE CARD CIRCLE 186

## Design Aids

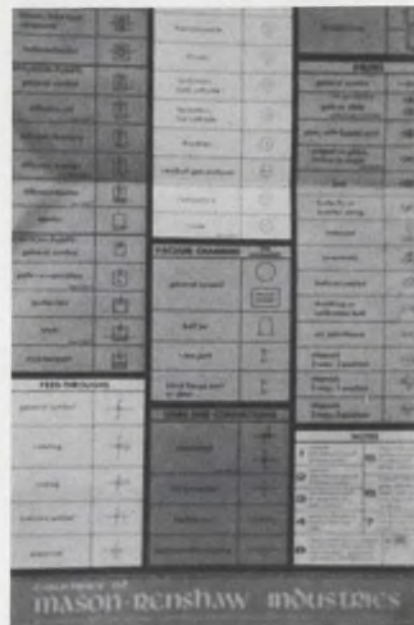

### Graphic symbols

A wall chart showing the symbols proposed in the American Vacuum Society Tentative Standard is offered free of charge to all engineers, scientists and technicians involved in high-vacuum work. Mason Renshaw Industries.

CIRCLE NO. 211



### Slide charts catalog

Various slide charts are the topic of a 20-page illustrated booklet which includes application examples. The booklet shows how products are specified by designers, how sales stories are made easy to grasp, and how demand is funneled to the correct equipment by means of slide charts. Perrygraf Corp.

CIRCLE NO. 212

# Application Notes



## Laser Fare

The latest issue of Laser Fare, a four-page quarterly publication on general laser topics, is now available. It includes a major article on measuring laser-beam intensity distributions and a summary of operating techniques and characteristics of Korad's CO<sub>2</sub> lasers. Korad Corp.

CIRCLE NO. 213

## Exercises in engineering

A self-study, pocket-sized magazine to help engineers maintain analytical skill contains problems with solutions. The publication, which is published monthly, contains problems in a variety of electronic areas. The answers to the problems in any one issue are given in the following issue. The booklet can serve as a review for new electronic devices and techniques.

Available for \$6 a year from Standard Professional Exercises, Box 2307, Sunnyvale, Calif. Single copies cost 60¢.

## Analog computation

A four-page technical bulletin describes novel control and computational techniques with magneto-resistance component modules. It gives examples of electrical circuits utilizing the technique for multiplying, dividing, and otherwise manipulating ac and dc signals that use flux-variable resistors in a bridge configuration. American Aerospace Controls, Inc.

CIRCLE NO. 214

# this man has your printed circuit problems well in hand

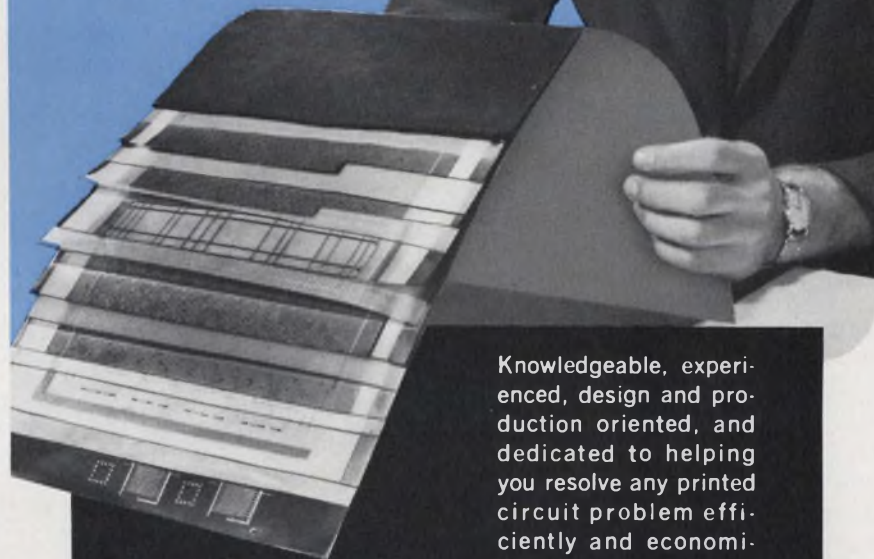

Knowledgeable, experienced, design and production oriented, and dedicated to helping you resolve any printed circuit problem efficiently and economically.

Methode is staffed, equipped, and experienced to provide you with a practically limitless printed circuit production capability from sub-miniature to king size, single to multi-layer boards with as many as 20 layers—with an established reputation for performance and reliability to meet the demands of any product, military or commercial.

If the space-age is pushing you into multi-layer integrated circuit designs, METHODE can show you how to keep the number of layers to a minimum. Your production costs will be reduced; reliability increased.

*We are confident these capabilities can prove beneficial to you.*

*We invite your inquiry.*



Printed Circuit Division

**Methode Electronics, Inc.**

General Offices:

7447 W. Wilson Ave., Chicago, Illinois 60656 • 312 867-9600

ON READER-SERVICE CARD CIRCLE 187

# New Literature



## Electronic components

A 400-page catalog lists electrical and electronic components for industrial OEM, institutional, and plant-maintenance needs. Listings give specifications and prices for circuit components such as semiconductors, tubes, relays, pots and switches, as well as for hardware, test equipment and tools. MIL spec numbers are listed where applicable. Also included are industrial sound systems and video tape equipment. An extra feature is the industrial-tube cross reference that relates the part numbers of various tube manufacturers. Almo Industrial Electronics, Inc.

CIRCLE NO. 215

## Injection molding

More and more electronic parts are being produced by the injection-molding process. The increasing requirements for intricate precision parts has led to refinement of this process. In most cases injection molding completely eliminates the need for costly machining and makes mass production of intricate parts economical. In cases where specific shapes cannot be produced by basic forming, parts are machined. Machining processes include turning, boring, drilling, tapping, threading, grinding, and surface profiling. This bulletin describes the process and has charts on materials properties. Diamonite Products Manufacturing Co.

CIRCLE NO. 216

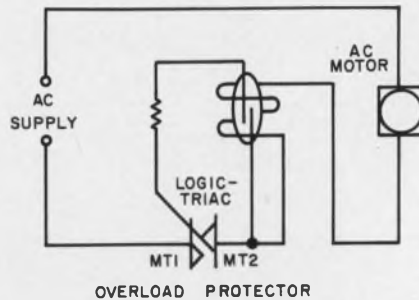

## Logic Triac

The power logic Triac, used for heating circuits, fan controls, motor protectors, full-wave reversing drives and various lamp applications is discussed in this booklet. It includes schematics with each application. International Rectifier.

CIRCLE NO. 217

## Semiconductor technology

Chemical products and materials used in processing solid-state devices are discussed in a 20-page catalog. The technology covered includes clean surface; bonding, diffusing and etching agents; protective coatings; encapsulants, and metallizing preparations. Transene Co., Inc.

CIRCLE NO. 218

## Plating components

A bulletin on rhodium sulphate TP contains data on electrical properties, corrosion resistance, electroplating specifications, hardness, thickness requirements for various needs, cost of plating, applications and physical properties of the plate. The bulletin gives suggested formulations for plating to thicknesses of 0.000020 in., 0.000050 in., 0.0001 in. and 0.0003 in. It describes required plating equipment, discusses preparation procedures, and gives operating data. The preferred method for determining the rhodium solution concentration and other analytical procedures are also discussed. Graphs show the time and current required to plate to various thicknesses. Technic, Inc.

CIRCLE NO. 219

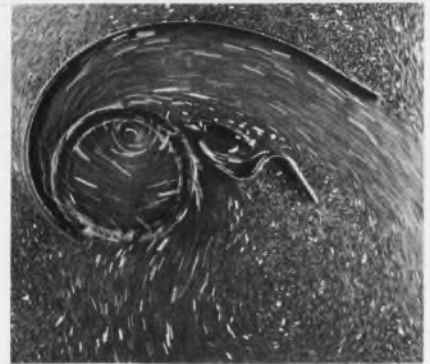

## Blowers brochure

Engineers, management and purchasing personnel in companies producing air-moving devices and air-cooled electronic equipment are the target of this 36-page color catalog. To demonstrate how blower units can be custom-designed or selected for best performance in particular systems, the brochure presents illustrated cases of centrifugal, axial, and crossflow blower applications from paper drying in a photocopy machine to air distribution in a digital computer. It then presents eight pages of data on determining air flow rate, determining pressure requirement, selecting blower type and size, and establishing other blower specifications. Torrington Manufacturing Co., Inc.

CIRCLE NO. 220



## Fiber optics

Spectral transmission, finishing efficiency, environmental testing, finishing techniques, and other details of flexible glass fiber optics are contained in this bulletin. Charts and graphs are included. Corning Glass Works.

CIRCLE NO. 221

Now, your Babcock 10 amp. full size crystal can relay will also switch dry circuit with the same set of contacts. These exclusive universal contacts have greatly simplified your relay stocking requirements. You can order one model to meet a given set of performance parameters without concern for load requirement —at no cost premium. Get complete information about this versatile relay, and the entire Babcock line, all with universal contacts.



The Babcock Model BR14 provides 4-pole, dry circuit to 10 Amp. operation in a small package . . . with time-tested reliability in aerospace applications.

**SPECIFICATIONS**

SIZE:  
1.3000" h. x 1.075" l. x 1.000" w.  
WEIGHT:  
Approx. 3.0 oz.  
OPERATE TIME:  
7.5 - 8.5 ms.

PULL-IN POWER:  
Low as 400 mw.  
LIFE:  
100,000 operations. min.  
TEMP. RANGE:  
-65°C to +125°C

Write Babcock Relays, Division of Babcock Electronics Corporation, 3501 Harbor Boulevard, Costa Mesa, California 92626; or telephone (714) 540-1234.



**FROM THE BABCOCK FAMILY OF CRYSTAL CAN RELAYS**

			
<b>TWICE SIZE</b> 4PDT dc to 10 Amps.	<b>FULL SIZE</b> DPDT dc to 10 Amps.	<b>HALF SIZE</b> SPDT & DPDT dc to 2 Amps.	<b>SIXTH SIZE</b> SPDT & DPDT dc to 1 Amp.

**Babcock**  
**Model BR 14**  
**four-pole,**  
**dry circuit to**  
**10 amp. relay...**  
**with**  
**universal contacts**

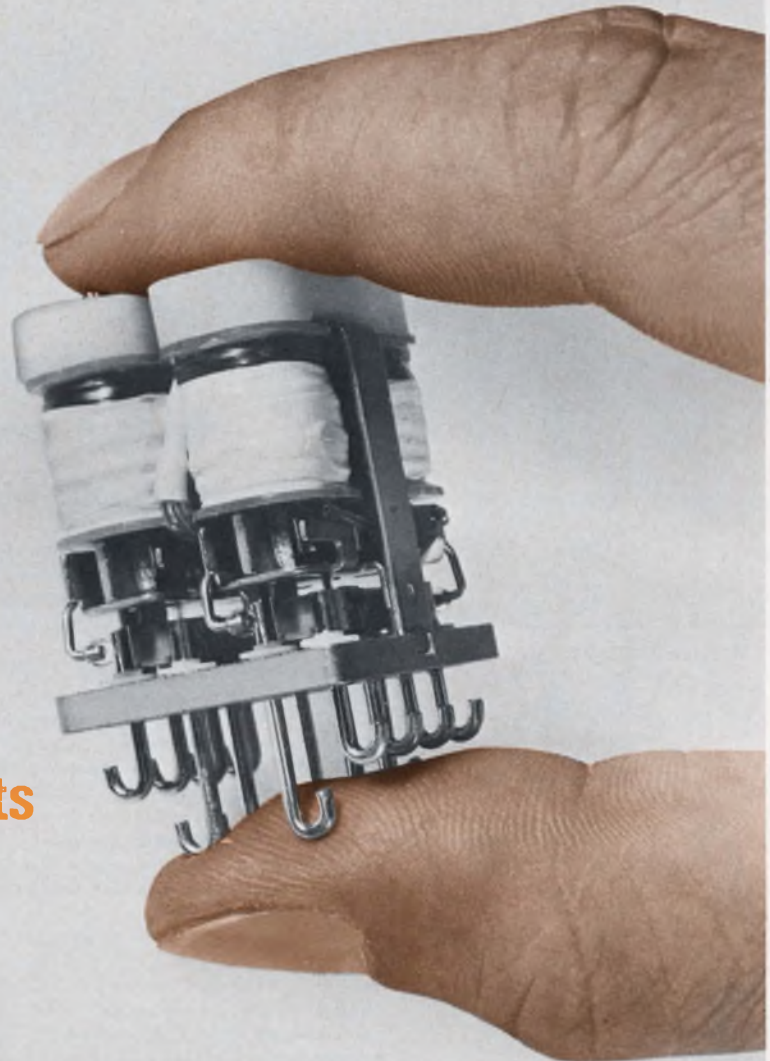

The original lacing tape  
is still the best . . .

. . . and saves money too!

*That's*

**GUDELACE® 18**

You ought to try  
a sample . . .



**GUDELACE**  
ties tight, makes  
firm harnessing—*fast!*

It is important, of course, for you to use tape that complies with military specs, or commercial stipulations, but the usual allowances for wax content in such specs give no consideration to the best lacing conditions. Gudebrod GUDELACE is made within the specs—BUT, it's made too, for easy handling, tight knotting, firm harnessing. THAT'S WHERE IT SAVES MONEY, in the harnessing operation. GUDELACE, the original harness lacing tape, is manufactured under strict control. Every yard is impregnated exactly the same, exactly right. You can count on that—and on getting better harnessing—*fast*—with minimum rejects. Why not send for a sample, test it any way you want. Let your harness crew try it. You'll be glad you did! (Remember, the Gudebrod Lacing Tape line includes tape for nearly every special situation—ask for The Product Data Book.)

**NOW—GUDEBROD HAS  
TWO AIDS TO FASTER—  
BETTER HARNESSING**



**CABLE-LACER®  
& GUDE-SNIPS®**

The production tested Cable-Lacer is now reduced in price—only \$9.95. Holds bobbin of tapes—makes tight knots. The palm held GUDE-SNIPS provide convenient tape cutting—using either right- or left-hand, \$3.75.

**G** **UDEBROD**

*Electronics Division*

**GUDEBROD BROS. SILK CO., INC.**

*Founded 1870*

**12 SOUTH TWELFTH STREET  
PHILADELPHIA, PA. 19107**

ON READER-SERVICE CARD CIRCLE 189

NEW LITERATURE



### Circuit catalog

Technical data on a line of IC logic assemblies and accessories are contained in a 96-page catalog, which includes descriptions, specifications and outlines of 200 different digital logic cards designed for use as decoders, counters, shift registers, comparators, generators, drivers, converters, amplifiers, oscillators and monostables. Digital logic accessories listed include general cards, logic card drawers, card files, power supplies, card connectors, breadboards for in-lines, wire-wrap panels, in-line sockets, flat-pack holders, patchboard kit and an in-line IC extractor. Cambridge Thermionic Corp.

CIRCLE NO. 222

### Plastics primer

A booklet outlining courses for the plastics industry includes a plastic materials primer. It analyzes 20 plastic materials, and covers type, description, price range, volume used, outstanding properties and limitations. The catalog offers summary courses in plastics fundamental, injection molding, extrusion, plastics in construction, plastics in packaging, thermoforming, decorating plastics, blow-molding, dielectric engineering, reinforced plastics and polymer technology.

*Available on company letterhead from International Plastics Industry Consultants, Inc., P.O. Box 1324, Long Island City, N.Y. 11101.*



### Capability catalog

Five groups of linear circuits—operational, high-frequency, power, differential and sense amplifiers—are discussed in an integrated-circuit guide. Device functions, characteristics and logic diagrams are included, along with a comparison chart and an application selector guide for digital circuits. Motorola Semiconductor Products, Inc.

CIRCLE NO. 224

### Molded mica capacitors

Technical data, drawings and illustrations of a series of mica capacitors, with ranges from 1 pF through 51,000 pF and voltage ratings of 100 V dc through 2500 V dc, are discussed in a 12-page brochure. Included is information for various temperature ratings and styles. Design and construction features include information on raw materials and processing methods, case styles and temperature-coefficient data. Electro Motive Manufacturing Co., Inc.

CIRCLE NO. 225

### Electric heating units

Application information, specifications and uses of standard heater racks, electric air-duct heaters and standard plug heaters are included in a 20-page illustrated catalog. Wiring data on one- and three-phase standard racks and illustrations of various custom racks and plugs are given. Trent, Inc.

CIRCLE NO. 226

If you're concerned with  
Transistor Pads and Clips—  
Heat Sinks and Adapters . . .

# JERMYN

ACCESSORIES

are worth  
a closer  
look . . .

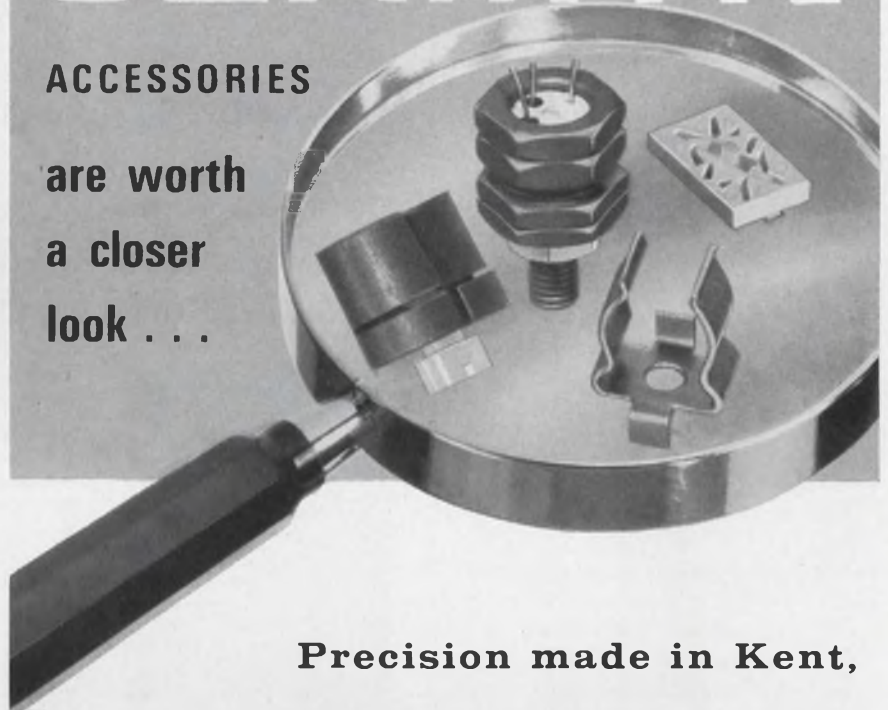

Precision made in Kent, England by JERMYN Industries, these important items of circuit hardware are manufactured with traditional English craftsmanship. They are stocked and sold exclusively in the U.S. by GUDEBROD. Ask for our new Catalog GJ100 which describes the full line—or tell us about your custom needs.

**G**UDEBROD

*Electronics Division*

ON READER-SERVICE CARD CIRCLE 190

Gudebrod Bros. Silk Co., Inc.

Founded 1870

12 South Twelfth Street

Philadelphia, Pa. 19107



### Plastic transistor guide

A guide to selecting plastic transistors, which includes silicon annular transistors, offers such information as major device parameters, voltage-vs-current selection information, a replacement table listing current industrial plastic transistors and a parameter interrelationship table. The catalog groups transistor types into categories to facilitate selection by application. Motorola Semiconductor Products, Inc.

CIRCLE NO. 227

### Resistor reference

Listing various types of resistors, together with engineering information, a catalog color-codes resistors into precision wire-wounds, high-speed wire-wounds and power wire-wounds. Featured are ladder and summing networks, precision resistance networks, and a cross-reference chart of MIL specifications. Typical circuits are included, illustrating the use of temperature-compensated wire-wounds as is a selection of beryllium oxide core resistors. RCL Electronics, Inc.

CIRCLE NO. 228

### Reprints Available

The following reprints are available free and in limited quantities. To obtain single copies, circle the number of the article you want on the Reader-Service Card.

*Open the gate to nanopower IC logic (No. 229)*

*Which delay line is best? (No. 230)*

*Digital chips shift into analog territory (No. 231)*

*Electronics starts solving the problems of the cities (No. 250)*

# Design Data from

## Transistor Design "How-To" Tips



Modern Transistor Electronics Analysis And Design, by Fred K. Manasse, Charles R. Gray, & John A. Ekiss, brings you a modern approach with practical "how-to" tips for transistor and integrated circuit design. Contains original material on two-terminal active devices, tunnel diode, p-n avalanching diodes, and Gunn effect diodes. Gives you a detailed examination of linear tuned amplifiers with practical analysis of design approach. Also covers transistor switching circuits, noise in transistors, choppers, and multiplexing. Pub. Sept. 1967, 512 pp., \$12.95. Order your 15 day examination copy by circling the number to the right.

Prentice-Hall, Inc.  
Englewood Cliffs, N.J. 07632

171

## Bipolar And Unipolar Transistors



Fundamentals Of Silicon Integrated Device Technology: Volume II: Bipolar And Unipolar Transistors, gives you a comprehensive, theoretical treatment of transistors. Edited by R. M. Burger & R. P. Donovan, this new guide will provide you with a new insight into the operating principles of these devices. You'll cover the entire range of bipolar transistor operation from the simple diffusion model to a very general model including the effect of many second order terms. Discussion of bipolar and unipolar transistors is aimed at integrated device structures as the most important structural elements. This information is equally applicable to discrete devices. Pub. Jan. 1968, 496 pp., \$15.00. Order your 15 day examination copy by circling the number to the right.

Prentice-Hall, Inc.  
Englewood Cliffs, N.J. 07632

172

## Interprets Circuit Problems

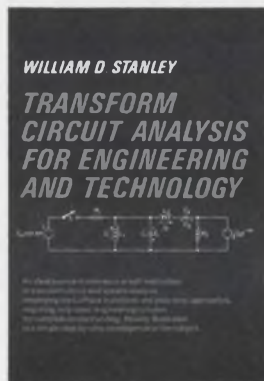

Transform Circuit Analysis For Engineers And Technicians, by William D. Stanley, explains transform methods of circuit interest and the use of these methods in engineering and technology. Emphasizes the Laplace transform and pole-zero approach for analysis and interpretation of your circuit problems. Shows steady-state AC circuit theory to emphasize the close similarity between transient response and the steady-state response of a circuit or system. Pub. Jan. 1968, 368 pp., \$11.50. Order your 15 day examination copy by circling the number to the right.

Prentice-Hall, Inc.  
Englewood Cliffs, N.J. 07632

173



# Manufacturers

Advertisements of booklets, brochures, catalogs and data sheets. To order use Reader-ServiceCard (Advertisement)

## State Space Analysis Of Control Systems



Designed to help you increase your skill and learn new techniques for solving problems of modern control theory. Presents detailed discussions of controllability and observability. Gives you numerous worked out examples for stability analysis based on the second method of Liapunov. Includes applications of this method to the optimization of control systems. Contains over 170 exercise problems to help you acquire a thorough working knowledge of the techniques and applications. Written by Katsuhiko Ogata, Pub. June 1966, 608 pp., \$14.95. Order your 15 day examination copy by circling the number to the right.

Prentice-Hall, Inc.  
Englewood Cliffs, N.J. 07632

174

## Radar Signal Analysis

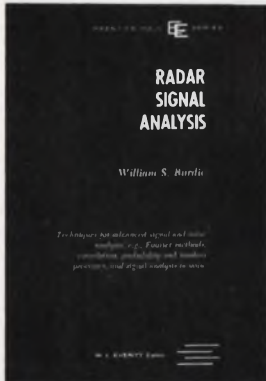

Covers all the principle techniques you need for signal analysis and processing. With a normal engineering math background, you'll have no difficulty understanding these techniques for more advanced signal and noise analysis. Covers Fourier methods, correlation, comparative signal analysis, probability, and random processes. Explains and uses Woodward's shorthand notation for commonly encountered functions. Develops fundamental waveform parameters such as bandwidth and time-duration to demonstrate basic signal capability in the areas of target parameter estimation and resolution. Written by William S. Burdic, Electro Sensor Systems Division of Autonetics, Pub. Jan. 1968, 368 pp., \$14.00. Order your 15 day examination copy by circling the number to the right.

Prentice-Hall, Inc.  
Englewood Cliffs, N.J. 07632

175

## A New Approach To Costs



Cost Accounting: A Managerial Emphasis, 2nd Edition, gives you a powerful new approach to costs as a management tool. Presents the newly emerging cost accounting concepts that let you plan, decide, and control on the basis of revealed facts. Helps you speed up decision-making, forecasting, and problem solving. Includes detailed information on replacing equipment, "make or buy", bidding on special orders, setting prices, building budgets, and product costing. Written by Charles T. Horngren, CPA, Pub. June 1967, 876 pp., \$13.25. Order you 15 day examination copy by circling the number to the right.

Prentice-Hall, Inc.  
Englewood Cliffs, N.J. 07632

176

## Electronic Design

ELECTRONIC DESIGN's function is:

- To aid progress in the electronics manufacturing industry by promoting good design.
- To give the electronic design engineer concepts and ideas that make his job easier and more productive.
- To provide a central source of timely electronics information.
- To promote two-way communication between manufacturer and engineer.

**Want a subscription?** ELECTRONIC DESIGN is sent free to qualified engineers and engineering managers doing design work, supervising design or setting standards in the United States and Western Europe. For a free subscription, use the postfree application form inside the back cover. If none is included, write to us direct for an application form.

If you do not qualify, you may take out a paid subscription for \$25 a year in the U.S.A., \$35 a year elsewhere. Single copies are \$1.50 each.

**If you change your address,** send us an old mailing label and your new address; there is generally a prepaid postcard for this inside the back cover. You will have to requalify to continue receiving ELECTRONIC DESIGN free.

**The accuracy policy of ELECTRONIC DESIGN is:**

- To make reasonable efforts to ensure the accuracy of editorial matter.
- To publish prompt corrections whenever inaccuracies are brought to our attention. Corrections appear at the end of the Letters column.
- To refuse any advertisement deemed to be misleading or fraudulent.

**Microfilm copies are available** of complete issues of ELECTRONIC DESIGN and individual articles, published since the beginning of 1961. Complete issues cost 4¢ a page, articles cost 50¢ a page; shipping and handling charges are extra. The minimum charge is \$3. For further details and to place orders, contact University Microfilms, Inc., 300 N. Zeeb Road, Ann Arbor, Mich. 48106; telephone (313) 761-4700.

**Want to contact us?** If you have any comments or wish to submit a manuscript or article outline, address your correspondence to:

Howard Bierman, Editor,  
ELECTRONIC DESIGN,  
850 Third Avenue,  
New York, N.Y. 10022.

# Design Data from Manufacturers

Advertisements of booklets, brochures, catalogs and data sheets. To order use Reader-Service Card.  
(Advertisement)

## Technical Journal on Op-Amps



Subscription to Analog Dialogue, engineering periodical devoted to the fundamentals and applications of op amps, now offered free to interested engineers. Objective of this journal is to publish technical articles on op amps from many sources including competitors so it can be used as a source book on this subject. The WORTH READING section includes current bibliography of articles published elsewhere on op amps. First three issues feature articles on Operational Integrators, Review of Op Amp Principles, Magneto-resistive Multipliers, and User's Guide to Op Amp Specs. Circle inquiry number for free subscription.

**Analog Devices, Inc.**  
221 Fifth Street  
Cambridge, Mass. 02142  
617/492-6000

# 177

## Bus Bars For Noise Reduction



A 16 page Technical Bulletin is now available, describing a new concept in power or signal distribution. Basic mechanical and electrical design principles, along with descriptive pictures and diagrams, are included in this bulletin. These compact buses can replace bulky cable harnesses and repetitive wiring for computer or modular application. This method of construction satisfies the demanding requirements of low inductance and resistance of high speed, solid state systems, while controlling electrical noises.

Visit us at the Nepcon/West Show, Booth 541

**Eldre Components, Inc.**  
1239 University Avenue  
Rochester, New York 14607

# 178

## A FREE Cross Reference Guide



to better Printed Circuit drafting

No engineer or draftsman should be without the NEW 1968 By-Buk Printed Circuit Drafting Aids P-45 Catalog with color-coded MIL-SPEC sizes. Also contains over 2000 pads, shapes, tapes, transistor tri-pads, spaced integrated circuit terminal pad sets and many other drafting aids for faster, more accurate, distortion-free printed circuit master drawings. Send for your FREE catalog.

**By-Buk Company**  
4326 West Pico Blvd., Los Angeles, Calif. 90019  
Telephone: (213) 937-3511

# 179

# Electronic Design

## Advertising Representatives

**New York 10022**  
Robert W. Gascoigne  
Thomas P. Barth  
Samuel M. Deitch  
Byron Adams  
850 Third Avenue  
(212) PLaza 1-5530  
TWX: 867-7866

**Philadelphia**  
William C. Repetto  
P. O. Box 206  
Merion Station, Pa. 19066  
(215) MO 4-1078

**Boston**  
Richard Parker  
40 Webb Street  
Salem, Mass. 01970  
(617) 742-0252

**Chicago 60611**  
Thomas P. Kavooras  
Berry Conner, Jr.  
720 N. Michigan  
(312) 337-0588

**Cleveland**  
(216) 247-7670

**Los Angeles 90303**  
Stanley I. Ehrenclou  
Terrence D. Buckley  
W. James Bischof  
2930 W. Imperial Highway  
Inglewood, Calif.  
(213) 757-0183

**San Francisco**  
Ashley P. Hartman  
175 South San Antonio Rd  
Ste. 243  
Los Altos, Calif. 94022  
(415) 941-3084

**Southwestern 75206**  
Tommy L. Wilson  
6200 North Central Expressway  
Dallas, Tex.  
(214) EMerson 1-2311

**London W. 1**  
Brayton C. Nichols  
44 Conduit Street

**Verviers, Belgium**  
Andre Jamar  
1, Rue Mallar, 1  
(087) 253.85

**Tokyo**  
Yoshihiro Takemura  
International Planning  
Service, Inc.  
Room 231 Tokyu-Mita Bldg.  
1, Shiba-Mita Koun-cho  
Minato-ku, Tokyo



**AMERICAN BUSINESS PRESS, INC.**

# Advertisers' Index

Advertiser	Page	Advertiser	Page	Advertiser	Page
AMP, Incorporated	40, 41	Fluke Mfg. Co., Inc., John	94, 95	RCA Electronics Components and Devices	Cover IV
Abbott Transistor Laboratories, Incorporated	14	General Cable Corporation	212	Radio Cores, Inc.	46
Acopian Corporation	197	General Radio Company	147	Redcor Corporation	199
Adams & Westlake Company, The	179	Grayhill, Inc.	198	Scientific Atlanta, Inc.	113
Alfred Electronics	176A-B	Gudebrod Bros. Silk Co., Inc.	216, 217	Servo Tek Products Company	202
Allen-Bradley Co.	119, 120, 121	Guardian Electric Manufacturing Company	59	Siemens America, Incorporated	105
Analog Devices, Inc.	54, 220	H P Associates	Cover II	Signalite, Incorporated	104
Applied Technology, Incorporated	52	Heath Company	170	Signetics Integrated Circuits, A Subsidiary of Corning Glass Works	207
B & B Motor & Control Corp.	206	Hewlett-Packard	1, 7, 48 A-B-C-D	Siliconix Incorporated	204
Babcock Relays, Division of Babcock Electronics Corporation	215	Honeywell, Precision Meter Division	51	Simpson Electric Company	45
Ballantine Laboratories, Inc.	167	Hughes Aircraft Company	23	Skottie Electronics, Inc.	154
Barnes Corporation	202	IMC Magnetics Corporation	152	Solotron Devices, Inc.	17
Beckman Instruments, Inc., Helipot Division	148	IRC, Inc.	163	Spectrol Electronics Corporation	144A
Beede Electrical Instrument Co., Inc.	58	ITT Cannon Electric A division of International Telephone and Telegraph Corp.	64	Sprague Electric Company	18, 20
Belden Corporation	100, 101	Indiana General Corporation	175	Stackpole Carbon Company	47, 141
Bourns, Inc.	55	Industrial Timer Corporation	188	Standard Condenser Corporation	99
Bulova Electronics Division of Bulova Watch Company	166	International Electronic Research Corporation	161	Switchcraft, Inc.	10
Burrughs Corporation	153	International Rectifier Corp.	191	Sylvania Electric Products, Inc.	32A-H
By-Buk Company	220	JFD Electronics Co./Components Division	16	Syntonic Instruments, Inc.	194
CML, Inc.	180	Janco Corporation	185	TRW, Inc., Capacitor Division	60
Cedar Engineering Division, Data Control Corporation	159	Johnson Company, E. F.	184	Technipower, A Benrus Subsidiary	49
Centralab, the Electronics Division of Globe-Union, Inc.	34	Keithley Instruments	168	Technical Information Corp.	210
Clairex Electronics, Inc.	177	Kepeco, Inc.	182	Tektronix Inc., Oscilloscopes	62
Clare & Co., C. P.	131	Leach Corporation	8, 9	Tempress Research Co.	42
Clifton, Division of Litton Industries	24	Litton Industries, Winchester Division	172, 173	Teradyne, Inc.	189
Cohn Corp., Sigmund	211	Lockheed Electronics Company	145	Texscan Corporation	169
Cohu Electronics, Inc.	165	Lundey Associates, Inc.	180	Transistor Devices, Inc.	48
Communication Electronics, Incorporated Components, Inc.	158, 193	Magnetic Shield Division, Perfection Mica Company	196	Union Carbide Corporation	4, 5, 56, 57, 56 A-B-C-D
Control Data Corporation, Analog-Digital Systems Division	35	Master Specialties Company	187	United Transformer Co.	Cover II
Coors Porcelain Co.	205	Measurements, A McGraw/Edison Division	190	Unitrode Corporation	11
Corning Electronics, Division of Corning Glass Works	6	Melabs, Inc.	222	Vantone Pump & Equipment Corporation	162
Couch Ordnance, Inc.	176	Methode Electronics, Inc.	213	Varian, Traveling Wave Tube Division	155
Crystallonics, Division of Teledyn, Inc.	192 A-B	Midtex, Incorporated Aemco Division	195	Victory Engineering Corporation	200
Curtis Development & Mfg. Co.	206	Monsanto Company	139	Waldom Electronics, Inc.	160
Cutler-Hammer	143	Motorola Semiconductor Products, Inc.	15, 164	Waters Manufacturing, Inc.	174
Dale Electronics, Inc.	144 A-B	NJE Corporation	171	Western Microwave Laboratories, Inc.	181
Damon Engineering, Inc.	30	Natel Engineering Co., Inc.	198	Wheelock Signals, Inc.	50
Datapulse, Incorporated	2	National Semiconductor Corporation	27, 29		
Deusch Electronics Components Division	183	Non-Linear Systems, Inc.	124, 125		
Digtran Company, The	194	Nortronics Company, Inc.	186		
Dow Corning Corporation	12, 13	Paktron Division, Illinois Tool Works Inc.	160 A-B-C-D		
Drake Manufacturing Company	39	Plastic Capacitors, Inc.	38		
Duncan Electronics, Inc.	151	Prentice-Hall, Inc.	218, 219		
Du Pont Co.	136A				
Eldre Components, Inc.	220				
Electro-Motive Mfg. Co., Inc., The	203				
Electronic Design	156, 157, 224				
Electronic Enclosures, Inc.	178				
Electronic Memories, Inc.	85				
Erie Technological Products, Inc.	53				

## Career Advertising

Delco Radio Division, General Motors	201
General Dynamics	133
Lockheed-California Company	135
Lockheed Missiles & Space Company	132
Loral Electronic Systems	136
National Cash Register Company, The	137
Sanders Associates, Inc.	209
Texas Instruments Incorporated	134, 135

Introducing a new circuit element:

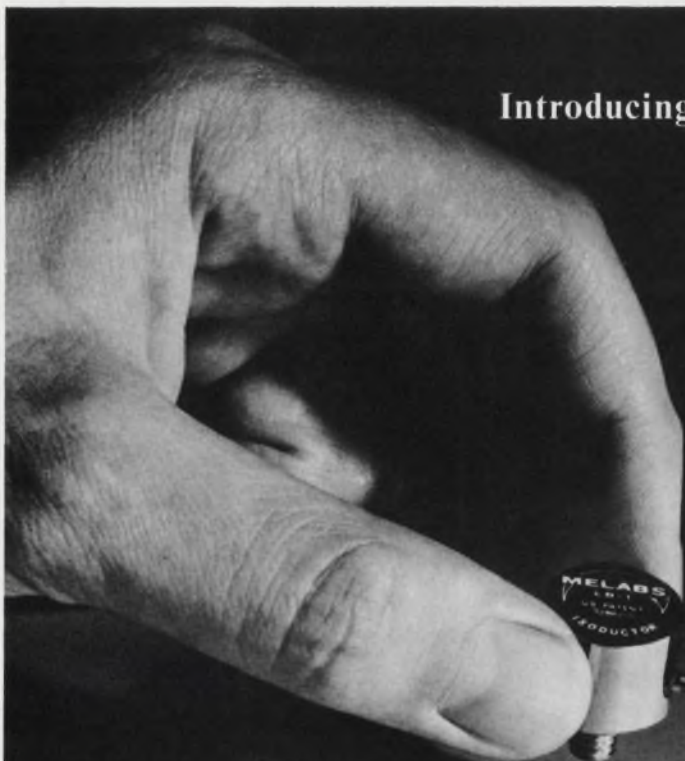

## THE ISODUCTOR

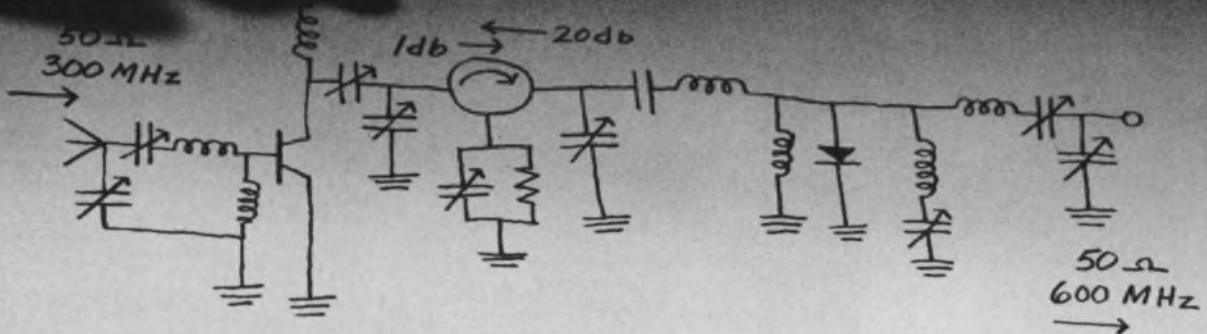

### For improved solid-state circuit stability in the 100-600 MHz band.

For the first time a non-reciprocal, passive, low loss circuit element—the ISODUCTOR—is available to solid-state-circuit designers. ISODUCTORS function like one-way pads. When used with power transistors (both are about the same size and cost), ISODUCTORS' non-reciprocal attenuation characteristic make transistors insensitive to load variations assuring stability with virtually no loss in power output. □ ISODUCTORS are a major breakthrough in component technology, and will eliminate some of the most frustrating circuit stability design problems. Typical performance at 300 MHz is illustrated at the right. □

Our 7-page Application Bulletin, #7-182, fully details the theory and performance of these unique devices. Send for your copy or call your local Melabs representative for a demonstration.

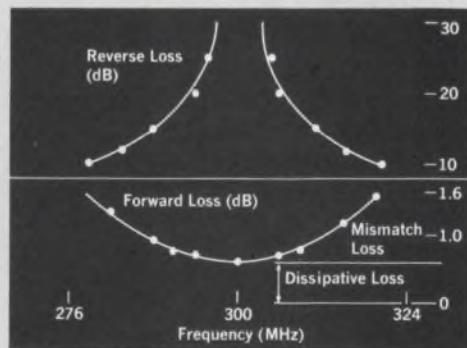

Insertion loss vs. frequency for ISODUCTOR terminated for 300 MHz operation.

3300 Hillview Avenue • Stanford Industrial Park • Palo Alto, California • (415) 326-9500 • TWX: (910) 373-1777  
 MELABS, S.A. • 43 Rue De Namur • Brussels, Belgium • Telephone 12-17-23 • TELEX MELABS BRU 23281 □ Exceptional opportunities exist on our technical staff for qualified engineers and scientists. Melabs is an equal opportunity employer.

# Information Retrieval Services

Requests will be promptly speed-processed by computer and mailed to the manufacturer within 3 days.

## New Products

Category	Page	RSN†	Category	Page	RSN†	Category	Page	RSN†
<b>Amplifiers</b>			holders, card	194	<b>326</b>	diode, high-power	150	<b>261</b>
fluidic	208	<b>346</b>	<b>Materials</b>			MOSFET, dual-gate	152	<b>258</b>
transducer	158	<b>255</b>	filler, glass and nylon	192	<b>323</b>	rectifier, bridge	162	<b>265</b>
voltage, variable gain	168	<b>266</b>	paste, gold conductive	192	<b>325</b>	rectifier, 5-kV	152	<b>257</b>
operational	208	<b>347</b>	quartz, fused	194	<b>327</b>	rectifier, 10-to-150-kV	154	<b>256</b>
<b>Components</b>			resin, acrylic	192	<b>324</b>	tetrode, 500-W	200	<b>345</b>
amplifier, fluidic	208	<b>346</b>	resin, powdered	198	<b>332</b>	transistor, plastic	162	<b>264</b>
capacitor variable	158	<b>255</b>	shielding, magnetic	196	<b>329</b>	transistor, unijunction	150	<b>259</b>
contact, relay	198	<b>330</b>	tape, resin fiber	196	<b>328</b>	<b>Systems</b>		
coupling, motor interval	211	<b>235</b>	Teflon, laminated	198	<b>331</b>	aligner, laser	190	<b>321</b>
counter, 8-digit	208	<b>233</b>	<b>Microwave Devices</b>			computer, Fourier		
delay line, passive	211	<b>237</b>	diode, junction	200	<b>342</b>	transform	182	<b>285</b>
detector, ionization	178	<b>284</b>	diode, radiation-resistant	160	<b>262</b>	converter, A/D	184	<b>286</b>
generator, pulse	176	<b>279</b>	loads, hot reference	204	<b>336</b>	detector, infrared	184	<b>287</b>
holders, card	194	<b>326</b>	modulator, 8-to-18-GHz	204	<b>337</b>	detector, ionization	178	<b>284</b>
microphone, 5000-Hz	208	<b>232</b>	tetrode, 500-W	200	<b>345</b>	signal simulator	188	<b>293</b>
relay, silent	208	<b>348</b>	transmitter, S-band	205	<b>338</b>	telemetry interrogator	202	<b>340</b>
resistor, photocontrolled	211	<b>234</b>	TWT, X-band	200	<b>344</b>	temperature test chamber	176	<b>281</b>
switch, impact	208	<b>349</b>	<b>Microwave Equipment</b>			thermometer, digital	180	<b>289</b>
transition, strip	204	<b>339</b>	antenna, airborne	200	<b>343</b>	<b>Test Equipment</b>		
transmitter, pressure	211	<b>236</b>	detector, infrared	184	<b>287</b>	bridge, conductivity	173	<b>275</b>
<b>Control Devices</b>			laser aligner	190	<b>321</b>	bridge, conductivity	173	<b>276</b>
counter, 8-digit interval	208	<b>233</b>	laser interferometer	186	<b>297</b>	clock, solid-state	173	<b>277</b>
ionization detector	178	<b>284</b>	laser welder	206	<b>334</b>	computer, Fourier		
thermometer, digital	180	<b>289</b>	load, hot reference	204	<b>336</b>	transform	182	<b>285</b>
<b>Data Processing</b>			modulator, diode	204	<b>337</b>	detector, infrared	184	<b>287</b>
attenuator, BCD	186	<b>295</b>	signal generator	174	<b>271</b>	detector, ionization	178	<b>284</b>
clock, solid-state	173	<b>277</b>	signal synthesizer	180	<b>288</b>	filter, digital	176	<b>280</b>
computer, Fourier			spectrum analyzer	173	<b>274</b>	generator, fixed-signal	170	<b>272</b>
transform	182	<b>285</b>	telemetry interrogator	202	<b>340</b>	generator frequency	180	<b>288</b>
converter, A/D	184	<b>286</b>	tetrode, 500-W	200	<b>345</b>	generator, pulse	176	<b>278</b>
converter, A/D	188	<b>291</b>	transmitter, I-band	202	<b>341</b>	generator, sweep	167	<b>268</b>
converter, synchro	190	<b>322</b>	transmitter, S-band	204	<b>338</b>	generator, sweep and marker	166	<b>269</b>
converter, tape	188	<b>292</b>	<b>Production Equipment</b>			generator, vhf signal	174	<b>271</b>
data storage	186	<b>296</b>	detector, infrared	184	<b>287</b>	laser aligner	190	<b>321</b>
filter, digital	176	<b>280</b>	laser aligner	190	<b>321</b>	laser interferometer	186	<b>297</b>
memory, 8192-word	186	<b>294</b>	laser interferometer	186	<b>297</b>	monitor, voltage	178	<b>259</b>
memory, 1024-word	190	<b>298</b>	laser welder	206	<b>334</b>	ohmmeter, audible	180	<b>290</b>
memory plane	190	<b>299</b>	sorter, automatic	206	<b>333</b>	ohmmeter, digital	167	<b>267</b>
telemetry interrogator	202	<b>340</b>	stripper, wire	206	<b>335</b>	oscilloscope	178	<b>282</b>
<b>Environmental Equipment</b>			temperature test chamber	176	<b>281</b>	picoanmeter	170	<b>273</b>
detector, ionization	178	<b>284</b>	<b>Semiconductor Devices</b>			power supply	178	<b>283</b>
temperature test chamber	176	<b>281</b>	amplifier	158	<b>254</b>	recorder, temperature	174	<b>283</b>
thermometer, digital	180	<b>289</b>	diode, dual-channel	150	<b>260</b>	spectrum analyzer	173	<b>274</b>
<b>Hardware &amp; Packaging</b>			diode, junction	200	<b>342</b>	telemetry interrogator	202	<b>340</b>
contact, relay	198	<b>330</b>	diode, power recovery	160	<b>262</b>	temperature test chamber	176	<b>281</b>
coupling, motor	211	<b>235</b>	diode, reference	160	<b>263</b>	tester, transducer	176	<b>278</b>
						thermometer, digital	180	<b>289</b>
						voltmeter, 3-range	168	<b>266</b>

†Refers to Reader-Service number

## New Literature

Blowers Brochure	220
Circuit Catalog	222
Electric Heating Units	226
Electronic Components	215
Fiber Optics	221

Injection Molding	216
Integrated Circuit Guide	224
Logic Triac	217
Molded Mica Capacitors	225
Plastic Primer	223
Plastic Transistor Guide	227
Resistor Reference	228
Semiconductor Technology	218

## Application Notes

Analog Computation	214
Laser Fare	213

## Design Aids

Graphic Symbols	211
Slide Charts	212

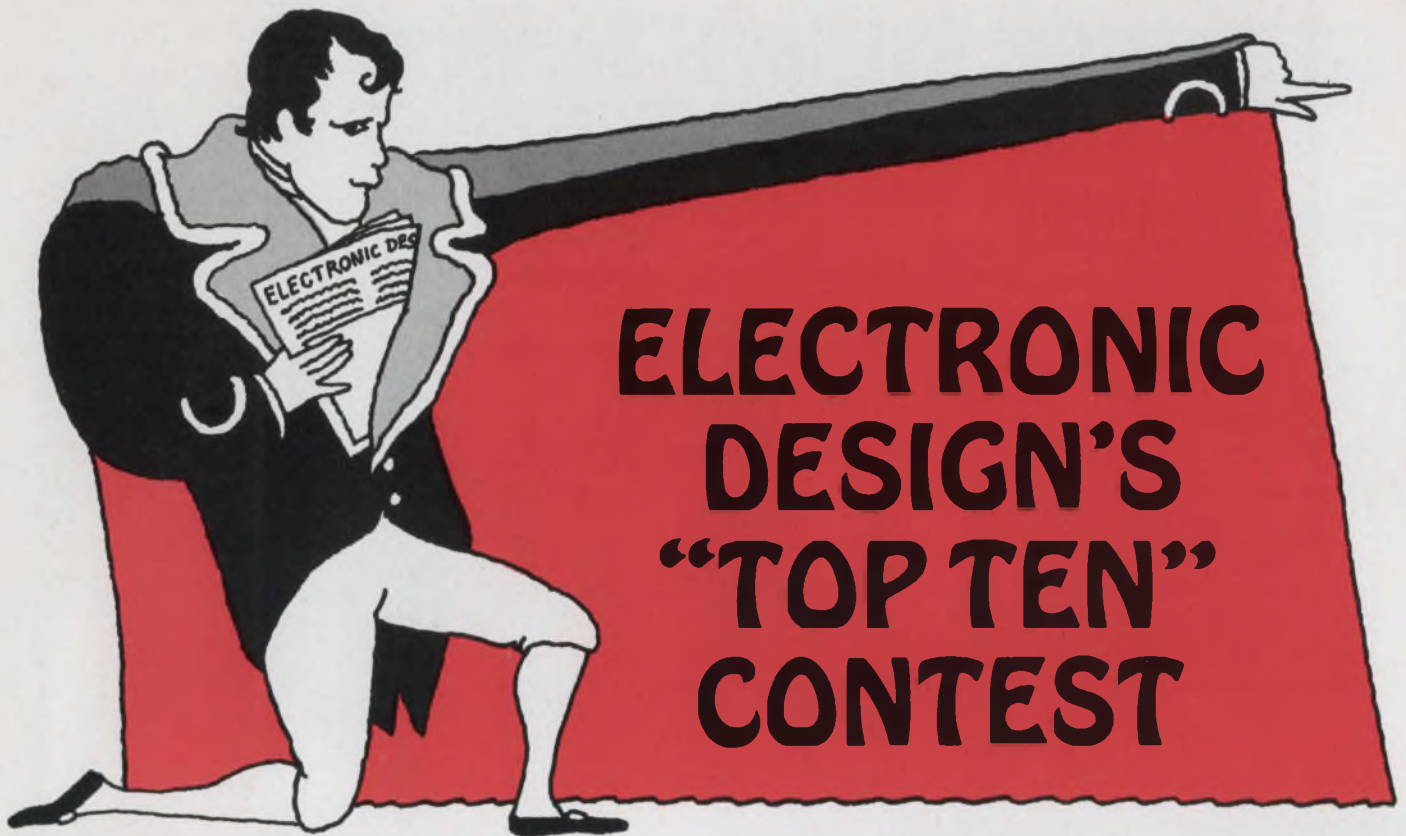

### First prize

2 round-trip tickets between New York and Paris VIA AIR FRANCE

### Plus 60 more valuable prizes

2nd prize—Deluxe Heathkit/Thomas "Paramount" Transistor Theatre Organ (Kit)

3rd prize—Deluxe Heathkit 23" Color TV (Kit)

4th through 11th prizes—EICO "Cortina" All Silicon Solid State 70 Watt Stereo Amplifier Kits

Plus 50 copies of "Microelectronic Design"

**All readers of Electronic Design are eligible. And it's easy to enter.**

All you have to do is pick the ten ads in this issue that you feel will be best remembered by your fellow readers. Your selections will be measured against the ten ads ranking highest in the "Recall Seen" category of Readers Recall, Electronic Design's method of measuring readership.

Use the entry blank to the right... Be sure to check the appropriate box on the entry blank as outlined in the rules on this page for both reader and marketer. Don't miss your chance to be a "Top Ten" Winner in '68.

All entries must be postmarked no later than midnight, February 27, 1968.

Winners will be notified by March 8, 1968.

### Marketing people! Ad people!

There's a separate contest open to personnel at companies and agencies. Use the entry blank which appears inside the front cover of advertiser copies of this issue... or the Reader Service card (or contact your nearest Electronic Design representative and he'll be happy to supply you with one). Make your "Top Ten" selections today. In addition to valuable prizes, you may win some free advertising for your company.

#### "Top Ten" Reader Contest Rules

1. Enter your "Top Ten" selections on the entry blank provided to the right or on any other reasonable facsimile. Be sure to indicate the name of the advertiser and page number for each of your choices. These choices need not be placed in rank order. (Ads placed by Hayden Publishing Company in Electronic Design should not be considered in this contest).
2. If more than one entry is submitted, none will be considered. Entry blank must be filled in completely, or it will not be considered. Electronic Design will pay postage for official entry blanks only.
3. To enter, readers must be engaged in electronic design engineering work, either by carrying out or supervising design engineering or by setting standards for design components and materials.
4. First prize is two tourist class, round-trip tickets between New York and Paris, via Air France. Transportation to and from point of embarkation in New York or Paris, and any other expenses incurred as part of this trip, are not included in the prize. No cash payments, or other substitutes, will be made in lieu of any prize.
5. Contest void where prohibited or taxed by law. Liability for any taxes on prizes is the sole responsibility of the winners.

#### "Top Ten" Manufacturer (company)/Advertising Agency Contest Rules

1. All rules for the Reader Contest will similarly apply for this contest, with one exception: readers engaged in electronic design engineering work, as defined in the rules above, are not eligible to participate in this special contest.
2. Entrants in this contest may use the Reader Service card or the entry blank appearing inside the front cover of advertiser copies of this (Jan. 4) issue. Blanks may also be obtained from your Electronic Design representative.
3. This special contest is open to marketing personnel only at all manufacturing companies and advertising agencies whether or not their companies or agencies have an advertisement in this issue. However, only those companies (or divisions thereof) advertising in this issue, and the advertising agencies placing such advertisements, are eligible for a free re-run of their advertisement, should a member of their organization win. Entrants from such companies and advertising agencies must clearly indicate the specific advertisement to be re-run (including page number) in the space at the bottom of the entry blank).

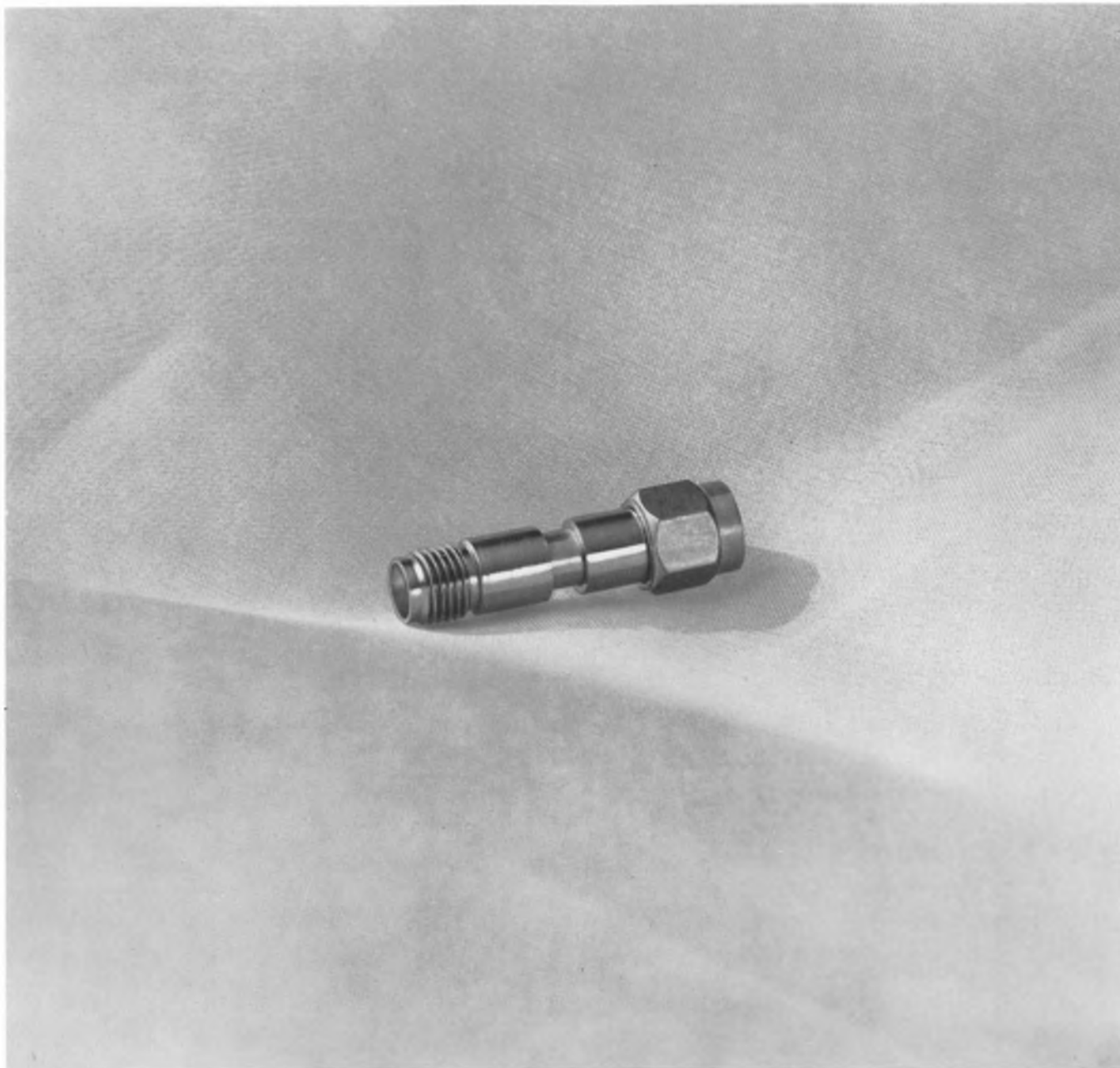

# Tranquilizer

If you've tried to put together a mixer/detector circuit for broadband microwave equipment, you know what a headache it is. No more. With HP's new 33800A Series Mixer/Detector modules most of the grief is gone.

Here's why. The 33800A's are miniaturized by hybrid/IC construction for simplicity and convenience. Just plug them in. No fabrication problem. You've got economy for superior performance—there is nothing similar to the 33800A's available.

As detectors, the 33800A's have tangential sensitivity of  $-50$  dBm, 2 to 12.4 GHz; output of  $3$  mV/ $\mu$ W. As mixers, they display noise figures of 7.5 dB, IF impedance of 100 ohms and VSWR of 2:1.

Price: 33801A and 33802A (negative or positive output): \$125. 33803A (matched pair mixer service, 33801A and 33802A): \$275.

For more details call your local HP field engineer or write Hewlett-Packard, Palo Alto, California 94304; Europe: 54 Route des Acacias, Geneva.

HEWLETT  PACKARD

SOLID STATE DEVICES

ON READER-SERVICE CARD CIRCLE 243

01711

# Laser-beam detectors...from RCA

MATERIAL	TYPE LASER	WAVELENGTH (Angstroms)	SPECTRAL RESPONSE	NOMINAL DIAMETER (inches)	RCA PHOTOMULTIPLIER TUBE TYPE NO.	
Ne	Gas	3324	S-20 or Special	3/4	8644	
N <sub>2</sub>	Gas	3371			8645	
Ar	Gas	4579			4459	
Ar	Gas	4765			4463	
Ar	Gas	4880			7265	
CdS	Semiconductor	4950			7326	
Ar	Gas	4965			C31000A	
Ar	Gas	5017			4464	
Ar	Gas	5145			4464C	
CaF <sub>2</sub> :Ho <sup>3+</sup>	Crystal	5512			4465	
Kr	Gas	5682		Dormer (.65 x .5)	4526	
LaF <sub>3</sub> :Pr <sup>3+</sup>	Crystal	5985		S-1	3/4	C70102B
Y <sub>2</sub> O <sub>3</sub> :Eu <sup>3+</sup>	Crystal	6113				7102
HgHe	Gas	6150				C70007A
HeNe	Gas	6328				
Al <sub>2</sub> O <sub>3</sub> :Cr <sup>3+</sup>	Crystal	6929				
Al <sub>2</sub> O <sub>3</sub> :Cr <sup>3+</sup>	Crystal	6934				
SrF <sub>2</sub> :Sm <sup>2+</sup>	Crystal	6969				
Al <sub>2</sub> O <sub>3</sub> :Cr <sup>3+</sup>	Crystal	7009				
Al <sub>2</sub> O <sub>3</sub> :Cr <sup>3+</sup>	Crystal	7041				
CaF <sub>2</sub> :Sm <sup>2+</sup>	Crystal	7083				
Al <sub>2</sub> O <sub>3</sub> :Cr <sup>3+</sup>	Crystal	7670				
GaAs	Semiconductor	8400				
Na-Ca-Si	Glass	9200				
Li-Mg-Al-Si	Glass	10150				
Y <sub>3</sub> Al <sub>5</sub> O <sub>12</sub> :Yb <sup>3+</sup>	Crystal	10296				
CaF <sub>2</sub> :Nd <sup>3+</sup>	Crystal	10460				
CaWO <sub>4</sub> :Pr <sup>3+</sup>	Crystal	10468				
K-Ba-Si	Glass	10600				
CO <sub>2</sub>	Gas	10600				
CaMoO <sub>4</sub> :Nd <sup>3+</sup>	Crystal	10610				
LaF <sub>3</sub> :Nd <sup>3+</sup>	Crystal	10633				
Y <sub>3</sub> Al <sub>5</sub> O <sub>12</sub> :Nd <sup>3+</sup>	Crystal	10648				
CaF <sub>2</sub> :Tm <sup>2+</sup>	Crystal	11160				

Working on detector circuits for use in the visible and near-infrared portion of the spectrum? Here's a useful tool: the RCA Laser Applications Chart and Preliminary Tube Selection Guide. Combined, they form a summary of many of RCA's coherent visible-radiation detection and mixing devices. All have broad bandwidth, low noise, and fast response. Both the Chart and Guide are published in the booklet PIT-704A, that also includes electrical characteristics, quantum efficiency data, and rise time curves. For your copy of this booklet, as well as technical data sheets on specific types, write: RCA Commercial Engineering, Section A18-P1, Harrison, New Jersey 07029.



RCA Photomultiplier Tubes for Laser-Beam Detection (PIT-704A).



Two examples of RCA Photomultipliers, offering high performance and high speed for visible and near-infrared laser-beam detection.

RCA Electronic Components and Devices



The Most Trusted Name in Electronics