

Electronic Design 15

VOL. 15 NO.

FOR ENGINEERS AND ENGINEERING MANAGERS.

JULY 19, 1967

A boom in linear microcircuits is starting to rock the design community and it's the user who stands to gain a lot. Monolithic circuits that amplify and process

analog signals are sprouting up in everything from televisions to telephones. And their makers are shooting for IF strips and GHz amplifiers on a chip (p.49).

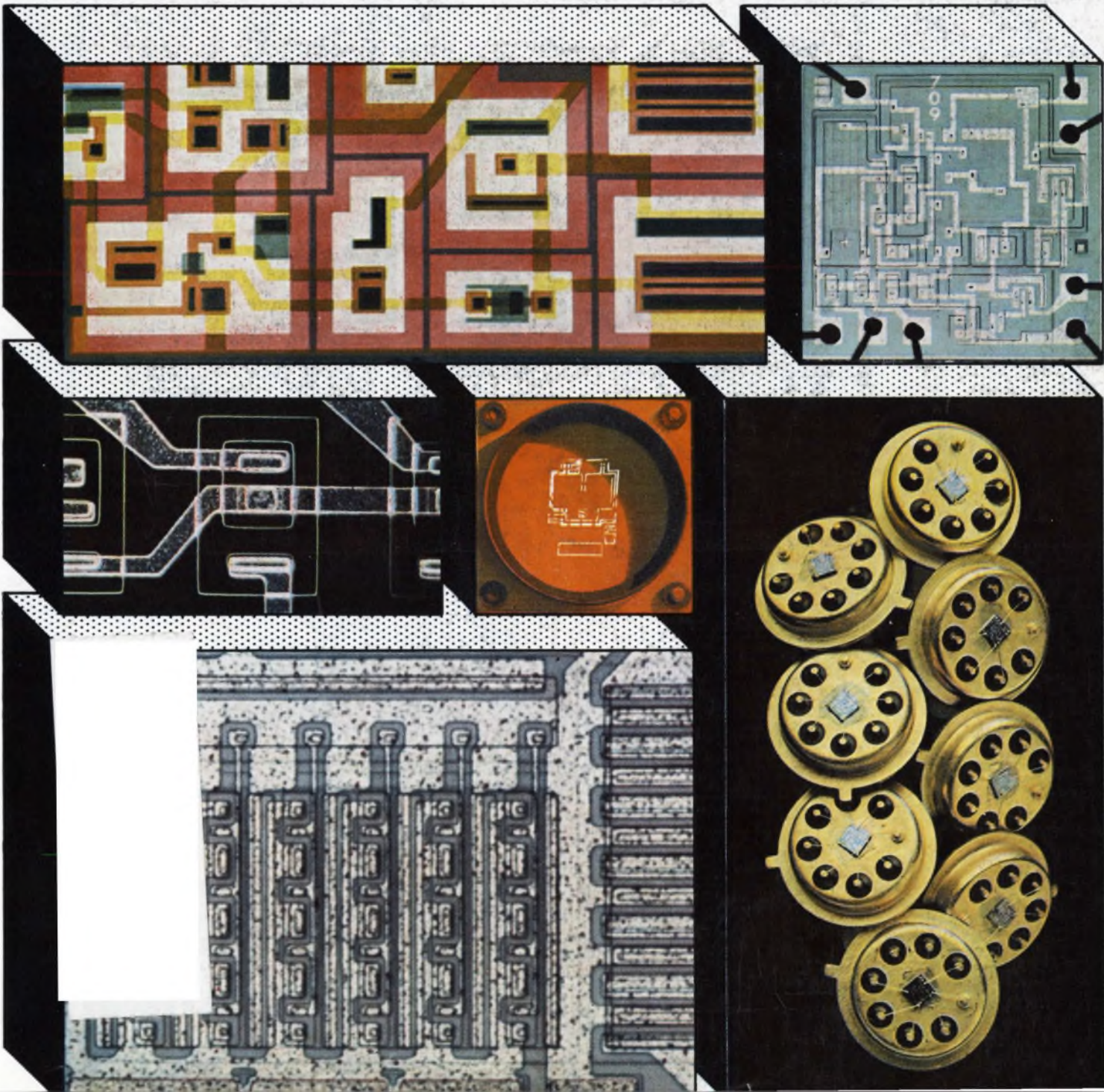

**"SPECIAL"
CUSTOM BUILT**



POWER TRANSFORMERS & INDUCTORS

TO YOUR SPECIFICATIONS

Exceptional quality and reliability is provided in all UTC designs. Over 30 years of engineering knowledge and experience backed by complete environmental testing and life testing facilities assure the highest standard in the industry. Full analysis and evaluation of materials are conducted in UTC's Material and Chemical Laboratories. Rigid quality control measures coordinated with exhaustive statistical findings and latest production procedures results in the industry's highest degree of reliability. Range covered in Power Transformers is from milliwatts to 100 KVA. Some typical applications include: Current Limiting, Filament, Isolation, Plate, Transistor Inverter, Transistor Supply.

**MILITARY AND COMMERCIAL TYPES FOR
EVERY PHASE OF THE ELECTRONICS ART**

POWER TRANSFORMERS • AUDIO TRANSFORMERS • INDUCTORS • PULSE TRANSFORMERS • ELECTRIC WAVE FILTERS • LUMPED CONSTANT DELAY LINES • HIGH Q COILS • MAGNETIC AMPLIFIERS • SATURABLE REACTORS • REFERENCE UNITS

<p>Low capacity current limiting filament transformer. Primary 118 V. 60 cycles to 6.3 V. at 3 A., 8 A. at short circuit. 25 MMFD capacity. 30 KV hipot and 200:1 capacity divider; 5 x 3 3/4 x 4 1/2", 9 lbs.</p>	<p>MIL-T-27B ultraminiature Scott connected power transformer, 5/16 Dia. x 13/32" H., 1/10 Oz. Primary 28 V 400 — with taps @ 50% & 86.6%. Two units provide 28 V two phase from three phase source.</p>	<p>Molded Power Transformer 3 Phase. Input 200V, 380-420 cps. Electrostatic Shield, 8 output windings, 26 terminals. MIL-T-27B, Grade 2 Class S. Max. Alt. 50K Ft. Size 6 x 2 1/2 x 5", 8 lbs.</p>
<p>Commercial type molded power transformer. Primary 115/230 V., 50/420 cycles to 680 VCT.-.015 A., 6.3 VCT.-1.2 A., 6.3 V.-.6A. Size: 2 1/2 x 3 x 2 7/8", weight: 1.6 lbs.</p>	<p>Three phase high voltage power transformer. Primary jumper hardware for easy conversion from delta to wye inputs. Made to MIL-T-27B specifications. Primary: 440 V 60 cycles delta or wye 3 phase input. Secondary: 2100 V line to line or 1215 V line to line @ 242 ma.</p>	<p>High current filament transformer. Primary 140/156 V., 47/63 cycles to 1.8 V.-1070 A. Current limiting through separate primary reactor, MIL-T-27B; 10 x 10 x 1 1/2", 150 lbs.</p>

Write for catalog of over
1,300 UTC TOP QUALITY
STOCK ITEMS
IMMEDIATELY AVAILABLE
from your local distributor.



UNITED TRANSFORMER CO.

DIVISION OF TRW INC. • 150 VARICK STREET, NEW YORK, N. Y. 10013

HI GO LO

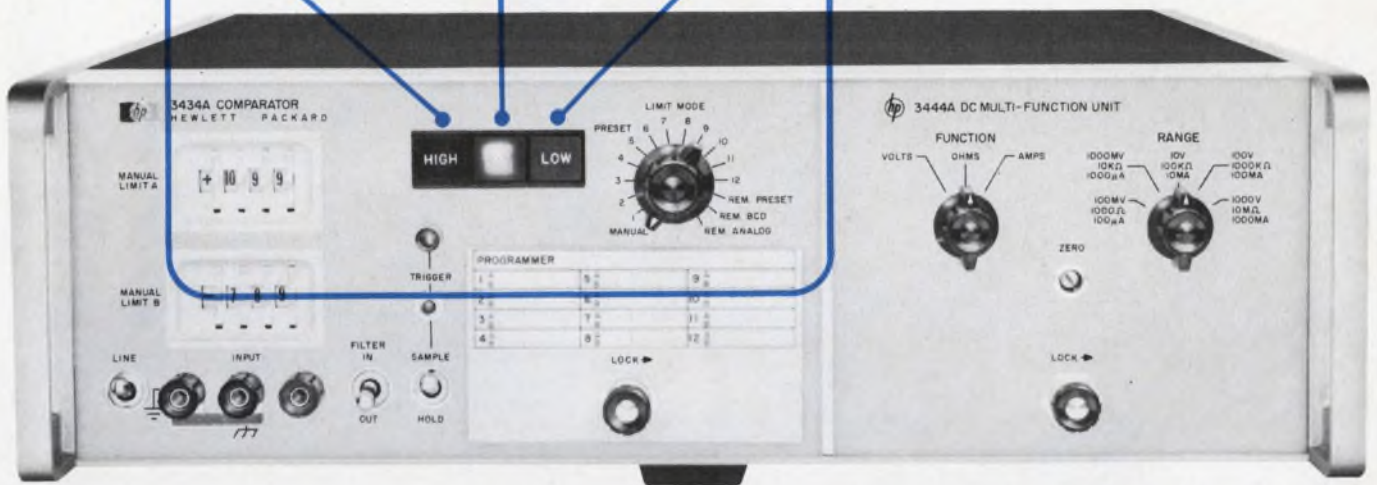

NEW LOW-COST DECISION MAKER

Cut the time and the cost of repetitive tests in your production line, incoming inspection, quality assurance and laboratory—with the new hp 3434A Comparator! This limit tester enables nontechnical personnel to rapidly pass, reject or sort devices under test. The green GO light says that the test item is within the two preset limits. Red HIGH indicates test value exceeds the higher limit. Yellow LOW tells you the value is below the lower limit. Basic unit costs only \$1575.00 plus plug-in and programmer.

The new all solid state 3434A mainframe accepts any of the 3440A Series plug-ins to provide a wide range of ac and dc voltage, current and resistance measurements with a basic accuracy of $\pm 0.03\%$ full scale. For production speed, an interchangeable pin board programmer enables you to preset 12 programs including limits, polarity, range and function using decimal notations.

Interchangeable Pin Board Programmer



Five modes of limit selection (3-digit with 10% overrange) are possible with the 3434A Comparator. (1) Front panel thumbwheels provide rapid selection of limits for routine testing. (2) Preset programs on the interchangeable pin-board programmer can be selected manually, or

(3) by remote contact closure to ground. (4) BCD (1-2-4-8) inputs can be used when more than 12 programs are needed. (5) An infinite number of limits can be selected remotely by analog voltages (± 11 V).

Talk with your hp field engineer about the possibilities of increasing speed and reliability of your routine test operations using the hp 3434A—hp's new LOW COST DECISION MAKER. Write or call Hewlett-Packard, Palo Alto, California, 94304. Telephone (415) 326-7000. Europe: 54 Route des Acacias, Geneva. Price: Basic unit hp Model 3434A, \$1575.00; interchangeable pin board programmer, \$225.00. Accepts all hp 3440A plug-ins listed below (\$40 to \$575).

Plug-in*	3441A	3442A	3443A	3444A	3445A	3446A
AC volts 10 V to 1000 V					•	•
DC volts 10 V to 1000 V	•	•	•	•	•	•
DC volts 100 mV to 1000 V			•	•		
DC amps 100 μ A to 1000 mA				•		
Ohms 1 k Ω to 10 M Ω				•		
Manual ranging	•	•	•	•	•	•
Remote ranging		•	•		•	•
Remote function						•
Full scale Voltage Accuracy	$\pm 0.03\%$	$\pm 0.03\%$	$\pm 0.03\%$	$\pm 0.03\%$	$\pm 0.06\%$ AC $\pm 0.03\%$ DC	$\pm 0.06\%$ AC $\pm 0.03\%$ DC

* The 3434A Comparator requires a plug-in to operate.
† $\pm 0.04\%$ I; $\pm 0.03\%$ R

097/8

HEWLETT  **PACKARD**
An extra measure of quality

ON READER-SERVICE CARD CIRCLE 2



No one hates Bill as much as H-P and Beckman.
And for that we love him.



Bill Busted doesn't expect to be loved.

He's not obsolete. We need him. And you need him. Bill's really a nice guy. Perhaps he is too persnickety and too great a perfectionist to be lovable. But you really can't expect a dedicated Quality Control Director to be a living doll. Bill knows his job.

We know ours, too. That's why we have people of Bill Busted's character and competence. And that's why CMC counters and other instruments are the finest that our human ingenuity and technology can deliver.

In this business everybody talks about quality and reliability. We, too, can talk about our 48-hour aging at 55°C, vibration testing, 100% electrical check-out (twice on every instrument), meticulous supervision, materials inspection, all our space-age instrumentation, and the only two Mil Spec counters on government's Qualified Products List. And we have a 52-man QC staff headed by finicky ol' Bill Busted.

But in the end, the best judge of quality and performance is you. So accept our challenge, and earn a free Crusading Engineer Medal in the process. Write for our Short Form Catalog, or for complete data on any CMC instrument that interests you. Then "Check the Specs," and make up your own mind. We're pretty sure of your decision.

One last favor... Bill Busted's birthday is the 20th of this month. If you have a moment, send him a little card. He needs to feel appreciated.

12973 Bradley / San Fernando, California
Phone (213) 367-2161 / TWX 910-496-1487



ON READER-SERVICE CARD CIRCLE 3

NEWS

- 13 News Scope
- 17 **Upside-down Mars craft heading for Venus**
Mariner V, now on a trip near the sun, is modified 1965 backup craft.
- 22 **Eye-catchers on parade**
A photoview of the world's largest consumer electronics show
- 26 **Holography uses are deemed 'illusory'**
Scientist doubts that 3-D television, movies and portraits are imminent.
- 29 Washington Report
- 40 Letters
- 45 **Editorial: A systems approach is needed to cope with copper shortages.**

TECHNOLOGY

- 49 **Staff Report: Tiny exploding world of linear microcircuits**
This issue's cover is a collage of photographs on the theme of linear microcircuits (counterclockwise from upper left): A mask section of National Semiconductor Corp.'s new op amp (see p. 70); a transistor on a custom linear microcircuit by Fairchild; the power section of Motorola's new 1-W monolithic audio amplifier; a stack of Fairchild's μ A709s; and Raytheon's 709 (see p. 58). In the center is an oscilloscope that is part of Westinghouse's electron-beam wafer-etching system (see p. 54).
- 50 The second microcircuit revolution
- 54 The tricks of the linear trade
- 58 The '709': Model T of the op amps
- 62 Off the shelf? Or off your design board?
- 70 The op-amp conjurer strikes again
- 76 **10 transistor leakage currents** are used in manufacturers' specifications. Understand this abracadabra and check it with your own test circuits.
- 86 **Stop your counter 'hanging up'** because of noise. Proper flip-flop recovery-time design controls pulse-spacing and reduces errors.
- 90 **Don't blame the component vendor** every time a circuit fails. Maybe the fault is with the specs or application, as four SCR case histories show.
- 94 **Micropower fast switching circuits** by combining complementary design with a working knowledge of what's happening at these levels.
- 100 Ideas for Design
- 110 NASA Tech Briefs

PRODUCTS

- 116 **Test Equipment:** Potentiometric voltmeter gets a logic assist.
- | | |
|--------------------------|----------------------|
| 124 Components | 133 Microelectronics |
| 130 Materials | 134 Microwaves |
| 132 Production Equipment | 136 Semiconductors |

Departments

- | | |
|-----------------------|-------------------------|
| 112 Book Reviews | 142 New Literature |
| 138 Design Aids | 146 Advertisers' Index |
| 140 Application Notes | 151 Designer's Datebook |

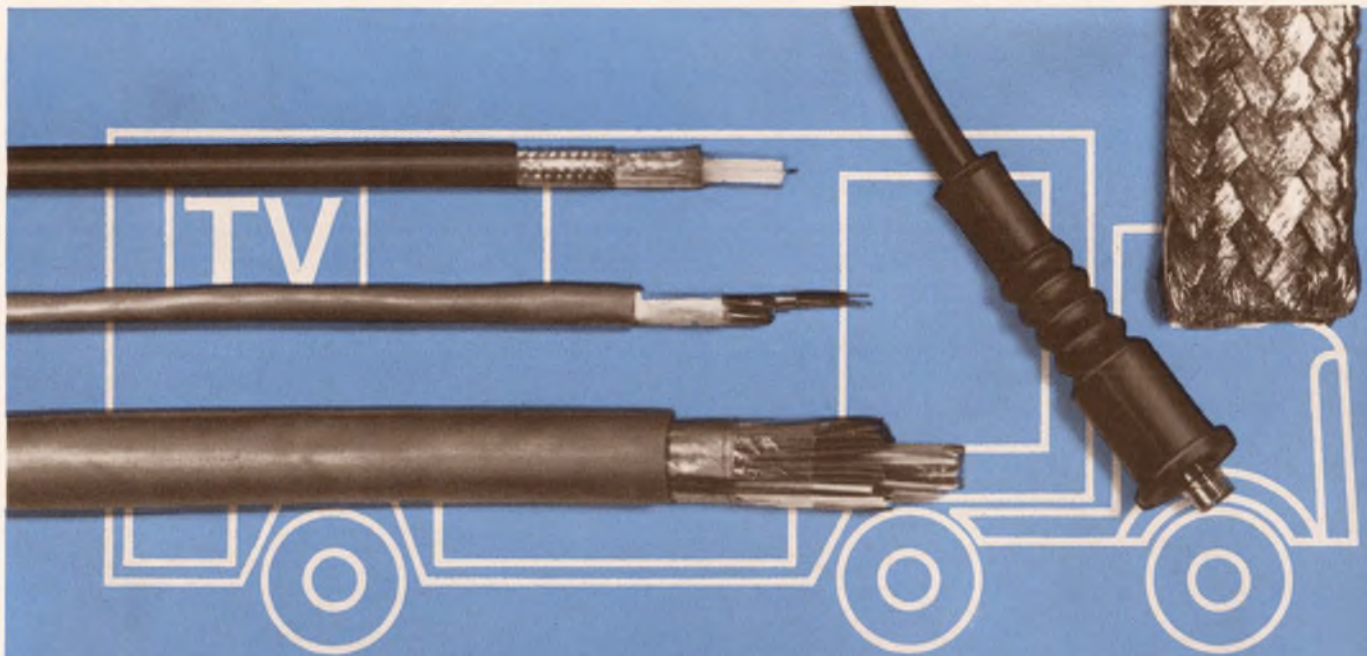

talk about systems...

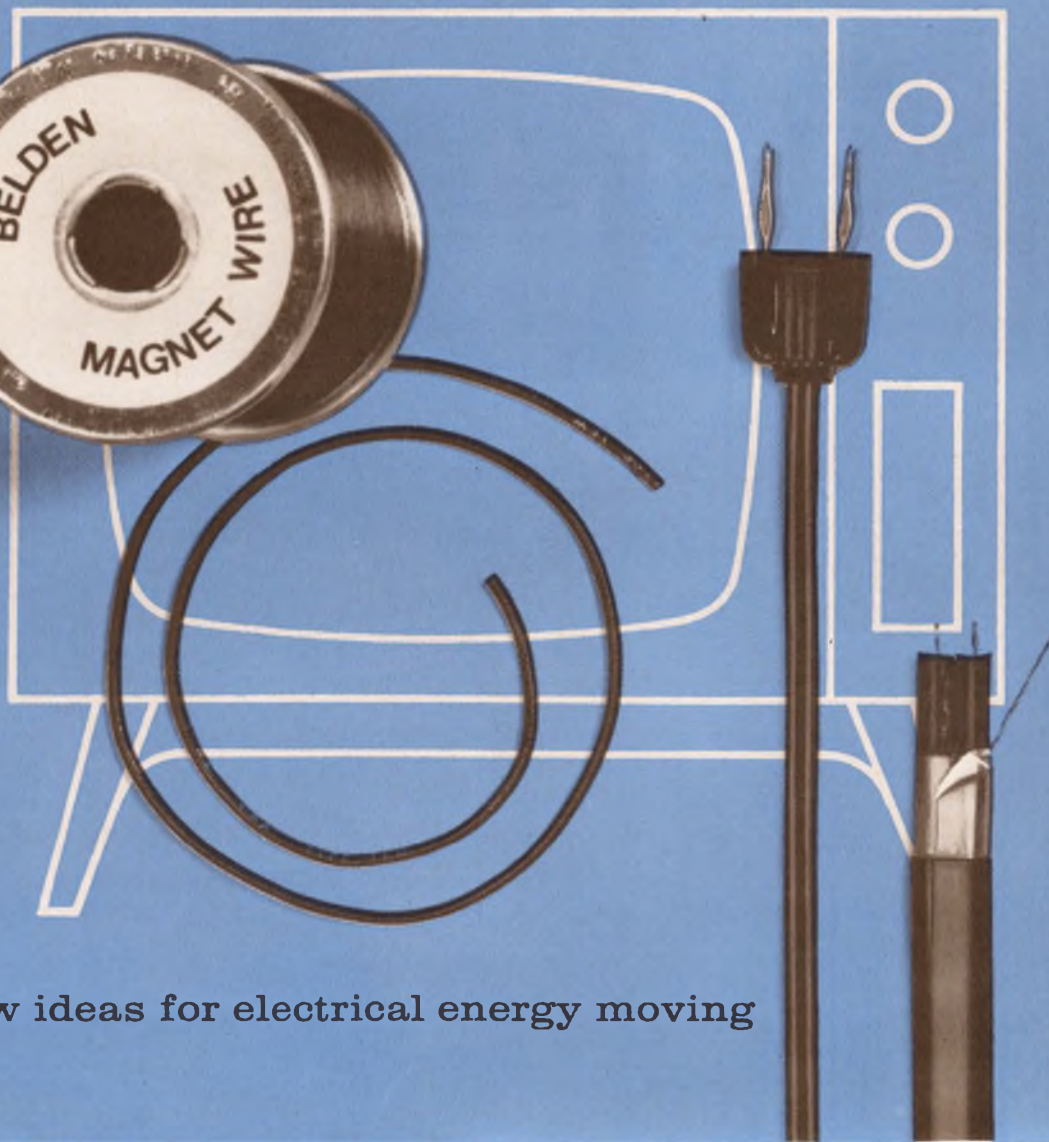
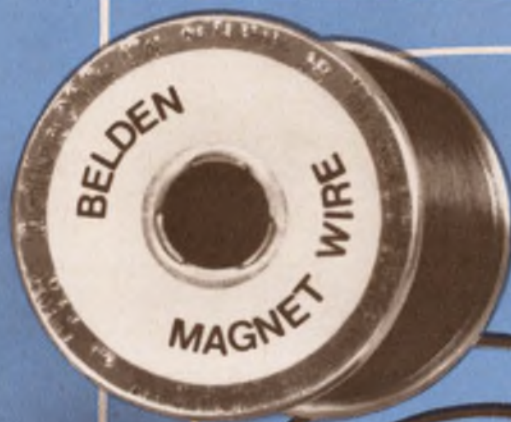

keeping new ideas for electrical energy moving

G-2-7

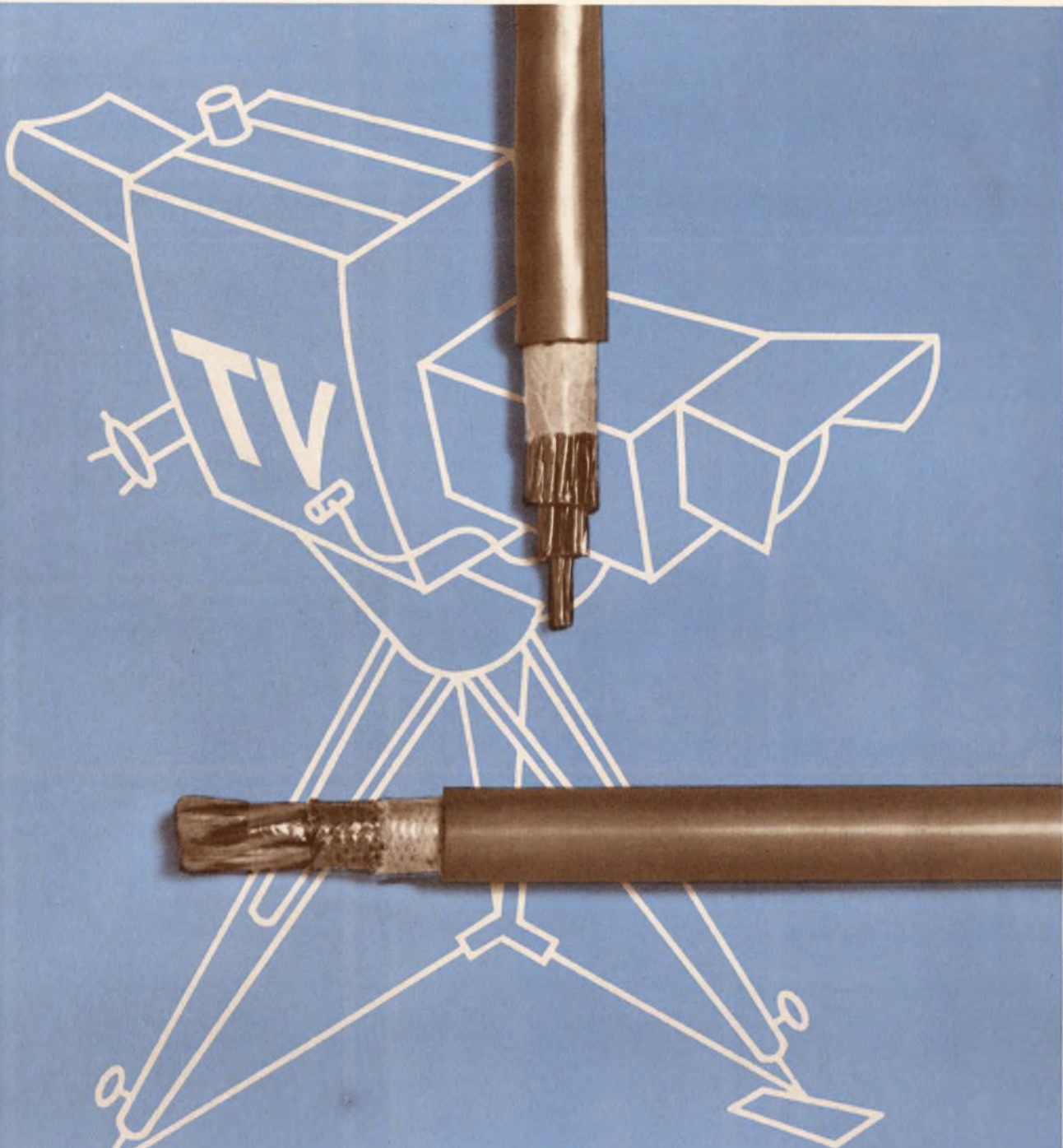

Television. Show Business. To Belden it's all a world of wire. Belden plays a leading role in many complex systems of sight and sound communication. By delving into design, processing, packaging and a host of factors, Belden's team of wire specialists have helped many people wring out hidden costs. Success takes a supplier that is really perceptive — one who makes all kinds of wire for all kinds of systems. Want to join us in wringing out values and costs? Just call us in . . . Belden Corporation, P.O. Box 5070-A, Chicago, Illinois 60680.



RG



Metal Glaze resistors offer .02% reliability and low cost

IRC Metal Glaze resistors now offer you a combination of proved reliability and economy that just can't be matched. You can upgrade your circuit designs and still keep the lid on costs.



- **RELIABILITY PROVEN DESIGN.** A design so conservatively rated that even at *twice rated load*, performance still far exceeds applicable MIL requirements.
- **RELIABILITY PROVEN BY TESTS.** After more than 4 million unit hours of testing, estimated maximum failure rate is .02%/1000 hours, full load @ 70°C, at 60% confidence. Failure is defined as $\Delta R > \pm 4\%$.
- **RELIABILITY PROVEN IN USE.** Millions used in a wide range of applications. No in-circuit failure—*catastrophic or otherwise*—has ever been reported.

Metal Glaze resistors offer other benefits, too: indestructible thick-film resistance element, plated-on copper

end cap, high-temperature soldered termination and a smooth, tough molded body that resists solvents, corrosion, and mechanical abuse.

For top resistor performance without any cost penalty, specify IRC Type RG. Write for data, prices, and sample. IRC, Inc., 401 N. Broad St., Phila., Pa. 19108.

CAPSULE SPECIFICATION

		
WATTAGE:	¼ W @ 70°C	½ W @ 70°C
RESISTANCE:	51Ω thru 150K	10Ω thru 470K
TOLERANCES:	± 2%, ± 5%	± 2%, ± 5%
TEMP. COEF.	± 200ppm/°C	± 200ppm/°C
IRC TYPE:	RG07	RG20



ON READER-SERVICE CARD CIRCLE 5

- 7 STANDARD single, dual, and triple units, including units with concentric shaft and vernier operation.

- 16 STANDARD resistance values from 50 ohms to 5 meg.

- 2 STANDARD tolerances 10% and 20%.

- 5 STANDARD resistance tapers.

- 18 STANDARD electrical tap options.

- 46 STANDARD shaft lengths from 3/8" to 6.0".

- 3 STANDARD shaft endings.

- 9 STANDARD variations of bushings.

- 4 STANDARD locating lug options.

- 4 STANDARD switch options with single and double pole.

Allen-Bradley offers a 1,000,001 standard variations of Type J Potentiometers

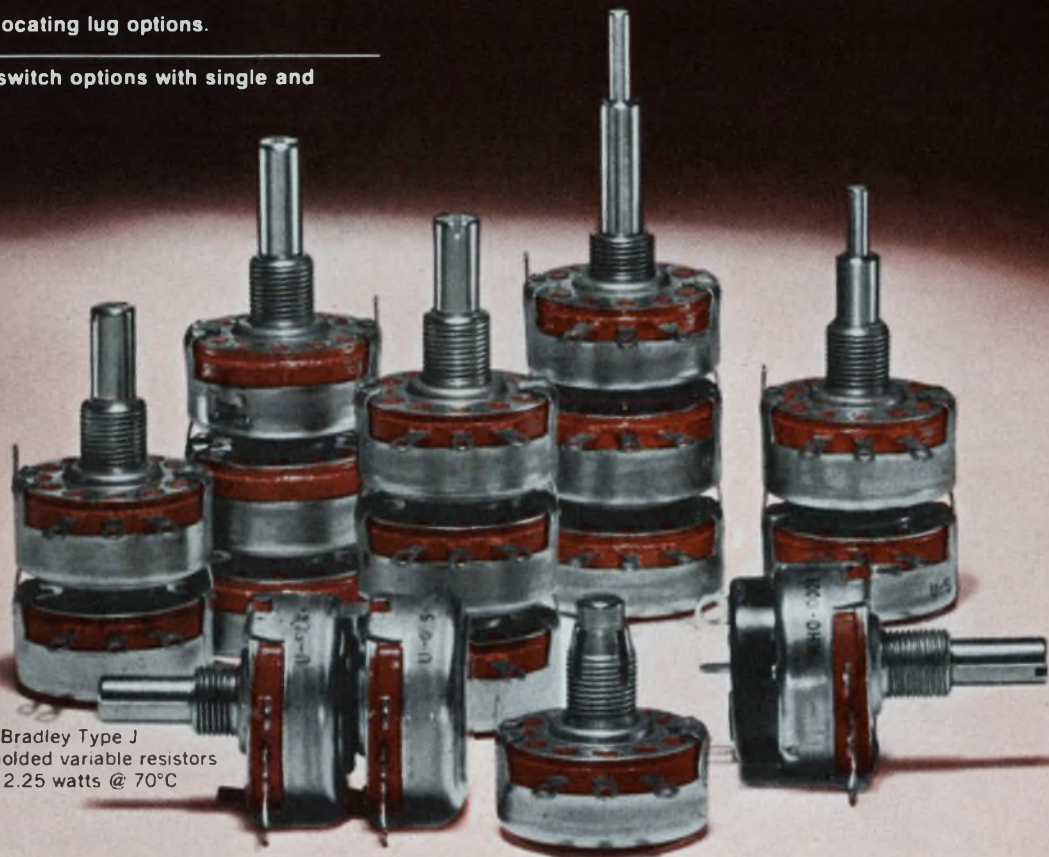

Allen-Bradley Type J
hot molded variable resistors
rated 2.25 watts @ 70°C

These *standard* variations in the Allen-Bradley Type J hot molded potentiometer line eliminate the need for a "special" control. When you include the numerous special resistance values and tapers in which the Type J can be supplied, the variations become virtually infinite.

Yet, all of these Type J variable resistors have one thing in common—each and every one is made by the same A-B hot molding process—your guarantee of "tops" in quality. The solid hot molded resistance track assures extremely long life—exceeding well beyond 100,000 complete operations on accelerated tests with less than 10% resistance change. Control is always smooth and free from the sudden turn-to-turn resistance changes of wire-

wound units. And being essentially noninductive, Type J controls can be used at the higher frequencies—where wire-wound units are totally impractical.

Let Allen-Bradley Type J variable resistors be the answer to your special requirements—it's almost certain there's a "standard" unit in the Type J line. And you *know* you're obtaining the ultimate in reliability and performance. For more complete information on Allen-Bradley Type J potentiometers, please write for Technical Bulletin 5200: Allen-Bradley Co., 1315 S. First St., Milwaukee, Wis. 53204. In Canada: Allen-Bradley Canada Limited. Export Office: 630 Third Ave., New York, N.Y., U.S.A. 10017.



ALLEN-BRADLEY
QUALITY ELECTRONIC COMPONENTS

367-IAB

ON READER-SERVICE CARD CIRCLE 6

Complementary Silicon Power— Direct-Couple Your Servo Drivers At Low Cost (and in less time)!



Use these six new, 5-ampere Motorola complementary silicon power transistor pairs to achieve enormous economies in the push-push, push-pull driver portions of your medium-current, industrial/computer servo amplifier designs . . . you'll save two ways:

1. You get all the circuit-simplifying advantages of direct-coupled, complementary symmetry plus realize a higher degree of frequency stability in both ac and dc-driven loads **WITHOUT** the addition of expensive, impedance-matching driver transformers.
2. It's easier than ever to eliminate costly over-design by plugging in 87.5 watts of TO-3 power-handling capability — a "power gap" area up to now necessarily filled by higher-priced, higher-current units — for only a few cents more than the price for power-limited (25 W) TO-66 devices!

And you now have the choice of 5-ampere silicon NPN or PNP polarity for your power switching, series and shunt regulator driver and output stage, dc-to-dc converter, inverter and hammer driver designs.

Eighteen Motorola complementary silicon power transistor pairs ranging from 1 to 15-amperes and 5 to 150 watts are immediately available from your franchised Motorola distributor for the broadest range of cost-cutting PNP/NPN applications possibilities in the industry. Investigate them today!

Complement your Design Know-How . . . with a series of three informative Application Notes on complementary silicon power audio/servo amplifier circuits. How to reduce phase shift and accompanying problems plus easy conversion to transformerless operation are discussed at length. Send for them.

Type	Polarity	P _o @ 25°C	I _c (cont.)	V _{ceo} (sus)	h _{FE} (min @ I _c)	f _r (min)	Price (100-up, 40 V)
2N4913, 14, 15 2N4904, 05, 06	NPN PNP	87.5 W	5 A	40, 60, 80 V	25 @ 2.5 A	4 MHz	\$1.60 2.25
2N5067, 68, 69 2N4901, 02, 03	NPN PNP				20 @ 1 A		1.20 1.84



MOTOROLA
Semiconductors

— where the priceless ingredient is care!





**DON'T GAMBLE
with your MICROCIRCUITS!**

Specify Rugged, Reliable

ERIE BLUE CHIP[®] CAPACITORS

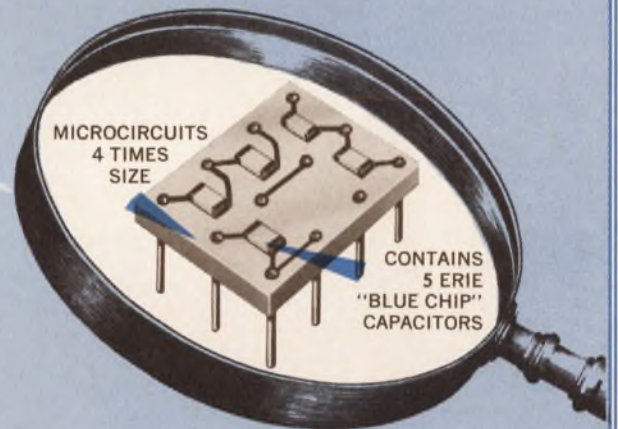

**10 to 1,000,000 pF CAPACITANCE RANGE... 50 or 100 WVdc
AVAILABLE NOW FOR MICROCIRCUIT APPLICATIONS**

When one manufacturer . . . ERIE . . . produces the most nearly perfect Ceramic Chip Capacitor in the industry . . . gambling with other chip brands becomes a real game of chance. Erie Chips are considered by knowledgeable engineers as more rugged in construction, they have higher temperature stability, maximum capacitance-to-volume ratio (10 pF to 1.0 mF), greater performance reliability, better solderability . . . and Erie offers an almost infinite variety of Chip Capacitors to suit any microcircuit requirement.

So when you visit Las Vegas . . . gamble. That's why you're there. But when you demand better performance from components in Microcircuits, place the only safe bet . . . ERIE Monobloc Ceramic Chip Capacitors.

Write for technical data on Ceramic Chip Capacitors, Request Monobloc Catalog 8000.

®Trademark for Erie Monobloc Ceramic Chip Capacitors

Another series of components in Erie's Project "ACTIVE" . . .
Advanced Components Through Increased Volumetric Efficiency.

ERIE

TECHNOLOGICAL

PRODUCTS, INC.



Erie, Pennsylvania

ON READER-SERVICE CARD CIRCLE 8

A new concept... optimum-technology integration

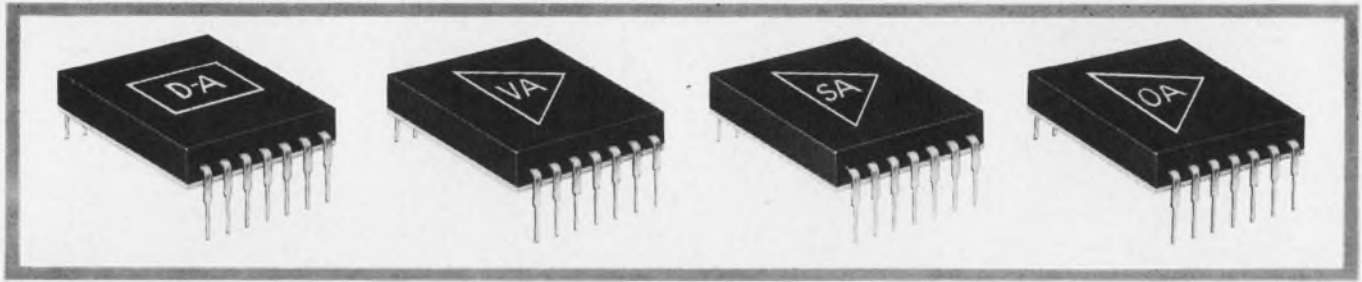

MODULELINE[®] microcircuits have solved the problems of technology trade-offs.

Silicon integrated circuits, thick and thin films, tantalum nitride or nickel-chromium on silicon, discrete semiconductor devices active or passive—each has its own technology advantages for the circuit designer.

Until today, the designer lived with the limitations of each technique as well. Circuit design and component selection finally ended after the battle with technology trade-offs.

MODULELINE[®] MICROCIRCUITS

Now Sprague introduces Moduline microcircuits. Simply put, Sprague selects the optimum technologies for you, integrates these various techniques into functional or multi-functional circuits, then packages them into dual in-line packages with 100 mil pin spacing.

Moduline microcircuits are complete! No additional "add-on" components are needed. Four standard circuits are available today. More will follow.

D to A CONVERTER

The Moduline UM1000 4-bit D to A converter combines ladder network, ladder switch, and buffer amplifier in one package.

The ladder network is a monolithic silicon chip with 9 deposited tantalum nitride precision resistors. Only this technology could give the UM1000 the ability to be expanded to 12 bits with less than 1/2 bit error.

The ladder switch is constructed from 8 complementary "low off-set" transistors mounted on a thin film circuit. Each transistor is discrete, to permit superior matching.

Lastly, the buffer amplifier consists of 4 NPN transistors and 12 nickel-

chromium resistors, again on a thin film. This type of resistor construction is chosen because of its very low temperature coefficient which provides precision tracking through a broad temperature range.

The Moduline UM1000 D to A converter is in a dual in-line package 0.72" long by 1.35" wide, with 14 pins on 100 mil centers, 1.4" between rows. It is specified over the full military temperature range of -55 to +125 C. Also available is the UM1200, specified for 0 to +70 C commercial applications.

VIDEO AMPLIFIER

Complete, ultra-flexible self-contained circuitry is provided by the Moduline UM1518 video amplifier.

The heart of the circuit is the monolithic amplification section. This is where old integrated amplifiers stopped. The UM1518 adds screen-deposited planar noble metal resistors inside the package, allowing gain from 5 to 50 volts and bandwidth from 40 Hz to 40 MHz to be chosen by nothing more than package pin selection.

Further technology integration adds discrete multi-layer Monolythic[®] micro capacitors to the ceramic substrate for A-C de-coupling of input and output. The single dual in-line package needs only the board space equal to two conventional single-chip DIP packages.

SENSE AMPLIFIER

The UM1519 combines 3 silicon monolithic integrated circuits and 8 deposited resistors on a ceramic substrate.

The resistors form a tappable voltage divider to allow selection of sensing voltage threshold level.

Two identical monolithic analog comparators receive the signal, then feed to a monolithic Exclusive OR gate.

The result is sensitivity and speed—12mV maximum differential input voltage for "1" output, strobe turn-on 30 nsec.—all produced by combining proven, high-volume integrated circuit chips. The UM1519 dual in-line package measures 1.3 inches between rows.

OPERATIONAL AMPLIFIER

The UM1522 operational amplifier answers the need to combine the advantages of discrete and integrated designs.

The discrete input Darlington-connected transistors are closely matched for low off-set. The multi-chip amplifier is a "no compromise" design. All chips are close-proximity mounted on the same substrate. The result is exceptionally low V_{BE} differential and close tracking over the full temperature range.

Six planar resistors are then bonded onto the substrate. They provide stability and high impedance for the input and output.

The UM1522 is in the same package as the video amplifier.

For further information write to:
Technical Literature Service
Sprague Electric Company
347 Marshall Street
North Adams, Mass. 01247



*Sprague and "S" are registered trademarks of the Sprague Electric Co.

ON READER-SERVICE CARD CIRCLE 11

News

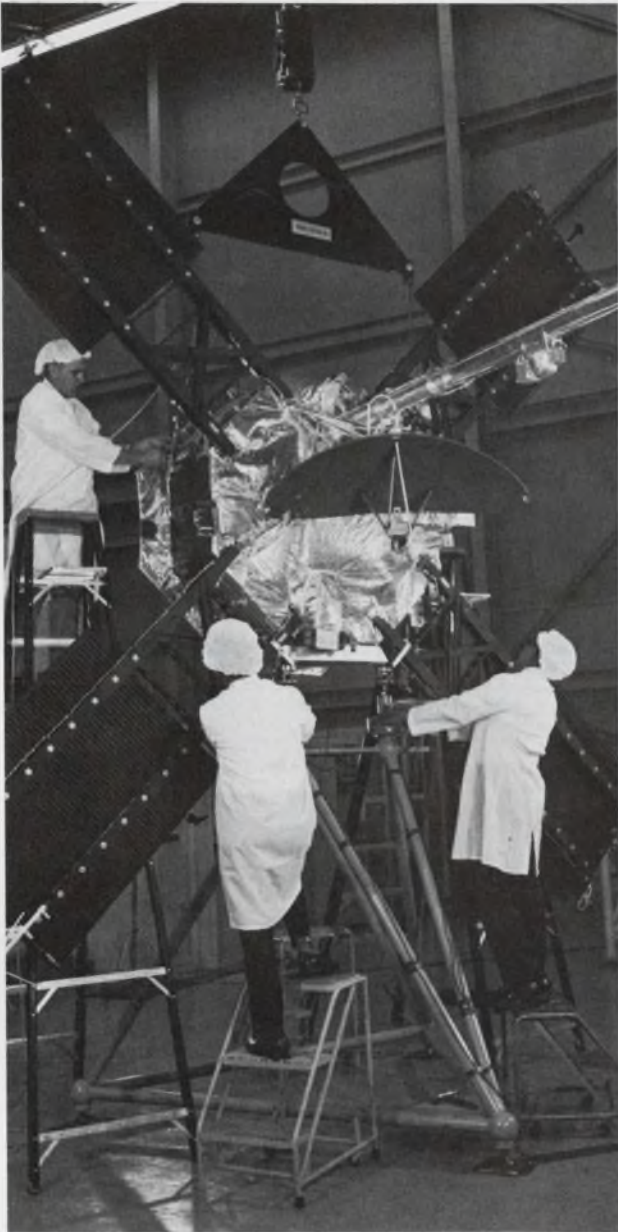

Mariner V, now on course for Venus, is a modified 1965 Mars backup craft. Page 17



Early electronic equipment catches eye at New York's Consumer Electronics Show. Page 22

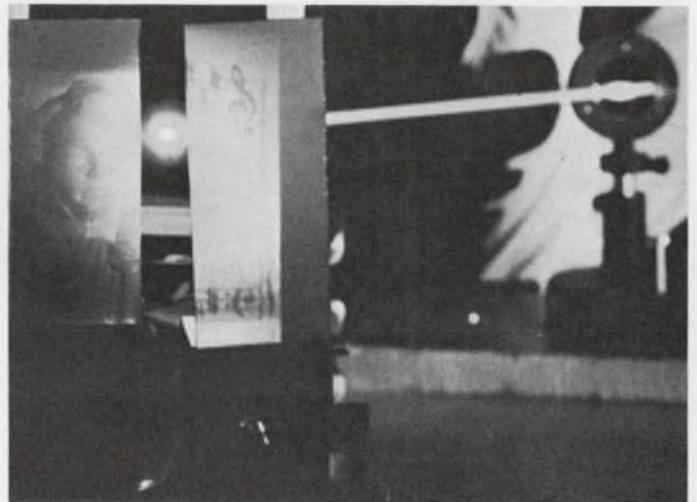

Holography expert ridicules predictions of uses for the nascent science as "illusory." Page 26

Also in this section:

Self-contained, fully automated triple-data unit spurs underwater research. Page 33

Gigahertz current oscillations produced in bulk crystals of germanium. Page 36

News Scope, Page 13 . . . Washington Report, Page 29 . . . Editorial, Page 45

Did You Know Sprague Makes 51 Types of Foil and Wet Tantalum Capacitors?

FOIL-TYPE RECTANGULAR TANTALEX® CAPACITORS



Type 300D polarized plain-foil
Type 301D non-polarized plain-foil
Type 302D polarized etched-foil
Type 303D non-polarized etched-foil

ASK FOR BULLETIN 3650

ON READER-SERVICE CIRCLE 162

FOIL-TYPE TANTALUM CAPACITORS TO MIL-C-3965C

CL20, CL21 tubular 125 C polarized etched-foil
CL22, CL23 tubular 125 C non-polar etched-foil
CL24, CL25 tubular 85 C polarized etched-foil
CL26, CL27 tubular 85 C non-polar etched-foil
CL30, CL31 tubular 125 C polarized plain-foil
CL32, CL33 tubular 125 C non-polar plain-foil
CL34, CL35 tubular 85 C polarized plain-foil
CL36, CL37 tubular 85 C non-polar plain-foil
CL51 rectangular 85 C polarized plain-foil
CL52 rectangular 85 C non-polar plain-foil
CL53 rectangular 85 C polarized etched-foil
CL54 rectangular 85 C non-polar etched-foil

ON READER-SERVICE CIRCLE 163

125 C FOIL-TYPE TUBULAR TANTALEX® CAPACITORS

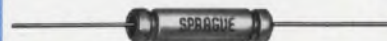

Type 120D polarized plain-foil
Type 121D non-polarized plain-foil
Type 122D polarized etched-foil
Type 123D non-polarized etched-foil

ASK FOR BULLETIN 3602C

ON READER-SERVICE CIRCLE 161

85 C FOIL-TYPE TUBULAR TANTALEX® CAPACITORS

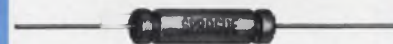

Type 110D polarized plain-foil
Type 111D non-polarized plain-foil
Type 112D polarized etched-foil
Type 113D non-polarized etched-foil

ASK FOR BULLETIN 3601C

ON READER-SERVICE CIRCLE 164

SINTERED-ANODE TUBULAR TANTALEX® CAPACITORS



Type 109D elastomer seal 85 C
Type 130D elastomer seal 125 C
Type 137D hermetic seal 125 C

ASK FOR BULLETINS 3700F, 3701B, 3703

ON READER-SERVICE CIRCLE 165

SINTERED-ANODE CUP STYLE TANTALEX® CAPACITORS



Type 131D 85 C industrial-type
Type 132D 85 C vibration-proof
Type 133D 125 C vibration-proof

ASK FOR BULLETINS 3710B, 3711

ON READER-SERVICE CIRCLE 166

SINTERED-ANODE CYLINDRICAL TANTALEX® CAPACITORS



Type 140D
up to 175 C operation,
1/8" diam.
Type 141D
up to 175 C operation,
1 1/8" diam.

ASK FOR BULLETIN 3800

ON READER-SERVICE CIRCLE 167

SINTERED-ANODE RECTANGULAR TANTALEX® CAPACITORS



Type 200D negative terminal grounded
Type 202D both terminals insulated

ASK FOR BULLETIN 3705A

ON READER-SERVICE CIRCLE 168

SINTERED-ANODE TANTALUM CAPACITORS TO MIL-C-3965C

CL14 cylindrical, 3/8" diam.
CL16 cylindrical, 3/8" diam., threaded neck
CL17 cylindrical, 1 1/8" diam.
CL18 cylindrical, 1 1/8" diam., threaded neck
CL44 cup style, uninsulated
CL45 cup style, insulated
CL55 rectangular, both terminals insulated
CL64 tubular, uninsulated
CL65 tubular, insulated

ON READER-SERVICE CIRCLE 169

For comprehensive engineering bulletins on the capacitor types in which you are interested, write to:

Technical Literature Service
Sprague Electric Company
347 Marshall Street
North Adams, Mass. 01247

45D-5158

SPRAGUE
THE MARK OF RELIABILITY

Sprague and (S) are registered trademarks of the Sprague Electric Co.

Top electronic firms boost sales in 1966

Of the 500 industrial companies reporting the largest sales in 1966, 37 were electronics manufacturers.

A compilation by *Fortune* magazine showed that 27 out of the 37 improved their standing over 1965. Four others appeared among the top 500 for the first time—Teledyne, Varian Associates, Sprague and Mallory.

The 10 top electronics companies in 1966 were:

Company	Sales (\$ million)	Rank '66	Rank '65	Rank '64
GE	7177	4	4	4
IBM	4247	9	9	9
Western Elec.	3623	11	11	11
Westinghouse	2581	19	18	17
RCA	2548	20	24	27
GT&E	2390	22	25	28
ITT	2121	28	30	31
Sperry Rand	1279	52	46	37
Litton	1172	57	72	85
Honeywell	914	87	101	89

The *Fortune* rankings in 1966, 1965 and 1964 of the remaining 27 electronics companies are:

NCR 91, 92 90; TRW 93, 107, 114; Raytheon 113, 136, 135; Motorola 118, 131, 143; Zenith 125, 142, 166; TI 138, 160, 184; Burroughs 157, 148, 154; Magnavox 173, 207, 267; GPE 178, 283, 274; Admiral 188, 231, 272; Collins 202, 244, 218; Emerson 229, 271, 275; Cons. Electronics Ind. 252, 265, 269; Teledyne 293, . . . , . . . ; Lear Siegler 309, 327, 304; Fairchild Camera 323, 343, 377; Cutler Hammer 336, 326, 359; H-P 341, 365, 415; Ampex 392, 385, 374; Control Data 394, 371, 425; Warwick 423, 445, 455; Amphenol 427, 494, . . . ; Arvin 432, 403, 451; Varian Assoc. 448, . . . , . . . ; Amp 462, 495, . . . ; Sprague 465, . . . , . . . ; Mallory 486, . . . , . . .

The largest jump of the 37 manufacturers was made by Teledyne, which increased its sales—largely through acquisitions—by over 196%. Relatively small gains were registered in 1966 by Sperry Rand and Control Data. IBM had the largest percentage of profit on sales—12.4%.

Such giants as American Telephone and Telegraph (apart from Western Electric), Philips, Siemens and Hitachi had 1965 sales large enough for a place on the list of 500, but they were tabulated separately by *Fortune*.

Mallory, the lowest-ranking electronics manufacturer on *Fortune's* U.S. list, had 1966 sales of nearly \$133 million.

Government bars most Federal eavesdropping

Attorney General Ramsey Clark has issued stringent new regulations that ban virtually all electronic eavesdropping by Federal agents, except in cases involving the national security.

They are the outcome of a two-year study by the Justice Dept. ordered by President Johnson when he cracked down on Federal snooping in a June 30, 1965, memorandum to all agencies.

The new regulations rule that:

- Wiretapping—interception of telephone conversations without the consent of either party—is absolutely prohibited under all circumstances other than for national-security reasons.

- Bugging—planting hidden microphones by trespass—is forbidden.

- The use of devices to pick up conversations without trespass is forbidden in all “constitutionally protected areas,” such as homes, private offices, hotel rooms and automobiles.

- Intrusion into constitutionally

privileged relationships, such as attorney-client talks, is forbidden, whether or not they take place in “constitutionally protected areas.”

- Electronic eavesdropping on a conversation with the consent of only one of the parties is allowed only with the written permission of the Attorney General. In emergencies, an agency head may authorize it, but he must still inform the Attorney General within 24 hours.

- All agency heads must keep electronic eavesdropping gear under lock and key, and maintain detailed records of all use it is put to.

The President's 1965 memorandum outlawed wiretapping in all but national-security cases, and was deemed to prohibit all bugging that involved physical trespass. It was not taken to apply, however, to the use of such gadgets as “detectaphones” (electronic stethoscopes for hearing through walls), “sill mikes and parabolic microphones that pick up conversation over a distance in the open.

The new regulations go well beyond the President's proscriptions, which came in the wake of disclosures, especially in Congress, that Federal agents were making wide use of electronic snooping often without their superiors' knowledge. The ban on devices that involve no physical trespass has generated much controversy, because conversations overheard in this manner have been admissible as evidence in court. Most other forms of electronic eavesdropping and wiretapping have been ruled unconstitutional.

The cost of the new ban to the electronics industry is incalculable because of the surreptitious nature of much eavesdropping (see “The Eavesdroppers,” *ELECTRONIC DESIGN*, XIV, No. 15 (June 21, 1966), 35-46). Estimates by putative experts of the annual dollar volume of business vary between \$1.5 and \$20 million, a mere drop in the industry's \$17 billion yearly-output bucket.

NATO is considering satellite communications

The North Atlantic Treaty Organization is testing the feasibility of setting up its own satellite communications network. If the tests, with U.S. defense satellites prove

News Scope

CONTINUED

successful, NATO may spend about \$45 million to link nearly all of the countries in the alliance through two NATO-owned satellites.

Ground stations at Casteau, Belgium, and Naples, Italy, are being used to train soldiers from Belgium, West Germany, Norway, Italy, Portugal, Britain and the United States in satellite communication techniques. The stations are being leased from Philco-Ford of Palo Alto, Calif., under a \$900,000 test-phase appropriation.

If NATO decides to put its own satellites in the sky, they would be launched by the U.S. Air Force from Douglas Thor-Delta rockets. The ground station, with antennas 20 and 40 feet in diameter, would be in all the NATO countries except France, Luxembourg and Iceland. The U.S. would pay about 25 per cent of the cost of the NATO communications system, but American companies probably would get the bulk of the prime contracting work.

Two-pound TV camera for space applications

What may be one of the world's smallest television cameras has been unveiled by RCA's Astro-Electronics Div. in N. J.

The two-pound unit, about the size of a home movie camera, is designed for use aboard future experimental satellites and by astronauts on manned spacecraft.



RCA's "Tom Thumb" TV camera

Installed in a satellite, it could be used to watch experiments and other spacecraft or it could be handheld by astronauts to provide live TV pictures of space or lunar environments, an RCA spokesman suggested.

Features that contribute to the unit's small size are "extensive" use of integrated circuits in the synch generator, and deflection and video amplifiers; smaller deflection and focus coils, which make it possible to improve resolution through a shaped magnetic field; and a one-half-inch vidicon imaging tube. The camera's resolution is reported to be 600 lines and it operates at a slow scan rate with a complete picture created every 1-1/2 seconds.

Federal funds sought for hugh radio telescope

The National Science Foundation is about to receive a request for funds to develop a huge 440-ft diameter, steerable radio telescope for radio and radar astronomy. It will be similar to the MIT Lincoln Laboratories 120-ft. radio telescope at Haystack Hill, Mass.

The request is contained in a proposal being prepared by a newly formed nonprofit corporation which has as its goal to develop a new, regional radio observatory in the Northeast. Called Northeast Radio Observatory Corporation (NEROC), the organization's members may initially include such formidable universities and scientific institutions as Harvard, MIT, Yale, and Brooklyn Polytechnic Institute.

Dr. Jerome Wiesner, MIT Provost, has been elected chairman; Edward Purcell, Harvard University professor, vice chairman of the new corporation.

If and when federal funds are forthcoming, the antenna, which would be considerably larger than the 250-ft. dish at Jodrell Bank, England, would operate at wavelengths as short as 5 cm. It would be enclosed in a space-frame radome and would employ a "new design concept" in order to achieve at minimum cost the precision surface and pointing accuracy required to operate so large a dish at such short wavelengths.

The observatory will be open to radio astronomers from all universities and scientific institutions.

Business data is sped to Europe by satellite

By using the Early Bird satellite, the International Business Machines Corp. has demonstrated that it is possible to transmit business data to Europe 15 times faster than over the transatlantic circuits normally used.

Tests have been conducted between nine IBM computing centers in this country and one in Paris. The signals were relayed by Early Bird, which is in orbit 22,300 miles above the Atlantic. The tests have shown, IBM reports, that it is technically feasible to increase the scope of international data-processing significantly.

A reel of magnetic tape was transmitted internationally in 30 minutes, compared with six to eight hours normally required.

IBM's system development laboratory near Raleigh, N. C., was the test control point. The data transmitted included samples representative of normal commercial operations. Among them were marketing and financial data and manufacturing information.

Common-carrier wide-band facilities were used in the tests. The wide-band circuit allows a range of frequencies that can sustain transmission at thousands of characters a second. Transmission over transatlantic voice circuits is generally at 150 to 250 characters a second.

Air Force to modify KC-135 for IR studies

Scientists at the Air Force Cambridge Research Laboratory will soon be using an unusual airborne observation platform to study the production and propagation of visible and infrared energy in the atmosphere.

An AFCL KC-135 aircraft is now undergoing extensive modification and, when new equipment is installed later this year, the jet will be flown from the North to the South magnetic pole.

Nine newly developed instruments will be installed on the aircraft, including an electronic scan spectrometer, a visible sky mapper, a filter photometer and two infrared radiometers.

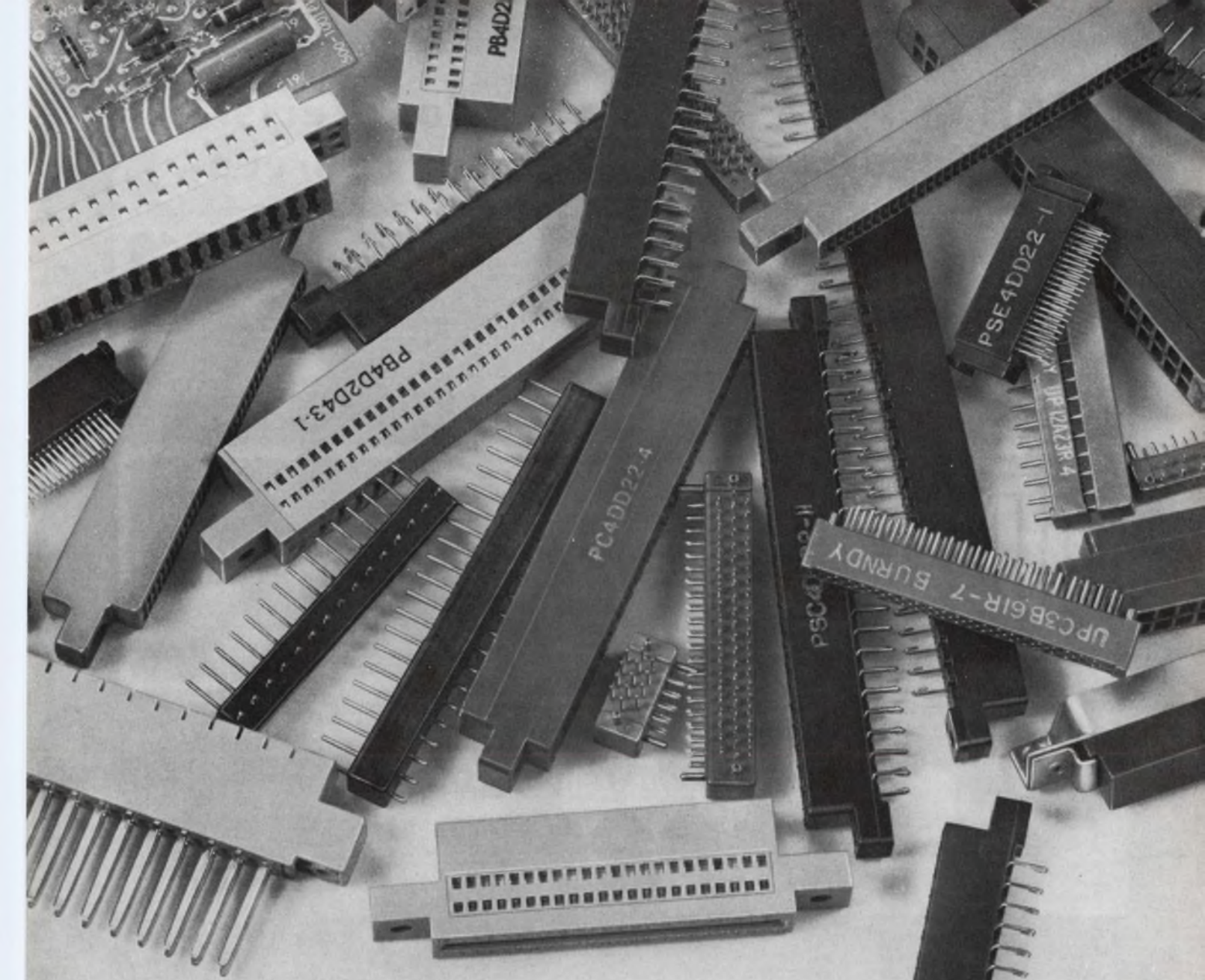

This is no line. This is a choice.

The way new uses for printed circuits are being found, it stands to reason that there should be enough different PC connectors available to insure that your application requirements are met squarely. Burndy gives you that choice.

In fact, we have more than 200 different PC connectors to choose from. And it's likely you'll find a connector that will meet the requirements of several projects. Individually, and as a group, the application potential is enormous. Call it choice . . . call it versatility. You're right on both counts.

This is part of what you have to choose from:

Card Receptacles

- Crimp removable contacts per MIL-C-

21097/B .156" spacing. Non-spec types for .078" .100" and .156" spacing. (The flexibility and convenience of crimp removable contacts often indicates new applications.)

- Solder or weld termination in spacings down to .050".
- Solderless wrap termination on .150" and .200" spacing.

Two-Piece Connectors

- Crimp removable contacts on .100" and .150" centers meet the requirements of the most rugged environments. Round socket contacts support wires against severe vibration and shock.
- Solder dip types on .100" and .150" spacing. 11 sizes from 13 to 92 contacts conform to several NASA drawings and

Signal Corps specifications SCL6250B (MIL-C-55302).

Are they reliable?

Today, Burndy PC connectors are being used in everything from business machines and

computers to telemetry systems. They wouldn't be if they weren't exactly that . . . reliable.

If you're involved with printed circuitry you'll want a copy of our PC connector catalog. Write now for catalog PC.

 **BURNDY**
Norwalk, Connecticut

PAR offers a line of superior precision voltage/current reference sources

**.001%
STABILITY**

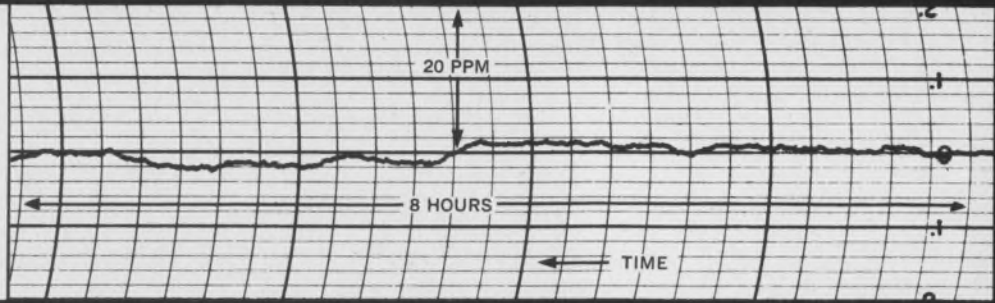

**.0001%
LINE & LOAD REGULATION**

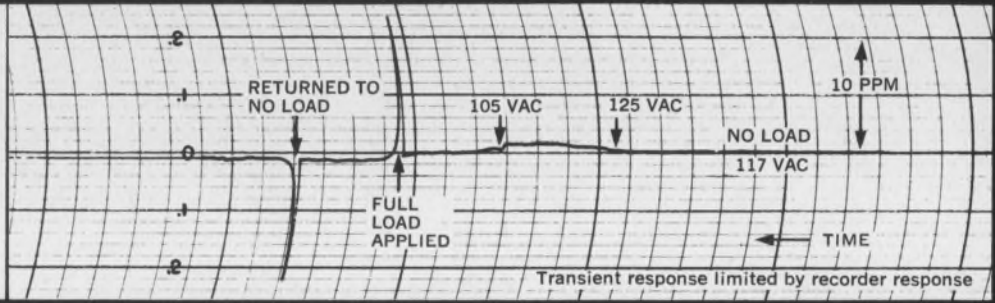

Model TC-260R

INDEX OF PAR REFERENCE SOURCES

MODEL NO.	OUTPUTS		ACCURACY		RESOLUTION		100 HOUR STABILITY		PRICE
	CONST. V.	CONST. I.	CONST. V.	CONST. I.	CONST. V.	CONST. I.	CONST. V.	CONST. I.	
TC-260R	0 to 60 V @ 2 A max.	0 to 2 A @ 60 V max. (Requires Ext. Resistors)	0.01%	0.01% ± Accuracy of Ext. Resistors	20 μV	Determined by Ext. Resistors	.001%	.001% ± stability of external resistors	\$1,250.
TC-100.2R	0 to 100 V @ 200 mA max.	0 to 100 mA* @ 100 V max.	0.01% of F. S.	0.02% of F. S.	1 mV	1 μA	.001%	.002%	\$1,500.
TC-602CR	0 to 6 V 0 to 60 V @ 2 A max.	0 to 60 mA 0 to 500 mA 0 to 2 A @ 60 V max.	0.01%	0.01%	1 μV min.	10 nA min.	.001%	.002%	\$1,750.
TC-100.2AR	0 to 100 V 0 to 10 V 0 to 1 V @ 200 mA max.	0 to 100 mA* 0 to 10 mA 0 to 1 mA @ 100 V max.	0.005%	0.01%	10 μV min.	10 nA min.	.001%	.002%	\$1,800.
TC-100.2BR	0 to 100 V 0 to 10 V 0 to 1 V @ 200 mA max.	0 to 100 mA* 0 to 10 mA 0 to 1 mA @ 100 V max.	0.005%	0.005%	100 nV min.	100 pA min.	.001%	.001%	\$2,200.
SF-Series (Fixed)	Any fixed voltage to 100 V @ 2 amps max.	Any fixed current to 2 amps @ 100 V max.	Within setting resolution		Up to 1 ppm of adjustable range about nominal		.001%	.001%	By quotation only

*Available to 200 mA (at extra charge).

Princeton Applied Research Corporation offers a sophisticated line of power supplies providing extremely stable voltage and current outputs whose accuracy is traceable to N.B.S. All models are completely solid state and feature a careful, conservative design leading to highly reliable operation. Indicative of the features found in these units is a unique chopper-stabilized amplifier with a DC open-loop gain of 5×10^6 , falling off no faster than 6 db/octave to unity gain. This insures extremely low output impedance (less than 10 micro-ohms at DC) and fast transient response without ringing.

PAR Reference Sources permit considerable operational flexibility, having been used in such diverse applications as serving as the reference voltage in analog computers to providing the constant current required in "bucking" coils in elaborate magnetometer systems. All units feature digital output selectors, complete short circuit protection, and low ripple and noise. Write for Bulletin No. 134.

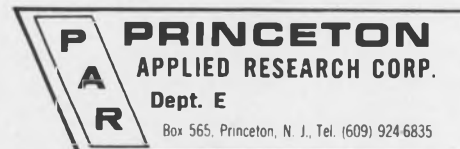

Upside-down Mars craft heading for Venus

Mariner V, formerly a backup for a 1965 mission, has been modified for its present trip near the sun

Neil Sclater
East Coast Editor

Mariner V, launched by the U.S. on June 14 and now hurtling toward Venus, is a "retread."

It was built originally as the backup spacecraft for Mariner IV, the Mars probe launched in November, 1964, that is still sending back signals from deep space. Designers merely changed the attitude of the backup vehicle. What was "top" for the Mars probe became "bottom" for the Venus craft. The modified spacecraft, which bids fair to become this nation's third successful planetary probe, is already transmitting valuable data as it coasts toward its expected Oct. 19 rendezvous with Venus.

Because it is traveling toward the sun rather than away from it, Mariner V is encountering different temperatures and environmental conditions from what it would have, had it made the trip to Mars in 1965. But it has inherited a wealth of experience from both the 1965 mission and from a Venus probe launched by the U.S. in 1962.

The solar panels, for example, have been reduced in area and reversed to minimize heating effects. A thermal shield has been placed on the sun side of the craft's octagonal, tub-shaped frame, and additional temperature-control devices have been installed.

The spacecraft is scheduled to sweep within 2500 miles of Venus to uncover further clues to the origin and composition of the cloud-shrouded planet.

Seven experiments planned

Mariner V is carrying equipment to perform several scientific experiments. The experiments and their objectives are:

- Ultraviolet photometry—to measure atomic hydrogen and oxygen in the Venusian upper atmosphere, from which the distribution and temperature of its upper atmosphere can be calculated.

phere can be calculated.

- Radio occultation—to determine, with S-band and ultra-high and very-high frequencies, refraction in the Venusian atmosphere. Occultation here refers to the alteration of radio signals as the spacecraft passes behind the planet.

- Magnetic-field measurement—to determine, with a helium magnetometer, the direction and strength of the magnetic field of Venus and to provide additional data on the interplanetary magnetic field.

- Trapped radiation—to observe charged particles of various energies during the entire mission.

- Solar wind—to study, with a solar plasma probe, the density, velocities and direction of the low-energy particles of the solar wind and their relation to Venus.

- Celestial mechanics—to study

the distance between the Earth and the sun and the mass and relative positions of Venus.

New instruments added

Some equipment on Mariner V has been installed especially for the Venus mission, while other is similar to that carried on the Mars fly-by. A new automatic data system prepares the instrument findings for transmission to Earth. Other new equipment includes a two-position high-gain antenna, antennas and receivers for the dual-frequency occultation experiment and an ultraviolet photometer.

Among the instruments that are similar to those carried on the Mars mission are trapped-radiation detectors, the solar plasma probe, and the helium vapor magnetometer. The radiation detectors and the plasma probe have been relocated to permit an unobstructed view of the sun.

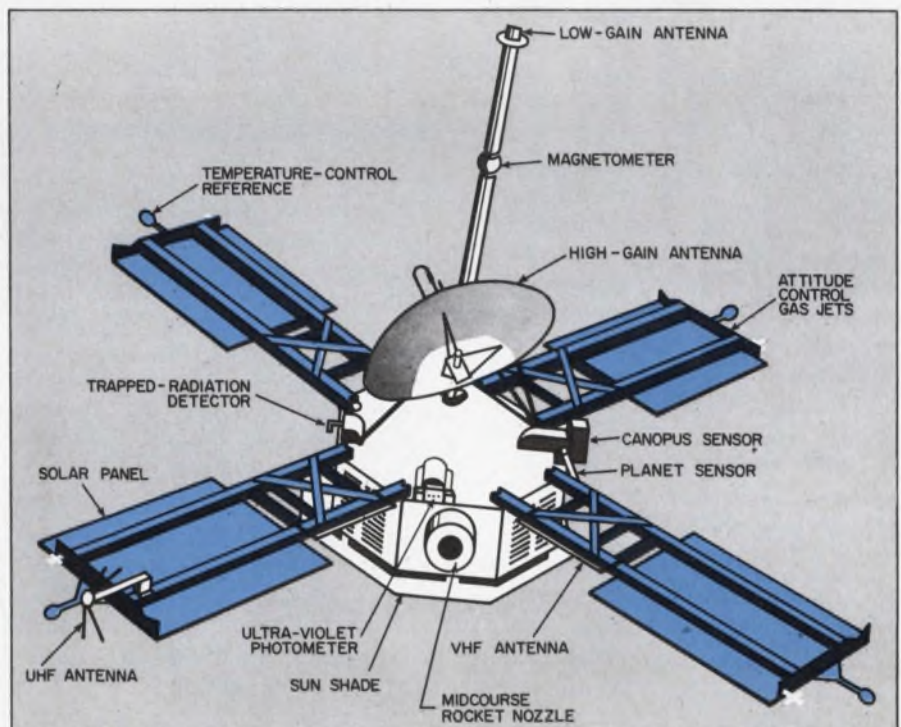

Mariner V is similar to earlier Mars probe Mariner IV. The solar panel area was halved to about 45 square feet, and reversed. The primary sun sensors and plasma probe were remounted on the bottom of the spacecraft. A new two-position, high-gain antenna and scientific experiments were added. The 550-pound craft is 9-1/2 feet high, and the solar panels extend 18 feet.

(Mariner V, continued)

All scientific instruments are now functioning and sending back useful data.

Scientists will correlate the orbital data obtained from Mariner V with that from the Mariner II Venus flight in 1962. They hope to determine more accurately the mass and position of Venus, the mass of the Moon, position of the Earth, and the Earth-to-sun distance. After flying past Venus, Mariner V will approach the sun closer than any previous probe.

The automatic data system controls and synchronizes the data recorded by all but the S-band occultation and celestial mechanics experiments. The latter two experiments depend only on the reception of telemetry transmission. The data from each of the other experiments are being reduced to a common, digital form and rate and are being fed to telemetry channels at intervals.

A 100-channel telemetry subsystem can sample 90 engineering and science measurements. While the spacecraft is en route to Venus, two-thirds of the capacity of the telemetry setup is being used for scientific purposes and one-third for engineering data. However, during Venus encounter the latter third will be used primarily to gather additional scientific data. Stored scientific data will be played back from a tape recorder after fly-by.

The 20-pound data automation system, built by Litton Systems, Inc., Woodland Hills, Calif., contains both real-time and non-real-time units, a buffer memory and a power converter.

The radio subsystem transponders and command subsystems were made by Motorola, Inc., Scottsdale, Ariz.

Occultation reveals refraction

The path of Mariner V's radio signals will be refracted as they pass through the Venusian atmosphere similarly to how light beams bend in water. The S-band occultation experiment will make use of this phenomenon to determine the density of the Venusian atmosphere.

As the spacecraft sweeps behind Venus, the telemetry signals will be deflected in a curved path by the

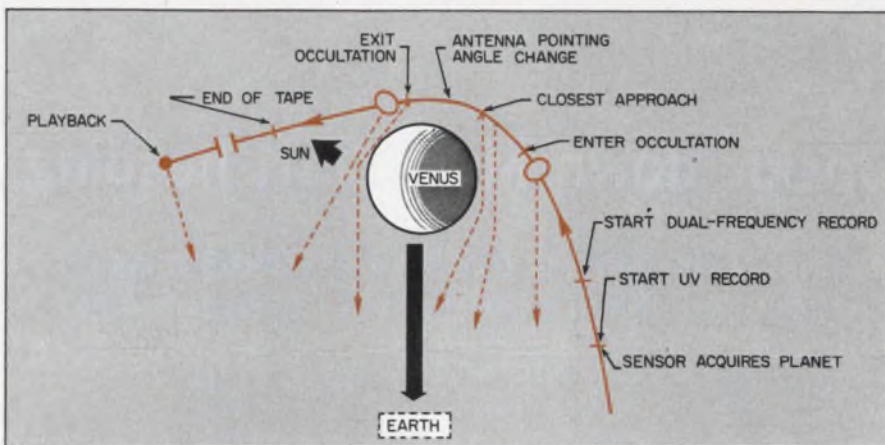

Venus encounter trajectory from a position above the earth. The spacecraft is expected to rendezvous with Venus for the fly-by on Oct. 19 after traveling 217 million miles. Bent rays around the planet represent expected refraction of S-band telemetry signals due to Venusian atmosphere.

atmosphere. The frequency and strength of the signals are expected to change. The refraction effect is determined by measuring the frequency shift of the 2298-MHz carrier. The loss in signal strength will be caused by unequal bending in the Venusian atmosphere.

The scientists believe that the atmosphere of Venus could be 200 times as dense as the Earth's. Therefore, they say, there is a possibility that the telemetry signals from the spacecraft may be trapped in a spiral path about Venus and never reach Earth during part of the occultation experiment.

Antenna opposes signal bending

To prepare for refraction of the signal by the Venusian atmosphere, the high-gain, two-position antenna will be pointed in a direction opposite to that of the expected bending. This offset of about 18 degrees will be made while the spacecraft is still behind Venus.

The dual-frequency propagation experiment is expected to furnish information on the electrons in the ionosphere of Venus. Measurements will be made of the dispersion effects in the frequency and phase of two transmitted signals.

A 423.3-MHz and a 49.8-MHz signal will be transmitted to the spacecraft from an antenna at Stanford University's Center for Radar Astronomy in California. It is expected that the high-frequency signal will be less affected by the electrons in the transmission path than the low-frequency signal.

The dual-frequency receiver on the spacecraft will compare the phase shifts of the signals, and from this information, scientists will estimate the number of electrons encountered. The data will be coded and transmitted to earth.

An ultra-high-frequency antenna for the experiment has been mounted at the outboard end of one of the solar panels, and two adjacent panel structures are being used as the vhf antenna for the experiment.

The primary power source for Mariner V is an arrangement of 17,640 photovoltaic solar cells, mounted on four panels facing the sun during most of the flight to Venus.

A rechargeable silver-zinc battery provided power during launching and a midcourse maneuver, and it will be used when the panels are turned away from the sun. It also can be used as an emergency backup power source.

The nominal power from the panels while the spacecraft is relatively near the earth is 370 watts but that this will be increased to about 550 watts during the Venus fly-by. Total power demand is about half that generated.

The Mariner V mission is being conducted by a team from NASA and the Jet Propulsion Laboratory. The laboratory, which designed and built the spacecraft, is at Pasadena, Calif., and is associated with the California Institute of Technology.

The launching with an Atlas D-Agena D vehicle from Cape Kennedy was managed by personnel from NASA's Lewis Research Center in Cleveland. ■ ■

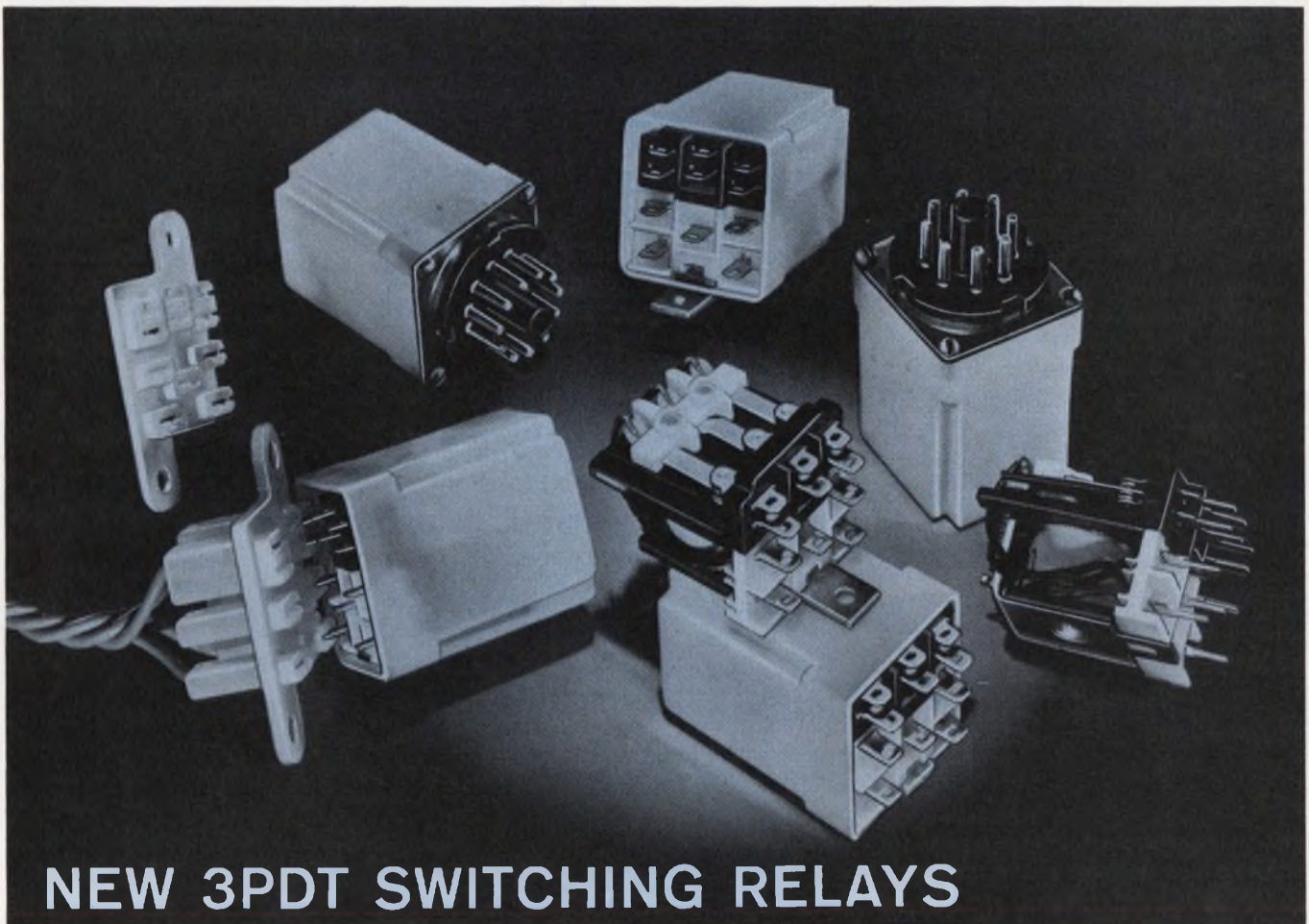

NEW 3PDT SWITCHING RELAYS are most "versatile" and "real cost savers"!

AC AND DC MINIATURE RELAY users have been presented with new cost-saving opportunities with the introduction of the RBM CONTROLS line of 3 pole double-throw switching relays.

The new **Type 93** line includes both open and enclosed types, and is characterized by their rugged construction features, conservative ratings, versatility, and, above all, by several important cost-reducing features.

FRONT WIRING—All terminals, both coil and contacts, are out the front of the terminal block surface. This "everything out the front" construction makes it easier to wire, with resulting reductions in assembly cost.

Another cost-reducing feature is the one-screw, single-hole front mounting standard, which cuts both mounting and assembly time.



← MOLDED PLUG

For 3/16" quick connect plug-in enclosed relay provides protection in handling and servicing.

WIRING FLEXIBILITY →

Both coil and contact terminals are out front for ease of wiring and low cost assembly.

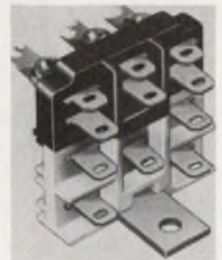

← CONTACT FLEXIBILITY

Button type (a) and crossbar (b) power contacts available on same relay for multiple switching operations.

LOW COST MOUNTING →

One screw, single hole standard front mounting reduces assembly time.

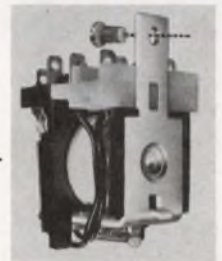

UL & CSA — Recognized under U/L Component Recognition Program and CSA with variety of contact ratings, coil voltages, and terminations.



Serving Major Markets Since 1921

RBM CONTROLS

Division Essex Wire Corporation
Logansport, Indiana

RBM
STANDARD CONTROLS
ARE AVAILABLE FROM YOUR
ELECTRONIC PARTS DISTRIBUTORS

ON READER-SERVICE CARD CIRCLE 14

Hovering helicopter's cargo weighed electronically

An electronic system that determines the weight and center of gravity of aircraft has been modified so that it can weigh cargo that is suspended from a hovering helicopter.

The basic system, developed more than a year ago by Fairchild Controls, Hicksville, N. Y., speeds weight and balance computations on commercial cargo planes. Continuous readings on two dials tell the flight crew if the plane is being properly loaded. Formerly it took 15 minutes of paperwork to make this determination.

In the system for the Army's heavy-duty CH-47 Chinook helicopter, the gross weight and center-of-gravity position are determined from air-pressure transducers installed on each of the dual-rotor helicopter's four flexible landing-gear struts. The weight of suspended cargo is determined from a load cell mounted in a connecting bolt on the lifting cable.

Helical bourdon sensing elements in each of the air-pressure transducers rotate wipers on internal potentiometers to produce voltage outputs proportional to the weights supported by each strut. The load-cell bolt produces a signal proportional to the deadweight of the ob-

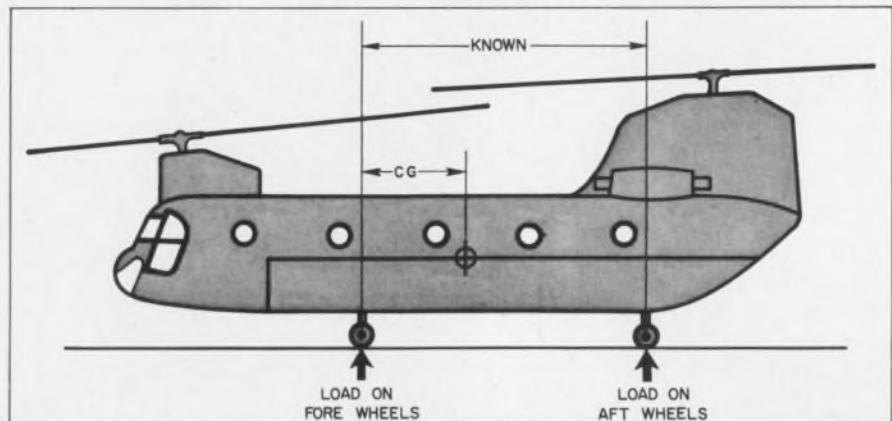

Weigh-in system permits helicopter to weight itself and determine its center of gravity. It also weighs objects on the lifting cable while craft is hovering.

ject being lifted while the helicopter hovers.

Circuitry sums the signals from the four helicopter struts and a servo-driven instrument converts the summed voltages into a counter reading. The counter is calibrated to show the loaded craft's weight to within 1 per cent of the maximum gross weight.

Another instrument in the system uses the same voltages to give a direct reading of the relative position of the center of gravity with respect to its design position. It is determined from the ratio of the load on the two nose wheels to the

total load. The instrument gives fore and aft deviations in inches.

Once the helicopter is off the ground, the pilot can switch the weight counter to give the weight of suspended cargo.

Knowledge of the gross weight of the helicopter and its distribution is necessary because if the craft is overloaded or if the load is improperly distributed, it may not get off the ground. Even if it does, it may become unmanageable in flight. And accurate weighing of cargo before it is placed in the helicopter is not always possible under combat conditions. ■ ■

Electron-beam welder developed for use in space

A portable electron-beam welder* has been developed to enable astronauts to make emergency repairs in space. Should meteoroids puncture the hull of the craft on deep-space missions, the holes could be patched during the flight.

A prototype of the new welding unit has been built by engineers at Westinghouse Research Laboratories in Pittsburgh and scientists at NASA's Marshall Space Flight Center in Huntsville, Ala.

The new Westinghouse welder uses a 500-watt-hour silver-zinc battery, that produces a 20,000-volt, 100-milliampere electron beam for more than five minutes. Separate

silver-zinc cells are used to heat the beam-generating tungsten filament.

The battery packs, the welder's high-voltage generator and its control circuitry are housed in a sealed vessel pressurized with an inert gas, sulfur hexafluoride.

The unit reportedly can make welds as neat and strong as those made with conventional welding equipment. An advanced version of the unit now being built will be used by NASA in a future in-orbit welding experiment. ■ ■

*See also "For metal rips in space, an electron welder," *ELECTRONIC DESIGN*, XIV, No. 23 (Oct. 11, 1966), 36.



Prototype electron-beam welder developed by Westinghouse is slated for space applications.

FOR THE FINEST FET FIGURES OF MERIT

UNION CARBIDE'S 2N4391

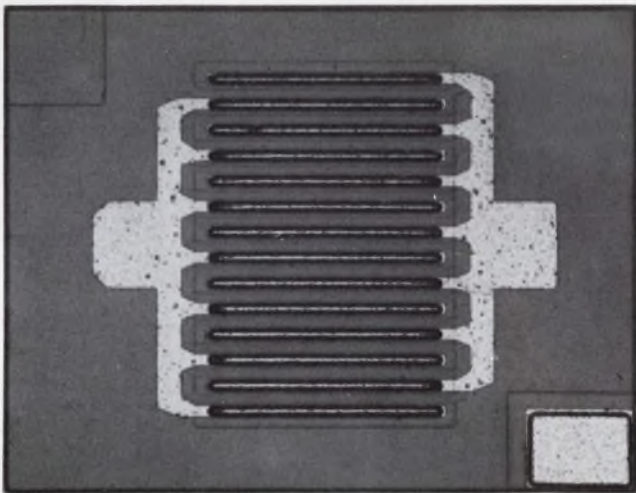

Photomicrograph of the geometry of the 2N4391 series.

Compare these two figures of merit. For amplifier performance the formula is $I_{D(off)}/D_{SS}$. For switching performance, use $r_{DS(on)} \times C_{iss}$. Sample the 2N4391 series for yourself. You'll discover the finest combination of figures of merit among any field effect transistors now available.

Use these devices as switches or amplifiers. We specify the 2N4391, 2, 3 primarily for switching applications, because of their low on-resistance and low capacitance. But, in any class lot of these devices you can select low frequency through UHF amplifier devices, with transconductance from 10 to 30,000 μ MHOS. Therefore, the Union Carbide 2N4391 is useful in the following applications—shunt switch, series switch, chopper, A/D converter, multiplier, linear ramp generator, or even a 200 MHz amplifier.



Semiconductor Department / 365 Middlefield Road, Mountain View, California 94040 / Telephone: (415) 961-3300 / TWX: 910-379-6942

ON READER-SERVICE CARD CIRCLE 15

Slim-lined, 7-transistor clock-radio, a-m/fm, built by Norelco, contains a 60-minute slumber switch and automatic frequency control on the fm band. The retail price is \$69.95.

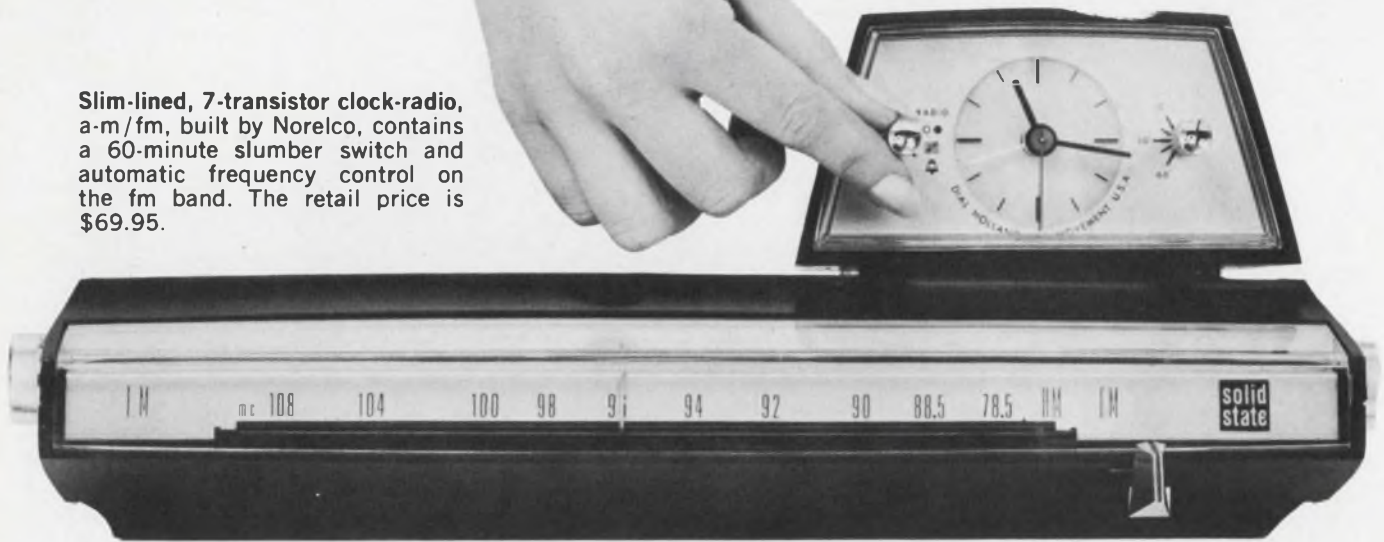

Eye-catchers on display

The largest Consumer Electronics Show ever held—11,000 products exhibited by over 100 U. S. and foreign concerns—drew 20,000 viewers in New York City last month. Wide diversity and innovation in design marked the exhibition.

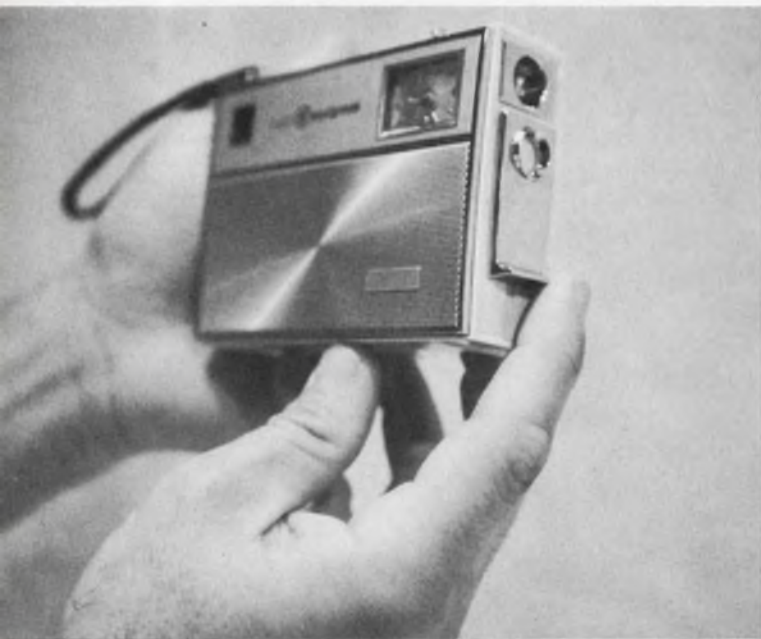

Four-in-one "personal console" contains an 8-transistor a-m radio, a Swiss watch, a flashlight and a flameless cigarette lighter. Everything operates off rechargeable nickel-cadmium batteries. It's available from General Electric for \$32.95.



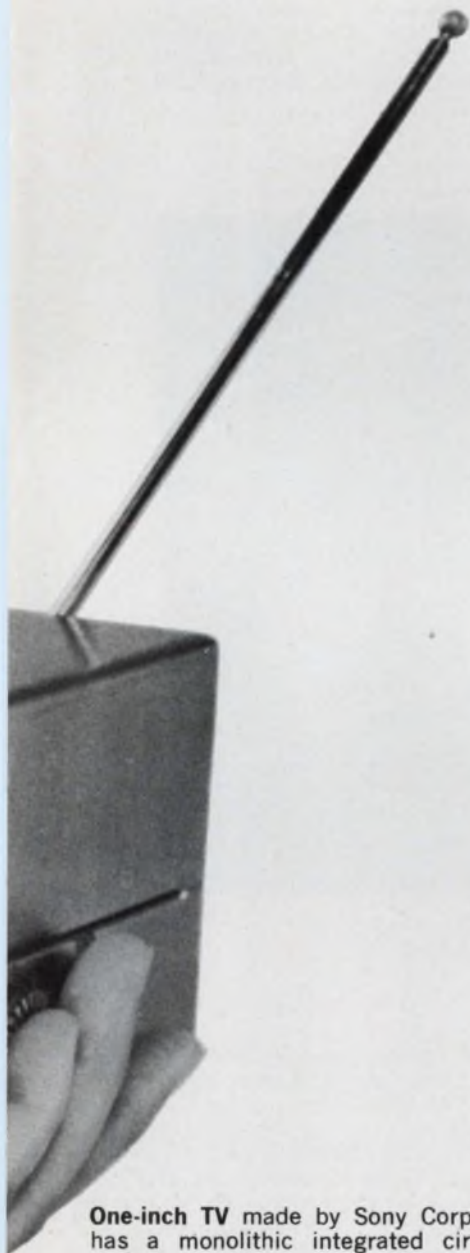

One-inch TV made by Sony Corp. has a monolithic integrated circuit. The vhf-uhf set weighs 2 pounds, is about half the size of a cigarette carton and is powered by rechargeable nickel-cadmium batteries. It works on ac current, too. When available in about 18 months, it will sell for close to \$200.

(continued on p. 24)

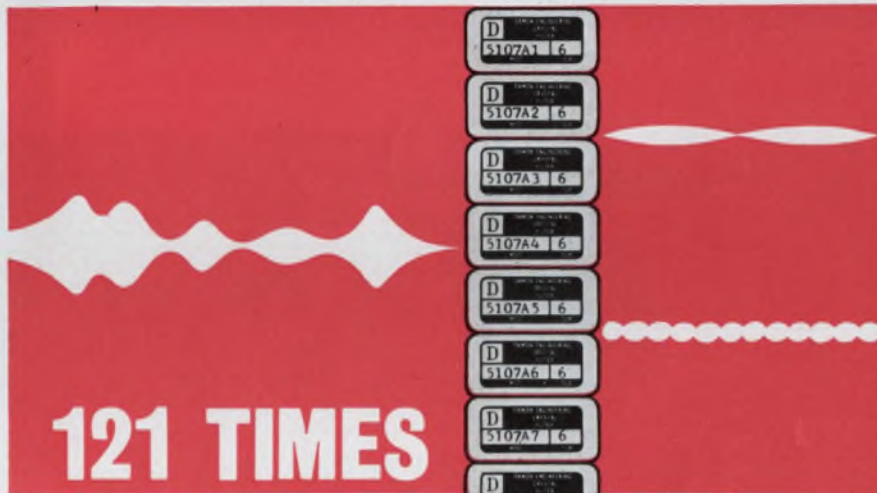
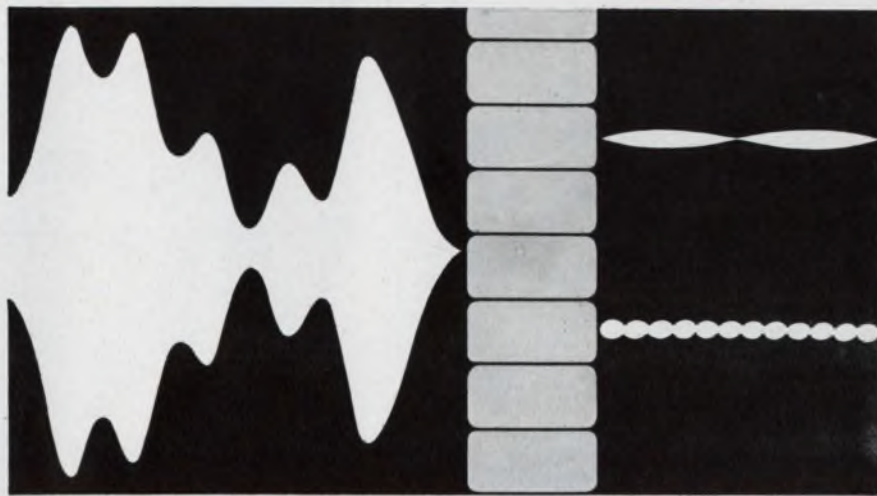

**121 TIMES
LESS DRIVE
POWER**
with Contiguous Comb
Filter Sets
by Damon

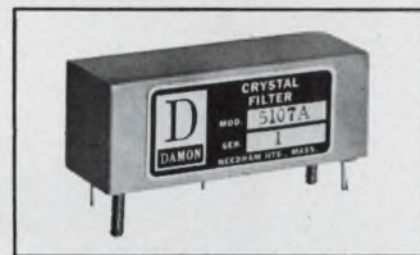

Typical Contiguous Comb Crystal Filter, Model 5107A is $1\frac{1}{16}$ " L x $\frac{3}{16}$ " W x $\frac{7}{8}$ " H.

Damon has produced a bank of 200 contiguous comb crystal filters that requires a total of 6.6 watts of drive power to obtain 10 milliwatts from each of the Gaussian (non-overshoot) response filters. This is only 1/121 of the 800 watts of drive power normally required to achieve the same output using conventional resistive padding techniques.

This significant achievement is the result of two advances in crystal filter technology: high efficiency contiguous comb crystal filters combined with new synthesis techniques. These advances permit the adherence to both frequency and time response specifications and offer a

new concept in the design of radar and other spectrum-based systems. Contiguous comb crystal filter banks are also the most reliable, efficient, compact and economical precision systems available for multichannel signal processing of all kinds.

Write for data on Gaussian Response Contiguous Comb Crystal Filters to Damon Engineering, Inc., Needham Heights, Mass. 02194, Tel. (617) 449-0800.

DAMON

ON READER-SERVICE CARD CIRCLE 16

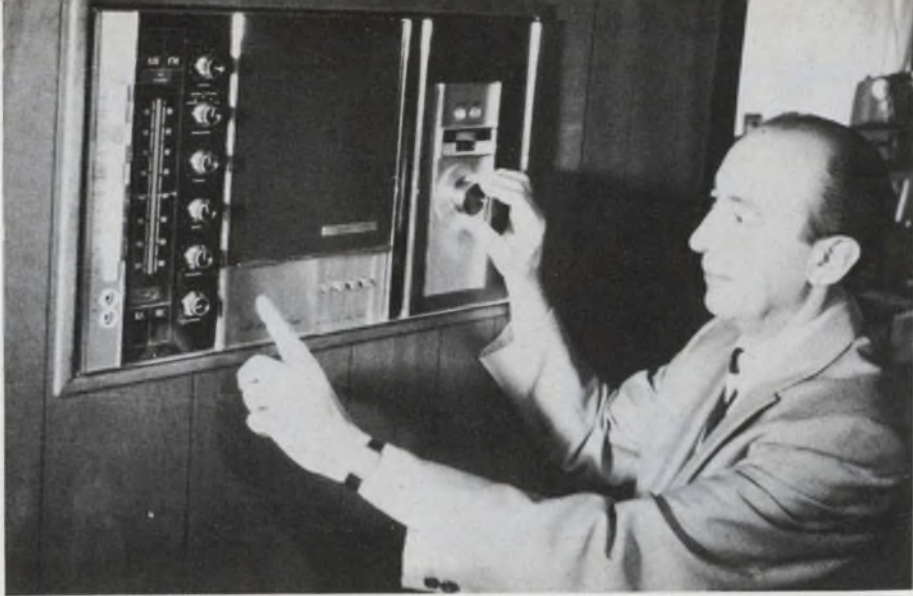

"Wall of Music" contains an a-m/fm receiver, a 162-track stereo tape recorder and a pair of speakers. With 22 minutes' operating time per track—on four-inch-wide tape—the listener can be treated to 30 hours of his favorite entertainment. It's sold by International Importers, Inc. of Chicago and costs about \$750.

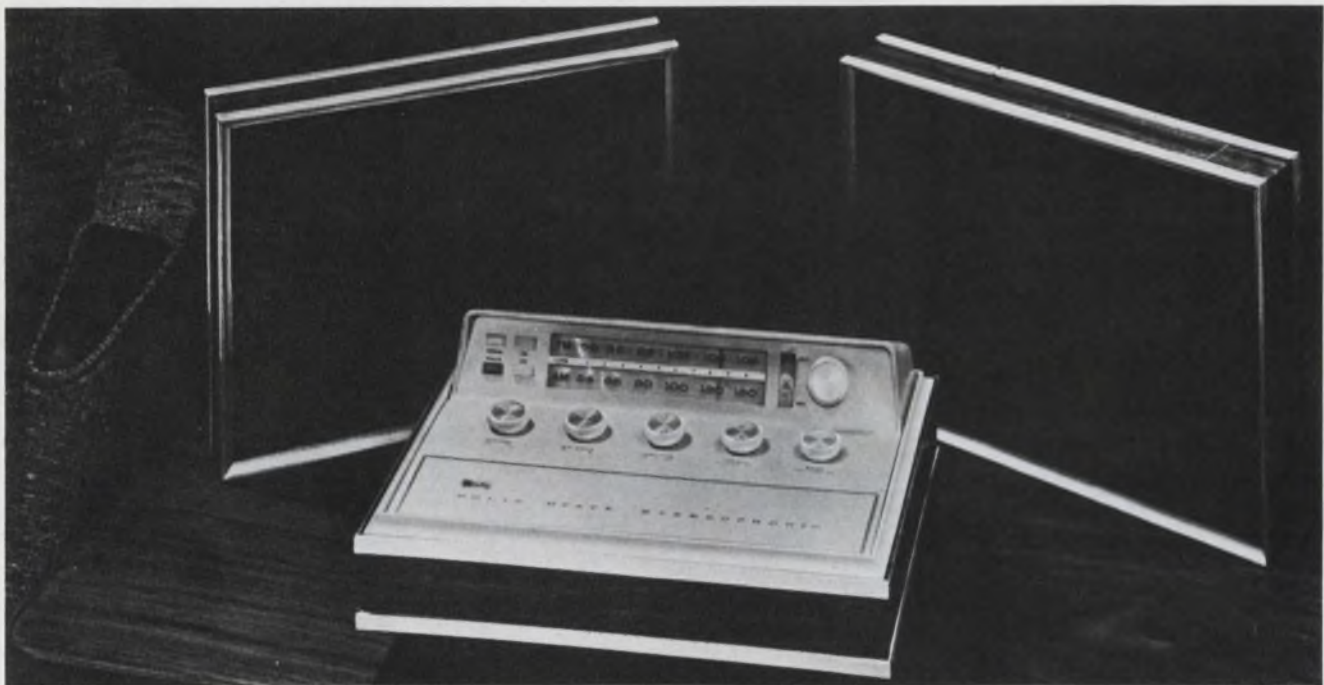

Table-top a-m/fm stereo radio contains 19 transistors and an integrated circuit. Available from Arvin industries, the unit with detachable speakers sells for \$149.95.



Musical chairs, anyone? For the stereo enthusiast who has everything: a \$1000 stereo lounge. The speakers are built into the sides of the chair and dialing knobs are overhead. Harmon-Kardon, Inc., of Plainview, N. Y., manufacturer, says it permits the listener to become "partially isolated from his conventional room environment."

ON READER-SERVICE CARD CIRCLE 17 ➤

Helipot's new Model 77 trimmer comes clean without fail.

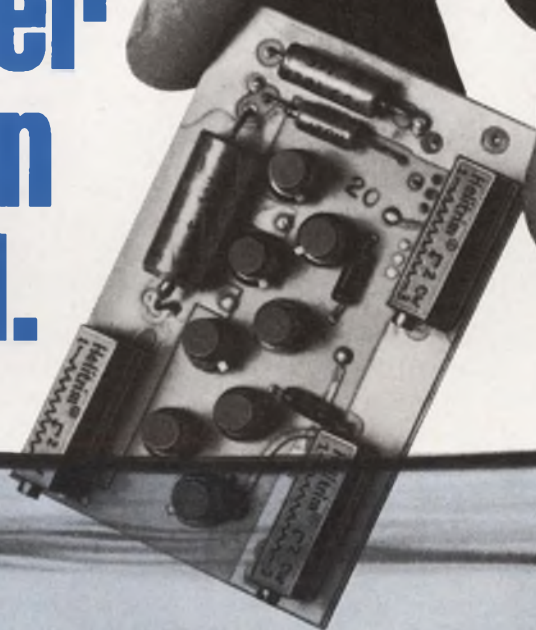



First \$1.10 cermet trimmer that's sealed for board washing!

The new Model 77 is an inexpensive wash-and-wear trimmer that's sealed for solvent washing on the board without failure. The cermet element gives wider performance parameters than any other adjustment potentiometer now on the market. Its pin spacing also makes it directly interchangeable with competitive models 3067 and 3068.

In the low price field, only Model 77 offers essentially infinite resolution, wide resistance range (10 ohm to 2 megohm), and other spec advantages shown at right. Quantity prices are as low as \$1.10.

Call your Helipot rep now for a free evaluation sample. Compare Model 77 with unsealed trimmers . . . you'll see there's really no comparison.

	 Helipot Model 77	 Competitive Model 3067 Wirewound	 Competitive Model 3068 Carbon
Resistance Range, ohms	10-2 meg	50-20 K	20 K-1 meg
Resistance Tolerance	10%	10%	20%
Resolution	Essentially infinite	1.7 (100 Ω) to 0.3 (20 K)	Essentially infinite
Sealing	Yes	No	No
Power Rating, watts	0.75	0.5	0.2
Maximum Operating Temp. °C	105	85	85

Beckman

INSTRUMENTS, INC.

HELIPOT DIVISION

FULLERTON, CALIFORNIA • 92634

Holography uses are deemed 'illusory'

Scientist characterizes the state of the art as a 'small world of dinky toys and book-ends'

Richard N. Einhorn
News Editor

A Bell Telephone Laboratories scientist who has contributed to research on holography ridicules some of the applications proposed for this intriguing science by prophets and pundits.

Dr. Robert J. Collier, speaking* at the IEEE Laser Engineering and Applications Conference at Washington, D. C., recently said:

"A number of prospects held out for holography are indeed illusory. Some ignore more promising competing techniques, others ignore or minimize the disadvantages of using coherent light and the disadvantages of applying a basically interferometric process. On the other hand, without the intense coherent light source, the laser, the prospects of optical holography would be nearly nil."

He singled out for criticism a front-page article in *The New York Times* of March 19, 1967. It envisioned a picture window on an apartment wall, in which the inhabitant could view a three-dimensional garden in "brilliant color . . . abloom with spring flowers." The viewer could peer behind objects in the picture by shifting his position in the room, the article suggested.

"Which prospect is more illusory, that of the field of flowers or the field of holography?" Dr. Collier remarked.

The scientist explained why holography does not lend itself to casual pictorial display:

■ Photographs of holograms are superior in quality to direct viewing of the hologram image because the hologram records the speckled pattern displayed by the subject under laser illumination. The viewer cannot eliminate this speckling merely by increasing the aperture of the eye, as he can do with the diaphragm of a camera.

■ With continuous-wave lasers, the subject must remain stationary,

or the closely spaced patterns that give the hologram its diffracting and imaging properties will smear, and no hologram will form. As Collier puts it, "The world of holography has up to now been a small, small world of dinky toys and book-ends."

He suggested that faster media and improved pulsed lasers might enable holograms of humans to be made provided that their eyes could be protected against the searing laser beams. However, he cautioned that there are decided limitations on what could be done.

For one thing, the scene must be illuminated only with laser light, he said. Otherwise, the incoherent light would fog the plate, and the information would be drowned in the blackness. This would rule out holograms of outdoor scenes or of normally illuminated indoor scenes. Nor is filtering an alternative at the present level of technology.

Collier also said that the size of the scene is limited by the power and the coherence length of the laser. Since the pulse lasts briefly, the power must obviously be very high to ensure sufficient illumination.

He explained coherence length as follows: If two points in the laser beam oscillate with a phase difference that is constant with time, then the laser is coherent for the distance between the points. If, however, the phase difference between the two points is not preserved, then the beam is not coherent along that length, and the observer will have to look for two points that are closer together.

In essence, this means that if the dimensions of the subject are greater than the coherence length, the subject cannot be recorded in its entirety on the hologram, because it is necessary for the light reflecting from the subject to interfere coherently with the reference beam.

In the recording of holograms, the plate should be exposed long

enough for the light to penetrate to the density that gives optimum diffraction efficiency. Present emulsions have a diffraction efficiency that is not much above 1%. But if the subject moves more than one-eighth of an optical wavelength, the hologram will be marred.

Collier also discussed the practical difficulties that hinder three-dimensional holographic television. One of the problems is bandwidth.

In order to give the illusion of three dimensions, a great many two-dimensional pictures must be transmitted. The electron beam of a vidicon or image orthicon tube would have to scan a vast number of bits of information, consisting of closely spaced oscillations, at extremely high frequencies. The bandwidth would have to be great enough to accommodate it. It has been estimated that a carrier frequency of roughly 10 GHz would be necessary for the transmission of a single hologram.

Conveniently, much of the holographic information is redundant and can be blanked out. If this is done intelligently, the bandwidth can be reduced without destroying the illusion of three dimensions. Moreover, scenes viewed from a distance, such as a horse race, do not require three dimensions.

One suggestion is to make a hologram, then selectively cut out a small portion of it, scan the recorded interference patterns with a photoscanner, transmit the information, receive it, illuminate it with a laser, project the image onto some sort of viewing screen, and do all this at a rate of about 60 frames per second, so that the eye will be deceived into thinking it is seeing a motion picture.

Collier says this seems to be theoretically possible, but that experiments to demonstrate the feasibility of this and other schemes have not been carried out. Until then, interferometry will remain the most obviously suitable application for holography. ■ ■

*"The Illusory World of Holography," delivered June 6, 1967.

you get a choice,



not a challenge

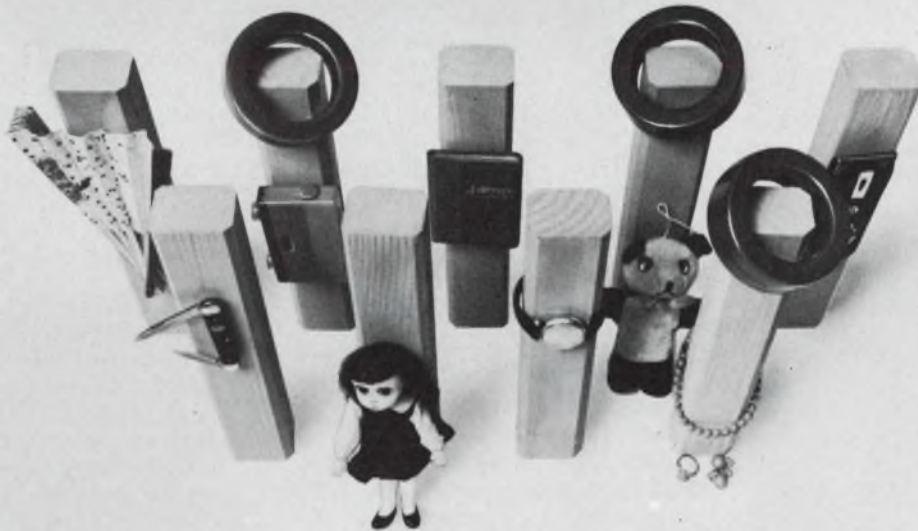

Industry's widest selection of powder cores gives you greater design flexibility

The trend toward smaller circuits and higher density packaging has posed a compaction problem for electrical design engineers—finding quality components small enough to do the job. Magnetics gives the designer more "elbow room" by providing the industry's most complete line of moly-permalloy powder cores—sizes as small

as 0.110" I.D. in the widest range of permeabilities and stabilizations.

We also give the designer involved with highly critical inductor stability factors more latitude with guaranteed temperature stabilization in miniature powder cores. All of these types are designed so they can be wound on present miniature toroidal winding equipment. The "M" type limits the change in inductance to $\pm 0.25\%$ from -65 to $+125^\circ\text{C}$. The "D" type limits the

change to $\pm 0.1\%$ from 0 to 55°C . The "W" type limits the change to $\pm 0.25\%$ from -55 to $+85^\circ\text{C}$. These stabilizations are available in all sizes and permeabilities.

If condensing a circuit design is your bugaboo, check Magnetics' powder core line—the one that gives you a choice, not a challenge. For the complete story, write Magnetics Inc., Butler, Pa. 16001





SEMICONDUCTORS

NEW IDEAS IN APPLICATION AND DESIGN

TRANSIENT-PROTECTED 1-AMP RECTIFIERS, HERMETICALLY SEALED IN SOLID GLASS, IN VOLUME PRODUCTION NOW

You can use them to replace many kinds of older style rectifier diodes. General Electric's A14 rectifier diodes are encapsulated in solid glass and available in voltage ratings from 50 volts to 800 volts PRV.

Four popular types are the 1N5059-1N5062 rated from 200 volts through 800 volts PRV. These devices are tran-

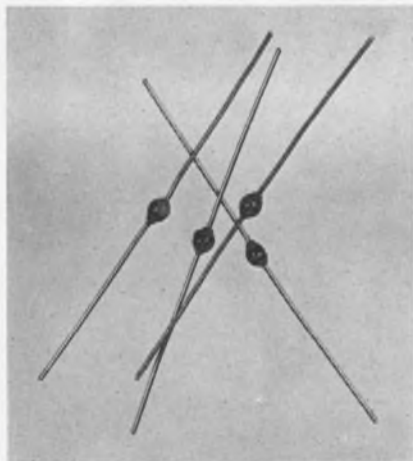

Actual size GE A14 rectifier diodes

sient voltage protected to dissipate up to 100 watts for 20 microseconds in the reverse direction.

A14's feature an all-diffused, glass passivated junction structure, high surge current capability, and low thermal impedance through dual heatsink design. The circuit protection offered by the A14, plus its stable performance, makes its use essential for both industrial and consumer applications where transient voltages may destroy conventional rectifier diodes.

For more information on General Electric A14's, just Circle Number 96 on the magazine inquiry card.

PAIR 'EM UP...

110-Amp, 1000-Volt SCR Rated to 10,000 Hz

Ask for the General Electric C158. It features high di/dt (200 amps/ μ sec.), high dv/dt (200 volts/ μ sec. minimum), and very low switching losses. Available in both flexible lead (C158) and flag terminal (C159) packages, these GE SCR's are rated 1,000 volts, 10 kHz sine wave and 5 kHz square wave. Applications include use in choppers, inverters, regulated power supplies, induction heating, radio transmitters, cycloconverters, DC-to-DC converters, and high frequency lighting. Circle Number 97.

250-Amp, 1000-Volt Rectifier Diode with 1.5 μ sec. Recovery Time

For use in the same circuits with your C158/C159 SCR's, specify General Electric A96/A97 rectifier diodes. A96/A97's are rated up to 6.25 kHz and housed in a flexible lead package. The new rectifier diodes feature a recovery time of just 1.5 μ sec. Both forward (A96) and reverse (A97) polarities are available. Match them up with the C158/C159 or other SCR's and power transistors and try them in your own applications. Or Circle Number 98 for specifications.

ACCURACY UP, RFI DOWN WITH GE'S NEW LOW-COST A-C POWER CONTROL MODULE

"Zero-voltage switching" is the key. GE's new S200 synchronous switch power control provides much lower RFI levels than are possible with electromechanical thermostats or phase-controlled semiconductors. And it has high accuracy with control point repeatability better than $\pm 0.5\%$ of sensor resistance. Keys to this high performance are a monolithic integrated firing circuit and a Triac power control device. Its user need only provide power, a resistive load (such as a resistance heater), a variable resistance sensor and a reference control resistor.

Potential uses include any resistive load application where a-c power control is needed. S200 power control modules are available in ratings of 10

and 15 amps RMS, at 120, 240 and 227 volts RMS, 50 to 60 Hz, for controlling resistive loads up to 4150 W. Use with General Electric's new Man-Made[®] diamond thermistor permits sensing and control of temperatures to 450 C. Housing dimensions of the S200 power control module are roughly $1\frac{1}{8}$ by $2\frac{1}{8}$ by $3\frac{1}{8}$ inches.

Circle Number 99 for full details on these new GE power control modules.

These are just a few examples of General Electric's total electronic capability. For more information on all GE semiconductor products, call your GE engineer/salesman or distributor. Or write to Section 220-59, General Electric Company, Schenectady, New York. In Canada: Canadian General Electric, 189 Dufferin St., Toronto, Ont. Export: Electronic Components Sales, IGE Export Division, 159 Madison Ave., New York, N. Y., U.S.A.

220-59

GENERAL  ELECTRIC



NASA fizzles on Washington pad

Cuts in the National Aeronautics and Space Administration's budget gave the space agency its poorest showing on Capitol Hill in its history. In excess of \$250 million, the slashes amounted to about five per cent of the \$5.1 billion the agency requested for 1968. But it was less by the size of the cuts than by the areas where they were applied that Congress let it be known that the NASA-Capitol Hill honeymoon was over. The feeling both in the House and the Senate is that the U.S. is committed to landing astronauts on the Moon, but that further space exploration can be deferred until more pressing domestic problems in education, social, medical and like programs have been settled.

The Apollo follow-up plans—"Apollo Applications Program" (AAP)—were deeply slashed. The Senate reduced the requested \$454.7 million by \$120 million; the House then voted at \$75 million cut. A Senate-House conference committee has yet to resolve the difference. The nuclear rocket program, especially NERVA, was badly hacked by the House, but the Senate limited its attack to words. House leaders of the fight to scratch NERVA admit that the \$70 million needed is small fry by NASA standards, but Congressmen William F. Ryan (D-N. Y.) and John W. Wydler (R-N. Y.) contend that the request is the thin end of the wedge to getting a \$100 billion manned flight to Mars off the ground.

Wydler and Ryan have teamed up with Donald Rumsfeld (R-Ill.) in questioning the agency's good faith and management ability in the wake of its alleged evasiveness over the Apollo fire. The House has approved a Rumsfeld measure to set up a 15-member aerospace safety panel.

Capitol Hill also dented the sustaining university program, which includes training grants for graduate students, and the launch vehicle procurement program, which took an especial beating in the House.

Of all the cutbacks, that which most directly affects the electronics industry was in the

Washington Report

S. DAVID PURSGLOVE,
WASHINGTON EDITOR

Voyager program. NASA asked for \$71.5 million for Voyager, which was due to orbit Mars in 1970 and land a capsule to search for surface data and signs of life. The Senate eliminated it entirely; the House wants to cut it by \$50 million.

NASA assailed by Congress

Not only did NASA hear charges of bad faith from Wydler, Ryan and Rumsfeld, the agency was the target of much more bitter criticism than usual in the debate on its budget requests. Congressman H. R. Gross (R-Iowa), the acknowledged fiscal conscience of the House, made a particularly scathing attack on NASA administrator James E. Webb. "As long as he heads this NASA affair," he told the House, "I, for one, am not going to vote one dollar for this business." Rep. James G. Fulton (R-Pa.), senior GOP member of the House Science and Astronautics Committee, called for various watchdog groups to keep an eye on NASA and for a Congressional investigation into the agency's use of engineering personnel.

Fulton believes NASA shifts its personnel less rapidly than it modifies its programs, with the result that scarce engineering talent is left vegetating in the slots of defunct programs while new ones beat the bushes for new staff.

FAA masks Vietnam war costs

The latest federal agency that has been found providing cover for Vietnam purchases so that the war budget looks as low as possible is the Federal Aviation Agency. The purchases are in the electronics field. The FAA, at its Aeronautical Center in Oklahoma City, is designing and building for the Army 22 "electronic communications systems," according to an agency spokesman. The total cost will be \$2.8 million. The FAA will also supply the Air Force in Vietnam with 15 mobile airport control towers costing \$1.56 million all told and 10 tower consoles totaling \$307,000.

The communications systems for the Army comprise control tower consoles, each accommodating four air traffic controllers, plus receivers, transmitters and recorders installed in mobile vans. In addition to the \$2.8 million, which will take a long time to show up on Army expense sheets, the FAA will provide the installation, checkout and spare parts.

The agency is already picking up a substantial part of what would normally be Army expenses in Vietnam. It developed the facilities at Tan Son Nhut airport in Saigon, alleged to be the world's busiest airport, and at nearby Bien Hoa, the second busiest.

Report assails human-factors data

The Pentagon's unending battle to coordinate engineering design with human-factors studies has been jolted by a Navy study that shows that human-factors engineers seldom provide the kind of material needed by design engineers, or else provide it in unintelligible form. Until now the brunt of the Pentagon's criticism had been felt by design engineers accused of ignoring human-factors data handed to them at great expense by the military establishment.

The new study was made for the Navy by Bunker-Ramo Corporation. It sought to analyze the manner in which design engineers solve design problems and apply human-factors information to design analysis. Bunker-Ramo chose 10 designers to solve design problems analytically and rough-sketch an aircraft control console. Bearing out previous studies made for the Pentagon, results showed that the engineers were concerned primarily with the equipment's electrical and mechanical functioning and had little interest in human-factors data. However, the study indicated the reason for the lack of interest: the present format of human-factors information is unacceptable to designers. The Bunker-Ramo team recommended that human-factors literature should be evaluated in terms of its applicability to design engineering and that it be recast for use by designers.

The 100-page report, AD-651 076, *A Further Study of the Use of Human Factors*

Information by Designers, is available for \$3.00 (65¢ in microfiche) from the Commerce Dept. Clearinghouse, Springfield, Va. 22151.

Paris air show worth \$17.5 million to U.S.

U.S. aircraft and electronics firms expect to sell \$17.5 million worth of equipment as a direct result of taking part in the Paris air show. The figures are the prediction of the Commerce Dept. which organized the U.S. firms' participation through the Bureau of International Commerce. Some observers view them skeptically, since the bureau has on several occasions been far more optimistic than most industry spokesmen. This time, however, the bureau has backed up its estimate with quotations from exhibitors. Lawrence Electronics, Burien, Wash., for example, reported a sell-out of everything on hand during the show's first four days. Burien's sales amounted to \$85,000.

'Think tanks' scurry again

About this time last year, Aerospace Corp. was laying off 100 members of its technical staff and System Development Corp. began to push diversification away from the Pentagon and into studies for other federal agencies. Other nonprofit and profit-making "think factories" were scurrying around for new markets as Congress cracked down on the special Air Force-Aerospace Corp. arrangement and made clear that other organizations would be affected.

A year later, all are still out hustling for new business. The new face in any corridor of the Dept. of Health, Education & Welfare, the Water Pollution Control Administration, the Office of Education or dozens of other federal agencies with available research money is that of the Washington representative of the "think tanks." For many of them, their source of funds is drying up. The House Appropriations Committee whacked \$22.8 million from the Pentagon's budget request for support of the nonprofit think factories. The Committee also chopped \$22.4 million from funds requested for other Pentagon "studies" in which the profit-making think tanks would have participated. Said veteran Defense Appropriations Subcommittee member Glenard P. Lipscomb (R-Calif.): "This is the hardest we have cracked down on how the Pentagon uses its money since I have been on the committee."

The Committee argued that the Defense Dept. was overdoing "studies" and was not riding herd closely enough on the financial aspects of research centers.



new 260[®] SERIES 5 VOM

We're at it again... making the 260[®] a better buy than ever. This latest improvement is built-in meter protection... standard on regular* 260 volt-ohm milliammeters—Series 5 and 5M.

It prevents mechanical damage to the moving element in the movement from instantaneous overloads up to 1,000,000%, or steady state overloads up to 500,000%. It also stops overheating or burnout of the armature coil, damage to hair springs, and calibration change due to high overloads. Otherwise the famous 260 remains unchanged.

If you now have a Series 1, 2, 3, or 4, 260 VOM, you can install your own meter protection. Ask your electronics distributor for a Simpson meter "safe/guard[®]." It takes only minutes to install.

260-5 with new meter protection..... **\$5800**
 260-5M (mirror scale) with meter protection..... **\$6000**

*260-5P has both meter and circuit protection except on the 1000V and 5000 V DC and AC ranges, and the 10-amp DC range. Price **\$88.00**

RANGES (20,000 o/v DC; 5000 o/v AC)

DC VOLTS: 0-0.25; 0-2.5; 0-10; 0-50; 0-250; 0-1000; 0-5000

AC VOLTS: 0-2.5; 0-10; 0-50; 0-250; 0-1000; 0-5000

DC MICROAMPERES: 0-50 (250 MV Drop)

DC MILLIAMPERES: 0-1; 0-10; 0-100; 0-500

DC AMPERES: 0-10 (250 MV Drop)

RESISTANCE RANGES: RX1 0-2000 ohms (12 ohms center) RX100 0-200K ohms (1200 ohms center) RX10K 0-20 megohms (120K ohms center)

ACCURACY: DC, ±2% F.S., AC, ±3% F.S.

Write for Bulletin 2076 showing the entire line of Simpson VOM's



SIMPSON ELECTRIC COMPANY
 5211 W. Kinzie Street, Chicago, Ill. 60644 • Phone: (312) ESTebrook 9-1121
 Representatives in Principal Cities... See Telephone Yellow Pages
 Export Dept: 400 W. Madison St., Chicago, Ill. 60606 Cable, Amergacc
 In Canada: Bach-Simpson Ltd., London, Ontario
 In India: Ruttonsha-Simpson Private Ltd., Vikhroli, Bombay

WORLD'S LARGEST MANUFACTURER OF ELECTRONIC TEST EQUIPMENT
 ON READER-SERVICE CARD CIRCLE 20

An avionics builder discovered Harowe when he needed a gearhead servo motor that never lost its cool

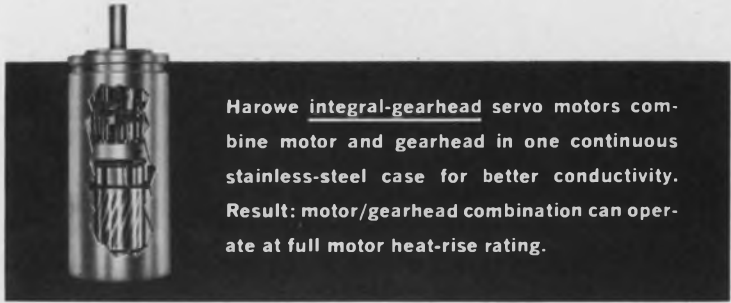

Harowe integral-gearhead servo motors combine motor and gearhead in one continuous stainless-steel case for better conductivity. Result: motor/gearhead combination can operate at full motor heat-rise rating.

Then he discovered he could get synchros with 10X normal life from the same place

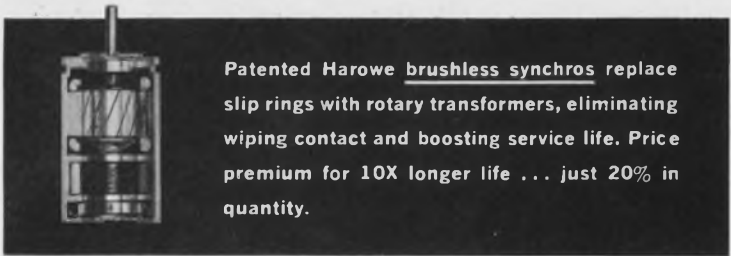

Patented Harowe brushless synchros replace slip rings with rotary transformers, eliminating wiping contact and boosting service life. Price premium for 10X longer life ... just 20% in quantity.

Discover some new solutions to your servo problems:



Harowe SERVO CONTROLS, INC.

20 Westtown Road • West Chester, Pa. 19380

RUSH technical data on . . .

	Reader Service No.
<input type="checkbox"/> Brushless Synchros & Resolvers —last up to 10X longer	141
<input type="checkbox"/> Conventional Synchros & Resolvers —all sizes; all types	142
<input type="checkbox"/> Servo Motors —with low starting voltage; high torque—including stepper and synchronous	143
<input type="checkbox"/> Motor-Generators —damping, rate, and integrating	144
<input type="checkbox"/> Integral-Gearhead Servo Motors —built together in one-piece case	145
<input type="checkbox"/> Size 5 Components —for lowest space and weight	146

Name _____ Title _____

Company _____

Address _____

Microplasmas stifled in avalanche diodes

Bell Laboratories scientists have succeeded in improving the response of silicon avalanche diodes by a factor of 70 with a new method of bias operation.

As an example, current gain in a silicon photodiode, previously limited to an avalanche multiplication factor of 50, was increased to 2500.

Improved performance is obtained by superimposing an ac voltage on the dc voltage, which is the same or slightly higher than the normal dc voltage used to bias the diodes. The ac voltage prevents premature avalanches by quenching microplasmas (local flaws in the diode where small areas of intense ionization are to be found).

The scientists report that the application of ac voltage to "uniform" diodes (those without microplasmas) has also produced a noticeable improvement in performance.

Gain is achieved in avalanche diodes by impact ionization of carriers; that is, under the influence of a high field the carriers acquire enough energy to knock valence electrons into the conduction band. This generates new carriers which by the same process create still more new carriers.

Because microplasmas now can be quenched, Bell Laboratories expects the production yield of usable silicon and germanium photodiodes to increase—especially for large-area diodes where microplasmas are more difficult to avoid.

The new technique is reported to have been applied successfully to germanium, silicon and gallium arsenide diodes. It also should allow production of photodiodes from previously unusable semiconductor materials such as indium antimonide or gallium phosphide, according to the researchers.

The new quenching technique is described in a paper by A. Goetzberger, H. Melchior, E. H. Nicollian, and W. T. Lynch, delivered at the recent IEEE Solid-State Device Research Conference in Santa Barbara, Calif. ■ ■



Don't risk it!

These wires were subjected to a transient current overload in a normal atmosphere.

The insulation smoked, then burst into flame. This won't happen with insulation of Du Pont TEFLON® fluorocarbon resins.

TEFLON will not propagate flame. It is *nonflammable* ... by all recognized vertical and horizontal flame tests.

The point is simply this: for proven reliability you need the combined benefits offered *only* by TEFLON. Nonflammability is just one. Among others: • *TEFLON TFE is rated for continuous use from -450°F. to +500°F.* • *TEFLON is inert to virtually all chemicals and corrosives.* • *TEFLON provides space and weight savings without sacrificing performance or long-term reliability.*

It comes as no surprise, then, that when reliability is considered, TEFLON answers the need. Its reliability has been proven in use for more than 20 years. We'd like to send you detailed performance data on the non-flammability of TEFLON. Write

Du Pont Company, Room 5268, Wilmington, Delaware 19898.

TEFLON®...for an extra measure of reliability!



Better Things for Better Living
...through Chemistry



SM Series:
Popular subminiature precision switch; up to 10 amps.



SE Series:
Environment-proof version of SM.



SX Series:
Smallest SPDT snap-action switch.



HM Series:
Hermetically sealed in metal and glass.



XE Series:
Environment-proof version of SX, epoxy sealed.

Switches shown approximately actual size.



Acres of design freedom in subminiature switches

You can quickly zero-in on exactly what you need when you turn to MICRO SWITCH. And, you may even pick up some new ideas to help you work out circuit or packaging problems.

Because here you have the industry's largest selection of subminiature switches—allowing you to meet any combination of requirements—size, weight, circuitry, electrical capacity, actuation, environment and reliability.

And, every one is an off-the-shelf item.

The reason: MICRO SWITCH specializes in switches—has been the industry leader for over 30 years.

You can take advantage of this design freedom by calling a Branch Office or Authorized Distributor (see Yellow Pages "Switches-Electric"). Or, write for Catalog 50.

MICRO SWITCH

FREEPORT, ILLINOIS 61032

A DIVISION OF HONEYWELL

HONEYWELL INTERNATIONAL — Sales and service offices in all principal cities of the world. Manufacturing in United States, United Kingdom, Canada, Netherlands, Germany, France, Japan.

ON READER-SERVICE CARD CIRCLE 48

New triple-data unit spurs sea research

An automatic underwater measuring system with no electrical connections can turn any ship into a potential research vessel.

The self-contained instrument package measures three essentials—temperature, salinity and depth—in oceans and rivers. The new package, three feet long and six inches in diameter, is merely lowered into the water on a rope or cable. It records the data on magnetic tape or a graph. It is hauled up in 20 minutes or so, and the magnetic tape is ready for further processing or the graphs can be read as soon as the instrument package is removed from its pressurized container.

Heretofore special facilities have been needed to make the measurements. Earlier versions of temperature-salinity-depth recording instruments have required connections to shipboard electronic equipment by means of cables. The self-contained instrument packages that were available measured only two of the three basic properties of the sea—temperature and depth.

With the new system, developed by Bisset-Berman of San Diego, the crews of merchant ships, ocean liners, warships or even low-flying helicopters can make the measurements and pass them along to scientists for evaluation.

One version of the package contains a magnetic tape unit that records digitized binary-coded decimal data in a standard half-inch, seven-track format. Once the instrument is recovered from the sea, the data can be entered directly into computers for processing. The recording rate is 50 characters a second. The records for more than 50 casts will fit on 100 feet of tape.

Another model has a cylindrical graphic plotter that uses pressure-sensitive chart paper, which eliminates pen and ink. The profile that is plotted does not need further processing for visual reading.

A lightweight model—weighing 50 pounds, including batteries—operates to a depth of 6000 feet. A deep probe, weighing 120 pounds, can make measurements down to 18,000 feet. ■ ■

It's Time to Try W-J's New Two-Stage Multi-Octave Compact YIG Filter

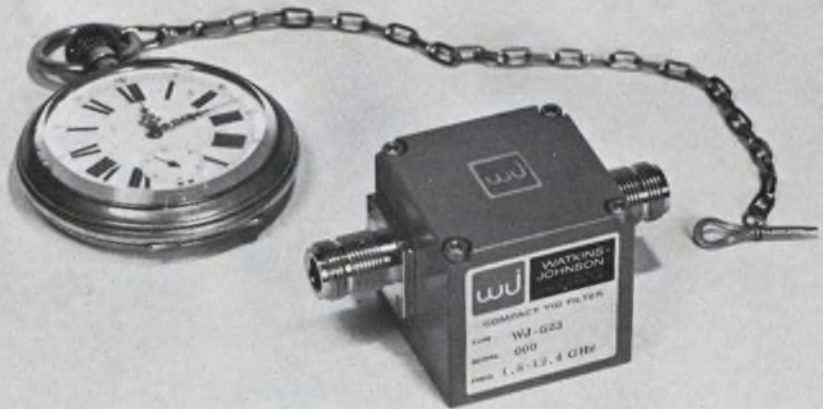

AS precise as a tick of time, the new WJ-623 performs exactly as you would expect of the best in YIG filters. This one adds a wide tuning range (2-12 GHz) to the W-J compact filter line. It boasts an unusual combination of virtues: high thermal stability, high reliability, long life, ruggedness, low tuning power requirement (less than 3 watts). A self-shielding magnet circuit built into the filter structure makes much of this possible.

The WJ-623 is as small as they come—2 inches cubed and weighing only 32 ounces. All in all, it is particularly suited for ultra-wideband receiving and frequency measuring applications. For specific requirements, the tuning sensitivity may be changed to 9 MHz/mA without increasing the tuning power. Optional bandwidths are available between 15 and 80 MHz.

WATKINS JOHNSON



3333 HILLVIEW AVENUE
STANFORD INDUSTRIAL PARK
PALO ALTO, CALIFORNIA 94304

Our first relay also the only one

That's because Bert Mitchell (his specialty is hybrids) found a crying need for a high voltage driver in a TO-5 package if only it were "fail-safe" and would cut out noise on the supply line.

Then, if it took standard DTL or TTL outputs so it could operate 28 VDC lamps or up to 300 mA relays, he felt you'd really have something.

You do. It's the NS-7673. And it

replaces the other.

It's a cermet hybrid IC. Designed so you hook one side to ground instead of to the supply voltage as you did in the past. That eliminates the problems of your relays latching up because of accidental grounding.

You get the "fail-safe" feature, while knocking out the noise problems at the supply voltage. Perfect.

*Inventive Bert Mitchell.
What's he right in
the middle of now?*



/lamp driver, is of its kind.

You can buy these drivers from our distributors. They have them in quantity. 1-24 \$34.80, 25-99 \$27.85, 100-999 \$23.20. If you don't know who they are, call your local National sales engineer or National Semiconductor Corporation, (203) 744-0060. For the specs, write us at Commerce Park, Danbury, Connecticut 06813.

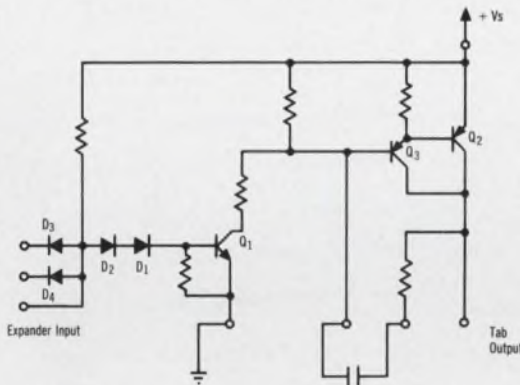

National Semiconductor



GHz current oscillations produced in bulk germanium

Another representative appears to have joined the growing list of solid-state microwave devices. Scientists at International Business Machines Corp. research division in Yorktown Heights, N Y., report discovery of a new oscillatory effect in bulk n-type germanium.

J. C. McGroddy and M. I. Nathan report finding that at high electric fields a bar of germanium (with n+

contacts on both end faces) can modulate a direct current passing through it with high-frequency oscillations in the gigahertz range.

So far the effect has been observed under pulsed conditions between 27° and 120°K. The frequency of the oscillations increases with the applied voltage. Typically, the frequency can be raised from 0.5 to 1.5 GHz by increasing the field in

the crystal from 2200 to 5000 V/cm. The lowest characteristic frequency of any sample is inversely proportional to the length of the crystal.

The scientists state that the onset of oscillations occurs only after the field has been raised to the point of electron drift saturation, that is, when the current through the crystal remains nearly constant despite increases in applied voltage. The saturation threshold depends strongly on the direction of current flow in the germanium crystal.

Although no effort was made to optimize power output, an output of 1.25 mW at 0.85 GHz for a power input of 70 watts was observed during the pulses.

The scientists feel that it is too early to assign practical applications to the phenomenon and further studies are under way to determine the mechanism that produces the current oscillations. At present, they say, it looks like a bulk-effect phenomenon but they cannot be sure. They have found no domain drifting through the germanium sample, as in Gunn-effect devices. The voltage derivative is exactly in phase at all points along the sample, a sort of standing-wave effect, they say. ■ ■

	VOLTS	GHz
a	24	—
b	54	0.59
c	74	0.65
d	98	0.70
e	122	0.77
f	150	1.35
g	175	1.40

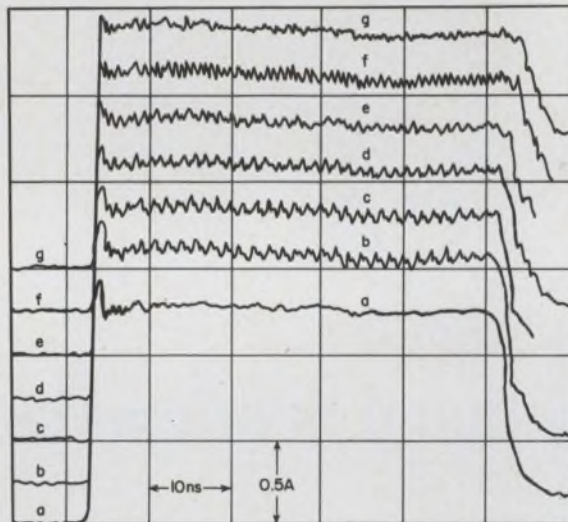

Oscillations in bulk germanium are superimposed on a number of current pulses at different levels of applied voltage. The chart shows that the frequency of oscillations increases slowly with the voltage.

Improved signal/noise ratio reported with new tape medium

A new magnetic recording tape said to provide better frequency response and higher information density than conventional tapes in computer, instrumentation and video applications has been developed by E. I. du Pont de Nemours and Co., Wilmington, Del.

The new recording medium contains chromium dioxide (du Pont uses the trademark Crolyn), a semiconductor that up to now has been technically too difficult to synthesize in the laboratory.

Du Pont recently demonstrated video, computer and instrumentation signals recorded on chromium dioxide and on iron oxide, a typical coating. Video images recorded at 3-3/4 in./s on the new tape seemed

to compare favorably with 7-1/2-in./s recordings made on iron oxide tape.

"We are able to put twice as much information on an inch of Crolyn at the same performance level," explained Robert J. Kerr, a Du Pont research engineer. This means that the tapes can be used either for recording narrower tracks or for recording at reduced head-to-tape speeds. Lower tape speeds are said to have been made possible by an improvement of at least 6 dB in signal-to-noise ratio relative to iron oxide. This advantage is also said to permit tape duplication with reduced losses.

The characteristics of the new material permit the fabrication of

computer tapes with half the normal coating thickness, yet able to provide the same peak-to-peak signal amplitude when recorded on available computer transports.

The tape is reported to exhibit less pulse crowding and less peak shift at packing densities of 800 bits per inch, and company spokesmen claim that it is feasible to extend the tape packing density beyond 800 b/in. without redesigning the tape transports.

A Du Pont spokesman said marketing plans for the new tapes were indefinite but it will cost 25 to 50 per cent more than iron oxide tape. The company does not currently plan to market audio tape containing Crolyn. ■ ■

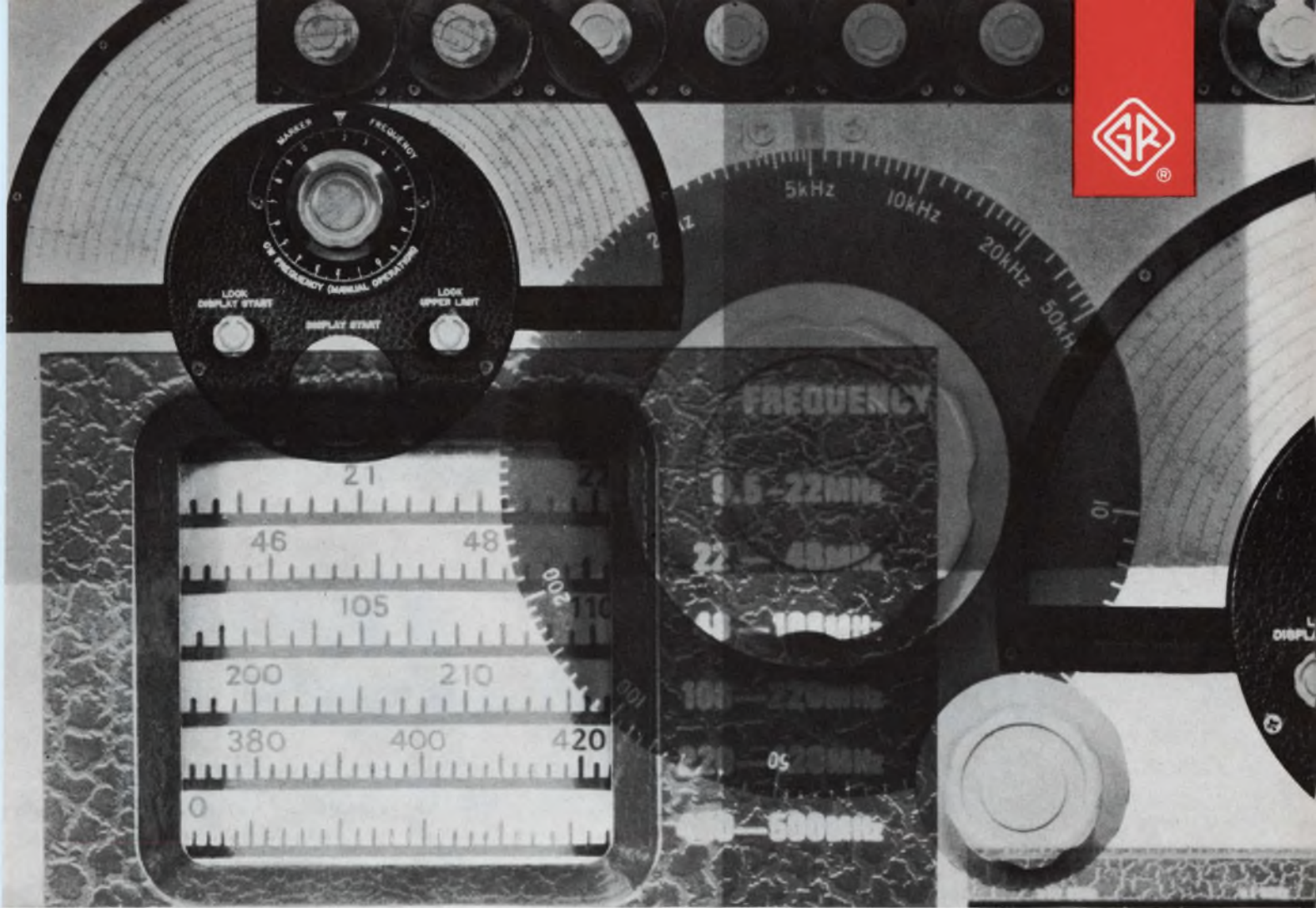

Dial GR for Sine-Wave Signals

Over 100 different models of GR oscillators, signal generators, and synthesizers are listed in our catalog. These sine-wave signal sources provide a wide choice of frequencies, power outputs, and modulation and sweeping capabilities. For instance:

Included among the oscillators are our four new "sync-able" oscillators, each a small (8 x 6 x 8 in.), self-contained unit with a sync jack for phase-locking to an external signal. These oscillators offer a wide choice of performance: fixed frequencies (to 10 kHz) or continuous tuning (to 2 MHz), up to 1-watt output, as much as 0.001% short-term frequency stability, and distortion as low as 0.05% or less.

If you need a high-resolution signal source with a wide choice of operating features, you can satisfy your need with one of the 80 versions of our frequency synthesizers. Their modular construction makes it possible to order any of the four basic models with from three to seven manual step-decade modules, programmable modules, and with or without a continuously adjustable decade module that provides additional resolution and sweep capability. Upper frequency limits of the four basic models are 100 kHz, 1 MHz,

12 MHz, and 70 MHz with maximum possible resolutions of 0.0001, 0.001, 0.01, and 0.1 Hz, respectively.

The newest addition to our ensemble of sine-wave sources is the 1026 Standard-Signal Generator. This unique instrument puts out $\frac{1}{2}$ watt into 50 Ω (10 V behind 50 Ω , 5 V when modulated), has excellent output leveling, and has true single-dial tuning over its entire 9.5- to 500-MHz frequency range. The ease of operation and outstanding performance of the 1026 in the most critical applications must be experienced to be appreciated. Request a demonstration and see for yourself.

Prices for GR sine-wave signal sources range from \$225 for a "sync-able" audio oscillator with 11 fixed frequencies to \$7515 for a full-complement, 70-MHz frequency synthesizer. For complete information, write General Radio Company, W. Concord, Massachusetts 01781; telephone (617) 369-4400; TWX (710) 347-1051. Sales Engineering Offices are located in major cities throughout the United States and Canada.



Type 1026 Standard-Signal Generator, \$6500 in U.S.A.

GENERAL RADIO

***Now problem: How to
move from Mil Type
CS to CSR Capacitors
in nothing flat.***

***Now solution: Start with
the new KEMET established
reliability spec conversion
chart. End up with our
new, low-cost, 100% temp
cycled and life tested CSRs.***

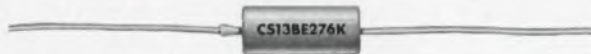

KEMET "J" SERIES
CS13 EXCEEDS MIL-C-26655B

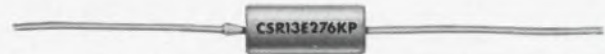

KEMET "J" SERIES
CSR13 EXCEEDS MIL-C-39003A

Except for the marking, they look the same. They're both among the most stable capacitors ever built for coupling, filter, bypass, blocking, and similar low-voltage applications.

So what's the difference?

It takes 33 pages of mil spec to define it. Plus 8 pages of detail sheet for each type. We've just boiled the significant difference-data down to 8 pages.

Our new conversion chart gives you characteristic-by-characteristic, test-by-test, part number-by-part number comparisons between MIL-C-26655B (the old spec you've been living with) and MIL-C-39003A (the new spec you need to live with now).

The basic product difference is established reliability, based on

BASIC ESTABLISHED RELIABILITY TEMPERATURE AND LIFE TESTING

GROUP A (every inspection lot)			
Subgroup 1	Failure Rate		Level
	L	M	P, R, S
1. Temp. cycle 5x; 40 hr. (min.) life 85°C, Vr (min.); Leakage, Dissipation Factor & Capacitance	N/A	100%*	100%*
2. X-ray (one plane)	N/A	N/A	100%
3. Seal	0.65 AQL	100%*	100%*
4. Leakage, Dissipation Factor & Capacitance			100% See No. 1 Above *Failure > 5% of lot means rejection.
Subgroup 2			
Visual & Mechanical Inspection	1.0 AQL, 7.6LQ All Failure Rate Levels		
GROUP B (every inspection lot except "L" Level)			
1. Temperature Stability	— 0.65 AQL, 4.8 LQ		
2. Surge Test	12 pieces — one failure allowed		
GROUP C (85° C Life Test on every inspection lot)			
1. Life Test:	110 Pieces are Tested for 250 Hours — One Failure Allowed		
2a. Extended Life	— 10 Pieces Minimum (each production lot) are Tested for 10,000 Hours. Leakage is Measured at 85° at 0, 250, 1000, 2000, 4000, 6000, 8000, & 10,000 hours.		
b.	At 10,000 hours parts are checked for leakage, Dissipation Factor, Capacitance change with temperature & sleeving resistance at 25°C.		

1000-hour failure rates under 100% temp and life testing. What it gives you is the most thoroughly debugged tantalum yet.

And we've got them, in-depth and in-stock at our distributors.

Our Type "J" tantalums are supplied in the L (2%), M (1%), and P (0.1%) failure rate levels for CSR13. They're available in 6 to 100 volts, and .0047 to 330µF.

And our new Type "Z" tantalums are supplied in the M (1%) failure-rate level for CSR09 miniatures. They're available in 6 to 75 volts, and 0.10 to 18µF.

Get the full story. Get your copy of our spec conversion chart. Get it now, before our competitors offer it. They can duplicate our charts. But not our tantalums.

For same day air mail shipment of your CS-CSR Conversion Chart, send your name, title and "CSR" on your letterhead, or call our nearest sales office.



UNION CARBIDE CORPORATION
Components Department
P. O. Box 5928
Greenville, S. C. 29606

KEMET is a registered trademark of Union Carbide Corporation

REGIONAL SALES OFFICES: New England: 300 First Avenue, Needham Heights, Mass. 02194, Tel.: 617-444-5400. Mid-Atlantic: 1341 Hamburg Turnpike, Wayne, New Jersey, Tel.: 201-696-2710. Mid-West and South: 11901 Madison Avenue, Cleveland, Ohio 44101, Tel.: 216-221-0600. West Coast: 13601 E. Whittier Blvd., Whittier, Calif. 90605, Tel.: 213-698-8077; 2680 Bayshore Frontage Rd., Mountain View, Calif. 94041, Tel.: 415-969-9390. Overseas Inquiries: Union Carbide Electronics Division, International Department, 270 Park Ave., New York 10017.

ON READER-SERVICE CARD CIRCLE 27

Need fast action on servo amplifiers?

Try Bulova first! Chances are, we can solve your problem better and faster than anyone else. Here's why:

1. We have the most complete line of Servo Amplifiers in the business—hundreds of standard designs to solve your problems! From 3.5 to 40 watts output power; 60 and 400 Hz.

2. Bulova Servo Amplifiers are engineered to reduce the number of components, producing low cost, high quality, trouble-free units. This frees you to concentrate on systems, rather than components.



3. High-density packaging—down to just 0.3 cu. in.! For example, Model S21220101: A 3.5 watt Servo Amplifier with gains of up to 5000—in the smallest package of its type on the market!

Another example:

The smallest package ever for a stable solid state servo amplifier producing 40 watts of output power! Need a unit fast to put into a breadboard or prototype? We can probably supply it, meeting most military specs (MIL-E-5272, MIL-E-5400, MIL-I-26600, etc.) You'll get assembly by personnel trained and certified by NASA, if desired. You'll get amplifiers built for 10,000 hours of operating life! And perhaps equally important, you'll get the unit you need fast!



Write today for your free copy of our 8-page Bulletin No. 10, containing complete specifications and ordering information. Also ask about our Resolver Amplifiers, Demodulators, Quadrature Reject and AGC Amplifiers. Address: Dept. ED-24.

Try Bulova First!

SERVO PRODUCTS

ELECTRONICS DIVISION
OF BULOVA WATCH COMPANY, INC.

61-20 WOODSIDE AVENUE
WOODSIDE, N.Y. 11377, (212) DE 5-6000

ON READER-SERVICE CARD CIRCLE 28

Letters

Designer rebuts claim his generator may lock up

Sir:

I feel as the bee must have felt when informed by the scientists (so the story goes) that their calculations proved that he could not fly [see "Three-phase generator may lock in subsequently," ED 12, June 7, 1967, p. 48].

The circuit shown in my Idea for Design, "Generation of 3-phase square waves simplified" [ED 8, April 12, 1967, p. 106], has been built several times with TT μ L, CM μ L and DT μ L logic elements and there has been no indication of misoperation. In fact, a divide-by-five version of this circuit is being produced as a single integrated circuit.

I suppose that our good luck with this approach is due to difficulty in obtaining elements with identical through delay so that all the outputs will transfer to their next state at the same time.

A quick examination of the circuit, reprinted below, will point up the difficulty in actually obtaining a transfer from the all-1s condition to the all-0s condition.

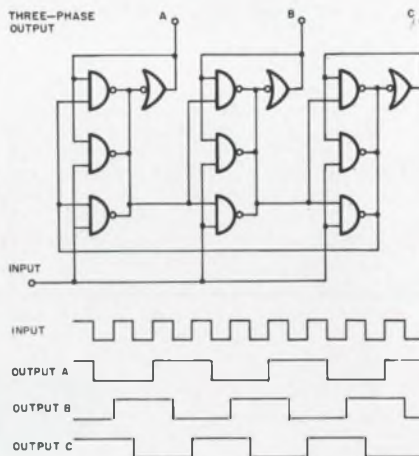

Assume to start that the clock is low and the outputs are all high. This is a stable condition that could occur on the initial application of power. Now suppose that the clock goes high. Can the output of one of the circuits go low? If it does go low, can the output of the next stage go low and could the input from the previous circuit have gone

low? Could all the circuits maintain a low long enough for a latch-up to result through two gate delays on all three stages, thus bringing about the transfer of the all-1s condition to the all-0s condition? Intuition and experience seem to indicate no. It seems far more plausible that the race between the gates will be resolved into an allowed state. A similar look at a transfer from an all-0s to an all-1s condition casts further doubt that this type of "hazardous" operation could continue unresolved on every transition of the clock.

I am very interested to know if anyone has had any difficulty obtaining the described operation reliably with this circuit.

John L. Nichols

Sr. Systems Engineer
Fairchild Semiconductor
Mountain View, Calif.

Epoxy device numbering praised for simplicity

Sir:

My hat's off to Fairchild for assigning the same number code to their line of epoxy transistors as their electrically equivalent metal-can counterparts. I commend Fairchild for—hopefully—setting a trend toward eliminating superfluous epoxy transistor type numbers. What could be simpler for telling that this plastic transistor is electrically equivalent to a 2N2369 than to call it an EN2369?

May all manufacturers follow this lead. Let's keep our confused system of transistor coding from becoming completely chaotic.

George R. Skoblin

Kearfott-San Marcos Div.
General Precision, Inc.
San Marcos, Calif.

Silver may be the key to electric cars' future

Sir:

I enjoyed reading your thoughts in the recent editorial in ED 12 ["Whom do the car makers think they are kidding?" June 7, 1967, p. 51]. I am, of course, glad to hear someone pin down some of those slippery points on silver cells.

(continued on p. 42)

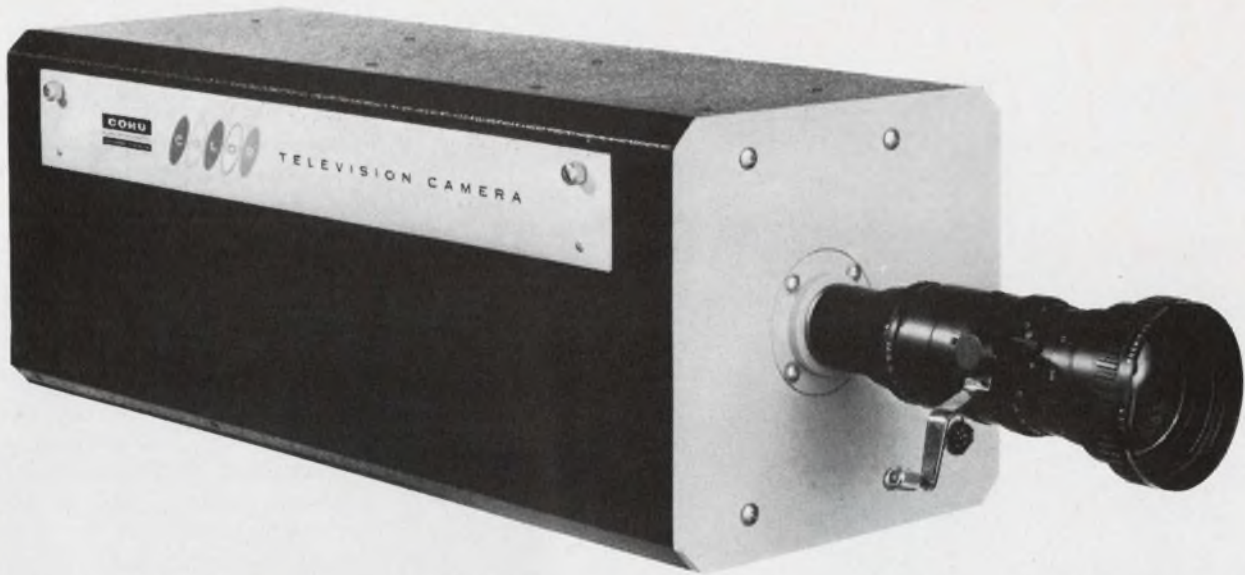

"Encoded **COLOR camera chain for \$30,000.
But don't hold your breath for delivery...right?"**

Wrong! Cohu delivers in 30 days.

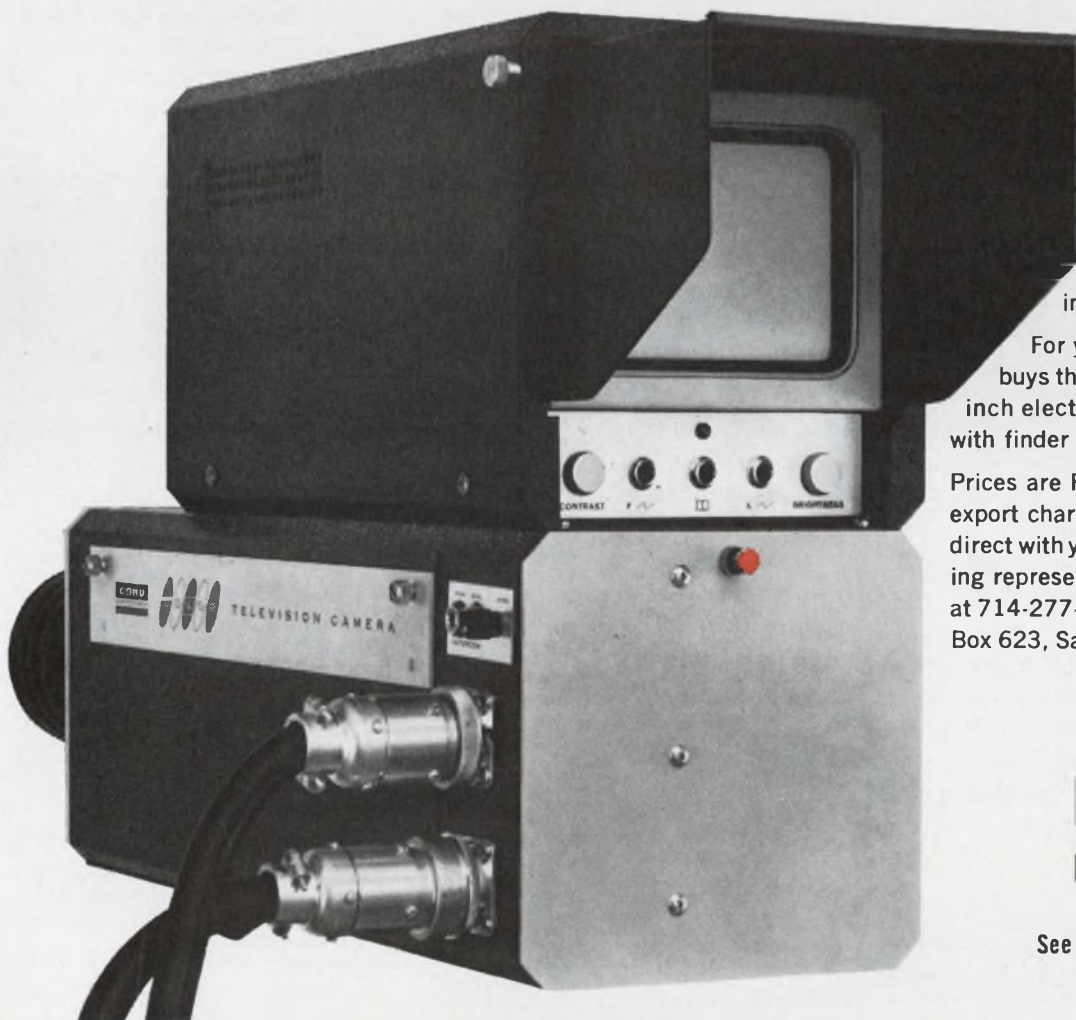

You heard us right, friend. \$30,000 buys our 1000 Series tri-vidicon camera – complete with solid-state camera control unit and NTSC video encoder. Less lens and cabling, of course. And we do deliver in thirty days.

For your mobile unit, \$31,000 buys the same chain with our 6½-inch electronic viewfinder. Camera with finder weighs a mere 58 pounds. Prices are FOB San Diego. Additional export charge. Place purchase orders direct with your nearest Cohu engineering representative. Or, call Bob Boulio at 714-277-6700. TWX 910-335-1244. Box 623, San Diego, California 92112.



See us at WESCON, Booth 3001

ON READER-SERVICE CARD CIRCLE 29

VICTOREEN HIGH VOLTAGE VACUUM TUBES SOLVE SWITCHING PROBLEMS

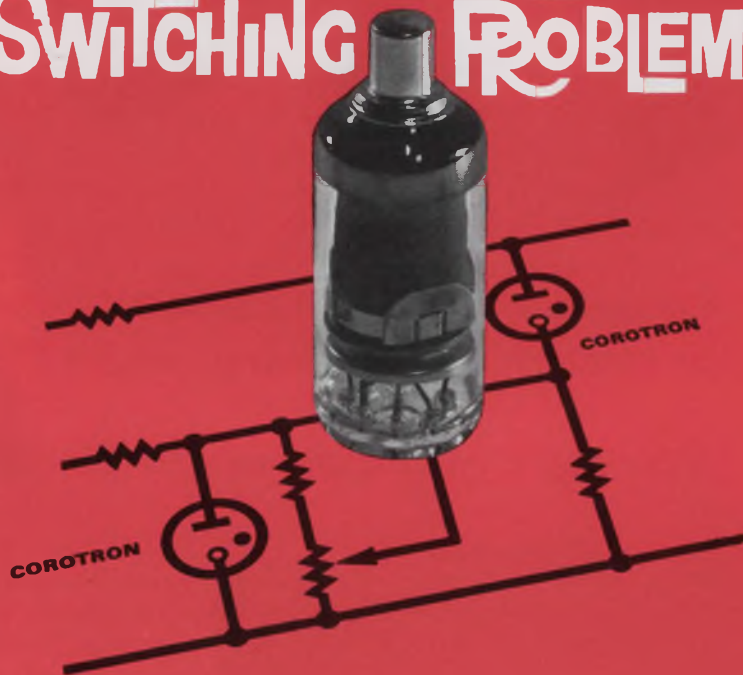

Victoreen high-voltage vacuum tubes make ideal components for switching circuits... as series or shunt regulators... as deflection amplifiers... or as inputs to pulse forming networks. Other uses which can capitalize on their superior performance, longer life, and compactness include—dunking, clamping, and crowbar circuits

Tube illustrated above, the Victoreen 6842 pentode with plate voltages to 4 kV, is shown in a typical shunt regulator circuit with two Victoreen Corotron corona type voltage regulators. Other tubes in the Victoreen line include —

- 7683** — Triode or pentode with plate voltages to 1 kV
- VX-80** — Triode with plate voltages to 4 kV
- VX-76** — Pentode with plate voltages to 5 kV
- 7235** — Triode with plate voltages to 10 kV
- 7234** — Pentode with plate voltages to 10 kV
- VX-107** — Beam pentode with plate voltages to 15 kV
- VX-68** — Vacuum high-voltage rectifier with 28,000 PIV; application as rectifier or clipper

8982-A

VICTOREEN INSTRUMENT DIVISION
10101 WOODLAND AVENUE • CLEVELAND, OHIO 44104
IN EUROPE: GROVE HOUSE, LONDON RD., ISLEWORTH, MIDDLESEX, ENGLAND



ON READER-SERVICE CARD CIRCLE 30

LETTERS

(continued from p. 40)

If it is assumed that there are roughly 2000 ounces of fine silver per car and, to have an issue of cars worth noting on the scene, say, a million cars, this would call for about two billion ounces of fine silver roaming about on the nation's highways. This would consume about 10 years' world silver production—or that of the U.S. for about 50 years, an amount equal to the U.S. treasury stock in hand and in everyone's pockets. And to cap it all, it would generate one horrendous, theft and refining business.

John Hoke

Washington, D. C.

Accuracy is our policy

In "Design transistorized regulators," ED 7, April 1, 1967, pp. 76-81, author Arthur Hogrefe has drawn attention to an error in Fig. 5, p. 80. The description of the output at the right of the figure should read: "+ 10 to 12 V output at 0.2 A; ripple less than 500 μ V (not μ A) p-p 120 mA."

In "Decapsulate components undamaged," ED 12, June 7, 1967, pp. 62-64, a printer's pie has garbled all the references to epoxy solvents in the table on p. 64, "Performance of various solvents." That portion of the table which was garbled is republished correctly below:

Solvent	Epoxy		
	1	2	3
Methylene chloride (23°C)	D	S	N
Dimethyl formamide (23°C)	N	N	N
Nitric acid (120°C)	D	D	D
Formic acid (23°C)	D	D	D
DeCap (110°C)	D	D	D
Uresolve (23°C)	N	D	N

Key:

1. Bisphenol A (polyamide-cure)
2. Bisphenol A (anhydride-cure)
3. Transfer-molded (amine-cure)

D—Disintegrated

S—Swelling or softening but no removal

N—Not effective

ON READER-SERVICE CARD CIRCLE 31 ➤



Don't let optical
limitations bother you ...

not any more.

There's really very little to worry about when you can get lenses that hold resolution to 1250 lines/mm.

The 30mm f1.2 Nikon Ultra-Micro Nikkor can do as much, and better, at 25:1 reduction. But don't sell the other five short.

The 105mm resolves 400 lines at 30:1; the 125mm, 400 lines at 25:1; the 155mm, 250 lines at 10:1; the 55mm, 500 lines at 4:1, and the 28mm, 650 lines at 10:1. Naturally, these are aerial resolution figures. Also they differ as to covering power and working distance.

The Ultra-Micro Nikkors were all developed specifically for photo-masking and are available from stock, ready to work for you.

Bet a Nikon Ultra-Micro Nikkor lens can put more geometry into less area than any optics you are now using. Why not make us prove it.

For complete details, write:

Nikon Inc. PTP Division Garden City, N.Y. 11533
Subsidiary of Ehrenreich Photo-Optical Industries, Inc.

Photo: Courtesy, RCA Electronic Components & Devices, Somerville, N.J.

CEA

This new IRC metal film resistor handles **4 power ratings**



Think of the convenience and savings

Now, an all-purpose precision metal film resistor that offers design flexibility and opportunities for substantial cost savings. Type CEA can be used at four different ratings with ΔR 's that are all well within MIL limits.

$\frac{1}{2}W @ 70^{\circ}C$	$1\% \Delta R$	$\frac{1}{4}W @ 70^{\circ}C$	$.5\% \Delta R$
$\frac{1}{4}W @ 125^{\circ}C$	$1\% \Delta R$	$\frac{1}{8}W @ 125^{\circ}C$	$.5\% \Delta R$

Flexibility is built-in. Even up to 300% overload, the CEA can be specified where low ΔR 's are required, or for a variety of ambient temperatures. Economy is built-in, too. You can combine your metal film needs to save money and simplify stocking.

All-purpose CEA resistors also have a moisture-resistant coating and a rugged cap and lead assembly. Write for data, samples and prices. IRC, Inc., 401 N. Broad Street, Philadelphia, Pa. 19108.

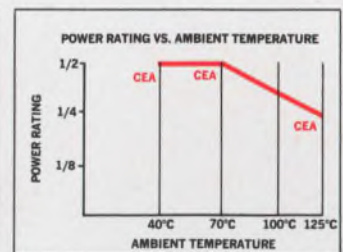
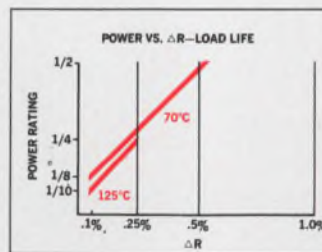

CAPSULE SPECIFICATIONS

MIL-R-10509	Meets or exceeds all performance requirements
Resistance	10 Ω to 1.5 meg.
Tolerance	$\pm 1\%$
Temp. Coef.	$\pm 100ppm/^{\circ}C$



ON READER-SERVICE CARD CIRCLE 32

Co-Publishers

James S. Mulholland, Jr.
Robert E. Ahrens Dorf

Editorial Director

Edward E. Grazda

Editor

Howard Bierman

Managing Editor

Robert C. Haavind

Technical Editors

Jeffrey N. Birstow
Peter N. Budzilovich
Maria Dekany
Roger K. Field

Careers and Management Editor

Howard S. Ravis

News Editors

Ralph Dobriner, Chief
Richard N. Einhorn

East Coast Editor

Neil Sclater

West Coast Editor

Ron Gechman

Copy Editor

Peter Beales

New Products Editors

David H. Sorgan
Daniel R. Butterly

Directory Editor

William Alvarez

Washington Editor

S. David Pursglove

Editorial Production

Dollie S. Viebig

Art Director

Clifford M. Gardiner

Art Assistant

William Kelly

Technical Illustrators

Cheh Nam Low
Sheila F. Ward
Richard Hartman

Production Manager

Thomas V. Sedita

Asst. Production Manager

Helen De Polo

Production Assistants

Bernard Wolinsky
Robert M. Henry
Murray Friedman

Circulation Manager

Nancy L. Merritt

Reader Service

Diane Mandell

EDITORIAL



A systems approach is needed to cope with copper shortages

The electronics industry's consumption of copper is growing exponentially. Despite Uncle Sam's recent release to defense-priority industries of 150,000 tons, the supply is still tight. As a result, lead times on deliveries run into months and valuable engineering time is wasted designing *around* the shortage.

What appears to be a solution is the substitution of other conductors. Aluminum manufacturers are quick to point out that their metal costs and weighs less for an equivalent ampacity. But the processing of aluminum is not always the same as that of copper, so new machinery, new capital and more time are consumed. Only the small print tells of the hodgepodge of techniques involved in joining aluminum. So, too, for sodium. Only the fine lettering reminds us of the violence of the reaction when a trace of moisture penetrates the metal's polyethylene sheath.

Instead of designing around the material, we feel that a better approach would be to design the entire material system—its supply, its priority, and even its properties. We agree with Philip Gomez, vice president of Texas Instruments' material facility, who urges a systems approach to the use of natural resources.

You can help yourself. Take a hard look at your material requirements. Must your contacts be solid copper? Can't they be selectively plated? Or use a copper button? What about your conductors? Can they be a copper-clad? Or brass? Or bronze? What about that wirewound potentiometer? Will conductive plastics do?

A system of priorities can help. Precious copper is now used in shell cases, roofing and auto radiators. It is still used in home plumbing. There are substitutes.

The metallurgists, too, could help. So far they have come up with a mere dozen copper alloys. They must triple this shortly, or you'll find your only copper source in your piping.

Foresight can help. That quarter in your pocket, which the Treasury Dept. engineered to ease a silver shortage, has contributed to a copper shortage that now alarms the Defense Dept. Look one step ahead. There is nickel in that quarter. There are also some 100 million tons of nickel in the bumpers of U.S. autos. Yet stainless-clad low-carbon steel does the job just as well. The writing is on the wall: Nickel is next.

Crying about politics in Chile won't help. Farsighted planning, engineering and evaluation of what we have will.

DAVID H. SURGAN

150 MHz, 2.4 ns

New performance from probe tip to CRT!

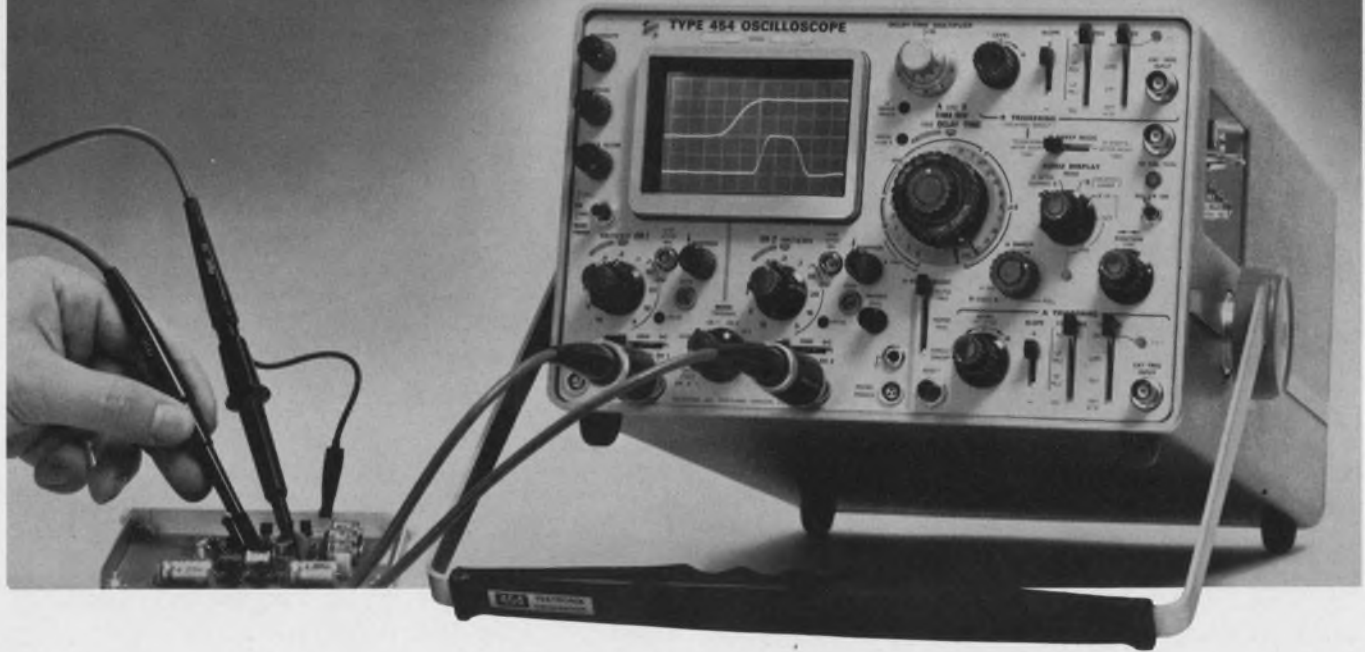

The Tektronix Type 454 is an advanced new portable oscilloscope with DC-to-150 MHz bandwidth and 2.4-ns risetime performance specified at the probe tip. The new P6047 10X Attenuator Probes and the optional FET and current probes are designed to solve your measurement problems.

The Type 454 has a dual-trace vertical, high-performance triggering, 5-ns/div delayed sweep and solid state design. You also can make 1 mV/div single-trace measurements and 5 mV/div X-Y measurements.

The dual-trace amplifiers provide the following capabilities with or without the P6047 probes:

Deflection Factor*	Risetime	Bandwidth
20 mV to 10 V/div	2.4 ns	DC to 150 MHz
10 mV/div	3.5 ns	DC to 100 MHz
5 mV/div	5.9 ns	DC to 60 MHz

*Front panel reading. With P6047 deflection factor is 10X panel reading.

The Type 454 can trigger to above 150 MHz internally, and provides 5 ns/div sweep speed in either normal or delayed sweep operation. The calibrated sweep range is from 50 ns/div to 5 s/div, extending to 5 ns/div with the X10 magnifier. Calibrated delay range is from 1 μ s to 50 seconds.

For further information, contact your nearby Tektronix field engineer, or write: Tektronix, Inc., P. O. Box 500, Beaverton, Oregon 97005.

Two P6047 Miniature 10X Attenuator Probes are included with the Type 454. They have a 10 M Ω input resistance and 10.3 pF input capacitance and provide DC-to-150 MHz bandwidth with 2.4-ns risetime performance when used with the Type 454.

The Optional P6045 FET Probe features unity gain with 10-M Ω input resistance and 4-pF input capacitance. With the Type 454 it provides a system risetime of 2.7 ns and a bandwidth of DC to 130 MHz from 20 mV/div to 10 V/div without signal attenuation. Probe power is obtained from a jack on the front panel of the Type 454.

The Optional P6020 Current Probe is easy to use with its clip-on feature and it provides up to 2.4-ns risetime and 150-MHz bandwidth when used with the Type 454.

Type 454/P6020 Characteristics (454 at 20 mV/div)

P6020	Deflection Factor	Risetime	Bandwidth
1 mA/mV	20 mA/div	3 ns	8.5 kHz to 120 MHz
10 mA/mV	200 mA/div	2.4 ns	935 Hz to 150 MHz

- Type 454 (complete with 2-P6047 and accessories) \$2550
 - Rackmount Type R454 (complete with 2-P6047 and accessories) . . . \$2635
 - Type P6045 FET Probe (010-0204-00) \$ 275
 - Type P6020 with Passive Termination (015-0066-00) \$ 135
- U.S. Sales Prices FOB Beaverton, Oregon



Research and development



... part of the Tektronix commitment
to progress in the measurement sciences

Technology

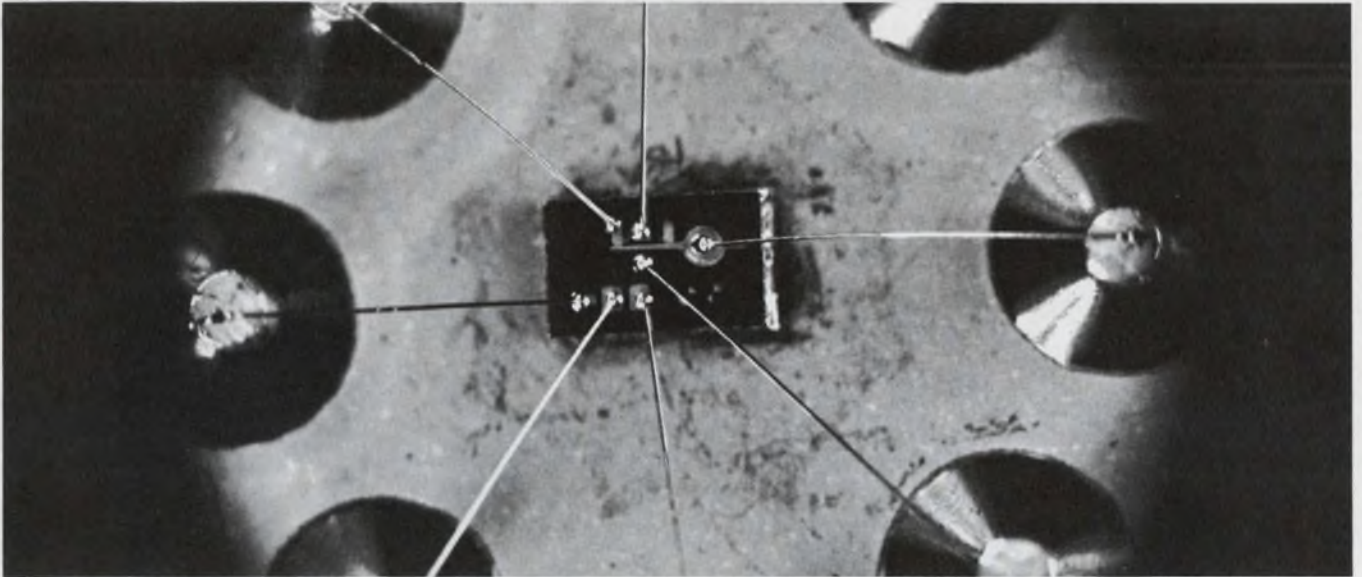

The big boom in linear microcircuits has sent many new devices like this tunable monolithic

to the market. A special report that brings the designer up to date starts on page 49



Ten transistor leakage currents are listed in makers' specifications. Learn the meaning

and implications of them and how to check them with your own test setups. Page 76

Also in this section:

Counters will not 'hang up' if the flip-flop recovery time is right. Page 86

Proper specification and application of components prevents needless failures. Page 90

Use micropower to design good high-speed switching circuits. Page 94

HP
has cut corners
to raise the
value of
your pulser dollar!

Square
wave
corners,
that is.



with a 10 MHz rep rate
and a 5 nsec rise time, too.



Here are the cleanest square waves available for your generator investment. The Hewlett-Packard 211B lets you do fast circuit work in applications normally reserved for more expensive instruments. With distortion of less than 5% and pulses as narrow as 30 nsec, the 211B makes two negative-going output pulses available simultaneously. One is from a 50-ohm source with a 5 nsec rise time and the other is from a 600-ohm source with a 70 nsec rise time. DC coupling prevents base line shift with rep rate changes and a true 50-ohm output impedance absorbs reflections from load mismatches. Synchronization on external signals is possible through an input trigger circuit.

Only \$450



The lower-priced 217A Square Wave Generator features the same rep rate and rise time as the 211B—and the same narrow pulses—but doesn't have the 600-ohm output or the external sync output.

Price: \$350

For more information, call your local HP field engineer or write Hewlett-Packard, Palo Alto, California 94304. Europe: 54 Routes des Acacias, Geneva.

HEWLETT  PACKARD

SIGNAL SOURCES

ON READER-SERVICE CARD CIRCLE 34

18702

The tiny, exploding world of linear microcircuits

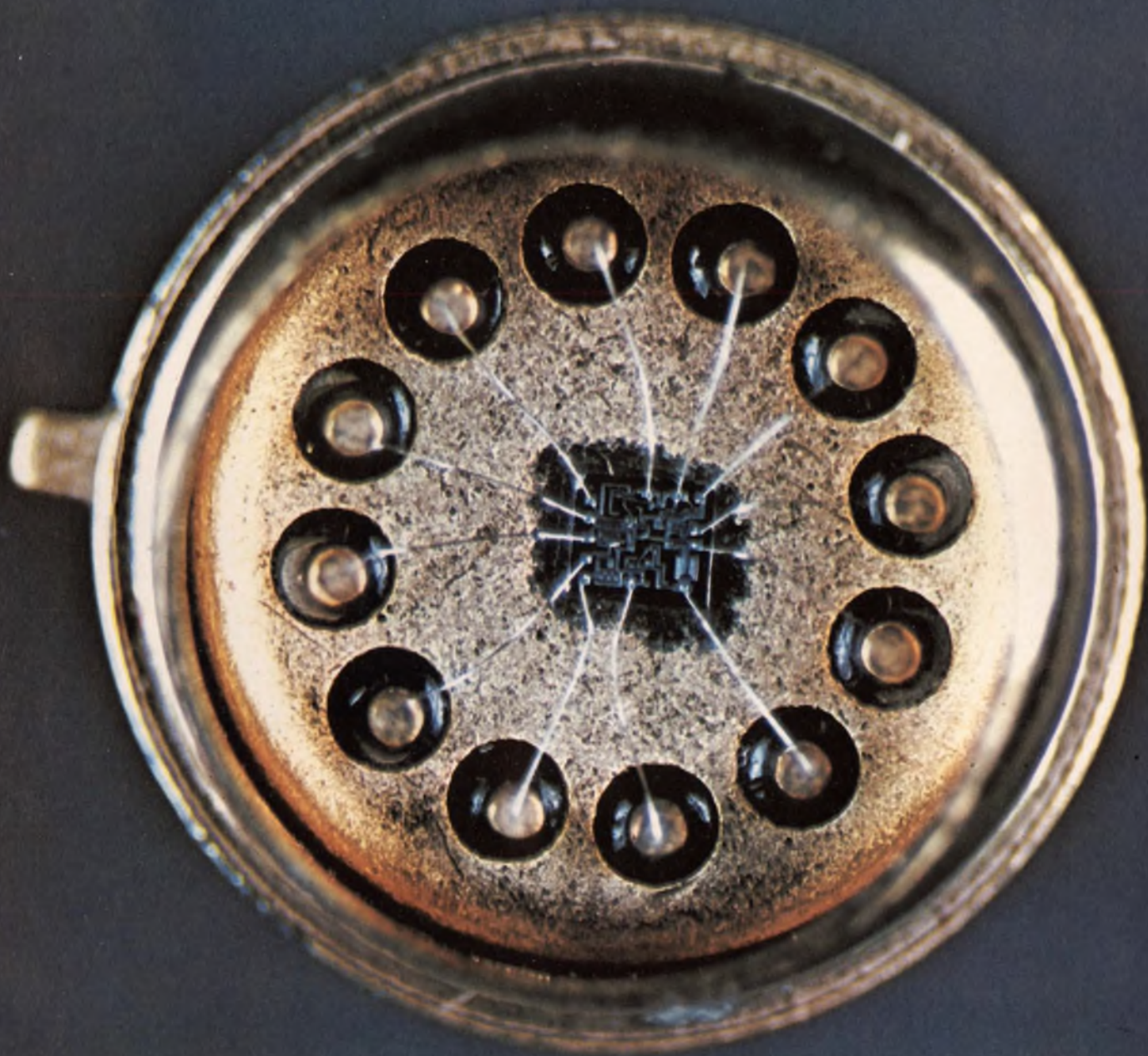

by Roger Kenneth Field, Microelectronics Editor

The second microcircuit revolution



Fairchild's Murray Siegel speaks out on how his company prices linear microcircuits. "Paradoxically," says Siegel, "we often drop our prices just as demand outstrips our production rate. This policy doesn't follow the classic law of supply and demand but it keeps our competitors off balance."

A new revolution in electronics is about to begin. The big microcircuit manufacturers are swinging their sights to the nondigital, or linear, market.

They have some powerful ammunition with which to start full-scale marketing. Their biggest weapon is the price of the linear microcircuit: it is rapidly approaching the point where it will be

cheaper than its discrete-component counterpart.

At first, the manufacturers aimed at digital circuits because of the high-volume computer market. Their efforts led to revolutionary changes in electronics. Now their target is the remainder of the industry.

This remainder forms a vast, rather amorphous market. Linear circuits have applications throughout the electronics industry: they amplify, detect, limit, invert, modulate and shift the phase of analog signals in everything from radar systems to television sets. They usually perform a variety of these operations for a specific purpose. The name of a linear circuit, when it has a name, usually states the function and frequency range—for example, audio amplifier. But some audio amplifiers operate to the megahertz range. And some operational amplifiers are excellent audio amplifiers. The answer for the design engineer is to look carefully at the specifications and the price and take the name with a grain of salt.

Alert designers have watched the average price of a linear microcircuit drop from nearly \$38 in 1964 to a shade over \$9 during the early months of this year. They aren't discouraged by high microcircuit prices; they know that the \$150 digital gate they played around with six years ago now sells for 37 cents.

The critical price level in this slide is just being reached; it is the point at which the monolithic circuit can be sold for less than the cost of the discrete components it replaces. At this price no designer can afford to ignore the microcircuit, regardless of whether the space and weight it saves are of any consequence to his design and regardless of whether the design benefits from the microcircuit's much touted reliability.

The Radio Corp. of America recently introduced just such a linear circuit. A single chip, the CA3034 automatic-frequency-control circuit, contains a dc amplifier, a phase shifter, a phase detector and two differential amplifiers. It costs \$1.75—about what the discrete parts alone cost.

"At this point anyone who is just thinking about designing with linears is already behind," says Minneapolis-Honeywell's principal engineer, Lawrence Bell. "The aware designers now have linears in equipment that's in the test and evaluation stage. A year ago we didn't have a single

product that contained a linear microcircuit; now there isn't a single product being designed without at least one. Why avoid them, when you can get a monolithic operational amplifier for a buck more than a single high-performance transistor?"

Prices can drop by production time

The outlook for future prices is even better, many designers believe. "I look at prices two to three years hence, and if my guess is right, I can use them," observes Richard Crawford, an engineer with Hewlett-Packard Laboratories, Palo Alto, Calif. "The equipment you design today goes into production in six to 18 months. And with semiconductors, prices can drop substantially by the time the unit hits the production line."

Semiconductor prices have generally behaved quite predictably. They can usually be counted on to drop 20 per cent annually. But the pricing of linear microcircuits seems peculiar to linear microcircuits: prices fall on the average of 30 per cent annually, but they don't fall uniformly in time or by device.

"Doesn't it seem a bit odd that we [manufacturers] drastically cut linear-circuit prices in the face of demands that exceed our ability to deliver?" asks Fairchild's Murray Siegel, manager of industrial applications engineering. "Each manufacturer is betting on the future.

"The cost of developing a linear microcircuit is rather high—much higher than that for developing a new digital circuit. We rarely get good yields on a new linear—no one does—so we price it high and try to recoup our initial investment.

"At first there's a peak in the demand for the circuit that represents small purchases by samplers, lab users and our competitors, whose insatiable curiosity can only be satisfied by a peek at the new chip. But after a couple of months, demand falls off while our customers evaluate the circuit and our competitors start tooling up to make it.

"About 12 months after its introduction, the circuit suddenly starts taking off, outstripping the supply. At that point, when our competitors come panting along ready to 'second source' our hot little linear, we plunge the price down to the bottom so they can't get back their investments in

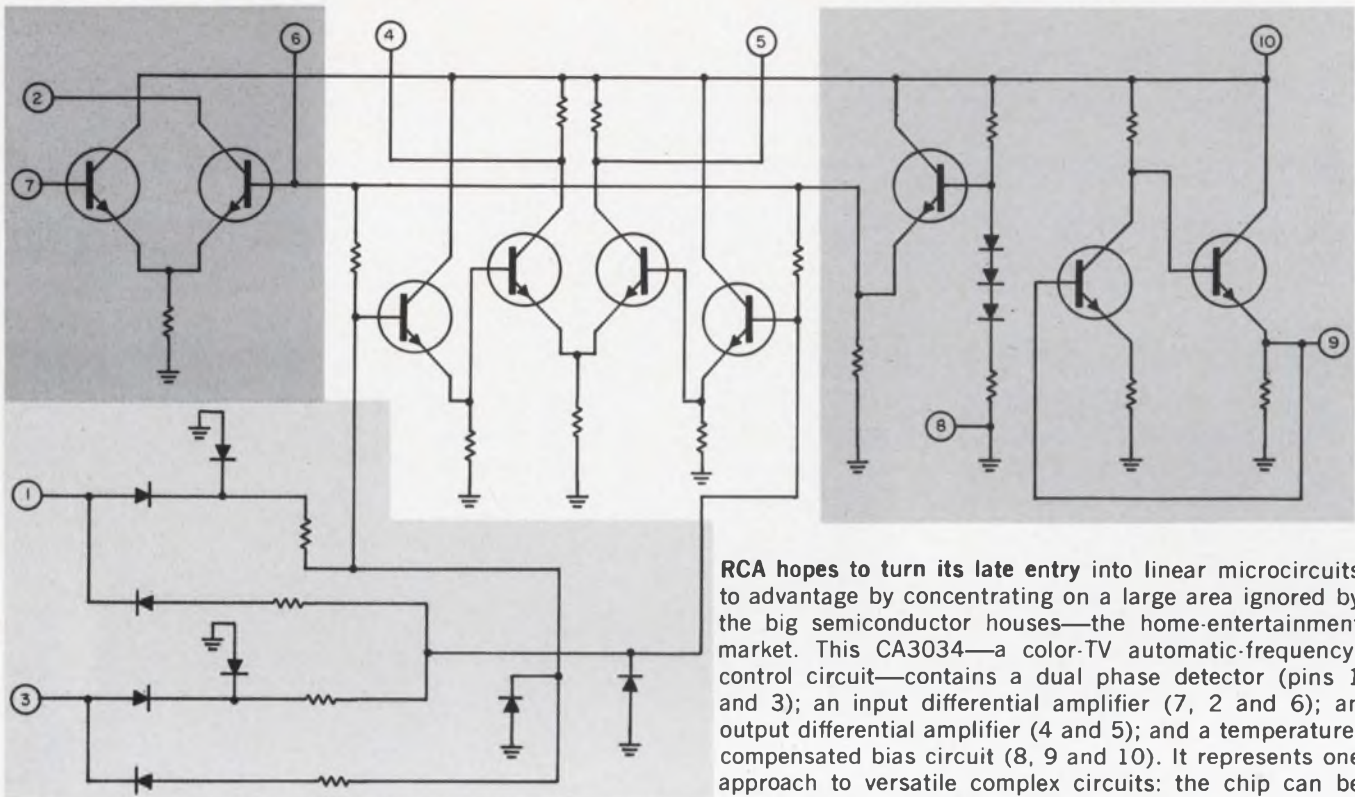

RCA hopes to turn its late entry into linear microcircuits to advantage by concentrating on a large area ignored by the big semiconductor houses—the home-entertainment market. This CA3034—a color-TV automatic-frequency-control circuit—contains a dual phase detector (pins 1 and 3); an input differential amplifier (7, 2 and 6); an output differential amplifier (4 and 5); and a temperature-compensated bias circuit (8, 9 and 10). It represents one approach to versatile complex circuits: the chip can be sold by working sections or as a unit.

the circuit. The major price drop usually occurs between 12 and 18 months after the circuit's introduction."

Siegel jocularly insists that many designers' problems with microcircuits don't really exist; the real problem is the price. And he tells this hypothetical story to illustrate his point:

"When a circuit costs \$30, guys tell me they can get better performance with a \$20 discrete amplifier module. When I tell them they can have the microcircuit for \$15, they complain that they still have to add external components for frequency compensation. So I tell them the circuit is only \$5. They point out it needs a feedback network. When I say \$2, their little eyes light up, and they suddenly find that feedback and frequency-compensating networks are no problem. And they'll even add a 5-cent resistor to get just the offset voltage they need. Then they turn around and find a hundred applications for the thing that they never would have thought of."

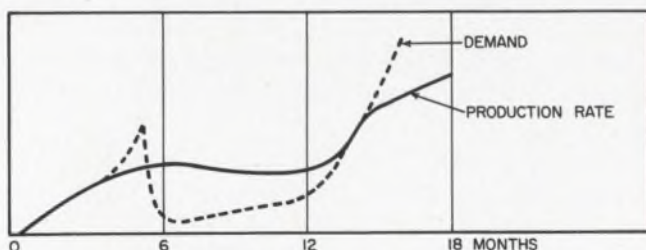

1. The early peak in the demand curve represents samplings of a new microcircuit, says Siegel. As demand soars (in 12 to 18 months), his firm drops its prices.

With all the price plunges, dollar sales of linear microcircuits have more than doubled each year since 1964. "Sales of linear microcircuits have increased as quickly as digital sales, and we haven't even tapped the consumer market," says ITT Semiconductor's marketing manager, Joseph Obot.

Meanwhile technological developments in monolithic-circuit design and wafer-processing have allowed manufacturers to increase the size of their chips, and hence their complexity.

"Last year a 40-mil-square die with around 30 components was the best bargain," says Fairchild's linear IC marketing manager, Jack Gifford, "but today it's a 55-mil chip with about 50 components. In two years the going chip will probably be 75 mils on a side and contain 100 or so components."

Find a linear circuit for the job

For the engineer who designs linear circuits and systems, the message is clear: his best bet is to design with a monolithic linear circuit *if* one exists or can be adapted to do the job. At present, that's a big "if."

Siegel sums up the situation this way: "We can't, in a monolithic linear, do half the functions of discrete-component linear circuits. And we don't claim that they can compete with 90 per cent of the discrete circuits. There is a lot of talk about linear microcircuits pervading the industry, but beyond all the ballyhoo, large chunks of television and a-m—fm sets will be truly integrated within two years."

In a sense, linears are at the same point in their development that digital monolithic circuits passed four years ago. But there are some not-so-subtle differences.

The processing techniques and equipment developed for digital circuits stand ready to serve the linear production lines. The market is psychologically much better prepared to accept and use linear microcircuits than it was at the introduction of digitals. But some problems remain.

No test equipment exists that can routinely check all the important parameters of linear microcircuits. In fact, there are no standard test procedures. Consequently both user and manufacturer must design special test equipment for each new circuit. Users are not used to specifying linear circuits as "black boxes," and manufacturers complain that their customers specify parameters that nobody can check, such as the beta of internal transistors.

Even when the users specify black-box parameters, they often pick some that the manufacturers cannot afford to test.

But the problem of testing is far from unsolvable. One user, Michael Krivak, a senior engineer with Bendix at Teterboro, N. J., says: "When user and designer get together, testing is a snap. We even use different circuitry in our testers, but the results mesh. User and maker must communicate."

The two big roadblocks

There are, however, two problems that are far more serious: There are only a handful of imaginative linear-microcircuit designers, and there is a fundamental disparity between the goals of users and the goals of manufacturers.

The designers of linear microcircuits must have a working knowledge of device physics, processing techniques and circuit design. And they must have a good idea of what the users need. The greatest chip in the world isn't worth the wire in its bonds if it can't be made in production or if it's the answer to only a few designers' needs.

This raises a crucial point in marketing that is peculiar to linear microcircuits. The manufacturers of digital circuits are naturally "on target" with their customers. Manufacturers aim to sell gates and flip-flops; users intend to buy gates and flip-flops. But with linears it's different.

Manufacturers create a new linear with the hope that it will be widely applicable. "Fairchild must push 10,000 of each circuit a month just to keep the girls on a production line from forgetting how to make it," says Siegel. But each user needs a circuit that will solve his particular problem.

The obvious area of compatibility between supply and demand is the sprawling consumer market. General Electric first announced a linear microcircuit in a clock-radio, in which the radio

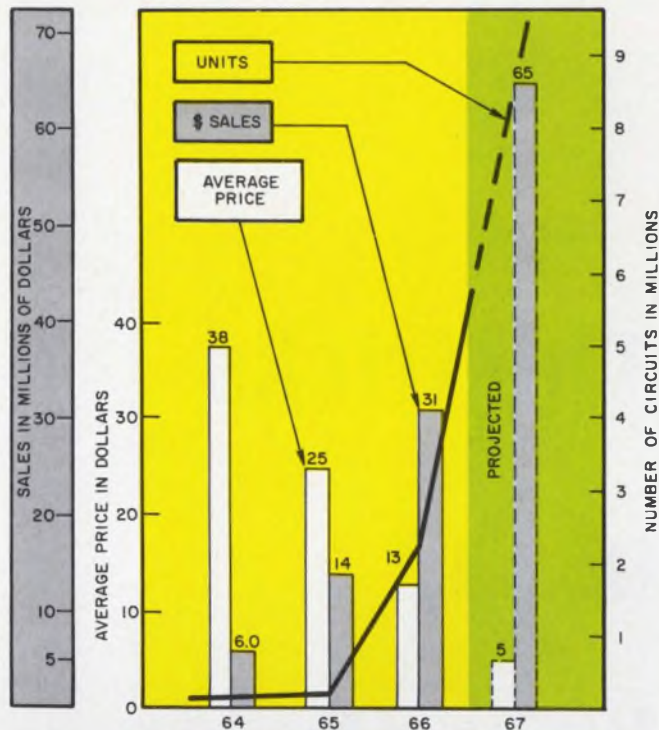

2. The average price plummets and the volume of linear microcircuits skyrockets as more and more new users use more and more devices. One manufacturer, Sprague, predicts a \$250 million business in linear microcircuits for 1970.

was palm-sized and removable. Philco-Ford followed with a two-chip microcircuit radio. Sony now makes a tiny radio about the size of a golf ball, but it has not yet attempted to market the radio in this country.

Designers of consumer equipment are forced to pinch pennies on parts, however. Consequently the U.S. semiconductor manufacturers have gravitated to the military market, where money flows easily and customers don't shop for bargains.

"I remember when Zenith went to the 'big three' semiconductor houses to integrate sections of its television sets," one engineer recalls. "Zenith got the cold shoulder." Another user who made similar suggestions says: "They told me to buy myself a good lunch on them and go home."

But the worm is turning. The latecomers to microcircuits are looking for fertile markets. RCA began putting microcircuits into television sets last fall, and last month it introduced a monolithic automatic-frequency-control circuit, which it uses in its color television sets. General Electric is setting up a linear plant in Syracuse, N. Y., to make circuits for consumer products. And the Netherlands firm Philips' Gloeilampen-Fabriek, N. V., is planning to produce a broad line of consumer linear circuits. Several U.S. semiconductor houses are starting to respond with hybrid and monolithic circuits, designed especially for home-entertainment products. And for the future, they have some interesting production tricks up their sleeves. ■ ■

The tricks of the linear trade

At present nearly all the linear circuits sold at competitive prices are made with what manufacturers refer to as "standard processing"—a six-mask method in which the wafers are planar-processed with the same series of steps. These include an n⁺-diffusion, epitaxial growth of n-silicon, a p-diffusion followed by another n⁺-diffusion, passivation with silicon oxide and deposition of the chip's intraconnections.

The standard process itself has changed slowly over the years. For example, the selective n⁺-doping that reduces parasitic capacitance—sometimes called the buried layer—is now standard. Five years ago it was a new trick. Microcircuits are in for even further processing changes, and these will become part of a "standard repertoire."

The complete array of new techniques will include: dielectric isolation; beam leads; multilayered intraconnections and passive components; and thin-film passive components. It will also combine bipolar transistors, MOSFETs and junction FETs on the same chip, in any combination, and the microcircuit designer's primary limitation will be his own imagination.

Beam leads and dielectric isolation are two methods for insulating each component—transistors, resistors and capacitors—from all the other components. The beam leads are thick gold intraconnections that actually support each component in its own little island of silicon. The silicon islands are hanging in air, which allows no leakage current between components.

Dielectric isolation achieves a comparable effect by insulating each component in a glass tub.

Thin-film resistors and capacitors are formed by evaporating, sputtering or vapor-phasing a resistive metal, such as tantalum or nichrome, in thin films on a substrate. These films are then selectively etched, leaving the proper shape for the desired resistance or capacitance. This is nothing new. What is new is the intention of a number of manufacturers to form thin-film components right on top of the monolithic circuit while it is still in wafer form—and to do it in the normal course of production. Texas Instruments, Fairchild, Union Carbide, Raytheon and Motorola are among the manufacturers attempting this. Radiation, Inc., has been doing it for some time.

The primary impetus behind many new developments is the fierce price competition: small

chips cost considerably less than large ones, and any development that serves to reduce chip size is indeed a valuable one. Increased chip area has a deleterious effect on yield for two reasons. Obviously the manufacturer can fit fewer circuits on a wafer, which costs a fixed amount to process. And each randomly occurring defect, such as a pinhole in the oxide layer, destroys the larger area occupied by the circuit that contains it.

Circuit area can be conserved by the simple expedient of careful mask layout. But further size reductions require improvement in the resolution of the photolithographic process that forms the devices. This in turn requires increased resolution or elimination of the masks that outline the patterns on the wafer and improvement or elimination of the photoresist used in the process. Another alternative is to put more components on a small chip by piling passive components on top.

The multipurpose multilayer

An important potion in the alchemy of microcircuits are multilayered intraconnections on the chip. Several layers of metal can permit any component on the chip to be connected to any other. This is of obvious benefit in complex digital circuits. But multilayering offers linear designers a great deal of freedom too.

For one thing, high-power integrated circuits will need more than one layer of metal to transport high currents about the chip. Motorola, one of several companies that is marketing a one-watt, monolithic amplifier, is experimenting with digital multilayered circuits.

Even more important, the multilayers can be used to house good, large-value capacitors without

occupying large portions of the chip. Multilayered capacitors can have bigger values and higher breakdown voltages than either junction or MOS capacitors. For example, Raytheon Semiconductors, Mountain View, Calif., has formed a 4500-pF capacitor on a chip that could normally hold only 500 picofarads of capacitance.

Multilayering on top of the chip presents no conceptual difficulties. But it does introduce difficulties at a very sensitive stage of the wafer-making process—the last step. At this point any defect knocks out a nearly finished chip, and manufacturers hate to waste money.

Multilayering is a tricky matter. Its execution requires several additional processing steps, and the layers are prone to the effects of thermal stress. Success here depends on a thermal savvy during processing that has not yet been acquired. But multilayered intraconnections are the key to large-scale digital arrays, and the manufacturers have every intention of producing these intraconnections. When they do, linear microcircuits will surely benefit from the spin-off.

In the integrated-circuit business you never have to go far to find R&D specialists proposing incredible circuits. Strangely enough, their dreams are often remarkably conservative.

Fairchild's manager of linear IC development, Marvin Rudin, sees microcircuit oscillators as stable as crystal oscillators in three to five years. He also predicts the appearance of monolithic IF strips by that time. In the near future, Rudin sees the development of micropower amplifiers, chips that will consume on the order of a microampere per stage. Another frontier is extremely high frequency. Here, even lead capacitance can impair performance.

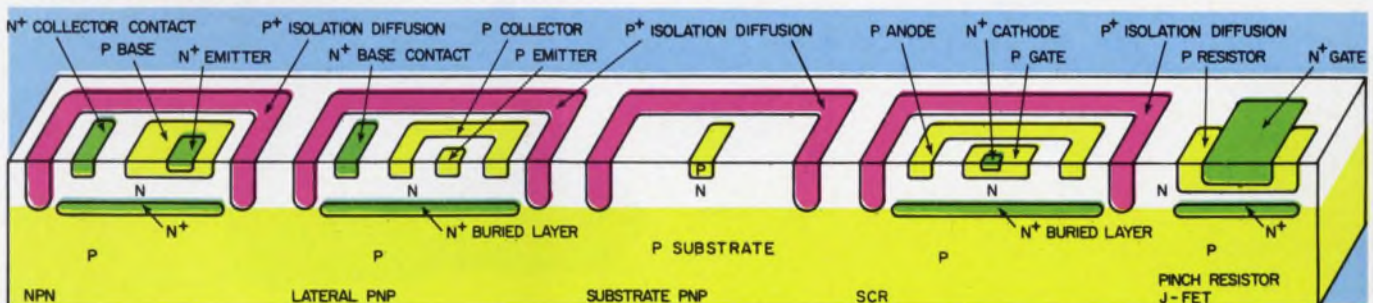

A rogues gallery of devices that can be designed into linear microcircuits made with the standard process.

About 1 pF is associated with the devices' parasitics when the p+ diffusion is used with the n+ buried layer.

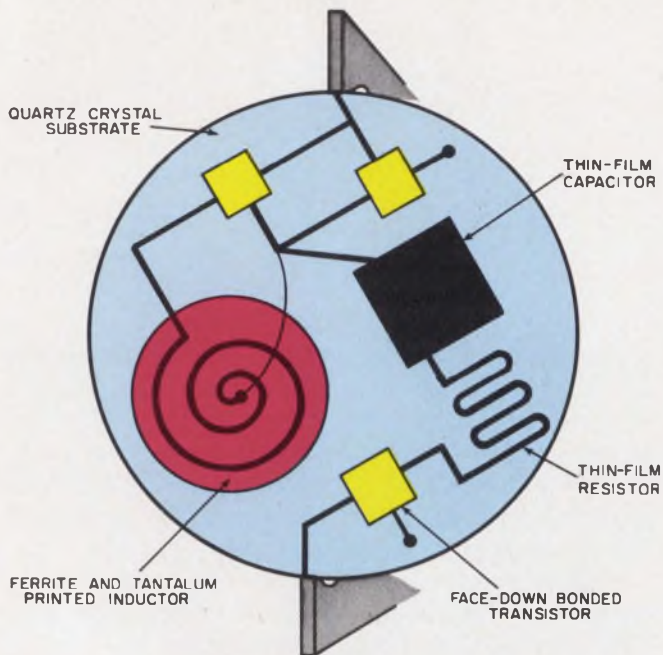

1. This filter uses a quartz crystal as a substrate. Tantalum thin films form passive components and transistors are mounted on the vibrating crystal. The filter, under development at Collins Radio, has a printed inductor. This hypothetical circuit is an artist's impression.

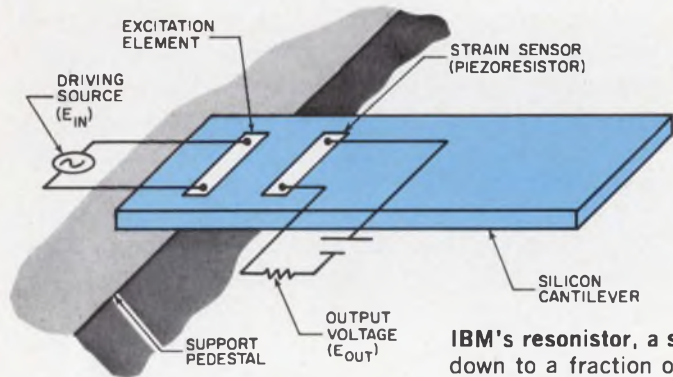

IBM's resonator, a silicon diving board, tunes in frequencies down to a fraction of a hertz. Vibrations are due to thermal expansions of the excitation element.

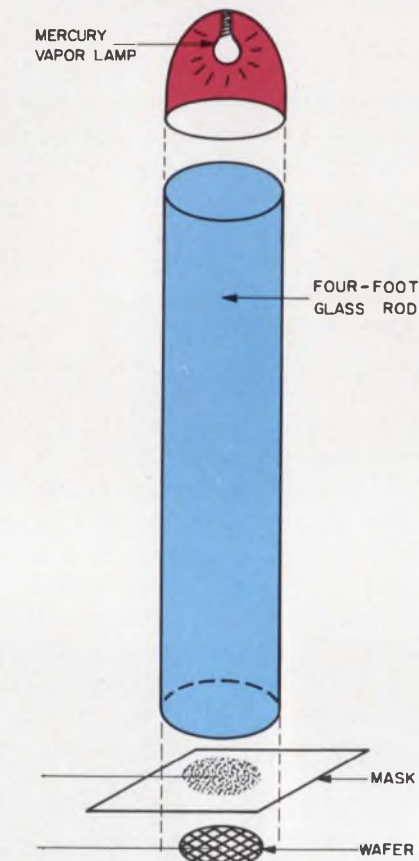

2. RCA's "near-contact" wafer printing system is believed to use a four-foot hollow rod to collimate light rays emanating from the mercury-vapor bulb. The wafer is separated from its mask by a small distance. The mask intercepts the light just as if it were in contact with the wafer.

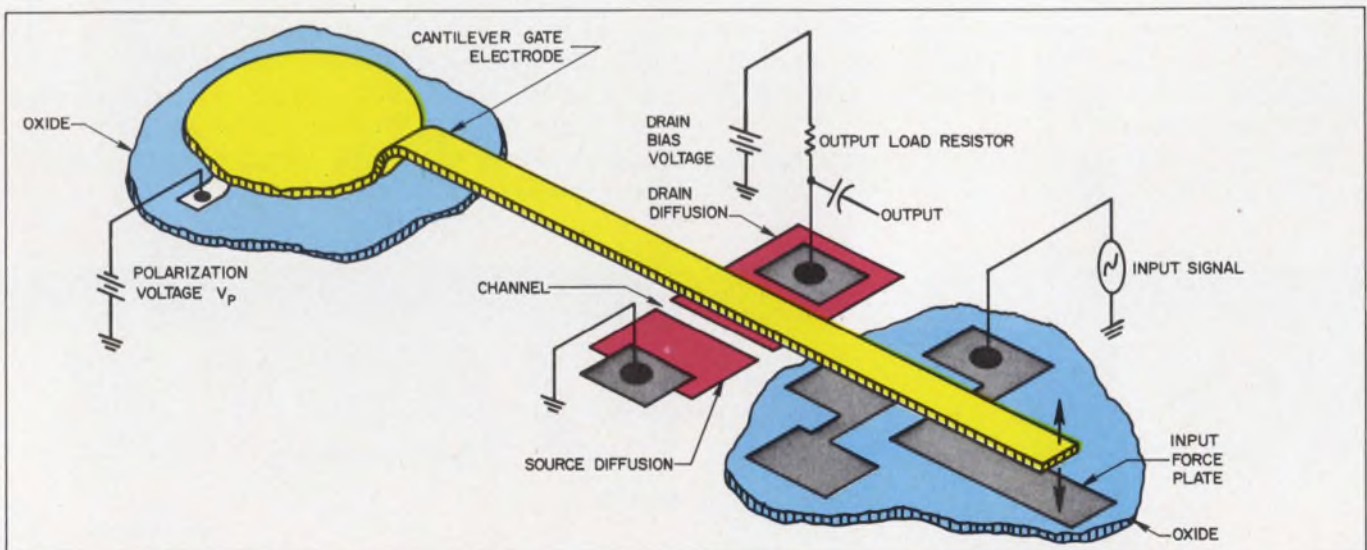

Westinghouse plans production of its resonant-gate transistor, a microcircuit filter element. As its biased gold

beam moves to and fro, the MOS channel depletes the current path, causing an output.

The 0.05 pF associated with a beam lead and the circuit's air isolation between transistors make it a strong ally in the fight to make a monolithic microwave amplifier. Raytheon hopes to market an L-band (1-to-2-GHz), monolithic beam-lead circuit before the end of the year.

A number of new concepts in microcircuit fabrication are also being explored to reach high-frequency territory. Some of the paths seem promising.

MOS arrays are being highly touted for complex digital circuits because of two things: the MOS transistor can be made as small as the sum of the widths of its diffusion stripes; and the basic MOS structure can be used to form resistors, capacitors and crossovers.

What few designers have realized is its important implication in the linear-circuit area. Its small size makes it ideal for certain very-high-frequency linear circuits.

At General Instruments, Hicksville, N. Y., Munny Mitchell, manager of linear device development, is making a monolithic MOS tuned amplifier that has its passband in the 400-600-MHz range. By combining MOS and stripline techniques, Mitchell is developing a uhf amplifier with a distributed LC network. At the same time he is designing an array with p-channel enhancement-mode MOS transistors. These allow the direct coupling of amplifier stages and the transistors serve multiple functions—they can be nonlinear load resistors and linear resistors, as well as active transistors, Mitchell observes. The upshot of the p-channel enhancement array? An a-m receiver on a chip!

"All you'll have to add is a battery, an antenna, a tuning capacitor or varactor diode, and a speaker," says Mitchell.

Unfortunately for many applications, stripline LC tuning is not effective at low frequencies (below uhf). But there are two integrated techniques that can produce low-frequency tuned circuits. One is a method that Westinghouse has been examining for over two years: the resonant-gate transistor. The device is expected in production by the fall. In it the tuning element is a gold beam, electroformed much like a beam lead. It hovers over the gate insulation of a MOSFET. The beam is biased; and it vibrates at its resonant mechanical frequency—3 to 50 kHz. As it vibrates, the electrostatic field under the glass insulation alternately pinches off and releases current through the MOSFET. The over-all effect is that the device responds to its pretuned frequency and rejects others. Its Q ranges between 50 and 150.

Another method for tuning under development at Collins Radio, Newport Beach, Calif., uses a quartz crystal as the substrate for a hybrid circuit. The substrate itself vibrates with tantalum

thin-film resistors, conductors and transistors all bonded to its surface. In addition a spiral of ferrite interwoven with a spiral of tantalum forms a small inductor right on the surface of the quartz substrate. This technique, Collins hopes, will lead to completely controllable microminiature filters (see Fig. 1).

Westinghouse's Molecular Div. and its Research Laboratory in Pittsburgh are testing electron-beam lithography as an approach to better resolution. Glasses tend to etch chemically at a somewhat enhanced rate when they are bombarded by electron beams with densities upwards of 0.1 coulombs/cm².

"The electron-beam method uses the glass itself as a photoresist," says Westinghouse's Technical Adviser Harry Knowles, "and when it is sufficiently developed for production-line use, it may well carve useful circuits as small as one mil by one mil." Such circuits, Knowles believes, will routinely operate at microwave frequencies. The electron-beam technique should be used for microcircuit production in about 3 years, he predicts.

Save those masks

The expendable masks presently used in the manufacture of microcircuits are costly and any method that eliminates them reduces the cost of making circuits, even if it does not improve resolution. ITT Semiconductors is experimenting with a lens-projection system that eliminates the masks. The lens reduces the artwork 4 to 1 as it projects onto the wafer. No lens system can achieve 0.1-mil geometries across a whole two-inch wafer. In the ITT method a laser interferometer will align the projection system as it steps and repeats across the wafer.

RCA has developed a "near-contact" method to save masks from the scrap heap. Masks are brought close to the wafers. The light shines down a four-foot hollow rod, and the collimated light exposes the photoresist on the wafer. (see Fig. 2).

These developments are a sample of the work going on in R&D laboratories at the major semiconductor manufacturers. As might be expected, most of the work applies at least as much to digital microcircuits as to linear. At the same time, in the case of multilayering, what's sauce for the digital goose is sauce for the linear gander.

The meat of this particular gander is the operational amplifier. This, and variations and elaborations on it, such as differential amplifiers and voltage regulators, account for practically half of all the different types of linear microcircuits that are available. An indication of how newly fledged the linear microcircuit is, is the fact that the pioneer operational amplifier is a mere 20 months old. ■ ■

The '709': Model T of the op amps

The most useful linear circuit is the operational amplifier. And by far the most popular monolithic operational amplifier is the 709.

The 709 is no more the definitive monolithic operational amplifier than the Model "T" was the definitive automobile. Like Henry Ford's flivver, the 709 was a daring design. And like the car that put America on wheels, the circuit that is making monolithic operational amplifiers popular will undoubtedly have a lasting effect on its successors. Ford once remarked that the public could purchase the Model "T" in any color, just so long as it were black. Marketing managers now tell designers that they can make their operational amplifiers any way they like, so long as the specifications equal or top those of the 709 and they connect to their power source on pins 4 and 7.

In the 20 months since its introduction, Fairchild's original $\mu A709$ is already being "second-sourced" by Raytheon, Motorola and Texas Instruments. At least five manufacturers are starting or planning the production of the 709. Three of these are Philco-Ford, ITT Semiconductors and Westinghouse Molecular.

Fairchild has not licensed the manufacturing rights to the $\mu A709$ (except to ITT Semiconductor, which has a blanket license for all of Fairchild's semiconductor products) and each version has a different, but vaguely familiar, name. RM 709, MC 1709G and SN52 709L are eight-lead, TO-5 versions of the $\mu A709$ by Raytheon, Motorola and Texas Instruments, respectively.

But a 709 by any other name is still a 709. At one time, when a Raytheon salesman was asked for a specification sheet on his 709, he reached into his briefcase and produced a copy of Fairchild's. This, however, was substantially inspired by showmanship. The Raytheon circuit is not an exact copy of the $\mu A709$. Even now, though all the 709s more than meet the original 709 specifications, their actual performances vary from manufacturer to manufacturer and from batch to batch with some manufacturers. Some 709s of some manufacturers, for example, can have up to double the open loop gain of other 709s. And some 709s emit perfectly random little trains of tiny pulses—microvolts referred to input—with no input signal whatever. Others don't.

There is, of course, no way to patent a set of specifications. Nor can a company register the

digits that designate a product. Fairchild has patented the current source supply on the input of the 709's first stage and has a patent pending on its second stage, which has a differential input and a single-ended output. But, as every inventor knows, patenting a design is one thing and enforcing the patent quite another.

The bumpy road to popularity

Fairchild hit upon the idea of manufacturing a monolithic operational amplifier during the autumn of 1964 and firmly committed itself to the task that November. Its marketing people and sales engineers queried hundreds of potential purchasers as to the specifications they would require. They all came back with reports that looked remarkably uniform. The designers wanted symmetrical power inputs that could operate with a voltage range of several volts. They wanted an output voltage swing of at least 10 volts, an input offset current of no more than half a microampere, a minimum gain of 10,000, a minimum input impedance of 150 k Ω , an input offset voltage drift of less than 10 $\mu\text{V}/^\circ\text{C}$ and power consumption of less than 200 mW. The tale of toil and trouble is now history: Fairchild matched or beat those specifications on every parameter. But now so have Raytheon, Motorola and Texas Instruments.

Fairchild began the 709 project by making the same mistake as the other manufacturers who were attempting to develop a high-performance monolithic operational amplifier. It tried to design a discrete component prototype and translate it into a monolith. But Fairchild was fortunate: the project almost immediately ran into trouble. And the company had a genius named Robert Widlar, who liked to play the linear microcircuit game by its own rules: Use transistors and diodes—even matched transistors and matched diodes—with impunity, but use resistors and capacitors—particularly those of large value—only where necessary. Even where a big resistor seemed inevitable, Widlar put a dc-biased transistor in its place. He exploited the monolith's natural ability to produce matched resistors and only assumed loose absolute values.

The first production lateral pnp in an operational amplifier appeared on the 709 as a level shifter. And the circuit also had a single substrate pnp.

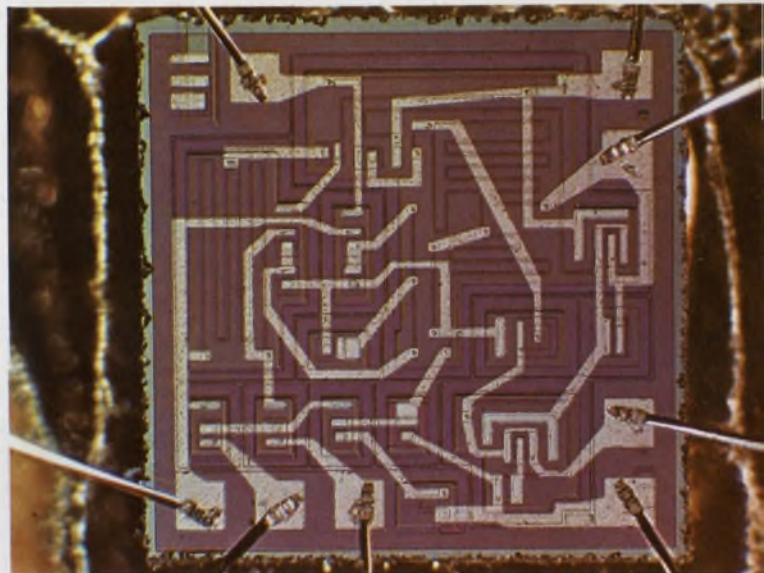

The ubiquitous μA709 gave Fairchild the lead in monolithic op-amps. But its production difficulties encouraged widespread "second-sourcing" of the circuit.

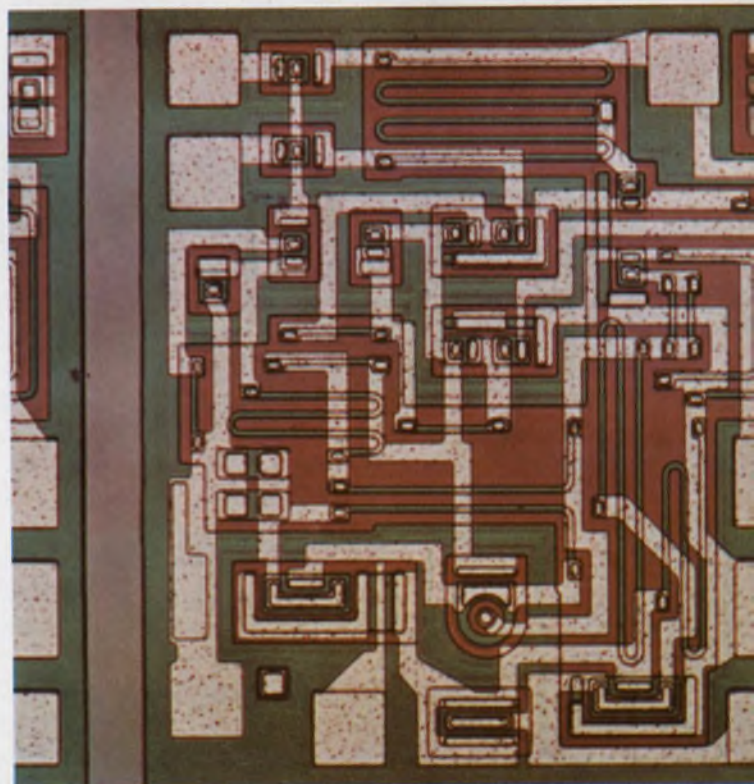

Motorola's 709, like other versions, does not look much like the original. The circular element on this chip, for example, is the 709's lateral pnp. Raytheon's version is seen on the cover of this issue (top, right).

The μ A709 hit the market in November, 1965, precisely one year after its formal conception, and its early yields were barely perceptible. But so was the demand. Many of the first circuits were afflicted with "channeling"—various leakages of current to the substrate, which was, as in most monoliths, the most negative point of the circuit.

"We had to test for isolation diode leakages, diode leakages and transistor leakages in every single circuit we shipped for many months," recalls a Fairchild employee. "In those early days," recalls Widlar, now Director of Science of National Semiconductor, "every 709 left the factory with a tear in its TO-5 can." But each brought in \$50.

The 709 was a smash hit from the start. Among the engineering departments all over the country that spotted the 709's potential was one at the Bendix Corp., Teterboro, N. J. There, an engineer in the flight control laboratory brought the circuit to the attention of the man who shortly became the largest single buyer of monolithic operational amplifiers. "We spotted the 709 in December of 1965, a month after it was introduced," says Robert Reade, Bendix's assistant purchasing director. "The spec sheet looked good. The 709 was far better than the monolithic op-amps on the market at the time—Texas Instruments' 524A and Westinghouse's 161Q. We immediately pumped the 709 right into our designs with every expectation that the price would fall drastically. In 1966 we used 80,000."

Reade believes that Fairchild's 709 gave the company virtually the entire monolithic operational amplifier market. But production difficulties, he says, kept the field open. "We had a need for 10,000 a month, and through the middle of 1966 Fairchild was turning out 250 a week."

Bendix looks ahead

Reade promptly offered contracts for 10,000 units that would meet the 709 specifications to five semiconductor manufacturers. Fairchild filled out its second 709 shift and added a third. It was now making 709s around the clock. By August, production capacity was running 40 per cent above its previous highs. With the production and testing problems licked, the company went from 1-1/2-inch wafers to 2 inches, ultrasonically bonded the circuits and started making them with metal masks that could take the punishment of high-volume production.

Fairchild knew that the circuit would take off by October, 1966. But its bolstered 709 output was inadequate to meet the staggering demand. The company made a single marketing error: It underestimated the demand by a factor of 10! In spite of this, in March 1967—16 months after its introduction—Fairchild lowered the price of the 709 to

\$15 (military) and \$5 (commercial).

Bendix's Michael Krivack, the engineer who apprised Reade of the 709's suitability as a standard amplifier, felt strongly that the performance of the 709 justified its success.

But he found that the 709 did have problems: it seemed unable to sustain a consistent common-mode rejection voltage; a spike could cause the output to latch up; and the saturation voltage drifted. Yet these flaws did not preclude its use in many applications. But regardless of the design, two precautions proved to be important. One was to provide it with proper dc paths when it was used as an ac amplifier. The other was the need for ac frequency compensation when it was used as a dc amplifier.

Honeywell's Lawrence Bell finds the two precautions well worth taking under these conditions:

- When the total input impedance (this time looking into the 709) is 10 k Ω or higher.
- When the design requires a drift of no more than a few microvolts/ $^{\circ}$ C referred back to input.
- When the closed-loop gain is 100 to 1000.

Closed-loop gain of the 709 is determined by the choice of feedback resistor. Bell makes the proper choice for his design and picks up other useful hints by first consulting an internal Honeywell-Aerospace memo entitled, "The Care and Feeding of the μ A709." (For a free copy see page 66.)

The case at unity gain

When the closed-loop gain approaches unity many an operational amplifier can run aground. Unity gain is their "worst-case" use, and many get finicky about output loads at unity gain. Data Technology Corp. president, Gerry Currie, found this out the hard way.

When the output lead of the 709 is designed to connect off the printed-circuit card, Fairchild recommends that the designer insert a 51- Ω resistor inside the feedback loop (in series with the output and the feedback resistor).

Currie tried it. It stabilized most of his units, but others needed special compensation. Currie feels he can't use a component in his designs that requires individual attention. He turned to an unconditionally stable, dielectrically isolated operational amplifier made by Radiation, Inc.

"Radiation's single-pole op-amp has only one problem for me," says Currie. "It required oddball power supply voltages." There is no standard power supply voltage for monolithic operational amplifiers. Currie refers to Radiation's asymmetrical requirement: +25 V, -15 V.

Operational amplifiers, like the 709, are readily available off the shelf. But with other linear circuits the user might have to collaborate with a manufacturer to get a microcircuit that will do the job.

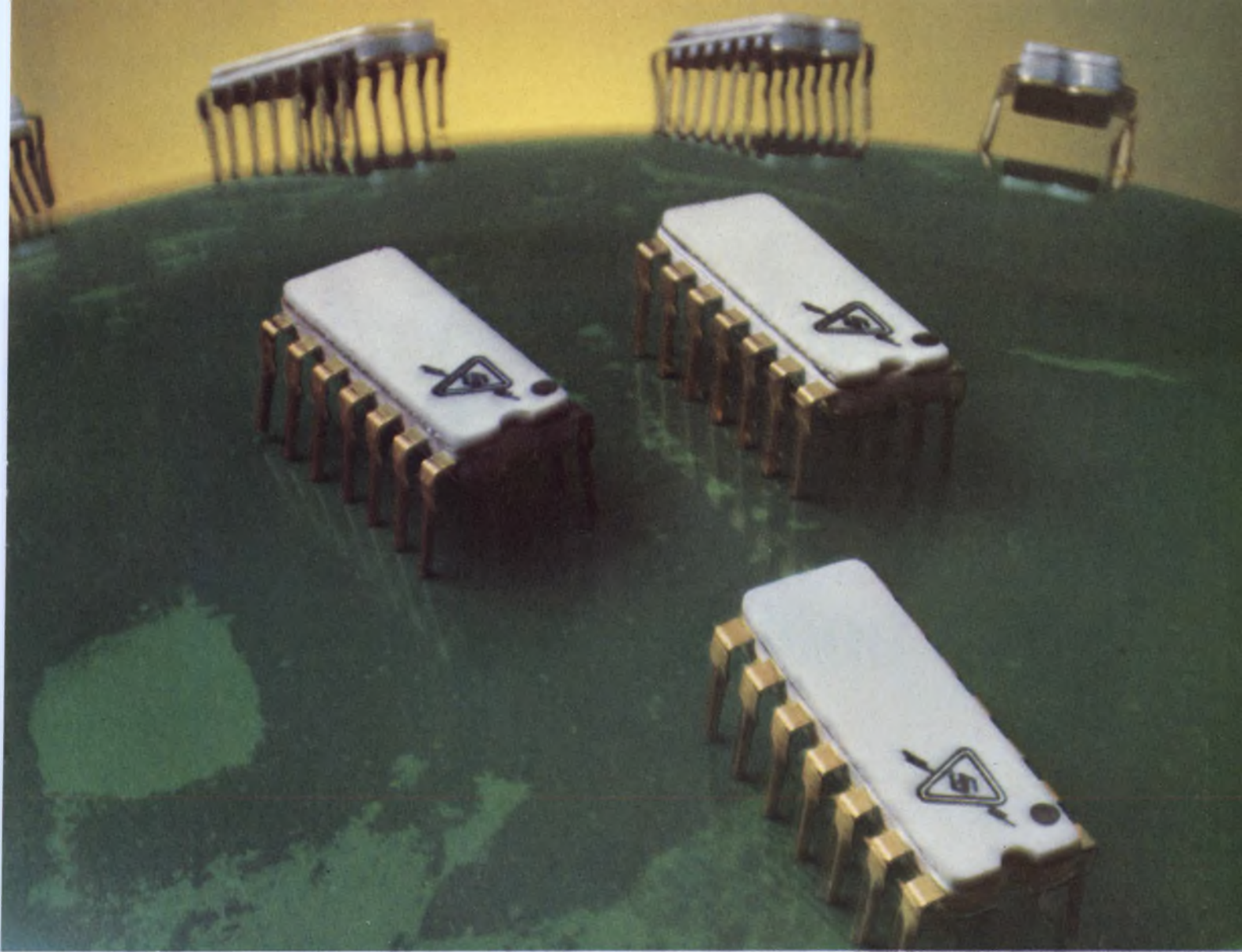

It pays to pick the fastest... in the computer race, it's SUHL/TTL.

We became deeply involved in TTL before anyone. That's why in TTL we're way ahead with SUHL[™] ICs, the fastest IC line in the industry.

Our SUHL line keeps breaking speed records—now down to 5 nsec—without compromising noise immunity and power dissipation. That's why we're the prime source for TTL and why Sylvania Universal High-level Logic ICs are being second-sourced. In fact, several of the largest electronic manufacturers standardized on SUHL ICs,

even though Sylvania was their only source.

We have the most modern manufacturing facilities in the industry. All our ICs are made with one optimum process to maximize performance characteristics of every unit. Automated test equipment insures the ultimate in production monitoring, final testing, and quality control. So get SUHL's speed and reliability.

Sylvania Semiconductor Division, Electronic Components Group, Woburn, Massachusetts 01801.

SYLVANIA
SUBSIDIARY OF
GENERAL TELEPHONE & ELECTRONICS **GTE**

Off the shelf? Or off your design board?

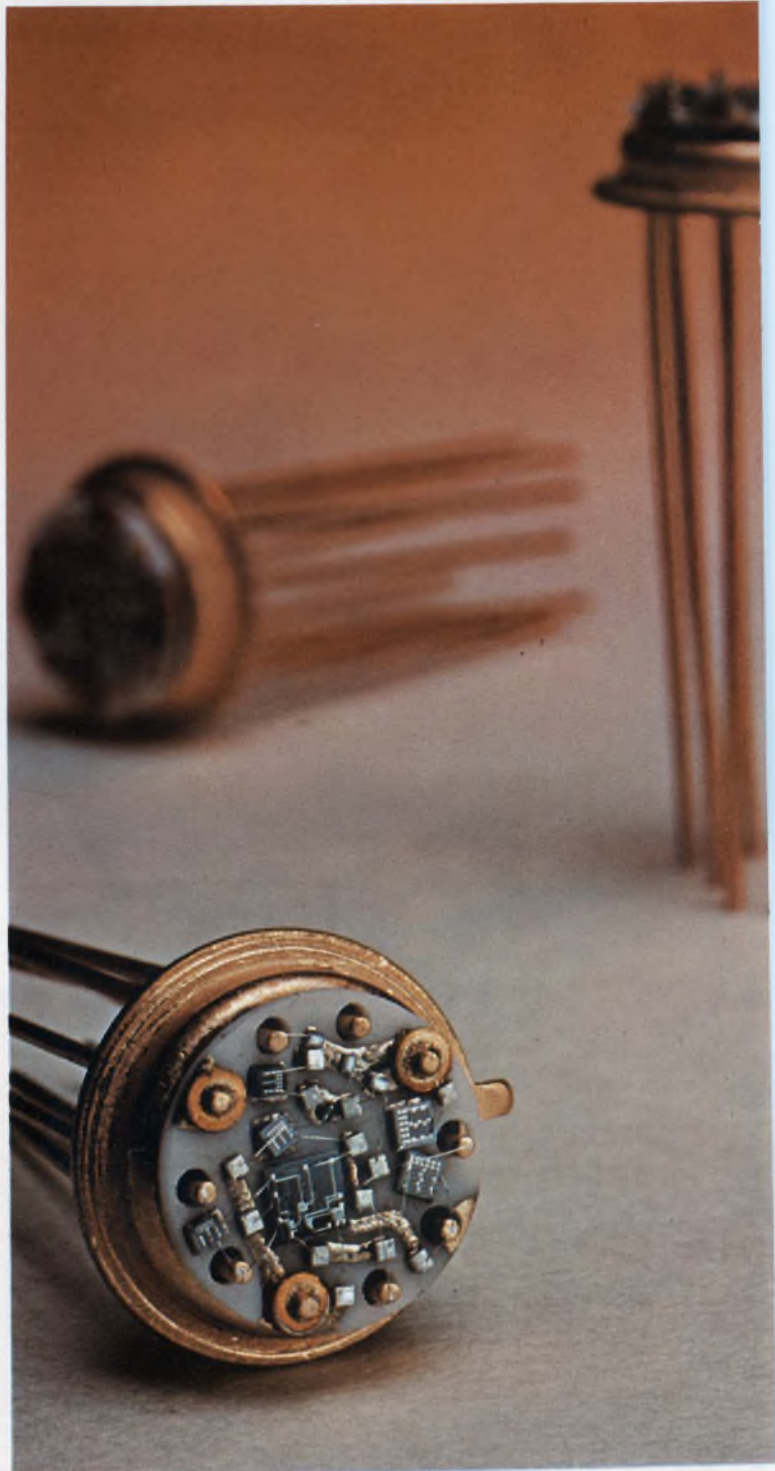

Motorola's Charles Moberly converted the circuit on these three headers into the linear microcircuit on page 49. This hybrid version was designed and built quickly, allowing Moberly and his colleagues time to develop the microcircuit.

If the designer of a system chooses to use linear microcircuits, he has two alternatives: either he buys them off the shelf and adapts them to his use or he works with a semiconductor manufacturer to develop custom circuits for his system. Each approach has its advantages and its pitfalls.

The custom approach

In custom design, the only external components the user need add to the microcircuit are those that cannot be integrated, such as adjustable passive components, inductors, large capacitors and accurate resistors with low-temperature coefficients. Since the circuit is developed for the design, the user has control over it: the manufacturer cannot make arbitrary design or processing changes.

But among the disadvantages associated with the development of custom monolithic circuits, the initial costs can run from \$30 thousand to well over \$100 thousand. Consequently it rarely pays to develop a custom monolithic unless upward of 10,000 units are needed. Even at this number, \$3 or more of the price of each circuit must be set aside for development. Turn-around time is often six to 18 months.

Learn the monolithic rules

Before a discrete-circuit designer can hold up his end in developing a custom microcircuit, he must know exactly what can be put on a chip and what can't be. He should also understand the design rules for monolithic circuits; they differ from those for discrete and hybrid circuits. Take, for example, the design of a television set. With discrete components, you specify absolute values and shoot for minimum component count. With monolithics, you specify matched components and shoot for minimum circuit area.

Matched components—resistors and transistors—can be specified with impunity, because their matching is a natural consequence of the manufacturing process. If two transistors lie side by side on a chip and their masks are fashioned with the same geometry, they are subjected to diffusions at the same time, temperature and intensity by virtue of their proximity in the diffusion furnace. Hence, their V_{RES} match within 2 mV.

To get extremely precise matching, the chips can then be tested and selected on that basis. But then the circuit must, for economic reasons, be simple. Union Carbide, for example, offers a matched monolithic transistor pair made in this manner and then selected for close match. Base currents are matched within 5 nA.

The area of a chip has to be allotted carefully. Resistors and capacitors take up far more space than transistors. If a circuit requires in excess of a total of 200 k Ω resistance or 500-pF capacitance, some of the resistance or capacitance will have to be outboarded—provided by external, discrete resistors or capacitors connected to the chip by specially provided terminals. Even these amounts of resistance and capacitance take roughly half the area of a 50-by-50-mil chip. Even if all the circuit's resistance and capacitance can be fitted on a chip of reasonable size, the performance of diffused passive components doesn't compare favorably with that of their discrete or thin-film counterparts. The breakdown voltage of diffused capacitors that use the emitter-base junction of a transistor, for example, is only around 6 volts. The temperature coefficient of diffused resistors is greater than 300 ppm/ $^{\circ}$ C, compared with 50 ppm/ $^{\circ}$ C for nichrome thin-film resistors. The tolerance on the absolute value of diffused resistors is about ± 10 per cent.

Unlike hybrid circuits—either thick or thin films—monolithic circuits cannot be built directly from a discrete-component breadboard: monolithics have parasitic capacitance between transistors, parasitic diodes associated with diffused resistors, and parasitic resistance associated with diffused and MOS capacitors. Heat dissipation is a function of chip design and package, but the latter becomes a substantial part of the cost of the finished circuit above a few watts. In such circuits the power transistor does occupy a substantial area, and, because of yield considerations, most monolithic designers feel that it does not pay to integrate it if it is to occupy more than 60 per cent of the chip.

With present "standard" or "near-standard" processing, a variety of devices can be integrated. On the same chip that contains bipolar transistors and diffused resistors and capacitors, it is possible to integrate MOS transistors, crossovers, capacitors, junction field-effect-transistors, SCRs and

Linear microcircuit blackbox checklist

With the following list, the user can specify linear microcircuits by measurements made at the terminals or outside the circuit's package. The list itself should serve only as a guide to the user. A specification that contains every parameter under every condition entered on this list would be very expensive indeed. But microcircuit masks are very expensive, and if the user neglects to specify a parameter or condition he needs, he will have made a costly mistake.*

Environment

- Operating-temperature range
- Storage-temperature range

Gain

- Frequency
- Source impedance
- Load impedance
- Power supply tolerance
- Open-loop or gain setting
- Voltage gain, V_o/V_{in}
- Transconductance, $\Delta I_o/\Delta V_{in}$
- Current gain, I_o/I_n
- Gain stability (gain vs temp)
- Gain linearity (gain vs signal level)

Bandwidth

- Source impedance
- Load impedance
- Power supply tolerance
- 3-, 6-, or 0- dB points

- Open or closed loop (if closed loop, what gain)
- Frequency response
- Gain-bandwidth product
- f_t
- Cutoff frequencies
- Gain margin
- Phase margin
- Slope of gain vs frequency
- Slew rate

Stability

- Temperature range
- Input-output conditions (capacitances and resistances)
- Expected life
- Maximum equivalent input drift (voltage and/or current)
- Dc stability
- Ac stability
- Phase margin with maximum feedback
- Maximum output capacitance

Noise

- Frequency and bandwidth
- Source resistance
- Noise figure (or equivalent input noise voltage)

Maximum output (dc)

- Power supply voltage
- Load impedance
- Minimum linear output voltage
- Minimum linear output current
- Maximum output impedance

Input (dc)

- Minimum input impedance
- Differential mode
- Common mode
- Maximum common-mode voltage
- Minimum common-mode rejection ratio (specify frequency and common-mode voltage swing)

Dynamic range (ac)

- Power supply voltage
- Load impedance
- Source impedance
- Maximum input before clipping
- Minimum unclipped output
- Dynamic range of input signal
- Minimum power output

Power supply

- Output voltages
- Tolerances
- Ripple and noise
- Impedance vs frequency
- Output power

Package

- Form (TO-5, flatpack)
- Salt spray, hermeticity
- Linear acceleration, shock

*Dean C. Bailey, "Black-boxing your linear integrated circuit," ELECTRONIC DESIGN, XII, No. 13 (June 22, 1964), 74-77.

two kinds of pnp-transistors—lateral pnps and substrate pnps. A lateral pnp is nothing more than two p-diffused resistors separated by the epitaxially grown n-silicon into which they are diffused (see page 55). These are not very good transistors—they can be dependably processed with gains of from 0.5 to 10—but they are available to drive npns, and they are made without a single additional processing step. The substrate pnp, as the name implies, is formed between a p-diffusion in the epitaxially grown n-silicon and the p-substrate. The substrate pnp is a decent transistor—it has better gain (≈ 30) than that of a lateral pnp. But it has around 10 times the base resistance of an npn. It does present, however, one serious problem to the microcircuit designer: each chip can have only one free-and-clear sub-

strate pnp, for each monolithic circuit has (by definition) only one substrate. (It is possible to have more than one substrate pnp, but they must share a common collector.)

The integrated SCR uses a lateral pnp. The SCR occupies the space of five transistors— ≈ 14 by 14 mils. But it can handle nearly one-third of an ampere. And it's smaller than a 100-mA transistor. The SCR has a turn-on time of 200 microseconds, with a recovery time of 1 to 4 microseconds. Oddly enough, the integrated version has two advantages over a discrete SCR. Its holding current, at 5 mils, is lower than that of a discrete device. And its gate drive currents are very low (≈ 200 mA.).

Obviously the integrated SCR must have some disadvantages; for if it didn't, discrete SCRs

would most certainly be made in "integrated" form. The breakdown voltage of the integrated device is lower—it breaks down at 30 to 40 volts. There is a parasitic leakage to the substrate. And there is a higher forward voltage drop (≈ 1.6 volts at 300 mA) associated with its higher "on" resistance of 2-3 Ω .

The routine problems of Charles Moberly

Charles Moberly, a senior engineer at Motorola's Government Electronics Div., Scottsdale, Ariz., integrated a circuit that contained a differential amplifier and an SCR. He needed 20,000 circuits—more than enough to justify the custom design of a monolithic circuit. But he needed some within six weeks—too soon to await the six-to-18-month monolithic turn-around time.

First he designed a hybrid version of the circuit on three separate headers. The monolithic circuit would have an integrated SCR and two matched transistors—tall orders to simulate with discrete transistors. So Moberly found a monolithic circuit with an SCR made by Motorola's Semiconductor Div., and he bonded it out (made a metalization mask that provided the SCR with bonding pads) and wired it onto a header. That chip happened to have a pair of matched transistors, and he also bonded those out and used them in the hybrid circuit. The complete hybrid circuit used three headers crammed with chips, but they worked.

Moberly then set about designing a single monolithic chip that would contain the entire circuit. He relaxed a bit. His hybrid version assured early delivery of the system.

In the first monolithic attempt, the SCR triggered all right, but it wouldn't turn off. Current leaked from the SCR's anode to the substrate. This current sustained the SCR, keeping it on with no gate drive current. In the second monolithic attempt Moberly changed the SCR's geometry and added a buried n^+ layer to stop the anode-to-substrate leakage. "We knew we were faced with a possible leakage problem," Moberly recalls, "and we took pains to avoid it. But in vain."

The second version had an SCR that turned off as well as on. Moberly and his colleagues were anxious to have an SCR with a high breakdown voltage, and they achieved it. But to do it they used a high-resistivity (lightly doped) n -epitaxial layer. The breakdown can vary from 10 volts with the use of 0.1 Ω -cm material to 50 volts with the use of 2 Ω /cm material. Moberly used 1 Ω /cm material.

Elsewhere on the chip, two transistors with bases shorted to collectors served as diodes. Hooked in series, they were expected to provide a drop of 0.7 volt each—a total of 1.4 volts. But the light doping increased the breakdown voltage of each of the base-to-emitter diodes to 0.75 V each.

And the pair dropped 100 mV more than they were expected to drop. Unfortunately, the two diodes served as a voltage source for three sections of the chip. The extra 100 millivolts across the diodes messed up the bias voltages throughout the differential-amplifier section of the circuit.

"We finally nailed it on the third try," Moberly says with a sigh. "We adjusted resistor values to get proper bias and we hit them right on the head."

Would that his problems were atypical. In fact, though, his design was relatively unencumbered by interactions between components, by unwanted feedback due to close proximity of output to input, and by untraceable oscillations on the chip. Moberly has had lots of experience with translations from discrete and hybrid to monolithic circuits. Remember this if you're tempted to think that the translation is merely a matter of having the right "dictionary." Note also that the development of a hybrid version prior to the monolithic circuit served two purposes: it effectively reduced the long lead time of the monolithic, and it allowed speedy delivery for the first systems, yet let them benefit from the reduced cost of the monolithic circuits. And it relieved the pressure on Moberly and his colleagues and permitted them to work with the experience of the hybrid design behind them.

The integrated junction FET is one of the most recent devices to be used in production linear microcircuits. With its gate disconnected, it is known as a "pinch-off" resistor. It is formed when an ordinary p -diffused resistor is heavily doped n^+ along its middle section. The n^+ -dopant extends downward almost to the bottom of the p resistor, and it nearly seals off the flow of current through it. Depending on the respective depths of the two diffusions and on the geometry of the p channel, resistors of almost any value can be made. If the n^+ surface is connected by a layer of metalization, a small voltage can deplete the channel right to the bottom of the p diffusion. This stops the current flow. This is an integrated form of the depletion junction FET (see page 55).

With present "standard" processing, the control of the diffusion depth is insufficient to ensure the repeatable formation of pinch resistors: their values vary widely. Both the pinch resistor and the junction FET should be designed into a circuit only with extreme caution.

If an unusual device can help your circuit, however, it is foolish to shun it simply because it is unusual. But it would be wise to collaborate with a manufacturer whose engineers have had experience with the device.

Texas Instruments' engineering manager of linear microcircuits, Lawrence Housey, is a soft-spoken fellow who views linear life as a series of trade-offs: "We can make extremely fast transis-

(continued on p. 68)

Free reprint

A copy of this report, "The tiny, exploding world of linear microcircuits," will be sent free of charge to readers who circle Reader-Service number 250.

Linear literature

Honeywell will send a copy of its document of solutions to various problems encountered with the μ A709 to readers who circle Reader-Service number. 474. It is entitled *The care and feeding of the μ A709*.

Radiation Inc. will send a comprehensive book that tells designers how to use monolithic operational amplifiers to those who write to the company's Microelectronic Div. (attention John Corser) at Melbourne, Fla. 32901, on company stationery.

Fairchild Semiconductors will send a *Linear Microcircuit Handbook*, which contains updated and new applications notes to readers who circle Reader-Service number 473.

Bibliography:

Camenzind, H. R. "Modulated Pulse Audio and Servo Power Amplifiers," *1966 International Solid-State Circuits Conf. Digest of Tech. Papers* (New York: Lewis Winner), IX, 90-91.

EEE's Second Annual Clinic—Linear Integrated Circuits (New York: Mactier Pub. Corp., 1967).

Emmons, S. P. "Low Drift Integrated Circuit DC Amplifier Uses TSS," *EEE*, XIII, No. 8 (August, 1965), 48-53.

Fowler, William L. "A Look at Linear Integrated Circuits," *Electronic Industries*, XXIV, No. 9 (Sept., 1965), 64.

Gay, M. J. "Log IF Strips Use Cascaded ICs," *ELECTRONIC DESIGN*, XIV, No. 17 (July 19, 1966), 56-59.

Giles, James N. "Integrated Operational Amplifier Frequency Compensation," *EDN*, X, No. 12 (Oct., 1965), 24-34.

Hirschfeld, Robert. "IC's Improve Differential Amplifiers—And Vice Versa," *Electronics*, XXXIX, No. 16 (Aug. 9, 1965), 75-79.

Mitchell, M. M. "The N-Channel MOS Device As an RF Amplifier," *1966 International Solid-State Circuits Conf. Digest of Tech. Papers* (New York: Lewis Winner), IX, 108-109.

Stata, Ray. "Operational Amplifiers," *Electromechanical Design*, IX, No. 9 (Sept., 1965); No. 11 (Nov., 1965).

Uzunoglu, Vasil. "Six Possible Routes to Noninductive Tuned Circuitry," *Electronics*, XXXVIII, No. 23 (Nov. 15, 1965), 114-117.

—. "Improving the Performance of Multipurpose IC's with Feedback," *ibid.*, XXXIX, No. 13 (June 27, 1966), 70-73.

Call your Monsanto field engineering representative for skilled consultation on your instrumentation needs

Our field engineering representative in your area (see listings below) stands ready to provide detailed technical information on the capabilities and applications of our line of "4th Generation" instruments. *Please don't hesitate to call.*



1 Bard Associates, Inc.
LaGrange Industrial Park
LaGrange, Illinois 60526
Tel: 312-354-0660
TWX: 910-683-1894
4002 Meadows Drive
Indianapolis, Indiana 46205
Tel: 317-849-2723
7700 Morgan Avenue South
Minneapolis, Minn. 55423
Tel: 612-866-1700

2 Dynamic Associates
1011 Cadillac Way
Burlingame, Calif. 94010
Tel: 415-344-2521
5190 West Washington
Los Angeles, California
90016
Tel: 213-933-5833

3 Eastern Instrumentation, Inc.
613 Cheltenham Avenue
Philadelphia, Pa. 19126
Tel: 215-927-6269
1002 Ingleside Avenue
Baltimore, Maryland 21228
Tel: 301-RI 4-3675
350 Northern Boulevard
Great Neck, Long Island
New York 11021
Tel: 516-466-9505
518 Franklin Avenue
Nutley, New Jersey 07110
Tel: 201-661-2000
Watergate Building
Suite 502
2600 Virginia Avenue, N.W.
Washington, D.C.
Tel: 202-333-8880

4 George Gregory Associates
7 Erie Drive
Natick, Mass. 01760
Tel: 617-235-9070 or
01-5-1330
9 South Main Street
Cheshire, Conn. 06410
Tel: 203-272-5040

5 Hyde Electronics Co., Inc.
888 South Lipan Street
Denver, Colorado 80223
Tel: 303-963-3456

5206 Constitution Ave. N.E.
Albuquerque, New Mexico
87110
Tel: 505-265-8895
4710 North 16th Street
Suite 107
Phoenix, Arizona 85016
Tel: 602-264-5609

6 IBL Engineering & Sales Co.
219 Preston Royal Center,
Suite 6
Dallas, Texas 75230
Tel: 214-363-2921 or 3698
3403 Audubon #5
Houston, Texas 77006
Tel: 713-523-8360
1903 West 34th Street
Austin, Texas 78703
Tel: 512-452-2064
5149 East 31st Street
Tulsa, Oklahoma 74135
Tel: 918-936-6305
1444 Calhoun Street
New Orleans, La. 70118
Tel: 504-895-4793

7 Martin P. Andrews, Inc.
319 Mott Road
Fayetteville, N.Y. 13066
Tel: 315-NE 7-3144 or 6405
TWX: 710-541-0401

8 McDonald-Griggs
Route 1
Pfafftown, N.C. 27040
Tel: 919-924-2182
3305 Patton Road
Suite #1
Huntsville, Alabama 35805
Tel: 205-539-9601 Office
2610 Seabreeze Court
Orlando, Florida 32805
Tel: 305-422-0039

9 The Satullo Company
4514 North Woodward Ave.
Royal Oak, Michigan 48072
Tel: 313-549-3910 or
566-2375
16801 Euclid Avenue
Cleveland, Ohio 44112
Tel: 216-486-2800
2801 Far Hills Avenue
Dayton, Ohio 45419
Tel: 513-293-7061

530 6th Avenue
Pittsburgh, Pennsylvania
Tel: 412-931-5200

10 Technical Representatives, Inc.
7049 Laupher Lane
Hazelwood, Missouri 63042
Tel: 314-JA 1-1000
TWX: 314-524-2964
6814 Farmview Lane
Wichita, Kansas 67206
Tel: 316-MU 2-4140
809 Sheridan Circle
Olathe, Kansas 66061
Tel: 913-ST 2-3775

11 Electrodesign Ltd.
9124 St. Lawrence Blvd.
Montreal 11, Quebec
Tel: 514-389-5914
83 Arthur Street
Ottawa, Ontario
Tel: 613-233-8815
491 Lawrence Avenue W.
Suite 405
Toronto, Canada
Tel: 416-787-0991

12 Cane-Jessup Co., Inc.
P.O. Box 250
1433A 130th, N.E.
Bellevue, Wash. 98004
Tel: 206-454-0691

13 Monsanto Electronics Technical Center
620 Passaic Avenue
West Caldwell, N.J. 07006
Phone: (201) 228-3800
TWX 710-734-4334

ELECTRONICS

Latest in the line of Monsanto IC counter/timers.

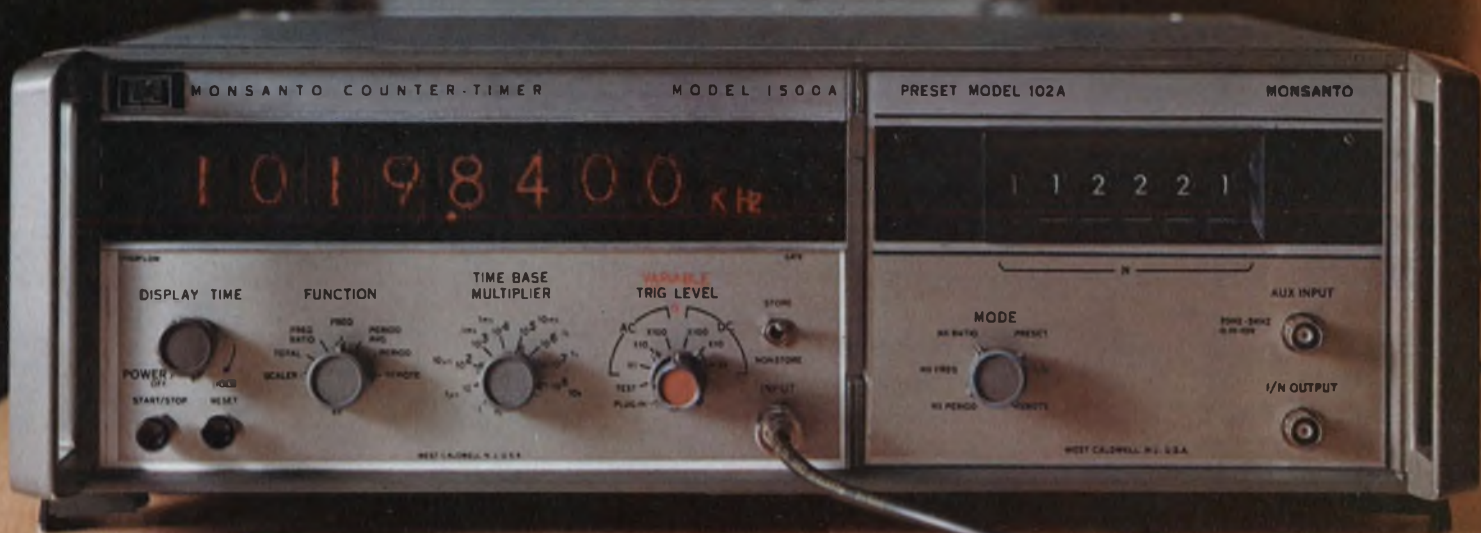

AVAILABLE PLUG-INS: TWO FREQUENCY CONVERTERS (50 MHz TO 500 MHz, 100 MHz TO 3 GHz); PRESCALER (dc TO 1 GHz); PRESET UNIT (20 Hz TO BEYOND 10 MHz); VIDEO AMPLIFIER (1 mV SENSITIVITY, 10 Hz TO 200 MHz); TIME INTERVAL UNIT (100 ns RESOLUTION); NON-COMMITTED PLUG-IN.

With 90% integrated circuit construction this new "4th generation" instrument is the most advanced plug-in counter/timer yet.

Our new model 1500A takes full advantage of IC capabilities to bring you: main-frame counting range from dc to over 125 MHz; to 3 GHz with a single plug-in. Remote programability by either contact closure or voltage level. Provision for external time base up to 10 MHz. And

naturally, the inherent stability and reliability of integrated circuit construction, as indicated by our two-year warranty. All this for only \$2,850 (U.S. dollars, FOB West Caldwell, N.J. exclusive of plug-ins). Circle the inquiry number for full technical details, or contact us directly at: Monsanto Electronics Technical Center, 620 Passaic Avenue, West Caldwell, N.J. 07006. Phone: (201) 228-3800; TWX 710-734-4334.



ELECTRONICS

ON READER SERVICE CARD, CIRCLE 124

(continued from p. 65)

tors by making smaller emitters and shallower diffusions, but these reduce voltage swing and power output. The user must sharpen his specifications. He has got to look at the chip as a black box and specify it that way. Then he must determine which performance characteristics are really important to his system. That way, we can make the trade-offs that can help him."

Housey observes that the distribution of most parameters is Gaussian, and even if the user's specs on each parameter are reasonably loose, it is to his advantage to eliminate specs he can live without. Let's say that 95 per cent of the circuits meet each specification but 10 specifications decrease the final test yield to under 50 per cent. The user pays for all the discards, and he pays for testing all the circuits. Knowing about microcircuit testing can save you many dollars. A shmoo plot on a sense amplifier, for example, is certainly handy for design purposes, but it is very expensive to obtain because of the time it takes. Following are some general tips on testing to use as a starter (you can learn lots more by close consultation with suppliers on this point):

- Dc tests are easier to make than ac, and it is always easier to make tests at ambient temperature than over a wide range.

- Many ac tests are related to their dc counterparts. Bandwidth, for example, is related to rise time. It's much easier for the manufacturer and ultimately cheaper for the user if he specifies rise time.

- A single tight ac spec can be extraordinarily expensive. Wesley Vincent, senior engineer of Motorola's Government Electronics Div., eliminated the specification on the gain-bandwidth product and found that the price of an operational

output was loaded with less than critical capacitance, the lead's small amount of distributed capacitance made the amplifier unstable.

Usually it's cheaper for the user to purchase what he can get and manipulate it into his system with a few external components, if he can eliminate a specification by so doing. Radiation's microcircuit product manager, Trygve Ivesdall, likes to recall the in-house request he once received for an operational amplifier with 1.5-mV input offset.

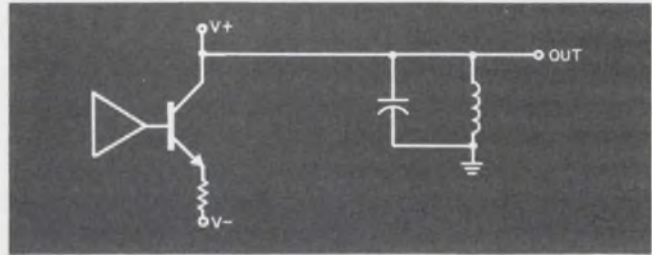

Isolated output needs no resistor

It's expensive to screen op-amps for a particular, exact offset voltage, he points out, and the user can easily trim a 15-mV offset to whatever he likes with a 5-cent resistor. "We can screen circuits for any tolerance on any parameter, but the user can easily adjust a couple of things, add a couple of cheap external components and keep his cost down," Ivesdall says.

In linears, as in all complicated new devices, the educational process that makes the wheels turn smoothly is a two-way street. "Most linears are designed so their specs look good," says Carl Ryan, senior engineer of Motorola's Government Electronics Div. "Manufacturers spec an amplifier from dc to 100 MHz. But who needs that bandwidth? I might want an i-f amplifier that has a 10-MHz bandwidth somewhere in this range. It takes lots of power to get a wide bandwidth, and I don't need it. Besides, the 3-dB bandwidth isn't important. The manufacturers should specify the useful bandwidth."

Donald Miller, an engineer with Hewlett-Packard Laboratories, Palo Alto, Calif., agrees. "They advertise 2-GHz gain-bandwidth so you think you can comfortably get 100 MHz at 10 dB," he notes. "But you only get 2 to 3 MHz. We need more meaningful specs."

Ryan points out that the user has to take care when hanging components on the output. "If they happened to use an emitter-follower output stage," he observes, "chances are you can't put a coil on the output, because it'll go unstable. A resistor between the amplifier and its output's compensation network can prevent the instability, but that's another part, and resistors use power." Ryan notes that inductors can be hung on an isolated output without serious repercussions. The

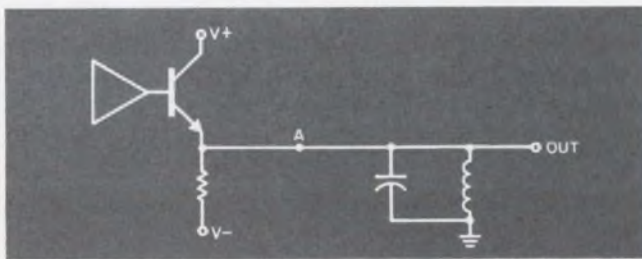

Ryan: "Emitter-follower needs resistor at 'A' "

amplifier he ordered went from \$60 to \$15. "Since then I've made sure I need what I spec," he says.

The complete black-box specification that the manufacturers prefer appears on the accompanying checklist. Often the user can avoid problems later if he takes the time to give the manufacturer a description of the system into which the circuit will go. One user, for example, purchased an operational amplifier that met all his specifications, but he overlooked one thing: the lead from his amplifier's output was long, and although the

nature of the load that the amplifier drives and the input it "sees" can be elusive. Richard Crawford and his engineer colleagues at Hewlett-Packard Laboratories ran into the following snags with a finicky unit:

"We hooked up the first linear we tried in the manufacturer's recommended circuit," Crawford says. "It oscillated at 50 to 60 MHz. After considerable effort, we traced the problem to the fact that its capacitive loading and source impedance were indeed slightly different from his recommended circuit. So we fiddled around with the power-supply decoupling. We had a capacitor from $B+$ to ground, from $B+$ to $B-$, and from $B-$ to ground. The linear suddenly became stable when we removed the capacitor between $B+$ and ground. Apparently the linear didn't mind looking at 100 pF with certain power-supply decouplings, but it strongly objected to others."

Oscillations are without a doubt the most severe chronic problem in linear microcircuits. But fortunately ringing can often be cured quite easily. Most of the cures are time-tested. ITT's Alfredo Gomez suggests these steps to hush oscillations:

- Use the right decoupling capacitors on the power supply leads. Keep it right near the terminal of the linear. The more noise in the power supply, the bigger the value.
- Check the inductance of external resistors.
- Shield the input from the output—a small piece of copper foil between the two sets of leads is an old remedy.
- Check the power-supply voltage setting. A slight adjustment either up or down might cure the instability. Be careful with this one, though. You don't want to turn out a touchy unit that will

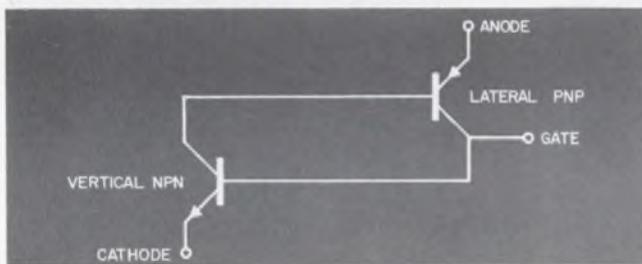

Westinghouse's integrated SCR

go unstable under normal field conditions.

- Return the input and output to ground with separate leads. This tried-and-true precaution is particularly important in high-current amplifiers.
- Make sure low-frequency or dc amplifiers have properly restricted bandwidth. Add a capacitor between the output and ground if the design can take the loss of bandwidth.

Crawford readily admits that his difficulties might not have been the fault of the amplifier. "But," he believes, "more complete characteriza-

tion of the device parameters could have helped us avoid problems. The spec sheets give you gain plots but not phase plots. They should give both. It would also help if they told you everything the unit does at unity gain. This is the worst case for stabilizing an amplifier, and it helps if the user knows what goes on there."

Crawford points out that, in a certain sense, the user is at the mercy of the manufacturer. He doesn't know the values of the components on a

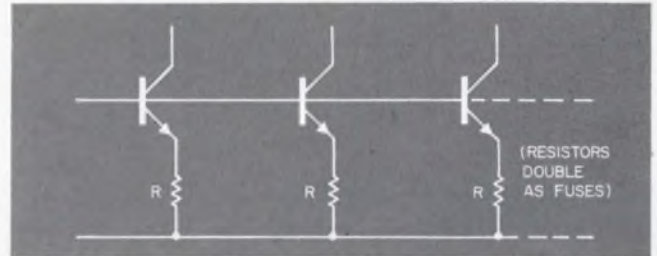

Fairchild's approach to high power

chip, and for competitive reasons, the manufacturer doesn't care to tell him. So Crawford feels that the manufacturer is obliged to provide as much data as he possibly can and warn users about treacherous configurations.

It is the specification sheets, then, that must characterize a device for the user, but there is no uniformity in presentation or data, and until recently there wasn't even a standard format. Seven months ago, however, the Electronic Industries Association created a standard format for linear microcircuits and sent it to each manufacturer. None responded. The 10-page form requires clear statements of performance characteristics, operating power levels, and current and voltage limits. The document (MED-3.3-2; 10/7-66) doesn't present the information as a manufacturer would. It is designed to present the specifications the way a user would want to see them. But the game of specsmanship forces manufacturers to publish and emphasize those parameters that appeal to the user—that make its devices look good. And since manufacturers see no advantage in the acquisition of a JEDEC number, they don't bother to register their linear circuits. Also, the form requires the statement of either minimum or maximum—the worst case—for each parameter. "The manufacturers advertise typical specs," observes Crawford, "but I have to design for worst-case. Naturally I prefer to see the worst-case specs on the circuits I use."

It is odd that the operational-amplifier module makers usually specify worst-case parameters, whereas manufacturers of monolithic operational amplifiers specify typical parameters. But perhaps the winds will change. One designer does seem to be in tune with the user. ■ ■

The op amp conjurer strikes again

The commonest user's complaint against the 709 operational amplifier is about its tendency to oscillate, particularly when operated at or near unity gain. Another limitation is its need for external frequency compensation before it can be used. Users also grumble about less serious problems: an operational amplifier should have a high open-loop gain. The Bode requirements are met pretty well by a gain of 10,000, but 100,000 would be better. Most operational amplifiers are ruined by a sustained short across their output, and most perform acceptably only within a rather limited range of supply voltage. The 709 is no exception.

The directors of National Semiconductor, a firm which had never made an operational amplifier, decided to shoot for one that would overcome these limitations. To design it, they hired the father of the 709, Bob Widlar, at double his Fairchild salary plus an option on 10,000 shares of stock at \$5—an option that is presently worth almost a third of a million dollars. Why Widlar?

At the age of 29, Widlar is hardly the model of an "organization man" designer. For kicks, he drives into the mountains and rams his Mercedes-Benz through hairpin turns at 50 mph. When he tires of driving, he pulls his car off the road, and spends a day or two chopping wood. (Between jaunts, Widlar keeps his sharpened, red-handled ax in one corner of his office. To the dismay of visitors, he often plays nervously with it while making a point about microcircuits.)

For relaxation, when the mood strikes him, Widlar drives to the San Francisco airport and purchases a ticket for the next flight. "I like bumming around," he admits, "and I don't much care where."

Widlar approaches the design of a microcircuit with the compulsive drive of a perfectionist. He uses every trick in the book and then some, and his microcircuits inevitably sport a dazzling array of Widlarisms. He can never quite overcome his strong commitment to his circuits. One Fairchild executive complained that his constant meddling, even after a design was complete, often interfered with the production of a circuit. But despite his idiosyncrasies, Widlar came to National with a number of impressive achievements: he had already designed the μ A702, the μ A710, the μ A711, the μ A726 and the μ A709.

Widlar's greatest asset was that he thought like

a user. He shared with every other designer of linear microcircuits the knowledge that operational-amplifier users want minimum offset voltage, offset current and bias current; infinite gain and frequency response, and zero power dissipation. It is self-evident that they also want high slew rate as well as unconditional stability, regardless of the closed-loop gain at which the amplifier is operated or the nature of the source and output impedances that the amplifier sees. But Widlar also knew that, for the vast majority of users, 100,000 gain is as good as a million times that figure. And though some users might prefer to push a stable 6-dB/octave roll-off closer to a perilous 12-dB/octave rate, most customers—particularly the largest—prefer to avoid the repeated cost involved in adding external components for frequency compensation. Many, Widlar felt, would prefer an internally compensated two-stage operational amplifier that would maintain stability, no matter what the user hung on its inputs or output.

Last month National Semiconductor announced the LM101, its new operational amplifier. It took Widlar nearly a year to design. The output of the LM101 can be shorted indefinitely without damage to the circuit and the only compensation it requires, even at unity gain, is a single 30-pF capacitor.

Widlar squeezes the design rules

Like the 709, the LM101 is both conservative and daring in the concept of its design. The 709 made only two simple additional demands on the standard digital process: it required its transistors to have high-quality junctions and more than a minimum current gain. The LM101 also requires a lateral pnp current gain of one. On the other hand the LM101 has almost no chip area set aside for diffused resistors; it uses transistors and pinch resistors in their place. It uses five lateral pnps, as opposed to the single lateral and single substrate pnp used by the 709 (see schematic). Widlar avoided the substrate pnp because he felt it would introduce unnecessary process control to get acceptable current gain and breakdown voltage. Instead he used a quasi-complementary output stage—an npn (*Q17*) driven by a lateral pnp (*Q16*)—to perform the same function without complications. He used a related combination in the input. Here a pair of



Bob Widlar, in his natural habitat, contemplates the use of a buried junction-FET as a constant-current supply for his LM101's bias circuit.



It's hard to find a resistor on the mask set of Widlar's LM101. Most of the high-value resistors are really dc-biased transistors, three are pinch resistors, and the largest ($R1 = 300\text{ k}\Omega$) is a buried FET. It is tricky to control its value, but the LM101 will work with a wide range, allowing Widlar to watch the buried FET in production.

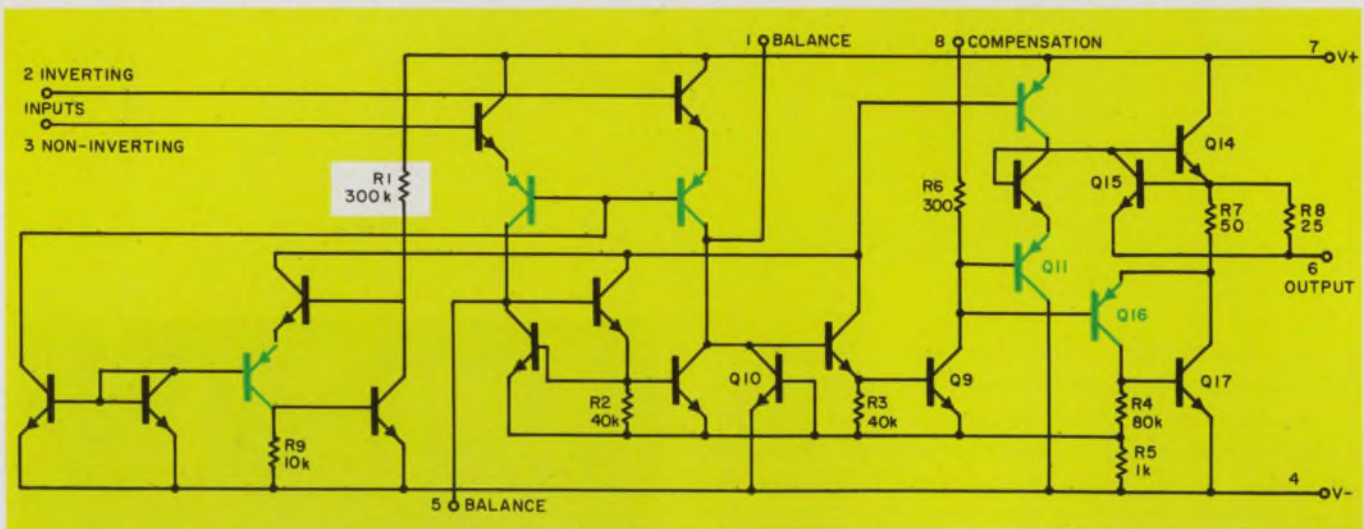

The schematic for Widlar's LM 101 shows his skillful avoidance of resistors. In this circuit, only R5 through R9 are diffused-base resistors. R2, R3 and R4 are pinch resistors. R1 is the 300-k Ω buried FET. Because he feels that substrate pnps are difficult to process, Widlar uses

nnp emitter-followers (Q1 and Q2) drive a pair of lateral pnps connected in a differential, common-base configuration. This npn-pnp combination, Widlar points out, is the circuit equivalent of a common-emitter pnp pair with high current gain, except that the effect of collector-base capacitance is much reduced.

Widlar designed in short-circuit protection of the output without limiting the output voltage swing with a resistor. He used a single device, Q15, as both a transistor and a diode to do it. When the voltage across R8 becomes large enough to turn on Q15, it conducts base drive from the output transistor Q14. This protects it from surges in the positive direction. Those in the negative direction cause a voltage drop across R7 and the collector-base diode of Q15 clamps the emitter of Q11. This lateral pnp causes Q9 to conduct heavily producing a voltage drop across R5, which turns on Q10 to limit the output current of Q9. Further output current increases begin to turn off Q16 and remove base drive from Q17.

The secret of the LM101's ability to get upwards of 25,000 gain at supply voltages of from ± 5 volts to ± 20 volts is its constant current resistor, R1. Its value is very roughly 300 k Ω : it is really a buried FET, the resistance of which is determined by the supply voltage. The chip is laid out in such a way that the supply voltage depletes the buried FET. The higher the voltage, the higher the FET's effective resistance. R1 powers the biasing circuit so that at high power supply voltages the chip does not dissipate excessive heat; at low voltages R1 provides sufficient current to run the bias circuitry.

The layout of a chip, Widlar feels, is an important part of the circuit design. His buried FET, for example, depends upon the power supply

combinations of npns and lateral pnps prolifically. Here he uses a total of six lateral pnps—which, like Q11 and Q16 appear in green. But the gain requirement of these pnps is higher than that of the one in the 709. It required a β of 0.01; these require a β of one.

voltage's creation of an electrostatic field that has an appreciable component perpendicular to the length of the FET. If the FET had been laid out parallel to the field of the power supply, its resistance would not vary. A good layout also saves chip area. The LM101, for example, is 45 by 45 mils—1000 square mils smaller than the 709.

"A sloppy layout could have made the LM101 a 50-by-100-mil chip," says Widlar, "even the 45-mil chip isn't the lower limit." He believes the chip could be reduced to 40 by 40 mils, but before he would do that he would put the 30-pF capacitor on the chip. "That would give the user an unconditionally stable, internally compensated, two-stage op amp with an open-loop gain of up to 200,000," he says. Quite a circuit!

"It isn't a circuit at all," explains Widlar. "It's a 'kluge'—a monstrous assortment of components on a chip—a very interesting 'kluge.'"

Widlar is fond of recalling Larry Housey's answer to a request for a definition of a linear microcircuit: "The test is simple," quipped Housey, Texas Instruments' manager of linear IC engineering. "They take the specs to the digital microcircuit designers. If they can't make it, it's a linear microcircuit."

There's more truth in that statement than a simple definition of a linear microcircuit. It is much harder to develop a new linear circuit than a digital. Widlar equates the development of a new linear to that of a whole family of digitals, for each new linear uses a fresh set of design tricks.

There is no royal road to the next trick, but a director of research at one big semiconductor house has found a simple way. When asked about his company's plans, he said bluntly: "We watch Bob Widlar to find out what we're going to do next in linears." ■ ■

When it comes to buying silicon power transistors and rectifiers, do you have to act like a tough pistol-packin' persuader?

From past experience, you may believe that's the only way of keeping your semiconductor supplier in line to avoid broken delivery promises, unexplained delays, constant expediting, rising costs, technical problems and quality control lapses.

Not anymore! Now you can lay that pistol down, because there is a new, easier way! The Slater way, of course. We've combined the idea of old-fashioned customer service with unique break-throughs in semiconductor technology that give us the highest quality yield rates in the industry. Our semiconductor lines are now in full production on:

POWER TRANSISTORS with ratings from 5 watts to 85 watts in TO-5, TO-53, and TO-57 packages, including the following types:

2N389	2N1047	2N1048A	2N1049B	2N1116	2N1768	2N2034
2N389A	2N1047A	2N1048B	2N1050	2N1117	2N1769	2N2858
2N424	2N1047B	2N1049	2N1050A	2N1690	2N2032	2N2859
2N424A	2N1048	2N1049A	2N1050B	2N1691	2N2033	2N2911

POWER RECTIFIERS with Slater's "controlled avalanche" process which eliminates need for matching—types 1N1183 thru 1N1190 (35 amp); 1N1191 thru 1N1198 (18 amp); 1N2128 thru 1N2138 (65 amp); 1N3765 thru 1N3768 (35 amp).

JAN and TX RECTIFIERS types 1N3189 thru 1N3191 to MIL-S-19500/155.

When you buy the Slater way, you won't have to point a pistol to get the kind of service you deserve. You'll get immediate delivery on any of the types listed — and the price quotes will convince you that we really mean business! Prove it to yourself—give us a call today. And just to make it easy, make that call collect.

SEMICONDUCTOR DIVISION, SLATER ELECTRIC INC., 45 SEA CLIFF AVE., GLEN COVE, N.Y., 516-671-7000

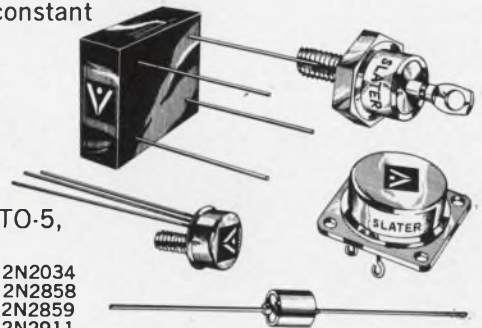

**There must be
an easier way to buy
silicon power transistors.
(and rectifiers too.)**

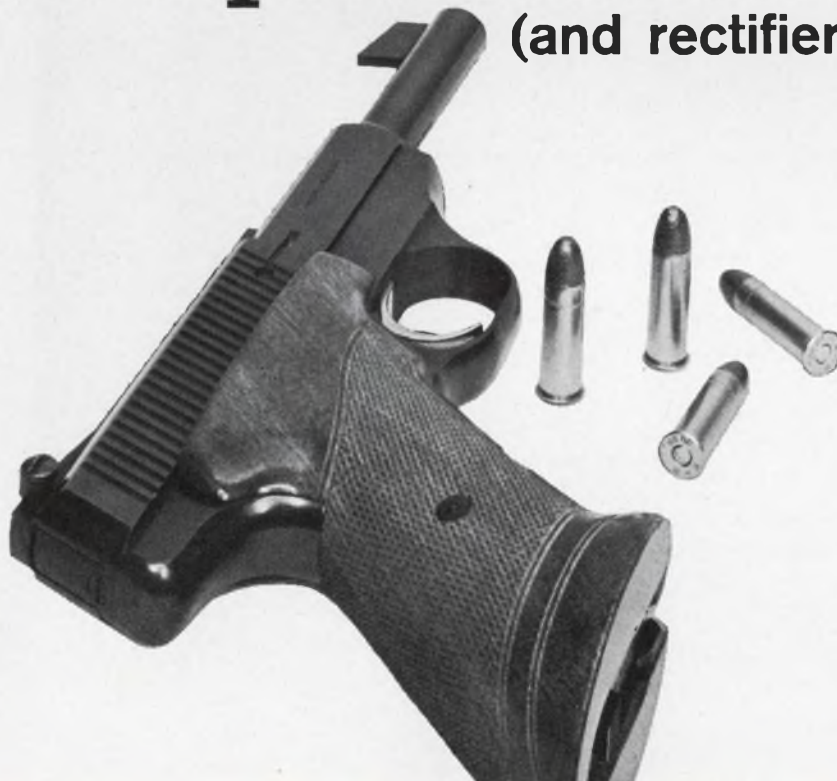

ON READER-SERVICE CARD CIRCLE 36

**These counters
will solve
your present
problems now...**



Model 5245L Counter with new 5258A Sensitive Prescaler



Model 5246L Counter with new 5254B Frequency Converter

...your future problems later.

HP counters will solve your present measurement problems first, and they'll be ready with the same versatility and high performance far into the future. They're always up to date, because their flexibility and performance are always widening. A large team of engineers is constantly working to keep the 5245L Counter, the 5246L Counter and their plug-ins the most advanced available. New accessories and plug-ins are continually being introduced to give you more versatility and protect your investment.

Latest examples of new plug-in versatility are shown in the photo: the 5254B Frequency Converter (0.2 to 3.0 GHz) and the 5258A Sensitive Prescaler (1 mV sensitivity from 1 to 200 MHz). Together, these two plug-ins will extend counter range from DC to 3 GHz. Or, if you like, you can cover DC to 12.4 GHz with just two plug-ins, the 5254B (0.2 to 3 GHz) and 5255A (1 to 200 MHz and 3 to 12.4 GHz).

The 5245L Counter accurately measures frequency, period, multiple period average, ratio and multiples of ratio and can be used to scale a signal by decades. Its time base aging rate is less than 3 parts in 10^7 day, and a dual FET input amplifier provides 1 Meg/25 pF input impedance, independent of attenuator setting. Basic counting rate is DC to 50 MHz. BCD output is standard. It accepts the exclusive Model 5255A 0.3 to 12.4 GHz Converter—no need to use more than one module to measure in this range. Price: Hewlett-Packard 5245L Counter, \$2950.

The economical 5246L Counter offers many of the 5245L's advantages, and is a basic 50 MHz counter. It measures frequency and frequency ratio, has display storage and 6-digit readout, and a time base crystal aging rate of $\pm 2 \times 10^{-7}$ per month. It accepts all accessories and plug-ins of the 5245L Counter. Price: Hewlett-Packard 5246L Counter, \$1850.

PLUG-INS TO USE WITH EITHER COUNTER:

- 5255A Heterodyne Converter, 0.3 GHz to 12.4 GHz (and 1 to 200 MHz). Price: \$1650.
- 5251A Plug-in Converter, 50 to 100 MHz. Price: \$300.
- 5252A Prescaler, DC to 350 MHz. Price: \$685.
- 5253B Plug-in Converter, 50 to 500 MHz. Price: \$500.
- 5254B Plug-in Converter, 0.2 to 3 GHz. Price: \$825.
- 5258A Prescaler, 1 to 200 MHz, 5 mV. Price: \$825.
- 5261A Video Amplifier, 1 mV RMS, 10 Hz to 50 MHz. Price: \$325.
- 5262A Time Interval Plug-in. Price: \$250.
- 5264A Preset Unit for normalized measurements. Price: \$650.
- 5265A Digital Voltmeter, 6-digit presentation of 10, 100 and 1000 V full-scale with 5% overrange capability. Price: \$575.

SOME OTHER ACCESSORIES:

- 5260A Automatic Frequency Divider for direct readout 0.3 to 12.4 MHz. Price: \$3450.
- 2590B Microwave Frequency Converter (phase-locked transfer oscillator), 0.5 to 15 GHz. Price: \$2150. (12-18 GHz optional).
- 5050A Printer, 20 lines/sec. Price: \$1750 + \$35/column.

For more information call your local HP field engineer or write Hewlett-Packard, Palo Alto, California 94304. Europe: 54 Route des Acacias, Geneva.



ON READER-SERVICE CARD CIRCLE 37

10 transistor leakage currents are used in manufacturers' specifications. Understand this abracadabra and check it with your own test circuits.

Leakage currents are some of the most widely cited yet least understood transistor parameters. They are nevertheless critical. The electronic designer must have a good grasp of them, otherwise he may find that soaring temperatures will cause gross signal errors, or even burn out the transistors in his equipment.

The aim of this article is to give a general definition of leakage, summarize its effects on transistors, review some of the more commonly measured types of leakage in transistors, and recommend a number of test circuits. An outline of safety procedures will help the transistor user to protect devices under test and to obtain more accurate and meaningful data. And a comprehensive résumé of various ways to specify leakage currents should make it easier to interpret manufacturers' specifications.

What is leakage current?

Leakage current in transistors is primarily due to the fact that semiconductors are partial conductors. In other words, whenever a reverse bias is applied to a diode in a transistor, a potential

gradient is set up across the junction which attracts either holes or electrons. As the holes or electrons drift to the potential source, a current flow occurs. This internal current flow is primarily a function of three factors: material, impurities and ambient temperature. All these factors tend to generate free holes or electrons, which under proper conditions will lead to a measurable current flow.

Another factor (Fig. 1) that contributes to measurable leakage is the surface condition of the semiconductor. Surface contamination and moisture content cause a detectable resistive effect. And as applied voltage increases, so, too, does the surface leakage. A combination of these two factors, surface and bulk, make up semiconductor diode leakage.

Many leakage currents can be measured

Measurement of the diode leakage currents in transistors is shown in Figs. 2 and 3.

The measurement of I_{CBO} (Fig. 2) is essentially the same as for the emitter-base diode. The applied constant voltage (usually a higher value than for I_{EBO}) is placed as a reverse bias across the collector-base diode. The current-measuring device (usually a sensitive microammeter) is

Ronald M. Mann, Senior Engineer, Texas Instruments, Inc., Dallas.



"When applying signals to a transistor under test, always start from zero," says the author, Ronny Mann, shown adjusting bias for the I_{CEX} measurement.

Ten common leakage currents

- I_{CEO} - Collector to emitter with base open
- I_{CBO} - Collector to base with emitter open
- I_{EBO} - Emitter to base with collector open
- I_{CER} - Collector to emitter with finite resistance between base and emitter
- I_{CES} - Collector to emitter with base short-circuited to emitter
- I_{CEX} - Collector to emitter with forward bias from base to emitter
- I_{ECR} - Emitter to collector with finite resistance between base and collector
- I_{ECS} - Emitter to collector with base short-circuited to collector
- I_{ECX} - Emitter to collector with forward bias from base to collector
- I_{ECO} - Emitter to collector with base open

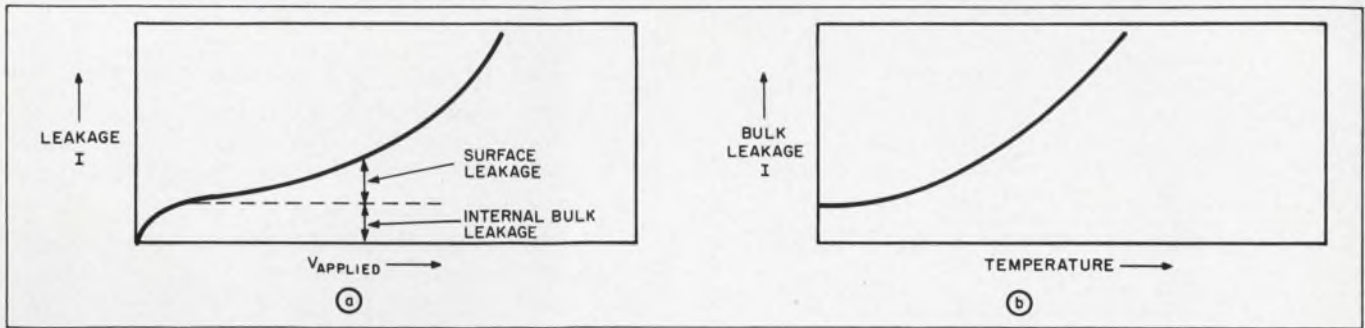

1. Major leakage current contributing factors are applied voltage (a) and ambient temperature (b).

placed between the base and the common, or return, side of the system.

The emitter-base diode has the same general leakage characteristics as the collector-base diode, but usually of a lower level and associated with a lower breakdown voltage. To measure I_{EBO} , a reverse bias is placed across the diode with a constant dc voltage source. The usual method is to place a current meter of appropriate accuracy and sensitivity in series with the return side of the system (between the base and the supply), as shown in Fig. 3.

The measurement of transistor leakage begins with the I_{CEO} measurement (Fig. 4). I_{CEO} is the leakage current from collector to emitter with the base open-circuited and reverse bias applied to the collector. It is usually quite large compared with either of the diode leakages, as much as by an order of magnitude. This measurement is helpful for applications where a high resistance is connected from base to emitter, as is common in a number of switching circuits.

Measurement of I_{CER} (Fig. 5) differs from I_{CEO} only in that a finite resistance is connected from base to emitter. The lower the resistance value, the lower the leakage current.

Measurement of I_{CES} (Fig. 6) is practically identical to I_{CEO} and I_{CER} . In fact, I_{CES} might

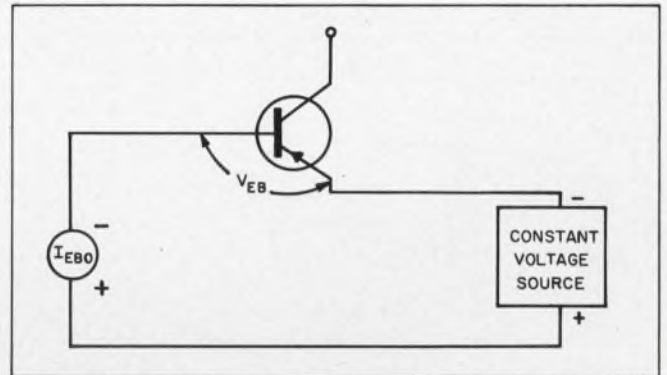

3. I_{EBO} measurement is made by applying reverse bias to the emitter.

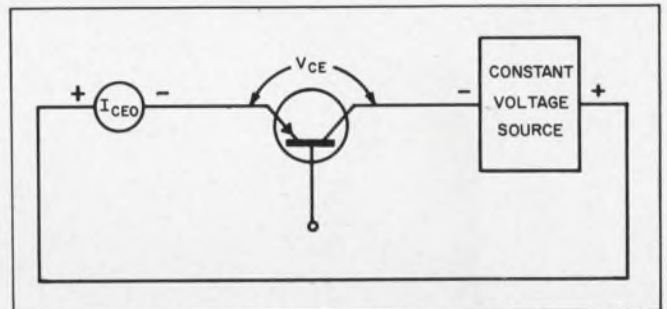

4. I_{CEO} measurement is made by applying voltage across the collector-emitter with the base open-circuited. Polarity is reversed for an npn transistor.

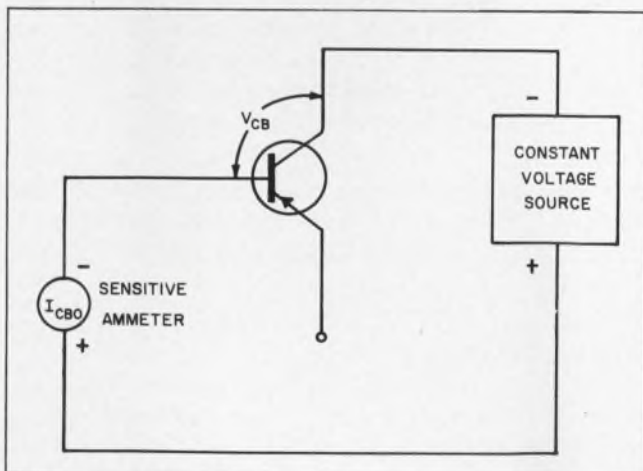

2. Basic I_{CBO} measurement block diagram employs only two instruments—voltage supply (with a meter) and a microammeter.

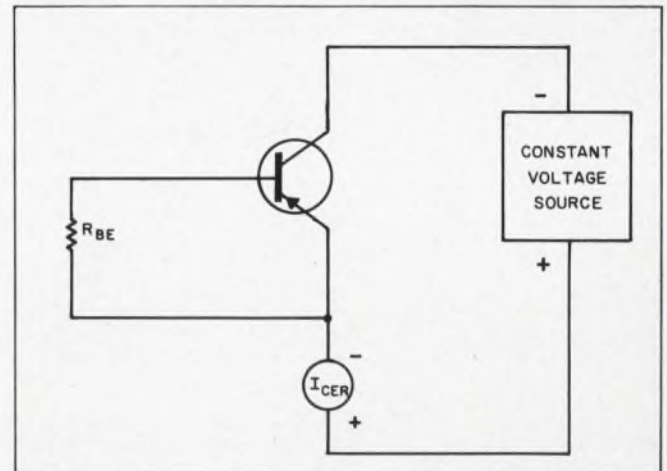

5. I_{CER} is measured in the same fashion as I_{CEO} except that a resistor is placed between the base and the emitter. A potentiometer can replace the fixed resistor.

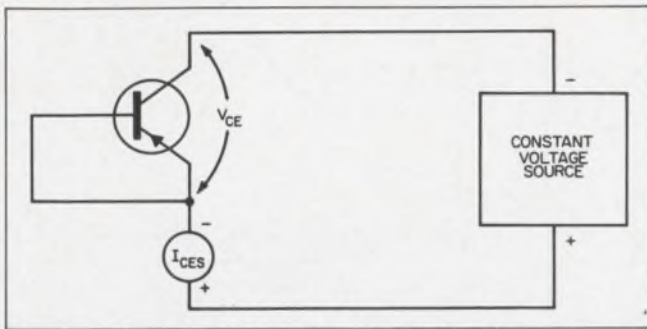

6. I_{CES} measurement is the same as for the I_{CER} except that the base is shorted to the emitter.

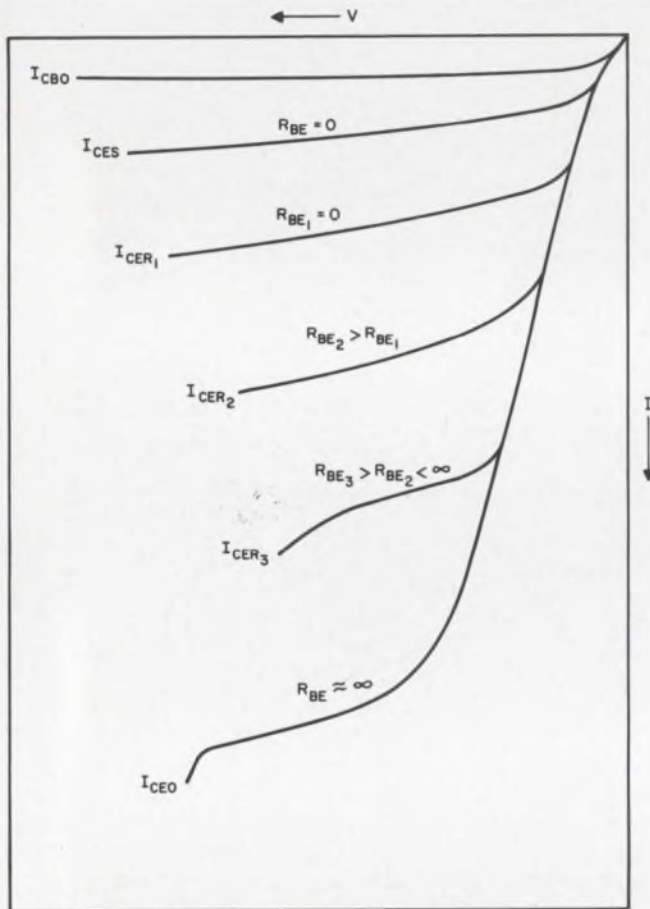

7. Relationship among I_{CEO} , I_{CER} , and I_{CES} shows their relative magnitudes (and corresponding importance to the designer).

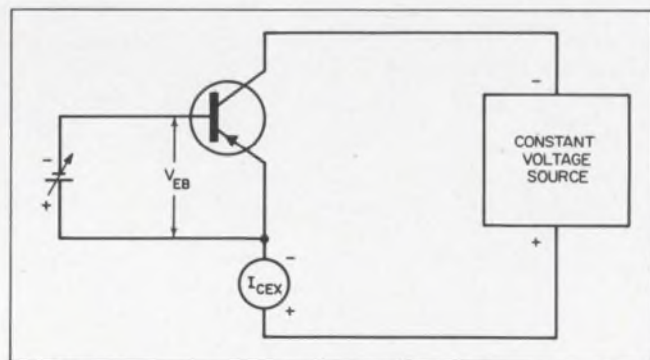

8. I_{CEX} measurement is made with addition of a low-impedance dc bias across the base-emitter diode. To avoid damage to the transistor, start with zero bias.

be called a special case of I_{CER} where the resistance value is zero, just as I_{CEO} might be described as a special case of I_{CER} where the resistance value is infinity. The value of I_{CES} closely approaches that of the collector-base diode leakage current.

The relationship between these various leakages is depicted in Fig. 7. The curves show that, when a fixed voltage is applied to an alloy transistor, the leakage current is lowest for I_{CRO} and increases as reverse bias is applied from collector to emitter. The leakage grows progressively from the point where the emitter-base resistance is zero to a maximum value when the base-to-emitter resistance is infinity.

The situation is similar (Figs. 8 and 9) for the I_{CEX} parameter. I_{CEX} is a measure of the transistor leakage current from collector to emitter with a reverse bias applied between collector and emitter and a small forward bias applied between base and emitter. The block diagram of Fig. 8 points up the definite relationship between I_{CEX} and the other I_{CE} measurements. The primary difference of I_{CEX} from the others is that the external resistance between base and emitter is replaced by a low-voltage, low-impedance dc source. I_{CEX} is of primary importance in applications where a small, forward base bias is applied, as in some switching circuits.

The curves of Fig. 9 for I_{CEX} bear a striking resemblance to those for I_{CER} in Fig. 7. The increase in applied base-emitter voltage corresponds to the increase in base-emitter resistance. As the value of the applied voltage approaches the device's V_{BE} , the leakage current curve nears its maximum and corresponds to the transistor's I_{CEO} curve.

Less common measurements of transistor leakages are those where the emitter is reverse-biased and the collector is placed on the common side of the supply system. Most of these parameters are applicable to switching uses and to some cases where differential outputs are used (such as for hi-fi or power amplifiers), where a Darlington configuration is used, or where the device is used in a common-collector mode for impedance transformation. Transistors have what is commonly referred to as a reverse beta, or gain, when the emitter is used as the collector. Most transistors, except such special devices as unijunction transistors, have a dc current gain on the average some three times less than normal when the emitter is used as the collector.

The measurement of I_{ECS} (base-collector shorted) and I_{ECR} (with a base-collector resistor) (Fig. 10) is basically the same as for their common-emitter counterparts, I_{CER} and I_{CES} . In this case, the reverse bias is applied to the emitter and leakage current is measured between

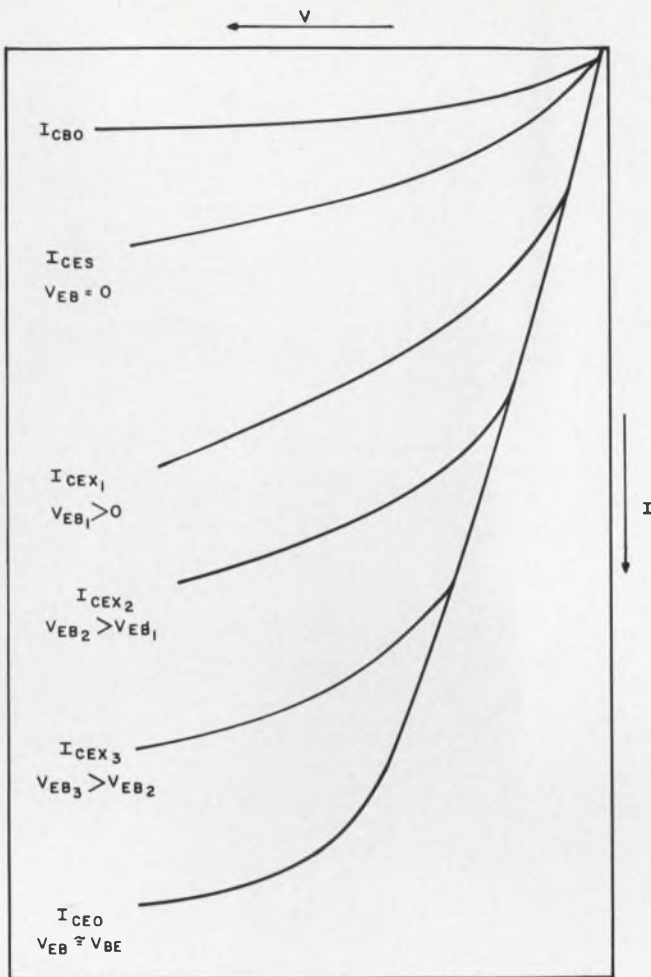

9. The effect of bias on the I_{CEX} measurement and its relationship to I_{CES} and I_{CEO} appear in this curve. Note the rapid increase in leakage current.

the collector and the common of the constant-voltage supply. The specified resistor, for I_{ECR} , or the short circuit, for I_{ECS} , is placed directly from base to collector. The curves in Fig. 11 for the emitter cutoff currents display a behavior pattern very dissimilar to those for the collector shown in Figs. 7 and 9. The emitter cutoff currents are larger in value than the simple diode leakage currents. They show that, as the applied emitter reverse bias and the resistance between collector and base are increased, so too is the current. Thus, the lower the resistance between collector and base is, the higher the useful emitter reverse bias will be, until it reaches the break-over voltage. Note that the resistance has the effect of increasing breakdown with little increase in leakage current.

Another emitter cutoff current encountered from time to time is I_{ECX} . This is measured (Fig. 12) the same way as the other emitter cutoff currents are, the only exception being that a voltage source is used in place of a resistor from base to collector. The same type of constant-voltage reverse bias is applied to the emitter as for the other I_{EC} parameters. The collector is returned to

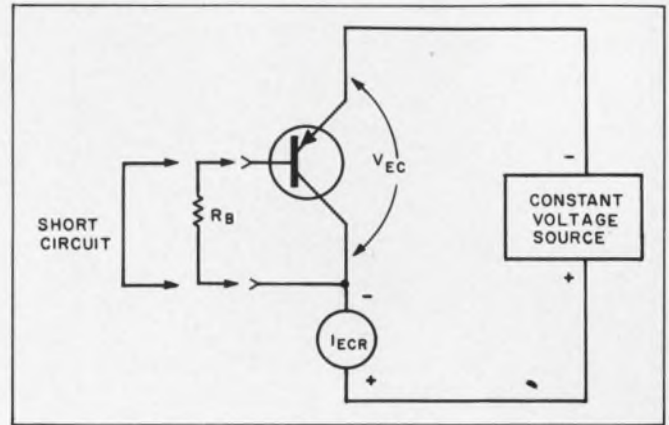

10. I_{ECS} and I_{ECR} measurements are performed by applying reverse bias to the emitter and placing a short or a resistor between the collector and the base. Polarity is reversed for an npn device.

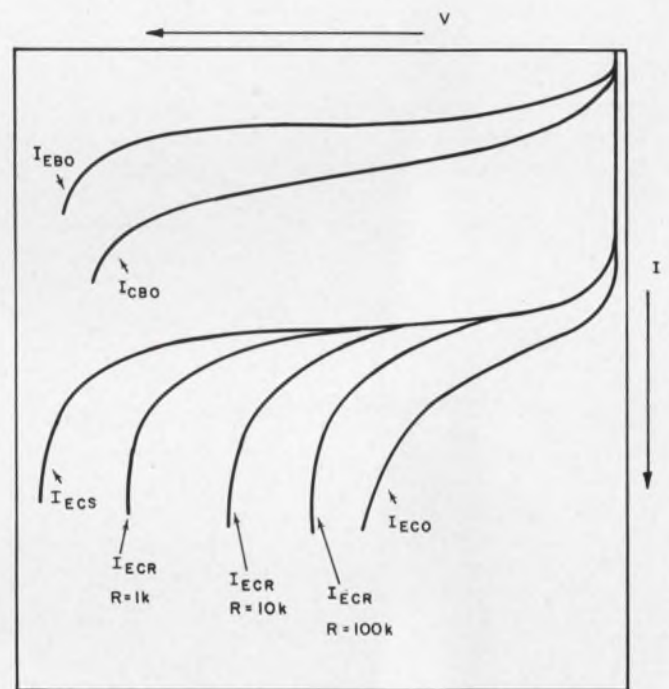

11. Emitter cutoff currents show their dependence on the resistor value used in the measurement of I_{ECR} . I_{EBO} has the lowest value of all emitter cutoff currents.

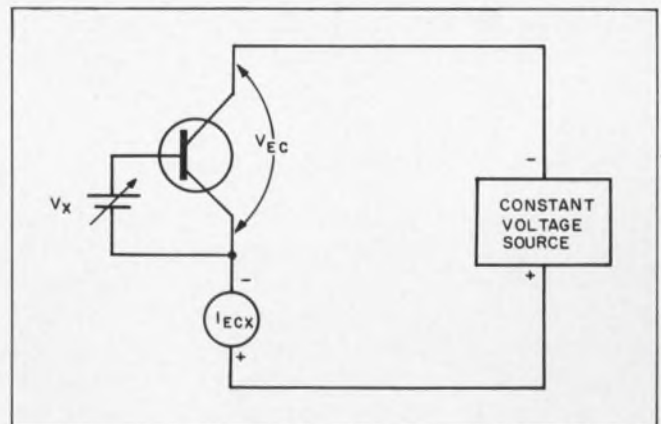

12. I_{ECX} measurement is made in a common-collector configuration.

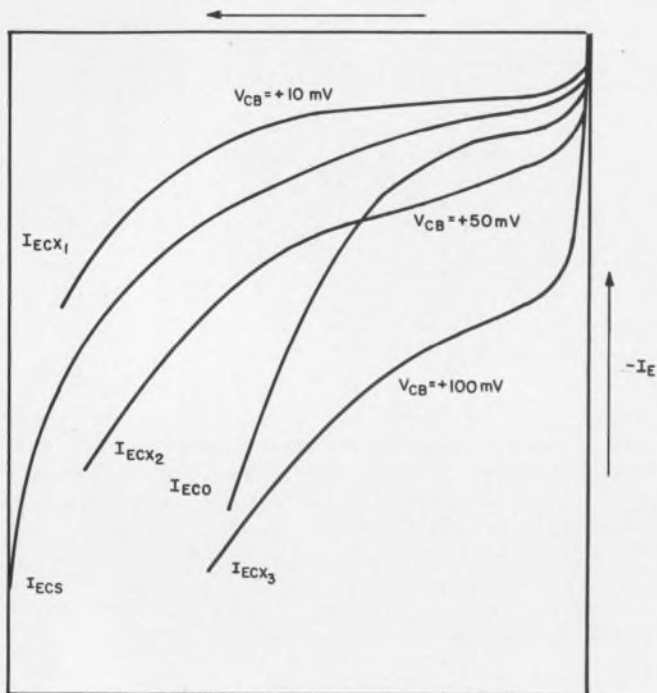

13. Relationship of I_{ECX} to other emitter cutoff currents shows that there is no definite correspondence.

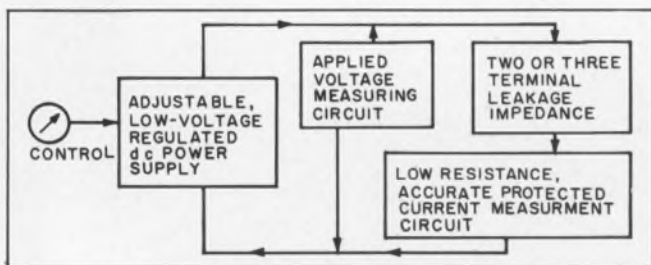

14. The simplicity of the test equipment required is demonstrated in this block diagram. For accurate leakage current measurement, the voltmeter must be connected as shown in this diagram.

the common through the microammeter. The relationship between this leakage, or cutoff, current and the other emitter currents appears in Fig. 13. These curves are for a typical germanium alloy transistor, and show that, as the collector-to-base voltage is increased, the leakage current increases. No definite relationship between I_{ECS} and I_{ECO} can be established as it can between I_{ECS} and I_{CEO} .

Only simple test equipment is needed

The basic test equipment for leakage current measurement is shown in Fig. 14. It includes a low-impedance, adjustable dc supply and a means of measuring the leakage current—normally a low-resistance, accurate current meter of suitable range. Some means of checking and adjusting the applied voltage to the proper value is also required. If the applied-voltage-measuring instrument is of a low-impedance type such that the

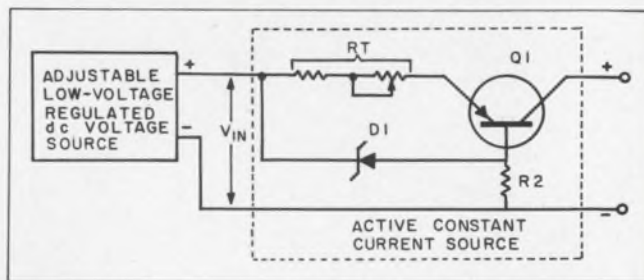

15. Current-limiting to the device under test can be achieved with a simple circuit.

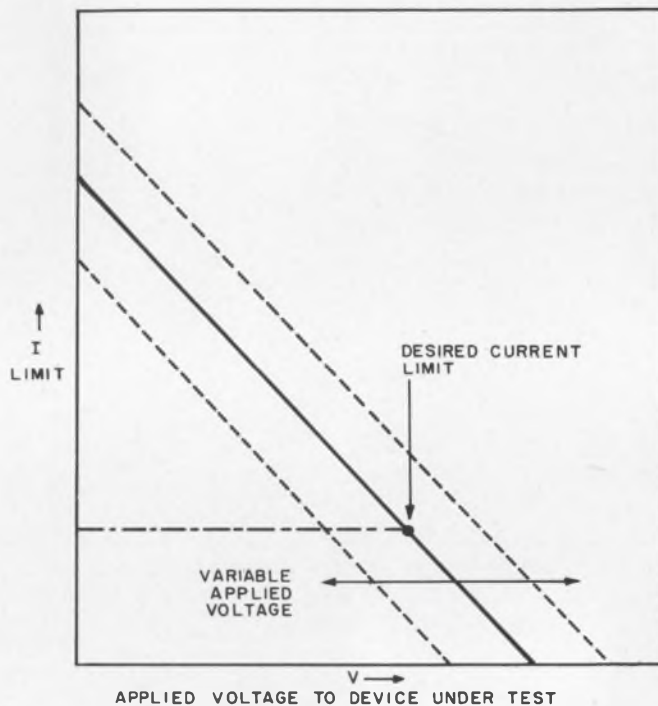

16. Disadvantage of current-limiting with a resistor is that current can easily exceed maximum safe limits for the device.

current that it draws is a significant part of the leakage current, the meter is usually placed as shown. This ensures that the current being measured is due only to the leakage of the unit under test. The result is a small error in the applied voltage to the transistor under test, but this is usually negligible when a low-resistance current-measuring system is used. The voltage drop across the current-measuring device must be much less than that developed across the unit under test.

The dc supply shown in Fig. 14 is adjustable. To prevent damage to units being measured, especially for more sensitive devices such as germanium high-frequency types, the applied voltage should be set to zero upon completion of each test before the transistor is removed from its socket. The voltage should be kept at zero, or some reduced value, until after the next unit to be tested has been inserted in the test fixture.

One essential feature, especially if any quantity of measuring is to be done, is a means of limiting

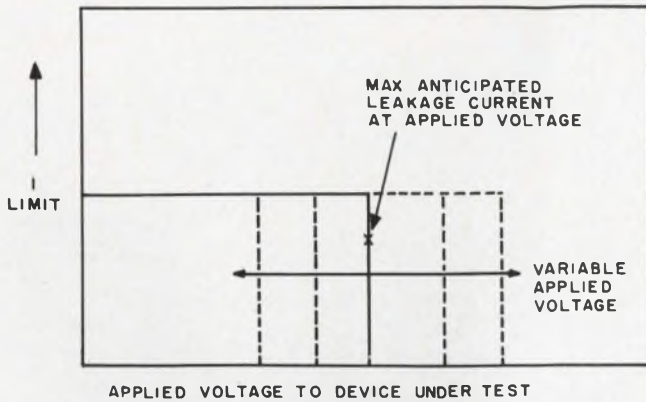

17. Active current-limiting should be used for best results. Any upper limit can be selected.

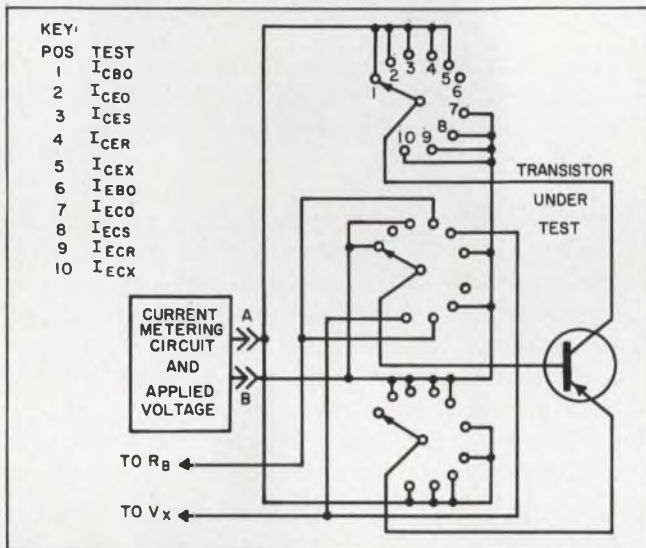

18. All ten leakage current measurements can be performed by placing a multiposition, three-deck wafer switch between the unit under test and the rest of the system. The switch can be solenoid-driven.

the amount of current that the dc supply can furnish to the unit under test (Fig. 15). Current-limiting can be performed with a resistor in series with the supply or with an active constant-current source^{1,2,3} like the one illustrated.

The use of a resistor as a current limiter in leakage measurement has disadvantages. Figure 16 shows a plot for current-limiting with a passive element. When a fixed resistor is used, the current limit can vary over a wide range and end up quite high under short-circuit conditions, especially if the resistor value is chosen to optimize at a point such as the plot shows. This optimum point is such that for the applied voltage the current limit is orders of magnitude above the leakage to be measured. Thus, at short circuit where V approaches zero, the current can be sizable.

A much more desirable approach is to use active current-limiting (Fig. 17). Here the current limit can be set at some reasonable level above the worst-case leakage to be encountered. The current

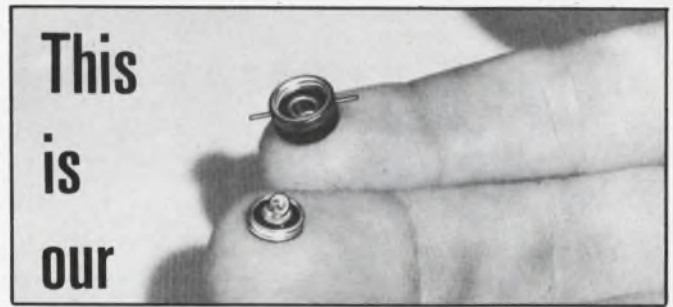

FLYING SAUCER LAMP!

It doesn't fly, has no resemblance to a saucer and there's nothing "outer space" about it! "Flying Saucer" is just the designer's affectionate nickname for this completely new concept in panel lighting.

The "Flying Saucer" lamp has two parts—a clear or colored Tenite Filter with a threaded socket that can be permanently bonded into a plastic panel or mounted on a PC board, and an incandescent lamp with a threaded base. The overall height of the assembly is .175" so that it can easily be used in a .220" plastic panel leaving it flush front and back.

In operation, the lamp illuminates the panel legends clearly through edge lighting while it is itself invisible. It produces a clearly legible panel board, especially for viewing under low ambient light conditions. In addition, it has numerous other advantages in performance, in economy.

If your equipment includes an illuminated panel, investigate the "Flying Saucer"—it's the newest concept in panel illumination! Write for Catalog CMT-2.

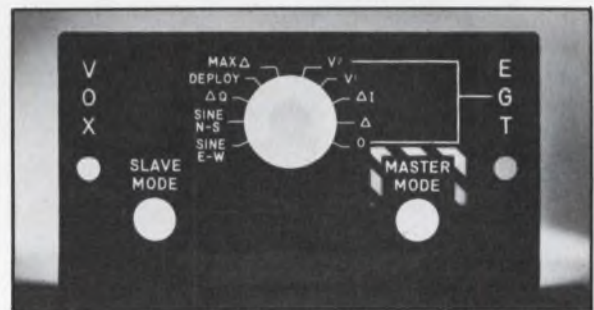

A "Flying Saucer" illuminated panel

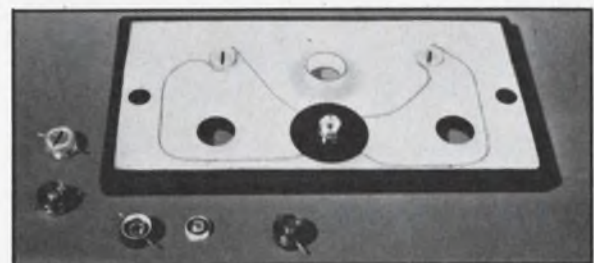

Lamp filter and leads are permanently bonded into the panel.

CHICAGO MINIATURE  LAMP WORKS

4433 RAVENSWOOD AVENUE • CHICAGO, ILLINOIS 60640

ON READER-SERVICE CARD CIRCLE 38

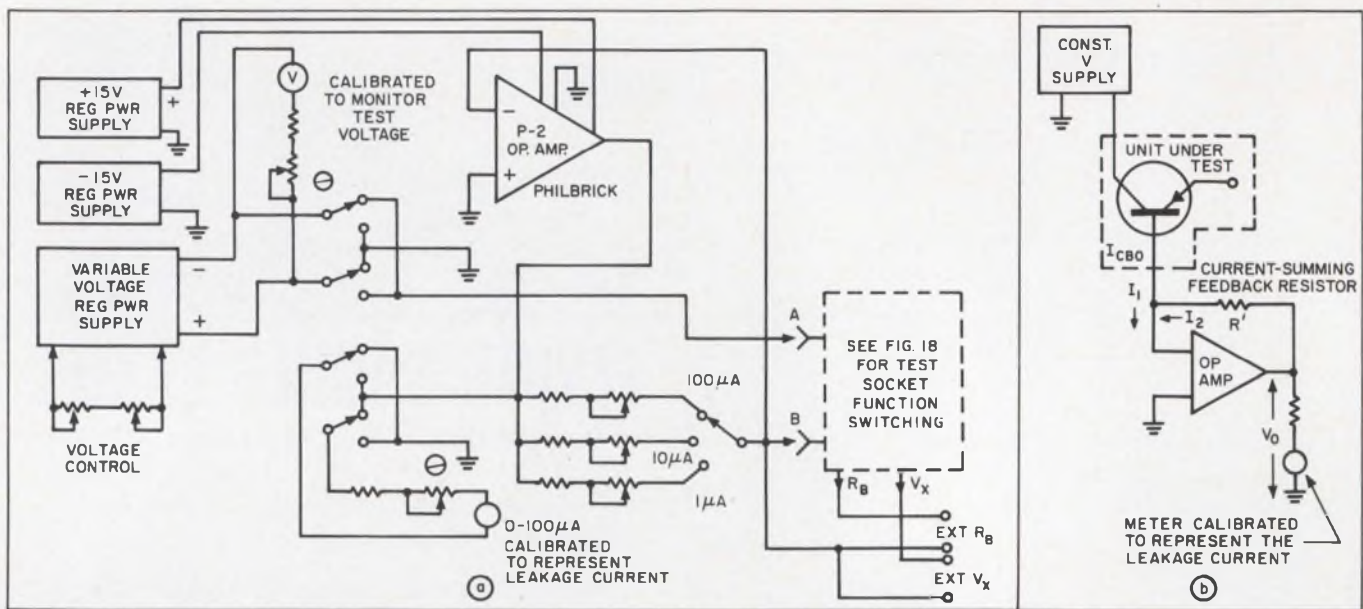

19. An over-all test setup with active current-limiting uses an operational amplifier (a). Functional hook-up of

the operational amplifier is shown in (b). The switch is in position for the I_{CBO} measurement.

remains constant, even under short-circuit conditions. As long as the current limit is above the leakage currents to be measured, the limiting action will not occur and accurate leakage measurements may be obtained over a wide range of applied voltage. Should a unit under test break down or be shorted while voltage is being applied to it, the limiting circuit will maintain the predetermined maximum attainable current.

Constructing the test set presents no problems

The first need in the construction and design of a versatile leakage test instrument is a means of switching the test socket to connect the element under test to the dc supply and current-measuring circuitry. One way to do this is shown in Fig. 18.

An over-all test setup is shown in Fig. 19a. Here use is made of the current-summing abilities of a commercially available transistor operational amplifier. This is made clearer in Fig. 19b. When the input current, I_1 , from the unit under test is, say, $1 \mu\text{A}$, and the feedback current, I_2 , is of equal magnitude but of opposite polarity, the net current into the amplifier is essentially zero. Because of the presence of some residual current and the high gain of the amplifier (50,000 or more), a voltage V_o representing the relative magnitude of the leakage current, I_1 , will appear at the output. If I_1 were to increase to $2 \mu\text{A}$, voltage V_o would increase and the summing current, I_2 , would increase to $2 \mu\text{A}$. The meter reading V_o would, if properly calibrated, also read $2 \mu\text{A}$.

The actual system as shown in Fig. 19a consists of such elements. The test socket function-switching represents the unit under test. A means of reversing polarity enables both npn and pnp transistors to be tested. The range-switching is

provided to allow the current-metering circuit to register ranges of leakage current. A means of supplying power to the amplifier and a circuit for determining the applied voltage to the unit under test are shown. This last is connected from the high side of the unit under test to the common, because the low side of the unit is at the summing junction of the operational amplifier, which for all practical purposes is at zero volts, or ground.

The system of Fig. 19a is a flexible, highly accurate one that limits current by means of the operational amplifiers. Care should be taken in such a system to prevent oscillation and to maintain accuracy through proper calibration and use.

An important consideration is that much leakage current testing has to be done on a go-no-go basis. This is particularly true in production testing of semiconductors and for large-volume users where a quality-control incoming inspection is required. The system of Fig. 19a can easily be adapted to such ends with the addition of voltage- and current-sensing logic elements.

Success in applying these techniques is subject to several conditions. These include:

- Ambient temperature will have considerable effect on the leakage.
- If the device has been warmed by physical contact or as a result of a recent test, the leakage measurement will be in error.
- Current-measuring errors may affect results. ■ ■

References:

1. Ronald M. Mann, "Constant Current Modules Use One Basic Board," *ELECTRONIC DESIGN*, X, No. 13 (June 21, 1962), 88-91.
2. —, "Rapid Constant Current Design Using Nomographs," *EDN*, VIII, No. 4 (April, 1963), 112-115.
3. —, "SCS Displaces Transistor," *ibid.*, X, No. 3 (March, 1966), 90-97.

Readout — bright, legible, IEE readout — makes the difference when the data must be accurately read at a glance, from any angle. That's the case with Lloyd Isaacs, Resident Manager of the Santa Monica office for Hornblower & Weeks — Hemphill, Noyes. On a busy trading day his clients start ringing for immediate quotations on New York prices. In 3/10 of a second, Isaacs gets and reads a crisp, brilliant figure from the IEE display on his electronic quoter. The client says *buy*. Done. He answers another line. Another client, and another quick-glance quotation goes out — accurately. IEE front-plane readouts assure that accuracy.

Whether *your* product is business machines, test equipment, or space instrumentation, your customers demand the best readout available. Give it to them with IEE rear-projection, front-plane readouts — your choice of sizes with



an unlimited selection of characters and colors. Send now for your copy of the new IEE Readout Catalog. Illustrated: IEE Series 120 Readout — 160° circular viewing angle; character boundaries 5/8" wide horizontal band drawn through .800" D circle. Brightness to 100 F. L.

"I double-E," the world's largest manufacturer of rear projection readouts. **IEE**
Industrial Electronic Engineers, Inc., 7720 Lebona Ave., Van Nuys, Calif. 91405.

**When big money rides on a stock quotation,
"readout" makes the difference!**

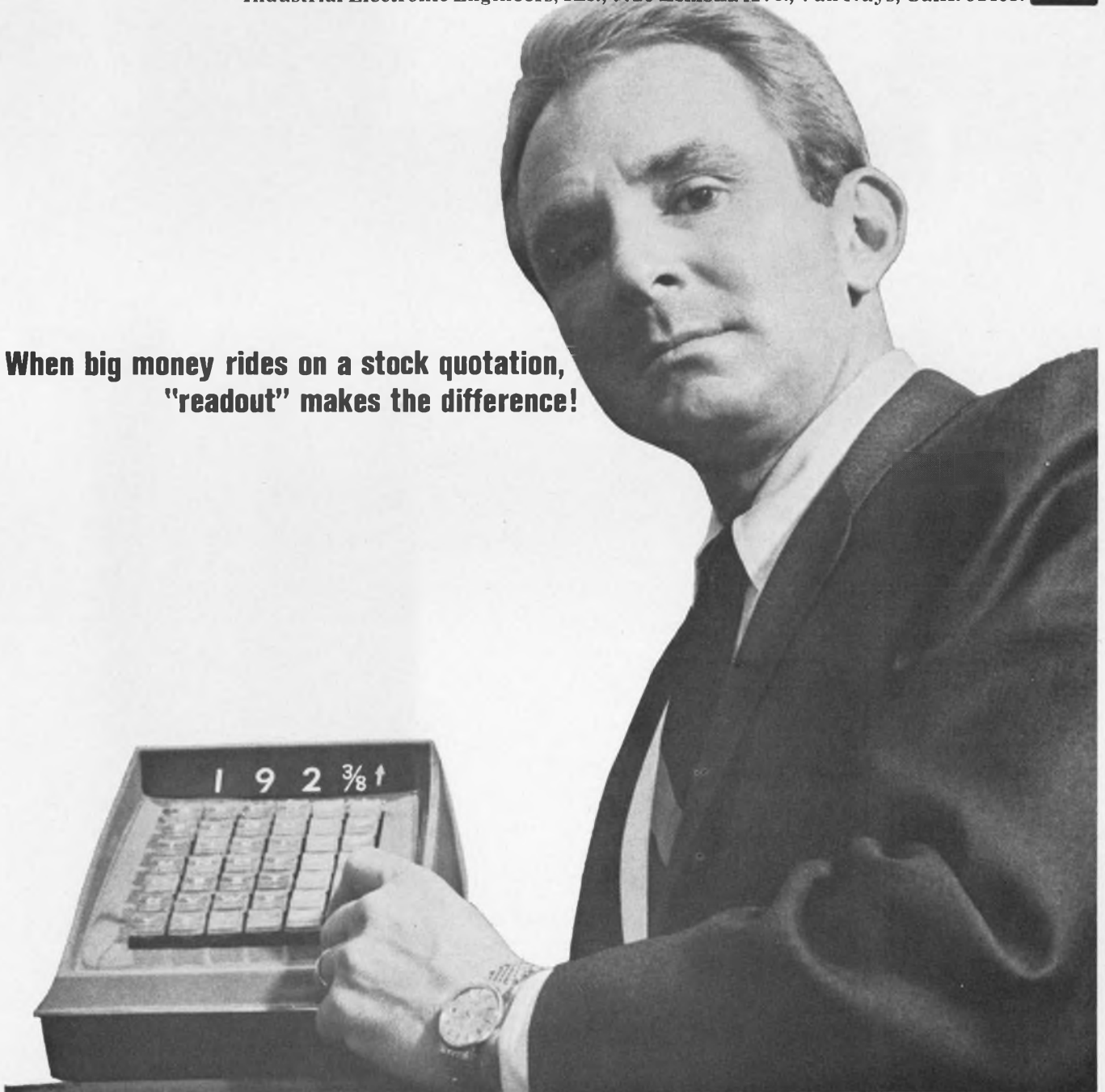

ON READER-SERVICE CARD CIRCLE 39

Total monolithic integration of analog subsystems:

When?

Now.

Big things are happening in Linear Integrated Circuits. And they're happening where they've always happened — at Fairchild (that's why we supply more LIC's off-the-shelf than all other manufacturers combined). We've got a pile of new data that belongs in your hands. Take a look:

NEW, IMPROVED PERFORMANCE

We've done new things with old products. The original 702 and 710 circuits have powerful new specifications:

μ A702 — Wideband DC Amplifier			μ A710 — High Speed Differential Comparator		
Typical Parameters	New	Former	Typical Parameters	New	Former
V_{os}	0.5mV	2.0mV	V_{os}	0.6mV	2.0mV
I_{os}	180nA	700nA	I_{os}	750nA	1.0 μ A
A_{vo}	3,600	2,600	t_{on}	40nS	40nS
$V_{os}/\Delta T$	2.5 μ V/ $^{\circ}$ C		A_{vo}	1,700	1,500
			$V_{os}/\Delta T$	2.5 μ V/ $^{\circ}$ C	

NEW PRODUCTS

We've introduced three completely new circuits to allow you even greater design flexibility:

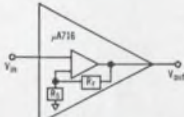
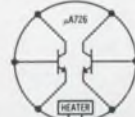
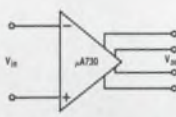
μ A716 — Low Distortion Medium Power Amplifier	μ A726 — Temperature Stabilized Transistor Pair	μ A730 — Differential Output Amplifier
 <p>Typical Characteristics</p> <p>A_{vc} 10, 20, 100, 200</p> <p>THD 0.05% @ 150mW</p> <p>I_{out} 100mA pk</p> <p>V_{out} 13V p-p</p>	 <p>Typical Characteristics</p> <p>$\Delta V_{be}/T$ 0.2μV/$^{\circ}$C</p> <p>$\Delta I_b/T$ 10pA/$^{\circ}$C</p> <p>h_{FE} 400 \pm 5%</p> <p>(-55 to +125$^{\circ}$C) (I_c = 100μA)</p> <p>LV_{CE0} 30V</p>	 <p>Typical Characteristics</p> <p>A_{vo} 145</p> <p>V_{os} 1mV</p> <p>I_{os} 0.5μA</p> <p>V_{out} 8 V p-p</p> <p>R_{out} 70Ω</p>

TOTAL LINEAR CAPABILITY

Fairchild volume production gives you the quantity you need of the circuit you need, when you need it. Choose from the improved 702 and 710; the all-new 716, 726 and 730; or from these field-proven standards:

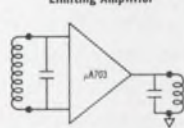
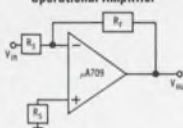
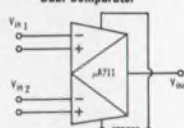
μ A703 — RF-IF Limiting Amplifier	μ A709 — High Gain Operational Amplifier	μ A711 — High Speed Dual Comparator
 <p>Typical Characteristics</p> <p>G_m 35 mmhos</p> <p>Y_{12} .001 mmhos</p> <p>I_{out} 4mA p-p</p> <p>R_{in} 3KΩ</p>	 <p>Typical Parameters</p> <p>V_{os} 1mV</p> <p>I_{os} 50nA</p> <p>A_{vo} 45,000</p> <p>V_{out} \pm 14V</p>	 <p>Typical Parameters</p> <p>V_{os} 1.0mV</p> <p>I_{os} 0.5μA</p> <p>t_{on} 40nS</p> <p>A_{vo} 1,500</p>

NEW, LOWER PRICES

Fairchild sells more so Fairchild sells for less. Our high volume allows us to again reduce your costs, across the board. For instance, look at these new prices:

702C	\$ 5.50	711C	\$16.00
703E	1.50	716C	5.75
709C	5.95	726C	12.50
710C	4.95	730C	3.85

(all prices are 1000-quantity, industrial grades)

FREE, NEW APPLICATIONS HANDBOOK

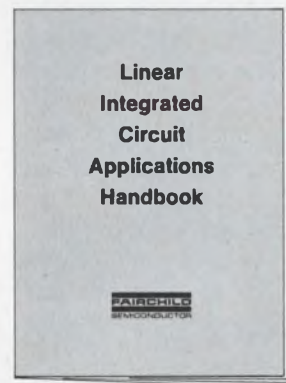

For a limited time, we'll send all inquirers our new 150-page Fairchild Linear Integrated Circuit Applications Handbook (just off the press). It's crammed with new design ideas, new applications, and new information on how to cut costs and improve performance utilizing Total Monolithic Integration (we'll also include complete specification data on the entire Fairchild LIC line). Along with this information, you receive complete rules and entry forms for our Special LIC Contest (see below).

CONTEST



Win a new Pontiac Firebird for a year

We've even developed a personal incentive for you to up-date your knowledge of the Fairchild LIC line and the benefits of designing with Total Monolithic Integration. It's an Analog Subsystem Design Contest. If you're a winner, we'll put you behind the wheel of a brand new Pontiac Firebird. Complete contest rules and entry forms are included with your LIC Handbook Data Kit (all you need to do is write us or call your Fairchild Distributor or Sales Office). You can enter as often as you want. But hurry: The contest closes on September 30.

CIRCLE READER SERVICE NUMBER

FAIRCHILD
SEMICONDUCTOR

Stop your counter from 'hanging up'

because of noise. Proper flip-flop recovery-time design controls pulse-spacing and reduces errors.

A difficulty in the use of some counters is to prevent the arrival of pulses faster than the counter can resolve them. In numerical systems, for example, where a bidirectional counter is driven by *add* and *subtract* pulses, rapid alternations of the input may cause counting errors. The counter may even stop altogether.

The system to be described reduces the possibility of such faults. It ensures that the recovery time of the flip-flop that supplies the *add* and *subtract* pulses is greater than the minimum resolving time of the counter.

Bidirectional counters of this type are often used in instrumentation systems where various physical quantities are measured by counting periodic variations of some parameter. Thus, length may be measured by counting the number of interference fringes—alternating light and dark bands—generated in an appropriate optical system. Similarly, magnetic flux density changes can be measured by counting the number of periodic alternations of voltage that occur when the flux density in the aperture of a properly biased superconducting quantum interference device (SQUID) is varied.^{1,2}

Quadrature voltages give add and subtract pulses

If appropriate sensors are available to produce a voltage with an amplitude that varies with a known period for a unidirectional change in the quantity to be measured, then it is necessary only to sense whether the unknown quantity is increasing or decreasing to be able to count the number of periods traversed. Sense information may be obtained by means of a second periodically varying voltage in quadrature (90° out of phase) with the first voltage, referenced to one period of the measured quantity. The following system enables two periodically varying voltages in quadrature to be converted into digital pulses capable of driving a reversible electronic counter.

The general approach to converting the quadrature waveforms v_A and v_B into digital *add* and

subtract pulses is to employ v_B to control the state of a flip-flop circuit (Fig. 1), and v_A to supply collector voltage for the flip-flop.

Figure 2 shows one period of output voltage from a SQUID, a typical sensor. Voltage v_A is proportional to the first derivative of SQUID voltage with respect to the flux density, B , and v_B is proportional to the second derivative of SQUID voltage with respect to B . The flip-flop collector supply voltage, v_{CS} , is an amplified, inverted and clipped reproduction of the negative swing of v_A ; the base drive voltage, v_{BD} , is a dc offset comparable to the negative swing of v_B . When B equals B_0 , v_{CS} is zero and v_{BD} is negative. As B increases from B_0 , v_{BD} goes positive. On further increase of B , v_{CS} goes positive, thus supplying collector voltage to the flip-flop. T_2 is conducting, so its collector voltage v_{C2} remains near zero. T_1 is biased off, so its collector voltage v_{C1} rises with v_{CS} . When $B = B_1$, v_{BD} falls and regenerative switching of the flip-flop causes a rapid drop in v_{C1} , which is differentiated to produce an *add* pulse. Further increase in B produces a drop in v_{C2} , which had risen during regenerative switching. This drop is nonregenerative and therefore too slow to produce a sizable differentiated pulse.

As B decreases from B_2 , when v_{CS} rises, v_{C2} rises, since v_{BD} keeps T_2 cut off. When v_{BD} rises, v_{C2} falls regeneratively, producing, by differentiation, a *subtract* pulse. Further decrease in B causes a nonregenerative drop in v_{C1} , which had risen during regenerative switching. This drop, too, is too slow to produce a sizable differentiated pulse.

If B is increasing and changes to decreasing, or vice versa, at any point in the cycle other than B_1 , no output pulse can occur because regenerative switching cannot take place. If alternations in B take place about B_1 , alternate *add* and *subtract* pulses will occur but not more closely spaced than the recovery time of the flip-flop. By design, flip-flop recovery time is greater than the minimum resolving time of the counter totaling the output pulses, so no residual counting errors occur.

Although the waveforms for v_A and v_B in Fig. 2 are sinusoidal, the circuit will operate satisfactorily with other waveshapes, providing only that the two inputs each exhibit peaks that are dis-

Robert L. Forgacs, Principal Engineer, Physics Dept. Scientific Laboratory, Ford Motor Co., Dearborn, Mich.

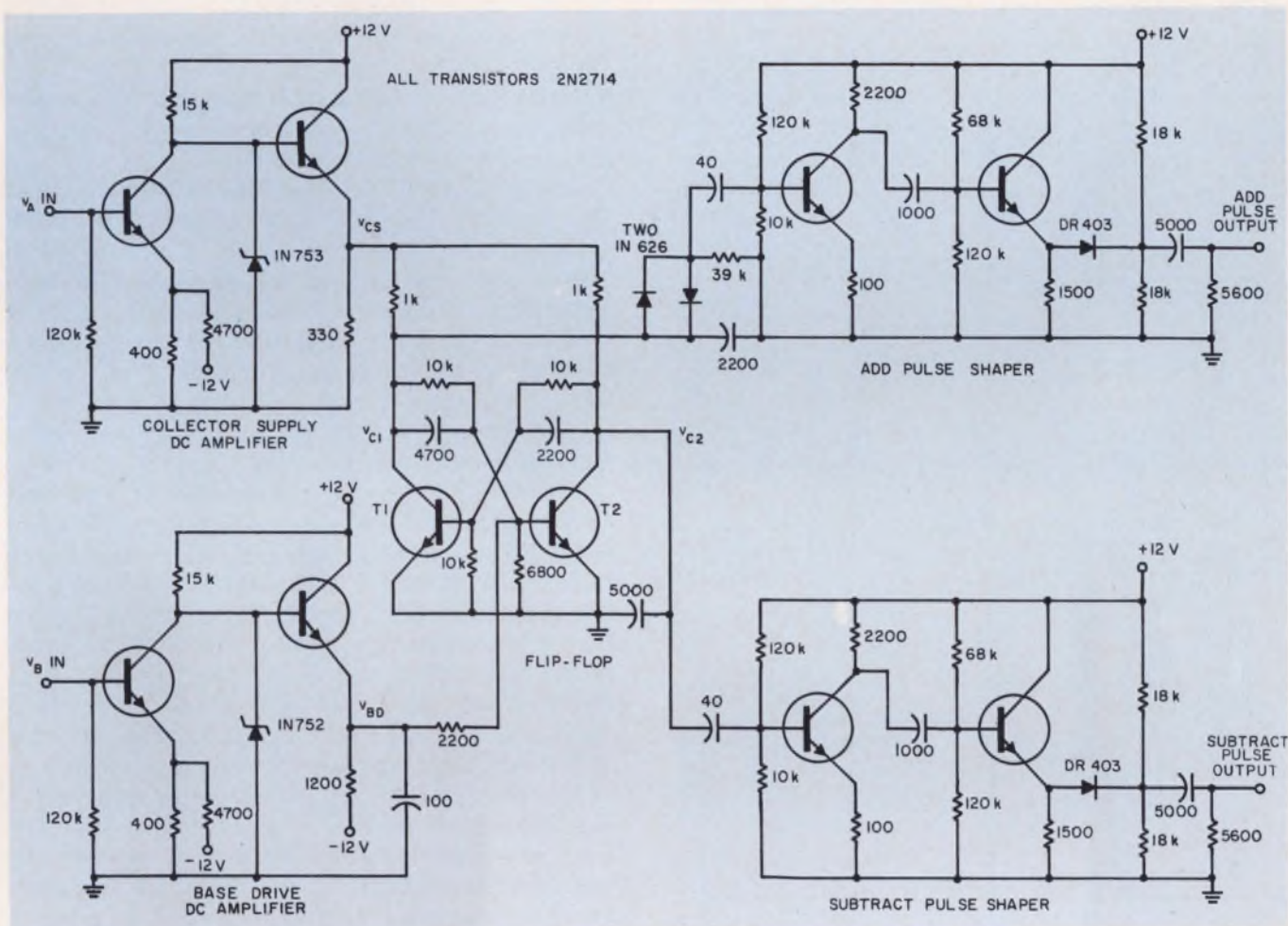

1. Flip-flop is controlled by quadrature inputs. Base drive is held to prevent premature reswitching during counter

recovery time. Low value collector resistors give 1- μ s transition time.

placed from each other by approximately one half the width of the base of the peak. An example of a source of suitable waveforms is a pair of photocells detecting the passage of a light spot, as on a cathode-ray tube.

Flip-flop has 15- μ s recovery time

In the circuit of Fig. 1, the collector supply dc amplifier consists of a conventional common-emitter amplifier dc-coupled to an emitter-follower. The component values are selected to permit the output level, v_{CS} , to swing between zero volts

(with input zero or positive) and approximately +5 volts (with input -0.4 volt or more negative), limited by a Zener diode. The base drive amplifier is similarly designed to yield output levels of -1.2 volts (with input zero or positive) and +4.4 volts (with input -0.4 volt or more negative). With these output levels the 2.2-k Ω resistance connected to one base of the flip-flop is small enough to permit regenerative switching to occur but large enough to prevent premature reswitching during the recovery time.

The flip-flop design gives a fast transition, the desired minimum recovery time and an adequate

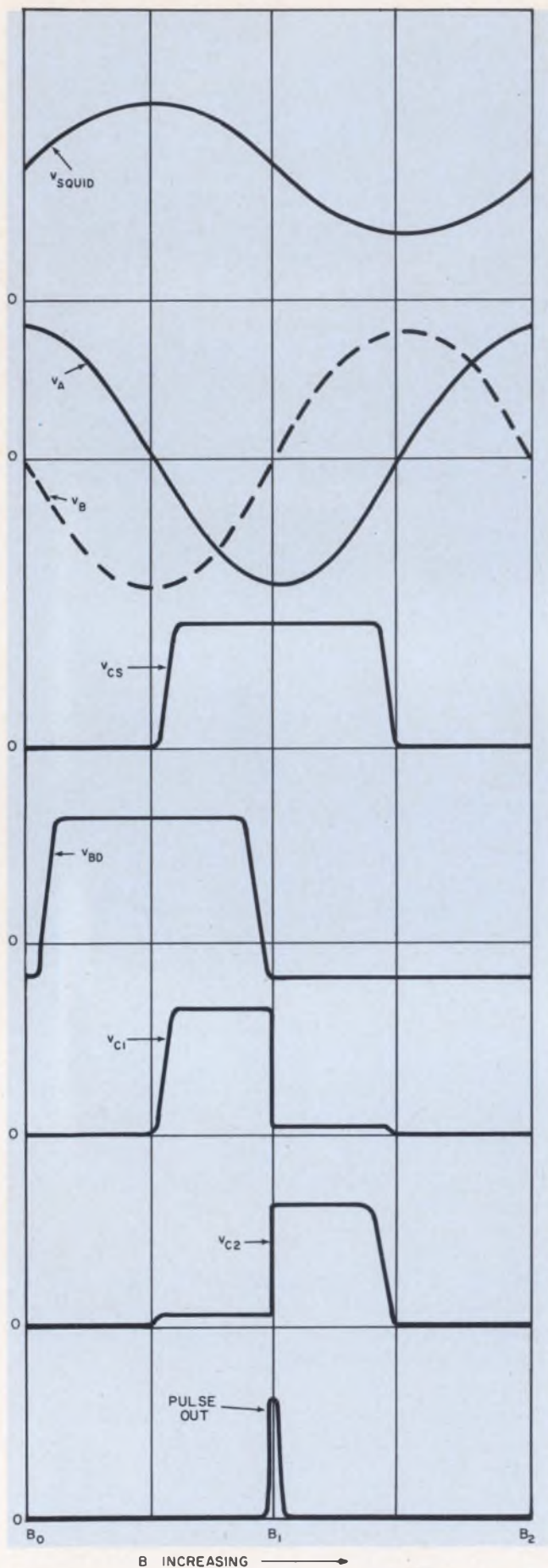

2. Quadrature voltages give "add" pulse with increasing input and "subtract" pulse with decreasing input.

collector level change on switching. The collector resistor values are made small enough to give a transition time of less than $1 \mu\text{s}$ without producing excessive current drain. Selection of suitably small resistors for the collector-to-base coupling circuits ensures adequate base current for full turn-on, despite low β , and permits a reasonable value of coupling capacitance. The coupling capacitors determine the exponential recovery time of the base voltage following cutoff, that is to say, the flip-flop recovery time. They are chosen for this and modified experimentally to yield a sufficiently small amplitude of extraneous output on regeneration on the opposite channel from the desired output.

Capacitors are connected to ground from each collector to minimize spurious outputs from non-regenerative collector excursions.

The two 1N626 diodes and the $39\text{-k}\Omega$ resistor at the input to the add pulse shaper, the 40-pF differentiating capacitors at the inputs to both shapers, and the biased DR403 diodes in both shapers, are incorporated to enhance the ratio of desired output pulse amplitude (on regeneration) to spurious output pulse amplitude. The remainder of the shaper circuitry consists of conventional common-emitter amplifiers ac-coupled to emitter-followers.

The reversible counter makes use of five Burroughs BIP-8054 modules (plus preamplifier and accumulator) rated at a maximum counting rate of 110 kHz . Paired pulse resolution is $9 \mu\text{s}$, compared with the $15\text{-}\mu\text{s}$ recovery time of the flip-flop in the count-pulse-generating circuitry. If input pulses are applied to the counter less than $9 \mu\text{s}$ apart, it may "hang up" and one or more of its displayed digits be extinguished. The counter would then have to be reset to resume counting.

The described circuit maintains at least $15 \mu\text{s}$ between output pulses, a rate well within the counter's capabilities. In the case of pulses with less than $15\text{-}\mu\text{s}$ separation, the circuit will suppress an occasional pulse so that its output rate never exceeds one pulse per $15 \mu\text{s}$. Thus noise at the counting point will be suppressed and, since the SQUID application demands a 5-kHz maximum counting rate, no residual errors will occur.

The circuit's maximum counting rate exceeds the 5-kHz requirement of the application by a factor of at least 2.5. For this reason no attempt was made to increase circuit speed any further. The circuit operates satisfactorily when the input level swings from zero to -0.2 volt or more. The output pulses have a rise time of less than $0.5 \mu\text{s}$ and amplitude of $+4$ volts. ■ ■

References:

1. R. L. Forgas and A. Warnick, "Digital-Analog Magnetometer Utilizing Superconducting Sensor," *Rev. Sci. Instr.*, XXXVIII, No. 2 (Feb., 1967), 214-220.
2. "Sensitive SQUID Measures Minute Magnetism," *ELECTRONIC DESIGN*, XIV, No. 17 (July 19, 1966), 35-37.

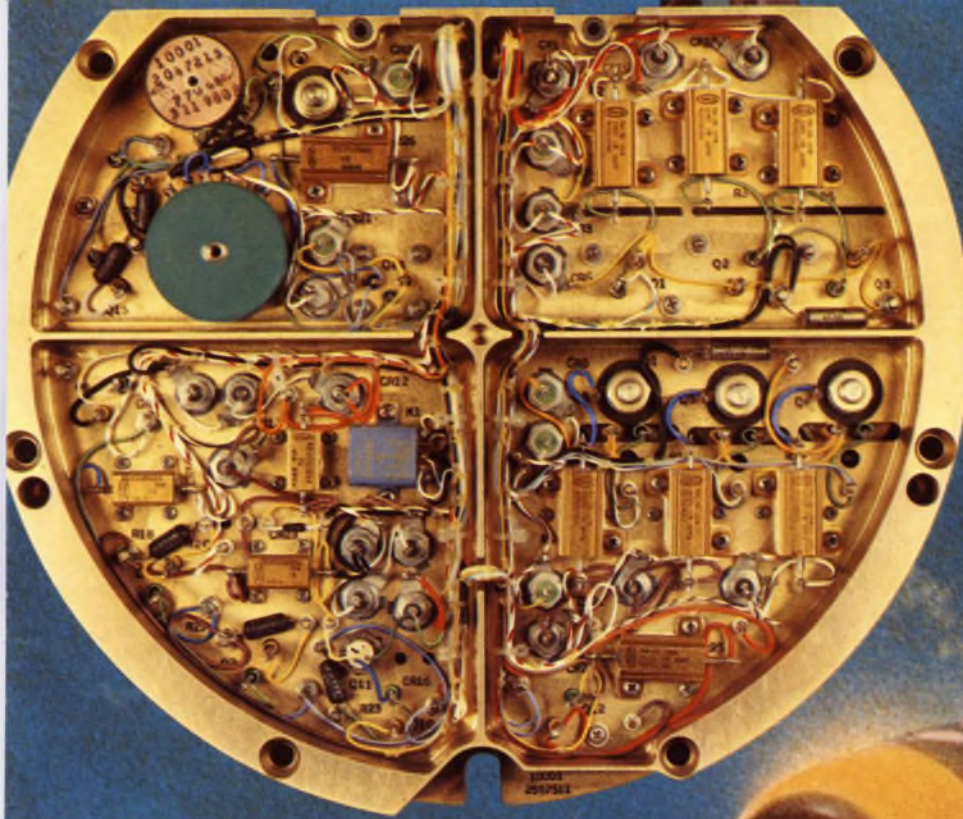

How Bendix* uses Dale's full range of precision power!



Electrodynamics Division selects Dale Wirewound Resistors for guidance system of Mark 46 submarine hunting torpedo.

Snaking down toward a hidden enemy, the Navy's Mark 46 torpedo provides a potent example of Dale wirewound versatility. Inside the guidance system, provided to Aerojet General by Bendix Corporation's Electrodynamics Division, a variety of Dale styles answer precision power demands.



TYPE RS Axial-lead, silicone-coated wirewound. Meets MIL-R-26D. Proven failure rate of .006%/1,000 hours backed by 32,000,000 unit test hours (full rated power, 60% confidence, 25° C, failure rate Δ R 1%).

TYPE RH Exceeds MIL-R-18546. Patented chassis-mount design provides: (1) Bonus power 25% to 108% above mil rating; (2) Exceptional stability when derated to mil levels.

TYPE PH Versatile through-chassis mounting with terminals on one or both sides. Meets electrical and environmental specs. of MIL-R-18546.

When you need precision wirewounds, call Dale. No other source offers as many models, as much design freedom or a stronger foundation for reliability.

Dale Resistors in Mark 46 Guidance System

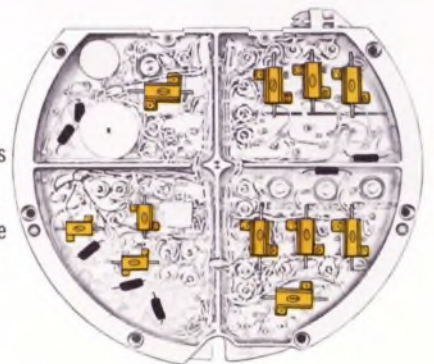

For action, phone 402-564-3131 or Circle 181 for Catalog A.



for optimum value in precision power wirewounds

DALE ELECTRONICS, INC. 1300 28th Avenue, Columbus, Nebraska 68601
In Canada: Dale Electronics Canada, Ltd.



DALE





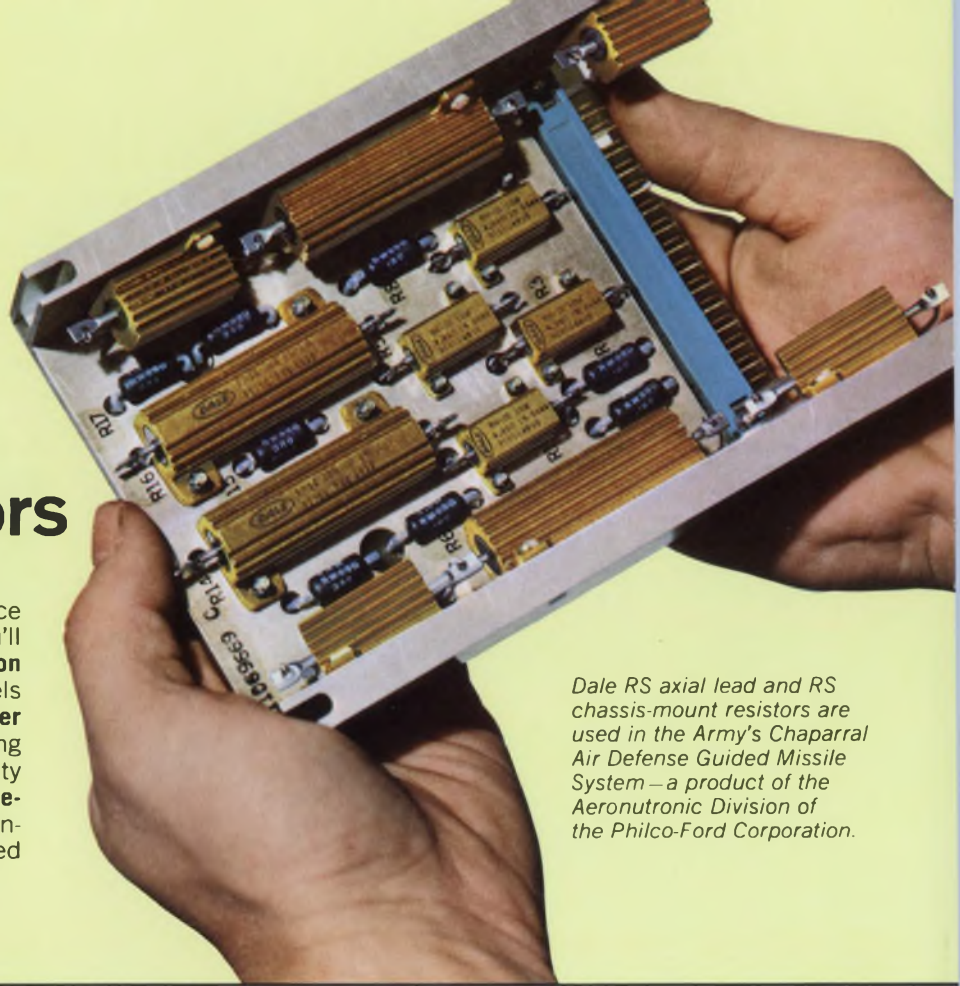



...a complete source for precision power resistors

Establish Dale as your complete source for precision power wirewounds. You'll gain added value from: **Broader Selection** ...10 different types, 64 different models ...up to 250 watts precision power. **Greater Design Versatility**...3 different mounting choices plus unmatched size/stability combinations. **Faster Reaction to your Special Needs**...more than 400 different non-standard variations are pre-engineered and ready for application in your circuit.



Dale RS axial lead and RS chassis-mount resistors are used in the Army's Chaparral Air Defense Guided Missile System—a product of the Aeronutronic Division of the Philco-Ford Corporation.

CHECK DALE'S COMPLETE PRECISION POWER LINEUP...

		RANGE	SIZES	WATTAGES	TOLERANCE	FEATURES
TYPE ARS		0.1 ohm to 40K ohms	3	2, 5, 10	1%	Established reliability, failure rate less than .00038% at 1000 hours of operation at 50% of rated power at 25° C.
TYPE AGS		0.1 ohm to 12.4K ohms	4	1, 2.25, 4, 7	1%	Established reliability, failure rate .00051% per 1000 hours. Estimated failure rate after GARD screening .00009% per 1000 hours. Beryllium oxide core for greater stability and hot spot elimination.
TYPE RS & RLS		0.1 ohm to 273K ohms	11	¼, ½, 1, 2, 2½, 3, 5, 7, 10	0.05% to 3%	Meet functional requirements of MIL-R-26D which supersedes MIL-R-26C and MIL-R-23379. Silicone coating. Weldable leads available. RS has axial leads. RLS has radial leads.
TYPE NS & NLS		1 ohm to 136.5K ohms	10	½, 1, 2, 2½, 3, 5, 7, 10	0.05% to 3%	Silicone coated, non-inductive winding. Type NLS has radial leads. Weldable leads available.
TYPE G & GL		0.1 ohm to 273K ohms	10	1, 1½, 2¼, 4, 6, 7, 10, 15	0.05% to 3%	G & GL resistance units offer decreased size with increased heat dissipation. Silicone coated. Meet functional requirements of MIL-R-26D which supersedes MIL-R-26C and MIL-R-23379. GL has radial leads.
TYPE GN & GNL		1 ohm to 136.5K ohms				GN & GNL have identical construction but are non-inductively wound. GNL has radial leads. Weldable leads available.
TYPE HG & NHG		HG: 0.1 ohm to 273K ohms NHG: 0.1 ohm to 136.5K ohms	4	15, 20, 35, 50	0.05% to 3%	HG features maximum heat dissipation at no increase in size. Meets or exceeds requirements of MIL-R-18546. Chassis-mounted molded radiator housing. NHG has identical construction but is non-inductively wound.
TYPE RH & NH		RH: 0.1 ohm to 273K ohms NH: 0.1 ohm to 136.5K ohms	6	7.5, 12.5, 25, 50, 100, 250	0.05% to 3%	RH resistance unit molded into radiator housing. Meets requirements of MIL-R-18546. Mounts on chassis. NH has identical construction but is non-inductively wound.
TYPE PH		0.1 ohm to 95.2K ohms	4	10, 25, 50, 100	0.05% to 3%	Silicone-sealed resistance unit in radiator housing. Mounts through hole in chassis. Also available with non-inductive winding.

Circle 181 for Catalog A



DALE ELECTRONICS, INC.
1300 28th Ave., Columbus, Nebraska 68601
In Canada: Dale Electronics Canada, Ltd.



DALE

Printed in U.S.A.

Want to benefit from a Hayden Happening?

Attend the Hayden "Write-In" at Wescon!

It's for engineers who want practical advice on how to write a technical article.

It's for engineers who have written articles and want them evaluated.

It's for engineers who have ideas for technical articles and want to discuss them with editors.

It's for engineers who have ideas (or even a completed manuscript) for a technical book and want a publisher's reaction.

It's for engineers who would like to meet editors over coffee and danish to discuss the benefits of writing for publication.

It's at the Rosewood Suite of San Francisco's Hilton. Please feel free to drop in anytime between 8 A.M. and 10 A.M., Tuesday, Wednesday, Thursday or Friday.



Hayden Publishing Co., Inc.
Publishers of Electronic Design and
MicroWaves magazines...Hayden,
Ahrens and Rider books.

Don't blame the component vendor

every time a circuit fails. Maybe the fault is with the specs or application, as four SCR case histories show.

All vendors of electronic components have some percentage of their devices returned as "field failures." These units either failed to function properly in a circuit or were catastrophically destroyed during operation. The natural impulse of the user in these cases is, of course, to blame the vendor, on the assumption that the failed units did not come up to specifications. On occasions this is valid. But when failure analysis is carried out on the returned devices, it is sometimes found that they are within specifications. The trouble then is in the application. In these instances, failure analysis must be carried further to pinpoint the actual cause of the trouble.

Here are four actual, typical cases which show how this was done on supposedly defective SCRs returned to a vendor. These descriptions are not given to vindicate the SCR vendor, but rather to demonstrate the importance of proper SCR specifications and application.

Improper specs cause trouble

A customer was using an SCR to control a dc motor. The designer had specified a turn-off time of 20 microseconds or less, and a blocking voltage of 500 volts. Of the initial shipment of devices with the specified ratings, 20 per cent were rejected by receiving inspection as functional failures.

The devices were returned to the vendor and subjected to a failure analysis. All were within the specification for turn-off time, and blocking characteristics. At this point, the vendor requested more information and a circuit diagram.

In the customer's circuit (Fig. 1), armature power was supplied from a single-phase, full-wave bridge rectifier through a series-connected SCR and a parallel-connected free-wheeling diode. Analysis of the circuit revealed that the reverse bias available for commutation (turn-off) was very small. The reverse bias present is due to the reverse recovery of the bridge diodes. Since turn-

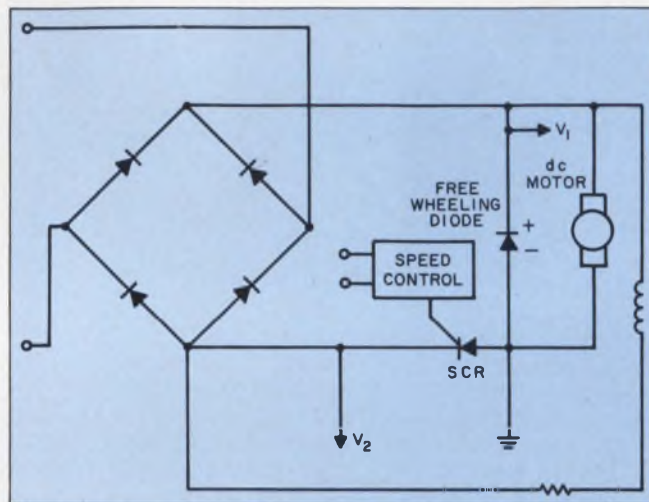

1. Turn-off time was incorrectly specified for this motor-control SCR circuit, so the devices were returned to the vendor as functional failures. But the culprit turned out to be a too small reverse bias in the circuit.

off time is partially a function of reverse recovery time, which is a function of reverse recovery current, the controlled rectifier must recover primarily through the natural recombination of carriers. This means that the time available for turn-off is that time when the supply voltage is below the combined threshold voltage of the diodes and controlled rectifier (approximately 0.5 volt per device) and, in this case, is about 50 microseconds.

The vendor undertook tests to establish the actual parameters required by the manufacturer's circuit. Although test conditions were not the actual operating conditions of the device, a correlation was found between standard turn-off time and proper operation. As a result, a maximum turn-off time of 18 microseconds was specified, and this, based on past experience, required the recovery time of the devices to be 3.5 microseconds or less.

A test run of 100 units meeting the new specifications was tried and accepted by the manufacturer. This led to changes in the manufacturer's specifications, which increased prices slightly, but also eliminated the problem.

Frank Durnya, Product Engineer, International Rectifier, El Segundo, Calif.

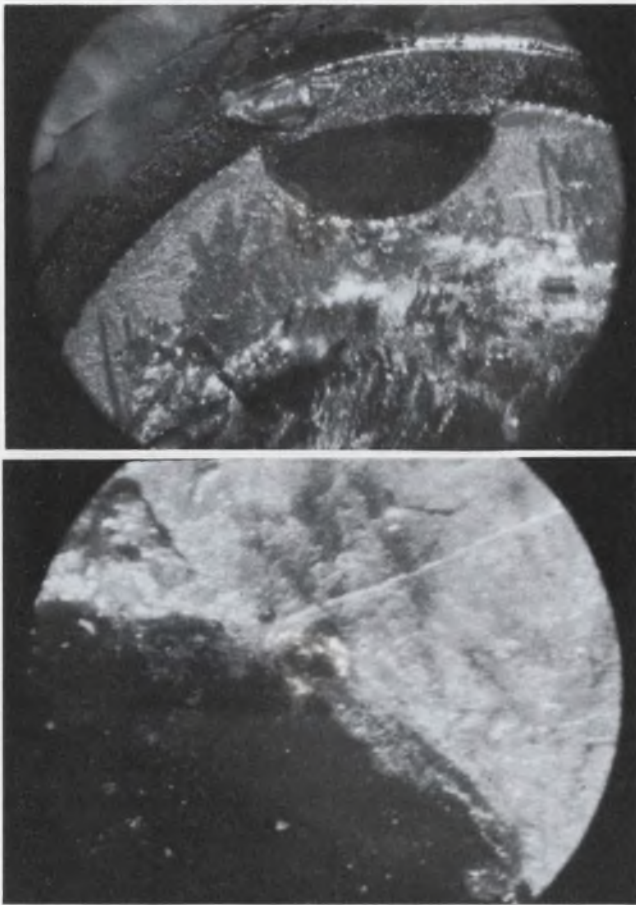

2. Microscopic examination revealed craters at the edge of the gate region which indicated that these SCRs shorted as a result of insufficient gate drive. The failures were eliminated when the manufacturer increased the current capability of the triggering supply.

Because of their inherent reliability, long life, silent operation, and high efficiency, SCRs are now widely used in power inverter circuits. Along with this increased use, however, has come an upsurge in the number of field failures, because the need to specify detailed switching parameters has not been recognized. Typical, or average, values of parameters on spec sheets do not reflect their probable variations from unit to unit.

A vendor, for instance, returned four SCRs with the laconic note, "Did not work in inverter circuit." The devices were standard units, and sales literature listed a "typical" turn-off time of 20 microseconds. (Typical, of course, means that the parameter specified is the average of many units tested.) The first parameter measured during failure analysis was turn-off time, which for the four units ranged from 23 to 28 microseconds. Based on this and an analysis of the user's application, the failure analysis engineer recommended a "maximum" turn-off time of 20 microseconds rather than the "typical" time specified. Four devices with the new parameter were sent to the manufacturer and performed perfectly in his equipment.

Specification check list

Parameters which must be specified for *any* silicon-controlled rectifier application are:

V_{DRM} and V_{RRM} — "Off"-state and reverse blocking voltage requirements

V_{GT} and I_{GT} — Gate firing characteristics

Current Rating— Required current capability under specified cooling conditions

Additional parameters which should be specified in applications such as power switching are:

dv/dt — Critical rate of rise of "off"-state voltage. This is the exponentially rising voltage waveform which, if exceeded, may cause the controlled rectifier to switch to the "on"-state.

t_q — Turn-off time. This is the minimum time interval required for the controlled rectifier to be able to regain its ability to block forward voltage after conducting forward current. In effect, it limits the frequency-handling capability of the controlled rectifier.

V_{TO} — Turn-on voltage (dynamic "on"-state voltage drop). This can be specified as a means of limiting internal losses when the controlled rectifier is to be used in high-frequency power applications.

$(t_d + t_r)$ — Turn-on time. This is the time required for a particular device to switch from the "off"-state to conduction of rated current.

Many of the shorted SCRs returned to a vendor as field failures have been used in inverter applications. In these cases careful analysis is required to isolate the cause of the failure, which may be due to either the circuit or the device.

Circuit considerations are important

As an example, a power supply manufacturer returned eight electrically shorted SCRs. They had been removed from an experimental inverter circuit, and an accurate and complete analysis was required. Since an electrical analysis was out of the question, the devices were cut open and a microscopic examination of the junction subassembly was made. This examination revealed a small crater at the edge of the gate region (Fig. 2). Craters of this type are indicative of di/dt failure, which can be caused either by soft gate drive or by exceeding the di/dt capability of the device.¹

An analysis of the gate-supply circuit used in the manufacturer's system showed that it had a maximum capability of 500 mA. This value was not within the required triggering specification for high di/dt operation, so high spot tempera-

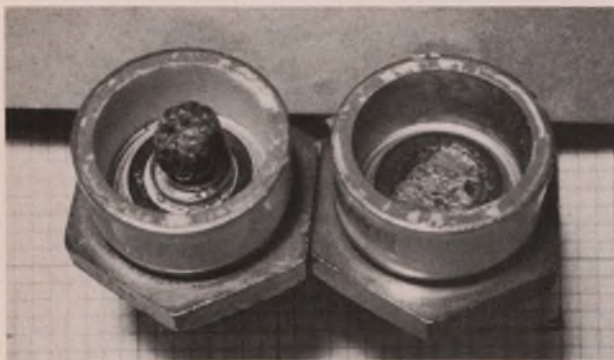
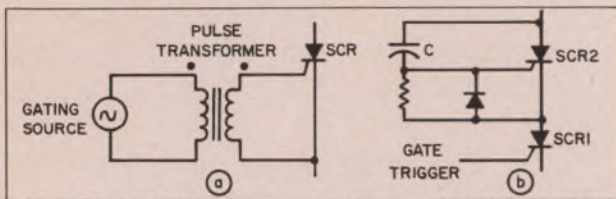

3. Insufficient gate drive can damage an SCR if the specification calls for high di/dt operation. This situation can arise when a pulse transformer with a low volt-microsecond product provides the gating pulse (a), or when a slave-firing technique is used (b).

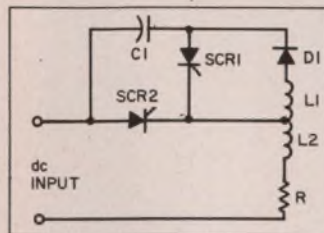

5. Large voltage transients can occur if the value of resistor R in this single-ended inverter circuit is too low.

4. Tell-tale clues can be found in SCR failure analysis, even in cases of catastrophic junction destruction. Here, silicon and solder splashed on the inside of the SCR package helped the failure analysis engineer to diagnose shorting by a voltage transient.

tures built up in the vicinity of the SCR gate contact, and shorting resulted. By increasing the current capability of the triggering supply, the manufacturer was able to eliminate this type of failure.

The soft gate drive in this case was occasioned by the pulse transformer (Fig. 3a) used to isolate the SCR gate from the source of the gating signal. The volt-microsecond product of the transformer, which is a measure of energy transfer between primary and secondary before saturation occurs, was low. Hence, the energy transferred to the SCR gate was not sufficient for proper di/dt operation.

Another configuration that frequently gives rise to insufficient gate drive is slave-firing of one or more SCRs in series. In one arrangement of this technique (Fig. 3b), when master $SCR1$ is triggered, it produces a gate signal, by means of capacitor C , for "slave" $SCR2$.

Even catastrophic failures can be analyzed

One of the most difficult types of SCR failures to analyze is where catastrophic junction destruction has occurred. Tests indicate that, although positive conclusions are difficult when devices are destroyed in this manner, certain conclusions can safely be drawn.

If the gate region has been destroyed, it may be concluded that the device failed from excessive di/dt . If the area beneath the cathode lead has been destroyed, two conclusions are possible: either the device was subjected to an extremely high surge current during normal conduction time, or the device suffered a voltage punch-through, followed by high current in the reverse direction because of the lack of reverse blocking capability.

In a case involving catastrophic failure, ten SCRs were returned from an inverter manufacturer as field failures. Nine of the devices were shorted in both the forward and reverse direction. When these were opened, in each case silicon and solder were found splashed on the inside of the package (Fig. 4).

The last device was shorted in the reverse direction, and would block forward voltage only. This device was also opened and the junction subassembly subjected to a microscopic examination. There was one pinhole punch-through on the periphery of the junction subassembly which had damaged the reverse blocking junction.

From these examinations, the failure analysis engineer concluded that the nine other controlled rectifiers were first shorted in the reverse direction by a voltage transient, and this was followed by a surge current due to the lack of reverse blocking capability. The failure analysis engineer then visited the manufacturer to locate the source of the voltage transient—at best, a difficult job. In this case the transient was tracked down with an oscilloscope and identified as being 10 microseconds long, with an amplitude of 1 kV, and occurring when the inverter was first fired up. Suitable circuit modifications were made and the troublesome transient was eliminated.

Typical of the circuits in which this type of transient problem can occur is the single-ended inverter circuit shown in Fig. 5. Damaging transients are particularly liable to develop if the value of resistor R is very small. A sizable value of R is thus required to avoid trouble. ■ ■

Reference:

1. Reuben Weschler, "di/dt Failures in SCR Circuits—Their Cause and Prevention," *ELECTRONIC DESIGN*, XIII, No. 17 (Aug. 16, 1965), 140-145.

An Ace on every Mission

Mark up another score when a Licon® environment-free sealed switch is specified. You get the same reliability and long life on a light plane panel as you do when you've got a hot jet dropping its landing gear or dropping its ordnance. A whole line of military approved and performance tested switches are detailed in this new book.

Take a look at it.
Send for your copy now.



**Strike hard with LICON...
fastest growing
full-line switch supplier**

it LICON
DIVISION ILLINOIS TOOL WORKS INC.
6615 WEST IRVING PARK ROAD - CHICAGO, ILLINOIS 60634

**Remember, you're never more than a few feet away from a product of ITW®*



A McDonnell Phantom photo



ON READER-SERVICE CARD CIRCLE 42

Micropower fast switching circuits

by combining complementary design with a working knowledge of what's happening at these levels.

High switching speed, large fan-out and micropower operation are generally taken to be conflicting circuit characteristics. Use of low-capacitance transistors in complementary pairs and the proper design theory, however, enable all three characteristics to be obtained in a single circuit.

Micropower requirements are growing

Deep-space probes and satellite systems employ switching circuits that operate in the region of 1 to 1000 microwatts in order to conserve solar-cell-battery power. RCTL circuits designed for this type of operation generally exhibit very slow switching rates that have been tolerated in the past for lack of an alternative solution. The increasing sophistication of these systems, however, demands circuits that are capable of handling more information at higher speeds while still maintaining their low power consumption characteristic. To meet these new demands, a circuit should be capable of:

- Micropower operation.
- Fast switching speed.
- Large fan-out.

In a sense, the three characteristics in one circuit contradict each other since micropower operation generally implies extremely high output impedances and very slow transistor switching rates, even when the circuit is unloaded. High output impedances seriously limit the fan-out capability and can also limit switching speed. This is because of the large RC time constants that are created by the effective series combination of the output impedance of the driving circuit and the input capacitance of the load circuit. To obtain optimum operation, output impedance must be reduced to as low a value as possible, and transistors with good switching characteristics at micropower levels must be employed.

Output impedance can be lowered considerably by designing circuits that use complementary pairs of transistors. The high output impedance of

noncomplementary flip-flops is due to the necessarily high-value collector resistor required for current-limiting in micropower circuits. This resistor is effectively in series with the input capacitance of the load circuits, and thus creates large RC time constants. At the same time, the resistor degrades circuit efficiency because it must always dissipate more power than the load receives. The complementary-configuration flip-flop requires no collector resistor because the blocking action of the opposite-polarity transistor permits current to flow to ground only through the load. The degrading effects of capacitive loading are also lessened by complementary design since, as one transistor is turning off, the other is turning on, thus augmenting the charging and discharging of the load capacitance. The remaining switching limitations at this point are found in the active devices within the circuit—the transistors.

The micropower region of circuit operation is a strange world with its own peculiar problems. Resistors, regardless of their ohmic value, act more like capacitors; circuit stray capacitance and load capacitance in picofarad quantities are intolerable; and switching transistors that provide excellent speed at higher current levels are extremely slow.

Normally, storage time is one of the major parameters used in the selection of a switching transistor; in the micropower region, however, it has been found that junction capacitance is of greater importance. The dependence of switching time on transistor junction capacitance can be exemplified by the following analysis of transistor switching characteristics.

Switching time depends on junction capacitance

The time delay intervals associated with transistor switching circuits are shown in Fig. 1. These time delays, and their causes, can be readily explained by applying charge-control theory.^{1, 2} The theory states, in essence, that, before a change in collector current can take place, a change must occur in the electrical charges stored in the transistor base region, in the junction capacitances (C_{ib} , C_{ob}), and in the stray capaci-

Jack Schroeder, Applications Engineer, Motorola Semiconductor Products, Phoenix, Ariz.

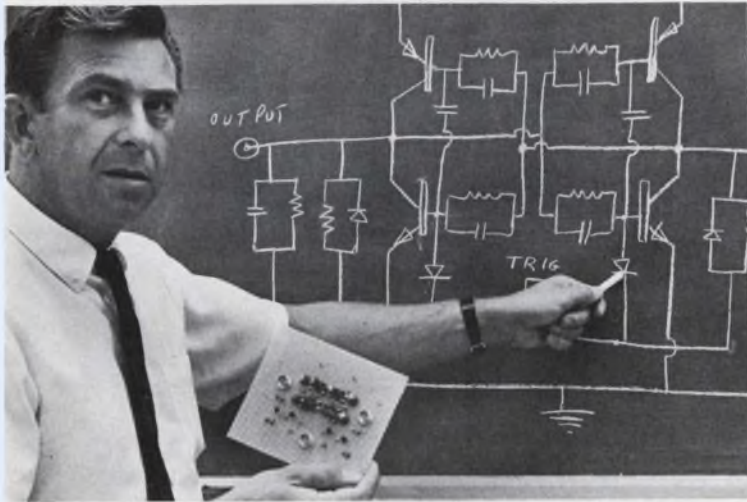

"Watch the layout," warns the author, "if you want the circuit to work at micropower levels."

tances of the circuit and transistor case.

When a constant-current drive signal is applied to the transistor base, the time required to change the collector current from one quiescent condition to another is given by:

$$\Delta t = \Delta Q / I_b, \quad (1)$$

where ΔQ is the charge that must be moved during a specific time interval and I_b is the base current applied to the transistor during that time interval.

For the various switching signal intervals, it can be shown³ that the applicable Q s are represented by the following equations:

Time delay interval:

$$Q_{OB} \approx (V_{OB} + V_{TF})(C_{ib} + C_{ob}); \quad (2)$$

Rise and fall time interval:

$$Q_A \approx I_C / \omega_\tau + \Delta V_{CB} C_{ob}; \quad (3)$$

Storage time interval:

$$Q_X \approx \tau_X I_{B1}. \quad (4)$$

Hence the following expressions can be derived (see Fig. 1):

$$t_d \approx [(V_{OB} + V_{TF})(C_{ib} + C_{ob})] / I_{B1}; \quad (5)$$

$$t_r \approx (I_C / \omega_\tau + \Delta V_{CB} C_{ob}) / I_{B1}; \quad (6)$$

$$t_f \approx (I_C / \omega_\tau + \Delta V_{CB} C_{ob}) / I_{B2}; \quad (7)$$

$$t_s \approx (\tau_X I_{B1}) / I_{B2}. \quad (8)$$

Examination of Eqs. 2 through 4 reveals that

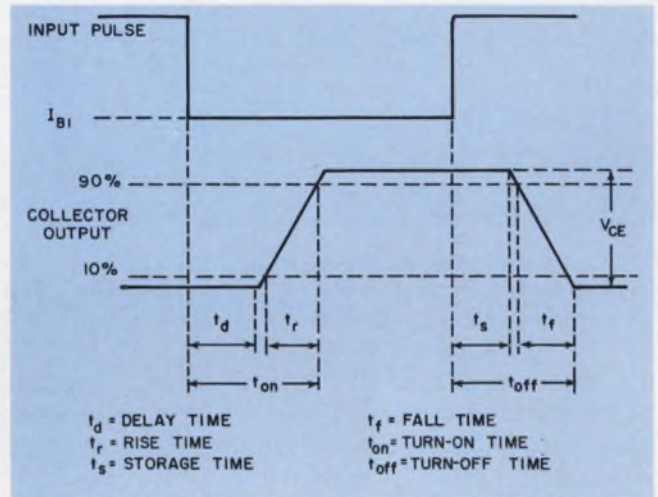

1. Several delay time intervals in transistor switching circuits take on additional significance at micropower levels.

Symbols used in equations

Q_{OB}	Off charge
V_{OB}	Off bias voltage
V_{TF}	Emitter-base forward voltage at threshold of conduction
C_{ib}	Emitter-base capacitance
C_{ob}	Collector-base capacitance
Q_A	Active region charge
I_C	Collector on current
ω_τ	Gain-bandwidth product (rad/s)
ΔV_{CB}	Change in collector-base voltage
Q_X	Excess base charge
τ_X	Lifetime of excess charge or storage time constant
I_{B1}	Turn-on base current
I_{B2}	Drive-off base current
ΔQ	Charge to be moved in specific time interval
t_d	Delay time
t_r	Rise time
t_s	Storage time
t_f	Fall time
I_L	Load current

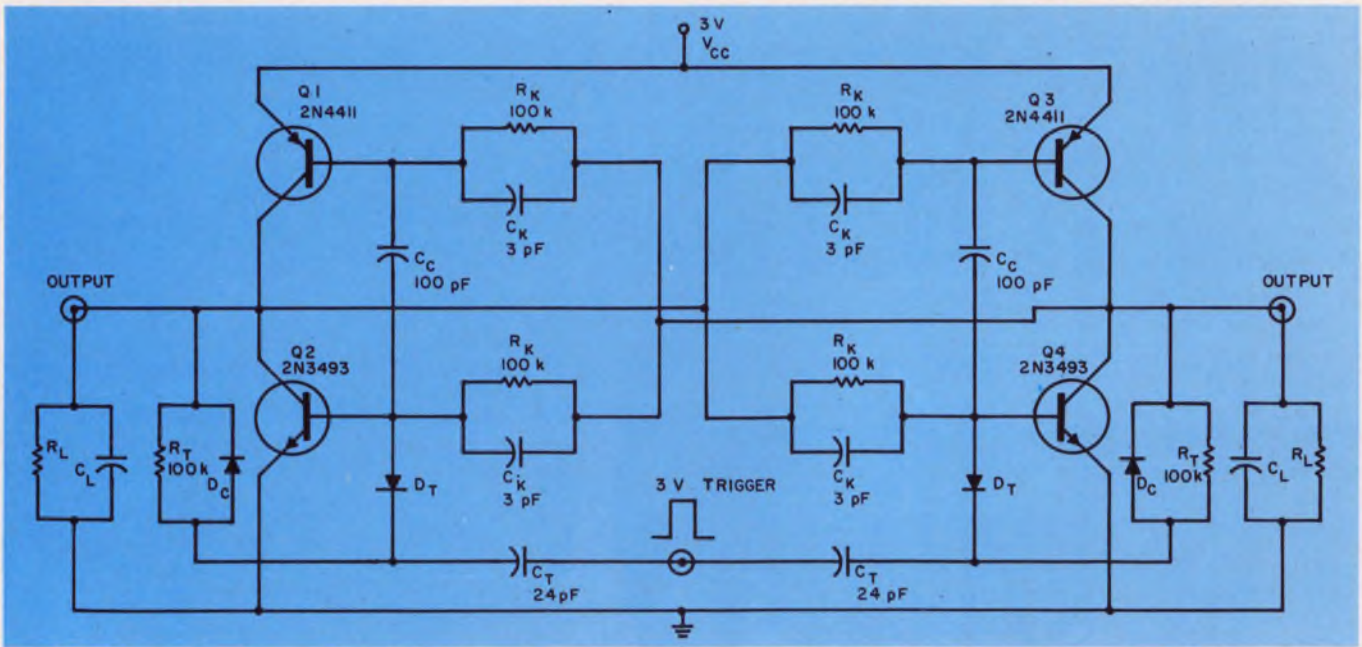

2. Complementary micropower flip-flop built with the 0-pF transistors can operate at 1 MHz with only about

140 μ W of power. Layout is important since stray capacitance tends to slow down the operation.

the various charges that must be moved are dependent on transistor parameters and circuit operating conditions. It can be seen, however, that, with the exception of Q_x , only the operating conditions and the transistor capacitances contribute significantly to the various Q_s at very low power levels.

switching speed can be increased by use of transistors with the lowest values of capacitance that can be achieved.

Equations 5 through 7, dealing with switching times, point up two important facts pertinent to all switching circuits:

The storage time factor formulated in Eq. 8 is related to the carrier recombination process and is a measure of the minority-carrier lifetime in the base and collector regions. This interval remains about the same regardless of current levels and is small in comparison with other switching times at micropower levels.

- For any specific transistor, switching speed at micropower levels will be inherently slower than at higher current levels.

Transistors with junction capacitances of less than 1 pF have been available for quite some time and complementary flip-flop design has long been employed in higher-power operations, but the

- For specified circuit operating conditions,

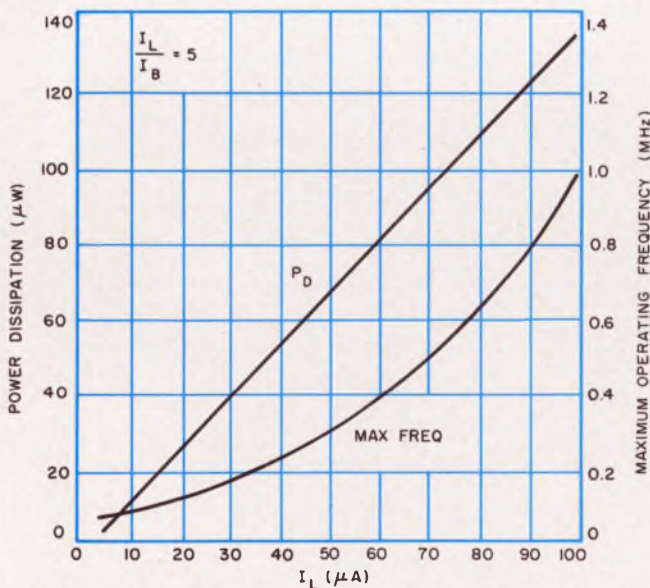

3. Operating-frequency dependence on load current is demonstrated in the above plot. Note the rapid increase in frequency with the increasing current.

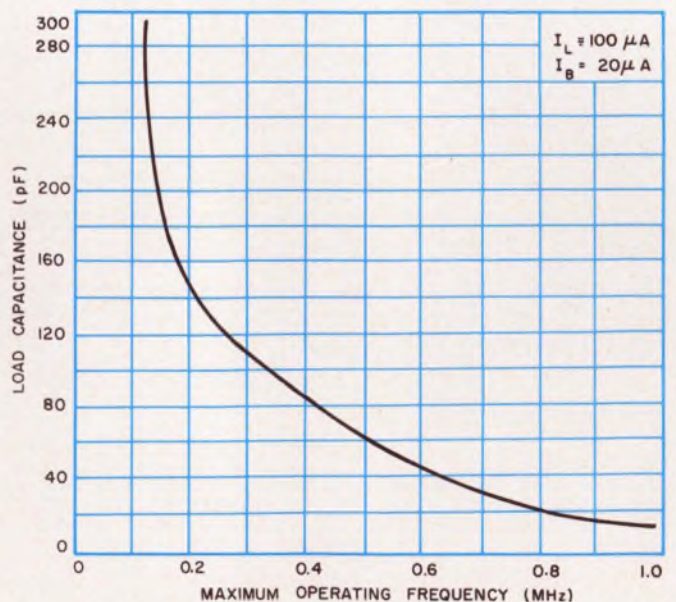

4. Increasing load capacitance rapidly "kills" the frequency response, even at the very low load and base currents. This again stresses importance of the layout.

combination of the two has not been possible because complementary pairs of low-capacitance transistors have not been available. Recently, however, the complementary 2N3493 and 2N4411 silicon switching transistors were introduced to fill this component gap. The maximum C_{ob} and C_{ib} of 0.7 pF of these 0-pF* transistors makes possible the hybrid combination of complementary circuitry and ultra-low-capacitance transistors.

Circuit layout is critical

The micropower flip-flop circuit in Fig. 2 is capable of 1-MHz operation with a power dissipation of 134 microwatts, or 90 kHz with only 4 microwatts' power dissipation. The circuit layout is critical. Stray capacitance from base to ground and from base to collector must be held to a minimum, because both tend to limit the switching speed of the circuit. The base-to-collector capacitance is especially important, since it is amplified by an amount equal to the voltage gain of the circuit (Miller effect).

Operation of the flip-flop begins when a positive trigger pulse at the input charges capacitor C_T through diode D_c and the npn transistor that is in the conduction stage. Capacitor C_T charges to the trigger level, less the forward drop of D_c . When the trailing edge of the trigger pulse arrives, C_T discharges into the base of the on transistor through D_T , turning it off. At the same time, the coupling capacitor C_c injects a positive charge into the base of the pnp transistor, turning it on. The transition time from off to on is very rapid, if the trigger source impedance is low and C_T injects enough charge to switch both transistors.

*Trademark of Motorola, Inc.

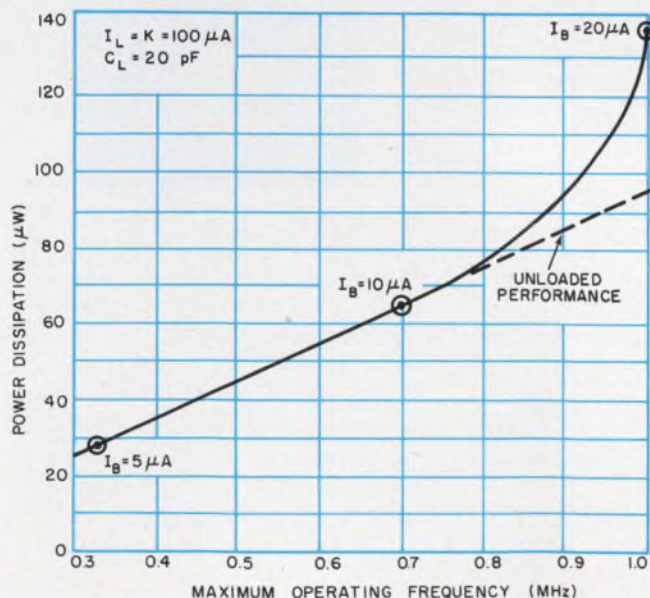

5. Power-vs-frequency plot reveals that increasing power beyond 140 μ W will not improve frequency response for a given circuit and the load capacitance.

Capacitor C_T should be just large enough to store the charge required to turn the npn transistors off. The ideal situation would be a complete discharge of C_T after changing the state of the flip-flop. If charge is left on C_T , it must discharge through R_T , thus reducing the maximum switching speed. Resistor R_T should be low enough to discharge C_T if all the charge is not used in turning the transistor off. If R_T is made too low, the transistor can come out of saturation during the pulse interval. A good compromise is to make R_T equal to R_K . Diode D_T should be off or back-biased before the next trigger pulse arrives, or it may allow some trigger energy to pass through and turn the transistor back on, which would oppose regeneration of the flip-flop. Selection of R_K is determined by the gain of the transistor for a steady-state dc condition. This condition must be considered for both npn and pnp transistors. Of course, the higher this RC combination is, the lower will be the maximum switching speed.

What kind of performance?

Performance characteristics of the circuit are shown in Figs. 3, 4, and 5. Figure 3 shows the power dissipated in the flip-flop as a function of the load current and indicates that power dissipation is linearly related to load current over the current range of 5 to 100 μ A. It also shows the maximum operating frequency of the circuit versus the load current. An operating frequency of 90 kHz is possible with only 4 μ W of power dissipation in the circuit; going up in frequency to 1 MHz increases the power dissipation to only 134 μ W. The maximum switching speed of the unloaded circuit is primarily determined by the base RC circuit, which in turn is determined by the gain of the device and the required charge to turn the transistor on.

Figure 4 demonstrates the effect of output loading. Shown is frequency versus load capacitance for a load current of 100 μ A. The circuit is capable of driving a 300-pF load with an operating frequency still above 100 kHz. Of course, with a lower output load capacitance, the allowable frequency of operation rises rapidly to the maximum dictated by the RC constant of the input circuit.

Figure 5 shows the performance trade-off between power dissipation and maximum operating frequency as a function of the base drive current. The power dissipation drops at about the same rate as the operating frequency. ■ ■

References:

1. Beaufoy and Sparks "The Junction Transistor as a Charge Control Device," *ATE Jour.*, Vol B, Oct., 1957, pp. 310-327.
2. *High-Speed Switching Transistor Handbook* (Chicago: Motorola Semiconductor Products Div., 1966), chap. 5.
3. *Ibid.*

New FETs, UJTs and SCRs from TI

Improve your products, create new designs with these "firsts" from Texas Instruments.

Most of these devices are available in the exclusive SILECT™ package with TO-18 pin-circle lead configuration. A preliminary report, covering 10 million hours of testing, concludes that SILECT transistors are capable of meeting military specifications and are as reliable as metal can devices tested under the same conditions.

Industry's first plastic-encapsulated MOS FET

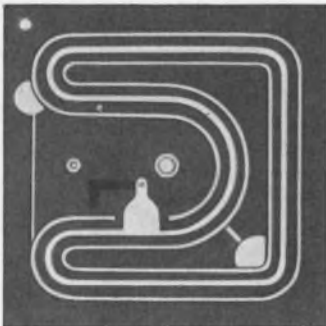

The TIXS67 is a p-channel silicon enhancement-mode field-effect transistor. It is the first such device to be encapsulated in plastic.

Its electrical characteristics make it suitable for switching and high-input-impedance amplifier applications from dc through medium-frequencies.

Circle 181 for data sheet.

New low-cost, high-voltage FET replaces vacuum tubes

The new TIXS78 silicon N-channel FET offers a 300-volt minimum breakdown voltage, making it a one-for-one replacement for many vac-

uum tube applications.

This new FET is priced for computer, industrial, communications and entertainment usage.

Circle 182 for data sheet.

New tetrode FET features industry's highest transconductance to capacitance ratio

The TIXS80 is a high-frequency metal-can tetrode FET that has a minimum transconductance of 5,000 μ mhos with a maximum reverse transfer capacitance of 0.8 pF. A second gate simplifies biasing, AGC, and oscillator injection circuitry.

In rf amplifiers, the TIXS80 provides high, stable gain at frequencies of 30 to 300 MHz without neutralizing.

Circle 183 for data sheet.

New economy matched-pair FETs

Here is a low-cost matched-pair FET assembly. The N-channel TIS68 pair, similar to the 2N3819, is matched for gate-leakage current and gate-source voltage. I_{DSS} and transconductance are matched within 5%.

Circle 184 for data sheet.

Matched dual FETs have high common-mode rejection capability

This is the first dual FET having matched output admittances as well as matched transconductances. Designated 2N5045, this TO-18 type metal-can dual features output admittance differential within 1 μ mho while transconductance and I_{DSS} are matched within 5%.

Circle 185 for data sheet.

Nine new FET switches feature lowest on-resistance

Here are industry's first low on-resistance switching FETs. The TIS73-75 series is offered in the SILECT package.

Circle 186 for data sheet.

New planar UJTs offer optimized characteristics for specific applications

The 2N4892-94 series of planar silicon UJTs in SILECT packages, and the 2N4947-49 family of metal case equivalents, are the only such devices on the market which are characterized for specific applications such as long-time-delays, SCR triggers, or high-frequency relaxation oscillators.

Leakage is typically 0.1 nA... one-thousand times lower than comparable alloy types.

Circle 187 for data sheet.

Smallest, lowest-cost SCR



TI's new TIC44-47 SCRs are priced only one-third as much as the metal-can equivalents. They are rated for 600 mA continuous dc current at 30, 60, 100, and 200 volts.

Circle 188 for data sheet.

Call your nearest TI sales representatives or authorized distributor for more information. If you prefer, write us at P.O. Box 5012, Dallas, Texas 75222.



TEXAS INSTRUMENTS
INCORPORATED

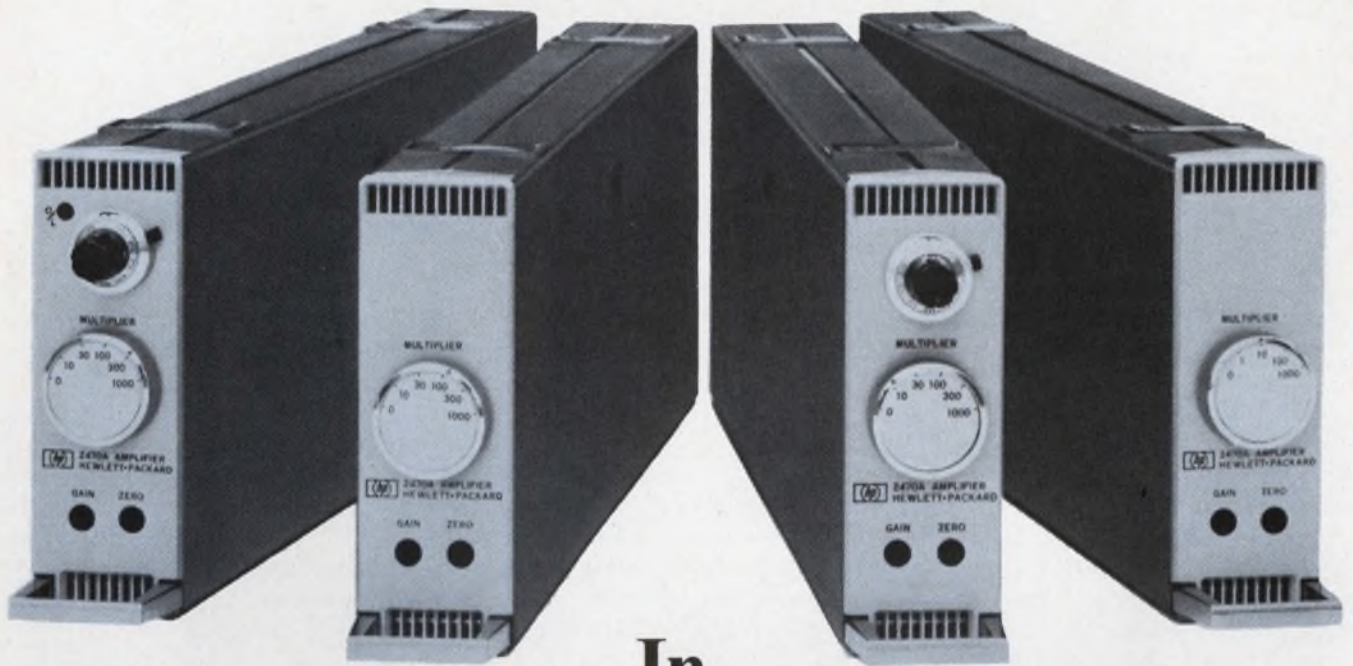

In differential data amplifiers which is more important: performance or economy?

Yes

There's no either-or when you pick the 2470A Data Amplifier.

Performance? The Hewlett-Packard 2470A has the highest across-the-board performance of any wideband amplifier of its type. Fixed gain steps X10 to X1000, X1 and precision vernier optional. DC linearity better than .002%, gain stability .005% per month. Constant 50 kHz bandwidth (3 dB), $\pm 10V$, 100 mA output. Differential input results in less than $1 \mu V/^{\circ}C$ drift, RTI; 120 dB CMR even at 60 Hz with 1 k Ω unbalance.

Economy? Each instrument is enclosed in a unique modular package, with self-contained transformer-isolated power supply and rugged connector—no "extra" dust

covers or carrying case to buy. Use on the bench, or plug ten into a combining case which occupies only $5\frac{1}{4}$ " of standard 19" rack space. The predicted MTBF for this design is more than 20,000 hours, assuring a long and trouble-free life. All included in the low price of \$585.

Applications? Use it on signals from low-level resistive transducers such as strain gages or thermocouples. Ideal for amplification over long transmission lines. Or use it with resistive or reactive loads: recorders, digital voltmeters, telemetry systems.

Any other questions? Contact your local Hewlett-Packard field engineer. Or write Hewlett-Packard, Palo Alto, California 94304; Europe: 54 Route des Acacias, Geneva.

HEWLETT  PACKARD

ON READER-SERVICE CARD CIRCLE 44

Simple circuit monitors thermostat arcing when its contacts open

In snap-type thermostats, such as a disk thermostat, there is an occasional condition that occurs on opening thermostat contacts known as pretravel. Pretravel is where the disk begins to warp as the opening temperature is reached, causing the pressure to be removed from the contacts before the snap. When this happens, the contacts do not make good contact, causing arcing which over a period can ruin the contacts and lead to failure of the thermostat.

This circuit detects the arc caused by pretravel. Its primary advantage over other circuits in use is its simplicity and low cost. It also has a memory (see figure).

The thermostat under test is connected to the circuit and placed in an oven or on a heater capable of bringing its temperature to above the point where the thermostat will open. When the thermostat is connected, the 28-volt supply appears across the continuity lamp, indicating that the thermostat contacts are closed.

Capacitor *C* will charge up to 28 volts. Its charging path is from ground through the cathode-gate junction of the SCR, through the diode and through *R1*. This fires the SCR, causing the arc light to come on. The reset button is then pushed to reset the circuit. The circuit is now primed and ready for the real test.

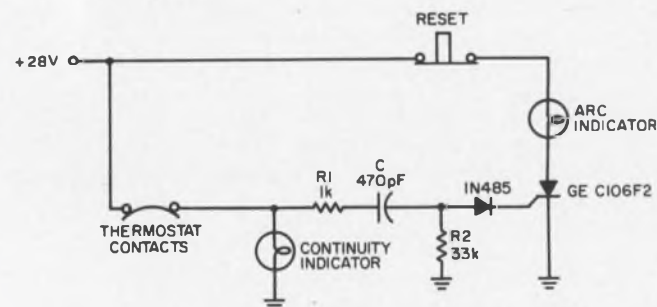

Arcing at the opening of thermostat contacts is monitored by the SCR-controlled lamp.

VOTE! Circle the Reader-Service-Card number corresponding to what you think is the best Idea-for-Design in this issue.

SEND US YOUR IDEAS FOR DESIGN. Submit your IFD describing a new or important circuit or design technique, the clever use of a new component, or a cost-saving design tip to our Ideas-for-Design editor. If your idea is published, you will receive \$20 and become eligible for an additional \$30 (awarded for the best-of-issue Idea) and the grand prize of \$1000 for the Idea of the Year.

When the thermostat reaches its opening temperature, it will either open clean or suffer pretravel. If it opens clean, then the voltage is removed from the continuity light. The capacitor now discharges through *R2* to ground, through the continuity light, and through *R1*. Since the diode will not conduct backwards, no current passes through it or the SCR gate.

If after a few milliseconds the thermostat closes again (arcing condition), the capacitor will charge. Again the charge path is through the cathode-gate junction of the SCR. This will fire the SCR, which once fired will stay on until the reset button is pushed.

A. G. Richardson, Test Evaluation Technician, Automated Specialties, Charlottesville, Va.

VOTE FOR 110

Level synchronizer uses two J-K flips-flops

In the design of bidirectional counters, the changing of the up/down order has to be synchronous with the counter clock. This is necessary because, when the up/down order changes at the same time as the counter clock toggles the flip-flops, the final state of the counter is indeterminate. But if the up/down order is synchronized, it can change state only immediately following the toggle enable edge of the counter clock. A design to achieve this employs two integrated circuit J-K flip-flops (Signetics SU series).

The state of *FF1* (see Fig. 1b) will be advanced to the most recent state of the up/down order every time that the clock line goes from a 1 to a 0. If the up/down order changes state while the clock line is low, this change will not cause the flip-flop to toggle until the trailing edge of the clock line has occurred. The possibility exists, however, that the up/down line will change state while the clock line is high. Should the up/down line change more than once while the clock is in the 1 state, the output of the first flip-flop may change before the trailing edge of the counter clock.

Since the presence of a 1 on the clock line inhib-

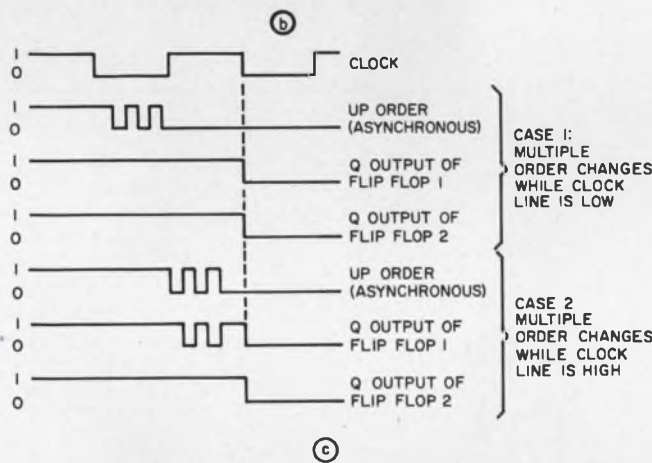
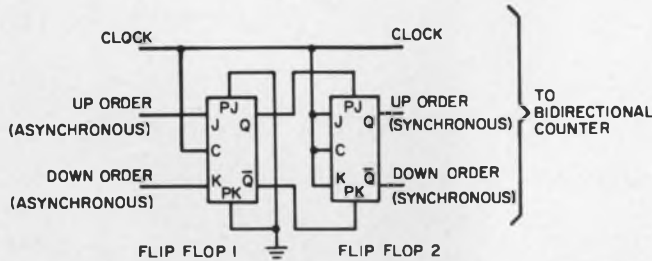
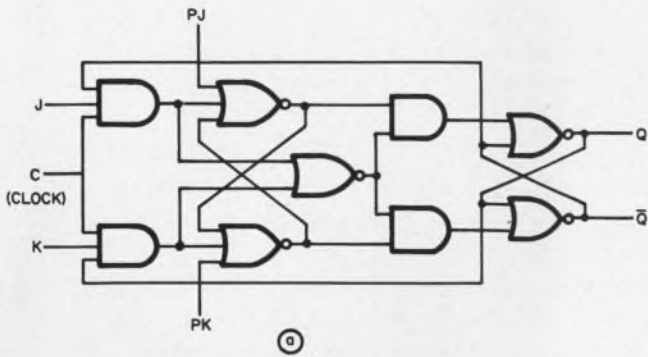

1. Up/down counter level synchronizer (b) is built with two integrated J-K flip-flops (a). Timing existing among various signals appears in (c).

its toggling through the *PJ* and *PK* inputs, *FF2* cannot toggle until the clock line has fallen. Thus, changes in *FF1* which occur while the clock line is high will not affect the output of *FF2*. Therefore the up/down order generated by *FF2* will change state only immediately following the trailing edge of the counter clock. Figures 1a, 1b, 1c give a graphical explanation of the synchronizer operation.

Gary F. Bruggemann, Submarine Signal Div., Raytheon Co., Lexington, Mass.

VOTE FOR 111

Transformer synchronizes UJT relaxation oscillator

A simple UJT relaxation oscillator was to be synchronized with the repetition rate of incoming telemetry pulses. Since the timing circuit, *R1* and *C1*, is high-impedance and easily loaded by con-

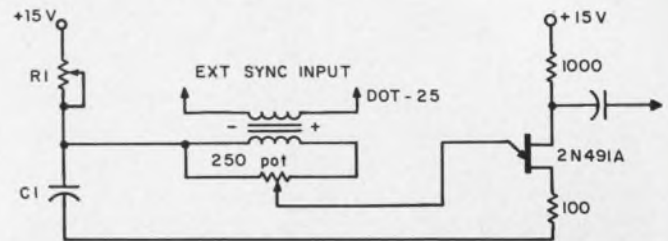

Synchronous signal coupled through a subminiature transformer does not load the oscillator timing circuit, *R1* and *C1*.

nection to other circuits, a "hands-off" method of injecting the synchronous signal was sought.

Any low-impedance secondary in series with the emitter of the UJT will add its pulse voltage to the emitter's waveform, edging it into synchronization. In this case a UTC DOT-25 subminiature transformer was used. The 250-ohm trimmer potentiometer not only damped out any ringing, but also gave good control over the amplitude of the synchronous pulse.

Capt. David M. Allburn, Engineer, Wright-Patterson AFB, Ohio.

VOTE FOR 112

Varactor's agc widens amplifiers' dynamic range

The simultaneous achievement of agc and wide dynamic range in transistor amplifiers is a classic problem. It is solved by appropriately exploiting the inherent wide-dynamic-range characteristics of the varactor.

The dc operating point of the transistor is held at the condition for maximum dynamic range throughout the agc cycle. Gain is controlled by varying the rf negative feedback with a variable emitter bypass element. Wide dynamic range is maintained throughout the agc cycle by using a varactor for the emitter bypass element as shown in the figure. Its noise contribution is negligible

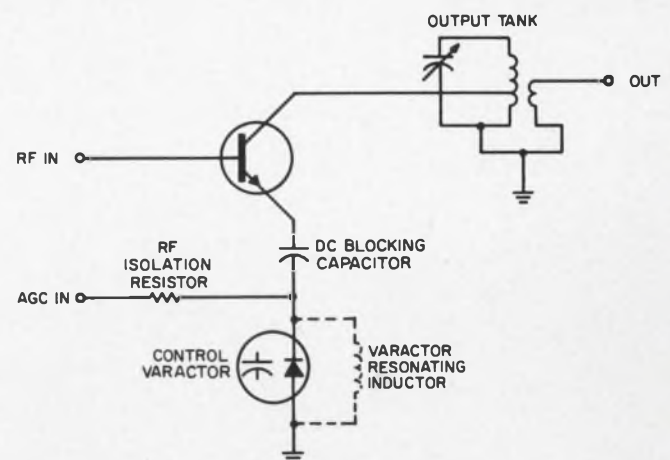

Varactor controls gain without contributing distortion. Gain control range can be extended by resonating the varactor.

since it does not pass dc. Both the nonlinear characteristic of voltage control and the linearity required to prevent distortion are simultaneously achieved by making the control voltage sufficiently higher than the signal voltage. If a varactor with the required ratings is not available, several varactors can be connected in series and/or parallel to achieve the desired breakdown voltage and capacitance.

The range of gain control is limited by the range of impedance of the varactor between its two bias limits. An inductor may be used in parallel with the varactor to increase the control range. It should resonate with the varactor when maximum bias is applied since the rf voltage is highest at resonance. The impedance change resulting from detuning the resonant circuit is much greater than that achievable with only a varactor.

George Crawford, Section Head, National Company Inc. Transceiver Department, Melrose, Mass.

VOTE FOR 113

Modified feedback simplifies programable voltage supply

In a programable voltage supply, using operational amplifiers, the output voltage is usually altered by varying R_2 with series switches, generally relays (Fig. a).

When transistors are used as switches, they require isolated transformer drive, adding to size

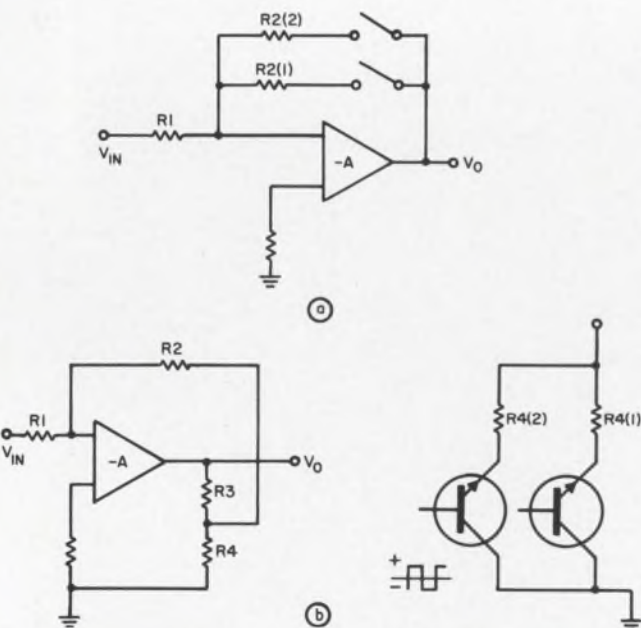

Transistor switching to program a power supply which uses operational amplifiers is possible when a standard circuit (a) is modified as shown (b).

and cost. To avoid this, the feedback network can be modified as shown in Fig. b and output is varied by programing R_4 only. The transfer function is given by:

$$V_o/V_{in} = (R_2/R_1) + (R_3/R_4) + (R_2/R_1)(R_3/R_4),$$

assuming large input resistance and large open-loop gain. Proper values of R_4 are switched in by using 2N2432 as switches, to give required output voltages.

S. K. Bhola, Applications Engineer, Transatron Electronic, Ltd., Maidenhead, England.

VOTE FOR 114

Voltage-controlled oscillator uses an integrated circuit

A voltage-controlled oscillator (VCO) better than 1% linear and insensitive to temperature may be built around an integrated-circuit voltage comparator (see figure).

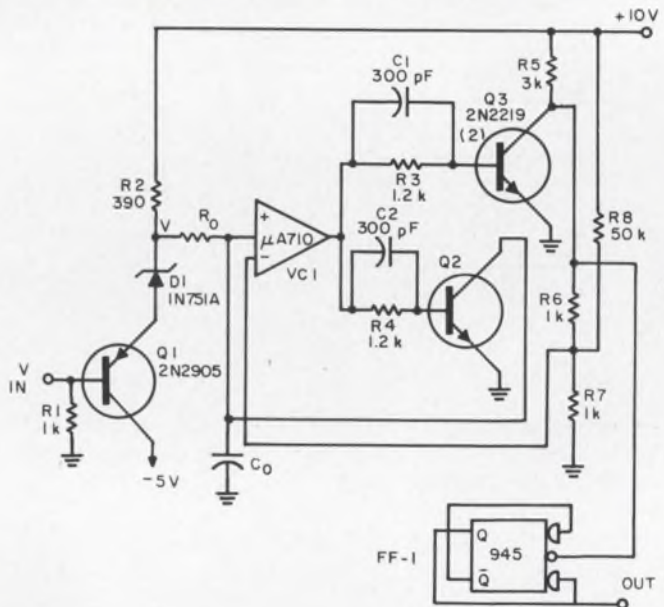

Voltage-controlled oscillator built around an IC has linearity of better than 1%.

The oscillator is basically an astable multivibrator. Capacitor C_0 charges toward V through R_0 . Voltage comparator $\mu A710$ compares the voltage on the capacitor with the reference voltage applied to its inverting terminal. If the voltage on the capacitor exceeds the reference voltage by more than a few millivolts, transistors Q_2 and Q_3 are turned on. Q_3 will shift the reference voltage to a new, lower value. At the same time, Q_2 is discharging C_0 to ground. When the voltage across C_0 hits the lower reference point, the voltage comparator will switch back to the original state, turning off Q_2 and Q_3 in the process. Thus, the voltage on C_0 is a sawtooth which starts at the lower reference voltage and charges toward the upper reference voltage. The values of

SPERRY

DIVISION OF
SPERRY RAND
CORPORATION

Sperry delivers Hybrids

Custom circuits from dual transistors
to integrated circuit arrays – you name it

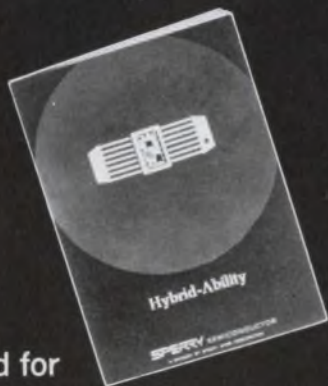

Send for
your copy of this
informative brochure

SPERRY

SEMICONDUCTOR, SPERRY RAND CORPORATION
NORWALK, CONNECTICUT 06852

- Please have salesman call with full details
- Please send me your Hybrid ability brochure
- I'm specifically interested in _____

_____ Please have a representative contact me.

NAME _____		TITLE _____	
COMPANY _____			
ADDRESS _____		PHONE _____	
CITY _____	STATE _____	ZIP _____	

Rushed?

Call our marketing headquarters (203) 847-3851
or TWX 710-468-0591 for further information.

both voltages are determined by R_5, R_6, R_7, R_8 and the state of Q_3 .

The time required to discharge C_o is much less than the time required to charge it. Accordingly, the waveform at the collector of Q_3 is a positive voltage with sharp spikes down to $V_{CE(sat)}$. A flip-flop in the divide-by-two configuration can be used to convert the waveform on the collector of Q_3 to a square wave. The advantage of using a flip-flop for squaring is the high symmetry which is obtained.

To calculate the frequency of the VCO as a function of V , the voltage applied to R_o , it is assumed that the discharge time is negligible and that the voltage comparator switches at the instant its terminal voltages are equal. A further assumption is an upper voltage reference, U , and a lower voltage reference, L . Then V_o , the voltage across C_o after L is reached is:

$$V_c = L + (V - L)(1 - e^{-t/RC}),$$

which is equal to U at the time of one period. Solving this equation for the frequency gives:

$$f = [2RC \ln (V - L) / (V - U)]^{-1},$$

where the 2 in the denominator is due to the division by two by the flip-flop.

Expanding the logarithmic term and dropping in significant terms results in:

$$\begin{aligned} f &= [4RC]^{-1} [(U - L) / (2V - U - L) \\ &\quad + (U - L)^3 / 3(2V - U - L)^3]^{-1} \\ &= [(2V - U - L) / 4RC(U - L)] \\ &\quad [1 - (U - L)^2 / 3(2V - U - L)^2]. \end{aligned}$$

With the values shown in the schematic, $U = 2.2$ volts, $L = 0.2$ volt. To operate in a region of good linearity, voltage V should be set at approximately 5 volts. As this VCO is modulated by very low-frequency signals, a very large coupling capacitor with a usual biasing arrangement would be required. Therefore, a voltage-shifting circuit consisting of R_1, R_2, D_1 and Q_1 is used. This circuit operates down to dc. With the input at zero, V will be approximately +5.3 volts.

With these values, frequency is given by:

$$f = (V_{in} + 4.2) / 4RC;$$

also:

$$df/dV \approx 1/4RC.$$

Steven E. Summer, Engineer, EDO Corporation, College Point, N. Y.

VOTE FOR 115

A continuous phase shifter for 60 Hz uses a Selsyn

The simultaneous measurement of several variables in biophysical research often requires a time-sharing approach. Since in many cases the

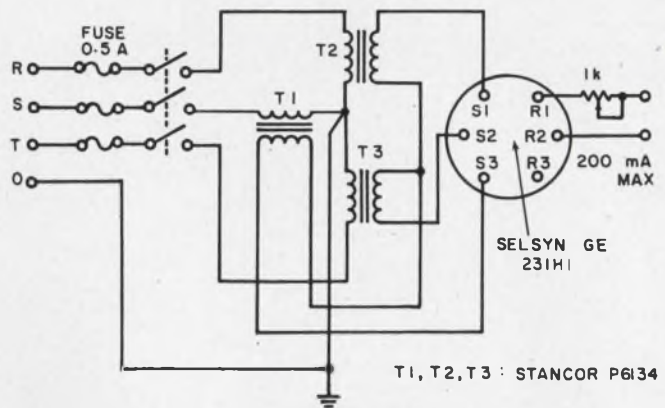

Continuous phase shift is obtained by varying the Selsyn rotor position. The output can be used to drive a chopper out of phase with the line frequency.

basic carrier is 60 Hz, the application of several mechanical choppers as demodulators and signal separators is usual.

The circuit shown in the figure permits a continuously adjustable phase shift from 0° to 360° at a constant output voltage with very little distortion of the output waveform.

The main component is a Selsyn differential generator. This has a 57.5-volt/57.5-volt ratio at 400 Hz and a rotor that is mechanically arrested. Its three-phase input is connected in a delta configuration to the secondary of normal, 12.6-volt filament transformers. The phase is varied by changing the rotor position. The variable series resistor in the secondary of the synchro permits adjustment of the chopper amplitude. Several Selsyns can be connected in parallel to the same set of filament transformers, to provide variable-phase drive voltages for several choppers.

Dieter Mayer, Johnson Research Foundation, University of Pennsylvania School of Medicine, Philadelphia.

VOTE FOR 116

RDL used to smooth IC gating circuit

An IC dual two-input gate can be used for a simple and reliable gating circuit. In coupling the gate to other circuits, however, a difficulty is that the output reference level of the gate changes as the control voltage changes. One way to overcome this is to use capacitor couplings, but this may not always be practical, as, for instance, in the case of pulse signals with very low repetition rates.

A simple solution to the problem is obtained with resistor diode logic (RDL), which can be formed into a reliable and smooth gating circuit.

The problem is illustrated first with the Fairchild μ L914 dual gates. Pins 1 and 2 are the inputs and pin 7 is the output of the first gate. Pins 3 and 5 are the inputs and pin 6 is the output of the

This CKR capacitor's price is right.



it's free.

We'd like to give you a free CKR ceramic capacitor. No strings attached. After you temperature-cycle it, drop-test it, and generally mistreat it, we don't think you'll let any other capacitor near your circuitry.

Marshall set out about two years ago to make the industry's finest ceramic capacitor. We think we've succeeded. Here's why: First, we developed a unique proprietary process that virtually eliminates the pin-holes that may occur in competitive devices. And this process provides a dielectric with an amazing density for its thinness.

But we didn't stop there. We made the dielectric strength of our material so high that it withstands four times the rated voltage. (That's well beyond existing test and operat-

ing requirements.) This superior dielectric also means Marshall capacitors do not require de-rating.

Programs like Apollo and Minuteman III demand extraordinary performance and reliability. That's why they specify Marshall capacitors.

This may be the one time you'll ever get something for nothing. Go ahead, take advantage of us.

For your free ceramic capacitor, circle inquiry no. 248.

MARSHALL INDUSTRIES



CAPACITOR DIVISION

formerly Electron Products

1960 Walker Ave., Monrovia, Calif. 91016

ON READER-SERVICE CARD CIRCLE 248

second gate.

With the single gate, control voltage e_c is injected into pin 2. The first gate is saturated, the voltage level at pin 7 is low, and no output is obtained when signal e_s is injected into pin 1. When e_c is off, voltage level at pin 7 is high and output is obtained at it when signal e_s is applied to pin 1.

The condition for gating is thus:

$$f(0) = \bar{e}_c \cdot e_s.$$

When the dual gate is used, control voltage e_c is injected into pin 5. The second gate is saturated and the voltage level at pin 6 is low. The output of pin 6 is injected into pin 2 and, since it is low, the first gate is not saturated—the voltage level at pin 7 is high. When signal e_s is injected into pin 1, there will be an output at pin 7.

With control voltage e_c off, voltage level at pin 6 is high, the first gate is saturated and no output is obtained at pin 7.

Once again, the condition for gating is:

$$f(0) = \bar{e}_c \cdot e_s.$$

Thus in both cases the voltage level at pin 7 has changed with the change in control voltage.

Smooth gating is obtained in the circuit of Fig. 1b where two dual two-input gates are used.

With control voltage e_c off, output at pin 7 of $G1$ is high and the voltage level at pin 6 is low (few tenths of a volt). Signal e_s , a positive-going pulse train, is applied through $R1$ across $R2$. The pulse level is sufficiently high to force $D1$ to conduct, thus clipping the pulse level across $R2$ to the level of the forward voltage drop across $D1$. The level is insufficient to trigger $G2$. On application of control voltage e_c to pin 2 of $G1$, the output at pin

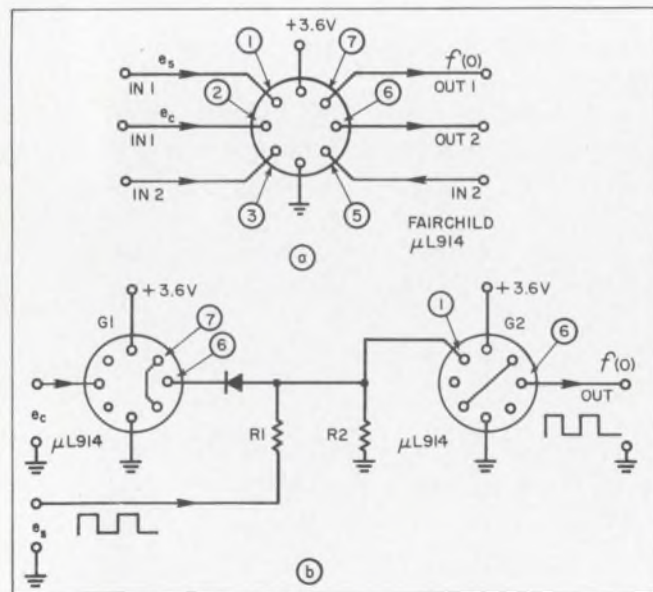

1. AND gate realized with one $\mu L914$ package (a) has an output (pin 7) that is a function of the control voltage e_c . The way to avoid this problem is illustrated in (b).

7 is low and causes the output level at pin 6 to be high. The voltage at pin 6 back-biases $D1$, which now offers a high impedance to the signal voltage. Full signal voltage appears across $R2$, minus a small drop across $R1$. The signal level is sufficient to gate $G2$. The reference input to $G2$ at pin 1 is always at ground potential irrespective of the changes in the control voltage. As a result, the output at pin 7 of $G2$ is always at the same reference level, permitting the gate to be coupled directly to other circuits.

Rumult Iltis, Research Engineer, Research & Development, American Laundry Machinery Industries, Cincinnati.

VOTE FOR 117

Time delay touch switch uses body stray voltage

Placing a finger in the depression in the insulating material (see figure) discharges the capacitor.

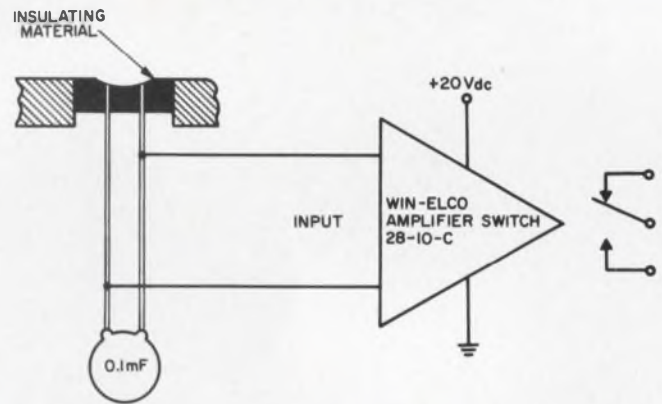

Time delay (off delay) of better than 10 s is possible with this circuit. The relay is actuated by placing a finger across the capacitor leads. It stays on for about 10 s after removal of the finger.

As long as contact is maintained, the relay will remain pulled in. When the finger is removed, the capacitor charges through the input circuitry of the device. Charging current keeps the relay pulled in. When the charging current of the capacitor drops below the threshold current of the amplifier, the relay drops out.

The Win-Elco unit consists of a double Darlington amplifier driving a reed switch. It costs \$24.95 in 1-9 lots.

Jack H. Still, Project Engineer, American Lava Corp., Laurens, S. C.

VOTE FOR 118

IFD Winner for April 12, 1967

L. E. Grothe, Senior Electronics Engineer, Babcock Electronics Corporation, Costa Mesa, Calif. His Idea, "Sine- to square-wave converter is self-powered," has been voted the \$50 Most Valuable of Issue Award.

Cast Your Vote for the Best Idea in this Issue.

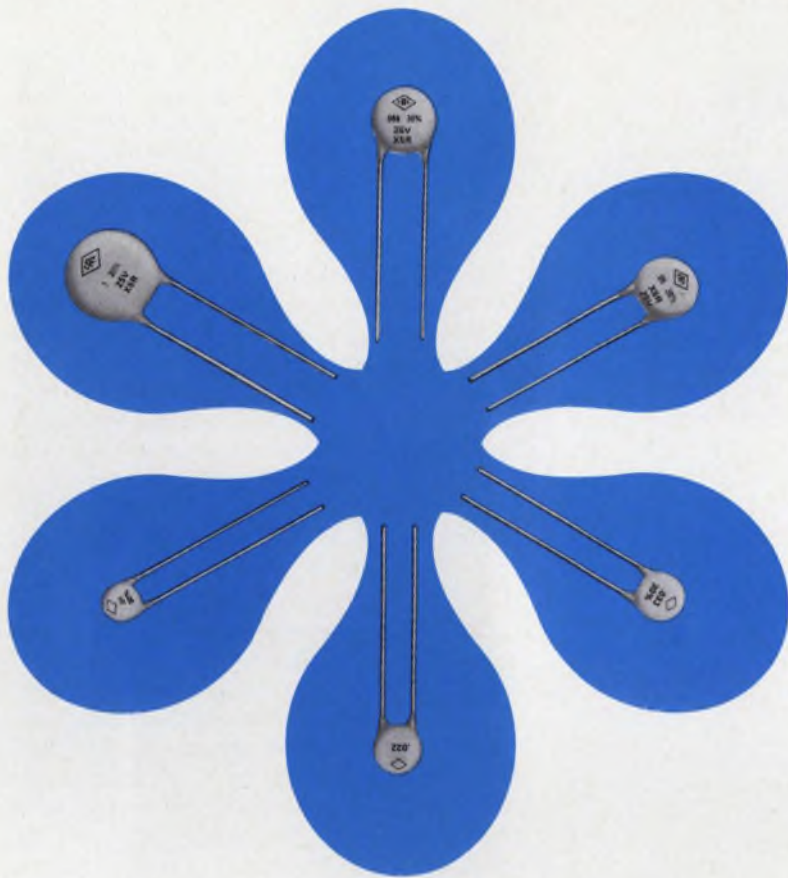

ANNOUNCING: THE "ULTRA" ULTRA-KAP®

Smaller Size... Outperforms Other Capacitors... Costs Less, Too!

"Inner space" continues to shrink in this trend to transistorization... but not the capacitance values you need in your design applications.

Centralab's answer: an improved 25V Ultra-Kap Disc Capacitor... smaller in size but not in performance.

This "ultra" Ultra-Kap goes one-up on previous Ultra-Kaps (which feature 100 times the capacitance of conventional ceramic dielectrics). Now you can use the Ultra-Kap instead of monolithic ceramic capacitors or mylar capacitors. It even replaces many 50V disc capacitors! Features improved temperature compensation characteristics, too—X5R (−55° to +85°C ±15% from 25°C).

All this at lower cost than with other capacitors, adding an extra touch of economy to your design applications... whether for consumer entertainment, communications, the military—or for medical, instrumentation and computer markets.

Get full details about the new "ultra" Ultra-Kap... and the complete Ultra-Kap line of ceramic disc capacitors... from your Centralab representative or drop us a line.



CENTRALAB
Electronics Division
GLOBE UNION INC.
5757 NORTH GREEN BAY AVENUE
MILWAUKEE, WISCONSIN 53201



Here's why they're "Ultra" Ultra-Kaps!

RANGE CHART					Minimum Insulation Resistance At Rated Voltage
Nominal Lead Spacing	Capacitance MFD	Maximum Diameter*	Tolerance	Maximum Dissipation Factor 5% @1 KHv	
.250	.01	.290	IMPROVED ULTRA-KAPS		10 MEGS
.250	.022	.405	16 Volt 25 Volt		10 MEGS
.250	.033	.405	+80-20% (Z) ±30%		10 MEGS
.250	.05	.515	or		10 MEGS
.375	.068	.590	±20% (M)		10 MEGS
.375	.1	.760			10 MEGS

*All Ultra-Kaps have a maximum thickness of .156 inches.

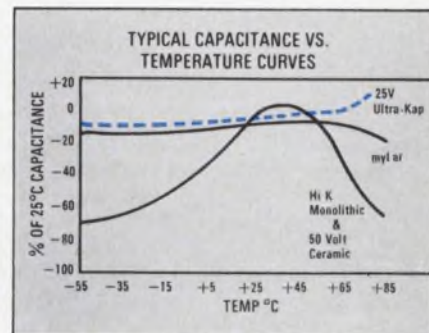

M-6723

EE openings on SRAM, Minuteman and other Boeing programs

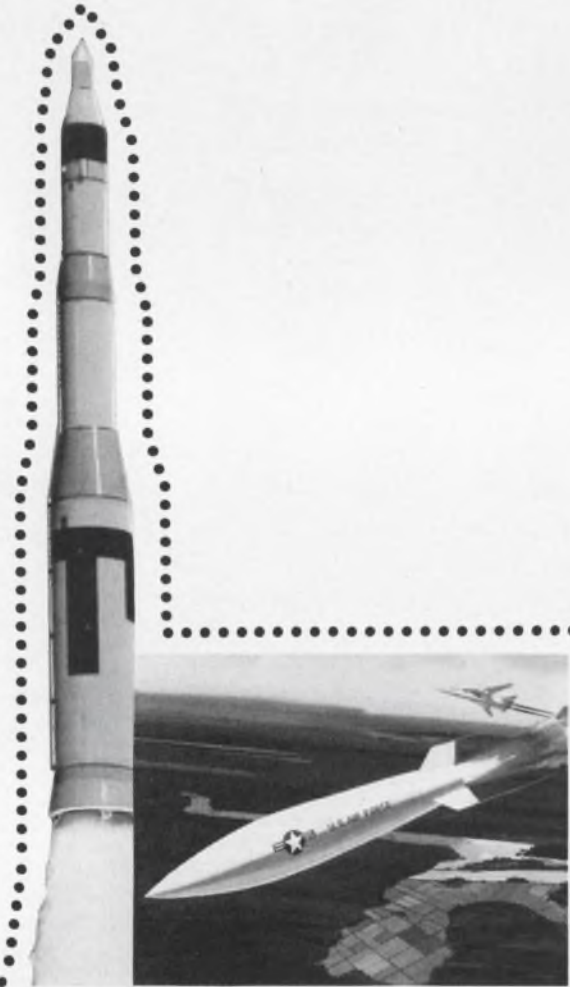

Boeing's deep involvement with the nation's major missile and space programs provides immediate career opportunities for electrical/electronic engineers at Seattle, Huntsville, and Kennedy Space Center.

Boeing is system integration contractor for SRAM, the U.S. Air Force's new Short-Range Attack Missile. The company also is weapon system integrator for the USAF advanced Minuteman II ICBM. In space, Boeing is prime contractor for the National Aeronautics and Space Administration's Lunar Orbiter, the moon-circling spacecraft which is helping NASA scientists select the best landing sites for Apollo astronauts. In addition, Boeing is a major mission-support contractor to NASA on the Apollo/Saturn V program, and is building the first stage of the Saturn V launch vehicle.

Immediate openings exist at Seattle on the SRAM, Minuteman and Lunar Orbiter programs. Assignments in test technology include data systems and instrumentation and test data handling and processing. Qualifications include a B.S. or M.S. in electrical engineering and two to five years applicable experience. Flight technology positions are available in flight control and flight mechanics. Qualifications include a B.S. or M.S. in electrical engineering with two to five years experience.

Additional Seattle openings exist in developmental design and electronic packaging. Design assignments are in airborne control systems, ground system electrical power systems, and environmental control, and require a B.S. degree in an applicable discipline plus related experience. Electronic packaging qualifications include a B.S. in electrical engineering plus applicable experience.

A number of openings also exist on the Apollo/Saturn V program. At Huntsville, assignments in flight mechanics and flight evaluation include operational trajectories, mission analysis, trajectory analysis, post-flight trajectories, flight simulation development, and flight dynamics. Qualifications include a B.S., M.S. or Ph.D. in electrical engineering. Openings also exist for electrical/electronic engineers at Kennedy Space Center.

Salaries are commensurate with experience and educational background. Moving and travel allowances are paid to newly employed personnel. Boeing is an equal opportunity employer.

Please fill in and mail the coupon to the location of your choice and qualifications. A Boeing representative will get in touch with you.

BOEING

MISSILE & INFORMATION SYSTEMS DIVISION
SPACE DIVISION

Other Divisions: Commercial Airplane • Vertol • Wichita
Also, Boeing Scientific Research Laboratories

I'm interested in a Boeing career; please contact me with details.

Name _____

Address _____

Phone (incl. area code) _____

City _____ State _____ Zip _____

I'm usually home between _____ and _____ (hours) on _____ (days)

Degree/Field of Interest _____

Please mail to the location of your choice and qualifications: SEATTLE: Mr. R. R. Laurie, The Boeing Company, P.O. Box 3999-EDD, Seattle, Washington 98124. HUNTSVILLE: Mr. John Hall, The Boeing Company, P.O. Box 1680-EDD, Huntsville, Alabama 35807. KENNEDY SPACE CENTER: Mr. G. S. McDaniel, The Boeing Company, P.O. Box 1698-EDD, Cocoa Beach, Florida 32931.

Free Career Inquiry Service

Absolutely Confidential

Respond to the career opportunities advertised in this issue. Fill out and send us this handy resume. **Electronic Design** will do the rest – neatly typed copies of this form will be mailed to the companies of your choice, indicated by the circled Career Inquiry Numbers at the bottom of this page.

15

Name				Home Phone	
Home Address (Street)			City	State	ZIP Code
Age	U.S. Citizen <input type="checkbox"/> Yes <input type="checkbox"/> No		Security Clearance		
Prime Experience			Secondary Experience		
Desired Salary			Availability Date		
Employment History – present and previous employers					
Company					
City, State					
Dates	to		to		to
Title					
Specialty					
Education – indicate major if degree is not self-explanatory					
Degree					
College					
City, State					
Dates	to		to		to
Additional Training – non-degree, industry, military, etc.					
Professional Societies					
Published Articles					

Career Inquiry Numbers:

900 901 902 903 904 905 906 907 908 909
 910 911 912 913 914 915 916 917 918 919

ELECTRONIC DESIGN
 850 Third Avenue
 New York, New York 10022

Portable detector shows helium leakage rates

Problem: Detect leaks in closed fluid systems. Soap solutions, mass spectrometers, or special devices sensitive to a specific gas, are not effective in all applications. Common tracer gases have posed problems involving safety or contamination or both.

Solution: Develop a portable helium detector that will measure helium leak rates from 1×10^{-3} to 1×10^{-6} cm^3/s with inert gas helium.

The gas detector unit is based on a comparison of the thermal-conductivity properties of various gases. A thermal-conductivity cell, consisting of two constantly driven thermistors in a balanced bridge circuit, helps detect the presence of gases

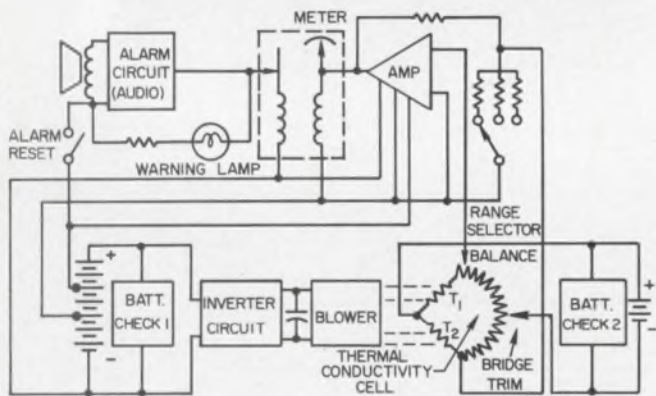

having thermal conductivities different from that of the ambient. The thermistors are matched and identically driven so that, when both are exposed to the ambience, the bridge output is null.

When either of the thermistors, T_1 or T_2 is exposed to a gas with a thermal conductivity unlike that of the ambient, that thermistor's resistance value changes, unbalancing the bridge circuit. A voltage is produced that drives the meter, which is calibrated to show directly the equivalent cm^3/s rate of helium gas leakage into the surrounding air.

A blower system pulls the ambient air at a constant rate through sampling tubes that contain the thermistors. One of the sampling tubes connects with an external fitting which accommodates three different probes: a gross-leakage probe to detect a relatively large concentration of helium in the air; a rigid pinpoint probe to locate the helium leakage source; and a flexible pinpoint probe to locate helium leakage sources in less accessible locations.

The unit is a hand-held detector with its own 7.7-lb battery pack supported on a strap-worn by the operator.

Appropriate calibration of the meter would

enable the device to detect gases with a relatively wide range of thermal conductivities.

Inquiries concerning this innovation may be directed to: Technology Utilization Officer, Marshall Space Flight Center, Huntsville, Ala. 35812 (B67-10065).

Fluid logic in counter

Problem: Design a binary counter with fluid elements. Each stage should produce one output pulse for each two input pulses.

Solution: A binary-counter stage consisting of two fluid flip-flops, each of which contains three fluid logic elements. The binary output is taken from the output of the second flip-flop.

Each flip-flop is constructed from a fluid amplifier (A_2, A_5) and a two-input, three-output element (A_1, A_4). The flip-flops are interconnected by the three-input, four-output elements (A_3, A_6).

When the binary input is low (no fluid pulse), A_3 controls the state of flip-flop 2. When the binary input is high (that is, when there is a fluid pulse), A_6 controls the state of flip-flop 1.

Initially, when there is no binary input, A_1 produces a reset pulse which does not affect flip-flop 2, since both flip-flops are in the reset state. When the binary input goes high, the A_3 reset is removed from flip-flop 2. Element A_6 produces a count pulse which switches flip-flop 1 into the count state. The count pulse from A_3 has no effect on flip-flop 2 because element A_5 has been locked on by A_4 ; therefore, flip-flop 2 remains in its initial state.

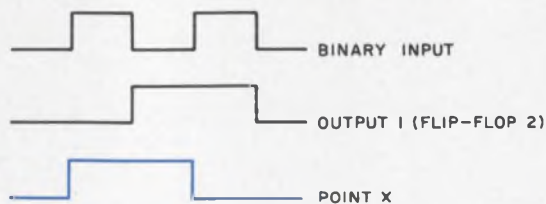
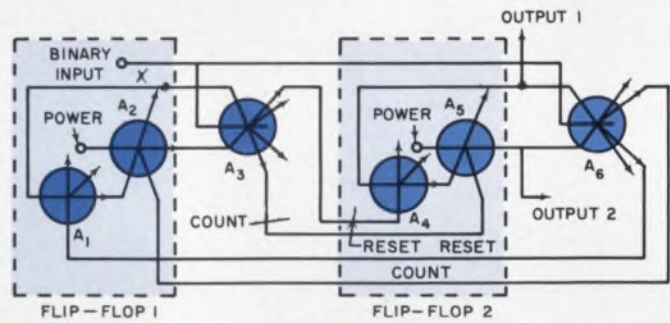

When the binary input goes back to high, the A_3 count pulse is removed, and A_6 sends a reset pulse to flip-flop 1, switching its state. When the binary input goes back to low, A_3 sends a reset pulse to flip-flop 2, switching its state. In this way, the flip-flops switch their state once for every two changes in the binary input.

For further information, contact: Technology Utilization Officer, Marshall Space Flight Center, Huntsville, Ala. 35812 (B65-0377).

Lockheed's electronics engineers have a lot of fingers in the...



It figures. The scope of production, development and study programs now underway at Lockheed-California range from "A" (ASW)... to "V" (V/STOL); with many stops in between, such as Military Rotary Wing Aircraft; Commercial Aircraft; Fighter-Bombers and Hypersonic Aircraft. They all have one thing in common: sophisticated electronic systems... and you can help to provide them.

The variety of projects at Lockheed have created openings for Electronics Engineers in the areas of Sensors; Data Processing; Navigation; Communications; Armament and Electrical Installation. If you're an electronics engineer equally at home with a formula or an idea... look into Lockheed-California. Send your resume to Mr. E. W. Des Lauriers, Professional Placement Manager, Department 1307, 2402 North Hollywood Way, Burbank, California 91503. Lockheed is an equal opportunity employer.

LOCKHEED - CALIFORNIA COMPANY — A DIVISION OF LOCKHEED AIRCRAFT CORPORATION

LOCKHEED

ON CAREER INQUIRY FORM CIRCLE 901

Radar Equipment Design Engineers

The Hughes Radar & Space Electronics Laboratories have important opportunities available for experienced Engineers.

Product design

Engineering assignments exist which involve the design and conceptual development of transmitters, modulators and power supplies employing BWO, CFA, Magnetron, Klystron and Traveling Wave Tubes. Desirable background would include a working knowledge of fabrication techniques, stress and thermal analysis, cooling, encapsulation, microminiaturization or high-voltage design.

Openings are available on nearly all levels—from those with a minimum of two years of applicable, professional experience through those who are interested in and qualified for senior supervisory positions.

Accredited degree and U.S. citizenship required.

For immediate consideration, please airmail your resume to:

MR. ROBERT A. MARTIN
Head of Employment
Hughes Aerospace Divisions
11940 W. Jefferson Blvd.
Culver City 31, California



HUGHES AIRCRAFT COMPANY
AEROSPACE DIVISIONS

An equal opportunity employer — M & F



Book Reviews

Networks and systems theory

Linear Networks and Systems, Benjamin C. Kuo (McGraw-Hill, New York), 411 pp. \$12.50.

This approach to networks and systems theory uses the state variable method. It provides an introduction to state variables and the state concept, and applies state variables and state equations to electric networks. Extensive coverage is given to signal flow graphs, flow graphs, and state diagrams; continuous-data and discrete-state systems are also treated. The book covers the conventional transform methods. The text is written at the junior undergraduate level.

Circuit design guide

Circuit Design for Audio, AM/FM, and TV, Engineering Staff of Texas Instruments, Inc. (McGraw-Hill, New York), 352 pp. \$14.50.

This is a guide to circuit design in the audio, AM/FM, and television areas. The result of several years of research and development by TI communications applications engineers, the book details the most current techniques and newest devices available. Time- and cost-saving procedures are emphasized throughout, and design examples are chosen to suggest the broad application of these procedures.

Active device design

Theory and Applications of Active Devices, Herbert J. Reich, John G. Skalnik and Herbert L. Krauss (D. Van Nostrand Co., Princeton, N.J.), 739 pp. \$12.75.

The authors of this text have attempted to present the fundamental principles of active-device circuits in a manner that will make the concepts applicable not only to presently available active devices, but also to devices that will inevitably develop in the future. Routine mathematical derivations are kept to a minimum by including such derivations in problems where the recom-

mended procedure and desired results are stated. Because important properties of individual devices are dependent on the physical phenomena involved in their operation, the authors discuss the physics of presently available devices and the relation of device parameters and characteristics to their physical properties before they discuss the various circuit functions.



Threshold logic

Threshold Logic, P. M. Lewis II and C. L. Coates (John Wiley & Sons, Inc., New York), 483 pp. \$15.00.

With the advent of reliable integrated circuits, the concept of threshold logic looms large in terms of its future impact on the design of logic systems. Yet there is little written on a formal approach to the design of logic systems utilizing threshold gates.

Accordingly, this book fills a gap by covering the subject from the points of view of both engineer and researcher. An engineer will find many detailed examples of synthesis steps, indicating that many circuits can be designed without detailed procedures. A researcher will find a complete coverage of the theory, including many novel approaches and results.

In view of the fact that threshold gates promise orders of gate number reductions in at least some types of logic, it seems that there will be more and more interest in both its theory and implementation.

—Peter N. Budzilovich



the course of tomorrow

Tomorrow does not merely happen — it is created. Scientists and engineers, like you, are working now on tomorrow's globe-spanning satellite communications networks . . . on miniature transceivers that are used today by downed airmen in Vietnam, and tomorrow will be pocket-sized communications links for doctors, businessmen . . . on laser systems that offer new possibilities for information handling.

As you help to shape technology's future, you build your own tomorrow. At Sylvania Electronic Systems, you'll find first-rate engineers, scientists and technical managers who span the complete communications spectrum of research, systems development, product and field engineering.

Join the tomorrow-builders. Send your resume in strict confidence to Mr. Kimball Shaw, Professional Staffing, Sylvania Electronic Systems, Division of Sylvania Electric Products Inc., Box 805, 40 Sylvan Road, Waltham, Mass. 02154.

*Opportunities in suburban Boston,
Buffalo or San Francisco.*

GTE
GENERAL TELEPHONE & ELECTRONICS
Total Communications from a single source through

SYLVANIA ELECTRONIC SYSTEMS

RESEARCH • SYSTEMS DEVELOPMENT • PRODUCT & FIELD ENGINEERING

An equal opportunity employer

ON CAREER INQUIRY FORM CIRCLE 902

...and switch to the highest quality switches ever made: Shallcross!

These are the switches designed for function and performance, not to low price. Yet they're priced competitively!

They give you a quality "feel." A solid feel. The kind you don't get in cheaper switches.

Not surprising. Because we use only the best materials and conservative design standards in creating Shallcross rotaries. For both commercial ratings and switches designed to MIL-S-3786.

All this pays-off for you. With Shall-

cross switches, you get lower initial contact resistance. So you can use them on more exacting applications.

You get better contact-resistance stability, so your equipment holds calibration better.

And you get better voltage and current ratings for a given size. More switch per volume.

You get versatility, too. Select from 1" wafer, 1 3/4" deck, and 2 1/2" deck configurations, plus round and oval ceramics — for every rotary application.

Join our rotary club. Switch to the Number One rotary switch: Shallcross. See your local Cutler-Hammer Sales Office or Shallcross Stocking Distributor. Or write for catalog N217.





Cutler-Hammer offers a complete selection of other quality switches. Commercial forms are covered in catalog LL-290, Military ratings in Catalog LL-291.

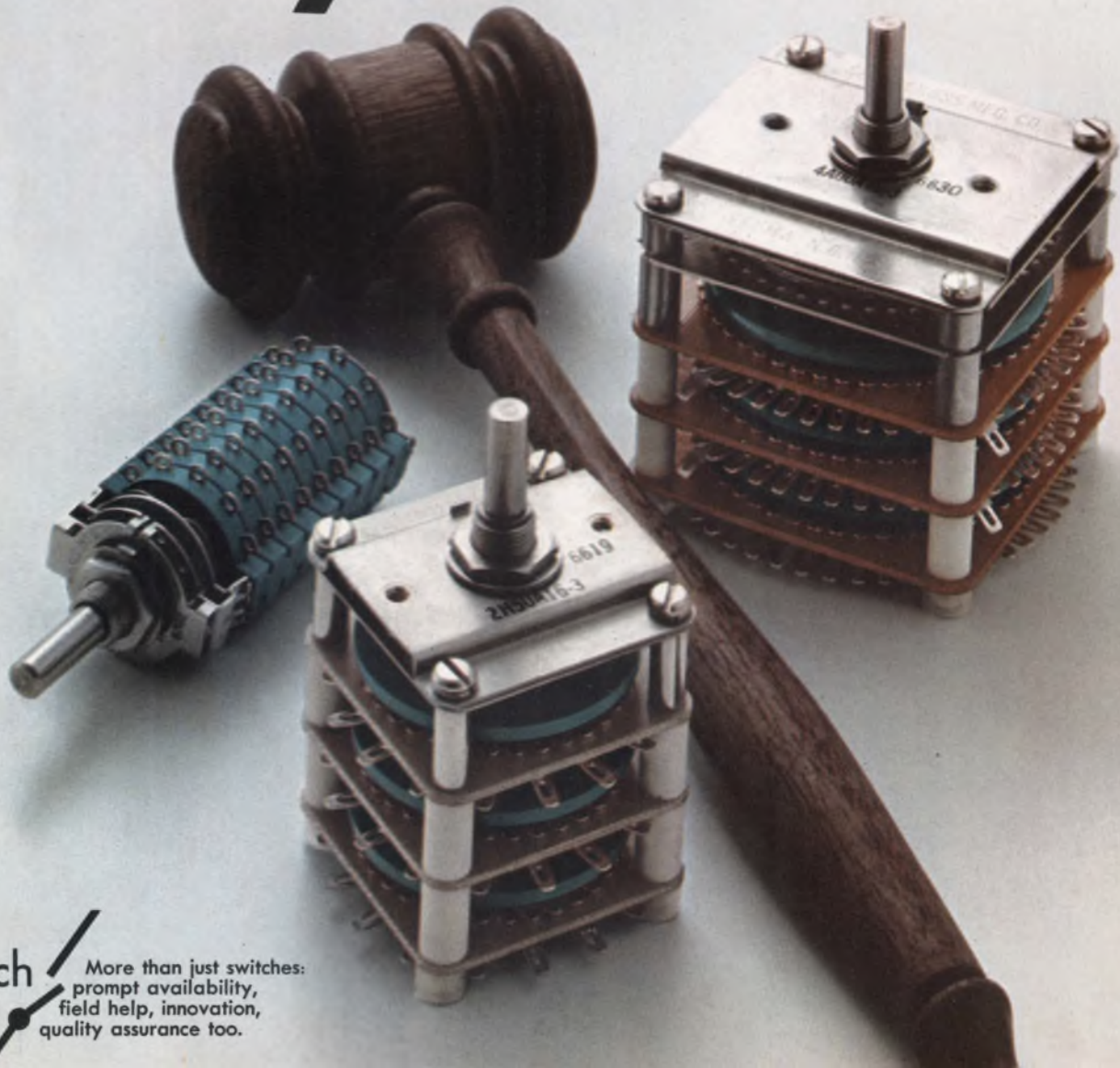

CUTLER-HAMMER
Milwaukee, Wisconsin 53201

Join our rotary club



Switch to No. 1  More than just switches: prompt availability, field help, innovation, quality assurance too.

Products

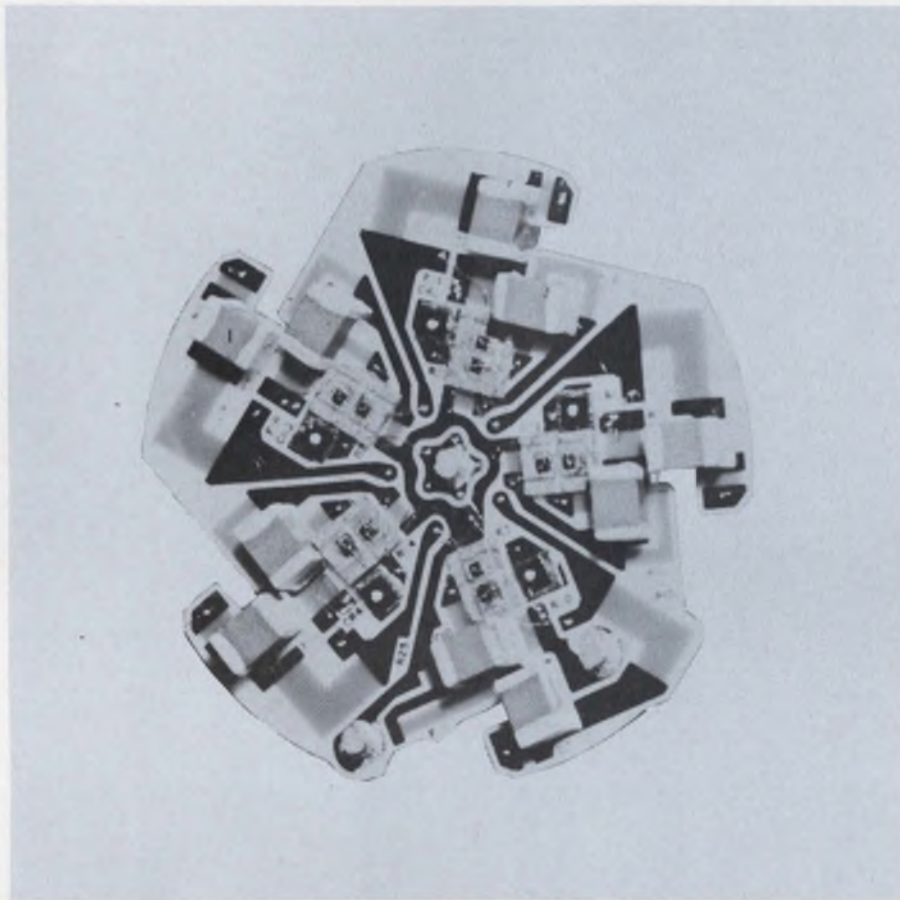

Electrically conductive thermoset polymer alloys are used to form conductive paths on hybrids, repair PC boards. Page 130

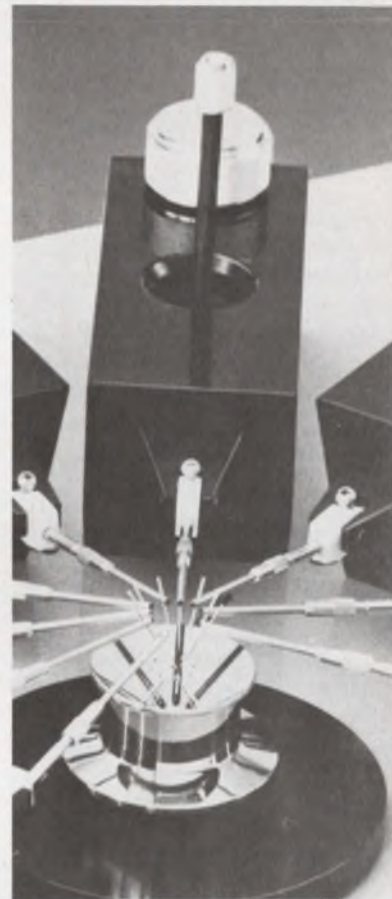

Semiconductors and ICs probed, tested. Page 132



Follow the lighted arrows to an accurate 5-digit reading. This dc voltmeter has a "logic-

assist" to guide production-line personnel through a quick and easy reading. Page 116

Also in this section:

Analog-to-frequency converter is 0.1% accurate. Page 124

Economy logarithmic amplifiers offer $100\text{-}\Omega$ Z_{out} to 1 kHz. Page 124

Design Aids, Page 138 . . . **Application Notes**, Page 140 . . . **New Literature**, Page 142

Potentiometric voltmeters are given a logic assist

James G. Biddle Company, Plymouth Meeting, Pa. Phone: (215) 646-9200. P&A: \$1950; October (by reservation only).

A solution to the problem of production-line testing at near digital-voltmeter speeds without DVM costs is offered by Biddle's Mentor instrumentation. Using a "logic-assisted potentiometer" principle, the basic dc voltmeter offers fast, "operator-proof" measurements to five places of accuracy.

The unit is designed to provide the stability and accuracy of a differential voltmeter or metrology-grade potentiometer without complicated operation, and the operational speed of the DVM without the need for frequent recalibration. The technique used in the design is simple: add a relay-logic array and a clever set of front-panel controls to a standard potentiometer circuit.

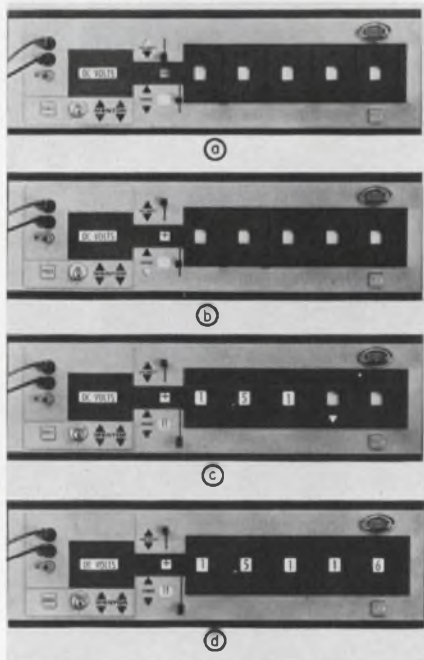

Follow the lighted arrows: If it is necessary to set polarity (a) the arrow lights up. Range arrow (b) guides setting of range and automatically sets decimal point. Balancing digits is done one at a time (c) until the final result is displayed (d).

The logic circuitry (reed relays and a bank of monolithic differential amplifiers) controls the sensitivity of the operational-amplifier null detector, adjusting it for finer and finer balance in the course of taking a 5-digit reading. It also controls the lamps behind the front panel display. Biddle prefers electromechanical relay logic to all-solid-state logic because of the lower absolute error.

The display consists of seven windows for polarity, range and a 5-digit reading, each with an associated lever switch and two arrows, up and down. The arrows indicate the direction in which the switch should be moved by the operator. For example, when an unknown input voltage is connected to the input terminals of the voltmeter, either the first window lights up to show polarity, or one of the associated arrows indicates that the switch must be shifted to the opposite polarity. When corrected, the polarity window lights, the arrow goes out, and an arrow indicator in the range section lights. When the lever is adjusted accordingly, the range window lights, showing the range in use. Then, transition is automatically made to the first digit, and so on down for each of the five decades in the display. No reading will appear at any window until its switch is properly set. If, during measurement, the input drifts, affected digits will be erased and the arrows will back-track to indicate the required readjustment. Thus, an incorrect reading is impossible. Either the reading is correct, or there is no reading. This feature also makes the unit suitable for direct use as a hi-go-lo limit tester, easily preset to any desired value within its measurement range.

The Mentor is entirely automatic, except for the manual balancing. The operator balances simply by doing as the arrows direct until the proper balance at each digit is hit upon and displayed. By including an

automatic BCD print-out capability gated by the same logic as the potentiometer, digits are printed only when a true balance is obtained. Using this feature, the only margin for an erroneous reading (human error in reading the numerals) is eliminated and accuracy relies only on the basic stability of the instrument.

The dc voltmeter has four ranges (with 10% overranging) covering 0 to 1099.99 V dc. Its limit of error is 100 ppm under rated operating conditions, and it requires calibration no oftener than once a year.

The line includes models for measurement of dc and ac voltages, dc and ac current, resistance ratio, dc voltage ratio, and combinations of these parameters. The particular parameter or combination is determined by interchangeable modular plug-ins for the basic instrument, the dc voltmeter. Availability of instruments in Biddle's 300-unit, pilot run will be determined by a reservation system.

CIRCLE NO. 251

Sine and square waves from 0.01 Hz to 1 MHz



Krohn-Hite Corp., 580 Massachusetts Ave., Cambridge, Mass. Phone: (617) 491-3211. P&A: \$550; fall, 1967.

An all-silicon, stable, low distortion signal source is available which can produce simultaneous square and sine wave outputs from 0.01 Hz to 1 MHz. Output power is 1/2 W (5 V into 50 Ω); 10 V open circuit. Specifications for the sine wave mode include: output impedance of 50 Ω , distortion of 0.03%. Square wave specifications are: rise time of 20 ns, output of 5 V, peak-to-peak open circuit (2.5 V, peak-to-peak, into 50 Ω).

CIRCLE NO. 252

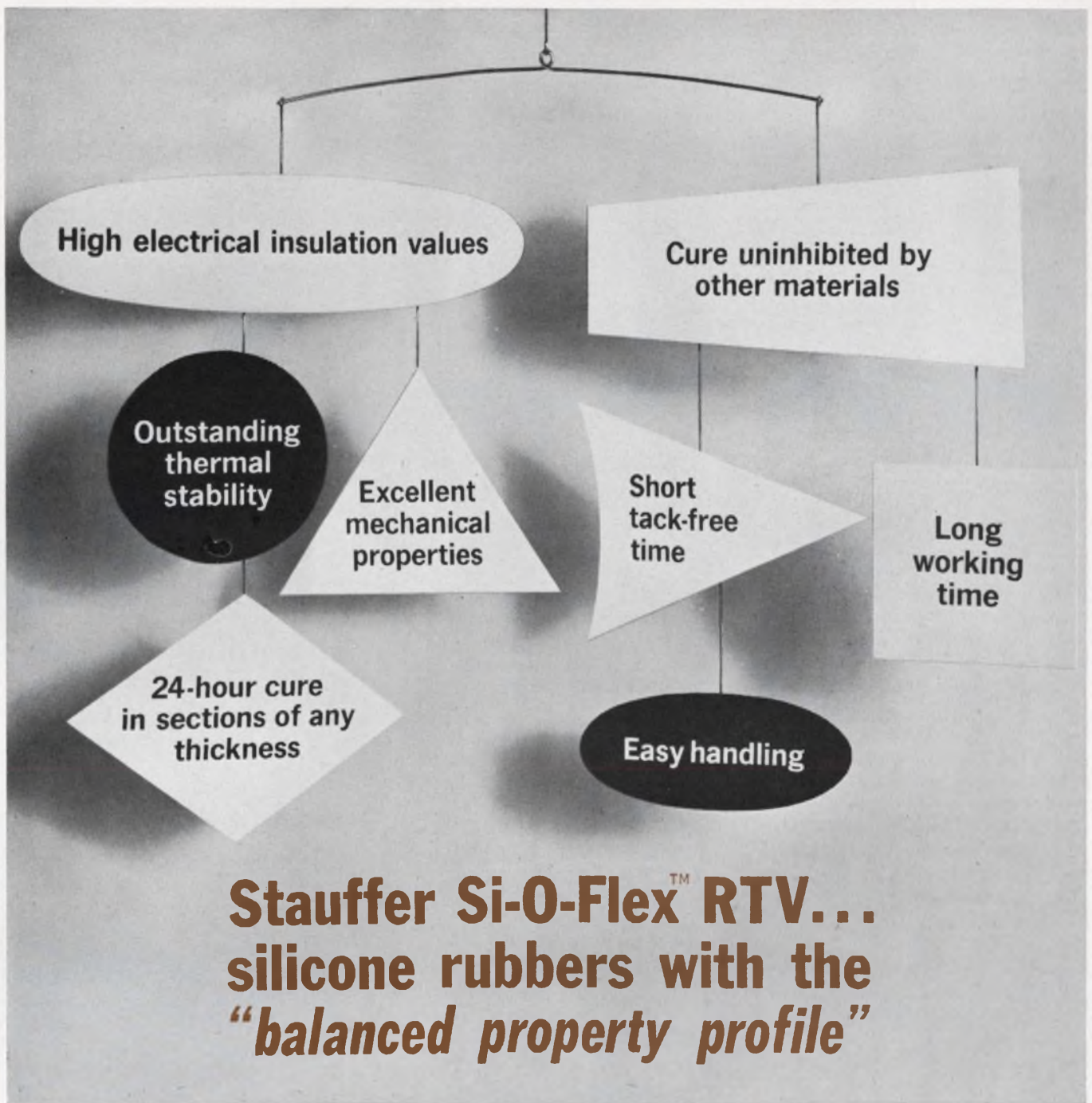

Stauffer Si-O-Flex SS-831, SS-832, SS-833 two-component RTV silicone rubbers show a rare combination of excellent overall properties. We call it their *balanced property profile*. This general superiority frequently means your present product can be upgraded . . . or that one Si-O-Flex can be used instead of several special-purpose silicones.

Stauffer's family of silicone rubber RTV's—and other silicone materials—is growing rapidly. We will be happy to send you full technical information . . . and to work with you in developing a product especially formulated for your needs. Just call on us.

Stauffer Chemical Company, Silicone Division, 380 Madison Avenue, New York, N. Y. 10017.

STAUFFER CHEMICALS . . . at work everywhere

ED

STAUFFER CHEMICAL COMPANY
Silicone Division, 380 Madison Avenue, New York, N. Y. 10017
Please send me information on Si-O-Flex SS-831, SS-832, SS-833.

My special interest is: _____

Name: _____

Company: _____

Address: _____

City: _____

State: _____

Zip: _____

Stauffer
CHEMICALS

ON READER-SERVICE CARD CIRCLE 49

Instrument light source self-contained

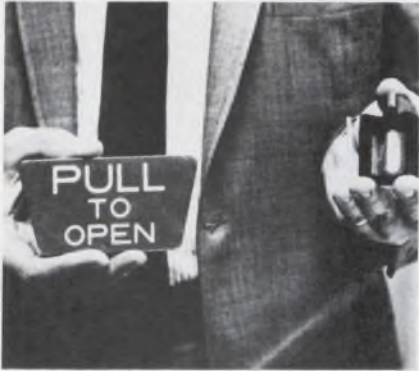

Canrad Precision Industries, Inc., 630 Fifth Ave., New York. Phone: (212) 246-0460.

Instrument and control markings that glow safely without external power are possible with these Beta-lights. The self-contained light sources have a useful life of 20 years or more without external power or the need for replenishment, replacement or maintenance. They are suited for applications where batteries or electrical wiring are impractical, as in instrument dials and controls, chassis illumination, probes and test equipment. The lights consist of a phosphor-lined glass tube containing a minute amount of radioactive tritium gas. Beta particles strike the phosphor coating, causing it to glow. Because tritium is a pure beta emitter, radiation is completely contained within the glass capsule. Various phosphors permit different colors to be produced.

CIRCLE NO. 253

Multi-channel dc amp has low zero drift

Hewlett-Packard, Sanborn Div., 175 Wyman St., Waltham, Mass. Phone: (617) 894-6300.

Low-gain dc amplification is available from a solid-state multi-channel amplifier featuring excellent gain stability and low zero drift. It is useful for communication link monitoring, telemetry recording, manufacturing process data handling, multistation observations, quality control records and multiple-design test measurements. Dual internal calibration sources are provided.

CIRCLE NO. 254

Dual-trace samplers quick on the draw



Tektronix, Inc., P.O. Box 500, Beaverton, Ore. Phone: (503) 644-0161. P&A: \$1150 and \$650; 6 wks.

A dual-trace sampling amplifier plug-in and sampling time-base plug-in provide dual-trace, 350-ps risetime capabilities with internal triggering for all Tektronix 561A, 564, 567 and 568 scopes. The 3SI sampling plug-in has two identical amplifiers with 350-ps risetime and dc-to-1-GHz bandwidth. The 50- Ω verticals feature a 2- to 200-mV/div calibrated deflection range and built-in delay lines. Five operating modes provide single, dual-trace and X-Y displays. The 3T77A sampling sweep has a calibrated sweep range from 10 μ s/div to 200 ps/div. It features internal or external triggering from 30 Hz to 1 GHz on pulses and from 100 kHz to 1 GHz with sine waves.

CIRCLE NO. 255

Time-mark generator accurate to 0.0003%



Accutronics, Inc., 12 S. Island, Batavia, Ill. Phone: (312) 879-1000. P&A: \$395; 1 to 2 wks.

The Master/marker portable time-mark generator derives its high accuracy from a high-stability quartz crystal. A special trimming device allows setting of all frequencies simultaneously to WWV. Frequency drift is less than 0.0003% in 24 hours at a constant ambient. Any of the eight ranges (1 Hz to 10 MHz) are available simultaneously or they can be selected individually.

CIRCLE NO. 256

Dc supply mounts 3-1/2-inch racks



E-Tronics, 5901 Noble Ave., Van Nuys, Calif. Phone: (213) 787-5581. P&A: \$90; 2 wks.

A 5-volt, 2-amp supply with automatic overload protection and self-recovery mounts on a 3-1/2-inch high rack panel. The output is adjustable by a 15-turn self-locking pot on the base. The power supply may be remotely sensed. Modules feature plug-in printed circuit board design, easy access to all components and dual silicon transistors.

CIRCLE NO. 257

Envelope delay tester up in accuracy



Acton Labs., Inc., 531 Main St., Acton, Mass. Phone: (617) 263-7765. P&A: \$5785; 90 days.

Designed to improve delay measurement accuracy, this solid-state unit measures transmission delay with accuracies to 0.5 μ s at a modulation frequency of 250 kHz. (Modulation frequencies of 25 and 83-1/3 Hz also are provided.) The internal carrier oscillator enables the unit to cover 100 Hz to 552 kHz. Reference frequency drift is 5×10^{-8} in 10 minutes. Measurements can be made by loop, end-to-end or end-to-end-return reference techniques.

CIRCLE NO. 258

Miniature meters for ac or dc



Voltron Products, Inc., 1020 S. Arroyo Pkwy., Pasadena, Calif. Phone: (213) 682-3377. P&A: \$40 to \$100; stock.

A series of miniature, portable voltmeters and ammeters is available for ac and dc with up to five measuring ranges on a single standard or expanded scale meter over a wide range of voltages and currents. Standard scale accuracy is $\pm 1\%$. Expanded scale accuracy is $\pm 0.25\%$. The rectifier circuit will maintain accuracy up to 20 kHz.

CIRCLE NO. 259

Go-no go milliohmmeter for production tests



Keithley Instruments, Inc., 28775 Aurora Rd., Cleveland. Phone: (216) 248-0400. Price: \$1140.

With an accept-reject indicator for production testing, this milliohmmeter offers: $10\text{-}\mu\Omega$ sensitivity, 13 ranges from 1 m Ω to 10 k Ω , 1% full scale accuracy and 0.25% repeatability. Typical uses include measurement of internal resistance of dry cells, resistivity profiles of thermoelectric materials, measurement of temperatures with thermistors and dry circuit tests of contacts.

CIRCLE NO. 260

cool comfort for avionic hot-spots



Nothing like a l-o-n-g, cool drink of dielectric fluid to keep miniaturized electronic systems on the job when there's not enough space or air to protect them against overheating.

Eastern liquid cooling systems for avionics take over where heat sinks, convection- or fan-cooling leave off. These simple, lightweight, compact packs are completely self contained — motors, heat exchangers, pumps, controls.

Some *famous-name* applications of Eastern liquid cooling packs for avionic systems: Nike Ajax, Hercules, Zeus; Hawk and Minuteman. That's pretty fast company to be in.



Interested? Send for
New Series C Bulletin, on
Liquid Cooling Systems



EASTERN INDUSTRIES

A Division of Laboratory For Electronics, Inc.
100 Skiff Street • Hamden, Connecticut

BRANCH OFFICES: Nashua, N.H., Lyndhurst, N.J., Wilmington, Del., Chicago, Ill.
Torrance, Calif. Also available in Canada

ON READER-SERVICE CARD CIRCLE 50

Plug-in memories ease assembly

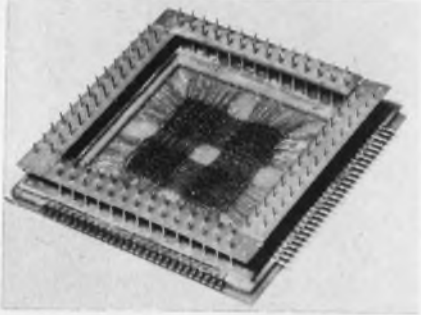

Ferroxcube Corp., Saugerties, N. Y. Phone: (914) 246-2811.

A stack of these core memory storage planes is mounted on a PC board as simply as a transistor or other component. Connection pins at the bottom of the stack are pushed through the board and these leads are then soldered in the usual manner. Frames are glass-epoxy laminate. The cores are fixed to a base plate of the same material with a lacquer. Low drive currents (190 mA) allow use of simple drive and selection circuits. The planes are wired in a 4-wire coincident current scheme. They are available in 8 standard configurations with bit capacities from 256 to 1024.

CIRCLE NO. 261

Program generator gives 6 serial channels

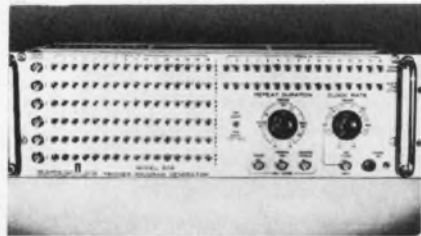

Datapulse, Inc., 10150 W. Jefferson Blvd., Culver City, Calif. Phone: (213) 871-0410. P&A: \$3590; 8 wks.

Six channels of serially programmed pulse outputs are provided by this trigger program generator. The 16-bit program may be extended by repeating bits or bit pairs. The unit is intended as a trigger source for pulse shaping and drive circuits. Applications include evaluation of magnetic memory devices, memory systems and other multi-channel pulse equipment.

CIRCLE NO. 262

Production ohmmeters accurate to 0.5%



Faradan Corp., 4130 Mennes Ave., Riverside, Calif. Phone: (213) 968-2111. P&A: \$245 and \$295; 3 to 4 wks.

Operational amplifier circuitry in these ohmmeters allows full-scale accuracy of 0.5% on all scales except 0 to 1 Ω , where a maximum 2% accuracy is obtained. Current through the test device is 3 mA on the 0-to-1- Ω scale. Model 40 has resistance scales of 0 to 1, 0 to 10 and 0 to 100 Ω and 0 to 1, 0 to 10 and 0 to 100 k Ω . The Model 41 extends the range to nine scales, including 0 to 100 M Ω .

CIRCLE NO. 263

1100-volt supplies power photomultipliers

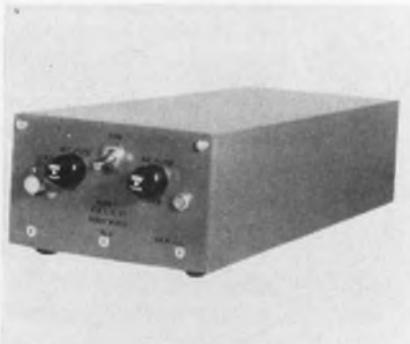

Celco, 70 Constantine Dr., Mahwah, N. J. Phone: (201) 327-1123.

A 1100-V power package for photomultiplier tubes operates at 117 V, 50 to 400 Hz, with line regulation at $\pm 0.025\%$ for 30% change in line voltage. Other features include a short-term drift after warm-up of less than 0.01%, a long-term drift of less than 0.35% and ripple minimized to 0.005% rms. Load regulation is 1.7%/mA.

CIRCLE NO. 264

Log level amp has 100-dB dynamic range

Hewlett-Packard, Sanborn Div., 175 Wyman St., Waltham, Mass. Phone: (617) 894-6300.

A solid-state, plug-in log level amplifier can record extremely wide ranges of signal amplitude on a linear dB scale. The unit can be used in direct writing recording systems which analyze large dynamic signals from low-output-impedance accelerometers or wide-bandwidth vibration and acoustic transducers. It can continuously monitor or record amplifier frequency response, filters, transmission networks and similar devices. The amplifier features 100 and 50-dB detection spans, ± 1 -dB detection accuracy, 5-Hz-to-100-kHz bandwidth, 100- μ V maximum sensitivity bottom scale and an internal calibration source.

CIRCLE NO. 265

Amplifier finds signal 56 dB below noise

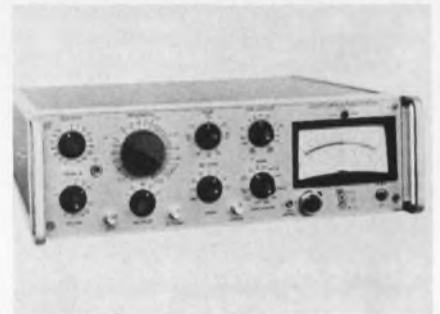

Princeton Applied Research Corp., P. O. Box 565, Princeton, N. J. Phone: (609) 924-6835. P&A: \$1600; 90 days.

A phase-sensitive detection system recovers extremely weak signals masked by much higher amplitude noise. The lock-in amplifier operates as extremely narrow-band detector with an equivalent noise bandwidth of less than 0.0025 Hz. The center frequency is locked to the input signal, essentially eliminating the drift problems encountered when narrow-banding to eliminate noise. With the use of synchronous detection, the unit can recover a signal 56 dB below ambient white noise in a 1-kHz bandwidth centered about signal frequency (minimum signal-to-noise ratio of 1).

CIRCLE NO. 266

50-MHz lab scope MIL-ruggedized

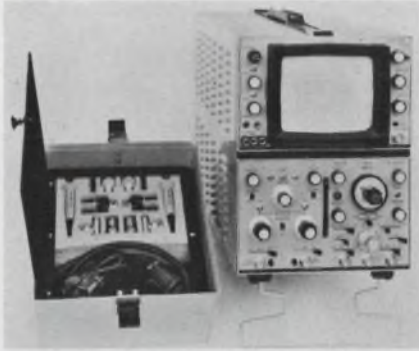

Hewlett Packard, 1501 Page Mill Rd., Palo Alto, Calif. Phone: (415) 326-7000. P&A: \$3100; September.

This fully ruggedized 50-MHz scope meets military shock, vibration, temperature and humidity requirements. Model AN/USM-281 meets all its electrical specs from -28° to $+65^{\circ}\text{C}$ and 95% humidity up to $+65^{\circ}\text{C}$. It is drip-proof, complying with MIL-S-108, and it meets the RFI specifications of MIL-16910C, Class I. It withstands shock tests of 1, 3, and 5-ft 400-lb hammer blows in three axes, in accordance with MIL-S-901. MTBF of the all solid-state instrument is 5000 hours under the terms of MIL-HDBK-217.

The unit comes equipped with a dual-channel 50-MHz vertical channel plug-in having a deflection factor range of 5 mV/cm to 20 V/cm. An X5 magnifier increases the deflection factor to 1 mV/cm, with 20-MHz response. The time-base plug-in supplied with the scope has sweep speed ranges from 0.1 $\mu\text{s}/\text{cm}$ to 2 s/cm and the X10 magnifier in the main frame can increase the fastest sweep speed to 10 ns/cm. The plug-in also includes delaying sweep.

Electrically and mechanically the scope and its plug-ins are similar to H-P's 180A. However, all circuit boards are dip-coated in a plastic resin, the CRT is shock-mounted and rf interference suppression is increased with a grounded, transparent conductive coating on the CRT faceplate and the use of rf filters on the power-line input. The scope is offered in portable or rack-mount versions. A civilian version is available without a name plate.

CIRCLE NO. 267

Vibration isolator is flexible corrugated coaxial assembly which connects rigid or semi-flexible transmission line to shock-mounted transmitters.

Rigid Line assembly consists of three sections of Seal-O-Flange, EIA, 50 ohm Rigid Line, a taper reducer; $1\frac{1}{2}^{\circ}$ to $\frac{7}{8}^{\circ}$, $\frac{7}{8}^{\circ}$ line, and $\frac{7}{8}^{\circ}$ miter elbow, joined by flanges.

End-fired waveguide to coaxial cable transition is an excellent example of making cable an integral part of an assembly. The coaxial cable is cut to within 2° of a standard at C band frequencies. VSWR of less than 1.25 is exhibited.

Small diameter, flexible, braided cable with solid irradiated polyethylene dielectric in a silver plated copper braid with outer jacket of irradiated polyethylene is used for both of these harnesses.

TNC connectors with a high temperature dielectric provide termination on assembly P-13. J-17 assembly's removable adapter provides bulkhead bushing with special gasketing material for operation under severe environmental conditions.

Extreme flexibility is a feature of the larger assembly. A silver plated, solid copper inner conductor is utilized for best conductivity at high frequencies. High temperature rated polyethylene forms a dielectric. The outer conductor is corrugated brass on phosphor bronze with an ablative coating. The short, straight length is similar in design but has a different end-flange arrangement.

Antenna feed assemblies are produced in varying lengths to match desired frequency. Fabricated of $\frac{7}{8}^{\circ}$, 77 $\frac{1}{2}$ ohm Styroflex[®] cable, an extremely soft outer conductor allows easy installation and greater chemical stability.

Size, space and weight problem solvers

With just about the ease with which you can bend a strand of cooked spaghetti, we can shape specified lengths of coaxial cable and solve very nasty transmission and installation problems in the process. And we do it without disturbing electrical and mechanical tolerances.

A coaxial cable assembly, designed to specific requirements, is often the ingenious solution to cable connections in close physical confines or under difficult environmental conditions. Very tight specs can be met: delay time, $\pm .02$ NS—phase length, 0.4° relative—VSWR, 1.01;

insertion loss, 0 to 40 db ± 0.5 db and 40 to 60 db ± 1.0 db—impedance, absolute value of average, 0.2%.

Phelps Dodge Electronics coaxial cable assemblies have been designed and built as tracking antenna harnesses, special oscillator and receiver lines, transitions to waveguide, airborne vibration isolators, matching sections, and for equalizing and balancing networks.

We have a new catalog that describes many more. Please write for it. *Bulletin CC, Issue 1.*

PHELPS DODGE ELECTRONIC PRODUCTS
NORTH HAVEN, CONNECTICUT



ON READER-SERVICE CARD CIRCLE 51

Demod carrier range runs 50 Hz to 40 kHz



Hewlett-Packard, Sanborn Div., 175 Wyman St., Waltham, Mass. Phone: (617) 894-6300.

Designed to acquire amplitude and phase information, this phase-sensitive demodulator accepts various plug-in phase-shift modules. Applications include error detection and amplification in experimental ac servo loops and system simulation setups, continuous monitoring of phase and amplitude, and driving strip chart recorders, tape recorders, panel meters or scopes. The unit has a carrier frequency range of 50 Hz to 40 kHz, 1-M Ω input impedance, a gain stability of better than 0.25%/10 $^\circ$ from 0 $^\circ$ to 40 $^\circ$ C, 500 mV/div sensitivity, and a frequency response of less than 3 dB down at 1/5 reference frequency.

CIRCLE NO. 268

Transfer functions analyzed digitally

Weston Instruments, Inc., Hatboro Industrial Pk, Hatboro, Pa. Phone: (201) 243-4700.

A high precision low-frequency digital transfer function analyzer has a frequency range of 0.00001 to 159.9 Hz. The resolution of measurement is 0.1% of full scale; the phase of 10 minutes of arc. It has fully floating and isolated interface with the unit under test and digital display of Cartesian, polar and log polar forms. The analyzer comprises a function generator and digital correlator.

CIRCLE NO. 269

Test system aligns trap frequencies

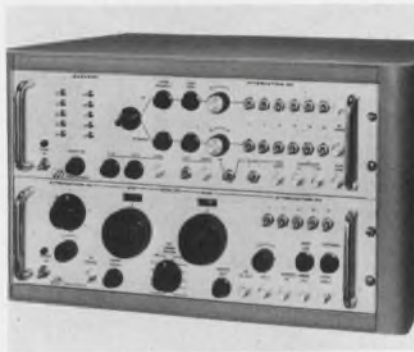

Sweep Systems, Inc., 3000 Shelby St., Indianapolis. Phone: (317) 787-8275. P&A: \$2450; 10 days.

This test system provides all uhf, vhf, i-f, video, chroma and trap alignment functions to completely align, test, or evaluate monochrome and color TV receivers. The instrument provides marker indications at the video and sound carrier frequencies of channels 2 through 83. The i-f portion provides up to 10 crystal-controlled pulse type markers and aligns trap frequencies without additional test station operations.

CIRCLE NO. 270

System records signals from isolated sensors



Develco, Inc., 440 Pepper, Palo Alto, Calif. Phone: (415) 321-6506.

Reliable measurements of signals generated in remote, high-interference environments are made by this light-coupled telemetry system. A flexible fiber optics "cable" transmits the modulated-light output of a GaAs diode between sensor and recorder and prevents coupling in of spurious electromagnetic radiation. Immunity of the optical link to RFI proves of value in integration tests of space vehicles and troubleshooting rf instruments.

CIRCLE NO. 271

Low cost tester handles J, MOSFETS



Electronic Manufacturing & Engineering Corp., 839 S. Wheeling, Tulsa, Okla. Phone: (918) 582-4188. P&A: \$360; 14 days.

Junction and MOS field-effects may be tested with this unit for pinchoff or gate threshold voltage, average dc and dynamic transconductance, I_{DSS} , shorts and opens. The solid-state instrument provides quick accurate displays, limited calculation, portability, easy separation from the scope and a highly stable pattern.

CIRCLE NO. 272

Low-cost amplifier spans 5 Hz to 10 MHz



California Electronic Manufacturing Co., P. O. Box 555, Alamo, Calif. Phone: (415) 932-3911. P&A: \$95; stock to 2 wks.

Because of its feedback design, this amplifier has good gain stability and low distortion over a bandwidth spanning low-frequency instrumentation and audio up into rf. Because of the bandwidth of 5 Hz to 10 MHz the unit is suited to telemetry applications in PDM, PCM and PAM work. Gain is adjustable from 10 to 100 with provisions for fixed gain. Output is 6 V p-p into 1 k Ω and 1.5 V p-p into 50 Ω .

CIRCLE NO. 273

Curve tracer mates with any dc scope



Rameco Corp., P.O. Box 580, Deerfield Beach, Fla. Phone: (305) 399-1980. Price: \$435.

Curve families for both bipolars and FETs are displayed when this curve tracer is used with any general purpose dc oscilloscope. Base current steps of 20, 100 and 200 μ A are provided with 4 ranges of sweep voltage to 240 V. The voltage steps for FET testing are continuously adjustable by means of a 10-turn pot and clock-type dial. A front panel switch selects any one of 12 load resistors ranging from 10 Ω to 100 k Ω .

CIRCLE NO. 274

Tester simulates transmission lines



Computer Devices Corp., 63 Austin Blvd., Commack, N. Y. Phone: (516) 543-4220.

This simulator acts as if it were a transmission line between two distant points for bench checking data handling capabilities. The unit incorporates a variable delay line and a self-contained power supply. The delay line simulates delays of cables up to 300 μ s. The simulator accepts, and, after the delay period, reproduces input pulses from 1 to 20 V p-p at frequencies from 50 kHz to 1 MHz in the RZ, NRZ, or bipolar split phase modes.

CIRCLE NO. 275

Funny...if you want things like pushbutton test sequencing in your IC tester, you have to buy the lower-priced make.

The Birtcher Model 800

has the most advanced features you'll find in an IC test set, yet it carries one of the lowest price tags. ■ For \$2000, you get a modular system with all this: five integral DC power supplies—one of them a constant current source, all of them digitally settable; a 10x20 crossbar (not pin board) matrix with provision for five external inputs or monitoring lines; pushbutton test sequencing



that allows high-speed testing of similar parameters (like multiple-input gates) without reprogramming; hook-up for external DVM or oscilloscope display; voltage *and* current measurements, accurate to 1% full scale. ■ For not very much more, you can add an integral pulse generator and decade load resistors and capacitors, and double your matrix capacity to 10x40. ■ The modular construction keeps it flexible, and there's a full complement of test adapters that makes it universal. Feature for feature, you won't find anything close to the Birtcher Model 800 at anything close to the price. (You'd have trouble matching Birtcher delivery time, too: 2 weeks ARO.) ■ Write us for detailed data sheets.



the BIRTCHER CORPORATION
INSTRUMENT DIVISION

1200 Monterey Pass Road / Monterey Park, California 91754 / (213) 264-6610

ON READER-SERVICE CARD CIRCLE 52

Analog-to-freq converter accurate to 0.1%

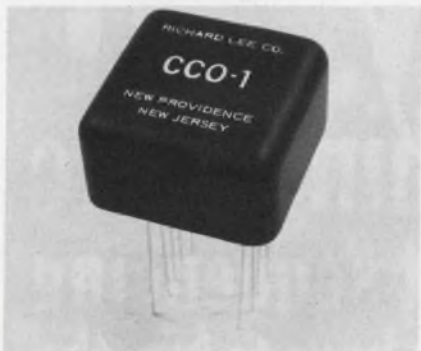

Richard Lee Co., Box 724, New Providence, N. J. Price: \$69.50.

For analog-to-frequency conversion, this current-controlled oscillator generates a square wave proportional to the applied input current with an accuracy of 0.1% full-scale. The usable full scale input current range is 250 μ A to 4 mA. The user determines the full-scale frequency between the limits of 5 Hz and 50 kHz with external timing capacitors.

CIRCLE NO. 276

Quartz wafer filter housed in HC 6/U

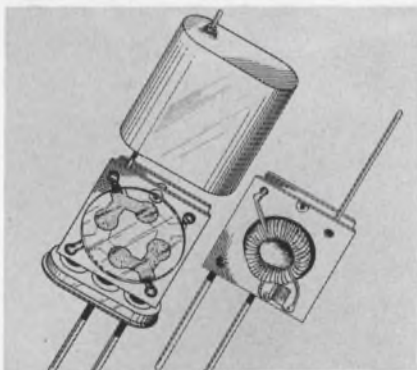

Clevite Corp., Piezoelectric Div., 232 Forbes Rd., Bedford, Ohio. Phone: (216) 232-8600.

A single-wafer 6-pole quartz filter designed for applications at or above 8 MHz is completely contained in a standard HC 6/U package. The network is prepared using vacuum deposition with all resonators contained in a single quartz wafer. Foil leads are attached to the wafer and these leads, in turn, to the terminals of a PC board. The configuration allows two half-lattice sections to be placed on the single wafer.

CIRCLE NO. 277

A-D module line covers many functions



Redcor Corp., 7800 Deering Ave., Canoga Pk., Calif. Phone: (213) 348-5892. P&A: \$250; stock.

Comparator, buffer amplifier, dynamic bridge amplifier, multiplexer and general-purpose sample-and-hold are some of the modules included in this analog-digital line. The modules feature compatibility with monolithic dual-in-line packaging. All module sizes and pin locations have been selected to conform to a standard power grid to facilitate interconnection.

CIRCLE NO. 278

Silicon photocells have flat readout areas

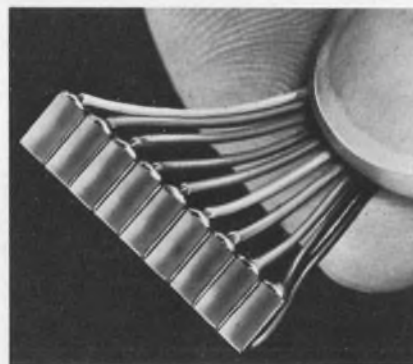

Sensor Technology, Inc., 7118 Gerald Ave., Van Nuys, Calif. Phone: (213) 873-1533.

Flat unobstructed active areas make for easier masking and mounting of these silicon readout photocells. The cells have edge contacts rather than the conventional top and bottom contacts. The flat and unobstructed surface of the cells makes it possible to mask directly on the cell surface, improving the optical coupling of the sensor to its sourcing member.

CIRCLE NO. 279

Economy log amps have low Z_{out}

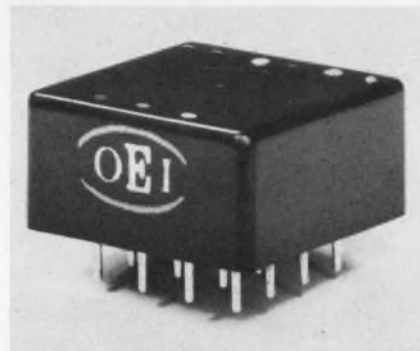

Optical Electronics, Inc., P. O. Box 11140, Tucson, Ariz. Phone: (602) 624-3605. P&A: \$55 (267/268), \$71 (269); stock to 10 days.

A series of 3 logarithmic amplifiers are offered with a low 100- Ω output impedance. Models 267 and 268 are polar amplifiers for dc-to-1-kHz signals. Model 269 is a bipolar amplifier for dc or ac signals up to 1 kHz. Applications range from general purpose signal compression for recording and measuring to analog function generation.

CIRCLE NO. 280

Epoxied mylar caps save space

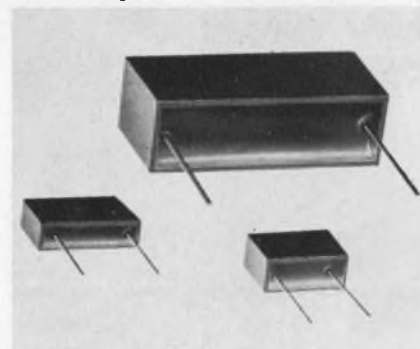

SEI Manufacturing, 18800 Parthenia St., Northridge, Calif. Phone: (213) 349-4111.

Epoxy-encased metallized mylar capacitors in a molded thin-rectangular configuration with radial leads are designed for circuits where "real estate" is scarce. The line is available in 100, 200, 400 and 600-volt sizes in capacitance values from 0.001 to 5 μ F with 20% to 1% tolerances. Operating temperature is -55° to $+125^{\circ}$ C and dissipation factor is 1% at 1 kHz and 25° C.

CIRCLE NO. 281

Coaxial connectors rated at 20 kVdc

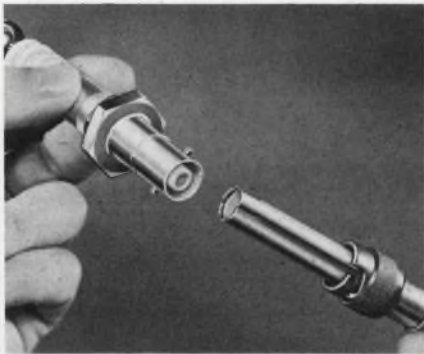

Reynolds Industries, Inc., 2105 Colorado Avenue, Santa Monica, Calif.
Phone: (213) 451-1741.

A series of precision cable connectors is available with a rating of 20,000 Vdc, and max leakage across the interface of less than 1 μ A at the voltage. The connector is designed to assure rated voltage standoff mated or unmated, and has recessed center contacts and pre-contact grounding for maximum personal safety. The connector is designed specifically for high energy physics applications. It takes RG 8/U or RG 213/U cable.

CIRCLE NO. 282

PC thumbwheel switch has digital readouts

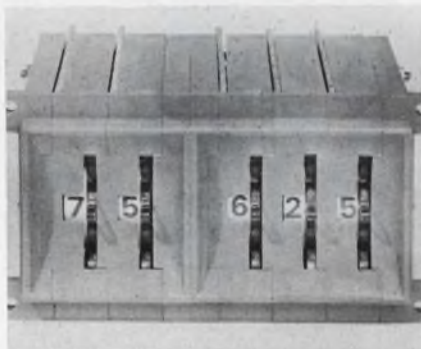

Inter-Market, Inc., 135 S. La Salle St., Chicago. Phone: (312) 332-6625.

A low-cost, edge-operated thumbwheel switch is claimed to be extremely reliable through its use of printed circuits. Available in standard and miniature sizes, the switches can be mounted directly, need no escutcheon plates, and have an integral and compact read-out with or without rear illumination.

CIRCLE NO. 283

INSIDE STORY

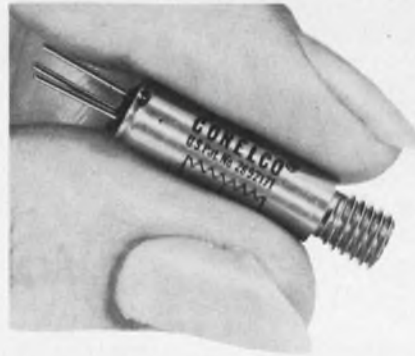

on CONELCO MIDGI-TRIM[®] Trimming Potentiometers



CONELCO trimming potentiometers have established new industry standards for resolution and accuracy with their patented, exclusive OUTSIDE-IN construction — where the wiper-contact travels inside the hollow core. A groove in the core keeps the contact nut and wiper on a precise track. This unique principle eliminates undesirable motion and provides improved shock and vibration environmental characteristics.

Mounting is simplified by the threaded end on the panel-type cylindrical trimmers. This feature allows easy mounting to instrument panels *without additional hardware* or drilling of extra holes. CONELCO trimmers can be sealed with a cap and O-ring assembly, making them ideal for encapsulating or tamper-proof requirements. The miniature size of the case allows mounting of up to 16 of these accurate, reliable trimmers within a space of ONE SQUARE INCH.

CONELCO trimmers incorporate a proprietary positive drive with a trouble-free ratcheting clutch action. The contact-wiper assembly idles at each end of mechanical travel so that electrical continuity is maintained and malfunction at the end stops is completely eliminated.

Other outstanding features of CONELCO trimming potentiometers include infinite resolution capability, power ratings of 1.5 watts, resistance from 0.5 ohms to 2 megohms — all in a package ONE-QUARTER INCH in diameter!

This same construction is available in rectangular, PCB, or multi-pot cases.

High-quality MIDGI-TRIM potentiometers are also available in 1/2" and 3/8" square configurations.

All CONELCO trimmers meet or exceed applicable environmental MIL specs, and are priced as low as \$3.25 each. *

Write today on your company letterhead detailing your application, and we will send you, at no obligation, a FREE 5k ohm panel-mount MIDGI-TRIM trimmer.

* in 500 quantities

CONELCO COMPONENTS

Subsidiary of **SYSTRON**  **DONNER**

CORPORATION

465 WEST FIFTH STREET, SAN BERNARDINO, CALIFORNIA 92401
PHONE: (714) 885-6847, TWX (910) 390-1157

ON READER-SERVICE CARD CIRCLE 54

Tech labs 2A* Tap Switch YOU CAN'T BUY

- MORE PRECISION
- LOWER CONTACT RESISTANCE
- HIGHER CURRENT CARRYING CAPACITY
- LONGER LIFE

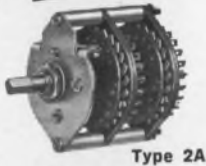

Type 2A



Type 20A

FOR THE PRICE

* Available in remote controlled versions, open or hermetically sealed. SEND FOR FREE CATALOG.

TECH LABORATORIES, INC.

Palisades Park, New Jersey

ON READER-SERVICE CARD CIRCLE 55

COUGH...GASP
...WHEEZE...
COUGH...

Sound familiar?

Many people have breathing problems—shortness of breath, persistent cough, too much phlegm—and they brush them off. They hardly notice—until their fun and work are interrupted, their happiness threatened, even their lives. Don't let it happen to you. It might be emphysema or some other respiratory disease. See your doctor. Use the coupon.

Paste on postcard

NTA, GPO, Box 2400, New York, N. Y. 10001

Send me the free booklet, "Your Breathing Troubles"

Name _____

Address _____

City _____ State _____ Zip Code _____

Published by National Tuberculosis Association, paid for by Christmas Seals.

COMPONENTS

Shielded coil forms have slug locking

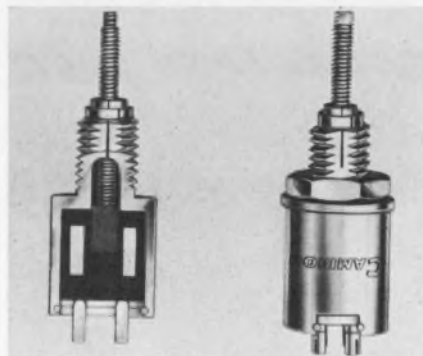

Cambridge Thermionic Corp., 445 Concord Ave., Cambridge, Mass. Phone: (617) 491-5400. P&A: 89¢ (500); stock.

A series of shielded, variable-inductance coil forms are available in either PBG or Copolymer styrene body material. A compression spring slug locking device affords positive locking under shock and vibration. No additional locking hardware is required. Terminal boards are of silicone-impregnated fiberglass with 2 to 6 terminations.

CIRCLE NO. 284

FET-input amplifier gives 20 mA into 500Ω

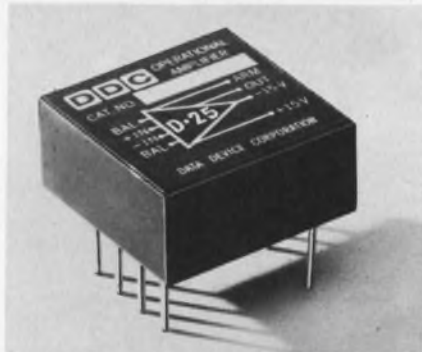

Data Device Corp., 240 Old Country Rd., Hicksville, N. Y. Phone: P&A: \$76 to \$85; stock.

A FET input amplifier provides up to ± 20 -mA load current into a 500- Ω load. The unit also provides input impedance of 10^{11} Ω , frequency for full output of 150 kHz at either input and open-loop gain of 102 dB into 10 k Ω and 93 dB into 500 Ω . Offset voltage, adjustable to zero externally, is 0.5 mV at 25°C. Voltage drift is available in five grades: 5, 10, 20, 30 and 45 μ V/°C.

CIRCLE NO. 285

Tubular electrodes in panel-mount caps

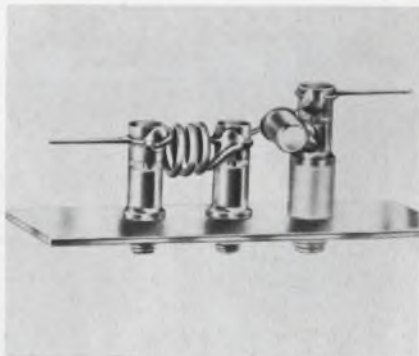

Johanson Manufacturing Corp.,
Boonton, N. J. Phone: (201) 334-
2676.

Panel-mount capacitors for military and commercial applications feature tubular electrodes. Advantages are low losses and low inductance at microwave frequencies. Components can be attached to the capacitors utilizing shorter leads. Capacitance ranges are 0.5 to 4.5, 0.5 to 8.5, 0.7 to 12 and 0.7 to 18 pF. Working voltage is 750 Vdc and Q is 500 minimum at 20 MHz.

CIRCLE NO. 286

Instrumentation amp for airborne use

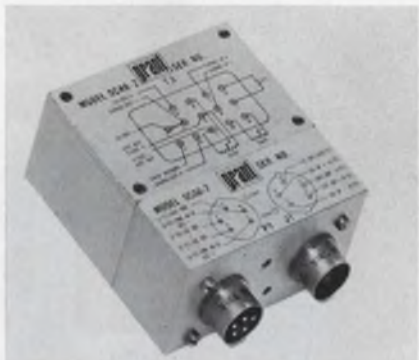

Grant Electronics, 2017 Glendon
Ave., Los Angeles. Phone: (213)
270-4759.

This compact, 5-ounce instrumentation amplifier performs in missile, spacecraft and airborne environments from -65° to 185° F. The design allows for a variety of sensor inputs as strain gauges, resistance temperature bridges or thermocouples. The unit contains an isolated, regulated 5-V transducer excitation supply. Gain is adjustable from 80 to 500 (2 to 12 mV/V). The output operates into a load of at least 10 k Ω without degradation.

CIRCLE NO. 287

We sell protection.

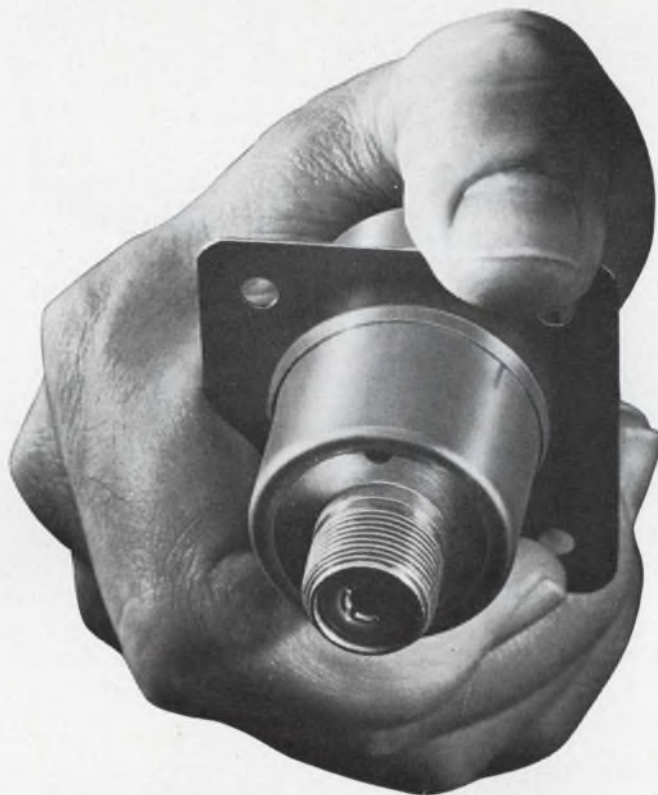

DALE SURGE ARRESTER ...one of more than 50 models now available to solve any overvoltage protection problem

We sell protection against any form of overvoltage. Dale's patented surge arrester design is now at work guarding everything from silicon rectifiers to vital airborne and ground antenna systems. No other commercially available arrester has proven so ultra-sensitive, yet so capable of bypassing repeated surges without substantial change in arc-over voltage. The secret: a special spark gap design which combines inductive arc rotation with a tapered spiral electrode. If you need protection against surge voltage, you can't afford to be without one of Dale's more than 50 arrester models.

For fast information call 605-665-9301
or write for Surge Arrester Catalog.



DALE ELECTRONICS, INC.
SIOUX DIVISION Dept. ED
Yankton, South Dakota

Write for new Facilities Report

Producers of: Toroids, Series Resonant Traps, Variable Pitch Inductors, Miniature High Frequency Inductors, Degaussing Coils, Industrial and Military Coils, Sub-Miniature Coils, Surge and Lightning Arresters, Custom Assemblies, Motor Driven Potentiometers.

“Just building a lipstick size relay that worked would have been easy.”



Building one around our great high-rel idea was another story.”

Wedge-action*, our great high-rel idea, is 9 years old. Our 2PDT lipstick-case size relay has been around for less than 2 years. But it's already a standard replacement for the competition in lots of MIL-R-5757/B applications.



Why? Because it outperforms every spec requirement for both high and low-level loads. Like all our wedge-action relays, it combines long contact wipe with high contact force to give you continually clean precious-metal mating surfaces throughout life. Competitively priced with fast delivery.

The lipstick is just one of our family of wedge-action relays, which cover almost every dry-circuit to 2 amp application. When you need a high-rel relay that really works, test one of ours and try your darndest to prove we're wrong. You won't be able to.

* U.S. Patent No. 2,866,046 and others pending.



Electro-Tec Corp.
SLIP RINGS • RELAYS • SWITCHES • OPTICS

P. O. Box 667 • Ormond Beach, Florida
(904) 677-1771 • TWX 810-857-0305

Manufacturing Facilities:
Ormond Beach, Fla. • Blacksburg, Va.

ON READER-SERVICE CARD CIRCLE 57

COMPONENTS

Current transducers based on Hall effect

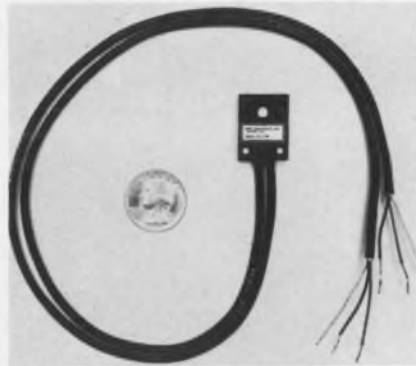

Ohio Semitronics, Inc., 1205 Chesapeake Ave., Columbus, Ohio. Phone: (614) 486-9561. Price: \$325.

For measuring steady-state, pulse or transient currents without physical or electrical connection to the test conductor, this Hall-effect transducer offers a rise time of less than 1 μ s. Dynamic range is 1 mA to 30 A and frequency response is flat to over 1 MHz. In application, a dc control current is applied to one input. The output is the analog of the current in a conductor threading the window.

CIRCLE NO. 288

Megohm resistors in tiny package

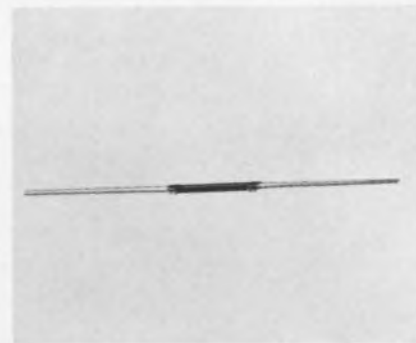

Resistance Products Co., Harrisburg, Pa. Phone: (717) 236-5081. Price: from \$2.50.

An 0.1-inch diameter, 9/16-inch long resistor is rated at 1/4 watt or 1000 volts. Resistance range is 1 M Ω to 5 G Ω . Terminations are 1-1/2-inch #20 AWG tinned copper leads. Type HADW is 0.1-inch diameter, 1-inch long, rated at 1/2 watt or 500 volts. Resistance range is 10 M Ω to 10 G Ω . Terminations are the same.

CIRCLE NO. 289

Bandpass, reject filters tunable to 10 MHz

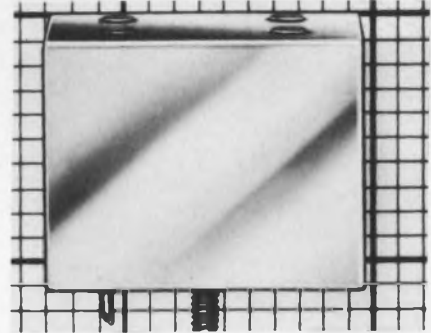

Cambridge Thermionic Corp., 445 Concord Ave., Cambridge, Mass. Phone: (617) 491-5400.

A bandpass filter and a band reject filter have a center operating frequency of 10 MHz. Each circuit includes four poles and four tuning elements to fit filter curve characteristics to individual operating requirements. The tunable coils and fixed mica capacitors which comprise each filter are mounted in a 1 x 0.875 x 0.875-inch solid block that shields the circuit from the effects of electrostatic and electromagnetic fields. Blocks are stud-mounted to the chassis to achieve a positive ground.

CIRCLE NO. 290

Active filters are 4-pole Bessel

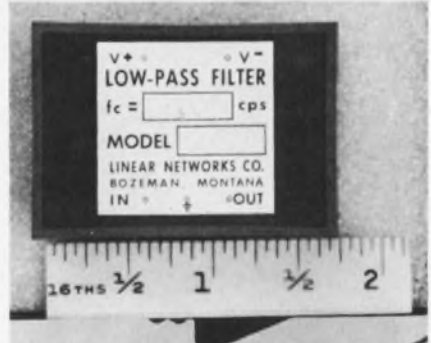

Linear Networks Co., P.O. Box 1103, Bozeman, Mont. Phone: (406) 585-8531. P&A: \$45; stock to 3 wks.

Active low-pass filter networks feature the 4-pole Bessel (linear-phase) frequency response characteristic. Attenuation over the operating temperature range of -4° to +70°C is 3 \pm 0.5 dB at cutoff frequency and 25 \pm 2 dB at 3 times cutoff. Standard cutoff frequencies are 1 to 1000 Hz.

CIRCLE NO. 291

Plug-in panels accept dual-in-lines

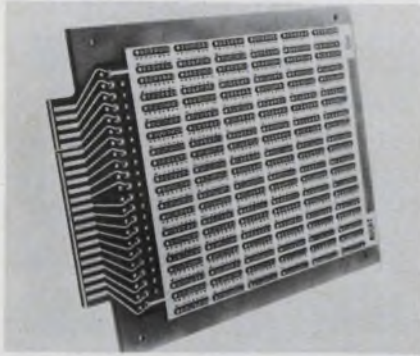

Augat, Inc., 33 Perry Ave., Attleboro, Mass. Phone: (617) 222-2202. P&A: \$1 to \$3 per pattern; stock to 5 wks.

High-density packaging panels for 14 and 16-lead plug-in ICs come in 30 and 60 patterns. The PC board is printed on both sides with power and ground takeoffs, and four-lead wiping, beryllium-copper gold-plated contacts for low contact resistance are used. Wire wrap or solder pot terminations and a polarizing notch PC edge connector takeoff are standard.

CIRCLE NO. 292

Tiny 4pdt relay measures 0.4 in.³

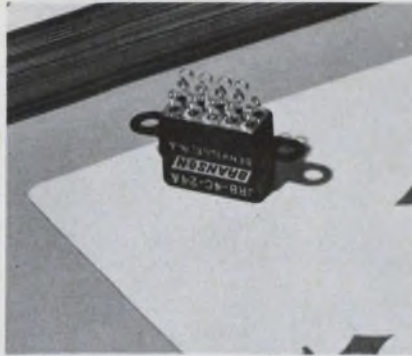

Branson Corp., P. O. Box 845, Den-ville, N. J. Phone: (201) 625-0600.

Housed in a 1/6 crystal can size package, this 4pdt relay provides a contact rating of 0.5 A 28 Vdc resistive and occupies a 0.04 in.³ volume. Contact arrangement is 4 form C contacts. Insulation resistance is 1000 MΩ. Operating life reportedly exceeds 100,000 operations, dielectric strength is 500 V rms, 350 V rms across contacts. Applications are in oceanography, aerospace and ground support.

CIRCLE NO. 293

Video amplifier gamma-corrected

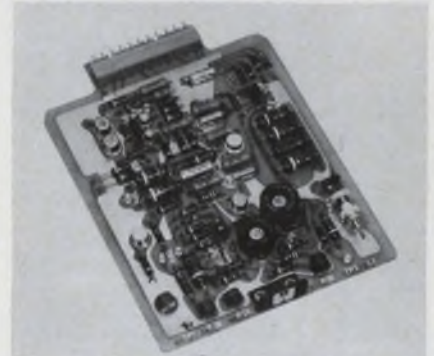

Beta Instrument Corp., 377 Elliot St., Newton, Mass. Phone: (617) 969-6510.

For CRT and storage tube display systems, this dc-coupled, 10-MHz, all-silicon plug-in amplifier has a gamma-corrected transfer function to produce a linear relationship between CRT light output and input video drive. The unit employs feedback and temperature-compensation to provide optimum gain stability and temperature independence, and may be direct-coupled to the CRT grid.

CIRCLE NO. 294

If you don't have one... let's hope you never need it

Valuable taped data can be erased or partially destroyed by unexpected exposure to magnetic fields... generated by electrical equipment, electronic gear, air transport instrumentation, electrical storms, etc. Such loss is costly and inconvenient. The data may even be irreplaceable.

Avoid these hazards

Use NETIC Tape Preservers

for storing and transporting your valuable tape data. They provide ideal insurance against such potential hazards. Available in numerous sizes and shapes to fit your needs.

Delivery from stock. Request catalog No. TP-1

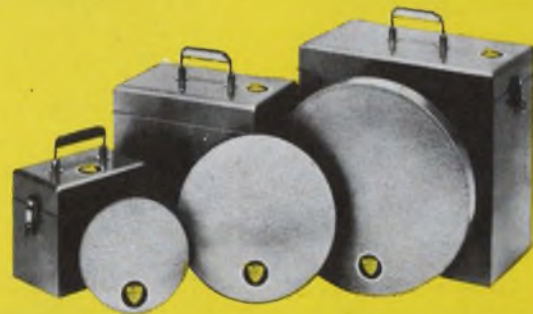

MAGNETIC SHIELD DIVISION

Perfection Mica Company

1322 N. ELSTON AVENUE • CHICAGO, ILLINOIS 60622

Phone 312. EV 4-2122 • TWX 910 221-0105

ON READER-SERVICE CARD CIRCLE 58

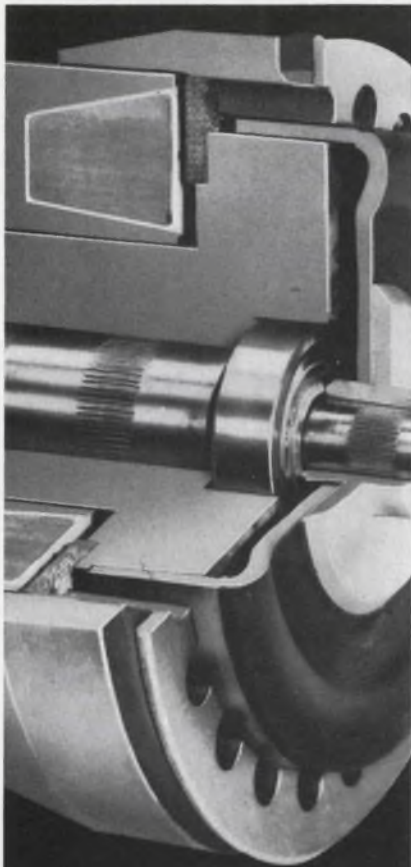

HYSTERESIS BRAKES & CLUTCHES BY MAGTROL

for precise control of

**SPEED
TENSIONING
LOAD SIMULATION
ANTI-BACKLASH**

- absolute precision
- infinite variability, infinite repeatability
- longest life
- from 2 oz. inches to 100 inch lbs.

Write or phone for new 20-page reference booklet containing hysteresis principles and applications, unit specifications and performance charts. Ask for booklet HCB.

MAGTROL INC.
240 SENECA ST. • BUFFALO, N. Y. 14204
716 — 856-7451

HYSTERESIS PIONEERS

ON READER-SERVICE CARD CIRCLE 59

MATERIALS

Thermoset polymer coat electrically conductive



Dynaloy, Inc., 408 Adams St., Newark, N. J. Phone: (201) 622-3228. Price: \$10 (2-oz kit), 3.50/oz (8 to 64 oz), (silver filler).

Thermosetting polymer alloy coatings for adhesion to glass, metals and ceramics are electronically conductive. The coatings are used for microcircuit conductive paths, chip bonding of hybrid circuits, shielding, component grounding, PC repair and silk-screenable circuit patterns. The base polymer system contains pure polymers in a xylene solvent. There are three conductive coatings containing either silver, palladium or gold fillers. Coatings may be applied by dipping, brushing, silk screening or spraying. The coating will air dry tack free in 15 minutes; baking at 200°C will completely crosslink the polymers.

CIRCLE NO. 295

Silver tapes metallize thermistors

Vitta Corp., Wilton, Conn. Phone: (203) 762-8366.

A silver tape composition forms conductive lands on thermistors, capacitors and piezoelectric substrates. The tape produces accurately placed metallizations and, after firing, gives bond strengths as high as 70 psi. The process eliminates OD grinding necessary to remove excess silver material such as the overflow of silver paint in wet coating processes. In conjunction with a tape transfer machine, the material can be used to produce coated layers on two sides at rates up to 8000 parts per hour.

CIRCLE NO. 296

Silicone encapsulant tough and transparent

Dow Corning, Midland, Mich. Phone: (517) 636-8019. Price: \$6.10 lb.

A high-strength silicone potting resin, reportedly the first translucent material of this type, has a tear strength of 100 pounds per inch. Its clarity makes it especially useful in such applications as circuit and component encapsulation, for detecting voids and inspecting for quality defects. The cured resin can be placed in service at any operating temperature between -65° and 250°C with no post cure. The material will cure at room temperature or cure can be accelerated by heat. Dielectric constant is 3.01 and dissipation factor is 0.0009, both at 100 Hz. Surface resistivity is greater than $7 \times 10^{16} \Omega$.

CIRCLE NO. 297

Copper-base headers for power transistors

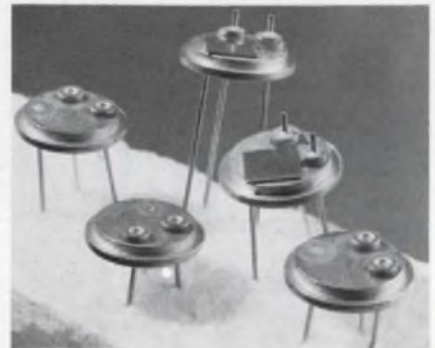

Mitronics, Inc., 132 Floral Ave., Murray Hill, N. J. Phone: (201) 464-3300. P&A: 30¢ to 80¢; 8 to 10 wks.

High-frequency and high-power TO-5 transistor headers are constructed on an OFHC copper base with steel weld ring and high-alumina lead isolators brazed on. The copper base provides excellent power dissipation properties and the design of the alumina lead isolators offers good high-frequency characteristics. The headers are available with two or three isolated leads for grounded-collector applications. For large-power devices a moly block is brazed on for hot-collector applications and a beryllia block for isolated-collector applications.

CIRCLE NO. 298

TO-3 heat sinks have wide mounting areas

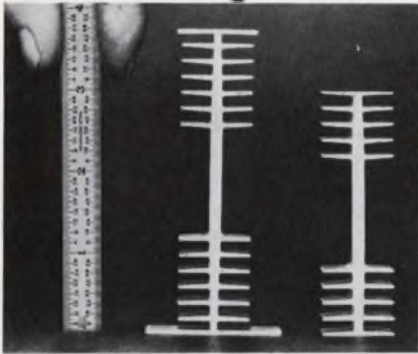

Advanced Development Corp., 2014 W. 139th St., Gardena, Calif. Phone: (213) 770-1143. P&A: \$10 per 5 ft (unplated); stock.

Two semiconductor heat sinks with 1-5/16-inch wide mounting spaces allow mounting as many as six TO-3 packages in a 6-inch length. A 3-inch model may be bracket-mounted, and a 3-3/4-inch model has a side-mounting flange. Available in any length, the heat sinks may be ordered with mounting hold patterns or mounting slots.

CIRCLE NO. 299

Solder stripes cut IC production cost

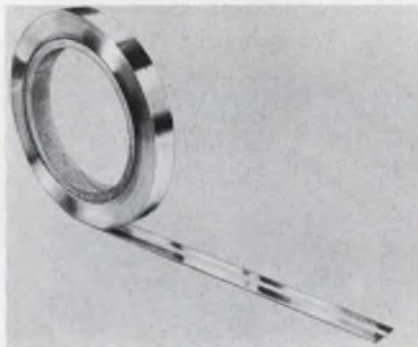

Sherman Industries, 36-07 Prince St., Flushing, N. Y. Phone: (212) 353-8012.

Production costs can be reduced using this solder striped metal for IC lead frames. These stripes are available in various tin, tin-lead and lead-silver alloys in thicknesses up to 0.005 in. and in any desired width. It is available in single or multiple solder stripes. Because the solder stripe is coated with the precise quantity of solder required to produce a reliable joint, no additional preplacements are required.

CIRCLE NO. 311

'Perforated' solder eliminates flux core

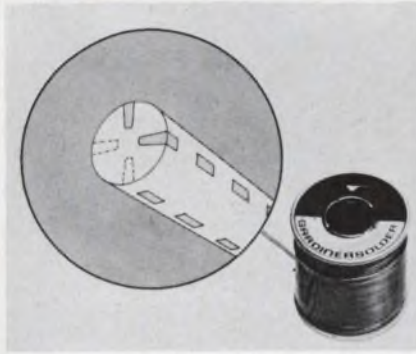

Gardiner Solder Co., 4820 S. Campbell Ave., Chicago. Phone: (312) 847-0100.

By doing away with the traditional core of flux, this solder contains only 0.5% flux by weight, rather than the usual 2.5 to 3.5%. Wetting ability is reportedly good. The solder has no flux core as such; it has thousands of micrometric perforations along the outside of the wire, each loaded with activated rosin flux. The flux itself is a non-chloride activated rosin flux.

CIRCLE NO. 312

Silicone compounds withstand thermal shock

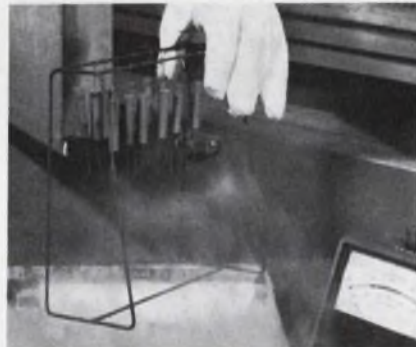

Dow Corning, Midland, Mich. Phone: (517) 636-8507. Price: \$2.97/lb.

In tests, 10-watt wirewound power resistors molded in this silicone compound have withstood 10 cycles from -65° to 350°C without cracking. The compound has been exposed to 1000 hours at 300°C with no significant changes in physical and electric properties. Arc resistance is 21 seconds and volume resistivity is 10^{14} Ω -cm. Dielectric constant at 1 MHz is 3.8 and dissipation factor is 0.0024.

CIRCLE NO. 313



"BLUE CHIP" TRANSFORMERS

for printed circuit applications

FROM STOCK!

Available in five case sizes (.10 to 1.2 cubic inches) with 62 new power ratings, Blue Chip transformers provide maximum flexibility for electrical and mechanical transistor circuit applications. Blue Chip transformers meet Mil-T-27B, Grade 5, Class S requirements. Typically the smallest size Blue Chip has a frequency response of ± 2 db, 300 to 100,000 Hz. Maximum distortion of 10% at 30 milliwatts, 300 to 100,000 Hz. Distortion on all types—10% or less. Write for your copy of complete electrical and mechanical specifications on Blue Chip transformers.



ADC PRODUCTS
A DIVISION OF MAGNETIC CONTROLS CO.
6405 CAMBRIDGE STREET • MINNEAPOLIS, MINN. 55426

ON READER-SERVICE CARD CIRCLE 60

ATTENUATE



Telonic Rotary Attenuators—available in 50 and 75 ohm impedances, DC to 1250 MHz, graduated in .1, 1, and 10 dB increments, and have a range up to 109 dB. Toggle Switch Attenuators also come in 50 and 75 ohms, cover DC to 300 MHz, steps of 0.5 and 1 dB, range up to 102 dB.

DETECT



Telonic Detectors—for general purpose applications with signal and sweep generators are useable to 3000 MHz, have a VSWR of less than 1.2:1, may be specified with 50 or 75 ohm impedance, and with a variety of connectors.

SWITCH



Telonic Coaxial Switches—compact, light weight, over 70 dB crosstalk rejection, with VSWR less than 1.1:1 and insertion below .1 dB, at 1 GHz. One pole, 6-position, two and four pole, 2-position are all available with optional external wafer switch.

Telonic
INSTRUMENTS

A Division of Telonic Industries, Inc.

60 N. First Ave., Beech Grove, Ind. 46107
Tel. (317) 787-3231 TWX-810-341-3202

SWEEP/SIGNAL GENERATORS AND ACCESSORIES

Representatives throughout the U.S., Canada and Overseas. Branch offices in Maldenhead, England, Frankfurt, Germany, and Milan, Italy.

PRODUCTION EQUIPMENT

Probe and test semiconductors, ICs



Alessi Associates, 8710 Pershing Dr., Playa del Ray, Calif. Phone: (213) 823-2255. P&A: from \$645; stock.

Semiconductor test stations incorporate from 2 to 9 Micropositioner instruments, a universal traversing stage with vacuum chuck, provision for a microscope mounting and electrical connections to test instruments. Designed for probing of integrated circuits, thin- and thick-film circuits, diodes and transistors, the test stations are comprised of Micropositioners and a traversing stage mounted to a base. Each probe point traverses 360° in a horizontal plane within an area measuring 0.3 inch in diameter. Contact pressure is adjustable over a range of from 2 to 20 grams. Holes are provided to customer requirement for mounting standard Bausch & Lomb or Nikon microscopes.

CIRCLE NO. 314

Five diode parameters can be tested in 72 ms

Electro Techniques Co., Inc., 18-36 Granite St., Haverhill, Mass. Phone: (617) 373-0031.

The basic go/no-go modular automatic diode tester performs five tests—one PIV single-limit test, two reverse-current single-limit tests, and two forward-current single-limit tests. In addition, shorts, opens and polarity tests are performed. Digital in-line thumbwheel switches facilitate operation. The test time is 72 ms for the complete cycle. Tests can be sequenced to occur automatically or manually, and test results can be monitored on analog outputs provided.

CIRCLE NO. 315

Semiconductor masks contact-printed

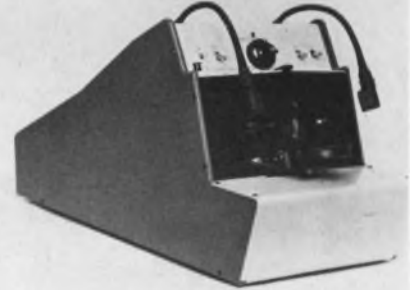

Siliconix, Inc., 1140 W. Evelyn Ave., Sunnyvale, Calif. Phone: (408) 245-1000. P&A: \$2195; 30 days.

At the rate of 100 per hour, this printer reproduces semiconductor masks with 0.1-mil lines having 0.02-mil edge definitions. Semiconductor yields are reportedly increased by using these plates only 15 or 20 times instead of the usual hundreds of times required of photo-reduced plates. Oxide pin holes and resultant yield losses, caused by scratches and dust accumulation on working plates, are reduced. The standard model accommodates 2 x 2-inch high-resolution plates; plate sizes up to 3 x 3 may be printed using special handling chambers.

CIRCLE NO. 316

Pin staking machine handles ceramics gently

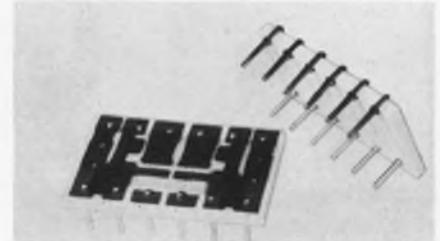

Microtek Electronics, Inc., 138 Alewife Brook Pkwy., Cambridge, Mass. Phone: (617) 491-4300.

A Thermoswage pin staking machine swages contact pins into ceramic substrates used in thick or thin-film circuitry. The machines reportedly eliminate ceramic fracturing, frequently a problem in production operations. The unit takes 0.01 to 0.025 seconds per swage. Materials such as copper, nickel, brass and kovar may be swaged.

CIRCLE NO. 317

ON READER-SERVICE CARD CIRCLE 61

Electronic organs use MOS ICs

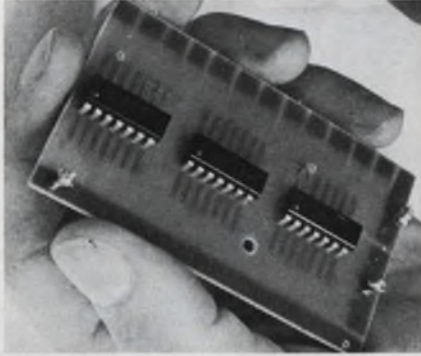

Motorola Semiconductor Products, Inc., P. O. Box 955, Phoenix. Phone: (602) 273-6900. P&A: about 50¢/flip-flop; stock.

A pair of MOS integrated circuits are aimed specifically for application in electronic organs. The MC1124P is a MOS frequency divider. It contains four toggle flip-flops; two cascaded internally and two separately. Thus, a divider chain may be formed using flip-flops from a single package or from separate packages. Toggle frequency is dc to 500 kHz. The MC1120P is a MOS dual keyer gate with sustain control inputs. Compatible with the frequency divider, this circuit provides high isolation and low intermodulation. Both circuits offer a noise immunity of 1 V and a minimum fan-out of 5 over a 0° to 75°C temperature range.

In a divider-type electronic organ, the divider chain and the keyer sections are prime locations for MOSFET ICs. Since the usual waveform used is a square wave, the digital flip-flop is the ideal frequency divider. An MC1124P divider section of a typical organ would be 12 IC packages mounted on a PC board. The keyer section of an organ also involves a large number of circuits since each note undergoes a number of voicing and keying operations. The MC1120P has been designed for the keying section and provides for the channeling of several notes at each keying position, giving better than 70-dB isolation. These functions are common to other consumer areas such as automotive, appliance and control products and the circuits should have applications there. Pricing is competitive with thick-film or discrete.

CIRCLE NO. 318

WHICH DEFLECTION YOKE FOR YOUR DISPLAY ?



Consult **SYNTRONIC**

YOKE SPECIALISTS

Syntronic's team of experts knows more about yoke design, engineering and quality control than anyone else. A solid 10-year record of leadership—acknowledged throughout the industry. Benefit from it.

syntronic **INSTRUMENTS, INC.**
100 Industrial Road, Addison, Illinois
Phone: Kingswood 3-6444

ON READER-SERVICE CARD CIRCLE 62

Need Fast Decay in Photocells?



Clairex Type 7H cells offer .0006 sec. at 100 ft-c

In addition to fast decay time, Clairex Type 7H photocells also provide 240 ohms @100 ft-c and CdS stability. They are available in TO-18 and TO-5 cases and in 6 resistance ranges.

CLAIREX ELECTRONICS, INC. ■ 1239 BROADWAY, NEW YORK, N. Y. 10001

ON READER-SERVICE CARD CIRCLE 63

McLEAN HEAT EXCHANGER



STABILIZES CABINET TEMPERATURE

Here's the latest addition to McLean's fine line of cooling equipment. Employing chilled water within a range of 66°F to 70°F, it maintains cabinet temperatures at 80°F with 1KW heat dissipation. Air is recirculated within the rack and cooled by the heat exchanger in the blower case. Room ambient air is not used. Cabinet air is not exhausted into the atmosphere. Unit can use refrigerated water or a refrigerant to obtain substantially more cooling. Or if a higher ambient is desired, warm or hot water will do the trick. Designed to meet individual specifications and applications.

Send for 1967 Catalog

Contains design and application information and 60 pages of advanced electronic cooling equipment.

McLEAN ENGINEERING LABORATORIES

Princeton Junction, N.J. 08550
Phone 609-799-0100
TELEX 84-3422

See us at the Wescon Show, Booth 3107.

ON READER-SERVICE CARD CIRCLE 64

MICROWAVES

Constant-Z limiter handles 7 kW peak

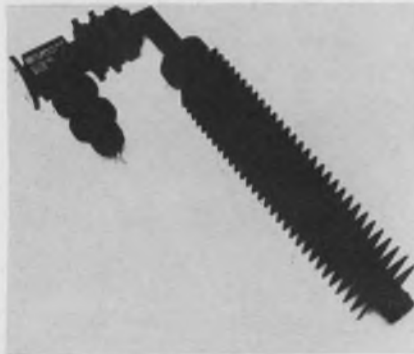

Micro State Electronics Corp., 152 Floral Ave., Murray Hill, N. J. Phone: (201) 464-3000.

A constant-impedance limiter handles high rf power levels at L-band. The unit can also be classified as a duplexer. Its frequency is 1250 to 1350 MHz, its normal rf power level is 7 kW peak, 180 watts average. Short-circuit power capability is 80 kW with a pulse width of 10 μ s. Insertion loss is 1 dB maximum and input VSWR is 1.4 under low- and high-power conditions. The unit meets naval shipboard spec MIL-E-16400 and RFI specs of MIL-I-16910.

CIRCLE NO. 319

S-band mixer preamps quiet to 6.5 dB

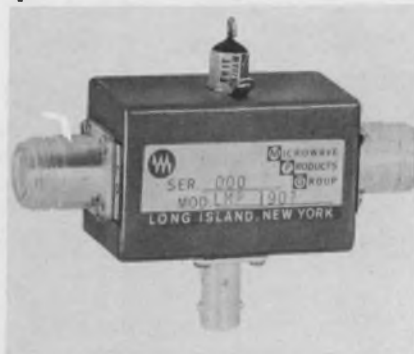

Consolidated Airborne Systems, Inc., 115 Old Country Rd., Carle Place, N. Y. Phone: (516) 741-1500.

Miniature mixer/preamps have an input frequency up to S-band with a maximum noise figure of less than 6.5 dB. The units measure 1 x 1-1/8 x 2-1/4 inches. Rf bandwidth is up to 10% of the input frequency with a choice of i-f output frequencies up to 90 MHz. Rf-to-i-f gain is greater than 25 dB.

CIRCLE NO. 320

Sp3t coax switch is fail-safe



Sage Laboratories, Inc., 3 Huron Drive, Natick, Mass. Phone: (617) 653-0844.

A single-pole triple-throw fail-safe switch provides minimum isolation of 60 dB, maximum insertion loss of 0.2 dB and maximum VSWR of 1.2 from dc to 3000 MHz. Switching time is 10 ms and life expectancy is reportedly 1 million operations. Switches in this series always return to position 1 in the event of a power failure. Available connector types are N, BNC, TNC, HN, SC and C A 28-V dc solenoid is standard. Indicator light circuits and 48 or 110-V dc solenoids are offered at no extra costs.

CIRCLE NO. 321

Rotary attenuators are small and rugged



Texscan Corp., 51 S. Koweba Lane, Indianapolis. Phone: (317) 632-7351. P&A: \$95 each; 1 to 2 wks.

Two models of miniature rotary attenuator provide excellent accuracies from dc to 500 MHz. They provide 0 to 1-dB attenuation in 0.1-dB steps and are available in 50 and 75- Ω models. Vswr is less than 1.1 at 500 MHz with insertion loss of 0.5 dB. Power rating is 1 watt.

CIRCLE NO. 322

Power tetrodes have low lead inductance



Eimac, Division of Varian, 301 Industrial Way, San Carlos, Calif. Phone: (415) 592-1221.

Two power tetrodes for distributed amplifier applications have four separate connectors to the active part of the grid, large cathode areas and low inductance support for cathodes and screens. The tubes are of ceramic and metal construction and are water-cooled. Self-resonant frequency is about 900 MHz.

CIRCLE NO. 323

Transistor amplifier has 60-dB dynamic range



Micro State Electronics Corp., 152 Floral Ave., Murray Hill, N. J. Phone: (201) 464-3000.

Four uhf octave transistor amplifiers are designed for military shipboard communications. The series consists of one preamp and post amplifier covering 250 to 500 MHz and another pair covering 500 to 1000 MHz. Gain for the preamps is 13 to 17 dB. Second and third order intermodulation resulting from two -40-dBm input signals are down 50 dB. Comparable specs for the post amplifiers are 16 to 20-dB gain.

CIRCLE NO. 324

Sample and hold. Sample and hold. Do dah. Do dah.

The closed-loop performance of Redcor/Modules' new Sample-and-Hold will put a smile on your face and a spring in your step. The 770-715 has an accuracy of 0.01%. If that don't get you, try a settling time of 5 microseconds for 20V step input. Or how about an input impedance of 10 megohms at 1 kc? Maybe a frequency response of DC to over 50 kHz? This performance, friends, is yours for a mere \$250 in quantities of 50. Redcor makes equally appealing comparators,

dynamic bridge and buffer amplifiers, 8-channel multiplexers, plus 0.1% Sample-and-Holds. They all have a great new pin layout that for the first time lets you easily interconnect modules with dual in-lines. So quit clapping your hands long enough to request complete data.

REDCOR CORPORATION

RC 7800 DEERING AVENUE
CANOGA PARK, CALIFORNIA 91304
(213) 348-5892 • TWX 213-348-2573

ON READER-SERVICE CARD CIRCLE 65

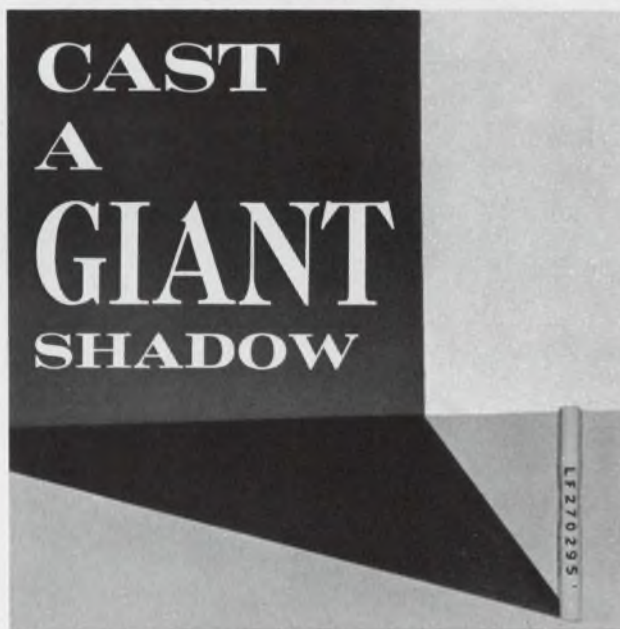

Cool your "overheat" problem! Get the Littelfuse miniature heat fuse for thermal overload protection. 7/8" long x 7/64" dia. Fully insulated. Crimp style connections.

LITTELFUSE

DES PLAINES, ILLINOIS

ON READER-SERVICE CARD CIRCLE 66

FET UNITY GAIN AMPLIFIER

Linearity: Better than .005%

Input impedance: Higher than 10^{10} ohms

Output impedance: Lower than 10 milliohms

Full output frequency: Better than 200 kHz

3/4 cu. in.



Features

Voltage Gain	Unity +0, -0005
Frequency Response	D.C. to 200 kHz, 20V p-p
Input Voltage	$\pm 10V$ to common maximum
Input Impedance	10^{10} ohms minimum
Input Offset Current	50 pA maximum
Output Voltage	$\pm 10V$ to common @ 5 mA max.
Output Impedance	10 milliohms maximum
Output Offset Voltage	$\pm 300\mu V$ maximum
Temperature Stability	$50\mu V/^{\circ}C$ $-25^{\circ}C$ to $+85^{\circ}C$
Operating Temperature	$-25^{\circ}C$ to $+85^{\circ}C$
Power Supply	+15 to +18 VDC -15 to -18 VDC
Package	1.12" x 1.12" x .62" Epoxy encapsulated module with 0.25" long, .040 diam. gold plated pins.
Mil Specs.	Meets MIL standards.

Applications

Signal buffering, instrumentation read in and read out, sample hold circuits, low impedance signal transmission.

The new FA101 field effect transistor amplifier includes protection against output short circuits and accidental supply voltage reversal; it requires no external zero adjustments and costs less than \$80.

Delivery: Stock to four weeks

Write or call Intronics for more information.
Phone 617-332-7350 • TWX 710-335-6835



57 CHAPEL ST. • NEWTON, MASS. 02158
ON READER-SERVICE CARD CIRCLE 67

SEMICONDUCTORS

Power transistors put out 250 A, 625 W

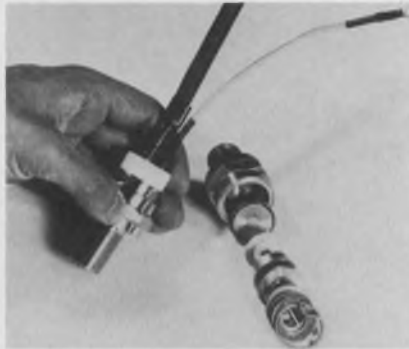

Westinghouse Electric Corp., Box 2278, Pittsburgh. Phone: (412) 391-2800. P&A: about \$300; stock.

Rated at 250 A and 625 W, this transistor provides more than double the current-handling capacity of previously available transistors. Since it is not necessary to parallel lower rated devices, the transistors can reduce cost and provide increased efficiency in inverter and series regulator applications. Gain is 10 at a 200-A collector current, maximum collector voltage is 120 V, saturation voltage is 2.5 V at a 250-A collector current and cutoff frequency is 1 MHz. The use of a sunburst junction design and Westinghouse's compression-bonded encapsulation package account for the high ratings.

CIRCLE NO. 348

Step-recovery diodes switch in picoseconds

Alpha Industries, Inc., 381 Elliott St., Newton Upper Falls, Mass. Phone: (617) 969-6480.

Silicon step-recovery diodes are designed for high-order, single-stage frequency multiplication and for pulse-sharpening applications. A typical unit, the 25-V model MO-281, has 100-ps transition time, 2-pF maximum capacitance and an operating range of -65° to $175^{\circ}C$. It is available in a glass or metal-ceramic package. Other diodes available have voltages from 15 to 65 V with capacitances to 10 pF and dissipation from 400 mW to 2 W.

Used as low-power frequency multipliers, outputs greater than 100 mW at S-band and 20 mW at X-band can be realized.

CIRCLE NO. 349

Silicon power transistors rated 5 to 85 watts

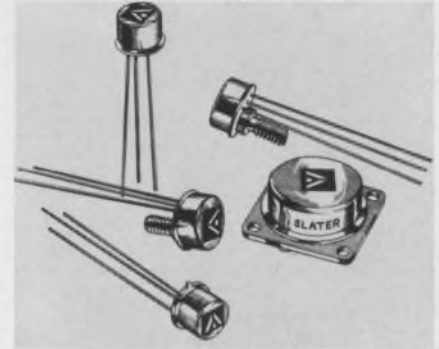

Slater Semiconductors, 45 Sea Cliff Ave., Glen Cove, N. Y. Phone: (516) 671-7100. P&A: \$4 to \$28 (100 lots); stock.

Silicon power transistors with power ratings from 5 to 85 watts are available in TO-5, TO-53 and TO-57 package configurations. Other specifications include collector currents up to 3 A, voltage ratings up to 240 V and typical saturation resistance of 0.7 Ω .

CIRCLE NO. 350

Zener diode series spans 2.4 to 200 V

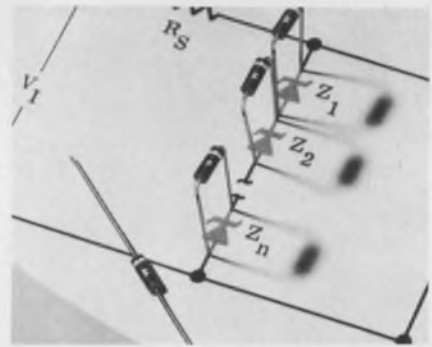

Motorola Semiconductor Products, Inc., P. O. Box 955, Phoenix. Phone: (602) 273-6900. P&A: 36¢ (5000-up); stock.

Priced as low as 36 cents (10% tolerance), these devices cover a Zener voltage span of 2.4 to 200 volts. Although rated at 1/2 watt with normal mounting conditions, they claim excellent failure resistance when overstressed in 1-W, 1000-hour testing. All units are 100% scope-tested, characterized at six critical points including TC and have a 10-watt surge rating. All devices above 14 volts have a leakage current typically less than 100 nA.

CIRCLE NO. 351

High-current diodes switch in nanoseconds

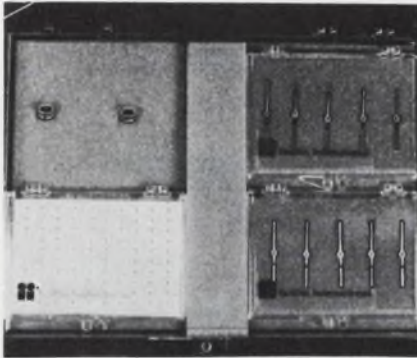

Isofilm International, 2013 Bahama St., Chatsworth, Calif. Phone: (213) 882-0565. P&A: \$1 to \$2; stock.

High-speed silicon diodes feature high current with good pulse-handling ability. Available in 100- to 300-mV turn-on voltages, the diodes are furnished in a modified DO-20 configuration or in pills, flat packs, stacks, encapsulated multiples, TO-18 and TO-5 cans. Applications include high-speed current pulsing, core memories and power supplies.

CIRCLE NO. 352

Silicon rectifiers disconnect quickly

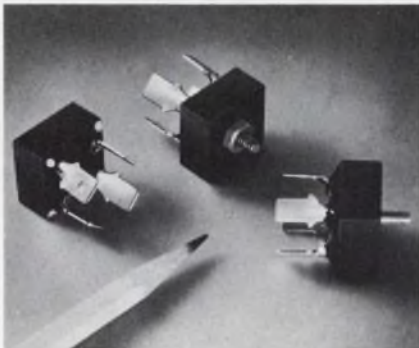

Sarkes Tarzian Inc., Semiconductor Div., 415 N. College Ave., Bloomington, Ind. Phone: (812) 332-1435.

Silicon rectifier assemblies using quick-disconnect terminals are designed to reduce assembly time in power supplies, relays, circuit breakers, machine tool controls, motor speed controls and timing equipment. Rated at 2 A, they are available with PIV ratings of 200 to 1000. The rectifiers have avalanche characteristics, providing protection from reverse transients.

CIRCLE NO. 353

ELECTRONIC DESIGN 15, July 19, 1967

I see a West-Cap[®]
ceramic
capacitor
in your
future
(I hope!)

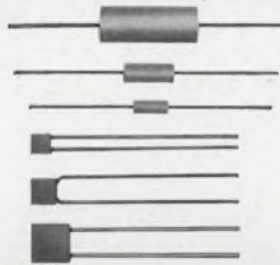

CAPACITANCE VALUES from 5pf to 10 μ f
VOLTAGE: 50 to 500 VDC
TOLERANCE down to 5%
TEMPERATURE RANGE: -55°C to 150°C
MEETS OR EXCEEDS MIL-C-11015



SAN FERNANDO ELECTRIC MFG. CO.
1509 FIRST STREET ■ SAN FERNANDO, CALIFORNIA 91341
TELEPHONE: (213) 365-9411 ■ TWX: (213) 764-5963

ON READER-SERVICE CARD CIRCLE 75

MOTORS, MOTOR SPEED

Bodine fractional horsepower motors, many full horsepower

CONTROLS, GEARMOTORS,

motors, Superior Electric Co., Inc. Slo-Syn Motors, B & B

VARIABLE SPEED DRIVES,

Synchronous Motors, General Electric Motors, Geartronics

STEPPING MOTORS

Apcor Multi-Speed Gearmotors and Reducers, Zero Max Variable

TIMERS, CHRONOMETERS,

Speed Drives, Helland Mechanical Overload Couplings, Miller

SPEED INDICATING

Rectifiers and Transformers, A.T.C. Timers and Counters,

SYSTEMS • ONE SOURCE

Chronometric Speed Counters, Vis-count Tachometer Speed

IMMEDIATE DELIVERY

Indicating Systems, Heller Speed Controls. All in our new

FACTORY LOW PRICES

64 page catalog No. 14-67. Write for your copy.

TECHNICAL ASSISTANCE



MOTOR AND CONTROL CORP.

96 SPRING STREET
NEW YORK, N.Y. 10012 (212) 966-5777

ON READER-SERVICE CARD CIRCLE 76





he just
solved
his problem
for \$41.75

If your problem is headed wire leads that . . . pull out . . . fail the bend test . . . call the "Problem Solvers" . . . that's us . . . chances are, we've solved your problem already.

Eliminate costly design and production delays . . . your problem is our business . . . call us today.

EMPORIUM SPECIALTIES INC.
Wire Forms Division

Plant and Engineering: Austin, Pennsylvania
General Sales Office: 2800 East 116th Street
Cleveland, Ohio 44120
Telephone: (216) 795-1640

ON READER-SERVICE CARD CIRCLE 77

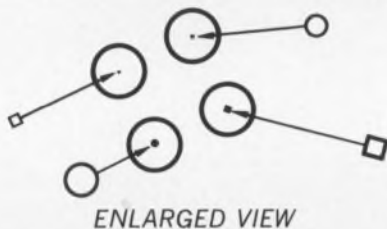

CAN YOU USE A 3 MICRON PINHOLE? SQUARE, ROUND?

Pinholes are available in all sizes and shapes — round and square from existing matrixes — other shapes to specification. Holes may be as small as 3 microns or up to 150 microns with tolerances of ± 1 micron. Metals may be nickel, stainless steel, moly, copper or bi-metal — one to two mills thick. Whatever your need for pinholes or other precision electroforming or etching, call or write—

BUCKBEE MEARS CO.
245 E. 6th St., St. Paul, Minn. / Phone 227-6371

ON READER-SERVICE CARD CIRCLE 78

Design Aids



Powdered metal properties

Similar in operation to a slide rule, this properties comparator gives the user various properties for specified densities of a number of nonferrous metal powders. Along with "at a glance" metallurgy, the handy plastic rule incorporates a C-D division scale, a temperature conversion scale, decimal-fraction equivalents and straight edges marked in inches and centimeters. New Jersey Zinc Co.

CIRCLE NO. 325

Capacitor conversion charts

Eight pages of charts compare the electrical characteristics, acceptance inspection tests and marking requirements of MIL-C-26655B and MIL-C-39003A solid tantalum capacitor established reliability specifications. It includes a cross-reference of superseded parts between the two specifications and a dash number cross-reference between detail sheet 1 of MIL-C-39003 and 1A of MIL-C-39003A. Also incorporated is a CSR09 (miniature tantalum) dash number-type designation reference. Union Carbide Corp., Components Div.

CIRCLE NO. 326

Hard-to-find design aids

Sixteen pages catalog a selection of special-purpose slide rules, calculators, slide charts, kits and other hard-to-find design aids to speed up and simplify those often-repeated calculations or searches for data. The catalog is organized into sections covering the mechanical, electronic, quality control and reliability and structural fields. Other sections include drawing aids and kits and design aids appealing to any field. Info, Inc.

CIRCLE NO. 327

PIN DIODES...

RF switching/variable attenuator applications
from 10 MHz to 1 GHz

Lowest insertion loss with high on-off ratios

Specified lifetime for guaranteed performance
at low frequencies

Glass, pill, and double stud packages

Proven reliability

... from HPA

These unique specialized diodes from Hewlett-Packard offer new design opportunities. Published reliability tests prove the long-term performance capabilities of these devices, and Application Note 912 tells you how to use them in attenuator design. For this data call your HP field engineer or write HP Associates, 620 Page Mill Road, Palo Alto, California 94304.

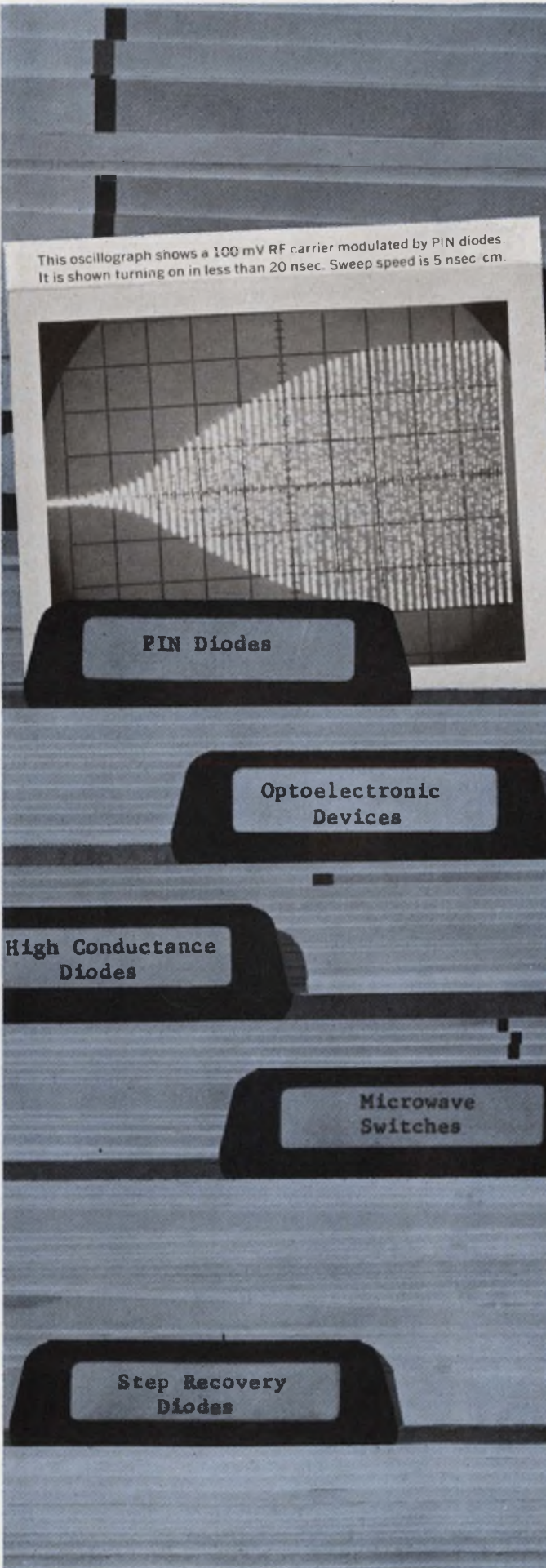

Electrical specifications at 25°C

Device	Breakdown Voltage BV_R @ 10 μ A	Forward Voltage V_f		Total Capacitance C_V @ -50 V	Series Resistance R_S $I_f=50$ mA	Lifetime T $I_f=50$ mA
		150 mA	100 mA			
3001	150	—	1.0	0.30	2.5	100
3002	200	1.0	—	0.30	2.5	100
3101	150	—	1.0	0.32	2.5	100
3102	200	1.0	—	0.30	2.5	100
3201	150	—	1.0	0.35	2.5	100
3202	200	1.0	—	0.32	2.5	100
Units	V min.	V max.		pF max.	Ω max.	nsec min.

2459

**HEWLETT
PACKARD**  **HP
ASSOCIATES**

ON READER-SERVICE CARD CIRCLE 80



**WHY SHOULD YOU
SPECIFY
MECATORN®
SPUN
REFLECTORS?**



The exclusive Torngren Mecatorm® hydraulically controlled spinning process has produced thousands of spun-to-specification "dishes" in use today by both military and commercial communication networks — at substantial savings over other more costly fabricating methods.

If you have a requirement for parabolic reflectors from 4 inches to 16 feet in diameter call Torngren today for complete details on the cost saving and metallurgical advantages of the Mecatorm® process.

Send for a free copy of our new capabilities brochure today!



C.W.

TORNGREN
COMPANY, INC.

236 Pearl St., Somerville, Mass. 02145
Area 617/666-3250

ON READER-SERVICE CARD CIRCLE 81

Application Notes

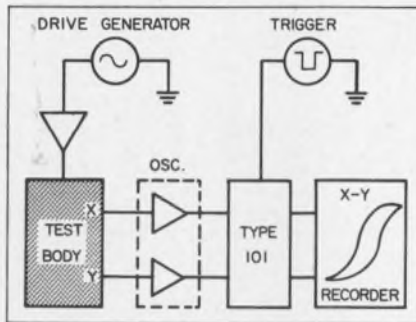

Hysteresis curve plotting

The manufacturer's waveform translator can transform, via sampling techniques, the high-frequency data into low-frequency data for handling by an X-Y recorder. Several setups are discussed in this six-page illustrated brochure. Photos and block diagrams of equipment setups are provided. Hewlett-Packard, Moseley Div.

CIRCLE NO. 328

Shunt motor data

The shunt motor has such good speed regulation that it is classified as a constant-speed type. Any load change, therefore, has little effect on speed at any speed setting. With feedback controls, the inherently good speed regulation of shunt motors can be improved to 1% or less over a limited speed range. These and other facts concerning the dc shunt motor—methods of varying motor speed, normal speed ratings, reversibility, dynamic braking tips, and brush-life—are presented in the Bodine Motorgram (Vol. 47, No. 3). Bodine Electric Co.

CIRCLE NO. 329

Monolithic DTL circuits

The characteristics of a family of monolithic DTL circuits are covered in twenty-two pages of text, schematics and charts. Typical characteristics are shown to give the systems designer information about the effect of the various parameters on circuit behavior. Limit curves are included to allow judicious trade-offs concerning supply voltages and temperatures. Signetics.

CIRCLE NO. 330

Semiconductor circuits

Twelve pages of application data deal with signal and power semiconductors and transistor circuits. The brochure contains tables, curves and schematics. Additional data sheets deal with silicon controlled rectifiers, a linear high-gain SCR amplifier and an extended range variable voltage circuit. General Electric.

CIRCLE NO. 331

RTL family

This note describes the functions and some typical applications of the manufacturer's S/RTL family. The six compatible elements of the family are discussed, together with various circuit arrangements, illustrated with logic drawings. Philco/Ford Microelectronics.

CIRCLE NO. 332

Photochoppers

Photochoppers have low offset and drift characteristics, and in most fast switching operations these considerations are of primary importance. The manufacturer's photochoppers and their applications are described in a five-page illustrated brochure. Hewlett-Packard.

CIRCLE NO. 333

Wideband IC amplifiers

The design of stable, low-noise, high-gain video amplifier circuits by cascading stages of the manufacturer's IC amplifier is described in a 2-page note. Westinghouse, Molecular Electronics Div.

CIRCLE NO. 334

SCR regulator circuits

Voltage control of high-current, low-voltage systems can be troublesome. With the proper triggering amplifier and adequate transient voltage protection, SCR voltage regulators can be very reliable. This 8-page illustrated note gives design procedures for a balanced bridge regulator and a magnetic summing regulator. Firing Circuits, Inc.

CIRCLE NO. 335

CRAFTSMANSHIP...a New England Tradition

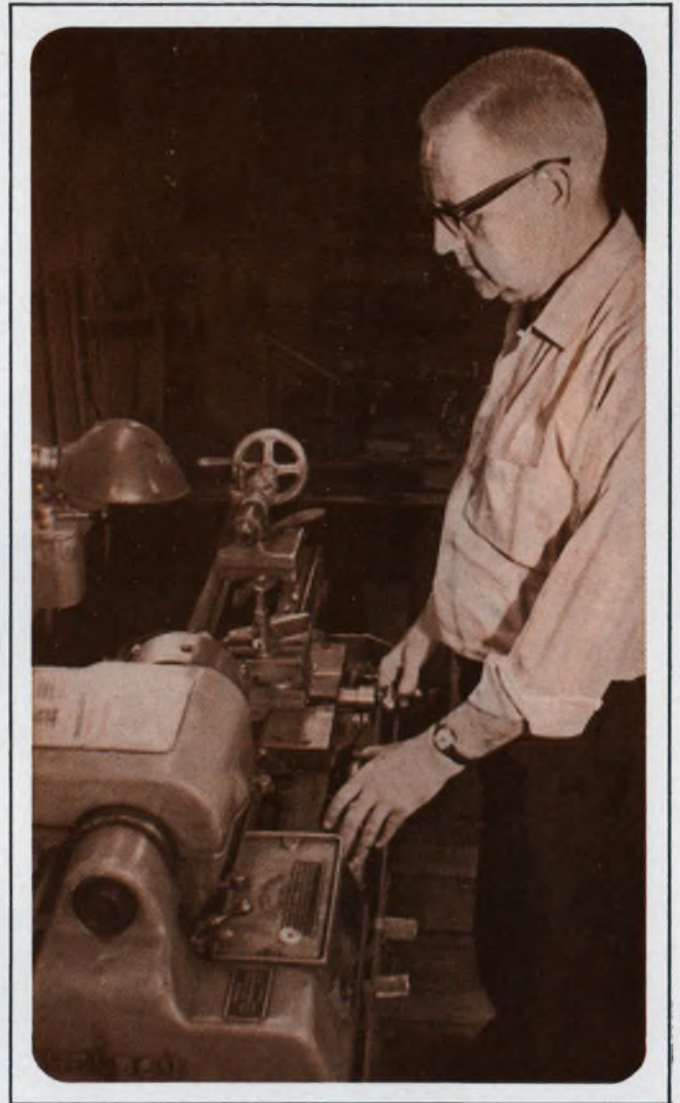
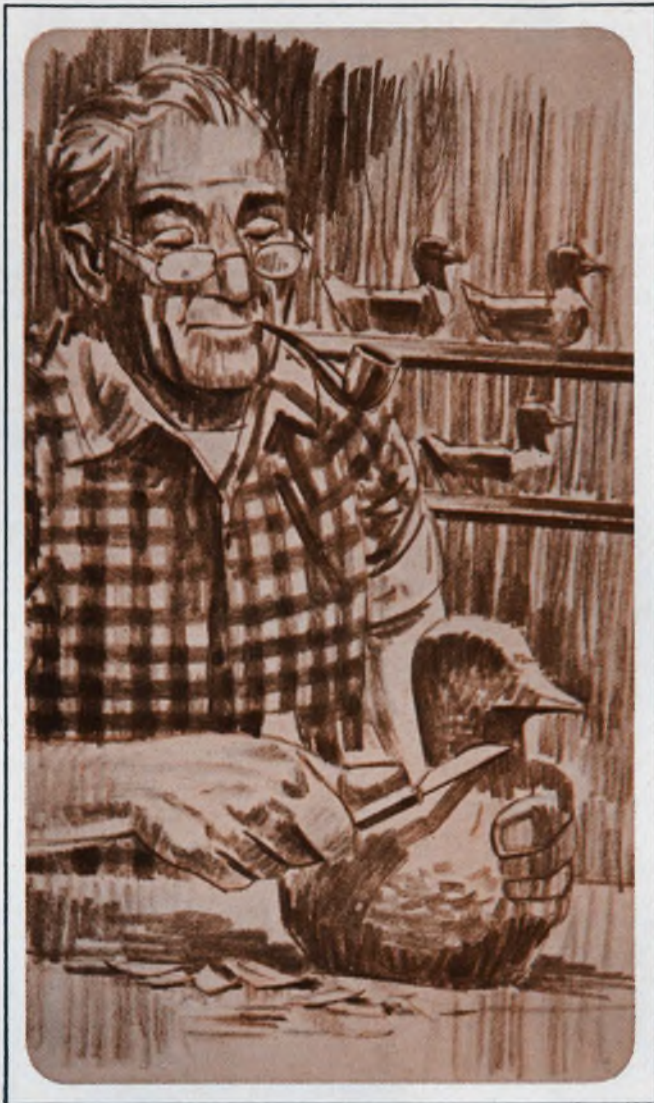

A TRADITION AT CLAROSTAT TOO is craftsmanship in the design and manufacture of potentiometers, resistors and switches. For more than 40 years, Clarostat has been the leading source of components designed and manufactured to the highest standards of craftsmanship at down-to-earth prices. The name Clarostat on a potentiometer, resistor or switch is your assurance of superior quality and honest value. Another respected tradition at Clarostat is quick service and fast, off-the-shelf delivery. When you add up all the reasons for specifying Clarostat, you see why so many have skipped the rest and continue to buy the best...

CLAROSTAT

CLAROSTAT MFG. CO., INC., DOVER, NEW HAMPSHIRE 03820

ON READER-SERVICE CARD CIRCLE 82

New Literature

HOW TO IMPROVE YOUR MEMORY

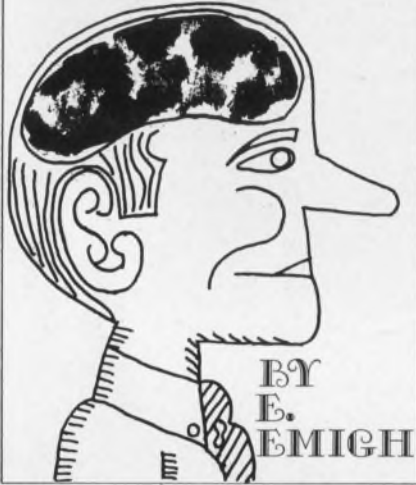

Improve your memory

If your memory needs a bit of improvement, try this 28-page booklet. "How to Improve Your Memory" is divided into five chapters: "The Secret of Memory Improvement," "Simple Associations," "Complex Associations," "Abstract Associations," and "Test"—where the reader is asked "What do 2-1/2D stacks and memories look like, and what are their outstanding features?" Assuming he passes, the reader can then tear out a "Diploma" stating that he has successfully completed the course on memory improvement. Electronic Memories.

CIRCLE NO. 336

Sigma 7 computer

Sigma 7 is suited for real-time, time-sharing applications that require fast computation, concurrent input/output, and high volume throughput. This 8-page brochure describes Sigma 7 capabilities as they relate to general-purpose computing, real-time systems control, and time-sharing applications. Also dealt with are hardware characteristics, programing systems, peripheral equipment and instructions. Scientific Data Systems.

CIRCLE NO. 337

Complex impedance tests

Details on the manufacturers family of integrated instruments for complex impedance, admittance and transfer function tests are given in this brochure. It describes instrumentation for materials research, electroacoustical transducers, electrical components, active and passive networks, mechanical and acoustical systems and impedance studies in physiology. Charts and photos are included. Dranetz Engineering Labs., Inc.

CIRCLE NO. 338

Bellows coupling selection

A brochure containing information on bellows type flexible couplings gives a life expectancy table and a method of choosing couplings. Included in the presentation are instructions and steps to follow in selecting the proper coupling. Servometer Corp.

CIRCLE NO. 339

Engineering thesaurus

A new edition of the EJC's first engineering thesaurus has been expanded to include terminology in the biological, physical and social sciences. Entitled "Thesaurus of Engineering and Scientific Terms," the 1000-page edition is intended to serve as a standardized vocabulary reference for use in information and data storage and retrieval systems. Preparation of the new edition represents a cooperative venture between Engineers Joint Council and the DOD Project LEX. The book contains several unique features which increase its usefulness. Terms in 17 subject categories will be listed in a subject category index; a permuted index will aid in providing access to the numerous multiword terms in the thesaurus, and a hierarchial index will show generic relationships under some 900 descriptions.

Available for \$18 and \$22.50 from Engineers Joint Council, 345 E. 47th St., N. Y. C.

Crimp-contact connectors

A 40-page volume includes specifications, illustrations and engineering data on removable crimp-contact connectors. The catalog shows connectors in a variety of contact sizes, with and without hoods, in draw-pull and screwlock types. Included is a design checklist and comparison chart which lists selection features. U.S. Components.

CIRCLE NO. 340

Industrial electronic products

This 312-page industrial electronics catalog lists products of 86 manufacturers and features product coverage for each manufacturer. Containing illustrations, the volume contains specifications and technical information on numerous products, as well as up-to-date OEM pricing.

Available on company letterhead from State Electronics Parts Corp., Hanover, N. J.

LEE

STOCK SPRINGS

OVER 2500 DIFFERENT DESIGNS
MANUFACTURED TO
ENGINEERED STANDARDS

1967

COMPRESSION

EXTENSION

TORSION

MUSIC WIRE

Fed. Spec. QQ-W-470

STAINLESS STEEL

Fed. Spec. QQ-W-423

INCONEL

Fed. Spec. QQ-W-370

IMMEDIATE
DELIVERY
FROM STOCK

ORDERS RECEIVED
BEFORE 2 PM
SHIPPED SAME DAY

LEE SPRING COMPANY

DIVISION OF ELECTRONICS, INC.

50 YEARS OF SERVICE

10 Mack Street, Brooklyn, N. Y. 11201 Phone (609) 212-8573

TELETYPE 212-543-9333

CATALOG #108-1967 © Lee Spring Co. Printed in U.S.A.

Wire and steel springs

A 52-page catalog is designed specifically to achieve savings in engineering and design time. It spells out engineering data and calculations, such as diameter, load, rate, solid height and tension on 2500 compression, extension and torsion springs of wire and stainless steel. Lee Spring Co.

CIRCLE NO. 341

Dage does give a DM for you!



For instance, DM polarizing lets you run ten mating pairs side by side without cross-plugging . . . color coding multiplies this by eight! You get bayonet-locking, superior cable gripping, weatherproof construction and crimp option . . . in accordance with Mil C 25516. DM's are miniature size and weight "coax" connectors with traditional Dage reliability. For full information call 317/736-6136.

DAGE ELECTRIC COMPANY, INC., Franklin, Indiana
Subsidiary of The Bendix Corporation

Bendix **Electronics**

FIRST WITH IDEAS • FIRST WITH QUALITY • FIRST WITH SERVICE
ON READER-SERVICE CARD CIRCLE 83

Telrex

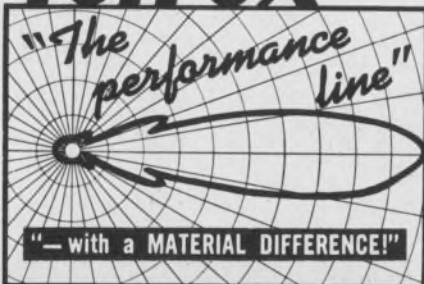

Telrex Communication Engineering Laboratories provides the Most Technically-Perfected Finest Communication Arrays — Precision Engineered, Manufactured, Tuned, Matched, Calibrated and "Balun" Fed for "Balanced-Pattern" and Maximum S/N Ratio.

Telrex "Beamed-Power" "Balanced-Pattern" ANTENNAS AND ANTENNA SYSTEMS

The Standard of Comparison, and the Choice of the Discriminating, Successful, Communication Engineer.

Telrex Antennas and Antenna Systems provide Optimum Performance and Reliability per element, per dollar, from 500 Kc to 1500 Mc.

Send for free Military, Commercial Tech Catalog CMS67, illustrating Antennas and Systems, Rotator-Selsyn Indicator Systems, "Baluns," Towers, Masts and Accessories.



ON READER-SERVICE CARD CIRCLE 84

NEW



Model 8095
Howard
Cyclohm Fan

Mounts on 2.81"
Centers. Free
air delivery, 22 CFM

Latest Addition to the *Cyclohm* Line of Fans and Blowers with Air to Spare

Face mounting matches industry standards. Rear mounting is a plus feature. Indestructible Nylon blades. All metal construction (no cracking, warping or distortion). Whisper-quiet operation. Guaranteed for 5 years to require no maintenance or re-lubrication.



For immediate delivery, contact Standard Motor Products Sales, 23 Broadway, Des Plaines, Ill. 60016. Telephone 312-827-7743. TWX 910-233-1658. For Cyclohm Fan and Blower Bulletins, address



HOWARD INDUSTRIES
MSL INDUSTRIES, INC./MOTOR GROUP
1760 STATE STREET
RACINE, WIS, 53404

ON READER-SERVICE CARD CIRCLE 85

NEW LITERATURE

Pulse generator data

A 36-page, two color catalog is divided into six sections for quick reference: pulse generators, pulse accessories, memory test systems, semiconductor test systems, programmed system elements and microwave system elements. Each section contains application notes and general information. Detailed specs and prices are given on each product, and the manufacturers line of pulse generators is summarized. Included in the presentation is a section entitled "Some useful relations in time domain", which serves as a reference for everyday use. E-H Research Lab., Inc.

CIRCLE NO. 342

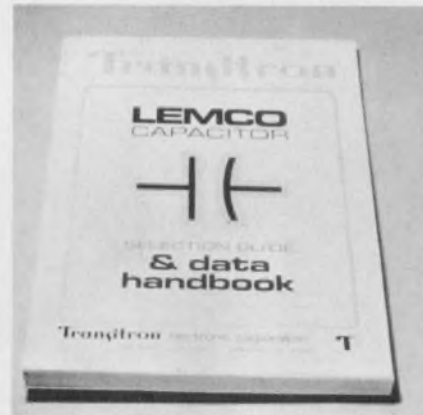

Capacitor catalog

A selection guide and data handbook on a line of Transitron capacitors is available. The brochure provides data on sintered mica, ceramic and polystyrene capacitor types for industrial, military and commercial applications. Transitron Electronic Corp.

CIRCLE NO. 343

Readout modules catalog

A brochure offering 9 data sheets describes incandescent modules for 14 to 16 and 24 to 28 volt ac-dc operation and neon modules for 150 to 160-V dc and 110 to 125-V ac circuits. The data sheets provide specifications and ordering information on caption modules, accessories, assembly and mounting instructions, a universal translator-driver for BCD and 10 to seven line converters for decimal inputs. Also included is a discussion of lamp performance characteristics. Dialight Corp.

CIRCLE NO. 344

Power supply data

This power supply "locator" contains 32-pages of specs and information on 11 series of supplies, broken into 135 models. General application notes, special models and graphs of current and voltage are included and defined. Pictures of series are shown and dimensions are given. The locator sheet serves as a handy cross-reference showing the overlapping characteristics of standard supplies in constant-current, constant-voltage/constant-current, and constant-voltage with current control categories. Rowan Controller Co.

CIRCLE NO. 345

Electroplated gold guide

A technical data sheet contains electrical, thermal, corrosion resistance, physical and optical data on electroplated gold coatings. Electrical properties of electroplated gold are given, including the resistivity effect of impurities on electrical resistance. Included in the presentation is a table which shows the effect of metal impurities on thermal conductivity. Specific values for all common physical constants are given, optical properties of electroplated gold, silver, and rhodium are shown graphically and specifications for electroplating with gold are set forth. Applications discussed include waveguides, tubes, variable resistors, contacts, moving and rotary switches, alarms and safety devices. Technic, Inc.

CIRCLE NO. 346

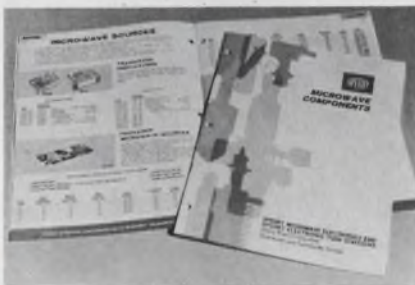

Microwave components

A 24-page illustrated catalog contains specifications and performance data on microwave components. Included is data on standard and custom-designed isolators, circulators, microwave sources, klystrons, TWTs, BWOs and phase shifters. Sperry Microwave.

CIRCLE NO. 347

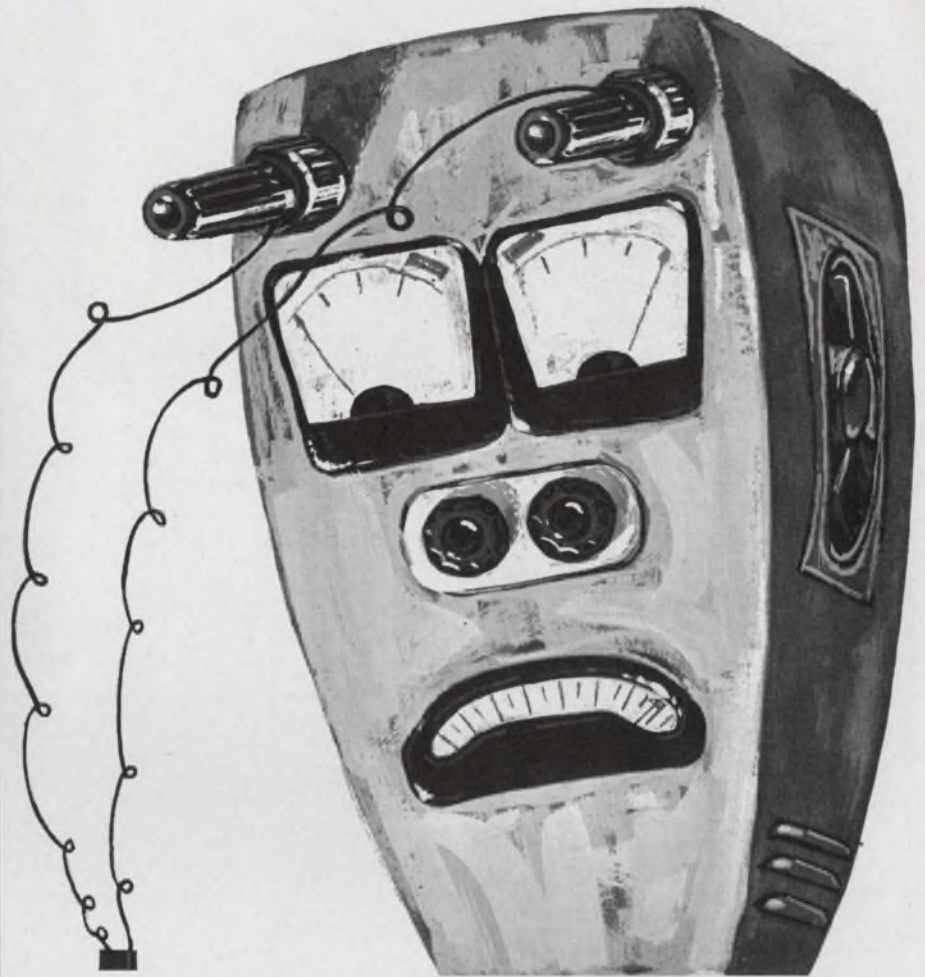

IS A MONSTER FEEDING YOUR BABY?

If "baby" is a modern IC package, then it's all too likely that the associated power supply is a big, old-fashioned monster. This needn't be so — because now you can re-fashion baby's power source to Technipower's new family of state-of-the-art power modules! High frequency power transformation puts efficiency 'way up around 80% — in dwarf-size packages — priced to fit your budget!

DESIGNED AND BUILT AS THE POWER SUPPLIES FOR MODERN MICRO MODULAR SYSTEMS

HF-80 Series: 30 Models, AC to DC, 4 to 60 VDC and up to 30 Amps. 0.1% line and 0.3% load regulation, 0.3% rms ripple, 2:1 adjustment range. Power to 360 Watts, Package densities in the order of 1.5 watts/in³, and prices start at just \$100.

HFT-80 Series: 4 Models, AC to DC, 2.5-10.5 VDC and up to 100 Amps. 0.1% line and 0.3% load regulation, less than 30 mv rms ripple, 2:1 adjustment range. Size for 100-Amp models is no larger than the average car battery.

CF-80 Series: 18 models, DC to DC, 4 to 60 VDC and up to 6 Amps. 0.1% line and 0.3% load regulation, 0.3% rms ripple, 2:1 adjustment range, full input to output isolation. Unique flat-pack cases for chassis or card bin mounting.

CM-95 Series: 14 models for DC to DC point of load regulation, up to 24 VDC and 1.5 Amps. These ice-cube size modules offer 0.5% regulation with 200:1 input ripple reduction, adjustable output voltage, short circuit protection, with either positive or negative output available. Best of all the price is just \$30 for any model, and much less in quantity.

Complete description, specifications, and prices are in the new 60 Page Technipower Catalog #671, available now. Ask your rep for a copy or write direct.

The catalog also gives you a complete fill-in on about 4000 power modules — none by any means out-of-date.

TECHNIPOWER

A DENRUS SUBSIDIARY

RIDGEFIELD, CONN. 06877 PHONE 203-853-1201

ON READER-SERVICE CARD CIRCLE 86

MOLDED Diallyl Phthalate

TERMINALS TEST JACKS

- Highest Reliability
- Meet Military Specs
MS-16108 Rev. F Test Jacks
MIL-T-55155 Terminals

Metal inserts are molded into high-temperature DIALLYL PHTHALATE, forming a strong integral unit that will not crack while soldering.

Replacements for competitive items available. Send us your requirements.

Nurl-Loc[®]

- Metal-to-metal press-in design
- Solid molded Diallyl Phthalate construction
- Highest radial and axial pullout resistance.

SEND FOR
CATALOG!

30 pages with complete drawings and specifications of over 500 terminals and test jacks, in 10 colors with Mil. Spec. ratings.



**ELECTRONIC
MOLDING CORP.**

36 Church St., Pawtucket, R. I. 02860
(401) 728-2100

ON READER-SERVICE CARD CIRCLE 88

If you are attending WESCON, and we hope you are, please be sure to pick-up your free copy of **Electronic Design's WESCON EXTRA** at booth 3622 in the Cow Palace's South Exhibit Hall. The EXTRA contains all the Show news you need to know.

The Editors

Advertisers' Index

Advertiser	Page	Advertiser	Page
ADC Products, A Division of Magnetic Controls Co.	131	Licon, Division Illinois Tool Works, Inc.	93
Allen-Bradley Co.	7	Littelfuse	135
B & B Motor & Control Corp.	137	MSL Industries Inc.	144
Beckman Instruments, Inc., Helipot Division	25	McLean Engineering Laboratories	134
Belden Corporation	4, 5	Magnetics, Inc.	27
Birtcher Corporation, The	123	Magtrol, Inc.	130
Buckbee Mears Co.	138	Marshall Industries-Capacitor Division	105
Bulova Electronics Division of Bulova Watch Company	40	MicroSwitch, A Division of Honeywell	32B
Burndy Corporation	15	Monsanto	66, 67
By-Buk Company	151	Motorola Semiconductor Products, Inc.	8
Centralab, the Electronics Division of Globe-Union, Inc.	107	National Semiconductor Corporation	34, 35
Chicago Miniature Lamp Works	81	Perfection Mica Company	129
Clairex Corporation	133	Phelps Dodge Electronic Products	121
Clarostat Mfg. Co., Inc.	141	Power/Mate Corp.	150
Cohu Electronics, Inc.	41	Princeton Applied Research Corp.	16
Computer Measurements Company	2	RBM Controls Division	19
Conelco Components	125	RCA Electronic Components and Devices	Cover IV
Cutler-Hammer	114	Redcor Corporation	135
Dage Electric Company, Inc.	143	San Fernando Electric Mfg. Co.	137
Dale Electronics, Inc.	88A-B, 127	Schweber Electronics	151
Damon Engineering, Inc.	23	Simpson Electric Company	31
Dialight Corporation	149	Slater Electric, Inc.	73
Du Pont Company	32A	Sperry Division of the Sperry Rand Corporation	103
Eastern Industries, A Division of Laboratory for Electronics, Inc.	119	Sperry Microwave Electronics Company	150
Ehrenreich Photo Optical Industries Inc.	43	Sprague Electric Company	10, 12
Eldre Components, Inc.	149	Stauffer Chemical Company	117
Electro Tec Corp.	128	Sylvania, Subsidiary of General Telephone & Electronics	61
Electronic Design	89, 147	Syntronic Instruments, Inc.	133
Electronic Molding Corp.	146	Tech Laboratories, Inc.	126
Emporium Specialties Inc.	138	Technipower, Inc., A Benrus Subsidiary	145
Erie Technological Products, Inc.	9	Tektronix, Inc., Oscilloscopes	46
Fairchild Semiconductor, A Division Fairchild Camera and Instrument Corporation	84, 85	Telonic Instruments, A Division of Telonic Industries, Inc.	132
General Electric Company, Semiconductor Products Department	28	Telrex Laboratories	144
General Radio Company	37	Texas Instruments Incorporated	98
Harowe Servo Controls, Inc.	32	Torngren Co., Inc., C. W.	140
Hewlett-Packard, Dymec Division	99	Uniform Tubes, Inc.	150
Hewlett-Packard, Harrison Division	Cover III	Union Carbide Corporation	21, 38, 39
Hewlett-Packard	1, 48, 74, 75, 139	United Transformer Co.	Cover II
Howard Industries, Inc.	144	Victoreen Instrument Division	42
IRC, Inc.	6, 44	Watkins-Johnson	33
ITT Semiconductors, A Division of International Telephone and Telegraph Corporation	152	Career Advertising	
Industrial Electronic Engineers, Inc.	83	Boeing Company, The	108
Intronics Incorporated	136	Hughes Aircraft Company	
Kistler Instrument Corporation	151	Aerospace Divisions	112
		Lockheed Missiles & Space Company	111
		Sylvania Electronic Systems	113

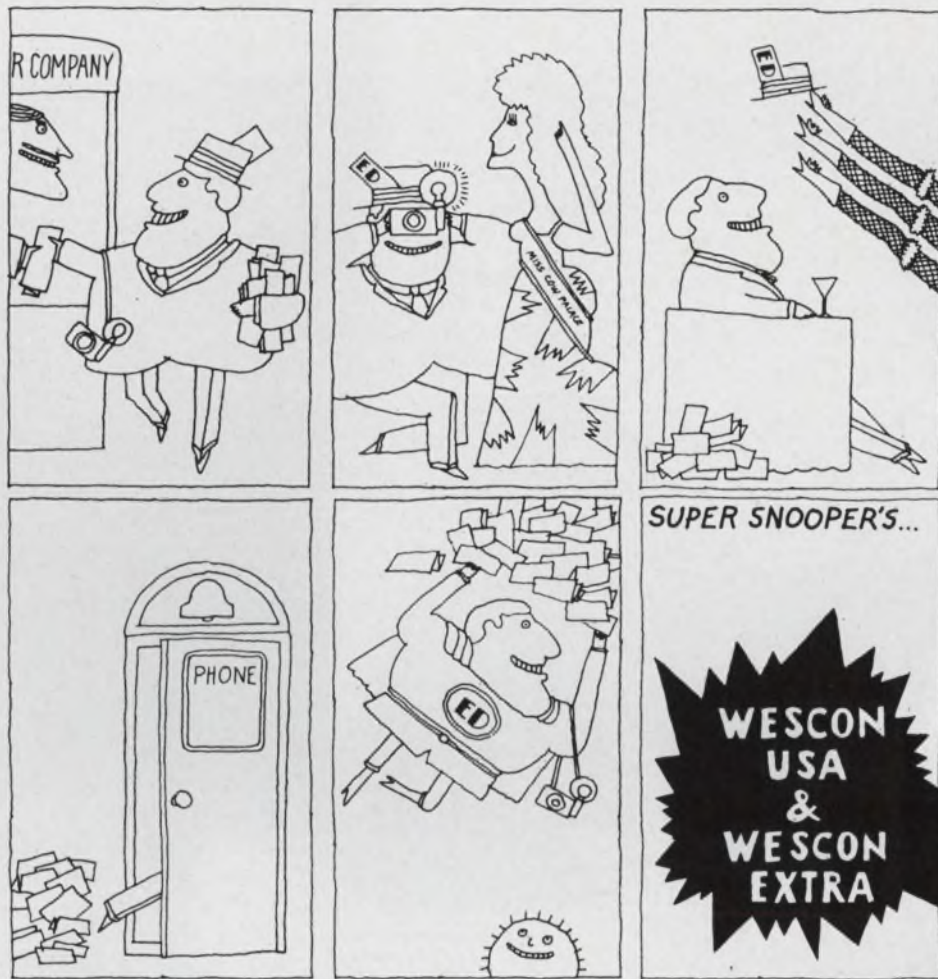

SELL PRIOR TO THE SHOW IN **WESCON USA**. YOUR PRODUCTS WILL BE SEEN BY 155,000 ENGINEERS AND ENGINEERING MANAGERS—THE MEN WHO SPECIFY. **ELECTRONIC DESIGN'S SUPER SNOOPER** HAS BEEN WORKING VERY HARD ON **WESCON USA**... IT'S OUR REGULAR AUGUST 16TH ISSUE, AND IT ALSO CONTAINS COMPLETE EDITORIAL ON THE SHOW. **SUPER SNOOPER AND STAFF** WILL HAVE IT PACKED WITH **WESCON NEWS**, **WESCON NEW PRODUCTS**, **WESCON TECHNICAL SESSIONS** PLUS FEATURE ARTICLES ON THE SHOW AND SAN FRANCISCO. YOU CAN ALSO GET ADDITIONAL ATTENTION AT THE SHOW WITH **ELECTRONIC DESIGN'S WESCON EXTRA**... PUBLISHED FOR AND DISTRIBUTED AT THE SHOW... ITS **SUPER DUPER** COVERAGE OF PRODUCTS AND SESSIONS MAKES IT A MUST FOR MANUFACTURERS WHO WANT TO GET THE MOST OUT OF **WESCON**.

NOTE: ADVERTISE IN THE AUGUST 2 ISSUE OR AUGUST 16 (**WESCON USA**) ISSUE AND YOUR ADVERTISEMENT CAN ALSO RUN IN THE **EXTRA** FOR A SMALL PREMIUM. THE **EXTRAS** (15,000 OF THEM) ARE DISTRIBUTED AT SHOW TIME AT THE COW PALACE AND AT HOTELS THROUGHOUT SAN FRANCISCO. CALL YOUR **ELECTRONIC DESIGN** REPRESENTATIVE OR ED CLANCY 212 PLAZA 1-5530 FOR ALL THE DETAILS ON THIS SUPER BARGAIN. DON'T DELAY, CALL ED TODAY... **AUGUST 2 (A READER RECALL ISSUE) CLOSSES JULY 3. AUGUST 16 (WESCON USA) CLOSSES JULY 17.**

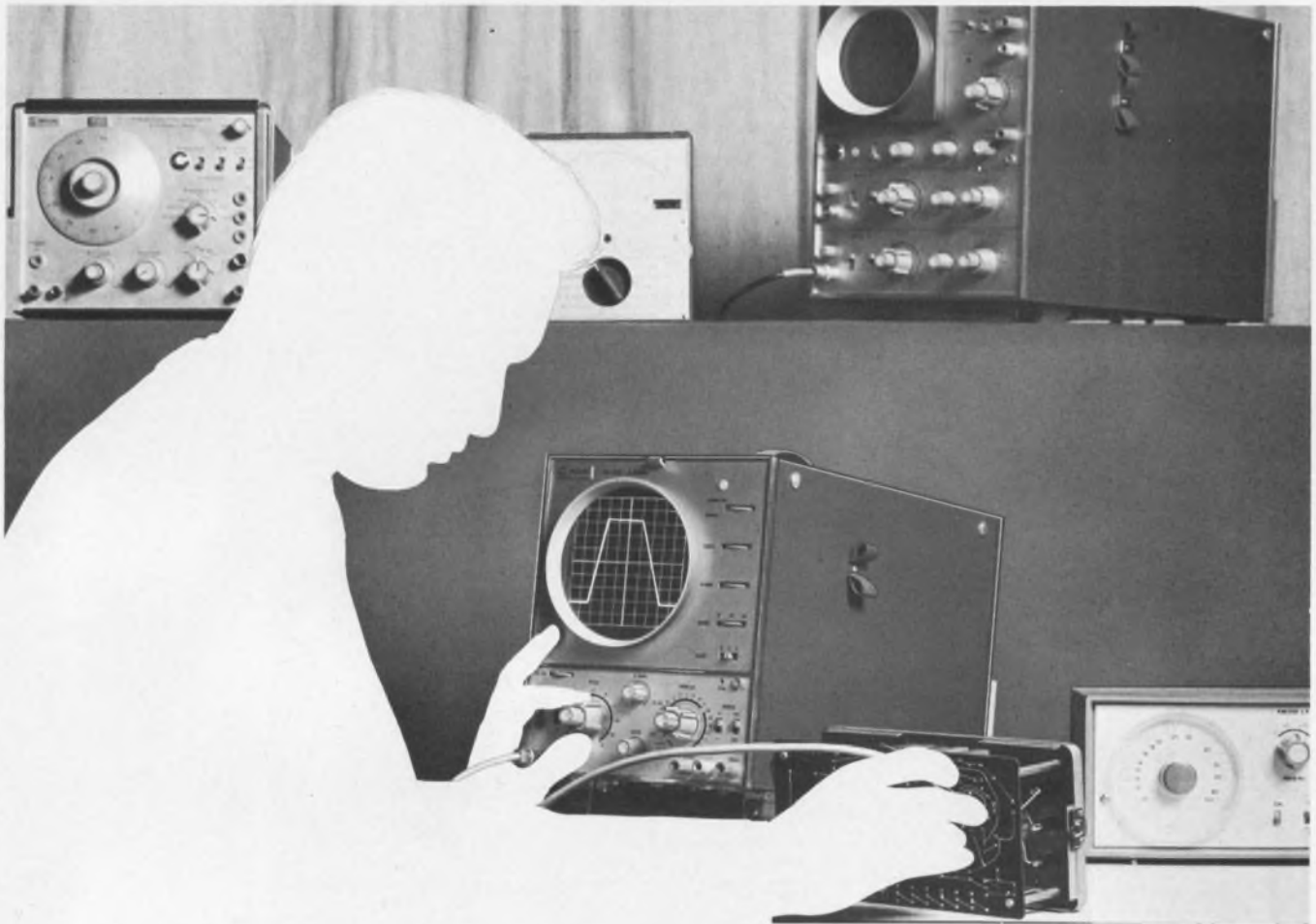

Move in for one of these versatile 10 MHz oscilloscopes ...they're tough yet highly sensitive

These lightweight instruments are basic tools for everyone to operate... on land, sea or in the air. There's a 40 - 400 Hz supply frequency range. And their low power consumption allows use away from a mains power supply with a DC/AC converter. Extensive use of solid state devices give you the reliability you demand; ergonomic styling the ease of operation you like.

So which one's for you?

The PM 3221 is a 13 cm scope with a 10 x 8 cm display area and incorporates a

delay line - ideal for pulse and computer applications. Sensitivity is 10 mV/cm from DC to 10 MHz; 1 mV/cm from DC to 2 MHz. Triggering is up to 10 MHz - automatically or with manual level control.

The PM 3230 is a double beam instrument with a specially developed CRT with guns mounted side by side to cover the full display area. Sensitivity is 20 mV/div (= 8 mm) from DC to 10 MHz; 2 mV/div from DC to 2 MHz. Triggering is very stable with simple controls.

A full description of these instruments is set out in an 8-page brochure. We will be glad to send you a copy.

Illustration: (Below) PM 3221, (above) PM 3230.

These instruments are part of a wide range of electronic measuring instruments which includes oscilloscopes, voltmeters, generators, transistor analysers and other test equipment... sold and serviced by the world-wide Philips organisation (experts in electronic measuring, too). Ask for the complete catalogue.



N. V. Philips, PIT-EMA Department,
Eindhoven, The Netherlands

PHILIPS



Electronic measuring instruments

ON READER-SERVICE CARD CIRCLE 89

Electronic Design Design Data from Manufacturers

Advertisements of booklets, brochures, catalogs and data sheets. To order use Reader-Service Card.

(Advertisement)

Advertising Representatives

New York 10022

Robert W. Gascoigne
Thomas P. Barth
Samuel M. Deitch
William C. Repetto
850 Third Avenue
(212) PLaza 1-5530
TWX: 867-7866

Philadelphia

P. O. Box 206
Merion Station, Pa. 19066
(215) MO 4-1073

Boston

Richard Parker
7 Redstone Lane
Marblehead, Mass. 01945
(617) 742-0252

Chicago 60611

Thomas P. Kavooras
Berry Conner, Jr.
720 N. Michigan
(312) 337-0538

Cleveland

(216) 247-7670

Los Angeles 90303

Stanley I. Ehrenclou
Terrence D. Buckley
W. James Bischof
2930 W. Imperial Highway
Inglewood, Calif.
(213) 757-0183

San Francisco

Ashley P. Hartman
175 South San Antonio Rd.
Ste. 243
Los Altos, Calif. 94022
(415) 941-3084

Southwestern 75206

Tommy L. Wilson
6200 North Central Expressway
Dallas, Tex.
(214) EMerson 1-2311

London W. 1

Brayton C. Nichols
44 Conduit Street

Verviers, Belgium

Andre Jamar
1, Rue Mallar, 1
(087) 253.85

Tokyo

Yoshihiro Takemura
International Planning
Service, Inc.
Room 231 Tokyu-Mita Bldg.
1, Shiba-Mita Koun-cho
Minato-ku, Tokyo



New Data On Numeric Readouts



Nine data sheets plus portfolio cover provide specifications and needed information to help answer your readout display requirements. Dialco Readouts offer choice of Incandescent (14-16V and 24-28V AC-DC) or Neon (150-160V DC; 110-125V AC) light sources; provide universal BCD to 7 line translator-driver; 10 line to 7 line converters for decimal input; or translator drivers for binary input.

Dialight Corporation

60 Stewart Ave., Brooklyn, N. Y. 11237
(212) 497-7600

171

Equipment Under Test Sign



Bright red and white signs to attach to equipment while it is under test to forestall accidental interference are available from POWER/MATE CORP., Hackensack, N. J. The company is offering these heavy cardboard signs along with their new Power Supply Module Catalog No. 117. The Catalog lists all of the many supplies available from PMC. The package will also include information about their new Uni-88—a 0-34 volt, 1.5 amp. supply that sells for only \$88.00. Racks and other accessories are also available. Write today.

Power/Mate Corp.

163 Clay St.
Hackensack, N. J. 07601

172

Laminated and Molded Bus Bars For Power Distribution

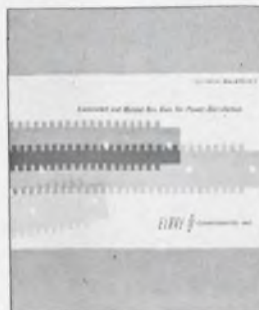

A 16 page Technical Bulletin is now available, describing a new concept in power distribution. Basic mechanical and electrical design principles, along with descriptive pictures and diagrams, are included in this bulletin. These compact buses can replace bulky cable harnesses and repetitive wiring for computer or modular application. This method of construction satisfies the demanding requirements of low inductance and resistance of high speed, solid state systems, while controlling electrical noises.

"see us at Wescon Booth 1313-1314"

Eldre Components, Inc.

1239 University Avenue
Rochester, New York 14607

173

ELECTRONIC DESIGN's aim is fourfold. It aids progress in the electronics manufacturing industry by promoting good design. It gives the electronic design engineer concepts and ideas that will make his job easier and more productive. The magazine serves as a central source of timely, up-to-the-minute electronics information. And finally it seeks to encourage two-way communication between manufacturer and engineer.

Want a subscription? ELECTRONIC DESIGN is circulated free of charge to qualified engineers and engineering management doing design work, supervising design or establishing standards in the United States, Western Europe and the United Kingdom. If you think that you are entitled to a free subscription, use the postfree application form that you will generally find inside the back cover. When it is not included, write to us direct for an application form.

If you are not qualified, you may take out a paid subscription at the following rates: \$25 a year if you live in the U.S.A. or \$35 a year if you live elsewhere. Single copies may be purchased for \$1.50 each.

If you change your address, send us an old mailing label and your new address; there is generally a prepaid postcard for this inside the back cover. If you have been receiving ELECTRONIC DESIGN free of charge, you will have to requalify to continue doing so.

We strive for accuracy. We take the utmost pains to ensure the highest standard of accuracy throughout the magazine. A single mistake in practical design information can have serious consequences. But to err is human, and for all the care we take, an occasional error slips through. Whenever this occurs, we publish a correction at the earliest opportunity. You will find these corrections printed at the end of the Letters column. If you should spot an error, be sure to let us know. You may save your colleagues heartaches.

Microfilm copies are available of complete issues of ELECTRONIC DESIGN that have been published since the beginning of 1961, and of single articles. Complete issues cost 4¢ a page, individual pages cost 50¢ each; shipping and handling charges are extra. The minimum charge is \$3; delivery time runs from 10 days for single pages to five weeks for complete issues. For further details and to place orders, get in touch directly with University Microfilms, Inc., 300 N. Zeeb Road, Ann Arbor, Mich. 48106; telephone (313) 761-4700.

Want to contact us? If you have any inquiries about these or other matters, or if you have a manuscript outline or article idea, address your correspondence to:

Howard Bierman, Editor,
ELECTRONIC DESIGN,
850 Third Avenue,
New York, N.Y. 10022.

Designing Around Tubing

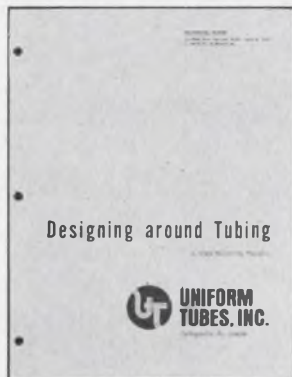

This six-page article details design considerations in determining whether a particular part should be machined from bar stock, formed from sheet or fabricated from tubing. Drawings and photos show how tubular parts have been designed so that they can be fabricated from tubing at considerable savings.

The data provides design criteria for tubular parts with flanges, bends, beads, flares, expanded ends, ultra-thin walls, turned-in ends and ID-radiused ends. Typical parts cited as fabricated best from tubing include spring contacts, cathode support sleeves, tone arms, and fuel cell nozzles to name a few.

Uniform Tubes, Inc.
Collegeville, Pa. 19426

174

Microwave Components



Now available, a new 26-page catalog of microwave components. SPERRY, long an acknowledged leader in exacting production requirements for microwave systems has compiled a ready reference source on components. Listings include isolators; circulators; solid-state, klystron and BWO sources; parametric, TWT and klystron amplifiers; delay lines; phase shifters and equalizers. Assistance with your specific application requirements is readily available. The line is represented nationally by Cain & Co. For your copy of the catalog write:

Sperry Microwave Electronics
P. O. Box 4648
Clearwater, Florida 33517

175

Engineers' Relay Handbook



A definitive work that is fast becoming a standard reference text for the relay user. Prepared and edited by the National Association of Relay Manufacturers, this book is a complete guide to the principles, properties, performance characteristics, application requirements, specifications, and testing of relays. Systems and product engineers will find the *Handbook* an indispensable help in determining the correct types of relays for their applications. For further information about this unique sourcebook, write Dept. ED.

Hayden Book Co., Inc.
116 W. 14th Street
New York, N. Y. 10011

176

Manufacturers

Advertisements of booklets, brochures, catalogs and data sheets. To order use Reader-Service Card.
(Advertisement)

GE MILITARY ELECTROLYTIC CAPACITORS

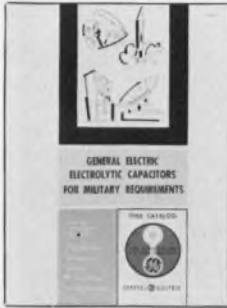

A 60-page catalog of General Electric capacitors of the electrolytic type for military requirements is available from Schweber. The catalog lists tantalum foil and slug as well as aluminum computer grade. Product information, application notes and military specifications are covered thoroughly. Circle bingo number below for catalog—call telephone number below for immediate shipment of GE capacitors.

Schweber Electronics
Westbury, New York 11590
516-334-7474

177

New Force Links for Tensile Testing



Bulletin 233-5/67 describes Series 930 quartz force links ideal for high speed measurement of dynamic tension and compression forces. Illustrated is the rigid factory-sealed assembly of a quartz load washer between two end nuts which minimizes precision mounting requirements while increasing installation convenience. Specifications are given for seven models with tension ranges to 25,000 lbs. and compression ranges to 45,000 lbs.

Kistler Instrument Corporation
8969 Sheridan Drive
Clarence, N. Y. 14031

178

New "Tape Lift" Printed Circuit Drafting Aids



No engineer or draftsman should be without the most up-to-date cross-reference guide to better Printed Circuit Drafting Catalog. It is complete with prices and illustrations of over 1200 sizes of "Tape Lift" pads, shapes and other aids for faster, more accurate, distortion-free printed circuit master drawings. Write for FREE catalog.

By-Buk Company
4326 West Pico Blvd., Los Angeles, Calif. 90019
Telephone: (213) 937-3511

179

Designer's Datebook

JULY						
S	M	T	W	T	F	S
						1
2	3	4	5	6	7	8
9	10	11	12	13	14	15
16	17	18	19	20	21	22
23	24	25	26	27	28	29

AUGUST						
S	M	T	W	T	F	S
		1	2	3	4	5
6	7	8	9	10	11	12
13	14	15	16	17	18	19
20	21	22	23	24	25	26
27	28	29	30	31		

For further information on meetings, use Reader Service card.

July 31-August 4
Research Conference on Instrumentation Science (Geneva, N. Y.)
Sponsor: ISA; Instrument Society of America, 530 William Penn Place, Pittsburgh, Pa. 15219

CIRCLE NO. 467

Aug. 13-17
Intersociety Energy Conversion Engineering Conference (Miami Beach)
Sponsor: ASME, IEEE *et al.*; A. Merrick Taylor, Douglas Aircraft Corp., Inc., Santa Monica, Calif. 90406

CIRCLE NO. 468

Aug. 22-25
Western Electronic Show and Convention (San Francisco)
Sponsor: WEMA; Ted Shields, WESCON, 3600 Wilshire Blvd., Los Angeles, Calif. 90005

CIRCLE NO. 469

Aug. 29-31
Conference on Engineering Applications of Electronic Phenomena (Ithaca, N. Y.)
Sponsor: Cornell University, IEEE, ONR; Conference Committee, School of Electrical Engineering, Philips Hall, Cornell University, Ithaca, N. Y. 14850

CIRCLE NO. 470

Aug. 28-30
Technical Conference on Electronic Materials (New York City)
Sponsor: AIME; L. R. Weisberg, Electronic Materials Committee, The Metallurgical Society of AIME, 345 E. 47 St., New York, N. Y. 10017

CIRCLE NO. 471

Aug. 29-31
Association for Computing Machinery Conference (Washington, D. C.)
Sponsor: ACM; M. J. Healy, c/o Association for Computing Machinery, Box 6, Annandale, Va. 22003

CIRCLE NO. 472

Every ITT 2N3375 gives you 66% more P_{OE} than EIA specs demand

28V CLASS B POWER OUTPUT VS FREQUENCY

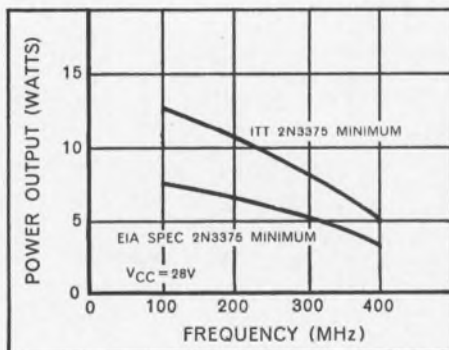

When you apply ITT 2N3375s, you get 5 watts minimum saturated power output at 400 MHz and $V_{CC}=28$ V, tested 100%.

The secret lies in ITT's unusually close control of resistivity, combined with interdigitated construction.

To find out more about the superior performance of the ITT 2N3375, write today for your free copy of "VHF/UHF Power Transistor Amplifier Design" and complete 2N3375 specs. Or see for yourself — order sample quantities off-the-shelf from your ITT distributor or factory representative. ITT Semiconductors is a division of International Telephone and Telegraph Corporation, 3301 Electronics Way, West Palm Beach, Florida.

ITT
SEMICONDUCTORS

FACTORIES IN WEST PALM BEACH, FLORIDA. PALO ALTO, CALIFORNIA. LAWRENCE, MASSACHUSETTS. HARLOW AND FOOTSCRAY, ENGLAND. FREIBURG AND NUREMBURG, GERMANY

ON READER-SERVICE CARD CIRCLE 102



new disciplines in DC



take the constant current model with < 200 microsecond recovery

Accurate DC Voltage Monitoring Circuit Eliminates Output Resistance Degradation

A new series of compact, precision regulated, all-silicon DC power supplies features constant current output useful down to the microamp region. Ripple, regulation, and stability are orders of magnitude better than comparably priced constant current supplies, and permit CCB models to be used as general purpose laboratory constant current sources for semiconductor circuit development, and for component evaluation and testing.

A constant current DC power supply must be able to change its output voltage rapidly in order to minimize load current transients. With the CCB Series, less than 200 μ S is required for transient load recovery to within 0.1%—even for load changes requiring full rated output voltage changes!

Placing a voltmeter across the output terminals of a normal constant current power supply degrades the load regulation and diminishes the load current both by a factor of $R_L/R_L + R_V$. (R_L = load resistance, R_V = voltmeter resistance.) The CCB Series eliminates this error by using an operational amplifier to feed the front panel voltmeter. This "replica" of the output voltage is also presented on rear terminals for possible connection to a more accurate differential or digital voltmeter, thus increasing the utility of these constant current supplies for component testing and sorting systems.

Three-Position Output and Meter Range Switch, 10-Turn Output Control With Resolution to 0.1 μ A • Continuously Variable Voltage Limiting • Output Impedance to 20,000 Megohms, Depending on Model Number and Range • High Speed Remote Programming From Resistance or Voltage Input, Can Be Modulated Using External AC Source • No Overshoot on Turn-On, Turn-Off, or Power Removal • Front and Rear Output Terminals • Half Rack Width, Rack Mounting Hardware Available.

CCB SERIES SPECIFICATIONS			
Output Current	0-750 MA	0-300 MA	0-100 MA
Voltage Compliance	0-50 V	0-100V	0-300V
Load Regulation	Less than 10 PPM of output +5 PPM of range setting		
Line Regulation	Less than 10 PPM		
RMS Ripple	Less than 100 PPM of output +10 PPM of range setting		
Size	3½" (89 MM) H x 8½" (216 MM) W x 12⅝" (321 MM) D		
Model	6177A	6181A	6186A
Price	\$425.	\$425.	\$425.

Contact your nearest Hewlett-Packard Sales Office for full specifications.

HEWLETT  PACKARD
POWER SUPPLIES

100 Locust Ave., Berkeley Heights, New Jersey 07922 AREA CODE 201 464-1234 TWX 710-984-7972

ON READER-SERVICE CARD CIRCLE 92



**Ready-made or
tailor-made...**

***RCA's new L-Band
Microwave
Power Source***

Instant specifications to fit—that's the versatility of the S190, RCA's new L-Band Solid-State Power Source. Designed for low-voltage operation for efficient use of battery and space in rocketsonde applications, the standard unit operates as a fundamental frequency oscillator delivering 200 mW of output power at 1680 MHz.

S190 employs a single RF transistor in a unique dual-cavity microwave circuit. Its specifications can be readily tailored for operation at any frequency in the range from 1.2 to 1.9 GHz. You can have the power output, temperature range, and packaging most suited to your application, as well as your selection of supply voltages from -15 to -30 Vdc with integral regulator; from -12 to -30 Vdc without regulator.

Available in a compact, rugged package, the S190 can withstand extreme shock, vibration, and acceleration conditions during operation with minimal variation in frequency. The device is temperature compensated to be frequency stable within 4 MHz.

For full information on RCA's S190 and how it can be tailor-made to your specifications, call your RCA Representative. For technical data, write: RCA Commercial Engineering, Section G-18Q, Harrison, N.J. 07029.

Typical Characteristics of S190 and S170 Power Sources

Parameter	S170V100	S190
Voltage	-20 Vdc	-20 Vdc
Current	160 mAdc	90 mAdc
Power Output	200 mW (Min.)	200 mW (Min.)
Frequency	1680 MHz	1680 MHz
Spurs	-10 dB @ 560 MHz -15 dB @ 1120 MHz -30 dB @ 3360 MHz	-60 dB @ 3360 MHz -20 dB @ 5040 MHz
Pulling Figure	2 MHz	4 MHz
Pushing Figure	1.5 MHz/Volt	0.5 MHz/Volt
Efficiency	8-10%	10-15%
Length	1.4 in	2.3 or 2.1 in
Weight	2.5 oz	3 or 2.5 oz



S190 L-Band
Solid-State
Power Source

RCA Electronic Components and Devices



The Most Trusted Name in Electronics