

JUN 24 1964

ELECTRA

de

ELECTRONIC



RONIC

esign

Semi-automatic assembly of electronic equipment using standard components can be readily affected without complex assembly setups, by means of glass-bonded mica modular mounting units such as the 2-stage preamplifier shown here. Components can be dip soldered, interconnections can be made by printed wiring, and various pins and plugs can be used to stack the units.

June 1954

Check
this
list of
**TRANSISTOR
APPLICATIONS**
already
in
hand
at...



Is there an application here that is significant to your operation or product design? If so, our Transistor Application Engineers are ready to confer with you.

Hydro-Aire is manufacturing point-contact and junction Transistors to the very high standards of quality control for which all Hydro-Aire products have become famous. In addition, it is an essential part of the program to explore with energy and imagination the ever-widening field of new uses constantly opening up for Transistors. This is why it is in your interests to keep in touch with us, so that you will benefit from our work both in current applications and applications that will be developing in the coming months.

PLEASE WRITE ON YOUR COMPANY LETTERHEAD.

CIRCLE ED-1 ON READER-SERVICE CARD FOR MORE INFORMATION

Staff

Edward E. Grazda	Editor
M. Mandell	Associate Editor
M. J. Friday	Assistant Editor
R. Graham	Assistant Editor
P. L. Canfield	Editorial Assistant
N. Asto	Production Manager
E. Dadinis	Assistant Production Manager
H. W. Schlager	Business Manager
J. B. Gilchrist	Circulation Manager

Co-Publishers

T. Richard Gascoigne
James S. Mulholland, Jr.

Advertising Representatives

New York: T. Richard Gascoigne,
James S. Mulholland, Jr.
Blair McClenahan
127 East 55th St.
New York 22, N. Y.
PLaza 3-8677

Chicago: Thomas P. Kavooras
664 No. Michigan Ave.
Chicago 11, Ill.
SUperior 7-8054

Los Angeles: Robert E. Ahrens Dorf
1140 Wilshire Blvd.
Los Angeles 17, Calif.
MAdison 9-2811

Circulation Policy

ELECTRONIC DESIGN is circulated only to qualified electronic design engineers of U. S. manufacturing companies, industrial consultants, and government agencies.

If design for manufacturing is your responsibility, you qualify for a subscription without charge provided you send us the following information on your company letterhead: your name and title; your company's name, address, and main product. Electronic, research, development, project, electrical, and chief engineers are typical qualifying titles.

If you have a design responsibility not indicated by your title, add a description of those responsibilities.

Any job change requires requalification.

Hayden Publishing Company, Inc.
127 East 55th Street
New York 22, New York

**Back issues of ELECTRONIC
DESIGN, when available,
may be obtained at a
charge of \$1.00 per copy.**



ELECTRONIC

DESIGN

Vol. 2
No. 6
June 1954

Contents

Cover	(see page 30)
Editorial	4
Engineering Review	5
Features	
Evaluating Tube-Clamping Shields, by Leroy Woods	14
Traveling-Wave Tube Amplifier	16
Meter-Type Sensitive Relay	18
Magnetic Shift Resistor	20
Decade Delay Line	22
Cartridge-Mounted Thermistor	24
C vs T For Capacitors, by R. G. Lindstrom	26
Step-Function Potentiometer	28
Modular Mounting Units	30
Design Forum	
Airborne Computer Amplifier, by S. Frangoulis	32
Departments	
New Products	34
New Literature	66
Patents	72
Books	76
Advertisers' Index	78

BPA

NBP

ELECTRONIC DESIGN is published monthly by Hayden Publishing Company, Inc. at 127 E. 55th Street, New York 22, N. Y., T. Richard Gascoigne, President; James S. Mulholland, Jr., Vice-President & Treasurer; and Ralph E. Marson, Secretary. Printed at Publishers Printing Company, New York, N. Y., ELECTRONIC DESIGN is circulated monthly without charge to men in the electronic industries who are responsible for the design and specification of manufactured devices, including development and design men of consulting laboratories and government agencies. Acceptance under section 34.64 P. L. & R. authorized. Copyright 1954 Hayden Publishing Company, Inc. 24,000 copies this issue.

JUN 24 1954

Not Only a

Time Delay Relay...



G-V THERMAL RELAYS

*Advanced
Engineering
Features!*

- Miniature and Octal Sizes
- Hermetically Sealed in Metal Shell
- Adjustable and Non-Adjustable
- Heater Voltages up to 230 Volts
- Fully Temperature Compensated
- Suitable for Military and Industrial Use
- Unequaled for Ruggedness and Precision

Greatly expanded production facilities assure prompt deliveries.

...with performance features never before possible

More and more engineers are finding other uses for these precise and rugged units—jobs which thermal relays of the usual bi-metal design often cannot do... such as:

- TUBE HEATER VOLTAGE REGULATION
- POWER SUPPLY OVERLOAD PROTECTION
- OVER- OR UNDER-VOLTAGE ALARM OR CUT-OFF
- LOW OR HIGH FREQUENCY CUT-OFF



Only G-V offers complete technical data and helpful engineering cooperation on THERMAL TIME DELAY RELAYS.

Write for bulletin and help with your particular problems.

G-V CONTROLS INC. 18 Hollywood Plaza
East Orange, New Jersey

U. S. and Foreign Patents Pending

CIRCLE ED-2 ON READER-SERVICE CARD FOR MORE INFORMATION

YOUR .5-FOOT SHELF IS NOT COMPLETE

...without these popular classics for engineers...published in profusion by the Technical Information Service of Helipot Corporation... leading litterateurs of precision potentiometers...as befits the world's largest manufacturer thereof.

Accuracy of Potentiometer Linearity Measurements by Robert McDonald and Irving Hogan...reprint of a research report originally published in the August 1953 issue of *Tele-Tech & Electronic Industries*... a study revealing that calculated linearity-error values are far less reliable than previously believed. Ask for Data File No. 624A

Characteristics of Precision Servo Computer Potentiometers by Donald C. Duncan...reprint of a talk presented at the American Institute of Electrical Engineers Conference on Feedback Controls Systems. Ask for Data File No. 624B

Computing with Servo-driven Potentiometers by F. R. Bradley and R. D. McCoy...reprinted from *Tele-Tech & Electronic Industries*...an examination of linearity and loading effects in analog systems... showing how errors may be eliminated...practical circuit techniques...restriction of potentiometer range, preloading, unloading with feedback amplifiers. Ask for Data File No. 624C

Electrical Noise in Wire-wound Potentiometers by Irving J. Hogan... reprint of a talk presented at the 1952 West Coast I.R.E. Convention...classification of noise by origin, methods of observing and measuring, system of units for expression of noise values. Ask for Data File No. 624D

Helipot Condensed Catalog...describes every model of Helipot* precision potentiometer and turns-counting Duodial...includes quick-comparison table of specifications for all series. Ask for Data File No. 624E

Helipot Model Selector...this handy device enables you quickly to determine the electrical and mechanical characteristics of all Helipots...provides easy reference to frequently used electrical data. Ask for M.S. No. 624F

*T.M. REG. U.S. PAT. OFF. • 275



ADAPTED FROM THE THINKER BY RUDIN

Helipot corporation

a division of **BECKMAN INSTRUMENTS, INC.**
SOUTH PASADENA, CALIFORNIA
PLANTS AT SOUTH PASADENA & MOUNTAINSIDE, NEW JERSEY
ENGINEERING REPRESENTATIVES IN PRINCIPAL CITIES
first in precision potentiometers

CIRCLE ED-3 ON READER-SERVICE CARD FOR MORE INFORMATION

Editorial...

Electronics and Defense

Speaking on "Electronics—A Vital Part of Our Defense" at the recent Electronics Components Symposium in Washington, D. C., Brig. Gen. Preston Corderman, Chief of the Signal Corps Engineering and Technical Division made some statements which merit the attention of all electronic designers, especially those engaged in military development work. He pointed out the importance of electronics in modern military operations, and emphasized the importance of the electronic components and equipment designer to the overall military program. To us, his *most significant* remarks included the following: "... we must make individual equipment designs as simple as possible, eliminating desirable but not essential features. We have had a tendency to demand great versatility in equipment, and in many instances I know that we have not evaluated this demand sufficiently well in economic terms of cost.

"We must reverse this trend, and be prepared to accept something less versatile, less complex, and less costly. We must ask the designer to keep this objective in high priority, and condition the user to waive some of the desirable features in order to obtain economy and simplicity. We in the Army are beginning to make some small progress along these lines—we expect to make a lot more.

"Closely allied to this problem of attaining increased simplicity—or less complexity—is the urgent necessity for eliminating unnecessary production costs. We have been requesting manufacturers developing Army electronic equipment to make an engineering cost analysis of development models and to point out to us those features of the design which would involve abnormally high production costs. Similar suggestions for reduction in production costs are often developed during Industrial Preparedness studies on production items. . ."

These remarks reflect an attitude that will be welcomed by electronic design engineers . . . who incidentally, also are taxpayers.

Engineering Review ...

Color TV Picture Tube . . . An experimental 19" color TV picture tube that produces a picture almost as large as that produced by a 19" monochrome tube has been developed. Known as the "Chroma-Sync Teletron", the shadow-mask-type tube produces a picture of 185 square inches.

Over 1,300,000 individual color dots of red, green, and blue phosphors are applied directly to the curved faceplate by a photographic process in triad form. The shadow mask has a curvature similar to that of the faceplate. It is rigid and self-supporting. The mask is positioned in such a manner that electrons passing through the holes in the mask strike the correct color phosphors.

Developed by Allen B. Du Mont Laboratories, Inc., 750 Bloomfield Ave., Clifton, New Jersey, the tube features a "Mono-convergence" tri-beam electron gun that does not require extensive circuitry. By reducing the beam-to-beam spacing, the deflection angle of the tube has been increased to 60°, resulting in a shorter neck of 9-15/32". The decreased beam-to-beam spacing does not cause any degradation of focus quality. It also eliminates the need for grading the size of the holes in the shadow mask. Individual beam circuitry

is not required to make each of the electron beams converge at the holes in the shadow mask.

Only an intermediate step towards a larger tube, the "Chroma-Sync" is a development model not in production. From a design standpoint, there are no features or components that limit the size of the tube or picture that can be produced. A shadow-mask-type picture tube now in production (see *ED, March, '54, pp. 24-25*) has a screen area of 104 square inches.

Cathode Emission Tester . . . A new instrument automatically produces a calibrated plot of the emission characteristics of the cathode of a diode on a cathode-ray oscilloscope screen. Negligible heat is contributed to the diode under test since the tube is subjected to only a 10 μ sec or 100 μ sec sawtooth pulse at rates of either 5cy or 30cy.

The cathode emission tracer was developed by L. A. Marzetta of the National Bureau of Standards, Washington 25, D.C. Two parallel-connected 304TH power triodes are connected in series with the test diode. The high transconductance of this type of tube permits large changes of plate current for moderate grid swings below zero bias. The grids of the control

triodes are raised from cutoff to zero bias with a brief sawtooth signal, resulting in the sawtooth pulse through the diode. This signal is also applied to the horizontal amplifier of the cathode-ray oscilloscope, and the voltage across the tube appears on the vertical amplifier. The composition of the signals produces the desired emission characteristic.

The instrument also provides a round-dot calibration marker whose position can be manually controlled. The current and voltage signals from the test diode to the oscilloscope alternate with rectangular calibration pulses. The amplitudes of these pulses are manually controlled and together produce the round-dot marker on the screen. Two meters on the instrument panel monitor the vertical and horizontal positions of the marker and indicate the diode voltage and current at any point on the trace.

Another convenient feature of the tracer is a special network capable of linearizing a tube characteristic in which the plate current varies as the three-halves power of the plate voltage. This feature eliminates the plotting of points on 2/3-power graph paper.

Tiny Radio for Civil Defense . . . A five-ounce radio receiver, which can be worn like a hearing aid, has been developed for use in civil defense. Described as an experimental model, it is tuned to a single broadcast frequency, 1260kc, which is one of two channels to be used by radio stations in broadcasting civil defense instructions to the general public during emergency periods.

Employing a transistor and a double-based germanium diode, the receiver is capable of continuous operation for more than a month without requiring replacement of its two small batteries. Developed by W. F. Chow and J. J. Suran of the General Electric Company, Syracuse, N. Y., the unit has a hearing-aid type earphone.

Business Data Computer

More than 10 million operations per hour can be performed by the Type 702 electronic commercial data processing machine shown here. Manufactured by International Business Machines Corp., 590 Madison Avenue, New York 22, N. Y., the computer is designed to handle the complex logic of business problems which involves a wide variety of input and output data, and many exceptions to the rules for handling them.



Engineering Review . . .

Radar Signal Recording . . . Providing valuable evidence in case of airport accidents, a new device simultaneously records both the radar and air-to-ground radio signals on two-channel magnetic tape. When the tape record is played back, the original air situation is recreated for review and analysis.

A standard tape recorder is used with a bandwidth compressor that reduces the air-traffic-control radar signal from about 1Mc to less than 10kc. This reduction is accomplished without noticeable degradation of picture quality. The compressor, called "Rafax", was developed by Haller, Raymond and Brown, Inc., State College, Pa. The equipment can be used with any standard radar.

In addition, a servo system is used to generate antenna rotation rate signals and a North mark signal that indicates when the antenna passes North. These signals are mixed with the voice signal and stored on the second channel of the tape.

Computer Courses . . . Special summer programs in Advanced Coding Techniques for Digital Computers and Business Applications of Digital Computers will be given at the Massachusetts Institute of Technology during August 2-6 and 16-27, respectively.

A survey of the field of Analog Computation will also be given from August 2-13. Lectures for this introductory course will cover mathematical equations encountered in engineering analysis, differential equations, and analog equipment. Tuition will be \$180.

Participants in the coding course should have at least two years' experience in the field and should be familiar with coding for one or more digital computers. Topics will include: the ideal; realization of the ideal through machine design; realization of the ideal through preliminary programming; library of sub-routines; location of mistakes; effect of equipment on

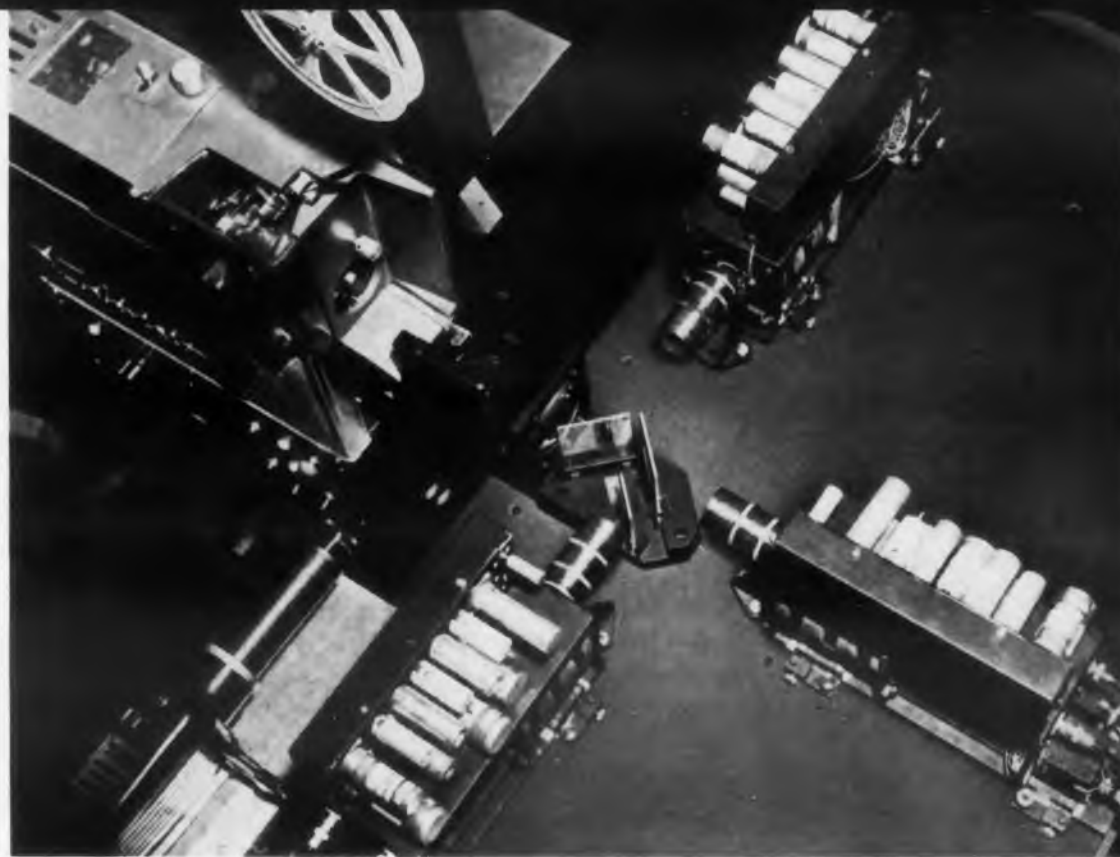

Color TV Camera

This "3-V" Camera televises color movies and slides. The color image from the projector (upper left) is focused into an optical arrangement of dichroic mirrors and a filter that splits the light into red, blue, and green portions and directs each portion to the proper "Vidicon" pickup tube. The system was developed by RCA Victor Division, Radio Corporation of America, Camden, N.J.

programming; other effects; and definition of terms. Early registration is urged. Tuition is \$100.

The latter course is designed to introduce the computer to the businessman. Tuition is \$250.

Full details and application blanks for both courses may be obtained from the Summer Session Office, Room 7-103, M.I.T., Cambridge 39, Mass. Academic credit is not offered for the courses.

Redesign for Weight-Saving . . . A weight reduction from 12-1/2 to 3-1/2 lb by redesigning an aircraft fire control computer was based on the development of ultra-low-torque potentiometers and standardized servo components.

Since the new potentiometers require 40% less torque than their predecessors, the servo drive motors and all components associated with the motors could

be reduced in size correspondingly. The new potentiometers are also smaller and lighter. They require only 0.02 in-oz torque each.

The potentiometers are produced by Electro-Mee Laboratory, Inc., 21-09 43rd Ave., Long Island City 1, N. Y. The servo components are manufactured by Servomechanisms, Inc. Post and Stewart Aves., Westbury, N. Y. (see *ED*, May, '54, pp 22 & 23). The new computer is not only lighter, but is also more reliable, performs more functions, and costs less than the older model. Both units are shown at the right.

Laboratory Directory . . . The *Directory of Commercial and College Laboratories*, previously compiled and published by the National Bureau of Standards, will be published in the future by the American Society for Testing Materials. The Directory lists the locations of testing laboratories together with types of commodities and the nature of investigations the laboratories are prepared to undertake.

The Directory is designed to aid the large number of purchasers who are not equipped to make their own acceptance tests and therefore have hesitated to buy on specification. It will also be of value to small manufacturers who are seeking testing services for raw materials and finished products. Until the revised ASTM Directory is completed, the present Directory, NBS Miscellaneous Publication M187, published in 1947, will continue to be available from the Superintendent of Documents, GPO, Washington 25, D. C.

Transistorized Fuel Gage . . . Transistors have replaced vacuum tubes in a fuel-measuring system that is 75% lighter, occupies 86% less space, and uses less than one-half as much power as systems of comparable accuracy using tubes.

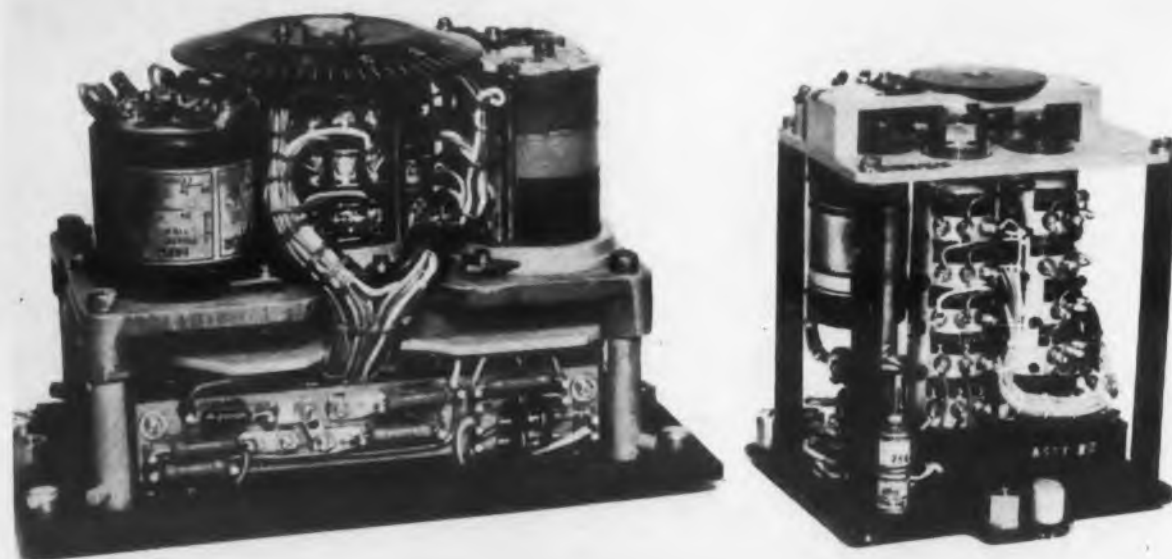

Through the use of ultra-low-torque potentiometers, the computer at the left was redesigned into the unit at the right with a 65% saving in weight.

Tests have proven that the new system, which was developed by the Aeronautical Division of Minneapolis-Honeywell Regulator Company, Minneapolis, Minn., will operate accurately over a temperature range from -67°F to $+167^{\circ}\text{F}$. It employs a power-type transistor.

Because transistors have almost unlimited life, it has been possible to hermetically seal both the indicator and the power unit in a single compact enclosure. This mounting greatly simplifies circuitry and eliminates the need for separate amplifiers, shock mounts and much of the associated wiring and inter-connection cable. Maintenance and installation are considerably simplified.

A typical two-unit transistorized system in which indicator and power unit have been combined weighs 2.28 lb. A three-unit gage system using vacuum tubes, separate shock mounts, power units, and necessary wiring would weigh more than 5-1/2 lb.

Cloud Ceiling Indicator . . . Light rays are employed to measure cloud ceilings over airport runways by a newly developed rotating-beam ceilometer now being installed at major airports. Control tower personnel, who may be located as far as ten miles from the main runway, relay the ceiling information to approaching planes. The system is illustrated below.

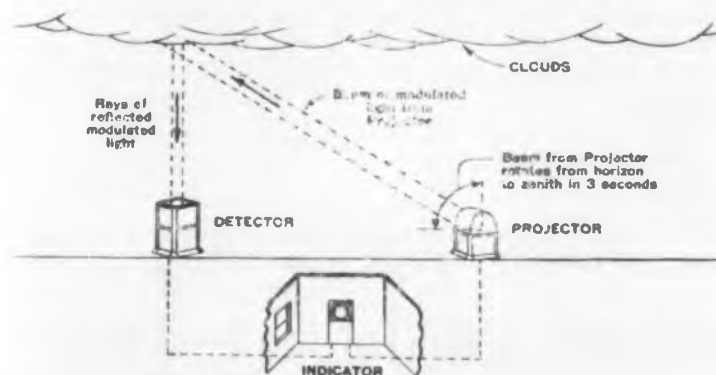

The new device, which was invented by L. W. Fosskett of the U. S. Weather Bureau and is being manufactured by Crouse-Hinds Company, 7 North Street, Syracuse, N. Y., consists of two components, a projector and receiver. By triangulation, these units are set along a fixed base line. The projector consists of a rotating beam assembly made up of two 24" parabolic mirrors that are mounted 180° apart. To enable the projector light signal to be differentiated from ordinary light, a four-paned cylindrical shutter enclosing a lamp is mounted at the focus of each mirror. The unit produces 120 light pulsations per sec.

The receiver catches these pulsations reflected off the clouds overhead in a mirror facing straight up. A photocell located at the mirror's focal point converts the pulsations into a signal sent by radio to the cloud ceiling indicator where ceiling is read in feet.

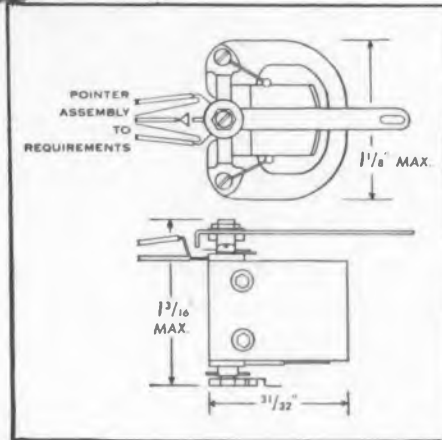
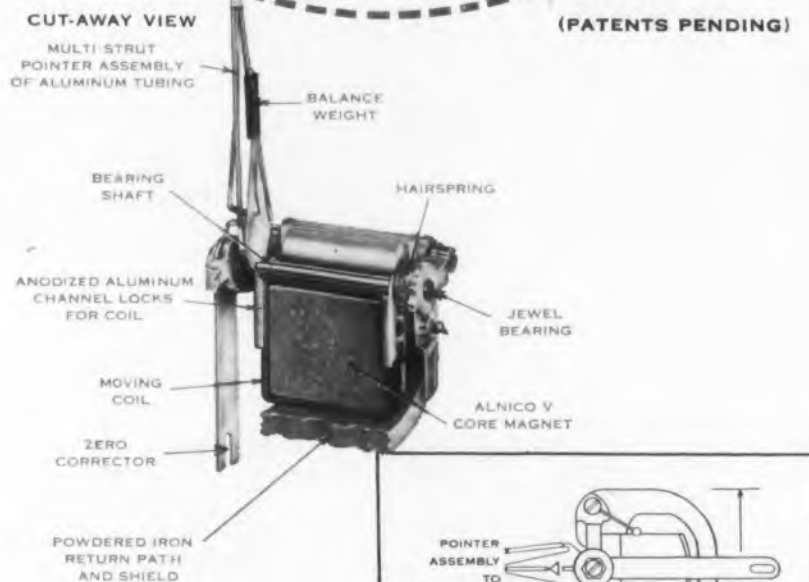
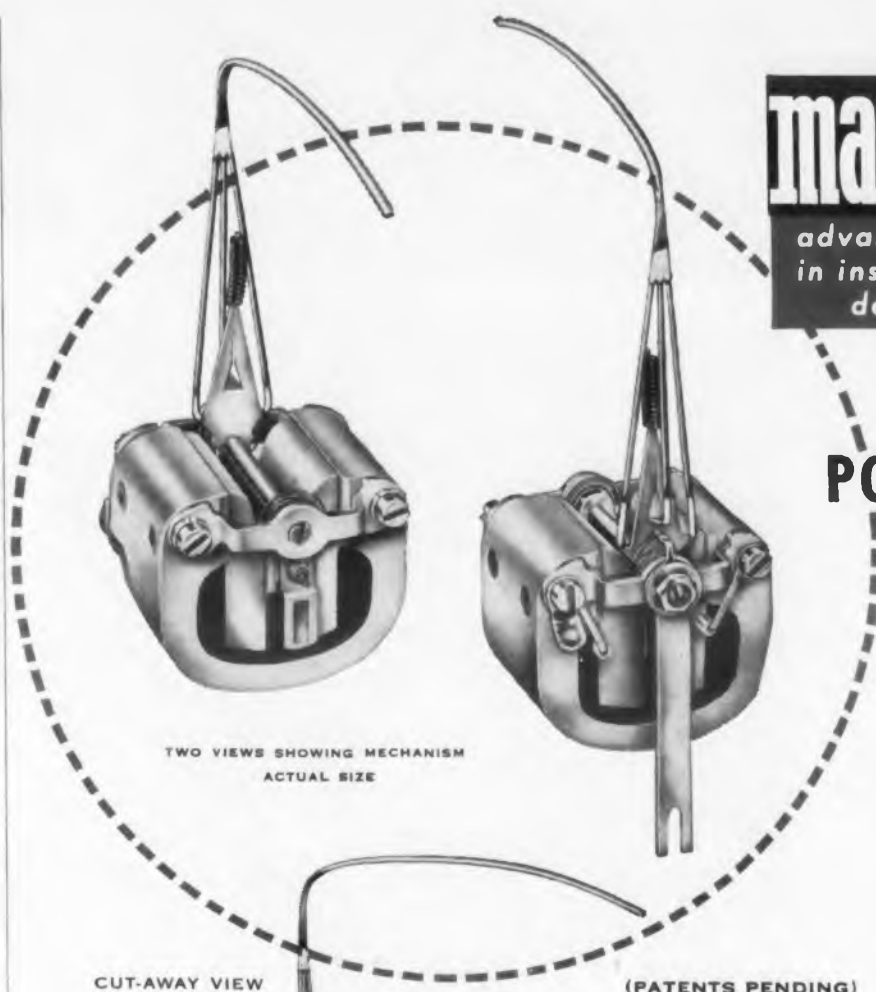

Reg. U. S. Pat. Off.



marion meters

MANUFACTURERS OF RUGGEDIZED AND "REGULAR" METERS AND RELATED PRODUCTS

Copyright 1954 Marion

POWERFUL MOVING COIL MECHANISM HAS GYRO-LIKE STABILITY

The Marion Type MEP-1 meter mechanism was designed to develop highest possible torque for a given volume of magnetic material. Its high torque, heavy eddy current damping and low relative inertia provide unusual performance characteristics simulating the stability of a gyro, in like environment. Already it is setting new and higher standards for reliability in moving coil indicating mechanism design for aircraft application, where the influence of vibration and rapid attitude changes on pointer indication are significant factors.

The gyro-like stability of the MEP-1 mechanism results from its unique mechanical design. An end-pivoted coil assembly, with a one piece bearing shaft and precise mechanical assembly operates in a self-shielded magnet structure which produces approximately 6000 Gauss in a single air gap. When the end-pivoted moving coil, of long turning radius, operates in a magnetic field of such strength, substantial gains in torque and eddy current damping are realized. This great torque, combined with relatively light weight, permits unit bearing loadings substantially lower (i. e. larger pivot and jewel radii) than heretofore normal.

MECHANISMS BY MARION

Although developed expressly for application in aircraft navigational instruments, many of the MEP-1 characteristics make it desirable for use as the sensitive element in control devices where it is required to initiate a control function. It is one of a number of Mechanisms by Marion that extend the field of moving coil mechanism application where previously size, weight or performance characteristics prevented their use.

Marion Electrical Instrument Company.
417 Canal Street, Manchester, N. H.

CIRCLE ED-4 ON READER-SERVICE CARD FOR MORE INFORMATION

Engineering Review . . .

Battle Control by TV . . . The ultimate in battle communications, enabling the commanders to "see" remote action by TV, may result from Signal Corps' tests with TV transmitting equipment mounted on tractor trailers. Supplemental equipment tested during recent maneuvers included an airborne TV system and another vehicle containing air-ground receivers and kinescopes.

This new use for "industrial" TV was disclosed at the 75th semiannual meeting of the Society of Motion Picture and Television Engineers by Captain H. C. Oppenheimer, Chief, TV Branch, Army Pictorial Service. Applications explored with mobile TV included: location, evaluation, and designation of artillery targets; data transmission; intelligence and reconnaissance; briefing tactical commanders; observation and control of amphibious landings; and harbor surveillance.

Automation Terminology . . . Standard terminology in the field of automatic controls will be developed by national groups concerned, according to the American Standards Association, 70 East 45th Street, New York 17, N. Y. The project, to be known as "Terminology for Automatic Controls" will be carried on by a committee under the auspices of the ASA.

Pollen Precipitator . . . Electrostatic precipitators have been "miniaturized" into a home appliance for removal of hayfever-causing pollen from the average-sized room. Only 30" high x 15" wide x 15" deep, the 60-pound unit, designated the "Miconaire", can remove 99% of the pollen, dust, and tobacco smoke in a room's atmosphere.

Produced by Raytheon Manufacturing Company, Waltham 54, Mass., the appliance consists of a small fan that draws the air over a set of parallel, charged, aluminum plates about 1" apart. The plates are charged to 13,000v by an electronic power supply circuit employing a 1B3 rectifier. The ionized pollen particles are repelled by the positive plates and attracted by the negative plates, to which they cling. After a few weeks, the assembly containing these plates is removed and washed in the sink, flushing away all the foreign matter.

Tests by hayfever sufferers have shown that the precipitator affords great relief. The appliance has a safety arrangement to disconnect the circuit when the cabinet is opened. It could possibly be combined with air conditioning.



DESIGNER'S

Micro-miniature Tantalytic capacitors give new design flexibility



Smallest electrolytic capacitors commercially available

Micro-miniature Tantalytic capacitors can now be supplied in ratings up to 20 volts, or, up to 8 microfarads in the $\frac{5}{16}$ " long case—higher capacitance in a $\frac{1}{2}$ " case size . . . with -0% to +100% capacitance tolerance. They give you new design flexibility in low-voltage, d-c circuits—particularly transistorized subminiature assemblies where space is at a premium.

Designed especially for nonresonant, noncritical applications such as coupling, by-pass and filtering, G-E micro-miniature Tantalytic capacitors outperform aluminum electrolytics in electrical stability, operating and shelf life because of the inert characteristics of tantalum metal. They operate over a -20C to +50C range and may be stored at -65C. With some capacitance derating, Tantalytic capacitors perform well below -20C—with some life limitations they will also perform satisfactorily above +50C.

You may obtain samples 2 to 3 weeks after your order is received at the factory. Production lots are supplied 6 to 8 weeks after the order is received. For more information see your G-E Apparatus Sales representative, or write for Bulletin GEA-6065.



G.E. builds dependability into electronic transformers—3 ways

From laboratory samples to the last production model, dependability is built into G-E electronic transformers. Here's how:

1. **INTEGRATED FACILITIES:** G-E labs, testing facilities, and materials sources are co-ordinated to help get you the transformers you want—when you want them.
2. **MECHANIZATION:** The G-E plant is mechanized and staffed to handle large-quantity production, while maintaining laboratory sample quality.
3. **EXPERIENCE:** G-E personnel have worked hand-in-hand with electronics manufacturers for years and consequently keep *your* problems in mind as they produce transformers for your particular, specialized applications. See your G-E Apparatus Sales representative for more information.

GENERAL  ELECTRIC

CIRCLE ED-5 ON READER-SERVICE CARD FOR MORE INFORMATION

ELECTRONIC DESIGN • June 1954



New electronic relays have high sensitivity

This new electronic resistance-sensitive relay is able to amplify minute currents carried by very delicate contacts. Even a wet thread will provide enough signal for it to operate.

Sensitivity level is set by adjusting dial, which can be locked in place. The relay may be remotely controlled from as far away as 500 feet. Each can be set for either "normal" (relay "drops-out") or "reverse" (relay "picks-up") operation of the magnetic relay included in the device.

Built for long life, its enclosure is weather-resistant and dust-tight. Terminals are easily accessible; all components of this G-E relay are open for ease in servicing. For further information send for Bulletin GEA-5893.

Fast, accurate circuit analysis

This self-contained, highly stable G-E self-balancing potentiometer rapidly converts small d-c voltages to measurable currents—without loading the measured circuit—for analysis of electronic circuits. It is consistently accurate because simple controls, and automatic, rapid circuit balance minimize operator errors. Easily changed resistor permits selection of input ranges from 100 microvolts to one volt d-c full scale with 5-milliampere d-c output. See Bulletin GEC-367.



Tiny signals amplified

Combining amplifying and rectifying elements in a unit, G-E amplistats (self-saturating magnetic amplifiers) "sense" small signal changes, amplify them greatly, and impart the amplified signal to a system to obtain the desired control. They give you the practical advantages of virtually instantaneous response, low power consumption, long life, and electrical signal isolation. Obtain assistance in applying G-E amplistats at your G-E Apparatus Sales Office. See Bulletin GEA-5950.



Small rectifier has high output

G-E germanium rectifiers offer the highest output in the smallest of rectifiers. For example, the dime-sized, sealed, air-cooled type is available in ratings up to 50 volts, 0.4 amperes d-c. Germanium rectifiers have these advantages: **high efficiency**—operate 98% to 99% efficient; **compactness**—small size and weight per watt output means you can build more compact assemblies; and **long life**—two-year life tests show no detectable aging. Write for Bulletin GEA-5773.



"Floated" Low-friction Gyro . . . By supporting the spin mechanism of a newly developed gyroscope in a special oily fluid, friction has been reduced to the extent that the gyro can measure less than 1/36,000 of one degree of arc of angular displacement.

This ultra-sensitive gyro was developed for use by the Air Force in automatic flight control systems for pilotless aircraft by the Aeronautical Division of Minneapolis-Honeywell Regulator Company, Minneapolis, Minn. The extremely rugged, three-pound unit has already been applied to other fields.

For the accurate speed control necessary to gyro precision, the gyro's synchronous motor is not run off the plane's 400cy system, which may vary several percent in frequency. The motor has its own a-c power supply, which is crystal-controlled to an accuracy of 1 part in a million in frequency. This crystal is periodically checked against the WWV frequency standard.

Industrial Electronic Servicing . . . Medium-sized industrial users of electronic laboratory, instrumentation, and communication equipment are being offered a new type of electronic maintenance by organizations devoted to servicing such equipment. One service company will enter into a service contract similar to those commonly available to the TV-receiver.

The Western Scientific Company, San Carlos, Calif., has an agreement with one research organization to keep each of its instruments in the condition specified by the manufacturer. Each instrument will receive a complete check-up twice each year, plus emergency servicing if required. This service is available to firms without their own service departments in the San Francisco Bay area.

Midwest firms can use the repair, maintenance, and reconditioning facilities of Chicago Electronic Laboratories, 1214 West Madison, Chicago 7, Ill. This service division will service the products of East and West Coast manufacturers of industrial TV, test equipment, etc.

Selenium Shortage . . . One producer of selenium rectifiers is meeting the present shortage of selenium by offering credits on new rectifiers to television servicemen who turn in discarded units.

Sarkes-Tarzian, Inc., Rectifier Div., 415 North College Ave., Bloomington, Ind., hopes to aid in the avoidance of the rationing of selenium by this plan. The President has approved stockpiling of the semiconductor metal for military needs in the event of a national emergency.



EQUIPMENT FOR ELECTRONIC MANUFACTURERS

Components	Fractional-hp motors	Development and Production Equipment
Meters, Instruments	Rectifiers	Soldering irons
Dynamotors	Timers	Resistance-welding control
Capacitors	Indicating lights	Current-limited high-potential tester
Transformers	Control switches	Insulation testers
Pulse-forming networks	Generators	Vacuum-tube voltmeter
Delay lines	Selsyns	Photoelectric recorders
Reactors	Relays	Demagnetizers
Motor-generator sets	Amplidynes	
Inductrols	Amplistats	
Resistors	Terminal boards	
Voltage stabilizers	Push buttons	
	Photovoltaic cells	
	Glass bushings	

General Electric Company, Apparatus Sales Division
Section C 667-28, Schenectady 5, New York

Please send me the following bulletins:
 for reference only X for planning an immediate project

- GEA-5773 Germanium Rectifiers
- GEA-5893 Electronic Resistance Sensitive Relay
- GEA-5950 Amplistats
- GEA-6065 Micro-miniature Tantalytic Capacitors
- GEC-367 Self-balancing Potentiometer

Name

Company

City State

CIRCLE ED-5 ON READER-SERVICE CARD FOR MORE INFORMATION

Really



HERMETICALLY SEALED Germanium Transistors



Vanquish vacuum tubes in computer circuits AFTER 3000 GRUELING TEST HOURS

NOT A SINGLE FAILURE! More than 200 of Radio Receptor Co.'s PNP diffused junction transistors, Type RR87, are giving tangible evidence they are really reliable. All the original units are still performing after 600,000 transistor hours in a computing machine development project now underway at one of the country's largest research centers.

Where short-lived vacuum tubes used to conk out one by one at a prohibitive rate, tiny RRco. transistors are proving their life-span far exceeds the bulky tubes in flip-flop, gates and other pulse circuits. What's more, these efficient transistors are "potted" in sub-assemblies, not removeable from the computer mechanism except as a unit. They *have* to be good!

When the RRco. trademark appears on transistors, diodes or selenium rectifiers you can always be sure they are *really reliable* . . . if you'd like guidance from our engineering group specializing in transistor circuitry, just write us now.

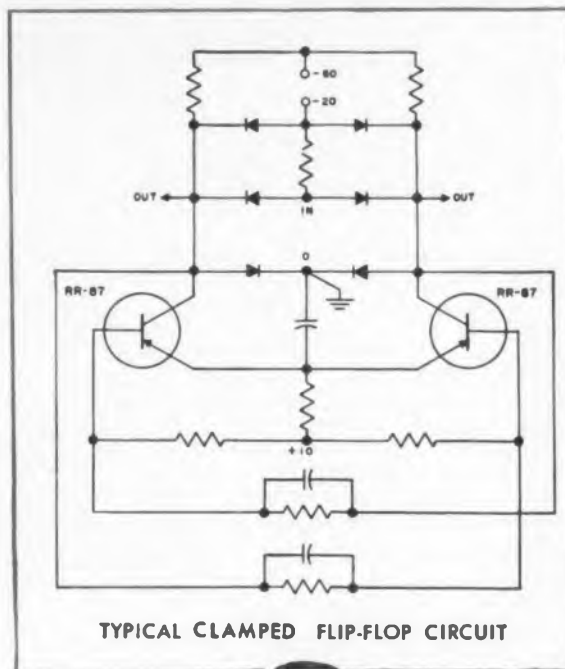

Another RRco. computer transistor recently developed is Type RR83. Ask for complete information regarding this as well as RR87.



RADIO RECEPTOR COMPANY, INC.
Seletron and Germanium Division

SALES OFFICES: 251 WEST 19th STREET, NEW YORK 11, N. Y., WATKINS 4-3633, FACTORIES IN BROOKLYN, N. Y.

CIRCLE ED-7 ON READER-SERVICE CARD FOR MORE INFORMATION

Engineering Review . . .

"Ionic" High Vacuum Pump . . . A simple, experimental air pump with no moving parts that can produce a vacuum as high as one billionth of normal atmospheric pressure has been developed. Known as the "ionic" pump, it may eventually be used in vacuum tube manufacture.

One form of the pump consists of a circular stainless steel box about two inches in diameter and an inch thick. Inside the box is a tungsten ring maintained at high potential. The metal walls of the box form the cathode. Carbon plates are mounted between the ring and the walls. The unit is supported between the poles of a powerful "Alnico" permanent magnet, as shown in the photograph.

The first step is to exhaust the vessel by standard mechanical means to 1/100,000 of an atmosphere. Then the vessel is connected to the ionic pump. When the current is turned on, a gaseous discharge occurs. The electrons are attracted to the tungsten-ring plate, but they are prevented from being collected immediately by the field of the magnet, which causes them to oscillate around the ring. During these oscillations they strike the gas atoms and ionize them.

The positively charged ions are attracted towards the pump walls, but hit the carbon plates and are driven into them, thereby evacuating the vessel.

This "ionic" experimental high-vacuum pump has no moving parts.

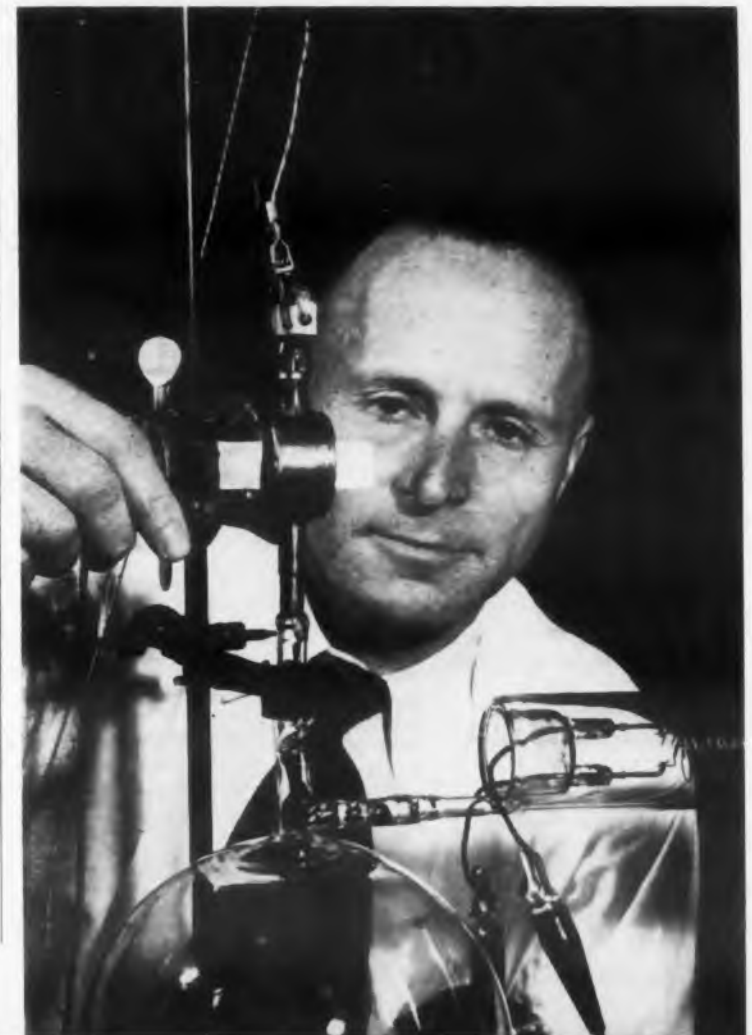

Tests show that many cubic centimeters of gas, measured at atmospheric pressure, can be absorbed by the carbon. The absorbed gases can be driven out of the carbon, and the plates reactivated by simply heating the entire pump.

The ionic pump was developed by Drs. A. M. Gurewitsch and W. F. Westendorp of the General Electric Company's Research Laboratory. They said that the pump works for practically all gases.

Color TV Test Aid . . . Color TV receivers could be checked during black-and-white broadcasts if newly developed color signal generators are approved by the FCC for installation and use by TV stations. The serviceman would not be required to wait for a color broadcast to check installations.

The generator would transmit a color test signal that would appear as a narrow vertical yellow-green bar visible at the extreme edge of color receivers, but would be practically unnoticeable on monochrome sets. The generator can be installed at low cost by stations already equipped to carry network color programs. It can also be easily installed at the time other stations modify equipment to broadcast color.

The system provides a means of smoother transition from monochrome to color TV broadcasting.

The new device, developed by the RCA Service Company, Radio Corporation of America, Camden, N. J., is a result of studies of recent proposals for continuous broadcasting of color TV signals for servicing and other purposes (see *ED*, January, 1954, p. 5). Experiments revealed that a green test signal alone gave a satisfactory servicing standard. The green test signal generator costs much less than a three-color test signal generator might cost. Satisfactory tests of the generator have already been made for the FCC.

By utilizing station breaks, the equipment could be used to provide regular color reception checks every 15 to 30 minutes without loss of sponsored programming time to the station. There are other advantages to the system: the signal is not objectionable to viewers of monochrome programs; the system will provide checks of station transmitting equipment; the plan provides for a color test signal which may well become a national test standard with which service personnel will rapidly become familiar; and the owner of a color receiver can observe the color signal to determine if his set needs service in advance of color broadcasts.

For more information on developments described in "Engineering Review", send inquiries directly to the address given in the individual item.

SIMPLIFIED ASSEMBLY

Non-Linear Systems, Inc., Del Mar, Calif., manufacturer of the Digital Voltmeter, found Formica nylon base printed circuits offer these important advantages: (1) Enables unskilled labor to assemble this complicated electronic instrument faster, easier, cheaper; with possibility of error almost negligible. (2) Reduces undesirable noise pick-up without shielding critical leads. (3) Assures exact wiring duplication. (4) Reduces cost of maintenance. (5) Establishes uniformity of performance in each Voltmeter produced.



Your electronic component will be better, smaller and less expensive when you use



printed circuits

Printed circuitry takes the "spaghetti" out of electronic components. Formica takes the experimentation out of printed circuitry. As a result of early, continuous and intensive research, Formica now offers you these "exclusives": ★ **Copper clad sheets with the base laminate engineered to fit your conditions . . . including operating temperatures up to 360° F.** ★ **Larger and more sheet sizes for greater economy.** ★ **Scientifically cleaned sheets (exclusive Formica process) for cleaner, sharper etching . . . better "solder ability."** ★ **Special Formica resists inks developed exclusively for circuit printing.** With Formica's broad experience in all phases of printed circuitry, right up to the point of circuit assembly—you can be sure your Formica copper clad sheets are as perfect and up-to-the-minute as it is scientifically possible to produce. Want to know more? Send for new booklet showing how you can make better printed circuits with Formica copper clad. The Formica Co., 4593 Spring Grove Ave., Cincinnati 32, Ohio.

CIRCUIT COST REDUCED 50%

Radio Craftmen, Inc., Chicago, needed a circuit of low moisture absorption, reliable electrical insulation, maximum capacity, hi-fi performance. Formica's new MF-41 copper clad . . . gave them all this, plus a 50% cost reduction.

NEW FORMICA GRADE BREAKS HEAT BARRIER. New FF-91 gives cleaner, sharper, better etched circuits; resists 500° F. solder up to 60 seconds . . . is not affected by operating temperatures up to 360° F. . . . has bond strength of 7 pounds . . . offers super insulation resistance . . . will not support fungi growth.

The Formica Co.
4624 Spring Grove Ave.
Cincinnati 32, Ohio

Gentlemen: Please send me at once and without obligation latest bulletin on Formica copper clad.

NAME _____
COMPANY _____
ADDRESS _____
CITY _____ ZONE _____ STATE _____

CIRCLE ED-8 ON READER-SERVICE CARD FOR MORE INFORMATION

TV Technician Training . . . To meet the growing shortage of TV technicians, the Radio-Electronics-Television Manufacturers Association, 777 14th St., N. W., Washington 5, D. C., is trying to stimulate the establishment of training courses to improve the proficiency of practicing technicians. At a later date, RETMA plans to prepare courses for other levels of radio and TV service training.

To accomplish its goal, RETMA is distributing a 17-page brochure outlining a recommended curriculum and the required equipment. The curriculum was prepared with the cooperation of the New York Trade School. To provide a uniform level of instructor competence, RETMA will sponsor a two-week teacher training course during July at the N. Y. Trade School. The Association hopes that the training courses will be promoted within communities by cooperation among TV distributors, servicemen and the community's schools.

Making Transistors

The elements of germanium transistors and diodes are positioned with an accuracy to 10^{-4} inches by means of this "scope" to insure uniform quality and precision. This production tool is used by Tung-Sol Electric, Inc., 95 Eighth Ave., Newark 4, N. J.



FROM 60,000 FT.



SERIES "E-Z 16" EASY RELEASE

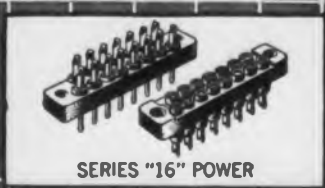

SERIES "16" POWER

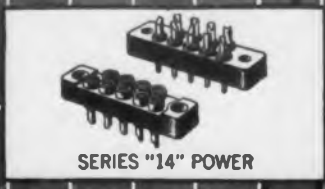

SERIES "14" POWER



SERIES "20" MINIATURE



SERIES "SM-20" SUBMINIATURE



SERIES "P-C" PRINTED CIRCUIT



SERIES "H-20" HERMETIC SEAL



SERIES "C-20" HEXAGONAL

BREAKDOWN VOLTAGE—VOLTS RMS

TO SEA LEVEL

new...
precision
**Continental
Connectors***

simplify your connector problems

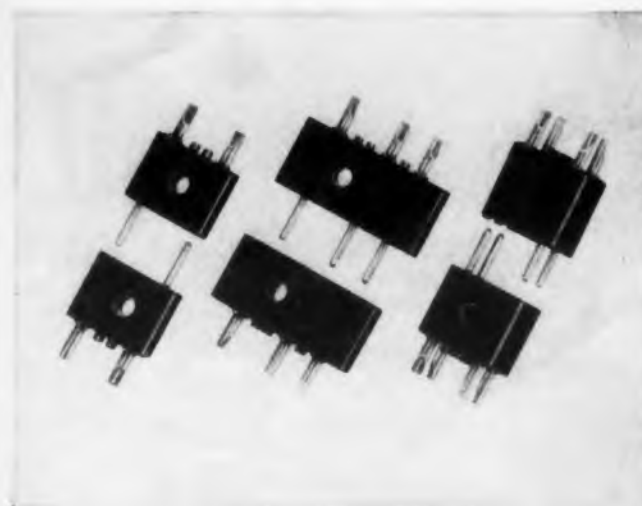

ACTUAL SIZE

Rectangular Series "G-20"
Subminiature Connectors

These unique reverse pin and socket connectors are miniaturized for use in small area applications. The molding is provided with a hole for convenient, space-saving side mounting. Precision machined sockets and pin contacts are gold plated over silver for low contact resistance. The "G-20" series is available with two, three or four contacts in Melamine, Plaskon-Alkyd, or Diallyl Phthalate molding compounds.

For complete, illustrated engineering literature, write Dept. EDG5, DeJUR-Amsco Corp., 45-01 Northern Blvd., Long Island City 1, N. Y.

Electronic Sales Division **DeJUR**

45-01 Northern Blvd., Long Island City 1, N. Y.

*WORLD'S LARGEST MANUFACTURERS OF MINIATURE PRECISION CONNECTORS

CIRCLE ED-9 ON READER-SERVICE CARD FOR MORE INFORMATION

Meetings

June 16-18: High Vacuum Symposium. Sponsored by Committee on Vacuum Techniques. Berkeley Carteret Hotel, Asbury Park, N. J. For information write to P. O. Box 1282, Boston, Mass.

June 21-25: AIEE Summer and Pacific General Meeting. Los Angeles, Calif. Contact AIEE, 33 West 39 Street, New York 18, N. Y.

June 21-July 2: Seminar on Analog Computers. Conducted by the Dept. of Electrical Engineering, Pennsylvania State Univ., in cooperation with various industrial organizations. State College, Pa. For information, write to Engineering Seminar Registration, General Extension Bldg., Pennsylvania State Univ., State College.

June 23-25: IRE Symposium on Global Communications. Statler Hotel, Washington, D. C. For information, write to Emerick Toth, 7438 Baltimore Ave., Takoma Park 12, Md.

June 23-26: Acoustical Society of America, 25th Anniversary Meeting. Hotel Statler, New York, N. Y. For information contact W. Waterfall, 57 East 55 Street, New York 22, N. Y.

August 25-27: 1954 Western Electronic Show and Convention, Pan-Pacific Auditorium and Ambassador Hotel, Los Angeles. For information, write to WESCON, 344 North La Brea Ave., Los Angeles 36, Calif.

September, 1954: International Scientific Radio Union. Amsterdam, The Netherlands.

September 1-16: Golden Jubilee Meeting of the International Electrotechnical Commission, University of Pennsylvania, Philadelphia, Pa.

September 13-24: First International Instrument Congress and Exposition, Commercial Museum and Convention Hall, Philadelphia, Pa.

September 15-17: Symposium on Information Theory, Massachusetts Institute of Technology, Cambridge 39, Mass. Sponsored by the Professional Group on Information Theory, IRE, and others. For information, write to Dr. R. M. Fano, Research Laboratory of Electronics, M.I.T.

September 16-18: Joint Electron Tube Engineering Council, General Conference, Chalfonte-Haddon Hall, Atlantic City, N. J.

October 4-6: National Electronics Conference, Hotel Sherman, Chicago, Ill.

October 13-17: 1954 Annual Convention, Audio Engineering Society, Hotel New Yorker, New York, N. Y. For information, write to C. J. LeBel, P. O. Box 12, New York 11, N. Y.

October 18-20: Radio Fall Meeting, Hotel Syracuse, Syracuse, N. Y.

November 10-11: Conference on Electronic Instrumentation and Nucleonics in Medicine, Morrison Hotel, Chicago, Ill.

Hughes Fusion-Sealed Germanium Diodes

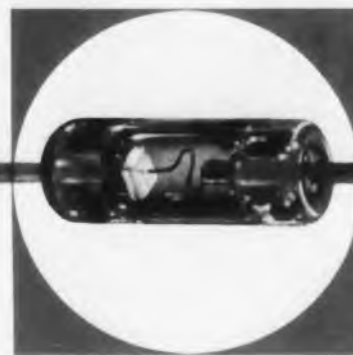

ACTUAL DIMENSIONS
DIODE BODY:
0.265 by 0.130 inches (maximum)
SHUNT CAPACITANCE:
0.5 μ f (maximum)
AMBIENT OPERATING
TEMPERATURE RANGE:
-78°C to +90°C

Hughes Point-Contact Germanium Diodes are fusion-sealed in a one-piece, gas-tight glass envelope . . . impervious to moisture, fumes or other external contaminating agents. The flexible dumet leads are especially suitable for spot-welding; or they can be iron- or dip-soldered as close as $\frac{1}{4}$ inch to the diode body—without special precautions.

The germanium crystal is permanently bonded to one lead, the cat whisker is welded to the other, and the point of the cat whisker is welded to the crystal. Hughes diodes are highly resistant to shock and vibration. Positive mechanical stability is achieved without risking contamination from fluxes, waxes or impregnants. And—each diode is thoroughly tested to ensure the stability of

its electrical and physical characteristics. All this means: sturdy, highly reliable diodes.

TYPES—The Hughes line of diodes comprises standard RETMA, JAN, and many special types. Special types are produced according to customer specifications and are tested at high or low temperatures . . . for specific recovery time . . . for matching in pairs or quads.

ELECTRICAL SPECIFICATIONS AT 25°C unless otherwise indicated

DESCRIPTION	RETMA or Hughes Type	Clip-In Hughes Type	Peak Inverse Voltage† (volts)	Absolute Maximum Inverse Working Voltage (volts)	Minimum Forward Current @ +1V (mA)	Maximum Inverse Current		Other Characteristics
						@ -50V (mA)	Other (mA)	
HIGH PEAK	1N55B	HD 2052	190	150	5.0		0.500 @ 150V	
	1N68A	HD 2053	150	100	3.0		0.625 @ 100V	
1 MEG TYPES	1N67A	HD 2054	100	80	4.0	0.050	0.005 @ 5V	
	1N99	HD 2055	100	80	10.0	0.050	0.005 @ 5V	
	1N100	HD 2056	100	80	20.0	0.050	0.005 @ 5V	
500K TYPES	1N89	HD 2057	100	80	3.5	0.100	0.008 @ 5V	
	1N97	HD 2058	100	80	10.0	0.100	0.008 @ 5V	
	1N98	HD 2059	100	80	20.0	0.100	0.008 @ 5V	
	1N116	HD 2060	75	60	5.0	0.100		
	1N117	HD 2061	75	60	10.0	0.100		
1N118	HD 2062	75	60	20.0	0.100			
GENERAL PURPOSE	1N90	HD 2063	75	60	5.0	0.500		
	1N95	HD 2064	75	60	10.0	0.500		
	1N96	HD 2065	75	60	20.0	0.500		
JAN TYPES	1N126*		75	60	5.0	0.850	0.050 @ 10V	Non-JAN equivalent, HD2070; clip-in, HD2066
	1N127**		125	100	3.0	0.300	0.025 @ 10V	Non-JAN equivalent, HD2071; clip-in, HD2067
	1N128***		50	40	3.0		0.010 @ 10V	Non-JAN equivalent, HD2072; clip-in, HD2068
COMPUTER TYPES	1N191	HD 2077		§	5.0	400K Ω min. between -10 and -50V @ 55°C§		Back resistance recovers to 50K Ω and 400K Ω (200K Ω for 1N192) in 0.5 μ sec and 3.5 μ sec max., respectively.‡
	1N192	HD 2078		§	5.0	200K Ω min. between -10 and -50V @ 55°C§		
	HD2013				50 @ 1V & 1 @ 0.35V	0.120 @ -3V		0.2 μ sec recovery time.°
	HD2014				50 @ 1V & 1 @ 0.35V	0.60 @ -6V		0.2 μ sec recovery time.°
UHF	HD2016A				UHF MIXER DIODE			
MISCELLANEOUS	HD2051		125	100	4.0	0.050		1N63 equivalent.

†That voltage at which dynamic resistance is zero when back voltage rises linearly at 90°/sec.

‡Back Recovery Time is measured with a forward pulse of 30mA, followed by a reverse pulse of 35 volts. Loop resistance of test circuit 2500 Ω max.

°Recovery time is that point at which the diode voltage reaches -1V after the initiation of a 6V back pulse through 20K Ω from an initial 3 mA forward bias. Total shunt capacitance is 20 μ f.

§Tested at 55°C. Test voltage is a continuous 60 cps sine wave. Peak Reverse Voltage across the diode is 70V. Peak Forward Voltage not less than +2V or Peak Forward Current not less than 20 mA, whichever occurs first.

*Formerly 1N69A.

**Formerly 1N70A.

***Formerly 1N81A.

Descriptive Bulletin SP2A is available on request.

Hughes

SEMICONDUCTOR SALES DEPARTMENT

Aircraft Company, Culver City, Calif.



New York Chicago

CIRCLE ED-10 ON READER-SERVICE CARD FOR MORE INFORMATION

Evaluating Tube-Clamping Shields

Leroy Woods, Director of Research

International Electronic Research Corporation, Burbank, Calif.

TUBE-CLAMPING shields for subminiature tubes must meet the unusually severe vibration and heat conditions encountered in subminiaturized equipment. This article discusses the problems involved in selecting a tube clamp and describes a new tube clamp and a specially developed method for determining the temperature of the tube envelope.

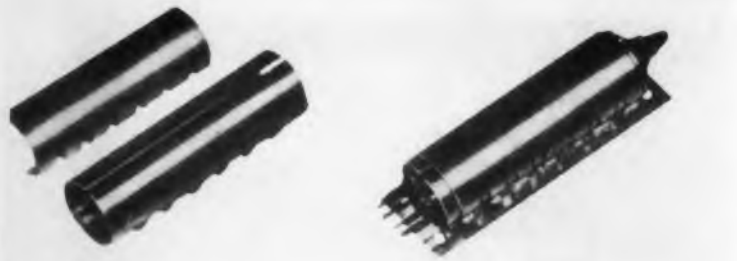

Fig. 1. A round-socket tube shield with its pure silver liner. A flat base has been added to the shield at the right. A standard spring holds these shields in place.

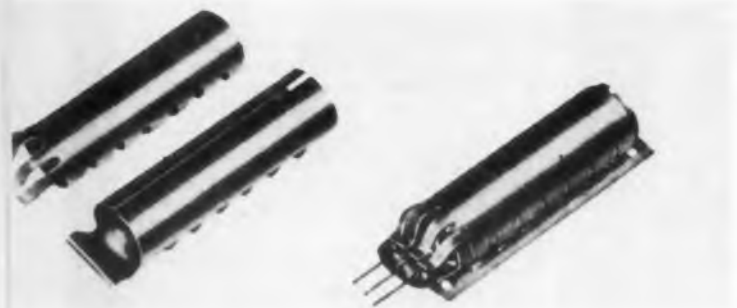

Fig. 2. A flat-socket tube shield and silver liner. The same shield plus a flat base at the right.

The primary source of cooling for subminiature tubes must depend upon conduction of the heat generated within the tube from the glass envelope to an adequate heat sink by means of an efficient tube clamping shield. Cooling of the tube by radiation or convection is very difficult in present equipment. Since glass is a poorer heat conductor than most metals, local hot spots develop in any part of the tube envelope that is not contacted by a heat-dissipating shield. These hot spots create local stresses and strains

in the glass envelope that can result in premature envelope failure.

In the past, accurate measuring of the bulb temperature of subminiature tubes has been done by two methods. First, fitting a tight copper ring around the tube and measuring the ring's temperature. Secondly, cementing a small wire thermocouple directly to the glass envelope and measuring the temperature at that point on the envelope. Either method has serious drawbacks when used to determine the cooling efficiency of heat dissipating tube shields. The first, due to its bulk; the second, due to the large temperature gradients that exist throughout the tube envelope and the change of the tube-to-shield-heat-transfer conditions resulting from the insertion of the thermocouple.

A third, superior method involves cutting a narrow slot lengthwise along the tube to a depth of approximately one-third the wall thickness of the glass envelope. A fine wire (No. 40 AWG) thermocouple or thermocouples are then cemented into this slot and the original contour of the tube is restored with a glass-like cement. Due to the more intimate contact with the glass envelope, the temperatures thus recorded run 25 to 30% higher than with the second method.

Using this new method, accurate comparisons between the heat conducting properties of shields can be determined. Hot spots due to lack of contact or other reasons can also be found. With this method, the actual temperature gradients that exist between the glass envelope and the shield can be accurately determined. These temperature gradients have been found to vary greatly with shield design, tube-to-shield spacing, pressure of the shield on the tube, and the amount of heat being dissipated by the tube. Contrary to some popular opinions, these temperature gradients cannot be determined by shield temperature measurements alone, and it has been found that by this method, shield temperatures do not give an accurate indication of envelope temperature.

The following tests, using the new method, were run in order to evaluate commercially available tube shields. The shields were soldered to a thick copper plate whose temperature was held at 21°C. A thermo-

couple was embedded in the wall of the envelope in the area opposite the plate of a 5703WA tube. On the tube used, this area was higher than the surrounding area and made the best possible contact with the tube shield, if the thermocouple had been embedded in a low spot, the temperature gradients would have been much higher. The results of these tests are shown in Fig. 4.

Available Materials

There is no presently available satisfactory spring-type material that is a good heat conductor. Use of the spring material to carry heat is an inefficient method, since the highest heat conductivity spring metal—a silver alloy containing 99-1/2% silver—is only 70% as efficient as copper. Beryllium copper, which is one of the few acceptable spring metals under severe vibratory conditions, is less than 20% as efficient as copper. Other spring alloys are even less efficient. Use of a poor heat conductor for tube shields results in large temperature gradients throughout the shield which, in turn, causes even higher gradients on the tube envelope. Where weight or size is a consideration—which is always the case in subminiature equipment—an inefficient heat-dissipating approach to obtain the necessary vibratory performance results in a large, heavy shield.

A series of shields for both round-button and flat-pressed subminiature tubes has been developed to overcome the deficiencies of the above shields. Pure silver is used as the shield, which may be fastened to the chassis by silver brazing, soft soldering, or riveting. Soft soldering, normally the only means of bonding other commercial shields to the chassis, has not proven to be mechanically adequate for most military applications. Two of these shields are shown in Figs. 1 and 2.

Fig. 3. Graph of temperature gradients between the envelope of a 5703 WA tube and its silver shield held at 21°C for the various listed shield conditions.

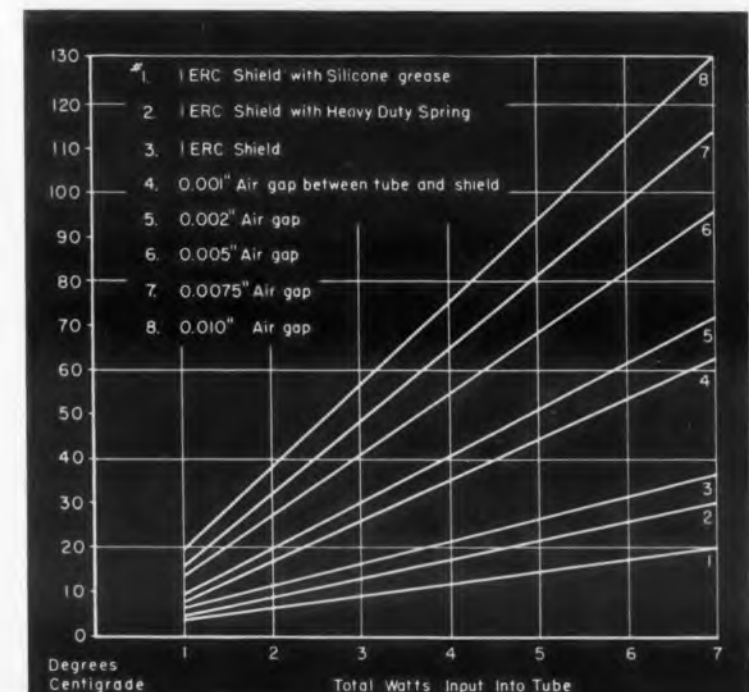

For maximum heat transfer to the heat sink, all shield manufacturers recommend bonding their shields to the heat sink. The pure silver used in the new series of shields is approximately 10% more efficient than pure copper when used as a heat conductor. An outer spring around the outer silver shield is used to clamp it firmly against the tube. Use of a spring to hold a tube to the chassis results in definite vibratory resonant conditions and their very harmful effects, and has been abandoned in this new approach. In this design, the tube is clamped firmly to the chassis with a dead metal which exhibits very high damping to any applied vibrations. The sole function of the spring is to hold this metal against the tube. The spring can in no way exhibit a vibratory resonant condition. Being soft, the shield tends to conform to any irregularities of the surface of the existing tube. The temperature rise of this shield with the 5703W.1 previously used is shown in Fig. 4D. Where absolute maximum heat transfer conditions are desired, the designers have gone one step further and provided a very soft, embossed silver inner-lining between the tube and the shield. This inner-lining makes an even more intimate contact with the tube. The need for this intimate contact is shown in Fig. 3. The effect of even small air gaps on the temperature gradients existing between tube and shield is great. Where the use of silicone grease to fill minor air gaps can be tolerated, it is very effective in lowering temperature gradients from tube to shield.

Easy Tube Installation

The problem of the tube moving lengthwise in the shield under vibratory conditions with the present commercially available shields has resulted in broken or shorted leads and associated circuit failure. Due to the fact that high spots, imperfections, etc. on the tube surface tend to inbed themselves into the soft silver, it is felt that the pure silver shield will definitely prevent this occurrence.

The difficulty of installing tubes into the present tube shields is well known throughout the industry. Many tube failures have resulted from the snapping or forcing of tubes into the present shields. Quite often these failures do not show up until the equipment is in the field and they are then attributed to other causes.

Upon insertion of the tube into the pure silver shield, no force is necessary. The spring, when placed upon the shield to lock the tube in place, presses only upon metal that is far more durable than the thin walls of a glass tube. To remove a tube from the presently available tube shields after installation within the confined spaces of present equipment is an almost impossible task without destroying the tube. The removal of the tube from the pure silver shield, even in the most confined space, is relatively simple, and in no way harms the tube. The shield can be opened by removing the spring and spreading the soft silver away from the tube.

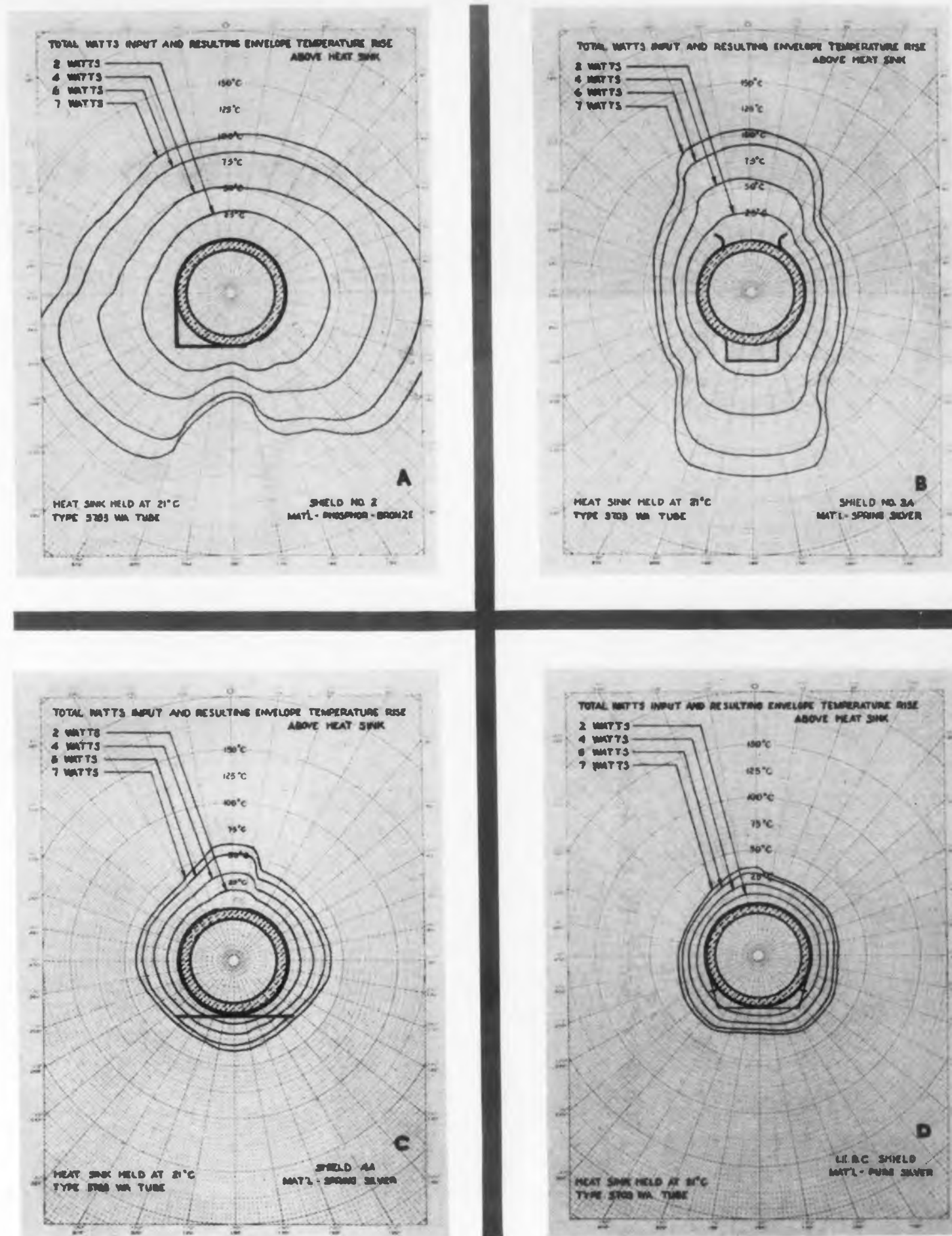

Fig. 4. The shapes of the various shields in these graphs are indicated by the heavy lines about the tubes. Since phosphor bronze is a poorer conductor, the gradients in A are large. Where the shield does not contact the envelope (B and C), gradients are high since air does not conduct much heat away.



Fig. 1. The complete Type HA-1 Traveling-Wave Tube Amplifier (above) with the capsule containing the traveling-wave tube.

Traveling-Wave Tube Amplifier

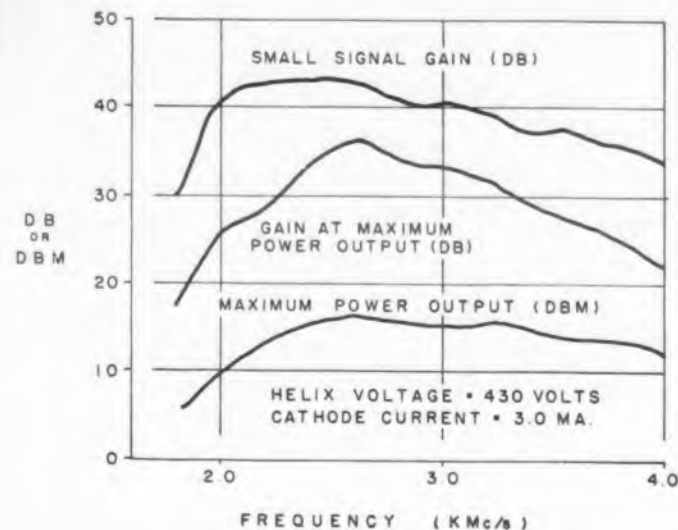

Fig. 3. Typical characteristics of the Amplifier at fixed values of voltage and current.

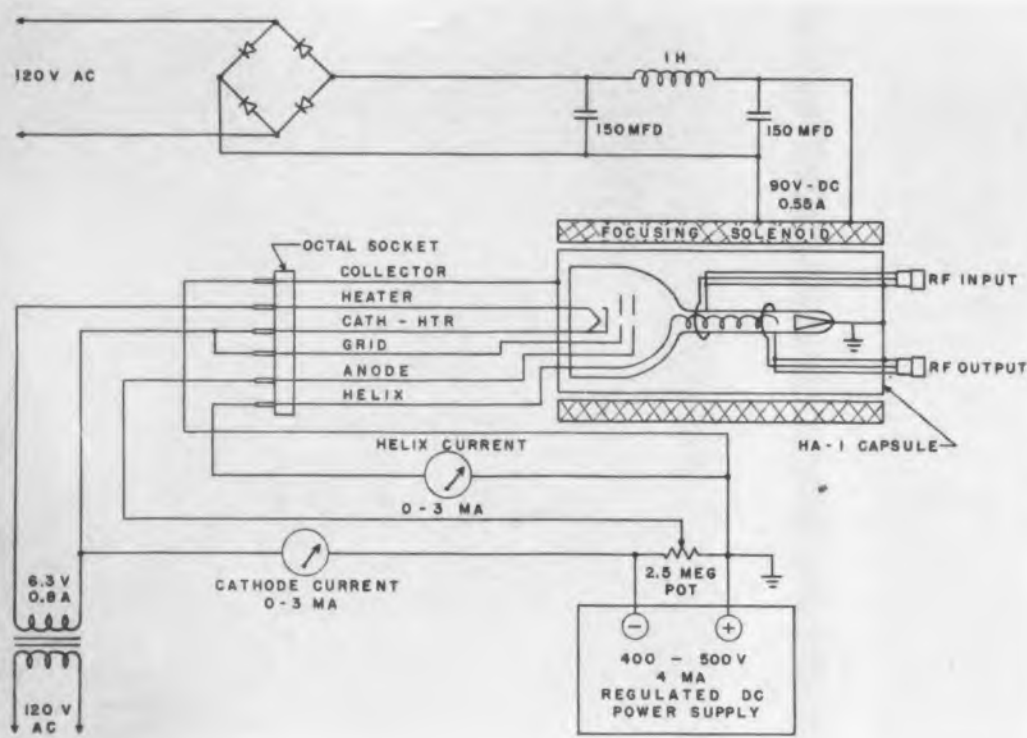
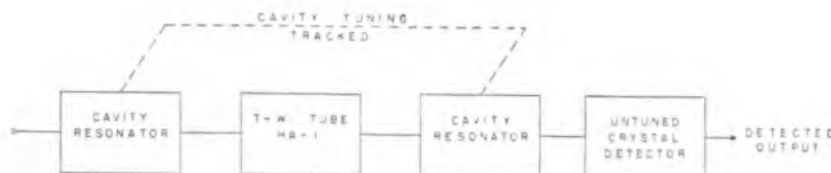

Fig. 2. Circuit diagram of the Amplifier and its power supplies.

Fig. 4. Block diagram of a simple untuned receiver using the Amplifier.



Fig. 5. Block diagram of a simple tuned receiver for the 2 to 4Mc range.



BROADBAND amplification between 2 and 4Mc is provided by the Type HA-1 traveling-wave tube amplifier shown in Fig. 1. The tube is useful where wideband and high gain are required at low level, such as in r-f preamplifiers, untuned r-f receivers, and microwave measurement techniques. Its phase or amplitude modulation ability as well as its wideband pulse amplification meet many special requirements in the S band.

The traveling-wave tube is mounted within a metal capsule and all internal adjustments within the capsule are made at the factory. In this form the tube can stand considerable mechanical shock and vibration without damage. The amplifier is a product of Huggins Laboratories, 700 Hamilton Avenue, Menlo Park, Calif. A circuit diagram of the tube and its power supplies is given in Fig. 2.

Better than 35db amplification, a noise figure less than 20db, and a power output greater than +10dbm anywhere within its range are outstanding characteristics of the amplifier. It requires no mechanical or electrical tuning adjustments as a function of frequency to produce these characteristics. Typical performance data of the Type HA-1 tube are shown in Figs. 3 and 6. The tube does not oscillate with open or short circuits simultaneously applied to both input and output with arbitrary adjustments of their phase.

The tube can be used as an important element in simple microwave receivers. For example, it can be used in conjunction with a broadband crystal detector as shown in the block diagram in Fig. 4, to provide a simple untuned receiver which covers the 2.0 to 4.0Mc range with a sensitivity (displayed signal amplitude equal to noise amplitude) between -70 and -75dbm.

If moderate selectivity is required, a simple tuned receiver, as shown in Fig. 5, which involves the use of tunable cavity resonators preceding and following the tube, can be constructed. In this fashion, greater sensitivity than that of the untuned type is gained.

The tube can be used as a pulse modulator to obtain r-f pulses with an extremely rapid rise time.

This is accomplished by applying the desired pulse to a low capacitance, zero current grid electrode while feeding a cw signal of the desired frequency into the r-f input. This electrode controls the cathode current, which in turn controls the amount of amplification of the tube. If the cathode current is cut to zero, the signal level at the output of the tube will be greater than 60db below the signal level obtained with a cathode current of 3.0ma. If the control electrode is driven from a 50 ohm source impedance, the tube is capable of generating r-f pulses with a rise time of less than 10 millimicrosec.

Putting the tube in operation requires only simple preliminary adjustments. The helix voltage is set to the specified value, the anode voltage is set to give 3.0ma cathode current, and the tube is positioned in the magnetic field to give a minimum helix current. After these simple operations, the tube will provide the characteristics shown in Fig. 3 without further adjustment of the amplifier.

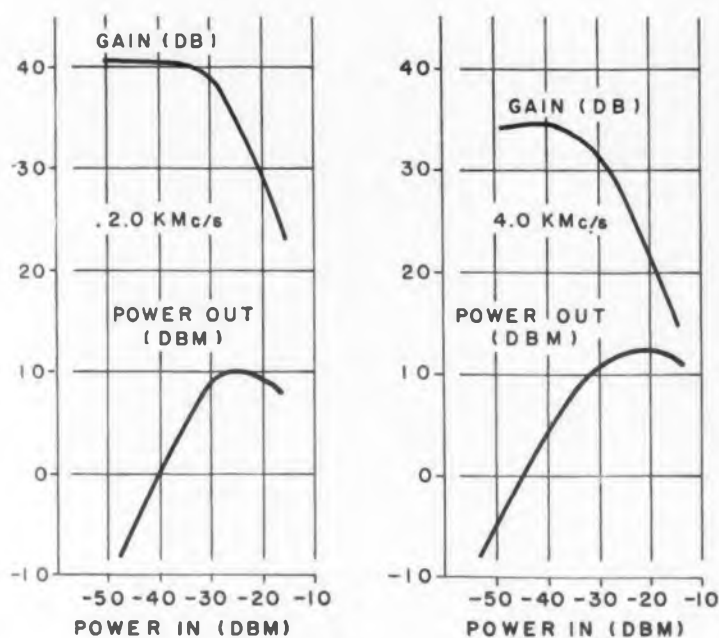

Fig. 6. Power output and gain as a function of driving power at 2 and 4Mc.

All d-c connections to the tube are provided at the end of a flexible cable with a standard octal plug. Radio frequency input and output is accomplished with flexible 50 ohm coaxial cables that terminate in improved BNC cable connectors. The VSWR measured in the input and output lines is less than 1.7:1 over the band. The matching structures within the tube capsule provide a d-c return path which facilitates the operation of the tube directly into untuned crystal detectors.

The power supply requirements of the tube are quite simple. A power source of 450 to 500v d-c at 4.0ma (adjustable and regulated) and 6.3v at 0.8amp a-c are needed for the tube. The focusing solenoid magnet requires 90v at 0.5amp with less than 1% ripple and develops 300 gauss.



FLASH!
NEW CTS-RATED 12CU6-25CU6
... with all the 6CU6's
features ... at no extra cost
... now available for
series-string operation.
Combined data sheet for
6CU6, 12CU6, and 25CU6
free on request.

GET LONGER . . . TROUBLE-FREE LIFE
AT NO EXTRA COST WITH CBS-HYTRON

CTS-RATED* **6CU6**

Why the CTS-Rated* 6CU6? The 6CU6 horizontal amplifier is rated the same as the 6BQ6GT . . . is electrically interchangeable with it. *But . . .* because the 6CU6 is rated for continuous television service, it will live under 6BQ6GT maximum ratings.

The 6BQ6GT is a good tube. (Heck, CBS-Hytron originated it.) But, it was designed for 10- and 12-inch TV sets. Today it carries the load in 21-inch sets. Furthermore, it must combat the accumulated dissipation caused by: 1. Line-voltage variations. 2. Faulty receiver adjustments. 3. Shifting values of components due to age

and overload. Result: The 6BQ6GT is often operated above maximum ratings.

Obviously, a brand-new design . . . not just an improved 6BQ6GT . . . was needed. The husky CBS-Hytron 6CU6 (See Mechanical Features) is the answer: a premium-performance tube *at no extra cost*. CTS-Rated, it offers generous safety margins for plate dissipation . . . high-voltage insulation . . . and high-line protection. Note also the bar graph showing much larger plate and envelope areas of CBS-Hytron 6CU6.

In the 6CU6 . . . another CBS-Hytron first . . . high voltage and heat meet their match. You forget run-away plate current, high-voltage arc-overs, and shrinking TV pictures. You gain by longer life . . . minimized service . . . happier customers. Try the CBS-Hytron 6CU6 today.

MECHANICAL FEATURES OF 6CU6

1. Heavier-gauge plate with large radiating fins.
2. Vents in beam plates and plate aligned for maximum radiation of heat from grids.
3. Anti-arc rings for uniform distribution of electrostatic field.
4. Anti-arc mica eyelets.
5. T-12 transmitting-type bulb.
6. Plate connection "hard-soldered" and positioned to reduce heat conduction and arcing.

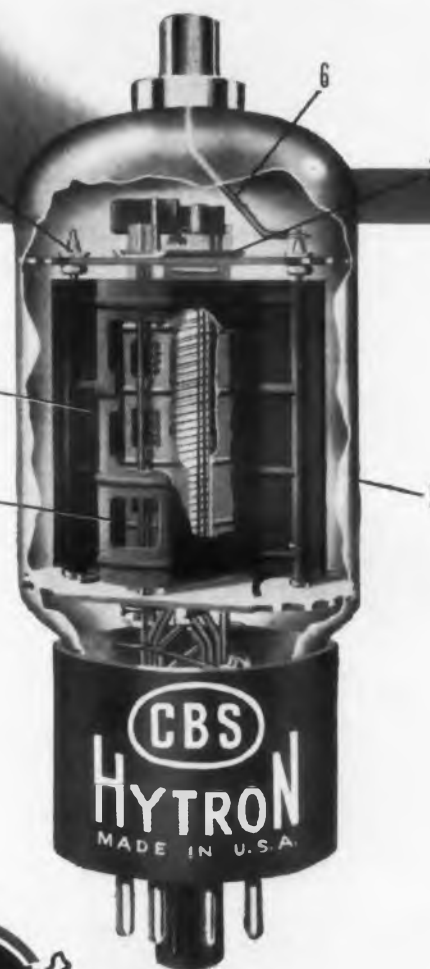

*Rated for Continuous Television Service

6CU6 OFFERS GREATER DISSIPATION RESERVES

6BQ6GT

6CU6

WITH 48.5% MORE BULB AREA

6BQ6GT

6CU6

WITH 31.5% MORE PLATE AREA

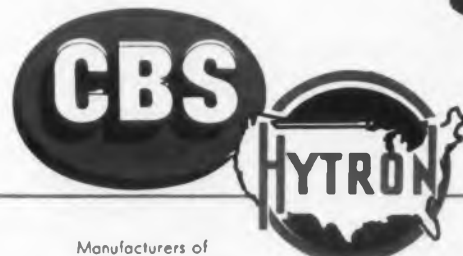

Manufacturers of Receiving Tubes Since 1921

CBS-HYTRON Main Office: Danvers, Massachusetts

A Division of Columbia Broadcasting System, Inc.

A MEMBER OF THE CBS FAMILY: CBS Radio • CBS Television • Columbia Records, Inc. CBS Laboratories • CBS-Columbia • CBS International • and CBS-Hytron

RECEIVING • TRANSMITTING • SPECIAL-PURPOSE • TV PICTURE TUBES • CRYSTAL DIODES AND TRANSISTORS

CIRCLE ED-11 ON READER-SERVICE CARD FOR MORE INFORMATION



New!

H H B SERIES EC

Printed Circuit CONNECTORS



H H B NO. 3370 CARD RECEPTACLE

Fifteen beryllium copper pressure contacts with solder tabs protruding from either the bottom, right or left side, or combinations. Polarizing key positions to suit requirements. Material: No. 3700 green mineral filled phenolic. Plating: gold on silver. [Also available in other materials and platings.] Overall 3 5/16-in. x 3/8-in. wide x 5/8-in. high.

H H B NO. 3371 CARD RECEPTACLE

Fifteen beryllium copper pressure contacts equipped with terminal pins at bottom only for quick solder dip assembly. Polarizing key positions to suit requirements. Material: No. 3700 green mineral filled phenolic. Plating: gold on silver. [Also available in other materials and platings]. Overall 3 5/16-in. x 3/8-in. wide by 5/8-in. high.



H H B NO. 3366 TERMINAL STRIP

—for periphery assembly of printed or etched cards. Fifteen terminal pins of phosphor bronze provided in lengths to accommodate 1/16-in. thick cards. Also available for 1/8-in., and 1/4-in. card thickness. Fast assembly by dip method of solder points. Material: No. 3700 green mineral filled phenolic. Plating: gold on silver. [Also available in other materials and plating.] Overall 2 21/64-in. x 5/16-in. wide x 5/16-in. high.

H H B NO. 3367 CONTACT STRIP

Same materials, dimensions, etc., as No. 3366 Terminal Strip. Pin contacts on one side mate with connector strip H H B 3372.

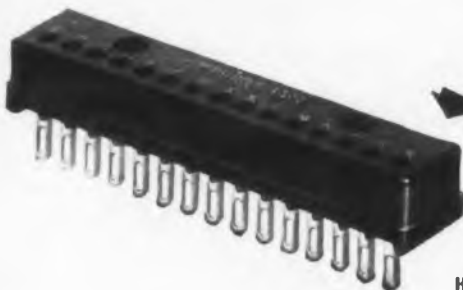

H H B NO. 3372 CONNECTOR STRIP

A female mating strip for male connectors H H B No. 3367, and No. 3369. Fifteen pressure type sockets of beryllium copper. Solder tabs for No. 20 wire. Two holes for permanent base mounting. Material: No. 3700 green mineral filled phenolic. Plating: gold on silver. [Also available in other materials and plating]. Overall 2 1/2-in. x 17/32-in. wide x 7/16-in. high.

H H B 3368 Terminal Strip and H H B 3369 Terminal Connector Strip available for stack assembly of printed or etched cards. Similar to H H B 3366 and H H B 3367 with straight through terminal pins.

Write for 8-page catalog bulletin.

H. H. BUGGIE, Inc.
726 Stanton Street
Toledo 4, Ohio

Sales Engineers in All Principal Cities

CIRCLE ED-12 ON READER-SERVICE CARD FOR MORE INFORMATION

Skilled in Electronic Component Parts
RESEARCH • DESIGN
ENGINEERING
MANUFACTURING

Meter-Type Sensitive Relay

ELIMINATION of a vacuum tube amplifier in a control circuit is possible through use of the Model 219 Sensitive Relay, which can operate on $25\mu\text{w}$ and control up to 9w. This is a power amplification factor of nearly 400,000. Offering the designer the possibility of considerable weight savings, this little relay has many uses in servo applications, voltage regulation, and null detection. It can operate directly from thermocouples or photocells. Two typical application circuits are shown in Figs. 2 and 3.

The cutaway view shown in Fig. 1 illustrates the construction of the unit. The relay mechanism is a fixed-coil, moving-magnet type having the characteristics of a d'Arsonval movement. The magnet vane is made of "Alnico V." Because of the small size and mass of the rotor assembly, the relay has excellent shock-resistant qualities. The contact circuit is completed through the torque spring, which provides a restoring force.

As current flows through the coils, the rotor is deflected in a direction determined by the polarity of the current. If the operating current is changed gradually, the moving contact will follow the rate of change until it touches the stationary contact. When rated current is applied instantaneously, contact is made in approximately 150millisec. At 10 times nominal closing current, contact is made in approximately 40millisec.

The relay should be isolated from vibration and shock to avoid contact chatter. The effect of contact chatter can be reduced by increasing the operating current

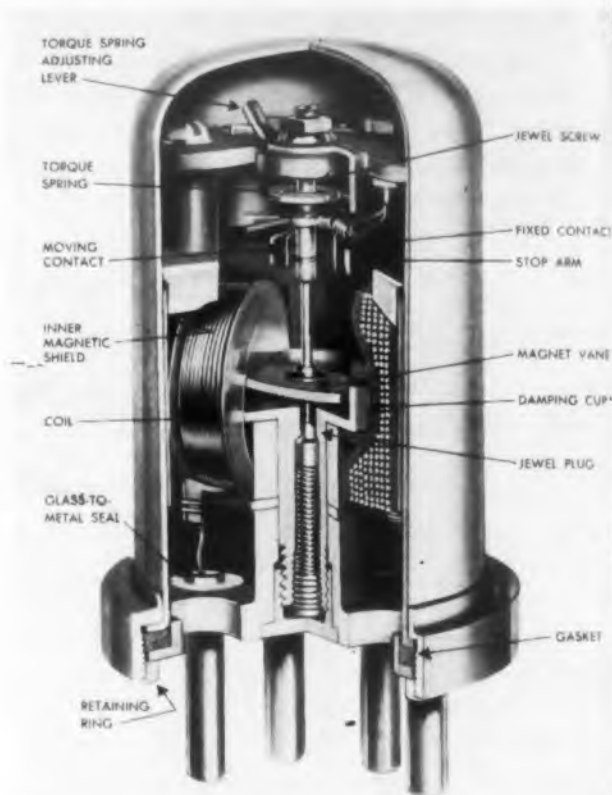

Fig. 1. Cutaway view of the Model 219 Sensitive Relay.

beyond the nominal closing value or by using a simple lock-in relay in the contact circuit. It is desirable to increase the coil current above the closing value wherever possible. The coils will safely dissipate up to 10,000 times the normal power input.

By presetting the angular position of the fixed contact, the operating power can be varied between practically 0 and $70\mu\text{w}$. Differential operation is also possible. The long-life Model 219 Relay is made by Thomas A. Edison, Inc., West Orange, N. J.

The platinum-iridium contacts, which are rated 350ma at 28v d-c, are available in spst or spdt, normally open or closed.

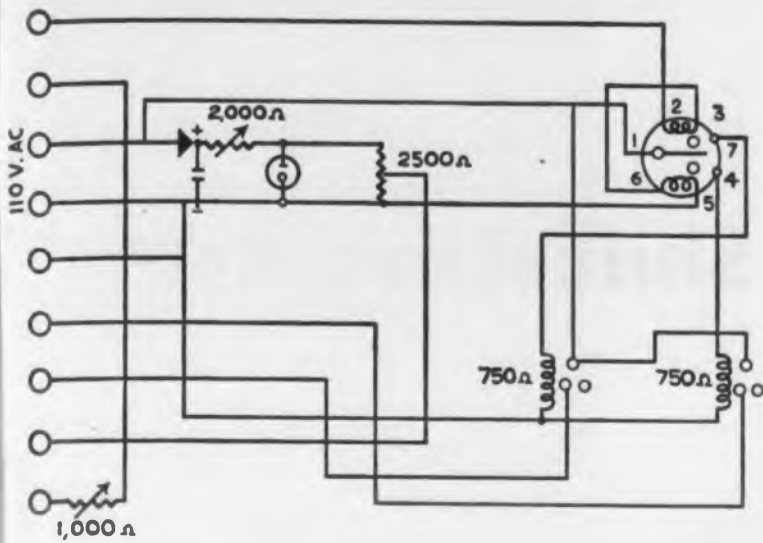

Fig. 2. In this voltage-regulator circuit the coils of a zero-center contact relay are in series with a voltage reference. The voltage can be mechanically regulated to $\pm 0.1v$.

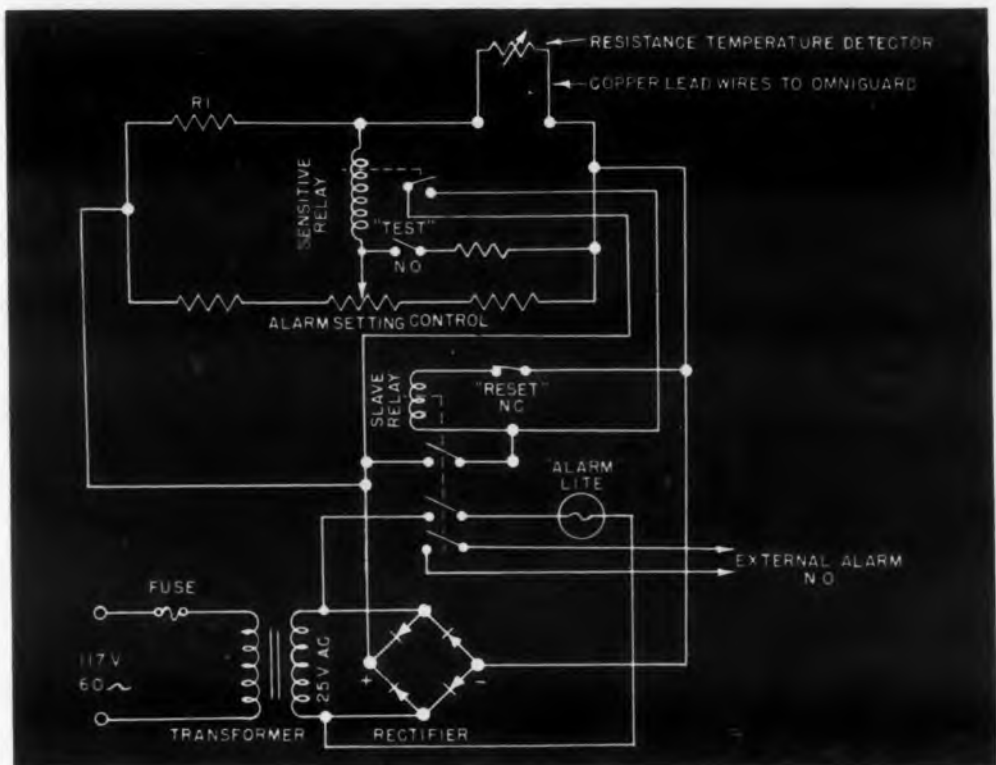

Fig. 3. In this temperature-alarm circuit the relay is a null-balance detector in the bridge circuit. During normal conditions, the resistance-temperature detector resistance is low, causing a current to flow through the relay coils, keeping the contacts open. When the temperature reaches the alarm point, the null is passed and the unbalance current of about $50\mu amp$ is insufficient to prevent the contacts from closing.

The relays are made with three types of bases: printed circuit, solder hook, and plug-in. They are made with closing current ratings of 0.10ma to 10ma for spst types and 0.10ma to 6.25ma for spdt types. The relays have been tested to more than 8 million cycles of operation. The plug-in base model weighs 0.15 lb and has a seated height of 2-17/32".

The magnetic circuit is shielded from external fields by a high-permeability shield and by a second external shield cover. Except for abnormally intense nearby fields, calibration will be maintained in any normal mounting position.

For lighter, more compact, Servo Systems

THE NEW

KEARFOTT PENNY SIZE SYNCHROS



Accurate . . . Rugged
Dependable

PERFORMANCE DATA

	TRANSMITTER	CONTROL TRANSFORMER
PRIMARY EXCITATION	26 VOLTS 400 CYCLES	11.8 VOLTS 400 CYCLES
INPUT CURRENT	95 Ma	137 Ma
INPUT IMPEDANCE	274/75° Ohms	82/68° Ohms
OUTPUT SECONDARY	11.8 VOLTS	23.5 VOLTS
RESIDUAL (NULL) VOLTAGE	40 Mv RMS 20 Mv Fund	40 Mv RMS 20 Mv fund
SENSITIVITY	200 Mv/Degree	400 Mv/Degree
WEIGHT	1.75 Oz.	1.75 Oz.
MAXIMUM ERROR from EZ	10 Minutes	10 Minutes

Kearfott now offers from production the smallest, accurate line of Synchros available. These Transmitters and Control Transformers, Resolvers and Differentials, conform to Navy BuOrd. Size 8. Integrally cast stator and stainless steel housing assemblies permit straight through bores, eliminating the fundamental errors of eccentricity; providing ruggedness and environmental resistance to these components.

KEARFOTT COMPONENTS INCLUDE:

Gyros, Servo Motors, Synchros, Servo and Magnetic Amplifiers, Tachometer Generators, Hermetic Rotary Seals, Aircraft Navigational Systems, and other high accuracy mechanical, electrical and electronic components.

Technical Data Sheets on these and other Synchros in various size ranges and for special applications available. Send for them today.



KEARFOTT COMPANY, INC., LITTLE FALLS, N. J.

Sales and Engineering Offices: 1378 Main Avenue, Clifton, N. J.
Midwest Office: 188 W. Randolph Street, Chicago, Ill. South Central Office: 6115 Denton Drive, Dallas, Texas
West Coast Office: 253 N. Vinado Avenue, Pasadena, Calif.

A GENERAL PRECISION EQUIPMENT CORPORATION SUBSIDIARY

CIRCLE ED-13 ON READER-SERVICE CARD FOR MORE INFORMATION

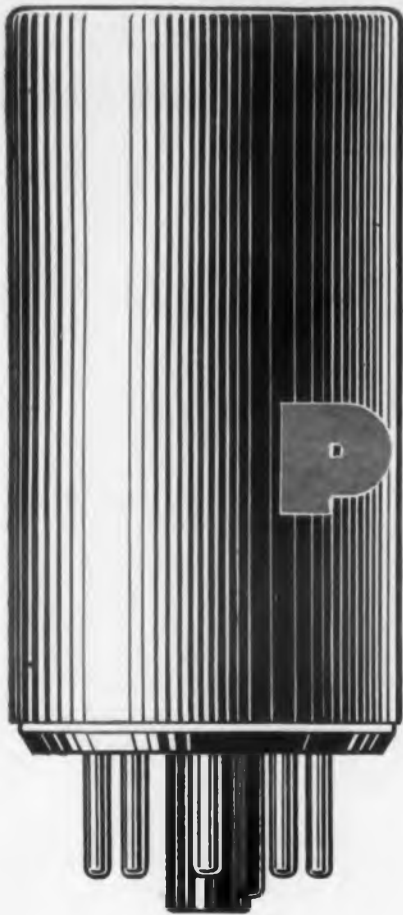

POTTER

PLUG-IN CAPACITORS fit YOUR NEEDS...

- easy field replacement
- rugged and dependable
- withstand 100°C temperature
- moisture and humidity proof
- vibration proof
- capacitors and special networks

Everything you want and need in plug-in capacitors you get with POTTER. Here are quality components designed and built for longtime, dependable performance . . . and when field replacement eventually becomes necessary, non-technical personnel can make the change *easily, instantly, surely.*

Yes, if your product calls for plug-ins, your call should be for POTTER



• WRITE FOR CATALOG 21-C.

**SPECIALISTS IN FIXED
PAPER CAPACITORS
SINCE 1925**



CIRCLE ED-14 ON READER-SERVICE CARD FOR MORE INFORMATION

Plug-In Shift Register



Fig. 1. Sixteen SR-100 Magnetic Shift Registers with their driving unit (left) in a standard assembly suitable for panel mounting.

OPERATING at any frequency between 0 and 100kc, the plug-in SR-100 Magnetic Shift Register shown above requires only one shift pulse per bit of information stored. By mounting the replaceable germanium diode outside the plastic case, the designers of this computer component combined compactness and ruggedness with ease of servicing. Its circuit diagram is shown in Fig. 3.

Any number of the units can be operated in series in computers for such applications as buffer storage between serial and parallel, synchronous and asynchronous, or low-speed and high-speed sections of a computing system; storage of orders or data; timing and distribution of control pulses;

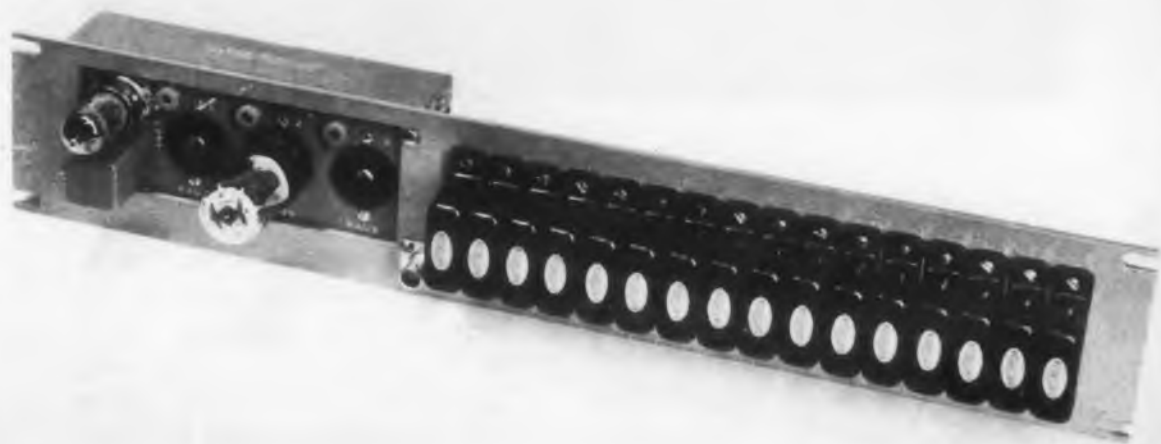

frequency division; and variable rate counter up to rated frequency. Information may be read out of the register in as many ways as it is read in. The unit is manufactured by Raytheon Manufacturing Company, Waltham 54, Mass.

The shift register requires no power to maintain

240
220
200
180
160
140
120
100
1.4
SHI

info
for
peal
any
of
imp
ing
ran
ove
was
2
pre
cap
ger
on
be
3-1
ful
pa
Or
in
m
va
sh
ar

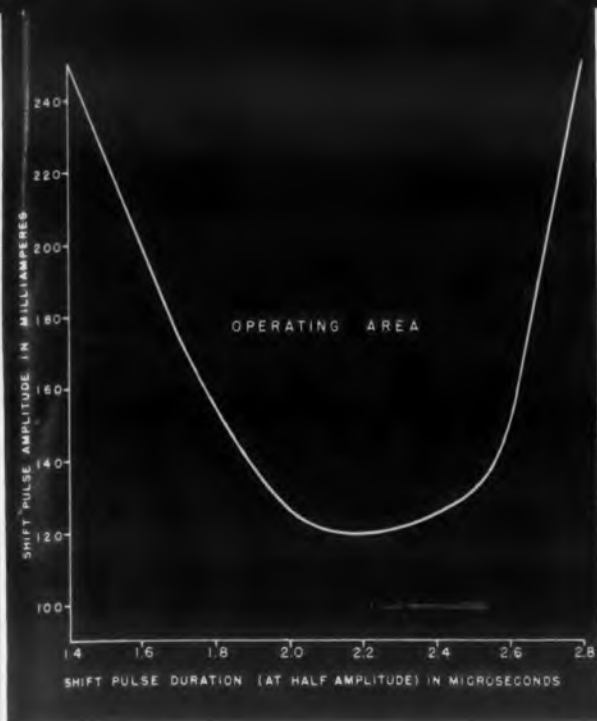

Fig. 2. Curve showing the operating range of the Register.

information stored in it. Power is only required for writing in information or for shifting it. A peak shift pulse of 225ma with a duration (at half amplitude) of 2.2 μ sec results in an output pulse of 16v with a one:zero ratio of 5:1 with a load impedance of 7500 ohms. Fig. 2 shows the operating range of the register. The curve indicates the range in amplitude and duration of the shift pulse over which the unit will operate. The plot data was taken on a 16-stage unit.

A driver is available for the shift register with provision for three small power pentodes, each capable of driving up to 16 units. The pulse is generated in a miniature triode. The driver is built on a chassis 6-1/2" x 3" x 1-1/2" in size, and may be mounted, along with 16 registers on a 19" x 3-1/2" panel, as shown in Fig. 1. A driver and its full load of 48 registers will fit on a 19" x 8-3/4" panel and still leave room for associated circuitry. Only as many power tubes as required are plugged in, and each missing tube is replaced by a plug-mounted capacitor (not shown in Fig. 1) equal in value to the tube input capacity to maintain the shape of the shift pulse. The resistor's dimensions are 2-1/2" long x 5/8" wide x 2-3/8" seated height.

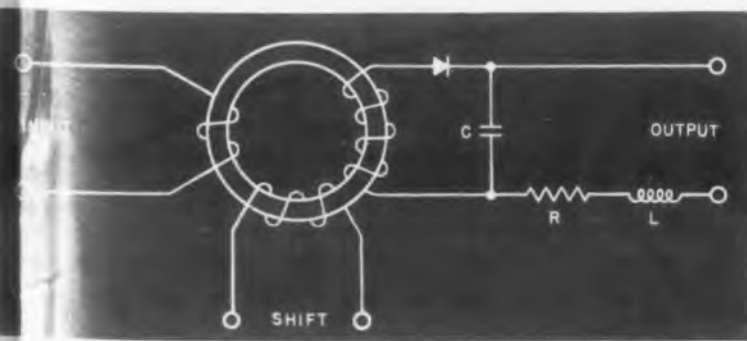

Fig. 3. Circuit diagram of the Register.

The New Servoscope® puts another engineer on your staff

**... but not
on your payroll**



The New Servoscope Saves Man-Hours

Are you engineering any type of feedback control system—regulators, governors, process controls, positioning or speed servos? With a Servoscope an extra engineer will be working for you on design synthesis, analysis or production test.

Discovers Mistakes Before You Make Them

Breadboard your intended servo system or other circuit designs—then, by either the frequency response or the transient response method, magnitude and phase curves can be obtained directly within minutes.

The Servoscope is available in two standard models - 1100A (0.1 to 20 cps.), 1100B (.15 to 30 cps.). Custom modifications for higher frequencies and units with built-in oscilloscopes quoted on request.

For detailed information on how this versatile test instrument can save manpower, materials and money, write Dept. ED-6

Output wave forms of Servoscope displayed against internal linear sweep generator, frequency 1/2 cps.



SERVO

**CORPORATION
OF AMERICA**



New Hyde Park, New York

CIRCLE ED-15 ON READER-SERVICE CARD FOR MORE INFORMATION

SC 113

WHAT ARE YOU LOOKING FOR in a paper tubular capacitor?

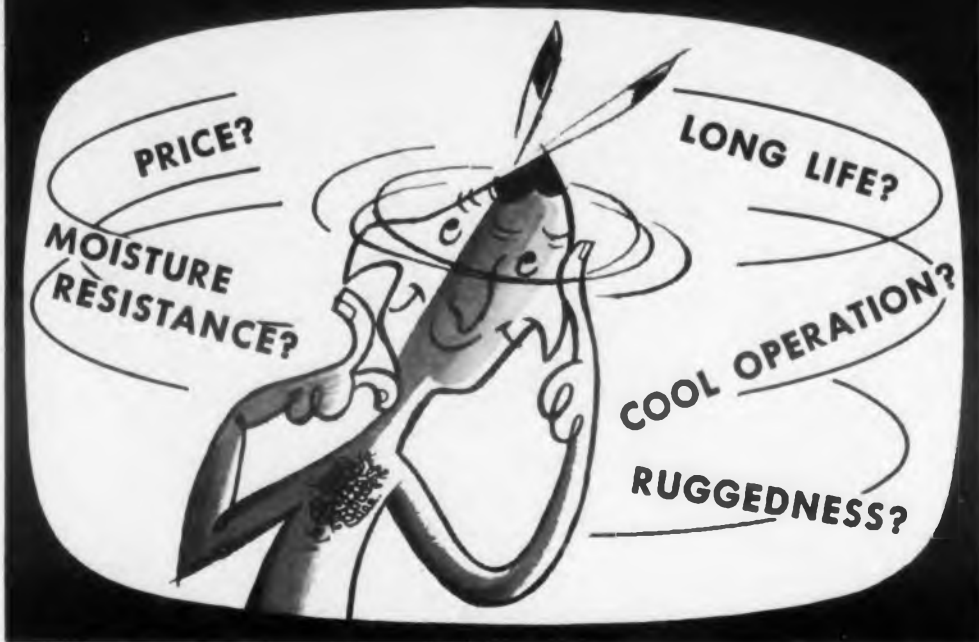

No matter what your particular applications problem in paper tubular capacitors—Sangamo can meet your need. You can choose from the following types:



TELECHIEF—The *premium* tubular. Molded in Humiditite . . . the Telechief offers amazing moisture resistance—satisfactory high temperature operation up to 85° C. (Contact our engineers about operating problems in the 100°—125° C range).

REDSKIN—An industry standard. Gives dependable *long life* operation at 85° C. The thermo-setting plastic case stands rough handling and the especially designed, flexible leads resist breakage—they can't pull out.



CERAMICHIEF—A ceramic-encased paper tubular. Here's quality at a price. Try it for high moisture resistance—long life. Wax, Resinex, or Mineral Oil impregnated. 85° C operation. The Ceramichief is ideal for plastic imbedment circuitry.

BUCKSKIN—An economical cardboard-encased paper tubular. Gives full Sangamo quality in applications where costs are a problem. Wax, Resinex, or Mineral Oil impregnation. Built to pass requirements of RTMA Spec. REC-118A.



P.S. For extremely critical applications—don't overlook Sangamo Types SA through SM. These hermetically-sealed, metal cased tubulars are built to MIL-C-25A Specs. Engineering Bulletin SC54-10 gives full information.



SANGAMO ELECTRIC COMPANY

SC54-10

MARION, ILLINOIS

CIRCLE ED-16 ON READER-SERVICE CARD FOR MORE INFORMATION

Decade Delay Lines



Fig. 1. These Decade Delay Lines facilitate delay specification at the developmental stage.

Fig. 2. Attenuation (ATT) and rise time (T_r , in μsec) vs delay (T) for one type of Decade Delay Line.

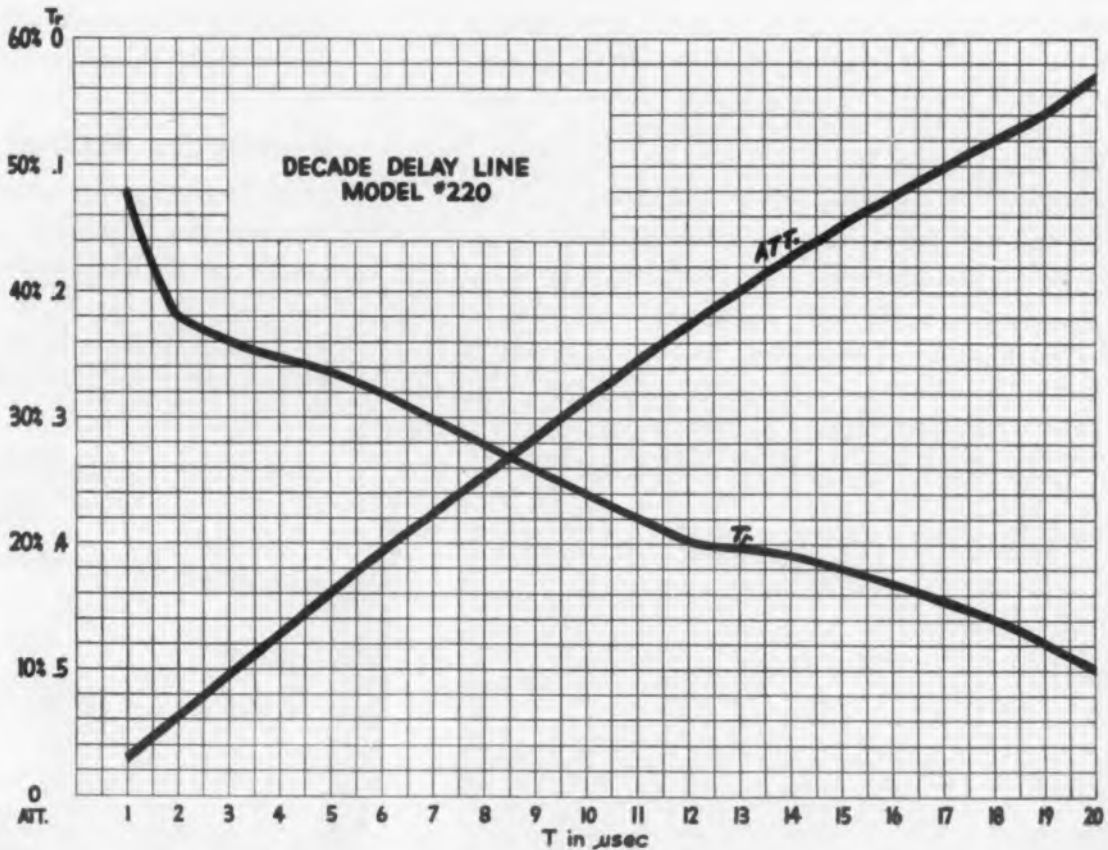

COMPUTER and radar designers will find these low-distortion Decade Delay Lines useful for development work wherever a delay line is to be specified. They can also be employed in the design of instrumentation systems, pulse-forming networks, for establishing coincidences in oscillography, etc. Four models are available, all similar in appearance to the one illustrated.

All models have a nominal characteristic impedance of 1000 ohms. The units are true decade delay lines and not tapped systems. They may be used at other impedance levels by means of matching resistor networks. Termination is, therefore, not provided within the unit, but is easily arranged at the input and output terminals. Delay calibration is made to $\pm 1\%$, and voltage ratings are 500v d-c, working voltage.

Model 205 has a total delay of $5.075\mu\text{sec}$, which is adjustable in steps of $0.025\mu\text{sec}$. At maximum delay the rise time is $0.20\mu\text{sec}$ and attenuation is 25% . Model 210 has a total delay of $10.05\mu\text{sec}$, which is adjustable in steps of $0.05\mu\text{sec}$. The rise time and attenuation at maximum delay are $0.30\mu\text{sec}$ and 40% , respectively.

Model 220 has a $20.05\mu\text{sec}$ total delay, which is adjustable in steps of $0.05\mu\text{sec}$. Fig. 2 shows the attenuation and rise-time characteristics of Model 220. Model 250 has a total delay of $50.1\mu\text{sec}$, which is adjustable in steps of $0.1\mu\text{sec}$. At maximum delay time, rise time is $2.0\mu\text{sec}$ and attenuation is 50% .

The units are available in 7-3/4" wide x 7-1/2" high x 9-1/2" deep mahogany cabinets, as shown, or in 7" high x 4" deep rack-mounting units to fit various length panels as specified. Produced by ESC Corporation, 534 Bergen Blvd., Palisades Park, N.J., they can be modified to specification. They weigh 5 lb. The lumped-constant delay lines are imbedded in resin and are free from jitter.



New General Electric "fleaweight" aircraft transformers 50% lighter

New insulation and coil winding process make possible smaller, lower-priced transformers, rated 50 to 500 va

With space and weight so much a premium in today's aircraft, you'll want to take advantage of the savings offered by the new G-E "fleaweight" transformers. Here's a line of transformers that are up to 60% smaller and 50% lighter . . . save you mounting space and materials . . . cost you less than existing units.

Combining silicone insulation and a new method of coil winding, the new "fleaweights" are especially suitable for operation in the higher ambient temperatures of today's high-speed aircraft. Use them for a wide range of 400-cycle aircraft applica-

tions including landing lights, navigation lights, and instruments. The "fleaweights," featuring a low center of gravity and strong vibration-resistant mounting, give you power reliability.

Like other units in the G-E line of electronic and aircraft transformers, the "fleaweights" are tailored to your particular, specialized requirements. If you need application engineering assistance, contact your nearest G-E Apparatus Sales Office. For literature on G-E transformers, write General Electric Company, Section 412-114, Schenectady 5, New York.

Progress is our most important product

GENERAL  ELECTRIC

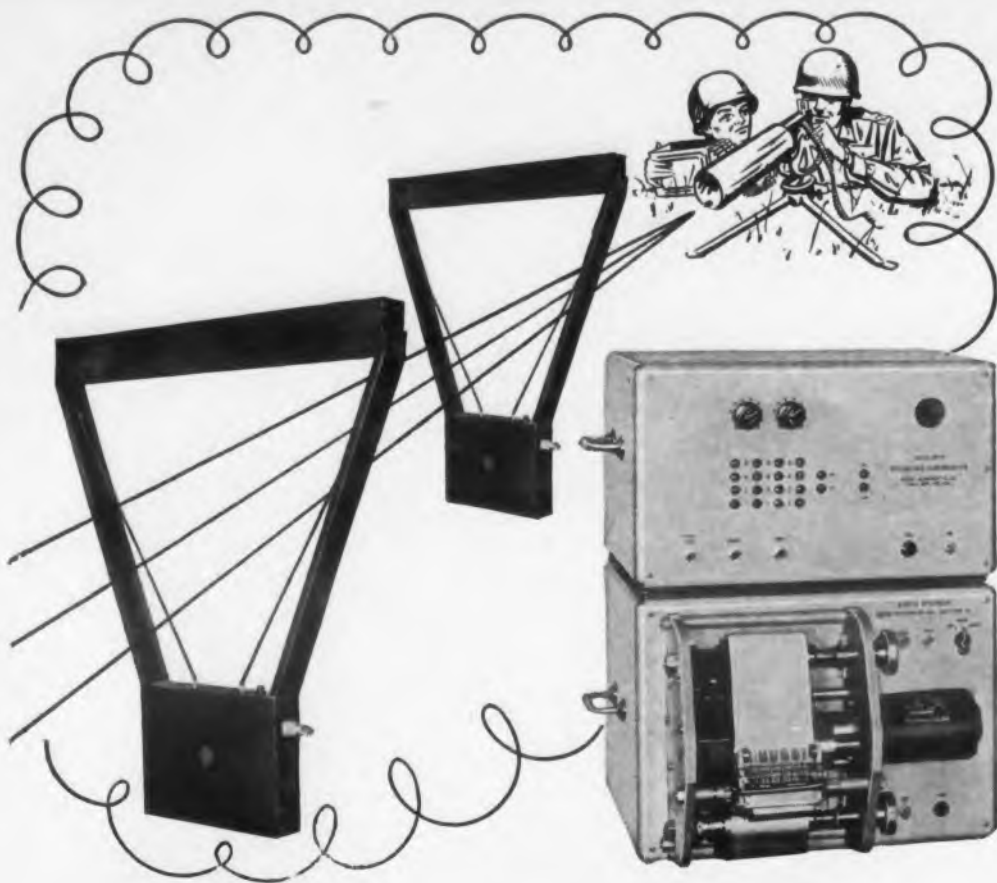

COMPLETE SYSTEMS FOR BALLISTICS TESTING . . .

WHERE ACCURACY COUNTS, THERE IS NO SUBSTITUTE
FOR POTTER INTEGRATED TESTING SYSTEMS

Only Potter offers complete systems for measuring and recording velocity, rate of fire, and other vital information. Typical of complete systems designed specifically for ballistics testing is the Model 3054 that measures and records each projectile velocity and rates of fire up to 9,000 rounds per minute.

OTHER POTTER BALLISTICS TEST EQUIPMENT INCLUDES:

Counter Chronographs

- Model 453—10 μ sec resolution.
- Model 456—0.625 μ sec resolution.
- Model 471— $\frac{1}{8}$ μ sec resolution.

Preset Interval and Delay Generators

- Model 553—Up to 1 second in 10- μ sec increments.
- Model 563—Up to 1 second in 1- μ sec increments.

Shaping Amplifier for Magnetized Projectiles

- Model 661—Shapes pulses from solenoid coils.

Photoelectric Detector Screens

- Model 601—Standard size.
- Model 601A—Double size.

Digital Recorders

- Model 960—5, 6, 7, and 8 digit recorders.

Custom Designs

- Doppler chronographs, missile data-handling systems, high-speed printers, and recorders.

Whether you are testing pistols, rifles, guns, rockets, powder or projectiles, there is a Potter instrument to meet your needs. Our engineers will welcome an opportunity to advise you in the selection of the most suitable components or complete system. Write today for a complete catalog. No obligation, of course.

Potter

POTTER INSTRUMENT COMPANY, INC.

115 Cutter Mill Road, Great Neck, N. Y.

CIRCLE ED-18 ON READER-SERVICE CARD FOR MORE INFORMATION

Cartridge-Mounted Thermistor

Fig. 1. The standard crystal cartridge in which the thermistor is mounted.

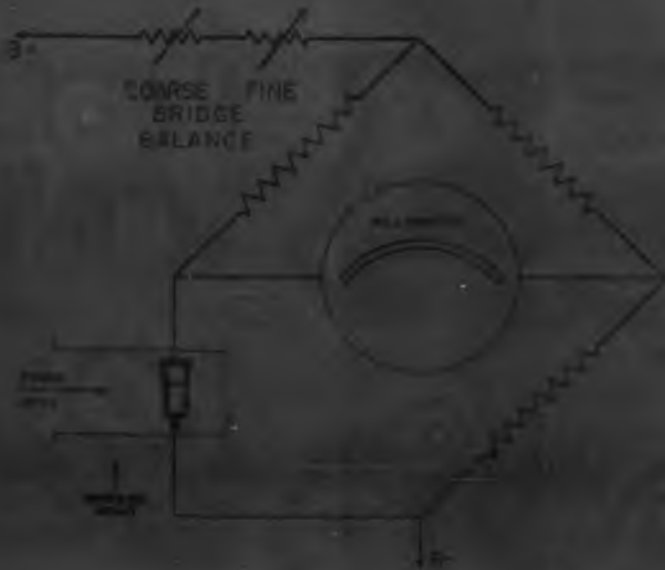

Fig. 2. The thermistor in a typical bridge measuring circuit.

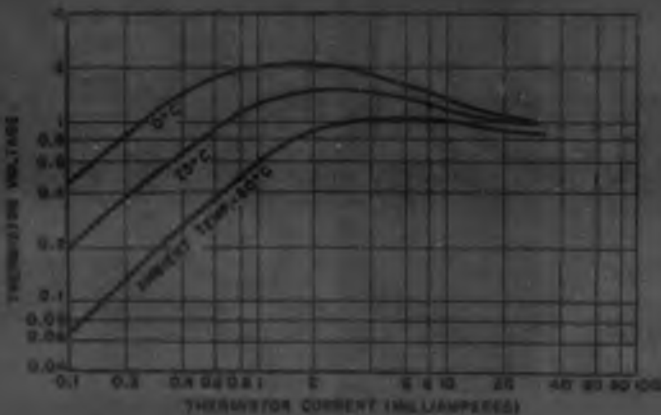

Fig. 3. Static characteristics of the Type N-333 Thermistor.

SPECIAL thermistor mounts for microwave power measurements are not required with the N-333 Thermistor, whose sensitive element is mounted in a standard crystal cartridge, as shown in Fig. 1. The cartridge may be inserted in all types of crystal detectors and probes, as shown in Fig. 4 below.

Power levels as low as a few microwatts can be readily measured at frequencies up to 12.4kMc. The unit is especially valuable when measuring pulsed r-f power.

The device consists of a tiny bead of semiconducting material of the 32A5/32A26 type supported by two platinum wires. The bead is mounted in the cartridge, which has the same outer dimensions as

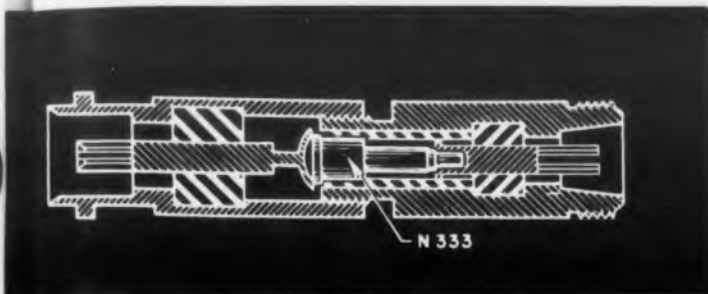

Fig. 4. The cartridge-mounted thermistor inserted in a standard, coaxial-cable crystal holder. The unit can be inserted in a waveguide in a similar manner.

a microwave crystal detector such as a 1N23B. The cartridge is hermetically sealed and tropicalized. The same unit is also available for use in barretter mounts as the Type N-333. Both types are manufactured by the Narda Corporation, 66 Main Street, Mineola, N.Y.

The thermistor's power-measuring ability is the result of its resistance vs temperature characteristics. Its static characteristics are shown in the graph in Fig. 3. A circuit utilizing the unit is given in Fig. 2. The d-c resistance may be varied over a range of 100 to 200 ohms or more, depending on the bias used. This variation allows the unit to be matched with all available microwave power meters and to operate in all bridge circuits.

The power-measuring ability of the thermistor unit can be most commonly applied in the microwave region. Thermistors are valuable for measuring pulsed r-f power because of their longer time constant of 1sec as compared with the time constants of barretter bolometers, which are too short for accurate pulse power measurements. For optimum impedance match, a tuner is often necessary, since crystal mounts rarely have exact impedance characteristics for use with thermistors.

Replacement of the unit due to burnout is as simple as changing a crystal. Power rating is 100mw. Its ambient temperature range is -40°C to 55°C . The assembly will stand a 5g shock test and a vibration test of 33cy at $1/16''$ amplitude.



New Instruments and Components to Aid in Design and Reduce Costs

by

TECHNITROL

Unique Variable Pulser is Valuable Laboratory Aid

The Technitrol Variable Pulser is a reliable, versatile instrument which converts the output of a laboratory oscillator into a series of pulses.

One use has been as a low pulse rate device to study the response of components and networks to isolated pulses. Another use has been as a variable pulse rate source to study P.R.F. sensitivity. Still another use has been as a constant high frequency source for a temporary clock pulse generator.

Characteristics

- Wide range of frequencies from 2 cps. to over 2.0 mcs.
- Pulse characteristics optimized with rise and fall times approximately 0.04 μs . and 0.06 μs . respectively.
- Duration of pulse variable from 0.2 μs . to 5.0 μs . in steps of 0.1 μs .
- Accurate, stable pulse duration controlled by electric delay lines.
- Amplitude continuously variable without distortion from 0 to 45 volts.
- Trigger pulse precedes output pulse to synchronize oscilloscopes, etc.

Tiny Encapsulated Pulse Transformers Wound to Your Requirements

Technitrol Pulse Transformers are wound on ferrite cores and cast in resin to form a $3/4''$ sealed unit.

Type TE has 2-inch pigtail leads of No. 20 wire. Type TP has 7-pin plug-in for miniature tube sockets. Lends itself admirably to printed circuits where holes can be drilled in the circuit board, the transformer plugged into these and the pins soldered to the circuit leads on the side opposite the body of the transformer.

Very Compact Delay Lines Designed to Fit Your Need

A Technitrol Delay Line—with not more than $1/4''$ diameter and $6 1/4''$ length, or in a package—will be designed for your particular circuit application. A variety of mountings offers you a wide choice.

- Delay: 0.01 to 1.6 μs .
 - Characteristic Impedance: 400 to 2500 ohms.
 - Wide Frequency Response: 0.5 μs . at 1200 ohms.
3 db down at 5 mcs
6 db down at 8 mcs
10 db down at 10 mcs
- Continuing intensive research and development is expected to make available even greater band-widths.
- Linear Phase: to 9 mcs and beyond

MORE INFORMATION ON REQUEST

TECHNITROL ENGINEERING COMPANY
2751 N. 4th St., Philadelphia 33, Pa.

Write Dept. D-6

Send Bulletin

- 186 Variable Pulser
 166 Pulse Transformers
 174 Delay Lines

NAME _____
COMPANY _____
ADDRESS _____
CITY _____ ZONE _____ STATE _____

CIRCLE ED-19 ON READER-SERVICE CARD FOR MORE INFORMATION



Death-defying performance

You can depend on C.T.C. coils to give a steady, star performance. They won't go dead despite threats of temperature, climate or vibration. And for very good reasons —

The mounting stud of every C.T.C. coil is fastened to the ceramic body in a special way that does away with weaknesses of ordinary coil fastenings. This special fastening makes C.T.C. coils vibration-proof. What's more, their tightness is preserved in hot, cold, dry or damp weather. All C.T.C. coils are precision-made, of course, to meet individual specifications — and to meet, or better, government specifications, as well. And continuous quality control is maintained.

As a result, you get a *guaranteed* electronic component — custom or standard — whose performance you can depend upon.

Precision-made C.T.C. components that benefit from C.T.C. high quality standards include terminals, terminal boards, capacitors, swagers, hardware, insulated terminals and coil forms. For

all specifications and prices, write Cambridge Thermionic Corporation, 457 Concord Avenue, Cambridge 38, Mass. West Coast manufacturers contact: E. V. Roberts, 5068 West Washington Blvd., Los Angeles 16 and 988 Market St., San Francisco, California.

Slug Tuned Coil Data: Single layer or pie type windings to your specifications. Forms of quality paper base phenolic or grade L-5 silicone impregnated ceramic. Mounting studs are cadmium plated brass; ring type terminals are silver plated brass. All units include slugs and mounting hardware. One style (Type C) available with retaining collars of silicone fibreglas which permit 2 to 4 terminals. Windings can be coated with resin varnish, wax or lacquer.



New CST-50 variable ceramic capacitor surpasses range of capacitors many times its size. Stands only 1/2" high when mounted, is less than 1/4" in diameter and has an 8-32 thread mounting stud. A tunable element of unusual design practically eliminates losses due to air dielectric giving large minimum to maximum capacity range (1.5 to 12MMFD).

C T C

CAMBRIDGE THERMIONIC CORPORATION

*makers of guaranteed electronic components,
custom or standard*



CIRCLE ED-20 ON READER-SERVICE CARD FOR MORE INFORMATION

C vs T for Capacitors

R. G. Lindstrom

Engr. Standards Department

Caphart-Farnsworth Co., Fort Wayne, Ind.

DESIGNERS of equipment operating over a wide temperature range will find this chart useful in choosing the most suitable type of capacitor. The chart shows the average or nominal change (in most instances) of capacity with temperature of nearly all of the various types of capacitors from the standpoint of materials used. The capacity change because of the voltage applied has not been considered and all curves were based on capacity measurements at 60cy a-c. The higher frequency measurements will increase the percentage change.

The information from which this chart was derived has been primarily compiled from manufacturers' literature, specifications, and certain reports. Nearly all of this information has been confirmed by test in regard to direction of change and curve approximation, however the amount of change has at times exceeded the limits indicated on the chart. (It should be noted that Military and RETMA specifications allow for a greater variation than indicated here, except for the Mica curves which have Mil-C-5 limits.) The one exception is the "Mylar" plastic foil, silicone oil impregnated, metal cased capacitor which some literature indicates has a negative coefficient, others positive, whereas our tests have indicated a positive coefficient. This disagreement would indicate further studies might be necessary wherever a plastic foil capacitor may be desired. This would be especially true where certain R-C networks need to be stable over a wide temperature range.

The ceramic capacitors are shown only to indicate the approximate Curie points for two different dielectric constants of the high K or GMV types. These two curves are indicative of how the Curie point may be varied by various formulations of ceramic compounds. The temperature coefficient type ceramic capacitors are not shown for this

ELECTRONIC DESIGN • June 1954

Key to Abbreviations Used on Graph

Symbol	Type-description	Remarks
E	Electrolytic, Aluminum Foil	
Glass	Monolythic Glass—Corning Glass	Equivalent in style and size to Mica
K1200	Ceramic	Dielectric Constant "K" of 1200
K6000	Ceramic	Dielectric Constant "K" of 6000
Mica C	Mica	Per Mil-C-5 Characteristic C
Mica F	Mica	Per Mil-C-5 Characteristic F
Mica G	Mica	Per Mil-C-5 Characteristic G
M.Oil	Paper—Mineral Oil Impregnant	
Mylar	Mylar Foil—Silicone Oil Impregnant	* Conflicting Information
Plastic	Paper, Plastic Impregnant, thermosetting	Molded Plastic Case
P	Polystyrene Foil—Silicone Oil Impregnant	
Silicone	Paper, Silicone Oil Impregnant	
T	Electrolytic, Tantalum Foil	"Tantalytics"
Teflon	Teflon Foil	
Wax	Paper, Wax Impregnant	

reason since any coefficient from slightly positive through a greatly negative change may be obtained. The low-temperature-coefficient ceramics are also limited in capacity range size for size.

This graph will aid in the indication of the right compensating or least effecting coefficient type capacitor, in conjunction with a resistor in any required stabilizing R-C network. After selection of the particular types, a more detailed study of the coefficient will have to be made in relation to the circuit such as the actual manufacturing tolerances of the coefficient, the retrace characteristics, effect of voltage, etc.

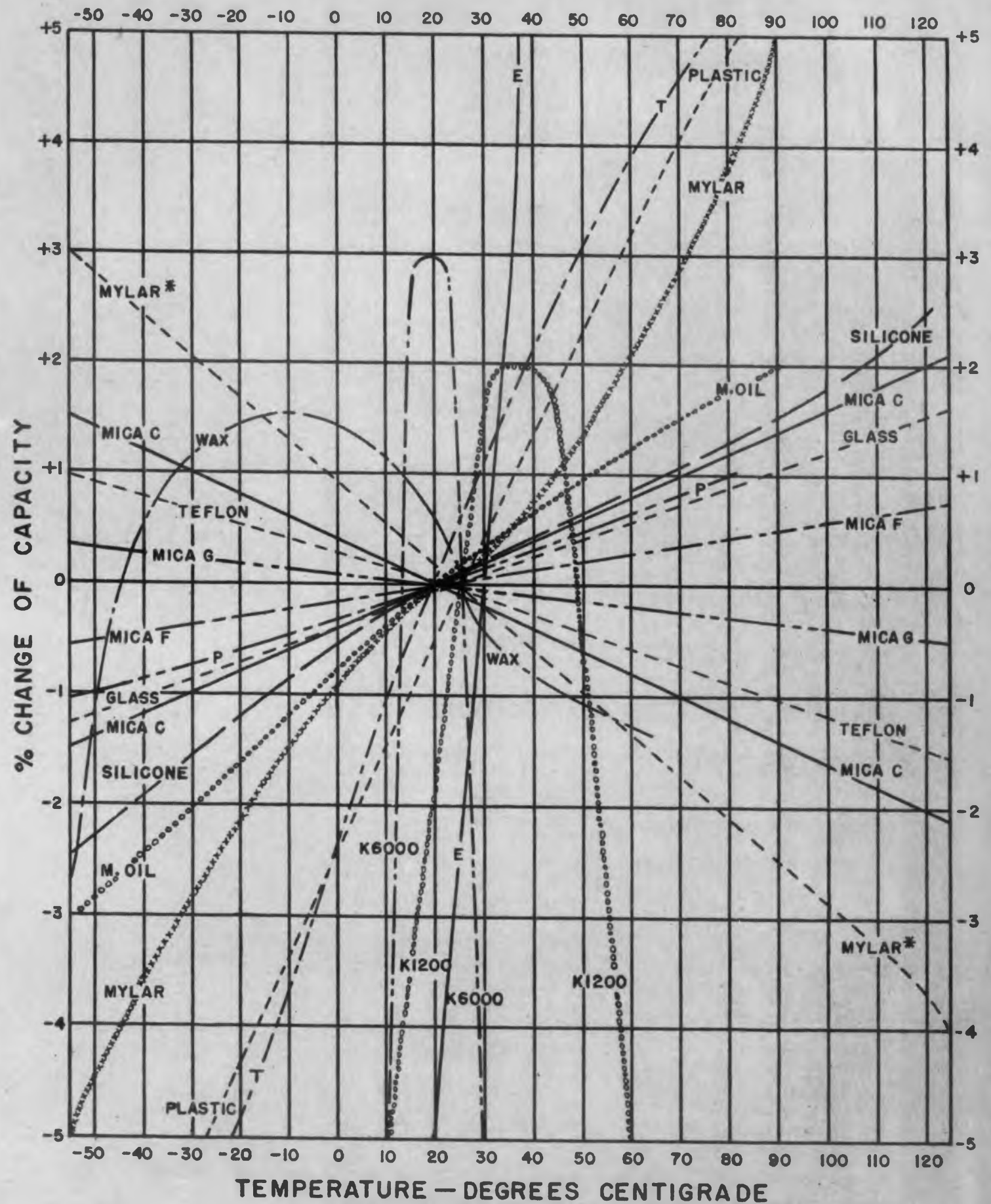

This graph of percent change in capacity vs temperature change for common capacitor insulation materials will aid the designer of equipment required to operate over a wide temperature range. A key to the abbreviation is at the left.

replacing GLASS with TEFLON

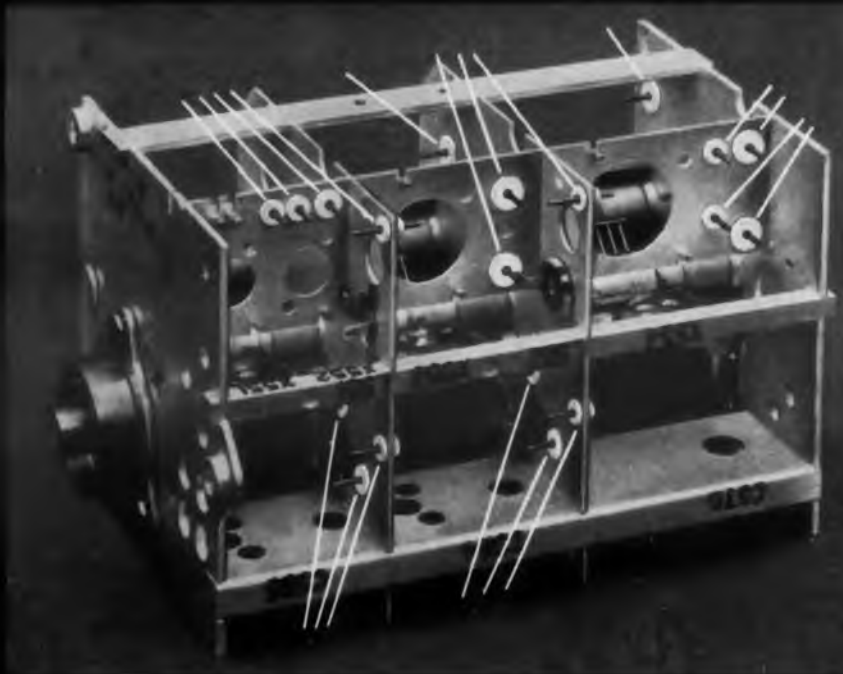

Chemelec Stand-Off and Feed-Through Insulators

● Tough, resilient TEFLON made these miniatures possible—and **BETTER**—than glass-insulated components.

COMPRESSION MOUNTING, without breakage.

WITHSTAND SHOCK and vibration in service.

NO ADDITIONAL HARDWARE NEEDED.

ASSEMBLY COSTS GREATLY REDUCED.

THE PLASTIC'S "MEMORY" securely locks insulators permanently in place. Minimum pull test 10 lbs., insulator to deck, hardware to insulator.

MINIATURIZATION is easily accomplished.

INVESTIGATE Chemelec Stand-Off and Feed-Through Insulators for superior service and lower assembly costs.

SEVEN STOCK SIZES, including sub-miniatures. Other dimensions feasible.

WRITE for Chemelec Bulletin EC-1153.

● TEFLON's superior insulating characteristics made these miniatures possible—and **BETTER**—especially for high frequency, high voltage or current, high temperature service.

HIGHER surface and volume resistivity.

LOWER loss factor and dielectric constant.

HIGHER dielectric strength.

WIDER service temperature range (−110° F to + 500° F).

ZERO water absorption (A.S.T.M. Test).

WON'T CARBONIZE under arcing or DC-plate.

**UNITED
STATES
GASKET
COMPANY**

**FLUOROCARBON
PRODUCTS, INC. DIVISION
CAMDEN 1 • NEW JERSEY**

Representatives in Principal
Cities Throughout the World



CIRCLE ED-21 ON READER-SERVICE CARD FOR MORE INFORMATION

Step-Function Potentiometer

ANALOG to digital information conversion, torque amplification, and transducer applications involving extremely small angular displacements are various uses of the miniature Model 108 Step-Function Potentiometers shown at the right. Their entire voltage output is obtained over shaft rotations of 3° , as demonstrated in the curve below.

The potentiometer brush travels over a short until it contacts a specially shaped, carbon-film resistance element that covers 3° of arc of the inside of a cylinder. After passing over the "step", the brush continues along a short until it has covered the 355° arc of electrical contact. The step

The output characteristic of the Step-Function Potentiometer. The units are available with more than one "step" per rotation.

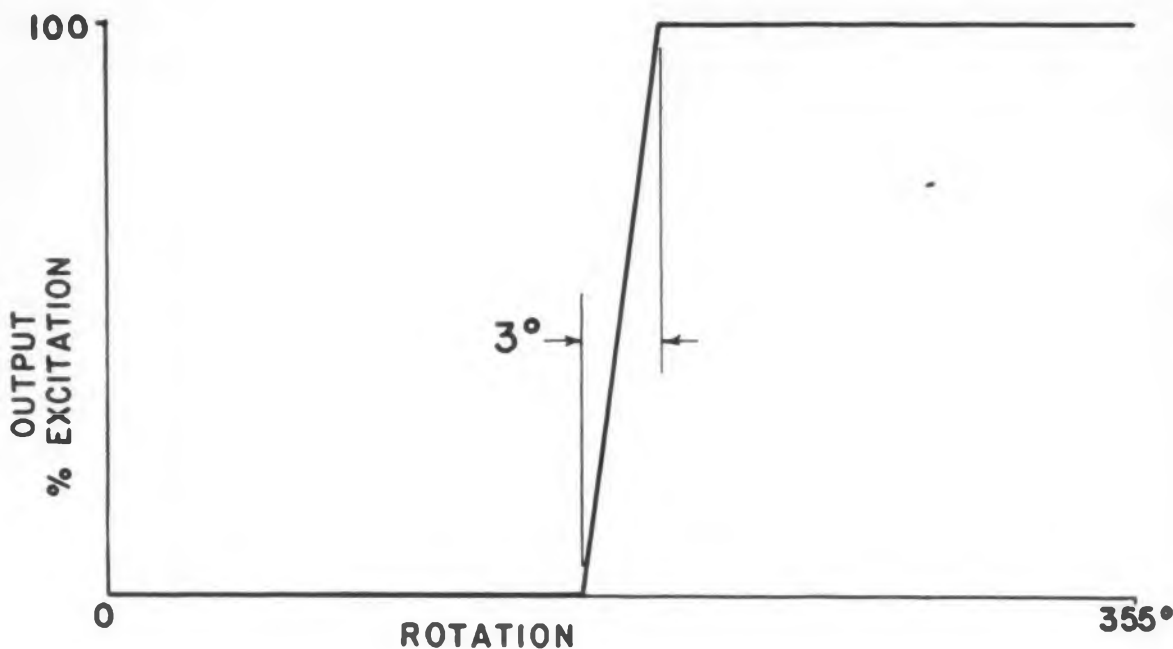

is generally placed in the center of the arc of contact. Up to 65 of these steps of virtually infinite resolution can be specified in one potentiometer, which means that the unit can be used as a square-wave generator. For conversion of analog to digital information, the potentiometer will thus convert shaft rotation into pulses. Steps of greater than 3° arc can be specified.

Manufactured by Computer Instruments Company, 218 E. Hartsdale Ave., Hartsdale, N.Y., the potentiometer is available in two models. Model 108 is equipped with ball bearings and a flange-type



The Model 108 Potentiometer has a ball-bearing mounting. The Model 108J has a sleeve-bearing mounting.

mounting. As Model 108J, the potentiometer is also available with a sleeve bearing and alternate bushing or flange-type mounting.

For torque amplification, the case of the Model 108 containing the resistance element is driven by a motor whose shaft is double-ended. A torque of as little as 0.1 in-oz will rotate the potentiometer shaft, and the resulting electrical signal will cause the motor shaft to rotate. This shaft drives the potentiometer case in such a direction as to reduce the potentiometer output signal and develop the stall torque of the motor, which typically ranges from 2 to 4 in-oz. The torque amplification is thus between 20:1 and 40:1.

For transducer applications, relay and switch types of controls have formerly been used. Because of their nature there is always a lag between input and output, so that response is hard to control and dead space must be large to offset hunting oscillations. With these units, however, the input to the clutch or motor coils is directly proportional to the relative displacement of input and output shafts, so that response is immediate and, with oscillations minimized, the dead space is zero.

The potentiometers are available with resistance ranges from 500 ohms to 10,000 ohms, $\pm 3\%$. Linearity is 3%. Mechanical rotation is continuous. Guaranteed life at 100rpm is 1×10^6 cycles. The unit weighs 1 oz and has an outside diameter of 1.093". Ambient operating temperature range is -55°C to 80°C .

The units will dissipate 0.1w as voltage dividers, and 2w as rheostats. The standard shaft length is 3/4", but other lengths may be specified.

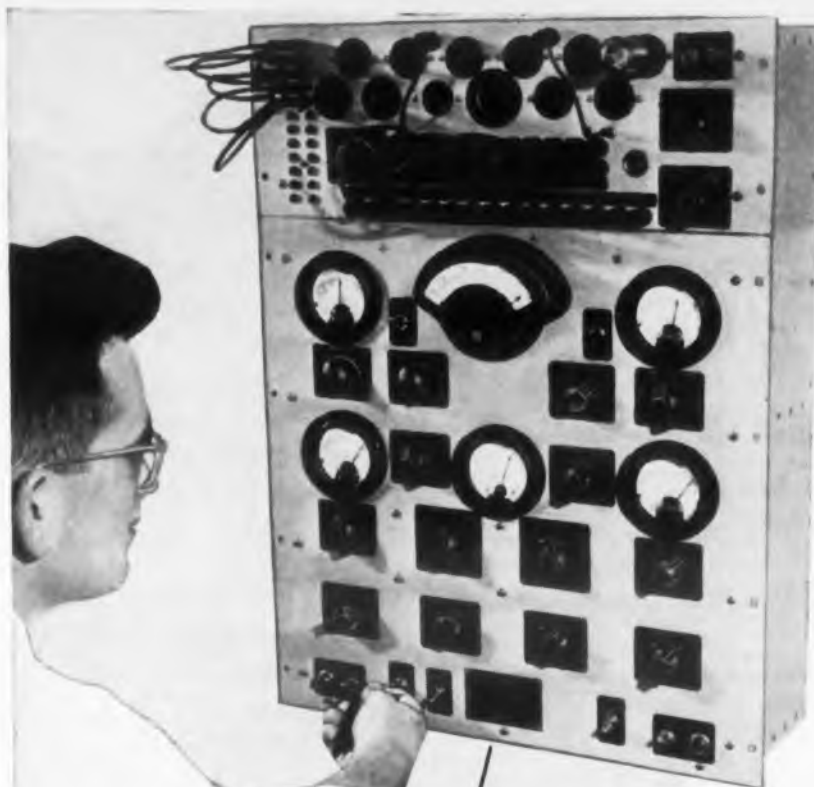

LABORATORY
FOR
ELECTRON
TUBES

Descriptive literature on Model 686 gladly sent on request. WESTON Electrical Instrument Corporation, 614 Frelinghuysen Ave., Newark 5, N. J.

WESTON
Instruments

WESTON

(686 Type 10A)

true mutual conductance

ELECTRON
TUBE ANALYZER

(over-all Gm accuracy 3% or better)

Tests tubes under actual circuit operating potentials.

Tube characteristic operating curves can be plotted for comparison with manufacturer's specifications.

Transconductance can be measured directly without need for null adjustments or correction factors.

Voltage Ratio method of measuring transconductance meets the IRE Standard 50 IRE 7.S2 paragraph 7.2.2.4.

Completely self-contained with all necessary power supplies, meters and switching for performing short tests, static characteristic measurements and grid to plate transconductance measurements.

A well filtered d-c power source is supplied, making it possible to test tubes with d-c potentials which can be accurately adjusted to correspond to actual circuit voltage operating conditions.

Precision meter shunts and multipliers are wire wound to 0.5 per cent accuracy.

Special circuitry makes meter loading effects negligible.

Regulated grid bias supply keeps this most critical voltage constant. Plate and screen supplies do not affect grid bias setting.

Wide range of measurement of transconductance provides good readings on all tubes from small subminiature types to large power control types. The true transconductance is obtained on all triodes and pentodes, including low mu control tubes having plate resistance as low as 250 ohms.

Transconductance ranges are available in the following combinations of range and grid signal voltages:

Grid Signal	1.0	0.5	0.2	0.1	Volts
Gm x 1	300	600	1500	3000	Micromhos
Gm x 10	3000	6000	15000	30000	Micromhos

The Gm x 1 range is especially useful in the measurement of subminiature tubes having low transconductance.

Reliability, Dependability and Accuracy assured by sound engineering, skilled manufacture and high quality components.

7049

CIRCLE ED-22 ON READER-SERVICE CARD FOR MORE INFORMATION

THERE IS AN **R-B-M** CONTROL To Fit Your Needs

A.C. MAGNETIC STARTERS

with Plasti-Clad
Magnet Coil

Write for
Bulletin 605



Full accessibility in a small package.

Contacts, coil and thermal element replacement with use of screwdriver only. Magnet coil—in molded phenolic case with riveted terminals—is completely embedded in a rock-hard resinous material, thus protecting against oil, dirt, moisture and normal mechanical damage.

HERMETICALLY SEALED RELAYS

Write for
Bulletin ASR



50% smaller — lighter.

R-B-M 22204-0 meets AN 3304-1 specifications. R-B-M engineers have developed the 22300-0 currently used in government electronic, airborne and ground equipment—as the electrical and mechanical equivalent of the AN 3304-1, yet 50% smaller in size with 1/2 the weight.

INDUSTRIAL CONTACTORS

with Plasti-Clad
Magnet Coil

Write for
Bulletin 600



**2-8 poles Non-Reversing.
2-5 poles Reversing.
25 Amp — 600 AC Max.**

Contacts can be replaced without removing wiring. To change coil, remove magnet frame and coil assembly only. 10 and 15 amp. poles can be changed from normally open to normally closed by using screwdriver only.

GENERAL PURPOSE RELAYS

Write for
Bulletin 570



**Low cost. Small size.
Dependable performance.
Available in many contact
arrangements.**

Whatever your needs for inexpensive, dependable relays for commercial applications—investigate R-B-M General Purpose Relays.

Other R-B-M products include: motor overload protectors, motor starting relays and low voltage DC electrical devices.

Consult R-B-M On Your Control Problems — Write Department L-6

R-B-M DIVISION
ESSEX WIRE CORPORATION
Logansport, Indiana

Controls for Electronic,
Refrigeration, In-
dustrial, Appliance,
Communication and
Automotive Industries



CIRCLE ED-23 ON READER-SERVICE CARD FOR MORE INFORMATION

Fig. 1. An example of a Modular Mounting Unit. This is a two-stage, high quality preamplifier, and is 2" x 2-1/2" x 2-1/2" in size.

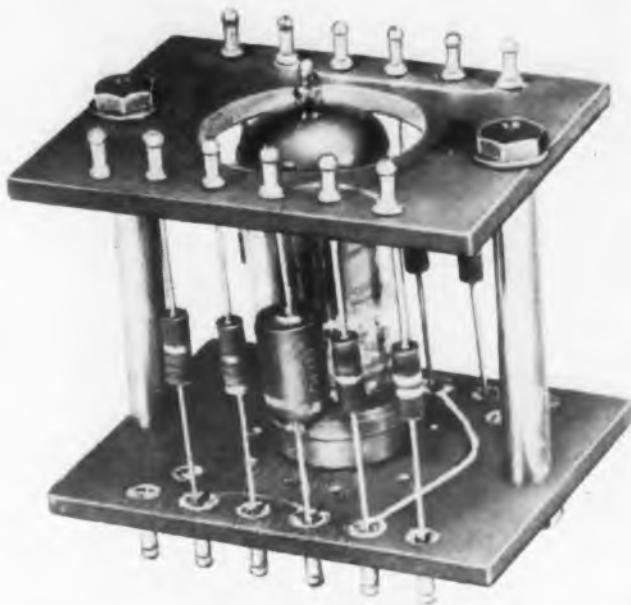

Modular Mounting Units

EXPENSIVE and complex production lines requiring machines to produce nonconventional components are not necessary to utilize "Mycalex" Modular Mounting Units, an example of which is shown in Fig. 1. Offering the space-saving and cost-reduction advantages of modular construction for "short production runs" of equipment, the units are available in a variety of sizes and can be molded or fabricated to specification. Equipment design changes and their required production line adjustments are easily made.

Developed by the Mycalex Corporation of America, Clifton Blvd., Clifton, N. J., the units consist of two glass-bonded mica insulation plates and two steel spacers. The base plate includes a molded-in tube socket and the top plate has an access hole for the tube and tube shield. Fired-on printed wiring can be readily added to the plates. Standard components are mounted between the plates and then all connections are dip-soldered. Terminals permit plugging into a printed circuit

plate used to integrate other Modular Mounting Units into a complete assembly. Various pins and plugs can be used to stack these units for ease of production and servicing.

Excellent ventilation of tubes and components is another feature of these units, which also offer all the insulation advantages of Mycalex.

Examples of three different base plates, one top plate and the spacers are shown in Fig. 2. These units are available in kit form for prototype experimentation by designers. The kits include a 1/4 oz jar of silver paste for making printed wiring.



Fig. 2. Top and bottom views of base plates for a 7-pin miniature tube, a 9-pin miniature tube, and two transistors; and one top plate (with hole). The steel spacers are shown at the left.



ular
ably.
d to
etion

com-
mits,
van-

ates,
n in
kit
de-
r of
g.



One or a Million . . .

How expensive are your design ideas?

How accurate are your prototypes?

How quickly can you swing from pilot to production?

Do your design changes run up cost because of prototype "unreliability"? In orders of one or one million, I-S BeCu^{MP} springs measure up to one single standard of performance. This allows you to check your design against production tolerances and tests — without the expense of ordering production quantities. Our "Short-Run" department was set up expressly to handle pilot runs and small production requirements as regular output — instead of treating them as costly "special orders".

I-S Short-Run = Same High Performance — Lower Cost



Two Other Important Advantages

- (1) *Our ability to produce a better spring faster and usually at a lower cost.*
- (2) *The specialized ability of our engineers to cooperate with your designers in developing your "problem" springs.*

Like many other leading manufacturers, you will find that these I-S facilities can make significant improvements in your manufacturing processes and in your product. And they most likely will save you money! One thing is certain . . . it costs nothing to compare — it may cost considerable, *not to!*

The design stage normally poses the basic problems of time and unit costs—plus the uncertainties of performance. By utilizing I-S engineering research and advanced spring-making techniques, you save in testing time and development—as well as in elimination of regular production waste. In addition, you are ready to go into million-plus production, without time-consuming engineering usually involved in the transition from bench-made prototypes to full line production.

For more information on BeCu^{MP} Springs, write today to reserve your copy of our newest catalog—No. 8; for Electronic Components, ask for No. 8-A.

Instrument Specialties Co. Inc.

270 BERGEN BOULEVARD, LITTLE FALLS, NEW JERSEY

Telephone Little Falls 4-0280

BeCu^{MP} = Beryllium Copper, Micro-Processed

CIRCLE ED-24 ON READER-SERVICE CARD FOR MORE INFORMATION



Airborne Computer Amplifier

By S. Frangoulis

Project Supervisor, Ford Instrument Company
Division of the Sperry Corporation,
Long Island City, N. Y.

Design Forum

LIGHT WEIGHT, small volume, ease of servicing, and the ability to withstand extremes of temperature, altitude, vibration, and shock were the physical objectives for the electronic designers of the airborne amplifier shown on these pages. The successful solution of these problems is demonstrated by the illustrations. Purpose of unit is to amplify or generate all the audio-frequency input signals to the Computer Set, Latitude and Longitude AN/ASN-6 (see *ED*, April, '54, p. 5), a "ground position indicator" for military aircraft.

Figs. 1 to 5 show the five subassemblies of the amplifier chassis. Notice the open-type construction

chassis to facilitate maintenance. The screw at the top of the unit fastens to a bracket on the main amplifier chassis to provide additional support against vibration and shock for the transformer.

Fig. 2 shows one of the control-transformer servo amplifiers used for the transmission of information to and within the computing system. One of the two tubes comprises a two-stage pre-amplifier for driving the second tube which controls a servo motor.

The servo amplifier shown in Fig. 3 is similar to the one shown in Fig. 2. It is associated with the computing networks of the system. The rectangular box contains a summation network, the output of which drives a servo amplifier. This unit has four stages of pre-amplification to drive the output stage.

Accurate Timing

A 400cy signal for driving the time motor in the computer is generated by the subassembly shown in Fig. 4. The time motor is a two-phase synchronous motor. The frequency generated is accurate to one part in 5000 over the full temperature range. This accuracy is required to furnish a precise time function for the integrating elements in the system. Each phase is driven by a pair of 6005 vacuum tubes. The 400cy signal is generated in a two-stage, feedback amplifier with a tuning fork acting as the frequency controlling element. This oscillator output is fed to the driver and phase inverter. The driver-inverter drives the 6005 tubes through appropriate phase-shifting networks. The cylindrical unit plugging into the octal socket is the tuning fork. Immediately below the tuning fork are two output transformers for coupling the 6005 tubes to the motor.

Fig. 5 shows the power supply that furnishes all filament power for the amplifier, as well as 250v d-c for the time amplifier and 150v d-c for the servo amplifiers. The cylindrical unit is a tantalum capacitor. The rectifier section employs three 6X4W tubes



Fig. 1. The computer transformer.

Fig. 2. One of the three control-transformer servo amplifiers.



Fig. 3. There are two of these servo amplifiers in the unit.

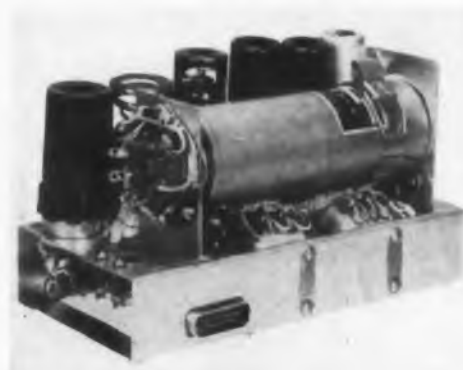

Fig. 4. The time motor in the computer is driven by a signal generated by this subassembly.

Fig. 5. The amplifier power supply subassembly.



of all transformers and the open-type shields for power stages to permit greater heat dissipation. The amplifier must operate at temperatures from -65°F to 160°F to altitudes of 50,000 ft. At these high altitudes there is little air available for cooling.

The computing transformer shown in Fig. 1 furnishes voltages for synchros and resolvers in the computing system. It also provides the high voltages necessary to excite the output stages of the servo amplifiers. The open-type construction minimizes weight. This transformer is mounted in a plug-in

operating in parallel. The arrangement is such that a filament failure in any tube does not unbalance the load on the remaining tubes. The unit includes a two-tube series regulator circuit for hum reduction.

Figs. 6 and 7 show two views of the main chassis assembly with all the sub-units removed. The fan seen in Fig. 6 is used to circulate air inside the amplifier to distribute the heat more evenly and to transfer heat to the outer case more efficiently. An external fan circulates air over the enclosure. The unit's fuses are shown in the upper left-hand region. A spare fuse container is also mounted inside the amplifier. The two-pin receptacle shown at the rear of the chassis engages two plugs in the case and conducts power to the external blower motor when the chassis is inserted in the case. These plugs are gasket sealed so that the pressure within the enclosure is maintained at high altitudes.

The "Y" shaped springs shown in Fig. 7 lock the plug-in assemblies into position after full engagement has been achieved. The key-hole slots are arranged to provide guidance for the mating of plug and receptacle, thereby reducing the possibility of bent pins in the connectors. The buttons below the connectors on the amplifiers shown in Figs. 2 and 3 mate with the key-hole slots. Large circular holes were punched in the main chassis to save weight.

Wiring Channel

Wiring to the subassemblies is contained in the wiring channel running the length of the chassis. This channel also contains a group of stand-off insulators for mounting gain-controlling resistors for the various servo loops in the computing system. By controlling the gain in this way, it is possible to use one standard servo amplifier subassembly design to meet the requirements of three different servo loops. The capacitors at the end of the chassis are tuning capacitors associated with the time motor in the computer.

All the subassemblies are mounted in the main chassis shown in Fig. 9. The internal fan forces air from left to right over the 12 tubes in the foreground and from right to left over the tubes in the back. On the inside of the front panel can be seen the gasket which is used to seal the enclosure. This photo also shows the use of turret-type sockets in the subassemblies. These provide compact packaging and simple fabrication by eliminating terminal boards.

Special Shock Mount

Fig. 8 shows the encased amplifier mounted in its normal position in the aircraft. The shock mount is furnished by Robinson Aviation Inc., Teterboro, N. J., and was especially designed for this amplifier. The special design was necessitated by stiffening ribs in the enclosure.

The method of holding the gasket sealing screws captive is also evident from this photo. The case is pressurized to minimize corona discharge and electrical leakage at high altitudes. The external blower is mounted in the hood shrouding the enclosure. Ambient air is drawn in from the lower rear at each side and forced forward over the top and down over the sides. About 175w generated inside the amplifier must be dissipated.

By using fungistatic materials throughout, it was possible to meet the fungus requirements of the specifications without the use of fungus-proofing compounds.

Figs. 6 and 7. Top and bottom views of the "skeleton" main chassis with all subassemblies removed.

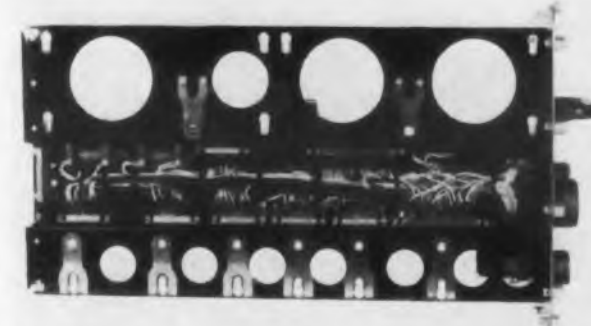
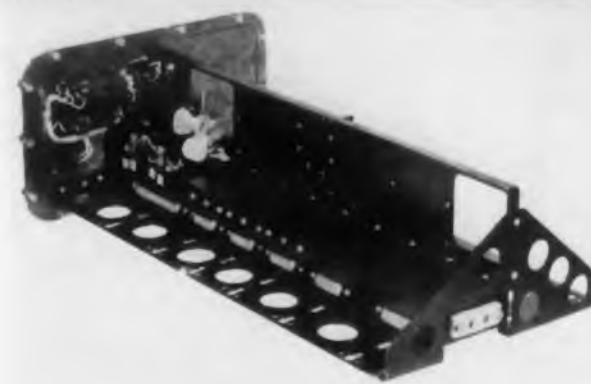

Fig. 8. The complete amplifier with its specially designed shock mount.



Fig. 9. The uncased amplifier.

to your specifications
...for quick delivery

You tell our engineers your needs, and Thermador's Electronics Plant goes into immediate operation. Complete, unsurpassed facilities and precision craftsmanship manufacture transformers that meet your most exacting requirements.

Your completed transformers are subjected to extreme environmental conditions; tested under critical loads. Thermador transformers with-

Precision-designed Thermador Transformers

stand the severest testing—will exceed any MIL requirements or exacting specifications. Thermador certifies your transformers without delay.

We work from your specifications to develop a transformer for your application, chassis or performance standards... one or a thousand. Delivery is quick. Tell us what you need. Call us today. Request literature from: Electronic Division, Thermador Electrical Manufacturing Company, 2000 South Camfield Avenue, Los Angeles 22, Calif. PARKVIEW 8-2105



THERMADOR
Electronic Division



SEVEN LEAGUES AHEAD
3-919

CIRCLE ED-34 ON READER-SERVICE CARD FOR MORE INFORMATION

New Products . . .

Silicon Junction Diodes Stable at High Temperatures

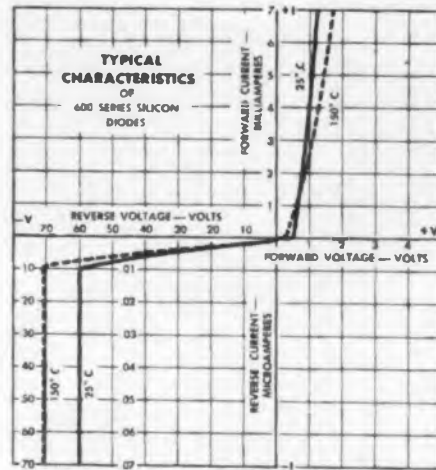

from 0.001 to 0.01μamp at rated voltages. They have glass-to-metal hermetic seals.

The minimum Zener voltage for the Type 601 is 50v. The minimum forward currents at 1v for the Type 601 are 3ma and 2ma for ambient temperatures of 25°C and 150°C, respectively.

For the Type 601, the maximum inverse currents at -1v are 0.01μamp and 20μamp at 25°C and 150°C, respectively. At -10v, these currents are 0.04μamp and 40μamp, respectively. For the Type 600, the maximum inverse currents at 25°C for -1v and -10v are 1μamp and 8μamp, respectively. The maximum peak inverse operating voltage of the Type 600 is -30v. The minimum forward current for the Type 600 at 25°C and 1v is 3ma.

These diodes are recommended for applications demanding either sharp Zener voltage characteristics or high-temperature stability. The cylindrically shaped units are about 1/2" long. Texas Instruments, Inc., Dept. ED, 6000 Lemmon Ave., Dallas 6, Texas.

CIRCLE ED-35 ON READER-SERVICE CARD FOR MORE INFORMATION

Miniature Power Resistors Withstand Extreme Shocks



Type RSE ruggedized, miniature power resistors are designed to solve both space and shock problems.

Available in 2w, 5w, and 10w sizes, they are sealed in a special silicone coating and housed in a black metal tubing. They have a complete welded construction from terminal to terminal.

The resistors are impervious to moisture (95% relative humidity at 40°C for 24 hours), and have a temperature coefficient of 0.00002/°C. Ranges are from 0.05 ohms to 55,000 ohms. Tolerances of 0.05%, 0.1%, 0.25%, 0.5%, 1%, and 3% are available. Dale Products, Inc., Dept. ED, 1318 28 Ave., Columbus, Neb.

CIRCLE ED-36 ON READER-SERVICE CARD FOR MORE INFORMATION

Auto Radio Tubes Filaments Take 12v

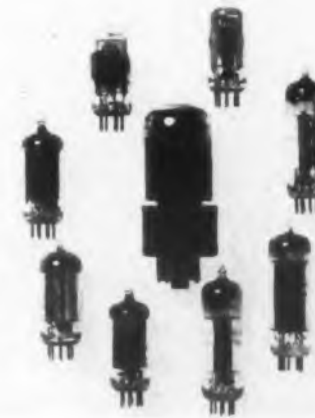

This series of tubes for 12v filament operation were designed for use in the radios of cars with 12v batteries. Designers can utilize parallel heater circuitry similar to that used for 6v auto receivers.

The tubes are designated the 12BA6 and 12BD6 (for r-f stages), the 12BE6 for conver-

ter service, the 12BA6 for i-f amplification, the duo diode-triode 12AV6 for second detection and audio engineering, the 12AQ5 and the 12V6GT (for audio amplification) and the 12X4 rectifier. They are equivalent to their 6v prototypes except for heater ratings. The 12V6GT is equivalent to the 6V6, but is in a T-9 envelope. Sylvania Electric Products, Inc., Dept. ED, 1740 Broadway, New York 19, N. Y.

CIRCLE ED-37 ON READER-SERVICE CARD FOR MORE INFORMATION

Transistor Transformers

Input, Interstage, and Output Types



This transistor transformer measures only 1/2" x 7/16" x 3/8". It is designed for transistorized circuitry use in audio amplifiers, hearing aids, and control circuits. It comes in input, interstage, and output models.

Impedance of the input type's primary coil is 200,000 ohms, with current in the primary coil of 0ma(d-c) and impedance in the secondary coil of 1000 ohms. Frequency response is down 3db at 200cy from 1000cy at the input stage, and the maximum power at 200cy is 0.5mw. Characteristics of the interstage type, in the same order as above, are: 20,000 ohms, down 3db at 100cy, and maximum is 1mw. For the output type, the characteristics are: 1000 ohms, 2.0ma, 100 ohms, down 3db at 120cy, and maximum power at 120cy at 15mw. Other models can be furnished to specification. Telex, Inc., Electro-Acoustic Division, Dept. KP, St. Paul 1, Minn.

CIRCLE ED-38 ON READER-SERVICE CARD FOR MORE INFORMATION

Magnetic Storage Elements

Can Operate At Rates to 500kc



This line of encapsulated magnetic storage elements includes types which can be operated at rates up to 500kc. They are very reliable units designed to serve

as storage elements, shift registers, and control elements.

The typical unit illustrated, Model SR-200, is a high speed unit using but one core per stored digit, and capable of working at rates up to 350kc. Designed for dip-solder assembly, its overall size is 9/16" x 1-5/8" x 1-7/8".

Some characteristics of this specific model include: 300ma nominal shift current; 0.5-1.5µsec shift pulse width; 15v output signal amplitude; recommended diode (external): Transitron T6 or Raytheon CK742; recommended driving tube: RCA 6146 (as many as 50 elements may be driven by a single tube). The Model SR-200 is also useful for circuit applications where it is desirable to replace vacuum tube circuitry with more reliable, less expensive magnetic elements; for example, by merely directly connecting the input connections to the output, the unit will function as a continuous-readout flip-flop. Epsco, Inc., Dept. ED, 126 Massachusetts Ave., Boston 15, Mass.

CIRCLE ED-39 ON READER-SERVICE CARD FOR MORE INFORMATION

Connectors

Meet Military Specs



The AN-"E" Series of multi-contact electric connectors were designed to resist extreme environmental conditions. They meet specification MIL-C-5015A (ASG). The

design provides for higher dielectric strength with greater resistance, water repellancy, resistivity, corrosion resistance, and a higher potential test voltage and current ratings than previous specifications.

Because of the insulator and grommet design, the circuits through the connector are completely sealed from cable to cable. The "E" type features two available insert materials: a new and lighter polychloroprene material and the latest development in silicones.

Shells are of single-piece construction with integral clamps. The angle 90° plug illustrated has a removable clamp. The plug is also available in straight, wall-mounting, and box types. Cannon Electric Co., Dept. ED, 3209 Humboldt St., Los Angeles 31, Calif.

CIRCLE ED-40 ON READER-SERVICE CARD FOR MORE INFORMATION

Wave Analyzer

Handles 14 Inputs Automatically



The heterodyne type, Series 901 Automatic Wave Analyzer provides completely automatic reduction of vibration, seismic, power line, transient, noise, shock, and similar data. The analysis is a Fourier analysis: amplitude vs frequency. In some instances, depending upon the repetition rate, an amplitude vs time plot for a given frequency can be provided.

Suited for operation from any source supplying a repetitive signal, such as a magnetic tape loop, the analyzer covers the frequency range of 3-2000cy. Its features include: variable bandwidth of 1/2-

45cy; analysis down to 3cy; amplitude accuracy of ±5% of reading on logarithmic scale; frequency accuracy 0.5% of reading; input voltage range 60db; and input impedance of 2-1/2Meg.

Analysis is recorded and up to 14 inputs are handled and selected completely automatically, including, if desired, the simultaneous analysis of from two up to the total number of inputs. The Davies Laboratories, Inc., Dept. ED, 4705 Queensbury Rd., Riverdale, Md.

CIRCLE ED-41 ON READER-SERVICE CARD FOR MORE INFORMATION



**ELCO
SCREWS
ARE
GOOD
SCREWS**



WOOD SCREWS
MACHINE SCREWS
MACHINE SCREW
NUTS
TAPPING SCREWS
THREAD-CUTTING
SCREWS
PHILLIPS AND
SEMS SCREWS
PIPE PLUGS
STOVE BOLTS
CAP SCREWS
LAG SCREWS
DRIVE SCREWS
SPECIAL SCREWS
COLD HEADED
PRODUCTS



ELCO TOOL AND SCREW CORPORATION
1948 BROADWAY • ROCKFORD, ILLINOIS

CIRCLE ED-43 ON READER-SERVICE CARD FOR MORE INFORMATION

Something Special in
**ROTARY
SWITCHES**

- ★ Single deck, single pole, 36 or 60 positions
- ★ Easily Ganged
- ★ Large Current Capacity
- ★ Non-Shorting with Detent
- ★ Isolated Shaft
- ★ Four Point Mounting

Here's the answer to complicated range or circuit switching problems in high quality test equipment or experimental apparatus.

A number of these single deck switches may be ganged to provide additional poles. Both switches have a special detent which also provides the non-shorting action. The rotor arm is actually *lifted* as it moves from one contact to the next. This Shallcross design provides more usable contacts in less space than conventional non-shorting switches. Write for prices and drawings. Shallcross Manufacturing Co., 526 Pusey Ave., Collingdale, Penna.

SPECIFICATIONS

Types 10061-S (60 pos.) and 10054-S (36 pos.)
Shaft Extension: 1" beyond spacers
Size: 4 7/8" sq. x 1 1/2" d.
Insulation: Phenolic. Isolated shaft.
Avg. Contact Resistance: 0.006 ohms max.

Type	#10061-S	#10054-S
Voltage Breakdown:	1500 v.	2500 v.
Current Capacities		
Carrying—	30 amps.	40 amps.
Breaking—	2 amps. at 110 v. a-c	3 amps. at 110 v. a-c

Shallcross

CIRCLE ED-44 ON READER-SERVICE CARD FOR MORE INFORMATION

New Products . . .

Sine-Cosine Potentiometer

Provides Two Outputs



The RL11C Sine-Cosine Potentiometer provides two output voltages accurately proportional to the sine and cosine of the angle of shaft rotation. This precision, wire-wound unit has many applications in radar, computer, and servomechanism work. It is especially useful for slow circular sweep on oscilloscopes or for low-frequency sine-wave generation.

The potentiometer is precision constructed, with ball bearings, precious metal contacts and silver slip rings to insure accuracy and long life. Standard resistance winding is 16,000 ohms $\pm 10\%$, a rating of 1.5w at 65°C, and a life expectancy of 350,000 revolutions, minimum. The output wave is pure sine or cosine with an average deviation of less than 0.5%. The unit has a 360° continuous rotation.

The RL11C type has an overall diameter of 2-5/8". The mounting shoulder is 35/64" long. All insulating materials are treated with fungicide varnish and the flange is anodized against salt-spray corrosion. Rawson Electrical Instrument Co., Dept. ED, 110 Potter St., Cambridge, Mass.

CIRCLE ED-45 ON READER-SERVICE CARD FOR MORE INFORMATION

Power Supply

Covers 380-420cy Frequency Range



This variable-frequency power supply covers the frequency range from 380cy to 420cy. Other frequency ranges are available in similar units. The unit is enclosed in a steel cabinet, the top of which is hinged for cable storage. It is portably mounted on solid rubber tired casters.

Rated at 1-1/2kva, the unit has a power factor of 0.9. Three phase output is 115/200v and voltage is held constant by an electronic regulator within $\pm 1\%$ over the full frequency range. Frequency is variable by means of a variable speed drive whose control wheel extends from the front panel. The drive motor operates on 220/440v, 3-phase, 60cy. American Electric Motors, Inc., Dept. ED, 4811 Telegraph Rd., Los Angeles 22, Calif.

CIRCLE ED-46 ON READER-SERVICE CARD FOR MORE INFORMATION



Brain Boxes by Cook

Mass Producers of Electronic Intelligence for America's Aircraft, Guided Missiles, Armament, and Industry presents a winning combination

RELAYS - SENSING DEVICES
TIME DELAYS - FINE INSTRUMENTS
400 CYCLE COMPONENTS
and associated apparatus, developed and produced by the
DIAPHLEX DIVISION

Comprehensive Electronic Systems prototyped by
COOK RESEARCH LABORATORIES
staffed with 350 scientists, engineers, technicians, draftsmen, and model makers.

Electronic Gear mass produced by the
ELECTRONIC SYSTEMS DIVISION

Qualified and completely Acceptance Tested by
INLAND TESTING LABORATORIES

A team coached and directed by management who know their jobs, stay on the job and get results.

We invite your inquiry.

Cook Electric Company

Established 1897

2700 Southport, Chicago 14, Illinois

Diaphlex—Aircraft Components and Accessories • **Wirecom**—Wire Communications, Protection & Distribution Apparatus • **Magnilastic**—Expansion Joints, Heavy Industry Equipment, and Airframe Structures • **Cook Research Laboratories**—8100 Monticello Avenue, Skokie, Illinois • **Inland Testing Laboratories**—1457 Diversey Parkway, Chicago 14, Illinois • **Electronic Systems Division**—2533 N. Ashland Avenue, Chicago 14, Illinois • **Subsidiary: Canadian Diaphlex Limited**—Aircraft Components and Accessories, Toronto, Ontario, Canada.

CIRCLE ED-47 ON READER-SERVICE CARD

ELECTRONIC DESIGN • June 1954

How to whip your relay problems!

Just call **ADVANCE...**
we're ready and
willing to make the
relays you need.

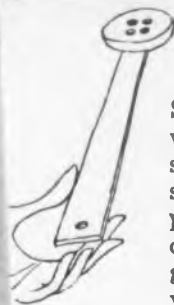

CONTACTS, for example

Say the word and we'll whip up the sizes... switch from fine silver to tungsten, palladium, silver-cadmium oxide, gold contacts, or... you name it!

INSULATION

Laminated phenolic, silicone glass, ceramic steatite, linen-base bakelite, or... you name it!



ANYTHING SPECIAL...

ADVANCE will engineer, develop and produce the custom relays you need in minimum time. Call ADVANCE for action.

For ELECTRONIC USES

We build a vast variety of sensitive, reliable relays...create superior new designs quickly. You'll find our quality control is now the tightest in the industry.

Write—and let us solve your relay problems



ADVANCE ELECTRIC AND RELAY CO.

2435-K NORTH NAOMI STREET
BURBANK, CALIFORNIA

CIRCLE ED-48 ON READER-SERVICE CARD

Non-Inductive Resistors

Accuracies of 1%, 0.5% or 0.1%

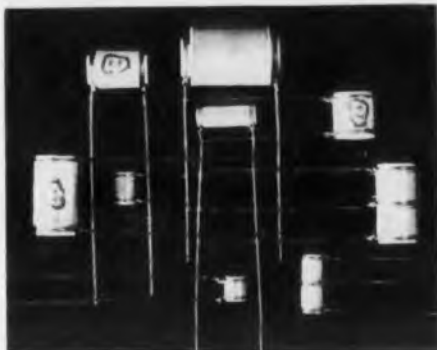

Offered in a series of standard value ranges from 0.1 ohm to 1 megohm, these Precision Resistors are available with accuracies of 1%, 0.5%, and 0.1%. Wound noninductively on nonhy-

groscopic ceramic bobbins and impregnated for moisture protection, they exhibit low thermal emf and a temperature coefficient of 0.000025 ohms/°C.

Nine sizes are supplied ranging in power capability from 1/4w to 1w, in diameter from 1/4" to 3/4", and in length from 5/16" to 1-1/4". In the standard units, values under 800 ohms are wound of Manganin wire, while values over 800 ohms are supplied in "Evanohm". Special alloys can be used where their characteristics are required, and special units can be produced with resistance values under 0.1 ohm, and over 1 megohm. K-F Development Co., Dept. ED, 2631 Spring St., Redwood City, Calif.

CIRCLE ED-49 ON READER-SERVICE CARD FOR MORE INFORMATION

Test Socket Adapters

For Radio, TV Measurements



These 7- and 9-pin miniature test socket adapters and 8-pin octal test socket adapters are useful for making measurements from the top of the chassis while the set is in operation. The adapters are inserted between the tube base and its socket, completing the circuit and making all connections readily accessible. Measurements can be made without tracing circuit wiring to test points below the chassis.

Other features are: extended test tabs for use with either alligator clips or test prods; mica-filled phenolic construction; high insulation resistance; and a low inter-element capacity of approximately 1mmfd. Designed for high voltage operation, their voltage breakdown between elements exceeds 1700v a-c or d-c. Pomona Electronics Co., Dept. ED, 524 West Fifth Ave., Pomona, Calif.

CIRCLE ED-50 ON READER-SERVICE CARD FOR MORE INFORMATION



*Career-chance
of a lifetime for*

RESEARCH and DESIGN SPECIALISTS

in LOCKHEED'S expanding Missile Systems Division

Recently formed from other Lockheed engineering organizations to prepare for the era of automatic flight, Lockheed's Missile Systems Division has a few openings for highly-qualified specialists in research, design and proposal work.

The type of work involved in the Division's contracts—along with its expansion program—makes these openings outstanding opportunities for achievement. The positions call for engineers of senior or group leader level. Engineers who qualify probably have worked on missile, radar-computer, counter-measure, IFF, AMTI or similar projects.

LOCKHEED *has openings for:*

Research Specialists

with broad experience in missile guidance problems, missile proposal work, control system analysis and evaluation, and servo-mechanisms. Strong electronics and electro-mechanical background needed.

Design Specialists

with broad experience in missile proposal work and systems analysis. The positions also require experience in missile design, electronics, communications, microwave techniques, systems evaluation, airframe design, aerodynamics, structures and mechanics.

In addition to outstanding career opportunities, the Missile Systems Division offers you excellent salaries commensurate with your experience, generous travel and moving allowances, an unusually wide range of employee benefits and a chance for you and your family to enjoy life in Southern California.

Coupon below is for your convenience.



L. R. Osgood Dept. ED-M-6

LOCKHEED MISSILE SYSTEMS DIVISION
7701 Woodley Avenue, Van Nuys, California

Dear Sir: Please send me information on the Missile Systems Division.

name _____

field of engineering _____

street address _____

city and state _____

CIRCLE ED-51 ON READER-SERVICE CARD FOR MORE INFORMATION

**IMMEDIATE
DELIVERY...
FROM STOCK!**



ACTUAL SIZE



CHICAGO

Molded TOROIDS

- **UNIFORM** ● **COMPACT**
- **EASILY COMBINED TO GIVE
DESIRED INDUCTANCE**

These plastic encapsulated toroid coils are wound on high density, high permeability, powdered molybdenum permalloy cores. Designed to provide the utmost in stability and ruggedness, CHICAGO toroids are extremely well insulated and have low temperature coefficients. Additional features include:

- High Q over a wide frequency range
- Close tolerance of plus, minus 1%
- High stability over temperature range of -55°C to 85°C
- Unaffected by humidity
- Minimum pickup from external magnetic fields
- Easily stacked, mounted with a single screw
- 1-1/16" diameter, 1/2" high, 90° spacing of terminals



SPECIAL TOROIDS

... engineered and built to exact specifications of inductance and Q, either cased or uncased, are available from Chicago Standard. Write today, outlining your requirements.



SPECIAL AUDIO FILTER NETWORKS

Audio filters for any specific application, band pass, band elimination, high pass, low pass, etc. can be designed to meet the characteristics you require.



**CHICAGO STANDARD
TRANSFORMER CORPORATION**
3501 ADDISON STREET • CHICAGO 18, ILLINOIS

EXPORT SALES: Roburn Agencies, Inc., 431 Greenwich Street, New York 13, N. Y.
CIRCLE ED-52 ON READER-SERVICE CARD FOR MORE INFORMATION

New Products . . .

Miniature Time Delay Relay

For Airborne Equipment



The Model 13100 relay is designed primarily for use with airborne equipment whose voltages are 24-29v d-c. With spdt contacts, dimensions are only 1" diam x 3" long, with weight less than 3 oz. A delay of 125-250millisec from 0° to 120°F at above voltage extremes is maintained by utilization of a new magnetic-capacitance delay system.

The relay will remain operative at 10g vibration from 10-250cy, and is designed to withstand steady-state acceleration to 50g.

Minimum life is 100,000 operations with 3amp, non-inductive contact loading.

Variations include: a-c or d-c operation, including 400cy; delay variations from 0.020-0.50sec; operating voltage from 5v to 150v; any combination of contacts to dpdt; available with instant reset time; fast make, slow break or slow make, fast break; and header connection arrangement to specifications. All of the relays are hermetically sealed self-contained units. Neomatic, Inc., Dept. ED, 9010 Bellanca Ave., Los Angeles 45, Calif.

CIRCLE ED-53 ON READER-SERVICE CARD FOR MORE INFORMATION

High-Strength Fastener

Easily Locked and Unlocked



The "Hi-Strength" Model HO Fastener is a one-piece stud without cross pins, milled sections or holes. It locks with a quarter turn clockwise, and unlocks counter clockwise. The design is self-contained, and the fastener cannot come apart.

Characteristics include: shear load of 4750 lb, tensile strength of 300 lbs, sheet separation 0.000", and permanent set after load 0.000". Range of the stud is 0.030".

Overall size of the fastener is 0.680" wide x 0.470" high. The spring assembly is only 1.490" long with 1" rivet centers. The stud has an oval head of 9/16" diam. Lion Fastener Company, Inc., Dept. ED, Honeoye Falls, N. Y.

CIRCLE ED-54 ON READER-SERVICE CARD FOR MORE INFORMATION



precision resolvers
SIZES 11, 15, 23



400~ servo motors



brushless induction potentiometers



RELIABLE AND STABLE PERFORMANCE

servo components, instruments, synchros



Let us quote on your detailed requirements.

American Electronic Mfg., Inc.
9503 W. JEFFERSON BLVD., CULVER CITY, CALIF.
TELEPHONE: TEXas 0-5581 • VERmont 0-6402

teflon*

... and We Can Deliver!



EXTRUDED & MOLDED ROD and TUBE Small Machined Parts! Sheets!

Heavy demand has put many TEFLON fabricators in a "back ordered" condition. The effect — stymied or crippled production on your end.

At FLEXROCK we have licked this problem. New TEFLON producing equipment has been added. We have substantially increased capacity. We can't take on all things just yet. But soon we will be ready to "throw the book at you" with a complete range of TEFLON services. RIGHT NOW we are set to ship you TEFLON Rod and Tube, extruded or molded, Sheets, and small parts — no matter how intricate — machined from Rod and Tube. We can promise good delivery — yes, FAST DELIVERY . . . with closest possible tolerances on your small parts. Tell us your needs — we will be happy to quote delivery and price.

*DuPont trade-mark
for tetrafluoro-
ethylene resin



SEND US YOUR "SPECS" LET US QUOTE!

FLEXROCK COMPANY
3608-B Filbert St., Phila. 1, Pa.

- We are enclosing sample, specs, and quantity for our TEFLON requirements. Please furnish quotation.
- Please send us your TEFLON Bulletin including stock list.

Name

Company

Address

City Zone State

CIRCLE ED-56 ON READER-SERVICE CARD

Foundation Chassis

Made in 5 Sizes

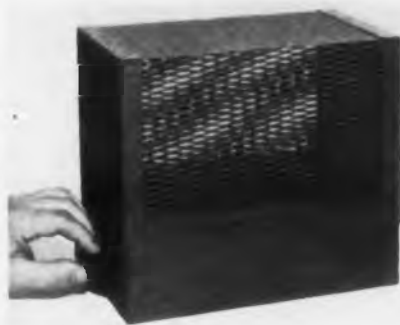

A series of five foundation chassis, suitable for amplifiers, transmitters, power supplies, and other electronic applications, features perforated covers that provide both ventilation and protection for parts mounted inside. Made of heavy steel, the chassis and covers are finished in marine gray ripple enamel. Detachable side handles are included.

Chassis depth is 3". The overall dimensions of the five models are: No. 3965, 5-1/2" x 10" x 9"; No. 3966, 8" x 12" x 9"; No. 3967, 7" x 17" x 9"; No. 3968, 10" x 14" x 9"; No. 3969, 10" x 17" x 9". Special sizes can be specified. Insuline Corporation of America, Dept. ED, Manchester, N. H.

CIRCLE ED-57 ON READER-SERVICE CARD FOR MORE INFORMATION

Temperature Measuring System

Provides High Signal Voltages



The "TME-25" Balance and Power Unit contains circuitry for the proper operation of 24 temperature probes plus one reference channel. A flexible laboratory measuring system, it is specifically designed to provide the high signal voltages required for operating telemetering systems, recording meters, and oscillographs without the use of bulky, power-consuming amplifying equipment.

The unit supplies the power necessary for probe excitation, and provides range and sensitivity adjustments for each measuring channel. By means of these adjustments, all types of telemetering signal inputs can be supplied. Units for greater or lesser numbers of measurements can also be supplied.

The temperature probes are precise high-speed resistance thermometers designed to operate over the range -70° to $+500^{\circ}$ F. Probe configurations are available for making surface, liquid, and gaseous temperature measurements. The system allows flexibility of measurements over various ranges without costly set-up time or the necessity of stocking a number of probes for different temperature spans. Arnoux Corp., Dept. ED, 1357 S. Hawthorne Blvd., Hawthorne, Calif.

CIRCLE ED-58 ON READER-SERVICE CARD FOR MORE INFORMATION



Eimac
QUALITY PRODUCTS
...for top performance!

Preformed Contact Finger Stock is an ideal electrical weather stripping around doors of equipment cabinets as well as being excellent for use with VHF and UHF circuitry. Silver plated, it comes in three widths— $\frac{1}{2}$ ", $\frac{3}{8}$ " and $1\frac{1}{8}$ " inches.

Variable vacuum capacitors come in three models, are lightweight, compact, eliminate the effects of dust and atmospheric conditions and have low inductance. Also available are eight types of fixed vacuum capacitors.

Air-system sockets, designed for Eimac tube types 4-400A, 4-1000A, 4X150A, and 4X150D, simplify cooling and assure adequate air-flow to various seals. The 4-400A socket can also be used with the 4-125A and 4-250A

radial-beam power tetrodes if desired.

HR heat dissipating connectors provide efficient heat transfer from the tube element and glass seal to the air while making electrical connections to plate and grid terminals. Precision machined from dural rod, HR connectors come in ten sizes to fit most of Eimac's internal anode tubes.

High Vacuum Rectifiers come in eight models, are instant heating, have radiation-cooled pyrovac* plates and can be operated in a variety of rectifying and voltage multiplying circuits. Also available are four types of mercury-vapor rectifiers.

*An Eimac trade name.

• For further information write our Application Engineering department

EITEL-McCULLOUGH, INC.

SAN BRUNO - CALIFORNIA

Export Agents: Frazar & Hansen, 301 Clay St., San Francisco, California



CIRCLE ED-59 ON READER-SERVICE CARD FOR MORE INFORMATION

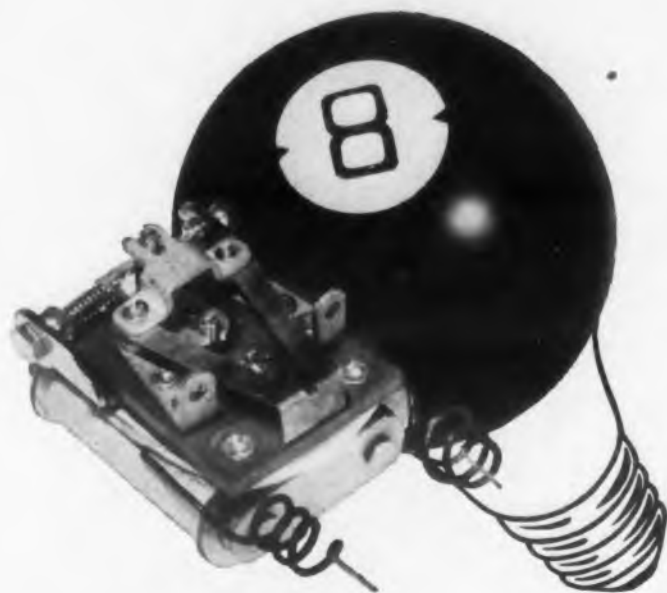

NEW LIGHT ON THE LAMP LOAD PROBLEM

This relay was developed for use in photoelectric street light controls, where, to the problem of handling an incandescent load without contact welding, is added the requirement of doing so on normally closed contacts.

The cold starting current drawn by an incandescent lamp bulb is many times greater than its running (hot) current. When, as in our testing procedures, the circuit is connected over heavy gauge wires direct to a "stiff" power line, and when the bulbs are allowed to cool fully between cycles, the starting current is 10 times the running current. Although it varies with different sizes and voltages

of bulb, a figure of 10 is conservative on 120 volt circuits.

The Type 51 Sigma Relay is a sensitive SPST contactor, normally closed. It operates at 100 milliwatts D. C. (3.2 ma, 10,000 ohm coil). Switches 10 Ampere Incandescent lamp load at 120 V. A. C. for a life expectancy of 5,500 times, or once per day for 15 years.

The Type 51 Relay should be given a try when 100 milliwatts coil signal must switch 10 to 25 Amps (24 V. D. C. or 110 V. A. C.) 10,000—100,000 times, on resistive or inductive loads.

SIGMA

SIGMA INSTRUMENTS, INC.
91 PEARL ST., SO. BRAINTREE, BOSTON 85, MASS.

CIRCLE ED-60 ON READER-SERVICE CARD FOR MORE INFORMATION

New Products . . .

Nylon Line Plug Made in Many Colors

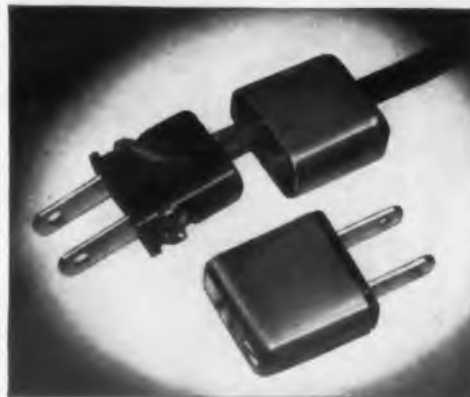

This line cord plug, designated Cat. No. 1420, is made of unbreakable nylon and has molded-in strain relief for the line cord. The unusual strength of the nylon permits a compact design about two-thirds the size of present designs. The nylon housing is available in a wide variety of colors. Industrial Devices, Inc., Dept. ED, Edgewater, N. J.

CIRCLE ED-55 ON READER-SERVICE CARD FOR MORE INFORMATION

Small TV Camera For Remote Test Observing



This Model 300-BV TV Camera for closed circuit used is valuable for the observation of materials undergoing tests in dangerous, remote, or inaccessible locations.

The unit features high resolution at low lighting levels and ease of service-

ability. Diamond Power Specialty Corporation, Dept. ED, Lancaster, Ohio.

Teflon Sheets Made 1/16" to 2" Thick

Pure Teflon sheets in thicknesses from 1/16" to 2" are available in sheets measuring 24" x 24", 30" x 30", 36" x 36", and 48" x 48". In addition the 24" x 24" sheet can be furnished 1/32" thick.

Special sizes up to 72" x 60" can also be supplied. Gaskets up to 60" OD can be made from these sheets. Chemical and Power Products, Dept. ED, 11 Broadway, New York 9, N. Y.

CIRCLE ED-62 ON READER-SERVICE CARD FOR MORE INFORMATION

New Components for designing Electronic Equipment for RELIABILITY-IN-SERVICE

Alden Components for Plug-in Unit Construction enable you to design to these Bold New Standards —

1. Circuitry subdivided function by function into plug-in units.
2. Tiny Tell-Tales spot troubles instantly.
3. Plug in replacement spares in 30 seconds.
4. All leads brought to single accessible point of check, numbered and color coded so layman can make first-level tests.

It's as simple as this —

1 Organize your circuitry function by function in compact vertical planes using Alden Terminal Mounting Cards, Ratchet-Slot Terminals and Card-mounting Sockets.



Alden Terminal Card Mounting System — for Packages — for Chassis.

2 Mount the circuitry planes in Alden Plug-in Packages and Basic Chassis which can be yanked out and replaced in 30 seconds.

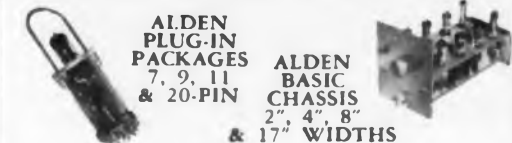

ALDEN
PLUG-IN
PACKAGES
7, 9, 11
& 20-PIN

ALDEN
BASIC
CHASSIS
2", 4", 8"
& 17" WIDTHS

3 Monitor each plug-in unit with tiny Alden Tell-Tales that spot trouble instantly, permit checks while operating, from front of panel.



ALDEN
MINI-TEST
POINT
JACK
#110BCS

ALDEN
MINIATURE
PAN-I-LITE
#86L

ALDEN
MINIATURE
FUSE-LITE
#440-4FH

4 Centralize unit interwiring at a single accessible point of check, with Alden Back Connectors and Serve-A-Unit Lock which allow color coding and symboling that "reads like a book".

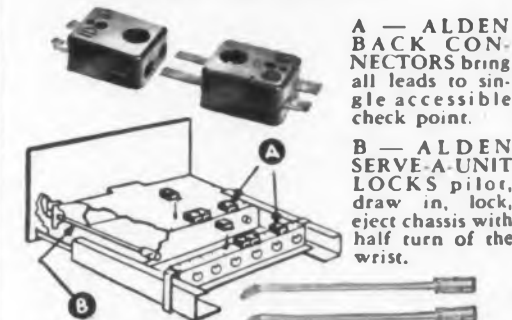

A — ALDEN
BACK CON-
NECTORS bring
all leads to sin-
gle accessible
check point.

B — ALDEN
SERVE-A-UNIT
LOCKS pilot,
draw in, lock,
eject chassis with
half turn of the
wrist.

ALL THIS CAN BE
ACCOMPLISHED
WITH STAND-
ARD ALDEN
COMPONENTS

To get details request
free: "Plug-in
Handbook Data"



6139 N. Main St., Brockton 64, Mass.
CIRCLE ED-63 ON READER-SERVICE CARD

ELECTRONIC DESIGN • June 1954

Variable Resistors

Tab Mounted



Designated Type LR-5 Variable Resistors, these miniature, low-cost, "bushingless" controls are for tab mounting in TV receivers, printed circuits, etc. Measuring only 0.894" diam, they dissipate $\frac{1}{2}w$ and can be supplied with any of nine different line switches.

The units are mounted by two tabs extending from the front covers in much the same way as many can-type capacitors. The tabs are inserted in rectangular slots of the mounting plate so that twisting the tab securely fastens the control. This construction eliminates the usual threaded brass bushing, lockwasher, and mounting nut. The shaft itself may be furnished with a knurl, a slot, or both.

These controls find greatest use as rear-of-chassis and concealed front panel controls in TV receivers, preset gain controls for multiple input pre-amplifiers, and other circuits requiring only occasional adjustment. Electronic Components Division, Dept. ED, Stackpole Carbon Company, St. Marys, Pa.

CIRCLE ED-64 ON READER-SERVICE CARD

Core Material

Usable to 30Mc

Ferramic "Q" is a core material for antenna rods, filter inductances, loading coils and r-f coils. It is also useful in applications requiring high Q, low-loss performance at any frequency up to 30Mc.

This soft magnetic material is stable in respect to age, shock, vibration and temperature. General Ceramics & Steatite Corporation, Dept. ED, Keasbey, N.J.

CIRCLE ED-65 ON READER-SERVICE CARD

CIRCLE ED-66 ON READER-SERVICE CARD



Here's Another Reason Why G.E. Can Supply the Aircraft Motor You Need

EXPERIENCE GAINED by General Electric engineers in the design, testing, and manufacture of this permanent-magnet motor is one more reason why G.E. is best equipped to supply the aircraft motor *you* need. And this motor is just one of the latest of hundreds of aircraft and armament motors supplied by G.E.

THIS PARTICULAR MOTOR, rated 1/100 hp and gear-reduced to 130 rpm, operates on 27.5 volts. Designed for dynamic brak-

ing, it can be stopped in 1/10 revolution by a fast-acting relay. Such performance makes it ideal for radar tuners, actuators, and blowers.

YOUR SPECIFICATIONS are all that G-E motor engineers need to begin applying their years of experience to your aircraft or armament motor problems. Contact your G-E Apparatus Sales Office today. Or write: General Electric Co., Section 704-28, Schenectady 5, N. Y.

GENERAL  ELECTRIC

MICRO SWITCH Precision Switches

A PRINCIPLE OF GOOD DESIGN

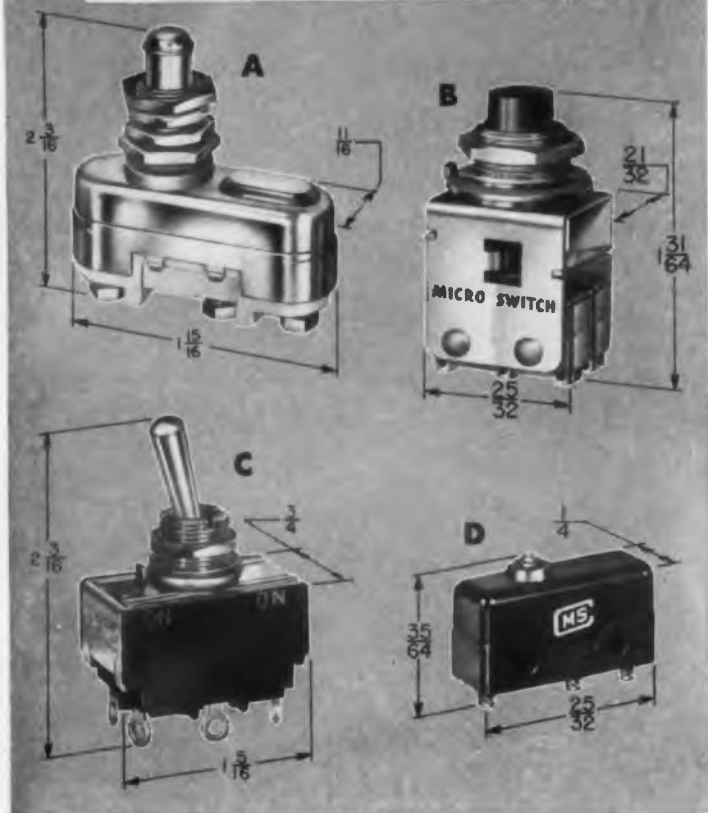

There are uses unlimited for these small MICRO SWITCH precision switches in electronic devices and instruments

A The high temperature basic switch will operate satisfactorily in a temperature range of from -50° to $+1000^{\circ}$ F. It is designed for applications which require a high-temperature switching component.

B The subminiature push button switch assembly is composed of two single-pole, double-throw subminiature switches. The plunger provides an unusually good snap make and break. Available with red or black plastic buttons and either solder post or turret-type, wrap-around terminals.

C This sealed toggle switch is supplied with an external panel seal and an internal bushing seal below the bat handle. It has a bushing for panel mounting and may also be supplied with keying tab.

D Tests show that this long-life subminiature switch is capable of operations in excess of 20 million. It is an improved type of the basic subminiature switch and is available with either solder post or turret type, wrap-around terminals.

MICRO SWITCH engineering service, fully experienced in every type of switch use, is available at 16 branch offices to consult with you on your switch application problem. A call to the branch office near you may save time and money.

MICRO SWITCH

A DIVISION OF MINNEAPOLIS-HONEYWELL REGULATOR COMPANY
FREEPORT, ILLINOIS



CIRCLE ED-68 ON READER-SERVICE CARD FOR MORE INFORMATION

New Products . . .

Memory Unit

Barium Titanate Crystal

The Model 393 Memory Unit is a small, potted crystal of ferroelectric material with a relatively square hysteresis loop. It consists of a crystal of barium titanate mounted in a standard crystal cartridge.

The memory of this device depends on its ability to sustain a polarized condition after the application of an electric field. The two possible polarities of domain orientation make up the two stable positions of the binary storage unit. Usually a pulse is applied to the unit in series with a load consisting of a capacitor and resistor in parallel. A typical load would consist of a 1500mmfd capacitor and a 2700 ohm resistor for use with 0.1μ sec pulses.

It is recommended that pulses of 50 to 100v be used for most efficient storage and recovery. Direct current breakdown is generally over 1000v. Glenco Corporation, Dept. ED, Metuchen, N.J.

CIRCLE ED-69 ON READER-SERVICE CARD FOR MORE INFORMATION

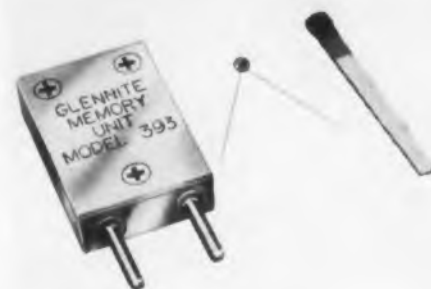

Capacitor-Resistor Bridge

Range 100 ohms to 5 Megohm



Capacitor-Resistor Bridge BF-60 quickly measures the important characteristics of substantially all types of capacitors and resistors and determines their quality. It detects opens,

shorts and intermittents, and the capacity between wires and shieldings, transformer windings, wires in cables, etc. It also measures the insulation resistance of paper, mica, and ceramic dielectric capacitors.

A high sensitivity amplified bridge circuit permits accurate and definitive readings. The unit has an adjustable d-c power supply and "eye" null detector. Its capacitance-measuring range is 0.00001mfd to 1000mfd in four ranges, and it measures resistances from 100 to 5,000,000 ohms. The unit is 5-1/2" x 7" x 10" in size and weighs 8 lb, 4 oz. Cornell-Dubilier Electric Corporation, Dept. ED, South Plainfield, N. J.

CIRCLE ED-70 ON READER-SERVICE CARD FOR MORE INFORMATION

ANOTHER FLASH-O-LENS AT WORK INSPECTING FILAMENT GUIDES AT Celanese Corporation



Lighting and magnifying the inspection area, FLASH-O-LENS speeds and simplifies the checking of filament guides on the coning machines at the Narrows, Va., plant of Celanese Corporation of America. That's just one of the many, many jobs on which FLASH-O-LENS is being used because its built-in bulb gives bright illumination — and its accurately ground lenses assure sharply detailed enlargement.

Battery and plug-in models available — priced from \$10.95. Write for literature and prices.

E. W. PIKE & CO., Inc.

492 NORTH AVENUE

ELIZABETH 3, N. J.

CIRCLE ED-71 ON READER-SERVICE CARD FOR MORE INFORMATION

Kanthal DR resistance wire
SAVES YOU UP TO 50% because...

. . . it is lighter in weight (more feet per pound), and the per pound price is low. Total savings approximately 50%.

. . . Kanthal DR improves the performance of resistors and precision equipment. Its electrical resistivity is high — 812 ohms per circular mil foot — its temperature coefficient is low ($\pm 0.00002^{\circ}$ C between -50° and $+150^{\circ}$ C), and it has a low thermal EMF to copper.

Available in fine gages and all types of insulation.

WRITE FOR FURTHER INFORMATION AND PRICES TODAY

KANTHAL THE KANTHAL CORPORATION
8 AMELIA PLACE, STAMFORD, CONN.

CIRCLE ED-72 ON READER-SERVICE CARD FOR MORE INFORMATION

New.. USECO ENGINEERING MANUAL



Send now for your copy of this new 36-page manual. It covers our complete line of Standardized Electronic Hardware.

It gives detailed prints and specifications covering types, sizes, materials, finishes and complete engineering data on our terminal lugs, terminal boards, insulated lugs, chassis bushings, stand-offs, spacers and other electronic items in both standard and miniature sizes. Mass production with quality control. Competitive prices. Prompt deliveries. Today's mail answered today! Terminal boards fabricated to manufacturer's specifications. Write for Engineering Manual.

U. S. ENGINEERING CO.

521 COMMERCIAL ST. • GLENDALE 3, CALIFORNIA

CIRCLE ED-73 ON READER-SERVICE CARD FOR MORE INFORMATION



improve design
simplify purchasing
speed production
with

C-D-F SPIRAL TUBING

Looking for low-cost tubing to reduce unit costs and improve product performance? Consider the use of C-D-F Spiral Tubing, a high strength plastic made from paper or fibre that is spirally wound and cured at high temperatures. In many cases it can replace rolled or molded laminated plastics... at a good cost saving. Small sizes, thin walls are not a problem. For many applications, dimensional stability and moisture resistance

is excellent. Coil forms, insulating tubes, paint roller tubes, shipping containers, bushings are just a few applications. Write today for 8-page Technical Folder ST-53, giving properties, sizes, tolerances on impregnated and unimpregnated round, square and rectangular C-D-F Spiral Tubing. Well illustrated. Call your C-D-F sales engineer (offices in principal cities)—he's a good man to know!

CDF
Continental-Diamond Fibre

CONTINENTAL-DIAMOND FIBRE COMPANY, NEWARK 107, DELAWARE

CIRCLE ED-74 ON READER-SERVICE CARD FOR MORE INFORMATION

ELECTRONIC DESIGN • June 1954

Power Supply For Use in Modular Systems



The Model 2 Modular Power Supply is especially designed for use with this firm's Modular System of electronic units. It provides power to operate three or more modular units, depending on those used. It

aids in the quick assembly of special function devices and in the design and construction of electronic equipment. Modular units are mechanically locked together. Interconnected by special patchcords, and the electronic function desired from each unit is selected by a multi-position switch.

The new power unit is only 15" long x 4-3/4" wide x 7-1/2" high, with a weight of 11 lb. It has an output of 80ma, +300v d-c; 15ma, -150v d-c; and 8amp, 6.3v a-c. It is connected to units by standard Modular power plugs. Audio Products Corp., Dept. ED, 2265 Westwood Blvd., Los Angeles 64, Calif.

CIRCLE ED-75 ON READER-SERVICE CARD FOR MORE INFORMATION

Precision Calibrator Triple-Purpose Instrument



This calibrator is a triple-purpose instrument combining highly stable a-c and d-c voltage sources and having an output range of zero to 10v for three selectable outputs: d-c, rms, and peak-to-peak of a 1000cy sine wave. A decade control provides steps of 1000mv, to which is added the setting of a 10-turn potentiometer. Dividing factors up to 1000 are obtained with a four-

position, push-button switch.

This control combination has a setting resolution of 0.01% for outputs above 10mv and of 1μv below 10mv. Long-term accuracy is 0.5% and short-term stability is better than 0.05% per hour. Distortion and hum on for alternating current is less than 0.5%. Internal impedances on a-c are exceptionally low, thus minimizing loading errors. Ballantine Laboratories, Inc., Dept. ED, Boonton, New Jersey.

CIRCLE ED-76 ON READER-SERVICE CARD FOR MORE INFORMATION

Admiral Sentinel
hallicrafters
AMI
M
VISMER
CROWN
H
GTS
LAU
Bendix
BODINE
HOWARD
Robertshaw-Fulton
Bell & Howell
Dominion
HAMILTON BENCH
BEAM
MAX TRAC
OAK MFG CO.
Cooper
WALSCO
Set Screw & Mfg. Co.

over 1500
Famous Manufacturers
POINT THE WAY TO SOLVING
YOUR PUZZLING PROBLEMS
with SETKO Set Screws

You're in "good company" when you put your set screw problems up to "Setko". These trademarks represent only a few of the many hundreds of famous products in which regular Setko Set Screws are used, or special types designed to meet some requirement of greater holding power, close precision setting, resistance to vibration, etc. One of the following 4 developments may be just what you need to insure against set screw failure.

Send for FREE
Bulletins

Improved Zip-Grip Self-Locking Set Screw Will lock to stay at any point

Fluted Socket Head Long approved by Federal Standards

Nu-Cup Set Screws Deeper cup-penetration, due to 42° sharper angle

Off-Set Self-Locking Set Screws Provide powerful spring-locking action

Send for FREE New Catalog No. 19. Illustrations, applications, data, sizes, prices on full line.

DON'T Bother to Write a Letter
Simply check items in which you are interested. Write your name and address in margin of this page, tear out and mail.

SET SCREW & MFG. CO. 265 Main Street — Bartlett, Ill.
We specialize in solving puzzling set screw problems.

FARADAY
Arvin
REYNOLDS
VERSAL INC.
ZEMITH RADIO
HURD
Reliable
A
Reco
AMPRO
S&C
UR
DELTA
M
SURE
TV
P&S
SOUTH BEND
OHIO
FURNAS
TRICO
FORD
MOTIOPHOTO
hotpoint
PENN CONTROLS
BENJAMIN
608 ED

CIRCLE ED-77 ON READER-SERVICE CARD FOR MORE INFORMATION

electromechanical

ENGINEERS

for research in and development of electro-mechanical radar and computing equipment.

THE MOST ADVANCED DEVELOPMENTS IN ELECTRONICS ARE BEING MADE IN THE SPHERE OF AIRBORNE RADAR AND ALLIED FIRE CONTROL SYSTEMS BECAUSE OF MILITARY EMPHASIS. FURTHER APPLICATIONS OF ELECTROMECHANICAL TECHNIQUES IN THESE FIELDS ARE CREATING NEW OPENINGS IN THE RADAR DIVISION OF HUGHES RESEARCH AND DEVELOPMENT LABORATORIES.

Engineers who have demonstrated ingenuity and inventive ability will find interest in the areas of work that call for devising reliable, maintainable, manufacturable designs for precision equipment developed in the Hughes Radar Division.

Equipment includes mechanical, electronic and microwave devices and systems to be manufactured in quantity. The equipment designs require use of such advanced techniques as subminiaturization, unitized "plug-in" construction, with emphasis on design for volume production. Knowledge of electronic components, materials, finishes and military specifications is useful.

ENGINEERS EXPERIENCED IN THE FIELD OF ELECTROMECHANICAL DESIGN FOR PRODUCTION. OR THOSE INTERESTED IN ENTERING THIS ORBIT. WILL FIND OUTLETS FOR THEIR ABILITIES AND IMAGINATION IN THESE ACTIVE AREAS.

Scientific and Engineering Staff

HUGHES

RESEARCH AND DEVELOPMENT LABORATORIES

Culver City, Los Angeles County, California

Assurance is required that relocation of the applicant will not cause disruption of an urgent military project.

New Products . . .

Selenium Rectifiers For Color TV Sets

This series of selenium rectifier stacks is for color TV sets. The units are designed for capacitive loads of 600ma, 700ma, and 750ma, and produced for maximum input voltage ratings of 130v, 172v, and 195v rms.

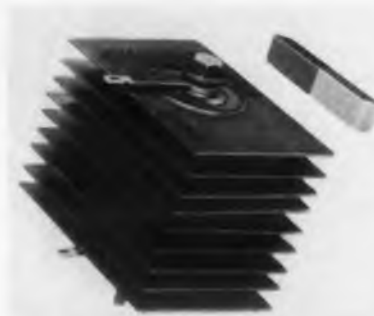

The construction employs a bellows type spring contactor such as is used in quality industrial rectifiers. The contactor affords a lower forward drop, lower temperature rise, and longer life. The 2" x 3" size of the plates results in a better form factor, giving the designer wider latitude in chassis layout. The illustration shows a Type RS609S rectifier stack which is rated for 195v rms input and 600ma output. International Rectifier Corp., Dept. ED, 1521 E. Grand Ave., El Segundo, Calif.

CIRCLE ED-78 ON READER-SERVICE CARD FOR MORE INFORMATION

Encapsulated Resistors In 0.1 to 4 Megohm Sizes



The "RB" Series of hermetically encapsulated resistors exceeds MIL-R-93A tests and meets characteristic "A" of JAN-R-93. Protection is achieved against both salt water immersion and humidity cycling.

The encapsulating enables thermocycling from -87° to 105°C , and the unit still retains original characteristics within $\pm 0.05\%$. Derate to zero watts at 125°C . The process insures a homogeneous mass, freedom from mechanical strain, and long component life with negligible failure due to adverse circumstances. Close tolerance is maintained after aging.

Resistance of the series is from 0.1Meg to 4Meg. Power ratings are from 1/4w to 1w. Wire temperature coefficients are available in E 20ppm/ $^{\circ}\text{C}$, J 120ppm/ $^{\circ}\text{C}$, and K 170ppm/ $^{\circ}\text{C}$, referred to an ambient of 25°C . Resistors may be obtained in tolerances up to 0.02%.

Solder lugs fabricated of tinned brass are provided, molded as an integral part of the resistor. Reon Resistor Corp., Dept. ED, 117 Stanley Ave., Yonkers 2, New York.

CIRCLE ED-79 ON READER-SERVICE CARD FOR MORE INFORMATION

"J" Type
"U" Type
"Latching Type"

FREE TRIAL SHOWS HOW!

SHAKEPROOF "SPEED-NUTS"*

T. M. REG. U. S. PAT. OFF.

SAVE TIME . . . REDUCE COSTS!

Designed to clip quickly and easily in place, SHAKEPROOF "SPEED NUTS" eliminate costly riveting, staking or welding operations. Light weight and easy handling speeds assembly.

SEND FOR FREE TEST KIT NOW!

T. M. REG. U. S. PAT. OFF.
BY LINNEMAN PRODUCTS, INC.

SHAKEPROOF

"Fastening Headquarters"

DIVISION OF ILLINOIS TOOL WORKS
St. Charles Road, Elgin, Illinois
Offices in principal cities

CIRCLE ED-80 ON READER-SERVICE CARD FOR MORE INFORMATION

Staver

Mini-Spring Mini-Shield Sub-Mini-Shield

dependable performance at **LOW COST**

Shielding and clamping devices that provide rigidity and protection for electronic tubes of various sizes. Designed for economy of both space and cost. Government accepted.

Let us quote on your special requirements.

THE Staver COMPANY INCORPORATED

Write for literature
47 NORTH SAXON AVE.
BAY SHORE, LONG ISLAND, N. Y.

CIRCLE ED-81 ON READER-SERVICE CARD FOR MORE INFORMATION

ELECTRONIC DESIGN • June 1954

Bourns sub-miniature TRIMPOTS

TRADE MARK

PROVIDE THE ULTIMATE
IN CIRCUIT TRIMMING

Simple screwdriver adjustment . . . The TRIMPOT is a 25 turn, fully adjustable wire-wound potentiometer, designed and manufactured exclusively by BOURNS Laboratories. Electrical settings in increments of 1/4 to 1/2% are securely maintained during vibration of 20 G's up to 2,000 cps or sustained acceleration of 100 G's. BOURNS' unique self-locking design eliminates cumbersome locknuts. Power rating is 1/4 watt at 100° F. Standard resistance values from 250 ohms to 25,000 ohms are available for immediate delivery. Information on higher and lower resistances on request.

BOURNS TRIMPOTS are accepted as standard components by aircraft and missile manufacturers and major industrial corporations.

9 TRIMPOTS TAKE LESS
SPACE THAN A 2¢ STAMP

Tiny cross-sectional size—only 1/4" x 5/16"—and rectangular shape save valuable panel space. Instruments are easy to mount individually or in stacked assemblies with two standard screws through the body eyelets.



Bourns also manufactures precision potentiometers to measure Linear Motion; Gage, Absolute, and Differential Pressure and Acceleration.



BOURNS LABORATORIES

6135 MAGNOLIA AVE. • RIVERSIDE, CALIFORNIA

Technical Bulletin On Request, Dept. 232

© B L PATENTS PENDING

CIRCLE ED-82 ON READER-SERVICE CARD FOR MORE INFORMATION

STREAMLINED AND RUGGED



BRAND
NEW

Cast Iron
Housing

Black Wrinkle
Finish

Sponge Rubber
Skid Pad

LINEMASTER

CLIPPER FOOT SWITCH

The streamlined Clipper Switch matches your unit's most modern features! Complete with all the rugged features of a heavy industrial switch. It is easily operated from sitting or standing position giving the worker a free hand for greater efficiency. Nearly 100% dustproof and yet accessible to wiring—just two screws to remove to reach interior mechanism.

Size—4 1/2" x 3 1/2" x 1 1/2" Wght. 2 lbs.

LINEMASTER SWITCH CORP.

130 Putnam Road • Woodstock, Conn.

WRITE FOR
BULLETIN
AND PRICES

Let us quote on
your switch
requirements

CIRCLE ED-83 ON READER-SERVICE CARD FOR MORE INFORMATION

ELECTRONIC DESIGN • June 1954

Multi-Contact Assemblies

Locked and Unlocked by Knobs



The Multi-Contact Double Screw Locking Assemblies feature quick and positive engagement and disengagement for mated connectors by the use of knobs at the top of the hood so designed

that they can be turned either by hand, coin, or screwdriver.

The lock screw within the hood is independent of the connector; any stress set up affects the steel hood alone. The nature of the assembly is such that the connector can be completely wired prior to assembly to the hood.

Contacts engage with the first turn of the screw locking device, and four regular guide pins are fully entered. When connectors are disengaged by means of alternate rotation of both knobs, a multiple audible click prevails, signalling that electrical engagement no longer exists. Further rotation completely disengages the hooded connector from the mating connector.

The assemblies are available with 34-, 50-, and 75-contact miniature connectors (MI Series) and will be available shortly for many others in the miniature series and on heavy-duty connectors (980 Series). U. S. Components, Inc., Dept. ED, 454-464 E. 148 St., New York 5, N. Y.

CIRCLE ED-84 ON READER-SERVICE CARD FOR MORE INFORMATION

Flexible Coupling

Compact, Has No Backlash



The "Tinymite" flexible shaft coupling is a small, simple unit with no backlash. It has many electronic applications, such as manual controls, tuning, plug-in units, sub-minia-

turization, or low power transmission. Measuring only 1/2" diam x 11/16" long, it operates on the improved Oldham principle. Weight is only 1/4 oz.

The coupling permits 5° angular or 1/16" offset misalignment. It fits 1/4" diam shafts. It has a nylon insulator and nickel-plated brass hubs. Renbrandt, Inc., Dept. ED, 98 Kirkland St., Cambridge 38, Mass.

CIRCLE ED-85 ON READER-SERVICE CARD FOR MORE INFORMATION

Pulse Forming Networks

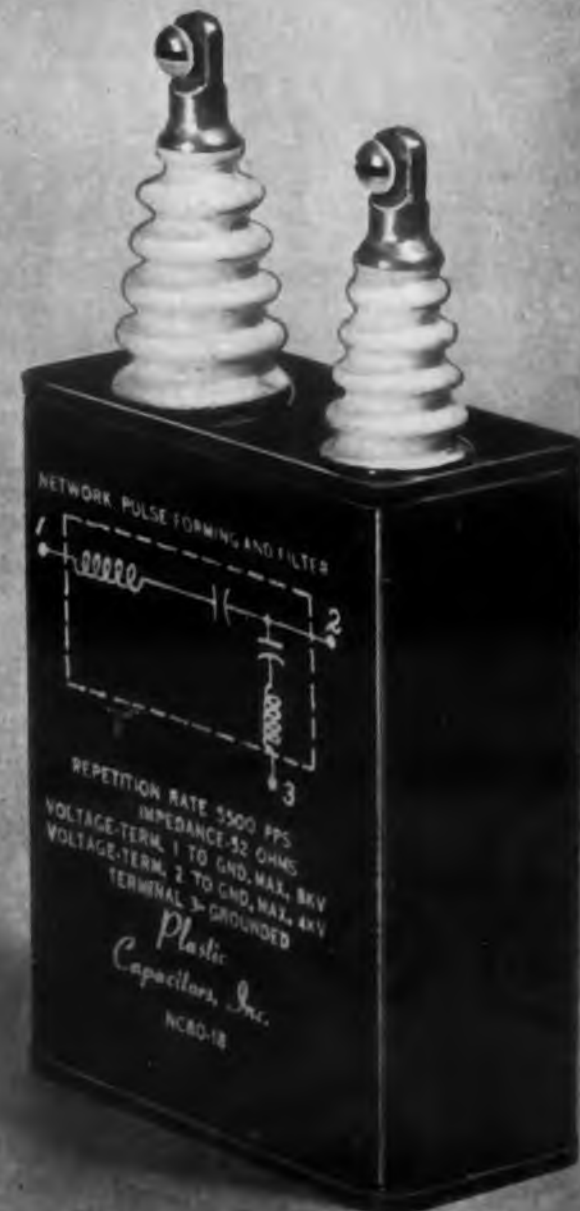

We are specialists with many years of experience in engineering and producing PULSE FORMING NETWORKS

We invite your inquiries. Ask for our complete catalogue on your company letterhead

- PLASTIC FILM CAPACITORS
- HIGH VOLTAGE POWER PACKS
- PULSE FORMING NETWORKS



Plastic Capacitors, Inc.

2511 W. MOFFAT STREET, CHICAGO 47, ILLINOIS

CIRCLE ED-86 ON READER-SERVICE CARD FOR MORE INFORMATION

MINIATURIZING YOUR EQUIPMENT?

Specify SIMPLEST, MOST COMPACT

AMPERITE

THERMOSTATIC DELAY RELAYS

MOST ECONOMICAL, HERMETICALLY SEALED



STANDARD



MINIATURE

Provide delays ranging from 2 to 120 seconds.

- Actuated by a heater, they operate on A.C., D.C., or Pulsating Current.
- Hermetically sealed. Not affected by altitude, moisture, or other climate changes.
- Circuits: SPST only — normally open or normally closed.

Amperite Thermostatic Delay Relays are compensated for ambient temperature changes from -55° to $+70^{\circ}$ C. Heaters consume approximately 2 W. and may be operated continuously. The units are most compact, rugged, explosion-proof, long-lived, and — very inexpensive!

TYPES: Standard Radio Octal, and 9-Pin Miniature.

PROBLEM? Send for Bulletin No. TR-81

BALLAST-REGULATORS

- Amperite Regulators are designed to keep the current in a circuit automatically regulated at a definite value (for example, 0.5 amp).
- For currents of 60 ma. to 5 amps. Operates on A.C., D.C., or Pulsating Current.
- Hermetically sealed, light, compact, and most inexpensive.

Maximum Wattage Dissipation:
T6½L—5W. T9—10W.



T9 BULB

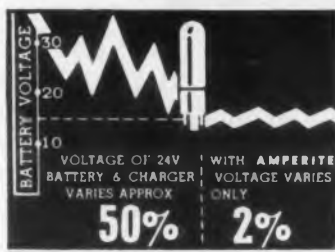
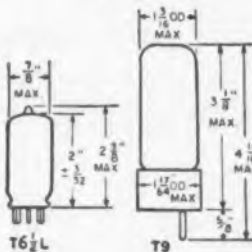

Amperite Regulators are the simplest, most effective method for obtaining automatic regulation of current or voltage. Hermetically sealed, they are not affected by changes in altitude, ambient temperature (-55° to $+90^{\circ}$ C), or humidity. Rugged; no moving parts; changed as easily as a radio tube.

Write for 4-page Technical Bulletin No. AB-51

AMPERITE CO. Inc., 561 Broadway, New York 12, N. Y.
In Canada: Atlas Radio Corp., Ltd., 560 King St., W., Toronto 2B

CIRCLE ED-87 ON READER-SERVICE CARD FOR MORE INFORMATION

New Products . . .

Pulse Generator

Adjustable Durations from 0.2-60,000 μ sec



A small, economical instrument, the Type 1217-A Unit Pulsar, provides continuously adjustable pulse durations from 0.2 μ sec to 60,000 μ sec. It is

powered by a Type 1203-A Unit Power Supply, to which it is easily attached. A self-contained oscillator drives the output at 12 fixed frequencies from 30cy to 100kc, and provision is made for external triggering at any frequency below 100kc.

Pulse rise time is less than 0.05 μ sec, and the fall time about 0.15 μ sec. The open circuit output voltage is 20v for pulses of either polarity. The internal output impedance is about 200 ohms for positive pulses and 1500 ohms for negative.

The generator is capable of approximating all three basic pulse-source waveforms: impulse, step function, and periodically repeated pulse of adjustable duration. A few typical applications are: square-wave testing of audio systems; gate or time-delay generator in testing computing or coincidence systems; checking overall transient response of TV systems; laboratory experiments in transient analysis; and producing pulse or pulse-modulated signal spectrums. General Radio Co., Dept. ED, 275 Massachusetts Ave., Cambridge 39, Mass.

CIRCLE ED-88 ON READER-SERVICE CARD FOR MORE INFORMATION

Power Supply Plug

Molded Direct to Cable



This power supply plug is molded directly to the cable, ready for connection with any standard octal radio socket. It eliminates all need for mechanical fitting or attaching of plug to cable.

The plug can be ordered to meet any application where from one to 11 pins are required. If desired, it can be supplied without the usual phasing pin. Custom designs and shapes can be produced for special

purpose applications. Phalo Plastics Corp., Dept. ED, Worcester, Mass.

CIRCLE ED-89 ON READER-SERVICE CARD FOR MORE INFORMATION

How to select G-E wires cables and cords

for fixtures
appliances
machine tools
portable tools
and electrical
equipment



FREE BOOKLET

puts complete data at your fingertips. Write Section W112-620, Construction Materials Division, General Electric Company, Bridgeport 2, Connecticut.

You can put your confidence in—

GENERAL ELECTRIC

CIRCLE ED-90 ON READER-SERVICE CARD FOR MORE INFORMATION

There's always room for a Fenwal Miniature THERMOSWITCH® control



SEND FOR BULLETIN

Designed for:
CRYSTAL OVENS
GUIDED MISSILES
WAVE GUIDES
RADAR • COMPUTERS
ANTENNAS

and many others where temperature control is vital and space is at a premium, the new Fenwal Miniature THERMOSWITCH units are real problem solvers.

Bringing you advantages never before found in so small a control, these rugged little devices are extremely sensitive to temperature variations and positive in action. Adjustable anywhere within the range of 0° F to 200° F, they maintain normal control characteristics under vibrations ranging up to 5 G's.

For details on how you can get maximum dependability of temperature control in minimum space, send for your copy of the Miniature THERMOSWITCH Control bulletin.

Write Fenwal Incorporated, 96 Pleasant St., Ashland, Mass.

Fenwal

THERMOSWITCH®

Electric Temperature Control and Detection Devices
SENSITIVE...but only to heat

CIRCLE ED-91 ON READER-SERVICE CARD FOR MORE INFORMATION

ELECTRONIC DESIGN • June 1954

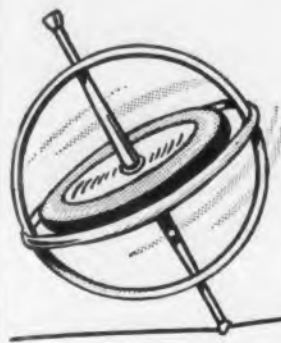

CASTELL push button LOCKTITE lead holder has PERFECT BALANCE

Perfect balance makes Push Button CASTELL LOCKTITE Holder the king of its class.

Exclusive collet holds lead in bull dog grip, preventing slipping or turning.

No graphite dust stains your fingers—because with one-hand push-button action you extend and retract the lead. No need to touch graphite. Comfortable "wood-pencil" feel—not metallic.

Equipped with easily-replaced clutch, giving your LOCKTITE indefinite life.

Imported CASTELL 9030 Lead inserted in your LOCKTITE Holder gives you the combination for brilliant results on your drawing board. Ask your Dealer for both—LOCKTITE Holder and Imported CASTELL 9030 Lead in 19 degrees, 7B to 10H.

AW. FABER-CASTELL
PENCIL COMPANY, INC., NEWARK 3, N. J.

CIRCLE ED-92 ON READER-SERVICE CARD FOR MORE INFORMATION



**MINIATURE
SPEED CHANGERS**
★
**COMPLETE
COMPACT
ADAPTABLE**

- Over 400 different Standard ratios! 10:9 to 531.441:1
- SMALL! 1.050" Diameter. Overall lengths: Class A, 3-1/8" Class B, 3-15/16" Class C, 4-3/4"
- Transmit power either way to 100:1 ratios!
- Concentric ball-bearing input and output shafts.
- Hardened steel spur gears.
- Permanent lubrication.
- Prompt deliveries on production or experimental quantities.

BULLETIN No. 100

Gives complete details. Write for it today to METRON INSTRUMENT COMPANY, 450 Lincoln Street, Denver 3, Colorado

BUILT BY **Metron** MAKERS OF INSTRUMENTS FOR PRECISION MEASUREMENTS

CIRCLE ED-93 ON READER-SERVICE CARD FOR MORE INFORMATION

Cavity Oscillator

Rocket Tube Type



The No. 192A Rocket Tube Cavity Oscillator is a small-size, coaxial line cavity oscillator employing the Sylvania u-h-f Planar Triode tube, which provides a highly stable r-f signal

source in both a cw and a pulse model. The unit features a single knob control and has fixed feedback.

The No. 192A is 8" long x 1-5/16" diam, and weighs 1lb, 3 oz. including tuning mechanism. It is available for frequencies from 1000 to 4000Mc with a tuning range of 400Mc/S. Pulse operation is 2000v peak with a peak pulse power of 200w. CW operation is 175v with an average power output of 100mw.

Tuning accuracy is $\pm 0.1\%$ with regulated power supply. Output connection is BNC or Type N jack. It has a Root counter for calibration. The cavity comes complete with tube and can be furnished with a regulated supply and frequency calibration curves. Amerac, Incorporated, Dept. ED, 116 Topsfield Road, Wenham, Mass.

CIRCLE ED-94 ON READER-SERVICE CARD FOR MORE INFORMATION

D-C Millivoltmeter

Has Direct Polarity Indication

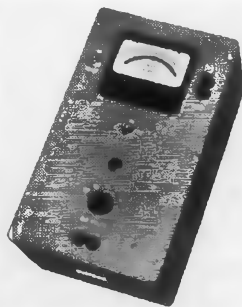

The "213-A" is a true d-c millivoltmeter, with high sensitivity, stable zero, and direct polarity indication. It features full scale deflection of 1.00mv d-c, a zero center movement with plus or minus deflection, and internal noise and drift kept below 10mv d-c. In addition, a d-c amplifier channel is available with a maximum gain of 1000,

low-output resistance, and stable zero and gain.

No warm-up time other than tube heating is necessary. Operation is from a 117v, 60cy source, and no damage results from heavy overloading. This unit is especially useful in transistor studies, circuit design, and microwave and radiation work. Other applications include bridge measurement use as a low-level amplifier driving cathode-ray and mechanical oscillographs, pen recorders and alarm relays. Industrial Control Co., Dept. ED, Straight Path Road, Wyandanch, L. I., N. Y.

CIRCLE ED-95 ON READER-SERVICE CARD FOR MORE INFORMATION



* Westinghouse Trade Mark No. 337,962

KOVAR* Glass-Sealing ALLOY

The ideal alloy for glass sealing, Kovar matches the expansivity of certain hard glasses over the entire working temperature range. It resists mercury attack, has ample mechanical strength and seals readily. A permanent and impervious bond is obtained by a closely controlled thickness of oxide on Kovar alloy interfused with hard glass.

Kovar is a cobalt, nickel, iron alloy, manufactured under very carefully controlled conditions, and supplied by Stupakoff in the form of: SHEET, ROD, WIRE, FOIL, TUBING, EYELETS, LEADS and FABRICATED SHAPES. The prominent users of KOVAR and the length of time they have employed this metal are convincing proof of satisfaction.

Full information on the use of Kovar is given in Stupakoff Bulletin 145, which we will send upon request.

Stupakoff
CERAMIC & MFG. CO.
Latrobe, Pennsylvania

CIRCLE ED-96 ON READER-SERVICE CARD FOR MORE INFORMATION

PROVED
through years of
users' experience



18 YEARS



7 YEARS

**Western
Electric**

16 YEARS



18 YEARS



18 YEARS



12 YEARS



18 YEARS



5 YEARS



13 YEARS



11 YEARS



15 YEARS



6 YEARS



18 YEARS



13 YEARS

Compare these features
of the CLARE Type J
Relay with ordinary
telephone-type relays

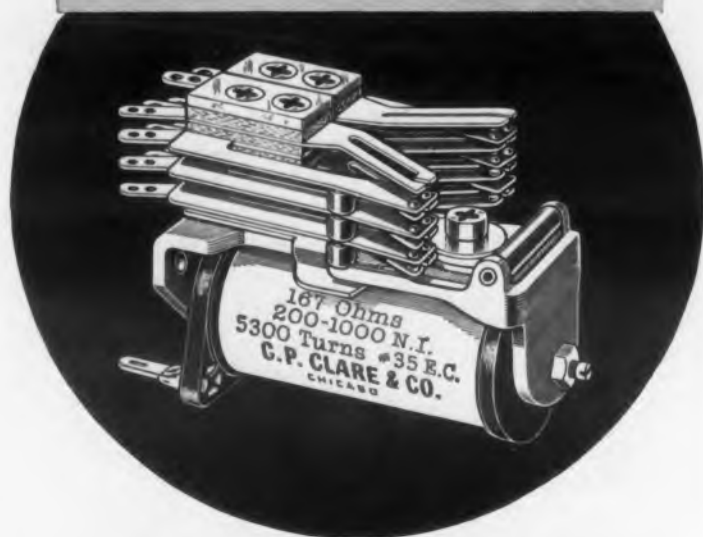

Extremely Small Size—Length: $2\frac{1}{4}$ " , Width: $1\frac{1}{8}$ " , Height (with 10 springs): $1\frac{1}{4}$ " , Net Weight: $2\frac{1}{4}$ oz. (approx.).

Large Current Capacity—Rated current carrying capacity: 4 amperes, 150 watts. Twin contact points (Palladium) standard.

Exclusive new features—Twin contacts operate independently of each other—minimize chance of contact failure.

Largest possible bearing surface for hinge-type armature.

Armature bearing pin turns in cylinder of different metal which is full width of the heel-piece.

Heelpiece designed and processed for extreme rigidity to take and hold fine adjustments.

Versatile Operation—Standard coils provide for fast operate and fast release (minimum of 1 to 2 milli-seconds). Coils may be provided for time delay on operation, time delay on release or both, also available, double wound coils. Operating voltage up to 220 volts d-c.

Armatures may be single (right or left) or double. Residual: lock screw (adjustable) or fixed.

Relay may be mounted on mounting bases or strips as well as upon mounting bars and individual mounting brackets. Also available with plug-in mounting.

Available with slip-on dust-tight covers or hermetically sealed in metal enclosures.

• Write for Engineering Data Book. Address C. P. Clare & Co., 3101 Pratt Blvd., Chicago 45, Illinois. In Canada: Canadian Line Materials Ltd., Toronto 13. Cable Address: CLARELAY.

CLARE RELAYS
FIRST IN THE INDUSTRIAL FIELD

CIRCLE ED-97 ON READER-SERVICE CARD FOR MORE INFORMATION

New Products . . .

Waveguide Connectors Provides Fast, Positive Decoupling

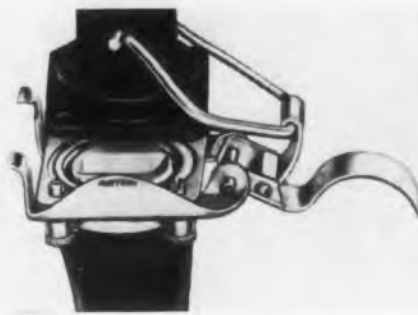

A line of quick disconnection fixtures permits fast, positive decoupling of waveguide flanges without the use of tools. Joints can conveniently be made while wearing gloves, under adverse conditions, where it would be difficult to decouple conventional flanges. Particularly adaptable to airborne installations, these units permit easy removal of waveguide sections that might otherwise impair refueling, gun loading, or radar system maintenance.

With the exception of four mounting studs and bolts, the fixtures are fabricated entirely of stainless steel. They mount directly on the choke flange, becoming an integral part of the waveguide assembly. Since the choke flange threads are thereby used only once, the wearing down of soft aluminum threads is practically eliminated.

These units have been designed to fit waveguide sizes from $2.0'' \times 1.0''$ down to $0.360'' \times 0.220''$. They will maintain pressurized joints up to 30psi at -55°C , and will remain r-f and pressure tight under severe vibration. Airtron, Inc., Dept. A, 1103 West Elizabeth Ave., Linden, N. J.

CIRCLE ED-98 ON READER-SERVICE CARD FOR MORE INFORMATION

Nylon Gears

Molded Parts Wear Longer



These molded nylon gears, sprockets, worms, rollers, etc., cost less and wear longer under non-lubricated conditions than steel or brass parts. Precision-molded nylon gears need no machining, being manufactured to exacting tolerances. They have

greater strength, more shock absorbance, and a higher temperature resistance than conventional parts.

Virtually silent in operation, they are lighter and are extremely flexible in design. They endure best against other nylon parts and practically as well against steel and brass. F. J. Kirk Molding Co., Dept. ED, Clinton, Mass.

CIRCLE ED-99 ON READER-SERVICE CARD FOR MORE INFORMATION

Stop Corrosion with RHODIUM PLATING

New uses for Rhodium Plating are constantly being found by electronic design engineers where hard, corrosion resistant electrical contact surfaces are required.

RHODIUM PLATE offers these advantages:

- assures low and stable contact resistance
- allows higher pressures to be used in sliding contacts
- not affected by atmospheric changes
- oxide-free contacts eliminate partial rectification and unwanted signals
- provides low noise level for moving contacts
- extremely long-wearing

These properties are particularly well-suited to electrical and electronic applications. RHODIUM plate affords excellent protection against atmospheric corrosion for printed circuits and permits incorporation of sliding contacts as part of the circuit.

Write for Free, detailed booklet on RHODIUM PLATING.



113 ASTOR STREET, NEWARK 5, NEW JERSEY

NEW YORK • SAN FRANCISCO • CHICAGO • LOS ANGELES

CIRCLE ED-100 ON READER-SERVICE CARD FOR MORE INFORMATION

Partners . . . YOU AND YOUR NO. 50 POCKET PAL

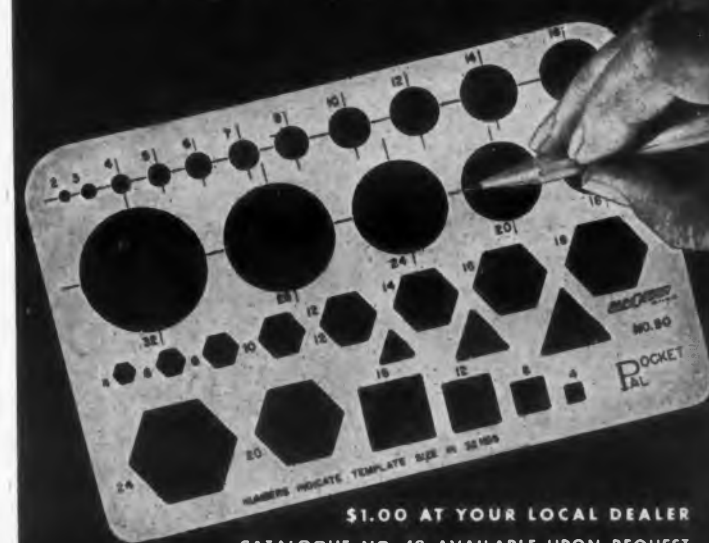

.030 MATTE FINISH MATHEMATICAL QUALITY DOUBLE-CURED PLASTIC.
ALL HOLES SMOOTH-MILLED TO ENGRAVING MACHINE ACCURACY.
ONE OF MORE THAN 30 RAPIDDESIGN TIME-SAVER TEMPLATES—ALL
OF WHICH ARE BETTER MADE, MORE USEFUL AND LESSER PRICED.

RAPIDDESIGN INC.
P. O. BOX 592 GLENDALE, CALIF.

CIRCLE ED-101 ON READER-SERVICE CARD FOR MORE INFORMATION

**first with hermetically
sealed receptacles**



**CANNON
PLUGS**

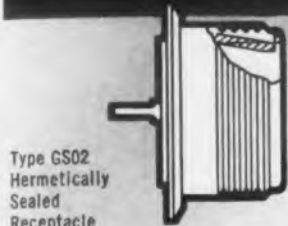

Type GS02
Hermetically
Sealed
Receptacle

... and still the leader for true hermetically sealed plugs and receptacles... pin or socket insert assemblies... in a variety of "AN" (Air Force-Navy) and Cannon K and KK shell sizes. Square, circular, or hex flanges with locknuts for panel mounting. Many insert arrangements available. Standard shell finish now combines copper flash, heavy cadmium plate and tin plate. Steel shells and contacts. Vitreous insulators fuse contacts to the shell to provide perfect hermetic seal.

IN PIN AND SOCKET INSERT ASSEMBLIES

Write for Hermetically Sealed Connector Bulletins. Cannon Electric Company, 3209 Humboldt Street, Los Angeles, California. Factories in Los Angeles; East Haven; Toronto, Canada; London, England. Representatives and distributors in all principal cities.



Refer to Dept. 143

CANNON ELECTRIC

Since 1915

CIRCLE ED-102 ON READER-SERVICE CARD FOR MORE INFORMATION

**ANOTHER NEW FAIRCHILD
POTENTIOMETER**



**TYPE 741
1-1/8" LINEAR**

You can gang up to five cups on a single shaft without increasing the 1 1/8" over-all diameter of the Type 741 because of its internal clamping construction. Phasing is easy and accurate too. Available in a resistance range of 500 to 25,000 ohms, this new potentiometer has a standard linearity of $\pm 0.5\%$. A one-piece palladium-silver alloy wiper and simplified slip ring construction give longer life with low noise and high resolution. Welded taps, and a newly-designed radial-type terminal board with gold-plated terminals, are other features.

SAMPLES AVAILABLE ON ORDER

The Type 741 is another reason why Fairchild can help you solve all your precision potentiometer problems. For more information, write Fairchild Camera & Instrument Corp., Potentiometer Division, 225 Park Avenue, Hicksville, L. I., N. Y., Department 140-47N.



CIRCLE ED-103 ON READER-SERVICE CARD FOR MORE INFORMATION

ELECTRONIC DESIGN • June 1954

Power Bridge

Covers 10-1000Mc Range



The VHF-UHF Power Bridge covers a frequency range of 10-1000-Mc. It is capable of measuring power levels from $2\mu w$ to 30mw in six ranges (0.1mw through 30mw, full scale). A self-balancing circuit is used, requiring a minimum of manual operation. The input impedance is 300 ohms balanced, and the YSWR is better than 1.3 in the frequency range specified. Total error is less than 5%.

The extensive range of applications includes gain measurements on tuners and converters, transmission measurements of active and passive networks (antennas, filters, etc.), and calibration of signal generating equipment. Recorder connections are made available. Electro-Metric Instrument Co., Dept. ED, 241 Centre St., New York 13, N. Y.

The extensive range of applications includes gain measurements on tuners and converters, transmission measurements of active and passive networks (antennas, filters, etc.), and calibration of signal generating equipment. Recorder connections are made available. Electro-Metric Instrument Co., Dept. ED, 241 Centre St., New York 13, N. Y.

CIRCLE ED-104 ON READER-SERVICE CARD FOR MORE INFORMATION

Heavy Duty Power Supplies

Regulated Within $\pm 1\%$



This heavy-duty series of a-c to d-c regulated power supplies is available in both portable (illustrated) and stationary types. These units are designed for use on 220-440v,

3-phase, 60cy a-c input, with any desired output voltages and current capacities. Each employs a dry-type, full-wave selenium rectifier and features excellent voltage regulation.

Output voltage is maintained within $\pm 1\%$, no load to full load with line fluctuations as high as $\pm 10\%$. Recovery time under extreme load and line variations is less than 0.2sec. A filter section composed of choke and condenser combination lowers ripple to less than 1% rms.

The supplies are equipped with magnetic-amplifier voltage regulators which are wear-free, rugged, and completely insensitive to vibrational damage or burn-out failure. There is a built-in cooling fan for dissipating heat, insuring continuous efficient operation at full load. Hufford Machine Works, Inc., Electronics Div., Dept. ED, 2201 Carmelina Ave., Los Angeles 64, Calif.

CIRCLE ED-105 ON READER-SERVICE CARD FOR MORE INFORMATION

TRANSFORMERS . . .

**. . . specified for the usual
. . . demanded for the
unusual**



"GTC" Transformers for television receiver applications . . . custom designed for high quality at minimum cost.

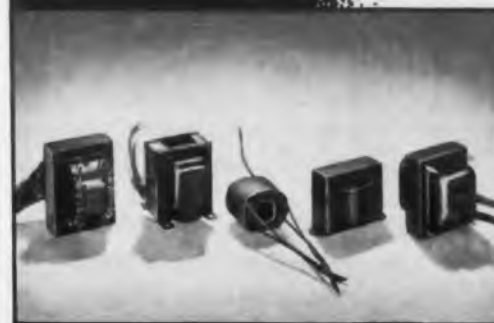

"GTC" Transformers for industrial and commercial applications . . . accurately engineered and fully recognized for finest quality.

Manufacturers specify "GTC" . . . for audio uses, communication, radar devices, test equipment, transmitters, and various other electronic-controlled devices.

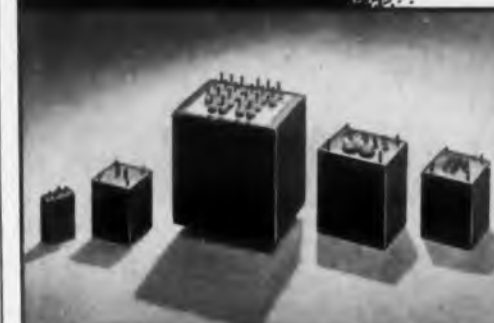

"GTC" Military Transformers . . . designed to meet rigid government specifications and to perform under the most severe and continuous operating conditions. MIL-T-27 and JAN-T-27.

Skilled engineering techniques make GTC a source for transformers in highly specialized and extremely unusual applications. Utilization of these techniques results in greater dependability, quality and better construction.

Our completely self contained plant's modern equipment guarantees transformer production in any quantity, to meet your requirements. We welcome your inquiry and will supply production samples where desired.



**GENERAL
TRANSFORMER COMPANY**

serving industry since 1928

18240 Harwood Avenue, Homewood, Illinois
(Suburb of Chicago)

CIRCLE ED-106 ON READER-SERVICE CARD FOR MORE INFORMATION

MINIATURE VIBRATION ISOLATORS

protect light-weight components



Type 275 Type 372 Type 302 Type 371

Light-weight instrument Barrymounts are extremely easy to use, and require very little space for installation. They provide a high degree of vibration protection for small instruments, sensitive relay assemblies, electronic sub-chassis, small motors, and similar light-weight units. Available in four types, they will support up to 9 lbs. per unit isolator. Vibration frequencies as low as 30 cps are isolated in all directions, for maximum rated load. For further information, write to The Barry Corporation, 775 Pleasant St., Watertown 72, Massachusetts.

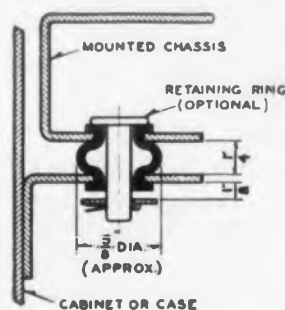

Light-weight instrument Barrymounts are extremely easy to use, and require very little space for installation. They provide a high degree of vibration protection for small instruments, sensitive relay assemblies, electronic sub-chassis, small motors, and similar light-weight units. Available in four types, they will support up to 9 lbs. per unit isolator. Vibration frequencies as low as 30 cps are isolated in all directions, for maximum rated load. For further information, write to The Barry Corporation, 775 Pleasant St., Watertown 72, Massachusetts.

CIRCLE ED-107 ON READER-SERVICE CARD FOR MORE INFORMATION

Pick 'DIAMOND H' RELAYS

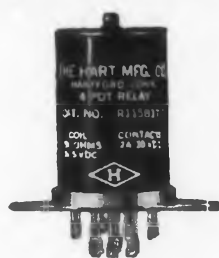

H
FOR HIGHER
VIBRATION
RESISTANCE

Vibration resistance range of "Diamond H" Series R Relays has been more than doubled, extending now from 0 to well over 1,000 cycles per second at 15 "G's." Hermetically sealed, miniature aircraft relays, they are basically 4PDT but are also available in DPDT and 4PDT with two independent coils, either or both of which will operate the unit. They meet all requirements of USAF Spec. MIL-R-5757B . . . and far surpass many.

Operating shock resistance exceeds 50 "G's"; temperature range is from -65° to +200°C. They operate consistently over 400,000 cycles without failure at 5 A. and go 3,500 or more under 30 A. at 30 V., D. C. resistive. Voltages up to 300 D. C. at 4/10 A. are carried for more than 400,000 cycles. Coil resistances up to 50,000 ohms available. Operating time is 10 ms. or less; drop out time 3 ms. or less. Sensitivity approaches 100 mw. at 30 "G's" operational shock resistance. Inter-electrode capacitance is less than 5 mmf. contacts to case; less than 2½ mmf. between contacts. All standard mounting arrangements.

Bulletin R-150, giving basic performance data under varying conditions, is yours on request. Our engineers are prepared to work with you to develop variations to meet your specific requirements. Tell us your needs.

THE HART MANUFACTURING COMPANY
210 Bartholomew Ave., Hartford, Conn.

CIRCLE ED-108 ON READER-SERVICE CARD FOR MORE INFORMATION

50

New Products . . .

Harmonic Wave Analyzer

Covers 50cy to 50kc



A new harmonic wave analyzer for continuous coverage of the frequency region from 50cy to 50kc combines small size, light weight, and low cost with high accuracy and sensitivity. A 1%

second harmonic of 100cy may be measured on this instrument with 5% accuracy. Good selectivity is achieved with a double half-lattice crystal filter which provides 3db attenuation at 14cy, and 40db attenuation at 75cy off resonance.

The output meter of this model is readily adjusted to 100% reading for any input voltage between 50mv and 500v. Internal voltage regulation preserves accuracy with line voltage variations up to -10%. Heater current of the local oscillator is Amperite-regulated for long term stability and frequency determining elements of the local oscillator are temperature compensated. Donner Scientific Co., Dept. ED, 2829 Seventh Street, Berkeley 10, Calif.

CIRCLE ED-109 ON READER-SERVICE CARD FOR MORE INFORMATION

Printed Circuit Pot Composition Type

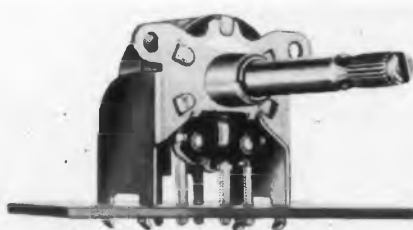

The Type YGC-B45 variable composition resistor has a self-supporting snap-in bracket for mounting directly to the printed circuit panel. The bracket eliminates the need for a separate supporting panel and the usual mounting hardware. The resistor snaps instantly into place on the panel, is held tightly by the bracket during soldering, and is permanently anchored by the solder. The bracket also prevents strain on the control or switch terminals. Anchor tabs are provided on the bracket for mounting directly to the cabinet when desired. No shaft protection is needed during soldering, because the shaft is above the panel with the control vertically mounted to the printed circuit panel. Chicago Telephone Supply Corp., Dept. ED, Elkhart, Ind.

CIRCLE ED-110 ON READER-SERVICE CARD FOR MORE INFORMATION

Announcing the NEW UNIT PULSER Small-Compact-INEXPENSIVE

A Laboratory-Quality Pulse Generator in the Unit Instrument Price Range.

PULSE DURATIONS: 0.2 to 60,000 μ s

REPETITION RATES: 0 to 100 kc

RISE TIME: 0.05 μ s

Write for the NEW VHF-UHF Bulletin for Data on G-R's Complete Line of Laboratory-Quality Unit Instruments.



Type 1217-A Unit Pulser: \$195

Type 1203-A Unit Power Supply: . \$ 40

GENERAL RADIO Company 275 Massachusetts Ave.
Cambridge 39, Mass.
90 West St. NEW YORK 6 920 South Michigan Ave. CHICAGO 5
1000 North Seward St. LOS ANGELES 38

CIRCLE ED-111 ON READER-SERVICE CARD FOR MORE INFORMATION

PHALO Hooks Up With Progress

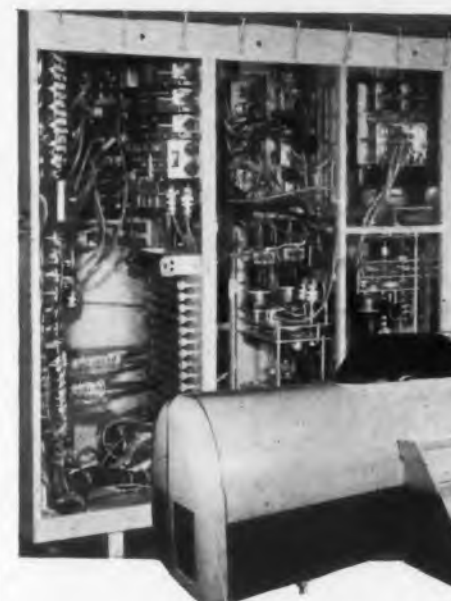

in
Simulated
Flight
with

LINK

The highly complex electronic systems of the LINK B-47B jet flight simulator shown here with the basic C-118 jet trainer are classic examples of LINK'S progressive approach to modern flight training. PHALON hook up wires have an important role in these electronic systems and in other key wiring operations which have made the famous LINK TRAINERS synonymous with the latest and the finest in simulated flight.

When the requirement is dependability in insulated wires, cables or cord sets, look to PHALO.

PHALO PLASTICS CORPORATION

25-1 FOSTER STREET, WORCESTER, MASSACHUSETTS

Insulated Wire and Cables — Cord Set Assemblies

CIRCLE ED-112 ON READER-SERVICE CARD FOR MORE INFORMATION

ELECTRONIC DESIGN • June 1954

Helipot technical paper 339

Accuracy of
Potentiometer Linearity
Measurements

BY ROBERT McDONALD & IRVING HOGAN
Research and Development Division
Helipot Corporation

Write today
for your free
copy of this
Technical Paper.
Ask for Data
File 624

Reprinted from August, 1953
TELE-TECH & ELECTRONIC INDUSTRIES

Helipot first in precision potentiometers

Helipot Corporation/South Pasadena, California
a division of BECKMAN INSTRUMENTS, INC.

348

CIRCLE ED-113 ON READER-SERVICE CARD FOR MORE INFORMATION

I-F Transformer For Printed Circuits and I-F Strips



The "Ulti-Mite" is a 43Mc i-f transformer with a tuning range of 25-90Mc. It features a new tuning principle that eliminates the conventional powdered iron core. Molded nylon studs provide smooth tuning that is not affected by vibration.

All adjustments are made from the top; only the terminals are exposed through the molded base. The base is a heat-resistant polyester resin, extremely stable and not affected by heat. The transformer can be easily dip-soldered with printed circuits and also adapted to conventional strips.

Inter-stage transformers, with and without traps, and a diode transformer are available in the "Ulti-Mite" design. All units are housed in 7/8" square aluminum cans with either spade-bolt or solder-lug mounting. Aladdin Radio Industries, Inc., Dept. ED, 705 Murfreesboro Rd., Nashville, Tenn.

CIRCLE ED-115 ON READER-SERVICE CARD FOR MORE INFORMATION

Sensitive Oscillograph

For d-c to 500kc Measurements

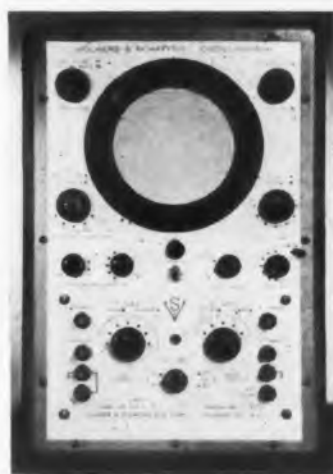

The VS-900 series of oscillographs features exceptionally high a-c sensitivity and unusual freedom from distortion. The d-c sensitivity is 700 μ v/cm, and a-c sensitivity is 10 μ v/cm. After a 5-minute warm-up period, d-c drifts seldom exceed 1mv.

The characteristics of the units are made possible by four distinct design features: heavy overall feedback (including d-c); d-c heated electronically regulated filaments; the "starved amplifier circuit"; and gas-diode coupling in a new circuit.

Frequency range upper limit is 500kc (3db down). Other features are dual rms and peak-to-peak calibration, and a band selector switch that makes it possible to reduce visible input tube noise when operating at a maximum sensitivity by narrowing the upper frequency limit down to 100kc, 50kc, 5kc or 1kc. Volkens & Schaffer Manufacturing Corp., Dept. ED, 1679 Broadway, Schenectady 6, N. Y.

CIRCLE ED-116 ON READER-SERVICE CARD FOR MORE INFORMATION

on the design table
...and in the
production line

ACE PRECISION
NYLON BALLS

KEEP THINGS MOVING SMOOTHLY IN
HUNDREDS OF INDUSTRIAL APPLICATIONS!

MASS-PRODUCED OF DuPONT NYLON FM No. 10001
TO CLOSE TOLERANCES OF $\pm .001$. Sizes 1/8" to 3/4"

Ace Nylon Balls have brought new design flexibility and production economy to many of America's largest manufacturers. Uniform, precision-fabricated, light-weight Ace Nylon Balls are tough at low temperatures, stable at high temperatures, and resistant to chemicals and abrasion. Ace Nylon Balls may add greater efficiency and economy to your products, too.

WHY NOT LET
OUR ENGINEERS
ADVISE YOU?

Complete facilities
for fabricating
plastic parts for all
industries. Estimates
submitted promptly
on receipt of blue-
prints or specifications.

Write for samples, bulletin,
price list today.

ACE PLASTIC COMPANY
Precision Plastic Fabricators and Extruders

91-58 Van Wyck Expressway • Jamaica 35, N. Y.

CIRCLE ED-117 ON READER-SERVICE CARD FOR MORE INFORMATION

Miniature ELASTIC STOP® nuts down to 0.109" across flats



NOW, miniature ELASTIC STOP nuts are available in sizes #0 through #4 in both SAE fine thread and USS coarse series—for special applications, such as electronics equipment and instruments. Smaller than any other self-locking nut they maintain a precise adjustment whether tightened against a seating surface or positioned at any point on a threaded member.

Nylon inserts make them self-locking, vibration-proof and re-usable, like all ELASTIC STOP nuts. They are simpler and less expensive to assemble than double nuts or soldered units.

WRITE FOR design information on Miniature Nuts and other special and standard ESNA fasteners. Address Dept. N38-657.



ELASTIC STOP NUT CORPORATION OF AMERICA

2330 Vauxhall Road, Union, N. J.

DESIGN HEADQUARTERS FOR SELF-LOCKING FASTENERS

CIRCLE ED-118 ON READER-SERVICE CARD FOR MORE INFORMATION

3 Soldering Operations in 1 Easy as ABC with KESTER "SOLDERFORMS"

- A** Solder screws and stud to can cover.
"Solderform" Disc & Rings 5% Silver
—95% Lead Alloy. Melting Point 680°F.
- B** Solder glass terminals to cover.
"Solderform" Rings 63% Tin—37%
Lead Alloy. Melting Point 361°F.
- C** Hermetically seal cover on can.
"Solderform" Ring 28.5%
Bismuth—28.5% Tin—43%
Lead Alloy. Softening Point 250°F.

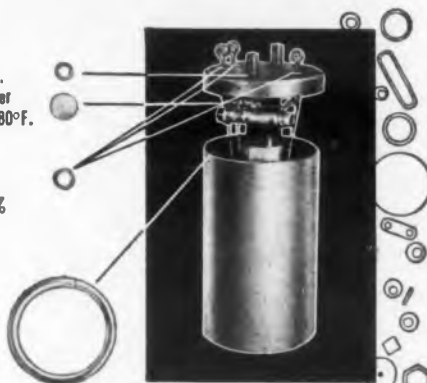

Here's a typical example of a tough resistance soldering job involving progressively lower melting temperatures. Kester "Solderforms" made sure this high precision oscillator coil came through every test successfully.

WRITE TODAY for free "Solderform" samples and literature.

KESTER
SOLDER COMPANY

4266 Wrightwood Avenue • Chicago 39, Illinois
Newark 5, New Jersey • Brantford, Canada

CIRCLE ED-114 ON READER-SERVICE CARD FOR MORE INFORMATION

ELECTRONIC DESIGN • June 1954

PRINTED CIRCUITS

can simplify your design . . .
speed output . . . cut costs

Eliminate wires! With Du Pont Conductive Coatings, you can print circuits for capacitors and couplings; for static shielding to replace foils and cans; for resistors and solder seals. Streamline your designs in television sets and radios, electronic equipment, meters and switchboards.

Coatings are easily applied by spray, brush, dip or stencil on metals or non-conductors. Fit right into high-speed assembly-line operation. Save you money. For up-to-date, descriptive bulletin write to: E. I. du Pont de Nemours & Co. (Inc.), Electrochemicals Department, Wilmington 98, Delaware.

DU PONT
CONDUCTIVE COATINGS

—Best for printed circuits!



BETTER THINGS FOR BETTER LIVING
...THROUGH CHEMISTRY

CIRCLE ED-119 ON READER-SERVICE CARD FOR MORE INFORMATION

High Dielectric Bobbins

For High "Q" Coils

PRECISION

MADE TO YOUR EXACT SPECIFICATIONS IN ANY SIZE, SHAPE, QUANTITY

Precision coil bobbins are fabricated from high dielectric materials and quality controlled to the most minute tolerances . . . Yet, because they are made on special high production equipment, they're available to you for prompt delivery at low unit cost. Cores are spirally wound dielectric kraft, fish paper, acetate, phenol impregnated or combinations. Flanges are cut to any specification for all types of mountings.

Request illustrated bulletin. Send specifications for samples.

We also manufacture paper tubes in all sizes, shapes, ID's and OD's.

Sales Representatives in:

New England: Framingham, Mass., Framingham 7091	Philadelphia: Philadelphia, Pa., Chestnut Hill 8-0282
New York, New Jersey: Jersey City, New Jersey, Journal Square 4-3574	Northern Ohio, Western Pennsylvania: Cleveland, Ohio, Atlantic 1-1060
Upstate New York: Syracuse, N.Y., Syracuse 76-8056	Indiana, Southern Ohio: Logansport, Indiana, Logansport 2555
Maryland: Baltimore, Maryland, Plaza 2-3211	Missouri, Southern Illinois, Iowa: St. Louis, Missouri, Sterling 2318
Canada: Montreal, Quebec, Canada, Walnut 2715	California: Pasadena, California, Sycamore 8-3919



PRECISION PAPER TUBE CO.

2055 W. CHARLESTON ST. CHICAGO 47, ILL.
Plant No. 2: 79 Chapel St., Hartford, Conn.
Also Mfrs. of Precision Coil Bobbins

CIRCLE ED-120 ON READER-SERVICE CARD FOR MORE INFORMATION

New Products . . .

Cross Guide Coupler
With Directivity of 22db or More

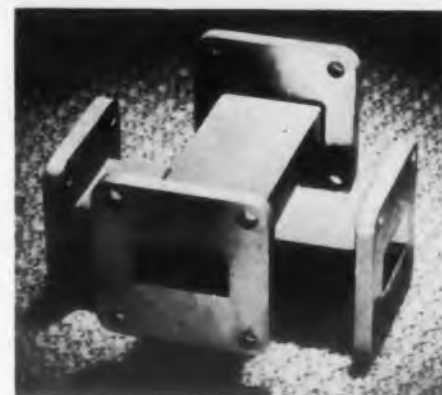

The Model X126E is the first of a new series of cross guide couplers designed for higher minimum directivity over the waveguide band, less coupling variation with frequency, and higher breakdown power. The X126E has a directivity of approximately 22db or more, a mean coupling level within 0.4db of 30db, and coupling variation of less than ± 0.6 db over the frequency range. Microwave Development Laboratories, Inc., Dept. ED, 220 Grove St., Waltham 54, Mass.

CIRCLE ED-122 ON READER-SERVICE CARD FOR MORE INFORMATION

Lab Power Amplifier
Has 15w Max Output



The Type 511A Power Amplifier is a general-purpose laboratory amplifier featuring low distortion, low noise, and excellent phase characteristics throughout the audio range and above. Having approximately 15w maximum output power, the unit has four output levels for optimum matching of loads with 5, 25, 200, or 1200 ohms.

The Amplifier is useful as a test driving source for tachometers, synchros, small motors and choppers. A phase compensation circuit permits the overall phase shift to be maintained at a constant value at any particular frequency regardless of gain setting, or it can be made zero for one gain setting at one frequency.

Frequency response is flat from 50cy to 30kc and down 0.5% at 10w output. In modulation distortion is less than 0.5% from 50cy to 15 ke for a phase frequency of 150cy. Output regulation is $\pm 5\%$ of rated output voltage from optimum load to open circuit at all impedance levels. The unit weighs 40 lb. Technology Instrument Corp., Dept. ED, 531 Main St., Acton, Mass.

CIRCLE ED-123 ON READER-SERVICE CARD FOR MORE INFORMATION

ELECTRONIC DESIGN • June 1954

A Ney Precious Metal Alloy Contact

NEY'S SMALL PARTS



PLAY A **BIG** PART IN
PRECISION INSTRUMENTS

A Ney Precious Metal Alloy Contact

Illustrated above is a Helipot single-turn Model J Potentiometer using Ney Precious Metal Contacts. These contacts were designed to meet the special requirements of this instrument and assure the utmost in linearity and electrical output.

The J. M. Ney Company has developed a number of precious Metal Alloys and fabricates these into contacts, wipers, brushes, slip rings, commutator segments and similar components for use in electrical instruments. Ney Precious Metal Alloys have ideal physical and electrical properties, high resistance to tarnish, and are unaffected by corrosive atmospheres. Consult the Ney Engineering Department for assistance in selecting the right Ney Precious Metal Alloy which will improve the electrical characteristics, prolong the life and accuracy of your instrument.

THE J. M. NEY COMPANY • 373 ELM ST., HARTFORD 1, CONN.

Specialists in Precious Metal Metallurgy Since 1812

5NY54A

CIRCLE ED-121 ON READER-SERVICE CARD FOR MORE INFORMATION

FREED Sets a NEW Standard for Performance

PRECISION TEST INSTRUMENTS

		
No. 1010A COMPARISON BRIDGE. Self contained—A.C. operated. Ideal for laboratory and production testing of resistors, condensers and inductors.	No. 1020B MEGOHM-METER, DIRECT READING. Self contained—A.C. operated. Electronically regulated supply, 1 megohm to 2 million megohms.	No. 1060 VACUUM TUBE VOLTMETER. A 50 megohm input impedance wide frequency range V.M. for use at audio and super-sonic frequencies.

TRANSFORMERS—MILITARY & COMMERCIAL

		
MILITARY PULSE TRANSFORMERS. Constructed to MIL-T-27 specifications. Designed for optimum pulse performance.	MINIATURE AUDIO. Hermetically sealed—constructed in accordance with MIL-T-27 specifications.	HIGH FIDELITY. 1/2 DB 20 CPS to 30 KC.

NEW COMPLETE CATALOG NOW AVAILABLE
FREED TRANSFORMER CO., INC.
 1727 Weirfield Street Brooklyn (Ridgewood) 27, N. Y.

CIRCLE ED-124 ON READER-SERVICE CARD FOR MORE INFORMATION

VHS* RELAY

(*Very High Sensitivity)

The VHS is a balanced armature, Alnico magnet type relay. It is internally shock mounted and resistant to vibration. The screw-on cover is gasket sealed. It can be opened and resealed.

Connections: 9 pin octal style.

Dimensions: - 1 3/4 diameter x 2 1/4 long. Weight: 4 ounces.



0.2 microamperes, (3000 ohms coil) or, 0.1 millivolts, (20 ohms.)

Sensitivity: - Infinite variations from 0.2 Ua. to 10 Amp. or 0.1 Mv. to 500 volts, self contained. Higher volts or amps with external multipliers. A.C. rectifier types. Trip point accuracies to 1%. Differential 1%.

Contacts: - SPST or SPDT, 5-25 Ma. D.C. Other ratings to 1 Amp. A locking coil gives high pressure and chatter free contact even under shock and vibration. Samples 3 to 4 weeks.

ASSEMBLY PRODUCTS, Inc.
 P.O. Box 191, Chagrin Falls 16, Ohio

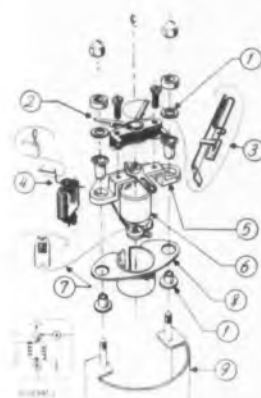

Write for explanation of symbols

CIRCLE ED-125 ON READER-SERVICE CARD FOR MORE INFORMATION

ELECTRONIC DESIGN • June 1954

Preset Counter

Operates to 5000 Counts/sec



The all-electronic Model 164 Preset Counter is a valuable automation component. When a predetermined value of count is reached, the instrument provides an electric circuit closure that may be

applied to start, stop, divert, modify or measure a continuous process flow. Recycling, when the predetermined count is reached, may be automatic or by independent control. An electro-mechanical register permits recording of one million of these predetermined counting cycles.

The counter can count revolutions, strokes and electrical signals which occur regularly or irregularly at rates between 0 and 5000 counts/sec. As a straight counter, it will record up to 10 billion units. Down time is minimized by provision for quick replacement of plug-in counter assemblies, register and relays. Atomic Instrument Company, Dept. ED, 84 Massachusetts Ave., Cambridge 39, Mass.

CIRCLE ED-126 ON READER-SERVICE CARD FOR MORE INFORMATION

Encapsulated Toroids

Easily Mounted and Stacked

This firm's toroids can now be provided in a new type of encasement assembly which greatly simplifies mounting problems. It is expected that there will be no increase in cost over uncased units.



An injection-molded, high-impact-strength plastic cup is used in combination with an appropriate disc and machine screw for containing the toroid. The screw is also used for holding the assembly firmly to the chassis. This type of encasing insulates, protects, and improves the appearance of the toroids.

Another feature of this mounting system is its adaptability to stacking. Individual cases are designed to interlock when placed on top of each other. Stacked units are attached to the chassis in the same manner as the single unit. As many units as desired can be stacked. Torocoil Co., Dept. ED, 1374 Mobile Court, St. Louis 10, Mo.

CIRCLE ED-127 ON READER-SERVICE CARD FOR MORE INFORMATION

measure vibration



WITHOUT CONTACT OR "LOADING"

... also Axial or Radial Displacement to .0001"

DYNAMIC MICROMETER
 Model 3600-A

Accurately measure and record dynamic or static displacement plus viewing the amplitude of dynamic movement of any metal body . . .

at any speed. Sensing unit is calibrated for direct reading. Measurements are independent of acceleration or frequency of displacement.

ALSO MEASURES:

Radial expansion due to high speeds
 Travel, bounce of relay contacts

Bearingslapin motors
 Shaft whip
 Eccentricity of commutators, slip rings

Write for literature and help on your problem!



ELECTRO PRODUCTS LABORATORIES
 4501-Edd N. Ravenswood Ave., Chicago 40, Ill.
 Canada:
 Atlas Radio Corp., Ltd., Toronto, Ont.

CIRCLE ED-128 ON READER-SERVICE CARD FOR MORE INFORMATION

A COMPLETE PLASTICS SERVICE

MATERIALS DEVELOPMENT



ENGINEERING DESIGN



MOLDING



LAMINATING AND FABRICATING



INSUROK
 Plastic

SALES OFFICES IN PRINCIPAL CITIES
 SIX PLANTS LOCATED THROUGHOUT THE UNITED STATES

The RICHARDSON COMPANY

FOUNDED 1858

2682-G Lake Street, Melrose Park, Illinois (Chicago District)

CIRCLE ED-129 ON READER-SERVICE CARD FOR MORE INFORMATION

ARE YOU READY FOR

Guaranteed
Core Performance?



TAPE WOUND CORES

Are you ready for a revolutionary concept in the electrical and electronic industry—the Magnetics, Inc. "Performance-Guarantee" on Tape Wound Cores. Guaranteed

to meet your specifications, and sold at standard prices, these Cores mean truly economical production of high permeability magnetic devices in your plant.

TABLE A
BASIC PHYSICAL CONSTANTS OF
COMMON MAGNETIC MATERIALS

Trade Name	% Ni	% Fe	Other	Grain Structure	Satur. Flux Density Gausses	Resistivity Microhm-Cm	Curie Point °C	Dens. Grams per cc
Hy Mu 80	79	17	4 Mo	"random"	8,700	57	420	8.72
48 Alloy	48	52		"random"	16,000	45	500	8.3
Orthonol	50	50		oriented	15,500	45	500	8.25
Magnesil	97	3 Si		oriented	20,000	48	700	7.65

TABLE B
TRADE NAMES OF SIMILAR MATERIALS

Hy-Mu 80	48 Alloy	Orthonol	Magnesil
4-79 Permalloy	Carpenter 49	Orthonik	Armco Oriented T
Mo-Permalloy	Allegheny 4750	Permeron	Hypersil
Mu Metal*	Hypernik	Deltamax	Orthosil
		Hypernik V	Silectron

Typical of the unusual scope of the material contained in Catalog TWC-100 are Tables A and B, reproduced from Page 4 of "Performance-Guaranteed Tape Wound Cores."

GET THE COMPLETE STORY

A wealth of new and unusual material on Tape Wound Cores is available to you in Catalog TWC-100, "Performance-Guaranteed Tape Wound Cores." Tables A and B of the catalog, reproduced on this page, present a striking illustration of material not to be found compiled together elsewhere.

Data and descriptive details on high permeability materials . . . factory core matching . . . free engineering design services . . . pages of characteristic graphs and tables . . . are yours for the asking. Simply write on your company letterhead.

MAGNETICS inc.

DEPT. ED-7, BUTLER, PENNSYLVANIA

CIRCLE ED-130 ON READER-SERVICE CARD FOR MORE INFORMATION

New Products . . .

Rubber Terminals

Hermetically Sealed



These hermetically sealed, feed-through, rubber terminals were designed to overcome some of the disadvantages of other types of terminals. Formed of rubber-insulated, copper-clad steel wire, excellent sealing qualities are achieved by crimping a tinned copper sleeve over the rubber insulation which is chemically bonded to the wire.

These terminals provide high leakage resistance, high dielectric strength, and prevent metallic migration under direct current. Oil leakage is prevented under internal pressures up to 30psi. The rubber insulation also absorbs shock and vibration, affording long service life. Robco Manufacturing Division, Dept. ED, Pilot International Corporation, 27-01 Bridge Plaza North, Long Island City 1, N. Y.

CIRCLE ED-131 ON READER-SERVICE CARD FOR MORE INFORMATION

Dual Dial

For Counting Turns

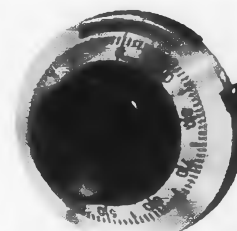

The RB series "Duodial" is for use in electronic, mechanical, hydraulic, and pneumatic applications to count the number of turns of a rotating component to the 100th of a turn. It can rotate either by its knob or by the shaft, and thus can

be used to count power-driven turns as well as being set to a desired value.

The unit consists of two coaxial dials and a black nylon knob integral with the inner dial. The inner dial is calibrated to count 100ths of each turn; the outer dial is calibrated to count the number of turns, up to 15. Critical readings of the inner dial are free from backlash.

An easily set, vibration-proof lock is provided. Reduced torque and easy reading are accomplished by a set of intermittent gears between inner and outer dials. Models are available to fit 1/4" and 1/8" diam shafts. Nominal diameter is 1-13/16"; nominal weight is 2-3/4 oz. Standard finish is satin chrome, black filled. Other colors and scale divisions are available on special order. Helipot Corp., Dept. ED, South Pasadena, Calif.

CIRCLE ED-132 ON READER-SERVICE CARD FOR MORE INFORMATION

ELECTRONIC DESIGN • June 1954



Good circuit design requires careful consideration of the components used to regulate the current. Circuit stability is readily obtained using Victoreen Current Regulator Tubes. These reliable, simple regulators replace expensive and complicated regulating circuits for either line or battery current.

Selection from more than 40 different tube types to your specifications is possible. Victoreen Current Regulator Tubes are built to exacting standards and will operate many thousands of hours under extremes of temperature, humidity and altitude.

WRITE For your copy of our brochure on Current Regulator Tubes . . . Address Components Division.

The Victoreen Instrument Co.
3800 PERKINS AVENUE • CLEVELAND 14, OHIO

CIRCLE ED-133 ON READER-SERVICE CARD FOR MORE INFORMATION

what is

available from **Pyramid**

The security of experience.

Pyramid has more experienced personnel (in years of actual designing and manufacturing of capacitors) than any other manufacturer.

The control of specially designed facilities. Pyramid is the only manufacturer of capacitors whose plants were planned and built specifically for the entire manufacturing process of capacitors from drawing board conception through reception of raw materials, fabrication, packaging and shipment.

The guarantee of one standard.

All Pyramid capacitors are one quality, made of the same quality materials demanded by rigid military specifications. Pyramid capacitors have a low leakage factor due to the non-hygroscopic insulating material used on all production. Pyramid delivers the best at no premium.

A complete line of capacitors—full ranges in all ratings and types.

▲ PYRAMID ELECTRIC COMPANY
1448 HUDSON BOULEVARD • NORTH BERGEN, N. J., U. S. A.

CIRCLE ED-134 ON READER-SERVICE CARD FOR MORE INFORMATION

ELECTRONIC DESIGN • June 1954

Waveguide Switch

Less Than 1.10 VSWR Over 17% Bandwidth



The Model 4426 Waveguide Switch is an electrically operated spdt section of the RG-50/U waveguide. The design employs insertion of the attenuator card into the disconnected member automatically, providing a termination for the switched member, as well as increasing the isolation between arms to better than 60db.

VSWR is less than 1.10 over a 17% bandwidth, and the entire unit is operated by a momentary pulse of 11v, 60cy power. Insertion loss through the connected member is less than 0.1db. Bogart Manufacturing Corp., Dept. ED, 315 Siegel Street, Brooklyn 6, N. Y.

CIRCLE ED-135 ON READER-SERVICE CARD FOR MORE INFORMATION

Eyelet

For Printed Wiring

These eyelets, with superior contact-making abilities, were especially designed to serve as jacks for self-locking, quick-disconnect-type connectors. They are also particularly useful in printed wiring where their upstanding heads facilitate dip soldering without immersing the panel.

Because the eyelets have dome-shaped heads, the inherent tension and stress factors set up in the forming operation provides a spring action to offset relaxation that might occur after they are set. In addition, the lower edge of the head has a serrated edge that improves the metal-to-metal contact and prevents the eyelet from turning. United Shoe Machinery Corporation, Dept. ED, 140 Federal St., Boston, Mass.

CIRCLE ED-136 ON READER-SERVICE CARD FOR MORE INFORMATION

Motion Picture Film

For High Speed Cameras

Two "Fastax" motion picture films, perforated for high-speed use, are ideally suited for the photographic analysis of motion and instrumentation. Whereas standard movie cameras shoot 24 pictures per sec, "Fastax" high-speed cameras shoot from 150 to 16,000 pictures per sec.

"Superior" 3 negative film (125 daylight, 100 tungsten) comes in the 35mm size only. High Speed Rapid Reversal (160 daylight, 125 tungsten) and negative stock (80 daylight, 64 tungsten) are made in 35 and 16mm sizes. Wollensack Optical Company, Dept. ED, Rochester, N. Y.

CIRCLE ED-137 ON READER-SERVICE CARD FOR MORE INFORMATION

CIRCLE ED-138 ON READER-SERVICE CARD >



CHECK 'EM BEFORE YOU USE 'EM WITH THE



RESISTANCE METER

presenting a new concept in RESISTANCE MEASUREMENTS

A unique circuit permits instant testing of capacitor leakage at 50 or 500 volts. The meter will also read resistances from 0 to 10,000,000 megohms, and tests insulation at 500 volts, as required by MIL specifications. Price—\$200.00.

Write, wire or telephone for a copy of our free brochure.

2821 POST OAK • HOUSTON, TEXAS



Hunting's Good!

80 JAN-type Centralab STANDOFFS in stock

Stop searching — Centralab has' em!

- All JAN standoffs carried in stock.
- All standoffs grade L-5
(JAN-I-8, JAN-I-10).
- High dielectric strength
(240 volts per mil.).
- Low loss at high frequencies
(Loss factor at 1 MC. — .007).
- High mechanical strength
(18,000 psi. modulus of rupture).
- Harder than quartz (7.5 Mohs' scale).
- Impervious to moisture or acids
(0 to .02% absorption).

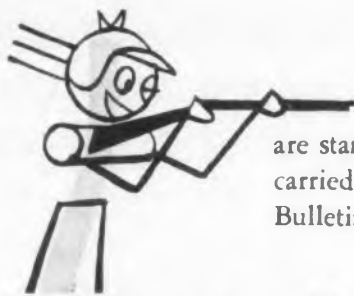

ORDERING is simplified too — all parts are stamped with the JAN designation. All units are carried in stock for immediate shipment. Write for Bulletin 42-181 for complete technical data.

Centralab

A Division of Globe-Union Inc.
952F E. Keefe Avenue • Milwaukee 1, Wisconsin
In Canada: 804 Mt. Pleasant Road, Toronto, Ontario



X-1

CIRCLE ED-140 ON READER-SERVICE CARD FOR MORE INFORMATION

New Products . . .

Insulated Terminal

Withstands 6000v



"Ampli-Bond" is an insulated terminal for users of heavy duty wire, sizes 8 to 4/0. It gives a positive and complete bond of the insulation to the terminal sleeve and insures uniform insulation thickness under confined crimping

pressures. It allows the use of large-size wire in restricted areas.

A tough vinyl insulation is used that will withstand a minimum of 6000v. Color coding is used for rapid identification. These bonded terminals are applied in one quick operation with the manufacturer's pneumatic hydraulic tooling. Terminals are available in a variety of tongue shapes, stud sizes and in both butt and parallel connectors. Aircraft-Marine Products, Inc., Dept. ED, 2100 Paxton St., Harrisburg, Pa.

CIRCLE ED-141 ON READER-SERVICE CARD FOR MORE INFORMATION

Ball-and-Disk Integrator

Precision, Long Life Unit

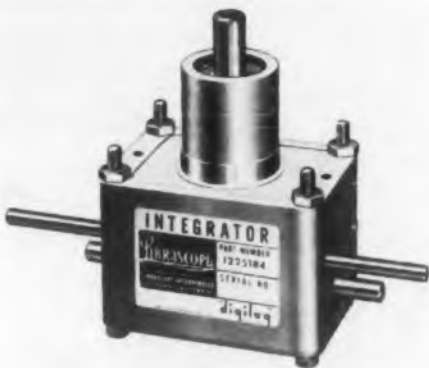

This improved ball-and-disk integrator is for use in totalizing, rate determination, differential analyzers, or as a closed loop mechanical servo-element or precision, variable-speed drive. Improvements include

the addition of a permanent lubrication device which greatly increases the life of the unit, and a lubricating oil that meets military specifications.

Other specifications include: 0.01% precision; dimensions of 1-7/8" x 2-3/4" x 3-1/4" high; and a weight of 21 oz. Super-finished balls and a tungsten carbide disk are employed for high performance and long life. Librascope, Inc., Dept. ED, 1607 Flower St., Glendale, Calif.

CIRCLE ED-142 ON READER-SERVICE CARD FOR MORE INFORMATION

NATIONAL COMPANY, INC., 61 SHERMAN ST., MALDEN 48, MASS.

National

COMPONENTS tuned to tomorrow

Write on your business letterhead—(or give your amateur call sign) for your free copy of National's new catalogs of quality knobs, dials, drives, chokes, terminals, plugs, bindings, insulators, spreaders, couplings, tube caps, grips and sockets, coils, coil forms, condensers and multi-band tank assemblies. Specify items in which you are interested. Write to Dept. DE-654

NEW CATALOGS

Write on your business letterhead—(or give your amateur call sign) for your free copy of National's new catalogs of quality knobs, dials, drives, chokes, terminals, plugs, bindings, insulators, spreaders, couplings, tube caps, grips and sockets, coils, coil forms, condensers and multi-band tank assemblies. Specify items in which you are interested. Write to Dept. DE-654

NEW CATALOGS

CIRCLE ED-143 ON READER-SERVICE CARD

**Pulse Transformers
For Computer Systems**



The "MDT" series pulse transformers are designed for use in driving magnetic drum or magnetic tape recording heads or for any application requiring moderately high power pulses. They have two primary windings and one secondary, and are characterized by fast rise and fall times and relatively long permissible on time.

The transformers are available in primary (each winding) to secondary turns ratios of 1:2, 1:1, 2:1, 3:1, 4:1, 5:1, and 6:1. They will match any recording head to any driving tube.

Typical figures for the MDT-1 transformer (1:1 ratio) being driven by a pair of 5881 tubes and driving a Raytheon magnetic drum recording head are: record current 200ma; peak voltage across head, 200v; maximum pulse width for less than 20% peak current fall off, 6μsec; current overshoot, less than 5% with critical damping. Magnetics Research Co., Dept. ED, 142 King St., Chappaqua, N. Y.

CIRCLE ED-144 ON READER-SERVICE CARD FOR MORE INFORMATION

**Deposited Carbon Resistors
For High Frequency Use**



"Carb-Ohms" are deposited carbon resistors valuable for high frequency applications, particularly where high values of resistance are essential. They also answer the need for closely matched units for computer network and other applications. They resist extremes of temperature and can be employed as replacements for wire-wound types in many applications.

The resistors are available hermetically sealed in glass, in a specifications series conforming to MIL-R-10509, and clad in humidity-impervious "Kel-F" and vinyl casings. They provide stability with time and freedom from variations due to climatic changes. Wattage rates range from 1/4w to 2w, with a resistance range of 20 ohms to 20 megohms. Phaostron Co., Dept. ED, 151 Pasadena Ave., South Pasadena, Calif.

CIRCLE ED-145 ON READER-SERVICE CARD FOR MORE INFORMATION

ELECTRONIC DESIGN • June 1954

For Improved and More Compact Circuits!

Sylvania's versatile new **POWER TRANSISTOR 2N68**

Here's a simple, rugged unit which provides an efficient solution to numerous power requirements including: Servo systems, control applications, and compact radio receivers.

This versatile Sylvania development permits 1.5 watts dissipation with no external heat sink. Its power gain is better than 10 db. And, it may be mounted in any position, with lead wires soldered or clipped for socket mounting. For further details and technical data, write today to Dept. 4E-1406, Sylvania.

Electrical Ratings

Collector to Base Voltage	-25 volts
Collector Current	-1.5 amps.
Dissipation in Free Air	1.5 watts

Typical Operating Conditions

Push-Pull Class B Amplifier ...	Grounded Grid or AC Grounded Collector Circuit.
Power Output	3 watts (MIN)
Collector Voltage	-12 volts
Load Resistance	24 ohms to each transistor.
Collector Current @ Zero Output	-5 ma
Collector Current @ 3 Watts Output	-320 ma
Collector Efficiency @ 3 Watts Output	75%
Power Gain	> 10 db
Frequency Response	> 10 KC

Another reason why it pays to specify Sylvania

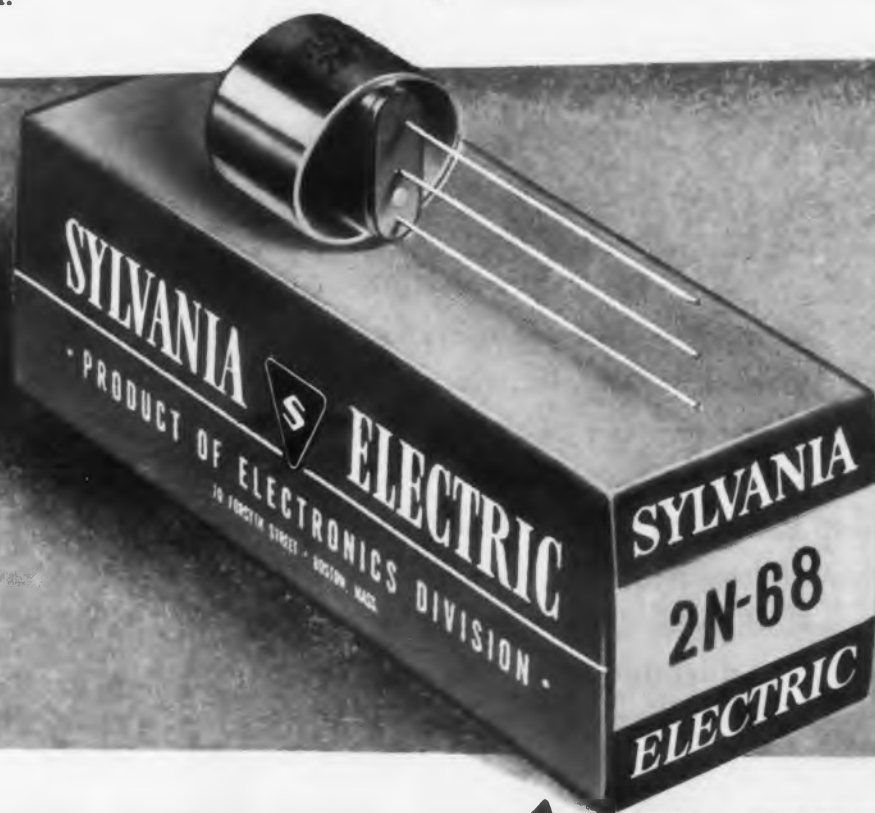

SYLVANIA

Sylvania Electric Products Inc., 1740 Broadway, New York 19, N. Y.

In Canada: Sylvania Electric (Canada) Ltd., University Tower Bldg., St. Catherine Street, Montreal, P. Q.

LIGHTING • RADIO • ELECTRONICS • TELEVISION

CIRCLE ED-146 ON READER-SERVICE CARD FOR MORE INFORMATION



*"It works. but
don't ask how!"*

That's what the Tech Sergeant wrote after inspecting this Servomechanisms, Inc. electronic computer that came out of a wrecked fighter in Korea.

The specs didn't call for operation after this kind of treatment — but we're not surprised. We build reliability and ruggedness into all our equipment.



Designed and Produced at El Segundo, California and Westbury, New York
CIRCLE ED-147 ON READER-SERVICE CARD FOR MORE INFORMATION

New Products . . .

Tuning Capacitor

Made in 0.4 to 0.8mmfd Range



A tuning capacitor for television and other high frequency apparatus has been added to this company's line. A miniature model, it is presently being produced in a range of 0.4mmfd to 0.8mmfd.

Of a balanced dielectric

construction, the unit consists of a metallized glass rotor, fitting to close tolerance within a metallized glass stator. Made of precision-bore glass tubing, rotor and stator are directly soldered to standard brass fittings for conventional chassis mounting.

This capacitor has a minimum Q of 500 at 50Mc. Tolerance is still within prescribed limits after 100,000 revolutions. The Hermaseal Co., Dept. ED, Elkhart, Indiana.

CIRCLE ED-148 ON READER-SERVICE CARD FOR MORE INFORMATION

Subminiature Switch

Has 12 Positions



This precision, low-loss, 12-position subminiature switch is for use where space and minimum size are important factors. Only 3/4 inch square, this wafer-type,

selector switch is designed for constant stability in conductivity and where resistance, inductance and capacitance must be kept to a minimum.

The switch has a break-down voltage of 1300v, a-c. At 115v, 60cy, the current-carrying capacity is 3amp. It has a 30° positive detent mechanism with adjustable stops. The rotor blades and stator contacts are solid silver alloy. All metal parts except the silver contacts are fabricated of stainless steel. The rotor shaft is furnished with 1/8" or 1/4" diam. R-F Electronics, Inc., Dept. ED, 291 N. E. Sixty-First Street, Miami, Fla.

CIRCLE ED-149 ON READER-SERVICE CARD FOR MORE INFORMATION

Correction

"Micro" for "Milli"

The description of the Model 432 Interval Timer on page 51 in the May, 1954 issue of *Electronic Design* incorrectly stated that the unit measures intervals of 0.01 to 999 μ sec. Actually the range is 0.01 to 999 *milliseconds*. This instrument is manufactured by Potter Instrument Co., Inc., 115 Cutter Mill Rd., Great Neck, N. Y.

"START TO FINISH"

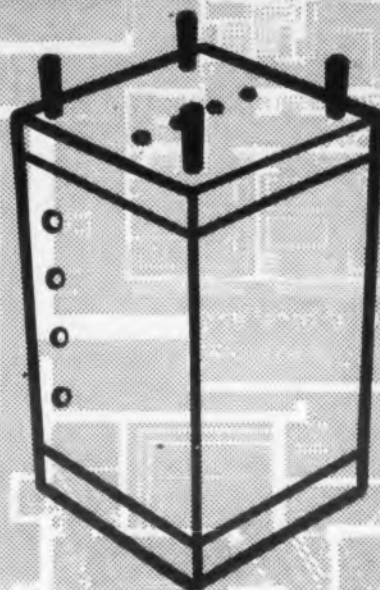

A HOUSING PLAN THAT WORKS!

OLYMPIC'S "start-to-finish" facilities are geared to your industrial housing needs. A stock of over 3000 sizes and shapes means prompt delivery of the right housing for you. Blueprint specifications are followed precisely by our metal craftsmen. What's more, you really can *consolidate* your specs with **OLYMPIC!**

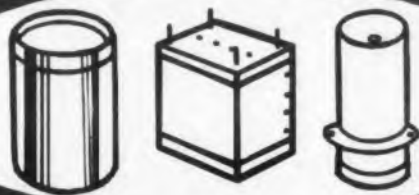

- **FABRICATIONS, DRAWINGS, PRECISION METAL STAMPINGS** . . . any form to house any product.
- **FACILITIES** . . . at your disposal are OLYMPIC'S complete sample shop, engineering, design and production departments.
- **FINISHING** "with a purpose" . . . Black Oxide, Cadmium Plated or Hot Tin Dipped. The correct finish for the job is the finish used.
- **MASS PRODUCTION PRICES** . . . OLYMPIC has quality at heart with your budget in mind.

Let OLYMPIC experts co-operate with you on that housing problem!

Write:

OLYMPIC
METAL PRODUCTS COMPANY, INC.
ALPHA, NEW JERSEY

CIRCLE ED-150 ON READER-SERVICE CARD

ELECTRONIC DESIGN • June 1954

Oil-Filled Capacitors

600-6000v D-C Working Voltages

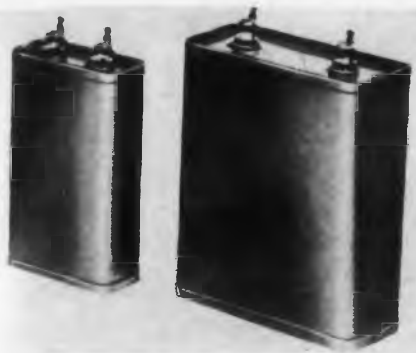

For use under extreme conditions of moisture and humidity, a complete series of square and rectangular type capacitors is offered in a wide variety of case sizes. The units range in

working voltage from 600v to 6000v d-c. "Indco" oil-filled units operate efficiently at temperatures from -40° to $+70^{\circ}\text{C}$. Units filled and impregnated with a new dielectric, "Pyroteen", provide operation at temperatures from -70° to $+90^{\circ}\text{C}$. Wax impregnation is also available.

Capacitors are hermetically sealed in lead-coated steel cases. They can be supplied with porcelain standoff terminals or riveted solder lug terminals for voltages below 2500v d-c. Standard capacity tolerance is $\pm 10\%$. Test voltage is twice rated from terminal to terminal, and twice rated plus 1000v from each terminal to case. Industrial Condenser Corp., Dept. EDN, 3243 N. California Ave., Chicago 18, Ill.

CIRCLE ED-151 ON READER-SERVICE CARD FOR MORE INFORMATION

Self-Locking Nut

Eliminates Lock Washers



A high-quality, low-cost nut that speeds assembly and eliminates the need for lock washers is self-locking and self-gripping.

A concave fastener made of hardened and spring-tempered high carbon steel, it has cut threads for strength and accuracy and a flange with turned-down corners that bite into the material to which it is applied. The spring flange is deflected as the screw is tightened so that tension is applied to the threads to prevent loosening of the screw. Four sizes are currently available: 6-32, 8-32, 10-24, and 10-32.

Assembly time is saved because the concave shape of the nut leads the screw into the tapped threads, and a wrench is not needed to hold the nut while the screw is run in. In addition, elimination of the lock washer saves the handling of one part. P-M Division, Waterbury Pressed Metal Co., Dept. ED, 300 Chase Ave., Waterbury, Conn.

CIRCLE ED-152 ON READER-SERVICE CARD FOR MORE INFORMATION

SILICONDUCTORS

(TRADE MARK)

ARE

PRECISION

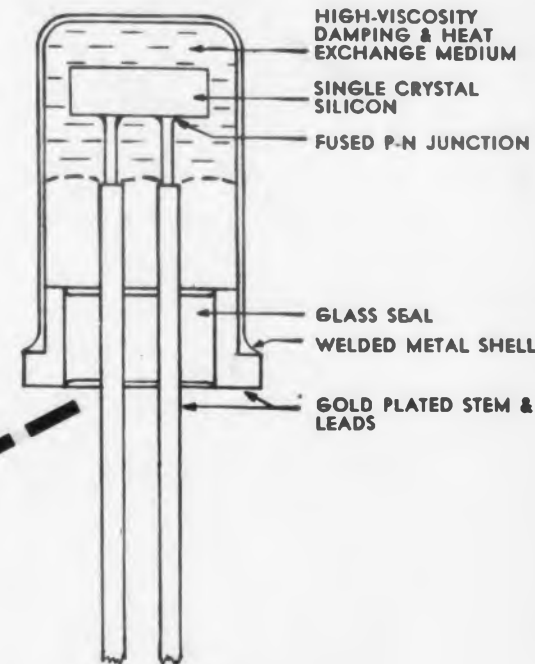

PRODUCED



ACTUAL SIZE

SILICON JUNCTION DIODES

by

NATIONAL SEMICONDUCTOR PRODUCTS

930 Pitner Avenue • DAvis 8-0800 • Evanston, Illinois

DIVISION OF NATIONAL FABRICATED PRODUCTS, INC.

CIRCLE ED-153 ON READER-SERVICE CARD FOR MORE INFORMATION

**At last!
Printed Circuit
Tube Sockets that**

**—withstand punishing
shock and vibration**

**made of
MYCALEX® 410
glass-bonded mica**

- LOSS FACTOR .014 at 1 mc/s
- POWER FACTOR .0015 at 1 mc/s
- HIGH DIELECTRIC STRENGTH
- NO CARBONIZATION
- ZERO COLD FLOW
- IMMUNE TO FUNGUS

MYCALEX printed circuit tube sockets effectively eliminate broken or loose connections that ordinarily result from tube insertion and removal, shock and vibration. An exclusive MYCALEX contact design permits a positive mechanical attachment in conjunction with a soldered connection. The mechanical attachment safeguards against stress at all times, insures the permanence of the soldered connection between printed circuit and socket contact. Troublesome intermittent contacts, costly repairs are thus eliminated.

Application of these sockets to your printed circuit can speed production, reduce rejects, improve performance. For information call or write J. H. DuBois, Vice President-Engineering, at Clifton, N. J., address below.

NOTE: MYCALEX 410 glass-bonded mica is an exclusive formulation of and manufactured only by the Mycalex Corporation of America. It meets all the requirements for Grade L-4B under Joint Army-Navy Specifications JAN-I-10.



MYCALEX TUBE SOCKET CORPORATION

Under exclusive license of Mycalex Corporation of America,
World's largest manufacturer of glass-bonded mica products

ADDRESS INQUIRIES TO —

General Offices and Plant: **123** Clifton Blvd., Clifton, N. J.



New Products . . .

Glass-Braided Lead Wire Teflon Insulated

This glass-braided "Tempelad" wire operates at temperatures from -55°C to $+200^{\circ}\text{C}$. The Teflon insulation exhibits excellent dielectric strength, low

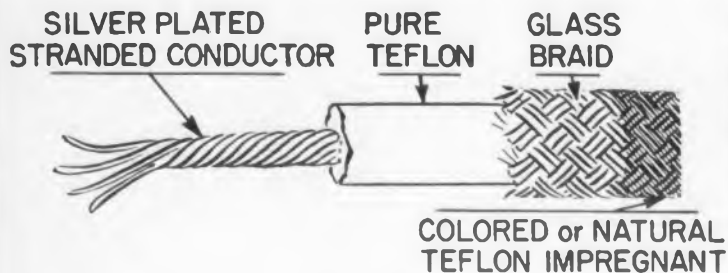

power factor, and a low dielectric constant. The secondary insulation of glass braid, also Teflon impregnated, affords unusual resistance to abrasion.

This wire is suitable for use with equipment working at a-c potentials up to 600v rms, in aircraft and other severe applications. It is a stranded construction, manufactured in sizes 28 AWG to 10 AWG inclusive, in any one of eight solid colors. Special tracer colors are also available. Hitemp Wires, Inc., Dept. ED, 26 Windsor Ave., Mineola, L. I., N. Y.

CIRCLE ED-155 ON READER-SERVICE CARD FOR MORE INFORMATION

Comparison Bridge Has 3 Test Frequencies



The compact Type No. 1010A Comparison Bridge is a comparison and limit bridge which may be used in both laboratory and production testing. Power line operation and the visual indicator with its high-gain selective amplifier make the unit completely self-contained.

Three test frequencies of 60cy, 1kc, and 10kc are available at ranges of 5% and 20%. Resistors from 1 ohm to 10meg, capacitors from 10mmfd to 1000mfd, and inductors from $10\mu\text{h}$ to 1000h can be measured. The unit's accuracy allows components to be adjusted to within an accuracy of $\pm 0.1\%$.

The voltage across the unknown may be varied from 0.1v to 10v. Freed Transformer Company, Inc., Dept. ED, 1715 Weirfield St., Brooklyn 27, N. Y.

CIRCLE ED-156 ON READER-SERVICE CARD FOR MORE INFORMATION



BRUSHES CONTACTS SLIP RINGS

...AND SLIP RING ASSEMBLIES



BRUSHES — CONTACTS — ASSEMBLIES

... Use **SILVER GRAPHALLOY** for applications requiring low electrical noise; low and constant contact drop; high current density and minimum wear.

EXTENSIVELY USED IN:

**SELSYNS • GUN FIRE CONTROLS
ROTATING THERMOCOUPLE and
STRAIN GAGE CIRCUITS
ROTATING JOINTS • DYNAMOTORS**

Wide range of grades available for standard and special applications.

Other Graphalloy Products



Oil-free, self-lubricating Bushings and Bearings (applicable -100° to $+300^{\circ}$ F.; with expansion coefficient half that of steel will not seize shaft at low temperature); oil-free Piston Rings, Seal Rings, Thrust and Friction Washers, Pump Vanes.

GRAPHITE METALLIZING CORPORATION

1046 Nepperhan Ave. • YONKERS, NEW YORK

- Please send data on Graphalloy BRUSHES and CONTACTS.
 Send data on BUSHINGS.

NAME & TITLE _____

COMPANY _____

STREET _____

CITY _____

ZONE _____

STATE _____

CIRCLE ED-157 ON READER-SERVICE CARD

The *Right Formula* For Solving Complex Problems . . .

HUBBELL *Interlock* CONNECTORS + *New* MAGNETIC DECISION ELEMENTS!

Magnetic Decision Elements, designed by Minnesota Electronics Corp. and developed in collaboration with the U. S. Naval Ordnance Laboratory, White Oak, Silver Spring, Md., are basic computer blocks for building the entire arithmetic, program, control, and memory sections of any digital computer.

Hubbell Interlock connectors were selected to provide a low contact resistance for each block, necessary for accurate results in computations. Automatic locking . . . quick disconnect feature makes possible rapid cascading in any desired performance pattern. Plugs cannot disconnect accidentally from blocks, yet can be quickly disconnected when intended.

For Further Information Write Dept. D

HARVEY HUBBELL, INC.
Interlock Dept., Bridgeport 2, Conn.

Plugboard (above) contains approximately 1,000 Magnetic Decision Elements, connected in various configurations by Hubbell Interlock Type "B" Automatic Locking Plugs to form basic computing structures. Inset shows closeup of computer blocks connected by wired Interlock Plugs.

CIRCLE ED-251 ON READER-SERVICE CARD FOR MORE INFORMATION

New... RELAYS

- SUB-MINIATURE
- ANTI-VIBRATION
- SUPER-RUGGED

WIDE SELECTION OF RELAY TYPES...

Sensitive from .010 watts. Hi temperature and temperature compensated. Fast operate or time delay. Frequency tuned (vibrating reed type).

Designed to meet or exceed
MIL R 5757B

Vibration: Withstands to as high as 20 Gs to 1000 cycles per second. Temperature range: -65° to 200°C. Life: Into the millions of operations. Open or hermetically sealed. Optional plug-in or solder terminals. Variety of mounting arrangements. High contact current.

SEND FOR CATALOG AND ENGINEERING DATA

NEOMATIC INC.

8010 BELLANCA • LOS ANGELES 45, CALIF. • OREGON 83814

CIRCLE ED-252 ON READER-SERVICE CARD FOR MORE INFORMATION

Wire-Wound Resistors

Withstand Up to 100°C



A new line of resistors, designated "Hy-Temperature," is designed to withstand continuous heat up to 100°C. Completely encased in ceramic with axial lead mounting for easy connecting, these resistors surpass all Mil-Specs. Resistance and tolerance markings can be stamped on the ceramic for added convenience.

These precision, wire-wound resistors are available on request with glass, silicone, or teflon covered wire. Eastern Precision Resistor Corp., Dept. ED, 130-11 90 Ave., Richmond Hill, Long Island, N. Y.

CIRCLE ED-158 ON READER-SERVICE CARD FOR MORE INFORMATION

Capacitors

Rated to 60kv



These type G-6 "Glaseap" glass tubular plastic dielectric capacitors feature light weight and compactness. They are designed for high-voltage direct current use or at low-frequency, low-voltage alternating currents.

"Glaseaps" are available in a complete range of ratings from 0.01mfd at 600v through 0.0015mfd at 60kv. Corson Electric Manufacturing Corp., Dept. ED, 540 39th St., Union City, N. J.

CIRCLE ED-159 ON READER-SERVICE CARD FOR MORE INFORMATION

Color TV Coils Kit

Contains 32 Items

This Color TV Coils Kit contains 32 items for use with shadow mask tubes. Designers of color TV receivers should find this kit valuable.

Included are a distributed constant delay line, a horizontal output transformer, horizontal dynamic-converging and dynamic-focusing transformers, horizontal dynamic-convergence phase control, width control, linearity control and a complete set of i-f video and color information circuit coils. Electrometric, Inc., Dept. ED, Woodstock, Ill.

CIRCLE ED-160 ON READER-SERVICE CARD FOR MORE INFORMATION

ENGINEERS! PURCHASING AGENTS!

Here's America's
NEWEST
Electronic Source
Guide!



1. Alphabetical list of over 700 manufacturers gives: company address, name of sales mgr., brief data on lines produced, plus names, address and telephone number of sales agents.
2. Alphabetical listing of 1000 trade names associates these names with the companies who use them.
3. Buyers guide of electronic components and equipment lists over 300 separate products.
4. Geographical listing of 600 manufacturers representatives supplying names, address, phone numbers; territory covered, and lines handled.
5. Distributors in this section specialize in supplying electronic parts and equipment to industry. Distributors are arranged in geographical sequence under the manufacturers whose lines they stock and sell. Procurement is made easy at the local level.
6. Geographic listing of over 1300 recognized distributors of electronic parts and equipment gives: firm name, address, buyer, owner or executive, trading area served.

10 DAY FREE TRIAL OFFER!

WHO'S WHO IN ELECTRONIC DISTRIBUTION 845 Leader Bldg.
Published by Radio Electronic Jobber News, Incorporated Cleveland 14, Ohio

Please send me one copy of WHO'S WHO IN ELECTRONIC DISTRIBUTION on a FREE TRIAL BASIS. In 10 days I will either remit \$7.50 to cover the cost or I will return this directory postpaid and notify you to that effect.

Firm Name

Address

City Zone State

a **UNIQUE** application . . . of a **NEW** principle
for a **BETTER** instrument

Doelcam

D-C Indicating Amplifier



Type
2HLA-3

Write for Bulletin 1A10

- ▶ **High Stability**
Less than 10 microvolts long term drift
 - ▶ **Wide Dynamic Response**
Flat from 0 to greater than 20 cps
 - ▶ **Magnetic Input**
Second-Harmonic Magnetic Converter for input stage
- Linearity within 1%**
High input impedance
Zero-center meter
Will drive recorders

THE DOELCAM D-C Indicating Amplifier is a completely self-contained instrument for the amplification and measurement of d-c voltages and currents of minute magnitude. A new design concept employing the remarkable sensitivity and inherent stability of the second harmonic magnetic converter is used in the input stage of the amplifier. This design feature, by eliminating all moving parts such

as mechanical choppers, makes this instrument ideally suited for applications where accuracy, reliability and insensitivity to changing ambient conditions are of prime importance.

Doelcam CORPORATION

SOLDIERS FIELD ROAD, BOSTON 35, MASS.
West Coast Office: 304 Tejon Pl., Palos Verdes, Calif.
Instruments for Measurement and Control
Synchros • Gyros • Servos • Microsyns • Servo Motors

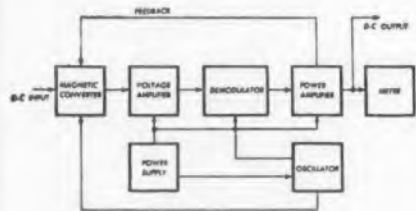

MAGNETIC INPUT . . . Block Diagram showing DOELCAM Second Harmonic Magnetic Converter as input stage . . . a new design concept

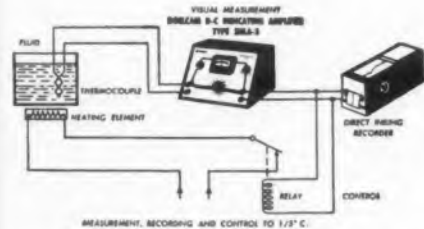

MEASUREMENT - RECORDING - CONTROL to 1/5° C. A typical Process Control application showing high accuracy of DOELCAM Type 2HLA-3

CIRCLE ED-162 ON READER-SERVICE CARD FOR MORE INFORMATION

New Products . . .

Germanium Diodes

For High Temperature Use

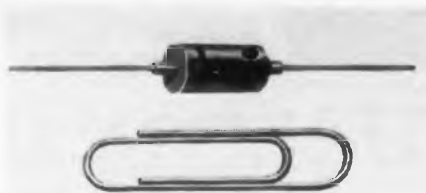

The "Red Dot" series of germanium diodes was especially developed for equipment operating at a high ambient tempera-

ture. Each unit is so sealed that exposure to 95% or more relative humidity for 500 hours at temperatures from 0° to 85°C will not appreciably change back resistance or cause appearance of hysteresis.

Through careful control of impurities in semiconductor, point-contact germanium diodes, this firm can produce diodes with excellent characteristics up to 100°C. Type G44, for example, has a minimum of 100,000 ohms resistance at -30v and 100°C; other types are available to customer specifications.

The diodes are provided for either clip-in or solder-in application. They measure 5/32" diam x 3/8" long, with 3/16" clip pins. All are supplied with #24 tinned copper, pigtailed leads. International Rectifier Corp., Dept. 3NR, 1521 E. Grand Ave., El Segundo, Calif.

CIRCLE ED-163 ON READER-SERVICE CARD FOR MORE INFORMATION

Rotary Selector Switches

Handle 2 to 8 Circuits

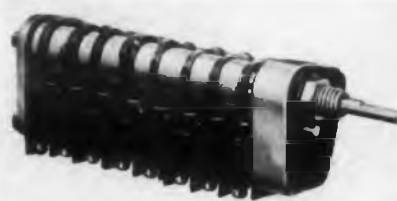

These subminiature selector switches offer a means of switching as many as eight different circuits with one compact

assembly. They are available with from two to eight switching units and from two to eight detent positions, with a 45° angle between detents. Virtually any switching sequence is possible.

The switches are panel-seated. Use of ultra-small spdt switching units provides a small size particularly well suited for use on electronic equipment control boards. The eight-switch assembly requires only a 1-17/64" diam mounting surface; overall length is less than 4". Switches are available with drilled, solder-type terminals or wrap-around type turret terminals. They are rated for an inductive load of 3amp at 30v d-c and 10amp at 125v or 250v a-c. Micro Switch, Division of Minneapolis-Honeywell Regulator Co., Dept. ED, Freeport, Ill.

CIRCLE ED-164 ON READER-SERVICE CARD FOR MORE INFORMATION

**YOU CAN'T
SHAKE 'EM LOOSE!**
BUT YOU CAN COOL 'EM OFF . . .



With BIRTCHEK

KOOL KLAMPS

BIRTCHEK KOOL KLAMPS will help keep your subminiature tubes COOL . . . and hold them firm and secure, regardless of how they are shaken, or vibrated.

KOOL KLAMPS are made of a specially developed heat treatable alloy 99 1/2% pure silver of high thermal conductivity.

KOOL KLAMPS under certain conditions are able to reduce bulb temperatures as much as 40° C. KOOL KLAMPS have proved of particular value in miniaturized electronic equipment.

Where heat conditions are less critical, beryllium copper KOOL KLAMPS are available.

The BIRTCHEK CORPORATION

4371 Valley Blvd.
Los Angeles 32, California

Dept. ED-6-4

Please send Bulletin which describes and illustrates Kool Klamps in detail.

Company
Attention of
City State
CIRCLE ED-165 ON READER-SERVICE CARD

ELECTRONIC DESIGN • June 1954

Hermetically Sealed Terminal

For Clip or Solder Mounting



This terminal is available in either feed-through or stand-off models for 0.250" punched holes. The design is ceramic-to-metal, with leakage resistance after wa-

ter immersion greater than 10,000 megohm voltage rating (sea level) of 1500v rms, and a terminal-to-ring capacity of less than 2.5mmfd. The terminals are for mounting either by solder or Tinnerman clip.

Metal parts of the terminal are of low-carbon rolled steel or brass, electro-tin plated. The terminals are built to withstand failure forces in excess of 150 lb, and thermal change from -110° to $+212^{\circ}$ F. Bennett Products Manufacturing Co., Dept. ED, P. O. Box 1055, Palo Alto, Calif.

CIRCLE ED-167 ON READER-SERVICE CARD FOR MORE INFORMATION

U-H-F Insulation

Retains Shape to 200° C

Rexolite 2101 is a glass fibre reinforced laminate of cross-linked styrene copolymer for u-h-f insulation purposes. This plastic provides good punchability and high impact strength. It can be subjected to rapid changes of temperature from -60° C to $+200^{\circ}$ C without delamination, and will retain its shape to 200° C.

Dielectric constant from 10 to 10,000Mc is 2.77. The dissipation factor at 10,000Mc is 0.0010. The Rex Corporation, Dept. ED, West Acton, Mass.

CIRCLE ED-168 ON READER-SERVICE CARD FOR MORE INFORMATION

Nylon Cement

Non-Brittle

"Nylaweld" is a liquid chemical mixture that produces practically invisible joints between pieces of FM-10001 nylon. Its high fluidity permits rapid coating by dipping, brushing, spreading or spraying. A plasticizing action makes all joints non-brittle.

Tensile strengths only slightly less than the strength of the material itself can be achieved by curing to specifications.

"Nylaweld" is useful in development and fabrication of products. It is possible to form and test a prototype before expending money for dies or molds. Joining two parts make possible the fabrication of pieces that could not ordinarily be machined as one. The Polymer Corporation of Pennsylvania, Dept. ED, Reading, Pa.

CIRCLE ED-169 ON READER-SERVICE CARD FOR MORE INFORMATION

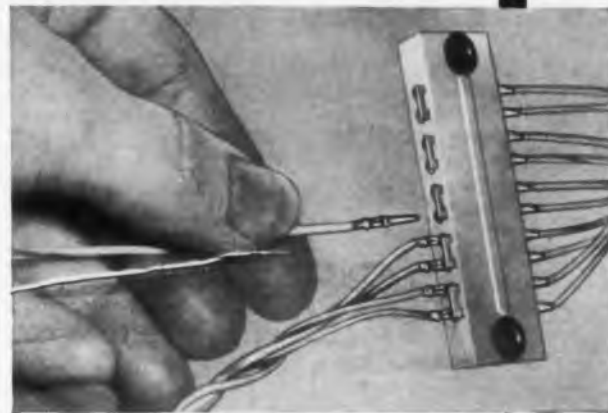

BASIC 10 CONNECTOR TAPER-BLOK WITH DUAL CONTACTS

Photo shows TAPER-BLOK with A-MP TAPER PINS in place. Strip measures only .610" x 2". Blocks, made of NYLON 10001, can also be stacked to accommodate hundreds of circuits.



TAPER PINS FOR MULTIPLE CONNECTORS, AN AND OTHER TYPES

Amphenol, Cannon, Continental and Winchester Connectors now are available with tapered receptacles for A-MP self-locking TAPER PINS. Saves over 80% of your wire assembly time and provides uniformly higher quality connections at lower cost.



TAPER TAB RECEPTACLE APPLICATIONS

More and more flat tabs on relays, switches and other components are being tapered to receive A-MP TAPER TAB RECEPTACLES. Fast easy assembly reduces costs and provides higher quality connections.

CIRCLE ED-170 ON READER-SERVICE CARD FOR MORE INFORMATION

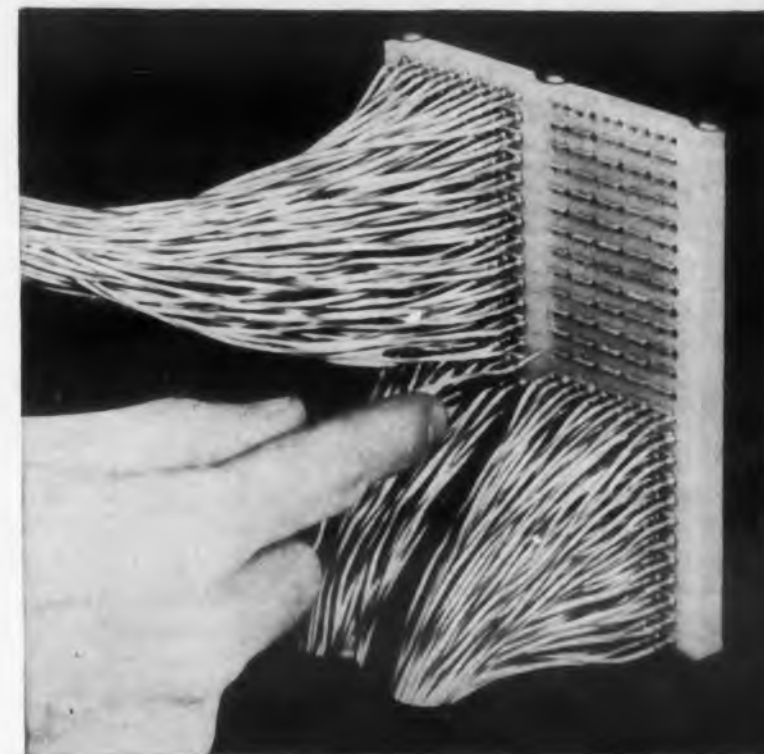

NEW AMP MINIATURE TAPER-BLOK For AMP Taper Pins

(Wire Ranges: #26 to #16)

NEW TAPER-BLOK FOR A-MP'S TAPER PINS HELPS YOU SAVE SPACE AND WEIGHT, SPEEDS UP WIRING ASSEMBLY, SIMPLIFIES DESIGN, AND REDUCES COST!

The TAPER-BLOK shown has receptacles for 1000 connections, yet measures only 4" x 5" x 3/8"! Receptacles are designed to receive A-MP self-locking Taper Pins which can be easily pushed in place with A-MP's CERTI-LOK measured energy insertion tool.

Extremely high contact pressure assures dependable, uniform, low resistance connections for electric and electronic circuits.

Assembled TAPER-BLOKS are available in 10 and 20 connector sizes with single or dual receptacles. TAPER-BLOK strips can be assembled by stacking to provide the number of connections required for your design. Write for specific information and latest prints.

AMP Trade Mark Reg. U.S. Pat. Off. © AMP



AIRCRAFT-MARINE PRODUCTS, INC.
2100 PAXTON STREET, Harrisburg, Pennsylvania

In Canada - AIRCRAFT-MARINE PRODUCTS, INC.
1764 Avenue Road, Toronto 12, Ontario, Canada

CIRCLE ED-170 ON READER-SERVICE CARD FOR MORE INFORMATION

ELECTRONIC DESIGN • June 1954

LIGHT HEAVY WEIGHT
Champion of relays.....



MINIATURE 3PDT RELAY

CONTACT RATINGS TO 20 AMPS

SHOCK AND VIBRATION
in accordance with
MIL-R-5757B -55°C to +100°C

OPERATION LIFE
50,000 MINIMUM
at 15 amp. w/60 amp. surge
for 10 millisecond at 115 V, 400 CPS.

COIL RESISTANCE — 1 to 80,000 OHMS

DIMENSIONS: 1-5/8" x 1-29/36" x 2-9/32"

VARIOUS METHODS OF MOUNTING AVAILABLE

PROMPT DELIVERY



For further information on this model 2007, write to:

ELECTRO-MECHANICAL SPECIALTIES CO., INC.

6819 MELROSE AVE. • LOS ANGELES 38, CALIFORNIA

CIRCLE ED-171 ON READER-SERVICE CARD FOR MORE INFORMATION

MARKEM MACHINES

Solve "IN-PLANT"
PRINTING PROBLEMS

- FASTER - NEATER - AT LOWER COST

The Markem Model 45AF Machine prints trade name, trade mark, specifications, etc., on resistors, condensers, capacitors, diodes, triodes, transistors, etc., at production rates. Feeds, prints, and ejects automatically. Quickly insertable type provides easy change in data being printed.

Write for further information. Submit sample of item you wish to mark.

WIRE LEAD
COMPONENT
PRINTING

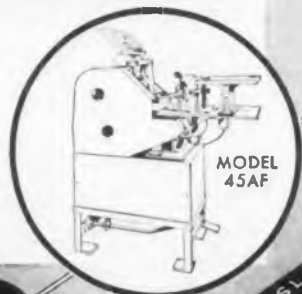

MODEL
45AF



MARKEM
MACHINE CO.
KEENE 19,
NEW HAMPSHIRE

CIRCLE ED-172 ON READER-SERVICE CARD FOR MORE INFORMATION

New Products . . .

Delay Lines

Compact Units in 0.01-1.6 μ sec

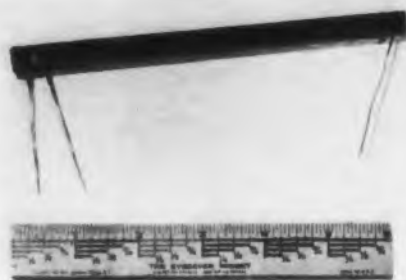

These lines can be obtained in a tubular shape or in a package with a wide choice of mounting. Delay can be varied from 0.01 μ sec to 1.6 μ sec. Characteristic impedance can be

had from 400 ohms to 2500 ohms.

Frequency response is wide. For instance, a line with 0.5 μ sec delay at 1200 ohms impedance has a frequency response of 3db down at 5Mc, 6db down at 8Mc, and 10db down at 10Mc. The lines are continuously wound and provide minimum pulse distortion. They are extremely stable with temperature variations. All lines are covered and impregnated to protect the winding from moisture and mechanical damage. Technitrol Engineering Co., Dept. ED, 2751 N. 4th St., Philadelphia 33, Pa.

CIRCLE ED-173 ON READER-SERVICE CARD FOR MORE INFORMATION

Electronic Chopper

Features Low Noise, No Drift

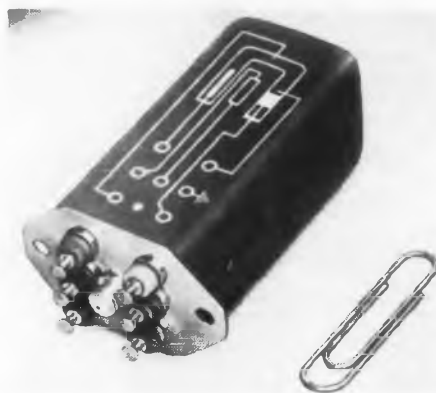

The Model 207 Electronic Chopper can be applied to amplifier stabilization, null measurement, servo-mechanisms, computing devices, and other electronic control circuits. It operates on an entirely new principle

involving the modulation of direct current voltages by alternate illumination at line frequency of a photoconductive element in a voltage divider. It converts low-level, high-impedance direct current into 400cy alternating current.

This design offers several advantages that include no drift with no applied voltage, and no output change produced by any resistance changes. It gives effective service for a minimum of 3000 hours. Noise amounts to less than 1mv referred to the input.

Case dimensions are 7/8" x 7/8" x 2" and the unit weighs 1.6 oz. Avion Instrument Corp., Dept. ED, Division of American Car and Foundry Company, 299-16 State Highway No. 17, Paramus, N. J.

CIRCLE ED-174 ON READER-SERVICE CARD FOR MORE INFORMATION

Defeat your "Arc Enemy" with CONTACT PROTECTORS



A unique application of
SELENIUM RECTIFIERS
developed by

Federal

TO PUT AN END TO
ARCING CONTACTS

Contact Protectors by Federal are a sure way to economy and longer life for relay contacts . . . to eliminate circuit failure and interference caused by arcing.

Now you can throw away your slide rule! . . . Select the Contact Protector for your application from Federal's extensive list.

Designed for use in AC or DC circuits . . . small in size . . . with pigtail leads for easy mounting. For full information, write to Federal, Dept. F-118.



Federal Telephone and Radio Company

SELENIUM-INTELIN DEPARTMENT

100 Kingsland Road

Clifton, N. J.

CIRCLE ED-175 ON READER-SERVICE CARD FOR MORE INFORMATION

FIND OUT



HOW TO
SAVE MONEY WITH
GRC SMALL DIE CASTINGS

This booklet tells how to: design for GRC small die castings, cast intricate shapes, and involved contours, simplify design, make 1-pc integral castings in place of multiple assemblies, eliminate machining operations. Contains technical data and information for designers and engineers, case histories, and other valuable facts.

Write today!

GRIES REPRODUCER CORP.

World's Foremost Producer of Small Die Castings
40 Second Street, New Rochelle, N. Y. • New Rochelle 3-8600

CIRCLE ED-176 ON READER-SERVICE CARD FOR MORE INFORMATION

ELECTRONIC DESIGN • June 1954

TR Shutter Tube

Provides Wave Guide Shorting



The "BL-58" offers wave guide shorting plus TR tube action. It has continuous crystal protection. When equipment is not in use, or is in standby condition with TR keep-alive voltage off, an automatic fail-safe shutter provides a minimum of 40db insertion loss ahead of the crystal. When equipment is in operation with voltage applied, the shutter action is automatically removed, and the TR tube functions normally. This complete package protection affords savings in both size and weight. Bomac Laboratories, Inc., Dept. ED, Salem Rd., Beverly, Mass.

CIRCLE ED-177 ON READER-SERVICE CARD FOR MORE INFORMATION

Telemeter Packages

With Plug-In Units

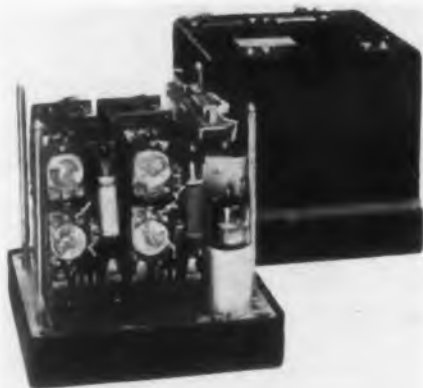

These telemeter packages incorporate plug-in sub-carrier oscillators which, when used with power supply and transmitter, provide a compact, rugged FM/FM system for telemetering many functions. The units

are cubical in shape, 4-1/2" (approx.) on the side. They may be combined to form an 8- or 12-band system. The oscillators are mounted vertically in the containers. Each package contains its own voltage regulator and calibration relays.

The packages will withstand environmental extremes of temperature, vibration, and acceleration. Semi-sealed construction prevents entry of foreign material into vital parts. The design permits rapid disassembly for adjustment or servicing.

There are two types of packages: Model TATP-3 operates in any four of the RDB bands below 22kc; Model TATP-4 operates in any of the bands from 22kc up. Standard power supplies are also available for operating up to three packages in combination with the company's 2w crystal controlled r-f transmitter. Pacific Division, Bendix Aviation Corp., Dept. ED, 11600 Sherman Way, North Hollywood, Calif.

CIRCLE ED-178 ON READER-SERVICE CARD FOR MORE INFORMATION

ELECTRONIC DESIGN • June 1954

FIVE SEVERE TESTS PROVE
EXTENDED LIFE... HIGH QUALITY
OF G-E GERMANIUM RECTIFIERS
FEATURING NEW ALL-WELDED
SEAM CONSTRUCTION

ABSOLUTE MAXIMUM RATINGS—T-55° C—RESISTIVE LOAD							
DIFFUSED JUNCTION RECTIFIER	1N91	1N92	1N93	1N151	1N152	1N153	1N158
RMS INPUT VOLTAGE (Volts)	—	—	—	35	70	105	130
PEAK INVERSE VOLTAGE* (Volts)	100	200	300	100	200	300	380
PEAK FORWARD CURRENT (Amps)	0.47	0.31	0.25	1.57	1.57	1.57	1.57
D.C. OUTPUT CURRENT* (Ma)	150	100	75	500	500	500	500
D.C. OUTPUT CURRENT— CAPACITIVE LOAD (Ma)	—	—	—	350	350	350	350
D.C. SURGE CURRENT (Amps)	25	25	25	25	25	25	25
FULL LOAD VOLTAGE DROP (volts peak)	0.5	0.5	0.5	0.7	0.7	0.7	1.4
LEAKAGE CURRENT (Ma @ rated P.I.V.)	2.7	1.9	1.2	2.4	1.9	1.2	0.8
CONTINUOUS REVERSE WORKING VOLTAGE (Volts D.C.)	30	65	100	30	65	100	185
OPERATING FREQUENCY (Kc)	50	50	50	50	50	50	50
STORAGE TEMPERATURE (°C)	85	85	85	85	85	85	85

*Typical absolute maximum ratings

1N91
1N92
1N93



1N151
1N152
1N153
1N158

ORDER IN QUANTITY FOR
IMMEDIATE DELIVERY

HERE are just five of many severe criteria G.E. insists be met before a diffused junction rectifier is shipped:

1. Life of every day's production is evaluated by sample lot operation at full current, full voltage, and at elevated temperatures under stringent on-off cycle conditions. Acceptance is made only after compliance with 10,000 hour standards.
2. 100% testing of specified characteristics.
3. Full load aging of *all* units.
4. Absolute hermetic seal is checked on *all* units.
5. A 1% quality control level is imposed on *each* shipment.

Your rectifier applications demand nothing less than these standards. Specify General Electric and receive a custom shipment of quality germanium products.

- HERMETICALLY SEALED.
- VERY LOW LOSSES.
- MINIATURE SIZE made possible by low internal losses.
- DESIGNED to meet all military humidity tests and shock and vibration requirements.
- MULTIPLE ARRANGEMENTS for full wave or bridge circuits.

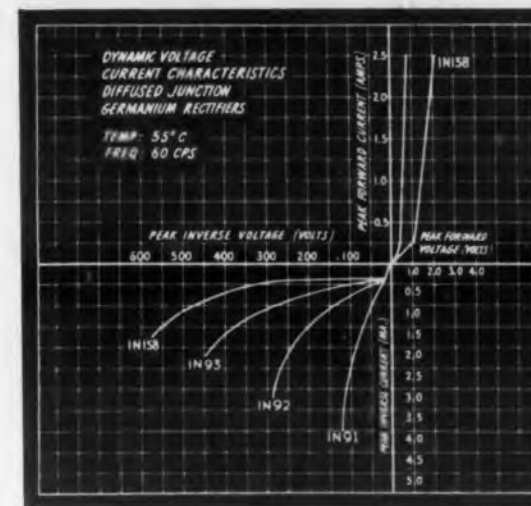

Send for complete G-E Diffused Junction Rectifier Information: General Electric Co., Sec. X7464, Electronics Park, Syracuse, N. Y.



GENERAL  ELECTRIC

CIRCLE ED-179 ON READER-SERVICE CARD FOR MORE INFORMATION



Hold that wiring with these all Nylon cable clips

- * Lightweight * Tough * Strong
- * No metal to corrode or cause short circuits
- * Easy to apply * No sharp edges
- * Chemically resistant
- * May be used from -60° to 250° F.

Send for samples and literature

WEKESSEY COMPANY

5253 N. Avondale Ave. * Chicago 30, Illinois

CIRCLE ED-180 ON READER-SERVICE CARD FOR MORE INFORMATION

DC-AC CHOPPERS

For 60 Cycle Use

Built to rigid commercial specifications.

Twenty-two types, both single and double pole.

Long life.

Low noise level.

Extreme reliability.

Write for Catalog 370.

STEVENS INCORPORATED ARNOLD

22 ELKINS STREET
SOUTH BOSTON 27, MASS.

CIRCLE ED-181 ON READER-SERVICE CARD FOR MORE INFORMATION

New Literature ...

Resistors and Rheostats 182

A new catalog featuring this company's complete line of resistance and power rheostats is now available. The twenty pages include illustrations and detailed specifications on all types of standard resistors as well as special size resistors and resistor mountings. One section of the bulletin is devoted to power rheostats of from 25 to 150w. The information contains data on special rheostat shaft and bushing assemblies, taper wound rheostats, tandem rheostat assemblies, etc. Tru-Ohm Products, Division of Model Engineering Corp., 2800 North Milwaukee Ave., Chicago 18, Illinois.

Microwave Dielectrometer 183

Publication of a four-page brochure describing the microwave dielectrometer has been announced by the manufacturer. The unit, designed to measure the dielectric constant and loss of a variety of materials at microwave frequencies, is pictured throughout the bulletin. Graphs of the waveguide and a block diagram of the instrument are included with the specifications, as well as factual information and performance data on the theories and its possible application. Central Research Laboratories, Inc., Dept. KP, Redwing, Minn.

Property Chart 184

A new property chart for electrical, electronic, and chemical applications has recently been released to guide the designer in the selection of material most adaptable to his requirements. In addition to the principle uses for steatites, alumina, cordierite, porcelain and lava, the chart gives a complete analysis of these materials delineating the following properties: water absorption, specific gravity, density, color, hardness, tensile strength, compressive strength, flexural strength, softening temperature, linear coefficient of thermal expansion 25°C-100°C and 25°C-600°C; TE value, dielectric strength (step 60 cy), dielectric constant, power factor and loss factor. M. Kirshberger & Co., Inc., 1425 37th Street, Brooklyn 18, N. Y.

Electronic Components 185

A 16-page, 2-color catalog contains the company's line of ceramic-insulated electronic components. In addition to the capacitors, resistors and printed circuits previously offered, this catalog includes a new line of temperature-compensating tubular "Ceramicon" capacitors and disc "Ceramicons" illustrated and fully described. The procedure for ordering by JAN-C-20A is also given. Erie Resistor Corporation, Dept. S, Erie, Penna.

Inductance Products 186

A complete line of transformers, reactors, filters and toroids and other special inductance products are given in this 26-page, 2-color catalog (No. A). A reactance-frequency nomograph is on page 24. This firm's linear standard amplifier, available in kit form, is also described. Prices are listed. United Transformer Company, 150 Varick St., New York 13, N.Y.

Investment Castings 187

A 12-page, two-color brochure gives some of the answers to the choice of production methods for small parts. The investment casting process is explained with illustrations and details of this method of production with a typical part are given. Comparison with investment casting with other production methods includes an explanation of the tooling, and patterns and samples necessary to produce parts by the process. Vascoloy-Ramet Corp., Waukegan, Illinois.

Printed Circuits 188

Printed circuits, their function, fabrication, and application are comprehensively outlined and described in a new 8-page brochure. Information on methods of application, materials, electrical characteristics, components such as capacitors, resistors, tube sockets, switches, transformers, etc., is included. Assembly with dip soldering and plated-through holes is described. Photocircuits Corporation, Glen Cove, New York.

Thermistor Manual

189

Static and dynamic characteristic curves of this firm's Carboly Thermistors fill 25 of the 53 pages of this manual (TH-13). Various applications and a complete description of this type of thermistor are also given. Carboly Division, General Electric Company, Detroit 32, Michigan.

Insulators

190

Bulletin EC-1153 is an 11-page catalog of stand-off and feed-through insulators. These insulators utilize Teflon for high-frequency use. Miniature types are also listed. Fluorocarbon Products, Inc., Division of United States Gasket Company, P.O. Box 93, Camden, N.J.

Self Clinching Fasteners

191

This firm's line of nuts for load-carrying threads in thin steel, brass, copper, or aluminum sheets are described in a new catalog. Design features and assembly cost savings effected through the use of these fasteners are outlined. Recommended installation pressures are tabulated, and the complete line of steel, stainless steel, monel and aluminum is covered. Dimensional data and ordering procedures are also included. Penn Engineering & Manufacturing Co., Doylestown, Pa.

Precision Potentiometers

192

This 2-color folder (Bulletin C-200) lists a series of high-precision, external phasing potentiometers. Available in logarithmic, sine-cosine, and other shaped functions, as well as linear types. These units can be ganged. DeJur-Amseo Corporation, 45-01 Northern Blvd., Long Island City 1, N.Y.

Power Cords

193

A complete line of power cords and male and female plugs are listed in this 29-page, 2-color catalog. Both light- and heavy-duty types are considered. Cords, Ltd, Division of the Essex Wire Corporation, 121 Dodge Ave., DeKalb, Ill.

Volt-Ammeter

194

The accurate volt-ammeter described in this 4-page bulletin measures by the "transfer" technique. This multi-range instrument has an accuracy of 0.05% over a frequency range of 20cy to 20kc. Current ranges are: 100, 250, and 500ma; and 1, 2, 5, and 5amp. Voltage ranges are 15, 30, 75, 150, and 300v. Charles Engelhard, Inc., 850 Passaic Ave., East Newark, N. J.

Variable Resistors

295

A complete line of variable resistors for printed wiring applications are described in this 4-page data sheet (No. 168). The units are mounted by a snap-in bracket that is also the support. Resistance ranges are 100 ohms to 10 megohms. The resistors are available with 3amp, 125v or 15amp, 10v spst switches. Chicago Telephone Supply Corporation, Elkhart, Ind.

Power Receptacles

296

Power receptacles for both 2- and 3-wire systems, heavy-duty switches and light sockets are listed in this 20-page catalog (No. 1-54), which also includes a price list. Slater Electric & Mfg. Co., Inc., Woodside, N. Y.

Equipment Cart

297

This little folder describes a 36" high x 24" long x 18" deep equipment cart known as the Model A-301 "Equipmobile", which is designed for moving or supporting laboratory equipment safely. The cart has a built-in, enclosed compartment and can support 500 lb. Esco Manufacturing Co., P. O. Box 344, Summit, Ill.

Time Delay Generator

298

This 2-page bulletin describes a time delay generator (Model A-5) valuable for designing radar, computer, control, counting, and other circuits where a delay must be specified. Linearity is better than 0.3% over a delay range of 1 to 1000 μ sec. The unit features low jitter, linear scales, highly stabilized power supplies, small repetition rate effects, and a blocking oscillator output. Rutherford Electronics Co., 3707 S. Robertson Blvd., Culver City, Calif.

Directional Couplers

299

Most of this folder (No. T-400) is devoted to an illustrated discussion of the characteristics of four types of microwave directional couplers. The discussion is designed to aid the electronic engineers in choosing the best coupler for their needs. Custom-made couplers designed by this organization are also illustrated. Airtron, Inc., 101 E. Elizabeth Ave., Linden, N. J.

Germanium Diodes and Transistors 300

This firm's germanium diodes and transistors are listed with their characteristics in this 8-page, 2-color catalog. Graphs of typical transistor performance are also given. The catalog is designated Bulletin G-23. Radio Receptor Company, Inc., 251 W. 19th Street, New York 11, N. Y.

announcing.... TAYLOR heavy-duty C6J/A

The new Taylor C6JA Xenon Thyatron has proved unusually dependable in industrial power supply applications.

Taylor's exclusive gold flow process grids maintain sharp cut off characteristics throughout tube life.

FEATURES

- Metalized Graphite Anode
- Large Overload Capacity
- High Shock Design

As always, Taylor is producing tubes of superior quality and outstanding performance for industrial and commercial applications. We invite your inquiry on standard or special tube types.

WRITE FOR LITERATURE ON FULL XENON TUBE LINE

Taylor HEAVY CUSTOM BUILT DUTY Tubes

TAYLOR TUBES INC., 2312-18 WABANSIA AVE., CHICAGO 47, ILL.

Canada: Atlas Radio Corp., Ltd.
560 King St., W., Toronto 2-B
Cable: ATRADCO

Export: Royal National Company
75 West St., New York 6, N. Y.
Cable: NATVARNCO

CIRCLE ED-301 ON READER-SERVICE CARD FOR MORE INFORMATION

A 10mc DECADE SCALER with 0.1 μ sec RESOLUTION



The EPIC Model 412 Fast Scaler has been designed to allow convenient and precise high speed counting of the fast pulses encountered in nuclear work, computer and pulse control problems, high frequency measurements (to 10mc), and small time interval measurements (to 0.1 μ sec. accuracy). The scale factor of 100 and the output pulse characteristics have been chosen so that almost all slow, conventional (app. 10⁵ counts/sec.) commercial scalers, and frequency counting equipment can be operated from the output pulse with ease, hence the speed and range of previously purchased slower equipment can be extended at a minimum of cost. 10mc Binary Scaler of 128 also available for those who prefer binary scalers.

FEATURES

1. Resolving Time: 0.1 μ sec.
2. Maximum Continuous Uniform Rate: 10 mc or 10⁷ counts/sec.
3. Interpolation: Simple neon light indicators usually available only in slower scalers.
4. Scale Factor: Decade scale of 100 for maximum reliability.

EPIC ELECTRICAL and PHYSICAL INSTRUMENT CORP.
25 WEST 43rd STREET New York 36, N. Y. Engineering Division
42-19 27th STREET
Tel.: Longacre 4-2265 L. I. C. 1, N. Y.

Complete literature on request to Dept. DD-6

CIRCLE ED-302 ON READER-SERVICE CARD FOR MORE INFORMATION

2½ times as accurate as others!

New G-E REFERENCE CAVITIES

have temp frequency drift of only ± 0.4 mc!

BUILD more reliable radar equipment with aid of G.E.'s new reference cavities! They narrow by 60% the temperature-drift limits of ± 1 mc (-40 C to $+100$ C) that apply with other cavities.

● Whether operating in heat or cold, your airborne radar will receive beacon signals accurately when G-E reference cavities are used. Vibration (up to 10 g's) and air-pressure changes (15 up to 45 PSIA, or down to 5" mercury) affect frequency only ± 0.1 mc and ± 0.15 mc respectively.

● G-E cavities weigh only 8 ounces. They are compact, with slotted corners for secure 4-bolt mounting. Designed for pressured waveguide systems. Get full information! Wire or write for Bulletin ETD-885, just off the press! *General Electric Company, Tube Department, Schenectady 5, N. Y.*



New

GL-6301.....9270 mc

GL-1Q26-A....9280 mc

GL-6452.....9350 mc

G-E X-band cavities can also be supplied for other frequencies.

GENERAL ELECTRIC

162-1B7

CIRCLE ED-197 ON READER-SERVICE CARD FOR MORE INFORMATION

FORD

DEVELOPMENT ENGINEERS

FOR: Design Engineering, Practical Research, Investigations of Theories, Functional Analysis

An interesting challenge for senior design engineers to work directly with top project supervisors helping through the prototype stage new developments in:

- Automatic Control Instruments
- Electronic Navigational Aids
- Magnetic Amplifiers
- Airborne Armament Systems
- Guided Missile Controls
- Computing Equipment

For these jobs we are interested in men with two or more years experience in electro-mechanical work related to the above fields or in men with superior scholastic records in physics, electrical, electronic or mechanical engineering.

YOU'LL LIKE WORKING AT FORD INSTRUMENT

- Not too large, not too small
- Stable but progressive company
- N. Y. C. location with all its additional varied opportunities
- Above-average fringe benefits
- Pension Plan
- Nine Paid Holidays
- Two Weeks vacation with pay
- Tuition assistance for further related studies

Our policy of permanency of positions and continuity of service does not allow us to employ engineers unless there is a clear and definite need for them projected years into the future. And we promote from within. If you can qualify, we urge you to contact by mail, or if in N. Y. C. phone:

Mr. P. F. McCaffrey, Stillwell 4-9000, Extension 416

FORD INSTRUMENT COMPANY

Division of the Sperry Corporation

31-10 Thomson Ave., Long Island City, N. Y. (20 minutes from the heart of New York City)

CIRCLE ED-198 ON READER-SERVICE CARD FOR MORE INFORMATION

New Literature . . .

Magnetic Amplifiers

199

A series of Magnetic Amplifiers for 60cy and 400cy operation as well as magnetic amplifier position servo systems are listed in this folder. The complete operating characteristics of the units are given. Magnetic Amplifiers, Inc., 632 Tinton Ave., New York 55, N.Y.

Special Products Service

200

The Special Products Division of this firm is described in this 19-page, 3-color brochure. It has facilities for research, development, design and fabrication of products to performance specifications. Among the products produced by this organization are radar components, servo systems, and r-f feed systems. Special Products Division, I-T-E Circuit Breaker Company, 601 East Erie Ave., Philadelphia 34, Pa.

Statistical Theory

A revised text of four lectures given by the author is set down in a 51-page booklet entitled "Statistical Theory of Extreme Values and Some Practical Applications", by E. J. Gumbel. The first comprehensive statistical treatment concerned with a series of recent problems of interest to engineers and statisticians, the methods described are based on the asymptotic theory of extremes. The developed theory shows how floods, droughts, tensile strength of materials, maximum gust loads, temperature and pressure extremes etc. can be treated as extremes of large samples. The methods are illustrated by many examples of actual data with the necessary tables and graphs. The publication includes full instructions for applying the techniques in practice, as well as an extensive bibliography. Price is 40 cents. Write direct to Government Printing Office, U. S. Department of Commerce, Washington 25, D. C.

Transmission Lines and Waveguides

201

Coaxial transmission lines and waveguides and associated accessories for v-h-f and u-h-f transmission are described in this 20-page, 3-color catalog. A price list is included. Prodelin, Inc., Kearny, N. J.

Beryllium Copper Components

202

Custom-made and stock beryllium copper components are covered, respectively, in these two catalogs (Nos. 8 and 8A). The physical properties of the material are given in the first publication, while the second booklet lists the stock items such as contact strips, high-frequency contact rings, and a "flea" contact for flatpress subminiature tubes. Two kits made up of sample components are also described. Instrument Specialties Company, Inc., 271 Bergen Boulevard, Little Falls, N.J.



silicon

Now . . . long-awaited silicon junction diodes are available; developed by Texas Instruments, a leading transistor manufacturer. Operating temperatures up to 150°C are safe, offering a new degree of design freedom!



junction

Now . . . extremely low back current characteristics, as low as 0.001 microamps at rated voltage. Glass-to-metal hermetic seals, of course. For more detailed information on these new silicon junction diodes — and on other new TI semiconductor products — write today.



diodes!



TEXAS INSTRUMENTS
INCORPORATED

6000 LEMMON AVE. DALLAS 9, TEXAS

CIRCLE ED-203 ON READER-SERVICE CARD
ELECTRONIC DESIGN • June 1954

Instrument Catalog

204

This 189-page catalog (No. 54) gives an extensive listing of meters, test equipment, special industrial controls, relays, switches, hardware, etc., of all manufacturers' lines stocked by this supply house. The organization also calibrates, prepares special scales for, and repairs meters. Electro-Tech Equipment Co., 308 Canal Street, New York 13, N. Y.

Carry-Through Printed Circuits

205

By using the printed circuits discussed in this four-page, 2-color bulletin (No. 106), selective dip-soldering is possible. The various materials used in the manufacture of carry-through printed circuits are discussed, as well as the current capacity of various line thicknesses of printed wiring. Insulated Circuits Incorporated, 115 Roosevelt Ave., Belleville, N.J.

Attenuation Data

206

A descriptive bulletin with attenuation characteristics of six models of standardized and stocked screen room filters has been issued recently by this firm. It deals with a line of single-double, and triple action filter units developed within the corporation. Acme Electronics, Inc., Division of the Aerovox Corp., Acton, Mass.

Hermetic Seals

207

Hermetic seal design and stock shapes and components for hermetic sealing are covered in this 20-page booklet. Various feedthrough assemblies, glass seal tubes, tubular button seals, multiple-electrode sealed headers, octal plugs, and gromets are listed. The Hermaseal Company, Inc., Elkhart, Ind.

Precision Resistors

208

This 30-page, 2-color catalog lists two series of precision, wire-wound resistors. A complete description of the materials used in these resistors is given. The units are available with lugs, wire leads, or with both terminals at one end. The Daven Company, 191 Central Ave., Newark, N. J.

Recording Oscillograph

209

Dynamic measurements are facilitated by the recording oscillograph described in this 16-page, 2-color bulletin (No. CEC-1500C). The various accessories for the unit are also listed. CEC Instruments, Inc., 300 N. Sierra Madre Villa, Pasadena 15, Calif.

Circuit Accessories

239

Grid caps, terminal boards and pins, diode clip boards, and various custom-made tuner coils and molded parts are described in a five-page bulletin (No. 1-53). Warren Plastics Corporation, Warren, Pa.

for critical voltage applications ... RMC HIGH VOLTAGE DISCAPS®

CAPACITY	DIELECTRIC	SIZE	AVAILABLE CAPACITY TOLERANCES	
2-KV				
331-470	1200-K	3/8"	± 20%	GMV
471-1000	1200-K	3/8"	± 20%	GMV
1001-2700	HI K	3/8"		GMV
2701-5000	HI K	3/8"		GMV
5001-10000	HI K	3/8"		GMV
3-KV				
220-500	1200-K	3/8"	± 20%	GMV
501-1000	1200-K	3/8"	± 20%	GMV
1001-5000	HI K	3/8"		GMV
4-KV				
181-680	1200-K	3/8"	± 20%	GMV
681-1000	HI K	3/8"		GMV
5-KV				
131-330	1200-K	3/8"	± 20%	GMV
331-1000	HI K	3/8"		GMV
6-KV				
101-220	1200-K	3/8"	± 20%	GMV
221-470	1200-K	3/8"	± 20%	GMV
221-1000	HI K	3/8"		GMV
471-1000	HI K	3/8"		GMV

POWER FACTOR: 1.5% Max. @ 1 KC (initial)
INSULATION: Durez phenolic—vacuum waxed



Discaps with a dielectric of 1200 K or over are not recommended for deflection yokes or other 15,750 cycle applications.

HIGH VOLTAGE DISCAPS for yoke and other applications

RMC DISCAPS assure the voltage safety factor required in deflection yoke or special electronic applications. These RMC high voltage DISCAPS are rated at 2000, 3000, 4000, 5000, and 6000 volts DC.

Now available in any capacity between 5 MMF and 10000 MMF, their smaller size and lower initial cost offer definite production ease and overall savings.

If you want proof that DISCAPS are the outstanding ceramic capacitors write us about your specific requirements and we will forward samples.

CAPACITY	DIELECTRIC	SIZE	AVAILABLE CAPACITY TOLERANCES	
2-KV				
5-47	N-750	3/8"	5-10-20%	GMV
48-68	N-750	1/2"	5-10-20%	GMV
69-82	N-750	3/8"	5-10-20%	GMV
83-130	N-750	3/8"	5-10-20%	GMV
131-200	N-1500	3/8"	5-10-20%	GMV
201-250	N-1500	3/8"	5-10-20%	GMV
251-330	N-1500	7/8"	5-10-20%	GMV
3-KV				
5-15	N-750	3/8"	5-10-20%	GMV
16-20	N-750	1/2"	5-10-20%	GMV
21-56	N-1500	3/8"	5-10-20%	GMV
57-180	N-1500	3/8"	5-10-20%	GMV
181-240	N-1500	3/8"	5-10-20%	GMV
241-330	N-1500	7/8"	5-10-20%	GMV
4-KV				
5-68	N-1500	3/8"	5-10-20%	GMV
69-180	N-1500	3/8"	5-10-20%	GMV
5-KV				
5-30	N-1500	3/8"	5-10-20%	GMV
31-60	N-1500	3/8"	5-10-20%	GMV
61-130	N-1500	3/8"	5-10-20%	GMV
6-KV				
5-20	N-1500	3/8"	-10-20%	GMV
21-100	N-1500	3/8"	-10-20%	GMV

POWER FACTOR: .1% Max. @ 1M C (initial)
INSULATION: Durez phenolic—vacuum waxed

DISCAP
CERAMIC
CAPACITORS



RADIO MATERIALS CORPORATION
GENERAL OFFICE: 3325 N. California Ave., Chicago 18, Ill.

FACTORIES AT CHICAGO, ILL. AND ATTICA, IND.
DISTRIBUTORS: Contact Jobbers Sales Co., P. O. Box 695, Fairlawn, N. J.

CIRCLE ED-210 ON READER-SERVICE CARD FOR MORE INFORMATION

James is the complete source for all vibratory products!*

THE ENGINEER'S STANDARD SINCE 1936

*Send your engineering problems to us



JAMES MODEL C-867
INPUT 6.3 VOLTS
OUTPUT 750 VOLTS D.C.

This Vibrator Power Supply is designed and manufactured to customer specifications by JAMES.

Similar assemblies for extreme limits of vibration, shock, temperature and reliability are now possible through the use of JAMES components . . . and JAMES' facilities for product design and engineering are at your disposal.

We invite your inquiries to our Engineering Department for their recommendations and quotation.

JAMES
VIBRAPOWR
4036 N. Rockwell St. • Chicago 18, Ill.
COMPANY

AUTO VIBRATORS • COMMUNICATIONS VIBRATORS • VIBRATOR POWER SUPPLIES • CHOPPERS • VIBRATORY COAXIAL SWITCHES

CIRCLE ED-212 ON READER-SERVICE CARD FOR MORE INFORMATION

New Literature . . .

Potentiometer Handbook

This looseleaf handbook resembles many tube manuals. Half of the 207-page book is devoted to a valuable and well-illustrated discussion of the precision potentiometer, its construction, and characteristics. Particular emphasis is given to the different methods for achieving precise nonlinear functions with potentiometers. A bibliography of the principal literature in the field of precision potentiometers is also included. The second half is a catalog of this firm's potentiometers. The cover is made of heavy, plastitized paper. The price of \$2 includes periodic releases of new technical information on potentiometers. Write direct to Technology Instruments Company, 531 Main Street, Acton, Mass.

Automatic Programming 214

A system of recording motion on magnetic tape and playing it back for automatic programming of production machines and processes is described in a new bulletin. Designated GEA-6092, the two-color, six-page publication outlines the principle of a new control that incorporates a magnetic tape recorder. It explains how record-playback control is especially valuable in bringing to small-lot manufacture many of the advantages of special, mass-production machines. General Electric Company, Schenectady 5, New York.

Instrument Ball Bearings 215

A load rating vs speed nomograph to aid in bearing specification is included in this 2-color, 20-page catalog of ball bearings for instruments. Metric and inch dimensions are both given. An illustrated explanation of bearing lubrication is also available. Fafnir Bearing Company, New Britain, Conn.

Battery Slide Rule Selector 216

This circular slide-rule-type application guide selects the proper chargeable battery for a particular ampere-hour requirement. Plastic-covered, the 4" x 5-1/2" guide lists all of this firm's nickel-silver alkaline batteries from 1/2 to 100 ampere-hours capacity. Setting the red arrow on the capacity required, gives the model numbers of the next smallest and next highest capacity batteries seen in two little windows. Setting the black arrow on the model number shows all of its characteristics through another little window. On the back of the guide, typical characteristic curves for the units are shown. Yardney Electric Corporation, 105 Chambers St., New York 7, N. Y.

TOROIDS

a Torrid Topic?

SEE A
C-A-C
MAN



UNCASED,
CASED
OR
MOLDED
PLASTIC



Stocked for RUSH DELIVERY

Since CAC introduced the first miniaturized line of toroids in 1948, it has maintained a policy of prompt service and high quality. Standard types of cased, uncased and molded plastic toroids are maintained for immediate delivery. By special order, any conceivable arrangement of closely coupled windings and multiplicity of taps may be supplied.

If toroids are a problem . . .

SEE YOUR CAC MAN

NEW YORK—Harold Gray Assoc.—LA. 4-4258
286 Fifth Ave., New York, N. Y.

PHILADELPHIA—Charles R. Hile Co.—Elgin 6-2266
Hillview Rd., Bx. 144, Paoli, Pa.

BALTIMORE—Charles R. Hile—Boulevard 1202J
(L. G. Korman) 5006 Kenwood, Baltimore 6, Md.

CHICAGO—Gassner & Clark Co.—Rogers Pk. 4-6121
6349 N. Clark, Chicago, Ill.

KANSAS CITY—E. W. McGrade Co.—Delmar 9242
6315 Brookside Plaza, Kansas City, Mo.

LOS ANGELES—Samuel O. Jewett—State 9-1214
13537 Addison St., Sherman Oaks, Calif.

HAMBURG—Cooper-Morgan, Inc.—Emerson 3405
P. O. Bx. 152, Hamburg, N. Y.

SYRACUSE—Naylor Electric Co.—2-3894
State Tower Bldg., Room 317, Syracuse 2, N. Y.

MERIDEN—Henry Lavin Assoc.—7-4555
(Henry Lavin) P. O. Bx. 196, Meriden, Conn.

NEEDHAM—Henry Lavin Assoc.—3-3446
(Robt. V. Curtin) 82 Curve St., Needham, Mass.

CLEVELAND—Ernie Kohler Assoc.—Olympic 1-1242
8905 Lake Ave., Cleveland 2, Ohio

COMMUNICATION ACCESSORIES CO.

Hickman Mills, Missouri

CIRCLE ED-217 ON READER-SERVICE CARD

Selenium Rectifier Handbook 218

This 3-color, 72-page book is both a handbook of selenium rectifier engineering and a catalog of this company's products. Designated Catalog No. 666, it contains many application circuits and a replacement guide for numerous TV and radio receivers. Plug-in and solder-mounting types are included. Rectifier Div., Sarkes-Tarzian, Inc., 415 North College Ave., Bloomington, Ind.

Resistor Products 219

This catalog (No. 54) has 22 pages listing many fixed and variable resistors. Controls, rheostats, ballast tubes, etc., and some rotary switches are illustrated with their characteristics. Clarostat Mfg. Co., Inc., 1 Washington St., Dover, N. H.

Radiant Heating 220

A 4-page illustrated booklet describes "Infralite", a new radiant heater which provides over 100w per sq in of lamp surface. The bulletin includes applications for the heater such as drying, baking, heating, vulcanizing, annealing, and others. N. J. Thermex Company, 535 Bergen Street, Harrison, N. J.

Precision Casting 221

In a 4-page illustrated circular, the firm describes steps in casting microwave and radar components from processing the plaster molds and cores to the completed precision unit. The booklet emphasizes the ability of the processor to maintain close tolerances easily and inexpensively, explains how simply casting patterns can be modified for design changes, and shows how the elimination of soldering and bending operations results in improved surface conditions and better electrical performance. Airtron, Inc., Dept. A, 1103 West Elizabeth Avenue, Linden, N. J.

Table of Secants and Cosecants 222

The recent demand for many-figure tables of trigonometric functions with the argument in decimal division of a degree has prompted this 46-page publication. "Table of Secants and Cosecants to Nine Significant Figures at Hundredths of a Degree" was prepared by the National Bureau of Standards for its Applied Mathematics Series 40. This table will serve as a useful companion to the previously published table of sines and cosines (Applied Mathematics, Series 5). As a result of the various tests applied, the entries are considered correct to within 0.10 of a unit in the last place given. Price of the table is 35 cents. Order direct from Government Printing Office, Washington 25, D. C.

NOW AVAILABLE

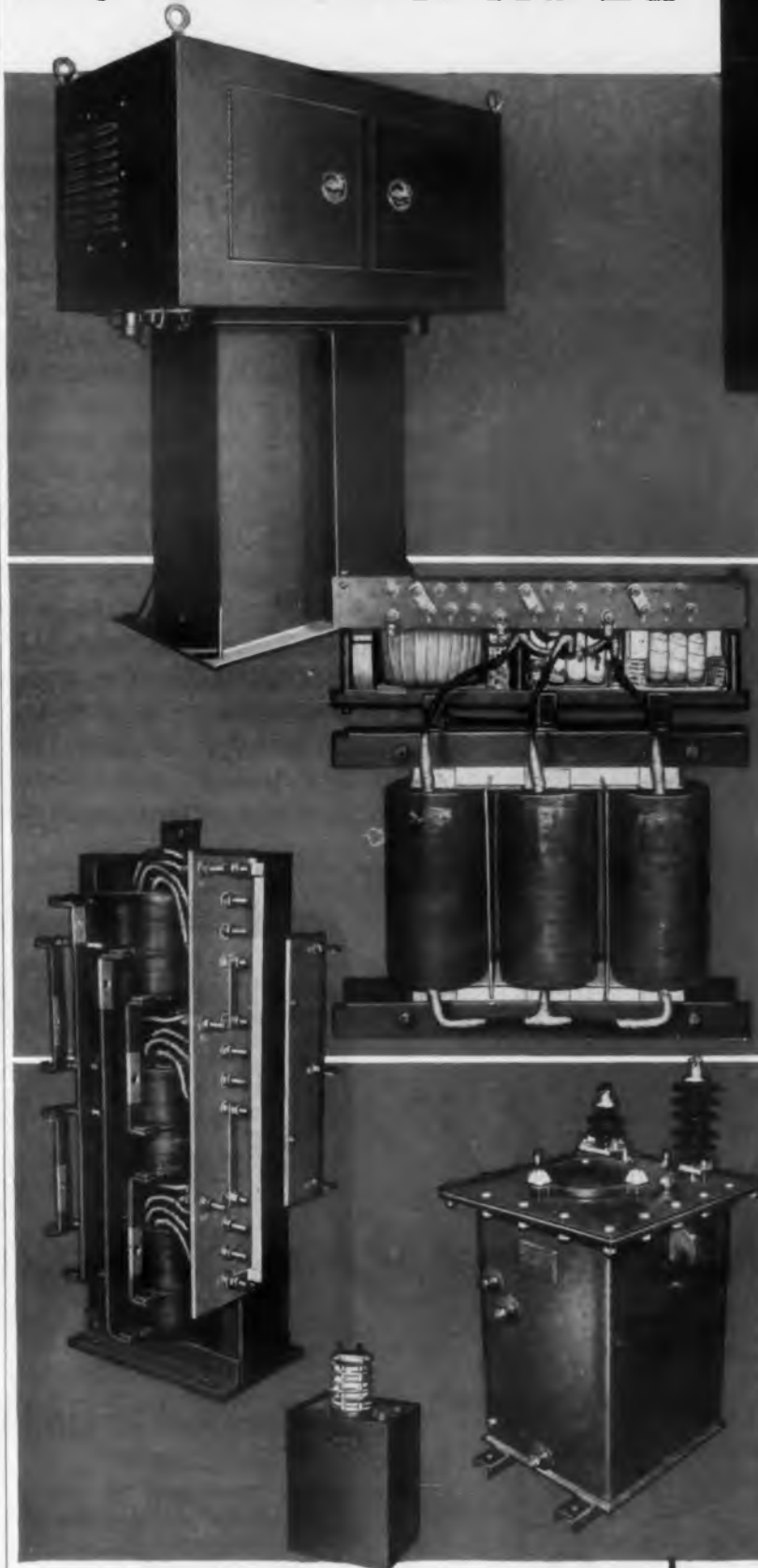

COMPLETE ASSEMBLIES or SUB-ASSEMBLIES for your **POWER SUPPLIES**

- UNITIZED RECTIFIERS
- PLATE-FILAMENT-REACTOR ASSEMBLIES
- PLATE TRANSFORMERS
- FILAMENT TRANSFORMERS
- FILTER REACTORS

Moloney now offers complete power supplies custom built to your needs. Complete power supplies or any sub-assembly can be had, manufactured to your most rigid specifications.

High Power or High Voltage offers no problem to Moloney, long experienced in the manufacture of quality transformers. Moloney, supplying transformers to the electrical industry for over 58 years, stands ready to apply this experience to the manufacture of your most exacting requirement for power supplies.

Per { RETMA } Standards
MIL-T-27

OIL • ASKAREL
DRY (Class A, B & H.)

Write today for Bulletin ST-3503
describing Specialty Transformers

ME54-13

M O L O N E Y E L E C T R I C C O M P A N Y

Power Transformers • Distribution Transformers • Step Voltage Regulators • Regulating Transformers • Load Ratio Control Transformers • Unit Substations • Network Transformers • Constant Current Transformers • Capacitors • Transformers For Electronics

SALES OFFICES IN ALL PRINCIPAL CITIES • FACTORIES AT ST. LOUIS 20, MO. AND TORONTO, ONT., CANADA

CIRCLE ED-223 ON READER-SERVICE CARD FOR MORE INFORMATION



ATR

INTRODUCES



The World's Finest Communication VIBRATORS

featuring:

- CERAMIC STACK SPACERS
- 1/4" DIAMETER POWER CONTACTS
- DRIVER-TYPE COIL CONSTRUCTION
- SPECIAL REED HINGE and WIRING
- POWER CAPABILITY UP TO 15 AMPERES

A COMPLETE LINE OF REPLACEMENT

ATR VIBRATORS

FOR AUTOMOTIVE, HOUSEHOLD and
TWO-WAY COMMUNICATION SETS

ATR VIBRATORS are proven units of the highest quality, engineered to perfection. They are backed by more than 23 years of vibrator design and research, development and manufacturing.
ATR pioneered in the vibrator field.



FREE - Just off the Press!
1954 ATR VIBRATOR
MASTER MANUAL

*See your jobber or write factory today
for complete information*

ATR

AMERICAN TELEVISION & RADIO CO.

Quality Products Since 1931
SAINT PAUL 1, MINNESOTA - U. S. A.

CIRCLE ED-224 ON READER-SERVICE CARD FOR MORE INFORMATION

Patents . . .

Electrical Gating Circuits . . . Patent No. 2,659,815. Daniel L. Curtis, Venice, Calif. (Assigned to Hughes Tool Company).

Since neon tubes have a life rating of about 25,000 hours, a gating circuit employing these tubes should be far more reliable than circuits employing the shorter-lived vacuum tubes or the less reliable crystal diodes. Two such circuits are shown in Figs. 1 and 2.

The gating signal generated by a flip flop oscillator (10, Fig. 1) is applied to one plate of the neon tube (11) through resistors 12 and 13. The negative pulse signal generated by a blocking oscillator (17) is applied to the same plate of the neon tube through a coupling capacitor (18). A direct current voltage of about

105v is applied to the other electrode of the neon tube through a resistor (16) and the output signal is differentiated by the capacitor 11 and resistor 22.

The flip flop oscillator 10 operates alternately at two voltage levels, one being a high positive voltage level of 105 volts and the other being a low voltage level of about zero volts. During the period of a high voltage level, the potential on both plates of the neon tube is the same and it will not conduct. During the period of low voltage level, the potential difference across the plates is sufficient to fire the neon tube so that it conducts and continues to conduct at a substantially constant voltage drop across the plates until the flip flop 10 changes to its period of low voltage level of operation. A negative sig-

A. R. C. CERAMIC INSULATED CONNECTORS



Minimize Leakage, Save Space

We developed this ceramic-insulated connector to obtain performance features we needed in our airborne communications and test equipment. Doubly silicone coated, it is virtually impervious to extremes of moisture, and mechanically stable under heat. Eight contact points per pin make for

low contact resistance. Being of small overall dimensions, these connectors are space savers. 2, 3, 4, 6, 8, 12 and 19 contact connectors each are available in three-key keyway combinations to prevent incorrect insertion. Design them into your equipment for extra dependability. Write for details.

Dependable Airborne Electronic Equipment Since 1928

AIRCRAFT RADIO CORPORATION
BOONTON, NEW JERSEY



CIRCLE ED-225 ON READER-SERVICE CARD FOR MORE INFORMATION

ELECTRONIC DESIGN • June 1954

ELEC

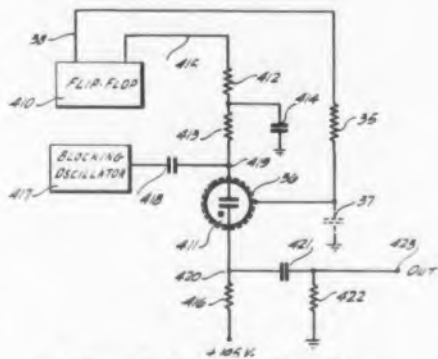
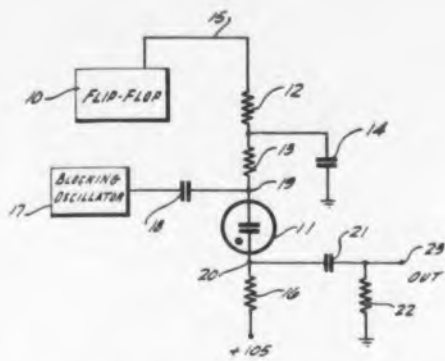

Figs. 1 (top) and 2. Two electrical gating circuits.

nal pulse of about 50v generated by oscillator 17 during a high voltage level period or when the neon tube is not conducting fails to appear at junction point 20 of the circuit and at the output terminal. A nega-

tive pulse generated at periods of low voltage level of operation of the flip flop oscillator when the neon tube is conducting appears at junction point 20 and at the output terminal.

This circuit gives satisfactory performance if the flip flop oscillator operates at a fairly rapid interval. A commercial neon tube requires a voltage across its plates when cold of 80 to 90v to fire and then conducts at about 50v. If the period of nonconduction is relatively short, the firing voltage is but a few volts above the operating voltage. At relatively longer periods of nonconduction, on the other hand, the required firing voltage increases rapidly after conduction ceases and results in the introduction of a spurious voltage pulse of undesired voltage level. To avoid this result, a conductive tube coating may be used to which a voltage is applied as shown in Fig. 2. This voltage keeps the neon gas ionized and lowers the firing voltage of the neon tube to a voltage a few volts above operating voltage. The same result can be achieved in other ways. Other circuits are described for even more reliably operating gating circuits.

i.e.r.c.

MINIATURE ELECTRON TUBE CLAMPING SHIELDS

give lower bulb temperatures and increased tube reliability!

Patent pending



PRESENT AND FUTURE INDUSTRIAL AND MILITARY ELECTRONIC EQUIPMENT REQUIREMENTS!

Accepted for North American Aviation's missile program.

First choice in tube shield clamps by the missile industry because, at no increase in weight, they reduce bare bulb temperatures 35% to 50% and operate successfully at 16G's from 0 to 2000 c.p.s.

International

electronic research corporation

For complete information write: I.E.R.C., 177 W. Magnolia Blvd., Burbank, Calif.

SALES REPRESENTATIVES:

NEW YORK: B. B. Taylor Company, Rockville Centre, Rockville Centre 6-1014
MASSACHUSETTS: Holliday-Hathaway Inc., Cambridge, Eliot 4-1751

CALIFORNIA: G. S. Marshall Co., Pasadena, Ryan 1-9663
ILLINOIS: Magnuson Associates, Chicago, Kildare 5-4426

CIRCLE ED-226 ON READER-SERVICE CARD FOR MORE INFORMATION



ELECTRONS, INCORPORATED
127 SUSSEX AVENUE
NEWARK 3, N. J.

*The eighteen EL C6J/A thyatrons in this 9,000 amp.
Sel-Res rectifier control have given 15,000 hours service
without a single failure.*

CIRCLE ED-227 ON READER-SERVICE CARD FOR MORE INFORMATION

OK UNDER MIL-E-5272 TESTS for
extreme temperatures
humidity-salt spray-vibration
Aerohm wire-wound trimmer potentiometers

Micro-miniature Series AP 1/2

- Two watts continuous at 80° C.
- Resistances from 10 to 20,000 ohms.
- Diameter 1/2 inch, depth 1/2 inch.
- Temperature coefficient 0.00002/degree C.
- Weight 1/4 ounce.
- Sealed well enough to permit potting.



Series AP 1/2

Series AP 1 1/2

- Four watts continuous at 80° C.
- Resistances from 10 to 100,000 ohms.
- Diameter 1 1/8 inch, depth 1/2 inch.
- Weight less than 3/4 ounce.
- Temperature coefficient 0.00002/degree C.



Series AP 1 1/2

All Aerohm potentiometers are individually checked through a quality-control system that guarantees you full performance from every unit in your order.

Write for full details and prices.



CIRCLE ED-228 ON READER-SERVICE CARD FOR MORE INFORMATION

**LESS LEAKERS with NICORO
 BRAZING ALLOY**



A Wesgo developed nickel bearing gold-copper alloy that possesses—

- ★ Improved wetting and flow characteristics
- ★ Greatly diminished tendency toward brittleness
- ★ Smaller grain size
- ★ Higher tensile strength

Vacuum tube manufacturers report a material reduction in number of leakers when conventional gold-copper alloys are replaced by Nicoro.

Write for circular on Nicoro and other Wesgo brazing alloys.

WESTERN GOLD & PLATINUM WORKS
 589 Bryant • San Francisco 7, Calif.

CIRCLE ED-229 ON READER-SERVICE CARD FOR MORE INFORMATION

Patents . . .

Focus Circuit for Cathode Ray Tube . . .

Patent No. 2,658,164. Werner J. Grunwald, Maywood, N. J. (Assigned to Allen B. DuMont Laboratories, Inc.).

The circuit shown in Fig. 3 provides a focus coil current for TV receivers or CRO's that varies from 45 to 80ma with a resultant voltage drop change of only 15%. This percentage compares very favorably with the 25% drop characteristic of presently used circuits for the same purpose. Since these focusing circuits supply current to other circuit elements such as amplifiers, this voltage drop affects their proper operation.

The circuit covered in the patent secures an operational improvement by using parallel resistors (18 and 20) with the focusing coil 16 in series with resistor 18 and with a differential connection or linkage between the contactors of the resistors so that when the resistance connected in

the circuit of one resistor is increased, that of the other is decreased. The resistors must be properly proportioned depending upon circuit elements. The ratio is about six to one in this application.

Fig. 3. An improved focusing circuit.

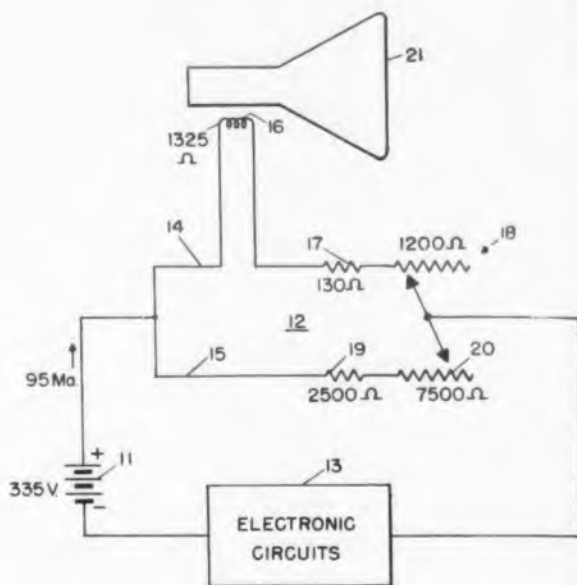

Stability and opportunity for ELECTRONIC ENGINEERS at the "Laboratory in the Sky"

One of America's leading centers of long-range radio and electronic developments offers outstanding opportunities for accomplishment, advancement and stability. Write for booklet describing projects, facilities and employee benefits.

INTERESTING ASSIGNMENTS IN:

Microwave Links • Pulse Networks • Radar
Direction Finders • Air Navigation Systems
Television Transmitters and Studio Equipment
Antennas • Computers • Guided Missiles
Telephone and Wire Transmission Systems
Microwave and Gas Discharge Tubes • Dielectrics

MAIL THIS COUPON TODAY

**Federal
Telecommunication
Laboratories**

A Division of International Telephone
and Telegraph Corporation



Federal Telecommunication ED-4
Laboratories
500 Washington Ave., Nutley, N. J.
Please send me a copy of "Your
future is with FTL."

Name _____

Address _____

City _____ Zone _____ State _____

CIRCLE ED-230 ON READER-SERVICE CARD FOR MORE INFORMATION

ELECTRONIC DESIGN • June 1954

Eig
Ener
able
to ap
free
Chief
Coun
Wash
ject
Of th
ones
tron
Elect
R. B.
a sim
erates
when
of wh
an au
more
select

AEC Patents For Industry

Eighteen patents owned by the Atomic Energy Commission have been made available for licensing. Licenses will be granted to applicants on a non-exclusive, royalty-free basis. Applicants should apply to the Chief, Patent Branch, Office of the General Counsel, U.S. Atomic Energy Commission, Washington 25, D.C., identifying the subject matter by patent number and title. Of the 18 patents released, the following ones are particularly interesting to electronic design and development engineers:

Electronic Timing Device (Patent No. 2,672,556); R. B. Leighton, inventor. This invention discloses a simple and reliable electronic device that generates an audio tone having one selected frequency when impressed with a plurality of impulses all of which occur within a selected time interval and an audio tone of different frequency when one or more of the impulses occur after the lapse of the selected time interval.

Survey Instrument (Patent No. 2,666,865); C. J. Borkowski, inventor. The rapid survey of surfaces, tools and containers for alpha and beta particles, gamma rays and slow and fast neutrons is made easier by the pulse-type instrument covered by this patent.

Liquid Level Control (Patent No. 2,667,178); M. S. Fred and E. G. Rauh, inventors. Independent control of the upper and lower levels of a liquid in a container is accomplished by this invention. Two measuring elements, whose resistance changes with the liquid levels, feed an electronic control device.

Ion Source (Patent No. 2,668,260); C. F. Barnett and C. B. Mills, inventors. The patent relates to a source of ions for a particle accelerator such as a cyclotron. The ion source comprises a carbon anode envelope and a pair of thermionic cathodes disposed inside the envelope. The cathodes are of such material that they are readily heated, so that when they are bombarded by ions of sufficient energy and intensity, they become incandescent and supply thermally emitted electrons to the plasma.

Voltage Regulator (Patent No. 2,668,272); E. J. Groth, inventor. Relates to a voltage regulator of the type wherein variations of the output voltage from a desired value are detected, amplified and then employed to control a variable resistive element in series with the source voltage.

CHATHAM ELECTRONICS ULTRA-STABLE REGULATED POWER SUPPLIES

**.002% REGULATION FOR
10% CHANGE IN LINE VOLTAGE**

For those laboratories requiring the utmost in stability and regulation from D.C. power supplies, Chatham Electronics offers a group of ultra-stable regulated power supplies. The use of a driftless regulating circuit and mercury cell batteries as a voltage reference provides the extreme stability attained. These units can be supplied to meet your power requirements. Some typical supplies are listed below:

D.C. VOLTAGE RANGE	CURRENT MILLIAMPERES	HUM MV	LINE REGULATION 110-120 VOLTS A.C.	LONG-TIME STABILITY*
400 to 1500	180	2	.002%	20
0 to 400	20	0.5	.005%	10
1500 to 3500	100	3	.005%	30
290 to 310	500	0.5	.002%	5
6.3 to 7.3	3 amps	10	.03%	1

*Max. drift in millivolts over 10 min. period

STANDARD REGULATED POWER SUPPLIES



These units are ruggedly built and designed to give long time, trouble free operation. Either positive or negative output may be grounded. All voltages and load currents are metered. Model E-50A (at left) also has a 6.3 volt 10 ampere output available. (Non-Regulated.)

MODEL	VOLTAGE RANGE	CURRENT MA	HUM	LINE VOLT. REG. 105-125 V.
EA-50A	0-500 Volts	0-300 MA	2 MV	1%
EA-48	160 to 1500 Volts	0-125 MA	Less than 20 MV	0.5%



CHATHAM ELECTRONICS CORP.

Executive and General Offices: LIVINGSTON, NEW JERSEY
Plants and Laboratories: NEWARK and LIVINGSTON, NEW JERSEY

CIRCLE ED-231 ON READER-SERVICE CARD FOR MORE INFORMATION

HIGH SPEED



ACTUAL SIZE

PATENT PENDING

Miniature Electromagnetic COUNTER



40 counts per second — higher rates with suitable circuit design

Miniaturized — only $27/32$ x $31/32$ x $1-17/32$ inches
Lightweight — 1.2 oz. (less cover); 1.5 oz. (with cover).

Shock-resistant dynamically balanced armature.

Reads 0 - 9999, 4 dials, non-reset.

Write for data sheet giving performance and dimensions of the Unimax C-100 Counter.

UNIMAX

Switch Division of the W. L. Maxson Corporation
460 WEST 34TH ST. NEW YORK 1, N. Y.

CIRCLE ED-232 ON READER-SERVICE CARD FOR MORE INFORMATION



★Specifically designed for industrial, laboratory and other semi-critical applications not quite met by standard controls. Designated as "C-Line" controls. Exposed metal parts have corrosion-resistant finishes. Suitable finish on terminals for ease of soldering. Close-fitting covers—no holes or cutouts. Packed in sealed plastic bags. Insist on the new "C-Line" controls for semi-critical requirements. Details on request.

Deluxe versions of carbon and wire-wound controls.

★ With 1 5/8" round nickel-plated shaft or 1/8" slotted shaft with locking bushing.

★ Electrical tolerances plus/minus 10% and 20% for carbons; 5% for wire-wound controls.

★ With factory-attached switches on special order.



CIRCLE ED-234 ON READER-SERVICE CARD FOR MORE INFORMATION

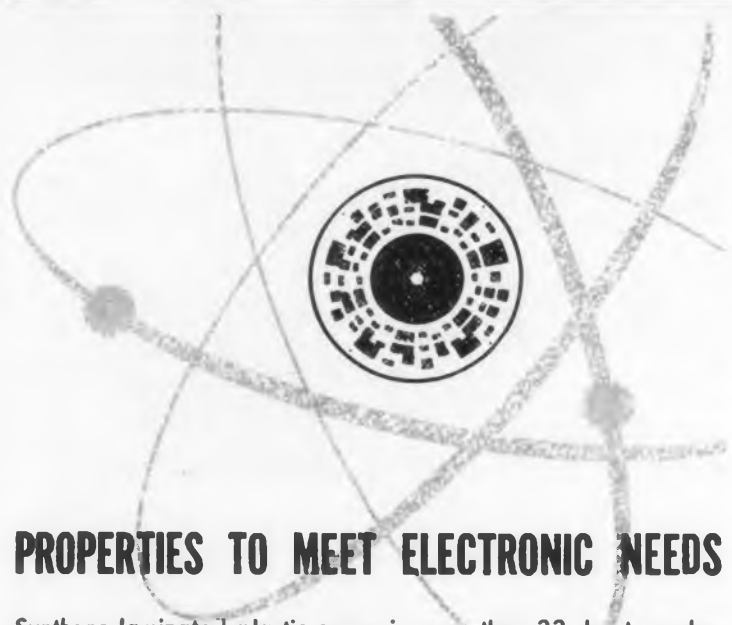

PROPERTIES TO MEET ELECTRONIC NEEDS
Synthane laminated plastic comes in more than 33 sheet grades, each with outstanding properties. Synthane combines dielectric strength and low power factor with heat and moisture resistance, dimensional stability, toughness, light weight, machinability and chemical resistance.

Besides sheets, Synthane is also available in rods, tubes, molded shapes and fabricated parts. For complete information, see the Synthane catalog. To get your copy, write to Synthane Corporation, 42 River Road, Oaks, Pennsylvania.



CIRCLE ED-235 ON READER-SERVICE CARD FOR MORE INFORMATION

Books . . .

Transistors—Theory and Practice . . . By Rufus P. Turner, 144 pages, paper bound. Gernsback Publications, Inc., 25 West Broadway, New York 7, N. Y. \$2.00.

How transistors work and what transistor circuits are like is described in simple language in this book. It is a good introduction to the subject for technicians as well as for many engineers whose work may not have brought them in contact with transistor literature.

The chapters cover semiconductor theory, transistor characteristics, equivalent circuits, transistor amplifiers, transistor oscillators, duality in transistor circuit design, triggers and switches, practical transistor circuits, tests and measurements, and characteristics of commercial transistors. At the end of each chapter a "Recommended Reading" list is included that gives articles containing information relating to the subject covered in the chapter.

Materials and Processes . . . By James F. Young, second edition, 1074 pages. John Wiley & Sons, Inc., 440 Fourth Ave., New York 16, N. Y. \$8.50.

Six new chapters have been added to this second edition of a valuable collection of information for the designer choosing materials for equipment. The book is one of the General Electric Series, all written by engineers employed by that organization. Like most of the material in the first edition, the added chapters are based on lectures given in the Advanced Engineering program of the General Electric Co.

The added chapters are entitled: Metallographic Examination; Structure and Properties of Nonmetallic Materials; Rubber; Ceramics, Porcelain, and Glass; Miscellaneous Nonmetallic Materials; and Statistical Methods Useful in Quality Control. Sections have been added on Tarnishing, Electric Contacts, and Nondestructive Testing. Many subjects have been expanded, such as bearing metals, superalloys, nonferrous elements, blow molding, shell molding, and pressure welding.

The new processes and materials covered supplement extensive treatments of the more familiar metals, alloys, and insulations. Nearly 50 pages are devoted to plastics. About half the volume is devoted to the standard industrial fabricating processes. The book is recommended as a useful tool to the practicing engineer.

...KULKA TERMINAL BLOCKS

CUT COSTS . . . SPEED PRODUCTION



● SIMPLIFY WIRING ●
NO SPLICING
NO LEAKS OR SHORTS

Molded Barrier-type Terminal Blocks in approved materials and several styles, ranging in size from miniature to jumbo (90 amps.). With or without plain or printed Marker Strips in fibre or bakelite.

Catalog on Request

KULKA ELECTRIC MFG. CO., Inc.

Manufacturers of Electrical Wiring Devices
MOUNT VERNON, N. Y.

CIRCLE ED-236 ON READER-SERVICE CARD FOR MORE INFORMATION



SORENSEN
electronic
FREQUENCY
CHANGERS

*50-60~ to 400~ (adjustable $\pm 10\%$)
*Frequency regulation $\pm 1\%$ — $\pm 0.01\%$ regulation at 400~ available
*250VA and 1000VA capacities

Sorensen *electronic* frequency changers are portable, quiet in operation, provide a source of frequency at load point, thus eliminating special wiring and installation. Good waveform and regulation of voltage and frequency are attained to a degree impossible with rotating equipment.

Write for information today.

SORENSEN
375 Fairfield Avenue, Stamford, Conn.

CIRCLE ED-237 ON READER-SERVICE CARD FOR MORE INFORMATION

it's
NEW!

it's
PORTABLE!

it's
ECONOMICAL!



Detectron
**DS-660
FREQUENCY
METER**

Designed for portability and low-cost as well as accuracy, the newly developed DS-660 will count and display any electrical or mechanical event which can be converted into a varying voltage of sufficient amplitude — from 10 to 100,000 events per second. Derives its time base from the 60 cycle line — which determines the accuracy — approximately .1%. Here is new and amazing reliability and circuitry available in one unit.

FEATURES:

- SELF CHECKING
- AUTOMATIC and MANUAL RESET
- DISPLAY from 1 to 10 SECONDS
- LIGHTWEIGHT — only 16 lbs.
- UTILIZES STANDARD PLUG-IN DECADES
- BASIC UNIT READS OUT TO 10 KC (4 decades)
- AIR COOLED (Fan)

Write TODAY for full technical information

THE Detectron CORPORATION, Dept. 92
5420 VINELAND AVE., NO. HOLLYWOOD, CALIF.

CIRCLE ED-238 ON READER-SERVICE CARD FOR MORE INFORMATION

Microwave Theory and Techniques . . . By Herbert J. Reich, Philip F. Ordung, Herbert L. Krauss, and John G. Skalnik, 901 pages. D. Van Nostrand Company, Inc., 250 Fourth Ave., New York, N. Y. \$12.50.

Although intended primarily as a textbook, this volume makes a useful reference source for the designer of equipment operating over 300Mc. Following some introductory chapters on the basic theory associated with high-frequency waves, the authors devote a chapter to each of the various components, techniques or oscillators used in microwave work.

Among the chapters are ones dealing with transmission lines, impedance matching and baluns, waveguides, coaxial-line components, resonators, triode and tetrode microwave amplifiers and oscillators, two- and three-cavity klystrons, reflex klystrons, magnetrons, and traveling-waves and double-beam tubes. Three appendices deal with the transformation from the rectangular to the Smith chart, dimensions, tolerances and frequency range for rigid rectangular waveguides, and doublet modes in a resonator system, respectively. A four-page symbol index is included.

Recommended Methods of Measurement on Receivers for Amplitude-Modulation Broadcast Transmissions . . . 91 pages. Prepared and published by the International Electrotechnical Commission, Geneva, Switzerland. Available from the American Standards Association, 70 East 45th Street, New York 17, N. Y. \$3.00.

Standard tests for sensitivity, interference, frequency response, distortion, stability, and other characteristics of a-m receivers are specified in this bi-lingual, paper-bound volume. The object of the IEC in preparing this specification was to make possible the comparison of measurements by different engineers, but it will be valuable to any designer of receivers.

The text is printed in French on the left-hand page and in English on the opposite page. All diagrams carry bi-lingual captions. There are 47 illustrations including circuit diagrams and graphs.

Design for Production . . . 68 pages. Published by the British Productivity Council. Available from the Office of Technical Services, Dept. of Commerce, Washington, D. C. (Price on application.)

This book is the report of a visit to American manufacturing plants by a group of British industrial specialists. Although intended for a foreign audience, the report makes valuable reading for project engineers and other design supervisors. Those features of American design departments that make for greatest efficiency and best functioning are often more apparent to the informed stranger than the participant.

FLUSHING

FANS

- BALL BEARINGS
GREASED FOR LIFE

COMPACT • LIGHT • SELF-CONTAINED

ROTRON Model BFV and CFV FANS are designed specifically for flushing instrument cabinets, transmitter cubicles and relay racks. They are self-contained and mount directly against cabinet walls or dust filter boxes. Motors are totally enclosed, mount in ANY position and do NOT require to be accessible for lubrication. Special, low-temperature rise, shaded-pole motors, allow continuous operation in high ambient temperatures. Have no commutators or sliprings and require no phase-splitting capacitors. Fans are beautifully finished and are an asset to any piece of equipment.

- 200—500 CFM (NAFM)
- 115 or 220 VOLT
50—60 CPS
TOTALLY ENCLOSED
- PUSH OR PULL



SHOWN:
MODEL CFV WITH GUARD



ROTRON

MANUFACTURING CO.
7 Schoonmaker Lane, Woodstock, N. Y.

CIRCLE ED-240 ON READER-SERVICE CARD FOR MORE INFORMATION



161 control steps!

That's what you get in Ward Leonard's 13" Multi-step plate rheostat — what's more, you get 161 steps whether it's a 2 ohm or a 1000 ohm plate.

You get smoother operation and longer life in any W/L rheostat and you take your pick from the most complete line of power rheostats ever offered for industrial and commercial applications.

Write for free data-packed Bulletin 60A. Ward Leonard Electric Co. 77 South St., Mount Vernon, N.Y. 4.12

WARD LEONARD ELECTRIC CO.

Result-Engineered Controls Since 1892

RESISTORS • RELAYS • MOTOR CONTROLS • CHROMASTER



CIRCLE ED-241 ON READER-SERVICE CARD FOR MORE INFORMATION

ANOTHER FAMOUS MARKET PLACE — Central Market
(Hallez Centrales)

ELECTRONIC

pin-points
its attention on the
**Electronic
Designer**

presents him with
concise but compre-
hensive Design Data

brings him feature
articles, nomographs,
composites, tabulations,
charts and graphs.

* Market Place for
Electronic Design
Innovation

VAC-TITE* COMPRESSION

To improve the quality of their products
and to keep them competitive cost-
wise, more manufacturers are turning
to HERMETIC SEAL... for headers
for critical applications, airborne use,
maintenance-free operation and for
the arc resistance of glass insulation.

V **r** **a** **i** **n**

on a vital theme

With production and variety increasing steadily, HERMETIC SEAL offers an unparalleled selection of multi-terminal headers, miniature plugs, individual terminals, rectangular plugs and connectors of every shape and size... plus condenser seals and crystal bases. These units are available in VAC-TITE* Compression Seals as well as conventional kovar designs. Try HERMETIC first because HERMETIC has always been first and foremost in its field.

*VAC-TITE is HERMETIC's new, vacuum-proof, compression-construction, glass to metal seal. In addition to special shapes, many standard sizes such as .800 O.D. and .900 O.D. multi-terminal headers and a large variety of individual terminals are available in VAC-TITE Compression Seals.

In addition to those shown, HERMETIC produces a wide variety of multi-headers with individual glass insulations.

Write for samples, data, prices.
We welcome the opportunity to work with you on special problems.

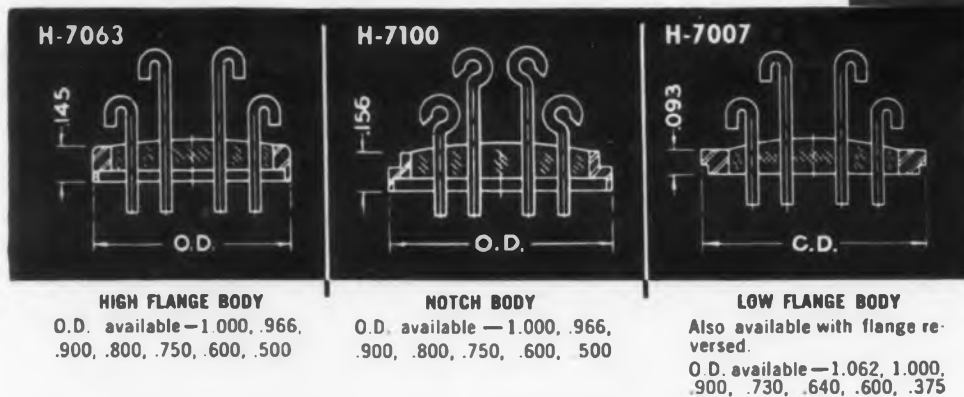

All parts shown available up to 21 terminals depending on O.D. Integral exhaust tubulation, color codes, alternate terminations may also be had. Terminal diameters up to .093 dia. depending on O.D.

F I R S T A N D F O R E M O S T I N M I N I A T U R I Z A T I O N

CIRCLE ED-268 ON READER-SERVICE CARD FOR MORE INFORMATION

Advertising Index

June 1954

Inquiry No.	Advertiser	Page
117	Ace Plastic Co.	51
48	Advance Electric & Relay Co.	37
228	Aerohm Corp.	74
170	Aircraft-Marine Products, Inc.	63
225	Aircraft Radio Corp.	72
63	Alden Products Co.	40
	American Electronic Mfg., Inc.	38
224	American Television & Radio Co.	72
87	Amperite Co., Inc.	46
125	Assembly Products, Inc.	53
100	Baker & Co.	48
107	Barry Corp., The	50
165	Birtcher Corp., The	62
82	Bourns Laboratories	45
12	Buggie, H. H., Inc.	18
11	CBS-Hytron	17
20	Cambridge Thermionic Corp.	26
102	Cannon Electric Co.	49
140	Centralab, Div. of Globe-Union Inc.	56
231	Chatham Electronics Corp.	75
52	Chicago Standard Transformer Corp.	38
97	Clare, C.P. & Co.	48
234	Clarostat Mfg. Co., Inc.	76
217	Communication Accessories Co.	70
74	Continental-Diamond Fibre Co.	43
47	Cook Electric Co.	36
9	DeJur-Amsco Corp.	12
238	Detectron Corp., The	77
162	Doelcam Corp.	62
119	du Pont, E. I., de Nemours & Co., Inc.	52
59	Eitel-McCullough Inc.	39
118	Elastic Stop Nut Corp. of America	51
43	Elco Tool & Screw Corp.	35
302	Electrical & Physical Instrument Corp.	67
171	Electro-Mechanical Specialties Co., Inc.	64
227	Electrons, Inc.	73
128	Electro Products Laboratories	53
23	Essex Wire Corp., R-B-M Div.	30
92	Faber-Castell, A. W. Pencil Co., Inc.	47
103	Fairchild Camera & Instrument Corp.	49
230	Federal Telecommunication Laboratories	74
175	Federal Telephone & Radio Co.	64
91	Fenwal Inc.	46
56	Flexrock Co.	39
198	Ford Instrument Co.	68
8	Formica Co., The	11
124	Freed Transformer Co., Inc.	53
2	G-V Controls, Inc.	3
5	General Electric Co., Apparatus Sales	8
17	General Electric Co., Apparatus Sales	23
66	General Electric Co., Apparatus Sales	41
90	General Electric Co., Construction Materials Div.	46
179	General Electric Co., Electronics Div.	65
197	General Electric Co., Tube Dept.	68
111	General Radio Co.	50
106	General Transformer Co.	49
157	Graphite Metallizing Corp.	66
176	Gries Reproducer Corp.	64
108	Hart Mfg. Co., The	50
251	Harvey Hubbell, Inc.	61
3	Helipot Corp.	4
113	Helipot Corp.	51
268	Hermetic Seal Products Co.	78
269	Hewlett-Packard Co.	79

HERMETIC SEAL PRODUCTS CO.

39 South Sixth St.
Newark 7, N. J.



Inquiry
0 Hu
Hu
1 Hy
4 Ins
226 Int
212 Jar
72 Ka
1 Ker
114 Ke
236 Kul
8 Lin
51 Loc
130 Ma
4 Me
172 Me
93 Me
68 Mi
223 Mc
154 My
143 Na
153 Na
252 Ne
121 Ne
34 No
150 Ol
112 Ph
71 Pik
86 Pla
14 Po
18 Po
120 Pre
134 Py
270 Ra
210 Ra
7 Ra
101 Ra
129 Ric
240 Ro
16 Sa
15 Se
147 Se
77 Se
80 Sh
44 Sh
60 Sig
237 So
138 So
81 St
181 Str
96 Str
146 Sy
235 Sy
301 Ta
19 Te
203 Te
232 Ur
73 U
2 U
133 Vi
241 W
180 W
229 W
22 W
253 W

Inquiry No.	Advertiser	Page
0	Hughes Aircraft Co.	13
	Hughes Research & Development Labs	44
1	Hydro-Aire, Inc.	2
51	Instrument Specialties Co., Inc.	31
37	International Electronic Research Corp.	73
74	James Vibrapower Co.	70
63	Kanthal Corp., The	42
72	Kearfott Co., Inc.	19
40	Kester Solder Co.	51
38	Kulka Electric Mfg. Co., Inc.	76
72	Linemaster Switch Corp.	45
46	Lockheed Aircraft Corp. Missile Systems Div.	37
53	Magnetics, Inc.	54
48	4 Marion Electrical Instrument Co.	7
50	172 Markem Machine Co.	64
62	93 Metron Instrument Co.	47
45	68 Micro Switch	42
18	223 Moloney Electric Co.	71
17	154 Mycalex Corp. of America	60
26	143 National Co., Inc.	56
49	153 National Semi-Conductor Products	59
56	252 Neomatic, Inc.	61
75	121 Ney, J.M., Co.	52
38	34 Norris-Thermador Corp. Electronics Div.	34
48	150 Olympic Metal Products Co., Inc.	58
76	112 Phalo Plastics Corp.	50
70	71 Pike, E. W., & Co., Inc.	42
43	86 Plastic Capacitors, Inc.	45
36	14 Potter Co., The	20
12	18 Potter Instrument Co., Inc.	24
77	120 Precision Paper Tube Co.	52
62	134 Pyramid Electric Co.	55
52	270 Radio Corp. of America, Tube Dept.	80
39	210 Radio Materials Corp.	69
51	7 Radio Receptor Co., Inc.	10
35	101 Rapi Design, Inc.	48
67	129 Richardson Co., The	53
64	240 Rotron Mfg. Co., Inc.	77
73	16 Sangamo Electric Co.	22
53	15 Servo Corp. of America	21
30	147 Servomechanisms, Inc.	58
47	77 Set Screw & Mfg. Co.	43
49	80 Shakeproof, Div. of Illinois Tool Works	44
74	44 Shallcross Mfg. Co.	36
64	60 Sigma Instruments, Inc.	40
46	237 Sorenson & Co., Inc.	76
39	138 Southwestern Industrial Electronics Co.	55
68	81 Staver Co., The	44
11	181 Stevens-Arnold, Inc.	66
53	96 Stupakoff Ceramic & Mfg. Co.	47
3	146 Sylvania Electric Products, Inc.	57
8	235 Synthane Corp.	76
23	301 Taylor Tubes, Inc.	67
41	19 Technitrol Engineering Co.	25
46	203 Texas Instruments, Inc.	68
65	232 Unimax Switch, Div. of The W. L. Maxson Corp.	75
68	73 U. S. Engineering Co.	43
50	21 U. S. Gasket Co.	28
49	133 Victoreen Instrument Co. The	55
60	241 Ward Leonard Electric Co.	77
64	180 Weckesser Co.	66
50	229 Western Gold & Platinum Works	74
4	22 Weston Electrical Instrument Corp.	29
51	253 Who's Who in Electronic Distribution	61
78		
79		

Complete Coverage!

10 cps to 4 mc



hp 400D

**VACUUM TUBE
VOLTMETER**

**Accurate within 2%
to 1 mc**

**Measures 0.1 milli-
volt to 300 volts**

Reads dbm direct

High sensitivity, stability, input impedance

Light, small, portable, dependable

-hp- 400D combines new features never before found in one voltmeter, with time-tested conveniences of the famous *-hp- 400C*.

Frequency coverage is extremely broad—10 cps to 4 mc. A new amplifier provides 56 db of feedback (mid-range) for highest stability and freedom from change by external causes. Input impedance is 10 megohms so circuits under test are not loaded. Coupling and by-pass condensers are sealed; electrolytic condensers are long-life type. Construction is highest quality throughout; circuitry is clean, easy to reach. New compact metal case simplifies handling, occupies less bench space. Front tilts upward for convenient reading angle.

Use the new *-hp- 400D* for measuring amplifier gain, network response, output level, hum and noise, power circuit, broadcast high frequency voltages, as an audio level meter, high gain broad band amplifier, null detector, waveform monitor, and coil "Q" meter. \$225.00.



**ELECTRONIC TEST
INSTRUMENTS**
for speed and accuracy

GET COMPLETE INFORMATION TODAY!

HEWLETT-PACKARD COMPANY

Dept. 3034K, Page Mill Road, Palo Alto, California

Please send information on:

400D 400A 400B 410B 404A

Name _____

Company _____

Street _____

City _____ Zone _____ State _____

Data subject to change without notice. Prices f.o.b. factory.



**-hp- 410B Vacuum Tube
Voltmeter**

Wide range, flat response ± 1 db, 20 cps to 700 mc. Small, convenient, simple to use. Diode probe places approximately $1.5 \mu\text{fd}$ capacity across circuit under test. This plus 10 megohms shunt impedance (high frequency) means circuits are not disturbed, and true voltage reading are assured. Also measures dc voltage to 1,000 volts and resistances to 500 megohms. \$245.00.



**-hp- 400A Vacuum Tube
Voltmeter**

Direct voltage readings between 10 cps and 1 mc. 30 millivolts sensitivity full scale; accuracy is $\pm 3\%$ to 100 kc, $\pm 5\%$ to 1 mc. Voltage range .005 to 300 volts. Input impedance 1 megohm shunted by $25 \mu\text{fd}$. \$185.00.

**-hp- 400B Vacuum Tube
Voltmeter**

For measurements 2 cps to 100 kc. Sensitivity 30 millivolts full scale. Measures voltage .005 to 300 volts, input impedance 9 megohms shunted by $25 \mu\text{fd}$. Accuracy $\pm 3\%$ to 100 kc. Usable as stabilized amplifier. \$195.00.



**-hp- 404A Battery-
Operated Voltmeter**

For general voltage measurements where ac power is not available. Compact, portable, splash-proof, ruggedly built. 2 cps to 50 kc, .0005 to 300 volts, impedance 10 megohms with $20 \mu\text{fd}$ shunt. Ideal for remote broadcast, carrier, strain gauge, telemetering, geophysical work; completely hum free measurements. \$185.00.

CIRCLE ED-269 ON READER-SERVICE CARD FOR MORE INFORMATION



DESIGNER'S NEWS

—from the RCA Tube Division

New "Premium" Miniature Twin Triodes for Military and Industrial Applications



*6101/6J6WA Military Control Type. For government end use only.

RCA-6101 and 6101/6J6WA* are medium-mu triodes designed principally for use as class A amplifiers and control tubes in mobile and aircraft equipment where uniformity of characteristics and dependable performance under shock and vibration are essential requirements. The tube can withstand an impact acceleration of 500 G max. and vibrational acceleration of 2.5 G max. Developed from the type 6J6, these "premium" types incorporate many structural improvements, and undergo stringent production controls and rigorous tests during and after manufacture.

New "Mighty Midget" Speaker for "Pocket-Personal" Radios



Contoured for economy of space, this new RCA-222S1 PM speaker features a 2½-in. cone and measures only 2¼ in. in diameter by 1¼ in. in depth. The weight is only 4.6 ounces, including a 1.0-ounce Alnico V magnet for high efficiency. Frequency range is 300-3500 cps and the voice-coil impedance is 12 ohms. Life-tested at 250 milliwatts, the speaker is designed for long trouble-free service in applications where space is at a premium.

New Dual-Band Oscilloscope for Color and Black-and-White TV



The new WO-78A 5-inch Oscilloscope permits accurate voltage measurements of TV signals throughout the video range in both color and black-and-white receivers. In the wide-band position, the WO-78A has a response flat within -1 db, from 3 cps to 4.5 Mc, with sensitivity of 0.1 volt peak-to-peak per inch (0.035 volt rms per inch). In the narrow-band position, sensitivity is 0.01 volt peak-to-peak per inch. Phase characteristics are excellent throughout entire frequency range.

Free Paper on Application Considerations for RCA Commercial Transistors

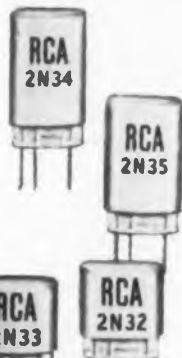

R. M. Cohen's popular technical paper entitled "Application Considerations for RCA Commercial Transistors" is now available on request. Included in the contents are: descriptions of problems involved in the application of RCA point-contact and junction type transistors and typical circuits for af and rf amplifiers, rf oscillators, and "flip-flop" circuits—as well as performance data for these circuits. For your free copy fill out coupon—or write for Reprint ST-817 to RCA, Commercial Engineering, Harrison, N.J.

New 90° Deflecting Yoke for Full Screen Focus



The new RCA-220D1 yoke is designed for rectangular-type 90° kinescopes operating at ultor voltages up to 18 kv. A ferrite core and precision-shaped cosine-type windings, treated with anti-corona silicone resin, provide high efficiency and good side and corner resolution. Molded insulation is employed to withstand the high peak voltage between the horizontal and vertical coils. The 220D1 is designed for use with the RCA-238T1 and RCA-239T1 horizontal-output and high voltage transformers.



RADIO CORPORATION OF AMERICA
ELECTRON TUBES

RCA Tube Division
Commercial Engineering, Section F18R, Harrison, N. J.
Please send me technical data on:

- RCA-6101
- Transistor Reprint ST-817
- RCA-222S1 "Mighty Midget" Speaker
- RCA-220D1 Yoke
- WO-78A Oscilloscope

Name _____
Firm _____
City _____ Zone _____ State _____

CIRCLE ED-270 ON READER-SERVICE CARD FOR MORE INFORMATION

Postmaster: Form 3547 Requested

HAYDEN PUBLISHING COMPANY, INC.
127 East 55th Street, New York 22, N. Y.

ELECTRONIC design