

Q 621.38
W527

**WESTERN
UNION**

Technical Review

Facsimile in Telegraphy

•

Recording Paper

•

Facsimile Transceiver

•

Microwave Lenses

•

**Thyratrons in Cable
Operation**

•

Xerographic Process

RECEIVED
LIBRARY R. P.

**VOL. 3
JANUARY**

**NO. 1
1949**

WESTERN UNION

Technical Review

VOLUME 3
NUMBER 1

Presenting Developments in Record Com-
munications and Published Primarily for
Western Union's Supervisory, Main-
tenance and Engineering Personnel.

JANUARY
1949

CONTENTS

	PAGE
FACSIMILE AND ITS PLACE IN TELEGRAPHY <i>P. J. Howe</i>	1
ELECTROSENSITIVE RECORDING PAPER FOR FACSIMILE TELEGRAPH APPARATUS AND GRAPHIC CHART INSTRUMENTS <i>Grosvenor Hotchkiss</i>	6
A FACSIMILE TRANSCEIVER FOR PICKUP AND DELIVERY OF TELEGRAMS <i>G. H. Ridings</i>	17
MICROWAVE LENSES <i>A. Boggs</i>	27
THYRATRONS IN LOADED CABLE MULTIPLEX <i>H. H. Haglund and A. W. Breyfogel</i>	34
THE XEROGRAPHIC PROCESS <i>F. B. Bramhall</i>	43

Published Quarterly by

THE WESTERN UNION TELEGRAPH COMPANY

COMMITTEE ON TECHNICAL PUBLICATION

P. J. HOWE , Development and Research Dept., <i>Chairman</i>	
F. B. BRAMHALL	Development and Research Dept.
I. S. COGGESHALL	Internat'l Communications Dept.
W. H. FRANCIS	Plant and Engineering Dept.
G. P. OSLIN	Public Relations Dept.
S. N. PHILLIPS	Commercial Department
M. J. REYNOLDS	Patent Department
H. M. SAUNDERS	Traffic Department

NELL ORGAN, *Secretary*

Address all communications to the Committee on Technical Publication,
THE WESTERN UNION TELEGRAPH Co., 60 Hudson St., New York 13, N. Y.

SUBSCRIPTIONS \$1.50 per year

PRINTED IN U.S.A.

(Copyright 1949 by The Western Union Telegraph Company)



Facsimile and Its Place in Telegraphy

P. J. HOWE

Recent developments by various laboratories of facilities for transmitting facsimile reproductions of printed and written copy, drawings, maps, etc., have given rise to much speculation as to the applications which such developments will have in industry and particularly in the record communication business.

In Western Union's reperforator switching program which is now approaching completion, 15 area centers, all interconnected by fast automatically operated circuits, will directly serve nearly every sizeable community in the United States. There will be but two, and in many cases only one interchange of messages between the terminal cities, and these will be handled in the switching centers by either push-button or automatic switching. The most recently installed offices incorporate automatic switching to trunks from branch and tributary offices, and push-button switching in the reverse direction. As each new office is placed in service, another increment is added to the overall transmission speed of telegrams. Completion of the program is confidently expected to give all that can be desired with respect to intercity transmission.

Terminal Handlings

With this modern system of switching centers and interconnecting network of automatically operated trunk circuits, the transmission time for a message to flash between the most widely separated "area centers" in the country is only a matter of seconds. Obviously the next consideration involves getting the patron's messages into this telegraph system quickly at points of origin, and then getting them out again at points of destination to the parties for whom they are intended. This is now the link in the chain of telegraph operations on which research is being concentrated. It is the remaining opera-

tion which presently is most dependent on human effort, and represents a large share of the Company's operating expense.

In order to provide direct service to the greatest number of people, an electrically operated device for installation on patrons' premises must be made available, which will be very simple and low in cost, yet capable of producing good, readable, permanent copy. Teleprinters have been extensively employed in business offices for this purpose. They have the distinct advantage of being operable directly from the perforated tape on which incoming messages are recorded in a reperforator office. However, teleprinters are complex and costly, and for that reason they do not lend themselves readily to a program of expansion to low volume users.

Facsimile

Facsimile operation offers the greatest promise as a means for serving the general public on a broad scale. Transmission and recording by facsimile are simpler, fundamentally, than by teleprinters and facsimile machines are much easier for the average person to use. The telefax developments described in this and other issues of the *TECHNICAL REVIEW* represents, therefore, only the beginning of what portends a new day in telegraphy.

In discussing the future of facsimile operation at terminals, it is necessary to consider carefully the relationship of facsimile to the existing trunk network of printer-operated circuits which interconnects the terminating offices. Switching centers throughout the country, and the printer circuits which connect them with each other and with terminating and tributary offices, are operated by a code transmission. Every message must first be converted into this code, manually, on a keyboard similar to that of a typewriter.

Facsimile transmission and reception, on the other hand, are automatic, right from the start, and are accomplished through a process in which the written message is "read" by the transmitter and transmitted by means of a band of frequencies which are varied according to the variations in light and dark areas on the copy.

Simultaneous utilization of these two fundamentally different forms of transmission gives rise to message handling problems at the terminal offices, where messages must be interchanged between patrons' facsimile circuits and code-operated trunk circuits. Message transfer from trunk circuits to facsimile is simple, because the received printer copy of a message can be scanned and converted into facsimile signals automatically by facsimile transmitters. In the reverse direction, however, the message which has been received by facsimile must be converted into printer code by a keyboard process before retransmission. To what extent this "originating" operation may be modified or eliminated by future engineering developments remains to be seen.

Two of the developments now in process of commercial application are the Deskfax patrons' transceiver described in this issue of the REVIEW, and the associated central office equipment which will be discussed in a subsequent issue. The latter consists of continuous type recorders, automatic transmitters, and concentrators by which the patrons' service can be most efficiently operated. In the new central office recorders, Teledeltos recording paper is fed continuously from a roll, as the recording proceeds, and the messages are removed separately as rapidly as completed. The transmitter is a vertical drum type which accepts copy of telegram size, and transmits automatically. The copy will ordinarily be the original copy as received by teleprinter—either page or gummed-down tape—but also may be typewriting or handwriting. Concentrators for telefax service may be operated either manually or automatically but undoubtedly, as the service grows, central office recorders, ready to operate, will be connected automatically to patron

lines whenever the patrons signal that they have messages to transmit.

The same types of transmitter and continuous recorder will also be used for operation outside the central office, whenever the volume of traffic is greater than can be handled expeditiously by the Deskfax transceiver. A combined installation of slot type automatic transmitter and continuous recorder is presently in operation in one of the large hotels in Washington, D.C. Similar equipment may be expected to become standard for broad scale use in hotels, agencies, office buildings, branches and numerous other points where telegrams may be sent and received, and thus will form the means by which better telegraph service will become more conveniently available to more and more people throughout the country.

The delivery of telegrams to people who do not have service media in the form of telefax, teleprinter, public telephone or other direct connecting devices will continue in the foreseeable future to require the services of a messenger. In order to reduce messenger travel to a minimum, it seems probable that unattended continuous type facsimile recorders can be advantageously employed in delivery areas not served by regular offices. Messengers working from stations within such areas should provide quicker delivery than possible when working from a more distant branch or central office. Similar equipment will also be used to serve apartment houses and one such house in New York is soon to be served by a continuous telefax recorder which incorporates an automatic message sealing device. The latter cuts the messages off the roll, as received, and folds and seals them automatically, without envelope, with only the address showing, ready for delivery.

Another approach to the solution of the delivery problem is by means of Telecar—a roving automobile equipped with an automatic, continuous-type telefax recorder, operated by radio from the telegraph central office. A car of this type was in trial service in Baltimore, Md., for upwards of two years, and now, anticipating the required licenses from the

Federal Communications Commission, a fleet of Telecars is being equipped to provide complete coverage in the suburban areas of Baltimore. In this installation, there will be four radio transmitters, located in different parts of the city, all controlled from the central office and each transmitting on its own wave length to the several cars in its respective area, each car being selectively called. Messages will be directed to the individual cars nearest the delivery points, permitting delivery to be made with the greatest promptitude. Depending on the economic results achieved in Baltimore, it seems probable that telecar delivery will take an important place in the future development of telegraph service, particularly in residential areas.

While the foregoing treats largely of telefax machines as already developed, it may truly be said that the field of facsimile has hardly been scratched and that various new types of mechanisms for facsimile transmitting and recording are already in advanced stages of laboratory development. Because of its simplicity of operation and lower cost, as compared with other forms of record communication, telefax will come into extensive use for interdepartmental communication in industry, at the same time affording each department ready access to Western Union for message service to distant points. As usage of facsimile expands and further experience is gained, technological advances in the art will open up new fields for its application, broader by far than any yet explored.

Facsimile Trunk Operation

"Through" operation from patron to patron by facsimile would offer certain service and operating advantages and open new fields of use now closed to any keyboard or oral public message transmission system. Transmission and recording at terminal and relay points could be automatic, once the technical and physical requirements had been met. Limited only by loss of definition where facsimile copy is scanned and retransmitted, there would be no chance of error at any point. Even the possible losses in definition that

might occur due to repeated recording and re-scanning can be minimized through the use of magnetic recording for storing and retransmitting the facsimile signals themselves. The development of techniques for facsimile relaying has progressed far in the laboratory, and there is no doubt that the future will find extensive application of such developments.

There have been several obstacles to exploitation of country-wide use of facsimile for general telegraph communication. First, it is only in recent years that the facsimile art has reached a stage of development where it can be considered a practical public message service facility. Secondly, transmission by facsimile requires an increased number of circuit channels or channels having a much wider frequency band width than required for printer operation. Finally, the existing trunk circuit network and switching offices provide such fast automatic transmission between terminating offices that the installation of new circuit facilities for facsimile operation must necessarily be geared to the demand for any such super-service, the additional volume it may be expected to attract, and the all-important consideration of economics. With reference to the second item, the cost of intercity circuit facilities represents only a part of the cost of doing business and hence it is not unlikely that future developments in facsimile will result in a simplification of equipment and operations that will more than offset the cost of increased channel facilities. There is also the possibility that technical developments may improve the relationship between band widths and quantity of intelligence transmitted by facsimile.

A voice frequency circuit with a band width of 3000 cycles will yield one facsimile circuit, capable of transmitting copy at the rate of 14.4 sq. in. per minute. On the basis of normal sized handwriting or typing on the usual sized blanks, this is equivalent roughly to one message per minute. On the other hand, the same 3000-cycle circuit can be split into 20 teleprinter circuits, each capable of handling nearly two messages per minute with automatic transmission. If two-channel

multiplex were employed, the capacity would be doubled.

The relationship between the message capacity of facsimile and code-operated circuits holds more or less constant, regardless of the frequency band width used. Western Union's 150,000-cycle carrier system, operated on its 4000-mega-cycle radio beam, is designed to accommodate 576 teleprinter channels, good for over 1000 messages per minute in each direction, whereas, if employed for facsimile it would yield only 32 3000-cycle facsimile circuits, equivalent to about 32 messages per minute. However, it should be pointed out that even in the brief period of time which has elapsed since this radio beam was engineered, there have been new developments in radio tubes and repeaters and radio terminal systems which make possible, today, a radio beam system with several hundred voice-frequency facsimile circuits. The principles of such a system have already had laboratory trials and system development work is now actively in progress.

It must not be overlooked that the equipment for dividing voice bands into teleprinter and two-channel multiplex is not cheap and that hence, the relative costs of facsimile and printer circuits for handling a given amount of intelligence are not nearly as unfavorable to facsimile as above indicated. Facsimile would have to bring about only a small reduction in equipment and operating expenses, together with an improvement in service, to justify a considerable increase in the overall cost of the communication channels.

Ultrafax and Radio Beams

Recently, there have been demonstrations by the Radio Corporation of America of an ultrafax system which, through the employment of television techniques and a wide-band radio beam, can transmit copy at higher speed than possible by any previously known system. In its public demonstration, ultrafax transmitted over a short distance 445 book pages per minute, a capacity which approximates in round numbers the 1000 telegram per minute capacity of Western Union's teleprinter-operated radio beam. Even though

the ultrafax probably used twice as much radio frequency spectrum as the Western Union radio beam, its performance furnishes evidence that the combination of microwave radio and television techniques offers very interesting possibilities. This development, together with the previously mentioned new techniques for providing several hundred facsimile circuits on a radio beam, indicates that the handicap for intercity communication which facsimile has suffered in the past will be largely overcome.

From an operating standpoint, the fundamental difference between the ultrafax and the Telegraph Company's system of code-operated teleprinter circuits is that with ultrafax, the messages transmit seriatim, with a vast amount of traffic concentrated in individual sending and receiving units at the terminals, whereas with teleprinter operation, many telegrams travel simultaneously, side by side, over individual channels which fan out in all directions to the terminating points. This latter system reduces to a minimum the task of collecting large volumes of traffic from various sources for transmission, and subsequently sorting, distributing, and retransmitting the telegrams to their multitudinous destinations, for delivery.

Ultrafax may become valuable for use where large volumes of written or printed copy must be transmitted in a great hurry between two terminal points. At the present time there is no normal demand in commercial telegraphy for any such volume transmission. Any attempt to channel into such a circuit enough commercial telegraph traffic to utilize even reasonably the circuit capacity would, at the present state of the art, immeasurably increase the complexity and cost of concentrating such loads from various origins onto a single circuit, and redistributing them to their various destinations at the receiving terminal.

The fact that Western Union is operating a radio beam system between New York, Philadelphia, Washington and Pittsburgh, and has already installed a television circuit on the beam between New York and Philadelphia, has a direct bear-

ing on the future development of facsimile services. The present beam not only offers potentialities for wide-band circuits for facsimile, but it also, at least in the New York-Philadelphia television circuit, suggests the possibility of applying some of the principles of ultrafax to telegraph message service. Obviously the present beam possesses the properties necessary for ultrafax transmission, so that utilization of the method would depend principally on the development of ways and means for fitting it into an existing telegraph system. It may be that, ultimately, some form or modification of ultrafax will be found to offer over-all advantages in the public message business and hence these possibilities are not being

overlooked in the Company's planning for the future.

Conclusions

The foregoing discussion offers an over-all picture of the present status of facsimile development in the telegraph business and also some of the major considerations, with both pros and cons, that will govern its future progress. There are still many problems to be solved before the future of facsimile will be completely unfolded, but it seems evident that the technical advances of the past few years are but stepping stones to the day when private and business correspondence by facsimile will become commonplace.

THE AUTHOR: P. J. Howe, Director of Systems Development of the D. & R. Department, came to Western Union in 1910 as an Engineering Assistant, after spending several years in the Engineering Department of the A. T. & T. Co.; he had previously graduated from Stevens Institute of Technology. In 1913 he was appointed Construction Engineer, responsible for outside plant engineering and, later on, for material inspection. While in this position, he organized new engineering groups which subsequently became the Transmission Research, Physical and Chemical Research, and Engineering Personnel Divisions. Mr. Howe became Central Office Engineer in 1934. He had charge of the planning and engineering of the first major reperfector switching installation at Richmond, Va., and the larger switching centers which were installed later at Atlanta, St. Louis and Dallas. He was made Assistant Chief Engineer in 1943, and in 1946 was appointed to his present position. In connection with the Telegraph Centennial in 1944, he co-authored with Vice President d'Humy, the Engineering Society paper "American Telegraphy after 100 Years", and he subsequently compiled for the Company's records a "History of Technical Progress, 1935-45", covering the Western Union engineering developments that led up to the present mechanization program. Mr. Howe became Chairman of the Committee on Technical Publication in 1946 and was largely instrumental in the establishment of **TECHNICAL REVIEW**.



Electrosensitive Recording Paper for Facsimile Telegraph Apparatus and Graphic Chart Instruments

GROSVENOR HOTCHKISS

AWARD of a Medal for "development of a dry electrosensitive recording blank which can be stored and handled like ordinary paper with practically no deterioration or change and which can be permanently marked by simple means" has been made by The Franklin Institute of the State of Pennsylvania.* This is a brief review of the development so honored, with some comments about a few of the many industrial and scientific instruments in which this electrosensitive paper and modern electrical recording techniques have found application.

This non-electrolytic recording material, which is insensitive to light, not readily marked by heat, unaffected by cold, and impervious to destructive fungus growth and parasitic organisms which were such a serious problem for the armed forces, was developed initially for recording facsimile telegrams. While it is used now for recording over a million telegrams a year, it is employed extensively, also, in graphic chart recording instruments for which it is marketed as a by-product of research of The Western Union Telegraph Company's laboratories under the registered trade name "Teledeltos".

Instantaneous, Dry, Permanent

Basically, Teledeltos is an electrically conductive paper thinly coated with opaque material which provides a light gray surface that instantaneously becomes black at any point where an electric current passes through the composite sheet. Its marking characteristics are such

that good half-tone reproduction as well as clear-cut line recording may be obtained. In general, it is suitable for electrical recording over a broad range of speeds and under a wide variety of conditions.

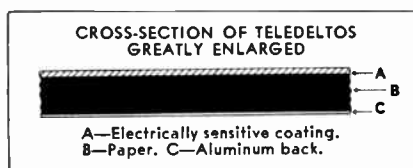

The ability of this recording paper to give optimum performance when dry is significant, not only because it makes possible direct electrical dry recording but also because, in doing so, it contributes greatly to simplification of design and ease of maintenance of recording instruments. Moreover, when Teledeltos is used for technical charts where exact dimensions may be vital, expansion and contraction caused by moisture are negligible.

Beginning in May, 1934, when Western Union research executives decided to develop intensively a facsimile system for the transmission of telegrams, recording processes were explored in detail. Although study was given to photographic methods, and as a result one such process was developed to a practical, commercial stage and used successfully for transatlantic cablephoto transmission,¹ efforts to adapt photographic methods to land-line telegraph service soon were abandoned because available photographic processes were both slow and comparatively costly.

Other experiments were made with percussion recording on wax-coated paper,

*Announcement of award appeared in Western Union TECHNICAL REVIEW, Vol. 2, No. 4, October 1948, page 176.

with heat-sensitive chemicals, and with hot air jet recording methods. Further research centered on contact stylus recording schemes with chemically treated wet papers. In this there was some familiarity with the prior art because chemical tape recorders had been used in telegraphy



Cablephoto film recorder was designed for Western Union's transatlantic picture service

for many years and Western Union's transmission testing machine then employed a method of chemical recording.² Although results did not meet the requirements of commercial telegraphy, advances were made, nevertheless, and a number of patents involving electrolytic action have been issued to Western Union research investigators in this branch of the telegraph art.³

Realization of how valuable a dry electrosensitive recording paper would be in overcoming the difficulties associated with electrolytic and other materials and methods was one important outcome of all this experimentation. As a result it was decided to re-examine every possibility in the field of dry electrical recording.

In the course of the ensuing investigation, conductive paper was coated with innumerable compounds of great variety. Among the many coatings tested, one, in

comparison with the rest, gave decidedly superior records. This was essentially vermilion printing ink which, on analysis, was shown to be pigmented with mercuric sulphide, an allotropic compound having, like carbon, the ability to exist in two different forms. In this case red mercuric sulphide was changed to black mercuric sulphide by the recording currents and excellent message reproduction was obtained at a stylus speed over the paper of about 24 inches per second, a rate sufficiently fast for telegraphy. With some other materials, however, it was found that recordings were produced primarily by blasting off the coating. Apparently, the passage of current produced forces which were electrostatic, electromagnetic, mechanistic and thermal, so that a chemical or allotropic color change was not always essential for marking. It has been shown, however, to be an important factor which assures superior definition of line.

Development of a new coating which has replaced the original vermilion, resulted in simplification of processing and permitted speedy, large-scale production. The improved paper has a light gray surface. To provide flexibility for its use with many different electrical recording circuits, Teledeltos now is made in two types designated "H" for high electrical resistance and "L" for low electrical resistance. Refinements of formulation, of materials, and of processing techniques have been continuous, with further improvements in prospect.



Manipulation of beater rolls governs fiber length and dispersion of conductive material

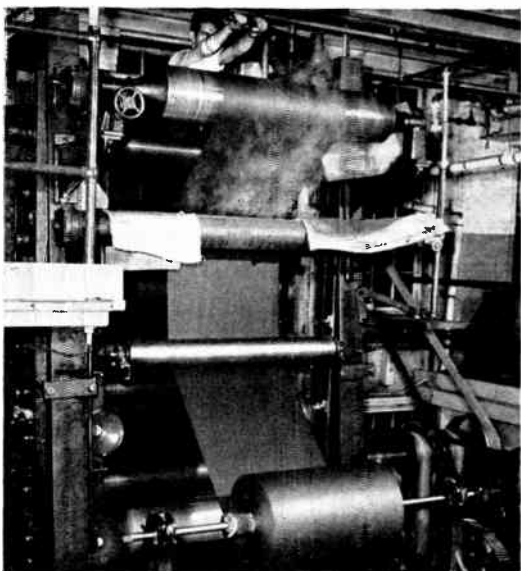

Supercalendar steams and presses black paper for correct resistance and smooth surface

Electrical Characteristics

Electrical characteristics of the finished product depend in large measure upon the use of high quality fibers or pulp, the proper degree of "beating", and the retention and uniform dispersion in the paper stock of a correct amount of conducting material for the type of Teledeltos being manufactured.

Marking current may be alternating or direct, of either positive or negative polarity, and may be applied to the electrosensitive coating by means of a metal stylus such as a steel wire 5 to 15 mils in diameter in a circuit completed through a metal platen or cylinder underneath the Teledeltos. When direct current is used, best results usually are obtained with a positive stylus. The potential required is a function of the speed at which the stylus moves over the Teledeltos. At comparatively low speeds, one inch per second for example, distinct marking is obtained on type L paper with either alternating or direct current at 110 volts applied through a current limiting resistance of 6,000 to 10,000 ohms to give some 10 to 20 milliamperes. On the other hand, with relative motion between stylus and recording paper 24 inches per second and above, the

open circuit potential should be at least 200 volts and the current through the Teledeltos should be from 15 to 30 milliamperes to produce marks of maximum contrast. With single-phase 50- or 60-cycle alternating current, a uniformly broken line is recorded since the potential passes through a zero value during each cycle. At higher frequencies or low recording speed the line appears unbroken. Good test records have been made at 350 inches per second. With proper circuit characteristics and with stylus or paper travel suitably adjusted, marks representing one ten-thousandth of a second can be recorded readily.

The degree to which voltage and current requirements for satisfactory marking depend upon the relative motion between the stylus and the Teledeltos is indicated in the accompanying Table, prepared by C. E. Mobius and W. N. Engler, for speeds from 0.1 to 2800 inches per minute. Voltage drop shown there is that from the stylus to the metal platen, and current is that required to produce a continuous mark or line of good intensity. The data for this Table were obtained with a stylus 10 mils in diameter, a stylus pressure of 15 grams and alternating current at 2,500 cycles. To control the mark-



Electrical tests are made during production. Note unfinished stock rolls in background

VOLTAGE AND CURRENT REQUIREMENTS FOR VARIOUS STYLUS SPEEDS

Recording Speed Inches per Minute	Low Resistance Teledeltos Type L (39)			High Resistance Teledeltos Type H (39)		
	Milli- amperes	Voltage Drop	Open Circuit Voltage	Milli- amperes	Voltage Drop	Open Circuit Voltage
0.1	10	20	45	(Not suitable)		
1.4	10-15	25	50	5	80	145
140	10-25	30-50	55	5-10	100-130	175
700	15-30	70-100	110	10-15	175-205	275
1400	15-30	80-115	200	10-20	230-325	350
1750	15-30	100-130	215	10-20	275-370	420
2800	15-30	100-140	220	10-20	275-380	440

ing current, it is recommended that the supply voltage be in excess of the open circuit voltages indicated and that suitable resistances be used in the stylus circuit to limit the current to the minimum required for satisfactory marking as, otherwise, excessive burning and an accumulation of carbon at the stylus may occur.

High-frequency signals may be applied directly to the stylus and platen. If an amplifier is used, best results are obtained when the output transformer provides an approximate impedance match to the recording paper. Such an amplifier should

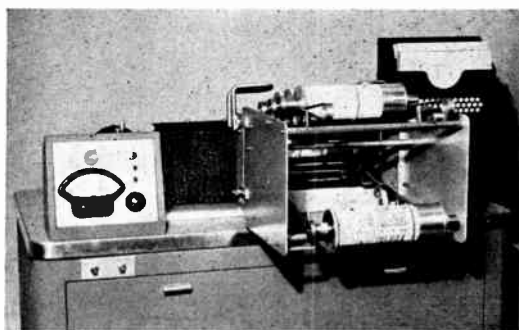

Drum-type facsimile telegram recorder

be capable of delivering power adequate to meet requirements given in the Table.

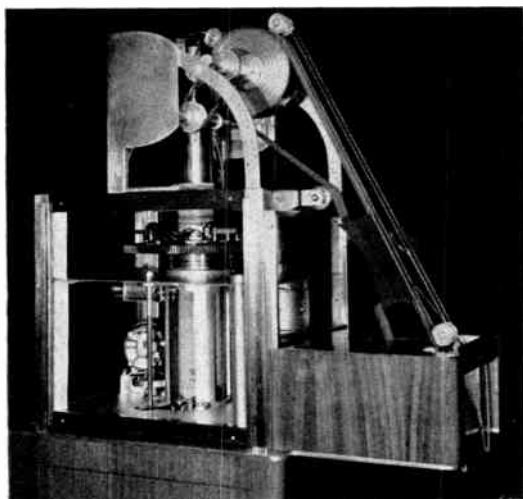

*Telegram recorder with stationary drum,
revolving stylus and continuous paper feed*

Recording Apparatus

Because Teledeltos was perfected originally for use with facsimile telegraph recorders where instantaneous, permanent message recordings requiring no drying or other processing are a fundamental requirement, it is natural that many such recorders have been designed to use this paper.

At least six distinctly different facsimile recorders have been used in Western Union Telegraph Company services and two new models now are in production.^{4 5 6 7} The most common facsimile carrier frequency employed is 2500 cycles with a maximum modulating frequency of 1200 cycles per second. The stylus travel with respect to the paper, as a rule,

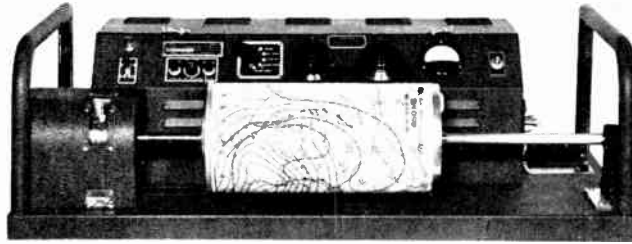

*Signal Corps type facsimile transceiver TT-1B/TXC-1
with weather chart recording*

is about 24 inches per second, and excellent recording is obtained with type H Teledeltos using 350 volts, open circuit, and some 15 milliamperes of modulated 2500-cycle alternating current at the stylus. For stylus material, steel piano wire of 10 mils diameter usually mounted on a piece of flat spring has been satisfactory but for continuous service, re-

drum operated at 60 rpm; thus the stylus travels over the paper at 18.8 inches per second. A tungsten wire stylus is used.

Teledeltos recorders have been used to monitor both the transmission and reception of pictures over cable, radio and land-line photo-process systems wherein, otherwise, the results are not known until film negatives have been developed. Messrs. Muirhead & Co., Ltd., of Elmers End, Kent, in England, furnished the recorder used for this purpose on HMS Vanguard during travels of royalty. This equipment, having a 66-mm (2.6 inch)-diameter drum normally operated at



*Message-a-minute facsimile telegram
recorder used in mobile Telecar motor
delivery service*

placements with longer-wearing hard-drawn tungsten wire are being made.

An outstanding facsimile transceiver especially well suited to reproduce 12-by 18-inch weather maps on type H Teledeltos is widely used by the Army and the Navy. This machine, made by Times Facsimile Corp., has a 6-inch diameter

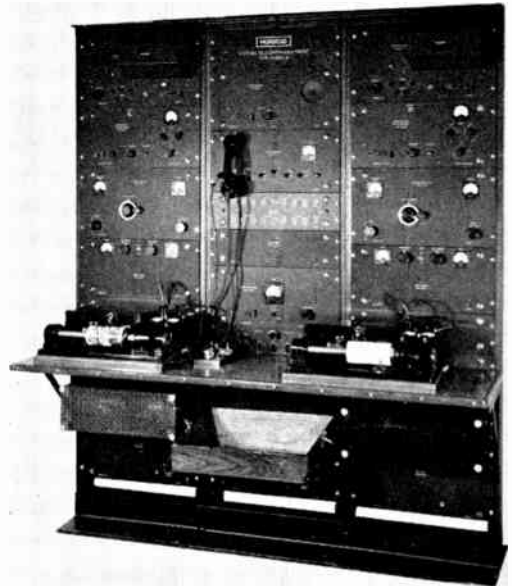

*Muirhead picture telegraph equipment with
Teledeltos monitor recorder at right*

60 rpm has a stylus-to-paper speed of 8.2 inches per second. The stylus is platinum-iridium wire attached to a short spring arm adjusted for 15 grams pres-

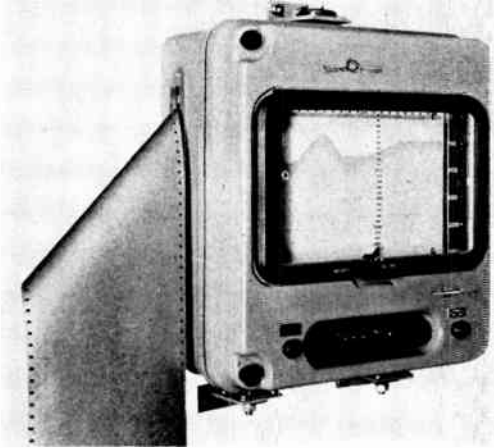

One type of Recording Fathometer or depth recorder made by Submarine Signal Company

sure. Open circuit potential at the stylus is 300 volts direct current. A 10,000-ohm resistor is connected in parallel, stylus to ground. Current is 10 to 50 milliamperes.

Among important industrial instruments using Teledeltos are marine Depth Recorders or Fathometers which, by means of echo sounding, show the dis-

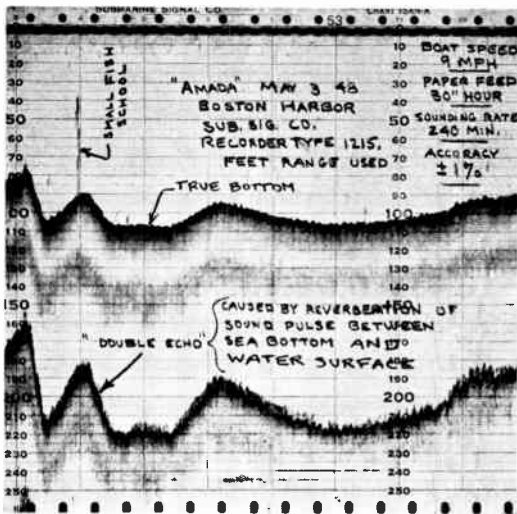

Echo sounding chart depicts harbor bottom

RECORDING PAPER

tance below surface level of anything having density different than that of the water, for example, sea bottom, submerged objects, and schools of fish. With continuous operation, the contour of the bottom over which a vessel moves is permanently recorded and its nature often may be distinguished. In addition to being a valuable aid to navigation this type of instrument now is used extensively by commercial fisheries all over the world.

Fathometers produced by Submarine Signal Company, Boston, Mass., employ both type H and type L Teledeltos with a conventional wire stylus of chrome-plated steel, usually 10 mils in diameter, mounted either at the end of rotating radial arms or on a belt which moves across the chart. Stylus pressure is adjustable between 2 and 10 grams and not critical within these limits. In different models, stylus scanning velocity is from 1.4 inches per second to 84 inches per second. Chart movement is from 1.5 inches per hour for deep sea navigation to 24 feet per hour for precision surveying in coastal waters.⁹

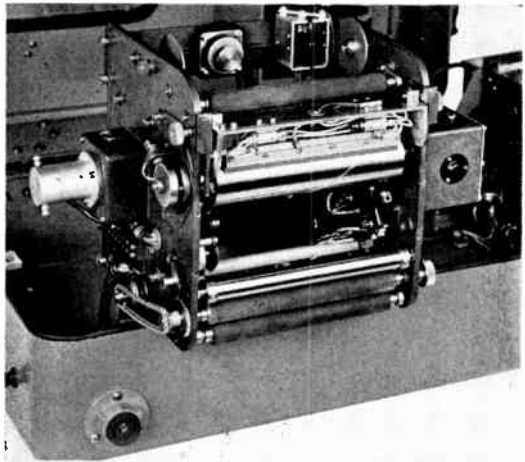

Spiral wire-and-blade recorder assembly of Bludworth Marine echo sounding equipment

In the Bendix-Marine instrument made at North Hollywood, Calif., wire styli are mounted on a revolving ring gear driven by a rubber pinion and guided by rubber rollers. For recording depth in feet, the

type L chart paper moves 1 inch per minute; for depth in fathoms, 1 inch in 6 minutes.

One depth recorder made by Bludworth Marine draws Teledeltos chart paper between a contact blade and a roller which carries a spiral wire conductor. The axial position of this spiral conductor at any moment fixes the point with respect to the base line at which a received impulse marks the chart. This is similar to an arrangement used in some facsimile telegraph recorders.

Automatic Train Recorders made by General Railway Signal Company, Rochester, N. Y., also employ Teledeltos, type L. These multi-stylus chronographs, associated with Centralized Traffic Control Machines, record the movement of trains on graphic charts varying in width from $9\frac{5}{8}$ inches to $29\frac{5}{8}$ inches and printed with time of day graduations scaled at 2 inches an hour. A distinctive feature of this slow-speed recorder is continuous transverse vibration of all styli by a motor, cam and guide bar to produce a mark that is $\frac{1}{16}$ -inch wide each time a stylus is energized momentarily.

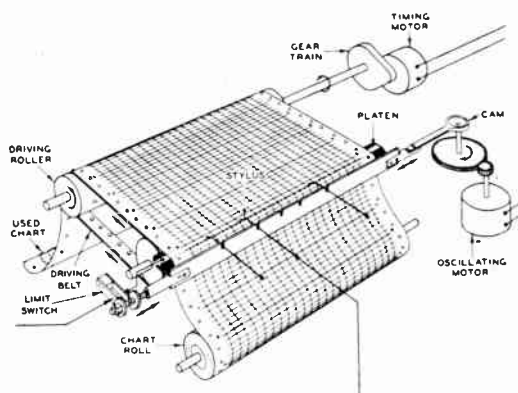

Oscillating stylus mechanism featured in G-R-S automatic train recorder

An apparatus made by American Instrument Company, Inc., Silver Spring, Md., from designs by Professors Taylor and Draper of Massachusetts Institute of Technology aeronautical engineering staffs¹⁰ is distinguished from most other Teledeltos recorders by the fact that it

successfully employs spark recording with an air gap one-eighth inch or less between stylus and electrosensitive paper. This is a recording high-speed engine indicator

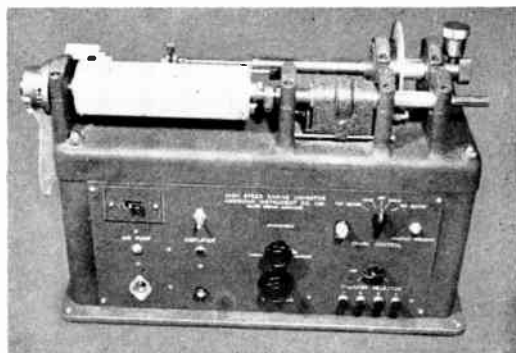

Spark recording high-speed engine indicator

which gives accurate pressure-time diagrams in testing internal combustion engines and fuels. The recorder drum about which the chart paper is clamped has a circumference of 9 inches and revolves normally at 700 to 2,400 rpm but may go as high as 5,000 rpm. The stylus arm carries a hard steel phonograph needle as the sparking stylus.

A noteworthy precision instrument is a multi-channel high-speed recorder specially designed and built for Wright Aeronautical Corp. by Graydon Smith & Company of Boston. This instrument, which is employed in gas turbine and other aircraft engine testing, is representative of many unique recording devices designed and built to meet the requirements of a specific research program. Graphs of 14 variables such as stress, strain, pressure, torque, speed and temperature may be made simultaneously together with 15 time-base reference lines.

Each galvanometer stylus is 7-mil-diameter tungsten wire $\frac{3}{16}$ -inch long mounted at the tip of an arm made of phosphor bronze tubing 40 mils in diameter and having a 1-mil wall, formed into a narrow triangle 5 inches long. Stylus pressure is about 2.5 grams. Type H Teledeltos is used. Maximum stylus motion occurs in recording a 35-cycle-per-second sine wave of 1.5-inch amplitude at a chart

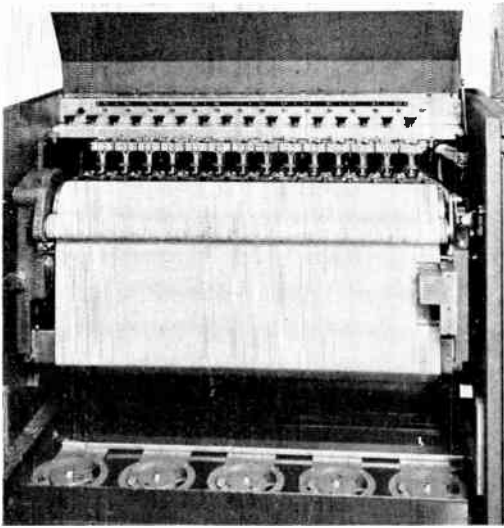

Instrument for engine research plots 14 variables and 15 time lines simultaneously

speed of 2 inches per second. Chart speeds of 2.0, 1.0, 0.5, 0.2, 0.1 and 0.05 inches per second are available.

At the Engineering Laboratories of International Business Machines Corp. a specially designed recording timer has been constructed for use as a test instrument to record mechanical movements and electrical impulses at a recurring rate of 200 per minute. A recording drum 8 inches in diameter is coupled or geared to the machine being studied. The stylus, which is 10-mil-diameter steel wire ad-

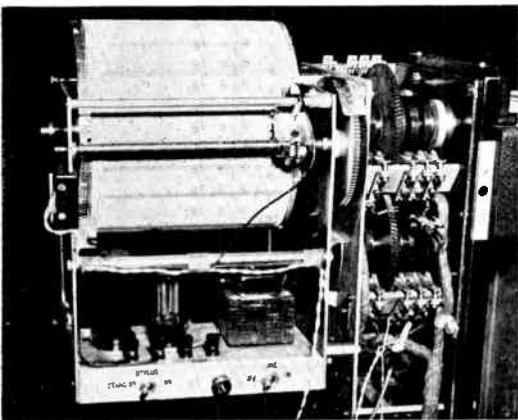

Laboratory chronograph made by International Business Machines Corp.

justed to 12 grams pressure, is moved parallel to the axis of the drum about 0.035 inch per drum revolution and, in operation, type L Teledeltos passes under the recording stylus at nearly 7 feet per second.

Modified Ink Recorders

While many industrial recorders have been made for Teledeltos, in some instances conventional ink recorders have been modified to use electrosensitive chart paper. For example, a modified Leeds and Northrup Micromax recorder, model S-40,000 series, in which the single pen was replaced by 20 styli and the paper drive speed increased to 2.5 inches per minute, has been used by Western Electric Company to chart the operation of oven thermostats for processing crystals. A timer interrupts the stylus current 1 second every 5 seconds to provide a measure of on-and-off intervals. The styli are 10-mil-diameter piano wire mounted on 5-mil-thick beryllium copper flat springs set at 5 to 10 grams pressure. With type H Teledeltos, 200 volts direct current applied through a current limiting resistance of 25,000 ohms for each stylus gives optimum results.

In a modified Esterline-Angus graphic ammeter, model AW, rated at 5 milliamperes, the pen was replaced by a stylus

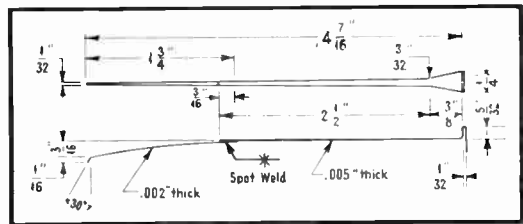

Stylus for modified graphic ammeter

to obtain desired high definition in recording radio signals. In this adaptation, a stylus made from 2-mil stainless steel sheet tapered to a point and bent at the tip for writing contact was found to be simple and serviceable. For extremely light pressure, a tapered endpiece was made about 2 inches long and narrowed from 1/16 inch down to 1/32 inch near the

tip, then this 2-inch section was welded to a more rigid member to form the whole writing element. With the point adjusted to barely touch the chart paper there is sufficient flexibility and no appreciable drag. The Teledeltos is held firmly and makes good contact against a metal backplate. Using type L Teledeltos, the current is limited to 2 milliamperes by resistance in series with the power source, preferably positive and not less than 300 volts.

A sound spectrograph developed at Bell Telephone Laboratories, now located at Murray Hill, N. J., employs Teledeltos for spectrogram pattern recording.¹¹ This instrument is a wave analyzer which produces a permanent visual record showing the distribution of energy in both frequency and time. With it there can be made visible patterns of speech and of other sounds, a development of significance in the field of speech training and education for the deaf. This application takes advantage of the fact that Teledeltos gives variable density or blackness of record with variable current so that energy intensity may be recorded.

Among "pattern" recorders using Teledeltos there is the phase-front plotter for centimeter waves made at RCA Laboratories, Princeton, N. J.¹² This plotter can be used to test centimeter-wave antennas.

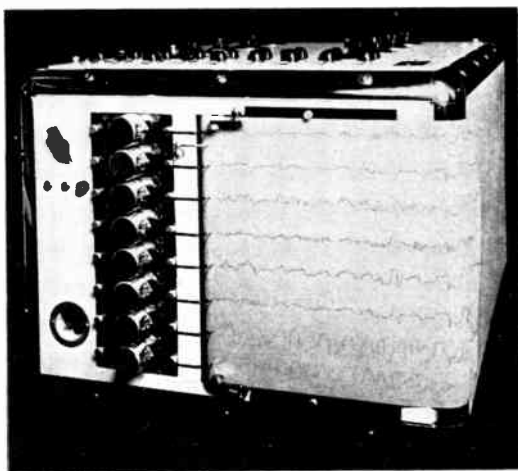

Top view of Garceau electroencephalograph, an 8-channel oscillograph brain wave recorder

to demonstrate principles of physical optics, or to measure the refractive index of dielectrics at radio frequencies. The recordings are equivalent to pictures of radio waves.

Since Teledeltos first became available it has been employed in various instruments made by Electro-Medical Laboratory, Inc., at Holliston, Mass. These range from simple chronographs for recording with straight lines the time relation of events, to multiple-channel direct-writing oscillographs for wave form charting and analysis.¹³

In the Garceau oscillograph, made by Electro-Medical, stylus design is of special interest. The stylus arms are 1/8-inch solid aluminum rods having replaceable tips. Each stylus tip is a small conical

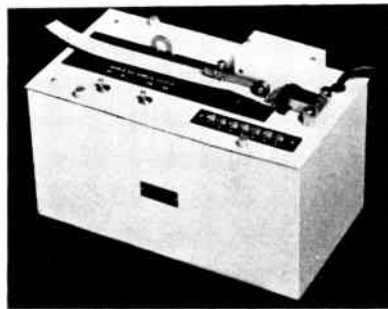

A Garceau recording timer or chronograph

point of refractory ruthenium alloy accurately ground and welded to a copper shank which is inserted into a hole bored in the end of a stylus arm. When the tip wears, after making some thousands of feet of record, it is removed like a phonograph needle and replaced.

One oscillographic direct-writing Teledeltos recorder for the medical profession actually is based on Western Union research in recording the minute signal impulses of submarine cable telegraphy. This is the Cardiofax, a new portable electrocardiograph to register electrical impulses of the heart, made by Electrofax, New Canaan, Conn. Licensed under Western Union patents, the amplifier and recorder combined are linear over a range of approximately 0.2 to 50 cycles per

second. The stylus movement is 20 mm each side of the center, a total of 40 mm. In this instrument, the stylus arm is unusually long and carries a long flexible stylus of 5-mil stainless steel sheet material which is not easily damaged.

The stylus pressure is not critical, the usual adjustment being of the order of 1 gram. The stylus current of approximately 3 milliamperes is applied in series with a 100,000-ohm resistor from the amplifier B supply. The stylus arm is driven by an especially designed dynamic type of oscillograph mechanism which produces an unusually large torque with the result that the drag of the stylus on the type L Teledeltos recording paper is entirely negligible.

Closely associated with medical instrument application is the use of Teledeltos in study and research laboratories at Boston University, Boston, Mass.,¹⁴ and other institutions where electrical recording devices have superseded the traditional smoked paper kymograph. At Boston University School of Medicine, recording is effected with 110-120 volt, 60-cycle,

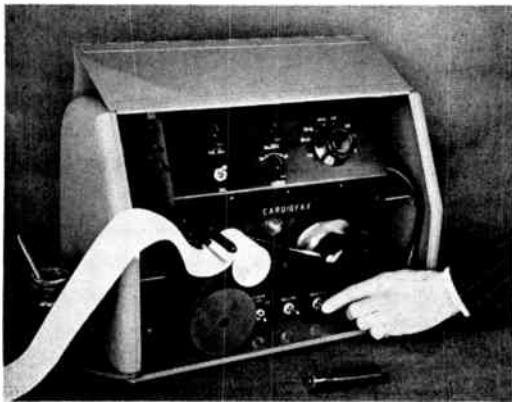

Cardiograph developed in Western Union's research laboratories charts heart impulses

alternating current through 10,000-ohm resistors and most styli arms are of music wire, fairly long, and tipped with writing points made from blunt ends of steel phonograph needles. In student laboratories, elimination of complicated apparatus and procedure helps focus attention on results rather than equipment.

RECORDING PAPER

There are, of course, many other situations in which Western Union Teledeltos is employed advantageously, but the few described were selected as typical and indicative of the broad field in which recording apparatus and techniques have been modernized by use of this unique by-product of telegraph research.

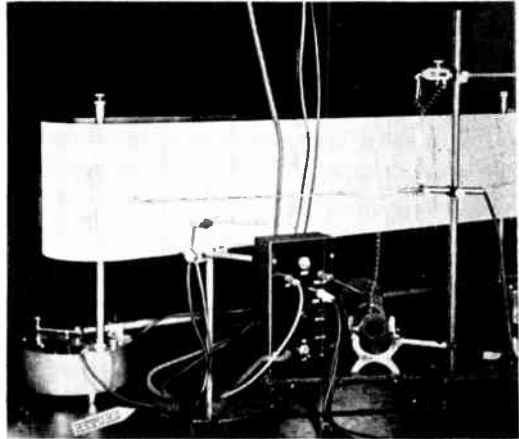

Teledeltos is superior for kymograph records

References

1. PICTURE TRANSMISSION BY SUBMARINE CABLE, J. W. MILNOR, *AIEE Transactions*, Volume 69, March 1941.
2. TELEGRAPH TRANSMISSION TESTING MACHINE, F. B. BRAMHALL, *AIEE Transactions*, Volume 50, No. 2, Jun. 1931.
3. U. S. PATENTS No. 2,181,533; No. 2,229,091; No. 2,251,742; No. 2,283,558; and No. 2,346,670.
4. THE AUTOMATIC TELEGRAPH, G. W. JANSON, *Communications*, Volume 19, No. 4, April 1939.
5. THE APPLICATION OF FACSIMILE TO COMMERCIAL RECORD COMMUNICATIONS, RALEIGH J. WISE, *Proceedings of the Association of American Railroads*, September 1941.
6. WESTERN UNION TELETYPE FACSIMILE, LEON G. POLLARD, *AIEE Transactions*, Volume 67, 1948.
7. FACSIMILE TRANSMISSION FOR PICKUP AND DELIVERY OF TELEGRAMS, G. H. RIDINGS, *AIEE Transactions* (Technical Paper 48-233), 1948.
8. RADIO AND THE ROYAL CRUISE, PICTURE AND TELEPHONE EQUIPMENT IN H.M.S. "VANGUARD", *The Electrician* (London), Volume 138, No. 5, January 31, 1947.
9. ECHO DEPTH SOUNDER FOR SHALLOW WATER, G. B. SHAW, *Electronics*, Volume 19, No. 9, September 1946.
10. THE M.I.T. INDICATOR, P. M. HELDT, *Automotive Industry*, July 28, 1944.
11. THE SOUND SPECTROGRAPH, W. KOENIG, H. K. DUNN, L. V. LACY, *Journal of the Acoustical Society of America*, Volume 17, July 1946.
12. PHASE-FRONT PLOTTER FOR CENTIMETER WAVES, HARLEY TAMS, *RCA Review*, Volume 8, No. 2, June 1947.
13. DIRECT-WRITING OSCILLOGRAPH BASED ON FACSIMILE PAPER, LOVETT GARCEAU, *Electrical Manufacturing*, Volume 31, No. 3, March 1943.
14. THE APPLICATION OF ELECTRICAL RECORDING METHODS TO THE STUDENT LABORATORY FOR PHYSIOLOGY AND PHARMACOLOGY, GEORGE L. MAISON and HANS O. HARTERLUS, *Journal of the Association of Medical Colleges*, Volume 22, No. 4, July 1947.



THE AUTHOR: Grosvenor Hotchkiss, Coordinating Engineer of the Development and Research Department, was graduated from the Polytechnic Institute of Brooklyn in 1918, and shortly thereafter joined the Traffic Department of Western Union as an Engineering Assistant. Subsequently, he acted for some years as Executive Assistant in the office of the President of the Teleregister Corporation, a subsidiary of Western Union. After returning to the parent company in 1935, he was Assistant to the Development Engineer until appointed to his present position in 1944. One of Mr. Hotchkiss's activities is to represent the D. & R. Department in business arrangements with other firms, which includes the marketing, here and abroad, of by-products such as Teledeltos; another is to assist in the preparation of technical material for the press. These activities have combined to give him an extensive knowledge of the properties and applications of Teledeltos. Mr. Hotchkiss is a past Member of the Society of Automotive Engineers and for some years was the editor of its Metropolitan Section monthly bulletin; he is a Member of the AIEE.

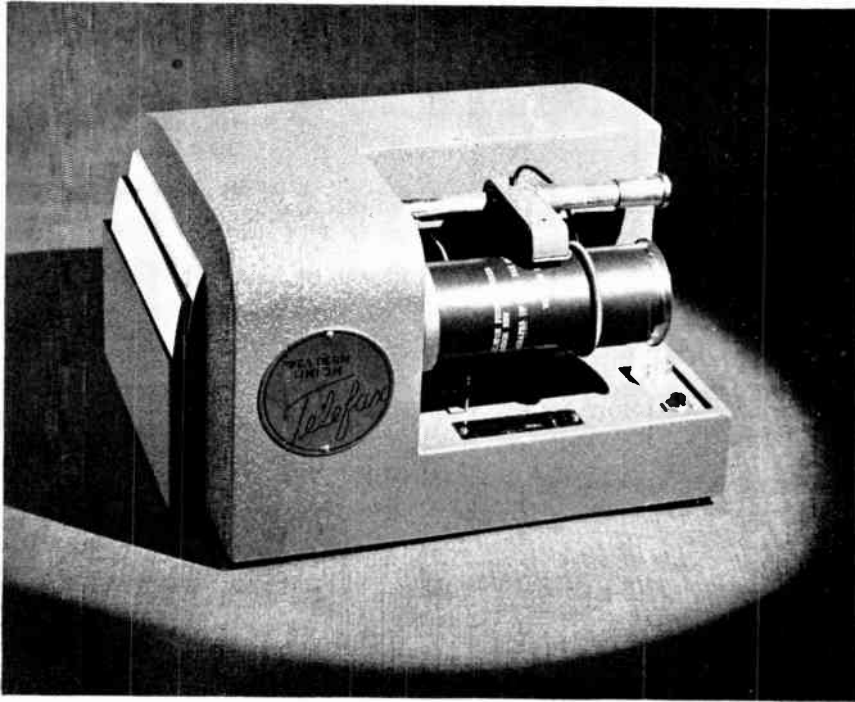

WESTERN UNION'S NEW DESKFAX

A Facsimile Transceiver for Pickup and Delivery of Telegrams

G. H. RIDINGS

A paper presented before the Winter General Meeting of the American Institute of Electrical Engineers in Pittsburgh, Pa., January 1948.
(Revised)

The mechanization program of Western Union, regarding which much has been said and written, has placed great emphasis on getting telegraph communications from one city to another in the quickest time practicable, at the least cost and with a minimum of human intervention. Direct circuits between the various cities have been increased in number many fold, and manual handling of messages has been replaced largely by mechanical switching methods at all but the terminating pickup and delivery points. All of these improvements have a great impact on the overall speed and

dependability of telegraph service. However, there is a vast majority of the American public whose use of the telegraph is only occasional, and who have no way of getting their telegrams to and from the telegraph office except by messengers or by telephone.

The most promising approach to the problem of providing faster terminal handling to these smaller patrons is the development and application of mechanical recording and transmitting devices which will be low enough in first cost and in operating and maintenance charges to permit their employment on a broad scale

for use in pickup and delivery service. The patrons to be served may be roughly grouped as:

1. Individual business houses.
2. Large office buildings, apartment houses and hotels, giving the occupants the benefit of direct connection to the central office, even though their individual use of the telegraph may be infrequent.
3. Residential areas, to be provided with automatic, conveniently located devices for pickup and Telecars for delivery. Telecars are automobiles equipped with message recorders having direct radio connection to the nearest central office.

It should be noted that all three objectives require direct wire communication with the central office by means of automatic or semi-automatic machines that will be simpler, less expensive, and easier to operate than telegraph printers, and better suited to written message service requirements than telephone recording. These requirements can be met only by employing some form of facsimile process.

What Has Already Been Accomplished

The basic ground work for a "Telefax"* service for pickup and delivery of telegrams by facsimile methods has been well laid and further progress should be at a rapid rate. The key of this development is a recording paper called "Teledeltos",* developed by Western Union and described in a separate article in this issue of TECHNICAL REVIEW.

Teledeltos is a dry recording paper which, unlike most recording media, requires no processing of any kind before or after recording. The coating of this conducting paper is light in color and turns black when an electrical current of about 20 milliamperes passes through it. Either alternating or direct current may be employed in recording. The paper is sensitive only to electrical impulses and is affected by light or moisture much less

*Registered Trademark of the Western Union Telegraph Company.

than is ordinary writing paper. It produces a clear-cut and permanent record, with no "fixing" of any kind required. There is no apparent ageing of records many years old. Teledeltos is extremely fast, pulses of 0.0001-second duration being easily recorded. It is capable of reproduction speeds many times the highest yet employed in commercial facsimile equipment. Its current density characteristic is such that fairly good half-tone reproduction may be obtained if desired, without special circuit arrangements. Its



Figure 1. Telefax transmitter-recorder with optical scanning

cost is a small fraction of the cost of photographic paper. Only the simplest of recording equipment is needed. Amplified tone signals, without rectification, may be applied directly to the paper by means of a stylus riding continuously on its surface.

A number of different types of automatic and semi-automatic transmitters, transmitter-recorders and recorders have been developed and employed commercially on a limited scale for the pickup and delivery of telegrams. Among these is the

transmitter-recorder shown in Figure 1, designed for use in a patron's office. It is about the size and shape of a teleprinter or typewriter. This machine may be placed on a table or desk or may be furnished complete with a pedestal. The machine is 11 inches high, 16½ inches wide and 15½ inches deep. It is self-contained, requiring only a pair of line wires, a ground, and a source of 110-volt, 50-60-cycle alternating current for its operation. This machine has three controls: a send-receive switch, a vernier control for adjusting the density of the recorded copy, and a starting switch. To transmit a telegram, the copy, either typed or handwritten on a blank of proper size, is wrapped by hand around the drum which protrudes from one side of the cover. The send-receive switch is set to "send" and the starting switch operated. Thereafter operation is entirely automatic. A call is set up in a concentrator at the central office. There, a switching unit in which the patron's lines terminate automatically connects an idle recorder to the circuit and the message is recorded. The scanning of the message for transmission is by a light beam and photoelectric cell, associated with a suitable system of lenses. After the message has been completely scanned, the patron's machine shuts down automatically.

To transmit a telegram from the central office to a patron, the attendant wraps the message about a drum and inserts it into one of several transmitters which are a part of the concentrator. She then connects the transmitter to the patron's line causing a buzzer to sound summoning him to his machine. The patron places a sheet of Teledeltos on the drum, sets the send-receive switch to "receive" and operates the start switch. Transmission starts immediately and automatically. When the message has been recorded and the transmitter stopped, a red signal lamp on the top of the patron's machine will light and the patron may stop the machine and remove the telegram. If the patron does not stop the machine it will continue to scan until the entire blank has been scanned, at which time it will shut itself off auto-

matically. If, in sending or receiving a message, the send-receive switch is inadvertently placed or left in the wrong position, the red signal lamp will light and transmission will not start until the switch is operated correctly.

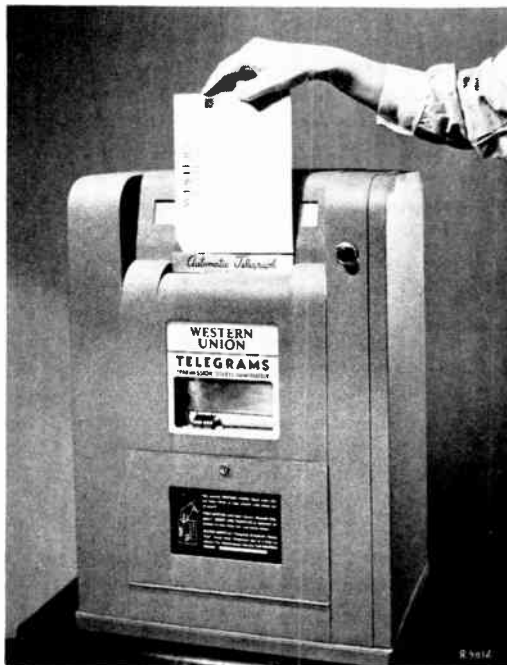

Figure 2. Automatic Telefax transmitter

Another Telefax development is the transmitter shown in Figure 2, designed to facilitate the pickup of telegrams in office buildings, apartment houses, hotels, and similar locations. In this equipment another step has been taken towards the goal of a completely automatic telegraph system. With these machines, it is easy to file a telegram. The sender or agent simply presses a button and drops the telegram into the slot in the front of the machine. This is all that is required of him. The telegram automatically wraps itself about the drum of the transmitter and the entrance to the slot closes, preventing the insertion of another telegram until the first one has been transmitted. Several of these machines may be operated over one line pair where the volume of business is light. Circuits from these transmitters terminate, in a central office,

in a facsimile receiving concentrator from which all of the functions of the transmitter are controlled. After the message has been recorded at the central office, the telegram is stripped from the drum of the transmitter and deposited into a receptacle beneath the drum, and the transmitter released.

Two types of transmitters are employed in this service. One is a wall model about 30 inches high, 15 inches wide and 8 inches deep. The other, illustrated in

in a public place, a coin slot mechanism may be employed.

Figure 3 illustrates an automatic Telefax recorder employed in the Telecar delivery service previously referred to. This recorder, which is controlled by radio from the central office, employs a roll of Teledeltos from which a length sufficient for one message is automatically formed into a cylinder and scanned internally, then cut from the roll and ejected from the front of the recorder. The pro-



Figure 3. Telefax recorder for mobile delivery of telegrams

Figure 2, is a table model, 24 inches high, 16 inches wide and 12 inches deep. This model may be equipped with a pedestal, if desired, so that it will rest directly on the floor. Both machines are completely self-contained, requiring only a pair of line wires, a ground, and a source of 110-volt, 50-60-cycle alternating current for their operation. Where an agent is employed to operate it, the machine is equipped with a push-button for starting. Where it is to be installed for unattended service, in an office building lobby for example, it may be equipped with a lock switch, for which charge account patrons in the building will be supplied with keys. In the case of the unattended installation

cess is automatic and while the operator of the car is delivering one telegram, another is being recorded and deposited into the convenient receptacle just under the dash of the car. Radio and control equipment is located in the trunk of the car.

Radical Changes in Design Necessary to Lower Equipment Cost

When the patron's transmitter-recorder, shown in Figure 1, was developed, it was expected that it would answer the service requirements of a large majority of small businesses. The results of the limited installations which have been in service throughout the war years have been

highly satisfactory. However, post-war economic conditions have made it necessary to develop a simpler and cheaper machine to serve a larger portion of the Telegraph Company's patrons, particularly those in the "small business" category, and thus make possible nationwide expansion of patron Telefax service.

To undertake such a development, it was necessary to think along radically different lines than heretofore. Conventional methods of scanning, line-feed, etc., had to be discarded. The simplest means of facsimile recording is that wherein the

itself, for the most part, into the development of a simple, economical, easy-to-use sending blank upon which writing and typing would have a different conductivity than the blank itself. Two methods for the preparation of sending copy have been developed. One method employs a sheet of Teledeltos similar to that which is used for the receiving copy. Over this is placed a sheet of special carbon paper; writing or typing on the back of this carbon paper transfers the electrically conducting carbon onto the surface of the Teledeltos. The carbon pene-

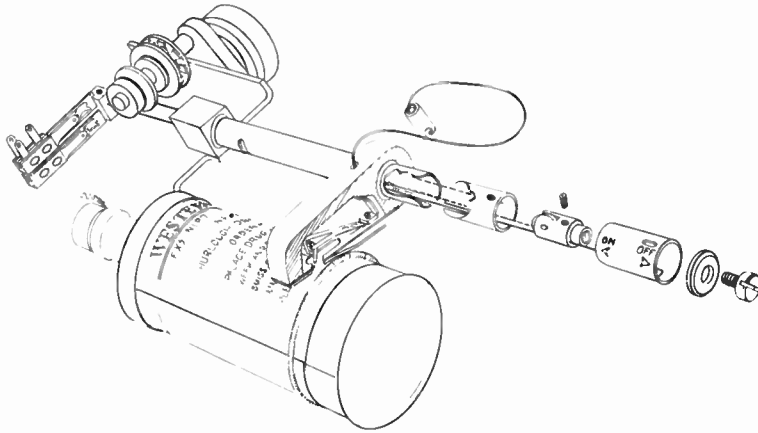

Figure 4. Schematic view of scanning mechanism of Deskfax transceiver

facsimile signals are applied directly to a stylus riding continuously on the surface of an electrosensitive record sheet. Since Teledeltos was already available for this purpose, this method of recording was retained for the new model transceiver. Now, it was reasoned, if some form of conductive pickup could be employed, this same stylus could be utilized to scan the sending copy and a really simple transceiver would result. Why not use conductive pickup? The principle is sound, as old as facsimile itself. True, it will not give good half-tone characteristics, but for message transmission this is not necessary.

What about the preparation of copy? The use of conductive pickup would simply mean furnishing patrons with a different kind of blank than would be provided for use with some other type of transmitter. The problem then resolved

trates the thin insulating coating of the Teledeltos, making contact with the conductive base of the paper. A stylus scanning such copy would traverse characters of low resistance, whereas the background of the paper would present an extremely high resistance—practically open circuit.

The second method employs a sheet of black conducting paper, which is the same as ordinarily coated to form Teledeltos. This method also involves the use of a special "carbon paper". In this case the so-called carbon paper is coated with a white insulating wax so that writing or typing on its reverse side transfers white insulating characters to the black conducting paper. A stylus traversing this subject copy would encounter characters of very high resistance—practically open circuit, whereas the background of the paper would present a fairly low resistance. Using such a sending blank, it is a

simple matter to key or modulate the output of a vacuum tube oscillator. With the aid of a bridge arrangement, it is equally easy to provide for signal conversion so that, with a simple adjustment, a "positive" or a "negative" may be transmitted from either of the two types of subject copy.

Mechanism of the New Transceiver

The simplest scanning mechanism for a facsimile machine consists of a drum upon which the original copy or recording sheet is mounted, and which rotates at constant speed while the scanning point or stylus moves at a uniform rate along the length of the drum. Of course, the same relative motion could be secured by causing the drum to move along its axis as it rotates, with the scanning point remaining fixed in space, but the former method is usually employed. Conventionally this relative motion, or line feed, is secured by means of a feed-screw and half-nut, but in the new transceiver, shown schematically in Figure 4, it is accomplished by winding up a cord on a drum or reel powered by a small clock motor. The reel is frictionally coupled to the motor shaft so that the stylus housing may be manually returned to the start position after the completion of each transmission. A slotted tubular track is provided to support and guide the stylus housing, with the slot fashioned in such a manner as to cause the stylus housing to be raised from the drum in the start position, to facilitate loading. The cord which is attached to the stylus housing at the pin projecting through the slot in the tube, passes over the pulley at the right end of the tube then back again through the tube to the reel on the clock motor shaft at the left of the machine. The motor causes the stylus housing to feed to the right and it is returned manually by pushing it towards the left at the end of transmission. The pin riding up the incline in the tube slot at the extreme left lifts the stylus housing to a vertical position. The stylus holder is a replaceable unit to facilitate renewal, and the stylus itself is pivoted so that when the

housing is in an upright position the stylus is completely withdrawn into it. Pivoting the stylus also prevents damage to this vital part of the mechanism, if the patron should improperly remove a blank from the drum without first returning the housing to the start (upright) position.

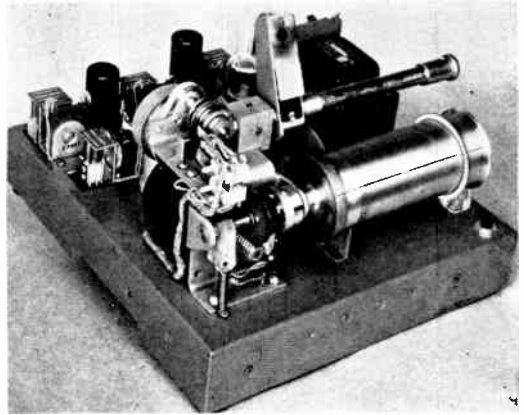

Figure 5. Deskfax transceiver—cover removed

"Deskfax"

Figure 5 is a close-up of the mechanism of the new transceiver. The subject copy or record sheet is held on the drum by the flange at its left end and by a toroidal spring which is rolled onto it from the right end. A small synchronous motor mounted on the rear of an L-shaped bracket drives the drum through a single set of gears, and a simple fabric brake on the drum shaft takes up any back-lash. On the drum shaft is a commutator which is used for phasing. Above the drum motor, on top of the bracket, is the small clock motor with frictionally coupled reel which causes the stylus housing to move out along the tube parallel to the drum. At the extreme right end of this tube is a sleeve which is connected by means of a rod extending through the tube back to a "start-stop" switch mounted on top of the bracket. This sleeve, which is operated manually to the left to start the transceiver, will be moved to the right or "off" position by the motion of the stylus housing as it completes the scanning of the message blank.

The controls of this transceiver are simpler than those of the larger machine of Figure 1. Both machines employ a start-stop switch which also serves as an end-of-message switch, but this newer transceiver does not have a send-receive switch nor a control to regulate the density of the recorded copy. In this transceiver, operation of the start switch automatically sets up the machine as a transmitter unless a call has been placed at the central office causing the buzzer to operate in the patron's machine. Under these conditions operation of the start switch automatically sets up the transceiver as a recorder.

Since the circuits from these transceivers may terminate in large concentrators at the central office, the use of number sheets there would be extremely cumbersome. Provision is therefore made for the patron to acknowledge individually the receipt of each telegram. This is accomplished by means of a push-button which he operates, after a small neon lamp and buzzer, on his machine, have indicated that the transmission to him is complete.

The mechanism is assembled from sim-

ple stamped and bent sheet metal parts and die castings wherever possible, with a minimum of machined parts, most of which are of the screw-machine variety. The drum and stylus-feed motors, gears, start-stop switch and stylus connector are inexpensive commercial items. There are no close tolerances and the stylus construction is such that considerable eccentricity of the drum may be tolerated. The entire mechanism mounts on the L-shaped bracket and may be assembled or disassembled in a very few minutes with no special tools. There are few adjustments, none critical.

Electronics and Control Circuits— Characteristics

The mechanism mounts across the front of a sheet-metal chassis which contains the electronics and control circuits. Wiring of the mechanism terminates on convenient terminal strips on the chassis to facilitate servicing or replacement. Figure 6 shows the complete unit with cover removed, and Figure 7 shows the underside of the chassis with bottom plate removed. Although the chassis measures only 10½ by 11½ inches, there is no crowding of parts;

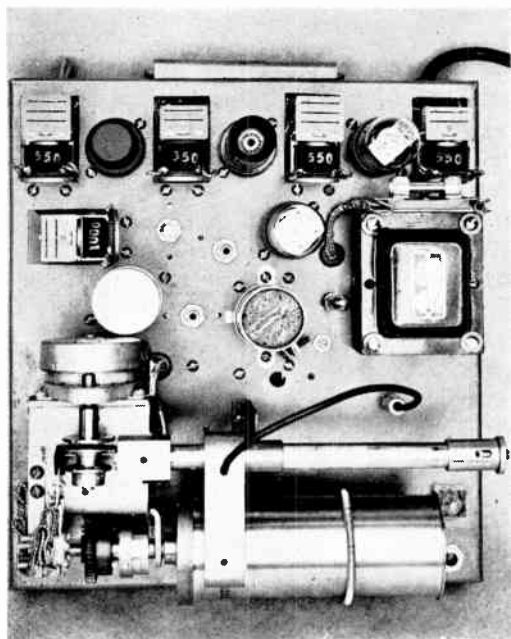

Figure 6. Top view of Deskfax transceiver showing layout of parts

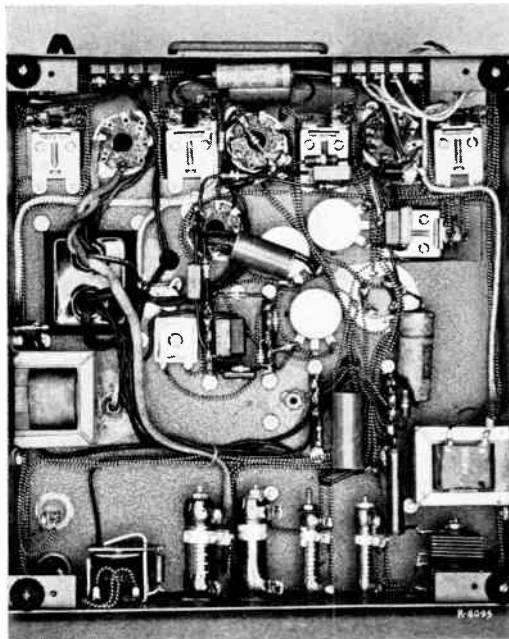

Figure 7. Bottom view of Deskfax transceiver showing accessibility of components

relays, vacuum tube sockets, terminal strips, and other vital components are readily accessible for test or maintenance purposes. The electronic circuits employ four tubes,—a rectifier for power supply, a dual triode which serves as oscillator and transmitting amplifier, and a high- μ pentode and a power output tube which serve as the recording amplifier. The use of separate tubes for transmitting and recording would appear an extravagance, but such is not the case. By switching tubes from one circuit to the other, one tube at most would be saved, the cost of which is more than outweighed by the simplification of switching and wiring which the use of separate tubes permits.

Controls are provided for transmitting and recording levels and for bridge balancing. These are set for each installation and remain unchanged unless servicing is required. A terminal strip is provided for attaching line wires and ground, another for attaching a rubber-covered power cord so that the desired length of cord for each installation may be provided. With the exception of the oscillator coil, all components of the electronic and control circuits are inexpensive commercial items. The power transformer is similar to that used in the smallest a-c table model radios. A transformer couples the amplifier to the line pair, serving as an output transformer when transmitting and as an input transformer when recording. Control relays are the inexpensive rugged type employed in juke boxes and pinball machines. No critical adjustments are required. The relays are mounted so that the contacts are accessible for cleaning. Wiring of the unit is comparable to that of a small table model radio and can be done in economical assembly-line fashion. The overall dimensions of the transceiver with cover and blank holder are $11\frac{1}{8}$ by $11\frac{1}{4}$ by 7 inches high. It weighs about 19 pounds. Maximum power consumption is 100 watts, and no power is consumed when the machine is idle.

The oscillator frequency is about 1900 cycles and since a total band width of 1900 cycles is adequate, the transceiver will operate over an ordinary telephone

pair. The two-inch drum rotates at 180 rpm and the line feed is 125 lines per inch, to match the index of cooperation of the central office equipment which employs a larger size blank. Blank size is $6\frac{1}{2}$ by $4\frac{1}{2}$ inches, with a useful message area of $5\frac{3}{8}$ by 3 inches. This will accommodate about 150 typewritten words and is transmitted in two minutes. No special provisions for synchronization are made, the synchronous driving motor being operated from the same commercial 50- or 60-cycle a-c power source employed at the central office. Phasing, signaling and other necessary control functions operate on a d-c basis using the physical wires with ground return through a center-tapped primary of the line coupling transformer. Phasing clutches on the central office transmitters and recorders are controlled by the commutator of the patron's machine.

Central Office Equipment— Circuit Operation

Circuits from patrons' transceivers terminate in Western Union central offices in concentrators made up in multiples of 50-patron units. Each 50-patron unit is provided with four conventional telegram-size optical transmitters and six conventional size page-type continuous recorders. The transmitters employ the so-called "color sensitive" photocell and improved electronics, so that messages received by tape printer, page printer and various other means may be retransmitted by Telefax with equal fidelity.

To send a message to a patron, the central office operator wraps the message about a drum, inserts the drum into a transmitter and plugs up to that patron's circuit. This removes positive standby potential and applies negative potential to the line over the simplex circuit which operates a relay in the patron's transceiver, causing the buzzer to sound. When the patron answers the call by loading his drum with a Teledeltos recording blank and operating the start switch, the buzzer stops and his transceiver is automatically set up as a recorder. As soon as the transceiver's tubes heat up, a relay operates to start the stylus-feed motor

and to send out phasing pulses (interruption of the direct current over the simplex loop). The central office transmitter phases immediately and the transmission of the message proceeds. When the message has been transmitted, the transmitter stops and polarity of the battery on the line is reversed, causing the acknowledge lamp and buzzer to operate in the patron's transceiver. After the patron has examined the recorded message he operates the acknowledge push-button which extinguishes the light, stops the buzzer and opens the simplex loop, giving an acknowledgement indication to the central office operator. The operator then removes her transmitter from the line.

To send a message to the central office, the patron wraps the subject copy, prepared as described previously, about the drum and operates the start switch. This sets up the transceiver as a transmitter and operates a relay at the central office which gives appropriate indication to the operator that a call from that patron is waiting. She connects a recorder to the calling circuit and operates a start button. As soon as the heat relay of the transceiver has operated, the recorder phases from the first phasing pulse from the transceiver's commutator. Contacts on the phasing relay reverse the potential on the line which starts the stylus feed motor at the transceiver. Transmission continues until the transceiver shuts down automatically or until the patron manually operates the start-stop switch. The recorder also stops and a light indicates to the operator that the message is complete. She rotates a paper-feed-out knob on the recorder until the conventional telegram blank length of paper is fed out, at which time the light is extinguished. The message is then torn off and the recorder disconnected.

The first concentrators for this service will be of the plug-and-jack manual type, the switching turret resembling the familiar PBX switchboard. Circuits have been worked out for a more automatic concentrator, with automatic line finders on the receiving side and push-button switching on the sending side, should this method of operation be found desirable.

Patron-to-Patron Transceiver

A machine similar to the Deskfax described above has been developed for patron-to-patron use. That is, two machines work together, directly, without any central office concentrator equipment. The same mechanism is employed with some rearrangement of the control circuits and a simple phasing circuit whereby one motor drifts into step with the other. Phasing is accomplished without the use of conventional magnets or clutches, employing the commutator on each motor shaft and an added capacitor which is connected across the recorder driving motor, causing it to run slightly under synchronous speed until pulses from the two commutators are in step, at which time the capacitor is removed and both motors run synchronously. Such machines may be used to provide intercommunication for business organizations or for pickup and delivery of telegrams, where only a few patrons are involved and a concentrator is not justified.

Installations of this type have been in operation in one of the Eastern cities for the past several months, from which considerable information has been obtained that has been helpful in improving the design. A number of ways were found to simplify and improve the mechanism and reduce the manufacturing costs. The trial installations have so decisively demonstrated the effectiveness of Telefax as a means for pickup and delivery of telegrams that quantity production of transceivers, incorporating all of the improvements resulting from the trials, is now under way. The manufacturing cost of the new unit is expected to be about one-third that of the larger patron's machine shown in Figure 1. Central office concentrator equipment is being manufactured for installations in six major cities. Although over a million telegrams a year are currently handled by facsimile equipment, the new installations will increase the volume of telegraph traffic handled by facsimile methods many fold, and should pave the way for still larger installations in the future, particularly for small volume telegraph users.



THE AUTHOR: Garvice H. Ridings, a graduate of Virginia Polytechnic Institute, has been associated with the Western Union since 1926, and with the Telefax group since shortly after its inception; he is now Assistant Telefax Research Engineer of the Development and Research Department. In the early part of the war, Mr. Ridings directed the installation at Washington of Western Union's facsimile equipment which carried British Embassy secret code messages for all parts of the empire. He has designed much of the Company's telefax apparatus for both central offices and customers, giving his attention usually to the more fully automatic devices. The ingenious new Deskfax transceiver, described in the above article, is the culmination of his major assignment in Telefax research and design. Mr. Ridings is a Member of the IRE.

Microwave Lenses

A. BOGGS

The development, under the impetus of military needs of the last war, of devices capable of successfully generating, transmitting and receiving super-high-frequency radio waves has opened up a new and attractive field to communications.

The attraction lies not so much in the fact that a previously unused region of the radio-frequency spectrum can now be exploited, as in the fact that these super-high-frequency, short-wave-length radio waves permit high directivity to be obtained with relatively simple and physically practicable antenna structures. With these extremely short waves, bona-fide point-to-point radio transmission is now a practical reality. The radio waves leaving the transmitter are confined to a prescribed narrow path and the receiving antenna will respond only to waves arriving within the limits of a small solid angle.

There is nothing new nor essentially different about these microwaves to distinguish them from the better known broadcast type of radio waves except their wave length. Both consist of electromagnetic energy propagated as a form of wave motion at a velocity depending upon the permeability and the dielectric constant of the intervening medium. In free space this velocity is 186,000 miles per second no matter what the wave length may be. It might be argued with good reason that because they are identical in nature equally good directivity could be obtained with either. This assumption is, of course, theoretically sound and the use of directive antenna systems antedated the advent of microwaves by many years. However, the degree to which concentration of the radiated energy was accomplished fell far short of that now realized with microwaves.

The efficiency of any directive antenna array depends primarily upon the number

and the accuracy of spacing of antenna elements employed, and upon the precision with which the antenna currents can be maintained in correct phase relations. The wave length at which the antenna array is designed to operate determines the element dimensions and spacing, and these factors in turn determine the area occupied by the system.

As an example for comparison, suppose a directive array for a 4000-megacycle microwave system occupies a circular plane area 4 feet in diameter and confines 50 per cent of the radiated energy within a conical path having a 6-degree apex angle. The diameter of a similar array which would yield a comparable result for a 1-megacycle broadcast wave can be estimated from consideration of the relative wave lengths. The wave length at 4000 megacycles is 7.5 centimeters or about 3 inches. At one megacycle the wave length is 30,000 centimeters. Multiplying 4 feet by 30,000 and dividing by 7.5, gives 16,000 feet or approximately 3 miles, as the diameter of an equivalent array for a 1-megacycle system. This would be an unwieldy structure, which might be used lying flat on the ground for communicating with the moon, but would be quite impractical for mounting vertically in order that its narrow beam might be directed toward some selected receiver on the earth's surface.

The assumed 4000-megacycle directive antenna array might have been made up of a large number of dipole antennas all lying in the same plane area and all parallel to one another. It would also have been essential that the excitation currents fed to each of these antennas be in phase, because the necessary condition for the radiation from this array to be concentrated in a parallel beam is that the wave radiated by each of the elementary antennas be in phase with that from all the

others. Construction of the antenna array might not be too difficult an undertaking, but the large number of radio-frequency feeder lines that would be needed, and the accurate adjustment of different line lengths to meet the phase requirements would present far too complex a problem.

However, it is not necessary to resort to this complicated procedure to achieve the end result represented by a multiplicity of in-phase radiations from elementary antennas lying in a common plane. Parabolic mirrors have been used for years to obtain concentrated search-light beams and, since light waves and radio waves are exactly the same thing except in the matter of wave length, it is reasonable to expect that a parabolic reflector would work as well with radio waves within the limitations imposed by size relative to the wave lengths involved.

The geometry of a parabola is such that if the source of radiated energy is located at a certain point on the axis, called the focus, energy striking the parabolic surface at any point will be reflected in a direction parallel to the axis. A second and equally important characteristic resulting from the parabolic shape, is that all possible paths leading from the focus to the parabola surface, and thence out to the plane of the open face are equal in length.

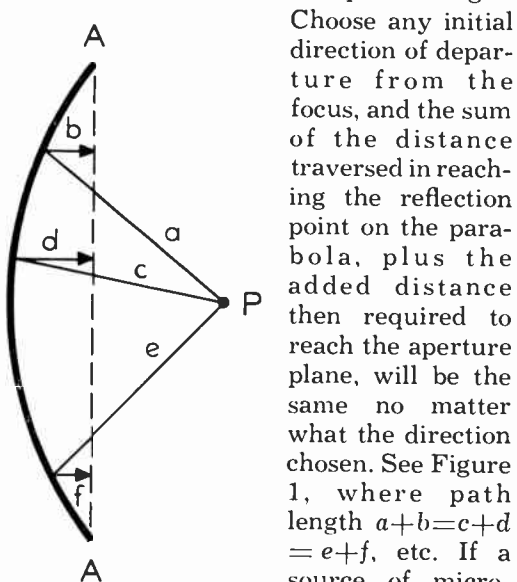

Figure 1. Parabolic reflector

Choose any initial direction of departure from the focus, and the sum of the distance traversed in reaching the reflection point on the parabola, plus the added distance then required to reach the aperture plane, will be the same no matter what the direction chosen. See Figure 1, where path length $a+b=c+d=e+f$, etc. If a source of microwave radiation be

located at the focus, all regions of any reflected wave front will be in phase when they reach the plane of the parabola aperture, since all will have travelled equal distances. Thus the parabolic reflector automatically insures the second required condition for a directive antenna array all the elements of which lie in a common plane. This requirement is that the radiation from all elements be in phase as was pointed out earlier in this discussion. The plane of the parabola aperture is then equivalent to this assumed array. The array in this case consists of an infinite number of radiating dipoles, since the entire aperture area is occupied by the radiating electro-magnetic field. There is no objection to this although so large a number is unnecessary. Parabolas from which a substantial fraction of the metal has been removed to form continuous slots in the reflecting surface work just as well.

Microwave Lenses

In the field of optics, another means for controlling the behavior of electro-magnetic waves is available. Lenses made of glass or other transparent materials can change the path direction of light, and in view of the success of the parabolic reflecting mirror in both fields it seems reasonable to expect that lenses, if they could be made large enough, could be used with radio waves as well. There is, however, an important difference between the two. With the parabola, the path of the waves is wholly in air and the only source of energy loss is that due to incomplete reflection at the surface. When a lens is used the radiation must pass through the lens, and a material that transmits light with negligible loss might absorb a large part of the energy in a radio wave, since the frequencies are so different. Therefore, while lenses may be applicable to radio waves, it cannot be assumed that a microwave lens and an optical lens will so closely resemble each other as do the parabolic reflectors.

In explaining the action of a microwave lens, discussion will be confined to the formation of a parallel beam from the divergent radiation from a primary source

such as a single dipole antenna. When a source of light is placed at the principal focus point on the axis of a convex lens, the light emerging from the opposite face of the lens is concentrated into a parallel beam. It is customary to say that each ray of light on passing through the curved surface of the lens is so bent that on emerging all are parallel. This concept of geometrical optics is useful in visualizing what happens, but has little value in the understanding of why it happens.

It will be recalled that the parabola formed a parallel beam by establishing identical phase at all points in a plane surface, this plane surface being the open face of the parabola which is of course perpendicular to the resultant direction of propagation of the beam. To accomplish the same result, the lens must bring about the same condition. The parabola did this by setting up equal path lengths in a common medium, the air, for all parts of the wave front. The lens does it differently. In travelling from the source to the emergent face of the lens, any selected path will lie partly in air and partly in the lens. Now the fundamental property of a lens is that the propagation velocity in the material of the lens is different from that in air. The relative lengths of the paths through air and through the lens can be adjusted by varying the thickness of the lens from center to periphery, so that the time consumed in traversing the air portion of the path plus that consumed in traversing the lens is equal for all paths. Equal time intervals represent equal phase shifts, and when this condition is attained a parallel beam or, as it is sometimes called, a plane wave is obtained. In optical lenses the velocity of wave propagation in the lens material is less than in air, and a convex shape must be used to change a divergent into a parallel beam. This can be understood from consideration of the situation shown in Figure 2. A wave starting from the point P will spread out equally in all directions and, after a time t_0 , a cross section of the wave front, defined as the locus of points of equal phase, may be represented by a circle of radius r since the velocity is the same in all directions; $r = V_a t_0$, where

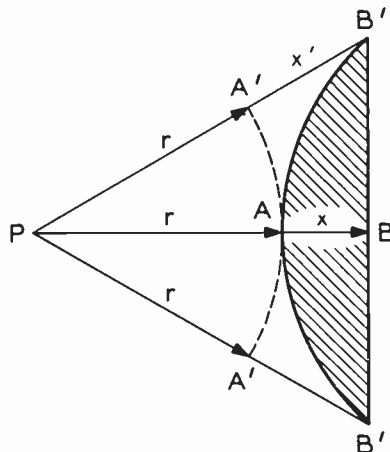

Figure 2. Convex lens

V_a is the velocity in air. If a convex lens is now interposed in the path of the beam, it may be imagined that at time t_0 the wave front is tangent to the curved surface of the lens at point A . To reach the opposite plane face of the lens at B , the portion of the wave incident at A travels the distance X through the lens. The outer portion of the wave which at time t_0 was in the position marked A' must travel the distance X' to reach the point B' on the plane face of the lens. The distance X is less than the distance X' but if the velocity in the lens is less than in air by the ratio X/X' , the wave will travel from A' to B' in the same time it travels from A to B . These two parts of the wave front will then be in phase, since they were in phase at A and A' . The curvature of the lens can be adjusted so that this condition will hold throughout the wave front, and the condition then existent on the plane face of the lens will be identical with that obtained with the parabolic reflector.

If the wave velocity in the lens were greater than in air, a concave instead of a convex lens would be used. This situation is illustrated in Figure 3.

In Figure 3, the wave front spreading out from the source P is represented by the arc of a circle of radius r , where $r = V_a t_0$. The outer portion of the wave has reached the lens at point A' at this time, while the central portion must still travel the distance X between points A and B to reach the lens surface. During the

ensuing time interval while the central portion of the wave is moving through air from A to B , the outer portion will be travelling through the lens for some distance X' . If it is desired that both portions of the wave reach a common plane in the lens, designated by the line $B-B'$, at the same time, it is necessary that the velocity in the lens be greater than the velocity in air, since X' is seen to be larger than X . If the velocity in the lens is greater than the velocity in air by the ratio X'/X , the two time intervals will be the same and

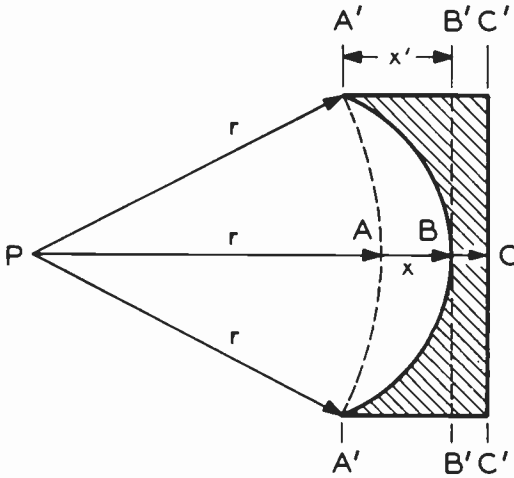

Figure 3. Concave lens

the two portions of the wave front will be in phase in the plane $B-B'$. The remaining portion of the lens between $B-B'$ and the face $C-C'$ will have no effect on the relative phases, since both paths lie within the lens where the velocity is constant. When the contour of the curved surface of the lens is properly adjusted, all portions of the wave front arrive in phase at $B-B'$ and therefore at the face, $C-C'$, of the lens.

Although it is true that in the materials used for optical lenses the velocity is always less than the velocity in air, it has been found possible to construct lenses for microwaves in which the lens velocity is the greater. This is the Wave Guide Lens.

Wave Guide Lens

This lens is made up of a multiplicity of wave guide sections of various lengths. The longest sections occur at the edges

of the lens and the shortest in the center, with a uniform gradation of length between these extremes. A section through the lens parallel to the direction of propagation would appear as shown in Figure 4.

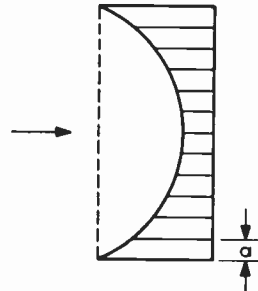

Figure 4. Section of wave guide lens

The explanation for the increased velocity in wave guides is found in the manner in which an electromagnetic wave is propagated through the guide. The individual waves do not travel from end to end of the guide in a straight line parallel to the center line, but follow diagonal paths inclined at an angle to the center line. The wave thus progresses through the guide by means of successive reflections from the inner surfaces of the opposite walls. This situation, and the reason why it results in a velocity in the forward direction greater than the normal wave velocity, is shown in Figure 5. The dashed lines represent the position of some individual wave front at two different times, t_1 and t_2 . The wave has a velocity V_a in a direction which makes an angle Q with the center line of the guide. This velocity V_a (the guide is assumed to be filled with air) and in the time interval $t_2 - t_1$ the wave will have moved from point A to point C , a distance in the diagonal direction equal to $V_a (t_2 - t_1)$, but the electromagnetic disturbance represented by field intensity in the wave front, if measured along the center line, will have moved from point A to point B . The distance $A-B$ is equal to the distance $A-C$

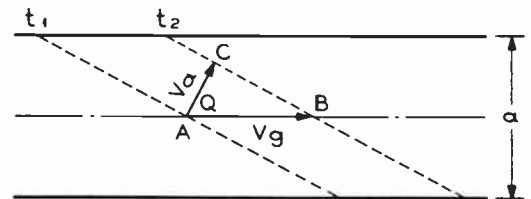

Figure 5. Wave propagation in a wave guide

divided by the cosine of the angle Q , $A - B = A - C/\text{Cos } Q$. The time interval is the same for both, so $V_g = V_a/\text{Cos } Q$ where V_g is the effective phase velocity in the guide. The cosine of an angle is never greater than unity and, therefore, V_g will always be greater than V_a and the ratio V_g/V_a will increase as the angle Q is increased. This is an undesirable feature of the wave guide lens since the angle at which the waves travel in the guide and, therefore, the resultant forward velocity increase with increasing wave length.

The curved surface of the lens can, therefore, have a contour which is strictly correct for but one wave length. This restriction is not too serious, if the system to which the lens is applied employs only a narrow range of wave lengths.

The cosine of the angle Q is given by the equation:

$$\text{Cos } Q = \sqrt{1 - \left(\frac{\lambda}{2a}\right)^2}$$

where a is the distance between opposite sides of the guide and λ is the wave length. This is an expression for the ratio of velocities which in optics is known by the name "index of refraction". In the wave guide lens the desired index of refraction, probably that for midband wave length, is obtained by adjusting the dimension " a ".

The Artificial Dielectric Lens

To avoid the effects of the too rapid variation of index of refraction with wave length inherent in the wave guide, a type of lens in which the focusing action is more closely analogous to that of an optical lens has been developed for use in wide-band microwave systems.

The time delay imposed upon a light wave in passing through glass or other transparent dielectric is a natural attribute of the mechanism by which light energy, which is electromagnetic in nature, is conducted through the dielectric. A dielectric material contains no free electric charges, but the bound charges may oscillate about their equilibrium positions under the influence of an applied oscillating electric field, subject to the restraints of neighboring charges and the

restoring forces set up by the electric polarization which results from disturbance of the equilibrium or neutral condition. These oscillating charges constitute miniature dipole antennas which re-radiate an electromagnetic wave whose frequency is that of the disturbance which initiated the oscillation. There is, however, a phase difference between the oscillations of these dipoles and that of the incident electric field. The charges, whether they be polar molecules or electrons in the atoms, have mass and therefore exhibit inertia. The restoring forces which arise when electrical equilibrium is disturbed resemble the action of springs opposing any departure from equilibrium. An electrical circuit, consisting of inductance and capacitance to which an alternating voltage is applied, is an analogous situation. That such a condition actually exists in dielectrics is evident from the phenomenon of anomalous dispersion. The index of refraction is found to increase rapidly with frequency as some critical frequency is approached. At this frequency, the index suddenly decreases from values greater to values less than unity. This performance resembles closely that of a resonant circuit as the applied voltage is varied through the resonant frequency region. However, if the frequencies with which one is working are far enough removed from the resonant frequency in case of an inductance—capacitance circuit or from the frequency of anomalous dispersion in a dielectric, the variation of response with frequency will be negligible.

The propagation of a light wave through a lens may then be regarded as a process of successive absorption and reradiation of the electromagnetic energy by oscillating molecular or atomic dipoles, with an increment of phase delay added by each repetition of the cycle of events.

This elementary picture becomes vastly complicated when the interactions in exchange of energy among the myriads of atoms composing the dielectric material are considered. A more satisfactory equivalent picture then might be a transmission line, made up of short sections of series inductance and shunt capacity in

which the transmitted energy is alternately stored up in the shunt capacity and passed on to the next section through the series inductance. This represents a lump-loaded line which, if properly designed, will produce a substantially constant propagation velocity at all frequencies up to at least one-half the cut-off frequency. This cut-off frequency of the lump-loaded line corresponds to the frequency of anomalous dispersion in a dielectric.

A solid dielectric lens of a material having suitably low losses could be used for radio waves, except for the fact that high efficiency in a lens is obtained only when the dimensions across the beam are large relative to the wave length. This size re-

ments in the direction of the electric field of the radio wave is not greater than half the resonant length, the variation in index will be negligible. Radio waves are generally polarized and, for this reason, the elements need be restricted in one direction only,—that parallel to the electric field, to avoid effects of resonance. The elements may be of any desired length in the direction parallel to the magnetic component of the wave, because the electrons will oscillate only parallel to the direction of the electric field. However, the thickness of the elements must be restricted since the magnetic field cannot penetrate a conducting material at high frequencies. If the elements are not quite

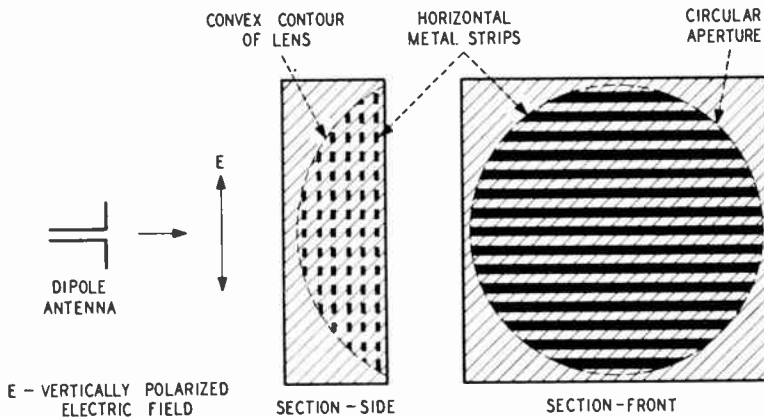

Figure 6. Artificial dielectric lens. Metallic strips imbedded in an insulating material

quirement would make a solid dielectric lens prohibitively heavy and also very costly to manufacture.

The artificial dielectric lens structure permits large areas without entailing excessive weight. In this lens, the free electrons in a conducting material perform the same function as the oscillating charges in a dielectric. The lens does not consist of conducting material throughout, but rather of small conducting elements suitably disposed in a supporting structure of an insulating material. The conducting elements must be small relative to the wave lengths involved, because otherwise resonant effects will be introduced and a variation in index of refraction will be observed. A dipole antenna is resonant when it is approximately one-half wave length long. If the dimension of the ele-

thin, the configuration of the wave will be changed due to distortion of its magnetic components.

These considerations lead to a structure consisting of thin copper discs or strips with insulating support and so spaced as to secure the proper phase relations as the wave energy is passed along from element to element. As in a real dielectric, the resultant time delay for any portion of the wave will be proportional to the number of absorption and reradiation cycles which it has experienced in passing through the lens. This lens, therefore, closely resembles a convex optical lens in shape. The convex shape is secured by placing more conducting elements in the center than at the edges. One resultant type of structure employing metallic strips is shown in Figure 6.

It has been shown that the parabolic reflector and the artificial dielectric lens are theoretically equivalent in so far as their focusing action is concerned. However, there are some points of difference in the performance of the two under actual operating conditions. The principal difference comes about from the means employed to combine the directive device and the radiating antenna.

When the parabola is used, the antenna is located near the plane of the parabola aperture. Thus only about one-half of the total radiated power is intercepted by the reflecting surface. This situation can be improved by placing a small reflector beyond the antenna to return a portion of the forward radiation back to the parabola. A hemispherical reflector would return all the forward radiation to the parabola, and so double the gain of the system if the radiation so returned were in phase with the backward radiation. This will be the case if the hemispherical reflector is located an integral number of half wave lengths from the antenna, a condition that can be strictly true for but one wave length.

Another effect, not predicted by the simple theory of the parabola which we have considered, is radiation from the edges. This produces small beams at the side of the main beam and even some radiation in the backward direction. This phenomenon is not confined to parabolic reflectors but is inevitable in all optical devices of limited extent when the illumina-

tion across the aperture is uniform. It is known as aperture diffraction and occurs with lenses as well as with reflectors. When microwave lenses are used, the radiation from the antenna is fed to the lens through a wave guide which, when it meets the lens, is flared out into a large opening that fits accurately the periphery of the lens. This arrangement simplifies the problem of constraining a major portion of the radiated energy to pass through the lens, and also tends to reduce the side lobes. This latter effect is the result of the manner in which energy is distributed across the lens by the flared wave guide feed. The energy falls off rapidly near the edges in a horizontal direction—if the antenna is vertical in the wave guide. The side lobes in the horizontal plane may be substantially reduced by a proper choice of flare angle in the feed. However, the side lobes in the vertical plane are little affected.

It is likely that much the same effects could be realized if some type of electromagnetic horn feed were applied to the parabola, and only experience can decide whether one is definitely superior to the other. But aside from its practical virtues, the artificial dielectric lens is a beautiful example of what may be accomplished through faith in the universal applicability of a fundamental principle.

References

1. RADIO LENSES, W. E. KOCK, *Bell Laboratories Record*, May 1946, page 193. *Proceedings IRE*, Nov. 1946, page 828.
2. METALLIC DELAY LENSES, W. E. KOCK, *The Bell System Technical Journal*, Jan. 1948, page 58.

THE AUTHOR: A. Boggs, Assistant to Transmission Research Engineer, majored in physics at Ohio State University, graduating in 1925. Following a year as Graduate Assistant in Physics, also at Ohio State, he received the Master of Science degree and then joined the Research Division of Western Union. His activities, largely devoted to telegraph transmission problems, have included: mathematical studies of various phases of signal transmission; investigation of inductive interference and development and application of mitigative equipment; development and application of carrier loading and impedance matching systems; correction of distortion and related problems. Mr. Boggs heads the group which is responsible for development of inductors, transformers and electric networks, and which has designed the numerous types of filters widely utilized in Western Union carrier systems. He is a member of Phi Beta Kappa, and Pi Mu Epsilon, honorary mathematics fraternity.



Thyratrons in Loaded Cable Multiplex

H. H. HAGLUND and A. W. BREYFOGEL

One of the interesting applications of electronic circuit components in telegraphy is the use of the thyratron tube or grid-controlled rectifier as a relaying element in a multiplex system which was developed for operating over Western Union's loaded transatlantic cable. While many of the features of this eight-channel system are unusual, they will be described only in sufficient detail to display the use of the thyratron as an important circuit element.

The cable circuit itself is made up of two sections: one between Hammel, Long Island and Bay Roberts, Newfoundland, a distance of 1,350 nautical miles; and one between Bay Roberts and Penzance, England, a distance of 2,021 nautical miles. The American and British ends are carried to New York and London, distances of 26 and 312 miles, respectively, over three conductors. The termi-

nal equipment is located at New York and London, with facilities provided for connecting any or all channels to land lines beyond these points.

THE LOADED SUBMARINE CABLE

Unlike other submarine cables that cross the Atlantic into England, this cable, known as 4-PZ, is inductively loaded. The permalloy loading material, in the form of a tape, is wound spirally around the copper core. Its purpose is to increase the inductance of the cable, thereby decreasing its attenuation and raising its signaling capacity well above that of non-loaded cables of comparable size and weight.

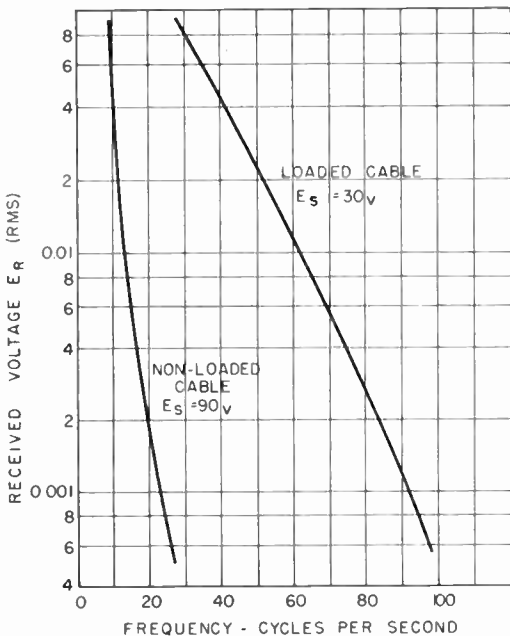

Figure 1. Attenuation Curves

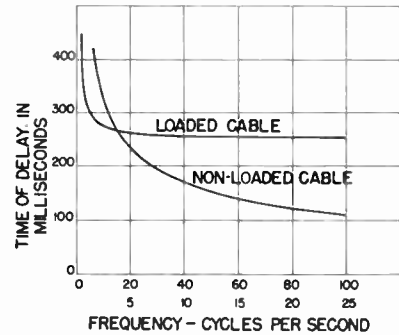

Figure 2. Time Delay Curves

Transmission Characteristics

Figure 1 shows the attenuation curves of the 4-PZ cable and a typical non-loaded cable, for their respective frequency bands. Figure 2 shows the delay or propagation functions of the same cables. Note that the loaded cable has a practically constant propagation time above 25 cycles.

Signal Shaping and Amplification

It is apparent from these curves that the received signals must be amplified and corrected for phase and amplitude dis-

tortion before they can be used. Signal shaping and signal amplification have been treated fully by others and will not be discussed here except to point out what constitutes a good signal shape. In general, the single pulses suffer so much attenuation that they are rarely more than twenty per cent as large as signals containing two or more pulses, as shown in Figure 3.

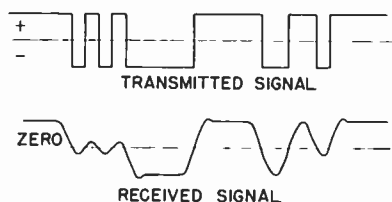

Figure 3. Signal attenuation

All signals of two or more units in length must be the same amplitude and must not tend to fall or tail off. Since the multiplex apparatus is designed to anticipate signal reversals and to "fill-in" the attenuated single pulses, signals having these general characteristics are satisfactory.

MULTIPLEX EQUIPMENT

It is well known that trunk telegraph circuits are channelized and operated with printers, the usual number of channels being two to four. Long circuits are generally sectionalized and at each junction a regenerative repeater is used to effect a complete restoration of signal before it is passed from one section to the other. The 4-PZ circuit falls in the latter category. Before describing any circuits in detail, the actual apparatus arrangement will be described briefly for one direction only.

The cable is designed to work simplex at a frequency of 100 cycles or 2400 letters per minute multiplex. When channelized, eight channels at 300 letters per minute are available. Since 100 cycles is too fast for the land-line connections, two wires are required to carry the signals between New York and Hammel, and between Penzance and London. A

third wire is used to carry a synchronizing signal. By making both terminals synchronize to a signal generated locally at the adjacent cable stations, the very accurate synchronism necessary with the 100-cycle signals is confined to the cable sections.

Distributors having two 4-channel face plates and two sets of brush arms are used at the terminals, and are driven and corrected by means well known. The transmitting segments of the two face plates are mechanically arranged so that pulses from one are transmitted a quarter cycle behind those from the other.

Special and much larger distributors, Figure 4, are used with the regenerative repeaters at Hammel, Bay Roberts and Penzance. They are true 8-channel distributors having 40 transmitting segments and 80 correcting and receiving segments. The brush arms are driven by phonic motors which receive their power from vacuum tube-controlled forks. These forks are kept in temperature-controlled ovens and have an accuracy of approximately one part in forty thousand.

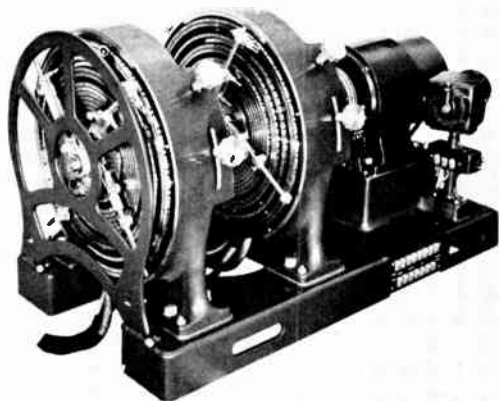

Figure 4. Distributor used with regenerative repeaters

The signals from New York are repeated into the receiving rings at Hammel through polar relays. Here they are picked up, momentarily stored on relays, and then transmitted into the cable. The arrangement is such that the signals from the two feeder circuits are interleaved

as shown in Figure 5. When all channels are idle (the condition indicated in the figure), single, double and longer duration pulses are transmitted. This arrangement requires every element of each repeater to function, so that a failure of any element becomes evident just as quickly when the channels are idle as it does

that lend themselves well to high-speed telegraphy. They operate by virtue of the fact that, for any specific positive anode potential, there is a critical value of control-grid voltage. If the control grid is maintained more negative than this critical value and the tube is not conducting, the anode current will remain zero. If the

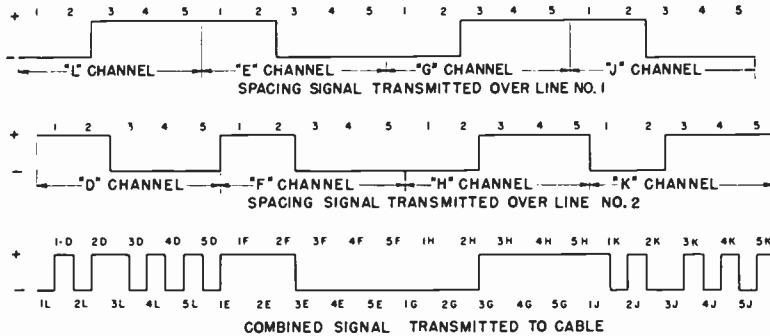

Figure 5. Interleaved signals from two feeder circuits

when all channels are operating. The polarity balance of 20 positive and 20 negative pulses prevents amplifier and apparatus bias.

At Bay Roberts the received signals are shaped, amplified and transmitted directly to the receiving rings. These rings function in connection with two thyratrons, two storing relays and suitable sending rings, to transmit to the next cable section signals that have been completely regenerated, i.e., corrected for phase and amplitude distortion.

The receiving equipment at Penzance is a duplicate of that at Bay Roberts, but the transmitting arrangement differs. The interleaved signals are there separated and transmitted to London in the same sequence and phase as when leaving New York.

The three main repeating points are provided with monitorial equipment for checking purposes. All stations are provided with apparatus for reversing the direction of transmission. This equipment is manually controlled by the station attendants.

THE THYRATRON

Thyratron tubes are used as circuit elements at the repeater stations only. The thyratron possesses unique characteristics

control grid is made less negative, the tube becomes conducting and the anode current assumes a value determined by the circuit parameters and the anode potential. In the conducting state, the tube voltage drop is quite low and is substantially independent of the grid potential. To extinguish the discharge and allow the grid to regain control, the anode potential must be reduced to zero or made negative.

For high-speed telegraph systems, this tube has distinct advantages over relays. It has neither travel time, bounce nor characteristic distortion, and can be controlled from voltages of relatively low order. The critical control-grid voltage for the tubes and potentials used in this system is of the order of -2 volts. The tube is suitable for signal selection, also for phase and bias correction.

THE APPLICATION OF THYRATRONS

Signal Selections

The receiving and interpolating or "fill-in" circuit, shown in Figure 6, is of particular interest and will be described first. It consists chiefly of two thyratrons, a pair of pickup rings, two sets of anode rings, two storing relays, a pair of transmitting rings and a source of signals. The relationship that the segments have to

each other is important. The front edges of the "A" pickup segments align with the front edges of the "AR" anode segments, and these segments are associated with relay SR-1 and tube T-1. Similarly, the front edges of the "B" pickup seg-

driven negative by an incoming signal, a negative potential is alternately applied to the grids of the two tubes and neither will start. Under this condition, current flows only through the left-hand windings of the storing relays and their tongues

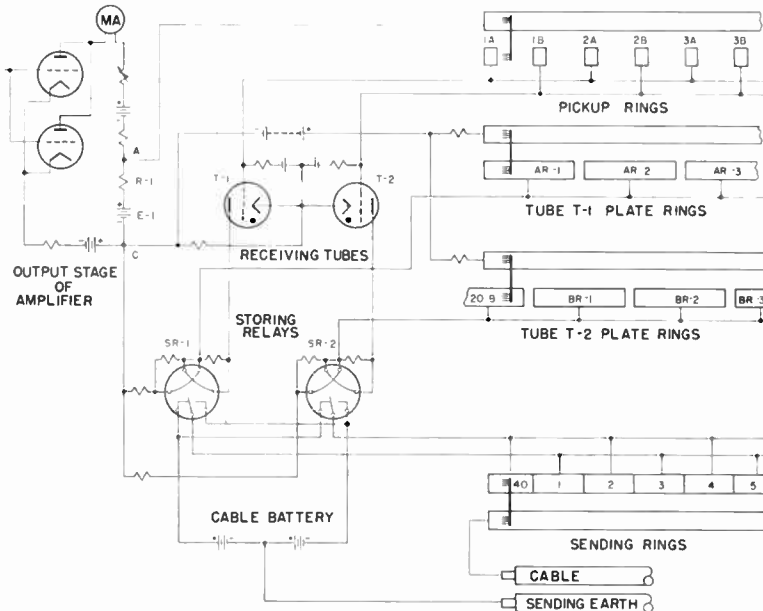

Figure 6. Receiving and interpolating circuit

ments align with the front edges of the "BR" anode segments which are associated with relay SR-2 and tube T-2.

For the present, it will be assumed that the brushes are maintained in synchronism with those of the distant station and that a correct phase relationship has been established. The signal voltage for controlling the operation of the thyratrons is obtained from a portion of the compensated output stage of a vacuum tube amplifier. It is the difference between the voltage drops across resistance R-1 and the battery E-1. This difference in voltage follows the signal and is either negative, zero or positive for corresponding signals.

These signal voltages are successively applied to the grids of the tubes through the pickup segments as the brushes move from left to right. Simultaneously with the contacting of a pickup segment, the anode is connected to positive battery through an anode segment and one winding of a storing relay. If point "A" is

are moved to the right. Negative signals are then retransmitted to the cable by the transmitting rings. If, however, point "A" is driven positive by the signal, a positive voltage is alternately applied to the grids of the tubes and each will start. Current will now flow through both windings of the storing relays. The current through the right-hand windings is twice that through the left, resulting in a movement of the tongues to the left. Positive signals are then retransmitted to the cable. Signals of two or more units in length are correctly regenerated in the above manner, and it only remains to show how the attenuated single pulses are properly interpolated or filled in by the tube circuits. This feature may best be explained with the aid of Figure 7.

Assume the received signal to be of the form illustrated at the top of Figure 7, and a phase relation indicated by the segments and their associated brushes. During the interval in which the signal was

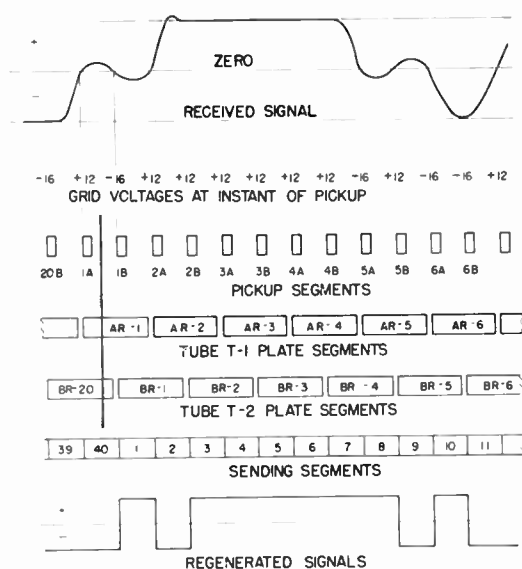

Figure 7. Attenuated single pulses interpolated by tube circuits

at its maximum negative value, a potential of -16 volts was alternately applied to the grids of the receiving tubes and neither tube became conducting. However, at the instant the brush makes contact with pickup segment 1-A, the received signal has decayed to zero and a potential of $+12$ volts is applied to the grid of tube T-1. Tube T-1 now becomes conducting and its anode current, in addition to positioning to the left the tongue of its associated relay SR-1, generates a negative potential of 28 volts which either adds to or subtracts from any voltage produced by the signal. Consequently, as the brush continues to segment 1-B, the voltage impressed on the grid of tube T-2 is not the $+12$ volts produced by the signal, but becomes the arithmetical sum of this voltage and that generated by the anode current of tube T-1, or -16 volts. Therefore, tube T-2 remains non-conducting and satisfies the condition coincident with receiving a negative pulse. Before the brush has reached pickup segment 2-A, the anode circuit for tube T-1 is interrupted at segment AR-1, extinguishing the tube and preventing it from further influencing the grid-controlling voltage. On reaching pickup segment 2-A, the brush applies a potential of $+12$ volts to

the grid of tube T-1, causing it again to become conducting. This operation satisfies the condition coincident with receiving the first pulse of a long positive signal. Succeeding positive pulses are properly interpreted because the voltage produced by the maximum positive signal is greater by 12 volts than the negative voltage generated by the anode current of either tube. In this manner, the attenuated single unit pulses are properly interpolated and retransmitted, as illustrated by the lower curve of Figure 7.

During the preceding discussion, it was assumed that the signal crossover always occurred at the instant a brush was in contact with a pickup segment. If perfectly shaped signals were being received and if the parasitic interference were at a negligible level, that assumption might hold true. Unfortunately, however, the received signals are seldom perfect or entirely free of distortion. To assure that the two receiving tubes will correctly interpret such signals, their interpolating ability must be broadened to extend over some portion of the positive and negative signal values. These interpolating limits or "tube limits" cover about half the total signal amplitude above and below the zero.

The thyatron tube has a very closely defined threshold grid voltage and, under optimum conditions, the tube will discriminate between fractional voltage differences. Under the operating conditions just described, where the grid circuit is momentarily connected to a source of potential, this voltage is not as closely defined as is desirable and some loss in selecting efficiency is experienced. With the voltage between the cathode and signal source set at the statically determined starting potential of -2 volts, it was found that the tube could not be depended upon to start each time the brush made contact with a pickup segment. To insure starting, this voltage had to be reduced to -1 volt. Also, to insure non-starting, this voltage had to be increased to -3 volts. There is, then, a region two volts wide through which the performance of the tube is nonpredictable and has been designated as the "area of uncertainty".

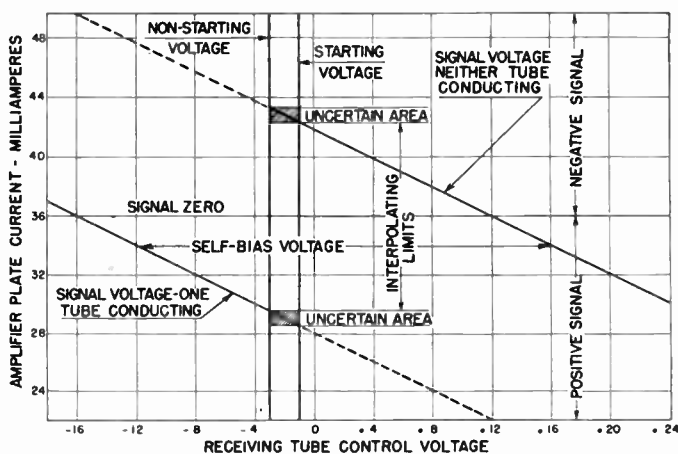

Figure 8. Signal limits chart

In Figure 8, an attempt has been made to show both the interpolating limits and the area of uncertainty in terms of the maximum signal swing and the voltage available for controlling the thyratrons. In this graph, the amplifier output current—representative of signal height—is plotted against the controlling voltage appearing between points “C” and “A” of Figure 6. It will be seen that the interpolating limits extend over approximately half the total signal swing, while about six per cent of the total signal swing is lost due to the threshold voltage being not very sharply defined, as mentioned earlier.

Phase Correction

The control circuit which determines when phase compensation is necessary, and its companion circuit for actuating

the mechanical corrector are shown in their simplest form in Figure 9. These circuits consist chiefly of four thyratrons, a pair of correcting rings, a mechanical corrector and a source of signals. The synchronizing tubes T-1 and T-2, together with the correcting rings, determine when phase compensation is needed, while the other two tubes actuate the correcting mechanism.

The signal voltage for controlling the operation of the synchronizing tubes is obtained from the same compensated output stage of the vacuum tube amplifier referred to earlier. The positive and negative controlling voltages appear alternately at the points “A” and “B” as the signal changes from positive to negative or vice versa. The tubes are arranged in an inverter circuit employing a biasing

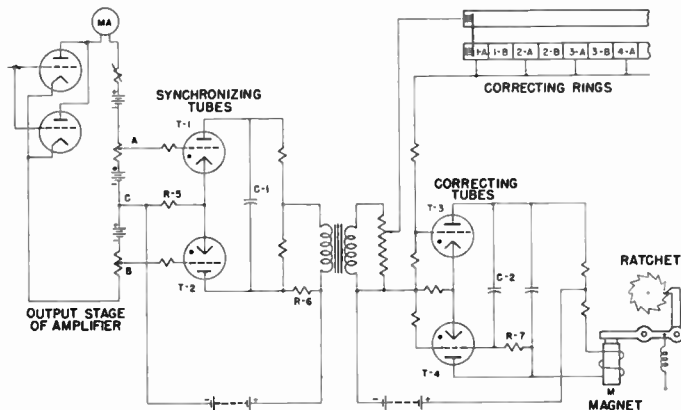

Figure 9. Phase correction control circuits

resistor R-5, so that response is obtained only when complete reversals occur and never from the attenuated single pulses.

The polar signals produced by the operation of the synchronizing tubes have a very steep wave front if the extinguishing condenser C-1 is small enough to allow the transient to be of short duration. A transformer is used in the common positive feed to the two tubes, its function being to separate the transient produced at the instant of signal reversal from the direct current component. The transient voltage thus produced is of short duration and exceptionally steep wave front. Two transients are produced, one by reversals from negative to positive and a second by reversals from positive to negative. The latter are only a fifth as large as the former, because of the shunting action of resistance R-6. The larger kicks are used to determine when correction is necessary.

The arrangement is such that the brushes at the receiving station rotate slightly slower than those at the sending station, and correct phase is assumed to exist when the correcting brush is in contact with an unused or dead correcting segment at the instant a signal reversal from positive to negative occurs. As the brushes fall behind, the correcting brush will eventually be in contact with a live segment at the instant such a signal reversal occurs. Under this condition, the grid of the corrector tube T-3 is connected to the source of voltage kicks and it starts. The starting of T-3 extinguishes its companion tube T-4 through the inverter circuit action. The corrector armature is now released, under the influence of its spring, and the brush arm is advanced, thereby restoring it to a true phase position. The corrector tube T-3 is extinguished by the restarting of tube T-4. This function is controlled by a delay circuit consisting of C-5 and HR-4, its purpose being to assure complete operation of the mechanical corrector. Bursts of corrections resulting from interference can also be avoided by this arrangement.

Figure 10 shows the incoming signals and the signals produced by the synchronizing tubes. The broken lines above

and below the zero of the upper curve indicate the points on the received wave where the tubes operate. The synchronizing tubes are never allowed to operate on the attenuated single pulses because these signals are not always well defined and are more likely to suffer phase distortion. The lower curve shows the transient voltages produced by the signal reversals.

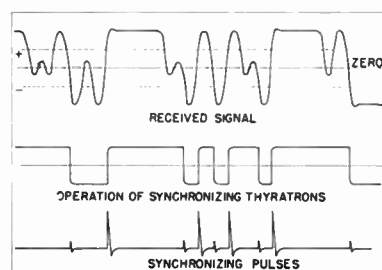

Figure 10. Synchronizing tube signals

Earth Current Correction

Incorporated in the amplifiers supplied for the first loaded cables were means for neutralizing the bias produced by earth currents. This neutralizing means provided a relay whose adjustment was such that it operated only when the signal had deviated from its true zero position by three or four per cent. The operation of this relay, through proper delay circuits, acted to restore the signal to its true position. This arrangement worked reasonably well, but somewhat greater stability has been obtained through the use of thyratrons arranged as shown in Figure 11. The signal voltage for controlling the operation of the tubes is also obtained from the compensated output stage of the amplifier, but from points sufficiently high on resistors R-1 and R-2 to assure non-operation on signals of normal height. Since the threshold voltage of the thyatron is quite accurately defined for an application of this kind, points "A" and "B" can be chosen within one or two per cent above the maximum signal height. Should the signal zero deviate from its normal position by this amount, the threshold voltage of the tube will have been reached and one or the other tube will become conducting.

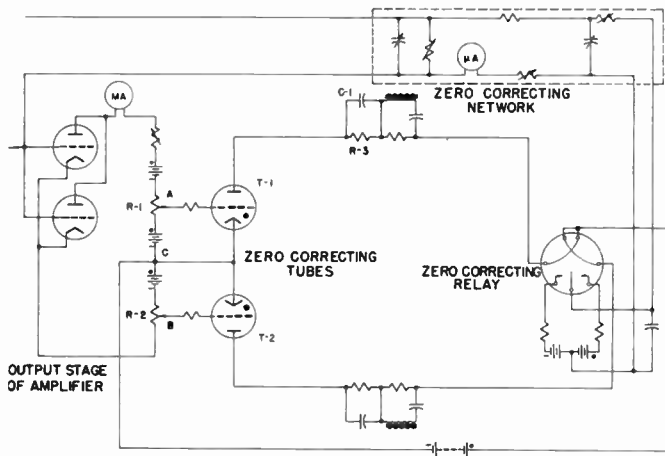

Figure 11. Earth current correction circuits

The tube circuit is of primary interest because of the method used to extinguish the arc. The anode of each tube is connected to positive battery through a simple network and one winding of a zero correcting relay as shown. The relay is of the three-position polar variety, its tongue moving to marking for currents originating in the branch controlled by tube T-1, and to spacing for currents flowing in the branch controlled by tube T-2.

The anode series networks are identical and only one need be considered. The function of the network is to extinguish the arc and shape the current pulse supplied to the relay. It has been found

T-1 starts, the impedance of the condenser C-1 and its shunt R-3 is zero to the flow of direct current, from which value it rises quickly, approaching the value of R-3, as the condenser becomes fully charged. The tube anode current is, then, the charging current to the condenser C-1. If the shunt resistance R-3 is sufficiently high, the tube anode current quickly falls to a value so low that the number of free ions in the arc will not sustain it, and the tube is extinguished. Other elements of the network limit the peak current and shape the current wave. As soon as the arc stops, the condenser discharges and resets the tube for subsequent operation.

A somewhat clearer picture of the circuit performance may be obtained from Figure 12. Here the signal is shown shifted from its normal zero position under the influence of a slow earth current. The dotted lines indicate the limits through which the signal may deviate before the zero correcting tubes operate. The other curves show the current pulses delivered to the zero correcting relay and the actual operation of the relay.

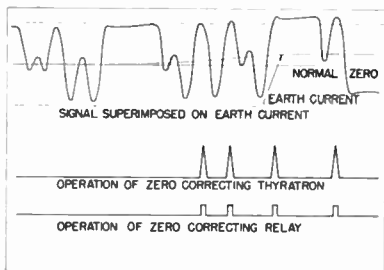

Figure 12. Zero correcting circuits

desirable to have the relay contacts remain closed for short periods of time, otherwise a minimum deviation of relatively long signals produces more than the needed amount of correction. The network, then, must be able to extinguish the arc shortly after it has been established. Prior to and at the instant tube

Conclusion

The performance of thyratrons on ocean cable equipment fully justifies their use at speeds above 70 to 80 cycles per second, where their superiority over relays becomes marked. Over a period of more than 15 years they have demonstrated that they have long life, require no main-

tenance, and that failures are rare. During this extended period they have made it possible to operate an overseas circuit at 400 words per minute, 24 hours each day, month-in and month-out, stable enough to carry the most exacting forms of tele-

printer operations, including the reperforator system and the varioplex. The cable to which the thyatron equipment is connected, is the fastest and most reliable single line of telegraph of any kind now spanning the Atlantic.

THE AUTHOR: H. H. Haglund, Apparatus Engineer of the P. & E. Department, joined Western Union in 1911 as an installer. When Barclay Automatic equipment was introduced into the Company's plant, he transferred to the operating department and worked as an automatic chief, progressively in charge of Barclay, Blue Code Morkrum, Green Code Morkrum and Multiplex equipment. During this period he also studied at the University of Utah where he obtained his engineering degree in 1921, and was subsequently transferred to the Engineer of Automatics' staff in New York. In 1925 he represented Western Union in cooperative work with Bell Telephone Laboratories on equipment for the first loaded cable, and supervised its installation and tests at Horta. Mr. Haglund in 1928 became head of the Ocean Cable equipment group which developed and supervised the installation and testing of new type automatic equipment for old style as well as new loaded cables and, during the war, for the Army's Alaskan and Aleutian Island cables, the Commercial Cable Company's and the Commercial Pacific Cable Company's cables. He is a Member of the AIEE.



THE AUTHOR: A. W. Breyfogel received his degree in engineering from the University of Illinois in 1922, after which he joined Western Union and was assigned to the Engineer of Automatics' division. Problems related to the transition from manual to automatic operation of ocean cables engaged his attention almost from the beginning. He has been closely and responsibly associated with the development of nearly all the automatic equipment used for operating Western Union's loaded and non-loaded cables. These activities have taken him at various times to Newfoundland, England and the Azores. During the war, he was actively and responsibly associated with the development of automatic ciphering apparatus (Telekrypton) for the Army, and various ocean cable projects for both the Army and the Commercial Cable Company. During this period, Mr. Breyfogel directed the installation and assisted with the initial operation of the Signal Corps cable system in Alaska. Since 1943, as Assistant to the Apparatus Engineer, he has been in charge of applied engineering problems pertaining to ocean cables, carrier and facsimile systems. He is a Member of the AIEE.

The Xerographic Process

F. B. BRAMHALL

The year 1948 brought the announcement of two developments which may well have a considerable impact on communications, in fact on every applied science in which electronics plays a principal role. The first of these, the Transistor or "solid-state amplifier", covered in an earlier issue of the REVIEW, is a lustily growing infant. The second was the subject of a modest announcement in the public press of October 23rd. At a Detroit meeting of the Optical Society of America on that day, Dr. R. M. Schaffert of the Battelle Memorial Institute and Joseph C. Wilson, President of the Haloid Company, presented papers announcing the first commercial utilization of a method of printing called "Xerography" (pronounced Zerógraphy). The scientific principle on which the process is based is of extreme interest to electronic laboratories, and the results achieved through its use arouse the imagination, to say the least.

A patent resulting from original work by Mr. Chester F. Carlson, a New York patent attorney, discloses the fundamentals of the process. A metal sheet or drum upon which a very thin layer of selenium has been deposited by evaporation may be made to retain a very substantial electrostatic charge on its surface until exposed to light. The amazing feature is that the charge on the surface of a "cell" so prepared may be removed in extremely small elemental areas by exposure to light. In other words, the properly prepared selenium coated metal surface may be made to act like a very fine-grain, light-sensitive mosaic. The surface charge may be dissipated by light of moderate and easily attainable intensity, in an exposure time comparable to that required for the exposure of good silver-sensitized photographic papers.

The immediate application foreseen by the Haloid Company, which will exploit

the process, is that of duplicating the printed or typed page. The light-sensitive sheet of selenium-coated metal is given a charge by being passed through a strong electrostatic field such as that employed in the Cottrell smoke precipitator, the result being the same as that achieved with the classical electrostatic generator or by rubbing a good insulator with a piece of silk. The charge is, of course, applied in a darkened chamber. The charged surface of the light-sensitive plate is then exposed, as in projection printing, to the positive image of the printed sheet to be copied. Wherever light strikes the surface, the charge is dissipated and those areas representing the black portions of the letters retain the charge. The surface is next dusted with a powder made up of a finely-divided, low-melting-point plastic and finely-divided dry pigment. This powder mixture adheres to the charged portions of the metallic surface representing the black areas of the printed page, i.e., the unexposed areas of the surface, and falls cleanly from the discharged areas representing the white of the printed page. The metal surface, now carrying the black dust in mirror image of the page, is brought in contact with a piece of ordinary paper charged electrostatically, exactly as the selenium surface was charged in the first instance. The black dust is transferred faithfully to the surface of the paper. To fix the "dust" letters on the paper, it is necessary only to pass it through a heated chamber or between heated rollers, the temperature of which is sufficient to fuse the low-melting-point plastic. The result is a printed page which, in some of the specimens exhibited, has definition equal to that of good photo-offset printing. It would appear that the mosaic properties of the selenium surface give a resolution at least

as fine as 200 lines per inch. The selenium surface is quickly cleaned by blowing air or by brushing, and may be reused indefinitely subject, of course, to some mechanical wear.

The development work and refinements which brought the technique of preparing the selenium surface and the powder mixture employed to their present state of perfection is attributed to the Battelle Memorial Institute of Columbus, Ohio.

The applications to communication and other electronic technologies are easily imagined. In high-speed television type facsimile, the process may well avoid the use of photo-sensitive film or paper. The flying light spot from the receiving kinescope or television receiving tube, if you will, may be focused on a moving selenium-sensitized surface in the form of

either a belt or a drum. The charging, exposure, dusting and transfer-to-paper process may be continuous and rapid. The Telegraph Company is presently engaged in the investigation of such possibilities.

Computing machines ranging all the way from the simple multiplying device employed in the punched-card type book-keeping equipment to the huge and complicated supercomputers of the great scientific laboratories and universities employ memory devices for the storing of information. Some of these devices are required to store figures and data for a very short period of time, seconds or even milliseconds, and others are required to store numerical data for hours, if not days. It may well be that the selenium-sensitized surface or "cell" of the Xerographic process will simplify if not revolutionize some of these storage techniques.

THE AUTHOR: For photograph and biography of Mr. F. B. Bramhall, see the October 1948 issue of **TECHNICAL REVIEW**.

11
12
13
14
15
16
17
18
19
20
21
22
23
24
25
26
27
28
29
30
31
32
33
34
35
36
37
38
39
40
41
42
43
44
45
46
47
48
49
50
51
52
53
54
55
56
57
58
59
60
61
62
63
64
65
66
67
68
69
70
71
72
73
74
75
76
77
78
79
80
81
82
83
84
85
86
87
88
89
90
91
92
93
94
95
96
97
98
99
100

