

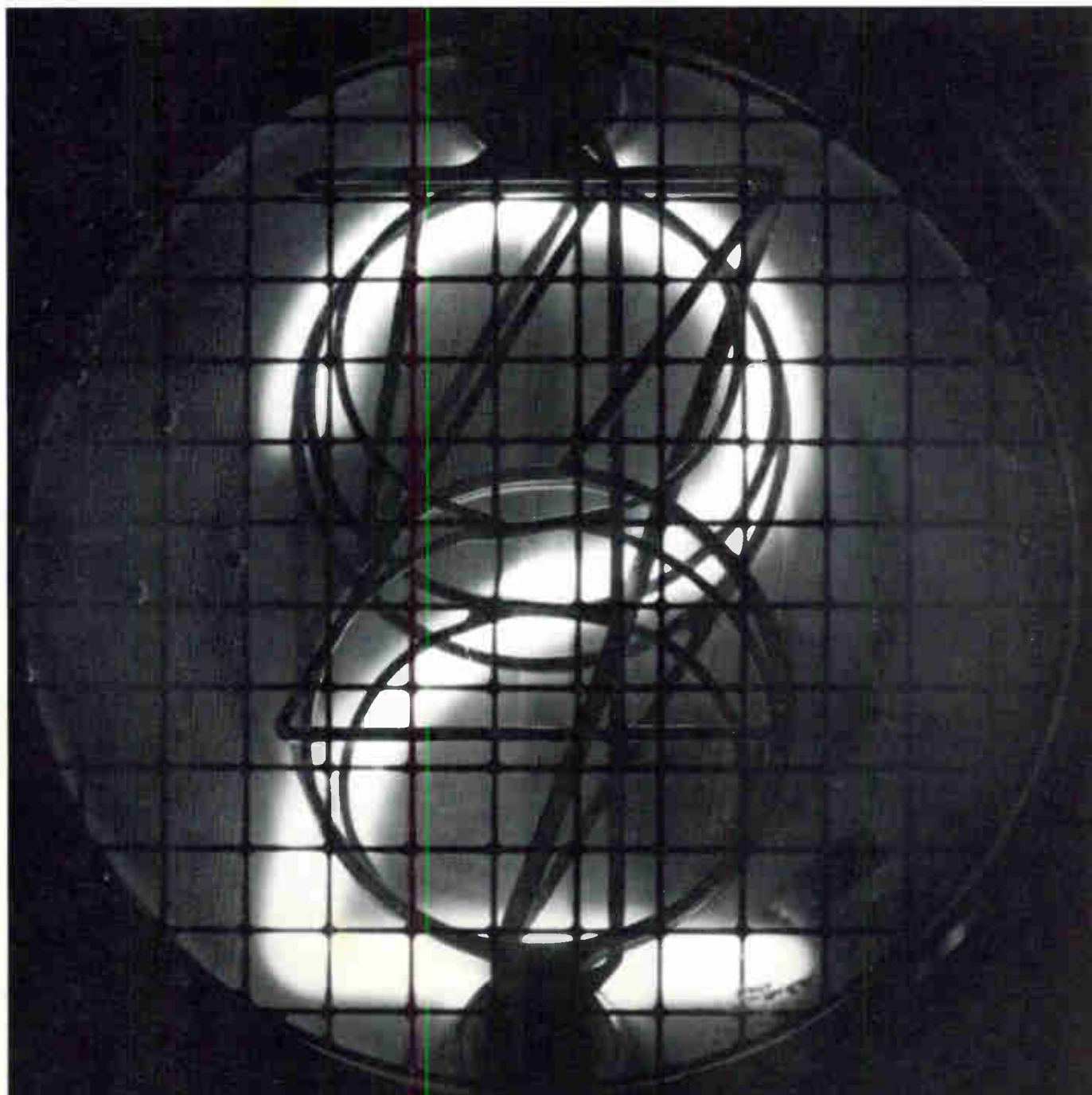

SERVICE SCOPE

NUMBER 53

DECEMBER 1968



Digital Systems Come of Age • Service Notes • Verifying Oscilloscope Performance

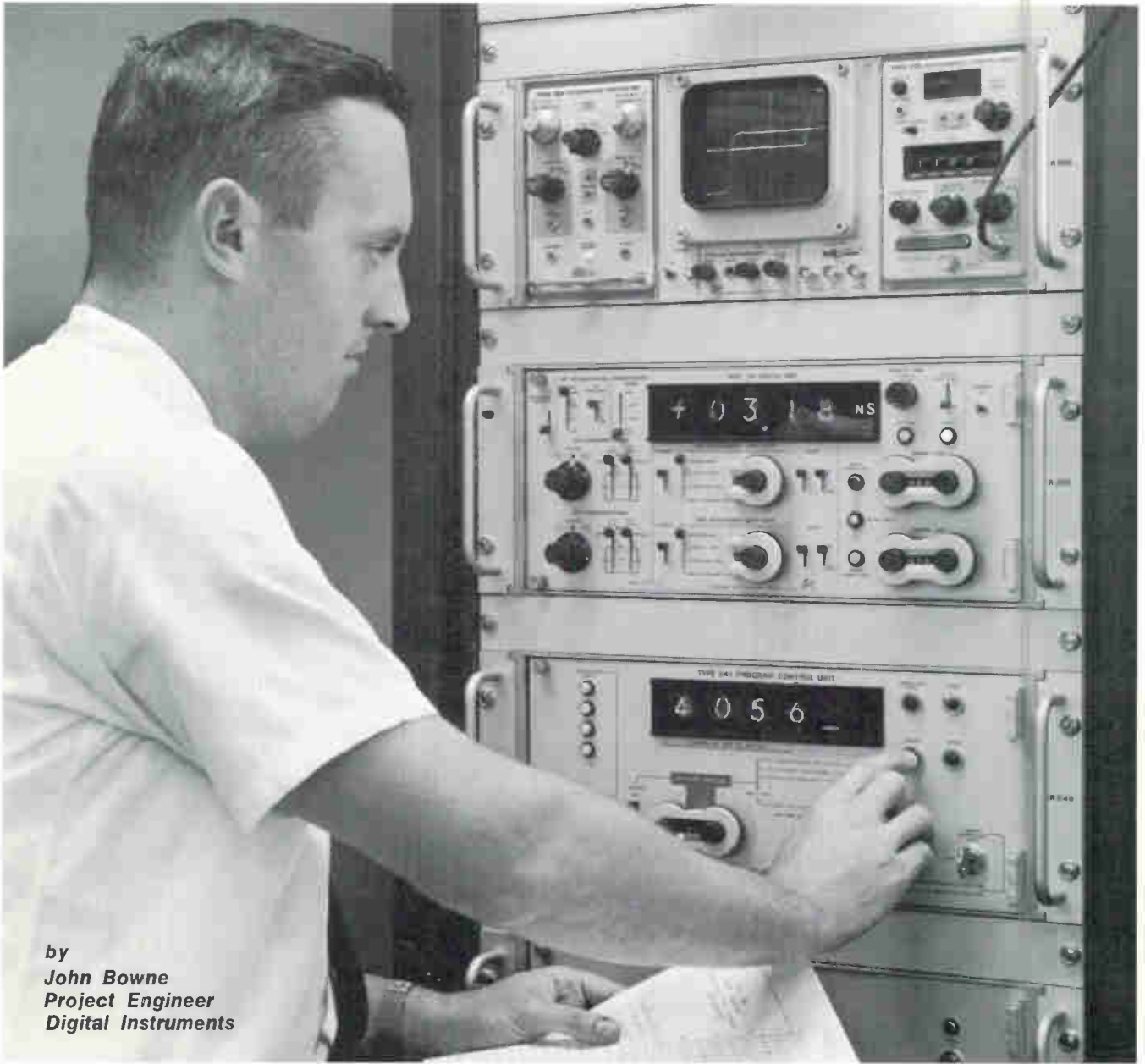

by
John Bowne
Project Engineer
Digital Instruments

DIGITAL SYSTEMS COME OF AGE

COVER

The displayed digit 2 is illustrative of the dual-purpose design of Tektronix digital components. These modular components are available: (1) individually, as components of a particular digital system; (2) assembled, as a Tektronix Measurement System (see p 16).

The widespread use of integrated circuits in the electronics industry, and the promise of even greater use in the near future, has focused attention on the need of externally programmable digital systems. To meet these needs Tektronix has developed a family of digital system components that meets IC-testing needs in manual, semi-automatic, or fully-automated measurement systems. Although these system components have been designed primarily with the integrated circuit tester in mind, their flexibility suggests them for many other types of testing.

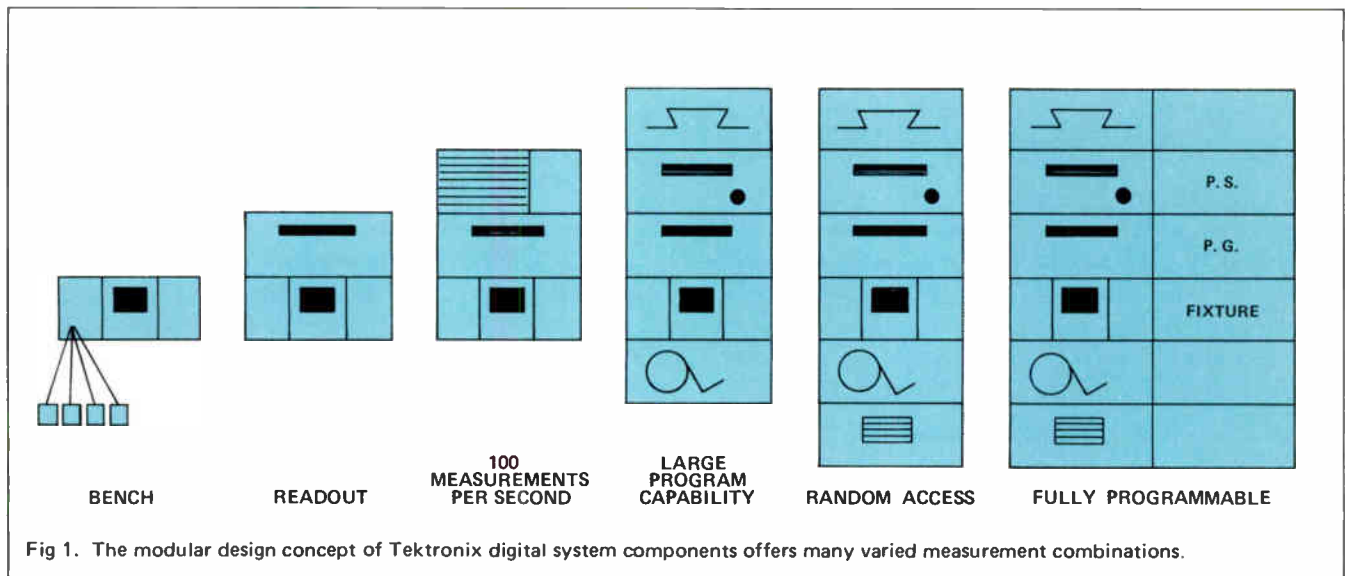

Tektronix digital systems are dynamic measurement systems. The basic measurement characteristics are determined by the combination of the sampling sweep unit (Type 3T5, Type 3T6), the sampling vertical unit (Type 3S5, Type 3S6), and the individual sampling head (Type S-1, Type S-2, Type S-3, Type S-4)*. The Type 568 Oscilloscope and Type 230 Digital Unit are then used to digitize and display the information.

A MODULAR DESIGN CONCEPT

A family of modular digital system components offering versatility and expandability eliminates much of the need for special-purpose test equipment. The wide choice of sampling heads combined with this design concept assures the user of a system that can be easily changed to accommodate current needs. In addition, the availability of wide range sampling sweep units (100 ps/div — 500 ms/div with digital delay,) assures the user of a time window with adequate resolution. The ability to upgrade a complete system by replacing only the sampling head provides an inexpensive hedge against system obsolescence.

The Type 230 Digital Unit is the heart of Tektronix systems. In addition, programmable sampling units, programmable pulse generators, sampling heads, and programming devices have been developed. These units serve as building blocks for simple and complex systems. Options such as disc memories, punched tape readers, tape punches, and probe choppers, have also been developed to provide the answer for a wide variety of applications.

Tektronix system components are designed to serve two distinct markets. First, they have been designed

to serve as components for the user to combine as he wishes. For example, if a test equipment engineering group is available, Tektronix systems are ideal for use as building blocks for more complex custom testers. Secondly, Tektronix offers digital measurement systems, including the systems engineering necessary for a particular measurement requirement. These systems are composed of Tektronix catalog products with additional equipment such as programmable pulse generators, programmable power supplies, fixtures, equipment racks and other equipment added to them.

Tektronix digital instruments provide digital readout of measurements that may also be displayed in analog form on a CRT. They offer measurement speeds in excess of 100 measurements per second, external programming of nearly all manual operations, and BCD data output (1 2 4 8). They allow dynamic switching time measurements to be made with greater speed, accuracy, and repeatability than a direct CRT measurement.

One of the unique aspects of the current line of Tektronix digital instrument components is the ability to correlate information between development, pilot production, and volume production. The wide choice of Tektronix programming options combined with the state-of-the-art performance provides an economical tester over a wide range of test requirements. For example, a small manual tester in a development phase uses the same basic measurement section as a high-speed production system even though that system is capable of elaborate program branching and a library of 1600 measurements. This uniformity of test conditions eliminates one of the major hazards of changing a device from a development environment into a production environment.

*Al Zimmerman, "The State of the Art in Sampling," Tektronix Service Scope, October 1968, pages 2-7.

The Type 230 Digital Unit

The heart of Tektronix Digital Systems is the Type 230 Digital Unit which operates in conjunction with programmable sampling units. The diagrams below illustrate how the counts are derived for voltage and time measurements.

The sampling plug-ins construct a display with each signal repetition contributing a sample. Because the samples per division are accurately controlled, the count of samples between 2 selected portions of a waveform is an accurate measure of the elapsed time. 0% to 100% intensified zones are generated that are variable in .5-cm increments by means of a 20-position switch. By using these zones and the signal delay, the user positions the 0% and 100% zones as desired. After the first sweep, the amplitudes corresponding to the zones are stored in memory circuits. Changes in amplitude automatically re-establish new 0% and 100% memory amplitudes.

In a typical time measurement, digitally selected voltage divider taps between the 0% and 100%

memory outputs are set for start and stop timing in 1% (or 1 mm) increments of either waveform of a dual-trace display. The selected percentage reference levels are then compared against the sampled input waveform on the second sweep. Coincidence of the waveform amplitudes with the selected percentage reference amplitudes is sensed by comparators which open and close the clock gate to the digital counter. The CRT display can be intensified for the duration of the measured interval as a reference check. The number of clock pulses are read out digitally in nanoseconds, microseconds, milliseconds, or seconds with decimal points included.

To measure voltage, start and stop comparators gate 1-MHz clock pulses for the period of time that a linear ramp voltage is at values between the 0% and 100% amplitudes. The number of clock pulses is proportional to the voltage between the selected measurement points. Readout is in mV and V with decimal points included.

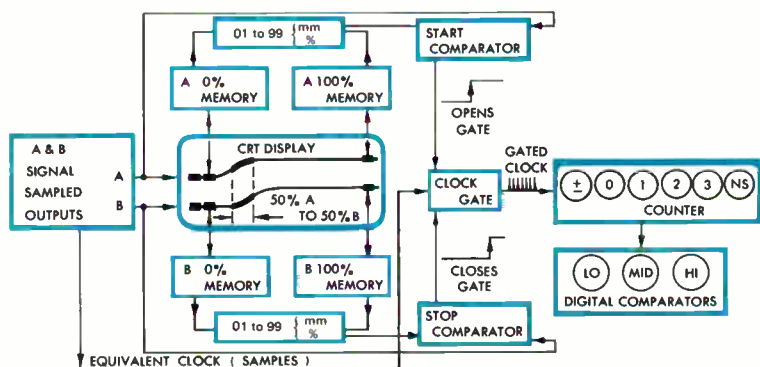

TYPE 230
Time Measurement

TYPE 230
Voltage Measurement

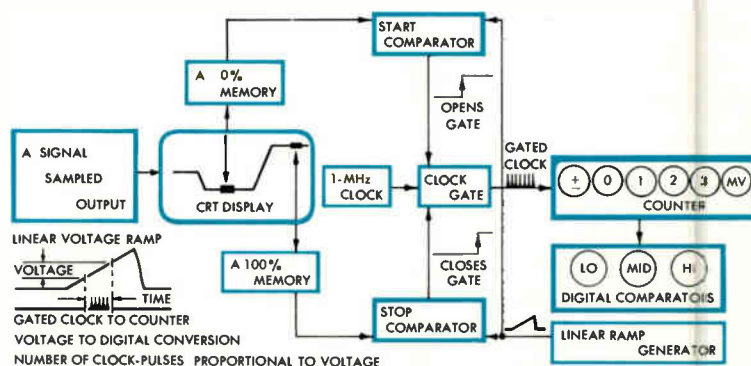

Incoming inspection is also an application that Tektronix measurement systems handle well. 100% dynamic testing now becomes feasible for incoming inspection of IC's, whether the 15-measurement Type 241 or the 1600-measurement Type 240 with disc option is used. Both cases allow measurement rates of over 100 measurements per second, and as a result component handling sets the maximum test rate in practice.

PROGRAMMING DIGITAL MEASUREMENTS

Once a user has become familiar with the Type 230/568/System (with sampling plug-ins) and has determined that some repetitive testing is required, the Type 241 Programmer is a logical choice. There is sufficient external programming capability to control a Type 230/568/3T5/3S5 and an additional 14 lines for external equipment (159 total lines). The programmer may be used manually or in the automatic sequence modes. Measurement limits may be programmed and out-of-limit conditions can stop the measurement sequence if desired.

A system composed of these units is ideal, both for bench use where similar tests are being conducted often, and for small pilot runs where devices are being characterized.

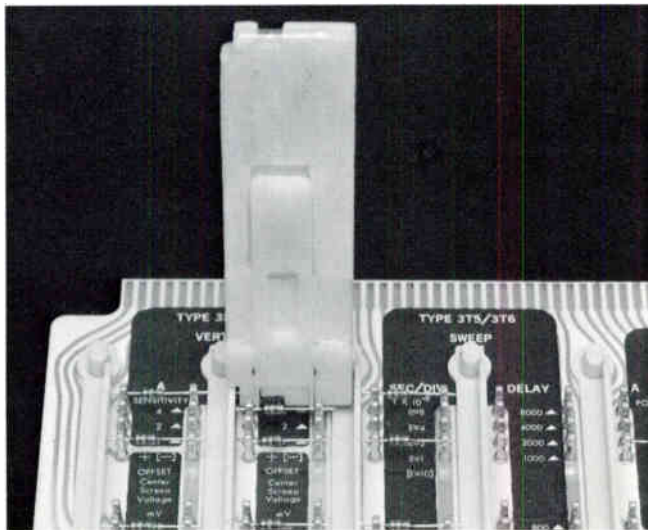

Fig 2. Type 241 program card with diode insertion tool. The card and tool are polarized so the diodes cannot be inserted incorrectly.

To prepare a program the user inserts the diodes provided into special mounting clips on the card with a special tool. Up to 15 different measurements may be programmed for any measurement sequence. The Type 241 also has storage space for 15 additional program cards.

Fig 3 shows a card being programmed for a risetime measurement. Most individual measurements require 15 to 20 diodes to be inserted.

An important feature of all Tektronix externally programmed digital systems is the high-speed program mode of operation. When the system is operating in this mode, the time base runs at a low-sample density of 100 samples per sweep when the instrument is not measuring. During the measurement portion of the sweep, however, 1000 samples are used for greater resolution. This feature eliminates wasted samples and allows testing rates well in excess of 100 measurements/second.

A unique feature of the external program mode is that measurements may be made that can not be performed in the manual mode. The figures below illustrate two such applications. In addition, if printed data output is required, printers are commercially available to connect directly to the Type 230.

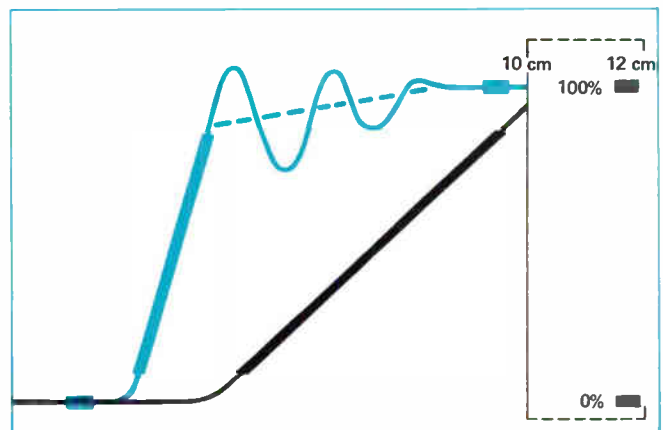

Fig 3. Externally programming the 0% and 100% to 12 cm keeps the memories from discharging after each sweep. A faster sweep may then be used for additional resolution in risetime measurements where ringing or dribble up is present.

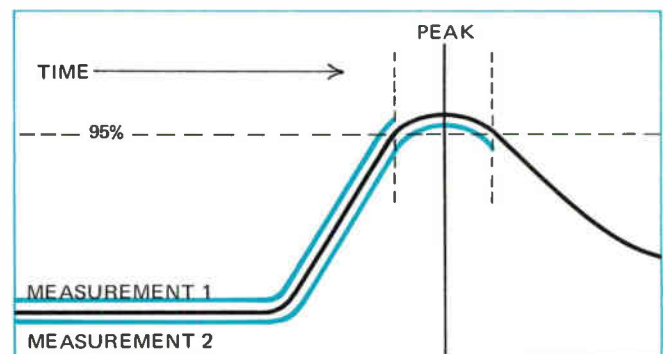
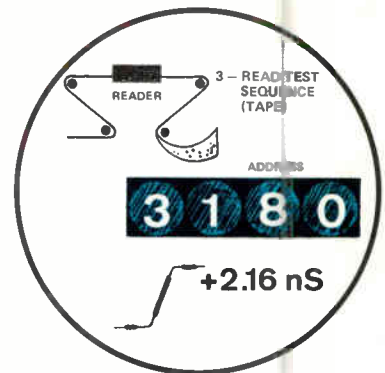
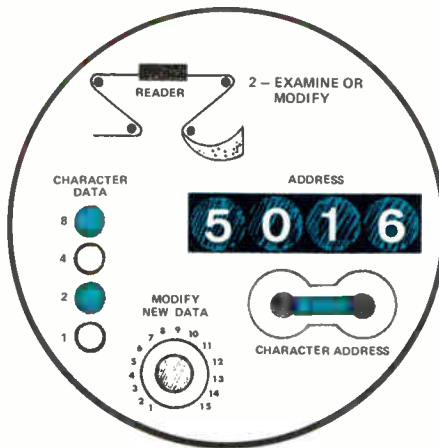
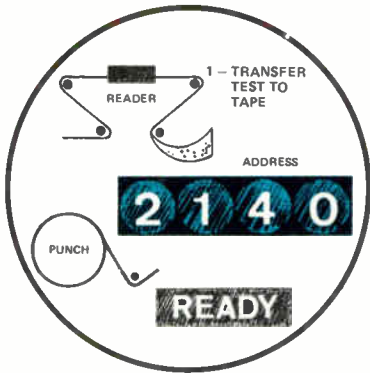

Fig 4. External programming allows inhibiting the counter reset in time-to-peak measurements. Thus two consecutive counts may be added (and divided by two if that line is not in use) to obtain an average value.



PUNCHED TAPE SYSTEM
 (1) EDITING, MODIFY, DUPLICATE
 (2) WRITE PROGRAMS EFFICIENTLY
 (3) STOP ON LIMITS

4 MEASUREMENTS / SEC



TYPE 240 – ADD DISC
 (4) LOADS DISC
 (5) MODIFY DISC DATA
 (6) MAKE SINGLE MEASUREMENT
 (7) BRANCHING AND DIAGNOSTIC ROUTINES, SORTING AND CLASSIFYING

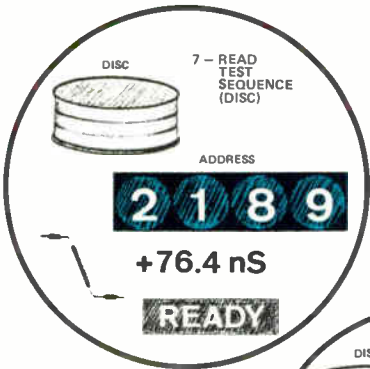

100 MEASUREMENTS / SEC

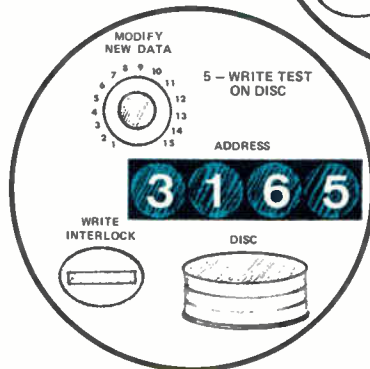
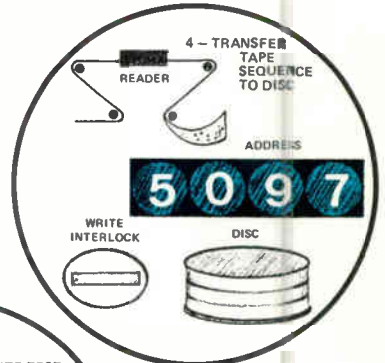

PROGRAMMING MODES OF THE TYPE 240. In the tape system above, the reader loads the shift register which allows: (1) a complete program tape to be punched; (2) program characters to be easily modified; (3) a complete measurement sequence to be made. In the disc system the random access disc loads the shift register which allows: (4) load shift register with tape reader and write data on disc; (5) store modified data on disc sector selected; (6) a single measurement to be made and; (7) a measurement sequence to be made (return to ready at sequence end).

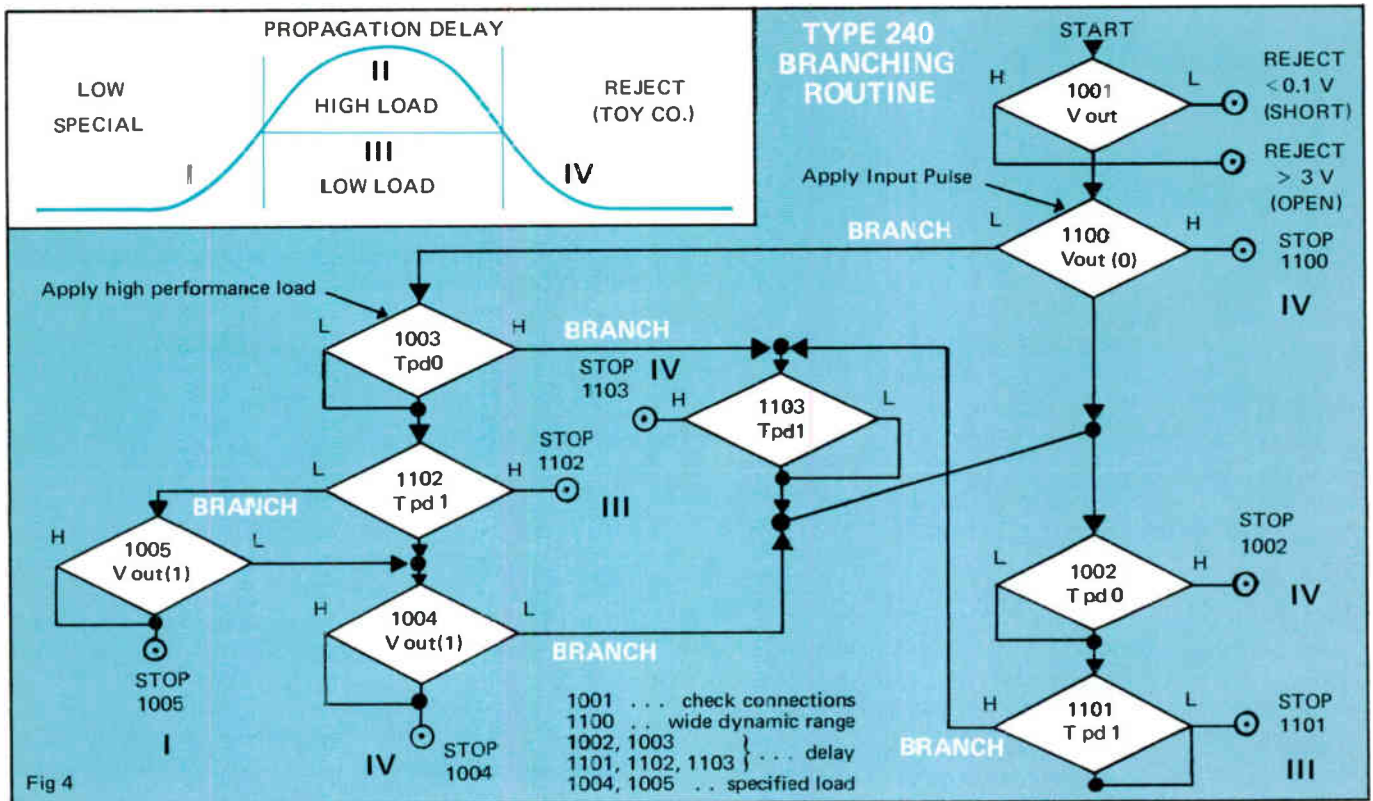

If the programming requirement is for greater than 15 measurements, or if program branching for diagnostic testing is desired, the Type 240 Program Control Unit is the logical choice. The Type 240 is designed to offer a flexible interface between the Type 230 and high measurement-rate systems.

A Punched Tape Reader may be used with the Type 240 for low-measurement rate systems. A maximum measurement rate of 4 measurements per second is available with this technique but the Disc Memory can be added later when programs are "debugged". The Punched Tape Reader is also convenient for loading programs into the Disc Memory.

The optional Tape Punch is used with the Type 240 for generating new program tapes. (Most small computers employ a teleprinter including tape punch that may also be used). If the Disc Memory is used, programs stored in the disc may be transferred to the Tape Punch for permanent storage. The combination of the Type 240 with a Punched Tape Reader offers a versatile systems configuration at a modest price. The Disc Memory can be added when the testing rate of 4 measurements per second is no longer adequate.

The Type 240 is designed to accept program data serial-by-bit from an optional Disc Memory, serial-by-character from an optional Punched Tape Reader, or

from an external source. When operating in this manner, the Type 240 acts as a 192-bit shift register which distributes parallel program instructions to the measurement section of the system. In addition, however, it contains the read, write, and control electronics for the optional Disc Memory, optional Tape Reader, and optional Tape Punch.

The optional Disc Memory provides measurement rates in excess of 100 measurements per second and offers sorting, classifying, and diagnostic test routines. The 8-track rotation disc is capable of storing 200 complete measurements per track, thus permitting random access to a library of 1600 independent measurements.

PROGRAMMING LOGIC

Tektronix has standardized on the use of fixed word length for the logic in the Type 240 Program Control Unit. This compromise was chosen because of its efficiency and flexibility in automated testing use. By incorporating an examine/modify mode into the program control unit, the greatest advantages of variable word length are present (i.e. ability to take a previous program and change only those portions of the program that are different). Using fixed word length allows the opportunity to interrupt in the middle of a test sequence (i.e. measurement 21 of a 35-measurement sequence), and check each bit of data. With variable word length it would be necessary to begin at programs

1-20 since portions would be set up at the beginning and not changed after that. An additional benefit is that the test sequence may be changed at will without extensive reprogramming changes.

The advantage of fixed word length to the digital system user is that data can be taken from a disc considerably faster, and any piece of data in all the registers may be monitored easily. The examine/modify mode allows changing the old program, writing it on the disc and punching a new tape from the disc.

The examine/modify mode is an extremely useful mode on the Type 240. When this mode is in operation character data lights indicate the data that is in the shift register. Characters may be selected by character address switches and the characters can then be modified by the modify pushbutton.

One of the inherent advantages of using the Disc Memory with the Type 240 is the ability to branch to a new measurement sequence as shown in fig 4. This then allows reclassifying of the device. This feature is also useful for checking-out of complete boards and assemblies. For example, if a signal is not found at the output, the program changes to a prior stage until the desired response is found. Automatically, the problem has been located to a stage instead of merely being rejected.

One of the most important features of the Type 240 is the ability to error-check all incoming data by means

of a parity check. Thus if there is a transmission error it will likely be found before it creates a measurement problem.

The Type 250 Auxiliary Program Unit is designed to provide 192 additional program lines (48-4-bit characters) for use in conjunction with the Type 240. This allows programming of pulse generators, power supplies, fixtures, or other peripheral equipment. Program buffering, including level conversion, level inversion, and D-to-A conversion are also performed by this unit. The Type 250 requires systems engineering and intra-connection wiring for operation. Program assembly cards consisting of shift register cards (serial-to-parallel conversion), and program boards (negative logic, resistance, and conductance) provide for versatile control of programmable functions.

Up to 2 Type 250's may be added to a Type 240 to extend programming capability. When 2 Type 250's are used with the disc memory, then the test format is a fixed word length of 144 4-bit characters and a 1080 measurement library is available.

The modular design of Tektronix digital components offers a wide range of versatility for measurement systems. The ability to upgrade the bandwidth of the system by replacing only the sampling heads ensures a useful testing system after the original test requirements are completed. The ability to add to a system at any time, with a minimum of interfacing problems, assures the user that his tester will not become obsolete.

TEKTRONIX DIGITAL SYSTEM COMPONENTS

TYPE	DESCRIPTION	PROGRAM LINES	PRICE
DIGITAL AND PROGRAM UNITS			
230	Digital Unit	104	\$2965
240	Program Control Unit	192	3750
241	Programmer	159	1950
R250	Auxiliary Program Unit	192	1400
PULSE GENERATORS			
R116 MOD 703 L	Programmable Pulse Generator	79	2775
R293 MOD 703 M	Programmable Pulse Generator	14	1300
PLUG-IN UNITS			
3A2	Analog/Digital Unit DC 500 kHz	—	520
3B2	Analog/Digital Time Base Unit 2 μ s - 1 s	—	675
3S1	Dual-Trace Sampling Unit	—	1150
3S2	Dual-Trace Sampling Unit*	—	800
3S5	Programmable Sampling Unit*	27	1450
3S6	Programmable Sampling Unit*	27	1450
3T2	Random Sampling Sweep Unit	—	990
3T5	Programmable Sampling Sweep	28	1550
3T6	Programmable Sampling Sweep	28	1550
3T77A	Sampling Sweep Unit	—	690
SAMPLING HEADS			
S1	350-ps Sampling Head	—	250
S2	50-ps Sampling Head	—	300
S3	350-ps Sampling Head	—	375
S4	25-ps Sampling Head	—	750
OPTIONAL ACCESSORIES			
Disc Memory	8-Track Disc Memory	—	6600
Tape Punch	Tape Punch	—	1250
Punched Tape Reader	Punched Tape Reader	—	2500

* Accepts two sampling heads

Service Notes

Chuck Phillips, of our factory repair center, passes along the following hints

REPLACING GRATICULE LIGHTS

A boot from an alligator clip makes an excellent bulb remover for graticule light bulbs. It is only necessary to clip a little material from the small end of the boot. Push the boot in so it grasps the end of the bulb snugly. Once the bulb is held firmly, it is only necessary to turn CCW and the bulb is easily removed.

Graticule lights should be replaced when the bulb darkens appreciably or uneven graticule illumination can occur.

Fig 1 illustrates a situation where one bulb was replaced and a dark bulb not replaced. Note the unevenness of the graticule illumination.

Fig 2 is the identical situation with both bulbs replaced.

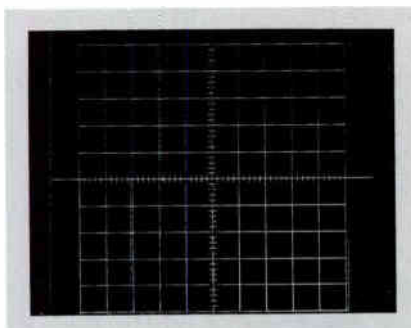

Fig 1. Uneven illumination.

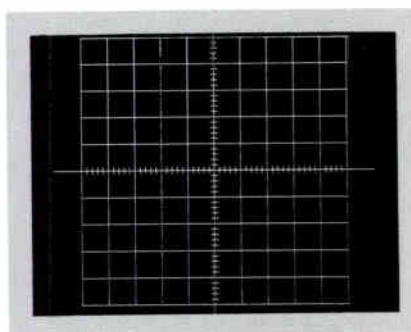
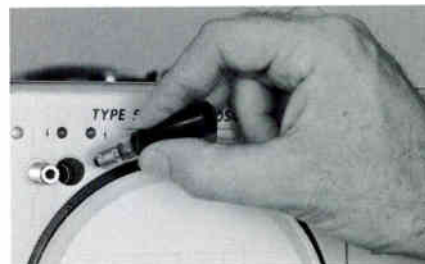

Fig 2. Dark bulb replaced.



INSTRUMENT APPEARANCE

Chuck also suggests that a liquid glass cleaner and furniture wax be available when calibrating equipment. The glass cleaner does an excellent job of cleaning graticules, CRT's, filters, and front panels. The furniture wax restores dull side panels and front panel knobs to a like-new appearance. In order to avoid too much wax Chuck suggests that you spray onto a cotton pad and then do the buffing with the pad. A few moments spent on optimizing the appearance of an oscilloscope can contribute greatly to the overall appreciation of the calibration effort.

USED INSTRUMENTS FOR SALE

1—Type 647 Transistorized Scope, compact, with full-size CRT. Also 10A2 dual trace preamp and 11B2A dual sweep base. Scope rated 50 MHz, updated time base allows steady triggering to 130 MHz. Purchased April 1967, offered at \$800. Contact: Mr. John Cone, 775 South Madison, Pasadena 91106. Telephone: days (213) 351-2320, eves (213) 792-5271.

1—Type 532, SN 7302; 1—Q Unit, SN 1206, with extra P7 CRT. Contact: Ken Reeves, Omark Industries/CCI Division, Box 660, Lewiston, Idaho. Telephone: (208) 776-2351.

1—Type 321A. Contact: Dick Bastyr, Research, Inc., Box 6164, Edina Station Minneapolis, Minnesota 55424. Telephone: (612) 941-3300.

1—Type 321A, SN 002605, complete with battery pack, carrying case, probe. Price: \$750.00. Contact: Jerry Erickson, Republic Electric & Development Co., 1050 W. Ewing Street, Seattle, Washington 98119. Telephone: AC (206) 284-5200.

1—Type 531 Oscilloscope, SN 21800, new CRT, excellent condition; 1—Type CA Plug-In, SN 40226. Price: \$500. Contact: D. Terazawa, Hewlett-Packard Co., 175 Wyman Street, Waltham, Maryland, 02154. Telephone: (617) 894-6300, ext. 334.

1—Type 2A60; 1—Type 3A72; 1—Type 3A1. Contact: Brian Somodi, Meditron Company, Santa Ana, California. Telephone: (714) 541-0468.

1—Type 310A, SN 020673. Contact: Mrs. Minet, 679 W. Glenoaks Blvd., Glendale, California. Office Telephone: (213) 225-6171.

1—Type C-30 Camera. Contact: Mr. John Strapman, Lumidor Products, 2500 W. 6th Avenue, Hialeah, Florida 33010. Telephone: (305) 887-7421.

1—Type 190A, SN 6047; 1—Type 180A, SN 7726; 1—Type 107, SN 1722. Contact: Marv Kalor, Instrumentation Services, 957 Winnetka Avenue, North Minneapolis, Minnesota 55427. Telephone: (612) 544-8916.

USED INSTRUMENTS WANTED

Used Tektronix Scope-Mobile® Cart suitable for 514AD or other 5-inch Tektronix Oscilloscopes of similar size. Prefer local replies. Must be reasonable and in good condition. Contact: Dennis Brunnenmeyer, Physicist, Aerojet-General, Building 3003, Box 15847, Sacramento, California. Telephone: (916) 355-3702.

verifying oscilloscope performance

*A discussion of the major
factors contributing to
measurement accuracy*

An oscilloscope, like other electronic test equipment, will not maintain its accuracy indefinitely. Aging of components, drift, environmental conditions and other factors make necessary regular inspections to determine if readjustments are required. Shipping an instrument from one location to another may affect accuracy and in extreme cases may cause instrument failure. Therefore, it is important to check an instrument's performance characteristics periodically to assure accuracy and to determine if calibration is required.

This article provides techniques and background information to verify the more important characteristics of general-purpose laboratory oscilloscopes. For this discussion, "performance check" is determining if a characteristic is within stated limits using a given technique. "Calibration" is adjusting controls or replacing components when a performance check shows limits have been exceeded.

All instruments should have regular performance checks at intervals determined optimum by the user; this interval is largely determined by environment, care in handling, accuracy required and the design of the oscilloscope. (Some oscilloscopes are designed to be highly reliable in



by
Charles H. Samuel
Test Staff Engineering Manager

adverse environments, while others are designed for laboratory environments.) A regular recalibration generally is not necessary if the performance check indicates that no characteristics are outside their limits.

The measurement methods given here are general ones; when an instrument's instruction manual lists a different method, the method listed in the manual should be used. It must be emphasized that the results of a measurement depend upon the method used and if a single characteristic is measured by two methods, two different results might be expected.

Test Equipment

Selecting the proper test equipment is a most important factor in checking oscilloscope performance. Inaccuracies in test equipment show up as apparent inaccuracies in the oscilloscope under test. As a rule of thumb test equipment should be four to ten times more accurate than the accuracy of the item being tested.^{1 2} Resolution capability of the test equipment must also be adequate to insure a measurement not adversely limited by the test equipment. For instance, one would not check a $20\text{ mV} \pm 2\%$ DC voltage source with a voltmeter having a maximum resolution of 1 mV (5% of 20 mV). In some cases it may be detrimental to have test equipment that is "too good" for the measurement being made. For instance, measuring instrument risetime with a step more than 10 times "faster" than the expected risetime can show errors that are due to the waveform used. Tektronix instrument manuals contain a complete listing of the test equipment required for instrument calibration.

Measurement and Nonmeasurement Characteristics

Oscilloscope performance can be broken down into two categories: Those that affect measurement accuracy, such as deflection factors and sweep times, and those that affect performance but don't affect measurement accuracy, such as triggering and writing speed.

In the following, only the most important general-purpose laboratory oscilloscope characteristics have been included. Specific oscilloscopes may have other important characteristics not listed here.

MEASUREMENT CHARACTERISTICS

Vertical Deflection Factors

The vertical deflection factor is the ratio of the amplitude of the input signal to the deflection on the cathode-ray tube, usually given in volts per division of deflection. Measurements of deflection factor accuracy should be made at or below the upper reference frequency discussed under bandwidth (between the two reference frequencies if the amplifier is AC coupled). If a probe is to be used with the oscilloscope, the vertical deflection factors should be checked with the probe in place, as shown in Fig 1.

For each attenuator setting (volts per division) apply a signal with accurately known amplitude to the vertical input of the oscilloscope. The amplitude of this signal should be sufficient to result in 50% to 80% of full graticule vertical deflection (closer to 80% is preferable from the standpoint of resolution on the cathode-ray tube). Carefully measure the deflection on the cathode-ray tube with the graticule and divide the known input voltage by the divisions of deflection. The quotient is the actual deflection factor and can be compared with the stated deflection factor to determine the percent of error. In some oscilloscopes the deflection factor may not be constant throughout the vertical dimension of the graticule. There may be slight errors in the deflection factor due to compression and expansion type nonlinearities. It is possible to check for this nonlinearity by centering a two-division display, then positioning the top of the display to the top of the graticule, measuring any changes in amplitude. Next, position the bottom of the display to the bottom graticule line, checking for any changes in amplitude. This type of nonlinearity usually ap-

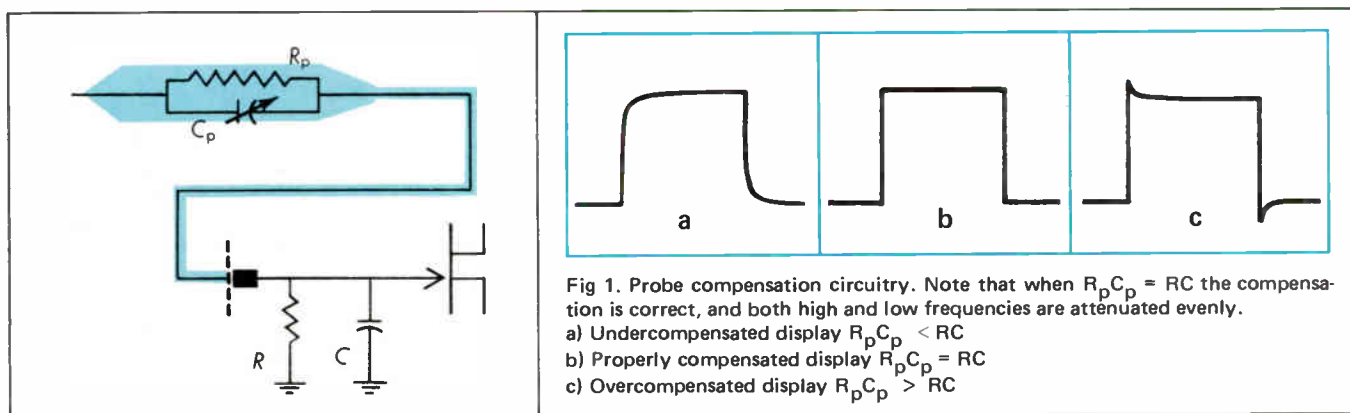

pears only at the graticule extremes. Therefore, if there is a need to make precision measurements with full graticule deflection or with smaller deflections positioned toward the top or bottom graticule limits, any nonlinearity measured should be taken into account.

Horizontal Time-Base Accuracies

Time-base steps are the deflection factors for the horizontal axis of the general purpose laboratory oscilloscope. They are expressed in terms of time per division of deflection. A known accurate time-mark generator is the most convenient signal source for making sweep-time measurements; however, an accurate sinewave generator can be used also. Internal graticules assist greatly in accurate sweep time measurement.

To measure time-base accuracies, apply accurate time marks or a sinewave corresponding to one mark or cycle per graticule division. Position a mark at the graticule line that starts the area to be measured. Next, determine the difference between the graticule line ending the area to be measured and its associated mark, and express this difference as a percentage of the area measured. Due to

possible edge nonlinearities, sweep times are typically measured from graticule line 1 to 9 (see fig 2).

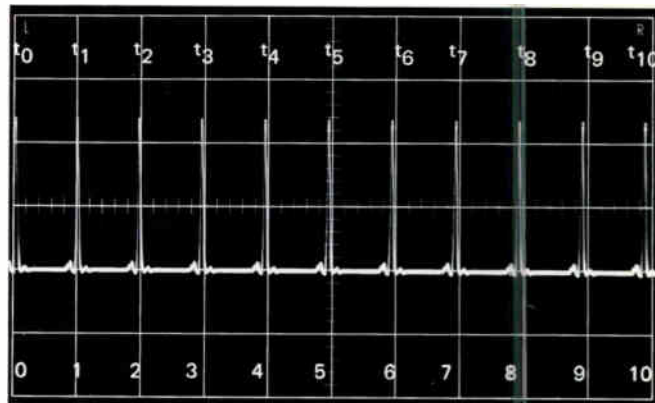

Fig 2. Example of timing 1.25% short.

Example: If the timing is to be measured over the center 8 divisions of the graticule, align t_1 with graticule line 1 and note the position of t_9 in relation to line 9. If t_9 is superimposed with line 9, there is no error; if it misses by 0.1 division, the timing is $0.1/8 = 0.0125$ or 1.25% "long" or "short."

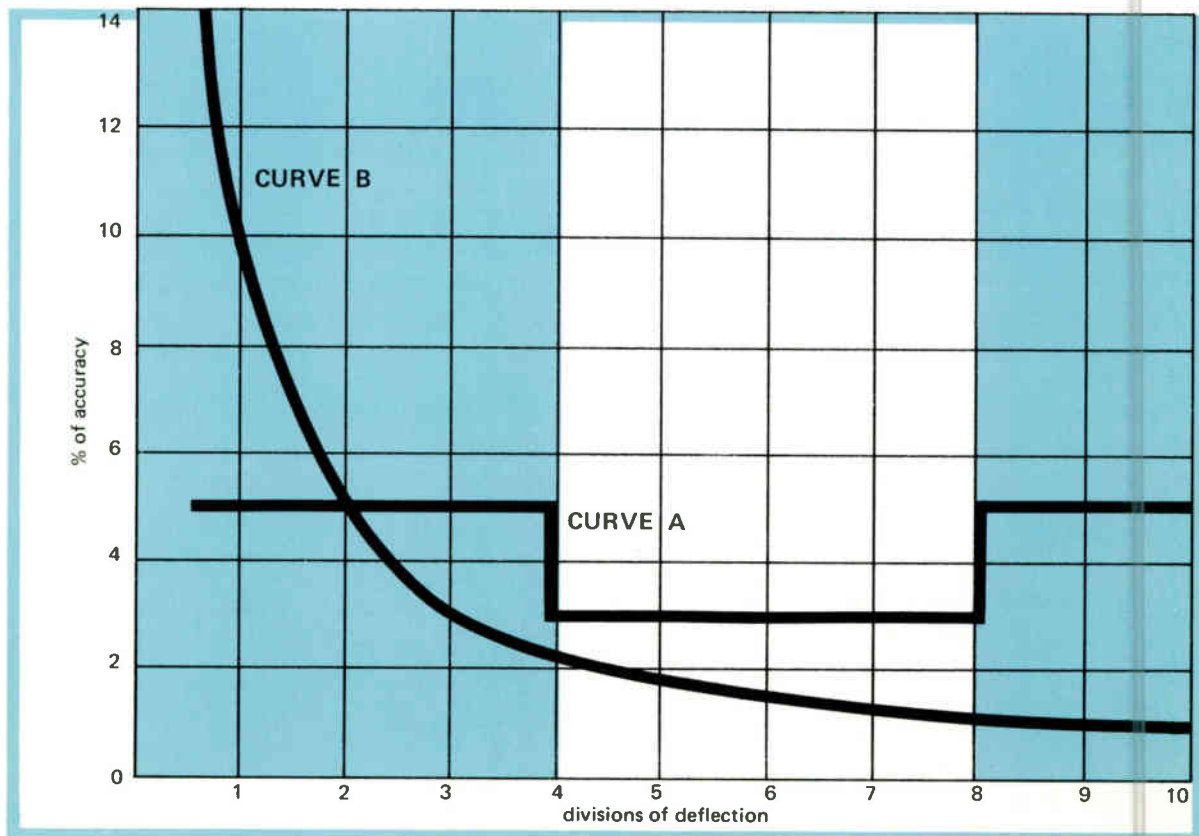
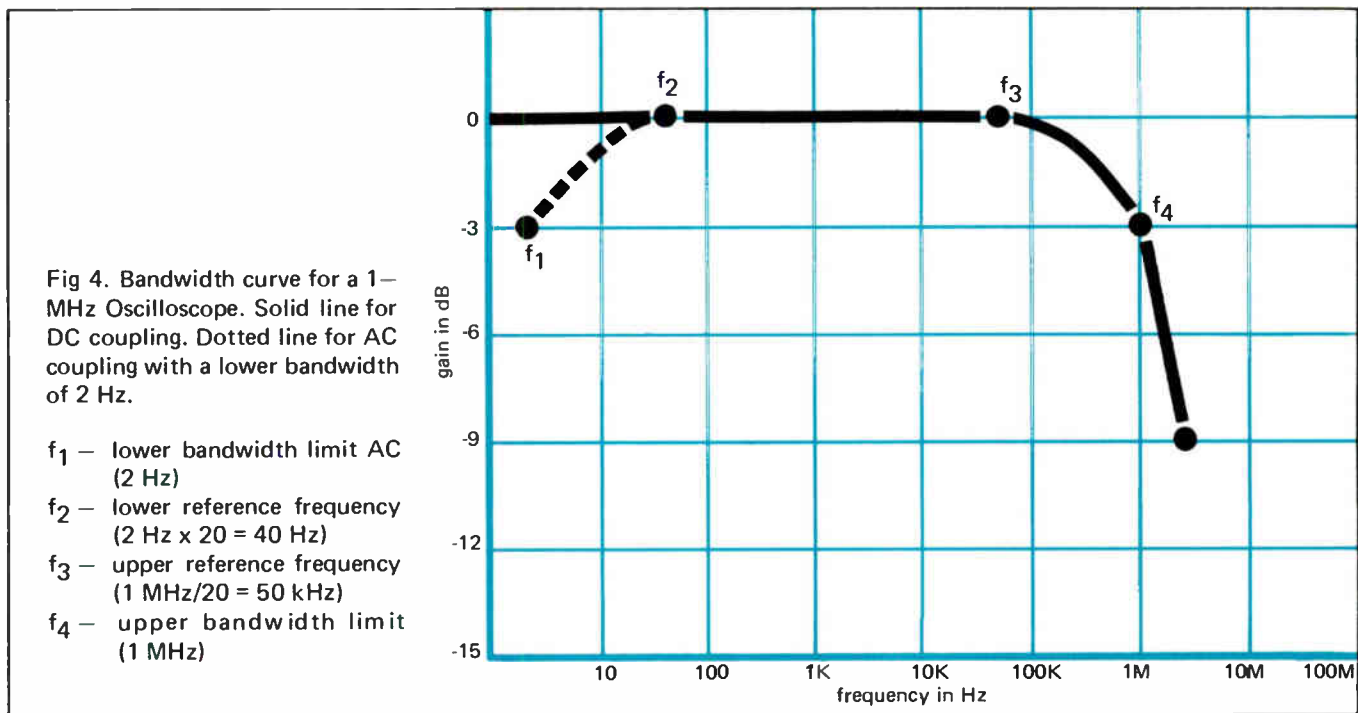

Fig 3. Accuracy vs. length of measured intervals. Note that a measured interval of 4–8 divisions provides optimum display accuracy. The shaded area at left is due to sweep non-linearity and resolution while the area at right is due to CRT non-linearity. Curve A may be shifted downward by optimizing on a single sweep speed and limiting temperature excursions.



A recent trend is to indicate an accuracy for the time base at different lengths of deflection, thus combining accuracy and linearity measurements. Timing errors, basic linearity errors and errors caused by lack of resolution combine and increase as the length of deflection on the cathode-ray tube face becomes less. For instance, a time base might have a timing accuracy within 3% over any 4 to 8 division segment but if measurements are to be made over less than 4 divisions, accuracy must decrease because of linearity problems and resolution errors. Curve A, figure 3 shows how a sweep with a basic accuracy of $\pm 3\%$ might be described. Assuming an ability for the observer to resolve 0.1 division intervals on the graticule, Curve B illustrates the additional error that can occur due to resolution considerations. The accuracy of any given measurement will be a combination of these two factors. It is possible to get around some resolution problems by measuring to exact graticule lines, using optical magnification, etc.

Bandwidth and Risetime

Bandwidth (bw) and risetime (t_r) are related by a constant in any given oscilloscope. (If the display amplifier has a gaussian response: bw in MHz x t_r in ns = 350.) Therefore, only one of these two characteristics needs to be measured. Risetime can usually be displayed over only a portion of the graticule and the accuracy of the measurement is dependent on sweep timing and resolution. Bandwidth can be measured more accurately, so quite often bandwidth is measured and risetime is calculated based on it.

Bandwidth is defined as the upper and lower limits of the band of frequencies an oscilloscope can display, its gain constant within 3 dB. Bandwidth is measured with a sinusoidal waveform to the first 3 dB down point ($\approx 30\%$) from the amplitude of a reference frequency (30% down rather than -3 dB is used because 30% is more easily read on a conventional graticule).

Bandwidth – Upper Frequency Limit

Apply a sinewave of 1/20 the upper bandwidth limit or less (reference frequency) from a constant amplitude sinewave generator to the oscilloscope vertical input. Adjust controls for a centered display of about 80% of the graticule height. Increase the frequency of the sinewave (its output amplitude must not be changed) until the display is 70% of its amplitude at the reference frequency. This frequency is the upper bandwidth limit.

Bandwidth – Lower Frequency Limit

In a DC-coupled oscilloscope the lower frequency limit is DC and the gain at DC should be equal to the gain at the upper reference frequency, not 3 dB down from it. Also, in a DC-coupled oscilloscope only the upper bandwidth limit may be given; that is, BANDWIDTH: 30 MHz means that the bandwidth is DC to 30 MHz.

An AC-coupled vertical amplifier has a lower frequency limit. To measure this, apply a lower reference frequency sinewave 20 or more times the frequency specified (not

to exceed the upper reference frequency) from a constant amplitude source to the vertical input. Adjust controls for a centered display amplitude which is about 80% of the graticule height. Decrease the sinewave frequency until the displayed amplitude is 70% of the lower reference frequency amplitude. This frequency is the lower frequency limit.

In both the upper and lower frequency limit measurements the source impedance and harmonic distortion of the sinewave can have a pronounced effect on the result; these should be as specified by the oscilloscope manufacturer or should be accounted for in the results of the measurement.

Risetime

As noted before, risetime is related to bandwidth and it probably is not necessary to measure risetime if bandwidth is satisfactory. Risetime is a measurement, on the display of a step-function waveform, of the interval between the instants at which the amplitude first reaches 10% and 90% of the reference amplitude (figure 4).

Apply a step-function with a risetime from 4 to 10 times "faster" than that of the oscilloscope to be measured. Measure the time required for the waveform to go from 10% to 90% of its amplitude. If a step function with a risetime less than 4 times "faster" must be used, the risetime of the oscilloscope (t_r scope) can be approximated as follows: $(t_r \text{ scope})^2 = (t_r \text{ measured})^2 - (t_r \text{ step})^2$. Sweep-time inaccuracies and resolution must be accounted for in the measurement.

Amplitude Calibrator Accuracy

Several kinds of amplitude calibrators are provided on general-purpose laboratory oscilloscopes. Their main purpose is to provide a voltage amplitude of known accuracy. The output waveform can be a sinewave but is most commonly a squarewave.

In some calibrators the waveform-producing circuitry can be disabled and the calibrator provides a DC voltage equal to the peak-to-peak value of the normal square-wave output. With this kind of calibrator, disable the waveform-producing circuitry and measure the output voltage with a differential or digital voltmeter. A digital voltmeter with automatic ranging makes it convenient to measure all calibrator output voltages in sequence, quickly. Compare the measured voltages with the labeled ones and determine the percentage error. Return the waveform-producing circuitry to its operating condition. Care should be taken that the voltmeter has the accuracy and resolution for the task, and that it does not present too great a load to the calibrator.

If the calibrator waveform-producing circuitry cannot be disabled, it can be checked with an oscilloscope which has a slideback voltmeter preamplifier. Both peaks of the calibrator's output waveform can then be compared dynamically to the slideback voltmeter's comparison voltage and the calibrator amplitude can be determined. A slightly less accurate method of checking the calibrator amplitude is to first calibrate the oscilloscope for a given display from a known amplitude voltage equal to the nominal calibrator voltage. Remove the known voltage and apply the calibrator voltage and measure it on the calibrated oscilloscope.

NONMEASUREMENT CHARACTERISTICS

Some characteristics of an oscilloscope's performance do not directly affect the accuracy of measurements but determine whether or not a measurement can be made. Two of these are triggering performance and writing speed.

Triggering

Measuring an oscilloscope's triggering performance is mainly a process of applying the proper signals and checking to see that a stable display is possible. Internal triggering is checked by applying signals of the specified amplitude and frequency to the vertical input and monitoring to see that a stable display can be obtained. The same procedure is followed for checking external triggering performance but the signal must be also applied to the external trigger input.

After checking the basic triggering, any special functions can be checked on a performance basis. When using automatic triggering the display should be stable when the specified signal is present and a trace should be displayed when no signal is present. AC, low frequency reject triggering should operate normally at frequencies above a few hundred Hz and only respond to large signals at 60 Hz.

Writing Speed

Writing speed is a figure of merit which describes the ability of a particular camera, film, oscilloscope, and phosphor to record a fast moving trace. Until recently this subject has been surrounded by some mystery. Recent studies indicate that there are measurement methods which are repeatable by most oscilloscope users.³

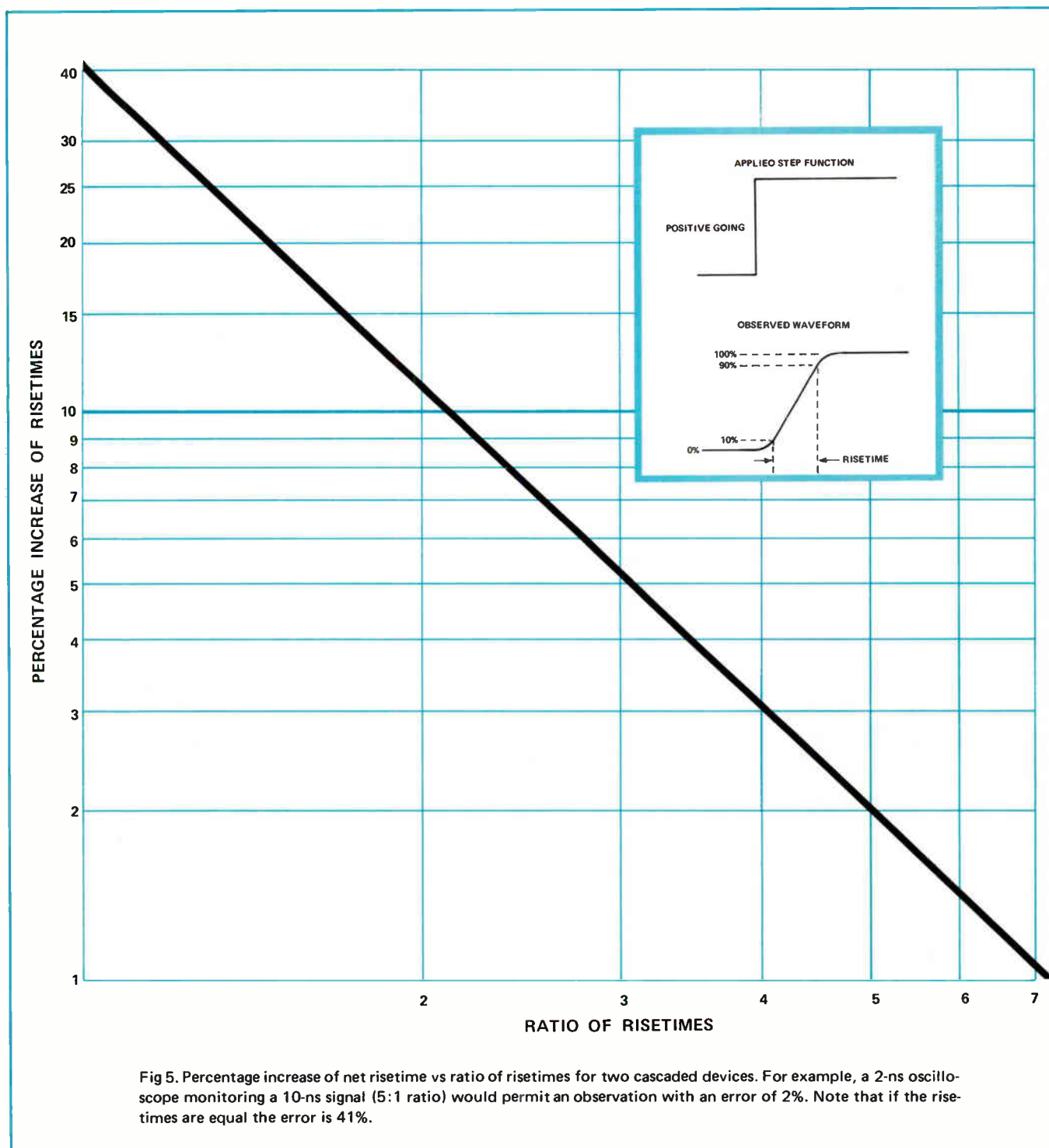

References

1. Russell, F. C., 'Industry's View of the 10:1 Ratio-of-Accuracy Requirement' 1966 Standards Lab Conference Proceedings p 121-123.
2. 'Calibration Program,' Standards Laboratory Information Manual, February 1968, Naval Inspector of Ordnance, Pomona, California p 1.6-1.7.
3. 'Developing a Writing Speed Specification,' Tektronix SERVICE SCOPE, April 1968 p 2-7.



SERVICE SCOPE

December 1968 • Tektronix, Inc., P.O. Box 500, Beaverton, Oregon, U. S. A. 97005



Tektronix Measurement Systems

In addition to digital system components, Tektronix offers Tektronix Measurement Systems. These measurement systems are designed to cover the range of automated dynamic measurements from small "bench" systems to high volume production and incoming inspection testers. Tektronix Measurement Systems use catalog products and add additional equipment such as programmable pulse generators, programmable power supplies, fixtures, and other equipment. Tektronix does the systems engineering to provide the digital measurement system for a particular measurement requirement. In addition, complete "systems" manuals are provided to facili-

tate servicing and calibration. In the case of the larger systems, Tektronix personnel install and check-out the equipment upon arrival at the customer's location. A test checkout program is provided with each system to assure proper calibration and operation of all system components.

The S-3130 Digital Measurement System is shown above. Full specifications on this, and smaller Tektronix Measurement Systems, are given on pages 27-47 of the New Products Supplement to Tektronix Catalog 27 (1968). For additional information contact your Tektronix Field Engineer.