

SWISS SOUND

NEWS AND VIEWS FROM STUDER

SWISS SOUND
A PUBLICATION OF
STUDER
PROFESSIONAL
AUDIO AG

June 1997
No 40



In this issue:

**Dear SWISS SOUND
Reader**
page 2

**STUDER at interna-
tional exhibitions**
page 2

**STUDER D950
Digital
Mixing Console**
page 3

**DigiMedia '95
Radio Automation**
page 9

STUDER V-EIGHT
page 12

**STUDER D733
CD TEXT Display**
page 14

**RSR - A Jewel in west-
ern Switzerland**
page 15

Dear SWISS SOUND Reader,



Bruno Hochstrasser

in my editorial of the last SWISS SOUND edition I had announced to you that interesting results of our research and development work would shortly be introduced to the trade. Now, at the International Television Symposium in Montreux, we are ready: A new generation of digital mixing consoles is making its premiere.

The most important technological advancement is the totally new digital signal processing part. In close cooperation with experts of the Swiss Federal Institute of Technology in Zurich (which for their pioneering achievements in the field of computer technology have received the Cray Award), a new DSP platform was created which in a very small space offers maximum computing power. The benefits to the user are not limited to the greatly reduced space requirement, but manifest themselves also in the lower price.

The first unit of these new mixing consoles is a production unit called D950. The reports which begin on page 3 of this SWISS SOUND

edition will provide you with the technical details.

Already at the AES Convention in Munich we were able to show a new product that impressively demonstrated our leading role in our traditional domain, the digital multitrack recording technology. This product, called V-EIGHT, is an eight-channel unit based on the principle of S-VHS recording, but with a series of typical STUDER quality characteristics such as die-cast aluminum alloy chassis, STUDER converters and built-in monitor mixer. Additional information on this product can also be found in this edition (beginning on page 12).

STUDER will in future also concentrate in the topics of "Computer assisted Radio". A first step is described in the paper starting on page 9.

And now I wish you much enjoyment in reading these interesting reports.

Sincerely yours,

Bruno Hochstrasser

Front page picture:
STUDER D950, the new digital Mixing Console

STUDER at international trade fairs

SWISS SOUND

Editor

Karl Otto Bäder

Desktop Publishing

Max Pfister

Contributors of this issue

Peter Glättli
Bruno Hochstrasser
Rudolf Kiseljak
Marino Ludwig
Robert Müller
Men Muheim
David Roth
Ulf Störmer

In the second half of March, audio experts from many parts of the world assembled in Munich for the annual European Convention of the Audio Engineering Society. Also STUDER was present (as every year since the founding of this society, as was explicitly mentioned by the Society) and demonstrated in addition to analog and digital mixing consoles also the new digital eight channel recording machine V-EIGHT, which was received with lively interest.

The next European AES Convention will take place in Amsterdam on May 16 - 19, 1998, and of course, again with the participation of STUDER.

Please mail your letters to:
SWISS SOUND STUDER
Althardstrasse 30
CH-8105 Regensdorf
Switzerland

II A Harman International Company

Reprint permitted with reference to SWISS SOUND (please send a copy to the editor)

Printed in Switzerland
10.26.3480 (Ed. 0697)



Third generation digital mixing system:

STUDER D950 Digital Mixing



Rudolf Kiseljak

STUDER, a company with a long tradition in audio engineering and design perfection, is now taking a major step toward a completely new technology in the field of digital mixing consoles. Based on long years of experience in the market and the latest scientific achievements, a new product family, the STUDER D950 has been created.

1. Applications

In all radio, television, film, music production or post production applications where medium or large digital mixing consoles are to be used the D950 family will offer an interesting, new problem solution. The completely new digital signal processing technique has, among other things, the effect that the space for this section of the mixing console requires only about half as much space. This means that installation is also possible in situations where space is at a premium.

Due to the scalable DSP architecture, the modular design, and the incredibly simplified configuration tools, a system can be easily adapted to a variety of tasks and its overall power can be distributed between several operator consoles. Even the most diverse requirements (broad-

casting, multitrack production, mixdown) can be handled by the same console; reconfiguration takes but a few seconds.

For film, TV and postproduction console versions with different surround formats can be configured.

Fully dynamic automation and integrated routers are, of course, available.

But also the economic aspects are significant: the new DSP components are much less costly to produce than the existing ones which has a positive influence on the price of the overall system.

2. Technology

In order to apply the latest high-speed parallel data processing techniques to audio applications, the D950 project was started jointly with researchers of the Swiss Federal Institute of Technology in Zurich. After intensive work a system is now available that uses not only the most powerful SHARC processors but features also full scalability of the DSP platform and the control system.



Fig. 1: STUDER D950 Digital Mixing Console

2.1 Session configuration

This concept allows the assignment of several DSP chips to different tasks, depending on the requirements. The power of the DSP core can be defined in small increments in order to “book” the optimally required percentage of the overall power for a specific task. From this, the idea of “Session configuration” was born; it means that on a given hardware base a number of completely different mixing consoles can be realized. The audio engineer can define for each music selection of a recording a mixing console which he regards as ideal for the task at hand.

Decisive is that reconfiguration must be possible without any loss of time. Once the new configuration is defined it takes but a few seconds to recall and load it.

The audio engineer can configure a “different” mixing console each day, for example:

Day 1 Live Broadcast configuration	Day 2 Multitrack Recording configuration	Day 3 Mixdown configuration
48 Mono Input Channels with - EQ - Delay 24 Stereo Input Channels with - EQ - EQ	48 Inline Channels with - EQ in monitor path - Comp/Lim/Exp/Gate in input path - Comp/Lim/Exp/Gate 4 Stereo Input Channels with 4 Stereo Input Channels with - EQ	96 Mono Input Channels with - EQ - Delay - IPL
0 Routing busses	48 Routing busses	8 Routing busses
8 Groups with - EQ	0 Groups	16 Groups
2 Master Outputs with - Output Limiter - EQ	4 Master Outputs	8 Master Outputs
8 Mono Auxiliaries 2 Stereo Auxiliaries	4 Mono Auxiliaries 4 Stereo Auxiliaries	12 Mono Auxiliaries 4 Stereo Auxiliaries
12 Clean feed busses	0 Clean feed busses	0 Clean feed busses

Fig. 2: Examples of Configurations

3.2 Channel type and number

Each channel can be defined as mono or stereo. From a central library individual process blocks (such as equalizer, delay, limiter/compressor) can be selected and assigned to the individual channels. It makes no difference whether these are input, group, master or AUX channels. Up to 256 channels can be configured for a D950 console. When the desired configuration of process blocks has been defined, it can be read into in the system at any time (see also Fig. 4).

Every feasible combination of AUX, Cleanfeed, multitrack selection, group and master buses can be defined. A digital router is integrated and eliminates the need for external patch panels.

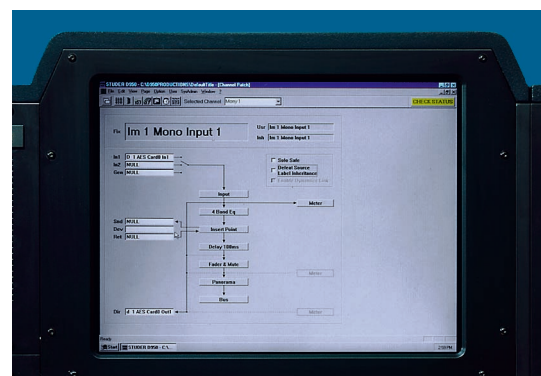

Fig. 3: Channel Setup

Session configuration



Men Muheim

One of the key features of the D950 is the automatic configurability. The long-standing STUDER standard enabled each customer to configure a mixing console that is tailored to his individually requirements. Today, however, this is done with a graphic configuration tool through which the specifications can be conveniently entered. After a brief compiler run the required hardware and the related costs are available and the entire software for the new system is generated automatically. This tool reduces the configuration procedure from several weeks to a few minutes which in turns shortens the delivery time.

A step that goes beyond the mixing console configurability in the traditional sense has been taken: the entire D950 system is so flexible that it is possible to change configurations on the fly. With the graphic controller the configuration that most closely matches the application can be selected from any number of "Session configurations".

Example: A music selection may have sophisticated dynamic units in each input channel, but already in the next selection these dynamic units should be sacrificed for more auxiliary buses. Within approximately 30 seconds the configured software is changed and a mixing console tailored to the actual applications is available.

3.3 Safety and reliability

The DSP section is the core of every digital mixing console. For this reason any faults occurring in this part of the system can become critical. The core of the STUDER D950 monitors itself. If a hardware or software error is detected, steps are immediately taken to protect the audio information. Subsequent processing is immediately assigned to a redundant DSP board (if installed). The audio engineer is notified of this reassignment by a message on the screen. The faulty board can now be hot swapped without interfering with the operation of the mixing console.

4. Ergonomics

The user interface of the STUDER D950 mixing console is designed for professional users. Particular attention has been given to the requirements of live operations. The access to all functions is fast and simple. As the user interface is similar to an analog mixing console, the time required for familiarization is very short.

Each channel operating unit contains the control elements for all parameters of the channel that has been selected. All channel operating units have the same design but they can be allocated to different functions (e.g. input, group, master). The main functions such as input selector, process block selectors and the AUX section can always be accessed directly. For this reason it is not necessary for the operator to call up "pages" or to intervene via the central control panel. This also simplifies the status feedback of the individual channel operating units.

The process block control can be assigned to four touch-sensitive rotary encoders; these control all parameters of the corresponding block.

The operation and especially the status feedback are simplified by the monitor of the graphic controller (for details see box "Graphic controller").

4.1 Channel swap function

Setting the parameters of a channel that is located relatively far off the mixing console center is often cumbersome because the audio engineer must move away from the optimum listening zone. On the STUDER D950 mixing console the corresponding channel can be swapped with a unit located in the middle, just for the duration of the set up, and then be swapped back.

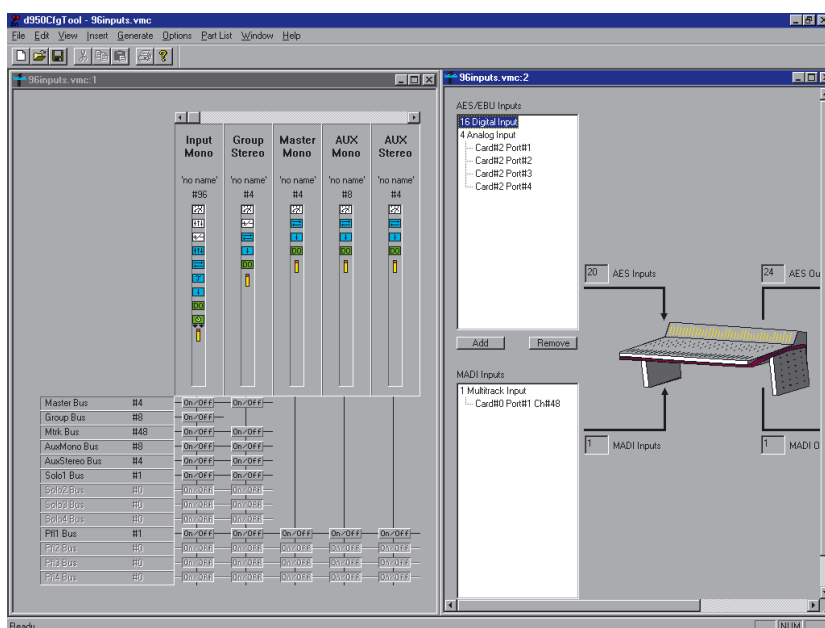

Fig. 4: Screen Shot from the Menu Session Configuration

Graphic controller GC



Ulf Störmer

A conspicuous feature of the new D950 is the integrated flat panel display. It serves as the monitor for the graphic controller, a Windows program that is abbreviated as GC. This program is used for operating all mixing console functions that go beyond the traditional procedures. This includes in particular the following areas:

- Global and channel-specific router control
- Recall and management of snapshots, snapshots sequences and cue points
- Saving of desk clipboards
- Assignment of the DSP channels to the fader strips
- Automation control and operation of the time code control
- Music selection and production management

Various windows and dialog boxes logically group the individual functions. The representation is optimized to highly simplified and intuitive operation.

A few samples will clarify this point. With the aid of the easy-to-grasp control matrix the setup of crosspoints becomes like child’s play, even in large mixing console configurations; in the snapshot window all mixing console parameters are accessible with a mouse click; in the pull-down automation tools the time code, loop points and mixpasses are under control at a glance. This is as simple as mixing console operation will ever get.

The concept of overall system configurability has been adopted also for the GC. As most functions are arranged in overlapping windows of modifiable sizes, each user can set up his work environment to suit his own requirements. These settings can, of course, be saved and recalled at any time. This allows fast and application-oriented operation of the D950 mixing

4.2 Organization of the channel operating units

Experience has shown that opinions are divided on how the channel operating units are to be correlated with the channel control units. One philosophy is to install one fader strip for each audio channel; this approach comes close the analog mixing console and operating “layers” or assignability are not needed.

By contrast, many users prefer smaller operator control panels, for example, with 24 fader strips for 48 channels. In this case, simple assignability plays a major role.

The STUDER D950 supports both philosophies. It is possible to operate each channel individually or to allocate up to ten physical channels to a fader strip. In an extreme case, for example, 120 channels could be controlled with 12 faders. This organization is part of the total configuration; for this reason it can be stored, modified and recalled. It is no longer necessary for the customer to define his channel organization already at the time the order for the mixing console is placed; subsequent changes are possible at any time.

4.3 Multiple operator stations

Up to four mutually independent user interfaces can access the same DSP platform. They have independent monitor sections, PFL and solo buses, as well as master outputs. The four operator stations can fulfill different functions in different studios, but they share the capacity of the common DSP core. It is also possible for the different studios to access the same audio signals (e.g. inputs); through the built-in routers also peripheral devices such as converters can be shared.

4.4 Signal monitoring facilities

In addition to the normal monitoring facilities of a conventional mixing console in the form of monitoring fields, the STUDER D950 offers additional monitoring paths which in the past have rarely been used. IPL or In Place Listening is the name of this new function. It allows signal monitoring by individual process blocks within a channel, in particular:

- after the input
- after the equalizer
- at the return point of the insert
- after the compressor/limiter, and
- after the control input of the compressor/limiter (side chain).

This IPL function is a very detailed control tool

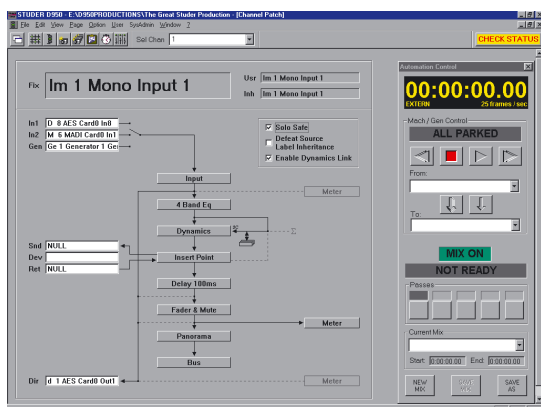

Fig. 5: Screen of the Graphic Controller

and enables the audio engineer to monitor at various points of the channel.

Each parameter of the mixing console can be stored dynamically and recalled based on a time code information.

The enormous versatility can, of course, be accompanied by a certain operation complexity. For this reason a very simple but in practice highly convincing concept has been introduced for the STUDER D950: all operator controls are touch sensitive. If any control is touched while automated takes are being played back, the control switches immediately from “read” to “write”. The correction induced by the actuation of the control is written immediately into the automation memory. As soon as the operator releases the control the corresponding parameter returns to the “read” state.

This procedure is so convincingly simple that the audio engineer no longer has to worry about automation and can concentrate himself fully on his artistic tasks.

Dynamic automation may either be integrated when the mixing console is ordered, or it can be retrofitted in the field.

6. Audio

6.1 Quality

The DSP platform of the STUDER D950 used processors with integrated floating point circuitry. The internal word width is 40 bits. This high resolution is responsible for the outstanding signal-to-noise ratios of this mixing console.

The truncation errors which are inevitably generated with all kinds of digital signal processing are kept so small by this high precision that they play no effect in the result. Also is the possibility to connect MADI-Formats directly to the DSP-Core a future safe investment with linear 24 bit at in- and outputs.

6.2 Interfaces

Digital audio connections are established directly on the DSP core in MADI or AES/EBU format.

The analog conversion is performed via peripheral devices from the STUDER D19 or D19m family. These peripheral devices can also be installed remotely and be connected to the mixing console via optical fiber cables (or coax); this minimizes the required cabling and allows conversion near the recording source.



Fig. 6: Monitor Control Field and Assign Control

5. Mixing console automation

5.1 Snapshots

Up to 256 different snapshot settings per music selection can be captured and stored, up to eight different sequences – that is, the chaining of any number of snapshots in any order – can be generated. When a snapshot is called the mixing console requires less than half a video frame for loading it.

5.2 Clipboard

The control system supports “Copy and paste” operations so that certain channel settings can be easily transferred to other channels. This greatly simplifies the work, particularly when a configuration is set up from scratch.

5.3 Dynamic automation

DSP core



Peter Glättli

The DSP core is a universal parallel computer that is based on the Distributed Shared Memory Architecture. An intelligent communications network forms the basis for fast interprocessor communication required for audio processing. The fail-safe concept of the core allows the insertion of redundant DSP boards into the system, which in the case of a fault automatically take over the functions of the failed board. In addition the boards can be hot swapped. In the signal processing core of our system, state-of-the-art technology is used:

A SHARC-DSP processor made by Analog Devices is applied. This is one of the most powerful signal processors that is currently available. It has a computing power of 120 Mflops (120 million floating point operations per second), is equipped with 128 Mbytes of on-chip memory and a separate input/output processor for communication with the outside world.

- Up to 120 SHARCs form the core and thus achieve a computing power of nearly 15 Gflops (15 billion floating point operations per second).
- The communications network is based on "Intelligent Communication", a concept for efficient parallel computers (communications power = 266 Mbytes/s) developed at the Swiss Federal Institute of Technology in Zurich under Prof. Gunzinger.
- The circuit boards are implemented in 8-layer SMD technology.
- MADi and AES/EBU audio interfaces are

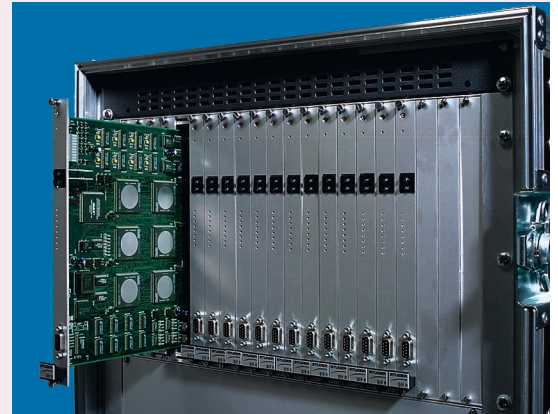

Fig. 7: 19"-Frame for all DSP-cards used in the system. Visible are the SHARC-Processors. Note the reduced space required compared with former solutions.

- available directly on the DSP boards.
- The core has a maximum power consumption of 500 W and features a very compact design.

Due to its modular design the core delivers exactly the required computing power. To enlarge the mixing console additional DSP boards are plugged in, the corresponding session configuration is loaded and the new console is ready for operation.

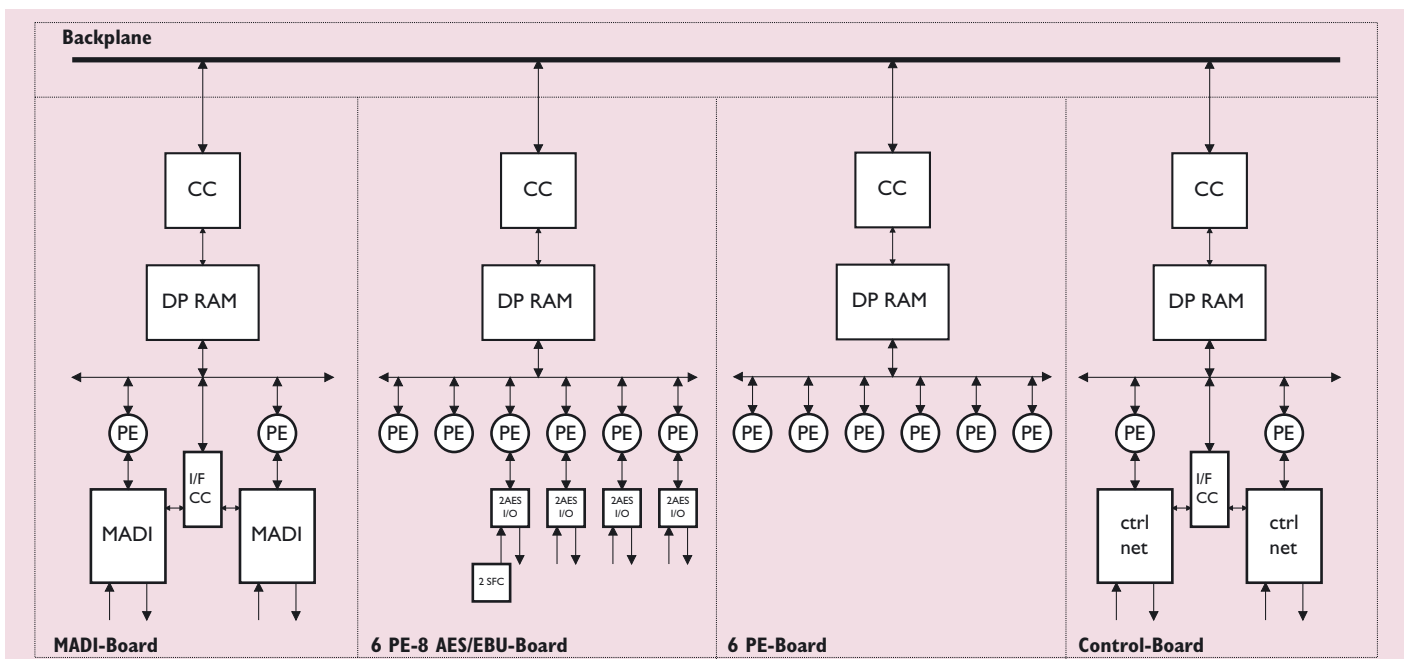

Fig. 8: Block Diagram of the DSP-Core.

Continuous system development leads to wide acceptance:

DigiMedia'95 Broadcast Automation



Marino Ludwig

Initially this system was designed strictly for CD automation but since then it has been considerably enhanced, initially through the integration of peripheral devices such as the Hard Disk Single Player or other external hard disk audio units. Subsequently, own hard disk audio recorders/players were integrated into the system that can be played back by means of the PCX cards in the work stations (up to 4 stereo channels directly from on-air station). The latest step involves the **integration of the proven Edigas/Edimix audio editor software from DAVID.**

This connection allows a smooth change from the existing DigiMedia data base to the editor, and after the audio files have been processed, the management is again assumed by the DigiMedia system. Different file formats can be recognized and managed.

Audio data are inserted and reproduced via the DigiMedia Audio Recorder/Player.

For combining the existing software modules of the two companies STUDER and DAVID, there are basically two integration configurations:

The diagram "Integration 1" gives a schematic overview of how the Edigas/Edimix editor can be integrated into the DigiMedia system.

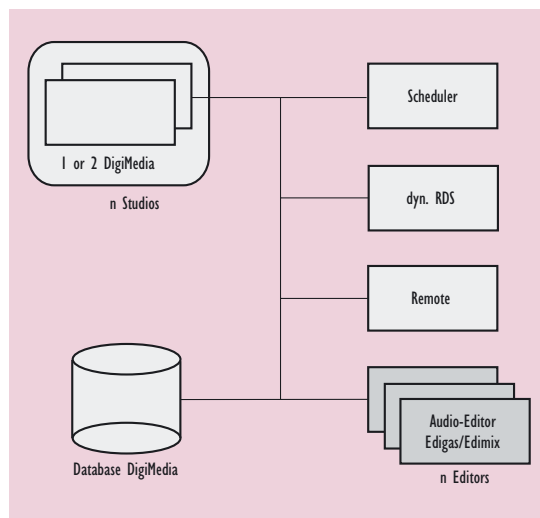

Fig. 1: "Integration 1"

"Integration 2" shows how the broadcast scheduling and playback of DigiMedia can be added to the DIGAS system. The two databases remain as discrete entities and can communicate with each other by means of "Drag & Drop" func-

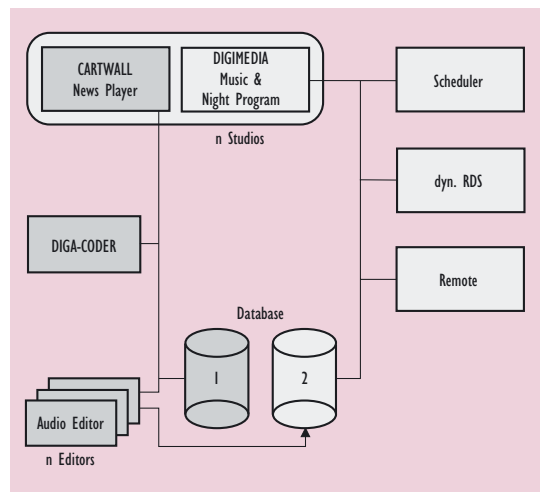

Fig. 2: "Integration 2"

It should be noted that in the DigiMedia system, in whatever combination, the following additional applications are now available:

Dynamic RDS:

Information from the database (e.g. music selection, artist) are transmitted to the RDS coder via a studio workstation interface; in addition also user-selected texts can be programmed and inserted ad-hoc. The work interface features various categories for specific messages (news, sports, weather or traffic information), or also station identifications.

The indication rate for the receiver is optimized for Radiotext in accordance with the RDS transmission priority.

The RDS module is also able to transmit text locked to a specific time based on the internal clock.

Remote module:

This supplementary package allows direct, delay-free control of the entire On Air screen, including access to music selections in the data base for "last minute" changes to the play list. Such a connection can be implemented with commercially available modems operating at 28,800 baud or higher, or also entirely wireless via GSM mobile telephones.

Also built in is a simple "chat" facility for direct communication between the remote reporter and the studio by means of a text window for short messages. The remote access can, of course, be password protected.

Fig. 3 shows the current, ergonomically enhanced on-air screen from which an expanded range of ancillary functions can be chosen. Also worth mentioning is the fast selection of jingles or other contributions directly from the two rows of keys on the right-hand side. These selections can be overlaid directly on a running program (instant play) or be inserted into the play list at the end of the current on air item.

Fig. 4 illustrates the recorder/player user interface that can be called directly from the library screen.

When PCX audio cards are installed in the editing or scheduling workstations and the music selections are chosen from the library (library card), it is possible to listen directly into the HD selection by means of an "Audio" key.

The same key is used also for starting the Edigas editor (Fig. 5) or for storing a new entry in the library. The recorder/player can select the parameters for data rate, sampling frequency, analog or digital recording in various data reductions, as well as linear WAVE files. Pre-selection for Autostart/Stop recording allows the recording to be turned on and off with the start and end of the modulation.

The editor (Fig. 5) presents itself to the user in 2 versions: the "full application" with all capabilities for fader and volume control, or minimized to the so-called "Easy Page" on which only the main functions are displayed in a large, easily visible format for ease of use.

Abb. 3: On-Air Screen

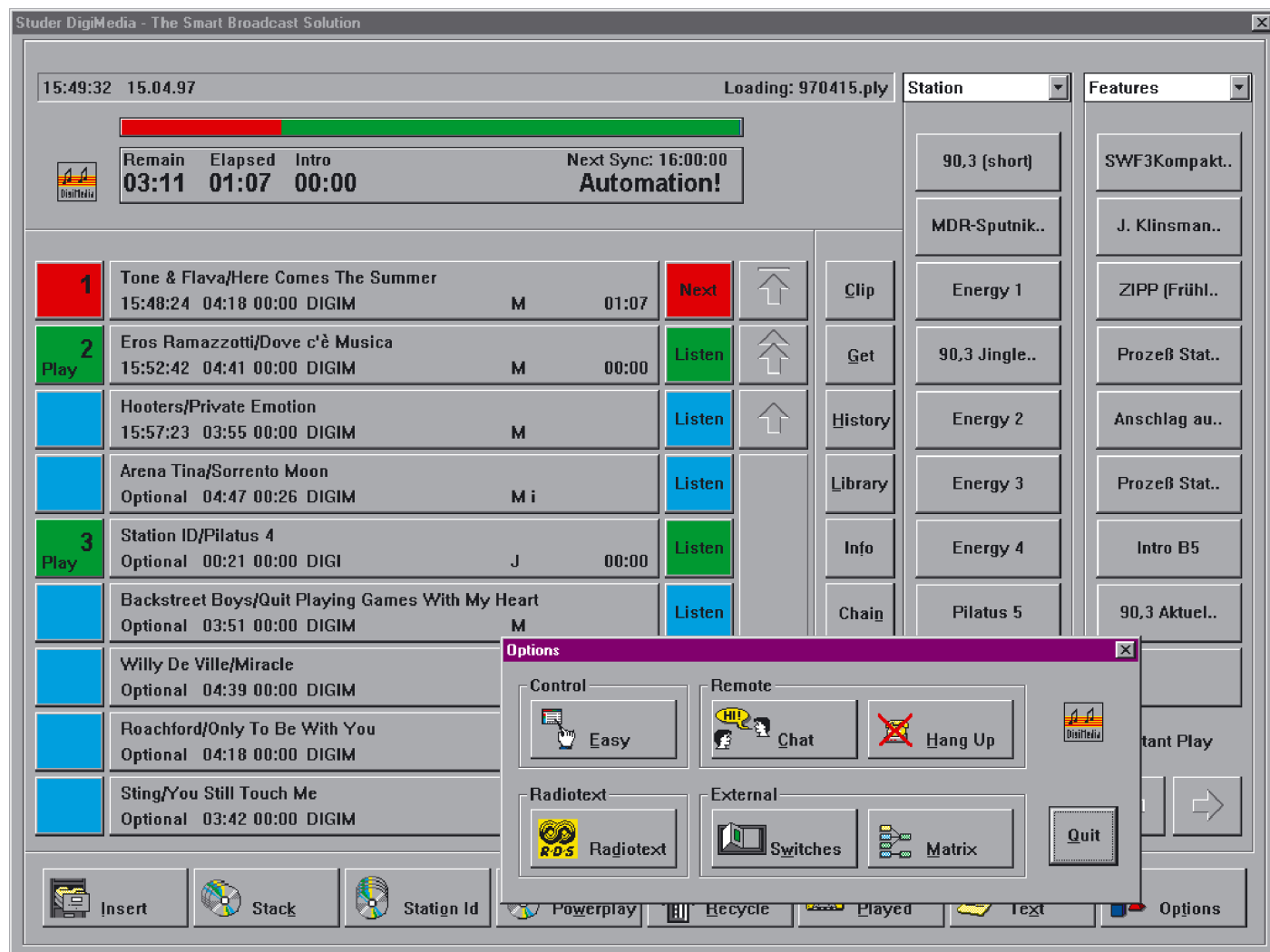

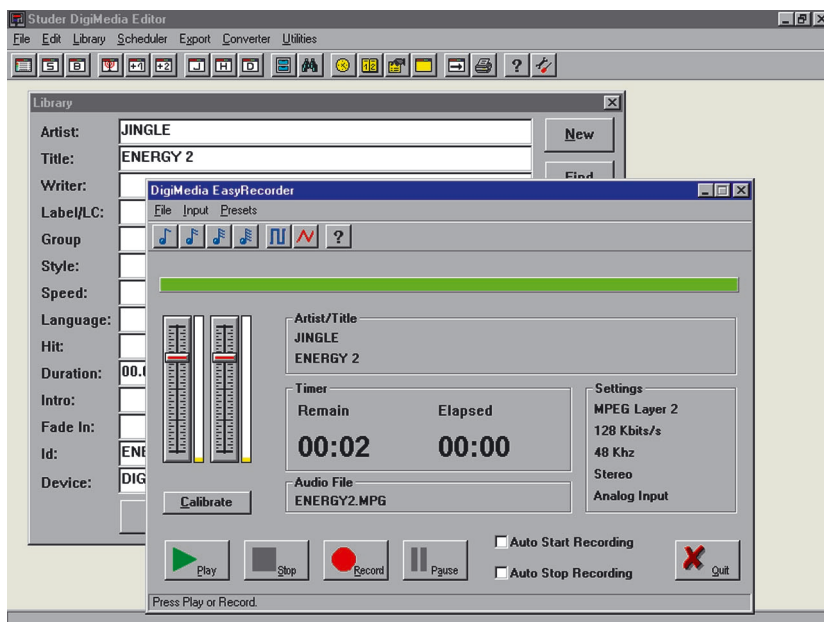

Fig. 4: Recorder/player screen

Basic system building blocks

The entire system, programmed as a 32 bit application, is hardware implemented on modern, commercially available PC structures which in turn are supported by Windows NT 4 or Windows 95.

This foundation also allows highly convenient handling of networked systems with 100 Mbit/s networks and server installations that range from several hours to several hundred hours of audio capacity.

The minimum hardware requirements for workstations and the network are specified by STUDER. The installation of the server, network and workstations are normally organized

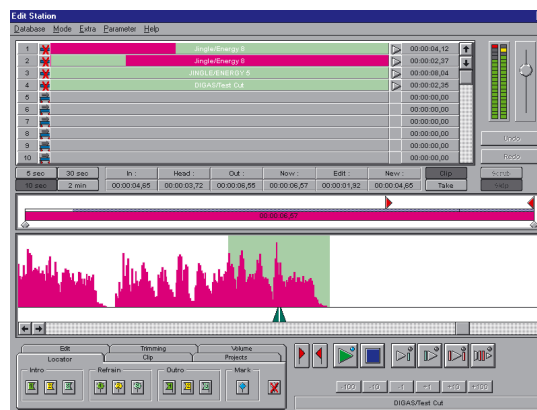

Fig. 5: Editor screen

Reference List - STUDER DigiMedia'95

* = Installed systems, in use
 () = Delivered and to be in use soon

Status: July '97

Country	Stat.	Customer	System Size/CD.capac./HD	Specialities
Switzerland	*	Radio BeO, Interlaken BE	800 CD /DCART/DMD	
	*	Radio Canal 3, Biel BE (D Prog.)	400 CD /HD-Server	2 separate syst. + common server
	*	Radio Canal 3, Biel BE (F Prog.)	400 CD /HD-Server	
	*	Radio Pilatus	1500 CD/ 20 GB HD	Remote/dyn. RDS
	*	Radio FM Meyrin, GE	300 CD	
	()	Radio Förderband, Bern	200 CD/ 90 GB HD	Remote/dyn. RDS
	()	Radio 32, Solothurn	200 CD/ 50 GB HD	dyn. RDS
Italy	*	ORBIT, Rome (Arabic Channel)	300 CD /NUMISYS-I	
	*	ORBIT, Rome (Classical Channel)	300 CD /NUMISYS-I	
	*	ORBIT, Rome (Pop Channel)	400 CD	
	*	Radio/TV San Marino	600 CD /HDX-2000	
UK	*	Retail Broadcast Systems, London	300 CD /HDX-2000	
	*	Retail Broadcast Systems, London	300 CD /HDX-2000	
	*	Retail Broadcast Systems, London	300 CD	
Poland	*	Radio West	300 CD /NUMISYS-I	
Taiwan	*	Classical Radio	400 CD	
Thailand	*	Radio Classical FM	300 CD/HDX2000	
Hungary	*	Magyar Rádió, Budapest	300 CD	
Sweden	*	Harddisk only system	WAVE/PCX	
Croatia	*	Radio Makarska Rivijera	1000 CD	
Latvia	*	Radio Business & Baltija	300 CD/DCART	
Marocco	()	Auvicom	400 CD	

A new digital 20 bit eight channel recorder

STUDER V-EIGHT



Robert Müller

The demand for higher resolution without sacrificing the recording time combined with the requirement for faster media replacement have induced Studer to introduce a modular 20 bit 8 channel recorder to the market. The STUDER V-EIGHT recorder is based on the S-VHS recording principle and is equipped with all functions required in professional audio applications. To satisfy the demands of a professional studio environment, the V-EIGHT is mounted on a very sturdy and distortion-free die-cast aluminum alloy chassis. The modular concept allows sample accurate interconnection of several units via a simple sync bus.

The linear 20-bit recording format

The STUDER V-EIGHT is based on the ADAT type II format which is an enhanced version of the existing ADAT format. This enhanced format allows recording with 16 or 20 bit resolution. The resolution is defined by simply pressing a button before the tape is formatted. As soon as a cassette is read the V-EIGHT detects automatically whether the recording was made with 20 bit or 16 bit resolution. Of course, 16 bit recordings are fully compatible between the V-EIGHT, Alesis ADAT, and ADAT-X1. This is a true alternative to the different disk based recording systems which generally achieve the claimed partial compatibility only through time-consuming file conversion. Have you ever waited for a 3 GB backup or restore of a hard disk? An 8 channel 60 minute, 20 bit tape contains 3 GB of audio data that are immediately accessible without any upload or download times!

Compatibility is also assured with respect to the system environment. The ADAT Sync as well as the ADAT optical interfaces use the same format as the existing Alesis models which allows full integration of the V-EIGHT. The optical interface allows full 20 bit data transfer but through dithering the V-EIGHT is able to reduce the data width to 16 bits in order to perform high-quality transfers to 16 bit media.

The "Direct Drive" tape deck

Fast access to tape locations and very gentle handling of the tape are assured by the fully professional tape deck. It is equipped with a direct drive capstan (fast stop/play transition), two independent DC spooling motors (neither an idler wheel nor mechanical brakes are

needed), and independent tape tension sensors. Tacho information is derived from the spooling motors. With the aid of this advanced technology it was possible to develop a software-controlled and consequently highly optimized tape deck.

Another characteristic of the tape deck is that two additional linear tracks can be recorded. One is used for time code recording. This allows continuous reading of the SMPTE/EBU TC during spooling as well as in jog/shuttle mode. The other is an analog AUX track. The audio information of the AUX track can either be derived internally or be recorded from an external source via separate XLR inputs/outputs.

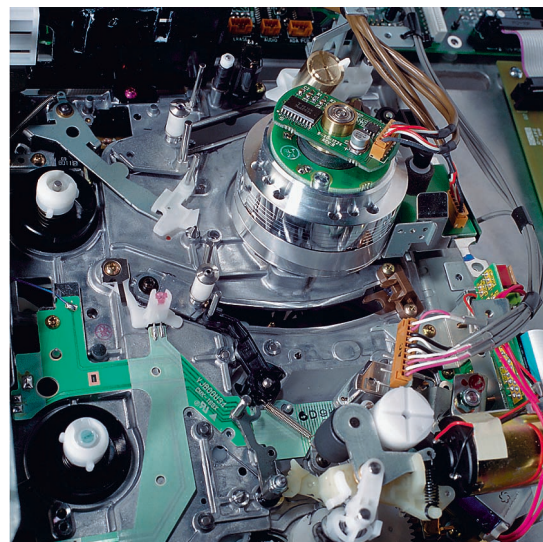

Fig. 1: View on the drive part

Operator controls in „Night Design“

To allow the equipment to be operated in a dark studio environment, the controls feature a "Night Design". All keys in passive state glow dimly which makes the controls easy to locate.

The peak levels as well as the tape deck status are shown on separate displays. The special display units allow a highly functional layout of the display panel. For example, the peak level meters, input status, tape counter, offset and locator addresses, equipment settings and much more can be read directly off the display.

Integrated SMPTE/EBU synchronizer

To allow the V-EIGHT to be fully utilized in professional time code applications, it is equipped with an integrated SMPTE/EBU TC reader/generator as a standard feature. As mentioned above, synchronization based on the separate TC track or the absolute time is possible. The synchronization as well as the TC generator can run with all standard frame rates (24, 25, 29.97 and 30 frames/second).

Jog/shuttle function

With the direct controllability of the tape deck a true jog/shuttle function can be implemented in the V-EIGHT. The function of the jog/shuttle wheel can be selected either via a change-over key or by pressing the wheel. In jog mode a specific audio position can be located in which case the audio is played back from the AUX track mentioned above. In shuttle mode the audio is read from the AUX track within the range of 1/4 to ten times the play speed. In this way a tape position can be searched across a larger speed range.

STUDER audio quality

What could be more important than reproduction of a recording with the highest quality? The worldwide renowned audio quality of STUDER products is ensured with the V-

EIGHT. The 20 bit A/D and D/A converter technology which is also used in the D827 DASH machine ensures absolute playback fidelity. For matching the level to an existing installation, individual, externally accessible trimmers for each channel are available that allow adjustment within the range of +4 dB to +24 dB.

Unique monitoring

To allow the production of a headphone and monitor mix without an external mixing console, a monitor mixer has been integrated in the V-EIGHT. The mixed down signal is available at the headphones as well as on a monitor output. The mixer features an additional input (return input from effect machines or looping in of additional eight channel units). The master signal of a V-EIGHT can now be connected to the return input of the next V-EIGHT. Via a separate return level potentiometer the first eight channels are mixed down together with those of the second V-EIGHT into a 16 channel monitor mix. This cascading can be expanded as desired.

The know-how and the experience of STUDER in the field of profession audio recording, combined with the widely accepted ADAT type II format ensure that the V-EIGHT can satisfy the requirements of broadcasting and recording studios.



Fig. 2:
Front of the
STUDER V-EIGHT unit.

Inauguration of STUDER Korea

An Nyeong Ha Sei Yo!

We are very proud to announce, that this month we have officially opened STUDER Korea in Seoul, South Korea.

Mr. *Soon Pyo Lee*, President, and Mr. *Je Ho Shin*, Director Sales & Marketing, and their team will be responsible for all STUDER market activities in South Korea. We believe that with this new organization, STUDER will be

able to ensure an excellent and professional service to our customers, and to quickly respond to today's and future market demands.

We wish the entire team best of luck and a very successful business in South Korea.

Haeng Woon Eul Kiwon Hammida!

In our next SWISS SOUND edition, you will be able to read more about STUDER Korea.



Not only music, but text also - CDs can be reproduced with additional information

STUDER D733 CD TEXT Display

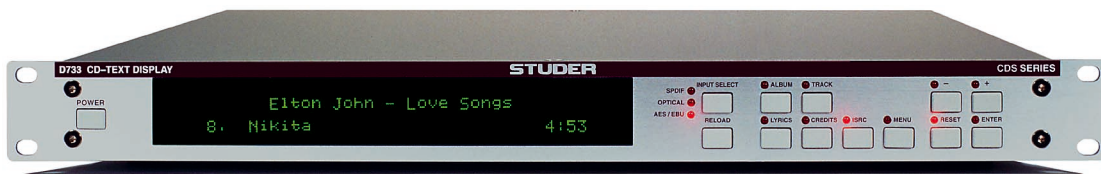

David Roth

CD Text is a new extension of the CD-Audio standard described in the red book. It allows to store additional text information such as the name of the artist, the track title and synchronized lyrics in the so far unused subcode channels R-W. CD Text was developed by Philips and Sony as a cost effective means of providing added features and functionality to the well established audio CD format.

CD Text is mainly intended for consumer use to allow future CD Players to display the track title direct on it's local display. Therefore, the booklet does not have to be used with the track number as a reference. In addition the name of the artist and other credits can be displayed as well. Many CD's contain also the song text in the booklet. For opera's this booklet is quite big and could be omitted, if the song text is also on the CD. Especially for titles in a foreign language, it makes it much easier to understand the lyrics, if it can be read simultaneously.

CD Text offers also the same advantages for professional applications. For broadcast or theatre applications for example, the track title gives much more evidence about the content of the track to be played than just the track number itself. Therefore, CD Text enables a higher operational safety. The additional text information may also be used for new broadcast services such as RDS and DAB. For DAB, CD Text might be used for the Programme Associated Data PAD. The radio DJ usually does not announce the name of the artist, the track title nor the album title. However, this information may be read on the DAB receiver

display. As a consequence, the listener knows which disc to buy in the next record shop. As can be seen, there is a clear commercial interest behind CD Text.

With the STUDER D733 CD Text Display you can indicate additional text information on a highly visible 2-line/40 character FTD display. The D733 can be connected to the digital output of your existing CD-Player, such as STUDER A727, A730 and D730...D732. A RS232 interface is also prepared for feeding the database of CAB systems and direct RDS and DAB services.

Even for CD's without text information, the

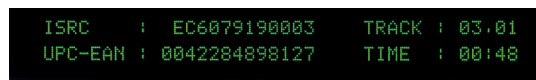

D733 is helpful. For all discs, the following is indicated:

- Track number
- Index number
- Track elapsed time
- Catalog number (UPC/EAN code)
- ISRC codes

For CD's with text in the program area, the D733 indicates in addition:

- Album title

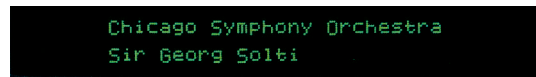

- Track titles

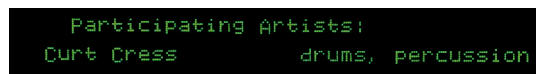

- Name of the artist

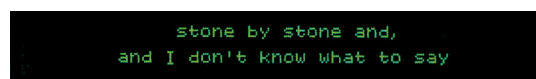

- other credits
- synchronized lyrics

In the next issue of the Swiss Sound we will let you know how to create a PQ file with text for CD-mastering and how to create your own

Block diagram

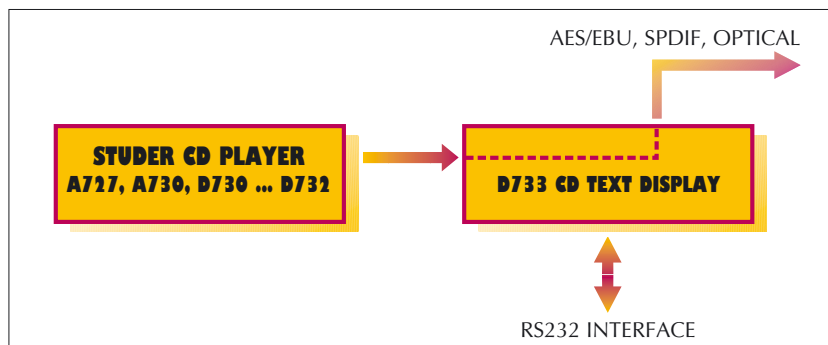

RSR - A Jewel in western Switzerland



Karl Otto Bäder

Precisely 75 years ago, Radio Lausanne, today RSR (Radio Suisse Romande) started as first swiss station with regular broadcast transmissions. Already in those days news played an important role.

The importance of information is today regarded to be more dominant than ever, and RSR has invested in a new information complex with the most advanced technology. On April 3, 1997, at 10:00 hrs. two new studios went on air, both equipped completely with digital STUDER devices.

As the planning engineers Jean-Luc Jeannet and Jean-Pierre Molliet explain, one studio serves for production and transmission of complete news magazines. Everything during this block, including the music, is generated in this studio. The second one ("Info pile") produces a news flash every full hour which will be integrated in the continuity of the different programs of the french speaking part of Switzerland.



The system is prepared in the STUDER factory

formats. Approx. 50% of all contributions from the outside world go life into transmission, the rest will be recorded ("Intake station"), edited if required, and finally stored on a server in bitreduced format (ISO/MPEG 1 Layer II). Quite a number of interviews comes still today from tape (Nagra, DAT); they are processed accordingly. For this reason all studios are equipped with additional playback devices for different media (CD, Tape, DAT); however, the main part originates more and more from harddisk via network.

For this reason one of the largest STUDER NUMISYS II installations ever built is integrated in the complex. It comprises totally 34 workstations for journalists, for scheduling, and for ON AIR. For editing purposes a number of these stations are loaded with DAVID editors.

It is interesting to see how RSR is handling the enormous information data flow at the console. Each information source should be accessible anytime, even if not always needed in the normal operation. Thus the concept of switcheable video monitors was dropped. Today every data source has its own monitor: the independent Jingle-Server (NUMISYS T-MAD) as a touch screen, the ISDN connections, the MADI-Router, the Intake-Station, the DAVID editor, the ON AIR workstation, and the text server connected to the international news agencies. Seven monitors round the console help to make the information flow structured and easy to control.

Our best congratulations to RSR - not only for their anniversary, but also for the future proof solution of their new information complex! ■



The news magazine studio, ready for operation

Core of each of the both control rooms is a STUDER D941 Digital Transmission Console. This desk offers full flexibility of the layout of the operational surface; advantage is taken by moving parts of the surface to other places if a complex program structure requires more operating staff.

Signal distribution is effected by a STUDER MADI Router with 500 inputs and 512 outputs. The connections to the consoles are made via glass fibre cables. The thick copper cable harnesses of former times are replaced by only few optical connections.

This router switches also the inputs which come in analogue telephone, ISDN or other Telecom