

# SENCORE

# NEWS

All American designed, produced, sold and serviced.

MAR/APR 1987  
Issue #131

WATS Free 1-800-843-3338

*Sencore Means Success In Electronic Servicing*

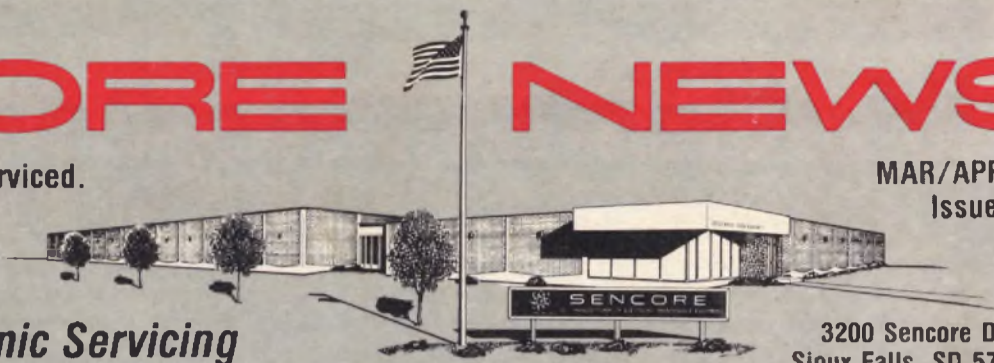

3200 Sencore Drive  
Sioux Falls, SD 57107

*Dedicated To Successful Troubleshooting In The Video, Audio, Communications,  
Industrial Electronic Repair, And Educational Markets*

## Page 3—

***Exciting New Products,  
The All New Sencore News, And  
Why Sencore Means Success For  
You In Electronic Servicing.***

## Page 16—

***How To Teach AC Electronics So  
Your Students And Technicians  
Understand Better And Learn  
Faster.***

## Page 10—

***Now Test Your Entire TV-RF,  
MATV, And Cable Systems  
Automatically With 100%  
Confidence!***

## Page 20—

***Learn About New And  
Rewarding Career Opportunities  
At Sencore.***

## Page 13—

***Now Take The Guesswork Out Of  
Your Stereo TV And VCR  
Troubleshooting With The All  
New SR68 Portable Stereo  
Readout.***

## Page 30 - 31—

***Act Today And Save Up To  
\$2,290 With Sencore's Success  
Shop Specials.***

***Plus . . .***

***Win Your Own \$8,175 Dream Shop (page 25) In Our  
All New Sencore Success Shop Sweepstakes! And—***

***See Why Sencore's All New Shopper's Guide  
Means Success For You In This New Year!***

**SENCORE**

3200 Sencore Drive, Sioux Falls, SD 57107  
Address Correction Requested

BULK RATE  
U.S. POSTAGE  
PAID  
PERMIT NO. 170

**Last chance to renew your  
Sencore News**

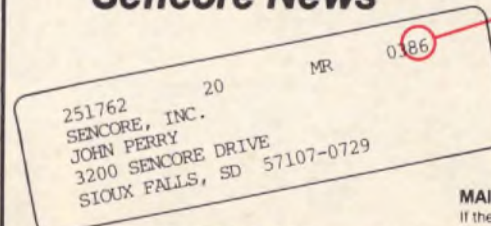

**This  
Number  
On Your  
Mailing  
Label**

### IMPORTANT!

If the last two digits in the upper right hand corner of your mailing label do not end in 86 or 87, this will be your last issue of the Sencore News. So, renew your subscription today and you won't miss a single important article or time-saving troubleshooting tip. See page 25 for your Sencore News Renewal Form.

**MAIL ROOM:**  
If the person on the label is no longer with your organization, this should be routed to his replacement or superior.

Route to:

1. \_\_\_\_\_
2. \_\_\_\_\_
3. \_\_\_\_\_

# PUSH

# Your Way To Success In Electronics Servicing

## with the Sencore SC61 Waveform Analyzer

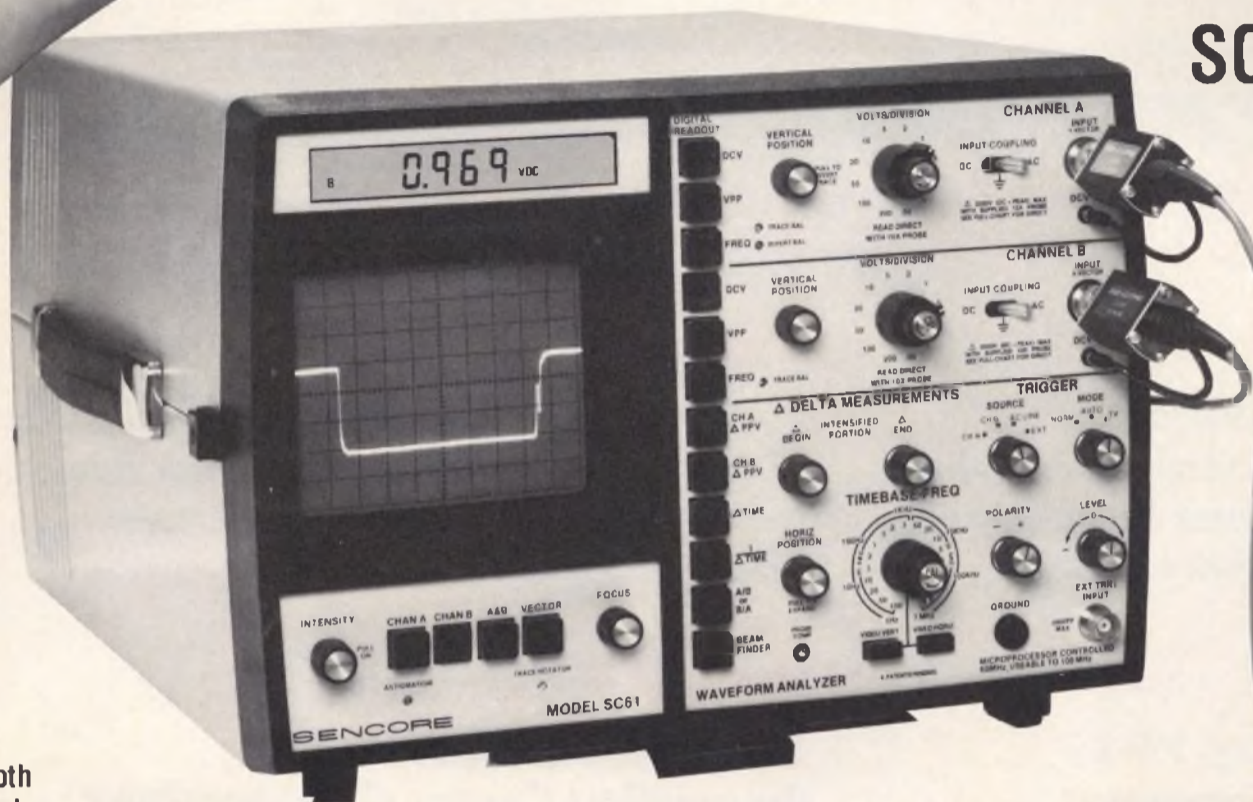

Analyze any waveform in seconds, with digital accuracy. All automatically at the PUSH of a button. Get your index finger ready. Make only one circuit connection for all tests. Here's how easy it is:

10 times faster,  
10 times more accurately,  
Zero chance for error.

Use both channels or only one as shown here.

Patented \$2995

### View The Waveform And Read DCV, VPP and FREQUENCY Automatically — In Just Seconds

Prepare by setting the SC61 TIMEBASE — FREQ to the same frequency of the waveform and watch it pop on the CRT with rock solid sync.

#### Success Step No. 1

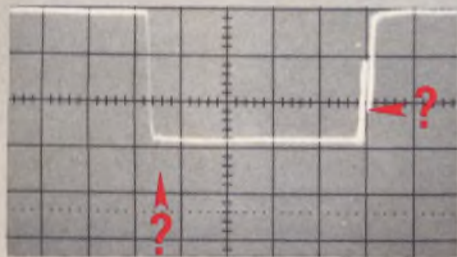

Compare the waveform to your schematic. Note questionable areas.

#### Success Step No. 2

READ VDC on digital meter.

1.579 VDC

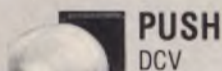

**PUSH DCV**  
Compare to DC voltage reading shown on your schematic.

#### Success Step No. 3

READ VPP on digital meter.

2.71 VPP

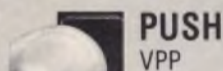

**PUSH VPP**  
Compare to VPP volts shown on your schematic.

#### Success Step No. 4

READ frequency on digital meter.

1.00012 MHz

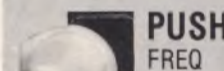

**PUSH FREQ**  
Compare to frequency shown on your schematic.

### Measure A Part Of The Waveform For Glitches, Interference, Rise Time, Duty Cycle, Time Duration, Etc.

#### Success Step No. 5

Adjust brightness so the portion of the waveform that you want to read is brighter.

Adjust controls until brighter part of the trace fits the portion of the waveform you wish to read.

Pull HORIZ POSITION switch to 10X EXPAND for accuracy.

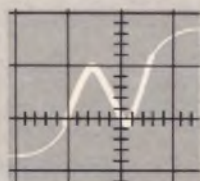
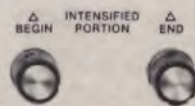
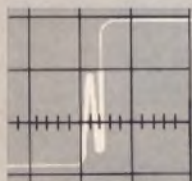

#### Success Step No. 6

Read intensified portion, for all DELTA measurements, by simply pushing the desired pushbutton and reading the same digital meter.

**PUSH** to read  $\Delta$  PPV directly.

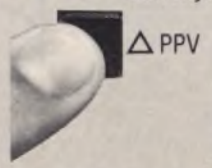

**PUSH** to read  $\Delta$  TIME in  $\mu$  Sec.



**PUSH** to convert time to freq.

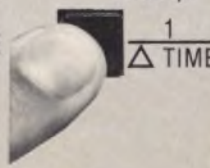

#### Success Step No. 7

Read frequency multipliers or dividers directly to speed up troubleshooting, to eliminate graticule counting, or to reduce costly calculating errors.

Connect probes to chip either way.

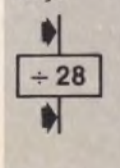

**PUSH** "A/B or B/A" pushbutton

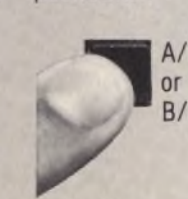

28000 B/A

Read divide or multiplier number directly. A/B indicator tells you how chip is connected.

OK, can you see how easy it is to quickly PUSH your way to success in electronic servicing? If your answer is YES and you still have that tingle in your index finger and can't wait to start pushing your way to success, pick up your telephone and help that index finger dial WATS Free 1-800-843-3338 for your first step! Give the Sencore phone operator your Area Code and she will immediately put you in contact with your friendly area Sales Engineer to answer

any other questions or discuss additional applications. We are ready when you are. How about now? Start pushing your way to success today!

**Call WATS Free 1-800-843-3338**

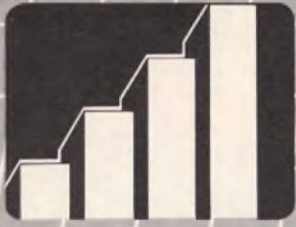

# Business Building Bulletin

## Why Sencore Means Success For You In Electronics: Exciting New Products, All New Sencore News, And A New Dedication To Serving You . . .

by Herb Bowden, President and CEO, Sencore, Inc.



educational VCR tapes in our new \$150,000 video studio. All of these things are designed to help you do your job better through better understanding of what you are doing. This has led to the most exciting part of my 35 year career as founder of Sencore, and that is new dedication to the age-old discovery that we need each other more than ever before so that we can both become more successful in our expanding and reliable electronics analyzing market. We, at Sencore, have gotten to thinking about this mutual reliance so much, that we have changed our theme to "Sencore Means Success In Electronic Servicing". Let me explain what I mean.

Moving back to our Sencore News, which is now celebrating its fifteenth year of helping you understand Sencore instruments better, we are looking at an all-new 1987 format. The Sencore News has

now been sectionalized with specialized writers; writers who have not only studied, taught and written about their assigned subjects, but have successfully operated their own service repair operations. These ten men make up the finest team of electronic circuit analyzing teachers ever assembled in the electronic industry. Total cost to Sencore, with overhead, benefits and all is nearly one million dollars a year and Sencore is picking up the whole tab for you. This is unmatched in the electronic instrument industry.

Let me introduce these talented Application Engineers to you, one at a time, so you can get to know them better and then learn to use them as part of your technical development team, free of charge, if you own Sencore instruments. Even the telephone call and seminars they hold are free. Our only pay comes from your purchases of Sencore

instruments. Therefore, we must limit their availability to those who own or are interested in purchasing Sencore equipment. Here are the ten stout-hearted men who make up this Sencore Application Engineering team.

Lastly, I will write this one-page article every issue of the Sencore News. I will continue to explain how at least 50 percent of your success is, and can be, tied directly to what Sencore does or can do for you, if you will simply avail yourself of the services available to you as a Sencore instrument owner.

How do you get this service to success? By simply taking your first step to success by dialing Sencore's number one success WATS Free number 1-800-843-3338, and talk to any of these highly qualified Sencore people . . . absolutely free and with no obligation. We are ready to help you become more successful, whenever you are. How about now?

**T**here is an air of excitement at Sencore as we boldly move into 1987. We are excited about our new, exclusive and innovative Sencore instruments; we hope that these new products turn you on, too. We are really excited about the new look of the Sencore News and new methods of printing that produce photos so clear that you can read every word on the front panel, so you know exactly what you are buying. And if that weren't enough, we are waiting with anticipation to start grinding out



**Cherlan Coffman, Sencore Newswriter and Editor.** Cherlan was a U.S. Naval electronics officer, vocational school instructor, TV repair shop owner, and is now editor of the Sencore News. His specialty is two-way communications and video. He will write a regular series, in each Sencore News from this issue on, called "Cherlan's Communications Corner", to explain how Sencore means success in two-way service.



**Chuck Robertson, Chief Application Engineer.** Chuck has been in U. S. Navy Electronics, has been a vocational school instructor, owned and operated his own TV repair shop, and operated a CATV distribution system. His specialty is two-way communications, video and RF distribution systems. Chuck will answer your most often asked questions in each issue of the Sencore News to show you how to be more successful when using Sencore instruments.



**Greg Carey, Application Engineer.** Greg is an EE graduate of the highly ranked School of Mines in Rapid City, SD. He started in our Service Department, advanced to Application Engineer, and now holds seminars, writes special articles about success, and makes VCR tapes in our new VCR studio. Greg provides information for most feature articles in the Sencore News.

**Rick Meyer, Application Engineer and Engineering Liaison.** Rick has a formal education in engineering, with a Masters Degree in Physics, but fell in love with the servicing end of doing things. Rick has also been an instructor at South Dakota State University, worked for Daktronics on electronic scoreboards, and owned and operated his own TV repair business, too. Rick writes feature articles for the Sencore News, communicates with design engineering about new products and holds seminars. He believes that your success is his success and writes with that view in mind.



**Tom Schulte, Application Engineer and Technical Advertising Writer.** Tom is a BSET who went into vocational school teaching for many years. Tom has furthered his career by qualifying for almost every conceivable proof-of-capability electronic award possible, including Commercial FCC license, Certified Electronic Technician, Advanced Class Amateur Radio License, teaching certificates, etc. Tom has also operated a TV business for many years. His specialty is video, audio and communications. He holds seminars and does technical writing for advertising when at the factory. Tom's Sencore News column will be called "Tom's Teaching Tips" as he brings us what he knows about instruments as they apply to more successful school teaching.



**Stan Warner, Application Engineer.** Stan has an electrical engineering degree from South Dakota State University. He has worked in the Sencore factory, the Sencore Service Department, and has now advanced to Application Engineer. Stan writes articles about what he runs into when traveling, and generates success stories to show others how to be successful.



**John Perry, National Sales Manager and Application Engineer.** John is an Electrical Engineer from the Boston area. He came to Sencore, right out of school, and was trained in sales. He started the Telemarketing Department at Sencore and now heads it up along with the Advertising and Promotion Departments. John does all of the promotional writing and contributes special use stories which specifically spell out how you can become successful by buying and using Sencore products.



**Norm Tipton, Application Engineer.** Norm is U.S. Air Force electronics trained, and has been an RCA Application Engineer and RCA distributor service manager. Norm's specialty is video and audio. Norm is a Sencore News writer and technical seminar holder. He will have an on-going column, in which he will bring back, from each field trip, interesting time-saving tips in each Sencore News, called "Tipton's Tips", to show you how you can be more successful in electronic service.

**Don Multerer, Application Engineer and Director of Sencore Seminars.** Don has a DeVry Technical Institute engineering degree. More so, he has 25 years with Sencore, starting as a technician, advancing to Service Manager, Field Application Engineer and now Director of Seminar Activity. Don's specialty is video and audio. Don will also have an on-going article where he will bring input from the field, in the form of technical shortcuts and new instrument uses, to add to your technical knowledge, so that you, too, may know why we say "Sencore Means Success In Electronic Service". Look for Don's "Successful Servicing Short-Cuts" article in each Sencore News issue.



**Brian Phelps, Application Engineer.** Brian graduated at the top of his class in the two year vocational training course at our local vocational school. He went to work in the Sencore Service Department and became the top producer in one year. He advanced to Application Engineering and is now holding seminars from coast to coast and writing technical copy when at the factory. Brian will also have a regular column on Factory and Field Successful Servicing, customer success stories, which he will collect from you as he travels.



**All New  
ST65 Stereo TV Adder  
\$895**

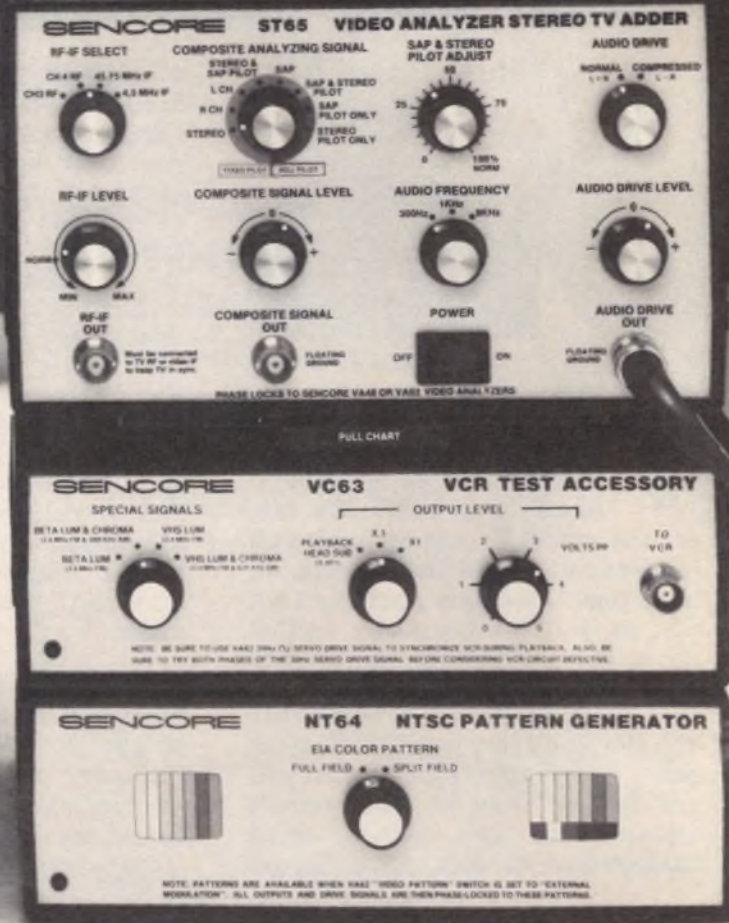
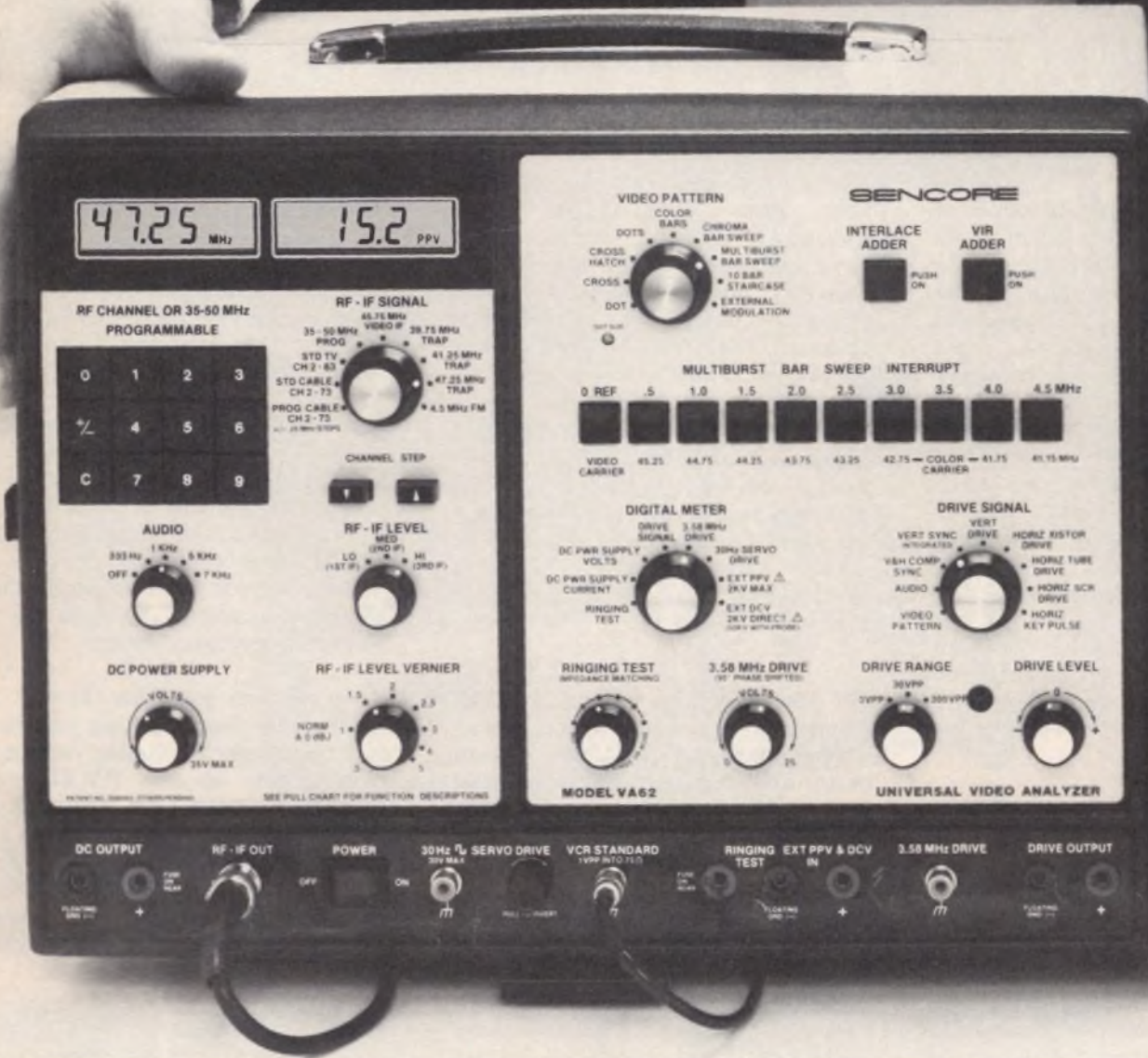

# Walk "Tough Dog" Troubles Out Of Any TV or VCR, Including MTS Stereo, With The Only Complete Video/Audio Analyzing System—In Half The Time . . . Or Your Money Back

Exclusive, industry standard VA62 Universal Video Analyzer . . . \$3,295 Patented

## Would you like to:

**Reduce analyzing time:** Isolate any problem to one stage in any TV or VCR, including MTS Stereo, in minutes, without breaking a circuit connection, using the tried and proven divide and conquer signal substitution method of troubleshooting?

**Cut costly callbacks and increase customer referrals** by completely performance testing TVs & VCRs before they leave your shop? Own the only analyzer that equips you to check all standard and cable channels with digital accuracy? Check complete RF, IF, video, chroma, and audio frequency response of any chassis in minutes without taking the back off the receiver or removing the chassis—plus, set traps dynamically right on the CRT too? Simplify alignment with exclusive multiburst pattern?

**Reduce costly inventory** from stocking yokes, flybacks, and other coils and transformers, for substitution only, with the patented Ringing Test? Run dynamic proof-positive test on any yoke, flyback, and integrated high voltage transformer . . . in- or out-of-circuit?

**Increase your profits by servicing Stereo TV** while decreasing the number of "tough dogs" due to inadequate test equipment? Performance test all aspects of stereo operation right from the antenna terminals? Troubleshoot any stereo problem right to the defective stage? Service Stereo TVs quickly, without any hassles?

**Protect your future** by servicing your customer's VCRs before they go to your competition? Walk out "tough dog" troubles in any VCR chrominance or luminance circuit—stage by stage—to isolate problems in minutes? Have proof-positive tests of the video record/play heads before you replace the entire mechanism?

**Increase your business** by meeting all TV, VCR, and MTS Stereo manufacturers' requirements for profitable warranty service work with this one universally recommended analyzer?

**Do all this and more with the only complete TV, VCR and MTS Stereo analyzing system on the market.** Prove it to yourself with Sencore's 30 day money back guarantee. Here's how . . .

### 30 Day Money Back Guarantee

Use the VA62 for 30 days to simplify all your video servicing, and tame your former "tough dogs." If at the end of 30 days, you aren't fully satisfied with your increased productivity and profits, return your VA62 for a full refund—including freight both ways. You have everything to gain and nothing to lose.

**Call Today, WATS Free 1-800-843-3338** or return the card to order or to receive more information about this complete analyzing system, including the free Simplified Operating Guide for the VA62 Universal Video Analyzer, a \$20.00 value.

### Accessories

**NT64 NTSC Generator . . . . . \$395**  
**VC63 VCR Accessory . . . . . \$495**  
**ST65 Stereo TV Adder . . . . . \$895**



## Here's How To Use Your VA62 And Accessories To Isolate TV, MTS, And VCR Problems In Just Minutes—By Simply Watching Your CRT!

by Tom Schulte, Technical Writer, CET

### Television Troubleshooting

#### Isolate RF/IF Troubles Without Confusing Scope Displays

It would be a lot easier to watch the CRT instead of using a scope when you troubleshoot individual RF and

IF stages. You already do that to a limited extent when you use a tuner subber to inject a known-good signal to the IF input and watch the CRT for a good display. But, when you see that the IF isn't working, you're back to signal tracing the individual IF stages with a meter and scope because the tuner subber can't provide signals for the individual IF stages.

**M**any technicians rely on a color bar generator and a tuner subber as their only signal sources for video troubleshooting. The color bar generator and tuner subber are especially easy to use, because they let you see the problem right on the CRT, but their uses are pretty limited for most problems in TV receivers, VCRs, or in the new MTS stereo decoder circuits. So, most technicians resort to a voltmeter or oscilloscope to trace signals for troubleshooting.

You quickly isolate problems in the following stages with your VA62 and its accessories:

#### Television

- RF
- IF Amps
- Video Detector
- Video Amps
- Chroma
- Sync
- Sweep Circuits
- Audio IF and Detector
- Audio Amps
- DC Bias and Supplies
- Flyback and Yoke

#### MTS Stereo

- All of the above, plus
- Common and Split Stereo IFs
- MTS Decoder
- Stereo Matrix and Audio

#### VCR (Including MTS Stereo VCRs)

- All of both above, plus
- FM Circuits (Including Heads)
- Servos

Here's just a sample of the efficient troubleshooting you'll do with your VA62 Video Analyzer...

Instead of being able to substitute a signal only at the tuner input with your color bar generator or at the IF input with your tuner subber - what if you could substitute a signal into any receiver stage and know, by simply watching the CRT, whether that stage is good? Troubleshooting individual circuits would be just as easy as using a crosshatch pattern to confirm that convergence is okay—or as easy as using your tuner subber to confirm that the receiver circuits following the IF input work properly.

Imagine being able to substitute a known-good signal at the input of the IF SAW filter, horizontal driver, or color demodulators—and know, just by looking at a familiar pattern on the CRT, whether the circuit works correctly (Figure 1).

That's the whole secret to effective troubleshooting with the VA62 Universal Video Analyzing System. The VA62 supplies the phase-locked video troubleshooting signals you need for substitution to any point in the receiver. (Because of the special, low impedance VA62 outputs, you don't have to disconnect components before substituting signals.) You isolate troubles to any stage by simply using the CRT display as an easy-to-interpret good/bad indicator.



**Fig. 1:** Equally bright bars on the left two-thirds of the screen, (0-3 MHz), without smear or ringing, indicates good luminance channel, performance from the antenna input to the CRT.

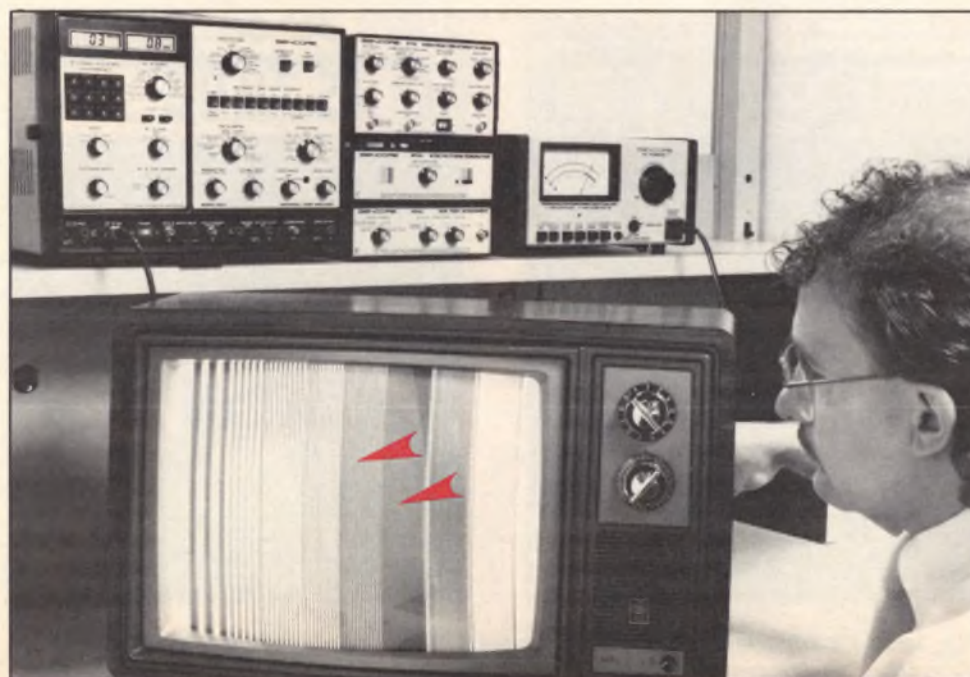

**Fig. 2:** Dark bars which correspond to video frequencies of 2.5 and 3.0 MHz indicate poor frequency response in luminance channel.

Your VA62's variable level 45.75 MHz video IF and 4.5 MHz FM audio IF signals let you substitute the proper signals to isolate problems to any of the IF stages in tube, transistor, and IC type receivers. You'll even conquer the IF/AGC loop problems that led you in circles before. Signal substitution with the VA62's innovative troubleshooting patterns causes any circuit defect to be immediately apparent on the CRT (Figure 2).

Isolating individual IF stage problems with the VA62 becomes just as easy as using your tuner subber to isolate problems between the tuner and IF. What makes it so easy is that your VA62 allows you to use the CRT as your good/bad indicator for isolating problems in any stage.

## Check AFT On All Channels In Seconds

If you could check for proper AFT lock-in range on all channels by simply watching the CRT, you could easily insure proper AFT performance on all the sets you service. Proper AFT action is especially important in cable-ready receivers that receive offset frequency channels from cable and in digital tuner receivers that don't have fine tuning controls. Improper AFT action causes poor picture, poor or no color, and/or unstable sync (Figure 3).

The digitally tuned RF output of your VA62 tunes the standard VHF-UHF channels, standard cable channels, and programmable offset cable channels to fully test any receiver's front end and AFT. You simply watch the CRT for a quick indication that the signal locks in on all the desired channels with programmed offsets to match those of the cable signal.

and don't properly block the interfering signal. If you just had a way to quickly "touch up" the adjacent carrier IF traps before you sent the set back to the customer, the interference would be trapped and you'd have a satisfied customer to spread the word.

Your VA62 Video Analyzer has just what you need. Exclusive, easy-to-use IF trap-setting signals let you dynamically check or adjust the IF section in minutes for best response and minimum adjacent channel interference on cable signals. You don't waste time hooking up a sweep/marker generator, detector probe, and bias supply; a single connection to the IF input jack is all you need. Just switch on a VA62 trap-setting signal and use the CRT as an easy indicator, while adjusting the IF trap for minimum interference on the screen (Figure 4).

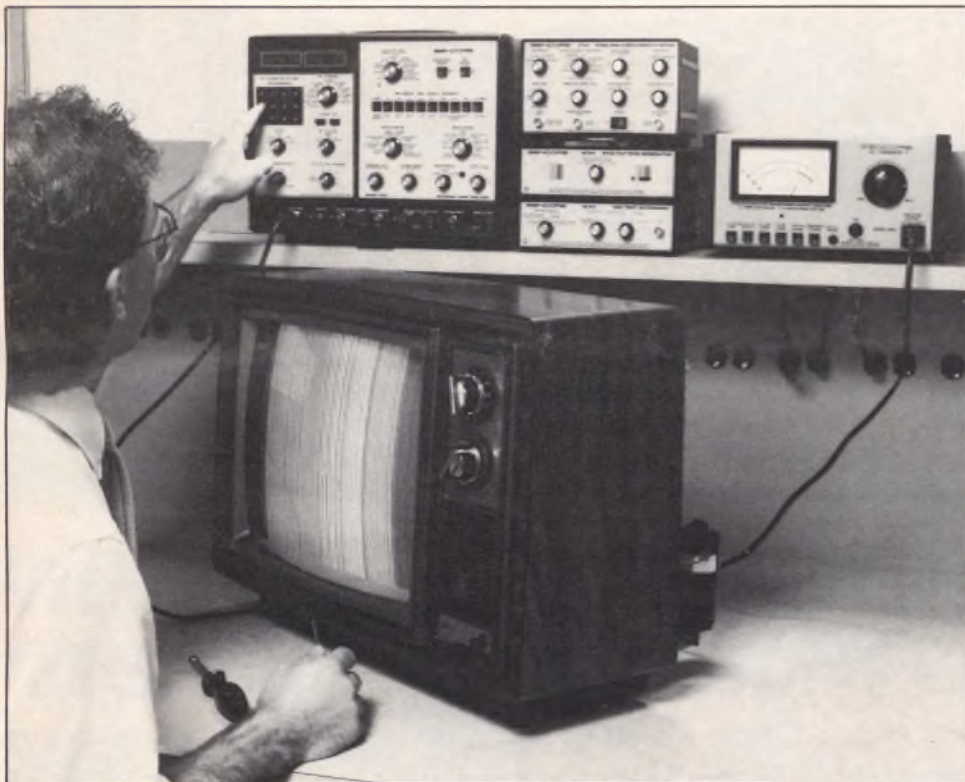

Fig. 3: Inability of the AFT to follow a cable channel offset is immediately apparent from the unstable CRT display with an offset VA62 signal.

## Eliminate Interference From Misadjusted IF Traps

How about adjusting the IF traps by making one signal connection and simply watching the CRT as you make the adjustments? Until now you've probably shied away from IF alignment because of the headaches it involves. But, because cable systems place signals on adjacent channels, the proper adjustment of receiver IF traps for adjacent carriers has become especially important.

Many receivers show colored interference bars running through the picture on some channels because a strong signal on the adjacent channel leaks through the IF. That happens because the IF trap settings never were quite right, or because they've drifted with age

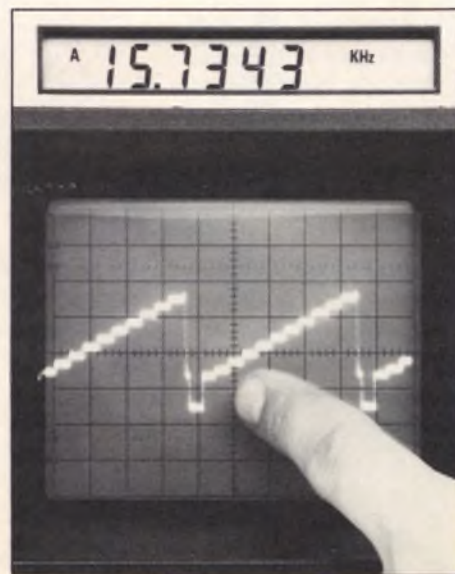

Fig. 4: Adjacent channel cable interference is easily minimized by simply adjusting the IF trap for minimum noise on the CRT while injecting the exclusive VA62 trap setting signal.

## Tame The New Synchronous Video Detector

How would you like to take one look at the CRT and know without a doubt that the synchronous video detector is aligned properly? (Figure 5A.) If it's not, the set will have poor contrast range and your customer will tell you that the picture is "washed out," or "all too dark," AGC overload or video amp defects also cause contrast range problems, and you quickly isolate them all with the VA62 10 Bar Staircase pattern (Figure 5B). Aligning the synchronous detector takes about 30 seconds, while you watch the results on the CRT.

takes about 30 seconds, while you watch the results on the CRT.

## Find Elusive Video Amp Problems

Would you like to have video amp problems give up the secret of their location with bold signals right on the CRT? The same troubleshooting patterns available as modulation on the RF and IF outputs are available as composite video at the VA62 drive output. You use the video pattern signals to substitute signals and isolate problems in any of the video stages.

Substituting the Multiburst Bar Sweep pattern at the input of a stage allows you to quickly determine, by watching the display on the CRT, whether that stage and those that follow are performing properly (Figure 6). Frequency response, ringing, or smear problems are no longer a hassle to isolate. Just like your tuner subber shows you on the CRT whether a problem is in the tuner or the IF, the Multiburst Bar Sweep pattern shows you on the CRT exactly which stage is causing a video problem.

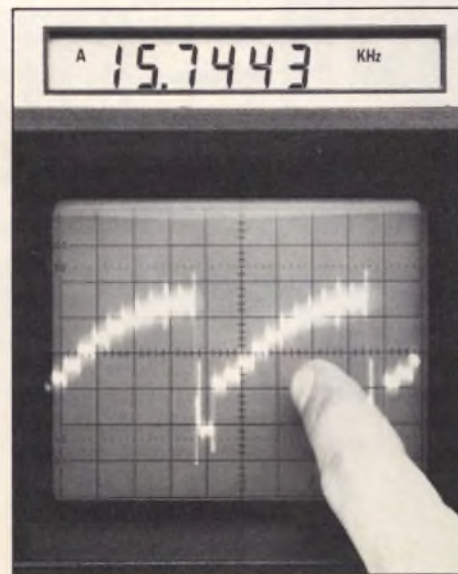

Fig. 5: The VA62 staircase pattern, viewed at the video detector output, should be linear, as shown at the left. The right display shows white compression, caused by a misadjusted synchronous detector or an improperly biased amplifier for instance, resulting in a "washed out" picture.

Since your VA62 drive signals are phase-locked to the RF signal, you leave the RF signal connected to the antenna input for a reference. Then, when you substitute a drive signal to a good stage, even if it's beyond the sync take-off point, you'll see a stable, locked-in pattern pop on the CRT to tell you that the stage is truly good.

## Isolate Tricky Chroma Frequency Response Problems To Any Stage

Wouldn't checking chroma bandpass response by watching the CRT for a good pattern be easier than using a sweep/marker generator? Proper color operation requires a flat frequency response over the 1 MHz range centered on the chroma subcarrier. Improper frequency response in a television receiver causes weak or improper colors or poor color sync. Troubleshooting that type of problem used to mean you had to go through a lengthy chroma bandpass response check with a sweep/marker generator. And, you still had no easy way of isolating the problem to a specific stage.

are good? Shutdown problems are easy to isolate when you use the VA62 horizontal drive signal to power the set back up and allow the set to show you which circuit caused the shutdown.

## Isolate Audio Problems Anywhere From The Tuner To The Speaker

Audio troubleshooting with your VA62 is just as easy as video, except instead of watching the CRT, you listen to the speaker for your good/bad indication.

The VA62's audio section gives you a choice of four low-distortion audio frequencies to modulate the RF,

Again, you use the speaker outputs as your troubleshooting indicators to quickly isolate MTS stereo problems. The ST65 or ST66 MTS accessories provide all the necessary RF, IF, composite audio, and special audio modulation signals you need to quickly isolate stereo troubles in the tuner, IF, stereo decoder, or audio circuits.

The speaker outputs tell you everything you need to quickly isolate the receiver stage that's restricting the stereo signal. The phase-locked accessory signals allow you to use the same easy VA62 signal substitution method, for MTS Stereo, that makes the rest of your audio and video troubleshooting so efficient.

## VCR Troubleshooting

### Troubleshoot VCR Heads Without Getting The Cold Sweats

Are you having fits trying to troubleshoot VCR heads? Have you ever installed an expensive set of heads and still had the same problem? Wouldn't you like to be able to simply watch the CRT for positive troubleshooting in the VCR head and FM circuits?

The VC63 VCR Test Accessory expands your VA62 drive signals with the special FM format video signals you need to quickly isolate problems in VCR FM circuits. This accessory includes an exclusive, easy-to-use head substitution signal that takes the guesswork out of expensive VCR head troubleshooting and replacement.

Connect the VC63's exclusive substitute head signal to the input of the VCR head preamps to isolate the cause of bad head symptoms

(Figure 8). When a good pattern appears on the screen, you know that all the VCR circuits from the preamps on work properly; you've eliminated seven to nine problems that could be causing the symptom. All that's left now are the head, rotary transformer, and head cable connections. The head is probably your problem, but to be sure, use the VC63 and the simple procedure outlined in Sencore News #127 (page 23).

## Complete NTSC Video Troubleshooting System

Your VA62 Video Analyzer is a complete video troubleshooting system. With it, you'll troubleshoot the entire standard NTSC television receiver. And, because you'd be disappointed in a troubleshooting system that doesn't allow you to grow with new technologies, the VA62 is designed to be expandable to meet your future troubleshooting needs—without forcing you to invest in capabilities you may not want or need right now.

## Expandable Troubleshooting System

The expansion capabilities of the VA62 allow accessories to enhance particular sections of the VA62 with the new signals you need to troubleshoot specialized video applications. You won't have to reinvest in a new troubleshooting system every time a new video technology is introduced.

Current VA62 accessories cover three VCR formats and MTS Stereo TV with an upcoming accessory for RGB monitors in the works. A brief description of the VA62 accessories follows:

VC63 VCR Test Accessory—provides the FM format "color



**Fig. 6: When you inject a known-good troubleshooting signal and a good pattern does not appear on the CRT, you know the trouble is between your injection point and the CRT.**

The exclusive VA62 Chroma Bar Sweep signal contains chroma sideband signals spaced 0.5 MHz on either side of the chroma subcarrier. The resulting pattern allows you to use the CRT as an easy indicator to determine whether the receiver has the required 1 MHz chroma response (Figure 7). You simply watch the CRT for an equally sharp response in the two outside bars, which represent the outer limits of the 1 MHz chroma bandpass. Substituting the Chroma Bar Sweep pattern to different stages in the receiver (from the tuner to the CRT drivers) immediately shows which stages are good and which stage is causing your color problem.

## Locate Sync And Sweep Defects Easily By Bypassing Shutdown

Instead of trying to isolate sync and sweep problems while the set isn't operating, why not let your VA62 show you on the CRT which stages

video IF, or sound IF signals; plus, they're available as direct audio at the VA62 drive output. You substitute these signals into any stage and simply listen to the speaker to isolate audio problems anywhere from the tuner input to the speaker.

## MTS Stereo Troubleshooting

### Troubleshoot MTS Stereo Without Expensive Board Swaps—Make More Profit On Every Service Job

You've followed the manufacturer's recommended MTS service procedure. You changed the stereo decoder board to fix a problem of poor stereo separation—but the receiver still had poor separation. Then you changed the board again because you thought the new board must have been defective. Still no improvement. Now what?



**Fig. 7: Sharp response in the outside bars of the Chroma Bar Sweep pattern means the TV has the chroma bandpass needed for a good color picture.**

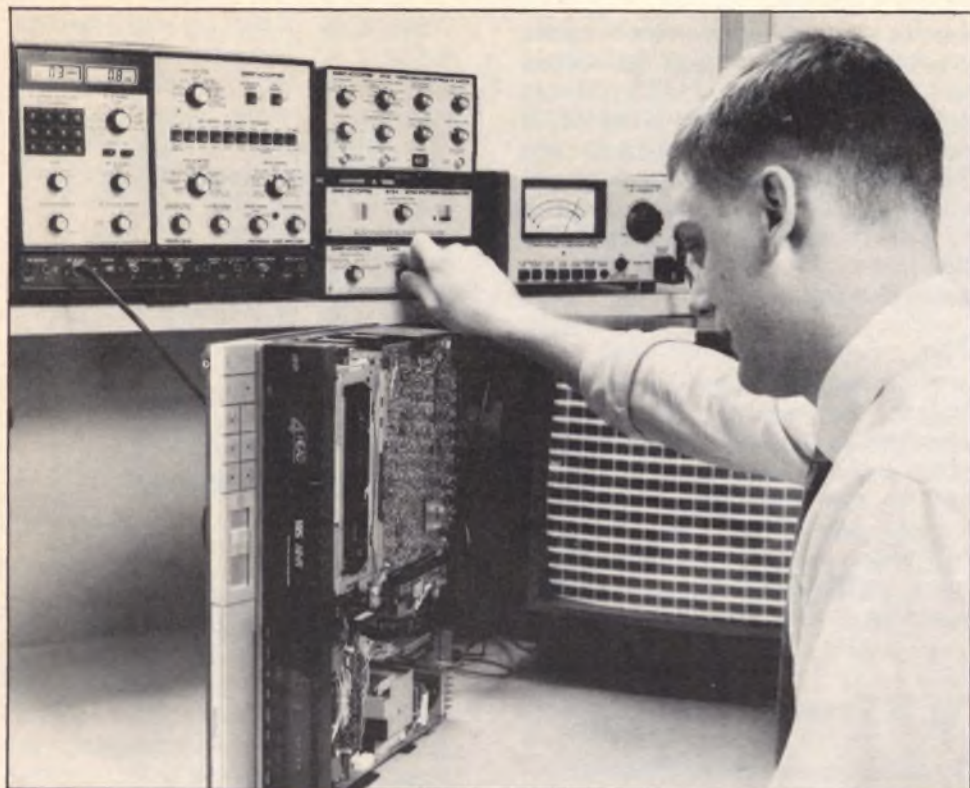

Fig. 8: The VCR head substitution signal lets you know immediately whether the heads are truly the cause of the bad or missing picture from the VCR.

under" signal and head substitution signal for troubleshooting VHS, Beta, and U-Matic VCRs.

**NT64 NTSC Pattern Generator**—provides phase-locked full-field and split-field NTSC color bar patterns you'll use for VCR and monitor testing. Required by some manufacturers for warranty service.

**ST65 Video Analyzer Stereo TV Adder**—provides phase-locked MTS format RF, IF, Composite, and Audio signals to isolate problems in any Stereo TV stage.

**ST66 Stereo TV Analyzer**—provides the same stereo signals phase-locked to your VA62, plus it has its own battery and video patterns, so you use it as a portable, stand-alone MTS performance tester as well.

**RGB Monitor Accessory (For Future Release)**—provides the special format signals you need to fully test digital and analog RGB monitors.

With the VA62 Universal Video Analyzer and accessories, you'll have a complete troubleshooting system configured for general video, VCR, MTS, or all three.

### Step Up Your Troubleshooting Confidence And Efficiency

With your VA62 you'll troubleshoot any video circuit quickly and easily. Your troubleshooting confidence and efficiency will skyrocket, because you'll know, just by looking at a familiar pattern on the CRT, whether each circuit is working properly. You no longer have to wonder whether you've really found the defective stage when you start replacing expensive parts.

To learn more about the VA62 complete Video Analyzing System, or if you're ready to order your own profit-making system, call WATS free 1-800-843-3338 today. Ask your Sales Engineer for a free copy of the VA62 Simplified Operating Guide. You and your customers will be glad you did.



## Absolutely Tops All Other Counters In Performance, Portability, And Value... Guaranteed Or Your Money Back!

There is no performance match on the market to an FC71 portable frequency counter.

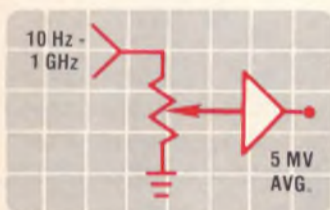

**Super Sensitive With Variable Input**—The FC71 is the most sensitive 1 GHz truly portable counter on the market with an unmatched sensitivity of 5 mV; you can measure signals with your FC71 that other counters just won't.

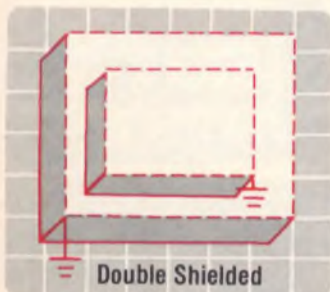

**RF Immune**—The FC71 is the most interference free counter on the market; no line cord to pick up interference, and it is all double shielded; guaranteed to operate where others won't, even at the most powerful transmitter site, or your money back.

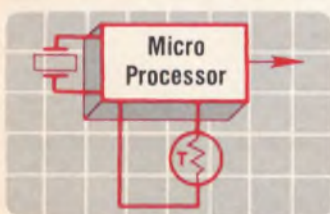

**FCC Accurate-Plus**—The FC71 is the most accurate counter in this price range, with .5 parts per million FCC accuracy from 10 Hz to 1 GHz; the counter stays accurate in use, as temperature correction is done by an exclusive, patent pending, special microprocessor controlled circuit. You can rest easy that you are FCC accurate year in and year out.

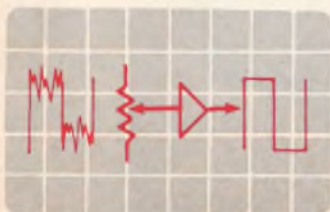

**Exclusive SNAP-ACTION™ Input Amplifier**—toggles only during signal transitions, unaffected by noise; means the fiddle-free sensitivity control is simply left at maximum over 90% of the time. You will operate your FC71 on noisy signals, such as in digital circuits, where others won't stop dancing.



Model FC71—\$995 Patented

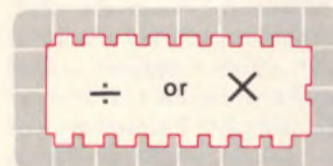

**Automatically Check Divide And Multiply Circuits**—Just store the input and read the divider output, or vice versa; this feature alone will nearly pay for your frequency counter.



**Exclusive IEEE Universal Bus Compatibility**—Monitor frequencies for documenting purposes or intermittent troubleshooting. You will get caught short with other counters; you will pay less for Sencore's IEEE bus, part number IB72, and you will still be able to use it with other Sencore equipment; it is universal.

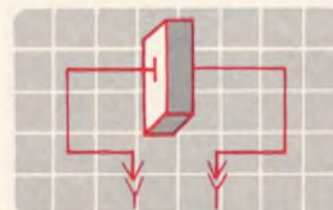

**Exclusive Crystal Check**—The FC71 is the only frequency counter that checks crystals to be sure that they are "putting out" at the right frequency.



**Highest Value, FCC Accurate, Portable Frequency Counter On The Market**—Before you pay at least two-thirds more and get less, you owe it to yourself to put the FC71 to the test on your bench or test site first. HERE IS OUR OFFER: Try an FC71 free for 15 days at no obligation. Put the FC71 through its paces and see for yourself just what a breakthrough in counter design it really is. If you're not 100% satisfied, simply return your FC71 and owe nothing. If you're ready to buy instead of trying, you

can save big by acting before April 30th. You will receive the BY234 Heavy Duty Battery (\$60 value) and the CC238 Carrying Case (\$50 value) at no charge. So, call us **WATS Free at 1-800-843-3338, TODAY** to say "YES" to the affordable counter you can rely on.





# Successful Servicing Shortcuts

## How To Successfully Turn Tough Dog Doozies Into Profitable Dollars

by Don Multerer, Special Accounts Manager, Director of Sencore Seminars



**H**e brought it to the Sencore demonstration workshop to see how the VA62 Video Analyzer system could walk out a tough-dog color problem in half the time. He called it a "doozy". In 24 years at Sencore, I have had the opportunity to troubleshoot about every TV chassis ever made. A "doozy" could add new and terrific challenges. When he finally showed up, his doozy turned out to be a 19" Sears table model. The color problem, however, turned out to be a real doozy... and a terrific challenge for the VA62 Video Analyzer.

### Top Side Check Out

Right away we ran a "topside" chassis check out. This quick VA62 performance check is a powerful tool that can give you a great head start on a tough dog. Hooking the VA62 RF cable to the Sears VHF antenna terminals and selecting channel 10 on the TV and VA62 and using the VA62's RCA rainbow color pattern, proved the original problem. No color. Next step. Pop the back off the set and scope for color waveforms. Right? Nope. Not yet. The VA62 gives you two special patented patterns that, with just two clicks of the pattern switch, can tell you which way to go once you do "pop" the back off.

### Bar Sweep Checks Performance From Tuner To CRT

The first pattern is the black and white bar sweep pattern. Why a B/W pattern for a color problem? Remember, a bar sweep pattern is a broadcast signal of multiburst frequencies from 0 to 4.5 MHz.

The color carrier and sideband frequencies are at the high end of the channel frequency spectrum. Frequency roll off in the tuner, tuner IF link, IF, or detector can cause loss of color. Look at the 3 MHz bar. See the fine vertical detail lines? These lines tell you high frequency

information is being properly processed from tuner to the CRT. Loss of the fine detail lines or washed out look could mean no color (Figure 1).

Should you pop the back off now? Not yet. Let's do another topside check. Take a close look at the 3.5 MHz multiburst bar. No detail is normal. The 3.58 is trapped out to prevent a 920 kHz beat in the video. Use this bar to check for color, too. Just reduce the color killer control (many are accessible). Look at the color pop in there! Have we lucked out with an easy fix? Switching the VA62 to color bars gives color, but it's running all over; "barber poling." The no color symptom has become a color sync problem.

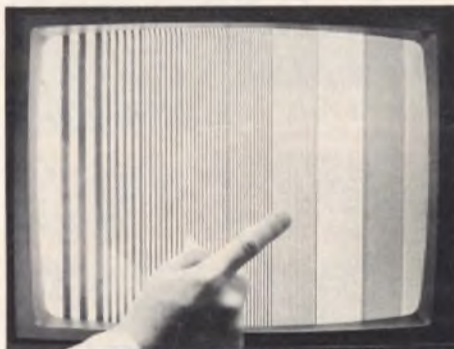

**Fig. 1: Sencore's patented Bar Sweep Pattern gives you an instant visual frequency response check to 4.5 MHz.**

Now, switch to the Chroma Bar Sweep pattern for a topside check of the chroma bandpass amp. You should see equal levels of detail in the 3 MHz and 4 MHz color sideband bars. Loss of detail means no color or reduced color through the bandpass amp. The detail looks fine for this Sears set. This tells you the problem is probably in the 3.58 MHz oscillator circuits... and you haven't taken the back off the set (Figure 2)!

A quick color oscillator adjustment may do the trick. Now take the back off the set. Can you see how the VA62 topside performance check headed you in the right troubleshooting direction?

### Exclusive VA62 Signals Isolate Color Problems

Adjust the 3.58 MHz color oscillator trimmer, (leaving the VA62 on channel 10) using the bar sweep pattern (no looking for test points or building special matching pads). Adjust the 3.58 MHz trimmer until the "barber poling" becomes one solid color bar. This Sears set adjusts to one solid color, but



**Fig. 2: The exclusive Sencore Chroma Bar Sweep gives you 3 dynamic parameter checks not available on any other pattern: saturation, hue, and 1 MHz frequency response.**

gradually rolls out of sync. That means the no sync problem is narrowed to IC340 & IC360 and their components. Let's divide and conquer to find which chip and/or circuit is the culprit. The VA62 provides the chroma signal information and 3.58 MHz oscillator drive output signals at the same time. Hook the VA62 3.58 MHz oscillator drive to burst input pin 12 of IC360 (Figure 3). Switching back to the VA62 rainbow color pattern, the color bars stabilize, but aren't rock solid.

Here is where the VA62 gives you proof positive test information. Leaving the VA62 3.58 MHz drive signal hooked in, hook the color bar pattern signal from the VA62 drive signal output to pin 10 of IC360. Set the VA62 drive level to .4 V P/P. Bang! The color snaps in. The VA62

totally replaced the chroma, burst, and 3.58 osc. chip signals, telling you the color sync problem definitely lies in chip IC340 or its components (Figure 3).

Change the chip, right? Not just yet. Run a voltage check around the chip using the built-in VA62 0-2000 VDC Digital Voltmeter. Checks out good. Time to change the chip? Nope. There is one signal we almost forgot. Pin 4 shows a 4 V P/P horizontal pulse. Let's scope it and see. Wait! Why drag over a scope? Use the built-in VA62, 0-2000 V P/P meter. The LCD readout shows 1.4 V P/P. Enough to make a difference? Let's find out. Switch the VA62 output drive to HORIZ KEY PULSE, adjust drive level to + 4 volts and hook in. How about that! This chip is good too! Not enough horizontal pulse to lock the color in. The VA62 P/P meter shows 360 V P/P horizontal drive at TP316. That's enough, but the anode of the shaping diode shows 60 V P/P (lost 300 V P/P across R360). This 18K had increased to 20 meg.

The VA62's capability to divide, conquer, and analyze signal chips and circuitry, saved us from unnecessarily changing chips and other components. Only the VA62 Video Analyzer system lets you successfully troubleshoot any TV/VCR video problem. Call WATS free 1-800-843-3338 and ask for your free copy of the all new Sencore VA62 Simplified Operating Guide, or a free 15 day risk free trial.

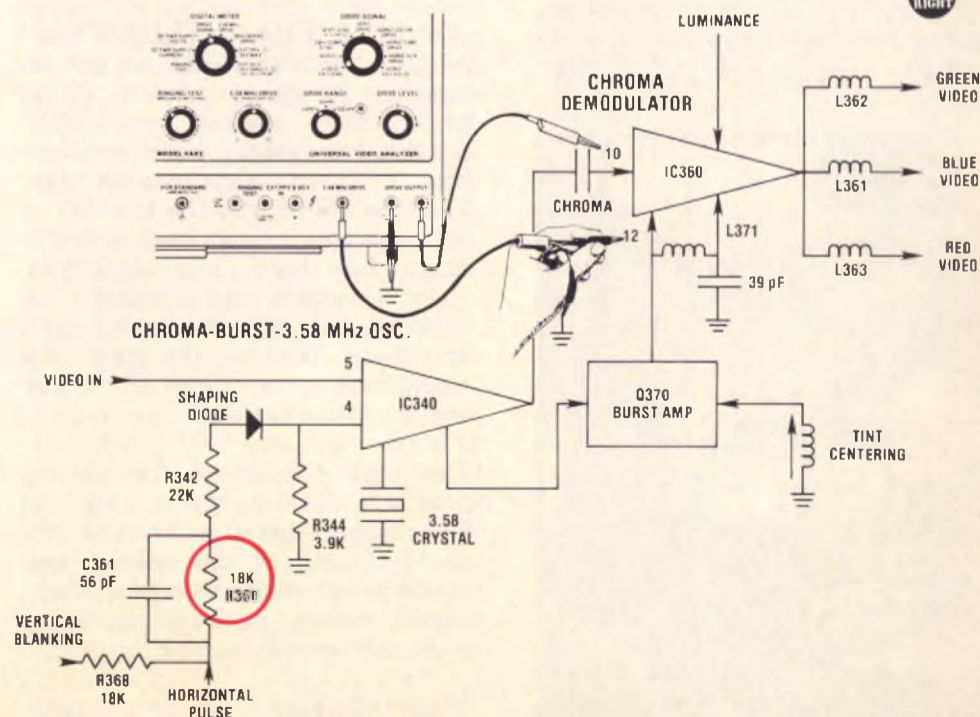

**Fig. 3: The VA62 lets you quickly replace IC Chip signals for proof positive chip testing.**



## With The FS74 "CHANNELIZER SR."™, You Can Test Entire TV-RF, MATV, And Cable Systems Automatically

by Brian Phelps, Application Engineer, Technical Writer

**C**onsumers are buying high quality video products such as VCRs, Stereo TVs, and complete integrated component systems. However, the high quality of these products (achieved by advancements such as the synchronous detector, comb filter, and S.A.W. filter) can do nothing for bad input signals. Consumer demand for higher quality video signals is growing.

Does this sound familiar? Just as you are ready to sit down to dinner, the phone calls start. The callers announce that the cable system is not working; all they get on TV is snow. What will you do? Could you have prevented it from happening in the first place? Read this article to see how the New FS74 "CHANNELIZER SR." helps you performance test and troubleshoot entire TV-RF, MATV, and CATV systems (using a map of the system) and how to quickly test the important TV-RF signal parameters. You'll detect problems early, and have more free time to enjoy.

### Performance Testing Helps Maintain The Signal Quality Your Customers Deserve

To provide quality signals, you (the servicer) must fully analyze system performance and take timely corrective action. When you use performance tests to isolate problems and detect degraded signals, you will have the opportunity to correct the problems early. The customers won't miss their favorite programs, and you won't miss the profit. Performance testing gives you the confidence to guarantee that your customer will have the best signal possible. Let's look at part of a typical system map that points out areas that you would want to performance test (Figure 2).

### System Maps Simplify Your Distribution Network And Show Key Areas To Performance Test

The FS74 "CHANNELIZER SR." is portable and ready to go on location when you do. When performance testing a TV-RF distribution system, you should use your FS74 and your system map. The map shows you the location of the main components such as trunk amps, line taps, and combiners. Using a system map simplifies the hundreds of individual lines and amplifiers. Without the map, you would have to memorize all the key areas.

The best prevention for system problems is a good working knowledge of the signal levels. Take the FS74 out to the system, and measure and record these important signal levels at major points in the system (Figure 3).

When problems occur, if you have taken performance readings, or have copies of the initial installation tests, you can quickly troubleshoot

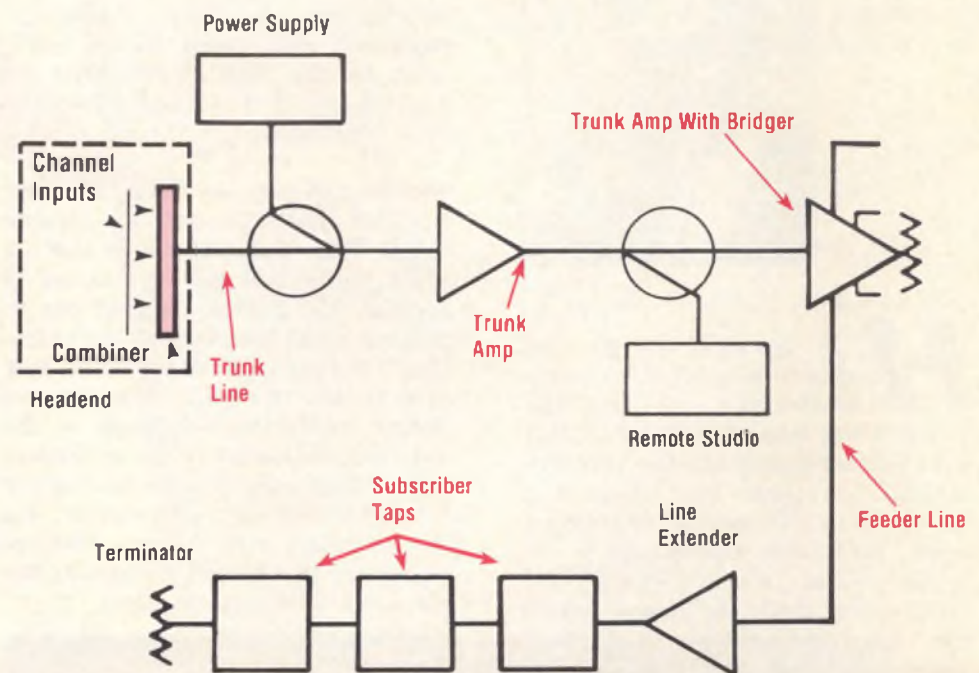

Fig. 2: Performance test key points within the distribution system to detect problems before they affect customer's service.

the system. The key to success in troubleshooting is to have the instrument that lets you accurately test all the TV-RF signal parameters. The FS74 tests these important signals automatically and eliminates the chance for error.

### How To Performance Check The Headend With The FS74 "CHANNELIZER SR."

*We need a good signal here to get a good signal at the rest of the system...*

The headend is the heart of the distribution system. It's at this point that the signal levels can be calibrated. Let's take a look at some typical performance tests that you'll need to make.

*RF carrier levels should be tested first: Why? Because the antenna could be turned the wrong direction, we could have a bad preamp, or bad cable from the antenna, or a bad modulator...*

One of the first parameters you should check is the RF carrier level. This level is critical because it is the main component in the RF signal. The RF carrier signal level should be adjusted by measuring the RF video level at the output of the signal processor with the FS74. The level should be set before the remaining system parameters are tested and/or adjusted.

*Balance the A/V levels for best overall system performance. The signal comes from sources like antenna, satellite, in house, etc.*



Fig. 1: Performance testing guarantees your customers are receiving quality signals.

What To Measure	What The Measurement Means To You
RF video carrier level	Checks drops for bad cables and amplifiers
RF audio carrier level	Identifies problems in modulation
Audio/video ratio	Verifies cable passes carrier levels
Signal-to-noise ratio	Finds bad signals and noisy amplifiers
Hum level percentage	Finds bad filter capacitors in power supplies
ACV and DCV on the cable	Locates broken cable, connectors, and power supplies

Fig. 3: Measure these important signals at key points in the system to identify and isolate common problems.

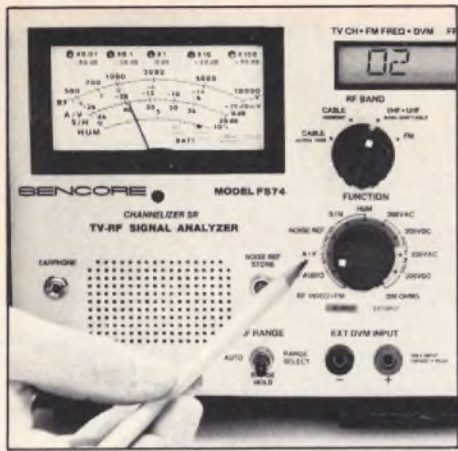

**Fig. 4: Testing the video and audio carrier amplitude ratio (A/V).**

The FS74 "CHANNELIZER SR." tests the A/V ratio automatically. *What could go wrong here? Bad audio feed or drift in the modulator.* This test tells you the ratio (in decibels) of the audio carrier amplitude to the video carrier amplitude (Figure 4). After you have set the video carrier amplitude, check the A/V ratio. If it does not match the level on your system diagram, or if the A/V ratio isn't better than 15 dB, you should re-adjust the audio carrier level.

**Test the S/N ratio on any in-use channel:** (Check S/N at the headend to ensure you don't have a bad modulator, or poor antenna system) check hum level too ...

Signal-to-noise is one performance test that many have problems with (Figure 5). The FS74 checks the signal-to-noise of each channel while it is in use (patent pending).

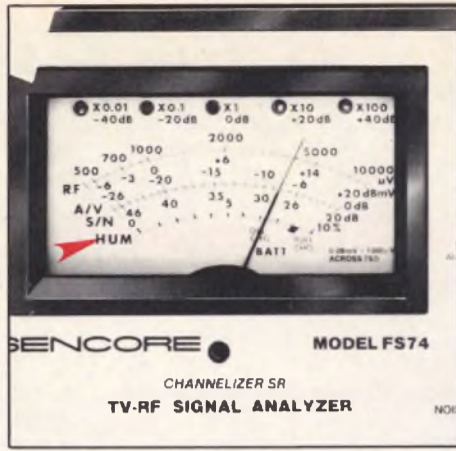

**Fig. 5: Measure the signal-to-noise ratio, for any channel, even while it is in use!**

Why is the S/N ratio important? *Poor S/N results in a snowy picture. If the S/N is bad, it can't be improved down the cable . . .* Let's look at a typical problem. If you have a noisy RF modulator, the noise will be on the channel only. To catch this type of problem, you will need to test the noise level on that particular channel.

**Test Hum level to catch failing power supplies:** *Why? Bad power supplies in the preamp, modulator or headend amplifiers are common.*

The CHANNELIZER measures the percentage of 60 and 120 Hz modulation of the RF carrier with the exclusive Hum level test. This



**Fig. 6: Ripple in an amplified power supply may cause the signal to be modulated by 60 or 120 Hz.**

type of modulation is often caused by excessive ripple in an amplifier's power supply. Other causes may be ground loops or nearby AC transmission lines. Like all the performance tests, this test is also done through the RF input.



**Fig. 7: Early detection prevents loss of service and proves the value of performance testing.**

Use the exclusive wideband monitor to catch elusive ghosting problems. *The only place to catch antenna ghosting problems is here at the headend.*

### Test Performance At Key Points Along The System

Compare periodic system readings with the recorded performance tests to prove your system is at its peak performance and to detect problems early.

You'll find problems before they cause loss of service to the customer. For example, an amplifier, with a power supply filter capacitor that is breaking down, can test good one day, but the next time you check you may find increased hum. With early detection, you can replace the power supply, prevent loss of service, and save the trouble of coming back when it does go bad (probably at dinner time).

## Troubleshooting

### Divide And Conquer Your System To Help Find The Trouble Much Faster

One of the first steps in locating defects is to determine what is

affected by the problem. *Do a performance test?* You want to know if the problem is only at one subscriber's tap or half of the town. Once you know this you can use your FS74 "CHANNELIZER SR." and system map to isolate the problem. If only one subscriber is affected, the problem lies in one of

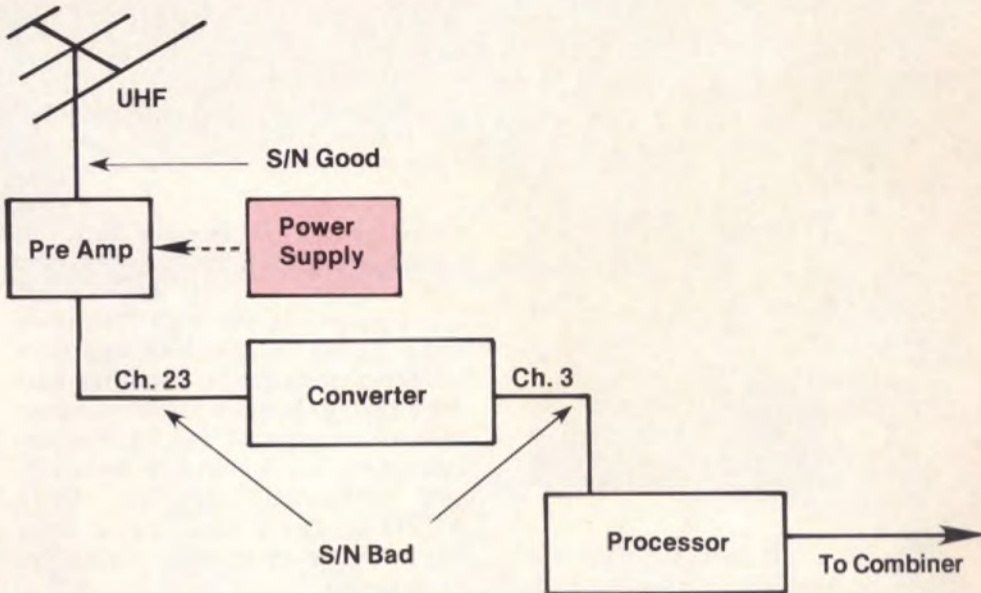

**Fig. 8: Power supply ripple decreases picture quality and is often observed on a single channel. This leads you back to the headend.**

the components in his line. If the symptoms are noticed throughout town, you know that the problem is somewhere common to all subscribers, possibly the headend.

Use the FS74 to isolate the problem further by determining if the problem is with only one channel or all channels. *One channel leads you back to the headend, or it could be a "suck out" caused by bad cables.* If the problem exists on only one channel, you should connect the FS74 before the combiner and analyze the signal. System blocks, such as channel converters, signal processors, or the antenna amplifiers, may easily cause this problem.

### What Causes Picture Quality And Signal-to-Noise Problems?

When you have S/N problems in your TV-RF system, you should first look at the signal at the input and output of the antenna preamplifier. There are many possible causes of poor signal-to-noise. Here are just three that you may encounter:

- 1) Loose or dirty connectors.
- 2) Amplifiers with a higher noise figure.
- 3) Automotive ignition or electrical motors.

Picture quality is easy to check with the FS74. Have you ever wanted to see what the picture really looked like at a tap or splitter while on a service call? Now you can see the problem at any point in the video distribution system with the FS74's wideband monitor. You can also see ghosting, hum, or the results of sync compression.

It's easy to see how the New FS74 "CHANNELIZER SR." lets you performance test and troubleshoot

Poor performance may also be caused by bad connections, shorted lines, and low AC or DC voltages carried over the cable. Bad connections and shorted lines are easily located with a quick continuity test using the ohms function on the FS74.



**Fig. 9: You can see the effects of ghosting, hum, or sync compression on the FS74's monitor.**

entire systems and verify all the important TV-RF signal parameters. You'll detect problems early while enhancing your chance of success. Simply pick up your phone, dial 1-800-843-3338, and ask for a FREE 15 day Self Demo.



# Field And Factory Servicing

## New LC77 AUTO-Z Adds Confidence And Efficiency With Automatic Cap/Coil Tests

by Brian Phelps, Application Engineer, Technical Writer



**A**s a former production technician, I understand what happens when a component tests good (or you misinterpret the test and think it's good), but it's actually bad. Especially when you are on the rate system. Units begin to pile up behind you, and you start to get frustrated. I know, I've been there! How can production test problems be prevented? Read on; you'll see how capacitors and inductors can be tested with the accuracy and confidence needed on the production line.

### Automatic Tests Eliminate Errors And Help Technicians Achieve High Efficiency

Assembly analyzers know that speed and accuracy is of the utmost importance. They must analyze and perform repairs as quickly as possible. Fiddling with knobs on test equipment and calculating values takes time and introduces errors. Assembly analyzers need instruments that let you simply press a button and know with 100% confidence that the component is either good or bad. Right? This same confidence is needed when inspecting incoming parts.

The incoming inspection people work with large quantities of capacitors and inductors. They want to test these components accurately and quickly. When you have to test hundreds, or even thousands of capacitors and coils, the LC77 AUTO-Z's automatic tests will help you achieve high efficiency without error.

### You'll Even Find Defective Capacitors And Inductors In Your Stockroom

By analyzing the component failures found in incoming inspection, manufacturing, testing, and servicing of products, Sencore gets plenty of experience with new and aging component problems. Everyday, we see the kind of

capacitor and coil failures that you are challenged with. For example, new capacitors may be out of tolerance or develop high ESR *even while sitting on the shelf*, and coils are often damaged in handling. Our solutions to these and other common failures (Figure 1) led to the development of the first Z METER, and ultimately to the LC77 AUTO-Z. Let's look at a first hand experience with defective capacitors.



Fig. 1: Experience in testing a wide range of cap/coil failures resulted in the development of the AUTO-Z.

### When Capacitors Are Bad Upon Receipt, Or Fail While Sitting On The Shelf, You'll Wish You Had An LC77 AUTO-Z

A short time ago, during the development of the LC77 AUTO-Z, Sencore's quality assurance and reliability departments were alerted to a major problem—approximately 5% of the units on the assembly line had failed testing. Not just one particular test, but random failures before and after aging and during production or quality assurance testing. These random failures made the problem particularly hard to isolate.

Technicians eventually narrowed the problem to a .1 uF, 100 volt, single layer, ceramic capacitor. This capacitor was used in every Sencore instrument for applications such as power supply filtering and decoupling. The capacitors were intermittently shorting at voltages much lower than the rated working voltage (some of these capacitors, though rated at 100 volts, shorted out at ten volts or less).

A quick check showed that the capacitor wasn't the same one that had been used in past production runs. A new vendor had been found that was able to supply a capacitor

that had the same value, working voltage, and tolerance, but was smaller and less expensive.

The most confusing and contributing factor was that samples of the capacitors had passed through our 100% incoming inspection system with no apparent problem. They had been checked for correct value, dissipation factor, and leakage at the rated voltage (dissipation factor is the inverse of quality and can be used as a measure of long term capacitor reliability). Each of the readings fell within the allowable tolerance.

After contacting several ceramic capacitor manufacturers and the EIA, we discovered that in this type capacitor, impurities or voids in the dielectric could cause shorting at lower than the rated working voltage.

About this time, the LC77 AUTO-Z was brought out of design and made ready for "in house" prototype



Fig. 2: Identifying even a small percentage of defective capacitors can improve quality.

testing. The reliability engineers used the new LC77 to test the defective capacitors for value, leakage, dielectric absorption, and effective series resistance (ESR). Over 2% of the capacitors tested had excessive dielectric absorption. This indicated that the capacitors weren't reliable and would probably fail under the circuit's normal working conditions. Had the LC77 been available at the outset, the entire lot would have been rejected.

What was the cost of accepting these bad components? Sencore received 101,220 capacitors that could potentially short at low working voltages. These capacitors cost the company only a nickel a piece, or \$5,061. Now add to the \$5061, the cost of having the production line stopped, the cost of the labor required to identify the problem, verify it, replace the capacitors, re-test and calibrate. The total? More than \$37,000!

We had already paid for the bad capacitors; there was no help from the manufacturer. With the LC77 AUTO-Z, we could have prevented this loss.

The LC77 AUTO-Z is the answer to successful testing of capacitors, inductors, yokes, and flybacks. It has the accuracy and gives the confidence you need for efficiency on the production line or in any service application.

Prove to yourself that the LC77 AUTO-Z will solve your capacitor and inductor test challenges. Call today, WATS Free 1-800-843-3338, and try an LC77 AUTO-Z in your manufacturing, service, or industrial application; you'll be satisfied. Guaranteed!



### Common Failure Modes Of Caps/Coils

Capacitor Type	Value Change	Excessive Leakage	High D.A.	High ESR
Paper	●	●		
Film	●	●		
Ceramic	●	●		
Electrolytic	●	●	●	●
Coils	Opens	Shorted Turns	Bad Connections	Poor Quality

Fig. 3: The common failure mode is determined by materials and construction. Random failures are particularly hard to isolate.

# Introducing The **All New**, Portable, SR68 Stereo TV Readout . . .

**Guaranteed To Add Speed And Confidence To Stereo TV and VCR Troubleshooting. Features Large, Easy-To-Read Dual Meters, Speaker Loads To 100 Watts, And Automatic Separation Tests To -40 dB.**

- Analyze Stereo TV Audio Line Or Speakers In dB Or Watts.
- Loads To 100 Watts For Dynamic Tests And Speaker Substitution.
- Measure Channel Separation To -40 dB Without Calculations.
- Battery Operated—Use In The Shop, Home, Or Field.

**SR68 Stereo TV Readout  
\$495**

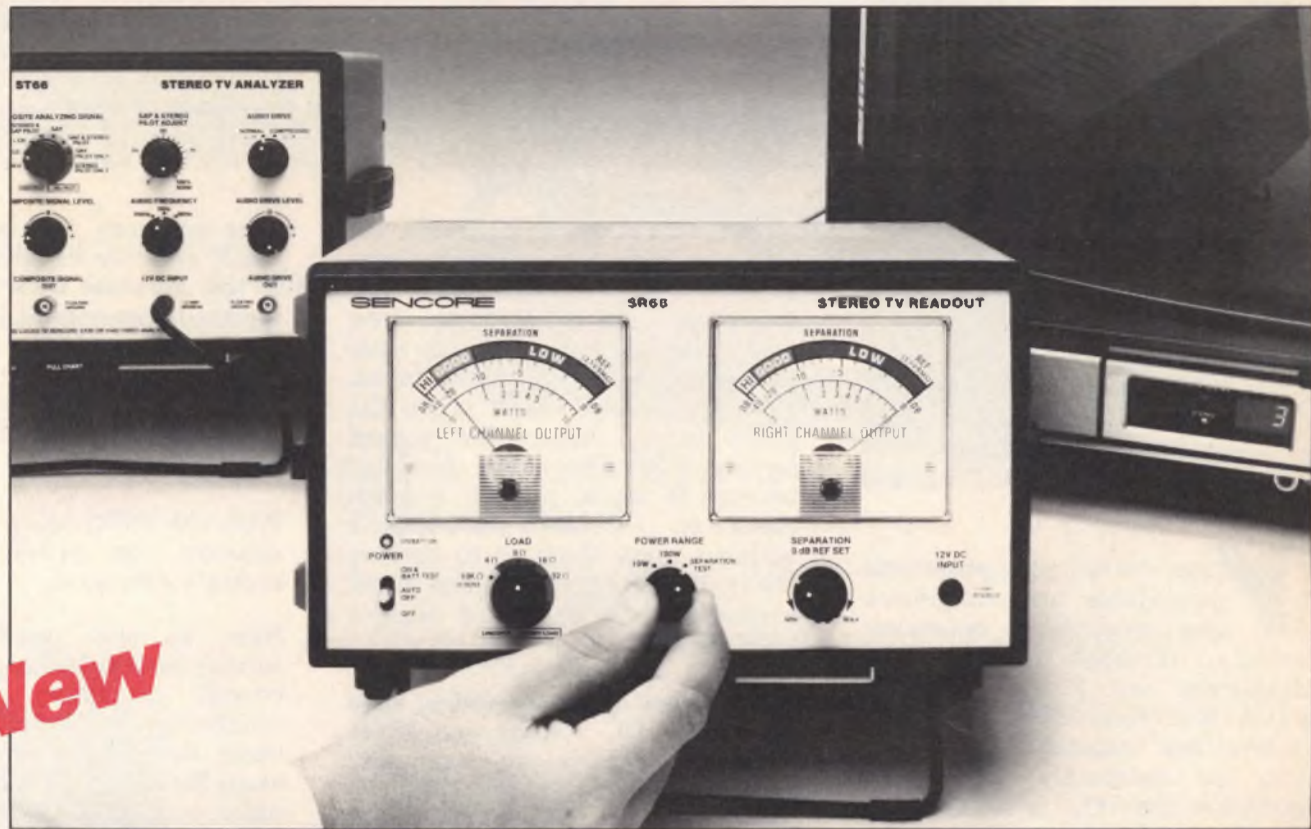

**Stereo TV Sales Are Topping The Charts . . . The SR68 Stereo TV Readout Helps You Service Them Profitably.**

In the past three years, approximately 5.25 million stereo televisions and VCRs were sold and an estimated 517 television stations are now transmitting in stereo. Multichannel television sound (MTS) technology has created new and exciting service opportunities that bring profit *and new challenges*. For example, have your customers wondered how to verify that their new TV is properly receiving and processing stereo signals? Are you seeing sets that "switch on" to stereo when a non-stereo program is being broadcast? Ever notice annoying popping and hissing noise in the speakers?

Are you equipped to visit the customer's home and quickly determine *with confidence* whether the set is receiving stereo, is out of adjustment, or needs to be brought to the shop for more extensive repair? Would you like positive troubleshooting indications to solve difficult challenges, at the shop and in the home?

Sencore's new SR68 Stereo TV Readout, *designed with your time in mind*, gives all the important troubleshooting readings essential to success in servicing stereo. The SR68 is a dual channel output measuring and dummy load system that enhances your present servicing package so you can check out any stereo TV or VCR in the home — and prove to the customer, with analog meters they easily understand, that their stereo TV or VCR works!

Leave your scope at the shop and save your digital meter for troubleshooting. No more laborious calculations to determine channel separation from voltmeter or oscilloscope readings. You remember the inconvenience and doubt don't you? First, you had to measure the voltages for both the left and right channels and then calculate 20 times the LOG of the larger value divided by

the smaller. You had to calculate separation after every critical adjustment. Whew! What an exercise in frustration.

Well, those days are over. On the SR68 Stereo Readout, the output signal levels are displayed in dB or watts on two, large, easy-to-read meters for worry free troubleshooting and proof of performance testing.

Dual dummy loads to 100 watts with 4, 8, 16, and 32 ohm impedances let you substitute for any speaker system. Or, you can use the 10 k ohm input for testing the stereo line outputs or paralleling with speakers for error free analyzing.



*The portable SR68 with large, analog meters gives stereo TV and VCR proof of performance that customers understand.*

**Editors Note:** Sencore's portable ST66 Stereo TV Analyzer provides the special stereo TV signals for home or field service, while the ST65 Video Analyzer Stereo TV Adder updates your VA62 Success Shop for servicing the entire stereo TV system (see page 17).

## SR68 Stereo TV Readout Specifications

**Input Impedances:** 10 k ohm  $\pm$  10% paralleled by 500 pF, 4, 8, 16 and 32 ohm. **Power Range:** 0-10 watt and 0-100 watt. **Power Accuracy:**  $\pm$  3% of full scale. **Separation Range:** 0 to -40 dB.

**Separation Accuracy:**  $\pm$  5% of the reading. **Frequency Response:**  $\pm$  1 dB from 50 Hz to 15 kHz. **Power:** 105 to 130 VAC with supplied PA235 AC adapter/charger. Battery operation with optional BY234 battery. **Auto Off:** shuts off after 30 minutes on battery. Auto off disabled when using external power. **Supplied Accessories:** 2 BNC to phono cables, 2 BNC to alligator clip cables. **Optional Accessories:** BY234 Battery Pack, PC253 Protective Cover/Lead storage.

**Weight:** 7.7 lbs. with battery (3.5 Kg), 6.1 lbs. without battery (2.8 Kg). **Size:** 6.5" x 11.5" x 11.5" HWD. (16.5 cm x 29.2 cm x 29.2 cm).

To use the SR68 to replace the speakers, simply set the impedance of the dummy load to match the the amplifier under test, and connect the supplied leads. Switch to the 10 k ohm position to monitor the audio line out jacks or when paralleling speakers.

The SR68 includes an automatic separation test to help you make complete performance tests in minutes to manufacturers specifications, without calculations. Performance tests, troubleshooting, and alignment in Stereo TV audio circuits are completed quickly and accurately with dual output levels displayed in dB or watts. You'll see the effect critical adjustments have on separation and output levels for *time saving troubleshooting confidence*, that's what it's all about.

**For Portable Convenience, Accuracy And Troubleshooting Confidence In Stereo Service, Use The SR68 Stereo TV Readout.**

With large, easy-to-read meters, separation tests to -40 dB, speaker loads to 100 watts, and portability, the SR68 brings you ingredients essential to success in stereo TV servicing. Call **1-800-843-3338** and ask your Sales Engineer about this new, exciting, profit builder.



# Communication Corner

## Sencore's Innovative FC71 1 GHz Portable Frequency Counter Solves Challenges Others Miss

by Cherlan Coffman, Application Engineer, Editor



**Y**ou learn to appreciate dependable test equipment when working in communications. Without reliable test equipment and a solid plan of attack, it is often difficult to isolate receiver and transmitter problems. You are constantly faced with questions like: Why is the received signal weak? Is it the receiver or the transmitted signal? Let's look at a typical transceiver problem and discover how it was finally solved.

### Sencore Test Instruments Bring Added Confidence Needed To Meet Daily Service Challenges

A low band transceiver had been set aside as not worth repairing. It had been in and out of repair shops and was finally returned to the customer with the comment, "it's not worth fixing." Let's see if you agree.

Figuring that it might prove useful (or at least it would be fun to tinker with), one of Sencore's Application Engineers picked up the transceiver. The symptoms were clear: no transmit and no receive. Right away the number one suspect was the power supply.

After a quick visual inspection, the unit was hooked to a bench power supply. The suspicion was confirmed. The transceiver drew only a few milliamps with very little change when the mike was keyed. Would a voltage check prove the power supply theory? We reached for the SC61 Waveform Analyzer because it would provide a quick check on DC and peak-to-peak voltages, plus allow us to observe the oscillator waveforms and check frequencies to 100 MHz with a single probe.

Every circuit point seemed to have the proper DC voltage, but there were no receive or transmit oscillator signals (Figure 1). Maybe the unit had been dropped and both crystals were broken! Here's where some of the shops may have chalked it up. The crystals (Xmit Receive)

were not ones you would have in stock. The only way to know for sure if the crystals were bad was to replace them—right? It would have been true, except we had an FC71 Frequency Counter. We simply yanked the crystals out and checked them with the FC71's Crystal Check feature (Figure 2).

With the FC71 (all in less than 15 seconds), we proved that both crystals were good.

Now, we were faced with some serious troubleshooting. What if the crystal oscillators really were oscillating, but the scope probe upset the circuits and made them stop? We checked this possibility by using a method we knew wouldn't load the circuit — the loose coupling of the FC71 using a Snoop Loop (Figure 3).

No such luck. No reading was obtained at either the receive or transmit oscillator. The oscillators were definitely dead. All the DC voltages were right. The crystals were good. What else could be wrong?

Where could we go from here? We looked at the schematic (Figure 1) to see what was up. Wouldn't Q-3 be the next suspect in the receive circuits? An in-circuit check with the TF46 Super Cricket Transistor and FET Tester showed the transistor good. Now what? Could transformer T-1 be out of alignment far enough to prevent the circuit from oscillating? Sure enough! After a few turns of the slug, the oscillator responded.

It was easy to adjust T-1 back on frequency without upsetting the circuits using the FC71 with the Snoop Loop. The receiver came to life and a single twist of T-2's slug restored the transmitter oscillator. With the Snoop Loop, the FC71 read the RF frequency at the driver but not at the final power amplifier. There was no RF power out.

Now the task was becoming interesting, and even fun. We had the problem worked down to the original trouble! We jumped to the output transistor Q-10 and almost had it off the PC board before realizing we should back up and test it with the Super Cricket. You might have guessed: the output transistor was good. And so was the driver transistor. Rats!! It was becoming quite apparent why this transceiver had been a shop hopper.

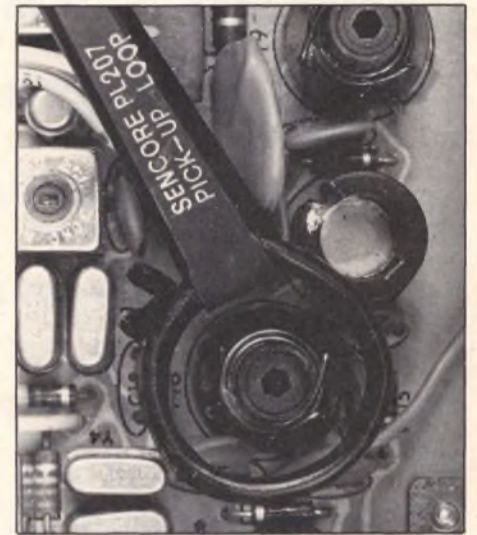

**Fig. 3: The Snoop Loop lets you quickly follow the frequency through the multiplier stages in a radio.**

The SC61 showed there was no gain at the driver transistor Q-9, so we ran a quick in-circuit check on L-2 with the LC75 Z METER 2. L-2 read 2.2 uH with 3 rings on the ringing test. It had plenty of turns and no iron core. We expected it to ring 10 rings or more. L-2 had a shorted turn. The replacement read 112 uH, had 13 rings, and restored the transmitter to full operation. We used the FC71's 5 mV sensitivity and Snoop Loop to double check the RF oscillator and multiplier stages. We even "stored" the output frequency in the FC71's memory and read it later to prove the transmit frequency was within FCC specs and didn't drift.

The transceiver was finally repaired. A rather simple failure that most properly equipped technicians would find in minutes. Could you have made a profit repairing it? The SC61, TF46, and LC75 increased our confidence to make this repair possible. Use these general purpose instruments and the FC71 1 GHz Frequency Counter to save time and enhance success in your daily communications service challenges.

The FC71 is a remarkable instrument that's easy to use. It's IEEE 488 compatible, triple shielded for RF immunity, and has 9.5 hour battery operation (there's no power robbing crystal oven). With .01 Hz resolution, less than .5 ppm/year aging, exclusive crystal check, ratio test, and NBS traceable accuracy, you can see why the FC71 will make your job easier and give you increased confidence. Call us today WATS Free 1-800-843-3338; ask for the complete specifications and a Free 15 Day Self Demo.



**Fig. 2: Test crystals at their fundamental frequency in seconds.**

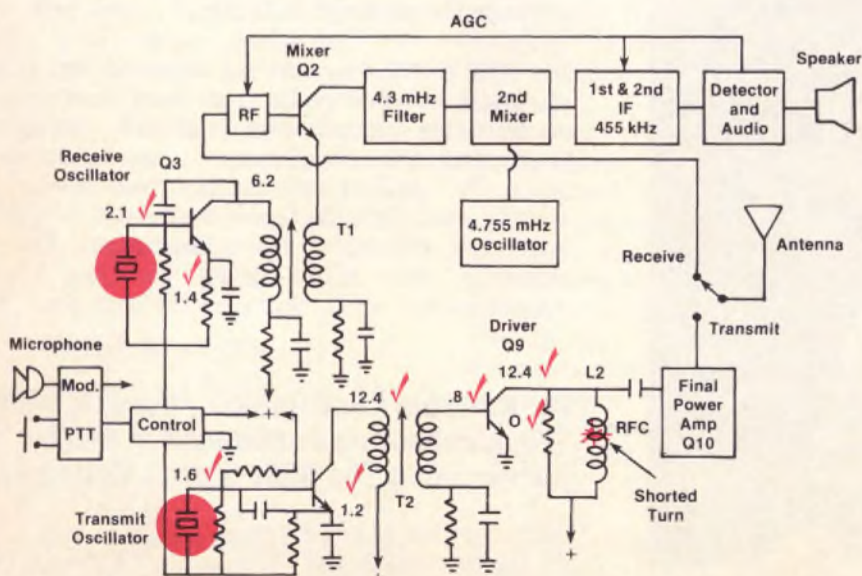

**Fig. 1: Proving the crystals good and following the frequency with the Snoop Loop provided positive troubleshooting leads . . . while normal DC voltages failed to head us in the right direction.**

# Now Catch Defective Caps And Coils, That All Other Testers Miss, With 100% Confidence And Reliability With Sencore's All New Z METER Line . . .

Sencore, the world leader in dynamic LC analyzing, announces 3 new patented analyzers exclusively designed to help you find defective caps and coils that other testers miss. So now you can choose the analyzer you need to eliminate your frustrating cap, coil, SCR, and triac problems forever!



**LC75 Z METER 2 \$995 patented**

Choose the LC75 Z METER 2 for market proven dynamic LC analyzing.

- ✓ It's the only dynamic LC analyzer that assures you of finding defective capacitors and inductors that all other testers miss.
- ✓ It's a complete dynamic capacitor tester that makes all four important performance tests to find even those capacitors that are just starting to go bad.
- ✓ It's a complete dynamic inductance tester that tests for value and for the coil's ability to work in-circuit.
- ✓ It checks other components, too, for added value. Transmission lines, leakage in insulation with high voltage applied, SCRs, triacs, and high voltage diodes.



**LC76 PORTA-Z \$1,295 patented**

Or step up to the LC76 PORTA-Z for 100% portable, dynamic LC analyzing to 1000 volts!

- ✓ It's the only dynamic portable LC analyzer that assures you of finding defective capacitors and inductors that all other testers miss.
- ✓ It's the first and only dynamic portable capacitor-inductor analyzer that assures you of finding defective capacitors and inductors anywhere.
- ✓ It's a complete dynamic, portable capacitor tester that gives you all four important analyzing tests to find even those capacitors that are just starting to go bad.
- ✓ It's a complete dynamic, portable inductance tester that tests for value and for the coil's ability to work in-circuit.
- ✓ It checks other components too: Transmission lines, leakage in insulation, SCRs, triacs and high voltage diodes.

Choose the Z METER that fits your applications. Then call 1-800-843-3338 and tell our receptionist your phone area code and you'll be connected to your Sales Representative, he'll arrange to put the Z METER you need on your bench for a Risk Free 15 Day Self Demo. Now's the time to eliminate your frustrating cap and coil problems forever.

**Call 1-800-843-3338 today.**



**LC77 AUTO-Z \$1,695 patented**

Or step up to the ultimate in dynamic LC analyzing with the LC77 AUTO-Z for 100% completely automated, portable, dynamic LC analyzing to 1000 volts!

- ✓ It's the only portable, fully automatic, dynamic LC analyzer that finds defective capacitors and inductors that all other testers miss.
- ✓ It's a completely automatic portable, dynamic capacitor tester that makes the four important capacitor tests 100 percent automatically without look ups, interpretation, or error. Just enter the capacitor value, rated voltage and tolerance and the AUTO-Z automatically reads the capacitor as good or bad.
- ✓ It's a completely automatic, portable, dynamic inductance tester too, that tests for both value and ability to work in-circuit. Enter the value and tolerance and push the tests you want. The meter gives direct measurements and also tells you whether the coil or transformer is good or bad.
- ✓ It checks other components too, for added value: SCRs, triacs, high voltage diodes, transmission lines, and insulation leakage.

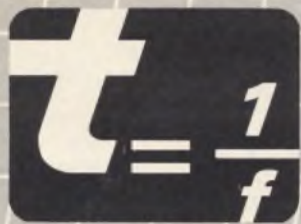

# Tom's Teaching Tips

**Do A Better Job Of Teaching Electronics With A Waveform Analyzer In Your Classroom—Call 1-800-843-3338!**

by Tom Schulte, Technical Writer, CET



I'd like to welcome you to this first of a regular series of columns. In each column, I'll offer tips and suggestions for making your job as an electronics instructor more productive and more successful.

In this column, I'd like to offer you some techniques for teaching waveform fundamentals more effectively using the Sencore SC61 Waveform Analyzer. You'll give your students a better grasp of the interrelationship of AC waveform parameters and make your job a lot easier.

## Teach Basic Waveform Fundamentals

To simplify teaching AC waveform fundamentals, you can use the SC61 Waveform Analyzer to allow you and your students to concentrate on the waveform, not on the scope. Apply a signal to the SC61 from a signal generator for the following:

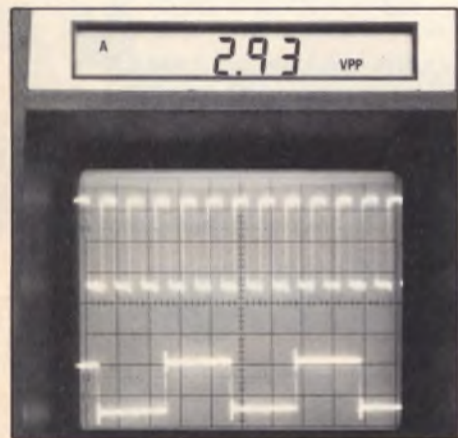

**Fig. 1: Digitally accurate peak-to-peak measurements for either channel are available at the push of a button.**

- Change the input signal's level, and let the students see on both the scope display and the digital display that as the waveform changes in size, the peak-to-peak level changes accordingly (Figure 1).

- Vary the signal's frequency and the students will immediately see

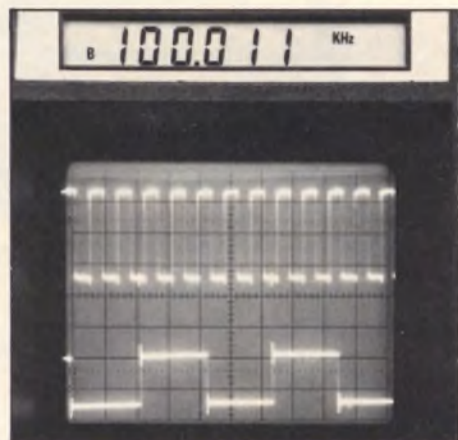

**Fig. 2: Automatic frequency measurements to 100 MHz are 10,000 times more accurate than a conventional scope.**

that as the waveform cycles get closer together on the scope display, the frequency on the digital display goes up proportionately (Figure 2).

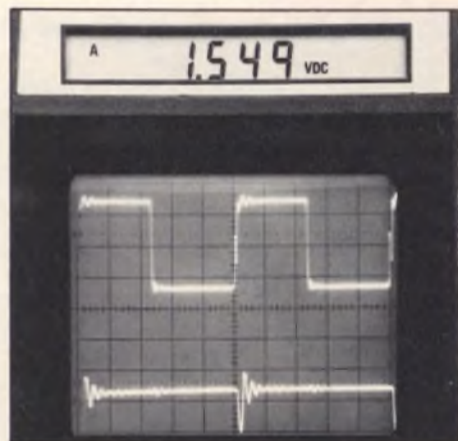

**Fig. 3: The DC level of a waveform is displayed simultaneously with the waveform.**

- Apply an AC signal riding on a DC level (use a signal generator with a DC offset control), and the students will see the waveform shift from the ground reference point (use DC input coupling for the scope display), plus they'll also immediately see the corresponding value of the DC level on the digital display (Figure 3).

In each case, you demonstrate the concepts for your students without getting caught up in the operation of the oscilloscope. The particulars of the equipment's operation stay in the background, while you and your students focus full attention on the waveform and its parameters.

## Teach Extended Waveform Analysis

As your students become more familiar with AC waveforms, and

start studying specific applications such as digital, video and communications, they'll be ready to look at signals in more detail. The SC61 helps you teach your students about the peak-to-peak level, time, and the equivalent frequency of *specific* portions of a single waveform and the frequency ratio and time relationship between two waveforms. Following are some examples of the types of analyses you can demonstrate:

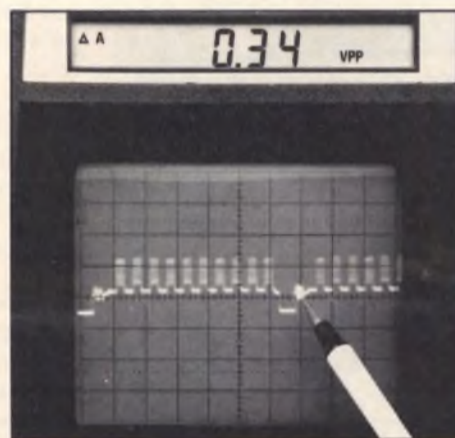

**Fig. 4: The amplitude of a specific portion of the waveform is displayed with digital accuracy.**

- While viewing a composite video waveform, use the SC61's DELTA PPV function to intensify the chroma burst. Show the burst's peak-to-peak amplitude directly on the digital display. Compare that to your result when you intensify the sync pulse. Per FCC specs, they're the same amplitude (Figure 4).

- While viewing the output of a digital timer, use the DELTA TIME function to intensify first the positive pulse and then the entire cycle. Divide the first time into the second to show the timer's duty cycle.

- While viewing the output of an AM transmitter modulated with a single tone, use the 1/DELTA TIME function to intensify one cycle of the modulation envelope. The resulting digital frequency display shows the frequency of the modulation. (Also good for showing the frequency of an interfering signal riding on a desired signal.)

- While viewing the input of a transmitter multiplier or digital divider on one channel and the output on the other channel, use the Ratio function to show a direct digital readout of the multiply or divide ratio (Fig. 5).

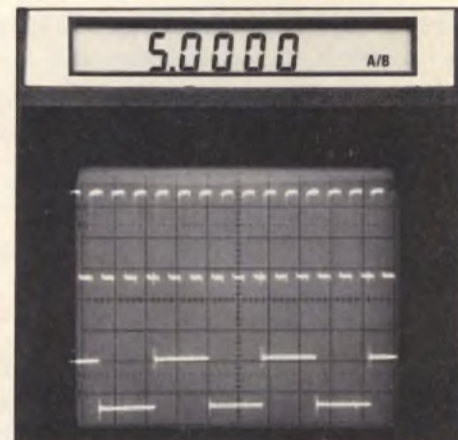

**Fig. 5: The frequency ratio function automatically displays the ratio of two waveforms.**

During each demonstration, the SC61 takes care of the calculations and allows you to concentrate on the concepts you're presenting to your class. The students learn more, while you work less.

## Student-Proof Design

As well as enhancing the quality of your instruction, the SC61's design also protects your equipment budget. The signal inputs are protected to 3000 volts (DC plus peak AC). Students can measure about anything they want to, including the output of a TV's horizontal output stage, without worrying about damaging the probe or scope.

The SC61 is also built to take the bumping, banging and dropping that always seem to happen with students. Sencore's QA Department sets aside five units from each production run for special quality testing (in addition to the extensive quality testing every unit undergoes) to insure continued rugged construction. These special tests include a 30" drop test and 15 minutes on a 3.2G shake table, after which the unit is tested for full compliance with all specifications. The end result is that 97% of Sencore instruments work for years without a single problem.

## A Better Job of Teaching With Fewer Problems

The SC61 allows you and your students to concentrate on the waveform. And when you want the students to learn manual oscilloscope operation, the digital display is available. In both cases, your students learn easier and you teach easier.





# 3 Reasons Why Now's The Time To Cash In On Today's Profitable Stereo TV Servicing Bonanza . . .

**1** Increasing Stereo TV Sales Of Over 207% Means A Huge Market Potential For Your Business.

MTS compatible chassis sales skyrocketed 207% in 1986, and according to the EIA forecast for 1987 an incredible increase of 187% is predicted for MTS equipped TV & VCR chassis. So it's easy to see the market for MTS testing and servicing is skyrocketing and now's the time to cash in.

**2** Acting Now Will Position You As The "Expert" For Years To Come And Make You The Envy Of Your Competition.

Acting now will guarantee you a strong profitable foothold in this rapidly expanding market. Just like those who were first to capitalize on the VCR market, those who take advantage of this huge stereo TV servicing opportunity will not only cash in on big profits, but will also build a reputation as the servicer who is out in front of his competition. Now's the time to corner the market.

**3** Only Sencore's New MTS TV Analyzers Truly Simplify Your MTS Servicing To Make It Easy For You To Cash In On This Skyrocketing Profit Potential.

Only Sencore's 2 new patent pending analyzers are designed to help you position yourself as the first and only complete MTS performance testing and servicing shop in your area. You'll be equipped to capture the market for big profits. Here's why . . .

**New**



**ST65 Video Analyzer Stereo TV Adder \$895 Patent Pending**

## Now You Can Analyze And Performance Test Any Stereo TV And VCR With Your Sencore Video Analyzer . . .

Update your VA48 or VA62 Sencore Video Analyzer to an integrated, phase-locked Stereo TV analyzing system for added profits: The special ST65 Video Analyzer Stereo TV Adder test signals now complement the full range of video analyzer signals to create a phase-locked stereo TV analyzer package, with troubleshooting capabilities second to none.

Performance test any stereo TV system with 100% confidence . . . without taking the back off the set. Test stereo separation, to be sure that the dbx<sup>®</sup> and stereo decoders are good. Make the all-important signal-to-noise test to prove that the stereo TV can produce noise-free stereo signals with good separation. Check crosstalk to ensure that the SAP and stereo signals do not interfere with each other and for audio to video circuit interference to assure correct IF alignment and trap settings.

Exclusive adjustable RF/IF levels match any stage so you will never get caught short. The ST65 provides a full range of adjustment for the stereo RF and IF signals, all the way from zero to a husky 5 mV to within 3 dB, so you'll always have the correct signal level to troubleshoot any manufacturers' circuits . . . and eliminate callbacks by simulating customer reception level in your shop.

Sencore simplified signal injection technique takes the fear out of troubleshooting any MTS receiver system. You can inject a known good MTS signal anywhere in any MTS TV/VCR receiver circuit without lifting components, cutting printed circuit board lands, or breaking any leads. Sencore's exclusive signal injection technique takes the fear out of knowing everything about every MTS receiver.

## . . . Or Make Quick And Profitable MTS Servicing A Snap Any Where, Any Time. . .

The only stand alone, completely portable, stereo TV tester on the market that lets you confidently analyze every stereo TV (MTS) circuit, plus more . . . Check stereo TVs on the showroom floor, in the home, or in the shop with the only portable analyzer that performance tests and troubleshoots every MTS circuit. Or, connect it on your bench to your VA48 or VA62 for a complete set of phase-locked troubleshooting signals.

Sencore's exclusive signal injection technique makes you an expert by truly simplifying MTS servicing. Just like the ST65, you have all the signals you need to completely performance test before or after repair and to troubleshoot all the stereo circuits from the tuner through to the speakers and once again Sencore's exclusive signal injection technique will make you an MTS servicing expert.

Video patterns to check performance of entire receiver. The ST66's exclusive video patterns are the plus that allow you to check for audio to video interference. They also check the stereo TV's video performance without carrying an extra generator.

Only tester guaranteed to tie troubles down to any and all stages. The ST66 is truly an exclusive development in stereo TV test equipment. It can be phase-locked to your video analyzer, or you have the option of picking it up and taking it with you to tie troubles down to any stereo stage. In fact, Sencore guarantees you can walk the problem out of any MTS receiver in half the time of any other MTS generator or your money back. Plus, if you act now, we'll help you get your profits rolling today. Here's what I mean . . .

## . . . Receive A \$75.00 Advertising And Promotion Package FREE By Calling 1-800-843-3338 Today!

Now's the time to capture the MTS testing and servicing market in your area and we'll help you do it! When you say "yes" to your ST65 or ST66 before May 30th you'll receive a \$75.00 advertising and promotion package specially designed to help you sell and promote your new exclusive service. Plus our exclusive interest FREE "Pay As You Grow" Investment Plan will put the unit of your choice on your bench for as little as \$75.00 a month—so call 1-800-843-3338 today to start cashing in on this big servicing potential or ask for a Free copy of Sencore's \$20.00 Simplified MTS Troubleshooting Guide.

**New**



**ST66 Stereo TV Analyzer \$1,295 Patent Pending**

# Thoroughly Analyze And Pinpoint Any RF Video Trouble, In Any Video Distribution System, Automatically To FCC Specifications

**New!**



**FS74 CHANNELIZER SR. — \$2,995**  
Patents Pending

At last, a TV-RF signal analyzer designed the way you want it. Have you been having trouble tuning in all of today's TV channels, standard and cable, with your present field strength meter? Have you ever been troubleshooting a distribution system, orienting an antenna or trying to bring in a very weak channel and wished your field strength meter had just a little more sensitivity? Ever dreamed of being able to automatically tell if any channels are shifted off the HRC or ICC system? Do automatic, FCC accurate, hassle-free tests for signal-to-noise ratio, audio to video ratio and hum level sound too good to be true? Have you ever checked out and OK'd a system with your present field strength meter only to discover line reflection problems, snow in the picture, auto ignition noise, sync compression, co-channel or adjacent channel interference?

Well, if you have run into any of these problems (And who hasn't?), you'll love the all new FS74 CHANNELIZER SR. The only TV-RF Signal Analyzer that actually allows you to accurately check the quantity and truly analyze the quality of every standard and cable TV channel.

Meet the all new FS74 Channelizer Sr.—the TV-RF Signal Analyzer you've been dreaming of. You just can't troubleshoot the pesky, time-robbing, frustrating problems we've mentioned above with any other TV-RF Signal Analyzer—Here's why:

- Exclusive all channel, microprocessor controlled tuner checks every standard and cable channel with FCC accuracy.
- Five microvolt super sensitivity gives you four times the measuring power on all VHF, UHF and FM channels.
- Exclusive "frequency offset" feature automatically retunes for cable HRC and ICC frequency offsets: 100% error proof so you don't have to remember all those offset channels and frequencies.
- Exclusive on-channel automatic signal-to-noise ratio test. Eliminates time-consuming signal comparison and chart reading.
- Exclusive audio to video ratio test measures directly in dB for easy comparison to FCC specifications.
- Exclusive automatic FCC accurate Hum level test; simply read the meter for hum level percentage on any channel that you select.
- Exclusive signal quality check with built-in wideband CRT monitor. You can also analyze and pinpoint RF video distribution troubles.
- Built-in autoranging AC/DC volt and ohmmeter makes troubleshooting a snap.

- Exclusive all weather design holds tighter than FCC specifications from  $-4^{\circ}$  to  $104^{\circ}\text{F}$
- Truly portable, field tested tough for dependable ease of use.

So you see, the FS74 CHANNELIZER SR. is the only TV-RF Signal Analyzer—at any price—designed to really troubleshoot the quantity . . . and the quality of any video distribution system. But don't just take our word for it—prove it to yourself.

### 15 Day Free Trial

We're so sure you'll detect RF video distribution problems quickly and accurately, we're willing to offer you a no obligation 15 day free trial. Put the FS74 through its paces for 15 days and see for yourself just what a breakthrough in field strength analyzer design it really is. If you're not 100% satisfied, simply return your FS74 and owe nothing.

Call **WATS Free, 1-800-843-3338**, today and tell us you want to put the FS74 to the test. If you're looking for more application notes and specifications, just tell our receptionist your area code and you'll automatically be transferred to your area Phone Sales Engineer.

**New!**

## Also Available: The All New FS73 CHANNELIZER JR.

If you're looking for the perfect FCC accurate performance tester, meet the FS74 CHANNELIZER SR.'s little brother—the FS73 CHANNELIZER JR. The FS73 CHANNELIZER JR. incorporates all the same exclusive automatic "Signal Quantity" checks as the FS74. So if you're looking for that perfect performance tester for your van, etc., check out this all new exclusive FS73 CHANNELIZER JR. To put an FS73 or FS74 to work for you, simplifying and analyzing RF distribution systems . . .

**Call WATS Free 800-843-3338**



**FS73 CHANNELIZER JR. — \$1,995**  
Patents Pending



## Tipton's Tips

### A Step-By-Step Walk Through Multi-Channel Television... The First Step To Success In MTS Service.

by Norm Tipton, Application Engineer, Field Sales Engineer



The past few weeks marked the beginning of the new Sencore Multi-channel Television Sound (MTS) Seminar program. The program is designed to walk you through any problem with the new Sencore ST65 and ST66 MTS Stereo TV Analyzer and to accomplish alignment in 3 minutes or less.

(For a complete rundown on MTS and Sencore's ST65 and ST66 Stereo TV Analyzer, refer to issue #130 Jan/Feb of the Sencore News.)

During the first few seminars, I was often asked, "What if you had more than one MTS problem; can the ST65 or ST66 locate them?" Let's look at a "what if" and find out.

Suppose someone brought in a TV set that had no audio. After you connect the RF output of the ST66 to the set's tuner, set the RF level to NORM, and the AUDIO FREQUENCY to 300 Hz; the CRT displays a perfect pattern, but absolutely no sound at all.

Relying upon the trustworthy divide and conquer method, set up the SC61 Waveform Analyzer to monitor the right and left line-out audio jacks of the MTS TV under test.

#### Phase-Locked Signals Let You Walk The Troubles Out Step By Step

All signal injections from the audio output connectors must be made with the RF connected to the tuner

so the injected signals will be phase-locked.

Using the ST66 Stereo TV Analyzer, connect the stereo test lead to the COMPOSITE SIGNAL OUT connector.

1. Inject composite audio into the stereo board composite input. (TP5) (Figure 1). Result: Audio returns.

Connect the stereo test lead to the RF-IF output connector on the ST66. (NOTE: RF to tuner is not required for IF injection. Phase-locking also takes place via the IF injection.)

2. Inject 45.75 MHz IF signal at the IF input. (TP2) Result: No audio.

3. Inject 45.75 MHz IF signal at first IF detector. (TP3) Result: No audio.

4. Inject 4.5 MHz IF signal at the 4.5 MHz input. (TP4) Result: No audio.

Can you see that you've isolated the trouble to the 4.5 MHz detector? Fix it; you now get a stereo pilot indication. It's ready to button up and take home, right? Seems so, but have you given it a thorough performance check?

#### Check Performance To Isolate Difficult Multiple Failures

Reconnect the RF to the tuner. Check the output on the SC61 with the COMPOSITE ANALYZING SIGNAL selector of the ST66 on R CH. Okay, got audio? Yes, but the left channel has audio too, and at the same amplitude as the right channel. Since you are injecting right channel only, how can this be? Didn't you get a stereo pilot indication? Exactly, a stereo pilot indication, not a stereo indication. It simply means you are receiving the transmitted stereo pilot (15,734 Hz) signal. Okay, with the ST66 this is a

picnic. Let's continue our dividing and conquering.

Reconnect the stereo test lead to the COMPOSITE SIGNAL OUT connector on the ST66 (COMPOSITE ANALYZING SIGNAL selector to R CH right channel only).

5. Inject COMPOSITE AUDIO into the stereo board composite input. (TP5) Result: Same as above with no improvement.



Fig. 2: A thorough performance check, with the ST66's special MTS signals, will help prevent call backs.

Connect the stereo test lead to the AUDIO DRIVE OUT connector. Set the AUDIO DRIVE selector to COMPRESSED.

6. Inject compressed audio (L-R) into the dbx<sup>®</sup> decoder chip. (TP 10) Result: You have right channel audio and a very small amount of left channel audio. Switching to left channel only, you have the opposite. Looks like stereo. Is it?

Reconnect the test lead to the COMPOSITE SIGNAL OUT connector on the ST66.

7. Taking one step back, inject composite stereo audio directly into the 2H (L-R) demodulator. (TP 6) Result: A little distorted, but definitely stereo. The reason for the slightly distorted sinewave is, the entire composite signal is present at

the 2H demodulator input instead of just the 2H signal because we bypassed the 2H filter between TP5 and TP6.

Having isolated the defect to the 2H filter and replacing it, you now have stereo and it is definitely ready for travel, right? Now, comes the gotcha.

The procedure above was accomplished with the AUDIO FREQUENCY of the ST66 set to 300Hz. Now set the AUDIO FREQUENCY to 8 kHz. Using just the RF input of the ST66, check right channel only. Oops, both channels are nearly equal in amplitude. Now what? On with the troubleshooting.

Since the dbx<sup>®</sup> decoder is responsible for the high frequency component, repeat step 6 above, but with 8 kHz audio. This time the result is hardly any separation at all. Check the dbx<sup>®</sup> chip supporting components before replacing the IC. Get out the Z METER.

After replacing a leaky capacitor in the high band response circuit of the dbx<sup>®</sup> decoder and completing a minor alignment of that circuit, you now have the MTS system repaired. Are you going to give it another performance check or are you going to assume it's fixed? That's right—one last check.

#### Finally Prevent Callbacks...

The final performance check reveals a perfectly working MTS. Great! What two things did this show?

1. Concerning MTS circuitry, you can not assume it is working to specification until it has been performance tested at 300 Hz and 8 kHz.

2. With the ST65 and ST66, you can walk any trouble (even multiple troubles) right out of an MTS circuit once you understand the block diagram and analyzer.

The troubleshooting procedure above can be found in our new MTS Troubleshooting Guide. Call for your free copy today 1-800-843-3338.

MTS has been on the market for three years now. This is one time you may step ahead of the line by investing in the exclusive ST65 Video Analyzer Stereo TV Adder or the ST66 Stereo TV Analyzer and grow with this new and profitable opportunity.

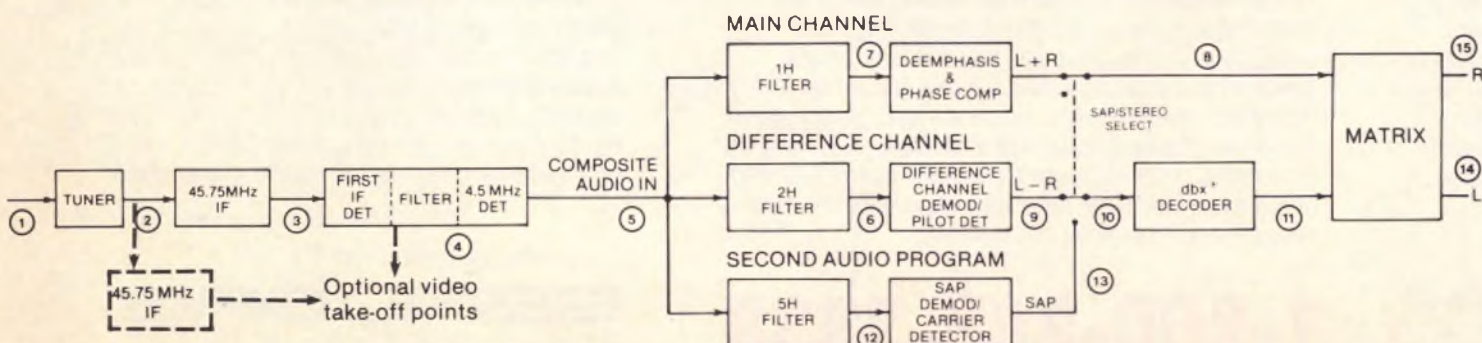

Fig. 1: Phase-locked signals from the ST66 Stereo TV Analyzer let you prove which circuits are working properly from the tuner to the speakers. Isolates defective stages in minutes.





# Sencore's People, Plans, And Progress

by Doug Bowden, Vice President of Human Resources



**A**t Sencore, the old adage that "our biggest asset is our people" is much more than a worn out phrase; it is a fact. If it wasn't for our employees, the Sencore name wouldn't be synonymous with success in the electronics industry.

That's why we would like to take this opportunity to recognize our dedicated staff and sincerely thank them for their continuous loyal service to our customers in 1986. The following employees were honored with awards at Sencore's Annual Awards Presentation in December, 1986. Also, announced at this presentation was the contribution of \$249,549.00 made by Sencore to the employees' profit sharing fund.

**← Millionaire's Club**  
Hank Moser, Chuck Griffin, and Tom Hyman.

**President's Choice Award** ▶  
(for outstanding performance in new product development)  
Terry Cook, Lab Director



Three individuals of our telemarketing team deserve special mention for efforts that we describe as being "superior".

Tom Hyman, Chuck Griffin and Hank Moser achieved this year what only two other people in the past have accomplished. In 1986, these three individuals each wrote over \$1 Million in business as Sales Engineers on our telemarketing team. This accomplishment earned Tom, Chuck, and Hank initiation into Sencore's exclusive Millionaire's Club.

You three deserve a special thanks for the extra time, work and effort that was needed to go that extra mile and become the best in your profession. Congratulations, Tom, Chuck and Hank and welcome to the club!

**← Manager's Choice Awards** (for their contribution in making Sencore successful in 1986)  
Dave Hofstad, Mechanical Engineer; Bob Van Kirk, Service Manager; Larrie Gulden, Purchasing Assistant; Barb Perrion, Telemarketing Secretary; and Grace Letsche, Quality Control Test Leader.

## Career Opportunities



Tom Schulte,  
Technical Writer

*"I have used Sencore products for many years and value them for their unique approaches to problem solving and for their state-of-the-art design. An opportunity to write about these products, from an applications viewpoint, was an exciting prospect."*

*Here at Sencore, I have found the challenges I was looking for, plus opportunities for advancement. Team effort is vital here; everyone's contribution is valued highly, and I feel that I am making a difference in the company's progress."*

When we say, "Sencore Means Success", we are referring not only to our customers but also to our many successful Sencore employees. Sencore is seeking goal oriented, technical people in all areas of the company. We have challenging positions open in Sales and Application Engineering to name a few. Before we talk further about these career opportunities, let's hear from two successful Sencore employees to find out what they like about Sencore.

### At Sencore we offer:

- A competitive salary and benefit package.
- Relocation package.
- Continuing education plan with full reimbursement.
- A professional, team work environment.
- State-of-the-art technology opportunities.
- A modern facility located in a city and state with affordable housing and a national "high quality of living" rating.

*"There are many reasons why I have chosen Sencore as an employer. Sencore's commitment to state-of-the-art technology guarantees me the technical growth I am looking for to expand my career. Sencore has also been established for 35 years, which gives me the job security I need to grow."*



Rob Barden,  
Sales Engineer

*The reason I chose Technical Sales is simple. I like working with people. Technical Sales also offers a lucrative salary as well as rapid career growth into areas such as Sales Management, Advertising and Marketing."*

### Technical Writer / Application Engineer

Are you interested in putting your ideas to work? In this position you would be responsible for writing Sencore News articles, product catalogs, product manuals and Sencore training materials. Also responsible for testing all new products just released from Engineering. If you have had two to five years of technical writing or servicing experience, you should apply by calling or sending your resume. Requires a two or four year Electronics degree.

To find out more about these challenging opportunities call and ask for our Human Resources Department.

### Production Technical Supervisor

The individual selected for this excellent opportunity will be fully responsible for coordinating, monitoring and analyzing all technical problems involving Sencore instruments as they are being manufactured on the Sencore product lines. This is a highly visible and responsible position which requires sound judgment and very strong technical expertise in the supervision of 8-10 technicians. A 2 year degree in electronics and 3-5 years of consumer electronic calibration experience are what is needed to qualify you for this position.

### Sales Engineers

If you are tired of being tied to a bench and have personal communication skills you would like to put to work, then you should apply for this position. Sencore Sales Engineers are Sencore's test equipment consultants assisting Sencore customers in the purchase of our products. All sales are made via the telephone from our headquarters in Sioux Falls, South Dakota. A two or four year electronics degree is a must for this position.

... or send your resume to:

**SENCORE**

Human Resources Department, SN/01  
3200 Sencore Drive  
Sioux Falls, SD 57107

**1-800-843-3338**

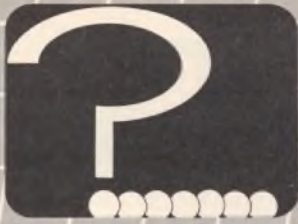

# Questions and Answers

## To Understand Multichannel Television Sound (MTS), A Review Of FM Modulation Will Help

by Chuck Robertson, Chief Application Engineer



**W**ith the release of Sencore's Multichannel Television Sound (MTS) Stereo TV Analyzers, models ST65 and ST66, and many of you getting Stereo TV in the shop for service, questions have come up about the level of audio modulation used in MTS service. In the Sencore News 129 and 130, we discussed the theory of stereo television, the make up of composite audio, universal block diagrams, troubleshooting trees, and took a step by step walk-through using the ST65 Video Analyzer Stereo TV Adder and the ST66 Stereo TV Analyzer. Refer to these News articles for questions on the theory of MTS.

Now, we'll briefly review FM, show the relationship of the amplitude of the modulating audio to deviation, and describe what this means to the audio signal at the receiver. Then we'll see how performance tests are made on any MTS system with the ST66.

### Prepare For Successful MTS Service With A Quick Review Of FM

FM is a type of modulation in which the amplitude of the carrier remains constant, but the frequency of the carrier is shifted above and below the assigned frequency. The amplitude of the modulating audio signal determines how far the carrier shifts (deviates) above and below the assigned frequency. The frequency of the modulating audio signal (tone, music, etc.) determines the rate of deviation (how fast the carrier shifts above and below its assigned frequency).

Let's look at a simple FM oscillator. Figure 1 shows a varicap controlled oscillator whose frequency is controlled by the capacitance of the varicap across the LC tank circuit. (The capacitance of a varicap is directly proportional to its reverse bias).

The larger the audio signal applied to the input, the greater the change in bias and the greater the change in capacitance. This shifts the oscillator further from its assigned frequency. In TV, the aural carrier is frequency modulated by the audio program. FM improves the quality of the received audio signal (less noise and interference). TV stations deviate the audio carrier 25 kHz above and below the assigned frequency and modulate with audio frequencies to 15 kHz. When the station is deviating their aural carrier  $\pm 25$  kHz, they are at the 100% modulation level.

When broadcasting stereo TV, (Figure 2) stations must be concerned with the modulation level of the main carrier by the main audio (L+R), the difference audio (L-R), the pilot, and SAP if used. Each will add to the amount of main carrier deviation.

In a typical FM modulator, operating in its linear region, if 2 volts of audio cause 25 kHz of deviation, then 1 volt will cause 12.5 kHz of deviation. In the receiver, the amplitude of the demodulated audio is dependent on the amount of carrier deviation. If the amount of deviation is doubled, the amplitude of the demodulated audio will also double.

### What Do I Need To Quickly And Accurately Troubleshoot Or Performance Test Any MTS Unit?

We have seen how the percent of modulation changes the amplitude of the audio signal in the receiver and have learned that the percent of modulation is always referenced to the 100% level in the main channel. Therefore, use a generator that lets you establish a reference level, at 100%, and enables you to predict

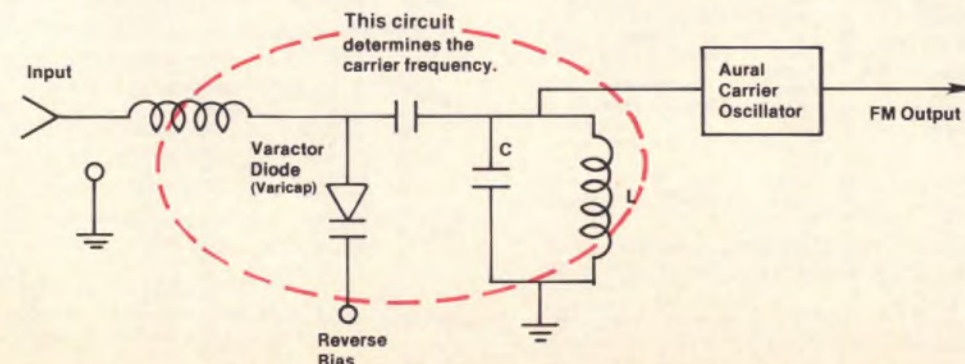

Fig. 1: The carrier frequency is controlled by the varicap diode; the greater the change in bias, the greater the change in frequency.

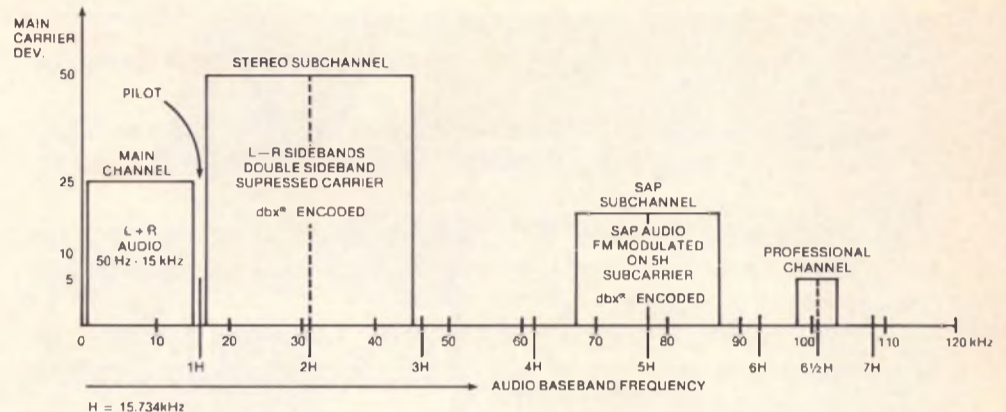

Fig. 2: Each signal will cause an amount of deviation proportional to its amplitude.

the test results with respect to this reference.

The SENCORE models ST65 and ST66 were designed with a 100% modulation level in Stereo and a 50% modulation level in the R or L CH position. This provides you with the same level of audio out, from a properly working set, in all stereo positions, plus the advantage of having a steady 100% stereo modulation level as a reference for troubleshooting and performance testing.

### With The ST66 Stereo TV Analyzer, You Can Performance Test Any MTS TV Or VCR In Minutes — From The Antenna Terminals.

1. Hook the RF output from the ST66 to the antenna input of the TV or VCR.
2. Turn both units on, and select stereo operation on both units. The ST66 is now supplying a stereo pilot and main channel audio with 100% modulation ( $\pm 25$  kHz deviation).

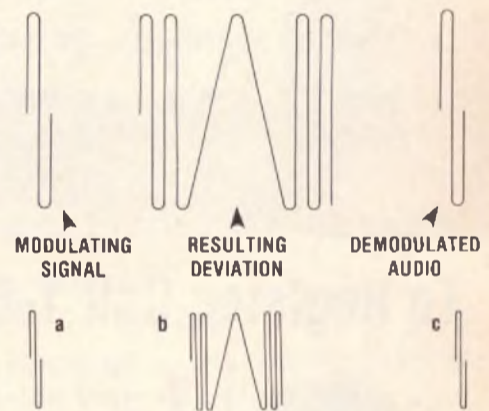

Fig. 3: Decreasing the modulating signal by 1/2 (a), causes 1/2 the deviation (b), which results in 1/2 the demodulated audio (c).

3. Read the output level with your scope or the SR68 Stereo TV Readout. This level is the performance of the main audio channel when a 100% modulation level signal ( $\pm 12.5$  kHz deviation) is applied.

4. Select R or L CH on the ST66. The ST66 now provides a pilot and main channel audio signal at the 50% modulation level ( $\pm 12.5$  kHz deviation). Read the stereo separation on the dual meters of the SR68 Stereo TV Readout or on your scope.

The performance of all the stereo circuits including the dbx<sup>®</sup> stereo difference channel have been tested dynamically, from the input (antenna) to the output (speaker or line out), in minutes.

We have reviewed FM, the relationships of the amplitude of the modulating audio to deviation, and what this means to the demodulated signal at the receiver. Have questions? Call WATS free today, 1-800-843-3338, and discuss the new ST65 and ST66 with your Sales Engineer.





# ALL NEW SENCORE SHOPPERS GUIDE

Here is a brief look at the 1987 Sencore product line. You'll want to take a minute to browse through this Shoppers Guide for highlights on the Sencore instruments you've been wanting to add to your bench, plus highlights of some new exciting products. But, before you do, pull out your Sweepstakes Return Card (inserted on page 25) so you can request more information on applications and specifications on specific instruments, or to order the instruments you want most factory direct. For quicker action, call us WATS Free, 1-800-843-3338, and we'll handle your requests or order TODAY. Whether you call or write though, you'll want to enter Sencore's Success Shop Sweepstakes. You just may win an \$8,175 Sencore Success Shop. See your entry certificate on page 25 for details. And for really big savings don't miss our "Success Shop Specials" on the inside back cover — they could save thousands. Happy shopping.

**Analyze defective waveforms faster, more accurately, and more confidently — every time . . . or your money back**



**SC61 Waveform Analyzer**  
Double Patented \$2,995

**End frustrating fiddling with confusing controls.** Exclusive ultra solid ECL balanced noise cancelling sync amplifiers, simplified controls, and bright blue dual trace CRT helps you measure signals to 100 MHz easier than ever.

**Accurately and confidently measure waveforms.** The SC61's exclusive front end gives you three times the measuring range of a regular scope: From a tiny 5 mV (tuner output) all the way to a whopping 2,000 V (horizontal output collector) without hesitation; patented 3,000 VPP input protection eliminates expensive "front end" repairs and costly equipment downtime.

**Exclusive one probe hook-up lets you quickly and accurately analyze any test point.** You can instantly read out DC volts, peak-to-peak volts and frequency with digital speed and accuracy 100% automatically, simply by pushing a button. There are no eyestraining graticules to count, no confusing controls to interpret and no frustrating calculations to make. It's a real troubleshooting confidence builder.

**Confidently analyze complex waveforms fast and easy.** Exclusive Delta measurements let you intensify any waveform portion by simply "Lighting Up" that portion with the Delta Positioning control and pushing a button for  $\Delta$  P-P,  $\Delta$  time and  $\Delta$  frequency time. You'll analyze glitches, interference signals, rise or fall times or voltage equivalents between levels — instantly at the push of a button.

**Speed your digital logic circuit testing.** Analyzing troublesome divide and multiply stages is quicker and error free — no time-consuming graticule counting or calculations. Simply push a button for ERROR FREE results.

To see what the SC61 can do for your personal troubleshooting productivity and analyzing confidence write for more information or CALL TODAY, WATS Free, 1-800-843-3338.

**Walk "tough dog" troubles out of any TV or VCR in half the time . . . or your money back**



**VA62 Video Analyzer**  
Double Patented \$3,295

**Reduce analyzing time:** Isolate any problem to one stage in any TV or VCR in minutes, without breaking a circuit connection, using the tried and proven signal substitution method of troubleshooting.

**Cut costly callbacks and increase customer referrals** by completely performance testing TVs & VCRs before they leave your shop. Own the only analyzer that equips you to check all standard and cable channels with digital accuracy. Check complete, RF, IF, video and chroma response of any chassis in minutes without taking the back off the receiver or removing the chassis plus set traps dynamically right on CRT too. Simplify alignment with exclusive multiburst pattern.

**Reduce costly inventory from stocking yokes, flybacks, and other coils and transformers, for substitution only,** with the patented Ringing Test. Run dynamic proof positive test on any yoke, flyback, and integrated high voltage transformer . . . in- or out-of-circuit.

**Protect your future** by servicing VCRs for your customers before they go to your competition. Walk out "tough dog" troubles in any VCR chrominance or luminance circuit—stage-by-stage—to isolate problems in minutes. The VC63 VCR test accessory gives you proof positive test of the video record/play heads before you replace the entire mechanism.

**Increase your business** by meeting all TV and VCR manufacturers' requirements (including the "NTSC" color bar pattern from the NT64 accessory) for profitable warranty service work with this one universally recommended analyzer.

For more information, or to find out about our 30 day money back guarantee, CALL TODAY, WATS Free, 1-800-843-3338.

Copyright © by Sencore, Inc.

dbx is a registered trademark of dbx, Inc. E-Z HOOK is a registered trademark of E-Z HOOK, Division of Tektest, Inc. Velcro is a registered trademark of Velcro USA, Inc.

**Trademarks of Sencore, Inc.:** Little Huey, "Super Cricket", "Z METER", MICRORANGER™, "POWERITE™" Waveform Analyzer, "AUTOTRACKING", "BEAM BUILDER", "CHANNELIZER JR.", "CHANNELIZER SR.", "Z METER 2", "PORTA-Z", "AUTO-Z", Snoop Loop, Sure-Hold, Needle Probe, Kangaroo Pouch, Touch Test Probe.

**Pricing Note:** All prices shown are U.S. dollars. Canada must add applicable Duty, Freight, and F.S.T. Prices and specifications subject to change without notice.

# ALL NEW SENCORE

Quickly, Easily, And Accurately  
Test, Troubleshoot, And Verify  
Any Mono/Stereo Sound Or  
SAP Channel Or Your Money Back

Sencore Proudly Brings You The  
Only Complete Analyzer For  
MTS Compatible Stereo TV,  
The ST66 Stereo TV Analyzer.



## New ST65 Video Analyzer Stereo TV Adder Patent Pending \$895

## New ST66 Stereo TV Analyzer Patent Pending \$1,295

**Have you already waited too long to update your shop for Stereo TV service?** Be the shop in your area that customers come to for service with their new Stereo TVs — and come back to with all their servicing needs. With almost half the new TVs having stereo capability, your base of potential new customers is enormous.

**Add profitable MTS TV analyzing capability to your Sencore video analyzer.** Add stereo TV capability to your VA62 with the ST65. You get RF and IF frequencies plus all the signals needed to perform tests of stereo separation, signal-to-noise, crosstalk, audio, pilot threshold, dbx®, stereo decoders, and more.

**Solve challenging problems:** By testing separation, you'll know that the customer is getting good left and right audio, and that the dbx® and stereo decoders are good. Signal-to-noise tests prove that the TV can produce noise free signals with good separation while crosstalk tests assure that SAP and stereo do not interfere with each other. Audio-to-video and video-to-audio interference tests (more critical in MTS TV) assure proper IF alignment and correctly set traps.

**Phase locked to video analyzer:** Exclusive Gen-Lock feature phase locks the ST65 analyzer to the VA62. Use the VA62 drive signals to troubleshoot video problems and the ST65 to troubleshoot stereo sound problems.

**Easy to use:** There are no complicated setups; simply select the signal you want, set the amplitude, and test. A handy pull chart guides you through every test. The challenge of stereo TV—new opportunities that spell success. Call your area Sales Engineer at 1-800-843-3338 to discuss this innovative stereo TV generator.

**Get in on the growing Stereo TV service market.** Leading manufacturers project that the stereo TV market will double by the end of 1986, and reach gigantic proportions by 1990. Sencore's new ST66 Stereo TV Analyzer gives you every important signal needed to enter this exciting service market.

**Exclusive phase-locked analyzer.** Phase-locked drive signals help you find defects in the stereo decoder or in the tuner or IF stages. Test all stereo circuits including the difficult noise reduction circuits. In addition, the exclusive pilot threshold test finds troublesome false triggering and loss of stereo problems.

**Analyze the entire Stereo TV system.** You'll find challenging MTS Stereo TV and Separate Audio Program (SAP) problems with confidence—right down to the defective stage by simply injecting MTS compatible RF, IF or composite signals into the tuner, IF section, or stereo decoder board, and observing the result on the TV screen, speakers, or scope.

**Video and audio tests in one package.** Check for interference between the color and audio circuits with the ST66 Stereo TV Analyzer color bar pattern. The portable ST66 Stereo TV Analyzer maintains NBS traceable accuracy; check stereo TVs anywhere—in the home, field, or shop with complete confidence.

**Solutions to tough challenges — innovatively designed with your time in mind.** Success is enhanced by the ST66's capability, the handy pull chart that guides you through each profitable test, the isolated chassis for error free troubleshooting, automatic shut off to conserve batteries, and Sencore's Exclusive Lifetime Made Right Guarantee. Call 1-800-843-3338 and ask your Sales Engineer for Sencore's exclusive 15 day Free Self Demo on this exciting new profit builder.



## New SR68 Stereo TV Readout

Dual Meters And Loads  
Solve Stereo TV Servicing  
Challenges

SR68 Stereo TV Readout  
\$495

**Solve stereo TV audio challenges without blaring speaker noise.** Dummy loads let you troubleshoot audio circuits at full power. No need to tie up your scope to monitor outputs. No more calculations to determine separation.

**Portable dummy loads, level meters, and separation tests save troubleshooting time.** Connect the TV's audio (line or speaker outputs) to the SR68's input, and start troubleshooting. You'll get simultaneous readings of the audio output of both channels in watts or dB to show performance and separation instantly.



# SHOPPERS GUIDE

Now test every CRT on the market . . . without ever buying another adaptor socket or coming up embarrassingly short in front of your customer . . .



**CR70 "BEAM BUILDER"™**  
Universal CRT Tester and Restorer  
Patented \$995

**A real customer's satisfaction builder.** Imagine the customer base you can build by being able to restore 9 out of 10 of the weak or shorted CRTs that you come across. Plus you'll be able to restore that older TV, Data Display Terminal or even an industrial scope CRT that your competition advised "just had to be replaced." That's why the CR70 is a real reputation builder.

**Cash in on the profitable restoration business.** You can earn an extra \$35 or more for every CRT restoration or rejuvenation — it makes every service call or carry-in more profitable. Plus when you back it with the "BEAM BUILDER™" exclusive "television picture tube guarantee" you're assured extra income and repeat business.

**Profitably handle trade-ins and rental sets.** Because you can restore 9 out of 10 of these expensive picture tubes rather than replacing them you can add a new profit generating service to your existing business.

**You'll never be caught embarrassingly short in front of a customer** because you'll always have the right adaptor socket and setup information in your setup book (or as close as a WATS Free call) right at your fingertips.

Earn big profits while you protect your instruments and build your reputation

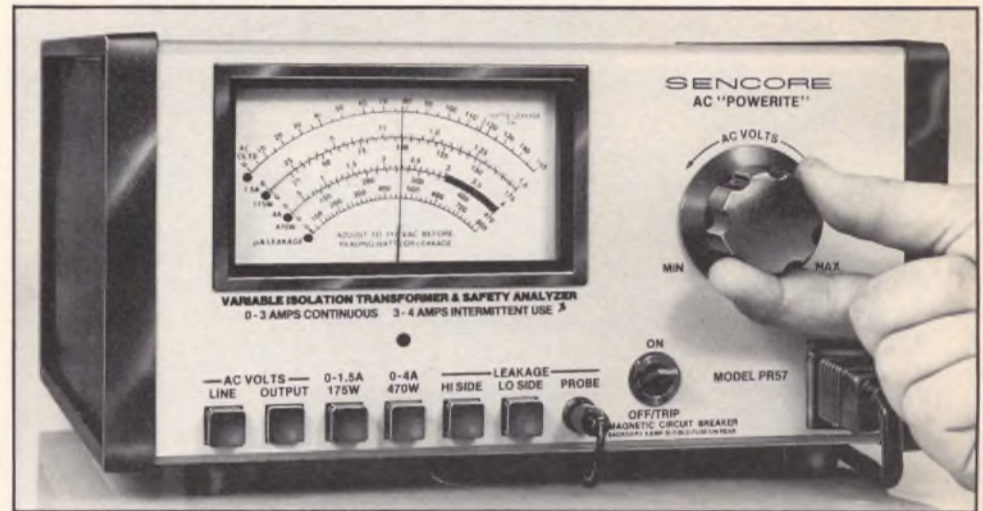

**PR57 POWERITE®**  
Patented \$395

**Protects you and your expensive test instruments.** Supplies supreme isolation from the AC line that saves you damaging downtime and costly repairs by isolating you and your instruments from the chassis under test.

**Tame tough startup and shutdown problems fast.** The continuously variable 0-150 VAC supply with 4 Amp circuit breaker will save you hundreds of dollars each year troubleshooting those time-consuming "tough dog" startup and shutdown problems.

**Keeps you from chasing phantom circuit problems.** The PR57 keeps you from spending time and dollars tracking down problems that do not exist because your AC line voltage is fluctuating too low or too high.

**Helps you avoid expensive part damage.** Large, easy to read, calibrated meter lets you know if your circuits are pulling the right power, so you avoid expensive part damage.

**Patented safety leakage tester** gives you peace of mind on every repair. Helps your customers avoid accidental shock and builds your reputation by testing for excess AC leakage with the simple touch of a probe. No expensive jigs or confusing "Jerry Rigged" circuits. Plus safety testing and charging a modest \$5.00 charge turns your PR57 into a profit builder that will earn you an extra \$5,000 a year in profits.

If you're interested in discovering just how the PR57 POWERITE® can earn you over \$5,000 in additional service income in just 12 months, give us a call, **WATS Free, 1-800-843-3338**, and let us put this positive profit generator to the test on your bench for 15 days absolutely Risk FREE.

Test any transistor or FET with 99% reliability in less than 15 seconds in- or out-of-circuit with the . . .

**TF46 Portable Super Cricket Transistor/FET Tester**  
Patented \$395



**Fast accurate test you can rely on.** Patented go/no-go in-circuit Cricket test is proven 99% reliable. Pushbutton Beta test for quick matching and comparing of semi-conductor parameters. Backup out-of-circuit leakage test gives you reliable tests every time.

**Easy to use — automatic lead identification.** You need no setup book or instructions. The TF46 automatically identifies transistor or FET configuration without interpretation. Plus a handy automatic power shut-off after 20 minutes so you're never caught with dead batteries.

If you're interested in faster, more reliable transistor FET testing write for more information or **CALL TODAY, WATS Free, 1-800-843-3338**, to put a TF46 on your bench for 15 days absolutely Risk FREE.

The information in this publication has been written, edited, and published by the Applications Department of Sencore, Inc.. Information contained herein was taken from one or more sources we consider reliable. Although such information has been carefully prepared, we make no representation as to its accuracy or completeness. Schools, government agencies, and others desiring to make copies of this information may do so without requiring further authorization as long as "Courtesy of Sencore" appears with the copy.

# ALL NEW SENCORE

**New** Exclusive, triple patented dynamic cap and coil analyzing . . . guaranteed to pinpoint your problem every time or your money back



with the all new LC75 "Z METER 2"  
Capacitor and Inductor Analyzer  
Triple Patented \$995

**Eliminate expensive part substitution and time-consuming shotgunning** with patented tests that give you results you can trust every time. Test all four capacitor parameters: Value, Leakage, Dielectric Absorption, and ESR; dynamically with up to 600 volts applied for guaranteed 100% reliable results — it's patented.

**Save time and money with the only patented 100% reliable, in- or out-of-circuit inductor test available.** Dynamically test inductors, yokes, flybacks, and even IHVTs for: Value, Shorts, and Opens; automatically under "dynamic" circuit conditions. You will have 100% proof positive tests.

**Reduce costly parts inventory with patented tests you can trust.** No more need to stock a large inventory of caps, coils, flybacks, and IHVTs for costly substitution. The "Z METER 2" eliminates time-consuming and expensive parts substituting and "shotgunning" with 100% reliable LC analyzing you can trust. At last you can troubleshoot cap and coil problems with 100% confidence and reliability.

**Test troublesome SCRs and triacs easily and automatically without investing in an expensive second tester.** The patented "Z METER 2" even tests SCRs, triacs, and High-Voltage Diodes dynamically with up to 600 volts applied. You'll even be able to turn chaos into cash by quickly locating transmission line distance to opens and shorts to within feet, in any transmission line.

Write for more information or call **WATS Free, 1-800-843-3338**, to put the world's only Dynamic LC Tester on your bench with a 15 day Free Self Demo.

**New** The LC76 Brings Portability To Cap And Coil Testing - Get Lab Accuracy Anytime, Anywhere



LC76 "PORTA-Z"™  
Capacitor and Inductor Analyzer  
Patented, \$1,295

**Guaranteed to increase your troubleshooting confidence—on the bench or in the field.** The LC76 PORTA-Z analyzer brings time tested and proven features to portable cap/coil testing. It's guaranteed to increase your troubleshooting confidence. With the LC76 PORTA-Z you get the know-how and expertise gained from Sencore's years of Z METER experience. Test capacitors from 1pF to 200,000 uF at voltages to 1000 volts—with NBS traceable accuracy on the bench or in the field!

**Locate capacitor failures other testers can't find.** Measure equivalent series resistance (ESR) to pinpoint this common capacitor problem. Test inductance values from 1 uH to 10 H. Test the quality (Q) of inductors and check TV yokes and flybacks with Sencore's exclusive Ringing test.

**Exclusive hi-pot test to 1000 volts (previously impossible in a portable) isolates leakage problems fast.** You get 9 continuous hours of battery operation. The LC76 uses a new state-of-the-art power circuit to let you dynamically test leakage at an unheard of portable 1000 volts, guaranteed.

**The most complete and versatile capacitor and inductor analyzer on the market.** Sencore's "Z METER" is the standard by which inductor/capacitor analyzers are measured. No other equipment performs total dynamic guaranteed L/C tests like the Z METER. Now with the portable LC76, all of the original Z METER's tests plus improvements like ESR and leakage tests to 1000 volts can be yours anywhere, anytime and anyplace. Call WATS Free 1-800-843-3338 to set up a 15 day Free Self Demo on the LC76.

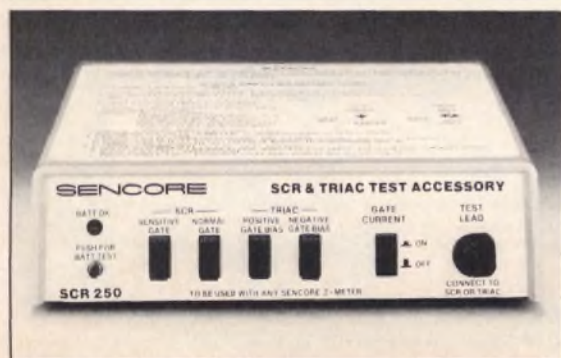

**New**  
SCR250  
SCR And Triac  
Test Accessory  
\$148

**Tests all SCRs and triacs.** The SCR250 tests all SCRs and triacs in both directions. It's completely isolated and the controlled internal battery supply protects sensitive gates while guaranteeing turn-on of the most demanding high current industrial SCRs and triacs. No more missing those triacs that check good in one direction but are leaky in the other.

**Exclusive dynamic leakage test.** SCRs and triacs are dynamically tested at their full working voltage. You'll never again get caught guessing whether or not an SCR or triac is good.

**Easy to use.** The SCR250 is truly "Innovatively Designed With Your Time In Mind," there's no complicated setup, and no need to look up specifications; just select, push the button and test. Mounts on your Z Meter with handy Velcro® strips.

# SHOPPERS GUIDE

**New**

**The Only Dynamic, Portable, Automatic Cap/Coil Analyzer Guaranteed To Quickly Find Defective Capacitors And Inductors That Other Testers Miss, Anywhere, Without Calculations, Look-up Tables, Or Error.**



**LC77 "AUTO-Z"™ Capacitor And Inductor Analyzer Patented, \$1,695**

**Automatic, Microprocessor Controlled For Accurate Error-Free Cap/Coil Analysis**

**Automatic microprocessor controlled for speed and accuracy.** The LC77 "AUTO-Z" brings speed, reliability, and extended ranges to cap/coil testing. Its advanced digital technology completely analyzes capacitors to 20 farads and inductors to 20 henrys. Enter the parameters: value, rated voltage and tolerance. The "AUTO-Z" makes the readings, compares them against EIA tables stored in memory, and displays whether the component is good or bad. With the push of a button you obtain the exact readings for value, leakage, dielectric absorption, ESR, inductor value, and ringing test.

**Exclusive capacitor and inductor ranges thoroughly test every cap/coil in the industry automatically—only the LC77 "AUTO-Z" allows you to test today's high tech components.** The "AUTO-Z" measures capacitors from 1 pF to 20 farads, with leakage tests to 1000 volts and ESR from 0.10 ohms to 2000 ohms and locates leakage (with .1 microamp resolution) in ceramic and tantalum capacitors that other testers can't find. Automatic ringing test checks inductors, yokes, flybacks, and switching transformers with 100% reliability.

**IEEE488 compatible for automated testing and data collection.** Use Sencore's IB72 to control the "AUTO-Z" over the IEEE488 Bus for data collecting, incoming inspection, and quality assurance tests.

**Portable - use in the field or in the factory.** The full power and potential of the LC77 "AUTO-Z" is packed into a light-weight, portable (battery and AC) package. The "AUTO-Z" is designed with CMOS logic, LCD technology and automatic shut-off feature for low power consumption (the LC77 operates over eight hours on one battery charge). Take the LC77 "AUTO-Z" wherever you check capacitors and inductors - in the field, shop or factory.

**To be satisfied that you can meet all the challenges new technology brings,** call today **1-800-843-3338** and set up a 15 day Free Self Demo on the "AUTO-Z".

**High Performance .5PPM Accurate Counter-and Day Long Portability**

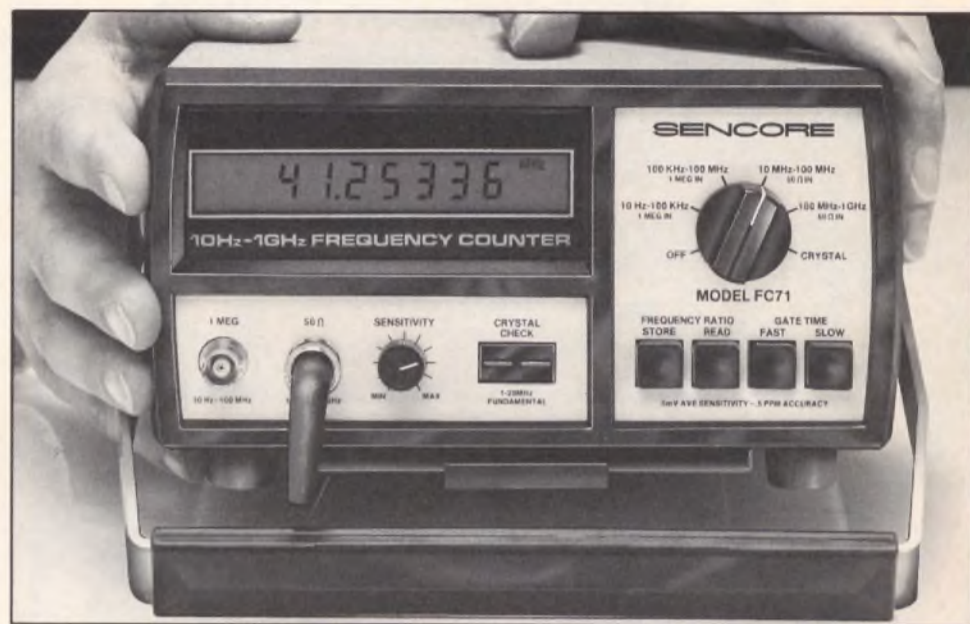

**FC71 Portable 1 GHz Frequency Counter Patented \$995**

**FCC accurate, 1 GHz band, 9½ hour battery operation for today's versatile testing needs.** Microprocessor-controlled time base provides .5 PPM accuracy from 10 Hz to 1 GHz anywhere, anytime. A single battery charge is all you need for a full day's FCC accurate, portable operation.

**Triple shielded for guaranteed interference free readings.** It's RF immune so you can finally reliably count even right at a transmitter site. No more dancing digits when you need an accurate count.

**Count signals other counters can't.** The FC71's 5 mV super sensitivity will even let you measure the output of RF generators and communication monitors. Super stability lets you count AM, FM signals and even audio signals with noise that drives other counters crazy. .01 Hz resolution in 1 second is ideal for setting PL tones, 30 Hz VCR servo controls and even critical audio adjustments.

**Special tests for added versatility and convenience.** Special frequency ratio test compares two frequencies and displays ratio directly. Exclusive crystal check tests the operating frequency of any crystal quickly and easily. You can even add an external IEEE 488 Bus controller (Model IB72-\$625) for automated testing applications.

**Performance you have to see to believe.** But prove it to yourself — put the FC71 to the test on your bench or test site today with a 15-day Free Self-Demo. **CALL TODAY , WATS Free, 1-800-843-3338.**

## **IB72 IEEE488 BUS INTERFACE ACCESSORY \$625**

**Automated testing saves time and eliminates errors:** Automation is the answer when your challenges includes repeated good/bad testing, data collection, and fault analysis. Use the IEEE488 system's automatic features to gather readings 24-hours a day, automate good/bad incoming component testing, increase productivity, and help workers handle complex processes. Sencore's IB72 adds IEEE488 to the SC61 Waveform Analyzer, FC71 1 GHz Frequency Counter, FS73 CHANNELIZER, JR., FS74 CHANNELIZER SR., or the LC77 "AUTO-Z".

**The SC61 Waveform Analyzer and the IEEE488 Bus replace six automated testers.** Locate intermittents or collect and analyze data for guided probe testing, engineering, and quality control by automating the SC61 Waveform Analyzer.

**Use the IEEE488 Bus to monitor transmitter frequencies to 1 GHz.** Monitor the frequency of transmitters, oscillators, or other circuits using the FC71 1 GHz Frequency Counter on an IEEE488 bus.

**The FS73 or FS74 CHANNELIZER and the IEEE488 Bus solves interference and missing channel problems.** Use the FS73 or FS74, on the IEEE488 bus to automatically long-term test CATV and MATV video distribution systems.

**New Automatic Cap/Coil Analyzing Speeds Component Inspection.** Use the LC77 "Auto Z" Meter and the IEEE488 bus for good/bad tests or to monitor value changes with time or temperature. It's time to get complete specifications and applications bulletins on interfacing your test instruments to the IEEE488 bus. Call **1-800-843-3338** and discuss your IEEE488 applications with your Sales Engineer.

# ALL NEW SENCORE

**Now Completely Performance Test Every Single TV Channel, In Any RF Distribution System, To FCC Specifications, 100% Automatically And 100% Faster Than Ever Before.**



**New**

**FS73 "CHANNELIZER JR."™  
TV-RF Performance Tester  
Patent Pending \$1,995**

Finally, automatic readings at the touch of a switch. No more tuning, measuring, and calculating to find audio-to-video ratios, signal-to-noise, and hum. The FS73's microprocessor does these performance tests (and more) on any channel automatically.

**Microprocessor-controlled digital tuner covers every channel.** Check any system—UHF, VHF, all cable channels (plus the 5-50 MHz channels), and the FM broadcast band. The FS73's digital tuner uses PLLs throughout for fast accurate results.

**Super 5 microvolt sensitivity and autoranged attenuator leaves hands free to make critical adjustments.** Measure the lowest signal levels at an antenna, to the strongest signals at the output of an amplifier without adjusting the range.

**Exclusive, automatic fine tuning with LCD readout of off-channel frequency locates shifted channels fast.** Tests non-standard shifted channels, too. AFT circuits lock the FS73 to the carrier and tell you how far the carrier is from its assigned frequency.

**Tune to standard cable shifted channels in seconds without looking up frequencies.** Simply select between HRC, ICC or non-shifted cable systems. The microprocessor automatically offsets the tuner the correct amount for each channel and displays the deviation from the standard frequency on the LCD readout.

**Exclusive signal-to-noise test (even on in-use channels) simplifies testing and saves time.** Compare the signal on any channel to the noise level on that same in-use channel. *The FS73 measures the actual noise* within the channel and automatically calculates the S/N ratio.

**Eliminate tedious pilot and carrier measurements—read audio-to-video ratio and hum on any channel (while it's in use) automatically.** No more calculations, simply tune the channel, select the A/V or Hum test, and the microprocessor does the rest. It's fast, easy, and error free. (Patent Pending)

**Thoroughly analyze and pinpoint any RF video trouble, in any video distribution system, automatically to FCC specifications**

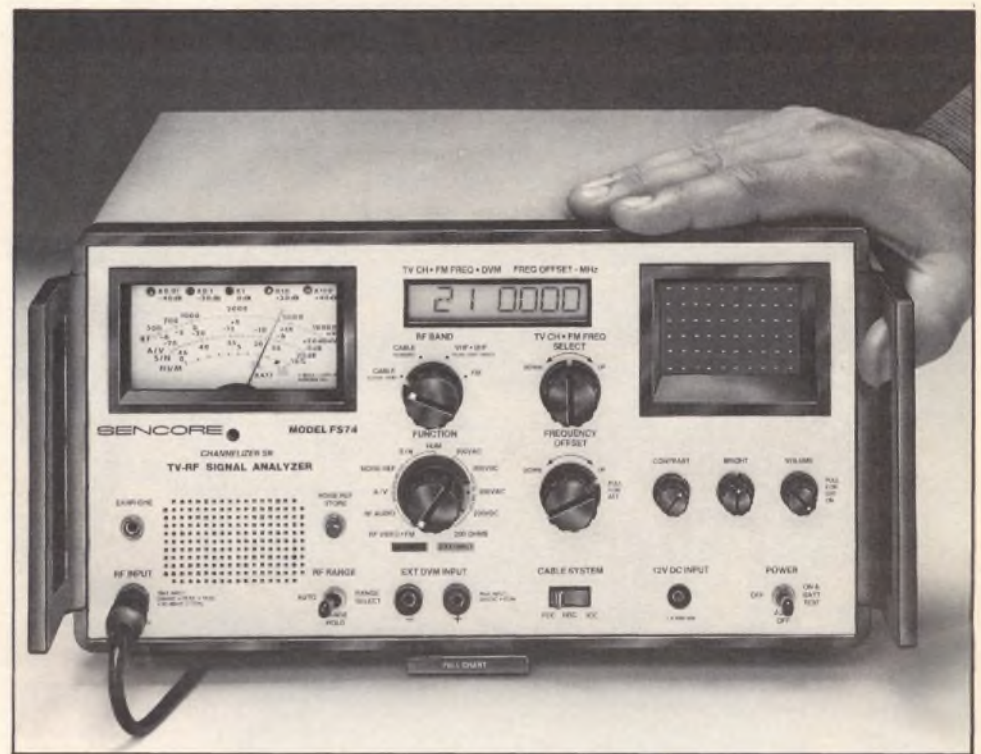

**New**

**FS74 "CHANNELIZER SR."™  
TV-RF Signal Analyzer  
Patent Pending \$2,995**

**Tune in all of today's standard and cable TV channels.** Exclusive all channel, microprocessor-controlled tuner checks every standard and cable channel with FCC accuracy.

**Super sensitivity to bring in weak signals and for orienting antennas.** Five microvolt super sensitivity gives you four times the measuring power on all VHF, UHF and FM channels.

**Automatic channel shift for HRC and ICC systems.** Exclusive "frequency offset" feature automatically retunes for cable HRC and ICC frequency offsets; 100% error proof so you don't have to remember all those offset channels and frequencies.

**Automatic hassle-free S/N ratio, A/V ratio, and hum level tests.** Exclusive on-channel automatic signal-to-noise ratio test. Eliminates time-consuming signal comparison and chart reading. Exclusive audio-to-video ratio test measures directly in dB for easy comparison to FCC specifications.

**Exclusive checks for ghosts, co-channel interference, line reflections and other signal quality checks.** Built-in 4 MHz wide bandwidth monitor lets you finally check the quality of your cable or MATV system to stop annoying callbacks.

**Built-in autoranging AC/DC volt and ohmmeter makes troubleshooting a snap.** Exclusive all-weather design holds tighter than FCC specifications from -4°F to +104°F. Truly portable, field tested tough for dependable ease of use.

**IEEE488 allows all tests to be performed under computer control.** Hands-off performance checks of all channels, and continuous, unattended monitoring for interference, are two of the ways your FS73 or FS74 and a computer can be used to solve tough problems.

**With growing profits in the TV-RF and cable service, don't you owe it to yourself to try the FS73 "CHANNELIZER JR."™ or FS74 "CHANNELIZER SR."™?** Call **1-800-843-3338** today to put a "CHANNELIZER" on a 15 day Free Self Demo in your shop or system.

# SHOPPERS GUIDE

Walk the troubles out of any stereo system in half the time . . .

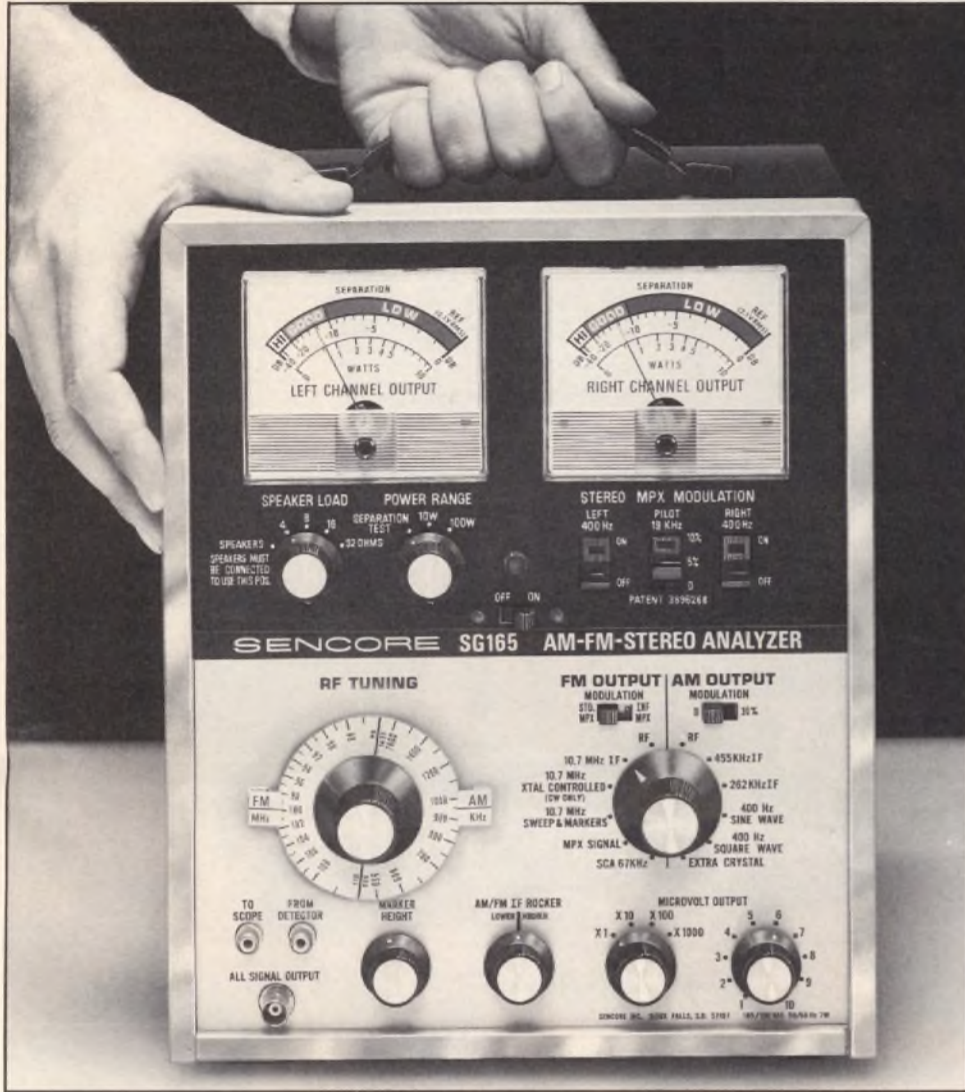

**SG165 AM-FM Stereo Analyzer**  
Patented \$1,295

**Saves you time on every job.** Finally you'll have everything in one instrument for complete stereo servicing: It has every signal and test you'll need for troubleshooting from the antenna terminals to the speakers. Having only one output cable for every AM or FM signal saves you time like never before and keeps your bench tangle-free. Plus all signals and tests are within FCC broadcast specs and tolerances are tighter than the transmitter itself.

**Reduces callbacks and increases your service reputation in your community.** Complete AM check: Separate microvolt controlled RF and 455 KHz and 262 KHz IF, plus a 400 Hz square wave gives you a signal for substitution in every AM radio stage. Complete FM stereo check: 88 to 108 MHz RF, 10.7 MHz IF (crystal-controlled or adjustable), and 5% and 10% pilot signals make FM servicing a snap.

**Dynamically speeds your RF & IF alignment.** It's an FM sweep and marker generator, plus offers you an even more innovative and exclusive vector alignment procedure for faster, more accurate alignment and alignment checks.

**Special meters guide you all the way.** Dual dB and watt meters backed with 100W speaker loads. You monitor every action on color-coded good-bad meters as you work on the different stages or align the MPX decoder.

If you want to cut your stereo troubleshooting time in half write us for more information or call **WATS Free, 1-800-843-3338**, and put the SG165 Stereo Analyzer on your bench absolutely Risk FREE.

100% automatic microprocessor-controlled DVM will save you at least an hour a day



**DVM56A Microranger®**  
Patented \$995

**It's fast.** The MICRORANGER® is totally autoranging. You simply select the function you want and touch the probe for instant measurements.

**It's accurate.** 4½ digit readout with a .075% DCV accuracy means reliable readings every time.

**It's versatile.** The MICRORANGER® has more functions and ranges than any other meter on the market, including dB, ACV peak-to-peak, true RMS, peak and null, and more.

**It's RF interference free.** The DVM56A holds rock solid under the largest broadcast transmitting tower.

For more information write or call us **WATS Free, 1-800-843-3338**, to put the DVM56A on your bench absolutely Risk FREE.

When the going gets tough, you need a tough DVM that keeps going

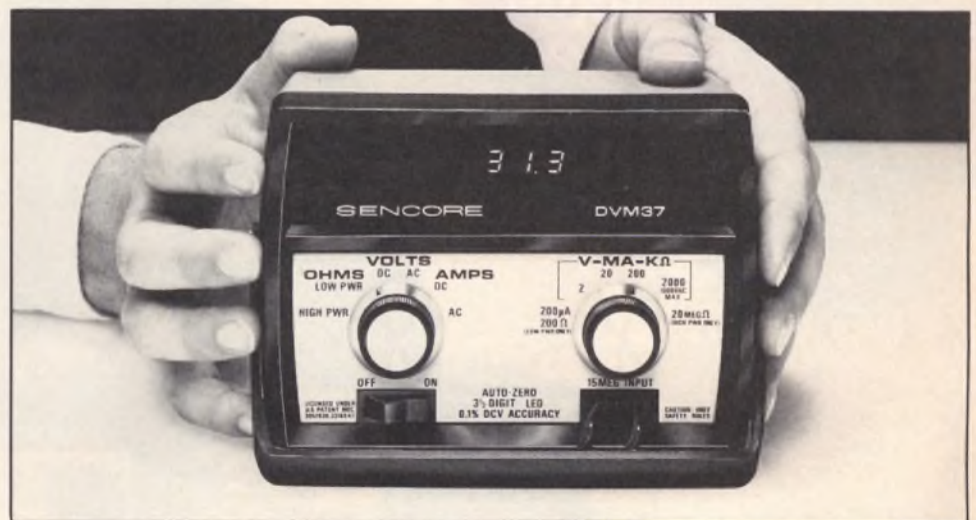

**The DVM37 3½ digit . . . .1% bench portable DVM**  
Double Patented \$395

**It's one tough meter.** An indestructible DVM that can handle tough use on both the bench and in the field.

**It's a prime standard.** .1% lab standard accuracy in a portable meter for field measurements you can count on every time.

**It's virtually burn-out proof.** Protection to 2 KV DC with 8 KV transient protection means you can confidently measure in more circuits without hesitation.

Write for more information or CALL TODAY, **WATS Free, 1-800-843-3338**, to put the toughest bench portable, lab accurate meter on your bench Risk Free TODAY!

# Sencore's Success

**Success  
Shop Deal**



Buy the:  
 SC61 Waveform Analyzer™ ..... \$2,995  
 VA62 Universal Video Analyzer™ ..... 3,295  
 VC63 VCR Test Accessory ..... 495  
 NT64 NTSC Pattern Generator ..... 395  
 EX231 Expander Jack ..... 148  
 For a Total Investment of ..... 7,328

**You  
SAVE Up To  
\$2,290**

You Get Free, Your Choice Of 2 Of These:  
 ST66 Stereo TV Analyzer ..... \$1,295  
 CR70 "BEAM BUILDER"™ ..... 995  
 LC75 "Z METER 2"™ ..... 995  
 DVM56A "MICRORANGER"® ..... 995

**Business  
Building Package**



Buy the:  
 SC61 Waveform Analyzer™ ..... \$2,995  
 VA62 Universal Video Analyzer™ ..... 3,295  
 For a Total Investment of ..... 6,290

**You  
SAVE \$1,785**

You Get Free All 3 Of These:  
 VC63 VCR Test Accessory ..... \$495  
 NT64 NTSC Pattern Generator ..... 395  
 ST65 Video Analyzer Stereo TV Adder ..... 895

# Shop Specials

Due to the current Yen/Dollar valuation and the resulting increased semiconductor prices, these specials absolutely end April 30th, 1987.



You SAVE UP TO \$895

Buy the:  
VA62 Universal Video Analyzer™ ..... \$3,295

You Get Free:  
ST65 Video Analyzer Stereo TV Adder..... \$895

Or

Choose 2 Of These:  
VC63 VCR Test Accessory..... \$495  
NT64 NTSC Pattern Generator..... 395  
PR57 "POWERITE"®..... 395  
DVM37 3½ Digit Portable DVM..... 395

Buy the:  
SC61 Waveform Analyzer™..... \$2,995

You Get For Only \$199:  
LC75 "Z METER 2"™..... \$995

Buy the:  
LC76 "PORTA-Z"™..... \$1,295

You Get Free:  
BY234 12V 2 A/H Battery Pack..... \$59.95  
CC254 Padded Nylon Carrying Case..... 99.00

You Save \$796

You Save \$158

Buy the:  
LC77 "AUTO-Z"™..... \$1,695

You Get Free:  
SCR250 SCR & Triac Test Assy..... \$148.00  
BY234 12 V 2 A/H Battery Pack..... 59.95  
CC254 Padded Nylon Carrying Case..... 99.00

Buy the:  
ST66 Stereo TV Analyzer..... \$1,295

You Get Free:  
BY234 12 V 2 A/H Battery Pack..... \$59.95  
PC253 Protective Cover and Lead Storage..... 49.50

Buy the:  
ST65 Video Analyzer Stereo TV Adder..... \$895

You Get Free:  
CC237 "Kangaroo" Lead Pouch..... \$24.95  
(2) TP225 "Sure-Hold" Adapter Probe..... 29.90

You SAVE \$306

You SAVE \$109

You SAVE \$54

## Announcing Sencore's Interest Free "Pay As You Grow" Investment Plan

This special investment plan puts you in your own Sencore Dream Shop for only pennies a day. Our special graduated low APR financing rates that run from 0% for 12 months to 9.9% for 48 months will save you hundreds of dollars versus conventional loans. Plus, there is no prepayment penalty for paying off early or adding on to your account as your business grows. Follow the steps below to see just how little your monthly investment will be for your own Sencore Success Shop.

- Step 1. Add up your instrument(s) total investment (or special package cost).
- Step 2. Deduct 10% for your standard down payment—this is your amount financed.
- Step 3. Find the closest to this amount (rounding up or down) on the bottom of the chart.
- Step 4. Follow the column up with your finger until you find the payment you feel is most desirable.
- Step 5. Now you're ready to call us at **1-800-843-3338** and ask for a Sales Engineer to work out your exact monthly investment schedule and get the wheels of success moving for you!

Length Of Installments  
(Simple Interest APR Loan)

48 Months 9.9% APR					\$82	\$96	\$110	\$124	\$137	\$151	\$165	\$178	\$192
36 Months 6.9% APR				\$82	\$98	\$115	\$131	\$148	\$164	\$180	\$197	\$213	\$229
24 Months 3.9% APR			\$91	\$113	\$136	\$159	\$181	\$204	\$227	\$249	\$272	\$294	\$317
12 Months 0% APR	\$83	\$125	\$167	\$208	\$250	\$292	\$333						

1000 1500 2000 2500 3000 3500 4000 4500 5000 5500 6000 6500 7000  
Amount Financed (Round Up Or Down To Nearest \$500)

# Sencore Means Success For You In This New Year Of Electronic Servicing

*Are you looking for success in Electronic Servicing? Then welcome to Sencore.*

**Over  
35  
Years**

For over 35 years, Sencore has been dedicated to just one goal—making you more successful in Electronic Servicing. We're proud to say that we plan on sticking to this simple, yet important, mission. You see, as we phase into our second generation of leadership, we realize that your success truly will mean a successful future for Sencore as well.

**Say  
Yes**

When you say "yes" to Sencore, you're saying "yes" to good old American ingenuity at its finest. With 93% of Sencore's product line holding at least one patent, you're assured of exclusive, time-saving, money-making features not available anywhere else. You see, Sencore instruments are designed by practical troubleshooting pros - for practical troubleshooting pros. That's why you can count on Sencore for test equipment that saves you that all-important analyzing time.



Sencore's engineers know from experience that as an Electronic Servicing Professional, your time really is money. Lost or wasted time is money right out of your pocket. Our designers know that every time you have to fiddle with a knob, connect and reconnect leads, or come up with an inconclusive or misleading test result, it costs you dearly. That's why as you review the Sencore product line, you'll notice that each Sencore instrument has a fresh, uncluttered, easy-to-use look. We put the complex electronics on the inside to help keep your operation simplified on the outside.

Each unit is 100% Made Right in America's heartland by skilled craftsmen who have your troubleshooting needs in mind. That's why Sencore products are literally world renowned for their toughness, quality, innovation, and outstanding value. Less than 2% are returned for warranty service.

## Dealing Direct With The Sencore Factory Adds To Your Success

**WATS Free  
1-800-843-3338**

Unlike others, Sencore's commitment to your success just begins at the delivery dock. Consider that one phone number **1-800-843-3338**, connects you, 24 hours a day, to a factory full of friendly folks dedicated to making you and your business more

successful. You get fast, friendly product delivery; most items are in stock and are shipped within 48 hours of receipt of your order. Our exclusive "Pay As You Grow" Investment Plan will put you in your Dream Shop for just dollars a day. So you literally pay as your Sencore instruments help you grow and prosper. That's why saying

**Pay As You Grow** "yes" to Sencore is saying "yes" to your future success.

**+ 72 Hour Service  
+ 48 Hours On Parts  
= Your Success**

Your service after the sale is second to none in any industry. Our standard 72 hour turn-around on service repairs and 48 hours on parts means maximum up-time and productivity from each instrument. Plus, since our Engineering, Service, and Quality Assurance organizations are under one roof, your serviced instrument is renovated to better-than-new performance with the latest engineering updates; is

refurbished to like-new appearance; and undergoes final aging and quality checks just like our new units - all at no extra cost. Best of all, you can be sure your serviced instrument is right on specifications, as each unit is calibrated against Sencore's NBS traceable Prime Standards Laboratory.

Sencore's industry exclusive Sencore News, Application Bulletins, Field Workshops, and helpful Application Engineers guarantee that you'll be getting the most from your investment. Our newly added, state-of-the-art, video production studio will even add a new dimension to your after the sale application support, with both operation and training tapes. Our obligation and support is just beginning instead of ending, when you buy test equipment from Sencore.



## Your Success Is Guaranteed

You can't make a wrong buying decision when you say "yes" to investing in Sencore. You're not investing in just an instrument; you're investing in your own piece of an entire organization dedicated to making you more successful.



The same WATS Free success number, **1-800-843-3338**, that connects you to a fast, friendly Order Processing Rep, also connects you to our Application Engineers for technical consultation, Service Technicians for quick field repair tips, and our Telemarketing Engineers for after the sale follow through—all at no added expense to you. You simply need to pick up the phone and ask.

**WATS  
Free**

Since every Sencore unit has quality built in and not troubleshot out, only Sencore can offer you a 100% Made Right Lifetime Guarantee. This exclusive Buyer Protection Plan assures you that your unit was engineered and manufactured right the first time - or we'll make it right - for the lifetime of the instrument, at no cost to you. It even guards your instrument for a lifetime against rusting out - so plan on profiting from your Sencore investment for a long time.



Finally, Sencore's no nonsense 30 Day Money Back Guarantee assures you that you've made the right choice. Every Sencore instrument and accessory is covered by the industry exclusive guarantee of satisfaction. Simply stated—if you're not 100% satisfied with your Sencore instrument, return it for a full refund—including freight both ways—and owe nothing. You're always sure that you've "bought right" when you say "yes" to a Sencore investment.

**30 Day  
Money Back  
Guarantee**

Start your success right now by buying right. See Sencore specials inside this cover.

*Herb Bowden*

Herb Bowden  
President/CEO



Mount Rushmore National Memorial, Black Hills of South Dakota

**Built In The Heartland Of The USA By Fellow Americans  
Showing The World We Are Still In Front**