

# RADIOTRONICS

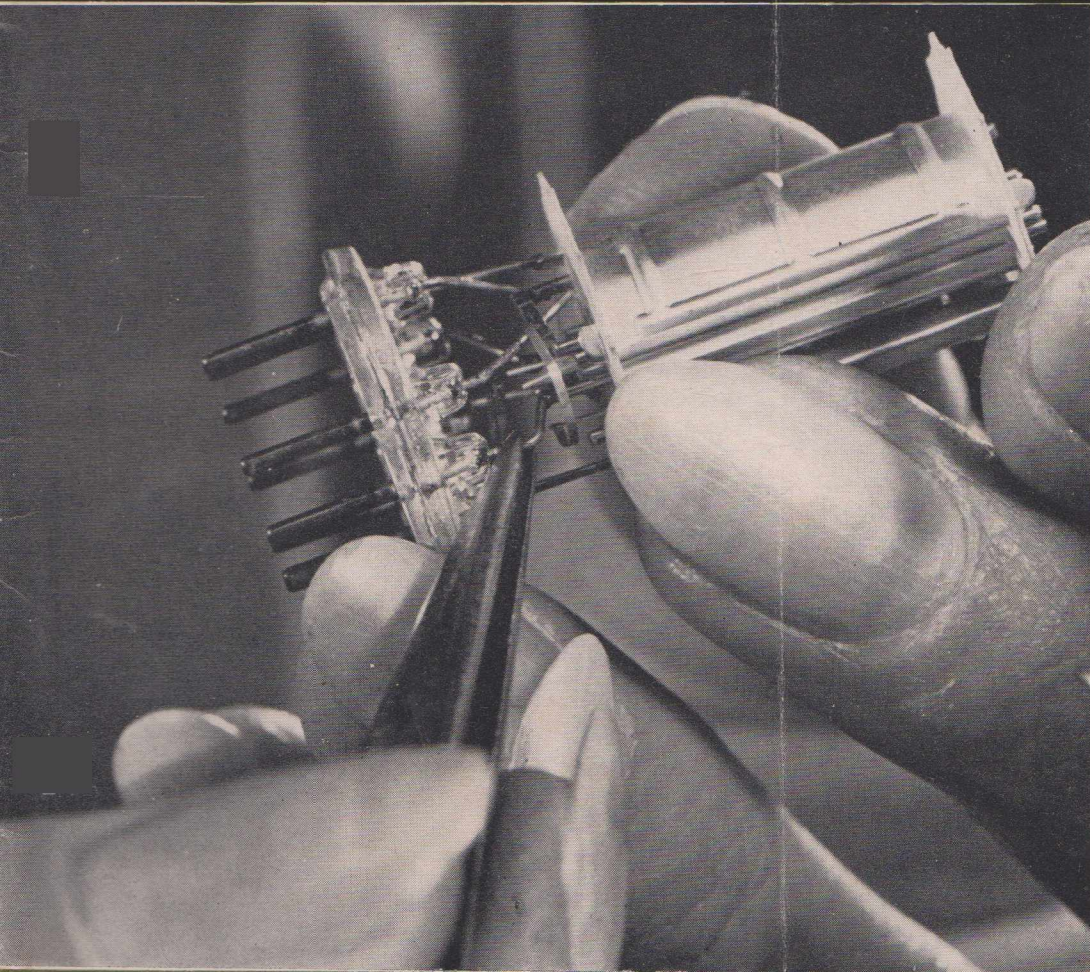

## IN THIS ISSUE

Valve Operation in TV  
Horizontal Output Stages 178

Biomedical Engineering ..... 186

Super Radiotron 19 F.N.P4  
Picture Tube ..... 193

### COVER:

*An example of the fine work  
involved in the manufacture of  
receiving valves.*

---

Vol. 30, No. 10      October, 1965

---

AN  PUBLICATION

REGISTERED IN AUSTRALIA FOR TRANSMISSION BY POST AS A PERIODICAL

# 10







capacitance across the yoke reaches the fully-charged condition. The equivalent capacitance across the yoke has several components, including of course the self-capacity of the yoke winding, and the self-capacity of the auto-transformer, electrode and stray capacitances transformed across the yoke winding by the auto-transformer.

Due to the transformer action a very high voltage is developed in the tertiary winding B-G in Fig. 1. The voltage spike at G is rectified to provide the EHT supply with the aid of the EHT diode, a filter capacitor being provided by the graphite coatings on the bulb of the picture tube.

Since the oscillatory action in the yoke is practically undamped during the flyback, the current in the yoke rises in the negative direction as the voltage across the yoke decreases towards zero. This is indicated by (3) in Figs. 2 and 3. Fig. 2 shows the yoke current and voltage waveforms and Fig. 3 shows the direction of current flow. Fig. 2 also shows at (4) the initial sharp fall in yoke current and rise in voltage across it, which commence with the cutting off of the output valve. See also Fig. 4. As the voltage across the yoke decreases towards zero, the charge on the equivalent transformed capacitance across the yoke, otherwise known as the yoke tuning capacitance, also decays.

Towards the end of the first half cycle of oscillation, the voltage at the auto-

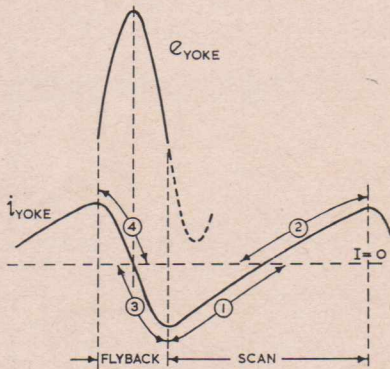

FIG. 2.—Yoke voltage and current waveforms.

transformer tap connected to the damper valve approaches the B+ level. As soon as the cathode of the damper valve becomes negative with respect to the plate, the damper valve is brought into conduction and further oscillatory action is damped out. The voltage at the damper tap of the transformer is then clamped to the B+ line, ignoring the small voltage drop in the valve itself.

This means that a low-resistance path to the B+ line is provided once the diode is conducting, and both plate and cathode are held at approximately the same potential. The voltage across the yoke is therefore clamped also. This results in a substantially linear decrease in yoke current, as indicated by (1) in Fig. 2. This is assuming a pure inductance; in fact a capacitor is used in series with the yoke winding, as shown in Fig. 1 for "S" correction purposes. The current through the damper valve charges the B Boost capacitor as shown in Fig. 5. The energy transferred to this capacitor is equal for practical purposes to the energy stored in the inductance when the yoke current is at its maximum negative value. During this process, the first half of the scan is traced out, the yoke current decaying towards zero from the negative direction.

Approximately half way through the line scan, the grid drive of the horizontal output valve rises above the cut off point and the output valve is brought into conduction again. The plate of the output valve is supplied from the B Boost capacitor in series with the B+ line. The plate current in the output valve and the current in the yoke increase linearly as indicated by (2) in

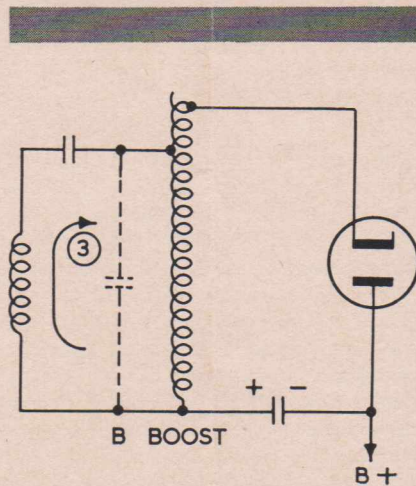

FIG. 3.

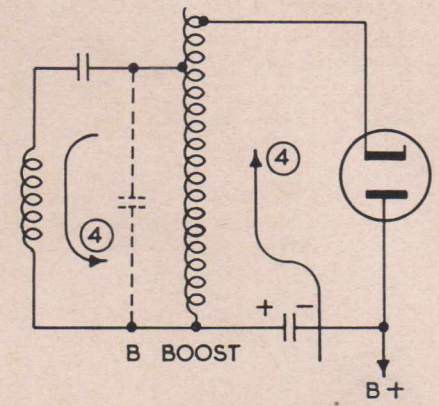

FIG. 4.

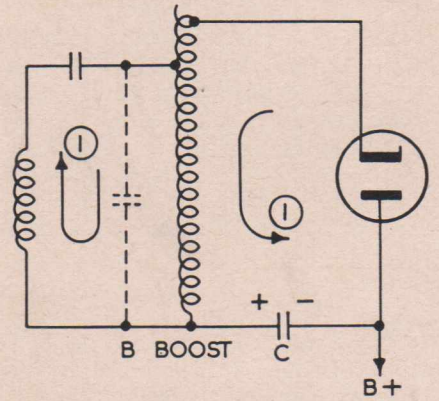

FIG. 5.

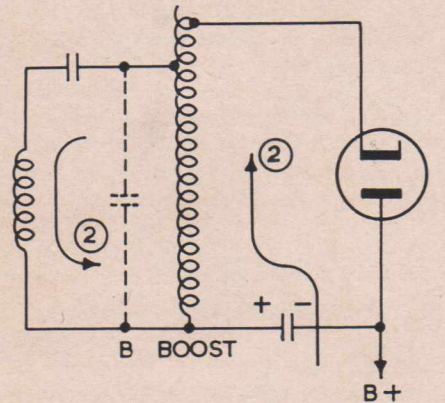

FIG. 6.

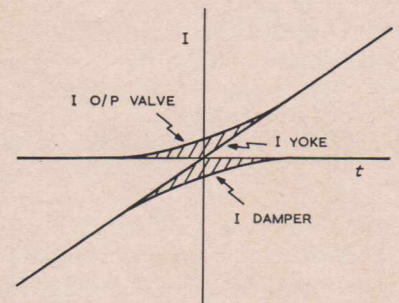

FIG. 7.—Output valve and damper currents transformed to yoke.



Fig. 2 and in Fig. 6 until the valve is cut off and the cycle repeats. Remember that a constant voltage applied across a pure inductance produces a linear sawtooth current change.

There is in fact an overlap near the centre of the scan when the damper diode is still conducting and the output valve has already been brought back

into conduction. This is shown in Fig. 7. This overlap helps to linearise the scan. To optimise linearity, a variable inductor is often placed in series with the damper. This controls the damper current and therefore yoke current during the first half of the scan. Other linearising methods include a foil cylinder around the neck of the picture tube inside the deflection yoke, whereby in-

duced currents in the foil cylinder also operate to linearise the first half of the scan.

The question of linearity in the second half of the scan is less troublesome. Since the horizontal output valve has a substantially linear characteristic and the drive waveform is a sawtooth, the major portion of the second half of the scan is sensibly linear.

## THE STABILISED STAGE

The circuitry of a stabilised horizontal output stage is similar to that of a non-stabilised stage except for the feedback network provided in the former. The feedback network is so designed that any decrease in output will make the dc level of the grid waveform less negative, thus driving the output valve harder and holding the scan width constant.

It will be obvious that any measure which controls the scan width in this way will also tend to regulate the amplitude of the high voltage spike which is to be rectified to provide the EHT supply for the picture tube. Whilst the circuit described here will tend to provide a constant-amplitude high voltage spike, it will not compensate for variations in load on the EHT supply such as those caused by brightness variations in the reproduced picture.

## OPERATION

The main point to consider here is the operation of the voltage-dependent resistor VDR which is introduced to stabilise the circuit. Fig. 8 shows a typical addition of a VDR to a horizontal output circuit. The VDR has a symmetrical non-linear characteristic. An element of this kind may be used as a rectifier for asymmetrical waveforms where the average voltage does not occur half-way between the positive and negative peaks, resulting in a current through the VDR which has a direct component.

Fig. 9 shows a VDR in association with a resistor and capacitor to form a simple integrating circuit. Also shown is the characteristic of the VDR, on which are superimposed a pulsed input signal having a direct component  $V_0$

developed by the rectifying action of the VDR and the current in the VDR, showing the direct component already mentioned. Assuming a substantially constant pulse width in the input signal to

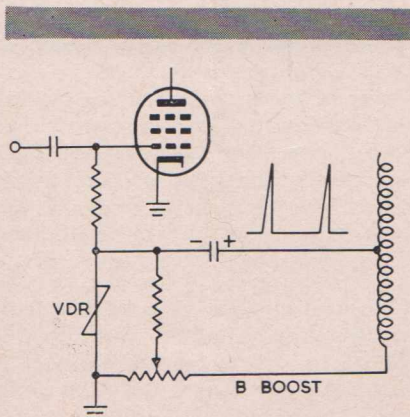

FIG. 8.—Circuit showing stabilising network.

the VDR, an output voltage  $V_0$  will be obtained which is dependent on the amplitude of the input signal and on the position of the average voltage of the input signal relative to the cross over point of the VDR characteristic.

Fig. 10, which consists of some of the essential elements of Fig. 8, is now used to explain the operation of the VDR. During flyback, the high voltage pulse generated in the yoke and therefore across the output transformer causes a high peak current through the VDR and the series-connected capacitor, charging the capacitor C as shown. Between pulses, capacitor C discharges through  $R_2$  as shown by  $i_2$ . Opposing current is set up in  $R_2$  by  $i_1$  from the +E terminal, this terminal representing the B Boost supply. The average vol-

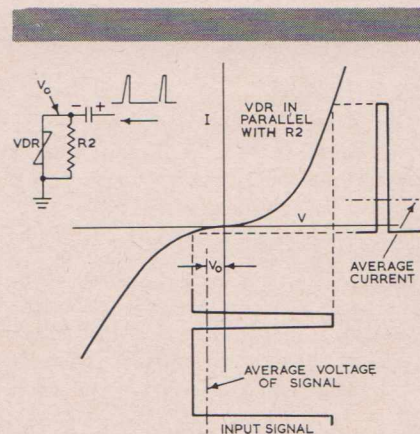

FIG. 9.—Voltage  $V_0$  is developed due to the rectifying action of the VDR.

aged by the difference between  $i_1$  and  $i_2$ , and is arranged to be always negative.

If the current  $i_1$  is varied by means of a potentiometer as shown in the practical circuit displayed in Fig. 8,  $V_0$  can be changed, thus adjusting the dc component of the grid drive. A small

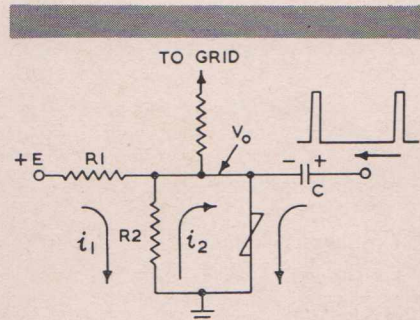

FIG. 10.—The VDR shows a low impedance to high voltage spikes.



shift in  $V_0$  will cause a large increase or decrease in current flow during the driving pulse due to the non-linear characteristic of the VDR, and will increase or decrease the charge on capacitor C, as the case may be, and will consequently vary the grid bias applied to the output valve.

An increase in the positive voltage supplied to the VDR from the B Boost (+E) line by an adjustment of the potentiometer makes the bias at the grid of the output valve more positive. This allows the valve to be driven harder and so increases the output. The higher output results in a higher peak current in the VDR and partly offsets the original adjustment of the preset control by developing a higher charge on the feedback capacitor C.

An increase in the output of the circuit due to a rise in mains voltage will increase the plate current of the output valve for a given bias. The increased output will produce a higher peak current in the feedback capacitor C with the resulting development of a higher charge on the capacitor. This makes the voltage fed back to the grid of the output valve more negative and reduces the drive, thus reducing the output. Similar reasoning may be applied for the case of a reduced d.c. supply to the VDR and for the case of a reduction in mains voltage.

Under regulated conditions, the output valve and the damper diode conduct for practically the whole cycle, and the waveform of the grid drive to the output valve is changed accordingly. This improves linearity, since the yoke voltage is clamped for a greater part of the cycle. However, greater stress is placed on the output valve since "above the knee" operation is necessary for this type of regulated circuit, and therefore plate dissipation is higher than for an unregulated circuit. When the B Boost diode is cut off, linearity is very dependent on the drive waveform.

### OUTPUT STAGE WAVEFORMS

Fig. 11 shows typical voltage and current waveforms which will be found in a stabilised horizontal output stage, and are presented here for a better understanding of the operation of the circuit. This diagram has been prepared with all the waveforms in the same phase relationship. The various voltages and currents are named as follows:

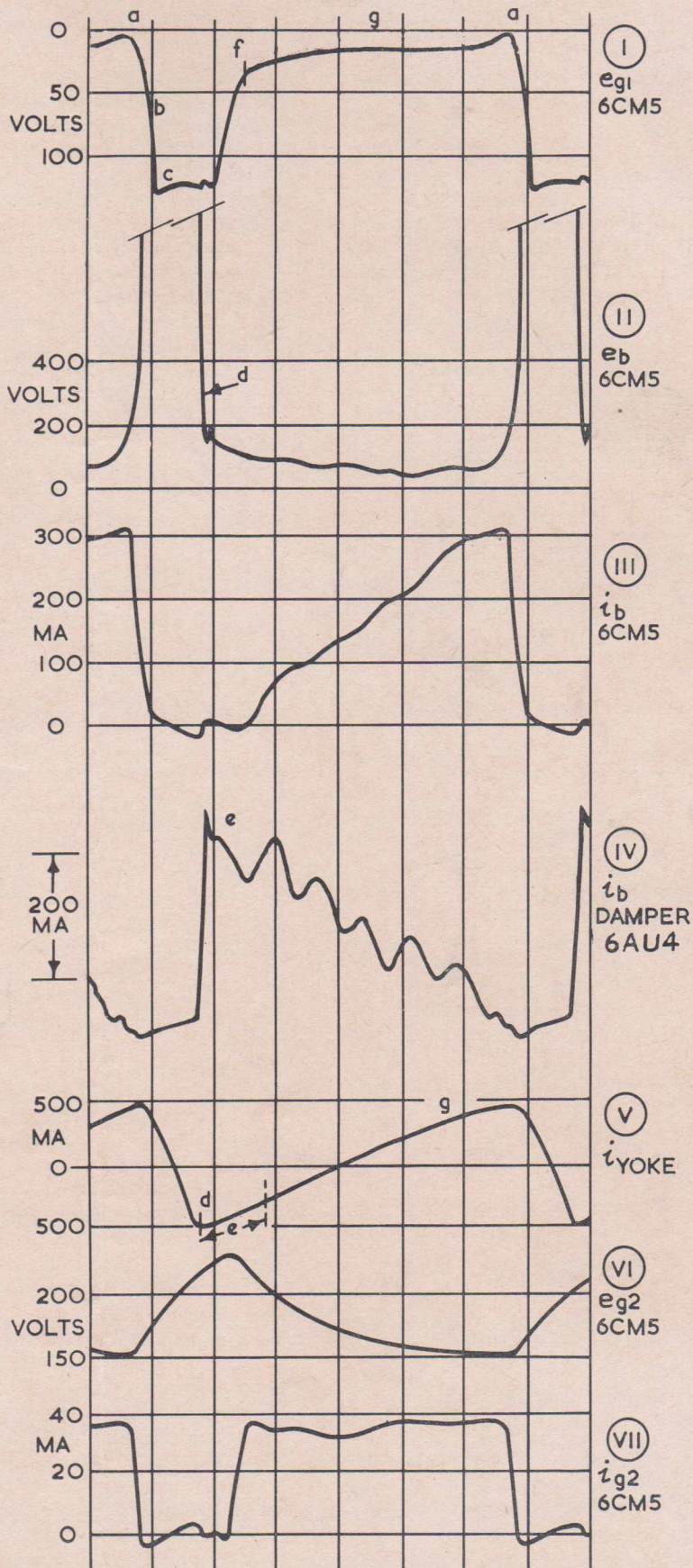

FIG. 11.—Voltage and current waveforms around the horizontal output stage of a typical stabilised receiver.



$e_{g1}$  is the grid voltage waveform of the output valve,  
 $e_b$  is the plate voltage waveform of the output valve,  
 $i_b$  is the plate current waveform of the output valve,  
 $i_{bd}$  is the plate current waveform of the damper valve.  
 $i_{g2}$  is the screen current waveform of the output valve,  
 $e_{g2}$  is the screen voltage waveform of the output valve,  
 $i_{yoke}$  is the yoke current.

It will be seen that the waveforms shown in Fig 11 are marked with lower case letters indicating certain significant stages in the development of the operating cycle, and it is around these points that the explanation will turn. At point (a), which indicates the point of maximum grid voltage at the output stage, it will be seen that  $i_b$  is at a maximum, the yoke current  $i_{yoke}$  is at a maximum, and the damper plate current  $i_{bd}$  is at a minimum. The screen current  $i_{g2}$  is at a maximum, as one would expect, so that the voltage  $e_{g2}$  is at a minimum.

The grid voltage of the output stage now moves sharply into the cut off region, as indicated by the area (b). In this region,  $i_b$  suddenly decreases towards zero, and consequently  $e_b$  suddenly increases and  $i_{g2}$  suddenly decreases. During the first part of the period (c) when the output valve is cut off,  $e_{g1}$  is very negative, well beyond the cut off point, and  $e_b$  reaches a very high value. The damper valve current is close to zero and the yoke current decreases through zero as the flyback commences. The output valve screen voltage  $e_{g2}$  commences to rise as the bypass capacitor charges.

At point (d) the voltage at the booster diode tap on the output transformer decreases through the B+ value, and the current through the damper valve suddenly increases. The flyback is complete at this stage and the scan commences at the left-hand side of the picture tube as shown by the substantially linear change in yoke current indicated in the diagram. For the rest of the scan period, the start of which occurs in region (e), the voltage across the yoke is held relatively constant. The damper current decreases during the scan and the yoke current initially decreases towards zero.

Quite early after the commencement of the scan, the grid voltage of the output valve rises above the cut off point (f), whereupon  $i_b$  starts to increase in a linear fashion,  $i_{g2}$  also increases, whilst  $e_b$  is held reasonably constant. The screen voltage of the output stage  $e_{g2}$  starts to decrease as the bypass capacitor is discharged. The damper current continues to decrease, whilst the yoke current is still decreasing towards zero in a linear way. During the following period (g) the rest of the scan is traced out, with  $i_b$  increasing linearly,  $i_{bd}$  decreasing, and the yoke current passing through zero linearly and then increasing in the opposite direction. The scan cycle is complete again at point (a).

The measurement and display of the

output valve plate voltage during the scan, and the grid voltage at the end of the scan, at least as far as the accurate measurement of values is concerned, has in the past presented major problems, due to the high impedances present in both circuits and due to the need to measure a few tens of volts in the presence of approximately 6 kilovolts in the case of the output valve plate circuit. The difficulties inherent in the making of these measurements have recently been largely removed by the design in the AWV Applications Laboratory of a probe and display unit for the purpose. Ref. Plate and Grid Voltage Display Unit for Deflection Valves, by G. N. Taylor, PROC. IREE (Aust.) Vol. 26, No. 7, July 1965, P239.

## TYPE 6CM5 IN STABILISED STAGES

It is now proposed to discuss the use of the 6CM5 valve in stabilised horizontal output stages, and this discussion, among other things, will serve to show in greater detail how the stabilised stage operates and how its objects are achieved. It will be clear that the preset adjustment associated with the use of the VDR will allow initial adjustment for output valves having a spread of characteristics.

When a valve is installed in the receiver, the variable feedback control, otherwise known as the VDR preset or B Boost preset control, is adjusted to give a predetermined B Boost voltage. This voltage is dependent on the peak plate current in the output valve, and therefore requires the same peak plate current irrespective of the characteristics of the particular valve installed in the output valve socket. For the purpose of these measurements valves have been selected to give a wide spread of results and for some measurements valves have been selected that are below production limits. If a valve with low plate current characteristics is used, this means that the negative bias on the output valve grid must be made less negative than for a valve with high plate current characteristics. (It is assumed that variations of screen current between individual valves do not complicate the issue by altering the screen voltage and causing a shift in the plate characteristics).

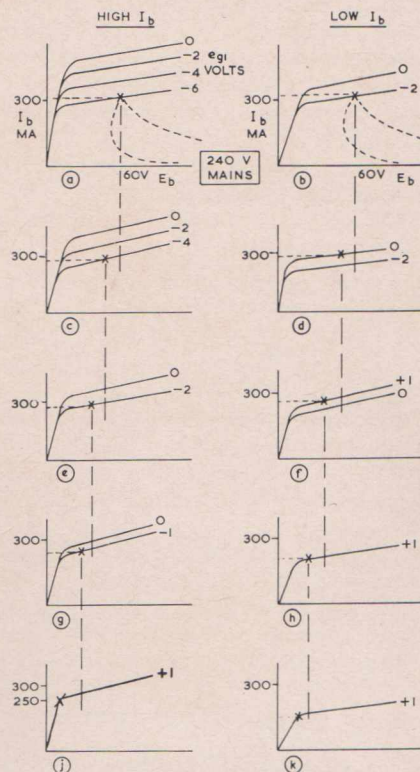

**FIG. 12.**—Regulation behaviour of two valves with the same  $i_{g2}$  curves, and with the mains voltage progressively reduced. "X" denotes the "end-of-scan" operating point on the load line. Regulation is lost when the grid is driven positive and hence grid leak bias is developed as shown at (f). In case of the other valve the loadline is driven into the knee just as grid leak bias is developed as shown at (j).



Fig. 12 shows the regulation behaviour of two valves, both of which have the same screen current characteristic, but having respectively a high plate current characteristic and a low plate current characteristic. Parts (a) and (b) of this figure show the initial setting-up condition with a mains voltage of 240 volts. Successive portions of the diagram show the effect of progressive reductions in the applied mains voltage.

As the mains voltage is reduced, the stabilising circuit tends to hold the peak plate current in the output valve constant by reducing the dc bias on this valve. As a result, the B Boost and EHT are stabilised to some degree. Actually the total B Boost voltage will fall due to the drop in  $B^+$ , and this will in turn cause a drop in the EHT. Since the deflection sensitivity is inversely proportional to the EHT value, less control of the grid voltage is in fact required than if the EHT voltage were held constant. It is therefore permissible for the plate current to decrease slightly with a decrease in the applied mains voltage.

Irrespective of the rating of the individual valve used in the output valve socket, the plate current characteristic will fall with a decreasing mains voltage due to decreases in heater dissipation and in the screen voltage. For this

reason the bias on the grid will move less negative. The lowering of the value of the B Boost supply, is in fact a change in supply voltage for the output valve, and this causes the load line to shift nearer the diode line of the valve.

Eventually grid current will be drawn in the output valve. As soon as this happens, or if the valve load line is driven into the diode line, regulation ceases. If grid current is drawn in the output valve before the diode line is reached, as shown in Fig. 12 (f), grid leak biasing will prevent further regulation, and peak plate current will fall as shown in Fig. 12 (h).

An alternative method of comparing the regulation behaviour of two valves is shown in Fig. 13. Here use is made of the plate current versus grid voltage curves of two selected valves for two values of mains voltage. Fig. 13 (a) shows a valve with normal plate current characteristics, and Fig. 13 (b) a valve with low plate current characteristics i.e. low knee plate current. In this diagram, "X" indicates the end of the scan operating point. It will be seen from the diagram that at normal mains voltage, the low knee valve is driven to only a very small bias at the end of the scan. As mains voltage

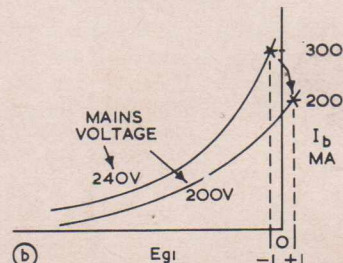
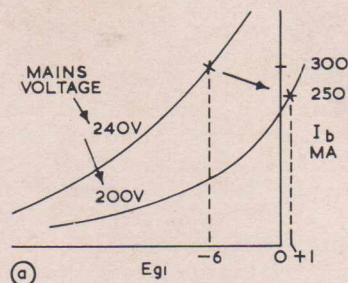

FIG. 13.—(a) Valve with normal plate current characteristics, and (b) valve with low plate current characteristics. "X" indicates the end of the scan operating point.

is reduced, this valve starts to draw grid current much earlier than the normal valve shown in part (a) of the diagram.

An actual plot of the load line showing how it shifts with mains voltage may be seen in Fig. 14. Here again the diagram shows both a valve with normal

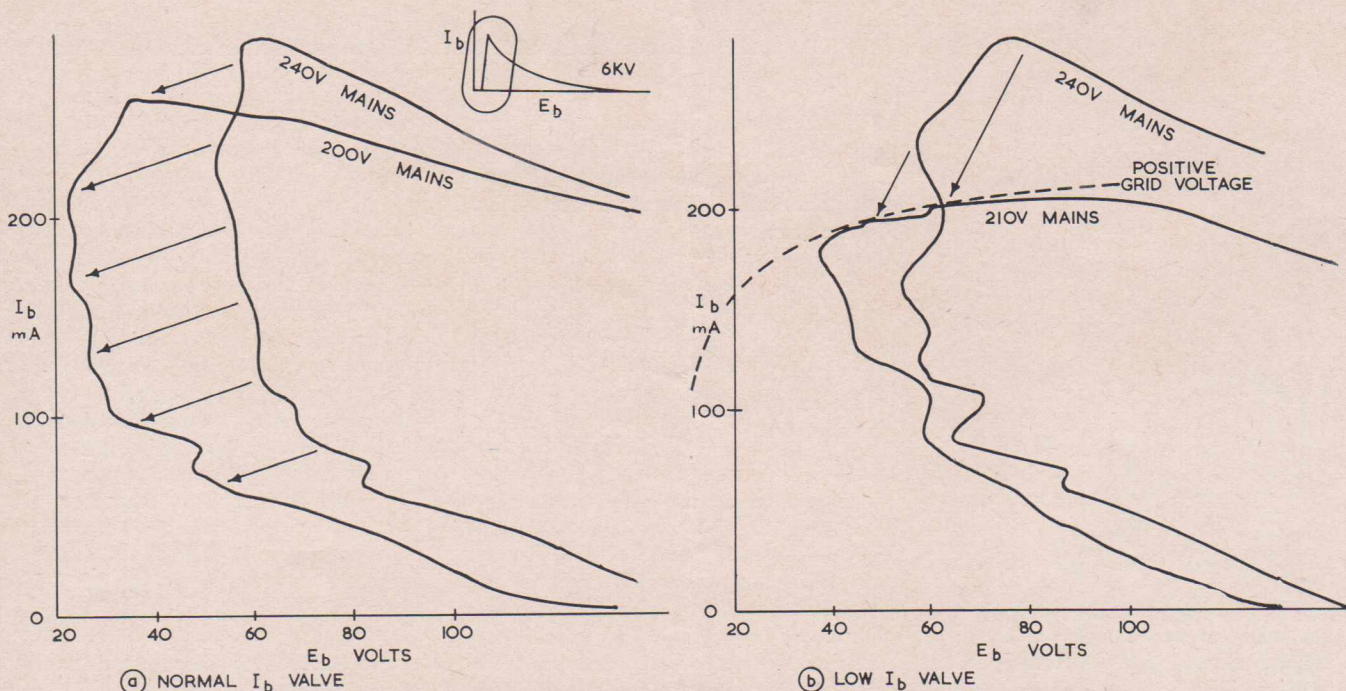

FIG. 14.—Load line shift with mains voltage: (a) normal  $i_b$  valve, (b) low  $i_b$  valve. Only the part of the load line during scan is shown.



plate current characteristic (a) and a valve with a low plate current characteristic (b).

If a valve exhibits high screen current at the end of the scan, the effective plate family characteristics will be lower at normal mains voltage, as shown in Fig. 15 (b), due to the reduced screen voltage, and the load line will drive into grid current at an earlier stage. Fig. 15 deals with plate voltage characteristics with (a) a zero-impedance screen voltage source and (b) a screen voltage source similar to that actually met in a receiver. High screen current has a similar effect on regulation to that of low plate current.

Regulation is lost when the load line is driven into the knee, regardless of plate current. Low plate current brings about loss of regulation before the load line drives into the knee, as seen in

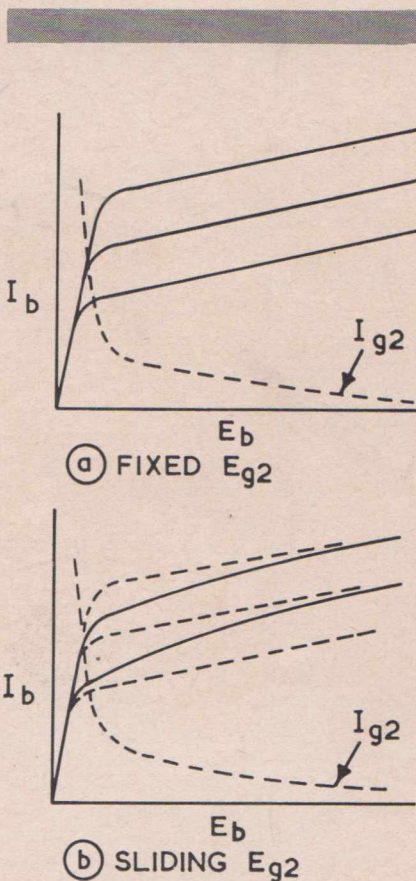

FIG. 15.—Plate voltage characteristics with (a) zero-impedance screen voltage source, and (b) screen impedance similar to that found in a typical receiver.

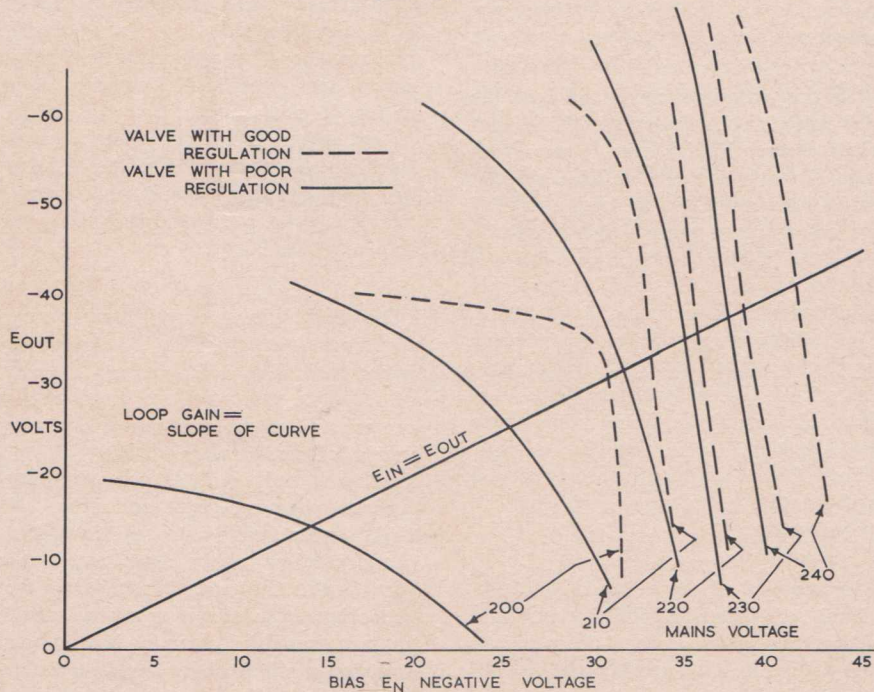
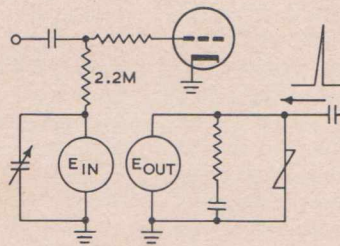

FIG. 16.—Loop gain curves for two selected valves.

Fig. 12. Actually as soon as grid current is drawn in a low plate current valve, the drop in B Boost will help to drive the load line into the knee at an earlier stage.

### CHARACTERISTICS OF NEGATIVE FEEDBACK LOOP

Taken generally, the regulation behaviour of the circuit is determined by the gain of the feedback path.

Let us commence here by defining loop gain. If in any system containing a feedback path, the loop is broken at any point and terminated with similar impedances to those which apply when the loop is closed, the loop gain is the ratio of the output at one side of the break to the input applied at the other side of the break. In the case of the

stabilised horizontal output circuit, the loop may conveniently be broken at the VDR.

The loop gain of the system will determine the regulation behaviour for incremental changes in mains voltage, i.e., whether the scan width increases, decreases or stays constant with small changes in mains voltage. Factors which affect the loop gain are (1) the  $g_m$  of the output valve, (2) the characteristics of the VDR unit, and (3) the plate current characteristics of the output valve. The plate current characteristics are important since they will determine the standing voltage at the VDR, and hence the operating point on the VDR characteristics.

The incremental loop gain has only a small influence on the mains voltage at which regulation is lost. This volt-



age is determined by the factors mentioned earlier, such as driving into the knee, and low plate current. However, it must be realised that the loss of regulation is due to a sudden reduction in loop gain.

Fig. 16 shows loop gain curves for two valves with different regulation performance plotted for various mains voltages. The method of plotting these curves will now be described. The junction of the VDR and the 2.2 megohm resistor

was opened, as shown in the diagram, and a negative dc voltage applied to the 2.2 megohm resistor from a low impedance source. A series network of 2.2 megohms and 0.0047 microfarads was placed in parallel with the VDR to simulate the grid load on the VDR, and the direct voltage measured at the top of the VDR. While the mains voltage was held constant, the input voltage was varied and plotted against the output voltage. The point where the two voltages are equal determines the operating point under normal operation. The

slope of the curve determines the loop gain at any point.

It can be seen from the curves that the loop gain for the valve with poor regulation starts to deteriorate at approximately 220 volts, whilst the valve with good regulation maintains its loop gain to less than 200 volts. It can also be seen that the average bias for the valve with poor regulation is reduced much faster than for the valve with good regulation as the mains voltage is reduced.

## CONCLUSION

The object of the work described in the report on which this article is based was to establish the factors affecting regulation behaviour in the stabilised horizontal output stages currently used in television receiver design. In particular, the influence of the output valve itself was investigated.

A typical stabilised circuit behaves as follows. As the mains voltage is slowly reduced, the width of the picture is held practically constant until a mains voltage is reached where the width collapses suddenly. Over the range of mains voltage where regulation is maintained, the width of the picture usually decreases slightly with mains voltage, but over a small range even a slight

*increase* in width may be observed as the mains voltage is reduced.

The behaviour in the stabilised range is due to small differences in loop gain around the VDR feedback path. These differences are due to (1) operating point on the VDR characteristics, (2) different VDR characteristics, and (3) differences in  $g_m$  between different output valves. All these factors are of only minor importance within the stabilised range as they change the picture width only slightly. The major item of interest is that which causes the sudden collapse of the picture as mains voltage is reduced. For a given circuit, this is caused by two important characteristics of the output valve.

### (a) Knee Plate Current

A good knee current allows a reasonable range over which the grid bias may shift in order to achieve regulation before grid current is drawn.

### (b) Screen Current

A low screen current reduces the effect of the finite screen circuit impedance on screen voltage. Consequently the plate current characteristics are not lowered appreciably if a low screen current valve is used. A valve with high knee plate current, however, can tolerate a higher value of screen current than, say, a bogie or average valve.





# Biomedical Engineering

**BIOMEDICAL** engineering is among the most recent additions to the technological professions. It is a "cross-disciplinary" branch of engineering, applying the skills and capabilities of modern electronics to the fields of biology, medicine and surgery. Its broad scope will tax the resources of the multi-disciplinary training of its practitioners. But it will offer corresponding rewards through the many benefits to the health of the inhabitants of this globe.

The worker in biomedical engineering should have a natural taste for the study of broader, more generalized, and more complex relationships than those found in most technologies. The training of the biomedical engineer will resemble that of the patent attorney who is both engineer and lawyer. At first, biology may seem strange to the engineering mind. Many biological phenomena are highly changeable, auto-dynamic, only approximately uniform, and only broadly controllable. They may also be inherently complex in their interrelationships; basic theories of biology only partially parallel those of the physical sciences.

On the practical side, the biomedical engineer needs close contacts with the user of biomedical equipment as well as knowledge of medical and surgical problems; the biomedical engineer must be thoroughly at home in the fields of medical practice and biological procedures.

One nonexclusive way of studying man is through biology, medicine, and engineering. To oversimplify, man (or any man-like extraterrestrial life form) is an organism sensitive toward his surroundings and reacting to them; enjoying spontaneous movement and the feedbacks necessary for such effective reaction to environment; possessing a selective information storage and retrieval system; and capable of communicating comprehensive information or requests for information to its fellow men or like life forms. Man therefore poses a vast field for biological engineering study.

It is natural that biological engineering in its present early stage resembles more a group of oases than a large

Dr. Alfred N. Goldsmith  
Hon. Vice-President and  
Senior Technical Consultant  
Radio Corporation of America  
New York City, N.Y.

intensively cultivated area. Its divisions are only beginning to be clearly defined and some of its areas are not only expanding but overlapping. In such a fluid field, the opportunities for accomplishment are many and diverse.

Since this paper is inherently a brief summary of the subject, credits for individual devices or methods are not listed. Only broad principles are presented, generally without details, to show the scope, diversity, and capability of available apparatus. Some of the methods and equipment herein cited are in the research stage; others are in development; and some are fully operational.

## Instrumentation

Measuring instruments form the solid basis of most scientific developments. The phenomena of biology are often encouragingly amenable to study, measurement, and orderly classification by methods recently developed in the electrical and electronics field. Available, for example, are control sensors, networks, feedback, circuit simulation of biological processes, telemetry, information sensors, and miniaturization. The impedance changes of parts of the body yield significant information. Thus a high-frequency current may be passed through the thorax and the respiratory rate and depth of inhala-

tion related to recording of the current variation.

The heart beat, or cardiac cycle, generates systematic blood-pressure changes, and related voltages that may be recorded by connection to electrodes in conductive contact with selected sections of the body (chest and legs). Such records are known as electrocardiograms (EKG). Detectable magnetic fields also accompany the cardiac cycle, making possible more remote study of the cardiac cycle. Heart beats can also be detected and measured by placing the subject on a freely movable platform and measuring the exerted muscular forces, thus enabling study of the training of athletes and the cause of such handicaps as limps.

Blood flow may be measured electromagnetically; it can also be determined by an ultrasonic meter operated by comparisons of ultrasonic pulses transmitted up- and downstream. Electronic counters of the number and size of particles in the blood stream (sanguinometers) give corresponding information on the blood corpuscles. The location of internal intestinal bleeding can be found by Geiger counters placed at intervals along a "swallow tube" ingested into the intestinal tract after "labelling" the red blood cells with a harmless, short-life radioisotope.

Blood velocity can be measured by applying an alternating voltage to two coils on opposite sides of a probe in one of the heart blood vessels (the aorta).

Voltages derived from other body activities can be recorded. These include encephalograms (EEG, or brain-wave records), and electromyograms (EMG, or muscle-activity waves). Electro-



myelograms, directly viewed on a kinescope, assist in the study of muscular and nervous disorders. Encephalograms assist in diagnosing brain lesions and areas involved in epilepsy, and are said to be useful in psychiatry. Records of potentials in the brain cortex (outer shell of the brain) are available through direct probes and are termed electrocorticograms.

Pressures in body cavities or on the body surface are measurable through tonometry. A piezoelectric transducer (e.g., a quartz crystal) is pressed against the sensitive area, and suitable electronic measurements enable derivation of the internal pressure. Strain gauges attached to the finger tip are known as plethysmographs.

Respiration rates and the carbon-dioxide cycle in breathing can be measured and electronically studied using analog computers. Stomachic activity (including peristaltic or digestive motion) can be registered even on the body surface using specialized amplifiers. Thus electrogastrigraphy permits systematic investigations of digestion.

Various types of eye movement can be recorded by electrooculography (EOG). The functioning of the normal and impaired eye motor system is thus recorded for diagnosis; often without any ocular restraint. Minute photoelectric or magnetic contacts to the eye are used.

Internal body structures (including intrusions such as calculi, or stones) are visualized by ultrasonic means. A source of ultrasonic energy is focussed through "sound optics" on the region to be examined. The reflected ultrasonic waves give an echo pattern permitting, for example, study of heart-valve movements, blood clots (thromboses), tumors in the heart, and heart-valve constrictions.

Among the most powerful and useful electronic devices for biomedical applications are the electron microscope and the image amplifier. The electron microscope vastly expands the available magnification range (up to 200,000 times magnification or more with a resolution of 10 angstroms or better). It has been invaluable in the study of bacteria, cell structures, and viruses. The chromosomes (bodies in the cell nucleus carrying hereditary information) are made up of the basic flat or threadlike assemblies (genes) which

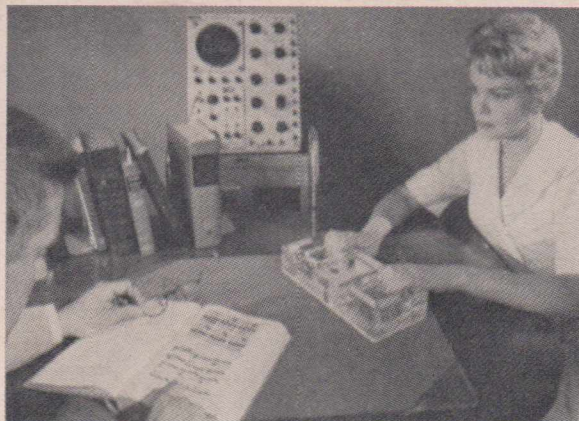

FIG. 1 — Laboratory model of an electrocardiogram transmitter. Patient dips finger into a conducting solution, and cardiogram is displayed on oscilloscope.

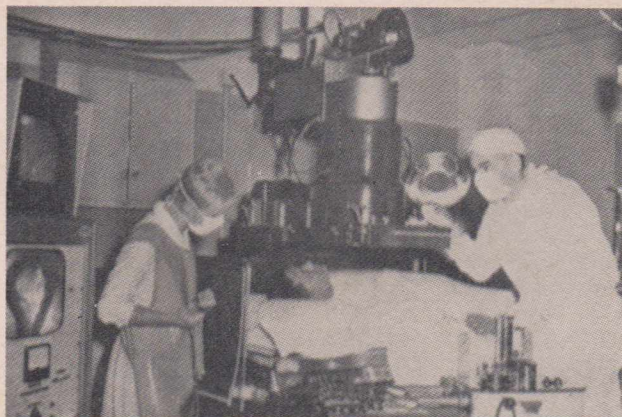

FIG. 2 — RCA closed-circuit TV at Johns Hopkins Hospital displays moving X-ray images. Examining room camera is linked to RCA TV tape recorder in adjacent room, permitting later playback and study.

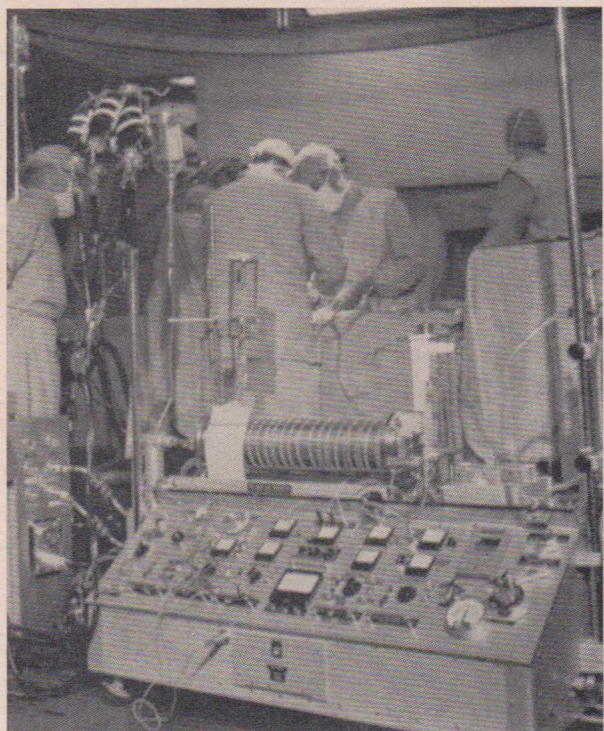

FIG. 3 — Complex open-heart surgery can now be performed that was too risky a few years ago. A patient's heart and lungs can now be by-passed for 6 hours without irreversible damage to the brain or other organs through the use of pump-oxygenator heart-lung machine at right.



contain orderly assemblies of the so-called nucleic acids and other chemical components. It is hoped that the electron-optical qualities of the electron microscope can be improved to the point where these sequences of nucleic acids can be seen, classified, and their significance visually decoded.

A convenient adjunct in biological temperature measurement is the thermistor whose stability, sensitivity, and thermal conductivity are obviously advantageous.

Thermoelectric modules can be used for cooling in such procedures as surgical or dental probings and microscopic examination of tissue.

Considerable experimentation and mathematical development have gone into producing electrical networks which simulate the neuron (nerve) system. Efforts, in considerable measure successful, have gone into developing a readily adjustable, low-power, compact, and inexpensive positive or negative pulse generator simulating the action and inhibition nerve impulses.

The techniques and apparatus of modern engineering, suitably modified, seem appropriate and largely adaptable to the needs of the biological arts. Further miniaturization, greater versatility, increased reliability, simplicity of operation, improved means of telemetering or carrying indications from inside the body, and reduced cost would be helpful.

### Laser Application

The utility of the laser for biological purposes stems from its peculiar capabilities and limitations. Though operating at very low energy efficiency, it can produce coherent light of an output peak power up to the range of 1 to 1,000 megawatts in very brief pulses; power densities from  $10^{12}$  to  $10^{15}$  watts per square centimeter; and correspondingly high optical field strengths. It can be used in place of the usual spark or arc excitation for vaporizing materials in solid samples over 50 microns in diameter, thus enabling spectrometric analysis.

So powerful a source may produce biological, therapeutic, or even genetic effects. It can be used to treat detached retinas (within the eye), or to extirpate intraocular tumors. The retinal expo-

sure time to the prefocused laser beam is about 500 microseconds. If tissue portions are stained with a dark dye, the laser beam energy will be selectively absorbed and the chosen tissue portion will be destroyed. The laser may ultimately be used in sub-microscopic surgery or even, conceivably, for cellular dissection.

Monofrequency laser beams passing through certain organic liquids emerge as multifrequency light thus pointing the way to chemical analytic methods of use in biology.

### Communication

Communication from within the body to local or distant points is another challenge. Data on physiological, chemical, or physical conditions in the tissues or cavities of the body can sometimes be secured from implanted or applied sensors, or by ingested combinations of sensors and signal-transmitting units (either inductive or radio "sondes").

Sometimes measurable by sondes are pressure, chloride-ion concentration, bioelectric potentials, partial pressures of gases (such as oxygen or carbon dioxide), ionizing-radiation intensity, motility, bleeding, respiration rate and fetal (embryonic) heart beat records.

In the "radio pill" placed in the intestinal tract, frequency- or pulse-modulation of a carrier in the 100 kc to 10 Mc range is used. Internal mercury battery sources may be employed, and signal transmission can be initiated or halted from outside the body.

Signals from within the body can be processed by known electronic methods for extraction of the signal from superimposed noise, signal recording, analysis of waveforms, record retrieval, and transmission to remote points over wire lines. The general practitioner may even run such tests from portable equipment in the patient's home under normal conditions, and send the signals by telephone line to a central collating, analyzing, and diagnosing station.

Some less usual applications of the sonde include telemetry of the condition of astronauts (e.g., blood pressure, body temperatures, respiration rate, and cardiographic data). An industrial application of telemetry is the determina-

tion or recording of physiological or psychological changes occurring in the worker on a specific job. Sophisticated methods of electrocardiography also enable early study of the developing heart beat in the fetus sometimes enabling avoidance or alleviation of later difficulties.

As microminiaturization and improved signal-identification methods are developed in the electronics field, they will find ready and useful application to the biological sonde equipment and techniques.

### Information Dissemination

The individual biologist, physician, specialist, or clinician will in growing measure require a modernized and comprehensive information-retrieval system to meet his current needs speedily and effectively. The corresponding concept of a "World Biomedical Information Center", while appealing, is perhaps too ambitious for complete and immediate realization; but local centers for the dissemination of requested information are frequently and hopefully proposed.

The individual physician, hospital, clinic, or biological investigator could call such an information center (by telephone or data circuit) requesting specific information and, through computerized techniques, receive a speedy answer.

While such information centers could not replace the lengthy experience and trained judgment of the scientist, they would be useful and dependable adjuncts or aids.

Diagnostic information thus provided would be based not only on comprehensive statistical data but also on modern diagnostic methods (e.g., the use of electrical analogues of the human cardiovascular system). Prognoses would become more dependable if based in part on an analog study of the various relevant parameters and their effects.

### Hospitalized and Ambulatory Patient Supervision

In the 7,000 American hospitals, 1,400,000 patients receive care every



day, and about 24,000,000 are hospitalized each year. The annual operating cost is \$8 billion, about two-thirds of which goes for labor. Although labor costs are not inherently high, they are increasing about \$500 million per year. Obviously, devices for reducing routine labor are urgently required.

Hospitals need elaborate data on patients, including identification, present illness, general history, results of examination and tests, data resulting from consultations, x-ray studies, tissue data, provisional diagnosis (including indicated medication or surgical intervention), progress of the patient under treatment, later or more definite diagnosis, and biopsy or autopsy results. Certain necessary data such as electrocardiograms may be electrically and continuously or intermittently sent and recorded at central monitoring stations which, in turn, may be provided with automatic alarm systems responsive to unfavorable developments.

Analogous recording systems have been devised for psychiatric cases, based to some extent on the patient's answers to a lengthy and largely standardized series of questions. It is attempted to elicit, record, and analyze (largely using electronic means) a complete history of the patient, his life and environment, and relevant data on his family.

### Prosthetics

Prosthetics primarily includes the temporary substitution of organs of the human body in emergencies or during operations, as well as longer-term replacement of essential organs. Biomedical engineering is called on to provide machines (generally electromechanical) to take over the organ's functions temporarily or permanently.

When heart action stops, the "cardiac pacemaker" applies timed electric impulses to stimulate heart action until it is restored to normal. More radical measures are required for some heart operations where a "dry heart" or "open heart" condition is needed by the surgeon for fairly prolonged activities. Unless the heart were bypassed during this period by means of an external artificial heart, the patient would die. It is hoped that a permanently implantable electromechanical

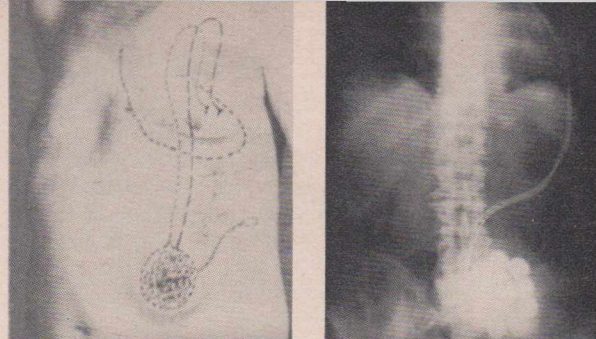

FIG. 4 — Left: Patient with diagram superimposed to show subcutaneously implanted pacemaker, an instrument that can stimulate failing heart action with electric impulses until normal action resumes. Right: X-ray of implanted pacemaker.



FIG. 5 — Surgeon in heart catheterization room is guided by TV image (fluoroscopic) of catheter as he threads the catheter through leg vein into left chamber of heart. The transeptal left heart catheterization aids diagnoses of heart defects.

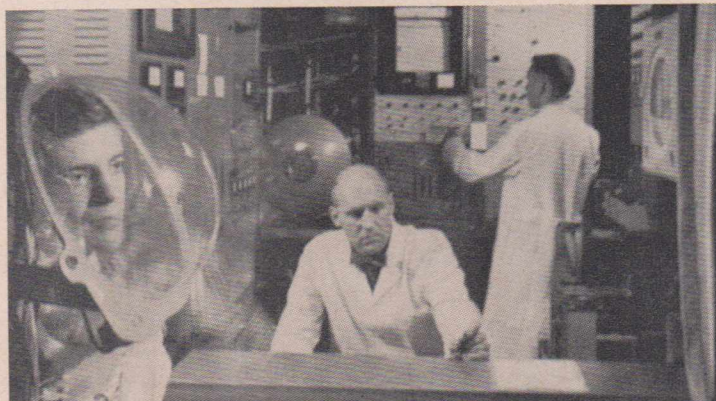

FIG. 6 — Metabolic chamber of National Institute of Arthritis and Metabolic Diseases helps studies of life processes. Expired air collected under mask is collected by continuous-stream gas analyzers.

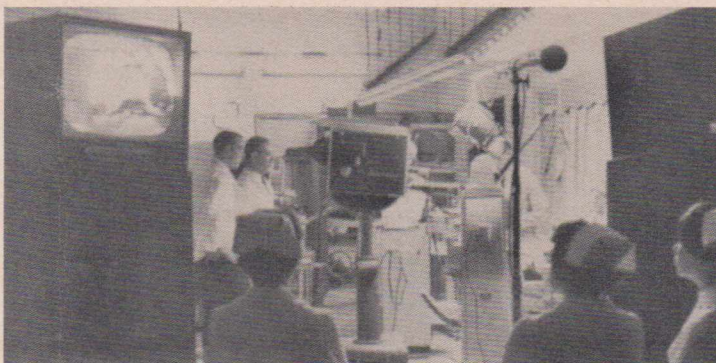

FIG. 7 — At University of Pennsylvania's School of Dentistry, an RCA closed-circuit TV system carries the pictures and the instructor's commentary to students at 16 monitoring locations.



heart will ultimately become available, or that replacement of heart valves or arteries by cardiovascular prostheses will become practicable.

Cryobiology (the use of extreme cold to deep-freeze tissues and, hopefully, to kill bacteria, viruses, or damaged cells) is under early study and shows some promise.

Under intensive development, and with considerable success, are artificial lungs and kidneys. A long series of important accomplishments in these and similar fields may be anticipated.

War-inflicted injuries and their repair greatly stimulated the development of prosthesis of limbs and hands. Something of the attained refinement of operation can be gained from a listing of the capabilities of an artificial arm which is electronically controlled, uses external power, is pre-programmed including storage of a number of programmed motions as well as patient selection between them or their modifications, and which has five degrees of freedom. Automatic hands provide a wide variety of chosen movements, either automatic action or voluntary control, and reasonable simplicity of construction and acceptable cost. Clenching of the hand and adjustable grasping with the fingertips are available. Some highly sophisticated pressure-sensitive controls, and also feedback at appropriate parts of movements for avoiding excessive pressures, are provided.

Various electronic aids for the blind are in an early stage of practical development. In one guidance equipment, an ultrasonic airwave generator produces a highly directional narrow beam, which is reflected by the target or obstacle and picked up by a receiver and earphone. Such devices are somewhat rudimentary and not as yet adequately satisfying to the user. Means have been developed for permitting the blind to operate a telephone switchboard, for example. Talking typewriters are also planned to enable typing by the blind.

Aids for the deaf and dumb also show promise. An "artificial ear" under development calls for the design and construction of assemblies of suitable electronic components reasonably closely simulating the normal ear and its associated processing structures and nerves.

The artificial larynx enables persons whose physical speaking capability has been lost to develop speech sounds of intelligible nature. It involves the resonant modulation, controlled by the user, of a buzzing sound generated by the device.

Stammer sufferers have been helped by the controlled production of a low-frequency masking tone which, when desired, prevents the patient from hearing his own voice.

### Computer Applications

In modern physical research, interest is largely centered on the submicroscopic elements of matter—that is, the atomic nucleus, and the so-called "elementary particles," their arrangements and interactions, and their internal and external effects. In biomedical research, there is growing emphasis and great potential utility to be derived in the study of the submicroscopic elements of living matter—that is, the cell nucleus, the chromosomes and genes, their component amino acids and porphyrins, their arrangements and controls, the enzymes which are their "messengers," and the resulting life forms, bodily characteristics, and behaviors.

In view of the many and complex mathematical calculations which may be required in biomedical research, recourse is had to the electronic computer. For example, in a thorough statistical analysis of 300 cardiac patients, values of 60 separate clinical parameters were required for each patient. Fortunately, computers can supply huge memories and random-access retrieval of stored information.

Such organs as the lungs, muscles, blood vessels, and even the skin produce variable and informative electric fields. A properly programmed computer can assimilate, analyze, and systematically help to interpret such field variations. Heart activity, as measured on the surface of the body, is usually shown in a somewhat distorted form due to interfering field forms. Computer techniques enable the detection, evaluation, and effective annulment of such unwanted artifacts and thus give the physician a correct record of heart action.

Using advanced pattern recognition techniques, electrocardiograms can be systematically classified and analyzed

thus providing a useful aid in hospital administration.

Computers, in the psychological realm, can simulate the interactions between members of groups in which reward or punishment result from the response of the remaining group members to the proposals or responses of a particular member of the group. It seems to be within the scope of computers to study human behavior, through a model, as a function of its payoffs.

### Genetic Studies and Selective Breeding

The biological inheritance of each human being is carried in detail, and later effectively developed, by complex chemical systems. Information governing the characteristics of the next generation is found in rather stable chemical configurations (genes, or heredity determinants). The genes are found as portions of larger threadlike structures (chromosomes) located within the nucleus of almost all living cells. When cell division (mitosis) occurs, the genes also replicate (duplicate) without change. Information from the genes is carried unidirectionally by "message-carrying" materials to the point where the final and desired chemical reaction and conformation occurs. These and other cellular reactions are thus apparently initiated and guided by enzymes.

The basic or chief material within the genes, called DNA (deoxyribonucleic acid) is a highly polymerized giant-molecular substance of peculiar double-intertwined-helical structure. Certain specific items of hereditary information with corresponding genes have been located within the chromosome of the fruit fly. Yet it is clear that the decoding of the full information within DNA genes, and chromosomes is a truly colossal task for the biochemist, biologist, and the computer expert. Further discussion of this unfinished task is beyond the scope of this paper. It should be mentioned, however, that when the computer has successfully contributed to the solution of the decoding problems involved, important medical results will follow such as understanding of the reasons for hereditary susceptibility to certain diseases such as cancer and hemophilia (uncon-



trollable bleeding), the action of carcinogenic (cancer-producing) chemicals and chemotherapeutic methods of controlling cancer, as well as the role of viruses, cell mutations, and enzymes in diseases.

### Biomedical Instruction

The role of electronics and other aids in the instruction of biological and medical students is partly established and steadily growing. Even so, the advantages of biomedical electronic education are as yet not fully recognized. Less than 50% of queried college deans and hospital administrators answered a questionnaire on this subject, although of those returning the questionnaire almost 80% were largely favourably disposed towards the field. About one-half of the queried medical school deans and one-third of the engineering school deans believed that biomedical-electronic instruction should be at postgraduate level.

Television is an obviously desirable agency for medical instruction in general. Images can be shown to large groups. Inaccessible locations within the body can be displayed via the endoscope (an optical probe, sometimes using flexible fiber optics). Infrared or ultraviolet illumination can be used to produce a visible television picture. The television camera can peer through a microscope and thus show greatly enlarged images. Desired degrees of contrast and color can be adjustably secured. Textual and graphic material can be displayed on a large screen. And medical, surgical, or psychiatric patients can be viewed in one room while the physician or lecturer shows the images, and addresses the students in another room.

On the teaching side, it is necessary that the equipment and operation be of high technical quality, convenient and flexible in operation, and capable of growth even into the postgraduate field. Available statistics indicate that, of the 86 medical schools in the United States, 40 use television with a corresponding investment of about \$3,000,000 in television and associated gear. Similarly 30 of the 48 United States dental schools use television.

In a parallel field, hospitals have found television useful in general administration, patient monitoring, radiology, surgical teaching, inventory con-

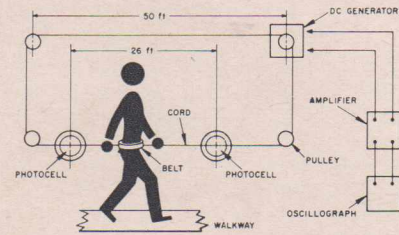
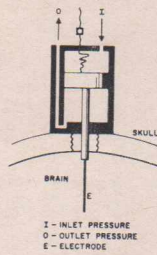

FIG. 8 — Subminiature hydraulic lift that controls precise penetration of electrode into brain of a hibernating squirrel during studies of life processes.

FIG. 9 — Tacograph system records data about an amputee's walk across an instrumented platform in studies of artificial limbs. Pattern of walk is recorded by interrupted-light photographs of the amputee's artificial leg.

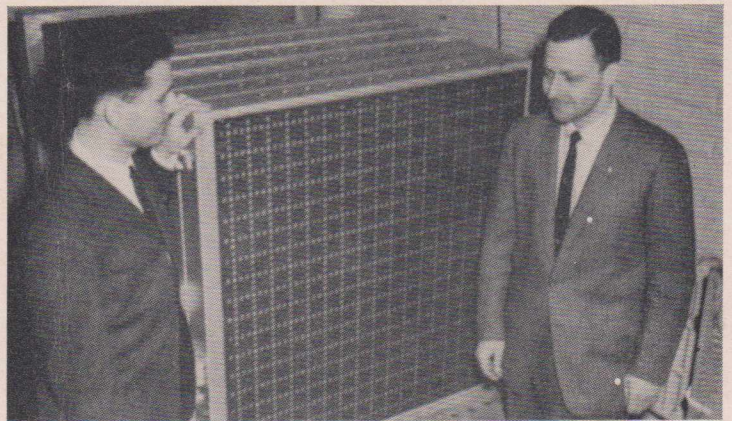

FIG. 10 — T. P. Kelley (left) and M. Herscher, and the functional electronic model of the frog's retina built by DEP Applied Research, RCA, Camden, N.J. This kind of simulation illustrates how biological processes are studied so that electronics can learn more about the processes of complex information handling.

trol (including pilferage detection), as well as in various associated activities such as diagnosis and treatment.

Color television offers added and sometimes essential advantages. In diagnosis by a group of physicians, color television is a most helpful aid. Operations, e.g., on the eye or ear, become most definitive and instructive in color. Microscope views can be shown effectively on large screens with the added color information. Instruction to nurses, refresher courses or timely information to practitioners, and even examinations of students are facilitated by the use of color television.

A highly ingenious method for creating informative artificially colored pictures has been invented and realized in practice wherein television images

taken by illumination at three different ultraviolet frequencies are reproduced, for example, in a conventional three-color television system. The color pictures thus displayed are often highly instructive in relation to tissue composition and structure even though they are specialized artifacts.

### Contribution of Biology to Engineering

Study of the physical (and psychological) behavior of animals has led to the formulation of rules or procedures that enable approximate engineering analogs of animal performance and controls to be devised. A new field has thus come into being called "cybernetics." In a narrow sense, cybernetics deals with physical or chemical feedback control in man and other animals.



In a broader sense, this field (also termed "bionics") deals with methods existent in nature for the control and functioning of biological processes and their possible adaptation and application in man-made systems or artifacts.

The negative feedback referred to above has as its element the initiation of a movement, the sensing of the magnitude of the error in the movement, a feedback correction of the error, and repetitions of the preceding processes with the aim of minimizing the error in the final step.

One obvious contribution which biology makes to engineering is that it shows that certain difficult problems can be solved (though often by methods based on, but differing radically from, those found in nature). As examples, the soaring flight of seagulls or condors showed that heavier-than-air flight was possible. The humming bird demonstrates that hovering flight as well as vertical or short take-off and landing are possible and that the ornithopter (flapping-wing) principle merits study. The bat shows that a highly precise and sophisticated "radar" or "sonar" system (using supersonic airwaves) is operative, thus indicating the feasibility of radar location and its further development. The retina and optic nerve system of man, and his cochlea and aural nerve system show respectively that (at least in conjunction with the brain) image recognition and speech understanding are possible. Scotopic vision (in dim light) and photopic vision (under normal illumination) show that wide range of illumination are feasible in producing useful luminous response.

Sensory systems of many animals have been intensively studied with possibly helpful or useful results in some cases. Among the animals in question are cats, cockroaches, dolphins, fruit flies, frogs, porpoises, and sea lions. It is also found that on occasion nature even provides alternative methods of achieving desirable results. For example, studies of the retinal

structures of the frog and of the fly show methods of visual image-production, and probably of perception as well, differing widely from those of man.

Modern cybernetics leans heavily on information theory, automation theory and practice, artificial and natural neural-network structures, communication theory, and methods for increasing reliability of operation using partly unreliable components. Further, the world of living organisms operate with dependence on so many variables interacting in such complex fashion that the usual mathematical theories of statistics and probability do not always hold for living systems.

Much interest has been aroused recently in the possibility of extra-terrestrial life; on the environmental factors helpful or prejudicial to such life; and even on the requisite tests and supplies required to sustain life in space.

Survival of man in space may depend on use of shielding against high magnetic fields, various types of electromagnetic radiation including x-radiation, meteorite impact, proton bombardment, and other injurious factors. Absence of usual gravitational fields may well prove to be so damaging after prolonged exposure, that artificial gravity (centrifugal force) may be necessary in spacecraft.

Of necessity, such matters as artificial atmosphere, food supply, water supply, and re-use of waste exhalations and secretions must be considered. Available supply systems seem fairly complex. Their present rather rudimentary stage of development may well be a precursor of workable and viable ecological systems.

## Conclusion

Considering the wide scope, and major value to humanity of biomedical engineering, it may fairly be said that in

this era of often affluent scientific endeavour, engineering in the life fields has been a somewhat meager beneficiary. Its relatively limited (and far from large-scale) support contrasts sharply with the highly favorable opinion held by many thoughtful scientific analysts of its high relative and absolute importance to our present and future civilization.

The field is, however, a difficult one in one fairly obvious respect. To "explain" a biological phenomenon implies its qualitative and quantitative understanding and the capability of its reasonably accurate prediction. It is true that many biological processes and their results can be measured with acceptable accuracy and sufficiency of interpretation by instrumentation based on presently known physical and chemical laws. Yet we cannot presently exclude the possibility that some principles and methods outside of present day scientific knowledge are necessary for a satisfying explanation and a logical understanding of many basic biological phenomena (e.g., genetic structure and mitotic (cell-divisional) growth).

Whether new branches of science or other disciplines will be required for the desired broadened knowledge in the biological field, and needed for its engineering congener, only time will tell. Clearly the field presents challenging vistas of potential major advances. It is already certain that the rational thinker and original investigator will have ample opportunity for rewarding accomplishments in biomedical engineering. This is indeed a domain for the ingenious, the creative, the determined and the tenacious. And its fruition bids fair to give much to humanity at large and to each of us in particular.

EDITOR'S NOTE: Credit is due to National Institute of Health for photos in Figs. 3 and 5; to that Institute and *International Science and Technology* for Figs. 6 and 8; and to New York University for Fig. 9.

**With Acknowledgement to RCA**



# SUPER RADIOTRON

## 19FNP4 PICTURE TUBE

The 19FNP4 is a directly viewed rectangular glass picture tube having an aluminised screen 15-3/16" x 12" with a minimum projected area of 172 square inches. It employs 114° magnetic deflection and low voltage electrostatic focus. Integral implosion protection is provided by a formed rim band and tension band around the periphery of the tube panel. Mounting lugs have been included in the tube design, thus eliminating the need for complicated mounting and implosion protection equipment in the receiver.

### GENERAL

Heater Voltage .....	6.3 volts
Heater Current .....	0.6 amp
Direct Interelectrode Capacitances:	
Cathode to all other electrodes .....	5 pf
Grid 1 to all other electrodes .....	6 pf
External conductive coating to anode:	
Maximum .....	1500 pf
Minimum .....	1000 pf
Faceplate .....	Filterglass
Light Transmission .....	48%
Phosphor .....	Aluminised P4 Sulphide
Fluorescence .....	White
Phosphorescence .....	White
Focusing Method .....	Electrostatic
Deflection Method .....	Magnetic
Deflection Angles (approx.):	
Diagonal .....	114°
Horizontal .....	102°
Vertical .....	85°
Tube Dimensions:	
Overall Length .....	11.375 ±0.250 inches
Greatest Width .....	16.545 ±0.125 inches
Greatest Height .....	13.500 ±0.125 inches
Diagonal .....	18.969 ±0.125 inches
Neck Length .....	4.125 ±0.125 inches

### Screen Dimensions (min.):

Horizontal .....	15.187 inches
Vertical .....	12.000 inches
Diagonal .....	17.562 inches
Area .....	172 sq. in.

Electron Gun ..... Unipotential

Bulb .....	J149F1
Bulb Contact .....	JEDEC J1-21
Base .....	JEDEC B7-208

### SOCKET CONNECTIONS

- Pin 1—Heater
- Pin 2—Grid No. 1
- Pin 3—Grid No. 2
- Pin 4—Grid No. 4
- Pin 5—Blank
- Pin 6—Grid No. 1
- Pin 7—Cathode
- Pin 8—Heater
- Bulb Contact—Anode

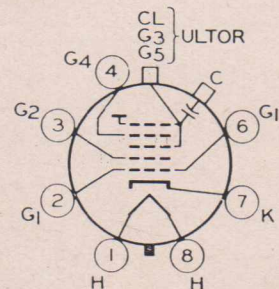



# RATINGS, DESIGN MAXIMUM SYSTEM

(Unless otherwise specified, voltage values are positive, and measured with respect to cathode)

Maximum Anode Voltage .....	20,000 volts
Minimum Anode Voltage .....	11,000 volts
Maximum Grid No. 4 Voltage .....	+1100, -550 volts
Maximum Grid No. 2 Voltage .....	550 volts
Minimum Grid No. 2 Voltage .....	200 volts
Grid No. 1 Voltage:	
Maximum Negative Value .....	-154 volts
Maximum Negative Peak Value .....	-220 volts
Maximum Positive Value .....	0 volts
Maximum Positive Peak Value .....	2 volts

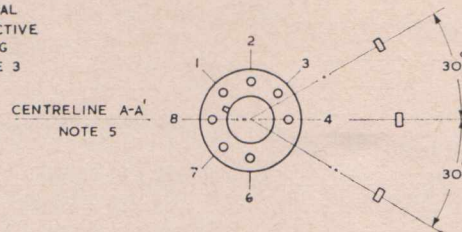
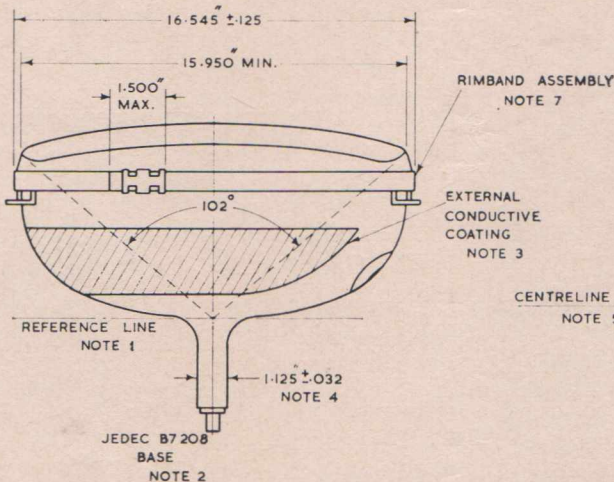
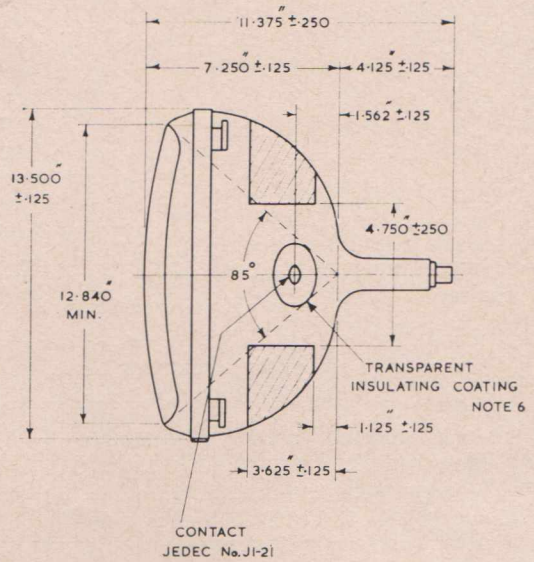
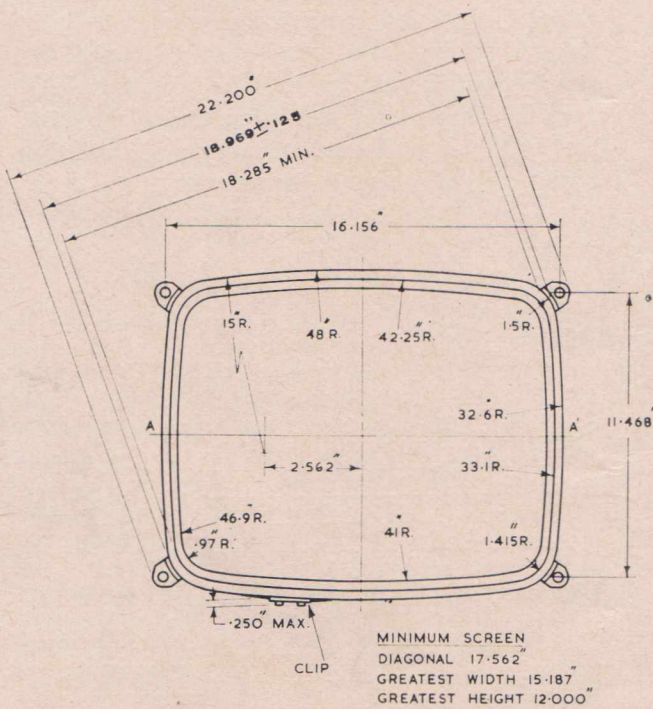



Maximum Heater-Cathode Voltage, Heater  
Negative with respect to Cathode:

During Warm-up, 15 secs ..... 450 volts  
After Warm-up Period ..... 200 volts

Maximum Heater-Cathode Voltage, Heater  
Positive with respect to Cathode:

..... 200 volts

## TYPICAL OPERATION, GRID DRIVE SERVICE

Unless otherwise specified, all voltage values are positive with respect to cathode)

Anode Voltage ..... 16,000 volts dc  
Grid No. 4 Voltage\* ..... 0-400 volts dc  
Grid No. 2 Voltage ..... 400 volts dc  
Grid No. 1 Voltage ..... -36 to -94 volts dc

## TYPICAL OPERATION, CATHODE DRIVE SERVICE

(Unless otherwise specified, all voltage values are positive with respect to Grid No. 1)

Anode Voltage ..... 16,000 volts dc  
Grid No. 4 Voltage\* ..... 0-400 volts dc  
Grid No. 2 Voltage ..... 400 volts dc  
Cathode Voltage ..... 36 to 78 volts dc

## MAXIMUM CIRCUIT VALUE

Grid No. 1 Circuit Resistance ..... 1.5 megohms

\* The grid No. 4 (or grid No. 4 to grid No. 1) voltage required for optimum focus of any individual tube will be a value between 0 and 400 volts independent of anode current. It will remain essentially constant for values of anode (or anode to grid No. 1) voltage and grid No. 2 (or grid No. 2 to grid No. 1) voltage within the ranges shown for these items.

## NOTES

NOTE 1. Yoke Reference Line is determined by plane surface of flared end of JEDEC Reference Line Gauge No. 126 when seated on funnel of tube. With minimum neck length tube, the PM centring magnet should extend no more than 2½" from Yoke Reference Line.

NOTE 2. Lateral strains on the base pins must be avoided. The socket should have flexible leads permitting movement. The perimeter of the base wafer will be inside a 1½" diameter circle concentric with the tube axis.

NOTE 3. External conductive coating forms supplementary filter capacitor and must be grounded

NOTE 4. Neck diameter may be a maximum of 1.168" at the splice.

NOTE 5. Base pin No. 4 aligns with centreline A-A' within 30° and is on the same side as anode contact J1-21.

NOTE 6. To clean this area, wipe only with a soft, dry lintless cloth.

NOTE 7. The Rimband assembly must be grounded.





*Radiotronics is published twelve times a year by the Wireless Press for Amalgamated Wireless Valve Co. Pty. Ltd.*

*The annual subscription rate in Australasia is £1, in the U.S.A. and other dollar countries \$3.00, and in all other countries 25/-.*

*Subscribers should promptly notify Radiotronics, P.O. Box 63, Rydalmere, N.S.W., and also the local Post Office of any change of address, allowing one month for the change to become effective.*

*Copyright. All rights reserved. This magazine, or any part thereof, may not be reproduced in any form without the prior permission of the publishers.*

*Devices and arrangements shown or described herein may embody patents. Information is furnished without responsibility for its use and without prejudice to patent rights.*

*Information published herein concerning new releases is intended for information only, and present or future Australian availability is not implied.*