

# PHILCO

## TECHREP DIVISION BULLETIN

Volume 4

November and December, 1954

No. 4

### *In This Issue...*

Editorial.....	<i>John E. Remich</i>	1
Crystal Checker.....	<i>Leland N. Van Allen</i>	2
NBS Research in Radio Propagation.....		4
Duplicating and Addressing System for Tape Relay Centers.....	<i>Capt. Thomas Cunningham</i>	23
What's Your Answer?.....		27
Index for Vol. IV.....		28
Solution to September-October "What's Your Answer?".....		29

**PHILCO**  
**TECHREP DIVISION**  
**BULLETIN**

*Published bimonthly by*

**The TechRep Division of Philco Corporation**  
**Philadelphia, Pennsylvania**

---

---

*Editor* . . . . . John E. Remich

*Managing Editor* . . . . . Gail W. Woodward

*Technical Editors* . . . . . Francis R. Sherman  
John W. Adams  
Baldwin G. Sullivan

---

---

*Editorial Office:*

**Technical Information Section**  
**Philco TechRep Division**  
**22nd St. and Lehigh Avenue**  
**Philadelphia 32, Penna.**

If any information contained herein conflicts with a technical order, manual, or other official publication of the U.S. Armed Forces, the information in the official publication should be used. Views expressed in this publication are the opinions of the authors and do not necessarily represent those of Philco Corporation. All technical information and circuits are presented without responsibility as to patent infringement.

# *Editorial . . .*

1954

by John E. Remich

*Manager, Technical Department*

As the fourth year of BULLETIN publication draws to a close, we wish to take this opportunity to express our appreciation to Philco Field Engineers for their excellent cooperation in contributing the many fine articles which have appeared during 1954.

During the past year, the BULLETIN has been converted to a bimonthly publication. In addition, a new and spritely "dress" was adopted for the magazine with the publication of the July-August issue. These changes, however, are mechanical ones, and do not affect the aim of the BULLETIN, which is to bring to the Field Engineer the latest and most helpful information relating to his specialty.

The year 1954 has seen a further interest in transistors, and new developments along this line have caused an increase in commercial applications for transistorized components. In a like manner, the almost unprecedented swing to automation has brought the servomechanism into sharp focus. Therefore, transistor and servomechanism articles have been conspicuous in the 1954 BULLETIN issues. It is felt that the Field Engineer will have increasing need for information concerning transistors and servomechanisms.

We welcome your further cooperation in 1955, and wish you success during the coming year.

# CRYSTAL CHECKER

by Leland N. Van Allen

Philco Field Engineer

**A description of a test device which can aid field maintenance men two ways: first, by decreasing equipment outages due to crystal failure, and second, by decreasing the effort involved in checking crystals.**

*(Editor's Note: The crystal checker described in this article was specifically designed to check the activity of crystals used in the AN/ARC-3 airborne equipment; however, a checker of this type can be used to determine the relative merit of crystals used in other equipments if acceptable standards, based on those described in this article, are established.)*

**C**RYSTALS FOR THE AN/ARC-3 airborne VHF transmitter-receiver, which is extensively used in U.S. aircraft, must be quite active to provide dependable service. Using agencies, realizing this, require that the AN/ARC-3 crystals be checked periodically. Such a check becomes a major problem to a typical military organization, which may have many thousands of crystals on hand. Checking quantities of crystals by trial in an operating set is obviously slow and impracticable, particularly when adjustments must be made to the equipment for each different crystal frequency. The alternate method of checking crystals by using a test oscillator and tuning for the signal on a communications receiver is very unsatisfactory from a technical viewpoint because this method indicates only whether a crystal will oscillate in the test-oscillator circuit—it provides no assurance that the crystal will operate in actual service.

The crystal checker to be described overcomes these disadvantages by providing a quick method of checking crystals for relative activity, which actually amounts to a crystal quality check. While specifically designed for checking crystals in the frequency range of 5 to 9

megacycles, it can be adapted for use with crystals of virtually any frequency by simply using different circuit components.

The schematic diagram of the crystal checker is shown in figure 1. The Pierce oscillator circuit was chosen because it is not frequency discriminating; i.e., it will permit a crystal of nearly any frequency to oscillate.

Any triode having suitable power requirements, such as a 6AT6, 6J5, 6C5, 1/2 6SN7, 6SR7, 6SQ7, etc., may be used. If a double triode is used, one section may be diode-connected and used for the power-supply rectifier, thus eliminating the need for a separate rectifier component.

To obtain adequate meter deflection, a fairly low value grid leak resistor (10K) is used to encourage grid-current flow. In addition, this low value ensures that differences in crystal activity will be reflected as substantial variations in the amount of grid current.

The r-f choke in the plate circuit must offer a high impedance to frequencies above the lowest-frequency crystal to be checked (in this case 5 megacycles),

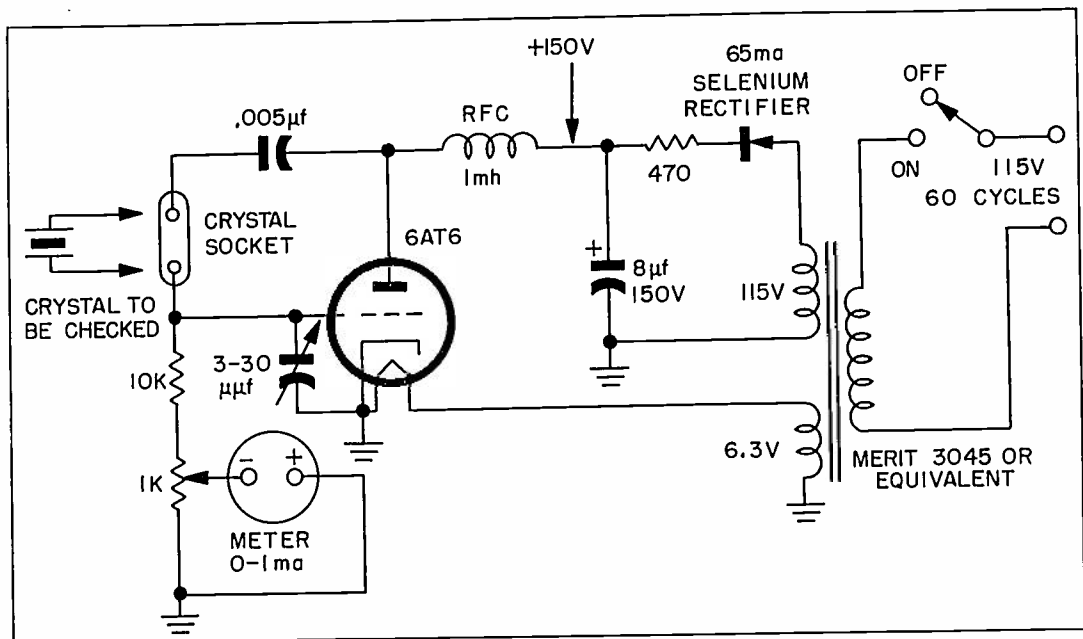


Figure 1. Schematic Diagram of Crystal Checker

and the grid-to-cathode trimmer is adjusted for maximum grid current on the lowest-frequency crystal to be checked.

The power supply can be fairly simple since good filtering of the output voltage is not necessary.

The crystal checker should be calibrated prior to use by plugging in several good crystals and setting the meter to indicate half-scale for the crystal giving the highest reading. When a crystal of unknown activity is checked, the reading obtained will then indicate the activity of that crystal relative to 0.5 of full scale (0.5 being used as 100%, or "perfect").

Experience with this checker has shown the following to be true: crystals having an activity of 60% or higher (0.3 to 0.5 on the meter scale) rarely fail in service; those producing a reading from 0.2 to 0.3 of the meter scale occasionally do not function properly in

use; and those producing readings of 0.2 or less are undependable.

With this in mind, the following interpretation of meter readings is suggested:

- 0 to 0.2—Bad
- 0.2 to 0.3—Questionable
- 0.3 to 0.5—Good

It is true that the use of this checker may result in the rejection of some crystals which *would* give satisfactory service; however, as a general rule, it is "better to be safe than sorry."

If desired, the frequency of each crystal may be checked, while it is operating in the checker, by using a communications receiver or frequency standard such as the BC-221; however, this check is not ordinarily necessary. Crystals seldom change frequency unless some physical damage is done to the quartz plate itself, and when this happens, an accompanying loss of activity is almost certain to occur.

# NBS RESEARCH IN RADIO PROPAGATION

**A broad program of research in radio propagation ensures development of better systems, more accurate standards, and more reliable propagation forecasts for use by the Government, industry, and science.**

**T**HE INCREASED UTILIZATION of the space available in the radio spectrum by almost every phase of industry, commerce, science, and the armed services has been the determining factor in formulating the program of the Central Radio Propagation Laboratory (CRPL) of the National Bureau of Standards. Technological developments have advanced the science of communications and electronics so that equipments now function at frequencies up to 100,000 megacycles. Accompanying these advances is the growing need for more information about the characteristics of radio energy under diverse conditions. Thus, in order to serve these interests more effectively the National Bureau of Standards is establishing a new multi-million-dollar radio research laboratory (see figure 1) in Boulder, Colorado.

As the Nation's central agency for collecting radio propagation data, CRPL in turn analyzes and disseminates information that aids reliable global aviation, all-weather shipping and harbor control, and world-wide communications. The Laboratory's studies of frequency allocation and interference affect the establishment and operation of AM, FM, and TV broadcast stations. Data on ultra-high-frequency radio propagation and the development of improved microwave methods are important to the Weather Bureau and military aerologists for use in upper-air temperature, humidity, and wind measurements. Accurate measurement methods and standards maintained by CRPL are essential to studies in many branches of engineering and

physics. Also, many industrial applications of radio require CRPL standards and measurement techniques.

## EARLY RADIO PROPAGATION ACTIVITIES

Radio propagation studies were formally begun at the Bureau in 1909 with the measurement of low-frequency radiations. The radio signals at these frequencies traveled comparatively short distances and only along the surface of the earth (so-called ground-wave transmission). The studies were extended to include higher frequencies after the basic demonstrations of ionospheric reflection of radio waves in 1926. In these experiments, the radio waves were directed toward the upper atmosphere (50 to 300 miles above the earth's surface). Here, the layers of ionized gases act very much like mirrors and bend the higher-frequency radio energy back toward the earth. Thus, by using ionospheric reflections, it became possible to transmit radio signals over extremely long distances.

In the subsequent decade NBS increased the scope and amount of its ionospheric measurements and theory, and developed techniques that were incorporated later in military radar and radio. However, full achievement of the value of systematic collection of radio propagation data was not accomplished until the Combined Chiefs of Staff (U.S. Armed Forces) established the Inter-service Radio Propagation Laboratory (IRPL) at NBS in the spring of 1942.



**Figure 1.** *Air View of the National Bureau of Standards Multimillion Dollar Research Center in Boulder, Colorado. This structure will house the Bureau's Central Radio Propagation Laboratory. The design of the building features a central spine, with one-story wings extending perpendicularly from it on either side. The structure takes advantage of the sloping terrain that rises from a state highway toward the Flatirons to the west. The buildings in the background, also part of the research center, are portions of the NBS-AEC Cryogenics Engineering Laboratory.*

During World War II, IRPL rendered continuous service to the military establishments. A direction-finder study, begun under the National Defense Research Committee (NDRC), was taken over by the Laboratory. Large quantities of ionospheric and other radio propagation data were accumulated from all over the world. With the development of radar, the need was further increased for propagation information at ultra-high frequencies and at the microwave frequencies (greater than 3,000 mc). Many groups from the Army, Navy, and Air Force were trained in the use of radio propagation information and techniques. Continuous liaison was maintained with the military concerning their communications operations. Staff members from the British

and Canadian Navies and the R.A.F. were assigned to IRPL, and liaison officers were assigned for duty with similar organizations in Australia, New Zealand, Great Britain, and Canada.

Regular ionospheric predictions were issued in a form that later became the monthly publication *Basic Radio Propagation Predictions*, CRPL Series D. A disturbance warning service was also established to forecast ionospheric storms that would interrupt radio communications. An extensive reporting and analysis program was maintained by NBS, the Carnegie Institute of Washington, the Army Signal Corps, and others active in the study of radio propagation. Hundreds of special propagation problems of both technical and

strategic value to communication and intercept work were solved. The most usable frequencies for many types of communications to all parts of the world were determined. Accompanying problems involving antenna design, power and receiver requirements, and frequency allocations were also solved. In addition, NBS was employed in the development of VHF and UHF standards, countermeasures work, and the regular standards activities carried over from before the war.

The service performed by IRPL and the other propagation laboratories during the war not only increased the dependability of radio but also showed that still greater improvements in radio equipment and communications could be attained through continued research. This experience showed that propagation information and research were vital to the effective use of radio communication, direction finding, radar, radio navigation, and other devices employing radio waves.

At the end of the war, a survey of future work needed by the Army, Navy, Air Force, Coast Guard, FCC, and non-Government interests led to the conclusion that the whole field of basic propagation research should be centralized. It was realized that if the progress and services rendered during the war were not continued, the Nation would lose much of the benefit derived from the original effort. Moreover, the United States would be at a disadvantage in comparison with other countries, while at the same time military and civilian radio activities would be greatly hampered. In addition, many Federal agencies, under the exigencies of wartime, had developed organizations working not only on applications of propagation to their problems, but also on fundamental research along parallel lines. Centralization of basic propagation research common to all the user agencies seemed, therefore, the best scheme to

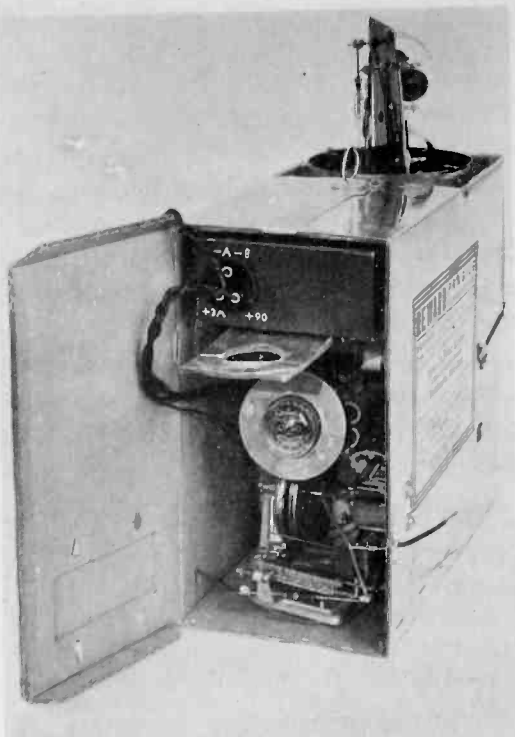
meet the needs of the country in this field without needless duplication of work.

Although the need for coordination was apparent, the magnitude of the task was too complex to achieve success in one organizational step. Accordingly, on May 1, 1946, the Central Radio Propagation Laboratory was established as one of the technical divisions of the National Bureau of Standards. A Radio Propagation Executive Council, organized to formulate general policy, included representatives of the Army, Navy, Air Force, FCC, CAA, Coast Guard, State Department, and the radio industry. Besides the existing IRPL functions, the new Laboratory assumed the duties of the NBS Radio Section. These included the maintenance and development of radio standards, the operation of radio broadcasting station WWV (which transmits standard radio frequencies, time signals, audio signals, and radio propagation information), the incipient standards work on high frequencies, radio countermeasures, and radiosondes; all of which are related, directly or indirectly, to propagation. Of particular importance was the promotion of standards development in the then-unexplored but rapidly growing fields of ultra-high and microwave frequencies.

Thus, the program of the new Central Radio Propagation Laboratory was designed to include all aspects of radio propagation research and investigation and many related activities. Experimental programs of world-wide scope were planned. These included measurements of radio field intensity, ionospheric absorption, radio noise, solar and geophysical effects, the structure of the atmosphere and ionosphere, and the influence of the ground and troposphere on radio propagation.

The information obtained from these studies of radio wave propagation is





**Figure 2.** *The Radiosonde, Originally Developed for the Navy by the National Bureau of Standards in 1936, Suspended from a Free Balloon, Telemeters Information on Upper-Air Pressure, Temperature, and Humidity. The instrument is in general use by the Navy, Army, Coast Guard, and Weather Bureau for collecting meteorological data employed in weather forecasting, and has replaced the airplane for obtaining information of this type. The radiosonde employs a modulator and oscillator, the ultra-high-frequency output of which is controlled by special resistors that are sensitive to changes in atmospheric phenomena. The changes in modulation frequency are thus measures of the phenomena studied.*

analyzed and disseminated by CRPL to all interested users of radio communications. The material is also employed in preparing predictions of radio-wave propagation conditions 3 months, 2 weeks, or even 6 hours in advance. As part of the operation of two standard-frequency radio broadcasting stations (WWV and WWVH), CRPL dispenses radio disturbance warnings to users of communications circuits over the North Atlantic and North Pacific areas. Further, the Laboratory has custody of the National primary standards of all electrical quantities used at frequencies be-

tween 10 kc. and 100 kc., and performs calibrations in terms of these standards.

The role of CRPL in national defense is both basic and operational. It conducts basic research and development work for use of the armed services and their contractors, and provides much of the operational information and guidance in the field of applied radio propagation. The radiosonde, shown in figure 2, is a good example of such work. The value of CRPL's program became even more apparent during the latter part of 1950 when its activities were again directed toward the needs of national defense and the requirements of the military.

CRPL prediction services were used for determining operating frequencies for both strategic and tactical operations in all parts of the world. Both long-haul, point-to-point, and intertheater communications utilized the detailed predictions that only the Laboratory could make, and for which the experience of the IRPL was invaluable. The Laboratory assisted in the preparation of tables of frequencies for communications between fleets and naval bases, flight charts for aircraft communications, tables and nomograms for frequency allocations, and detailed short-term predictions for specific areas. Warnings of sudden radio disturbances or ionospheric storms which could interfere with radio communications were sent to the armed services, with instructions as to what action should be taken to maintain communications. Ionosphere recorders were installed at field and advance-base propagation stations to obtain on-the-spot information. Analysis and testing of navigation and direction finding systems were necessary to ensure the success of fleet operations, aircraft missions (both long- and short-distance), and intercept and intelligence work. Propagation data and standards over wide frequency ranges were required for phases of radar such as search, early warning, fire

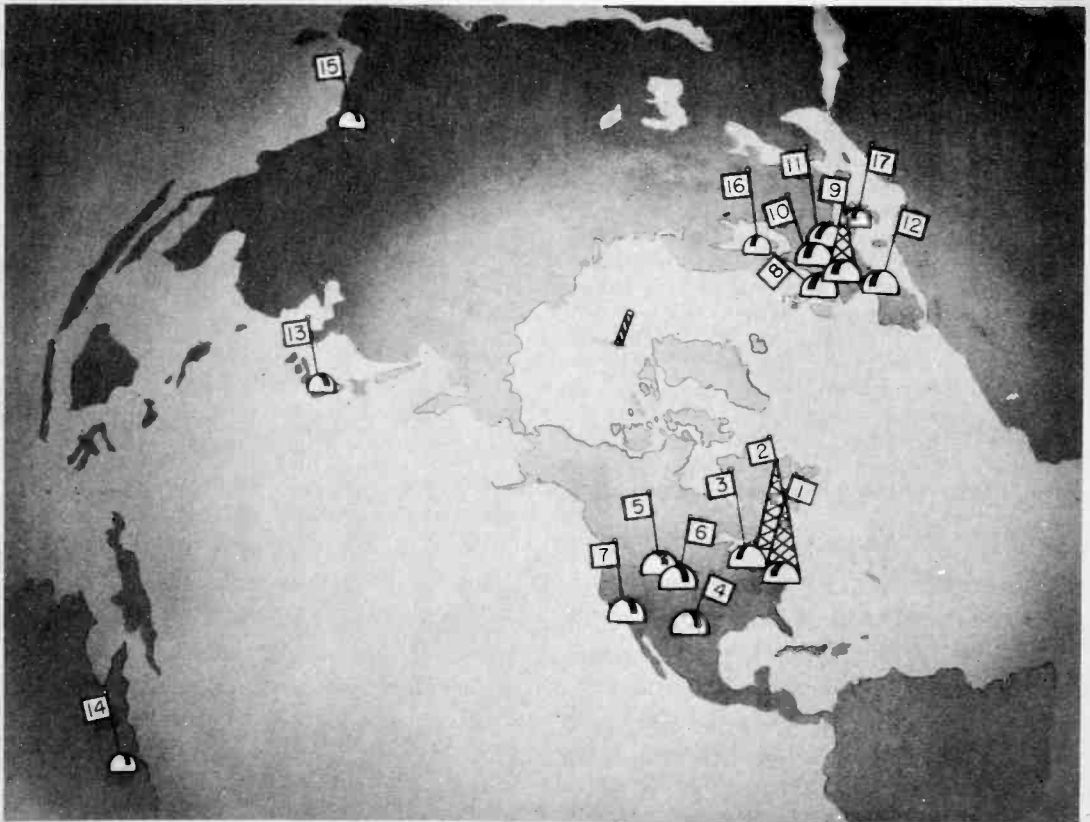
control (ground, air, naval, anti-aircraft), blind bombing, navigational radar, beacons, identification, and distance-measuring equipment.

### CURRENT CRPL ACTIVITIES

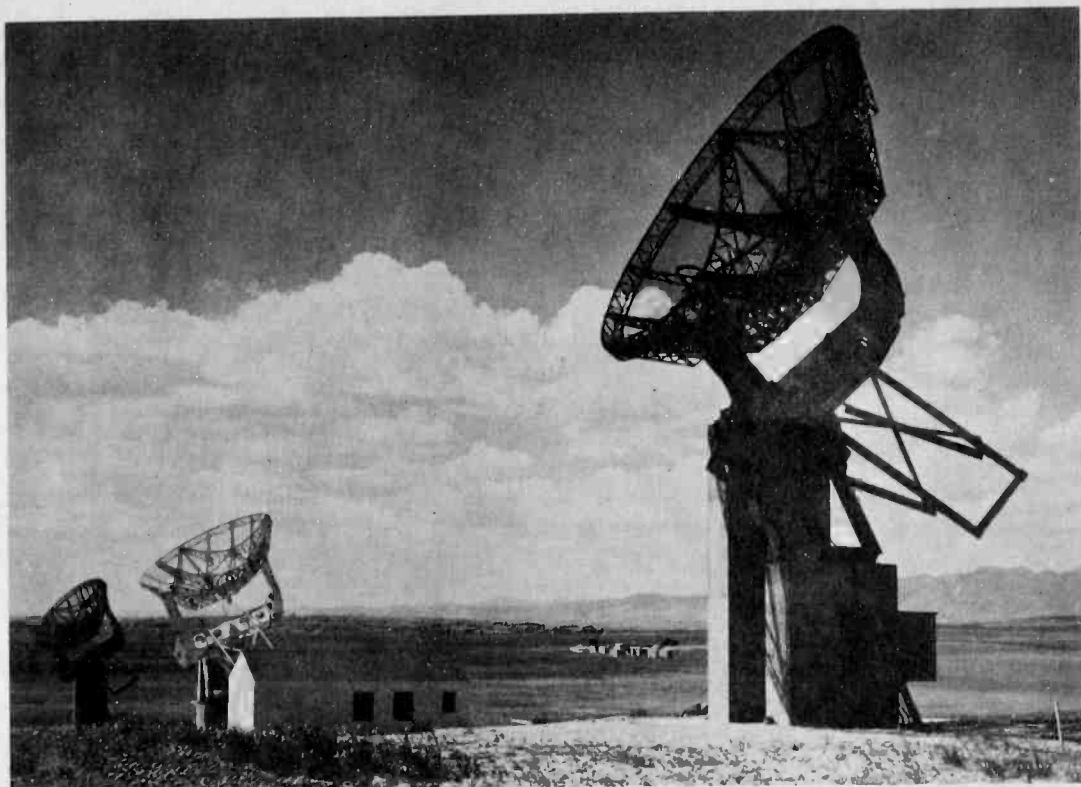
Current activities are divided along research lines essentially according to the manner in which radio energy is propagated. Responsibility for pursuing the program is assigned to three laboratories and a service section. The Ionosphere Research Laboratory investigates the physical phenomena affecting the ionosphere and radio propagation in and through the ionosphere (50 to 300 miles above the earth's surface). The Systems Research Laboratory is concerned with the characteristics of radio

systems depending on propagation in the troposphere (up to about 10 miles above the surface of the earth). The Measurements Standards Laboratory performs research and develops standards and methods of measurement for all electrical quantities used at radio frequencies. Finally, the CRPL propagation prediction services correlate the wide-spread observations made by CRPL and other laboratories (both foreign and domestic as shown in figure 3) and prepare propagation predictions for users of the radio spectrum.

These many activities have uniquely prepared the NBS Central Radio Propagation Laboratory for the role of consultant and adviser to the Federal Government on matters pertaining



**Figure 3. Network of World-Wide Observatories Supplying CRPL with Solar Activity Information. (Numbered flags designate location of each observatory.) 1: NBS and Naval Observatory, Washington, D.C.; 2: Cornell University, New York; 3: McMath-Hulbert Observatory, Michigan; 4: Sacramento Peak, New Mexico; 5: Climax, Colorado; 6: Boulder, Colorado; 7: Mt. Wilson, California; 8: Greenwich, England; 9: Meudon, France; 10: Wendelstein, Germany; 11: Kanzelhoehe, Austria; 12: Pic du Midi, Pyrenees; 13: Tokyo, Japan; 14: Mt. Stromlo, Australia; 15: India; 16: Sweden; 17: Italy.**



*Figure 4. Gun Barrel Hill, Colorado, NBS Field Station Containing Three Giant Wurtzburg Antennas. These devices are arranged to receive signals of a certain frequency radiated from the sun and to track the sun automatically as it moves across the sky. Each antenna is tuned to receive a different frequency from the many emitted by the sun.*

to international radio communication agreements. Members of CRPL have served on many international commissions and have given their services to many national committees concerned with the allocation of radio communication circuits.

### **IONOSPHERE RESEARCH LABORATORY**

Like most of the major functions in CRPL, the program of the Ionosphere Research Laboratory is based on primary research in the physical laws governing radio propagation. Studies of electromagnetic wave propagation theory are required to ascertain and apply the physical laws that form the framework for practical operating techniques. The studies also provide a basis for extrapolation of existing theories to new situations without costly reproduction of field experiments. Closely related are

theoretical investigations of the mechanism of radio frequency emission from the sun, in particular, solar noise bursts. On the experimental side, a 50-foot array of radiometers is being constructed near Boulder; and two other radio telescopes are used to measure solar emissions in the 160- and 480-mc. frequency regions (see figure 4). The upper atmosphere physics program includes an investigation of the complex motions which this region undergoes as a result of the gravitational tidal forces exerted by the sun and the moon. For instance, experiments using radio reflections from the ionosphere have shown that winds in the upper atmosphere have periodic variations and travel at speeds up to 300 miles per hour.

A thorough knowledge and understanding of the nature and cause of ionization in the upper atmosphere is vitally important to the operation of the

CRPL prediction service. Characteristics of the ionospheric layers are determined at many radio sounding stations throughout the world. Some are operated by NBS; others form a network of cooperating observatories that exchange information at regular intervals. NBS-maintained field stations are located at Anchorage and Point Barrow, Alaska; Ft. Belvoir, Va.; Narsarsuak, Greenland; Ramey Air Force Base, P.R.; Ft. Randolph, Canal Zone; Guam; and Maui, Territory of Hawaii.

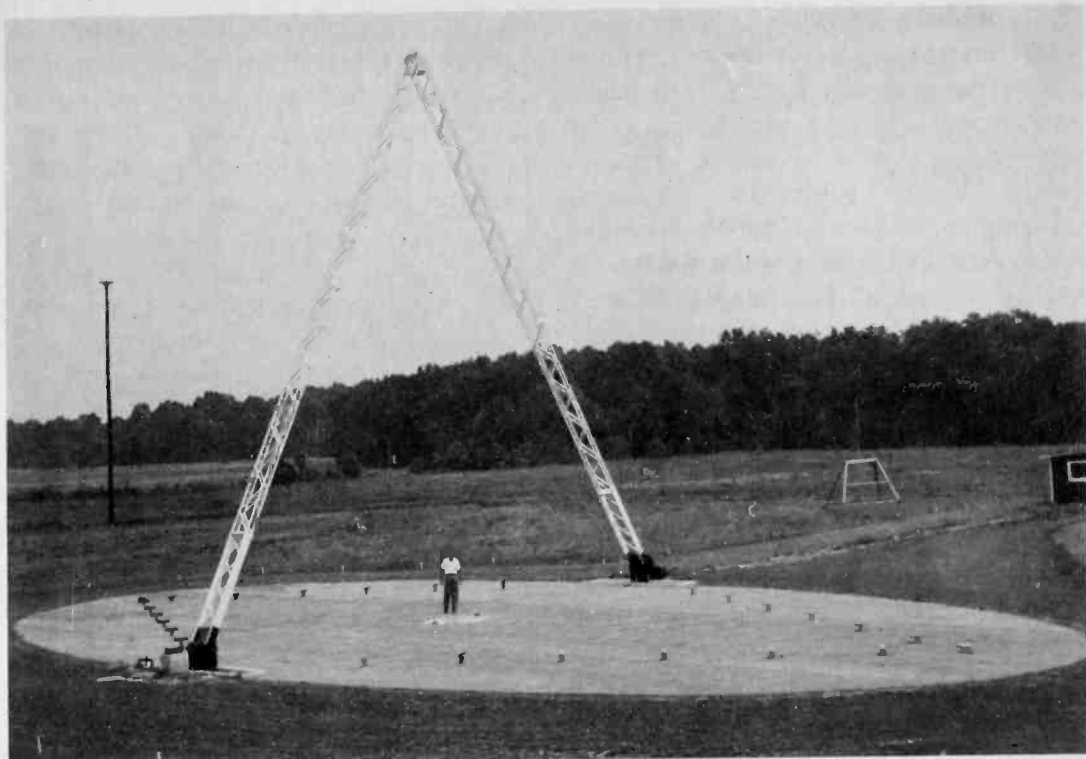
The propagation data received by CRPL from a selected group of such radio sounding stations, together with information from cooperating solar and magnetic observatories, are the basis for NBS forecasts of ionospheric radio propagation disturbances. General forecasts, a few weeks and days in advance, are prepared from the 27-day recurrence tendency of ionospheric disturbances and from application of solar-terrestrial relationships. More specific forecasts are made a few hours in advance from studies of variations in the earth's magnetic field and from trends in ionospheric and radio propagation observations over a broad area. Advance forecasts are furnished directly to representatives of civilian and military government communication agencies, commercial enterprises, technical laboratories, and individuals. Short-term forecasts every 6, 8, or 24 hours are furnished to representatives of key agencies and have wide distribution by broadcast and teletype. Short-term forecasts for communication circuits across the North Atlantic are prepared every 6 hours in the NBS forecasting center at Ft. Belvoir, Va., and broadcast twice each hour by radio station WWV. Similar forecasts for paths across the North Pacific are prepared in the Anchorage, Alaska, forecasting center and broadcast by radio station WWVH.

In addition to studies of the ionosphere directly related to the transmis-

sion of intelligence, CRPL conducts an extensive research program aimed at discovering how the upper atmosphere may be useful even during critical disturbance periods. A multifrequency ionosphere recorder, sweeping from 1 to 25 mc. in as little as 15 seconds, was developed for routine observations at all field stations. In addition, CRPL pioneered in developing a multifrequency recorder covering the low- and very-low-frequency ranges, from 50 kc. to 1.15 mc. It is hoped that, through study of the fundamental properties and basic laws governing the practical usage of low frequencies, an understanding will be obtained that will permit more accurate prediction of the behavior of transmitted radio energy.

Instruments have recently been completed to measure precisely the velocity of propagation of radio waves over the earth at frequencies between 100 and 200 mc. Measurements will be made of the effects of atmospheric conditions and the effects of reflection from terrain features on the velocity. The measurements are expected to yield useful information on the ultimate accuracy and reliability of certain types of radio navigation systems.

Included in the prediction and forecasting services of CRPL are recommendations of the maximum usable frequencies that may be employed during any transmission period. Studies are being continually conducted over long-distance paths to observe effects such as scattering of radio waves of certain frequencies by the ionosphere or the ground. These effects are additional tools for the study of propagation conditions and improvement of communications. A controlled radio path has been established between Sterling, Va., and Boulder, Colorado (1500 miles); and as an experiment, a circuit was established between Sterling, Va., and Cedar Rapids, Iowa, using the moon to reflect the signal. Still other studies are being



**Figure 5. NBS Model Antenna Range.** This range is believed to be the largest of its kind designed to measure antenna radiation patterns in the vertical plane. The inverted-V structure supports a self-contained target transmitter at the vertex and is designed to move in a 180-degree arc. The antenna to be tested is placed at the center of the oval-shaped ground plane. The model techniques that are used permit an investigation of antenna characteristics in the 1-to-25-mc. region while actually operating at frequencies between 60 and 1500 mc.

performed in the arctic regions to find why and how communication on certain frequencies is affected by the highly active aurora.

CRPL is also developing new and improved antenna systems for propagation investigations. A model antenna range, shown in figure 5, is used to investigate antennas in a model ratio of 60 to 1.

The ever-increasing use of radio waves for both civilian and military purposes and the corresponding demands for useful frequencies make the problem of frequency allocation more and more acute. The present trend is to utilize higher and higher frequencies, and thereby extend into the microwave region as far as practicable. In this region, perhaps the chief factor limiting the prediction of propagation conditions is atmospheric absorption. In order to obtain data on this phenomenon, large

cavity resonators (100 centimeters in diameter) have been constructed. They have a cavity  $Q$  (measurement of efficiency) of over one million. With this apparatus, it is possible to study molecular structure through microwave spectra, ionic absorption, and the absorption of atmospheric constituents under various meteorological conditions.

## **SYSTEMS RESEARCH LABORATORY**

All of the systems research activities of CRPL were transferred to Boulder, Colorado, in 1951. Here the rolling plains, extending hundreds of miles eastward from the mountain regions, are utilized in many phases of radio propagation research. The mountains, too, are put to use: several transmitters are located on Cheyenne Mountain, near Colorado Springs, which affords an almost perpendicular drop of more than 2000

feet to the floor of the plains. The program of this laboratory is divided between frequency utilization research and investigations of tropospheric propagation phenomena.

Frequency utilization research is concerned with obtaining information to assist in the allocating, regulating, and advisory activities of such agencies as the Federal Communications Commission, International Radio Consultative Committee, the Armed Forces, and various other governmental and private organizations employing radio methods of communication, navigation, and control. Experiments have been conducted in which mobile recording units have traveled over areas serviced in common by several TV and FM stations to determine the amount of interference offered by each station. Other mobile stations have been placed on top of Pike's Peak to determine the effects of antenna heights on radio-wave propagation. The accumulation of such noise data on terrestrial and extraterrestrial noise from all parts of the world is expected to assist in the prediction of noise levels in relation to geographical location, season, time of day, frequency, and phase of the sunspot cycle. A suitable receiver-recorder has now been developed with such necessary special features as narrow bandwidth; good noise figure, high stability, and multichannel recording features.

The several types of modulation available for the transmission of intelligence are also studied by CRPL because of their effect on both the allocation and utilization of frequencies. This program includes a determination of information-bearing capabilities, minimum bandwidth requirements, and minimum satisfactory signal-to-noise and signal-to-interference ratios for various systems, as well as effects of choice of frequencies and fading of signals.

Studies of the effect of irregular and

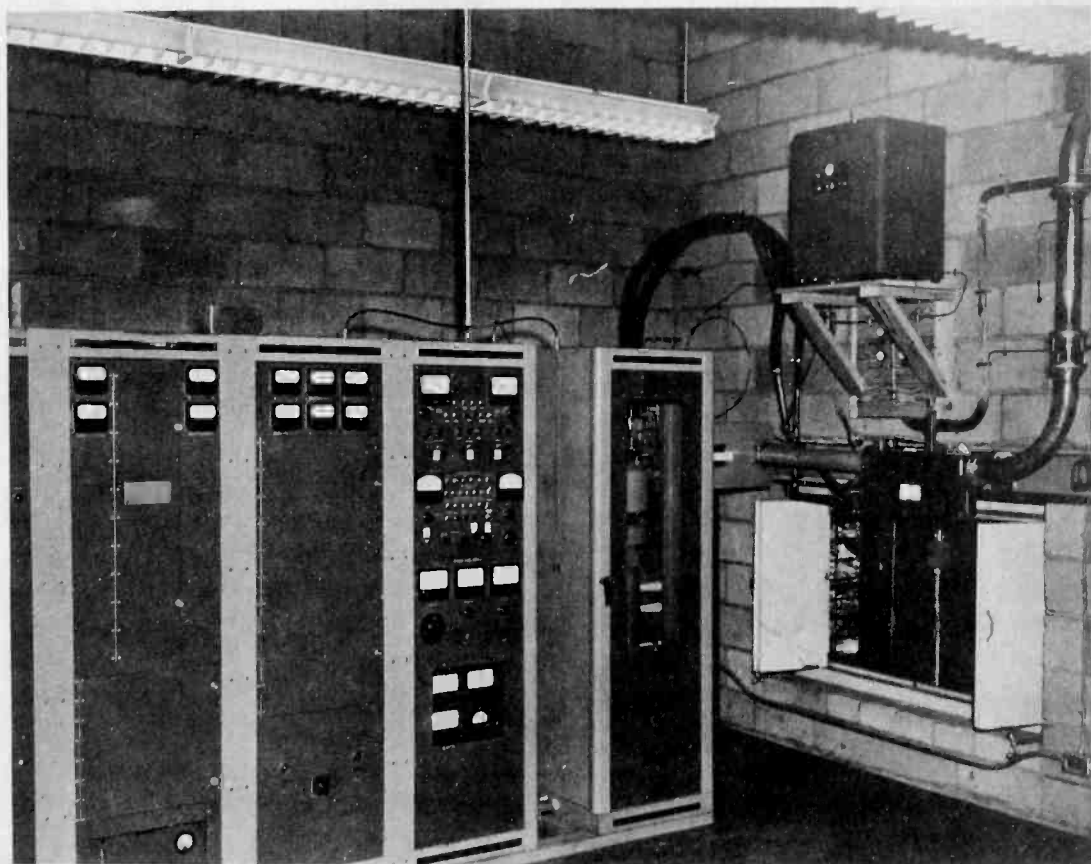
inhomogeneous terrain were originated by CRPL to provide basic information and theories for application to system studies and, in general, to promote further understanding of the physical concept of electromagnetic wave propagation in the presence of such terrain. Experimental data from other sources, such as the Armed Forces and the FCC, are integrated into the CRPL program for study and analysis. Mobile field-strength measurements are made over various types of terrain at frequencies up to 500 mc. The experiments are conducted with single or double transmitters employing antennas up to 30 feet in length. Conventional house trailers, such as the one shown in figure 6, have been modified to carry the electronic transmitting and recording equipment relatively shock-free over rough terrain. A series of experiments dealing with the refraction and tropospheric reflection of radio waves over mountain obstacles has led to a new concept concerning the installation in mountainous regions of TV and FM broadcasting stations.

Besides the sun and terrain, the troposphere has also been found to have a profound influence on radio propagation, particularly at frequencies above 50 mc. This influence is most striking at distances beyond the line of "radio sight," where the cause of abnormally high observed field-strength levels and of seasonal and diurnal (daily) variations are not well understood. Experiments have shown the presence of reliable signals more than 500 miles from the transmitter, whereas previous theories predict a maximum range of only somewhat greater than the radio horizon at the frequencies employed.

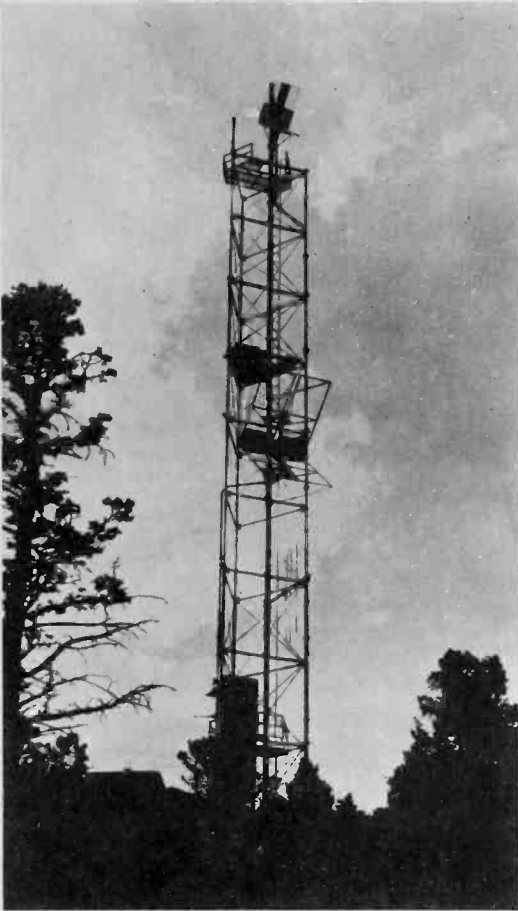
Several transmitters are installed on Cheyenne Mountain (see figures 7, 8, and 9) and on Pike's Peak as part of a research program designed to obtain field-strength data under all types of air-to-air, air-to-ground, and ground-to-



*Figure 6. Mobile Research Unit Used by the National Bureau of Standards to Measure the Field Strength of Radio Signals. Mobile units such as these have been sent to Pikes Peak to determine range of transmitted signals from installations in the general area. Others have cruised in service areas common to several transmitters to determine the amount of interference offered by each station. The antenna (on top of trailer) can be raised to a height of 30 feet by remote control while the unit is in motion.*



*Figure 7. Three-Cavity Klystron Transmitter Operated by the National Bureau of Standards on Top of Cheyenne Mountain, Colorado. This instrument is used in the CRPL tropospheric propagation research program in studying the characteristics of signals transmitted over distances beyond "radio-line-of-sight."*



**Figure 8.** *Transmitting Antennas at the Summit Site of NBS Field Station on Cheyenne Mountain, Colorado, Employed in the CRPL Tropospheric Propagation Research Program. The metal tower supports two antenna arrays for transmitting signals at frequencies of 100 and 198.2 mc. The semipyramidal horn antenna at the base of the tower radiates energy at a frequency of 1046 mc. This summit site is one of two similar installations on Cheyenne Mountain: the summit is 9000 feet above sea level; the second site is 2000 feet below it, but does not include the 1046-mc. transmitter.*

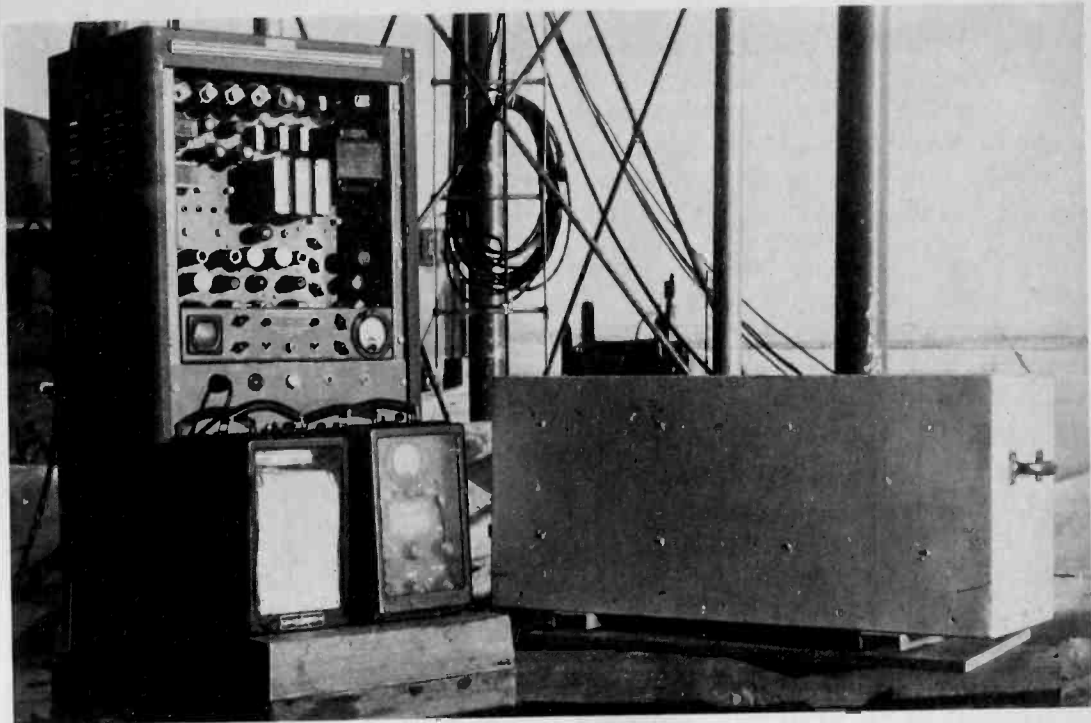
ground radio transmitting conditions. By making measurements at frequencies between 100 and 1600 mc., data are obtained which permit a correlation with the relatively large amount of existing FM and TV propagation data. This information has disclosed certain radio-wave characteristics that existing theories have not predicted. These data also serve as a basis for establishment of more comprehensive and exact theories governing propagation of radio energy in the troposphere.



**Figure 9.** *Semipyramidal Horn Antenna Located on Top of Cheyenne Mountain, Colorado. The radiator is used in experiments designed to determine the conditions of the troposphere causing reliable reception of signals more than 500 miles from the transmitter. This antenna radiates 1.6 megawatts of effective power at a frequency of 1046 mc.*

In order to study the meteorological conditions associated with the observed results from the Cheyenne Mountain tropospheric propagation research program, a 500-foot tower has been installed along the transmission path near Haswell, Colorado. Special meteorological instruments and microwave refractometers developed by the Bureau are employed on the tower to study the variations in refractive index of the lower portion of the atmosphere. Some of the associated equipment is shown in figures

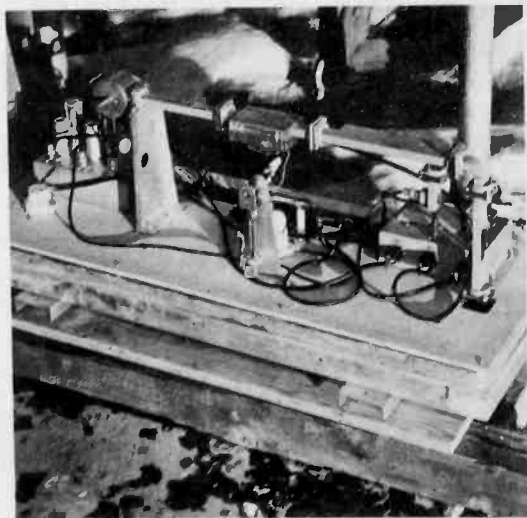




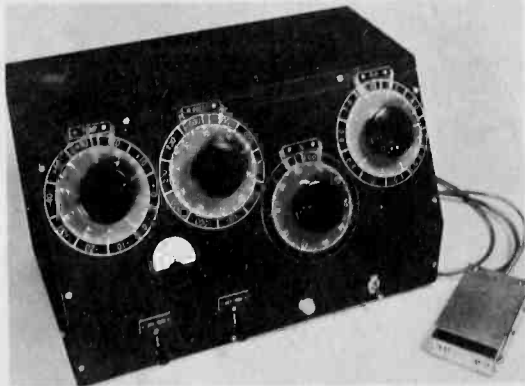
**Figure 10.** *The NBS Microwave Refractometer Employed at a Midwestern Site Near Boulder, Colorado, as Part of a Program for Measuring the Refractive Index of the Lower Atmosphere. The unit at the left includes the electronic control and recording circuits. The box-like unit at the right contains the microwave elements and associated electronic components. During a measurement, this unit is raised to the top of a 500-foot tower.*

10, 11, and 12. Tropospheric variations have been found to have an important influence on the strength and fading characteristics of VHF and UHF radio signals received at great distances. Dur-

ing recent years, several Government agencies have organized this type of information into a form suitable for the efficient allocation of radio frequencies in the radio spectrum ranging around



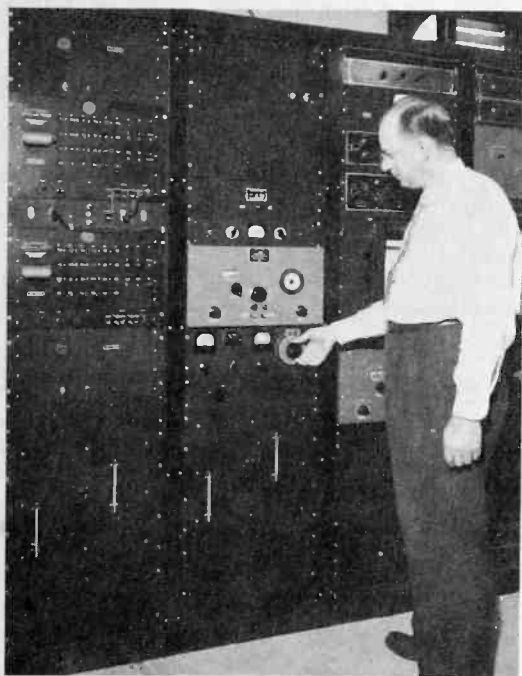
**Figure 11.** *Microwave Components of NBS Microwave Refractometer Used by CRPL to Measure the Refractive Index of the Lower Atmosphere. In normal use, these components are suspended from the top of a 500-foot tower.*



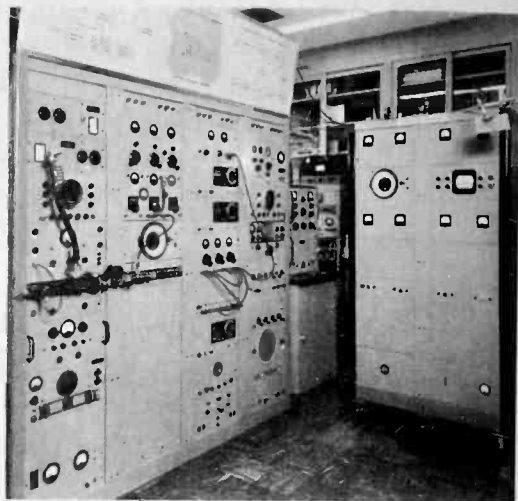
**Figure 12.** *Analogue Computer for Solving the Radio Refractive Index Equation. This device is one of the products of the CRPL instrumentation program devoted to the development of equipment to be used in studies of the ionosphere and troposphere. This instrument computes the refractive index automatically from observed meteorological parameters, including temperature, atmospheric pressure, and relative humidity.*

50 mc. The Radio Technical Committee for Aeronautics, for instance, has requested CRPL to supply information that will eventually lead to the allocation of frequencies for air-ground communications and navigational facilities.

A program is in operation to supply basic radio propagation data for the frequency range of 30 to 6,000 mc. in a form adaptable for use in operational analysis of different communications systems. The Department of Defense, through one of its agencies vitally interested in radio propagation information for the VHF and UHF portion of the spectrum, has assisted CRPL in obtain-



**Figure 13.** *NBS Primary Resonator Frequency Standard. Temperature-controlled quartz crystals are made to resonate at a frequency of 100 kc. Several of the oscillators are offset from 100 kc. by a small number of cycles to permit comparison measurements by dual electronic counters. A variable oscillator is also employed in the comparison measurements. The accuracy of this system is more constant than the rotation of the earth, the present National standard of time. Therefore, deviation of the oscillator frequency (and, therefore, that transmitted by WWV) from the mean sidereal day must be computed. These variations are periodically issued as corrections to the NBS frequency standard utilized by science, industry, and commerce.*



**Figure 14.** *The NBS Microwave Adjustable Frequency Standard with Which Secondary Frequency Standards Are Calibrated for Government Agencies, Defense Activities, Science, and Industry. The pair of dolly-mounted racks to the right contain the electronic components of the Model II ammonia clock.*

ing a large amount of radio transmission loss data over almost the entire United States. The analysis and interpretation of these data must take into consideration the seasonal and diurnal variations occurring in the different regions of the world. The information will also be related to such factors as antenna heights, terrain effects, meteorological and climatological conditions, and antenna directivity effects.

### MEASUREMENT STANDARDS LABORATORY

The Central Radio Propagation Laboratory is responsible for the maintenance and development of electrical standards and standards of measurement in the frequency range between 30 kc. and 100,000 mc. (see figures 13 and 14). The NBS standard of frequency is composed of a series of quartz crystal oscillators, each of which vibrates at an extremely constant rate of 100,000 cycles per second. The reference vibrations are electrically multiplied and divided to produce a whole series of standard-frequency signals ranging from a few cycles up to 100,000

megacycles. This range makes it possible to conduct precise research and development programs in radio-frequency standards. These standards are incorporated into the measurement of quantities such as dielectric constant and power factor, impedance, power, field strength, attenuation, voltage, magnetic permeability, and current. In addition to the "laboratory" standards, CRPL broadcasts standard carrier frequencies (2.5, 5, 10, 15, 20, and 25 mc.) from WWV, shown in figures 15 and 16, and three from station WWVH (5, 10, and 15 mc.) that are utilized by organizations depending on precise frequency measurement or control.

The need for standards of electrical quantities applicable to the constantly expanding field of electronics had been recognized for some time, but the establishment of suitable standards has been complicated by rapid developments in the field and the continuous extension of the useful frequency range. Even low-frequency (audio) standards have not

yet reached the perfection generally desired, and standards at all frequencies are continuously being improved. CRPL maintains a continuing program aimed at developing basic and better transfer standards of measurement, instruments, instrumentation techniques, methods of measurement, and analysis of the electrical quantities.

Standard methods of measuring dielectric constant and power factor of solids, liquids, and gases have been established by CRPL over a wide range of radio frequencies. Many instruments and comparison standards have been and are being developed for measuring specimens used in the NBS high-polymer program, the Bureau of Mines oil recovery program, CAA studies of antenna housings, the ASTM standardization program, and for other similar applications by private industry and educational institutions. The expanded development of microwave equipment during World War II has been responsible for added emphasis on the study of dielec-



**Figure 15.** Exterior of NBS Radio Broadcasting Station WWV, Beltsville, Maryland. From this station, standard radio frequencies of 2.5, 5, 10, 15, 20, and 25 mc. are transmitted continuously with accuracies of two parts in 100 million. Two standard audio frequencies, 600 and 440 cycles, are broadcast on all radio frequencies. Telephone poles support the antenna system, from which signals are transmitted to all parts of the world.



**Figure 16.** Interior of NBS Radio Broadcasting Station WWV. The banks of six transmitters are carefully monitored and precisely controlled to generate signals with an accuracy of two parts in 100 million.

tric and magnetic properties of materials at the microwave frequencies (300 to 100,000 mc.). A program for the improvement and automation of dielectric measurements has led to the development of refractometers for observing the refractive index of the atmosphere, and has contributed to the study of the propagation of microwaves. Related studies have included investigations of transmission-line characteristics, gas measurement, high- $Q$  circuits (re-entrant cavities), and the calibration of capacitors, inductors, and special radio components.

In the frequency range between 30 mc. and 300 mc., standards are being developed for a variety of impedances, including single components, lumped constant and distributed constant networks, and linear and nonlinear, balanced and unbalanced, unilateral and bilateral, active and passive devices. Impedance standards of all magnitudes currently used are being developed. In the 300- to 30,000-mc. range, studies are being made on a waveguide-discontinuity type of absolute standard of

impedance and reliable sliding loads for use as secondary standards.

Standard techniques are available for measuring power between 10 kc. and 300 mc. and within the power range between a microwatt and a megawatt depending on frequency and waveform. Present measuring equipment is capable of handling mostly c-w power. The equipment will eventually handle pulsed power, c-w modulated and pulse modulated, dissipated or monitored by measuring devices, under matched conditions for optimum efficiency, or when fed into any conceivable impedance. Throughout the frequency range, investigations are in progress on absolute and independent methods of power measurements using devices such as bolometers, thermistors, and calorimeters for cross-checking absolute accuracy. A new microcalorimeter has been developed for low power levels, and work is continuing on the development of a high-power water calorimeter.

CRPL also maintains programs directed toward the further development

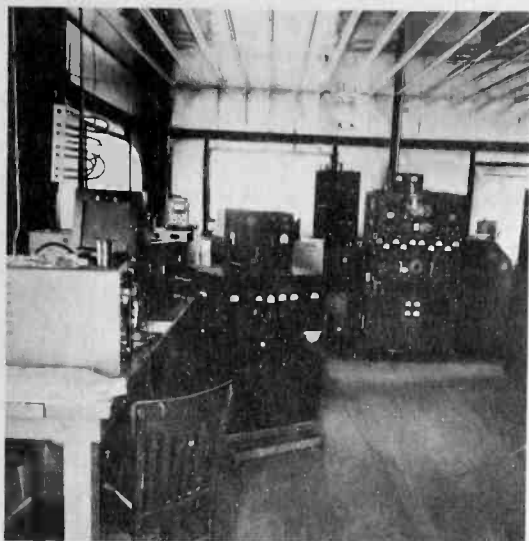
of attenuators of various types, notably the waveguide-below-cutoff attenuators for practically the entire frequency range. Reliable primary standards of r-f voltage have been developed for use over a wide range of voltage and frequency; investigations are continuing for the improvement of these standards and the development of new, stable secondary standards. Work is also progressing toward the development of r-f current standards. In cooperation with the FCC and other regulatory agencies, CRPL maintains national reference standards of radio field strength for the benefit of broadcast stations and users of dielectric heating, diathermy, and other interference-producing electrical apparatus.

At the present time, no working primary frequency standards are absolutely free of drift, aging, or instantaneous changes. However, variations have been reduced by a factor of 1000 within the past 30 years; and a constancy of better than 1 part in 1 billion over a 24-hour period is now available. Nevertheless, requirements in defense, research, and communication still exceed the performance of the best primary oscillators operating under precisely controlled conditions of temperature, vibration, and voltage. Experiments are currently being performed on new types of standards operating at higher frequencies and lower temperatures, and on synthetically produced quartz crystals.

The lack of authentic comparative information on the characteristics of powdered iron and other magnetic materials was responsible for a research program aimed at the development of instruments and methods to measure accurately permeability and loss factor. The resulting instrument is known as an r-f permeameter and serves as a secondary standard. It is now possible to establish specifications for powdered iron based on the accurate results of NBS instruments and standards.

Standard frequency broadcasts were begun by the National Bureau of Standards in 1923 on announced schedules. The usefulness of the broadcasts has been continuously extended, and the service has been improved in accuracy, reliability, and availability in the United States and throughout nearly all the rest of the world. Accurate time signals, time intervals, audio frequencies, radio frequencies, and time announcements in voice and code are now continuously available on six frequencies of WWV (Beltsville, Md.) and on three frequencies of WWVH (Maui, Hawaii). They are relied on by many commercial, scientific, and governmental agencies, as well as the Armed Forces. In addition to the normal maintenance activities associated with the stations, a continuing improvement program is in progress, typified, for instance, by the installation of single-sideband transmitters at WWV to reduce the width of the frequency spectrum now used. Another example is demonstrated by an activity located on Gun Barrel Hill near Boulder, Colorado. Here, CRPL has completed the installation of a laboratory, as shown in figure 17, to monitor continuously radio carrier and modulation frequencies and field strength from radio stations WWV and WWVH. The results of this work should prove to be useful in predicting frequency errors to be expected in the carrier and sidebands for different communication paths, time, and carrier frequencies.

The rapid development during World War II of microwave equipment has led to its application in radar, navigational aids, communication systems, relay systems, and many defense weapons such as guided missiles. In addition to the standards developed for this region of the spectrum, research is being conducted on the utilization of microwaves for atomic frequency and time standards, spectroscopy of gases, and precision interferometry.



**Figure 17.** Interior of NBS Field Station Near Boulder, Colorado, Established to Monitor and Study the Signals Transmitted by Radio Station WWV and WWVH. The station is also used as one of the network of ionosphere probing stations maintained by, or operated in cooperation with, the National Bureau of Standards. The C3 ionosphere recorder (right, background) is one of the basic instruments used widely by science and the military for investigating the outer atmosphere by radar techniques.

The limitations of the present standard of time, the mean solar day, have instigated a search for new methods to determine time and frequency. The original NBS atomic clock utilized the absorption characteristics of ammonia to provide a control element in a servo loop containing a precision oscillator. The success of this initial experiment has led to the further development of atomic clocks utilizing cesium atoms. The latest NBS cesium beam clock now under development is shown in figure 18, and is expected to attain an accuracy of 1 part in 10 billion.

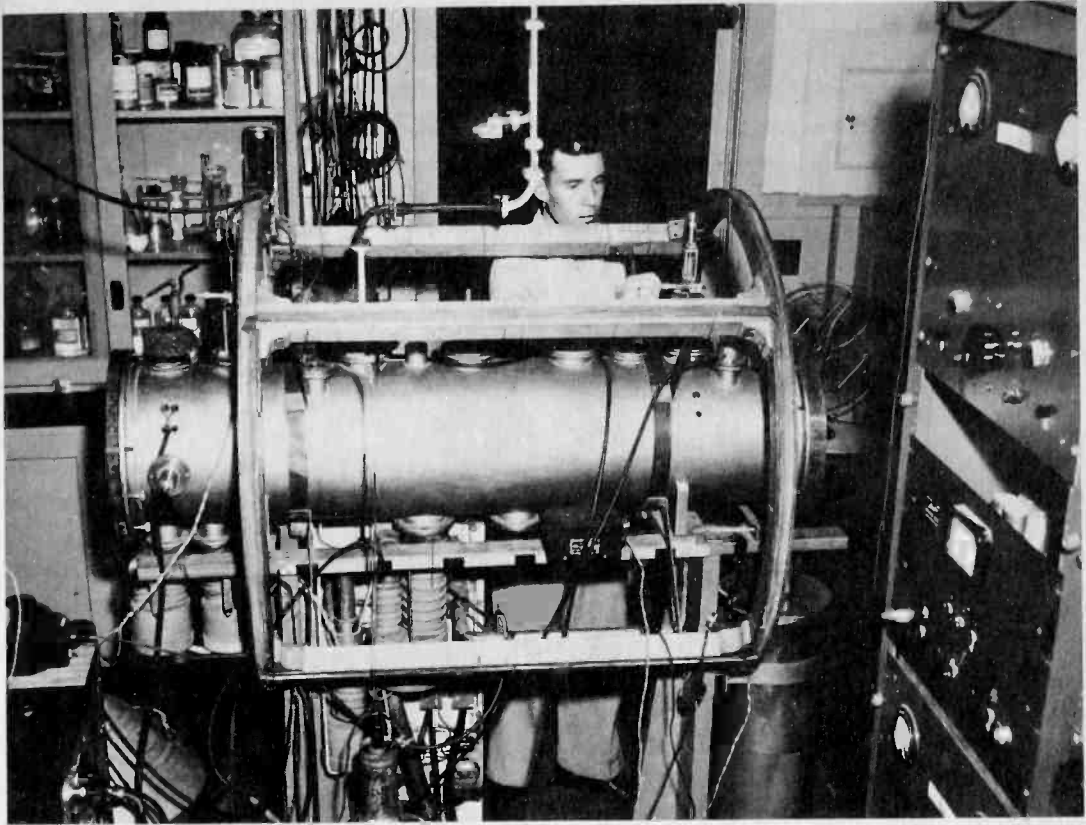
The microwave absorption characteristics at microwave frequencies of most gases are being utilized in spectroscopic analysis in much the same manner as infrared and ultraviolet techniques are employed. A current project involves the compilation and dissemination of new and revised information on microwave spectrum lines for use as reference standards and for research purposes.

Optical interferometers have proven invaluable for the precise measurement of short distances and of wavelengths of optical radiations. For microwave frequencies, work is progressing toward the development of a precision interferometer which will measure longer distances (1 to 50 meters) and wavelengths of microwave radiations with great absolute accuracy. The instrument will also make possible a highly accurate measurement of the velocity of light.

### **REGULAR PROPAGATION PREDICTION SERVICES**

The radio frequency predictions now issued by CRPL are essentially in the form developed for the armed services during World War II. However, much progress has been made in reducing many of the errors. Included among the errors and common to all systems of predictions are those caused by the lack of accuracy in available methods of predicting solar activity, by insufficient world-wide distribution of ionosphere observations, and by day-to-day variations of ionosphere characteristics around the monthly median values. One serious source of error, that of presentation, use, and interpretation of data, is being overcome by the development of a true map representation of basic radio propagation predictions, both for the entire world and for the arctic region. It is contemplated that the final form of presentation will consist of 12 maps, one for each even hour of GCT, for a given month, and for each of the characteristics for which predictions are desired.

In order to prepare predictions of the best sky-wave operating frequencies for communication paths all over the world, CRPL collects and analyzes ionospheric data from 76 stations having world-wide geographical distribution. The results of the analyses are compiled and distributed to scientists and scientific organizations in the United States and in many



**Figure 18. NBS Atomic Beam Clock.** A beam of cesium atoms is discharged and made to move down the cylinder from left to right. When these atoms pass through the electromagnetic field set up by microwave energy, they vary from a straight-line path. Suitable instruments can be arranged to detect this variation and feed a voltage back into the microwave generator so as to make it correct itself, and, thereby, produce the correct frequency. With this system, accuracies can be obtained of better than one part in 10 billion.

foreign countries. CRPL series F, *Ionospheric Data*, is a 90-page monthly document distributed to the cooperating observatories, military and civilian governmental agencies, industry, and scientific organizations. The series includes, in addition to ionospheric and radio propagation data, tables of solar flares, coronal data, and sunspot numbers, radio propagation quality figures, and geomagnetic data.

CRPL series D, *Basic Radio Propagation Predictions*, is issued monthly as an aid in determining the best sky-wave frequencies over any path at any time of the day for average conditions for the month of prediction. Each issue of this series predicts the maximum usable frequencies 3 months in advance of their expected occurrence. Included are

charts of extraordinary-wave critical frequency for the F2 layer, of maximum usable frequencies for a transmission distance of 4000 km., of percentage of time for transmission by the sporadic-E layer in excess of 15 mc. for a distance of 2000 km., and other information concerning the sporadic-E and regular-E layers. Methods for using the charts included in CRPL series D are given in NBS Circular 465, *Instructions for the Use of Basic Radio Propagation Predictions*.\*

Twice a month, CRPL issues the Ja series to those who wish later information concerning maximum usable frequencies. Series Ja carries revision factors for the advance radio propagation predictions made in the series D publication. In addition CRPL issues semi-

weekly the series J reports, *Advance Radio Propagation Forecasts for North Atlantic Paths*, to those interested in the quality of reception over these communication circuits. The forecasts include an estimate of propagation quality for the first 7 days after the issuance of the information and an estimate of the disturbed periods within the next 25 days. A similar series, series Jp, supplies information for users of communication paths across the North Pacific. Still shorter term forecasts are given to NBS radio stations WWV and WWVH for world-wide transmission, and CRPL is prepared to issue reports every hour or oftener by telephone to governmental users requiring this special type of information.

Ionospheric physics, of which the CRPL prediction services represent one of the practical outcomes, has the whole earth and the outer atmosphere as its laboratory; the research "team" includes scientists from many countries who make observations at remote locations. As an agency of the Federal Government, CRPL maintains close ties with its counterparts in other countries. as

◦ Available from the Superintendent of Documents, U.S. Government Printing Office, Washington 25, D. C., for 30 cents. The series D publication is available from the same source at 10 cents per issue or on a subscription basis for \$1.00 per year (foreign \$1.25).

well as universities, research institutions, and communication companies in the United States and abroad. This type of cooperative study of universal problems of the upper atmosphere and radio propagation will reach a peak of activity in 1957-58, when at least 28 countries plan intensive joint investigations in many fields of geophysics. This period of widespread observational programs coordinated in space or time is called the International Geophysical Year, or IGY.

Through CRPL, the National Bureau of Standards will participate in the IGY by employing its facilities maintained at half a dozen remote outposts. Moreover, the experience and training of its staff will be utilized for observing the outer atmospheric phenomena. The program will include overhead and oblique ionospheric soundings, radar observations of aurora, and some types of ionospheric wind measurements. Special "World Days," selected by an international coordinating agency, will be the occasion for intensive observations of all ionospheric phenomena, as well as solar activity, cosmic rays, and phenomena observable with the aid of rockets. The results of this tremendous program are expected to yield more exact knowledge of many natural phenomena which affect everyday activities in science, industry, and commerce.

•••••  
 •  
 •  
 •  
 •  
**ERRATUM**  
 •  
 •  
 •  
 •  
 •  
 •  
 •  
 •  
 •  
 •  
 •  
 •

**September and October issue, page 7;**  
**Figure 2 is shown as having four parts. The upper two drawings (labels A and B) should have a caption reading "Figure 1. Amplifier With Cathode Degeneration A. Schematic Diagram B. Equivalent Circuit."**

•••••



# DUPLICATING AND ADDRESSING SYSTEM FOR TAPE RELAY CENTERS

by Captain Thomas Cunningham

Signal Maintenance Officer "SHAPE"

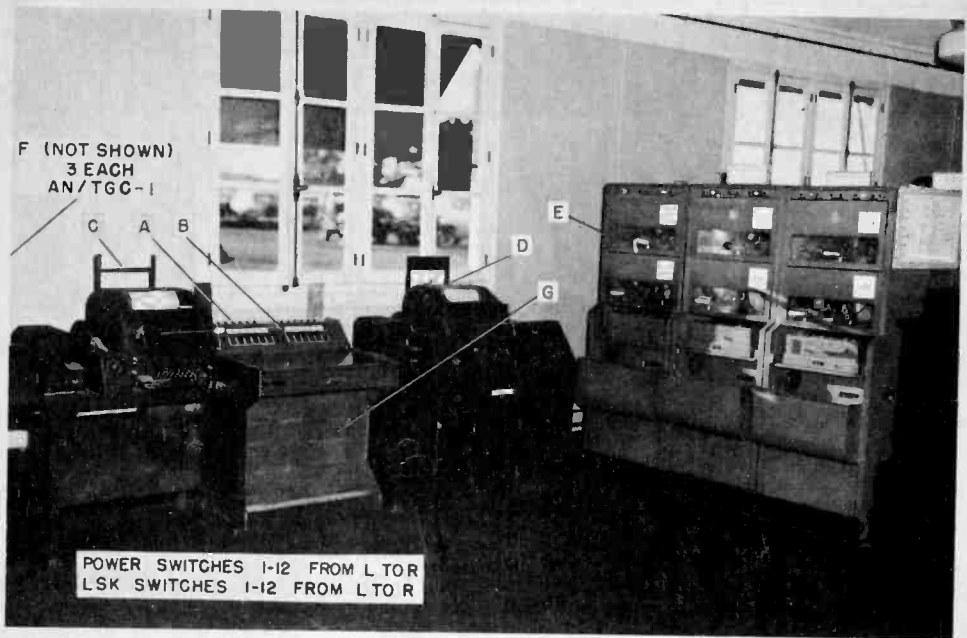
Teletype is today used more extensively than other forms of telegraphy for fast and efficient handling of message traffic. These facilities, which include direct point-to-point private line services, switched exchange (TWX) systems, and tape relay, play the all-important part of linking our Armed Forces communications channels throughout the world.

**T**APE RELAY SYSTEMS handle the major part of the message traffic to overseas destinations, using both wire and radio as transmission mediums. At the terminal stations of these systems, messages are received in written form, either by messenger service or by tributary teletypewriter circuitry. Each message that is to be sent via tape relay networks is processed by the message centers of these terminal stations, where routing indicators, message identifying number, the precedence, and transmission instructions are added to the message. The message is then prepared on perforated tape and sent automatically by means of a transmitter distributor. At the distant terminal station or intermediate tape relay station, the message is received on a typing reperforator, which simultaneously types and reperforates the message on a similar tape. The advantages of such a system over manually operated circuits are that in cases where the message must be relayed through an intermediate station, much time is saved in retransmitting the original message, and operating personnel requirements are considerably lessened. Upon reaching the designated terminal station, the message is reproduced locally in page copy form for local delivery, or, in the case of tributary teletype circuits, is sent on by a transmitter distributor.

Quite often a single-message text is directed to one or more addresses, constituting multiple address and book messages which may require separate routing at the originating terminal station or at an intermediate relay. Considerable time may be saved in the transmission of these types of messages if duplicate tapes are prepared in order that simultaneous sending can be initiated over the different routes. It is highly desirable, therefore, that each tape relay center be equipped with an efficient duplicating and addressing section, quite often referred to as ZVA.

## ZVA SYSTEM

Duplicating and addressing (ZVA) systems should be designed to provide maximum flexibility with the minimum of equipment. The installation described in this article, shown in figure 1, provides a means of reproducing duplicate-message tapes from either of two operating positions in any quantity up to twelve simultaneously. This system is composed of six AN/TGC-1 packaged teletypewriter sets, two Model 19 teletypewriter sets, and a control console. Selection of the desired number of duplicate-message tapes to be produced is accomplished by manipulation of line switching keys mounted on the control console. Motor control switches are also provided on this unit, to activate the



**Figure 1.** *Installation of Duplicating and Addressing System, Showing Equipment Layout*

reperforators in the AN/TGC-1 equipments that are to be used. Information in the headings of messages may be inserted or deleted from any message by switching the reperforators either in or out of the circuit.

### CONSTRUCTION

Each M-19 teletypewriter set is strapped C<sub>2</sub> to C<sub>3</sub>, and C<sub>4</sub> to C<sub>5</sub>, as shown in part A of figure 2. Line connections are made at C<sub>1</sub> and C<sub>6</sub> of each unit with their distant ends terminated in teletype plugs. This places the Transmitter Distributor, Keyboard, and Typing Unit of the M-19 table in series, which allows automatic or manual sending and also provides a page copy on the Typing Unit for checking errors in the tape.

The line from M-19 #1 is plugged into the MJ-4 jack of AN/TGC-1 set "C", and the selector switches for this unit are set for split duplex-polar operation. The neutral teletype signal from the M-19 is thus converted to a polar signal for transmission to all reperforator receiving relays. The polar signal

output from terminal #10 of set "C" is wired in series through all #5 and #6 terminals of the line switching keys. (See part B of figure 2.) This provides a closed loop for all reperforators when the line switching keys are in the "down" position.

The line from M-19 #2 is plugged into the MJ-4 jack set of "F", and the wiring is from terminal #10 of set "F" to terminals #3 and #4 of the line switching keys. This provides a closed circuit for all reperforators when the line switching keys are in the "up" position.

All reperforator receiving relays are wired to the #1 and #2 terminals of their respective line switching keys. Marking battery is also furnished at terminals #7 and #8 of the line switching keys, as shown in part B of figure 2, in order to have the reperforators run closed when the line switching keys are in the center position. The transmitter circuits of sets "A", "B", "D", and "E" are not used, and the selector switches of these units are set for normal duplex-polar operation.



The power circuit is modified as shown in part C of figure 2, and the motor control toggle switches are wired in series with the reperforator motor circuit at the motor fuse.

(Editor's Remarks: ZVA systems, although not new in idea, have posed a constant problem in construction. Usually the chief difficulties encountered are during switching operations, where extraneous characters might be typed as a result of short intervals of circuit interruption. For this reason this article was of sufficient interest to us to warrant further research. Therefore, we directed relevant questions to the Bell Laboratories to verify the technical soundness of Captain Cunningham's design. The questions, together with the answers received, are listed below.

Q. Can the line windings of twelve WE 255A relays be connected in series successfully in a polar circuit without introducing sufficient characteristic distortion to produce marginal operation of the equipment?

A. "Assuming a  $\pm 15$ -milliampere series circuit, a driving source of plus and minus 130 volts, the use of a single winding on each relay, and 60 WPM operation, characteristic distortion effects in a circuit containing twelve relays would be much smaller than the distortion tolerance of a Teletype Corporation typing reperforator. For circuit conditions other than those assumed, the percentage change of current during the shortest signalling element to be transmitted may be calculated from the  $L/R^*$  ratio of the circuit. If during the shortest pulse (including input distortion) to be transmitted a build-up to less than 90% of steady

state current is indicated, alternative circuitry should be considered."

Q. Would a parallel arrangement of these windings be more advantageous?

A. "Parallel connection of branch circuits, each branch containing a line relay for operating a typing reperforator, provides a somewhat superior circuit. In this case, each branch should consist of current limiting resistance and a line relay with two windings connected in series-aiding. As compared with the series circuit, the resistance of each branch would be increased by a factor of two, and the inductance reduced by a factor of three, so that the time constant would be reduced by a factor of six. The total current from the driving source would be increased by a factor of six; therefore, the current should be limited to  $7\frac{1}{2}$  milliamperes per branch circuit, to prevent excessive deterioration of the contacts on the master relay which is driving the multiple branch circuits."

Q. Under normal operating conditions, can the armature of the polar relay be depended upon to remain positioned on its marking contact during transfer of the line winding between two closed circuits, to prevent extraneous characters from appearing in the message text as a result of the switching operation?

A. "The armature of the 255A relay in good adjustment will usually remain on the contact to which it was last operated, even though the operation flux is reduced to zero. The holding force is, however, normally quite small, and may be materially reduced or actually made negative by poor adjustment of the relay. Even with a positive holding force, the

\* The inductance of each of the two windings is about 1.25 henrys at normal signalling frequencies, and, since the two windings are closely coupled, the inductance of the winding in series-aiding is very nearly four times this value.

combined effect of interfering currents, building vibration, and the like might cause the armature to leave its contact momentarily during switching operations. For these rea-

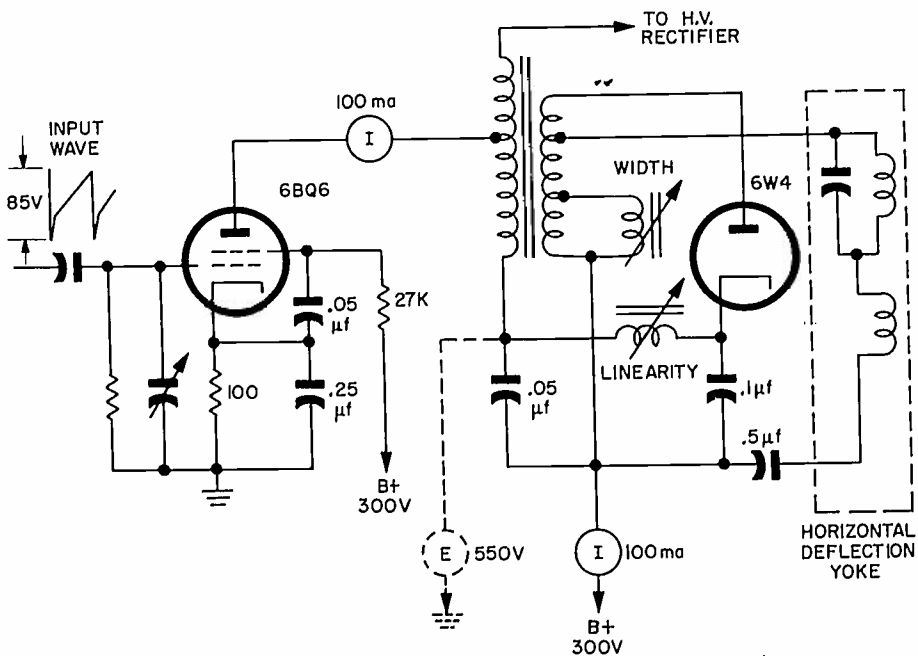
sons it is considered sound design practice to provide a small holding current during switching operations when maintenance of the marking condition is a requirement.”)

### “What’s Your Answer?”

This problem was submitted by Philco Field Engineer Leland Van Allen, who noted the unusual conditions described in the problem during one of his frequent bouts in the TV servicing field.

The schematic shows a typical circuit found in TV horizontal deflection systems. As shown by the presence of the voltmeter, the damper circuit produces a 250-volt boost in the B+ voltage, thereby making the supply voltage for the output tube 550 volts. If the circuit is traced, it will be noted that the output tube plate current is the same as the B+ supply current—in the case shown we have assumed a value of 100 ma. A simple calculation will show that the B+ supply power is 30 watts, and that the plate input power of the output tube is 55 watts.

The problem is to explain where the additional 25 watts for the output tube come from.



(Solution next issue)

## Index for Vol. IV Philco TechRep Division BULLETIN

	Month	Page
<b>A</b>		
Antenna Instructions, Simple Aid To	July-Aug.	2
<b>C</b>		
Conference on Cryogenic Engineering, 1954	July-Aug.	6
Cryogenic Engineering Laboratory, NBS-AEC	May-June	30
Cryogenic Engineering, 1954 Conference on	July-Aug.	6
Crystal Substitution For Radio Receiver R-19/TRC-1	July-Aug.	13
Crystal Checker	Nov.-Dec.	2
<b>D</b>		
Duplicating and Addressing System for Tape Relay Centers	Nov.-Dec.	23
<b>E</b>		
Editorials:		
BULLETIN Plans	May-June	3
The Growth of Field Engineering	July-Aug.	1
Wanted—BULLETIN Articles	Sept.-Oct.	1
	Nov.-Dec.	1
Electronic Clinical Thermometer	May-June	18
Engineering Report	Sept.-Oct.	11
<b>H</b>		
Homemade Training Slides	Sept.-Oct.	2
<b>L</b>		
Listening Device	May-June	18
<b>N</b>		
NBS-AEC Cryogenic Engineering Laboratory	May-June	30
NBS Research in Radio Propagation	Nov.-Dec.	4
New Philco Training Manual	Sept.-Oct.	29
<b>P</b>		
Philco Training Manual, New	Sept.-Oct.	29
<b>R</b>		
Radio Propagation, NBS Research in	Nov.-Dec.	4
Relay, Voice Operated	Sept.-Oct.	13
R-19/TRC-1, Crystal Substitution For Radio Receiver	July-Aug.	13
<b>S</b>		
Servicing Synchros and Servomechanisms:		
Part 1	May-June	4
Part 2	July-Aug.	15
Part 3	Sept.-Oct.	16
Shoran Equipment	July-Aug.	23
Simple Aid to Antenna Instruction	July-Aug.	2
Surface-Barrier Transistor:		
Part 1	May-June	19
Part 2	July-Aug.	7

## Index (Cont.)

	Month	Page
<b>T</b>		
Tape Relay Centers, Duplicating and Addressing System for	Nov.-Dec.	23
Thermometer, Electronic Clinical	May-June	18
Thevenin Equivalents For Vacuum-Tube Circuits	Sept.-Oct.	6
Training Slides—Homemade	Sept.-Oct.	2
Transistor, Surface-Barrier:		
Part 1	May-June	19
Part 2	July-Aug.	7
<b>V</b>		
Vacuum-Tube Circuits, Thevenin Equivalents For	Sept.-Oct.	6
Voice Operated Relay	Sept.-Oct.	13
<b>W</b>		
“What’s Your Answer?”		
“Double-Pole-Double-Throw Switch” Problem	May-June	29
Solution	July-Aug.	29
“Class-B Linear R-F Amplifier” Problem	July-Aug.	22
Solution	Sept.-Oct.	28
“Neon Lamp” Problem	Sept.-Oct.	5
Solution	Nov.-Dec.	29
“TV Deflection Power” Problem	Nov.-Dec.	27

### Solution to . . . September-October

#### “What’s Your Answer?”

The action of the neon lamp can be summarized as follows:

1. The neon lamp will light as soon as the switch is closed, and will remain on for approximately 0.6 second. Since the voltage across the lamp is d.c., only one of the electrodes will glow.
2. After the 0.6-second interval, the lamp will extinguish and remain off for approximately 2.4 seconds.
3. At the end of the 2.4-second interval, the lamp will light again and remain on as long as the circuit is energized. This time the opposite electrode will glow, because the polarity of the voltage is reversed.

The above analysis can easily be verified by calculating the time constant involved and consulting a “Universal RC Time Constant Chart.”

**CONSULTING, PROJECT, AND FIELD ENGINEERING**

- ELECTRONICS • COMMUNICATIONS**
- POWER PLANT • REFRIGERATION**
- SPECIAL SYSTEMS**

**"3-D" TRAINING**

- COURSE MATERIAL**
- TRAINING DEVICES**
- INSTRUCTORS**



**WRITING, PROCESSING, AND PUBLISHING  
OF TECHNICAL LITERATURE**

- TECHNICAL MANUALS • INSTRUCTION BOOKS**
- CATALOGING • TECHNICAL REPORTS**
- DESCRIPTIONS OF MANUFACTURE**