

PHILCO

TECHREP DIVISION BULLETIN



SEPTEMBER

1953

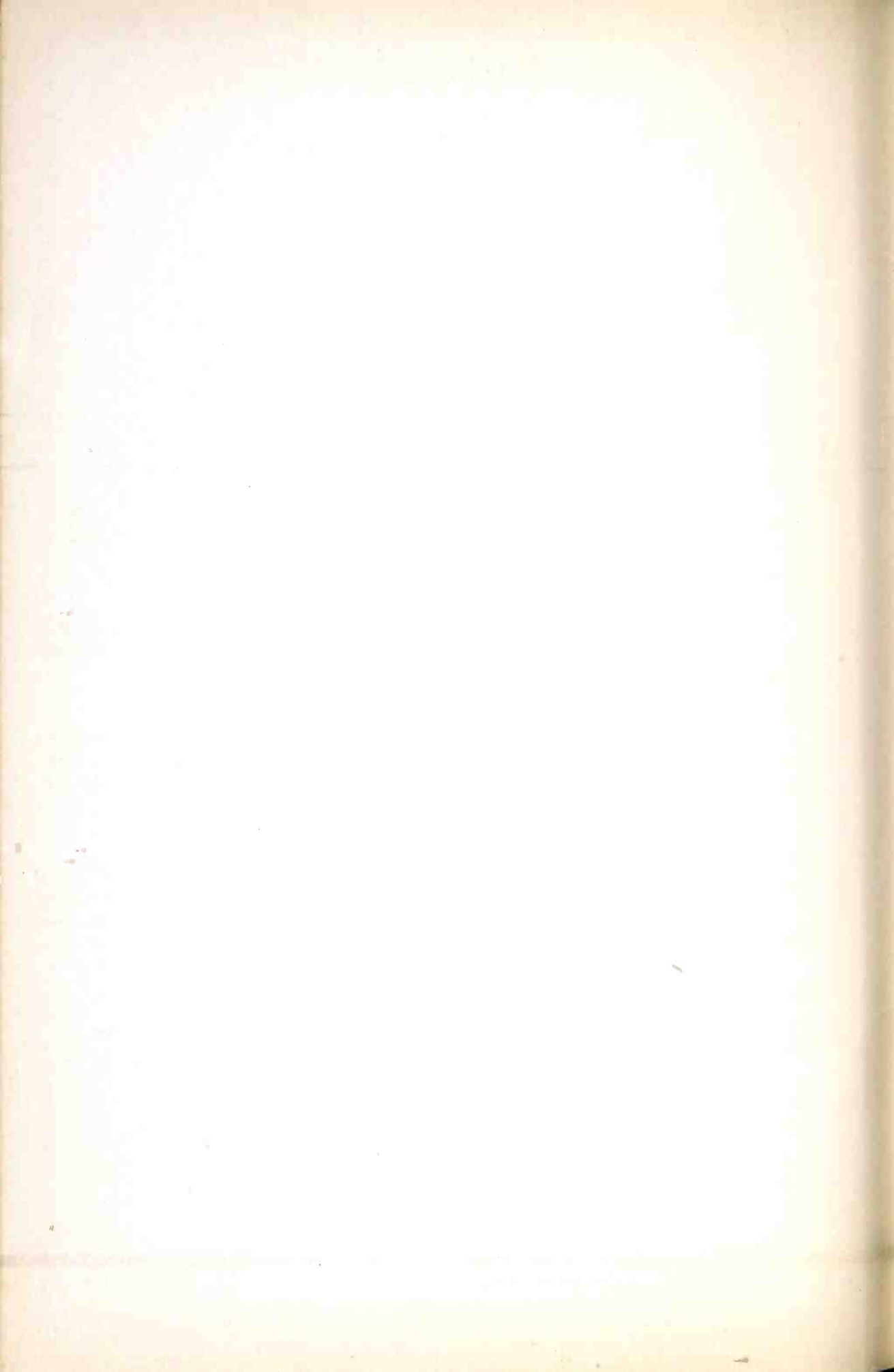

PHILCO

TECHREP DIVISION

BULLETIN

Published monthly by
The TechRep Division of Philco Corporation
Philadelphia, Pennsylvania

Volume III

SEPTEMBER, 1953

Number 9

CONTENTS

Editorial	3
<i>By John E. Remich</i>	
Philco Transportable Microwave Communications System	4
<i>By Charles M. Volkland</i>	
Short Cuts to Crystal Frequency Determination	11
<i>By Robert Clemick</i>	
The Piezoelectric Effect	13
<i>By Gail W. Woodward</i>	
A Regulated Voltage Source	30
What's Your Answer?	32
Cellular Electronic Construction	33
Errata	36
Solution to Last Month's "What's Your Answer?"	Inside Back Cover

Editor
John E. Remich

Managing Editor
Gail W. Woodward

Technical Editors
Francis R. Sherman
John W. Adams

EDITORIAL OFFICE:
Technical Information Section
Philco TechRep Division
22nd St. and Lehigh Avenue
Philadelphia 32, Penna.

If any information contained herein conflicts with a technical order, manual, or other official publication of the U.S. Armed Forces, the information in the official publication should be used. Views expressed in this publication are the opinions of the authors and do not necessarily represent those of Philco Corporation. All technical information and circuits are presented without responsibility as to patent infringement.

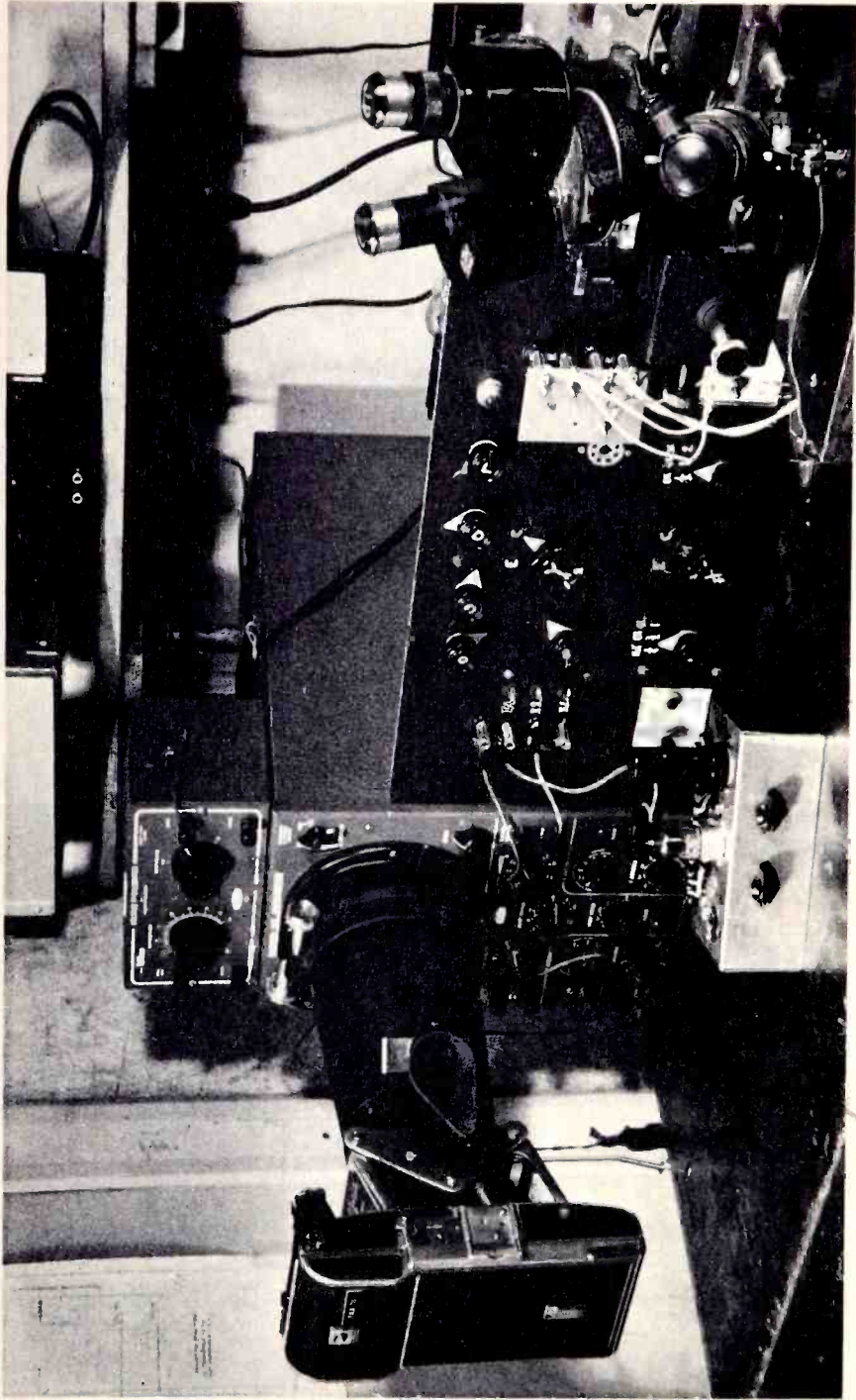

A Typical Laboratory Transistor Test Setup. (This equipment plots families of curves that represent various static transistor parameters. At the right is a micromanipulator for adjusting points and a binocular microscope for three-dimensional viewing. The circuitry needed to produce the test voltages and currents is located in the unit at the center of the photo. This unit provides swept signals so that the oscilloscope at the left can display any voltage or current characteristic as required. The family of curves is produced by a series of sweeps, each one representing an incremental change in some static parameter. The camera attachment is used to obtain a permanent record of oscilloscope patterns. With this equipment, an entire family of curves can be obtained in minutes—an operation that would require hours of careful labor using the point-by-point method of taking data.)

Editorial

TRANSPORTABLE COMMUNICATIONS

By John E. Remich, Manager, Technical Department

The lead article in this issue of the BULLETIN covers a new adaptation of the Philco Microwave Radio Relay equipment. The Transportable version of the CLR-6/CMT-4 combination fills a long-recognized need for a reliable, quickly installed communications system. We feel that an important milestone in the field of communications has been achieved with this equipment.

The equipment not only has obvious advantages from a military standpoint, but also has extremely important civilian applications. Ordinarily, civilian needs do not warrant such highly specialized designs, and the lack of adequate equipment becomes apparent only in times of emergency. In the past, the radio amateur has partly filled this need, and has often been the only source of communications in disaster areas. In fact, many citations of timely assistance are on record. However, these voluntary activities often leave much to be desired.

The channel capacity of the CLR-6/CMT-4 combinations means that one mobile unit could supply sufficient communications for a relatively large area, and would therefore do the work of many ordinary mobile units. Since the units are compact and completely self-contained, facilities could be supplied to practically any area that could be reached by land, sea, or air.

We feel that a great future awaits the mobile phase of civil communications, and that future trends will be directed toward greater and greater mobility of existing equipment.

PHILCO TRANSPORTABLE MICROWAVE COMMUNICATIONS SYSTEM

by Charles M. Volkland

Philco Government and Industrial Division

A self-contained transportable version of the well-known Philco CLR-6.

MILITARY AND CIVILIAN communications men, have long recognized the need for a facility capable of providing dependable and high-quality multichannel communications circuits for the support of tactical, emergency, or disaster operations. To be capable of satisfying the requirements for this type of service, a communications system must be sufficiently transportable to lend itself to speedy installation under adverse field conditions, and should provide a high degree of reliability, security, and channelization flexibility.

The development and military utilization of electronic equipment operating in the microwave frequency spectrum during World War II gave considerable promise of providing a communications medium capable of satisfying the above requirements. The resulting development, during this period, of several military microwave communications systems revealed that such systems incorporated many of the desired characteristics of conventional wire facilities with the additional advantages inherent in wireless transmission. However, the circuit complexities, together with associated operational and maintenance difficulties, were a limiting factor in the utilization of this new medium; consequently, microwave communications systems did not see widespread application during the hostilities.

During the post-war period, Philco continued to devote a large portion of its engineering resources to further research and development of microwave

communications, and, as a result, is now firmly established as the industry's largest supplier of microwave equipment by a considerable margin. This position has been made possible through the development and subsequent mass production of a reliable and trouble-free microwave package, the CLR-6 and associated multiplex equipment, which has been widely accepted by leading industrial, common-carrier, Government, and military agencies throughout the United States. Using unitized construction and JAN components, this equipment has been given military nomenclature of AN/TRC-30, with the further distinction of being accepted by American Telephone and Telegraph Company for common-carrier service.

Recognizing the civilian and military requirement for a transportable communications system, Philco now offers a packaged and completely self-contained microwave communications facility utilizing the CLR-6 Universal Terminal/Repeater as the basic unit. Weighing less than 4-1/2 tons, the packaged unit is transportable over ground by special tie-down to a flat-bed truck, by air in a C-119 cargo plane, or over water, for beach landing, by suitable watercraft. Designed for point-to-point link or radio-relay communications, the unit will function either as a terminal or as a repeater, providing basic voice plus 24 duplex voice channels. If required, 16 teletype channels may be provided in place of one of the voice channels. Drop-out and insertion are provided for each

voice channel on a party-line basis, with either two- or four-wire termination available. Signaling may be accomplished on a ringdown or selective-dial basis.

The CLR-6 microwave equipment operates in the 6000- to 7500-megacycle frequency spectrum, which includes common-carrier, industrial, and Government bands. Numerous advantages are obtained with this choice of frequency. The wave-guide components, parabolic antennas, and passive reflectors have dimensions which permit ease of transportation and installation, and have a rigidity and ruggedness well suited for transportable applications. The high antenna gain and narrow beam width obtained at this frequency make possible an equipment design with excellent operating characteristics, including low noise level, freedom from interference, interception, or jamming, and high propagation reliability. These factors, together with a power output of approximately one watt, a safety factor of

30-db in signal intensity, and the utilization of a stand-by CLR-6 unit, ensure the highest degree of communications reliability for this system.

The use of CMT-5 single-side-band, suppressed-carrier multiplex and CT-3 carrier-teletype units capable of transmitting at speeds of 65 words per minute contributes the greatest possible channelization flexibility.

An over-all view of the complete microwave equipment is shown in figure 1. Equipment items are suitably arranged on shock-mounted relay racks, which are installed along the center of the shelter unit. Primary and stand-by CLR-6 Microwave Terminal/Repeater units are installed side by side at the rear of the shelter, and the desired number of voice and teletype channel assemblies are mounted on the remaining four relay racks. The antenna system includes a 102-ft. aluminum-alloy sectional tower upon which is mounted two 4-ft. x 5-ft., 9-in. passive reflectors, as shown in figure 2, and two 4-ft. para-

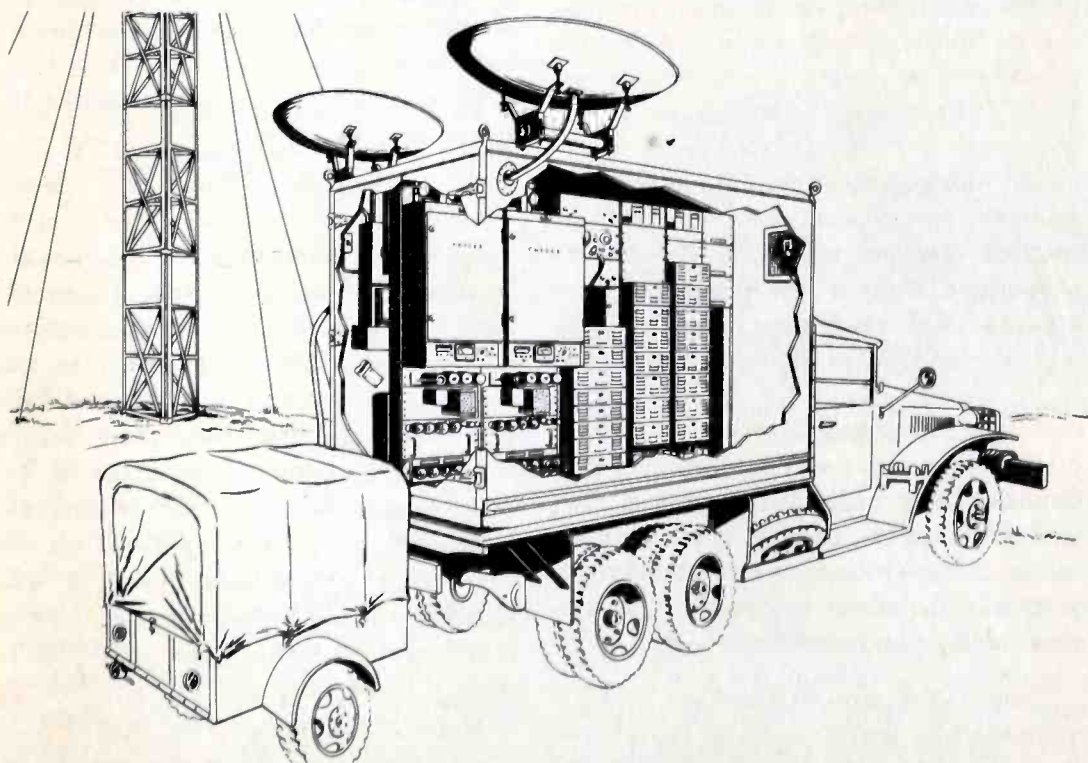

Figure 1. Cutaway View of Philco Transportable Microwave Relay Communications Center, Showing Equipment in Position

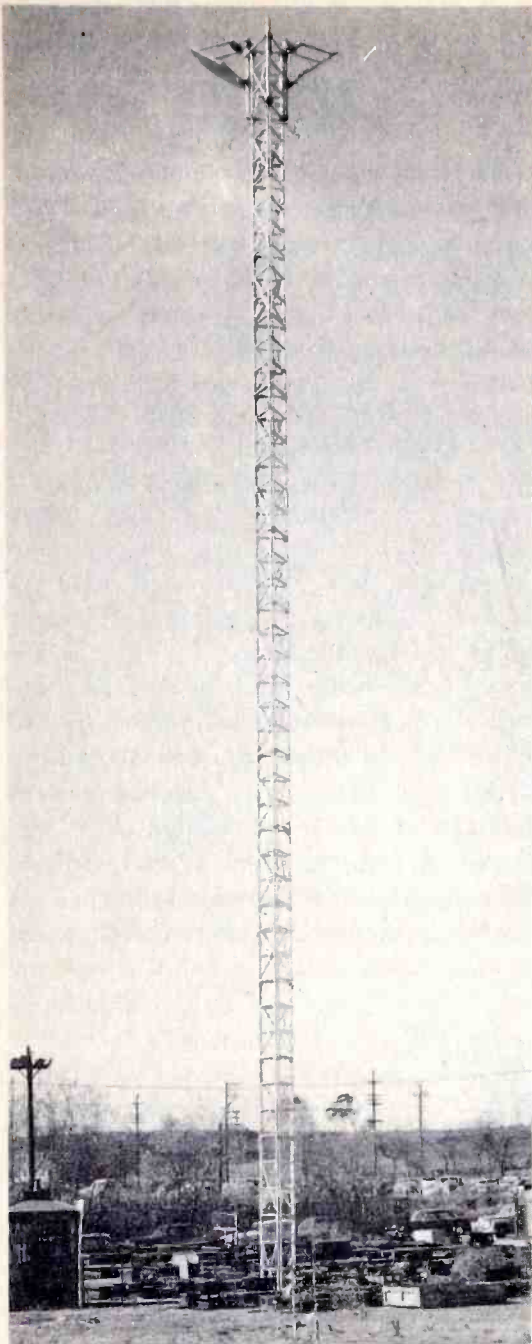

Figure 2. Assembled Tower Ready For Operation

bolic antennas which are mounted on brackets installed on the roof of the shelter, as shown in figure 3. Additional accessories include test equipment, spare tubes, and miscellaneous articles. All components, including the tower, are stored in the shelter during transit. A PE-95, 10-kw. power unit (shown in the foregoing illustrations) is recommended for use as a power source.

DESCRIPTION OF BASIC COMPONENTS

Figure 4 shows the equipment lineup as viewed from the right-rear of the shelter, and figure 5 shows a left-rear view—the primary and stand-by CLR-6 units are in the foreground, and the multiplex equipments are located in adjacent racks.

CLR-6 Microwave Radio Relay

The CLR-6, which is the basic unit and the heart of the transportable package, contains all r-f, i-f, and wide-band amplifier components with associated power supplies, test monitor panel, and control equipment. Capable of operation in the common-carrier band (5925—6425 mc.), the industrial band (6575—6875 mc.), or the Government band (7125—7425 mc.), the CLR-6 employs a unique locked-oscillator, feed-back principle of operation requiring only a single, long-life klystron for both receiving and transmitting in one direction. By means of the feed-back circuit, the klystron tracks the incoming frequency-modulated signal. As a result, the output signal is always a true and undistorted replica of the incoming signal and excellent signal quality is obtained, even over long relay systems.

Using the associated 4-ft. parabolic antenna, the CLR-6 with a standard power output of 1 watt has an effective power gain of 36 db, resulting in an effective radiated power output of 4 kw. The 6000—7500-mc. band and the 1 watt of transmitter power combine to produce an extremely high degree of propagation reliability. The CLR-6 is conservatively rated to provide a fading margin of 30 db with a receiver threshold of -105 dbw, and a minimum signal-to-noise ratio at the i-f output of 15 db. This margin of safety ensures excellent communications, even during brief periods when the strength of the received signal may fall to one-thou-

sandth of its normal value. The Philco CLR-6 Microwave Radio Relay equipment has been designed to incorporate advanced techniques and facilities for reducing maintenance cost and servicing time. Reliability is enhanced through the use of custom-designed test equipment (for example, the unit at the center of the photo in figure 6 is the Philco Microwave Test Set); built-in metering facilities, which allow for testing without the need for external instruments; conveniently located test points; plug-in and unitized assemblies; and pretuned klystrons, filters, and amplifier circuits. Equipment cabinets are designed to permit easy access for maintenance, and the repeater chassis are interchangeable and easily replaced. All tubes and components meet JAN specifications, where applicable, and are operated well below their maximum ratings to ensure long life.

CMT-5 Frequency-Division Multiplex

The CMT-5 uses frequency-division multiplexing to provide up to 24 duplex

voice channels plus a service channel complete with two-wire termination and facilities for dial and ringdown signaling. (Figure 7, which is a complete block diagram of the microwave relay system, illustrates the multiplexing functions.) This carrier-telephone system consists of the basic voice-band channel and up to three groups of eight carrier channels employing suppressed-carrier, single-sideband transmission. Alternate channels use the upper and lower sidebands, and the transmitted signals of the highest carrier channel of each group do not exceed a maximum frequency of 47 kc. The second and third groups of eight carrier channels are obtained by the use of group modulators and demodulators.

The voice-channel frequency response of the carrier channels is from 300 to 2700 cycles within +1 db and -3 db relative to the attenuation at 1000 cycles. At 50 and 3500 cycles the channels have an attenuation of at least 40 db. Signaling is accomplished on tone frequencies outside of the voice

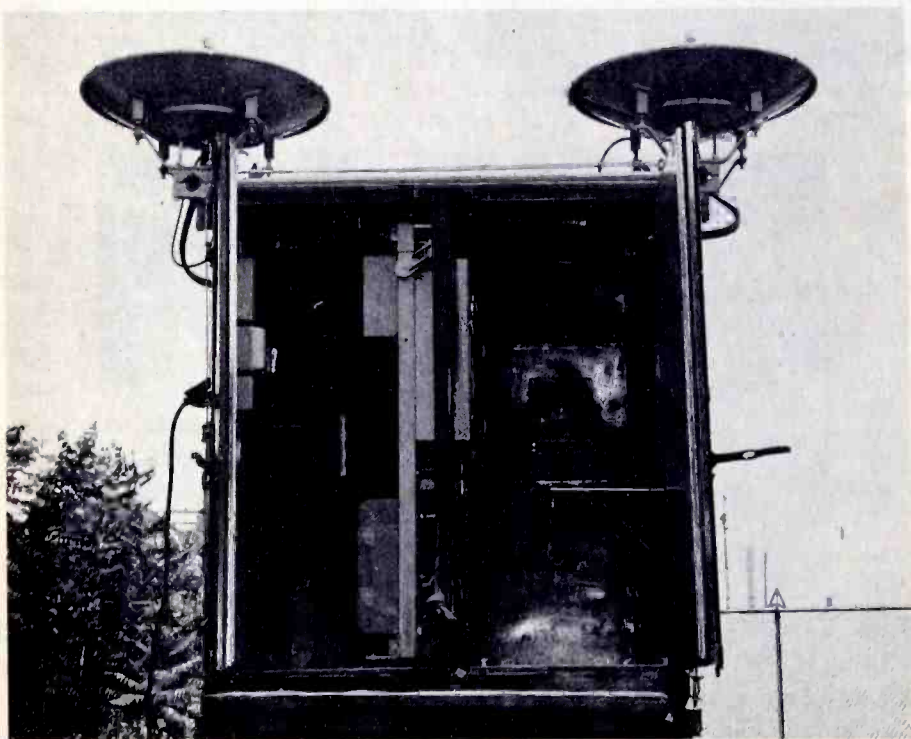

Figure 3. Rear View of Truck, Showing Microwave Dishes Mounted in Operating Position

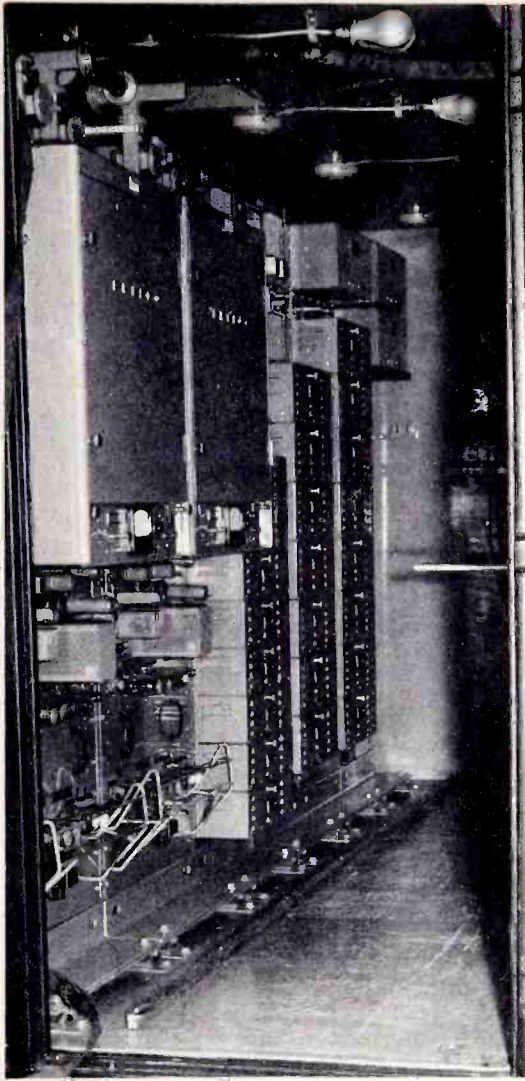

Figure 4. Right Rear View of Equipment Located in the Truck

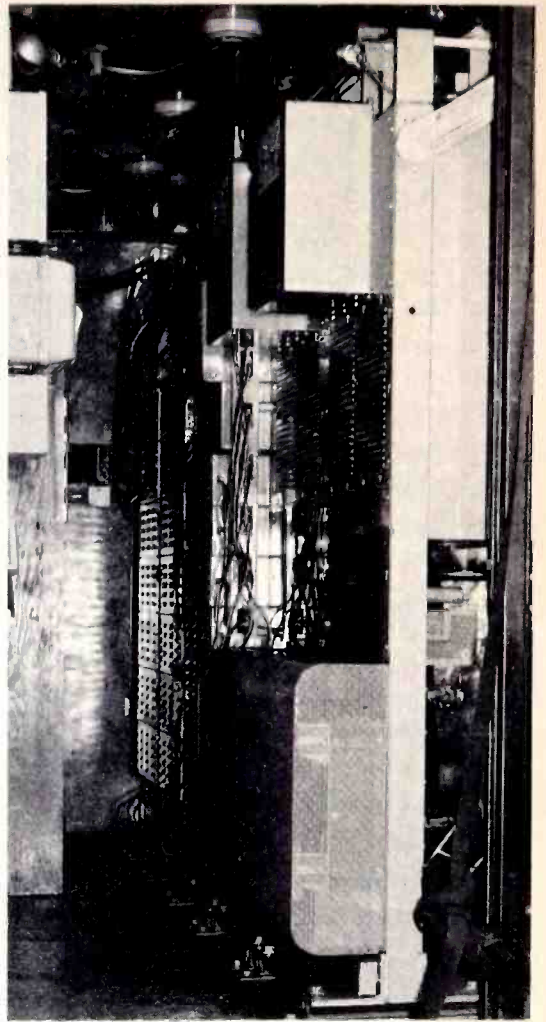

Figure 5. Left Rear View of Equipment Located in the Truck

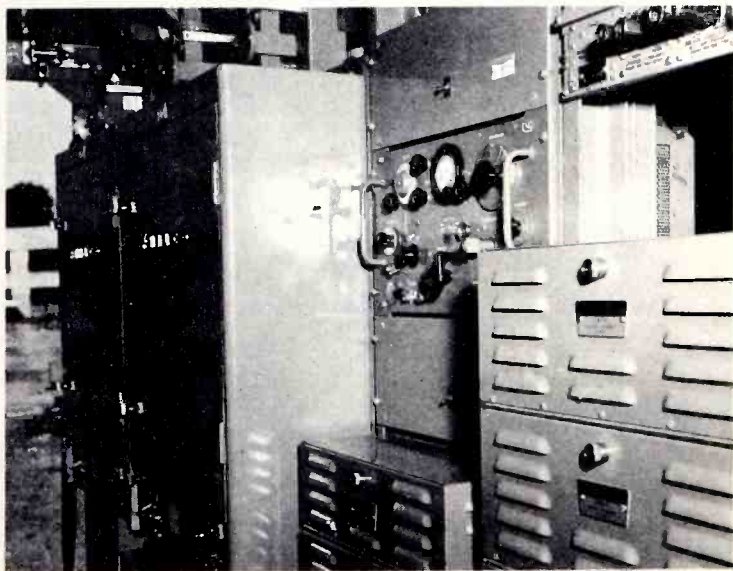

Figure 6. View of Equipment in the Truck, Looking Toward the Rear

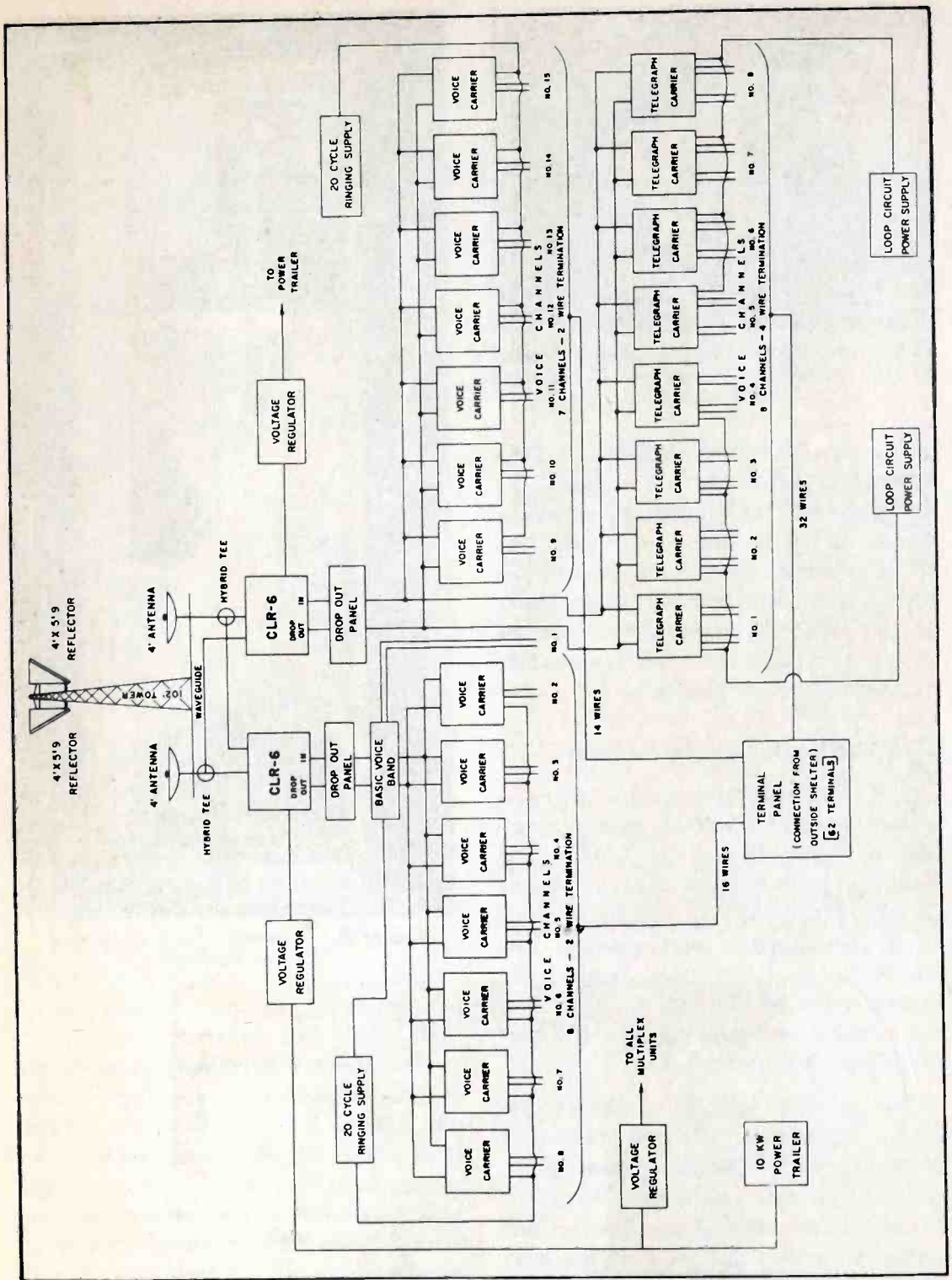

Figure 7. Block Diagram of Transportable Microwave Relay

channels, located in the CLR-6 spectrum between frequency-multiplexed carrier channels.

Either two-wire or four-wire termination is obtained by means of changes in

external strap connections. A common oscillator is used in each CMT-5 carrier terminal for both the modulator and demodulator circuits. In this way a complete duplex carrier terminal is provided and both circuits are locked together in

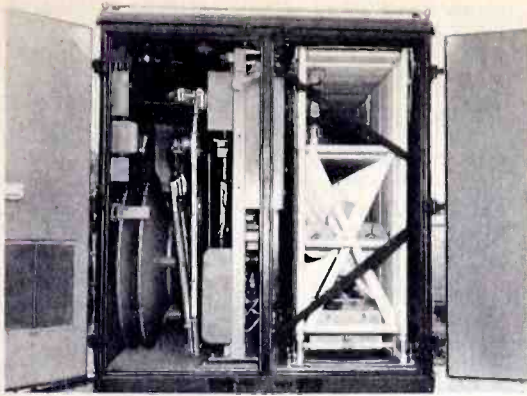

Figure 8. Rear View of Fully Packed Truck, Showing Storage of Equipment for Transport

frequency. Maximum operational flexibility and reliability are achieved by incorporating an independent power supply in each basic voice-band and carrier channel and in each group modulator and demodulator. Components are conveniently mounted, so that the wiring and parts are readily accessible for inspection and service.

CT-3 Carrier-Telegraph Multiplex

The CT-3 is composed of a telegraph transmitter and telegraph receiver, similar in construction to the CMT-5. The telegraph transmitter sends tone signals in accordance with d-c signals received from the teletype loop circuits. The transmitter and associated receiver are designed for on-off AM signaling and are capable of supplying 65-words-per-minute printer channels.

The receiver includes a filter which selects signals of only one frequency from the group of signals present on the common circuit. The selected signal is amplified and rectified, and the rectified output is used to operate a keying relay in accordance with the signal keying. Test jacks are provided for checking the operation of the telegraph units, and components are conveniently mounted to provide ready access for inspection and service.

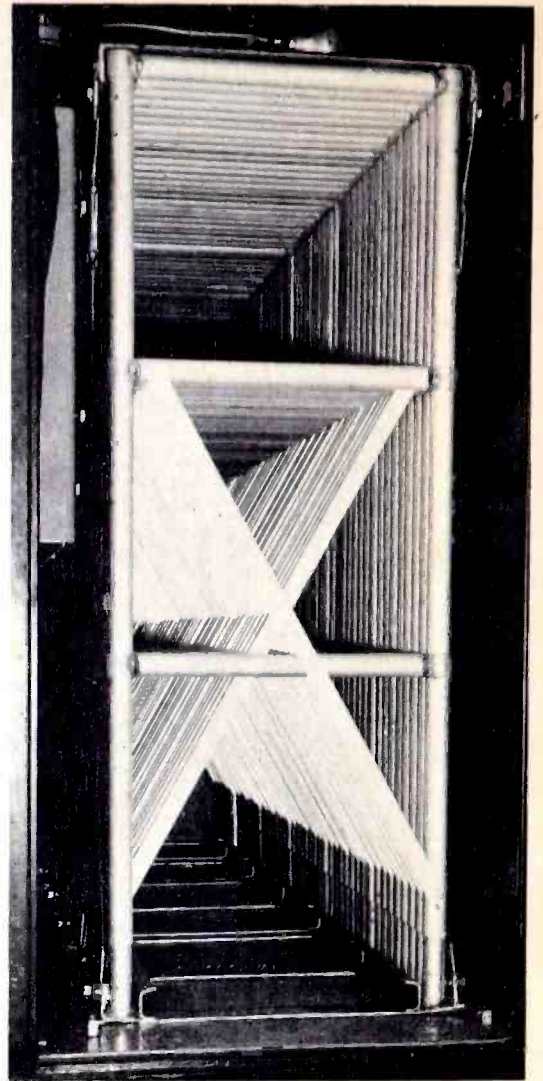

Figure 9. Close-up View of Stored Tower Sections

Tower

The 102-ft. guyed tower is provided in 6-ft. sections, each consisting of three 6-ft. x 29-in. ladder sections constructed from 2-in. diameter, heat-treated aluminum alloy. The 6-ft. sections join together by means of swivel couplers to form 6-ft. tower sections of triangular cross section.

During transit, the complete antenna system is disassembled and stored in the shelter. Refer to figure 8. Figure 9 shows a close-up of the stored tower sections.

SHORT CUTS TO CRYSTAL FREQUENCY DETERMINATION

By Robert Clemick

Headquarters Technical Staff

SOME DIFFICULTY has been encountered in the field in determining the correct fundamental crystal frequencies to be used in different types of equipments. In some cases, personnel have requested crystals which could not be used for the purpose intended because the calculations were incorrect.

The correct procedure for determining the crystal frequencies for various equipments may be found in the appropriate technical manuals or instruction books. However, the following general examples may help to acquaint the field engineer with the procedures used to obtain the correct crystal frequency for a few of the equipments used by AACS. The methods described may be adapted to other equipments of conventional design.

VHF TRANSMITTERS

The crystal frequency for a VHF transmitter may be determined by merely dividing the assigned frequency by the number of times the crystal frequency is multiplied in the transmitter. For example, in the BC-640 VHF transmitter, and in the BC-625 (transmitter of the SCR-522 or SCR-624 VHF equipment), the crystal frequency is multiplied 18 times. Therefore, the crystal frequency is equal to the assigned frequency divided by 18. Should operation on 125 mc. be desired, the crystal frequency can be found by simply dividing 125 mc. by 18.

$$\begin{aligned} F_{\text{xtal}} &= \frac{125 \text{ mc.}}{18} \\ &= 6.9444 \text{ mc. or } 6944.4 \text{ kc.} \end{aligned}$$

The crystal frequencies for operation

between 100 mc. and 156 mc. are 5555.5 kc. and 8666.6 kc., respectively. Consequently, any crystals to be used with either the BC-640 or the BC-625 must be ground to a frequency within these limits.

VHF RECEIVERS

When calculating the correct crystal frequency for a VHF receiver, it is necessary to consider the receiver intermediate frequency, since the high-frequency oscillator operates at a frequency higher or lower than the channel frequency, depending upon the specific design of the unit. First, subtract the intermediate frequency from the channel frequency (if the oscillator frequency is lower than the channel frequency), and divide the result by the frequency-multiplication factor. If the oscillator frequency is higher than the channel frequency, add the intermediate frequency to the channel frequency before dividing by the frequency-multiplication factor. In the case of the BC-624 (receiver of the SCR-522 and SCR-624), the intermediate frequency is 12 mc., the oscillator frequency is lower than the channel frequency, and the crystal frequency is multiplied 11 times. If the receiver is to operate on 125 mc., then, from the above:

$$F_{\text{xtal}} = \frac{125 \text{ mc.} - 12 \text{ mc.}}{11} = 10272.7 \text{ kc.}$$

Since the BC-624 receiver has a frequency range of 100 mc. to 156 mc., application of the formula above will show that crystal frequencies for this receiver will lie between 8000 kc. and 13090.9 kc.

In the AN/FRR-3 receiving equipment, the oscillator frequency is higher than the received frequency. Since the intermediate frequency is 465 kc., the oscillator frequency must be equal to the channel frequency plus 465 kc. The crystal frequency is equal to the oscillator frequency divided by the number of times the crystal frequency is multiplied in the equipment. The formula is:

$$\text{crystal frequency (kc.)} = \frac{\text{channel frequency (kc.)} + 465}{\text{harmonic (multiplier)}}$$

The following table indicates the crystal harmonics to be used on the different bands of the receiver:

TABLE I

BAND	FREQ. RANGE (mc.)	CRYSTAL FREQ. (mc.)	HARMONIC USED
1	2.4 to 4.2	1.4 to 2.3	2nd
2	4.2 to 6.9	2.3 to 3.7	2nd
3	6.9 to 11.2	2.4 to 3.9	3rd
4	11.2 to 17.5	2.3 to 3.6	5th
5	17.5 to 23.0	2.2 to 3.4	7th
5 (alt)	17.5 to 26.0	2.5 to 3.8	7th

If it is desired to operate on 12.2 mc., Band 4 must be used. The high frequency oscillator (h.f.o.) frequency will be the fifth harmonic of the crystal frequency:

$$F_{\text{hfo}} = 12.2 \text{ mc.} + 465 \text{ kc.} = 12.665 \text{ mc.}; \text{ therefore,}$$

$$F_{\text{xtal}} = \frac{12.665}{5} = 2.533 \text{ mc.}$$

To operate on 4.8 mc. (Band 2), the second harmonic of the crystal must be used. Thus,

$$F_{\text{xtal}} = \frac{4.8 + .465}{2} = 2.6325 \text{ mc.}$$

H-F RADIO TELETYPE EXCITERS

In the O-5/FR Exciter Unit, the crystal output and the output of a 200-kc.

variable, low-frequency oscillator are added together in a mixer stage to produce r-f excitation for the transmitter. The output of the exciter is confined to a 2000—6000-kc. range. It is necessary to multiply this frequency in the transmitter when operation at higher frequencies is desired.

The assigned frequency of a radio teletype circuit is the mean of the mark and space frequencies. The transmitter mark frequency is 425 cycles higher than the assigned frequency, while the transmitter space frequency is 425 cycles lower than the assigned frequency. The crystal frequency is based upon the mark frequency, and all frequency adjustments of the unit are made initially on the mark frequency. The crystal frequency is 200 kc. lower than the output frequency of the exciter unit. If operation in the 2000—6000-kc. range is desired, first add 425 cycles to the assigned frequency, and then subtract 200 kc. to obtain the crystal frequency. For operation on 4550 kc.,

$$F_{\text{xtal}} = 4550 \text{ kc.} + 425 \text{ c.p.s.} = 4550.425 - 200 \text{ kc.} = 4350.425 \text{ kc.}$$

Should operation at a higher frequency be desired, it is first necessary to determine how many times the exciter output frequency must be multiplied in the transmitter to obtain the desired assigned frequency at the output of the transmitter. The exciter output is usually multiplied two, four, or eight times. When the multiplier is determined, the crystal frequency is obtained by dividing the channel frequency plus 425 cycles by the multiplier, and then subtracting 200 kc. For example, if operation on 13007 kc. is desired:

$$F_{\text{xtal}} = \frac{13007 \text{ kc.} + 425 \text{ c.p.s.}}{4} = 3251.856 \text{ kc.} - 200 \text{ kc.} = 3051.856 \text{ kc.}$$

THE PIEZOELECTRIC EFFECT

Part I of Two Parts

by Gail W. Woodward
Technical Headquarters Staff

A general discussion of the theory of piezoelectric materials and their application to modern electronic devices.

THE PIEZOELECTRIC EFFECT was first noticed long before science achieved any degree of repute. The story is told how, in the 1700's, traders used to sit around their campfires mystifying their contemporaries with the strange behavior of tourmaline crystals, then

known as the "Ceylon Magnet". Tourmaline, when heated, displayed the amusing, and then inconceivable, property of attracting bits of dry ash toward certain portions of the crystal. As soon as one of the particles of ash touched the crystal it quickly jumped

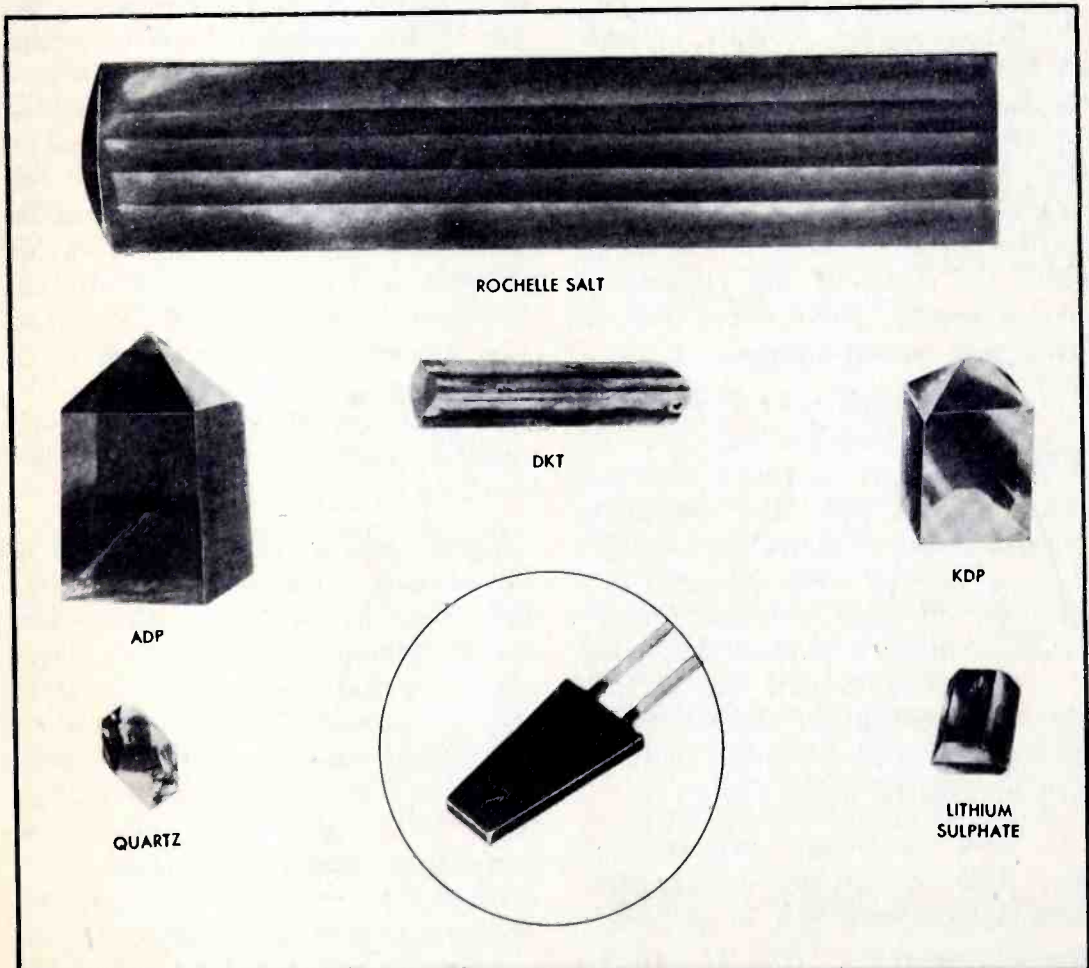

This photograph shows a few of the many possible crystal formations. With the exception of quartz, these crystals were grown by artificial means. Such crystals grow to full size (up to 24 inches) in from three weeks to three months. The unit in the circle is a typical Bimorph element such as are found in modern phonograph pickups. Photo courtesy Brush Electronics Company.

away and would then be repelled when approached by the same portion of the crystal; yet, other portions of the crystal would again attract the same ash until actual contact was made, whereupon the strange repulsion again occurred.

This effect was considered merely an odd bit of magic until late in the 19th century, when scientists became interested in the nature of crystal-electrical phenomena. It was observed that the heated crystal displayed an electrostatic potential that behaved exactly as did static electricity generated by any of the available methods. In fact, a Leyden jar could be charged with nothing more than a hot crystal. The effect was promptly named the *pyroelectric effect*, for obvious reasons. Actually, however, the pyroelectric effect is relatively insignificant, and generates very little of the electrostatic potential. The major effect of the heat is to cause thermal expansion of the crystal. The resulting mechanical displacement produces electricity by virtue of the piezoelectric effect. The term "piezo" comes from the Greek, and means *to press*.

In 1880, Jacques and Pierre Curie made the first measurements as to the effects of pressure on piezoelectric materials; and, in 1881, they showed the converse nature of piezoelectricity; i.e., the same crystals when subjected to a potential difference undergo a corresponding change in physical dimension. It is interesting to note that in their original investigations the Curies developed the X-cut crystal, which is often referred to as the Curie cut.

In 1894, quantitative measurements were made on various characteristics. These measurements were remarkable in

* The Kerr effect is the change in polarization of a light beam produced by a crystal under electrostatic stress. This effect has been used in the construction of a light valve that converts changes in voltage to changes in light transmission.

that modern experimental technique has shown them to be accurate within a few percent. At that time another interesting effect, now called the Kerr effect*, was also observed and described.

After the preliminary investigations, little activity was directed toward the study of piezoelectricity until the submarine menace of World War I created an urgent need for underwater detection devices. In 1917, P. Langevin found it possible to use quartz as an electro-mechanical transducer. He applied for a U. S. patent on his device in 1920, and was no doubt overjoyed when the patent was granted in 1941. Langevin might appropriately be called the Father of Ultrasonics. During this same period, W. G. Cady produced the first quartz resonator used to control the frequency of an oscillator. He is credited with the first quartz-crystal-controlled oscillator, even though Langevin described the mechanical resonance property of quartz and noted the undesirable effects it produced in his transducers. Rochelle salt was also under extensive study by A. M. Nicholson, who produced a number of successful applications of piezoelectricity to the field of communications, and who is credited with the first crystal-controlled oscillator.

Again came a lull in the activity of investigators in piezoelectric phenomena until early in the 1930's, when widespread interest began to bring piezoelectric crystals** out of the laboratory into commercial use. From that time, interest has mounted until at the present time very extensive use is being made of the piezoelectric effect. Uses vary from devices for measuring the force of the blow required to kill a rat to very precise mechanisms for the

**Piezoelectric crystals are sometimes called Seignette electrics, after Pierre de la Seignette (an apothecary of La Rochelle, France) who, in 1672 first isolated Rochelle salt for medicinal use.

measurement of time. Quartz crystals that have damping factors considerably better than those of the best gravity pendulums can now be made.

NATURE OF PIEZOELECTRICITY

Piezoelectricity is a very distinct property not to be confused with electrostriction, pyroelectricity, or other electro-mechanical phenomena. For example, the piezoelectric potential is directly proportional to the mechanical stimulus producing it, and displays a converse nature, i.e., an electrical stimulus will result in a corresponding mechanical deformation. Electrostriction is the dielectric mechanical deformation that accompanies the charging of a capacitor. Here the mechanical stimulus is proportional to the square of the voltage. Furthermore, in electrostriction the converse effect is not present, i.e., deformation of the dielectric will not generate a voltage. As is the case with the pyroelectric effect, electrostriction may be present in a piezoelectric material, but usually to a much less degree, particularly at lower voltages.

Electrostriction is responsible for the action of a capacitor, and is related by a basic law as follows: *In an electric field, a dielectric material tends to assume a configuration that will minimize the energy of the system.* This action shows why a capacitor will discharge and why energy is required to charge it. The law is remarkably similar to the one describing the behavior of a magnetic field (this law states that the magnetic lines of force tend to assume the shortest possible length).

The ability of a crystal to generate piezoelectricity is due to the presence of electrostatic atomic dipoles within the crystal. (These dipoles are the electrostatic equivalent of magnetic dipoles in a piece of iron.) When a crystal grows, it displays a very remarkable

ability to grow in a precise manner—an ability which is ordinarily called “habit”. While the habit can be modified by environment, it is always the same for a given set of conditions. Piezoelectric crystals tend to grow in an unsymmetrical manner, and the result is a predominance of atomic dipoles aligned in a certain direction. A crystal in equilibrium displays no net charge because surface charges accumulate to balance the system. However, if the crystal is strained (mechanically), the internal charge is either condensed or rarified so that balance no longer exists. Of course, if a crystal is left undisturbed in a strained condition, surface leakage will eventually restore balance. If the crystal structure were symmetrical, there would be a balance of the dipoles and no net alignment would occur. This is the case with most metallic crystals, which display very little, if any, piezoelectric activity.* Polycrystalline substances also do not show any appreciable piezoelectric activity, because the random arrangement of crystals in such substances results in cancellation (no net electrostatic alignment).

The piezoelectric action can be described, with the aid of figure 1. In this figure the internal charges are shown by means of polarized dipoles. It is assumed that the charges are captive, or tightly held in the crystal structure. The surface charges, which are limited in motion by the high leakage resistance of the crystal, accumulate as shown. For this condition, since none of the charges are readily mobile, the crystal would show zero potential difference so far as any external measurements are concerned. If the crystal is

* This is a very fortunate circumstance, particularly in the case of semiconductor crystals used in diodes and transistors. If selenium and germanium displayed any piezoelectric activity, crystal diodes and transistors would show pronounced microphonic tendencies, the absence of which are quite desirable.

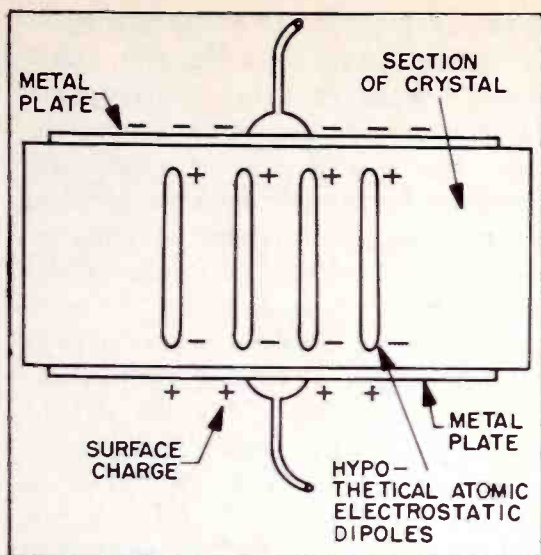

Figure 1. Cross-Section View of Piezoelectric Crystal, Showing Dipole Alignment (Dipoles Greatly Exaggerated)

strained, however, so that the internal charges are condensed, the internal electrostatic field strength will increase, thereby causing an unbalanced condition in which the internal dipoles predominate. This makes the top of the crystal positive with respect to the bottom.

The resultant potential persists until such time as leakage permits the surface charge to balance the internal voltage again. As soon as the strain is released, the crystal will spring back to its original shape and the internal charge will assume its former magnitude, thus leaving a predominant surface charge (negative at the top with respect to the bottom). This charge will then leak off until balance is again restored.

The time required for restoration of balance to occur is of interest. Suppose that a leakage of 100 megohms exists across a crystal which has a capacitance of 1000 μmf . A one-volt charge would restore to 0.37 volt in 0.1 second, and virtually complete restoration would occur in 0.5 second.

Figure 1 also shows why an applied potential will deform the crystal. If the top and bottom of the crystal are provided with metallic plates which are

connected to a voltage source, the dipoles will either be stretched or compressed, depending upon the polarity of the applied voltage. For example, if the top of the crystal were made negative with respect to the bottom, the crystal would elongate vertically because of electrostatic attraction, and, if the polarity were reversed, the crystal would contract.

While the action of electrostatic charges shows how piezoelectricity can occur, a more detailed model is required to achieve any real accuracy. The model proposed by Lord Kelvin is more accurate and, although the validity of its structure has not been upheld by X-ray analysis, it has been very valuable in analyzing qualitatively the behavior of certain crystals. The model serves well to illustrate piezoelectric action, provided that the analysis is not carried too far.

Figure 2 shows a simplified version of the Kelvin model. The atomic dipoles are considered to occupy a hexagonal structure, as shown by the three crossed dipoles. These dipoles are assumed to be rigidly held in the molecular structure, and those in adjacent molecules maintain an identical orientation (it must be remembered that the figure shows only one structure—actually, a great many would be contained in a single crystal). The hexagonal structure is suggested by the general shape of a single quartz crystal.

When the dipoles are subjected to an electrostatic field, they try to align themselves with that field, and, since they are bound into the crystal, the crystal itself is distorted as a result. Part A of figure 2 shows this action. For the conditions shown, dipole *a* will not rotate because it is already in alignment with the applied field, but dipoles *b* and *c* will try to rotate, as shown by the solid arrows. This rotational force will result in a divergence between dipoles *b* and *c*, and the crystal will

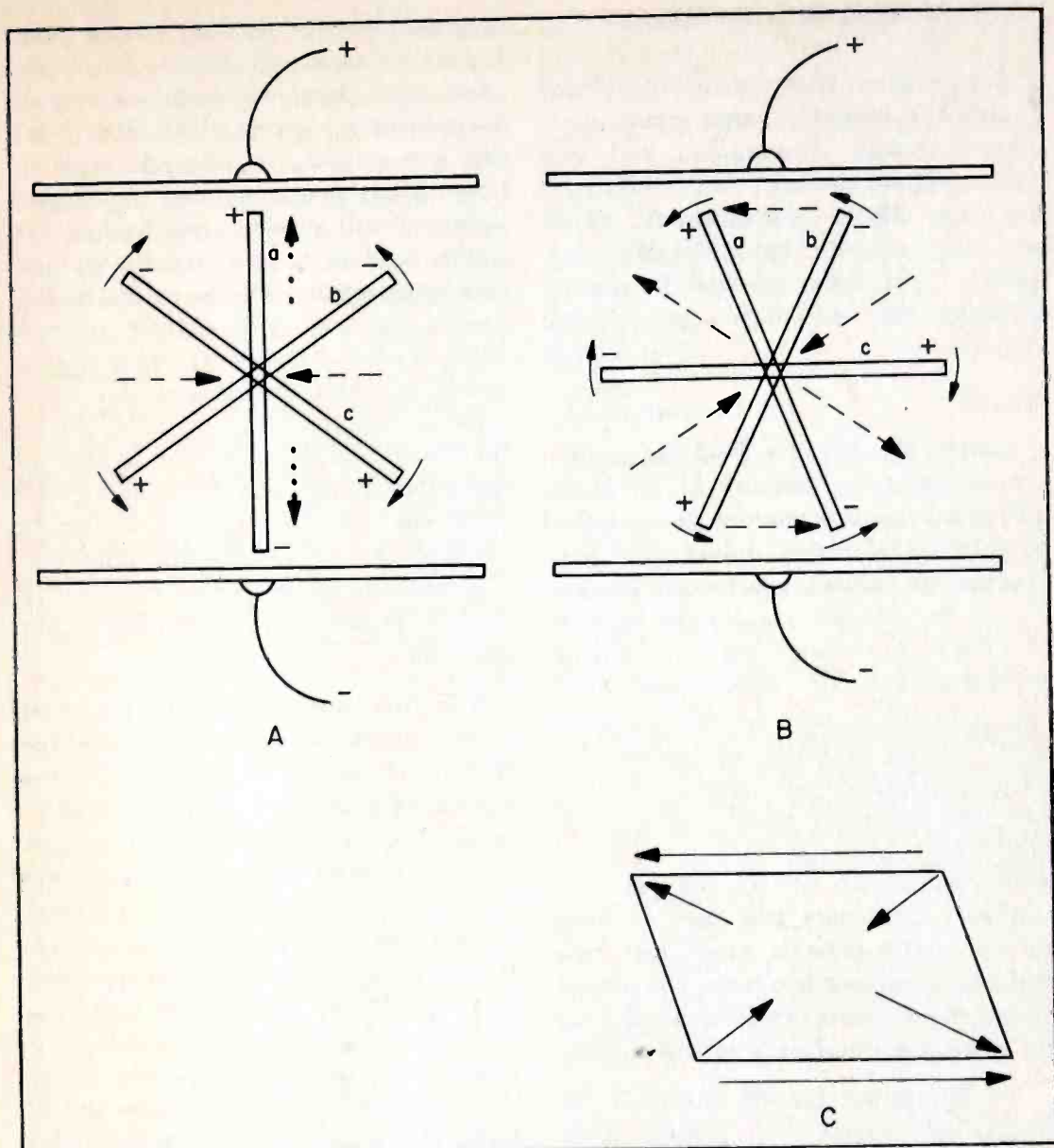

Figure 2. Cross-Section View of Piezoelectric Crystal, Showing Production of Shearing Deformation

tend to shrink, as shown by the dashed arrows. The vertical components of dipole rotation will result in a thickening of the crystal, as shown by the dotted arrows.

Part B of figure 2 shows a similar structure that has been rotated 60 degrees (corresponding to a different crystal cut). In this case, all of the dipoles are subjected to a rotating force, as shown by the solid arrows. The dashed arrows indicate the direction of the distortion that will result from the applied

voltage. The resulting deformation of the crystal is shown in part C of figure 2. This is known as a shearing deformation, because the top of the crystal moves in one direction and the bottom moves in the other. It can be seen that all vertical vector components cancel; therefore, no net change in thickness will occur.

The model used in figure 2 can also be used to show how mechanical strain will generate a voltage by displacing the dipoles. In this analysis, the approach used above is merely reversed.

PIEZOELECTRIC MATERIALS

A great many materials exhibit piezoelectric properties — some more than others. Quartz, Tourmaline, and Rochelle salt are the best known of these, but many salts, as well as certain waxes and ceramics (after being suitably processed), have been revealed by recent investigations to have pronounced activity.

Quartz

Quartz has led the field in oscillatory applications because of its desirable mechanical properties and relative abundance. Of course, only a small percentage of natural quartz can be employed in piezoelectric devices because of a great many flaws that occur during natural growth. To obtain perfect crystals, it would be very desirable to grow quartz under carefully controlled conditions, but artificial crystals grown to date are extremely small (only a few millimeters long), and they require a very long growth period. Natural crystals vary from very tiny ones to huge smoky quartz crystals seven feet long and weighing over five tons. The largest known clear quartz crystal is about four feet long and weighs about 100 pounds.

An interesting use of quartz is the crystal ball employed by certain spiritualists. Such balls are highly prized because the refractive index varies with aspect and therefore produces rather weird optical effects (however, these effects are evidently not those advertised by the owners). One of the largest crystal balls, a sphere over a foot in diameter, is located at the Smithsonian Institution*.

Quartz is very hard (about 7 on the Moh scale) and tends to shatter if stressed excessively. Cutting and grinding once imposed a problem that now

* The value of this ball is largely aesthetic — it is a scientific curiosity of great optical beauty.

appears to be well on the way to a satisfactory solution. Diamond saws lubricated with kerosene have been used extensively in cutting slabs from crystals, and grinding is done with conventional abrasives. A number of alkaline solutions will dissolve quartz, but hydrofluoric acid is preferred for etching processes because it is much faster. Recently, the use of a sharply focused beam of ultrasonic energy has been suggested as a cutting medium. The sound wave impinging on the quartz slab to be cut would pulverize a thin section of the material, and would produce a very clean cut, free of foreign particles—a condition not obtainable with other cutting methods. Sound waves can also be used to remove foreign particles after grinding.

The first step in the processing of natural quartz is the examination of the crystals for flaws and the marking for discard of portions that cannot be used. Visual inspection will often disclose the presence of internal flaws, but more precise methods are ordinarily employed. In one method a polarized light beam is passed through the crystal, and any flaws are immediately made visible in the form of shadows. This method is considerably improved by submerging the crystal in a tank of transparent liquid that has the same refractive index as quartz, to eliminate reflections from the crystal surface. Since pure quartz is invisible in such a medium, the flaws stand out with remarkable clarity.

After the usable quartz is selected, the orientation of the crystal axes is determined by the use of X-ray or optical diffraction. The diffraction characteristic of a quartz crystal varies with angular position, and thus provides a means of accurately determining the orientation of the axes, even in a small, irregular fragment of a crystal. Figure 3 shows the axial designations on a typical crystal. The long axis is called the Z axis, and is perpendicular to the

other axes. The X axes are represented by lines drawn through the edges made by intersecting faces so that they cross the Z axis. The Y axes are represented by lines drawn perpendicular to the faces and they also cross the Z axis. Obviously, there are more than one each of the X and Y axes. The X axis is sometimes called the electrical axis; the Y axis, the mechanical axis; and the Z axis, the optical axis.

After the orientation of the crystal axes is determined, small sections, or slabs, are sawed from the crystal, many usable slabs being obtained from a single crystal. Actually, the so-called commercial crystal is but a small section of a single crystal. The rough slab is then ground to precision tolerances, cleaned, and mounted in a suitable holder.

The crystal slabs are designated

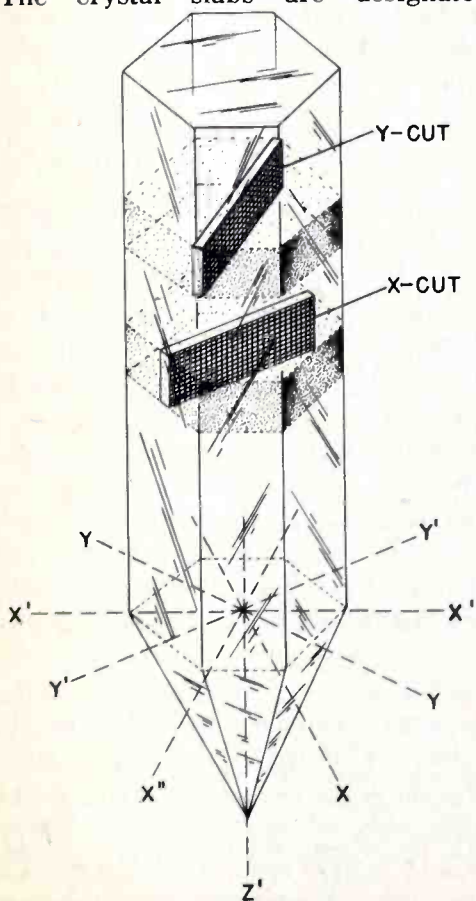

Figure 3. Simplified Drawing of Quartz Crystal, Showing Axes and Basic Crystal Cuts

according to their angle of cut with respect to the axes. The X (Curie) and Y cuts are shown in figure 3. There are a great many possible cuts, and several systems of notation for odd cuts have been developed. However, it is not within the scope of this article to cover these aspects of the subject. If specific information on such details is desired, refer to items 1, 3, and 4 listed in the Bibliography.

Tourmaline

Tourmaline has properties similar to those of quartz, but is somewhat less active piezoelectrically. Because of the greater abundance of natural quartz, tourmaline is not economically suitable and is seldom used.

Rochelle Salt

Rochelle salt (sodium potassium tartrate), one of the many piezoelectric salts, is probably the most well known and widely used of such substances. Its ease of growth and extremely high piezoelectric activity (about 1000 times that of quartz) are the main reasons for its continued use. The main disadvantages of Rochelle salt are that the piezoelectric activity falls off rapidly above 45°C ., and that the crystal structure disintegrates above about 56°C .. Furthermore, since they contain (and are soluble in) water, Rochelle salt crystals must be provided with a moisture-resistant coating if exposure to ordinary atmospheric conditions is required.

Commercial Rochelle salt crystals are grown from solution in relatively large quantities. Many methods for artificial growth have been developed, but the most successful use a supersaturated salt solution. Small fragments of single crystals, called "seeds," are placed in a groove at the bottom of a rocking tank. The tank is then provided with a continuous flow of concentrated salt solution, and it is rocked to agitate the solution so that a uniform concentration

is obtained. The initial temperature of the solution is just above that of saturation, and a slow, carefully controlled cooling schedule is followed. As the cooling progresses, the solution reaches a supersaturated condition, and the salt begins to "freeze out of solution" into a crystalline form. The seeds provide a surface to which the crystalline structure attaches itself and also ensure controlled growth, because growth continues according to the "habit" of the seed. With this method large crystals which are vastly superior to natural crystals in both uniformity and purity can be grown in slightly over a month.

Other Salts

It has been mentioned that a great many salts show piezoelectric activity. Some of these are quite easy to grow artificially and therefore present very attractive commercial possibilities.

Ammonium dihydrogen phosphate (ADP) has been developed into an extensively used product which has the advantage of operating up to the 60° to 80° C. range. It is more active than quartz, though not so active as Rochelle salt. Many submarine detection devices have used ADP crystals in the electroacoustical transducer. ADP crystals weighing more than 40 pounds have been grown in a manner similar to that of Rochelle salt.

Ethylene diamine tartrate (EDT) crystals have been grown and used to great advantage, primarily in telephone filtering networks for carrier equipments.

Ceramics

A number of polycrystalline ceramics have been used in the construction of capacitors because of their excellent insulating qualities and an extremely high dielectric constant. The titanates are representative of such ceramics.

In the process of investigation of

these capacitors it was found that after being subjected to large electrostatic stresses some of the capacitors displayed piezoelectric activity. The piezoelectric activity of barium titanate disappears at 120° C., and the dielectric constant shows a sharp peak (around 6000) at the same temperature. The loss of activity is due to a thermal reordering of the crystal's molecular structure, and will be discussed in more detail later in this article.

Polycrystalline barium titanate is ordinarily not piezoelectric because the net internal charge due to the molecular electric dipoles is cancelled by the random orientation of the dipoles. However, if the material is heated to above 120° C. and then subjected to an intense electric field (say 10 kv. per cm.), the atomic dipoles will align themselves in the direction of the field, very much as the molecules in a hot piece of steel will readily align themselves with a magnetic field.

If the material is then cooled to well below the 120° C. point while the electric field is maintained, the atomic dipoles will be trapped in their aligned positions. The field can then be removed and the polycrystalline sample will be piezoelectrically active to a high degree*. While the activity of barium titanate is not as great as that of Rochelle salt, its high dielectric constant (about 1200 at room temperatures) and high temperature characteristic (useful up to 110° C.) make it quite useful. In addition, most ceramics have considerably better mechanical properties than

* Such electrostatic forming has long been known in connection with electrets. The electret is made of a wax which contains a crystalline acid. The wax is melted into an insulating container and is then cooled while being subjected to a strong electrostatic field. When cool, the mass of wax displays a voltage, and behaves electrically very much like a permanent magnet behaves magnetically. Electrets were used extensively in Japanese microphones in World War II but are mainly curiosities in this country.

Rochelle salt, and they are not water-soluble.

Ceramic materials not only are very useful members of the piezoelectric family but also studies of their response to electrostatic stress and temperature have resulted in a valuable increase in the knowledge of the nature of piezoelectricity.

MECHANICAL NATURE

Since the piezoelectric effect produces an electromechanical action, the nature of the mechanical motion becomes an integral part of this discussion. In general, piezoelectric activity applies to two forms of motion—resonant and non-resonant. Devices that produce the resonant form are designed to take advantage of the fact that all physical structures have one or more natural periods of vibration as determined by purely physical attributes. For example, the tuning fork is constructed so as to vibrate strongly at only one particular frequency.

Devices that produce the nonresonant form merely use the piezoelectric material as a means of translating mechanical motion into an electrical analog or vice versa. Since the nonresonant applications entail a knowledge of resonant characteristics, the latter will be discussed first. (Nonresonance will be discussed in Part II.)

RESONANCE

A study of the tuning fork provides an easy access to the subject of mechanical resonance. Figure 4 shows the basic tuning fork and its equivalent electrical circuit. The mass of the vibrating element is likened to the property of inductance, while the elasticity of the spring action is likened to the property of capacitance. For example, distorting a spring is like charging a capacitor, with the applied force repre-

senting the capacitor voltage. A stressed spring when released will tend to assume its former position and will do so eventually (provided that its elastic limit—the capacitor's breakdown voltage—is not exceeded). However, if a mass is present for the spring to act upon, the spring will be carried beyond its zero-stress position to a position that represents a stress in the opposite direction, whereupon the spring tends to force the mass in the opposite direction. In this manner the spring will vibrate back and forth until all of the initial energy (inserted by the initial stress) is used up. Frequency is determined by mass and elasticity as analogs for inductance and capacitance in an equivalent circuit.

How long the tuning fork will vibrate, after being struck, depends upon how fast the initial influx of energy is dissipated. With an ordinary tuning fork air friction accounts for most of the losses and internal friction accounts for the remainder. In applications where sound output is not its primary function, the fork can be mounted in a vacuum, thus leaving only the internal friction to dissipate energy. Such a fork will vibrate for a comparatively long period of time after being struck.

Figure 5 shows how a steel tuning fork can be used as an electromechanical transducer. The coil, if energized from an a-c source, will alternately increase and decrease the magnetic attraction for the prongs of the fork, which

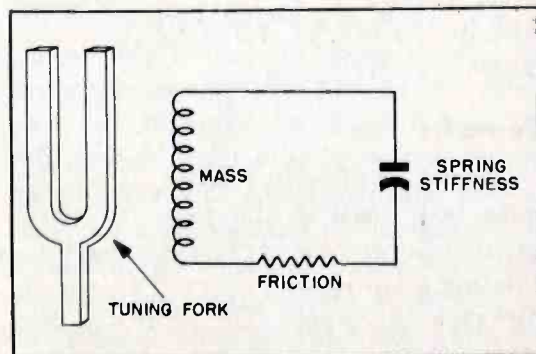

Figure 4. Tuning Fork and Electrical Equivalent

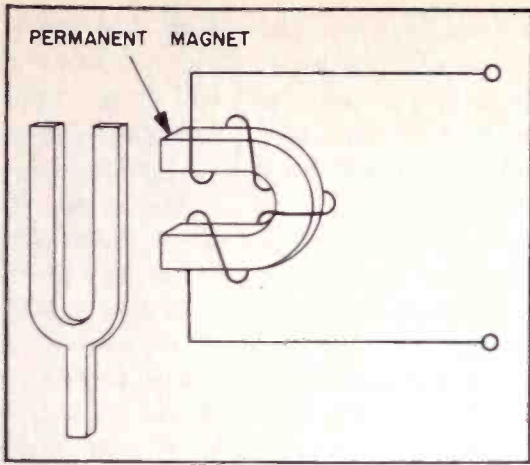

Figure 5. Tuning Fork with Electric Drive

will then move in step with the frequency of the applied a.c. At frequencies far from the natural resonant frequency of the fork, the prongs will vibrate but very little, and hence very little power will be absorbed by the circuit. However, at resonance the prongs will vibrate at maximum amplitude, and maximum power will be absorbed. Figure 6 shows a plot of coil current versus frequency (at constant voltage), for such a circuit. It can be seen that the curve obtained is a good approximation of that for a series-resonant circuit. If desired, the equivalent series resistance can be determined from the ratio of E to I , the circuit Q can be determined from the sharpness of the curve, and, from these values, equivalent units of L and C can be calculated. Thus it can be seen that the mechanical circuit can be shown in equivalent form entirely in terms of electrical values.

The action of a piezoelectric resonator is quite similar to that of the tuning fork, except that electrostatic excitation is used instead of magnetic. As was shown earlier, a voltage will deform the crystal, and vice versa. This voltage can be thought of as introducing a mechanical wave into a structure that will tend to vibrate at certain frequencies. Here we enter into a field of great complexity—so complex that most analysis is done on an empirical basis.

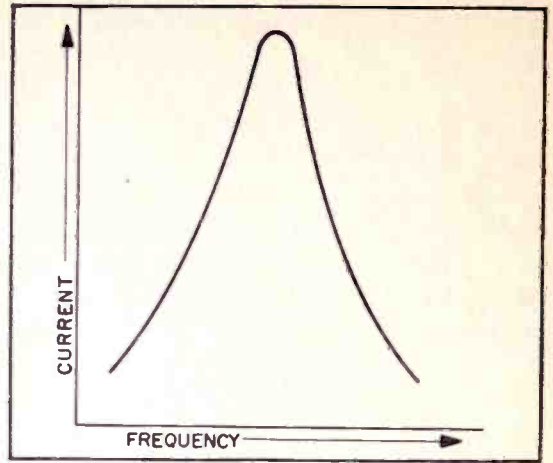

Figure 6. Plot of Current Versus Frequency for the Circuit in Figure 5

Modes

Mechanical vibration of solid bodies can be broken down into four modes. These are:

1. Strain
2. Flexure
3. Torsion
4. Coupled (two or more of above combined)

A strain can have six degrees of freedom—three from pure tension or compression along any one of three dimensions, and three from shearing of any one of three dimensions. Of course, if any elastic body is compressed it will tend to extend along the other two dimensions, so that the six degrees of freedom are not completely independent. Examples of shear and compression of a solid body are shown in figure 7.

Flexure is a bending mode that is characterized by the tines of a tuning fork. Flexure, which can appear as shown in figure 8, can be obtained by expanding the length of the top of the slab while reducing the length of the bottom.

Torsion is a twisting mode, as shown in figure 9. This mode is difficult to

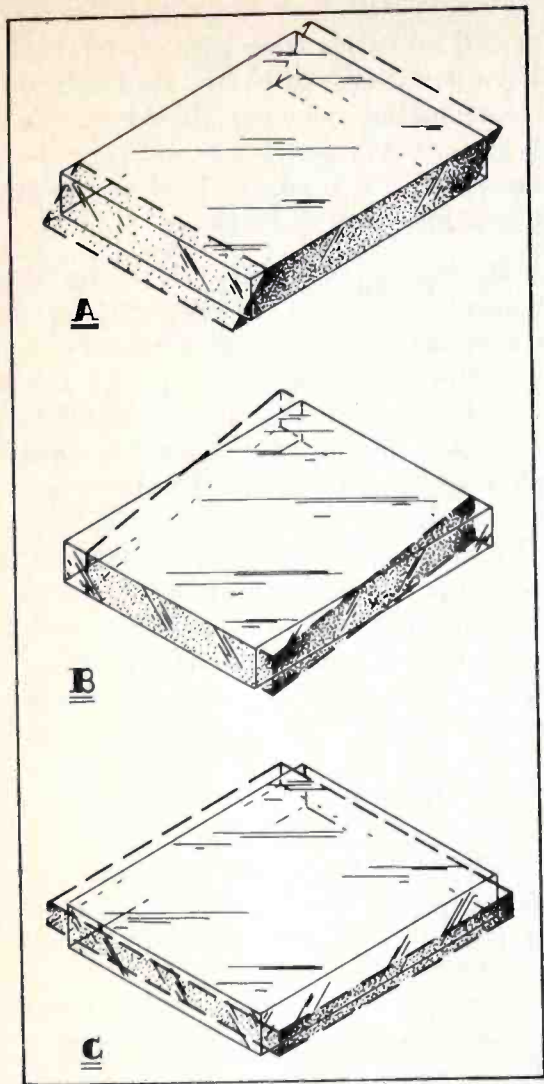

Figure 7. Distortion of a Solid Body, Showing:
A. Thickness Shear
B. Face Shear
C. Compression

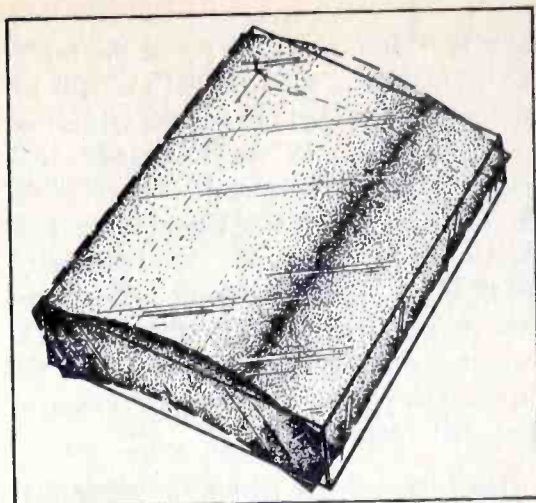

Figure 8. Distortion of a Solid Body, Showing Flexure

excite, and is used only in special applications.

Coupled modes are produced by the combination of two or more of the other modes. Coupling can take place by common components of mass, elasticity, or friction (inductive, capacitive, or resistive coupling, respectively). For example, suppose that a torsional mode has a part of the body moving in the same direction that excitation of a shear mode would produce—the final mode is a complex, inductively coupled combination of two modes. This could lead to three separate and distinct resonant frequencies, one each for shear, torsion, and coupled modes. The dominant frequency would be determined by the

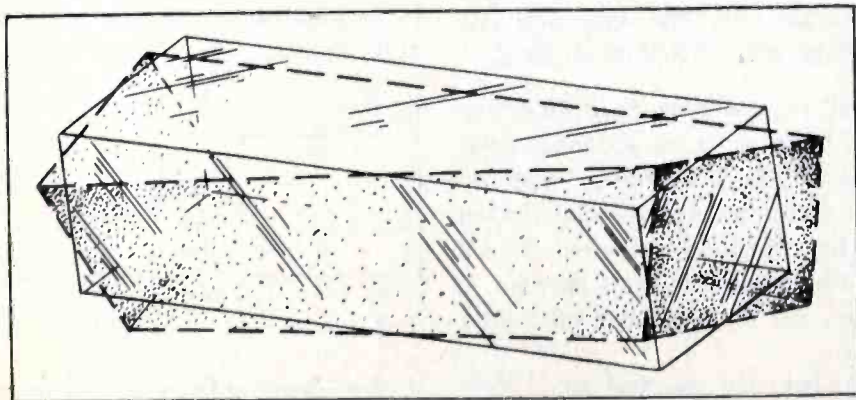

Figure 9. Distortion of a Solid Body, Showing Torsion

relative vibrational activity of the body for each mode. One obvious way out of such a difficulty is to shape the vibrating body so that the various mode frequencies are well separated—it is then an easy matter to suppress undesired modes. For example, low-frequency longitudinal compressional vibrations can be obtained through the use of a long, narrow crystal, and thickness vibrations are best obtained by using a thin, flat plate.*

The manner in which a particular mode of vibration will be induced into a crystal is dependent upon how the electrodes are attached to the crystal and how the crystal was cut from the original specimen. Figures 1 and 2 illustrate how the arrangement of atomic dipoles with respect to the electrodes can excite different modes of vibration (these figures show excitation of strain vibrations).

Overtones

In addition to the modes discussed above, overtone vibrations are also possible. Part A of figure 10 shows a crystal in fundamental shear vibration; parts B and C show the second and third overtones. The term overtone is used in preference to harmonic because the overtone frequencies are not *exact* multiples of the fundamental. In use, a crystal designed for overtone operation will be marked for the overtone frequency rather than the fundamental.

A crystal in overtone operation can readily be likened to an antenna operated at harmonic frequencies. For example, an antenna can only be driven at its odd harmonic frequencies without changing the feed system. Likewise, a crystal can only be operated efficiently

* A good example of a practical use of more than one mode is found in the well-known Bliley SMC-100 crystal. It is designed so that the crystal can be operated at either 100 kc. or 1000 kc., depending upon which mode is favored by the external circuit.

at odd overtones for a given mounting. Even overtones can be obtained only if the mounting system is altered (if this is done, fundamental and odd overtone operation is not good). However, even overtones are seldom used.

Overtone operation is particularly useful in modern VHF and UHF equipment where crystal control of frequency is desirable. The design of a crystal that would vibrate directly at such high frequencies would involve impossibly small physical dimensions, but the proper use of overtones makes such operation possible with a minimum number of frequency multipliers. Stable operation in the 100-mc. to 200-mc. range has been achieved by using the higher (5th to 15th) overtones of relatively large rugged crystals.

Mounting

Mounting a crystal slab imposes the most serious design problem in the entire subject of crystals. The mount must protect and support the crystal, provide

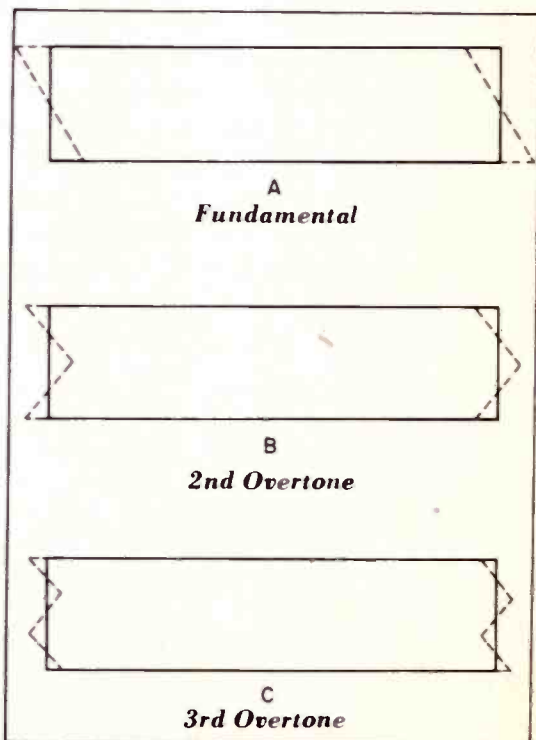

Figure 10. Overtone Shear Vibration (Cross-Section View of Crystal)

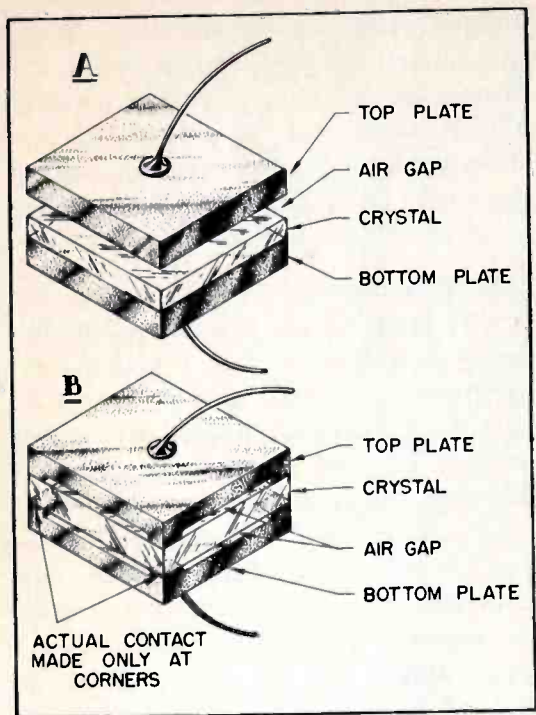

Figure 11. Early Crystal Mountings
 A. Air Gap Type
 B. Clamp Type

electrical connections, and yet must impose minimal mechanical restrictions on desired vibrational modes. It could be said that the crystal must be rigidly held so that it can vibrate freely.

Early crystal mounts employed an air space between the crystal face and one electrode, as shown in part A of figure 11. However, this mount is very susceptible to mechanical shock, and can only be located in certain positions. Furthermore, a great deal of friction is produced by the lower electrode and the air in the air gap. (It is extremely

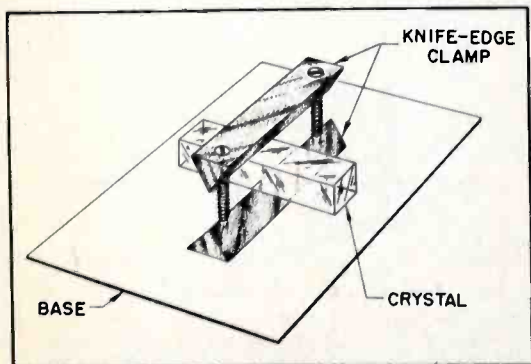

Figure 12. Knife-Edge Mount for Longitudinally Vibrating Crystal

important to avoid an air gap equal to an even number of quarter wavelengths.) Part B of figure 11 shows a clamped crystal mount that reduces frictional losses by reducing the surface area of the electrodes that contact the crystal. This holder can operate in any position, and can be used to restrict certain unwanted modes, but it still imposes severe frictional losses.

One solution to the problem is to provide mechanical support at only the vibrational nodes (a node is a point of minimum mechanical displacement). In figure 12 a bar is clamped by means of knife edges so that it is free to extend and compress in the longitudinal dimension; however, such a mount is mechanically delicate. An alternate solution is to use clamping bars, as shown in figure 13. This method results in frictional losses between the crystal and the mount. Optimum design is obviously a compromise between desired mechanical and electrical characteristics. Figure 14 shows a knife-edge clamp for a thickness shear mode—the entire edge could not contact the mount without serious loading, and face plates with air gaps would have to be provided for excitation.

It has been found that coating the surface of the crystal with a thin film of metal is the best way to secure a low-friction electrical connection. The metal-

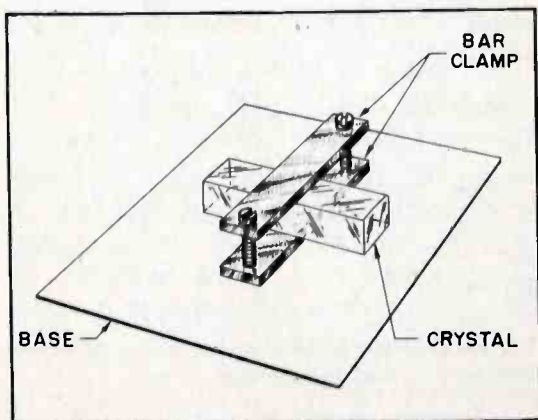

Figure 13. Bar Mount for Longitudinally Vibrating Crystal

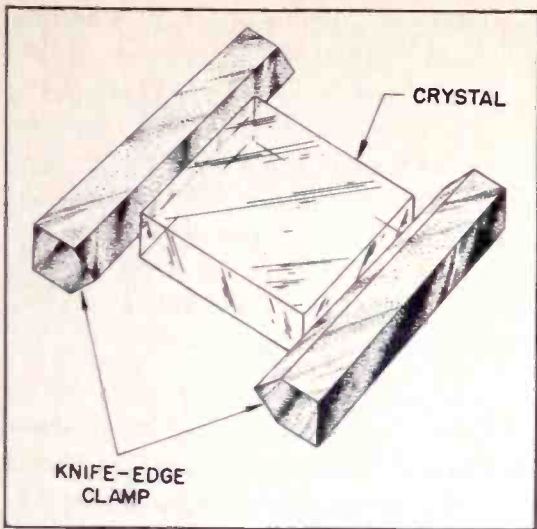

Figure 14. Knife-Edge Clamp for Supporting a Crystal Operating in Thickness Shear

lic film must be sufficiently thin that it does not materially alter the mass of the crystal, and yet it must be a good conductor. Gold leaf pressed on, or cemented to, the surface of the crystal has been used with success. A thin film of gold or silver can be evaporated or plated directly onto the crystal. Contact is then made by means of a spring clip, or flexible support wires can be soldered directly to the metallic film.

Figure 15 shows two mounts that would be useful for shear modes. The plated contacts in part A of figure 15 are brought out to the edge of the crystal, to facilitate mounting in the spring clip.

Since support at nodal points is desired, some rapid method of determining nodes is in order. This can be done by means of several methods. One method consists of coating the surface of a vibrating crystal with a thin film of oil; the coating of oil will tend to become thicker at the nodal points. When placed in a strong light, the oil film will produce diffraction that varies with the thickness of the film, and the nodes are easily viewed.

Another widely used method consists of sprinkling a layer of lycopodium

powder* over the crystal face. When the crystal vibrates, the particles are thrown away from vibrating portions of the crystal, and arrange themselves along modal lines. The resulting pattern can easily be observed or photographed for a permanent record.

In most thickness shear modes the crystal faces are in motion and nodal-point mounting is not practical. An ingenious mounting system shown in part A of figure 16 is used with great success. The two wires, made of small-diameter spring stock, are soldered directly to the metal-coated crystal faces, and are secured to heavy support rods. Each wire is made one mechanical quarter wavelength (or some odd quarter-wavelength multiple) long. Thus the ends of the wires secured to the support rods can be rigidly held while the crystal faces are free to vibrate—the principle is quite similar to that of using quarter-wavelength stubs to support an open-wire transmission line.

* A very fine, highly inflammable powder that is obtained from the spores of certain plants.

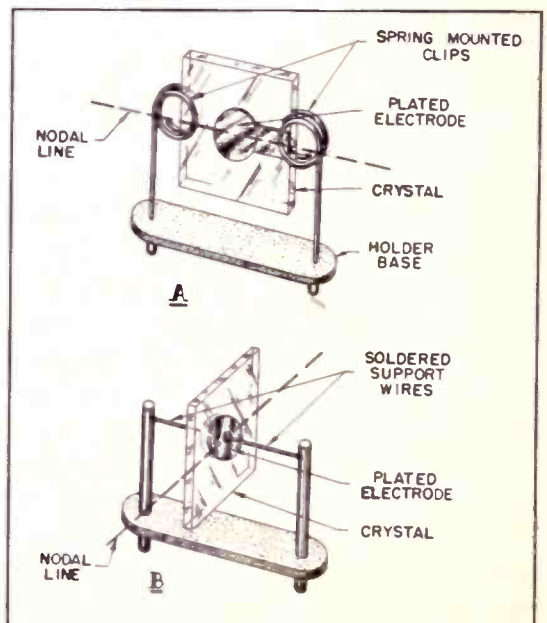

Figure 15. Nodal-Line Mounting of Plated Crystals for Face-Shear Modes
A. Spring-Clip Mounting
B. Soldered-Lead Mounting

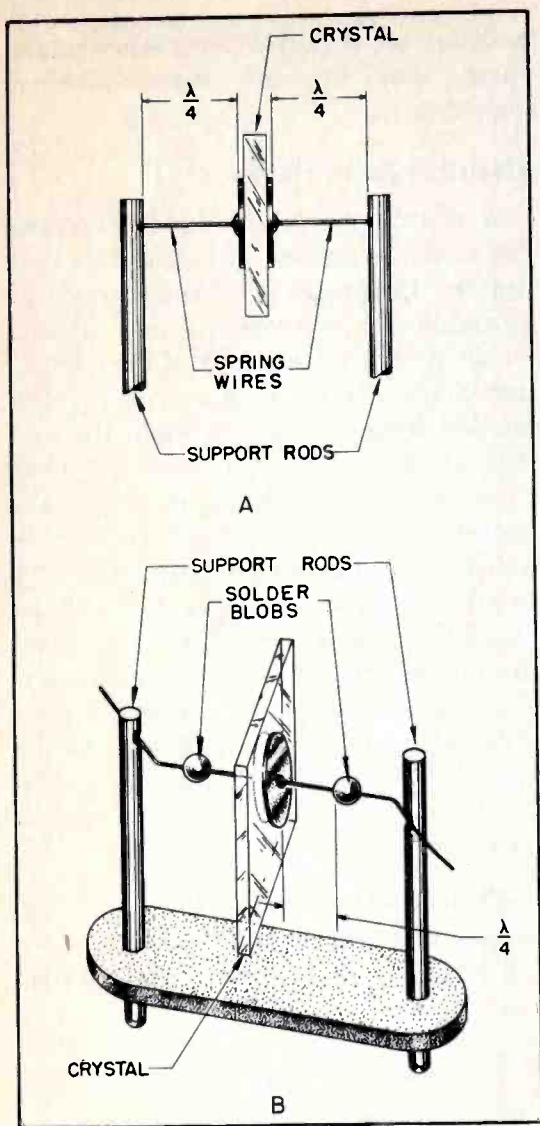

Figure 16. Resonant Spring Mount for Plated Thickness-Shear Crystal
A. Basic (Fixed)
B. Adjustable

In practice it would be unlikely that the support rods would be located at exactly the right distance apart. Hence, the setup shown in part B of figure 16 would be used. Ordinarily the separation is several wavelengths, so that the spring wire nodal points occur somewhere between the crystal face and the support rod. A large blob of solder is located on the wire at some odd quarter-wavelength multiple from the crystal face. This blob acts as a large mass, and produces a node at its effective center of mass. Since the solder can be located at any desired point, it allows the use

of a particular mount for a wide range of crystal frequencies. (The solder blobs correspond to adjustable transmission-line support stubs.) This form of mounting shows a definite tendency to restrict vibrational modes to the chosen one, but it does not interfere with odd overtone vibrations. Furthermore, it has been found that, while this mount introduces very little frictional loss into the crystal, reliable mechanical support is provided.

Friction accounts for the losses sustained by a vibrating crystal, and most of the friction is produced by the mount and the surrounding air. Once a satisfactory mount is obtained, air damping is the next in order of importance. Surrounding a crystal in a hydrogen atmosphere can reduce damping by a factor of four, because the light hydrogen molecules impose less friction than the heavy air molecules. However, a vacuum mount can provide a twofold or threefold improvement over hydrogen. Figure 17 shows a vacuum-mounted quartz resonator recently developed by the National Bureau of Standards.

Temperature

Temperature plays a profound role in the piezoelectric effect. As was pointed out for Rochelle salt, piezoelectric activity falls off as temperature increases, and at a certain temperature, ceases entirely. This temperature is called the Curie temperature. Most of the salts and ceramics have very low Curie temperatures, and, while this makes artificial piezoelectric formation readily possible, it also imposes a limitation. Quartz, on the other hand, has a high Curie temperature (over 550° C.).

The Curie temperature occurs when the atomic vibrations within the crystal become sufficiently violent to cause disordering of the crystal structure. This action disorients the atomic electric

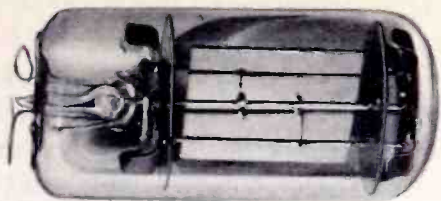

Figure 17. *Vacuum-Mounted Quartz Resonator Used by the National Bureau of Standards as a Frequency Standard*

dipoles in a random manner, thereby removing any piezoelectric activity. Disordering of the crystal structure is also usually accompanied by a new crystal shape. For example, a cubic crystal may change into a tetragonal crystal above the Curie temperature.

Any change in temperature will also result in a change in volume of a solid body. Since the resonant frequency of a solid body is determined largely by physical dimensions, a crystal will have what is called a temperature coefficient of frequency. Depending upon how the crystal is cut, and excited, this coefficient can be either positive or negative, and the sign can even reverse as temperature is varied. The ideal approach is to cut, shape, and excite the crystal so that the curve of temperature versus frequency is flat over the normal range of operating temperatures—such a crystal is said to have a zero temperature coefficient of frequency. Figure 18 shows the temperature characteristics of two types of crystal cuts. The GT cut shows a zero coefficient over a very wide range of frequencies, while the CT cut has a zero coefficient over only a small range. As is indicated by the vertical axis of the graph in figure 18, the units are expressed in parts per million, and, at any particular temperature the coefficient is expressed in parts per million per degree centigrade. Where precise control is desired, the crystal holder will be mounted in either melting ice (0 degrees centigrade) or a constant-temperature oven which is operated in a flat

portion of the frequency-temperature curve that is well above ambient temperature.

Electrical Equivalence

A vibratory crystal suitably mounted can easily be excited at frequencies that produce the proper mechanical mode of vibration (or overtones of that mode). At the resonant frequency of the crystal, maximum energy is absorbed. If the applied frequency is too high, the motion of the mechanical mass will tend to lag the applied voltage (lagging phase angle), and if the applied frequency is too low, the mechanical mass will tend to vibrate ahead of the applied voltage (leading phase angle). This represents the characteristics of a series-resonant electrical circuit. Since the holder consists of two electrodes connected to the crystal, it forms shunt capacitance. The basic equivalent circuit is shown in part A of figure 19.*

Typical values of a 430-kc., X-cut crystal vibrating in the thickness mode are given by F. E. Terman as follows:

$$L = 3.3 \text{ henries}$$

$$C = 0.042 \mu\mu\text{f.}$$

* This circuit is extremely simplified because a complete circuit would require that other modes and a multiplicity of other distributed capacitances be shown. Other vibratory modes would appear as additional series R-L-C combinations shunting C_H . Each mode has its own representative values.

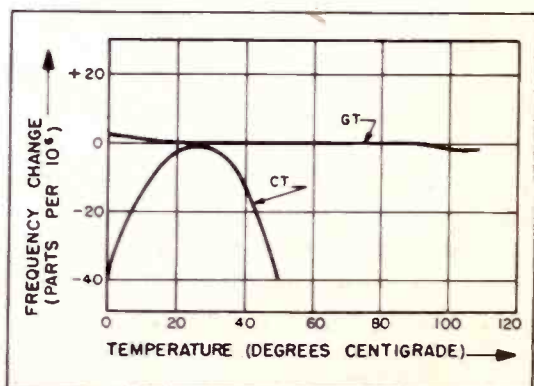

Figure 18. *Temperature Characteristics of Two Types of Crystal Cuts*

$$C_H = 5.8 \mu\mu\text{f.}$$

$$R = 4500 \text{ ohms}$$

Since C and C_H are effectively in series, as far as L is concerned, it can be seen that C_H has very little effect upon frequency. When the equivalent circuit is arranged as shown in part B of figure 19, it can be seen that the two capacitors effectively form a tap on a parallel-resonant circuit. Thus the circuit will display antiresonance at a frequency slightly higher than natural mechanical resonance (resonance is produced by C and L alone, but in antiresonance C_H and C are in series). The holder, while modifying antiresonance, has no effect upon resonance. Part C of figure 19 shows a plot of impedance versus frequency for the crystal and holder. The impedance is an inverse function of C_H and R , and is quite large.

The Q of the crystal circuit is defined as the ratio: X_L/R . For the crystal mentioned above, the Q would be about 2000. To show how the frictional losses affect Q , consider a typical high quality, 100-kc. crystal, as shown in Table I.

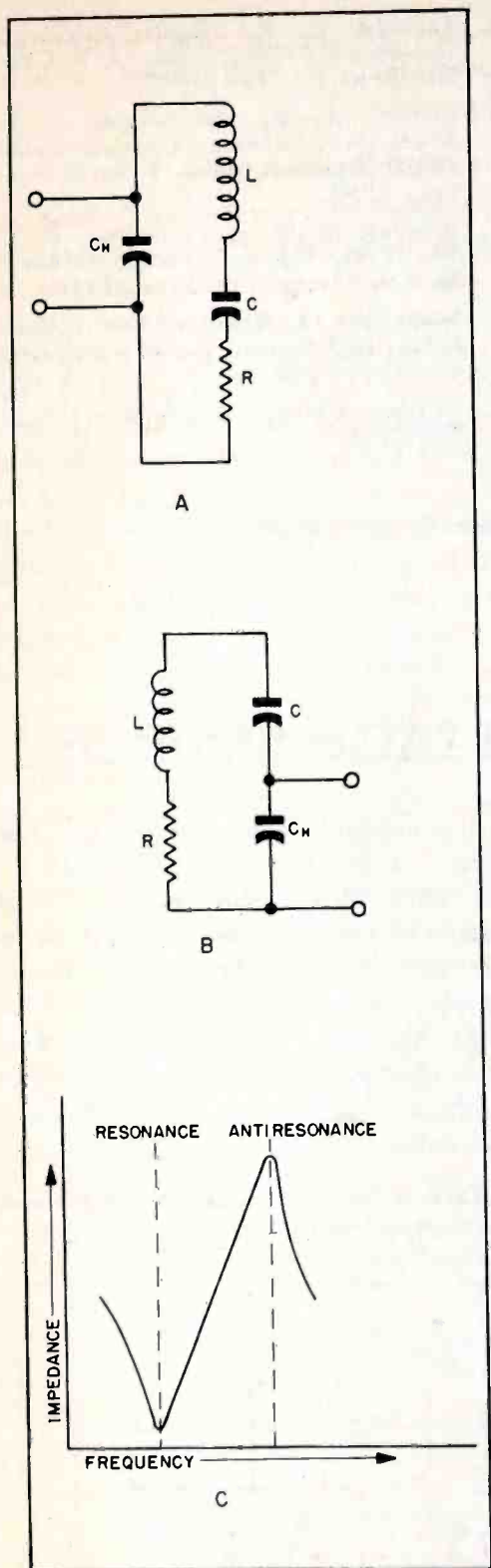

Figure 19. Equivalent Electrical Circuit of Quartz Resonator in a Holder

- A. Showing Electrical Components
- B. Redrawn to Illustrate Voltage-Divider Action
- C. Plot of Impedance Versus Frequency for Crystal and Holder

TABLE I

TREATMENT	Q (approx.)
Ground surfaces— mounted in air	25,000
Ground surfaces— mounted in hydrogen	100,000
Ground surfaces— mounted in vacuum	200,000 to 300,000
Etched surfaces— mounted in vacuum	500,000
Etched and polished surfaces— mounted in a vacuum	600,000

The 24-to-1 improvement in Q means that frictional losses have been reduced

by that factor. Of course, the higher the Q the greater will be the tendency for the crystal to vibrate at one particular frequency. The best gravity pendulums (which are considered to be very accurate time indicators) have Q values in the region of 500,000.

BIBLIOGRAPHY

1. Cady, W. G., *Piezoelectricity*, McGraw-Hill Book Co., Inc., 1946.
2. Buckley, H. E., *Crystal Growth*, John Wiley & Sons, Inc., 1951.
3. Terman, F. E., *Radio Engineers' Handbook (Third Edition)*, McGraw-Hill Book Co., Inc., 1947.
4. Ladner, A. W. and Stoner, C. R., *Short Wave Wireless Communication (Fifth Edition)*, John Wiley & Sons, Inc., 1950.
5. Sterling, G. E. and Monroe, R. B., *The Radio Manual (Fourth Edition)*, D. Van Nostrand Co., Inc., 1950.
6. Blackburn, J. F., *Components Handbook (MIT Series)*, McGraw-Hill Book Co., Inc., 1949.
7. "Piezotronics," Brush Electronics Company.

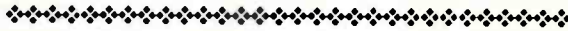

A REGULATED VOLTAGE SOURCE

A source of regulated voltage is always very useful around an electronics maintenance shop. The device in this article provides a number of VR-tube stabilized voltages that will remain fairly accurate regardless of line-voltage and load conditions.

As shown in figure 1, the device consists of four VR tubes, two resistors, five pin jacks, and two flexible leads with plugs. The flexible leads connect

to the terminals of a power supply. Any supply of about 400-volt rating will do, but the Philco Demonstrator Power Supply is recommended. For this function the bleeder resistor of the Power Supply should be removed, and the 1500-ohm resistor should be replaced by a shorting strip. The current drain is about 20 ma. with a B+ of about 380 volts.

Table I lists the voltages available at the various jacks.

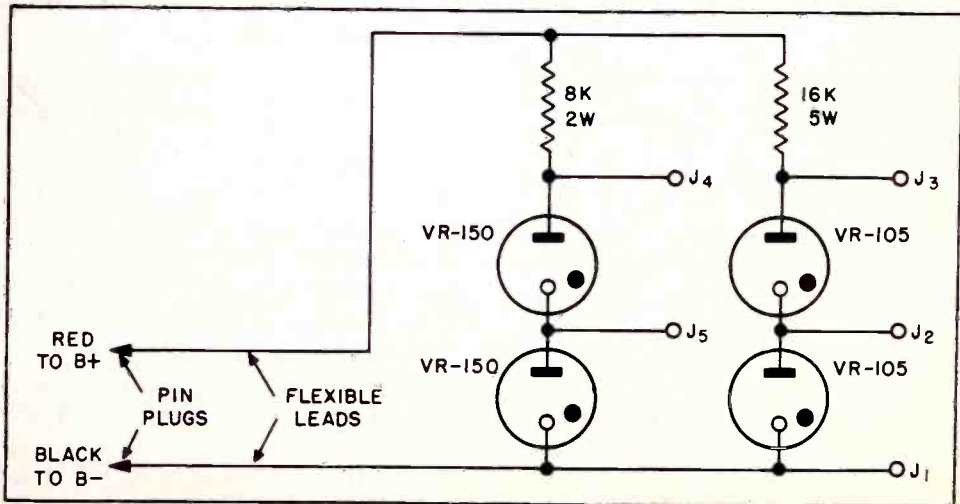

Figure 1. Schematic Diagram of Regulated Voltage Source

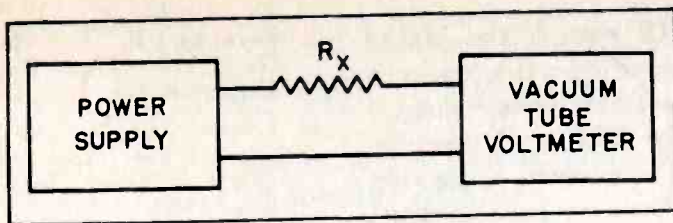

Figure 2. Block Diagram of Setup For Measuring Large Resistances

TABLE I

JACKS		VOLTAGE
Negative	Positive	
J ₁	J ₂	108
J ₁	J ₃	216
J ₁	J ₄	300
J ₁	J ₅	150
J ₂	J ₃	108
J ₅	J ₄	150
J ₂	J ₅	42
J ₂	J ₄	192
J ₃	J ₃	66
J ₃	J ₄	84

The above voltages are not laboratory standards, but are sufficiently accurate for most applications. A number of uses are immediately evident, such as:

1. Testing accuracy of d-c voltmeters.
2. In conjunction with precision resistors testing accuracy of d-c milliammeters.
3. Testing VR tubes.
4. Testing capacitors at rated voltage.
5. Measuring large-value resistors.

The above items are self-evident with the possible exception of number 5.

Figure 2 shows the setup used for measuring large-value resistors. Suppose, for example, that an 11-megohm VTVM is being used. It can be seen that if the B+ voltage, meter voltage, and meter resistance are known, the resistor value can readily be calculated. (Of course, the voltage can be read directly, and the meter resistance can be determined from the operating manual.) In the case of the 11-megohm meter, the unknown resistance can be determined as follows:

$$R_x = \frac{11(E_1 - E_2)}{E_2}$$

where:

R_x is unknown resistor value in megohms

E_1 is source voltage

E_2 is meter reading

For example, if E_1 were 300 volts and the meter read 1 volt, R_x would be about 3300 megohms. This indicates roughly the upper limit of resistance, using the above components.

Marion J. Langan
Philco Field Engineer

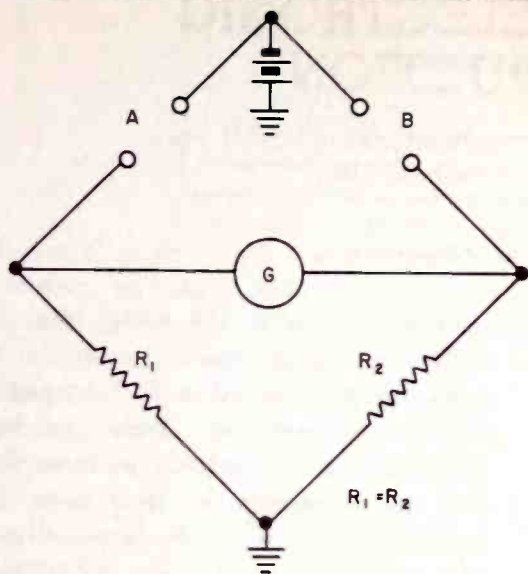

What's Your Answer?

This month's problem, suggested by George Case and John Adams, Technical Headquarters Staff, is one of logic in the field of electronics.

A technician has 12 precision resistors, all of the same ohmic value except one, which is defective. He does not know which is the defective resistor, nor whether its value is too high or too low. The Wheatstone bridge shown in the drawing is the only test instrument available for checking the resistors. Depending on the values of resistance connected to its arms, this bridge indicates either balance or imbalance, and, in the latter case, the direction of imbalance (i.e., which arm contains the higher resistance, and which the lower resistance). It does not have any provision for indicating resistance values. For example, if the above resistors were connected in two series groups of six each, one group to terminals A, and the other group to terminals B, the bridge would show imbalance because of the high or low value of the defective resistor; however, it would not reveal which group contains the defective resistor. The only information revealed is which group has the higher resistance and which has the lower resistance. Any similar combinations of all good resistors attached to the bridge terminals would, of course, result in a balanced condition.

As proof of his testing proficiency, the technician identifies the defective resistor and determines whether its value is high or low with only three bridge measurements. Using logic, can you devise a fool-proof procedure that might be used for this purpose?

It can be done, as will be shown in the solution next month.

CELLULAR ELECTRONIC CONSTRUCTION

A solderless assembly method using small replaceable units of standardized size.

PRINTED ELECTRONIC circuits in which conducting patterns etched on plastics take the place of conventional wiring have come into fairly wide use. For the problem of connecting components and tubes to the printed sheets, several solutions have been offered. However, the diversity of these solutions and their inability to gain widespread acceptance indicates that an entirely satisfactory answer has not yet been found.

A novel approach to the problem, currently being investigated by the National Bureau of Standards is shown in figure 1. Small 3-contact molded blocks or cells, each containing one or two circuit elements—resistors, capacitors, or inductors—are pressed against the etched circuit pattern by means of springs that are extensions of the tube socket contacts (see figure 2). No soldering is needed. This experimental technique is one of a number under study at the Bureau in a program, sponsored by the Navy Bureau of Aeronautics, for improving construction and maintenance of electronic equipment. Proposed by Dr. P. J. Selgin of the NBS engineering electronics laboratory, the cellular assembly method has several interesting features that could prove to be advantageous.

The individual molded cells are about $\frac{7}{8}$ inch high by $\frac{1}{2}$ inch wide by $\frac{1}{4}$ inch thick. Each has three contacts, one on the top and two on the bottom. The cells are grouped together in "building blocks," each block comprising two tubes and twelve cells held in a compact bundle by means of a suitable frame. The top surface of the block consists of a spring assembly containing the tube socket and the necessary spring

contacts. When the block is fastened to the printed base plate by means of screws, springs in the spring assembly apply substantial pressure to the top terminal of each cell, and thus hold the two bottom terminals firmly in contact with the printed circuit pattern. Positive and noise-free electrical connection is further assured by the application of a thin film of grease to the cell contacts.

The two-tube block is considered an optimum-sized subassembly in the NBS system. Any number of the blocks can be mounted on a suitably-printed base plate of sufficient area. Potentially inexpensive, they are compact (about $2\frac{1}{4}$ by 1 by $1\frac{3}{16}$ inches, exclusive of tubes), and are easy to store and to handle. They are extremely rugged, and as long as a block is secured to the base plate, none of the cells can vibrate or shake loose.

A noteworthy feature of the technique is the achievement of quick replaceability—of both blocks and cells—without the use of plugs or connectors. If conventional plug-in assemblies were made as small as the NBS blocks, the plug would add substantially to both size and cost. The elimination of both soldering labor and multiple connectors results in a double saving.

In case of trouble, an entire block can be easily removed for repair or replacement, simply by loosening the screws that hold it to the base plate. Either on the spot or after return to the factory or service laboratory, defective blocks can be quickly repaired by replacing faulty cells. Each cell is identified by suitable markings.

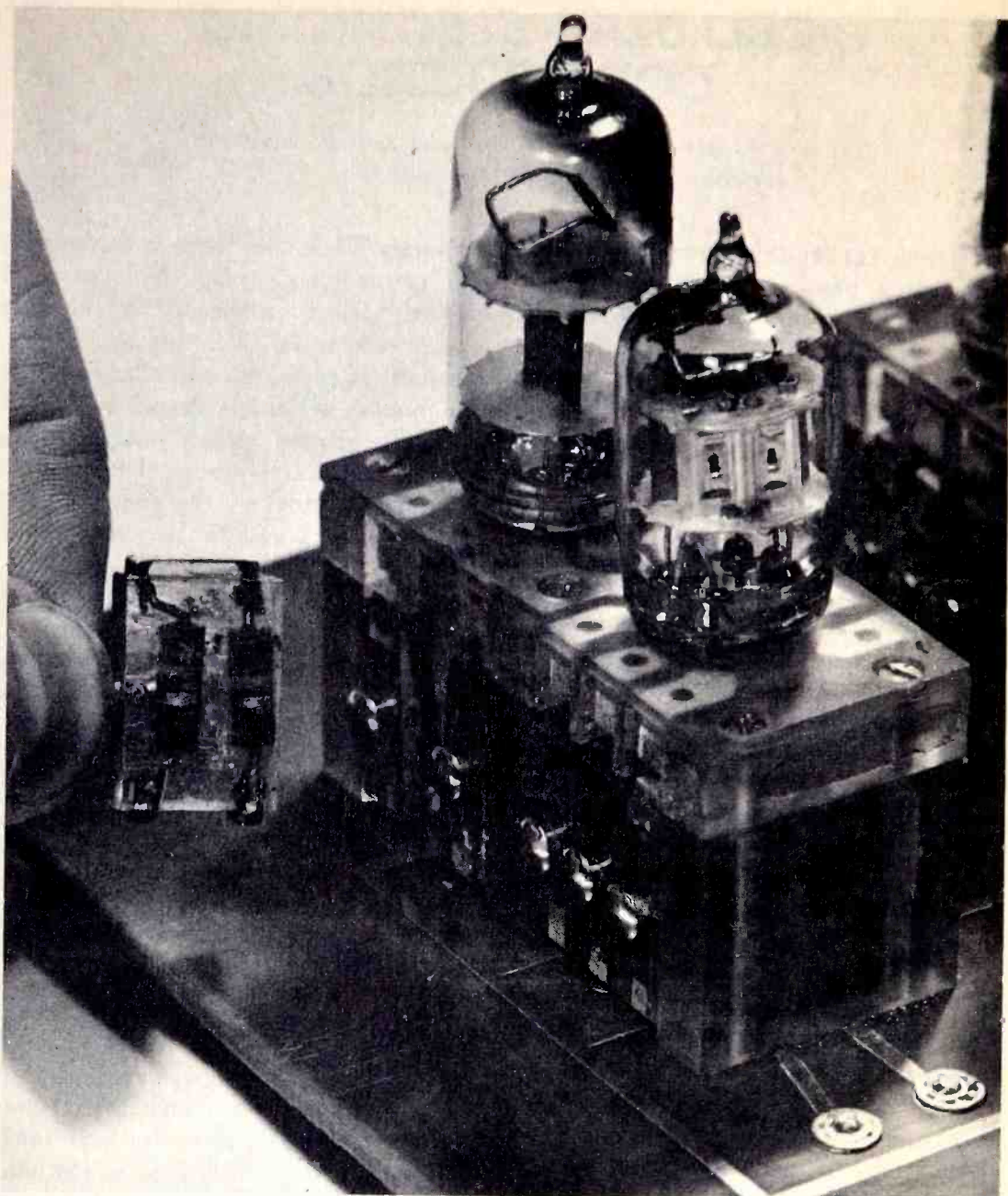

Figure 1. *Close-up view showing details of the cellular technique of electronic assembly that is being investigated by the National Bureau of Standards. Three-terminal molded cells, each containing one or two components, fit into two-tube "building blocks." A spring connected to a tube pin presses against the top terminal of each cell, and holds the bottom terminals in contact with a copper circuit pattern etched on the insulating base plate. Each block contains twelve cells, six on each side. No soldering is needed, labor costs for assembly are reduced, and defective two-tube blocks or individual cells are easily replaced. The experimental technique is one of the approaches being investigated by the Bureau in a Navy-sponsored program for development of methods to make electronic equipment more compact, more reliable, and simpler and cheaper to produce and service.*

An important aspect of the use of three-terminal cells in the NBS technique is the fact that positive pressure can be maintained at three points—and

only three points—by a single spring. Fortunately, in the great majority of electronic circuits not more than two circuit elements need be connected elec-

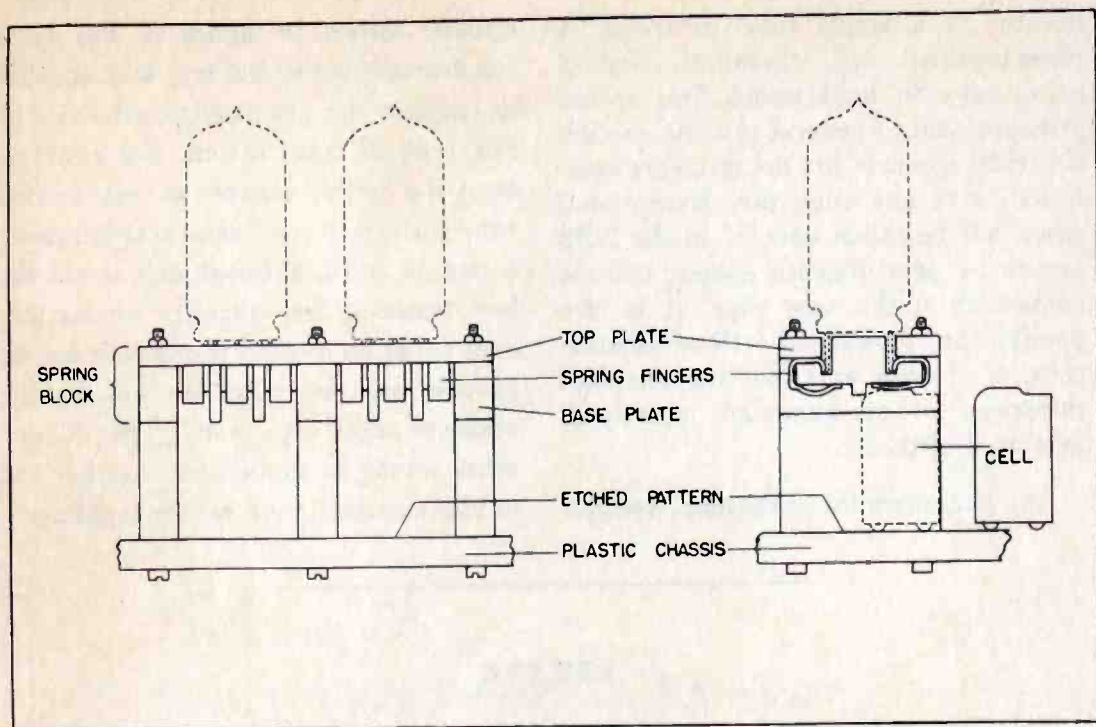

Figure 2. Drawing showing details of the NBS cellular assembly method.

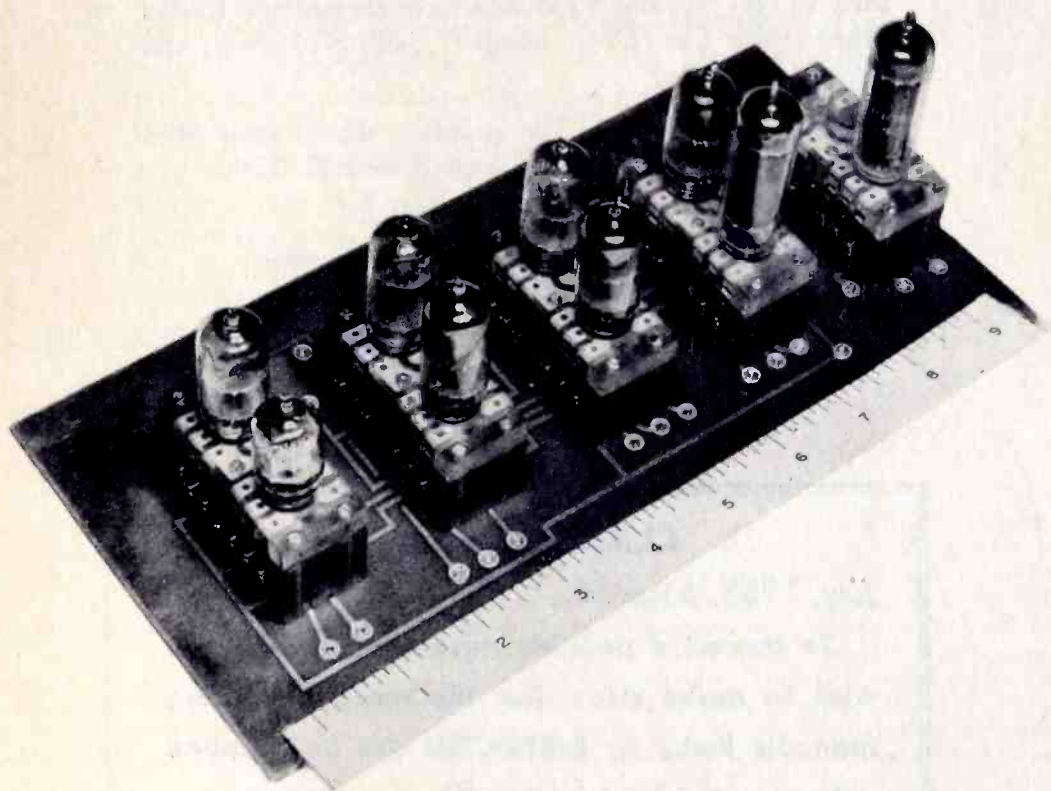

Figure 3. A nine-tube working unit constructed at NBS, using the experimental cellular assembly technique. For experimental purposes each cell was fitted with a tiny knob, and the two-tube blocks were spaced far enough apart to permit withdrawal of the cells without removal of the blocks from the base plate. In production, however, space would be saved by omitting the knobs and mounting the blocks close together. Repairs could be made quickly by removing a defective block, held to the base plate by six screws, and either substituting an entire new block or replacing the defective cells.

trically to a single tube electrode. A three-terminal cell, therefore, besides being easy to hold under firm spring pressure, will in general provide enough electrical contacts for the elements associated with any tube pin. Exceptional cases can be taken care of in the NBS system by providing for a spare cell not connected to the tube pins. It is also possible to provide for three-terminal cells of double or triple the standard thickness, to accommodate occasional oversized elements.

An experimental nine-tube cellular

circuit, shown in figure 3, has been constructed at the Bureau, and appears to confirm the practical possibilities of this type of construction. For convenience, the limited number of cells needed were formed at room temperature, using a casting resin, although this is not the best material. For quantity production, cells could be molded in phenolic by the process now in wide use for making resistors and capacitors. The components would be spotwelded together and to the terminal tabs before molding.

ERRATA

July, 1953, page 10. Table II incorrectly lists the manufacturer of the two transformers and the two reactors. L_1 , L_2 , T_1 , and T_2 should have carried the *United Transformer Co. (UTC)* numbers S-38, S-37, S-57, and S-44, respectively.

Same issue, page 9. The problem should have been credited to Philco Field Engineer Robert M. Tink.

CLARIFICATION

July, 1953, page 16.

To correct a possible misunderstanding, we wish to make clear that the trouble-shooting manuals listed as **RESTRICTED** can be supplied only to authorized personnel.

Solution To . . .

Last Month's "What's Your Answer?"

When the two capacitors were connected together, the equalization of charge involved moving electrons from one capacitor to the other. This action resulted in the radiation of energy from the system, so that half of the total was dissipated in the matched radiation resistance of the circuit. This 50% loss is characteristic of any impedance-matched system. In this particular case the impedance of free space is reflected into the circuit by induction (moving electrons).

