

BROADCAST

Communique



**NAB '93—TAKING YOU
INTO THE FUTURE AT BOOTH 2218**





Stop Talking Dirty.

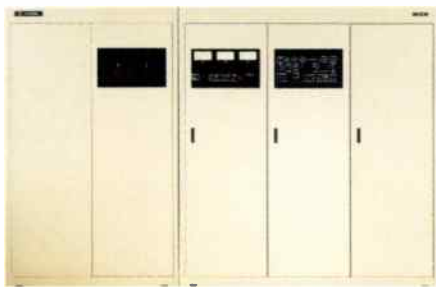

Clean up your act with a Harris DX Series transmitter. Our patented digital modulation delivers the strongest, cleanest AM signal yet. With over 145% positive peak capability. As well as the lowest THD and IMD ever.

What's more, you get 100% solid state reliability. Along with patented lightning protection that's proven itself at more than 200 sites worldwide. And with typical AC to RF efficiency of 86% or better, you'll

get the lowest power costs of any AM transmitter.

If you're ready for some more sweet talk about the DX Series 10-50 kW* transmitters, call Harris Allied today.

USA 217-222-8200
FAX 217-224-1439
Canada 800-268-6817
FAX 416-764-0729

 **HARRIS
ALLIED**

TAKING The Lead

An Antidote to the Curse of Interesting Times

by **MARTHA B. RAPP**
Manager - Marketing Communications

Perhaps you've heard the ancient Chinese curse, "May you live in interesting times."

But even if you haven't heard it, one thing is clear: Those of us who are involved in any aspect of broadcasting today are living the curse. And it really doesn't matter whether our medium is television, radio, or both.

As Harris Allied prepares for NAB '93, it is impossible to forget— even for a second— just how interesting and uncertain the times have become.

If you're in radio, you face a constant barrage of information about new technologies. RBDS, satellite program delivery, miniaturization, all-digital air chains—the list, already lengthy, grows longer by the day.

If you're in TV, you can't escape the imminent realities of the NTSC-HDTV transition, especially unique in U.S. broadcasting as the first impactive change that is being mandated instead of market-driven.

As you brace yourself for the inevitability of these changes, you may be wondering what responses will make the most sense economically and functionally for your station. You may even be looking for an antidote to the curse of change, however interesting.

In this issue of Broadcast Communiqué and at NAB '93, we'll highlight solutions that may be just such an antidote for your station.

For radio broadcasters, we'll present new opportunities to generate revenue with such technologies as RBDS. We'll focus on MiniDisc, and its promise for every aspect of audio, from news gathering to on-air playback. We'll show you our exclusive new Audiometrics computer, developed by broadcasters for broadcasters, as well as such digital

products as hard disc storage and automation systems and digital editors.

On the transmission side, we'll display on latest-generation equipment, including DX Series digital solid state MW transmitters; Digit™, our 50 Watt digital FM exciter that can be used today to upgrade almost any FM transmitter, and the industry's largest selection of AM and FM RF equipment.

For television broadcasters, we'll focus on a complete range of HDTV-ready transmitters, including our new Sigma™ Series 15 - 240 kW IOT line designed from the ground up for the NTSC-HDTV transition, and we'll provide other simulcasting solutions. We'll also show you our newest video and satellite communications products and present ways in which we can provide true value engineering to any systems project you are planning.

Please plan to visit us at the Las Vegas Convention Center, Booth #2218, North (Radio) Hall at NAB '93. And if you won't be attending this year, please don't hesitate to contact us if we can be of service.

While no antidote has the power to remove the curse of interesting times, we offer ours as a booster that may enable you to make the most of them. 

CONTENTS

Radio TodayPages 4-5

If you're an FM'er interested in new ways to attract listeners and generate revenue, RBDS may be perfect for you.

Radio RFPage 6

Digital AM and FM radio transmission equipment to be among Harris Allied's Radio RF focuses at NAB.

Satellite UpdatePage 7

It's priced right. It's a top performer. It's SEDAT®-compatible. It's Scientific-Atlanta's new digital satellite receiver.

Product ShowcasePages 8, 9

Inside StoryPage 10

Tech Talk.....Page 10

Interested in storing 74 minutes of high quality stereo audio on a 2.5-inch disc? Welcome Mini-Disc and ATRAC.

Systems TodayPage 11

Harris Allied's 'Value engineering' gives NEWSCHANNEL 8's new facility top performance, functionality and flexibility.

TV Today.....Page 12, 13

Proudly introducing Sigma™— a family of IOT transmitters designed from ground up for the NTSC-HDTV transition.

HDTV Questions and Answers - second of two articles.

Warehouse Specials.....Page 14

Broadcast Communiqué is a bi-monthly publication of **Harris Allied Broadcast Division** which includes four operations:

Quincy, IL: RF equipment manufacturing; RF and audio systems; service and training.

Richmond, IN: Radio studio and satellite equipment distribution.

Florence, KY: Fixed and mobile video and satellite communications systems.

Cambridge, U.K.: RF equipment manufacturing; European radio studio equipment distribution.

On The Cover: Mobile "Jumbotron" display unit delivered by Harris Allied's systems operation for Sony Corporation of America.

RADIO Today

Reading Your Radio With RBDS

by JAMES HAUPTSTUECK,
Digital Radio Product Manager

Reading your radio— can this be right? It sounds peculiar, maybe even abnormal. How can you read RF? And even if you could, why would you want to, or admit to it?

Thanks to RBDS (Radio Broadcast Data Service) technology and the many positives it delivers to FM broadcasters, reading the radio is emerging as one of the hottest trends in the U.S. radio broadcast industry. The positives come in a variety of types and styles, ranging from new ways to win listeners, new avenues for income generation, and new opportunities to attract new advertisers and to increase sales to current clients.

In fact, more than 25 radio stations in the United States are already transmitting RBDS, and many more are planning to take advantage of this revolutionary technology.

Background of RBDS

RBDS has its roots in European RDS technology which has attracted thousands of broadcast users since it went

into service in 1986. Currently more than 50 manufacturers produce over 200 different models of RDS radios. RDS has achieved success throughout Europe, and new developments as well as new ways of harnessing this technology are emerging daily.

Here in the U.S., the FCC has tested and approved a standard for RBDS and RBDS radios will soon begin hitting the U.S. market. Automotive manufacturers will begin installing RBDS radios in a few mid-year '93 car models and expand from there. As probably the largest backer of RBDS technology, auto makers are working to develop a global positioning system for vehicles. Use of RBDS will allow auto makers to get closer to success than they've ever been before.

There will also be a variety of after-market RBDS radios available from most of the major manufacturers. Soon it will be hard to find a radio that is not RBDS compatible.

The RBDS data stream is actually an SCA on the FM baseband added at 57 kHz. Use of bi-phase modulation techniques reduces bandwidth and digital artifacts. The signal is phase-locked to

the 19 kHz pilot which keeps intermodulation to a minimum. A low injection level 2 kHz further reduces intermodulation.

Applying RBDS To Your Operation

Lets take a look at some of the new features that RBDS brings to radio and what they will mean to you and your listener:

Radio Text (RT), one of RBDS's best features for the broadcaster, provides the ability to send text of your choosing to radios tuned into your frequency. Imagine being able to send advertisements — or song titles, artist and label information — while songs are playing. The possibilities are endless. You can sell this space on the radio to open up a whole new cash flow. Pretty exciting stuff!

The Radio Text capacity is 64 characters at a time, and characters can be stored or displayed in real time. How about doing contests and promos in text form while continuing your regular broadcast? This area can and will produce good revenues for those willing to use it.

Program Service (PS) will allow you to display your call letters and/or slogan in text form on the face of the radio. Consumers will see who they are listening to and your station will get high visibility. How much money is currently spent to display call letters and slogans to the public? RBDS will put this information in front of your audience at a rate you determine.

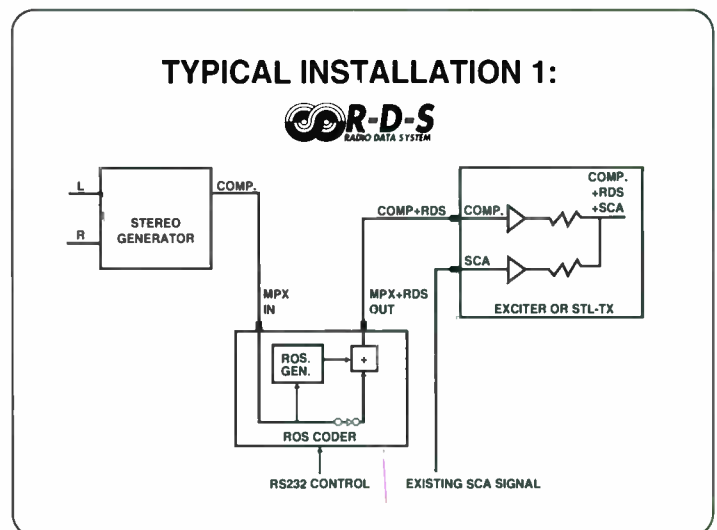
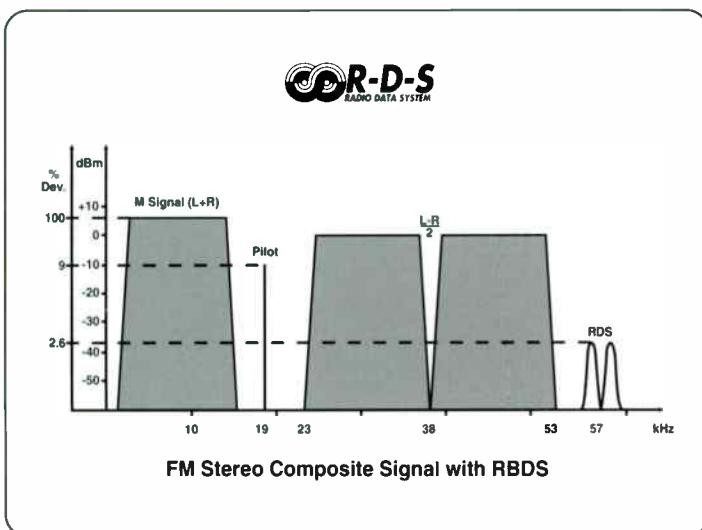

Program Type (PT) will let you display your format. It will also allow the end user to search by format type instead of searching every frequency. If listeners prefer country, for example, they'll be able to search from country station to country station. This feature will be used most frequently by those who travel considerably and have no idea which station carries their favorite format. It will also give you the ability to target your selected audience more closely. However, end users will still be able to search and scan frequencies the way they do today, and the majority of local listeners will continue to lock their favorite stations in on their presets.

Clock and Time (CT) will permit you to send accurate time to the user. In fact, auto makers will stop putting clocks in cars beyond the one included on the radio. The clock can be updated every minute, and it can also be synchronized with WWV or any source you choose.

Alternate Frequency (AF) will allow the radio to constantly monitor select frequencies for the strongest signal. This has great potential for broadcasters with LMAs and applications where programming is simulcast over a large area. In these applications, the radio will automatically switch to the strongest signal strength without making the listener aware of the switch. Assume you have several translators in the area, all on different frequencies. Your RBDS coder will tell the radio which frequencies to monitor, and then stay on the strongest one. Just imagine being able to hold

those listeners for a longer time. Your advertisers will love the advantage you can offer them.

Traffic Announcement (TA) is a wonderful tool for the listener. The RBDS system will allow you to send traffic announcements to the radio in audio and text form. When the user enables the TA capability, the radio will sense the incoming signal, tune to the correct station, adjust the volume, then return to its prior state upon completion. Even if listener is using a cassette or CD, the smart radio will pause during the announcement and return afterward. We are sure that the EBS will look long and hard at incorporating RBDS into the new standards to be established.

There are many other applications available for RBDS technology as well. Paging companies and other businesses are willing and eager to lease this data stream from you, and other applications—for example, sending traffic information to electronic road signs, electronic billboards, and so forth—are truly endless. Even if you don't want to be bothered with these applications, you can always lease them to another party for added income.

Getting Started

RBDS is very simple to install and operate. Hardware and software costs are expected to be low, which is really amazing for a new technology offering such potential. Coding systems will start around \$1,500 with high end systems in the area of \$6,500.

The Positives At A Glance:

- New ways to win listeners
- New avenues for income generation:
 - Radio Text
 - Program Service
 - Program Type
 - Clock and Time
 - Alternate Frequency
 - Traffic Announcements
- New opportunities to attract new advertisers
- New opportunities to increase sales to current clients

Surely payback on the equipment will be quick with the advertising advantages and leasing potentials that will be opened.

In its continuing role as the leader in broadcast technologies, Harris Allied now offers RBDS equipment from RE America and from Modulation Sciences. RE America offers several types of rack-mountable encoding and decoding equipment while Modulation Sciences offers a plug-in computer card approach.

Call the experts at Harris Allied to see how you can increase your profitability by using today's technologies to your advantage. ✓

TYPICAL INSTALLATION 2:

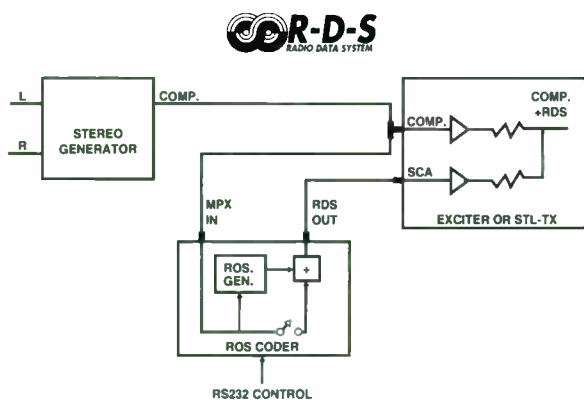

TYPICAL INSTALLATION 3:

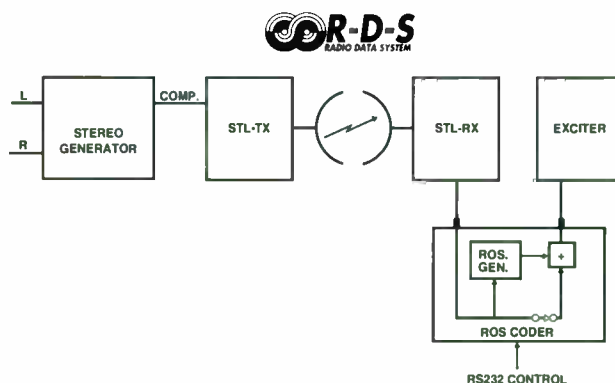

Radio RF Products Bring Reality Of All-Digital Air Chain Closer

While radio broadcasting has been inching toward the promises of an all-digital air chain for some time now, Harris Allied's NAB '93 exhibit will bring the reality closer.

Among innovative Harris radio transmission products are Digit™, the world's first truly digital FM exciter, and an expanded line of DX Series digital solid state medium wave transmitters.

Both offer precision-perfect audio performance; simple designs, and flexibility that make them ideal for today's applications without compromising their suitability for tomorrow.

Digital FM Exciter

Harris' Digit™, the first true digital input/RF output device, is available with an optional 16-bit analog to digital converter for compatibility with today's analog air chains. In fact, this exciter can be used to upgrade almost any FM transmitter.

While Digit produces 50 Watts of RF output power with rugged wideband FET output devices, power can be limited to 15 Watts to ensure safe and reliable operation with older FM transmitters.

Operating with 32-bit Direct Digital Synthesis (DDS) precision and 0.6 Hz resolution, Digit rivals compact disc quality in many areas. For international N+1 applications, Digit's N+1 option allows channels to be selected in any increment with no requirements for out-tuning.

Unlike analog exciters that degenerate over time, Digit provides sustainable performance. By replacing VCO/PLL technology with a unique Numerically Controlled Oscillator, Digit overcomes poor low frequency separation and PLL unlock caused by audio transients. The need to continuously adjust linearity correction circuits also is eliminated.



**PT 5FM, solid state
5 kW FM transmitter**

Also At NAB '93:

- **Harris Platinum Series™ PT 5FM, 5 kW Solid State FM Transmitter:** Harris PT FM Transmitters, also available in 2, 4, 8 and 10 kW models, feature an ultra-reliable FET solid state design. Hot-pluggable power amplifier modules operate in a parallel/redundant configuration. These transmitters require only 10% the recommended maintenance of FM tube transmitters and provide unrivaled FM performance.
- **Harris GATES FIVE FA, 5 kW Frequency-Agile Solid State Medium Wave Transmitter:** This Polyphase PDM all-solid state transmitter allows frequencies to be changed over the medium wave broadcast band in less than three minutes. GATES Series transmitters are available in 1, 2.5 and 5 kW models.
- **Harris HT 10FM, 10 kW Single Tube FM Transmitter:** Field-proven high-performance HT FM transmitters are available in power levels from 3.5 through 35 kW.
- **Harris HT 1FM, 1 kW Solid State FM Transmitter:** These reliable low power solid state FM transmitters also are available in 250 W and 500 W models.

Another advantage of Digit is precise digital control modulation, allowing optimum level settings. The unit's digital input reduces susceptibility to magnetic and RF interference, microphonics and environmental extremes.

During NAB, Digit will be displayed in Harris' new DT 20FM, a 20 kW FM transmitter.

Expanded DX Product Line

Harris' DX Series transmitters, introduced in 1987, have become a world standard for medium wave broadcast applications. No other transmitter can compare with the Harris DX for low operating costs, digital audio performance, ease of maintenance and reliability. Only Harris' patented Digital Amplitude Modulation, invented by Senior Staff Scientist Hilmer I. Swanson, can give broadcasters superior performance in all transmitter categories.

Since 1987, more than 275 DX transmitters have gone into service with power levels ranging from 10 to 300 kW. Each new and higher power level has proven not only to be reliable, but to have the lowest operating costs of any medium wave transmitter in its power range. New DX owners are saving thousands of dollars yearly in their operating budgets.

During NAB '93, Harris Allied will premiere three new DX Series products, the DX 15, a 15 kW MW transmitter; the DX 100FM/DX 300FA, 100 and 300 kW ruggedized frequency-agile MW transmitters, and the new power block series of 100, 120 and 150 kW building blocks for high power DX transmitters from 200 to 2,000 kW. The 100, 120 and 150 kW power blocks are also offered as stand-alone transmitters. These new products were developed to expand Harris Allied's international product line and are currently being offered for international use.

Like the entire DX Series, the new DX products offer:

- Lowest operating costs.
- Field-proven reliability.
- Digital audio performance.
- Exceptional ruggedness.
- Front panel diagnostics.
- High average modulation capability.
- User-friendly control and operation.
- Modular construction for ease of maintenance.

Offering quality broadcast products with exceptional value for over 70 years, Harris Allied is committed to providing state-of-the-art products today with a constant focus on the future. As all-digital broadcast facilities and in-band DAB continue to evolve, you can count on Harris to provide you with the most effective broadcast solutions. ▶

SATELLITE Update

New Receiver From Scientific-Atlanta Is Clear Winner

by JEFF NORDSTROM,
Manager - Satellite Sales

In today's competitive radio market, the ability to take advantage of the wide selection of satellite network programming is essential for business success. For many small-market stations, though, the cost of the digital satellite receiver needed to capture that programming has been too high. That is, until now.

Scientific-Atlanta's new Encore™ DSR-3610 Digital Satellite Receiver truly represents the next generation of satellite-delivered audio technology. We at Harris Allied believe it is the right product at the right time. The Encore DSR-3610 combines a high-performance, reliable receiver with a SEDAT™-compatible digital audio decoder in one slim, rack-mountable unit (1-3/4" high). It features transponder agility and channel agility for greater programming flexibility. The Encore DSR-3610, priced at \$3,195, is the flagship of a new and exciting product line recently introduced by Scientific-Atlanta.

For many stations, the Encore DSR-3610 can provide the reception capacity needed to become an affiliate of a major radio network and benefit from the broad selection of satellite-delivered network programming. The Encore can also provide those stations with the capacity to choose from today's huge selection of specialty programming — such as talk shows, ski reports, and stock reports — available from specialty networks and syndicators.

For larger stations, accustomed to using one or more digital receivers, the Encore DSR-3610 offers better performance and the ability to further increase reception capacity — all at less than half the cost of prior receivers.

Network-affiliated radio stations will benefit from the Encore DSR-3610's SEDAT compatibility as more and more national networks convert their satellite audio transmissions to SEDAT. The Encore DSR-3610 also supports the DATS format 15 kHz and 7.5 kHz.

The Features and Specs You Asked For

The Encore DSR-3610 boasts the following features:

- Two audio channels standard, two additional channels optional. Outputs may be combined for stereo.
- Transponder and channel agility.
- Local and remote control.
- L-band input accepts either stabilized or lower cost non-stabilized C- or Ku-band block converter.
- SEDAT-OSI compressed digital audio interface.
- Capable of receiving the entire SEDAT family of algorithms.
- AES/EBU non-compressed digital audio interface.
- One data port.
- Front panel display/control.
- Front panel headphone monitor jack.

Here are some of the Encore DSR-3610's more impressive audio decoder specifications:

- Frequency response 20 Hz to 20 kHz and 20 Hz to 10 kHz, both $\pm 0.3\text{dB}$.

- Output level +8 dBm nominal, ± 24 dBm peak into 600 ohms balanced load.
- THD 0.1 percent maximum for 20Hz to 20 kHz.
- Dynamic range 90 dB minimum.
- Sample rate 48 kHz.

A Track Record of Excellence

Scientific-Atlanta has long been recognized as the world leader in satellite audio technology. They invented digital audio satellite transmission and reception in the early 1980's and they pioneered digital audio compression with the introduction of their SEDAT system in 1989. In fact, most of their original DAT 32 receivers are still operating today.

Harris Allied has been an industry leader in distribution for many years, distributing more than 5,000 radio, studio, and transmission products from more than 250 leading suppliers. Harris Allied is the only distributor with a 10 year history of supplying all formats of satellite audio equipment, from a large inventory, to radio stations and networks worldwide. Harris Allied is pleased to be selected as Scientific-Atlanta's distributor of the Encore DSR-3610. Offering quality products such as the Encore DSR-3610 helps us continue our tradition of providing radio stations with technology that saves money and increases broadcasting capabilities.

For further information on purchasing or leasing the Encore DSR-3610, please contact Harris Allied at 317-962-8596.

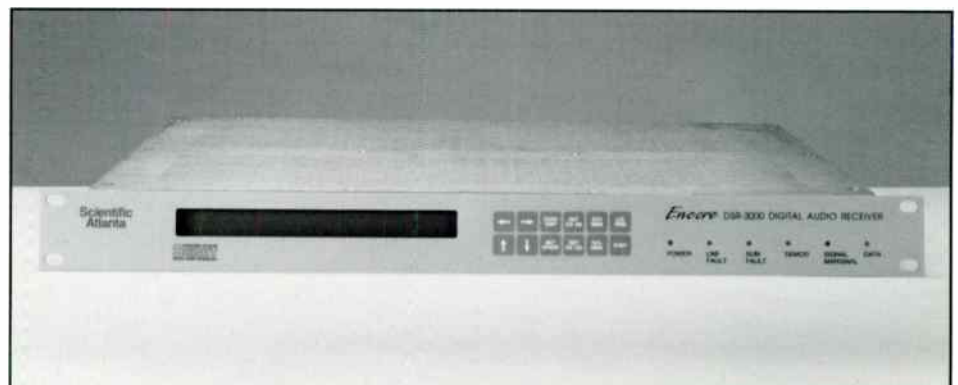

PRODUCT Showcase



Henry Engineering TIS

Henry Engineering's new Telephone Information System (TIS) lets your station turn on a new stream of revenue without dipping too far into current revenues. Previously, menu-selectable services such as skilines, weatherlines, sportslines, etc., were realistic only when big budgets existed. Henry has now made this form of revenue enhancement affordable.

Over eight minutes of information is digitally stored and divided among up to 10 separate revenue-producing services.

Harris Allied has complete information on the easy operation and easy-to-acquire price. Turn on some new dollars.



Gepco Wire & Cable

Because Gepco Wire and Cable listens, you now have a simple way to route AES/EBU digital audio (and time code) around the building. This 110 Ohm AES/EBU compatible twisted pair is available in a one pair configuration (5524) and a four pair package (552404).

Both of these Gepco cables comply with UL and pass the UL 1581 vertical flame test.

At Harris Allied we're ready to discuss applications and field questions. We'll be happy to give you our ideas on applications which this new wire now makes possible.



SKB Racks

Lightweight, yet strong, the SKB-19 inch racks are made of military grade 50-100 ultra high molecular weight polyethylene material. They're stackable and less than half the weight of wooden racks. Draw-tight latch front and rear covers are gasket-sealed to keep moisture and dirt out.

With each rack comes sufficient mounting hardware plus spares.



BEST Small FERRUPS Line

If your station runs on a PC/hard disk, you're playing off-the-air roulette if you're not power protected. The BEST family of FERRUPS' uninterruptible power supplies gives you black-out power back-up and protects as completely as the laws of physics allow.

Lightning, surge and spike protection plus voltage regulation and noise isolation help ensure against costly downtime and loss.

Harris Allied has a BEST UPS in many different capacities. Whether your need is a small 500 VA or a hefty 18 KVA, talk with us about BEST power protection and conditioning.



Aphex DIGICODER™

The DIGICODER™ Stereo Generator by Aphex provides the quality of digital in an analog design. DIGICODER™ exceeds 18 bit performance without the hassle of A-D, D-A converters and provides two independent, adjustable transmitter outputs.

Specifications include: better than 65 dB separation at 15 kHz; zero overshoot lowpass filter, and true real-time through put.

Call and we'll explain how DIGICODER™ achieves world class analog audio with digital stability.

Illustrations, drawings, descriptions, measurements, weights and prices are subject to change without notice. Leasing and financing are available in most states with approved credit, plus sales tax. Harris Allied disclaims any implied warranties of merchantability or of fitness for any particular purpose. Since Harris Allied cannot control the manner of use of products after their sale, Harris Allied will not be responsible for any consequential or indirect damages. Since Harris Allied is only acting as a distributor of products manufactured by other companies, Harris Allied expressly limits its liabilities to any warranty extended by the manufacturer. Harris Allied will pass these guarantees through to the customer.

HARRIS ALLIED © 1993

Every radio station
in the U.S. & Canada is
in this book



9 lbs. \$160.00

Every radio station
in the U.S. & Canada
is in this book



2 lbs. \$39.95

The smallest, most efficient and
lowest priced is radio's best annual:
The M Street Radio Director.

Order your 1992/93 edition direct at
212-473-4668.

Only \$39.95* delivered.

*Plus tax.

TASCAM

**HARRIS
ALLIED**
800-622-0022

Fax (317) 966-0623 • In Canada (800) 268-6817

NEW! For Broadcasters

Presenting a new Workforce of sound solutions that are designed for the 24-hour-a-day use and abuse your operation dishes out. Here, under on roof and one brand name, is the latest offering of the newest Tascam products.

CD-401 MKII Rackmount CD Player

LA 40 MKII Pro-IHF, IHF-Pro Converter



RA4000 Random Access Digital Recorder/Editor

134B 4 Track AV SyncaSet

DA-60 DAT With Tape Monitoring

DA 88 Affordable Digital Multitrack

Tascam, the world's largest manufacturer of recording equipment, and Harris Allied, the world's supplier, combine to offer the greatest values in our industry.

See overleaf for out of this world features and benefits and down to earth prices . . .



TASCAM DEBUTS PROFESSIONAL HIGH PERFORMANCE RACK-MOUNT CD PLAYER

TASCAM introduces the CD-401MKII Professional CD Player, adding "cue to music" and pitch control to the features of the current CD-401 model. Designed for the professional recording production studio and broadcast environment, the economical, high-performance, rack-mount CD-401MKII features Fader Start, Auto Cue, Pitch Control, Single Play, Digital Out, 4 Mode Time Counter, 4 Mode Repeat, Index Search, Auto Space and both XLR balanced and RCA unbalanced outputs at appropriate levels and impedances. Suggested retail for the CD-401MKII is \$849. Special \$599.



TASCAM DA-60 SETS NEW STANDARD FOR PROFESSIONAL DAT RECORDING

With the announcement of the TASCAM DA-60, new standards for both features and affordability are established to meet the needs of the audio professional in film and video post-production, as well as audio mastering.

The DA-60 Professional DAT Recorder features 4 heads for off tape "confidence" monitoring; RAM buffer for instant start; accurate Dial Search capability; Auto Cue; Auto Punch In/Out with Rehearsal capability; gapless Punch In and Out; $\pm 12.5\%$ Pitch Control on playback; two Locate points; Absolute Time, Start, End and Program numbers which can be recorded independently in the sub-code area; user-selectable Copy Protection; Cue and Review a 1x, 3x or 9x play speed; Error monitor LED; AES/EDU AND SP/DIF digital I/O; Word Clock I/O; and a 37-pin Parallel Port for external transport control.

In addition, with the optional SY-D6 Synchronizer Board, the DA-60 will offer a SMPTE/EBU reader/generator; chase SMPTE timecode with offset capability; lock to Video sync; and offer a 9-pin serial port for direct editor control.

The DA-60 has a suggested retail price of \$5,499. The SY-D6 has a suggested retail price of \$599.



VERSATILE NEW TASCAM A/V SYNCASET DECK

The TASCAM 134-B is a balanced input/output 4-channel / 4-track A/V cassette recorder. The 134-B, replaces both the 133-B, stereo plus cue, cassette and the 234, four-track multitrack cassette with features and versatility that is perfect for Multi-Image, A/V production and presentation.

In addition to all the A/V and Multi-Image production and presentation features found on the 133-B such as, 25 Hz cue tone, 5 repeat modes, 3 locate points, Cue rewind, Cue stop, Locate/Auto play. The 134-B has 4 track record/playback capability, sophisticated auto-presentation features, Mic mixing, Dolby B & C type noise reduction, Shuttle control, Accessory II port for external control and 4 x 2 mixing capability.

The 134-B has suggested retail price of \$1349, Special \$989.95.



TASCAM DEFINES THE AFFORDABLE DIGITAL FUTURE OF MULTITRACK RECORDING

TASCAM, the world's largest manufacturer of recording equipment, and the originator of affordable multitrack, now defines the future of affordable digital multitrack with the introduction of the DA-88 eight-track recorder.

Designed to deliver today's digital recording technology to the project studio and post production environments, the DA88's Hi-8 format allows up to 100 minutes of recording time-enough for an entire CD project, feature film or video project.

But features and specs aside, the DA-88 has one benefit that cannot be measured or written about. Great sound. Which is the reason, more than any other, that it is destined to be found in a wide variety of recording applications.

Suggested retail list \$4499.



TASCAM INTRODUCES SUCCESSOR TO THE LA-40 LINE CONVERTER

Here's the New LA-40 MKII 4-channel Bi-directional Balanced & Unbalanced Line converter. It's the successor to TASCAM'S popular LA-40.

The LA-40 MKII has added Ground Lift switches for each independent channel and an overall Master switch. All switches on the rear panel Plus a ± 6 dB trim pot for each channel located on the front panel.

The LA-40 MKII besides being a (+4 to -10 or -10 to +4) line converter box, an unbalanced input signal, by using the "Input Link" feature, will allow the LA-40 MKII to also be used as a distribution amp and the signal to be taken from any XLR output numbered higher than the unbalanced input. IE: #1 input may be linked to be distributed to output #2, #3, #4 but not #1.

The LA-40 MKII has a suggested retail price of \$450. Special \$299.95.



TASCAM UNVEILS THE RA-4000 RANDOM ACCESS DIGITAL RECORDING/EDITING SYSTEM

The TASCAM RA-4000 Random Access Recording/Editing System, is a dedicated stand alone unit, that has been optimized for use by the Audio for Video Post Production Mixer.

The RA-4000 features an easy to use interface, the RC-4000, that focuses on the single most important function to the Post Production Mixer . . . Editing!!! The RC-4000 has dedicated buttons for all editing functions, large transport controls and an easy-to read, large LCD display for fast operation.

The RA-4000 is a dedicated computer specifically designed for post production recording and editing.

The RA-4000 has a suggested retail price of \$5499 and the RC-4000 retails for \$1499.

Broadcasters have great ears too.

Join the family of top American recording studio professionals using Hafler amplifiers. Treat yourself to the legendary name of Hafler, the most dependable studio amplifier available.

Why buy just another good amp when you can enjoy our "rich, elegant studio reference audio quality" at prices that will fit your budget. Just ask the experts at Harris Allied.

8:00 a.m. to 8:00 p.m. EST
Phone: 800-622-0022 Fax: 317-966-0623

Hafler amplifiers. *The standard.*

Hafler

	Suggested Retail	Special Price	NAB
Hafler Pro 1200 <i>60 watts per channel</i>	\$500	\$355	
Hafler Pro 2400 <i>120 watts per channel</i>	\$630	\$445	
Hafler Pro 5000 <i>325 watts per channel</i>	\$1200	\$715	

Prices good through 5/12/93. Quantities may be limited and are subject to prior sale. All sales subject to appropriate sales tax.

HARRIS ALLIED

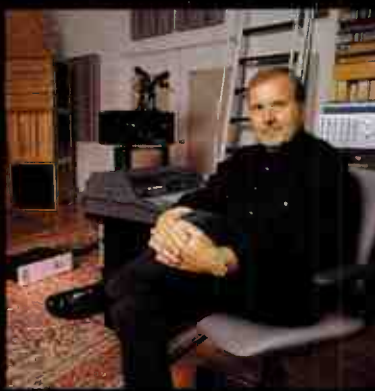

"Jim Strickland's simple (less is more) design of the trans-nova makes it the most uncolored power amplifier I have heard. It doesn't add or take away from the music. For me this makes the trans-nova an ideal monitoring tool."

TOM JUNG
DMP RECORDS



"For the past ten years, I've used Hafler amplifiers here at Capitol's 'Tower Mastering'. I'm more than pleased with the sound quality and dependability they provide. The many artists I've mastered, know they can rely on our monitors when they're powered by Hafler."

WALLY TRAUGOTT
TOWER MASTERING
CAPITOL RECORDS



"Here at Conway we have 21 Hafler amplifiers that don't lie...and both of my systems at home are built around Hafler components."

JOHN HURST
TECHNICAL DIRECTOR
CONWAY RECORDING STUDIOS



"...Once in a while a product comes along that is an incomparable value. Hafler power amps fit squarely into that category: pure abundant transparent power amplification, no gimmicks, and no high price tag. If only all equipment decisions were so easy...."

PAT SCHOLES
DIRECTOR OF ENGINEERING
ARDENT STUDIOS



"...One might ask why I chose Hafler, when with the budgets I've had I could have spent thousands more on esoteric amplifiers. The answer is simple. I think for the money spent, these are the finest amplifiers obtainable. ...Hafler amplifiers... The Standard..."

PATRICK WEBER
RECORD PLANT, MCA RECORDS,
CAPITOL RECORDS,
PATRICK WEBER ENGINEERING



Mounting Solutions for Mounting Problems

Several years ago, Middle Atlantic Products charted a difficult but rewarding course. The stated goal was to do one thing and to do it best.

The one thing was concentration and focus on solving the problems one encounters when trying to accomplish standards of good engineering practice with rack installs. The workmanship, durability, beauty and class of the Middle Atlantic line have made their products the standard by which comparisons are made.

Consider their 19" rackmount storage drawer...

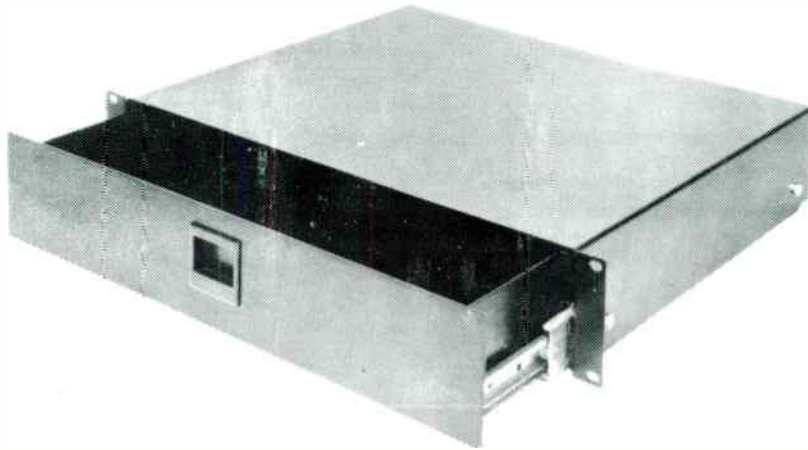

3 sizes: 3.5, 5.25 or 7". Keylock option available

CD & Cassette Partitions available.

This family of storage drawers provides convenient storage of many items that need to stay with your install. The fully enclosed top insures that the contents stay in and dust and cabling stays out! Front panel has an attractive flush spring-loaded latch that engages when the drawer is closed. Full extension ball bearing side releases on the slides. Keylock option secures the contents from theft. Inside dimensions are 15-7/8" wide X 14" deep, inside height is 1/2" less than overall height ordered. Drawer bodies are 16 gage crs, black powder coat finish. Faceplate is .090 aluminum. Please specify brushed black anodized or textured powder coat finish. Three sizes to choose from.

 **HARRIS
ALLIED**
BROADCAST EQUIPMENT

800-622-0022

World Radio History



Middle Atlantic Products

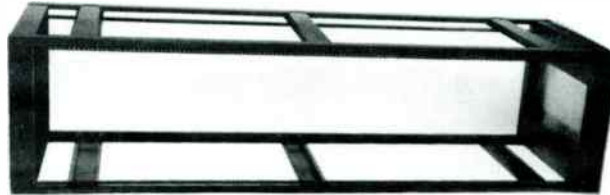

The slim - 50 is a welded electronic enclosure designed for maximum flexibility for diverse installation requirements.

- 12 gage steel corners, 14 gage steel tops & bottoms
- Laser cut $\frac{1}{4}$ " structural steel internal braces for strength
- Attractive & durable textured black powder coat finish
- Standard front & rear 10 gage threaded rack rail, fully adjustable
- Electrical knock outs are positioned in 3 areas with $\frac{1}{2}$ ", $\frac{3}{4}$ ", 1", 1 $\frac{1}{2}$ " sizes
- Tops are vented with facilities to accept a standard 10" fan for forced air cooling
- Large cable entry opening in bottoms
- Built in skirted wheel base
- A very slim 21 $\frac{1}{8}$ " wide
- Available 25" or 30" inside depth
- Rear door standard

We will configure rack tops & bottoms for any requirements (raceways, cooling, power etc.). Modern laser fabrication technology allows for precise, economical and quick modifications to your specifications.

WELDED PART NO.	RACKING HEIGHT	DEPTH
50-44-25	77" (44 space)	25"
50-40-25	70" (40 space)	25"
50-37-25	64 $\frac{3}{4}$ " (37 space)	25"
50-44-30	77" (44 space)	30"
50-40-30	70" (40 space)	30"
50-37-30	64 $\frac{3}{4}$ " (37 space)	30"

Audiometrics 386-33 Computer Designed and built with the broadcast environment in mind. Can be pre-configured for a variety of broadcast oriented options.

Roland DM80 Digital Editor An audio work station designed for the professional. The AES /EBU digital outputs deliver a true 24-bit digital signal for excellent noise and distortion specs and superb sound.

Re-America RE533 RBDS Coder Turn RBDS radio text into profits talking to "Smart radios". Features PS, PTY, PTYN, TP, PI, TA, AF, DI, M/S, CT & RT displays.

AKG DSE 7000 Digital Editor The controller console is designed for maximum speed and simplicity. Dedicated buttons, smooth responsive slide controls and rotary control simplifies editing and cuing. Edit, copy, slide tracks, mix, "undo", test & produce effortlessly.

Arrakis Trak-Star Digital Mixer-Editor-Recorder The first cost effective multi-track digital audio recorder, mixer and editor designed specifically for the radio broadcast professional. Create spots, jingles & liners with ease. Record and store on disk. It's a multi-track studio in a compact box.

Gentner Audisk Digital Storage System Audisk is a digital storage system that allows you to record and automatically play back hours of commercials, ID's, promos, PSAs, jingles, music, weather, news - anything a radio station wants aired.

Scientific Atlanta - DSR 3001 Digital Satellite Receiver The next generation of economical satellite delivered audio technology in a one rock unit; high performance frequency & channel agil receiver. Reception capacity of broad selection of satellite delivered network programming.

Tascam DA-88 Digital 8 Track Recorder /Editor Great sound! Easy-to-use simplicity delivers digital recording technology to the project studio and post productions environments on up to 100 minutes on cassette tape.

TIME	MON., APRIL 19	TUE., APRIL 20	TIME	WED., APRIL 21	THURS., APRIL 22
	NAB Show Hours 9 a.m. to 6 p.m.				9 a.m. to 3 p.m.
9:00			9:00		
9:30			9:30		
10:00			10:00		
10:30			10:30		
11:00			11:00		
11:30			11:30		
12:00			12:00		
12:30			12:30		
1:00			1:00		
1:30			1:30		
2:00			2:00		
2:30			2:30		
3:00			3:00		
3:30			3:30		
4:00			4:00		
4:30			4:30		
5:00			5:00		
5:30			5:30		
6:00			6:00		
6:30			6:30		
7:00			7:00		

HARRIS ALLIED BOOTH 2218 NORTH HALL

PT 5FM, 5 kW Solid State FM Transmitter

Also available in 2, 4, 8 and 10 kW models, feature an ultra-reliable FET solid state design. Hot-pluggable power amplifier modules operate in a parallel/ redundant configuration. Requires only 10% the recommended maintenance of tubes.

HT 1FM, 1kW Solid State FM Transmitter

These reliable low power solid state FM transmitters also are available in 250 W and 500 W models.

GATES FIVE FA, 5 kW Frequency-Agile Solid State Medium Wave Transmitter

This Polyphase PDM all-solid state transmitter allows frequencies to be changed over the medium wave broadcast band in less than three minutes.

Sceptre Series 5 kW Solid State UHF TV Transmitter

3 - 30 kW ATV-ready features an ultra-reliable, modular all-solid state design. Provides extensive on-air service capability; VDU display for transmitter status, and remote capability.

Platinum Series® 30 kW Solid State VHF Transmitter

ATV-ready 1 - 60 kW replaces tubes with multiple fault-protected hot-pluggable solid state power amplifiers which operate in parallel. Requires up to 90% less maintenance than tubes, provides extensive on-air service capability.

HT 10FM, 10 kW Single Tube FM Transmitters

Field-proven high-performance HT FM transmitters are available in power levels from 3.5 through 35 kW.

Navigator Series UTV-1000 Solid State UHF TV Transmitter

Navigator Series transmitters and translators are available in power levels from 10 through 1000 W, and single tetrode models are available for 5 and 10 kW applications.

Platinum Sentry This option allows users of Harris Platinum™ Series solid state VHF TV transmitters to easily access complete transmitter status information, and also provides some control capability, from a personal computer. Packages are available for either remote or extended use.

Harris VHF and UHF Television Antennas
(Numerous models will be presented)

NEW @ NAB 1993

Sigma™ Series 15 - 240 kW UHF Television Transmitters

Designed from the ground up specifically for the HDTV transition. These all-new IOT (Inductive Output Tube) transmitters provide exceptional NTSC efficiency and performance now and HDTV capability for the future. Sigma transmitters are available in models for common amplification or separate amplification with a solid state sound option. A wide variety of options further enable you to tailor your transmitter.

S-2A Air-Transportable Satellite Uplink System

This containerized air-transportable uplink system can be used for Ku-Band and/or C-Band applications. The S-2A meets FCC, Intelsat and Eutelsat standards.

Platinum Series® HT EL Solid State VHF TV Transmitter

These compact 500, 1000 and 2,000 Watt Transmitters feature an affordable 100 percent solid state design and are available for any world standard. HT EL transmitters use single-phase power.

S-18A Satellite Communications Vehicle

This compact mobile Ku-band system, equipped with a 1.8 M Vertex offset fed antenna, is ideal for uplinking news or special events, and is easily adaptable for voice and data applications.

Digitrol and DC-128 Remote Control

Digitrol is a flexible PC-based serial remote monitor/controller that provides 16 status and 16 analog signals and 32 control signals. The DC-128--offers 16 analog and status and 16 control outputs and is expandable.

Additional DX Series Digital Solid State MW Transmitters

Premiering three new DX Series products: The DX 15, MW transmitter; the DX 100FM /DX 300FA, 100kW and 300 kW ruggedized frequency-agile MW transmitters, and the new power block series of 100, 120 and 150 kW building blocks for high power DX transmitters from 200 to 2,000 kW. The power blocks are also offered as stand-alone transmitters. These new products are currently being offered for international use.

Harris Digit™ 50 Watt Digital FM Exciter

The first true digital input/RF output device, Digit is available with an optional 16-bit analog to digital converter for compatibility with today's analog air chains. Can be used to upgrade almost any FM transmitter. Operating with 32-bit Direct Digital Synthesis (DDS) precision and 0.6 Hz resolution, Digit rivals compact disc quality in many areas. Digit provides sustainable performance. Unique Numerically Controlled Oscillator overcomes poor low frequency separation and PLL unlock.

HARRIS ALLIED

BOOTH 2218

NORTH HALL

World Radio History

NAB 1993

Convention Pocket Planner

ANDREW

HARRIS ALLIED

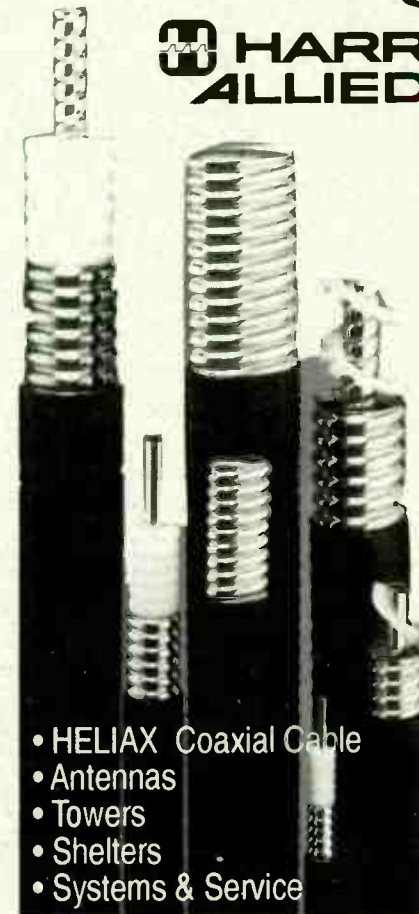

- HELIAX Coaxial Cable
- Antennas
- Towers
- Shelters
- Systems & Service

Andrew Corporation:

Serving the
Broadcast Industry
for over 50 years

Come see us at

Booth 15674

800•622•0022

Stick It In Your Gear

About the size of an audio cassette, these small solutions are in most of the radio stations in this country. The STM-2 mic pre-amp is one of the more popular in the Stick-On series. Adjust gain to match any pro mic and bring it up to line level. Stick it in small places. Permanent or mobile. Requires optional DC supply.

\$197⁰⁰/pr
Price Includes Free Federal Express



Pure Clarity

This STDA-3 mono distribution amplifier takes a balanced or unbalanced bridging input (with 20 dB of gain) and provides 3 outputs. Requires optional DC supply.

\$175⁰⁰/pr
Shipping Included



You Can Take It With You

Full 44.1 kHz, 16-bit resolution on location in the smallest formats. Denon's new portable DAT recorder, the DTR-80P. Up to 3.5 hours of demanding digital quality in a package 21 ounces light and 3.55 x 1.56 x 6.6 inches small, including battery pack. The quality is big. Everything else is small, including the price. Meets SCMS standards.

\$765⁰⁰
Free Shipping



A Little Black Magic

When you receive these, hook'em up and LISTEN! How on earth could all that rich, balanced sound be coming from boxes that are only 6 inches across, 9 inches tall and 5.5 inches deep? They've earned their reputation and popularity. Control 1 miniature loudspeaker system from JBL. The stereo pair. (black) only...

\$186⁰⁰/pr

Order Today. We'll ship it today.



Free Shipping



You're Gonna Love This Deal

The Audiometrics CD 10 Compact Disc Cartridge Machine is the natural evolution of a great idea. We simply made it better. This broadcast-ready CD player features cartridge autolock, programmable EOM indicator, instant start with music and true broadcast standard construction. Take CDs direct-to-air with confidence. Special NAB show price...

\$1,049⁰⁰
Order Today and get Free Federal Express



A Crown Jewel

More of these deliver power to control and production room monitors than all others combined. The Crown D-75 power amplifier. Designed, built and carefully checked to assure reliability. XLR and 1/4" inputs. 35 watts per channel.

\$435⁰⁰

Price Includes Shipping



QUANTITIES MAY BE LIMITED AND ARE SUBJECT TO PRIOR SALE. ALL SALES SUBJECT TO APPROPRIATE SALES TAX.

HARRIS BROADCAST ALLIED EXPRESS

HARRIS BROADCAST ALLIED EXPRESS



Charge it with MasterCard or Visa or use your Harris Allied Account.

800•622•0022

800•622•0022

Heard But Not Seen

Audio-Technica's new MT830R is truly a MICROphone. This tiny lavalier is most at home on your lapel. When you want to hear it but not see it, this sub-miniature condenser is the way to go.



(Requires Phantom Power.)
\$175⁰⁰

Free Federal Express With Every Order

New Gold Standard

Here's a famous profile. While the face is familiar, this is actually the 1990s upgrade of that famous mic you're thinking of. This is EV's newer RF27M/D. It's everything the industry loves about RE20 plus improved specs including an even wider frequency response.

\$459⁰⁰

You Don't Pay Shipping Charges

HARRIS BROADCAST ALLIED EXPRESS

Issue No.4 Volume No.1

Bright Ideas

These lamps are in the rules and regulations. Not by name, but by specification. When you're relamping this spring, do it with the best-Duro-test. Far left: A-21, 116 watt medium screw-in base, clear, in packs of 6 each.

\$27⁰⁰/pk

PS-40-682, 620 watt bayonet mogul base, clear, in packs of 2 each.

\$62⁰⁰/pk

We'll Treat You To Free Federal Express Delivery



Keep It Constant

Simple, straight forward, state-of-the-art, stereo. Symmetrix 421 AGC Leveler. This new AGC (Automatic Gain Control) leveler smoothly pulls back those levels that are too high and boosts those that are too low. No thump. No pump. No breathing. No big price.

\$439⁰⁰

Price Includes Free Federal Express

Stereo On The Go

Marantz is *the* machine! Portable field recording and Marantz go together. Now look what they've done to your Marantz PMD222: built-in, balanced XLR microphone input; three heads; pause/play for live intro; modular phone jack; variable speed control, and line level input. The new standard for the broadcast industry.

\$280⁰⁰

Order Today And Get Free Federal Express



The Clear Choice

Free Shipping



HARRIS BROADCAST ALLIED EXPRESS

800•622•0022

Free Shipping



800•622•0022

Federal Express guarantees two-day delivery in the continental U.S. Free shipping applies only to items featured in this circular. Orders must be received by 5:00 PM Eastern for same day shipment. Prices guaranteed through 5/12/93. Quantities may be limited.





Arrakis 12,000 Series

You'll find the Arrakis name on more mixing consoles than any other brand. Arrakis consoles are engineered to sell.

Arrakis considers all needs including price and performance ratios. What you get is a great combination of features and benefits at the right price. This is true of all Arrakis consoles and particularly obvious in the 12,000 Series. The 12,000 Series can be specified in 8, 18, or 28-input mainframe and an array of electronic option choices.

Arrakis builds more and more different types of consoles. Call us for complete information on the 12,000 Series pictured, as well as the other popular Arrakis consoles.

Call Later.

Our extended hours make it easier to call on the service, selection and support of Harris Allied, the nation's largest supplier of broadcast equipment.



Eastern
8:00 am-8:00 pm



Central
7:00 am-7:00 pm



Mountain
6:00 am-6:00 pm



Pacific
5:00 am-5:00 pm

800-622-0022



Middle Atlantic Model DAT

Stores 27 DAT boxes in Middle Atlantic's Digital Audio Tape Holder - Model DAT.

Tip partitions prevent tapes from falling over. For easy access, tapes stand on end and protrude 3/8". Constructed of 20 gage steel with a black powder coat finish, the face comes in two finishes. This 19" rackmount holder occupies only three units in your rack.



Bryco DATRAX DRP-40

One of the great features about DAT cassettes is the space savings. Up to 3.5 hours of digital quality on one cassette. Long-term logger formats can get up to a week on one tape.

But, you still need appropriate storage. You need the Bryco DATRAX. The cost-effective table-top or wall-mount rack for DAT storage. Neatly store 40 DAT tapes in their cases in a space that's just a little larger than a stack of the cassette boxes alone.



Copper Products

Harris Allied has the industry's largest selection of copper for RF control. Strap wide enough for AM and FM radio and even wider for control at TV frequencies. Soft drawn wire for ground system installation and repair. Copper screen for ground systems or for room shielding.

Call the largest source of broadcast copper products today for application, price and delivery information. Harris Allied does it all.



Tascam DA-88

Tascam, the world's largest manufacturer of recording equipment, and the originator of affordable multitrack, now defines the future of affordable digital multitrack with the DA-88 eight-track recorder.

Designed to deliver today's digital recording technology to the project studio and post production environment, the DA-88's Hi-8 format allows up to 100 minutes of recording time enough for an entire CD project, feature film or video project.

Features and specs aside, the DA-88 has one benefit that cannot be measured or written about. Great sound! It is therefore destined to be found in a wide variety of recording applications. Just ask us. We'll mail or fax complete information.



Titus ON AIR Lights

This may well be the planet's classiest warning light! It'll light up "ON AIR" and numerous other phrases in several languages, horizontal or vertical. Genuine woods are available to match most decors. Gold or silver trim.



AIRcorp 500

Now you can have the control, the convenience and the quality enjoyed by major broadcasters around the world with the AIRcorp 500 PH Pro-Announcer.

Two versions are available. One for radio and one for TV.

Microphone quality is enhanced, room noise disappears and absolute level control is achieved. You will hear the difference the moment you plug earphones into the AIRcorp exclusive front panel earphone jack.

This microphone processor is for professionals. It was designed for you. And Harris Allied is one of the few places that stocks this popular, hard-to-find product.

INSIDE Story

Compiled by JUDITH A. FAWCETT
Harris Allied Broadcast Division

James Woods Named Director and Distribution Product Line Manager

James Woods has been appointed Director and Distribution Product Line Manager for Harris Allied Broadcast Division. Based at Harris Allied's Richmond, Indiana facility, Jim will direct all aspects of Harris Allied's worldwide broadcast equipment distribution. He succeeds Roy M. Ridge who has retired from the broadcast industry to pursue other business interests.



Joining Harris Corporation as a marketing associate in 1983, Jim has held positions in domestic radio, domestic TV and was Sales Manager for Europe and Africa. Most recently he has served as Senior Marketing Manager of ATV development for the broadcast division.

Jim graduated with a BSE degree in mechanical engineering from Purdue University in Lafayette, Indiana. Before joining Harris Allied, he worked for several broadcast stations in the U.S. With his extensive background in both domestic and international sales, Jim brings to Harris Allied both a keen interest and experience in the global broadcast community.

Roy Ridge pioneered independent multi-brand broadcast equipment distribution as founder of Allied Broadcast Equipment Corporation at Richmond in the mid 1960s. Today with more than 5,000 different products from over 350 manufacturers and the largest selection of digital radio studio products, the company is the world's largest single source for radio studio equipment.

Harris Allied and Wolf Coach Announce Systems Agreement

Harris Allied Broadcast Division and Wolf Coach have announced an agreement for the development, integration, marketing and sales of mobile video production, satellite and ENG systems effective immediately.

Wolf Coach, headquartered at Auburn, Massachusetts, will engineer and construct "system ready" mobile units of all sizes for delivery to Harris Allied's systems operation in Florence, Kentucky. Harris Allied will provide systems engineering and will supply and integrate all audio, video and RF equipment. Detailing, systems testing and customer support will also be provided by Harris Allied. The systems will be marketed worldwide under the Harris Allied name.

In addition, the two companies will "blend" current product lines and jointly develop new products. This action will enable customers to contact Harris Allied for a comprehensive range of mobile systems, from portable Ku-band and C-band satellite uplink systems to the most up-to-the-moment video production vehicles on the market.

Wolf Coach has been building mobile units for over 25 years, with applications in communications, government, health care and marketing worldwide. Harris Allied became involved in the fixed and mobile video systems business with the 1991 acquisition of Midwest Communication's Systems Division. The systems group has pioneered such major innovations as portable uplink

systems and automatic satellite locator technology, and has delivered nearly 500 mobile video systems worldwide.

Harris Allied Announces Plans to Develop and Manufacture HDTV Equipment For Zenith/AT&T System

Harris Allied Broadcast Division has announced plans to develop and manufacture broadcast equipment for the Zenith/AT&T Digital High Definition Television (HDTV) System.

Harris will support the rapid deployment of digital HDTV 4-VSB (four-level Vestigial Sideband) modulation and transmitting equipment to broadcasters should the Federal Communications Commission adopt the Zenith/AT&T HDTV Digital Spectrum Compatible (DSC) HDTV System as the new broadcast standard. This technology would be used in exciter for Harris' HDTV-ready UHF television transmitter line, which includes 15 - 240 kW IOT transmitters; 3 - 30 kW solid state transmitters, and 60 - 280 kW MSDC transmitters.

"Harris has been extensively involved in HDTV, from providing the RF test bed for the Advanced Television Test Center to participating in systems testing," says Frank A. Svet, vice president and TV RF product line manager for Harris Allied. "We intend to use our expertise in television transmission and video systems as well as digital technology to be a leading HDTV supplier."

HDTV transmission processing equipment combines and formats digitally-compressed video, compressed audio and ancillary data for error correction pre-coding and data equalization so as to remove transmission errors and ghosting. DSC-HDTV's unique pilot carrier and pre-coding, which assure carrier acquisition and rejection of interference from existing NTSC television signals, also are part of the transmission processing and modulation equipment. 

Sony MiniDisc Uses ATRAC

by JAMES HAUPTSTUECK,
Digital Radio Products Manager

Sony's new MiniDisc may soon change the broadcast industry. Indeed, the MiniDisc format could be used for every aspect of audio, from news gathering to on-air playback.

Obviously so radical a change in medium would be unthinkable were it not for the incredible benefits of MiniDisc technology: Portability, price of the equipment and discs themselves, and the ability to record over and over on the same disc are only a few—and the list goes on and on.

Lets focus a bit (versus a byte) on the technology itself: Through ATRAC (Adaptive Transform Acoustic Coding), Sony's MiniDisc allows 74 minutes of high quality stereo audio to be recorded on a single 2.5-inch magneto-optical disc! Since a magneto-optical disc of such a compact size normally would only hold

about 15 minutes of audio, it's easy to see why added storage capacity is among MiniDisc's greatest strengths.

ATRAC technology uses psychoacoustic principles, non-uniform frequency and time-splitting to achieve its end.

Although the disc's small size makes it susceptible to increased quantization noise, psychoacoustic principles enable this noise to be kept to a minimum by simultaneously masking inaudible sounds. For analogy, if you were talking as a jet flew overhead, your conversation would not be heard. The same principle applies to MiniDisc: Softer sounds are masked by louder sounds, and the removal of a degree of the inaudible sound allows recording time to be increased.

For each block of time, ATRAC analyzes the signal and determines the sensitivity. Sensitive regions are recorded accurately, while the remaining regions are recorded less accurately. The result is a high fidelity recording at 1/5th the bit rate.

ATRAC analyzes sounds in non-uniform frequency divisions, with more divisions in the lower frequencies and fewer in the higher frequencies. This actually enables greater accuracy in signal analysis when using psychoacoustic principals.

Non-uniform time splitting also allows increased storage. This psychoacoustic principal is based on the premise that the ear changes its sensitivity quickly when sound is changing quickly, and slowly when sound is changing slowly. Sony changes the time length blocks accordingly: Time blocks can run from 1.45 ms to 11.6 ms depending on how active the music is.

While true audio enthusiasts will never be satisfied with less than pure audio reproduction, with MiniDisc we must weigh the benefits for broadcast versus the purity of audio. Whether or not you agree with the principals involved here, the economics make MiniDisc a realistic and viable medium for the future. Take a good listen for yourself to decide whether this new cost effective technology is right for you. 

SYSTEMS *Today*

Harris Allied Brings Good News

by PETE RIGHTMIRE

NEWCHANNEL 8 provides 24-hour-a-day news service to eight cable systems in the District of Columbia, Maryland and the northern area of Virginia. During the day, NEWSCHANNEL 8 airs national news to all regions. At night, NEWSCHANNEL 8 airs news programming that is specific to each of the three service areas. Advertisers can tailor their messages to a particular audience with commercials targeted to each region as well. This is a unique approach to a news service, made possible by the extensive use of sophisticated robotics and automation systems.

Harris Allied designed NEWSCHANNEL 8's facility from the ground up, using what Jay Adrick, head of Harris Allied's systems operation, calls "value engineering." "ALLNEWSCO needed a facility that could compete with both local and network news coverage, but on an equipment budget that was far less than that of a typical network facility," Adrick said. "We evaluated each piece of equipment based on functionality, performance, and price. Then we chose only the equipment that would work together as a system to do the job. And we designed the system to grow with the needs of the operation."

Harris Allied began assembly of the system in June 1991 at their facility in Kentucky. This pre-assembly is one of the proven time- and cost-saving methods used by the Harris engineers on each project. They lay out a system as it will be installed at the customer's facility. Equipment is mounted in racks and consoles, wiring is completed, and the system is tested before it leaves the Harris Allied shop. In the case of NEWSCHANNEL 8 this became vitally important — the construction of NEWSCHANNEL 8's new building took longer than scheduled. This allowed only five weeks for the Harris Allied engineers to install the system and get it on-line. On-site installation began on September 1, 1991, and NEWSCHANNEL 8 was on the air



October 8. This would have been virtually impossible if not for the pre-assembly and testing method used by Harris Allied.

The success of NEWSCHANNEL 8 lies in its ability to offer three simultaneous independent program and commercial feeds to its viewing regions. This would be an extremely expensive, labor-intensive task if performed using traditional operations and programming methods.

That's why camera robotics and commercial insertion automation systems play such an important part in the NEWSCHANNEL 8 operation. The systems were designed to run with a minimum staff to keep down costs.

The NEWSCHANNEL 8's three Ikegami studio cameras are controlled by an AutoCam camera robotics system from Total Spectrum Manufacturing (TSM). The AutoCam also controls a fourth camera, mounted on the news studio wall, that provides a cover shot of the news set. One operator can handle all four cameras and the teleprompter during a news show.

In master control, an Alamar automation system controls a Utah Scientific AVS2B large-matrix routing switcher. Thanks to this unique 3-channel master control system, one operator can supervise the program and commercial activity of all three regional feeds. Three Sony BVC-10 Betacarts under the Alamar system's control are used for commercial insertion. Seven Beta SP

transports provide "time shift" and "program repeat" capability for all three channels.

The master control system is integrated with the station's traffic system for scheduling uploading, "as run" downloading, and reconciliation of the "as run" log. Without this level of automation, the proper feed and tracking of program and commercial material for three separate, simultaneous channels would be a logistics nightmare.

The NEWSCHANNEL 8 facility is extensive, including two TV broadcast studios, a TV production control room, eight on- and off-line edit bays, a central news record and feed room, a multi-format dubbing center, a post-production room, and management offices. All sources feed the post-production room so it can be used as a back-up live control room, as was necessary during election night. Harris Allied also designed and constructed two S-23 mobile satellite uplink vehicles and installed four satellite downlink systems to ensure that NEWSCHANNEL 8 could cover the news, wherever it happened.

After 16 months on the air, how is the system working for NEWSCHANNEL 8? Well enough for John Hillis, ALLNEWSCO, Inc. president, and David Evans, NEWSCHANNEL 8 director of operations, to agree to be in a Harris Allied testimonial ad. You know you've done a good job when customers are willing to go public with their support for you.



New at NAB:
Harris Sigma™ Series
IOT TV Transition Transmitter

by LARRY BOONE
UHF Product Line Manager

With HDTV terrestrial broadcasting on the horizon, the direction of transmitter development continues to evolve. Broadcasters will be faced with important decisions on the choice of transmitter equipment that will meet current and future needs.

The new Harris Sigma™ Series family of UHF television transmitters, to be unveiled at NAB '93, has been planned with your future in mind. Designed from the ground up, these transition transmitters have been developed for both today's NTSC standards and tomorrow's HDTV.

Featuring a flexible family architecture, Sigma™ Series transmitters are available in power levels from 15 through 240 kW. A wide variety of options further enable you to tailor your transmitter for your specific application. Combining low cost of ownership, high efficiency, ease of maintenance and a top level of manufacturing quality, our all-new IOT (Inductive Output Tube) transmitters provide exceptional NTSC efficiency and performance now and HDTV capability for the future.

Full Range of Customer Benefits

Sigma™ Series transmitters provide excellent customer benefits such as full RF chain redundancy, IPA headroom, and ability to field upgrade transmitter power. Thyatron crowbar protection and a field-proven Class AB IPA yield benefits of longer tube life and lower product maintenance. A newly designed exciter and patented correctors provide exceptional linearity and signal performance. The design of the Sigma™ Series transmitters has focused on system simplicity, ease of maintenance, performance, and most importantly, the

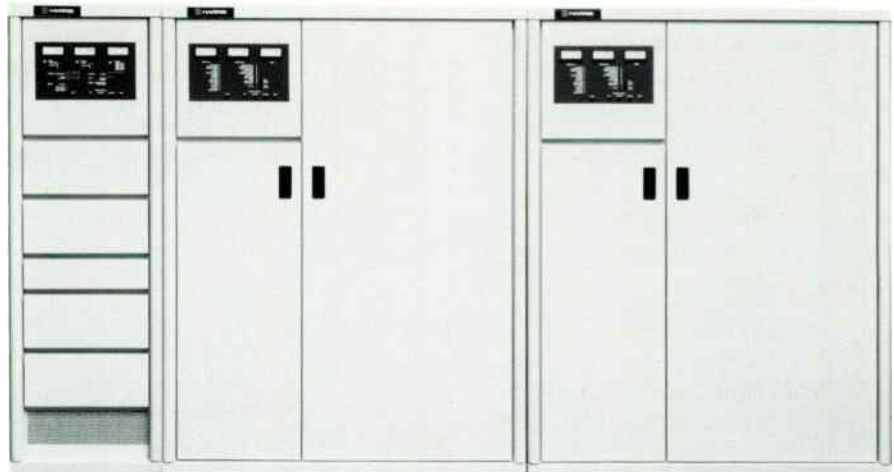

ability to transition to HDTV when necessary.

From straightforward logic control of transmitter on/off sequences, fast-acting fault protection and front panel LED status indicators to extensive remote status and measurement interface, Sigma™ transmitters are designed for maximum ease of use for the operator. The control and monitoring units have been ergonomically designed for ease of use. Each PA cabinet has its own independent control, monitoring and remote interface allowing it to be maintained as a separate entity. The exciter rack, which can accommodate dual exciters, is also equipped with a system control panel, system monitoring, power metering and full remote control interfaces. The Sigma™ family of transmitters comply with the rigorous IEC-215 safety standards.

New Modular Single Drawer Exciter

The new Sigma™ modular single drawer exciter, housed in a slide-out design with hinged IF modules, allows maximum accessibility without the need for extender cards or leads. The exciter generates visual and aural IF signals that are fully pre-corrected and filtered to meet the requirements for System M and the IOT. Sigma™ Series transmitters are available with an optional fully-redundant exciter with automatic changeover capability which offers the greatest reliability and peace of mind.

Crowbar Protection

Sigma™ transmitters have utilized the thyatron for overcurrent protection. All IOTs have to be protected from damage caused by internal arcs, and this is pro-

vided by the beam voltage power supply crowbar circuit. A device must sense a rapid increase in current and interrupt the beam current before damage is caused. This action is accomplished with a beam current detector and a crowbar operating in parallel with the IOT. Once the crowbar has fired, high speed vacuum switches remove the three phase mains supply. The high-speed thyatron crowbar circuit provides a more failsafe and reliable protection against damage from tube arcs than any other device and this translates into longer IOT life.

Combined Amplification for On-Air Reliability

When using Sigma™ transmitters in combined amplification, a Magic Tee combiner is used to sum the output of multiple power amplifiers to deliver the desired output peak sync power. Should a fault occur in a power amplifier, the Magic Tee transfers the affected amplifier to a test load for service and repair. The rest of the transmitter continues to operate at reduced power. Combined amplification, while not needing a diplexer, has its main advantage in system redundancy. In a 60 kW system, two identical amplifiers of 30 kW peak sync are employed, and in the event of an IOT failure, there would be only a 3 dB drop in output power after combiner adjustment.

The IOTs used in the Sigma™ Series family of transmitters typically achieve a 100% figure of merit in common amplification during average program transmission. Each IOT has its own beam power supply which is rated for continuous black picture operation. Oil-filled HV beam supplies are used for long-term reliability and minimal maintenance. The

collectors for each IOT are cooled by a simple single-stage external water/glycol system with dual pumps and fans. 20 kW IOT collectors are air-cooled, and 40 kW IOT collectors are water/glycol or air cooled.

Other Benefits

These transmitters will give users many benefits including:

- **Exceptional NTSC Performance:** Excellent IOT linearity is achieved via patented correction circuit in the IPA and exciter, yielding very low levels of intermodulation between luminance, color and aural signals.
- **A True HDTV-Ready Transmitter:** The linearity and headroom of the IOT, exciter and drive circuits are designed for the transmission of Quadrature Amplitude Modulated (QAM) or other digital bit stream signals.
- **Typical Transmitter System Efficiency Exceeding 70%:** High IOT efficiency is achieved without complex beam pulsing or a multiple stage collectors.
- **Extensive Redundancy:** Each power amplifier cabinet features its own IPA beam supplies, cooling system with redundant fans and dual pumps, plus control and monitoring.
- **Unsurpassed Reliability:** Depending on the configuration, Sigma™ transmitters will continue to operate at reduced power should a fault occur.

Sigma™ Series transmitters represent the sum of Harris' leadership in broadcast transmission innovation, digital technology, solid state design and total systems integration. We are uniquely positioned to support you with more than a wide variety of transmitters as you prepare for the transition from NTSC to HDTV. Drawing on the resources of our division and those of Harris Corporation, we stand ready to address your total needs, from studio through antenna.

As we develop our line of HDTV-ready products, we consider your total broadcast requirement - not just those of an individual product. Our goal is to provide equipment that will work with every other part of your system, meeting your most exacting requirements for long-term reliability, performance and economy both for today and tomorrow's broadcast world.

HDTV Questions and Answers:

Second of Two Articles

Q. Will today's amplifiers be suitable for HDTV?

Yes. While QAM— like all amplitude modulated signals, does require a linear dynamic range, several power amplifiers will be extremely well-suited for HDTV. These amplifiers include Inductive Output Tubes (IOTs), depressed collector klystrons, and solid state devices.

Q. Will HDTV require wider beam-width/lower gain antennas?

No. In fact we foresee little need to reduce antenna gain, broaden elevation pattern beam-width, and relatedly, increase transmitter power requirements.

Q. Why won't a wider beam-width antenna be necessary?

A wide beam-width antenna illuminates close-in coverage areas (typically one to 10 miles) with high field-strength levels. These levels, which can be reflected off of various objects and then propagated to the more distant coverage area, can create a reflection (ghosting) problem— a prime concern for HDTV.

Additionally, a wide beam-width antenna needlessly wastes power by directing a significant portion of the beam skyward. This detracts from useful power needed at radio horizon to establish good coverage.

Current NTSC antennas carefully shape the vertical pattern to avoid skyward reflection. They also direct the pattern downward to the service area to provide uniform coverage along a radial from the transmitting antenna to a distant reception point. This soundly-established and efficient use of radiated energy can work as well for HDTV.

Q. What about HDTV antenna gain requirements?

It has been argued that amplitude and phase characteristics of the HDTV signal will require lower gain antennas than NTSC, and that gain may have to be reduced by as much as 50%. In reality however, there is no indication the HDTV signal will put any restrictions on antenna gain. In fact, a recent HDTV field test used a high gain end-fed Harris WaveStar® antenna with outstanding results!

Q. But do current NTSC antennas have the proper elevation gains?

Yes, they should. Today's antennas exhibit elevation pattern coverage variations to the order of tenths of dBs over a 6 MHz channel— more than adequate for HDTV. They also have lower elevation gain than UHF antennas manufactured in the 1950's and 1960's. Previously, antenna elevation gains of 30, 40 and even 50 were common, but today's new slotted antennas have elevation gains ranging from 20 to 30.

Q. Do current antennas generate variations in amplitude and group delay?

No. Today's antennas already smoothly respond to variations in amplitude and group delay over important portions of their coverage patterns. Moreover, such variations more likely are a result of propagation effects and receiving antennas than the transmitting antenna.

Q. But won't HDTV require even more?

Yes, and this is why digital HDTV systems will use adaptive equalizers to correct transmission impairments— whatever their source. Field demonstrations are proving that proposed HDTV systems have a level of robustness that produces excellent pictures with less signal-to-noise ratio than NTSC.

Use of medium and high gain antennas for HDTV will allow broadcasters to use lower power transmitters, important from a cost standpoint.

Q. Are any current antennas particularly suited to HDTV?

Broadband panel antennas should be very desirable for HDTV. Their wideband design will make it possible for several channels to be multiplexed into a single antenna. The wideband design also will provide pattern stability needed for good amplitude and phase performance.

Q. We've covered a lot of generalities, but how can I learn more about my specific operation?

We invite you to contact Harris Allied at 217-222-8200, Extension 3131. Our force of television sales specialists, transmission design and applications engineers and systems integrators will be happy to discuss your particular goals, concerns and desires and help you develop a solution tailored to your unique requirements.

WAREHOUSE Specials

Arrakis Demo Studio Package



Console

- Arrakis 10,000 series 18 position mainframe
- 7 — XAR1 Air One input modules
- 7 — XAR2 Air Two input mod. (Air One + pan/bal.)
- 2 — XAR3 Air Three input mod. (Air Two + 2 aux sends)
- 2 — XST1 Stereo One input mod. (Air Three + 3 band eq)
- 2 — AX1 Aux send/ret. mod. (w/assign and solo)
- 1 — X7P1 Seven position remote selector
- 4 — XSP1 Single slide fader cont. panel/master fader
- 1 — XDA1 Stereo 5 out distribution amplifier
- 1 — XRS1 Routing out distribution amplifier
- 1 — XRS1 Routing switcher control panel (2-16 position thumbwheels)
- 1 — XCR1 Clock control panel
- 1 — XCT1 Cart remote control panel
- 1 — XRR1 Reel-to-reel control panel

Modulink Furniture

- 1 — S/UNBALANCED U Modulux Supreme studio furniture
- 1 — ZX/SLP Tabletop 30 degree sloped equipment rack
- 2 — ZXTT1 Turntable isolator, cut for Technics SP25
- 2 — Z/SURR-4 Ten RU equipment rack kit for pedestals
- 1 — Z/SPRO-CT Supreme double pedestal cart bridge
- 1 — ZX/BCS-60 Console bridge with copy stand - 60"
- 1 — ZS/ERP-L-8RU Tabletop left equipment pod - 8RU
- 1 — ZS/ERP-R-8RU Tabletop right equip. pod - 8 RU
- 1 — ZX/INIT-16 Interview table - 16"x72"

COMPLETE PACKAGE List . . . \$28,480.00

NOW...\$19,900.00

A-LINE Dub Center

Put a complete studio in a 31" deep by 25-1/2" wide space that is 75" high. This show demo unit is laminated oak and has 28" of over-bridge rack space. It is uncrated but can be shipped via padded van.

Original list was \$1,256.00

Sale Price...\$400.00



OTARI MTR-10C

The professional standard for reel to reel. Two new half-track 1/4" three-speed machines in original factory packing with full warranty.

Original list was \$9,295

Sale Price...\$6,995.00

Otari MKIII-2 • 1/4" Two Channel Recorder.....	\$2,950.00
Otari ZA52L.32 • MKIII-2 & MKIII-4 • Floor Stand.....	225.00
Revox PR99 • Play Only • 3-3/34 and 7-1/2 ips.....	1,800.00
Sonomag 452 • Stereo Bi-Directional Carousel.....	1,600.00
Tascam CD 701 • CD Player.....	995.00
Alpha Audio DR2-15 • Hard Disc Recorder w/Remote Control.....	1,875.00
Panasonic SV3900 • Digital Audio Tape Recorder.....	1,195.00
Moseley SCG-8 • Subcarrier Generator • 195 kHz.....	1,100.00
Modulation Sciences SCA 186 • Sidekick w/Rack Mount (67 kHz).....	2,695.00
Delta OIB-1 • Impedence Bridge w/18 In Leads.....	1,800.00
CRL SG800A • Digital FM Stereo Generator w/Filter.....	1,995.00
Comrex 3XR • Multiline Decoder.....	5,000.00
Nakamichi MR1 • Master Cassette Deck.....	495.00
Denon DN970FA • CD Cart Player.....	1,400.00
Burk Technologies ARC16 • 16 Channel Remote Control System.....	2,750.00
A-Line 200 • Cart Rack • Charcoal Gray.....	125.00
Ward Beck Modified L3242 • Console • Used/Above Average • Mono/Stereo.....	5,000.00

Unless noted otherwise, all items are new, demos or returned equipment.

Special prices end May 12, 1993. Quantities may be limited and are subject to prior sale. All Sales subject to appropriate sales tax.



When The Leader In Broadcast Technology Introduces A Computer, It's Time To Ask Why.

This computer's beauty is more than skin deep. It has an FCC Class B rating, internal shielding, and includes RFI and EMI filtering.

It comes complete with 386 33 Mhz motherboard, a 120 Mb IDE hard drive with 64K cache with a MTBF of 150,000 hours, 5.25" and 3.5"

floppy drive, 2 Mb RAM expandable to 16 Mb, a 14" .28 pitch SVGA monitor, Microsoft DOS version 5.0 with manuals, optional rack mount and much more.

The Audiometrics 386 33 is the first computer designed and built with the broadcast environment in mind. It handle

the many specific tasks you do, with endurance and simplicity as priorities, not after thoughts.

From hardware to software. From editors to voice mail. We can preconfigure a variety of broadcast options into your system.

The best computer technology at a price

that's right for today's broadcast professional—just \$1,895.

8:00 a.m. to 8:00 p.m. EST
1-800-622-0022
Fax 317-966-0623
Canada 1-800-268-6817
Toronto 416-731-3697

 **HARRIS
ALLIED**

NTSC~HDTV



When it's time for change trust Harris Allied to have the answer

IOT efficiency with HDTV capability. That's what you'll get with the all-new Harris Sigma™ Series, a family of 15–240 kW UHF TV transmitters.

Designed from the ground up specifically for the HDTV transition, Sigma sums Harris' experience in broadcast transmission innovation, digital technology, solid state design and total systems integration.

Sigma will provide you with

exceptional redundancy, headroom and protection with such features as main/standby exciters, EEV-approved thyatron crowbar protection for the IOT and reserve IPA power. You'll appreciate the low-maintenance design with user-friendly controls, easy sub-assembly access and the lowest ambient noise level available. Our field-proven IPA and newly developed exciter should give you

years of trouble-free operation. What's more, a wide range of configurations and options will ensure you get the best transmitter for your application now or when you move to HDTV.

We invite you to find out why Sigma is *the* no-compromise choice for now and the future. Trust Harris Allied to have the answer. The world's leader in broadcast technology.



sigma
THE TRANSITION TRANSMITTER

Phone: 217-222-8200 Fax: 217-224-1439

 **HARRIS
ALLIED**