

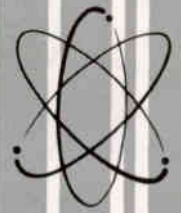

# Techni-talk

COMPLETE ELECTRONIC SERVICING INFORMATION  
radio • tv • hi-fi



Vol. 14, No. 5

Nov. 1962

## G-E HORIZONTAL PHASE DETECTOR I

The least understood area of a modern television receiver appears to be that portion of the receiver most subject to strange symptoms and hard to analyze phenomena. This is the horizontal synchronizing circuit in general, and the horizontal frequency control circuit in particular.

It is hoped that these articles will help to clarify this subject by presenting the theory in the every day language and normal technical terms used and understood by the television service technician.

Soon after the inception of television, it became obvious that the synchronization of the horizontal oscillator in the receiver by the direct application of transmitted sync pulses was unsatisfactory.

### Random Noise

The amplitude of the sync required is quite critical and the wide variation in signal strengths of the received channels gives anything but consistent results. Furthermore, the normal noise pulses encountered in fringe or electrically saturated areas, because of their random character, intrude themselves at inopportune times. This then results in anything from tearing out portions of the picture to a complete disarrangement of the entire raster.

Obviously, as the horizontal oscillator can not discriminate between wanted and unwanted pulses, some other approach is required.

Since it is not within the scope of this text to compare or evaluate methods used, the discussion will be confined to the circuitry found in the "Designer Series" of the General Electric receivers. This will avoid the natural confusion resulting from trying to completely understand too many systems at once.

### Basic Diode Operation

Although for simplicity, the circuits to be analyzed are constructed around semiconductor diodes, it must be positively appreciated that this fact has no real bearing on the operation of the circuits. Unless, therefore, specific comments appear pertaining to semiconductors, it

should be assumed that any form of diode will give the results being discussed.

Figure 1 illustrates the basic phase detector circuit.

Instead of starting with this, however, let's begin with something more basic, such as Figure 2.

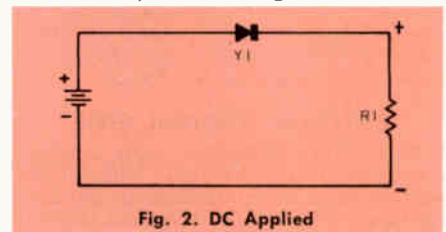

Fig. 2. DC Applied

In this circuit, with the battery polarity as shown, it is obvious that the diode will pass current thus allowing a voltage drop to appear across the resistive load as indicated. It would be equally obvious that if the battery polarity is reversed, no current will flow and, of course, no voltage drop will occur across the resistive load. At this point, in order to make our theory realistic, it should be pointed out that in the case of semiconductors, the last statement is not literally true. Some conduction does take place but this is normally of such insignificant value as opposed to the

(Continued to Page 3)

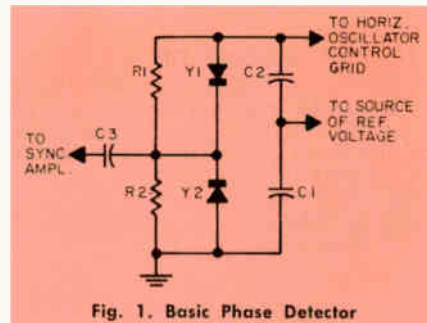

Fig. 1. Basic Phase Detector

## G-E TUNE-UP PLAN, RECIPE BOOK WIDELY USED BY SERVICE DEALERS

More than 11,000 TV Guide listings and Tune-Up sales promotion kits were acquired by service dealers who took advantage of the business-building "TV Tune-Up Spectacular" sponsored by General Electric.

The program featured ten programs on the nation-wide "Today" show network hook-up before and during the World Series. These programs urged consumers to have their sets properly adjusted by independent service dealers.

Consumers were shown a test pattern and asked if the image that appeared on their sets matched the announcer's description.

Simultaneously, during World Series Week, the names and addresses of independent service dealers who handle General Electric "Service De-

signed" receiving tubes and "Black Daylite" replacement picture tubes were listed in the local editions of TV Guide. Service dealers who signed up in the program thus had their names put before all viewers in their areas.

Service dealers also are continuing to put to good use the "Food in Focus" recipe book offered exclusively by General Electric as a business-building drawing card — aimed to interest the housewife. These books (ETR-3353) still are available through authorized tube distributors, and make an excellent sales promotion piece for dealers.

**STILL AVAILABLE** — This colorful recipe book is still being offered to service dealers as a business-builder with a direct appeal to the housewife.



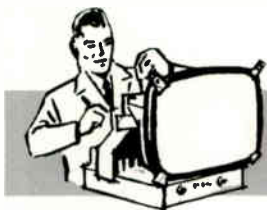

## BENCH NOTES

### SERVICE UNIFORMS

I would like to offer the suggestion that GE stress the idea that more service men wear service uniforms. I have noticed a remarkable improvement in my customer relations since I have been doing this. It seems to gain a great deal more respect and assures the customers that they have a competent, professional man taking care of their equipment. My customers don't even seem to mind paying the bill as much.

Jeff Griffin  
Debuze Radio  
7409 Halsted  
Chicago, Ill.

*Editor's Note: Send for Publication number ETR-3321 which describes all service clothing. Send request to: Editor, TECHNICAL, G-E Receiving Tube Dept., Owensboro, Ky.*

### ANTENNA TERMINAL STRIP

I use the clothespin type antenna connection in my TV shop. I have tried various ways of connecting the antenna to the pin plugs which are used on most TV sets. The easiest way I have found is to solder a couple of "Minigator clips" on a screw type terminal strip. When the clothes pin connector won't work all that is necessary is to clip the connector to this gadget. Then the "Minigator clips" will hold the pins.

Max Barlow  
Barlow's TV Service  
P.O. Box 3  
Rose Bud, Ark.

### MAKE AND BREAK

I would like to suggest a way to make and break a connection for testing a part or replacing a defective component.

I wind small coils of copper wire and cut them about  $\frac{3}{8}$ " long. When a connection from a condenser, resistor, etc. is cut, I leave stubs of equal lengths over which I slip the small coil of wire. This provides a good connection when I resolder the joint and eliminates the high temperature and twisting needed to pull original connections loose from multiple connection points. A minimum of solder and heat is required and it does not shorten the original length. Extra length is also available if needed and it provides a quick way for future repairs and testing.

Harry L. Baney  
1722 E. 22nd St.  
Muncie, Ind.

### BATTERY SAVER

To eliminate rapid battery drain when using metal clad batteries in early model transistor radios i.e. GE 795, in which the clamp part of the battery holder is connected to the plus side of the battery. The metal jacket of the battery should be insulated from the clamp with plastic tape.

Edwin J. Minner  
2086 Hopewell Rd.  
Bethlehem, Pa.

### NEED MORE WALL SPACE?

If you have a small shop, and wall space is at a premium, you may welcome a suggestion that I have used to advantage.

Most shops have unused ceiling space that can be used to mount the following rack for charts, price lists, etc.

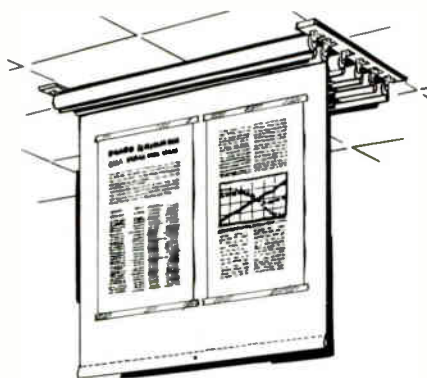

Rolls are discarded window shades and charts are fastened with tape to the shades for easy replacement.

Robert E. Diegoli  
Bob's Radio Hospital  
270 Court St.  
Plymouth, Mass.

### REVERSE TIP

After using a soldering gun awhile the side used gets worn and bent. To help extend its life it pays to remove the tip and reverse it. Then each side of the tip gets the same wear.

Jake Nelson  
915 Sherman St.  
Rotterdam 3, N. Y.

### TAPPING PLASTIC

When a hole in plastic has worn so it needs a larger self-tapping screw, start the larger screw in the original hole a few turns, then hold a hot soldering gun to the screw.

Turn the hot screw into the softened plastic, leaving the screw in until the plastic cools.

Back the screw out and you'll find you have tapped the hole with perfect threads for the larger screw.

S. Clark  
Box 2162  
East Bradenton, Fla.

### MAGNETIC PICKUP

If after drilling a chassis you would like to remove the filings from the area without hunting a brush, or vacuum cleaner your electric soldering gun makes an ideal electromagnet. Pick up the filings with the "heat on," and hold until deposited — a slight tap will remove any sticking to the elements.

Carter TV Service  
1000 Grace  
Crawfordsville, Ind.

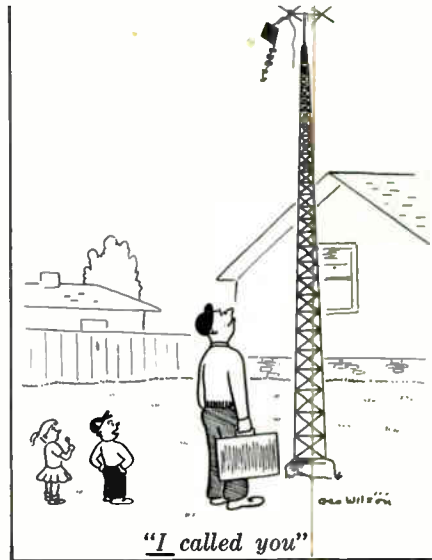

### MANUFACTURERS AID SERVICEMEN

If a serviceman gets stuck on any type of set, he will, of course, refer to the schematic. What if the set has no identification on it? Without a proper model number, the desired schematic cannot be found at any price. Thus, without the needed data, an otherwise repairable set cannot be repaired.

To cite an actual example: I had a 1949 table model General Electric radio to repair, but not a trace of model number or serial number could be found on the chassis or inside the cabinet. I only knew that it was a 1949 General Electric table model radio. Having faced this type of problem before, I wrote to the General Electric Company, Radio Receiver Dept., 1101 Broad St., Utica, N.Y. enclosing the following data: 1) a comprehensive sketch of the top side of the set — showing the actual layout of the parts on the top side of the chassis. 2) A pictorial sketch of the suspected portion of the underside of the chassis. The wires going to resistors, capacitors, and other components were copied in the actual color of the wires. This was done with colored pencils. 3) The tubes were listed.

In a few days I received a copy of the schematic which included the model number. The model number was then marked on both the chassis and inside the cabinet for future reference.

Any reputable company will give this same type of service to a serviceman if he identifies himself as being a bona fide repairman. If one had a camera to photograph a suspected section or the topside of the chassis, this would be better than sketching the parts layout.

I have had this problem many times and the manufacturers have always helped me. Why not try it the next time you have this problem?

A. von Zook  
Corralitos Radio Shop  
142 Hames Road  
Corralitos, Calif.

### NOTE:

Those desiring to have letters published in this column should write the Editor Techni-Talk, Electronic Components Division, General Electric Company, Owensboro, Kentucky. For each such letter selected for publication you will receive \$10.00 worth of General Electric tubes. In the event of duplicate or similar items, selection will be made by the Editor and his decision will be final. The Company shall have the unlimited right without obligation to publish or otherwise use any idea or suggestion sent to this column.

Caution: The ideas and suggestions expressed in this column are those of the individual writers. These ideas and suggestions have not been tried by the General Electric Company and therefore are not endorsed, sponsored or recommended.



# G-E HORIZONTAL PHASE DETECTOR I

(Continued from Page 1)

forward conduction that it may be completely disregarded in practical application.

The next logical step is illustrated in Figure 3 which shows an AC source of voltage substituted for the battery.

During the positive excursions of each cycle, current will flow and a voltage will appear across the resistor.

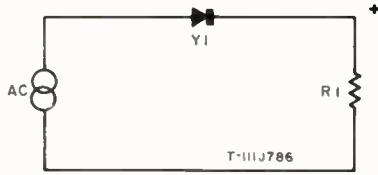

Fig. 3. AC Applied

During the negative half of the cycle, except in the case of semi-conductors, no current will flow.

Examination with an oscilloscope would reveal that we do not have pure DC, however. If we assume that the source provides a sine wave, the ripple seen across the load resistor might appear as in Figure 4.

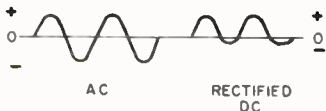

Fig. 4. Zero Axis

From this, it can be seen that in reality, we have taken an AC waveform and merely shifted its zero axis so that although it is still AC, most of it is positive with a little negative component. A tube type diode, of course, would not have this negative portion as in the reverse direction the resistance is infinite allowing no conduction at all.

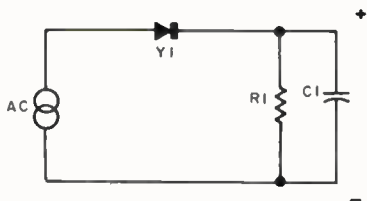

Fig. 5. Added Capacitor

By the simple application of a capacitor across the resistive load, however, as in Figure 5, this negative component is also raised above the base line and we have a DC voltage, whose ripple content depends on the ratio of capacitor to load. In other words, the higher the value of the load and capacity used, the lower the ripple will be and stated another way, the purer the DC will be. Figure 6 illustrates the effect of the capacitor across the load resistor.



Fig. 6. Effect of Capacitor

## Shunt Circuit

So far, the discussion has concerned itself with what is called a "series circuit." For some applications, however, it is better to use a "shunt circuit," as illustrated in Figure 7.

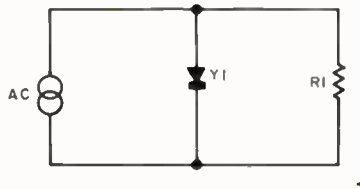

Fig. 7. Shunt Circuit

During the positive halves of each cycle in this configuration, no voltage will appear across the load resistor because all of the current is short circuited through the diode. On the negative halves, however, the major portion of the current flows through the load thus resulting in a voltage drop of negative polarity as shown.

At this point, we come to a portion of our story which is not always recognized. Any attempt to filter the ripple in this circuit by the application of a capacitor across the load resistor as was done in the series circuit will, depending on its size, reduce the DC as in this form it will also represent an AC short across the voltage source as shown in Figure 8. The circuit shown in Figure 9 overcomes this difficulty.

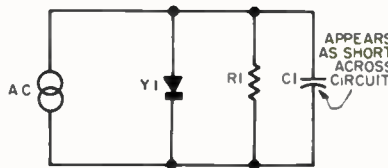

Fig. 8. Shunt Capacity

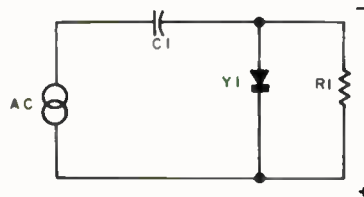

Fig. 9. Blocking Capacitor

Here the capacitor is connected as a coupling or blocking capacitor. In order that you may appreciate its function as a filter capacitor, it is necessary to visualize the voltage source as being a very low impedance as referred to the load resistor.

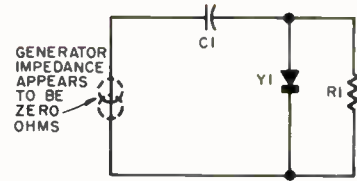

Fig. 10. Parallel Capacity

If the source of voltage was for example zero impedance, we could then say that the capacitor was attached in parallel with the load resistor as shown in Figure 10. As long as the load value is high, we may still assume this condition. Because, however, the capacitor is in series with the source, we have eliminated the disadvantage of the AC loading which would have resulted with the parallel arrangement. Close scrutiny will show that the capacitor appears as a load on the source *only* during the positive half cycles, during which time the diode offers a low series impedance with the capacitor.

## Circuit Operation

At this point it, appears that a complete explanation of the operation of this apparently simple circuit would be helpful as upon this background much of the phase detector theory depends.

Referring further to Figure 9, assume that the generator is supplying an AC waveform. The frequency and shape are not important to this discussion so for ease in thinking, consider a sine wave.

During the positive half of a cycle, it is agreed that the diode conducts. The diode then looks like a very low impedance. In fact, for practical purposes, we may look at this as a short circuit as shown in Figure 11. In

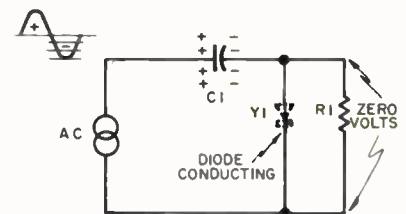

Fig. 11. Positive Half-Cycle

other words, during the positive half cycles, the diode becomes a switch which connects the capacitor across the AC source. The capacitor then charges as shown.

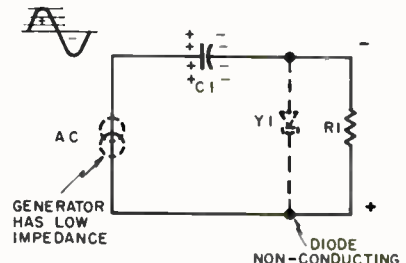

Fig. 12. Negative Half-Cycle

(Continued to Page 7)

What's new!

## G-E DEVELOPS "LAMILITE" PICTURE TUBE

Used in New 22-pound  
16 inch Portable TV

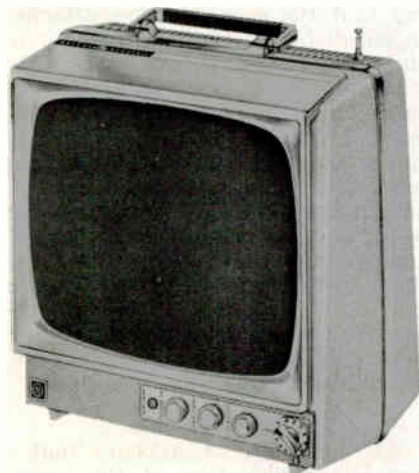

Climaxing a long-term development program, the General Electric Company now has an entirely new method of providing a safety shield across the viewing surface of a television picture tube.

The new type shielding is used on all G-E "LAMILITE," picture tubes and consists of a thin coating of tough plastic which in effect is similar to the safety coating used on photo flash bulbs.

Television tubes for many years have been installed in sets behind a separate glass or plastic panel to provide maximum safety to viewers. More recently, tubes have been in-

© T M General Electric Company

troduced with a second glass panel bonded to the faceplate of the tube. The new General Electric product consists of a thin, tough, double layer of lightweight plastic, bonded permanently to the face of the picture tube. The result is a reduction in length.

### UL Approved

This new integral face plate has passed accelerated life testing as well as a variety of safety tests involving deliberate breakage. As a result of these tests, supervised by the Underwriters Laboratories, "LAMILITE" picture tubes have been listed and authorized to bear the UL label. The inner layer has a tough, stretchy character, while the outer layer, which is bonded to the inner layer, is harder and less elastic. It is this combination which gives the "LAMILITE" picture tube its desirable protective qualities.

U.L. calls for accelerated aging tests, which are equivalent to 10 years of life at household temperatures. Humidity tests are required at 100 degrees F., 95% humidity, for 500 hours. After these tests, the tubes must pass safety criteria of new tubes. In the laboratory tests, over 30 "LAMILITE" picture tubes were deliberately broken to prove out the protective qualities. There were no cases of shield failure. U. L. also checks tubes mounted in TV sets to assure that the protective quality of the safety system is maintained after installation.

General Electric has spent over five years perfecting and developing this new "LAMILITE" picture tube shield. As a part of the development, two major problems had to be solved. First, finding a plastic sufficiently tough and resistant to change, as well as possessing excellent optical properties. Then, working out a manufacturing method to enable low-cost, mass production and yet capable of producing a finished product without blemishes or defects introduced by the processing.

The basic materials used to produce the "LAMILITE" picture tube are not new. They have been in wide use in the electronics as well as other industries for many years. The inner plastic is of the buteral family and the outer of the buterate family. It is the special combination of these to this application which is new. The process consists of laminating sheets of the two materials together and, through a vacuum forming process, bonding them to the tube. This process forms a smooth shield over the tube which offers perfect viewing qualities.

### Improved Picture Quality

Light from the picture, which is generated in the phosphor screen on the inside face of the tube, must travel through the glass of the tube face as well as through any air gap and safety glass to reach the viewer's eyes. Each time this picture light passes through a material having a different refractive index, some light is reflected back to the screen causing diffusion, loss of contrast and loss of picture detail. Also, all room illumination impinging upon the set creates reflections at each interface which detract from the picture quality. Since the plastic used in "LAMILITE" picture tubes has essentially the same refractive index as glass, it has only one such interface, namely the outside surface. Some protective systems have as many as three. In comparison, the "LAMILITE" picture tube is far freer of these picture-quality-destroying reflections. A neutral density tint is added to the outer layer to provide contrast improvement in the TV picture.

The new General Electric "QX" line of 16-inch portables is the first to use the "LAMILITE" picture tube. Light in weight, compact, adaptable to a wide variety of viewing uses, these receivers demonstrate plainly how the "LAMILITE" picture tube aids the set designer in meeting the coming trend in American viewing habits.

NEW GENERAL ELECTRIC  
TUBES AND COMPACTRONS  
LISTED BY RECEIVER

tubes



Here is a list of NEW General Electric receiving tubes and compactrons and the manufacturers using these types in their receivers. Be ready to service the new model re-

ceivers by having at least one of each type on hand. They are now available from your General Electric tube distributor.

TYPE	SET MANUFACTURER	FUNCTION
4GZ5	Admiral TV	Audio Output
6AF11*	GE-TV	AGC sync. sep. and video amp.
6AL11*	GE-TV	FM detector and audio output amp.
6BE3*	GE-TV	Damper
6DM4	Zenith TV	Damper
6HZ8	Philco, Zenith	Video amp. and sync. sep.
11AR11*	GE-TV	IF amp.
12AL11*	Not available	FM detector and audio output amp.
15AF11*	RCA-TV	AGC sync. sep. and video amp.
21GY5*	Philco and Westinghouse	Hor. output

\* Compactron types



# Tele-Clues

## "MX" SCHEMATIC

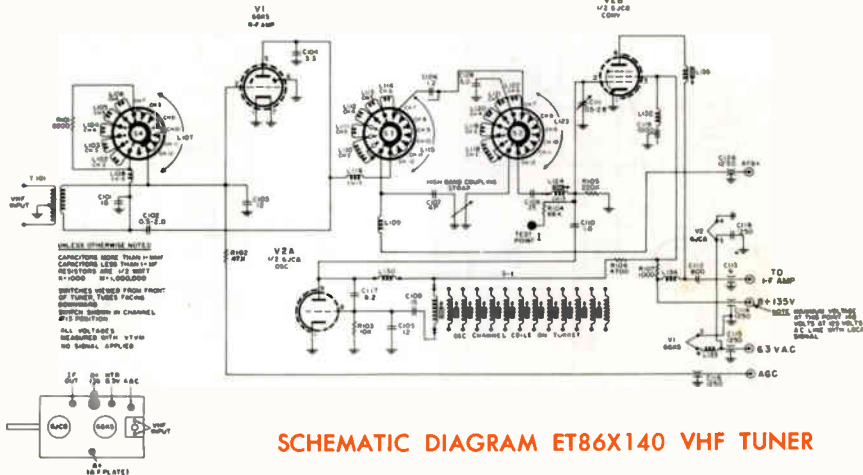
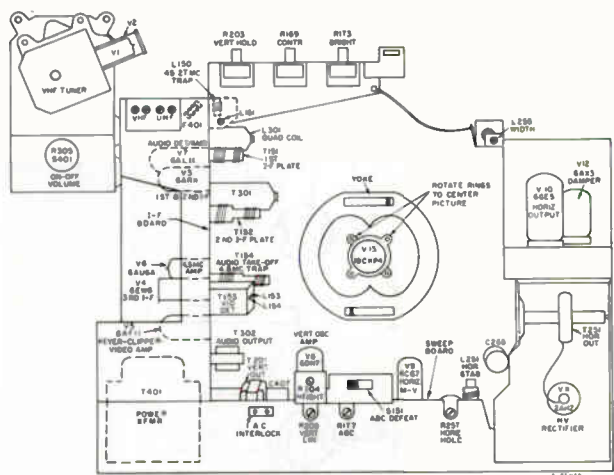

SCHMATIC DIAGRAM ET86X140 VHF TUNER

19" "MX" CHASSIS COMPONENT AND ADJUSTMENT LOCATIONS

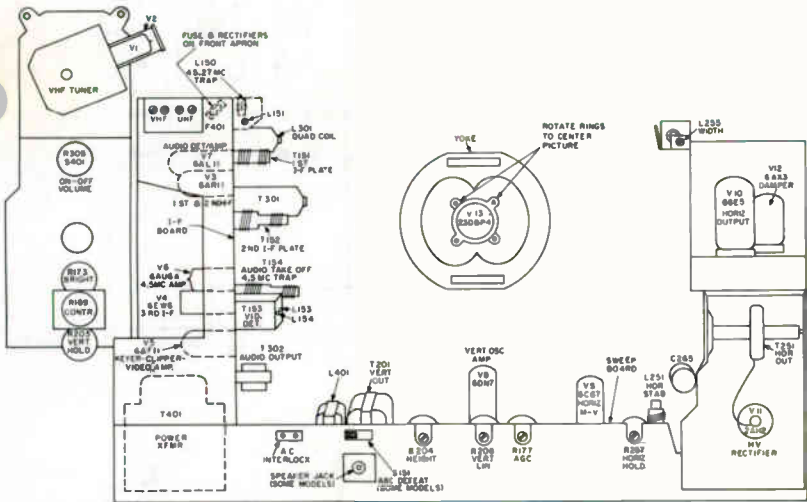

23" "MX" CHASSIS COMPONENT AND ADJUSTMENT LOCATIONS

### "MX" TUNERS

The following tuners are used in the "MX" line of General Electric receivers. Since the main differences between most of these tuners and those used in the "MW" line are mechanical, it is suggested that you refer to the appropriate tuner on the "MW" Tele-Clue Schematic for circuit information.

- ET86X139 12 Position, Manually tuned, without Automatic Fine Tuning — see ET-86X112
- ET86X140 See schematic on this page
- ET86X141 12 Position, Manually tuned, without AFT — see ET86X111
- ET86X142 13 Position, Manually tuned, without AFT — see ET86X115
- ET86X143 12 Position, Used with Power Selector — see ET86X114
- ET86X152 12 Position, Manually tuned, with AFT — see ET86X113
- ET86X153 13 Position, Manually tuned, with AFT — see ET86X115

### NEW TELE-CLUE BINDER ETR-1095-A

A 3-ring binder complete with all Tele-Clues and Tele-Clue Schematics plus tabbed dividers is now available from your General Electric tube distributor. This binder will also hold over 100 issues of Techni-Talk. Ask your distributor for ETR-1095-A or use order coupon on page 7.



Schematic diagram for "MX" line of General Electric Receivers. These receivers use a 19 or 23 inch electrostatic aluminized picture tube and six compactrons.



## TELEVISION

### Protecting Picture Tube Removal of Spark Gap Can Reduce Life of Picture Tube

Several factors have entered into the design of picture tubes which may increase the possibility of internal arcing. Some of these are a more compact design and higher operating voltages.

Basically what happens is, when not grounded, a static charge builds upon the focus element due to the close proximity to the anode ring. This charge will eventually seek a lower potential and will arc to G<sub>2</sub> (the screen electrode). In turn, since the screen electrode is near G<sub>1</sub> (the control grid) the arc continues to this element and then to the cathode or lowest potential element. In the case of the grid to cathode arcing, the emissive material will be torn from the cathode which, in itself, decrease the emissive life of the tube. Small particles of material are set free and may move from the area to short elements within the gun and thus cause complete tube failure.

In order to alleviate this failure possibility, a spark gap has been added in all recent General Electric chassis. This spark gap is connected between the G<sub>2</sub> (screen grid) element and ground and is designed to arc over when a static charge appears on this element not in excess of 2,000 volts.

Should arc over occur within the tube, the high potential will be shunted to ground when it reaches the screen grid thus protecting the cathode coating from being damaged. Cases have been observed where the arcing has been annoying to the customer and to limit this, the spark gap has been removed by uniformed service personnel.

If the spark gap is found to be defective for some reason, it should be replaced and never permanently removed, as this is a picture tube protection device. Humidity and line voltage variations may alter conditions which create arcing; therefore, not all conditions will remain the same over long periods of time and often the arcing stops after a short operating period.

## RADIO

### Troubleshooting Hints Models P820A, P821A P822A

1. The quiescent current drain of this model series runs between 12 to 15 mils.
2. The filter load resistor R18 is located in the couplate between pins 5 and 6.
3. When replacing an i-f can, the plastic shield must be replaced in order to prevent shorting of the copper straps.
4. Symptoms — weak and distorted audio, low current drain (approximately 4 - 6 mils) — most often

caused by circuit board copper flash, shorting between R21 and R17.

5. Symptom — distortion when using earphone — adjust value of R15 using a 50K potentiometer until distortion clears up. Then measure resistance of potentiometer and substitute with a fixed resistor of the same value.

6. Symptom — dead or intermittent audio — check for shorted or open C9, a green .47mfd., disc type capacitor.

7. Symptom — open straps on top of the board — Pin 3 of RC network to Pin 2 of T1, TR3 base to Pin 4 of T2 or TR3 collector to Pin 3 of T3.

### G-E Horizontal Phase Detector I

*(Continued from Page 3)*

During the negative half cycles, the diode cannot conduct which is like opening the switch. Referring to Figure 12, we have the effect of the charged capacitor being clamped across the load resistor through which it discharges. Note that in this drawing, the diode is indicated as non-conducting and the source represents a low impedance.

Another way of looking at this is to realize that during the positive half cycle, there is no voltage across the resistor as it is shorted out by the diode which is busily charging the capacitor. During the negative half cycle, the charged capacitor is then applied across the load, supplying it with the energy received during the positive half.

If now, the ratio of capacity and resistance provides a discharging time that is longer than the time it takes for the AC to switch direction, the capacitor never completely discharges. This means that during successive cycles of charging time, the current required to fill the capacitor becomes only that necessary to replace the amount lost through the load during the negative or discharge time. Carried to extreme, if the capacitor could be made perfect and the load was infinite, it would be possible to reach a point where no further current could flow through the diode because the capacitor would maintain a charge which would just equal the source voltage. This may be considered as a reverse bias to the diode which cannot conduct until either the source voltage becomes greater than the bias or the bias itself is reduced by discharging through the load.

With the foregoing as background, it is now possible to examine the creation of the phase detector circuit.

*(to be continued)*

Use Order Coupon Below

### ORDER COUPON

General Electric Company  
Department "B"  
3800 N. Milwaukee Ave.  
Chicago 41, Illinois

Enclosed is money order or check payable to General Electric Company for:

Quantity	Price
..... ETR-1095 Three-ring binder with tabbed dividers and all Tele-Clues and Tele-Clue Schematics published to date . . . . .	\$3.75 each.....
..... ETR-2000 Three-ring Techni-talk binder with tabbed dividers for Tele-Clues and Tele-Clue Schematics	\$2.00 each.....
..... ETR-2579 Complete set of Techni-talk back issues Vol. 1, No. 1 — Vol. 13, No. 5 (Includes all Tele-Clues and Tele-Clue Schematics) . . . . .	\$3.50 each.....
..... ETR-2144 Service Call Board . . . . .	\$5.00 each.....
..... ETR-2790 Soldering Iron Holder . . . . .	\$1.20 each.....

NAME.....

STREET ADDRESS.....

CITY, ZONE NO. AND STATE.....

(Please Print)

If you are receiving more than one copy of **TECHNI-TALK**, please cut out the order coupon with your address on the other side. Mark "Duplicate" and mail to Editor, **TECHNI-TALK**, General Electric Co., Owensboro, Ky.



# NEW G-E SERVICE AIDS

## Service Call Board ETR-2144

If you don't already have one of the General Electric Service Call Boards, ETR-2144, get one today. It can save you both time and money every day.

This G-E Service Call Board makes it easy to keep track of jobs. You see at a glance what calls, pick-ups and deliveries are to be made — when and where.

Entries are written on a rotating plastic sleeve with a marking pencil and erased or changed with the wipe of a cloth.

The rotating plastic sleeve is the real feature! As you turn it each day, all deadlines move up so nothing can be overlooked.



Ask your G-E tube distributor for a Service Call Board ETR-2144. If he is unable to supply you use order coupon on page 7. The price is only five dollars.

## Soldering Iron Holder ETR-2790

The General Electric Soldering Iron Holder is designed to rest on a flat surface or to be mounted on the edge of a service bench. This holder will accommodate soldering irons up to 3/4 inch in diameter.

If you use a soldering iron you need a holder that will protect your hands, wires, diagrams and tools from burns. Since this soldering iron holder completely covers the tip, it provides adequate protection for the user. The Gen-

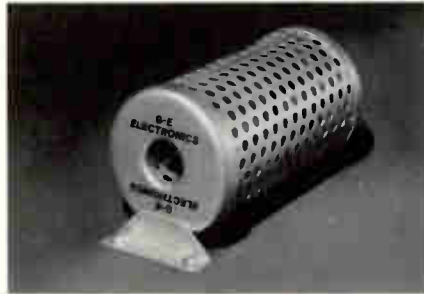

eral Electric Soldering Iron Holder can be mounted vertically on the service bench. This places the iron off the working area but still readily available. It can also be used in a horizontal position.

Ask your G-E tube distributor for ETR-2790 or use the handy order coupon on page 7. The price is only one dollar and twenty cents.

*Kempton's  
Korner*



Your General Electric tube distributor can supply you with a complete selection of advertising and business aids. Some of these are supplied at no charge and others at a modest price.

One of the Bench Notes on page two comments on improved customer relations when wearing G-E service uniforms. This experience indicated the value of having a professional appearance.

In view of the increasing crime rate, many people are hesitant about letting someone not readily recognized into their home. These uniforms help the customer to immediately identify you as an electronic technician.

Your name on the front makes it easy for customers to call you by name. This may help "break the ice" with new customers and could improve your relationship with repeat customers.

Your distributor can supply complete information and take your order.

### ERRATA

Please make the following change in box on page 6 of the Volume 14, Number 4 issue:

Change tube type 6GX11 to 6G11.



**Techni-talk**



TECHNI-TALK DISTRIBUTION OFFICE

**GENERAL ELECTRIC**

SCHENECTADY, NEW YORK

BULK RATE  
U. S. POSTAGE  
PAID  
Schenectady, N. Y.  
Permit No. 148

Vol. 14, No. 5

Nov. 1962

### In this issue:

	Page
G-E Horizontal Phase Detector.....	1
G-E Tune-Up Plan.....	1
Bench Notes .....	2
What's New: "LAMILITE" Picture Tube 4	
"MX" Tele-Clue Schematic.....	5
Service Notes .....	7
Service Aids .....	8

Techni-talk on AM, FM, TV Servicing, published bi-monthly by ELECTRONIC COMPONENTS DIVISION, GENERAL ELECTRIC COMPANY, OWENSBORO, KY. In Canada: Canadian General Electric Co., Ltd., 189 Dufferin St., Toronto 3, Ontario. R. G. Kempton, Editor. Copyright 1962 by General Electric Company.

MR DONALD L HANSEN  
1779 WOODALL DR  
MINNEAPOLIS 21 MINN

E221

### PLEASE NOTE:

If there is any error in the address shown above, will you please clip it out, make any correction and return to me. Also if you are receiving two or more copies, please return the address panel to me and mark it "DUPLICATE."

R. G. Kempton, Editor

This copy of **Techni-talk** comes to you through the courtesy of your General Electric tube distributor.



**ELECTRONICS**

NOTE: The disclosure of any information herein conveys no license under any General Electric patent and, in the absence of an express written agreement to the contrary, the General Electric Company assumes no liability for patent infringement (or any other liability) arising out of use of such information by others.