



Copyright 1958 by General Electric Company

## Color Receivers—V

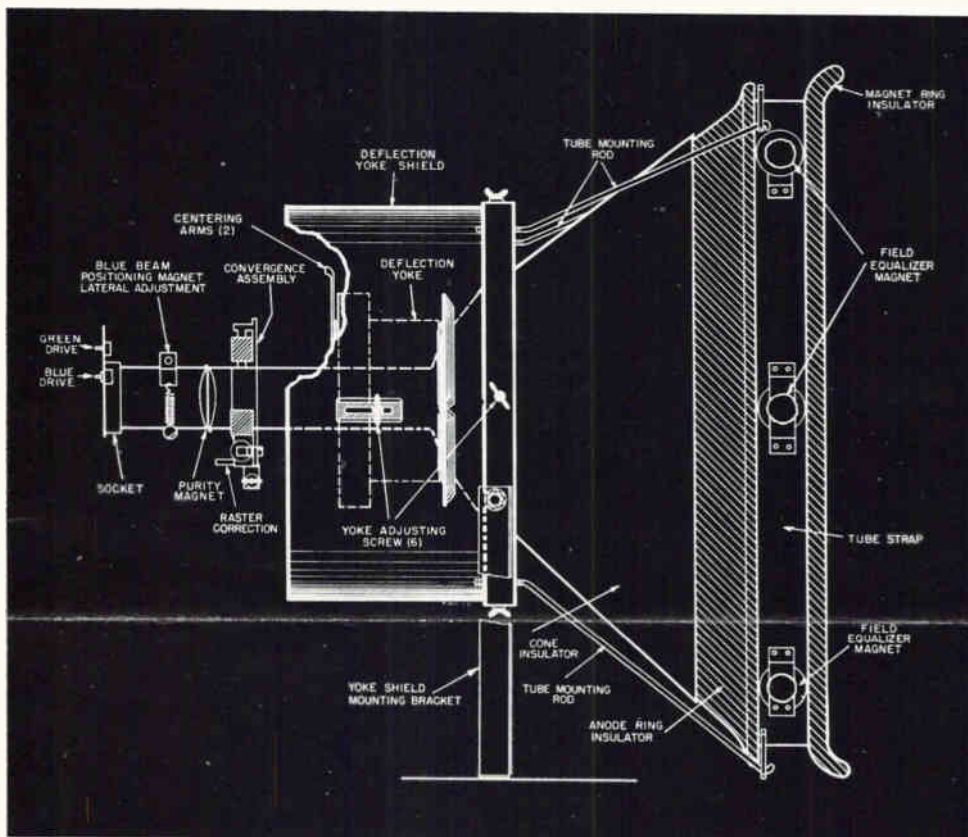

Fig. 1. Side view of picture tube with purity, deflection and convergence components.

### Mechanical Adjustments

Fig. 1 is a side view of the color picture tube and shows the location of various adjustable components which directly control the three electron beams. The purpose of each component and the effect it has on the electron beams should help clarify the operation of this type picture tube. Each component will be described as it appears going from right to left in Fig. 1. This should not be considered as the proper order for making adjustments. Always follow the information given in receiver manufacturer's instructions.

### Field Equalizing Magnets

At the right of Fig. 1 three of the six field equalizer magnets can be seen. The purpose of these magnets is to counteract the effects of any magnetic fields which may cause impure color areas at the edges of the screen. Each magnet can be adjusted by either turning or pushing the outside knob either in or out on its slip-screw mounting. When the magnet is as far away as possible from the rim of the

picture tube, it is partially enclosed in a metal cup which acts as a "keeper" and short-circuits most of the magnetic field. The adjustment of these magnets is part of the "purity" adjustment. This adjustment is usually made with only the red gun operating (green and blue guns biased "off"). The blue and green fields are then checked individually and "touch-up" adjustments made if necessary. Any external magnetic field including the earth's magnetic field can alter the normal path of the three electron beams and cause one or more of the beams to strike incorrect color dots.

If, after making the purity adjustments, it is not possible to obtain a raster that is pure in color it is possible the metal bell of the picture tube has become magnetized. This magnetism will produce discoloration along the outside edges of the raster and must be removed. This is accomplished by a simple procedure known as demagnetizing or "degaussing." The usual method used for degaussing is to place the magnetized object in an a-c field of sufficient strength to overcome the permanent magnetism and then gradually remove the a-c field.

### How to Make a Degaussing Coil

In order to properly degauss the metal in a picture tube a rather sizeable coil with adequate strength is required. Some coils designed for this purpose are now commercially available but a coil can be wound in a short time and at a reasonable cost. The material required is about four and one half pounds of No. 20 enameled wire, a 10-12 ft a-c line cord with plug, a roll of friction tape, and a roll of plastic electrical tape. The coil is made by winding about 425 turns of the No. 20 magnet wire on a round form about 12 inches in diame-



Save your fingers! Use G-E Tube Puller to remove and replace "HOT" tubes. Ask your distributor for No. ETR-1094.



Fig. 2. Degaussing coil constructed as described.

# TECHNI-TALK

on AM, FM, TV Servicing

published bi-monthly by  
ELECTRONIC COMPONENTS DIVISION



SCHENECTADY 5, N. Y.

In Canada  
CANADIAN GENERAL ELECTRIC CO., LTD.  
189 Dufferin St., Toronto 3, Ontario

R. G. KEMPTON, Editor

ter. If the correct size form is not available, a pail or waste paper basket which is reasonably close in size can be used. Connect and solder each end of the coil to the a-c line cord: then completely cover the wire and connections first with friction tape and then with plastic tape. A degaussing coil which was wound on a waste basket and constructed as described above is shown in Fig. 2.

### Degaussing Picture Tube

Before starting the degaussing operation make sure that all six equalizing magnets are pulled as far away from the rim of the picture tube as possible. The receiver should be turned "on" and the degaussing coil connected to an a-c outlet. The coil should be held parallel with the front of the receiver and moved up against the safety glass. Move the center of the coil around the edges of the picture tube and then around the front and sides of the cabinet. Do not move the coil near the speaker or any of the magnetic adjustments on the neck of the picture tube. Then with the coil still held parallel with the front of the receiver, move the coil in a circular motion and slowly step back away from the receiver until no noticeable effect is visible on the raster.

Try to complete the degaussing operation in about one minute or as quickly as possible. Degaussing coils are designed for operation only over very short periods of time and will overheat in a very few minutes. *Always remove the coil from a-c outlet as soon as operation is completed to prevent damage from overheating.*

### Deflection Yoke

The next adjustable component is the deflection yoke. The operation and purpose of this unit are familiar to most monochrome service technicians. The usual adjustment on the black and white receiver is to move the yoke as close to the front of the picture tube as possible and then align it so the top and bottom edges of the raster are straight. In the color receiver the yoke is not positioned as close as possible to the front of the tube but is positioned to produce good red-field purity over the largest screen area (only red gun turned "on"). The centering arms located at the rear of the

yoke are used to center the picture both horizontally and vertically.

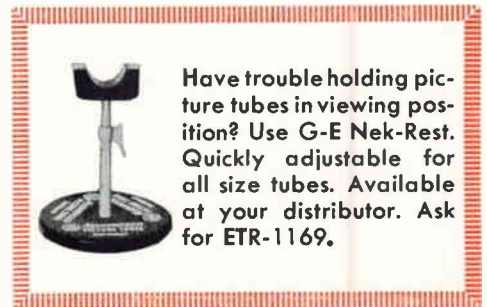

Have trouble holding picture tubes in viewing position? Use G-E Nek-Rest. Quickly adjustable for all size tubes. Available at your distributor. Ask for ETR-1169.

### Convergence Assembly

The convergence assembly is located somewhat in back of the yoke. This unit is composed of three individual magnetic assemblies each one positioned directly over its respective electron gun convergence pole piece, as shown in Fig. 4. The location of these pole pieces in relation to the other parts of the gun structure is shown on the right of Fig. 3 (only red gun pole piece visible). Each individual magnetic assembly includes either a permanent magnet or a d-c winding which is used as a *static convergence adjustment* and two or more electro-magnetic windings which function as *dynamic convergence adjustments*.

Static convergence adjustments bend each of the three beams so they converge and cross over at the center of the aperture mask shown at point "A" in Fig. 5. It can be visualized that any external magnetic influence at the guns will change the angle of the beams and therefore the point at which they converge and cross over.

Since all three beams must be swept both horizontally and vertically, when the point of convergence is at the aperture mask in the center of the screen (point "A" in Fig. 5), it will be somewhat in back of the mask (point "B" in Fig. 5) as the beams approach the edges. Assuming that all three beams converge cor-

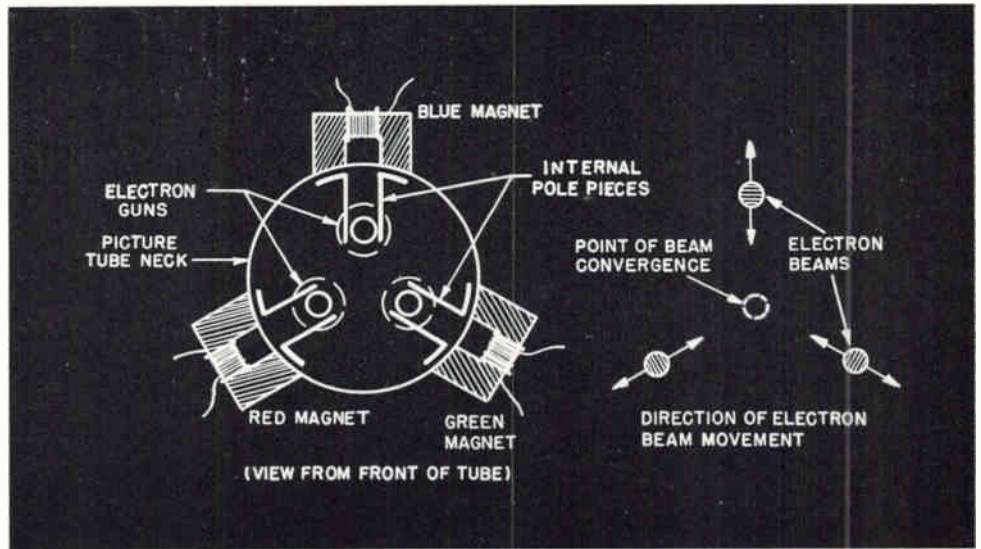

Fig. 4. Position of magnetic assembly over convergence polepieces and direction of beam movement.

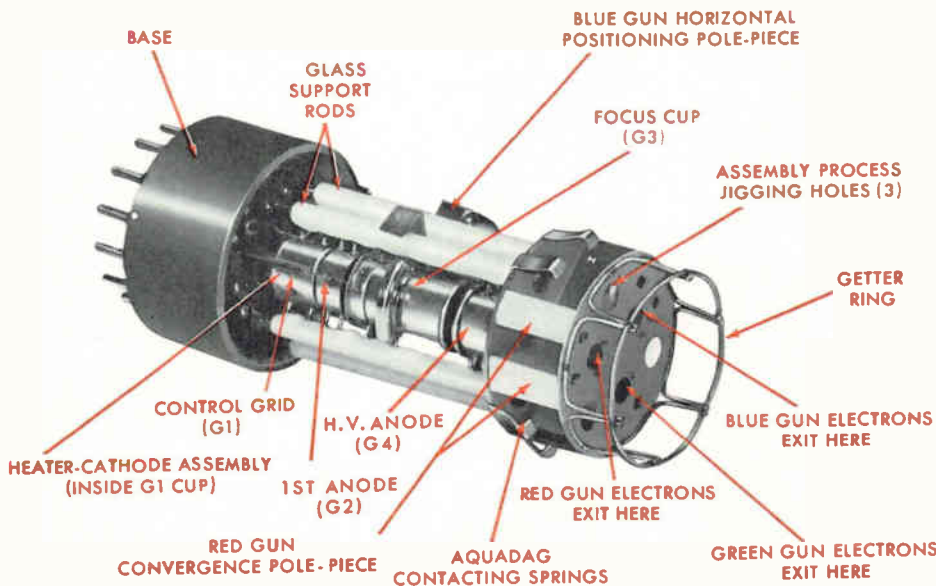

Fig. 3. Electron gun assembly used in aperture mask picture tube.

# COMPLETE INDEX OF TECHNI-TALK

## Vol. 1, No. 1 through Vol. 10, No. 2

- Vol. 1, No. 1** Television Reception—The Antenna—1  
How to get the most out of your test equipment—VOM—How to make HV-Multiplier
- Vol. 1, No. 2** Television Reception—The Antenna—2  
How to get the most out of your test equipment—Tube Tester
- Vol. 1, No. 3** The Head-End—1  
Selecting an oscilloscope for TV servicing  
How to get the most out of your test equipment—Capacitance-resistance Bridge
- Vol. 1, No. 4** The Head-End—2  
Kill that retrace—Vertical
- Vol. 1, No. 5** Video Detector, A.G.C. and Video Amplifier  
Tele-Clues No. 1 thru 8  
How to get the most out of your test equipment—Vacuum Tube Voltmeter
- Vol. 1, No. 6** D-C Restoration and Sweep Circuits  
Tele-Clues No. 9 thru 16  
General Electric Model 1201D Loudspeaker  
Variable Reluctance Stylus Wear Considerations  
How to get the most out of your test equipment—Signal Generator—1
- Vol. 2, No. 1** Synchronizing Pulses and Circuits  
Tele-Clues No. 17 thru 24  
Tele-Tips No. 1 thru 5
- Vol. 2, No. 2** Horizontal AFC Systems  
Tele-Clues No. 25 thru 32  
Tele-Tips No. 6 thru 10  
How to get the most out of your test equipment—Signal Generator—2
- Vol. 2, No. 3** Deflection Circuit Waveforms and RF Power Supplies  
Tele-Clues No. 33 thru 40  
Tele-Tips No. 11 thru 15  
How to get the most out of your test equipment—Cathode Ray Oscillograph—1
- Vol. 2, No. 4** Horizontal Deflection Circuits and Kickback Power Supplies  
Addition of A.G.C. to G-E 805 series T and S  
Tele-Clues No. 41 thru 48  
Tele-Tips 16 thru 20  
How to get the most out of your test equipment—Cathode Ray Oscillograph—2
- Vol. 2, No. 5** Conversion of 10- and 12-inch receivers to 14- and 16-inch—G-E Model 811, Admiral Model 4H16S  
Tele-Clues No. 49 thru 56  
Tele-Tips 21 thru 25  
Resistor Substitution Boxes
- Vol. 2, No. 6** Conversion of 10- and 12-inch receivers to use larger size picture tubes—G-E Model 809, RCA Model 730TV2  
Kill that retrace—Horizontal  
Tele-Clues No. 57 thru 64  
Tele-Tips 26 thru 30  
Capacitor Substitution Boxes
- Vol. 3, No. 1** Conversion of 10- and 12-inch receivers to use larger size picture tubes—G-E Model 820, Philco Model 48-1001  
Make your own Service Bench  
Tele-Clues No. 65 thru 72  
Tele-Tips No. 31 thru 35
- Vol. 3, No. 2** Conversion of 10- and 12-inch receivers to use larger size picture tubes—G-E Model 12C101, Stromberg-Carlson Model TV-12  
Tele-Clues No. 73 thru 80  
Tele-Tips No. 36 thru 39
- Vol. 3, No. 3** Conversion of 10- and 12-inch receivers to use larger size picture tubes—G-E Model 802, Capehart-Farnsworth Model 651P  
Tele-Clues No. 81 thru 88  
Tele-Tips No. 40 thru 43
- Vol. 3, No. 4** Conversions to larger size picture tube—G-E Model 10C101, RCA Model KRS-20  
Tele-Clues No. 89 thru 96  
Tele-Tips No. 44 thru 47
- Vol. 3, No. 5** Conversions to larger size picture tube—G-E Model 910, RCA Model 630TS to 14 inch  
Tele-Clues No. 97 thru 104  
Tele-Tips No. 48 thru 51
- Vol. 3, No. 6** Conversions to larger size picture tube—G-E Model 815, Motorola Model VF-102  
Tele-Clues No. 105 thru 112  
Tele-Tips No. 52 thru 55
- Vol. 4, No. 1** Conversion to larger size picture tube—Motorola Model 12VT16  
TV Receiver Noise  
Tele-Clues No. 113 thru 120  
Tele-Tips No. 56 thru 58
- Vol. 4, No. 2** Conversions to larger size picture tube—RCA Model 630TS to 20 inch  
Use of an AM Signal Generator in place of Cross-Hatch Generator
- Vol. 4, No. 3** FCC Lifts TV "Freeze"  
Complete list of channel frequencies  
Nationwide Table of TV Frequency Assignments (1952)

- Vol. 4, No. 4** The Television Picture Tube-I—Phosphor Specifications and Implosions  
Tele-Clues No. 121 thru 128  
Tele-Tips No. 59 and 60
- Vol. 4, No. 5** The Television Picture Tube-II—Electron Gun and Gun Defects  
Tele-Clues Index
- Vol. 4, No. 6** The Television Picture Tube-III—Gun Defects cont'd and Cathode Images  
Tele-Clues No. 129 thru 133  
Tele-Tip No. 61
- Vol. 5, No. 1** The Television Picture Tube-IV—Construction of a Picture Tube Tester  
Tele-Clues No. 134 thru 140
- Vol. 5, No. 2** Report on UHF Reception
- Vol. 5, No. 3** The General Electric UHF 103 Tuner-I  
Tele-Clues No. 141 thru 148  
Tele-Tips No. 63 and 64
- Vol. 5, No. 4** The General Electric UHF 103 Tuner-II  
Tele-Clues No. 149 thru 155  
Tele-Tip No. 65
- Vol. 5, No. 5** Aluminized Picture Tube Replacement Guide  
Tele-Clues No. 156 thru 162  
Tele-Tips No. 65 thru 67
- Vol. 5, No. 6** Color TV-I Color Reproduction  
Tele-Clues No. 163 thru 170  
**and**
- Vol. 6, No. 1** Tele-Tips No. 68 and 69
- Vol. 6, No. 2** Color TV-II—Construction of a Color Box  
Tele-Clues No. 171 thru 180
- Vol. 6, No. 3** Color TV-III—Visible Spectrum and Chromaticity Charts  
Tele-Clues No. 181 thru 188  
Tele-Tip No. 70
- Vol. 6, No. 4** Color TV-IV—Development of Color Signals UHF Antenna Installations
- Vol. 6, No. 5** Color TV-V—Color Signal Frequencies and Balanced Modulation  
Tele-Clues No. 189 thru 194  
Tele-Tip No. 71
- Vol. 6, No. 6** Color TV-VI—Vectors
- Vol. 7, No. 1** Color TV-VII—Development of Chrominance Signal  
Tele-Clue Schematic "N" Chassis
- Vol. 7, No. 2** Color TV-VIII—Color Signal Phase and Amplitude and Burst Signal  
Tele-Clues No. 195 thru 202  
Tele-Tips No. 72 and 73
- Vol. 7, No. 3** Color TV-IX—Gamma Correction, Delay Lines and Block Diagram of Transmitter  
Tele-Clues No. 203 thru 207
- Vol. 7, No. 4** Use of New 600 Milliampere Tubes in Earlier Series-Heater Receiver-I—G-E Models 20T2, 20C105, 20C106 and 21C200
- Vol. 7, No. 5** Open Heaters in Picture Tubes Due to Arc-over  
Tele-Clues No. 208 thru 213  
Tele-Tips No. 74 and 75
- Vol. 7, No. 6** Replacement of 21AP4 Metal with 21ZP4-B Aluminized Glass Picture Tube  
Use of New 600 Milliampere Tubes in Earlier Series-Heater Receivers-II—G-E 14-, 16- and 17-inch Models
- Vol. 8, No. 1** Transistors  
Tele-Clue Schematic "S" Chassis
- Vol. 8, No. 2** Color TV-X—Aperture Mask and Post Acceleration Type Picture Tubes
- Vol. 8, No. 3** New 300 and 450 MA Series-String Tubes  
Tele-Clue Schematic "MM" Chassis
- Vol. 8, No. 4** A Plan for Success—TV Service Shop Plans  
**and 5** Tele-Clue Schematic "U" Chassis
- Vol. 8, No. 6** General Electric ST-16A Color Alignment Generator
- Vol. 9, No. 1** New General Electric Germanium TV Rectifiers with Replacement Guide
- Vol. 9, No. 2** Color Receivers-I—Tuner and Video I-F Amplifiers
- Vol. 9, No. 3** Color Receivers-II—Video Detectors and Video Amplifiers—Block Diagram and Schematic for General Electric "CL" Color Receiver  
**and 4**
- Vol. 9, No. 5** Color Receivers-III—Burst Gate, Subcarrier Generation, Synchronous Detectors and Chroma Amplifiers  
**and 6** Tele-Clues No. 214 thru 221
- Vol. 10, No. 1** Color Receivers-IV—Matrixing Circuits and Aperture Mask Tube  
Tele-Clues No. 222 thru 228  
Tele-Tip No. 76
- Vol. 10, No. 2** Color Receivers-V—Mechanical Adjustments on Aperture Mask Tube  
Complete Index of Techni-talk Vol. 1, No. 1 thru Vol. 10, No. 2

Copies of most issues are still available. If you are missing any copies and cannot obtain them from your distributor, send five cents for each issue to: Techni-Talk, Room 219, Bldg. 267, General Electric Co., Schenectady 5, N. Y.

rectly at the center, as the beams are swept toward the edge, the point of convergence will be along the dotted arc shown in Fig. 5. Under these conditions, all three beams will not be "pinpointed" but will be somewhat separated, as shown on the left side of Fig. 5. A larger than normal percentage of the beam current may then be lost due to striking the edges of the aperture mask holes. That portion of each beam which gets through the aperture mask may not hit a single triad but, since the beams are wider apart, could hit three different triads. Obviously the convergence would be "way off" under these conditions.

To obtain convergence over the entire screen it is necessary to magnetically influence the beams so they converge at all times at the aperture mask and not at any other point. Current waveforms which are directly opposite to the "static convergence arc" (shown in Fig. 5) are obtained from the horizontal and vertical circuits and applied to the dynamic convergence windings in the convergence assembly. These waveforms and how they are properly shaped and used will be described in a later issue.

#### Raster Size Correction

The raster size control shown at the bottom of the convergence assembly in Fig. 1 is the adjustment for an oversize red or green raster. This condition will be indicated by a small amount of red (in the case of an oversize red raster) and by a small amount of green (in the case of an oversize green raster) on the upper edge of the top and the lower edge of the bottom crosshatch lines.

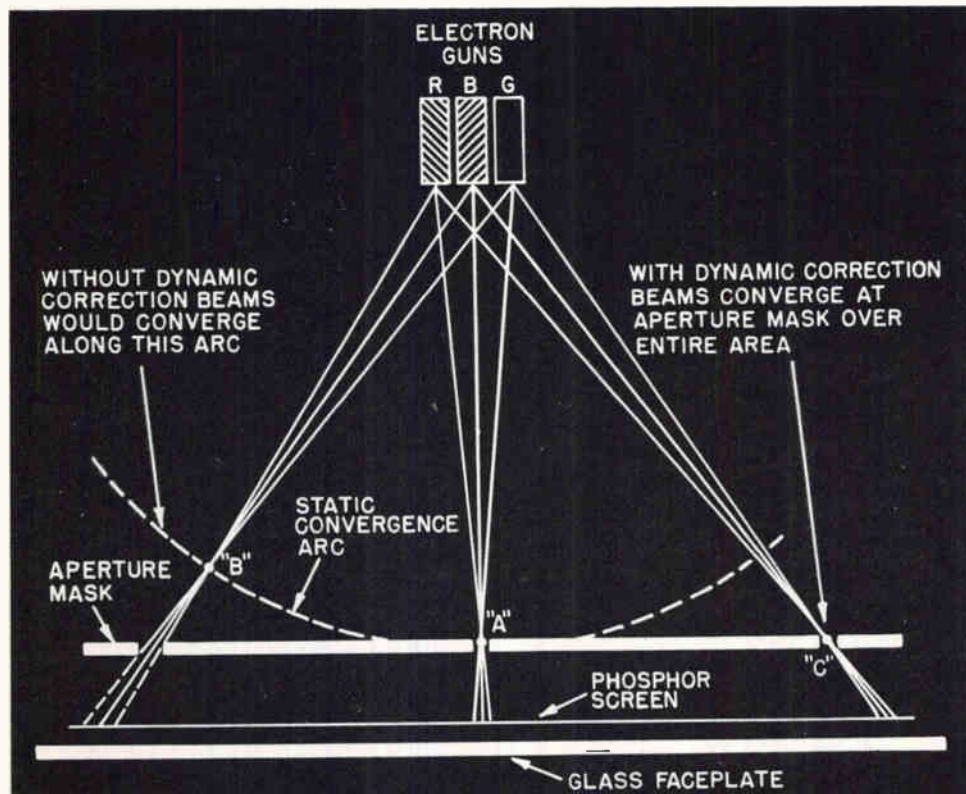
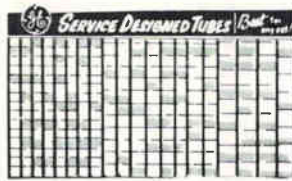

Fig. 5. Point of convergence with and without dynamic correction.



Do you have a tube dispenser? If not, ask your distributor for a G-E SEE-LECT-A-TUBE. This wall-mounted unit holds 250 tubes with all types visible. Friction ridges on each side allow any tube to be removed without affecting the position of any other tube. Ask for ETR-1219.

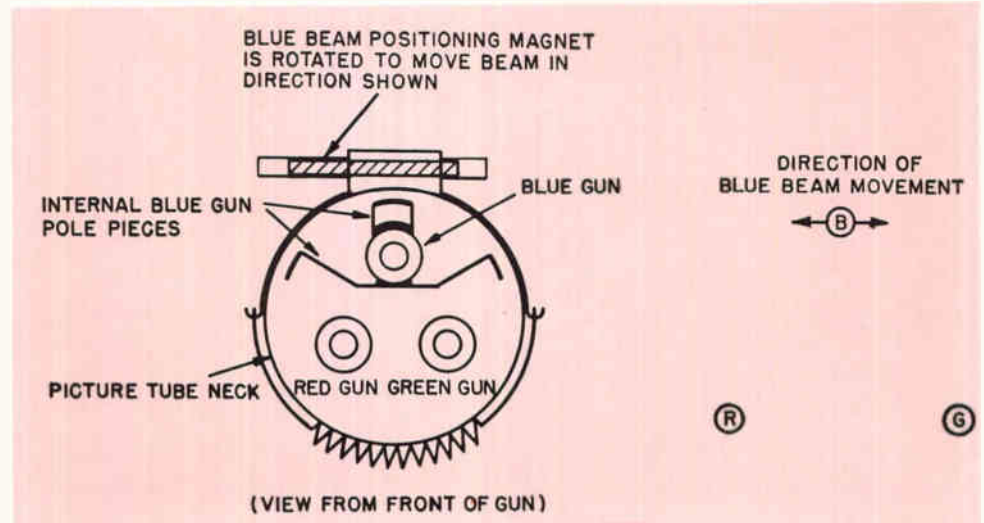

Fig. 6. Approximate position of blue beam positioning magnet and direction of movement.

#### Purity Magnet

The purity magnet is shown at the left of the convergence assembly in Fig. 1. This magnet is located in line with the gap between grids number 3 and 4. This unit is composed of two thin ring magnets which may be rotated with respect to

each other to increase or decrease the strength of the magnetic field. The adjustment of this unit brings the "starting points" of the electron beams to the points for which the tube was designed. It also corrects for the earth's magnetic field effects.

#### Blue Beam Positioning Magnet

The blue beam positioning magnet is next to the purity magnet in Fig. 1. This is an adjustable permanent type magnet located over the blue gun positioning pole piece as shown in Fig. 6. As this magnet is rotated it causes the blue beam to move either left or right on a horizontal plane as shown at the right of Fig. 6.

It may be found that better convergence can be obtained by positioning this magnet between the blue and red guns or with the center of the magnet directly over the blue gun pole piece shown on the left of Fig. 6. The position which results in the best convergence should be considered as the "right" position.

#### Red and Green Drive Controls

The red and green drive controls shown at the extreme left of Fig. 1 are used when making the "grey scale" adjustment. These two controls are adjusted to equalize the drive on all three guns and produce white "highlights" in a monochrome picture. Approximate settings are ordinarily made with the brightness control set at a high level.

(to be continued)

# BENCH NOTES

Contributions to this column are solicited. For each question, short-cut or chronic-trouble note selected for publication, you will receive \$10.00 worth of electronic tubes. In the event of duplicate or similar items, selection will be made by the editor and his decision will be final. The Company shall have the right without obligation beyond the above to publish and use any suggestion submitted to this column. Send contributions to The Editor, Techni-talk, Electronic Components Division, General Electric Company, Schenectady 5, New York.

## SERVICE HINTS

### General Electric "U" Chassis and All Chassis Using Semiconductor Type Phase Detector

Quick check for defective horizontal phase detector. Short plates of diodes, check picture for floating condition. If picture floats, replace diodes. If picture does not float through sync, check horizontal oscillator circuit for trouble.

### Hatpaint "U" Chassis

Removal of 6BQ6 horizontal output tube will facilitate sound transformer adjustments or any sound circuit repairs. This will remove B plus boost and high voltage from the chassis.

Wedgebrook TV Sales  
603 Walton Rd.  
Pittsburgh 36, Pa.

## SAFETY GLASS REMOVAL

In most TV receivers with removable safety glass, there are a number of handling problems:

- Glass might fall when it is removed from bottom.
- Glass removed from front frequently sticks to gaskets or sides of cabinet.
- When glass comes out sideways, it may stick to gaskets.

Due to the tremendous amount of safety glass cleaned in my shop, I have developed a better and safer method to remove the safety glass. A rubber suction cup about four inches in diameter is screwed to a file handle. This enables me to remove the safety glass from almost any receiver without chance of breakage.

J. J. Schalit  
1674 Pennsylvania St.  
Denver 3, Colorado

## TIME SAVERS

1. When you get a little radio with the 35Z5 or 35W4 burned out; or you suspect that the tubes are not in the right sockets, you can save yourself the expense of burning out a new tube if you plug the radio into a "variac" type of AC autotransformer and "crank" up the voltage slow and easy. This way you can tell if just one tube or the whole string is going to get the full voltage from the line cord. The presence of a line short can be determined this way without even taking the radio out of its cabinet. Also, this procedure for "checking for shorts" is very impressive on the waiting customer.

2. The new type Band-Aids (the tan colored type that is advertised as so adhesive they will pick up an egg on contact) is the best thing we've ever found to patch up the big tears in speaker cones. Of course, just use the ends and cut off the gauze part in the middle.

3. We have more success soldering the filament pins on intermittent picture tubes by squirting a tiny amount of liquid solder flux from a regular hypodermic syringe right into the pin. Of course, open up the pin first by melting the solder. The flux will boil out and clean the tungsten wire inside when you resolder it.

4. Did you give up trying to clean those foggy plastic safety glasses? Try a little penetrating oil on a soft cloth. You will see a miracle. Wipe it off as thoroughly as possible afterwards. Don't buy "Liquid Wrench"; it is not penetrating oil. We have also been using penetrating oil to clean tuner contacts and volume controls for years.

5. When you have to change a volume control assembly, or a filter condenser, or a set of seleniums; for heaven's sake don't cut each wire off individually. Where several wires all are soldered to the same lug—cut off the whole lug. That way you reduce your chances of error when putting in the new part, and you speed yourself up considerably, because you resolder the wires in bunches. This even applies to changing tube sockets; and will cut your time to at least half for most jobs.

Leo A. Scarpino  
Electronics of Omaha  
4624 So. 24th Street  
Omaha, Nebraska

What's new!

## 6CL8-A—5CL8-A TRIODE-TETRODE

The 6CL8-A is a miniature tube which contains a sharp-cutoff tetrode and a medium-mu triode in one envelope. Intended primarily for service as a combined triode oscillator and tetrode mixer in VHF television tuners, the tube features a controlled heater warm-up characteristic which makes it especially suited for use in television receivers with series-connected heaters.

The 6CL8-A is unilaterally interchangeable, both electrically and mechanically, with the 6CL8. It differs primarily from the 6CL8 in having a tetrode section with lower grid-plate capacitance and higher transconductance.

Except for heater ratings, 5CL8-A is identical with the 6CL8-A.

	5CL8-A	6CL8-A	
Heater Voltage, AC or DC . . .	4.7	6.3	Volts
Heater Current . . . . .	0.6	0.45	Amperes
Heater Warm-up Time . . . . .	11	11	Seconds

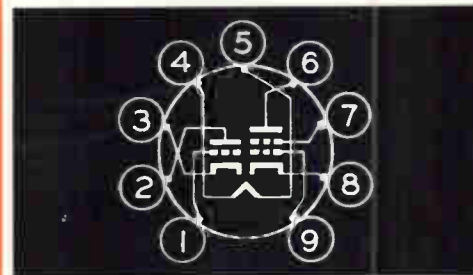

## AVERAGE CHARACTERISTICS

	Tetrode Section		Triode Section	
Plate Voltage . . . . .	100	125	125	Volts
Screen Voltage . . . . .	100	125	...	Volts
Grid-Number 1 Voltage . . . . .	0	-1.0	...	Volts
Cathode-Bias Resistor . . . . .	...	...	56	Ohms
Amplification Factor . . . . .	...	...	40	
Plate Resistance, approx . . . . .	100000	5000		Ohms
Transconductance . . . . .	8200	6400	8000	Micromhos
Plate Current . . . . .	...	12	15	Milliamperes
Screen Current . . . . .	...	4.0	...	Milliamperes
G <sub>1</sub> Voltage, approx. . . . .	...	-10	-9	Volts
I <sub>B</sub> = 10 Microamperes				

This copy of Techni-talk comes to you through the courtesy of your local General Electric Tube Distributor.

ELECTRONIC COMPONENTS DIVISION  
**GENERAL ELECTRIC**  
Schenectady 5, N. Y.

**BULK RATE**  
U.S. Postage  
**PAID**  
Schenectady, N. Y.  
Permit No. 148

Ed Carr TV  
Box 248  
Beach City, Ohio  
E-222

8-25-56

AVAILABLE THROUGH YOUR  
AUTHORIZED GE TUBE DISTRIBUTOR