



RADIO TUBES

Techni-talk

on AM, FM, TV Servicing

Copyright 1950 by General Electric Company

CONVERSION OF 10- AND 12-INCH RECEIVERS TO USE LARGER SIZE PICTURE TUBES

The last issue of Techni-talk contained information on converting a GE Model 811 from a ten-inch to either a twelve- or sixteen-inch picture tube. Also included was conversion information on an Admiral Model 4H16S which was converted from a ten-inch to a fourteen-inch picture tube. In this issue we shall discuss a General Electric Model 809 which was converted to use either a sixteen- or seventeen-inch picture tube, and an RCA 730 TV1 converted to use a fourteen-inch picture tube.

The following discussion is a description of the procedure followed which produced satisfactory results with respect to the particular model converted. If a conversion is attempted on a similar model of an earlier or later date or on a different model from the same manufacturer, then additional adjustments and steps may be necessary. The changes which were made have not been approved by the manufacturer and may therefore invalidate the manufacturer's warranty.

GENERAL ELECTRIC MODEL 809

The first receiver converted was a General Electric Model 809 shown before conversion in Fig. 1A. This is a series filament type receiver using a 10FP4 picture tube. The cabinet is somewhat unusual in that the chassis is mounted on an angle with the top of the front

panel slightly recessed. There is adequate cabinet space to mount either a twelve-, fourteen-, sixteen- or seventeen-inch picture tube. Both a sixteen-inch General Electric 16KP4 and a seventeen-inch General Electric 17BP4-A picture tube were used as they are the currently preferred sizes.

The chassis was removed from the cabinet and the yoke replaced with a new General Electric Cat. No. RLD-024 deflection yoke and an RLF-038 Focus Coil which are available at your General Electric or Ken-Rad tube and parts distributor. The old focus coil may be used if it can be readily mounted to the new yoke. Considerable time may be saved in both mounting and adjusting, however, if a new focus coil is used.

This same thing is true in regard to the horizontal sweep transformer. The old transformer can be used if it is the ferrite core type marked 77J1. A few of the early Model 809 receivers were manufactured with the same transformer used in the Model 810 receiver. Information on rewiring these few receivers will be supplied upon request. It was considered advisable, though not necessary, to replace the horizontal sweep transformer with a General Electric RTO-085 which was designed for use in sixteen-, seventeen- and nineteen-inch receivers. This supplied a higher anode voltage

plus additional sweep width with the added advantage of being able to use the width control. It was found that the original transformer could be used by disconnecting the horizontal size control. The two wires originally connected to this control were disconnected and the ends taped. The white wire was transferred from the No. 8 terminal of the sweep transformer to the No. 4 terminal which placed the horizontal coils across terminals 4 and 6 of the sweep transformer. These same connections were used on the new transformer. The horizontal drive control was adjusted for adequate width and the raster size was about the same as Tele-Chue No. 50 which appeared in the Vol. 2 No. 5 issue. It may be necessary to check the B+ voltages and try substituting a new 12SN7-GT (V 10) and/or a 19BG6-G (V 13) tube if the width is insufficient.

If the horizontal linearity is somewhat stretched on the left side after the linearity control has been properly adjusted, change the .03 mfd capacitor (C 335) which is connected between the cathode of the damper tube and B- to .05 mfd. This capacitance may vary and can be determined by using the capacitance box described on page 7.

The height was found to be inadequate and represented a considerable problem in this particular circuit which is shown after revision

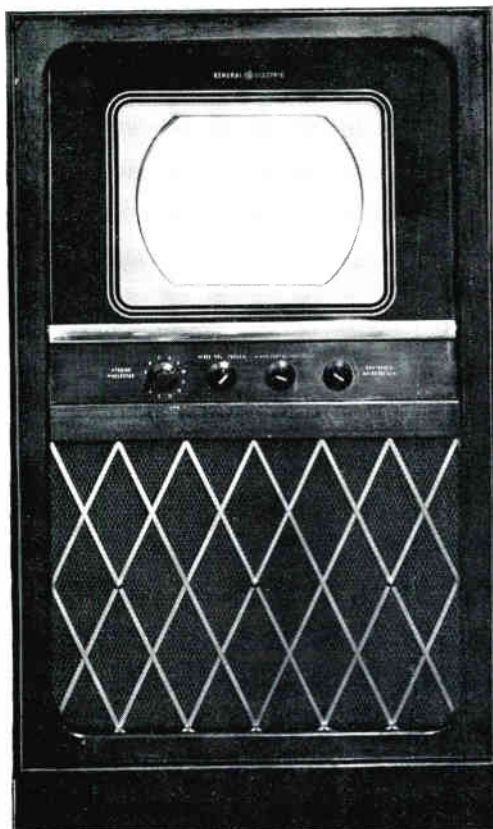

1A



1B



1C

Fig. 1A General Electric Model 809 receiver before conversion. Fig. 1B is the same receiver converted to use a 16KP4 rectangular picture tube. Fig. 1C is the same receiver converted to use a 17BP4-A rectangular picture tube.

TECHNI-TALK

on AM, FM, TV Servicing

Published by

TUBE DIVISIONS, ELECTRONICS DEPARTMENT

GENERAL ELECTRIC

SCHENECTADY 5, N. Y.

R. G. KEMPTON—Editor

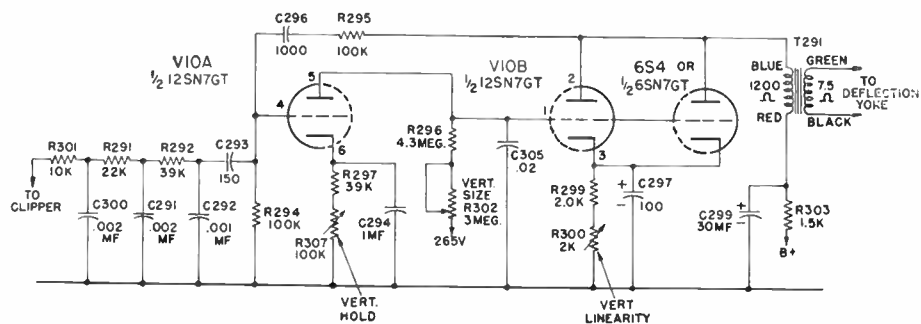

Fig. 2. Vertical multivibrator circuit after making the necessary changes to obtain sufficient sweep for either a 16KP4 or a 17BP4-A rectangular picture tube.

connection. The yoke and focus coil were assembled and the picture tube inserted. The top of the picture tube was slightly tipped toward the front, but this was compensated for when the mask was mounted. Some of the wires on the picture tube socket also had to be lengthened. If any difficulty is experienced with the 12AT7 tube move the front of the picture tube slightly toward the opposite side.

All necessary connections including a grounding wire from the graphite coating on the picture tube to chassis were made. A piece of bare wire fastened to the picture tube in several places with scotch tape was used and this was grounded under one of the self-tapping screws. The front of the 16KP4 picture tube was fastened to the chassis with a piece of metal hanger strap commonly used on antenna chimney mounts, although a canvas strap could have been used. The set was turned on and adjusted to obtain a linear test pattern. The width was controlled by adjustment of the horizontal drive and linearity controls.

CABINET CHANGES

The safety glass and mask were removed from the cabinet. The safety glass was held in place by a polished brass bar which was fastened to the cabinet with four machine screws. A cardboard template about $\frac{1}{8}$ " larger on all sides than the faceplate of the 16KP4 picture tube was made and fastened to the center of the front panel $1\frac{1}{2}$ " above the four screw holes. A scriber or sharp pointed tool was used to mark along the edge of the template and a key-hole saw was used to cut this section out.

A 16-inch rectangular mask measuring $12" \times 15\frac{1}{2}"$ was placed flush with the front panel. This type of mask is manufactured by both the Deitz Miracle Lens Co. and the Tele-Plastics Co. The panel area which showed on either side of the mask was lighter in color than the rest of the cabinet so this area was varnished with a walnut varnish stain. When this dried the mask was inserted into the recessed top section and held in place by the brass bar using the four original screws. The rubber strip was removed from the bottom of the safety glass panel and placed between the mask and the brass bar with the open end down. This held the bottom of the mask securely between the front of the panel and the brass bar. A $\frac{3}{8}"$ rubber grommet was inserted from the back between each top corner and the wooden panel. This held the mask in place and when the chassis was placed in the cabinet, the faceplate of the picture tube was practically flush with the inside of the mask. Any small variation between the mask and picture tube faceplate may be corrected by slightly shifting the mask or chassis before the final assembly. The finished conversion is shown in Fig. 1B.

If a 17BP4-A picture tube were used the same type mask as shown in Fig. 1B except in the seventeen-inch size may be used. A somewhat different effect can be obtained at a slightly reduced cost by using a mask designed for use in back of a safety glass. A seventeen-inch conversion using this type mask is shown in Fig. 1C. These masks are made of a thin plastic and are available in a light or dark royalite

color which is a shade of green. They are made in all popular picture tube sizes and are particularly suitable for use in either the GE Model 809 or 811 receivers because of the large panel of safety glass. This type mask is manufactured by Precision Plastics Inc. in Chicago and represented by the Hy-Art Co., 136 Liberty St., New York City. The name of a distributor near you can be obtained by writing the Hy-Art Co.

The inside wooden panel must be cut out using a seventeen-inch template and following the same instruction given for the sixteen-inch cutout. The original safety glass may be used with the paint masking removed. This paint can be scraped off with a razor blade; however it will be considerably easier to use a good sharp putty knife and some acetone. The acetone can be purchased in most drug stores and can be poured on the paint backing and spread around with the putty knife. Start to remove the paint immediately as the acetone is extremely volatile.

The mask may then be placed in the new opening and the safety glass placed over it. Both pieces will be held in place when the brass bar is attached.

RCA MODEL 730 TV1 OR TV2

The next receiver converted was a ten-inch RCA radio-phonograph combination Model 730 TV2 shown after conversion in Fig. 4. The Model 730 TV1 uses the same chassis in a slightly different cabinet. Due to insufficient cabinet space a General Electric 16KP4 fourteen-inch rectangular picture tube was the largest size which could be used without major cabinet changes. In view of the size and weight of this receiver only the TV chassis and the front panel shown in Fig. 5 were removed from the customer's home.

CHASSIS CHANGES

The 50° deflection yoke was replaced with a 70° deflection yoke such as the Todd-J-70.

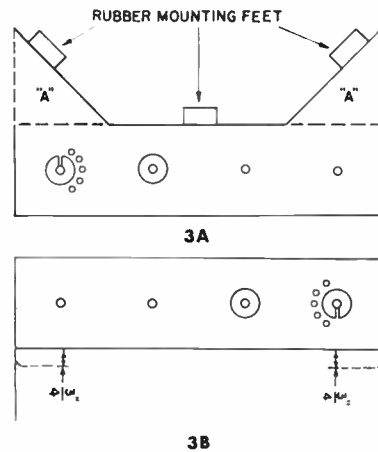

Fig. 3A. Front portion of General Electric Model 809 chassis showing the cuts in braken lines which should be made to accommodate a larger size picture tube. Fig. 3B shows the vertical portion of the chassis which is bent as indicated by the braken line.

in Fig. 2. The vertical charging capacitor C 305 was varied, again using the capacitor box described on page 7. This resulted in non-linearity and fold-over at the bottom. A similar result was obtained when the plate resistor R-296 was varied. A number of possible circuits were considered, and the one chosen was the one which could be made with a minimum of wiring changes and therefore consumed very little time. The circuit is shown in Fig. 2 and is merely connecting either one-half of a 6SN7-GT or a 6S4 in parallel with the output section of the 12SN7-GT (V 10B). The chassis for some Model 809 receivers are already punched with an additional hole for an octal tube socket. This is located next to the vertical multivibrator tube (V 10). Several wires run through this hole and must therefore be relocated if a 6SN7-GT tube is used. However, a 6S4, which is a nine-pin miniature, can be mounted in this space without rearranging the wires. Chassis not having this extra socket hole will have to be punched or drilled out. The reason a six-volt tube was chosen instead of a twelve was due to the current requirements being 0.6 ampere. This can be obtained by connecting either the 6SN7-GT or 6S4 filament between the a-c plug and pin twelve of the 16KP4 picture tube. In this way the voltage across each filament string is reduced by 6.3 volts and the operation of the receiver is not affected.

The 12SN7-GT (V 10B) cathode resistor (R 299) was changed to 2000 ohms and the charging capacitor (C 305) to .02 mfd to obtain sufficient height with good vertical linearity.

Mounting the picture tube on this chassis was also somewhat of a problem. The front section of the chassis on which the 10FP4 picture tube rested was removed by first removing the controls and then the three self-tapping screws on each side. The filter choke and audio output transformer were also removed. The triangular sections of the front marked "A" in Fig. 3A were removed by cutting along the dotted lines with a hack saw. The vertical side pieces were then bent over as shown in Fig. 3B to provide a support bracket for the picture tube. This was $\frac{3}{4}"$ above the top of the chassis. A piece of sponge rubber cushion was fastened to each support to provide a shock mounting.

The shield around the high-voltage compartment was removed next. The width and horizontal linearity controls were removed and the HV anode wire disconnected. The rivets holding the yoke support bracket and the resistor terminal strips were drilled out. A section four inches down from the top extending one inch toward the side and one and one-half inches toward the back was cut out using a hack saw. A one-inch wide diagonal section of the perforated top cover was also removed. Tin snips may be used without removing the shield from the chassis but these are rather difficult to use and the resulting job is rather rough in appearance.

The yoke bracket was remounted about one and one-quarter inches above and about one and one-half inches back from the former mounting holes. The half-moon section of the yoke bracket was removed and reformed by bending so that the yoke was raised an additional $\frac{1}{4}"$. All this was necessary to prevent the bell of the picture tube from resting on the 12AT7 oscillator-converter tube. The resistor terminal strips were remounted and a new eight-inch piece of HV lead was used for the anode

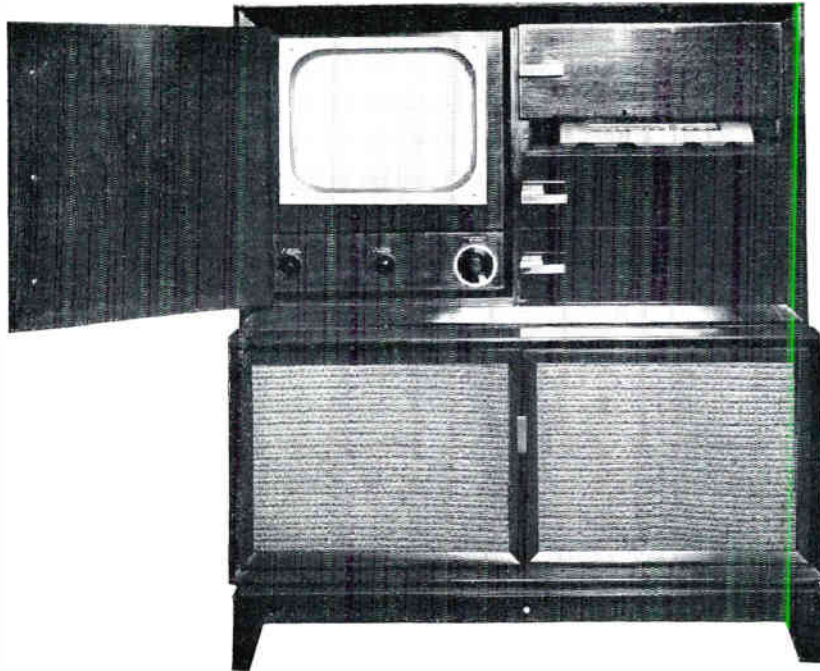

Fig. 4. RCA Model 730 TV2 shown after being converted to use a General Electric 14CP4 rectangular picture tube.

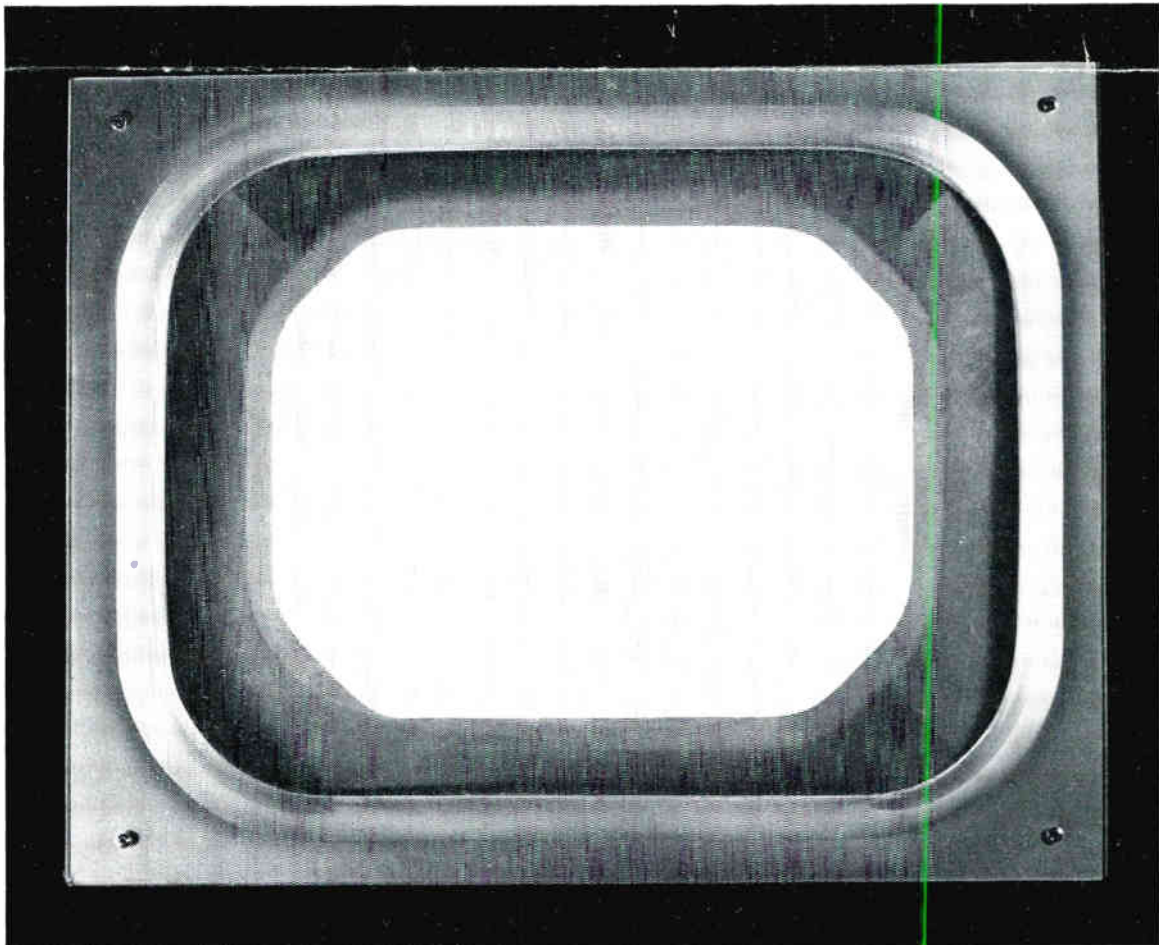

Fig. 5. Front panel of the receiver shown in Fig. 4 with the new fourteen-inch mask attached and placed over the original ten-inch mask.

Merit MD-1 or Stancor DY-7. The old yoke was used as a wiring guide. It was also necessary to remove the HV compartment shield and replace the horizontal sweep transformer in order to obtain sufficient width with good horizontal linearity. A Stancor No. A-8128 was used, however a similar type such as the Stanwyck No. 998 may be used. A No. 979 listed as a separate item in the Stanwyck Catalog as the replacement coil windings for the Stanwyck 998 transformer may also be substituted for the original windings. The replacement of only the windings on the horizontal sweep transformer will result in a considerable saving as the list price of this is about one-third of the complete transformer. The width control was not used and the two wires were taped and not reconnected into the circuit.

A 500-mmfld capacitor was connected across the horizontal windings of the yoke. This connection was made between the center terminal of the horizontal centering control and pins 4 and 6 of the 5V4-G damper tube. The 6BG6-G screen resistor was changed from 1700 ohms to 17000 ohms and the B+ side was connected to the B+ boost voltage which was available at terminal #1 on the horizontal sweep transformer. The B+ side of the 1000-ohm resistor (R 150) in the vertical output transformer circuit was also transferred to the B+ boost voltage.

A piece of shielding was attached to the graphite coating on the picture tube using several pieces of scotch tape. The other end

was fastened to the chassis when the picture tube was inserted to provide a ground connection.

The ion trap magnet coil could not be used due to the neck of the 14CP4 being shorter than the 10BP4. This was not disconnected, however, as it was part of the negative voltage supply circuit. It was taped to the chassis and a new General Electric Cat. No. RET-003 ion trap magnet was used as a replacement.

The 14CP4 picture tube was inserted and the necessary electrical connections were made. It was necessary to adjust the horizontal drive and horizontal linearity controls as well as the height and vertical linearity controls for a symmetrical test pattern.

CABINET CHANGES

The front panel which was removed from the cabinet is shown in Fig. 5 with the old ten-inch mask in back of the new plastic fourteen-inch mask. This panel was marked with a scriber using a fourteen-inch cardboard template which was centered over the old opening. This template was made by using the larger perimeter of the beveled portion of a fourteen-inch mask for size. Incidentally these templates should not be discarded but kept for future use. The section marked off was cut out using a keyhole saw. Four holes were drilled and countersunk as shown in Fig. 5 and the plastic mask was mounted onto the wooden panel using four small brass screws.

The chassis and front panel were returned to the customer's home and placed into the cabinet.

The inside wooden panel which supports the bell of the picture tube was also changed to accommodate the new fourteen-inch picture tube. This panel was marked using the same template previously used. The four angles and screws which held the 10BP4 in place were removed and the section marked off was sawed out. Four holes, two on the bottom and one on each side near the top were drilled about one-quarter inch in from the sawed edge. The four screws were inserted and the four angles mounted. Only the two bottom screws were tightened to hold the picture tube in place. The chassis complete with picture tube was placed into the cabinet and the front panel was mounted onto the cabinet. The picture tube was centered by adjusting and tightening the four mounting angles. It was necessary to remove and replace the front panel a few times in order to properly center the picture tube. Finally all screws and knobs were replaced and all electrical connections made, which completed the conversion.

While these circuit modifications have been carefully tested, the General Electric Company can, of course, assume no responsibility for the application of these suggestions to the conversion of any particular receiver. General Electric offers this article as a suggestion of one possible way of making the conversion but it does not represent that this is the only way or the best way of accomplishing the conversion.

In the next issue conversion information on two more television receivers will be included.

KILL THAT RETRACE

Information on the elimination of the horizontal retrace only is included in this issue. An article describing a circuit which could be used to remove the vertical retrace lines was included in the Vol. 1 No. 4 August-September 1949 issue. The vertical retrace lines are the diagonal white lines, which can be seen on receivers not using a vertical blanking circuit, when the brightness control is advanced.

Most technicians have also been troubled at one time or another by horizontal retrace lines which may appear as vertical white lines similar to Fig. 1. This type of line is due to improper damping and when the horizontal hold control is adjusted it will move in the opposite direction from the direction in which the picture moves. A defect at the transmitter will also result in

this same condition. The fold-over shown in Fig. 2 is usually caused by the horizontal retrace being too slow. This condition is frequently encountered when a capacitance is placed across the secondary of the horizontal sweep transformer to increase the picture size. Both of these defects will disappear if the horizontal retrace is completely blanked out.

(Continued on page 7)



Fig. 1. The faint vertical white line at the left may be due to a defect in the damping circuit. The fine tuning control was adjusted to accentuate the whites.

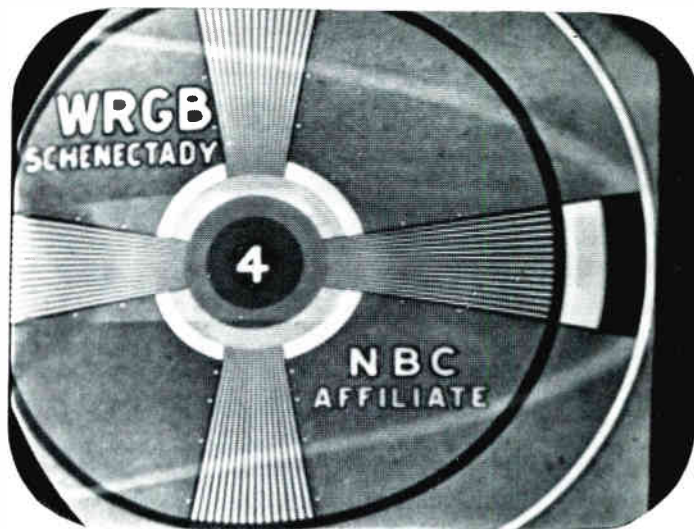
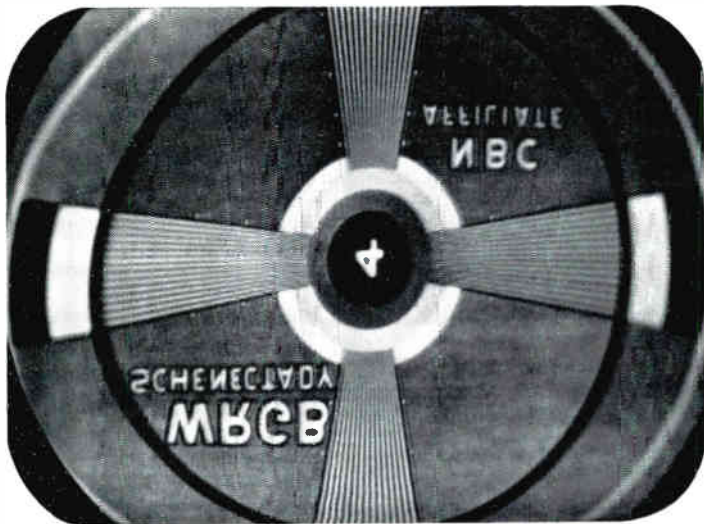

Fig. 2. Horizontal fold-over usually caused by the horizontal retrace being too slow.

Tele-Clues

Included in this issue are eight more defects which may occur in a television receiver. The first two indicate the effect of transposing either the vertical or the horizontal wires on the deflection yoke, the third shows a defect which may occur in the General Electric 810 line of receivers. Also included are five different Television Picture Tube defects.



Tele-Clue No. A-57—The defect shown above would only appear if the deflection yoke has been changed or rewired and is the result of the wires going to the vertical coils being reversed. The letters NBC which are normally at the bottom are now at the top and reversed. This change may also be necessary when converting to a projection system or when a mirror is used. One application using a mirror would be over a hospital bed which would enable a patient to view television from a horizontal position.

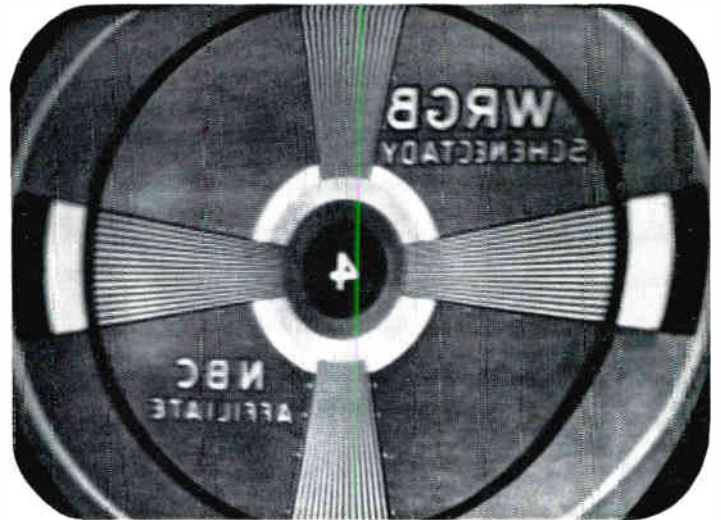

Tele-Clue No. A-58—The defect shown here would also only appear if the deflection yoke has been changed or rewired and is the result of the wires going to the horizontal coils being reversed. The letters WRGB which are normally on the left are now on the right and reversed. The result is the same as Tele-Clue No. A57 turned upside down.

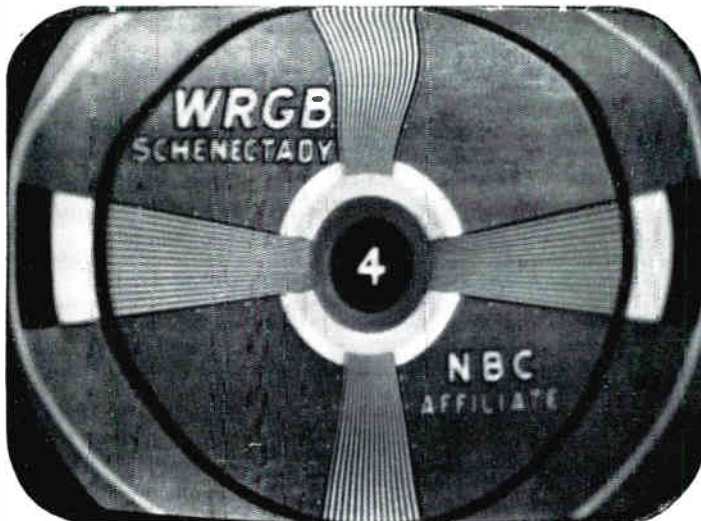

Tele-Clue No. E-59—The curve and waviness which appears only at the top of the picture may be due in the General Electric Model 810 line of receivers to the resistance of R98 in Fig. 1 being too low. When replacing use a 56000-ohm resistor.

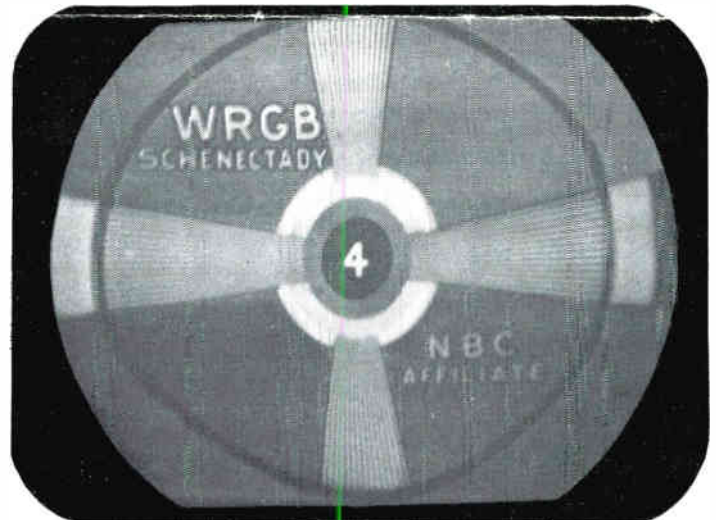

Tele-Clue No. H-60—A washed out picture may be due to a low emission or "soft" picture tube. This same type picture will result when the voltage on the No. 2 grid of the picture tube is reduced by leakage to ground.

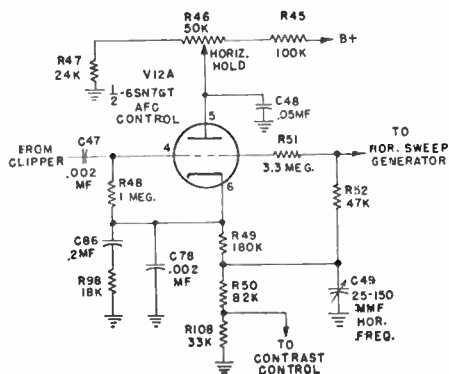
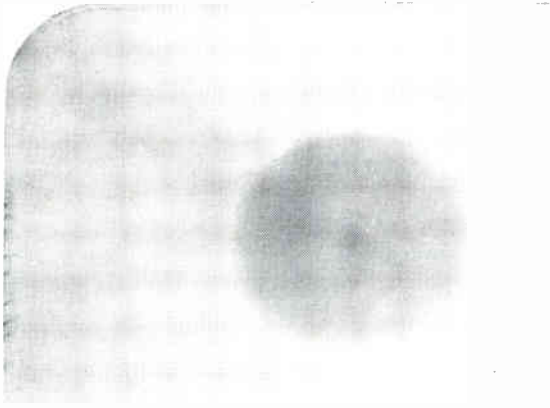
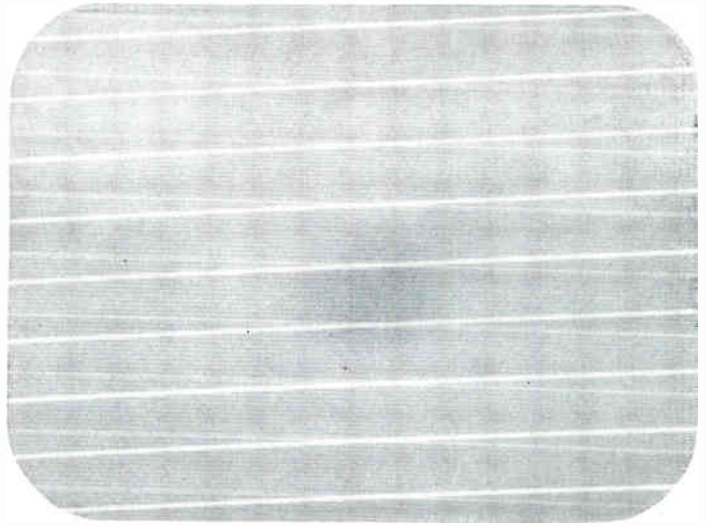

Fig. 1. AFC control circuit used in the General Electric Model 810 line of TV receivers.



Tele-Clue No. H-61—This illustrates a severe ion spot on a round tube. This was a common defect which began to appear after a few hours' service on pre-war television picture tubes. The use of either a metal-backed aluminized screen or a different type electron gun structure requiring an ion trap has virtually eliminated this defect.



Tele-Clue No. H-62—This is a slight ion spot which may in time result in the type shown in Tele-Clue No. H-61. Misadjustment of the ion trap, particularly in the larger size picture tubes, may also result in a discoloration at the center of the screen similar to the above.

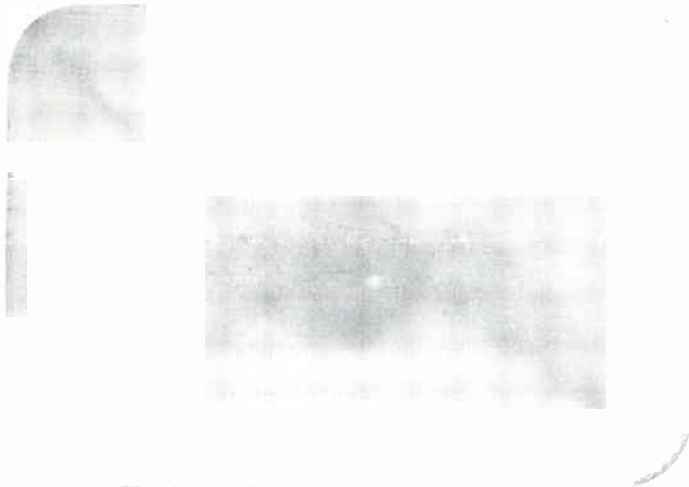

Tele-Clue No. H-63—This represents an ion spot on a rectangular tube and is called an "X" burn.

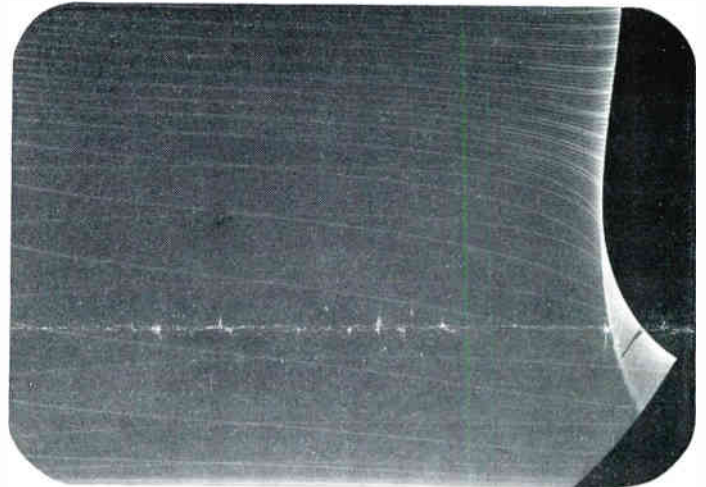

Tele-Clue No. H-64—The raster distortion shown here is due to a portion of the metal cone on a metal cone type picture tube being magnetized. This may appear as if the horizontal or vertical linearity controls require adjustment. A check as to whether the metal cone is magnetized is to rotate the tube 90°. A pull at either the top or bottom will move with the tube and will then appear on either the left or right side.

TELE-TIPS

26. A heater-cathode short in the 6W4-GT damper tube in GE Models 820 and 830 will cause the picture tube to blank out. This is normal in most receivers as a result of the complete loss of high voltage, however in these two models the anode voltage is normal. This is due to a separate filament winding being used to supply only the picture and damper tubes. The cathode of the picture tube is connected to the filament and when a short develops between the cathode and filament in the damper tube the cathode voltage is increased. This makes the cathode voltage much higher than the grid voltage resulting in the picture tube being blanked out.

27. In order to give added protection against ion burn and also to permit the control of aluminum thickness for maximum brightness, metal backed or aluminized picture tubes in the 16-inch and larger sizes will require a single magnet type ion trap. As you know, the 10-inch 10FP4 and 10FP4-A as well as

the 12-inch 12KP4 and 12KP4-A aluminized tubes do not require an ion trap.

28. In cases where the height is insufficient in receivers using a 6SN7-GT as a vertical oscillator the new 6BL7-GT can be substituted. This will provide a considerable increase in the vertical sweep without any circuit changes. The only consideration is filament current which is 1.5 amperes. See "What's New" on the back page of this issue for additional information.

29. In cases where the height is insufficient in receivers using a 12AU7 as a vertical oscillator the new 12BH7 can be substituted. This tube will provide a considerable increase in the vertical sweep without any circuit changes. Information on this tube appeared in the "What's New" column in the Vol. 2 No. 5 issue of Techni-talk.

30. A defect in linearity may sometimes be corrected by adjustment of the ion trap.

KILL THAT RETRACE—Continued from page 4

One circuit which is extremely simple to use is shown in Fig. 3. This supplies the screen grid of the picture tube with B+ voltage during the trace portion and a negative blanking pulse during the retrace portion of each horizontal line.

Remove the 47-mmfd capacitor (this value will vary in different receivers) from across one section of the deflection yoke and substitute an eight-inch piece of outside insulated shielded wire. The length of this wire will vary depending upon the capacitance which it replaces.

A piece of 75-, 150-, or 300-ohm twin-lead can also be used but it should be considerably longer. Disconnect the wire supplying the screen voltage to the picture tube (pin #10) and tape the end with a high-voltage tape. Connect the shielded wire as shown in Fig. 3 with the inside conductor connected from the "hot side" of the yoke to pin #10 on the picture tube. Do not ground the shield. The cable may be held in place by taping to the neck of the picture tube.

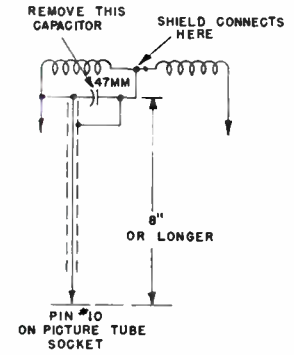

Fig. 3. Horizontal retrace elimination circuit which will eliminate the defects shown in Figs. 1 and 2.

CAPACITOR SUBSTITUTION BOXES

In the last issue of "Techni-talk" two resistor substitution boxes were described. Since a means of substituting capacitors quickly and easily is equally important in service work, two capacitor substitution boxes were designed for this purpose and are shown in Fig. 1.

The first of these covers a capacitance range of from 25 mmfd. to 400 mmfd. and the second from 500 mmfd. to 0.5 mfd. All of the capacitors used have a working voltage rating of 500 or 600 volts. Mica capacitors were used in the low-capacitance box and are recommended in the high-capacitance box in the values up to .01 mfd., although paper capacitors may be used in the .001 mfd. and higher values. The high-capacitance box also provides for an external condenser of any value desired to be included in the switching system by means of two binding posts.

Both boxes are wired in a similar manner by forming a ring of #14 tinned wire to serve as the common lead. The various capacitors are connected between this wire ring and the respective switch points. This results in a rigid assembly with a minimum of lead inductance. The common lead and the arm of the switch are brought out to banana jacks for connections to the test leads. The wiring diagrams shown in Figures 2 and 3 illustrate this method of wiring quite clearly. The switches used in both boxes are Mallory Cat. No. 1311L, 11-position, single-pole, non-shorting switches with the switch in the high-capacitance box set to stop at the seventh position. The scale for one box was drawn on paper and pasted to the panel under the knob. The other scale was printed on the top panel with white ink. Both units are built in 3" x 4" x 5" metal utility boxes.



Fig. 1. Photograph showing the completed capacitor substitution boxes.

Many uses for these capacitor substitution boxes will suggest themselves, such as tuning condensers across horizontal deflection coils, as frequency determining condensers in multivibrators, as coupling capacitors in audio circuits and sweep circuits and as bypass condensers in low frequency circuits. These capacitor boxes, when used in conjunction with the resistor boxes described in the previous issue, will prove invaluable when making TV receiver conversions. As with the resistor boxes described in the last issue, caution should be used when working with high frequency RF and IF circuits, and in all cases it is advisable to use the shortest possible leads between the boxes and the circuits under test.

If one realizes the limitations of these units as well as their usefulness, they will more than repay for the time and effort spent building them and certainly help to keep the profits rolling in.

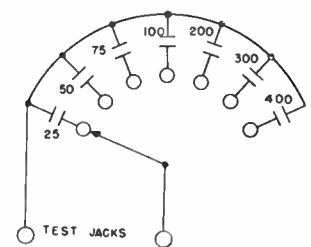

Fig. 2. Circuit diagram for low capacitance substitution box. The capacities are shown in mmfd.

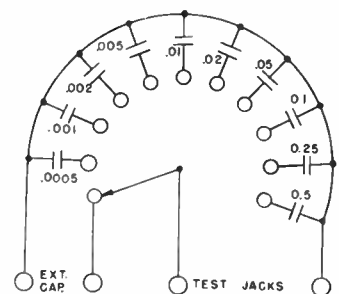

Fig. 3. Circuit diagram for high capacitance substitution box. The capacities are shown in mfd.

BENCH NOTES

Contributions to this column are solicited. For each question, short cut or chronic-trouble note selected for publication, you will receive \$10.00 worth of electronic tubes. In the event of duplicate or similar items, selection will be made by the editor and his decision will be final. Send contributions to The Editor, Techni-talk, Tube Division, General Electric Company, Schenectady 5, New York.

TIME SAVER ON NUT REPLACEMENT

It is frequently difficult to replace small nuts on i.f. transformer shield cans, etc., which have been removed for servicing and which are located in virtually inaccessible places. The main difficulty is in getting the nut started. This can be quite easily accomplished by threading the nut over a short piece of small wire and then pressing the end of the wire against the end of the screw which is to receive the nut. The nut is then allowed to drop or fall along the wire to the screw, and then, with another piece of wire can be started. After the nut is started (which is the point of this article), then usual tools are used to "snug" it. The ends of most screws are slightly concave to facilitate holding the guide wire in place. The guide wire can, of course, also be bent if necessary to reach difficult places more readily.

This little tip has saved me a lot of trouble when various holding or grasping tools are not the answer.

— Grant C. S. Pfoil
Shertz,
Texas

NEED A RIVET?

An excellent substitute for hollow rivets is a section of a tube prong cut from a discarded tube. It must be cut with a file or saw since cutters mash it together. There is a choice of sizes which will mushroom perfectly and make good electrical and mechanical contact.

— Loren Timberman
1507 Crestview Dr.
Springfield, Ohio

ION TRAP ADJUSTMENT

When the picture tube doesn't seem bright enough sometimes it is necessary to move the focus coil front a little to give the ion trap enough room for proper adjustment. Many times with the double magnet-type trap it is not far enough front on the picture tube to give full brightness to the picture. If the picture is still not bright enough and tube replacement is necessary, it is best to replace with a metal-backed General Electric picture tube which does not require an ion trap magnet.

— Fred B. Jones
Jones Radio Company
Box 93
Douglassville, Pa.

EDITOR'S NOTE: See Tele-Tip No. 27 for exception.

MAGNETIC ATTRACTION

An easy way of preventing a lot of trouble when cutting or drilling holes for tube sockets, mounts, etc. on new or custom made equipment is by using a small but powerful PM speaker magnet or any other permanent magnet which has a diameter of at least 2 inches. By placing the magnet beneath the spot which is to be worked on most of the fillings will be attracted by the magnet, preventing them from getting into circuits where they may cause shorts or arc-overs. This is especially important on TV chassis. After use, the magnet may be easily cleaned by brushing it with a piece of coarse steel wool.

— James Hurst
22 June Street
Fall River, Mass.

CLEANING TV MASKS

When it is necessary to clean picture tube rubber masking use carbon tet on a tissue or a piece of clean cloth. The results will be surprising.

— Ed Olson, WZJF
3205 No. 11th St.
St. Louis 7, Mo.

What's new!

6BL7-GT

The 6BL7-GT is a low- μ twin triode designed primarily for use as a combined vertical deflection amplifier and vertical oscillator in television receivers. High permeance, high transconductance, and high plate current make the 6BL7-GT especially suitable for use with wide-deflection-angle picture tubes.

Heater Voltage (A-C or D-C)	6.3 Volts
Heater Current	1.5 Amperes
Vertical Deflection Amplifier*—Each Section	
Plate Voltage	450 Volts
Cathode Bias Resistor	1200 Ohms
Grid Input Voltage (approx)	
Peak-to-peak Sawtooth Component	36 Volts
Negative Peaking Component	44 Volts
D-C Plate Current	11 Ma.
Plate Output Voltage (approx)	
Peak-to-peak Sawtooth Component	270 Volts
Peak Positive Pulse Component	600 Volts

* Using a deflecting yoke whose vertical coils have an inductance of approximately 40 mH and a vertical deflection output transformer with a turns ratio of 11:1 and an impedance of 20,000 ohms.

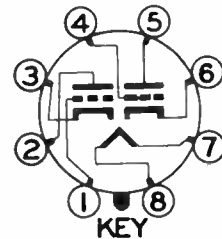

24AP4

The 24AP4 is a magnetic-focus and -deflection, direct-view picture tube for television service. It provides a 16 $\frac{3}{4}$ by 22 $\frac{3}{8}$ -inch picture with rounded sides. Features of this tube are a metal-cone envelope, an electron gun designed to be used with an external ion-trap magnet, and a high-quality, neutral-density faceplate to increase picture contrast and detail under high ambient light conditions.

Deflecting Angle, approximate	70 Degrees
Over-all Length	23 $\frac{3}{8}$ \pm 1/8 Inches
Greatest Diameter of Bulb	2 $\frac{1}{2}$ \pm 1/8 Inches
Anode Contact—Metal Cone Lip	
RECOMMENDED OPERATING CONDITIONS	
Anode Voltage (Average = 20 Foot lamberts)	15,000 Volts
Grid No. 2 Voltage	300 Volts
Grid No. 1 Voltage	-33 to -77 Volts
Focusing-coil Current (RMA Coil No. 109)	117 Milliampers
Ion-trap Field Intensity (single magnet type)	36 Gauss

Electronics Department
GENERAL ELECTRIC
Company
Schenectady 5, N. Y.

Sec. 34.66 P.L.&R.
U. S. POSTAGE
PAID
Schenectady, N. Y.
Permit No. 148

Boyd's Radio Service
411 Fredericksburg Rd.
San Antonio 1, Texas
E-223/J-75

6-13-49

POSTMASTER: If addressee has moved and new address is known, notify sender on Form 3547, postage for which is guaranteed. When Form 3547 is sent abandon this mailing. Return only if no correct address is available.

TELEVISION
PICTURE TUBE

**REPLACEMENT
GUIDE**

**A MUST FOR ALL SERVICE
TECHNICIANS!**

Shows all tube types recommended
by General Electric for use as
replacements.

Available now!

SEE YOUR DISTRIBUTOR!