

THE OSCILLOGRAPHER

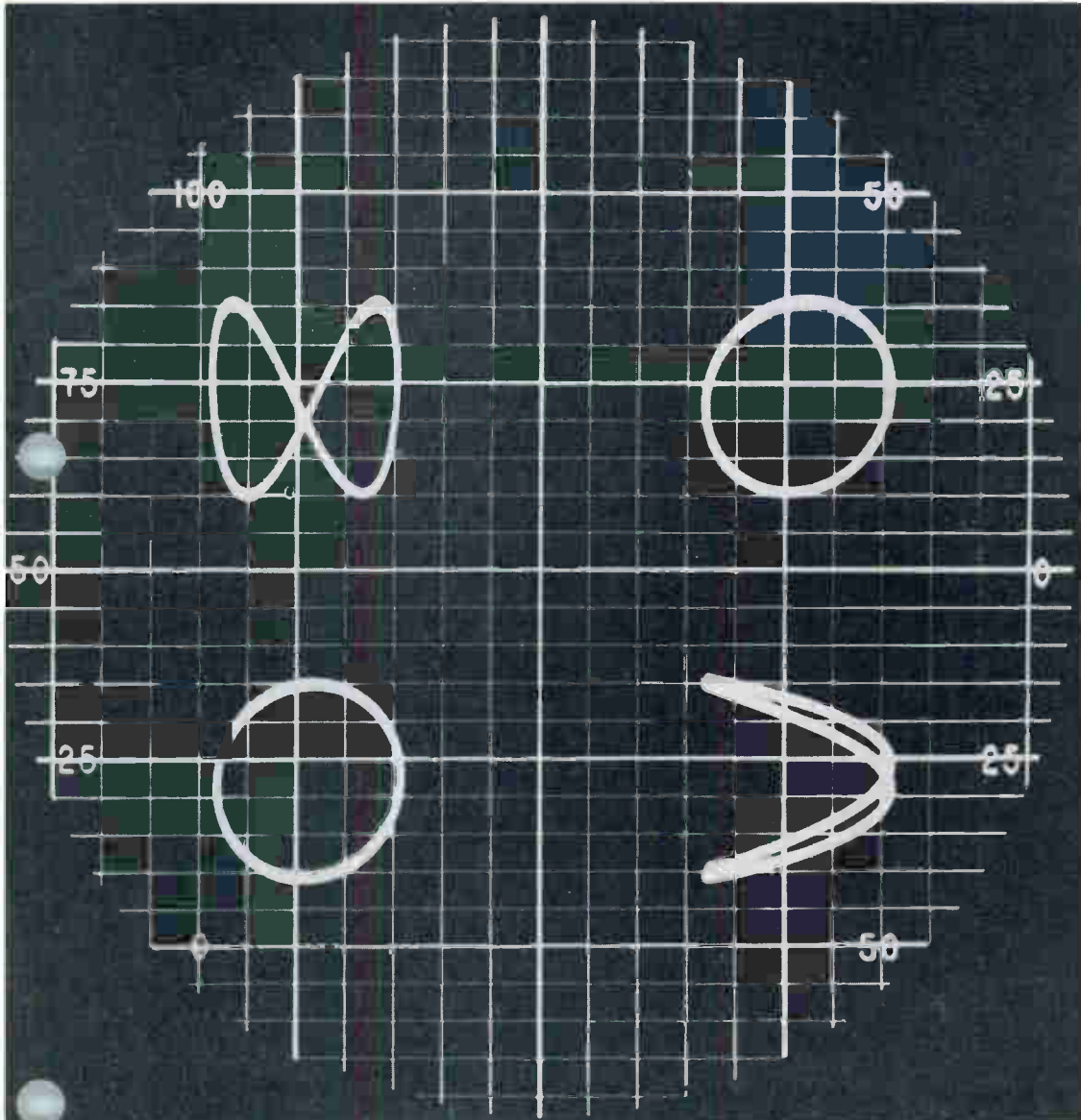

Vol. 15, No. 4



... and all with one Exposure

See Page 2

"Who and Why"

Du Mont Selling Agents



Harry C. Gawler

GAWLER-KNOOP COMPANY

Harry C. Gawler started his long career in radio and electronics with the Westinghouse Electric Manufacturing Company in 1903. In that year he assisted in the design and fabrication of a laboratory spark coil wireless transmitter and a silver filing cohera receiver using a polarized relay and a headphone.

In 1904, Mr. Gawler joined the United States Navy and graduated from the first Navy Wireless class in June of that year. When he was discharged from the Navy in 1904, Professor R. A. Fessenden of the National Electric Signal Company invited him to assist in the fabrication of governmental wireless equipment. During the seven years following Mr. Gawler took active part in the design, development, test and operation of the 500 cycle synchronous rotary gap transmitters located at Arlington, Virginia and on the United States Ships Birmingham and Salem. Important data was gathered by him during the tests between these vessels and the land-based station which he used to compile tables for two National Bureau of Standards circulars.

(Continued on Page 16)

On the Cover

A single-exposure oscillogram taken from the screen of a Du Mont Type 324 Oscillograph. The four phenomena are presented simultaneously through the use of two Du Mont Type 330 Electronic Switches. This is one of the many unusual applications of the electronic switch. This and other unusual applications are described in the article "Using a Modern Electronic Switch" starting on the opposite page.

THE OSCILLOGRAPHER



A publication devoted exclusively to the cathode-ray oscillograph providing the latest information on developments in equipment, applications, and techniques. Permission for reprinting any material contained herein may be obtained by writing to the Editor at address below.

Published quarterly and Copyright 1956 by
Allen B. Du Mont Laboratories, Inc.

Technical Products Division
760 Bloomfield Ave.
Clifton, N. J.

Neil Uptegrove — Editor
Jerome Haberkost- Asst. Editor

TABLE OF CONTENTS

	Page
"Who and Why"	
Du Mont Selling Agents	2
<i>Features</i>	
Using a Modern Electronic Switch.....	3
Complete Versatility in Portable Instrumentation Type 331	13
Dirty Pictures	14
<i>Miscellaneous</i>	
Show	15
Change of Name	16

Using A Modern Electronic Switch

Carl E. Webb

Senior Engineer, Low Frequency Instruments

Electronic switches have been available commercially for many years. However, the wideband d-c coupled electronic switch is a sufficiently new arrival in the field of electronic instrumentation that all of its uses and the techniques for obtaining best results may not be fully known. This article describes some of these uses and techniques as they have become known during the development and field testing of the Du Mont Type 330 Electronic Switch.

A Review of Switch Operation

The switch circuitry commutates back and forth between two inputs in such a manner that signals from them appear alternately at the output. When the alternate signals at the output are fed to an oscillograph, the persistence of the screen and the persistence of the eye combine to give the illusion of two continuous patterns. Generally, a variable d-c voltage is added to the signal in each channel so that the oscillograph patterns corresponding to each of the two signal inputs may be separated from each other on the face of the cathode ray tube.

There are usually two modes of operation of the switch; triggered or free-running. In the free-running mode, the switching action is controlled by an astable multivibrator which has no synchronous relation to the signals under view. In this mode of operation, two continuous patterns are seen as a result of the lack of synchronization since each successive switching transition occurs at a different point of the sweep. If the frequency or repetition rate of the signals under view happens to be harmonically related to the switching rate used, a stroboscopic effect occurs in which the switching waveform becomes apparent. This is usually not a cause of annoyance if the frequencies are not close to each other.



**Du Mont Type 330
Electronic Switch**

In triggered operation, the switching action is bistable and is actuated by some external signal. Ordinarily this is the gate or saw output from the oscillograph. In this case the switching transitions occur during the retrace time of the oscillograph. This has the advantage that no switching transients occur during the sweep time. In the Type 330, a control is provided to allow switching on either the rising or falling portion of the trigger waveform. Thus the switching can be made to occur during retrace time whether the CRO gate output is positive or negative.

Switching Tails

A major problem in any electronic switch is the transient or "tail" which occurs during switching. This occurs because the circuit action uses two tubes alternatively gated into a common load. Ideally, the edge of the gating waveform applied to the grid of the tube coming on should be the complement of the edge of the waveform applied to the grid of the tube going off. In the practical case this is not possible, with the result that a discontinuity in the load current occurs during switching resulting in a spike in the output voltage. In the Type 330, these tails are minimized by using a gating waveform with a fast rise time and by using a switching circuit which of itself tends to suppress tails. Since they are not normally in synchronization with the signals under view, they are rarely annoying in this instrument. In triggered operation, of course, they do not appear on screen.

Techniques Synchronizing the Oscillograph

In most cases it is desirable to synchronize the oscillograph externally from one of the two inputs. There are two reasons for this. First, if internal sync is used, the CRO will try to sync on both the switching waveform and each of the signals in turn. The result will often be an unintelligible pattern. Secondly, the phase relationship between the two signals is not correctly indicated on the oscillograph since the time base is no longer related to just one of the inputs but to each in turn. A typical synchronizing connection when viewing harmonically related signals is shown in Figure 1.

There are certain cases, however, in which it is desirable and perhaps necessary to use internal sync in the oscillograph. One of these is the case where the two signals to be viewed are not harmonically related to each other. A not uncommon situation in which this is so is that in which a signal is introduced to one channel and timing markers to the other. Crystal controlled marker generators cannot be synchronized by the signal and the signal may come from some system which cannot be synchronized with the markers. If the CRO is synchronized externally from one of the inputs, the other will not be locked in. In many cases it is possible to use internal sync in the oscillograph so that the oscillograph synchronizes on each signal in turn as it appears at the switch output. Certain conditions must be observed, however, if this is to be done successfully. It was stated above that, when internal sync is used, the oscillograph tries to sync on the switching square wave as well as on the signals. An objectionable effect from this can be avoided in two ways. First, the electronic switch may be operated in the triggered mode and a short time constant be introduced in the oscillograph sync amplifiers. The effect of this is to differentiate the switching square wave so that, by the time the sweep hold-off circuit has recovered, the switching square wave is no longer effective in the sync amplifier. The action of this is shown in Figure 2. Note that the signals must contain sufficient high frequency components to pass through this short time constant circuit. Note also that the portion of the sync amplifier following this high pass filter must have a sufficiently good frequency response to pass frequencies above the cut off frequency of the r-c circuit. For this reason it is usually

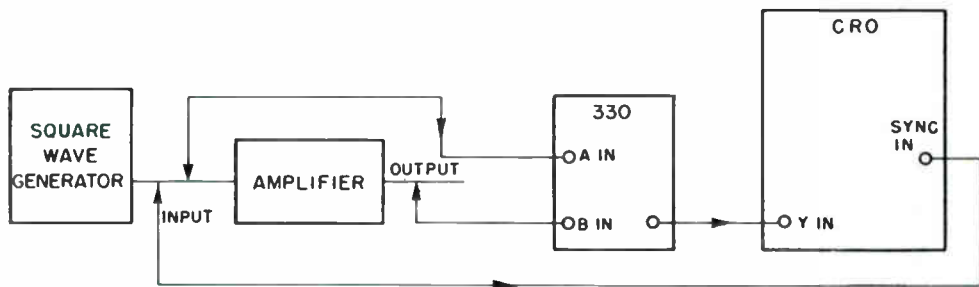
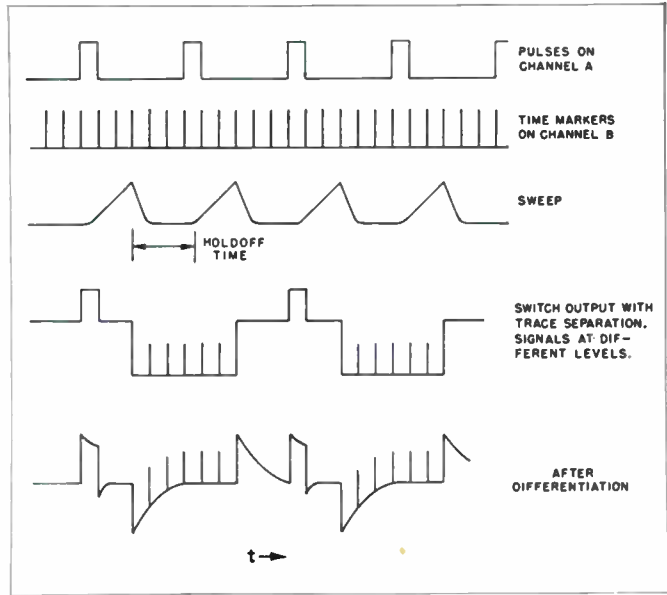

Figure 1. Typical connection for synchronization of related signals.

Figure 2. The effect of differentiator circuit on a sync waveform.



necessary to put the short time constant near the output of the sync amplifier rather than at the input. In the Type 329-A the sync shaper will do this job satisfactorily. In practice, the values shown in Figure 3 have been satisfactory. A variety of combinations having approximately the same time constant would be as good.

In addition to triggered operation, internal sync can also be used if the 1 kc. free running switching mode is used and the sweep repetition rate is appreciably higher than 1 kc. While some sweeps will still be triggered by the switching square wave, these will be less frequent than those triggered by the signals and may not be objectionable. Here again, the differentiator in the CRO sync circuit will give better results.

It should be emphasized that internal sync in the oscillograph should be used only where the nature of the signals requires it. In all other cases synchronizing the oscillograph externally from one of the two inputs is preferable.

Triggered vs. Free Running Operation of the Switch

Under certain conditions, only one of the two modes of operation will give a satisfactory presentation. Under other conditions both modes will be satisfactory.

Triggered operation will give the best presentation in the middle range of sweep speeds. Switching transients occur while the beam is off, ensuring clean traces.

Free running operation should be used under the following circumstances:

a. Low sweep repetition rate.

At low repetition rates, use of triggered switching will result in a flicker or, in the extreme, seeing the two traces alternately rather than simultaneously. If the oscillograph is a.c. coupled, slope of the traces will result in triggered operation owing to the period of the switching wave being longer than the time constants of the CRO coupling circuits.

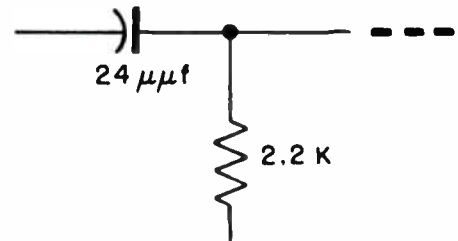

Figure 3. Constants used in sync shaper circuit in Types 323-A and 329-A Cathode-ray Oscillograph.

b. Single transients.

To see traces for each channel during a single sweep of the CRO it is necessary to sample both channels many times during a single sweep time. This, of course, requires free running operation. The shortest single transient which may be successfully observed depends upon the fastest free running switching rate available and upon the minimum number of segments tolerable in each trace. With a 100 kc. switching rate, a transient of 200 microseconds duration may be observed with 20 segments in each trace. This is shown in Figure 4.

At very high sweep speeds and repetition rates, the 1 kc. free running mode gives a very clean presentation without the external connections and adjustment necessary for triggered operation.

In free running operation not that the bandpass of the CRO amplifier must be sufficient to handle the switching square wave used without excessive distortion.

Multiple Switch Operation

By using additional electronic switches, any reasonable number of channels may be viewed simultaneously. Each additional switch will give one additional channel. Upon casual consideration it might be thought that the addition of an extra switch to one already in use would give two new channels. However, this is not so since one channel of the original switch must be used to handle the output of the added switch thus removing that input as a point of signal introduction. The only limit to the number of channels which may be viewed simultaneously by adding switches are: (1) lower duty cycle for each trace because of the sharing of time between more traces

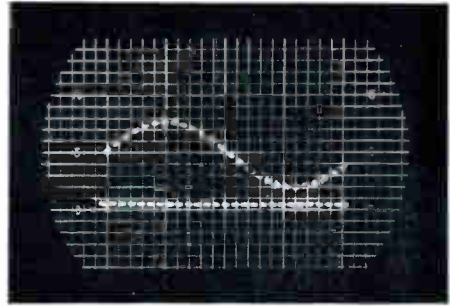

Figure 4. Display resulting using a rapid switching rate to observe both channels of switch simultaneously.

with consequent lower intensity and (2) complexity of controls.

Two factors not present in single switch operation must be considered when using multiple switch connections. First, caution must be used in phase measurements since all signals may not pass through the same amount of amplifier circuitry. In the case of fast pulses or signals of high frequency, appreciable phase error may result. Consider Figure 5. Signals X and Y pass through the amplifiers of switch 1 and of switch 2 and suffer the added phase shift of the two amplifiers. Signal Z, however passes only through the amplifier of switch 2. Thus the phase relationship between signal X and Y and signal Z measured on the oscillograph will be in error by the amount of phase shift in the amplifier of switch 2. In many cases, harmful effects from this may be avoided by proper choice of inputs. This is shown in Figure 6. Suppose that it is desired to measure the phase between signals X and Y by viewing them on an oscillograph simultaneously with the output of a Du Mont Type 300 Marker Generator, signal Z. If signals X and Y are

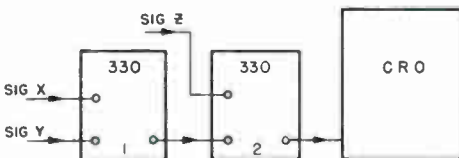

Figure 5. Arrangement used to get three channel display.

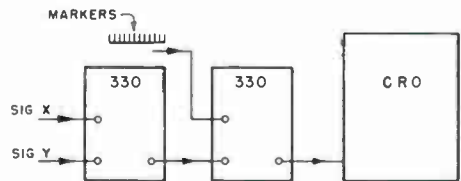

Figure 6. Arrangement used to minimize phase shift effect between signals X and Y (see text).

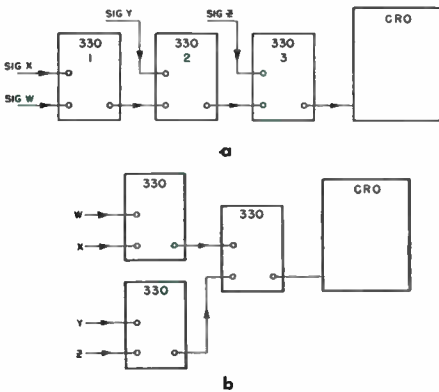

Figure 7. Block diagrams showing set up with more than two electronic switches.

introduced to inputs A and B of switch 1 the phase error between them will be negligible. They both pass through the matched amplifiers of switch 1 and pass together through the channel B amplifier of switch 2. Although the timing markers introduced to channel A of switch 2 suffer phase shift with respect to signals X and Y, this is not significant since the markers are used only as a yardstick which may be moved horizontally with respect to the interval which it is to measure without losing the accuracy of the measurement.

When more than two switches are connected in cascade, certain patterns of connection tend to reduce phase error. The three switches shown in Figure 7 are an example. To obtain a four trace pattern the switches may be con-

nected as shown in Figure 7a or as shown in Figure 7b. Let us assume that the phase shift through each switch amplifier is ϕ . In Figure 7a signals X and W undergo a phase shift of 3ϕ , signal Y undergoes a phase shift of 2ϕ , and signal Z undergoes a phase shift of ϕ . Thus considerable phase error is introduced which may be intolerable in some measurements. In the connection of Figure 7b all signals undergo a phase shift of 2ϕ . The accuracy of phase measurements now is only slightly less than that of single switch operation.

Another point to remember in multiple switch operation is that not all of the switches can be used in the triggered (alternate sweep) mode; some must be free running. The reason for this is shown in Figure 8 where mistakenly, both switches are being operated in the triggered mode. In Figures 8b, c, and d, several cycles of the CRO sweep are indicated. The square waves show the "on" channel of each switch during a given sweep. Since both switches are triggered by the CRO retrace they are, of course, in phase. Figure 8a. shows that signals X and Y can appear on the CRO only when channel B of switch 2 is on. However, Figure 8c and d show that whenever channel B of switch 2 is on, channel A of switch 1 is on and channel B is off. Thus only signals Y and Z appear on the CRO. Whether signals Y and Z or signals X and Z appeared would be only accidental but the result is always the same; i.e. only two signals are seen although two switches are used. This condition is readily avoided by operating one of the switches in the free running mode.

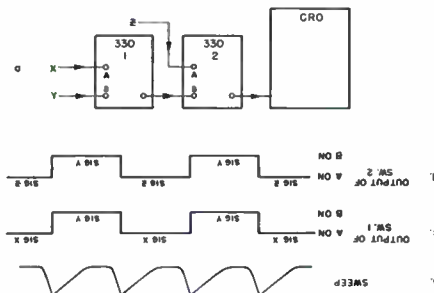

Figure 8. Relationship of display components when both electronic switches are mistakenly operated in triggered mode (see text).

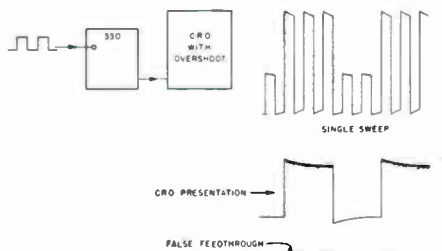

Figure 9. Exaggerated drawing of the effects of overshoot in the oscillograph amplifiers.

Unusual Effects

Occasionally some unusual effects have been observed when using an electronic switch have caused confusion until the reasons for them were determined. The significant ones observed are described below.

False feed through:

a. Owing to overshoot in the oscillograph.

If there is severe overshoot in the oscillograph used, an effect occurs which gives the appearance of crosscoupling between channels. This is shown in Figure 9. Here a square wave is shown on channel A while no signal has been introduced to channel B. A single sweep is drawn so that the switching wave form may be seen as well as the square wave signal. Note that the oscillograph amplifier is causing overshoot on the switching square wave itself. At the positive peak of the square wave, the magnitude of the switching square wave is greater than at the negative peak of the square wave. The effect when observing the oscillograph pattern is a thickening of the line modulated by the waveshape of the signal on the opposite channel. This may give a false indication of cross coupling. It is easily recognized by the fact that it will be less apparent at lower switching speeds and will disappear when the triggered mode is used. It is corrected by removing the cause of overshoot in the oscillograph.

b. When viewing very low frequency signals.

If a-c coupling is used in the oscillograph, another false cross coupling effect may be observed when viewing very low frequency signals. In Figure 10 a 1 cps square wave applied to channel A and no signal is applied to channel B. It has been stated elsewhere that, because of the chopping action of the switch, the true dc relation between the input signals is always maintained. This holds true

here. However, as the channel A sine wave goes from its positive peak to its negative peak and back again the average value of the composite output waveform shifts. Since this shift is slower than the time constants in the CRO coupling circuit a shift of the entire pattern occurs on the CRT screen. There is thus a movement of the channel B trace which is in the form of a sine wave 180 degrees out of phase with the sine wave on channel A. A distortion of the channel A trace itself is, of course, implied in the shift also. Similar effects occur with other kinds of low frequency inputs such as very low frequency square waves. The actual effect depends upon the relationship of the period of the function to the time constant of the coupling circuit in the oscillograph. A d-c coupled oscillograph will avoid this trouble. It is only apparent for very low frequency functions.

The Missing Pulse

At times, when using an electronic switch in triggered operation, a pulse or signal is observed to appear and disappear on one channel as the trigger sensitivity control is varied even though two traces are present indicating proper action of the triggered switching circuit. This condition may occur when a situation such as that shown in Figure 11 exists. On channel A the input to a decade counter is viewed. On channel B it is desired to view the output pulse from the counter. The CRO sweep is adjusted to view 5 input pulses. For purposes of simplification a perfect sawtooth sweep will be assumed. The waveforms of Figure 11. b. c. d and e show that the output pulse from the counter appears only on every

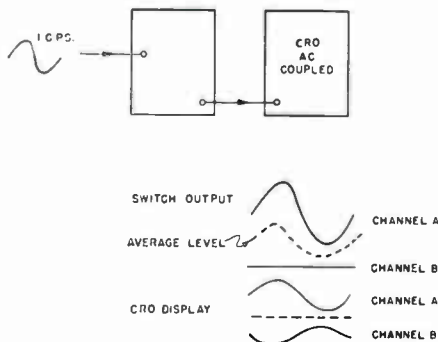

Figure 10. Drawing showing the effects of an a-c coupled oscillograph on low frequency phenomena.

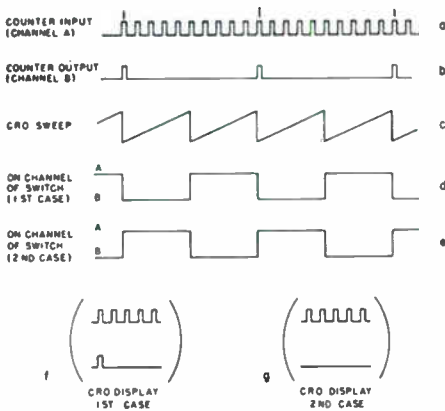

Figure 11. The case of the missing pulse.

other sweep. If the relationship between the switching action is that shown in Figure 11d the output pulse will be seen on the CRO, if the relationship is that shown in Figure 11e, it will not. Since the trigger sensitivity control can be used to change the phase of the switching action relative to the sweep, operating it can make the output pulse appear and disappear. This unusual effect can be avoided by using the free running mode.

Applications

The use of an electronic switch makes possible time measurements between two or more functions with unusual ease and accuracy. When a dual channel display is obtained with an electronic switch, the same gun and the same time base are used for each trace and there is little chance for error in time measurements.

Simultaneous viewing of two or more functions is a valuable assistance to rapid understanding of the function of various circuits. It is often found that the solution to an elusive problem comes easily when waveforms from two or more parts of the circuit are seen together in their correct time relationship. The examples given below suggest the variety of uses to which a dual channel display may be put.

1. Input and Output of Delay Line May Be Compared

Figure 12 shows how both input and output of a delay line may be viewed simultaneously. The delay time of the line may be

accurately measured on a calibrated oscillograph and an excellent comparison of waveshapes made. The utility of this in adjusting a lumped constant line is obvious. This is particularly so since it avoids difficulties resulting from overshoot or distortion in the test squarewave. The line may be adjusted merely to make the output waveform a faithful reproduction of the input.

In comparing the input and output of delay lines it may be desired only to compare the waveshapes closely and not to measure the delay time. In this case the time delay between input and output will be a nuisance since it prevents direct superposition of the two waveforms.

In this case the input and output waveforms may be superimposed on the oscillograph screen by using internal synchronization as described previously. The oscillograph will then synchronize on each of the two signals in turn so that they will both appear at approximately the same place on the screen in spite of occurring at different times.

2. Multiple Traces Obtainable By Using More Than One Switch

If it is desired to view more than two phenomena simultaneously additional traces may be obtained by adding more electronic switches. Since the output of the switch is at d-c zero, d-c coupling may be used throughout. One extra switch is required for each additional

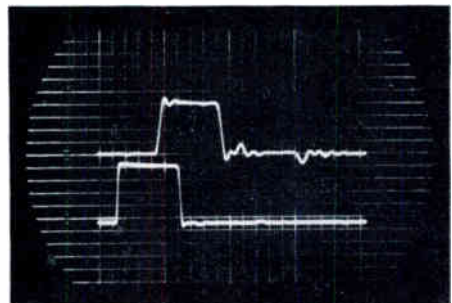
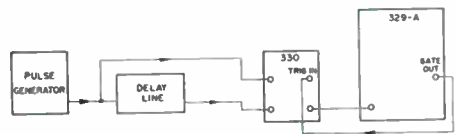
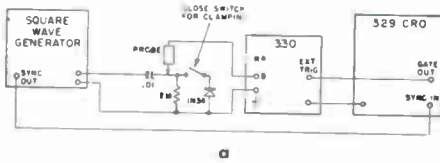
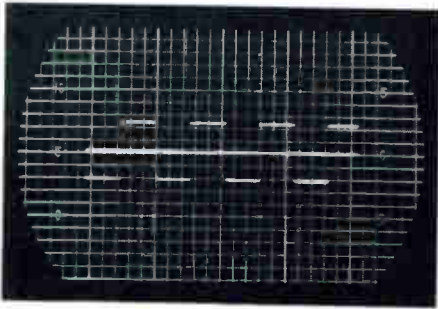

Figure 12. Set up and resulting display when the electronic switch is used to align delay lines.



a



b

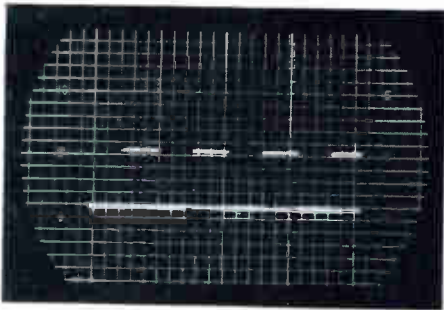

c

Figure 13. Use of electronic switch to present signals referenced to a ground point.

function which it is desired to view. As noted in Figure 5 two switches were used to give a three trace presentation. It can be seen that, with a multiple switch connection, not all of the switches can operate in the triggered mode. The reason for this is, referring to Figure 5, that switches 1 and 2 are both triggered from the same source. Whenever switch 2 is passing channel B switch 1 will be passing channel A. Channel B of switch 1 will never appear at the output of switch 1 when switch 2 is passing channel B. The effect is that of a two beam presentation although three switches are used. This condition may be avoided by using one of the switches in the free running mode. A sufficient range of free running frequencies is provided to ensure a good presentation in this case.

3. Ground Reference Line May Be Provided for Single Signal Presentation

In some circuit analysis, it is desired to know the level of a signal with respect to ground or some other reference. The electronic switch may be used for this purpose using the following procedure:

With both input attenuators in the d-c coupled position and no signal fed to either channel, the two traces are superimposed. The signal under observation is applied to either channel. The trace of the unused channel then serves as a ground reference line. In Figures 13b and 13c this system is used to show a square wave before and after passage through a clamping circuit. The same principle may, of course, be used to show the difference in level between two signals as well as between one signal and ground.

4. Timing Markers May Be Displayed

In Figure 14 a solution is shown to the problem of displaying fast timing markers with-

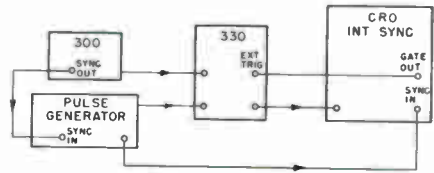

a

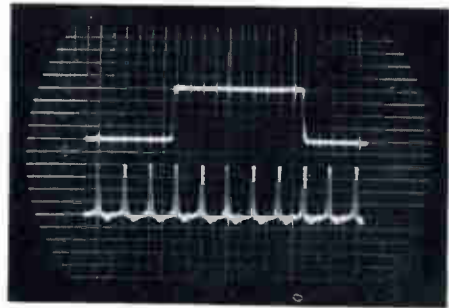

b

Figure 14. CRO display using electronic switch for injection of timing signals without interfering with signal under observation.

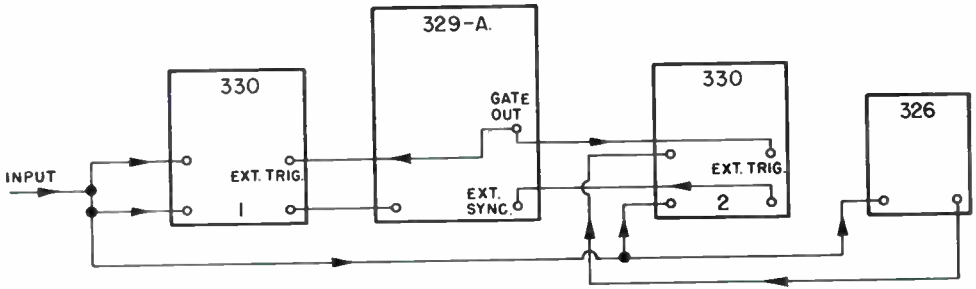

Figure 15. Set up to employ electronic switch as sync delay switch.

out interfering with the waveform under analysis. The sweep speed in the photograph is 0.1 microseconds per large scale division. The high accuracy of this system is insured by the fact that the same sweep voltage and deflection plates are used for both traces. The calibrating waveform may be of any waveshape such as the output of a marker generator, as shown in the photograph, or a sine wave from a signal generator or frequency meter. This principle may be used to measure sine wave frequency in high frequency oscillographs where lack of a wide band X amplifier may prevent the use of lissajous patterns.

5. Switch May Be Used With Delay Circuit To Compare Waveforms Occurring At Different Times

The use of the electronic switch is not restricted to signals being fed to the Y amplifier. In Figure 15 an application is shown wherein one switch is used in the sync circuit. In the figure, the signal to be observed is fed to both channels of switch Number 1. The output of this switch is fed to the Y input of the oscillograph. The synchronizing signal from the signal source is fed to channel B of

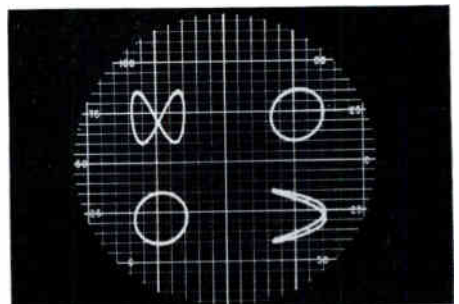
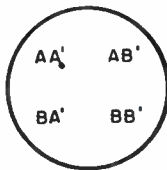
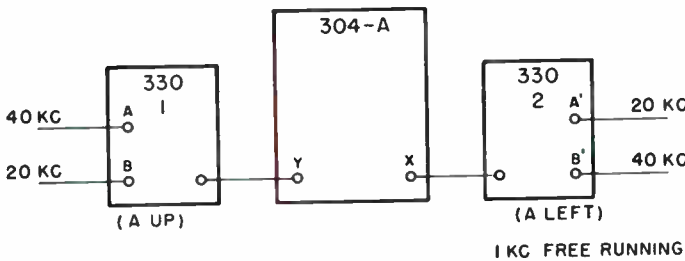

Figure 16. Set up and display when electronic switches are used to compare four signals on one cathode-ray screen.

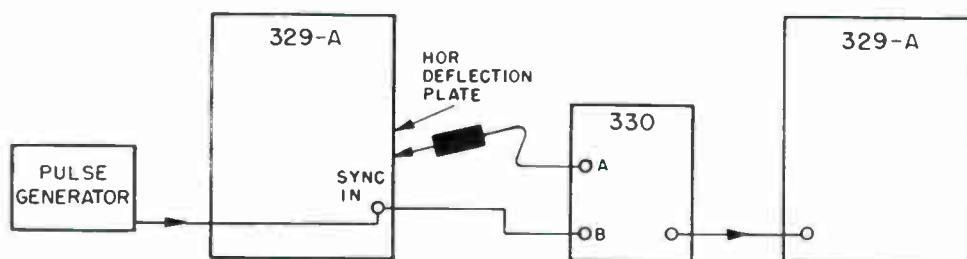

Figure 17. Set up and display when electronic switch is used to determine internal signal delay in oscillograph.

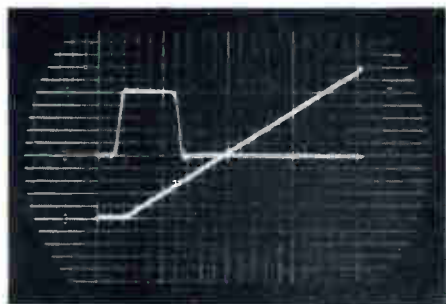

Figure 17-a

switch number 2 and also to a Type 326 Delay Unit. The output of the Type 326 is fed to the external synchronizing connection on the oscillograph. Both switches are operated in the triggered mode and are driven by the gate output of the oscillograph. Alternate sweeps are thus driven respectively by the delayed and undelayed sync pulse. In the case shown, this device is employed to compare parts of a signal with parts of the same signal occurring later in time. The same system could be used to compare two signals occurring at different times.

6. Switch Used In X Amplifier Circuit

Another application where a switch is used in other than in the Y amplifier circuit is shown in Figure 16. Here switch number 1 is connected to the Y amplifier input. Switch number 2 is connected to the X amplifier input. Sine waves of four frequencies are fed to the four inputs respectively. If both switches are free running at different frequencies, four lissajous patterns will be obtained. These represent the frequency relation between each of the inputs

to switch number 1 and each of the inputs to switch number 2.

7. Synchronized And Synchronizing Functions Observed

Figure 17 shows the pulse used to trigger the sweep of an oscillograph together with the triggered sweep. The time delay between the two may be readily measured and effect of variations in the trigger pulse upon the sweep studied.

8. Typical Application In Color Television

In Figure 18 the I and Q signals in a color TV system are displayed together.

The applications illustrated here are not meant to be inclusive but merely to demonstrate the versatility of the dual channel display and to suggest the many ways in which it facilitates a measurement or helps in the qualitative understanding of the operation of a circuit. It is apparent that as the great aid to circuit development afforded by the multiple trace presentation is becoming understood in the industry the electronic switch is rapidly taking its full place in modern instrumentation.

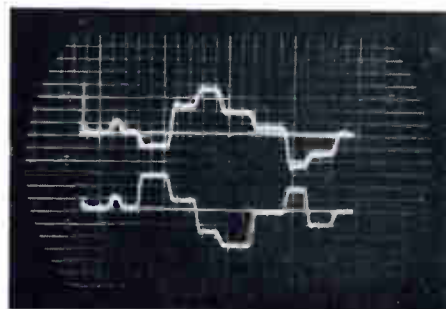

Figure 18. Color T-V I and Q signals displayed simultaneously through use of electronic switch.

COMPLETE versatility in portable instrumentation

TYPE 331



Du Mont Type 331 Cathode-ray Oscillograph

Here is a portable instrument that is as easy to handle as a multimeter and yet constitutes a precision oscillograph, providing complete facilities for accurate time and amplitude measurements. Weighing slightly more than 19 pounds *including* the protective cover (containing the accessory probe and the instruction book) the Type 331 is ruggedly designed even for the most casual handling. For example, the power transformer serves as part of the structural design for lightness and good balance.

As an oscillograph, the Type 331 is capable of displaying, with great fidelity, waveforms which contain amplitude components that change value as rapidly as 0.08 *microseconds*. As an electronic voltmeter, potentials of 0.4 volts to 400 volt may be displayed with *full-scale* deflection at any frequency between 0 and 4 megacycles. The built-in amplitude calibrator signal is accurate to 2 percent. The accurately calibrated sweep system of the Type 331 allows measurements in time from 0.08 *microseconds* to 2.5 *seconds*. Although rarely necessary, the calibration of the sweep system is easily checked *without* external equipment. This is based on the fact that power line frequencies are accurate to less than one-half percent and therefore may be used as a time

standard. Amplitude calibration too, may be checked with a known powerline or a dry-cell battery of known potential.

The compactness and the wide range of functions of the Type 331 does *not*, as one might expect, mean that the construction is cramped and unserviceable. The illustration shows the two "swinging chassis" that permit convenient access to any tube or component in the unit.

The Type 331 competes with any laboratory instrument in its frequency range and at less than half the occupied bench space. Operation on the floor too, is convenient because the Type 331 is equipped with four "legs" on the back panel placing the front panel at a suitable level for comfortable manipulation of controls. The Type 331 is ideally suited for computer servicing because of its portability and stability and has already become standard servicing equipment for several computers.

More complete information and specifications may be had simply by writing to the editor of the OSCILLOGRAPHER at the address shown on page 2.

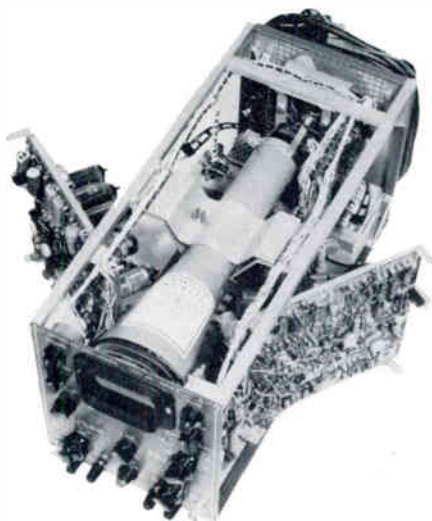

Swing Away Chassis Simplifies Service

DIRTY

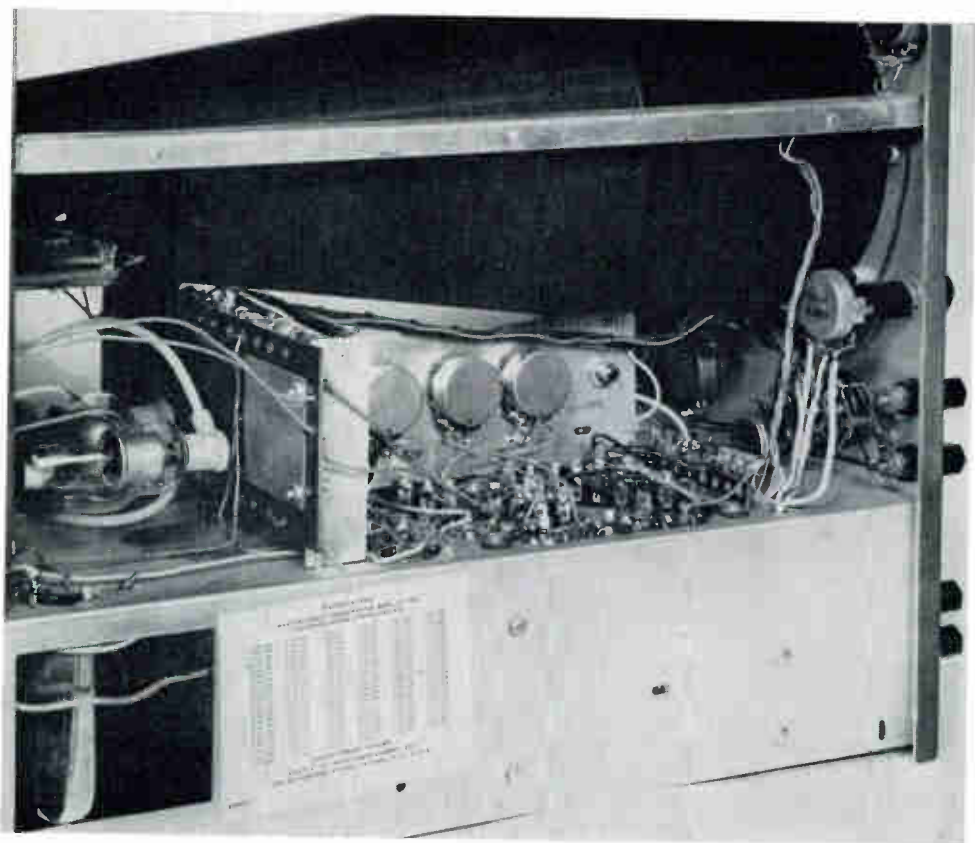

This photograph shows a Du Mont Type 304-H in new condition for comparison with the photo at right.

Last August, Hurricane "Diane" swirled up through the northeastern part of the United States carrying with it some eleven inches of rain. Naturally, river beds in the area couldn't possibly carry off all this water without overflowing and serious flooding resulted. The floods set new "high water marks" and many industries in New England were put out of operation.

Many of these industries use Du Mont equipment as "tools of the trade" and conse-

quently this equipment was damaged by the silt-laden flood waters.

Since then the Instrument Service Department has restored many of these instruments to original condition. One of the worst looking, judging by outward appearances, was a Du Mont Type 304-H Oscillograph which served as a piece of test gear for Mr. E. K. Dayesne in his television receiver repair establishment in Woonsocket, Rhode Island.

PICTURES

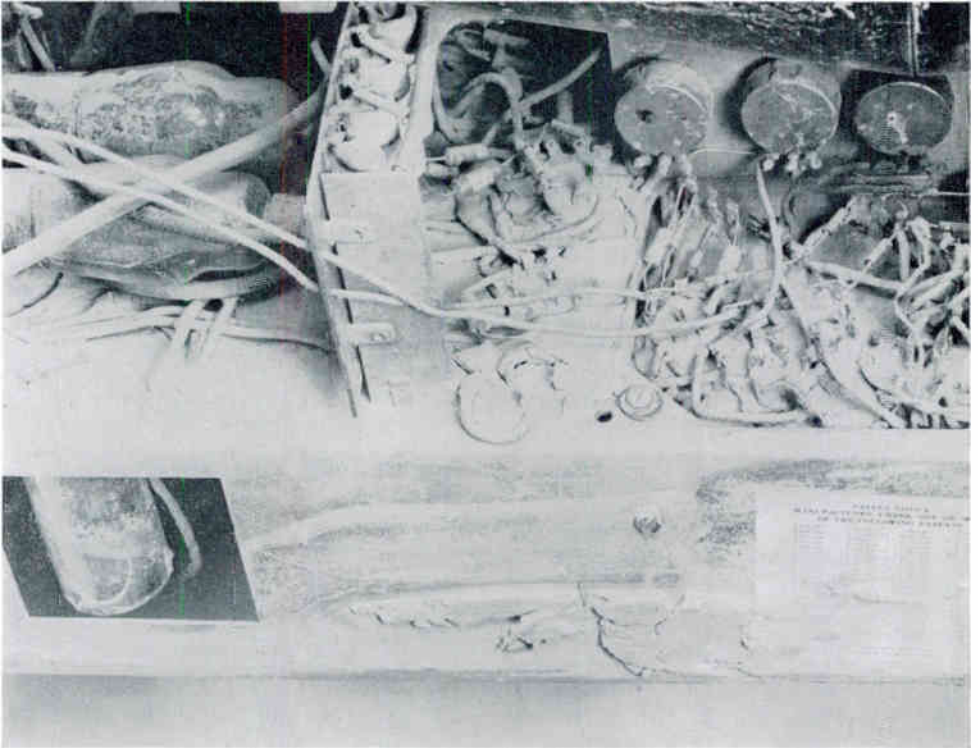

This is an unretouched photograph of a portion of a Type 304-H which survived the New England floods of August, 1955.

A portion of the Type 304-H is shown in the illustration at the upper right of this page and is pictured as received except for the removal of the cabinet. Compare this picture with the one at the upper left and the amount of deposited silt becomes apparent.

In spite of the nearly half-inch layer of mud, sand and silt deposited on the chassis, the instrument performed normally when the Instrument Service Department "fired it up".

See

DU MONT

at the

SHOW

IN Y C

BOOTHS —

264,266,268

167,169,171



"Who and Why"

(Continued from page 2)

The National Electric Signal Company loaned Harry to the New York Herald in 1910 so he could get the Herald radio station OHX on the air. He served as operator of OHX until the autumn of 1912. Later, he was appointed the first wireless inspector for the New England District.

Harry's interest in the Signal Corps Company of the Massachusetts Militia increased while he was serving as New England Wireless Inspector and he joined the militia as a private in 1913. Rapid advancements to sergeant and then to mast signal electrician formed a basis for his appointment as a cadet to the Massachusetts Officers' Training School. He was commissioned a First Lieutenant before completion of the two-year course.

Through the cooperation of Captain Harry Chase of the Massachusetts Signal Corps Company and the Signal Corps at Washington, he helped expand the company into a battalion consisting of three companies, a headquarters, a wire, and a radio company. Captain Chase was commissioned a Major and Harry became the Captain of the radio company. Almost immediately after the battalion was formed it was ordered to Fort Bliss, Texas, to help control the border incidents.

After the tour of duty in Texas, Harry Gawler returned to New England and took active part in the New England Radio Amateur's Association. At the request of the Navy, he organized the Amateur Section Radio Stations for communications use in the event of impending hostilities.

In March of 1917, Harry transferred to the United States Naval Reserve at the request of

Admiral S. C. Hooper to serve as an aide on the staff of Admiral H. O. Dunn, Commandant of Naval Base 13, Punta Delgada, in the Azores for the duration of hostilities. While at this post, the Portuguese Government awarded him the "Orden Militar du Aviz" transmitted through the Navy Department.

In the summer of 1920, he resigned from the Wireless Inspection Service to join the young Radio Corporation of America as Manager of Domestic Sales at the invitation of David Sarnoff. In the Fall of 1923 he left RCA to be appointed a sales representative for the now-famous General Radio Company of Cambridge, Massachusetts, continuing in this capacity until 1928 concurrently functioning as a sales representative for Wireless Specialty Apparatus Company of Jamaica Plains, Massachusetts.

Harry Gawler has been active in sales representation since 1923, representing such companies as DeForest Radio Company and the Federal Telegraph Company. It was while he was sales agent for DeForest that he met Allen B. Du Mont and when Du Mont developed the first commercial cathode-ray tube in the United States he joined Du Mont as a sales engineer. Incidentally, the first six tubes made by Du Mont in his basement laboratory were sold by Harry to Dr. A. Hoyt Taylor at the Naval Research Laboratories in Washington, D. C.

During World War II, Gawler was appointed Tube Sales Manager of Du Mont Laboratories and at the end of hostilities, returned to private practice as a Selling Agent. To date, he has been a Selling Agent for 32 years.

INSTRUMENT DIVISION RENAMED "TECHNICAL PRODUCTS DIVISION"

The ever increasing number of products offered to industry have necessitated a change in our name to "TECHNICAL PRODUCTS DIVISION".

The products manufactured and marketed by the Technical Products Division include a complete line of equipment for studio and broadcast operation, industrial television, cathode-ray and associated electronic equipment,

automotive test apparatus, military electronic and electromechanical devices and mobile communications gear. In addition, the division engages in a considerable amount of research and development for both governmental and private agencies. A well-planned program of expansion and diversification with special emphasis on elements and systems for automation and industrial processes is also underway.