

THE OSCILLOGRAPHER

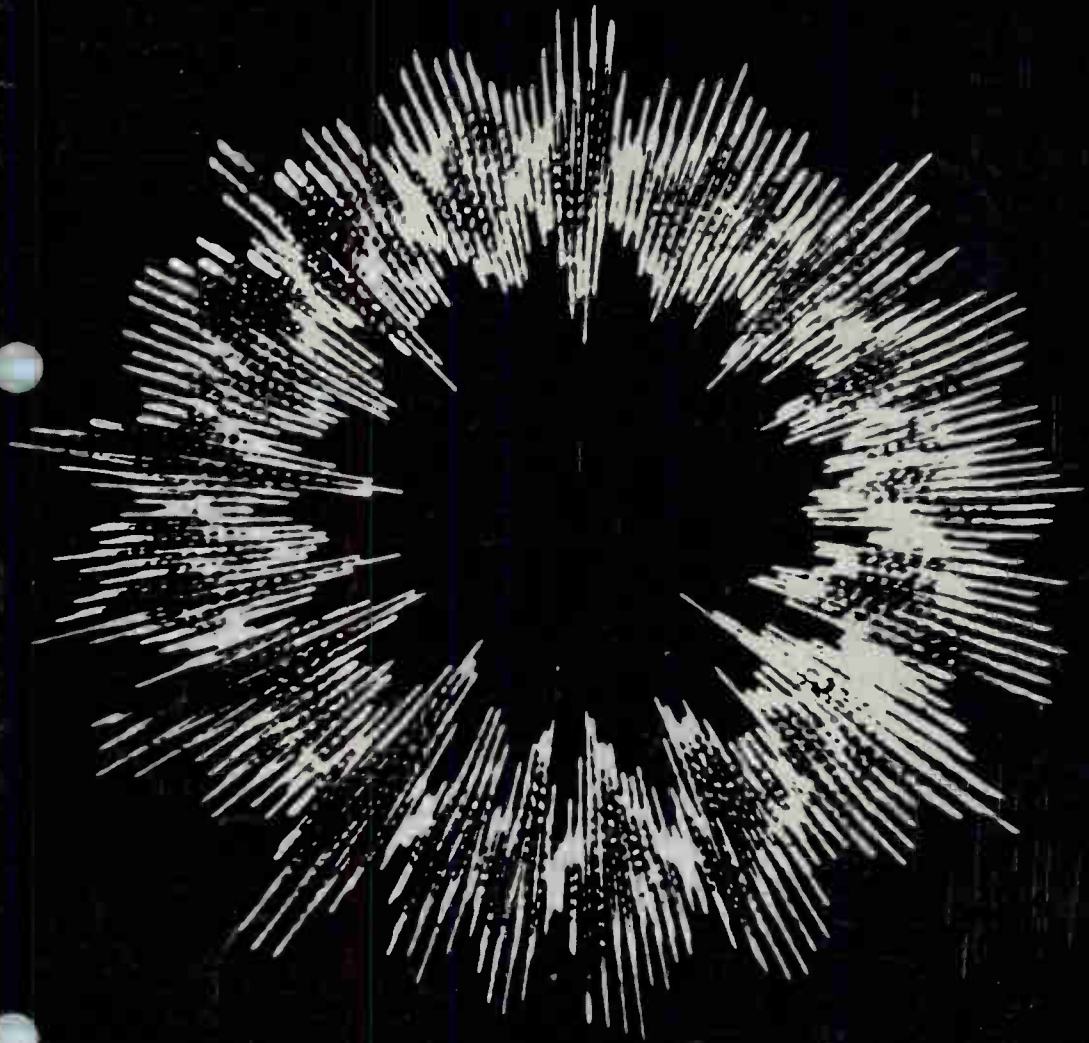

Vol. 12, No. 2

APRIL-JUNE, 1950



World Radio History

VIBRATION OF A TURN-TABLE

SEE PAGE 2

The Use of Supplementary Lenses with the Du Mont Type 314-A Oscillograph-record Camera

The focal distance of the lens of the Du Mont Type 314-A Oscillograph-record Camera as used with the periscope or a tripod mount is $14\frac{1}{4}$ inches from the face of the cathode-ray tube. Object:image ratio is 6:1. The camera can be used to obtain different image reduction ratios, however, or to photograph smaller or larger fields, such as in photocopying, by the use of supplementary lenses. The supplementary lenses may be attached to the camera lens by standard adapter rings such as the Telek series. For the $f/2.8$

camera lens, a series VI, $1\frac{1}{2}$ inch diameter adapter should be used, and for the $f/1.5$ camera lens, a series VII, $1\frac{3}{4}$ inch diameter adapter is required. Depending upon the object:image ratio desired, either a positive or negative supplementary lens may be used. For object:image ratios greater than 6:1, negative supplementary lenses are used while for object:image ratios less than 6:1, positive supplementary lenses are used. Supplementary lenses up to +5 diopters and -2 diopters are commercially available.

In response to requests from numerous readers, we are reprinting the graph below, revised and in more usable form, which

(Continued on Page 22)

THE OSCILLOGRAPHER



A publication devoted exclusively to the cathode-ray oscillograph, providing the latest information on developments in equipment, applications, and techniques. Permission for reprinting any material contained herein may be obtained by writing to the Editor at address below.

Published quarterly
by

Allen B. Du Mont Laboratories, Inc.
Instrument Division
1000 Main Ave.
Clifton, N. J.

Neil Uptegrove - Editor
© 1950

CONTENTS

	Page
Use of Supplementary Lenses with the Du Mont Type 314-A Camera	2
Your Assistance Please	2
Techniques of Photo-Recording	3
A Single-sweep Triggering Circuit	18
The Du Mont Type 5XP— Cathode-ray Tube	20
The Du Mont Type 2547 Cable and Type 2546 Chassis Cable Connector	21
The Men Behind Our Products	23
Visitors from Abroad	24
Bibliography	24

Your Assistance Please

We have always looked on the publication of the *Oscillographer* as a service to those directly or indirectly interested in oscillographic techniques. This outlook has prompted us to run a series of articles devoted to such accessory devices as a diode limiter, a single sweep trigger circuit, a balanced input adapter, etc. However, if this series is to be continued, we must have help. Surely those using oscillographic equipment in the field are in a good position to discover useful and interesting accessory devices or time saving techniques.

The *Oscillographer* will gladly consider for publication articles on new and interesting techniques or accessories, which its readers have developed in their work.

(Continued on Page 16)

ON THE COVER

This unique oscillogram is an indication of the vibration of an electrically driven turntable as it rotates through 36 degrees of its total cycle. The transducer employed was a standard piezo-electric vibration pickup. The pattern was recorded from a specially developed Du Mont Polar-Coordinate indicator.

Techniques of

PHOTO - RECORDING

by H. P. Mansberg

Photographic recording from the cathode-ray oscillograph is a relatively simple operation, provided a few basic considerations are borne in mind. Neither extensive experience, nor elaborate equipment is required to achieve excellent results, although cameras specifically designed for oscillographic photography provide a convenience and versatility that are difficult to equal with conventional cameras.

Stationary Patterns

The stationary pattern is the simplest to photograph, since the image recurs reproducibly from cycle to cycle without change. To record this type of pattern the operator need only open the camera shutter long enough to photograph at least one complete sweep.

If the shutter does not remain open for this minimum time part of the pattern may be missing, as shown in the oscillogram of Figure 1. Beyond this minimum shutter time, neither the length of exposure nor the iris-diaphragm opening is particularly critical. Even with stationary patterns of high frequency the exposure is the same as with low-frequency phenomena since, as the sweep speed for displaying higher frequencies is increased, the repetition rate of the recurrent sweep also increases. The net result is that the



Figure 1. A portion of this oscillogram is missing because the exposure time was less than one sweep cycle

photographic emulsion receives the same total exposure. To illustrate the effects of varying exposure times upon a stationary pattern, Figure 2 shows three identical oscillograms taken with different exposures: A was given the minimum exposure; B, a slightly longer exposure; and C, a very long exposure. Note that the effect is merely that of increasing the apparent line width of the oscillogram. In all cases, however, these oscillograms are still useful.

Thus, the general rule may be stated: when an oscillograph is operating on continuous sweep, with a given setting of the intensity control, the exposure re-

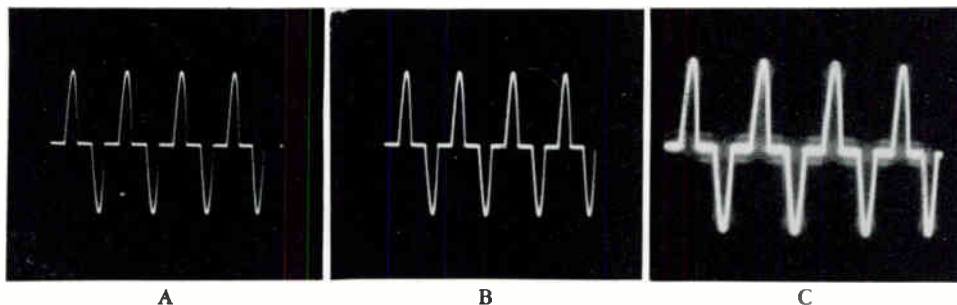

Figure 2. Three identical patterns given different exposure. (A) Too short; (B) correct exposure; (C) too long. Note that all three are usable

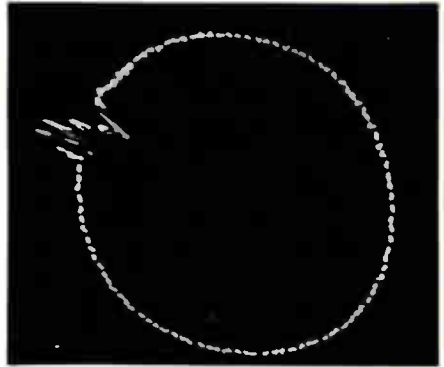
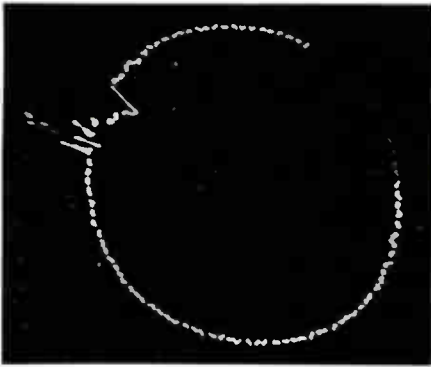

Figure 3. An illustration of the use of a brightening gate to record one cycle. In the oscilloscope at left the duration of the gate was insufficient

quired with a particular camera will be constant regardless of the sweep or signal frequency, and will vary inversely with the area covered by the electron beam. For

When the pattern is varying continuously, the photographic technique becomes more critical. One method of accomplishing this type of photographic recording is to set the intensity control of the oscillograph at cut-off. A brightening gate or pulse is then applied to the grid of the cathode-ray tube to brighten the beam for one cycle of the phenomenon or sweep. Figure 3 shows a polar-coordinate oscillogram of the vibration in a rotating machine. Notice that in the oscillogram on the left the brightening gate was not long enough to record the complete cycle.



Figure 4. This oscillogram was deliberately over exposed to record the high-writing-speed portions of the trace

this reason, and for this case, it is sufficient for the oscillograph and camera manufacturers to publish a simple table of exposures for the various oscillographs with a given camera. (See table on Page 17). For the oscillographs not listed and for different cameras, the basic principles discussed later may be employed.

A table of exposures supplied by the manufacturer should by no means be accepted as a standard from which one must not deviate. In many applications the judgment of the operator is necessary. The table should be used as a guide for obtaining a rough idea of what the correct exposure would be under average conditions. In some cases it may be necessary to increase the exposure time given to obtain

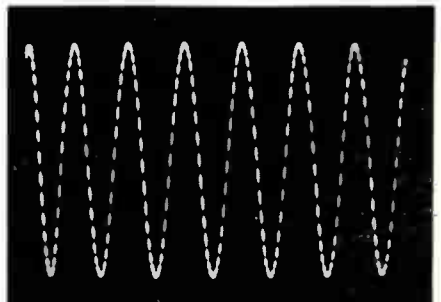
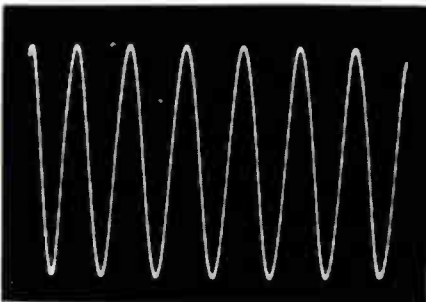
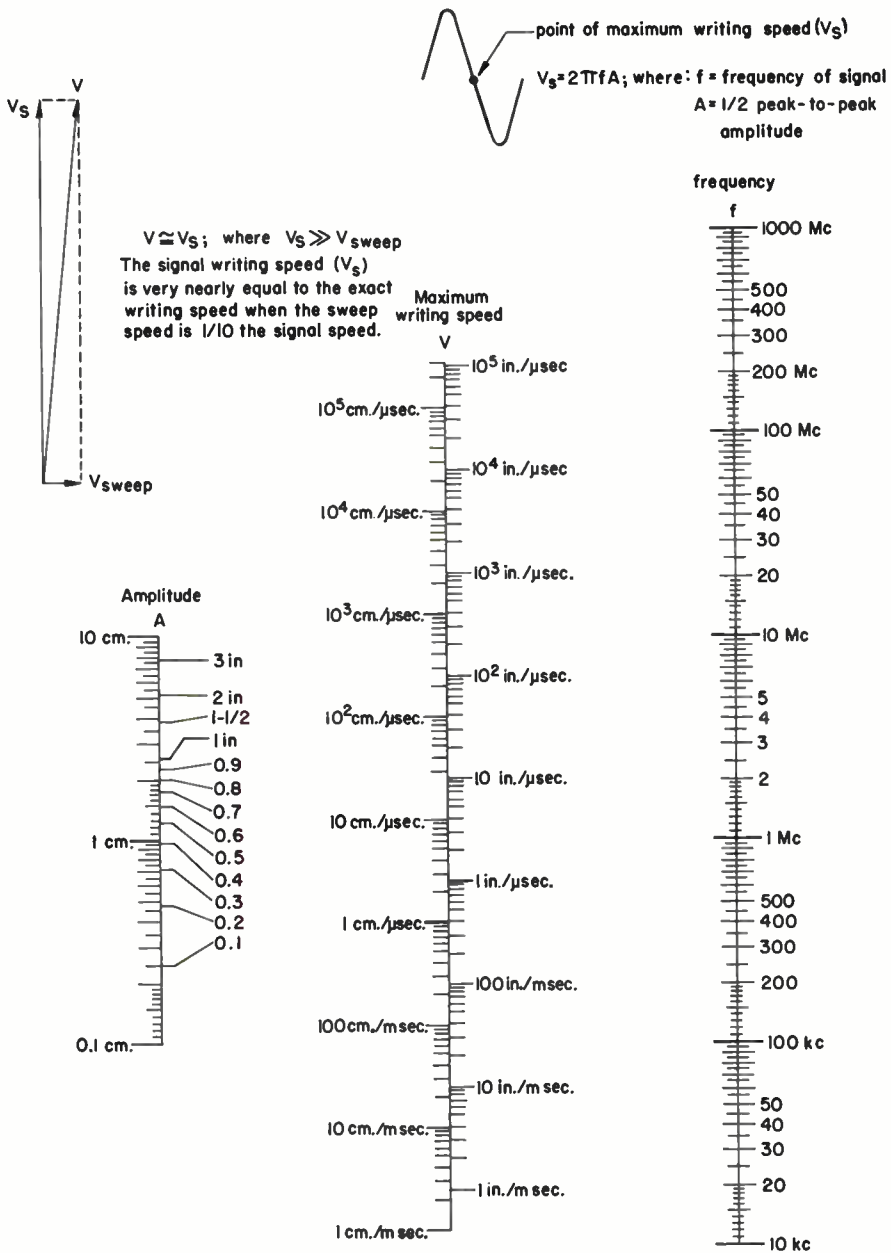

Figure 5. The effect of intensity-control setting on beam modulation. Modulation was brought out in oscillogram at right by decreasing intensity

NOMOGRAPH RELATING AMPLITUDE, FREQUENCY, AND MAXIMUM WRITING SPEEDS FOR SINUSOIDAL TRACES



1 μ sec. = 1 microsecond = 1/1,000,000 second.

1 Mc = 1 megacycle per second = 1,000,000 cps.

1 msec. = 1 millisecond = 1/1000 second.

1 kc = 1 kilocycle per second = 1000 cps.

Frequency range may be extended below 10 kc or above 1000 Mc by applying a suitable factor.

Figure 6. Nomograph for determining sinusoidal writing speeds

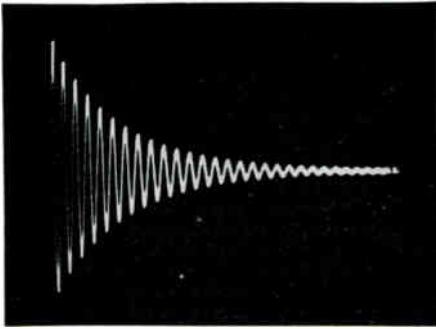

Figure 7. Typical damped oscillation, useful for determining writing speeds of transients

a certain desired effect. For example, in Figure 4 we have an oscillogram of a sawtooth voltage in which the return-time is a very short percentage of the total sawtooth. In order to achieve sufficient density to record the return-time, the oscillogram was deliberately overexposed. The result is that the return-time has the proper density while the slow-writing part of the wave is greatly over-exposed. Frequently signals are encountered containing widely differing writing speeds, and it is necessary to choose an exposure which will show that part which is considered most important.

When recording patterns in which intensity modulation is present, as in Figure 5, the intensity modulation can be brought out more clearly by turning down the intensity control and increasing the exposure. If the intensity modulation happens to be an undesired one, the reverse procedure is indicated.

Single Transients

To record single-transient phenomena,

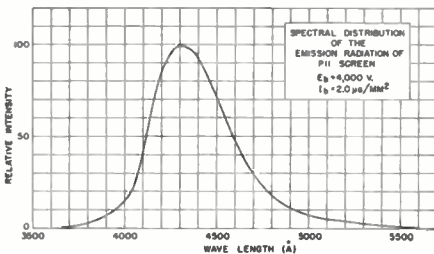

Figure 8. Spectral distribution curve of the Type P11 screen phosphor

further basic considerations are necessary. Most of the problems encountered with stationary or recurrent phenomena are also encountered with transient phenomena, although the exposure is generally much more critical. The problem is usually that of obtaining sufficient density for high-speed recordings. The first factor to determine is the approximate writing speed of the transient. For example, if the transient is a sinewave, the maximum writing speed, or rate of change, occurs at the X axis or cross-over point. In this particular case if a large number of cycles are displayed on the cathode-ray-tube screen, the sweep speed or horizontal component of the writing speed is negligible, so that the writing speed is merely the vertical component or $2\pi fA$, where f is the frequency and A is one-half the peak-to-peak amplitude. A simple way of determining this writing speed is to use a nomograph, such as that shown in Figure 6.

By drawing a straight line from the known frequency point to the amplitude scale, the intersection on the writing-speed scale gives the maximum writing speed of the sinewave.

For various other types of waveforms the maximum writing speed in the transient may be approximated under the given conditions by photographing a single damped oscillation such as that shown on Figure 7. Notice that in this damped oscillation the density decreases to that of the background fog at the higher peak-to-peak amplitudes, which corresponds to the faster writing speeds. By selecting and measuring on the oscillogram the cycle which displays the minimum usable density, the maximum photographic writing rate may be computed by using the foregoing formula. In measuring the amplitude of the selected peak, the object-to-image ratio of the camera must be taken into consideration, and the size of the peak restored to its true, on-screen amplitude before computation. The maximum writing rate has often been defined, for a given lens and photographic emulsion, as that writing speed which produces a density of 0.1 above film fog. This density is considered to be the mini-

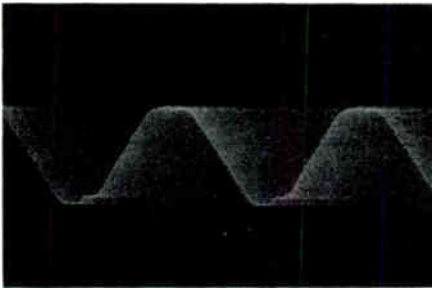

Figure 9. Sinewaves recorded from a P7 screen. Blurring is due to the long-persistence component of this screen material

imum usable density for photographing oscillograms by standard methods.

Before making recordings, the characteristics of the cathode-ray oscillograph and the cathode-ray tube must also be considered. In general, the most satisfactory phosphor for photography is the RMA Type P11 screen. Because of its high actinic light output, it has the highest pho-

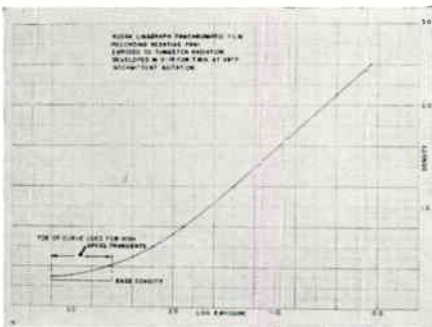

Figure 10. H and D curve for Linograph Pan recording film. Arrow at left indicates toe of curve used for high-speed transients

tographic efficiency of all the phosphors. A spectral-distribution curve of the light output of a P11 screen is shown in Figure 8. Note that the maximum emission occurs at 4300 Ångstroms, which is roughly the point at which the more common photographic emulsions are most sensitive. Of course when the light output for a given phenomenon is sufficient, any phosphor will produce satisfactory recordings for either stationary or transient phenomena.

Frequently, the same oscillograph has to be used both for visual observation and for photographic recording. In this case, it is desirable to use a screen capable of efficient operation for both purposes. Two such screens are the RMA standard Types P2 and P7 screens. Since both are long-persistence screens, they ordinarily would not be satisfactory for photographing varying phenomena or for continuously moving-film recordings. The persistence of these screens would cause a blurring of the recording. This is apparent from the oscillogram of Figure 9. Here this train of sinewaves was recorded from a P7 screen. This severe blurring could have been eliminated by the use of a blue filter of the proper spectral transmission between the cathode-ray tube and the camera. Thus the yellow, or long-persistence component would have been filtered out, and only the blue, short-persistence component would have reached the camera.

In some cases the residual persistence of the P2 screen proves too long and therefore a very dark blue filter is required to remove completely any traces of persistence. This reduces the effective transmitted light to such an extent that a better alternative would be the use of the P7 screen in which the phosphorescence and fluorescence occur in rather widely separated positions of the spectrum. Using a photographic emulsion which is not sensitive to the persistent part of the radiated spectrum helps considerably.

Recording Materials

Many problems of oscillograph photography are simplified by the choice of the proper recording medium. The majority

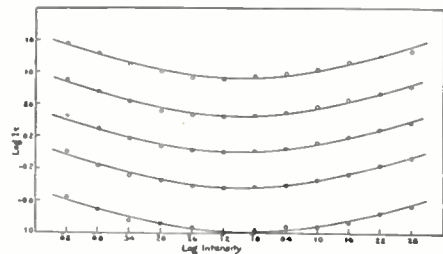

Figure 11. A set of curves of the failure of the reciprocity law

of oscillograph-record cameras employ 35-mm film. This almost universal choice stems largely from both economic and technical considerations. A lens with, say, a one-to-one image-reduction ratio, a focal length sufficient to cover the entire usable area of the screen, and the aperture required for high-speed recording (no greater than $f/2.8$, and preferably $f/1.5$) would be extremely expensive, and could not be justified by the majority of applications. On the other hand, a large selection of relatively inexpensive and fast lenses is readily available for 35-mm cameras. Moreover, 35-mm film is extremely economical to use and is available at most local photographic-supply stores. Also, the greatest variety of emulsions is available in the 35-mm size.

The image reduction ratio provided by lenses for 35-mm photography offers an increase by a factor of approximately 3 in image brightness, enabling the recording of higher writing rates for a given lens aperture.

The emulsions most commonly employed for oscillographic photography are: Panchromatic — or red-and-yellow sensitive, Orthochromatic — or blue-green sensitive, and the so-called color-blind — or blue and ultra-violet sensitive emulsions. Orthochromatic and blue-sensitive films are advantageous when it is necessary to avoid response to the persistence, or yellow light. In addition, these films are easily handled in a darkroom under a safe-light, while panchromatic films must be handled in total darkness. However, panchromatic films have the advantage, when it is desirable to photograph the persistent, or yellow, component of the image. Panchromatic films in 35mm size are also more readily available in local photo-supply shops.

The fastest recording emulsions for oscillograph photography we have yet found are Linagraph Pan and Linagraph Ortho, manufactured by Eastman Kodak Co. When processed properly, Linagraph Pan can provide maximum photographic writing rates higher than those of Super XX.

For many applications where a negative is not required, 35mm recording

paper can supply direct paper recordings. Paper has the advantages of lower cost, less processing time, and ease of reading. However, the fastest recording papers are slower than average films such as Panatomic X. Table I shows a comparison of most of the available photographic recording papers. The fastest paper-base emulsion was found to be Eastman-Kodak Type 697 which is only about 70% as fast as Panatomic X.

TABLE I
COMPARISON OF EMULSIONS

Emulsion Type	Relative Emulsion Speeds determined from maximum writing rates	Eastman Kodak 3 Relative Emulsion Speeds for short exposure to blue light
E.K. Pan.X Film	1	—
E.K. 1115 Paper	0.4	80
E.K. 697 Paper	0.73	125
E.K. 1127 Paper	0.47	200
E.K. 1057 Paper	0.47	100
Grant 633 Paper	0.1	
Grant 635 Paper	0.33	
Grant P235 Paper	0.3	

I have used the terms "fast Film" and "film speeds"; perhaps these terms should be clarified, especially in their relation to oscillograph photography. The relation between photographic density and exposure is often expressed as a D vs. log E curve where: D equals the reciprocal of the logarithm of transmission ($D=1/\log T$), and the exposure E equals light intensity multiplied by time ($E=It$). This D vs.

log E curve is frequently known as the H and D curve (for Hurter and Driffield). The H and D curve for Linagraph Pan film is shown in Figure 10*. Notice that the curve has a "toe" and a fairly linear long slope. The slope at any particular portion of this curve is called the *gamma*, and this *gamma* determines the contrast of a given photograph. From this type of characteristic curve many methods for specifying an emulsion speed, or index, have been derived. One method, for example, extends the slope of the straight line portion and derives a speed index (Inertia index) from the intersection of this line and the log-exposure scale.

These ratings do not apply accurately to oscillograph photography, however, because of the extreme conditions under which exposures are often made. For example, in recording high-speed transients, the exposure often occurs in the "toe" of the curve, approaching the density of the film base. Then again when exposing for stationary patterns, densities above 2 are not uncommon.

One of the fundamental laws of photography, the so-called Bunsen and Roscoe Reciprocity Law (1876), states that for a given density the exposure or light intensity, multiplied by time, is a constant. ($It=K$) In other words, for a given density the exposure time may be decreased if the light intensity is increased proportionately. All deviations from this law are known as failures of the reciprocity law. With short exposure times this reciprocity law does fail. Figure 11 shows a set of curves illustrating this failure. It is evident that for a given density there is an optimum light intensity and exposure time. The importance of this effect is obvious when one realizes that the shortest exposure times are encountered in the photography of high-speed transients. For example, for a single transient, a writing speed of 400 inches per microsecond represents an exposure time of 10^{-11} seconds for each individual portion of the photographic emulsion.

*These curves are obtainable for various emulsions from their respective manufacturers.

Processing Techniques

The processing of most oscillographic negatives is the same as any standard processing of 35mm film. Employing such a developer as Eastman Kodak D-76 will yield fine-grain oscillograms, even on 35mm film. However, development time is not as critical as for conventional 35mm photographs because of the very limited density range required. Therefore fine-grain development is very rarely necessary in oscillography, and in actual practice faster developers are used so that a minimum of time is wasted in producing oscillograms. For example, in processing 90 percent of the oscillographic recordings at Du Mont Laboratories, the film is developed in either D-72, diluted 1 to 1, at 68° F., for about 5 minutes, or in D-19, full strength, for 6 minutes. This fast development combined with fixing in fresh hypo of 5 to 10 minutes and washing for another 5 to 10 minutes supplies us with a dry oscillogram recording in about 30 minutes.

For the processing of high-speed transient recordings, however, techniques not used in ordinary photography must be employed because of the unusual emulsion effects mentioned previously. The technique found most successful for processing high-speed oscillograms is to prolong the development time of the film in a high-emulsion-speed developer, such as Eastman Kodak D-19. This development is usually much longer than the specifications of the film manufacturer. The prin-

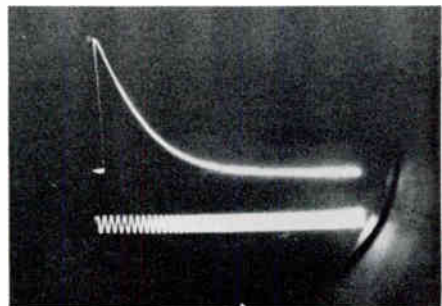

Figure 12. An example of high-emulsion-speed development. Developing time was prolonged to achieve sufficient density of the extremely rapid rise time

ciple of prolonging the development time is based upon raising the operating point of the emulsion on the H and D curve so that a greater slope or "*gamma*" is obtained. Thus, in spite of the fact that the grain and the density of fog are raised, an optimum point of image density above fog is found. A development time of 9 minutes, at 70° F., in D-19, has been found to give optimum results in raising the maximum photographic writing rate for a given camera and oscillographic equipment. An example of high-emulsion-speed development is shown in Figure 12; here it was necessary to prolong the development time in order to obtain sufficient density of the rise time in this oscillogram. Although the fog and grain in this oscillogram are very high, the rise time of the pulse has been properly reproduced.

Various other methods for increasing the maximum photographic writing rates have been attempted, such as: (1) hypersensitizing the film before exposure by bathing, exposure to vapor, or exposure to light; (2) "Latensification" by bathing between exposure and development; (3) intensification after development. None of these techniques have been found to be as effective as a prolonged development, although intensification sometimes does produce an improvement.

Chemical reduction, on the other hand, is a process very often employed to improve the quality of recordings (see figure 13). In oscillograph photography it is always preferable to overexpose. Overexposed negatives can easily be reduced in a chemical solution such as Farmers Reducer*, with a resulting increase in contrast because of the elimination of base fog. In fact, chemical reduction always seems to improve an oscillogram except when the image density is very low. Various reducer formulae have certain characteristics which can be utilized to improve negatives. For example, there are so-called subtractive reducers which subtract equally from all densities; there are proportional reducers which reduce all the densities in proportion; super-proportional reducers

which have a higher reduction ratio for the higher densities than for the lower ones; and sub-proportional reducers where the reduction ratio is greater for the lower densities than for the higher ones.

Reduction of fog can also be accomplished by the use of fog-reducing agents, such as benzotriazol and 6-nitrobenzimidazol, which when added to developers in very small quantities enable further prolonging of development time without excessive fog. These anti-fog agents also serve to slow up a developer and, therefore, to increase the contrast when making prints or lantern slides. For prints, glossy paper is always preferred, since the texture of other surfaces tends to obscure details of the pattern.

Sources of Fog

In the course of preparing oscillograms of either high-speed transients or stationary patterns, problems of undesired illumination causing fog are often encountered. One source of fog is halation of either the film or the cathode-ray tube spot. The effect of halo is shown in Figure 13. This particular halo was caused by the film being overexposed. Note that on the upper oscillogram the halo effect has been eliminated by chemical reduction. This chemical reduction, by virtue of the properties discussed above, eliminated the lower density fog which was the result of halation.

Halo around the cathode-ray-tube spot is caused by total reflection beyond the critical angle at the glass-air surface. Im-

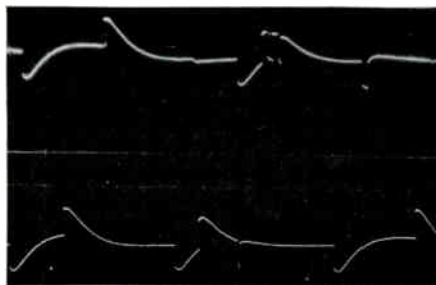

Figure 13. Two similar oscillograms, the lower of which was chemically reduced to eliminate the halo and to improve the general contrast

*Readily available from most local photographic-supply stores.

proved methods of screen coating have resulted in less halo. Another method of reducing halo is to increase the thickness of the glass in the cathode-ray tube so that it is as great as the nominal radius of curvature. Since this is impractical, one of the experimental techniques has been to cement a thick, cup-shaped disc of clear plastic to the cathode-ray-tube face with a cement whose index of refraction was the same as that of the plastic. While this procedure is theoretically sound, the difficulty of processing makes its use impractical.

However, the most practical way of reducing halo normally, is to decrease the intensity-control setting of the oscillograph to the point where adequate density is still achieved. The chemical reduction method mentioned above is also very useful.

An unusually severe example of halo is shown in the oscillogram of Figure 14.

Cathode-Glow

Another source of undesired illumination is "cathode glow". This effect is caused by the integration on the film, of light coming directly from the cathode of the electron gun. This light penetrates the screen and if the shutter of the camera is open for an appreciable length of time, serious fogging results. This effect is most severe when panchromatic film is used, particularly when it is given high-emulsion-speed processing. In this case the shutter cannot be left open for more than two seconds. An example of this "cathode glow" is shown in Figure 15. The fogging can be reduced or eliminated by either of several methods, or with a combination of

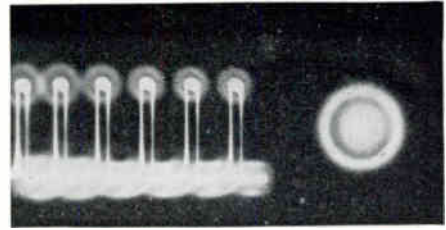

Figure 14. Illustration of excessive fogging owing to halo. Halo is caused by total reflection beyond the critical angle at the glass-air surface

them. One method is to keep the shutter open for only the minimum practical time necessary to record the pattern. Another means is to use a blue-sensitive film which is insensitive to the red light of the cathode. Still another method is to use a blue filter between the camera and cathode-ray tube. The cathode fogging in Figure 15 was eliminated by a blue filter used with orthochromatic film. Perhaps the best method, which completely removes all cathode fogging, is to employ a cathode-ray tube with a metallized coating on the inside surface of the phosphor. This coating is opaque to light, yet transparent to high-energy electrons. However, such a metallized coating is practical only in cathode-ray tubes operated at high accelerating potentials.

Another source of undesired illumination is stray emission. One form of stray emission is electron reflection from internal parts of the cathode-ray tube. For example, the oscillogram of Figure 16 shows fogging at the top, caused by reflection from one of the deflection plates. Electron reflection can usually be prevented by proper positioning of the spot with the

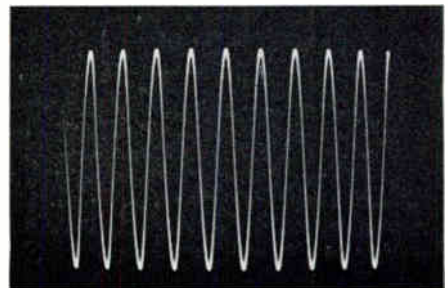
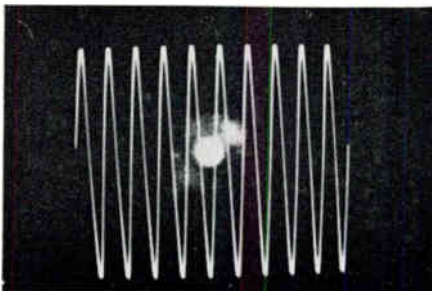

Figure 15. (Left) An example of "cathode-glow". (Right) Cathode-glow eliminated by the use of a blue filter. Recording on orthochromatic film also reduces this type of fog

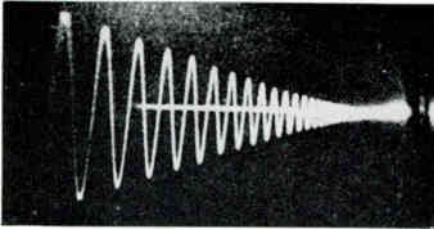

Figure 16. Illustration of electron reflection

positioning control of the cathode-ray oscillograph. Other forms of stray emission are due to the combination of a high-accelerating field and secondary emission which cause bombardment of the screen by stray electrons or ions. Emission of electrons from intensifier bands of high-voltage tubes cause similar disturbances. An example of this may be seen in Figure 17. Sometimes secondary emission can be reduced by "ageing" the cathode-ray tube at full operating potentials. Stray emission caused by high field intensities may be minimized by changing the distribution of accelerating voltage between second anode and intensifier. Fortunately, since these secondary electrons usually have a lower velocity, metallized screens are relatively opaque to them.

Another source of stray light is sometimes encountered in the case of single-transient exposures, due to the fact that the blanking gate causes transient changes in the grid-cathode voltage of the cathode-ray tube. These changes cause an illuminated spot to appear at the edge of the pattern, as shown in Figure 18. Tran-

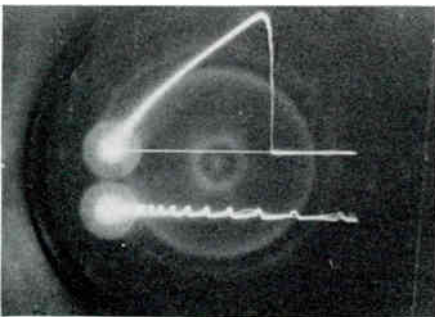

Figure 17. Fogging owing to secondary emission from the intensifier bands of the cathode-ray tube

sients in the grid-cathode voltage sometimes are caused by surges in the line voltage. This type of fogging can be minimized by turning the cathode-ray tube at average brightness down to such a value that no transient occurring can produce a stationary spot.

Fogging can also be caused by external light. An oscillograph camera should include a light shield between the camera lens and the cathode-ray-tube screen. Sometimes fogging will occur due to light that enters through a viewing port in this light shield. Such viewing ports should be equipped with shutters, or with red or amber filters so that only light to which the film is insensitive can enter the light shield and reflect into the camera lens. Enough yellow light is emitted from the cathode-ray-tube phosphor so that the trace can be viewed through this filter. Fogging as a result of stray light from the incandescent filaments of tubes in the oscillograph can be eliminated by a blue filter placed at the face of the cathode-ray tube, and by use of orthochromatic film.

Because of the high voltage used in oscillographs designed for high-speed transients, unusual difficulties are sometimes encountered with static exposures on the film due to leakage of electrical charge. To avoid this, all metal parts, such as the pressure plate and film gate, should be grounded to a common point, with the oscillograph. An example of static fogging is shown in the oscillogram of Figure 19.

Under certain conditions, X-ray fogging may occur due to the high accelerating potentials used. The X-rays generated are generally so soft that they will not penetrate the cathode-ray tube or the camera. Any X-ray fogging usually originates outside the camera or cathode-ray tube from sources such as rectifier tubes or high-voltage test equipment. Simple shielding can nearly always eliminate this.

Continuous-Motion Recording

Generally speaking, there are two types of oscillographic photography: continuous-motion and single exposure. Continuous-motion recording, is, as the name im-

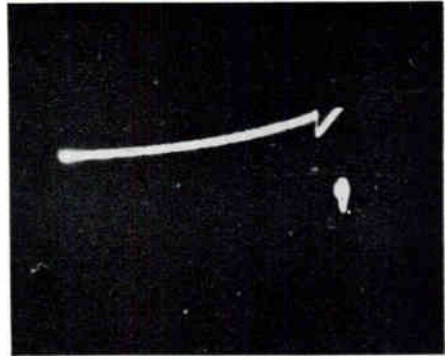
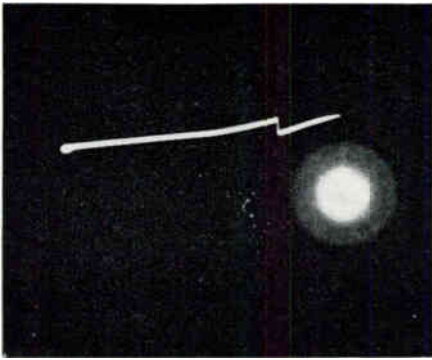

Figure 18. Brilliant spot in oscillogram at left is caused by a transient in the grid-cathode voltage of the cathode-ray tube. Spot was minimized in the oscillogram at right by reducing the intensity.

plies, the technique of moving a film strip continuously across the focal plane (not as in the case of moving-picture photography, where the film undergoes a succession of rapid pull-down periods). The obvious method for using a continuously moving film recorder is to run the film in such a direction that it provides the time base.

However, for many applications, such as recording of high frequencies or of very narrow pulses, this becomes impractical because of the tremendous speeds required. Film speed in a moving-film camera is not so great a limitation for high-frequency recording if the oscillograph sweep is operated to provide a time base perpendicular to the length of the film. This results in a recording where consecutive sweeps appear across the width of the film and are separated by a distance depending upon the repetition rate of the sweeps and the speed of the moving film. A comparison of the two methods for recording on moving film is shown in Figure 20. Note that when the oscillograph's sweep is used to provide the time base, the pulses can be expanded much further, more detail can be seen, and more efficient use is made of the total area of the film. The film speed necessary to achieve a desired separation between consecutive traces may be found from the formula:

$$S = \frac{HF}{M}$$

where S equals the film speed in inches per second, H equals the maximum height of the pulse or sine wave which is to be recorded from the cathode-ray-tube screen, M is equal to the optical-reduction ratio of the camera lens, and F is equal to the frequency of repetition of the sweep in cycles per second. This method of recording is often used in biological research, using cathode-ray oscillographs and recording cameras. As an example, Figure 21 shows a recording, made by this method, of the action potential of a frog's sciatic nerve. In this recording a tremendous number of pulses have been recorded on a given length of film by allowing the images of the pulses to interlace, as can be seen in the oscillogram.

When a phenomenon contains both high-frequency and low-frequency compo-

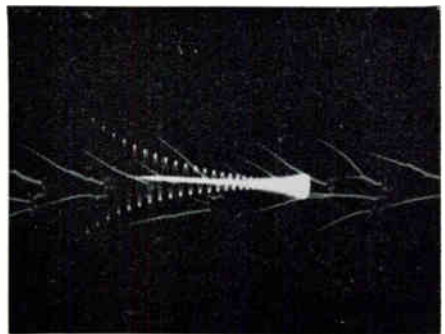

Figure 19. An example of static fog. Proper grounding of camera elements eliminates this type of fog

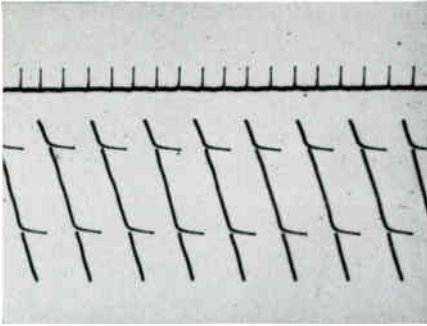

Figure 20. A comparison of two methods of continuous-motion recording. At top, film motion provided the time base. Below, oscillograph sweep was employed

nents, the problem of recording them becomes rather complicated. Such a pattern is shown in Figure 22, where the beginning of the transient is a high-frequency, shocked oscillation changing abruptly to a very-low-frequency oscillation. The most satisfactory method for recording this type of phenomenon is to trigger a single sweep of the oscillograph, which sweep is of proper speed and direction to expand the initial, high-frequency part of the transient. At the end of its sweep, the spot remains stationary without blanking out, while the motion of the film, which is relatively slow, provides the time base for displaying the low-frequency part of the phenomenon. The resulting oscillogram appears in Figure 23. This technique has many useful applications because it can be modified in several ways so that the oscillograph's sweep can be used to increase or decrease the effective speed of motion of the film. Probably the greatest advantage of this technique is that it

results in more economy of film, by making it unnecessary to use great lengths of film to resolve properly the high-frequency transient phenomena. In order to interpret this type of recording subsequently, it is necessary to provide a calibration for time on the film, so that the correct perspective is attained when studying the oscillogram.

Calibration

To evaluate oscillograms quantitatively, it is useful to have amplitude calibration, time calibration and identification of the recording on the negative itself. Amplitude calibration can be recorded on the film directly, by double exposing a known voltage from a voltage calibrator. Amplitude calibration can be made more useful by superimposing upon the oscillogram rectangular or polar coordinates, as shown in Figure 24. This can be accomplished by making a double exposure of a ruled transparent scale, illuminated from behind, or by the use of an edge-illuminated, clear plastic scale. Another method for amplitude-calibrating oscillograms is to produce a matrix, as in Figure 25, of dots on the cathode-ray-tube screen, with accurately known, vertical and horizontal, stepped voltages. A recording is then made of this matrix. The advantages of such a matrix are that non-linear deflections caused by cathode-ray tubes or associated amplifiers are indicated by this method. The matrix can be used for calibrating the oscillogram by placing the negative of the matrix over the negative of the oscillogram.

Time calibration is made either by bright or dark markers on the oscillogram

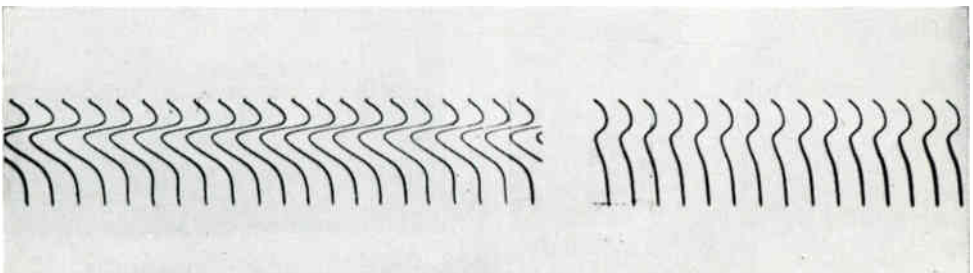

Figure 21. An oscillogram of nerve reaction potentials, showing interlacing of patterns.

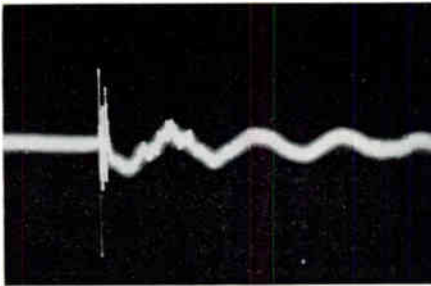

Figure 22. Shock transient and subsequent oscillations of a coil spring, displayed without use of the oscillograph sweep

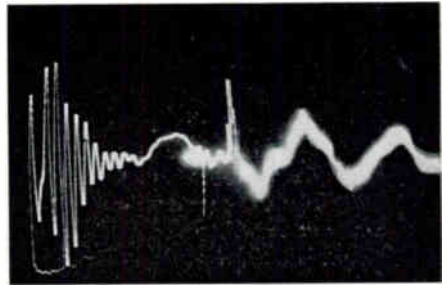

Figure 23. Same pattern as Fig. 22. Oscillograph sweep was used in addition to film motion to display initial portion

trace, by vertical pips, or by oscillations produced on a base line above or below the oscillogram. Samples of intensity markers produced by modulating the cathode-ray-tube grid or cathode are shown in the oscillograms of Figure 26 and 27. Either bright or dark markers can be used, but dark markers sometimes obscure important information. Note that in one oscillogram overshoot of the pulse is not visible because a dark timing marker occurred at this point, while in the other oscillogram the timing marker brightened the beam at this point. An example of time calibration using vertical pips is seen in Figure 26.

Identification of the data associated with an oscillogram should properly be recorded on the film to which it belongs, so that it is a permanent part of the nega-

tive. Recording of data by just writing on the film after it is processed can result in errors; and it is not permanent. Proper photographic identification is accomplished by writing data on an illuminated, ground-glass surface, and by double-exposing this upon an unused corner of the oscillogram or upon the following frame.

• • •

Effort to develop the best in photographic equipment for oscillographic recordings, has removed most of the difficulties which were previously encountered in such work. Today, excellent recording of practically all oscillographic phenomena may be obtained, provided the proper attention to formulated techniques is observed. Moreover, while the recording of oscillograms is essentially a photographic operation, one should always bear in mind

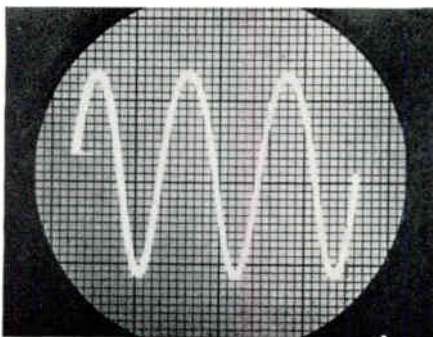

Figure 24. Quantitative analysis is facilitated by double-exposing calibrated scale onto oscillogram

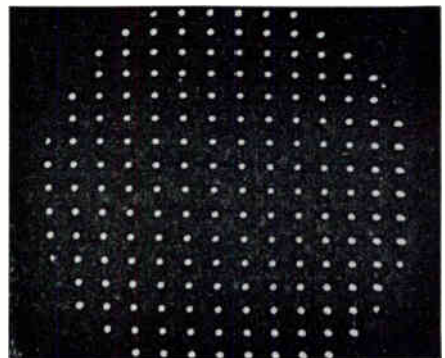

Figure 25. A matrix of dots which can be used for time calibration by superimposing on negative

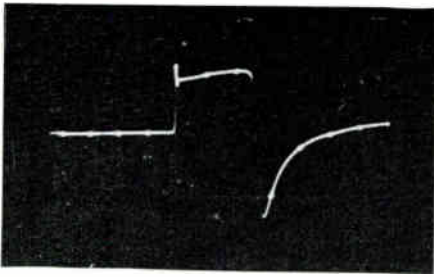

Figure 26. An example of intensity-modulated timing markers, which brighten the trace at known intervals

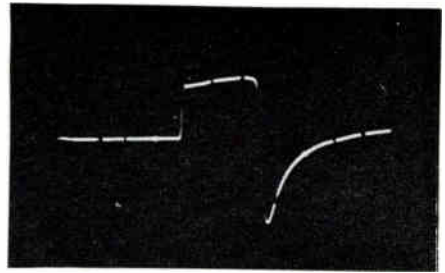

Figure 27. Intensity-modulated timing markers that blank the trace. Note that overshoot is obscured by one marker.

the nature and characteristics of oscillographic equipment.

Mr. H. P. Mansberg is an Electronic Engineer with the Applications Section, Instrument Division, Allen B. Du Mont Laboratories, Inc., and is the author of

numerous articles and papers on oscillographic photography.

This article was adapted from a paper delivered by Mr. Mansberg during a Symposium on Oscillography, conducted by Allen B. Du Mont Laboratories, Inc., for the New Jersey Chapter of the A.I.E.E. in October, 1949.

REFERENCES

H. P. Mansberg, "A New, Versatile Camera for the Cathode-ray Oscillograph", THE OSCILLOGRAPHER, Vol. 10, No. 4, Page 2, October-December, 1948.

C. E. Kenneth Mees, "The Theory of the Photographic Process", MacMillan Co., Pages 236-260, 1942.

Rudolph Feldt, "High Speed Photographic Recording and Projection Oscillography with the New Du Mont Type 5RP 5RP Multiband Tube", THE OSCILLOGRAPHER, Vol. 7, No. 4, Page 1, July-August, 1945.

C. Berkley, "Suppression of Halo Around the CRT Spot", UNPUBLISHED INTERNAL ENGINEERING REPORT No. 24, Allen B. Du Mont Laboratories, April 5, 1943.

R. Feldt, "Long Persistence CR Tube Screens," Electronic Industries, Vol. V, Page 70, October 1946.

R. Feldt, "Luminescent Screens for Cathode-ray Oscillography", THE OSCILLOGRAPHER, Vol. 11, No. 2, Page 3, April-June 1949.

W. Nethercot, "Recording of High Speed Transient Phenomena", Electronic Engineering, Vol. 16, Page 369, February 1944.

P. S. Christaldi, "The Evaluation of Specifications for Cathode-ray Oscillographs," Technical Paper delivered at IRE National Convention, March 7-10, 1949.

H. P. Mansberg, "The New Du Mont Type 314-A, Oscillograph-record Camera", THE OSCILLOGRAPHER, Vol. 11, No. 3, Page 3, July-September 1949.

H. P. Mansberg, "An Illuminated Data Card for Use with the Du Mont Type 271-A Oscillograph-Record Camera", THE OSCILLOGRAPHER, Vol. 11, No. 4, October-December, 1949.

ASSISTANCE

(Continued from Page 2)

Since our publication is a service and not a profit-making organ, we can not pay for any contributions. Of course, all work will be properly accredited.

Contributions should be as complete as possible, including description and specifications. Whenever possible, circuit diagrams and oscillograms should be en-

closed. The roughness of the copy is of little importance.

The *Oscillographer* is hopeful that its subscribers will heed this invitation for contributions. For we have always envisioned the true purpose of this publication, as a clearing house for new developments, applications, and techniques in the rapidly growing field of oscillography. Certainly in such a program the interested subscriber must play an active part.

Average Exposure Guide For Du Mont Cathode-ray Oscilloscopes

WITH STATIONARY PATTERN OF TEN SINEWAVE CYCLES ON SCREEN
MEDIUM INTENSITY SETTINGS

E. K. Panatomic-X Film

D-76 Developer—14 Minutes

For E. K. Type 1115 Paper—use twice the listed exposure

For E. K. Super XX, Linagraph Ortho or Linagraph Pan and D-19 Developer, use 1/4 of the listed exposure or two diaphragm stops higher.

Du Mont Oscillograph, Type No.	Cathode-ray Tube	Accelerating Voltage	Diaphragm Setting	Exposure		Sweep Frequency cps
				Seconds		
208-B	5LP11-A	1400	5.6	1		15- 30,000
241	5JP11-A	1500	5.6	1		15- 30,000
247	5CP11-A	3000	8	1/2		60- 30,000
247-A+263-B	5RP11-A	11,550	16	1/2		60- 30,000
248	5JP11-A	4000	11	1/2		60-100,000
248-A+253-B	5RP11-A	12,000	16	1/2		60-100,000
250-A	5CP11-A	3200	8	1/2		1-150,000
250-AH+263-B	5RP11-A	13,700	16	1/2		1-150,000
256-D	5CP11-A	4000	11	1/2		80- 2300
274-A	5BP11-A	1000	4	1		60- 30,000
275-A	5CP11-A	3000	8	1		1-60
279	5SP11	4500	9	1/2		15- 30,000
280-A	5XP11-A	11,900	16	1/2		30
288-A	5XP11-A	19,000	16	1/2		30
281-A	5RP11-A	8000	16	1/2		60
281-A+263-B	5RP11-A	14,000	16	1/2		60
281-A+286-A	5RP11-A	29,000	16	1/2		60
294-A	5XP11	12,000	16	1/2		10-150,000
304	5CP11-A	1780	5.6	1		2- 30,000
304-H	5CP11-A	3000	8	1/2		2- 30,000

NOTE: for sweeps slower or faster than those given, decrease or increase (respectively) the exposure proportionately.

AVERAGE SINGLE TRANSIENT RECORDING SPEEDS OF DU MONT CATHODE-RAY OSCILLOGRAPHS

For Eastman Kodak Linagraph Pan (5244) and D-19 Developer — 9 minutes.

For Eastman, Kodak Super XX-Developed in D-19 Maximum Photographic Writing Speeds will be slightly less than the given values.

Oscillograph Type	Tube Type	Maximum Accelerating Potential Volts		Maximum Photographic Writing Speed With P11 Screen, In./qsec	
		E _b	E _b	F/2.8	F/1.5
208-B	5LP11-A	1120	1400	0.08	0.3
241	5JP11-A	1100	1500	0.08	0.3
247	5CP11-A	1550	3000	0.8	2.8
247-A+263-B	5RP11-A	1550	11,550	10	35
248	5JP11-A	2000	4000	1.2	4.2
248-A+263-B	5RP11-A	2000	14,000	20	70
250-A	5CP11-A	1700	3200	1	3.5
250-AH+263-B	5RP11-A	1700	13,700	10	35
256-D	5CP11-A	2000	4000	1.2	4.2
274-A	5BP11-A	1000	1000	0.04	0.14
275-A	5CP11-A	1500	3000	0.8	2.8
279	5SP11	1700	4500	1.6	5.6
280-A	5XP11-A	1900	11,900	40	140
281-A	5RP11-A	4000	8000	40	140
281-A+263-B	5RP11-A	4000	16,000	60	200
281-A+286-A	5RP11-A	4000	29,000	80	280
288-A	5XP11-A	1900	19,000	50	175
294	5XP11-A	1700	12,000	10	35
304	5CP11-A	1400	1780	0.09	0.4
304-H	5CP11-A	1400	3000	0.8	2.8

A Single-Sweep Triggering Circuit

By M. Maron

It is sometimes necessary to examine on the oscillographic screen the starting portion of a wave train such as that shown in the oscillogram of Figure 1. If the occurrence of the phenomenon is not fully under the operator's control, numerous difficulties arise in the proper presentation of the pattern. If a repetitive sweep is employed, the starting portion of the wave is obscured by the steady-state portion, and no accurate examination is possible. If a driven sweep is used to examine just the starting portion, two obstacles are encountered:

1. The single sweep continues to be triggered by the cycles of the steady-state portion of the wave train. Thus, the steady portion again obscures the starting portion, as demonstrated in Figure 2.

2. The single sweep on the majority of oscillographs can be adjusted to trigger on either a positive or a negative signal, but not both. It must, therefore, be known in advance whether the signal to be examined starts with a positive or negative slope. If, with nothing known about the signal to be examined, the single sweep is adjusted to trigger on a positive signal, and the unknown signal starts with a negative slope, then the sweep will not be triggered until after the slope of the signal becomes positive. Thus a considerable portion of the first cycle of the signal under examination will be lost.

The circuit shown in Figure 3 was de-

[Editor's note: Frequently tests and measurements performed with the cathode-ray oscillograph may be greatly facilitated by the use of various accessory devices. Limiter and clipper circuits, delay lines, special sweep synchronizing and triggering circuits, voltage calibrators, balanced-input adapters, transducers, and attenuators are but a few examples. The following article is the fourth of a series describing the design and function of such accessory devices.]

veloped by the Applications Engineering Section of the Instrument Division of Allen B. Du Mont Laboratories, Inc., to overcome the above difficulties. This circuit provides a *single* negative pulse to trigger the single sweep at the start of such a wave pattern, regardless of the polarity of the initial slope of the signal.

The negative output pulse is produced by the firing of the thyatron, V3, (See Figure 3). When the thyatron fires, its anode voltage drops. This drop in voltage becomes a sharp, negative pulse after coupling through the 2900- $\mu\mu\text{f}$ output capacitor.

The thyatron must be arranged to fire as soon as possible after the start of the wave train under examination. The greater the delay in firing, the greater is the portion of the waveform that is lost. The thyatron will fire as soon as its grid voltage reaches the critical level. Thus,

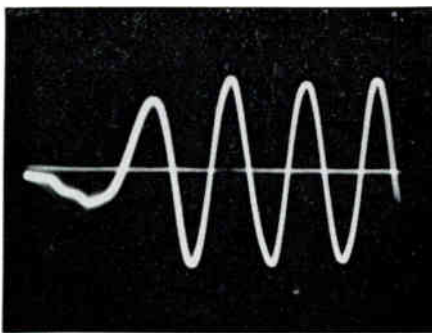

Figure 1. Wave train displayed, using the single-sweep triggering circuit. Compare with Figure 2

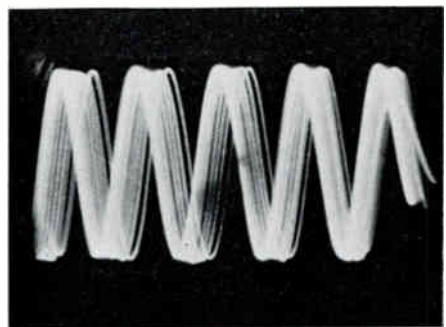

Figure 2. Same wave train as Fig. 1, displayed without single-sweep triggering circuit

the more the signal under investigation is amplified before reaching the grid of the thyatron, the sooner the grid voltage of the thyatron will reach the critical amplitude and cause the thyatron to fire. In the circuit of Figure 3, tube V1a provides an amplification of about 15.

In order that this circuit will operate with either a positive or negative input signal, the stages V1b, V2a, and V2b are included. As is apparent from the schematic of Figure 3, any signal applied to the grid of V1a and appearing amplified at the grid of V1b, will appear also at the plate and cathode of V1b, as two signals equal in amplitude and opposite in phase. Whichever of these two signals is positive will pass through one section of the diode, V2, and appear on the grid of the thyatron, causing the thyatron to trigger. Thus, regardless of the polarity of the input signal, this circuit will produce a sharp, negative trigger pulse.

Once the thyatron begins to conduct, it will continue so until its anode voltage is reduced to the extinction point. It would seem that all that must be done to extinguish the thyatron would be to short the anode to ground momentarily. This is not the case, however, as soon as the short is removed, the sudden increase in plate voltage couples to the grid of

the thyatron as a strong positive pulse, causing the tube to conduct again.

This difficulty may be overcome by the insertion of a 2900- μmf capacitor between the anode and ground, rather than shorting the anode directly to ground. At the instant the capacitor is inserted, the anode voltage drops practically to zero, extinguishing the thyatron. The capacitor then charges up gradually, becoming almost fully charged in a fraction of a second, a time interval long enough to eliminate entirely the possibility of a positive pulse coupling onto the grid of the thyatron. When the capacitor is removed from the circuit, there is practically no change in the voltage level of the anode of the thyatron, since the capacitor has already been almost fully charged to the level of the anode. Thus, again, there can be no positive pulse developed on the grid of the thyatron, and the tube will remain extinguished.

In this circuit, a momentary contact switch is employed to insert the capacitor. A 2.7 megohm resistor is connected across the capacitor when the switch is open.

Mr. M. Maron is an Electronic Engineer with the Development Engineering Section of the Instrument Division of Allen B. Du Mont Laboratories, Inc.

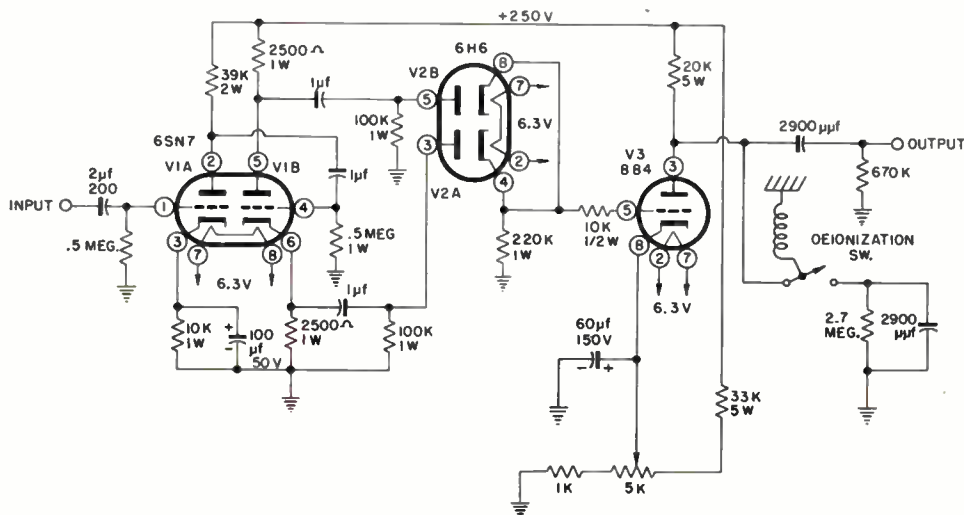

Figure 3. Schematic diagram of single-sweep triggering circuit.

THE DU MONT TYPE 5XP - CATHODE-RAY TUBE

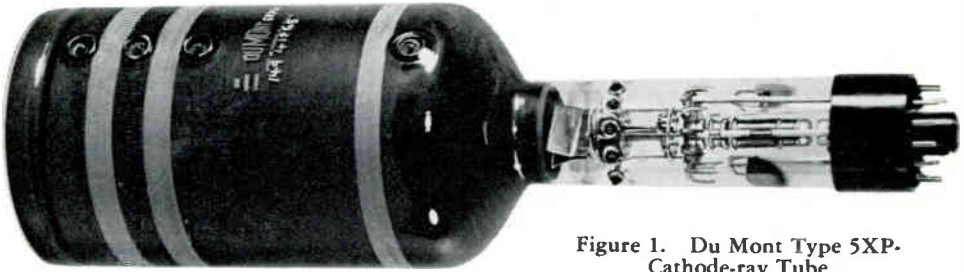

Figure 1. Du Mont Type 5XP-Cathode-ray Tube

The Du Mont Type 5XP- is the most sensitive cathode-ray tube commercially available today. With a second anode potential of 1000 volts, and a third anode potential of 2000 volts, as little as 12 volts will produce a full inch of vertical

deflection. Even when the tube is operated with a third-anode potential of 20,000 volts, as little as 46 volts will produce an inch of vertical deflection.

Externally, the Type 5XP- is similar to the Du Mont Type 5RP-A Cathode-ray Tube, the chief difference being the fact that the Type 5XP- is $\frac{7}{8}$ -inch longer. Except for the deflection factors, electrical specifications for the two tube types are similar.

The extremely high sensitivity of the Type 5XP- Cathode-ray Tube is the result of a unique electron gun and deflection plate structure. As visible in Figure 2, the vertical deflection plates of the Type 5XP- are unusually long, and the spacing between them is unusually small. Yet capacitance between D_3 and D_4 is held to 1.7 uuf.

Satisfactory operation of the Type 5XP- at high ratios of third-anode to second anode voltages is another feature of the Type 5XP-, with ratios as high as 10 to one being feasible.

When operated at high accelerating potentials, the light output of the Type 5XP- is sufficient for the observation and photographic recording of high-speed single transients, and for high-frequency applications in general. Also, the high light output permits the use of the Type 5XP- in conjunction with the Du Mont Type 2542 Projection Lens, for projection oscillography.

In order to keep interaction between the deflection-plate pairs to a minimum, an electrostatic shield is placed between them.

The Type 5XP- High-sensitivity Cathode-ray Tube is now employed in the

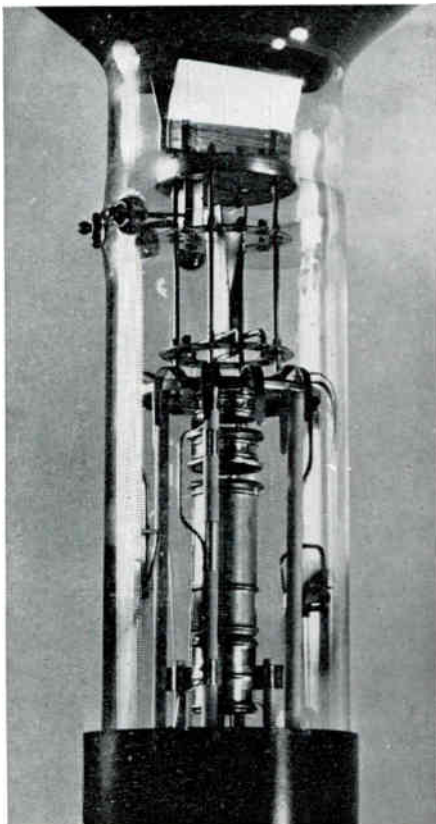

Figure 2. Electron-gun and deflection-plate structure of the Du Mont Type 5XP- Cathode-ray Tube

THE DU MONT TYPE 2547 CABLE AND TYPE 2546 CHASSIS CABLE CONNECTOR

The Type 2547 High-voltage Cable and the Type 2546 Chassis Cable Connector are specially designed for use with cathode-ray oscillographs in which it is necessary to take accelerating voltage from one chassis to another.

The Type 2547 High-voltage Cable is six feet in length, and is flexible. It consists of a stranded wire conductor and a braided copper shield, enclosed in an insulating jacket of synthetic rubber. The cable is equipped with a female connector at one end, for attachment to the Type 2546 Chassis Cable Connector. The Type 2547 carries a termination at the other end which attaches to the source of high voltage. The connections of this cord set use standard Type AN-24 Shells. This cable is designed to carry up to 25 kilovolts, dc, at low current values, with minimum corona loss. It is used presently in the Du Mont Types 248-A, 250-H, 281-A, 280-A, 263-B and 286-A instruments.

The Type 2546 Chassis Cable Connector is constructed to mount on the chassis of the instrument in which the high voltage is to be used. This male connector includes a cast aluminum mounting shell consisting of a receptacle approximately 1½ inch O.D., and a mounting plate approximately 1¾ inch square with four No. 6 mounting holes; a male plug enclosed in molded rubber; and a three-foot lead-in of stranded copper, encased in synthetic rubber.

The mating surfaces of the High-voltage Cable and Chassis Cable Connector are molded of a specially compounded synthetic rubber, and they are slightly con-

Du Mont Types 280-A, 288-A and 294-A Cathode-ray Oscillographs. In addition, in special cases, it has been installed in such instruments as the Du Mont Type 256-D Cathode-ray Oscillograph and the Du Mont Type 281-A Cathode-ray Indicator. The Type 5XP- may generally be installed in instruments presently employing the Type 5RP-A Cathode-ray Tube, with

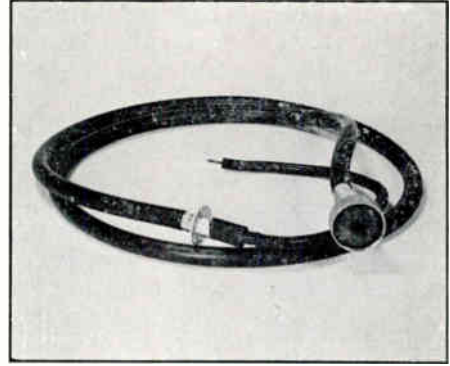

Figure 1. Type 2547 High-voltage Cable

vex in shape. Thus, when the surfaces are drawn tightly together, all air is excluded from the joint. This is essential to satisfactory operation, since air pockets would cause corona, and possibly break-down across the mating surface.

These two units now can be purchased from Du Mont for use in the assembly of laboratory equipment requiring the transmission of low currents at high potentials from one chassis to another.

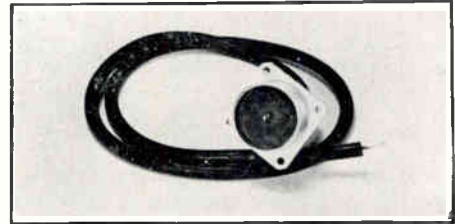

Figure 2. Type 2546 Chassis Cable Connector

minor mechanical modifications, and frequently it may be used in place of the Type 5CP-A, with somewhat more extensive modifications.

For additional information on the Du Mont Type 5XP-, and on its use, write the Instrument Division, Allen B. Du Mont Laboratories, Inc., 1000 Main Avenue, Clifton, New Jersey.

SUPPLEMENTARY LENS

(Continued from Page 2)

serves as a guide in selecting the proper supplementary lens for a given application.

This graph shows the focal length of the supplementary lens (given in diopters) required for a given object: image ratio or field size, and the distance at which the object will be in focus. To obtain the number of diopters required for a specific object: image ratio or field size, project a vertical line from the object: image scale to the diopter curve, and a horizontal line from there to the positive or negative diopter scale. To obtain the

focal distance for this case, project a vertical line from the diopter curve to the distance curve and from the point located on the distance curve, project a horizontal line to the distance scale. It will be noted that for most integral object: image ratios, the diopter lens required is not an integral number. Although lenses of any strength can be supplied by most optometrists, it is preferable to obtain a standard supplementary lens and to use the corresponding object: image ratio closest to the desired one; or with a standard supplementary lens, the focus of the camera lens may be readjusted slightly to obtain the desired object: image ratio.

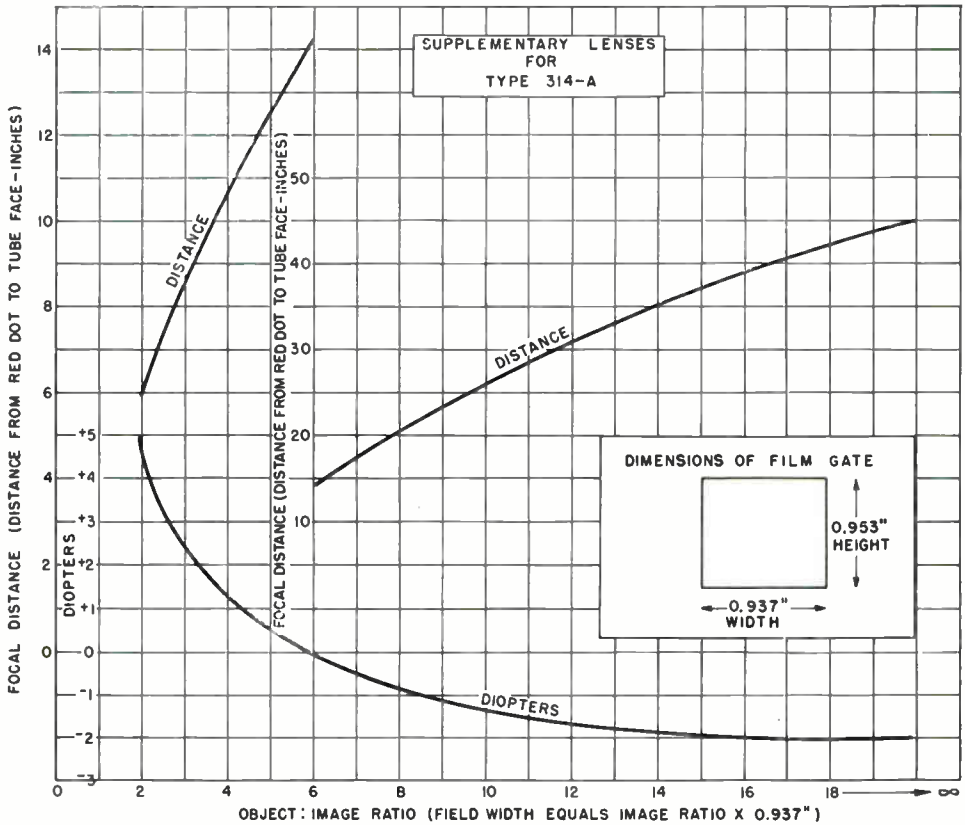

Figure 1. Graph for determining proper supplementary lens for a given application. This graph may be employed for the Du Mont Type 314-A Oscillograph-record Camera, or any other camera employing a lens having a focal length of 50 mm

THE MEN BEHIND OUR PRODUCTS



Carl Berkley, Head of the Applications Engineering Section of the Instrument Division, was born in New York City in 1917. He attended the College of the City of New York. From 1936 to 1938,

he was a motion picture camera man at the Browning Studios, and in 1938 and 1939, he was a teacher of photography in the New York public schools. From 1939 to 1941, Mr. Berkley served as a technician engaged in biological research and exhibit work in the Laboratory of Experimental Biology at the American Museum of Natural History in New York City. In 1941, he was employed at the Agfa-Ansco Company, Binghamton, New York, where he was engaged in the development of multi-layer color films.

Mr. Berkley has been associated with Allen B. Du Mont Laboratories, Inc. since 1942, in engineering and applications work on cathode-ray tubes and instruments. In 1947 he assumed the duties of Head of the Applications Engineering Section.



Rudolph H. Arp, Head of the Instrument Test Department, was born in New Jersey in 1917, and was educated in the public schools of Clifton, New Jersey. Upon graduation, the New York Electrical

School in 1927, Mr. Arp entered the radio servicing field, and he was thus engaged when he joined Du Mont Laboratories in 1942. Mr. Arp was first a member of the Instrument Test Department, and served subsequently with the Instrument Service and Teleset Service Departments. He was placed in charge of the Instrument Test Department in 1947.

Grover C. Seymour, Manager of the Instrument Service Department, was born in Holyoke, Massachusetts, in 1880, and was educated in the schools of Massachusetts and New Jersey.



Mr. Seymour joined Du Mont Laboratories in 1944, as an applications engineer, and, until the end of the war worked as assistant to Mr. Leonard F. Cramer*. Mr. Seymour was then transferred to assist in the expediting of the manufacture of cabinets for television receivers.

In October, 1947, Mr. Seymour was appointed his present post of Manager of the Instrument Service Department.

C. P. Martin, Purchasing Agent of the Instrument Division, was born in New York City in 1908 and attended All Hallows Institute and Fordham University. After several years with a stock brokerage firm he entered the real estate business and was in charge of contract placement and procurement of materials and supplies.



He joined Du Mont in 1944 as a buyer and expeditor. When the Purchasing Department was decentralized in February 1943, he was assigned to the Instrument Division as Senior Buyer. In February 1950, he was appointed Purchasing Agent of the Instrument Division.

*for biographical sketch of Mr. Cramer, see *The Oscillographer*, Vol. II, No. 3, 1949; Page 2.

VISITORS FROM ABROAD

The Instrument Division of Allen B. Du Mont Laboratories, Inc., has, since the last publication of the *Oscillographer*, had the honor of entertaining the following visitors from abroad:

Mr. Claes Akerbald, Consulting Engineer of Ana Aktiebolag, Stockholm, Sweden.

Prof. E. Baumann, E.T.H. Zurich, Switzerland.

Capt. Pierre J. Bu'oz, Ministere de l'Air, French Army, Paris, France.

Prof. H. Horinder, University of Uppsala, Uppsala, Sweden.

Gunnar Johnson, Radio Research Engineer of Luxor Radio, A.B., Motala, Sweden.

David Malmquist, Ph. D., Geophysicist of the Boliden Mining Company, Boliden, Sweden.

Dr. Marsili, Chief Engineer and member of the Board of Directors of the San Giorgio Company, Genoa/Sestri, Italy.

Mr. George H. Sample, of Sample House, Melbourne, Australia, Du Mont's Australian Representative.

A. Serras, Casa Serras, Lisbon, Portugal.

BIBLIOGRAPHY

The following bibliography of contemporary publications, prepared from abstract bulletins compiled by Du Mont's Technical Library may be of interest to those engaged in the application of the cathode-ray oscillograph.

"Feedback Improves Response of D-C Amplifier." J. F. Lash in *Electronics*; Vol. 22, No. 2, pp. 109-111, February 1949.

"Zur Energieverteilung der Sekundärelektronen." R. Kollath in *Annalen Der Physik*; Vol. 1, No. 7-8, pp. 357-380, 1947.

"Experimental Observation of Amplification by Interaction between Electron Streams." A. V. Hollenberg in *Bell System Technical Journal*; Vol. 28, No. 1, pp. 52-58, January 1949.

"Oscillation Amplitude in Simple Valve Oscillator." A. Gladwin in *Wireless Engineer*; Vol. 26, No. 308, pp. 159-170, May 1949.

"Some Characteristics of Diodes with Oxide-Coated Cathodes." W. Ferris in *RCA Review*; Vol. 10, No. 1, pp. 134-149, March 1949.

"Single-Valve Frequency." K. C. Johnson in *Wireless World*; Vol. 55, No. 4, pp. 122-123, April 1949.

"The Practical Determination of the Reverberation Time of a Room with the Cathode-Ray Oscillograph." A. Moles in *Radio franc*; No. 2, pp. 4-8, February 1949.

"Use of Electron Diffraction Camera as Ultraoscilloscope and Suggested Application to Contact Erosion." J. Lander in *Journal of Applied Physics*; Vol. 19, No. 12, pp. 1128-1129, December 1948.

"Spiral-Beam Method for Amplitude Modulation of Magnetrons." J. Donal, Jr. and R. Bush in *Proceedings of the I.R.E.*; Vol. 37, No. 4, pp. 375-382, April 1949.

"Determination of Pulse Period of Electron Multiplier Tubes." G. Paap in *Review of Scientific Instruments*; Vol. 19, No. 9, pp. 568-569, September 1948.

"Power Diodes." E. Rowe, R. Wyke and W. Macrae in *Electronic Engineering*; Vol. 20, No. 247, pp. 285-287, September 1948.

"404A Broadband Amplifier Tube." G. T. Ford in *Bell Laboratories Rec*; Vol. 27, No. 2, pp. 59-61, February 1949.