

TECHNICAL MANUAL



SYLVANIA *TUBES*

SYLVANIA

SYLVANIA ELECTRIC PRODUCTS INC. • 1740 BROADWAY, NEW YORK 19, N. Y.

In Canada: Sylvania Electric (Canada) Ltd.
University Tower Bldg., St. Catherine Street, Montreal, P. Q.

LIGHTING • RADIO • ELECTRONICS • TELEVISION • ATOMIC ENERGY

Let Sylvania Help You . . .

Besides this Technical Manual, Sylvania Electric has a large assortment of Sales and Service helps for Radio and Television Service Men. Most of these are free for the asking.

Semi-technical literature, such as Characteristics Sheets, TV Tube Complement Book and Radio and Television Instruction Charts are in constant demand by successful servicemen, electronics schools and manufacturers.

Sylvania News, a monthly publication, features a separate Technical Section, items of trade interest and service helps.

Window and Door Decals, Window Displays, price literature, direct mail helps, newspaper mats . . . in fact, complete local advertising campaigns prepared by a nationally famous advertising agency and coordinated with Sylvania's national campaigns are available.

Practically all of the above helps are available at nominal or no cost.

Business Record Books, Job Record Cards, Service Forms, Personalized Stationery, Billheads and Business Cards, Tools, Service Kits, and many other aids can be purchased at manufacturer's cost through the cooperation of Sylvania Electric Products, Inc.

Ask your Sylvania Distributor for complete information, or write:

Advertising Distribution Department

Sylvania Electric Products, Inc.,

1100 Main St., Buffalo 9, N. Y.

The information in this Technical Manual is furnished without assuming any obligations. Mention or reference to patented circuits does not constitute permission for their use.

*Prepared and Released By The
TECHNICAL PUBLICATIONS SECTION
EMPORIUM, PENNSYLVANIA*

COPYRIGHT 1955 BY
SYLVANIA ELECTRIC PRODUCTS, INC.
TENTH EDITION
2nd Printing Revised

THE SYLVANIA TECHNICAL MANUAL

FOREWORD

The 10th Edition of the Sylvania Technical Manual marks the 26th year Sylvania has made this valuable book available to radio and television servicemen throughout the United States. The first Sylvania Technical Manual was issued in 1929.

Completely revised, the 10th Edition contains technical data covering over 1,000 receiving tubes, special purpose tubes, and picture tubes. In addition to a complete, up-to-date data section on receiving tubes, it contains the latest in color television types and series string television types.

New features added in the 10th Edition are:

(1) Sylvania Special Purpose Tube Charts, containing transmitting tubes, subminiatures, gas control tubes, gas regulators, and special purpose receiving tubes, e.g., computer tubes, u h f amplifiers, ruggedized tubes, etc.

(2) Sylvania Tube Tester Settings on the 184 most popular receiving tubes, is included with the tube data.

(3) All new RETMA style basing diagrams.

Other outstanding features of the 10th Edition:

A new Sylvania Crystal Diode Chart.

A Revised Resistance Coupled Amplifier Section with index.

Characteristic curves on popular receiving tubes.

Valuable information of tube ratings and characteristics in the Appendix.

The one-volume, pocket-size, loose-leaf-binder format has been maintained in the 10th Edition, although there are now more pages of information than ever before. Supplements containing details of new Sylvania tube types as they are developed will continue to be issued with *Sylvania News* from time to time, and can easily be added to the binder.

While the primary objective of the Sylvania Technical Manual continues to be the wide dissemination of necessary information to radio and television servicemen, its contents comprehensively cover so many fields it will prove of great value to engineers, equipment technicians, maintenance men and experimenters.

The information and data contained in this manual is furnished without assuming any obligations. Mention or reference to patented circuits does not constitute permission for their use.

SYLVANIA ELECTRIC PRODUCTS INC.

TABLE OF CONTENTS

Foreword	III
Radio and Television Receiving Tubes In Numerical Order	
Condensed Data Section (Radio and Television Receiving Types) Tabbed Divider	
Television Picture Tube Types	Tabbed Divider
Special Purpose Types and Crystals	Tabbed Divider
Appendix	Tabbed Divider
Fundamental Properties of Vacuum Tubes	1
Vacuum Tube Ratings	2
Receiving Tube Screen Voltage Ratings	5
Receiving Tube Rectifier Ratings	6
Series String Television	7
Amplifier Classification	8
Use of Curves	9
Tube and Base Diagram Symbols	12
Handling of Picture Tubes	13
Tube Outlines Section	15
Resistance Coupled Amplifier Section	21
Sylvania Product Directory	46
Sylvania Aids for Servicemen	47

TYPES 00A, 01A, 0Y4

(See Condensed Data Section)

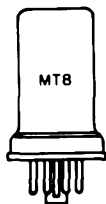

**SYLVANIA TYPE OZ4
OZ4A
OZ4G**

FULL-WAVE GAS RECTIFIER

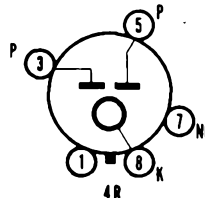

MECHANICAL DATA

	OZ4, OZ4A	OZ4G
Bulb.....	Metal, Outline 8-3	T-7, Outline 7A-1
Base.....	Small Wafer Octal 6-Pin	Dwarf Octal 5-Pin
Basing.....	4R	4R
Cathode.....	Cold	Cold
Mounting Position.....	Any	Any

ELECTRICAL DATA

HEATER CHARACTERISTICS

Heater Voltage..... None Required

MAXIMUM RATINGS AND CHARACTERISTICS

(Design Center Values—Except as Noted)

	OZ4, OZ4G	OZ4A
Peak Starting Plate Supply Voltage (Min) ...	300	Volts
Peak Plate to Plate Voltage.....	1000	Volts
Peak Inverse Plate Voltage.....		880 Volts
Peak Plate Current.....	200	Ma
D C Output Current (Max).....	75	85 Ma
D C Output Current (Min).....	30	30 Ma
D C Output Voltage.....	300	300 Volts
Average Dynamic Tube Voltage Drop.....	24	24 Volts

SYLVANIA TUBE TESTER SETTINGS

	A	B	C	D	E	F	G	Test or K
139/140	70	1	—	0	6	—	99†	ZW
	70	3	—	0	6	—	99†	ZW
219/220	—	1	8	11	8	Z	3*	—
	—	1	8	11	8	Z	5*	—

* Diode gas test does not apply.

† Push Z before W; release W before Z.

TYPES 1A3, 1A4, 1A4P, 1A4T

(See Condensed Data Section)

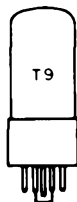

SYLVANIA TYPE 1A5GT
PENTODE POWER AMPLIFIER

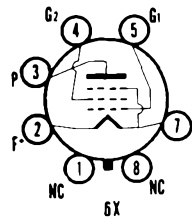

MECHANICAL DATA

Bulb.....	T-9, Outline 9-11
Base.....	Intermediate Octal 7-Pin
Basing.....	6 X
Mounting Position.....	Any

1A5GT (Cont'd)

ELECTRICAL DATA

FILAMENT CHARACTERISTICS

Filament Voltage D C.....	1.4 Volts
Filament Current.....	50 Ma

TYPICAL OPERATION

Class A₁ Amplifier

Plate Voltage.....	85	90 Volts
Grid No. 2 Voltage.....	85	90 Volts
Grid No. 1 Voltage ¹	-4.5	-4.5 Volts
Plate Current.....	3.5	4.0 Ma
Grid No. 2 Current.....	0.7	0.8 Ma
Transconductance.....	800	850 μ mhos
Plate Resistance.....	0.3	0.3 Megohm
Load Resistance.....	25000	25000 Ohms
Power Output.....	100	115 Mw
Total Harmonic Distortion.....	10.0	7.0 Percent

NOTE:

1. Self bias is recommended for battery operation, although it reduces the power output slightly. It makes a separate bias supply unnecessary and allows the bias to decrease in proportion with the decrease in B supply volts with age.

TYPE 1A6

(See Condensed Data Section)

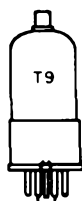

SYLVANIA TYPE 1A7GT
HEPTODE CONVERTER

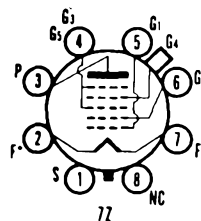

MECHANICAL DATA

Bulb.....	T-9, Outline 9-18
Base.....	Small Wafer Octal 8-Pin With Metal Sleeve
Basing.....	7Z
Top Cap.....	Miniature
Mounting Position.....	Any

ELECTRICAL DATA

FILAMENT CHARACTERISTICS

Filament Voltage D C.....	1.4 Volts
Filament Current.....	50 Ma

MAXIMUM RATINGS (Design Center Values)

Plate Voltage.....	110 Volts
Grid No. 2 Voltage.....	110 Volts
Grid No. 3 and 5 Voltage.....	60 Volts
Grid No. 3 and 5 Supply Voltage.....	110 Volts
Cathode Current.....	4.0 Ma

TYPICAL OPERATION

Plate Voltage.....	90 Volts
Grid No. 3 and 5 Voltage ¹	45 Volts
Grid No. 2 Voltage.....	90 Volts
Grid No. 4 Voltage (Control Grid) ²	0 Volts
Grid No. 1 Resistor (Osc. Grid).....	0.2 Megohm
Plate Current.....	0.6 Ma
Grid No. 3 and 5 Current.....	0.7 Ma
Grid No. 2 Current.....	1.2 Ma
Grid No. 1 Current.....	0.035 Ma
Plate Resistance.....	0.6 Megohm
Total Cathode Current.....	2.5 Ma
Conversion Transconductance	
Grid No. 4 Voltage at 0 Volts.....	250 μ mhos
Grid No. 4 Voltage at -2 Volts.....	50 μ mhos
Grid No. 4 Voltage at -3 Volts.....	5 μ mhos

NOTES:

1. Obtained preferably by using a properly by-passed 70,000 ohm resistor in series with a 90 volt supply.
2. A resistance of at least 1.0 megohm should be in the grid return to negative filament pin.

TYPES 1AB5, 1AF4, 1AF5

(See Condensed Data Section)

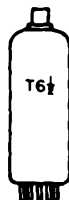

SYLVANIA TYPE 1AX2
HIGH VOLTAGE HALF-WAVE RECTIFIER

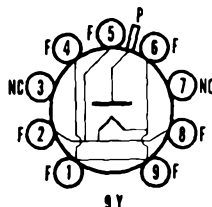

MECHANICAL DATA

Bulb	T-6 1/2, Outline 6A-2
Base	Miniature Button 9-Pin
Basing	9 Y
Top Cap	Skirted Miniature
Mounting Position	Any

ELECTRICAL DATA

FILAMENT CHARACTERISTICS

Filament Voltage ¹	1.4 Volts
Filament Current	650 Ma

DIRECT INTERELECTRODE CAPACITANCES

Plate to Filament	0.7 μ f
-------------------	-------------

MAXIMUM RATINGS (Design Center Values—Except as Noted)

Flyback Rectifier Service²

Maximum Inverse Plate Voltage	25 Kv
Total D C and Peak (Abs. Max.)	20 Kv
D C	45 Ma
Peak Plate Current	0.5 Ma
Average Plate Current	

CHARACTERISTICS

Tube Voltage Drop (Conducting 7 Ma)	200 Volts
-------------------------------------	-----------

TYPICAL OPERATION

Similar to Type 1 X2B

NOTES:

- The filament voltage should never be less than 1.2 volts or more than 1.6 volts.
- For operation in a 525-line, 30 frame system, the duty cycle of the voltage pulse must not exceed 15% of one scanning cycle.

WARNING

This tube may produce soft X-rays which can constitute a health hazard unless adequately shielded.

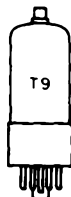

SYLVANIA TYPE 1B3GT
HALF-WAVE RECTIFIER

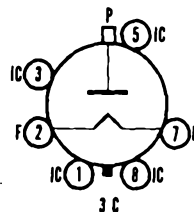

MECHANICAL DATA

Bulb	T-9, Outline 9-51
Base	Intermediate Shell Octal 6-Pin
Basing	3C
Top Cap	Small
Mounting Position	Any

1B3GT (Cont'd)

ELECTRICAL DATA

FILAMENT CHARACTERISTICS

Filament Voltage ¹	1.25 Volts
Filament Current.....	200 Ma

DIRECT INTERELECTRODE CAPACITANCES

Plate to Filament.....	1.3 μ f
------------------------	-------------

MAXIMUM RATINGS (Design Center Values—Except as Noted)

Flyback Voltage Rectifier²

Inverse Plate Voltage	
Total D C and Peak (Abs. Max.).....	26 Kv
D C.....	21 Kv
Peak Plate Current.....	50 Ma
Average Plate Current.....	0.5 Ma

R F Voltage Rectifier

Peak Inverse Plate Voltage (Abs. Max.).....	33 Kv
Peak Plate Current.....	30 Ma
Average Plate Current.....	1.0 Ma
Maximum Frequency of Supply Voltage.....	100 Kc
Minimum Frequency of Supply Voltage.....	1.5 Kc

CHARACTERISTICS

Tube Voltage Drop Measured with Tube Conducting	
7 Ma (approx.).....	100 Volts

NOTES:

- Under no circumstances should the filament voltage be less than 1.05 volts or more than 1.45 volts.
- For operation in a 525-line, 30 frame system the duty cycle of the voltage pulse must not exceed 15% of one scanning cycle.

APPLICATION

The Sylvania Type 1B3GT is a filamentary type half-wave diode intended for service as the high voltage rectifier in television receivers and other high voltage rectifier applications.

SYLVANIA TUBE TESTER SETTINGS

	A	B	C	D	E	F	G	Test or K
139/140	1.4	0	2457	0	8	—	28	V
219/220	1.25	2	13578	14	7	U	9*	—

* Diode gas test does not apply.

AVERAGE CHARACTERISTICS

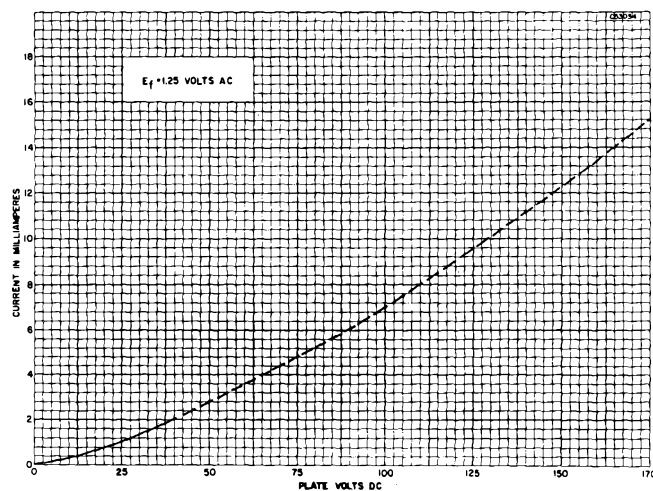

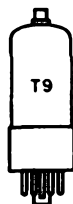

SYLVANIA TYPE 1G3GT

HV HALF-WAVE RECTIFIER

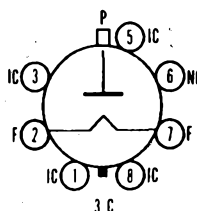

MECHANICAL DATA

Bulb	T-9
Base ¹	B5-82, Intermediate-Shell Octal 5-Pin or B5-85 Short, Intermediate-Shell Octal 5-Pin B6-8, Intermediate-Shell Octal 6-Pin or B6-60 Short, Intermediate-Shell Octal 6-Pin B7-47 Short, Intermediate-Shell Octal 7-Pin or B7-166, Intermediate-Shell Octal 7-Pin
Cap.	C1-34
Outline	9-51 or 9-52
Basing ²	3C
Cathode	Coated Filament
Mounting Position	Any

ELECTRICAL DATA

FILAMENT CHARACTERISTICS

Filament Voltage ³	1.25 Volts
Filament Current	200 Ma

DIRECT INTERELECTRODE CAPACITANCES (Approx.)

Plate to Filament and Internal Shield	1.3 $\mu\mu\text{f}$
---------------------------------------	----------------------

MAXIMUM RATINGS (Design-Center Values—Except as Noted)

Flyback Voltage Rectifier⁴

Inverse Plate Voltage	26,000 Volts
Total DC and Peak (Absolute Value)	21,000 Volts
DC	50 Ma
Peak Plate Current	0.5 Ma
Average Plate Current	0.5 Ma

R F Voltage Rectifier

Peak-Inverse Plate Voltage (Absolute Value)	33,000 Volts
Peak Plate Current	30 Ma
Average Plate Current	1.0 Ma
Frequency of Supply Voltage	
Minimum	1.5 Kc
Maximum	100 Kc

CHARACTERISTICS

Tube Drop for $I_b = 7 \text{ Ma}$ (approx.)	100 Volts
--	-----------

NOTES:

- On the 5-Pin bases, Pin 1 is omitted.
On the 5-Pin bases, the 6-Pin bases, and the 7-Pin base JETEC No. B7-166, Pin 4 is omitted.
On the 5-Pin bases, the 6-Pin bases, and the 7-Pin base JETEC No. B7-47, Pin 6 is omitted.
- Socket terminals 1, 3, 4, 5, 6, and 8 may be connected to terminal 7 or to a corona shield which connects to terminal 7. Terminals 4 and 6 may be used as tie points for components at or near filament potential.
- Under no circumstances should the filament voltage be less than 1.05 volts or more than 1.45 volts.
- For operation in a 525-line, 30-frame system as described in "Standards of Good Engineering Practice for Television Broadcast Stations; Federal Communications Commission," the duty cycle of the voltage pulse must not exceed 15% of one scanning cycle.

APPLICATION

The Sylvania Type 1G3GT is a filamentary half-wave diode intended for service as the high voltage rectifier in television receivers and other high voltage rectifier applications. The Type 1G3GT is identical to the Type 1B3GT except that the overall and seated heights of the Type 1G3GT are each $\frac{1}{2}$ inch shorter than for the Type 1B3GT.

WARNING

X-ray radiation shielding may be necessary to protect against possible danger of personal injury from prolonged exposure at close range if this tube is operated at higher than the manufacturer's Maximum Rated Plate Voltage or 16,000 volts, whichever is less.

1G3GT (Cont'd)

AVERAGE CHARACTERISTICS

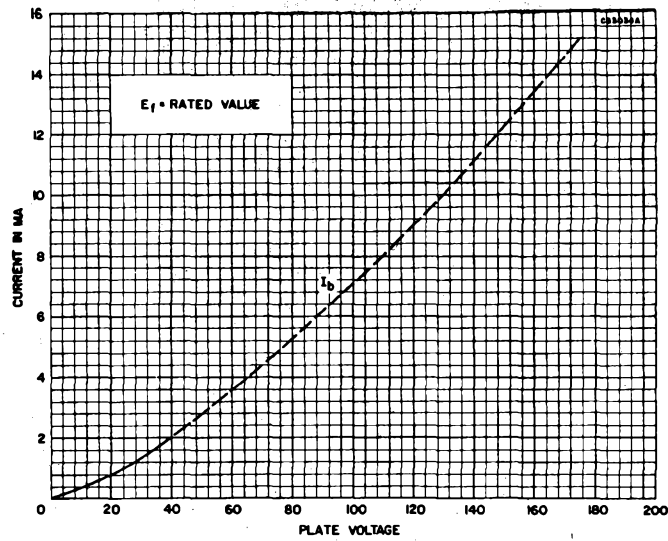

**TYPES 1B4/951, 1B4P, 1B5/25S,
1B7GT, 1C3, 1C5GT, 1C6,
1C7G, 1D5G, 1D5GT,
1D7G, 1D8GT, 1E4, 1E5,
1E5GT, 1E5GP, 1E7GT, 1F4,
1F5G, 1F6, 1F7G, 1F7GV,
1G4GT, G, 1G5G, 1G6GT,
G, 1H4G, GT**

(See Condensed Data Section)

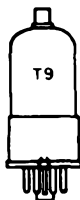

SYLVANIA TYPE 1H5GT
DIODE HIGH-MU TRIODE

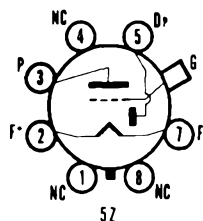

MECHANICAL DATA

Bulb.....	T-9, Outline 9-18
Base.....	Small Wafer Octal, Metal Sleeve 7-Pin
Basing.....	5Z
Top Cap.....	Miniature
Mounting Position.....	Any

ELECTRICAL DATA

FILAMENT CHARACTERISTICS

Filament Voltage D C.....	1.4 Volts
Filament Current.....	50 Ma

APPLICATION

For other information on this type refer to corresponding lock-in Type 1LH4 which is identical in electrical characteristics.

TYPES 1H6GT, 1J5G, 1J6GT, G

(See Condensed Data Section)

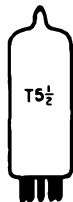

SYLVANIA TYPE 1L4
SHARP CUTOFF PENTODE

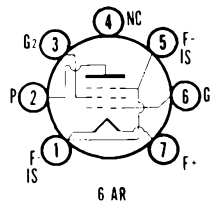

MECHANICAL DATA

Bulb.....	T-5 1/2, Outline 5-2
Base.....	Miniature Button 7-Pin
Basing.....	6AR
Mounting Position.....	Any

1L4 (Cont'd)

ELECTRICAL DATA

FILAMENT CHARACTERISTICS

Filament Voltage D C.....	1.4 Volts
Filament Current.....	50 Ma
Filament Voltage D C (Abs. Max.).....	1.6 Volts

TYPICAL OPERATION

Plate Voltage.....	90	90 Volts
Grid No. 2 Voltage.....	67.5	90 Volts
Grid No. 1 Voltage.....	0	0 Volts
Plate Current.....	2.9	4.5 Ma
Grid No. 2 Current.....	1.2	2.0 Ma
Transconductance.....	925	1025 μ mhos
Plate Resistance.....	0.6	0.35 Megohm
Grid No. 1 Bias for $I_b = 10 \mu$ a.....	-6.0	-8.0 Volts

Note: For use in R-C coupled amplifiers see appendix.

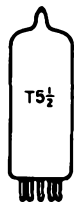

SYLVANIA TYPE 1L6
PENTAGRID CONVERTER

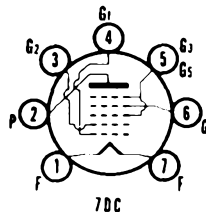

MECHANICAL DATA

Bulb.....	T-5 1/2, Outline 5-2
Base.....	Miniature Button 7-Pin
Basing.....	7 DC
Mounting Position.....	Any

ELECTRICAL DATA

FILAMENT CHARACTERISTICS

Filament Voltage D C.....	1.4 Volts
Filament Current.....	50 Ma

DIRECT INTERELECTRODE CAPACITANCES

	Shielded ¹	Unshielded
Grid No. 4 to Plate.....	0.36	0.46 μ mf Max
Grid No. 2 to Grid No. 4.....	0.24	0.24 μ mf
Grid No. 1 to Grid No. 4.....	0.19	0.19 μ mf
R F Input: c_4 to All.....	7.5	7.5 μ mf
Oscillator Input: c_1 to All except c_2	2.2	2.2 μ mf
Oscillator Output: c_2 to All except c_1	2.6	2.6 μ mf
Mixer Output: Plate to All.....	12.0	7.0 μ mf
Grid No. 1 to Plate.....	0.10	0.15 μ mf Max

MAXIMUM RATINGS (Design Center Values)

Plate Voltage.....	110 Volts
Grid No. 3 and 5 Voltage.....	65 Volts
Grid No. 3 and 5 Supply Voltage.....	110 Volts
Grid No. 2 Voltage (Oscillator Plate).....	110 Volts
Total Cathode Current.....	4.0 Ma

TYPICAL OPERATION

Plate Voltage.....	90 Volts
Grid No. 2 Voltage (Anode Grid).....	90 Volts
Grid No. 3 and 5 Voltage ²	45 Volts
Grid No. 4 Voltage (Control Grid).....	0 Volts
Plate Current.....	0.5 Ma
Grid No. 3 and 5 Current.....	0.6 Ma
Grid No. 2 Current (Anode Grid).....	1.2 Ma
Grid No. 1 Current (Osc. Grid).....	0.035 Ma
Total Cathode Current.....	2.35 Ma
Grid No. 4 Circuit Resistance.....	1.0 Megohm
Grid No. 1 Circuit Resistance.....	0.2 Megohm
Conversion Transconductance	
Grid No. 4 at 0 Volts.....	300 μ mhos
Grid No. 4 at -3.5 Volts (approx.).....	10 μ mhos
Oscillator Transconductance ³	550 μ mhos

NOTES:

- External shield No. 316 connected to Pin 1.
- Obtained preferably by using a properly by-passed dropping resistor of from 45,000 to 75,000 ohms in series with the B supply.
- Not oscillating with $E_{c1} = 0$ V, $E_b = 90$ V, E_{c3} and 5 = 45 V, $E_{c2} = 90$ V, $E_{c4} = 0$ V.

APPLICATION

Sylvania Type 1L6 is a miniature type pentagrid converter designed for use in low drain battery operated receivers. It is similar in construction and application to Types 1A7GT and 1LA6. The small size and low current requirements recommend it for use in small portable receivers.

TYPE 1LA4

(See Condensed Data Section)

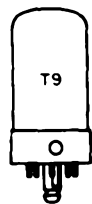

SYLVANIA TYPE 1LA6
HEPTODE CONVERTER

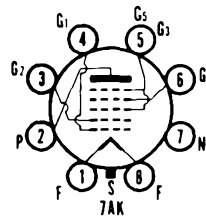

MECHANICAL DATA

Bulb.....	T-9, Outline 9-30
Base.....	Lock-in 8-Pin
Basing.....	7AK
Mounting Position.....	Any

ELECTRICAL DATA

FILAMENT CHARACTERISTICS

Filament Voltage D C.....	1.4 Volts
Filament Current.....	50 Ma
Filament Voltage D C (Abs. Max.).....	1.6 Volts

TYPICAL OPERATION

Plate Voltage.....	90 Volts
Grid No. 2 Voltage (Anode Grid).....	90 Volts
Grid No. 3 and 5 Voltage ¹	45 Volts
Grid No. 4 Voltage (Control Grid).....	0 Volts
Plate Current.....	0.55 Ma
Grid No. 3 and 5 Current.....	0.6 Ma
Grid No. 2 Current.....	1.2 Ma
Grid No. 1 Current.....	0.035 Ma
Conversion Transconductance.....	250 μ mhos
Plate Resistance.....	0.75 Megohm
Control Grid Bias for $g_c = 10 \mu$ mhos.....	-3 Volts
Oscillator Grid (g1) Resistor.....	0.2 Megohm
Maximum Allowable Grid 4 Resistance to Negative Filament.....	1.0 Megohm

NOTE:

1. Obtained preferably by using a properly by-passed voltage dropping resistor of 45,000 to 70,000 ohms in series with the B supply voltage.

APPLICATION

Similar in construction and application to the Type 1L6. Sylvania Type 1R5 is recommended for use in new equipment.

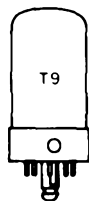

SYLVANIA TYPE 1LB4
PENTODE POWER AMPLIFIER

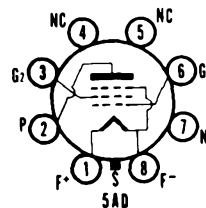

MECHANICAL DATA

Bulb.....	T-9, Outline 9-30
Base.....	Lock-in 8-Pin
Basing.....	5AD
Mounting Position.....	Any

ELECTRICAL DATA

FILAMENT CHARACTERISTICS

Filament Voltage D C.....	1.4 Volts
Filament Current.....	50 Ma
Filament Voltage D C (Abs. Max.).....	1.6 Volts

MAXIMUM RATINGS (Design Center Values)

Plate Voltage.....	110 Volts
Grid No. 2 Voltage.....	110 Volts
Cathode Current.....	6.0 Ma

1LB4 (Cont'd)

TYPICAL OPERATION

Plate Voltage.....	45	62.5	67.5	90 Volts
Grid No. 2 Voltage.....	45	62.5	67.5	90 Volts
Grid No. 1 Voltage.....	-4.5	-5.0	-6.0	-9.0 Volts
Plate Current (Zero Signal).....	1.6	3.8	3.8	5.0 Ma
Grid No. 2 Current (Zero Signal).....	0.3	0.8	0.8	1.0 Ma
Transconductance.....	650	875	875	925 μ mhos
Plate Resistance (approx.).....	0.4	0.3	0.3	0.25 Megohm
Load Resistance.....	20000	16000	16000	12000 Ohms
Power Output.....	35	90	100	200 Mw
Total Harmonic Distortion.....	10	10	10	10 Percent

Sylvania Type 3V4 is recommended for use in new equipment.

TYPES 1LC5, 1LC6, 1LD5, 1LE3, 1LG5

(See Condensed Data Section)

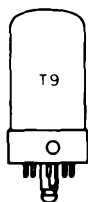

SYLVANIA TYPE 1LH4
DIODE HIGH-MU TRIODE

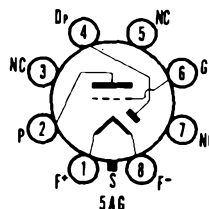

MECHANICAL DATA

Bulb.....	T-9, Outline 9-30
Base.....	Lock-in 8-Pin
Basing.....	5AG
Mounting Position.....	Any

ELECTRICAL DATA

FILAMENT CHARACTERISTICS

Filament Voltage D C.....	1.4 Volts
Filament Current.....	50 Ma
Filament Voltage D C (Abs. Max.).....	1.6 Volts

TYPICAL OPERATION

Plate Voltage.....	90 Volts
Grid No. 1 Voltage ¹	0 Volts
Plate Current.....	0.15 Ma
Transconductance.....	275 μ mhos
Amplification Factor.....	65
Plate Resistance.....	0.24 Megohm

NOTE:

1. A resistor of at least 1.0 megohm should be in the grid return. The negative filament voltage should be connected to Pin 8.

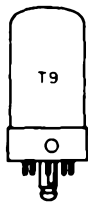

SYLVANIA TYPE 1LN5
SHARP CUTOFF R F PENTODE

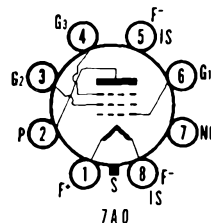

MECHANICAL DATA

Bulb.....	T-9, Outline 9-30
Base.....	Lock-in 8-Pin
Basing.....	7AO
Mounting Position.....	Any

1LN5 (Cont'd)

ELECTRICAL DATA

FILAMENT CHARACTERISTICS

Filament Voltage D C.....	1.4 Volts
Filament Current.....	50 Ma
Filament Voltage D C (Abs. Max.).....	1.6 Volts

TYPICAL OPERATION

Plate Voltage.....	90 Volts
Grid No. 2 Voltage.....	90 Volts
Grid No. 1 Voltage.....	0 Volts
Plate Current.....	1.6 Ma
Grid No. 2 Current.....	0.35 Ma
Transconductance.....	800 μ mhos
Plate Resistance (approx.).....	1.1 Megohms
Grid No. 1 Bias for $g_m = 10 \mu$ mhos (approx.).....	-4.5 Volts

NOTE:

1. Negative filament return to Pin 8.

Sylvania Type 1U4 is recommended for use in new equipment.

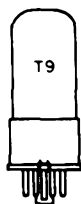

SYLVANIA TYPE 1N5GT
SHARP CUTOFF R F PENTODE

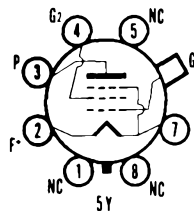

MECHANICAL DATA

Bulb.....	T-9, Outline 9-18
Base.....	Small Wafer Octal With Metal Sleeve 7-Pin
Basing.....	5Y
Mounting Position.....	Any

ELECTRICAL DATA

FILAMENT CHARACTERISTICS

Filament Voltage D C.....	1.4 Volts
Filament Current.....	50 Ma

TYPICAL OPERATION

Plate Voltage.....	90 Volts
Grid No. 2 Voltage.....	90 Volts
Grid No. 1 Voltage.....	0 Volts
Plate Current.....	1.2 Ma
Grid No. 2 Current.....	0.3 Ma
Transconductance.....	750 μ mhos
Plate Resistance (approx.).....	1.5 Megohms
Grid No. 1 Bias for $g_m = 50 \mu$ mhos.....	-3.2 Volts
$g_m = 5 \mu$ mhos.....	-4.0 Volts

NOTE:

1. Negative filament return to Pin 7.

**TYPES 1N6G, 1P5GT, G, 1Q5GT,
G, 1Q6, 1R4**

(See Condensed Data Section)

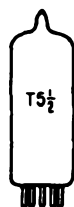

SYLVANIA TYPE 1R5

HEPTODE CONVERTER

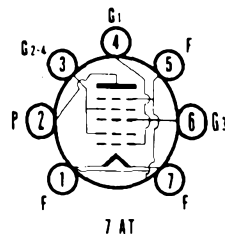

MECHANICAL DATA

Bulb	T-5 1/2, Outline 5-2
Base	Miniature Button 7-Pin
Basing	7AT
Mounting Position	Any

ELECTRICAL DATA

FILAMENT CHARACTERISTICS

Filament Voltage D C	1.4 Volts
Filament Current	50 Ma
Filament Voltage D C (Abs. Max.)	1.6 Volts

DIRECT INTERELECTRODE CAPACITANCES

	Shielded ¹	Unshielded
Mixer Grid to Plate: g3 to p	0.3	0.4 μmf Max
R F Input: g3 to All	7.0	7.0 μmf
Mixer Output: p to All	12.0	7.5 μmf
Oscillator Input: g1 to All	3.8	3.8 μmf
Coupling: g1 to g3	0.2	0.2 μmf Max
Oscillator Grid to Plate: g1 to p	0.1	0.1 μmf Max

MAXIMUM RATINGS (Design Center Values)

Plate Voltage	90 Volts
Grid No. 2 and 4 Voltage	67.5 Volts
Grid No. 2 and 4 Supply Voltage	90 Volts
Cathode Current	5.5 Ma
Positive D C Grid No. 3 Voltage	0 Volts

CHARACTERISTICS AND TYPICAL OPERATION²

Plate Voltage	45	67.5	90 Volts
Grid No. 2 and 4 Voltage	45	67.5	67.5 Volts
Grid No. 3 Voltage	0	0	0 Volts
Oscillator Grid (Grid No. 1) Voltage R M S	15	25	25 Volts
Oscillator Grid (Grid No. 1) Current	150	250	250 μa
Oscillator Grid (Grid No. 1) Resistance	0.1	0.1	0.1 Megohm
Plate Resistance (approx.)	0.5	0.4	0.4 Megohm
Plate Current	0.7	1.4	1.5 Ma
Grid No. 2 and 4 Current	2.1	3.5	3.5 Ma
Cathode Current	3.0	5.2	5.3 Ma
Conversion Transconductance	210	280	280 μmhos
Grid No. 3 Voltage for $g_c = 10 \mu\text{mhos}$ (approx.)	-7	-13	-13 Volts
Grid No. 3 Voltage for $g_c = 100 \mu\text{mhos}$ (approx.)	-2.2	-4.9	-5.0 Volts

NOTES:

- Shield No. 316 connected to Pin 1.
- The characteristics shown were obtained with separate excitation. The characteristics under these conditions correspond very closely with those obtained in self-excited oscillatory circuit operating with zero bias.

SYLVANIA TUBE TESTER SETTINGS

	A	B	C	D	E	F	G	Test or K
139/140	1.4	2	45	4	1	016	60	T
	1.4	2	45	4	0	8	65	U
219/220	1.4	7	51	39	1	036T	2	---
	1.4	7	51S	63	5	4X	3	---

1S5 (Cont'd)

AVERAGE PLATE CHARACTERISTICS

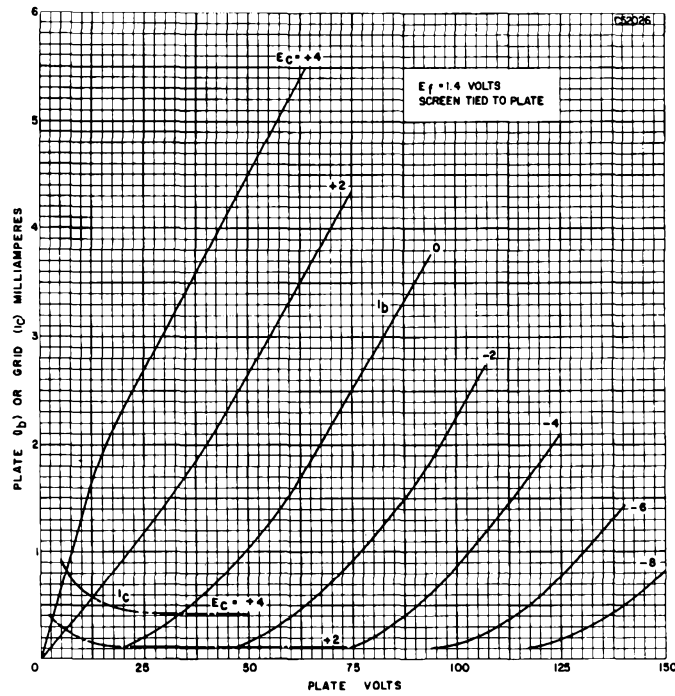

AVERAGE CHARACTERISTICS

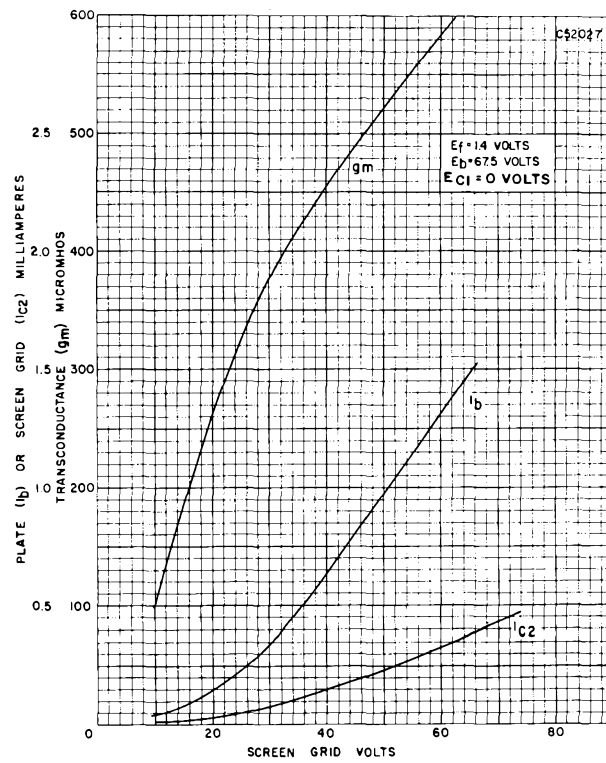

SYLVANIA ELECTRONIC TUBES

TYPES 1SA6GT, 1SB6GT

(See Condensed Data Section)

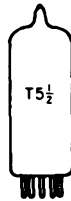

SYLVANIA TYPE 1T4 REMOTE CUTOFF R F PENTODE

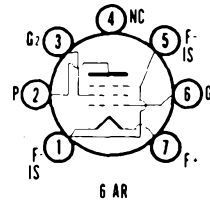

MECHANICAL DATA

Bulb	T-5 1/2, Outline 5-2
Base	Miniature Button 7-Pin
Basing	6 AR
Mounting Position	Any

ELECTRICAL DATA

FILAMENT CHARACTERISTICS

Filament Voltage	1.4 Volts
Filament Current	50 Ma
Filament Voltage D C (Abs. Max.)	1.6 Volts

DIRECT INTERELECTRODE CAPACITANCES (Shielded)¹

Grid to Plate	0.01 μmf Max
Input	3.6 μmf
Output	7.5 μmf

MAXIMUM RATINGS (Design Center Values)

Plate Voltage	90 Volts
Grid No. 2 Voltage	90 Volts
Positive Grid No. 1 Voltage	0 Volts
Total Cathode Current	5.5 Ma

CHARACTERISTICS AND TYPICAL OPERATION

Class A₁ Amplifier

Plate Voltage	45	67.5	90	90 Volts
Grid No. 2 Voltage	45	67.5	45	67.5 Volts
Grid No. 1 Voltage	0	0	0	0 Volts
Plate Current	1.7	3.4	1.8	3.5 Ma
Grid No. 2 Current	0.7	1.5	0.65	1.4 Ma
Transconductance	700	875	750	900 μmhos
Plate Resistance (approx)	0.35	0.25	0.8	0.5 Megohm
Grid No. 1 Bias for 10 μmhos	-10	-16	-10	-16 Volts

NOTE:

- Shield No. 316 connected to Pin No. 1.

APPLICATION

Sylvania Type 1T4 is an rf remote cutoff pentode of the miniature style of construction. It is especially designed for radio frequency amplifier service in compact, light weight, portable equipment.

SYLVANIA TUBE TESTER SETTINGS

	A	B	C	D	E	F	G	Test or K
139/140	1.4	2	45	4	1	016	17	V
219/220	1.4	1	457	64	7	036Y	2	---
	1.4	5	147	64	7	036Y	2	---

1R5 (Cont'd)

AVERAGE CONVERSION CHARACTERISTICS (SEPARATE EXCITATION)

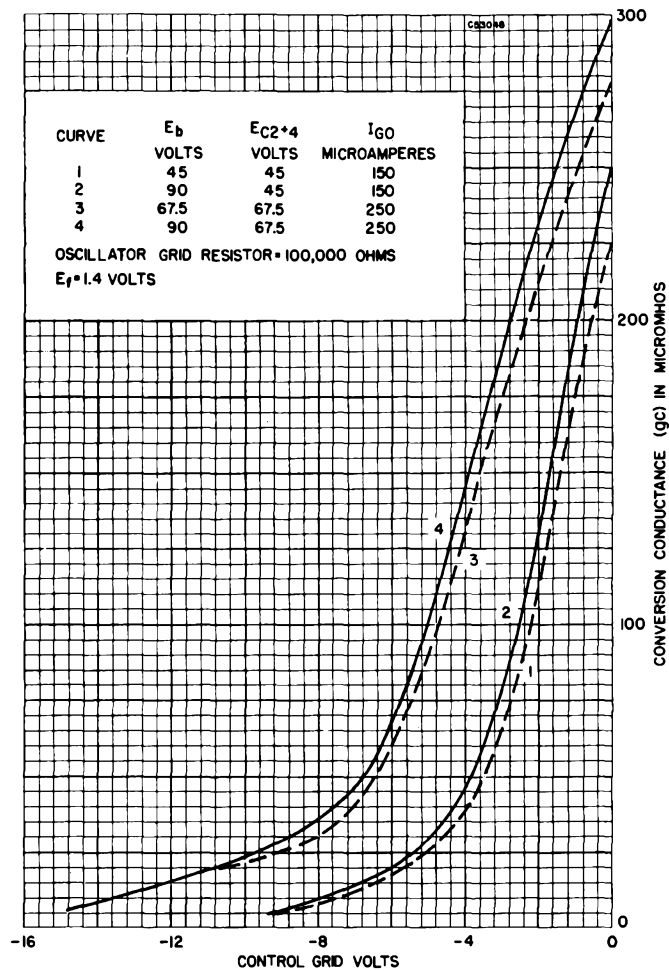

AVERAGE CONVERSION CHARACTERISTICS (SEPARATE EXCITATION)

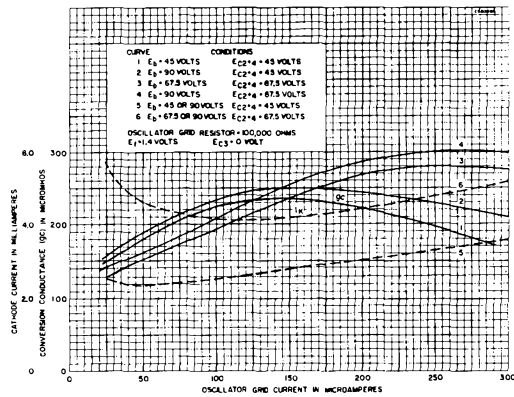

TYPE 1S4

(See Condensed Data Section)

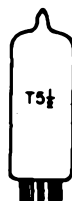

SYLVANIA TYPE 1S5

DIODE PENTODE

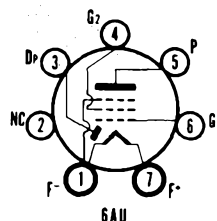

MECHANICAL DATA

Bulb	T-5 1/2, Outline 5-2
Base	Miniature Button 7-Pin
Basing	6AU
Mounting Position	Any

ELECTRICAL DATA

FILAMENT CHARACTERISTICS

Filament Voltage D C	1.4 Volts
Filament Current	50 Ma
Filament Voltage D C (Abs. Max.)	1.6 Volts

DIRECT INTERELECTRODE CAPACITANCES (Unshielded)

Grid to Plate	0.2 μf
Input	2.2 μf
Output	2.4 μf

MAXIMUM RATINGS (Design Center Values)

Class A₁ Amplifier

Plate Voltage	90 Volts
Grid No. 2 Voltage	90 Volts
Positive D C Grid No. 1 Voltage	0 Volts
Negative D C Grid No. 1 Voltage	50 Volts
Cathode Current	3.0 Ma
Diode Current for Continuous Operation	0.25 Ma

CHARACTERISTICS AND TYPICAL OPERATION

Class A₁ Amplifier

Plate Voltage	67.5	90 Volts
Grid No. 2 Voltage	67.5	90 Volts
Grid No. 1 Voltage	0	0 Volts
Plate Current	1.6	2.7 Ma
Grid No. 2 Current	0.4	0.5 Ma
Transconductance	625	720 μmhos
Plate Resistance (approx.)	0.6	0.5 Megohm
Grid No. 1 Bias for $I_b = 10 \mu\text{a}$		-5 Volts
Average Diode Current at 10 Volts D C		1.5 Ma

APPLICATION

Sylvania Type 1S5 is a diode pentode of the miniature construction, especially designed for detector-audio service in compact, light weight, portable equipment. The high operating efficiency allows the tube to be used with extremely low B supply voltages. The internal construction of Type 1S5 is similar to that of Sylvania Type 1LD5. For use in resistance coupled circuits, see appendix.

SYLVANIA TUBE TESTER SETTINGS

	A	B	C	D	E	F	G	Test or K
139/140	1.4	2	4	4	4	68	23	V
	1.4	2	4	4	0	—	55	T
219/220	1.4	1	27	14	7	046U	5	—
	1.4	1	27	44	7	T	3*	—

* Diode gas test does not apply.

1T4 (Cont'd)

AVERAGE PLATE CHARACTERISTICS TRIODE CONNECTED

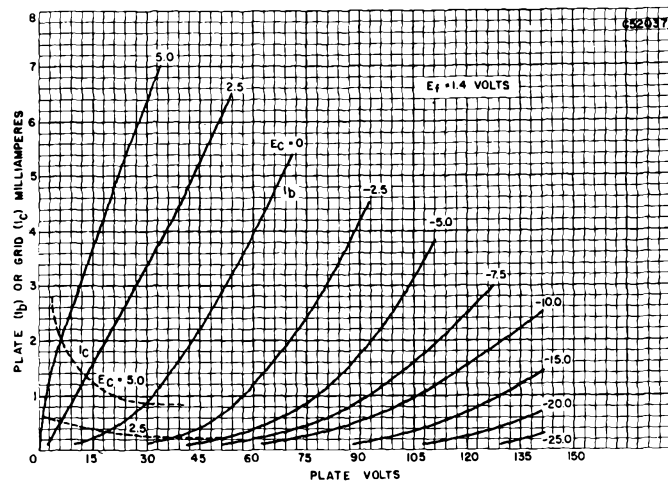

AVERAGE TRANSFER CHARACTERISTICS

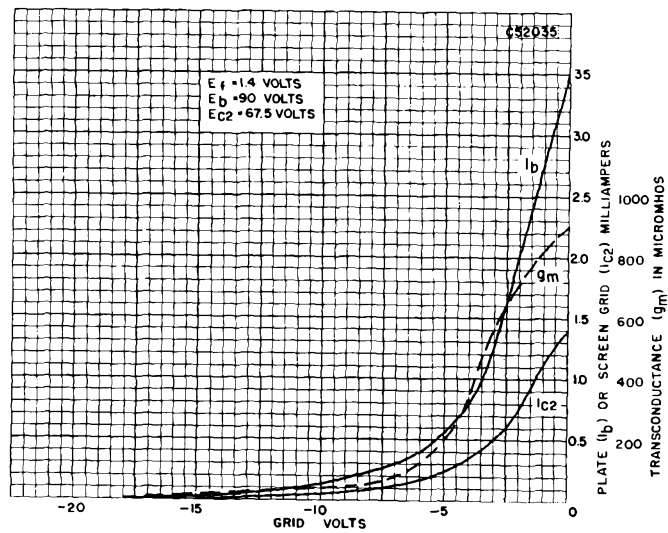

1T4 (Cont'd)

AVERAGE PLATE CHARACTERISTICS

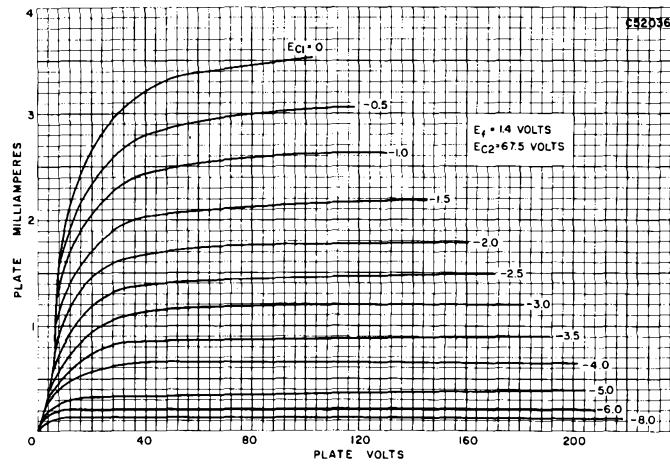

TYPE 1T5GT

(See Condensed Data Section)



SYLVANIA TYPE 1U4 SHARP CUTOFF R F PENTODE

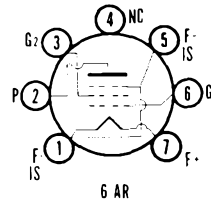

MECHANICAL DATA

Bulb.....	T-5 1/2, Outline 5-2
Base.....	Miniature Button 7-Pin
Basing.....	6AR
Mounting Position.....	Any

ELECTRICAL DATA

FILAMENT CHARACTERISTICS

Filament Voltage D C.....	1.4 Volts
Filament Current.....	50 Ma
Filament Voltage D C (Abs. Max.).....	1.6 Volts

DIRECT INTERELECTRODE CAPACITANCES (With or Without Shield)¹

Grid to Plate.....	.008 μ f Max
Input.....	3.6 μ f
Output.....	7.5 μ f

MAXIMUM RATINGS (Design Center Values)

Plate Voltage.....	110 Volts
Grid No. 2 Voltage.....	110 Volts
Positive Grid No. 1 Voltage.....	0 Volts
Total Cathode Current.....	6.5 Ma

CHARACTERISTICS AND TYPICAL OPERATION

Class A₁ Amplifier

Plate Voltage.....	90 Volts
Grid No. 2 Voltage.....	90 Volts
Grid No. 1 Voltage.....	0 Volts
Plate Current.....	1.6 Ma
Grid No. 2 Current.....	0.45 Ma
Transconductance.....	900 μ mhos
Plate Resistance (approx.).....	1.5 Megohms
Grid No. 1 Bias for $I_b = 10 \mu$ a.....	4.0 Volts

1U4 (Cont'd)

NOTE:

- Shield No. 316 connected to Pin No. 1 or 5.

APPLICATION

Sylvania Type 1U4 is a sharp cutoff r f pentode very similar in application and characteristics to Type 1LN5. Data required for its use in resistance coupled amplifier circuits are shown in appendix.

SYLVANIA TUBE TESTER SETTINGS

	A	B	C	D	E	F	G	Test or K
139/140	1.4	2	45	4	1	016	20	V
219/220	1.4	1	57S	26	7	036U	2	—

AVERAGE PLATE CHARACTERISTICS

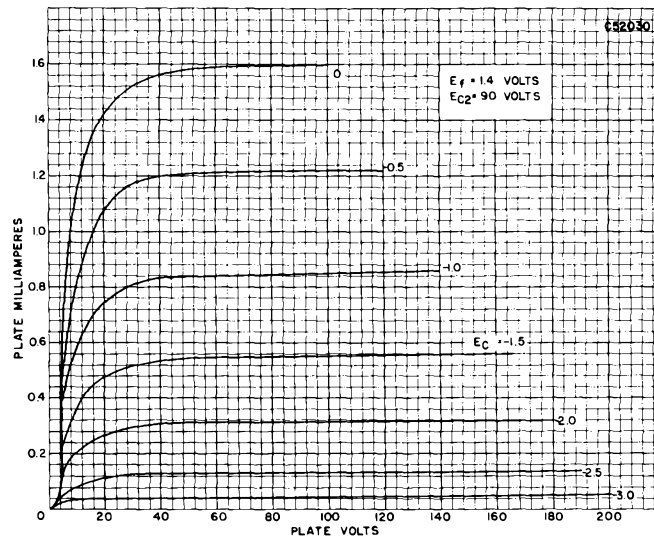

SYLVANIA TYPE 1U5 DIODE PENTODE

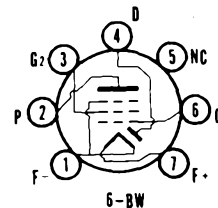

MECHANICAL DATA

Bulb.....	T-5 1/2, Outline 5-2
Base.....	Miniature Button 7-Pin
Basing.....	6BW
Mounting Position.....	Any

1U5 (Cont'd)

ELECTRICAL DATA

FILAMENT CHARACTERISTICS

Filament Voltage D C.....	1.4 Volts
Filament Current.....	50 Ma
Filament Voltage D C (Abs. Max.).....	1.6 Volts

DIRECT INTERELECTRODE CAPACITANCES (Unshielded)

Grid to Plate	0.2 μ f
Input.....	2.2 μ f
Output.....	2.4 μ f

NOTE:

Except for base diagram and capacitances, the Type 1U5 is identical to the Type 1S5. R-C Coupled Amplifier data is given in the Appendix. See Type 1S5 for other data and characteristics curves.

SYLVANIA TUBE TESTER SETTINGS

	A	B	C	D	E	F	G	Test or K
139/140	1.4	2	48	4	1	016	25	V
	1.4	2	48	4	7	—	55	T
219/220	1.4	1	7	13	7	036U	2	—
	1.4	1	7	45	7	T	4*	—

* Diode gas test does not apply.

TYPES 1U6, 1V

(See Condensed Data Section)



SYLVANIA TYPE 1V2
HALF-WAVE RECTIFIER

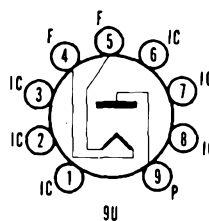

MECHANICAL DATA

Bulb.....	T-6 1/2, Outline 6-2
Base.....	Small Button 9-Pin
Basing.....	9U
Mounting Position.....	Any

ELECTRICAL DATA

FILAMENT CHARACTERISTICS

Filament Voltage A C.....	0.625 Volt
Filament Current.....	300 Ma

MAXIMUM RATINGS (Design Center Values)

Peak Inverse Plate Voltage.....	7500 Volts
Peak Plate Current.....	10 Ma
Average Plate Current.....	0.5 Ma

APPLICATION

Sylvania Type 1V2 is a half-wave rectifier designed especially for use in television circuits using fly-back or high frequency oscillator supplies.

TYPE 1W4

(See Condensed Data Section)



SYLVANIA TYPE 1X2B

H-V HALF-WAVE RECTIFIER

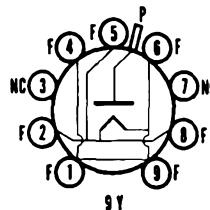

MECHANICAL DATA

Bulb.....	T-6 1/2, Outline 6A-2
Base.....	Small Button 9-Pin
Basing (Note 1).....	9Y
Top Cap.....	Skirted Miniature
Mounting Position.....	Any

ELECTRICAL DATA

FILAMENT CHARACTERISTICS

Filament Voltage.....	1.25 Volts
Filament Current.....	200 Ma

DIRECT INTERELECTRODE CAPACITANCES

Plate to Filament.....	1.0 μ f
------------------------	-------------

MAXIMUM RATINGS (Design Center Values—Except as Noted)

Flyback Rectifier Service²

Peak Inverse Plate Voltage (Abs. Max.).....	22 Kv
Steady State Peak Plate Current.....	45 Ma
D C Output Current.....	0.5 Ma
Tube Voltage Drop for $I_b=7$ Ma.....	100 Volts

CHARACTERISTICS AND TYPICAL OPERATION

Flyback Rectifier Service²

Positive Peak Plate Voltage.....	18 Kv
Negative Peak Plate Voltage.....	2.0 Kv
D C Output Voltage (approx.).....	18 Kv
D C Output Current (approx.).....	100 μ a
Peak Plate Current.....	35 Ma

NOTES:

1. Pins 3 and 7 can be used as a tie point for the filament dropping resistor and high voltage resistor. Do not connect to the low voltage circuits.
2. For operation in a 525 line, 30 frame system, the duty cycle of the voltage pulse must not exceed 15% of one scanning cycle.

APPLICATION

Sylvania Type 1X2B is a miniature filament type diode designed for use as a high voltage rectifier in television receivers and other high voltage rectifier applications. It is applicable for use in both flyback and r f types of supplies as well as for use at power line frequency. The 1X2B supersedes Types 1X2 and 1X2A which are identical except for lower Peak Inverse Plate Voltage.

SYLVANIA TUBE TESTER SETTINGS

	A	B	C	D	E	F	G	Test or K
139/140	1.4	8	12345	0	8	—	72	T
(Converted tester, see roll chart)								
219/220	1.25	0	124568	58	2	T	9*	—

* Diode gas test does not apply.

TYPES 2A3, 2A3H, 2A5,
2A6, 2A7, 2A7S

(See Condensed Data Section)



SYLVANIA TYPE 2AF4

UHF TRIODE

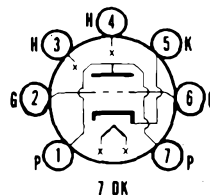

ELECTRICAL DATA

HEATER CHARACTERISTICS

Heater Voltage.....	2.35 Volts
Heater Current.....	600 Ma
Heater Warm-up Time (See SERIES STRING HEATERS section in Appendix).....	
Maximum Heater-Cathode Voltage.....	50 Volts
Total D C and Peak.....	25 Volts
D C, Heater Positive with Respect to Cathode.....	

For other rating, operation, and application data, refer to corresponding Type 6AF4, which is identical except for heater ratings.

APPLICATION

The Sylvania Type 2AF4 is intended for service in television receivers employing series connected heaters. For information on specially controlled heaters for series string operation refer to the SERIES STRING HEATERS section of the Appendix.

TYPES 2B7, 2B7S, 2E5, 2G5, 2S/4S

(See Condensed Data Section)



SYLVANIA TYPE 2T4

UHF TRIODE

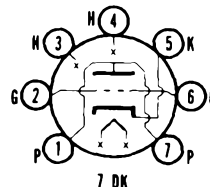

ELECTRICAL DATA

HEATER CHARACTERISTICS

Heater Voltage.....	2.35 Volts
Heater Current.....	600 Ma
Heater Warm-up Time (See SERIES STRING HEATERS Section in Appendix).....	
Maximum Heater-Cathode Voltage.....	50 Volts
Total D C and Peak.....	25 Volts
D C, Heater Positive with Respect to Cathode.....	

For other rating, operation, and application data, refer to corresponding Type 6T4, which is identical except for heater ratings.

APPLICATION

The Sylvania Type 2T4 is intended for service in television receivers employing series connected heaters. For information on specially controlled heaters for series string operation refer to the SERIES STRING HEATERS section of the Appendix.

SYLVANIA TUBE TESTER SETTINGS

	A	B	C	D	E	F	G	Test or K
139/140	2.5	0	46	0	2	2	38	U
	2.5	0	23	0	3	6	38	U
219/220	2.5	3	467	24	4	2X	1	5
	2.5	3	124	24	4	6X	7	5

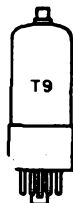

SYLVANIA TYPE 2B3

HV HALF-WAVE RECTIFIER

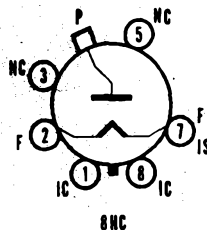

MECHANICAL DATA

Bulb	T-9
Base ¹	B6-8, Intermediate-Shell Octal 6-Pin or B6-60 Short, Intermediate-Shell Octal 6-Pin
Cap.	C1-34
Outline	9-51 or 9-52
Basing	8HC
Cathode	Coated Filament
Mounting Position	Any

ELECTRICAL DATA

FILAMENT CHARACTERISTICS

Filament Voltage ²	1.75 Volts
Filament Current	250 Ma

DIRECT INTERELECTRODE CAPACITANCE (Unshielded)

Plate to Filament (approx.)	1.3 μ f
-----------------------------	-------------

MAXIMUM RATINGS (Design Maximum Values)³

Flyback Voltage Rectifier⁴

Inverse Plate Voltage	
Total DC and Peak	27,000 Volts
DC	22,000 Volts
Peak Plate Current	50 Ma
Average Plate Current	0.5 Ma

CHARACTERISTICS

Tube Drop for $I_b = 7$ Ma (approx.)	100 Volts
--------------------------------------	-----------

NOTES:

1. Bases B6-8 and B6-60. Pins 4 and 6 removed.
2. Under no circumstances should the filament voltage be less than 1.5 volts or more than 2.0 volts.
3. Design-Maximum Ratings are the limiting values, expressed with respect to bogey tubes, at which satisfactory tube life can be expected to occur. In order to obtain satisfactory circuit performance, therefore, the equipment designer must establish the circuit design so that no design maximum value is exceeded with a bogey tube under the worst probable operating conditions with respect to the combined effect of supply voltage variation, equipment component variation, equipment control adjustment, load variation and other variation associated with the equipment or the environment of the equipment.
4. For operation in a 525 line, 30 frame system as described in "Standards of Good Engineering Practice for Television Broadcast Stations; Federal Communications Commission," the duty cycle of the voltage pulse must not exceed 15% of one scanning cycle.

APPLICATION

The Sylvania Type 2B3 is a filamentary half-wave diode intended for service as the high voltage rectifier in television receivers. Differing from Type 1B3GT in higher filament ratings it offers possibilities for operation from a flyback transformer without filament dropping resistor.

WARNING:

X-ray radiation shielding may be necessary to protect against possible danger of personal injury from prolonged exposure at close range if this tube is operated at higher than the manufacturer's Maximum Rated Plate Voltage or 16,000 volts, whichever is less.

2B3 (Cont'd)

AVERAGE PLATE CHARACTERISTICS

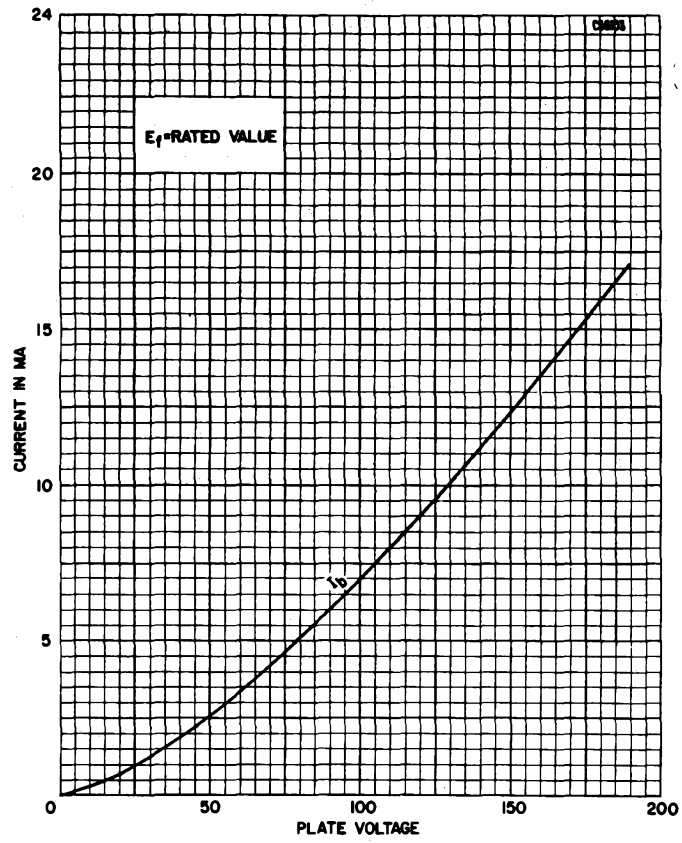

TYPES 2V2, 2V3G, 2W3, GT, 2Z2/284

(See Condensed Data Section)



SYLVANIA TYPE 3A2 HALF-WAVE RECTIFIER

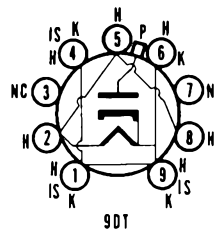

MECHANICAL DATA

Bulb	T-6 1/2, Outline 6A-2
Base	Small Button 9-Pin
Basing	9DT
Top Cap	Skirted Miniature
Mounting Position	Any

ELECTRICAL DATA

HEATER CHARACTERISTICS

Heater Voltage	3.15 Volts
Heater Current	220 Ma

DIRECT INTERELECTRODE CAPACITANCES (Approx.)

Plate to Heater, Cathode and Internal Shield	1.0 μ f
--	-------------

MAXIMUM RATINGS (Design Center Values)

Pulsed-Rectifier Service¹

Peak Inverse Plate Voltage	18000 Volts
Peak Plate Current	80 Ma
Average Plate Current	1.5 Ma

NOTE:

- For operation in a 525-line, 30 frame system, the duty cycle of the voltage pulse must not exceed 15% of one scanning cycle.

APPLICATION

Sylvania Type 3A2 is a half-wave vacuum rectifier designed as a high voltage pulse rectifier for use in the scanning systems of color television receivers.

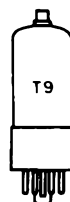

SYLVANIA TYPE 3A3 HALF-WAVE RECTIFIER

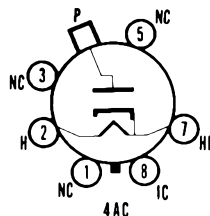

MECHANICAL DATA

Bulb	T-9
Base	Intermediate Shell Octal 6-Pin
Basing	4AC
Maximum Overall Length	4 1/16"
Maximum Seated Height	3 1/2"
Top Cap	Small
Mounting Position	Any

ELECTRICAL DATA

HEATER CHARACTERISTICS

Heater Voltage	3.15 Volts
Heater Current	220 Ma

DIRECT INTERELECTRODE CAPACITANCES (Approx.)

Plate to Heater, Cathode and Internal Shield	1.5 μ f
--	-------------

3A3 (Cont'd)

MAXIMUM RATINGS (Design Center Values)

Pulsed Rectifier Service¹

Peak Inverse Plate Voltage	30000 Volts
Peak Plate Current	80 Ma
Average Plate Current	1.5 Ma

NOTE:

1. For operation in a 525-line, 30 frame system, the duty cycle of the voltage pulse must not exceed 15% of one scanning cycle.

APPLICATION

Sylvania Type 3A3 is a half-wave vacuum rectifier designed as a high voltage pulse rectifier for use in the scanning systems of color television receivers.

TYPES 3A5, 3A8GT

(See Condensed Data Section)



SYLVANIA TYPE 3A5
DUO DIODE

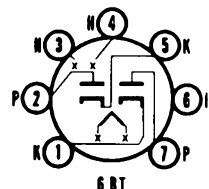

ELECTRICAL DATA

HEATER CHARACTERISTICS

Heater Voltage	3.15 Volts
Heater Current	600 Ma
Heater Warm-up Time (See SERIES STRING HEATERS Section in Appendix)	
Maximum Heater-Cathode Voltage	
Total D C and Peak	200 Volts
D C, Heater Positive with Respect to Cathode	100 Volts

For other rating, operation, and application data, refer to corresponding Type 6AL5, which is identical except for heater ratings.

APPLICATION

The Sylvania Type 3A5 is intended for service in television receivers employing series connected heaters. For information on specially controlled heaters for series string operation refer to the SERIES STRING HEATERS section of the Appendix.

SYLVANIA TUBE TESTER SETTINGS

	A	B	C	D	E	F	G	Test or K
139/140	3.3	0	—	0	1	—	48	T
	3.3	0	—	0	3	—	48	T
219/220	3.3	3	14	21	4	X	2*	5
	3.3	3	45	21	4	X	7*	1

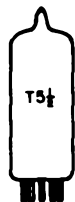

SYLVANIA TYPE 3AU6

SHARP CUTOFF R F PENTODE

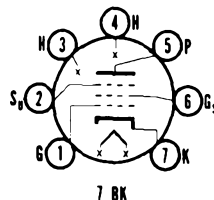

ELECTRICAL DATA

HEATER CHARACTERISTICS

Heater Voltage.....	3.15 Volts
Heater Current.....	600 Ma
Heater Warm-up Time (See SERIES STRING HEATERS Section in Appendix).....	
Maximum Heater-Cathode Voltage	
Total D C and Peak.....	200 Volts
D C, Heater Positive with Respect to Cathode.....	100 Volts

For other rating, operation, and application data, refer to corresponding Type 6AU6, which is identical except for heater ratings.

APPLICATION

The Sylvania Type 3AU6 is intended for service in television receivers employing series connected heaters. For information on specially controlled heaters for series string operation refer to the SERIES STRING HEATERS section of the Appendix.

SYLVANIA TUBE TESTER SETTINGS

	A	B	C	D	E	F	G	Test or K
139/140	3.3	0	—	0	4	36	33	W
219/220	3.3	3	4	21	4	16Y	5	7



SYLVANIA TYPE 3AV6

DUO DIODE TRIODE

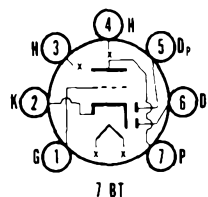

ELECTRICAL DATA

HEATER CHARACTERISTICS

Heater Voltage.....	3.15 Volts
Heater Current.....	600 Ma
Heater Warm-up Time (See SERIES STRING HEATERS Section in Appendix).....	
Maximum Heater-Cathode Voltage	
Total D C and Peak.....	200 Volts
D C, Heater Positive with Respect to Cathode.....	100 Volts

For other rating, operation, and application data, refer to corresponding Type 6AV6, which is identical except for heater ratings.

APPLICATION

The Sylvania Type 3AV6 is intended for service in television receivers employing series connected heaters. For information on specially controlled heaters for series string operation refer to the SERIES STRING HEATERS section of the Appendix.

3AV6 (Cont'd)

SYLVANIA TUBE TESTER SETTINGS

	A	B	C	D	E	F	G	Test or K
139/140	3.3	0	—	0	3	3	46	T
	3.3	0	—	0	4	—	51	T
	3.3	0	—	0	5	—	51	T
219/220	3.3	3	4	35	4	1T	7	2
	3.3	3	4	40	4	T	5*	2
	3.3	3	4	40	4	T	6*	2

TYPES 3B7/1291, 3BA6

(See Condensed Data Section)

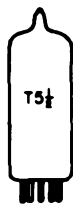

SYLVANIA TYPE 3BC5 SHARP CUTOFF R F PENTODE

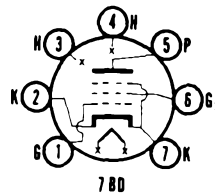

ELECTRICAL DATA

HEATER CHARACTERISTICS

Heater Voltage.....	3.15 Volts
Heater Current.....	600 Ma
Heater Warm-up Time (See SERIES STRING HEATERS Section in Appendix).....	
Maximum Heater-Cathode Voltage Total D C and Peak.....	200 Volts
D C, Heater Positive with Respect to Cathode.....	100 Volts

For other rating, operation, and application data, refer to corresponding Type 6BC5, which is identical except for heater ratings.

APPLICATION

The Sylvania Type 3BC5 is intended for service in television receivers employing series connected heaters. For information on specially controlled heaters for series string operation refer to the SERIES STRING HEATERS section of the Appendix.

SYLVANIA TUBE TESTER SETTINGS

	A	B	C	D	E	F	G	Test or K
139/140	3.3	0	4	0	4	36	70	T
219/220	3.3	3	47S	65	4	16Z	5	2
	3.3	3	24S	65	4	16Z	5	7



SYLVANIA TYPE 3B2
HV HALF-WAVE RECTIFIER.

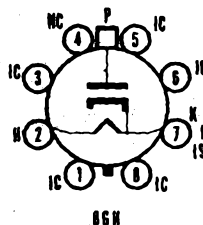

MECHANICAL DATA

Bulb.....	T-12
Base.....	B8-71, Short Jumbo Shell Octal, 8-Pin
Top Cap.....	C1-1, Small
Outline.....	See Drawing
Basing.....	86H
Cathode.....	Coated Unipotential
Mounting Position.....	Any

ELECTRICAL DATA

HEATER CHARACTERISTICS

Heater Voltage.....	3.15 Volts
Heater Current.....	220 Ma

DIRECT INTERELECTRODE CAPACITANCES (Approx.)

Plate to (h + k + I.S.).....	1.8 μ f
------------------------------	-------------

MAXIMUM RATINGS (Design Center Values—Except as Noted)

Pulsed Rectifier Service¹

Inverse Plate Voltage.....	35,000 Volts
Total DC and Peak (Absolute Max.).....	25,000 Volts
DC.....	80 Ma
Peak Plate Current.....	1.1 Ma
Average Plate Current.....	

CHARACTERISTICS

Tube Drop with DC Plate Current of 7 Ma.....	135 Volts
---	-----------

NOTES:

1. Pins 1, 3, 5 and 7 may be connected together. Pins 2, 6 and 8 may be connected together. Pin 4 may be connected to either pin 2 or pin 7, or may be used as a tie point for a heater dropping resistor. Do not use pin 4 as a low potential tie point.
2. For operation in a 525-line, 30-frame system as described in "Standards of Good Engineering Practice for Television Broadcast Stations; Federal Communications Commission."

APPLICATION

The Sylvania Type 3B2 is a half-wave, high voltage rectifier contained in a T-12 envelope. It is designed for application as a high voltage rectifier in color television receivers.

WARNING:

X-ray radiation shielding may be necessary to protect against possible danger of personal injury from prolonged exposure at close range if this tube is operated at higher than the manufacturer's Maximum Rated Anode Voltage or 16,000 volts, whichever is less.

3B2 (Cont'd)

AVERAGE PLATE CHARACTERISTICS

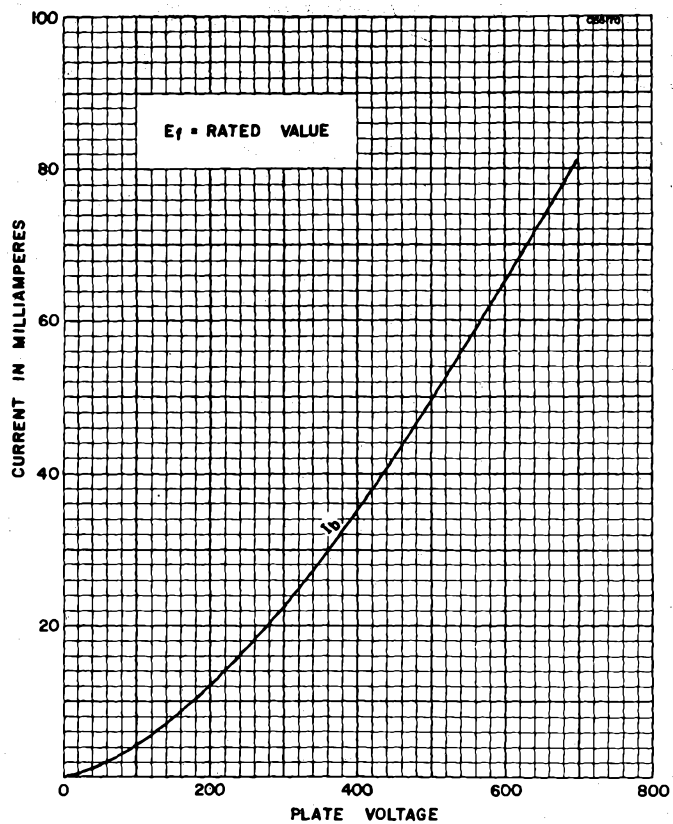

SYLVANIA ELECTRONIC TUBES

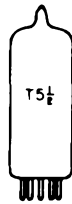

SYLVANIA TYPE 3BE6

HEPTODE CONVERTER

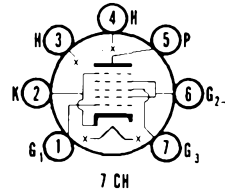

ELECTRICAL DATA

HEATER CHARACTERISTICS

Heater Voltage	3.15 Volts
Heater Current	600 Ma
Heater Warm-up Time (See SERIES STRING HEATERS Section in Appendix)	
Maximum Heater-Cathode Voltage	
Total D C and Peak	200 Volts
D C, Heater Positive with Respect to Cathode	100 Volts

For other rating, operation, and application data, refer to corresponding Type 6BE6, which is identical except for heater ratings.

APPLICATION

The Sylvania Type 3BE6 is intended for service in television receivers employing series connected heaters. For information on specially controlled heaters for series string operation refer to the SERIES STRING HEATERS section of the Appendix.

SYLVANIA TUBE TESTER SETTINGS

	A	B	C	D	E	F	G	Test or K
139/140	3.3	0	—	0	4	46	85	W
	3.3	0	—	0	5	3	35	U
219/220	3.3	3	4	13	4	067U	5	2
	3.3	3	4S	41	4	1X	6	2

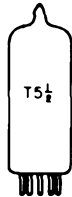

SYLVANIA TYPE 3BN6

GATED BEAM DISCRIMINATOR

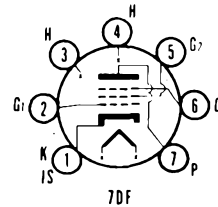

ELECTRICAL DATA

HEATER CHARACTERISTICS

Heater Voltage	3.15 Volts
Heater Current	600 Ma
Heater Warm-up Time (See SERIES STRING HEATERS Section in Appendix)	
Maximum Heater-Cathode Voltage	
Total D C and Peak	200 Volts
D C, Heater Positive with Respect to Cathode	100 Volts

For other rating, operation, and application data, refer to corresponding Type 6BN6, which is identical except for heater ratings.

APPLICATION

The Sylvania Type 3BN6 is intended for service in television receivers employing series connected heaters. For information on specially controlled heaters for series string operation refer to the SERIES STRING HEATERS section of the Appendix.

3BN6 (Cont'd)

SYLVANIA TUBE TESTER SETTINGS

	A	B	C	D	E	F	G	Test or K
139/140	3.3	0	—	0	3	25	47	V
	3.3	0	—	0	3	056	32	V
219/220	3.3	3	4	34	4	25U	7	1
	3.3	3	4	21	4	056U	7	1

TYPE 3BY6

(See Condensed Data Section)



SYLVANIA TYPE 3BZ6
SEMI-REMOTE CUTOFF PENTODE

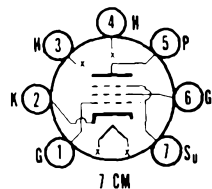

ELECTRICAL DATA

HEATER CHARACTERISTICS

Heater Voltage	3.15 Volts
Heater Current	600 Ma
Heater Warm-up Time (See SERIES STRING HEATERS Section in Appendix)	
Maximum Heater-Cathode Voltage	
Heater Negative with Respect to Cathode	
Total D C and Peak	300 Volts
Heater Positive with Respect to Cathode	
D C	100 Volts
Total D C and Peak	200 Volts

For other rating, operation, and application data, refer to corresponding Type 6BZ6, which is identical except for heater ratings.

APPLICATION

The Sylvania Type 3BZ6 is intended for service in television receivers employing series connected heaters. For information on specially controlled heaters for series string operation refer to the SERIES STRING HEATERS section of the Appendix.

SYLVANIA TUBE TESTER SETTINGS

	A	B	C	D	E	F	G	Test or K
139/140	3.3	0	—	0	4	36	50	W
219/220	3.3	3	4S	38	4	16Y	5	2

TYPE 3C6/XXB

(See Condensed Data Section)

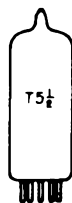

SYLVANIA TYPE 3CB6

SHARP CUTOFF R F PENTODE

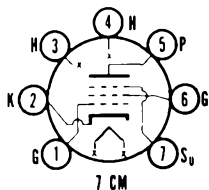

ELECTRICAL DATA

HEATER CHARACTERISTICS

Heater Voltage.....	3.15 Volts
Heater Current.....	600 Ma
Heater Warm-up Time (See SERIES STRING HEATERS Section in Appendix).....	
Maximum Heater-Cathode Voltage	
Heater Negative with Respect to Cathode	
Total D C and Peak.....	300 Volts
Heater Positive with Respect to Cathode	
D C.....	100 Volts
Total D C and Peak.....	200 Volts

For other rating, operation, and application data, refer to corresponding Type 6CB6, which is identical except for heater ratings.

APPLICATION

The Sylvania Type 3CB6 is intended for service in television receivers employing series connected heaters. For information on specially controlled heaters for series string operation refer to the SERIES STRING HEATERS section of the Appendix.

SYLVANIA TUBE TESTER SETTINGS

	A	B	C	D	E	F	G	Test or K
139/140	3.3	0	—	0	4	36	60	W
219/220	3.3	3	4S	26	4	167Y	5	2

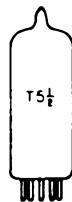

SYLVANIA TYPE 3CF6

SHARP CUTOFF PENTODE

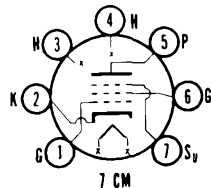

ELECTRICAL DATA

HEATER CHARACTERISTICS

Heater Voltage.....	3.15 Volts
Heater Current.....	600 Ma
Heater Warm-up Time (See SERIES STRING HEATERS Section in Appendix).....	
Maximum Heater-Cathode Voltage	
Heater Negative with Respect to Cathode	
Total D C and Peak.....	300 Volts
Heater Positive with Respect to Cathode	
D C.....	100 Volts
Total D C and Peak.....	200 Volts

For other rating, operation, and application data, refer to corresponding Type 6CF6, which is identical except for heater ratings.

3CF6 (Cont'd)

APPLICATION

The Sylvania Type 3CF6 is intended for service in television receivers employing series connected heaters. For information on specially controlled heaters for series string operation refer to the SERIES STRING HEATERS section of the Appendix.

SYLVANIA TUBE TESTER SETTINGS

	A	B	C	D	E	F	G	Test or K
139/140	3.3	0	---	0	4	36	60	W
219/220	3.3	3	4S	63	4	16Z	5	2



SYLVANIA TYPE 3CS6
DUAL CONTROL HEPTODE

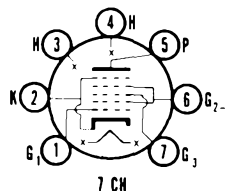

ELECTRICAL DATA

HEATER CHARACTERISTICS

Heater Voltage	3.15 Volts
Heater Current	600 Ma
Heater Warm-up Time (See SERIES STRING HEATERS Section in Appendix)	
Maximum Heater-Cathode Voltage	
Total D.C. and Peak	200 Volts
D.C., Heater Positive with Respect to Cathode	100 Volts

For other rating, operation, and application data, refer to corresponding Type 6CS6, which is identical except for heater ratings.

APPLICATION

The Sylvania Type 3CS6 is intended for service in television receivers employing series connected heaters. For information on specially controlled heaters for series string operation refer to the SERIES STRING HEATERS section of the Appendix.

TYPES 3D6, 3E5, 3E6, 3LE4, 3LF4

(See Condensed Data Section)



SYLVANIA TYPE 3Q4
BEAM POWER AMPLIFIER

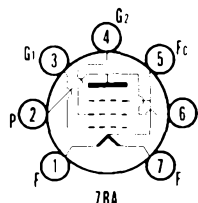

MECHANICAL DATA

Bulb	T-5 1/2, Outline 5-2
Base	Miniature Button 7-Pin
Basing	7BA
Mounting Position	Any

Note: With the exception of the base diagram given above, the Type 3Q4 is identical to Type 3V4.

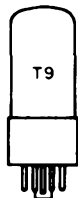

SYLVANIA TYPE 3Q5GT

BEAM POWER AMPLIFIER

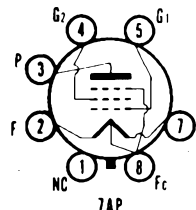

MECHANICAL DATA

Bulb.....	T-9, Outline 9-11
Base.....	Intermediate Octal 7-Pin
Basing.....	7AP
Mounting Position.....	Any

ELECTRICAL DATA

FILAMENT CHARACTERISTICS

	Series	Parallel
Filament Voltage D C.....	2.8	1.4 Volts
Filament Current.....	50	100 Ma
Filament Voltage D C (Abs. Max.).....	3.2	1.6 Volts

TYPICAL OPERATION

Class A Amplifier	Series ¹		Parallel ²	
Plate Voltage.....	90	110	85	90
Grid No. 2 Voltage.....	90	110	85	90
Grid No. 1 Voltage.....	-4.5	-6.6	-5.0	-4.5
Peak A F Signal Voltage.....	4.5	5.1	5.0	4.5
Plate Current.....	8.0	8.5	7.0	9.5
Grid No. 2 Current.....	1.0	1.1	0.8	1.3
Transconductance.....	2000	2000	1950	2200
Plate Resistance (approx.).....	80000	110000	70000	90000
Load Resistance.....	8000	8000	9000	8000
Power Output ³	230	330	250	270
Total Harmonic Distortion.....	8.5	8.5	5.5	6.0

NOTES:

1. A 270 ohm resistor should be connected between pins 7 and 8 to balance current in the two filament sections.
2. For parallel operation, connect pins 1 and 8 to the positive voltage and pin 7 to the negative.
3. Use of a peak signal voltage equal to the bias voltage gives power output of 400 Mw at 10% distortion for series connection and 500 Mw at 10% distortion for the parallel connection.

Sylvania Type 3V4 is recommended for use in new equipment.

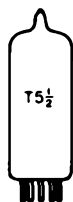

SYLVANIA TYPE 3S4

PENTODE POWER AMPLIFIER

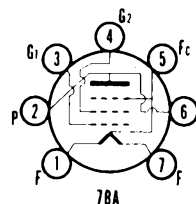

MECHANICAL DATA

Bulb.....	T-5 1/2, Outline 5-2
Base.....	Miniature Button 7-Pin
Basing.....	7BA
Mounting Position.....	Any

ELECTRICAL DATA

FILAMENT CHARACTERISTICS

	Series	Parallel ¹
Filament Voltage D C.....	2.8	1.4 Volts
Filament Current.....	50	100 Ma

MAXIMUM RATINGS (Design Center Values)

	Series	Parallel ¹
Plate Voltage.....	90	90 Volts
Screen Voltage.....	67.5	67.5 Volts
Cathode Current (Zero Signal) ²	6	12 Ma

3S4 (Cont'd)

CHARACTERISTICS AND TYPICAL OPERATION

Class A ₁ Amplifier	Series		Parallel	
	67.5	90	67.5	90
Plate Voltage	67.5	90	67.5	90
Grid No. 2 Voltage	67.5	67.5	67.5	67.5
Negative Grid Voltage	-7	-7	-7	-7
Peak Signal Voltage	7	7	7	7
Plate Current (Zero Signal)	6.0	6.1	7.2	7.4
Grid No. 2 Current (Zero Signal)	1.2	1.1	1.5	1.4
Transconductance	1400	1425	1550	1575
Load Resistance	5000	8000	5000	8000
Plate Resistance (approx.)	0.1	0.1	0.1	0.1
Total Harmonic Distortion	12	13	10	12
Maximum Signal Power Output	160	235	180	270

NOTES:

- For parallel operation, tie pins 1 and 7. Negative end of filament connected to pin No. 5.
- When series filament connections are used, a shunting resistor should be used across the negative filament section (pins 1 and 5) to limit cathode current to the value specified. If other tubes in a series filament string contribute to the filament current, another resistor should be connected between pins 1 and 7 to carry any excess current over the ratings.

APPLICATION

Sylvania Type 3S4 is a miniature power amplifier pentode designed for service in portable, battery operated equipment. The electrical characteristics of the 3S4 are similar to those of the 1S4. The Type 3S4, however, is designed for operation from either a 1.4 volt or 2.8 volt filament supply.

AVERAGE PLATE CHARACTERISTICS

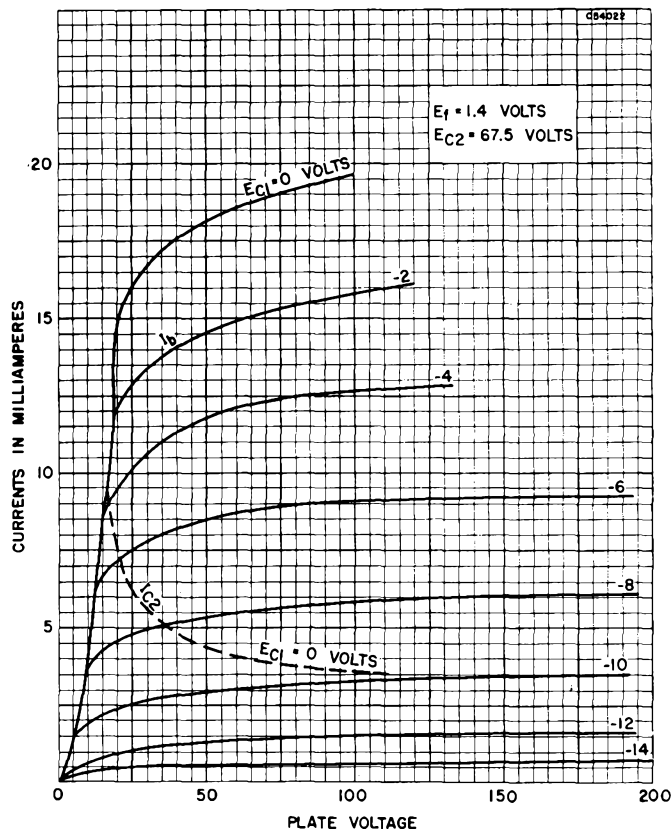

3S4 (Cont'd)

AVERAGE OPERATION CHARACTERISTICS

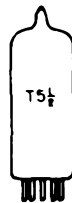
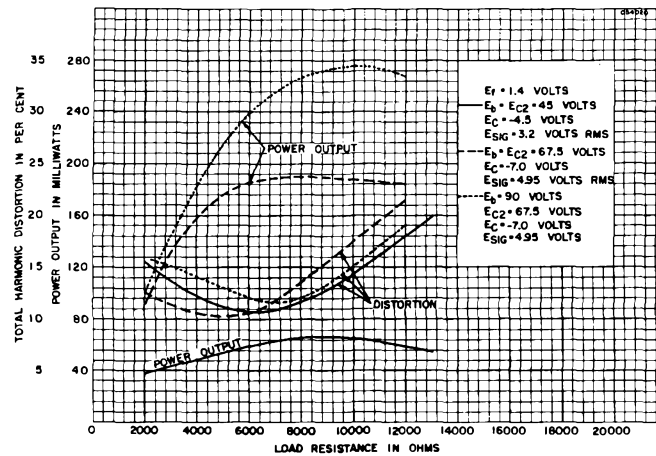

SYLVANIA TYPE 3V4 PENTODE POWER AMPLIFIER

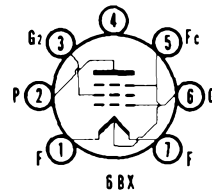

MECHANICAL DATA

Bulb.....	T-5 1/2, Outline 5-2
Base.....	Miniature Button 7-Pin
Basing.....	6B X
Mounting Position.....	Any

ELECTRICAL DATA

FILAMENT CHARACTERISTICS

	Series	Parallel
Filament Voltage D C.....	2.8	1.4 Volts
Filament Current.....	50	100 Ma

DIRECT INTERELECTRODE CAPACITANCES (Unshielded)

Grid No. 1 to Plate.....	0.20 μf Max.
Input.....	5.5 μf
Output.....	3.8 μf

MAXIMUM RATINGS (Design Center Values)

	Series	Parallel
Plate Voltage.....	90	90 Volts
Grid No. 2 Voltage.....	90	90 Volts
Cathode Current (Zero Signal).....	6	12 Ma

3V4 (Cont'd)

CHARACTERISTICS AND TYPICAL OPERATION

Class A ₁ Amplifier	Series	Parallel	
Plate Voltage	90	85	90 Volts
Grid No. 2 Voltage	90	85	90 Volts
Negative Grid Voltage	-4.5	-5	4.5 Volts
Peak Signal Voltage	4.5	5	4.5 Volts
Plate Current (Zero Signal)	7.7	6.9	9.5 Ma
Grid No. 2 Current (Zero Signal)	1.7	1.5	2.1 Ma
Transconductance	2000	1975	2150 μ mhos
Load Resistance	10000	10000	10000 Ohms
Total Harmonic Distortion	7	10	7 Percent
Maximum Signal Power Output	0.24	0.25	0.27 Watt

NOTE:

- When series filament connections are used a shunting resistor should be used across the negative filament section (pins 1 and 5) to limit cathode current to the value specified. If other tubes in a series filament string contribute to the filament current, another resistor should be connected between pins 1 and 7 to carry any excess current over the ratings.

APPLICATION

Sylvania Type 3V4 is a miniature power amplifier pentode designed for service in the output stage of portable equipment. The filament is center tapped to permit operation from a 1.4 volt or 2.8 volt source. Except for basing, the Type 3V4 is identical to the Type 3Q4.

SYLVANIA TUBE TESTER SETTINGS

	A	B	C	D	E	F	G	Test or K
139/140	2.5	2	45	4	1	016	45	U
219/220	2.5	1	57S	32	7	036X	2	

AVERAGE PLATE CHARACTERISTICS

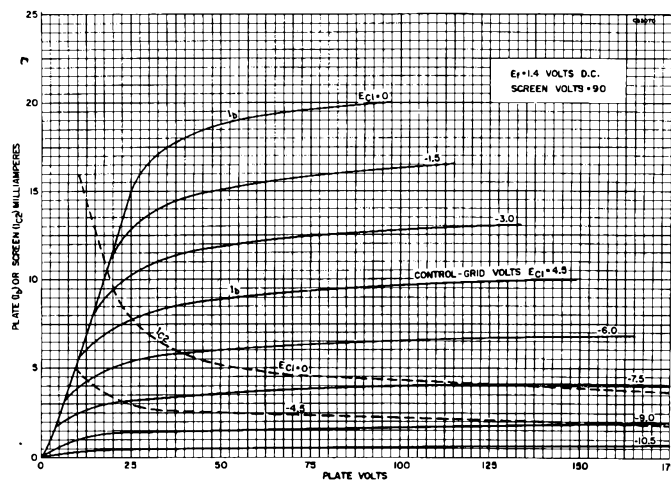

3V4 (Cont'd)

AVERAGE OPERATION CHARACTERISTICS

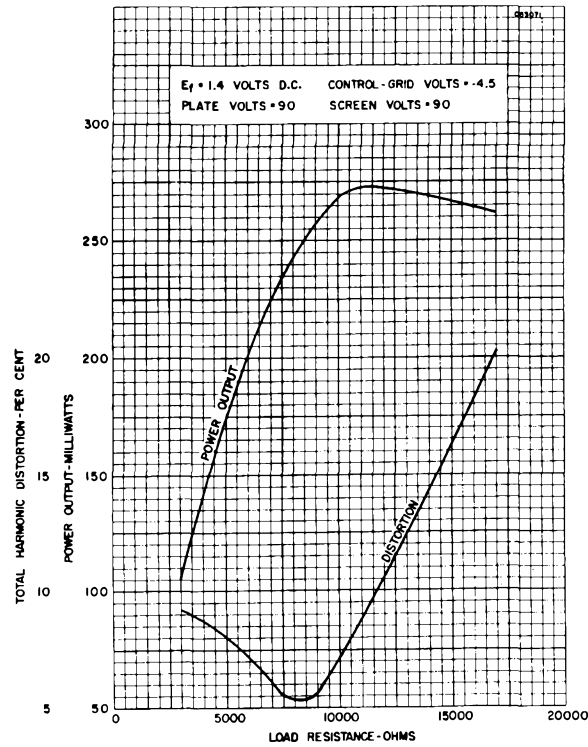

TYPE 4A6G

(See Condensed Data Section)

TYPE 4BC8—See 6BC8



SYLVANIA TYPE 4BQ7A
 MEDIUM-MU DUO TRIODE

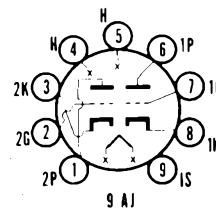

ELECTRICAL DATA

HEATER CHARACTERISTICS

Heater Voltage	4.2 Volts
Heater Current	600 Ma
Heater Warm-up Time (See SERIES STRING HEATERS Section in Appendix)	
Maximum Heater-Cathode Voltage	
Total D C and Peak	200 Volts
D C, Heater Positive with Respect to Cathode	100 Volts

For other rating, operation, and application data, refer to corresponding Type 6BQ7A, which is identical except for heater ratings.

4BQ7A (Cont'd)

APPLICATION

The Sylvania Type 4BQ7A is intended for service in television receivers employing series connected heaters. For information on specially controlled heaters for series string operation refer to the SERIES STRING HEATERS section of the Appendix.

SYLVANIA TUBE TESTER SETTINGS

	A	B	C	D	E	F	G	Test or K
139/140	5.0	0	—	0	1	3	17	W
	5.0	0	—	0	3	7	17	W
219/220	5.0	4	58	20	5	2X	1	3
	5.0	4	35	20	5	7X	6	8

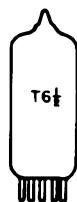

SYLVANIA TYPE 4BZ7
MEDIUM-MU DUO TRIODE

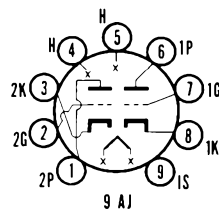

ELECTRICAL DATA

HEATER CHARACTERISTICS

Heater Voltage.....	4.2 Volts
Heater Current.....	600 Ma
Heater Warm-up Time (See SERIES STRING HEATERS Section in Appendix).....	
Maximum Heater-Cathode Voltage.....	
Total D C and Peak.....	200 Volts
D C, Heater Positive with Respect to Cathode.....	100 Volts

For other rating, operation, and application data, refer to corresponding Type 6BZ7, which is identical except for heater ratings.

APPLICATION

The Sylvania Type 4BZ7 is intended for service in television receivers employing series connected heaters. For information on specially controlled heaters for series string operation refer to the SERIES STRING HEATERS section of the Appendix.

SYLVANIA TUBE TESTER SETTINGS

	A	B	C	D	E	F	G	Test or K
139/140	5.0	0	—	0	1	3	31	U
	5.0	0	—	0	3	7	31	U
219/220	5.0	4	58	23	5	2X	1	3
	5.0	4	35	23	5	7X	6	8



SYLVANIA TYPE 5AM8

DIODE PENTODE

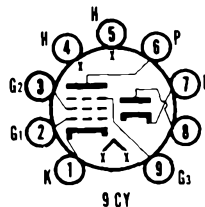

ELECTRICAL DATA

HEATER CHARACTERISTICS

Heater Voltage.....	4.7 Volts
Heater Current.....	600 Ma
Heater Warm-up Time (See SERIES STRING HEATERS Section in Appendix).....	
Maximum Heater-Cathode Voltage	
Total D C and Peak.....	200 Volts
D C, Heater Positive with Respect to Cathode.....	100 Volts

For other rating, operation, and application data, refer to corresponding Type 6AM8, which is identical except for heater ratings.

APPLICATION

The Sylvania Type 5AM8 is intended for service in television receivers employing series connected heaters. For information on specially controlled heaters for series string operation refer to the SERIES STRING HEATERS section of the Appendix.

SYLVANIA TUBE TESTER SETTINGS

	A	B	C	D	E	F	G	Test or K
139/140	5.0	0	—	0	3	36	75	W
	5.0	0	—	0	8	—	47	T
219/220	5.0	4	57S	77	5	23Z	6	1
	5.0	4	1S	3S	5	T	8*	7



SYLVANIA TYPE 5AN8

TRIODE PENTODE

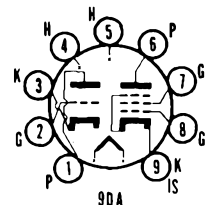

ELECTRICAL DATA

HEATER CHARACTERISTICS

Heater Voltage.....	4.7 Volts
Heater Current.....	600 Ma
Heater Warm-up Time (See SERIES STRING HEATERS Section in Appendix).....	
Maximum Heater-Cathode Voltage	
Total D C and Peak.....	200 Volts
D C, Heater Positive with Respect to Cathode.....	100 Volts

For other rating, operation, and application data, refer to corresponding Type 6AN8, which is identical except for heater ratings.

APPLICATION

The Sylvania Type 5AN8 is intended for service in television receivers employing series connected heaters. For information on specially controlled heaters for series string operation refer to the SERIES STRING HEATERS section of the Appendix.

SYLVANIA TUBE TESTER SETTINGS

	A	B	C	D	E	F	G	Test or K
139/140	5.0	0	—	0	1	3	27	W
	5.0	0	—	0	3	079	63	W
219/220	5.0	4	59S	25	5	2Y	1	3
	5.0	4	3S	80	5	078Z	6	9

4BQ7A (Cont'd)

APPLICATION

The Sylvania Type 4BQ7A is intended for service in television receivers employing series connected heaters. For information on specially controlled heaters for series string operation refer to the SERIES STRING HEATERS section of the Appendix.

SYLVANIA TUBE TESTER SETTINGS

	A	B	C	D	E	F	G	Test or K
139/140	5.0	0	—	0	1	3	17	W
	5.0	0	—	0	3	7	17	W
219/220	5.0	4	58	20	5	2X	1	3
	5.0	4	35	20	5	7X	6	8

A



SYLVANIA TYPE 5AQ5
BEAM POWER AMPLIFIER

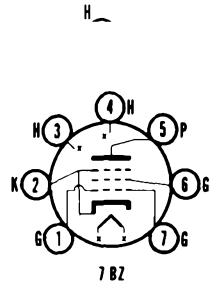

ELECTRICAL DATA

HEATER CHARACTERISTICS

Heater Voltage.....	4.7 Volts
Heater Current.....	600 Ma
Heater Warm-up Time (See SERIES STRING HEATERS Section in Appendix).....	
Maximum Heater-Cathode Voltage.....	200 Volts
Total D C and Peak.....	100 Volts
D C, Heater Positive with Respect to Cathode.....	

For other rating, operation, and application data, refer to corresponding Type 6AQ5, which is identical except for heater ratings.

APPLICATION

The Sylvania Type 5AQ5 is intended for service in television receivers employing series connected heaters. For information on specially controlled heaters for series string operation refer to the SERIES STRING HEATERS section of the Appendix.

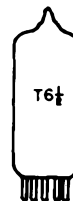

SYLVANIA TYPE 5AT8
TRIODE PENTODE

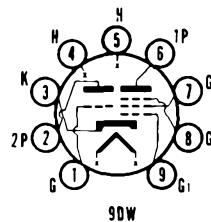

ELECTRICAL DATA

HEATER CHARACTERISTICS

Heater Voltage.....	4.7 Volts
Heater Current.....	600 Ma
Heater Warm-up Time (See SERIES STRING HEATERS Section in Appendix).....	
Maximum Heater-Cathode Voltage.....	200 Volts
Total D C and Peak.....	100 Volts
D C, Heater Positive with Respect to Cathode.....	

For other rating, operation, and application data, refer to corresponding Type 6AT8, which is identical except for heater ratings.

APPLICATION

The Sylvania Type 5AT8 is intended for service in television receivers employing series connected heaters. For information on specially controlled heaters for series string operation refer to the SERIES STRING HEATERS section of the Appendix.

TYPE 5AU4

(See Condensed Data Section)

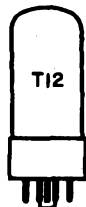

SYLVANIA TYPE 5AU4
FULL WAVE RECTIFIER

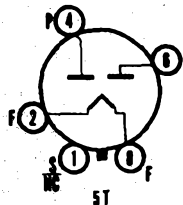

MECHANICAL DATA

Bulb.....	T-12
Base.....	BB-114, Short Medium Shell Octal 8-Pin
Outline.....	(Straight-Sided) 12-104
Basing.....	5T
Cathode.....	Coated Filament
Mounting Position.....	Vertical ¹

ELECTRICAL DATA

FILAMENT CHARACTERISTICS

Filament Voltage.....	5.0 Volts
Filament Current.....	3.75 Amperes

MAXIMUM RATINGS (Design Center Values)²

Rectifier Service³	
Peak Inverse Plate Voltage.....	1400 Volts
A C Plate Supply Voltage Each Plate, R M S (See Rating Chart I).....	500 Volts
Steady State Peak Plate Current Each Plate (See Rating Chart II).....	1.075 Amperes
Transient Peak Plate Current Each Plate ⁴ (See Rating Chart III).....	5.25 Amperes
D C Output Current.....	(See Rating Chart I)

AVERAGE CHARACTERISTICS

Tube Voltage Drop Tube Conducting 350 Ma Each Plate.....	50 Volts
---	----------

TYPICAL OPERATION

Full Wave Rectifier—Capacitor Input Filter		
A C Plate Supply Voltage Each Plate, R M S ⁵	300	400 Volts
Filter Input Capacitor.....	40	40 μ f
Effective Plate Supply Resistance Each Plate.....	30	50 Ohms
D C Output Current.....	350	325 Ma
D C Output Voltage at Filter Input.....	275	395 Volts
Full Wave Rectifier—Choke Input Filter		
A C Plate Supply Voltage Each Plate, R M S ⁵		500 Volts
Filter Input Choke.....		10 Henrys
D C Output Current.....		325 Ma
D C Output Voltage at Filter Input.....		395 Volts

NOTES:

- Horizontal operation is permitted if pins 2 and 4 are in a vertical plane.
- See "Interpretation of Rating Charts."
- For use with sinusoidal supply voltages within the frequency range of 25 to 1000 c p s.
- Maximum duration 0.2 second.
- A C plate voltage is measured without load.

APPLICATION

The Sylvania Type 5AU4 is a filamentary, full-wave, high vacuum rectifier designed for service in the power supply of television receivers or other equipment having high current requirements.

5AU4 (Cont'd)

RATING CHART I

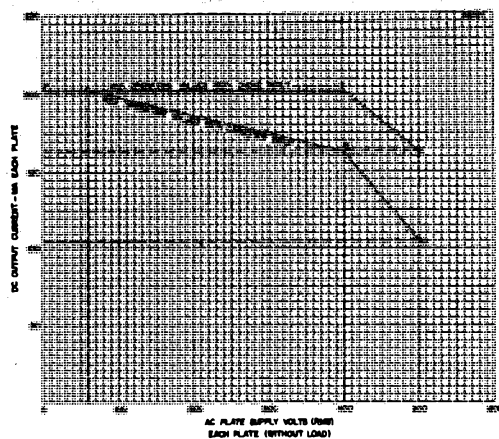

RATING CHART II

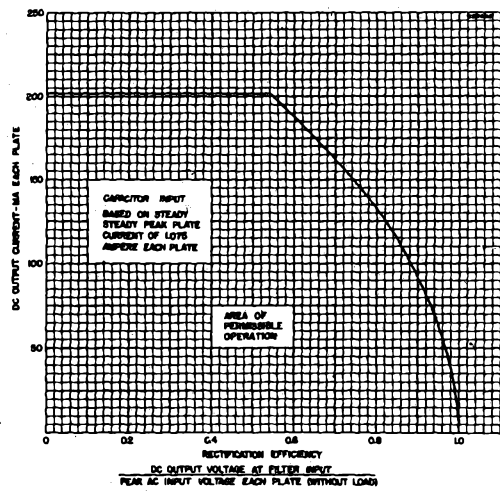

RATING CHART III

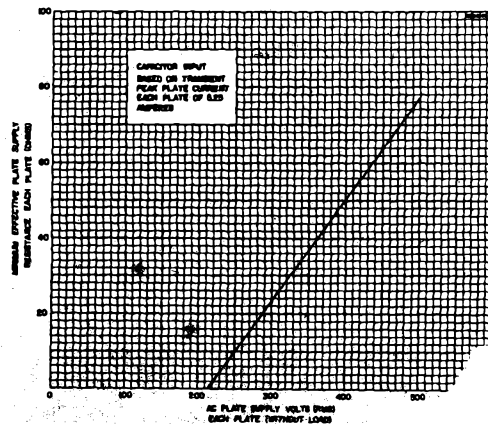

SYLVANIA ELECTRONIC TUBE

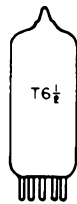

SYLVANIA TYPE 5AV8
TRIODE PENTODE

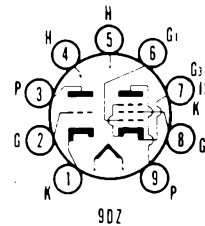

MECHANICAL DATA

Basing..... 9DZ

ELECTRICAL DATA

HEATER CHARACTERISTICS

Heater Voltage..... 4.7 Volts
 Heater Current..... 600 Ma
 Heater Warm-up Time (See SERIES STRING HEATERS
 Section in Appendix)
 Maximum Heater-Cathode Voltage
 Total D C and Peak..... 200 Volts
 D C, Heater Positive with Respect to Cathode..... 100 Volts

For other rating, operation, and application data, refer to corresponding Type 6AN8, which is identical except for heater ratings and basing.

APPLICATION

The Sylvania Type 5AV8 is intended for service in television receivers employing series connected heaters. For information on specially controlled heaters for series string operation refer to the SERIES STRING HEATERS section of the Appendix.

SYLVANIA TUBE TESTER SETTINGS

	A	B	C	D	E	F	G	Test or K
139/140	5.0	0	2	0	4	49	58	W
	5.0	0	7	0	5	3	42	U
219/220	5.0	4	15S	65	5	68Z	9	7
	5.0	4	57	32	5	2X	3	1

TYPES 5AW4, 5AX4GT, 5AZ4

(See Condensed Data Section)



SYLVANIA TYPE 5B8
TRIODE PENTODE

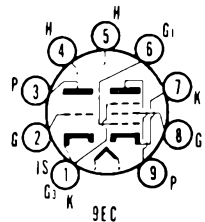

MECHANICAL DATA

Bulb..... T-6 1/2, Outline 6-2
 Base..... Small Button 9-Pin
 Basing..... 9EC
 Mounting Position..... Any

ELECTRICAL DATA

HEATER CHARACTERISTICS

Heater Voltage..... 4.7 Volts
 Heater Current..... 600 Ma
 Heater Warm-up Time (See SERIES STRING HEATERS
 Section in Appendix)
 Maximum Heater-Cathode Voltage
 Total D C and Peak..... 200 Volts
 D C, Heater Positive with Respect to Cathode..... 100 Volts

5B8 (Cont'd)

DIRECT INTERELECTRODE CAPACITANCES (Unshielded)

Triode Section

Grid to Plate.....	1.7 μf
Grid to (k+I.S. +h and Pentode g3).....	1.9 μf
Plate to (k+I.S. +h and Pentode g3).....	1.4 μf

Pentode Section

Grid No. 1 to Plate.....	.05 μf Max.
Grid No. 1 to (k+g2+h).....	6.0 μf
Plate to (k+g2+g3+I.S. +h and Triode k).....	2.6 μf
Plate to (k+g2+h).....	.15 μf

Coupling

Triode Grid to Pentode Plate.....	.0078 μf
Pentode Grid No. 1 to Triode Plate.....	.0033 μf
Triode Plate to Pentode Plate.....	.060 μf

MAXIMUM RATINGS AND CHARACTERISTICS

Refer to corresponding Type 6AN8 which is identical except for basing, heater characteristics and direct interelectrode capacitances.

APPLICATION

The Sylvania Type 5B8 is intended for service in television receivers employing series connected heaters. For information on specially controlled heaters for series string operation refer to the SERIES STRING HEATERS section of the Appendix.

TYPE 5BE8—See 6BE8

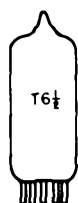

SYLVANIA TYPE 5BK7A
MEDIUM-MU DUO TRIODE

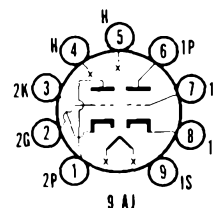

ELECTRICAL DATA

HEATER CHARACTERISTICS

Heater Voltage.....	4.7 Volts
Heater Current.....	600 Ma
Heater Warm-up Time (See SERIES STRING HEATERS Section in Appendix).....	
Maximum Heater-Cathode Voltage.....	
Total D C and Peak.....	200 Volts
D C, Heater Positive with Respect to Cathode.....	100 Volts

For other rating, operation, and application data, refer to corresponding Type 6BK7A, which is identical except for heater ratings.

APPLICATION

The Sylvania Type 5BK7A is intended for service in television receivers employing series connected heaters. For information on specially controlled heaters for series string operation refer to the SERIES STRING HEATERS section of the Appendix.

SYLVANIA TUBE TESTER SETTINGS

	A	B	C	D	E	F	G	Test or K
139/140	5.0	0	—	0	1	3	17	W
	5.0	0	—	0	3	7	17	W
219/220	5.0	4	58	25	5	2X	1	3
	5.0	4	35	25	5	7X	6	8



SYLVANIA TYPE 5J6

MEDIUM-MU DUO TRIODE

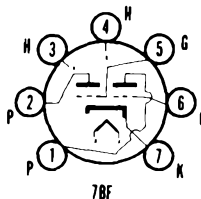

ELECTRICAL DATA

HEATER CHARACTERISTICS

Heater Voltage.....	4.7 Volts
Heater Current.....	600 Ma
Heater Warm-up Time (See SERIES STRING HEATERS Section in Appendix).....	
Maximum Heater-Cathode Voltage.....	200 Volts
Total D C and Peak.....	100 Volts
D C, Heater Positive with Respect to Cathode.....	

For other rating, operation, and application data, refer to corresponding Type 6J6, which is identical except for heater ratings.

APPLICATION

The Sylvania Type 5J6 is intended for service in television receivers employing series connected heaters. For information on specially controlled heaters for series string operation refer to the SERIES STRING HEATERS section of the Appendix.

SYLVANIA TUBE TESTER SETTINGS

	A	B	C	D	E	F	G	Test or K
139/140	5.0	0	—	0	2	6	37	U
	5.0	0	---	0	1	5	37	U
219/220	5.0	3	4S	41	4	6X	1	7
	5.0	3	4S	41	4	5X	2	7

TYPE 5T4

(See Condensed Data Section)

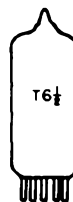

SYLVANIA TYPE 5T8

TRIPLE DIODE TRIODE

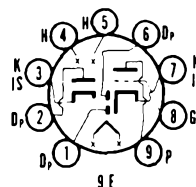

ELECTRICAL DATA

HEATER CHARACTERISTICS

Heater Voltage.....	4.7 Volts
Heater Current.....	600 Ma
Heater Warm-up Time (See SERIES STRING HEATERS Section in Appendix).....	
Maximum Heater-Cathode Voltage.....	200 Volts
Total D C and Peak.....	100 Volts
D C, Heater Positive with Respect to Cathode.....	

For other rating, operation, and application data, refer to corresponding Type 6T8, which is identical except for heater ratings.

APPLICATION

The Sylvania Type 5T8 is intended for service in television receivers employing series connected heaters. For information on specially controlled heaters for series string operation refer to the SERIES STRING HEATERS section of the Appendix.

5T8 (Cont'd)

SYLVANIA TUBE TESTER SETTINGS

	A	B	C	D	E	F	G	Test or K
139/140	5.0	0	—	0	4	9	50	T
	5.0	0	—	0	3	—	50	T
	5.0	0	—	0	2	—	50	T
	5.0	0	—	0	1	—	50	T
219/220	5.0	4	53	35	5	8T	9	7
	5.0	4	53	35	5	T	1*	7
	5.0	4	57	35	5	T	2*	3
	5.0	4	53	35	5	T	6*	7



TYPE 5U4G
5U4GB

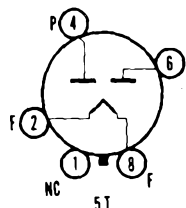

MECHANICAL DATA

	5U4G	5U4GB
Bulb.....	ST16, T-11 or T-12, Outline 16-3	T-12, Outline 12-104
Base.....	Medium Shell Octal 5-Pin Short Medium Shell Octal 5-Pin Flared Medium Shell Octal 5-Pin	Short Medium Shell Octal 5-Pin or Flared Medium Shell Octal 5-Pin or Short Medium Shell Octal 8-Pin
Basing.....	5T	5T
Mounting Position ¹	Vertical	Vertical

ELECTRICAL DATA

FILAMENT CHARACTERISTICS

Filament Voltage.....	5.0 Volts
Filament Current.....	3.0 Amperes

MAXIMUM RATINGS (Design Center Values)²

Rectifier Service³

	5U4G	5U4GB
Peak Inverse Plate Voltage.....	1550	1550 Volts
AC Plate Supply Voltage Each Plate (R.M.S.).....	(See Chart I)	(See Chart IA)
D C Output Current Each Plate.....	(See Chart I)	(See Chart IA)
Steady State Peak Plate Current Each Plate (See Rating Chart II).....	0.8	1.0 Amperes
Transient Peak Plate Current Each Plate (See Rating Chart III).....	4.0	4.6 Amperes

CHARACTERISTICS

Tube Voltage Drop		
Tube Conducting: 225 Ma Each Plate.....	44	44 Volts
275 Ma Each Plate.....		50 Volts
300 Ma Each Plate.....		54 Volts

TYPICAL OPERATION

Full-Wave Rectifier—Capacitor Input Filter

	5U4G		5U4GB	
A C Plate Supply Voltage				
Each Plate (R.M.S.) ⁴	300	450	300	450 Volts
Filter Input Capacitor.....	40	40	40	40 μ f
Effective Plate Supply				
Resistance Each Plate.....	35	85	21	67 Ohms
D C Output Current.....	245	225	300	275 Ma
D C Output Voltage at Filter Input.....	290	470	290	460 Volts

Full-Wave Rectifier—Choke Input Filter

A C Plate Supply Voltage				
Each Plate (R.M.S.) ⁴		550		550 Volts
Filter Input Choke.....		10		10 Henrys
D C Output Current.....		225		275 Ma
D C Output Voltage at Filter Input.....		440		420 Volts

5U4G, 5U4GB (Cont'd)

NOTES:

1. Horizontal operation is permitted if Pins 1 and 4 are in a vertical plane.
2. See Rating Charts which represent boundary conditions of operation, operation beyond the boundaries is not permitted.
3. For use with sinusoidal supply voltages within the frequency range of 25 to 1000 cps.
4. A C plate voltage is measured without load.

SYLVANIA TUBE TESTER SETTINGS

	A	B	C	D	E	F	G	Test or K
139/140	5.0	6	—	0	2	—	20	Y
	5.0	6	—	0	5	—	20	Y
219/220	5.0	2	8	12	8	Z	4*	—
	5.0	2	8	12	8	Z	6*	—

* Diode gas test does not apply.

RATING CHART I

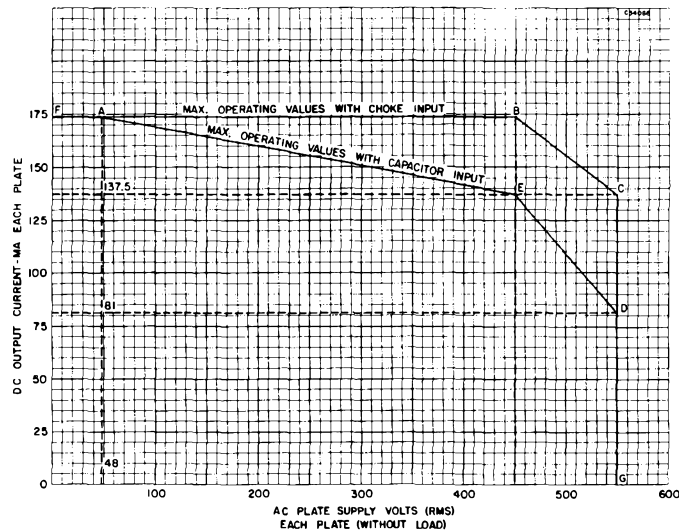

5U4G, 5U4GB (Cont'd)

RATING CHART 1A

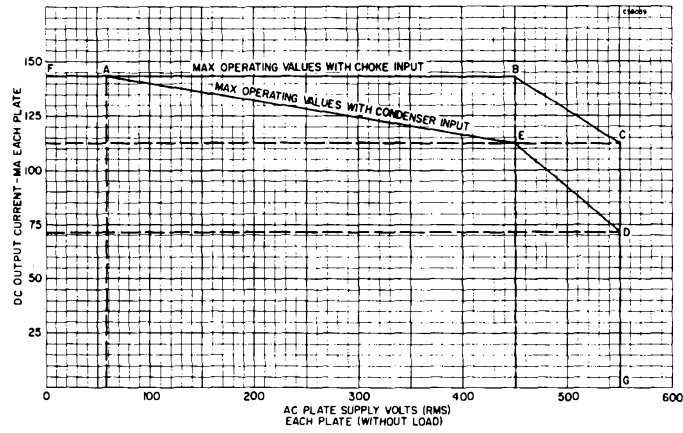

RATING CHART II

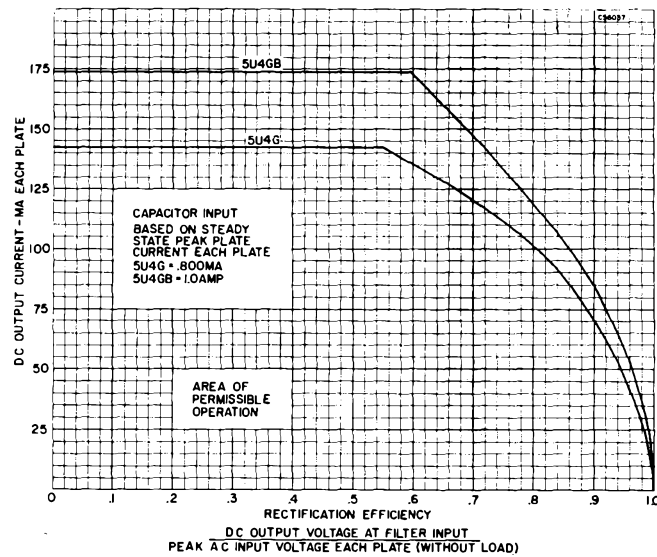

5U4G, 5U4GB (Cont'd)

RATING CHART III

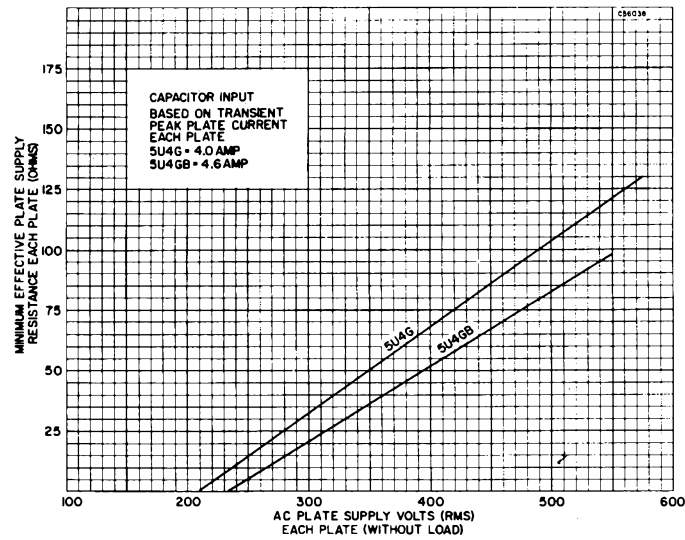

TYPE 5U4GA

(See Condensed Data Section)

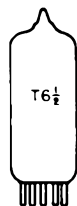

SYLVANIA TYPE 5U8

TRIODE PENTODE

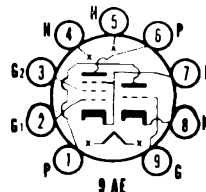

ELECTRICAL DATA

HEATER CHARACTERISTICS

Heater Voltage.....	4.7 Volts
Heater Current.....	600 Ma
Heater Warm-up Time (See SERIES STRING HEATERS Section in Appendix).....	
Maximum Heater-Cathode Voltage Total D C and Peak.....	200 Volts
D C, Heater Positive with Respect to Cathode.....	100 Volts

For other rating, operation, and application data, refer to corresponding Type 6U8, which is identical except for heater ratings.

APPLICATION

The Sylvania Type 5U8 is intended for service in television receivers employing series connected heaters. For information on specially controlled heaters for series string operation refer to the SERIES STRING HEATERS section of the Appendix.



SYLVANIA TYPE 5V4G

FULL-WAVE RECTIFIER

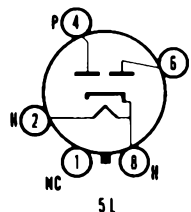

MECHANICAL DATA

Bulb.....	ST-14, Outline 14-3
Base.....	Medium Octal 5-Pin
Basing.....	5L
Mounting Position.....	Any

ELECTRICAL DATA

HEATER CHARACTERISTICS

Heater Voltage.....	5.0 Volts
Heater Current.....	2.0 Amperes

MAXIMUM RATINGS (Design Center Values)

Peak Inverse Plate Voltage.....	1400 Volts
Peak Plate Current Each Plate.....	525 Ma
Tube Voltage Drop at 175 Ma Each Plate.....	25 Volts

CHARACTERISTICS AND TYPICAL OPERATION

Full-Wave Rectifier—Capacitor Input to Filter

A C Plate Voltage Each Plate (R M S).....	375 Volts	Max
D C Output Current.....	175 Ma	Max
Effective Plate Supply Impedance Per Plate.....	100 Ohms	Min

Choke Input to Filter

A C Voltage Per Plate (R M S).....	500 Volts	Max
D C Output Current.....	175 Ma	Max
Input Choke Value.....	4.0 Henrys	Min

APPLICATION

Sylvania Type 5V4G is a cathode type high vacuum rectifier designed for full-wave applications. It is identical to the 83V except that an octal base is used. The cathode is connected internally to the heater.

SYLVANIA TUBE TESTER SETTINGS

	A	B	C	D	E	F	G	Test or K
139/140	5.0	6	—	0	2	—	20	Y
	5.0	6	—	0	5	—	20	Y
219/220	5.0	2	8	11	8	Z	4*	—
	5.0	2	8	11	8	Z	6*	—

* Diode gas test does not apply.

5V4G (Cont'd)

AVERAGE OPERATING CONDITIONS CAPACITOR INPUT TO FILTER

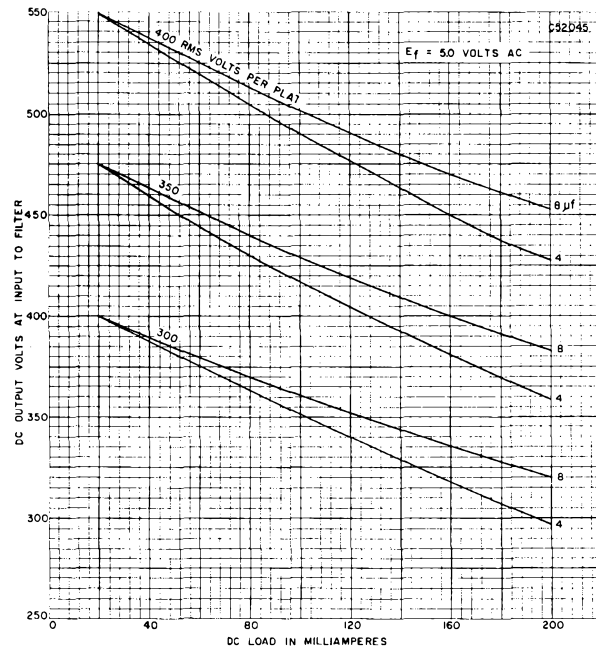

AVERAGE OPERATING CONDITIONS CHOKE INPUT TO FILTER

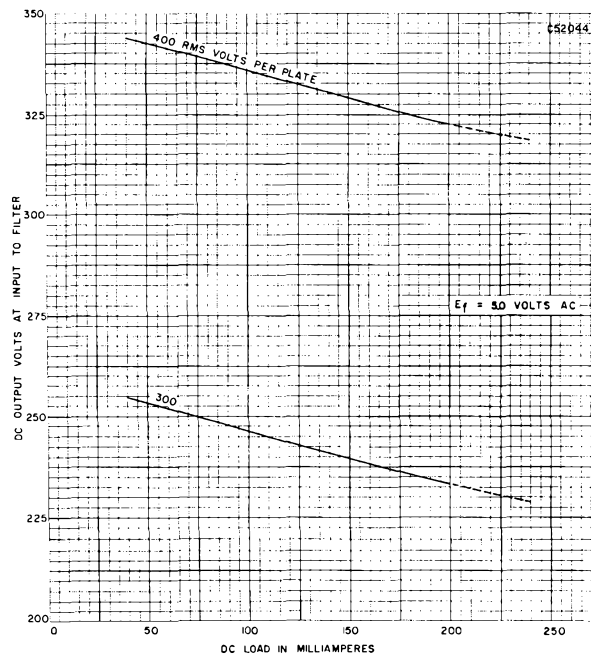

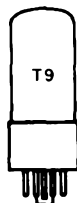

SYLVANIA TYPE 5V6GT

BEAM POWER AMPLIFIER

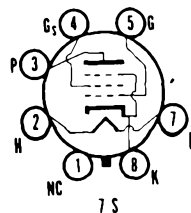

ELECTRICAL DATA

HEATER CHARACTERISTICS

Heater Voltage.....	4.7 Volts
Heater Current.....	600 Ma
Heater Warm-up Time (See SERIES STRING HEATERS Section in Appendix).....	
Maximum Heater-Cathode Voltage	
Total D C and Peak.....	200 Volts
D C, Heater Positive with Respect to Cathode.....	100 Volts

For other rating, operation, and application data, refer to corresponding Type 6V6GT, which is identical except for heater ratings.

APPLICATION

The Sylvania Type 5V6GT is intended for service in television receivers employing series connected heaters. For information on specially controlled heaters for series string operation refer to the SERIES STRING HEATERS section of the Appendix.

TYPES 5W4, G, GT, 5X3, 5X4G

(See Condensed Data Section)

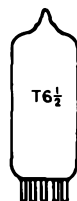

SYLVANIA TYPE 5X8

TRIODE PENTODE

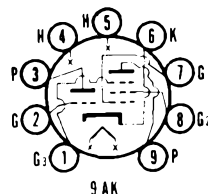

ELECTRICAL DATA

HEATER CHARACTERISTICS

Heater Voltage.....	4.7 Volts
Heater Current.....	600 Ma
Heater Warm-up Time (See SERIES STRING HEATERS Section in Appendix).....	
Maximum Heater-Cathode Voltage	
Total D C and Peak.....	200 Volts
D C, Heater Positive with Respect to Cathode.....	100 Volts

For other rating, operation, and application data, refer to corresponding Type 6X8, which is identical except for heater ratings.

APPLICATION

The Sylvania Type 5X8 is intended for service in television receivers employing series connected heaters. For information on specially controlled heaters for series string operation refer to the SERIES STRING HEATERS section of the Appendix.

SYLVANIA TUBE TESTER SETTINGS

	A	B	C	D	E	F	G	Test or K
139/140	5.0	0	—	0	4	0279	62	V
	5.0	0	—	0	5	3	44	U
219/220	5.0	4	5S	38	5	78Y	9	6
	5.0	4	5S	44	5	2X	3	6



SYLVANIA TYPE 5V3 FULL-WAVE RECTIFIER

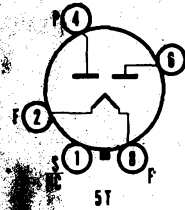

MECHANICAL DATA

Bulb	T-12
Base	BB-118, Short Medium Shell Octal 8-Pin
Outline	12-104
Basing	5T
Cathode	Coated Filament
Mounting Position	Vertical ¹

ELECTRICAL DATA

FILAMENT CHARACTERISTICS

Filament Voltage, A C or D C	5.0 Volts
Filament Current	3.8 Amperes

RATINGS (Design Center Values)²

Rectifier Service³

Peak Inverse Plate Voltage	1400 Volts Max.
A C Plate Supply Voltage Each Plate, R M S (See Rating Chart I)	500 Volts Max.
Steady State Peak Plate Current Each Plate (See Rating Chart II)	1.2 Amperes Max.
Transient Peak Plate Current Each Plate (See Rating Chart III)	5.5 Amperes Max.
D C Output Current	(See Rating Chart I)

AVERAGE CHARACTERISTICS

Tube Voltage Drop Tube Conducting 350 Ma Each Plate	47 Volts
--	----------

TYPICAL OPERATION

Full Wave Rectifier—Capacitor Input Filter

A C Plate Supply Voltage Each Plate, R M S ⁴	300	425 Volts
Filter Input Capacitor	40	40 μ f
Effective Plate Supply Resistance Each Plate	24	56 Ohms
D C Output Current	380	350 Ma
D C Output Voltage at Filter Input	285	430 Volts

Full Wave Rectifier—Choke Input Filter

A C Plate Supply Voltage Each Plate, R M S ⁴	500 Volts
Filter Input Choke	10 Henrys
D C Output Current	350 Ma
D C Output Voltage at Filter Input	385 Volts

NOTES:

- Horizontal operation is permitted if pins 2 and 4 are in a vertical plane.
- See "Interpretation of Rating Charts."
- For use with sinusoidal supply voltages within the frequency range of 25 to 1000 cps.
- A C plate voltage is measured without load.

APPLICATION

The Sylvania Type 5V3 is a filamentary, full-wave, high vacuum rectifier designed for service in the power supply of color television receivers or other equipment requiring high current.

SYLVANIA TYPE 5V3 (Cont'd)

RATING CHART I

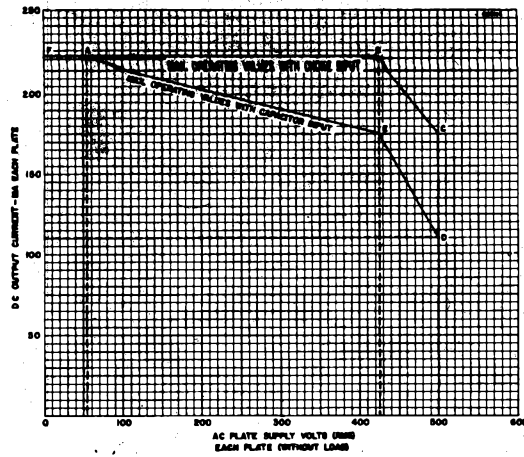

RATING CHART II

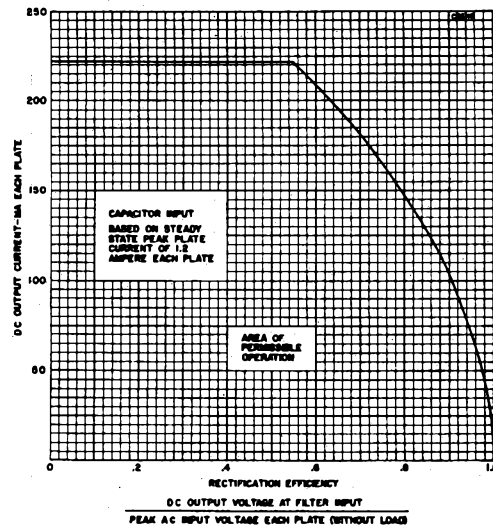

RATING CHART III

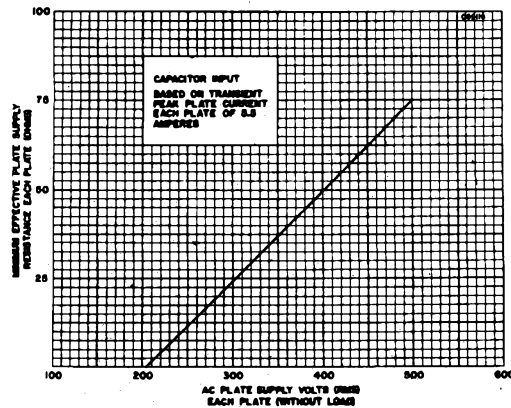

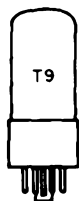

SYLVANIA TYPE 5Y3G
5Y3GT

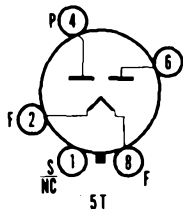

SYLVANIA TYPE 5Y4G
FULL-WAVE RECTIFIER

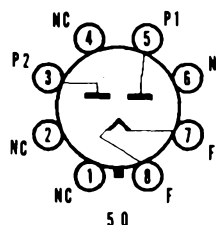

MECHANICAL DATA

	5Y3G	5Y3GT	5Y4G
Bulb.....	ST-14	T-9	ST-14
Outline.....	14-3	9-13	14-3
Base.....	Medium Octal 5-Pin	Intermediate Octal 5-Pin	Medium Octal 8-Pin
Basing.....	5T	5T	5Q
Mounting Position ¹	Vertical	Vertical	Vertical

ELECTRICAL DATA

FILAMENT CHARACTERISTICS

Filament Voltage.....	5.0 Volts
Filament Current.....	2.0 Amperes

MAXIMUM RATINGS (Design Center Values)

Peak Inverse Plate Voltage.....	1400 Volts
A C Plate Supply Voltage Each Plate.....	See Rating Chart
Steady State Peak Plate Current Each Plate.....	400 Ma
Transient Peak Plate Current Each Plate.....	2.2 Amperes
Steady State D C Output Current Each Plate.....	See Rating Chart
Tube Voltage Drop (Measured with Tube Conducting 125 Ma Each Plate).....	60 Volts

TYPICAL OPERATION

Full-Wave Rectifier Service

	Capacitor Input	Choke Input
A C Plate Supply Voltage Each Plate (R M S).....	350	500 Volts
Input Capacitor.....	10	μ f
Input Choke.....	50	10 Henries
Effective Plate Supply Impedance Each Plate.....	50	Ohms
D C Output Current.....	125	125 Ma
D C Output Voltage.....	350	390 Volts

NOTE:

- Horizontal operation permitted if pins 2 and 4 are in a vertical plane for basing 5T and pins 1 and 4 for basing 5Q.

APPLICATION

Sylvania Types 5Y3G, 5Y3GT and 5Y4G are identical except for bulb and basings; they are similar to Type 80.

SYLVANIA TUBE TESTER SETTINGS

	A	B	C	D	E	F	G	Test or K
139/140	5.0	6	—	0	2	—	22	Y
	5.0	6	—	0	5	—	22	Y
219/220	5.0	2	8	14	8	Z	4*	—
	5.0	2	8	14	8	Z	6*	—

* Diode gas test does not apply.

5Y3G, 5Y3GT, 5Y4G (Cont'd)

RATING CHART

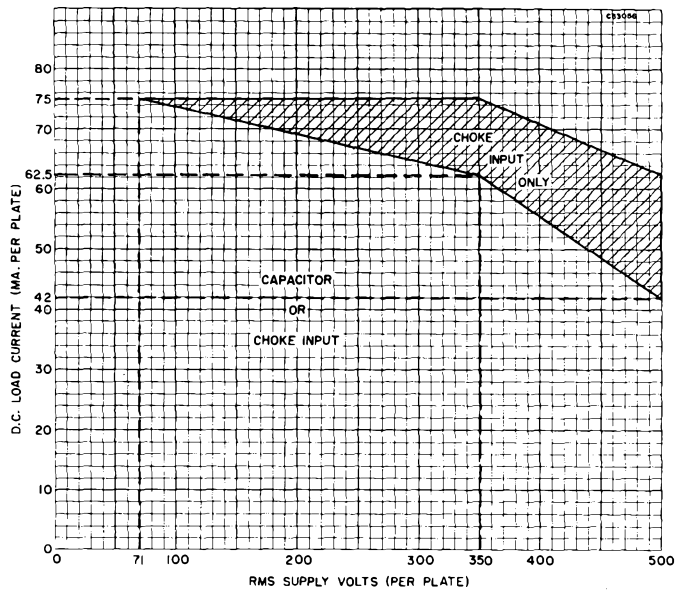

AVERAGE OPERATING CHARACTERISTICS

CAPACITOR INPUT TO FILTER

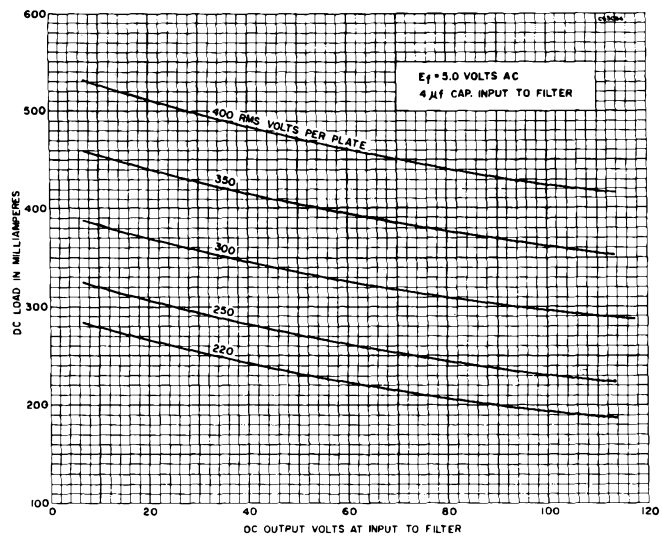

5Y3G, 5Y3GT, 5Y4G (Cont'd)

AVERAGE OPERATING CHARACTERISTICS CHOKE INPUT TO FILTER

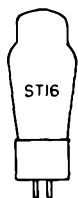
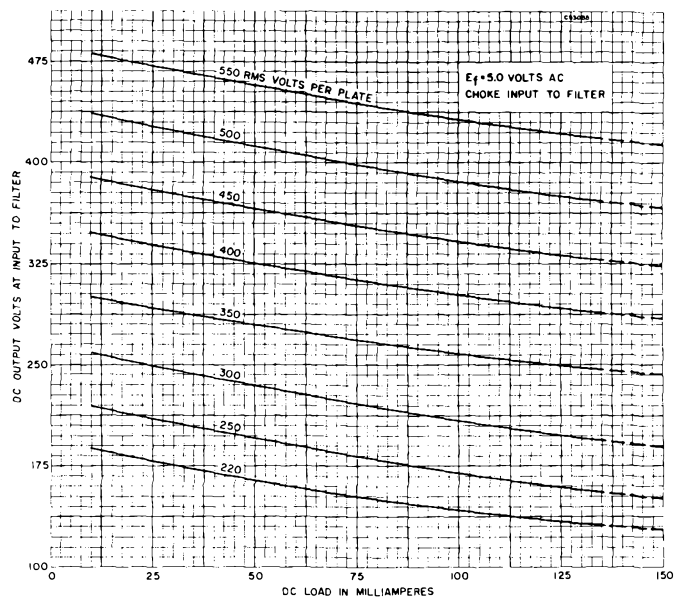

SYLVANIA TYPE 5Z3
FULL-WAVE RECTIFIER

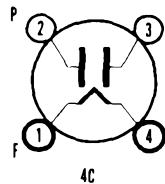

MECHANICAL DATA

Bulb	ST-16, Outline 16-1
Base	Medium 4-Pin
Basing	4C
Mounting Position	Vertical ¹

NOTE:

- Horizontal operation permitted if pins 1 and 2 are in a vertical plane.

For further data on Type 5Z3, refer to corresponding Type 5U4G which is identical except for basing.

TYPES **5Z4, 6A3, 6A4,**
6A5G, 6A6, 6A7S

(See Condensed Data Section)



SYLVANIA TYPE 6A7

HEPTODE CONVERTER

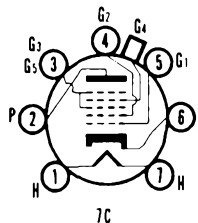

MECHANICAL DATA

Bulb.....	ST-12, Outline 12-6
Base.....	Small 7-Pin
Basing.....	7C
Top Cap.....	Small
Mounting Position.....	Any

For typical operation refer to Type 6A8 which is electrically identical.

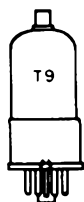

SYLVANIA TYPE 6A8

6A8G

6A8GT

HEPTODE CONVERTER

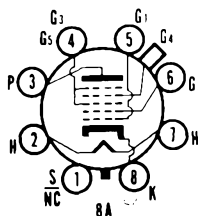

MECHANICAL DATA

	6A8	6A8G	6A8GT
Bulb.....	Metal	ST-12	T-9
Outline.....	8-4	12-8	9-18
Base.....	Small Wafer	Small Octal	Small Wafer
	Octal		Octal
Basing.....	8A	8A	8A
Top Cap.....	Miniature	Miniature	Miniature
Mounting Position.....	Any	Any	Any

ELECTRICAL DATA

HEATER CHARACTERISTICS

Heater Voltage.....	6.3 Volts
Heater Current.....	300 Ma
Maximum Heater-Cathode Voltage.....	90 Volts

TYPICAL OPERATION

Plate Voltage.....	100	250 Volts
Grid No. 3 and 5 Voltage (Screen Grid).....	50	100 Volts
Grid No. 4 Voltage.....	-1.5	-3.0 Volts
Grid No. 1 Resistance.....	50000	50000 Ohms
Grid No. 2 Voltage (Anode Grid).....	100	250 ¹ Volts
Plate Current.....	1.1	3.5 Ma
Grid No. 3 and 5 Current.....	1.3	2.7 Ma
Grid No. 2 Current.....	2.0	4.0 Ma
Grid No. 1 Current (Osc. Grid).....	0.25	0.4 Ma
Conversion Transconductance.....	360	550 μ mhos
Self Bias Resistor.....	300	300 Ohms
Plate Resistance.....	0.6	0.36 Megohm
Signal Grid Bias for $g_m = 3 \mu$ mhos (Grid No. 4).....	-20	Volts
$g_m = 6 \mu$ mhos.....		-35 Volts

NOTE:

1: Through a 20,000 ohm resistor.

Type 6A7 is identical in ratings and operating conditions to Type 6A8G/GT.



SYLVANIA TYPE 6AB4
R F TRIODE

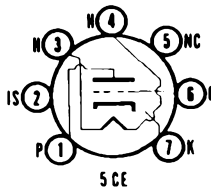

MECHANICAL DATA

Bulb	T-5 1/2, Outline 5-2
Base	Miniature Button 7-Pin
Basing	5CE
Mounting Position	Any

ELECTRICAL DATA

HEATER CHARACTERISTICS

Heater Voltage	6.3 Volts
Heater Current	150 Ma
Maximum Heater-Cathode Voltage	90 Volts

DIRECT INTERELECTRODE CAPACITANCES

	Shielded ¹	Unshielded
Grid to Plate	1.5	1.5 $\mu\mu\text{f}$
Input	2.2	2.2 $\mu\mu\text{f}$
Output	1.4	0.50 $\mu\mu\text{f}$
Grounded Grid Operation		
Plate to Cathode	0.20	0.24 $\mu\mu\text{f}$
Input	5.2	5.0 $\mu\mu\text{f}$
Output	2.6	1.7 $\mu\mu\text{f}$

MAXIMUM RATINGS (Design Center Values)

Plate Voltage	300 Volts
Plate Dissipation	2.5 Watts
Negative Control Grid Voltage D C	-50 Volts

TYPICAL OPERATION

Class A₁ Amplifier

Plate Voltage	100	250 Volts
Cathode Resistor	270	200 Ohms
Plate Current	3.7	10 Ma
Transconductance	4000	5500 μmhos
Amplification Factor	60	60
Plate Resistance	15000	10900 Ohms
Control Grid Bias for $I_b = 10 \mu\text{a}$ (approx.)	-5	-12 Volts

APPLICATION

Sylvania Type 6AB4 is a miniature triode to be used as a grounded-grid r f amplifier, frequency converter or oscillator at frequencies below 300 mc. Electrically it is equal to one section of a Type 12AT7.

SYLVANIA TUBE TESTER SETTINGS

	A	B	C	D	E	F	G	Test or K
139/140	6.3	0	—	0	2	6	38	U
219/220	6.3	3	4	27	4	6X	1	7

**TYPES 6AB5/6N5, 6AB6G,
6AB7/1853, 6AC5G, GT**

(See Condensed Data Section)



**SYLVANIA TYPE 6AC7 /
1852
PENTODE AMPLIFIER**

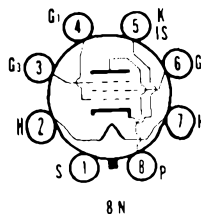

MECHANICAL DATA

Bulb.....	Small	Metal, Outline 8-1
Base.....	Small	Wafer Octal 8-Pin
Basing.....		8N
Mounting Position.....		Any

ELECTRICAL DATA

HEATER CHARACTERISTICS

Heater Voltage.....	6.3 Volts
Heater Current.....	450 Ma
Maximum Heater-Cathode Voltage.....	90 Volts

DIRECT INTERELECTRODE CAPACITANCES¹

Grid to Plate.....	0.015 μf Max
Input.....	11 μf
Output.....	5 μf

MAXIMUM RATINGS (Design Center Values)

Plate Voltage.....	300 Volts
Plate Dissipation.....	3.02 Watts
Grid No. 2 Voltage.....	150 Volts
Grid No. 2 Supply Voltage.....	300 Volts
Grid No. 2 Dissipation.....	0.38 Watt
Self Bias Resistor (Minimum).....	160 Ohms
Grid No. 1 Circuit Resistance with Self Bias	
Fixed Screen Voltage.....	0.25 Megohm
Series Screen Resistor.....	0.50 Megohm

TYPICAL OPERATION

Class A₁ Amplifier

Plate Voltage.....	300	300 Volts
Grid No. 2 Supply Voltage.....	150	300 Volts
Grid No. 2 (Screen) Resistor.....		60000 Ohms
Grid No. 3 (Suppressor) Grid Voltage.....	0	0 Volts
Self Bias Resistor.....	160	160 Ohms
Plate Current.....	10	10 Ma
Grid No. 2 Current.....	2.5	2.5 Ma
Transconductance.....	9000	9000 μmhos
Plate Resistance (approx.).....	1.0	1.0 Megohm

NOTE:

1. With shell connected to cathode.

SYLVANIA TUBE TESTER SETTINGS

	A	B	C	D	E	F	G	Test or K
139/140	6.3	0	—	0	6	36	45	W
219/220	6.3	2	7	71	7	46SY	8	5

**TYPES 6AD5GT, 6AD6G, 6AD7G,
6AE5GT, 6AE6G, 6AE7GT**

(See Condensed Data Section)

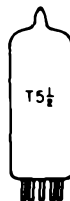

SYLVANIA TYPE 6AF4

UHF TRIODE

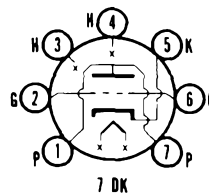

MECHANICAL DATA

Bulb	T-5 1/2, Outline 5-2
Base	Miniature Button 7-Pin
Basing	7DK
Mounting Position	Any

ELECTRICAL DATA

HEATER CHARACTERISTICS

Heater Voltage	6.3 Volts
Heater Current	225 Ma
Maximum Heater-Cathode Voltage	
Total D C and Peak	50 Volts
D C, Heater Positive with Respect to Cathode	25 Volts

DIRECT INTERELECTRODE CAPACITANCES (Unshielded)

Grid to Plate	1.9 $\mu\mu\text{f}$
Input	2.2 $\mu\mu\text{f}$
Output	0.45 $\mu\mu\text{f}$

MAXIMUM RATINGS (Design Center Values)

UHF Oscillator Service

Plate Voltage	150 Volts
Plate Input	2.5 Watts
Plate Dissipation	2.25 Watts
Negative Grid Voltage	50 Volts
Grid Current	8 Ma
Cathode Current	28 Ma
Grid Circuit Resistance	
Fixed Bias	Not Recommended
Cathode Bias	0.5 Megohm

CHARACTERISTICS

Class A₁ Amplifier

Plate Voltage	80 Volts
Cathode Bias Resistor	150 Ohms
Plate Current	16 Ma
Transconductance	6600 μmhos
Amplification Factor	15
Plate Resistance	2270 Ohms

TYPICAL OPERATION (Oscillator at 950 mc)

Plate Voltage	100 Volts
Grid Voltage (Self Bias)	-4 Volts
Grid Resistor	10000 Ohms
Plate Current	22 Ma
Grid Current (approx.)	400 μa

APPLICATION

Sylvania Type 6AF4 is a miniature medium mu triode designed for service as a uhf oscillator.

SYLVANIA TUBE TESTER SETTINGS

	A	B	C	D	E	F	G	Test or K
139/140	6.3	0	46	0	2	2	19	X
	6.3	0	32	0	3	6	19	X
219/220	6.3	3	467	12	4	2V	1	5
	6.3	3	124	12	4	6V	7	5

6AF4 (Cont'd)

AVERAGE PLATE CHARACTERISTICS

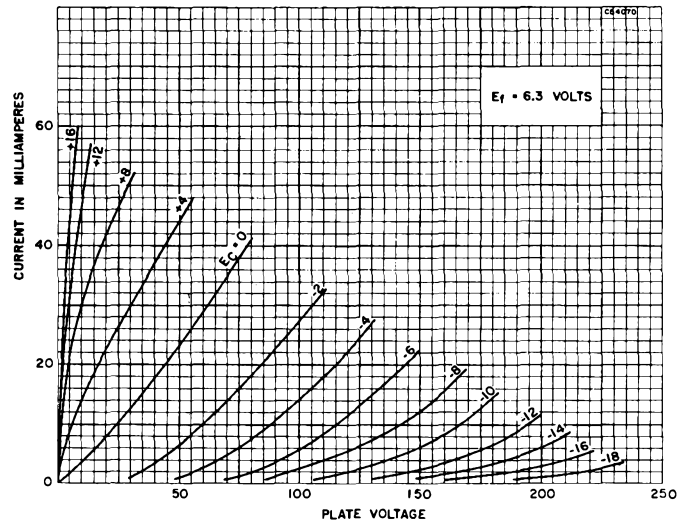

AVERAGE CHARACTERISTICS

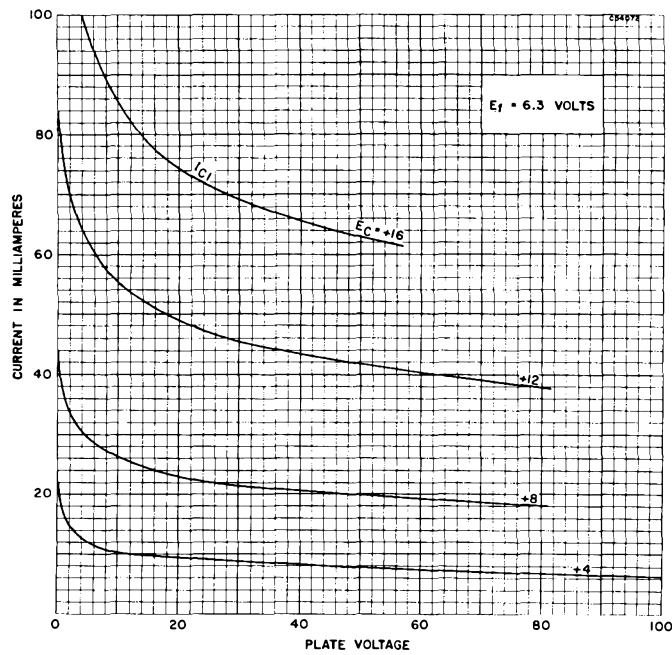

TYPES 6AF4A, 6AF5G, 6AF6G

(See Condensed Data Section)

SYLVANIA ELECTRONIC TUBES



SYLVANIA TYPE 6AG5

SHARP CUTOFF R F PENTODE

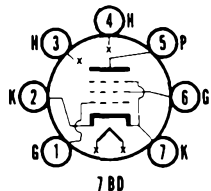

MECHANICAL DATA

Bulb	T-5 1/2, Outline 5-2
Base	Miniature Button 7-Pin
Basing	7BD
Mounting Position	Any

ELECTRICAL DATA

HEATER CHARACTERISTICS

Heater Voltage	6.3 Volts
Heater Current	300 Ma
Maximum Heater-Cathode Voltage	90 Volts

DIRECT INTERELECTRODE CAPACITANCES

	Shielded ¹	Unshielded
Grid to Plate	0.020	0.030 μmf Max
Input	6.6	6.5 μmf
Output	3.1	1.8 μmf

MAXIMUM RATINGS (Design Center Values)

Plate Voltage	300 Volts
Grid No. 2 Supply Voltage	300 Volts
Grid No. 2 Voltage	See Rating Chart for Type 6AM8
Plate Dissipation	2.0 Watts
Grid No. 2 Dissipation	0.5 Watt
Positive D C Grid No. 1 Voltage	0 Volts

CHARACTERISTICS AND TYPICAL OPERATION

Class A₁ Amplifier

	Triode ²		Pentode		
	250	180	100	125	250 Volts
Plate Voltage	250	180	100	125	250 Volts
Grid No. 2 Voltage	Plate	Plate	100	125	150 Volts
Cathode Resistor	820	330	180	100	180 Ohms
Plate Current	5.5 ³	7.0 ³	4.5	7.2	6.5 Ma
Grid No. 2 Current			1.4	2.1	2.0 Ma
Transconductance	3800	5700	4500	5100	5000 μmhos
Plate Resistance (approx.)	0.01	0.008	0.6	0.5	0.8 Megohm
Amplification Factor	42	45			
Grid No. 1 Voltage for $I_b = 10 \mu\text{a}$			-5	-6	-8 Volts

NOTES:

- External shield No. 316 connected to pin No. 7.
- Grid No. 2 tied to plate.
- Total current flowing to plate + grid No. 2.

APPLICATION

Sylvania Type 6AG5 is a miniature sharp cutoff pentode designed for service as an i f amplifier or r f amplifier at frequencies up to approximately 400 mc. The 6AG5 features low input and output capacitances and high gm. Isolation of input and output circuits is made possible through the use of two cathode leads. It is similar to Type 6BC5.

SYLVANIA TUBE TESTER SETTINGS

	A	B	C	D	E	F	G	Test or K
139/140	6.3	0	4	0	4	36	30	V
219/220	6.3	3	47S	73	4	16Z	5	2
	6.3	3	42S	73	4	16Z	5	7

6AG5 (Cont'd)

AVERAGE PLATE CHARACTERISTICS

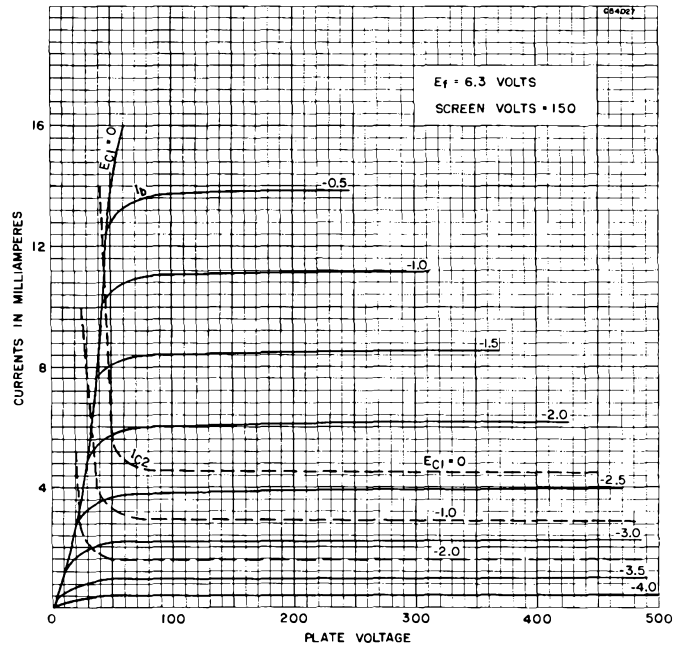

AVERAGE PLATE CHARACTERISTICS TRIODE CONNECTED

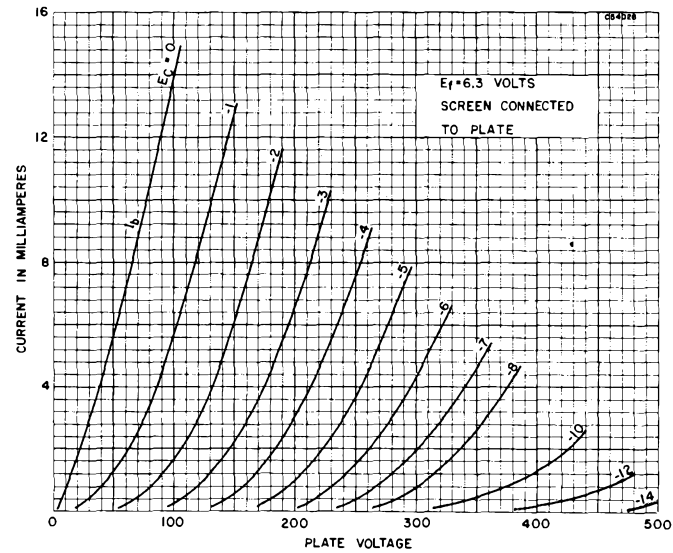

6AG5 (Cont'd)

SCREEN GRID RATING CHART

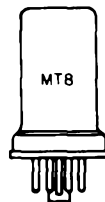
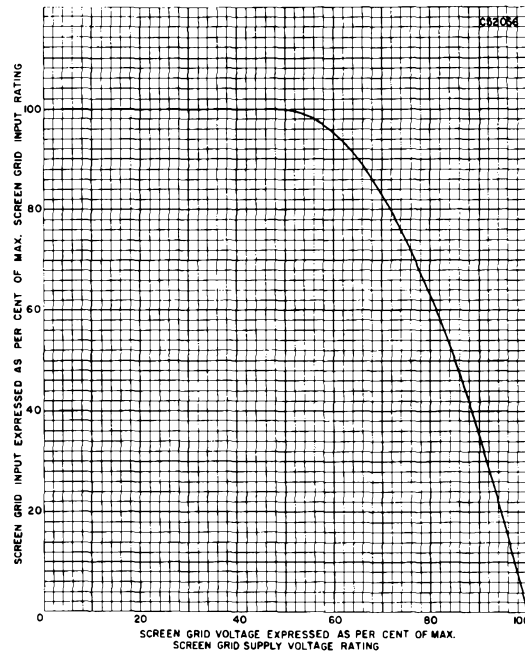

SYLVANIA TYPE 6AG7
PENTODE VIDEO AMPLIFIER

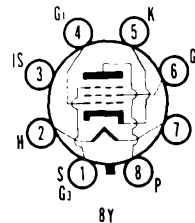

MECHANICAL DATA

Bulb.....	Metal, Outline 8-6
Base.....	Small Wafer Octal 8-Pin
Basing.....	8Y
Mounting Position.....	Vertical!

ELECTRICAL DATA

HEATER CHARACTERISTICS

Heater Voltage.....	6.3 Volts
Heater Current.....	650 Ma
Maximum Heater-Cathode Voltage.....	90 Volts

DIRECT INTERELECTRODE CAPACITANCES

(Shell Connected to Cathode)

Grid to Plate.....	0.060 $\mu\mu\text{f}$
Input.....	13.0 $\mu\mu\text{f}$
Output.....	7.5 $\mu\mu\text{f}$

MAXIMUM RATINGS (Design Center Values)

Plate Voltage.....	300 Volts
Plate Dissipation.....	9.0 Watts
Grid No. 2 Voltage.....	300 Volts
Grid No. 2 Dissipation.....	1.5 Watts
Positive D C Grid No. 1 Voltage.....	0 Volts
Grid No. 1 Circuit Resistance.....	
Fixed Bias.....	0.25 Megohm
Cathode Bias.....	1.0 Megohm

6AG7 (Cont'd)

TYPICAL OPERATION

Class A₁ Amplifier

Plate Voltage.....	300 Volts
Grid No. 2 Voltage.....	150 Volts
Grid No. 1 Voltage.....	-3.0 Volts
Self Bias Resistor.....	81 Ohms
Plate Current (Zero Signal).....	30 Ma
Plate Current (Maximum Signal).....	30.5 Ma
Grid No. 2 Current (Zero Signal).....	7.0 Ma
Grid No. 2 Current (Maximum Signal).....	9.0 Ma
Transconductance.....	11000 μ mhos
Plate Resistance.....	0.13 Megohm
Load Resistance.....	10000 Ohms
Power Output.....	3.0 Watts
Total Harmonic Distortion.....	7.0 Percent

NOTE:

- Horizontal operation is permitted if pins 2 and 7 are in vertical plane.

SYLVANIA TUBE TESTER SETTINGS

	A	B	C	D	E	F	G	Test or K
139/140	6.3	0	---	0	6	36	25	W
219/220	6.3	2	7	23	7	46Z	8	5

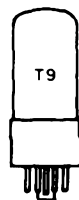

SYLVANIA TYPE 6AH4GT

VERTICAL DEFLECTION AMPLIFIER

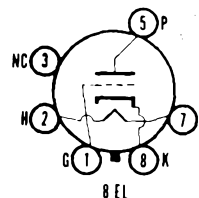

MECHANICAL DATA

Bulb.....	T-9, Outline 9-41
Base.....	Short Intermediate Shell Octal 6-Pin
Basing.....	8EL
Mounting Position.....	Any

ELECTRICAL DATA

HEATER CHARACTERISTICS

Heater Voltage.....	6.3 Volts
Heater Current.....	0.75 Ampere
Maximum Heater-Cathode Voltage	
D C, Heater Positive With Respect to Cathode.....	100 Volts
Total D C and Peak.....	200 Volts

MAXIMUM RATINGS (Design Center Values—Except as Noted)

Vertical Deflection Amplifier²

Plate Voltage.....	500 Volts
Peak Positive Plate Voltage (Abs. Max.).....	2000 Volts
Plate Dissipation ³	7.5 Watts
Positive Grid Voltage.....	0 Volts
Peak Negative Pulse Grid Voltage.....	200 Volts
Average Cathode Current.....	60 Ma
Peak Cathode Pulse Current.....	180 Ma
Grid Circuit Resistance.....	2.2 Megohms

CHARACTERISTICS

Plate Voltage.....	250	250 Volts
Grid Voltage.....	-33	-23 Volts
Plate Current.....	5.0	30 Ma
Transconductance.....		4500 μ mhos
Amplification Factor.....		8
Plate Resistance.....		1780 Ohms
Grid Voltage for I _b =0.5 Ma (approx.).....		-40 Volts

NOTES:

- Shield No. 308 connected to cathode.
- For operation in a 525 line, 30 frame system, the duty cycle of the voltage pulse must not exceed 15% of one scanning cycle.
- An adequate bias resistor or other means is required to protect the tube in the absence of excitation.

6AH4GT (Cont'd)

APPLICATION

Sylvania Type 6AH4GT is a low- μ high permeance triode for use as a vertical deflection amplifier in television receivers. It will furnish high plate currents at low plate voltages and will withstand the high pulse voltages encountered in this application.

SYLVANIA TUBE TESTER SETTINGS

	A	B	C	D	E	F	G	Test or K
139/140	6.3	0	—	0	3	5	24	Y
219/220	6.3	2	7S	17	7	12	5	8

AVERAGE PLATE CHARACTERISTICS EACH SECTION

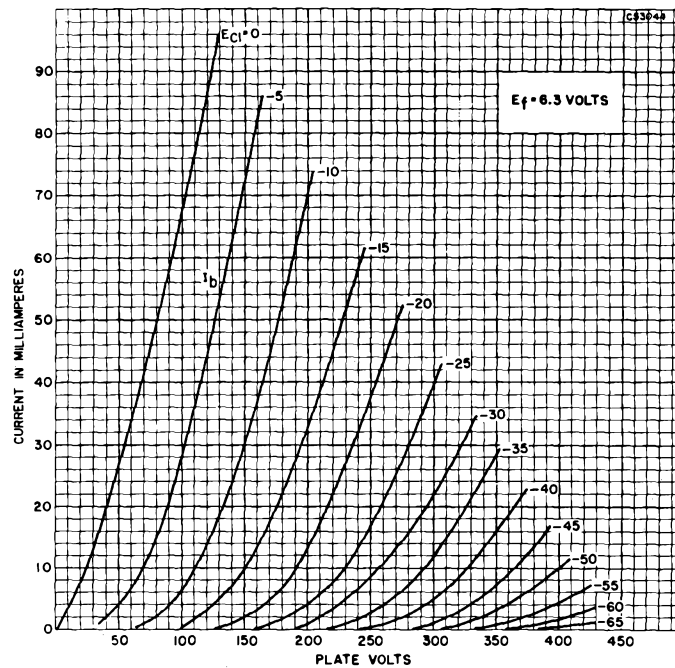

TYPE 6AH5G

(See Condensed Data Section)

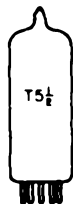

SYLVANIA TYPE 6AH6

SHARP CUTOFF R F PENTODE

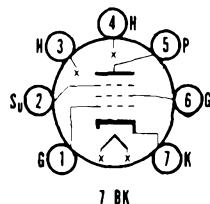

MECHANICAL DATA

Bulb.....	T-5 1/2, Outline 5-2
Base.....	Miniature Button 7-Pin
Basing.....	7BK
Mounting Position.....	Any

ELECTRICAL DATA

HEATER CHARACTERISTICS

Heater Voltage.....	6.3 Volts
Heater Current.....	450 Ma
Maximum Heater-Cathode Voltage.....	90 Volts

DIRECT INTERELECTRODE CAPACITANCES (Shielded)¹

Grid to Plate.....	.020 μ f Max
Input.....	10 μ f
Output.....	3.6 μ f

MAXIMUM RATINGS (Design Center Values)

Plate Voltage.....	300 Volts
Plate Dissipation.....	3.2 Watts
Grid No. 2 Voltage.....	150 Volts
Grid No. 2 Dissipation.....	0.4 Watt
Cathode Current.....	13 Ma

TYPICAL OPERATION

	Pentode Connected	Triode Connected
Plate Voltage.....	300	150 Volts
Grid No. 2 Voltage.....	150	150 Volts
Grid No. 3 Voltage.....	Tie to Cathode	
Cathode Bias Resistor.....	160	160 Ohms
Plate Current.....	10.0	12.5 Ma
Grid No. 2 Current.....	2.5	Ma
Transconductance.....	9000	11000 μ mhos
Amplification Factor.....		40
Plate Resistance (approx.).....	500000	3600 Ohms
Grid No. 1 Bias for $I_b = 10 \mu$ a (approx.).....	-7.0	-7.0 Volts

NOTE:

- Shield No. 316.

APPLICATION

Sylvania Type 6AH6 is a sharp cutoff pentode designed for use in television, video and if circuits where wide band amplification and low impedance output is required. The triode operating conditions are given to permit its use in cathode follower circuits. The suppressor grid does not have large enough plate current control for practical use.

SYLVANIA TUBE TESTER SETTINGS

	A	B	C	D	E	F	G	Test or K
139/140	6.3	0	—	0	4	36	39	W
219/220	6.3	3	4S	22	4	16Y	5	7

TYPES 6AH7GT, 6AJ4, 6AJ5

(See Condensed Data Section)

NOTE; 6AJ5 data continued on page following this supplement.

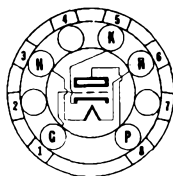

8-DK



Sylvania Type 6AK4

HIGH FREQUENCY TRIODE

PHYSICAL SPECIFICATIONS

Base	Subminiature Button, Flexible Leads
Bulb	T-3
Maximum Bulb Length	1.375"
Minimum Lead Length	1.500"
Mounting Position	Any
Basing	8-DK

RATINGS

Heater Voltage AC or DC	6.3 Volts
Maximum Plate Voltage	250 Volts
Maximum Heater to Cathode Voltage	90 Volts
Maximum Plate Dissipation	3.0 Watts
Maximum Cathode Current	20 Ma.

Direct Interelectrode Capacitances:

	Shielded*	Unshielded
Grid to Plate	1.3	1.4 μ f.
Input	2.0	1.8 μ f.
Output	1.7	0.6 μ f.

*With 0.405" diameter shield connected to cathode

TYPICAL OPERATION

Heater Voltage	6.3 Volts
Heater Current	150 Ma.
Plate Voltage	200 Volts
Grid Voltage* Obtained from Self Bias Resistor of	680 Ohms
Plate Current	9.5 Ma.
Transconductance	3800 μ mhos
Amplification Factor	20
Plate Resistance	5300 Ohms
Grid Voltage for Plate Current Cut-Off to 10 μ a.	-20 Volts

*Provides an operating bias of approx. 6.5 volts.
Fixed bias operation is not recommended.

APPLICATION

Sylvania Type 6AK4 is a general purpose medium mu triode in the subminiature style. This tube is a commercial version of the 6K4 and is considered a replacement for it.

At frequencies of around 500 mc, an output of approximately $\frac{3}{4}$ watt may be obtained when used in a suitable circuit.

SYLVANIA RADIO TUBES

Issued as a supplement to the manual in SYLVANIA NEWS for April 1952

6AK4 (cont'd)

Sylvania Type 6AK4

AVERAGE PLATE CHARACTERISTICS

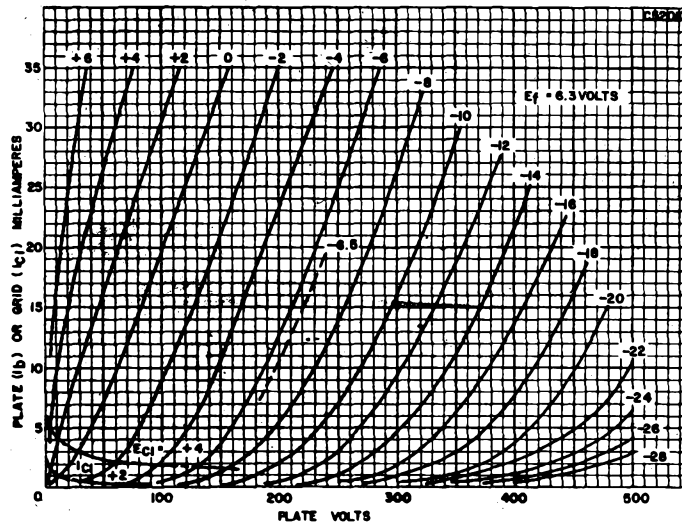

Sylvania Type 6AK4

AVERAGE TRANSFER CHARACTERISTICS

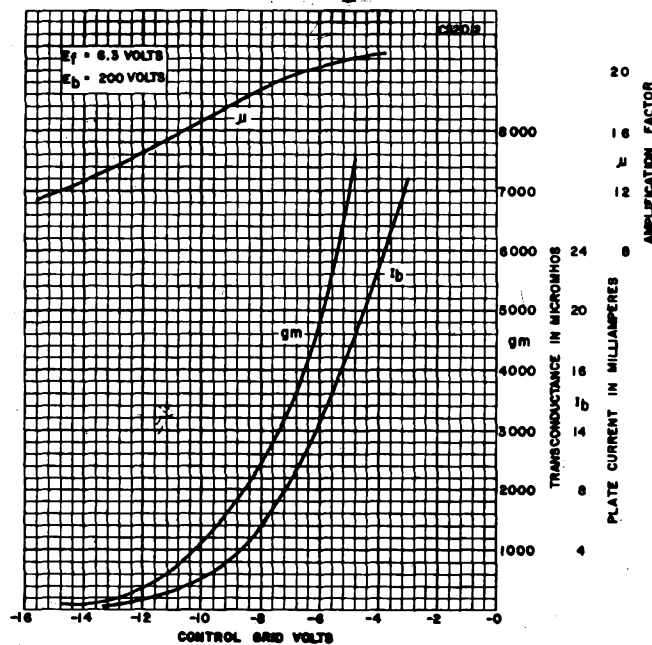



SYLVANIA TYPE 6AK5

HIGH FREQUENCY PENTODE

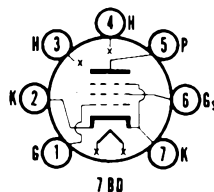

MECHANICAL DATA

Bulb.....	T-5 1/2, Outline 5-1
Base.....	Miniature Button 7-Pin
Basing.....	7BD
Mounting Position.....	Any

ELECTRICAL DATA

HEATER CHARACTERISTICS

Heater Voltage.....	6.3 Volts
Heater Current.....	175 Ma
Maximum Heater-Cathode Voltage.....	120 Volts

DIRECT INTERELECTRODE CAPACITANCES

	Shielded ¹	Unshielded
Grid to Plate.....	.02	.03 $\mu\mu\text{f}$
Input.....	4.0	4.0 $\mu\mu\text{f}$
Output.....	2.8	2.1 $\mu\mu\text{f}$

MAXIMUM RATINGS (Design Center Values)

Plate Voltage.....	180 Volts
Plate Dissipation.....	1.7 Watts
Grid No. 2 Voltage.....	140 Volts
Grid No. 2 Dissipation.....	0.5 Watt
Grid No. 2 Supply Voltage.....	180 Volts
Positive Grid No. 1 Voltage.....	0 Volts
Cathode Current.....	18 Ma

TYPICAL OPERATION

Class A₁ Amplifier

Plate Voltage.....	120	180 Volts
Grid No. 2 Voltage.....	120	120 Volts
Cathode Bias Resistor ²	180	180 Ohms
Plate Current.....	7.5	7.7 Ma
Grid No. 2 Current.....	2.5	2.4 Ma
Transconductance.....	5000	5100 μmhos
Plate Resistance (approx.).....	0.30	0.50 Megohm

NOTES:

1. Shield No. 316 connected to cathode.
2. Fixed bias operation is not recommended.

APPLICATION

Sylvania Type 6AK5 is a miniature sharp cutoff rf pentode capable of operation up to 400 mc. The dual cathode leads, when properly used, help isolate input and output circuits, thereby permitting greater gain per stage.

SYLVANIA TUBE TESTER SETTINGS

	A	B	C	D	E	F	G	Test or K
139/140	6.3	0	4	0	4	36	50	U
219/220	6.3	3	47S	27	4	16Y	5	2
	6.3	3	24S	27	4	16Y	5	7

6AK5 (Cont'd)

AVERAGE PLATE CHARACTERISTICS

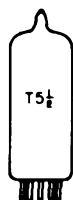
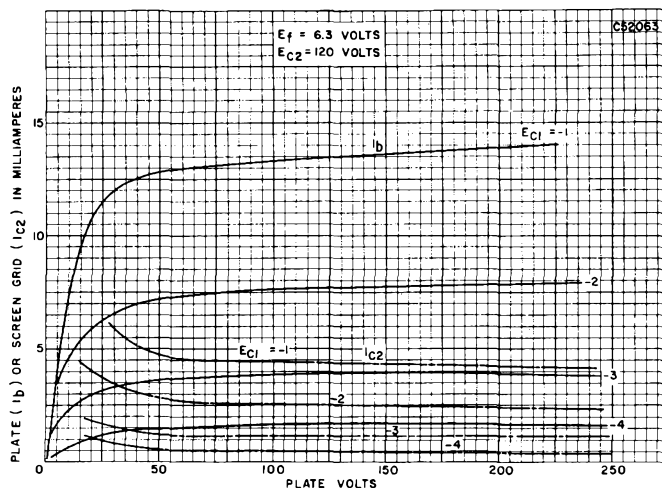

SYLVANIA TYPE 6AK6 PENTODE POWER AMPLIFIER

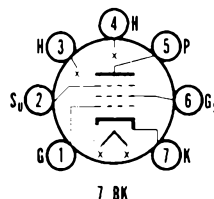

MECHANICAL DATA

Bulb.....	T-5 1/2, Outline 5-2
Base.....	Miniature Button 7-Pin
Basing.....	7BK
Mounting Position.....	Any

ELECTRICAL DATA

HEATER CHARACTERISTICS

Heater Voltage.....	6.3 Volts
Heater Current.....	150 Ma
Maximum Heater-Cathode Voltage, D.C.....	100 Volts

DIRECT INTERELECTRODE CAPACITANCES (Unshielded)

Grid to Plate.....	0.12 $\mu\mu f$
Input.....	3.6 $\mu\mu f$
Output.....	4.2 $\mu\mu f$

MAXIMUM RATINGS (Design Center Values)

Plate Voltage.....	300 Volts
Plate Dissipation.....	2.75 Watts
Grid No. 2 Voltage.....	250 Volts
Grid No. 2 Dissipation.....	0.75 Watt

TYPICAL OPERATION

Class A₁ Power Amplifier

Plate Voltage.....	180 Volts
Grid No. 2 Voltage.....	180 Volts
Grid No. 1 Voltage.....	-9 Volts
Grid No. 3.....	Connected to Cathode at Socket
Plate Current (Zero Signal).....	15 Ma
Grid No. 2 Current (Zero Signal).....	2.5 Ma
Transconductance.....	2300 μmhos
Plate Resistance.....	0.2 Megohm
Load Resistance.....	10000 Ohms
Total Harmonic Distortion.....	10 Percent
Maximum Signal Power Output.....	1.1 Watts

6AK6 (Cont'd)

APPLICATION

Sylvania Type 6AK6 is a power amplifier pentode designed for use in radio equipment where power consumption must be kept to a minimum. This tube may also be used to advantage in power amplifiers where isolation between input and output circuits is desired because of its highly effective screen grid. Electrically, the Type 6AK6 is similar to Type 6G6G.

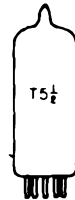

SYLVANIA TYPE 6AL5
DUO DIODE

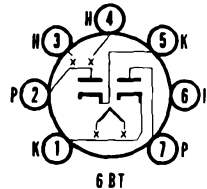

MECHANICAL DATA

Bulb	T-5 1/2, Outline 5-1
Base	Miniature Button 7-Pin
Basing	6BT
Mounting Position	Any

ELECTRICAL DATA

HEATER CHARACTERISTICS

Heater Voltage	6.3 Volts
Heater Current	300 Ma
Maximum Heater-Cathode Voltage	330 Volts

DIRECT INTERELECTRODE CAPACITANCES

	Shielded ¹	Unshielded
Plate Input (Each Section)	3.2	2.5 μf
Plate to Plate	.026	.068 μf
Cathode Input (Each Section)	3.6	3.4 μf

MAXIMUM RATINGS (Design Center Values)

Peak Inverse Plate Voltage	330 Volts
Peak Plate Current Each Plate	54 Ma
D C Output Current Each Plate	9.0 Ma

TYPICAL OPERATION

A C Plate Voltage Per Plate	117 Volts
Effective Plate Supply Impedance Each Plate	300 Ohms Min
D C Output Current Each Plate	9.0 Ma

NOTE:

- Shield No. 316 connected to Pin 6.

APPLICATION

Sylvania Type 6AL5 is a miniature double diode designed for high frequency operation. Each section has a resonant frequency of approximately 700 mc. An internal shield is provided to permit independent operation of each diode.

SYLVANIA TUBE TESTER SETTINGS

	A	B	C	D	E	F	G	Test or K
139/140	6.3	0	—	0	1	—	55	T
	6.3	0	—	0	3	—	55	T
219/220	6.3	3	14	21	4	X	2*	5
	6.3	3	45	21	4	X	7*	1

* Diode gas test does not apply.

6AL5 (Cont'd)

AVERAGE OPERATING CHARACTERISTICS HALF-WAVE RECTIFICATION—SINGLE DIODE

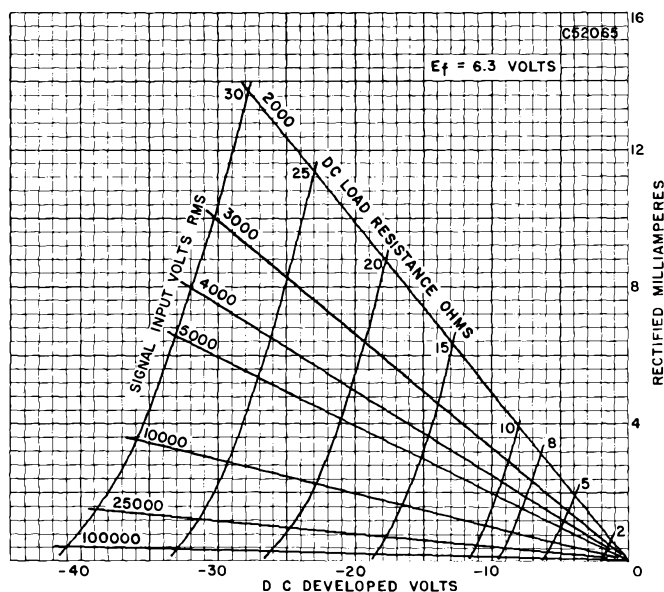

TYPE 6AL6G

(See Condensed Data Section)

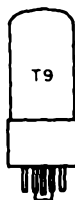

SYLVANIA TYPE 6AL7GT
TUNING INDICATOR

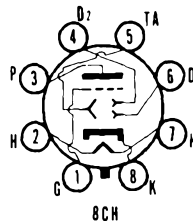

MECHANICAL DATA

Bulb	T-9, Outline 9-7
Base	Intermediate Shell Octal 8-Pin
Basing	8CH
Mounting Position	Any

ELECTRICAL DATA

HEATER CHARACTERISTICS

Heater Voltage	6.3 Volts
Heater Current	150 Ma
Maximum Heater-Cathode Voltage	90 Volts

TYPICAL OPERATION

Tuning Indicator Service

Target Voltage	315 Volts
Grid Voltage	0 Volts
Deflection Electrode Voltages ²	0 Volts
Deflection Sensitivity (approx.) (Per Volt)	1 mm
Grid Voltage for Fluorescent Cutoff (approx.)	-7.0 Volts
Cathode Bias Resistor (approx.)	3300 Ohms

6AL7GT (Cont'd)

NOTES:

1. When not used for fluorescent control the grid should be connected to the cathode.
2. The illustration shows the fluorescent areas controlled by the deflection electrodes connected to D1, D2 and D3, respectively.

APPLICATION

Sylvania Type 6AL7GT is a tuning indicator tube using the principle of the cathode ray tube and designed for use with fm circuits in addition to a m. Circuits other than those shown may be used utilizing the grid and/or D3 for additional control such as squelch and limiting voltages.

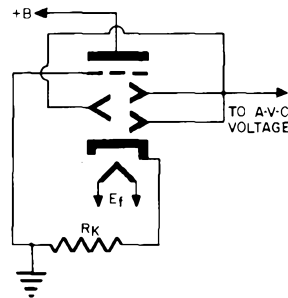

FIG. 1

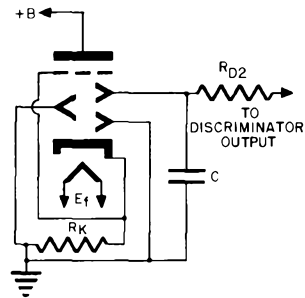
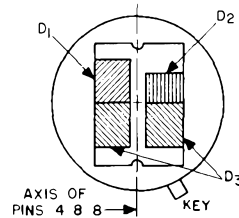

FIG. 2

CONDITIONS:

+B = 250 V DC APPROX.
 $R_k = 3300$ OHMS
 $R_{D2} = 1.0$ MEGOHM
 $C = 0.05$ MICROFARAD



PATTERN RESPONSE IN VARIOUS CIRCUITS

CONTROL VOLTAGE SOURCE	SIGNAL	CIRCUIT (SEE FIG.)	OFF CHANNEL (-)	ON CHAN. OFF TUNE (-)	ON TUNE	ON CHAN. OFF TUNE (+)	OFF CHANNEL (+)
DISCRIMINATOR	FM	2					
AVC	AM	1					

TYPE 6AM4

(See Condensed Data Section)

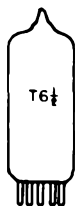

SYLVANIA TYPE 6AM8 DIODE PENTODE

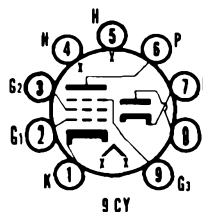

MECHANICAL DATA

Bulb	T-6 1/2, Outline 6-2
Base	Small Button 9-Pin
Basing	9CY
Mounting Position	Any

ELECTRICAL DATA

HEATER CHARACTERISTICS

Heater Voltage	6.3 Volts
Heater Current	450 Ma
Maximum Heater-Cathode Voltage	
Total D C and Peak	200 Volts
D C, Heater Positive with Respect to Cathode	100 Volts

DIRECT INTERELECTRODE CAPACITANCES

Pentode	Shielded ¹	Unshielded
Grid to Plate	0.015	0.015 $\mu\mu\text{f}$ Max
Input	6.0	6.0 $\mu\mu\text{f}$
Output	3.4	2.6 $\mu\mu\text{f}$
Diode		
Input: p to (h+k)	2.3	1.7 $\mu\mu\text{f}$
Cathode to (h+p)	4.0	4.0 $\mu\mu\text{f}$
Coupling: (diode p to pentode p)	0.035	0.10 $\mu\mu\text{f}$
Coupling: (diode p to grid 1)	0.005	0.006 $\mu\mu\text{f}$
Coupling: (diode k to pentode p)	0.15	0.15 $\mu\mu\text{f}$

MAXIMUM RATINGS (Design Center Values)

Plate Voltage	300 Volts
Plate Dissipation	2.8 Watts
Grid No. 2 Voltage	See Rating Chart
Grid No. 2 Supply Voltage	300 Volts
Grid No. 2 Dissipation	0.5 Watt
Positive Grid No. 1 Voltage	0 Volts
Grid No. 3 Voltage	0 Volts
Grid No. 1 Circuit Resistance	
Cathode Bias	1.0 Megohm
Fixed Bias	0.25 Megohm
Diode Current for Continuous Operation	5.0 Ma

CHARACTERISTICS

Plate Voltage	200 Volts
Grid No. 2 Voltage	150 Volts
Grid No. 3 Voltage	0 Volts
Cathode Resistor	120 Ohms
Plate Current	11.5 Ma
Grid No. 2 Current	2.7 Ma
Transconductance	7000 μmhos
Plate Resistance (Approx.)	0.6 Megohm
Grid No. 1 Voltage for $I_b = 10 \mu\text{a}$	-8 Volts
Diode Plate Voltage for Diode Current of 50 Ma ²	10 Volts

NOTES:

1. Shield No. 315.
2. Test condition only. Operating conditions must not exceed the design center rating.

APPLICATION

Sylvania Type 6AM8 is a miniature diode-pentode designed for use as a combined video detector and last if stage. The pentode section has a sharp cutoff characteristic and is similar to the Type 6CB6. The diode is similar to one section of a 6AL5.

SYLVANIA TUBE TESTER SETTINGS

	A	B	C	D	E	F	G	Test or K
139/140	6.3	0	0	0	3	36	60	W
	6.3	0	0	0	8	—	49	T
219/220	6.3	4	57S	77	5	23Z	6	1
	6.3	4	15	35	5	T	8*	7

* Diode gas test does not apply.

6AM8 (Cont'd)

AVERAGE PLATE CHARACTERISTICS

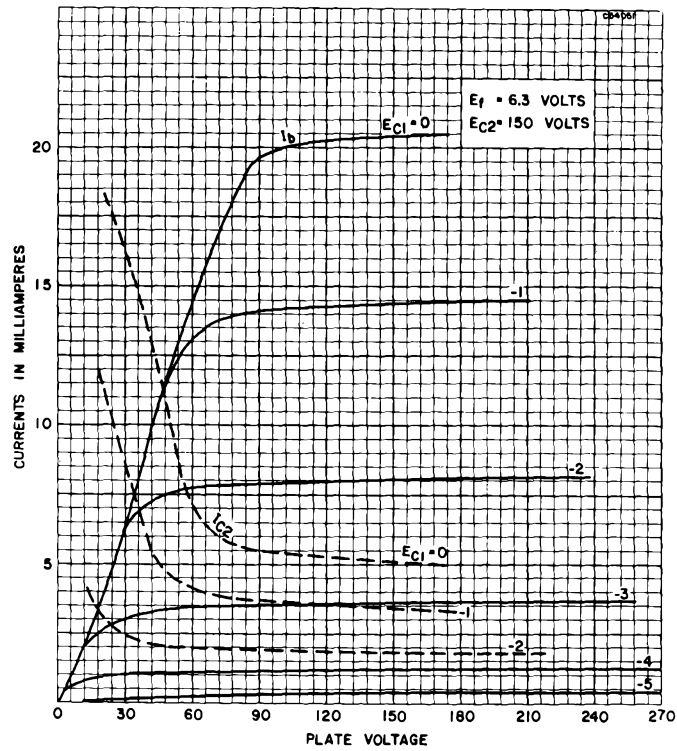

AVERAGE TRANSFER CHARACTERISTICS

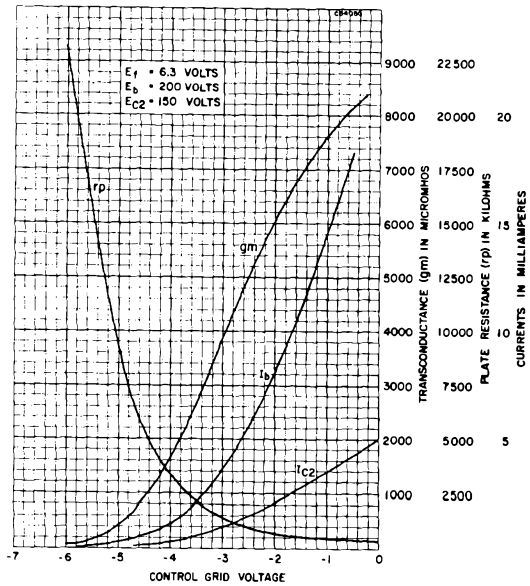

6AM8 (Cont'd)

RATING CHART

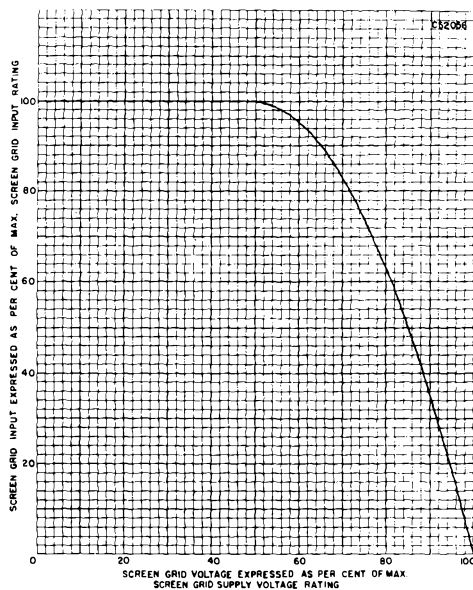

SYLVANIA TYPE 6AN4 UHF TRIODE

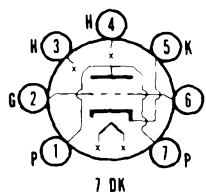

MECHANICAL DATA

Bulb	T-5 1/2, Outline 5-1
Base	Miniature Button 7-Pin
Basing	7DK
Mounting Position	Any

ELECTRICAL DATA

HEATER CHARACTERISTICS

Heater Voltage	6.3 Volts
Heater Current	225 Ma
Maximum Heater-Cathode Voltage	
Total D C and Peak	200 Volts
D C, Heater Positive with Respect to Cathode	100 Volts

DIRECT INTERELECTRODE CAPACITANCES

	Shielded ¹	Unshielded
Grid to Plate	1.7	1.7 $\mu\mu\text{f}$
Input	3.3	2.9 $\mu\mu\text{f}$
Output	1.8	0.25 $\mu\mu\text{f}$
Heater to Cathode ²	2.9	3.0 $\mu\mu\text{f}$
Grid to Cathode ²	2.6	2.6 $\mu\mu\text{f}$
Plate to Cathode ²	0.18	0.20 $\mu\mu\text{f}$

Grounded Grid Operation

Input	5.7	5.5 $\mu\mu\text{f}$
Output	3.4	1.8 $\mu\mu\text{f}$

6AN4 (Cont'd)

MAXIMUM RATINGS (Design Center Values)

Plate Voltage	300 Volts
Plate Dissipation	4 Watts
Cathode Current	30 Ma
Grid Circuit Resistance	
Fixed Bias	0.1 Megohm
Cathode Bias	0.5 Megohm

CHARACTERISTICS AND TYPICAL OPERATION

Class A₁ Amplifier

Plate Voltage	200 Volts
Cathode Bias Resistor	100 Ohms
Plate Current	13 Ma
Transconductance	10000 μ mhos
Amplification Factor	70
Grid Voltage for $I_b = 20 \mu$ a	-7 Volts

Mixer Service

Plate Voltage	125 Volts
Cathode Bias Resistor	270 Ohms
Plate Current	7.0 Ma
Oscillator Injection Voltage (R M S)	1.4 Volts
Conversion Transconductance	2900 μ mhos

NOTES:

1. Shield No. 316.
2. Measured between specified elements only. When external shield is used, it shall be grounded.

APPLICATION

Sylvania Type 6AN4 is a miniature high-mu triode designed for use as a grounded grid amplifier or mixer in u h f television applications.

AVERAGE PLATE CHARACTERISTICS

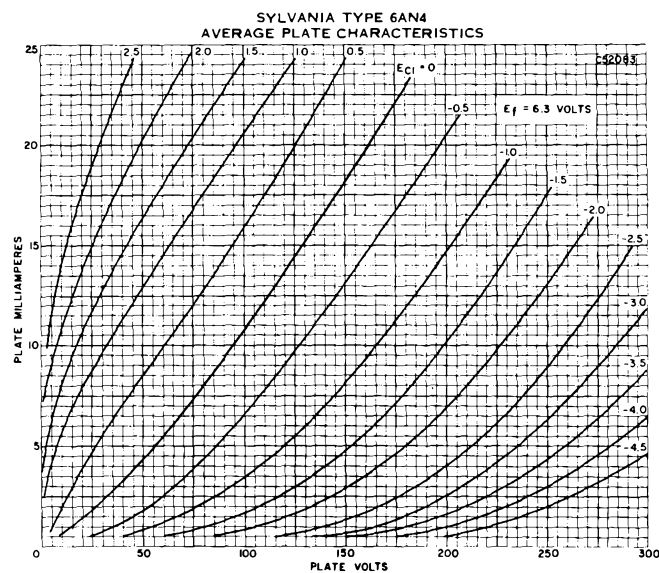

6AN4 (Cont'd)

AVERAGE TRANSFER CHARACTERISTICS

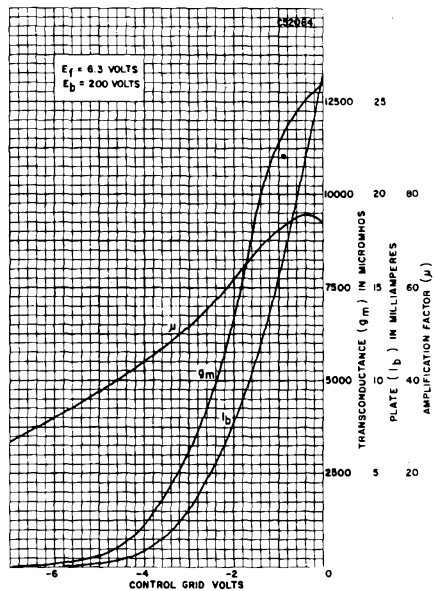

AVERAGE TRANSFER CHARACTERISTICS

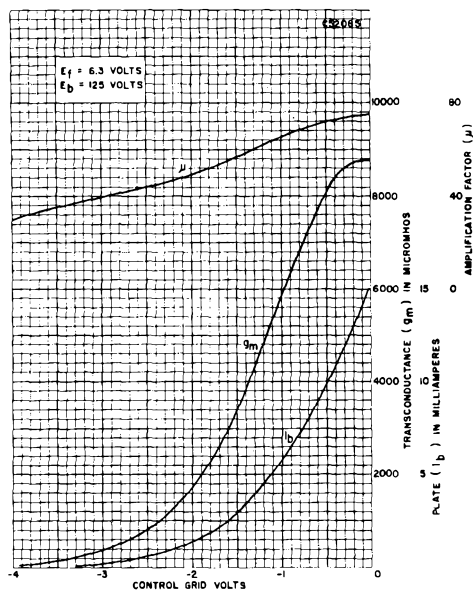

TYPE 6AN5

(See Condensed Data Section)



SYLVANIA TYPE 6AN8

TRIODE PENTODE

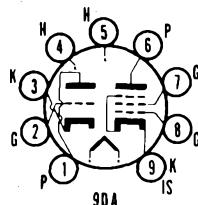

MECHANICAL DATA

Bulb.....	T-6 1/2, Outline 6-2
Base.....	Small Button 9-Pin
Basing.....	9DA
Mounting Position.....	Any

ELECTRICAL DATA

HEATER CHARACTERISTICS

Heater Voltage.....	6.3 Volts
Heater Current.....	450 Ma
Maximum Heater-Cathode Voltage	
Total D C and Peak.....	200 Volts
D C, Heater Positive with Respect to Cathode.....	100 Volts

DIRECT INTERELECTRODE CAPACITANCES (Unshielded)

Triode Section

Grid to Plate.....	1.5 μf
Input.....	2.0 μf
Output.....	0.27 μf

Pentode Section

Grid No. 1 to Plate.....	0.04 μf	Max
Input.....	7.0 μf	
Output.....	2.3 μf	
Triode Grid to Pentode Plate.....	0.005 μf	
Pentode Grid No. 1 to Triode Plate.....	0.006 μf	
Pentode Plate to Triode Plate.....	0.045 μf	

MAXIMUM RATINGS (Design Center Values)

	Triode	Pentode
Plate Voltage.....	300	300 Volts
Grid No. 2 Supply Voltage.....		300 Volts
Grid No. 2 Voltage.....	See Rating Chart for Type 6AM8	
Positive Grid No. 1 Voltage.....	0	0 Volts
Plate Dissipation.....	2.5	2.0 Watts
Grid No. 2 Input.....		0.5 Watt
Grid No. 1 Circuit Resistance ¹		
Cathode Bias.....	1.0	1.0 Megohm
Fixed Bias.....	0.5	0.25 Megohm

CHARACTERISTICS

	Triode	Pentode
Plate Supply Voltage.....	200	200 Volts
Grid No. 2 Supply Voltage.....		150 Volts
Grid No. 1 Voltage.....	-6	Volts
Cathode Bias Resistor.....		180 Ohms
Plate Current.....	13	9.5 Ma
Grid No. 2 Current.....		2.8 Ma
Amplification Factor.....	19	
Plate Resistance (approx.).....	5750	300000 Ohms
Transconductance.....	3300	6200 μmhos
Grid No. 1 Voltage for $I_b = 10 \mu\text{a}$ (approx.)..	-19	-8 Volts

NOTE:

1. If either section is operating at maximum rated conditions, the grid No. 1 circuit resistance for both sections should not exceed the stated values.

APPLICATION

Sylvania Type 6AN8 is a medium-mu triode and sharp cutoff pentode contained in a 9-pin, miniature envelope. It is intended for application in color and monochrome television receivers. The pentode section may be used as an i f amplifier, video amplifier, a g c amplifier and reactance tube. The triode is well suited for use in low frequency oscillator, sync clipper, sync separator and phase splitter circuits.

6AN8 (Cont'd)

AVERAGE PLATE CHARACTERISTICS TRIODE SECTION

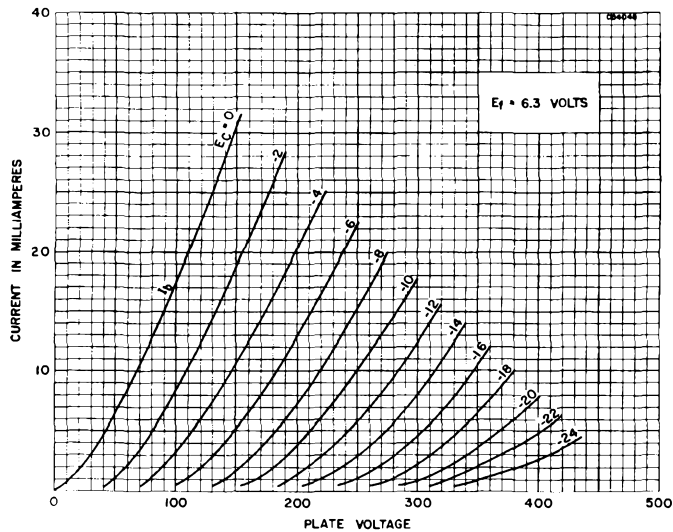

AVERAGE PLATE CHARACTERISTICS PENTODE SECTION

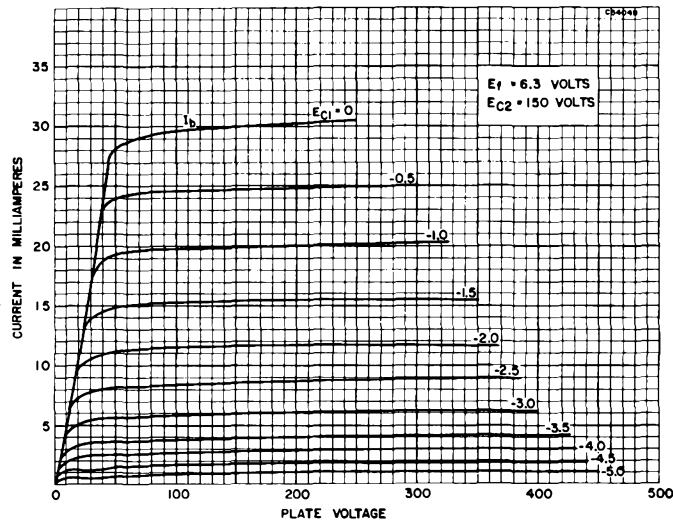

6AN8 (Cont'd)

AVERAGE TRANSFER CHARACTERISTICS TRIODE SECTION

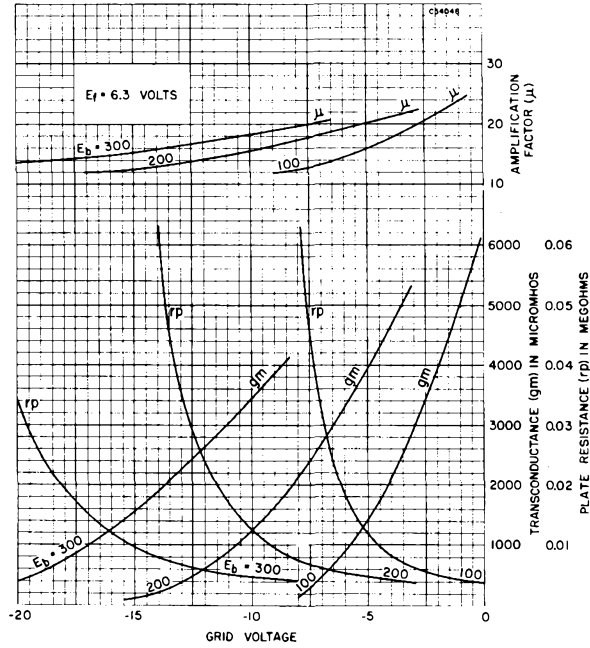

AVERAGE TRANSFER CHARACTERISTICS PENTODE SECTION

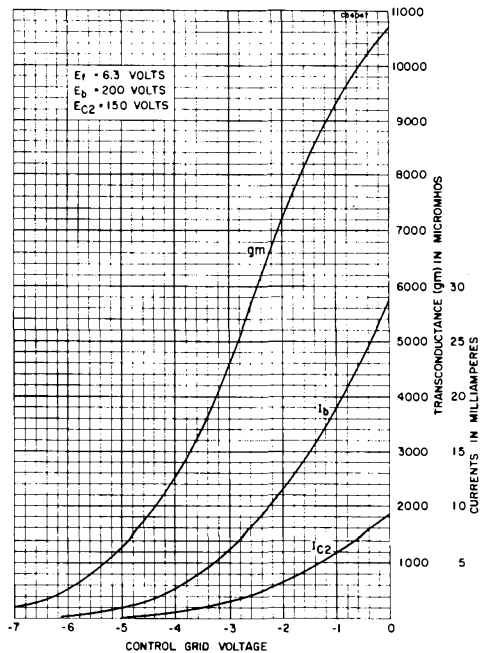



SYLVANIA TYPE 6AQ5 BEAM POWER AMPLIFIER

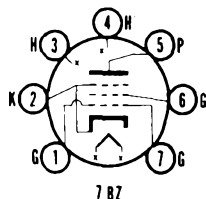

MECHANICAL DATA

Bulb	T-5 1/2	Outline 5-3
Base	Miniature	Button 7-Pin
Basing		7BZ
Mounting Position		Any

ELECTRICAL DATA

HEATER CHARACTERISTICS

Heater Voltage	6.3 Volts
Heater Current	450 Ma
Maximum Heater-Cathode Voltage	
Total D C and Peak	200 Volts
D C, Heater Positive with Respect to Cathode	100 Volts

DIRECT INTERELECTRODE CAPACITANCES (Unshielded)

Grid to Plate	0.4 μf
Input	8.0 μf
Output	8.5 μf

MAXIMUM RATINGS (Design Center Values—Except as Noted)

	Class A ₁ Amplifier	Vertical Deflection Amplifier Triode Connected!
Plate Voltage	250	250 Volts
Peak Positive Plate Voltage (Abs. Max.)		1100 Volts
Plate Dissipation (Note 2 Vert. Defl. Amp.)	12	9 Watts
Peak Negative Grid Voltage		250 Volts
Grid No. 2 Voltage	250	Volts
Grid No. 2 Dissipation	2.0	Watts
Average Cathode Current		35 Ma
Peak Cathode Current		105 Ma
Grid No. 1 Circuit Resistance		
Fixed Bias	0.1	Megohm
Cathode Bias	0.5	2.2 Megohms
Bulb Temperature (At Hottest Point)	250°	C

CHARACTERISTICS AND TYPICAL OPERATION

	Triode Connected	Class A ₁ Amplifier	
Plate Voltage	250	180	250 Volts
Grid No. 2 Voltage	250	180	250 Volts
Grid No. 1 Voltage	-12.5	-8.5	-12.5 Volts
Peak A F Grid No. 1 Voltage		8.5	12.5 Volts
Plate Current (Zero Signal)	49.5	29	45 Ma
Plate Current (Maximum Signal)		30	47 Ma
Grid No. 2 Current (Zero Signal)		3.0	4.5 Ma
Grid No. 2 Current (Maximum Signal)		4.0	7.0 Ma
Transconductance	4800	3700	4100 μmhos
Amplification Factor	9.5		
Plate Resistance (approx.)	1970	58000	52000 Ohms
Control Grid Bias For I _b = 0.5 Ma	-37		Volts
Load Resistance		5500	5000 Ohms
Maximum Signal Power Output		2.0	4.5 Watts
Total Harmonic Distortion (approx.)		8.0	8.0 Percent
Class AB₁ Power Amplifier (2 Tubes)			
Plate Voltage			250 Volts
Grid No. 2 Voltage			250 Volts
Grid No. 1 Voltage			-15 Volts
Peak A F Grid to Grid Voltage			30 Volts
Plate Current (Zero Signal)			70 Ma
Plate Current (Maximum Signal)			79 Ma
Grid No. 2 Current (Zero Signal)			5.0 Ma
Grid No. 2 Current (Maximum Signal)			13 Ma
Transconductance (Per Tube)			3750 μmhos
Plate Resistance (Per Tube)			60000 Ohms
Effective Load Resistance (Plate to Plate)			10000 Ohms
Total Harmonic Distortion			5 Percent
Maximum Signal Power Output			10 Watts

NOTES:

- For operation in a 525 line, 30 frame system, the duty cycle of the voltage pulse must not exceed 15% of one scanning cycle.
- In stages operating with grid leak bias, an adequate cathode bias resistor or other suitable means is required to protect the tube in the absence of excitation.

6AQ5 (Cont'd)

APPLICATION

Sylvania Type 6AQ5 is a miniature beam power pentode intended for service as a general purpose audio power amplifier or vertical deflection amplifier in television receiver sweep circuits. The Type 6AQ5 is equivalent to the Type 6V6GT within its maximum ratings.

SYLVANIA TUBE TESTER SETTINGS

	A	B	C	D	E	F	G	Test or K
139/140	6.3	0	4	0	4	36	37	Y
219/220	6.3	3	14	25	4	067Z	5	2
	6.3	3	47	25	4	16Z	5	2

AVERAGE PLATE CHARACTERISTICS

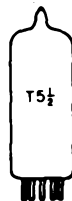
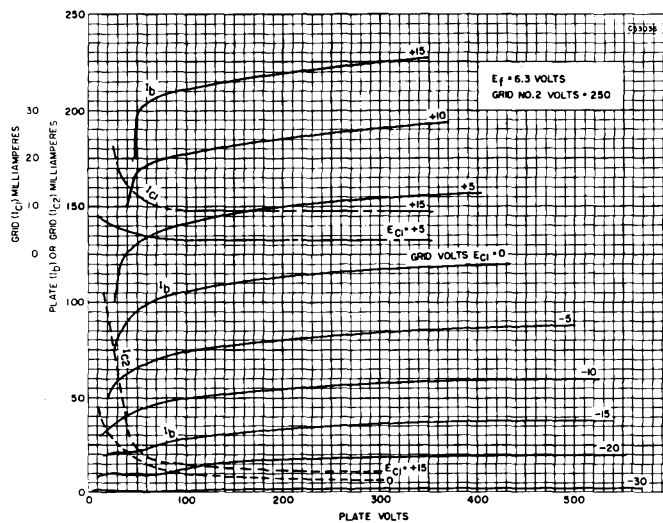

SYLVANIA TYPE 6AQ6
DUO DIODE HIGH-MU TRIODE

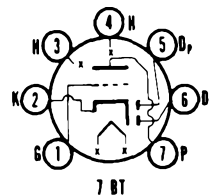

MECHANICAL DATA

Bulb	T-5 1/2, Outline 5-2
Base	Miniature Button 7-Pin
Basing	7BT
Mounting Position	Any

ELECTRICAL DATA

HEATER CHARACTERISTICS

Heater Voltage	6.3 Volts
Heater Current	150 Ma
Maximum Heater-Cathode Voltage	90 Volts

MAXIMUM RATINGS (Design Center Values)

Plate Voltage	300 Volts
---------------	-----------

6AQ6 (Cont'd)

TYPICAL OPERATION

Class A₁ Amplifier

Plate Voltage.....	100	250 Volts
Grid Voltage.....	-1.0	-3.0 Volts
Plate Current.....	0.8	1.0 Ma
Transconductance.....	1150	1200 μ mhos
Amplification Factor.....	70	70
Plate Resistance.....	61000	58000 Ohms

APPLICATION

Sylvania Type 6AQ6 is similar to Type 6Q7 but has lower heater current and lower internal capacitances.

TYPE 6AQ7GT

(See Condensed Data Section)

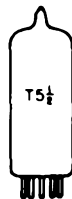

SYLVANIA TYPE 6AR5 BEAM POWER AMPLIFIER

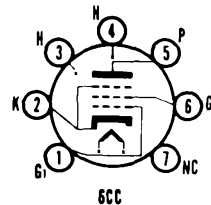

MECHANICAL DATA

Bulb.....	T-5 1/2, Outline 5-3
Base.....	Miniature Button 7-Pin
Basing.....	6CC
Mounting Position.....	Any

ELECTRICAL DATA

HEATER CHARACTERISTICS

Heater Voltage.....	6.3 Volts
Heater Current.....	400 Ma
Maximum Heater-Cathode Voltage.....	90 Volts

MAXIMUM RATINGS (Design Center Values)

Plate Voltage.....	250 Volts
Plate Dissipation.....	8.5 Watts
Grid No. 2 Voltage.....	250 Volts
Grid No. 2 Dissipation.....	2.5 Watts
Grid No. 1 Circuit Resistance.....	
Fixed Bias.....	0.1 Megohm
Cathode Bias.....	0.5 Megohm

TYPICAL OPERATION

Plate Voltage.....	250	250 Volts
Grid No. 2 Voltage.....	250	250 Volts
Grid No. 1 Voltage.....	-16.5	-18 Volts
Self Bias Resistor.....	420	500 Ohms
Plate Current (Zero Signal).....	34	32 Ma
Plate Current (Maximum Signal).....	35	33 Ma
Grid No. 2 Current (Zero Signal).....	5.7	5.5 Ma
Grid No. 2 Current (Maximum Signal).....	10	10 Ma
Transconductance.....	2400	2300 μ mhos
Plate Resistance (approx.).....	65000	68000 Ohms
Load Resistance.....	7000	7600 Ohms
Power Output.....	3.2	3.4 Watts
Total Harmonic Distortion.....	7	11 Percent

APPLICATION

Sylvania Type 6AR5 is a miniature beam power amplifier similar to Types 7B5 and 6K6G, with the plate and screen voltage maximum rating being lower for the 6AR5.

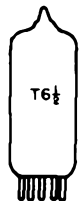

SYLVANIA TYPE 6AR8

SHEET-BEAM TUBE

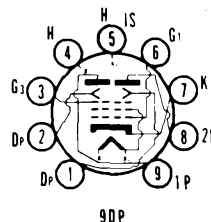

MECHANICAL DATA

Bulb.....	T-6 1/2, Outline 6-3
Base.....	Small Button 9-Pin
Basing.....	9DP
Mounting Position.....	Any

ELECTRICAL DATA

HEATER CHARACTERISTICS

Heater Voltage.....	6.3 Volts
Heater Current.....	300 Ma

DIRECT INTERELECTRODE CAPACITANCES (Approx.)

	Unshielded
Deflector No. 1 and No. 2 to All.....	4.8 $\mu\mu\text{f}$
Grid No. 1 to All Except Plates.....	7.5 $\mu\mu\text{f}$
Plate No. 1 and No. 2 to All.....	0.4 $\mu\mu\text{f}$
Grid No. 1 to Deflector No. 1.....	0.040 $\mu\mu\text{f}$ Max
Grid No. 1 to Deflector No. 2.....	0.060 $\mu\mu\text{f}$ Max
Plate No. 1 to Plate No. 2.....	0.4 $\mu\mu\text{f}$
Deflector No. 1 to Deflector No. 2.....	0.38 $\mu\mu\text{f}$

MAXIMUM RATINGS (Design Center Values)

Plate No. 1 and Plate No. 2 Voltage.....	300 Volts
Plate No. 1 and Plate No. 2 Dissipation (Each Plate).....	2.0 Watts
Accelerator Voltage.....	300 Volts
Peak Deflector No. 1 and Deflector No. 2 Voltage.....	± 150 Volts
Positive D C Grid No. 1 Voltage.....	0 Volts
D C Cathode Current.....	30 Ma
Grid No. 1 Circuit Resistance	
Fixed Bias.....	0.1 Megohms
Cathode Bias.....	0.25 Megohms

CHARACTERISTICS AND TYPICAL OPERATION

Average Characteristics with Deflectors Grounded

Plate No. 1 Voltage.....	250 Volts
Plate No. 2 Connected to Plate No. 1	
Accelerator Voltage.....	250 Volts
Deflectors No. 1 and No. 2 Voltage.....	0 Volts
Cathode Bias Resistor.....	300 Ohms
Total Plate Current.....	10 Ma
Accelerator Current.....	0.4 Ma
Grid No. 1 Transconductance.....	4000 μmhos
Grid No. 1 Voltage, Approx., for I_b (Total) = 10 μa	14 Volts

Average Deflector Characteristics

Plates No. 1 and No. 2 Voltage.....	250 Volts
Accelerator Voltage.....	250 Volts
Cathode Bias Resistor.....	300 Ohms
Deflector Switching Voltage, Max. ²	20 Volts
Deflector Bias Voltage for Minimum Deflector	
Switching Voltage ²	- 8 Volts
Voltage Difference Between Deflectors for	
$I_{b1} = I_{b2}$, Approx.....	0 Volts
Plate No. 1 Current, Max.	
$E_{b1} = -15$ Volts, $E_{b2} = +15$ Volts.....	1.0 Ma
Plate No. 2 Current, Max.	
$E_{b1} = +15$ Volts, $E_{b2} = -15$ Volts.....	1.0 Ma
Deflector No. 1 Current, Max.	
$E_{b1} = +25$ Volts, $E_{b2} = -25$ Volts.....	0.5 Ma
Deflector No. 2 Current, Max.	
$E_{b1} = -25$ Volts, $E_{b2} = +25$ Volts.....	0.5 Ma

NOTES:

- Pin 5 should be connected directly to ground.
- Deflector switching voltage is defined as the total voltage change required on either deflector, with an equal and opposite change on the other deflector, to switch the plate current from one plate to the other.

APPLICATION

The Type 6AR8 is a sheet-beam tube intended for use as a color television synchronous detector. A pair of balanced deflectors directs the beam to either of the two plates and a control grid varies the intensity of the beam. The use of this tube in color television receivers eliminates the need for phase-inversion circuits preceding the matrixes.

The 6AR8 should be so located in the receiver so that it is not subjected to stray magnetic fields.

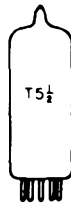

SYLVANIA TYPE 6AS5 BEAM POWER AMPLIFIER

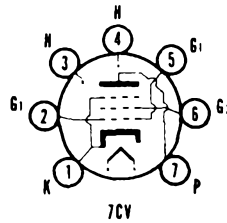

MECHANICAL DATA

Bulb	T-5 1/2, Outline 5-3
Base	Miniature Button 7-Pin
Basing	7CV
Mounting Position	Any

ELECTRICAL DATA

HEATER CHARACTERISTICS

Heater Voltage	6.3 Volts
Heater Current	800 Ma
Maximum Heater-Cathode Voltage	90 Volts

DIRECT INTERELECTRODE CAPACITANCES

Grid to Plate	0.6 $\mu\mu\text{f}$
Input	12 $\mu\mu\text{f}$
Output	6.2 $\mu\mu\text{f}$

MAXIMUM RATINGS (Design Center Values)

Plate Voltage	150 Volts
Grid No. 2 Voltage	117 Volts
Plate Dissipation	5.5 Watts
Grid No. 2 Dissipation	1.0 Watt
Grid No. 1 Circuit Resistance	
Fixed Bias	0.1 Megohm
Cathode Bias	0.5 Megohm

CHARACTERISTICS AND TYPICAL OPERATION

Class A₁ Amplifier

Plate Voltage	150 Volts
Grid No. 2 Voltage	110 Volts
Grid No. 1 Voltage	8.5 Volts
Peak A F Grid No. 1 Voltage	8.5 Volts
Plate Current (Zero Signal)	35 Ma
Plate Current (Maximum Signal)	36 Ma
Grid No. 2 Current (Zero Signal)	2 Ma
Grid No. 2 Current (Maximum Signal)	6.5 Ma
Transconductance	5600 μmhos
Load Resistance	4500 Ohms
Total Harmonic Distortion	10 Percent
Maximum Signal Power Output	2.2 Watts

APPLICATION

Sylvania Type 6AS5 is a miniature, beam power pentode designed primarily for service as the audio power output stage in automobile and a c operated receivers. It is capable of delivering a relatively high output with low supply voltages.

SYLVANIA TUBE TESTER SETTINGS

	A	B	C	D	E	F	G	Test or K
139/140	6.3	0	5	0	3	26	25	Y
219/220	6.3	3	45S	16	4	26Z	7	1
	6.3	3	42S	16	4	56Z	7	1



SYLVANIA TYPE 6AS8 5AS8

SINGLE DIODE
SHARP CUTOFF PENTODE

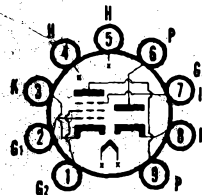

9DS

MECHANICAL DATA

Bulb.....	T-6 1/2
Base.....	E9-1, Small Button 9-Pin
Outline.....	6-2
Basing.....	9DS
Cathode.....	Coated Unipotential
Mounting Position.....	Any

ELECTRICAL DATA

HEATER CHARACTERISTICS

	5AS8	6AS8
Heater Voltage.....	4.7	6.3 Volts
Heater Current.....	600	450 Ma
Heater Warm-up Time ¹	11	Seconds
Heater-Cathode Voltage (Design Center Values)		
Heater Negative with Respect to Cathode		200 Volts Max.
Total D C and Peak		
Heater Positive with Respect to Cathode		100 Volts Max.
D C.....		200 Volts Max.
Total D C and Peak		

DIRECT INTERELECTRODE CAPACITANCES (Unshielded)

Pentode Section	
Grid No. 1 to Plate.....	0.02 μ f Max.
Input: g1 to (h+k+g2+g3).....	7.0 μ f
Output: p to (h+k+g2+g3).....	2.4 μ f
Coupling	
Pentode Grid to Diode Plate.....	0.005 μ f Max.
Pentode Plate to Diode Cathode.....	0.15 μ f Max.
Pentode Plate to Diode Plate.....	0.10 μ f Max.
Diode Section	
Plate to Heater, Cathode and Internal Shield.....	3.0 μ f

MAXIMUM RATINGS (Design Center Values)

Pentode Section	
Plate Voltage.....	300 Volts
Plate Dissipation.....	2.5 Watts
Grid No. 2 Voltage.....	See 6AM8 Rating Chart
Grid No. 2 Supply Voltage.....	300 Volts
Grid No. 2 Dissipation.....	0.5 Watt
Positive Grid No. 1 Voltage.....	0 Volts
Grid No. 3 Voltage.....	0 Volts
Grid No. 1 Circuit Resistance	
Cathode Bias.....	1.0 Megohm
Fixed Bias.....	0.25 Megohm
Diode Section	
Peak Inverse Plate Voltage.....	330 Volts
Peak Plate Current.....	50 Ma
D C Plate Current.....	5 Ma

CHARACTERISTICS AND TYPICAL OPERATION

Class A₁ Amplifier	
Plate Supply Voltage.....	200 Volts
Grid No. 2 Supply Voltage.....	150 Volts
Grid No. 3 Voltage.....	Connected to Cathode at Socket
Cathode Resistor.....	180 Ohms
Plate Current.....	9.5 Ma
Grid No. 2 Current.....	3.0 Ma
Transconductance.....	6200 μ mhos
Plate Resistance (approx.).....	0.3 Megohm
Grid No. 1 Voltage for $I_b = 10 \mu$ a (approx.).....	-8 Volts

NOTES:

1. Heater warm-up time is defined as the time required for the voltage across the heater to reach 80% of its rated value after applying four (4) times rated heater voltage to a circuit consisting of the tube heater in series with a resistance equal to three (3) times rated heater voltage divided by rated heater current.

APPLICATION

The Sylvania Types 5AS8 and 6AS8 have a diode and pentode contained in a miniature envelope. The pentode section has sharp cutoff characteristics and may be used as an IF amplifier, video amplifier and ago amplifier. The high perveance diode can be used as an audio detector, video detector or d c restorer.

SYLVANIA ELECTRONIC TUBES

6AS8, 5AS8 (Cont'd)

AVERAGE PLATE CHARACTERISTICS

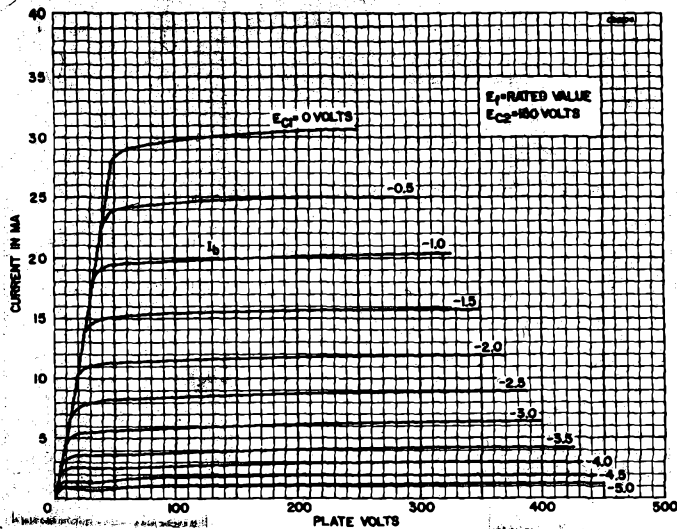

AVERAGE TRANSFER CHARACTERISTICS

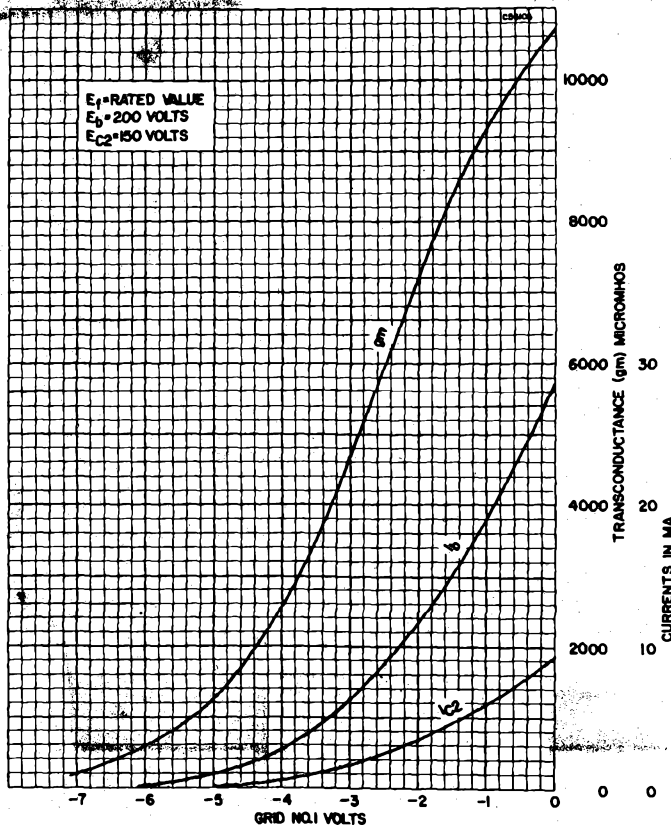

6AS5 (Cont'd)

AVERAGE PLATE CHARACTERISTICS

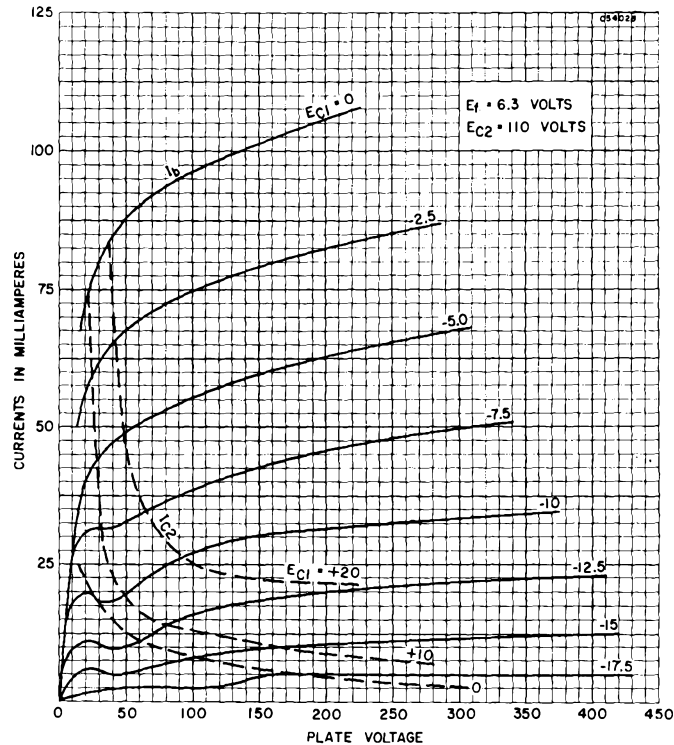

TYPES 6AS6, 6AS8

(See Condensed Data Section)



SYLVANIA TYPE 6AT6
DUO DIODE HIGH-MU TRIODE

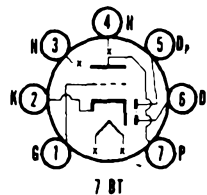

MECHANICAL DATA

Bulb	T-5 1/2, Outline 5-2
Base	Miniature Button 7-Pin
Basing	7BT
Mounting Position	Any

ELECTRICAL DATA

HEATER CHARACTERISTICS

Heater Voltage	6.3 Volts
Heater Current	300 Ma
Maximum Heater-Cathode Voltage	90 Volts

SYLVANIA ELECTRONIC TUBES

6AT6 (Cont'd)

DIRECT INTERELECTRODE CAPACITANCES (Shielded)¹

Grid to Plate	2.1 $\mu\mu\text{f}$
Input	2.3 $\mu\mu\text{f}$
Output	1.1 $\mu\mu\text{f}$
Diode Plate to Grid (Max.)	0.025 $\mu\mu\text{f}$

MAXIMUM RATINGS (Design Center Values)

Plate Voltage	300 Volts
Plate Dissipation	0.5 Watt
Positive Grid Voltage	0 Volts
Diode Current (Each Section)	1.0 Ma

CHARACTERISTICS AND TYPICAL OPERATION

Class A₁ Amplifier

Plate Voltage	100	250 Volts
Grid Voltage	-1	-3 Volts
Plate Current	0.8	1.0 Ma
Transconductance	1300	1200 μmhos
Amplification Factor	70	70
Plate Resistance	54000	58000 Ohms
Average Diode Current at 10 Volts D.C.	2.0	2.0 Ma

NOTE:

- Shield No. 316 connected to cathode.

APPLICATION

Sylvania Type 6AT6 is a miniature duo-diode, high- μ triode suitable for second detector audio amplifier service. Each section is independent except for a common cathode. Characteristics are similar to Type 6Q7G. Resistance coupled amplifier data may be found in the Appendix.

SYLVANIA TUBE TESTER SETTINGS

	A	B	C	D	E	F	G	Test or K
139/140	6.3	0	---	0	3	3	55	T
	6.3	0	---	0	4	---	55	T
	6.3	0	---	0	5	---	55	T
219/220	6.3	3	4	37	4	1T	7	2
	6.3	3	4	41	4	T	5*	2
	6.3	3	4	41	4	T	6*	2

* Diode gas test does not apply.

AVERAGE PLATE CHARACTERISTICS

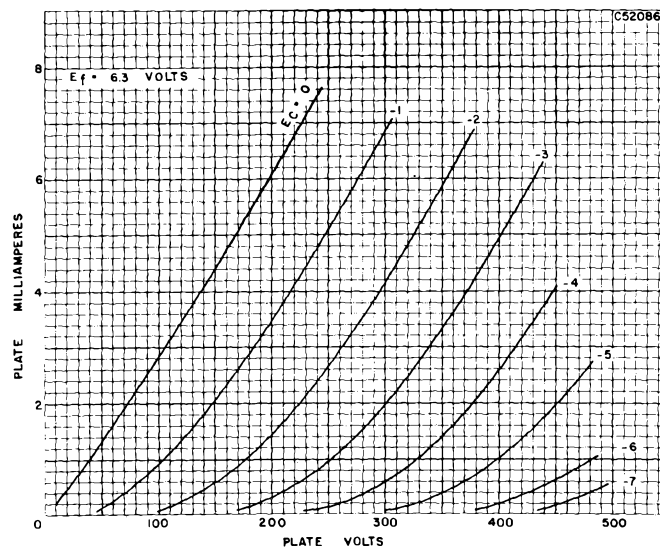

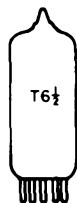

SYLVANIA TYPE 6AT8

TRIODE PENTODE CONVERTER

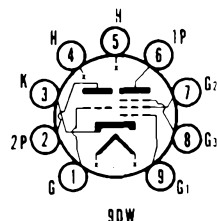

MECHANICAL DATA

Bulb	T-6 1/2, Outline 6-2
Base	Small Button 9-Pin
Basing	9DW
Mounting Position	Any

ELECTRICAL DATA

HEATER CHARACTERISTICS

Heater Voltage	6.3 Volts
Heater Current	450 Ma

DIRECT INTERELECTRODE CAPACITANCES

Pentode Unit	Shielded ¹	Unshielded	
Grid No. 1 to Plate	0.016	0.025 μ f	Max
Input	4.7	4.5 μ f	
Output	1.6	0.9 μ f	
Triode Unit			
Grid to Plate	1.5	1.5 μ f	
Input	2.4	2.0 μ f	
Output	1.0	0.5 μ f	
Pentode Grid No. 1 to Triode Plate	0.04	0.05 μ f	Max
Pentode Plate to Triode Plate	0.007	0.05 μ f	Max

NOTE:

1. Shield No. 315 connected to cathode.

For other rating, operation, and application data, refer to corresponding Type 6X8, which is identical except for basing and interelectrode capacities.



SYLVANIA TYPE 6AU4GT

DAMPER DIODE

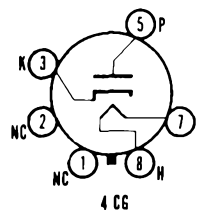

MECHANICAL DATA

Bulb	T-9, Outline 9-44
Base	Short Intermediate Octal
Basing	4CG
Mounting Position	Any

ELECTRICAL DATA

HEATER CHARACTERISTICS

Heater Voltage	6.3 Volts
Heater Current	1.8 Amperes
Maximum Heater-Cathode Voltage	
Heater Negative with Respect to Cathode	
D.C.	900 Volts
Total D.C. and Peak (Abs. Max.)	4500 Volts
Heater Positive with Respect to Cathode	
D.C.	100 Volts
Total D.C. and Peak	300 Volts

DIRECT INTERELECTRODE CAPACITANCES (Unshielded)

Heater to Cathode	4.0 μ f
Plate to Cathode and Heater	8.5 μ f
Cathode to Plate and Heater	11.5 μ f

MAXIMUM RATINGS (Design Center Values—Except as Noted)

Damper Diode²	
Peak Inverse Plate Voltage (Abs. Max.)	4500 Volts
D.C. Plate Current	175 Ma
Steady State Peak Plate Current	1050 Ma
Plate Dissipation	6.0 Watts

CHARACTERISTICS

Average Tube Voltage Drop for $I_b = 350$ Ma.	25 Volts
---	----------

6AU4GT (Cont'd)

TYPICAL OPERATION

Damper Service—90° Deflection Scan System

Peak Inverse Plate Voltage.....	3.65 Kv
Peak Heater-Cathode Voltage.....	3.9 Kv
Average Cathode Current.....	120 Ma
Peak Cathode Current.....	500 Ma
Boosted B+ Voltage.....	640 Volts
Plate Dissipation.....	2.8 Watts

NOTES:

1. May be either 5 or 6-pin. Socket terminals #1 (if used), 2, 4 and 6 shall not be used as tie points. Pin #1 may be omitted on 5-Pin base.
2. For operation in a 525-line, 30 frame system, the duty cycle of the horizontal voltage pulse must not exceed 15% of one scanning cycle. Power rectification service is not recommended.

APPLICATION

Sylvania Type 6AU4GT is an indirectly heated half-wave rectifier designed primarily for service as a damping diode in television receivers. It is capable of withstanding extremely high voltage pulses between cathode and both heater and plate elements.

AVERAGE PLATE CHARACTERISTICS

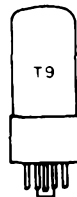
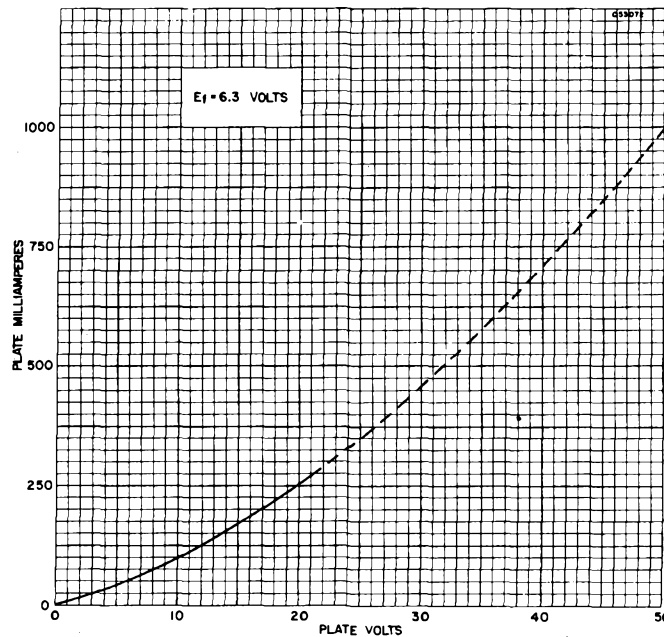

SYLVANIA TYPE 6AU5GT
BEAM POWER AMPLIFIER

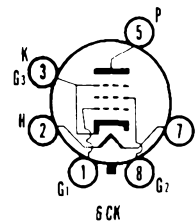

MECHANICAL DATA

Bulb.....	T-9, Outline 9-11
Base.....	Intermediate Octal 6-Pin
Basing.....	6CK
Mounting Position.....	Any

6AU5GT (Cont'd)

ELECTRICAL DATA

HEATER CHARACTERISTICS

Heater Voltage.....	6.3 Volts
Heater Current.....	1.25 Amperes
Maximum Heater-Cathode Voltage	
Total D C and Peak.....	200 Volts
D C, Heater Positive with Respect to Cathode.....	100 Volts

DIRECT INTERELECTRODE CAPACITANCES

Grid to Plate.....	0.5 $\mu\mu\text{f}$
Input.....	11.3 $\mu\mu\text{f}$
Output.....	7.0 $\mu\mu\text{f}$

MAXIMUM RATINGS (Design Center Values—Except as Noted)

Horizontal Deflection Amplifier¹

Plate Supply Voltage D C (Boost + D C Supply).....	550 Volts
Peak Positive Plate Voltage (Abs. Max.).....	5500 Volts
Peak Negative Plate Voltage.....	1250 Volts
Plate Dissipation ²	10 Watts
Grid No. 2 Voltage D C.....	200 Volts
Grid No. 2 Dissipation.....	2.5 Watts
Peak Negative Grid No. 1 Voltage.....	300 Volts
Average Cathode Current.....	110 Ma
Peak Cathode Current.....	400 Ma
Grid No. 1 Circuit Resistance.....	0.47 Megohm
Bulb Temperature (At Hottest Point).....	210° C

CHARACTERISTICS

Pentode Operation

Plate Voltage.....	60	115 Volts
Grid No. 2 Voltage.....	175	175 Volts
Grid No. 1 Voltage.....	0	-20 Volts
Plate Current.....	210	60 Ma
Grid No. 2 Current.....	25	6.8 Ma
Transconductance.....		5600 μmhos
Plate Resistance.....		6000 Ohms
Grid No. 1 Bias With $E_b = 115$ V and $E_{c2} = 150$ V for $I_b = 1$ Ma (approx.).....		-45 Volts

Triode Connected

Plate Voltage.....	100 Volts
Grid No. 2 Voltage (Tied to Plate).....	100 Volts
Grid No. 1 Voltage.....	-4.5 Volts
Amplification Factor.....	5.9

NOTES:

- For operation in a 525 line, 30 frame system, the duty cycle of the voltage pulse must not exceed 15% of one scanning cycle.
- In stages operating with grid leak bias, an adequate cathode bias resistor or other suitable means is required to protect the tube in the absence of excitation.

APPLICATION

Sylvania Type 6AU5GT is a beam power amplifier designed especially for use as a horizontal scanner in television receivers using magnetic deflection.

SYLVANIA TUBE TESTER SETTINGS

	A	B	C	D	E	F	G	Test or K
139/140	6.3	0	—	0	3	57	23	Y
219/220	6.3	2	7	15	7	18Z	5	3

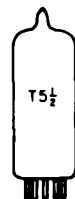

SYLVANIA TYPE 6AU6
SHARP CUTOFF R F PENTODE

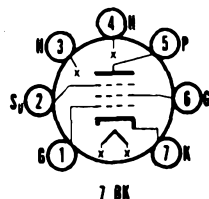

MECHANICAL DATA

Bulb.....	T-5 1/2, Outline 5-2
Base.....	Miniature Button 7-Pin
Basing.....	7BK
Mounting Position.....	Any

6AU6 (Cont'd)

ELECTRICAL DATA

HEATER CHARACTERISTICS

Heater Voltage	6.3 Volts
Heater Current	300 Ma
Maximum Heater-Cathode Voltage	
Heater Negative with Respect to Cathode	180 Volts
Heater Positive with Respect to Cathode	100 Volts

DIRECT INTERELECTRODE CAPACITANCES (Unshielded)

Grid to Plate0035 μf	Max
Input	5.5 μf	
Output	5.0 μf	

MAXIMUM RATINGS (Design Center Values)

Plate Voltage	300 Volts
Plate Dissipation	3 Watts
Grid No. 2 Supply Voltage	300 Volts
Grid No. 2 Voltage	(See Rating Chart for Type 6AM8)
Grid No. 2 Dissipation	0.65 Watt
Grid No. 2 Supply Voltage	300 Volts
Positive Grid No. 1 Voltage	0 Volts

CHARACTERISTICS AND TYPICAL OPERATION

Plate Voltage	100	250	250 Volts
Grid No. 3		Connected to Cathode at Socket	
Grid No. 2 Voltage	100	125	150 Volts
Cathode Bias Resistor	150	100	68 Ohms
Grid No. 1 Voltage	-1.0	-1.0	-1.0 Volt
Plate Current	5.0	7.6	10.6 Ma
Grid No. 2 Current	2.1	3.0	4.3 Ma
Plate Resistance	0.5	1.5	1.0 Megohms
Transconductance	3900	4500	5200 μmhos
Grid No. 1 Voltage for $I_b = 10 \mu\text{a}$	-4.2	-5.5	-6.5 Volts

APPLICATION

Sylvania Type 6AU6 is a miniature sharp cutoff pentode, r f amplifier capable of operation up to 400 mc. Resistance coupled amplifier data is given in the Appendix.

SYLVANIA TUBE TESTER SETTINGS

	A	B	C	D	E	F	G	Test or K
139/140	6.3	0	—	0	4	36	33	W
219/220	6.3	3	4	21	4	16Y	5	7

AVERAGE PLATE CHARACTERISTICS

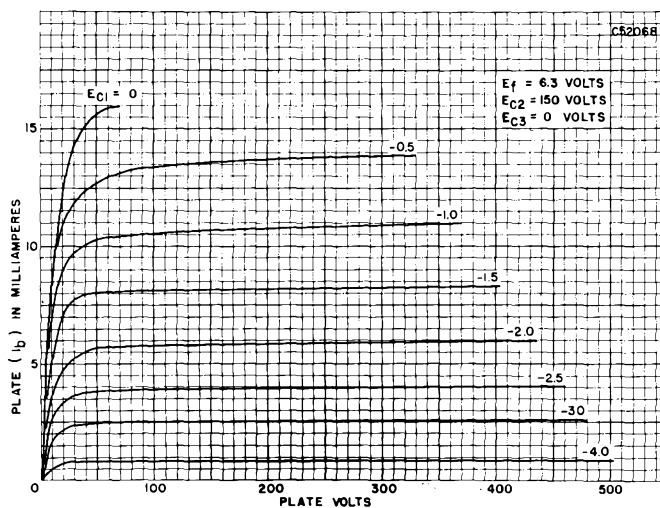

6AU6 (Cont'd)

AVERAGE PLATE CHARACTERISTICS

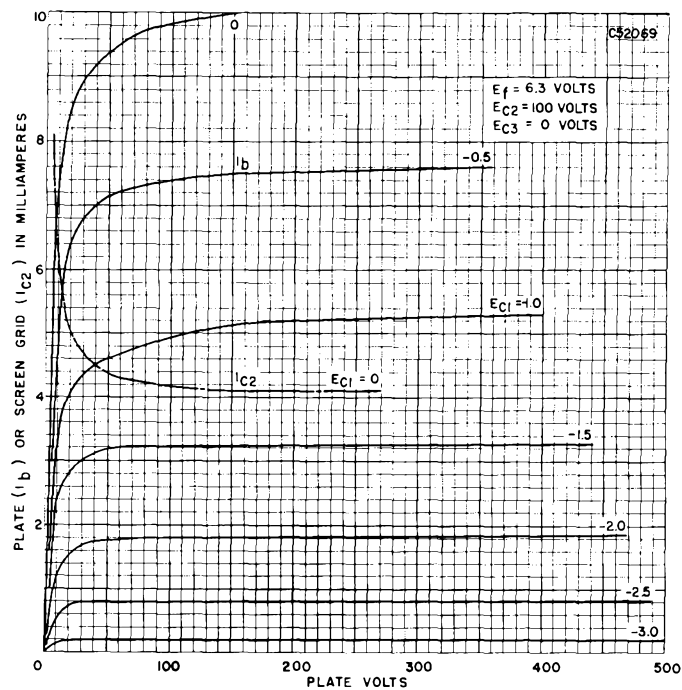

AVERAGE TRANSFER CHARACTERISTICS

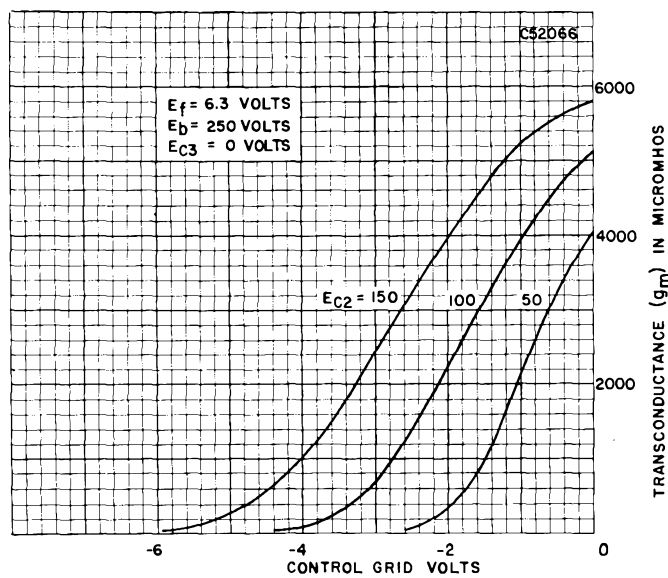

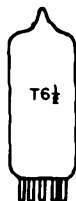

SYLVANIA TYPE 6AU8

TRIODE PENTODE

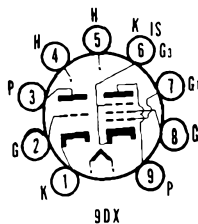

MECHANICAL DATA

Bulb	T-6 $\frac{1}{2}$
Base	E9-1, Miniature, 9 Button-Pin
Outline	6-3
Basing	9D X
Cathode	Coated Unipotential
Mounting Position	Any

ELECTRICAL DATA

HEATER CHARACTERISTICS

Heater Voltage	6.3 Volts
Heater Current	600 Ma
Heater Warm-up Time	(See Series String Heaters in Appendix)
Heater-Cathode Voltage (Design Center Values)	
Heater Negative with Respect to Cathode	
Total D C and Peak	200 Volts Max.
Heater Positive with Respect to Cathode	
D C	100 Volts Max.
Total D C and Peak	200 Volts Max.

DIRECT INTERELECTRODE CAPACITANCES (Unshielded)

Triode	
Grid to Plate	2.2 μf
Input	2.6 μf
Output	0.34 μf
Pentode	
Grid to Plate	0.044 μf
Input	7.5 μf
Output	2.4 μf
Coupling	
Pentode Grid No. 1 to Triode Plate	0.006 μf Max.
Triode Grid to Pentode Plate	0.022 μf Max.
Pentode Plate to Triode Plate	0.12 μf Max.

RATINGS (Design Center Values)

	Triode	Pentode
Plate Voltage	300	300 Volts Max.
Grid No. 2 Supply Voltage		300 Volts Max.
Grid No. 2 Voltage	See Rating Chart for Type 6AM8	
Plate Dissipation	2.5	3.0 Watts Max.
Grid No. 2 Dissipation		1.0 Watt Max.
Positive Grid No. 1 Voltage		0 Volts Max.
Grid No. 1 Circuit Resistance		
Fixed Bias	0.5	0.25 Megohm Max.
Self Bias	1.0	1.0 Megohm Max.

CHARACTERISTICS AND TYPICAL OPERATION

	Triode	Pentode
Class A₁ Amplifier		
Plate Voltage	150	200 Volts
Grid No. 2 Voltage		125 Volts
Cathode Bias Resistor	150	82 Ohms
Amplification Factor	40	
Plate Resistance (approx.)	.0082	.15 Megohm
Transconductance	4900	7000 μmhos
Plate Current	9.0	15 Ma
Grid No. 2 Current		3.4 Ma
Grid No. 1 Voltage (approx.) for $I_b = 100 \mu\text{a}$.	-6.5	8 Volts d c

APPLICATION

The Sylvania Type 6AU8 is a medium μ triode and sharp cutoff pentode contained in a 9-pin miniature envelope. It is intended for service in television receivers employing a series string heater arrangement. The triode section is designed for operation as a sync separator. The pentode section is designed to serve as a video amplifier.

AVERAGE PLATE CHARACTERISTICS TRIODE SECTION

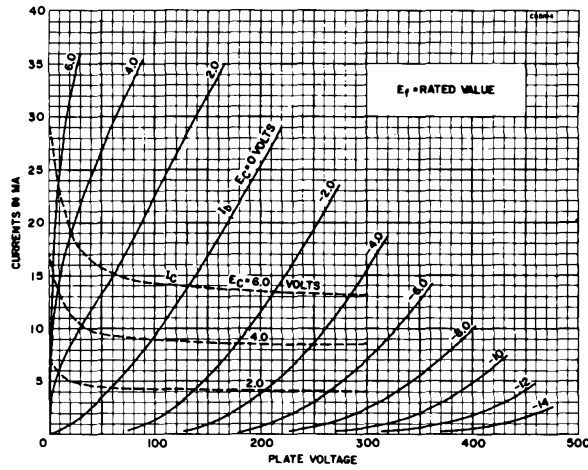

AVERAGE PLATE CHARACTERISTICS PENTODE SECTION

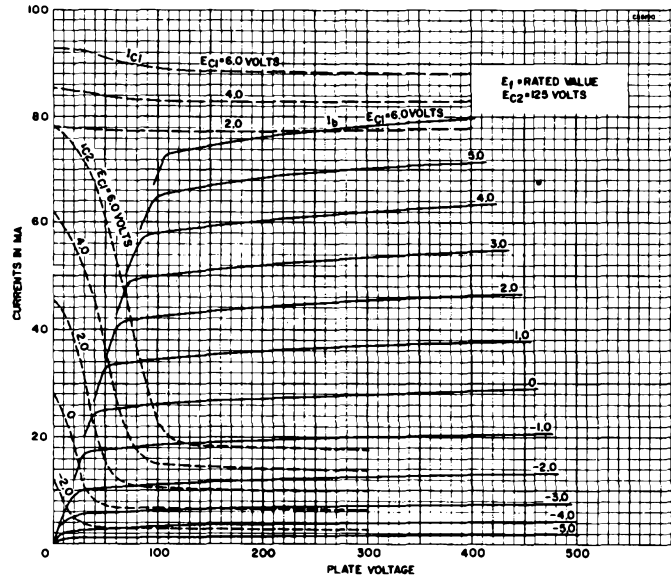

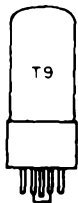

SYLVANIA TYPE 6AV5GT

BEAM POWER AMPLIFIER

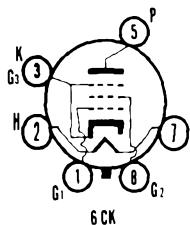

MECHANICAL DATA

Bulb..... T-9, Outline 9-11 or 9-41
 Base..... Intermediate Shell Octal 6-Pin or
 Short Intermediate Shell Octal 6-Pin
 Basing..... 6CK
 Mounting Position..... Any

ELECTRICAL DATA

HEATER CHARACTERISTICS

Heater Voltage..... 6.3 Volts
 Heater Current..... 1.2 Amperes
 Heater-Cathode Voltage.....
 D C, Heater Positive with Respect to Cathode..... 100 Volts
 Total D C and Peak..... 200 Volts

DIRECT INTERELECTRODE CAPACITANCES (Unshielded)

Grid to Plate..... 0.7 μf
 Input..... 14 μf
 Output..... 7.0 μf

MAXIMUM RATINGS (Design Center Values—Except as Noted)

Horizontal Deflection Amplifier¹

D C Plate Supply Voltage (Boost + D C Power Supply).... 550 Volts
 Peak Positive Plate Voltage (Abs. Max.)..... 5500 Volts
 Peak Negative Plate Voltage..... 1250 Volts
 Plate Dissipation²..... 11 Watts
 Peak Negative Grid No. 1 Voltage..... 300 Volts
 D C Grid No. 2 Voltage..... 175 Volts
 Grid No. 2 Dissipation..... 2.5 Watts
 Average Cathode Current..... 110 Ma
 Peak Cathode Current..... 400 Ma
 Grid No. 1 Circuit Resistance..... 0.47 Megohm
 Bulb Temperature (At Hottest Point)..... 210° C

AVERAGE CHARACTERISTICS

	Instantaneous Values	
Plate Voltage.....	60	250 Volts
Grid No. 2 Voltage.....	150	150 Volts
Grid No. 1 Voltage.....	0	-22.5 Volts
Plate Current.....	225	55 Ma
Grid No. 2 Current.....	25	2.1 Ma
Plate Resistance (approx.).....		20000 Ohms
Transconductance.....		5500 μmhos
Grid No. 1 Voltage for $I_b = 1 \text{ Ma}$ (approx.).....		-46 Volts
Triode Amplification Factor ³		4.3

NOTES:

- For operation in a 525 line, 30 frame system, the duty cycle of the voltage pulse must not exceed 15% of one scanning cycle.
- In stages operating with grid leak bias, an adequate cathode bias resistor or other suitable means is required to protect the tube in the absence of excitation.
- Triode connection (screen tied to plate) with $E_b = E_{c2} = 150 \text{ Volts}$ and $E_{c1} = -22.5 \text{ Volts}$.

APPLICATION

Sylvania Type 6AV5GT is a beam power pentode designed primarily for use as the horizontal deflection amplifier in television receivers.

SYLVANIA TUBE TESTER SETTINGS

	A	B	C	D	E	F	G	Test or K
139/140	6.3	0	---	0	3	57	21	Y
219/220	6.3	2	7	12	7	18Z	5	3

6AV5GT (Cont'd)

AVERAGE PLATE CHARACTERISTICS

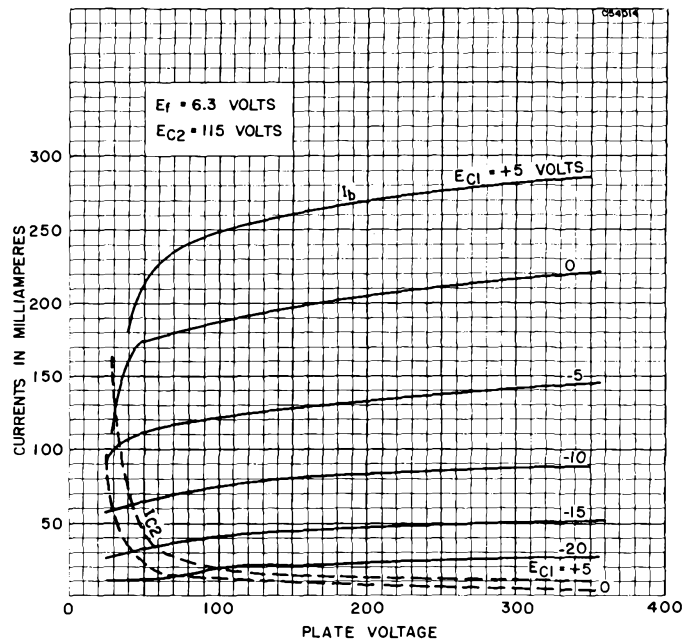

AVERAGE PLATE CHARACTERISTICS

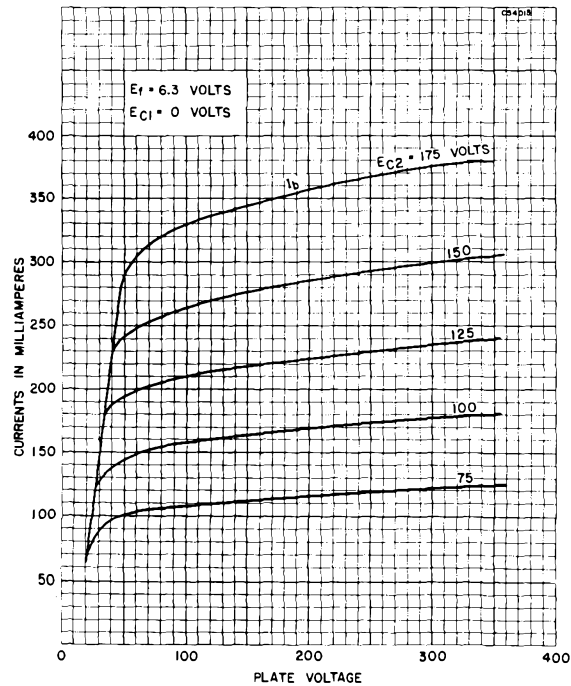

6AV5GT (Cont'd)

AVERAGE TRANSFER CHARACTERISTICS

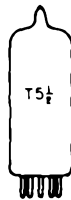
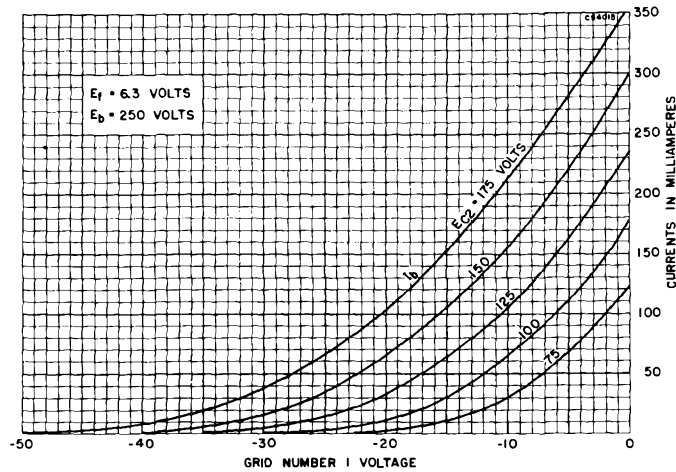

SYLVANIA TYPE 6AV6
DUO DIODE TRIODE

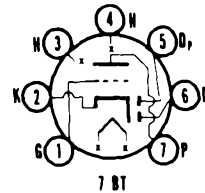

MECHANICAL DATA

Bulb.....	T-5 1/2, Outline 5-2
Base.....	Miniature Button 7-Pin
Basing.....	7BT
Mounting Position.....	Any

ELECTRICAL DATA

HEATER CHARACTERISTICS

Heater Voltage.....	6.3 Volts
Heater Current.....	300 Ma
Maximum Heater-Cathode Voltage.....	90 Volts

DIRECT INTERELECTRODE CAPACITANCES (Shielded)¹

Grid to Plate.....	2.1 μf
Input.....	2.3 μf
Output.....	0.9 μf

MAXIMUM RATINGS (Design Center Values)

Plate Voltage (Triode Section).....	300 Volts
Diode Plate Current Each Diode.....	1.0 Ma

CHARACTERISTICS AND TYPICAL OPERATION

Class A₁ Amplifier

Plate Voltage.....	100	250 Volts
Grid Voltage.....	-1	-2 Volts
Plate Current.....	0.5	1.2 Ma
Plate Resistance.....	80000	62500 Ohms
Transconductance.....	1250	1600 μmhos
Amplification Factor.....	100	100

6AV6 (Cont'd)

NOTE:

- Shield No. 316 connected to cathode.

APPLICATION

Sylvania Type 6AV6 is a miniature high- μ duo-diode triode designed for second detector-audio amplifier use in radio receivers. Its characteristics are similar to Types 6SF5GT and 7B4 except for a slightly higher transconductance. Resistance coupled amplifier data is given in the Appendix.

SYLVANIA TUBE TESTER SETTINGS

	A	B	C	D	E	F	G	Test or K
139/140	6.3	0	---	0	3	3	60	X
	6.3	0	---	0	4	---	55	T
	6.3	0	---	0	5	---	55	T
219/220	6.3	3	4	37	4	1T	7	2
	6.3	3	4	41	4	T	5*	2
	6.3	3	4	41	4	T	6*	2

* Diode gas test does not apply.

AVERAGE TRANSFER CHARACTERISTICS

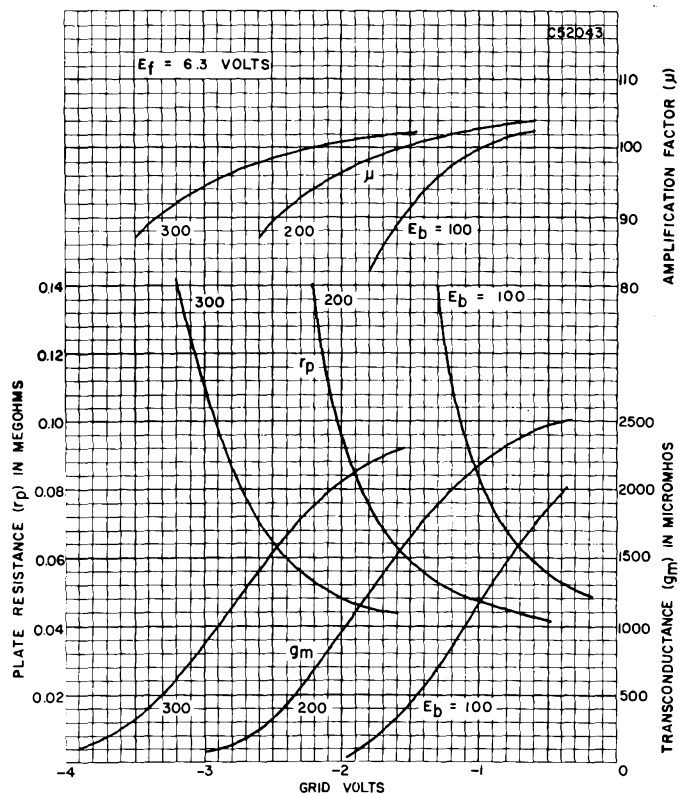

6AV6 (Cont'd)

AVERAGE PLATE CHARACTERISTICS

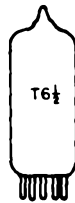
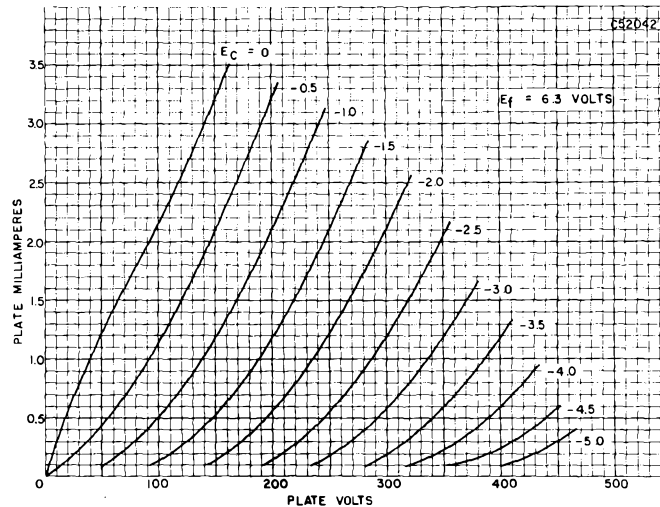

SYLVANIA TYPE 6AV8
TRIODE PENTODE

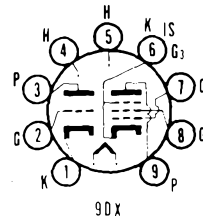

MECHANICAL DATA

Bulb.....	T-6 1/2, Outline 6-3
Base.....	Miniature Button 9-Pin
Basing.....	9DX
Mounting Position.....	Any

ELECTRICAL DATA

HEATER CHARACTERISTICS

Heater Voltage.....	6.3 Volts
Heater Current.....	600 Ma
Heater Warm-up Time (See SERIES STRING HEATERS Section in Appendix).....	
Maximum Heater-Cathode Voltage	
D C and Peak.....	200 Volts
D C, Heater Positive with Respect to Cathode.....	100 Volts

DIRECT INTERELECTRODE CAPACITANCES

	Shielded ¹	Unshielded	
Triode Section			
Grid to Plate.....	2.2	2.2 $\mu\mu\text{f}$	
Input.....	3.4	3.2 $\mu\mu\text{f}$	
Output.....	1.7	0.32 $\mu\mu\text{f}$	
Pentode Section			
Grid to Plate.....	0.030	0.036 $\mu\mu\text{f}$	
Input.....	11.0	11.0 $\mu\mu\text{f}$	
Output.....	3.6	2.8 $\mu\mu\text{f}$	
Coupling: (Pentode Grid No. 1 to Triode Plate).....	0.005	0.008 $\mu\mu\text{f}$	Max
Coupling: (Pentode Plate to Triode Grid).....	0.008	0.030 $\mu\mu\text{f}$	Max
Coupling: (Pentode Plate to Triode Plate).....	0.050	0.20 $\mu\mu\text{f}$	Max

6AW8 (Cont'd)

MAXIMUM RATINGS (Design Center Values)

	Triode	Pentode
Plate Voltage.....	300	300 Volts
Grid No. 2 Supply Voltage.....		300 Volts
Grid No. 2 Voltage.....	See Rating Chart for Type 6AM8	
Plate Dissipation.....	1.0	3.25 Watts
Grid No. 2 Dissipation.....		1.0 Watt
Negative Grid No. 1 Voltage.....		50 Volts
Positive Grid No. 1 Voltage.....		0 Volts
Grid No. 1 Circuit Resistance		
Fixed Bias.....	0.5	0.25 Megohm
Self Bias.....	1.0	1.0 Megohm

CHARACTERISTICS AND TYPICAL OPERATION

Class A ₁ Amplifier	Triode	Pentode
Plate Voltage.....	200	200 Volts
Grid No. 2 Voltage.....		150 Volts
Grid No. 1 Voltage.....	-2	0 Volts
Cathode Bias Resistor.....		180 Ohms
Amplification Factor.....	70	
Plate Resistance (approx.).....	.0175	0.4 Megohm
Transconductance.....	4000	9000 μ mhos
Plate Current.....	4.0	13 Ma
Grid No. 2 Current.....		3.5 Ma
Grid No. 1 Voltage for $I_b = 10 \mu$ a (approx.)..	-5	-10 Volts

NOTE:

1. Shield No. 315 tied to cathode base pin of section under test.

APPLICATION

Sylvania Type 6AW8 is intended for service in television receivers employing a series string heater arrangement. The triode section is designed for operation as a sync separator. The pentode section is designed to serve as a video amplifier. For information on specially controlled heaters for series string operation refer to the SERIES STRING section of the Appendix.

SYLVANIA TUBE TESTER SETTINGS

	A	B	C	D	E	F	G	Test or K
139/140	6.3	0	2	0	4	79	53	W
	6.3	0	4	0	5	3	48	T
219/220	6.3	4	15	52	5	78SY	9	6
	6.3	4	56	36	5	2T	3	1

AVERAGE PLATE CHARACTERISTICS TRIODE SECTION

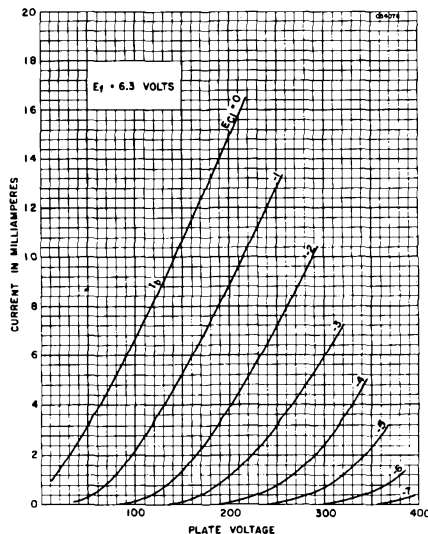

6AW8 (Cont'd)

AVERAGE TRANSFER CHARACTERISTICS

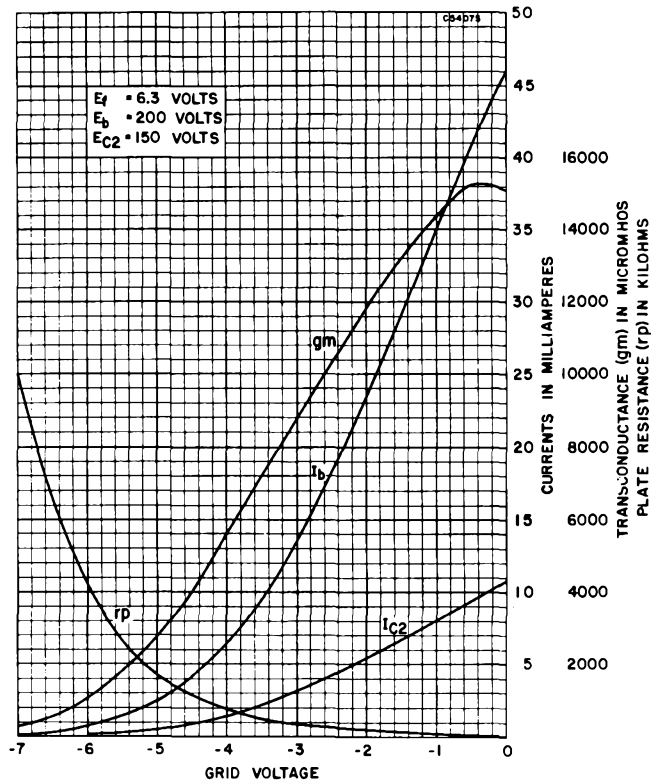

AVERAGE TRANSFER CHARACTERISTICS

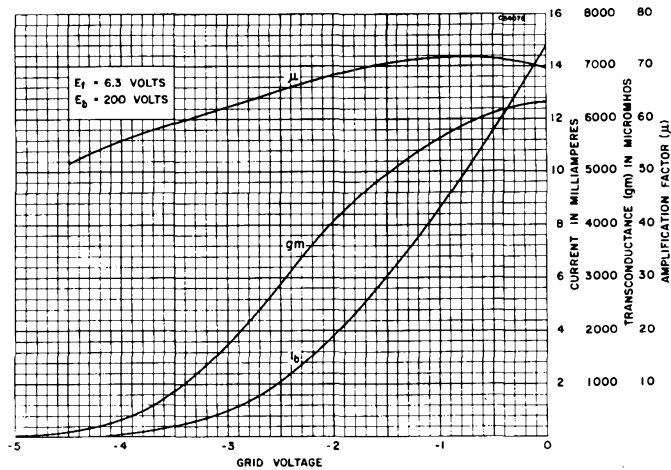

6AW8 (Cont'd)

AVERAGE PLATE CHARACTERISTICS PENTODE SECTION

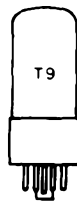
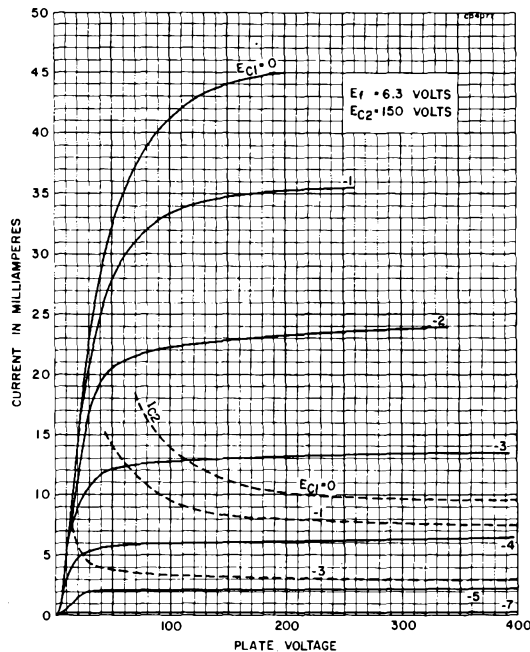

SYLVANIA TYPE **6AX4GT**
DAMPER DIODE

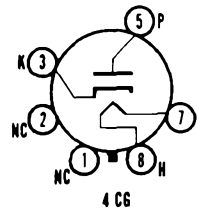

MECHANICAL DATA

Bulb.....	T-9, Outline 9-41
Base.....	Short Intermediate Shell Octal 6-Pin
Basing.....	4CG
Mounting Position.....	Any

ELECTRICAL DATA

HEATER CHARACTERISTICS

Heater Voltage.....	6.3 Volts
Heater Current.....	1.2 Amperes
Maximum Heater-Cathode Voltage.....	
Heater Negative with Respect to Cathode (Abs. Max.)	
D C.....	900 Volts
Total D C and Peak.....	4400 Volts
Heater Positive with Respect to Cathode	
D C.....	100 Volts
Total D C and Peak.....	300 Volts

MAXIMUM RATINGS (Design Center Values—Except as Noted)

Damper Service²	
Peak Inverse Voltage (Abs. Max.).....	4400 Volts
Steady State Peak Current.....	750 Ma
Plate Dissipation.....	4.8 Watts
Average Tube Drop (at 250 Ma).....	32 Volts
D C Plate Current.....	125 Ma

NOTES:

1. Pins 1, 2, 4 and 6 shall not be used as tie points.
2. For operation in a 525 line, 30 frame system, the duty cycle of the voltage pulse must not exceed 15% of one scanning cycle.

6AX4GT (Cont'd)

APPLICATION

Sylvania Type 6AX4GT is an indirectly heated half-wave rectifier, designed for service as a damping diode in television receiver direct drive sweep circuits.

SYLVANIA TUBE TESTER SETTINGS

	A	B	C	D	E	F	G	Test or K
139/140	6.3	0	7	1	3		17	Y
219/220	6.3	7	8	11	8	Z	5*	3

* Diode gas test does not apply.

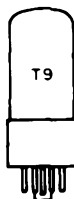

SYLVANIA TYPE 6AX5GT
FULL-WAVE RECTIFIER

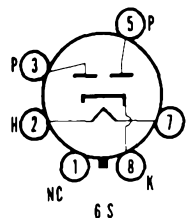

MECHANICAL DATA

Bulb	T-9, Outline 9-41
Base	Short Intermediate Shell Octal 6-Pin
Basing	6S
Mounting Position	Any

ELECTRICAL DATA

HEATER CHARACTERISTICS

Heater Voltage	6.3 Volts
Heater Current	1.2 Amperes
Maximum Peak Heater-Cathode Voltage	450 Volts

MAXIMUM RATINGS (Design Center Values)

Peak Inverse Plate Voltage	1250 Volts
Peak Plate Current (Per Plate)	375 Ma

TYPICAL OPERATION

Capacitor Input to Filter (Full-Wave Rectifier)

A C Voltage Per Plate (R M S)	350	450 Volts
Plate Supply Impedance Per Plate	50	105 Ohms
Filter Input Capacitor	10	10 μ f
D C Output Voltage at Input to Filter (approx.)		
Half-Load Current of 62.5 Ma	395	Volts
40.0 Ma		540 Volts
Full-Load Current of 125 Ma	350	Volts
80 Ma		490 Volts

Choke Input to Filter (Full-Wave Rectifier)

A C Voltage Per Plate (R M S)	350	450 Volts
Filter Input Choke	10	10 Henries
D C Output Voltage at Input to Filter (approx.)		
Half-Load Current of 75 Ma	270	Volts
62.5 Ma		365 Volts
Full-Load Current of 150 Ma	250	Volts
125 Ma		350 Volts

APPLICATION

Sylvania Type 6AX5GT is a full-wave rectifier featuring the unipotential cathode. It is designed for use in both home and automobile radio receivers.

SYLVANIA TUBE TESTER SETTINGS

	A	B	C	D	E	F	G	Test or K
139/140	6.3	0	—	0	1	—	23	Y
	6.3	0	—	0	3	—	23	Y
219/220	6.3	2	7	14	7	Z	3*	8
	6.3	2	7	14	7	Z	5*	8

* Diode gas test does not apply.

TYPE 6AX6G

(See Condensed Data Section)



SYLVANIA TYPE **6AX7**
HIGH-MU DUO TRIODE

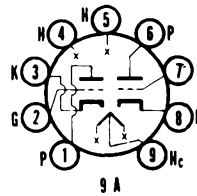

ELECTRICAL DATA

HEATER CHARACTERISTICS

	Parallel	Series
Heater Voltage.....	3.15	6.3 Volts
Heater Current.....	600	300 Ma
Heater Warm-up Time	Applied to Parallel Connection Only (See SERIES STRING HEATERS Section in Appendix)	
Maximum Heater-Cathode Voltage	200 Volts	
Total D C and Peak	100 Volts	
D C, Heater Positive with Respect to Cathode.....		

For other rating, operation, and application data, refer to corresponding Type 12AX7, which is identical except for heater ratings.

APPLICATION

The Sylvania Type 6AX7 is intended for service in television receivers employing series connected heaters. For information on specially controlled heaters for series string operation refer to the SERIES STRING HEATER section of the Appendix.

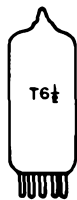

SYLVANIA TYPE **6AX8**
TRIODE PENTODE

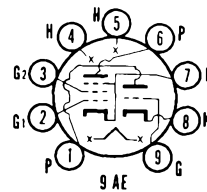

MECHANICAL DATA

Bulb.....	T-6 1/2
Base.....	Small Button, 9-Pin
Outline.....	6-2
Basing.....	9AE
Cathode.....	Coated Unipotential
Mounting Position.....	Any

ELECTRICAL DATA

HEATER CHARACTERISTICS

Heater Voltage.....	6.3 Volts
Heater Current.....	450 Ma
Heater-Cathode Voltage	
Heater Negative with Respect to Cathode	90 Volts Max.
Total D C and Peak	90 Volts Max.
Heater Positive with Respect to Cathode	
Total D C and Peak	90 Volts Max.

TYPE 6AX8 (Cont'd)

DIRECT INTERELECTRODE CAPACITANCES (Shielded)¹

Pentode

Grid No. 1 to Plate	0.006 μf Max.
Input: g1 to (h + k & g3 & IS + g2)	5.0 μf
Output: p to (h + k & g3 & IS + g2)	3.5 μf

Triode

Grid to Plate	1.8 μf
Grid to Cathode (h + k)	2.5 μf
Plate to Cathode (h + k)	1.0 μf
Cathode to Heater (approx.)	3.5 μf

RATINGS (Design Center Values)

	Triode	Pentode
Plate Voltage	300	300 Volts Max.
Plate Dissipation	2.7	2.8 Watts Max.
Grid No. 2 Supply Voltage	—	300 Volts Max.
Grid No. 2 Voltage	See Rating	Chart for Type 6AM8
Grid No. 2 Dissipation	—	0.5 Watt Max.
Positive D C Grid No. 1 Voltage	0	0 Volts Max.

CHARACTERISTICS AND TYPICAL OPERATION

	Triode	Pentode
Plate Voltage	150	250 Volts
Grid No. 2 Voltage	—	110 Volts
Cathode Resistor	56	120 Ohms
Plate Current	18	10 Ma
Grid No. 2 Current	—	3.5 Ma
Transconductance	8500	4800 μmhos
Amplification Factor	40	—
Plate Resistance (approx.)	0.005	0.4 Megohm
Grid No. 1 Voltage for Ib = 10 μa	-12	-12 Volts

NOTE:

- Shield No. 315.

APPLICATION

The Sylvania Type 6AX8 is a medium mu triode and high gm pentode designed for use as a video amplifier and sync separator.

TYPES 6B4G, 6B5, 6B6G, 6B7, 6B7S, 6B8G, GT

(See Condensed Data Section)

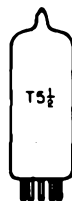

SYLVANIA TYPE 6BA6 REMOTE CUTOFF R F PENTODE

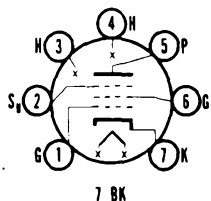

MECHANICAL DATA

Bulb	T-5 1/2, Outline 5-2
Base	Miniature Button 7-Pin
Basing	7BK
Mounting Position	Any

ELECTRICAL DATA

HEATER CHARACTERISTICS

Heater Voltage	6.3 Volts
Heater Current	300 Ma
Maximum Peak Heater-Cathode Voltage	90 Volts

DIRECT INTERELECTRODE CAPACITANCES (Unshielded)

Grid to Plate0035 μf Max.
Input	5.5 μf
Output	5.0 μf



SYLVANIA TYPE 6AZ8
MEDIUM MU TRIODE
SEMI-REMOTE CUTOFF PENTODE

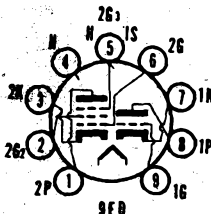

MECHANICAL DATA

Bulb	T-6 $\frac{1}{2}$
Base	E9-1, Small Button 9-Pin
Outline	6-2
Basing	9ED
Cathode	Coated Unipotential
Mounting Position	Any

ELECTRICAL DATA

HEATER CHARACTERISTICS

Heater Voltage	6.3 Volts
Heater Current	450 Ma
Heater-Cathode Voltage (Design Center Values)	
Heater Negative with Respect to Cathode	
Total D C and Peak	200 Volts Max.
Heater Positive with Respect to Cathode	
D C	100 Volts Max.
Total D C and Peak	200 Volts Max.

DIRECT INTERELECTRODE CAPACITANCES (Unshielded)

Triode Section	
Grid to Plate	1.7 μ f
Grid to (h + k + I.S.)	2.0 μ f
Plate to (h + k + I.S.)	1.7 μ f
Pentode Section	
Grid No. 1 to Plate	0.02 μ f Max.
Grid No. 1 to (h + k + g ₂ + g ₃ + I.S.)	6.5 μ f
Plate to (h + k + g ₂ + g ₃ + I.S.)	2.2 μ f
Coupling	
Triode Grid to Pentode Plate	0.027 μ f Max.
Pentode Grid No. 1 to Triode Plate	0.020 μ f Max.
Pentode Plate to Triode Plate	0.045 μ f Max.

MAXIMUM RATINGS (Design Center Values)

	Triode Section	Pentode Section
Plate Voltage	300	300 Volts
Grid No. 2 Supply Voltage		300 Volts
Grid No. 2 Voltage	See 6AM8 Rating Chart	
Positive Grid No. 1 Voltage	0	0 Volts
Plate Dissipation	2.6	2.0 Watts
Grid No. 2 Input:		
For Grid No. 2 Voltages up to 150 Volts		0.5 Watt
For Grid No. 2 Voltages Between 150 and 300 Volts	See 6AM8 Rating Chart	
Maximum Circuit Values ¹		
Cathode Bias	1.0	1.0 Megohms
Fixed Bias	0.5	0.25 Megohm

CHARACTERISTICS AND TYPICAL OPERATION

	Triode Section	Pentode ² Section
Class A ₁ Amplifier		
Plate Supply Voltage	200	200 Volts
Grid No. 2 Supply Voltage		150 Volts
Grid No. 1 Voltage	-6	Volts
Cathode Bias Resistor		180 Ohms
Plate Current	13	9.5 Ma
Grid No. 2 Current		3 Ma
Transconductance	3300	6000 μ mhos
Amplification Factor	19	
Plate Resistance (approx.)	5750	300,000 Ohms
Grid No. 1 Voltage (approx.) for Plate Current of 10 μ a	-19	Volts
Grid No. 1 Voltage (approx.) for Transconductance of 100 μ mhos		-12.5 Volts

NOTES:

- If either unit is operated at maximum rated conditions, Grid No. 1 Circuit Resistances for both units should not exceed the stated values.
- The heater-cathode voltage should not exceed the value of the operating cathode bias because the voltage between the heater and cathode is also applied between the cathode and Grid No. 3. The net result is the make Grid No. 3 Negative with respect to cathode with possible change in tube characteristics.

APPLICATION

The 6AZ8 is a miniature medium mu triode and semi-remote cutoff pentode designed for application in television receivers. The triode is well suited for operation as a sync separator, sync clipper, low frequency oscillator and phase splitter. The pentode may be used as an i f amplifier, video amplifier, a p c amplifier, and reactance tube.

SYLVANIA ELECTRONIC TUBES

6AZ8 (Cont'd)

AVERAGE PLATE CHARACTERISTICS (TRIODE SECTION)

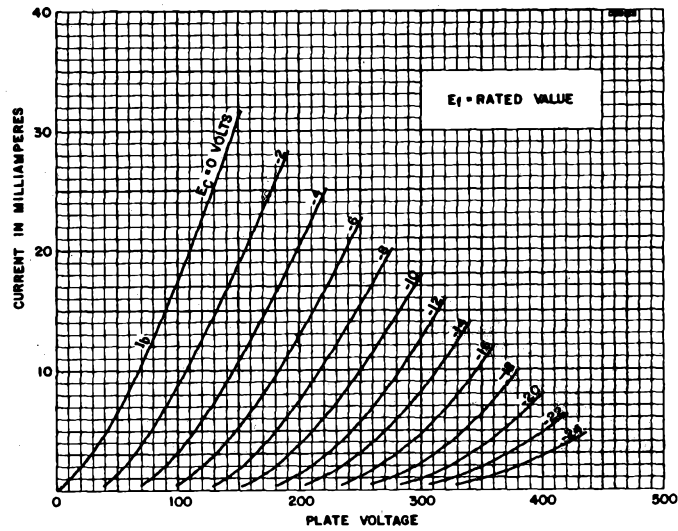

AVERAGE PLATE CHARACTERISTICS (PENTODE SECTION)

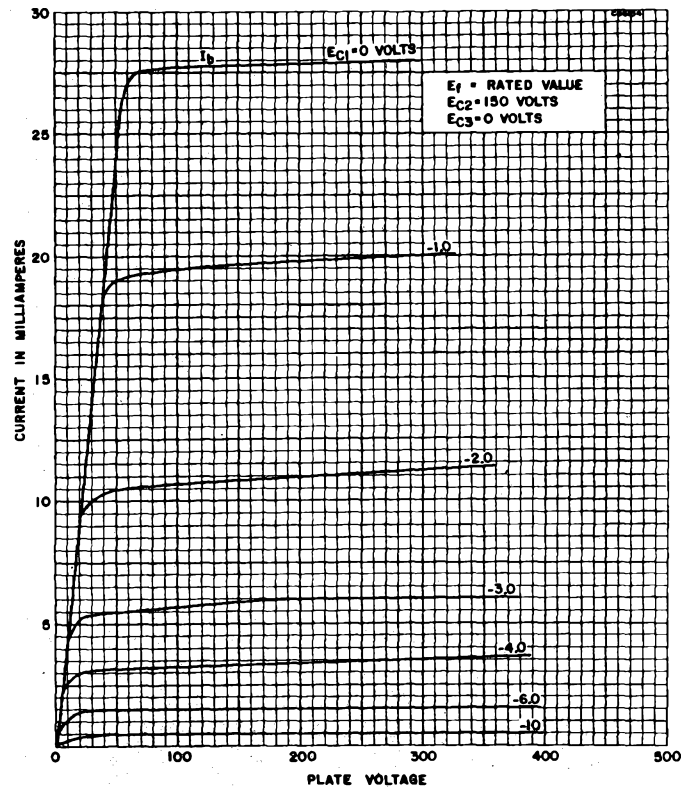

SYLVANIA ELECTRONIC TUBES

6BA6 (Cont'd)

MAXIMUM RATINGS (Design Center Values)

Plate Voltage	300 Volts
Plate Dissipation	3.0 Watts
Grid No. 2 Voltage	125 Volts
Grid No. 2 Supply Voltage	300 Volts
Grid No. 2 Dissipation	0.6 Watts
Positive Grid No. 1 Voltage	0 Volts
Negative Grid No. 1 Voltage	-50 Volts

CHARACTERISTICS AND TYPICAL OPERATION

Class A₁ Amplifier

Plate Voltage	100	250 Volts
Grid No. 2 Voltage	100	100 Volts
Cathode Bias Resistor ¹	68	68 Ohms
Grid No. 3 Voltage	Connected to Cathode	at Socket
Plate Current	10.8	11.0 Ma
Grid No. 2 Current	4.4	4.2 Ma
Transconductance	4300	4400 μ mhos
Plate Resistance (approx.)	0.25	1.0 Megohm
Grid No. 1 Voltage for Transconductance of 40 μ mhos (approx.)	-20	-20 Volts

NOTE:

1. Provides an operating bias of 1.0 volt. Fixed bias operation is not recommended.

APPLICATION

Sylvania Type 6BA6 is a miniature, semi-remote cutoff pentode designed primarily for service as a high gain r f or i f amplifier. The tube features low grid to plate capacitance and high transconductance.

SYLVANIA TUBE TESTER SETTINGS

	A	B	C	D	E	F	G	Test or K
139/140	6.3	0	—	0	4	36	32	W
219/220	6.3	3	4S	29	4	16Y	5	7

AVERAGE PLATE CHARACTERISTICS

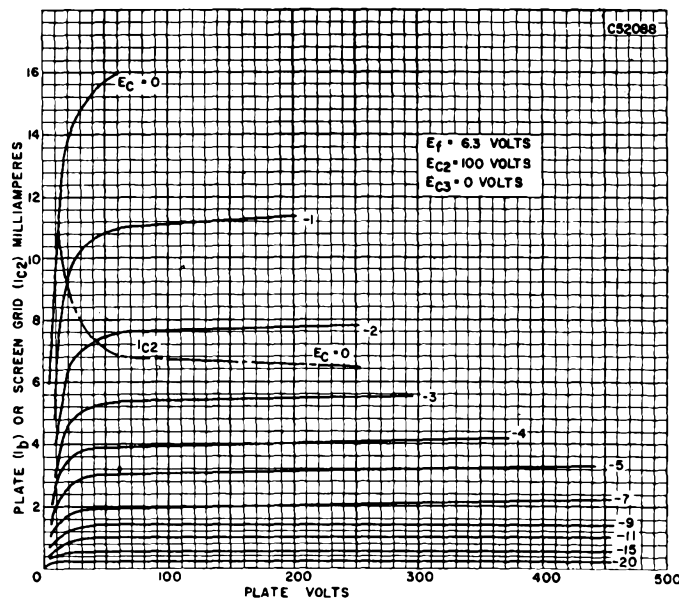

TYPE 6BA7

(See Condensed Data Section)



SYLVANIA TYPE 6BA8

TRIODE PENTODE

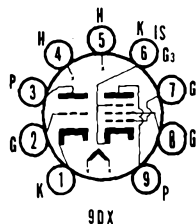

MECHANICAL DATA

Bulb.....	T-6½, Outline 6-3
Base.....	E9-1, Miniature Button, 9-Pin
Basing.....	9D X
Mounting Position.....	Any

ELECTRICAL DATA

HEATER CHARACTERISTICS

Heater Voltage.....	6.3 Volts
Heater Current.....	600 Ma
Heater Warm-up Time.....	(See Series String Heaters in Appendix)
Maximum Heater-Cathode Voltage.....	200 Volts
D C and Peak.....	100 Volts
D C, Heater Positive with Respect to Cathode.....	

DIRECT INTERELECTRODE CAPACITANCES

	Shielded ¹	Unshielded
Triode		
Grid to Plate.....	2.2	2.2 μmf
Input.....	2.7	2.5 μmf
Output.....	2.2	0.7 μmf
Pentode		
Grid to Plate.....	.030	0.036 μmf Max.
Input.....	11.0	11.0 μmf
Output.....	3.6	2.8 μmf
Coupling		
Pentode Grid No. 1 to Triode Plate.....	.005	.008 μmf Max.
Pentode Plate to Triode Grid.....	.012	.022 μmf Max.
Pentode Plate to Triode Plate.....	.050	0.20 μmf Max.

RATINGS (Design Center Values)

	Triode	Pentode
Plate Voltage.....	300	300 Volts Max.
Grid No. 2 Supply Voltage.....		300 Volts Max.
Grid No. 2 Voltage.....	See Rating	Chart for Type 6AM8
Plate Dissipation.....	2.0	3.25 Watts Max.
Grid No. 2 Dissipation.....		1.0 Watt Max.
Negative Grid No. 1 Voltage.....		50 Volts Max.
Positive Grid No. 1 Voltage.....		0 Volts Max.
Grid No. 1 Circuit Resistance		
Fixed Bias.....	0.5	0.25 Megohm Max.
Self Bias.....	1.0	1.0 Megohm Max.

CHARACTERISTICS AND TYPICAL OPERATION

	Triode	Pentode
Class A₁ Amplifier		
Plate Voltage.....	200	200 Volts
Grid No. 2 Voltage.....		150 Volts
Grid No. 1 Voltage.....	-8	0 Volts
Cathode Bias Resistor.....		180 Ohms
Amplification Factor.....	18	
Plate Resistance (approx.).....	6700	400,000 Ohms
Transconductance.....	2700	9000 μmhos
Plate Current.....	8.0	13 Ma
Grid No. 2 Current.....		3.5 Ma
Grid No. 1 Voltage for I _b = 10 μa (approx.).....	-16	-10 Volts

NOTE:

- Shield No. 315 tied to cathode base pin of section under test.

APPLICATION

The Sylvania Type 6BA8 is intended for service in television receivers employing a series heater string. The triode may be used as a sync clipper or sync separator. The pentode section is designed primarily to serve as a video amplifier. For information on specially controlled heaters for series string operation refer to the SERIES STRING section of the Appendix.

6BA8 (Cont'd)

AVERAGE PLATE CHARACTERISTICS PENTODE SECTION

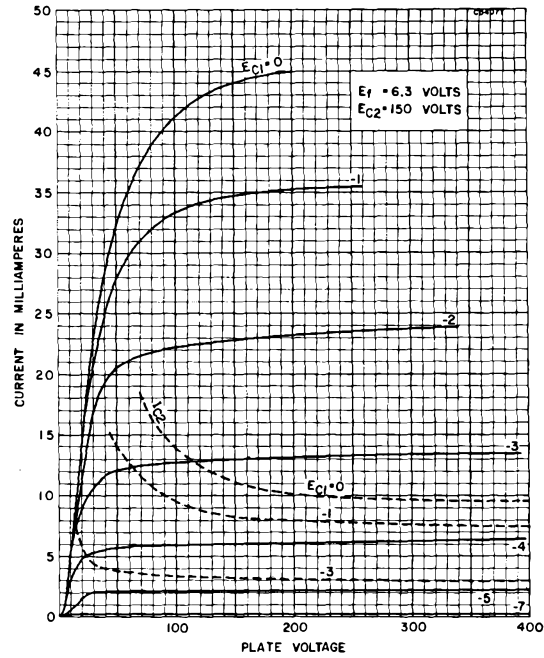

AVERAGE PLATE CHARACTERISTICS TRIODE SECTION

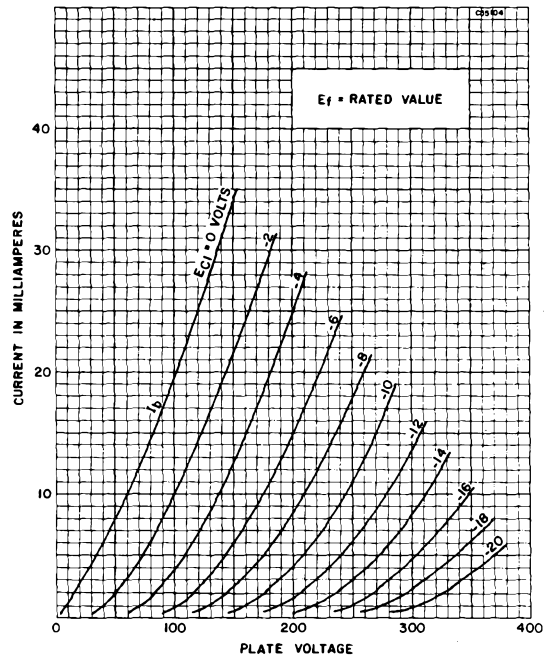



SYLVANIA TYPE 6BC4

U H F MEDIUM-MU TRIODE

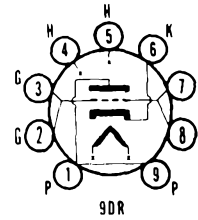

MECHANICAL DATA

Bulb.....	T-6 1/2, Outline 6-1
Base.....	Small Button 9-Pin
Basing.....	9DR
Mounting Position.....	Any

ELECTRICAL DATA

HEATER CHARACTERISTICS

Heater Voltage.....	6.3 Volts
Heater Current.....	225 Ma
Maximum Peak Heater-Cathode Voltage.....	75 Volts

DIRECT INTERELECTRODE CAPACITANCES (Approx.)

	Unshielded
Grid to Plate.....	1.6 $\mu\mu\text{f}$
Input.....	2.9 $\mu\mu\text{f}$
Output.....	0.26 $\mu\mu\text{f}$
Heater to Cathode.....	2.7 $\mu\mu\text{f}$

MAXIMUM RATINGS (Design Center Values)

Class A₁ Amplifier

Plate Voltage.....	250 Volts
Plate Dissipation.....	2.5 Watts
Cathode Current.....	25 Ma
Grid No. 1 Circuit Resistance.....	
Fixed Bias.....	Not Recommended
Cathode Bias.....	0.5 Megohms

AVERAGE CHARACTERISTICS AND TYPICAL OPERATION

Class A₁ Amplifier

Plate Supply Voltage.....	150 Volts
Cathode Bias Resistor.....	100 Ohms
Plate Current.....	14.5 Ma
Transconductance.....	10000 μmhos
Amplification Factor.....	48
Plate Resistance.....	4800 Ohms
Grid Bias, Approx., for Plate Current of 10 μa	-10 Volts

APPLICATION

The Type 6BC4 is a u h f medium-mu triode for use as the r f amplifier in cathode-drive circuits of u h f television tuners covering the frequency range of 470 to 890 mc.



SYLVANIA TYPE 6BC5

SHARP CUTOFF R F PENTODE

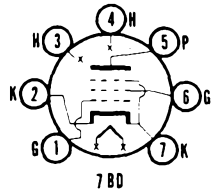

MECHANICAL DATA

Bulb.....	T-5 1/2, Outline 5-2
Base.....	Miniature Button 7-Pin
Basing.....	7BD
Mounting Position.....	Any

ELECTRICAL DATA

HEATER CHARACTERISTICS

Heater Voltage.....	6.3 Volts
Heater Current.....	300 Ma
Maximum Heater-Cathode Voltage.....	90 Volts

6BC5 (Cont'd)

DIRECT INTERELECTRODE CAPACITANCES

Pentode Connected	Shielded ¹		Unshielded	
Grid to Plate.....	0.020		0.030 μf Max	
Input.....	6.6		6.5 μf	
Output.....	2.6		1.8 μf	
Triode Connected (Grid No. 2 Tied to Plate)				
Grid to Plate.....	2.5		2.5 μf	
Input.....	4.0		3.9 μf	
Output.....	4.3		3.0 μf	

MAXIMUM RATINGS (Design Center Values)

	Triode Connected ²		Pentode Connected	
Plate Voltage.....	300		300 Volts	
Plate Dissipation.....	2.5 ³		2.0 Watts	
Grid No. 2 Voltage.....	Plate		See Rating Chart For Type 6AM8	
Grid No. 2 Supply Voltage.....	Plate		300 Volts	
Grid No. 2 Dissipation.....			0.5 Watts	
Positive Grid No. 1 Voltage.....	0		0 Volts	

CHARACTERISTICS AND TYPICAL OPERATION

Class A₁ Amplifier—Pentode Connected

Plate Voltage.....	100	125	250 Volts
Grid No. 2 Voltage.....	100	125	150 Volts
Cathode Resistor.....	180	100	180 Ohms
Transconductance.....	4900	6100	5700 μmhos
Plate Resistance (approx.).....	0.6	0.5	0.8 Megohm
Plate Current.....	4.7	8.0	7.5 Ma
Grid No. 2 Current.....	1.4	2.4	2.1 Ma
Grid No. 1 Voltage for $I_b = 10 \mu\text{a}$	-5	-6	-8 Volts

Triode Connected²

Plate Voltage.....	250	180 Volts
Cathode Resistor.....	820	330 Ohms
Transconductance.....	4400	6000 μmhos
Plate Resistance (approx.).....	9000	6000 Ohms
Amplification Factor.....	40	42
Plate Current.....	6.0	8.0 Ma

NOTES:

1. External shield No. 316 connected to pin 7.
2. Screen grid tied to plate.
3. Total current flowing to plate and screen.

APPLICATION

Sylvania Type 6BC5 is a sharp cutoff r f pentode amplifier of miniature construction. It may be used at frequencies up to 400 mc and is particularly useful in television receivers where a slightly higher gain than that obtained with the similar Type 6AG5 is desired.

SYLVANIA TUBE TESTER SETTINGS

	A	B	C	D	E	F	G	Test or K
139/140	6.3	0	4	0	4	36	70	T
219/220	6.3	3	47S	64	4	16Z	5	2
	6.3	3	24S	64	4	16Z	5	7

6BC5 (Cont'd)

AVERAGE PLATE CHARACTERISTICS TRIODE CONNECTED

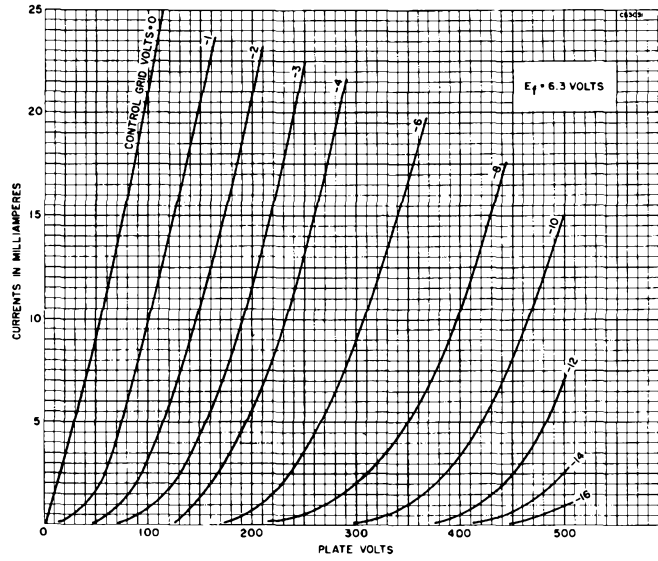

AVERAGE TRANSFER CHARACTERISTICS

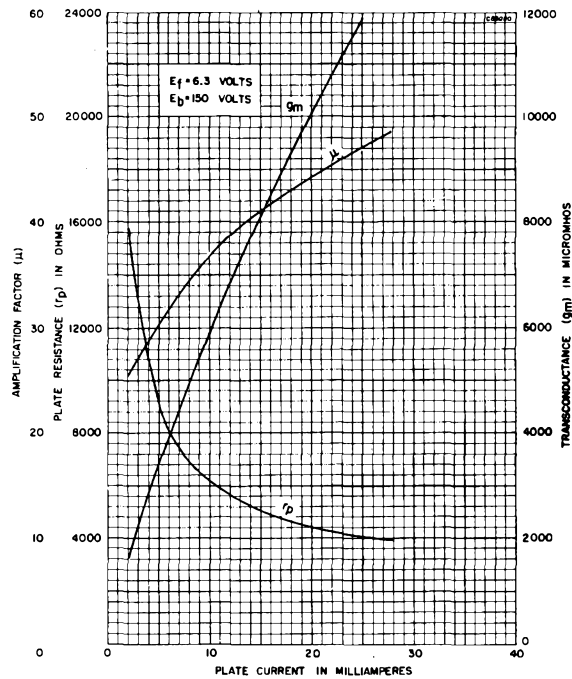

6BC5 (Cont'd)

AVERAGE PLATE CHARACTERISTICS

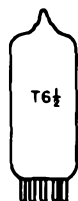
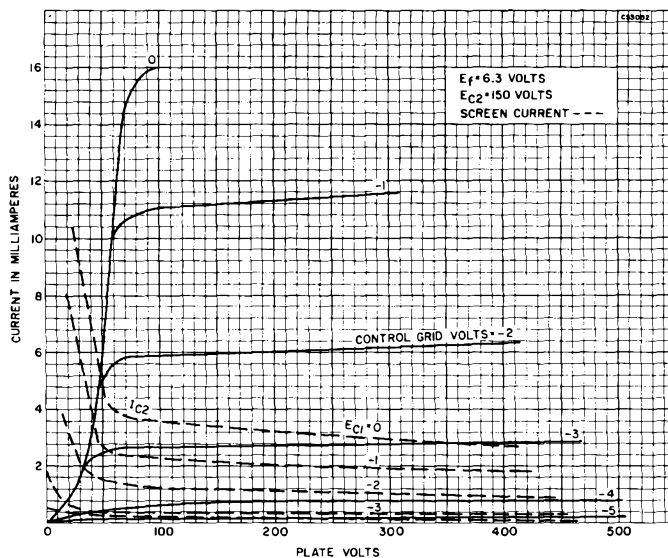

SYLVANIA TYPE 6BC7
TRIPLE DIODE

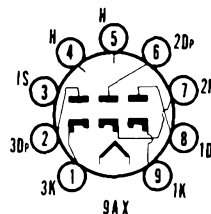

MECHANICAL DATA

Bulb.....	T-6 1/2, Outline 6-2
Base.....	Small Button 9-Pin
Basing.....	9AX
Mounting Position.....	Any

ELECTRICAL DATA

HEATER CHARACTERISTICS

Heater Voltage.....	6.3 Volts
Heater Current.....	450 Ma
Maximum Peak Heater-Cathode Voltage.....	200 Volts

DIRECT INTERELECTRODE CAPACITANCES (Unshielded)

Plate Diode No. 1 to All Other Elements.....	3.5 $\mu\mu\text{f}$
Plate Diode No. 2 to All Other Elements.....	5.5 $\mu\mu\text{f}$
Plate Diode No. 3 to All Other Elements.....	3.5 $\mu\mu\text{f}$

MAXIMUM RATINGS (Design Center Values)

Diode Operation Current (Per Plate).....	12 Ma
--	-------



**SYLVANIA TYPE 6BC8
4BC8
MEDIUM MU DUO TRIODE**

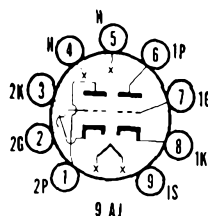

MECHANICAL DATA

Bulb.....	T-6 1/2
Base.....	E9-1, Small Button, 9-Pin
Outline.....	6-2
Basing.....	9AJ
Cathode.....	Coated Unipotential
Mounting Position.....	Any

ELECTRICAL DATA

HEATER CHARACTERISTICS

	6BC8	4BC8
Heater Voltage.....	6.3	4.2 Volts
Heater Current.....	400	600 Ma
Heater Warm-up Time (See Appendix).....		11 Seconds
Heater-Cathode Voltage (Design Center Values)		
Heater Positive with Respect to Cathode		
D C Component.....	100	100 Volts Max.
Total D C and Peak.....	200	200 Volts Max.
Heater Negative with Respect to Cathode ¹		
Total D C and Peak.....	200	200 Volts Max.

DIRECT INTERELECTRODE CAPACITANCES (Shielded)²

	Section 1	Section 2
Grid to Plate.....	1.4	1.4 μf
Input.....	2.5	2.5 μf
Output.....	1.3	1.3 μf
Heater to Cathode.....	2.3	2.3 μf
Plate Section No. 1 to Plate Section No. 2.....	0.015	μf Max.
Grid Section No. 1 to Grid Section No. 2.....	0.007	μf Max.

RATINGS (Design Center Values - Each Section)

Plate Voltage ¹	250 Volts Max.
Plate Dissipation.....	2 Watts Max.
Cathode Current.....	20 Ma Max.
Grid Circuit Resistance.....	0.5 Megohm Max.

CHARACTERISTICS - (Each Section)

Class A₁ Amplifier	
Plate Voltage.....	150 Volts
Grid Voltage.....	0 Volts
Cathode Bias Resistor.....	220 Ohms
Plate Current.....	10 Ma
Transconductance.....	6200 μmhos
Amplification Factor.....	35
Grid Voltage for $g_m = 50 \mu\text{mhos}$ (approx.).....	13 Volts

NOTES:

1. This rating may be as high as 300 volts max. under cutoff conditions when the tube is used as a cascade amplifier and the two sections are connected in series.
2. Shield No. 315.

APPLICATION

The 4BC8 and 6BC8 are twin triodes intended for application as V H F cascade amplifiers in television receivers. The 4BC8 features a 600 Ma heater and controlled heater warm-up time for operation in television receivers employing a series heater string.

6BC8 4BC8 (Cont'd)

AVERAGE PLATE CHARACTERISTICS

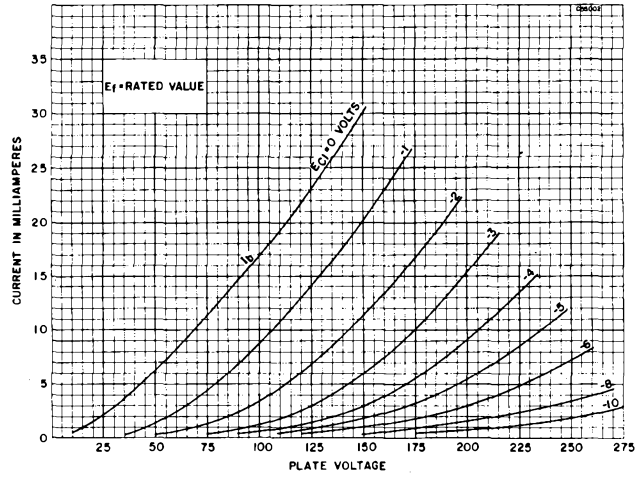

AVERAGE TRANSFER CHARACTERISTICS

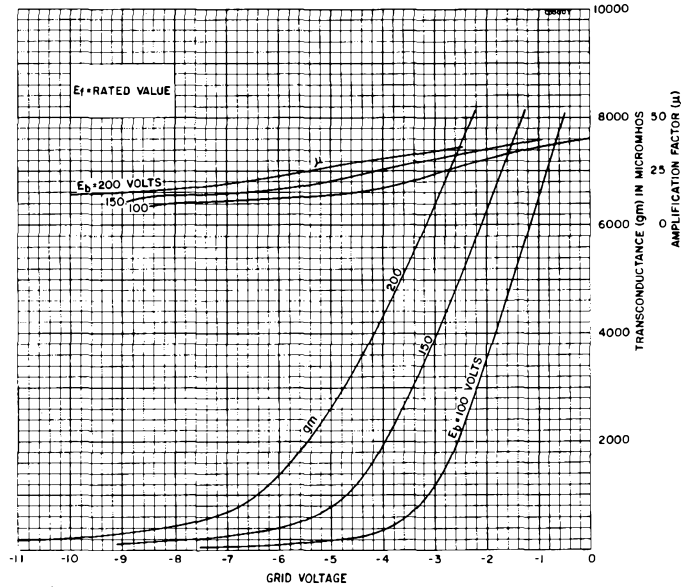

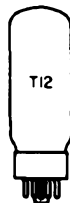

**SYLVANIA TYPE 6BD4
6BD4A**
HIGH VOLTAGE REGULATOR

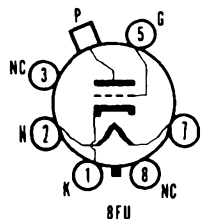

MECHANICAL DATA

Bulb.....	T-12
Base.....	Short Jumbo Shell Octal
Basing.....	8FU
Maximum Overall Length.....	5 1/8"
Maximum Seated Height.....	4 3/8"

ELECTRICAL DATA

HEATER CHARACTERISTICS

Heater Voltage (A C or D C).....	6.3 Volts
Heater Current.....	600 Ma
Maximum Peak Heater-Cathode Voltage.....	180 Volts

DIRECT INTERELECTRODE CAPACITANCES

Grid to Plate.....	1.0 μf
Input.....	3.8 μf
Output.....	0.04 μf Max

MAXIMUM RATINGS (Design Center Values)

	6BD4	6BD4A
D C Plate Voltage.....	20000	27000 Volts
Unregulated D C Supply Voltage.....	40000	55000 Volts
Grid Voltage		
D C Value.....	-125	-125 Volts
Peak Value.....	-550	-550 Volts
D C Plate Current.....	1.5	1.5 Ma
Plate Dissipation.....	20	25 Watts
Grid Circuit Resistance		
With Unregulated Supply with Equivalent Resistance of More Than 8 Megohms.....	3.0	4.0 Megohms
With Unregulated Supply with Equivalent Resistance of Less Than 8 Megohms.....	See Curve A	See Curve B

CHARACTERISTIC

Amplification Factor.....	1650
---------------------------	------

WARNING

The high voltage at which the 6BD4 is operated may be extremely dangerous to the user. Great care should be taken during the adjustment of circuits.

Operation of the 6BD4 at plate voltages above 16,000 volts (absolute value) results in the production of X-rays which can constitute a health hazard unless adequately shielded.

APPLICATION

The Types 6BD4 and 6BD4A are beam triode, high-voltage, low current regulators, which may be used to supply regulated voltages for color television picture tubes. The principle difference between Types 6BD4 and 6BD4A is the maximum value of regulated voltage that may be obtained.

6BD4, 6BD4A (Cont'd)

GRID CIRCUIT RESISTANCE

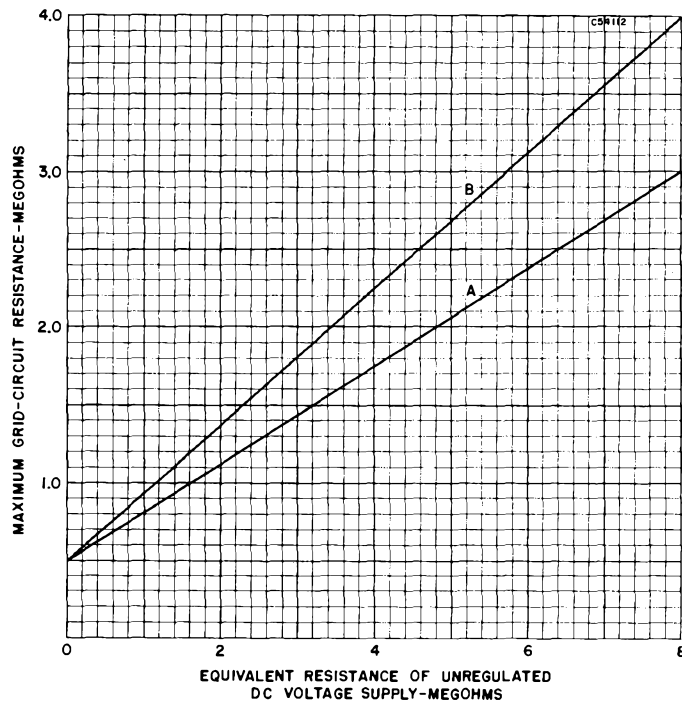

TYPE 6BD5GT

(See Condensed Data Section)



SYLVANIA TYPE 6BD6 REMOTE CUTOFF R F PENTODE

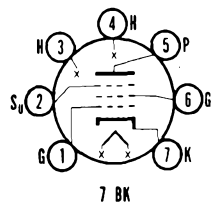

MECHANICAL DATA

Bulb	T-5 1/2, Outline 5-2
Base	Miniature Button 7-Pin
Basing	7BK
Mounting Position	Any

ELECTRICAL DATA

HEATER CHARACTERISTICS

Heater Voltage	6.3 Volts
Heater Current	300 Ma
Maximum Heater-Cathode Voltage	90 Volts

SYLVANIA ELECTRONIC TUBES

6BD6 (Cont'd)

CHARACTERISTICS AND TYPICAL OPERATION

Class A₁ Amplifier

Plate Voltage	100	250 Volts
Grid No. 3 Voltage ¹	0	0 Volts
Grid No. 2 Voltage	100	100 Volts
Grid No. 1 Voltage	-1	-3 Volts
Plate Current	13	9 Ma
Grid No. 2 Current	5	3.5 Ma
Plate Resistance	0.12	0.7 Megohm
Transconductance	2350	2000 μ mhos
Grid No. 1 Voltage for $g_m = 10 \mu$ mhos	-35	-35 Volts

NOTE:

1. Pin 2 connected to pin 7 at socket.

APPLICATION

Sylvania Type 6BD6 is a miniature remote cutoff pentode designed for service as a radio frequency or intermediate frequency amplifier. Electrically, the Type 6BD6 is similar to the Type 6SK7GT.



SYLVANIA TYPE 6BE6
HEPTODE CONVERTER

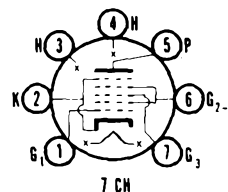

MECHANICAL DATA

Bulb	T-5 1/2, Outline 5-2
Base	Miniature Button 7-Pin
Basing	7CH
Mounting Position	Any

ELECTRICAL DATA

HEATER CHARACTERISTICS

Heater Voltage	6.3 Volts
Heater Current	300 Ma
Maximum Heater-Cathode Voltage	90 Volts

DIRECT INTERELECTRODE CAPACITANCES (Unshielded)

Grid No. 3 to Plate	0.30 μ f Max
Grid No. 3 to Grid No. 1	0.15 μ f Max
R F Input (Grid No. 3 to All)	7.0 μ f
Oscillator Input (Grid No. 1 to All)	5.5 μ f
Mixer Output (Plate to All)	8.0 μ f
Grid No. 1 to Cathode	3.0 μ f
Grid No. 1 to All Except Cathode	2.7 μ f
Grid No. 1 to Plate	0.1 μ f
Cathode to All Electrodes Except Grid No. 1	15.0 μ f

MAXIMUM RATINGS (Design Center Values)

Plate Voltage	300 Volts
Plate Dissipation	1.0 Watt
Grid No. 2 and 4 Voltage	100 Volts
Grid No. 2 and 4 Supply Voltage	300 Volts
Grid No. 2 and 4 Dissipation	1.0 Watt
Positive Grid No. 3 Voltage	0 Volts
Negative Grid No. 3 Voltage	50 Volts
Cathode Current	14 Ma

CHARACTERISTICS AND TYPICAL OPERATION

Separate Excitation¹

Plate Voltage	100	250 Volts
Grid No. 2 and 4 Voltage	100	100 Volts
Grid No. 3 Voltage	-1.5	-1.5 Volts
Grid No. 1 Resistance	20000	20000 Ohms
Grid No. 1 Current	0.5	0.5 Ma
Conversion Transconductance	455	475 μ mhos
Plate Resistance (approx.)	0.4	1.0 Megohm
Plate Current	2.6	2.9 Ma
Grid No. 2 and 4 Current	6.0	6.8 Ma
Cathode Current	10.1	10.2 Ma
Grid No. 3 Voltage for $G_c = 10 \mu$ mhos (approx.)	-30	-30 Volts

NOTE:

1. Data for self-excitation in a zero bias circuit corresponds very closely to that for separate excitation.

6BE6 (Cont'd)

APPLICATION

Sylvania Type 6BE6 is a miniature style heptode converter. It is similar in application to Type 6SA7GT and lock-in Type 7Q7. Operation data as given are for separate excitation but corresponds very closely to that obtained with self-excitation. The small size of this tube lends itself readily to the design of light-weight compact equipment.

SYLVANIA TUBE TESTER SETTINGS

	A	B	C	D	E	F	G	Test or K
139/140	6.3	0	—	0	4	46	85	W
	6.3	0	—	0	5	3	35	U
219/220	6.3	3	4	13	4	067U	5	2
	6.3	3	4S	41	4	1X	6	2

AVERAGE CONVERSION CHARACTERISTICS SELF EXCITATION

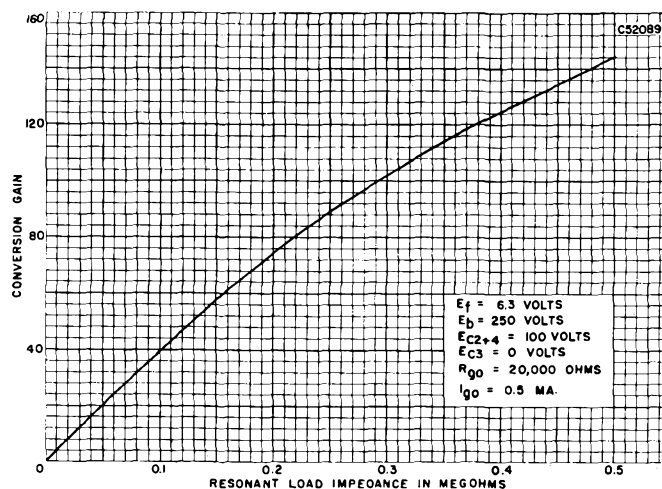

AVERAGE CONVERSION CHARACTERISTICS SEPARATE EXCITATION

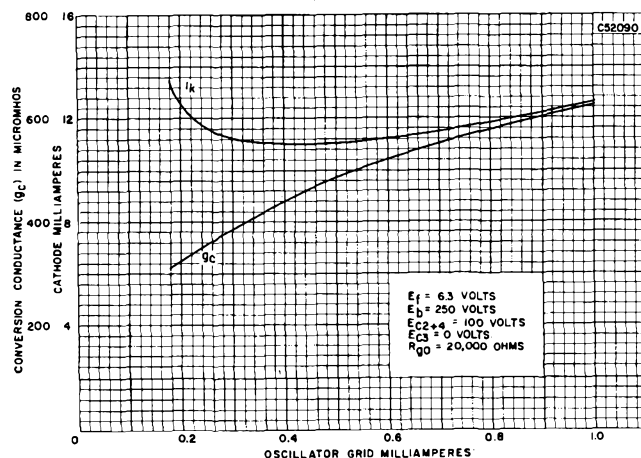

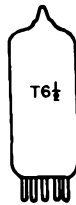

**SYLVANIA TYPE 6BE8
5BE8**
MEDIUM MU TRIODE
SHARP CUTOFF PENTODE

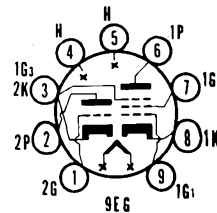

MECHANICAL DATA

Bulb	T-6½
Base	E9-1, Miniature Button, 9-Pin
Outline	6-2
Basing	9EG
Cathode	Coated Unipotential
Mounting Position	Any

ELECTRICAL DATA

HEATER CHARACTERISTICS

	5BE8	6BE8	
Heater Voltage	4.7	6.3	Volts
Heater Current	600	450	Ma
Heater Warm-up Time (See Appendix)	11		Seconds
Heater-Cathode Voltage (Design Center Values)			
Heater Negative with Respect to Cathode			
Total D C and Peak	200	200	Volts Max.
Heater Positive with Respect to Cathode			
D C	100	100	Volts Max.
Total D C and Peak	200	200	Volts Max.

DIRECT INTERELECTRODE CAPACITANCES (Approx.)

Triode		
Grid to Plate (g to p)	1.8	μμf
Input: g to (k+pentode g3+I.S.+h)	2.8	μμf
Output: p to (k+pentode g3+I.S.+h)	1.5	μμf
Pentode		
Grid to Plate (g1 to p)	.040	μμf Max.
Input: g1 to (k+g2+h)	4.4	μμf
Output: p to (k+g2+g3+triode k+I.S.+h)	2.6	μμf
Plate to (k+g2+h)	.30	μμf
Coupling		
Triode Grid to Pentode Plate	.010	μμf
Pentode Grid No. 1 to Triode Plate	.009	μμf
Triode Plate to Pentode Plate	.065	μμf

RATINGS (Design Center Values)

	Triode	Pentode	
Plate Voltage	300	300	Volts Max.
Grid No. 2 Supply Voltage		300	Volts Max.
Grid No. 2 Voltage	See Rating Chart for Type 6AM8		
Plate Dissipation	2.5	2.8	Watts Max.
Grid No. 2 Dissipation		0.5	Watt Max.
Positive Grid No. 1 Voltage	0	0	Volts Max.
Grid No. 1 Circuit Resistance ¹			
Fixed Bias	0.5	0.25	Megohm Max.
Self Bias	1.0	1.0	Megohm Max.

CHARACTERISTICS AND TYPICAL OPERATION

Class A ₁ Amplifier ²	Triode	Pentode	
Plate Voltage	150	250	Volts
Grid No. 2 Voltage		110	Volts
Grid No. 1 Voltage	0	0	Volts
Cathode Bias Resistor	56	68	Ohms
Amplification Factor	40		
Plate Resistance (approx)	.005	0.4	Megohm
Transconductance	8500	5200	μmhos
Plate Current	18	10	Ma
Grid No. 2 Current		3.5	Ma
Grid No. 1 Voltage (aprox.) for Ib = 10 μa	-12	-10	Volts

NOTES:

1. If either unit is operating at maximum rated conditions, Grid No. 1 Circuit Resistance for both units shall not exceed the stated values.
2. When reading characteristics of the pentode section all triode elements shall be at ground potential. Thus, because of internal connections to pin No. 3, the pentode suppressor will also be at ground.

APPLICATION

The 6BE8 is a miniature, medium mu triode and sharp cutoff pentode intended for use as a v h f oscillator mixer. The basing is unique in that the pentode No. 3 grid and internal shield are connected to the triode cathode. The 5BE8 employs controlled heater warm-up time for service in series string television receivers; otherwise, the 5BE8 is identical to the 6BE8.

6BE8, 5BE8 (Cont'd)

AVERAGE PLATE CHARACTERISTICS (Triode Section)

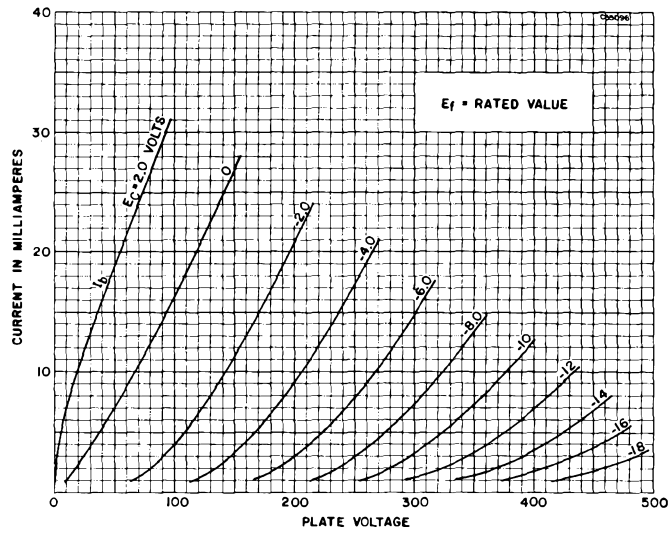

AVERAGE PLATE CHARACTERISTICS (Pentode Section)

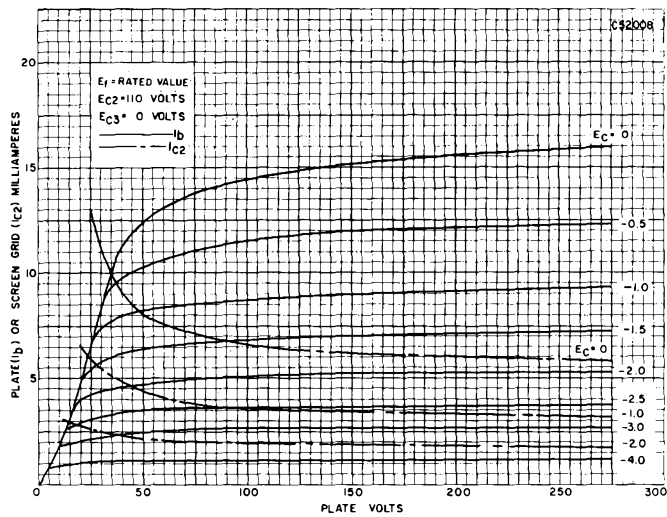

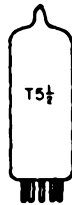

SYLVANIA TYPE 6BF5

BEAM POWER AMPLIFIER

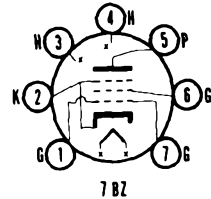

MECHANICAL DATA

Bulb.....	T-5 1/2, Outline 5-3
Base.....	Miniature Button 7-Pin
Basing.....	7BZ
Mounting Position.....	Any

ELECTRICAL DATA

HEATER CHARACTERISTICS

Heater Voltage.....	6.3 Volts
Heater Current.....	1.2 Ampere
Maximum Heater-Cathode Voltage	
Total D C and Peak.....	200 Volts
D C, Heater Positive with Respect to Cathode.....	100 Volts

DIRECT INTERELECTRODE CAPACITANCES

Grid to Plate.....	0.65 μ mf
Input.....	14 μ mf
Output.....	6 μ mf

MAXIMUM RATINGS (Design Center Values—Except as Noted)

Class A₁ Amplifier

Plate Voltage.....	250 Volts
Plate Dissipation.....	5.5 Watts
Grid No. 2 Voltage.....	117 Volts
Grid No. 2 Dissipation.....	1.25 Watts

Vertical Deflection Amplifier (Triode Connected)¹

Plate Voltage, D C.....	250 Volts
Peak Positive Plate Voltage (Abs. Max.).....	900 Volts
Plate Dissipation ²	5.0 Watts
Peak Negative Grid No. 1 Voltage.....	250 Volts
Average Cathode Current.....	40 Ma
Peak Cathode Current.....	120 Ma
Grid No. 1 Circuit Resistance.....	2.2 Megohms

CHARACTERISTICS AND TYPICAL OPERATION

Class A₁ Amplifier

Plate Voltage.....	110 Volts
Grid No. 2 Voltage.....	110 Volts
Grid No. 1 Voltage.....	-7.5 Volts
Peak A F Grid No. 1 Voltage.....	7.5 Volts
Plate Current (Zero Signal).....	36 Ma
Plate Current (Maximum Signal).....	39 Ma
Grid No. 2 Current (Zero Signal).....	4.0 Ma
Grid No. 2 Current (Maximum Signal).....	10.5 Ma
Transconductance.....	7500 μ mhos
Plate Resistance.....	12000 Ohms
Load Resistance.....	2500 Ohms
Maximum Signal Power Output.....	1.9 Watts
Total Harmonic Distortion (approx.).....	10 Percent

Triode Connected

Plate Voltage.....	225 Volts
Grid No. 2 Voltage.....	Connected to Plate
Grid No. 1 Voltage.....	-30 Volts
Plate Current.....	10 Ma
Transconductance.....	2700 μ mhos
Amplification Factor.....	6.7
Plate Resistance.....	2500 Ohms
Grid No. 1 Bias for I _b = 0.5 Ma (approx.).....	-40 Volts

NOTES:

- For operation in a 525 line, 30 frame system, the duty cycle of the voltage pulse must not exceed 15% of one scanning cycle.
- In stages operating with grid-leak bias, an adequate cathode bias resistor or other suitable means is required to protect the tube in the absence of excitation.

SYLVANIA TUBE TESTER SETTINGS

	A	B	C	D	E	F	G	Test or K
139/140	6.3	0	4	0	4	36	18	W
	6.3	0	3	0	4	46	18	W
219/220	6.3	3	14S	10	4	067Y	5	2
	6.3	3	47S	10	4	16Y	5	2

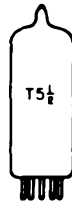

SYLVANIA TYPE 6BF6

DUO DIODE TRIODE

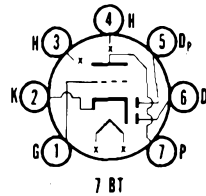

MECHANICAL DATA

Bulb	T-5 1/2, Outline 5-2
Base	Miniature Button 7-Pin
Basing	7BT
Mounting Position	Any

ELECTRICAL DATA

HEATER CHARACTERISTICS

Heater Voltage	6.3 Volts
Heater Current	300 Ma
Maximum Peak Heater-Cathode Voltage	90 Volts

DIRECT INTERELECTRODE CAPACITANCES

	Shielded ¹	Unshielded
Grid to Plate	2.0	2.0 $\mu\mu\text{f}$
Input	1.8	1.8 $\mu\mu\text{f}$
Output	1.1	0.8 $\mu\mu\text{f}$

CHARACTERISTICS AND TYPICAL OPERATION

Class A₁ Amplifier

Plate Voltage	250 Volts
Grid Voltage	-9 Volts
Plate Current	9.5 Ma
Transconductance	1900 μmhos
Plate Resistance	8500 Ohms
Amplification Factor	16
Load Resistance	10000 Ohms
Power Output	300 Mw
Total Harmonic Distortion	6.5 Percent
Average Diode Current Per Plate With 10 Volts D C Applied	0.8 Ma

NOTE:

- Shield No. 316.

APPLICATION

Sylvania Type 6BF6 is a miniature twin diode, medium mu triode. It is designed for service as a combined detector, amplifier and automatic volume control tube. Electrically, the Type 6BF6 is similar to the Type 6SR7. Data for use in Resistance Coupled Amplifier Circuits is given in the Appendix.



SYLVANIA TYPE 6BG6G

BEAM POWER AMPLIFIER

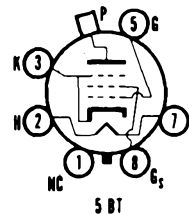

MECHANICAL DATA

Bulb	ST-16, Outline 16-5
Base	Medium Shell Octal 6-Pin
Basing	5BT
Cap.	Small
Mounting Position	Vertical ¹

ELECTRICAL DATA

HEATER CHARACTERISTICS

Heater Voltage	6.3 Volts
Heater Current	900 Ma
Maximum Heater-Cathode Voltage	
Total D C and Peak	200 Volts
D C, Heater Positive with Respect to Cathode	100 Volts

6BG6G (Cont'd)

DIRECT INTERELECTRODE CAPACITANCES (Unshielded)

Grid No. 1 to Plate	0.34 μf Max
Input	12 μf
Output	6.5 μf

MAXIMUM RATINGS (Design Center Values—Except as Noted)

Horizontal Deflection Amplifier²	
D C Plate Supply Voltage (Boost + D C Power Supply) ...	700 Volts
Peak Positive Plate Voltage (Abs. Max.)	6600 Volts
Peak Negative Plate Voltage	1500 Volts
Plate Dissipation	20 Watts
Grid No. 2 Voltage	350 Volts
Grid No. 2 Dissipation	3.2 Watts
Average Cathode Current	110 Ma
Peak Cathode Current	400 Ma
Peak Negative Grid No. 1 Voltage	300 Volts
Grid No. 1 Resistance	0.47 Megohm
Bulb Temperature (At Hottest Point)	210° C

TYPICAL OPERATING CONDITIONS

Horizontal Deflection Amplifier Notes 2 & 3	
D C Plate Supply Voltage (Boost + D C Power Supply) ...	550 Volts
Grid No. 2 Voltage	250 Volts
Cathode Bias Resistor	100 Ohms
Grid No. 1 Signal Voltage	
Sawtooth Component	75 Volts
Negative Peaking Component	50 Volts
Plate Current	85 Ma
Grid No. 2 Current	10 Ma
Peak Cathode Current	300 Ma
Average Grid No. 1 Current	30 μa
Peak Positive Plate Voltage	5500 Volts
Peak Negative Plate Voltage	550 Volts
Grid No. 1 Circuit Resistance	1.0 Megohm

NOTES:

1. Horizontal operation permitted if Pins 2 and 7 are in a vertical plane.
2. For operation in a 525-line, 30 frame system, the duty cycle of the voltage pulse must not exceed 15% of one scanning cycle.
3. For 17", 70° deflection CR tube with 12 kv second anode voltage.

APPLICATION

Sylvania Type 6BG6G is a pentode beam power amplifier designed for use as a horizontal deflection driver tube in television receivers using electro-magnetic deflection.

SYLVANIA TUBE TESTER SETTINGS

	A	B	C	D	E	F	G	Test or K
139/140	6.3	0	—	0	8	47	27	Y
219/220	6.3	2	7	20	7	58Z	9	3

AVERAGE PLATE CHARACTERISTICS

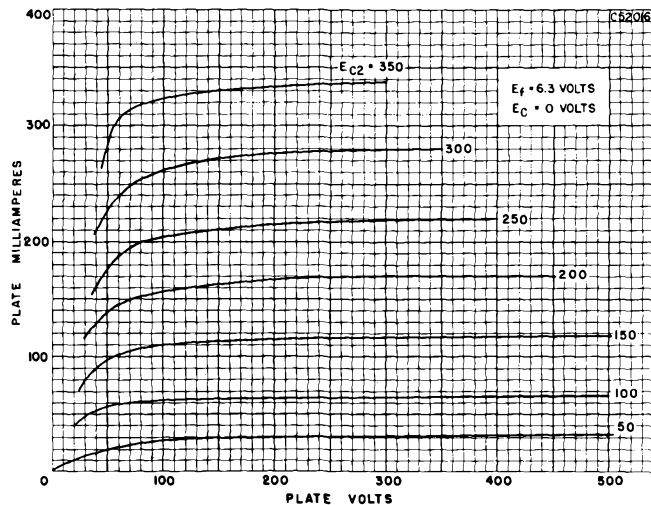

6BG6G (Cont'd)

AVERAGE PLATE CHARACTERISTICS

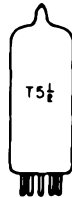
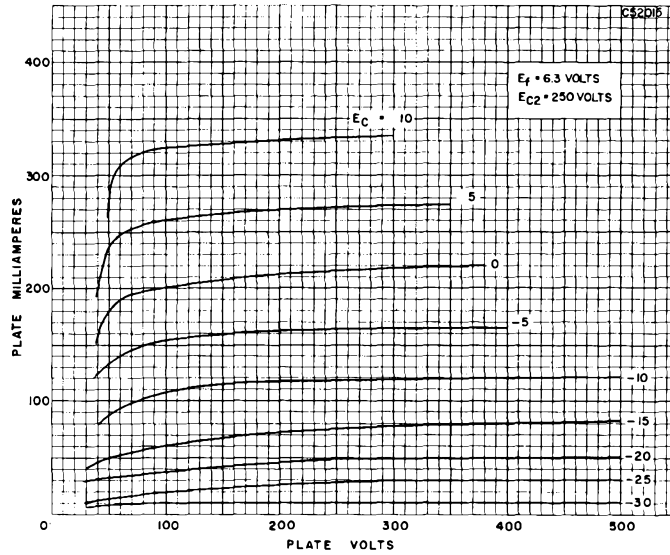

SYLVANIA TYPE 6BH6 SHARP CUTOFF R F PENTODE

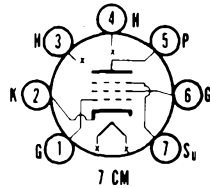

MECHANICAL DATA

Bulb	T-5 1/2, Outline 5-2
Base	Miniature Button 7-Pin
Basing	7CM
Mounting Position	Any

ELECTRICAL DATA

HEATER CHARACTERISTICS

Heater Voltage	6.3 Volts
Heater Current	150 Ma
Maximum Heater-Cathode Voltage	90 Volts

DIRECT INTERELECTRODE CAPACITANCES (Unshielded)

Grid to Plate	0.0035 μ f
Input	5.4 μ f
Output	4.4 μ f

MAXIMUM RATINGS (Design Center Values)

Plate Voltage	300 Volts
Plate Dissipation	3.0 Watts
Grid No. 2 Voltage	(See Rating Chart for Type 6AM8)
Grid No. 2 Supply Voltage	300 Volts
Grid No. 2 Dissipation	0.5 Watts
Positive Grid No. 1 Voltage	0 Volts
Negative Grid No. 1 Voltage	-50 Volts

6BH6 (Cont'd)

TYPICAL OPERATION

Class A₁ Amplifier

Plate Voltage.....	100	250 Volts
Grid No. 2 Voltage.....	100	150 Volts
Grid No. 3 Voltage.....	Connected to Cathode at Socket	
Grid No. 1 Voltage.....	-1.0	-1.0 Volt
Plate Current.....	3.6	7.4 Ma
Grid No. 2 Current.....	1.4	2.9 Ma
Transconductance.....	3400	4600 μ mhos
Plate Resistance.....	0.7	1.4 Megohms
Grid No. 1 Bias (approx.)		
For $I_b = 10 \mu$ a.....	-5.0	-7.7 Volts

APPLICATION

Sylvania Type 6BH6 is a sharp cutoff rf pentode of miniature construction. It has a 150 Ma heater which makes it useful in a c/d c receivers, and in mobile equipment requiring low heater drain. Data for use in Resistance Coupled Amplifier Circuits is given in the Appendix.

SYLVANIA TUBE TESTER SETTINGS

	A	B	C	D	E	F	G	Test or K
139/140	6.3	0	—	0	4	36	50	U
219/220	6.3	3	4	41	4	16X	5	2



SYLVANIA TYPE 6BJ6 REMOTE CUTOFF PENTODE

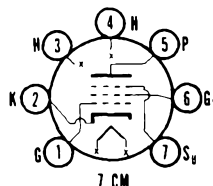

MECHANICAL DATA

Bulb.....	T-5 1/2, Outline 5-2
Base.....	Miniature Button 7-Pin
Basing.....	7CM
Mounting Position.....	Any

ELECTRICAL DATA

HEATER CHARACTERISTICS

Heater Voltage.....	6.3 Volts
Heater Current.....	150 Ma
Maximum Heater-Cathode Voltage.....	90 Volts

DIRECT INTERELECTRODE CAPACITANCES

	Shielded ¹	Unshielded
Grid to Plate.....	0.0035	0.0035 μ f Max
Input.....	4.5	4.5 μ f
Output.....	5.5	5.5 μ f

MAXIMUM RATINGS (Design Center Values)

Plate Voltage.....	300 Volts
Plate Dissipation.....	3.0 Watts
Grid No. 2 Supply Voltage.....	300 Volts
Grid No. 2 Voltage.....	(See Rating Chart for Type 6AM8)
Grid No. 2 Dissipation.....	0.6 Watts
Positive Grid No. 1 Voltage.....	0 Volts
Negative Grid No. 1 Voltage.....	-50 Volts

CHARACTERISTICS AND TYPICAL OPERATION

Class A₁ Amplifier

Plate Voltage.....	100	250 Volts
Grid No. 2 Voltage.....	100	100 Volts
Grid No. 3 Voltage.....	(Pin 7 Connected to Pin 2 at Socket)	
Grid No. 1 Voltage.....	-1.0	-1.0 Volt
Plate Current.....	9.0	9.2 Ma
Grid No. 2 Current.....	3.5	3.3 Ma
Transconductance.....	3650	3600 μ mhos
Plate Resistance.....	0.25	1.3 Megohms

NOTE:

1. Shield No. 316 connected to Pins 2 and 7.

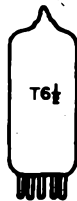

SYLVANIA TYPE 6BH8 8BH8

Sharp Cutoff Pentode
Medium-Mu Triode

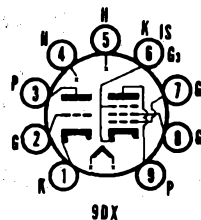

MECHANICAL DATA

Bulb.....	T-6 1/2
Base.....	E9-1, Small Button 9-Pin
Outline.....	6-3
Basing.....	9D X
Cathode.....	Coated Unipotential
Mounting Position.....	Any

ELECTRICAL DATA

HEATER CHARACTERISTICS

	6BH8	8BH8
Heater Voltage.....	6.3	8.4 Volts
Heater Current.....	600	450 Ma
Heater Warm-up Time.....	11	11 Seconds
Heater-Cathode Voltage (Design Center Values)		
Heater Negative with Respect to Cathode		
Total D C and Peak.....	200	200 Volts Max.
Heater Positive with Respect to Cathode		
D C.....	100	100 Volts Max.
Total D C and Peak.....	200	200 Volts Max.

DIRECT INTERELECTRODE CAPACITANCES (Unshielded)

Triode	
Grid to Plate.....	2.4 μ f
Input.....	2.6 μ f
Output.....	0.38 μ f
Pentode	
Grid to Plate.....	0.046 μ f
Input.....	7.0 μ f
Output.....	2.4 μ f
Coupling: (Pentode Grid No. 1 to Triode Plate).....	0.004 μ f
Coupling: (Triode Grid to Pentode Plate).....	0.016 μ f
Coupling: (Pentode Plate to Triode Plate).....	0.095 μ f

RATINGS (Design Center Values)

	Triode	Pentode
Plate Voltage.....	300	300 Volts Max.
Grid No. 2 Supply Voltage.....		300 Volts Max.
Grid No. 2 Voltage.....	See Screen Grid Rating Chart on Page 5 of Appendix 10th Ed. Tech. Manual	
Plate Dissipation.....	2.5	3.0 Watts Max.
Grid No. 2 Dissipation.....		1.0 Watt Max.
Grid No. 1 Circuit Resistance		
Fixed Bias.....	0.5	0.25 Megohm Max.
Self Bias.....	1.0	1.0 Megohm Max.

CHARACTERISTICS AND TYPICAL OPERATION

Class A₁ Amplifier

	Triode	Pentode
Plate Voltage.....	150	200 Volts
Grid No. 2 Voltage.....		125 Volts
Grid No. 1 Voltage.....	-5	Volts
Cathode Bias Resistor.....		82 Ohms
Amplification Factor.....	17	
Plate Resistance (approx.).....	5,150	150,000 Ohms
Transconductance.....	3,300	7,000 μ mhos
Plate Current.....	9.5	15 Ma
Grid No. 2 Current.....		3.4 Ma
Grid No. 1 Voltage (approx.) for $I_b = 100 \mu$ a.....	-14	-8 Volts

NOTE:

1. Heater Warm-up Time is defined as the time required for the voltage across the heater to reach 80% of its rated value after applying four (4) times rated heater voltage to a circuit consisting of the tube heater in series with a resistance equal to three (3) times rated heater voltage divided by rated heater current.

APPLICATION

These tubes are intended for service in television receivers employing a series string heater arrangement. The triode section is designed for operation as a sync separator, amplifier, clipper or as a sweep oscillator. The pentode section is designed to serve as a video amplifier.

The 6BH8 employs a 600 Ma heater while the 8BH8 has a 450 Ma heater. Both types have controlled heater warm-up time and are intended for use in receivers having a series heater string.

SYLVANIA ELECTRONIC TUBES

Issued as a supplement to the manual in Sylvania News for February 1957

SYLVANIA TYPE 6BH8 (Cont'd)
8BH8

AVERAGE PLATE CHARACTERISTICS
(TRIODE SECTION)

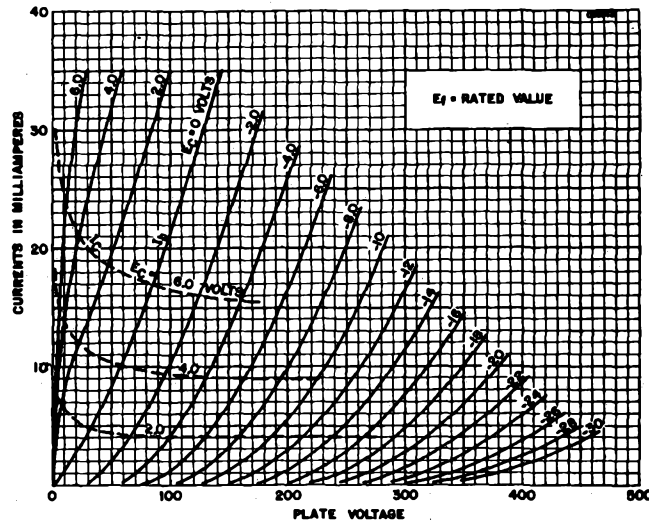

AVERAGE PLATE CHARACTERISTICS
(PENTODE SECTION)

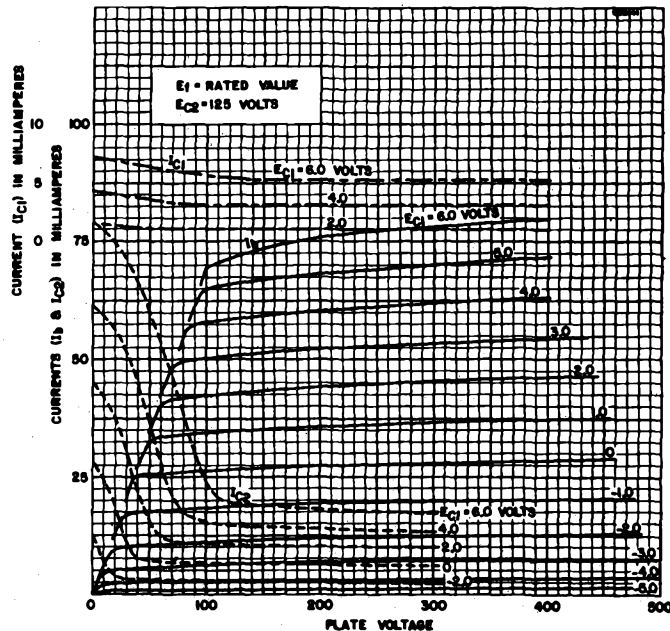

SYLVANIA ELECTRONIC TUBES

6BJ6 (Cont'd)

APPLICATION

Sylvania Type 6BJ6 is a miniature, remote cutoff pentode designed for service as an r f or i f amplifier. The 6BJ6 features low input and output capacitances, relatively high gm and low current heater.

SYLVANIA TUBE TESTER SETTINGS

	A	B	C	D	E	F	G	Test or K
139/140	6.3	0	—	0	4	36	29	W
219/220	6.3	3	4	48	4	16Z	5	2

AVERAGE TRANSFER CHARACTERISTICS

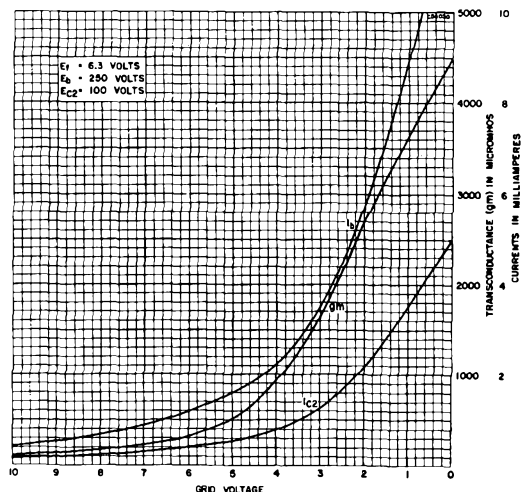

AVERAGE TRANSFER CHARACTERISTICS

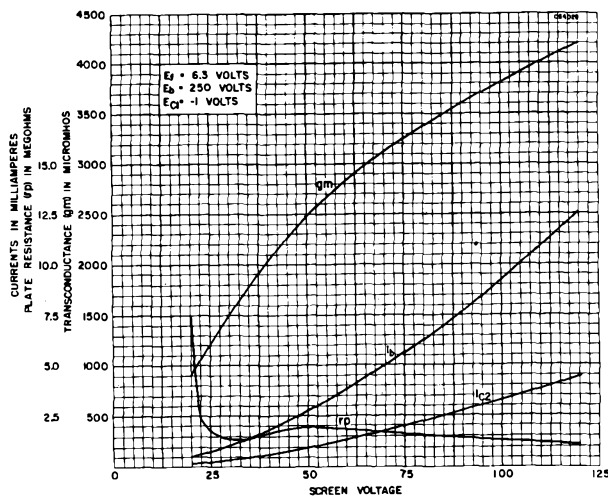

6BJ6 (Cont'd)

AVERAGE PLATE CHARACTERISTICS

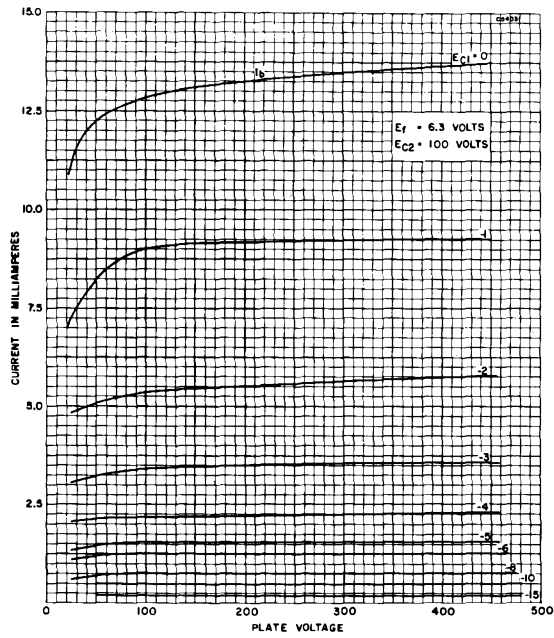

SCREEN GRID RATING CHART

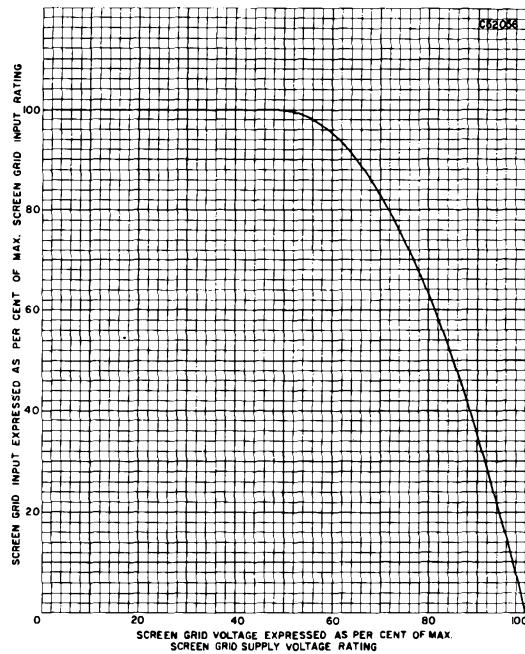



SYLVANIA TYPE 6BJ8
MEDIUM MU TRIODE
DOUBLE DIODE

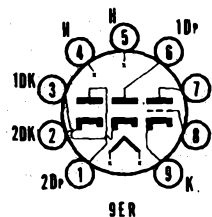

MECHANICAL DATA

Bulb	T-6½
Base	E9-1, Small Button 9-Pin
Outline	6-3
Basing	9ER
Cathode	Coated Unipotential
Mounting Position	Any

ELECTRICAL DATA

HEATER CHARACTERISTICS

Heater Voltage	6.3 Volts
Heater Current	600 Ma
Heater Warm-up Time ¹	11 Seconds
Heater-Cathode Voltage (Design Center Values)	
Heater Negative with Respect to Cathode	
Total DC and Peak	200 Volts Max.
Heater Positive with Respect to Cathode	
DC	100 Volts Max.
Total DC and Peak	200 Volts Max.

DIRECT INTERELECTRODE CAPACITANCES (Unshielded)

Diode Section

No. 1 Diode Plate to No. 1 Diode Cathode + Heater	1.9 μf
No. 2 Diode Plate to No. 2 Diode Cathode + Heater	1.9 μf
No. 1 Diode Cathode to No. 1 Diode Plate + Heater	4.6 μf
No. 2 Diode Cathode to No. 2 Diode Plate + Heater	4.6 μf

Triode Section

Grid to Plate	2.6 μf
Input: g to (h + Tk)	2.8 μf
Output: p to (h + Tk)	0.31 μf

Coupling

No. 1 Diode Plate to Triode Grid	0.070 μf Max.
No. 2 Diode Plate to Triode Grid	0.11 μf Max.
No. 1 Diode Cathode to All:	
1 Dk to (h + Tk + 2Dk + Tp + 1Dp + Tg + 2Dp)	4.8 μf
No. 2 Diode Cathode to All:	
2 Dk to (h + Tk + 1Dk + Tp + 1Dp + 2Dp + Tg)	4.8 μf
No. 1 Diode Plate to No. 2 Diode Plate	0.060 μf Max.
No. 1 Diode Plate to All:	
1 Dp to (h + Tk + 1Dk + 2Dk + Tp + 2Dp + Tg)	3.0 μf
No. 2 Diode Plate to All:	
2 Dp to (h + Tk + 1Dk + 2Dk + Tp + 1Dp + Tg)	3.0 μf

MAXIMUM RATINGS—Each Section
(Design Center Values—Except as Noted)

	Class A ₁ Amplifier	Vertical Deflection Amplifier
Triode Section		
Plate Voltage	300	300 Volts
Peak Positive Pulse Plate Voltage (Abs. Max.)		1200 Volts
Peak Negative Pulse Grid Voltage		250 Volts
Positive DC Grid Voltage	0	Volts
Maximum Plate Dissipation ²	3.5	3.5 Watts
Average Cathode Current	20	20 Ma
Peak Cathode Current		70 Ma
Grid Circuit Resistance		
Self Bias	1.0	2.2 Megohms
Fixed Bias	1.0	Megohms
Diode Section		
Peak Plate Current, (each plate)		54 Ma
DC Current, (each plate)		9 Ma

CHARACTERISTICS AND TYPICAL OPERATION

	Class A ₁ Amplifier	Triode Section
Plate Voltage	90	250 Volts
Grid Voltage	0	-9 Volts
Plate Current	13.5	8.0 Ma
Transconductance	4700	2800 μmhos
Amplification Factor	22	20
Plate Resistance (approx.)	4700	7150 Ohms
Plate Current at E _c = -12.5 Volts DC		1.7 Ma
Grid Voltage (approx.) for I _b = 10 μa	-7	-18 Volts

6BJ8 (Cont'd)

Average Current Each Plate at 10 Volts D.C.
Voltage Drop Each Section at $I_b = 9$ Ma DC.

Diode Section
50 Ma
2.6 Volts

NOTES:

1. Heater warm-up time is defined as the time required for the voltage across the heater to reach 80% of the rated heater voltage after applying 4 times rated heater voltage to a circuit consisting of the tube heater in series with a resistance equal to three times the rated heater voltage divided by the rated heater current.
2. For operation in a 525 line, 30-frame system as described in "Standards of Good Engineering Practice for Television Stations; Federal Communications Commission." The duty cycle of the voltage pulse must not exceed 15% of one scanning cycle.
3. In stages operating with grid leak bias, an adequate cathode bias resistor or other suitable means is required to protect the tube in the absence of excitation.
4. Test conditions only.

APPLICATION

The Sylvania Type 6BJ8 is a miniature, medium μ triode, double diode intended for use as a phase splitter, phase comparator and horizontal deflection oscillator. The tube features controlled heater warm-up time to insure dependable operation in series string receivers and separate cathode connections for each section.

AVERAGE PLATE CHARACTERISTICS

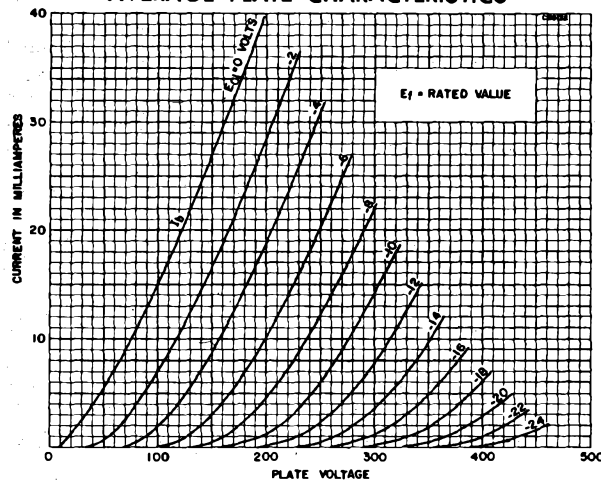

AVERAGE TRANSFER CHARACTERISTICS

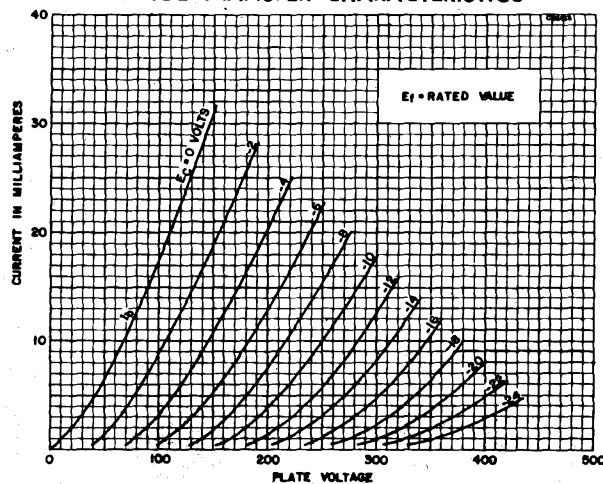

SYLVANIA ELECTRONIC TUBES

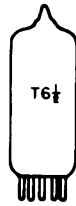

SYLVANIA TYPE 6BJ7

TRIPLE DIODE

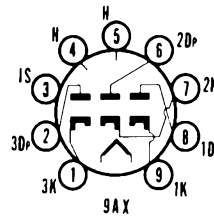

MECHANICAL DATA

Bulb	T-6 1/2, Outline 6-2
Base	Small Button 9-Pin
Basing	9AX
Mounting Position	Any

ELECTRICAL DATA

HEATER CHARACTERISTICS

Heater Voltage	6.3 Volts
Heater Current	450 Ma
Maximum Heater-Cathode Voltage	
Heater Positive with Respect to Cathode	100 Volts
Heater Negative with Respect to Cathode	330 Volts

MAXIMUM RATINGS (Design Center Values)

Television D C-Restorer Service

Peak Inverse Plate Voltage	330 Volts
Peak Plate Current per Plate	10 Ma
D C Output Current per Plate	1.0 Ma

CHARACTERISTICS

Tube Voltage Drop, Each Section	
$I_b = 10$ Ma D C	2.7 Volts

APPLICATION

The Sylvania Type 6BJ7 is a miniature triple diode intended primarily for use as a d c restorer in each of three signal channels of color television receivers. The electrical characteristics of each section of the 6BJ7 are similar to those of each section of the 6AL5.



SYLVANIA TYPE 6BK4

HIGH VOLTAGE REGULATOR

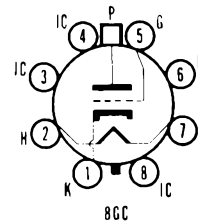

MECHANICAL DATA

Bulb	T-12
Base	Short Jumbo Shell Octal
Maximum Overall Length	5 7/32"
Maximum Seated Height	4 11/16"
Basing	8GC
Top Cap	Small
Mounting Position	Any

ELECTRICAL DATA

HEATER CHARACTERISTICS

Heater Voltage (A C or D C)	6.3 Volts
Heater Current	200 Ma
Maximum Heater-Cathode Voltage	
Heater Positive with Respect to Cathode	Not Recommended
Heater Negative with Respect to Cathode	225 Volts

DIRECT INTERELECTRODE CAPACITANCES

Grid to Plate	0.03 μ f
Input	2.6 μ f
Output	1.0 μ f Max

6BK4 (Cont'd)

MAXIMUM RATINGS (Design Center Values)

D C Plate Voltage	25000 Volts
Unregulated D C Supply Voltage	55000 Volts
Grid Voltage	
D C Value	-125 Volts
Peak Value During 20 Sec. Warm-Up	400 Volts
D C Plate Current	1.5 Ma
Plate Dissipation	25 Watts
Grid Circuit Resistance for use with Flyback Transformer H.V. Supply	3.0 Megohms

CHARACTERISTICS

Amplification Factor (Approx.)	2000
--------------------------------	------

NOTE:

- Do not use Pins 3, 4, 6 and 8 for tie points.

WARNING

The high voltages at which the 6BK4 is operated may be extremely dangerous to the user. Great care should be taken during the adjustments of circuits.

Operation of the 6BK4 at plate voltages above 16,000 volts (absolute value) results in the production of X-rays which can constitute a health hazard unless adequately shielded.

APPLICATION

The Type 6BK4 is a beam triode, high voltage low current regulator that may be used in color television receivers to supply regulated picture tube voltages.

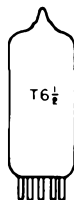

SYLVANIA TYPE 6BK5
BEAM POWER AMPLIFIER

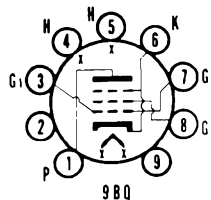

MECHANICAL DATA

Bulb	T-6 1/2, Outline 6-3
Base	Small Button 9-Pin
Basing	9BQ
Mounting Position	Any

ELECTRICAL DATA

HEATER CHARACTERISTICS

Heater Voltage	6.3 Volts
Heater Current	1.2 Amperes
Maximum Heater-Cathode Voltage	100 Volts

DIRECT INTERELECTRODE CAPACITANCES (Unshielded)

Grid to Plate	0.6 μf
Input	13 μf
Output	5.0 μf

MAXIMUM RATINGS (Design Center Values)

Class A₁ Amplifier

Plate Voltage	250 Volts
Plate Dissipation	9 Watts
Grid No. 2 Voltage	250 Volts
Grid No. 2 Dissipation	2.5 Watts
Positive Grid No. 1 Voltage	0 Volts
Grid No. 1 Circuit Resistance	
Fixed Bias	0.1 Megohm
Cathode Bias	0.5 Megohm

6BK5 (Cont'd)

CHARACTERISTICS AND TYPICAL OPERATION

Plate Voltage	250 Volts
Grid No. 2 Voltage	250 Volts
Grid No. 1 Voltage	5 Volts
Peak A F Grid No. 1 Voltage	5 Volts
Plate Current (Zero Signal)	35 Ma
Plate Current (Maximum Signal)	37 Ma
Grid No. 2 Current (Zero Signal)	3.5 Ma
Grid No. 2 Current (Maximum Signal)	10 Ma
Plate Resistance (approx.)	100,000 Ohms
Transconductance	8,500 μ mhos
Load Resistance	6,500 Ohms
Maximum-Signal Power Output	3.5 Watts
Total Harmonic Distortion (approx.)	7 Percent

APPLICATION

The Sylvania Type 6BK5 is a miniature beam power amplifier designed for use as the audio power output stage in radio and television receivers. The 6BK5 features high power sensitivity, high transconductance and high plate efficiency.

SYLVANIA TUBE TESTER SETTINGS

	A	B	C	D	E	F	G	Test or K
139/140	6.3	0	7	0	1	69	28	Y
	6.3	0	6	0	1	79	28	Y
219/220	6.3	4	57	24	5	38Z	1	6
	6.3	4	35	24	5	78Z	1	6

AVERAGE PLATE CHARACTERISTICS

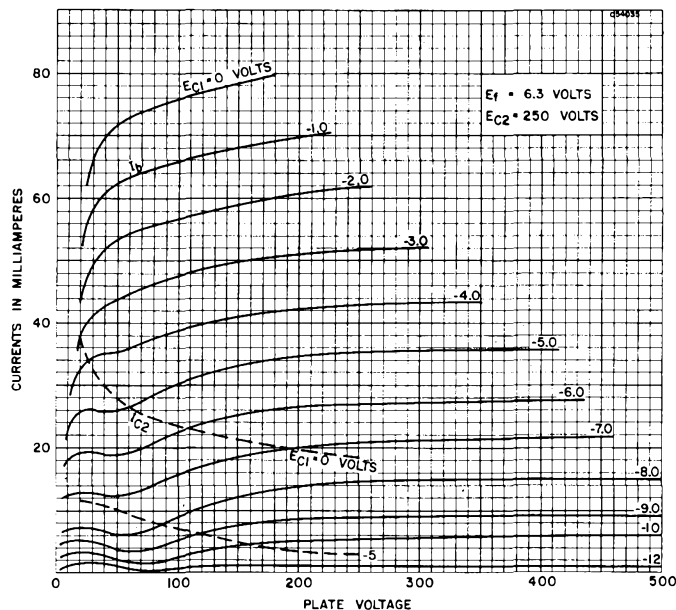

6BK5 (Cont'd)

AVERAGE PLATE CHARACTERISTICS

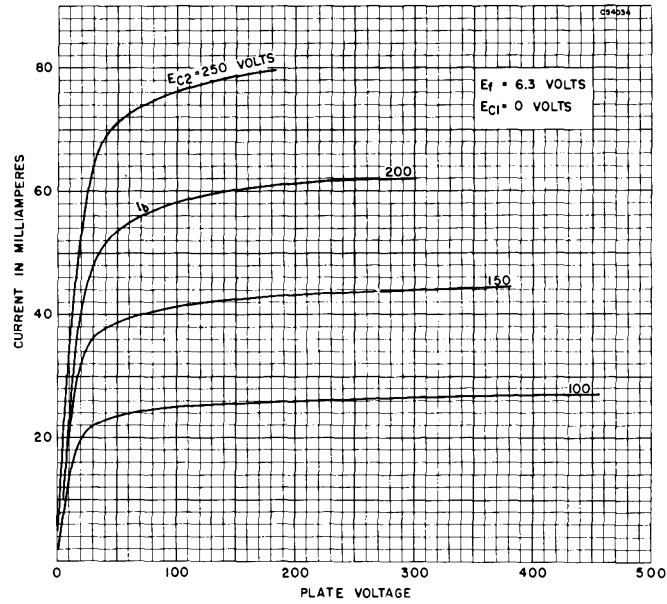

AVERAGE TRANSFER CHARACTERISTICS

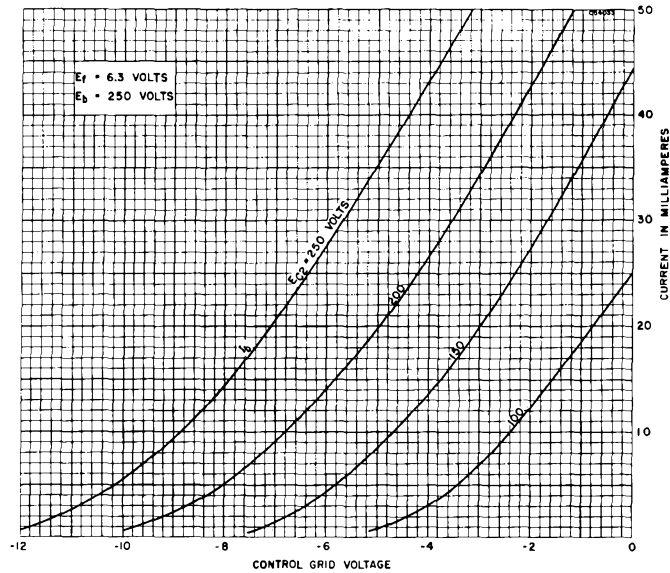

6BK5 (Cont'd)

AVERAGE OPERATION CHARACTERISTICS

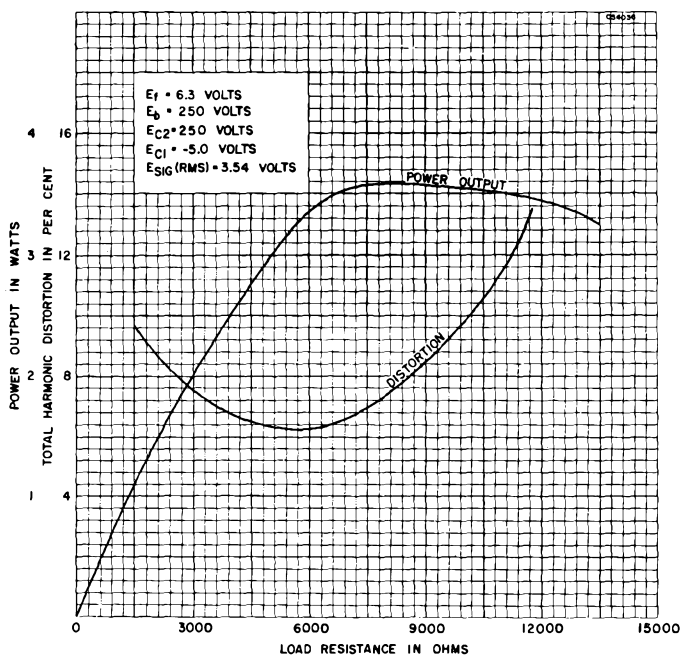

TYPE 6BK6

(See Condensed Data Section)

SYLVANIA TYPE 6BK7

DUO TRIODE R F AMPLIFIER

TYPICAL OPERATION

Class A₁ Amplifier

Plate Voltage	100	150 Volts
Cathode Bias Resistor	120	56 Ohms
Plate Current	9.0	18 Ma
Amplification Factor	37	40
Plate Resistance (approx.)	6100	4700 Ohms
Transconductance	6100	8500 μ mhos
Grid Voltage for $I_b = 10 \mu$ a (approx.)	-9	-12 Volts

The Sylvania Type 6BK7 is identical mechanically and similar electrically to Sylvania Type 6BK7A. Heater characteristics of these tube types are identical. Type 6BK7 is replaced by Type 6BK7A.

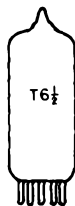

SYLVANIA TYPE 6BK7A
DUO TRIODE R F AMPLIFIER

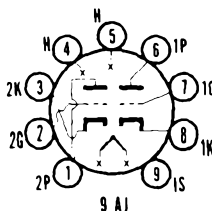

MECHANICAL DATA

Bulb.....T-6 1/2, Outline 6-2
Base.....Small Button 9-Pin
Basing.....9AJ
Mounting Position.....Any

ELECTRICAL DATA

HEATER CHARACTERISTICS

Heater Voltage.....6.3 Volts
Heater Current.....450 Ma
Peak Heater-Cathode Voltage¹.....90 Volts Max

DIRECT INTERELECTRODE CAPACITANCES (Unshielded)

	Section 1 ²	Section 2
Grid to Plate.....	1.8	1.8 μf
Input.....	3.0	3.0 μf
Output.....	1.0	0.9 μf
Heater to Cathode.....	2.8	3.0 μf
Grid to Grid (Max).....	0.004	μf
Plate to Plate (Max).....	0.075	μf
Grounded Grid Operation		
Plate to Cathode.....	0.22	0.22 μf
Input.....	6.0	6.0 μf
Output.....	2.4	2.4 μf

MAXIMUM RATINGS (Design Center Values)

Plate Voltage.....300 Volts
Plate Dissipation (Each Section).....2.7 Watts
Negative D C Grid Voltage.....50 Volts

CHARACTERISTICS AND TYPICAL OPERATION

Class A₁ Amplifier (Each Section)

Plate Voltage.....150 Volts
Cathode Bias Resistor.....56 Ohms
Plate Current.....18 Ma
Transconductance.....9300 μmhos
Amplification Factor.....43
Plate Resistance.....4600 Ohms
Grid Voltage for $I_b = 10 \mu\text{a}$-11 Volts

NOTES:

- When operated as a cascode amplifier and the two sections are connected in series, the heater-cathode voltage of the grounded grid stage may be as high as 250 volts maximum with the heater negative with respect to the cathode.
- Section 1 connects to Pins 6, 7 and 8. Section 2 connects to Pins 1, 2 and 3.

APPLICATION

The Sylvania Type 6BK7A is a medium mu twin triode designed for use as a cascode amplifier below approximately 300 mc. The tube features high gain, low noise figure and shielding between sections to minimize internal capacity. The Type 6BK7A is considered as the replacement for the Type 6BK7.

SYLVANIA TUBE TESTER SETTINGS

	A	B	C	D	E	F	G	Test or K
139/140	6.3	0	—	0	1	3	18	W
	6.3	0	—	0	3	7	18	W
219/220	6.3	4	58	25	5	2X	1	3
	6.3	4	35	25	5	7X	6	8

6BK7A (Cont'd)

AVERAGE PLATE CHARACTERISTICS

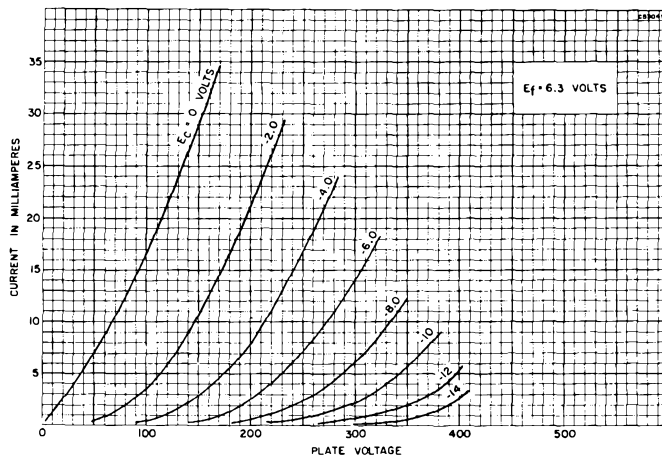

AVERAGE TRANSFER CHARACTERISTICS

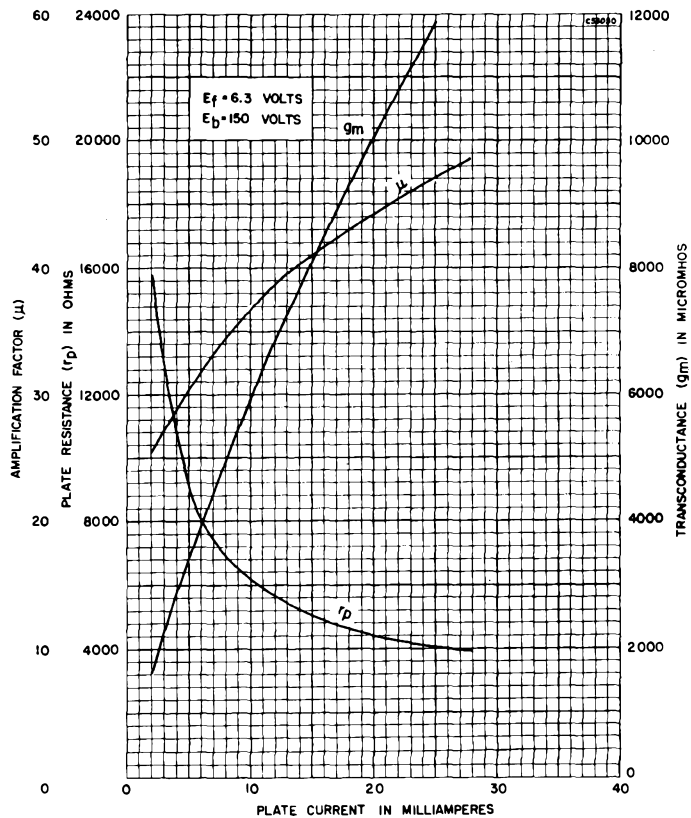



SYLVANIA TYPE 6BL4

HALF-WAVE RECTIFIER

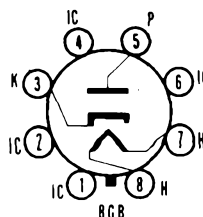

MECHANICAL DATA

Bulb	T-12
Base	Short Jumbo Shell Octal 8-Pin with External Barriers
Maximum Overall Length	45/8"
Maximum Seated Height	4 1/16"
Basing	8GB
Mounting Position	Any

ELECTRICAL DATA

HEATER CHARACTERISTICS

Heater Voltage	6.3 Volts
Heater Current	3.0 Amps
Maximum Peak Heater-Cathode Voltage	
Heater Negative with Respect to Cathode (Abs. Max.) ²	
Total D C and Peak	4500 Volts
D C	900 Volts
Heater Positive with Respect to Cathode	
Total D C and Peak	300 Volts
D C	100 Volts

DIRECT INTERELECTRODE CAPACITANCES (Approx.)

	Unshielded
Plate to Heater and Cathode	11.5 μ f
Heater to Cathode	5.0 μ f
Cathode to Heater and Plate	16 μ f

MAXIMUM RATINGS (Design Center Values—Except as Noted)

Damper Service³	
Peak Inverse Plate Voltage (Abs. Max.) ²	4500 Volts
Plate Dissipation	8.0 Watts
Plate Current, D C	200 Ma
Peak Plate Current	1200 Ma

NOTES:

- Do not use Pins 1, 2, 4 and 6 for tie points.
- Under no circumstances should this absolute value be exceeded.
- For operation in a 525-line, 30 frame television system, the duty cycle of the voltage pulse must not exceed 15% of one scanning cycle.

APPLICATION

The Sylvania Type 6BL4 is a half-wave vacuum rectifier which is particularly suited for use as a damper diode in color television receivers.

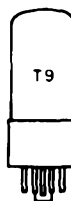

SYLVANIA TYPE 6BL7GT

DUO TRIODE

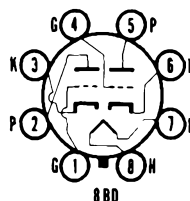

MECHANICAL DATA

Bulb	T-9, Outline 9-41
Base	Short Intermediate Octal 8-Pin
Basing	8BD
Mounting Position	Any

ELECTRICAL DATA

HEATER CHARACTERISTICS

Heater Voltage	6.3 Volts
Heater Current	1.5 Amperes
Maximum Peak Heater-Cathode Voltage	200 Volts

6BL7GT (Cont'd)

DIRECT INTERELECTRODE CAPACITANCES (Unshielded)

	Section 1 ¹	Section 2
Grid to Plate.....	6.0	6.0 $\mu\mu\text{f}$
Input.....	4.2	4.6 $\mu\mu\text{f}$
Output.....	0.9	0.9 $\mu\mu\text{f}$

MAXIMUM RATINGS (Design Center Values)

Vertical Oscillator²

Plate Voltage.....	500 Volts
Peak Negative Pulse Grid Voltage.....	400 Volts
Average Cathode Current.....	60 Ma
Peak Cathode Current.....	210 Ma
Grid Circuit Resistance.....	2.2 Megohms
Plate Dissipation (each plate) ³	10 Watts

Vertical Deflection Amplifier²

Plate Voltage.....	500 Volts
Peak Positive Pulse Plate Voltage.....	2000 Volts abs Max
Peak Negative Pulse Grid Voltage.....	250 Volts
Average Cathode Current.....	60 Ma
Peak Cathode Current.....	210 Ma
Grid Circuit Resistance.....	2.2 Megohms
Plate Dissipation (each plate) ³	10 Watts

TYPICAL OPERATION

Class A₁ Amplifier—Single Section

Plate Voltage.....	250 Volts
Grid Voltage.....	-9.0 Volts
Plate Current.....	40 Ma
Transconductance.....	7000 μmhos
Amplification Factor.....	15
Plate Resistance.....	2150 Ohms
Grid Voltage (approx.) for $I_b = 50 \mu\text{a}$	-23 Volts

NOTES:

1. Section 1 connects to Pins 4, 5 and 6.
2. For operation in a 525 line, 30 frame system, the duty cycle of the voltage pulse must not exceed 15% of one scanning cycle.
3. Total dissipation of both sections is limited to 12 watts.

APPLICATION

Sylvania Type 6BL7GT is a high transconductance duo triode designed for use as a vertical deflection amplifier in television receivers. The high current available at low voltage provides the power necessary to deflect wide angle picture tubes.

SYLVANIA TUBE TESTER SETTINGS

	A	B	C	D	E	F	G	Test or K
139/140	6.3	0	78	1	7	5	32	Y
	6.3	0	7	1	3	3	32	Y
219/220	6.3	7	68	21	8	1Z	2	3
	6.3	7	38	21	8	4Z	5	6



SYLVANIA TYPE 6BN6

GATED BEAM DISCRIMINATOR

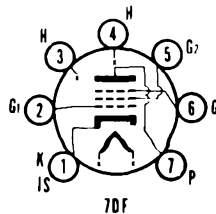

MECHANICAL DATA

Bulb	T-5 1/2, Outline 5-3
Base	Miniature Button 7-Pin
Basing	7DF
Mounting Position	Any

ELECTRICAL DATA

HEATER CHARACTERISTICS

Heater Voltage	6.3 Volts
Heater Current	300 Ma
Maximum Heater-Cathode Voltage	90 Volts

DIRECT INTERELECTRODE CAPACITANCES (Unshielded)

Grid No. 1 to All Other Electrodes	4.2 μf
Grid No. 3 to All Other Electrodes	3.3 μf
Grid No. 1 to Grid No. 3	0.004 μf Max

MAXIMUM RATINGS (Design Center Values)

Plate Supply Voltage	300 Volts
Accelerator Voltage	100 Volts
Peak Positive Limiter-Grid Voltage	55 Volts
Total Cathode Current	11.5 Ma

CHARACTERISTICS AND TYPICAL OPERATION

Limiter-Discriminator Service

Input Signal Center Frequency	10.7	10.7	4.5 Mc
Frequency Deviation	± 75	± 75	± 25 Kc
Plate Supply Voltage	85	285	270 Volts
Plate Voltage	63	122	121 Volts
Accelerator Voltage	55	100	100 Volts
Cathode Bias Resistor (Variable) ¹	200-400	200-400	200-400 Ohms
Plate Load Resistor	85000	330000	330000 Ohms
Plate Linearity Resistor	470	1500	1000 Ohms
Integrating Capacitor	0.002	0.001	0.001 μf
Coupling Capacitor	0.25	0.01	0.25 μf
Minimum Signal Voltage for Limiting			
Action (R M S) ²	1.25	1.25	1.25 Volts
Average D C Plate Current	0.25	0.49	0.44 Ma
Accelerator Current	4.1	9.8	10.0 Ma
Input Signal Level for A M Rejection			
Adjustment ¹	1.25	2.0	2.0 Volts
A M Rejection at $E_{sig} = 2.0$ Volts (R M S)	31	20	25 db
A M Rejection at $E_{sig} = 3.0$ Volts (R M S)	30	29	30 db
Total Harmonic Distortion	2.0	1.6	1.8 Percent
Peak Audio Output Voltage	6.0	16.6	16.8 Volts

NOTES:

- The cathode resistor should be adjusted for maximum a m rejection in the output of the limiter-discriminator stage at the specified signal level. A M rejection is measured with an applied signal containing 30% a m and 30% f m.
- At signal levels above specified value, limiting is within ± 2 decibels.

Adequate shielding between components of the limiter grid and the quadrature grid must be used to insure proper phasing of the voltage developed at the quadrature grid.

Standard de-emphasis requirements for f m are included.

The Q of the quadrature grid circuit should be high enough to develop a minimum of 4 volts (r m s) signal with 2 volts (r m s) of the center-frequency signal applied to the limiter grid. It is recommended that the coil be shunted by a minimum of 10 μf . The capacitance may be composed of tube input capacitance, stray capacitance, and distributed capacitance, as well as physical capacitance.

APPLICATION

Sylvania Type 6BN6 is a gated beam tube in miniature construction designed primarily for the combined operations of limiter, discriminator and audio voltage amplifier in f m and inter-carrier television receivers. It may also be used as a sync separator and square-wave generator.

6BN6 (Cont'd)

SYLVANIA TUBE TESTER SETTINGS

	A	B	C	D	E	F	G	Test or K
139/140	6.3	0	—	0	3	25	48	V
	6.3	0	—	0	3	056	35	V
219/220	6.3	3	4	34	4	25U	7	1
	6.3	3	4	21	4	056U	7	1

TYPICAL FM SOUND DISCRIMINATOR AND INTERNAL CONSTRUCTION OF THE TYPE 6BN6

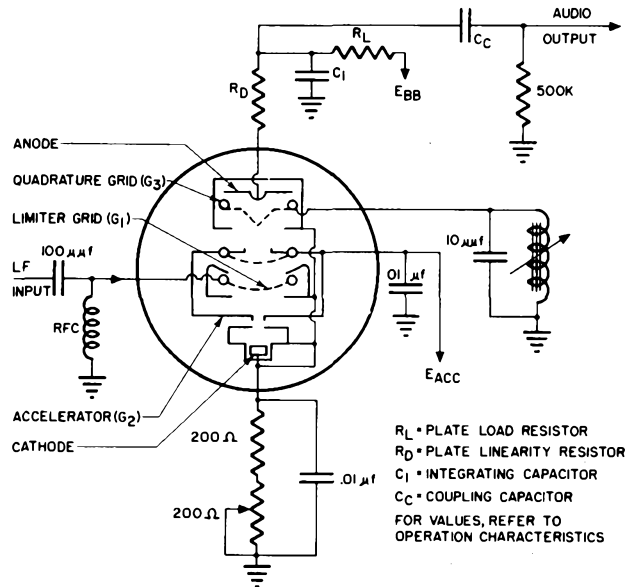

AVERAGE CHARACTERISTICS

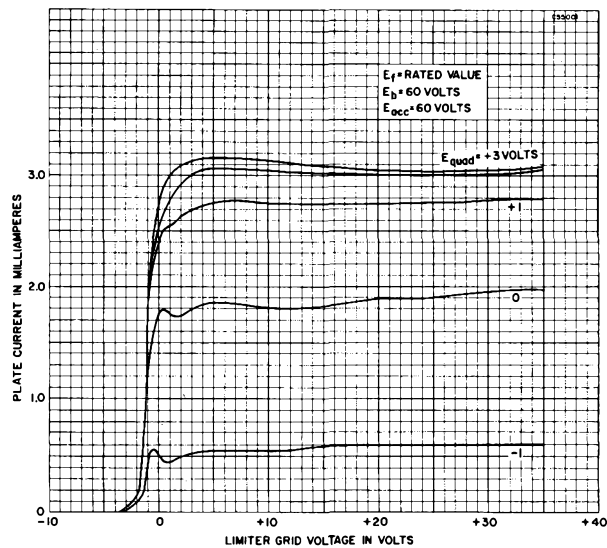

TYPE 6BN7

(See Condensed Data Section)

SYLVANIA TYPE

6BQ6G
6BQ6GA
6BQ6GT
6BQ6GTA

BEAM POWER AMPLIFIER

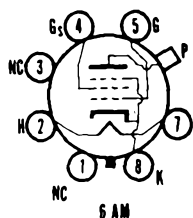

MECHANICAL DATA

	6BQ6G	6BQ6GA
Bulb	ST-12, Outline 12-8	T-11
Base	Small Shell Octal	Medium Shell Octal 7-Pin
Basing	6AM	6AM
Top Cap.	Skirted Miniature	Skirted Miniature
Mounting Position	Any	Any
	6BQ6GT	6BQ6GTA
Bulb	T-9, Outline 9-49	T-9, Outline 9-50
Base	Intermediate Shell Octal	Short Intermediate Shell Octal
Basing	6AM	6AM
Top Cap.	Skirted Miniature	Skirted Miniature
Mounting Position	Any	Any

ELECTRICAL DATA

HEATER CHARACTERISTICS

Heater Voltage	6.3 Volts
Heater Current	1.2 Amperes
Maximum Heater-Cathode Voltage	
Total D C and Peak	200 Volts
D C, Heater Positive with Respect to Cathode	100 Volts

DIRECT INTERELECTRODE CAPACITANCES (Approx.)

	6BQ6GA	6BQ6GTA 6BQ6GT 6BQ6G
Grid to Plate	0.8	0.6 μf
Input	14	15 μf
Output	6.5	7.5 μf

MAXIMUM RATINGS (Design Center Values—Except as Noted)

Horizontal Deflection Amplifier¹

	6BQ6GTA 6BQ6GA 6BQ6G	6BQ6GT
Plate Voltage, D C	600	550 Volts
Peak Positive Plate Voltage (Abs. Max.)	6000	5500 Volts
Peak Negative Plate Voltage	1250	1250 Volts
Plate Dissipation ²	11	11 Watts
Grid No. 2 Voltage, D C	175	175 Volts
Grid No. 2 Dissipation	2.5	2.5 Watts
Peak Negative Grid No. 1 Voltage	300	300 Volts
Average Cathode Current	110	110 Ma
Peak Cathode Current	400	400 Ma
Grid No. 1 Circuit Resistance	0.47	0.47 Megohm
Bulb Temperature at Hottest Point	See Note 3	

CHARACTERISTICS

	6BQ6G 6BQ6GA	6BQ6GT 6BQ6GTA
Pentode Operation: With $E_b = 250$ V, $E_{c2} = 150$ V, $E_{c1} = -22.5$ V		
Plate Current	55 Ma	
Grid No. 2 Current	2.1 Ma	
Transconductance	5500 μmhos	
Plate Resistance	20000 Ohms	

6BQ6G, 6BQ6GA 6BQ6GT, 6BQ6GTA (Cont'd)

	6BQ6G 6BQ6GA 6BQ6GT	6BQ6GTA
Zero Bias: With $E_b = 60$ V and $E_{c2} = 150$ V (Instantaneous Values)		
Plate Current	225	260 Ma
Grid No. 2 Current	25	26 Ma
Cutoff: For $I_b = 1$ ma with $E_b = 250$ V and $E_{c2} = 150$ V		
Grid No. 1 Voltage (approx.)	-46	-43 Volts
Triode Amplification Factor:		
$E_b = E_{c2} = 150$ V and $E_{c1} = -22.5$ V	4.3	4.3 Volts

NOTES:

- For operation in a 525-line, 30 frame system, the duty cycle of the voltage pulse must not exceed 15% of one scanning cycle.
- In stages operating with grid leak bias, an adequate cathode bias resistor or other suitable means is required to protect the tube in the absence of excitation.
- Maximum bulb temperature at hottest point:

6BQ6GA	-190°C
6BQ6G	-200°C
6BQ6GTA	-220°C
6BQ6GT	-220°C

APPLICATION

These tubes are beam power amplifiers designed for service as the horizontal amplifier in television receivers. They are generally interchangeable except that the Types 6BQ6G, 6BQ6GA and 6BQ6GTA have slightly higher maximum ratings than the Type 6BQ6GT. In substituting one for the other, the difference in maximum bulb temperatures should be considered in addition to the maximum voltage and power dissipation differences. The Sylvania Type 6BQ6GTA is recommended to replace the others in most circuits as it has both the highest maximum electrical ratings and highest maximum bulb temperature.

SYLVANIA TUBE TESTER SETTINGS

	A	B	C	D	E	F	G	Test or K
139/140	6.3	0	5	0	8	034	21	Y
219/220	6.3	2	7	10	7	045Y	9	8

AVERAGE PLATE CHARACTERISTICS

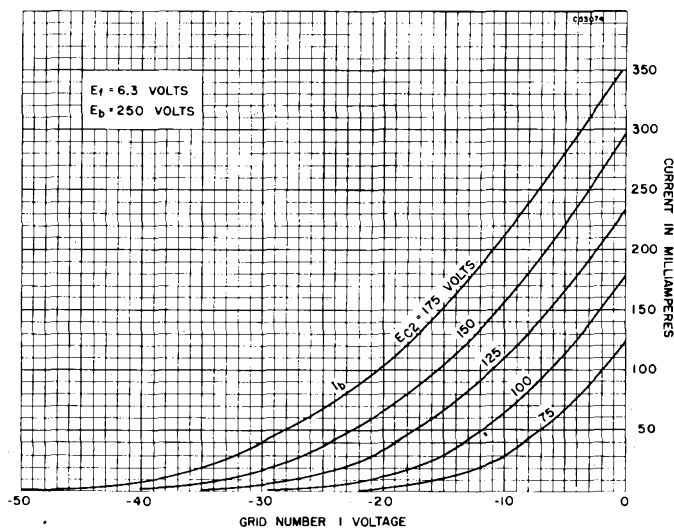

6BQ6G, 6BQ6GA 6BQ6GT, 6BQ6GTA (Cont'd)

AVERAGE PLATE CHARACTERISTICS

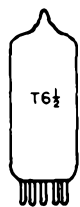
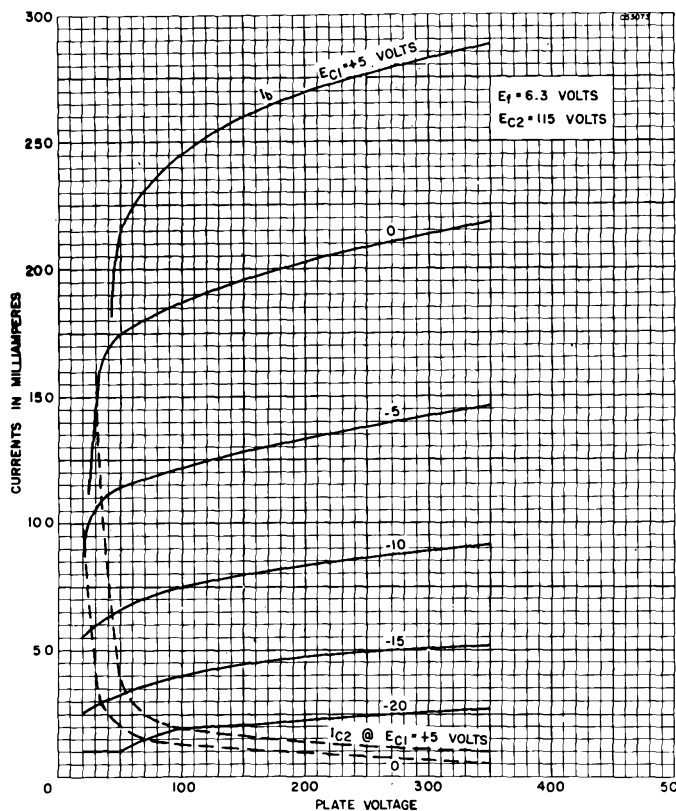

T6 $\frac{1}{2}$

SYLVANIA TYPE 6BQ7 MEDIUM-MU DUO TRIODE

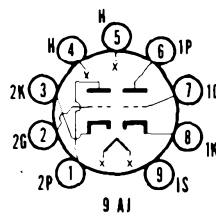

Type 6BQ7 is similar to its replacement—Type 6BQ7A. The Type 6BQ7 has a lower transconductance and amplification factor.

TYPICAL OPERATION

Class A₁ Amplifier

Plate Voltage	150 Volts
Cathode Bias Resistor	220 Ohms
Plate Current	9.0 Ma
Transconductance	6000 μ mhos
Plate Resistance	5800 Ohms
Amplification Factor	35

6BQ7 (Cont'd)

SYLVANIA TUBE TESTER SETTINGS

	A	B	C	D	E	F	G	Test or K
139/140	6.3	0	—	0	1	3	20	W
	6.3	0	—	0	3	7	20	W
219/220	6.3	4	58	25	5	2X	1	3
	6.3	4	35	25	5	7X	6	8

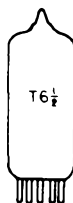

SYLVANIA TYPE 6BQ7A

VHF DUO TRIODE

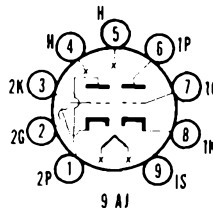

MECHANICAL DATA

Bulb	T-6 1/2, Outline 6-2
Base	Small Button 9-Pin
Basing	9AJ
Mounting Position	Any

ELECTRICAL DATA

HEATER CHARACTERISTICS

Heater Voltage	6.3 Volts
Heater Current	400 Ma
Maximum Heater-Cathode Voltage	200 Volts

DIRECT INTERELECTRODE CAPACITANCES (Shielded)¹

	Section 1 ²	Section 2
Grid to Plate	1.2	1.2 $\mu\mu\text{f}$
Input	2.6	$\mu\mu\text{f}$
Output	1.2	$\mu\mu\text{f}$
Plate to Cathode	0.12	0.12 $\mu\mu\text{f}$
Heater to Cathode	2.6	2.6 $\mu\mu\text{f}$
Plate to Plate	0.010	$\mu\mu\text{f}$
Plate Section 2 to Plate and Grid Section 1	0.024	$\mu\mu\text{f}$
Grounded Grid Operation		
Input		5.0 $\mu\mu\text{f}$
Output		2.2 $\mu\mu\text{f}$

MAXIMUM RATINGS (Design Center Values—Each Section)

Plate Voltage	250 Volts
Plate Dissipation	2 Watts
Cathode Current	20 Ma
Grid Circuit Resistance	0.5 Megohm

CHARACTERISTICS AND TYPICAL OPERATION

Class A₁ Amplifier—Each Section

Plate Voltage ³	150	Volts
Cathode Bias Resistor	220	Ohms
Plate Current	9	Ma
Transconductance	6400	μmhos
Plate Resistance	5900	Ohms
Amplification	38	
Grid Voltage for $I_b = 100 \mu\text{a}$ (approx.)	-6.5	Volts

Direct Coupled R F Grounded Grid Operation⁴

	Section 1	Section 2
Plate Supply Voltage	250	250 Volts
Plate Voltage	135	115 Volts
Negative Grid Voltage	-1	Volts
Cathode Bias Resistor	100	Ohms
Grid Resistor		0.5 Megohm
Plate Current	10	10 Ma
Grid Current	0	0 Ma
Grid Voltage for $I_b = 10 \mu\text{a}$ (approx.)	-14	Volts

Push-Pull R F Grounded Grid Operation

Plate Voltage	150 Volts
Grid Voltage	-2 Volts
Cathode Bias Resistor (Common to Both Sections)	100 Ohms
Plate Current	10 Ma

6BQ7A (Cont'd)

NOTES:

1. RETMA shield No. 315.
2. Section No. 1 connects to Pins 6, 7 and 8. Section No. 2 connects to Pins 1, 2 and 3.
3. Under cutoff conditions, in r f grounded grid circuits with direct coupled drive, this voltage may be as high as 300 volts.
4. Section No. 1 (Driver) is directly coupled to Section No. 2 (Driven Grounded Grid Amplifier.)

APPLICATION

Sylvania Type 6BQ7A is a miniature, medium μ , twin triode intended for service as the first amplifier in tuners or v h f television receivers or other applications requiring a high gain, low noise twin triode amplifier. The Type 6BQ7A is considered as a replacement for Type 6BQ7.

AVERAGE TRANSFER CHARACTERISTICS

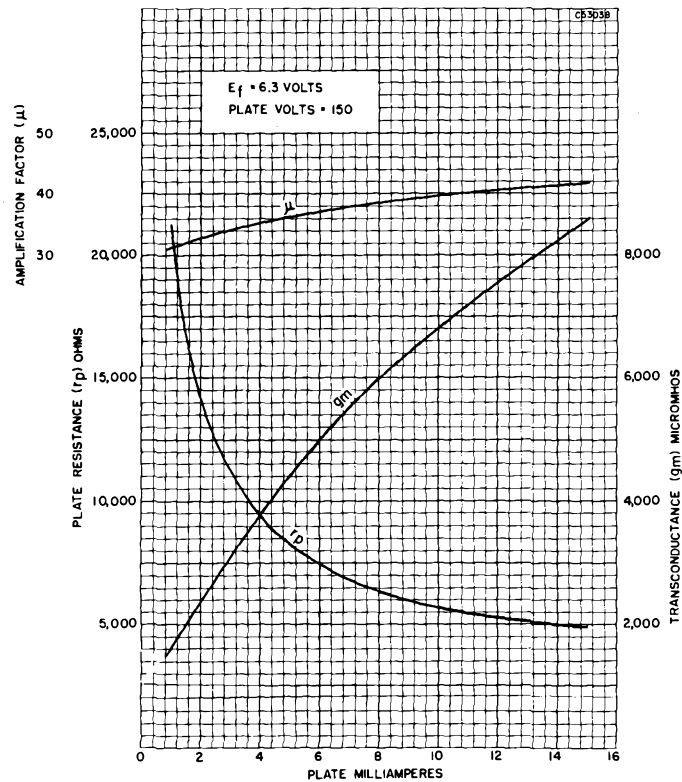

6BQ7A (Cont'd)

AVERAGE PLATE CHARACTERISTICS

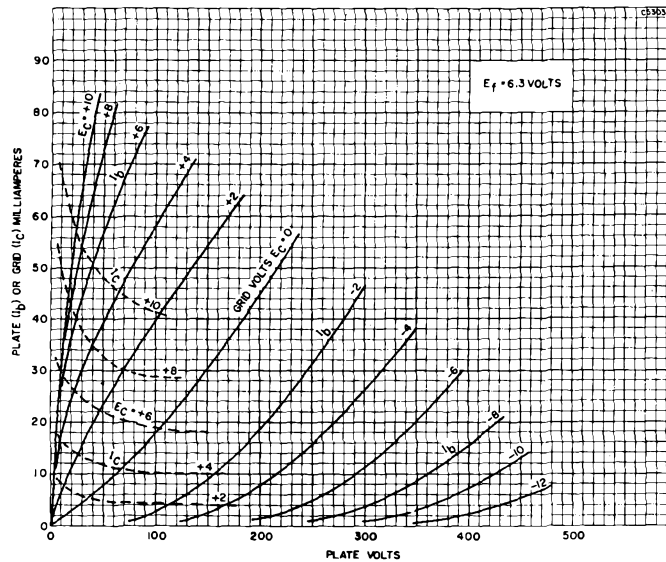

TYPE 6BU5

(See Condensed Data Section)

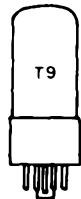

SYLVANIA TYPE 6BX7GT DUO TRIODE

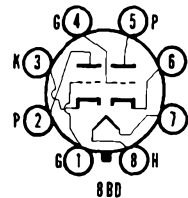

MECHANICAL DATA

Bulb.....	T-9, Outline 9-41
Base.....	Short Intermediate Shell Octal
Basing.....	8BD
Mounting Position.....	Any

ELECTRICAL DATA

HEATER CHARACTERISTICS

Heater Voltage.....	6.3 Volts
Heater Current.....	1.5 Amperes
Maximum Heater-Cathode Voltage.....	200 Volts
Total D C and Peak.....	100 Volts
D C, Heater Positive with Respect to Cathode.....	

MAXIMUM RATINGS (Design Center Values—Except as Noted)

Vertical Deflection Amplifier and Oscillator (Notes 2 & 3)

Plate Voltage.....	500 Volts
Peak Positive Plate Voltage (Abs. Max.).....	2000 Volts
Plate Dissipation ⁴	
Each Plate.....	10 Watts
Both Plates.....	12 Watts
Positive Grid Voltage D C.....	0 Volts
Peak Negative Grid Voltage.....	250 Volts
Average Cathode Current D C (Each Section).....	60 Ma
Grid Circuit Resistance.....	2.2 Megohms
Peak Cathode Current D C (Each Section).....	180 Ma

6BX7GT (Cont'd)

CHARACTERISTICS (Each Section)

Plate Voltage	100	250	Volts
Grid Voltage	0		Volts
Cathode Resistor	0	390	Ohms
Plate Current	80	42	Ma
Amplification Factor		10	
Transconductance		7600	μ mhos
Plate Resistance		1300	Ohms
Grid Voltage for $I_b = 50 \mu$ a		-40	Volts

NOTES:

- Section No. 1 connects to Pins 4, 5 and 6.
- For operation in a 525-line, 30 frame system, the duty cycle of the voltage pulse must not exceed 15% of one scanning cycle.
- When one section is operated as an oscillator it is recommended that section No. 1 (Pins 4, 5 and 6) be used.
- An adequate bias resistor or other means is required to protect the tube in the absence of excitation.

APPLICATION

Sylvania Type 6BX7GT is a high perveance double triode designed for use as a vertical amplifier and/or oscillator in television receivers.



**SYLVANIA TYPE 6BY5G
6BY5GA**
FULL-WAVE RECTIFIER

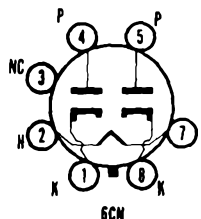

MECHANICAL DATA

	6BY5G	6BY5GA
Bulb	ST-14, Outline 14-3	T-12, Outline 12-101
Base	Medium Shell Octal	Short Medium Octal
Basing	6CN	6CN
Mounting Position	Any	Any

ELECTRICAL DATA

HEATER CHARACTERISTICS

Heater Voltage	6.3	Volts
Heater Current	1.6	Amperes
Maximum Heater-Cathode Voltage		
Heater Negative with Respect to Cathode	450	Volts
Heater Positive with Respect to Cathode	100	Volts

MAXIMUM RATINGS (Design Center Values)

Peak Inverse Voltage		
Rectifier Service	1400	Volts
Damper Service	2500	Volts
D C Output Current	175	Ma
Peak Plate Current	525	Ma
Tube Drop at 175 Ma Per Plate	32	Volts

TYPICAL OPERATION

Full-Wave Rectifier, Capacitor Input Filter

A C Plate Supply Voltage Each Plate (R M S)	375	Volts
Filter Input Capacitor	8	μ f
Effective Plate Supply Impedance Per Plate	100	Ohms
D C Output Voltage	380	Volts
D C Output Current	175	Ma

NOTE:

- In a 525-line, 30 frame system, the duty cycle of the voltage pulse must not exceed 15% of one scanning cycle.

APPLICATION

Sylvania Types 6BY5G and 6BY5GA are duo diodes with separate unipotential cathodes. They are suitable for damper diode service in television deflection circuits or rectifier service in conventional power supply applications.

6BY5G (Cont'd)

SYLVANIA TUBE TESTER SETTINGS

	A	B	C	D	E	F	G	Test or K
139/140	6.3	0	—	0	2	—	19	Y
	6.3	0	—	0	3	—	19	Y
219/220	6.3	2	78	11	7	Z	4*	1
	6.3	2	17	11	7	Z	5*	8

* Diode gas test does not apply.

TYPE 6BY6

(See Condensed Data Section)



SYLVANIA TYPE 6BZ6
SEMI-REMOTE CUTOFF PENTODE

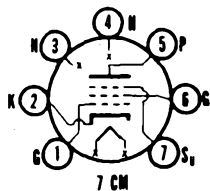

MECHANICAL DATA

Bulb	T-5 1/2, Outline 5-2
Base	Miniature Button 7-Pin
Basing	7CM
Mounting Position	Any

ELECTRICAL DATA

HEATER CHARACTERISTICS

Heater Voltage	6.3 Volts
Heater Current	300 Ma
Maximum Heater-Cathode Voltage	
Total D C and Peak	200 Volts
D C, Heater Positive with Respect to Cathode	100 Volts

DIRECT INTERELECTRODE CAPACITANCES

	Shielded ¹	Unshielded
Grid to Plate	0.015	0.02 μf Max
Input	7.5	7.5 μf
Output	2.8	1.8 μf

MAXIMUM RATINGS (Design Center Values)

Plate Voltage	300 Volts
Plate Dissipation	2.5 Watts
Grid No. 2 Voltage	See Rating Chart for Type 6AM8
Grid No. 2 Supply Voltage	300 Volts
Grid No. 2 Dissipation	0.5 Watt
Grid No. 1 Circuit Resistance	
Fixed Bias	0.25 Megohm
Self Bias	1.0 Megohm

CHARACTERISTICS AND TYPICAL OPERATION

Class A₁ Amplifier

Plate Voltage	200 Volts
Grid No. 2 Voltage	150 Volts
Grid No. 3 Voltage	Connected to Cathode at Socket
Cathode Bias Resistor	180 Ohms
Plate Current	11.0 Ma
Grid No. 2 Current	2.6 Ma
Plate Resistance (approx.)	0.6 Megohm
Transconductance	6100 μmhos
Grid No. 1 Voltage for gm of 50 μmhos (approx.)	-23 Volts

NOTE:

1. External shield No. 316 connected to Pin No. 2 (cathode) at socket.

6BZ6 (Cont'd)

APPLICATION

Sylvania Type 6BZ6 is designed for application as a gain control i f amplifier in television receivers. The semi-remote cutoff characteristic of the 6BZ6 eliminates possible distortion resulting from high signal levels, as well as distortion caused by a g c time delay. This tube also features high transconductance, thus providing maximum gain in low signal areas.

AVERAGE PLATE CHARACTERISTICS

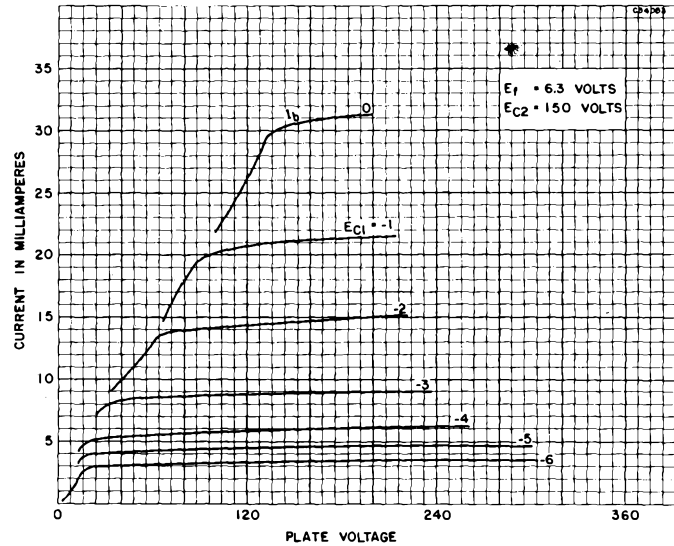

AVERAGE TRANSFER CHARACTERISTICS

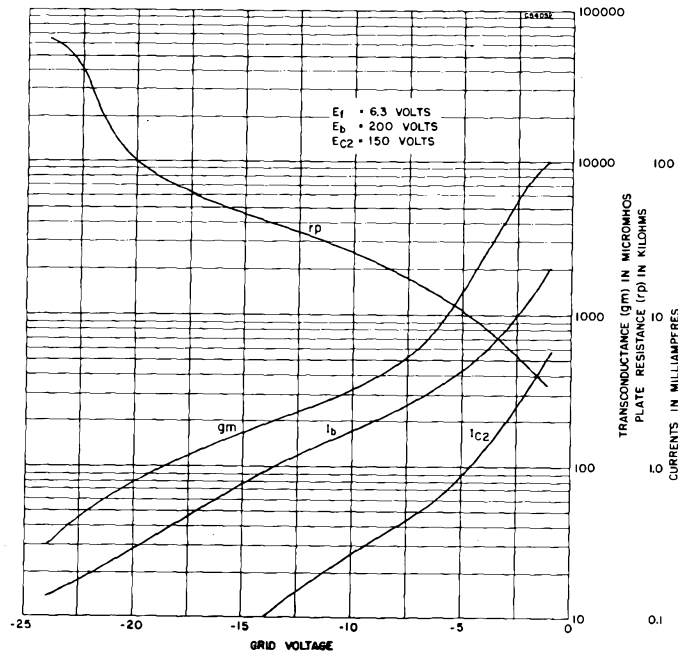

SYLVANIA ELECTRONIC TUBES

6BZ6 (Cont'd)

SCREEN GRID RATING CHART

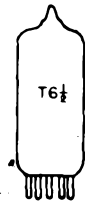
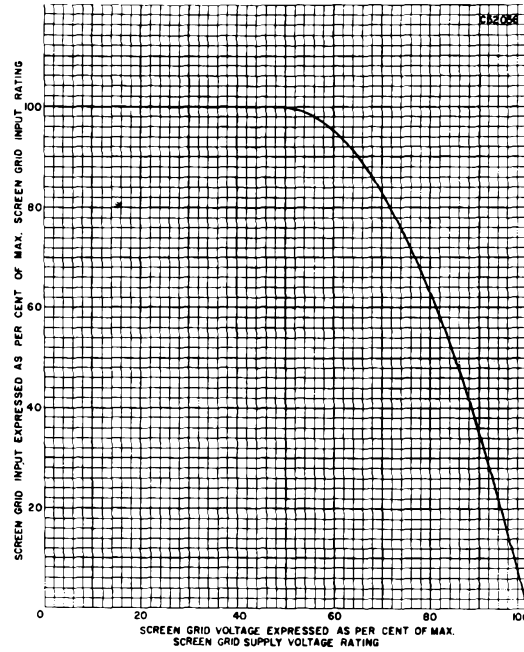

SYLVANIA TYPE 6BZ6 VHF DUO TRIODE

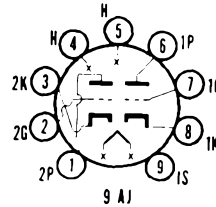

MECHANICAL DATA

Bulb	T-6 1/2 Outline 6-2
Base	Small Button 9-Pin
Basing	9AJ
Mounting Position	Any

ELECTRICAL DATA

HEATER CHARACTERISTICS

Heater Voltage	6.3 Volts
Heater Current	400 Ma
Maximum Heater-Cathode Voltage	
Heater Positive with Respect to Cathode	200 Volts
Heater Negative with Respect to Cathode ¹	200 Volts

DIRECT INTERELECTRODE CAPACITANCES (Shielded)²

	Section 1 ³	Section 2
Grid to Plate	1.2	1.2 $\mu\mu\text{f}$
Input	2.6	$\mu\mu\text{f}$
Output	1.2	$\mu\mu\text{f}$
Plate to Cathode	0.12	0.12 $\mu\mu\text{f}$
Heater to Cathode	2.6	2.5 $\mu\mu\text{f}$
Plate to Plate	0.010	$\mu\mu\text{f}$
Plate Section 2 to Plate and Grid Section 1	0.024	$\mu\mu\text{f}$

Grounded Grid Operation

Input	5.0 $\mu\mu\text{f}$
Output	2.2 $\mu\mu\text{f}$

6BZ7 (Cont'd)

MAXIMUM RATINGS (Design Center Values—Each Section)

Plate Voltage	250 Volts
Plate Dissipation	2 Watts
Cathode Current	20 Ma
Grid Circuit Resistance	0.5 Megohm

CHARACTERISTICS

Class A Amplifier (Each Section)

Plate Voltage	150 Volts
Cathode Bias Resistor	220 Ohms
Plate Current	10 Ma
Transconductance	6800 μ mhos
Amplification Factor	36
Plate Resistance	5300 Ohms
Grid Voltage for $I_b = 100 \mu$ a (approx)	7 Volts

NOTES:

1. When operated with the two sections direct drive cascode amplifier it is permissible for this voltage to be as high as 300 volts under cutoff conditions.
2. Shield No. 315.
3. Section 1 connects to Pins 6, 7 and 8. Section 2 connects to Pins 1, 2 and 3.

APPLICATION

Sylvania Type 6BZ7 is a miniature medium mu duo triode designed for use in low noise v h f amplifier application and particularly for cascode operation.

SYLVANIA TUBE TESTER SETTINGS

	A	B	C	D	E	F	G	Test or K
139/140	6.3	0	—	0	1	3	32	U
	6.3	0	—	0	3	7	32	U
219/220	6.3	4	58	24	5	2X	1	3
	6.3	4	53	25	5	7X	6	8



SYLVANIA TYPE 6C4
HIGH FREQUENCY POWER TRIODE

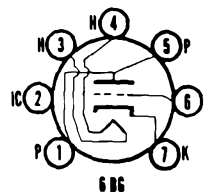

MECHANICAL DATA

Bulb	T-5 1/2, Outline 5-2
Base	Miniature Button 7-Pin
Basing	6BG
Mounting Position	Any

ELECTRICAL DATA

HEATER CHARACTERISTICS

Heater Voltage	6.3 Volts
Heater Current	150 Ma
Maximum Heater-Cathode Voltage	200 Volts

DIRECT INTERELECTRODE CAPACITANCES

	Shielded ¹	Unshielded
Grid to Plate	1.4 μ f	1.6 μ f
Input	1.8 μ f	1.8 μ f
Output	2.5 μ f	1.3 μ f

MAXIMUM RATINGS (Design Center Values)

	Class A ₁ Amplifier	Class C Telegraphy
Plate Voltage	300	300 Volts
Plate Dissipation	3.5	5.0 Watts
Plate Current		25 Ma
Negative D C Grid Voltage		-50 Volts
D C Grid Current		8 Ma
Grid Circuit Resistance		
Fixed Bias	0.25	0.25 Megohm
Cathode Bias	1.0	1.0 Megohm



SYLVANIA TYPE 6BN4
2BN4
3BN4

VHF TRIODE

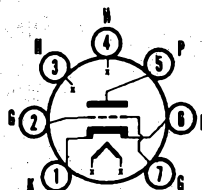

7EG

MECHANICAL DATA

Bulb.....	T-5½
Base.....	E7-1, Miniature Button 7-Pin
Outline.....	5-2
Basing.....	7EG
Cathode.....	Coated Unipotential
Mounting Position.....	Any

ELECTRICAL DATA

HEATER CHARACTERISTICS

	2BN4	3BN4	6BN4
Heater Voltage.....	2.3	2.8	6.3 Volts
Heater Current.....	600	450	200 Ma
Heater Warm-up Time.....	11	11	Seconds
Heater-Cathode Voltage (Design Max. Values)			
Heater Negative with Respect to Cathode			
Total DC and Peak.....			100 Volts
Heater Positive with Respect to Cathode			
Total DC and Peak.....			100 Volts

DIRECT INTERELECTRODE CAPACITANCES (Shielded)

Grid to Plate.....	1.2 μ f
Input.....	3.2 μ f
Output.....	1.4 μ f
Heater to Cathode.....	2.8 μ f

MAXIMUM RATINGS (Design Maximum Values)

Plate Voltage.....	275 Volts
Plate Dissipation.....	2.2 Watts
Positive DC Grid Voltage.....	0 Volts
DC Cathode Current.....	22 Ma
Grid Circuit Resistance.....	0.5 Megohms

CHARACTERISTICS AND TYPICAL OPERATION

Class A₁ Amplifier

Plate Voltage.....	150 Volts
Cathode Bias Resistor.....	220 Ohms
Plate Current.....	9.0 Ma
Transconductance.....	6800 μ mhos
Amplification Factor.....	43
Plate Resistance (approx.).....	6300 Ohms
Grid Voltage (approx.) for I _b = 100 μ a.....	-6 Volts

NOTE:

1. Heater warm-up time is defined as the time required for the voltage across the heater to reach 80% of its rated value after applying four (4) times rated heater voltage to a circuit consisting of the tube heater in series with a resistance equal to three (3) times rated heater voltage divided by rated heater current.

APPLICATION

The Sylvania Type 6BN4 is a miniature medium mu triode designed primarily for use as an amplifier in VHF television tuners. The characteristics of the 6BN4 are similar to one section of a 6BZ7.

The 3BN4 employs a 450 ma heater and the 2BN4 has a 600 ma heater. Both tube types have controlled heater warm-up time for operation in receivers employing a series heater string.

6BN4, 3BN4, 2BN4 (Cont'd)

AVERAGE PLATE CHARACTERISTICS

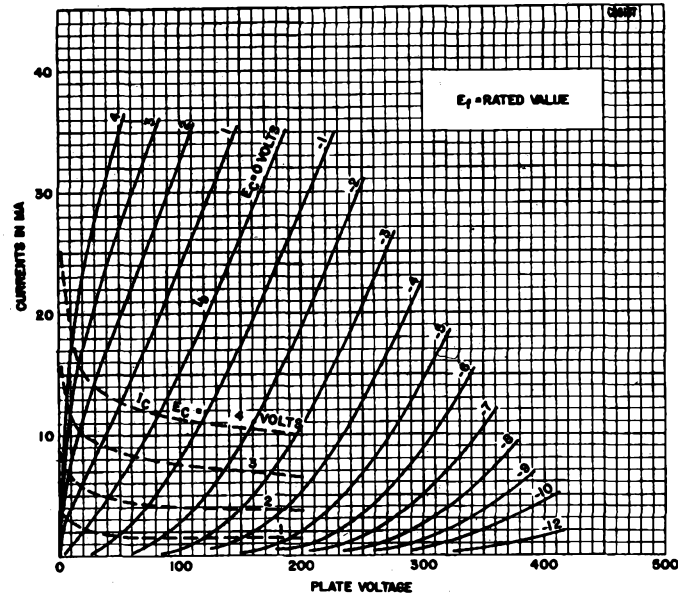

AVERAGE TRANSFER CHARACTERISTICS

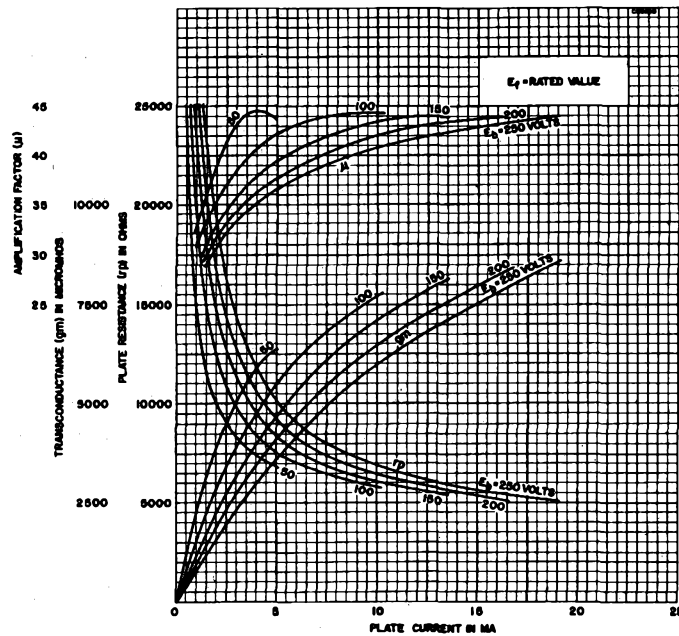

SYLVANIA ELECTRONIC TUBES



SYLVANIA TYPE 6BN8 8BN8

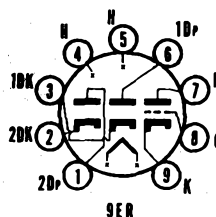

MECHANICAL DATA

Bulb.....	T-6½
Base.....	E9-1, Small Button 9-Pin
Outline.....	6-3
Basing.....	9ER
Cathode.....	Coated Unipotential
Mounting Position.....	Any

ELECTRICAL DATA

HEATER CHARACTERISTICS

	6BN8	8BN8
Heater Voltage.....	6.3	8.4 Volts
Heater Current.....	600	450 Ma
Heater Warm-up Time.....	11	11 Seconds
Heater-Cathode Voltage (Triode and Diodes Design Center Values)		
Heater Negative with Respect to Cathode		
Total D C and Peak.....	200	200 Volts Max.
Heater Positive with Respect to Cathode		
D C.....	100	100 Volts Max.
Total D C and Peak.....	200	200 Volts Max.

DIRECT INTERELECTRODE CAPACITANCES (Unshielded)

Triode	
Grid to Plate.....	2.5 μ f
Input: g to (h + Tk).....	3.6 μ f
Output: p to (h + Tk).....	0.25 μ f
Diodes	
No. 1 Diode Plate to No. 1 Diode Cathode + Heater.....	1.9 μ f
No. 2 Diode Plate to No. 2 Diode Cathode + Heater.....	1.9 μ f
No. 1 Diode Cathode to No. 1 Diode Plate + Heater.....	4.8 μ f
No. 2 Diode Cathode to No. 2 Diode Plate + Heater.....	4.8 μ f
Coupling	
No. 1 Diode Plate to Triode Grid.....	0.060 μ f Max.
No. 2 Diode Plate to Triode Grid.....	0.10 μ f Max.
No. 1 Diode Cathode to All:	
1Dk to (h + Tk + 2Dk + Tp + 1Dp + Tg + 2Dp)...	5.0 μ f
No. 2 Diode Cathode to All:	
2Dk to (h + Tk + 1Dk + Tp + 1Dp + 2Dp + Tg)...	5.0 μ f
No. 1 Diode Plate to No. 2 Diode Plate.....	0.070 μ f Max.
No. 1 Diode Plate to All:	
1Dp to (h + Tk + 1Dk + 2Dk + Tp + 2Dp + Tg)...	3.0 μ f
No. 2 Diode Plate to All:	
2Dp to (h + Tk + 1Dk + 2Dk + Tp + 1Dp + Tg)...	3.0 μ f

MAXIMUM RATINGS (Design Center Values)

Plate Voltage.....	300 Volts
Positive D C Grid Voltage.....	0 Volts
Plate Dissipation.....	1.5 Watts
Grid Circuit Resistance.....	1.0 Megohm
Peak Plate Current (Each Plate).....	54 Ma
D C Current (Each Plate).....	9 Ma

CHARACTERISTICS AND TYPICAL OPERATION

	Triode Section	
Class A₁ Amplifier		
Plate Voltage.....	100	250 Volts
Grid Voltage.....	-1	-3 Volts
Plate Current.....	1.5	1.6 Ma
Transconductance.....	3500	2500 μ mhos
Amplification Factor.....	75	70
Plate Resistance (approx.).....	21,000	28,000 Ohms
Grid Voltage (approx.) for Ib = 10 μ a.....	-2.5	-5.5 Volts
Average Current Each Plate at 10 Volts D C ¹		50 Ma
Voltage Drop Each Section at Ib = 9 Ma D C.....		2.6 Volts

NOTE:

1. Heater warm-up time is defined as the time required for the voltage across the heater to reach 80% of its rated value after applying four (4) times rated heater voltage to a circuit consisting of the tube heater in series with a resistance equal to three (3) times rated heater voltage divided by rated heater current.

NOTE:

2. Test conditions only.

APPLICATION DATA

The Sylvania Type 6BN8 is a miniature, high μ triode, double diode intended for application in color and monochrome television receivers. The tube features separate cathode connections for each section and controlled heater warm-up time to insure dependable operation in series string receivers. The 8BN8 is identical to the 6BN8 except for heater characteristics.

SYLVANIA ELECTRONIC TUBES

SYLVANIA TYPE 6BN8, 8BN8 (Cont'd)

AVERAGE PLATE CHARACTERISTICS

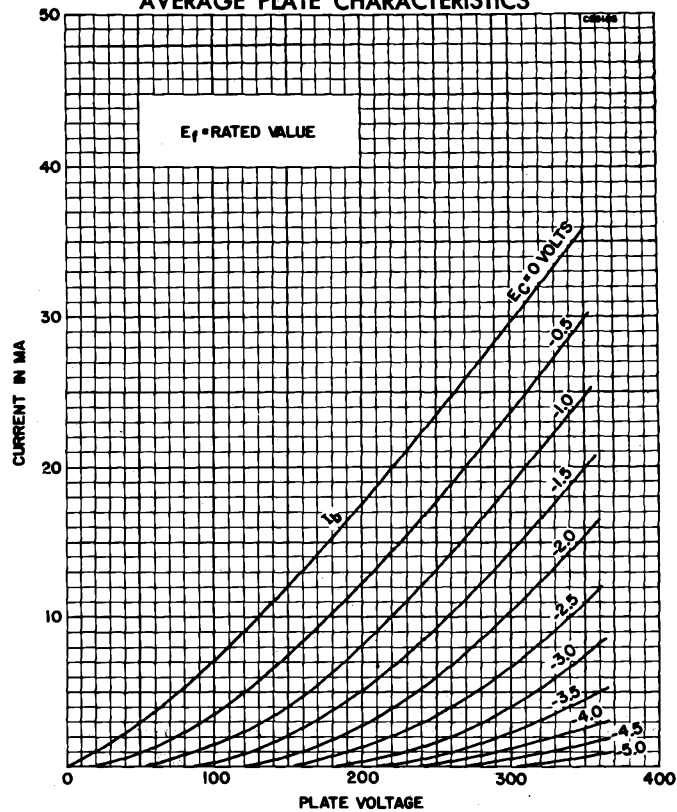

AVERAGE TRANSFER CHARACTERISTICS

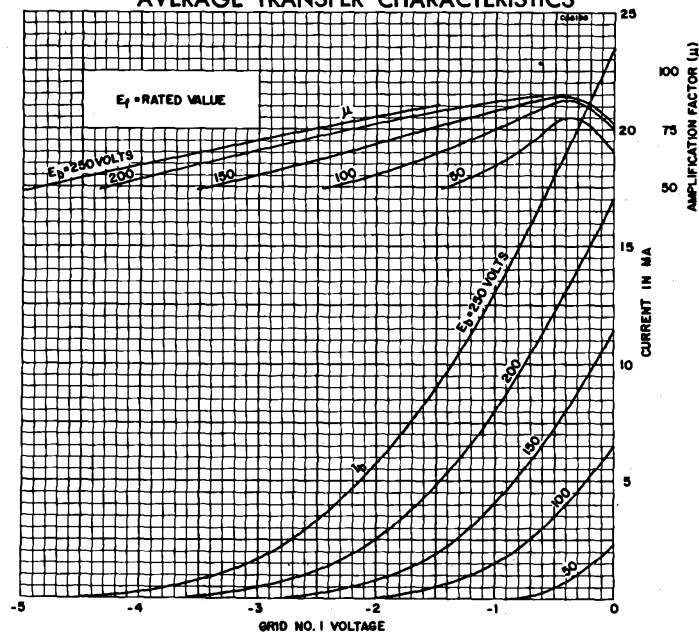

SYLVANIA ELECTRONIC TUBES



SYLVANIA TYPE 6BQ5
BEAM POWER AMPLIFIER

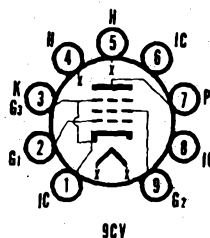

MECHANICAL DATA

Bulb.....	T-6½
Base.....	E9-1, Miniature Button 9-Pin
Outline.....	6-4
Basing.....	9CV
Cathode.....	Coated Unipotential
Mounting Position.....	Any

ELECTRICAL DATA

HEATER CHARACTERISTICS

Heater Voltage.....	6.3 Volts
Heater Current.....	760 Ma
Heater-Cathode Voltage (Design Center Values)	
Heater Negative with Respect to Cathode.....	100 Volts Max.
Heater Positive with Respect to Cathode.....	100 Volts Max.

DIRECT INTERELECTRODE CAPACITANCES

Grid No. 1 to Plate.....	0.5 μ f Max.
Input.....	10.8 μ f
Output.....	6.5 μ f
Grid No. 1 to Heater.....	0.25 μ f Max.

RATINGS (Design Center Values)

Plate Voltage ¹	300 Volts Max.
Grid No. 2 Voltage ¹	300 Volts Max.
Negative Grid No. 1 Voltage.....	100 Volts Max.
Plate Dissipation.....	12 Watts Max.
Grid No. 2 Dissipation.....	2 Watts Max.
Cathode Current.....	65 Ma Max.
Grid No. 1 Circuit Resistance	
Fixed Bias.....	0.3 Megohm Max.
Cathode Bias.....	1.0 Megohm Max.

CHARACTERISTICS AND TYPICAL OPERATION

	Triode Operation ²			Pentode Operation		
	Single Tube Class A ₁	Class AB ₁ Push-pull	Class A ₁ Single Tube	Class A ₁ Single Tube	Class AB ₁ Push-pull	Class AB ₁ Push-pull
Plate Voltage.....	250	250	300	250	250	300 Volts
Grid No. 2 Voltage.....	—	—	—	250	250	300 Volts
Grid No. 1 Voltage.....	—	—	—	-7.3	—	— Volts
Cathode Resistor ³	270	270	270	135	130	130 Ohms
Grid Voltage (RMS) ⁴	6.7	8.4	10	4.3	8	10 Volts
Plate Current (Zero-Signal).....	34	40	48	48	62	72 Ma
(Maximum Signal).....	36	53.4	52	49.5	75	92 Ma
Grid No. 2 Current (Zero Signal).....	—	—	—	5.5	7.0	8 Ma
(Maximum Signal).....	—	—	—	10.8	15	22 Ma
Transconductance.....	—	—	—	11,300	—	— μ mhos
Amplification Factor ¹	—	—	—	19	—	—
Plate Resistance.....	—	—	—	38,000	—	— Ohms
Load Resistance.....	3,500	—	—	5,200	—	— Ohms
Load Resistance (Plate to Plate).....	—	10K	10K	—	8K	8K Ohms
Maximum-Signal Power Output ¹	1.95	3.4	5.2	5.7	11	17 Watts
Total Harmonic Distortion ¹	9	2.5	2.5	10	3.0	4.0 Percent

6BQ5 (Cont'd)

NOTES:

1. When the heater and positive voltages are obtained from a storage battery by means of a vibrator, the maximum values of the plate and Grid No. 2 Voltages are 250 volts and that of the plate dissipation 9 watts.
2. Grid No. 2 connected to plate.
3. Common cathode resistor for push-pull applications.
4. Per Grid.
5. Measured from Grid No. 2 to Plate.
6. For Pentode Operation—Class A Amplifier Service, the maximum signal power output and total distortion are measured at fixed bias and therefore represent the power output available during the reproduction of speech and music. When a sustained sine wave is applied to the control grid the bias across the cathode resistor will readjust itself as a result of the increased plate and screen grid currents. This will result in approximately 10 percent reduction in power output.
7. Measured with fixed bias.

APPLICATION

The Sylvania Type 6BQ5 is a beam power pentode audio amplifier designed for service in the output stage of high quality audio amplifiers or other equipment requiring high power output at relative low distortion.

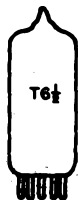

SYLVANIA TYPE 6BR8

5BR8

**MEDIUM MU TRIODE
SHARP-CUTOFF PENTODE**

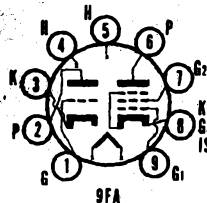

MECHANICAL DATA

Bulb	T-6½
Base	E9-1 Miniature Button 9-Pin
Outline	6-2
Basing	9FA
Cathode	Coated Unipotential
Mounting Position	Any

ELECTRICAL DATA

HEATER CHARACTERISTICS

	5BR8	6BR8
Heater Voltage	4.7	6.3 Volts
Heater Current	600	450 Ma
Heater Warm-up Time ¹	11	Seconds
Heater-Cathode Voltage (Design Center Values)		
Heater Negative with Respect to Cathode		250 Volts Max.
Heater Positive with Respect to Cathode		100 Volts Max.
DC		200 Volts Max.
Total DC and Peak		

DIRECT INTERELECTRODE CAPACITANCES

Triode Section	Shielded ²	Unshielded
Grid to Plate	1.8	1.8 μf
Grid to Cathode	2.5	2.5 μf
Plate to Cathode	1.0	0.4 μf
Heater to Cathode	3.0	3.0 μf
Pentode Section		
Grid No. 1 to Plate	0.008	0.015 μf Max.
Input	5.0	5.0 μf
Output	3.5	2.6 μf
Heater to Cathode	3.0	3.0 μf

MAXIMUM RATINGS (Design Center System)

	Triode Section	Pentode Section
Plate Voltage	300	300 Volts
Grid No. 2 Voltage	See 6AM8 Rating Chart	
Grid No. 2 Supply Voltage		300 Volts
Positive Grid Voltage	0	0 Volts
Plate Dissipation	2.7	2.8 Volts
Grid No. 2 Dissipation		0.5 Watt

CHARACTERISTICS AND TYPICAL OPERATION

Class A ¹ Amplifier	Triode Section	Pentode Section
Plate Voltage	150	250 Volts
Grid No. 2 Voltage		110 Volts
Cathode Resistor	56	68 Ohms
Plate Current	18	10 Ma
Grid No. 2 Current		3.5 Ma
Transconductance	8500	5200 μmhos
Amplification Factor	40	
Plate Resistance (approx.)	5000	400,000 Ohms
E_{c1} for $I_b = 10 \mu\text{a}$ (approx.)	-12	-10 Volts

NOTES:

- Heater warm-up time is defined as the time required for the voltage across the heater to reach 80% of its rated value after applying four (4) times rated heater voltage to a circuit consisting of the tube heater in series with a resistance equal to three (3) times rated heater voltage divided by rated heater current.
- With external JETEC No. 315 shield connected to cathode of section under test.

APPLICATION

The Sylvania Types 5BR8 and 6BR8 have a medium μu triode and sharp-cutoff pentode contained in one envelope. Types 5BR8 and 6BR8 have controlled heater warm-up time for series string operation.

SYLVANIA ELECTRONIC TUBES

6BR8, 5BR8 (Cont'd)

AVERAGE PLATE CHARACTERISTICS (TRIODE SECTION)

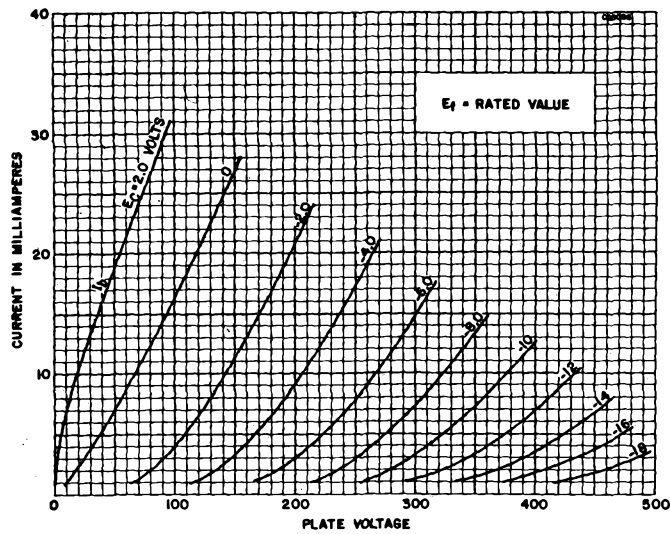

AVERAGE PLATE CHARACTERISTICS (PENTODE SECTION)

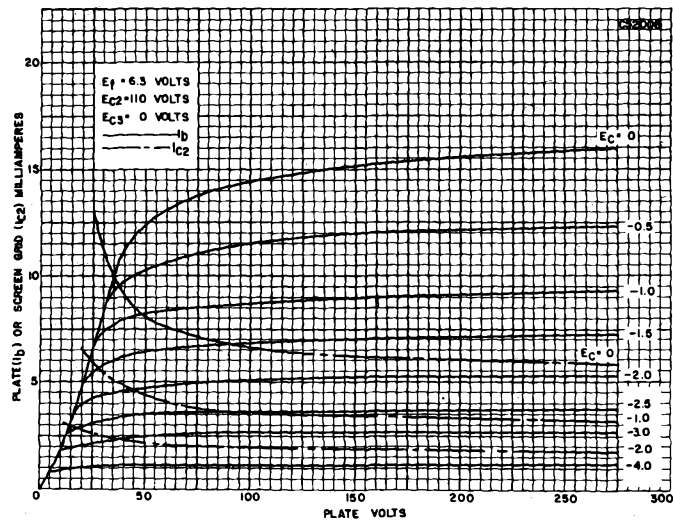

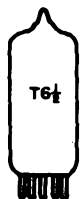

SYLVANIA TYPE **6BS8**
5BS8
4BS8
 MEDIUM MU
 DOUBLE TRIODE

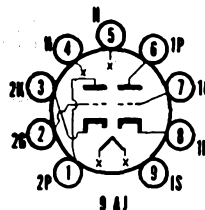

MECHANICAL DATA

Bulb	T-6 1/2
Base	Miniature Button 9-Pin
Outline	6-2
Basing	9AJ
Cathode	Coated Unipotential
Mounting Position	Any

ELECTRICAL DATA

HEATER CHARACTERISTICS

	4BS8	5BS8	6BS8
Heater Voltage	4.5	5.6	6.3 Volts
Heater Current	600	450	400 Ma
Heater Warm-up Time ¹	11	11	Seconds
Heater-Cathode Voltage (Design Center Values) Heater Negative with Respect to Cathode Total D C and Peak			200 Volts Max.
Heater Positive with Respect to Cathode D C			100 Volts Max.
Total D C and Peak			200 Volts Max.

DIRECT INTERELECTRODE CAPACITANCES (Shielded)²

	Section 1	Section 2
Grid to Plate	1.15	1.15 μ f
Input	2.6	μ f
Output	1.2	μ f
Heater to Cathode	2.6	2.6 μ f
Plate to Cathode	0.15	0.15 μ f Max.
Coupling		
Plate to Plate	0.01	μ f Max.
Plate of Section 2 to Plate and Grid of Section 1	0.024	μ f Max.
Grounded Grid Operation		
Input	5.0	5.0 μ f
Output	2.2	2.2 μ f

MAXIMUM RATINGS (Design Center Values)

Plate Voltage	150 Volts
Plate Dissipation (Each Section)	2.0 Watts
D C Cathode Current	20 Ma
Grid Circuit Resistance (Each Section)	0.5 Megohm

CHARACTERISTICS AND TYPICAL OPERATION

Class A₁ Amplifier (Each Section)

Plate Voltage	150 Volts
Cathode Bias Resistor	220 Ohms
Plate Current	10 Ma
Transconductance	7200 μ mhos
Amplification Factor	36
Plate Resistance	5000 Ohms
Grid Voltage for $I_b = 10 \mu$ a (Section 2 only)	-7 Volts
Cascode Amplifier³	
Plate Supply Voltage	250 Volts
Plate Current	16 Ma
Grid Voltage	-1 Volt
Transconductance	10,000 μ mhos
E_{c1} for $g_m = 50 \mu$ mhos (approx.)	-6 Volts

NOTES:

1. Heater warm-up time is defined as the time required for the voltage across the heater to reach 80% of its rated value after applying four (4) times rated heater voltage to a circuit consisting of the tube heater in series with a resistance equal to three (3) times rated heater voltage divided by rated heater current.
2. External shield No. 315.
3. Section 2 (Pins 1, 2 and 3) is intended as the input section of the cascode circuit.

APPLICATION

The Types 4BS8, 5BS8 and 6BS8 are miniature, medium mu, twin triodes designed for use as low noise v h f cascode amplifiers. The 4BS8 and 5BS8 have controlled heater warm-up time for series string operation.

SYLVANIA ELECTRONIC TUBES

6BS8, 5BS8, 4BS8 (Cont'd)

AVERAGE PLATE CHARACTERISTICS

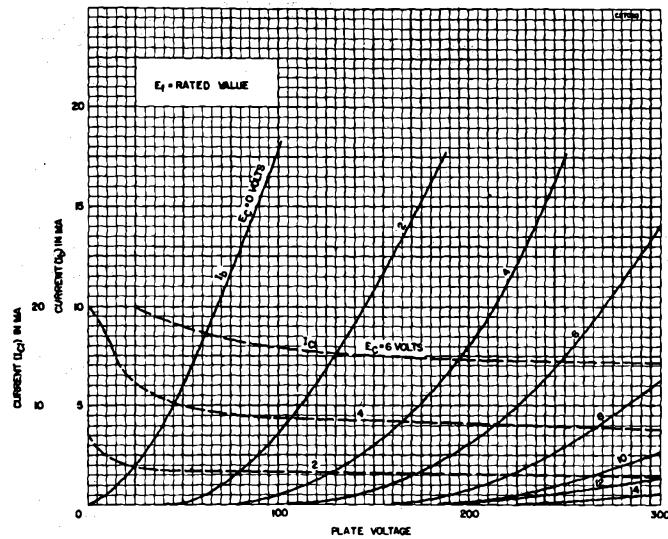

AVERAGE TRANSFER CHARACTERISTICS

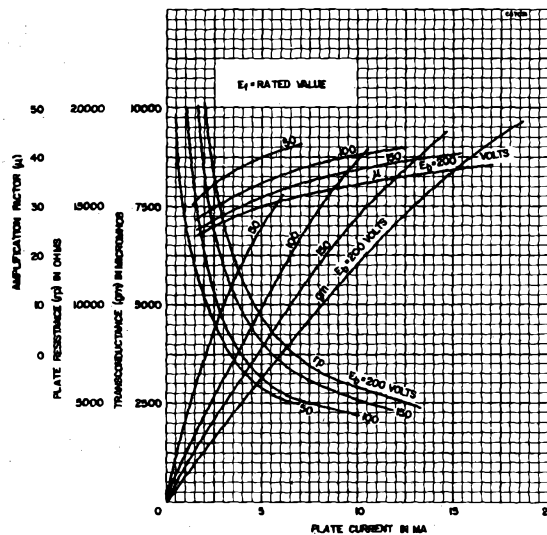

SYLVANIA ELECTRONIC TUBES

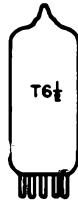

**SYLVANIA TYPE 6BT8
5BT8**
DUODIODE
SHARP CUTOFF PENTODE

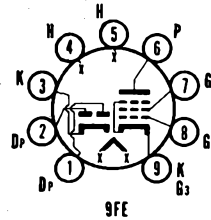

MECHANICAL DATA

Bulb.....	T-6½
Base.....	E9-1, Miniature Button 9-Pin
Outline.....	6-2
Basing.....	9FE
Cathode.....	Coated Unipotential
Mounting Position.....	Any

ELECTRICAL DATA

HEATER CHARACTERISTICS

	5BT8	6BT8
Heater Voltage.....	4.7	6.3 Volts
Heater Current.....	600	450 Ma
Heater Warm-up Time.....	11	Seconds
Heater Negative with Respect to Cathode Total D C and Peak.....		200 Volts Max.
Heater Positive with Respect to Cathode D C.....		100 Volts Max.
Total D C and Peak.....		200 Volts Max.

DIRECT INTERELECTRODE CAPACITANCES (Unshielded)

Pentode Section	
Grid No. 1 to Plate.....	.04 μ f Max.
Input.....	7.0 μ f
Output.....	2.3 μ f
Diode (Each Section)	
Plate to (h + k).....	1.3 μ f
Cathode to (h + p).....	3.0 μ f
Coupling	
Pentode Grid No. 1 to Diode Plate.....	0.005 μ f
Pentode Plate to Diode Plate.....	0.020 μ f

RATINGS (Design Center System)

Plate Voltage.....	300 Volts Max.
Grid No. 2 Supply Voltage.....	300 Volts Max.
Grid No. 2 Voltage.....	See Rating Chart
Positive Grid No. 1 Voltage.....	0 Volts Max.
Plate Dissipation.....	2.0 Watts Max.
Grid No. 2 Input.....	0.5 Watts Max.
Grid No. 1 Circuit Resistance	
Fixed Bias.....	0.25 Megohm Max.
Self Bias.....	1.0 Megohm Max.

CHARACTERISTICS AND TYPICAL OPERATION

Plate Voltage.....	200 Volts
Grid No. 2 Voltage.....	150 Volts
Cathode Bias Resistor.....	180 Ohms
Plate Current.....	9.5 Ma
Grid No. 2 Current.....	2.8 Ma
Transconductance.....	6200 μ mhos
Plate Resistance (approx.).....	300,000 Ohms
Grid No. 1 Voltage for $I_b = 10 \mu$ amp (approx.).....	-8 Volts
Average Diode Current with 10 Volts D C Applied (Each Section).....	8.0 Ma

NOTE:

1. Heater warm-up time is defined as the time required for the voltage across the heater to reach 80% of its rated value after applying four (4) times rated heater voltage to a circuit consisting of the tube heater in series with a resistance equal to three (3) times rated heater voltage divided by rated heater current.

APPLICATION

The Sylvania Types 5BT8 and 6BT8 have a double diode and sharp cutoff pentode contained in one envelope. The pentode section may be used as an IF amplifier, video amplifier, a gc amplifier or reactance tube. Type 5BT8 has controlled heater warm-up time for series string operation.



SYLVANIA TYPE **6BU8**
3BU8
4BU8

DUAL CONTROL
DUO PENTODE

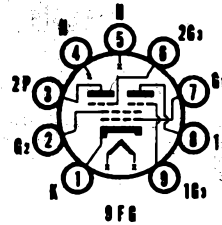

MECHANICAL DATA

Bulb	T-6½
Base	E9-1, Small Button 9-Pin
Outline	6-3
Basing	9FG
Cathode	Coated Unipotential
Mounting Position	Any

ELECTRICAL DATA

HEATER CHARACTERISTICS

	3BU8	4BU8	6BU8
Heater Voltage	3.15	4.2	6.3 Volts
Heater Current	600	450	300 Ma
Heater Warm-up Time ¹	11	11	Seconds
Heater-Cathode Voltage (Design Maximum Values) ²			
Heater Negative with Respect to Cathode			200 Volts Max.
Total D C and Peak			
Heater Positive with Respect to Cathode			100 Volts Max.
D C			200 Volts Max.
Total D C and Peak			

DIRECT INTERELECTRODE CAPACITANCES (Unshielded)

Grid No. 3 to Plate (Each Section)	1.9 μmf
Grid No. 1 to All	6.0 μmf
Grid No. 3 (Each Section) to All	3.6 μmf
Plate (Each Section) to All	3.0 μmf
Grid No. 3 (Section 1) to Grid No. 3 (Section 2)	0.015 μmf Max.

MAXIMUM RATINGS (Design Maximum Values)³

Plate Voltage (Each Section)	300 Volts
Grid No. 2 Voltage	150 Volts
Positive D C Grid No. 3 Voltage (Each Section)	3.0 Volts
Negative D C Grid No. 3 Voltage (Each Section)	50 Volts
Peak Positive Grid No. 3 Voltage (Each Section)	50 Volts
Negative D C Grid No. 1 Voltage	50 Volts
Plate Dissipation (Each Section)	1.1 Watts
Grid No. 2 Dissipation	0.75 Watts
D C Cathode Current	12 Ma
Grid No. 1 Circuit Resistance	0.5 Megohms
Grid No. 3 Circuit Resistance (Each Section)	0.5 Megohms

CHARACTERISTICS AND TYPICAL OPERATION

Both Sections Operating

Plate Voltage (Each Section)	100	100 Volts
Grid No. 2 Voltage	67.5	67.5 Volts
Grid No. 3 Voltage (Each Section)	-10	0 Volts
Grid No. 1 Voltage	Note 3	Note 3
Plate Current (Each Section)		2.2 Ma
Grid No. 2 Current	6.5	3.3 Ma
Cathode Current	6.6	7.8 Ma

Each Section Separately with Plate and Grid No. 3 of Opposite Section Grounded

Plate Voltage	100	100 Volts
Grid No. 2 Voltage	67.5	67.5 Volts
Grid No. 3 Voltage	0	0 Volts
Grid No. 1 Voltage	0	Note 3
Plate Current		2.2 Ma
Grid No. 3 Transconductance		180 μmhoe
Grid No. 1 Transconductance	1500	μmhoe
Grid No. 3 Voltage (approx.) for $I_b = 100 \mu a$		-4.5 Volts
Grid No. 1 Voltage (approx.) for $I_b = 100 \mu a$		-2.3 Volts

NOTES:

1. Heater warm-up time is defined as the time required for the voltage across the heater to reach 80% of its rated value after applying four (4) times rated heater voltage to a circuit consisting of the tube heater in series with a resistance equal to three (3) times rated heater voltage divided by rated heater current.
2. Design-Maximum Ratings are the limiting values expressed with respect to bogen tubes at which satisfactory tube life can be expected to occur. To obtain satisfactory circuit performance, therefore, the equipment designer must establish the circuit design so that no design-maximum value is exceeded with a bogen tube under the worst probable operating conditions with respect to supply-voltage variation, equipment component variation, equipment control adjustment, load variation, and environmental conditions.
3. Grid Current adjusted for 100 μa d c.

SYLVANIA ELECTRONIC TUBES

6BU8, 3BU8, 4BU8 (Cont'd)

APPLICATION

The Sylvania Types 6BU8, 4BU8 and 3BU8 have dual pentodes with separate plates and separate No. 3 Grids contained in one envelope. They are primarily intended for service as a combined sync separator-clipper and AGC tube in television receivers. The 4BU8 and 3BU8 are identical to the 6BU8 except they have controlled heater warm-up time for series string operation.

AVERAGE CHARACTERISTICS

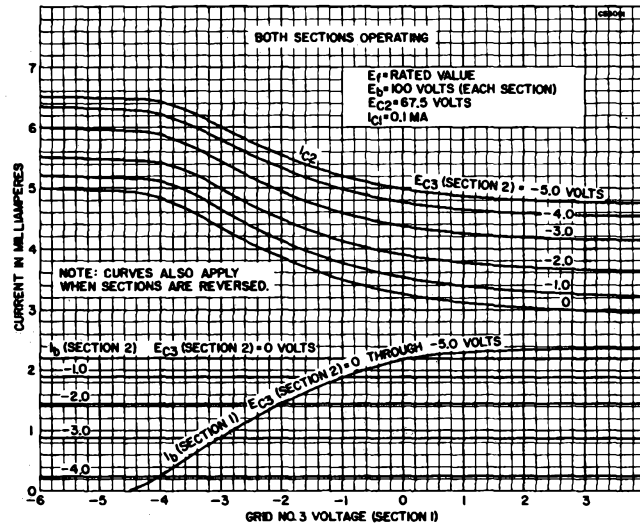

AVERAGE TRANSFER CHARACTERISTICS

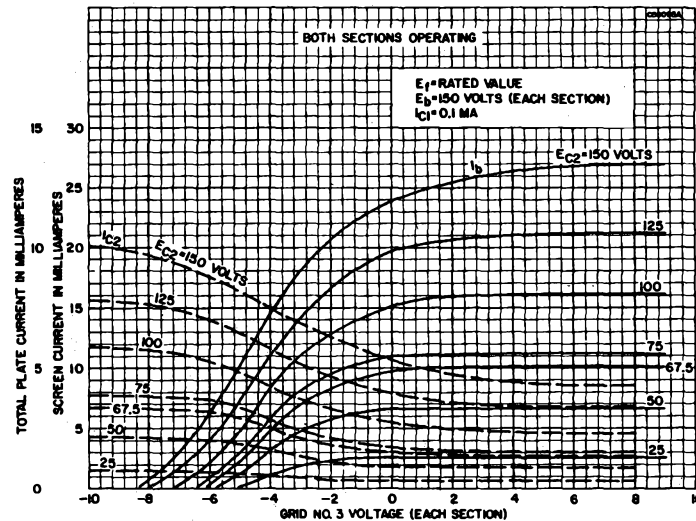



**SYLVANIA TYPE 6BW4
12BW4**
FULL WAVE RECTIFIER

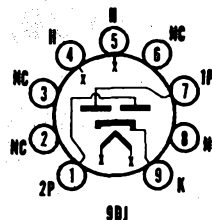

MECHANICAL DATA

Bulb.....	T-6½
Base.....	E9-1 Miniature Button, 9-Pin
Outline.....	6-3
Basing.....	9DJ
Cathode.....	Coated Unipotential
Mounting Position.....	Any

ELECTRICAL DATA

HEATER CHARACTERISTICS

	6BW4	12BW4
Heater Voltage ¹ A C or D C.....	6.3	12.6 Volts
Heater Current.....	900	450 Ma
Maximum Heater Cathode Voltage Heater Negative, D C.....	450	Volts

MAXIMUM RATINGS (Design Center Values)¹

Rectifier Service

Peak Inverse Plate Voltage.....	1275 Volts
A C Plate Supply Voltage Each Plate, R M S (See Rating Chart I).....	450 Volts
D C Output Current.....	See Rating Chart I
Steady State Peak Plate Current Each Plate (See Rating Chart II).....	350 Ma
Transient Peak Plate Current Each Plate (See Rating Chart III).....	2.0 Amperes

AVERAGE CHARACTERISTICS

Tube Voltage Drop Tube Conducting: 100 Ma Each Plate.....	40 Volts
---	----------

TYPICAL OPERATION

Full Wave Rectifier—Capacitor Input Filter

A C Plate Supply Voltage Each Plate, R M S ²	325 Volts
Filter Input Capacitor.....	40 μf
Effective Plate Supply Resistance, Each Plate.....	82 Ohms
D C Output Current.....	100 Ma
D C Output Voltage at Filter Input.....	330 Volts

Full Wave Rectifier—Choke Input Filter

A C Plate Supply Voltage Each Plate, R M S ²	450 Volts
Filter Input Choke.....	10 Henrys
D C Output Current.....	100 Ma
D C Output Voltage at Filter Input.....	360 Volts

NOTES:

1. See "Interpretation of Rating Charts."
2. A C plate voltage is measured without load.
3. The 12BW4 is intended to be used in automotive service from a nominal 12 volt battery source. The heater is therefore designed to operate over the 10.0 to 15.9 voltage range encountered in this type of service. The maximum ratings of the tube provide for an adequate safety factor such that the tube will withstand the wide variation in supply voltages.

APPLICATION

The Sylvania 6BW4 and 12BW4 are miniature cathode type full wave rectifiers featuring relatively high output current capabilities. The 12BW4 is intended primarily for use in auto receivers having a 12 volt heater supply.

6BW4, 12BW4 (Cont'd)

RATING CHART I

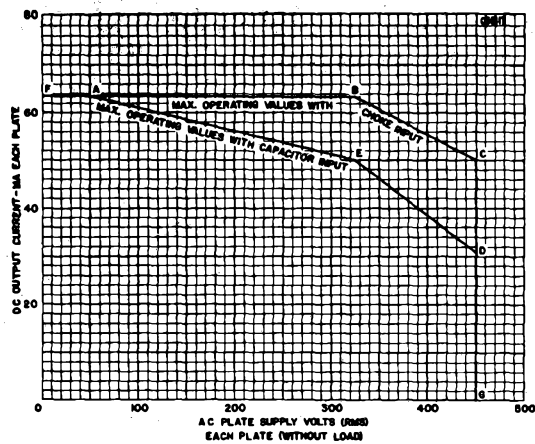

RATING CHART II

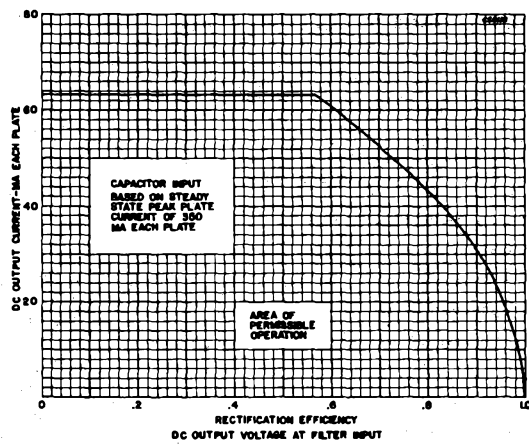

RATING CHART III

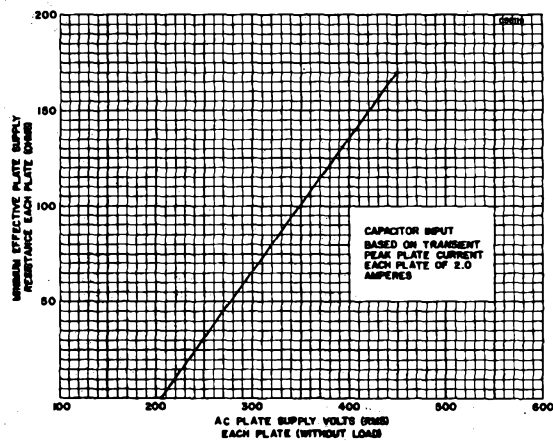

SYLVANIA ELECTRONIC TUBES

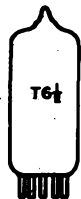

SYLVANIA TYPE 6BW8

DUO-DIODE
SHARP CUTOFF PENTODE

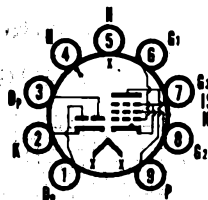

MECHANICAL DATA

Bulb.....	T-6 $\frac{1}{2}$
Base.....	E9-1, Small Button 9-Pin
Outline.....	6-2
Basing.....	9HK
Cathode.....	Coated Unipotential
Mounting Position.....	Any

ELECTRICAL DATA

HEATER CHARACTERISTICS

Heater Voltage.....	6.3 Volts
Heater Current.....	450 Ma
Heater-Cathode Voltage (Design Center Values)	
Heater Negative with Respect to Cathode	
Total D C and Peak.....	200 Volts Max.
Heater Positive with Respect to Cathode	
D C.....	100 Volts Max.
Total D C and Peak.....	200 Volts Max.

DIRECT INTERELECTRODE CAPACITANCES (Unshielded)

Pentode Section

Grid No. 1 to Plate.....	0.02 $\mu\mu\text{f}$ Max.
Input.....	4.8 $\mu\mu\text{f}$
Output.....	2.6 $\mu\mu\text{f}$

Diode Section

Grid No. 1 to Each Diode Plate.....	0.006 $\mu\mu\text{f}$ Max.
Diode Plate No. 1 to Cathode and Heater.....	1.3 $\mu\mu\text{f}$
Diode Plate No. 2 to Cathode and Heater.....	1.2 $\mu\mu\text{f}$

MAXIMUM RATINGS¹ (Design Maximum Values)

Plate Voltage.....	330 Volts
Grid No. 2 Supply Voltage.....	330 Volts
Grid No. 2 Voltage.....	See Rating Chart
Positive Grid No. 1 Voltage.....	0 Volts
Negative Grid No. 1 Voltage.....	55 Volts
Plate Dissipation.....	3.0 Watt
Grid No. 2 Dissipation.....	0.55 Watt
Grid No. 1 Circuit Resistance	
Cathode Bias.....	0.5 Megohms
Fixed Bias.....	0.1 Megohms
Average Diode Current (Each Diode).....	5.0 Ma

CHARACTERISTICS AND TYPICAL OPERATION

Pentode—Class A1 Amplifier

Plate Voltage.....	250 Volts
Grid No. 2 Voltage.....	110 Volts
Cathode Bias Resistor.....	68 Ohms
Plate Current.....	10 Ma
Grid No. 2 Current.....	3.5 Ma
Transconductance.....	5200 μmhos
Plate Resistance (approx.).....	250,000 Ohms
E _{c1} Voltage for I _b = 10 μa (approx.).....	-10 Volts
Average Diode Current with 5 Volts D C applied ²	20 Ma

NOTES:

1. Design Maximum Ratings are the limiting values expressed with respect to bogey tubes at which satisfactory tube life can be expected to occur for the types of service for which the tube is rated. Therefore, the equipment designer must establish the circuit design so that initially and throughout equipment life no design maximum value is exceeded with a bogey tube under the worst probable operating conditions with respect to supply voltage variation, equipment component variation, equipment control adjustment, load variation and environmental conditions.
2. Test condition only.

APPLICATION DATA:

The Type 6BW8 is a duo-diode sharp-cutoff pentode. The diode and pentode units are provided with separate cathodes. The pentode unit is suited for use as a sound intermediate-frequency amplifier, sound limiter, and automatic-gain-control keyer while the diodes are essentially intended for use as a horizontal phase detector in television receivers.

SYLVANIA TYPE 6BW8 (Cont'd)

AVERAGE PLATE CHARACTERISTICS

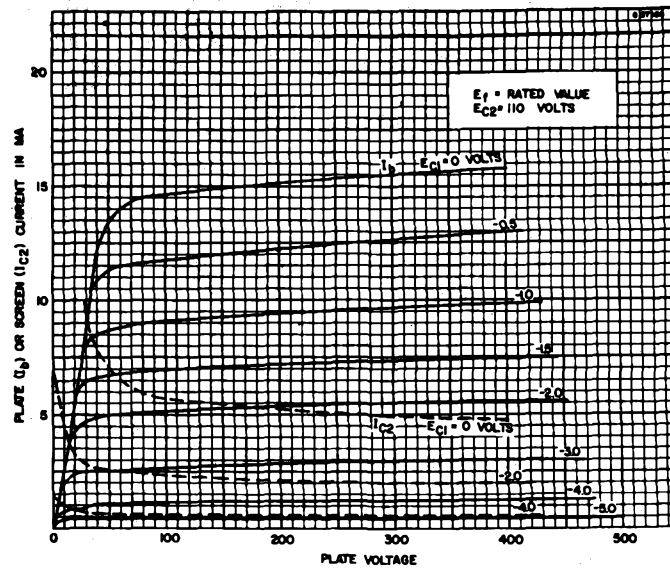

AVERAGE PLATE CHARACTERISTICS

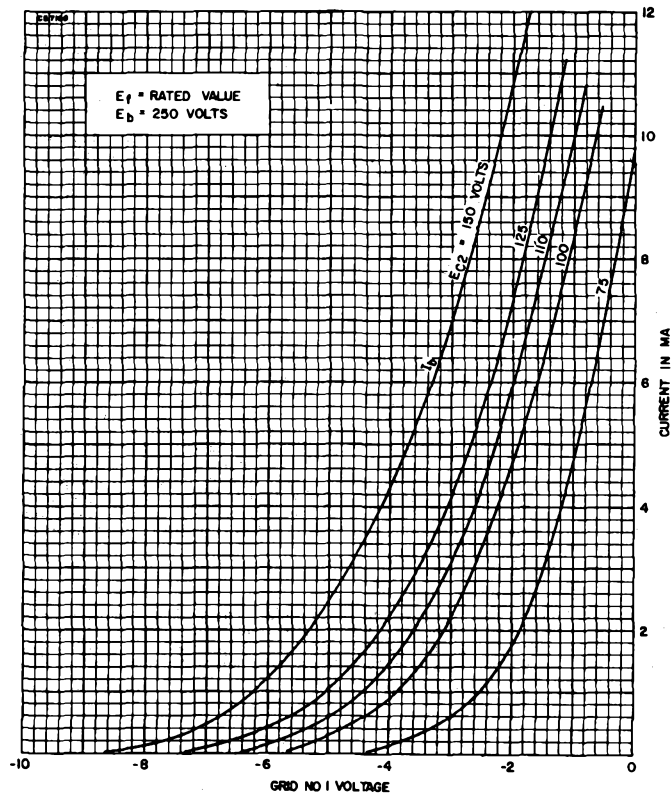

SYLVANIA ELECTRONIC TUBES

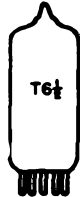

SYLVANIA TYPE 6BY8
 HALF WAVE DIODE
 SHARP CUTOFF PENTODE

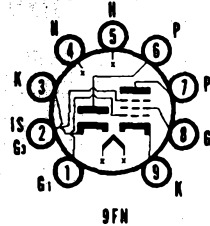

MECHANICAL DATA

Bulb	T-6 $\frac{1}{2}$
Base	E9-1, Miniature Button 9-Pin
Outline	6-3
Basing	9FN
Cathode	Coated Unipotential
Mounting Position	Any

ELECTRICAL DATA

HEATER CHARACTERISTICS

Heater Voltage	6.3 Volts
Heater Current	600 Ma
Heater Warm-up Time ¹	11 Seconds
Heater Cathode Voltage (Design Center Values)	
Heater Negative with Respect to Cathode	
Total D C and Peak	200 Volts Max.
Heater Positive with Respect to Cathode	
D C	100 Volts Max.
Total D C and Peak	200 Volts Max.

DIRECT INTERELECTRODE CAPACITANCES (Shielded)²

Grid to No. 1 Plate	0.0035 μ f Max.
Input: g1 to (h+k+g2+g3+l.S.)	5.5 μ f
Output: p to (h+k+g2+g3+l.S.)	5.0 μ f
Diode Plate to All:	
dp to (h+dk+k+g1+g2+g3+p+l.S.)	4.8 μ f

MAXIMUM RATINGS (Design Center System)

Pentode Section	
Plate Voltage	300 Volts
Grid No. 2 Voltage	See 6AM8 Rating Chart
Grid No. 2 Supply Voltage	300 Volts
Negative Grid No. 1 Voltage	50 Volts
Positive Grid No. 1 Voltage	0 Volts
Plate Dissipation	3 Watts
Grid No. 2 Dissipation	0.65 Watts
Diode Section	
Peak Inverse Plate Voltage	430 Volts
Peak Plate Current	180 Ma
D C Plate Current	45 Ma

CHARACTERISTICS AND TYPICAL OPERATION

Class A₁ Amplifier

Plate Voltage	100	250	250 Volts
Grid No. 3 Voltage	Connected to Cathode at Socket		
Grid No. 2 Voltage	100	125	150 Volts
Cathode Resistor	150	100	68 Ohms
Plate Current	5.0	7.6	10.6 Ma
Grid No. 2 Current	2.1	3.0	4.3 Ma
Transconductance	3900	4500	5200 μ mhos
Plate Resistance (approx.)	0.5	1.5	1.0 Megohms
E _{c1} for I _b = 10 μ a (approx.)	-4.2	-5.5	-6.5 Volts
Average Diode Current with 10 Volts D C Applied (Test Condition Only)	60 Ma		

NOTES:

1. Heater Warm-up Time is defined as the time required for the voltage across the heater to reach 80% of its rated value after applying four (4) times rated heater voltage to a circuit consisting of the tube heater in series with a resistance equal to three (3) times rated heater voltage divided by rated heater current.
2. External Shield No. 315 connected to Pentode Cathode.

APPLICATION

The Sylvania Type 6BY8 has a sharp cutoff pentode and high permeance diode contained in one envelope. The diode section is similar to one section of a 6AL5 and is intended for limiter or detector applications. The pentode section is similar to a 6AU6 and is intended for use as an rf or if amplifier. Type 6BY8 has a controlled heater warm-up time for series string operation.

SYLVANIA ELECTRONIC TUBES

1. All tube ratings are based on the maximum values is exceeded with supply-voltage variation, the worst probable operating conditions with respect to adjustment, load variation, and environmental conditions.
2. Use external shield No. 315.

APPLICATION

The Sylvania Type 6BZ8 is a miniature, medium μ , semi-remote cutoff double triode designed for use in low noise VHF amplifier application and particularly for cascade operation. The 4BZ8 is identical to the 6BZ8 except for heater characteristics. The 4BZ8 has a 600 ma heater and controlled heater warm-up time and is intended for use in series heater string television receivers.

6BZ6 (Cont'd)

SCREEN GRID RATING CHART

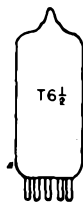
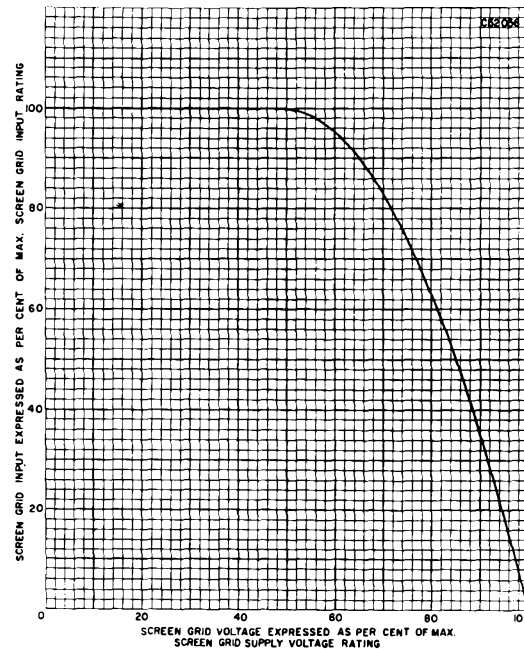

SYLVANIA TYPE 6BZ7
VHF DUO TRIODE

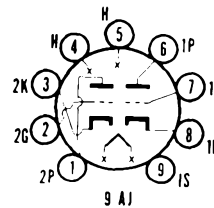

MECHANICAL DATA

Bulb	T-6 1/2, Outline 6-2
Base	Small Button 9-Pin
Basing	9AJ
Mounting Position	Any

ELECTRICAL DATA

HEATER CHARACTERISTICS

Heater Voltage	6.3 Volts
Heater Current	400 Ma
Maximum Heater-Cathode Voltage	
Heater Positive with Respect to Cathode	200 Volts
Heater Negative with Respect to Cathode	200 Volts

DIRECT INTERELECTRODE CAPACITANCES (Shielded)²

	Section 1 ¹	Section 2
Grid to Plate	1.2	1.2 μf
Input	2.6	μf
Output	1.2	μf
Plate to Cathode	0.12	0.12 μf
Heater to Cathode	2.6	2.6 μf
Plate to Plate	0.010	μf
Plate Section 2 to Plate and Grid Section 1	0.024	μf

Grounded Grid Operation

Input	5.0 μf
Output	2.2 μf

6BZ7 (Cont'd)

MAXIMUM RATINGS (Design Center Values—Each Section)

Plate Voltage	250 Volts
Plate Dissipation	2 Watts
Cathode Current	20 Ma
Grid Circuit Resistance	0.5 Megohm

CHARACTERISTICS

Class A Amplifier (Each Section)

Plate Voltage	150 Volts
Cathode Bias Resistor	220 Ohms
Plate Current	10 Ma
Transconductance	6800 μ mhos
Amplification Factor	36
Plate Resistance	5300 Ohms
Grid Voltage for $I_b = 100 \mu$ a (approx)	7 Volts

NOTES:

- When operated with the two sections direct drive cascode amplifier it is permissible for this voltage to be as high as 300 volts under cutoff conditions.
- Shield No. 315.
- Section 1 connects to Pins 6, 7 and 8. Section 2 connects to Pins 1, 2 and 3.

APPLICATION

Sylvania Type 6BZ7 is a miniature medium mu duo triode designed for use in low noise vhf amplifier application and particularly for cascode operation.

SYLVANIA TUBE TESTER SETTINGS

	A	B	C	D	E	F	G	Test or K
139/140	6.3	0	—	0	1	3	32	U
	6.3	0	—	0	3	7	32	U
219/220	6.3	4	58	24	5	2X	1	3
	6.3	4	53	25	5	7X	6	8

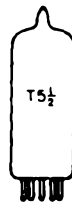

SYLVANIA TYPE 6C4
HIGH FREQUENCY POWER TRIODE

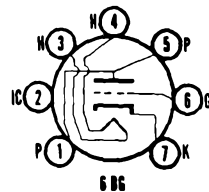

MECHANICAL DATA

Bulb	T-5 1/2, Outline 5-2
Base	Miniature Button 7-Pin
Basing	6BG
Mounting Position	Any

ELECTRICAL DATA

HEATER CHARACTERISTICS

Heater Voltage	6.3 Volts
Heater Current	150 Ma
Maximum Heater-Cathode Voltage	200 Volts

DIRECT INTERELECTRODE CAPACITANCES

	Shielded ¹	Unshielded
Grid to Plate	1.4	1.6 μ f
Input	1.8	1.8 μ f
Output	2.5	1.3 μ f

MAXIMUM RATINGS (Design Center Values)

	Class A ₁ Amplifier	Class C Telegraphy
Plate Voltage	300	300 Volts
Plate Dissipation	3.5	5.0 Watts
Plate Current		25 Ma
Negative D C Grid Voltage		-50 Volts
D C Grid Current		8 Ma
Grid Circuit Resistance		
Fixed Bias	0.25	0.25 Megohm
Cathode Bias	1.0	1.0 Megohm

6C4 (Cont'd)

CHARACTERISTICS AND TYPICAL OPERATION

Class A₁ Amplifier

Plate Voltage	100	250 Volts
Grid Voltage ²	0	8.5 Volts
Plate Current	11.8	10.5 Ma
Plate Resistance (approx.)	6250	7700 Ohms
Transconductance	3100	2200 μ mhos
Amplification Factor	19.5	17
Grid Voltage for $I_b = 10 \mu$ a (approx.)	-10	-25 Volts

Class C Telegraphy³

Plate Voltage	300 Volts
Grid Voltage	-27 Volts
Plate Current	25 Ma
Grid Current (approx.)	7 Ma
Grid Driving Power (approx.)	0.35 Watt
Power Output (approx.)	5.5 Watts

NOTES:

- Shield No. 316 connected to cathode.
- Transformer or impedance type input coupling devices are recommended to minimize resistance in the grid circuit.
- Approximately 2.5 watts output can be obtained when the 6C4 is used at 150 megacycles as an oscillator with a grid resistor of 10,000 ohms and with maximum rated input.

APPLICATION

Sylvania Type 6C4 is a miniature, general purpose, medium mu triode intended for service as an oscillator, a detector or amplifier. Approximately 2.5 watts output can be obtained when the 6C4 is used as an oscillator at 150 mc. Electrically, the 6C4 is similar to the 6J5GT and one section of a 12AU7. Curves under type 12AU7 may be also used for type 6C4. Resistance Coupled Amplifier Data is in the Appendix.

SYLVANIA TUBE TESTER SETTINGS

	A	B	C	D	E	F	G	Test or K
139/140	6.3	0	23	0	4	6	55	U
219/220	6.3	3	245	36	4	6Z	1	7
	6.3	3	241	36	4	6Z	5	7

AVERAGE PLATE CHARACTERISTICS

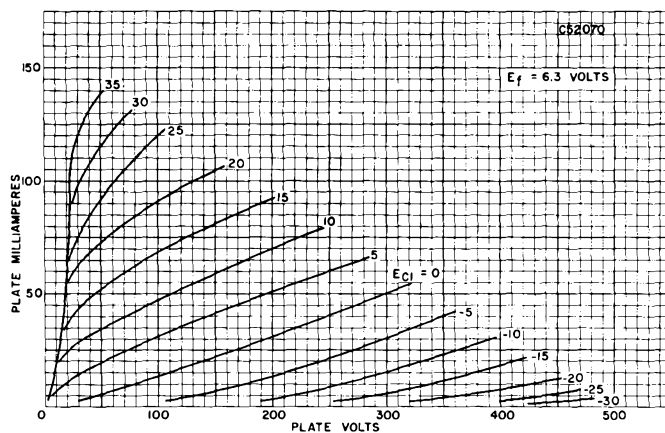



**SYLVANIA TYPE 6C5
6C5GT**
MEDIUM MU TRIODE

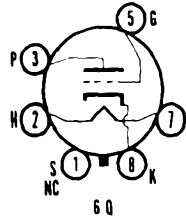

MECHANICAL DATA

	6C5	6C5GT
Bulb	Metal, Outline 8-3	T-9, Outline 9-12
Base	Small Wafer Octal 6-Pin	Small Wafer Octal 6-Pin
Basing	6Q	6Q
Mounting Position	Any	Any

ELECTRICAL DATA

HEATER CHARACTERISTICS

Heater Voltage	6.3 Volts
Heater Current	300 Ma
Maximum Heater-Cathode Voltage	90 Volts

MAXIMUM RATINGS (Design Center Values)

Plate Voltage	300 Volts
Plate Dissipation	2.5 Watts
Positive Grid Voltage	0 Volts

TYPICAL OPERATION

Class A Amplifier

Plate Voltage	250 Volts
Grid Voltage	-8.0 Volts
Plate Current	8.0 Ma
Transconductance	2000 μ mhos
Amplification Factor	20
Plate Resistance	10000 Ohms
Maximum D C Grid Circuit Resistance	1.0 Megohm

Data for use in Resistance Coupled Amplifier Circuits is given in the Appendix.

TYPES 6C6, 6C7, 6C8G

(See Condensed Data Section)

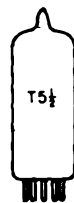

SYLVANIA TYPE 6CA5
BEAM POWER AMPLIFIER

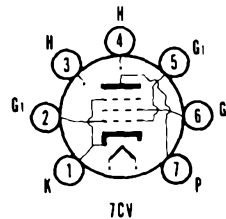

MECHANICAL DATA

Bulb	T-5 1/2, Outline 5-3
Base	Miniature Button 7-Pin
Basing	7CV
Mounting Position	Any

ELECTRICAL DATA

HEATER CHARACTERISTICS

Heater Voltage	6.3 Volts
Heater Current	1.2 Amperes

For other rating, operation, and application data, refer to corresponding Type 12CA5, which is identical except for heater ratings.



SYLVANIA TYPE 6CB5

BEAM POWER AMPLIFIER

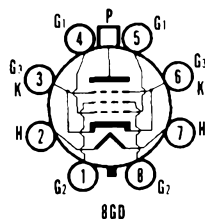

MECHANICAL DATA

Bulb	ST-16
Base	Short Jumbo Shell Octal 8-Pin with External Barriers
Maximum Overall Length	5 1/2"
Maximum Seated Height	4 1/2"
Basing	8GD
Top Cap	Small
Mounting Position	Any

ELECTRICAL DATA

HEATER CHARACTERISTICS

Heater Voltage	6.3 Volts
Heater Current	2.5 Amps
Maximum Heater-Cathode Voltage	
Total D C and Peak	200 Volts
D C, Heater Positive with Respect to Cathode	100 Volts

DIRECT INTERELECTRODE CAPACITANCES (Approx.)

	Unshielded
Grid to Plate	0.8 $\mu\mu\text{f}$
Input	24 $\mu\mu\text{f}$
Output	10 $\mu\mu\text{f}$

MAXIMUM RATINGS (Design Center Values—Except as Noted)

Horizontal Deflection Amplifier¹

Plate Supply Voltage, (D C and Boost)	700 Volts
Peak Positive Pulse Plate Voltage (Abs. Max.) ²	6800 Volts
Plate Dissipation	23 Watts
Peak Negative Pulse Plate Voltage	-1500 Volts
D C Grid No. 2 Voltage	200 Volts
D C Grid No. 1 Voltage	-50 Volts
Grid No. 2 Dissipation	3.6 Watts
Peak Negative Pulse Grid No. 1 Voltage	-200 Volts
D C Plate Current	200 Ma
Grid No. 1 Circuit Resistance	0.47 Megohms
Bulb Temperature (At Hottest Point)	210° C

NOTES:

- For operation in a 525-line, 30 frame system, the duty cycle of the voltage pulse must not exceed 15% of one scanning cycle.
- Under no circumstance should this absolute value be exceeded.

APPLICATION

The Sylvania Type 6CB5 is a high-perveance beam power vacuum tube designed especially for use as a horizontal deflection amplifier tube in color television receivers.



SYLVANIA TYPE 6CB6

SHARP CUTOFF R F PENTODE

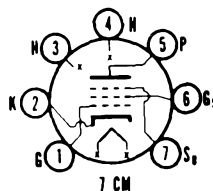

MECHANICAL DATA

Bulb	T-5 1/2, Outline 5-2
Base	Miniature Button 7-Pin
Basing	7CM
Mounting Position	Any

ELECTRICAL DATA

HEATER CHARACTERISTICS

Heater Voltage	6.3 Volts
Heater Current	300 Ma
Maximum Heater-Cathode Voltage	90 Volts

6CB6 (Cont'd)

DIRECT INTERELECTRODE CAPACITANCES (Unshielded)

Grid to Plate.....	0.020 μf Max
Input.....	6.5 μf
Output.....	2.0 μf

MAXIMUM RATINGS (Design Center Values)

Plate Voltage.....	300 Volts
Plate Dissipation.....	2.0 Watts
Grid No. 2 Supply Voltage.....	300 Volts
Grid No. 2 Voltage.....	(See Rating Chart for Type 6AM8)
Grid No. 2 Dissipation.....	0.5 Watt

CHARACTERISTICS AND TYPICAL OPERATION

Class A₁ Amplifier

Plate Voltage.....	200 Volts
Grid No. 2 Voltage.....	150 Volts
Cathode Bias Resistor.....	180 Ohms
Plate Current.....	9.5 Ma
Grid No. 2 Current.....	2.8 Ma
Transconductance.....	6200 μmhos
Plate Resistance (approx.).....	0.6 Megohm
Grid No. 1 Voltage for $I_b = 10 \mu\text{a}$ (approx.).....	-8 Volts

APPLICATION

Sylvania Type 6CB6 is a sharp cutoff pentode of the miniature construction designed for television use as an i f amplifier operating in the vicinity of 40 megacycles. It may also be used as an r f amplifier in v h f television tuners. An added feature is the separate connection for the suppressor grid and internal shield.

SYLVANIA TUBE TESTER SETTINGS

	A	B	C	D	E	F	G	Test or K
139/140	6.3	0	---	0	4	36	60	W
219/220	6.3	3	4S	30	4	167Y	5	2

AVERAGE PLATE CHARACTERISTICS

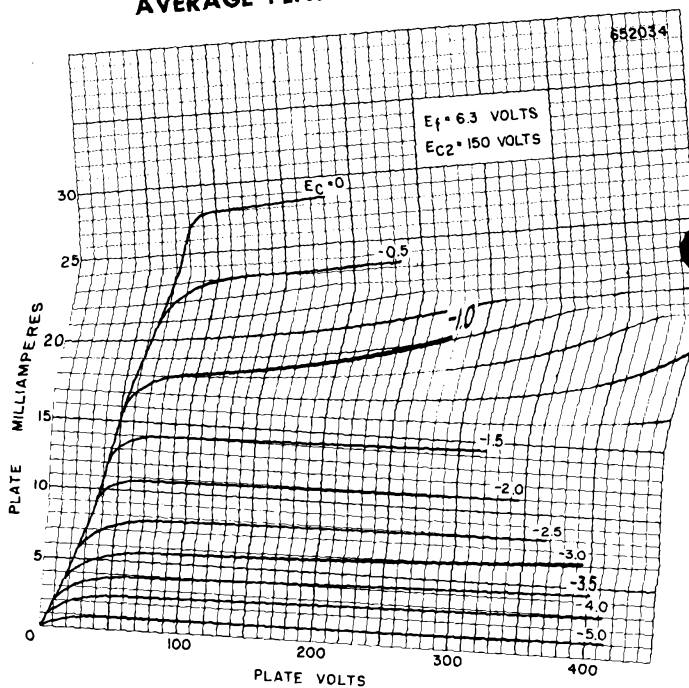

SYLVANIA ELECTRONIC TUBES

6CB6 (Cont'd)

AVERAGE CHARACTERISTICS

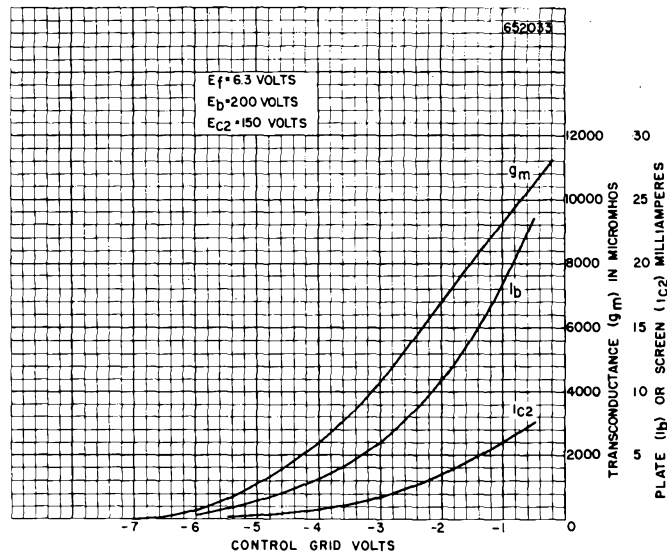

SYLVANIA TYPE 6CD6G
 BEAM POWER AMPLIFIER

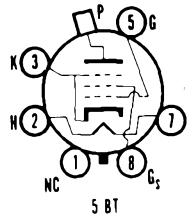

MECHANICAL DATA

Bulb.....	ST-16, Outline 16-5
Base.....	Medium Shell Octal 6-Pin
Basing.....	5BT
Top Cap.....	Small
Mounting Position.....	Vertical ¹

ELECTRICAL DATA

HEATER CHARACTERISTICS

Heater Voltage.....	6.3 Volts
Heater Current.....	2.5 Amperes
Maximum Heater-Cathode Voltage	
D C, Heater Positive with Respect to Cathode.....	100 Volts
Total D C and Peak.....	200 Volts

DIRECT INTERELECTRODE CAPACITANCES (Approximate)

Grid to Plate.....	0.8 μf
Input.....	24 μf
Output.....	9.5 μf

MAXIMUM RATINGS (Design Center Values—Except as Noted)

Horizontal Deflection Amplifier²

D C Plate Supply Voltage (Boost + D C Power Supply)...	700 Volts
Peak Positive Plate Voltage (Abs. Max.).....	6600 Volts
Peak Negative Plate Voltage.....	1500 Volts
Plate Dissipation ³	15 Watts
Peak Negative Grid No. 1 Voltage.....	200 Volts
D C Grid No. 2 Voltage.....	175 Volts
Grid No. 2 Dissipation.....	3.0 Watts
Average Cathode Current.....	200 Ma
Peak Cathode Current.....	700 Ma
Grid No. 1 Circuit Resistance.....	0.47 Megohm
Bulb Temperature (At Hottest Point).....	210° C

6CD6G (Cont'd)

CHARACTERISTICS

	Instantaneous Values	
Plate Voltage	60	175 Volts
Grid No. 2 Voltage	100	175 Volts
Grid No. 1 Voltage	0	-30 Volts
Plate Current	230	75 Ma
Grid No. 2 Current	21	5.5 Ma
Transconductance		7700 μ mhos
Plate Resistance		7200 Ohms
Grid No. 1 Voltage for $I_b = 1.0$ Ma (approx.)		-55 Volts
Triode Connected		
Plate Voltage		175 Volts
Grid No. 2 Voltage		175 Volts
Grid No. 1 Voltage		-30 Volts
Amplification Factor		3.9

TYPICAL OPERATION

Horizontal Deflection Amplifier, 90° Picture Tube

Plate Supply Voltage	300 Volts
Average Plate Voltage (Boost + Supply)	620 Volts
Peak Positive Plate Voltage (D C Component + Pulse)	5600 Volts
Average Plate Current	113 Ma
Peak Plate Current	380 Ma
Plate Dissipation	11.0 Watts
Grid No. 2 Voltage	125 Volts
Grid No. 2 Current	16 Ma
Grid No. 2 Dissipation	2 Watts
Grid No. 1 Input Voltage	
Peak to Peak	180 Volts
Sawtooth Component	140 Volts
Anode Voltage (Picture Tube)	17.2 Kv
Anode Current (Picture Tube)	100 μ a

NOTES:

- Horizontal operation permitted if plane of Pins 2 and 7 is vertical.
- For operation in a 525-line, 30 frame system, the duty cycle of the voltage pulse must not exceed 15% of one scanning cycle.
- In stages operating with grid leak bias, an adequate cathode bias resistor or other suitable means is required to protect the tube in the absence of excitation.

APPLICATION

Sylvania Type 6CD6G is a beam power amplifier designed for use as a horizontal deflection amplifier in television receivers.

SYLVANIA TUBE TESTER SETTINGS

	A	B	C	D	E	F	G	Test or K
139/140	6.3	0	—	0	8	47	20	Y
219/220	6.3	2	7	12	7	58Z	9	3

AVERAGE PLATE CHARACTERISTICS

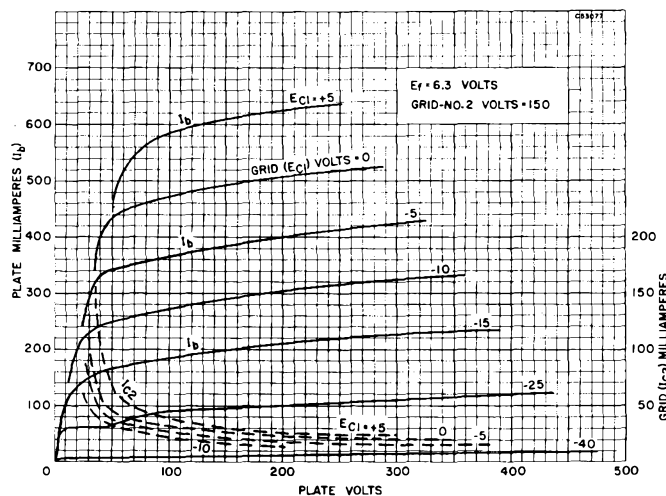



SYLVANIA TYPE 6CE5
3CE5
4CE5

SHARP CUTOFF PENTODE

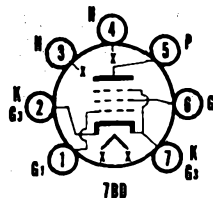

MECHANICAL DATA

Bulb.....	T-5 $\frac{1}{2}$
Base.....	E7-1, Miniature Button 7-Pin
Outline.....	5-2
Basing.....	7BD
Cathode.....	Coated Unipotential
Mounting Position.....	Any

ELECTRICAL DATA

HEATER CHARACTERISTICS

	6CE5	4CE5	3CE5
Heater Voltage.....	6.3	4.2	3.15 4olts
Heater Current.....	300	450	600 Ma
Heater Warm-up Time ¹		11	11 Seconds
Heater-Cathode Voltage (Design Center Values)			
Heater Negative with Respect to Cathode			
Total D C and Peak.....			200 Volts Max.
Heater Positive with Respect to Cathode			
D C.....			100 Volts Max.
Total D C and Peak.....			200 Volts Max.

DIRECT INTERELECTRODE CAPACITANCES (Unshielded)

Grid No. 1 to Plate.....	.003 μ f Max.
Input.....	6.5 μ f
Output.....	1.9 μ f

MAXIMUM RATINGS (Design Center Values)

Plate Voltage.....	300 Volts
Grid No. 2 Supply Voltage.....	300 Volts
Grid No. 2 Voltage.....	See 6AM8 Rating Chart
Plate Dissipation.....	2.2 Watts
Grid No. 2 Dissipation.....	0.5 Watt
Grid No. 1 Circuit Resistance.....	1.0 Megohm

CHARACTERISTICS AND TYPICAL OPERATION

Plate Voltage.....	125 Volts
Grid No. 2 Voltage.....	125 Volts
Grid No. 1 Voltage.....	-1.0 Volts
Plate Current.....	11 Ma
Grid No. 2 Current.....	2.3 Ma
Transconductance.....	7600 μ mhos
Plate Resistance (approx.).....	0.3 Megohm
Grid No. 1 Voltage for $I_b = 35 \mu$ a (approx.).....	-5.0 Volts

NOTE:

1. Heater warm-up time is defined as the time required for the voltage across the heater to reach 80% of the rated heater voltage after applying four (4) times rated heater voltage to a circuit consisting of the tube heater in series with a resistance equal to three (3) times the rated heater voltage divided by the rated heater current.

APPLICATION

The Sylvania Types 6CE5, 4CE5, and 3CE5 have a sharp cutoff pentode contained in a miniature envelope. It is designed primarily to be used as an RF or IF amplifier. Types 4CE5 and 3CE5 have controlled heater warm-up time for series string operation.

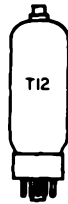

SYLVANIA TYPE 6CD6GA
BEAM POWER AMPLIFIER

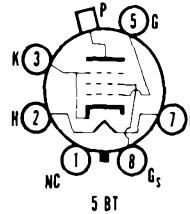

MECHANICAL DATA

Bulb.....	T-12, Outline 12-106
Base.....	Short Medium Shell, 8-Pin
Basing.....	5BT
Top Cap.....	Small
Mounting Position.....	Vertical ¹

ELECTRICAL DATA

HEATER CHARACTERISTICS

Heater Voltage.....	6.3 Volts
Heater Current.....	2.5 Amperes
Maximum Heater-Cathode Voltage	
Total D C and Peak.....	200 Volts
D C, Heater Positive with Respect to Cathode.....	100 Volts

MAXIMUM RATINGS (Design Center Values—Except as Noted)

Horizontal Deflection Amplifier²

Plate Voltage, (D C Supply and Boost).....	700 Volts
Peak Positive Plate Voltage (Abs. Max.).....	7000 Volts
Plate Dissipation ³	20 Watts
Grid No. 2 Voltage.....	175 Volts
Grid No. 2 Dissipation.....	3.0 Watts
Peak Negative Grid No. 1 Voltage.....	200 Volts
Average Cathode Current.....	200 Ma
Peak Cathode Current.....	700 Ma
Grid No. 1 Circuit Resistance.....	0.47 Megohms
Bulb Temperature (At Hottest Point).....	225° C

For operation and application data refer to corresponding Type 6CD6G, whose operating characteristics are identical to Type 6CD6GA.

NOTES:

- Horizontal operation permitted if plane of Pins 2 and 7 is vertical.
- For operation in a 525 line, 30 frame system, the duty cycle of the voltage pulse must not exceed 15% of one scanning cycle.
- In stages operating with grid leak bias, an adequate cathode bias resistor or other suitable means is required to protect the tube in the absence of excitation.

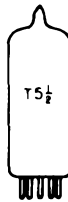

SYLVANIA TYPE 6CF6
SHARP CUTOFF R F PENTODE

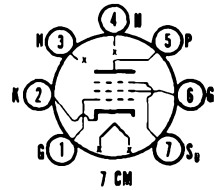

Identical to Type 6CB6 except for closely controlled grid cutoff characteristics. It is intended for use in gain controlled if amplifiers or vhf tuners. Characteristics curves for the Type 6CB6 may also be used for Type 6CF6.

TYPICAL OPERATION

Conditions: $E_b = 200$ Volts $E_{c2} = 150$ Volts $R_k = 180$ Ohms	
Control Grid Voltage for $I_b = 35 \mu a$ (approx.).....	-6.5 Volts

SYLVANIA TUBE TESTER SETTINGS

	A	B	C	D	E	F	G	Test or K
139/140	6.3	0	—	0	4	36	60	W
219/220	6.3	3	4S	63	4	16Z	5	2

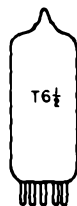

SYLVANIA TYPE 6CG7

MEDIUM-MU DUO TRIODE

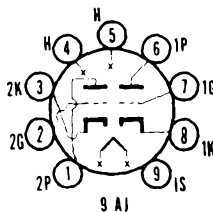

MECHANICAL DATA

Bulb	T-6 1/2, Outline 6-3
Base	Small Button 9-Pin
Basing	9AJ
Mounting Position	Any

ELECTRICAL DATA

HEATER CHARACTERISTICS

Heater Voltage	6.3 Volts
Heater Current	600 Ma
Heater Warm-up Time (See SERIES STRING HEATERS Section in Appendix)	
Maximum Heater-Cathode Voltage	
Total D C and Peak	200 Volts
D C, Heater Positive with Respect to Cathode	100 Volts

For other rating, operation and application data, refer to corresponding Type 6SN7GT, which is electrically identical except for heater ratings.

APPLICATION

The Sylvania Type 6CG7 may be used in television receivers employing series connected heaters. For information on specially controlled heaters for series string operation refer to the SERIES STRING HEATERS section of the Appendix.

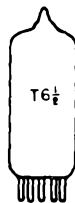

SYLVANIA TYPE 6CL6

PENTODE POWER AMPLIFIER

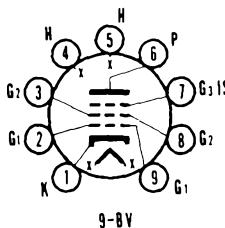

MECHANICAL DATA

Bulb	T-6 1/2, Outline 6-3
Base	Small Button 9-Pin
Basing	9BV
Mounting Position	Any

ELECTRICAL DATA

HEATER CHARACTERISTICS

Heater Voltage	6.3 Volts
Heater Current	650 Ma
Maximum Heater-Cathode Voltage	90 Volts

DIRECT INTERELECTRODE CAPACITANCES (Unshielded)

Grid to Plate	0.12 μf
Input	11.0 μf
Output	5.5 μf

MAXIMUM RATINGS (Design Center Values)

Plate Supply Voltage	300 Volts
Plate Voltage	300 Volts
Plate Dissipation	7.5 Watts
Grid No. 3 Voltage	0 Volts
Grid No. 2 Voltage	See Rating Chart for Type 6AM8
Grid No. 2 Supply Voltage	300 Volts
Grid No. 2 Dissipation	1.7 Watts
Grid No. 1 Voltage (Positive)	0 Volts
Grid No. 1 Voltage (Negative)	50 Volts
Grid No. 1 Circuit Resistance	
Fixed Bias	0.1 Megohm
Cathode Bias	0.5 Megohm
Bulb Temperature (At Hottest Point)	200° C

Sylvania Type 6CG7

MEDIUM-MU DUO TRIODE

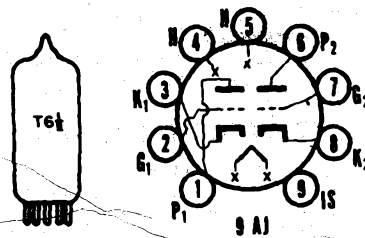

PHYSICAL SPECIFICATIONS

Bulb	T-6t $\frac{1}{2}$
Base	Small Button, 9-Pin
Basing	9A1
Maximum Overall Length	2 $\frac{1}{2}$ "
Maximum Seated Height	2 $\frac{3}{8}$ "
Cathode	Coated Unipotential
Mounting Position	Any

RATINGS¹

Heater Voltage	6.3 Volts	
Heater Current	600 Ma	
Heater Warm-up Time (approx.) ²	11 Seconds	
Maximum Heater-Cathode Voltage		
Total D C and Peak	200 Volts	
D C, Heater Positive with Respect to Cathode	100 Volts	
Class A₁ Amplifier		
Maximum Plate Voltage	300 Volts	
Maximum Plate Dissipation		
Each Plate	3.5 Watts	
Both Plates	5.0 Watts	
Maximum Cathode Current	20 Ma	
Maximum Grid Circuit Resistance, Fixed Bias	1.0 Megohm	
	Vertical ³ Deflection Oscillator	Horizontal ³ Deflection Oscillator
Maximum Plate Voltage	300	300 Volts
Maximum Plate Dissipation		
Each Plate	3.5	3.5 Watts
Both Plates	5.0	5.0 Watts
Maximum Peak Negative Grid Voltage	400	600 Volts
Maximum Average Cathode Current	20	20 Ma
Maximum Peak Cathode Current	70	300 Ma
Maximum Grid Circuit Resistance	2.2	2.2 Megohms
Direct Interelectrode Capacitances (Unshielded—approx.)		
	Section 1 ^{2,4}	Section 2
Grid to Plate	4.0	4.0 μ f
Input	2.3	2.3 μ f
Output	2.2	2.2 μ f

CHARACTERISTICS AND TYPICAL OPERATION

Class A₁ Amplifier		
Plate Voltage	90	250 Volts
Grid Voltage	0	-8.0 Volts
Plate Current	10	9.0 Ma
Plate Resistance (approx.)	6700	7700 Ohms
Transconductance	3000	2600 μ mhos
Amplification Factor	20	20
Plate Current at E _c = -12.5 Volts		1.3 Ma
Grid Voltage for I _b = 10 μ a (approx.)	-7.0	-18 Volts

NOTES:

- Design Center Values for each section except as noted.
- See Heater Warm-up Time Measurements.
- For operation in a \$25 line, 30 frame system as described in "Standards of Good Engineering Practice for Television Broadcasting Stations; Federal Communications Commission." The duty cycle of the voltage pulse must not exceed 15% of one scanning cycle.
- Section No. 1 connects to pins 4, 5 and 6. Section No. 2 connects to pins 1, 2 and 3.

SYLVANIA RADIO TUBES

Issued as a supplement to the manual in Sylvania News for February 1953

6CG7 (cont'd)

APPLICATION

The Sylvania Type 6CG7 may be used as the horizontal and vertical deflection oscillator in television receivers employing a series heater string. The 6CG7 may also be employed as a sync separator and amplifier. Electrically, the 6CG7 is identical to the 6SN7GT.

HEATER WARM-UP TIME MEASUREMENTS

Heater warm-up time is defined as the time required in the circuit shown below for the voltage across the heater terminals to increase from zero to the heater test voltage (V_1). The conditions used in conjunction with the test circuit depend upon the rated heater voltage and current of the tube under test as indicated in the table which follows:

- E—Applied Voltage, RMS or D C = 25 Volts
- R—Total Series Resistance = 31.5 Ohms
- V_1 —Heater Test Voltage, RMS or D C = 5.0 Volts
- E_f —Rated Heater Voltage of Tube Under Test = 6.3 Volts
- I_f —Rated Heater Current of Tube Under Test = 0.6 Amps.

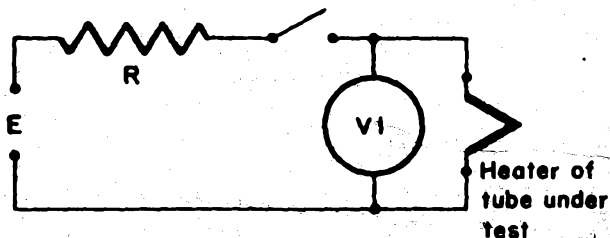

AVERAGE PLATE CHARACTERISTICS

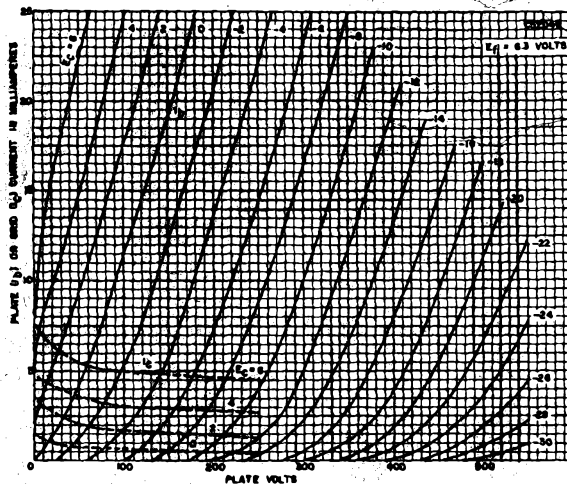



SYLVANIA TYPE 6CG8

6CG8A^P

5CG8

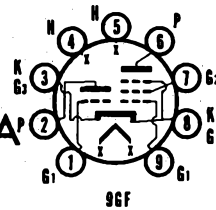

**MEDIUM MU TRIODE
SHARP CUTOFF PENTODE**

MECHANICAL DATA

Bulb	T-6 $\frac{1}{2}$
Base	E9-1, Small Button 9-Pin
Outline	G-2
Basing	9GF
Cathode	Coated Unipotential
Mounting Position	Any

ELECTRICAL DATA

HEATER CHARACTERISTICS

	5CG8	6CG8	6CG8A
Heater Voltage	4.7	6.3	6.3 Volts
Heater Current	600	450	450 Ma
Heater Warm-up Time ¹	11		11 Seconds
Heater-Cathode Voltage (Design Center Values)			
Heater Negative with Respect to Cathode			200 Volts Max.
Total D C and Peak			
Heater Positive with Respect to Cathode			100 Volts Max.
D C			200 Volts Max.
Total D C and Peak			

DIRECT INTERELECTRODE CAPACITANCES

	Shielded ²	Unshielded
Triode Section		
Grid to Plate	1.5	1.5 μ f
Grid to (k + h)	3	2.6 μ f
Plate to (k + h)	1	0.05 μ f
Pentode Section		
Grid No. 1 to Plate	0.016	0.03 μ f Max.
Grid No. 1 to (k+g3+g2+h)	5	4.8 μ f
Plate to (k+g3+g2+h)	1.6	0.9 μ f
Coupling		
Pentode Grid No. 1 to Triode Plate	0.04	0.05 μ f Max.
Pentode Plate to Triode Plate	0.007	0.05 μ f Max.
Heater to Cathode	5.5 ²	5.5 μ f

MAXIMUM RATINGS (Design Center Values)

	Triode Section	Pentode Section
Converter Service		
Plate Voltage	250	250 Volts
Grid No. 2 Supply Voltage		250 Volts
Grid No. 2 Voltage	See 6AM8 Rating Chart	
Plate Dissipation	1.5	2 Watts
Negative Grid No. 1 Voltage	40	40 Volts
Positive Grid No. 1 Voltage	0	0 Volt
Grid No. 2 Input:		
For Grid No. 2 Voltages up to 150 Volts		0.5 Watt
For Grid No. 2 Voltages Between 150 and 300 Volts	See 6AM8 Rating Chart	
Grid No. 1 Input	0.5	Watt
Grid No. 1 Circuit Resistance		
Fixed Bias		0.1 Megohm
Self Bias		0.5 Megohm

AVERAGE CHARACTERISTICS

	Triode Section	Pentode Section
Plate Voltage	100	250 Volts
Grid No. 2 Voltage		150 Volts
Plate Current	8.5	7.7 Ma
Grid No. 2 Current		1.6 Ma
Cathode Bias Resistor	100	200 Ohms
Amplification Factor	40	
Plate Resistance (approx.)	6900	750,000 Ohms
Transconductance	5800	4600 μ mhos
Grid No. 1 Voltage for $I_b = 10 \mu$ A (approx.)	-10	-10 Volts

TYPICAL OPERATION

	Triode Section as 250 Mo Osc.	Pentode Section as Mixer ⁴
Plate Voltage	150	150 Volts
Grid No. 2 Voltage		150 Volts
Mixer Grid No. 1 Supply Voltage		-3.5 Volts
Oscillator Voltage at Mixer Grid No. 1 (RMS)		2.6 Volts
Plate Current	13	6.2 Ma
Grid No. 2 Current		1.8 Ma
Grid No. 1 Current	3.6	Ma
Grid No. 1 Current		2 μ a

SYLVANIA ELECTRONIC TUBES

6CG8, 6CG8A, 5CG8 (Cont'd)

Mixer Grid No. 1 Circuit Resistance		120,000 Ohms
Oscillator Grid Resistor	2700	Ohms
Conversion Transconductance		2100 μ mhos
Oscillator Power Output (approx.)	0.5	Watt

NOTES:

1. Heater warm-up time is defined as the time required for the voltage across the heater to reach 80% of the rated heater voltage after applying four (4) times rated heater voltage to a circuit consisting of the tube heater in series with a resistance equal to three (3) times the rated heater voltage divided by the rated heater current.
2. Shield No. 315 connected to cathode.
3. Shield No. 315 connected to ground.
4. With separate excitation and triode section grounded.

APPLICATION

The Sylvania Types 6CG8, 6CG8A and 5CG8 have medium mu triode and sharp cutoff pentode contained in a T-6½ envelope. They are designed primarily for service as a VHF oscillator and mixer in TV receivers utilizing an IF in the order of 40 mc. Types 5CG8 and 6CG8A have controlled heater warm-up time for series string operation.

AVERAGE PLATE CHARACTERISTICS (TRIODE SECTION)

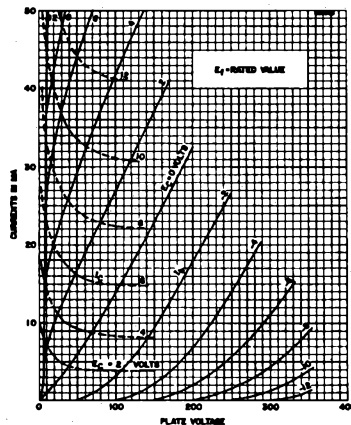

AVERAGE PLATE CHARACTERISTICS (PENTODE SECTION)

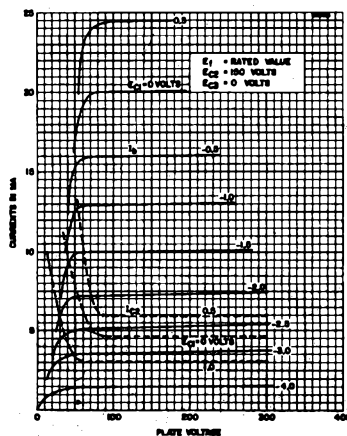



SYLVANIA TYPE 6CH8

MEDIUM MU TRIODE
SHARP CUTOFF PENTODE

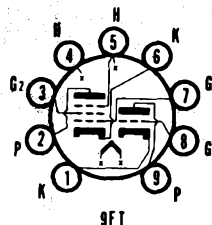

9FT

MECHANICAL DATA

Bulb	T-61½
Base	E9-1, Small Button 9-Pin
Outline	6-2
Basing	9FT
Cathode	Coated Unipotential
Mounting Position	Any

ELECTRICAL DATA

HEATER CHARACTERISTICS

Heater Voltage	6.3 Volts
Heater Current	450 Ma
Heater-Cathode Voltage (Design Center Values)	
Heater Negative with Respect to Cathode	
Total D C and Peak	200 Volts Max.
Heater Positive with Respect to Cathode	
D C	100 Volts Max.
Total D C and Peak	200 Volts Max.

DIRECT INTERELECTRODE CAPACITANCES (Unshielded)

Triode Section	
Grid to Plate	1.6 μ f
Grid to (k+h+g3+I.S.)	1.9 μ f
Plate to (k+h+g3+I.S.)	1.6 μ f
Pentode Section	
Grid No. 1 to Plate	.025 μ f Max.
Grid No. 1 to (k+h+g3+g2+I.S.)	7.0 μ f
Plate to (k+h+g3+g2+I.S.)	2.25 μ f
Coupling	
Triode Grid to Pentode Plate	0.005 μ f
Pentode Grid No. 1 to Triode Plate	0.02 μ f
Pentode Plate to Triode Plate	0.04 μ f

MAXIMUM RATINGS (Design Center Values)

	Triode Section	Pentode Section
Plate Voltage	300	300 Volts
Grid No. 3 Voltage		0 Volts
Grid No. 2 Supply Voltage		300 Volts
Grid No. 2 Voltage	See 6AM8 Rating Chart	
Positive Grid No. 1 Voltage	0	0 Volts
Plate Dissipation	2.6	2.0 Watts
Grid No. 2 Input:		
For Grid No. 2 Voltages up to 150 Volts	0.5	0.5 Watt
For Grid No. 2 Voltages Between 150 and 300 Volts	See 6AM8 Rating Chart	
Grid No. 1 Circuit Resistance ¹		
Fixed Bias	0.5	0.25 Megohm
Cathode Bias	1.0	1.0 Megohm

CHARACTERISTICS AND TYPICAL OPERATION

	Triode Section	Pentode Section
Plate Supply Voltage	200	200 Volts
Grid No. 3 Voltage		0 Volt
Grid No. 2 Supply Voltage		150 Volts
Grid No. 1 Voltage	-6	Volts
Cathode Bias Resistor		180 Ohms
Plate Current	13	9.5 Ma
Grid No. 2 Current		2.8 Ma
Transconductance	3300	6200 μ mhos
Amplification Factor	19	
Plate Resistance (approx.)	5750	300,000 Ohms
Grid No. 1 Voltage for $I_b = 10 \mu$ a (approx.)	-19	-8 Volts

NOTE:

1. If either section is operating at maximum rated conditions, the Grid No. 1 circuit resistance for both sections should not exceed the stated values.

APPLICATION

The Sylvania Type 6CH8 has a medium mu triode and sharp cutoff pentode contained in one envelope. The pentode section may be used as a reactance tube, IF, video or AGC amplifier. The triode section may be used as a low frequency oscillator, sync clipper, sync separator or phase splitter.

SYLVANIA ELECTRONIC TUBES

6CH8 (Cont'd)

AVERAGE PLATE CHARACTERISTICS (TRIODE SECTION)

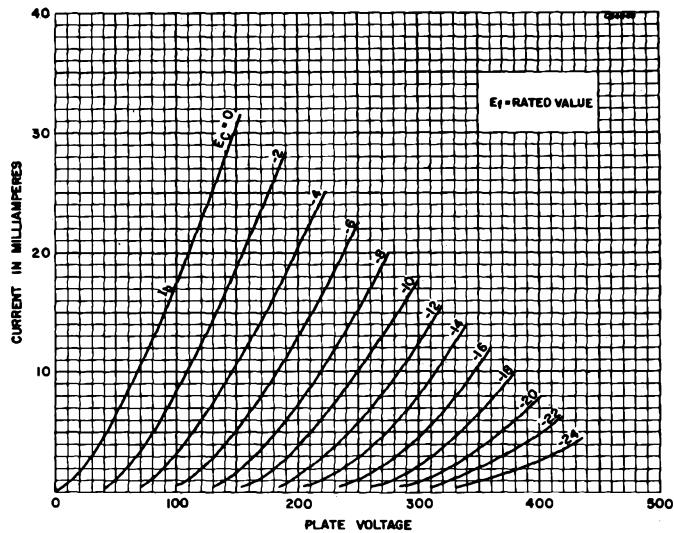

AVERAGE PLATE CHARACTERISTICS (PENTODE SECTION)

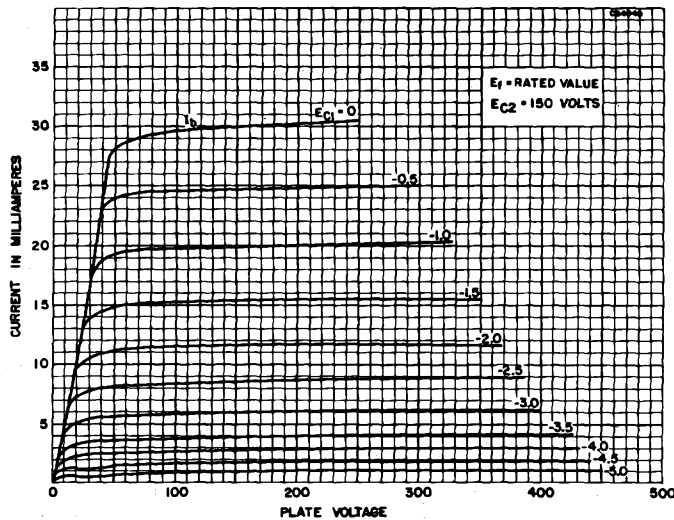



SYLVANIA TYPE 6CL5
HORIZONTAL
DEFLECTION AMPLIFIER

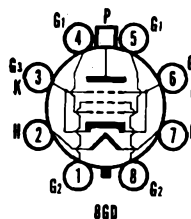

MECHANICAL DATA

Bulb	T-12
Base	BB-118, Short Medium Shell Octal, 8-Pin
Outline	12-106
Basing	8GD
Top Cap	C1-1 Small
Cathode	Coated Unipotential
Mounting Position	Vertical

ELECTRICAL DATA

HEATER CHARACTERISTICS

Heater Voltage	6.3 Volts
Heater Current	2.5 Amperes
Maximum Heater-Cathode Voltage	
Heater Negative with Respect to Cathode	
Total D C and Peak	200 Volts
Heater Positive with Respect to Cathode	
D C	100 Volts
Total D C and Peak	200 Volts

DIRECT INTERELECTRODE CAPACITANCES (Unshielded)

Grid No. 1 to Plate	0.7 μ f
Input	20.0 μ f
Output	11.5 μ f

MAXIMUM RATINGS (Design Center Values—Except as Noted)

Horizontal Deflection Amplifier²

D C Plate Supply Voltage	700 Volts
(Boost + D C Power Supply)	
Peak Positive Pulse Plate Voltage (Abs. Max.)	7000 Volts
Peak Negative Pulse Plate Voltage	1500 Volts
Plate Dissipation ³	25 Watts
Peak Negative Grid No. 1 Voltage	200 Volts
D C Grid No. 2 Voltage	200 Volts
Grid No. 2 Dissipation	4.0 Watts
Average Cathode Current	240 Ma
Peak Cathode Current	840 Ma
Grid No. 1 Circuit Resistance	0.47 Megohm
Bulb Temperature (at Hottest Point)	225 Degrees C

AVERAGE CHARACTERISTICS

Plate Voltage	175 Volts
Grid No. 2 Voltage	175 Volts
Grid No. 1 Voltage	-40 Volts
Plate Current	90 Ma
Grid No. 2 Current	7.0 Ma
Transconductance	6500 μ mhos
Amplification Factor ⁴	3.0
Plate Resistance (approx.)	6000 Ohms
Ec1 for Ib = 1.0 Ma (approx)	-75 Volts
Instantaneous Plate Knee Values	
Eb = 80 V, Ec2 = 100 V, and Ec1 = 0 V	
Ib = 280 Ma and Ic2 = 20 Ma.	

NOTES:

- Horizontal operation permitted if plane of pins 2 and 7 is vertical.
- For operation in a 525-line, 30-frame system as described in "Standards of Good Engineering Practice for Television Broadcasting Stations; Federal Communications Commission." The duty cycle of the voltage pulse must not exceed 15% of one scanning cycle.
- In stages operating with grid-leak bias, an adequate cathode bias resistor or other suitable means is required to protect the tube in the absence of excitation.
- Amplification factor obtained with Grid No. 2 tied to plate and operating as a triode connected amplifier.

APPLICATION DATA:

The Sylvania Type 6CL5 is a beam power amplifier designed for use as a horizontal deflection amplifier in color television receivers.

SYLVANIA ELECTRONIC TUBES

Issued as a supplement to the manual in Sylvania News for May, 1958

SYLVANIA ELECTRONIC TUBES



SYLVANIA TYPE 6CL8
6CL8A
5CL8
5CL8A
9CL8

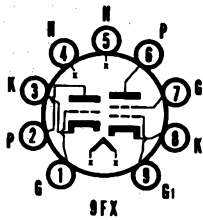

**MEDIUM MU TRIODE
SEMI-REMOTE CUTOFF TETRODE**

MECHANICAL DATA

Bulb	T-6½
Base	E9-1, Miniature Button, 9-Pin
Outline	6-2
Basing	9FX
Cathode	Coated Unipotential
Mounting Position	Any

ELECTRICAL DATA

HEATER CHARACTERISTICS

	5CL8A 5CL8	6CL8A 6CL8	9CL8
Heater Voltage	4.7	6.3	9.5 Volts
Heater Current	600	450	300 Ma
Heater Warm-up Time ¹	11	11	11 Seconds
Heater-Cathode Voltage (Design Center Values)			
Heater Negative with Respect to Cathode	200 Volts Max.		
Heater Positive with Respect to Cathode	100 Volts Max.		
Total D C and Peak	200 Volts Max.		

DIRECT INTERELECTRODE CAPACITANCES

	Shielded ²			Unshielded
Triode Section				
Grid to Plate	1.8			1.8 μ f
Input: g to (h + k)	2.7			2.7 μ f
Output: p to (h + k)	1.2			0.4 μ f
Tetrode Section				
	6CL8A 6CL8A	5CL8 9CL8	5CL8A 6CL8 6CL8A	5CL8 6CL8 9CL8
Grid No. 1 to Plate	0.01	.016	.02	.028 μ f Max.
Input: g1 to (h + k + g2)	5.0	5.0	5.0	5.0 μ f
Output: p to (h + k + g2)	3.4	3.0	2.4	2.0 μ f
Cathode to Heater (Either Section—approx.)	2.5	2.5	2.5	2.5 μ f

MAXIMUM RATINGS (Design Center Values)

	Triode Section	Tetrode Section
Plate Voltage	300	300 Volts
Grid No. 2 Supply Voltage		300 Volts
Grid No. 2 Voltage	See 6AM8 Rating Chart	
Plate Dissipation	2.7	2.8 Watts
Grid No. 2 Dissipation		0.5 Watt
Positive Grid No. 1 Voltage	0	0 Volt
Grid No. 1 Circuit Resistance		
Fixed Bias	0.5	0.25 Megohm
Self Bias	1.0	1.0 Megohm

CHARACTERISTICS AND TYPICAL OPERATION

	Triode Section	Tetrode Section
Class A₁ Amplifier		
Plate Voltage	125	125 Volts
Grid No. 2 Voltage		125 Volts
Grid No. 1 Voltage	0	-1.0 Volts
Cathode Bias Resistor	56	Ohms
Plate Current	15	12 Ma
Grid No. 2 Current		4.0 Ma
Transconductance (5CL8A, 6CL8A) ³	8000	5800 μ mhos
Plate Resistance (approx.)	5000	100,000 Ohms
Grid No. 1 Voltage for $I_b = 10 \mu$ a (approx.)	-9	-10 Ohms

NOTES

1. Heater warm-up time is defined as the time required for the voltage across the heater to reach 80% of the rated heater voltage after applying four (4) times rated heater voltage to a circuit consisting of the tube heater in series with a resistance equal to three (3) times the rated heater voltage divided by the rated heater current.
2. Shield No. 315.
3. The transconductance for the tetrode section of the 5CL8A and 6CL8A is 6400 micromhos.

SYLVANIA ELECTRONIC TUBES

6CL8, 6CL8A, 5CL8, (Cont'd) 5CL8A, 9CL8

APPLICATION

The Sylvania Types 5CL8, 5CL8A, 6CL8, 6CL8A and 9CL8 have a medium mu triode and a semi-remote cutoff tetrode contained in one envelope. They are intended primarily for use as a combined VHF oscillator and mixer. Types 5CL8, 5CL8A, 6CL8, 6CL8A and 9CL8 have controlled heater warm-up time for series string operation.

AVERAGE PLATE CHARACTERISTICS (TETRODE SECTION)

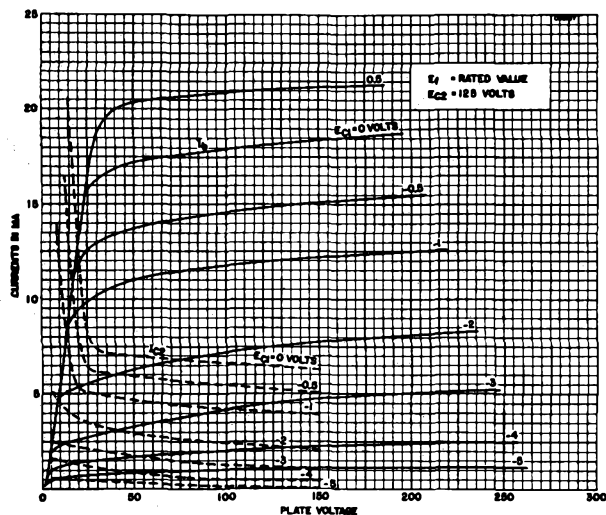

AVERAGE PLATE CHARACTERISTICS (TRIODE SECTION)

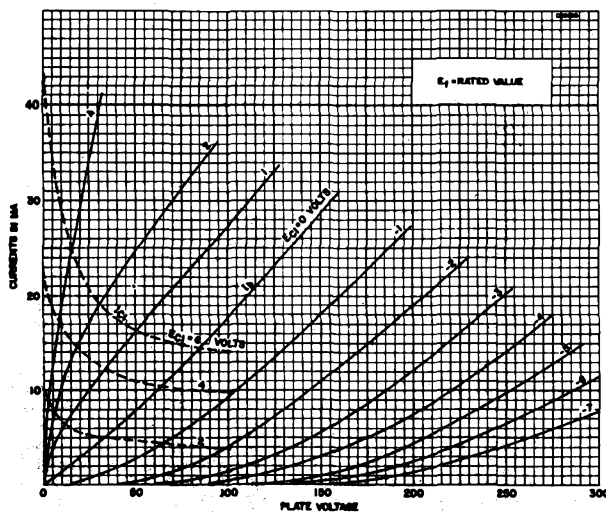

SYLVANIA ELECTRONIC TUBES

6CL6 (Cont'd)

CHARACTERISTICS AND TYPICAL OPERATION

Class A₁ Amplifier

Plate Voltage	250 Volts
Grid No. 3 Voltage	Connected to Cathode at Socket
Grid No. 2 Voltage	150 Volts
Grid No. 1 Voltage	-3.0 Volts
Peak A F Grid No. 1 Voltage	3.0 Volts
Plate Current (Maximum Signal)	31 Ma
Plate Current (Zero Signal)	30 Ma
Grid No. 2 Current (Maximum Signal)	7.2 Ma
Grid No. 2 Current (Zero Signal)	7.0 Ma
Plate Resistance (approx.)	0.15 Megohm
Transconductance	11000 μ mhos
Load Resistance	7500 Ohms
Total Harmonic Distortion	8 Percent
Maximum Signal Power Output	2.8 Watts
Grid No. 1 Bias for $I_b = 10 \mu$ a (approx.)	-14 Volts

Video Amplifier, 4 Mc Bandwidth

Plate Supply Voltage	300 Volts
Grid No. 3 Voltage	Connected to Cathode at Socket
Grid No. 2 Supply Voltage	300 Volts
Grid No. 2 Resistor	24000 Ohms
Grid No. 1 Voltage	-2.0 Volts
Grid No. 1 Resistance	0.1 Megohm
Grid No. 1 Signal Voltage (Peak to Peak)	3.0 Volts
Plate Current (Zero Signal)	30 Ma
Grid No. 2 Current (Zero Signal)	7.0 Ma
Load Resistance	3900 Ohms
Voltage Output (Peak to Peak)	132 Volts

APPLICATION

The Type 6CL6 is a miniature power pentode designed primarily for use as the video output amplifier in television receivers. It is useful for driving large television picture tubes and for wide-band amplifiers in industrial and laboratory equipment.

SYLVANIA TUBE TESTER SETTINGS

	A	B	C	D	E	F	G	Test or K
139/140	6.3	0	59	0	3	36	29	Y
	6.3	0	36	0	3	59	29	Y
219/220	6.3	4	359S	27	5	28Z	6	1
	6.3	4	258S	27	5	039Z	6	1

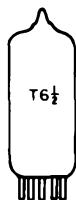

SYLVANIA TYPE 6CM6
BEAM POWER PENTODE

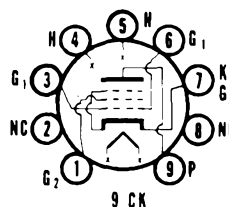

MECHANICAL DATA

Bulb	T-6 1/2, Outline 6-3
Base	Small Button 9-Pin
Basing	9CK
Mounting Position	Any

ELECTRICAL DATA

HEATER CHARACTERISTICS

Heater Voltage	6.3 Volts
Heater Current	450 Ma
Maximum Heater-Cathode Voltage	
D C, Heater Positive with Respect to Cathode	100 Volts
Total D C and Peak	200 Volts

DIRECT INTERELECTRODE CAPACITANCES (Unshielded)

Grid to Plate	0.7 μ f
Input	8.0 μ f
Output	8.5 μ f

6CM6 (Cont'd)

MAXIMUM RATINGS (Design Center Values—Except as Noted)

Class A₁ Amplifier

Plate Voltage.....	315 Volts
Plate Dissipation.....	12 Watts
Grid No. 2 Voltage.....	285 Volts
Grid No. 2 Dissipation.....	2 Watts
Grid No. 1 Circuit Resistance	
Fixed Bias.....	0.1 Megohm
Cathode Bias.....	0.5 Megohm

Vertical Deflection Amplifier¹

	Pentode Connected	Triode Connected
Plate Voltage.....	315	315 Volts
Peak Positive Plate Voltage (Abs. Max.).....	2000	2000 Volts
Plate Dissipation ²	8	8 Watts
Grid No. 2 Voltage.....	285	Volts
Grid No. 2 Dissipation ²	1.75	Watts
Peak Negative Grid Voltage.....	250	250 Volts
Average Cathode Current.....	40	40 Ma
Peak Cathode Current.....	120	120 Ma
Grid No. 1 Circuit Resistance, Cathode Bias..	2.2	2.2 Megohms

NOTES:

1. For operation in a 525-line, 30 frame system, the duty cycle of the voltage pulse is not to exceed 15% of one scanning cycle.
2. In stages operating with a grid leak bias, an adequate cathode bias resistor or other suitable means is required to protect the tube in the absence of excitation.

For Characteristics and Typical Operation refer to Type 6V6GT which is identical except for envelope size and maximum ratings.

SYLVANIA TUBE TESTER SETTINGS

	A	B	C	D	E	F	G	Test or K
139/140	6.3	0	4	0	4	026	35	Y
	6.3	0	6	0	4	024	35	Y
219/220	6.3	4	56	26	5	013Z	9	7
	6.3	4	35	26	5	016Z	9	7

TYPE 6CR6

(See Condensed Data Section)



SYLVANIA TYPE 6CS6 DUAL CONTROL HEPTODE

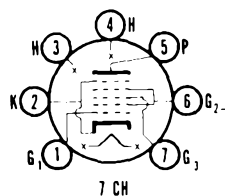

MECHANICAL DATA

Bulb.....	T-5 1/2, Outline 5-2
Base.....	Miniature Button 7-Pin
Basing.....	7CH
Mounting Position.....	Any

ELECTRICAL DATA

HEATER CHARACTERISTICS

Heater Voltage.....	6.3 Volts
Heater Current.....	300 Ma
Maximum Heater-Cathode Voltage	
D C, Heater Positive with Respect to Cathode.....	100 Volts
Total D C and Peak.....	200 Volts

DIRECT INTERELECTRODE CAPACITANCES (Unshielded)

Grid No. 1 to Plate.....	0.07 μ f Max
Grid No. 3 to Plate.....	0.36 μ f Max
Grid No. 1 Input (g1 to h+k+g2+g3 and g5).....	5.5 μ f
Grid No. 3 Input (g3 to h+k+g1+g2+g5).....	7.0 μ f
Output (p to All).....	7.5 μ f
Coupling (g1 to g3).....	0.22 μ f Max

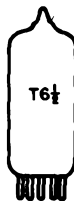

SYLVANIA TYPE 6CM7 8CM7

DOUBLE TRIODE

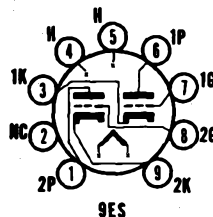

9ES

MECHANICAL DATA

Bulb.....	T-6½
Base.....	E9-1, Small Button, 9-Pin
Outline.....	6-3
Basing.....	9ES
Cathode.....	Coated Unipotential
Mounting Position.....	Any

ELECTRICAL DATA

HEATER CHARACTERISTICS

	6CM7	8CM7
Heater Voltage.....	6.3	8.4 Volts
Heater Current.....	600	450 Ma
Heater Warm-up Time ¹	11	11 Seconds
Heater-Cathode Voltage (Design Center Values)		
Heater Negative with Respect to Cathode		
Total D C and Peak.....	200	200 Volts Max.
Heater Positive with Respect to Cathode		
D C.....	100	100 Volts Max.
Total D C and Peak.....	200	200 Volts Max.

DIRECT INTERELECTRODE CAPACITANCES (Unshielded)

	Triode No. 1	Triode No. 2
Grid to Plate (g to p).....	3.8	3.0 μμf
Input: g to (k + h).....	2.0	3.5 μμf
Output: p to (k + h).....	0.5	0.4 μμf

RATINGS (Design Center Values—Except as Noted)

Vertical Deflection Oscillator and Amplifier²

	Triode No. 1 (Oscillator)	Triode No. 2 (Amplifier)
D C Plate Voltage.....	500	500 Volts Max.
Peak Positive Pulse Plate Voltage.....		2200 Volts Abs. Max.
Peak Negative Pulse Grid Voltage.....	200	200 Volts Max.
Plate Dissipation ³	1.25	5.5 Watts Max.
Average Cathode Current.....	15	20 Ma Max.
Peak Cathode Current.....	70	70 Ma Max.
Grid Circuit Resistance		
Cathode Bias.....	2.2	2.5 Megohms Max.
Fixed Bias.....	2.2	1.0 Megohms Max.

AVERAGE CHARACTERISTICS

	Triode No. 1 (Oscillator)	Triode No. 2 (Amplifier)
Plate Voltage.....	200	250 Volts
Grid Voltage.....	-7	-8 Volts
Plate Current.....	5	20 Ma
Transconductance.....	2000	4400 μmhos
Amplification Factor.....	21	18
Plate Resistance.....	10,500	4100 Ohms
Plate Current at E _c = -10 Volts.....	1.0	Ma
Grid Voltage for I _b = 10 μa.....	-14	Volts

NOTES:

1. Heater Warm-up Time is defined as the time required for the voltage across the heater to reach 80% of its rated value after applying four (4) times rated heater voltage to a circuit consisting of the tube heater in series with a resistance equal to three (3) times rated heater voltage divided by rated heater current.
2. For operation in a 525 line, 30-frame system as described in "Standards of Good Engineering Practice for Television Broadcasting Stations; Federal Communications Commission." The duty cycle of the voltage pulse must not exceed 15% of one scanning cycle.
3. In stages operating with grid leak bias, an adequate cathode bias resistor or other suitable means is required to protect the tube in the absence of excitation.

APPLICATION

Each of these types is a miniature double triode having dissimilar sections. Section No. 1 is intended for operation as a vertical deflection oscillator and Section No. 2 as a vertical deflection amplifier. The 8CM7 features a 450 Ma heater and is identical to the 6CM7 except for heater characteristics. Both types have controlled heater warm-up time and are intended for use in series string television receivers.

SYLVANIA ELECTRONIC TUBES

Issued as a supplement to the manual in Sylvania News for January 1957

SYLVANIA TYPE **6CM7** (Cont'd)
8CM7

AVERAGE PLATE CHARACTERISTICS
SECTION I

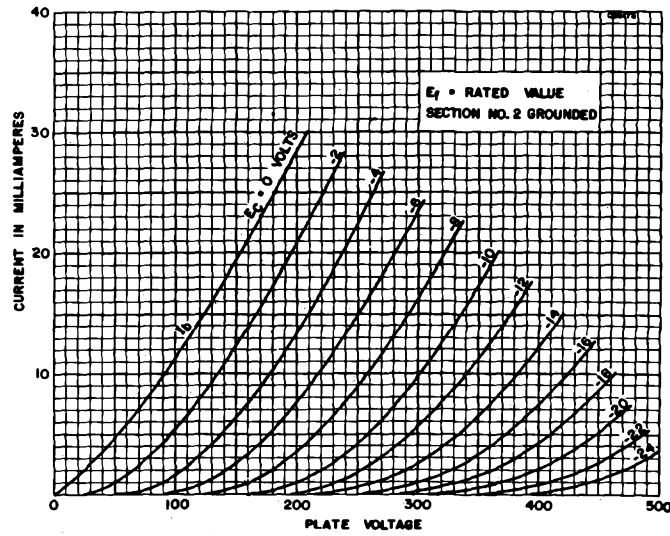

AVERAGE PLATE CHARACTERISTICS
SECTION II

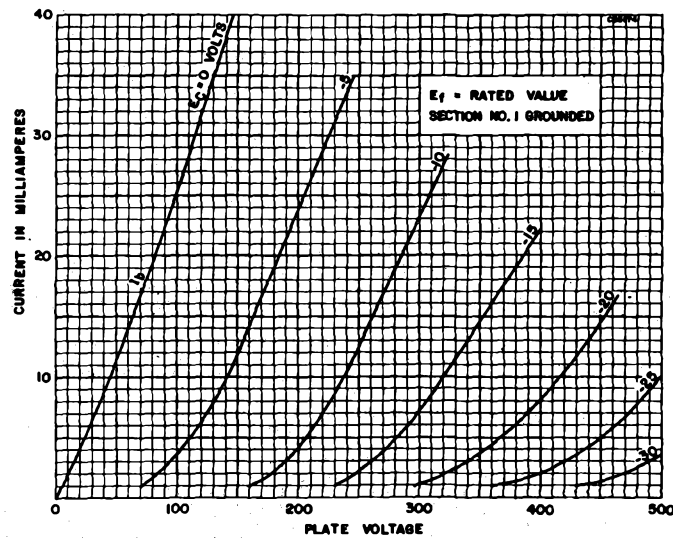



**SYLVANIA TYPE 6CM8
5CM8**
HIGH-MU TRIODE
SHARP CUTOFF PENTODE

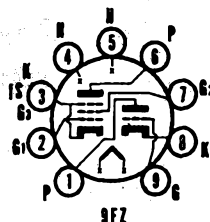

MECHANICAL DATA

Bulb	T-6 1/2
Base	E9-1, Small Button 9-Pin
Outline	6-2
Basing	9FZ
Cathode	Coated Unipotential
Mounting Position	Any

ELECTRICAL DATA

HEATER CHARACTERISTICS

	5CM8	6CM8
Heater Voltage	4.7	6.3 Volts
Heater Current	600	450 Ma
Heater Warm-up Time ¹	11	11 Seconds
Heater-Cathode Voltage (Design Center Values)		
Heater Negative with Respect to Cathode		200 Volts Max.
Total D C and Peak		
Heater Positive with Respect to Cathode		100 Volts Max.
D C		200 Volts Max.
Total D C and Peak		

DIRECT INTERELECTRODE CAPACITANCES (Approx.)

Triode Section		
Grid to Plate		1.9 μf
Input: g to (h + k)		1.6 μf
Output: p to (h + k)		0.22 μf
Pentode Section		
Grid No. 1 to Plate		0.02 μf Max.
Input: g1 to (h+k+g2+g3+I.S.)		6.0 μf
Output: p to (h+k+g2+g3+I.S.)		2.6 μf
Coupling		
Pentode Plate to Triode Grid		0.01 μf Max.
Pentode Grid No. 1 to Triode Plate		0.15 μf Max.
Pentode Plate to Triode Plate		0.10 μf Max.

MAXIMUM RATINGS (Design Center Values)

	Triode Section	Pentode Section
Plate Voltage	300	300 Volts
Grid No. 2 Supply Voltage		300 Volts
Grid No. 2 Voltage	See 6AM8 Rating Chart	0 Volts
Positive Grid No. 1 Voltage	0	0 Volts
Plate Dissipation	1.0	2.0 Watts
Grid No. 2 Dissipation		0.5 Watt
Grid No. 1 Circuit Resistance		
Self Bias		1.0 Megohm
Fixed Bias		0.25 Megohm

CHARACTERISTICS

	Triode Section	Pentode Section
Class A ₁ Amplifier		
Plate Supply Voltage	250	200 Volts
Grid No. 2 Voltage		150 Volts
Grid No. 1 Voltage	-2	0 Volts
Cathode Bias Resistor		180 Ohms
Plate Current	1.8	9.5 Ma
Grid No. 2 Current		2.8 Ma
Amplification Factor	100	
Plate Resistance (approx.)	50,000	600,000 Ohms
Transconductance	2000	6200 μmhos
Grid No. 1 Voltage for $I_b = 10 \mu\text{a}$ (approx.)		-8 Volts

NOTE:

1. Heater warm-up time is defined as the time required for the voltage across the heater to reach 80% of its rated value after applying four (4) times rated heater voltage to a circuit consisting of the tube heater in series with a resistance equal to three (3) times rated heater voltage divided by rated heater current.

APPLICATION

The Sylvania Type 6CM8 is a high mu triode and sharp cutoff pentode. The pentode section may be used as an I F amplifier, video amplifier, AGC amplifier and reactance tube. The 5CM8 is identical to the 6CM8 except for heater characteristics. Both types employ controlled heater warm-up time for service in series heater string television receivers.

6CM8, 5CM8 (Cont'd)

AVERAGE PLATE CHARACTERISTICS (PENTODE SECTION)

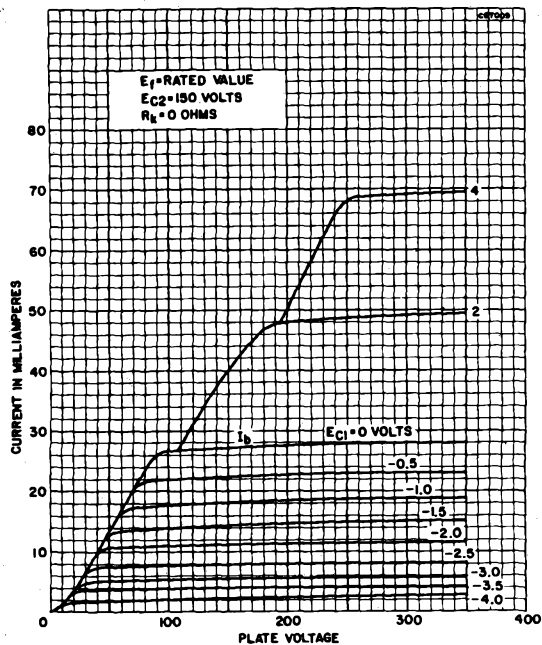

AVERAGE PLATE CHARACTERISTICS (TRIODE SECTION)

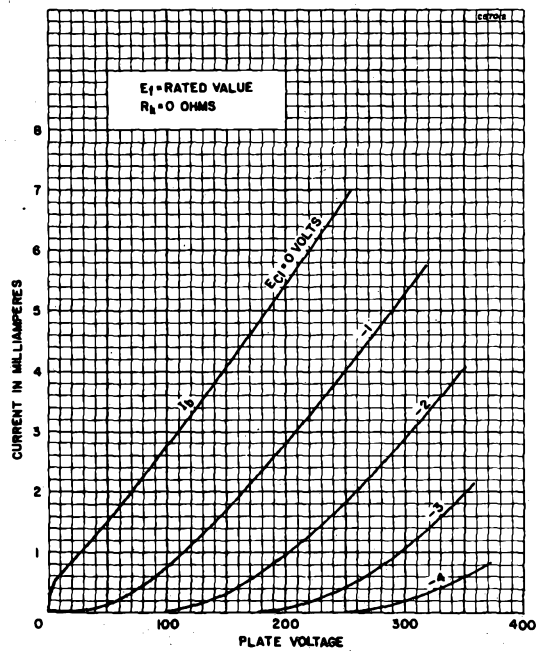

SYLVANIA ELECTRONIC TUBES



SYLVANIA TYPE 6CM7

8CM7

DOUBLE TRIODE

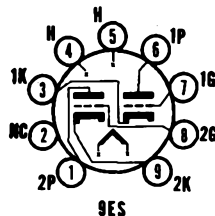

MECHANICAL DATA

Bulb.....	T-6½
Base.....	E9-1, Small Button, 9-Pin
Outline.....	6-3
Basing.....	9ES
Cathode.....	Coated Unipotential
Mounting Position.....	Any

ELECTRICAL DATA

HEATER CHARACTERISTICS

	6CM7	8CM7
Heater Voltage.....	6.3	8.4 Volts
Heater Current.....	600	450 Ma
Heater Warm-up Time¹.....	11	11 Seconds
Heater-Cathode Voltage (Design Center Values)		
Heater Negative with Respect to Cathode Total D C and Peak.....	200	200 Volts Max.
Heater Positive with Respect to Cathode D C.....	100	100 Volts Max.
Total D C and Peak.....	200	200 Volts Max.

DIRECT INTERELECTRODE CAPACITANCES (Unshielded)

	Triode No. 1	Triode No. 2
Grid to Plate (g to p).....	3.8	3.0 μf
Input: g to (k + h).....	2.0	3.5 μf
Output: p to (k + h).....	0.5	0.4 μf

RATINGS (Design Center Values—Except as Noted)

Vertical Deflection Oscillator and Amplifier²

	Triode No. 1 (Oscillator)	Triode No. 2 (Amplifier)
D C Plate Voltage.....	500	500 Volts Max.
Peak Positive Pulse Plate Voltage.....		2200 Volts Abs. Max.
Peak Negative Pulse Grid Voltage.....	200	200 Volts Max.
Plate Dissipation³.....	1.25	5.5 Watts Max.
Average Cathode Current.....	15	20 Ma Max.
Peak Cathode Current.....	70	70 Ma Max.
Grid Circuit Resistance		
Cathode Bias.....	2.2	2.5 Megohms Max.
Fixed Bias.....	2.2	1.0 Megohms Max.

AVERAGE CHARACTERISTICS

	Triode No. 1 (Oscillator)	Triode No. 2 (Amplifier)
Plate Voltage.....	200	250 Volts
Grid Voltage.....	-7	-8 Volts
Plate Current.....	5	20 Ma
Transconductance.....	2000	4400 μmhos
Amplification Factor.....	21	18
Plate Resistance.....	10,500	4100 Ohms
Plate Current at E _c = -10 Volts.....	1.0	Ma
Grid Voltage for I _b = 10 μa.....	-14	Volts

NOTES:

1. Heater Warm-up Time is defined as the time required for the voltage across the heater to reach 80% of its rated value after applying four (4) times rated heater voltage to a circuit consisting of the tube heater in series with a resistance equal to three (3) times rated heater voltage divided by rated heater current.
2. For operation in a 525 line, 30-frame system as described in "Standards of Good Engineering Practice for Television Broadcasting Stations; Federal Communications Commission." The duty cycle of the voltage pulse must not exceed 15% of one scanning cycle.
3. In stages operating with grid leak bias, an adequate cathode bias resistor or other suitable means is required to protect the tube in the absence of excitation.

APPLICATION

Each of these types is a miniature double triode having dissimilar sections. Section No. 1 is intended for operation as a vertical deflection oscillator and Section No. 2 as a vertical deflection amplifier. The 8CM7 features a 450 Ma heater and is identical to the 6CM7 except for heater characteristics. Both types have controlled heater warm-up time and are intended for use in series string television receivers.

SYLVANIA ELECTRONIC TUBES

Issued as a supplement to the manual in Sylvania News for January 1957

SYLVANIA TYPE 6CM7 (Cont'd)
8CM7

AVERAGE PLATE CHARACTERISTICS

SECTION I

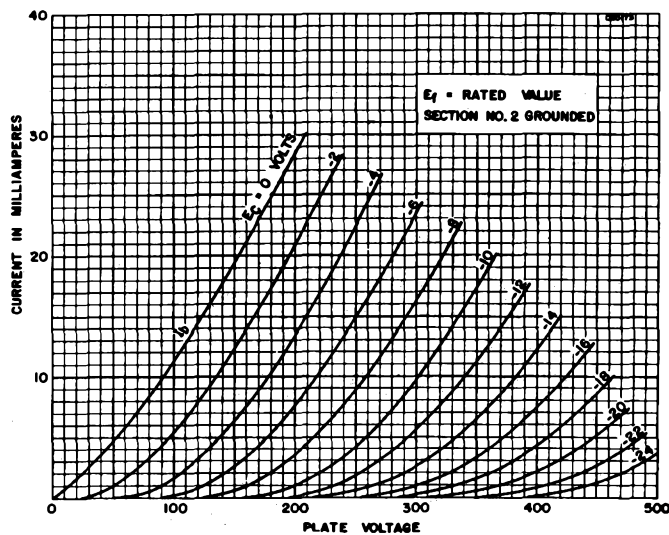

AVERAGE PLATE CHARACTERISTICS

SECTION II

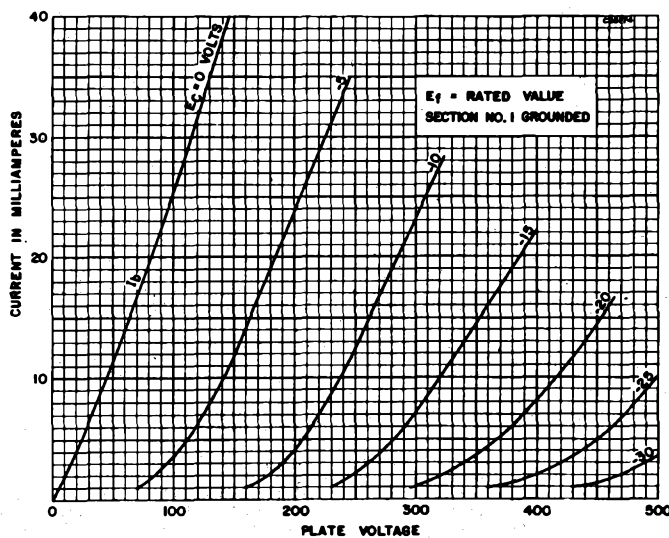



**SYLVANIA TYPE 6CM8
5CM8**
HIGH-MU TRIODE
SHARP CUTOFF PENTODE

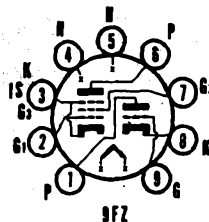

MECHANICAL DATA

Bulb.....	T-6 1/2
Base.....	E9-1, Small Button 9-Pin
Outline.....	6-2
Basing.....	9FZ
Cathode.....	Coated Unipotential
Mounting Position.....	Any

ELECTRICAL DATA

HEATER CHARACTERISTICS

	5CM8	6CM8
Heater Voltage.....	4.7	6.3 Volts
Heater Current.....	600	450 Ma
Heater Warm-up Time ¹	11	11 Seconds
Heater-Cathode Voltage (Design Center Values) Heater Negative with Respect to Cathode Total D C and Peak.....		200 Volts Max.
Heater Positive with Respect to Cathode D C.....		100 Volts Max.
Total D C and Peak.....		200 Volts Max.

DIRECT INTERELECTRODE CAPACITANCES (Approx.)

Triode Section		
Grid to Plate.....		1.9 μ f
Input: g to (h + k).....		1.6 μ f
Output: p to (h + k).....		0.22 μ f
Pentode Section		
Grid No. 1 to Plate.....		0.02 μ f Max.
Input: g1 to (h+k+g2+g3+I.S.).....		6.0 μ f
Output: p to (h+k+g2+g3+I.S.).....		2.6 μ f
Coupling		
Pentode Plate to Triode Grid.....		0.01 μ f Max.
Pentode Grid No. 1 to Triode Plate.....		0.15 μ f Max.
Pentode Plate to Triode Plate.....		0.10 μ f Max.

MAXIMUM RATINGS (Design Center Values)

	Triode Section	Pentode Section
Plate Voltage.....	300	300 Volts
Grid No. 2 Supply Voltage.....		300 Volts
Grid No. 2 Voltage.....	See 6AM8 Rating Chart	0 Volts
Positive Grid No. 1 Voltage.....	0	2.0 Watts
Plate Dissipation.....	1.0	0.5 Watt
Grid No. 2 Dissipation.....		
Grid No. 1 Circuit Resistance Self Bias.....		1.0 Megohm
Fixed Bias.....		0.25 Megohm

CHARACTERISTICS

	Triode Section	Pentode Section
Class A ₁ Amplifier		
Plate Supply Voltage.....	250	200 Volts
Grid No. 2 Voltage.....		150 Volts
Grid No. 1 Voltage.....	-2	0 Volts
Cathode Bias Resistor.....		180 Ohms
Plate Current.....	1.8	9.5 Ma
Grid No. 2 Current.....		2.8 Ma
Amplification Factor.....	100	
Plate Resistance (approx.).....	50,000	600,000 Ohms
Transconductance.....	2000	6200 μ mhos
Grid No. 1 Voltage for I _b = 10 μ a (approx.).....		-8 Volts

NOTE:

1. Heater warm-up time is defined as the time required for the voltage across the heater to reach 80% of its rated value after applying four (4) times rated heater voltage to a circuit consisting of the tube heater in series with a resistance equal to three (3) times rated heater voltage divided by rated heater current.

APPLICATION

The Sylvania Type 6CM8 is a high mu triode and sharp cutoff pentode. The pentode section may be used as an I F amplifier, video amplifier, AGC amplifier and reactance tube. The 5CM8 is identical to the 6CM8 except for heater characteristics. Both types employ controlled heater warm-up time for services in series heater string television receivers.

6CM8, 5CM8 (Cont'd)

AVERAGE PLATE CHARACTERISTICS (PENTODE SECTION)

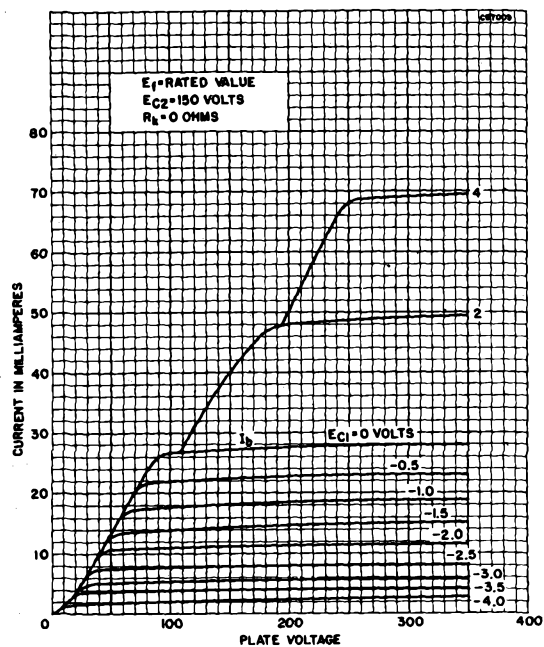

AVERAGE PLATE CHARACTERISTICS (TRIODE SECTION)

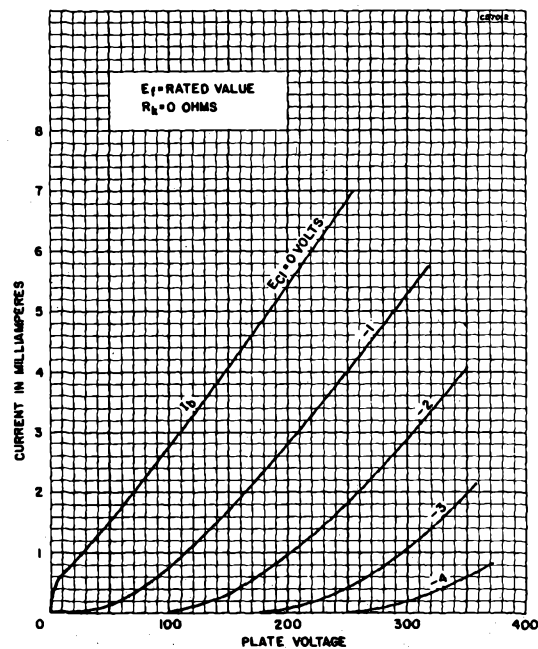

SYLVANIA ELECTRONIC TUBES

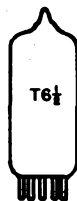

SYLVANIA TYPE 6CN7 8CN7

DOUBLE DIODE
HIGH MU TRIODE

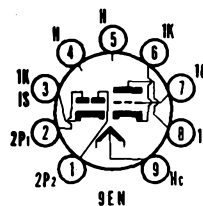

MECHANICAL DATA

Bulb.....	T-6½
Base.....	E9-1, Small Button 9-Pin
Outline.....	G-2
Basing.....	9EN
Cathode.....	Coated Unipotential
Mounting Position.....	Any

ELECTRICAL DATA

HEATER CHARACTERISTICS

	6CN7	8CN7
Heater Voltage ¹ Series/Parallel.....	6.3/3.15	8.4/4.2 Volts
Heater Current.....	300/600	225/450 Ma
Heater Warm-up Time ¹	11	11 Seconds
Heater-Cathode Voltage (Design Center Values)		
Heater Negative with Respect to Cathode		
Total D C and Peak.....	200	200 Volts Max.
Heater Positive with Respect to Cathode		
D C.....	100	100 Volts Max.
Total D C and Peak.....	200	200 Volts Max.

DIRECT INTERELECTRODE CAPACITANCES²

Triode Grid to Plate.....	1.8 μf
Triode Input.....	1.5 μf
Triode Output.....	0.5 μf
Grid to Each Diode Plate.....	0.006 μf
Diode p1 to (dk + h).....	3.6 μf
Diode p2 to (dk + h).....	3.6 μf

RATINGS (Design Center Values)

Plate Voltage.....	300 Volts Max.
Positive D C Grid Voltage.....	0 Volts
Plate Dissipation.....	1.0 Watt Max.
Diode Current for Continuous Operation.....	5.0 Ma Max.
Each Diode.....	5.0 Ma Max.

CHARACTERISTICS AND TYPICAL OPERATION

Class A ₁ Amplifier		
Plate Voltage.....	100	250 Volts
Grid Voltage.....	-1.0	-3.0 Volts
Amplification Factor.....	70	70
Plate Resistance (approx.).....	54,000	58,000 Ohms
Transconductance.....	1300	1200 μmhos
Plate Current.....	0.8	1.0 Ma
Average Diode Current, Each Diode with 5.0 Volts D C Applied.....		20 Ma

NOTES:

1. Heater Warm-up Time applies to parallel connection only.
2. Heater Warm-up Time is defined as the time required for the voltage across the heater to reach 80% of its rated value after applying four (4) times rated heater voltage to a circuit consisting of the tube heater in series with a resistance equal to three (3) times rated heater voltage divided by rated heater current.
3. Without external shield.

APPLICATION

These tubes have separate cathodes for each section. Either tube may be used as a combined horizontal phase detector and reactance tube for series heater string television receivers. The triode section may be used in sync-separator, sync-amplifier, or audio-amplifier circuits. The 6CN7 has a 600 Ma heater and the 8CN7 has a 450 Ma heater. Both tubes have controlled heater warm-up time.

SYLVANIA ELECTRONIC TUBES

Issued as a supplement to the manual in Sylvania News for October 1956

SYLVANIA TYPE **6CN7** (Cont'd)
8CN7

AVERAGE PLATE CHARACTERISTICS

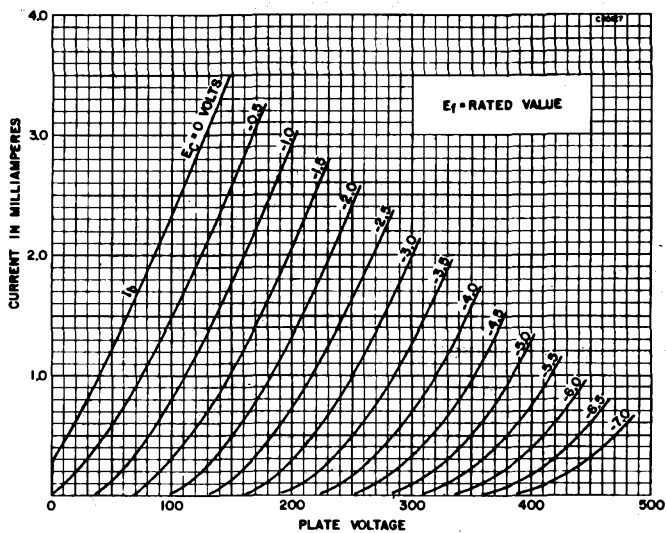

AVERAGE TRANSFER CHARACTERISTICS

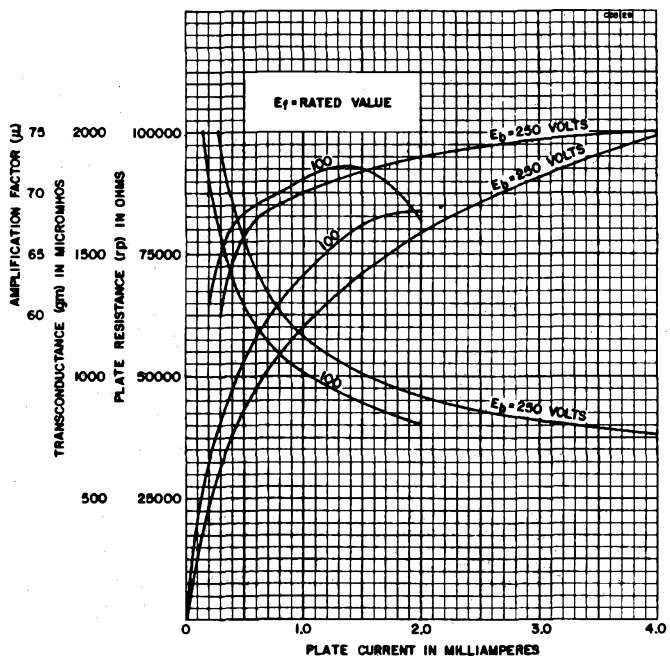



SYLVANIA TYPE 6CQ8

MEDIUM MU TRIODE
SHARP CUTOFF TETRODE

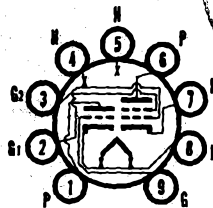

9GE

MECHANICAL DATA

Bulb	T-6 1/2
Base	E9-1, Miniature Button 9-Pin
Outline	6-2
Basing	9GE
Cathode	Coated Unipotential
Mounting Position	Any

ELECTRICAL DATA

HEATER CHARACTERISTICS

Heater Voltage	6.3 Volts
Heater Current	450 Ma
Heater Warm-up Time ¹	11 Seconds
Heater Cathode Voltage (Design Center Values)	
Heater Negative with Respect to Cathode	
Total D C and Peak	200 Volts Max.
Heater Positive with Respect to Cathode	
D C	100 Volts Max.
Total D C and Peak	200 Volts Max.

DIRECT INTERELECTRODE CAPACITANCES

Triode Section	Shielded ²	Unshielded
Grid to Plate	1.8	1.8 μf
Input: g to (h+k)	2.7	2.7 μf
Output: p to (h+k)	0.4	1.2 μf
Pentode Section		
Grid No. 1 to Plate	0.019	0.015 μf Max.
Input: g1 to (h+k+g2+I.S.)	5	5 μf
Output: p to (h+k+g2+I.S.)	2.5	3.3 μf
Coupling		
Triode Plate to Tetrode Plate	0.07	0.01 μf Max.

MAXIMUM RATINGS (Design Center Values)

	Triode Section (Oscillator)	Tetrode Section (Mixer)
Plate Voltage	300	300 Volts
Grid No. 2 Voltage	See 6AM8 Rating Chart	300 Volts
Grid No. 2 Supply Voltage		300 Volts
Positive Grid Voltage	0	0 Volts
Plate Dissipation	2.7	2.8 Watts
Grid No. 2 Input (Up to 150 Volts)		0.6 Watt
Grid No. 2 Input (150 Volts to 300 Volts)	See 6AM8 Rating Chart	Chart
Grid Input	0.5	Watt
Grid Circuit Resistance		
Fixed Bias	0.5	0.25 Megohm
Cathode Bias	1.0	1.0 Megohm

CHARACTERISTICS AND TYPICAL OPERATION

Class A ₁ Amplifier	Triode Section	Tetrode Section
Plate Voltage	125	125 Volts
Grid No. 2 Voltage		125 Volts
Grid No. 1 Voltage		-1.0 Volts
Cathode Resistor	56	Ohms
Plate Current	15	12 Ma
Grid No. 2 Current		4.2 Ma
Transconductance	8000	5800 μmhos
Amplification Factor	40	
Plate Resistance (approx.)	5000	140,000 Ohms
Ec1 for Ib = 100 μa (approx.)	-7	-7 Volts

NOTES:

1. Heater warm-up time is defined as the time required for the voltage across the heater to reach 80% of its rated value after applying four (4) times rated heater voltage to a circuit consisting of the tube heater in series with a resistance equal to three (3) times rated heater voltage divided by rated heater current.
2. With external JETEC No. 315 shield connected to cathode of section under test.

APPLICATION DATA:

The Sylvania Type 6CQ8 is a miniature medium mu triode and sharp cutoff tetrode designed for use as a combined v h f oscillator and mixer.
Type 6CQ8 has controlled heater warm-up time for series string operation.

6CQ8 (Cont'd)

AVERAGE PLATE CHARACTERISTICS (TETRODE SECTION)

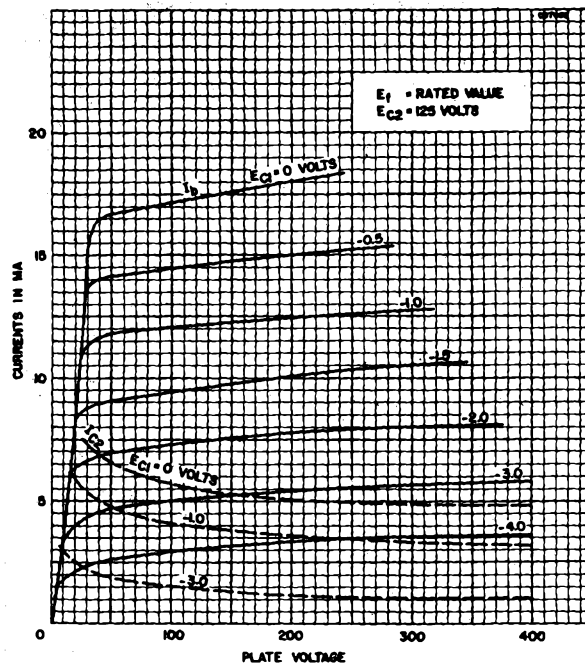

AVERAGE PLATE CHARACTERISTICS (TRIODE SECTION)

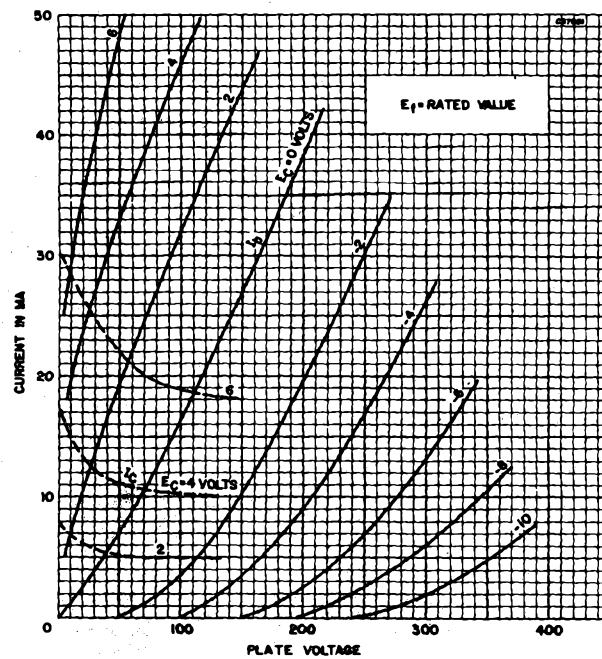

SYLVANIA ELECTRONIC TUBES



**SYLVANIA TYPE 6CR6
12CR6**

**DIODE DETECTOR
REMOTE CUTOFF PENTODE**

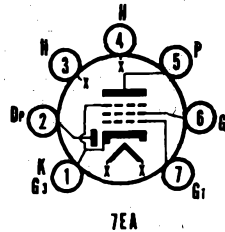

7EA

MECHANICAL DATA

Bulb.....	T-5 1/2
Base.....	E7-1, Miniature Button 7-Pin
Outline.....	5-2
Basing.....	7EA
Cathode.....	Coated Unipotential
Mounting Position.....	Any

ELECTRICAL DATA

HEATER CHARACTERISTICS

	6CR6	12CR6
Heater Voltage.....	6.3	12.6 Volts
Heater Current.....	300	150 Ma
Heater-Cathode Voltage (Design Center Values)		
Heater Negative with Respect to Cathode		100 Volts Max.
Total D C and Peak.....		100 Volts Max.
Heater Positive with Respect to Cathode		
Total D C and Peak.....		100 Volts Max.

MAXIMUM RATINGS (Design Center Values)

Plate Voltage.....	300 Volts
Grid No. 2 Supply Voltage.....	300 Volts
Grid No. 2 Voltage.....	See 6AM8 Rating Chart
Plate Dissipation.....	2.5 Watts
Grid No. 2 Dissipation.....	0.3 Watt
Positive D C Grid No. 1 Voltage.....	0 Volts
Grid No. 1 Circuit Resistance.....	1.0 Megohm

CHARACTERISTICS AND TYPICAL OPERATION

Class A₁ Amplifier

Plate Voltage.....	250 Volts
Grid No. 2 Voltage.....	100 Volts
Grid No. 1 Voltage.....	-2 Volts
Plate Current.....	9.6 Ma
Grid No. 2 Current.....	2.6 Ma
Transconductance.....	2200 μ mhos
Plate Resistance (approx.).....	0.8 Megohm
Grid No. 1 Voltage for G _m = μ mhos (approx.).....	-32 Volts
Minimum Diode Current with 10 Volts D C Applied.....	2 Ma

APPLICATION

The Sylvania Types 6CR6 and 12CR6 have a diode detector and remote cutoff pentode contained in one envelope. The pentode section is intended for use as an audio amplifier in which AVC voltage is applied to the No. 1 Grid for improved AVC operation in receivers.

6CR6, 12CR6 (Cont'd)

AVERAGE PLATE CHARACTERISTICS

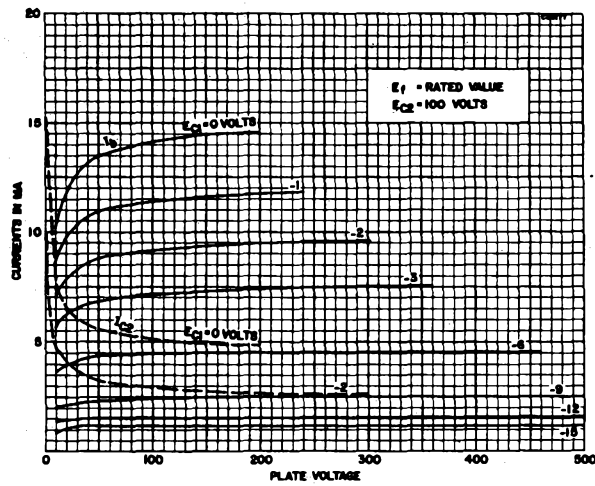

AVERAGE TRANSFER CHARACTERISTICS

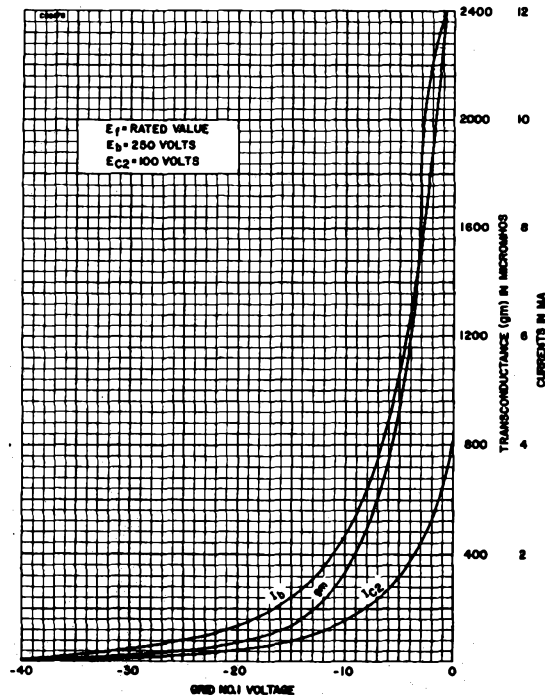

SYLVANIA ELECTRONIC TUBES

6CL6 (Cont'd)

CHARACTERISTICS AND TYPICAL OPERATION

Class A₁ Amplifier

Plate Voltage	250 Volts
Grid No. 3 Voltage	Connected to Cathode at Socket
Grid No. 2 Voltage	150 Volts
Grid No. 1 Voltage	-3.0 Volts
Peak A F Grid No. 1 Voltage	3.0 Volts
Plate Current (Maximum Signal)	31 Ma
Plate Current (Zero Signal)	30 Ma
Grid No. 2 Current (Maximum Signal)	7.2 Ma
Grid No. 2 Current (Zero Signal)	7.0 Ma
Plate Resistance (approx.)	0.15 Megohm
Transconductance	11000 μ mhos
Load Resistance	7500 Ohms
Total Harmonic Distortion	8 Percent
Maximum Signal Power Output	2.8 Watts
Grid No. 1 Bias for $I_b = 10 \mu$ a (approx.)	-14 Volts

Video Amplifier, 4 Mc Bandwidth

Plate Supply Voltage	300 Volts
Grid No. 3 Voltage	Connected to Cathode at Socket
Grid No. 2 Supply Voltage	300 Volts
Grid No. 2 Resistor	24000 Ohms
Grid No. 1 Voltage	-2.0 Volts
Grid No. 1 Resistance	0.1 Megohm
Grid No. 1 Signal Voltage (Peak to Peak)	3.0 Volts
Plate Current (Zero Signal)	30 Ma
Grid No. 2 Current (Zero Signal)	7.0 Ma
Load Resistance	3900 Ohms
Voltage Output (Peak to Peak)	132 Volts

APPLICATION

The Type 6CL6 is a miniature power pentode designed primarily for use as the video output amplifier in television receivers. It is useful for driving large television picture tubes and for wide-band amplifiers in industrial and laboratory equipment.

SYLVANIA TUBE TESTER SETTINGS

	A	B	C	D	E	F	G	Test or K
139/140	6.3	0	59	0	3	36	29	Y
	6.3	0	36	0	3	59	29	Y
219/220	6.3	4	359S	27	5	28Z	6	1
	6.3	4	258S	27	5	039Z	6	1

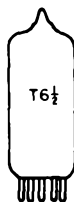

SYLVANIA TYPE 6CM6
BEAM POWER PENTODE

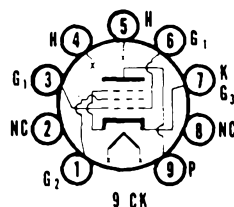

MECHANICAL DATA

Bulb	T-6 1/2, Outline 6-3
Base	Small Button 9-Pin
Basing	9CK
Mounting Position	Any

ELECTRICAL DATA

HEATER CHARACTERISTICS

Heater Voltage	6.3 Volts
Heater Current	450 Ma
Maximum Heater-Cathode Voltage	
D C, Heater Positive with Respect to Cathode	100 Volts
Total D C and Peak	200 Volts

DIRECT INTERELECTRODE CAPACITANCES (Unshielded)

Grid to Plate	0.7 μ f
Input	8.0 μ f
Output	8.5 μ f

6CM6 (Cont'd)

MAXIMUM RATINGS (Design Center Values—Except as Noted)

Class A₁ Amplifier

Plate Voltage.....	315 Volts
Plate Dissipation.....	12 Watts
Grid No. 2 Voltage.....	285 Volts
Grid No. 2 Dissipation.....	2 Watts
Grid No. 1 Circuit Resistance.....	
Fixed Bias.....	0.1 Megohm
Cathode Bias.....	0.5 Megohm

Vertical Deflection Amplifier¹

	Pentode Connected	Triode Connected
Plate Voltage.....	315	315 Volts
Peak Positive Plate Voltage (Abs. Max.).....	2000	2000 Volts
Plate Dissipation ²	8	8 Watts
Grid No. 2 Voltage.....	285	Volts
Grid No. 2 Dissipation ²	1.75	Watts
Peak Negative Grid Voltage.....	250	250 Volts
Average Cathode Current.....	40	40 Ma
Peak Cathode Current.....	120	120 Ma
Grid No. 1 Circuit Resistance, Cathode Bias..	2.2	2.2 Megohms

NOTES:

- For operation in a 525-line, 30 frame system, the duty cycle of the voltage pulse is not to exceed 15% of one scanning cycle.
- In stages operating with a grid leak bias, an adequate cathode bias resistor or other suitable means is required to protect the tube in the absence of excitation.

For Characteristics and Typical Operation refer to Type 6V6GT which is identical except for envelope size and maximum ratings.

SYLVANIA TUBE TESTER SETTINGS

	A	B	C	D	E	F	G	Test or K
139/140	6.3	0	4	0	4	026	35	Y
	6.3	0	6	0	4	024	35	Y
219/220	6.3	4	56	26	5	013Z	9	7
	6.3	4	35	26	5	016Z	9	7

TYPE 6CR6

(See Condensed Data Section)

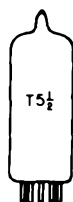

SYLVANIA TYPE 6CS6 DUAL CONTROL HEPTODE

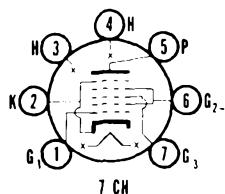

MECHANICAL DATA

Bulb.....	T-5 1/2, Outline 5-2
Base.....	Miniature Button 7-Pin
Basing.....	7CH
Mounting Position.....	Any

ELECTRICAL DATA

HEATER CHARACTERISTICS

Heater Voltage.....	6.3 Volts
Heater Current.....	300 Ma
Maximum Heater-Cathode Voltage.....	
D C, Heater Positive with Respect to Cathode.....	100 Volts
Total D C and Peak.....	200 Volts

DIRECT INTERELECTRODE CAPACITANCES (Unshielded)

Grid No. 1 to Plate.....	0.07 μ f Max
Grid No. 3 to Plate.....	0.36 μ f Max
Grid No. 1 Input (g1 to h+k+g2+g3 and g5).....	5.5 μ f
Grid No. 3 Input (g3 to h+k+g1+g2+g5).....	7.0 μ f
Output (p to All).....	7.5 μ f
Coupling (g1 to g3).....	0.22 μ f Max

6CS6 (Cont'd)

MAXIMUM RATINGS (Design Center Values)

Plate Voltage	300 Volts
Plate Dissipation	1.0 Watt
Grid No. 2 and 4 Voltage	100 Volts
Grid No. 2 and 4 Supply Voltage	300 Volts
Grid No. 2 and 4 Dissipation	1.0 Watts
Cathode Current	14 Ma
Grid No. 1 Circuit Resistance	0.47 Megohm
Grid No. 3 Circuit Resistance	2.2 Megohms

CHARACTERISTICS

Plate Voltage	10	100	100 Volts
Grid No. 2 and 4 Voltage	30	30	30 Volts
Grid No. 1 Voltage	0	0	-1.0 Volts
Grid No. 3 Voltage	0	-1.0	0 Volts
Plate Current	2.0	0.8	1.0 Ma
Grid No. 2 and 4 Current	4.5	5.5	1.3 Ma
Transconductance			
Grid No. 1			1100 μ hos
Grid No. 3	1500		μ hos
Plate Resistance (approx.)	0.7		1.0 Megohm
Grid Voltage for $I_b = 50 \mu$ a			
Grid No. 1			-2.5 Volts
Grid No. 3	-2.2		Volts

APPLICATION

Sylvania Type 6CS6 is a miniature dual control heptode designed for television service as a combined sync separator and sync clipper. A constant sync output is developed in a well-designed circuit. The sharp cutoff characteristics of grid 3 make the Type 6CS6 particularly adaptable to this type of operation.

SYLVANIA TUBE TESTER SETTINGS

	A	B	C	D	E	F	G	Test or K
139/140	6.3	0	—	0	4	46	19	V
	6.3	0	—	0	5	3	42	U
219/220	6.3	3	4	49	4	067SU	5	2
	6.3	3	4	19	4	1SU	6	2

AVERAGE PLATE CHARACTERISTICS

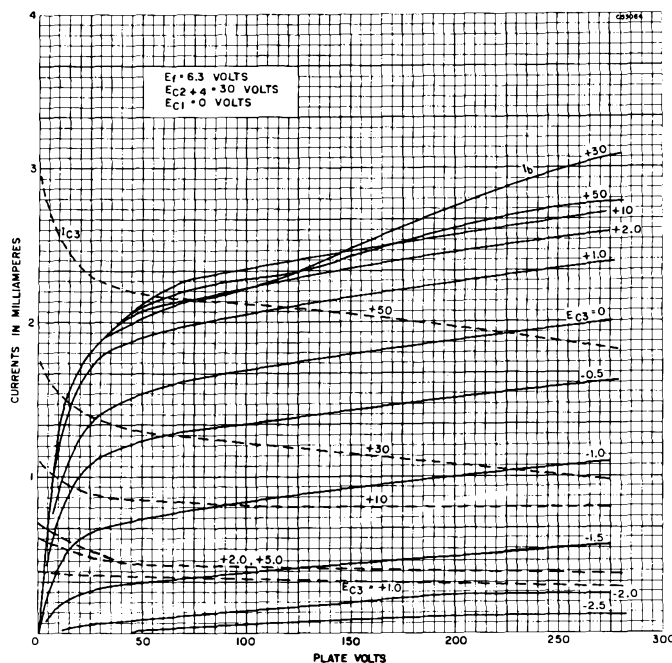

6CS6 (Cont'd)

AVERAGE PLATE CHARACTERISTICS

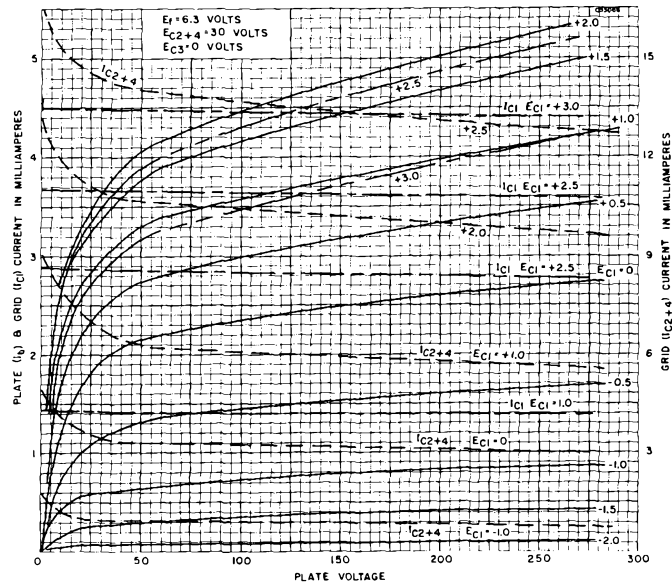

AVERAGE TRANSFER CHARACTERISTICS

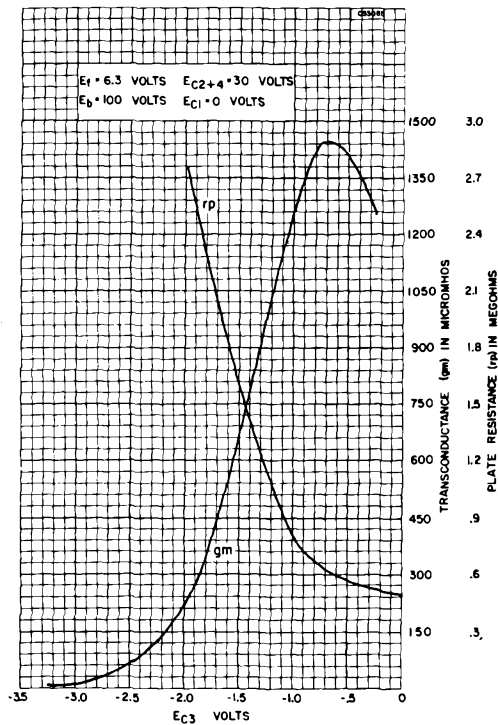

6CS6 (Cont'd)

AVERAGE TRANSFER CHARACTERISTICS

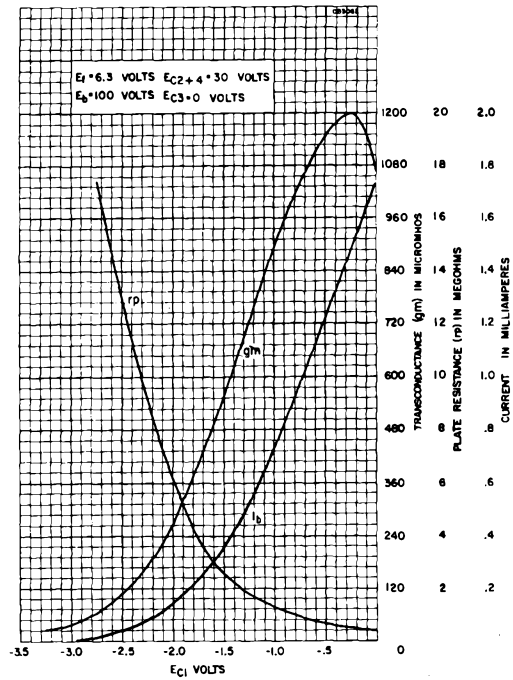

AVERAGE CHARACTERISTICS

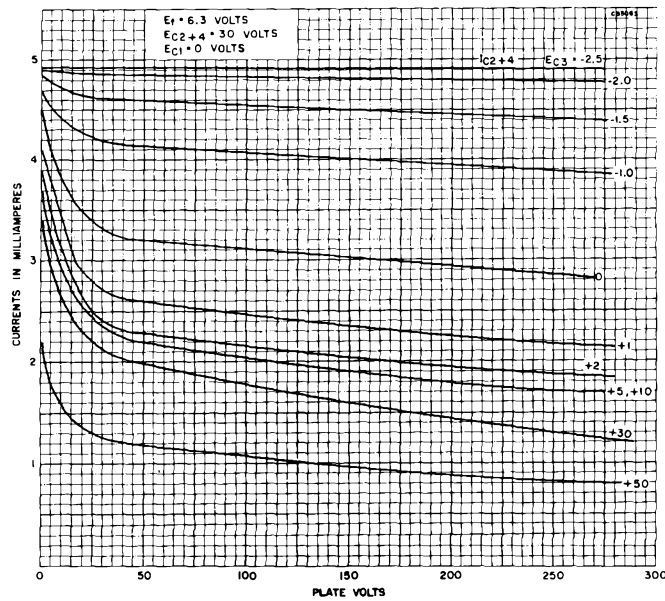



SYLVANIA TYPE 6CS7 DOUBLE TRIODE

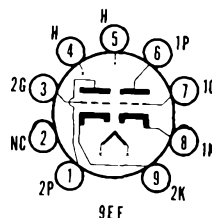

MECHANICAL DATA

Bulb	T-6 1/2
Base	E9-1, Small Button, 9-Pin
Outline	6-3
Basing	9EF
Cathode	Coated Unipotential
Mounting Position	Any

ELECTRICAL DATA

HEATER CHARACTERISTICS

Heater Voltage	6.3 Volts
Heater Current	600 Ma
Heater Warm-up Time (See Appendix)	11 Seconds
Heater-Cathode Voltage (Design Center Values)	
Heater Negative with Respect to Cathode	
Total D C and Peak	200 Volts Max.
Heater Positive with Respect to Cathode	
D C	100 Volts Max.
Total D C and Peak	200 Volts Max.

DIRECT INTERELECTRODE CAPACITANCES (Unshielded)

	Triode No. 1 ¹	Triode No. 2
Grid to Plate	2.6	2.6 μf
Input: g to (k+h+e.s.)	1.8	3.0 μf
Output: p to (k+h+e.s.)	0.5	0.5 μf

RATINGS (Design Center Values—Except as Noted)

Vertical Deflection Oscillator and Amplifier²

	Triode No. 1 ¹ (Oscillator)	Triode No. 2 (Amplifier)
D C Plate Voltage	500	500 Volts Max.
Peak Positive Pulse Plate Voltage (Abs. Max.)		2200 Volts
Peak Negative Pulse Grid Voltage	400	250 Volts Max.
Plate Dissipation ³	1.25	6.5 Watts Max.
Average Cathode Current	20	30 Ma Max.
Peak Cathode Current	70	105 Ma Max.
Grid Circuit Resistance	2.2	2.2 Megohms Max

AVERAGE CHARACTERISTICS

	Triode No. 1 ¹	Triode No. 2
Plate Voltage	250	250 Volts
Grid Voltage	-8.5	-10.5 Volts
Plate Current	10.5	19.0 Ma
Transconductance	2200	4500 μmhos
Amplification Factor	17.0	15.5
Plate Resistance	7700	3450 Ohms
Plate Current at $E_c = -16$ Volts		3.0 Ma
Grid Voltage for $I_b = 10 \mu\text{a}$	-24	Volts
Grid Voltage for $I_b = 50 \mu\text{a}$		-22 Volts

NOTES:

1. Triode No. 1 connects to pins 6, 7 and 8.
Triode No. 2 connects to pins 1, 3 and 9.
2. For operation in a 525 line, 30-frame system as described in "Standards of Good Engineering Practice for Television Broadcasting Stations; Federal Communications Commission." The duty cycle of the voltage pulse must not exceed 15% of one scanning cycle.
3. In stages operating with grid leak bias, an adequate cathode bias resistor or other suitable means is required to protect the tube in the absence of excitation.

APPLICATION

The Sylvania Type 6CS7 is a miniature double triode having dissimilar sections. Section No. 1 is intended for operation as a vertical deflection oscillator and Section No. 2 as a vertical deflection amplifier. The 6CS7 incorporates controlled heater warm-up time to insure dependable operation in television receivers employing a series heater string.

6CS7 (Cont'd)

AVERAGE PLATE CHARACTERISTICS

Triode No. 1

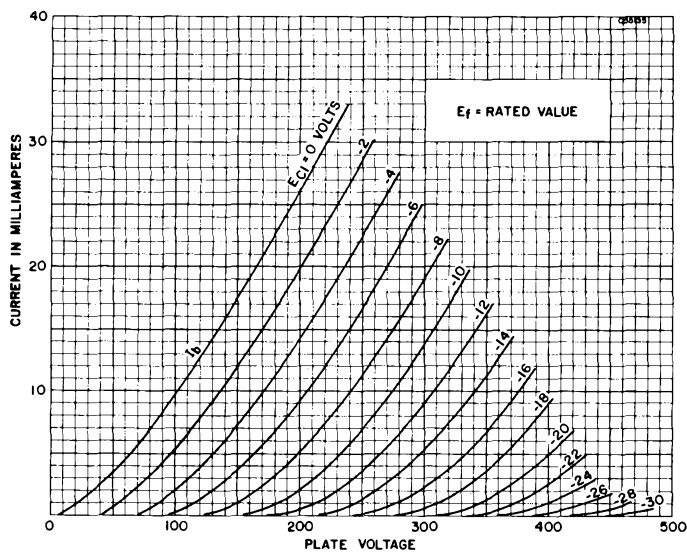

AVERAGE PLATE CHARACTERISTICS

Triode No. 2

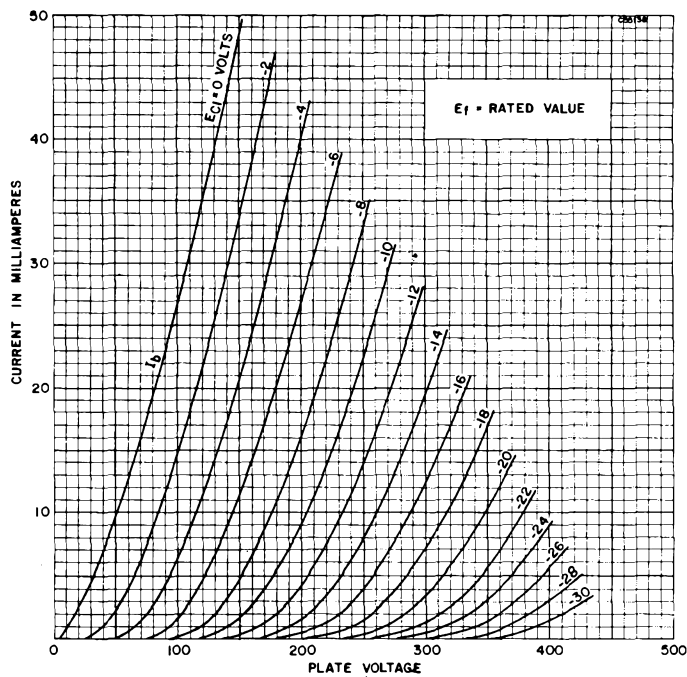

SYLVANIA ELECTRONIC TUBES

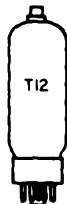

SYLVANIA TYPE 6CU6
BEAM POWER AMPLIFIER

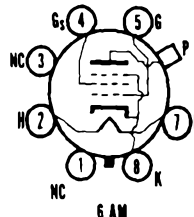

MECHANICAL DATA

Bulb.....	T-12, Outline 12-105
Base.....	Medium Shell Octal
Basing.....	6AM
Mounting Position.....	Any

ELECTRICAL DATA

HEATER CHARACTERISTICS

Heater Voltage.....	6.3 Volts
Heater Current.....	1.2 Amperes
Maximum Heater-Cathode Voltage	
Total D C and Peak.....	200 Volts
D C, Heater Positive with Respect to Cathode.....	100 Volts

DIRECT INTERELECTRODE CAPACITANCES

Grid to Plate.....	0.55 μmf
Input.....	15 μmf
Output.....	7.0 μmf

MAXIMUM RATINGS (Design Center Values)

Identical to Type 6BQ6GTA except:	
Maximum D C Plate Supply Voltage.....	550 Volts

CHARACTERISTICS AND TYPICAL OPERATION

Identical to Type 6BQ6GTA

APPLICATION

The Sylvania Type 6CU6 is a beam power amplifier designed for service as the horizontal deflection amplifier in television receivers. It has similar ratings and identical characteristics to Type 6BQ6GTA.

**TYPES 6D5G, 6D6, 6D7, 6D8G,
6DB6, 6DC6, 6DE6**

(See Condensed Data Section)

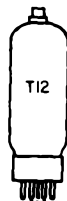

SYLVANIA TYPE 6DN6
25DN6
BEAM POWER AMPLIFIER

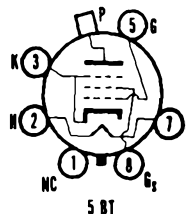

MECHANICAL DATA

Bulb.....	T-12
Base.....	B8-118, Short Medium Shell Octal, 8-Pin
Basing.....	5BT
Top Cap.....	C1-1 Small
Cathode.....	Coated Unipotential
Mounting Position.....	Vertical ¹

6DN6, 25DN6 (Cont'd)

ELECTRICAL DATA

HEATER CHARACTERISTICS

	6DN6	25DN6	
Heater Voltage	6.3	25.0 Volts	
Heater Current	2.5	0.60 Amperes	
Heater Warm-up Time (See Appendix)		11 Seconds	
Heater-Cathode Voltage (Design Center Values)			
Heater Negative with Respect to Cathode			
Total D C and Peak	200	200 Volts	Max.
Heater Positive with Respect to Cathode			
D C	100	100 Volts	Max.
Total D C and Peak	200	200 Volts	Max.

DIRECT INTERELECTRODE CAPACITANCES (Approx.)

Grid No. 1 to Plate	0.8 μmf
Input	22 μmf
Output	11.5 μmf

RATINGS (Design Center Values—Except as Noted)

Horizontal Deflection Amplifier:

D C Plate Supply Voltage			
(Boost + D C Power Supply)	700 Volts		Max.
Peak Positive Pulse Plate Voltage (Abs. Max.)	6600 Volts		
Peak Negative Pulse Plate Voltage	1500 Volts		Max.
Plate Dissipation ¹	15 Watts		Max.
Peak Negative Grid No. 1 Voltage	200 Volts		Max.
D C Grid No. 2 Voltage	175 Volts		Max.
Grid No. 2 Dissipation	3.0 Watts		Max.
Average Cathode Current	200 Ma		Max.
Peak Cathode Current	700 Ma		Max.
Grid No. 1 Circuit Resistance	0.47 Megohm		Max.
Bulb Temperature (At Hottest Point)	225° C		Max.

AVERAGE CHARACTERISTICS

Pentode Operation:

With $E_b = 125$ V, $E_{c2} = 125$ V and $E_{c1} = -18$ V

Plate Current	70 Ma
Grid No. 2 Current	6.3 Ma
Transconductance	9000 μmhos
Plate Resistance (approx.)	4000 Ohms

Zero Bias:

With $E_b = 50$ V, $E_{c2} = 100$ V and $E_{c1} = 0$ V (Instantaneous Values)

Plate Current	240 Ma
Grid No. 2 Current	30 Ma

Cutoff:

For $I_b = 0.5$ Ma with $E_b = 125$ V and $E_{c2} = 125$ V

Grid No. 1 Voltage (approx.)	-36 Volts
------------------------------	-----------

Triode Amplification Factor:

With $E_b = E_{c2} = 125$ V and $E_{c1} = -18$ V

4.35

NOTES:

- Horizontal operation permitted if plane of Pins 1 and 3 is vertical.
- For operation in a 525 line, 30 frame system as described in "Standards of Good Engineering Practice for Television Broadcasting Stations; Federal Communications Commission." The duty cycle of the voltage pulse must not exceed 15% of one scanning cycle.
- In stages operating with grid leak bias, an adequate cathode bias resistor or other suitable means is required to protect the tube in the absence of excitation.

APPLICATION DATA

The Sylvania Types 6DN6 and 25DN6 are beam power amplifiers designed for use as horizontal deflection amplifiers in television receivers having low B supply voltages. These types exhibit extremely low plate knee characteristics at zero bias.

The 25DN6 features a 25.0 volt, 600 Ma heater and controlled heater warm-up time for series string operation. Except for heater characteristics, the 25DN6 is identical to the 6DN6.

6DN6, 25DN6 (Cont'd)

AVERAGE PLATE CHARACTERISTICS

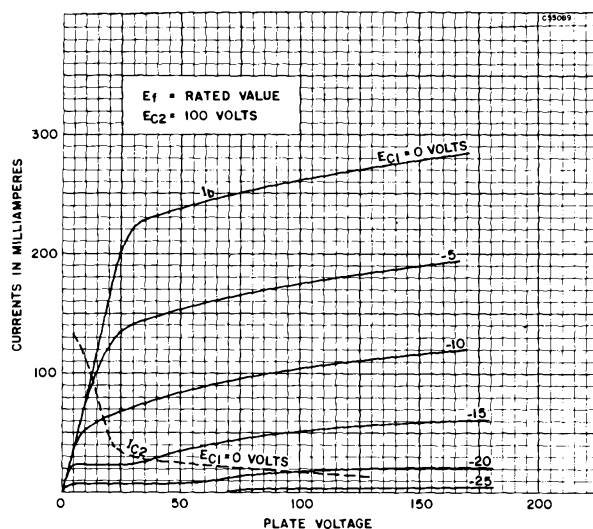

AVERAGE PLATE CHARACTERISTICS

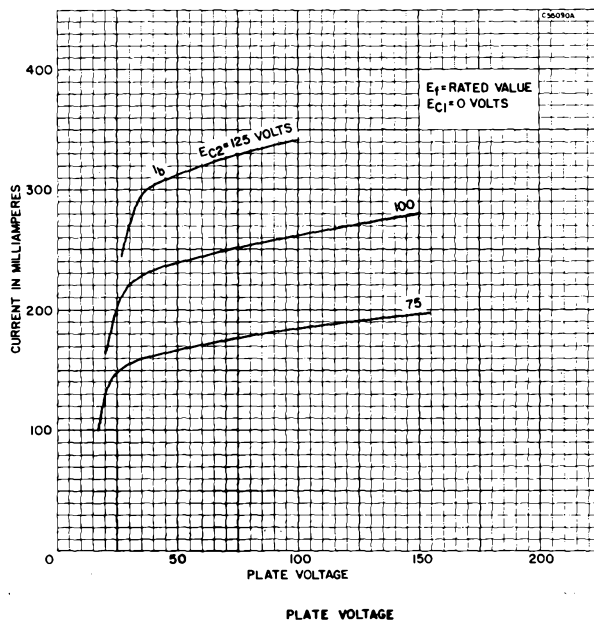

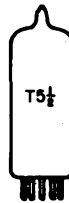

**SYLVANIA TYPE 6CU5
12CU5
17CU5**

BEAM POWER TUBE

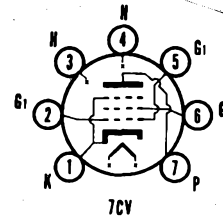

MECHANICAL DATA

Bulb.....	T-5½
Base.....	E7-1, Miniature Button, 7-Pin
Outline.....	5-3
Basing.....	7CV
Cathode.....	Coated Unipotential
Mounting Position.....	Any

ELECTRICAL DATA

HEATER CHARACTERISTICS

	6CU5	12CU5	17CU5
Heater Voltage.....	6.3	12.6	16.8 Volts
Heater Current.....	1200	600	450 Ma
Heater Warm-up Time¹.....		11	11 Seconds
Heater-Cathode Voltage (Design Center Values)			
Heater Neg. with Respect to Cath.			200 Volts Max.
Heater Pos. with Respect to Cath.	200	200	200 Volts Max.
Total D C and Peak.....	200	200	200 Volts Max.

DIRECT INTERELECTRODE CAPACITANCES (Unshielded)

Grid to Plate.....	0.7 μf
Input.....	13.2 μf
Output.....	8.6 μf

RATINGS (Design Center Values)

Plate Voltage.....	135 Volts Max.
Grid No. 2 Voltage.....	117 Volts Max.
Plate Dissipation.....	6.0 Watts Max.
Grid No. 2 Dissipation.....	1.25 Watts Max.
Positive D C Grid No. 1 Voltage.....	0 Volts Max.
Grid No. 1 Circuit Resistance	
Fixed Bias.....	0.1 Megohm Max.
Cathode Bias.....	0.5 Megohm Max.
Bulb Temperature (At hottest point).....	220° C Max.

CHARACTERISTICS AND TYPICAL OPERATION (Single Tube)

Class A₁ Amplifier

Plate Voltage.....	120 Volts
Grid No. 2 Voltage.....	110 Volts
Grid No. 1 Voltage.....	-8.0 Volts
Peak AF Grid No. 1 Voltage.....	8.0 Volts
Zero Signal Plate Current.....	49 Ma
Maximum Signal Plate Current.....	50 Ma
Zero Signal Grid No. 2 Current.....	4.0 Ma
Maximum Signal Grid No. 2 Current.....	8.5 Ma
Plate Resistance (approx.).....	10,000 Ohms
Transconductance.....	7,500 μmhos
Load Resistance.....	2,500 Ohms
Maximum Signal Power Output.....	2.3 Watts
Total Harmonic Distortion (approx.).....	10 Per cent

NOTE:

1. Heater warm-up time is defined as the time required for the voltage across the heater to reach 80% of its rated value after applying four (4) times rated heater voltage to a circuit consisting of the tube heater in series with a resistance equal to three (3) times rated heater voltage divided by rated heater current.

APPLICATION

These tubes are intended primarily for use in the audio output stage of television receivers employing low B supply voltages. The 12CU5 employs a 600 Ma heater while the 17CU5 has a 450 Ma heater. Both types have controlled heater warm-up time and are intended for use in receivers having a series heater string. The 6CU5, 12CU5 and 17CU5 exhibit characteristics similar to those of the 50C5.

SYLVANIA ELECTRONIC TUBES

Issued as a supplement to the manual in Sylvania News for Nov.-Dec. 1956

SYLVANIA TYPE 6CU5 (Cont'd)

12CU5

17CU5

AVERAGE PLATE CHARACTERISTICS

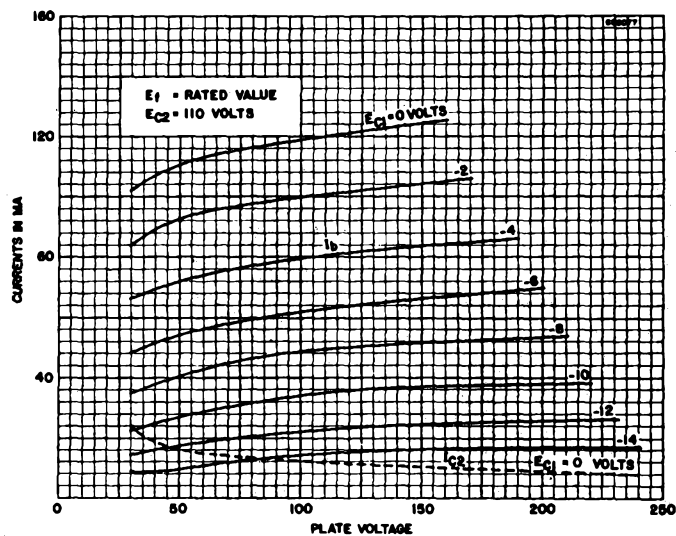

AVERAGE OPERATION CHARACTERISTICS

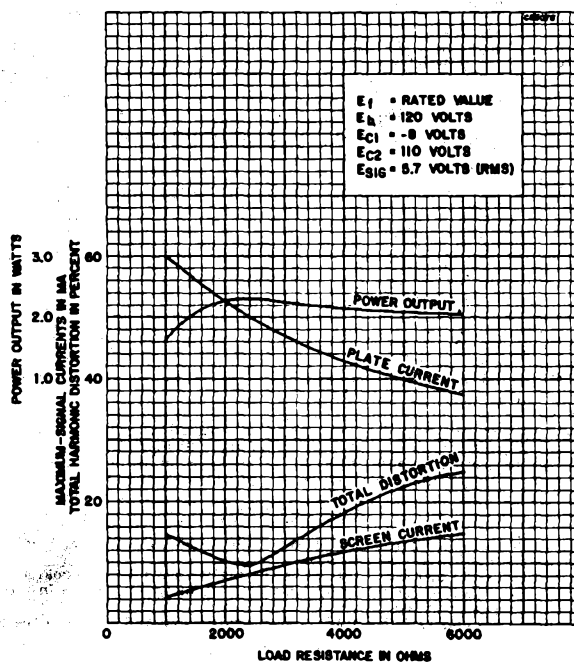

SYLVANIA ELECTRONIC TUBES



SYLVANIA TYPE 6CU8

MEDIUM MU TRIODE
SHARP CUTOFF PENTODE

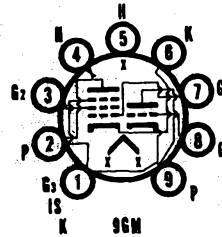

MECHANICAL DATA

Bulb	T-6 $\frac{1}{2}$
Base	E9-1, Small Button 9-Pin
Outline	6-2
Basing	9GM
Cathode	Coated Unipotential
Mounting Position	Any

ELECTRICAL DATA

HEATER CHARACTERISTICS

Heater Voltage	6.3 Volts
Heater Current	450 Ma
Heater Warm-up Time ¹	11 Seconds
Heater-Cathode Voltage (Design Center Values)	
Heater Negative with Respect to Cathode	
Total D C and Peak	200 Volts Max.
Heater Positive with Respect to Cathode	
D C	100 Volts Max.
Total D C and Peak	200 Volts Max.

DIRECT INTERELECTRODE CAPACITANCES (Unshielded)

Triode Section

Grid to Plate	1.6 μ f
Grid to (k+h+g3+I.S.)	1.9 μ f
Plate to (k+h+g3+I.S.)	1.6 μ f

Pentode Section

Grid No. 1 to Plate	0.025 μ f Max.
Grid No. 1 to (k and g3+g2+h+Tk+I.S.)	7.0 μ f
Plate to (k and g3+g2+h+Tk+I.S.)	2.4 μ f

Coupling

Pentode Grid No. 1 to Triode Plate	0.02 μ f
Pentode Plate to Triode Plate	0.04 μ f
Triode Grid to Pentode Plate	0.005 μ f

MAXIMUM RATINGS (Design Center Values)

	Triode Section	Pentode Section
Plate Voltage	300	300 Volts
Grid No. 2 Supply Voltage		300 Volts
Grid No. 2 Voltage	See 6AM8 Rating Chart	
Plate Dissipation	2.6	2 Watts
Positive Grid No. 1 Voltage	0	0 Volt
Grid No. 2 Input:		
For Grid No. 2 Voltages up to 150 Volts		0.5 Watt
For Grid No. 2 Voltages Between 150 Volts and 300 Volts	See 6AM8 Rating Chart	
Grid No. 1 Circuit Resistance		
Fixed Bias	0.5	0.25 Megohm
Self Bias	1.0	1.0 Megohm

AVERAGE CHARACTERISTICS

	Triode Section	Pentode Section
Plate Voltage	200	200 Volts
Grid No. 2 Voltage		150 Volts
Grid Voltage	-6	Volts
Cathode Bias Resistor		180 Ohms
Plate Current	13	9.5 Ma
Grid No. 2 Current		2.0 Ma
Transconductance	3300	6200 μ mhos
Amplification Factor	19	
Plate Resistance	5750	300,000 Ohms
E _{c1} for I _b = 10 μ a (approx.)	-19	-8 Volts

NOTE:

1. Heater warm-up time is defined as the time required for the voltage across the heater to reach 80% of its rated value after applying four (4) times rated heater voltage to a circuit consisting of the tube heater in series with a resistance equal to three (3) times rated heater voltage divided by rated heater current.

6CU8 (Cont'd)

APPLICATION

The Sylvania Type 6CU8 is a medium mu triode and sharp cutoff pentode contained in a T-6½ envelope. The pentode section is suitable for use as an IF, video or agc amplifier. The triode section is well suited for use in low frequency oscillator, sync-separator, sync-clipper and phase-splitter circuits. Type 6CU8 has controlled heater warm-up time for series string operation.

AVERAGE PLATE CHARACTERISTICS (PENTODE SECTION)

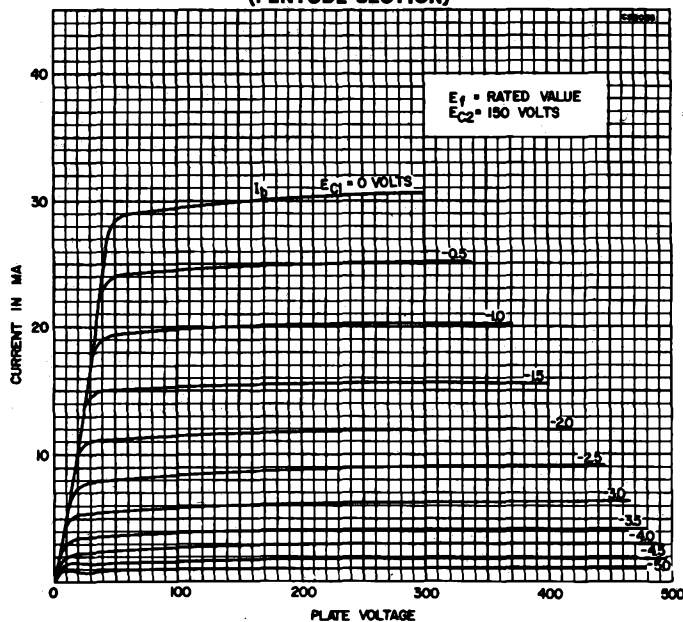

AVERAGE PLATE CHARACTERISTICS (TRIODE SECTION)

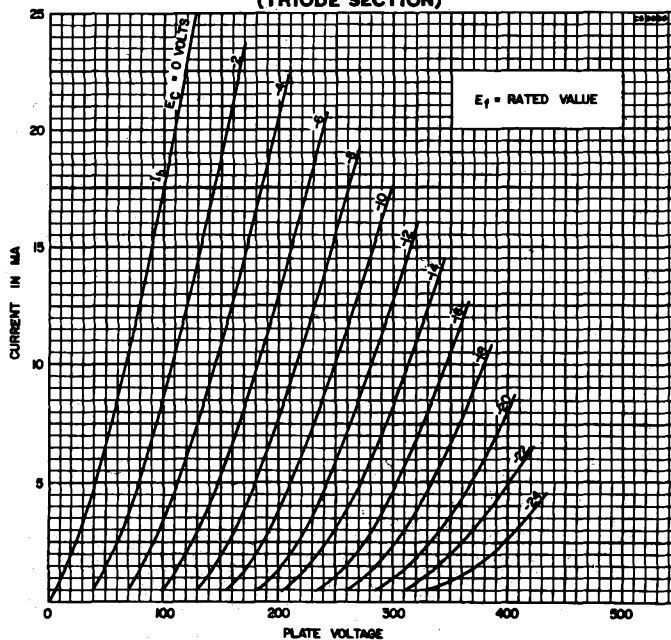

SYLVANIA ELECTRONIC TUBES

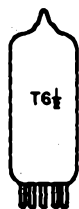

**SYLVANIA TYPE 6CX8
8CX8**
MEDIUM MU TRIODE
SHARP CUTOFF PENTODE

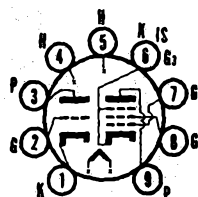

9DX

MECHANICAL DATA

Bulb	T-6½
Base	E9-1, Small Button, 9-Pin
Outline	6-3
Base	9DX
Cathode	Coated Unipotential
Mounting Position	Any

ELECTRICAL DATA

HEATER CHARACTERISTICS

	6CX8	8CX8
Heater Voltage	6.3	8.0 Volts
Heater Current	750	600 Ma
Heater Warm-up Time		11 Seconds
Heater-Cathode Voltage (Design Max. Values)		
Heater Negative with Respect to Cathode		
Total D C and Peak		200 Volts Max.
Heater Positive with Respect to Cathode		
D C		100 Volts Max.
Total D C and Peak		200 Volts Max.

DIRECT INTERELECTRODE CAPACITANCES (Unshielded)

Triode Section

Grid to Plate	4.4 μ f
Input	2.2 μ f
Output	0.38 μ f

Pentode Section

Grid No. 1 to Plate	0.06 μ f
Input	9.0 μ f
Output	4.4 μ f

Coupling

Pentode Grid No. 1 to Triode Plate	0.005 μ f Max.
Pentode Plate to Triode Grid	0.018 μ f Max.
Pentode Plate to Triode Plate	0.17 μ f Max.

MAXIMUM RATINGS (Design Maximum Values)¹

	Triode Section	Pentode Section
Plate Voltage	330	330 Volts
Grid No. 2 Supply Voltage		330 Volts
Grid No. 2 Voltage	See 6AM8 Rating Chart	
Positive Grid No. 1 Voltage	0	0 Volts
Plate Dissipation	2.0	5.0 Watts
Grid No. 2 Dissipation		1.1 Watts
Grid No. 1 Circuit Resistance		
Fixed Bias	0.5	0.25 Megohm
Cathode Bias	1.0	1.0 Megohm

CHARACTERISTICS AND TYPICAL OPERATION

	Triode Section	Pentode Section
Class A1 Amplifier		
Plate Voltage	150	200 Volts
Grid No. 2 Voltage		125 Volts
Cathode Bias Resistor	150	68 Ohms
Plate Current	9.2	24 Ma
Grid No. 2 Current		5.2 Ma
Transconductance	4600	10,000 μ mhos
Amplification Factor	40	
Plate Resistance (approx.)	8700	70,000 Ohms
Grid No. 1 Voltage for $I_b = 100 \mu$ a (approx.)	-5.0	-8.5 Volts
Plate Knee Characteristics: (Instantaneous Values)		
$E_b = 40$ Volts, $E_{c2} = 125$ Volts, $E_{c1} = 0$ Volts		
Plate Current		40 Ma
Grid No. 2 Current		15.5 Ma

NOTES:

- Heater warm-up time is defined as the time required for the voltage across the heater to reach 80% of its rated value after applying four (4) times rated heater voltage to a circuit consisting of the tube heater in series with a resistance equal to three (3) times rated heater voltage divided by rated heater current.
- Design-maximum ratings are the limiting values expressed with respect to bogie tubes at which satisfactory tube life can be expected to occur. To obtain satisfactory circuit performance, therefore, the equipment designer must establish the circuit design so that no design-maximum value is exceeded with

SYLVANIA ELECTRONIC TUBES

6CX8, 8CX8 (Cont'd)

a bottle tube under the worst probable operating conditions with respect to supply-voltage variation, equipment component variation, equipment control adjustment, load variation, and environmental conditions.

APPLICATION

The Sylvania Type 6CX8 is a miniature, medium- μ triode and a sharp-cutoff pentode. The pentode section is intended for use as a video amplifier and the triode section has a variety of low frequency amplifier and oscillator applications. The 8CX8 has controlled heater warm-up time for series string operation.

AVERAGE PLATE CHARACTERISTICS (PENTODE SECTION)

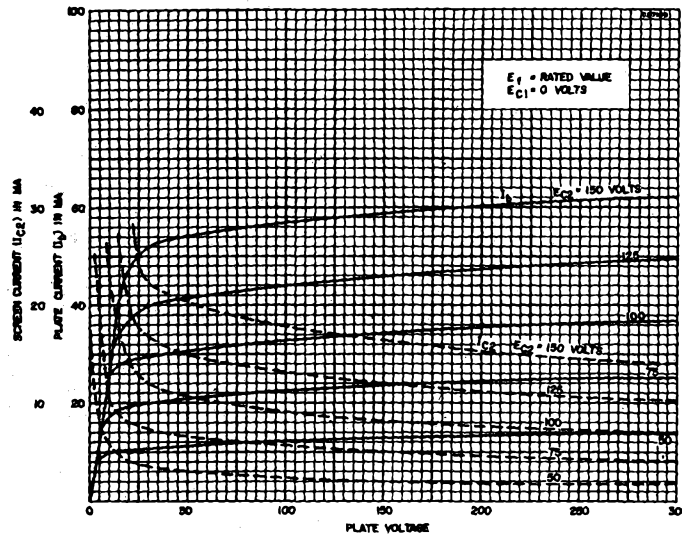

AVERAGE TRANSFER CHARACTERISTICS (TRIODE SECTION)

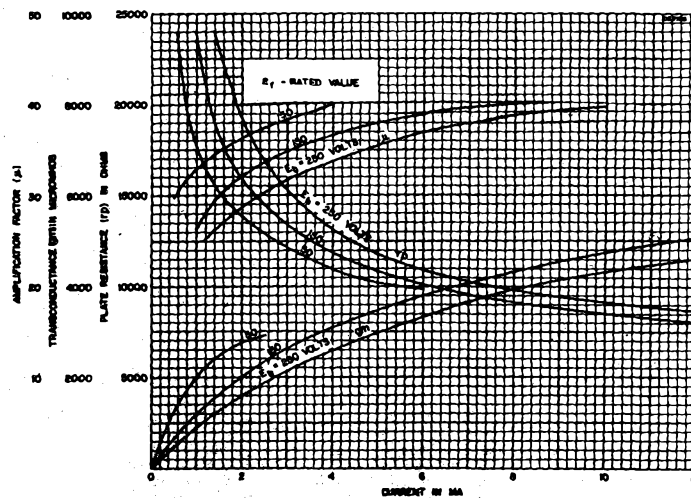



SYLVANIA TYPE 6CY5
VHF AMPLIFIER
2CY5
3CY5
4CY5

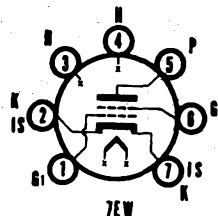

MECHANICAL DATA

Bulb	T-5½
Base	E7-1, Miniature Button 7-Pin
Outline	5-2
Basing	7EW
Cathode	Coated Unipotential
Mounting Position	Any

ELECTRICAL DATA

HEATER CHARACTERISTICS

	2CY5	3CY5	4CY5	6CY5
Heater Voltage	2.4	2.9	4.5	6.3 Volts
Heater Current	600	450	300	200 Ma
Heater Warm-up Time ¹	11	11	11	Seconds
Heater-Cathode Voltage (Design Maximum Values) ²				
Heater Negative with Respect to Cathode				100 Volts Max.
Total D C and Peak				100 Volts Max.
Heater Positive with Respect to Cathode				100 Volts Max.
Total D C and Peak				100 Volts Max.

DIRECT INTERELECTRODE CAPACITANCES (Shielded)³

Grid No. 1 to Plate	0.03 $\mu\mu\text{f}$
Input	4.5 $\mu\mu\text{f}$
Output	3.0 $\mu\mu\text{f}$

MAXIMUM RATINGS (Design Maximum Values)

Plate Voltage	180 Volts
Grid No. 2 Supply Voltage	180 Volts
Grid No. 2 Voltage	See 6AM8 Rating Chart
Plate Dissipation	2.0 Watts
Grid No. 2 Dissipation	0.5 Watts
Positive Grid No. 1 Voltage	0 Volts
Cathode Current	20 Ma

CHARACTERISTICS AND TYPICAL OPERATION

Plate Voltage	125 Volts
Grid No. 2 Voltage	80 Volts
Grid No. 1 Voltage	-1 Volt
Plate Current	10 Ma
Grid No. 2 Current	1.5 Ma
Transconductance	8000 μmhos
Plate Resistance	0.1 Megohm
Grid No. 1 Voltage for $I_b = 20 \mu\text{a}$	-6 Volts

NOTES:

- Heater warm-up time is defined as the time required for the voltage across the heater to reach 80% of its rated value after applying four (4) times rated heater voltage to a circuit consisting of the tube heater in series with a resistance equal to three times rated heater voltage divided by rated heater current.
- Design-Maximum Ratings are limiting values of operating and environmental conditions applicable to a bogey electron device of a specified type as defined by its published data, and should not be exceeded under the worst probable conditions.
 The device manufacturer chooses these values to provide acceptable serviceability of the device, taking responsibility for the effects of changes in operating conditions due to variations in device characteristics.
 The equipment manufacturer should design so that initially and throughout life no design-maximum value for the intended service is exceeded with a bogey device under the worst probable operating conditions with respect to supply-voltage variation, equipment component variation, equipment control adjustment, load variation, signal variation, and environmental conditions.

APPLICATION

The 2CY5, 3CY5, 4CY5 and 6CY5 are miniature, sharp cutoff tetrodes designed particularly for service as a vhf amplifier in television receiver tuners. Except for heater characteristics the 2CY5, 3CY5, 4CY5 and 6CY5 are identical. The 2CY5, 3CY5 and 4CY5 feature controlled heater warm-up time for use in series string television receivers.

6CY5, 2CY5, 3CY5, 4CY5 (Cont'd)

AVERAGE PLATE CHARACTERISTICS

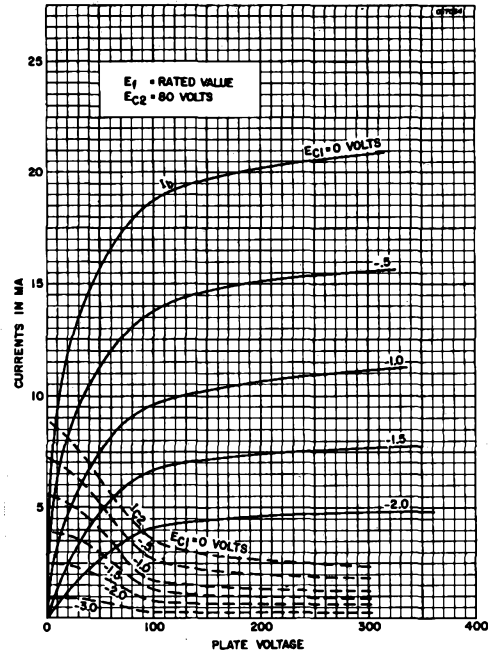

AVERAGE TRANSFER CHARACTERISTICS

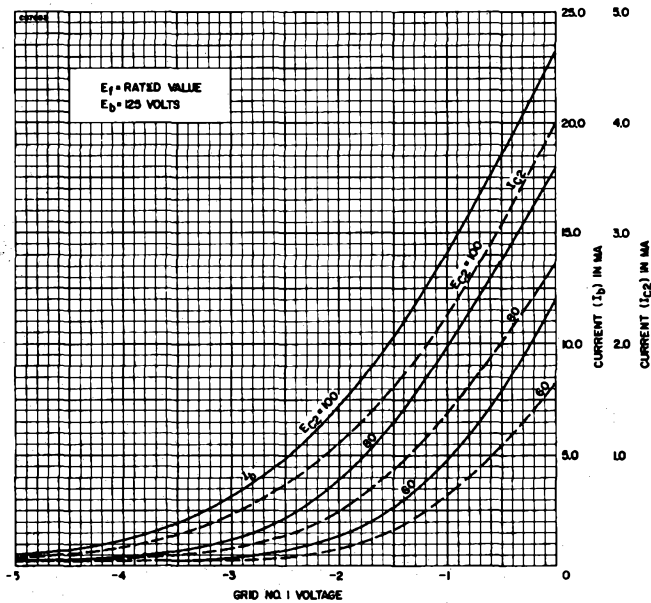

SYLVANIA ELECTRONIC TUBES

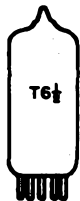

SYLVANIA TYPE 6CZ5
BEAM PENTODE AMPLIFIER

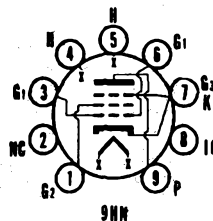

MECHANICAL DATA

Bulb	T-6 1/2
Base	E9-1, Miniature Button, 9-Pin
Outline	8-3
Basing	9HN
Cathode	Coated Unipotential
Mounting Position	Any

ELECTRICAL DATA

HEATER CHARACTERISTICS

Heater Voltage	6.3 Volts
Heater Current	450 Ma
Heater Warm-up Time ¹	11 Seconds
Heater-Cathode Voltage (Design Center Values)	
Heater Negative with Respect to Cathode	
Total D C and Peak	200 Volts Max.
Heater Positive with Respect to Cathode	
D C	100 Volts Max.
Total D C and Peak	200 Volts Max.

DIRECT INTERELECTRODE CAPACITANCES

Grid No. 1 to Plate	0.7 μ f Max.
Input: g1 to (k+h+g3+g2)	8 μ f
Output: p to (k+h+g3+g2)	8.5 μ f

MAXIMUM RATINGS (Design Center Values—Except as Noted)²

	Vertical Deflection Amp.	Class A ₁ Power Amp.
D C Plate Voltage	315	350 Volts
Peak Positive Plate Voltage (Abs. Max.)	2200 ³	Volts
D C Grid No. 2 Voltage	285	285 Volts
Peak Negative Grid No. 1 Voltage	250	Volts
Plate Dissipation	10	12 Watts
Grid No. 2 Input	2	2 Watts
Average Cathode Current	40	Ma
Peak Cathode Current	140	Ma
Grid No. 1 Circuit Resistance		
Fixed Bias	0.5	0.1 Megohm
Cathode Bias	1	1 Megohm
Bulb Temperature (At Hottest Point)	250	250 Degrees C

CHARACTERISTICS

Plate Voltage	250 Volts
Grid No. 2 Voltage	250 Volts
Grid No. 1 Voltage	-14 Volts
Plate Current	46 Ma
Grid No. 2 Current	4.6 Ma
Transconductance	4800 μ mhos
Plate Resistance (approx.)	73,000 Ohms
Grid No. 1 Voltage for I _b = 100 μ a (approx.)	-35 Volts
Instantaneous Plate Knee Values	
E _b = 70 Volts, E _{c2} = 250 Volts, E _{c1} = 0 Volts	
I _b = 130 Ma, I _{c2} = 16 Ma	

TYPICAL OPERATION

AF Power Amplifier	Single Tube Class A ₁	Push Pull Class AB ₁
Plate Voltage	250	350 Volts
Grid No. 2 Voltage	250	280 Volts
Grid No. 1 Voltage	-14	-23.5 Volts
Peak AF Grid No. 1 Voltage	13	Volts
Peak AF Grid to Grid Voltage ^{4,5}		47 Volts
Zero Signal Plate Current	46	46 Ma
Maximum Signal Plate Current	48	103 Ma
Zero Signal Grid No. 2 Current	4.6	3 Ma
Maximum Signal Grid No. 2 Current	8	13 Ma
Transconductance	4800	μ mhos
Load Resistance	5000	Ohms
Load Resistance (Plate to Plate)		7500 Ohms
Power Output	5.4	21.5 Watts
Total Harmonic Distortion	10	1 Percent

6CZ5 (Cont'd)

NOTES:

1. Heater warm-up time is defined as the time required for the voltage across the heater to reach 80% of its rated value after applying four (4) times rated heater voltage to a circuit consisting of the tube heater in series with a resistance equal to three (3) times rated heater voltage divided by rated heater current.
2. For operation in a 525-line, 30-frame system as described in "Standards of Good Engineering Practice for Television Broadcast Stations; Federal Communications Commission," the duty cycle of the pulse must not exceed 15% of one scanning cycle.
3. Under no circumstances should this absolute value be exceeded.
4. No Grid No. 1 Current should flow during any part of the input cycle.
5. Low resistance is required by the Grid No. 1 circuit such as transformer or impedance coupling devices.

APPLICATION

The Sylvania Type 6CZ5 is a miniature, beam pentode intended primarily for use as a vertical deflection amplifier or audio amplifier. The 6CZ5 has controlled heater warm-up time for series string operation.

AVERAGE PLATE CHARACTERISTICS

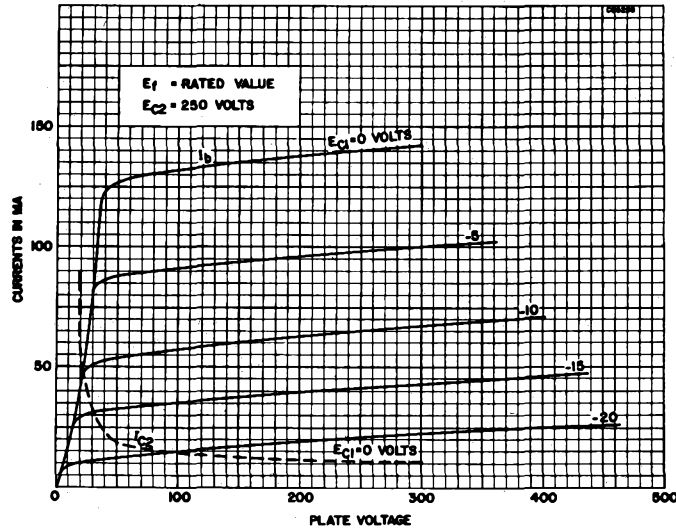

AVERAGE TRANSFER CHARACTERISTICS

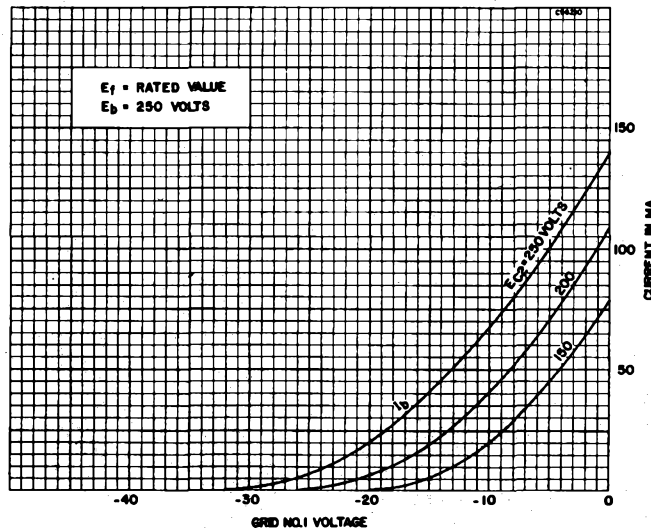

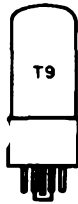

SYLVANIA TYPE 6DA4
12D4
17D4

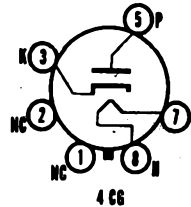

MECHANICAL DATA

Bulb.....	T-9
Base.....	B5-82 Intermediate Shell Octal 5-Pin B6-8 Intermediate Shell Octal 6-Pin B5-85 Short Intermediate Shell Octal 5-Pin B6-60 Short Intermediate Shell Octal 6-Pin
Outline.....	9-11 or 9-41
Basing ¹	4CG
Cathode.....	Coated Unipotential
Mounting Position.....	Any

ELECTRICAL DATA

HEATER CHARACTERISTICS

	6DA4	12D4	17D4	
Heater Voltage.....	6.3	12.6	16.8	Volts
Heater Current.....	1.2	0.60	0.45	Amperes
Heater Warm-up Time ²		11	11	Seconds
Heater-Cathode Voltage (Design Maximum Values)				
Heater Negative with Respect to Cathode				
D C.....	900	900	900	Volts Max.
Total D C and Peak.....	4400	4400	4400	Volts Max.
Heater Positive with Respect to Cathode				
D C.....	100	100	100	Volts Max.
Total D C and Peak.....	300	300	300	Volts Max.

DIRECT INTERELECTRODE CAPACITANCES (Approx.)

Heater to Cathode.....	3.0 μ f
Plate to Cathode and Heater.....	6.0 μ f
Cathode to Plate and Heater.....	8.0 μ f

RATINGS (Design Maximum System)³

Damper Service⁴			
Peak Inverse Plate Voltage.....	4400	Volts	Max.
Plate Dissipation.....	5.5	Watts	Max.
Steady State Peak Current.....	900	Ma	Max.
D C Plate Current.....	155	Ma	Max.
D C Plate Current (Design Center System).....	145	Ma	Max.

CHARACTERISTICS

Tube Voltage Drop for $I_b = 250$ Ma.....	22	Volts
---	----	-------

NOTES:

1. Pins 1, 2, 4 and 6 should not be used as tie points.
2. Heater Warm-up Time is defined as the time required for the voltage across the heater to reach 80% of its rated value after applying four (4) times rated heater voltage to a circuit consisting of the tube heater in series with a resistance equal to three (3) times rated heater voltage divided by rated heater current.
3. Design-Maximum Ratings are the limiting values expressed with respect to bogey tubes at which satisfactory tube life can be expected to occur. To obtain satisfactory circuit performance, therefore, the equipment designer must establish the circuit design so that no design-maximum value is exceeded with a bogey tube under the worst probable operating conditions with respect to supply-voltage variation, equipment component variation, equipment control adjustment, load variation, and environmental conditions.
4. For operation in a 525 line, 30 frame system as described in "Standards of Good Engineering Practice for Television Broadcasting Stations; Federal Communications Commission." The duty cycle of the voltage pulse not to exceed 15% of a scanning cycle.

APPLICATION NOTES:

The Sylvania Types 6DA4, 12D4, and 17D4 are indirectly heated half-wave rectifiers designed for service as damping diodes in direct-drive sweep circuits in television receivers.
The 12D4 and 17D4 have controlled heater warm-up time for series string operation.

SYLVANIA ELECTRONIC TUBES

Issued as a supplement to the manual in Sylvania News for February 1958

6DA4 (Cont'd)

12D4

17D4

AVERAGE CHARACTERISTICS

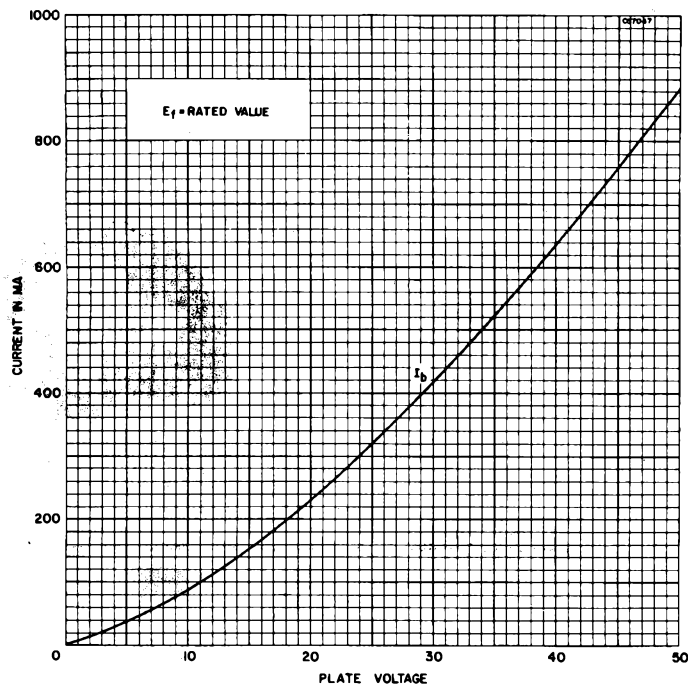

SYLVANIA ELECTRONIC TUBES



**SYLVANIA TYPE 6DB5
12DB5**
BEAM PENTODE AMPLIFIER

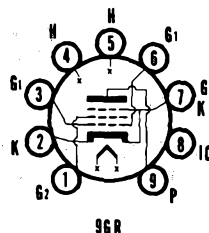

MECHANICAL DATA

Bulb	T-6½
Base	E9-1, Miniature Button, 9-Pin
Basing	9GR
Cathode	Coated Unipotential
Mounting Position	Any

ELECTRICAL DATA

HEATER CHARACTERISTICS

	6DB5	12DB5
Heater Voltage	6.3	12.6 Volts
Heater Current	1.200	0.600 Amperes
Heater Warm-up Time ¹		11 Seconds
Heater-Cathode Voltage (Design Center Values)		
Heater Negative with Respect to Cathode		
Total D C and Peak		200 Volts Max.
Heater Positive with Respect to Cathode		
D C		100 Volts Max.
Total D C and Peak		200 Volts Max.

DIRECT INTERELECTRODE CAPACITANCES

Grid No. 1 to Plate	0.5 μf Max.
Input: g1 to (k+h+B.P.+g2)	15 μf
Output: p to (k+h+B.P.+g2)	9 μf

MAXIMUM RATINGS (Design Center Values—Except as Noted)²

**Vertical Deflection
Amplifier Service**

D C Plate Voltage	300 Volts
Peak Positive Plate Voltage (Abs. Max.)	2000 ³ Volts
D C Grid No. 2 Voltage	150 Volts
Peak Negative Grid No. 1 Voltage	250 Volts
Plate Dissipation	10 Watts
Grid No. 2 Dissipation	1.25 Watts
Average Cathode Current	55 Ma
Peak Cathode Current	200 Ma
Grid No. 1 Circuit Resistance	
Fixed Bias	0.1 Megohm
Cathode Bias (Rk = 100 Ohms, Min.)	2.2 Megohms
Bulb Temperature (At Hottest Point)	250 Degrees C

TYPICAL OPERATION

AF Power Amplifier

	Triode Connected	Class A ₁ Amplifier	
Plate Voltage	225	110	200 Volts
Grid No. 2 Voltage		110	125 Volts
Grid No. 1 Voltage	-30	-7.5	Volts
Cathode Bias Resistor			180 Ohms
Peak AF Grid No. 1 Voltage		7.5	8.5 Volts
Zero Signal Plate Current		49	46 Ma
Max. Signal Plate Current		50	47 Ma
Zero Signal Grid No. 2 Current		4	2.2 Ma
Max. Signal Grid No. 2 Current		10	8.5 Ma
Plate Resistance	1500	13,000	28,000 Ohms
Transconductance	3800	8000	8000 μmhos
Load Resistance		2000	4000 Ohms
Power Output		2.1	3.8 Watts
Total Harmonic Distortion		10	10 Percent

NOTES:

1. Heater warm-up time is defined as the time required for the voltage across the heater to reach 80% of its rated value after applying four (4) times rated heater voltage to a circuit consisting of the tube heater in series with a resistance equal to three (3) times rated heater voltage divided by rated heater current.
2. For operation in a 525-line, 30-frame system as described in "Standards of Good Engineering Practice for Television Broadcast Stations; Federal Communications Commission," the duty cycle of the pulse must not exceed 15% of one scanning cycle.
3. Under no circumstances should this absolute value be exceeded.
4. No Grid No. 1 Current should flow during any part of the input cycle.

6DB5, 12DB5 (Cont'd)

APPLICATION

The Sylvania Types 6DB5 and 12DB5 are miniature, beam pentodes intended primarily for use as a vertical deflection amplifier or audio amplifier. The 12DB5 has controlled heater warm-up time for series string operation.



**SYLVANIA TYPE 6DE6
4DE6**
SHARP CUTOFF PENTODE

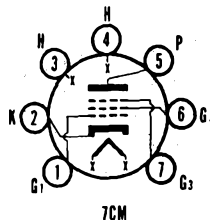

MECHANICAL DATA

Bulb	T-5 1/2
Base	E7-1, Miniature Button 7-Pin
Outline	5-2
Basing	7CM
Cathode	Coated Unipotential
Mounting Position	Any

ELECTRICAL DATA

HEATER CHARACTERISTICS

	6DE6	4DE6
Heater Voltage	6.3	4.2 Volts
Heater Current	300	450 Ma
Heater Warm-up Time ¹		11 Seconds
Heater-Cathode Voltage (Design Center Values)		
Heater Negative with Respect to Cathode		200 Volts Max.
Total D C and Peak		
Heater Positive with Respect to Cathode		100 Volts Max.
D C		200 Volts Max.
Total D C and Peak		

DIRECT INTERELECTRODE CAPACITANCES

	Shielded	Unshielded
Grid No. 1 to Plate	.015	025 μ f Max.
Input: g1 to (h+k+g2+g3+I.S.)	6.5	6.5 μ f
Output: p to (h+k+g2+g3+I.S.)	3.0	2.0 μ f

MAXIMUM RATINGS (Design-Maximum Values)²

Class A ₁ Amplifier	
Plate Voltage	330 Volts
Grid No. 2 Supply Voltage	330 Volts
Grid No. 2 Voltage	See 6AM8 Rating Chart
Plate Dissipation	2.3 Watts
Grid No. 2 Input	0.55 Watt
Positive Grid No. 1 Voltage	0 Volts

CHARACTERISTICS AND TYPICAL OPERATION

Class A ₁ Amplifier	
Plate Voltage	125 Volts
Grid No. 3 Voltage	Connected to Cathode at Socket
Grid No. 2 Voltage	125 Volts
Cathode Bias Resistor	56 Ohms
Plate Current	15.5 Ma
Grid No. 2 Current	4.2 Ma
Transconductance	8000 μ mhos
Plate Resistance (approx.)	0.25 Megohm
Transconductance with E _{c1} = -5.5, R _K = 0	700 μ mhos
E _{c1} for I _b = 20 μ a	-9 Volts

NOTES:

- Heater warm-up time is defined as the time required for the voltage across the heater to reach 80% of its rated value after applying four (4) times rated heater voltage to a circuit consisting of the tube heater in series with a resistance equal to three (3) times rated heater voltage divided by rated heater current.
- Design-maximum ratings are limiting values of operating and environmental conditions applicable to a bogey electron device of a specified type as defined by its published data, and should not be exceeded under the worst probable conditions.
The device manufacturer chooses these values to provide acceptable serviceability of the device, taking responsibility for the effects of changes in operating conditions due to variations in device characteristics.
The equipment manufacturer should design so that initially and throughout life no design-maximum value for the intended service is exceeded with a bogey device under the worst probable operating conditions with respect to supply-voltage variation, equipment component variation, equipment control adjustment, load variation, signal variation, and environmental conditions.

APPLICATION

The Sylvania 6DE6 and 4DE6 are sharp cutoff pentodes intended for service as an automatic gain controlled i f amplifier in television receivers. The 4DE6 has controlled heater warm-up time for series string operation.

SYLVANIA ELECTRONIC TUBES

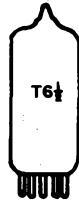

SYLVANIA TYPE **6DE7**
10DE7
13DE7

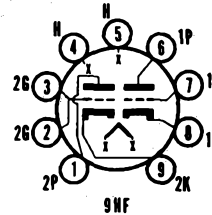

MECHANICAL DATA

Bulb	T-6½
Base	E9-1, Miniature Button 9-Pin
Outline	6-3
Basing	9HF
Cathode	Coated Unipotential
Mounting Position	Any

ELECTRICAL DATA

HEATER CHARACTERISTICS

	6DE7	10DE7	13DE7
Heater Voltage	6.3	9.7	13.0 Volts
Heater Current	900	600	450 Ma
Heater Warm-up Time ¹	—	11	11 Seconds
Heater-Cathode Voltage (Design Maximum Values) ²			
Heater Negative with Respect to Cathode	Total DC and Peak		200 Volts Max.
Heater Positive with Respect to Cathode	DC		100 Volts Max.
	Total DC and Peak		200 Volts Max.

DIRECT INTERELECTRODE CAPACITANCES (Unshielded)

	Triode No. 1	Triode No. 2
Grid to Plate	4.0	8.5 μf
Input: g to (h + k)	2.2	5.5 μf
Output: p to (h + k)	0.52	1.0 μf

RATINGS² (Design Maximum Values—Except as Noted)

Vertical Deflection Oscillator and Amplifier³

	Triode No. 1 Oscillator	Triode No. 2 Amplifier
DC Plate Voltage	330	275 Volts Max.
Peak Positive Pulse Plate Voltage (Abs. Max.)	—	1500 Volts
Peak Negative Pulse Grid Voltage	400	250 Volts Max.
Plate Dissipation ⁴	1.5	7.0 Watts Max.
Average Cathode Current	22	50 Ma Max.
Peak Cathode Current	77	175 Ma Max.
Grid Circuit Resistance	—	—
Self Bias	2.2	2.2 Megohms

AVERAGE CHARACTERISTICS

	Triode No. 1	Triode No. 2
Plate Voltage	250	150 Volts
Grid No. 1 Voltage	-11	-17.5 Volts
Plate Current	5.5	35 Ma
Transconductance	2000	6500 μmhos
Amplification Factor	17.5	6.0
Plate Resistance (approx.)	8750	925 Ohms
Grid Voltage for $I_b = 10 \mu\text{a}$	-20	— Ohms
Grid Voltage for $I_b = 50 \mu\text{a}$	—	-44 Volts
Plate Current at $E_c = -24 \text{ Vdc}$	—	10 Ma
Plate Knee Characteristics		
$E_b = 60 \text{ V}; E_c = 0$ (Instantaneous Values)	—	80 Ma

NOTES:

1. Heater warm-up time is defined as the time required for the voltage across the heater to reach 80% of the rated heater voltage after applying four (4) times rated heater voltage to a circuit consisting of the tube heater in series with a resistance equal to three (3) times the rated heater voltage divided by the rated heater current.
2. Design Maximum Ratings are the limiting values expressed with respect to bogy tubes at which satisfactory tube life can be expected to occur. To obtain satisfactory circuit performance, therefore, the equipment designed must establish the circuit design so that no design-maximum value is exceeded with a bogy tube under the worst probable operating conditions with respect to supply-voltage variation, equipment component variation, equipment control adjustment, load variation, and environmental conditions.
3. For operation in a 525 line, 30 frame system as described in "Standards of Good Engineering Practice for Television Stations; Federal Communications Commission." The duty cycle of the voltage pulse must not exceed 15% of one scanning cycle.
4. In stages operating with grid leak bias, an adequate bias resistor or other suitable means is required to protect the tube in the absence of excitation.

SYLVANIA ELECTRONIC TUBES

SYLVANIA TYPE 6DE7, 10DE7, 13DE7 (Cont'd)

APPLICATION NOTES

The Sylvania Types 6DE7, 10DE7, and 13DE7 have dissimilar double triodes contained in a miniature envelope. Triode No. 1 is intended for use as a Vertical Deflection Oscillator and Triode No. 2 is intended for use as a Vertical Deflection Amplifier. Types 10DE7 and 13DE7 have controlled heater warm-up time for series string operation.

AVERAGE PLATE CHARACTERISTICS (Triode No. 1)

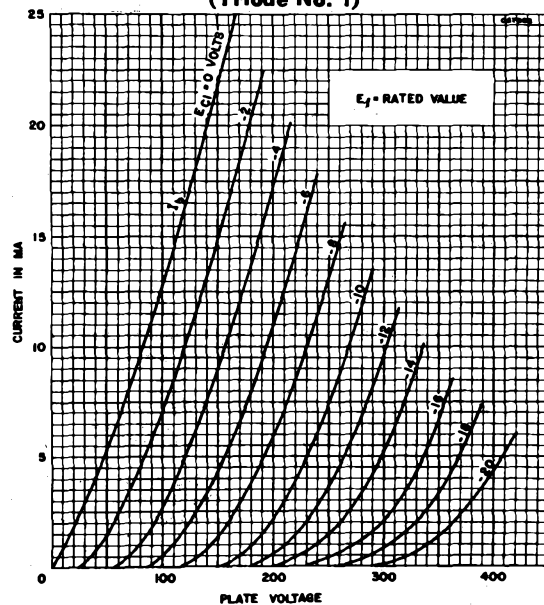

AVERAGE PLATE CHARACTERISTICS (Triode No. 2)

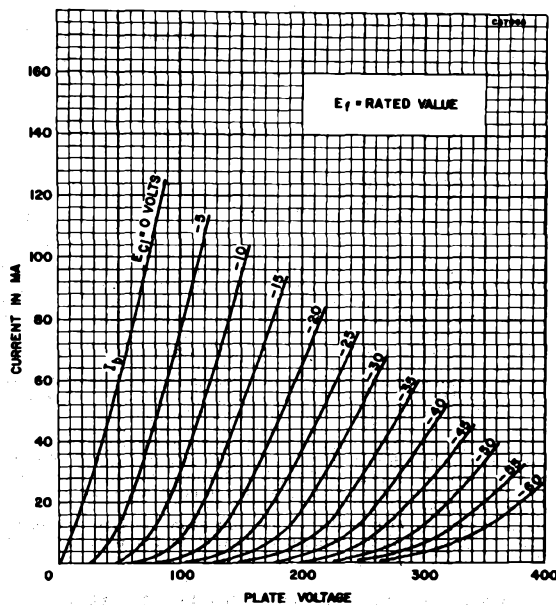

SYLVANIA ELECTRONIC TUBES

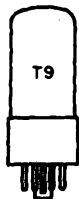

SYLVANIA TYPE 6DG6GT

PENTODE POWER AMPLIFIER

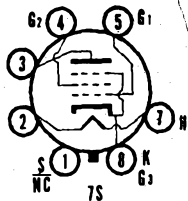

MECHANICAL DATA

Bulb.....	T-9
Base.....	B6-81 or B7-7 Intermediate Shell Octal or B6-84 or B7-59 Short Intermediate Shell Octal
Outline.....	9-11 or 9-41
Basing.....	7S
Cathode.....	Coated Unipotential
Mounting Position.....	Any

ELECTRICAL DATA

HEATER CHARACTERISTICS

Heater Voltage.....	6.3 Volts
Heater Current.....	1.2 Amperes
Heater-Cathode Voltage (Design Center Values)	
Heater Negative with Respect to Cathode	
Total D C and Peak.....	200 Volts Max.
Heater Positive with Respect to Cathode	
D C.....	100 Volts Max.
Total D C and Peak.....	200 Volts Max.

MAXIMUM RATINGS (Design Center Values)

Class A₁ Amplifier	
Plate Voltage.....	200 Volts
Grid No. 2 Voltage.....	125 Volts
Plate Dissipation.....	10 Watts
Grid No. 2 Dissipation.....	1.25 Watts
Grid No. 1 Circuit Resistance	
Fixed Bias.....	0.1 Megohm
Cathode Bias.....	0.5 Megohm

CHARACTERISTICS AND TYPICAL OPERATION (Single Tube)

Class A₁ Amplifier		
Plate Voltage.....	110	200 Volts
Grid No. 2 Voltage.....	110	125 Volts
Grid No. 1 Voltage.....	-7.5	Volts
Cathode Bias Resistor.....		180 Ohms
Peak AF Grid No. 1 Voltage.....	7.5	8.5 Volts
Zero-Signal Plate Current.....	49	46 Ma
Maximum-Signal Plate Current.....	50	47 Ma
Zero-Signal Grid No. 2 Current.....	4.0	2.2 Ma
Maximum-Signal Grid No. 2 Current.....	10	8.5 Ma
Plate Resistance (approx.).....	13,000	28,000 Ohms
Transconductance.....	8000	8000 μ mhos
Load Resistance.....	2000	4000 Ohms
Maximum-Signal Power Output.....	2.1	3.8 Watts
Total Harmonic Distortion (approx.).....	10	10 Percent

NOTE:

- Pin No. 1 omitted on bases B6-81 and B6-84.

APPLICATION

The Sylvania Type 6DG6GT is a beam power pentode intended for service as an audio power amplifier. Electrical characteristics of the 6DG6GT are identical to those of the 6W6GT.

6DG6GT (Cont'd)

AVERAGE PLATE CHARACTERISTICS

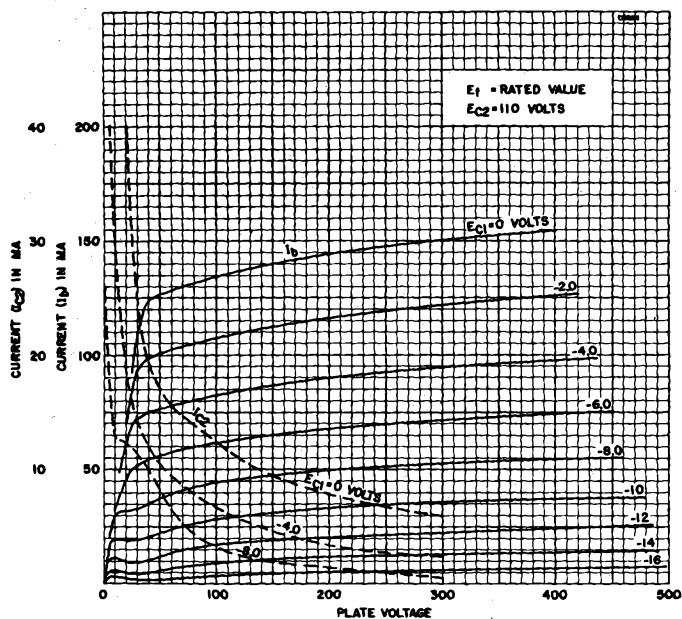

AVERAGE TRANSFER CHARACTERISTICS

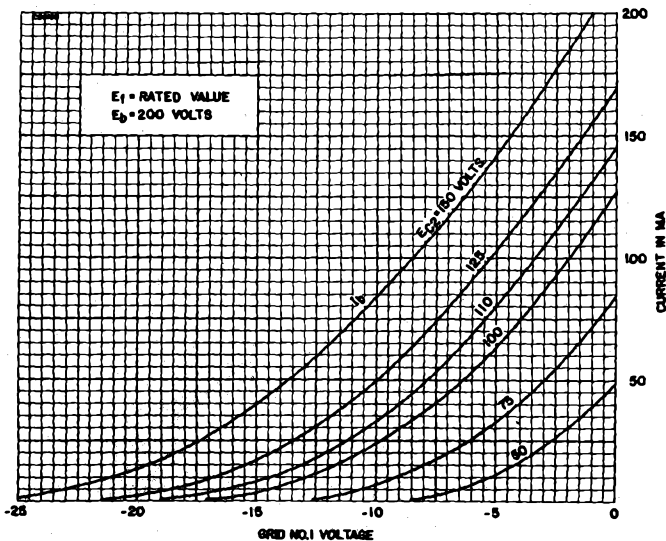

SYLVANIA ELECTRONIC TUBES



SYLVANIA TYPE 6DK6
3DK6
4DK6

SHARP CUTOFF PENTODE

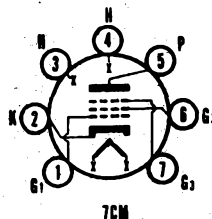

MECHANICAL DATA

Bulb.....	T-5 1/2
Base.....	E7-1, Miniature Button 7-Pin
Outline.....	5-2
Basing.....	7CM
Cathode.....	Coated Unipotential
Mounting Position.....	Any

ELECTRICAL DATA

HEATER CHARACTERISTICS

	3DK6	4DK6	6DK6
Heater Voltage.....	3.15	4.2	6.3 Volts
Heater Current.....	600	450	300 Ma
Heater Warm-up Time ¹	11	11	Seconds
Heater-Cathode Voltage (Design Center Values)			
Heater Negative with Respect to Cathode			300 Volts Max.
Total D C and Peak.....			100 Volts Max.
Heater Positive with Respect to Cathode			200 Volts Max.
D C.....			
Total D C and Peak.....			

DIRECT INTERELECTRODE CAPACITANCES (Unshielded)

Grid No. 1 to Plate.....	0.02 μf
Input.....	6.3 μf
Output.....	1.9 μf

MAXIMUM RATINGS (Design Center Values)

Plate Voltage.....	300 Volts
Grid No. 2 Voltage.....	150 Volts
Plate Dissipation.....	2.0 Watts
Grid No. 2 Dissipation.....	0.5 Watts

TYPICAL OPERATION AND CHARACTERISTICS

Plate Voltage.....	125 Volts
Grid No. 3.....	Connected to Cathode at Socket
Grid No. 2 Voltage.....	125 Volts
Cathode Bias Resistor.....	56 Ohms
Plate Current.....	12.0 Ma
Grid No. 2 Current.....	3.8 Ma
Transconductance.....	9800 μmhos
Grid No. 1 Bias for Ib of 20 μa (approx.).....	-6.5 Volts

NOTE:

1. Heater warm-up time is defined as the time required for the voltage across the heater to reach 80% of its rated value after applying four (4) times rated heater voltage to a circuit consisting of the tube heater in series with a resistance equal to three (3) times rated heater voltage divided by rated heater current.

APPLICATION

The Sylvania Types 3DK6, 4DK6 and 6DK6 are miniature sharp cutoff pentodes designed for service as if amplifiers in television receivers. Types 3DK6 and 4DK6 have controlled heater warm-up time for series string operation.

6DK6, 3DK6, 4DK6, (Cont'd)

AVERAGE PLATE CHARACTERISTICS

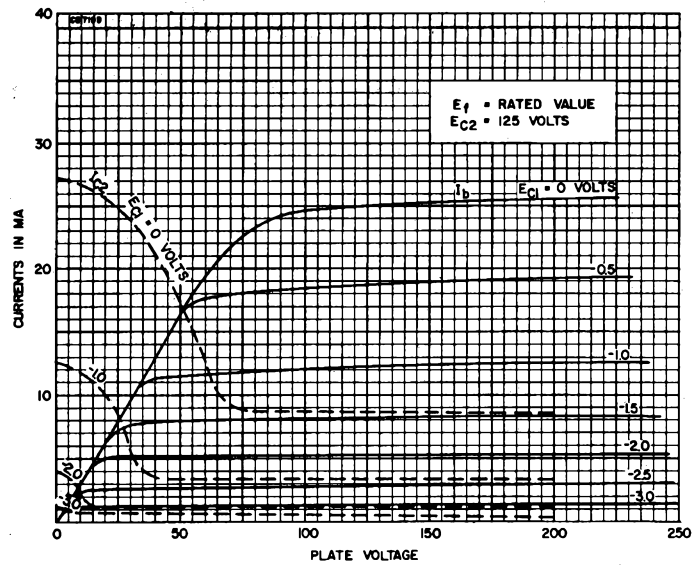

AVERAGE TRANSFER CHARACTERISTICS

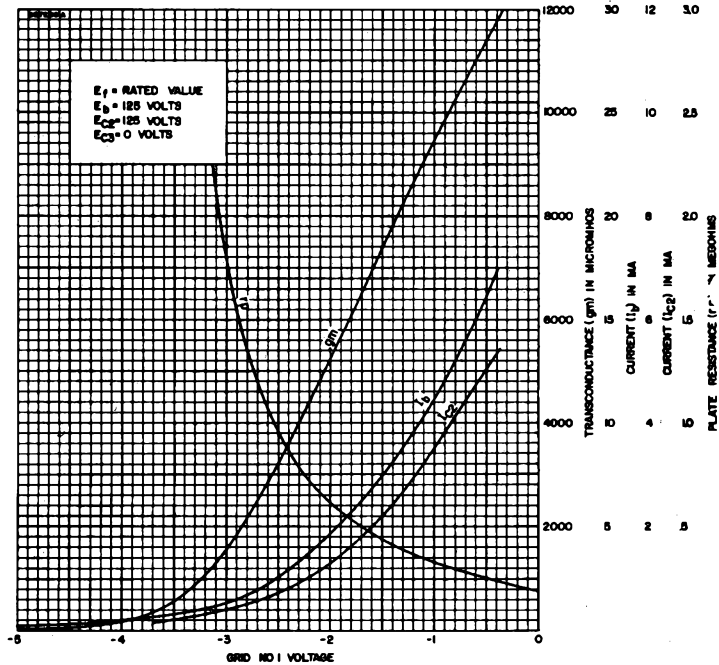



SYLVANIA TYPE **6DQ6**
12DQ6
25DQ6

BEAM POWER AMPLIFIER

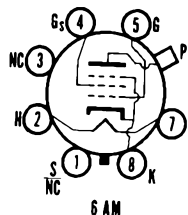

MECHANICAL DATA

Bulb.....	T-12
Base.....	B7-119, Short Medium Shell Octal, 7-Pin
Outline.....	12-105
Basing.....	6AM
Top Cap.....	C1-3 or C1-33 Skirted Miniature
Cathode.....	Coated Unipotential
Mounting Position.....	Any

ELECTRICAL DATA

HEATER CHARACTERISTICS

	6DQ6	12DQ6	25DQ6
Heater Voltage.....	6.3	12.6	25 Volts
Heater Current.....	1.2	0.6	0.3 Amperes
Heater Warm-up Time (See Appendix)		11	Seconds
Heater-Cathode Voltage (Design Center Values)			
Heater Neg. with Respect to Cathode			200 Volts Max.
Total D C and Peak.....	200	200	
Heater Pos. with Respect to Cathode			100 Volts Max.
D C.....	100	100	
Total D C and Peak.....	200	200	200 Volts Max.

DIRECT INTERELECTRODE CAPACITANCES (Approximate)

Grid No. 1 to Plate.....	0.55 μ f
Input.....	15.0 μ f
Output.....	7.0 μ f

RATINGS (Design Center Values—Except as Noted)

Horizontal Deflection Amplifier¹

D C Plate Supply Voltage (Boost + D C Power Supply)	550 Volts Max.
Peak Positive Pulse Plate Voltage (Abs. Max.)	6000 Volts
Peak Negative Pulse Plate Voltage	1375 Volts Max.
Plate Dissipation ²	15 Watts Max.
Peak Negative Grid No. 1 Voltage	300 Volts Max.
D C Grid No. 2 Voltage	175 Volts Max.
Grid No. 2 Dissipation	2.5 Watts Max.
Average Cathode Current	120 Ma Max.
Peak Cathode Current	440 Ma Max.
Grid No. 1 Circuit Resistance	0.47 Megohm Max.
Bulb Temperature (At Hottest Point)	220 Deg. C. Max.

AVERAGE CHARACTERISTICS

Pentode Operation: With $E_b = 250$ V, $E_c = 150$ V and $E_{c1} = 22.5$ V	
Plate Current.....	75 Ma
Grid No. 2 Current.....	2.4 Ma
Transconductance.....	6000 μ mhos
Plate Resistance (Approx.).....	20,000 Ohms
Zero Bias: With $E_b = 60$ V, $E_c = 150$ V and $E_{c1} = 0$ V (Instantaneous Values)	
Plate Current.....	300 Ma
Grid No. 2 Current.....	27 Ma
Cutoff: For $I_b = 1.0$ Ma with $E_b = 250$ V and $E_c = 150$ V	
Grid No. 1 Voltage (Approx.).....	-50 Volts
Triode Amplification Factor:	
With $E_b = E_c = 150$ V and $E_{c1} = -22.5$ V.....	4.1

NOTES:

- For operation in a 525 line, 30 frame system as described in "Standards of Good Engineering Practice for Television Broadcasting Stations; Federal Communications Commission." The duty cycle of the voltage pulse must not exceed 15% of one scanning cycle.
- In stages operating with grid leak bias, an adequate cathode bias resistor or other suitable means is required to protect the tube in the absence of excitation.

APPLICATIONS

The Sylvania Types 6DQ6, 12DQ6 and 25DQ6 are beam pentodes designed for service as horizontal deflection amplifiers. The 12DQ6 features a 600 Ma heater and controlled heater warm-up time for service in television receivers employing a series heater string. Other than heater characteristics, the three types are identical.

TYPES 6E5, 6E6, 6F5, 6FSG, GT

(See Condensed Data Section)

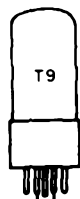

SYLVANIA TYPE 6F6 6F6G 6F6GT

PENTODE POWER AMPLIFIER

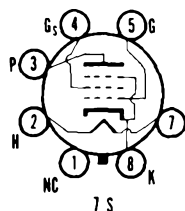

MECHANICAL DATA

	6F6	6F6G	6F6GT
Bulb.....	Metal, Outline 8-6	ST-14, Outline 14-3	T-9, Outline 9-15
Base.....	Small Wafer Octal 7-Pin	Medium Octal 7-Pin	Intermediate Octal 7-Pin
Basing.....	7S	7S	7S
Mounting Position.....	Any	Any	Any

ELECTRICAL DATA

HEATER CHARACTERISTICS

Heater Voltage.....	6.3 Volts
Heater Current.....	700 Ma

TYPICAL OPERATION

Class A Amplifier (Single Tube)

	Pentode		Triode
Plate Voltage.....	250	285	250 Volts
Grid No. 2 Voltage.....	250	285	Plate Volts
Grid No. 1 Voltage ¹	-16.5	-20	-20 Volts
Peak A F Grid Voltage.....	16.5	20	20 Volts
Plate Current (Zero Signal).....	34	38	31 Ma
Plate Current (Maximum Signal).....	36	40	34 Ma
Grid No. 2 Current (Zero Signal).....	6.5	7.0	Ma
Grid No. 2 Current (Maximum Signal).....	10.5	13	Ma
Transconductance.....	2500	2550	2600 μ mhos
Amplification Factor.....			6.8
Plate Resistance (approx.).....	80000	78000	2600 Ohms
Load Resistance.....	7000	7000	4000 Ohms
Power Output.....	3.2	4.8	0.85 Watts
Total Harmonic Distortion.....	8.0	9.0	6.5 Percent

Push-Pull Amplifier

	Class A ₁ Pentode	Class AB ₂ Pentode Triode	
Plate Voltage.....	315	375	350 Volts
Grid No. 2 Voltage.....	285	250	Plate Volts
Grid No. 1 Voltage.....	-24	-26	-38 Volts
Peak A F Grid to Grid Voltage.....	48	82	123 Volts
Plate Current (Zero Signal).....	62	34	48 Ma
Plate Current (Maximum Signal).....	80	82	92 Ma
Grid No. 2 Current (Zero Signal).....	12	5	Ma
Grid No. 2 Current (Maximum Signal).....	19.5	19.5	Ma
Load Resistance (Plate to Plate).....	10000	10000	6000 Ohms
Power Output.....	11	18.5	13 Watts
Total Harmonic Distortion.....	4.0	3.5	2.0 Percent

NOTE:

- Maximum Grid No. 1 Circuit Resistance
Fixed Bias 0.1 Megohm
Cathode Bias 0.5 Megohm

TYPES 6F7, 6F7S, 6F8G, 6G5/6H5, 6G6G, 6H4GT, 6H5

(See Condensed Data Section)



**SYLVANIA TYPE 6DQ6
12DQ6
25DQ6**

BEAM POWER AMPLIFIER

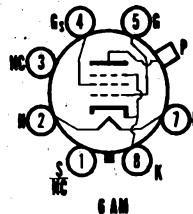

MECHANICAL DATA

Bulb	T-12
Base	B7-119, Short Medium Shell Octal, 7-Pin
Outline	12-105
Basing	6AM
Top Cap.	C1-3 or C1-33 Skirted Miniature
Cathode	Coated Unipotential
Mounting Position	Any

ELECTRICAL DATA

HEATER CHARACTERISTICS

	6DQ6	12DQ6	25DQ6
Heater Voltage	6.3	12.6	25 Volts
Heater Current	1.2	0.6	0.3 Amperes
Heater Warm-up Time (See Appendix)		11	Seconds
Heater-Cathode Voltage (Design Center Values)			
Heater Neg. with Respect to Cathode			
Total D C and Peak	200	200	200 Volts Max.
Heater Pos. with Respect to Cathode			
D C	100	100	100 Volts Max.
Total D C and Peak	200	200	200 Volts Max.

DIRECT INTERELECTRODE CAPACITANCES (Approximate)

Grid No. 1 to Plate	0.55 μ mf
Input	15.0 μ mf
Output	7.0 μ mf

SETTINGS (Design Center Values—Except as Noted)

Horizontal Deflection Amplifier¹

D C Plate Supply Voltage (Boost + D C Power Supply)	550 Volts Max.
Peak Positive Pulse Plate Voltage (Abs. Max.)	6000 Volts
Peak Negative Pulse Plate Voltage	1375 Volts Max.
Plate Dissipation ²	15 Watts Max.
Peak Negative Grid No. 1 Voltage	300 Volts Max.
D C Grid No. 2 Voltage	175 Volts Max.
Grid No. 2 Dissipation	2.5 Watts Max.
Average Cathode Current	120 Ma Max.
Peak Cathode Current	440 Ma Max.
Grid No. 1 Circuit Resistance	0.47 Megohm Max.
Bulb Temperature (At Hottest Point)	220 Deg. C. Max.

AVERAGE CHARACTERISTICS

Pentode Operation: With $E_b = 250$ V, $E_{c2} = 150$ V and $E_{c1} = -22.5$ V	
Plate Current	75 Ma
Grid No. 2 Current	2.4 Ma
Transconductance	6000 μ mhos
Plate Resistance (Approx.)	20,000 Ohms
Zero Bias: With $E_b = 60$ V, $E_{c2} = 150$ V and $E_{c1} = 0$ V (Instantaneous Values)	
Plate Current	300 Ma
Grid No. 2 Current	27 Ma
Cutoff: For $I_b = 1.0$ Ma with $E_b = 250$ V and $E_{c2} = 150$ V	
Grid No. 1 Voltage (Approx.)	-50 Volts
Triode Amplification Factor:	
With $E_b = E_{c2} = 150$ V and $E_{c1} = -22.5$ V	4.1

NOTES:

- For operation in a 525 line, 30 frame system as described in "Standards of Good Engineering Practice for Television Broadcasting Stations; Federal Communications Commission." The duty cycle of the voltage pulse must not exceed 15% of one scanning cycle.
- In stages operating with grid leak bias, an adequate cathode bias resistor or other suitable means is required to protect the tube in the absence of excitation.

APPLICATIONS

The Sylvania Types 6DQ6, 12DQ6 and 25DQ6 are beam pentodes designed for service as horizontal deflection amplifiers. The 12DQ6 features a 600 Ma heater and controlled heater warm-up time for service in television receivers employing a series heater string. Other than heater characteristics, the three types are identical.

SYLVANIA ELECTRONIC TUBES

Issued as a supplement to the manual in Sylvania News for May-June 1956

SYLVANIA ELECTRONIC TUBES

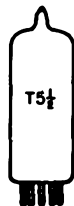

SYLVANIA TYPE 6DS5
BEAM POWER PENTODE

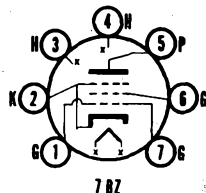

MECHANICAL DATA

Bulb.....	T-5 1/2
Base.....	E7-1, Miniature Button 7-Pin
Outline.....	5-3
Basing.....	7BZ
Cathode.....	Coated Unipotential
Mounting Position.....	Any

ELECTRICAL DATA

HEATER CHARACTERISTICS

Heater Voltage.....	6.3 Volts
Heater Current.....	800 Ma
Heater Cathode Voltage (Design Center Values)	
Heater Negative with Respect to Cathode.....	90 Volts Max.
Heater Positive with Respect to Cathode.....	90 Volts Max.

DIRECT INTERELECTRODE CAPACITANCES (Unshielded)

Grid No. 1 to Plate.....	0.19 μ f
Input: g1 to (h+k+g2+g3).....	9.5 μ f
Output: p to (h+k+g2+g3).....	6.3 μ f

MAXIMUM RATINGS (Design Center Values—Except as Noted)

Class A₁ Amplifier

Plate Voltage.....	250 Volts.
Grid No. 2 Voltage.....	250 Volts
Plate Dissipation.....	8 Watts
Grid No. 2 Input.....	2 Watts
Grid No. 1 Circuit Resistance	
Fixed Bias.....	0.1 Megohm
Cathode Bias.....	1.0 Megohm
Bulb Temperature (At Any Point).....	250 Degrees C

CHARACTERISTICS AND TYPICAL OPERATION (Single Tube)

Class A₁ Amplifier

Plate Voltage.....	200	250 Volts
Grid No. 2 Voltage.....	200	200 Volts
Cathode Bias Resistor.....	180	270 Ohms
Peak AF Grid No. 1 Voltage.....	7.5	9.2 Volts
Zero-Signal Plate Current.....	34.5	27 Ma
Maximum Signal Plate Current.....	32.5	25 Ma
Zero-Signal Grid No. 2 Current.....	3.5	3 Ma
Maximum Signal Grid No. 2 Current.....	9	9 Ma
Plate Resistance (approx.).....	28,000	28,000 Ohms
Transconductance.....	6000	5800 μ mhos
Load Resistance.....	6000	8000 Ohms
Maximum Signal Power Output.....	2.8	3.6 Watts
Total Harmonic Distortion (approx.).....	10	10 Percent

APPLICATION

The Sylvania Type 6DS5 is a miniature beam power pentode intended for service as a high efficiency and high power sensitivity audio power amplifier.



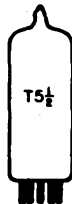

**SYLVANIA TYPE 6DT6
4DT6
3DT6**

SHARP CUTOFF PENTODE

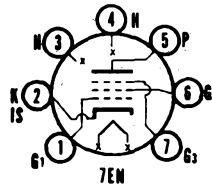

MECHANICAL DATA

Bulb.....	T-5 1/2
Base.....	E7-1, Miniature Button 7-Pin
Outline.....	5-2
Basing.....	7EN
Cathode.....	Coated Unipotential
Mounting Position.....	Any

ELECTRICAL DATA

HEATER CHARACTERISTICS

	3DT6	4DT6	6DT6
Heater Voltage.....	3.15	4.2	6.3 Volts
Heater Current.....	600	450	300 Ma
Heater Warm-up Time ¹	11	11	Seconds
Heater-Cathode Voltage (Design Center Values)			
Heater Negative with Respect to Cathode			200 Volts Max.
Total D C and Peak			
Heater Positive with Respect to Cathode			100 Volts Max.
D C			200 Volts Max.
Total D C and Peak			

DIRECT INTERELECTRODE CAPACITANCES (Shielded)²

Grid No. 1 to Plate.....	0.02 μ f
Grid No. 1 to Grid No. 3.....	0.1 μ f
Grid No. 3 to All Other Electrodes.....	6.1 μ f
Grid No. 1 to Grid No. 2, Grid No. 3, Heater, and Internal Shield and Cathode.....	5.8 μ f
Grid No. 3 to Plate.....	1.4 μ f

MAXIMUM RATINGS (Design Center Values)

Plate Voltage.....	300 Volts
Grid No. 3 Voltage.....	25 Volts
Grid No. 2 Supply Voltage.....	300 Volts
Grid No. 2 Voltage.....	See 6AM8 Rating Chart
Positive Grid No. 1 Voltage.....	0 Volts
Positive Plate Dissipation.....	1.5 Watts
Grid No. 2 Input:	
For E_{c2} up to 150 Volts.....	1.0 Watt
For E_{c2} between 150 and 300 Volts.....	See 6AM8 Rating Chart
Grid No. 1 Circuit Resistance.....	
Fixed Bias.....	0.25 Megohm
Cathode Bias.....	0.5 Megohm

CHARACTERISTICS

Class A₁ Amplifier	
Plate Supply Voltage.....	150 Volts
Grid No. 3 Supply Voltage.....	0 Volts
Grid No. 2 Supply Voltage.....	100 Volts
Cathode Bias Resistor.....	560 Ohms
Plate Current.....	1.1 Ma
Grid No. 2 Current.....	2.1 Ma
Transconductance	
Grid No. 1 to Plate.....	800 μ mhos
Grid No. 3 to Plate.....	515 μ mhos
Plate Resistance (approx.).....	0.15 Megohms
Grid No. 1 Voltage for $I_b = 10 \mu$ a (approx.).....	-4.5 Volts
Grid No. 3 Voltage for $I_b = 10 \mu$ a (approx.).....	-3.5 Volts

TYPICAL OPERATIONAL CHARACTERISTICS

Input Signal to Grid of Driver Tube.....	15	200	500 mv RMS
Plate Supply Voltage.....	250	250	250 Volts
Grid No. 3 Voltage.....	-5	-6	-6.4 Volts
Grid No. 2 Supply Voltage.....	100	100	100 Volts
Cathode Resistor.....	560	560	560 Ohms
Plate Load Resistor.....	0.27	0.27	0.27 Megohm
Plate Current.....	0.23	0.22	0.21 Ma
Grid No. 2 Current.....	3.4	5.5	6 Ma
Grid No. 1 Current.....	0.013	0.6	0.8 Ma
Bandwidth:			
For a Total Harmonic Dist. of 10%.....	65	120	118 kc
AM Rejection (approx.) ⁴	33	29	28 db
RMS Audio Output (approx.):			
With ± 7.5 kc of 4.5 Mc.....	5.5	6.5	7.5 Volts
With ± 25 kc of 4.5 Mc.....	17	21	23 Volts
Total Harmonic Distortion:			
With ± 25 kc of 4.5 Mc.....	2	3	4 Percent
Sensitivity:			
With ± 7.5 kc of 4.5 Mc.....			5 ⁵ Millivolts
With ± 25 kc of 4.5 Mc.....			15 ⁵ Millivolts

SYLVANIA ELECTRONIC TUBES

6DT6, 4DT6, 3DT6 (Cont'd)

NOTES:

1. Heater warm-up time is defined as the time required for the voltage across the heater to reach 80% of its rated value after applying four (4) times rated heater voltage to a circuit consisting of the tube heater in series with a resistance equal to three (3) times rated heater voltage divided by rated heater current.
2. External shield No. 316 connected to cathode.
3. Bias developed across the 560,000 ohms resistor by means of grid rectification obtained from the Locked Oscillator.
4. Ratio of the audio output voltage produced by 30% amplitude modulation of the 4.5 Mc carrier frequency to the audio output produced by ± 25 kc deviation from the 4.5 Mc carrier frequency, with a modulating frequency of 400 cycles in both cases.
5. Signal level at which detector circuit will handle the indicated deviation in frequency from the mean value of 4.5 Mc, before distortion occurs.

APPLICATION DATA

Types 3DT6, 4DT6 and 6DT6 are sharp cutoff pentodes contained in a miniature envelope. These types are especially suitable for use in the Locked-Oscillator, Quadrature-Grid FM detector circuit because of the sharp cutoff characteristics of Grid No. 3. They are also desirable for applications where a sharp cutoff Grid No. 3 and Grid No. 1 are required, such as in delay circuits, gain controlled amplifier circuits and mixer circuits.

Types 3DT6 and 4DT6 have controlled heater warm-up time for series string operation.

TYPICAL LOCKED-OSCILLATOR, QUADRATURE-GRID FM DETECTOR CIRCUIT

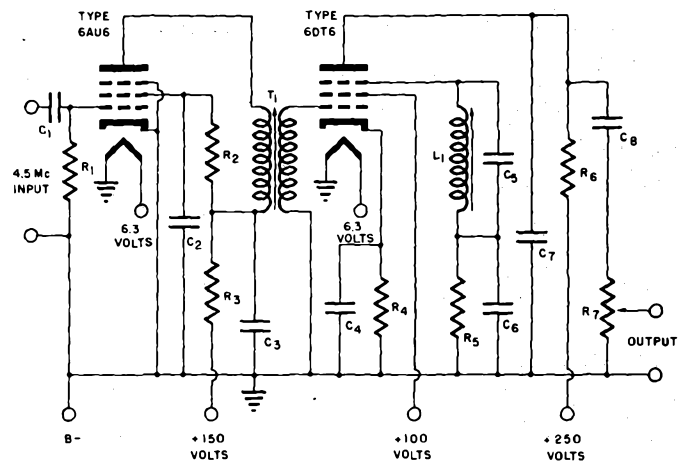

C1—47 μf
 C2, C3, C4, C8—0.01 μf
 C5—18 μf
 C6—0.05 μf
 C7—100 to 1000 μf

R1—100 K Ohms
 R2—12 K Ohms
 R3—1 K Ohm
 R4—560 Ohms
 R5—560 K Ohms
 R6—270 K Ohms
 R7—0.5 Megohm Pot.

L1—Slug-tuned inductor with a Q of 50, and tunable to 4.5 Mc.
 T1—Slug-tuned bifilar wound 4.5 Mc IF transformer with ratio of 1 to 1.5 and a Q greater than 60.



**SYLVANIA TYPE 6H6
6H6GT**
DUO DIODE

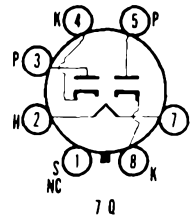

MECHANICAL DATA

	6H6	6H6GT
Bulb.....	Metal, Outline 8-5	T-9, Outline 9-11
Base.....	Small Wafer Octal 7-Pin	Intermediate Octal 7-Pin
Basing.....	7Q	7Q
Mounting Position.....	Any	Any

ELECTRICAL DATA

HEATER CHARACTERISTICS

Heater Voltage.....	6.3 Volts
Heater Current.....	300 Ma

TYPICAL OPERATION

A C Voltage per Plate (R M S).....	150 Volts Max
D C Output Current.....	8 Ma Max

TYPE 6J4

(See Condensed Data Section)

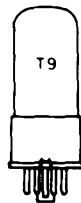

**SYLVANIA TYPE 6J5
6J5GT**
MEDIUM-MU TRIODE

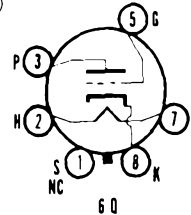

MECHANICAL DATA

	6J5	6J5GT
Bulb.....	Metal, Outline 8-3	T-9, Outline 9-12
Base.....	Small Wafer Octal 6-Pin	Small Wafer Octal 6-Pin
Basing.....	6Q	6Q
Mounting Position.....	Any	Any

ELECTRICAL DATA

HEATER CHARACTERISTICS

Heater Voltage.....	6.3 Volts
Heater Current.....	300 Ma
Maximum Heater-Cathode Voltage.....	90 Volts

DIRECT INTERELECTRODE CAPACITANCES¹

	6J5	6J5GT
Grid to Plate.....	3.4	3.8 $\mu\mu\text{f}$
Input.....	3.4	4.2 $\mu\mu\text{f}$
Output.....	3.6	5.0 $\mu\mu\text{f}$

TYPICAL OPERATION

Class A Amplifier

Plate Voltage.....	90	250 Volts
Grid Voltage ²	0	8 Volts
Plate Current.....	10.0	9.0 Ma
Transconductance (approx.).....	3000	2600 μmhos
Amplification Factor.....	20	20
Plate Resistance (approx.).....	6700	7700 Ohms

NOTES:

1. Type 6J5GT with standard shield and Type 6J5 with shell connected to cathode.
2. The D C Grid Circuit Resistance should not exceed 1.0 megohm.

APPLICATION

Type 6J5GT is similar to one section of a Type 6SN7GTA and is identical to this type in application and operating conditions. Characteristics curves for Type 6SN7GTA also apply to Type 6J5GT. It is also similar to Type 7A4. Resistance Coupled Amplifier Circuit data may be found in the Appendix.

6J5, 6J5GT (Cont'd)

SYLVANIA TUBE TESTER SETTINGS

	A	B	C	D	E	F	G	Test or K
139/140	6.3	0	—	0	1	4	36	W
219/220	6.3	2	7S	28	7	5Y	3	8

AVERAGE PLATE CHARACTERISTICS

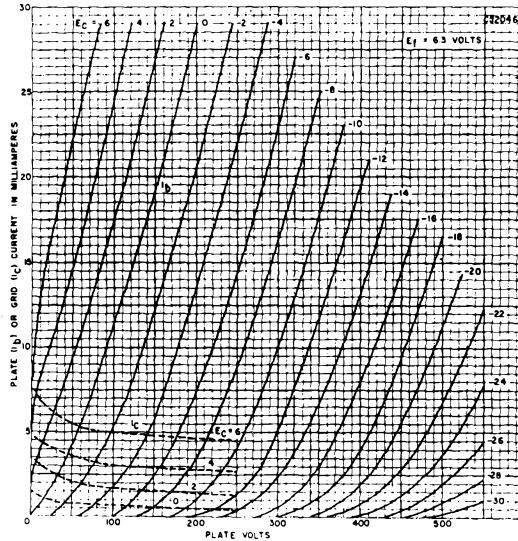

AVERAGE TRANSFER CHARACTERISTICS

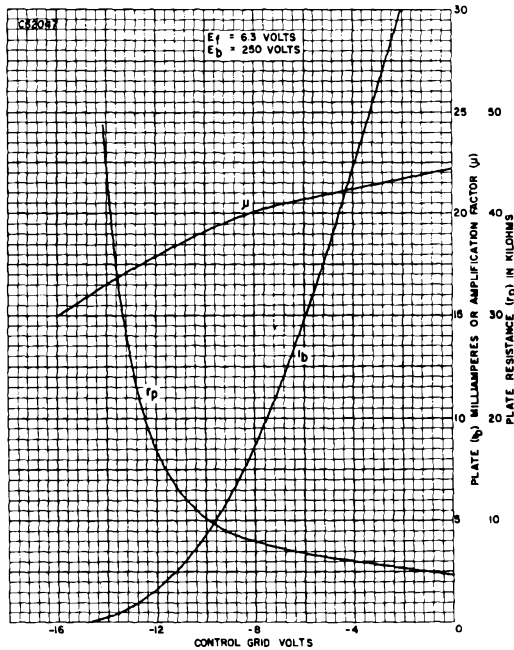



SYLVANIA TYPE 6J6

DUO TRIODE

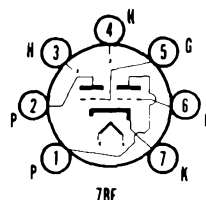

MECHANICAL DATA

Bulb.....	T-5 1/2, Outline 5-2
Base.....	Miniature Button 7-Pin
Basing.....	7BF
Mounting Position.....	Any

ELECTRICAL DATA

HEATER CHARACTERISTICS

Heater Voltage.....	6.3 Volts
Heater Current.....	450 Ma
Maximum Peak Heater-Cathode Voltage.....	100 Volts

DIRECT INTERELECTRODE CAPACITANCES (Unshielded)

Grid to Plate.....	1.6 $\mu\mu\text{f}$
Grid to Cathode.....	2.2 $\mu\mu\text{f}$
Plate to Cathode.....	0.4 $\mu\mu\text{f}$

MAXIMUM RATINGS (Design Center Values—Each Section)

Plate Voltage.....	300 Volts
Plate Dissipation.....	1.5 Watts
Plate Current.....	15 Ma
Grid Voltage.....	-40 Volts
Grid Current.....	8.0 Ma

CHARACTERISTICS AND TYPICAL OPERATION

(Each Section—Except as Noted)

Class A₁ Amplifier

Plate Voltage.....	100 Volts
Self Bias Resistor (Notes 1 & 2).....	50 Ohms
Plate Current.....	8.5 Ma
Transconductance.....	5300 μmhos
Amplification Factor.....	38
Plate Resistance.....	7100 Ohms

Class C Oscillator or R F Amplifier (Push-Pull)

Plate Voltage.....	150 Volts
Grid Voltage ³	-10 Volts
Plate Current.....	30 Ma
Grid Current.....	16 Ma
Driving Power.....	0.35 Watt
Power Output.....	3.5 Watts

Mixer Service

Plate Voltage.....	150 Volts
Cathode Bias Resistor ²	820 Ohms
Oscillator Peak Voltage.....	3 Volts
Plate Current.....	4.8 Ma
Plate Resistance.....	10000 Ohms
Conversion Transconductance.....	1900 μmhos

NOTES:

1. Value is for both sections operating as specified.
2. Under rated maximum conditions, total grid circuit resistance should not exceed 0.5 megohm. Fixed bias operation is not recommended.
3. Obtained by a grid resistor of 625 ohms or a cathode resistor of 220 ohms.

APPLICATION

Sylvania Type 6J6 is a miniature double triode employing a common uni-potential cathode. It is intended for service as a high frequency oscillator, amplifier or mixer.

When operated as a Class C amplifier at moderate frequencies, power outputs in the order of 3.5 watts may be obtained.

SYLVANIA TUBE TESTER SETTINGS

	A	B	C	D	E	F	G	Test or K
139/140	6.3	0	—	0	2	6	42	U
	6.3	0	—	0	1	5	42	U
219/220	6.3	3	4S	41	4	6X	1	7
	6.3	3	4S	41	4	5X	2	7

6J6 (Cont'd)

**AVERAGE PLATE CHARACTERISTICS
EACH SECTION**

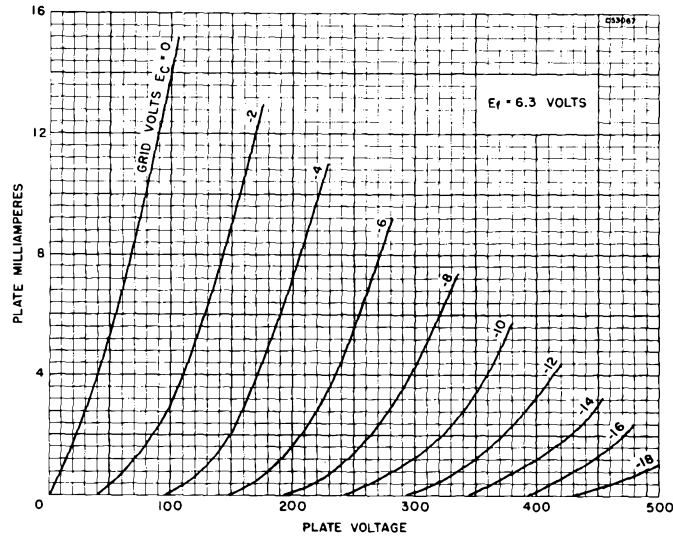

**AVERAGE TRANSFER CHARACTERISTICS
EACH SECTION**

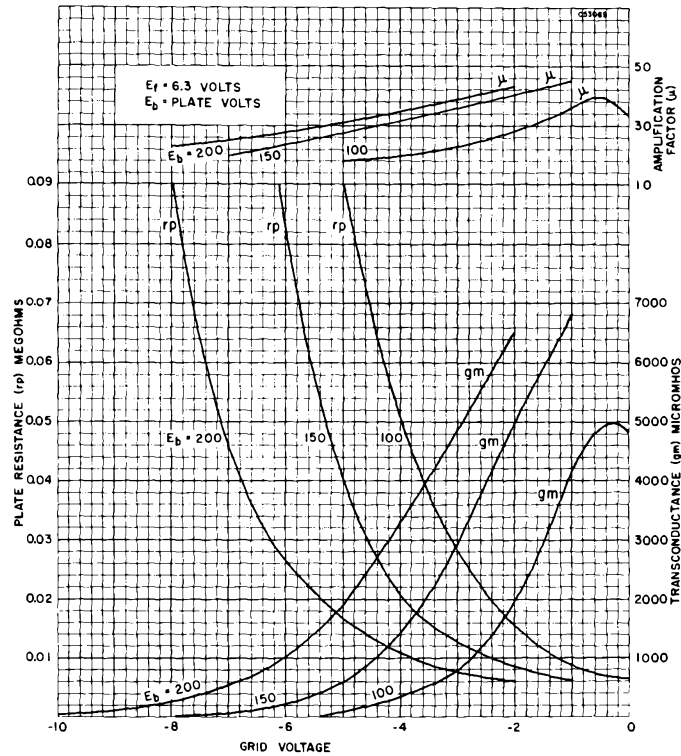

SYLVANIA ELECTRONIC TUBES

TYPES 6J7G, GT, 6J8G, 6K4, 6K5GT, G

(See Condensed Data Section)

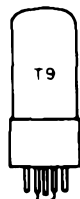

SYLVANIA TYPE 6K6GT POWER OUTPUT PENTODE

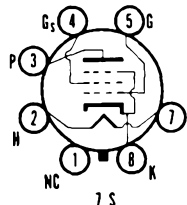

MECHANICAL DATA

Bulb	T-9, Outline 9-11
Base	Intermediate Shell Octal 7-Pin
Basing	7S
Mounting Position	Any

ELECTRICAL DATA

HEATER CHARACTERISTICS

Heater Voltage	6.3 Volts
Heater Current	400 Ma
Maximum Heater-Cathode Voltage	
Total D C and Peak	200 Volts
D C, Heater Positive with Respect to Cathode	100 Volts

DIRECT INTERELECTRODE CAPACITANCES (Unshielded)

Grid No. 1 to Plate	0.5 $\mu\mu f$
Input	5.5 $\mu\mu f$
Output	6.0 $\mu\mu f$

MAXIMUM RATINGS (Design Center Values)

Plate Voltage	315 Volts
Plate Dissipation	8.5 Watts
Grid No. 2 Voltage	285 Volts
Grid No. 2 Dissipation	2.8 Watts
Positive Grid No. 1 Voltage	0 Volts
Grid No. 1 Circuit Resistance	
Fixed Bias	0.1 Megohm
Cathode Bias	0.5 Megohm

CHARACTERISTICS AND TYPICAL OPERATION

Plate Voltage	100	250	315 Volts
Grid No. 2 Voltage	100	250	250 Volts
Grid No. 1 Bias Voltage	-7	-18	-21 Volts
Peak A F Grid Voltage	7	18	21 Volts
Plate Current (Zero Signal)	9	32	25.5 Ma
Grid No. 2 Current (Zero Signal)	1.6	5.5	4.0 Ma
Plate Current (Maximum Signal)	9.5	33	28 Ma
Grid No. 2 Current (Maximum Signal)	3	10	9 Ma
Transconductance	1500	2300	2100 μmhos
Plate Resistance (approx.)	104000	90000	110000 Ohms
Load Resistance	12000	7600	9000 Ohms
Power Output	0.35	3.4	4.5 Watts
Total Harmonic Distortion	11	11	15 Percent

Push-Pull Class A₁ Amplifier (Values for Two Tubes)

	Fixed Bias	Self Bias
Plate Voltage	285	285 Volts
Grid No. 2 Voltage	285	285 Volts
Grid No. 1 Bias Voltage	-25.5	Volts
Cathode Bias Resistor		400 Ohms
Peak A F Grid to Grid Voltage	51	51 Volts
Plate Current (Zero Signal)	55	55 Ma
Grid No. 2 Current (Zero Signal)	9	9 Ma
Plate Current (Maximum Signal)	72	61 Ma
Grid No. 2 Current (Maximum Signal)	17	13 Ma
Load Resistance (Plate to Plate)	12000	12000 Ohms
Maximum Signal Power Output	10.5	9.8 Watts
Total Harmonic Distortion	6	4 Percent

APPLICATION

Sylvania Type 6K6GT is a high efficiency pentode power amplifier designed for service at audio frequencies.

6K6GT (Cont'd)

SYLVANIA TUBE TESTER SETTINGS

	A	B	C	D	E	F	G	Test or K
139/140	6.3	0	—	0	1	034	50	Y
219/220	6.3	2	7	16	7	045Y	3	8

AVERAGE PLATE CHARACTERISTICS

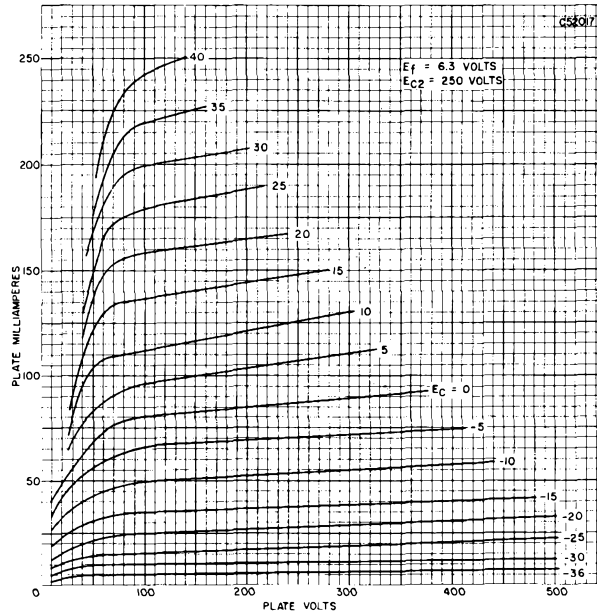

AVERAGE PLATE CHARACTERISTICS TRIODE CONNECTED

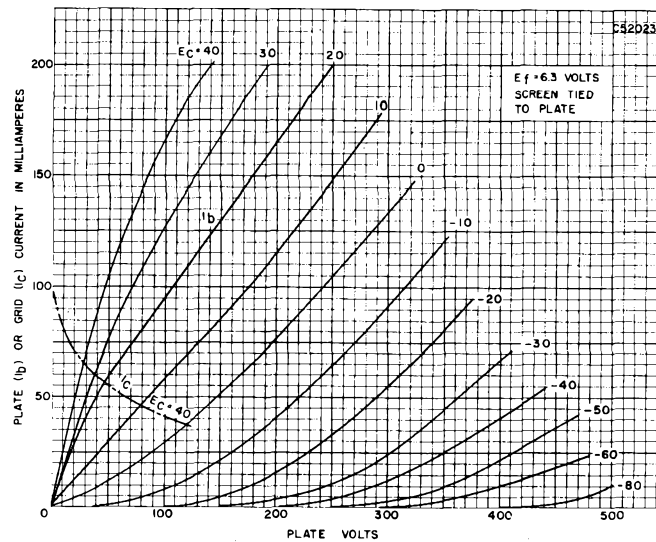

6K6GT (Cont'd)

AVERAGE CHARACTERISTICS

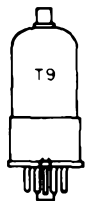
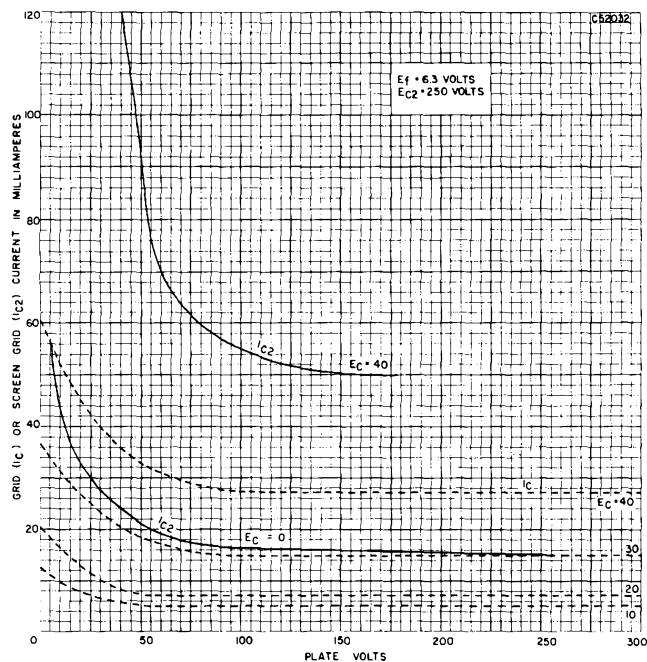

SYLVANIA TYPE **6K7**
6K7G
6K7GT

REMOTE CUTOFF R F PENTODE

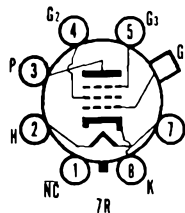

MECHANICAL DATA

	6K7	6K7G	6K7GT
Bulb.....	Metal	ST-12	T-9
Outline.....	8-4	12-8	9-18
Base.....	Small Wafer Octal	Small Octal	Small Wafer Octal
Basing.....	7R	7R	7R
Top Cap.....	Miniature	Miniature	Miniature
Mounting Position.....	Any	Any	Any

ELECTRICAL DATA

HEATER CHARACTERISTICS

Heater Voltage.....	6.3 Volts
Heater Current.....	300 Ma
Maximum Heater-Cathode Voltage.....	90 Volts

6K7, 6K7G, 6K7GT (Cont'd)

MAXIMUM RATINGS (Design Center Values)

Plate Voltage	300 Volts
Plate Dissipation	2.75 Watts
Grid No. 2 Voltage	125 Volts
Grid No. 2 Supply Voltage	300 Volts
Grid No. 2 Dissipation	.35 Watt
Positive Grid No. 1 Voltage	0 Volts

TYPICAL OPERATION

Class A₁ Amplifier

Plate Voltage	100	250	250 Volts
Grid No. 2 Voltage	100	100	125 Volts
Grid No. 1 Voltage	-1.0	-3.0	-3.0 Volts
Grid No. 3 Voltage	Tie to Cathode		
Plate Current	9.5	7.0	10.5 Ma
Grid No. 2 Current	2.7	1.7	2.6 Ma
Transconductance	1650	1450	1650 μ mhos
Plate Resistance	0.15	0.8	0.6 Megohm
Control Grid Bias for $g_m = 2 \mu$ mhos	-38.5	-42.5	-52.5 Volts

TYPES 6K8, G, GT, 6L5G

(See Condensed Data Section)



SYLVANIA TYPE 6L6
6L6G
6L6GA

BEAM POWER AMPLIFIER

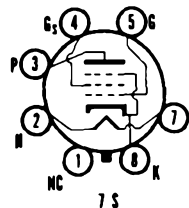

MECHANICAL DATA

	6L6	6L6G	6L6GA
Bulb	Metal	ST-16	ST-14
Base	Small Wafer Octal	Medium Octal	Medium Octal
Outline	10-1	16-3	14-3
Basing	7S	7S	7S
Mounting Position	Any	Any	Any

ELECTRICAL DATA

HEATER CHARACTERISTICS

Heater Voltage	6.3 Volts
Heater Current	900 Ma
Maximum Heater-Cathode Voltage	180 Volts

MAXIMUM RATINGS (Design Center Values)

	Triode Connection	Pentode Connection
Plate Voltage	275	360 Volts
Grid No. 2 Voltage		270 Volts
Plate Dissipation	19	19 Watts
Grid No. 2 Dissipation		2.5 Watts
Grid No. 1 Circuit Resistance		
Fixed Bias	0.1	0.1 Megohm
Cathode Bias	0.5	0.5 Megohm

6L6, 6L6G, 6L6GA (Cont'd)

CHARACTERISTICS AND TYPICAL OPERATION

Class A ₁ Amplifier (Single Tube)	Triode Connection		Pentode Connection	
Plate Voltage	250	250	300	350
Grid No. 2 Voltage	250	250	200	250
Grid No. 1 Voltage	-20	-14	-12.5	-18
Peak A F Signal Voltage	20	14	12.5	18
Plate Current (Zero Signal)	40	72	48	54
Plate Current (Max. Signal)	44	79	55	66
Grid No. 2 Current (Zero Signal)		5.0	2.5	2.5
Grid No. 2 Current (Max. Signal)		7.3	4.7	7.0
Transconductance	4700	6000	5300	5200
Plate Resistance	1700	22500	35000	33000
Load Resistance	5000	2500	4500	4200
Power Output	1.4	6.5	6.5	10.8
Total Harmonic Distortion	5	10	11	15

Push-Pull Amplifier	Class A ₁		Class AB ₁		Class AB ₂	
Plate Voltage	250	270	360	360	360	360
Grid No. 2 Voltage	250	270	270	270	225	270
Grid No. 1 Voltage	-16	-17.5	-22.5	-22.5	-18	-22.5
Peak A F Grid to Grid Voltage	32	35	45	45	52	72
Plate Current (Zero Signal)	120	134	88	88	78	88
Plate Current (Max. Signal)	140	155	132	140	142	205
Grid No. 2 Current (Zero Signal)	10	11	5	5	3.5	5
Grid No. 2 Current (Max. Signal)	16	17	15	11	11	16
Transconductance (Each Tube)	5500	5700				
Plate Resistance (Each Tube)	24500	23500				
Load Resistance	5000	5000	6600	3800	6000	3800
Power Output	14.5	17.5	26.5	18	31	47
Total Harmonic Distortion	2	2	2	2	2	2

AVERAGE PLATE CHARACTERISTICS

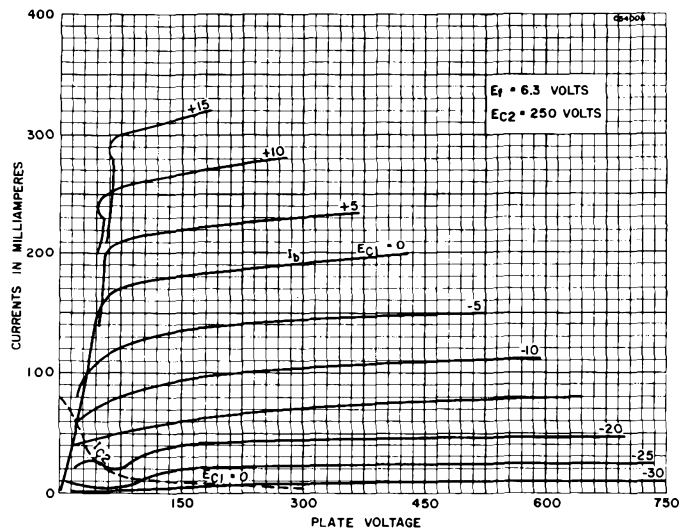

6L6, 6L6G, 6L6GA (Cont'd)

AVERAGE PLATE CHARACTERISTICS

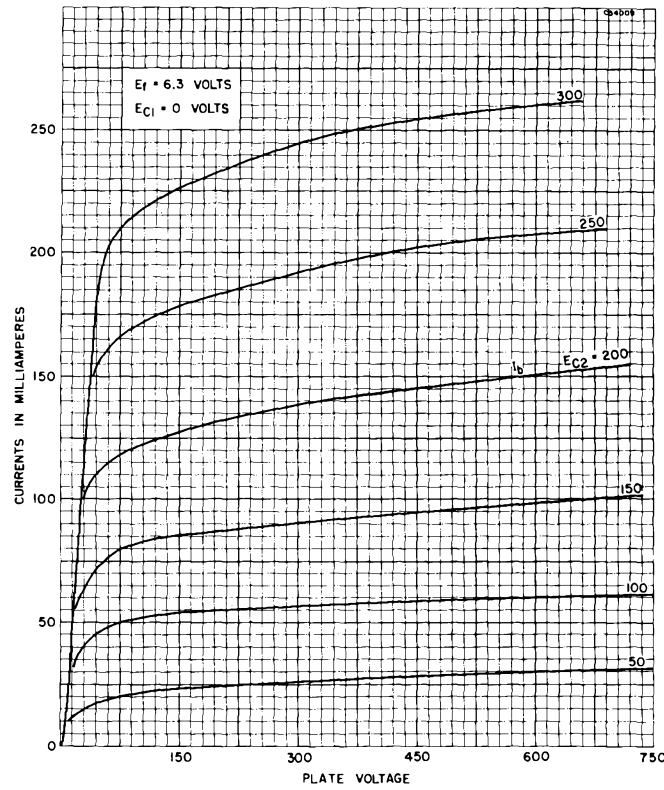

AVERAGE PLATE CHARACTERISTICS TRIODE CONNECTED

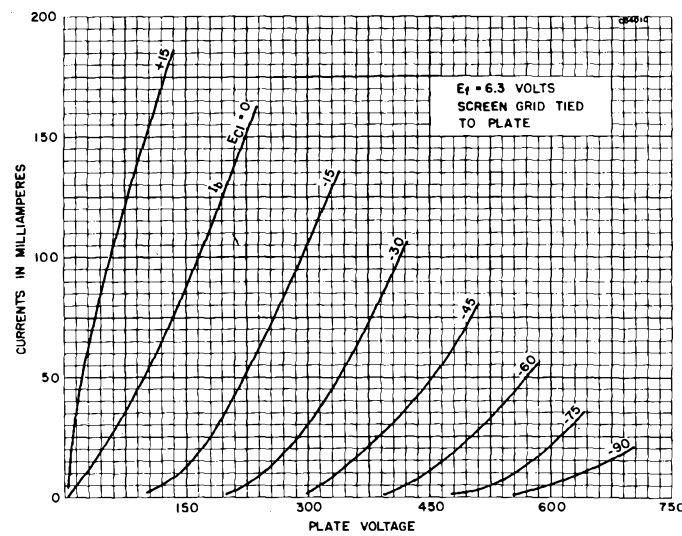

6L6, 6L6G, 6L6GA (Cont'd)

AVERAGE OPERATION CHARACTERISTICS

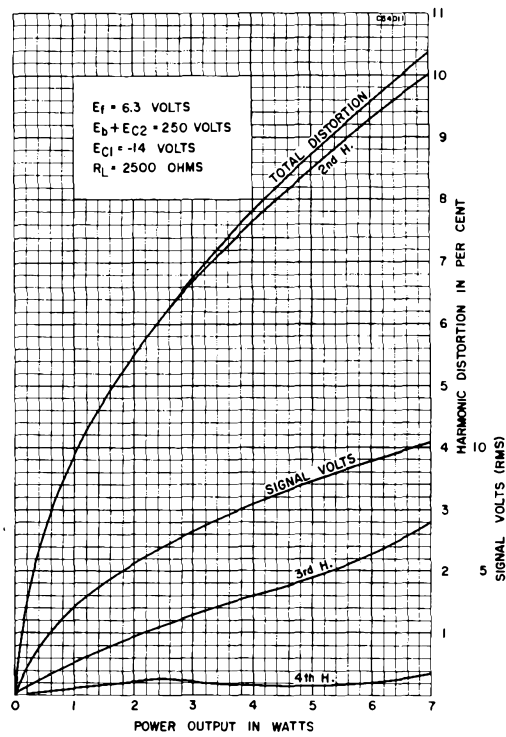

AVERAGE OPERATION CHARACTERISTICS

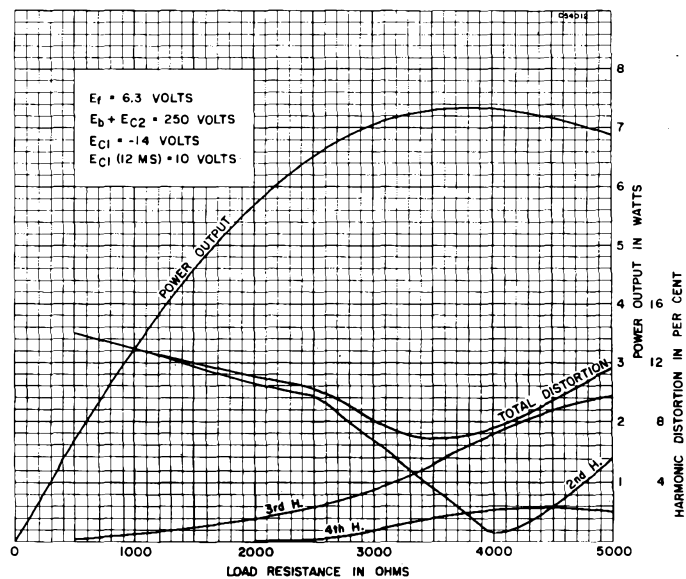

SYLVANIA TYPE 6L6GB

BEAM POWER PENTODE

MECHANICAL DATA

Bulb.....	T-12, Outline 12-102
Base.....	Med. or Short Med. Shell Octal
Basing.....	7S
Mounting Position.....	Any

The Sylvania Type 6L6GB is identical to Type 6L6 except for bulb size.

SYLVANIA TUBE TESTER SETTINGS

	A	B	C	D	E	F	G	Test or K
139/140	6.3	0	—	0	1	034	27	Y
219/220	6.3	2	7	19	7	045Z	3	8



SYLVANIA TYPE 6L7
6L7G
HEPTODE CONVERTER OR AMPLIFIER

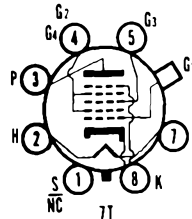

MECHANICAL DATA

	6L7	6L7G
Bulb.....	Metal, Outline 8-4	ST-12, Outline 12-8
Base.....	Small Wafer Octal	Small Octal
Basing.....	7T	7T
Top Cap.....	Miniature	Miniature
Mounting Position.....	Any	Any

ELECTRICAL DATA

HEATER CHARACTERISTICS

Heater Voltage.....	6.3 Volts
Heater Current.....	300 Ma
Maximum Heater-Cathode Voltage.....	90 Volts

TYPICAL OPERATION

Mixer

Plate Voltage.....	250	250 Volts
Grids No. 2 and 4 Voltage.....	100	150 Volts
Grid No. 1 Voltage (R F Input Grid).....	-3.0	-6.0 Volts
Grid No. 3 Voltage (Oscillator Input Grid).....	-10	-15 Volts
Peak Oscillator Voltage Applied to Grid No. 3.....	12	18 Volts
Plate Current.....	2.4	3.3 Ma
Grids No. 2 and 4 Current.....	7.1	9.2 Ma
Conversion Transconductance.....	375	350 μ mhos
Plate Resistance.....	>1.0	>1.0 Megohm
Grid No. 1 Bias for $G_c = 5 \mu$ mhos.....	-30	-45 Volts

Class A₁ Amplifier

Plate Voltage.....	250 Volts
Grids No. 2 and 4 Voltage.....	100 Volts
Grid No. 1 Voltage.....	-3 Volts
Grid No. 3 Voltage.....	-3 Volts
Plate Current.....	5.3 Ma
Grid No. 2 Current.....	6.5 Ma
Transconductance.....	1100 μ mhos
Amplification Factor.....	670
Plate Resistance.....	0.6 Megohm
Grids No. 1 and 3 Bias for $g_c = 475 \mu$ mhos.....	-6 Volts
$g_c = 75 \mu$ mhos.....	-10 Volts
$g_c = 5 \mu$ mhos.....	-15 Volts

(approx.)

TYPES 6N4, 6N6G

(See Condensed Data Section)

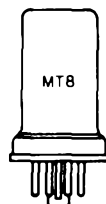

SYLVANIA TYPE **6N7**
6N7GT
DUO TRIODE POWER AMPLIFIER

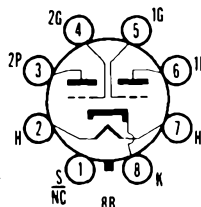

MECHANICAL DATA

	6N7	6N7GT
Bulb.....	Metal, Outline 8-6	T-9, Outline 9-11
Base.....	Small Wafer Octal 8-Pin	Intermediate Octal 8-Pin
Basing.....	8B	8B
Mounting Position.....	Any	Any

ELECTRICAL DATA

HEATER CHARACTERISTICS

Heater Voltage.....	6.3 Volts
Heater Current.....	800 Ma
Maximum Heater-Cathode Voltage.....	90 Volts

MAXIMUM RATINGS (Design Center Values)

Plate Voltage.....	300 Volts
Plate Dissipation (Per Plate).....	5.5 Watts
Dynamic Peak Plate Current (Per Plate).....	125 Ma

TYPICAL OPERATION

Class AB₂ Power Amplifier (Both Sections—Except as Noted)

Grid Impedance at 400 Cycles.....	0	516 ¹ Ohms
Plate Supply Impedance.....	0	1000 Ohms
Zero Signal Plate Voltage.....	300	300 Volts
D C Grid Voltage.....	0	0 Volts
Peak Signal Voltage (Per Grid).....	29	41 Volts
Zero Signal Plate Current (Per Plate).....	17.5	17.5 Ma
Maximum Signal Plate Current (Per Plate).....	35	35 Ma
Maximum Signal Peak Grid Current (Per Grid).....	20	22 Ma
Load Resistance (Plate to Plate).....	8000	8000 Ohms
Power Output.....	10	10 Watts
Total Harmonic Distortion.....	4	8 Percent

Class A Driver (Triodes Parallel Connected)

Plate Voltage.....	250	294 Volts
Grid Voltage.....	-5	-6 Volts
Plate Current.....	6	7 Ma
Plate Resistance.....	11300	11000 Ohms
Transconductance.....	3100	3200 μ hmos
Amplification Factor.....	35	35

NOTE:

1. The 516 ohms impedance shown consists of 500 ohms resistance and 50 mh inductance.

Data for use in Resistance Coupled Amplifier Circuits is given in the Appendix.

TYPES **6P5GT, 6P7G, 6Q6,**
6Q6G, 6Q6G/6T7G,
6Q7, G, GT, 6R6G,
6R7, GT, G, 6R8

(See Condensed Data Section)



SYLVANIA TYPE 6S4 MEDIUM-MU TRIODE

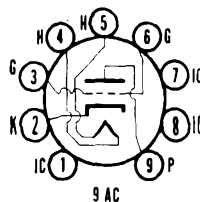

MECHANICAL DATA

Bulb	T-6 1/2, Outline 6-3
Base	Small Button 9-Pin
Basing	9AC
Mounting Position	Any

ELECTRICAL DATA

HEATER CHARACTERISTICS

Heater Voltage	6.3 Volts
Heater Current	600 Ma
Maximum Heater-Cathode Voltage Total D C and Peak	200 Volts
D C, Heater Positive with Respect to Cathode	100 Volts

DIRECT INTERELECTRODE CAPACITANCES (Unshielded)

Grid to Plate	2.6 μmf
Input	4.2 μmf
Output	0.9 μmf

MAXIMUM RATINGS (Design Center Values—Except as Noted)

Vertical Deflection Amplifier¹

Plate Voltage	500 Volts
Peak Positive Plate Voltage (Abs. Max.)	2200 Volts
Plate Dissipation ²	7.5 Watts
Peak Negative Grid Voltage	250 Volts
Average Cathode Current	30 Ma
Peak Cathode Current	105 Ma
Grid Circuit Resistance—Cathode Bias	2.2 Megohms

CHARACTERISTICS

Plate Voltage	250 Volts
Grid Voltage	-8 Volts
Plate Current	26 Ma
Transconductance	4500 μmhos
Amplification Factor	16
Plate Resistance	3600 Ohms
Plate Current at $E_c = -15 \text{ V}$	4.5 Ma
Grid Voltage for $I_b = 50 \mu\text{a}$	-23 Volts

Vertical Deflection Amplifier

70° Picture Tube—15 kv 2nd Anode Voltage

Plate Supply Voltage	435 Volts
Plate Output Voltage	
Peak to Peak	900 Volts
Sawtooth Component	320 Volts
Grid Input Voltage	
Peak to Peak	60 Volts
Sawtooth Component	40 Volts
Average Cathode Current	16 Ma
Peak Cathode Current	40 Ma
Cathode Resistor	1200 Ohms

NOTES:

- For operation in a 525-line, 30 frame system, the duty cycle of the voltage pulse must not exceed 15% of one scanning cycle.
- In stages operating with grid leak bias, an adequate cathode bias resistor or other suitable means is required to protect the tube in the absence of excitation.

APPLICATION

The Sylvania Type 6S4 is a miniature medium mu triode designed for use as a vertical deflection amplifier in television receivers.

SYLVANIA TUBE TESTER SETTINGS

	A	B	C	D	E	F	G	Test or K
139/140	6.3	0	2679	0	4	4	39	Y
219/220	6.3	4	13578	27	5	6Z	9	2

6S4 (Cont'd)

AVERAGE PLATE CHARACTERISTICS

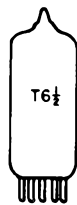
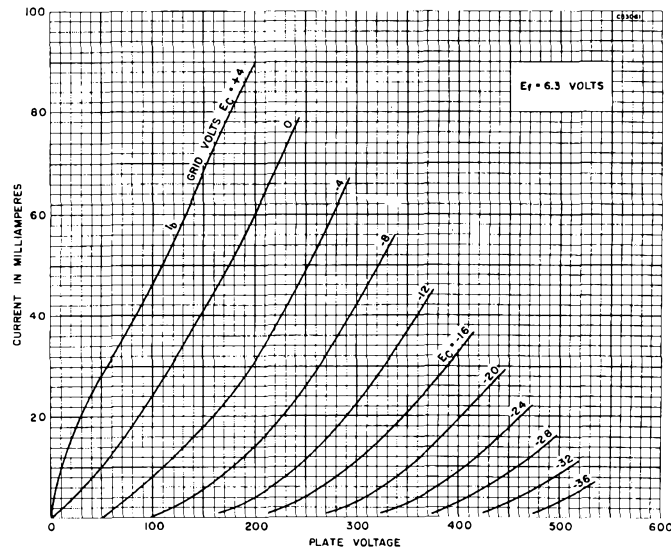

SYLVANIA TYPE 6S4A MEDIUM MU TRIODE

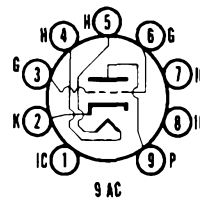

ELECTRICAL DATA

HEATER CHARACTERISTICS

Heater Voltage.....	6.3 Volts
Heater Current.....	600 Ma
Heater Warm-up Time (See SERIES STRING HEATERS Section in Appendix)	
Maximum Heater-Cathode Voltage	
Total D C and Peak.....	200 Volts
D C, Heater Positive with Respect to Cathode.....	100 Volts

For other rating, operation, and application data, refer to corresponding Type 6S4, which is identical except for heater ratings.

APPLICATION

The Sylvania Type 6S4A is intended for service in television receivers employing series connected heaters. For information on specially controlled heaters for series string operation refer to the SERIES STRING HEATERS section of the Appendix.

TYPES 6S7, G

(See Condensed Data Section)

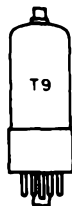

SYLVANIA TYPE 6S8GT

TRIPLE DIODE TRIODE

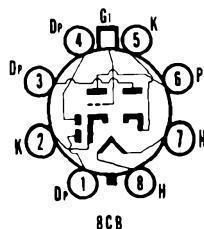

8CB

MECHANICAL DATA

Bulb.....	T-9, Outline 9-23
Base.....	Intermediate Octal 8-Pin
Basing.....	8CB
Top Cap.....	Miniature
Mounting Position.....	Any

ELECTRICAL DATA

HEATER CHARACTERISTICS

Heater Voltage.....	6.3 Volts
Heater Current.....	300 Ma
Maximum Heater-Cathode Voltage.....	90 Volts

TYPICAL OPERATION

Plate Voltage.....	100	250	Volts
Grid Voltage.....	-1.0	-2.0	Volts
Plate Current.....	0.4	0.9	Ma
Transconductance.....	900	1100	μ mhos
Amplification Factor.....	100	100	
Plate Resistance.....	0.11	0.091	Megohm
Average Diode Current with 10 Volts Applied (Each Diode).....	2.5	2.5	Ma

Data for use in Resistance Coupled Amplifier Circuits is given in the Appendix.

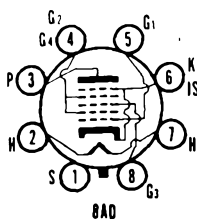

8AD

SYLVANIA TYPE 6SA7 6SA7GT

HEPTODE CONVERTER

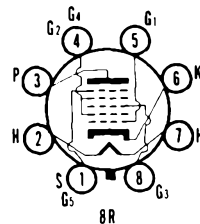

8R

MECHANICAL DATA

	6SA7	6SA7GT
Bulb.....	Metal, Outline 8-1	T-9, Outline 9-11
Base.....	Small Wafer Octal 8-Pin	Intermediate Octal 8-Pin
Basing.....	8R	8AD
Mounting Position.....	Any	Any

ELECTRICAL DATA

HEATER CHARACTERISTICS

Heater Voltage.....	6.3 Volts
Heater Current.....	300 Ma
Maximum Heater-Cathode Voltage.....	90 Volts

DIRECT INTERELECTRODE CAPACITANCES

	6SA7 ¹	6SA7GT ²
Grid No. 3 to All (Signal Input).....	9.5	9.5 μ f
Plate to All (Mixer Output).....	9.5	9.5 μ f
Grid No. 1 to All (Oscillator Input).....	7.5	8.0 μ f
Cathode to All Except Grid No. 1.....	5.0	μ f
Grid No. 1 to All Except Cathode.....	4.4	μ f
Grid No. 3 to Plate.....	0.25	0.5 μ f Max
Grid No. 3 to Grid No. 1.....	0.15	0.4 μ f Max
Grid No. 1 to Plate.....	0.06	μ f Max
Grid No. 1 to Cathode.....	2.6	μ f

MAXIMUM RATINGS (Design Center Values)

Plate Voltage.....	300 Volts
Plate Dissipation.....	1.0 Watt
Grids No. 2 and 4 Voltage.....	100 Volts
Grid No. 2 Supply Voltage.....	300 Volts
Grids No. 2 and 4 Dissipation.....	1.0 Watt
Positive D C Grid No. 3 Voltage.....	0 Volts
Negative D C Grid No. 3 Voltage.....	50 Volts
D C Cathode Current.....	14 Ma

6SA7, 6SA7GT (Cont'd)

TYPICAL OPERATION

	Self Excitation ³		Separate Excitation	
Plate Voltage.....	100	250	100	250 Volts
Grids No. 2 and 4 Voltage.....	100	100	100	100 Volts
Grid No. 3 Voltage.....	0	0	-2	-2 Volts
Grid No. 5 and Shell.....	0	0	0	0 Volts
Grid No. 1 Resistor (Oscillator Grid).....	20000	20000	20000	20000 Ohms
Plate Current.....	3.2	3.4	3.3	3.5 Ma
Grid No. 2 and 4 Current.....	8.0	8.0	8.5	8.5 Ma
Grid No. 1 Current.....	0.5	0.5	0.5	0.5 Ma
Conversion Transconductance.....	425	450	425	450 μ mhos
Plate Resistance (approx.).....	0.5	0.8	0.5	1.0 Megohm
Grid No. 3 Bias for $g_c = 2 \mu$ mhos	-35	-35	-35	-35 Volts

NOTES:

1. With Pin 1 connected to Pin 6.
2. With shield No. 308 connected to Pin 6.
3. Values shown are approximate and are for a Hartley circuit with a feedback of approximately 2 volts peak in the cathode circuit.

APPLICATION

Sylvania Type 6SA7 is a heptode converter similar in characteristics and application to Types 6BE6 and 7Q7.

SYLVANIA TUBE TESTER SETTINGS

	A	B	C	D	E	F	G	Test or K
139/140	6.3	0	—	0	1	037	85	W
	6.3	0	—	0	2	4	26	W
219/220	6.3	2	7S	76	7	048Y	3	6
	6.3	2	7	30	7	5X	4	6

TYPE 6SB7Y

(See Condensed Data Section)



SYLVANIA TYPE 6SC7
HIGH-MU DUO TRIODE

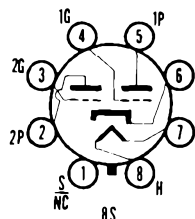

MECHANICAL DATA

Bulb.....	Metal, Outline 8-1
Base.....	Small Wafer Octal 8-Pin
Basing.....	8S
Mounting Position.....	Any

ELECTRICAL DATA

HEATER CHARACTERISTICS

Heater Voltage.....	6.3 Volts
Heater Current.....	300 Ma
Maximum Heater-Cathode Voltage.....	90 Volts

6SC7 (Cont'd)

TYPICAL OPERATION

Class A Amplifier (Each Section)

Plate Voltage	250 Volts
Grid Voltage	-2.0 Volts
Plate Current	2.0 Ma
Transconductance	1325 μ mhos
Amplification Factor	70
Plate Resistance (approx.)	53000 Ohms

Phase Inverter

Plate Supply Voltage	90	300 Volts
Self Bias Resistor	3750	1675 Ohms
Plate Current (Per Section)	0.15	0.65 Ma
Plate Load Resistor (Per Plate)	0.25	0.25 Megohm
Grid Resistor for Following Tubes	0.5	0.5 Megohm
Amplification at 5 Volts R M S Output	30	42
Maximum Signal Peak Output Voltage (R M S)	18	110 Volts

APPLICATION

Sylvania Type 6SC7 is a high mu double triode suitable for audio amplifier or phase inverter service. Data for use in Resistance Coupled Amplifier service is given in the Appendix.

TYPES 6SD7GT, 6SE7GT, 6SF5, GT, 6SF7

(See Condensed Data Section)

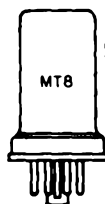

SYLVANIA TYPE 6SG7 6SG7GT

SEMI-REMOTE CUTOFF R F PENTODE

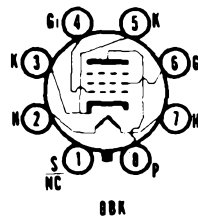

MECHANICAL DATA

	6SG7	6SG7GT
Bulb	Metal, Outline 8-1	T-9, Outline 9-12
Base	Small Wafer Octal 8-Pin	Small Wafer Octal 8-Pin
Basing	8BK	8BK
Mounting Position	Any	Any

ELECTRICAL DATA

HEATER CHARACTERISTICS

Heater Voltage	6.3 Volts
Heater Current	300 Ma
Maximum Heater-Cathode Voltage	90 Volts

TYPICAL OPERATION

Class A₁ Amplifier

Plate Voltage	100	250	250 Volts
Grid No. 2 Voltage	100	125	150 Volts
Grid No. 1 Voltage	-1.0	-1.0	-2.5 Volts
Self Bias Resistor	90	60	190 Ohms
Plate Current	8.2	11.8	9.2 Ma
Grid No. 2 Current	3.2	4.4	3.4 Ma
Transconductance	4100	4700	4000 μ mhos
Plate Resistance (approx.)	0.25	0.9	>1.0 Megohm
Grid No. 1 Bias for $g_m = 40 \mu$ mhos	-11.5	-14.0	-17.5 Volts



**SYLVANIA TYPE 6SH7
6SH7GT**

SHARP CUTOFF R F PENTODE

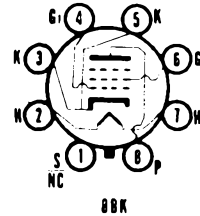

MECHANICAL DATA

	6SH7	6SH7GT
Bulb	Metal, Outline 8-1	T-9, Outline 9-12
Base	Small Wafer Octal 8-Pin	Small Wafer Octal 8-Pin
Basing	8BK	8BK
Mounting Position	Any	Any

ELECTRICAL DATA

HEATER CHARACTERISTICS

Heater Voltage	6.3 Volts
Heater Current	300 Ma
Maximum Heater-Cathode Voltage	90 Volts

MAXIMUM RATINGS (Design Center Values)

Plate Voltage, D C	300 Volts
Plate Dissipation	3.0 Watts
Grid No. 2 Voltage	150 Volts
Grid No. 2 Supply Voltage	300 Volts
Grid No. 2 Dissipation	0.7 Watt
Positive Grid No. 1 Voltage	0 Volts

TYPICAL OPERATION

Class A₁ Amplifier

Plate Voltage	100	250 Volts
Grid No. 2 Voltage	100	150 Volts
Grid No. 1 Voltage	-1	-1 Volts
Self Bias Resistor	135	65 Ohms
Plate Current	5.3	10.8 Ma
Grid No. 2 Current	2.1	4.1 Ma
Transconductance	4000	4900 μ mhos
Plate Resistance (approx.)	0.35	0.9 Megohm
Grid No. 1 Bias for $g_m = 10 \mu$ mhos	-4.0	-5.5 Volts

NOTES:

1. With shell connected to cathode.
2. Shield No. 308 connected to cathode.

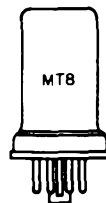

**SYLVANIA TYPE 6SJ7
6SJ7GT**

SHARP CUTOFF R F PENTODE

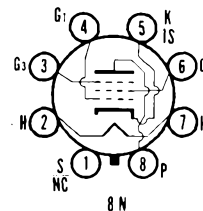

MECHANICAL DATA

	6SJ7	6SJ7GT
Bulb	Metal, Outline 8-1	T-9, Outline 9-12
Base	Small Wafer Octal 8-Pin	Small Wafer Octal 8-Pin
Basing	8N	8N
Mounting Position	Any	Any

ELECTRICAL DATA

HEATER CHARACTERISTICS

Heater Voltage	6.3 Volts
Heater Current	300 Ma
Maximum Heater-Cathode Voltage	90 Volts

DIRECT INTERELECTRODE CAPACITANCES

	6SJ7 ¹	6SJ7GT ²
Grid to Plate	0.005	0.005 μ f Max
Input	6.0	7.0 μ f
Output	7.0	7.0 μ f

6SJ7, 6SJGT (Cont'd)

MAXIMUM RATINGS (Design Center Values)

Plate Voltage.....	300 Volts
Plate Dissipation.....	2.5 Watts
Grid No. 2 Voltage.....	125 Volts
Grid No. 2 Supply Voltage.....	300 Volts
Grid No. 2 Dissipation.....	0.7 Watt
Positive Grid No. 1 Voltage.....	0 Volts

TYPICAL OPERATION

Class A₁ Amplifier—Pentode Connected

Plate Voltage.....	100	250 Volts
Grid No. 2 Voltage.....	100	100 Volts
Grid No. 1 Voltage.....	-3.0	-3.0 Volts
Grid No. 3 Voltage.....	Tie to Cathode	
Plate Current.....	2.9	3.0 Ma
Grid No. 2 Current.....	0.9	0.8 Ma
Transconductance.....	1575	1650 μ mhos
Plate Resistance (approx.).....	0.7	>1.0 Megohm

Triode Connected

Plate Voltage.....	180	250 Volts
Grids No. 2 and 3 Voltage.....	Connected to Plate	
Grid No. 1 Voltage.....	-6.0	-8.5 Volts
Plate Current.....	6.0	9.2 Ma
Transconductance.....	2300	2500 μ mhos
Amplification Factor.....	19	19
Plate Resistance.....	8200	7600 Ohms

NOTES:

1. Shell connected to cathode.
2. Shield No. 308 connected to cathode.

APPLICATION

A sharp cutoff pentode having similar, but not identical, characteristics to Type 6J7 and 7C7. Data for use in Resistance Coupled Amplifier Circuits is given in the Appendix.

SYLVANIA TUBE TESTER SETTINGS

	A	B	C	D	E	F	G	Test or K
139/140	6.3	0	—	0	6	36	48	W
219/220	6.3	2	7S	54	7	46Y	8	5

AVERAGE PLATE CHARACTERISTICS

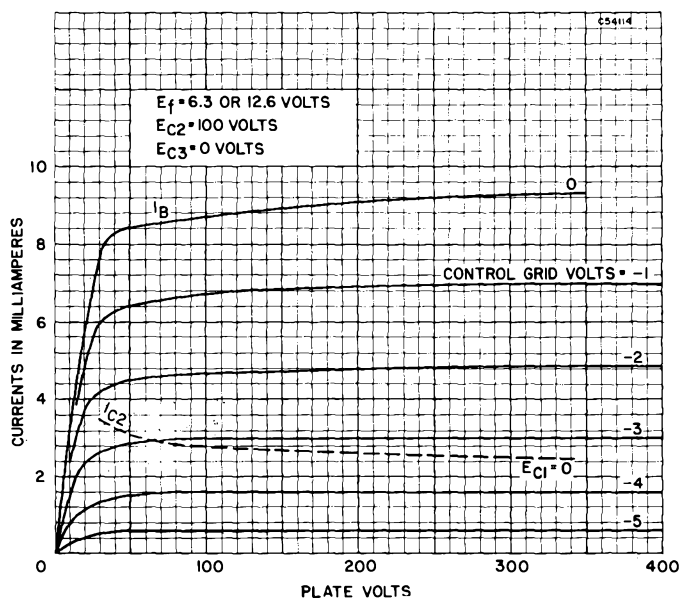

TYPES 6SK7, GT

(See Condensed Data Section)

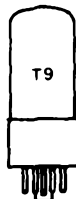

SYLVANIA TYPE 6SL7GT

HIGH-MU DUO TRIODE

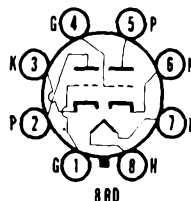

MECHANICAL DATA

Bulb.....	T-9, Outline 9-11
Base.....	Intermediate Shell Octal 8-Pin
Basing.....	8BD
Mounting Position.....	Any

ELECTRICAL DATA

HEATER CHARACTERISTICS

Heater Voltage.....	6.3 Volts
Heater Current.....	300 Ma
Maximum Heater-Cathode Voltage.....	90 Volts

DIRECT INTERELECTRODE CAPACITANCES¹

	Section 1 ²	Section 2
Grid to Plate.....	2.8	2.8 $\mu\mu\text{f}$
Grid to Cathode.....	3.0	3.4 $\mu\mu\text{f}$
Plate to Cathode.....	3.8	3.2 $\mu\mu\text{f}$
Plate to Plate.....		0.4 $\mu\mu\text{f}$
Grid to Grid.....		0.65 $\mu\mu\text{f}$
Grid Section 2 to Plate Section 1.....	0.13	$\mu\mu\text{f}$

MAXIMUM RATINGS (Design Center Values—Each Section)

Plate Voltage.....	250 Volts
Plate Dissipation.....	1.0 Watt
Positive Grid Voltage.....	0 Volts

CHARACTERISTICS AND TYPICAL OPERATION

Class A Amplifier (Each Section)

Plate Voltage.....	250 Volts
Grid Voltage.....	-2 Volts
Cathode Bias Resistor.....	870 Ohms
Plate Current.....	2.3 Ma
Transconductance.....	1600 μmhos
Amplification Factor.....	70
Plate Resistance.....	44000 Ohms

NOTES:

- Shield No. 308 connected to cathode.
- Section No. 1 connects to pins 4, 5 and 6. Section No. 2 connects to pins 1, 2 and 3.

APPLICATION

The Sylvania Type 6SL7GT is a high-mu duo triode designed for service as a resistance coupled amplifier or phase inverter. Data for use in Resistance Coupled Amplifier Circuits is given in the Appendix.

SYLVANIA TUBE TESTER SETTINGS

	A	B	C	D	E	F	G	Test or K
139/140	6.3	0	78	1	7	5	70	W
	6.3	0	78	1	3	3	70	W
219/220	6.3	7	68S	18	8	1U	2	3
	6.3	7	38S	18	8	4U	5	6

6SL7GT (Cont'd)

AVERAGE PLATE CHARACTERISTICS

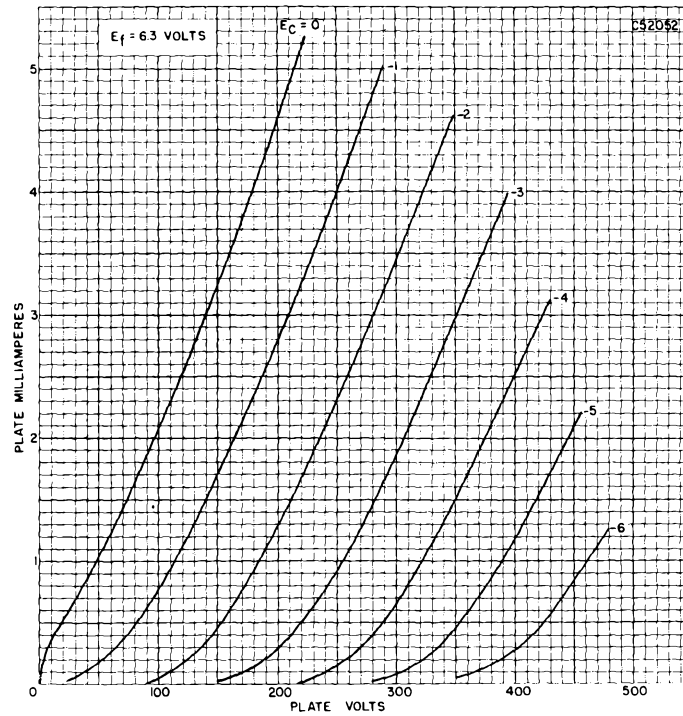

AVERAGE TRANSFER CHARACTERISTICS

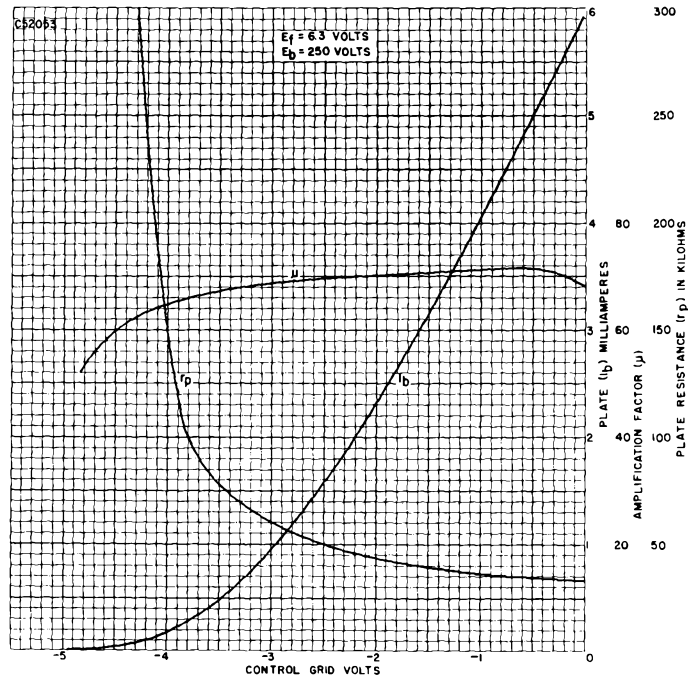

SYLVANIA ELECTRONIC TUBES

SYLVANIA TYPE 6SN7GT

DUO TRIODE

The Sylvania Type 6SN7GT is identical to Type 6SN7GTA except for lower plate voltage and plate dissipation ratings.

MAXIMUM RATINGS (Design Center Values—Except as Noted)

Plate Voltage, D.C.	300 Volts
Peak Positive Plate Voltage as Vertical Deflection Amplifier (Abs. Max.)	1200 Volts
Plate Dissipation ¹	
Each Plate	3.5 Watts
Both Plates	5.0 Watts

NOTES:

- In stages operating with grid leak bias, a cathode bias resistor or other suitable means is required to protect the tube in the absence of excitation.

SYLVANIA TUBE TESTER SETTINGS

	A	B	C	D	E	F	G	Test or K
139/140	6.3	0	678	1	7	5	36	W
	6.3	0	278	1	3	3	36	W
219/220	6.3	7	68	39	8	1V	2	3
	6.3	7	38	39	8	4V	5	6

AVERAGE TRANSFER CHARACTERISTICS

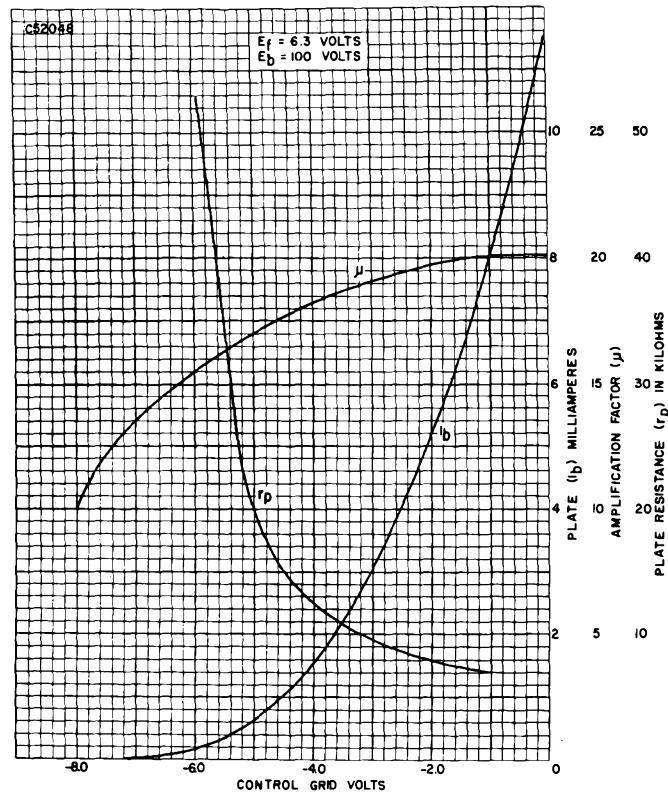

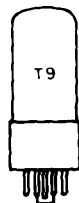

SYLVANIA TYPE 6SN7GTA

MEDIUM-MU DUO TRIODE

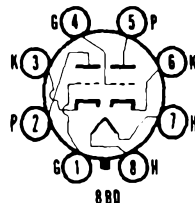

MECHANICAL DATA

Bulb.....	T-9, Outline 9-11 or 9-41
Base.....	Intermediate Shell Octal 8-Pin or Short Intermediate Shell Octal 8-Pin
Basing.....	8BD
Mounting Position.....	Any

ELECTRICAL DATA¹

HEATER CHARACTERISTICS

Heater Voltage.....	6.3 Volts
Heater Current.....	600 Ma
Maximum Heater-Cathode Voltage	
Total D C and Peak.....	200 Volts
D C, Heater Positive with Respect to Cathode.....	100 Volts

DIRECT INTERELECTRODE CAPACITANCES—Unshielded (Approx.)

	Section 1 ²	Section 2
Grid to Plate.....	4.0	3.8 $\mu\mu\text{f}$
Input.....	2.2	2.6 $\mu\mu\text{f}$
Output.....	0.7	0.7 $\mu\mu\text{f}$

MAXIMUM RATINGS (Design Center Values—Except as Noted)

	Class A ¹ Amplifier	Vertical ³ Deflection Amplifier
Plate Voltage.....	450	450 Volts
Peak Positive Plate Voltage (Abs. Max.).....		1500 Volts
Plate Dissipation		
Each Plate.....	5.0	5.0 Watts
Both Plates.....	7.5	7.5 Watts
Peak Negative Grid Voltage.....		250 Volts
Cathode Current.....	20	20 Ma
Peak Cathode Current.....		70 Ma
Grid Circuit Resistance		
Fixed Bias.....	1.0	1.0 Megohm
Cathode Bias.....	1.0	2.2 Megohms

	Vertical ³ Deflection Oscillator	Horizontal ³ Deflection Oscillator
Plate Voltage.....	450	450 Volts
Plate Dissipation		
Each Plate.....	5.0	5.0 Watts
Both Plates.....	7.5	7.5 Watts
Peak Negative Grid Voltage.....	400	600 Volts
Average Cathode Current.....	20	20 Ma
Peak Cathode Current.....	70	300 Ma
Grid Circuit Resistance.....	2.2	2.2 Megohms

CHARACTERISTICS AND TYPICAL OPERATION

Class A₁ Amplifier

Plate Voltage.....	90	250 Volts
Grid Voltage.....	0	-8.0 Volts
Plate Current.....	10	9.0 Ma
Plate Resistance (approx.).....	6700	7700 Ohms
Transconductance.....	3000	2600 μmhos
Amplification Factor.....	20	20
Grid Voltage for $I_b=1.3$ Ma.....		-12.5 Volts
Grid Voltage for $I_b=10\mu\text{a}$ (approx.).....	-7.0	-18 Volts

NOTES:

- All ratings, operating conditions and characteristics are for each section except where otherwise stated.
- Section No. 1 connects to pins 4, 5 and 6. Section No. 2 connects to pins 1, 2 and 3.
- For operation in a 525-line, 30 frame system, the duty cycle of the voltage pulse must not exceed 15% of one scanning cycle.

APPLICATION

The 6SN7GTA is a medium mu duo triode. It may be used as a combined vertical oscillator and vertical deflection amplifier in television receivers or in audio amplifier service. It is electrically equivalent to the 6SN7GT except for higher voltage and dissipation ratings.

Data for use in Resistance Coupled Amplifiers is given in the Appendix.

6SN7GTA (Cont'd)

AVERAGE PLATE CHARACTERISTICS

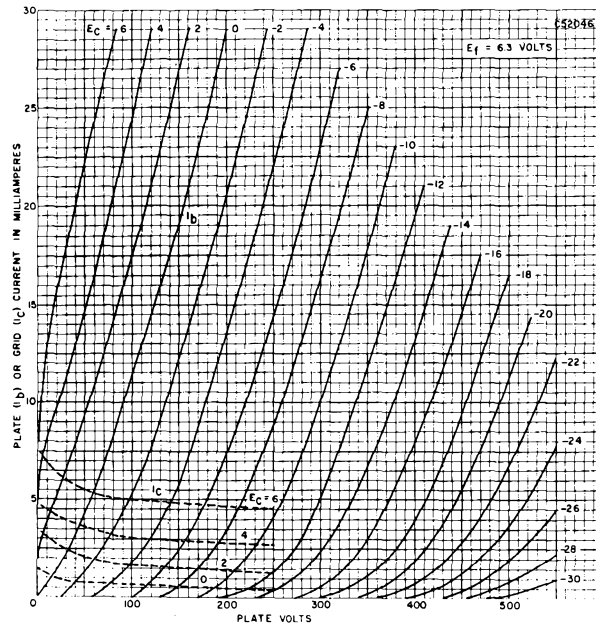

AVERAGE TRANSFER CHARACTERISTICS

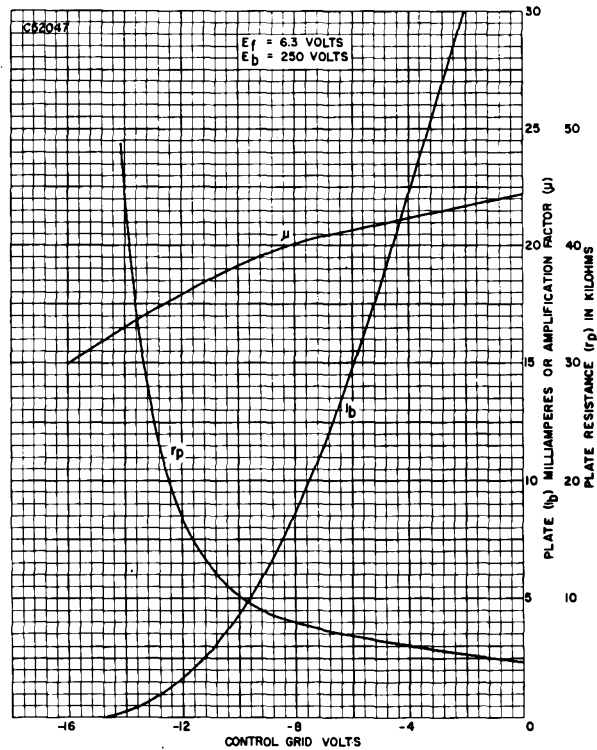

SYLVANIA TYPE 6SN7GTB

MEDIUM-MU DUO TRIODE

ELECTRICAL DATA

HEATER CHARACTERISTICS

Heater Voltage.....	6.3 Volts
Heater Current.....	600 Ma
Heater Warm-up Time (See SERIES STRING HEATERS Section in Appendix)	
Maximum Heater-Cathode Voltage	
Total D C and Peak.....	200 Volts
D C, Heater Positive with Respect to Cathode.....	100 Volts

For other rating, operation, and application data, refer to corresponding Type 6SN7GTA, which is identical except for heater ratings.

APPLICATION

The Sylvania Type 6SN7GTB is intended for service in television receivers employing series connected heaters. For information on specially controlled heaters for series operation refer to the SERIES STRING HEATERS section of the Appendix.

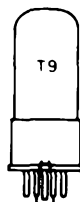

SYLVANIA TYPE 6SQ7
6SQ7GT
DUO DIODE HIGH-MU TRIODE

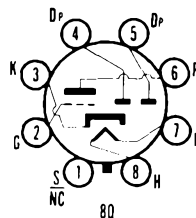

MECHANICAL DATA

	6SQ7	6SQ7GT
Bulb.....	Metal, Outline 8-1	T-9, Outline 9-12
Base.....	Small Wafer Octal 8-Pin	Small Wafer Octal 8-Pin
Basing.....	8Q	8Q
Mounting Position.....	Any	Any

ELECTRICAL DATA

HEATER CHARACTERISTICS

Heater Voltage.....	6.3 Volts
Heater Current.....	300 Ma
Maximum Heater-Cathode Voltage.....	90 Volts

CHARACTERISTICS AND TYPICAL OPERATION

Class A Amplifier

Plate Voltage.....	100	250 Volts
Grid Voltage.....	-1	-2 Volts
Plate Current.....	0.5	1.1 Ma
Transconductance.....	925	1175 μ mhos
Amplification Factor.....	100	100
Plate Resistance.....	0.11	.085 Megohm

Data for use in Resistance Coupled Amplifier Circuits is given in the Appendix.

SYLVANIA TUBE TESTER SETTINGS

	A	B	C	D	E	F	G	Test or K
139/140	6.3	0	7	1	5	8	55	T
	6.3	0	7	1	2	—	55	T
	6.3	0	7	1	3	—	55	T
219/220	6.3	7	8	36	8	2T	6	3
	6.3	7	8	40	8	T	4*	3
	6.3	7	8	40	8	T	5*	3

* Diode gas test does not apply.

TYPES 6SR7GT, 6SS7, 6ST7, 6SV7, 6SZ7

(See Condensed Data Section)

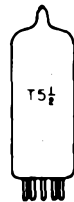

SYLVANIA TYPE 6T4 UHF TRIODE

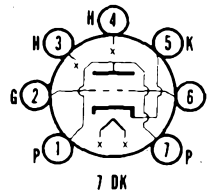

MECHANICAL DATA

Bulb	T-5 1/2, Outline 5-1
Base	Miniature Button 7-Pin
Basing	7DK
Mounting Position	Any

ELECTRICAL DATA

HEATER CHARACTERISTICS

Heater Voltage	6.3 Volts
Heater Current	225 Ma
Maximum Heater-Cathode Voltage	
Total D C and Peak	50 Volts
D C, Heater Positive with Respect to Cathode	25 Volts

DIRECT INTERELECTRODE CAPACITANCES

	Shielded ¹	Unshielded
Grid to Plate	1.7	1.7 $\mu\mu\text{f}$
Input	3.3	2.6 $\mu\mu\text{f}$
Output	2.0	0.4 $\mu\mu\text{f}$
Heater to Cathode ²	3.0	3.0 $\mu\mu\text{f}$
Grid to Cathode ²	2.4	2.4 $\mu\mu\text{f}$
Plate to Cathode ²	.22	.24 $\mu\mu\text{f}$

MAXIMUM RATINGS (Design Center Values)

Plate Voltage	200 Volts
Plate Dissipation	3.5 Watts
Grid Current	8 Ma
Cathode Current	30 Ma

CHARACTERISTICS

Plate Voltage	80 Volts
Cathode Bias Resistor	150 Ohms
Plate Current	18 Ma
Transconductance	7000 μmhos
Amplification Factor	13
Plate Resistance	1860 Ohms
Grid Voltage for 50 μa Plate Current	-15 Volts

TYPICAL OPERATION

Oscillator at 950 Mc

Plate Voltage	80 Volts
Grid Voltage (Self Bias)	-4 Volts
Grid Resistor	10000 Ohms
Plate Current	18 Ma
Grid Current (approx.)	400 μa

NOTES:

- Shield No. 316.
- Measured between specified elements only. When external shield is used, it shall be grounded.

APPLICATION

The Sylvania Type 6T4 is a miniature low-mu triode designed for service as a u h f oscillator.

SYLVANIA TUBE TESTER SETTINGS

	A	B	C	D	E	F	G	Test or K
139/140	6.3	0	46	0	2	2	30	U
	6.3	0	23	0	3	6	30	U
219/220	6.3	3	467	24	4	2X	1	5
	6.3	3	124	24	4	6X	7	5

6T4 (Cont'd)

AVERAGE TRANSFER CHARACTERISTICS

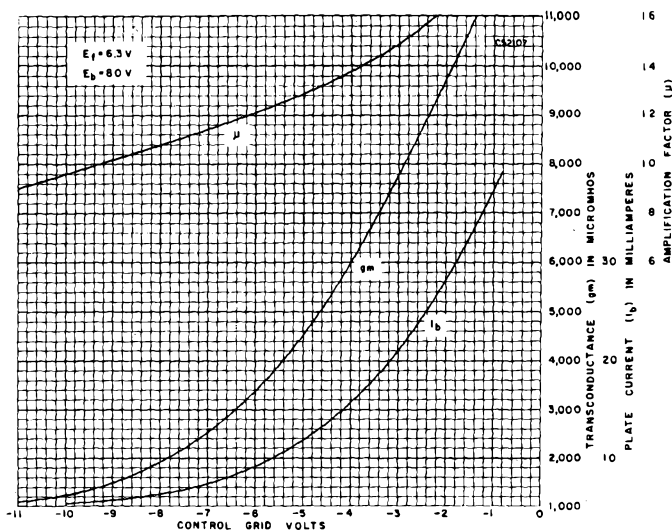

AVERAGE PLATE CHARACTERISTICS

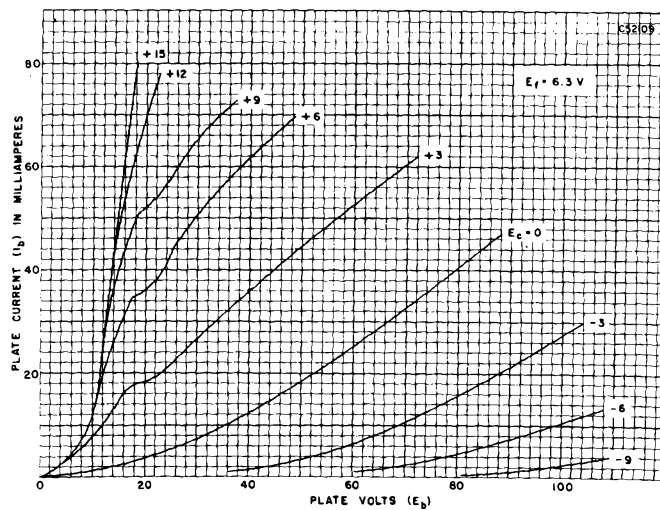

TYPES 6T5, 6T7G, 6T7G/6Q6G

(See Condensed Data Section)

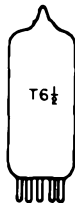

SYLVANIA TYPE 6T8

TRIPLE-DIODE TRIODE

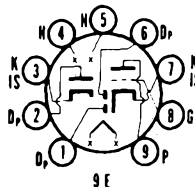

MECHANICAL DATA

Bulb	T-6 1/2, Outline 6-2
Base	Small Button 9-Pin
Basing	9E
Mounting Position	Any

ELECTRICAL DATA

HEATER CHARACTERISTICS

Heater Voltage	6.3 Volts
Heater Current	450 Ma
Maximum Heater-Cathode Voltage	90 Volts

DIRECT INTERELECTRODE CAPACITANCES (Unshielded)

Grid to Each Diode Plate	0.035 μ f
Diode Input (Pins 1 or 6)	3.8 μ f
Diode Input (Pin 2)	4.5 μ f

MAXIMUM RATINGS (Design Center Values)

Plate Voltage	300 Volts
Plate Dissipation	1.0 Watt
Maximum Diode Current (Each Plate)	5.0 Ma

TYPICAL OPERATION

Class A₁ Amplifier

Plate Voltage	100	250 Volts
Grid Voltage	-1.0	-3.0 Volts
Plate Current	0.8	1.0 Ma
Transconductance	1300	1200 μ mhos
Amplification Factor	70	70 Ohms
Plate Resistance	54000	58000 Ohms

APPLICATION

A miniature triple-diode triode designed for use in a m/fm receivers. The triode section is similar to the Types 6AQ6 and 6Q7GT. Data for use in Resistance Coupled Amplifier Circuits is given in the Appendix.

SYLVANIA TUBE TESTER SETTINGS

	A	B	C	D	E	F	G	Test or K
139/140	6.3	0	—	0	4	9	50	T
	6.3	0	—	0	3	—	50	T
	6.3	0	—	0	2	—	50	T
	6.3	0	—	0	1	—	50	T
219/220	6.3	4	53	35	5	8T	9	7
	6.3	4	53	35	5	T	1*	7
	6.3	4	57	35	5	T	2*	3
	6.3	4	53	35	5	T	6*	7

* Diode gas test does not apply.

TYPE 6U4GT

(See Condensed Data Section)



SYLVANIA TYPE 6U5

ELECTRON RAY INDICATOR TUBE

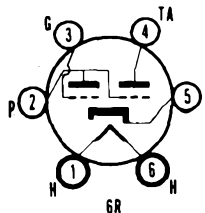

MECHANICAL DATA

Bulb	T-9, Outline 9-26
Base	Small 6-Pin
Basing	6R
Mounting Position	Any

ELECTRICAL DATA

HEATER CHARACTERISTICS

Heater Voltage	6.3 Volts
Heater Current	300 Ma
Maximum Heater-Cathode Voltage	90 Volts

MAXIMUM RATINGS (Design Center Values)

Maximum Plate Supply Voltage	285 Volts
Maximum Target Voltage	285 Volts
Minimum Recommended Target Voltage	125 Volts

TYPICAL OPERATION

Plate Supply Voltage	100	200	250	Volts
Target Supply Voltage	100	200	250	Volts
Plate Current (Triode Unit) ¹	0.19	0.19	0.24	Ma Max
Target Current (approx.) ¹	1.0	3.0	4.0	Ma
Grid Voltage (Triode Unit) (approx.) ²	0	0	0	Volts
Grid Voltage (Triode Unit) (approx.) ³	-8.0	-18.5	-22.0	Volts
Triode Plate Resistor	0.5	1.0	1.0	Megohm

NOTES:

1. With triode grid voltage of zero volts.
2. For shadow angle of 90 degrees.
3. For shadow angle of 0 degrees.

The 6U5 should be used as a replacement for tube Types 6T5, 6H5 and 6G5.

TYPES 6U6GT, 6U7G

(See Condensed Data Section)



SYLVANIA TYPE 6U8

H F TRIODE PENTODE

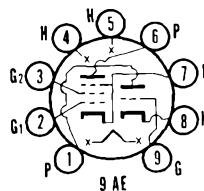

MECHANICAL DATA

Bulb	T-6 1/2, Outline 6-2
Base	Small Button 9-Pin
Basing	9AE
Mounting Position	Any

ELECTRICAL DATA

HEATER CHARACTERISTICS

Heater Voltage	6.3 Volts
Heater Current	450 Ma
Maximum Heater-Cathode Voltage	90 Volts

6U8 (Cont'd)

DIRECT INTERELECTRODE CAPACITANCES

Pentode	Shielded ¹	Unshielded
Grid No. 1 to Plate	0.006	0.01 μf Max
Input	5.0	5.0 μf
Output	3.5	2.6 μf
Triode		
Grid to Plate	1.8	1.8 μf
Grid to Cathode	2.5	2.5 μf
Plate to Cathode	1.0	0.4 μf
Cathode to Heater (Each Section)	3.0	3.0 μf

MAXIMUM RATINGS (Design Center Values)

	Triode	Pentode
Plate Voltage	330	300 Volts
Plate Dissipation	2.7	2.8 Watts
Grid No. 2 Voltage		300 Volts
Grid No. 2 Dissipation		0.5 Watt
Positive Grid No. 1 Voltage	0	0 Volts

CHARACTERISTICS AND TYPICAL OPERATION

	Triode	Pentode
Plate Voltage	150	250 Volts
Grid No. 2 Voltage		110 Volts
Cathode Resistor	56	68 Ohms
Plate Current	18	10 Ma
Grid No. 2 Current		3.5 Ma
Transconductance	8500	5200 μmhos
Amplification Factor	40	
Plate Resistance (approx.)	0.005	0.4 Megohm
Grid No. 1 Voltage for Plate Current of 10 μa .	-12	-10 Volts

NOTE:

- Shield No. 315.

APPLICATION

A triode pentode designed for use as a local oscillator-pentode mixer and other combined functions in fm and tv receivers.

SYLVANIA TUBE TESTER SETTINGS

	A	B	C	D	E	F	G	Test or K
139/140	6.3	0	—	0	3	36	83	Y
	6.3	0	—	0	1	5	20	W
219/220	6.3	4	58S	69	5	23Z	6	7
	6.3	4	57S	17	5	9Y	1	8

AVERAGE PLATE CHARACTERISTICS PENTODE SECTION—TRIODE CONNECTED AND TRIODE SECTION

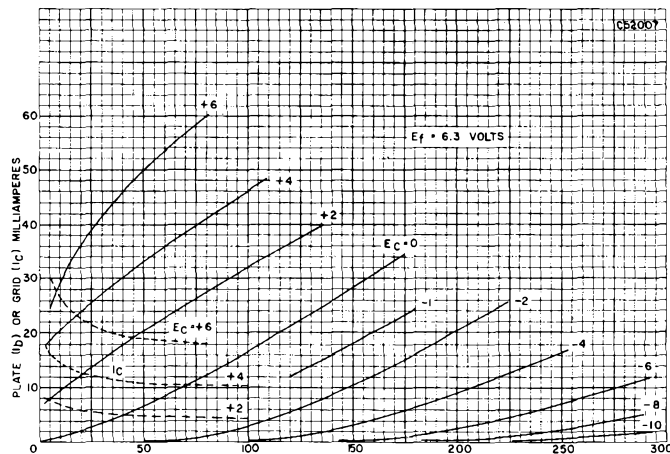

6U8 (Cont'd)

AVERAGE PLATE CHARACTERISTICS PENTODE SECTION

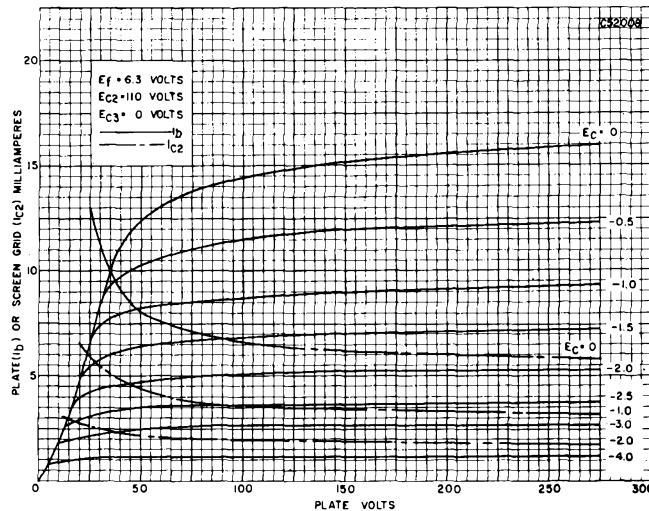

SYLVANIA TYPE **6V3A**
DAMPER DIODE

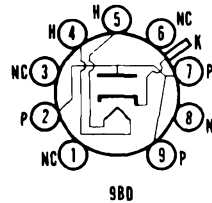

MECHANICAL DATA

Bulb.....	T-6 1/2
Base.....	Small Button 9-Pin
Basing.....	9BD
Maximum Overall Length.....	3 1/16 Inches
Maximum Seated Height.....	2 3/4 Inches
Cap.....	Skirted Miniature
Cathode.....	Unipotential
Mounting Position.....	Any

ELECTRICAL DATA

HEATER CHARACTERISTICS

Heater Voltage.....	6.3 Volts
Heater Current.....	1.75 Amperes
Maximum Heater-Cathode Voltage	
Heater Positive with Respect to Cathode	
D C.....	100 Volts
Total D C and Peak.....	300 Volts
Heater Negative with Respect to Cathode (Abs. Max. Values) ¹	
D C.....	750 Volts
Total D C and Peak.....	6750 Volts

MAXIMUM RATINGS (Design Center Values—Except as Noted)

Damper Service²	
Peak Inverse Plate Voltage (Abs. Max.) ¹	6000 Volts
Plate Dissipation.....	2.7 Watts
Steady State Peak Plate Current.....	800 Ma
D C Output Current.....	135 Ma

CHARACTERISTICS

Tube Voltage Drop	
$I_b = 250$ Ma D C.....	19 Volts

6V3A (Cont'd)

NOTES:

- Should not be exceeded under any condition of high line voltage or misadjustment.
- For operation in a 525-line, 30 frame system, the duty cycle of the voltage pulse must not exceed 15% or one scanning cycle. Operation of this tube as a power rectifier is not recommended.

APPLICATION

Indirectly heated half-wave rectifier designed for service as a damping diode in television receiver direct drive sweep circuits. The cathode is connected to the top cap.

Except for bulb length, the Type 6V3A is identical to the Type 6V3. The 6V3A should be considered as the replacement for the Type 6V3.

SYLVANIA TUBE TESTER SETTINGS

	A	B	C	D	E	F	G	Test or K
139/140	6.3	0	75	0	2	—	19	Y
	6.3	0	35	0	6	—	19	Y
	6.3	0	37	0	4	—	19	Y
219/220	6.3	4	579	10	5	Z	2*	1
	6.3	4	259	10	5	Z	7*	1
	6.3	4	257	10	5	Z	9*	1

USE EXTERNAL ADAPTER

* Diode gas test does not apply.

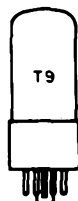

SYLVANIA TYPE **6V6**
6V6GT

BEAM POWER AMPLIFIER

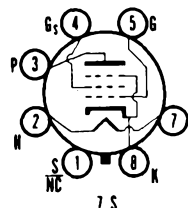

MECHANICAL DATA

	6V6	6V6GT
Bulb	Metal, Outline 8-6	T-9, Outline 9-11 or 9-41
Base	Small Water Octal	Intermediate or Short Int. Octal
Basing	7S	7S
Mounting Position	Any	Any

ELECTRICAL DATA

HEATER CHARACTERISTICS

Heater Voltage	6.3 Volts
Heater Current	450 Ma
Maximum Heater-Cathode Voltage	
Total D C and Peak	200 Volts
D C, Heater Positive with Respect to Cathode	100 Volts

DIRECT INTERELECTRODE CAPACITANCES

Grid to Plate	0.7 μ f
Input	9.0 μ f
Output	7.5 μ f

6V6, 6V6GT (Cont'd)

MAXIMUM RATINGS (Design Center Values—Except as Noted)

Class A₁ Amplifier

Plate Voltage.....	315 Volts
Grid No. 2 Voltage.....	285 Volts
Plate Dissipation.....	12 Watts
Grid No. 2 Dissipation.....	2 Watts
Grid No. 1 Circuit Resistance	
Fixed Bias.....	0.1 Megohm
Cathode Bias.....	0.5 Megohm

Vertical Deflection Amplifier—Triode Connected¹

Plate Voltage.....	315 Volts
Peak Positive Plate Voltage (Abs. Max.).....	1200 Volts
Plate Dissipation ²	9 Watts
Peak Negative Grid Voltage.....	250 Volts
Average Cathode Current.....	35 Ma
Peak Cathode Current.....	105 Ma
Grid Circuit Resistance Cathode Bias.....	2.2 Megohms

CHARACTERISTICS AND TYPICAL OPERATION

Class A₁ Amplifier (Single Tube)

Plate Voltage.....	180	250	315 Volts
Grid No. 2 Voltage.....	180	250	225 Volts
Grid No. 1 Voltage.....	-8.5	-12.5	-13.0 Volts
Peak A F Grid No. 1 Voltage.....	8.5	12.5	13.0 Volts
Plate Current (Zero Signal).....	29	45	34 Ma
Plate Current (Maximum Signal).....	30	47	35 Ma
Grid No. 2 Current (Zero Signal).....	3	4.5	2.2 Ma
Grid No. 2 Current (Maximum Signal).....	4	7.0	6 Ma
Plate Resistance (approx.).....	50000	50000	80000 Ohms
Transconductance.....	3700	4100	3750 μ mhos
Load Resistance.....	5500	5000	8500 Ohms
Maximum Signal Power Output.....	2.0	4.5	5.5 Watts
Total Harmonic Distortion (approx.).....	8	8	12 Percent

Class AB₁ Amplifier (Two Tubes in Push-Pull)

Plate Voltage.....	250	285 Volts
Grid No. 2 Voltage.....	250	285 Volts
Grid No. 1 Voltage.....	-15	-19 Volts
Peak A F Grid to Grid Voltage.....	30	38 Volts
Plate Current (Zero Signal).....	70	70 Ma
Plate Current (Maximum Signal).....	79	92 Ma
Grid No. 2 Current (Zero Signal).....	5.0	4.0 Ma
Grid No. 2 Current (Maximum Signal).....	13	13.5 Ma
Effective Load Resistance (Plate-to-Plate).....	10000	8000 Ohms
Total Harmonic Distortion.....	5.0	3.5 Percent
Maximum Signal Power Output.....	10	14 Watts

Triode Connected Characteristics

Plate Voltage.....	250 Volts
Grid Voltage.....	-12.5 Volts
Plate Current.....	49.5 Ma
Transconductance.....	5000 μ mhos
Amplification Factor.....	9.8
Plate Resistance.....	1960 Ohms
Grid Voltage for I _b = 0.5 Ma (approx.).....	-36 Volts

NOTES:

- For operation in a 525-line, 30 frame system, the duty cycle of the voltage pulse must not exceed 15% of one scanning cycle.
- In stages operating with grid leak bias, an adequate cathode bias resistor or other suitable means is required to protect the tube in the absence of excitation.

APPLICATION

The Types 6V6 and 6V6GT are beam power pentodes intended for service as a general purpose audio power amplifier or vertical deflection amplifier in television receiver sweep circuits. They are similar to lock-in Type 7C5 and miniature Type 6CM6.

SYLVANIA TUBE TESTER SETTINGS

	A	B	C	D	E	F	G	Test or K
139/140	6.3	0	—	0	1	034	37	Y
219/220	6.3	2	7	24	7	045Z	3	8

6V6, 6V6GT (Cont'd)

AVERAGE PLATE CHARACTERISTICS

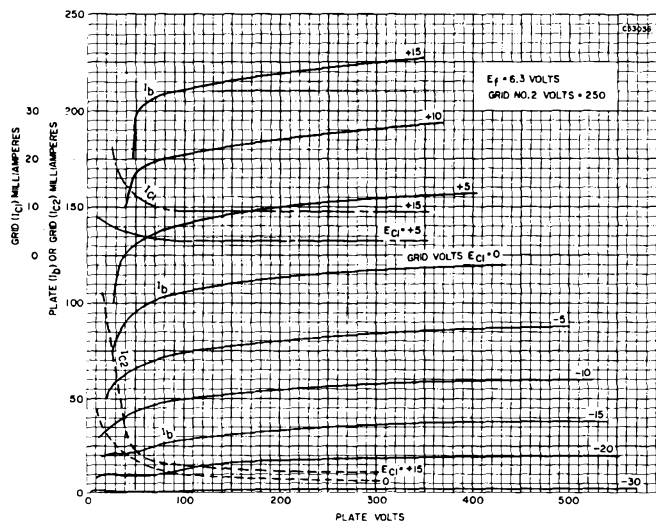

AVERAGE PLATE CHARACTERISTICS TRIODE CONNECTED

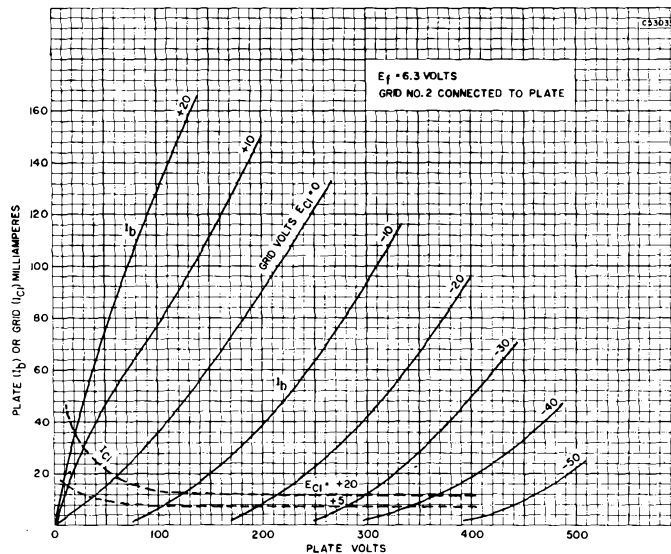

TYPES 6V7G, 6V8

(See Condensed Data Section)

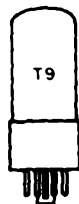

SYLVANIA TYPE 6W4GT

HALF-WAVE RECTIFIER

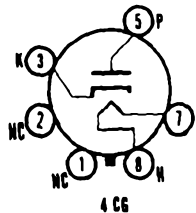

MECHANICAL DATA

Bulb.....	T-9, Outline 9-11
Base.....	Intermediate Octal 6-Pin
Basing ¹	4CG
Mounting Position.....	Any

ELECTRICAL DATA

HEATER CHARACTERISTICS

Heater Voltage.....	6.3 Volts
Heater Current.....	1.2 Amperes
Maximum Heater-Cathode Voltage	
Heater Positive with Respect to Cathode	
D C.....	100 Volts
Total D C and Peak.....	300 Volts
Heater Negative with Respect to Cathode (Abs. Max.)	
D C.....	500 Volts
Total D C and Peak.....	2300 Volts

MAXIMUM RATINGS (Design Center Values—Except as Noted)

Dampers Service ²	
Peak Inverse Plate Voltage (Abs. Max.).....	3850 Volts
Plate Dissipation.....	3.5 Watts
Steady State Peak Plate Current.....	750 Ma
D C Output Current.....	125 Ma

CHARACTERISTICS

Tube Voltage Drop at 250 Ma D C.....	21 Volts
--------------------------------------	----------

NOTES:

1. Socket terminals 1, 2, 4 and 6 should not be used as tie points.
2. For operation in a 525-line, 30 frame system, the duty cycle of the voltage pulse must not exceed 15% of one scanning cycle. Operation as a power rectifier is not recommended.

SYLVANIA TUBE TESTER SETTINGS

	A	B	C	D	E	F	G	Test or K
139/140	6.3	0	57	1	3	—	15	X
219/220	6.3	7	18	9	8	V	5*	3

* Diode gas test does not apply.

TYPE 6W5G

(See Condensed Data Section)

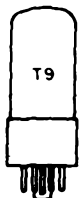

SYLVANIA TYPE 6W6GT

BEAM POWER AMPLIFIER

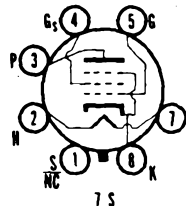

MECHANICAL DATA

Bulb.....	T-9, Outline 9-11 or 9-41
Base.....	Intermediate Shell Octal or Short Intermediate Shell Octal
Basing.....	7S
Mounting Position.....	Any

6W6GT (Cont'd)

ELECTRICAL DATA

HEATER CHARACTERISTICS

Heater Voltage.....	6.3 Volts
Heater Current.....	1.2 Amperes
Maximum Heater-Cathode Voltage	
Total D C and Peak.....	200 Volts
D C, Heater Positive with Respect to Cathode.....	100 Volts

DIRECT INTERELECTRODE CAPACITANCES

Grid to Plate.....	0.8 μf
Input.....	15 μf
Output.....	9.0 μf

MAXIMUM RATINGS (Design Center Values—Except as Noted)

Class A₁ Amplifier

Plate Voltage.....	300 Volts
Grid No. 2 Voltage.....	150 Volts
Plate Dissipation.....	10 Watts
Grid No. 2 Dissipation.....	1.25 Watts
Grid No. 1 Circuit Resistance	
Fixed Bias.....	0.1 Megohm
Cathode Bias.....	0.5 Megohm

Vertical Deflection Amplifier—Triode Connected¹

D C Plate Voltage.....	300 Volts
Peak Positive Plate Voltage (Abs. Max.).....	1200 Volts
Plate Dissipation ²	7.5 Watts
Peak Negative Grid Voltage.....	250 Volts
Average Cathode Current.....	40 Ma
Peak Cathode Current.....	140 Ma
Grid No. 1 Circuit Resistance, Cathode Bias.....	2.2 Megohms

CHARACTERISTICS AND TYPICAL OPERATION (Single Tube)

Class A₁ Amplifier

Plate Voltage.....	110	200 Volts
Grid No. 2 Voltage.....	110	125 Volts
Grid No. 1 Voltage.....	-7.5	Volts
Cathode Bias Resistor.....		180 Ohms
Peak A F Grid No. 1 Voltage.....	7.5	8.5 Volts
Plate Current (Zero-Signal).....	49	46 Ma
Plate Current (Maximum Signal).....	50	47 Ma
Grid No. 2 Current (Zero-Signal).....	4.0	2.2 Ma
Grid No. 2 Current (Maximum Signal).....	10	8.5 Ma
Plate Resistance (approx.).....	13000	28000 Ohms
Transconductance.....	8000	8000 μmhos
Load Resistance.....	2000	4000 Ohms
Maximum Signal Power Output.....	2.1	3.8 Watts
Total Harmonic Distortion (approx.).....	10	10 Percent

Triode Connected

Plate Voltage.....		225 Volts
Grid No. 1 Voltage.....		-30 Volts
Plate Current.....		22 Ma
Transconductance.....		3800 μmhos
Amplification Factor.....		6.2
Plate Resistance.....		1600 Ohms
Grid No. 1 Voltage (approx.) for $I_p = 0.5$ Ma.....		-42 Volts

Vertical Deflection Amplifier, Triode Connected 90° Picture Tube—17.2 kv 2nd Anode Voltage

Plate Supply Voltage.....		310 Volts
Plate Output Voltage		
Peak to Peak.....		535 Volts
Sawtooth Component.....		310 Volts
Grid No. 1 Input Voltage		
Peak to Peak.....		110 Volts
Sawtooth Component.....		60 Volts
Average Cathode Current.....		35 Ma
Peak Cathode Current.....		90 Ma
Cathode Resistor.....		1100 Ohms

NOTES:

- For operation in a 525 line, 30 frame system, the duty cycle of the voltage pulse must not exceed 15% of one scanning cycle.
- In stages operating with grid leak bias, an adequate cathode bias resistor or other suitable means is required to protect the tube in the absence of excitation.

APPLICATION

The Sylvania Type 6W6GT is a beam power pentode intended for service as a general purpose audio power amplifier or vertical deflection amplifier in television receiver sweep circuits.

6W6GT (Cont'd)

SYLVANIA TUBE TESTER SETTINGS

	A	B	C	D	E	F	G	Test or K
139/140	6.3	0	—	0	1	034	18	X
219/220	6.3	2	7S	12	7	045Z	3	8

AVERAGE PLATE CHARACTERISTICS

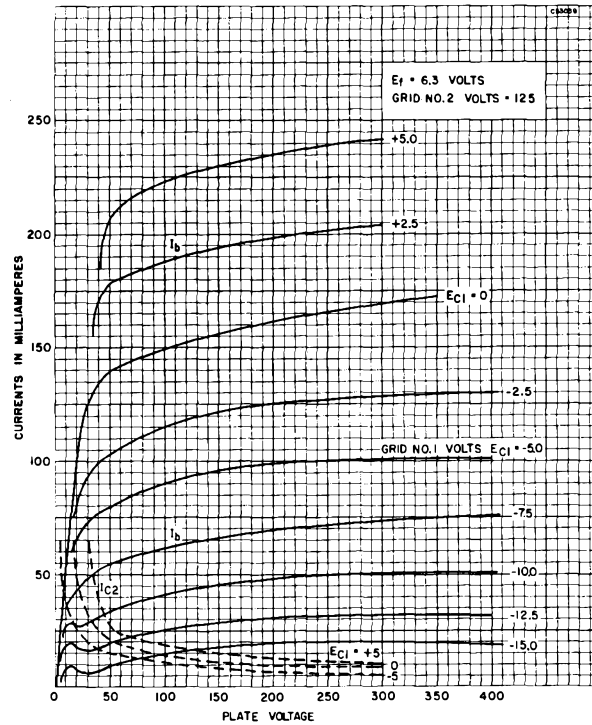

AVERAGE PLATE CHARACTERISTICS TRIODE CONNECTED

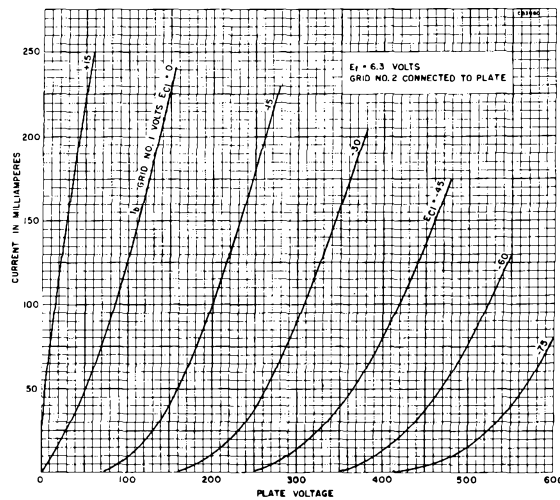

TYPE 6W7G

(See Condensed Data Section)



SYLVANIA TYPE 6X4 FULL-WAVE RECTIFIER

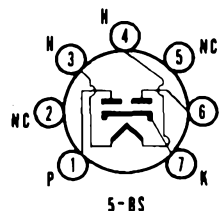

MECHANICAL DATA

Bulb	T-5 1/4, Outline 5-3
Base	Miniature Button 7-Pin
Basing	5BS
Mounting Position	Any

ELECTRICAL DATA

HEATER CHARACTERISTICS

Heater Voltage	6.3 Volts
Heater Current	600 Ma
Maximum Heater-Cathode Voltage	
Heater Negative with Respect to Cathode	450 Volts
Heater Positive with Respect to Cathode	100 Volts

MAXIMUM RATINGS (Design Center Values)

Peak Inverse Plate Voltage	1250 Volts
A C Plate Supply Voltage (R M S) With D C Output	
Current of 35 Ma Per Plate (Each Plate)	325 Volts
Steady State Peak Plate Current	210 Ma
Rectification Efficiency to Keep Within Steady State	
Peak Current Rating at 35 Ma Per Plate	67.5 Percent
Transient Peak Plate Current Per Plate (Each Plate) ¹	1.0 Ampere
Minimum Plate Supply Resistance Per Plate for	
325 Volt R M S Supply	325 Ohms
Tube Voltage Drop (70 Ma Per Plate)	22 Volts
D C Output Current Each Plate with 325 Volts	
A C Plate Supply Voltage (R M S)	
Capacitor Input to Filter	35 Ma
Choke Input to Filter	42 Ma

CHARACTERISTICS AND TYPICAL OPERATION

Full-Wave Rectifier

	Input to Filter	
	Capacitor	Choke
A C Plate Supply Voltage Per Plate (R M S)	325	450 Volts
Filter Input Capacitor ²	10	μf
Filter Input Choke (Minimum)		10 Henrys
Total Effective Plate Supply Impedance		
(Per Plate) ²	525	Ohms
D C Output Current	70	70 Ma
D C Output Voltage at Filter Input (approx.):		
For D C Cathode Current of 35 Ma	365	395 Volts
70 Ma	310	385 Volts
Difference (Voltage Regulation)	55	10 Volts
Percentage Regulation	15	2.5 Percent

NOTES:

1. If capacitor input circuits are to be used, protect the circuits against the possibility of hot-switching and do not exceed a maximum peak current value of one (1) ampere during the initial cycles of the hot-switching transient.
2. When a filter capacitor larger than 10 μf is used, it may be necessary to add additional plate supply impedance to limit the hot-switching transient plate current to the rated maximum.

APPLICATION

The 6X4 is a miniature, full-wave, cathode type rectifier. It is intended for service in compact a c or auto receivers where the average current is not in excess of 70 ma. It is similar electrically to Type 6X5GT.

SYLVANIA TUBE TESTER SETTINGS

	A	B	C	D	E	F	G	Test or K
139/140	6.3	0	—	0	2	—	22	Y
	6.3	0	—	0	5	—	22	Y
219/220	6.3	3	4	12	4	Z	1*	7
	6.3	3	4	12	4	Z	6*	7

* Diode gas test does not apply.

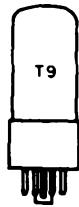

**SYLVANIA TYPE 6X5
6X5GT**

FULL-WAVE RECTIFIER

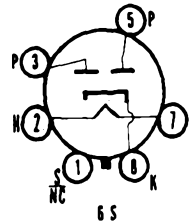

MECHANICAL DATA

Bulb..... T-9, Outline 9-11
 Base..... Intermediate Octal 6-Pin
 Basing..... 6S
 Mounting Position..... Any

ELECTRICAL DATA

HEATER CHARACTERISTICS

Heater Voltage..... 6.3 Volts
 Heater Current..... 600 Ma
 Maximum Heater-Cathode Voltage..... 450 Volts

MAXIMUM RATINGS (Design Center Values)

Peak Inverse Voltage..... 1250 Volts
 Steady State Peak Plate Current (Each Plate)..... 210 Ma
 Tube Voltage Drop (70 Ma Per Plate)..... 22 Volts

TYPICAL OPERATION

Capacitor Input to Filter

Plate Voltage (Each Plate—R M S)..... 325 Volts
 D C Output Current..... 70 Ma
 Effective Plate Supply Impedance (Each Plate)¹..... 150 Ohms

Choke Input to Filter

Plate Voltage (Each Plate—R M S)..... 450 Volts
 D C Output Current..... 70 Ma
 Input Choke Value..... 10 Henrys
 Min.

NOTE:

1. Additional impedance may be required when a filter of more than 40 μ f is used.

SYLVANIA TUBE TESTER SETTINGS

	A	B	C	D	E	F	G	Test or K
139/140	6.3	0	—	0	1	—	20	Y
	6.3	0	—	0	3	—	20	Y
219/220	6.3	2	7	13	7	Z	3*	8
	6.3	2	7	13	7	Z	5*	8

* Diode gas test does not apply.

6X5, 6X5GT (Cont'd)

AVERAGE CHARACTERISTICS

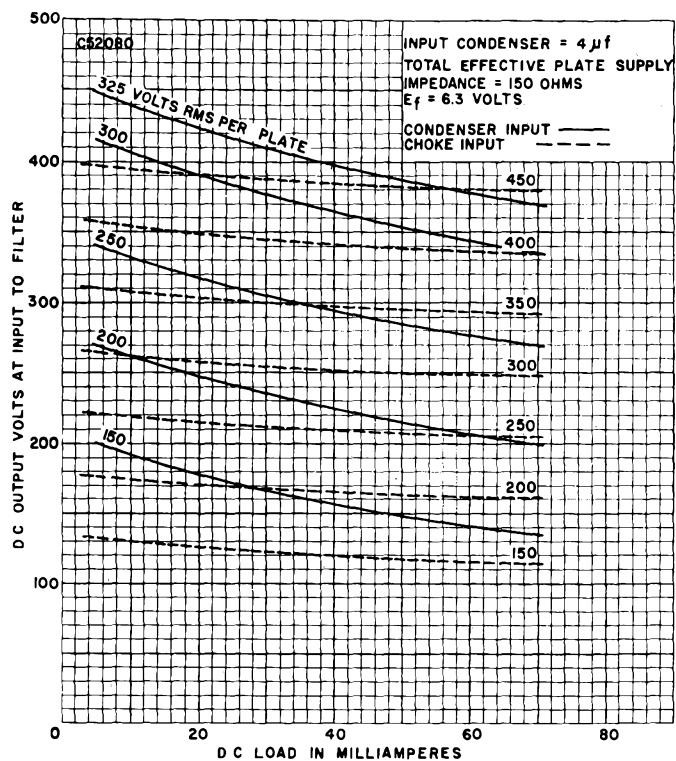

SYLVANIA TYPE 6X8
 H F TRIODE PENTODE

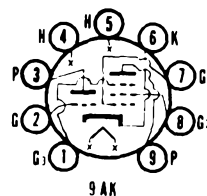

MECHANICAL DATA

Bulb.....	T-6 1/2, Outline 6-2
Base.....	Small Button 9-Pin
Basing.....	9AK
Mounting Position.....	Any

ELECTRICAL DATA

HEATER CHARACTERISTICS

Heater Voltage.....	6.3 Volts
Heater Current.....	450 Ma
Maximum Peak Heater-Cathode Voltage.....	100 Volts

DIRECT INTERELECTRODE CAPACITANCES

	Shielded ¹	Unshielded	
Triode Section:			
Grid to Plate.....	1.4	1.4 μf	
Input.....	2.6	2.0 μf	
Output.....	1.0	0.5 μf	
Pentode Section:			
Grid No. 1 to Plate.....	0.06	0.09 μf	Max
Input.....	4.5	4.3 μf	
Output.....	1.4	0.7 μf	
Coupling:			
Pentode Grid No. 1 to Triode Plate.....	0.035	0.045 μf	Max
Pentode Plate to Triode Plate.....	0.008	0.040 μf	Max

6X8 (Cont'd)

MAXIMUM RATINGS (Design Center Values)

Converter Service	Triode Section as Oscillator	Pentode Section as Mixer
Plate Voltage.....	250	250 Volts
Grid No. 2 Supply Voltage.....		250 Volts
Grid No. 2 Voltage.....	See Screen Grid Rating Curve	
Grid No. 1 Voltage		
Negative Bias.....		40 Volts
Positive Bias.....		0 Volts
Plate Dissipation.....	1.5	2.0 Watts
Grid No. 2 Input.....		0.4 Watt
Grid No. 1 Input.....	0.5	Watt
Grid No. 1 Circuit Resistance		
Fixed Bias.....	0.1	Megohm
Cathode Bias.....	0.5	Megohm

CHARACTERISTICS

	Triode	Pentode
Plate Voltage.....	100	250 Volts
Grid No. 3.....	Connected to	Cathode at Socket
Grid No. 2 Voltage.....		150 Volts
Cathode Bias Resistor.....	100	200 Ohms
Amplification Factor.....	40	
Plate Resistance (approx.).....	6900	750000 Ohms
Transconductance.....	5800	4600 μ mhos
Grid No. 1 Bias for Plate Current of 10 μ a (approx.).....	-10	-10 Volts
Plate Current.....	8.5	7.7 Ma
Grid No. 2 Current.....		1.6 Ma

TYPICAL OPERATION

	Triode Section as 250 Mc Osc.	Pentode Section as Mixer ²
Plate Voltage.....	150	150 Volts
Grid No. 3.....	Connected to Cathode at Socket	
Grid No. 2 Voltage.....		150 Volts
Mixer Grid No. 1 Supply Voltage.....		-3.5 Volts
Oscillator Voltage at Mixer		
Grid No. 1 (R.M.S.).....		2.6 Volts
Mixer Grid No. 1 Circuit Resistance.....		120000 Ohms
Oscillator Grid Resistor.....	2700	Ohms
Conversion Transconductance.....		2100 μ mhos
Plate Current.....	13	6.2 Ma
Grid No. 2 Current.....		1.8 Ma
Grid No. 1 Current.....	3.6	Ma
Grid No. 1 Current.....		2.0 μ a
Oscillator Power Output (approx.).....	0.5 ¹	Watt

NOTES:

- External shield No. 315 tied to cathode.
- With separate excitation and triode unit grounded.
- In tv or fm receivers, it is generally desirable to operate the oscillator with less power input than shown in the tabulated data in order to avoid over-excitation and excessive oscillator radiation.

APPLICATION

A miniature medium- μ triode and a sharp cutoff pentode in one envelope. Designed primarily for use as a combined oscillator and mixer in television receivers utilizing an if in the order of 40 mc. The 6X8 gives performance comparable to that obtainable with a 6AG5 mixer and an oscillator consisting of one unit of a Type 6J6.

SYLVANIA TUBE TESTER SETTINGS

	A	B	C	D	E	F	G	Test or K
139/140	6.3	0	—	0	4	0279	48	V
	6.3	0	—	0	5	3	37	U
219/220	6.3	4	5S	38	5	78Y	9	6
	6.3	4	5S	44	5	2X	3	6

6X8 (Cont'd)

AVERAGE PLATE CHARACTERISTICS PENTODE SECTION

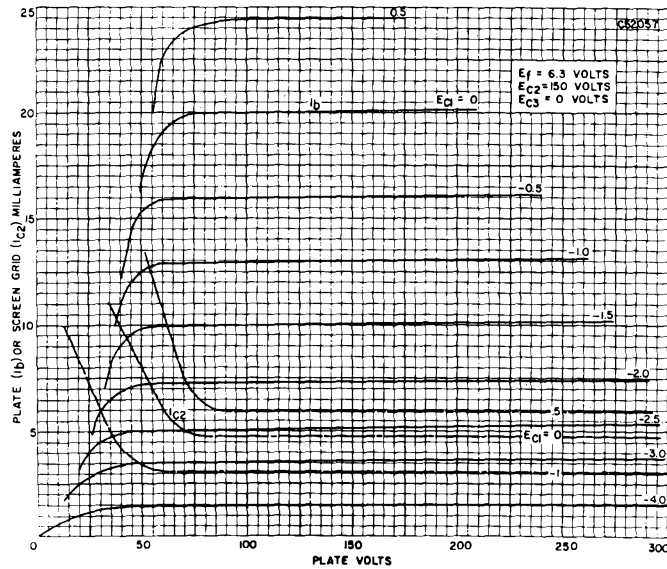

AVERAGE OPERATING CHARACTERISTICS PENTODE SECTION—SEPARATE EXCITATION

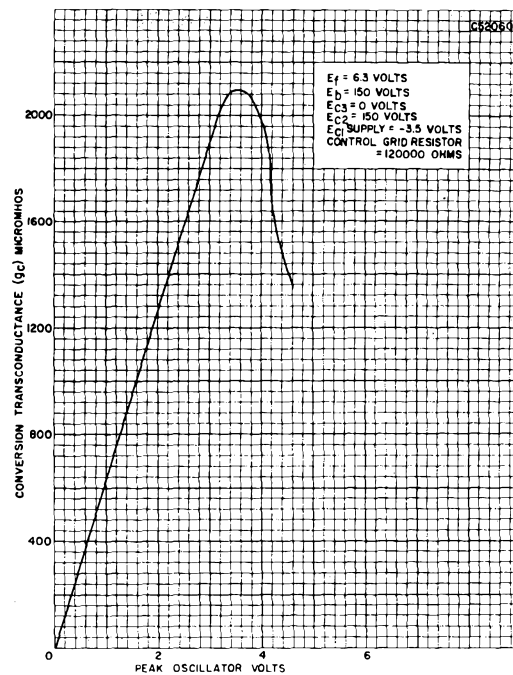

6X8 (Cont'd)

SCREEN GRID RATING CHART

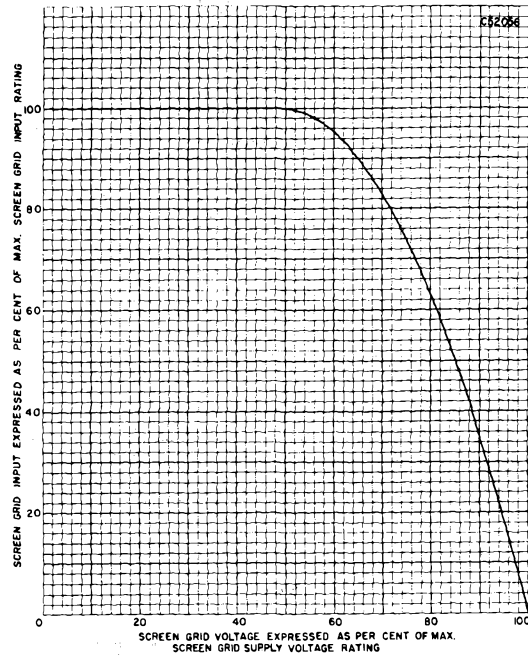

AVERAGE PLATE CHARACTERISTICS
TRIODE SECTION

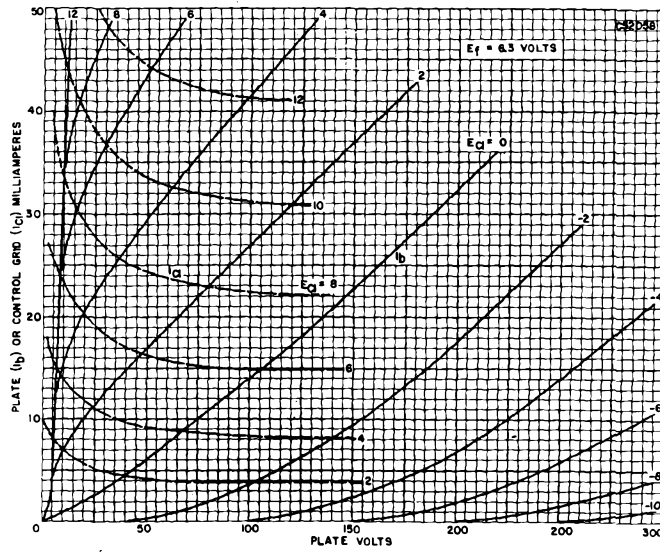

SYLVANIA ELECTRONIC TUBES

6X8 (Cont'd)

AVERAGE PLATE CHARACTERISTICS PENTODE SECTION—TRIODE CONNECTED

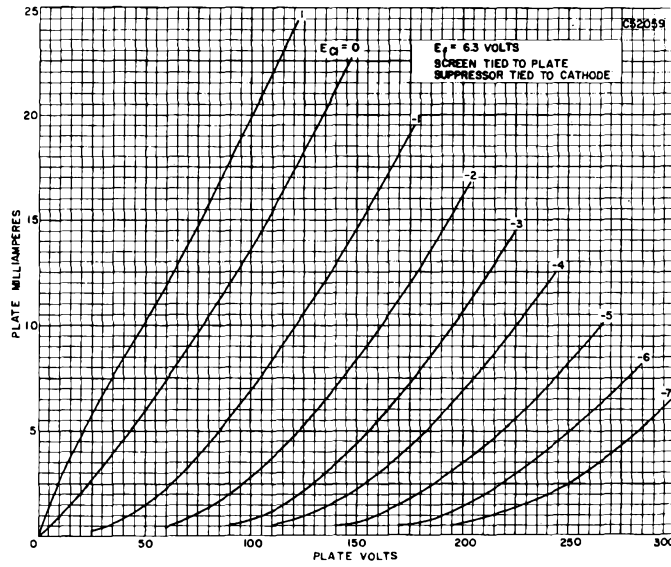

AVERAGE OPERATING CHARACTERISTICS PENTODE SECTION—SEPARATE EXCITATION

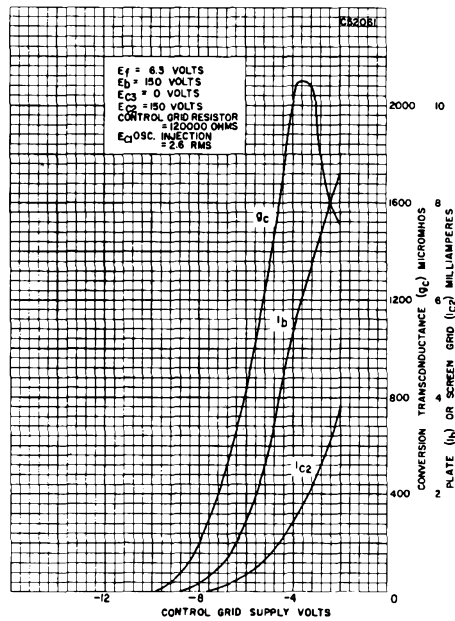

TYPES 6Y3G, 6Y5, 6Y5V

(See Condensed Data Section)

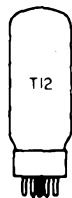

SYLVANIA TYPE 6Y6G 6Y6GA

BEAM POWER AMPLIFIER

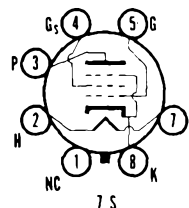

MECHANICAL DATA

	6Y6G	6Y6GA
Bulb.....	ST-14, Outline 14-3	T-12, Outline 12-101
Base.....	Medium Octal 7-Pin	Medium or Short Medium Octal 7-Pin
Basing.....	7S	7S
Mounting Position.....	Any	Any

ELECTRICAL DATA

HEATER CHARACTERISTIC

Heater Voltage.....	6.3 Volts
Heater Current.....	1.25 Amperes
Maximum Heater-Cathode Voltage.....	180 Volts

MAXIMUM RATINGS (Design Center Values)

Plate Voltage.....	200 Volts
Plate Dissipation.....	12.5 Watts
Grid No. 2 Voltage.....	See Screen Grid Rating Curve or Type 6AM8
Grid No. 2 Supply Voltage.....	200 Volts
Grid No. 2 Dissipation.....	1.75 Watts
Grid No. 1 Circuit Resistance.....	
Fixed Bias.....	0.1 Megohm
Cathode Bias.....	0.5 Megohm

CHARACTERISTICS AND TYPICAL OPERATION

Class A₁ Amplifier

Plate Voltage.....	135	200 Volts
Grid No. 2 Voltage.....	135	135 Volts
Grid No. 1 Voltage.....	-13.5	-14 Volts
Peak A F Grid No. 1 Voltage.....	13.5	14 Volts
Plate Current (Zero Signal).....	58	61 Ma
Plate Current (Maximum Signal).....	60	66 Ma
Grid No. 2 Current (Zero Signal).....	3.5	2.2 Ma
Grid No. 2 Current (Maximum Signal).....	11.5	9 Ma
Transconductance.....	7000	7100 μmhos
Plate Resistance (approx.).....	9300	18300 Ohms
Load Resistance.....	2000	2600 Ohms
Maximum Signal Power Output.....	3.6	6.0 Watts
Total Harmonic Distortion (approx.).....	10	10 Percent

SYLVANIA TUBE TESTER SETTINGS

	A	B	C	D	E	F	G	Test or K
139/140	6.3	0	—	0	1	03	19	X
219/220	6.3	2	7	12	7	045Z	3	8

TYPE 6Y7G

(See Condensed Data Section)

TYPES 6Z3, 6Z4, 6Z4/84,
6Z5, 6Z5/12Z5,
6Z7G, 6ZY5G,
7A4, 7A5

(See Condensed Data Section)

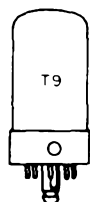

SYLVANIA TYPE 7A6
DUODIODE

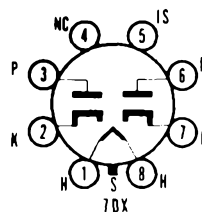

MECHANICAL DATA

Bulb	T-9, Outline 9-30
Base	Lock-In 8-Pin
Basing	7DX
Mounting Position	Any

ELECTRICAL DATA

HEATER CHARACTERISTICS

Heater Voltage	6.3 Volts
Heater Current	150 Ma
Maximum Heater-Cathode Voltage	330 Volts

TYPICAL OPERATION

A C Voltage Per Plate (R M S)	150 Volts
D C Output Current	8.0 Ma

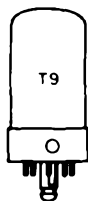

SYLVANIA TYPE 7A7
REMOTE CUTOFF R F PENTODE

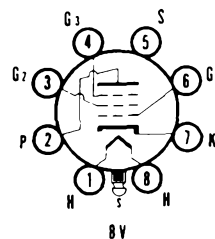

MECHANICAL DATA

Bulb	T-9, Outline 9-30
Base	Lock-In 8-Pin
Basing	8V
Mounting Position	Any

ELECTRICAL DATA

HEATER CHARACTERISTICS

Heater Voltage	6.3 Volts
Heater Current	300 Ma
Maximum Heater-Cathode Voltage	90 Volts

TYPICAL OPERATION

Plate Voltage	100	250 Volts
Grid No. 2 Voltage	100	100 Volts
Grid No. 1 Voltage	-1.0	-3.0 Volts
Self Bias Resistor	60	260 Ohms
Grid No. 3	Connect to Cathode	
Plate Current	13.0	9.2 Ma
Grid No. 2 Current	4.0	2.6 Ma
Transconductance	2350	2000 μ mhos
Plate Resistance	0.12	0.8 Megohm
Control Grid Bias for $G_m = 10 \mu$ mhos	35	-35 Volts

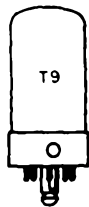

SYLVANIA TYPE 7A8

OCTODE CONVERTER

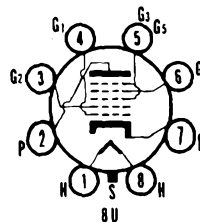

MECHANICAL DATA

Bulb	T-9, Outline 9-30
Base	Lock-in 8-Pin
Basing	8U
Mounting Position	Any

ELECTRICAL DATA

HEATER CHARACTERISTICS

Heater Voltage	6.3 Volts
Heater Current	150 Ma
Maximum Heater-Cathode Voltage	90 Volts

DIRECT INTERELECTRODE CAPACITANCES (Shielded)¹

Grid No. 4 to Plate	0.15 μf	Max
Grid No. 4 to Grid No. 2	0.3 μf	Max
Grid No. 4 to Grid No. 1	0.15 μf	Max
Grid No. 1 to Grid No. 2	0.60 μf	
R F Input, Grid No. 4 to All	7.5 μf	
Osc. Output, Grid No. 2 to All Except Grid No. 1	3.4 μf	
Osc. Input, Grid No. 1 to All Except Grid No. 2	3.8 μf	
Mixer Output, Plate to All	9.0 μf	

MAXIMUM RATINGS (Design Center Values)

Plate Voltage	300 Volts
Grids No. 3 and 5 Supply Voltage	300 Volts
Grids No. 3 and 5 Voltage	100 Volts
Grid No. 2 Supply Voltage	300 Volts
Grid No. 2 Voltage	200 Volts
Plate Dissipation	1.0 Watt
Grids No. 3 and 5 Dissipation	0.3 Watt
Grid No. 2 Dissipation	0.75 Watt
Cathode Current	13.0 Ma
Positive Grid No. 4 Voltage	0 Volts

TYPICAL OPERATION

Plate Voltage	100	250 Volts
Grids No. 3 and 5 Voltage	75	100 Volts
Grid No. 4 Voltage (Signal Grid)	-3.0	3.0 Volts
Grid No. 2 Voltage (Osc. Anode)	100	250 Volts ²
Grid No. 1 Resistor (Osc. Grid)	50000	50000 Ohms
Plate Current	1.8	3.0 Ma
Grids No. 3 and 5 Current	2.7	3.2 Ma
Grid No. 2 Current	2.8	4.2 Ma
Grid No. 1 Current	0.2	0.4 Ma
Self Bias Resistor	400	280 Ohms
Plate Resistance65	.70 Megohm
Conversion Transconductance	375	550 μmhos
Grid No. 4 Voltage for $G_c = 2 \mu\text{mhos}$	-22.5	-30 Volts

CHARACTERISTICS

Oscillator, Non-oscillating Condition³

Grid No. 2 Current	10 Ma
Transconductance (Grid No. 1 to Grid No. 2)	1600 μmhos
Amplification Factor (Grid No. 1 to Grid No. 2)	65

NOTES:

- Shield No. 308 connected to cathode.
- Applied through 20,000 ohm resistor for $E_{r2} = 250 \text{ V}$.
- Measurements taken with $E_{v1} = 250 \text{ volts}$; $E_{r2} = 180 \text{ volts}$; $E_{r3} = 100 \text{ Volts}$; $E_{v1} = 0 \text{ volts}$.

APPLICATION

Sylvania Type 7A8 is a single-ended oscillator-mixer tube. The addition of a suppressor grid serves to increase the plate resistance for improved performance, particularly when operated at low plate supply voltages.

SYLVANIA TUBE TESTER SETTINGS

	A	B	C	D	E	F	G	Test or K
139/140	6.3	0	----	0	1	056	70	W
	6.3	0	----	0	2	45	93	X
219/220	6.3	1	8S	65	8	056X	2	7
	6.3	1	8	41	8	4U	3	7

TYPES 7AB7, 7AD7, 7AF7

(See Condensed Data Section)

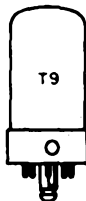

SYLVANIA TYPE 7AG7 SHARP CUTOFF PENTODE

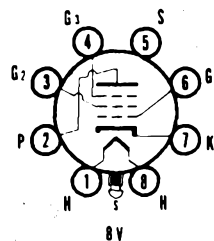

MECHANICAL DATA

Bulb	T-9; Outline 9-30
Base	Lock-In 8-Pin
Basing	8V
Mounting Position	Any

ELECTRICAL DATA

HEATER CHARACTERISTICS

Heater Voltage	6.3 Volts
Heater Current	150 Ma
Maximum Heater-Cathode Voltage	90 Volts

AVERAGE CHARACTERISTICS AND TYPICAL OPERATION

Plate Voltage	100	250	Volts
Grid No. 2 Voltage	100	250	Volts
Grid No. 3 Voltage	Connected to Cathode at Socket		
Grid No. 1 Voltage	1.0	Note 1	
Self Bias Resistor	480	250	Ohms
Plate Current	1.6	6.0	Ma
Grid No. 2 Current	0.5	2.0	Ma
Transconductance	2500	4200	μmhos
Plate Resistance	.71	>1.0	Megohms
Control Grid Bias for $I_b = 10 \mu a$	-3.5	-10.0	Volts

NOTE: 1. Bias voltage developed is approximately 2.0 volts. Fixed bias operation is not recommended.

TYPE 7AH7, 7AJ7

(See Condensed Data Section)

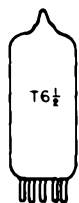

SYLVANIA TYPE 7AU7 MEDIUM-MU DUO TRIODE

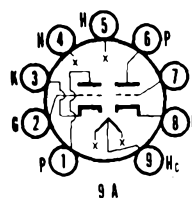

ELECTRICAL DATA

HEATER CHARACTERISTICS

Heater Voltage Series/Parallel	7.0/3.5	Volts
Heater Current Series/Parallel	300/600	Ma
Heater Warm-up Time (See SERIES STRING HEATERS Section in Appendix)		
Maximum Heater-Cathode Voltage	200	Volts
Total D C and Peak	100	Volts
D C, Heater Positive with Respect to Cathode		

For other rating, operation, and application data, refer to corresponding Type 12AU7, which is identical except for heater ratings.

APPLICATION

The Sylvania Type 7AU7 is intended for service in television receivers employing series connected heaters. For information on specially controlled heaters for series string operation refer to the SERIES STRING HEATERS section of the Appendix.

NOTE: 1. Applies to parallel connection only.

TYPES 7B4, 7B5

(See Condensed Data Section)

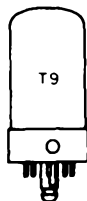

SYLVANIA TYPE 7B6 DUODIODE HIGH-MU TRIODE

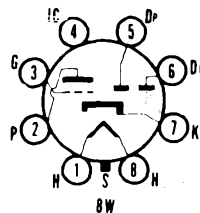

MECHANICAL DATA

Bulb	T-9, Outline 9-30
Base	Lock-In 8-Pin
Basing	8W
Mounting Position	Any

ELECTRICAL DATA

HEATER CHARACTERISTICS

Heater Voltage	6.3 Volts
Heater Current	300 Ma

CHARACTERISTICS

Plate Voltage	100	250 Volts
Grid No. 1 Voltage	1.0	2.0 Volts
Plate Current	0.4	0.9 Ma
Transconductance	900	1100 μ mhos
Amplification Factor	100	100
Plate Resistance	110000	91000 Ohms
Diode Drop at 0.8 Ma		10 Volts

Data for use in Resistance Coupled Amplifier Circuits is given in the Appendix.

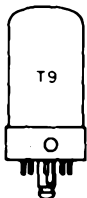

SYLVANIA TYPE 7B7 REMOTE CUTOFF PENTODE

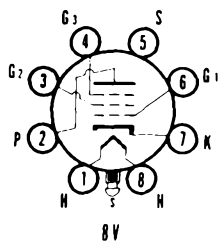

MECHANICAL DATA

Bulb	T-9, Outline 9-30
Base	Lock-in 8 Pin
Basing	8V
Mounting Position	Any

ELECTRICAL DATA

HEATER CHARACTERISTICS

Heater Voltage	6.3 Volts
Heater Current	150 Ma
Maximum Heater-Cathode Voltage	90 Volts

DIRECT INTERELECTRODE CAPACITANCES (Shielded)†

Grid to Plate	0.004 μ mf	Max
Input	5.0 μ mf	
Output	6.0 μ mf	

MAXIMUM RATINGS (Design Center Values)

Plate Voltage	300 Volts
Plate Dissipation	2.25 Watts
Grid No. 2 Voltage	100 Volts
Grid No. 2 Dissipation	0.25 Watts
Positive Grid No. 1 Voltage	0 Volts

7B7 (Cont'd)

CHARACTERISTICS AND TYPICAL OPERATION

Plate Voltage.....	100	250	Volts
Grid No. 2 Voltage.....	100	100	Volts
Grid No. 1 Voltage.....	-3.0	-3.0	Volts
Self Bias Resistor.....	300	300	Ohms
Suppressor.....	Connect to Cathode	at Socket	
Plate Current.....	8.2	8.5	Ma
Grid No. 2 Current.....	1.8	1.7	Ma
Transconductance.....	1675	1750	μ mhos
Plate Resistance.....	0.3	0.75	Megohm
Control Grid Bias for $G_m = 10 \mu$ mhos.....	-40	-40	Volts

NOTE:

- Shield No. 308. Internal Shield connects to Pin No. 5.

APPLICATION

Sylvania Type 7B7 is a remote cutoff pentode suitable for rf or if service. An internal shield connects to Pin No. 5 in order to obtain a low grid to plate capacity.

SYLVANIA TUBE TESTER SETTINGS

	A	B	C	D	E	F	G	Test or K
139/140	6.3	0	—	0	1	036	36	W
219/220	6.3	1	8	30	8	036Y	2	7

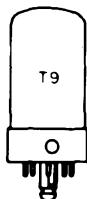

SYLVANIA TYPE 7B8
HEPTODE CONVERTER

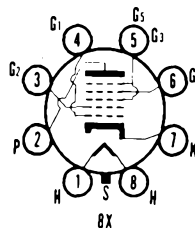

MECHANICAL DATA

Bulb.....	T-9, Outline 9-30
Base.....	Lock-In 8-Pin
Basing.....	8 X
Mounting Position.....	Any

ELECTRICAL DATA

HEATER CHARACTERISTICS

Heater Voltage.....	6.3	Volts
Heater Current.....	300	Ma

TYPICAL OPERATION

Plate Voltage.....	100	250	Volts
Grid No. 3 and 5 Voltage.....	50	100	Volts
Grid No. 2 Voltage (Note 1 for $E_{c2} = 250$ V).....	100	250	Volts
Grid No. 1 Resistor.....	50000	50000	Ohms
Grid No. 4 Voltage.....	-1.5	-3.0	Volts
Plate Current.....	1.1	3.5	Ma
Grid No. 3 and 5 Current.....	1.3	2.7	Ma
Grid No. 2 Current.....	2.0	4.0	Ma
Grid No. 1 Current.....	0.25	0.4	Ma
Self Bias Resistor.....	360	300	Ohms
Conversion Transconductance.....	360	550	μ mhos
Plate Resistance.....	0.6	0.36	Megohm
Grid No. 4 Bias (approx.) for $g_c = 6 \mu$ mhos.....		-35	Volts
$g_c = 3 \mu$ mhos.....	-20		Volts

CHARACTERISTICS

Oscillator, Non-oscillating Condition²

Grid No. 2 Current.....	4	Ma
Transconductance (Grid No. 1 to Grid No. 2).....	1150	μ mhos
Amplification Factor (Grid No. 1 to Grid No. 2).....	75	

NOTES:

- Applied through a 20,000 ohm resistor.
- Measurements taken with $E_b = 250$ volts; $E_{c2} = 100$ volts; $E_{c3} = 55$ volts; $E_{c4} = -2.0$ volts; $E_{c1} = -1.0$ volt.

TYPE 7C4

(See Condensed Data Section)

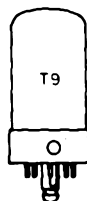

SYLVANIA TYPE 7C5 BEAM POWER AMPLIFIER

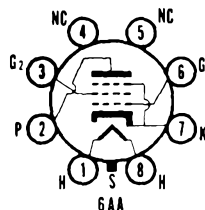

MECHANICAL DATA

Bulb.....	T-9, Outline 9-31
Base.....	Lock-in 8-Pin
Basing.....	6AA
Mounting Position.....	Any

ELECTRICAL DATA

HEATER CHARACTERISTICS

Heater Voltage.....	6.3 Volts
Heater Current.....	450 Ma

DIRECT INTERELECTRODE CAPACITANCES (With Shield No. 308)

Grid to Plate.....	0.4 μmf
Input.....	9.5 μmf
Output.....	9.0 μmf

For other rating, operation, and application data, refer to corresponding Type 6V6GT, which is identical except for mechanical data, and capacities.

SYLVANIA TUBE TESTER SETTINGS

	A	B	C	D	E	F	G	Test or K
139/140	6.3	0	—	0	1	036	37	Y
219/220	6.3	1	8	14	8	036Y	2	7

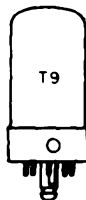

SYLVANIA TYPE 7C6 DUODIODE HIGH-MU TRIODE

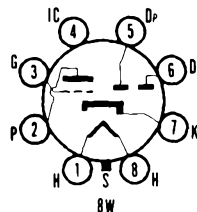

MECHANICAL DATA

Bulb.....	T-9, Outline 9-30
Base.....	Lock-in 8-Pin
Basing.....	8W
Mounting Position.....	Any

ELECTRICAL DATA

HEATER CHARACTERISTICS

Heater Voltage.....	6.3 Volts
Heater Current.....	150 Ma

CHARACTERISTICS

Plate Voltage.....	100	250 Volts
Grid No. 1 Voltage.....	0.0	-1.0 Volts
Plate Current.....	1.0	1.3 Ma
Transconductance.....	850	1000 μmhos
Amplification Factor.....	85	100
Plate Resistance.....	1.0	0.1 Megohm
Diode Voltage Drop at 0.8 Ma.....		10 Volts

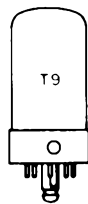

SYLVANIA TYPE 7C7
SHARP CUTOFF PENTODE

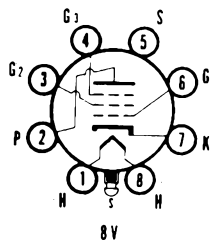

MECHANICAL DATA

Bulb	T-9, Outline 9-30
Base	Lock-In 8-Pin
Basing	8V
Mounting Position	Any

ELECTRICAL DATA

HEATER CHARACTERISTICS

Heater Voltage	6.3 Volts
Heater Current	150 Ma

TYPICAL OPERATION

Plate Voltage	100	250 Volts
Grid No. 2 Voltage	100	100 Volts
Grid No. 1 Voltage	-3.0	-3.0 Volts
Self Bias Resistor	1350	1200 Ohms
Grid No. 3	Connected to Cathode at Socket	
Plate Current	1.8	2.0 Ma
Grid No. 2 Current	0.4	0.5 Ma
Transconductance	1250	1300 μ mhos
Plate Resistance	1.2	2.0 Megohms

Data for use in Resistance Coupled Amplifier Circuits is given in the Appendix.

TYPES 7E5, 7E6, 7E7

(See Condensed Data Section)

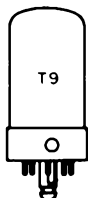

SYLVANIA TYPE 7F7
HIGH-MU DUO TRIODE

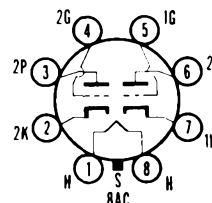

MECHANICAL DATA

Bulb	T-9, Outline 9-30
Base	Lock-In 8-Pin
Basing	8AC
Mounting Position	Any

ELECTRICAL DATA

HEATER CHARACTERISTICS

Heater Voltage	6.3 Volts
Heater Current	300 Ma

MAXIMUM RATINGS (Design Center Values)

Plate Voltage	300 Volts
Plate Dissipation	1.0 Watt

For typical operation, and application data, refer to corresponding Type 6SL7GT, which is identical except for mechanical data and maximum plate voltage rating. Data for use in resistance coupled amplifier circuits is given in the appendix.



SYLVANIA TYPE 7F8

DUO TRIODE

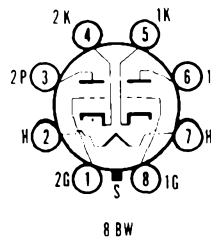

MECHANICAL DATA

Bulb	T-9, Outline 9-32
Base	Lock-In 8-Pin
Basing	8BW
Mounting Position	Any

ELECTRICAL DATA

HEATER CHARACTERISTICS

Heater Voltage	6.3 Volts
Heater Current	300 Ma

CHARACTERISTICS AND TYPICAL OPERATION (Each Section)

Plate Voltage	250 Volts
Self Bias Resistor	500 Ohms
Plate Current	6.0 Ma
Transconductance	3300 μ mhos
Amplification Factor	48
Control Grid Bias for $I_b = 10\mu$ a (approx.)	-11.0 Volts
Maximum Grid Circuit Resistance	0.5 Megohm

TYPES 7G7, 7G8, 7H7, 7J7, 7K7, 7L7

(See Condensed Data Section)

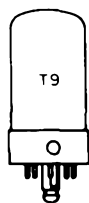

SYLVANIA TYPE 7N7

MEDIUM-MU DUO TRIODE

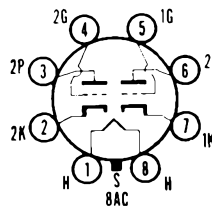

MECHANICAL DATA

Bulb	T-9, Outline 9-31
Base	Lock-in 8-Pin
Basing	8AC
Mounting Position	Any

ELECTRICAL DATA

HEATER CHARACTERISTICS

Heater Voltage	6.3 Volts
Heater Current	600 Ma
Maximum Heater-Cathode Voltage	90 Volts

DIRECT INTERELECTRODE CAPACITANCES (Shielded)^{1, 2}

	Section 1	Section 2
Grid to Plate	3.0	3.0 μ f
Input	3.4	2.9 μ f
Output	2.0	2.4 μ f

MAXIMUM RATINGS (Design Center Values)

Plate Voltage	300 Volts
Plate Dissipation (Per Section)	2.5 Watts
Positive Grid Voltage	0 Volts

7N7 (Cont'd)

NOTES:

1. Shield No. 308 connected to cathode.
2. Section 1 connects to pins 5, 6 and 7. Section 2 connects to pins 2, 3 and 4.

For typical operation as a Class A₁ Amplifier refer to corresponding Type 6SN7GTA. Data for use in Resistance Coupled Amplifier Circuits is given in the Appendix. Curves under Type 6SN7GTA may also be used for the Type 7N7.

SYLVANIA TUBE TESTER SETTINGS

	A	B	C	D	E	F	G	Test or K
139/140	6.3	0	—	0	2	4	36	W
	6.3	0	—	0	5	5	36	W
219/220	6.3	1	78	25	8	4Y	3	2
	6.3	1	28	25	8	5Y	6	7

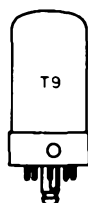

SYLVANIA TYPE 7Q7
HEPTODE CONVERTER

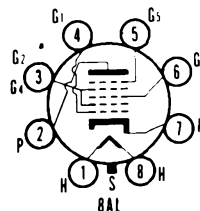

MECHANICAL DATA

Bulb.....	T-9, Outline 9-30
Base.....	Lock-In 8-Pin
Basing.....	8AL
Mounting Position.....	Any

ELECTRICAL DATA

HEATER CHARACTERISTICS

Heater Voltage.....	6.3 Volts
Heater Current.....	300 Ma

TYPICAL OPERATION

Refer to corresponding Type 6SA7 which is identical except for Conversion Transconductance.

Conversion Transconductance (Separately Excited Condition)	
$E_b = 100 \text{ V.}, E_{c2} = 100 \text{ V.}, E_{c3} = -2\text{V.}$	525 μmhos
$E_b = 250 \text{ V.}, E_{c2} = 100 \text{ V.}, E_{c3} = -2\text{V.}$	550 μmhos

TYPES 7R7, 7S7, 7T7, 7V7, 7W7

(See Condensed Data Section)

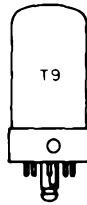

SYLVANIA TYPE 7Y4
FULL-WAVE RECTIFIER

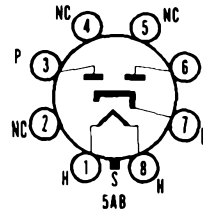

MECHANICAL DATA

Bulb.....	T-9, Outline 9-30
Base.....	Lock-In 8-Pin
Basing.....	5AB
Mounting Position.....	Any

ELECTRICAL DATA

HEATER CHARACTERISTICS

Heater Voltage.....	6.3 Volts
Heater Current.....	500 Ma

For other rating, operation, and application data, refer to corresponding Type 6X5GT, which is identical except for heater ratings, and mechanical data.

**TYPES 7Y6, 7X7/XXFM, 7Z4, 10,
12A(112A), 12A4, 12A5,
12A6, 12A6GT, 12A7, 12A8,
GT, 12AH7GT**

(See Condensed Data Section)

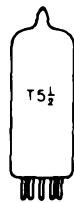

SYLVANIA TYPE 12AL5
DUO DIODE

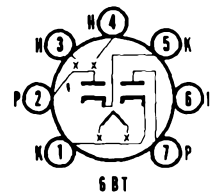

ELECTRICAL DATA

HEATER CHARACTERISTICS

Heater Voltage.....	12.6 Volts
Heater Current.....	150 Ma

For other rating, operation, and application data, refer to corresponding Type 6AL5, which is identical except for heater ratings.



SYLVANIA TYPE 10C8
TRIODE PENTODE

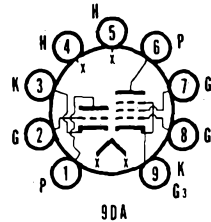

MECHANICAL DATA

Bulb.....	T-6½
Base.....	E9-1, Small Button 9-Pin
Outline.....	6-2
Basing.....	9DA
Cathode.....	Coated Unipotential
Mounting Position.....	Any

ELECTRICAL DATA

HEATER CHARACTERISTICS

Heater Voltage.....	10.5 Volts
Heater Current.....	300 Ma
Heater Warm-up Time ¹	11 Seconds
Heater Cathode Voltage (Design Maximum Values)	
Heater Positive with Respect to Cathode, D.C.....	100 Volts
Total D.C. and Peak.....	200 Volts
Heater Negative with Respect to Cathode	
Total D.C. and Peak.....	200 Volts

DIRECT INTERELECTRODE CAPACITANCES (Unshielded)

	Triode Section	Pentode Section
Grid No. 1 to Plate.....	1.6	0.04 μf Max.
Input.....	2.4	7.0 μf
Output.....	0.20	2.2 μf
Coupling		
Pentode Grid No. 1 to Triode Plate.....		0.008 μf Max.
Triode Grid to Pentode Plate.....		0.006 μf Max.
Pentode Plate to Triode Plate.....		0.06 μf Max.

MAXIMUM RATINGS (Design Maximum Values)²

Class A1 Amplifier

	Triode Section	Pentode Section
Plate Voltage.....	300	300 Volts
Grid No. 2 Supply Voltage.....		300 Volts
Grid No. 2 Voltage.....	See 6AM8 Rating Chart	
Positive Grid No. 1 Voltage.....	0	0 Volts
Plate Dissipation.....	2.0	2.2 Watts
Grid No. 2 Dissipation.....		0.55 Watt
Grid No. 1 Circuit Resistance		
Fixed Bias.....	0.5	0.25 Megohm
Cathode Bias.....	1.0	1.0 Megohm

Vertical Deflection Service³

	Triode Section Vertical Osc.	Pentode Section Vertical Amp. ⁴
D.C. Plate Voltage.....	300	300 Volts
Peak Positive Pulse Plate Voltage.....		1000 Volts
Peak Negative Grid Voltage.....	400	250 Volts
Plate Dissipation.....	1.0	2.5 ⁵ Watts
D.C. Cathode Current.....	12	18 Ma
Peak Cathode Current.....	35	55 Ma
Grid Circuit Resistance		
Fixed Bias.....	2.2	Megohms
Cathode Bias.....	2.2	2.2 Megohms
Grid Leak Bias.....	2.2	2.2 Megohms

CHARACTERISTICS AND TYPICAL OPERATION

	Triode Section	Pentode Section
Plate Voltage.....	250	135 Volts
Grid No. 2 Voltage.....		135 Volts
Cathode Resistor.....	390	100 Ohms
Plate Current.....	7.3	11.5 Ma
Grid No. 2 Current.....		3.2 Ma
Transconductance.....	4400	8000 μmhos
Amplification Factor.....	53	40 ¹
Plate Resistance (approx.).....	1200	190,000 Ohms
E _{c1} for I _b = 10 μa (approx.).....	-10	Volts
E _{c1} for I _b = 50 μa (approx.).....		-6 Volts
Plate Knee Characteristics (Pentode Section—Triode Connected)		
Plate Voltage.....		135 Volts
Grid No. 1 Voltage.....		0 Volts
Plate Current (Instantaneous).....		33 Ma

10C8 (Cont'd)

NOTES:

1. Heater warm-up time is defined as the time required for the voltage across the heater to reach 80% of its rated value after applying four (4) times rated heater voltage to a circuit consisting of the tube heater in series with a resistance equal to three (3) times rated heater voltage divided by rated heater current.
2. Design-Maximum ratings are limiting values of operating and environmental conditions applicable to bogey electron device of a specified type as defined by its published data, and should not be exceeded under the worst probable conditions.
The device manufacturer chooses these values to provide acceptable serviceability of the device, taking responsibility for the effects of changes in operating conditions due to variations in device characteristics.
The equipment manufacturer should design so that initially and throughout life no design-maximum value for the intended service is exceeded with a bogey device under the worst probable operating conditions with respect to supply-voltage variation, equipment component variation, equipment control adjustment, load variation, signal variation, and environmental conditions.
3. For operation in a 525-line, 30-frame system as described in "Standards of Good Engineering Practice for Television Broadcasting Stations, Federal Communications Commission." The duty cycle of the voltage pulse is not to exceed 15% of a scanning cycle.
4. Triode connected.
5. In stages operating with grid-leak bias, an adequate cathode bias resistor or other suitable means is required to protect the tube in the absence of excitation.

APPLICATION

The Type 10C8 has a high-mu triode and general purpose pentode contained in a miniature envelope. The pentode section is suitable for use as a vertical deflection amplifier when triode connected.

Type 10C8 has controlled heater warm-up time for series string operation.

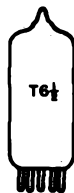

SYLVANIA TYPE 12AB5

BEAM POWER PENTODE

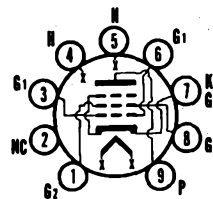

MECHANICAL DATA

Bulb.....	T-6½
Base.....	E9-1, Small Button 9-Pin
Outline.....	6-3
Basing.....	9EU
Cathode.....	Coated Unipotential
Mounting Position.....	Any

ELECTRICAL DATA

HEATER CHARACTERISTICS

Heater Voltage ¹	12.6 Volts
Heater Current.....	0.2 Ampere
Heater-Cathode Voltage (Design Center Values) Heater Negative with Respect to Cathode	
Total D C and Peak.....	200 Volts Max.
Heater Positive with Respect to Cathode	
D C.....	100 Volts Max.
Total D C and Peak.....	200 Volts Max.

DIRECT INTERELECTRODE CAPACITANCES (Unshielded)

Grid to Plate: (g1 to p).....	0.7 μμf
Input: g1 to (h + k + g2 + g3).....	8.0 μμf
Output: p to (h + k + g2 + g3).....	8.5 μμf

RATINGS (Design Center Values)

Class A₁ Amplifier	
Plate Voltage.....	315 Volts Max.
Plate Dissipation.....	12 Watts Max.
Grid No. 2 Voltage.....	285 Volts Max.
Grid No. 2 Dissipation.....	2 Watts Max.
Grid No. 1 Circuit Resistance	
Fixed Bias.....	0.1 Megohm Max.
Cathode Bias.....	0.5 Megohm Max.

CHARACTERISTICS AND TYPICAL OPERATION

Class A₁ Amplifier (Single Tube)

Conditions:			
Plate Voltage.....	180	250	250 Volts
Grid No. 2 Voltage.....	180	200	250 Volts
Grid No. 1 Voltage.....	-8.5		-12.5 Volts
Cathode Bias Resistor.....		270	Ohms
Peak AF Grid No. 1 Voltage.....	8.5	10.5	12.5 Volts
Zero Signal Plate Current.....	29	33.5	45 Ma
Maximum Signal Plate Current.....	30	36.0	47 Ma
Zero Signal Grid No. 2 Current.....	3.0	1.6	4.5 Ma
Maximum Signal Grid No. 2 Current.....	4.0	3.2	7.0 Ma
Plate Resistance (approx.).....	50,000		50,000 Ohms
Transconductance.....	3700	4000	4100 μmhos
Load Resistance.....	5500	6000	5000 Ohms
Maximum Signal Power Output.....	2.0	3.3	4.5 Watts
Total Harmonic Distortion.....	8	12	8 Percent

Class A₁ Push-Pull Amplifier (Values are for Two Tubes)

Conditions:	
Plate Voltage.....	250 Volts
Grid No. 2 Voltage.....	250 Volts
Grid No. 1 Voltage.....	-15 Volts
Peak AF Grid No. 1 to Grid No. 1 Voltage.....	30 Volts
Zero Signal Plate Current.....	70 Ma
Maximum Signal Plate Current.....	79 Ma
Zero Signal Grid No. 2 Current.....	5 Ma
Maximum Signal Grid No. 2 Current.....	13 Ma
Plate-to-Plate Load Resistance.....	10,000 Ohms
Maximum Signal Power Output.....	10 Watts
Total Harmonic Distortion.....	5 Percent

NOTE:

1. This tube is intended for use in automobile radios operated from a nominal 12 volt battery. Design of the tube is such that the heater will operate satisfactorily over the range 10.0 volts to 15.9 volts, and that the maximum ratings provide a safety factor for the wide voltage variation encountered with this type of supply.

APPLICATION

The 12AB5 is a miniature beam power pentode designed primarily for service as an audio power amplifier in auto radios having a 12 volt heater supply. Except for heater characteristics, electrically the 12AB5 is identical to the 6CM6 and the 12CM6.

SYLVANIA ELECTRONIC TUBES

Issued as a supplement to the manual in Sylvania News for March 1957

12AB5 (Cont'd)

AVERAGE PLATE CHARACTERISTICS

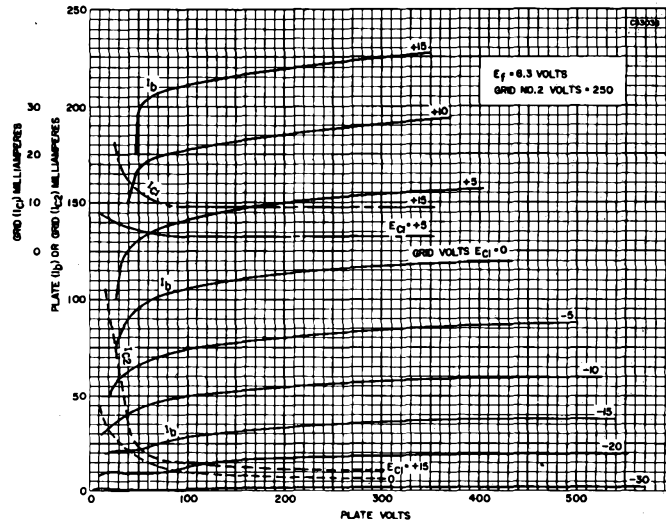

AVERAGE PLATE CHARACTERISTICS (TRIODE CONNECTED)

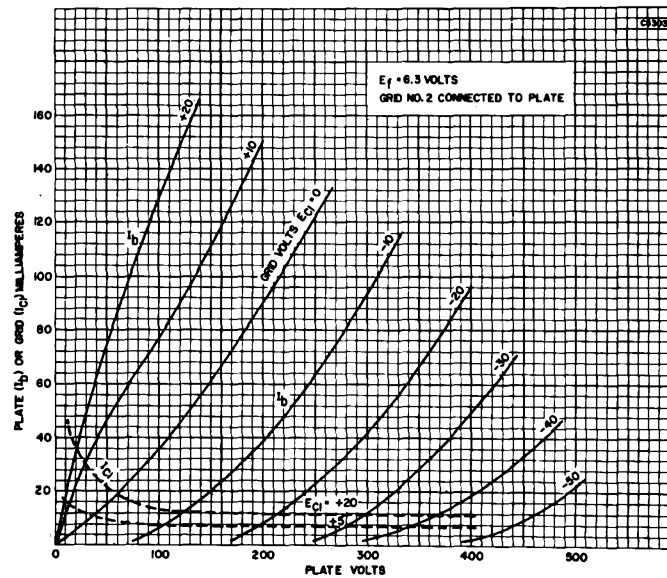

SYLVANIA ELECTRONIC TUBES



SYLVANIA TYPE 12AC6

Remote Cutoff Pentode

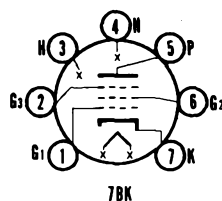

MECHANICAL DATA

Bulb.....	T-5½
Base.....	E7-1, Miniature Button 7-Pin
Outline.....	5-2
Basing.....	7BK
Cathode.....	Coated Unipotential
Mounting Position.....	Any

ELECTRICAL DATA

HEATER CHARACTERISTICS

Heater Voltage ¹	12.6 Volts
Heater Current.....	150 Ma
Heater-Cathode Voltage (Design Center Values)	
Heater Negative with Respect to Cathode.....	30 Volts Max.
Heater Positive with Respect to Cathode.....	30 Volts Max.

DIRECT INTERELECTRODE CAPACITANCES

	Shielded ²	Unshielded
Grid No. 1 to Plate.....	.004	.005 $\mu\mu\text{f}$
Input.....	4.3	4.3 $\mu\mu\text{f}$
Output.....	5.0	5.0 $\mu\mu\text{f}$

RATINGS (Design Center Values)

Plate Voltage.....	30 Volts Max.
Grid No. 2 Voltage.....	30 Volts Max.
Cathode Current.....	20 Ma Max.
Grid No. 1 Circuit Resistance.....	10 Megohms Max.

CHARACTERISTICS AND TYPICAL OPERATION

Class A ₁ Amplifier	
Plate Voltage.....	12.6 Volts
Grid No. 3 Voltage (Connected to Cathode at Socket).....	0 Volts
Grid No. 2 Voltage.....	12.6 Volts
Grid No. 1 Voltage ³	
Grid No. 1 Resistor.....	2.2 Megohms
Plate Current.....	550 μa
Grid No. 2 Current.....	200 μa
Transconductance ⁴	730 μmhos
Plate Resistance (approx.).....	0.5 Megohm
Grid No. 1 Voltage for $G_m = 10 \mu\text{mhos}$ (approx.), $E_{c3} = 0$	-5.2 Volts
Grid No. 3 Voltage for $G_m = 10 \mu\text{mhos}$ (approx.), $E_{c1} = 0$	-3.7 Volts

NOTES:

1. This tube is intended for use in automobile radios operated from a nominal 12 volt battery. Design of the tube is such that the heater will operate satisfactorily over the range 10.0 volts to 15.9 volts, and that the maximum ratings provide a safety factor for the wide voltage variation encountered with this type of supply.
2. Shield No. 316.
3. Average contact potential is developed across the specified resistor.
4. Measured from Grid No. 1 to plate.

APPLICATION NOTES

The Sylvania Type 12AC6 is a miniature remote cutoff pentode intended for use as an RF or IF amplifier. It is designed for operation where the heater, plate and screen voltages are supplied directly from a 12 volt automotive storage battery.

SYLVANIA TYPE 12AC6 (Cont'd)

AVERAGE PLATE CHARACTERISTICS

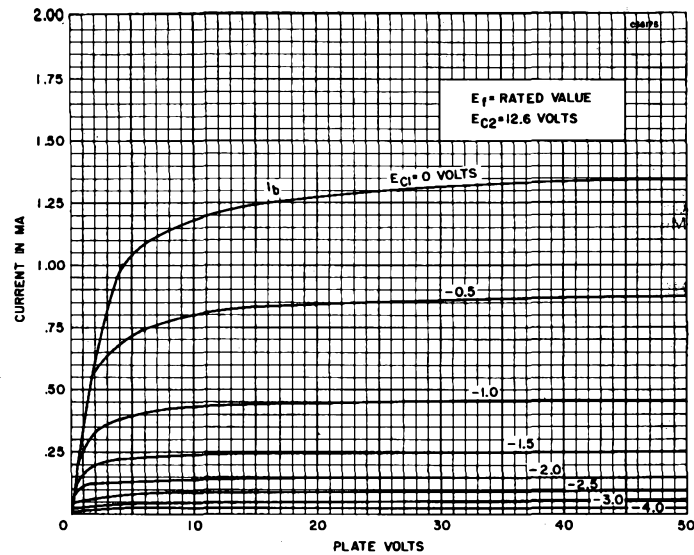

AVERAGE TRANSFER CHARACTERISTICS

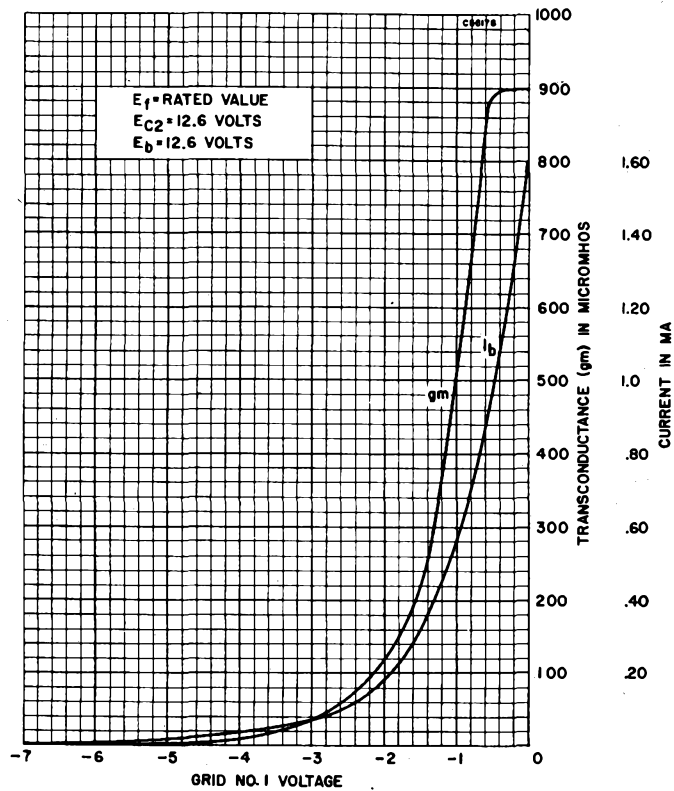

SYLVANIA ELECTRONIC TUBES



SYLVANIA TYPE 12AD6 PENTAGRID CONVERTER

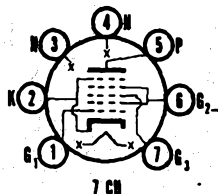

MECHANICAL DATA

Bulb.....	T-5½
Base.....	E7-1, Miniature Button 7-Pin
Outline.....	5-2
Basing.....	7CH
Cathode.....	Coated Unipotential
Mounting Position.....	Any

ELECTRICAL DATA

HEATER CHARACTERISTICS

Heater Voltage ¹	12.6 Volts
Heater Current.....	150 Ma
Heater-Cathode Voltage (Design Center Values)	
Heater Negative with Respect to Cathode.....	30 Volts
Heater Positive with Respect to Cathode.....	30 Volts

DIRECT INTERELECTRODE CAPACITANCES

	Shielded ³	Unshielded
Grid No. 3 to Plate.....	0.25	0.30 μf Max.
Grid No. 3 to Grid No. 1.....	0.15	0.15 μf Max.
RF Input: g3 to (h + k + g1 + g2 & g4 + g5 + p)....	8.0	8.0 μf
Oscillator Input: g1 to (h + k + g1 + g2 & g4 + g3 + g5)....	5.5	5.5 μf
Mixer Output: p to (h + k + g1 + g2 & g4 + g3 + g5)....	13.0	8.0 μf
Oscillator Output: k to (h + g2 & g4 + g3 + p).....	20.0	15.0 μf
Oscillator Grid to Cathode g1 to (k + g5).....	3.0	3.0 μf
Oscillator Grid No. 1 to Plate.....	0.05	0.1 μf Max.

RATINGS (Design Center Values)

Plate Voltage.....	30 Volts Max.
Grids No. 2 and No. 4 Voltage.....	30 Volts Max.
Grids No. 2 and No. 4 Supply Voltage.....	30 Volts Max.
Negative DC Grid No. 3 Voltage.....	30 Volts Max.
Positive DC Grid No. 3 Voltage.....	0 Volts Max.
Cathode Current.....	20 Ma Max.
Grid No. 3 Circuit Resistance.....	10 Megohms Max.

CHARACTERISTICS AND TYPICAL OPERATION

Converter—Self Excitation

Plate Voltage.....	12.6 Volts
Grids No. 2 and No. 4 Voltage.....	12.6 Volts
Grid No. 3 Voltage ²	
Grid No. 3 Resistor.....	2.2 Megohms
Plate Current.....	450 μa
Grids No. 2 and No. 4 Current.....	1500 μa
Grid No. 1 Resistor (Oscillator Grid).....	33,000 Ohms
Grid No. 1 Voltage, RMS (Oscillator Grid).....	1.6 Volts
Grid No. 1 Current (Oscillator Grid).....	50 μa
Conversion Transconductance.....	260 μmhos
Plate Resistance (approx.).....	1.0 Megohm
Cathode Current.....	2000 μa
Grid No. 3 Voltage for Gc = 5 μmhos (approx.).....	-2.2 Volts
Grid No. 3 Voltage for Gc = 20 μmhos (approx.).....	-1.8 Volts

Oscillator—Not Oscillating

Plate Voltage.....	12.6 Volts
Grids No. 2 and No. 4 Voltage ⁴	12.6 Volts
Grid No. 3 Voltage.....	0 Volts
Grid No. 1 Voltage.....	0 Volts
Transconductance.....	3800 μmhos
Amplification Factor.....	9.0
Cathode Current.....	5.0 Ma
Grid No. 1 Voltage for Ib = 10 μa (approx.).....	-4.0 Volts

NOTES:

1. This tube is intended for use in automobile radios operated from a nominal 12 volt battery. Design of the tube is such that the heater will operate satisfactorily over the range 10.0 volts to 15.9 volts, and that the maximum ratings provide a safety factor for the wide voltage variation encountered with this type of supply.
2. External shield No. 316 connected to Pin 2.
3. Average contact potential is developed across the specified grid resistor.
4. Connected to plate.

SYLVANIA ELECTRONIC TUBES

Issued as a supplement to the manual in Sylvania News for May 1957

12AD6 (Cont'd)

APPLICATION

The Sylvania Type 12AD6 is a miniature, pentagrid converter intended for use as a combined oscillator and mixer. It is designed for operation where the heater, plate and screen voltages are supplied directly from a 12 volt automotive storage battery

AVERAGE PLATE CHARACTERISTICS

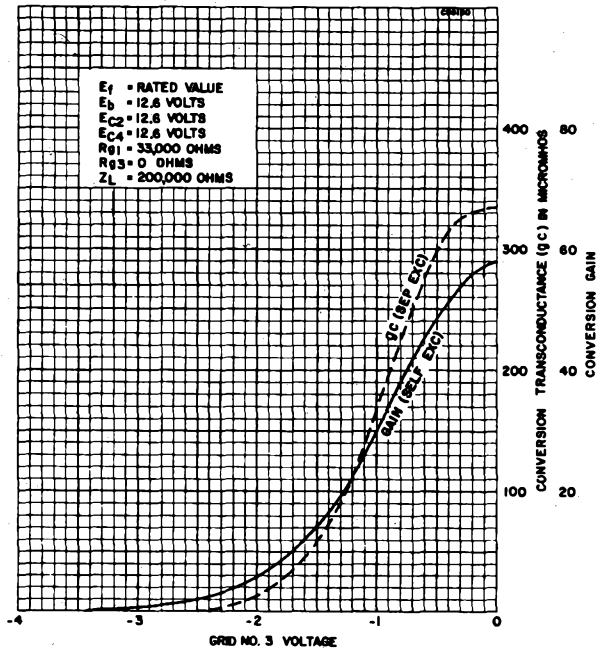

SYLVANIA

TYPE 12AD7

HIGH MU DOUBLE TRIODE

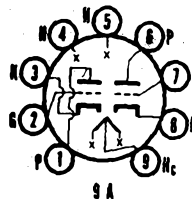
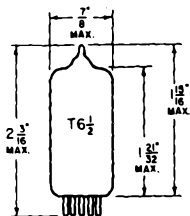

MECHANICAL DATA

Bulb	T-6½
Base	E9-1, Small Button 9-Pin
Outline	6-2
Basing	9A
Cathode	Coated Unipotential
Mounting Position	Any

ELECTRICAL DATA

HEATER CHARACTERISTICS

Heater Voltage (ac or dc)	12.6/6.3 Volts
Heater Current	225/450 Ma
Heater-Cathode Voltage (Design Center Values)	
Heater Negative with Respect to Cathode	
Total D C and Peak	200 Volts Max.
Heater Positive with Respect to Cathode	
D C	100 Volts Max.
Total D C and Peak	200 Volts Max.

DIRECT INTERELECTRODE CAPACITANCES (Approx.)¹

	Shielded ²	Unshielded
Section 1		
Grid to Plate	1.8	1.8 μuf
Input: g to (h + k + i.s. + e.s.)	1.7	1.6 μuf
Output: p to (h + k + i.s. + e.s.)	1.6	0.50 μuf
Section 2		
Grid to Plate	1.8	1.8 μuf
Input: g to (h + k + i.s. + e.s.)	1.7	1.6 μuf
Output: p to (h + k + i.s. + e.s.)	1.9	0.45 μuf

MAXIMUM RATINGS (Design Center Values) Each Section

Plate Voltage	300 Volts
Plate Dissipation	1.0 Watts
Positive D C Grid Voltage	0 Volts
Negative D C Grid Voltage	50 Volts

CHARACTERISTICS AND TYPICAL OPERATION

Class A₁ Amplifier—Each Section

Plate Voltage	250 Volts
Grid Voltage	-2 Volts
Plate Current	1.25 Ma
Plate Resistance	62,500 Ohms
Transconductance	1600 μmhos
Amplification Factor	100

Resistance Coupled Amplifier¹—Each Section

Heater Voltage ³	6.3 Volts
Plate Supply Voltage	250 Volts
Unbypassed Cathode Resistance	3300 Ohms
Grid Circuit Resistance	470,000 Ohms
Plate Load Resistance	270,000 Ohms
RMS Hum Level at Plate, Max.	3.0 Millivolts

NOTES:

- Section No. 1 connects to Pins 6, 7 and 8.
Section No. 2 connects to Pins 1, 2 and 3.
- Shield No. 315.
- The heater sections are operated in parallel from a 6.3 volt supply balanced to ground.
- See 12 X7 data (for R/C).

APPLICATION

A miniature, non-microphonic low hum, high μ double triode for audio pre-amplifier use.

SYLVANIA ELECTRONIC TUBES

Issued as a supplement to the manual in Sylvania News for September 1956

AVERAGE PLATE CHARACTERISTICS

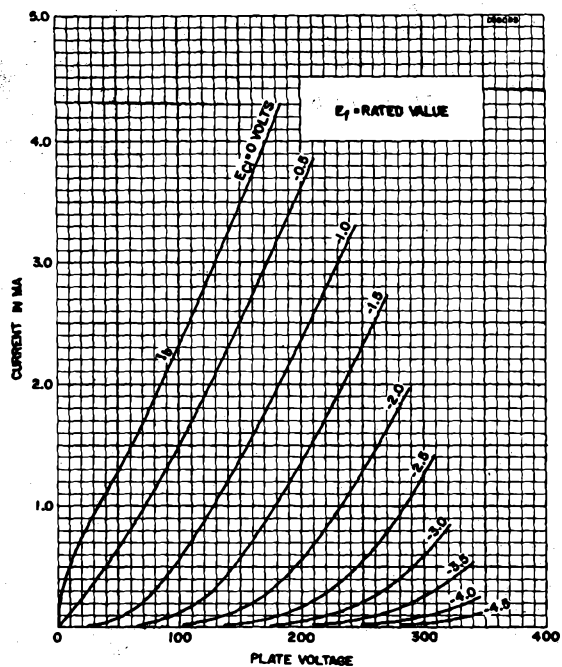

AVERAGE TRANSFER CHARACTERISTICS

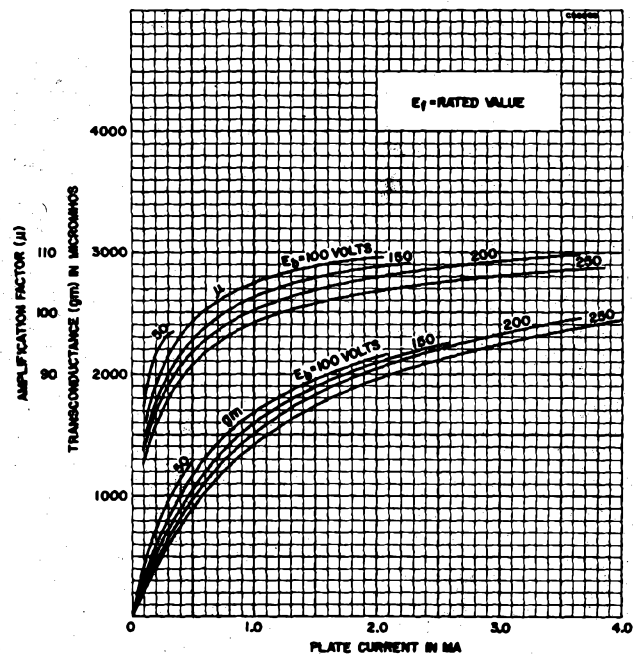

SYLVANIA ELECTRONIC TUBES



SYLVANIA TYPE 12AE6

DOUBLE DIODE
MEDIUM MU TRIODE

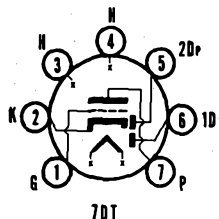

MECHANICAL DATA

Bulb	T-5 1/2
Base	E7-1, Miniature Button 7-Pin
Outline	5-2
Basing	7DT
Cathode	Coated Unipotential
Mounting Position	Any

ELECTRICAL DATA

HEATER CHARACTERISTICS

Heater Voltage ¹	12.6 Volts
Heater Current	150 Ma
Heater-Cathode Voltage (Design Center Values)	
Heater Negative with Respect to Cathode	
Total DC and Peak	30 Volts Max.
Heater Positive with Respect to Cathode	
Total DC and Peak	30 Volts Max.

DIRECT INTERELECTRODE CAPACITANCES (Unshielded)

Grid to Plate	2.0 μ f
Input	1.8 μ f
Output	1.1 μ f
Diode to Diode	0.9 μ f

RATINGS (Design Center Values)

Plate Voltage	30 Volts Max.
Cathode Current	20 Ma Max.
Grid Circuit Resistance	10 Megohms Max.
Average Diode Current	1.0 Ma Max.

CHARACTERISTICS AND TYPICAL OPERATION

Class A₁ Amplifier—Each Section

Plate Voltage	12.6 Volts
Grid Voltage	0 Volts
Plate Current	750 μ a
Transconductance	1000 μ mhos
Amplification Factor	15
Plate Resistance	15,000 Ohms
Average Diode Current, Each Diode	
With 10 Volts DC Applied (Test Condition Only)...	2.0 Ma

Resistance Coupled Amplifier

Plate Supply Voltage	14.4 Volts
Grid Voltage ³	
Grid Resistor	2.2 Megohms
Plate Load Resistor	0.47 Megohm
Input Capacitor	0.01 μ f
Output Capacitor	0.01 μ f
Grid Resistor of Following Stage	2.2 Megohms
Signal Source Impedance	1000 Ohms
Voltage Gain at 400 CPS ³	10

NOTES:

1. This tube is intended for use in automobile radios operated from a nominal 12 volt battery. Design of the tube is such that the heater will operate satisfactorily over the range 10.0 volts to 15.9 volts, and that the maximum ratings provide a safety factor for the wide voltage variation encountered with this type of supply.
2. Average contact potential is developed across the specified grid resistor.
3. Measured at an output voltage of 1.0 volt RMS.

APPLICATION

The Sylvania Type 12AE6 is a miniature double diode, medium mu triode intended for use as a second detector audio amplifier. This tube is designed for operation where the heater and plate voltages are supplied directly from a 12 volt automotive storage battery.

SYLVANIA ELECTRONIC TUBES

Issued as a supplement to the manual in Sylvania News for April 1957

12AE6 (Cont'd)

AVERAGE PLATE CHARACTERISTICS

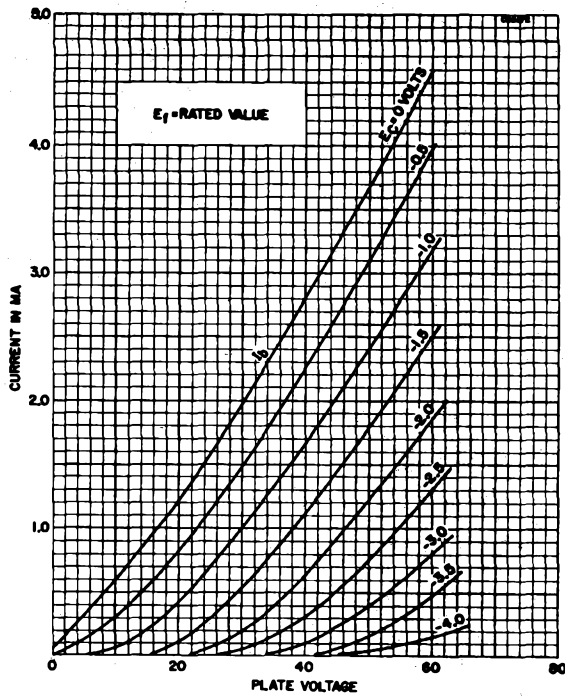

AVERAGE TRANSFER CHARACTERISTICS

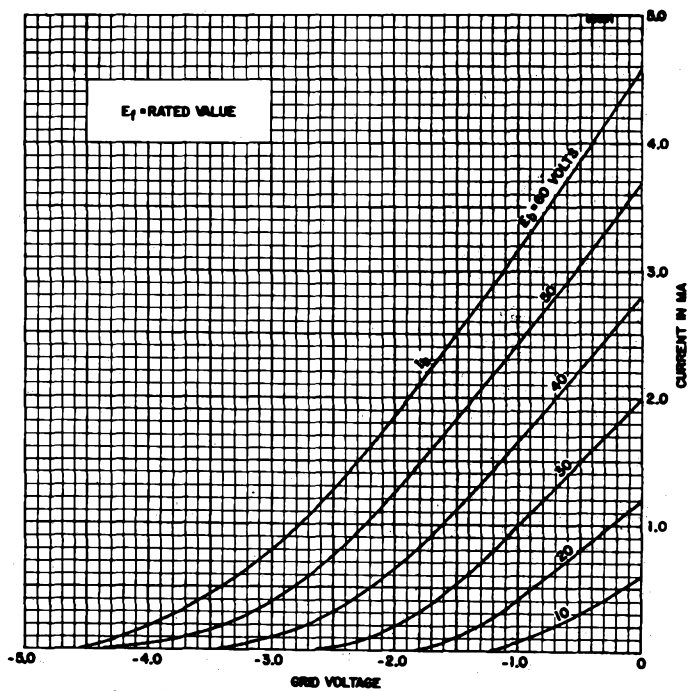

SYLVANIA ELECTRONIC TUBES

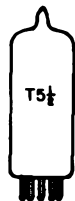

SYLVANIA TYPE 12AF6

REMOTE CUTOFF PENTODE

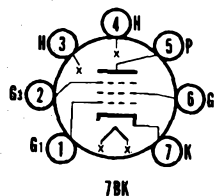

MECHANICAL DATA

Bulb	T-5 1/2
Base	E7-1, Miniature Button 7-Pin
Outline	5-2
Basing	7BK
Cathode	Coated Unipotential
Mounting Position	Any

ELECTRICAL DATA

HEATER CHARACTERISTICS

Heater Voltage ¹	12.6 Volts
Heater Current	150 Ma
Heater-Cathode Voltage (Design Maximum Values) ²	
Heater Negative with Respect to Cathode	16 Volts Max.
Heater Positive with Respect to Cathode	16 Volts Max.

DIRECT INTERELECTRODE CAPACITANCES (Unshielded)

Grid to Plate	0.006 μmf
Input	5.5 μmf
Output	4.8 μmf

RATINGS (Design Maximum Values)²

Plate Voltage	16 Volts Max.
Grid No. 2 Voltage	16 Volts Max.
Positive DC Grid No. 1 Voltage	0 Volts Max.
Grid No. 1 Circuit Resistance	2.2 Megohms Max.

CHARACTERISTICS AND TYPICAL OPERATION

Plate Voltage	12.6 Volts
Grid No. 3 Voltage	0 Volts
Grid No. 2 Voltage	12.6 Volts
Grid No. 1 Supply Voltage	0 Volts
Plate Current	0.8 Ma
Grid No. 2 Current	0.3 Ma
Transconductance	1250 μmhos
Plate Resistance (approx.)	0.3 Megohms
Grid No. 1 Resistor (Bypassed)	2.2 Megohms
Grid No. 1 Voltage (approx.) for $G_m = 40 \mu\text{mhos}$	-2.7 Volts

NOTES:

1. This tube is intended for use in automobile radios operated from a nominal 12-volt battery. Design of the tube is such that the heater will operate satisfactorily over the range 10.0 volts to 15.9 volts, and that the maximum ratings provide a safety factor for the wide voltage variation encountered with this type of supply.
2. Design-Maximum Ratings are the limiting values expressed with respect to bogie tubes at which satisfactory tube life can be expected to occur. To obtain satisfactory circuit performance, therefore, the equipment designer must establish the circuit design so that no design-maximum value is exceeded with a bogie tube under the worst probable operating conditions with respect to supply-voltage variation, equipment component variation, equipment control adjustment, load variation and environmental conditions.

APPLICATION

The Sylvania Type 12AF6 is a remote cutoff pentode RF or IF amplifier contained in a miniature envelope. It is designed for operation where the potentials will be supplied directly from a 12-volt automobile storage battery.

SYLVANIA ELECTRONIC TUBES

Issued as a supplement to the manual in Sylvania News for June 1957

12AF6 (Cont'd)

AVERAGE PLATE CHARACTERISTICS

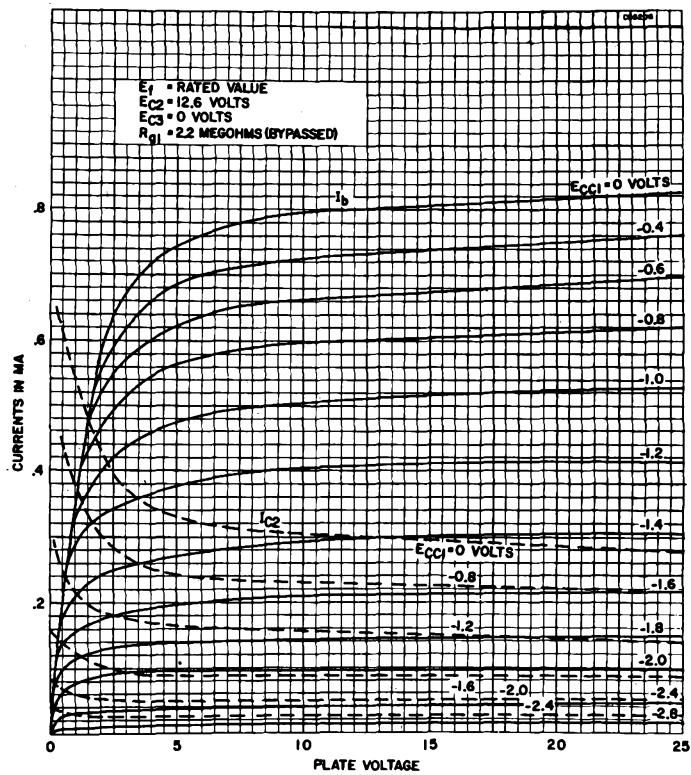

AVERAGE TRANSFER CHARACTERISTICS

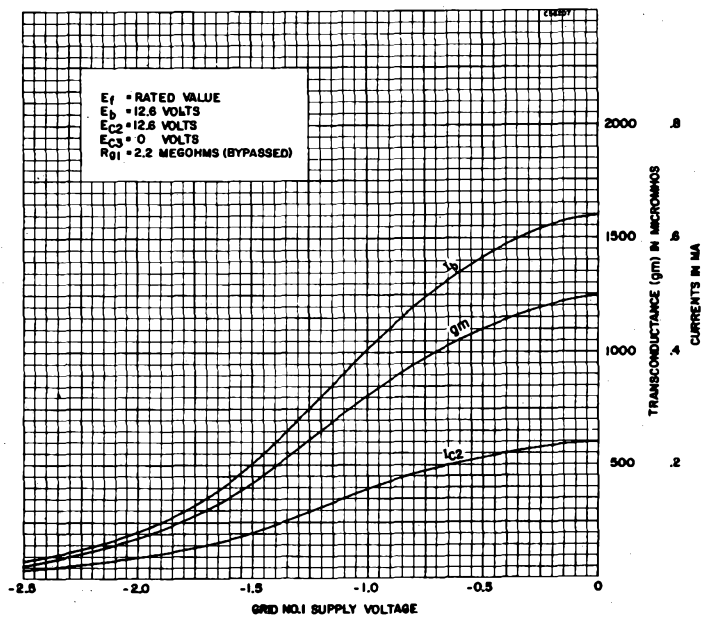

SYLVANIA ELECTRONIC TUBES

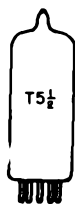

SYLVANIA TYPE 12AJ6

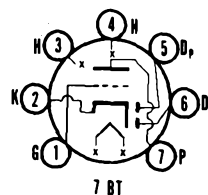

MECHANICAL DATA

Bulb	T-5 $\frac{1}{2}$
Base	E7-1, Miniature Button 7-Pin
Outline	5-2
Basing	7BT
Cathode	Coated Unipotential
Mounting Position	Any

ELECTRICAL DATA

HEATER CHARACTERISTICS

Heater Voltage ¹	12.6 Volts
Heater Current	150 Ma
Heater-Cathode Voltage (Design-Center Values)	
Heater Negative with Respect to Cathode	30 Volts Max.
Heater Positive with Respect to Cathode	30 Volts Max.

DIRECT INTERELECTRODE CAPACITANCES (Unshielded)

Grid to Plate	2.0 μf
Input: g to (h + k)	2.2 μf
Output: p to (h + k)	0.8 μf
Diode to Diode	0.9 μf

RATINGS (Design-Center Values)

Plate Voltage	30 Volts Max.
Cathode Current	20 Ma Max.
Grid Circuit Resistance	10 Megohms Max.
Average Diode Current	1.0 Ma Max.

CHARACTERISTICS AND TYPICAL OPERATION

Class A₁ Amplifier

Plate Voltage	12.6 Volts
Grid Voltage	0 Volts
Plate Current	750 μa
Transconductance	1200 μmhos
Amplification Factor	55
Plate Resistance	45,000 Ohms
Average Diode Current with 10 Volts Applied (Each Diode) ²	2.0 Ma

Resistance Coupled Amplifier

Plate Supply Voltage	12.6 Volts
Grid Voltage ³	
Grid Resistor	1.0 Megohm
Plate Load Resistor	1.0 Megohm
Input Capacitor	0.02 μf
Output Capacitor	0.01 μf
Grid Resistor of Following Stage	2.0 Megohms
Voltage Gain at 400 CPS ⁴	16

NOTES:

1. This tube is intended for use in automobile radios operated from a nominal 12 volt battery. Design of the tube is such that the heater will operate satisfactorily over the range 10.0 volts to 15.9 volts, and that the maximum ratings provide a safety factor for the wide voltage variation encountered with this type of supply.
2. Test condition only.
3. Average contact potential developed across specified grid resistor.
4. Measured at an output voltage of 1.0 volt RMS.

APPLICATION NOTES

The Sylvania Type 12AJ6 is a miniature double diode, high-mu triode intended for use as a second detector audio amplifier.

It is designed for operation where the heater and plate voltages are supplied directly from a 12-volt automotive storage battery.

SYLVANIA TYPE 12AJ6 (Cont'd)

AVERAGE PLATE CHARACTERISTICS

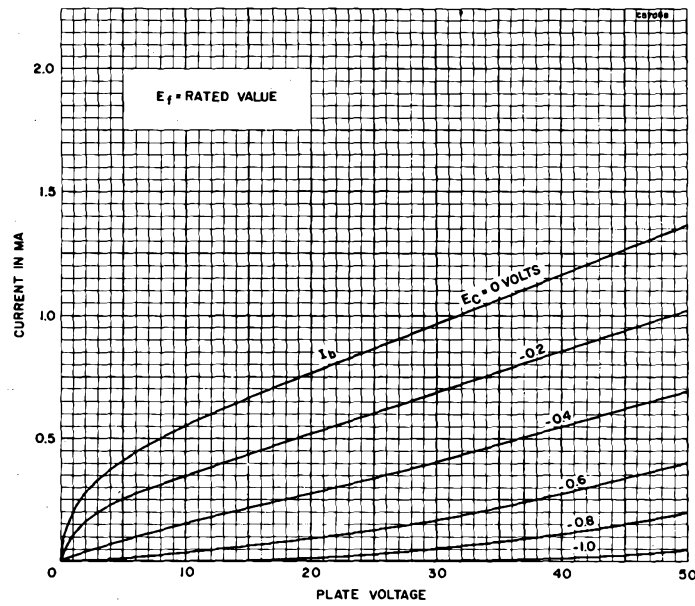



SYLVANIA TYPE 12AQ5

BEAM POWER AMPLIFIER

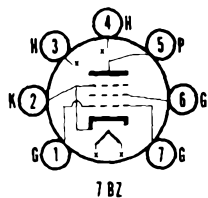

ELECTRICAL DATA

HEATER CHARACTERISTICS

Heater Voltage.....	12.6 Volts
Heater Current.....	225 Ma

For other rating, operation, and application data, refer to corresponding Type 6AQ5, which is identical except for heater ratings.

SYLVANIA TUBE TESTER SETTINGS

	A	B	C	D	E	F	G	Test or K
139/140	12.6	0	4	0	4	36	32	Y
	12.6	0	3	0	4	46	32	Y
219/220	12.6	3	47	25	4	16Z	5	2
	12.6	3	14	25	4	067Z	5	2

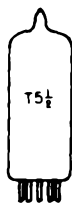

SYLVANIA TYPE 12AT6

DUO DIODE HIGH-MU TRIODE

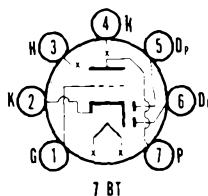

ELECTRICAL DATA

HEATER CHARACTERISTICS

Heater Voltage.....	12.6 Volts
Heater Current.....	150 Ma

For other rating, operation, and application data, refer to corresponding Type 6AT6, which is identical except for heater ratings. Data for use in resistance coupled amplifier circuits is given in the appendix.

SYLVANIA TUBE TESTER SETTINGS

	A	B	C	D	E	F	G	Test or K
139/140	12.6	0	—	0	3	3	52	T
	12.6	0	—	0	4	—	55	T
	12.6	0	—	0	5	—	55	T
219/220	12.6	3	4	36	4	1T	7	2
	12.6	3	4	39	4	T	5*	2
	12.6	3	4	39	4	T	6*	2

* Diode gas test does not apply.

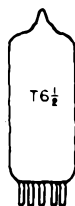

SYLVANIA TYPE 12AT7

DUO TRIODE

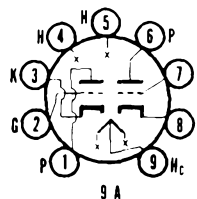

MECHANICAL DATA

Bulb.....	T-6 1/2, Outline 6-2
Base.....	Small Button 9-Pin
Basing.....	9A
Mounting Position.....	Any

ELECTRICAL DATA

HEATER CHARACTERISTICS

Heater Voltage Series/Parallel.....	12.6/6.3 Volts
Heater Current Series/Parallel.....	150/300 Ma
Maximum Heater-Cathode Voltage.....	90 Volts

DIRECT INTERELECTRODE CAPACITANCES (Unshielded)

	Section 1 ¹	Section 2	
Grid to Plate.....	1.5	1.5	μf
Input.....	2.2	2.2	μf
Output.....	0.5	0.4	μf
Grid to Grid.....	.005		μf Max
Plate to Plate.....	0.4		μf Max
Heater to Cathode.....	2.4	2.4	μf
Grounded Grid Operation			
Plate to Cathode.....	0.2	0.2	μf
Input.....	4.6	4.6	μf
Output.....	1.8	1.8	μf

MAXIMUM RATINGS (Design Center Values—Each Section)

Plate Voltage.....	300 Volts
Plate Dissipation.....	2.5 Watts

TYPICAL OPERATION

Class A₁ Amplifier—Each Section

Plate Voltage.....	100	180	250	Volts
Grid Voltage.....	-1	-1	-2	Volts
Cathode Bias Resistor.....	270	90	200	Ohms
Plate Current.....	3.7	11.0	10.0	Ma
Plate Resistance.....	15000	9400	10900	Ohms
Transconductance.....	4000	6000	5500	μmhos
Amplification Factor.....	60	62	60	
Grid Voltage for $I_b = 10 \mu\text{a}$	-5	-8	-12	Volts

NOTE:

1. Section No. 1 connects to pins 6, 7 and 8.

APPLICATION

A miniature, high-mu duo triode designed for use as a grounded grid amplifier at frequencies up to 300 mc. A center tapped heater permits either 6.3 or 12.6 volt operation.

Data for use in Resistance Coupled Amplifier Circuits is given in the Appendix.

SYLVANIA TUBE TESTER SETTINGS

	A	B	C	D	E	F	G	Test or K
139/140	12.6	0	5	0	3	7	40	U
	12.6	0	5	0	1	3	40	U
219/220	12.6	4	589	27	5	2X	1	3
	12.6	4	359	27	5	7X	6	8

12AT7 (Cont'd)

AVERAGE PLATE CHARACTERISTICS

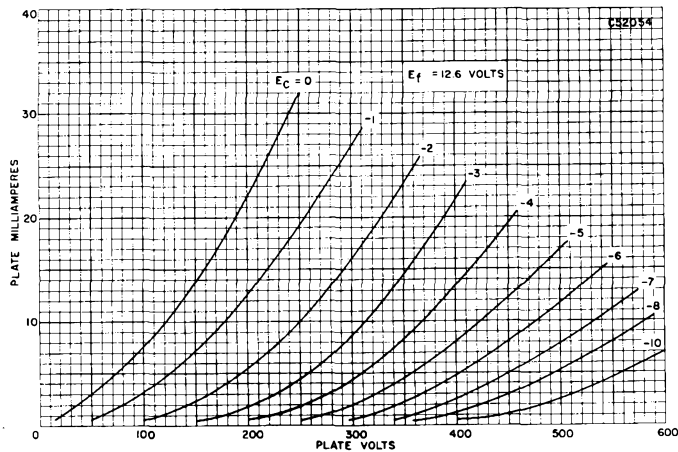

AVERAGE TRANSFER CHARACTERISTICS

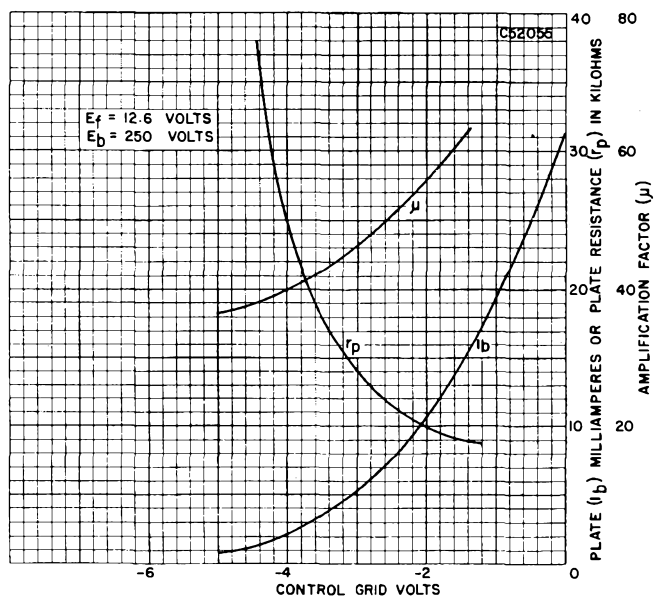

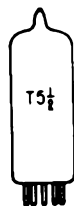

SYLVANIA TYPE 12AU6

SHARP CUTOFF PENTODE

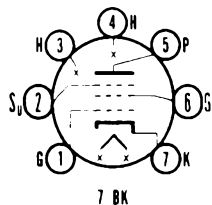

ELECTRICAL DATA

HEATER CHARACTERISTICS

Heater Voltage.....	12.6 Volts
Heater Current.....	150 Ma

For other rating, operation, and application data, refer to corresponding Type 6AU6, which is identical except for heater ratings.

SYLVANIA TUBE TESTER SETTINGS

	A	B	C	D	E	F	G	Test or K
139/140	12.6	0	—	0	4	36	47	U
219/220	12.6	3	4	20	4	16Y	5	7

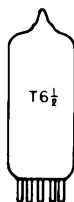

SYLVANIA TYPE 12AU7

MEDIUM-MU DUO TRIODE

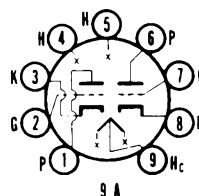

MECHANICAL DATA

Bulb.....	T-6 1/2, Outline 6-2
Base.....	Small Button 9-Pin
Basing.....	9A
Mounting Position.....	Any

ELECTRICAL DATA

HEATER CHARACTERISTICS

Heater Voltage Series/Parallel.....	12.6/6.3 Volts
Heater Current Series/Parallel.....	150/300 Ma
Maximum Heater-Cathode Voltage	
Total D C and Peak.....	200 Volts
D C, Heater Positive with Respect to Cathode.....	100 Volts

DIRECT INTERELECTRODE CAPACITANCES

	Shielded ¹	Unshielded
Grid to Plate: Section 1 ²	1.5	1.5 $\mu\mu\text{f}$
Section 2 ²	1.5	1.5 $\mu\mu\text{f}$
Input: (g to h + k) Section 1.....	1.8	1.6 $\mu\mu\text{f}$
Section 2.....	1.8	1.6 $\mu\mu\text{f}$
Output: (p to h + k) Section 1.....	2.0	0.40 $\mu\mu\text{f}$
Section 2.....	2.0	0.32 $\mu\mu\text{f}$

MAXIMUM RATINGS—Each Section (Design Center Values—Except as Noted)

	Class A ₁ Amplifier	Vertical ¹ Deflection Amplifier
Plate Voltage.....	300	300 Volts
Peak Positive Plate Voltage (Abs. Max.).....		1200 Volts
Plate Dissipation ⁴		
Each Plate.....	2.75	2.75 Watts
Both Plates.....	5.5	5.5 Watts
Peak Negative Grid Voltage.....		250 Volts
Average Cathode Current.....	20	20 Ma
Peak Cathode Current.....		60 Ma
Grid Circuit Resistance		
Fixed Bias.....	0.25	Megohm
Cathode Bias.....	1.0	2.2 Megohms

12AU7 (Cont'd)

MAXIMUM RATINGS— Each Section (Design Center Values—Except as Noted)

	Vertical ¹ Deflection Oscillator	Horizontal ¹ Deflection Oscillator
Plate Voltage.....	300	300 Volts
Plate Dissipation		
Each Plate.....	2.75	2.75 Watts
Both Plates.....	5.5	5.5 Watts
Peak Negative Grid Voltage.....	400	600 Volts
Average Cathode Current.....	20	20 Ma
Peak Cathode Current.....	60	300 Ma
Grid Circuit Resistance.....	2.2	2.2 Megohms

CHARACTERISTICS AND TYPICAL OPERATION

Class A₁ Amplifier (Each Section)

Plate Voltage.....	100	250 Volts
Grid Voltage.....	0	-8.5 Volts
Plate Current.....	11.8	10.5 Ma
Plate Resistance (approx.).....	6500	7700 Ohms
Transconductance.....	3100	2200 μ mhos
Amplification Factor.....	20	17
Grid Voltage for $I_b = 10 \mu$ a (approx.).....		-24 Volts

NOTES:

- External shield No. 315 connected to cathode of section under test.
- Section No. 1 connects to pins 6, 7 and 8. Section No. 2 connects to pins 1, 2 and 3.
- For operation in a 525-line, 30 frame system, the duty cycle of the voltage pulse must not exceed 15% of one scanning cycle.
- In stages operating with grid leak bias, an adequate cathode bias resistor or other suitable means is required to protect the tube in the absence of excitation.

APPLICATION

The Type 12AU7 is a T-6 1/2 double triode having separate cathodes. It is intended primarily for service as a horizontal or vertical deflection oscillator, vertical deflection amplifier and Class A₁ resistance coupled amplifier. Each section of the 12AU7 is electrically similar to the Type 6C4.

Data for use in Resistance Coupled Amplifier Circuits is given in the Appendix.

SYLVANIA TUBE TESTER SETTINGS

	A	B	C	D	E	F	G	Test or K
139/140	12.6	0	5	0	3	7	60	U
	12.6	0	5	0	1	3	60	U
219/220	12.6	4	589	41	5	2Z	1	3
	12.6	4	359	41	5	7Z	6	8

AVERAGE PLATE CHARACTERISTICS

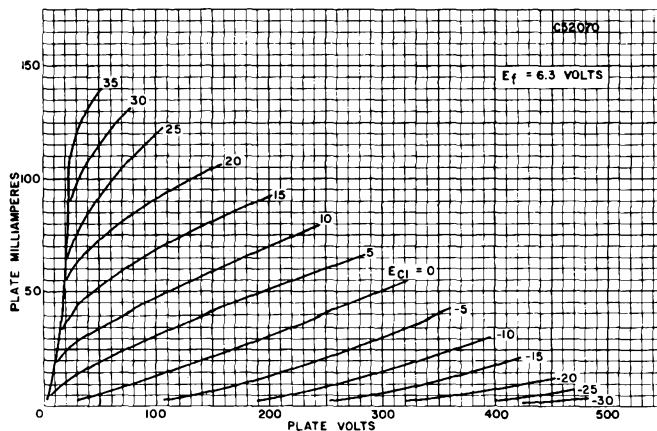

12AU7 (Cont'd)

AVERAGE TRANSFER CHARACTERISTICS

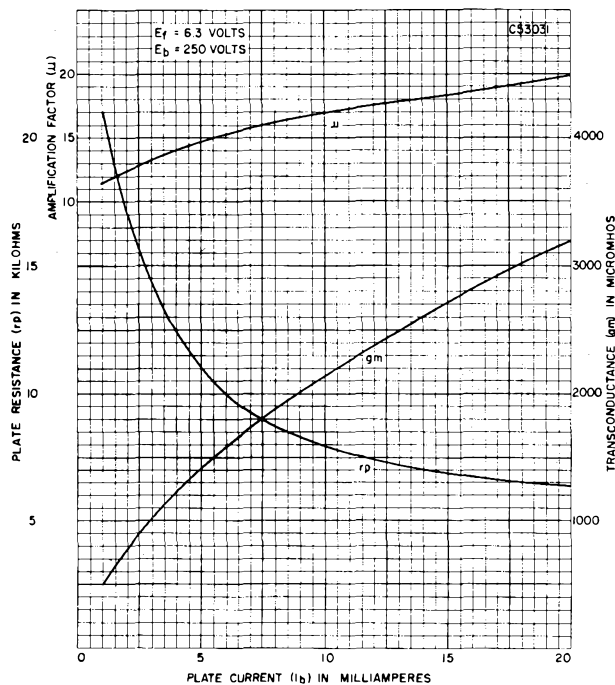

SYLVANIA TYPE 12AU7A

MEDIUM-MU DUO TRIODE

The Sylvania Type 12AU7A is electrically identical to Type 12AU7. Structural changes result in improved mechanical rigidity, more uniform electrical characteristics along with better life and stability.

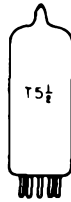

SYLVANIA TYPE 12AV6

DUO DIODE TRIODE

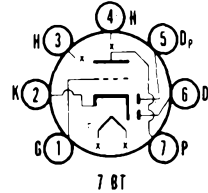

ELECTRICAL DATA

HEATER CHARACTERISTICS

Heater Voltage	12.6 Volts
Heater Current	150 Ma

For other rating, operation, and application data, refer to corresponding Type 6AV6, which is identical except for heater ratings.

SYLVANIA TUBE TESTER SETTINGS

	A	B	C	D	E	F	G	Test or K
139/140	12.6	0	—	0	3	3	47	T
	12.6	0	—	0	4	—	55	T
	12.6	0	—	0	5	—	55	T
219/220	12.6	3	4	35	4	1T	7	2
	12.6	3	4	40	4	T	6*	2
	12.6	3	4	40	4	T	5*	2

* Diode gas test does not apply.

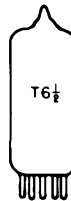

SYLVANIA TYPE 12AV7

MEDIUM-MU DUO TRIODE

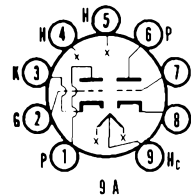

MECHANICAL DATA

Bulb	T-6 1/2, Outline 6-2
Base	Small Button 9-Pin
Basing	9A
Mounting Position	Any

ELECTRICAL DATA

HEATER CHARACTERISTICS

Heater Voltage Series/Parallel	12.6/6.3 Volts
Heater Current Series/Parallel	225/450 Ma
Maximum Heater-Cathode Voltage	90 Volts

DIRECT INTERELECTRODE CAPACITANCES

	Shielded ¹	Unshielded
Grid to Plate (Each Section)	1.9	1.9 μμf
Input (Each Section)	3.2	3.1 μμf
Output (Section 1) ²	1.3	0.5 μμf
(Section 2)	1.6	0.4 μμf
Heater to Cathode (Each Section)	4.0	3.8 μμf
Grounded Grid Operation		
Input (Each Section)	7.0	6.9 μμf
Output (Section 1) ²	2.8	2.0 μμf
(Section 2)	3.2	2.0 μμf
Plate to Cathode (Each Section)	0.23	0.24 μμf

MAXIMUM RATINGS (Design Center Values)

Plate Voltage	300 Volts
Plate Dissipation (Each Section)	2.7 Watts
Negative Grid Voltage	50 Volts

12AV7 (Cont'd)

CHARACTERISTICS AND TYPICAL OPERATION

Class A₁ Amplifier (Each Section)

Plate Voltage	100	150 Volts
Cathode Bias Resistor	120	56 Ohms
Plate Current	9.0	18 Ma Max
Transconductance	6100	8500 μ mhos
Amplification Factor	37	41
Plate Resistance	6100	4800 Ohms
Grid Voltage for $I_b = 10 \mu$ a	-9	-12 Volts

Data for use in Resistance Coupled Amplifier Circuits is given in the Appendix.

NOTES:

- Shield No. 315 connected to cathode.
- Section 1 connects to Pins 6, 7 and 8. Section 2 connects to Pins 1, 2 and 3.

SYLVANIA TUBE TESTER SETTINGS

	A	B	C	D	E	F	G	Test or K
139/140	12.6	0	5	0	1	3	35	U
	12.6	0	5	0	3	7	35	U
219/220	12.6	4	589	25	5	2X	1	3
	12.6	4	359	25	5	7X	6	8

AVERAGE PLATE CHARACTERISTICS

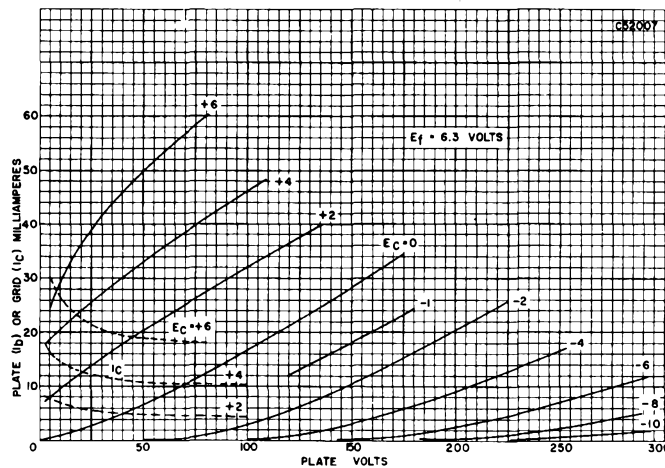

TYPE 12AW6

(See Condensed Data Section)

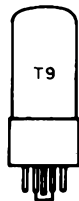

SYLVANIA TYPE 12AX4GT
TV DAMPER DIODE

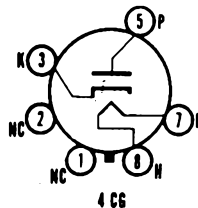

ELECTRICAL DATA

HEATER CHARACTERISTICS

Heater Voltage.....	12.6 Volts
Heater Current.....	600 Ma

For other rating, operation, and application data, refer to corresponding Type 6AX4GT, which is identical except for heater ratings.

SYLVANIA TUBE TESTER SETTINGS

	A	B	C	D	E	F	G	Test or K
139/140	12.6	0	7	1	3	—	17	Y
219/220	12.6	7	8	11	8	Z	5*	3

* Diode gas test does not apply.

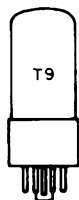

SYLVANIA TYPE 12AX4GTA
TV DAMPER DIODE

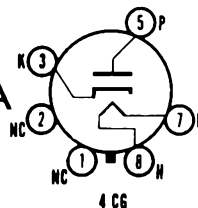

ELECTRICAL DATA

HEATER CHARACTERISTICS

Heater Voltage.....	12.6 Volts
Heater Current.....	600 Ma
Heater Warm-up Time (See SERIES STRING HEATERS Section in Appendix)	
Maximum Heater-Cathode Voltage	
Heater Negative with Respect to Cathode	
D C.....	900 Volts
Total D C and Peak.....	4400 Volts
Heater Positive with Respect to Cathode	
D C.....	100 Volts
Total D C and Peak.....	300 Volts

For other rating, operation, and application data, refer to corresponding Type 6AX4GT, which is identical except for heater ratings.

APPLICATION

The Sylvania Type 12AX4GTA is intended for service in television receivers employing series connected heaters. For information on specially controlled heaters for series string operation refer to the SERIES STRING HEATERS section of the Appendix.

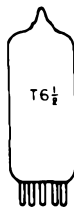

SYLVANIA TYPE 12AX7

HIGH-MU DUOTRIODE

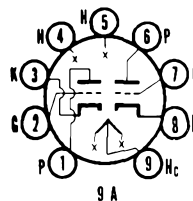

MECHANICAL DATA

Bulb	T-6 1/2, Outline 6-2
Base	Small Button 9-Pin
Basing	9A
Mounting Position	Any

ELECTRICAL DATA

HEATER CHARACTERISTICS

Heater Voltage Series/Parallel	12.6/6.3 Volts
Heater Current Series/Parallel	150/300 Ma
Maximum Peak Heater-Cathode Voltage	180 Volts

DIRECT INTERELECTRODE CAPACITANCES

	Section 1 ¹		Section 2	
	Shielded ²	Unshielded	Shielded ²	Unshielded
Grid to Plate	1.7	1.7	1.7	1.7 μpf
Input	1.8	1.6	1.8	1.6 μpf
Output	1.9	0.46	1.9	0.34 μpf

MAXIMUM RATINGS (Design Center Values) Each Section

Plate Voltage	300 Volts
Plate Dissipation	1.0 Watt
Positive D C Grid Voltage	0 Volts
Negative D C Grid Voltage	-50 Volts

CHARACTERISTICS AND TYPICAL OPERATION

Class A₁ Amplifier—Each Section

Plate Voltage	100	250 Volts
Grid Voltage	-1	-2 Volts
Plate Current	0.5	1.2 Ma
Plate Resistance	80000	62500 Ohms
Transconductance	1250	1600 μmhos
Amplification Factor	100	100

Data for use in Resistance Coupled Amplifier Circuits is given in the Appendix.

NOTES:

- Section No. 1 connects to Pins 6, 7 and 8. Section No. 2 connects to Pins 1, 2 and 3.
- External shield No. 315 connected to cathode of section under test.

APPLICATION

The Sylvania Type 12AX7 is a miniature high-mu twin triode having separate cathodes. It is designed for service as an audio voltage amplifier or phase inverter in portable or compact equipment. The center tapped filament of the Type 12AX7 permits operation on 12.6 or 6.3 volts. For characteristic curves use those under Type 6AV6, whose triode section has identical electrical characteristics to one section of the 12AX7.

SYLVANIA TUBE TESTER SETTINGS

	A	B	C	D	E	F	G	Test or K
139/140	12.6	0	5	0	1	3	16	V
	12.6	0	5	0	3	7	16	V
219/220	12.6	4	589S	19	5	2U	1	3
	12.6	4	359S	19	5	7U	6	8

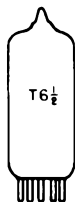

SYLVANIA TYPE 12AY7

HIGH-MU DUO TRIODE

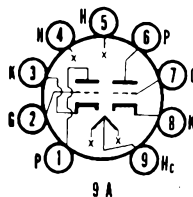

MECHANICAL DATA

Bulb	T-6 1/2, Outline 6-2
Base	Small Button 9-Pin
Basing	9A
Mounting Position	Any

ELECTRICAL DATA

HEATER CHARACTERISTICS

Heater Voltage Series/Parallel	12.6/6.3 Volts
Heater Current Series/Parallel	0.15/0.3 Ampere
Maximum Heater-Cathode Voltage	90 Volts

DIRECT INTERELECTRODE CAPACITANCES

Grid to Plate	1.3 $\mu\mu\text{f}$
Input	1.3 $\mu\mu\text{f}$
Output	0.6 $\mu\mu\text{f}$

MAXIMUM RATINGS (Design Center Values)

Plate Voltage	300 Volts
Plate Dissipation	1.5 Watts
Cathode Current	10 Ma

CHARACTERISTICS AND TYPICAL OPERATION

Class A₁ Amplifier (Each Section)

Plate Voltage	250 Volts
Grid Bias Voltage	-4.0 Volts
Amplification Factor	40
Transconductance	1750 μmhos
Plate Current	3.0 Ma

Low Level Amplifier Service (Each Section)

Heater Voltage (A C or D C) with Pin 9 to B-	6.3 Volts
Plate Supply Voltage	150 Volts
Plate Load Resistor	20000 Ohms
Cathode Resistor	2700 Ohms
Cathode Capacitor	40 μf
Grid Resistor	0.1 Megohm
Voltage Gain	12.5

APPLICATION

A miniature, medium mu, duo triode designed for use in the first audio stages of high gain audio frequency amplifiers. It is especially designed for low noise and low microphonic characteristics. To realize the low hum capabilities, the heaters should be operated in parallel at 6.3 volts.

Data for use in Resistance Coupled Amplifier Circuits is given in the Appendix.

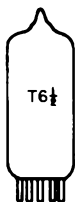

SYLVANIA TYPE 12AZ7

DUO TRIODE

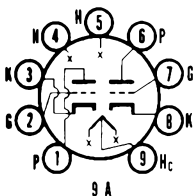

MECHANICAL DATA

Bulb	T-6 1/2, Outline 6-2
Base	Small Button 9-Pin
Basing	9A
Mounting Position	Any

ELECTRICAL DATA

HEATER CHARACTERISTICS

Heater Voltage Series/Parallel	12.6/6.3 Volts
Heater Current Series/Parallel	225/450 Ma
Maximum Heater-Cathode Voltage	90 Volts

12AZ7 (Cont'd)

DIRECT INTERELECTRODE CAPACITANCES

	Shielded ¹	Unshielded
Grid to Plate (Each Section).....	1.9	1.9 $\mu\mu\text{f}$
Input (Each Section).....	3.2	3.1 $\mu\mu\text{f}$
Output (Section 1) ²	1.3	0.5 $\mu\mu\text{f}$
Output (Section 2).....	1.6	0.4 $\mu\mu\text{f}$
Grounded Grid Operation		
Input (Each Section).....	7.0	6.9 $\mu\mu\text{f}$
Output (Section 1) ²	2.8	2.0 $\mu\mu\text{f}$
Output (Section 2).....	3.2	2.0 $\mu\mu\text{f}$
Plate to Cathode.....	0.23	0.24 $\mu\mu\text{f}$

NOTES:

1. Shield No. 315.
2. Section 1 connects to pins 6, 7 and 8.

For maximum ratings and characteristics refer to Type 12AT7, which is identical except for heater ratings and interelectrode capacities.

SYLVANIA TUBE TESTER SETTINGS

	A	B	C	D	E	F	G	Test or K
139/140	12.6	0	5	0	1	3	29	X
	12.6	0	5	0	3	7	29	X
219/220	12.6	4	589S	36	5	2V	1	3
	12.6	4	359S	36	5	7V	6	8

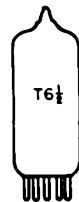

SYLVANIA TYPE 12B4
TRIODE

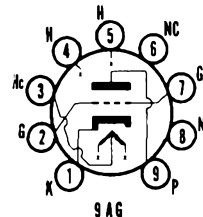

MECHANICAL DATA

Bulb.....	T-6 1/2, Outline 6-3
Base.....	Small Button 9-Pin
Basing.....	9AG
Mounting Position.....	Any

ELECTRICAL DATA

HEATER CHARACTERISTICS

Heater Voltage (Series/Parallel).....	12.6/6.3 Volts
Heater Current (Series/Parallel).....	300/600 Ma
Maximum Heater-Cathode Voltage	
Total D C and Peak.....	200 Volts
D C, Heater Positive with Respect to Cathode.....	100 Volts

DIRECT INTERELECTRODE CAPACITANCES

Grid to Plate.....	4.8 $\mu\mu\text{f}$
Input.....	5.0 $\mu\mu\text{f}$
Output.....	1.5 $\mu\mu\text{f}$

MAXIMUM RATINGS (Design Center Values—Except as Noted)

	Vertical ¹ Deflection Amplifier	Class A ₁ Amplifier
D C Plate Voltage.....	550	550 Volts
Peak Positive Plate Voltage (Abs. Max.).....	1000	Volts
Plate Dissipation ²	6.0	6.0 Watts
Peak Negative Grid Voltage.....	250	Volts
Average Cathode Current.....	30	Ma
Peak Cathode Current.....	105	Ma
Grid Circuit Resistance		
Cathode Bias.....	2.2	2.2 Megohms
Fixed Bias.....		0.47 Megohm

12B4 (Cont'd)

CHARACTERISTICS AND TYPICAL OPERATION

Class A₁ Amplifier

Plate Voltage.....	150 Volts
Grid Voltage.....	-17.5 Volts
Plate Current.....	34 Ma
Amplification Factor.....	6.5
Plate Resistance (approx.).....	1030 Ohms
Transconductance.....	6300 μ mhos
Plate Current at $E_c = -23$ Volts.....	9.6 Ma
Grid Voltage for $I_b = 200 \mu$ a.....	-32 Volts

NOTES:

1. For operation in a 525-line, 30 frame system, the duty cycle of the voltage pulse must not exceed 15% of one scanning cycle.
2. In stages operating with grid leak bias, an adequate cathode bias resistor or other suitable means is required to protect the tube in the absence of excitation.

APPLICATION

The Sylvania Type 12B4 is a miniature, low μ , high perveance triode amplifier designed for service as a Class A amplifier or vertical deflection amplifier in television receiver sync circuits. The center tapped heater permits operation from a 6.3 or 12.6 volt source.

SYLVANIA TUBE TESTER SETTINGS

	A	B	C	D	E	F	G	Test or K
139/140	12.6	0	67	0	4	3	20	Y
	12.6	0	36	0	4	7	20	Y
219/220	12.6	4	357	13	5	2Z	9	1
	12.6	4	235	13	5	7Z	9	1

AVERAGE PLATE CHARACTERISTICS

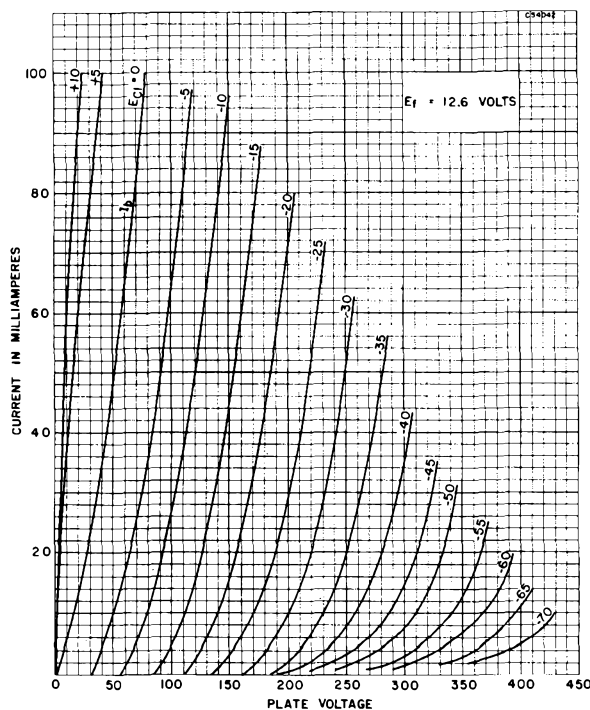

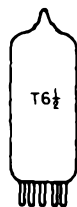

SYLVANIA TYPE 12B4A

TRIODE

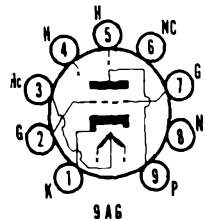

ELECTRICAL DATA

HEATER CHARACTERISTICS

Heater Voltage Series/Parallel.....	12.6/6.3 Volts
Heater Current Series/Parallel.....	300/600 Ma
Heater Warm-up Time ¹ (See SERIES STRING HEATERS Section in Appendix)	
Maximum Heater-Cathode Voltage.....	200 Volts
Total D C and Peak.....	100 Volts
D C, Heater Positive with Respect to Cathode.....	

For other rating, operation, and application data, refer to corresponding Type 12B4, which is identical except for heater ratings.

APPLICATION

The Sylvania Type 12B4A is intended for service in television receivers employing series connected heaters. For information on specially controlled heaters for series string operation refer to the SERIES STRING HEATERS section of the Appendix.

NOTE:

1. Applies to parallel heater connection only.

TYPES 12B7, 12B8GT

(See Condensed Data Section)



SYLVANIA TYPE 12BA6

REMOTE CUTOFF PENTODE

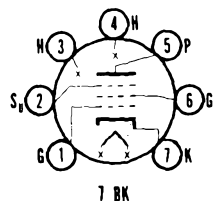

ELECTRICAL DATA

HEATER CHARACTERISTICS

Heater Voltage.....	12.6 Volts
Heater Current.....	150 Ma

For other rating, operation, and application data, refer to corresponding Type 6BA6, which is identical except for heater ratings.

SYLVANIA TUBE TESTER SETTINGS

	A	B	C	D	E	F	G	Test or K
139/140	12.6	0	—	0	4	36	30	W
219/220	12.6	3	4	37	4	16Z	5	7

TYPE 12BA7

(See Condensed Data Section)

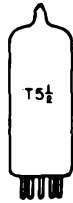

SYLVANIA TYPE 12BD6
REMOTE CUTOFF R F PENTODE

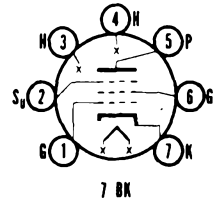

ELECTRICAL DATA

HEATER CHARACTERISTICS

Heater Voltage..... 12.6 Volts
Heater Current..... 150 Ma

For operation and application data, refer to corresponding Type 6BD6, which is identical except for heater ratings.

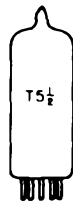

SYLVANIA TYPE 12BE6
HEPTODE CONVERTER

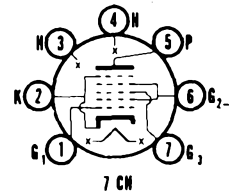

ELECTRICAL DATA

HEATER CHARACTERISTICS

Heater Voltage..... 12.6 Volts
Heater Current..... 150 Ma

For other rating, operation, and application data, refer to corresponding Type 6BE6, which is identical except for heater ratings.

SYLVANIA TUBE TESTER SETTINGS

	A	B	C	D	E	F	G	Test or K
139/140	12.6	0	—	0	5	3	27	X
	12.6	0	—	0	4	64	18	V
219/220	12.6	3	4	78	4	067X	5	2
	12.6	3	4	27	4	1X	6	2

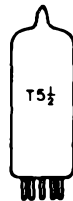

SYLVANIA TYPE 12BF6
DUODIODE TRIODE

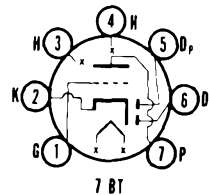

ELECTRICAL DATA

HEATER CHARACTERISTICS

Heater Voltage..... 12.6 Volts
Heater Current..... 150 Ma

For operation and application data, refer to corresponding Type 6BF6, which is identical except for heater ratings.

Data for use in Resistance Coupled Amplifier Circuits is given in the Appendix.

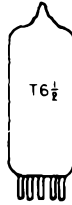

SYLVANIA TYPE 12BH7

MEDIUM-MU DUOTRIODE

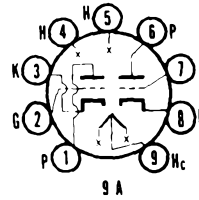

MECHANICAL DATA

Bulb	T-6 1/2, Outline 6-3
Base	Small Button 9-Pin
Basing	9A
Mounting Position	Any

ELECTRICAL DATA

HEATER CHARACTERISTICS

Heater Voltage Series/Parallel	12.6/6.3 Volts
Heater Current Series/Parallel	300/600 Ma
Maximum Peak Heater-Cathode Voltage	
Total D C and Peak	200 Volts
D C, Heater Positive with Respect to Cathode	100 Volts

DIRECT INTERELECTRODE CAPACITANCES (Unshielded) ¹

	Section 1	Section 2
Grid to Plate	2.6	2.6 μf
Input	3.2	3.2 μf
Output	0.5	0.4 μf
Plate to Plate	0.8	μf

MAXIMUM RATINGS (Design Center Values—Except as Noted)

	Vertical Deflection Amplifier	Class A ₁ Amplifier
Plate Voltage	450	300 Volts
Peak Positive Plate Voltage (Abs. Max.)	1500	Volts
Plate Dissipation (Each Section)	3.5	3.5 Watts
Peak Negative Pulse Grid Voltage	250	Volts
Average Cathode Current (Each Section)	20	20 Ma
Peak Cathode Current	70	Ma
Grid Circuit Resistance		
Fixed Bias		0.25 Megohm
Cathode Bias	2.2	1.0 Megohms
	Vertical ² Deflection Oscillator	Horizontal ² Deflection Oscillator
D C Plate Voltage	450	450 Volts
Plate Dissipation		
Each Plate	3.5	3.5 Watts
Both Plates	7.0	7.0 Watts
Peak Negative Grid Voltage	400	600 Volts
Average Cathode Current	20	20 Ma
Peak Cathode Current	70	300 Ma
Grid Circuit Resistance	2.2	2.2 Megohms

CHARACTERISTICS AND TYPICAL OPERATION

Class A₁ Amplifier

Plate Voltage	250 Volts
Grid Voltage	-10.5 Volts
Plate Current	11.5 Ma
Transconductance	3100 μmhos
Amplification Factor	16.5
Grid Voltage for $I_b = 50 \mu\text{a}$	-23 Volts
Plate Resistance (approx.)	5300 Ohms

Vertical Deflection Amplifier²

Plate Voltage	350 Volts
Cathode Bias Resistor	560 Ohms
Grid Input Voltage	
Peak to Peak Sawtooth Component (approx.)	25 Volts
Negative Peaking Component (approx.)	32 Volts
Plate Current	16 Ma
Plate Output Voltage	
Peak Positive Pulse Component	670 Volts
Peak to Peak Sawtooth Component	230 Volts
Sweep Height (16RP4 or 16TP4 with 14 Kv on Anode)	10 1/2 Inches

NOTES:

- Section 1 connects to pins 6, 7 and 8.
- For operation in a 525-line, 30 frame system, the duty cycle of the voltage pulse must not exceed 15% of one scanning cycle.

12BH7 (Cont'd)

APPLICATION

A medium-mu duo triode with separate cathodes. The tube has semi-high permeance units and is capable of operation as a vertical deflection amplifier.

SYLVANIA TUBE TESTER SETTINGS

	A	B	C	D	E	F	G	Test or K
139/140	12.6	0	95	0	1	3	23	W
	12.6	0	65	0	3	7	23	W
219/220	12.6	4	589S	17	5	2Y	1	3
	12.6	4	539S	17	5	7Y	6	8

AVERAGE PLATE CHARACTERISTICS

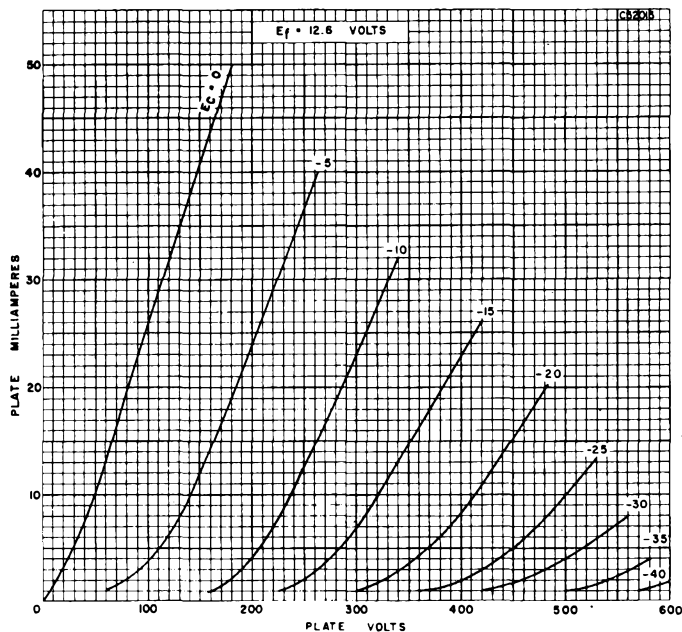

SYLVANIA TYPE 12BH7A
MEDIUM-MU DUOTRIODE

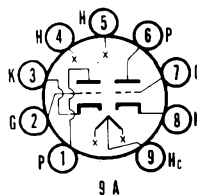

ELECTRICAL DATA

HEATER CHARACTERISTICS

Heater Voltage Series/Parallel	12.6/6.3 Volts
Heater Current Series/Parallel	300/600 Ma
Heater Warm-up Time (See SERIES STRING HEATERS Section in Appendix)	
Maximum Heater-Cathode Voltage	200 Volts
Total D C and Peak	100 Volts
D C, Heater Positive with Respect to Cathode	100 Volts

For other rating, operation, and application data, refer to corresponding Type 12BH7, which is identical except for heater ratings.

12BH7A (Cont'd)

NOTE:

1. Applies to parallel connection only.

APPLICATION

The Sylvania Type 12BH7A is intended for service in television receivers employing series connected heaters. For information on specially controlled heaters for series string operation refer to the SERIES STRING HEATERS section of the Appendix.

SYLVANIA TUBE TESTER SETTINGS

	A	B	C	D	E	F	G	Test or K
139/140	12.6	0	95	0	1	3	21	W
	12.6	0	65	0	3	7	21	W
219/220	12.6	4	589S	18	5	2Y	1	3
	12.6	4	539S	18	5	7Y	6	8



SYLVANIA TYPE 12BK5
BEAM POWER AMPLIFIER

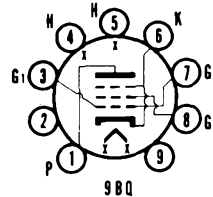

ELECTRICAL DATA

HEATER CHARACTERISTICS

Heater Voltage	12.6 Volts
Heater Current	600 Ma
Heater Warm-up Time (See SERIES STRING HEATERS Section in Appendix)	
Total D C and Peak	200 Volts
D C, Heater Positive with Respect to Cathode	100 Volts

For other rating, operation, and application data, refer to corresponding Type 6BK5, which is identical except for heater ratings.

APPLICATION

The Sylvania Type 12BK5 is intended for service in television receivers employing series connected heaters. For information on specially controlled heaters for series string operation refer to the SERIES STRING HEATERS section of the Appendix.

TYPE 12BQ6GA

(See Condensed Data Section)



SYLVANIA TYPE 12BL6

SEMI-REMOTE
CUTOFF PENTODE

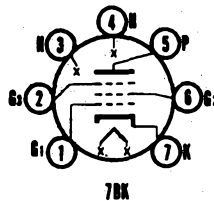

MECHANICAL DATA

Bulb	T-5 1/2
Base	E7-1, Miniature Button 7-Pin
Outline	5-2
Jasing	7BK
Cathode	Coated Unipotential
Mounting Position	Any

ELECTRICAL DATA

HEATER CHARACTERISTICS

Heater Voltage ¹	12.6 Volts
Heater Current	150 Ma
Heater-Cathode Voltage (Design-Center Values)	
Heater Negative with Respect to Cathode	30 Volts Max.
Heater Positive with Respect to Cathode	30 Volts Max.

DIRECT INTERELECTRODE CAPACITANCES (Shielded)

Grid No. 1 to Plate	0.006 μ f Max.
Input	6.5 μ f
Output	4.8 μ f

MAXIMUM RATINGS (Design-Center Values)

Plate Voltage	30 Volts
Grid No. 2 Voltage	30 Volts
Cathode Current	20 Ma
Grid No. 1 Circuit Resistance	10 Megohms

CHARACTERISTICS AND TYPICAL OPERATION

Plate Voltage	12.6 Volts
Grid No. 3 Voltage ²	0 Volts
Grid No. 2 Voltage	12.6 Volts
Grid No. 1 Voltage ³	-0.65 Volts
Plate Current	1350 μ a
Grid No. 2 Current	500 μ a
Transconductance ⁴	1350 μ mhos
Plate Resistance (approx.)	0.5 Megohm
Grid No. 1 Voltage for $G_m^4 = 10 \mu$ mhos (approx.)	-6.0 Volts
Grid No. 1 and No. 3 Voltage for $G_m^4 = 10 \mu$ mhos (approx.)	-5.0 Volts

NOTES:

- This tube is intended for use in automobile radios operated from a nominal 12-volt battery. Design of the tube is such that the heater will operate satisfactorily over the range 10.0 volts to 15.9 volts, and the maximum ratings provide a safety factor for the wide voltage variation encountered with this type of supply.
- Connected to Cathode at socket.
- Average contact potential bias developed across a 2.2 megohm grid resistor.
- From Grid No. 1 to plate.

APPLICATION

The Sylvania Type 12BL6 is a miniature semi-remote cutoff pentode intended for use as a r f or i f amplifier. It is designed for operation where the heater, plate and screen voltages are supplied directly from a 12-volt automotive storage battery.

12BL6 (Cont'd)

AVERAGE PLATE CHARACTERISTICS

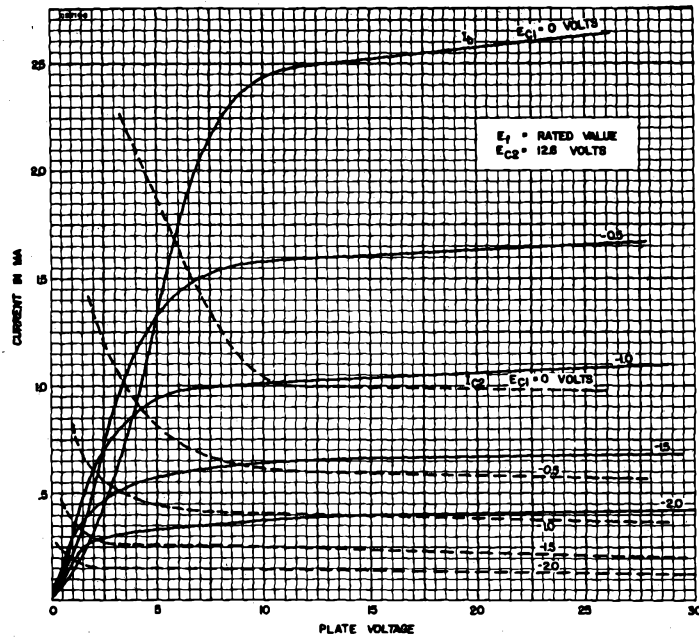

AVERAGE TRANSFER CHARACTERISTICS

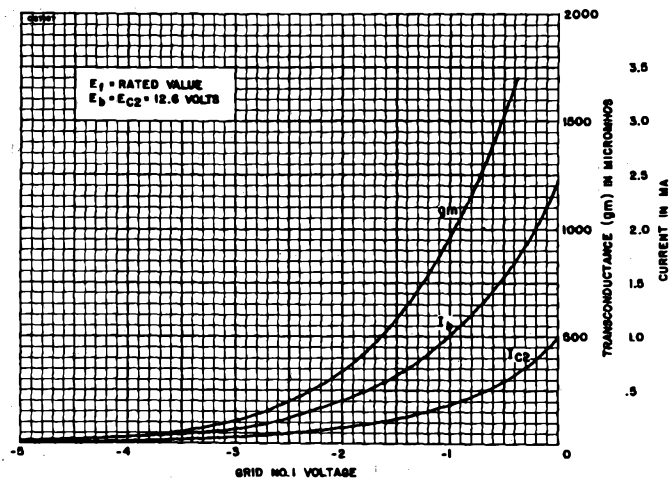

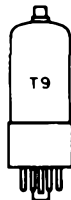

SYLVANIA TYPE 12BQ6GTA

BEAM POWER AMPLIFIER

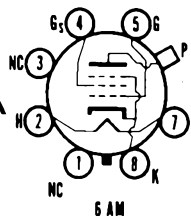

ELECTRICAL DATA

HEATER CHARACTERISTICS

Heater Voltage.....	12.6 Volts
Heater Current.....	600 Ma
Heater Warm-up Time (See SERIES STRING HEATERS Section in Appendix)	
Maximum Heater-Cathode Voltage.....	200 Volts
Total D C and Peak.....	100 Volts
D C, Heater Positive with Respect to Cathode.....	100 Volts

For other rating, operation, and application data, refer to corresponding Type 6BQ6GTA, which is identical except for heater ratings.

APPLICATION

The Sylvania Type 12BQ6GTA is intended for service in television receivers employing series connected heaters. For information on specially controlled heaters for series string operation refer to the SERIES STRING HEATERS section of the appendix.

SYLVANIA TUBE TESTER SETTINGS

	A	B	C	D	E	F	G	Test or K
139/140	12.6	0	5	0	8	034	20	Y
219/220	12.6	2	7	10	7	045Y	9	8

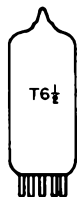

SYLVANIA TYPE 12BR7

DUO DIODE TRIODE

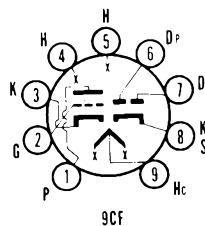

MECHANICAL DATA

Bulb.....	T-6½
Base.....	E9-1, Small Button 9-Pin
Outline.....	6-2
Basing.....	9CF
Cathode.....	Coated Unipotential
Mounting Position.....	Any

ELECTRICAL DATA

HEATER CHARACTERISTICS

Heater Voltage Series/Parallel.....	12.6/6.3 Volts
Heater Current.....	225/450 Ma
Heater-Cathode Voltage (Design Center Values)	
Heater Negative with Respect to Cathode.....	
Total D C and Peak.....	200 Volts Max.
Heater Positive with Respect to Cathode.....	
D C.....	100 Volts Max.
Total D C and Peak.....	200 Volts Max.

DIRECT INTERELECTRODE CAPACITANCES (Shielded)

Triode Grid to Plate.....	1.9 μf
Triode Input.....	2.8 μf
Triode Output.....	1.0 μf
Diode Input (Each Diode).....	2.0 μf

12BR7 (Cont'd)

RATINGS (Design Center Values)

Plate Voltage (Triode).....	300 Volts Max.
Plate Dissipation (Triode).....	2.5 Watts Max.
Peak Inverse Diode Voltage.....	300 Volts Max.
Peak Diode Current.....	60 Ma Max.

CHARACTERISTICS AND TYPICAL OPERATION

Class A₁ Amplifier

Plate Voltage.....	100	250 Volts
Cathode Bias Resistor.....	270	200 Ohms
Amplification Factor.....	60	60
Plate Resistance (approx.).....	15000	10900 Ohms
Transconductance.....	4000	5500 μ mhos
Plate Current.....	3.7	10 Ma
Grid Voltage (approx.) for $I_b = 10 \mu$ a.....	-5	-12 Volts
Average Diode Current, Each Diode with 5.0 Volts D C Applied.....		17 Ma

NOTE:

1. Shield No. 315.

APPLICATION

The Sylvania Type 12BR7 is a miniature high mu triode duo diode intended for application in monochrome and color television receivers.



SYLVANIA TYPE 12BR7 PENTODE VIDEO AMPLIFIER

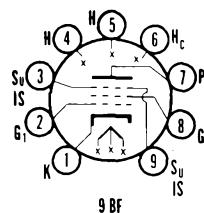

MECHANICAL DATA

Bulb.....	T-6 1/2
Base.....	E9-1, Miniature Button 9-Pin
Outline.....	6-3
Basing.....	9BF
Cathode.....	Coated Unipotential
Mounting Position.....	Any

ELECTRICAL DATA

HEATER CHARACTERISTICS

Heater Voltage.....	12.6/6.3 Volts
Heater Current.....	300/600 Ma
Heater-Cathode Voltage (Design Center Values)	
Heater Negative with Respect to Cathode	
Total D C and Peak.....	200 Volts Max.
Heater Positive with Respect to Cathode	
D C.....	100 Volts Max.
Total D C and Peak.....	200 Volts Max.

DIRECT INTERELECTRODE CAPACITANCES (Unshielded)

Grid No. 1 to Plate: (g1 to p).....	0.055 μ f
Input: g1 to (h+k+g2+Shield and g3).....	11.0 μ f
Output: p to (h+k+g2+Shield and g3).....	3.0 μ f

RATINGS (Design Center Values)

Plate Voltage.....	300 Volts Max.
Grid No. 2 Voltage.....	175 Volts Max.
Negative Grid No. 1 Voltage.....	50 Volts Max.
Plate Dissipation.....	6.25 Watts Max.
Grid No. 2 Dissipation.....	1.0 Watt Max.
Grid No. 1 Circuit Resistance	
Fixed Bias.....	0.25 Megohm Max.
Self Bias.....	1.0 Megohm Max.

12BV7 (Cont'd)

CHARACTERISTICS AND TYPICAL OPERATION

Plate Voltage	250 Volts
Grid No. 2 Voltage	150 Volts
Cathode Resistor	68 Ohms
Plate Current	27 Ma
Grid No. 2 Current	6.0 Ma
Plate Resistance, approx.	85,000 Ohms
Transconductance	13,000 μ mhos
Amplification Factor	1,000
Grid No. 1 Voltage for $I_b = 20 \mu$ a	12 Volts
Triode Amplification Factor	28
Minimum Plate Current with $E_{c2} = 180$ V, RK = 0 Ohms, $E_{c1} = 8.0$ V	0.5 Ma

APPLICATION

The 12BV7 is a miniature high transconductance pentode designed for use as a video amplifier.

SYLVANIA TYPE 12BY7

PENTODE VIDEO AMPLIFIER

MECHANICAL DATA

Bulb	T-6 1/2, Outline 6-3
Base	Small Button 9-Pin
Basing	9BF
Mounting Position	Any

ELECTRICAL DATA

HEATER CHARACTERISTICS

Heater Voltage (Series/Parallel)	12.6/6.3 Volts
Heater Current (Series/Parallel)	300/600 Ma
Maximum Heater-Cathode Voltage	200 Volts

DIRECT INTERELECTRODE CAPACITANCES (Unshielded)

Grid to Plate	0.063 μ f
Input	10.2 μ f
Output	3.5 μ f

MAXIMUM RATINGS (Design Center Values)

Plate Voltage	300 Volts
Plate Dissipation	6.5 Watts
Grid No. 2 Voltage	180 Volts
Grid No. 2 Dissipation	1.1 Watt
Grid No. 1 Voltage	
Negative	50 Volts
Positive	0 Volts
Grid No. 1 Resistance	
Fixed Bias	0.25 Megohm
Cathode Bias	1.0 Megohm

12BY7 (Cont'd)

CHARACTERISTICS AND TYPICAL OPERATION

Class A₁ Amplifier

Plate Voltage.....	250 Volts
Grid No. 2 Voltage.....	180 Volts
Cathode Bias Resistor.....	100 Ohms
Plate Current.....	26 Ma
Grid No. 2 Current.....	5.75 Ma
Transconductance.....	11000 μ mhos
Plate Resistance.....	93000 Ohms
Grid No. 1 Voltage for $I_b = 20 \mu$ a.....	-11.6 Volts
Amplification Factor (Triode Connected).....	28.5
Amplification Factor.....	1035

APPLICATION

The Sylvania Type 12BY7 is a miniature, high transconductance pentode designed for use as a video amplifier in television receivers. It is capable of furnishing large output voltages across low values of load resistance and supply voltages.

SYLVANIA TUBE TESTER SETTINGS

	A	B	C	D	E	F	G	Test or K
139/140	12.6	0	45	0	6	39	39	Y
219/220	12.6	4	569S	25	5	28Z	7	1

AVERAGE PLATE CHARACTERISTICS

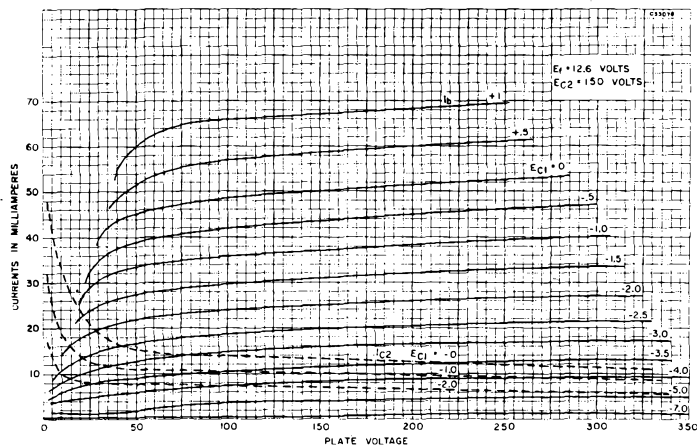

12BY7 (Cont'd)

AVERAGE TRANSFER CHARACTERISTICS

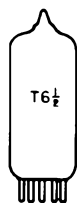
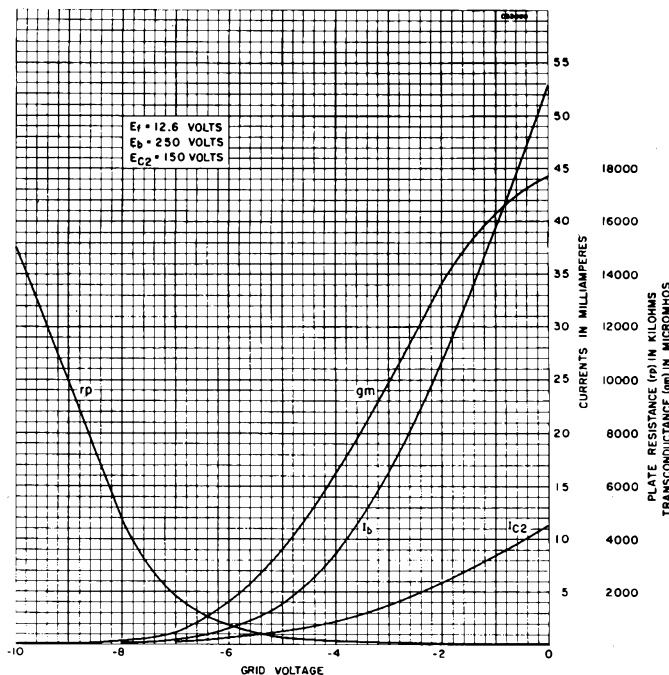

SYLVANIA TYPE 12BY7A VIDEO PENTODE

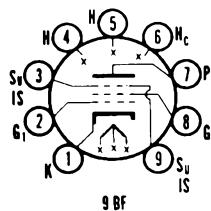

ELECTRICAL DATA

HEATER CHARACTERISTICS

Heater Voltage Series/Parallel	12.6/6.3 Volts
Heater Current Series/Parallel	300/600 Ma
Heater Warm-up Time (See SERIES STRING HEATERS Section in Appendix) ¹	
Total D C and Peak	200 Volts
D C, Heater Positive with Respect to Cathode	100 Volts

For other rating, operation, and application data, refer to corresponding 12BY7, which is identical except for heater ratings.

NOTE:

1. Applies to parallel connection only.

APPLICATION

The Sylvania Type 12BY7A is intended for service in television receivers employing series connected heaters. For information on specially controlled heaters for series string operation refer to the SERIES STRING HEATERS section of the Appendix.

TYPES 12BZ7, 12C8

(See Condensed Data Section)

SYLVANIA ELECTRONIC TUBES



SYLVANIA TYPE 12CA5

BEAM POWER AMPLIFIER

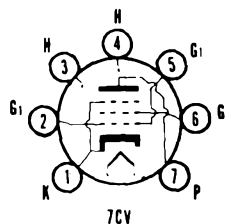

MECHANICAL DATA

Bulb	T-5 1/2, Outline 5-3
Base	Miniature Button 7-Pin
Basing	7CV
Mounting Position	Any

ELECTRICAL DATA

HEATER CHARACTERISTICS

Heater Voltage	12.6 Volts
Heater Current	600 Ma
Heater Warm-up Time (See SERIES STRING HEATERS Section in Appendix)	
Maximum Heater-Cathode Voltage	
Total D C and Peak	200 Volts
D C, Heater Positive with Respect to Cathode	100 Volts

DIRECT INTERELECTRODE CAPACITANCES

Grid No. 1 to Plate	0.5 μf
Input	15.0 μf
Output	9.0 μf

MAXIMUM RATINGS (Design Center Values)

Plate Voltage	130 Volts
Plate Dissipation	5.0 Watts
Grid No. 2 Voltage	130 Volts
Grid No. 2 Dissipation	1.4 Watts
Positive D C Grid No. 1 Voltage	0 Volts
Grid No. 1 Circuit Resistance	
Fixed Bias	0.1 Megohm
Cathode Bias	0.5 Megohm
Bulb Temperature (At Hottest Point)	180° C

CHARACTERISTICS AND TYPICAL OPERATION

Class A₁ Amplifier

Plate Voltage	110	125 Volts
Grid No. 2 Voltage	110	125 Volts
Grid No. 1 Voltage	-4.0	-4.5 Volts
Peak A F Grid No. 1 Voltage	4.0	4.5 Volts
Plate Current (Zero Signal)	32	37 Ma
Plate Current (Maximum Signal) (approx.)	31	36 Ma
Grid No. 2 Current (Zero Signal)	3.5	4.0 Ma
Grid No. 2 Current (Maximum Signal) (approx.)	7.5	11 Ma
Transconductance	8100	9200 μmhos
Plate Resistance	16000	15000 Ohms
Load Resistance	3500	4500 Ohms
Total Harmonic Distortion (approx.)	5	6 Percent
Maximum Signal Power Output	1.1	1.5 Watts

APPLICATION

Sylvania Type 12CA5 is a miniature beam pentode designed primarily for use in the audio frequency output stage of radio and television receivers. The tube features high power sensitivity at relatively low plate and screen voltages. It may be used in television receivers employing series string heaters.

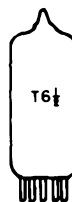

SYLVANIA TYPE 12CM6

BEAM POWER AMPLIFIER

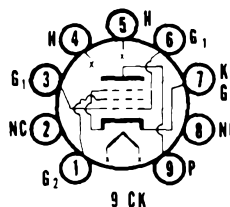

ELECTRICAL DATA

HEATER CHARACTERISTICS

Heater Voltage	12.6 Volts
Heater Current	225 Ma

For other rating, operation, and application data, refer to corresponding Type 6CM6, which is identical except for heater ratings.



SYLVANIA TYPE 12BZ7
HIGH-MU TWIN TRIODE

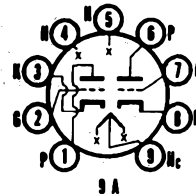

MECHANICAL DATA

Bulb.....	T-6 1/2
Base.....	E9-1, Small Button 9-Pin
Outline.....	6-3
Basing.....	9A
Cathode.....	Coated Unipotential
Mounting Position.....	Any

ELECTRICAL DATA

HEATER CHARACTERISTICS

Heater Voltage Series/Parallel.....	12.6/6.3 Volts
Heater Current Series/Parallel.....	300/600 Ma
Maximum Heater-Cathode Voltage.....	
Heater Negative with Respect to Cathode.....	180 Volts Max.
Heater Positive with Respect to Cathode.....	180 Volts Max.

DIRECT INTERELECTRODE CAPACITANCES (Unshielded)

	Section 1	Section 2
Grid to Plate.....	2.5	2.5 $\mu\mu\text{f}$
Input.....	6.5	6.5 $\mu\mu\text{f}$
Output.....	0.7	0.55 $\mu\mu\text{f}$
Plate to Plate.....		1.3 $\mu\mu\text{f}$

MAXIMUM RATINGS (Design Center Values) Each Section

Plate Voltage.....	300 Volts
Plate Dissipation.....	1.5 Watts
Positive D C Grid Voltage.....	0 Volts
Negative D C Grid Voltage.....	50 Volts
Grid No. 1 Circuit Resistance.....	5.0 Megohms

CHARACTERISTICS AND TYPICAL OPERATION

Class A₁ Amplifier—Each Section

Plate Voltage.....	250 Volts
Grid Voltage.....	-2 Volts
Plate Current.....	2.5 Ma
Plate Resistance.....	31,800 Ohms
Transconductance.....	3200 μmhos
Amplification Factor.....	100

NOTES:

1. Maximum Value that can be used where Grid No. 1 bias is developed by means of contact potential.

APPLICATION

The Sylvania Type 12BZ7 is a miniature high mu twin triode designed primarily for use as a sync separator and sync amplifier in television receivers. It is also useful in clipping circuits and as a general purpose audio amplifier.

SYLVANIA TYPE 12BZ7 (Cont'd)

AVERAGE PLATE CHARACTERISTICS

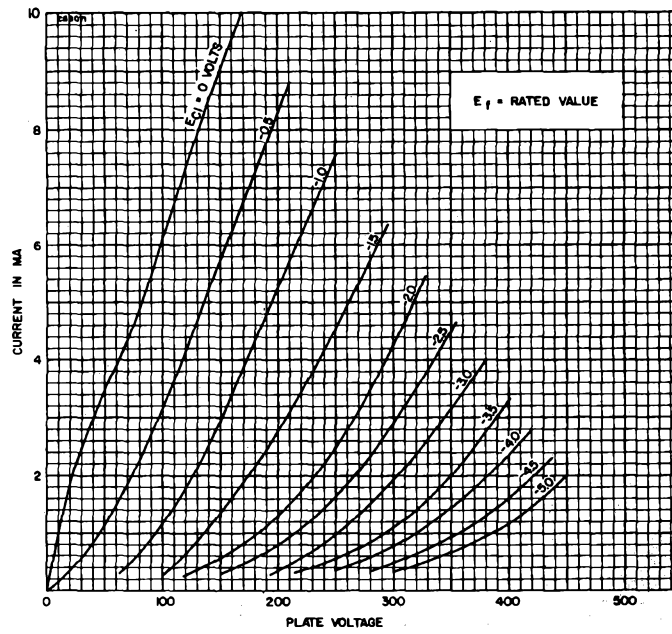



SYLVANIA TYPE 12CN5

SHARP CUTOFF PENTODE

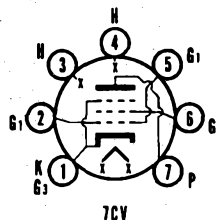

MECHANICAL DATA

Bulb.....	T-5 1/2
Base.....	E7-1, Miniature Button 7-Pin
Outline.....	5-3
Basing.....	7CV
Cathode.....	Coated Unipotential
Mounting Position.....	Any

ELECTRICAL DATA

HEATER CHARACTERISTICS

Heater Voltage ¹	12.6 Volts
Heater Current.....	450 Ma
Heater-Cathode Voltage (Design Center Values)	
Heater Negative with Respect to Cathode.....	16 Volts Max.
Heater Positive with Respect to Cathode.....	16 Volts Max.

DIRECT INTERELECTRODE CAPACITANCES

	Shielded	Unshielded
Grid No. 1 to Plate.....	0.2	0.25 μ f Max.

MAXIMUM RATINGS (Design Center Values)

Plate Voltage.....	16 Volts
Grid No. 2 Voltage.....	16 Volts
Positive Grid No. 1 Voltage.....	0 Volts
Grid No. 1 Circuit Resistance.....	2.2 Megohms

CHARACTERISTICS AND TYPICAL OPERATION

Plate Voltage.....	12.6 Volts
Grid No. 2 Voltage.....	12.6 Volts
Grid No. 1 Voltage ²	
Grid No. 1 Resistor.....	2.2 Megohms
Plate Current.....	4.5 Ma
Grid No. 2 Current.....	0.35 Ma
Transconductance.....	3800 μ mhos
Plate Resistance (approx.).....	40,000 Ohms

NOTES:

1. This tube is intended for use in automobile radios operated from a nominal 12-volt battery. Design of the tube is such that the heater will operate satisfactorily over the range 10.0 volts to 15.9 volts, and that the maximum ratings provide a safety factor for the wide voltage variation encountered with this type of supply.
2. Average contact potential bias developed across the specified grid resistor.

APPLICATION

The Sylvania Type 12CN5 is a miniature sharp-cutoff pentode intended for use as an I F amplifier in automobile radio receivers. It is designed primarily to operate where the heater, plate, and screen voltages are obtained directly from a 12-volt automotive storage battery.

12CN5 (Cont'd)

AVERAGE PLATE CHARACTERISTICS

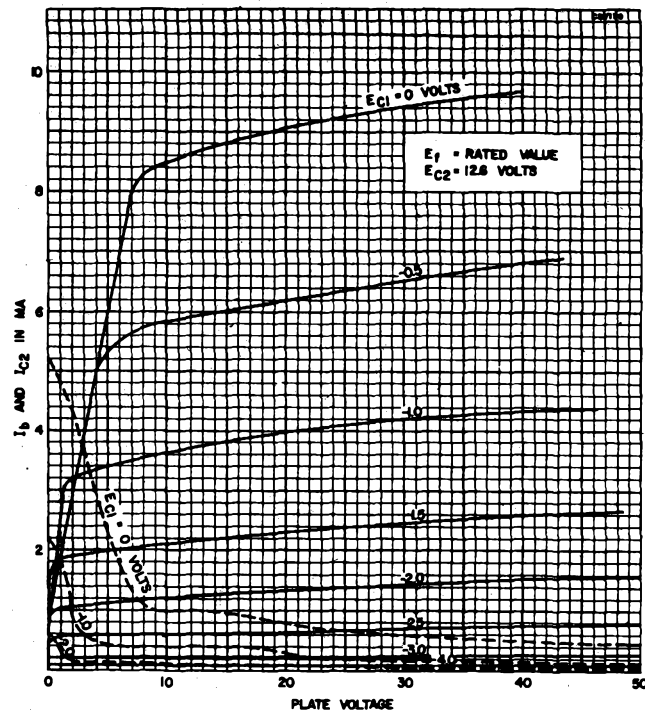

AVERAGE TRANSFER CHARACTERISTICS

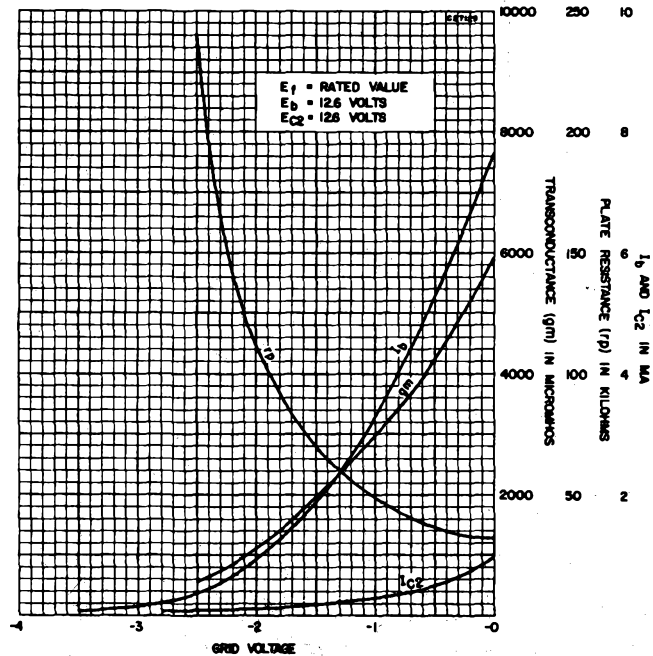

SYLVANIA ELECTRONIC TUBES

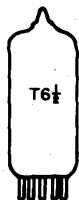

SYLVANIA TYPE 12CT8

MEDIUM MU TRIODE
PENTODE VIDEO AMPLIFIER

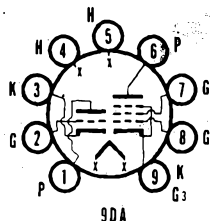

MECHANICAL DATA

Bulb	T-6½
Base	E9-1, Small Button 9-Pin
Outline	6-2
Basing	9DA
Cathode	Coated Unipotential
Mounting Position	Any

ELECTRICAL DATA

HEATER CHARACTERISTICS

Heater Voltage	12.6 Volts
Heater Current	300 Ma
Heater Warm-up Time ¹	11 Seconds
Heater Cathode Voltage (Design-Maximum Values)	
Heater Positive with Respect to Cathode, D.C.	100 Volts
Total D.C. and Peak	200 Volts
Heater Negative with Respect to Cathode	
Total D.C. and Peak	200 Volts

DIRECT INTERELECTRODE CAPACITANCES (Unshielded)

	Triode Section	Pentode Section
Grid No. 1 to Plate	2.2	0.044 μ f
Input	2.4	7.5 μ f
Output	0.19	2.4 μ f
Coupling		
Pentode Grid No. 1 to Triode Plate		0.010 μ f Max.
Triode Grid to Pentode Plate		0.016 μ f Max.
Pentode Plate to Triode Plate		0.16 μ f Max.

MAXIMUM RATINGS (Design Maximum Values)²

	Triode Section	Pentode Section
Plate Voltage	300	300 Volts
Grid No. 2 Supply Voltage		300 Volts
Grid No. 2 Voltage	See 6AM8 Rating Chart	
Positive Grid No. 1 Voltage	0	0 Volts
Plate Dissipation	2.5	2.75 Watts
Grid No. 2 Dissipation		0.9 Watts
Grid No. 1 Circuit Resistance		
Fixed Bias	0.5	0.25 Megohm
Self Bias	1.0	1.0 Megohm

CHARACTERISTICS AND TYPICAL OPERATION

	Triode Section	Pentode Section
Plate Voltage	150	200 Volts
Grid No. 2 Voltage		125 Volts
Cathode Resistor	150	82 Ohms
Plate Current	9.0	15 Ma
Grid No. 2 Current		3.4 Ma
Transconductance	4900	7000 μ mhos
Amplification Factor	40	
Plate Resistance (approx.)	8200	150,000 Ohms
E _{c1} for I _b = 100 μ a (approx.)	-6.5	-8 Volts

NOTES:

1. Heater warm-up time is defined as the time required for the voltage across the heater to reach 80% of its rated value after applying four (4) times rated heater voltage to a circuit consisting of the tube heater in series with a resistance equal to three (3) times rated heater voltage divided by rated heater current.
2. Design-maximum ratings are limiting values of operating and environmental conditions applicable to bogey electron device of a specified type as defined by its published data, and should not be exceeded under the worst probable conditions.

The device manufacturer chooses these values to provide acceptable serviceability of the device, taking responsibility for the effects of changes in operating conditions due to variations in device characteristics.

The equipment manufacturer should design so that initially and throughout life no design-maximum value for the intended service is exceeded with a bogey device under the worst probable operating conditions with respect to supply-voltage variation, equipment component variation, equipment control adjustment, load variation, signal variation, and environmental conditions.

12CT8 (Cont'd)

APPLICATION

Type 12CT8 has a medium triode and pentode amplifier contained in a miniature envelope. The pentode section is intended for use as a video amplifier. Type 12CT8 has controlled heater warm-up time for series string operation.



SYLVANIA TYPE 12CX6

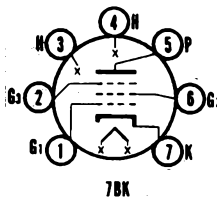

MECHANICAL DATA

Bulb	T-5½
Base	E7-1, Miniature Button 7-Pin
Outline	5-2
Basing	7BK
Cathode	Coated Unipotential
Mounting Position	Any

ELECTRICAL DATA

HEATER CHARACTERISTICS

Heater Voltage ¹	12.6 Volts
Heater Current	150 Ma
Heater-Cathode Voltage (Design-Maximum Values) ²	
Heater Negative with Respect to Cathode	30 Volts
Heater Positive with Respect to Cathode	30 Volts

DIRECT INTERELECTRODE CAPACITANCES (Unshielded)

Grid No. 1 to Plate	0.050 μ f Max.
Input: g1 to (h + k + g2 + g3)	7.6 μ f
Output: p to (h + k + g2 + g3)	6.2 μ f

MAXIMUM RATINGS (Design-Maximum Values)²

Plate Voltage	33 Volts
Grid No. 2 Voltage	33 Volts
Positive D C Grid No. 1 Voltage	0 Volts
Grid No. 1 Circuit Resistance	10 Megohms

CHARACTERISTICS AND TYPICAL OPERATION

Plate Voltage	12.6 Volts
Grid No. 2 Voltage	12.6 Volts
Grid No. 1 Voltage ⁴	
Grid No. 1 Resistor	2.2 Megohms
Plate Current	3.0 Ma
Grid No. 2 Current	1.4 Ma
Transconductance ⁴	3100 μ mhos
Plate Resistance (approx.)	40,000 Ohms
Grid No. 1 Voltage for $I_b = 10 \mu$ a (approx.)	-4.5 Volts

NOTES:

- This tube is intended for use in automobile radios operated from a nominal 12-volt battery. Design of the tube is such that the heater will operate satisfactorily over the range from 10.0 to 15.9 volts, and that the maximum ratings provide a safety factor for the wide voltage variations encountered with this type of supply.
- Design-Maximum ratings are the limiting values expressed with respect to bogey tubes at which satisfactory tube life can be expected to occur. To obtain satisfactory circuit performance, therefore, the equipment designer must establish the circuit design so that no design-maximum value is exceeded with a bogey tube under the worst probable operating conditions with respect to supply voltage variation, equipment component variation, equipment control adjustment, load variation, and environmental conditions.
- Average contact potential developed across specified grid resistor.
- Signal applied in series with 1.0 μ f grid-leak capacitor.

APPLICATION NOTES

The Sylvania Type 12CX 6 is a miniature, sharp-cutoff pentode intended for use as an rf amplifier. It is designed for operation where the heater, plate and screen voltages are supplied directly from a 12-volt automotive storage battery.

SYLVANIA TYPE 12CX6 (Cont'd)

AVERAGE PLATE CHARACTERISTICS

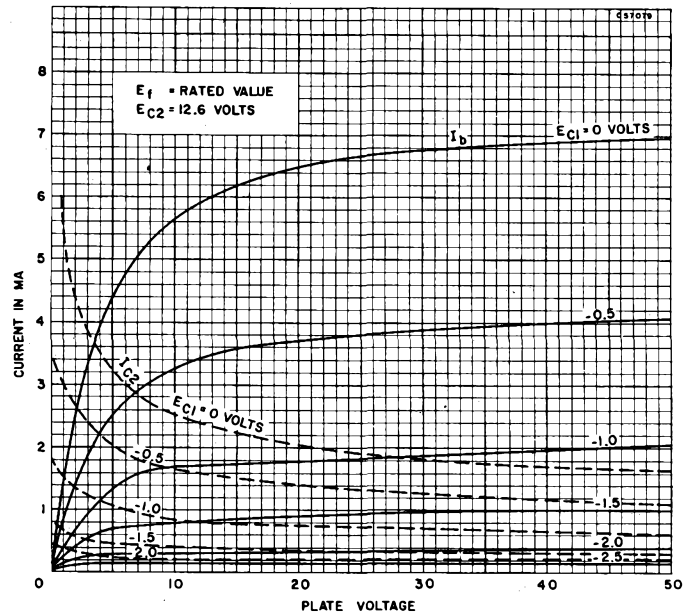

AVERAGE TRANSFER CHARACTERISTICS

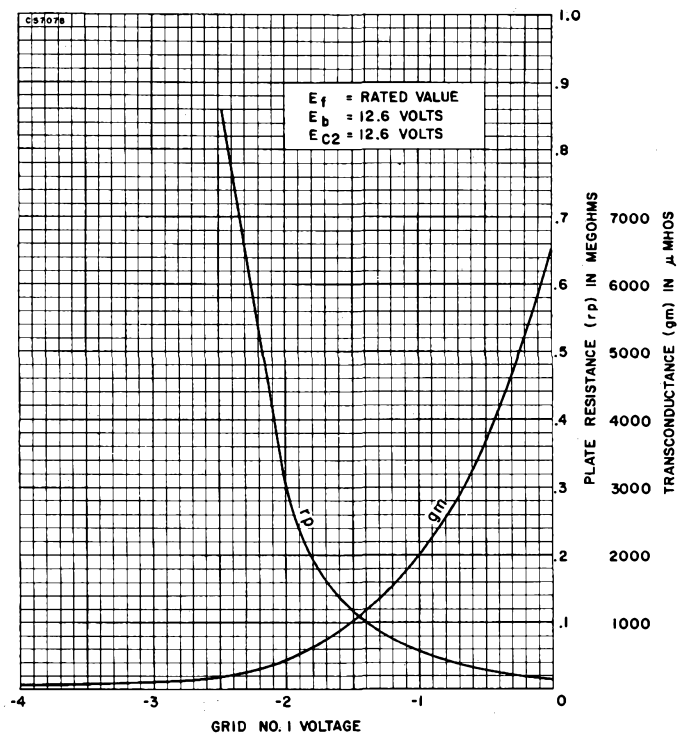

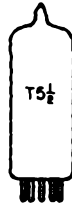

SYLVANIA TYPE 12EG6

DUAL-CONTROL HEPTODE

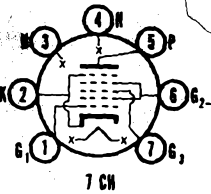

MECHANICAL DATA

Bulb	T-5 1/2
Base	E7-1, Miniature Button 7-Pin
Outline	5-2
Basing	7CH
Cathode	Coated Unipotential
Mounting Position	Any

ELECTRICAL DATA

HEATER CHARACTERISTICS

Heater Voltage ¹	12.6 Volts
Heater Current	150 Ma
Heater-Cathode Voltage (Design Center Values)	
Heater Negative with Respect to Cathode	30 Volts Max.
Heater Positive with Respect to Cathode	30 Volts Max.

DIRECT INTERELECTRODE CAPACITANCES (Shielded)²

Grid No. 3 to Plate	0.25 μ mf Max.
Grid No. 3 to Grid No. 1	0.15 μ mf Max.
RF Input:	
g3 to (h+k+g1+g2+4+g5+p)	6.5 μ mf
Grid No. 1	
to (h+k+g1+g2+4+g3+g5+p)	5.7 μ mf
RF Output:	
p to (h+k+g1+g2+4+g3+g5)	12 μ mf
Grid No. 1 to Cathode	3.2 μ mf
Grid No. 1 to Plate	0.04 μ mf
Cathode to All Electrodes, Except Grid No. 1	23 μ mf

MAXIMUM RATINGS (Design Center Values)

Plate Voltage	30 Volts
Grid No. 2 and Grid No. 4 Voltage	30 Volts
Grid No. 2 and Grid No. 4 Supply Voltage	30 Volts
Positive Grid No. 3 Voltage	0 Volts
Negative Grid No. 3 Voltage	30 Volts
Cathode Current	20 Ma
Grid No. 3 Circuit Resistance	10 Megohms

CHARACTERISTICS AND TYPICAL OPERATION

Plate Voltage	12.6 Volts
Grid No. 2 and Grid No. 4 Voltage	12.6 Volts
Grid No. 3 Voltage ³	-0.8 Volts
Grid No. 1 Voltage ⁴	-0.8 Volts
Plate Current	0.4 Ma
Grid No. 2 and Grid No. 4 Current	2.4 Ma
Transconductance ⁵	800 μ mhos
Plate Resistance (approx.)	0.15 Megohms
Grid No. 3 Voltage and Grid No. 1 Voltage	
for $Gm^5 = 10 \mu$ mhos (approx.)	-3.0 Volts

NOTES:

- This tube is intended for use in automobile radios operated from a nominal 12 volt battery. Design of the tube is such that the heater will operate satisfactorily over the range 10.0 volts to 15.9 volts, and that the maximum ratings provide a safety factor for the wide voltage variation encountered with this type of supply.
- External Shield No. 316 connected to cathode or Pin No. 2.
- Grid No. 3 Voltage is obtained through a resistor (R-9) connected to Grid No. 1 which obtains its voltage from an AVC circuit. The value of the resistor connecting Grid No. 1 to Grid No. 3 is influenced by circuit and AVC voltage variations.
- Bias voltage for Grid No. 1 is normally obtained from an AVC circuit, therefore, the value of the resistor (R-10) connected to Grid No. 1 is influenced by circuit and AVC voltage variations. Bias voltage for Grid No. 1 can also be developed across a 2.2 megohm resistor by means of contact potential.
- From Grid No. 3 to Plate.

SYLVANIA TYPE 12EG6 (Cont'd)

TYPICAL DUAL CONTROL R-F AMPLIFIER CIRCUIT

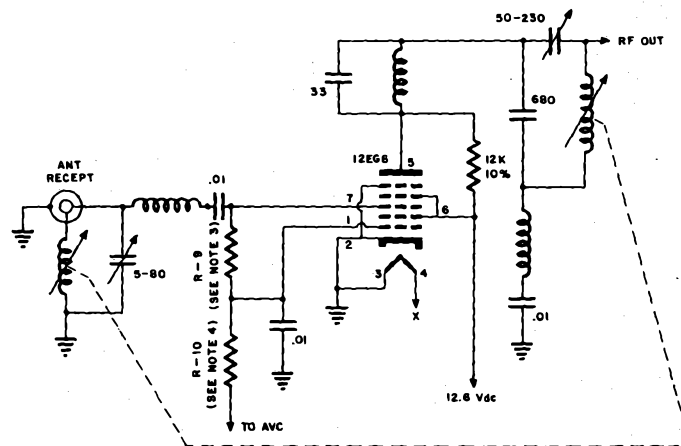

APPLICATION

The Sylvania Type 12EG6 is a dual control heptode contained in a T-6½ envelope. It is intended for use as an RF amplifier where the application of AVC control voltage to two control grids is a definite advantage in reducing back biasing of the AVC line (a condition encountered when receiving strong RF signals.) It is designed for operation where the heater plate, and grids No. 2 and No. 4 voltages are supplied directly from a 12-volt automotive storage battery.



SYLVANIA TYPE 12EL6

DOUBLE DIODE
HIGH MU TRIODE

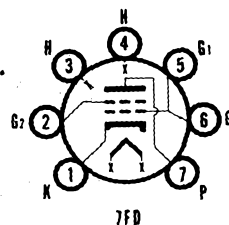

MECHANICAL DATA

Bulb	T-5 1/2
Base	E7-1, Miniature Button 7-Pin
Outline	5-2
Basing	7FB
Cathode	Coated Unipotential
Mounting Position	Any

ELECTRICAL DATA

HEATER CHARACTERISTICS

Heater Voltage ¹	12.6 Volts
Heater Current	150 Ma
Heater-Cathode Voltage (Design Center Values)	
Heater Negative with Respect to Cathode	30 Volts Max.
Heater Positive with Respect to Cathode	30 Volts Max.

DIRECT INTERELECTRODE CAPACITANCES (Unshielded)

Grid to Plate	1.8 μ f
Input: g to (h + k)	2.2 μ f
Output: p to (h + k)	1.0 μ f
Diode Plate to Diode Plate	1.0 μ f

MAXIMUM RATINGS (Design Center Values)

Plate Voltage	30 Volts
Cathode Current	20 Ma
Grid Circuit Resistance	10 Megohms
Average Diode Current	1.0 Ma

CHARACTERISTICS AND TYPICAL OPERATION

Class A₁ Amplifier

Plate Voltage	12.6 Volts
Grid Voltage	0 Volts
Plate Current	750 μ a
Transconductance	1200 μ mhos
Amplification Factor	55
Plate Resistance	45,000 Ohms
Average Diode Current with 10 Volts Applied (Each Diode) ²	2.0 Ma

Resistance Coupled Amplifier

Plate Supply Voltage	12.6 Volts
Grid Voltage ³	
Grid Resistor	1.0 Megohm
Plate Load Resistor	1.0 Megohm
Input Capacitor	0.02 μ f
Output Capacitor	0.01 μ f
Grid Resistor of Following Stage	2.0 Megohms
Voltage Gain at 400 CPS ⁴	16

NOTES:

- This tube is intended for use in automobile radios operated from a nominal 12 volt battery. Design of the tube is such that the heater will operate satisfactorily over the range 10.0 volts to 15.9 volts, and that the maximum ratings provide a safety factor for the wide voltage variation encountered with this type of supply.
- Test condition only.
- Contact potential bias developed across specified grid resistor.
- Measured at an output voltage of 1.0 volt RMS.

APPLICATION

The Sylvania Type 12EL6 is a miniature double diode, high mu triode intended for use as a second detector audio amplifier. It is designed for operation where the heater and plate voltages are supplied directly from a 12 volt automotive storage battery.

12EL6 (Cont'd)

AVERAGE PLATE CHARACTERISTICS

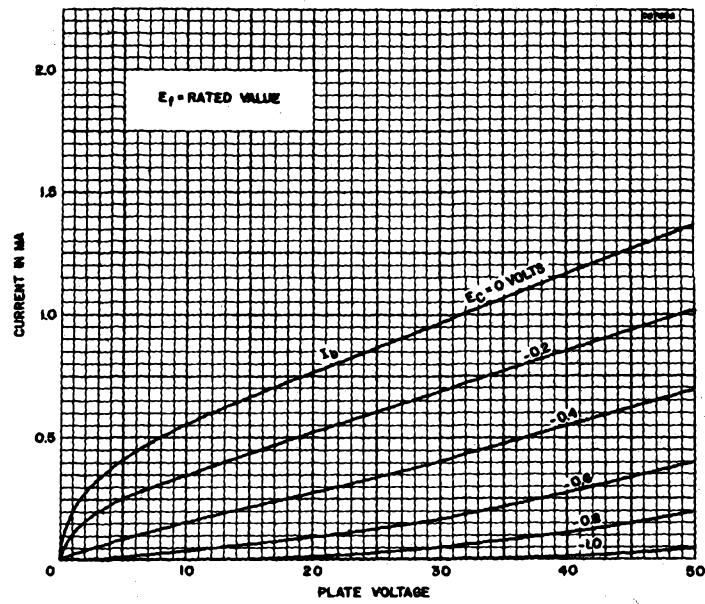

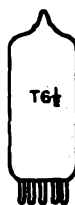

SYLVANIA TYPE 12EM6

DIODE-TETRODE

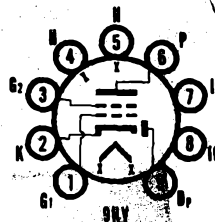

MECHANICAL DATA

Bulb	T-6 1/2
Base	EQ-1, Miniature Button 9-Pin
Outline	6-3
Basing	9HV
Cathode	Coated Unipotential
Mounting Position	Any

ELECTRICAL DATA

HEATER CHARACTERISTICS

Heater Voltage ¹	12.6 Volts
Heater Current	500 Ma
Heater-Cathode Voltage (Design Center Values)	
Heater Positive with Respect to Cathode	30 Volts Max.
Heater Negative with Respect to Cathode	30 Volts Max.

MAXIMUM RATINGS (Design Center Values)

Plate Voltage	30 Volts
Grid No. 2 Voltage	30 Volts
Plate Dissipation	0.5 Watts
Grid No. 1 Resistance	15 Megohms
Average Diode Current	10 Ma.

CHARACTERISTICS

Class A₁ Amplifier

Plate Voltage	12.6 Volts
Grid No. 2 Voltage	12.6 Volts
Grid No. 1 Voltage ²	
Grid No. 1 Resistor	2.2 Megohms
Plate Current	6.0 Ma
Grid No. 2 Current	1.0 Ma
Transconductance	5000 μ mhos
Plate Resistance (approx.)	4000 Ohms
Average Diode Current at 10 Volts D.C. Reverse	1.0 Ma

TYPICAL OPERATION

Plate Voltage	12.6 Volts
Grid No. 2 Voltage	12.6 Volts
Grid No. 1 Voltage ³	
AF Grid No. 1 Voltage (RMS)	1.0 Volts
AF Signal Source Resistance	200,000 Ohms
Plate Current ⁴ (Signal Applied)	2.5 Ma
Load Resistance	3500 Ohms
Power Output	10 Mw
Total Harmonic Distortion	10 Percent

NOTES:

- This tube is intended for use in automobile radios operated from a nominal 12 volt battery. Design of the tube is such that the heater will operate satisfactorily over the range 10.0 volts to 15.9 volts, and that the maximum ratings provide a safety factor for the wide voltage variation encountered with this type of supply.
- Contact potential bias developed across a 2.2 megohm resistor.
- Bias voltage is developed across a 15 megohm resistor by means of Grid No. 1 rectification (obtained when applying the specified signal voltage) and contact potential.
- With no signal applied to Grid No. 1 and bias developed solely by contact potential, the plate current is 6.0 ma.

APPLICATION

The Sylvania Type 12EM6 is a miniature diode-tetrode designed for use in automobile receivers. The diode section is intended for use as a detector while the tetrode section is designed to be used as a power amplifier driver. It is designed for operation where the heater, plate and screen voltages are supplied directly from a 12 volt automotive storage battery.



SYLVANIA TYPE 12F8

Duo Diode Pentode

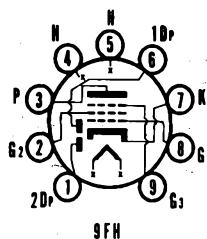

MECHANICAL DATA

Bulb	T-6½
Base	E9-7, Miniature Button 9-Pin
Outline	6-2
Basing	9FH
Cathode	Coated Unipotential
Mounting Position	Any

ELECTRICAL DATA

HEATER CHARACTERISTICS

Heater Voltage ¹	12.6 Volts
Heater Current	150 Ma
Heater-Cathode Voltage (Design Center Values)	
Heater Negative with Respect to Cathode	30 Volts
Heater Positive with Respect to Cathode	30 Volts

DIRECT INTERELECTRODE CAPACITANCES

Grid to Plate	0.06 μ f
Input g ¹ to (g ² + g ³ + h + k)	4.5 μ f
Output p to (g ² + g ³ + h + k)	3.0 μ f
Diode to Diode	0.3 μ f

RATINGS (Design Center Values)

Plate Voltage	30 Volts Max.
Grid No. 2 Voltage	30 Volts Max.
Positive D C Grid No. 1 Voltage	0 Volts Max.
Grid No. 1 Circuit Resistance	10 Megohms Max.
Average Diode Current	1.0 Ma Max.

CHARACTERISTICS AND TYPICAL OPERATION

Plate Voltage	12.6 Volts
Grid No. 2 Voltage	12.6 Volts
Grid No. 1 Voltage	0 Volts
Plate Current	1.0 Ma
Grid No. 2 Current	0.38 Ma
Transconductance	1000 μ mhos
Plate Resistance (approx.)	0.33 Megohm
Grid No. 1 Voltage (approx.) for gm = 10 μ mhos	-5 Volts
Average Diode Current with 10 Volts D C applied	2 Ma
(Test Condition Only)	

NOTE:

1. This tube is intended for use in automobile radios operated from a nominal 12 volt battery. Design of the tube is such that the heater will operate satisfactorily over the range 10.0 volts to 15.9 volts, and that the maximum ratings provide a safety factor for the wide voltage variation encountered with this type of supply.

APPLICATION NOTES

The Sylvania Type 12F8 is a double detector diode and remote cutoff pentode with a common cathode. The pentode section is intended for use as an AF voltage amplifier. It is designed for operation where the heater and plate potentials are supplied directly from a 12 volt automotive battery.

SYLVANIA ELECTRONIC TUBES

Issued as a supplement to the manual in Sylvania News for July 1957

SYLVANIA TYPE 12F8 (Cont'd)

AVERAGE PLATE CHARACTERISTICS

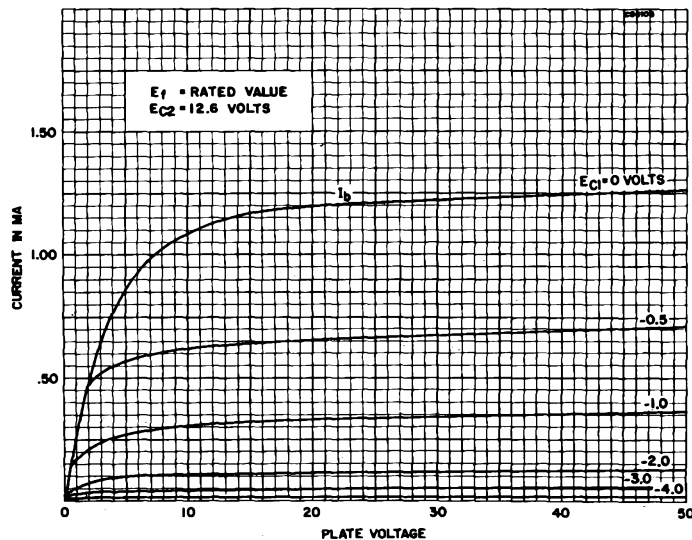

AVERAGE TRANSFER CHARACTERISTICS

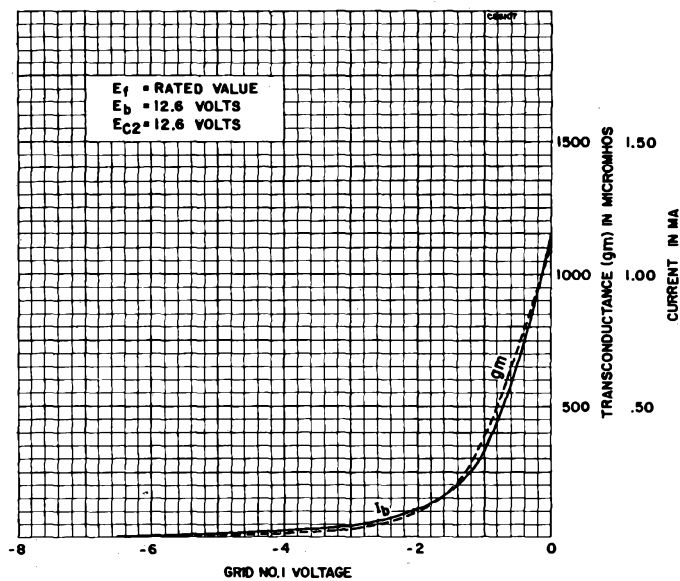



SYLVANIA TYPE 12CU6

BEAM POWER AMPLIFIER

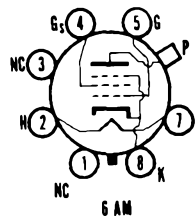

ELECTRICAL DATA

HEATER CHARACTERISTICS

Heater Voltage.....	12.6 Volts
Heater Current.....	600 Ma
Heater Warm-up Time (See SERIES STRING HEATERS Section in Appendix)	
Maximum Heater-Cathode Voltage	
Total D C and Peak.....	200 Volts
D C, Heater Positive with Respect to Cathode.....	100 Volts

For other rating, operation, and application data, refer to corresponding Type 6CU6, which is identical except for heater ratings.

APPLICATION

The Sylvania Type 12CU6 is intended for service in television receivers employing series connected heaters. For information on specially controlled heaters for series string operation refer to the SERIES STRING HEATERS section of the Appendix.

SYLVANIA TUBE TESTER SETTINGS

	A	B	C	D	E	F	G	Test or K
139/140	12.6	0	—	0	8	034	22	Y
219/220	12.6	2	7	13	7	045Z	9	8

TYPE 12DQ6—See 6DQ6

TYPES 12F5GT, 12G4, 12H4, 12H6

(See Condensed Data Section)

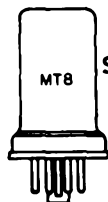

SYLVANIA TYPE 12J5

12J5GT

MEDIUM-MU TRIODE

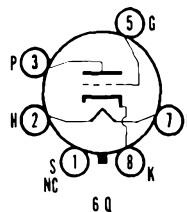

ELECTRICAL DATA

HEATER CHARACTERISTICS

Heater Voltage.....	12.6 Volts
Heater Current.....	150 Ma

For other rating, operation, and application data, refer to corresponding Type 6J5GT, which is identical except for heater ratings.

SYLVANIA TUBE TESTER SETTINGS

	A	B	C	D	E	F	G	Test or K
139/140	12.6	0	—	0	1	4	36	W
219/220	12.6	2	7	31	7	5V	3	8

TYPES 12J7GT, G, 12K7GT, G, 12K8, GT

(See Condensed Data Section)

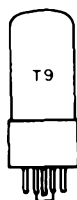

SYLVANIA TYPE 12L6GT BEAM POWER AMPLIFIER

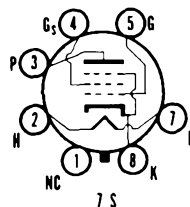

ELECTRICAL DATA

HEATER CHARACTERISTICS

Heater Voltage.....	12.6 Volts
Heater Current.....	600 Ma
Heater Warm-up Time (See SERIES STRING HEATERS Section in Appendix)	
Maximum Heater-Cathode Voltage	
Heater Negative with Respect to Cathode	
Total D C and Peak.....	300 Volts
Heater Positive with Respect to Cathode	
D C.....	100 Volts
Total D C and Peak.....	200 Volts

For other rating, operation, and application data, refer to corresponding Type 25L6GT, which is identical except for heater ratings.

APPLICATION

The Sylvania Type 12L6GT is intended for service in television receivers employing series connected heaters. For information on specially controlled heaters for series string operation refer to the SERIES STRING HEATERS section of the Appendix.

SYLVANIA TUBE TESTER SETTINGS

	A	B	C	D	E	F	G	Test or K
139/140	12.6	0	0	0	1	034	18	W
219/220	12.6	2	7	13	7	045Z	3	8

TYPES 12L8GT, 12Q7GT, G, 12S8

(See Condensed Data Section)

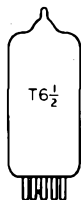

SYLVANIA TYPE 12J8

Duo Diode Tetrode

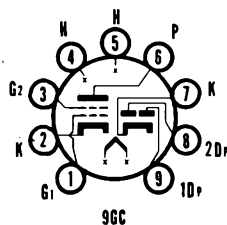

MECHANICAL DATA

Bulb	T-6 $\frac{1}{2}$
Base	E9-1, Miniature Button 9-Pin
Outline	6-2
Basing	9GC
Cathode	Coated Unipotential
Mounting Position	Any

ELECTRICAL DATA

HEATER CHARACTERISTICS

Heater Voltage ¹	12.6 Volts
Heater Current	325 Ma
Heater-Cathode Voltage (Design Center Values)	
Heater Positive with Respect to Cathode	30 Volts Max.
Heater Negative with Respect to Cathode	30 Volts Max.

DIRECT INTERELECTRODE CAPACITANCES (Unshielded)

Tetrode

Grid to Plate	0.7 μ f
Input: g1 to (h + Tk + g2)	10.5 μ f
Output: p to (h + Tk + g2)	4.4 μ f

Coupling

No. 1 Diode Plate to Tetrode Grid No. 1	0.04 μ f Max.
No. 2 Diode Plate to Tetrode Grid No. 1	0.015 μ f Max.

RATINGS (Design Center Values)

Plate Voltage	30 Volts Max.
Grid No. 2 Voltage	30 Volts Max.
Grid No. 1 Resistance	10 Megohms Max.
Average Diode Current (Each Diode)	5.0 Ma Max.

TYPICAL OPERATION

Plate Voltage	12.6 Volts
Grid No. 2 Voltage	12.6 Volts
Grid No. 1 Voltage ²	
Grid No. 1 Resistor	2.2 Megohms
AF Grid No. 1 Voltage (RMS)	1.6 Volts
Grid No. 1 Resistor Bypass Condenser	1.0 μ f
Plate Current (Zero Signal)	12 Ma
Grid No. 2 Current (Zero Signal)	1.5 Ma
Transconductance	5500 μ mhos
Plate Resistance (approx.)	6000 Ohms
Load Resistance	2700 Ohms
Maximum Signal Power Output	20 Mw
Total Harmonic Distortion	5 Per cent
Average No. 1 Diode Current at 5 Volts DC ³	8.5 Ma
Average No. 2 Diode Current at 5 Volts DC ³	12.0 Ma

NOTES:

1. This tube is intended for use in automobile radios operated from a nominal 12 volt battery. Design of the tube is such that the heater will operate satisfactorily over the range 10.0 volts to 15.9 volts, and that the maximum ratings provide a safety factor for the wide voltage variation encountered with this type of supply.
2. Average contact potential is developed across the specified grid resistor.
3. Test condition only.

APPLICATION NOTES

The Sylvania Type 12J8 is a miniature double-diode, tetrode intended for use as a detector and audio power amplifier driver. It is designed for operation where the heater, plate and screen voltages are supplied directly from a 12 volt automotive storage battery.

SYLVANIA ELECTRONIC TUBES

Issued as a supplement to the manual in Sylvania News for September 1957

SYLVANIA ELECTRONIC TUBES

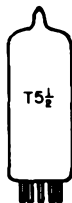

SYLVANIA TYPE 12K5

SPACE-CHARGE TETRODE

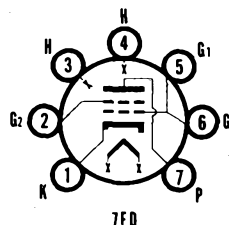

MECHANICAL DATA

Bulb	T-5 $\frac{1}{2}$
Base	E7-1, Miniature Button 7-Pin
Outline	5-3
Basing	7FD
Cathode	Coated Unipotential
Mounting Position	Any

ELECTRICAL DATA

HEATER CHARACTERISTICS

Heater Voltage ¹	12.6 Volts
Heater Current	400 Ma
Heater-Cathode Voltage (Design Center Values)	
Heater Negative with Respect to Cathode	30 Volts Max.
Heater Positive with Respect to Cathode	30 Volts Max.

MAXIMUM RATINGS (Design Center Values—Except as Noted)

Plate Voltage	30 Volts
Positive Grid No. 1 Voltage (Abs. Max.)	16 Volts
Negative Grid No. 2 Voltage	20 Volts
Grid No. 2 Circuit Resistance	10 Megohm

CHARACTERISTICS

Plate Voltage	12.6 Volts
Grid No. 1 (Space-charge Grid) Voltage	12.6 Volts
Grid No. 2 (Control Grid) Voltage ²	0.5 Volts
Plate Current	40 Ma
Grid No. 1 (Space-charge Grid) Current	75 Ma
Transconductance	15,000 μ mhos
Amplification Factor	7.2
Plate Resistance	480 Ohms

TYPICAL OPERATION

Plate Voltage	12.6 Volts
Grid No. 1 (Space-charge Grid) Voltage	12.6 Volts
Grid No. 2 (Control Grid) Voltage ³	2.0 Volts
Peak AF Grid No. 2 Voltage	2.5 Volts
AF Signal Source Resistance	100,000 Ohms
Load Resistance	800 Ohms
Plate Current ⁴	8.0 Ma
Grid No. 1 (Space-charge Grid) Current	75 Ma
Power Output	40 Mw
Total Harmonic Distortion	10 Percent

NOTES:

1. This tube is intended for use in automobile radios operated from a nominal 12 volt battery. Design of the tube is such that the heater will operate satisfactorily over the range 10.0 volts to 15.9 volts, and that the maximum ratings provide a safety factor for the wide voltage variation encountered with this type of supply.
2. Average contact potential bias developed across a 2.2 megohm resistor.
3. Bias voltage is developed across a 2.2 megohm resistor by means of Grid No. 2 rectification (obtained when applying the specified signal voltage) and contact potential.
4. With no signal applied to Grid No. 2 and bias developed solely by contact potential, the plate current is 40 Ma.

APPLICATION

Sylvania Type 12K5 is a space-charge tetrode. It is designed for use where plate, space-charge grid and heater potentials are obtained directly from a 12 volt automotive battery.

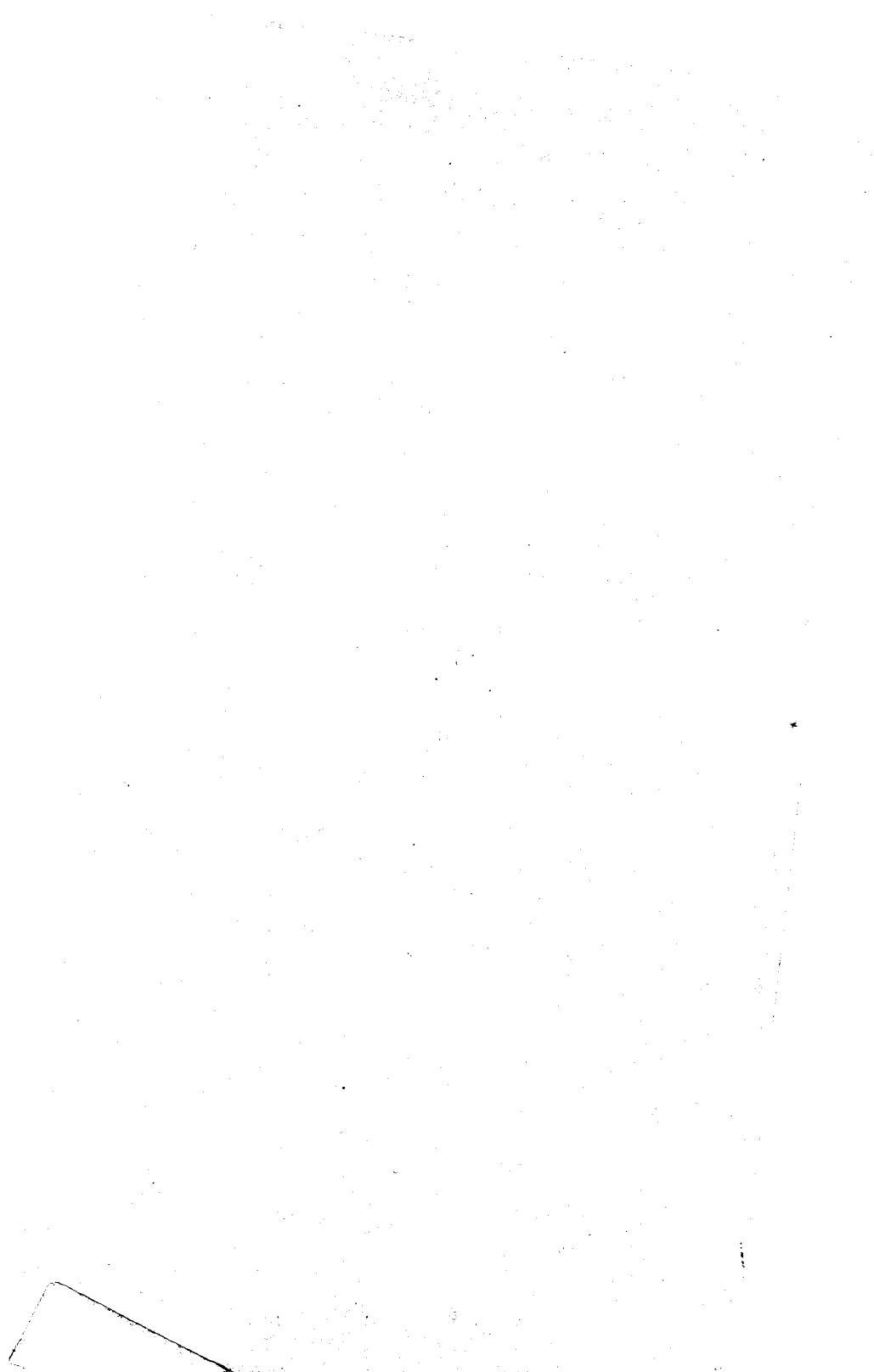

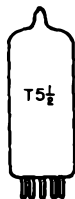

**SYLVANIA TYPE 12R5
17R5**
BEAM POWER PENTODE

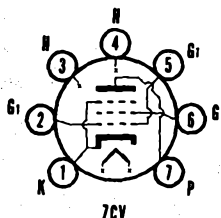

MECHANICAL DATA

Bulb	T-5 1/2
Base	E7-1, Miniature Button 7-Pin
Outline	5-3
Basing	7CV
Cathode	Coated Unipotential
Mounting Position	Any

ELECTRICAL DATA

HEATER CHARACTERISTICS

	12R5	17R5
Heater Voltage (A C or D C)	12.6	16.8 Volts
Heater Current	600	450 Ma
Heater Warm-up Time ¹	11	11 Seconds
Heater-Cathode Voltage (Design Center Values)		
Heater Negative with Respect to Cathode		
Total D C and Peak	300	300 Volts Max.
Heater Positive with Respect to Cathode		
D C	100	100 Volts Max.
Total D C and Peak	200	200 Volts Max.

DIRECT INTERELECTRODE CAPACITANCES (Unshielded)

Grid No. 1 to Plate	0.55 μ f
Input	13 μ f
Output	9.0 μ f

MAXIMUM RATINGS (Design Center Values—Except as Noted)

Vertical Deflector Amplifier²—Pentode Connected

Plate Voltage	150 Volts
Grid No. 2 Voltage	150 Volts
Peak Positive Pulse Plate Voltage (Abs. Max.)	1500 Volts
Plate Dissipation ³	4.5 Watts
Grid No. 2 Dissipation ³	1.0 Watt
Peak Negative Pulse Grid No. 1 Voltage	150 Volts
Average Cathode Current	45 Ma
Peak Cathode Current	155 Ma
Grid No. 1 Circuit Resistance	
Self Bias	2.2 Megohms

CHARACTERISTICS AND TYPICAL OPERATION

Plate Voltage	110 Volts
Grid No. 2 Voltage	110 Volts
Grid No. 1 Voltage	-8.5 Volts
Plate Current	40 Ma
Grid No. 2 Current	3.3 Ma
Transconductance	7000 μ mhos
Plate Resistance	13,000 Ohms
Grid No. 1 Voltage for $I_b = 0.5$ Ma (approx.)	-22 Volts

INSTANTANEOUS PLATE KNEE VALUES

$E_b = 45$ V, $E_{c2} = 110$ V, and $E_{c1} = 0$
 $I_b = 120$ Ma and $I_{c2} = 17$ Ma.

NOTES:

- Heater warm-up time is defined as the time required for the voltage across the heater to reach 80% of the rated heater voltage after applying four (4) times rated heater voltage to a circuit consisting of the tube heater in series with a resistance equal to three (3) times the rated heater voltage divided by the rated heater current.
- For operation in a 525-line, 30-frame system as described in "Standards of Good Engineering Practice for Television Broadcast Stations; Federal Communications Commission," the duty cycle of the voltage pulse must not exceed 15% of one scanning cycle.
- In stages operating with grid leak bias, an adequate cathode bias resistor or other suitable means is required to protect the tube in the absence of excitation.

APPLICATION

The Sylvania Types 12R5 and 17R5 are miniature, beam power pentodes designed for use as vertical deflection amplifiers. Types 12R5 and 17R5 have controlled heater warm-up time for series string operation.

12R5, 17R5, (Cont'd)

AVERAGE PLATE CHARACTERISTICS

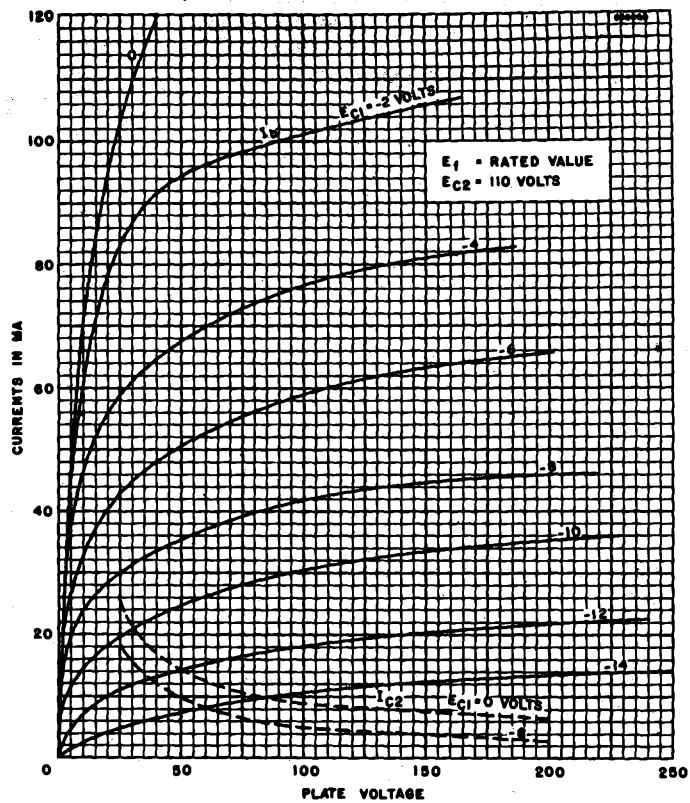

SYLVANIA ELECTRONIC TUBES

12SA7GT SYLVANIA TYPE

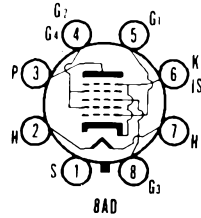

HEPTODE CONVERTER

12SA7

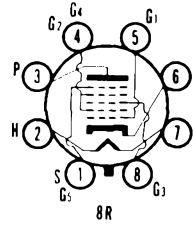

ELECTRICAL DATA

HEATER CHARACTERISTICS

Heater Voltage.....	12.6 Volts
Heater Current.....	150 Ma

For other rating, operation, and application data, refer to corresponding Type 6SA7GT, which is identical except for heater ratings.

SYLVANIA TUBE TESTER SETTINGS

	A	B	C	D	E	F	G	Test or K
139/140	12.6	0	—	0	1	037	85	W
	12.6	0	—	0	2	4	42	U
219/220	12.6	2	7	83	7	048V	3	6
	12.6	2	7	22	7	5V	4	6

TYPES 12SC7, 12SF5 GT

(See Condensed Data Section)

SYLVANIA TYPE 12SF7

DIODE REMOTE CUTOFF R F PENTODE

MECHANICAL DATA

Bulb.....	Metal, Outline 8-1
Base.....	Small Wafer Octal 8-Pin
Basing.....	7AZ
Mounting Position.....	Any

ELECTRICAL DATA

HEATER CHARACTERISTICS

Heater Voltage.....	12.6 Volts
Heater Current.....	150 Ma

TYPICAL OPERATION

Plate Voltage.....	100	250 Volts
Grid No. 2 Voltage.....	100	100 Volts
Grid No. 1 Voltage.....	-1.0	-1.0 Volts
Self Bias Resistor.....	65	65 Ohms
Plate Resistance (approx.).....	0.2	0.7 Megohm
Transconductance.....	1975	2050 μ mhos
Plate Current.....	12.0	12.4 Ma
Grid No. 2 Current.....	3.4	3.3 Ma
Grid No. 1 Voltage for $g_m = 10 \mu$ mhos.....	-35	-35 Volts



SYLVANIA TYPE 12SG7
SEMI-REMOTE CUTOFF R F PENTODE

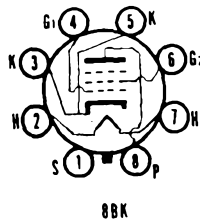

ELECTRICAL DATA

HEATER CHARACTERISTICS

Heater Voltage.....	12.6 Volts
Heater Current.....	150 Ma

For other rating, operation, and application data, refer to corresponding Type 6SG7, which is identical except for heater ratings.

TYPES 12SH7, 12SJ7, GT

(See Condensed Data Section)

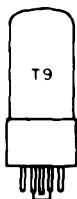

SYLVANIA TYPE 12SK7GT
REMOTE CUTOFF PENTODE

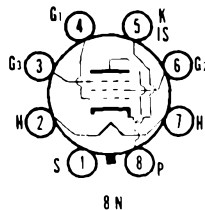

ELECTRICAL DATA

HEATER CHARACTERISTICS

Heater Voltage.....	12.6 Volts
Heater Current.....	150 Ma

For other rating, operation, and application data, refer to corresponding Type 6SK7GT, which is identical except for heater ratings.

TYPE 12SL7GT

(See Condensed Data Section)

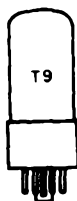

SYLVANIA TYPE 12SN7GT
MEDIUM-MU DUOTRIODE

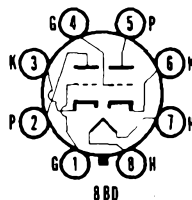

ELECTRICAL DATA

HEATER CHARACTERISTICS

Heater Voltage.....	12.6 Volts
Heater Current.....	300 Ma

For other rating, operation, and application data, refer to corresponding Type 6SN7GT, which is identical except for heater ratings.



SYLVANIA TYPE 12U7
MEDIUM MU DUO TRIODE

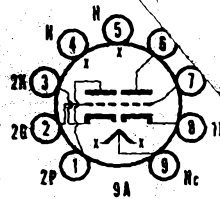

MECHANICAL DATA

Bulb.....	T-6½
Base.....	ES-1, Miniature Button 9-Pin
Outline.....	6-2
Basing.....	9A
Cathode.....	Coated Unipotential
Mounting Position.....	Any

ELECTRICAL DATA

HEATER CHARACTERISTICS

Heater Voltage.....	12.6 Volts
Heater Current.....	150 Ma
Heater-Cathode Voltage (Design Center Values)	
Heater Positive with Respect to Cathode.....	30 Volts Max.
Heater Negative with Respect to Cathode.....	30 Volts Max.

DIRECT INTERELECTRODE CAPACITANCES

	Section 1 ²		Section 2	
	Shielded ³	Unshielded	Shielded	Unshielded
Grid to Plate.....	1.5	1.5	1.5	1.5 μf
Input: g to (h+k).....	1.8	1.6	1.8	1.6 μf
Output: p to (h+k).....	2.0	0.4	2.0	0.32 μf

MAXIMUM RATINGS (Design Center Values)

Plate Voltage.....	30 Volts
Cathode Current.....	15 Ma
Grid Circuit Resistance	
Fixed Bias.....	0.25 Megohm
Cathode Bias.....	1.0 Megohm

CHARACTERISTICS AND TYPICAL OPERATION

Class A₁ Amplifier—Each Section

Plate Voltage.....	12.6 Volts
Grid Voltage.....	0 Volts
Plate Current.....	1.0 Ma
Transconductance.....	1600 μmhos
Amplification Factor.....	20
Plate Resistance (approx.).....	12,500 Ohms
Grid Voltage for I _b = 10 μa (approx.).....	-1.5 Volts

NOTES:

1. This tube is intended for use in automobile radios operated from a nominal 12 volt battery. Design of the tube is such that the heater will operate satisfactorily over the range 10.0 volts to 15.9 volts, and that the maximum ratings provide a safety factor for the wide voltage variation encountered with this type of supply.
2. Section 1 connects to pins 6, 7 and 8. Section 2 connects to pins 1, 2 and 3.
3. External shield No. 315 connected to cathode of section under test.

APPLICATION

The Sylvania Type 12U7 is a general purpose, medium mu, dual triode, having separate cathodes for each section. It is designed for operation where the heater and plate voltages are supplied directly from a 12-volt automotive storage battery.

12U7 (Cont'd)

AVERAGE PLATE CHARACTERISTICS

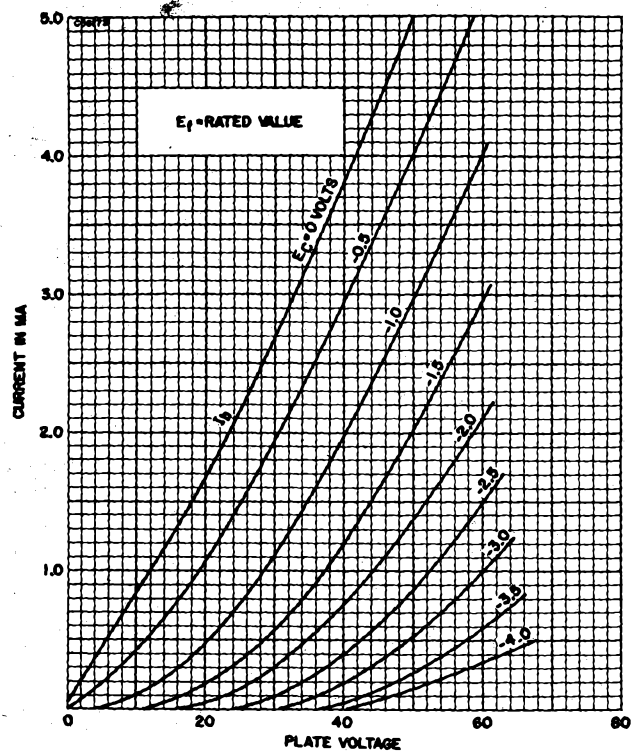

AVERAGE TRANSFER CHARACTERISTICS

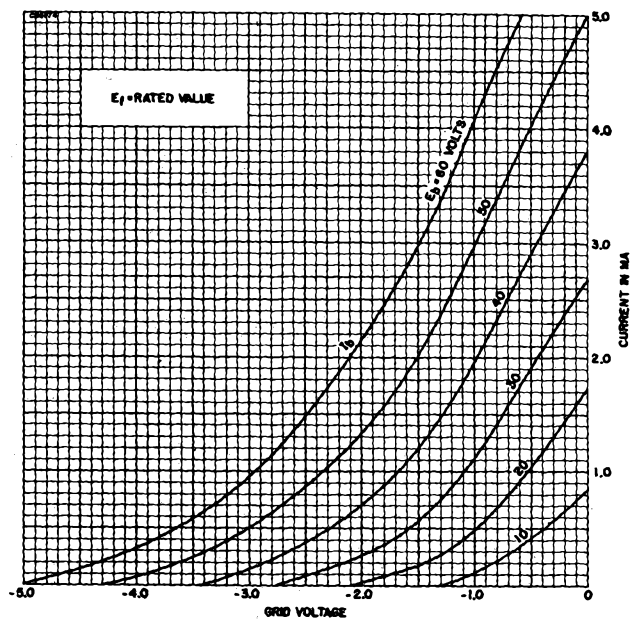

12SN7GT (Cont'd)

SYLVANIA TUBE TESTER SETTINGS

	A	B	C	D	E	F	G	Test or K
139/140	12.6	0	78	1	7	5	36	W
	12.6	0	78	1	3	3	36	W
219/220	12.6	7	68	23	8	1Y	2	3
	12.6	7	38	23	8	4Y	5	6

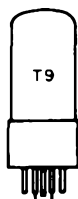

SYLVANIA TYPE 12SQ7GT
DUODIODE HIGH-MU TRIODE

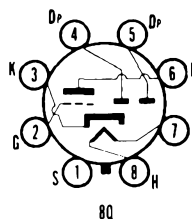

ELECTRICAL DATA

HEATER CHARACTERISTICS

Heater Voltage.....	12.6 Volts
Heater Current.....	150 Ma

For other rating, operation, and application data, refer to corresponding Type 6SQ7GT, which is identical except for heater ratings.

TYPES 12SR7, 12V6GT

(See Condensed Data Section)

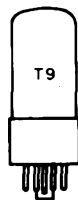

SYLVANIA TYPE 12W6GT
BEAM POWER AMPLIFIER

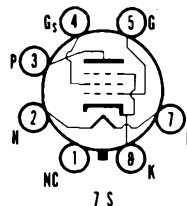

ELECTRICAL DATA

HEATER CHARACTERISTICS

Heater Voltage.....	12.6 Volts
Heater Current.....	600 Ma
Heater Warm-up Time (See SERIES STRING HEATERS Section in Appendix)	
Maximum Heater-Cathode Voltage	
Heater Negative with Respect to Cathode	
Total D C and Peak.....	300 Volts
Heater Positive with Respect to Cathode	
D C.....	100 Volts
Total D C and Peak.....	200 Volts

For other rating, operation, and application data, refer to corresponding Type 6W6GT, which is identical except for heater ratings.

APPLICATION

The Sylvania Type 12W6GT is intended for service in television receivers employing series connected heaters. For information on specially controlled heaters for series string operation refer to the SERIES STRING HEATERS section of the Appendix.

12W6GT (Cont'd)

SYLVANIA TUBE TESTER SETTINGS

	A	B	C	D	E	F	G	Test or K
139/140	12.6	0	—	0	1	034	20	X
219/220	12.6	2	7S	12	7	045Z	3	8



SYLVANIA TYPE 12X4
FULL-WAVE RECTIFIER

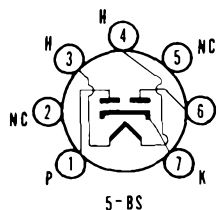

ELECTRICAL DATA

HEATER CHARACTERISTICS

Heater Voltage.....	12.6 Volts
Heater Current.....	300 Ma

For other rating, operation, and application data, refer to corresponding Type 6X4, which is identical except for heater ratings.

SYLVANIA TUBE TESTER SETTINGS

	A	B	C	D	E	F	G	Test or K
139/140	12.6	0	—	0	2	—	19	Y
	12.6	0	—	0	5	—	19	Y
219/220	12.6	3	4	11	4	Z	1*	7
	12.6	3	4	11	4	Z	6*	7

* Diode gas test does not apply.

TYPES 12Z3, 12Z5, 13, 14A4, 14A5

(See Condensed Data Section)

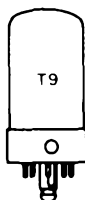

SYLVANIA TYPE 14A7
REMOTE CUTOFF R F PENTODE

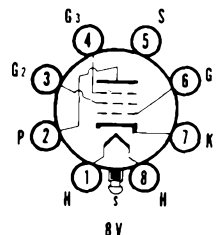

ELECTRICAL DATA

HEATER CHARACTERISTICS

Heater Voltage.....	12.6 Volts
Heater Current.....	150 Ma

For operation and application data, refer to corresponding Type 7A7, which is identical except for heater ratings.

TYPE 14AF7/XXD

(See Condensed Data Section)

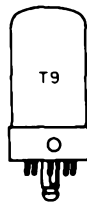

SYLVANIA TYPE 14B6
DUODIODE HIGH-MU TRIODE

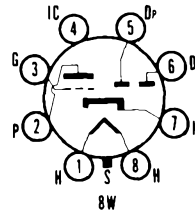

ELECTRICAL DATA

HEATER CHARACTERISTICS

Heater Voltage.....	12.6 Volts
Heater Current.....	150 Ma

For operation and application data, refer to corresponding Type 7B6, which is identical except for heater ratings.

TYPES 14B8, 14C5, 14C7, 14E6, 14E7, 14F7, 14F8, 14H7, 14J7, 14N7

(See Condensed Data Section)

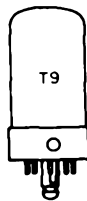

SYLVANIA TYPE 14Q7
HEPTODE CONVERTER

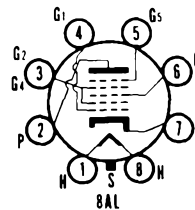

MECHANICAL DATA

Bulb.....	T-9, Outline 9-30
Base.....	Lock-In 8-Pin
Basing.....	8AL
Mounting Position.....	Any

ELECTRICAL DATA

HEATER CHARACTERISTICS

Heater Voltage.....	12.6 Volts
Heater Current.....	150 Ma

TYPICAL OPERATION

Refer to corresponding Type 6SA7 which is identical except for Conversion Transconductance.

Conversion Transconductance (Separately Excited Condition)

$E_{b1} = 100 \text{ V.}, E_{c2} = 100 \text{ V.}, E_{c3} = -2 \text{ V.}$	525 μmhos
$E_{b1} = 250 \text{ V.}, E_{c2} = 100 \text{ V.}, E_{c3} = -2 \text{ V.}$	550 μmhos

TYPES 14R7, 14S7, 14W7,
14X7, 14Y4, 14Z3, 15,
16, 16B, 18, 19

(See Condensed Data Section)



SYLVANIA TYPE 19BG6G
BEAM POWER AMPLIFIER

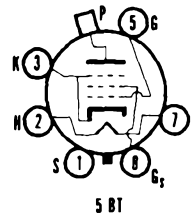

ELECTRICAL DATA

HEATER CHARACTERISTICS

Heater Voltage.....	18.9 Volts
Heater Current.....	300 Ma

For other rating, operation, and application data, refer to corresponding Type 6BG6G, which is identical except for heater ratings.

TYPES 19C8, 19J6

(See Condensed Data Section)

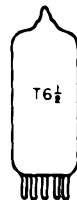

SYLVANIA TYPE 19T8
TRIPLE-DIODE TRIODE

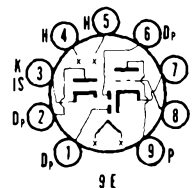

ELECTRICAL DATA

HEATER CHARACTERISTICS

Heater Voltage.....	18.9 Volts
Heater Current.....	150 Ma

For other rating, operation, and application data, refer to corresponding Type 6T8, which is identical except for heater ratings.

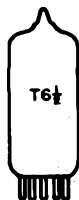

SYLVANIA TYPE 17H3 DAMPER DIODE

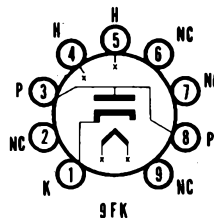

MECHANICAL DATA

Bulb.....	T-6½
Base.....	E9-1, Small Button 9-Pin
Outline.....	6-3
Basing.....	9FK
Cathode.....	Coated Unipotential
Mounting Position.....	Any

ELECTRICAL DATA

HEATER CHARACTERISTICS

Heater Voltage.....	17.5 Volts
Heater Current.....	300 Ma
Heater Warm-up Time ¹	11 Seconds
Heater Cathode Voltage (Design Maximum Values)	
Heater Positive with Respect to Cathode.....	100 Volts Max.
D C.....	200 Volts Max.
Total D C and Peak.....	
Heater Negative with Respect to Cathode.....	500 Volts Max
D C.....	2000 Volts Max
Total D C and Peak.....	

DIRECT INTERELECTRODE CAPACITANCES (Approx.)

Plate to Heater and Cathode.....	4.0 μf
Cathode to Heater and Plate.....	5.5 μf
Heater to Cathode.....	2.0 μf

MAXIMUM RATINGS (Design Maximum Values)²

Damper Service ³	
Peak Inverse Plate Voltage.....	2000 Volts
Steady-State Peak Plate Current.....	450 Ma
D C Plate Current.....	75 Ma
Plate Dissipation.....	3.0 Watts

AVERAGE CHARACTERISTICS

Tube Voltage Drop.....	
I _b = 140 Ma D C.....	22 Volts

NOTES:

1. Heater warm-up time is defined as the time required for the voltage across the heater to reach 80% of its rated value after applying four (4) times rated heater voltage to a circuit consisting of the tube heater in series with a resistance equal to three (3) times rated heater voltage divided by rated heater current.
2. Design-Maximum Ratings are limiting values of operating and environmental conditions applicable to a bogey electron device of a specified type as defined by its published data, and should not be exceeded under the worst probable conditions.
The device manufacturer chooses these values to provide acceptable serviceability of the device, taking responsibility for the effects of changes in operating conditions due to variations in device characteristics.
The equipment manufacturer should design so that initially and throughout life no design-maximum value for the intended service is exceeded with a bogey device under the worst probable operating conditions with respect to supply-voltage variation, equipment component variation, equipment control adjustment, load variation, signal variation, and environmental conditions.
3. For operation in a 525-line, 30-frame system as described in "Standards of Good Engineering Practice for Television Broadcasting Stations; Federal Communications Commission." The duty cycle of the voltage pulse must not exceed 15% of on-scanning cycle.

APPLICATION

The Type 17H3 is a half-wave diode designed for use as a damping diode in horizontal deflection circuits of series string TV receivers.

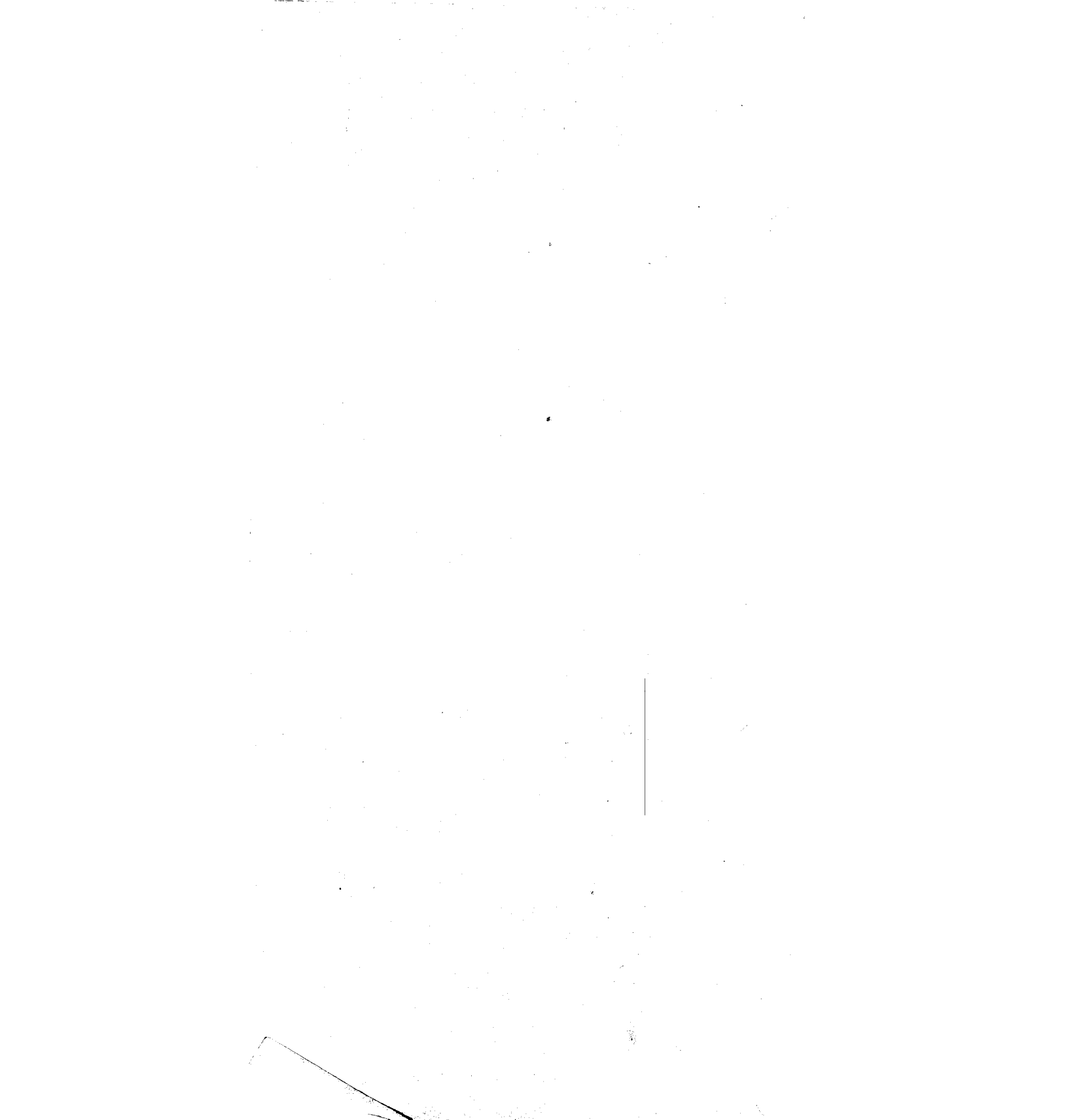

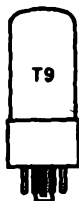

SYLVANIA TYPE 18A5

HORIZONTAL DEFLECTION AMPLIFIER

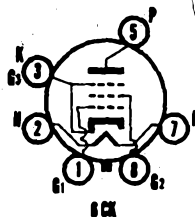

MECHANICAL DATA

Bulb.....	T-9
Base.....	B6-8, Intermediate-Shell Octal, 6-Pin B6-60, Short Intermediate-Shell Octal, 6-Pin
Outline.....	9-15 or 9-43
Basing.....	6CK
Cathode.....	Coated Unipotential
Mounting Position.....	Any

ELECTRICAL DATA

HEATER CHARACTERISTICS

Heater Voltage.....	18.5 Volts
Heater Current.....	300 Ma
Heater Warm-up Time ¹	11 Seconds
Heater-Cathode Voltage (Design Maximum Values)	
Heater Negative with Respect to Cathode	
Total D C and Peak.....	200 Volts Max.
Heater Positive with Respect to Cathode	
D C.....	100 Volts Max.
Total D C and Peak.....	200 Volts Max.

DIRECT INTERELECTRODE CAPACITANCES (Unshielded)

Grid No. 1 to Plate.....	0.7 μf
Input.....	13 μf
Output.....	7.0 μf

MAXIMUM RATINGS (Design Maximum Values)²

Horizontal Deflection Amplifier Service³	
D C Plate Supply Voltage (Boost + D C Power Supply).....	350 Volts
Peak Positive Pulse Plate Voltage.....	3000 Volts
Peak Negative Pulse Plate Voltage.....	600 Volts
D C Grid No. 2 Voltage.....	160 Volts
Peak Negative Grid No. 1 Voltage.....	250 Volts
Plate Dissipation ⁴	9 Watts
Grid No. 2 Dissipation.....	2.5 Watts
Average Cathode Current.....	90 Ma
Peak Cathode Current.....	310 Ma
Grid No. 1 Circuit Resistance.....	1.0 Megohm
Bulb Temperature (At Hottest Point).....	190 Degrees C

AVERAGE CHARACTERISTICS

Plate Voltage.....	200 Volts
Grid No. 2 Voltage.....	125 Volts
Grid No. 1 Voltage.....	-17 Volts
Plate Current.....	40 Ma
Grid No. 2 Current.....	1.1 Ma
Transconductance.....	4800 μmhos
Plate Resistance.....	27,000 Ohms
Ec1 for Ib = 1.0 Ma (approx.).....	-36 Volts
Triode Amplification Factor:	
With Eb = Ec2 = 125 V and Ec1 = -17 V.....	4.6

INSTANTANEOUS PLATE KNEE VALUES

Eb = 60 V, Ec2 = 125 V, Ec1 = 0, Ib = 165 Ma and Ic2 = 15 Ma

NOTES:

- Heater warm-up time is defined as the time required for the voltage across the heater to reach 80% of its rated value after applying four (4) times rated heater voltage to a circuit consisting of the tube heater in series with a resistance equal to three (3) times rated heater voltage divided by rated heater current.
- Design-Maximum Ratings are limiting values of operating and environmental conditions applicable to a bogey electron device of a specified type as defined by its published data, and should not be exceeded under the worst probable conditions.
The device manufacturer chooses these values to provide acceptable serviceability of the device, taking responsibility for the effects of changes in operating conditions due to variations in device characteristics.
The equipment manufacturer should design so that initially and throughout life no design-maximum value for the intended service is exceeded with a bogey device under the worst probable operating conditions with respect to supply-voltage variation, equipment component variation, equipment control adjustment, load variation, signal variation, and environmental conditions.

18A5 (Cont'd)

3. For operation in a 525-line, 30-frame system as described in "Standards of Good Engineering Practice for Television Broadcasting Stations; Federal Communications Commission." The duty cycle of the voltage pulse must not exceed 15% of one scanning cycle.
4. In stages operating with grid-leak bias, an adequate cathode bias resistor or other suitable means is required to protect the tube in the absence of excitation.

APPLICATION

Sylvania Type 18A5 is a beam power pentode contained in a T-9 bulb. It is designed for use as a horizontal deflection amplifier in compact series string TV receivers.

TYPES 19V8, 19X8, 20, 22,
 24A, 25, 25A6, G,
 GT, 25A7GT, 25AC5GT,
 25AV5GT, 25AX4GT,
 25B5, 25B6G, 25B8,
 25BK5, 25BQ6GA,
 25C6G, 25CD6G

(See Condensed Data Section)



SYLVANIA TYPE 25CD6GA
 BEAM POWER AMPLIFIER

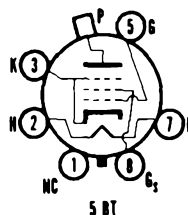

ELECTRICAL DATA

HEATER CHARACTERISTICS

Heater Voltage.....	25 Volts
Heater Current.....	600 Ma
Heater Warm-up Time (See SERIES STRING HEATERS Section in Appendix)	
Maximum Heater-Cathode Voltage	
Total D C and Peak.....	200 Volts
D C, Heater Positive with Respect to Cathode.....	100 Volts

For other rating, operation, and application data, refer to corresponding Type 6CD6G, which is identical except for heater ratings.

APPLICATION

The Sylvania Type 25CD6GA is intended for service in television receivers employing series connected heaters. For information on specially controlled heaters for series string operation refer to the SERIES STRING HEATERS section of the Appendix.

SYLVANIA TUBE TESTER SETTINGS

	A	B	C	D	E	F	G	Test or K
139/140	25.0	0	—	0	8	47	20	Y
219/220	25.0	2	7	14	7	58Z	9	3

TYPE 25D8GT

(See Condensed Data Section)

TYPE 25DN6—See 6DN6

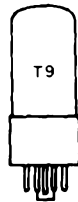

**SYLVANIA TYPE 25L6
25L6GT**
BEAM POWER AMPLIFIER

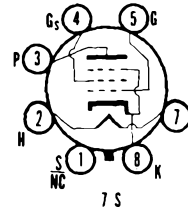

MECHANICAL DATA

	25L6	25L6GT
Bulb.....	Metal, Outline 8-6	T-9, Outline 9-11
Base.....	Small Wafer Octal 7-Pin	Intermediate Octal 7-Pin
Basing.....	7S	7S
Mounting Position.....	Any	Any

ELECTRICAL DATA

HEATER CHARACTERISTICS

Heater Voltage.....	25 Volts
Heater Current.....	300 Ma
Maximum Heater-Cathode Voltage.....	90 Volts

MAXIMUM RATINGS (Design Center Values)

Plate Voltage.....	200 Volts
Plate Dissipation.....	10 Watts
Grid No. 2 Voltage.....	125 Volts
Grid No. 2 Dissipation.....	1.25 Watts
Grid No. 1 Circuit Resistance.....	
Cathode Bias.....	0.5 Megohm
Fixed Bias.....	0.1 Megohm

CHARACTERISTICS AND TYPICAL OPERATION

Class A₁ Amplifier

Plate Voltage.....	110	200 Volts
Grid No. 2 Voltage.....	110	125 Volts
Grid No. 1 Voltage.....	-7.5	Volts
Cathode Bias Resistor ¹	0	180 Ohms
Peak A F Grid No. 1 Voltage.....	7.5	8.5 Volts
Plate Current (Zero Signal).....	49	46 Ma
Grid No. 2 Current (Zero Signal).....	4.0	2.2 Ma
Plate Current (Maximum Signal).....	50	47 Ma
Grid No. 2 Current (Maximum Signal).....	10.0	8.5 Ma
Transconductance.....	8000	8000 μmhos
Plate Resistance (approx.).....	13,000	28,000 Ohms
Load Resistance.....	2000	4000 Ohms
Power Output.....	2.1	3.8 Watts
Total Harmonic Distortion (approx.).....	10	10 Percent

NOTE:

1. Fixed bias operation at maximum ratings is not recommended.

APPLICATION

The Sylvania Types 25L6 and 25L6GT are pentode audio power amplifiers designed for series string operation, capable of delivering relatively high power output with low supply voltages.

SYLVANIA TUBE TESTER SETTINGS

	A	B	C	D	E	F	G	Test or K
139/140	25	0	—	0	1	034	18	W
219/220	25	2	7	13	7	045Z	3	8

25L6, 25L6GT (Cont'd)

AVERAGE PLATE CHARACTERISTICS

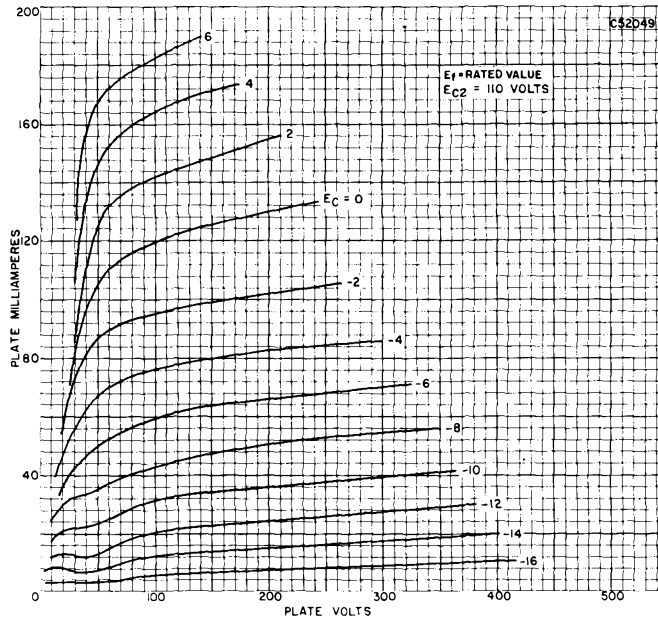

AVERAGE CHARACTERISTICS

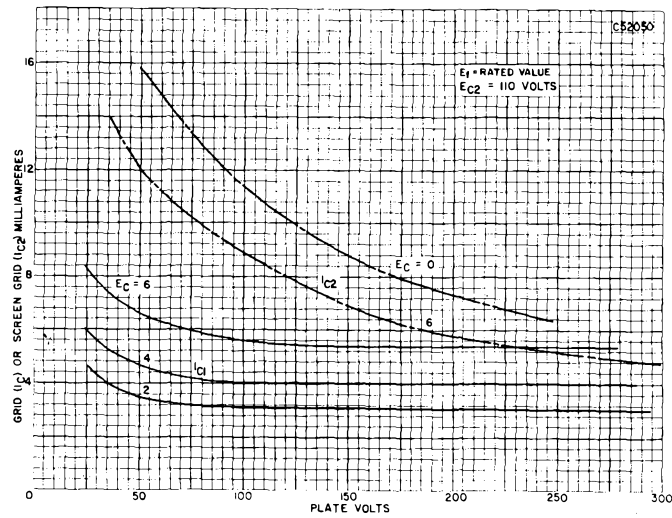

25L6, 25L6GT (Cont'd)

AVERAGE PLATE CHARACTERISTICS TRIODE CONNECTED

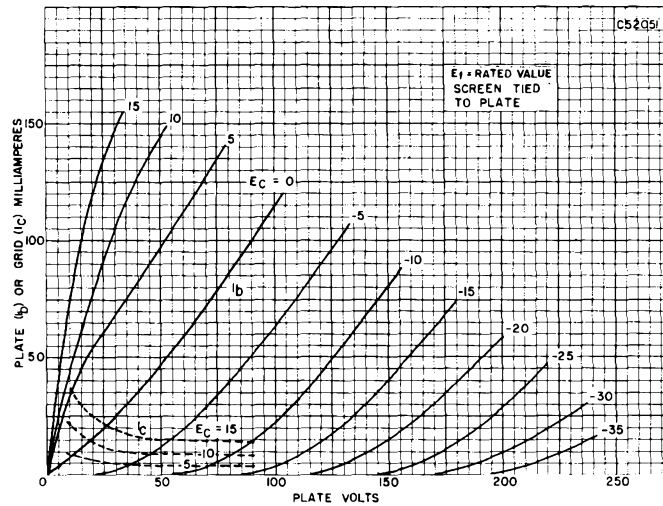

TYPES 25N6G, 25Y5, 25W6GT

(See Condensed Data Section)



SYLVANIA TYPE 25Z5
HIGH-VACUUM RECTIFIER

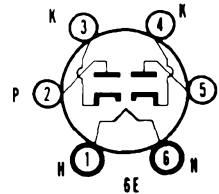

MECHANICAL DATA

Bulb	T-9 or ST-12
Base	Small 6-Pin
Basing	6E
Mounting Position	Any

ELECTRICAL DATA

HEATER CHARACTERISTICS

Heater Voltage	25.0 Volts
Heater Current	300 Ma
Maximum Heater-Cathode Voltage	350 Volts

MAXIMUM RATINGS (Design Center Values)

Peak Inverse Plate Voltage	700 Volts
Steady State Peak Current Per Plate	450 Ma
A C Plate Voltage Per Plate (R M S)	235 Volts
D C Output Current Per Plate	75 Ma
Tube Voltage Drop at 150 ma Per Plate	22 Volts

25Z5 (Cont'd)

TYPICAL OPERATION

Half-Wave Rectifier—Single Section Capacitor Input Filter

A C Plate Supply Voltage (R M S)	117	150	235 Volts
Filter Input Capacitor	16	16	16 μ f
Minimum Total Effective Plate			
Supply Impedance	15	40	100 Ohms
D C Output Current Per Plate	75	75	75 Ma

Voltage Doubler

	Half Wave	Full Wave
A C Plate Voltage Per Plate (R M S)	117	117 Volts
Filter Input Capacitor	16	16 μ f
Minimum Total Effective Plate		
Supply Impedance	30	15 Ohms
D C Output Current	75	75 Ma

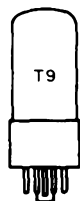

SYLVANIA TYPE 25Z6GT
HIGH-VACUUM RECTIFIER

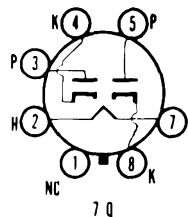

MECHANICAL DATA

Bulb	T-9, Outline 9-11
Base	Intermediate Octal 7-Pin
Basing	7Q
Mounting Position	Any

For other rating, operation, and application data, refer to corresponding Type 25Z5, which is identical except for mechanical data.

TYPES 26, 26A6, 26A7, 26C6,
26D6, 27, 28Z5, 30, 31,
32, 32L7GT, 33, 34,
35/51

(See Condensed Data Section)

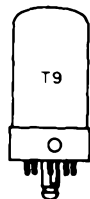

SYLVANIA TYPE 35A5
BEAM POWER AMPLIFIER

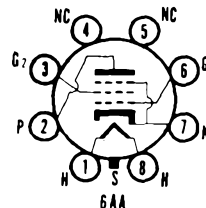

MECHANICAL DATA

Bulb	T-9, Outline 9-31
Base	Lock-In 8-Pin
Basing	6AA
Mounting Position	Any

SYLVANIA ELECTRONIC TUBES

35A5 (Cont'd)

ELECTRICAL DATA

HEATER CHARACTERISTICS

Heater Voltage..... 35.0 Volts
 Heater Current..... 150 Ma

For other rating, operation and application data, refer to corresponding Type 35L6GT, which is identical except for mechanical ratings.



SYLVANIA TYPE 35B5
 BEAM POWER AMPLIFIER

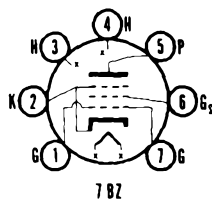

The Type 35B5 has a lower plate voltage rating but identical operating characteristics to the Type 35L6GT. Refer to the 35L6GT for operation and application data under the 110 volt plate voltage condition only.



SYLVANIA TYPE 35C5
 BEAM POWER AMPLIFIER

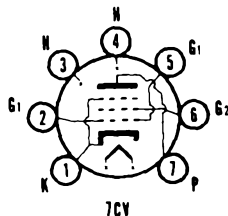

The Type 35C5 has a lower plate voltage rating but identical operating characteristics to the Type 35L6GT. Refer to the 35L6GT for operation and application data under the 110 volt plate voltage condition only.

SYLVANIA TUBE TESTER SETTINGS

	A	B	C	D	E	F	G	Test or K
139/140	35	0	5	0	3	26	16	W
	35	0	2	0	3	56	16	W
219/220	35	3	24	14	4	56Z	7	1
	35	3	54	14	4	26Z	7	1

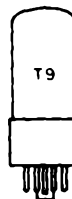

SYLVANIA TYPE 35L6GT
 BEAM POWER AMPLIFIER

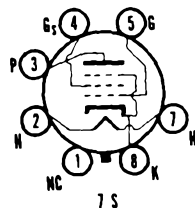

MECHANICAL DATA

Bulb..... T-9, Outline 9-11 or 9-41
 Base..... Short or Intermediate Octal, 7-Pin
 Basing..... 7S
 Mounting Position..... Any

35L6GT (Conf'd)

ELECTRICAL DATA

HEATER CHARACTERISTICS

Heater Voltage	35 Volts
Heater Current	150 Ma
Maximum Heater-Cathode Voltage	90 Volts

MAXIMUM RATINGS (Design Center Values)

Plate Voltage	200 Volts
Plate Dissipation	8.5 Watts
Grid No. 2 Voltage	125 Volts
Grid No. 2 Dissipation	1.0 Watt
Grid No. 1 Circuit Resistance	
Cathode Bias	0.5 Megohm
Fixed Bias	0.1 Megohm

CHARACTERISTICS AND TYPICAL OPERATION

Class A₁ Amplifier

Plate Voltage	110	200 Volts
Grid No. 2 Voltage	110	125 Volts
Grid No. 1 Voltage	-7.5	0 Volts
Cathode Bias Resistor ¹	0	180 Ohms
Peak A F Grid No. 1 Voltage	7.5	8.0 Volts
Plate Current (Zero Signal)	40	43 Ma
Grid No. 2 Current (Zero Signal)	3.0	2.0 Ma
Plate Current (Maximum Signal)	41	43 Ma
Grid No. 2 Current (Maximum Signal)	7.0	5.5 Ma
Transconductance	5800	6100 μ mhos
Plate Resistance (approx.)	14,000	34,000 Ohms
Load Resistance	2500	5000 Ohms
Power Output	1.5	3.0 Watts
Total Harmonic Distortion (approx.)	10	10 Percent

NOTE:

- Fixed bias operation at maximum ratings is not recommended.

APPLICATION

The Sylvania Type 35L6GT is a pentode audio power amplifier designed for series string operation, capable of delivering relatively high power output with low supply voltages. It is similar, except for filament operation, to the Types 25L6GT and 50L6GT.

SYLVANIA TUBE TESTER SETTINGS

	A	B	C	D	E	F	G	Test or K
139/140	35	0	—	0	1	034	20	W
219/220	35	2	7S	16	7	045Z	3	8

AVERAGE PLATE CHARACTERISTICS

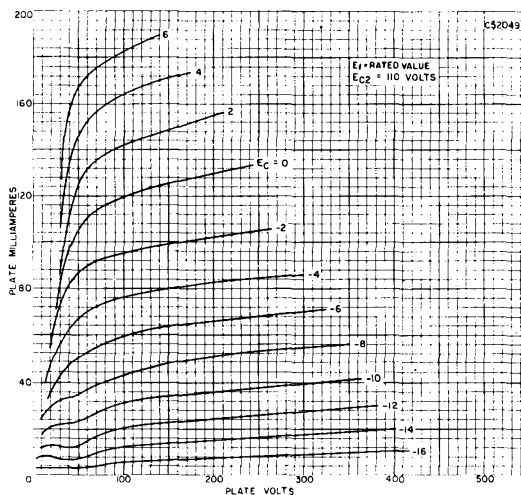



SYLVANIA TYPE 35W4

HALF-WAVE RECTIFIER

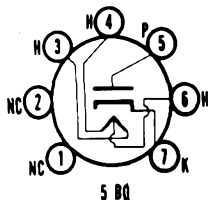

MECHANICAL DATA

Bulb	T-5 1/2, Outline 5-3
Base	Miniature Button 7-Pin
Basing	5BQ
Mounting Position	Any

ELECTRICAL DATA

HEATER CHARACTERISTICS

Heater Voltage (Maximum)	35 Volts
Heater Voltage	32 Volts
Heater Current	150 Ma

MAXIMUM RATINGS (Design Center Values)

Peak Inverse Plate Voltage	330 Volts
Peak Plate Current	600 Ma
D C Output Current	
With Panel Lamp (No Shunting Resistor)	60 Ma
(With Shunting Resistor)	90 Ma
Without Panel Lamp	100 Ma
Panel Lamp Section Voltage (Panel Lamp Open)	15 Volts
Peak Heater-Cathode Voltage	330 Volts
Tube Voltage Drop at 200 Ma Plate Current	18 Volts

TYPICAL OPERATION (Half-Wave Rectifier Service)

Capacitor Input to Filter

Panel Lamps No. 40 or 47 and C Input = 40 μf

Heater Voltage	32	32	32	32	Volts
Heater Current	150	150	150	150	Ma
Plate Supply (R M S)	117	117	117	117	Volts
Minimum Effective Plate Supply Impedance	15	15	15	15	Ohms
Panel Lamp Shunting Resistor		300	150		100 Ohms
D C Output Current	60	70	80		90 Ma

Without Panel Lamp and C input = 40 μf

Heater Voltage	35	Volts
Heater Current	150	Ma
Plate Supply Voltage (R M S)	117	Volts
Minimum Effective Plate Supply Impedance	15	Ohms
D C Output Current	100	Ma
Maximum Value of Panel Lamp Shunting Resistor		
70 Ma Output	800	Ohms
80 Ma Output	400	Ohms
90 Ma Output	250	Ohms

APPLICATION

Miniature half-wave rectifier with tapped heater for panel lamp operation. Connect panel lamp to pins 4 and 6. It is similar in application to Types 35Z5GT and 35Y4. The characteristic curves for the lower voltage condition under Type 35Z5GT may also be applied to Type 35W4.

SYLVANIA TUBE TESTER SETTINGS

	A	B	C	D	E	F	G	Test or K
139/140	35	0	6	0	4	—	21	Y
	35	0	6	2	4	—	21	Y
219/220	35	3	46	10	4	Z	5*	7
	35	3	46	10	6	Z	5*	7

* Diode gas test does not apply.

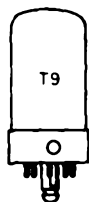

SYLVANIA TYPE 35Y4
HALF-WAVE RECTIFIER

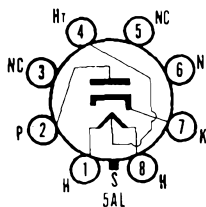

MECHANICAL DATA

Bulb..... T-9, Outline 9-31
 Base..... Lock-In 8-Pin
 Basing..... 5AL
 Mounting Position..... Any

ELECTRICAL DATA

HEATER CHARACTERISTICS

Heater Voltage..... 35 Volts
 Heater Current..... 150 Ma

For other rating, operation, and application data, refer to corresponding Type 35Z5GT, which is identical except for mechanical data.

SYLVANIA TUBE TESTER SETTINGS

	A	B	C	D	E	F	G	Test or K
139/140	35	0	4	0	1	—	18	X
	35	0	4	4	1	—	18	X
219/220	35	8	14	9	1	Z	2*	7
	35	8	14	9	4	Z	2*	7

* Diode gas test does not apply.

Connect panel lamp to pins 1 and 4.

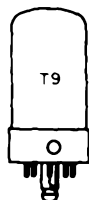

SYLVANIA TYPE 35Z3
HALF-WAVE RECTIFIER

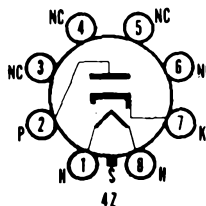

MECHANICAL DATA

Bulb..... T-9, Outline 9-31
 Base..... Lock-In 8-Pin
 Basing..... 4Z
 Mounting Position..... Any

ELECTRICAL DATA

HEATER CHARACTERISTICS

Heater Voltage..... 35.0 Volts
 Heater Current..... 150 Ma
 Maximum Heater-Cathode Voltage..... 350 Volts

MAXIMUM RATINGS (Design Center Values)

Peak Inverse Plate Voltage..... 700 Volts
 Steady State Peak Plate Current..... 600 Ma
 Tube Voltage Drop at 200 Ma D C Plate Current..... 18 Volts

TYPICAL OPERATION

Half-Wave Rectifier

A C Plate Voltage (R M S)..... 117 235 Volts
 Minimum Total Effective Plate Supply Impedance..... 15 100 Ohms
 D C Output Current..... 100 100 Ma

Characteristics are the same as those of 35Z4GT and 35Y4 except that the latter makes provision for the use of a pilot lamp.

SYLVANIA TYPE 35Z5GT

HALF-WAVE RECTIFIER

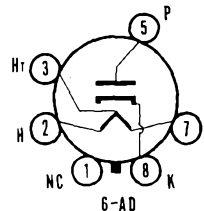

MECHANICAL DATA

Bulb.....	T-9
Outline.....	9-11 or 9-41
Base.....	Intermediate Shell Octal 6-Pin
Basing.....	Short Intermediate Shell Octal 6-Pin
Mounting Position.....	6AD
	Any

ELECTRICAL DATA

HEATER CHARACTERISTICS

	Without Panel Lamp	With No. 40 or 47 Panel Lamp
Heater Voltage		
Entire Heater (Pins 2 and 7).....	35	35 Volts
Panel Lamp Section (Pins 2 and 3).....	7.5	5.5 Volts
Heater Current		
Between Pins 2 and 7.....	150	Ma
Between Pins 3 and 7.....		150 Ma
Maximum Heater-Cathode Voltage (D C).....	350	350 Volts

MAXIMUM RATINGS (Design Center Values)

A C Plate Voltage (R M S).....	235 Volts
Peak Inverse Plate Voltage.....	700 Volts
Steady State Peak Plate Current.....	600 Ma
Panel Lamp Section R M S Voltage	
When Panel Lamp Fails.....	15 Volts
Steady State D C Output Current:	
With Panel Lamp and no Shunting Resistor.....	60 Ma
With Panel Lamp and Shunting Resistor.....	90 Ma
Without Panel Lamp.....	100 Ma
Panel Lamp Shunting Resistor:	
D C Output Current of 70 Ma.....	800 Ohms
D C Output Current of 80 Ma.....	400 Ohms
D C Output Current of 90 Ma.....	250 Ohms
Tube Voltage Drop with Tube Conducting	
200 Ma D C Plate Current.....	18 Volts

CHARACTERISTICS AND TYPICAL OPERATION

Half-Wave Rectifier with No. 40 or 47 Panel Lamp

Capacitor Input to Filter

A C Plate Supply Voltage (R M S).....	117	117	117	117	235 Volts
Filter Input Capacitance.....	40	40	40	40	40 μ f
Minimum Total Effective Plate Supply Impedance.....	15	15	15	15	100 Ohms
Panel Light Shunting Resistor.....		300	150	100	Ohms
D C Output Current.....	60	70	80	90	60 Ma

Half-Wave Rectifier Without Panel Lamp

Capacitor Input to Filter

A C Plate Supply Voltage (R M S).....	117	235 Volts
Filter Input Capacitance.....	40	40 μ f
Minimum Total Effective Plate Supply Impedance.....	15	100 Ohms
D C Output Voltage at Input to Filter (Approx.):		
At 50 Ma (Half Load).....	140	280 Volts
At 100 Ma (Full Load).....	120	235 Volts
Percent Regulation.....	14	16 Percent
D C Output Current.....	100	100 Ma

NOTE:

1. Plate Current must not flow through tap section (Pins 2 and 3).

APPLICATION

The Sylvania Type 35Z5GT is a half-wave rectifier designed for use in a c/d c line operated radio receivers. The heater is tapped to permit operation of a panel lamp. Connect panel lamp to pins 2 and 3.

35Z5GT (Cont'd)

SYLVANIA TUBE TESTER SETTINGS

	A	B	C	D	E	F	G	Test or K
139/140	35	0	2	0	3	—	18	Y
	35	0	2	6	3	—	18	Y
219/220	35	7	23	10	2	Z	5*	8
	35	7	23	10	3	Z	5*	8

* Diode gas test does not apply.

AVERAGE OPERATING CHARACTERISTICS

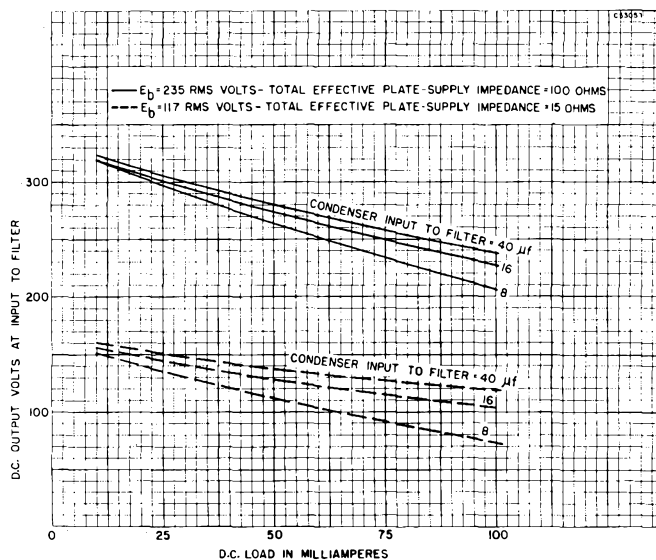

TYPES 35Z6G, 36, 37,
38, 39/44, 40

(See Condensed Data Section)

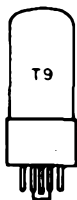

SYLVANIA TYPE 40A1
HORIZONTAL STABILIZER

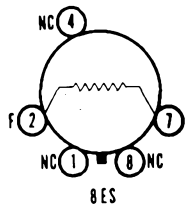

MECHANICAL DATA

Bulb	T-9, Outline 9-9
Base	Intermediate Shell Octal 5-Pin
Basing	8ES
Mounting Position	Vertical, Base Down
Filament	Iron
Type of Cooling	Radiation

40A1 (Cont'd)

MAXIMUM RATINGS (Absolute Maximum Values)

Current Range.....	70 to 90 Ma
Voltage Range.....	20 to 60 Volts
Ambient Temperature.....	65° C

TYPICAL OPERATION (Average)

Current at 40 Volts.....	80 Ma
Current at 20 Volts.....	74 Ma
Current at 60 Volts.....	90 Ma

APPLICATION

The Type 40A1 is a gas filled ballast tube designed to maintain relatively constant current over a specified operating voltage range. The type is designed for application as a horizontal deflection stabilizer in television receivers.

TYPES 40B2, 40Z5/45Z5GT,
41, 42, 43, 44, 45,
45A, 45Z3, 46, 47,
48, 49, 50, 50A1

(See Condensed Data Section)

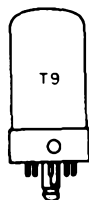

SYLVANIA TYPE 50A5
BEAM POWER AMPLIFIER

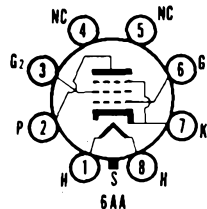

MECHANICAL DATA

Bulb.....	T-9, Outline 9-31
Base.....	Lock-In 8-Pin
Basing.....	6AA
Mounting Position.....	Any

ELECTRICAL DATA

HEATER CHARACTERISTICS

Heater Voltage.....	50 Volts
Heater Current.....	150 Ma

For other rating, operation, and application data, refer to corresponding Type 50L6GT, which is similar except for mechanical data.

SYLVANIA TUBE TESTER SETTINGS

	A	B	C	D	E	F	G	Test or K
139/140	50	0	—	0	1	036	20	X
219/220	50	1	8	13	8	036Z	2	7

TYPE 50AX6G

(See Condensed Data Section)

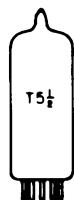

SYLVANIA TYPE 50B5 BEAM POWER AMPLIFIER

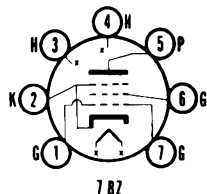

For other rating, operation, and application data, refer to corresponding Type 50C5, which is identical except for the base diagram.

SYLVANIA TUBE TESTER SETTINGS

	A	B	C	D	E	F	G	Test or K
139/140	50	0	4	0	4	36	18	W
219/220	50	3	14	14	4	067Z	5	2
	50	3	74	14	4	16Z	5	2



SYLVANIA TYPE 50C5 BEAM POWER AMPLIFIER

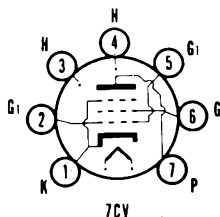

MECHANICAL DATA

Bulb	T-5 1/2
Base	Miniature Button 7-Pin
Outline	5-3
Basing	7CV
Mounting Position	Any

ELECTRICAL DATA

HEATER CHARACTERISTICS

Heater Voltage	50 Volts
Heater Current	150 Ma
Maximum Heater-Cathode Voltage	180 Volts

MAXIMUM RATINGS (Design Center Values)

Plate Voltage	135 Volts
Grid No. 2 Voltage	117 Volts
Plate Dissipation	5.5 Watts
Grid No. 2 Dissipation	1.25 Watts
Control Grid Circuit Resistance	
Fixed Bias	0.1 Megohm
Cathode Bias	0.5 Megohm

50C5 (Cont'd)

CHARACTERISTICS AND TYPICAL OPERATION (Single Tube)

Class A₁ Amplifier

Plate Voltage	110 Volts
Grid No. 2 Voltage	110 Volts
Grid No. 1 Voltage	-7.5 Volts
Peak A F Grid No. 1 Voltage	7.5 Volts
Plate Current (Zero-Signal)	49 Ma
Plate Current (Maximum-Signal)	50 Ma
Grid No. 2 Current (Zero-Signal)	4.0 Ma
Grid No. 2 Current (Maximum-Signal)	8.5 Ma
Plate Resistance (approx.)	10,000 Ohms
Transconductance	7,500 μ mhos
Load Resistance	2,500 Ohms
Maximum-Signal Power Output	1.9 Watts
Total Harmonic Distortion (approx.)	9.0 Percent

APPLICATION

The Sylvania Type 50C5 is a miniature, beam power amplifier designed for service as the audio power output stage of a c/d c receivers. The Type 50C5 features relatively high power output at low B supply voltage.

SYLVANIA TUBE TESTER SETTINGS

	A	B	C	D	E	F	G	Test or K
139/140	50	0	5	0	3	26	18	Y
	50	0	2	0	3	56	18	Y
219/220	50	3	24	13	4	56Z	7	1
	50	3	54	13	4	26Z	7	1

AVERAGE PLATE CHARACTERISTICS

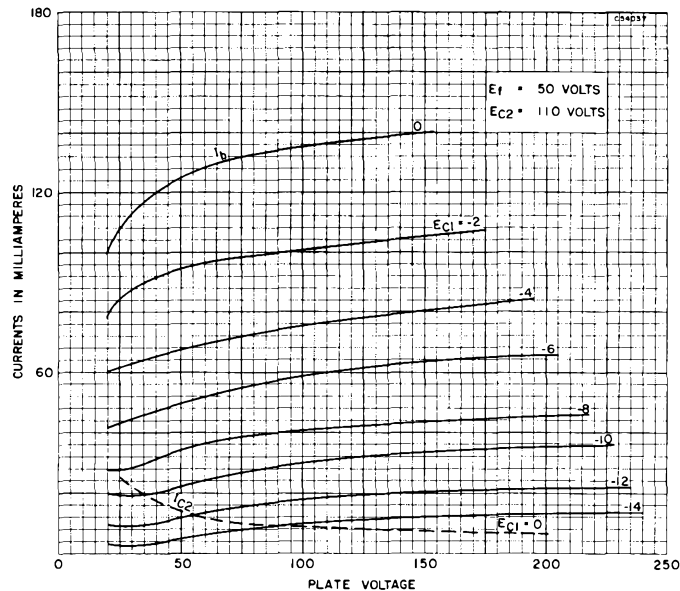

50C5 (Cont'd)

AVERAGE OPERATION CHARACTERISTICS

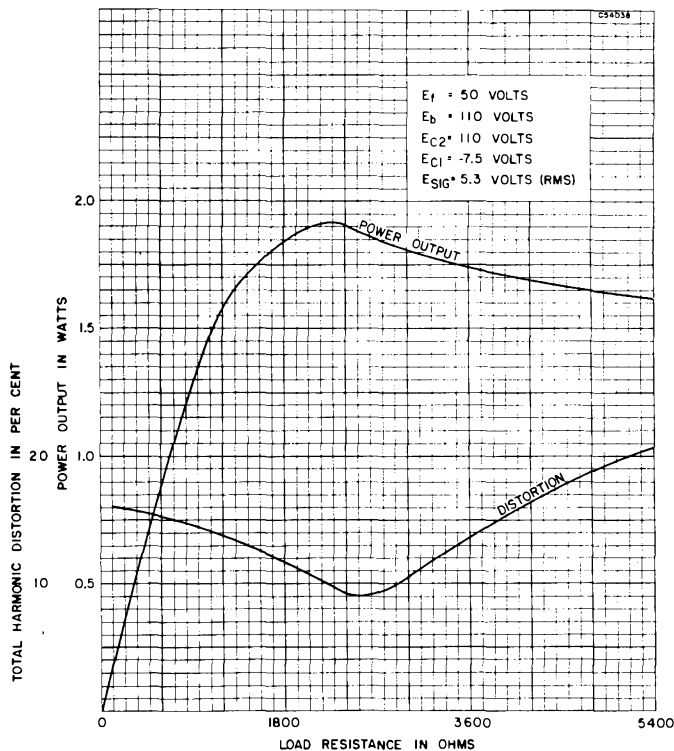

TYPE 50C6G

(See Condensed Data Section)

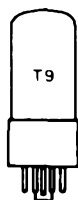

SYLVANIA TYPE 50L6GT
BEAM POWER AMPLIFIER

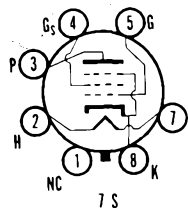

MECHANICAL DATA

Bulb	T-9, Outline 9-11
Base	Intermediate Octal 7-Pin
Basing	7S
Mounting Position	Any

ELECTRICAL DATA

HEATER CHARACTERISTICS

Heater Voltage	50 Volts
Heater Current	150 Ma

For other rating, operation, and application data, refer to corresponding Type 25L6GT, which is identical except for heater and mechanical ratings.

50L6GT (Cont'd)

SYLVANIA TUBE TESTER SETTINGS

	A	B	C	D	E	F	G	Test or K
139/140	50	0	—	0	1	034	20	X
219/220	50	2	7	14	7	045Z	3	8

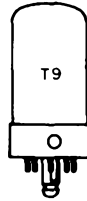

SYLVANIA TYPE 50X6
HIGH-VACUUM RECTIFIER

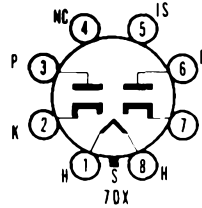

MECHANICAL DATA

Bulb.....	T-9, Outline 9-31
Base.....	Lock-In 8-Pin
Basing.....	7DX
Mounting Position.....	Any

ELECTRICAL DATA

HEATER CHARACTERISTICS

Heater Voltage.....	50.0 Volts
Heater Current.....	150 Ma
Maximum Heater-Cathode Voltage.....	350 Volts

For other rating, operation, and application data, refer to corresponding Type 25Z5, which is identical except for heater ratings and mechanical data.

TYPE 50Y6GT

(See Condensed Data Section)

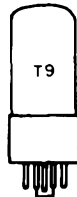

SYLVANIA TYPE 50Y7GT
HIGH-VACUUM RECTIFIER DOUBLER

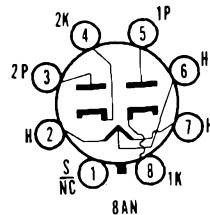

MECHANICAL DATA

Bulb.....	T-9, Outline 9-11
Base.....	Intermediate Octal 8-Pin
Basing.....	8AN
Mounting Position.....	Any

ELECTRICAL DATA

HEATER CHARACTERISTICS

Heater Voltage (A C or D C).....	50 Volts
Heater Current.....	150 Ma

50Y7GT (Con'td)

TYPICAL OPERATION

Full Wave Voltage Doubler

	No Lamp			With Lamp ¹		
A C Plate Supply Voltage (R M S).....	117			117		Volts
D C Output Current.....	75			65		Ma
Plate Supply Impedance (Minimum).....	15			15		Ohms
Panel Lamp Shunting Resistor.....				250		Ohms
Panel Lamp Voltage.....				5.5		Volts

	No Lamp			With Lamp		
Half Wave Rectifier Per Section						
A C Plate Supply Voltage (R M S).....	117	150	235	117	150	235 Volts
Filter Input Capacitor.....	16	16	16	16	16	16 μ f
Plate Supply Impedance Minimum.....	15	40	100	15	40	100 Ohms
D C Output Current.....	75	75	75	65	65	65 Ma
Panel Lamp Voltage.....				5.5	5.5	5.5 Volts
Panel Lamp Shunting Resistor.....				250	250	250 Ohms

NOTE:

1. With No. 40 or 47 Panel Lamp.
Connect panel lamp to pins 6 and 7.

TYPES 50Z7G, 51, 51S, 52,
53, 55, 55S, 56,
56AS, 57, 57AS, 58,
58AS, 59, 64, 64A,
65, 65A, 67, 67A,
68, 68A, 70A7GT,
70L7GT, 71, 71A, 71B,
75, 76, 77, 78, 79

(See Condensed Data Section)



SYLVANIA TYPE 80
FULL-WAVE RECTIFIER

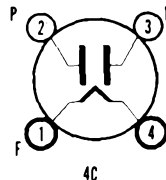

MECHANICAL DATA

Bulb.....	ST-14, Outline 14-1
Base.....	Medium 4-Pin
Basing.....	4C
Mounting Position.....	Vertical ¹

ELECTRICAL DATA

FILAMENT CHARACTERISTICS

Filament Voltage.....	5.0 Volts
Filament Current.....	2.0 Amperes

80 (Cont'd)

MAXIMUM RATINGS (Design Center Values)

Peak Inverse Plate Voltage (A C or D C).....	1400 Volts
A C Plate Supply Voltage Each Plate (R M S)	
Capacitor Input at 125 Ma Max. Load.....	350 Volts
Choke Input at 125 Ma Max. Load.....	500 Volts
Steady State Peak Plate Current Each Plate.....	400 Ma
Transient Peak Plate Current Each Plate.....	2.2 Amperes
Tube Voltage Drop (125 Ma Per Plate).....	60 Volts

TYPICAL OPERATION

Full-Wave Rectifier Service

	Input to Filter	
	Capacitor	Choke
A C Plate Supply Voltage Each Plate.....	350	500 Volts
Input Capacitor.....	10	μf
Input Choke.....		10 Henry
Effective Plate Supply Impedance Each Plate.....	50	Ohms
D C Output Current.....	125	125 Ma
D C Output Voltage.....	350	390 Volts

NOTE:

1. Horizontal operation permitted if pins 1 and 2 are in a vertical plane.

SYLVANIA TUBE TESTER SETTINGS

	A	B	C	D	E	F	G	Test or K
139/140	5.0	0	—	0	1	—	22	Y
	5.0	0	—	0	2	—	22	Y
219/220	5.0	1	4	13	4	Z	2*	—
	5.0	1	4	13	4	Z	3*	—

* Diode gas test does not apply.

TYPE 81

(See Condensed Data Section)

TYPE 82V

(See Condensed Data Section)

TYPES 84/6Z4, 85, 85AS,
88, 89, 89Y, 95, 96,
98, X99, 117L7/M7GT,
117L7GT, 117N7GT,
117P7GT, 117Z4GT

(See Condensed Data Section)



SYLVANIA TYPE 117Z3
HALF-WAVE RECTIFIER

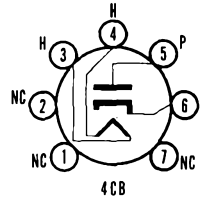

MECHANICAL DATA

Bulb..... T-5 1/2, Outline 5-3
Base..... Miniature Button 7-Pin
Basing..... 4CB
Mounting Position..... Any

ELECTRICAL DATA

HEATER CHARACTERISTICS

Heater Voltage (A C or D C)..... 117 Volts
Heater Current..... 40 Ma
Maximum Peak Heater-Cathode Voltage
Heater Negative with Respect to Cathode..... 175 Volts
Heater Positive with Respect to Cathode..... 100 Volts

MAXIMUM RATINGS (Design Center Values)

Peak Inverse Plate Voltage..... 330 Volts
A C Plate Supply Voltage (R M S)..... 117 Volts
Steady State Peak Plate Current..... 540 Ma
Transient Peak Plate Current..... 2.5 Amperes
D C Output Current..... 90 Ma
Tube Voltage Drop at 180 Ma D C..... 22.5 Volts

CHARACTERISTICS AND TYPICAL OPERATION

Half-Wave Rectifier—Capacitor Input Filter

A C Plate Supply Voltage (R M S)..... 117 Volts
Filter Input Capacitor..... 30 μ f
Total Effective Plate Supply Impedance..... 20 Ohms
D C Output Current..... 90 Ma
D C Output Voltage at Filter Input (approx.)
D C Output Current 90 Ma..... 110 Volts
D C Output Current 45 Ma..... 130 Volts

SYLVANIA TUBE TESTER SETTINGS

	A	B	C	D	E	F	G	Test or K
139/140	117	0	3	0	4	—	16	X
219/220	117	3	14	10	4	Z	5*	6

* Diode gas test does not apply.

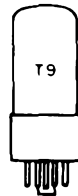

SYLVANIA TYPE 117Z6GT
HIGH-VACUUM RECTIFIER

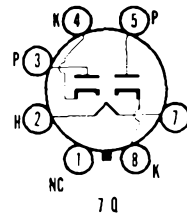

MECHANICAL DATA

Bulb..... T-9, Outline 9-11
Base..... Intermediate Octal 7-Pin
Basing..... 7Q
Mounting Position..... Any

ELECTRICAL DATA

HEATER CHARACTERISTICS

Heater Voltage..... 117 Volts
Heater Current..... 75 Ma
Maximum Heater-Cathode Voltage..... 350 Volts

MAXIMUM RATINGS (Design Center Values)

Peak Inverse Plate Voltage..... 700 Volts
Peak Plate Current Per Plate..... 360 Ma
D C Output Current Per Plate..... 60 Ma
Average Tube Drop at 120 Ma Output Current..... 15 Volts

117Z6GT (Cont'd)

TYPICAL OPERATION

Half-Wave Rectifier with Capacitor Input Filter¹

Plate Supply Voltage (R M S)	117	150	235 Volts
Input Filter Capacitor	40	40	40 μ f
Minimum Effective Plate Supply Impedance (Per Plate)	15	40	100 Ohms
D C Output Current (Per Plate)	60	60	60 Ma

Voltage Doubler

	Half Wave	Full Wave
Plate Supply Voltage Per Plate (R M S)	117	117 Volts
Input Filter Capacitor	40	40 μ f
Minimum Effective Plate Supply Impedance Per Plate	30	15 Ohms
D C Output Current (Per Plate)	60	60 Ma

NOTE:

1. The Sections may be used separately or in parallel.

TYPES 182B/482B, 183/483, 210T, 401, 484

(See Condensed Data Section)

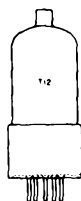

SYLVANIA TYPE 807 807W

BEAM POWER AMPLIFIER

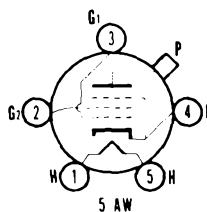

	807	807W
Bulb	ST-16	T-12
Outline	16-2	12-107
Base	Medium Shell Small 5-Pin	5-Pin Low Loss Phenolic
Basing	5AW	5AW
Cap.	Small	Small
Mounting Position	Any	Any

ELECTRICAL DATA

HEATER CHARACTERISTICS

Heater Voltage	6.3 Volts
Heater Current	0.9 Amperes
Maximum Peak Heater-Cathode Voltage	± 135 Volts

DIRECT INTERELECTRODE CAPACITANCES

Grid No. 1 to Plate (Shielded)	0.2 μ f Max
Input (Unshielded)	12 μ f
Output (Unshielded)	7 μ f

MAXIMUM RATINGS (Design Center Values)

	Class AB ₁ Triode Connected ¹ A F Power Amplifier and Modulator	
	CCS ²	ICAS ³
Plate Voltage	400	400 Volts
D C Plate Current at Max. Sig. ⁴	125	125 Ma
Plate Plus Grid 2 Input at Max. Sig. ⁴	50	50 Watts
Plate Plus Grid 2 Input ⁴	25	30 Watts
Class AB₂ A F Power Amplifier and Modulator		
D C Plate Voltage	600	750 Volts
Grid 2 Voltage	300	300 Volts
D C Plate Current at Max. Sig. ⁴	120	120 Ma
Plate Input at Max. Sig. ⁴	60	90 Watts
Grid 2 Input at Max. Sig. ⁴	3.5	3.5 Watts
Plate Dissipation	25	30 Watts

807, 807W (Cont'd)

Class C R F Power Amplifier and Oscillator (Values Apply to 60 Mc)

D C Plate Voltage.....	600	750 Volts
D C Grid 2 Voltage.....	300	300 Volts
D C Grid 1 Voltage.....	-200	-200 Volts
D C Plate Current.....	100	100 Ma
D C Grid 1 Current.....	5	5 Ma
Plate Input.....	60	75 Watts
Grid 2 Input.....	3.5	3.5 Watts
Plate Dissipation.....	25	30 Watts

TYPICAL OPERATION

Class AB₁ A F Power Amplifier and Modulator

(2 Tubes Triode Connected)

	CCS ²	ICAS ³
D C Plate Voltage.....	400	400 Volts
D C Grid 1 Voltage ⁵	-45	-45 Volts
Peak A F Grid 1 to Grid 1 Voltage ⁶	90	90 Volts
D C Plate Current (Zero Signal).....	60	60 Ma
D C Plate Current (Maximum Signal).....	140	140 Ma
Effective Load Resistance (Plate to Plate).....	3000	3000 Ohms
Maximum Signal Driving Power (Approx.).....	0	0 Watts
Total Harmonic Distortion.....	3	3 Percent
Maximum Signal Power Output (Approx.).....	15	15 Watts

Class AB₂ A F Power Amplifier and Modulator (Values are for two tubes)

	CCS ²			ICAS ³
D C Plate Voltage.....	400	500	600	750 Volts
D C Grid 2 Voltage ⁷	300	300	300	300 Volts
D C Grid 1 Voltage (Fixed Bias).....	-25	-29	-30	-32 Volts
Peak Grid to Grid Signal Voltage.....	78	86	78	92 Volts
Plate Current (Zero Signal).....	90	72	60	52 Ma
Plate Current (Maximum Signal).....	240	240	200	240 Ma
Grid 2 Current (Zero Signal).....	2.0	0.9	0.7	0.5 Ma
Grid 2 Current (Maximum Signal).....	15	12	16	17 Ma
Load Resistance (Plate to Plate).....	3200	4240	6400	6950 Ohms
Driving Power (Maximum Signal) (Approx.) ⁸	0.2	0.2	0.1	0.2 Watts
Power Output (Approx.) ⁹	55	75	80	120 Watts

Class C Unmodulated R F Power Amplifier or Oscillator (Single Tube)

	CCS ²			ICAS ³
D C Plate Voltage.....	400	500	600	750 Volts
Grid 2 Voltage ⁷	250	250	250	250 Volts
Grid 2 Dropping Resistor.....	20000	42000	50000	85000 Ohms
Grid 1 Voltage ¹⁰	-45	-45	-45	-45 Volts
Peak Signal Voltage.....	65	65	65	65 Volts
Plate Current.....	100	100	100	100 Ma
Grid 2 Current.....	7.5	6.0	7.0	6.0 Ma
Grid 1 Current (Approx.).....	3.5	3.5	3.5	3.5 Ma
Driving Power (Approx.).....	0.2	0.2	0.2	0.2 Watt
Power Output (Approx.).....	25	30	40	50 Watts

NOTES:

- Grid 2 connected to plate.
- CCS—Continuous Commercial Service.
- ICAS—Intermittent Commercial and Amateur Service.
- Averaged over any audio frequency cycle of sine-wave form.
- The d c grid 1 circuit resistance should be limited to 100,000 ohms with fixed bias or 500,000 ohms with cathode bias.
- The driver stage should be capable of supplying the No. 1 grids of the class AB₁ stage with the specified driving voltage at low distortion.
- May be obtained from a separate well regulated source or from the plate supply voltage if a voltage divider is used.
- The effective grid circuit resistance should not exceed 500 ohms per grid, or the impedance 700 ohms.
- Distortion in practical circuits should not exceed 5%, 5% and 3% respectively, under CCS conditions.
- Bias may be provided by use of 12,800 ohm grid leak, 410 ohm cathode resistor, fixed separate source or a combination of these. The grid circuit resistance should not exceed 30,000 ohms.

SYLVANIA TUBE TESTER SETTINGS

	A	B	C	D	E	F	G	Test or K
139/140	6.3	0	—	0	8	023	30	Y
219/220	6.3	1	5	20	5	023Z	9	4

TYPES 950, 951

(See Condensed Data Section)



SYLVANIA TYPE 5642 HALF-WAVE RECTIFIER

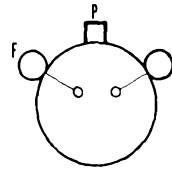

5642

MECHANICAL DATA

Bulb.....	T-3
Base.....	Flexible Leads
Basing.....	5462
Lead Diameter.....	0.017" +0.002
	-0.001
Cathode.....	Filamentary
Mounting Position.....	Any

ELECTRICAL DATA

HEATER CHARACTERISTICS

Filament Voltage.....	1.25 Volts
Filament Current (Per Tube).....	200 Ma

DIRECT INTERELECTRODE CAPACITANCES (Unshielded)

Filament to Plate.....	0.6 μ f
------------------------	-------------

MAXIMUM RATINGS (Design Center Values)

Half Wave Rectifier Service

Peak Inverse Voltage.....	10000 Volts
Steady State D C Output Current.....	0.25 Ma
Steady State Peak Plate Current ¹	5 Ma
Minimum Frequency of Supply Voltage.....	5 Kc

CHARACTERISTICS

Tube Voltage Drop ²	30 Volts
--------------------------------------	----------

TYPICAL OPERATION

Pulse Type Rectifier Doubler in Television Scanning Circuit²

Peak Plate Pulse Voltage.....	8000 Volts
D C Output Current.....	150 μ a
Output Voltage (Two Tubes).....	12000 Volts

NOTES:

1. The duration of the voltage pulse should not exceed 15% of one horizontal scanning cycle. In a 525 line interlaced two to one 30 frame per second system, 15% of one horizontal scanning cycle is 10 microseconds.
2. Measured with applied d c voltage at 4.0 ma.

APPLICATION

The Sylvania Type 5642 is a subminiature half-wave rectifier designed for service in high efficiency, compact high voltage power supplies. The long flexible leads allow it to be wired in, thus reducing insulation and leakage problems.

TYPES 9002, 9003, 9006, XXB, XXD, XXFM, XXL

(See Condensed Data Section)

CONDENSED DATA SECTION

TYPE	CLASS	CONSTRUCTION		EMITTER			USE	PLATE VOLTS	SCREEN VOLTS	NEG. GRID VOLTS	PLATE CUR-RENT MA.	SCREEN CUR-RENT MA.	PLATE ① RESISTANCE OHMS	AMP. ② FACTOR OR G _m μMHOS	POWER OUTPUT MW.	SUGGESTED REPLACEMENT TYPE		
		STYLE	BASE DIAG.	TYPE	VOLTS	AMP.												
00A	Triode	ST-14	4D	Fil.	5.0	0.25	Detector	45	0	1.5	30,000	20	01A		
01A	Triode	ST-14	4D	Fil.	5.0	0.25	Det. Amp.	90 135	4.5 9.0	2.5 3.0	11,000 10,000	8.0 8.0			
0Y4	Gas Diode	Metal	4BU	Cold K	H-W Rectifier	117 A C Volts Per Plate, RMS, 75 Ma Max., 40 Ma Min. Output Current										
0Z4A	Gas Duodiode	T-7	4R	Ionic	F.W. Rectifier	300 A C Volts Per Plate, RMS, 110 Ma Max., 30 Ma Min. Output Current										
1A3	Diode	T-5½	5AP	Cath.	1.4	0.15	Detector	Single Diode, Cathode Type for H F Use										
1A4	Tetrode	ST-12	4K	Fil.	2.0	0.06	R F Amplifier	90 180	67.5 67.5	3.0 3.0	2.2 2.3	0.9 0.8	600,000 1.0 Meg.	720 750	1A4P, 1A4T		
1A4P	Pentode	ST-12	4M	Fil.	2.0 2.0	0.06 0.06	R F Amplifier	135 180	67.5 67.5	3.0 3.0	2.2 2.3	0.9 0.8	1 Meg. 1 Meg.	625 725			
1A4T	Tetrode	ST-12	4K	Fil.	2.0 2.0	0.06 0.06	R F Amplifier	135 180	67.5 67.5	3.0 3.0	2.2 2.2	0.7 0.7	350,000 600,000	625 650			
1A5GT	Pentode	GT	6X	Fil.	1.4	0.05	Pwr. Amplifier	85 90	85 90	4.5 4.5	3.5 4.0	0.7 0.8	300,000 300,000	800 850	100 115			
1A6	Heptode	ST-12	6L	Fil.	2.0 2.0	0.06 0.06	Converter	135 180	67.5 67.5	3.0 3.0	1.8 1.5	2.1 2.0	400,000 500,000	275▼ 300▼	G ₂ =135 V. at 2.0 Ma.■ G ₂ =180 V. at 2.5 Ma.■			
1A7GT,G	Heptode	GT, T-9	7Z	Fil.	1.4	0.05	Converter	90	45	0.0	0.55	0.60	600,000	250▼	E _{c2} =90, I _{c2} =1.2 Ma			
1AB5	Pentode	Lock-In	5BF	Fil.	1.2 1.2	0.13 0.13	R F Amplifier	90 150	90 150	0 1.5	3.5 6.8	0.8 2.0	275,000 120,000	1,100 1,350			
1AF4	Pentode	T-5½	6AR	Fil.	1.4	0.025	R F Amplifier	67.5 90.0	67.5 90.0	0.0 0.0	1.0 1.65	0.3 0.5	2 Meg.♦ 1.8 Meg.♦	825 950	1U4		
1AF5	Diode Pentode	T-5½	6AU	Fil.	1.4	0.025	Detector Amplifier	67.5 90.0	67.5 90.0	0.0 0.0	0.7 1.1	0.25 0.4	2.3 Meg.♦ 2.0 Meg.♦	500 600	1S5		

① Load Resistance for Power Output Tubes
 ② Transconductance for Tetrodes, Pentodes, Etc.
 ▼ Conversion Transconductance

♦ Approximate
 † Plate to Plate
 ■ Through 20,000 Ohms

‡ Per Tube or Section—No Signal
 § Plate and Target Supply
 ▲ Self Bias Cathode Resistor—Ohms

CONDENSED DATA SECTION—Cont.

TYPE	CLASS	CONSTRUCTION		EMITTER			USE	PLATE VOLTS	SCREEN VOLTS	NEG. GRID VOLTS	PLATE CUR-RENT MA.	SCREEN CUR-RENT MA.	PLATE ① RESISTANCE OHMS	AMP. ② FACTOR OR G _m μMHOS	POWER OUTPUT MW.	SUGGESTED REPLACEMENT TYPE	
		STYLE	BASE DIAG.	TYPE	VOLTS	AMP.											
1B4	Tetrode	ST-12	4K	Fil.	2.0	0.06	R F Amplifier	90 180	67.5 67.5	3.0 3.0	1.6 1.7	0.7 0.6	1.0 Meg.♠ 1.5 Meg.♠	600 650	1B4P 1B4T	
1B4/951	Tetrode	ST-12	4K	Fil.	2.0	0.06	R F Amplifier	Same as Type 1B4								1B4 P or T
1B4P	Pentode	ST-12	4M	Fil.	2.0 2.0	0.06 0.06	R F Amplifier	135 180	67.5 67.5	3.0 3.0	1.6 1.7	0.7 0.6	1.5 Meg. 1.5 Meg.	560 650		
1B5/25S	Duodi Triode	ST-12	6M	Fil.	2.0	0.06	Det. Amplifier	135	3.0	0.8	35,000	20		
1B7GT	Heptode	GT	7Z	Fil.	1.4	0.10	Converter	90	45	0	1.5	1.3	350,000	350▼	G ₂ =90 V. at 1.6 Ma.	1A7GT	
1C3	Triode	T-5½	5CF	Fil.	1.4	0.05	Amplifier	90 90	0.0 3.0	4.5 1.4	11,200♠ 19,000♠	14.5 14.5		
1C5GT	Pentode	GT	6X	Fil.	1.4	0.1	Pwr. Amplifier	83 90	83 90	7.0 7.5	7.0 7.5	1.6 1.6	0.11 Meg. 0.115 Meg.	1,500 1,550	200 240	1S4	
1C6	Heptode	ST-12	6L	Fil.	2.0 2.0	0.12 0.12	Converter	135 180	67.5 67.5	3.0 3.0	1.3 1.5	2.5 2.0	600,000 700,000	300▼ 325▼	G ₂ =135 V. at 3.1 Ma.■ G ₂ =180 V. at 4.0 Ma.■		
1C7G	Heptode	ST-12	7Z	Fil.	2.0	0.12	Converter	Same as 1C6									
1D5G	Tetrode	ST-12	5R	Fil.	2.0	0.06	R F Amplifier	180	67.5	3.0	2.3	0.7	600,000	750	1D5GP, 1D5GT	
1D5GP	Pentode	ST-12	5Y	Fil.	2.0 2.0	0.06 0.06	R F Amplifier	135 180	67.5 67.5	3.0 3.0	2.2 2.3	0.9 0.8	1 Meg. 1 Meg.	625 725		
1D5GT	Tetrode	ST-12	5R	Fil.	2.0 2.0	0.06 0.06	R F Amplifier	135 180	67.5 67.5	3.0 3.0	2.2 2.2	0.7 0.7	350,000 600,000	625 650		
1D7G	Heptode	ST-12	7Z	Fil.	2.0 2.0	0.06 0.06	Converter	135 180	67.5 67.5	3.0 3.0	1.8 1.5	2.1 2.0	400,000 500,000	275▼ 300▼	G ₂ =135 V. at 2.0 Ma.■ G ₂ =180 V. at 2.5 Ma.■		

① Load Resistance for Power Output Tubes
 ② Transconductance for Tetrodes, Pentodes, Etc.
 ▼ Conversion Transconductance

♠ Approximate
 ▲ Plate to Plate
 ■ Through 20,000 Ohms

‡ Per Tube or Section—No Signal
 § Plate and Target Supply
 ▲ Self Bias Cathode Resistor—Ohms

CONDENSED DATA SECTION—Cont.

TYPE	CLASS	CONSTRUCTION		EMITTER			USE	PLATE VOLTS	SCREEN VOLTS	NEG. GRID VOLTS	PLATE CURR. MA.	SCREEN CURR. MA.	PLATE RESISTANCE OHMS	AMP. FACTOR OR G _m μMHOS	POWER OUTPUT MW.	SUGGESTED REPLACEMENT TYPE	
		STYLE	BASE DIAG.	TYPE	VOLTS	AMP.											
1D8GT	Diode Triode Pentode	GT	8AJ	Fil.	1.4	0.1	Det. Amplifier Pwr. Amplifier	67.5	0	0.6	55,500	25		
								90	0	1.1	43,500	25		
								67.5	67.5	6.0	3.8	0.8	200,000♦	875	100	
								90	90	9.0	5.0	1.0	200,000♦	925	200	
1E4	Triode	T-9	5S	Fil.	1.4	0.05	Det. Amplifier	Same Characteristics as Type 1LE3									
1E5G	Tetrode	ST-12	5R	Fil.	2.0	0.06	R F Amplifier	180	67.5	3.0	1.7	0.6	650	1E5GP, 1E5GT	
1E5GP	Pentode	ST-12	5Y	Fil.	2.0	0.06	R F Amplifier	135	67.5	3.0	1.6	0.7	1.5 Meg.	560		
						2.0		0.06	180	67.5	3.0	1.7	0.6	1.5 Meg.	650	
1E5GT	Tetrode	ST-12	5R	Fil.	2.0	0.06	R F Amplifier	Same as Type 1E5G								1E5GP	
1E7GT	Pentode	ST-12	8C	Fil.	2.0	0.24	Pwr. Amplifier Push Pull Max. Signal	90	90	3.0	3.8	1.1	340,000	1,150	110		
						0.24		135	135	4.5	7.5	2.2	260,000	1,425	290		
						0.24		135	135	7.5	10.5♦	3.5♦	24,000‡	575		
						2.0		0.24	135	135	4.5	7.5	2.2	24,000‡		575
1F4	Pentode	ST-14	5K	Fil.	2.0	0.12	Pwr. Amplifier	90	90	3.0	4.0	1.1	20,000	1,400	110		
					2.0	0.12		135	135	4.5	8.0	2.4	16,000	1,700	310		
1F5G	Pentode	ST-14	6X	Fil.	2.0	0.12	Pwr. Amplifier	Same as 1F4									
1F6	Duodi Pentode	ST-12	6W	Fil.	2.0	0.06	R F Amplifier	180	67.5	1.5	2.2	0.7	1 Meg.‡	650		
1F7G	Duodi Pentode	ST-12	7AD	Fil.	2.0	0.06	R F Amplifier	Same as 1F6									
1F7GV	Duodi Pentode	ST-12	7AF	Fil.	2.0	0.06	R F Amplifier	Same as 1F7G except diodes one above the other									
1G4GT, G	Triode	GT, T-9	5S	Fil.	1.4	0.05	Amplifier	90	6.0	2.3	10,700	8.8		

① Load Resistance for Power Output Tubes
 ② Transconductance for Tetrodes, Pentodes, Etc.
 ▼ Conversion Transconductance

♦ Approximate
 † Plate to Plate
 ‡ Through 20,000 Ohms

‡ Per Tube or Section—No Signal
 § Plate and Target Supply
 ▲ Self Bias Cathode Resistor—Ohms

CONDENSED DATA SECTION—Cont.

TYPE	CLASS	CONSTRUCTION		EMITTER			USE	PLATE VOLTS	SCREEN VOLTS	NEG. GRID VOLTS	PLATE CUR-RENT MA.	SCREEN CUR-RENT MA.	PLATE RESISTANCE OHMS	AMP. FACTOR OR G _m μMHOS	POWER OUTPUT MW.	SUGGESTED REPLACEMENT TYPE	
		STYLE	BASE DIAG.	TYPE	VOLTS	AMP.											
1G5G	Pentode	ST-14	6 X	Fil.	2.0	0.12	Pwr. Amplifier	90	90	6.0	8.7	3.0	8,500	1,500	250		
					2.0	0.12		124	124	11.0	10.7	4.3	8,000	600			
					2.0	0.12		135	135	13.5	9.7	3.6	9,000	1,550	550		
1G6GT, G	Duo Triode	GT, T-9	7AB	Fil.	1.4	0.10	Class A Amp. Class B Pwr. Amplifier	90	0.0	1.0‡	45,000	30	675		
								90	0.0	1.0‡		
1H4G, GT	Triode	ST-12	5S	Fil.	2.0	0.06	Amplifier	90	4.5	2.5	11,000	9.3		
					2.0	0.06		135	9.0	3.0	10,300	9.3			
					2.0	0.06		180	13.5	3.1	10,300	9.3			
1H6G, GT	Duodi Triode	ST-12,GT	7AA	Fil.	2.0	0.06	Amplifier	135	3.0	0.8	35,000	20		
1J5G	Pentode	ST-14	6 X	Fil.	2.0	0.12	Pwr. Amplifier	135	135	16.5	7.0	1.8	13,500	1,000	450		
1J6GT, G	Duo Triode	T-9 ST-12	7AB	Fil.	2.0	0.24	Amplifier	Characteristics same as Type 19									
1LA4	Pentode	Lock-In	5AD	Fil.	1.4	0.05	Pwr. Amplifier	85	85	4.5	3.5	0.7	0.3 Meg.	800	100		
								90	90	4.5	4.0	0.8	0.3 Meg.	850	115		
1LC5	Pentode	Lock-In	7AO	Fil.	1.4	0.05	R F Amplifier	45	45	0.0	1.1	0.35	0.7 Meg.‡	750		
								90	45	0.0	0.15	0.30	1.5 Meg.‡	775		
1LC6	Heptode	Lock-In	7AK	Fil.	1.4	0.05	Converter	45	35	0.0	0.7	0.75	0.3 Meg.	250▼	E _{c2} = 45 V. Max I _{c2} = 1.4 Ma		
								90	35	0.0	0.75	0.70	0.65 Meg.	275▼			
1LD5	Diode Pentode	Lock-In	6A X	Fil.	1.4	0.05	Det. Amplifier	45	45	0	0.55	0.12	0.9 Meg.	550		
								90	45	0	0.6	0.1	0.75 Meg.	575		
1LE3	Triode	Lock-In	4AA	Fil.	1.4	0.05	Amplifier	90	0.0	4.5	11,200	14.5		
								90	3.0	1.4	19,000	14.5		

① Load Resistance for Power Output Tubes
 ② Transconductance for Tetrodes, Pentodes, Etc.
 ▼ Conversion Transconductance

‡ Approximate
 † Plate to Plate
 ■ Through 20,000 Ohms

‡ Per Tube or Section—No Signal
 † Plate and Target Supply
 ▲ Self Bias Cathode Resistor—Ohms

CONDENSED DATA SECTION—Cont.

TYPE	CLASS	CONSTRUCTION		EMITTER			USE	PLATE VOLTS	SCREEN VOLTS	NEG. GRID VOLTS	PLATE CUR-RENT MA.	SCREEN CUR-RENT MA.	PLATE ① RESISTANCE OHMS	AMP. ② FACTOR OR Gm μMHOS	POWER OUTPUT MW.	SUGGESTED REPLACEMENT TYPE	
		STYLE	BASE DIAG.	TYPE	VOLTS	AMP.											
3B7/1291	Duo Triode	Lock-In	7BE	Fil.	2.8	.110	Pwr. Amplifier	135	0	22.0	Class AB ₂	20	1,500		
					1.4	.220	Oscillator	180	0	25.0						Class C R F Pwr. Amplifier 2800 Mw. at 25 Mc. 1400 Mw. at 125 Mc.
3BA6	Pentode	T-5½	7CC	Cath.	3.15	0.6	R F Amplifier	Characteristics Same as Type 6BA6 for Series String Use									
3BY6	Heptode	T-5½	7CH	Cath.	3.15	0.6	Sync. Separator	Characteristics Same as 6BY6 for Series String Use									
3C6/XXB	Duo Triode	Lock-In	7BW	Fil.	1.4	0.10	Det. Amplifier	90	0	4.5	11,200	14.5	3B7	
					2.8	0.05		90	0	3.2	12,800	14.1		
3D6	Beam Power	Lock-In	6BB	Fil.	1.4	0.220	Amplifier	150	90	4.5	9.9	1.0	14,000	2400	600		
3E5	Pentode	T-5½	6BX	Fil.	1.4	.050	Pwr. Amplifier	67.5	67.5	5.0	5.0	1.0	120,000	1,300	100	3V4	
					2.8	.025	Pwr. Amplifier	90	90	8.0	6.0	1.5	140,000	1,200	200		
								67.5	67.5	5.0	4.5	1.0	110,000	1,200	90		
				90	90	8.0	5.5	1.5	120,000	1,100	175						
3E6	Pentode	Lock-In	7CJ	Fil.	1.4	0.1	R F Amplifier	90	90	0	4.2	1.7	.25 Meg.	2000		
					2.8	.050		90	90	0	2.9	1.2	.325 Meg.	1700		
3LE4	Pentode	Lock-In	6BA	Fil.	2.8	0.05	Pwr. Amplifier	90	90	9.0	9.0	1.8	110,000	1,600	300	3LF4, 3V4	
					1.4	0.10		90	90	9.0	10.0	2.0	100,000	1,750	325		
3LF4	Beam Pentode	Lock-In	6BB	Fil.	1.4	0.10	Pwr. Amplifier	90	90	4.5	9.5	1.3	90,000	2,200	270	3LE4, 3V4	
					2.8	0.05		Pwr. Amplifier	110	110	6.6	10.0	1.4	100,000	2,200		400
								90	90	4.5	8.0	1.0	80,000	2,000	230		
				110	110	6.6	8.5	1.1	110,000	2,000	330						
3Q5GT, G	Beam Amplifier	T-9	7AP	Fil.	1.4	0.10	Pwr. Amplifier	Characteristics Same as Type 3LF4									3V4
4A6G	Duo Triode	ST-12	8L	Fil.	2.0	0.12	Pwr. Amplifier	Class B Amp.	P to P Load 8,000	20	1,000		
					4.0	0.06		90	1.5	10.8						

① Load Resistance for Power Output Tubes
 ② Transconductance for Tetrodes, Pentodes, Etc.
 ▼ Conversion Transconductance

♠ Approximate
 ▲ Plate to Plate
 ■ Through 20,000 Ohms

† Per Tube or Section—No Signal
 § Plate and Target Supply
 ▲ Self Bias Cathode Resistor—Ohms

CONDENSED DATA SECTION—Cont.

TYPE	CLASS	CONSTRUCTION		EMITTER			USE	PLATE VOLTS	SCREEN VOLTS	NEG. GRID VOLTS	PLATE CUR-RENT MA.	SCREEN CUR-RENT MA.	PLATE ① RESISTANCE OHMS	AMP. FACTOR OR G _m μMHOS	POWER OUTPUT MW.	SUGGESTED REPLACEMENT TYPE	
		STYLE	BASE DIAG.	TYPE	VOLTS	AMP.											
5AU4	Duo Diode	T-12	5T	Fil.	5.0	4.5	Full Wave Pwr. Rectifier	40 μf Cap. Input—400 V. RMS Plate, 325 Ma. D C Output 10 Henrys Choke Input—500 V. RMS Plate, 325 Ma. D C Output									
5AW4	Duo Diode	T-12	5T	Fil.	5.0	4.0	F.W. Rectifier	450 Volts Per Plate RMS, 250 Ma. Output Current with Cap. Input to Filter, Peak Current = 750 Ma. Per Plate								5U4GB	
5A X4GT	Duo Diode	GT	5T	Fil.	5.0	2.5	F.W. Rectifier	350 V. RMS Plate, 175 Ma. D C Output, Cond. Input 500 V. RMS Plate, 175 Ma. D C Output, Choke Input									
5AZ4	Duo Diode	Lock-In	5T	Fil.	5.0	2.0	F.W. Rectifier	Characteristics Same as Type 5Y3GT									
5T4	Duo Diode	Metal	5T	Fil.	5.0	2.0	F.W. Rectifier	450 V. RMS Per Plate, 225 Ma. D C Output, Cond. Input Filter 550 V. RMS Per Plate, 225 Ma. D C Output, Choke Input Filter								5U4G	
5U4GA	Duo Diode	T-11	5T	Fil.	5.0	3.0	F.W. Rectifier	40 μf Cap. Input—450 V. RMS Per Plate, 250 Ma. Output, 460 V. D C Output 10H Choke Input—550 V. RMS Per Plate, 250 Ma. Output, 440 V. D C Output								5U4GB	
5W4, G, GT	Duo Diode	Metal, GT	5T	Fil.	5.0	1.50	F.W. Rectifier	350 Volts RMS Per Plate, 110 Ma. D C Output Current, Capacitor Input to Filter									5Y4G
5X3	Duodiode	ST-14	4C	Fil.	5.0	2.0	Rectifier	400 V. Per Plate, RMS, 110 Ma. Output Current, Choke or Cond. Input to Filter 1275 V. Per Plate, RMS, 30 Ma. Output Current, Choke or Cond. Input to Filter									
5X4G	Duo Diode	ST-16	5Q	Fil.	5.0	3.00	F.W. Rectifier	Characteristics Same as Type 5U4G									5U4G
5Z4	Duo Diode	Metal	5L	Fil.	5.0	2.0	F.W. Rectifier	350 V. RMS Plate, 125 Ma. D C Output, Cond. Input 500 V. RMS Plate, 125 Ma. D C Output, Choke Input									
6A3	Triode	ST-16	4D	Fil.	6.3	1.00	Pwr. Amplifier	250	45.0	60.0	Fixed Bias 850▲	2,500	4.2	3,200		
					6.3	1.00		325	68.0	40.0‡		3,000♠	15,000		
					6.3	1.00		325	40.0‡		5,000♠	10,000		

① Load Resistance for Power Output Tubes
 ② Transconductance for Tetrodes, Pentodes, Etc.
 ▼ Conversion Transconductance

♠ Approximate
 ‡ Plate to Plate
 ■ Through 20,000 Ohms

‡ Per Tube or Section—No Signal
 § Plate and Target Supply
 ▲ Self Bias Cathode Resistor—Ohms

CONDENSED DATA SECTION—Cont.

TYPE	CLASS	CONSTRUCTION		EMITTER			USE	PLATE VOLTS	SCREEN VOLTS	NEG. GRID VOLTS	PLATE CUR-RENT MA.	SCREEN CUR-RENT MA.	PLATE ① RESISTANCE OHMS	AMP. ② FACTOR OR Gm μMHOS	POWER OUTPUT M.W.	SUGGESTED REPLACEMENT TYPE	
		STYLE	BASE DIAG.	TYPE	VOLTS	AMP.											
1LG5	Semi Remote Cutoff Pentode	Lock-In	7AO	Fil.	1.4	0.05	R F Amplifier	45	45	0	1.5	0.45	0.35 Meg.♦ >1.0 Meg. 0.5 Meg.♦	800		
								90	45	0	1.7	0.4		800		
								90	90	1.5	3.7	0.9		1,150		
1N6G	Diode Pentode	T-9	7AM	Fil.	1.4	0.05	Pwr. Amplifier	90	90	4.5	3.1	0.6	25,000	800	100		
1P5GT, G	Remote Cutoff Pentode	T-9	5Y	Fil.	1.4	0.05	R F Amplifier	90	90	0.0	2.3	0.7	800,000	750	1N5, 1T4	
1Q5GT, G	Beam Amplifier	T-9	6AF	Fil.	1.4	0.10	Pwr. Amplifier	90	90	4.5	9.5	1.6	2,200	270	1A5	
1Q6	Diode Pentode	T-3	8CO	Fil.	1.25	0.04	Det. Amplifier	30	30	0	0.33	0.09	500,000	330		
								67.5	67.5	0	1.60	0.40	400,000	600		
1R4	H F Diode	Lock-In	4AH	Cath.	1.4	0.15	Detector	117 V. RMS			1.0	Resonant Frequency 1,500 Mc.					
1S4	Pentode	T-5½	7AV	Fil.	1.4	0.10	Pwr. Amplifier	45	45	4.5	3.8	0.8	100,000♦	1,250	65	3S4	
								90	67.5	7.0	7.4	1.4	100,000♦	1,575	270		
1SA6GT	Pentode	GT	6BD	Fil.	1.4	0.05	R F Amplifier	45	45	0	1.1	0.3	700,000	750	1N5GT	
								67.5	67.5	0	2.4	0.7	600,000	950		
								90	67.5	0	2.45	0.68	800,000	970		
1SB6GT	Diode Pentode	GT	6BE	Fil.	1.4	0.05	Det. Amplifier	45	45	0	0.6	0.16	900,000	500	1LD5	
								90	67.5	0	1.45	0.38	700,000	665		
1T5GT	Pentode	T-9	6X	Fil.	1.4	0.05	Pwr. Amplifier	90	90	6.0	6.5	0.8	0.25 Meg.♦	1,150	170	1C5, 1Q5	
1U6	Heptode	T-5½	7DC	Fil.	1.4	0.025	Converter	67.5	45	0	0.5	0.6	550,000	260▼	(Ga=67.5 V., 0.95 Ma)		
								90	45	0	0.55	0.55	600,000	275▼	(Ga=90 V., 1.1 Ma)		
1V	Diode	ST-12	4G	Cath.	6.3	0.30	H.W. Rectifier	350 V. RMS Plate, 45 Ma. D C Output									6Z3
1W4	Pentode	T-5½	5BZ	Fil.	1.4	.050	Pwr. Amplifier	90	90	9.0	5.0	1.0	0.25 Meg.	925	200		
2A3	Triode	ST-16	4D	Fil.	2.5	2.5	Pwr. Amplifier	250	45.0	60	2,500	4.2	3,500	2A3H	
								300	62.0	40 per tube	3,000▲	15,000			
2A3H	Triode	ST-16	4D	Cath.	2.5	2.5	Pwr. Amplifier	Same as Type 2A3									2A3

① Load Resistance for Power Output Tubes
 ② Transconductance for Tetrodes, Pentodes, Etc.
 ▼ Conversion Transconductance

♦ Approximate
 ▲ Plate to Plate
 ■ Through 20,000 Ohms

‡ Per Tube or Section—No Signal
 § Plate and Target Supply
 ▲ Self Bias Cathode Resistor—Ohms

CONDENSED DATA SECTION—Cont.

TYPE	CLASS	CONSTRUCTION		EMITTER			USE	PLATE VOLTS	SCREEN VOLTS	NEG. GRID VOLTS	PLATE CUR-RENT MA.	SCREEN CUR-RENT MA.	PLATE ① RESISTANCE OHMS	AMP. ② OR G _m μMHOS	POWER OUTPUT M.W.	SUGGESTED REPLACEMENT TYPE
		STYLE	BASE DIAG.	TYPE	VOLTS	AMP.										
2A5, KR25	Pentode	ST-14	6B	Cath.	2.5	1.75	Pwr. Amplifier	250 285	250 285	16.5 20.0	34 38	6.5 7.0	7,000 7,000	3,200 4,800	
2A6	Duodi Triode	ST-12	6G	Cath.	2.5	0.80	Det. Amplifier	250	2.0	0.9	91,000	100	
2A7, 2A7S	Heptode	ST-12	7C	Cath.	2.5	0.80	Converter	Same Characteristics as Types 6A7 or 6A8G								
2B7, 2B7S	Diode Pentode	ST-12	7D	Cath.	2.5	0.80	Det. Amplifier	100 250	100 100	3.0 3.0	5.8 6.0	1.7 1.5	300,000 800,000	950 1,000	
2E5	Electron Ray	T-9	6R	Cath.	2.5	0.80	Indicator	Same Characteristics as Type 6E5								
2G5	Electron Ray	T-9	6R	Cath.	2.0	0.8	Indicator	Characteristics Same as Type 6U5								2E5
2S/4S	Duo Diode	ST-12	5D	Cath.	2.5	1.35	Detector	Approximate 40 Ma. Per Plate, 50 Ma. D C Output								
2V2	Diode	T-11	8FV	Fil.	2.5 1.25	0.2 0.4	High Voltage Rectifier	TV Service Peak Inverse Volts D C=15 Kv. Peak Current=80 Ma. Average Current D C=2.0 Ma. Peak Inverse Volts D C=21 Kv. Peak Current=80 Ma. Average Current D C=1.0 Ma.								
2V3G	Diode	ST-12	4Y	Fil.	2.5	5.0	H.W. Rectifier	6000 V. RMS Plate, 2 Ma. D C Output								2X2A
2W3, GT	Diode	Metal, GT	4X	Fil.	2.5	1.5	H.W. Rectifier	350 Volts RMS, 55 Ma. Max. D C Output Current with Cap. Input to Filter								2Z2
2Z2/G84	Diode	ST-12	4B	Fil.	2.5	1.50	H.W. Rectifier	350 Volts Per Plate RMS, 50 Ma. Output Current								2W3
3A5	Duo Triode	T-5½	7BC	Fil.	1.4 2.8	0.22 0.11	Amplifier	90 135	2.5 20.0	3.7	8,300	15 2,000	
3A8GT	Diode Triode Pentode	GT	8AS	Fil.	2.8 1.4	.050 .100	Det. Amplifier Amplifier	90 90	0 90	0 0	0.2 1.5	0 0.5	0.2 Meg. 0.8 Meg.	325 250	1H5 and 1N5 1C3 and 1S5
3B5GT	Beam Amplifier	GT	7AQ	Fil.	1.4 2.8	0.10 0.05	Amplifier	45 67.5	45 67.5	4.5 7.0	4.4 6.7	0.3 0.5	8,000 5,000	1,400 1,500	70 180	

① Load Resistance for Power Output Tubes
 ② Transconductance for Tetrodes, Pentodes, Etc.
 ▼ Conversion Transconductance

♣ Approximate
 † Plate to Plate
 ■ Through 20,000 Ohms

‡ Per Tube or Section—No Signal
 § Plate and Target Supply
 ▲ Self Bias Cathode Resistor—Ohms

CONDENSED DATA SECTION—Cont.

TYPE	CLASS	CONSTRUCTION		EMITTER			USE	PLATE VOLTS	SCREEN VOLTS	NEG. GRID VOLTS	PLATE CUR-RENT MA.	SCREEN CUR-RENT MA.	PLATE ① RESISTANCE OHMS	AMP. ② FACTOR OR G _m μMHOS	POWER OUTPUT MW.	SUGGESTED REPLACEMENT TYPE
		STYLE	BASE DIAG.	TYPE	VOLTS	AMP.										
6E7	Pentode	ST-12	7H	Cath.	6.3	0.30	Amplifier	Same as 6D6								6D6
6F5, GT, G	Triode	Metal, GT ST-12	5M	Cath.	6.3	0.3	Amplifier	100	1.0	0.4	85,000	100	
6F7, 6F7S	Triode Pentode	ST-12	7E	Cath.	6.3	0.30	Amplifier	100	(Tri.) 100	2.0	0.9	66,000	100	
6F8G	Duo Triode	ST-12	8G	Cath.	6.3	0.60	Amplifier Inv.	250	3.0	3.5	1.5	16,200	8.5	6SN7GT
6G5/6H5	Electron Ray	T-9	6R	Cath.	6.3	0.30	Indicator	0 to 22	850,000	1,100	(Pent.)	6U5/6G5
6G6G	Pentode	ST-12	7S	Cath.	6.3	0.15	Pwr. Amplifier	135 180	135 180	6.0 9.0	11.5 15.0	2.0 2.5	170,000 175,000	2,100 2,300	600 1,100	6K6
6H4GT	Diode	GT	5AF	Cath.	6.3	0.15	Rectifier	100	4.0	7A6
6H5	Electron Ray	T-9	6R	Cath.	6.3	0.30	Indicator	Same as 6G5/6H5								6U5/6G5
6J4	Triode	T-5½	7BQ	Cath.	6.3	0.4	Amplifier	150	200▲	15.0	4,500	55	
6J7G, GT	Pentode	Metal ST-12 GT	7R	Cath.	6.3	0.30	R F Amplifier	100 250	100 100	3.0 3.0	2.0 2.0	0.5 0.5	1.0 Meg. >1.0 Meg.	1,185 1,225	6SJ7
6J8G	Triode Heptode	ST-12	8H	Cath.	6.3	0.30	Mixer Osc.	Characteristics Same as Type 7J7								
6K4	Triode	T-3	6K4	Cath.	6.3	0.15	R F Amplifier	200	680▲	11.5	4,650	16	6AK4
6K5GT, G	Triode	GT, ST-12	5U	Cath.	6.3	0.30	Amplifier	250	3.0	1.10	50,000	70	6F5
6K8, G, GT	Triode Hexode	Metal ST-12, GT	8K	Cath.	6.3	0.30	Mixer Oscillator	250 100 100	100 100	3.0 3.0	2.5 2.3	6.0 6.2	600,000 400,000	350▼ 325▼	(Hexode Section) (Hexode Section)	
6L5G	Triode	ST-12	6Q	Cath.	6.3	.150	Amplifier	250	0	9	8.0	0	9,000	1900	
6N4	Triode	T-5½	7CA	Cath.	6.3	0.20	Amplifier	180	3.5	12.0	5,400	32	6C4

① Load Resistance for Power Output Tubes
 ② Transconductance for Tetrodes, Pentodes, Etc.
 ▼ Conversion Transconductance

◆ Approximate
 ▲ Plate to Plate
 ■ Through 20,000 Ohms

‡ Per Tube or Section—No Signal
 § Plate and Target Supply
 ▲ Self Bias Cathode Resistor—Ohms

CONDENSED DATA SECTION—Cont.

TYPE	CLASS	CONSTRUCTION		EMITTER			USE	PLATE VOLTS	SCREEN VOLTS	NEG. GRID VOLTS	PLATE CUR-RENT MA.	SCREEN CUR-RENT MA.	PLATE ① RESISTANCE OHMS	AMP. ② FACTOR OR G _m μMHOS	POWER OUTPUT M.W.	SUGGESTED REPLACEMENT TYPE	
		STYLE	BASE DIAG.	TYPE	VOLTS	AMP.											
6N6G	Duo Triode	ST-14	7AU	Cath.	6.3	0.8	Direct Coupled Pwr. Amplifier	300	0	42 Output 9.0 Input	24,000	2400	4,000		
6P5GT	Triode	T-9	6Q	Cath.	6.3	.300	Amplifier	250	13.5	5	9,500	13.8			
6P7G	Pentode Triode	ST-12	7U	Cath.	6.3	0.30	Amplifier	Same as 6F7									6F7
6Q6, 6Q6G	Diode Triode	6Y	Cath.	6.3	0.15	Det. Amplifier	250	3.0	1.2	65	6T7G	
6Q6G/6T7G	Duodi Triode	7V	Cath.	6.3	0.15	Det. Amplifier	250	3.0	1.2	65	6T7G	
6Q7, G, GT	Duodiode Triode	Metal ST-12 GT	7V	Cath.	6.3	0.30	Det. Amplifier	100	1.5	0.8	58,000	70		
								250	3.0	1.0	58,000	70		
6R6G	Pentode	ST-12	6AW	Cath.	6.3	0.30	R F Amplifier	250	100	3.0	7.0	1.7	800,000‡	1,450		
6R7, G, GT	Duodiode Triode	Metal GT, ST-12	7V	Cath.	6.3	0.30	Det. Amplifier	250	9.0	9.5	8,500	16	6SR7	
6R8	Triple Diode Triode	T-6½	9E	Cath.	6.3	0.45	Det. Amplifier	250	9.0	9.5	8,500	16	300		
6S7, G	Remote Cutoff Pentode	Metal ST-12	7R	Cath.	6.3	0.15	R F Amplifier	135	67.5	3.0	3.7	0.9	1.0 Meg.	1,250	6K7	
								250	100	3.0	8.5	2.0	1.0 Meg.	1,750		
6SB7Y	Heptode	Metal	8R	Cath.	6.3	.300	Converter	250	100	1.0	3.8	10.0	1.0 Meg.	950▼			
6SD7GT	Pentode	T-9	8N	Cath.	6.3	.300	R F Amplifier	250	100	2	6.0	1.9	1.0 Meg.	3600			
6SE7GT	Pentode	GT	8N	Cath.	6.3	0.3	R F Amplifier	100	100	1.0	5.5	2.4	.25 Meg.‡	3,100	6SJ7GT	
								250	100	1.5	4.5	1.5	1.0 Meg.‡	3,400		
6SF5, GT	Triode	Metal, GT	6AB	Cath.	6.3	0.30	Amplifier	250	2.0	0.9	66,000	100		
6SF7	Diode Pentode	Metal	7AZ	Cath.	6.3	0.30	Detector R F Amplifier	100	100	1.0	12.0	3.4	200,000‡	1,975	6SV7	
								250	100	1.0	12.4	3.3	700,000‡	2,050		

① Load Resistance for Power Output Tubes
 ② Transconductance for Tetrodes, Pentodes, Etc.
 ▼ Conversion Transconductance

♦ Approximate
 † Plate to Plate
 ■ Through 20,000 Ohms

‡ Per Tube or Section—No Signal
 § Plate and Target Supply
 ▲ Self Bias Cathode Resistor—Ohms

CONDENSED DATA SECTION—Cont.

TYPE	CLASS	CONSTRUCTION		EMITTER			USE	PLATE VOLTS	SCREEN VOLTS	NEG. GRID VOLTS	PLATE CUR-RENT MA.	SCREEN CUR-RENT MA.	PLATE ① RESISTANCE OHMS	AMP. ② FACTOR OR G _m μMHOS	POWER OUTPUT MW.	SUGGESTED REPLACEMENT TYPE	
		STYLE	BASE DIAG.	TYPE	VOLTS	AMP.											
6A X6G	Duo Diode	ST-14	7Q	Cath.	6.3	2.5	F.W. Rectifier	350 V. RMS Plate, 250 Ma. D C Output, Cond. Input									
6B4G	Triode	ST-16	5S	Fil.	6.3	1.0	Pwr. Amplifier	Characteristics Same as Type 6A3									6A3
6B5	Duo Triode	ST-14	6AS	Cath.	6.3	0.80	Pwr. Amplifier	300	Input Triode	0	8.0		
								300	Output Triode	45.0	7,000	4,000		
6B6G	Duodi Triode	ST-12	7V	Cath.	6.3	0.30	Det. Amplifier	250	20	0.9	91,000	100	6Q7GT	
6B7, 6B7S	Duodi Pentode	ST-12	7D	Cath.	6.3	0.30	R F or I F Amplifier	100	100	3.0	5.8	1.7	300,000	950		
					6.3	0.30		250	125	3.0	9.0	2.3	600,000	1,125		
6B8, GT, G	Duodi Pentode	Metal, GT	8E	Cath.	6.3	0.30	Det. Amplifier	Characteristics Same as Type 6B7									
6BA7	Heptode	T-6½	8CT	Cath.	6.3	.300	Converter	250	100	1	3.8	10	1.0 Meg.	950▼		
6BD5GT	Beam Amplifier	GT	6CK	Cath.	6.3	0.90	TV Horizontal Amplifier	Max. Peak Positive Pulse Plate Voltage = 4,000 V. Max. D C Cathode Current = 100 ma. Max. Plate Dissipation = 10 Watts, Max. Screen Dissipation = 3.0 Watts									6BQ6GTA
6BK6	Duodi Triode	T-5½	7BT	Cath.	6.3	0.3	Det. Amplifier	250	-2.0	1.2	62,500	100		
								100	-1.0	0.5	80,000	100		
6BN7	Duo Triode with Different Triode Sections	T-6½	9AJ	Cath.	6.3	0.75	Osc. Triode 1 Amp. Triode 2	120	1.0	5.0	14,000	28		
								250	15.0	24.0	2,200	12		
6BU5	Beam Pentode	T-12	8FP	Cath.	6.3	0.15	TV High Voltage Regulator	20,000	70	3.4	0.55		
								20,000	70	2.4	1.0	0.4		
6BY6	Heptode	T-5½	7CH	Cath.	6.3	0.3	Sync. Separator	10	25	0	1.4	3.5	I _b = 50 μa When E _{c3} = 2.5 V				

① Load Resistance for Power Output Tubes
 ② Transconductance for Tetrodes, Pentodes, Etc.
 ▼ Conversion Transconductance

♦ Approximate
 † Plate to Plate
 ■ Through 20,000 Ohms

‡ Per Tube or Section—No Signal
 § Plate and Target Supply
 ▲ Self Bias Cathode Resistor—Ohms

CONDENSED DATA SECTION—Cont.

TYPE	CLASS	CONSTRUCTION		EMITTER			USE	PLATE VOLTS	SCREEN VOLTS	NEG. GRID VOLTS	PLATE CUR-RENT MA.	SCREEN CUR-RENT MA.	PLATE ① RESISTANCE OHMS	AMP. ② FACTOR OR G _m μMHOS	POWER OUTPUT MW.	SUGGESTED REPLACEMENT TYPE	
		STYLE	BASE DIAG.	TYPE	VOLTS	AMP.											
6C6	Pentode	ST-12	6F	Cath.	6.3	0.30	Amplifier	100	100	3.0	2.0	0.50	1 Meg.	1,185	77	
				6.3	0.30		250	100	3.0	2.0	0.50		1,225			
				6.3	0.30	As Triode	180	5.3	5.3	11,000	20			
				6.3	0.30		250	8.0	6.5	10,000	20			
6C7	Duodi Triode	ST-12	7G	Cath.	6.3	0.30	Det. Amplifier	250	9.0	4.5	16,000	20	6SR7GT	
6C8G	Duo Triode	ST-12	8G	Cath.	6.3	0.30	Amplifier Inv.	250	4.5	3.2	22,500	36		
6CR6	Diode Pentode	T-5½	7EA	Cath.	6.3	0.3	Det. Audio Amplifier	250	100	2.0	9.5	3.0	200,000	1,950		
6D5G	Triode	6Q	Cath.	6.3	0.70	Pwr. Amplifier	275	40	31	7,200	4.7	1,400		
6D6	Pentode	ST-12	6F	Cath.	6.3	0.30	Amplifier	100	100	3.0	8.0	2.2	250,000♦	1,500	78	
				6.3	0.30		250	100	3.0	8.2	2.0	800,000♦	1,600			
6D7	Pentode	ST-12	7H	Cath.	6.3	0.30	Amplifier	Same as 6C6								6C6
6D8G	Heptode	ST-12	8A	Cath.	6.3	0.15	Converter	135	67.5	3.0	1.5	1.7	600,000	325▼	G ₂ = 135 V. at 1.8 Ma. G ₃ = 250 V. at 4.5 Ma.■	7A8	
				6.3	0.15		250	100	3.0	3.5	2.6	400,000	550▼			
6DB6	Pentode	T-5½	7CM	Cath.	6.3	0.30	Color Demod.	150	150	1.0	5.8	6.6	50,000	2,050 μmhos when E ₂₃ = -3 V.		
6DC6	Pentode	T-5½	7CM	Cath.	6.3	0.30	R F Amplifier	200	150	180▲	9.0	3.0	500,000	5,500	Semi-Remote Cutoff		
6DE6	Pentode	T-5½	7CM	Cath.	6.3	0.30	R F Amplifier	200	150	180▲	9.5	2.3	600,000♦	6,200		
6E5	Electron Ray	T-9	6R	Cath.	6.3	0.30	Indicator	100§	(Series Plate Resistor 0.5 Megs. Target Current 1.0 Ma. Grid Bias = 3.3 for 90° Shadow)							6U5
				250§	(Series Plate Resistor 1.0 Meg. Target Current 4.0 Ma. Grid Bias = 8.0 for 90° Shadow)											
6E6	Duo Triode	ST-14	7B	Cath.	6.3	0.60	Pwr. Amplifier	180	20.0	11.5	15,000♦	6.0	750	1,600	
				250		27.5	18.0	14,000♦	6.0					

① Load Resistance for Power Output Tubes
 ② Transconductance for Tetrodes, Pentodes, Etc.
 ▼ Conversion Transconductance

♦ Approximate
 † Plate to Plate
 ■ Through 20,000 Ohms

‡ Per Tube or Section—No Signal
 § Plate and Target Supply
 ▲ Self Bias Cathode Resistor—Ohms

CONDENSED DATA SECTION—Cont.

TYPE	CLASS	CONSTRUCTION		EMITTER			USE	PLATE VOLTS	SCREEN VOLTS	NEG. GRID VOLTS	PLATE CUR-RENT MA.	SCREEN CUR-RENT MA.	PLATE ① RESISTANCE OHMS	AMP. ② FACTOR OR G_m μ MHOS	POWER OUTPUT MW.	SUGGESTED REPLACEMENT TYPE		
		STYLE	BASE DIAG.	TYPE	VOLTS	AMP.												
6A4	Pentode	ST-14	5B	Fil.	6.3	0.30	Pwr. Amplifier	135 180	135 180	9.0 12.0	13.0 22.0	2.8 3.9	52,600 60,000	2,100 2,500	700 1,500	6K6GT		
6A4/LA	Pentode	ST-14	5B	Fil.	6.3	0.30	Pwr. Amplifier	100 180	100 180	6.5 12.0	9.0 22.0	1.6 3.9	11,000 8,000	1,200 2,200	310 1,400			
6A5G	Triode	ST-16	6T	Cath.	6.3	1.25	Pwr. Amplifier	250	0	45	60	0	800	5,250	3750			
6A6	Duo Triode	ST-14	7B	Cath.	6.3	0.8	Pwr. Amplifier	300	0	35.0	Per Plate	8,000▲	Max. Signal	10,000	6N7G		
					6.3	0.8	Driver	250	5.0	6.0	11,300	35			
					6.3	0.8	Driver	294	6.0	7.0	11,000	35			
6A7S	Heptode	ST-12	7C	Cath.	6.3	0.30	Converter	Same as Type 6A7									6A7	
6AB5/6N5	Electron Ray	T-9	6R	Cath.	6.3	0.15	Indicator	135§ Series Plate Resistor 0.25 Meg., Target Current 2.0 Ma., Grid Bias = 10 for 0° Shadow										
6AB6G	Duo Triode	ST-12	7AU	Cath.	6.3	0.50	Pwr. Amplifier	250	Input Triode	0	5.0		
								250	Output Triode	34.0	8,000	3,500	6N6G		
6AB7/1853	Pentode	Metal	8N	Cath.	6.3	0.45	Amplifier	300	200	3.0	12.5	3.2	700,000	5,000			
6AC5GT, G	Triode	GT, ST-12	6Q	Cath.	6.3	0.40	Pwr. Amplifier	250	0.0	5.0‡	(Class B, Two Tubes)		8,000			
6AD5GT	Triode	GT	6Q	Cath.	6.3	0.30	Amplifier	250	2.0	0.9	66,000	100			
6AD6G	Electron Ray	T-9	7AG	Cath.	6.3	0.15	Indicator	100§ Ray Control Volts = 45 for 0° Shadow, = -23 Volts for 135° Shadow										
					6.3	0.15		150§ Ray Control Volts = 75 for 0° Shadow, = -50 Volts for 135° Shadow										
6AD7G	Triode Pentode	ST-14	8AY	Cath.	6.3	0.85	Triode Amplifier	250	25	3.7	19,000♦	6			
					6.3	0.85		Pentode Amp.	250	250	16.5	34.0	6.5	7,000	2,500	3,200		
6AE5GT, G	Triode	GT	6Q	Cath.	6.3	0.30	Amplifier	95	15	7.0	3,500	4.2			

① Load Resistance for Power Output Tubes
 ② Transconductance for Tetrodes, Pentodes, Etc.
 ▼ Conversion Transconductance

♦ Approximate
 ▲ Plate to Plate
 ■ Through 20,000 Ohms

‡ Per Tube or Section—No Signal
 § Plate and Target Supply
 ▲ Self Bias Cathode Resistor— Ohms

CONDENSED DATA SECTION—Cont.

TYPE	CLASS	CONSTRUCTION		EMITTER			USE	PLATE VOLTS	SCREEN VOLTS	NEG. GRID VOLTS	PLATE CUR-RENT MA.	SCREEN CUR-RENT MA.	PLATE ① RESISTANCE OHMS	AMP. ② FACTOR OR G _m μMHOS	POWER OUTPUT MW.	SUGGESTED REPLACEMENT TYPE
		STYLE	BASE DIAG.	TYPE	VOLTS	AMP.										
6AE6G	Duo Plate Triode	ST-12	7AH	Cath.	6.3	0.15	Remote Cut-Off	250	1.5	6.5	25,000	25	
				6.3	0.15	Sharp Cut-Off	250	35.0	0.01	
				6.3	0.15		250	1.5	4.5	35,000	33	
				6.3	0.15		250	9.5	0.01	
6AE7GT	Duo Triode	GT	7AX	Cath.	6.3	0.50	Amplifier	250	13.5	5.0	9,300	14	Per Section	
(Driver for P.P. 6AC5GT = 250 V. 10 Ma., 6AC5GT Plate Ma. = 76 Output 9.5 Watts with 10,000 Ohms Load)																
6AF4A	Medium Mu Triode	T-5½	7DK	Cath.	6.3	0.225	U H F Oscillator	Identical to Type 6AF4 Except for Bulb Length, Bulb Length = 1¼ Inches								6AF4
6AF5G	Triode	ST-12	6Q	Cath.	6.3	0.30	Amplifier	180	18.0	7.0	4,900	7.4	
6AF6G	Twin Electron Ray	T-9	7AG	Cath.	6.3	0.15	Indicator	100§ Ray Control Volts = 60‡ for 0° Shadow, ‡Zero Volts for 100° Shadow 135§ Ray Control Volts = 81‡ for 0° Shadow, ‡Zero Volts for 100° Shadow 250§ Ray Control Volts = 155‡ for 0° Shadow, ‡Zero Volts for 100° Shadow								
6AH5G	Beam Amplifier	ST-16	6AP	Cath.	6.3	0.90	Amplifier	350	250	18.0	54.0	2.5	4,200	5,200	10,800	6L6G
6AH7GT	Duo Triode	GT	8BE	Cath.	6.3	0.30	Amplifier	100	3.6	3.7	10,300	16	
				6.3	0.30	(Per Unit)	180	6.5	7.6	8,400	16	
6AJ4	Triode	T-6½	9BX	Cath.	6.3	0.225	U H F Amplifier	125	68▲	16	4,200‡	42	
6AJ5	Pentode	T-5½	7BD	Cath.	6.3	0.175	R F Amplifier	28	28	0.1	2.7	1.0	100,000	2,500	
6AL6G	Beam Amplifier	ST-16	6AM	Cath.	6.3	0.90	Pwr. Amplifier	Same as 6L6G								6L6G
6AM4	Triode	T-6½	9BX	Cath.	6.3	0.225	U H F Amplifier	200	100▲	10	8,700‡	85	
6AN5	Pentode	T-5½	7BD	Cath.	6.3	0.45	Pwr. Amplifier	120	120	6.0	35.0	12.0	12,500‡	8,000	1,300	6AQ5
6AQ7GT	Duodiode Triode	GT	8CK	Cath.	6.3	0.30	Det. Amplifier	250	2.0	2.3	44,000	70	
6AS6	Pentode	T-5½	7CM	Cath.	6.3	.175	R F Amplifier	120	120	2	5.2	3.5	110,000	3200	
6AS8	Diode Pentode	T-6½	9DS	Cath.	6.3	0.45	Det. Amplifier	Max. D C Plate Current—5 Ma. (Diode)				3.0	300,000‡	6,200
								200	150	180▲	9.5					

① Load Resistance for Power Output Tubes

② Transconductance for Tetrodes, Pentodes, Etc.

▼ Conversion Transconductance

‡ Approximate

▲ Plate to Plate

■ Through 20,000 Ohms

‡ Per Tube or Section—No Signal

§ Plate and Target Supply

▲ Self Bias Cathode Resistor—Ohms

CONDENSED DATA SECTION—Cont.

TYPE	CLASS	CONSTRUCTION		EMITTER			USE	PLATE VOLTS	SCREEN VOLTS	NEG. GRID VOLTS	PLATE CUR-RENT MA.	SCREEN CUR-RENT MA.	PLATE ① RESISTANCE OHMS	AMP. ② FACTOR OR G _m μMHOS	POWER OUTPUT MW.	SUGGESTED REPLACEMENT TYPE		
		STYLE	BASE DIAG.	TYPE	VOLTS	AMP.												
6SK7, GT	Remote Cutoff Pentode	Metal, GT	8N	Cath.	6.3	0.30	R F Amplifier	100 250	100 100	1.0 3.0	13.0 9.2	4.0 2.6	120,000♦ 800,000♦	2,350 2,000			
6SR7GT	Duodi Triode	Metal, GT	8Q	Cath.	6.3	.300	Det. Amplifier	250	9	9.5	8,500	16			
6SS7	Remote Cutoff Pentode	Metal	8N	Cath.	6.3	0.15	R F Amplifier	100 250	100 100	1.0 3.0	12.2 9.0	3.1 2.0	0.12 Meg.♦ 1.0 Meg.♦	1,930 1,850	6SG7GT		
6ST7	Duodi Triode	Metal	8Q	Cath.	6.3	.15	Det. Amplifier	250	9	9.5	8,500	16			
6SV7	Diode Pentode	Metal	7AZ	Cath.	6.3 6.3	0.30 0.30	Det. Amplifier	100 250	100 150	1.0 1.0	3.7 7.5	1.4 2.8	700,000 1.5 Meg.	2,600 3,600			
6SZ7	Duodiode Triode	Metal	8Q	Cath.	6.3	0.15	Amplifier	250	3.0	1.0	58,000	70	6SQ7GT		
6T5	Electron Ray	ST-12	6R	Cath.	6.3	0.30	Indicator	250§	0-22	3.0	6U5/6G5		
6T7G	Duodiode Triode	ST-12	7V	Cath.	6.3	0.15	Det. Amplifier	100 250	1.5 3.0	0.3 1.2	95,000 62,000	65 65			
6T7G/6Q6G	Duodi Triode	ST-12	7V	Cath.	6.3	0.15	Det. Amplifier	250	3.0	1.2	62,000	65	6T7G		
6U4GT	Diode	GT	4CG	Cath.	6.3	1.2	H.W. Rectifier	350 A C Volts Per Plate RMS, 125 Ma. Output Current, 335 V. D C Output, 20μf Cap. Input								6W4GT	
6U6GT	Beam Power	T-9	7S	Cath.	6.3	.75	Pwr. Amplifier	200	135	14	55	3.0	3,000	6200	5,500		
6U7G	Remote Cutoff Pentode	ST-12	7R	Cath.	6.3	0.30	R F Amplifier	100 250	100 100	3.0 3.0	8.0 8.2	2.2 2.0	250,000 800,000	1,500 1,600	6SK7GT, 6K7GT		
6V7G	Duodi Triode	ST-12	7V	Cath.	6.3	0.3	Det. Amplifier	Same Characteristics as Type 85									
6V8	Triple Diode Triode	T-6½	9AH	Cath.	6.3	0.45	Det. Amplifier	100 250	1.0 3.0	0.8 1.0	54,000 58,000	70 70			
6W5G	Duo Diode	ST-12	6S	Cath.	6.3	0.90	F.W. Rectifier	325 V. RMS Per Plate, 90 Ma. D C Output, Cond. Input Filter 450 V. RMS Per Plate, 90 Ma. D C Output, Choke Input Filter								6X5G	
6W7G	Pentode	ST-12	7R	Cath.	6.3	.150	R F Amplifier	250	100	3	2.0	0.5	1 Meg.	1250			

① Load Resistance for Power Output Tubes

② Transconductance for Tetrodes, Pentodes, Etc.

▼ Conversion Transconductance

♦ Approximate

‡ Plate to Plate

■ Through 20,000 Ohms

‡ Per Tube or Section—No Signal

§ Plate and Target Supply

▲ Self Bias Cathode Resistor—Ohms

CONDENSED DATA SECTION—Cont.

TYPE	CLASS	CONSTRUCTION		EMITTER			USE	PLATE VOLTS	SCREEN VOLTS	NEG. GRID VOLTS	PLATE CUR-RENT MA.	SCREEN CUR-RENT MA.	PLATE ① RESISTANCE OHMS	AMP. FACTOR ② OR G _m μMHOS	POWER OUTPUT MW.	SUGGESTED REPLACEMENT TYPE	
		STYLE	BASE DIAG.	TYPE	VOLTS	AMP.											
6Y3G	Diode	ST-12	4AC	Cath.	6.3	0.70	H.W. Rectifier	5000 A C Volts Per Plate RMS 7.5 Ma. Output Current									2 X2A
6Y5	Duo Diode	ST-12	6J	Cath.	6.3	0.80	F.W. Rectifier	350 V. RMS Per Plate, 50 Ma. D C Output									6 X5G
6Y5V	Duo Diode	ST-12	6J	Cath.	6.3	0.80	F.W. Rectifier	350 V. RMS Per Plate, 60 Ma. D C Output									6 X5G
6Y7G	Duo Triode	ST-12	8B	Cath.	6.3	0.6	Class B Amp.	Same Characteristics as Type 79									
6Z3	Diode	4G	Cath.	6.3	0.30	H.W. Rectifier	350 V. RMS Plate, 50 Ma. D C Output									1V
6Z4, 6Z4/84	Duo Diode	ST-12	5D	Cath.	6.3	0.50	F.W. Rectifier	350 V. RMS Per Plate, 60 Ma. D C Output, Cond. Input Filter									6 X5G
6Z5, 6Z5/12Z5	Duo Diode	ST-12	6K	Cath.	6.3 12.6	0.80 0.40	F.W. Rectifier	230 V. RMS Per Plate, 60 Ma. D C Output									6 X5G 14Y4
6Z7G	Duo Triode	ST-12	8B	Cath.	6.3	0.3	Class B Amp.	135 180	0 0	60 60	9,000 12,000	2,500 4,200		
6ZY5G	Duo Diode	ST-12	6S	Cath.	6.3	0.30	F.W. Rectifier	325 A C Volts Per Plate RMS, 40 Ma. Output Current. Capacitor Input to Filter									0Z4, 6 X5
7A4	Triode	Lock-In	5AC	Cath.	6.3	0.30	Amplifier	90 250	0.0 8.0	10.0 9.0	6,700 7,700	20 20		
7A5	Beam Pentode	Lock-In	6AA	Cath.	6.3	0.75	Pwr. Amplifier	110 125	110 125	7.5 190▲	40.0 44.0	3.0 3.3	16,000 17,000	5,800 6,000	1,500 2,200		
7AB7	Pentode	Lock-In	8B0	Cath.	6.3	0.15	Amplifier	250	100	2.0	4.0	1.3	500,000	1,800		
7AD7	Pentode	Lock-In	8V	Cath.	6.3	0.60	Video Amplifier	300 300	150 125	68▲ 68▲	28 25	7.0 6.0	300,000	9,500	(Class A ₁ Amplifier) (Class A ₁ Video Amplifier)		
7AF7	Duo Triode	Lock-In	8AC	Cath.	6.3	0.30	Amplifier	100 100 250	0 3.0 10	10.8‡ 5.0‡ 9.0‡	6,500 8,400 7,600	17 16 16	R _k = 600 Ohms R _k = 1,100 Ohms		
7AH7	Semi-Remote Pentode	Lock-In	8V	Cath.	6.3	0.15	R F Amplifier	250	250	250▲	6.8	1.9	1.0 Meg.	3,300		

① Load Resistance for Power Output Tubes
 ② Transconductance for Tetrodes, Pentodes, Etc.
 ▼ Conversion Transconductance

◆ Approximate
 ▲ Plate to Plate
 ■ Through 20,000 Ohms

‡ Per Tube or Section—No Signal
 § Plate and Target Supply
 ▲ Self Bias Cathode Resistor—Ohms

CONDENSED DATA SECTION—Cont.

TYPE	CLASS	CONSTRUCTION		EMITTER			USE	PLATE VOLTS	SCREEN VOLTS	NEG. GRID VOLTS	PLATE CUR-RENT MA.	SCREEN CUR-RENT MA.	PLATE ① RESISTANCE OHMS	AMP. ② FACTOR OR Gm μ MHOS	POWER OUTPUT MW.	SUGGESTED REPLACEMENT TYPE
		STYLE	BASE DIAG.	TYPE	VOLTS	AMP.										
7AJ7	Pentode	Lock-In	8V	Cath.	6.3	.3	R F Amplifier	250	100	3	2.2	0.7	1 Meg.	1,575	
7B4	Triode	Lock-In	5AC	Cath.	6.3	0.30	Amplifier	100 250	1.0 2.0	0.4 0.9	85,000 66,000	100 100	
7B5	Pentode	Lock-In	6AE	Cath.	6.3	0.40	Pwr. Amplifier	100 250 315	100 250 250	7.0 18.0 21.0	9.0 32.0 25.5	1.6 5.5 4.0	104,000 68,000 75,000	1,500 2,300 2,100	350 3,400 4,500	6K6GT
7C4	H.F. Diode	Lock-In	4AH	Cath.	6.3	0.15	Detector	117 V. RMS			5.0	Resonant Frequency 900 Mc.				
7E5	Triode	Lock-In	8BN	Cath.	6.3	.15	Amp.-Oscillator	180	3	5.512 Meg.	36	
7E6	Duo Diode Triode	Lock-In	8W	Cath.	6.3	0.30	Det. Amplifier	250 100	9.0 3.0	9.5 3.9	8,500 11,000	16 16.5	
7E7	Duo Diode Pentode	Lock-In	8AE	Cath.	6.3	0.30	Det. Amplifier	100 250	100 100	1.0 3.0	10.0 7.5	2.7 1.6	150,000 \diamond 700,000 \diamond	1,600 1,300	
7G7	Pentode	Lock-In	8V	Cath.	6.3	0.45	R F Amplifier	250	100	2.0	6.0	2.0	800,000 \diamond	4,500	
7G8	Duo Tetrode	Lock-In	8BV	Cath.	6.3	.3	Amplifier	250	100	2.5	4.5 \ddagger	0.8 \ddagger	225 Meg.	2,100	
7H7	Semi-Remote Pentode	Lock-In	8V	Cath.	6.3	0.30	R F Amplifier	100 250	100 150	1.5 180 \blacktriangle	7.5 10.0	2.6 3.2	350,000 \diamond 800,000 \diamond	4,000 4,000	
7J7	Triode Heptode	Lock-In	8BL	Cath.	6.3	0.30	Mixer Oscillator	100 250 100 250 \blacksquare	100 100 100 (R_{c1} = 50,000) (R_{c1} = 50,000)	3.0 3.0 3.0 3.2	1.5 1.4 3.2 5.0	2.6 2.8 1.5 Meg. (Triode Grid Current = 0.3 Ma.) (Triode Grid Current = 0.4 Ma.)	500,000 280 ∇ 290 ∇	(Heptode) (Heptode) (Triode) (Triode)	
7K7	Duo Diode Triode	Lock-In	8BF	Cath.	6.3	0.30	Det. Amplifier	250	2.0	2.3	44,000	70	
7L7	Pentode	Lock-In	8V	Cath.	6.3	0.30	R F Amplifier	100 250	100 100	1.0 1.5	5.5 4.5	2.4 1.5	100,000 \diamond 1.0 Meg. \ddagger	3,000 3,100	R_k = 125 R_k = 250	

① Load Resistance for Power Output Tubes
 ② Transconductance for Tetrodes, Pentodes, Etc.
 ∇ Conversion Transconductance

\diamond Approximate
 \ddagger Plate to Plate
 \blacksquare Through 20,000 Ohms

\ddagger Per Tube or Section—No Signal
 \S Plate and Target Supply
 \blacktriangle Self Bias Cathode Resistor—Ohms

CONDENSED DATA SECTION—Cont.

TYPE	CLASS	CONSTRUCTION		EMITTER			USE	PLATE VOLTS	SCREEN VOLTS	NEG. GRID VOLTS	PLATE CURR. MA.	SCREEN CURR. MA.	PLATE ① RESISTANCE OHMS	AMP. ② FACTOR OR G _m μMHOS	POWER OUTPUT MW.	SUGGESTED REPLACEMENT TYPE
		STYLE	BASE DIAG.	TYPE	VOLTS	AMP.										
7R7	Duo Diode Pentode	Lock-In	8AE	Cath.	6.3	0.3	Detector R F Amplifier	100	100	2.0	3.4	1.0	500,000‡	2,100	
								100	100	1.0	5.5	2.2	350,000‡	3,000	
								250	100	2.0	3.5	1.0	1,800,000‡	2,200	
								250	100	1.0	6.2	1.6	1,000,000‡	3,200	
7S7	Triode Heptode	Lock-In	8BL	Cath.	6.3	0.30	Mixer Oscillator	100	100	2.0	1.9	3.0	500,000‡	500▼	(Heptode)	
								250	100	2.0	1.8	3.0	1.25 Meg. †	525▼	(Heptode)	
								100	R _{e1} =50,000	3.0	(Triode Grid Current = 0.3 Ma.)	(Triode)				
								250■	R _{e1} =50,000	5.0	(Triode Grid Current = 0.4 Ma.)	(Triode)				
7T7	Pentode	Lock-In	8V	Cath.	6.3	0.30	Amplifier	100	100	1.0	5.3	2.1	350,000	4,000	
					6.3	0.30		250	150	1.0	10.8	4.1	900,000	4,900	
7V7	Pentode	Lock-In	8V	Cath.	6.3	0.45	R F Amplifier	300	150	160▲	10.0	3.9	300,000	5,800	
7W7	Pentode	Lock-In	8BJ	Cath.	6.3	0.45	R F Amplifier	Characteristics Same as Type 7V7.								
7X6	Duo Diode	Lock-In	7DX	Cath.	6.3	1.2	Rectifier Doubler	235 Volts Per Plate RMS, 75 Ma. D C Output Per Plate (H.W. Rectifier) 117 Volts Per Plate RMS, 75 Ma. D C Output (Voltage Doubler)								
7X7/XXFM	Duo Diode Triode	Lock-In	8BZ	Cath.	6.3	0.30	Det. Amplifier	100	0	1.2	85,000	85	
								250	1.0	1.9	67,000	100	
7Z4	Duo Diode	Lock-In	5AB	Cath.	6.3	0.90	F.W. Rectifier	325 A C Volts Per Plate RMS, 100 Ma. Output Current, Capacitor Input to Filter 450 A C Volts Per Plate RMS, 100 Ma. Output Current. Choke Input to Filter 6 Henrys Min.								
10	Triode	ST-16	4D	Fil.	7.5	1.25	Pwr. Amplifier	250	23.5	10.0	13,000	8.0	400	
								350	32.0	16.0	11,000	8.0	900	
								425	40.0	18.0	10,200	8.0	1,600	
12A, 112A	Triode	ST-14	4D	Fil.	5.0	0.25	Det. Amplifier	90	4.5	5.0	5,400	8.5	35	
								135	9.0	6.2	5,100	8.5	130	
12A4	Triode	T-6½	9AG	Cath.	6.3	0.60	Amplifier	250	9.0	23	2,500	20	
					12.6	0.30				
12A5	Pentode	ST-12	7F	Cath.	12.6	0.30	Pwr. Amplifier	100	100	15.0	19.0	6.0	4,500	1,700	800	
					6.3	0.60		180	180	25.0	48.0	14.0	3,300	2,400	3,400	

① Load Resistance for Power Output Tubes
 ② Transconductance for Tetrodes, Pentodes, Etc.
 ▼ Conversion Transconductance

♦ Approximate
 ▲ Plate to Plate
 ■ Through 20,000 Ohms

† Per Tube or Section—No Signal
 ‡ Plate and Target Supply
 ▲ Self Bias Cathode Resistor—Ohms

CONDENSED DATA SECTION—Cont.

TYPE	CLASS	CONSTRUCTION		EMITTER			USE	PLATE VOLTS	SCREEN VOLTS	NEG. GRID VOLTS	PLATE CUR-RENT MA.	SCREEN CUR-RENT MA.	PLATE ① RESISTANCE OHMS	AMP. ② FACTOR OR G _m μMHOS	POWER OUTPUT MW.	SUGGESTED REPLACEMENT TYPE		
		STYLE	BASE DIAG.	TYPE	VOLTS	AMP.												
12A6	Beam Amplifier	Metal	7S	Cath.	12.6	0.15	Pwr. Amplifier	250	250									
12A6GT	Beam Amplifier	T-9	7S	Cath.	12.6	0.15	Pwr. Amplifier	Same as 12A6										
12A7	Diode Pentode	ST-12	7K	Cath.	12.6	0.30	Rectifier Amplifier	125 V. RMS Plate, 30 Ma. D C Output (Rect.)										
								135	135	13.5	9.0	2.5	13,500	975	550			
12A8G, GT	Heptode	ST-12, GT	8A	Cath.	12.6	0.15	Converter	100	50	1.5	1.1	1.3	500,000	360▼	E _{c2} = 100 V., I _{c2} = 2.0 Ma.			
								250	100	3.0	3.5	2.7	300,000	550▼	E _{c2} = 250 V., I _{c2} = 4.0 Ma.			
12AH7GT	Duo Triode	GT	8BE	Cath.	12.6	0.15	Amplifier	100	3.6	3.7	10,300	16			
								180	6.5	7.6	8,400	16			
12AW6	Pentode	T-5½	7CM	Cath.	12.6	0.15	R F Amplifier	250	150	200▲	7.0	2.0	0.8 Meg.	5,000	12AU6		
								125	125	100▲	7.2	2.1	0.5 Meg.	5,100			
								100	100	100▲	5.5	1.6	0.3 Meg.	4,750			
12B7	Pentode	Lock-In	8V	Cath.	12.6	0.15	Amplifier	Same as Lock In Type 14A7									14A7	
12B8GT	Triode Pentode	GT	8T	Cath.	12.6	0.30	Triode Amplifier Pentode Amp.	90	0.0	2.8	37,000	90	6AT6		
								90	90	3.0	7.0	2.0	200,000	1,800	6BA6		
12BA7	Heptode	T-6½	8CT	Cath.	12.6	0.15	Converter	Characteristics Same as Type 6BA7										
12BQ6GA	Beam Amplifier	T-11	6AM	Cath.	12.6	0.6	Horiz. Amp.	Characteristics Same as Type 6BQ6GTA									12BQ6GTA	
12BZ7	Duo Triode	T-6½	9A	Cath.	6.3	0.6	Sync. Separator or Amplifier	250	2.0	2.5‡	31,800	100			
					12.6	0.3												
12C8	Duodi Pentode	Metal	8E	Cath.	12.6	0.15	Det. Amplifier	See Type 6B8										
12F5GT	Triode	T-9	5M	Cath.	12.6	.150	Amplifier	250	2	0.9	66,000	100			
12G4	Triode	T-5½	6BG	Cath.	12.6	0.15	Amplifier	Same as One Section of Type 6SN7GTA										
12H4	Triode	T-5½	7DW	Cath.	6.3	0.3	Amplifier	Same as One Section of Type 6SN7GTA										
					12.6	0.15												
12H6	Duo Diode	Metal	7Q	Cath.	12.6	0.15	Rectifier	117 A C Volts Per Plate RMS, 8.0 Ma. Output Current Per Plate									12AL5	

① Load Resistance for Power Output Tubes
 ② Transconductance for Tetrodes, Pentodes, Etc.
 ▼ Conversion Transconductance

♦ Approximate
 † Plate to Plate
 ■ Through 20,000 Ohms

‡ Per Tube or Section—No Signal
 § Plate and Target Supply
 ▲ Self Bias Cathode Resistor—Ohms

CONDENSED DATA SECTION—Cont.

TYPE	CLASS	CONSTRUCTION		EMITTER			USE	PLATE VOLTS	SCREEN VOLTS	NEG. GRID VOLTS	PLATE CUR-RENT MA.	SCREEN CUR-RENT MA.	PLATE ① RESISTANCE OHMS	AMP. ② FACTOR OR G _m μMHOS	POWER OUTPUT MW.	SUGGESTED REPLACEMENT TYPE
		STYLE	BASE DIAG.	TYPE	VOLTS	AMP.										
12J7GT, G	Pentode	GT, ST-12	7R	Cath.	12.6	0.15	R F Amplifier	Characteristics Same as Type 6J7								
12K7GT, G	Pentode	GT, ST-12	7R	Cath.	12.6	0.15	R F Amplifier	Characteristics Same as Type 6K7								
12K8, GT	Triode Hexode	Metal, GT	8K	Cath.	12.6	0.15	Mixer Oscillator	Characteristics Same as Type 6K8GT								
12L8GT	Duo Pentode	GT	8BU	Cath.	12.6	0.15	Pwr. Amplifier	110 180	110 180	5.5 9.0	6.1‡ 13.0‡	1.3‡ 2.8	14,000‡ 10,000‡	1,680‡ 2,150‡	300‡ 1,000‡	
12Q7GT, G	Duo Diode Triode	GT, ST-12	7V	Cath.	12.6	0.15	Det. Amplifier	Characteristics Same as Type 6Q7GT								
12S8GT	3 Di Triode	T-9	8CB	Cath.	12.6	.150	Det. Amplifier	250	2.0	0.9	91,000	100	
12SC7	Triode	Metal	8S	Cath.	12.6	.150	Amplifier	250	2.0	2.0	53,000	70	
12SF5, GT	Triode	T-9	6AB	Cath.	12.6	.150	Amplifier	250	2.0	0.9	66,000	100	
12SH7	Pentode	Metal	8BK	Cath.	12.6	0.15	R F Amplifier	Characteristics Same as Type 6SH7								
12SJ7, GT	Pentode	Metal, GT	8N	Cath.	12.6	0.15	R F Amplifier	Characteristics Same as Type 6SJ7								
12SL7GT	Duo Triode	GT	8BD	Cath.	12.6	0.15	Amplifier	Characteristics Same as Type 6SL7GT								
12SR7	Duo Diode Triode	Metal	8Q	Cath.	12.6	0.15	Det. Amplifier	Characteristics Same as Type 6SR7GT								
12V6GT	Beam Amplifier	GT	7S	Cath.	12.6	0.225	Pwr. Amplifier	Characteristics Same as Type 6V6GT								
12Z3	Diode	ST-12	4G	Cath.	12.6	0.30	H.W. Rectifier	235 V. RMS Per Plate, 55 Ma. D C Output, Condenser Input Filter								
12Z5	Duo Diode	7L	Cath.	12.6	0.30	Rect. Doub.	225 V. RMS Per Plate, 60 Ma. D C Output, Condenser Input Filter								
14A4	Triode	Lock-In	5AC	Cath.	12.6	.150	Amplifier	250	8	9	7,700‡	20	
14A5	Beam Power	Lock-In	6AA	Cath.	12.6	.150	Pwr. Amplifier	250	250	12.5	30	3.5	7,500	3000	2,800	

- ① Load Resistance for Power Output Tubes
 ② Transconductance for Tetrodes, Pentodes, Etc.
 ▼ Conversion Transconductance

- ♦ Approximate
 † Plate to Plate
 ■ Through 20,000 Ohms

- ‡ Per Tube or Section—No Signal
 § Plate and Target Supply
 ▲ Self Bias Cathode Resistor—Ohms

CONDENSED DATA SECTION—Cont.

TYPE	CLASS	CONSTRUCTION		EMITTER			USE	PLATE VOLTS	SCREEN VOLTS	NEG. GRID VOLTS	PLATE CURRENT MA.	SCREEN CURRENT MA.	PLATE ① RESISTANCE OHMS	AMP. ② FACTOR OR Gm μ MHOS	POWER OUTPUT MW.	SUGGESTED REPLACEMENT TYPE	
		STYLE	BASE DIAG.	TYPE	VOLTS	AMP.											
14AF7/XXD	Duo Triode	Lock-In	8AC	Cath.	12.6	0.15	Amplifier	Characteristics Same as Type 7AF7									
14B8	Heptode	Lock-In	8X	Cath.	12.6	0.15	Converter	Characteristics Same as Type 7B8									
14C5	Beam Amplifier	Lock-In	6AA	Cath.	12.6	0.225	Pwr. Amplifier	Characteristics Same as Type 6V6GT									
14C7	Pentode	Lock-In	8V	Cath.	12.6	0.15	R F Amplifier	100	100	1.0	5.7	1.8	400,000 \diamond	2,275		
								250	100	3.0	2.2	0.7	1.0 Meg. \diamond	1,575		
14E6	Duodi Triode	Lock-In	8W	Cath.	12.6	.150	Det. Amplifier	250	9.0	9.5	8,500	16		
14E7	Duo Diode Pentode	Lock-In	8AE	Cath.	12.6	0.15	Det. Amplifier	Characteristics Same as Type 7E7									
14F7	Duo Triode	Lock-In	8AC	Cath.	12.6	0.15	Amplifier	Characteristics Same as Type 7F7									
14F8	Duo Triode	Lock-In	8BW	Cath.	12.6	0.15	Osc. Amplifier	Characteristics Same as Type 7F8									
14H7	Semi-Remote Pentode	Lock-In	8V	Cath.	12.6	0.15	R F Amplifier	Characteristics Same as Type 7H7									
14J7	Triode Heptode	Lock-In	8BL	Cath.	12.6	0.15	Mixer Oscillator	Characteristics Same as Type 7J7									
14N7	Duo Triode	Lock-In	8AC	Cath.	12.6	0.30	Amplifier	Characteristics Same as Type 7N7									
14R7	Duo Diode Pentode	Lock-In	8AE	Cath.	12.6	0.15	Det. Amplifier	Characteristics Same as Type 7R7									
14S7	Triode Heptode	Lock-In	8BL	Cath.	12.6	0.15	Mixer Oscillator	Characteristics Same as Type 7S7									
14W7	Pentode	Lock-In	8BJ	Cath.	12.6	.225	R F Amplifier	300	300	10.0	3.9	0.3 Meg.	5800		
14X7	Duodi Triode	Lock-In	8BZ	Cath.	12.6	.150	Det. Amplifier	250	1.0	1.9	67,000	100		
14Y4	Duodiode	Lock-In	5AB	Cath.	12.6	0.300	F.W. Rectifier	450 V. RMS Plate, 70 Ma. D C Output, Choke Input 325 V. RMS Plate, 70 Ma. D C Output, Cond. Input									
14Z3	Diode	4G	Cath.	14.0	0.30	H.W. Rectifier	250 V. RMS Plate, 60 Ma. D C Output									12Z3
15	Pentode	ST-12	5F	Cath.	2.0	0.22	Amplifier	135	67.5	1.5	1.85	0.3	800,000	750		
16, 16B	Diode	4B	Fil.	7.5	H.W. Rectifier	81	

① Load Resistance for Power Output Tubes
 ② Transconductance for Tetrodes, Pentodes, Etc.
 ▼ Conversion Transconductance

\diamond Approximate
 $\&$ Plate to Plate
 \blacksquare Through 20,000 Ohms

‡ Per Tube or Section—No Signal
 § Plate and Target Supply
 ▲ Self Bias Cathode Resistor—Ohms

CONDENSED DATA SECTION—Cont.

TYPE	CLASS	CONSTRUCTION		EMITTER			USE	PLATE VOLTS	SCREEN VOLTS	NEG. GRID VOLTS	PLATE CUR-RENT MA.	SCREEN CUR-RENT MA.	PLATE RESISTANCE OHMS	AMP. FACTOR OR G _m μMHOS	POWER OUTPUT MW.	SUGGESTED REPLACEMENT TYPE	
		STYLE	BASE DIAG.	TYPE	VOLTS	AMP.											
18	Pentode	ST-14	6B	Cath.	14.0	0.30	Pwr. Amplifier	See Type 6F6G.									
19	Duo Triode	ST-12 GT	6C	Fil.	2.0	0.26	Pwr. Amplifier	135	0	10.0	10,000	2,100		
					2.0		3.0	3.4	10,000	1,900				
					2.0		6.0	0.2	10,000	1,600				
19C8	3 Diode Triode	T-6½	9E	Cath.	18.9	.150	Det. Amplifier	100	1.0	0.5	80,000	100		
19J6	Duo Triode	T-5½	7BF	Cath.	18.9	0.15	Mixer	Characteristics Same as Type 6J6									
19V8	Triple Diode Triode	T-6½	9AH	Cath.	18.9	0.15	Det. Amplifier	Characteristics Same as Type 6V8									
19X8	Triode Pentode	T-6½	9AK	Cath.	18.9	0.15	Oscillator Mixer	Characteristics Same as Type 6X8									
20	Triode	T-8	4D	Fil.	3.3	0.132	Pwr. Amplifier	90	16.5	2.8	9,600	3.5	50		
								135	22.5	6.0	6,500	3.5	130		
22	Tetrode	ST-14	4K	Fil.	3.3	0.132	Amplifier	135	67.5	1.5	3.7	1.3	250,000	500		
24A, 24S	Tetrode	ST-14	5E	Cath.	2.5	1.75	R F Amplifier	180	90	3.0	4.0	1.7	400,000	1,000		
					2.5	1.75		250	90	3.0	4.0	1.7	600,000	1,050		
25, 25S	Duodi Triode	6M	Fil.	2.0	0.06	Det. Amplifier	135	3.0	1.0	20	1B5/25S	
25A6, G, GT	Pentode	Metal ST-14 GT	7S	Cath.	25.0	0.30	Pwr. Amplifier	95	95	15.0	20.0	4.0	45,000	2,000	900		
								135	135	20.0	37.0	8.0	35,000	2,450	2,000		
								160	120	18.0	33.0	6.5	42,000	2,375	2,200		
25A7GT	Diode Pentode	GT	8F	Cath.	25.0	0.30	H.W. Rectifier Pwr. Amplifier	117 A C Volts Per Plate, RMS, 75 Ma. Output Current									
					25.0	0.30		100	100	15.0	20.5	4.0	4,500	1,800	770		
25AC5GT	Triode	GT	6Q	Cath.	25.0	0.30	Pwr. Amplifier Dyn. Coupled Amplifier	110	+15	45.0	15,200	58		
					25.0	0.30		165	Bias from 6AE5GT Driver	46.0	2,000	2,000			
25AV5GT	Pentode	GT	6CK	Cath.	25.0	0.30	Horiz. Amplifier	Characteristics Same as Type 6AV5GT									25BQ6GTA
25AX4GT	Diode	T-9	4CG	Cath.	25.0	0.30	Damper	Characteristics Same as Type 6A X4GT									

① Load Resistance for Power Output Tubes
 ② Transconductance for Tetrodes, Pentodes, Etc.
 ▼ Conversion Transconductance

♦ Approximate
 † Plate to Plate
 ■ Through 20,000 Ohms

‡ Per Tube or Section—No Signal
 § Plate and Target Supply
 ▲ Self Bias Cathode Resistor—Ohms

CONDENSED DATA SECTION—Cont.

TYPE	CLASS	CONSTRUCTION		EMITTER			USE	PLATE VOLTS	SCREEN VOLTS	NEG. GRID VOLTS	PLATE CUR-RENT MA.	SCREEN CUR-RENT MA.	PLATE ① RESISTANCE OHMS	AMP. ② FACTOR OR G _m μMHOS	POWER OUTPUT M.W.	SUGGESTED REPLACEMENT TYPE		
		STYLE	BASE DIAG.	TYPE	VOLTS	AMP.												
25B5	Duo Triode	ST-12	6D	Cath.	25.0	0.30	Pwr. Amplifier	See Type 25N6G										
25B6G	Pentode	ST-14	7S	Cath.	25.0	0.30	Pwr. Amplifier	105	105	16.0	48.0	2.0	1,700	4,800	2,400	25A6GT		
								200	135	23.0	62.0	1.8	2,500	5,000	7,100			
25B8	Triode Pentode	T-9	8T	Cath. Cath.	25	0.15	Triode Amplifier Pentode Amp.	100 100 100	1.0 3.0	0.6 7.6 2.0	75,000 185,000	112 370			
25BK5	Beam Amplifier	T-6½	9BQ	Cath.	25.0	0.30	Pwr. Amplifier	Characteristics Same as Type 6BK5										
25BQ6GA	Beam Amplifier	T-11	6AM	Cath.	25.0	0.30	Horiz. Amplifier	Characteristics Same as Type 6BQ6GTA										
25C6G	Beam Power	ST-14	7S	Cath.	25.0	.300	Amplifier	200	135	14.0	61	2.2	2,600	7,100	6,000			
25CD6G	Beam Power Amplifier	ST-16	5BT	Cath.	25.0	0.6	Horiz. Deflection Amplifier	Characteristics Same as Type 6CD6G										
25D8GT	Diode Triode Pentode	8AF	Cath.	25.0	0.15	Det. Amplifier	100 100 100	1.0 3.0	.5 8.5 2.7 100	100 1,900	(Triode) (Pentode)	12AV6 and 12BD6		
25N6G	Duo Triode	ST-12	7W	Cath.	25.0	0.30	Pwr. Amplifier	110 180	110* 100*	0 0	45 46	7.0* 5.8*	2,000 4,000	2,000 3,800			
25W6GT	Beam Amplifier	T-9	7S	Cath.	25.0	0.30	Amplifier	Characteristics Same as Type 6W6GT										
25Y5	Duo Diode	ST-12	6E	Cath.	25.0	0.30	Rect. Doubler	117 V. RMS Per Plate, 75 Ma. D C Output, Per Plate 235 V. RMS Plate, 75 Ma. D C Output Per Plate									25Z5	
26	Triode	ST-14	4D	Fil.	1.5	1.05	Amplifier	90 180	7.0 14.5	2.9 6.2	8,900 7,300	8.3 8.3			
26A6	Pentode	T-5½	7BK	Cath.	26.5	0.07	R F Amplifier	26.5 250	26.5 250	1.7 10.5	0.7 4.0	250,000 1,000,000			
26A7	Duo Pentode	T-9	8BU	Cath.	26.5	0.6	Pwr. Amplifier	26.5	26.5	4.5	20	2.0	1,500	5,500‡	200			
26C6	Duodi, Triode	T-5½	7BT	Cath.	26.5	0.07	Det. Amplifier	Same Characteristics as Type 7E6										

① Load Resistance for Power Output Tubes
 ② Transconductance for Tetrodes, Pentodes, Etc.
 ▼ Conversion Transconductance
 * Input Triode

♠ Approximate
 † Plate to Plate
 ■ Through 20,000 Ohms

‡ Per Tube or Section—No Signal
 § Plate and Target Supply
 ▲ Self Bias Cathode Resistor—Ohms

CONDENSED DATA SECTION—Cont.

TYPE	CLASS	CONSTRUCTION		EMITTER			USE	PLATE VOLTS	SCREEN VOLTS	NEG. GRID VOLTS	PLATE CUR-RENT MA.	SCREEN CUR-RENT MA.	PLATE ① RESISTANCE OHMS	AMP. ② FACTOR OR G _m μMHOS	POWER OUTPUT MW.	SUGGESTED REPLACEMENT TYPE	
		STYLE	BASE DIAG.	TYPE	VOLTS	AMP.											
26D6	Heptode	T-5½	7CH	Cath.	26.5	0.07	Converter	26.5	26.5	0.5	0.45	1.6	270		
								100	100	1.5	2.8	8.0	500,000	455		
								250	100	1.5	3.0	7.8	1,000,000	475		
27, 27S	Triode	ST-12	5A	Cath.	2.5	1.75	Amplifier	90	6.0	3.0	10,000	9.0		
					2.5	1.75		135	9.0	4.7	9,000	9.0		
					2.5	1.75		180	13.5	5.0	9,000	9.0		
					2.5	1.75		250	21.0	5.2	9,250	9.0		
					2.5	1.75			
28Z5	Double Diode	Lock-In	6BJ	Cath.	28.0	0.24	F.W. Rectifier	325	A C Volts Per Plate, RMS, 100 Ma. Output Current, Condenser Input to Filter								
					28.0	0.24		450	A C Volts Per Plate, RMS, 100 Ma. Output Current, 6h Choke Input to Filter								
30	Triode	ST-12	4D	Fil.	2.0	0.06	Amplifier	90	4.5	2.5	11,000	9.3		
					2.0	0.06		135	9.0	3.0	10,300	9.3		
					2.0	0.06		180	13.5	3.1	10,300	9.3		
31	Triode	ST-12	4D	Fil.	2.0	0.13	Pwr. Amplifier	135	22.5	8.0	7,000	3.8	185		
					2.0	0.13		180	30.0	12.3	5,700	3.8	375		
32	Tetrode	ST-14	4K	Fil.	2.0	0.06	R F Amplifier	135	67.5	3.0	1.7	0.4	950,000	640		
					2.0	0.06		180	67.5	3.0	1.7	0.4	1.2 Meg.	650		
					2.0	0.06		180	67.5	6.0		
32L7GT	Diode Beam Amplifier	GT	8Z	Cath.	32.5	0.30	Rectifier	125 RMS Volts Per Plate, 60 Ma. Output Current. Condenser Input to Filter									
					0.30	Pwr. Amplifier	110	110	7.5	40.0	3.0	2,600	6,000	1,000		
33	Pentode	ST-14	5K	Fil.	2.0	0.26	Pwr. Amplifier	135	135	13.5	14.5	3.0	7,000	1,450	700		
					2.0	0.26		180	180	18.0	22.0	5.0	6,000	1,700	1,400		
34	Pentode	ST-14	4M	Fil.	2.0	0.06	R F Amplifier	67.5	67.5	3.0	2.7	1.1	400,000	560		
					2.0	0.06		135	67.5	3.0	2.8	1.0	600,000	600		
					2.0	0.06		180	67.5	3.0	2.8	1.0	1 Meg.	620		
35/51, 35S/51S	Tetrode	ST-14	5E	Cath.	2.5	1.75	R F Amplifier	180	90	3.0	6.3	2.5	300,000	1,020		
					2.5	1.75		250	90	3.0	6.5	2.5	400,000	1,050		

① Load Resistance for Power Output Tubes
 ② Transconductance for Tetrodes, Pentodes, Etc.
 ▼ Conversion Transconductance

♦ Approximate
 † Plate to Plate
 ■ Through 20,000 Ohms

‡ Per Tube or Section—No Signal
 § Plate and Target Supply
 ▲ Self Bias Cathode Resistor—Ohms

CONDENSED DATA SECTION—Cont.

TYPE	CLASS	CONSTRUCTION		EMITTER			USE	PLATE VOLTS	SCREEN VOLTS	NEG. GRID VOLTS	PLATE CUR-RENT MA.	SCREEN CUR-RENT MA.	PLATE ① RESISTANCE OHMS	AMP. ② FACTOR OR G _m μMHOS	POWER OUTPUT MW.	SUGGESTED REPLACEMENT TYPE		
		STYLE	BASE DIAG.	TYPE	VOLTS	AMP.												
35Z6G	Duo Diode	ST-14	7Q	Cath.	35.0	0.30	Doub. Rectifier	117 V. RMS Plate, 110 Ma. D C Output										
36, 36A	Tetrode	ST-12	5E	Cath.	6.3	0.30	R F Amplifier	100	55	1.5	1.8	Not over 1/3 Plate Cur.	550,000	850	Adjust Bias for .1 Ma. Plate Current Without Signal			
					6.3	0.30		135	67.5	1.5	2.8		475,000	1,000				
					6.3	0.30		180	90	3.0	3.1		500,000	1,050				
					6.3	0.30		250	90	3.0	3.2		550,000	1,080				
					6.3	0.30		250	20 to 25	6.0♠								
37, 37A	Triode	ST-12	5A	Cath.	6.3	0.30	Amplifier	90	6.0	2.5	11,500	9.2				
					6.3	0.30		135	9.0	4.1		10,000	9.2				
					6.3	0.30		180	13.5	4.3		10,200	9.2				
					6.3	0.30		250	18.0	7.5		8,400	9.2				
					6.3	0.30					
38, 38A	Pentode	ST-12	5F	Cath.	6.3	0.30	Pwr. Amplifier	100	100	9.0	7.0	1.2	15,000	875	270			
					6.3	0.30		135	135	13.5	9.0	1.5	13,500	925	550			
					6.3	0.30		180	180	18.0	14.0	2.4	11,600	1,050	1,000			
					6.3	0.30		250	250	25.0	22.0	3.8	10,000	1,200	2,500			
					6.3	0.30				
39, 39/44, 39A	Pentode	ST-12	5F	Cath.	6.3	0.30	R F Amplifier	90	90	3.0	5.6	1.6	375,000	960				
					6.3	0.30		180	90	3.0	5.8	1.4	750,000	1,000				
					6.3	0.30		250	90	3.0	5.8	1.4	1 Meg.	1,050				
					6.3	0.30					
40	Triode	ST-14	4D	Fil.	5.0	0.25	Amplifier	135	1.5	0.2	150,000	30			
40A1	Ballast	T-9	8ES	Regulator	Avg. Operating Current—74 Ma. at 20 Volts; 150 Ma. at 40 Volts; 155 Ma. at 60 Volts										
40B2	Ballast	T-9	8ES	Regulator	Avg. Operating Current—140 Ma. at 20 Volts; 150 Ma. at 40 Volts; 155 Ma. at 60 Volts										
40Z5/45Z5GT	Diode	GT	6AD	Cath.	45	0.15	H.W. Rectifier	Characteristics Same as Type 35Y4										
41	Pentode	ST-12	6B	Cath.	6.3	0.40	Pwr. Amplifier	Characteristics Same as Type 6K6GT and 7B5										
42	Pentode	ST-14	6B	Cath.	6.3	0.65	Pwr. Amplifier	Characteristics Same as Type 6F6G										
43	Pentode	ST-14	6B	Cath.	25.0	0.30	Pwr. Amplifier	Characteristics Same as Type 25A6GT										
44	Pentode	5F	Cath.	6.3	0.30	Amplifier	See Type 39 or 39/44									39/44	

① Load Resistance for Power Output Tubes
 ② Transconductance for Tetrodes, Pentodes, Etc.
 ♣ Conversion Transconductance

♠ Approximate
 † Plate to Plate
 ‡ Through 20,000 Ohms

‡ Per Tube or Section—No Signal
 § Plate and Target Supply
 ▲ Self Bias Cathode Resistor—Ohms

CONDENSED DATA SECTION—Cont.

TYPE	CLASS	CONSTRUCTION		EMITTER			USE	PLATE VOLTS	SCREEN VOLTS	NEG. GRID VOLTS	PLATE CUR-RENT MA.	SCREEN CUR-RENT MA.	PLATE ① RESISTANCE OHMS	AMP. ② FACTOR OR G _m μMHOS	POWER OUTPUT MW.	SUGGESTED REPLACEMENT TYPE
		STYLE	BASE DIAG.	TYPE	VOLTS	AMP.										
45	Triode	ST-14	4D	Fil.	2.5	1.5	Pwr. Amplifier	180	31.5	31.0	2,700	3.5	830	
					2.5	1.5		250	50.0	34.0	3,900	3.5	1,600	
					2.5	1.5		275	56.0	36.0	4,600	3.5	2,000	
45A	Triode	4D	Fil.	2.5	1.50	Pwr. Amplifier	325	68	43	3,200	3.5	3,000	45
45Z3	Diode	T-5½	5AM	Cath.	45.0	0.075	H.W. Rectifier	117 A C Volts Per Plate RMS, 65 Ma. Output Current, Min. Supply Impedance = 15 Ohms								
46	Dual Grid Triode	ST-16	5C	Fil.	2.5	1.75	Pwr. Amplifier	250	Tie Gs to P	33.0	22.0	6,400	5.6	1,250	
					2.5	1.75	(Class B)	300	Tie Gs to G	0	150 Peak Per Tube	5,200▲	2 Tubes	16,000	
					2.5	1.75	(Class B)	400	Tie Gs to G	0	200 Peak Per Tube	5,800▲	2 Tubes	20,000	
47	Pentode	ST-16	5B	Fil.	2.5	1.75	Pwr. Amplifier	250	250	16.5	31.0	6.0	7,000	2,500	2,700	2A5
48	Tetrode	ST-16	6A	Cath.	30.	0.40	Pwr. Amplifier	95	95	20.0	52	12.0	1,500	3,900	2,000	
								125	100	22.5	52	12.0	1,500	3,900	3,000	
49	Dual Grid Triode	ST-14	5C	Fil.	2.0	0.12	Class A Amp. Class B Amp.	135	Gs to P	20	6.0	11,000	4.7	170	
					180	Gs to G	0	4.0	2 Tubes	12,000▲	
50	Triode	ST-16	4D	Fil.	7.5	1.25	Pwr. Amplifier	300	54.0	35.0	4,600	3.8	1,600	
					7.5	1.25		350	63.0	45.0	4,100	3.8	2,400	
					7.5	1.25		400	70.0	55.0	3,670	3.8	3,400	
					7.5	1.25		450	84.0	55.0	4,350	3.8	4,600	
50A1	Ballast	T-6½	9CM	Fil. Ballast	Avg. Operating Current—52 Ma. at 30 Volts; 54 Ma. at 50 Volts; 56 Ma. at 65 Volts								
50A X6G	Duo Diode	ST-14	7Q	Cath.	50.0	0.30	F.W. Rectifier	Characteristics Same as Type 6A X6G.								
50C6G	Beam Amplifier	ST-14	7S	Cath.	50.0	0.15	Pwr. Amplifier	135	135	13.5	58.0	3.5	9,300	7,000	3,600	
								200	135	14.0	61.0	2.2	18,300	7,100	6,000	
50Y6GT	Duo Diode	GT	7Q	Cath.	50.0	0.15	F.W. Rectifier	Characteristics Same as Type 6Y6G								
50Z7G	Duo Diode	ST-12	8AN	Cath.	50	0.15	F.W. Rectifier	117 V. RMS Per Plate, 65 Ma. D C Output								

① Load Resistance for Power Output Tubes
 ② Transconductance for Tetrodes, Pentodes, Etc.
 ▼ Conversion Transconductance

♦ Approximate
 ▲ Plate to Plate
 ■ Through 20,000 Ohms

‡ Per Tube or Section—No Signal
 § Plate and Target Supply
 ▲ Self Bias Cathode Resistor—Ohms

CONDENSED DATA SECTION—Cont.

TYPE	CLASS	CONSTRUCTION		EMITTER			USE	PLATE VOLTS	SCREEN VOLTS	NEG. GRID VOLTS	PLATE CUR-RENT MA.	SCREEN CUR-RENT MA.	PLATE ① RESISTANCE OHMS	AMP. ② FACTOR OR G _m μMHOS	POWER OUTPUT M.W.	SUGGESTED REPLACEMENT TYPE		
		STYLE	BASE DIAG.	TYPE	VOLTS	AMP.												
51, 51S	Tetrode	ST-14	5E	Cath.	2.5	1.75	Amplifier	See Type 35, 35/51									35	
52	Dual Grid Triode	ST-14	5C	Fil.	6.3	0.30	Class A Amp. Class B Amp.	110 180 2 Tube	0	43 3.0	2,000 10,000	5.2	1,500 5,000	6A4/LA		
53	Duo Triode	ST-14	7B	Cath.	2.5	2.0	Pwr. Amplifier	Characteristics Same as Type 6N7GT										
55	Duodi Triode	ST-12	6G	Cath.	2.5	1.0	Det. Amplifier	Characteristics Same as Type 6V7G										
55S	Duodi Triode	ST-12	6G	Cath.	2.5	1.00	Det. Amplifier	250	20	8.0	7,500	8.3	350	55		
56, 56S	Triode	ST-12	5A	Cath.	2.5	1.0	Amplifier Detector	250 250	13.5 20.0‡	5.0	9,500	13.8			
56AS	Triode	ST-12	5A	Cath.	6.3	0.40	Amplifier	250	13.5	5.0	9,500	13.8	76		
57, 57S	Pentode	ST-12	6F	Cath.	2.5	1.0	Amplifier	100	100	3.0	2.0	0.5	1 Meg.	1,185			
					2.5	1.0	Detector	250	100	3.0	2.0	0.5	1 Meg.	1,225			
					2.5	1.0	Detector	250†	100	4.3‡	Adjust Bias for 0.1 Ma. Plate Current Without Signal							
57AS	Pentode	ST-12	6F	Cath.	6.3	0.40	Amplifier	250	100	3.0	2.0	0.5	1 Meg.	1,225	6C6		
58, 58S	Pentode	ST-12	6F	Cath.	2.5	1.0	Amplifier	100	100	3.0	8.0	2.2	250,000	1,500			
					2.5	1.0	Amplifier	250	100	3.0	8.2	2.0	800,000	1,600			
58AS	Pentode	ST-12	6F	Cath.	6.3	0.40	Amplifier	250	100	3.0	8.2	2.0	800,000	1,600	6D6,78		
59	Pentode	ST-16	7A	Cath.	2.5	2.0	Pwr. Amplifier Triode	250 250	250 Tie Gs to P	18.0 28.0	35.0 26.0	9.0	6,000 5,000	2,500 2,600	3,000 1,250			
					2.5	Triode— Class B	300	Tie Gs to G	0	10.0‡	4,600‡	15,000 (2 tubes)			
					2.5	Triode— Class B	400	Tie Gs to G and Su to P	0	13.0‡	6,000‡	20,000 (2 tubes)			
64, 64A	Tetrode	5E	Cath.	6.3	0.40	Amplifier	180	90	3.0	3.1	1.5	500,000	1,050	36		
65, 65A	Tetrode	5E	Cath.	6.3	0.40	Amplifier	180	90	3.0	4.5	1.3	750,000	1,000	39/44		
67, 67A	Triode	5A	Cath.	6.3	0.40	Det. Amplifier	180	13.5	4.3	10,200	9.2	37		

① Load Resistance for Power Output Tubes
 ② Transconductance for Tetrodes, Pentodes, Etc.
 † Conversion Transconductance
 ‡ Applied Through 250,000 Ohms

‡ Approximate
 † Plate to Plate
 ‡ Through 20,000 Ohms

‡ Per Tube or Section—No Signal
 † Plate and Target Supply
 ‡ Self Bias Cathode Resistor—Ohms

CONDENSED DATA SECTION—Cont.

TYPE	CLASS	CONSTRUCTION		EMITTER			USE	PLATE VOLTS	SCREEN VOLTS	NEG. GRID VOLTS	PLATE CUR-RENT MA.	SCREEN CUR-RENT MA.	PLATE ① RESISTANCE OHMS	AMP. ② FACTOR OR G _m μMHOS	POWER OUTPUT MW.	SUGGESTED REPLACEMENT TYPE
		STYLE	BASE DIAG.	TYPE	VOLTS	AMP.										
68, 68A	Pentode	5E	Cath.	6.3	0.40	Pwr. Amplifier	135	90	13.5	14	3.0	7,500	1,400	650	38
70A7GT	Diode Beam Amplifier	T-9	8AB	Cath.	70.0	0.15	H.W. Rectifier Pwr. Amplifier	125 V. 110	RMS Plate, 60 Ma. Output 110	7.5	40	3.0	2,500	5,800	1,500	70L7GT
70L7GT	Diode Beam Pentode	GT	8AA	Cath.	70.0	0.15	H.W. Rectifier Amplifier	117 A C Volts RMS, 110	70 Ma. Output Current. 110	7.5	40	3.0	15,000	7,500	1,800	
71	Triode	ST-14	4D	Fil.	5.0	0.50	Pwr. Amplifier	180	40.5	20	4,800	3	790	71A
71A	Triode	ST-14	4D	Fil.	5.0	0.25	Pwr. Amplifier	90	16.5	10.0	3,000	3	125	
					5.0	0.25		135	27.0	17.3	3,000	3	400	
					5.0	0.25		180	40.5	20.0	4,800	3	790	
71B	Triode	ST-14	4D	Cath.	5.0	0.125	Pwr. Amplifier	180	40.5	20	4,800	3	790	71A
75, 75S	Duodi Triode	ST-12	6G	Cath.	6.3	0.30	Det. Amplifier	250	2.0	0.9	91,000	100	
76	Triode	ST-12	5A	Cath.	6.3	0.30	Amplifier	100	5.0	2.5	12,000	13.8	
					6.3	0.30		250	13.5	5.0	9,500		
					6.3	0.30		250	20.0	Adjust Bias for 0.2 Ma. Plate Current Without Signal			
77	Pentode	ST-12	6F	Cath.	6.3	0.30	Amplifier	100	60	1.5	1.7	0.4	600,000	1,100	
					6.3	0.30		250	100	3.0	2.3	0.5	>1.0 Meg.	1,250	
78	Pentode	ST-12	6F	Cath.	6.3	0.30	Amplifier	90	90	3.0	5.4	1.3	300,000	1,275	
					6.3	0.30		180	75	3.0	4.0	1.0	1 Meg.	1,100		
					6.3	0.30		250	100	3.0	7.0	1.7	800,000	1,450		
					6.3	0.30		250	125	3.0	10.5	2.6	600,000	1,650		
					6.3	0.30		250	125	3.0	10.5	2.6	600,000	1,650		
79	Duo Triode	ST-12	6H	Cath.	6.3	0.60	Pwr. Amplifier	250	Class B	0	21.0	Both Triodes	14,000	8,000	6N7
80M	Duo Di. M.V.	4C	Fil.	5.0	2.00	F.W. Rectifier	450 V. RMS Per Plate, 125 Ma. D C Output								80
81, 81M	Diode	ST-16	4B	Fil.	7.5	1.25	H.W. Rectifier	700 A C Volts Per Plate, RMS, 85 Ma. Output Current. Condenser Input to Filter								
82	Mercury Vapor Duo Diode	ST-14	4C	Fil.	2.5	3.0	F.W. Rectifier	550 A C Volts Per Plate RMS, 115 Ma. Output Current, Choke Input—6 Henrys Min. 450 A C Volts Per Plate RMS, 115 Ma. Output Current, Capacitor Input to Filter								

① Load Resistance for Power Output Tubes

② Transconductance for Tetrodes, Pentodes, Etc.

▼ Conversion Transconductance

♠ Approximate

♣ Plate to Plate

■ Through 20,000 Ohms

‡ Per Tube or Section—No Signal

§ Plate and Target Supply

▲ Self Bias Cathode Resistor—Ohms

CONDENSED DATA SECTION—Cont.

TYPE	CLASS	CONSTRUCTION		EMITTER			USE	PLATE VOLTS	SCREEN VOLTS	NEG. GRID VOLTS	PLATE CUR-RENT MA.	SCREEN CUR-RENT MA.	PLATE ① RESISTANCE OHMS	AMP. ② FACTOR OR G _m μMHOS	POWER OUTPUT MW.	SUGGESTED REPLACEMENT TYPE	
		STYLE	BASE DIAG.	TYPE	VOLTS	AMP.											
82V		ST-16	4C	Fil.	5.0	3.00	F.W. Rectifier	550 A C Volts Per Plate RMS, 225 Ma. Output Current, Choke Input—3 Henrys Min. 450 A C Volts Per Plate RMS, 225 Ma. Output Current, Capacitor Input to Filter									82
83V	Mercury Vapor Duo Diode	ST-14	4AD	Cath.	5.0	2.00	F.W. Rectifier	500 A C Volts Per Plate RMS, 175 Ma. Output Current, Choke Input—4 Henrys Min. 375 A C Volts Per Plate RMS, 175 Ma. Output Current, Capacitor Input to Filter									5V4G
84/6Z4	Duo Diode	ST-12	5D	Cath.	6.3 6.3	0.50 0.50	F.W. Rectifier	325 A C Volts Per Plate RMS, 60 Ma. Output Current. Condenser Input to Filter 450 A C Volts Per Plate RMS, 60 Ma. Output Current. 10h Choke Input to Filter									
85	Duodi Triode	ST-12	6G	Cath.	6.3	0.30	Det. Amplifier	Characteristics Same as Type 6V7G									6V7G
85AS	Duodi Triode	ST-12	6G	Cath.	6.3	0.30	Det. Amplifier	250	9.0	4.5			16,000	20		85	
88	Duo Diode		4C	Fil.	5.0	2.00	F.W. Rectifier	450 V. RMS Per Plate, 125 Ma. D C Output									83V
89	Pentode	ST-12	6F	Cath.	6.3	0.40	Pwr. Amplifier	180	180	18.0	20.0	3.0	8,000	1,550	1,500		
					6.3	0.40	Triode	160	Gs+Su to P	20.0	17.0	7,000	4.7	300			
					6.3	0.40	Triode Class B	180	Tie Su to P	0	3.0		9,400‡	Tie Gs to G	3,500 (2 tubes)		
89 Y								Same as Type 89. Has low-loss base									
95	Pentode		6B	Cath.	2.5	1.75	Pwr. Amplifier	315	315	22.0	42	8.0	7,000	2,300	5,000	2A5	
96	Diode		4G	Cath.	10.0	0.50	H.W. Rectifier	350 V. RMS Plate, 100 Ma. D C Output									1V
98																	84
X99	Triode	T-9	4D	Fil.	3.3	.063	Det. Amplifier	Same as V99									
117L7GT	Beam Power Diode	T-9	8AO	Cath.	117	.090	Amplifier	105	105	5.2	43	4.0	4,000	5,300	850		
				Cath.	117		H.W. Rect.	117 V. RMS Plate, 75 Ma. D C Output, Cond. Input									
117L7/M7GT	Diode Beam Amplifier	GT	8AO	Cath.	117	0.09	H.W. Rectifier Pwr. Amplifier	117 A C Volts RMS, 75 Ma. Output Current, Capacitor Input to Filter	105	105	5.2	43	4.0	17,000‡	5,300	850	

① Load Resistance for Power Output Tubes
 ② Transconductance for Tetrodes, Pentodes, Etc.
 ▼ Conversion Transconductance

‡ Approximate
 † Plate to Plate
 ■ Through 20,000 Ohms

‡ Per Tube or Section—No Signal
 § Plate and Target Supply
 ▲ Self Bias Cathode Resistor—Ohms

CONDENSED DATA SECTION—Cont.

TYPE	CLASS	CONSTRUCTION		EMITTER			USE	PLATE VOLTS	SCREEN VOLTS	NEG. GRID VOLTS	PLATE CUR-RENT MA.	SCREEN CUR-RENT MA.	PLATE ① RESISTANCE OHMS	AMP. ② FACTOR OR Gm μMHOS	POWER OUTPUT M.W.	SUGGESTED REPLACEMENT TYPE	
		STYLE	BASE DIAG.	TYPE	VOLTS	AMP.											
117N7GT	Beam Power Diode	T-9	8AV	Cath.	117	.090	Amplifier Rectifier	100	100	6.0	51	5.0	3,000	7,000	1,200		
117P7GT	Diode Beam Amplifier	GT	8AV	Cath.	117.0	0.09	H.W. Rectifier Pwr. Amplifier	117 V. RMS Plate, 75 Ma. D C Output	105	105	5.2	43	4.0	4,000	5,300	850	
117Z4GT	Diode	GT	5AA	Cath.	117	0.04	H.W. Rectifier	117 V. RMS Plate, 90 Ma. D C Output									
182B/482B	Triode	ST-14	4D	Fil.	5.0	1.25	Pwr. Amplifier	250	35.0	20	4,500	5.0	1,350	71A or 45	
183/483	Triode	ST-14	4D	Fil.	5.0	1.25	Pwr. Amplifier	250	65.0	20	4,500	3.0	1,800	71A or 45	
210T	Triode	ST-16	4D	Fil.	7.5	1.25	Pwr. Amplifier	Standard Type 10 with Ceramic Base, See Type 10 Characteristics									
401	Triode	4D	Cath.	3.0	1.35	Det. Amplifier	90	3.0	5.0	9,500	9.5	27	
484	Triode	5A	Cath.	2.8	1.60	Det. Amplifier	180	9.0	6.0	9,300	12.5	485	
950	Pentode	5K	Fil.	2.0	0.125	Pwr. Amplifier	135	135	16.5	5.5	2.0	13,500	950	575	33	
951	Tetrode	4K	Fil.	2.0	0.60	Amplifier	180	67.5	3.0	1.7	0.4	1.2 Meg.	650	1B4P	
9001	Pentode	T-5½	7PM	Cath.	6.3	0.15	Det. Amplifier	90	90	3	1.2	0.5	1,000,000		
								250	100	3	2.0	0.7	1 Meg. Min.	1,400		
9002	Triode	Min.	7BS	Cath.	6.3	0.15	Amplifier	250	7.0	6.3	11,400	25		
9003	Pentode	Min.	7BD	Cath.	6.3	0.15	R.F. Amplifier	250	100	3.0	6.7	2.7	700,000	1,800		
9006	U H F Diode	T-5½	6BH	Cath.	6.3	0.15	Rectifier	270 V. RMS Plate, 5 Ma. D C Output									
XXB	Duo Triode	Lock-In	7BW	Fil.	1.4	0.10	Amplifier	90	0	4.5	11,200	14.5		
XXD	Duo Triode	Lock-In	8AC	Cath.	12.6	0.15	Amplifier	See Type 14AF7/XXD									
XXFM	Duodi Triode	Lock-In	8BZ	Cath.	6.3	0.30	Det. Amplifier	See Type 7X7.									
XXL	Triode	Lock-In	5AC	Cath.	6.3	0.30	Amplifier	100	0	10.0	7,000	25	7A4	
								250	8.0	8.0	8,700	20		

① Load Resistance for Power Output Tubes
 ② Transconductance for Tetrodes, Pentodes, Etc.
 ▼ Conversion Transconductance

♦ Approximate
 † Plate to Plate
 ■ Through 20,000 Ohms

‡ Per Tube or Section—No Signal
 § Plate and Target Supply
 ▲ Self Bias Cathode Resistor—Ohms

BASE DIAGRAMS FOR CONDENSED DATA CHART—Cont.

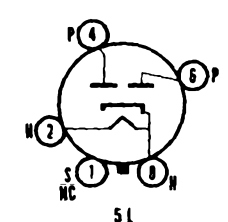
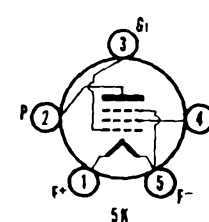
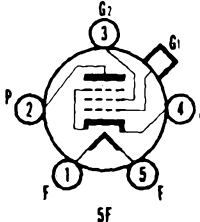
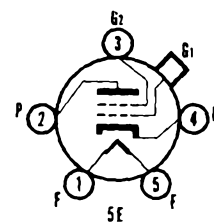
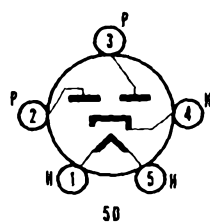
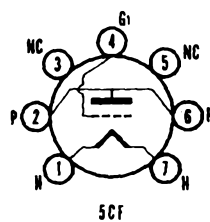
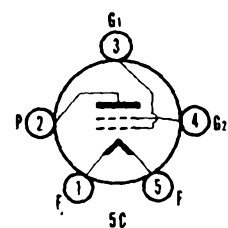
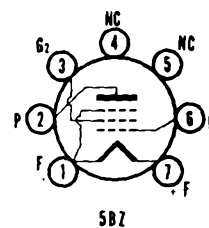
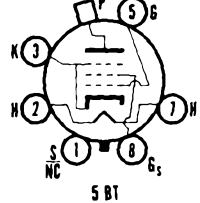
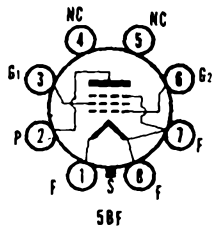
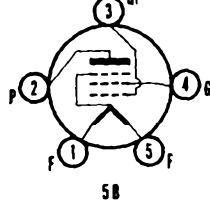
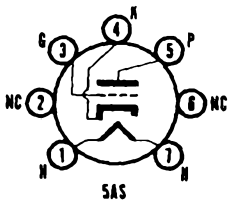
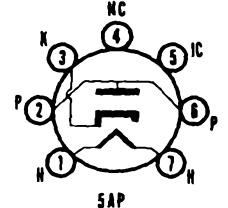
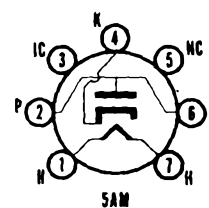
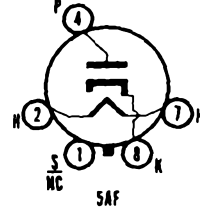
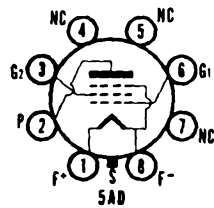
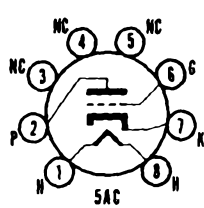
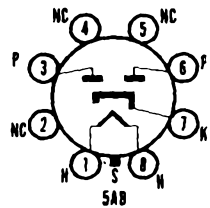

BASE DIAGRAMS FOR CONDENSED DATA CHART—Cont.

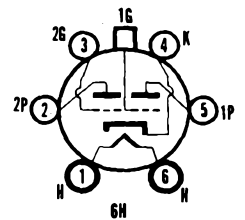
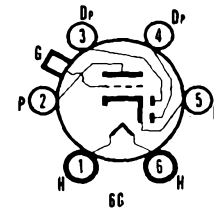
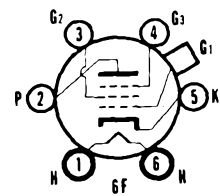
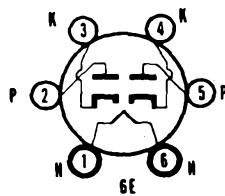
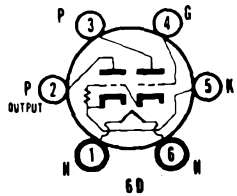
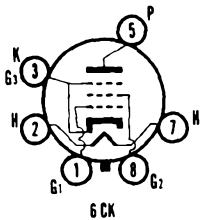
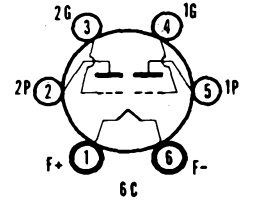
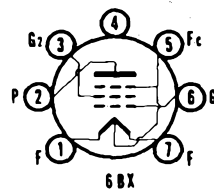
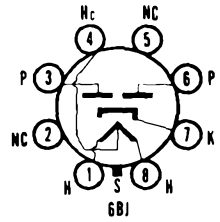
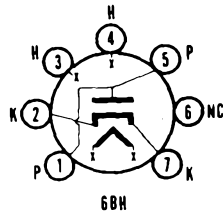
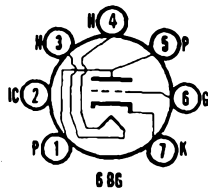
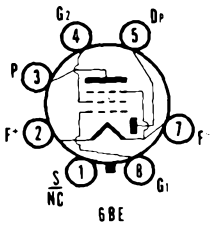
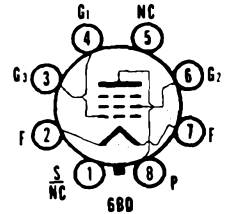
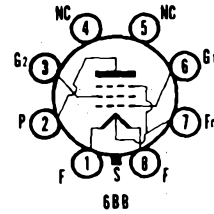
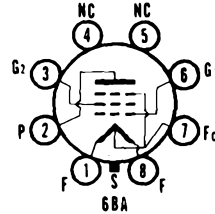
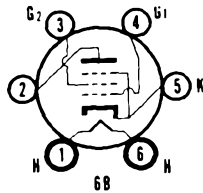
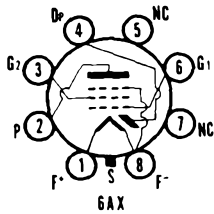
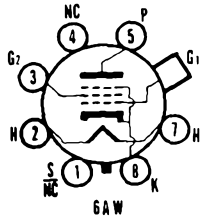

BASE DIAGRAMS FOR CONDENSED DATA CHART—Cont.

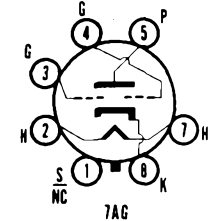
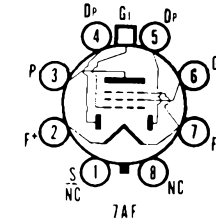
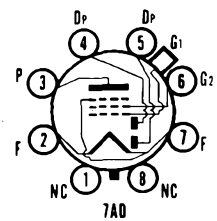
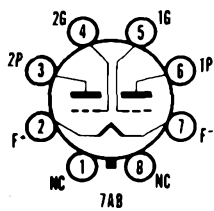
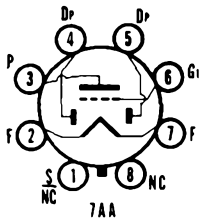
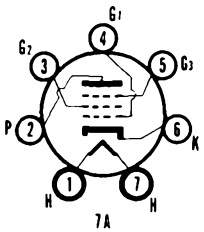
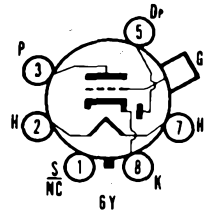
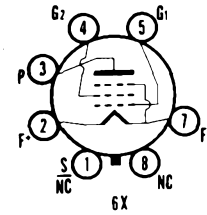
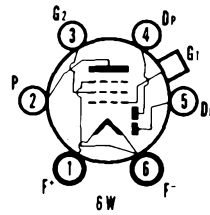
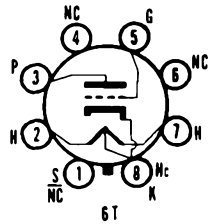
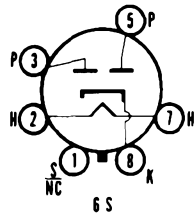
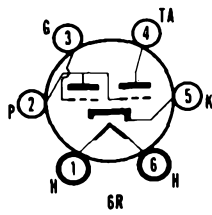
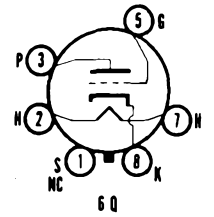
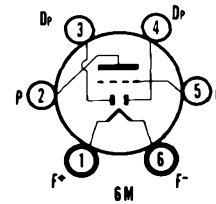
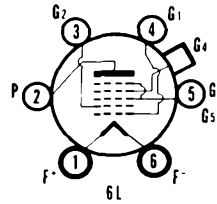
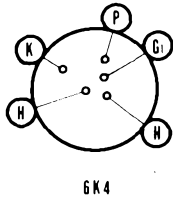
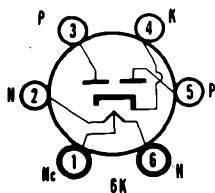
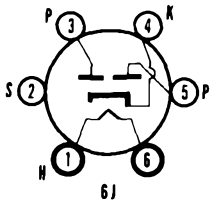

BASE DIAGRAMS FOR CONDENSED DATA CHART—Cont.

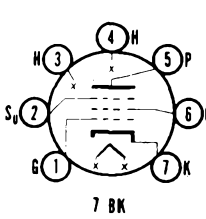
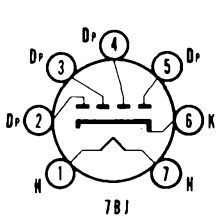
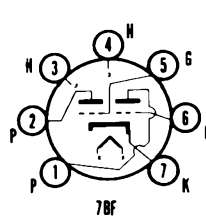
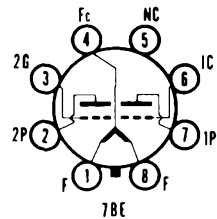
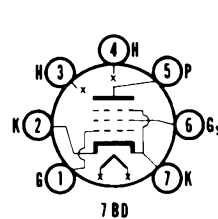
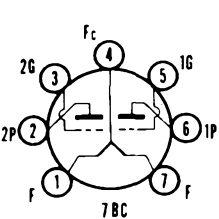
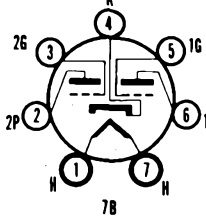
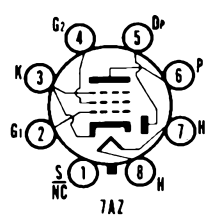
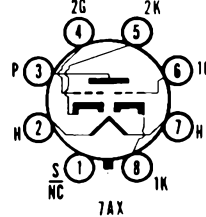
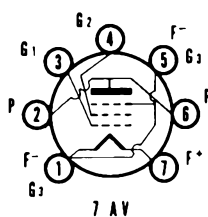
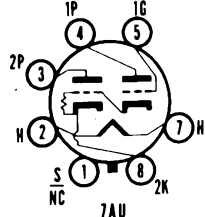
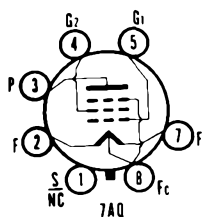
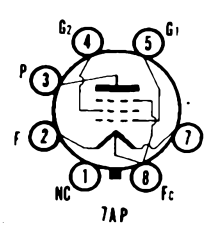
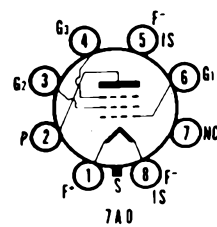
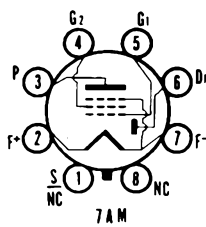
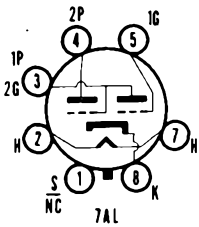
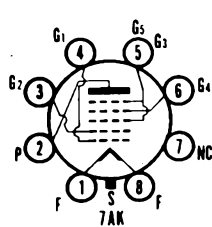
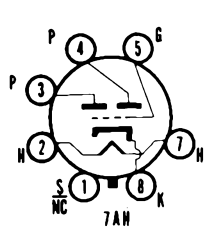

BASE DIAGRAMS FOR CONDENSED DATA CHART—Cont.

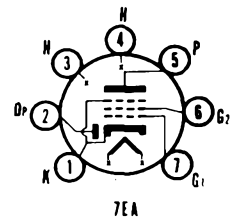
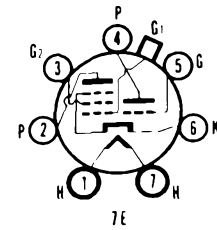
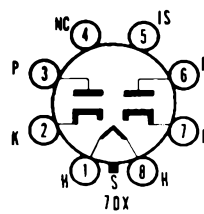
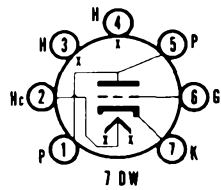
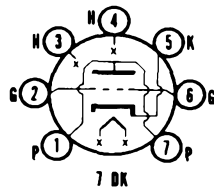
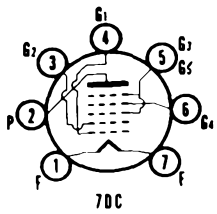
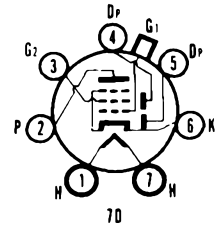
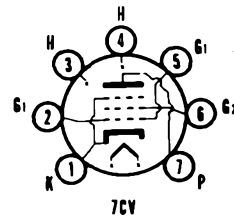
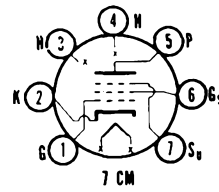
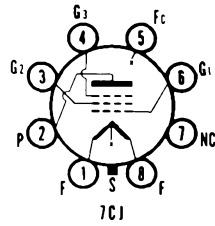
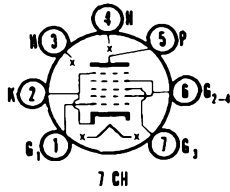
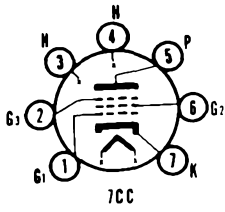
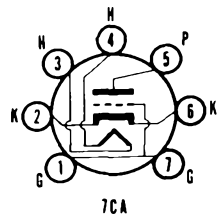
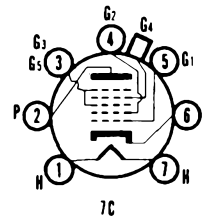
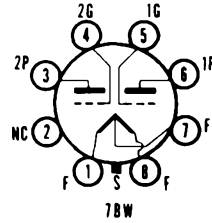
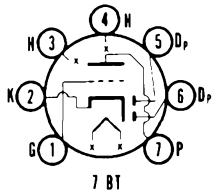
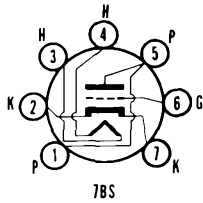
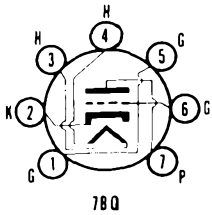

BASE DIAGRAMS FOR CONDENSED DATA CHART—Cont.

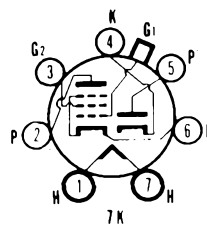
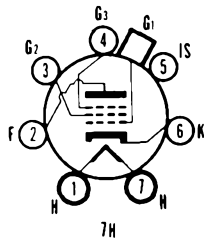
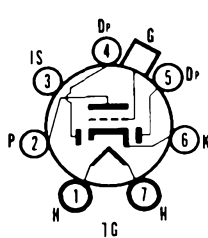
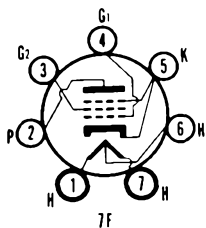

7L

- 1 H
- 2 P2
- 3 K2
- 4 Hc
- 5 K1
- 6 P1
- 7 H

7PM

- 1 G
- 2 K
- 3 H
- 4 H
- 5 P
- 6 Gs
- 7 K, Su, IS

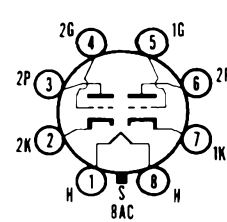
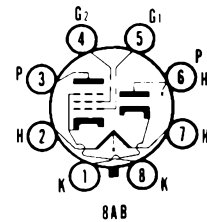
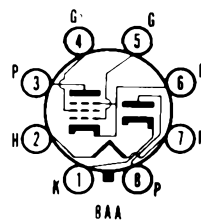
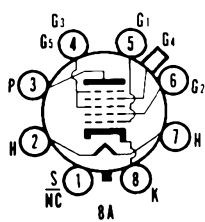
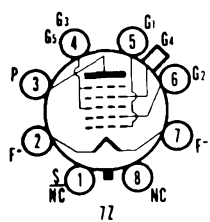
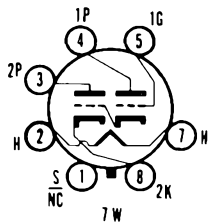
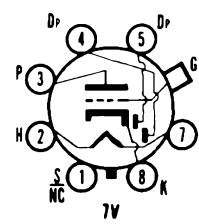
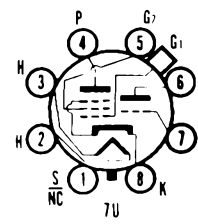
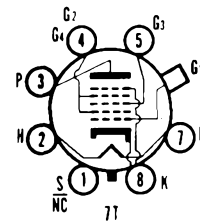
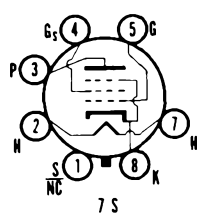
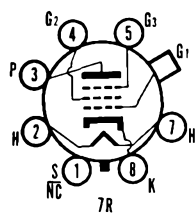
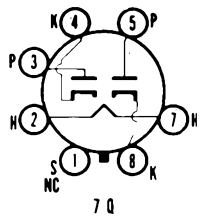

BASE DIAGRAMS FOR CONDENSED DATA CHART—Cont.

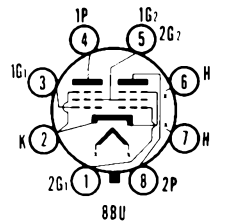
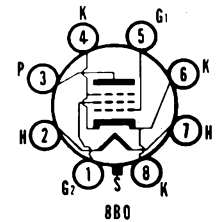
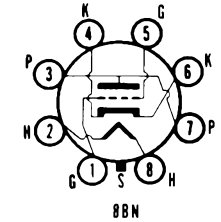
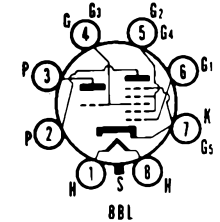
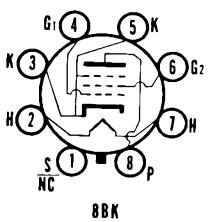
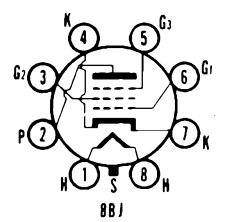
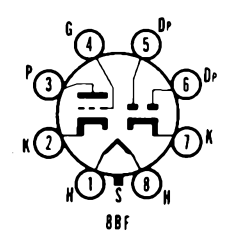
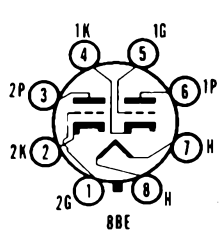
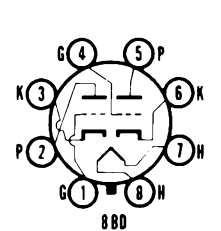
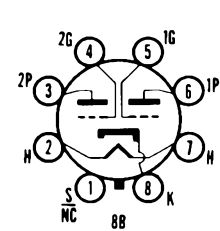
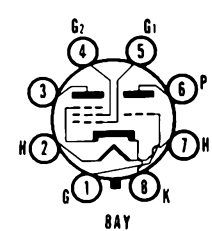
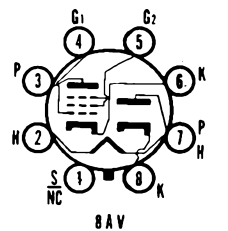
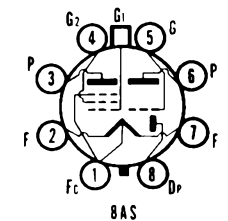
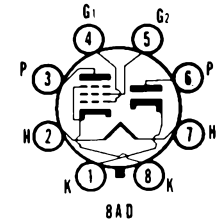
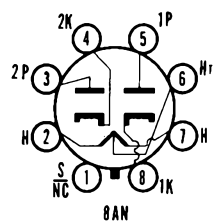
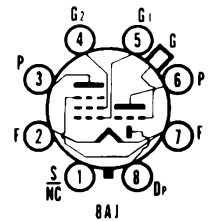
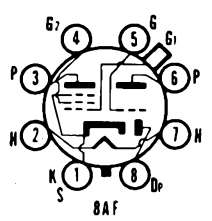
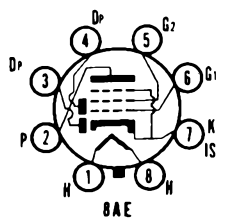

BASE DIAGRAMS FOR CONDENSED DATA CHART—Cont.

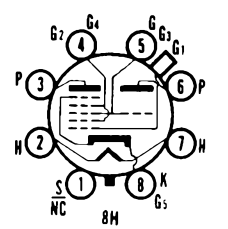
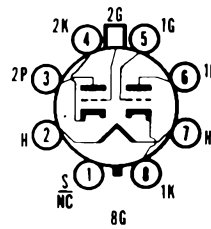
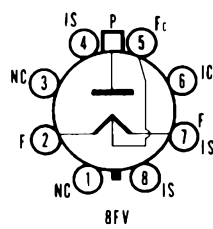
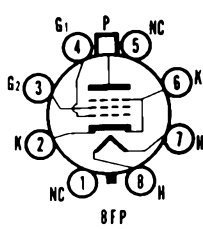
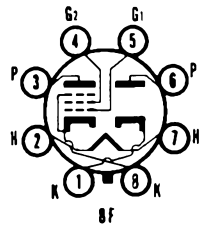
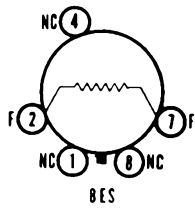
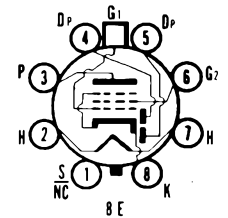
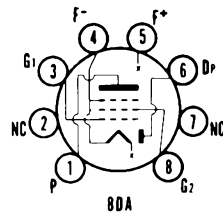
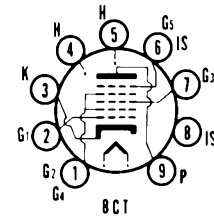
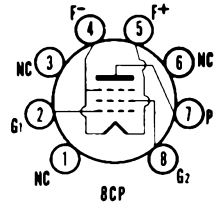
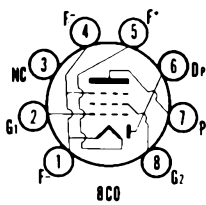
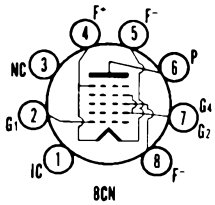
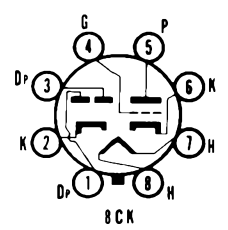
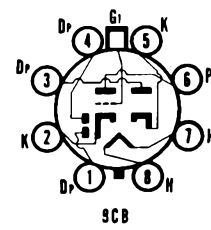
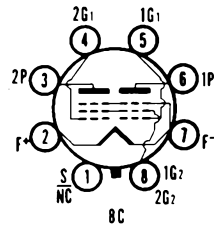
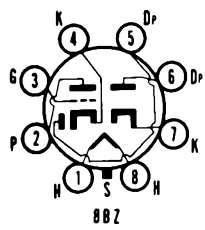
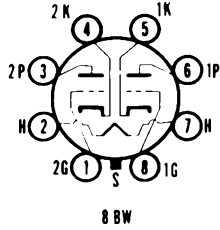
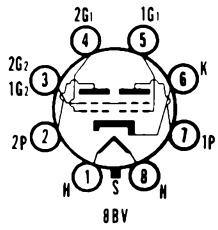

BASE DIAGRAMS FOR CONDENSED DATA CHART—Cont.

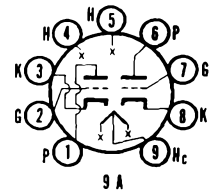
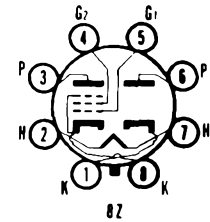
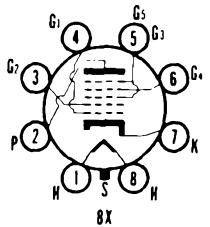
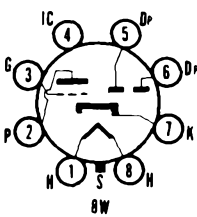
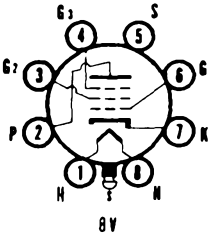
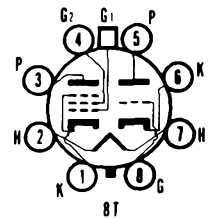
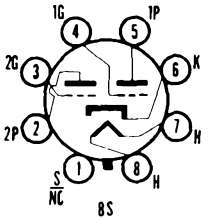
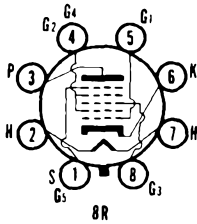
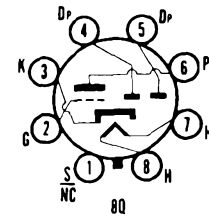
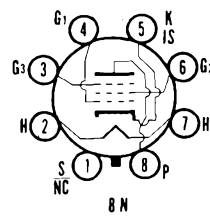
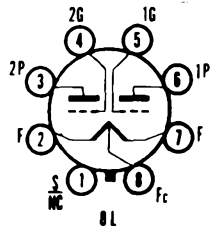
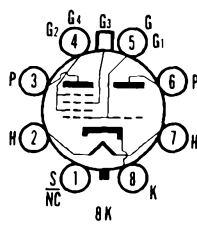

BASE DIAGRAMS FOR CONDENSED DATA CHART—Cont.

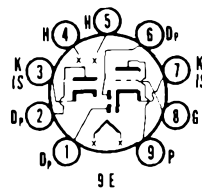
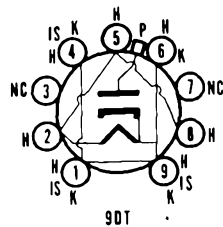
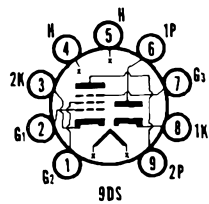
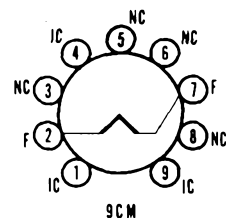
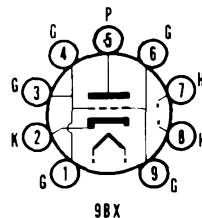
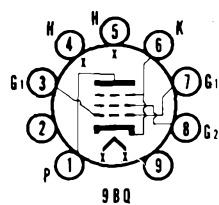
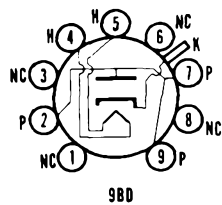
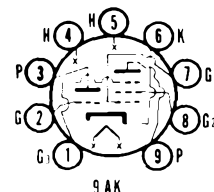
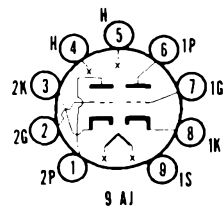
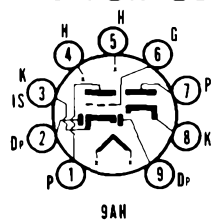
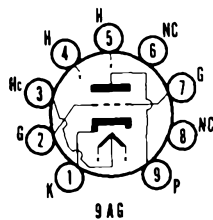

SYLVANIA TYPE 2AP1A 2AP-A*

OSCILLOSCOPE TUBE

2" Direct Viewed
Round Glass Type

Electrostatic Deflection
Electrostatic Focus

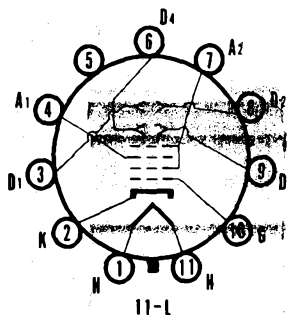
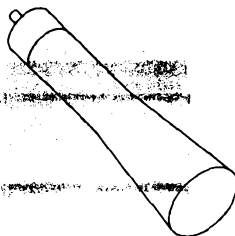

CHARACTERISTICS

GENERAL DATA

Focusing Method.....	Electrostatic
Deflecting Method.....	Electrostatic
Phosphor.....	P1
Fluorescence.....	Green
Persistence.....	Medium
Faceplate.....	Clear

*In addition to the Type shown, the 2AP-A can be supplied with several other screen phosphors.

ELECTRICAL DATA

Heater Voltage.....	6.3 Volts
Heater Current.....	0.6 Amperes
Direct Interelectrode Capacitances (approx.)	
Cathode to All Other Electrodes.....	5.5 μ f
Grid to All Other Electrodes.....	8.0 μ f
Between Deflecting Plates 1-2 ¹	0.6 μ f
Between Deflecting Plates 3-4 ¹	1.1 μ f
Deflecting Plate 1 ² to All Other Electrodes.....	8.5 μ f
Deflecting Plate 3 ² to All Other Electrodes.....	9.0 μ f
Deflecting Plate 1 to All Other Electrodes Except D2.....	8.0 μ f
Deflecting Plate 2 ² to All Other Electrodes Except D1.....	4.6 μ f
Deflecting Plate 3 to All Other Electrodes Except D4.....	7.5 μ f
Deflecting Plate 4 ² to All Other Electrodes Except D3.....	6.0 μ f

MECHANICAL DATA

Minimum Useful Screen Diameter.....	1 $\frac{3}{4}$ Inches
Nominal Overall Length.....	7 $\frac{7}{8}$ Inches
Base.....	Small Shell Magnal 11-Pin
Basing.....	11L

RATINGS

MAXIMUM RATINGS (Absolute Maximum Values)

Anode No. 2 Voltage.....	1100 Volts d c
Anode No. 1 Voltage.....	550 Volts d c
Grid Voltage	
Negative Value.....	125 Volts d c
Positive Value.....	0 Volts d c
Peak Heater-Cathode Voltage	
Heater Negative with Respect to Cathode.....	125 Volts
Heater Positive with Respect to Cathode.....	10 Volts
Peak Voltage Between Anode No. 2 and Any Deflection Plate.....	660 Volts

SYLVANIA TYPE 2AP1A, 2AP-A* (Cont'd)

TYPICAL OPERATING CONDITIONS

Anode No. 2 Voltage ¹	1000 Volts d c
Anode No. 1 Voltage for Focus.....	137 to 300 Volts d c
Grid Voltage Required for Cutoff ⁴	-30 to -90 Volts d c
Deflection Factor	
Deflecting Plates 1-2 ⁵	204 to 256 Volts d c/Inch
Deflecting Plates 3-4 ⁶	157 to 235 Volts d c/Inch

CIRCUIT VALUES

Grid Circuit Resistance.....	1.5 Megohms Max.
Deflection Circuit Resistance.....	5.0 Megohms Max.

NOTES:

1. Deflecting Plate 1 is Pin No. 3.
Deflecting Plate 2 is Pin No. 8.
Deflecting Plate 3 is Pin No. 9.
Deflecting Plate 4 is Pin No. 6.
2. With D1 Positive with Respect to D2, the spot is deflected toward Pin No. 4;
with D3 Positive with Respect to D4, the spot is deflected toward Pin No. 1.
3. Brilliance and definition decrease with decreasing Anode No. 2 Voltage. In general, Anode No. 2 Voltage should not be less than 500 volts.
4. Visual extinction of undeflected focused spot.
5. Deflecting Plates 1-2 are nearer the screen.
6. Deflecting Plates 3-4 are nearer the base.

2AP1

Sylvania Type 2AP1A replaces Type 2AP1.

SYLVANIA TYPE 3AP1A 3AP-A*

OSCILLOSCOPE TUBE

3" Direct Viewed
Round Glass Type

Electrostatic Deflection
Electrostatic Focus

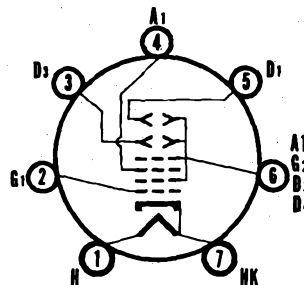
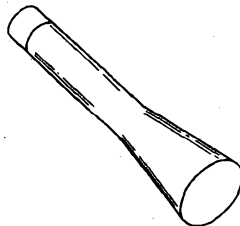

7-CE

CHARACTERISTICS

GENERAL DATA

Focusing Method.....	Electrostatic
Deflecting Method.....	Electrostatic
Phosphor.....	P1
Fluorescence.....	Green
Persistence.....	Medium
Faceplate.....	Clear

*In addition to the type shown, the 3AP-A can be supplied with several other screen phosphors.

ELECTRICAL DATA

Heater Voltage.....	2.5 Volts
Heater Current (approx.).....	2.1 Ampere
Direct Interelectrode Capacitances (approx.)	
Grid No. 1 to All Other Electrodes.....	9 μ f
Deflecting Plate 1 ¹ to All Other Electrodes.....	8.5 μ f
Deflecting Plate 3 ¹ to All Other Electrodes.....	6.5 μ f

MECHANICAL DATA

Minimum Useful Screen Diameter.....	2 $\frac{3}{4}$ Inches
Nominal Overall Length.....	11 $\frac{1}{2}$ Inches
Base.....	Medium 7-Pin
Basing.....	7CE

RATINGS

MAXIMUM RATINGS (Absolute Maximum Values)

Anode No. 2 Voltage.....	1650 Volts d c
Anode No. 1 Voltage.....	1100 Volts d c
Grid No. 1 Voltage	
Negative Bias Value.....	140 Volts d c
Positive Bias Value.....	0 Volts d c
Peak Voltage Between Anode No. 2 and Any Deflecting Plate.....	550 Volts

TYPICAL OPERATING CONDITIONS

Anode No. 2 Voltage ¹	1500 Volts d c
Anode No. 1 Voltage.....	240 to 560 Volts d c
Grid No. 1 Voltage Required for Cutoff ²	-25 to -75 Volts d c
Deflection Factor ⁴ ₃	
Deflecting Plates 1-2 ³	90 to 137 Volts d c/Inch
Deflecting Plates 3-4 ¹	88 to 130 Volts d c/Inch

CIRCUIT VALUES

Grid No. 1 Circuit Resistance.....	1.5 Megohms Max.
Deflection Circuit Resistance.....	5.0 Megohms Max.

SYLVANIA TYPE 3AP1A, 3AP-A* (Cont'd)

NOTES:

1. With D2 positive with respect to D1, the spot is deflected toward Pin No. 1.
2. With D4 positive with respect to D3, the spot is deflected toward Pin No. 5.
3. Brightness and definition decrease with decreasing Anode No. 2 Voltage.
4. Anode No. 2 Voltage should not be less than 1000 Volts.
5. Total extinction of undeflected focused spot.
6. Plane through the tube axis and Pin 8 makes an angle with the trace produced by Deflecting Plates 3-4 by an angular tolerance measured about the axis; of 10 degrees.
7. Angle between D1-D2 trace and D3-D4 trace is $90^\circ \pm 3^\circ$.
8. Deflecting Plates 1-2 are nearer the screen.
9. Deflecting Plates 3-4 are nearer the base.

3AP1

Sylvania Type 3AP1A replaces Type 3AP1.

SYLVANIA TYPE 3BP1A 3BP-A*

OSCILLOSCOPE TUBE

3" Direct Viewed
Round Glass Type

Electrostatic Deflection
Electrostatic Focus

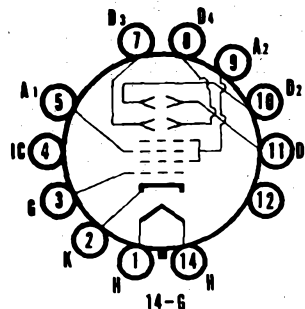
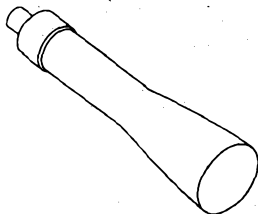

CHARACTERISTICS

GENERAL DATA

Focusing Method	Electrostatic
Deflection Method	Electrostatic
Phosphor	P1
Fluorescence	Green
Persistence	Medium
Faceplate	Clear

*In addition to the type shown, the 3BP-A can be supplied with several other screen phosphors.

ELECTRICAL DATA

Heater Voltage	6.3 Volts
Heater Current	0.6 Ampere
Direct Interelectrode Capacitances (approx.)	
Cathode to All Other Electrodes	8.0 μmf
Grid to All Other Electrodes	8.5 μmf
Between Deflecting Plates 1-2 ¹	2.0 μmf
Between Deflecting Plates 3-4 ¹	2.0 μmf
Deflecting Plate 1 ² to All Other Electrodes	8.0 μmf
Deflecting Plate 3 ² to All Other Electrodes	6.0 μmf
Deflecting Plate 1 to All Other Electrodes Except D2	6.0 μmf
Deflecting Plate 2 ² to All Other Electrodes Except D1	5.0 μmf
Deflecting Plate 3 to All Other Electrodes Except D4	4.0 μmf
Deflecting Plate 4 ² to All Other Electrodes Except D3	6.0 μmf

MECHANICAL DATA

Minimum Useful Screen Diameter	2 $\frac{3}{4}$ Inches
Nominal Overall Length	10 Inches
Base	Medium Shell Diheptal 12-Pin
Basing	14G

RATINGS

MAXIMUM RATINGS (Absolute Maximum Values)

Anode No. 2 Voltage	2200 Volts d c
Anode No. 1 Voltage	1100 Volts d c
Grid Voltage	
Negative Value	200 Volts d c
Positive Value	0 Volts d c
Peak Heater-Cathode Voltage	
Heater Negative with Respect to Cathode	125 Volts
Heater Positive with Respect to Cathode	10 Volts
Peak Voltage Between Anode No. 2 and Any Deflection Plate	550 Volts

SYLVANIA TYPE 3BP1A, 3BP1-A* (Cont'd)

TYPICAL OPERATING CONDITIONS

Anode No. 2 Voltage	2600 Volts d.c.
Anode No. 1 Voltage	400 to 690 Volts d.c.
Grid Voltage Required for Outline	-30 to -90 Volts d.c.
Deflection Factor	
Deflecting Plates 1-2	178 to 222 Volts d.c./Inch
Deflecting Plates 3-4	118 to 178 Volts d.c./Inch

CIRCUIT VALUES

Grid Circuit Resistance	1.5 Megohms Max.
Deflection Circuit Resistance	5.0 Megohms Max.

NOTES:

1. Deflecting Plate 1 is Pin No. 11.
Deflecting Plate 2 is Pin No. 10.
Deflecting Plate 3 is Pin No. 7.
Deflecting Plate 4 is Pin No. 8.
2. With D1 Positive with Respect to D2, the spot is deflected toward Pin No. 5.
With D3 Positive with Respect to D4, the spot is deflected toward Pin No. 2.
3. Brilliance and definition decrease with decreasing Anode No. 2 Voltage. In general, Anode No. 2 Voltage should not be less than 1500 volts.
4. Visual extinction of undeflected focused spot.
5. Deflecting Plates 1-2 are nearer the screen.
6. Deflecting Plates 3-4 are nearer the base.

3BP1

Sylvania Type 3BP1A replaces Type 3BP1.

SYLVANIA TYPE 3JP1 3JP*

TELEVISION PICTURE TUBE

Special Purpose Tube
3" Direct Viewed
Round Glass Type

Electrostatic Deflection
Electrostatic Focus
Post Deflection Accelerator

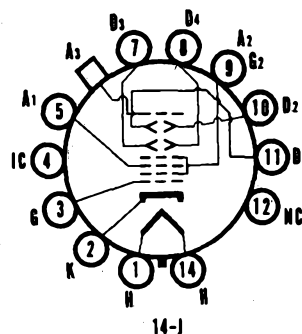
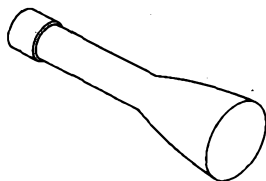

CHARACTERISTICS

GENERAL DATA

	3JP1	3JP2	3JP7	3JP12
Focusing Method			Electrostatic	Electrostatic
Deflecting Method			Electrostatic	Electrostatic
Types*	3JP1	3JP2	3JP7	3JP12
Fluorescence	Green	Green	Blue-White	Orange
Phosphorescence			Yellow	Medium-Long
Persistence	Medium	Long	Long	Clear
Faceplate				Clear

*In addition to the types shown, the 3JP can be supplied with several other screen phosphors.

ELECTRICAL DATA

Heater Voltage	6.3 Volts
Heater Current (approx.)	0.6 ± 10% Amperes
Direct Interelectrode Capacitances (approx.)	
Cathode to All Other Electrodes	8 μf
Grid No. 1 to All Other Electrodes	8 μf
Between Deflecting Plates 1-2 ¹	2.5 μf
Between Deflecting Plates 3-4 ¹	2 μf
Deflecting Plate 1 ¹ to All Other Electrodes	8 μf
Deflecting Plate 2 ¹ to All Other Electrodes	7 μf
Deflecting Plate 3 ¹ to All Other Electrodes	7 μf
Deflecting Plate 4 ¹ to All Other Electrodes	8 μf

MECHANICAL DATA

Minimum Useful Screen Diameter	2 1/4 Inches
Nominal Overall Length	10 Inches
Bulb Contact (Recessed Small Ball Cap)	J1-22
Base (Medium Shell Diheptal 12-Pin)	B12-37
Basing	14J

RATINGS

MAXIMUM RATINGS (Absolute Maximum Values)

Anode No. 3 Voltage	4400 Volts d c
Anode No. 2 Voltage	2200 Volts d c
Anode No. 1 Voltage	1100 Volts d c
Grid No. 1 Voltage	
Negative Bias Value	220 Volts d c
Positive Bias Value	0 Volts d c
Positive Peak Value	2 Volts
Peak Heater-Cathode Voltage	
Heater Negative with Respect to Cathode	140 Volts
Heater Positive with Respect to Cathode	140 Volts
Peak Voltage Between Anode No. 2 and Any Deflecting Plate	550 Volts

TYPICAL OPERATING CONDITIONS

Anode No. 3 Voltage ²	3000 Volts d c
Anode No. 2 Voltage ³	1500 Volts d c
Anode No. 1 Voltage	300 to 515 Volts d c
Grid No. 1 Voltage Required for Cutoff ⁴	-22.5 to 67.5 Volts d c
Deflection Factor ^{5,6}	
Deflecting Plates 1-2 ¹	127-173 Volts d c/Inch
Deflecting Plates 3-4 ¹	94-128 Volts d c/Inch

SYLVANIA TYPE 3JP1, 3JP* (Cont'd)

CIRCUIT VALUES

Grid No. 1 Circuit Resistance.....	1.5 Megohms Max.
Deflection Circuit Resistance.....	5.0 Megohms Max.

NOTES:

1. Positive voltage on Pin No. 1 will deflect spot approximately toward Pin No. 5. Positive voltage on Pin No. 7 will deflect spot approximately toward Pin No. 2.
2. Anode No. 3 voltage should not be less than 3000 volts for high speed scanning.
3. Recommended minimum value of Anode No. 2 Voltage.
4. Visual extinction of undeflected focused spot.
5. The plane through the tube axis and each of the following items may vary from the trace produced by Deflecting Plates 1-2 by the following angular tolerances measured about the tube axis; Pin 5, 10 degrees; cap (on same side of tube as Pin 5) 10 degrees.
6. Angle between D1-D2 trace and D3-D4 trace is $90^\circ \pm 3^\circ$.
7. Deflecting Plates 1-2 are nearer the screen.
8. Deflecting Plates 3-4 are nearer the base.

SYLVANIA TYPE 3KP1 3KP*

Oscilloscope Tube
3" Direct Viewed

Round Glass Type
Electrostatic Deflection
Electrostatic Focus

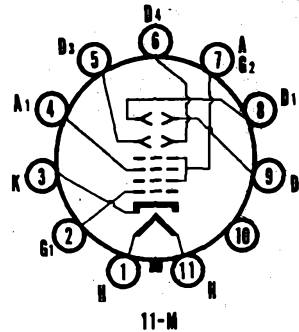
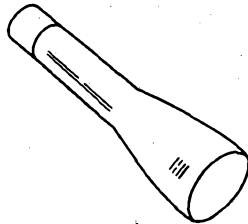

CHARACTERISTICS

GENERAL DATA

Focusing Method.....	Electrostatic			
Deflecting Method.....	Electrostatic			
Types*	3KP1	3KP4	3KP7	3KP11
Fluorescence.....	Green	White	Blue	Blue
Phosphorescence.....			Yellow	
Persistence.....	Medium	Short	Long	Short
Faceplate.....	Clear			

*In addition to the types shown, the 3KP-can be supplied with several other screen phosphors.

ELECTRICAL DATA

Heater Voltage.....	6.3 Volts
Heater Current (approx.).....	0.6 ± 5% Amperes
Direct Interelectrode Capacitances (approx.)	
Grid No. 1 to All Other Electrodes.....	8 μf
Between Deflecting Plates 1-2 ¹	2.5 μf
Between Deflecting Plates 3-4 ¹	2.5 μf
Deflecting Plate 1 ¹ to All Other Electrodes.....	11 μf
Deflecting Plate 2 ¹ to All Other Electrodes.....	8 μf
Deflecting Plate 3 ¹ to All Other Electrodes.....	7 μf
Deflecting Plate 4 ¹ to All Other Electrodes.....	8 μf

MECHANICAL DATA

Minimum Useful Screen Diameter.....	2 3/4 Inches
Nominal Overall Length.....	11 1/2 Inches
Bulb Contact (Recessed Small Ball Cap).....	J1-22
Base (Medium Shell Magnal 11-Pin).....	B11-66
Basing.....	11M
Mounting Position.....	Any

RATINGS

MAXIMUM RATINGS (Absolute Maximum Values)

Anode No. 2 Voltage ¹	2750 Volts d c
Anode No. 1 Voltage.....	1100 Volts d c
Grid No. 1 Voltage	
Negative Bias Value.....	220 Volts d c
Positive Bias Value.....	0 Volts d c
Positive Peak Value.....	2 Volts
Peak Heater-Cathode Voltage	
Heater Negative with Respect to Cathode.....	140 Volts
Heater Positive with Respect to Cathode.....	140 Volts
Peak Voltage Between Anode No. 2 and Any Deflecting Plate.....	550 Volts

TYPICAL OPERATING CONDITIONS

Anode No. 2 Voltage ¹	2000 Volts d c
Anode No. 1 Voltage.....	320 to 600 Volts d c
Grid No. 1 Voltage Required for Cutoff ⁴	-38 to -90 Volts d c
Deflection Factor ^{3, 4}	
Deflecting Plates 1-2 ¹	100 to 136 Volts d c/Inch
Deflecting Plates 3-4 ¹	76 to 104 Volts d c/Inch

SYLVANIA PICTURE TUBES

SYLVANIA TYPE 3KP1, 3KP* (Cont'd)

CIRCUIT VALUES

Grid No. 1 Circuit Resistance.....	1.5 Megohms Max.
Resistance in any Deflecting Electrode Circuit....	5.0 Megohms Max.

NOTES:

1. With D1 Positive with Respect to D2, the spot is deflected toward Pin 4.
With D3 Positive with Respect to D4, the spot is deflected toward Pin 1.
2. Anode No. 2 power input should be limited to 6 watts.
3. Recommended minimum value of Anode No. 2 Voltage is 1000 volts for Type 3KP1. Recommended minimum value of Anode No. 2 Voltage is 1500 volts for Types 3KP4 and 3KP11.
4. Visual extinction of undeflected focused spot.
5. The angle between the trace produced by D3 and D4 and its intersection with the plane through the tube axis and Pin 1 does not exceed 10%.
6. Angle between D1-D2 trace and D3-D4 trace is $90^\circ \pm 3^\circ$.
7. Deflecting Plates 1-2 are nearer the screen.
8. Deflecting Plates 3-4 are nearer the base.

SYLVANIA TYPE 3MP1 3MP*

Oscilloscope Tube
3" Direct Viewed

Round Glass Type
Electrostatic Focus

Electrostatic Deflection

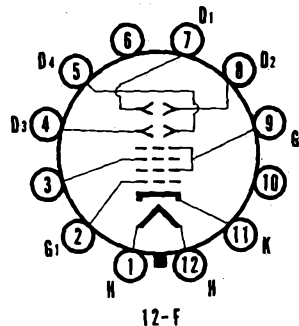
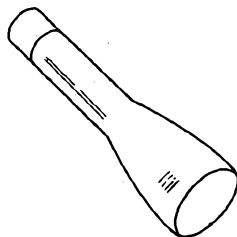

CHARACTERISTICS

GENERAL DATA

Focusing Method.....	Electrostatic
Deflecting Method.....	Electrostatic
Phosphor.....	P1
Fluorescence.....	Green
Persistence.....	Medium
Faceplate.....	Clear

*In addition to the type shown, the 3MP can be supplied with several other screen phosphors.

ELECTRICAL DATA

Heater Voltage.....	6.3 Volts
Heater Current (approx.).....	0.6 Ampere
Direct Interelectrode Capacitances (approx.)	
Cathode to All Other Electrodes.....	2.2 μf
Grid to All Other Electrodes.....	10.3 μf
Between Deflecting Plates 1-2 ¹	1.3 μf
Between Deflecting Plates 3-4 ¹	1.2 μf
Deflecting Plate 1 ² to All Other Electrodes	
Except D2.....	4.4 μf
Deflecting Plate 2 ² to All Other Electrodes	
Except D1.....	5.6 μf
Deflecting Plate 3 ² to All Other Electrodes	
Except D4.....	5.0 μf
Deflecting Plate 4 ² to All Other Electrodes	
Except D3.....	4.5 μf

MECHANICAL DATA

Minimum Useful Screen Diameter.....	2 3/4 Inches
Nominal Overall Length.....	8 Inches
Base.....	Small Shell Duodecal 12-Pin
Basing.....	12F

RATINGS

MAXIMUM RATINGS (Absolute Maximum Values)

Anode No. 2 Voltage.....	2750 Volts d c
Anode No. 1 Voltage.....	1100 Volts d c
Grid Voltage	
Negative Value.....	220 Volts d c
Positive Bias Value.....	0 Volts d c
Positive Peak Value.....	2 Volts
Peak Heater-Cathode Voltage	
Heater Negative with Respect to Cathode.....	140 Volts
Heater Positive with Respect to Cathode.....	140 Volts
Peak Voltage Between Anode No. 2 and	
Any Deflection Plate.....	550 Volts

TYPICAL OPERATING CONDITIONS

Anode No. 2 Voltage ³	2000 Volts d c
Anode No. 1 Voltage for Focus.....	400 to 700 Volts d c
Grid Voltage Required for Cutoff ⁴	0 to -126 Volts d c
Deflection Factor	
Deflecting Plates 1-2 ⁵	230 to 290 Volts d c/Inch
Deflecting Plates 3-4 ⁶	220 to 280 Volts d c/Inch

SYLVANIA PICTURE TUBES

SYLVANIA TYPE 3MP1, 3MP* (Cont'd)

CIRCUIT VALUES

Grid Circuit Resistance	1.5 Megohms Max.
Deflection Circuit Resistance	5.0 Megohms Max.

NOTES:

1. Deflecting Plate 1 is Pin No. 7.
Deflecting Plate 2 is Pin No. 8.
Deflecting Plate 3 is Pin No. 4.
Deflecting Plate 4 is Pin No. 5.
2. D1-D2 trace aligns with Pin No. 4 and tube axis $\pm 10^\circ$.
Positive voltage on D1 deflects beam approximately toward Pin No. 4.
Positive voltage on D3 deflects beam approximately toward Pin No. 1.
3. Brilliance and definition decreases with decreasing Anode No. 2 Voltage.
In general, Anode No. 2 Voltage should not be less than 1500 Volts.
4. Visual extinction of undeflected focused spot.
5. Deflecting Plates 1-2 are nearer the screen.
6. Deflecting Plates 3-4 are nearer the base.

SYLVANIA TYPE 3RP1 3RP*

TELEVISION PICTURE TUBE

Special Purpose Tube
3" Direct Viewed

Electrostatic Deflection
Electrostatic Focus

Round Glass Type

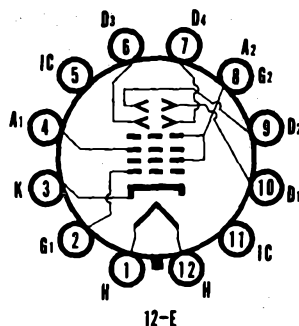
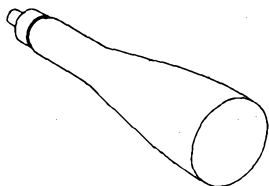

CHARACTERISTICS

GENERAL DATA

Focusing Method.....	Electrostatic
Deflection Method.....	Electrostatic
Types*	3RP1 3RP4
Fluorescence.....	Green White
Phosphorescence.....	
Persistence.....	Medium Short-Medium
Faceplate.....	Clear

*In addition to the types shown, the 3RP can be supplied with several other phosphors.

ELECTRICAL DATA

Heater Voltage.....	6.3 Volts
Heater Current.....	0.6 ± 10% Ampere
Direct Interelectrode Capacitances (approx.)	
Grid to All Other Electrodes.....	8.5 μmf
Between Deflecting Plates 1-2.....	2.0 μmf
Between Deflecting Plates 3-4.....	2.0 μmf
Deflecting Plate 1 ¹ to All Other Electrodes.....	11.0 μmf
Deflecting Plate 2 ¹ to All Other Electrodes.....	8.0 μmf
Deflecting Plate 3 ¹ to All Other Electrodes.....	7.0 μmf
Deflecting Plate 4 ¹ to All Other Electrodes.....	8.0 μmf

MECHANICAL DATA

Minimum Useful Screen Diameter.....	2¾ Inches
Nominal Overall Length.....	9½ Inches
Base (Small-Shell Duodecal 10-Pin).....	B10-75
or (Small-Shell Duodecal 12-Pin).....	B12-43
Basing.....	12E

RATINGS

MAXIMUM RATINGS (Absolute Maximum Values)

Anode No. 2 Voltage.....	2750 Volts d c
Anode No. 1 Voltage.....	1100 Volts d c
Grid Voltage	
Negative Bias Value.....	220 Volts d c
Positive Bias Value.....	0 Volts d c
Positive Peak Value.....	2 Volts
Peak Heater-Cathode Voltage	
Heater Negative with Respect to Cathode.....	140 Volts
Heater Positive with Respect to Cathode.....	140 Volts
Peak Voltage Between Anode No. 2 and Any Deflection Plate.....	550 Volts

TYPICAL OPERATING CONDITIONS

Anode No. 2 Voltage ¹	2000 Volts d c
Anode No. 1 Voltage for Focus.....	330 to 620 Volts d c
Maximum Grid Voltage Required for Cutoff ²	-135 Volts d c
Deflection Factor ^{100V}	
Deflecting Plates 1-2 ³	146 to 198 Volts d c/Inch
Deflecting Plates 3-4 ³	104 to 140 Volts d c/Inch

SYLVANIA TYPE 3RP1, 3RP* (Cont'd)

CIRCUIT VALUES

Grid Circuit Resistance.....	1.5 Megohms Max.
Deflection Circuit Resistance.....	5.0 Megohms Max.

NOTES:

1. Positive voltage on Pin No. 10 will move spot approximately in direction of Pin No. 4. Positive voltage on Pin No. 6 will move spot approximately in direction of Pin No. 1.
2. Brilliance and definition decrease with decreasing Anode No. 2 Voltage. In general, Anode No. 2 Voltage should not be less than 1500 volts.
3. Visual extinction of undeflected focused spot.
4. Angle between trace produced by plates D1-D2 and the plane through the tube axis and Pin No. 4 does not exceed 10°.
5. Angle between D1-D2 trace and D3-D4 trace is $90^\circ \pm 30^\circ$.
6. Deflecting Plates 1-2 are nearer the screen.
7. Deflecting Plates 3-4 are nearer the base.

SYLVANIA TYPE 5ADP1 5ADP*

OSCILLOSCOPE TUBE

5" Direct Viewed
Round Glass Type
Flat Faceplate

Clear Faceplate
Electrostatic Focus
Electrostatic Deflection

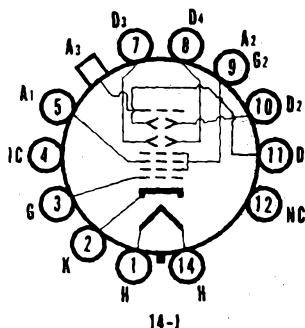
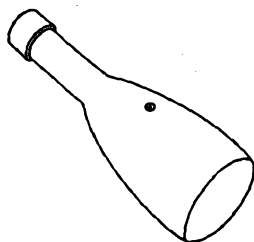

CHARACTERISTICS

GENERAL DATA

Focusing Method	Electrostatic			
Deflection Method	Electrostatic			
Types*	5ADP1	5ADP2	5ADP7	5ADP11
Fluorescence	Green	Blue-Green	Blue	Blue
Phosphorescence		Green	Yellow	
Persistence	Medium	Long	Long	Short
Faceplate	Clear			

*In addition to the types shown, the 5ADP— can be supplied with several other screen phosphors.

ELECTRICAL DATA

Heater Voltage	6.3 Volts	
Heater Current	0.6 ± 10% Amperes	
Direct Interelectrode Capacitances		
	Min.	Max.
Cathode to All Other Electrodes	3.1	5.8 μf
Grid No. 1 to All Other Electrodes	4.2	7.9 μf
Between Deflecting Plates 1-2	1.7	3.1 μf
Between Deflecting Plates 3-4	0.7	1.3 μf
Deflecting Plate 1 ¹ to All Other Electrodes Except D2	2.7	6.1 μf
Deflecting Plate 2 ¹ to All Other Electrodes Except D1	2.7	6.1 μf
Deflecting Plate 3 ¹ to All Other Electrodes Except D4	2.1	4.0 μf
Deflecting Plate 4 ¹ to All Other Electrodes Except D3	2.1	5.0 μf

MECHANICAL DATA

Minimum Useful Screen Diameter	4 1/4 Inches
Nominal Overall Length	16 3/4 Inches
Bulb Contact (Recessed Small Cavity Cap)	J1-22
Base (Medium Shell Diheptal 12-Pin)	B12-37
Basing	14J
Base Alignment	
D1-D2 trace aligns with Pin No. 5 and Tube Axis	± 10 Degrees
Positive Voltage on D1 deflects beam approx. toward Pin No. 5	
Positive Voltage on D3 deflects beam approx. toward Pin No. 2	
Angle Between traces D1-D2 and D3-D4	90 ± 1 Degrees
Bulb Contact Alignment	
J1-22 contact aligns with D1-D2	± 10 Degrees
J1-22 contact on same side as Pin No. 5	

SYLVANIA TYPE 5ADP1, 5ADP* (Cont'd)

RATINGS

MAXIMUM RATINGS (Absolute Maximum Values)

Anode No. 3 Voltage	6600 Volts d c
Anode No. 2 Voltage ²	2860 Volts d c
Ratio of Anode No. 3 Voltage to Anode No. 2 Voltage	2.3 : 1
Anode No. 1 Voltage for Focus	1100 Volts d c
Grid No. 1 Voltage	
Negative Bias Value	220 Volts d c
Positive Bias Value	0 Volts d c
Positive Peak Value	2 Volts
Peak Heater-Cathode Voltage	
Heater Negative with Respect to Cathode	200 Volts d c
Heater Positive with Respect to Cathode	200 Volts d c
Peak Voltage Between Anode No. 2 and Any Deflection Plate	550 Volts

TYPICAL OPERATING CONDITIONS

Anode No. 3 Voltage	3000 Volts
Anode No. 2 Voltage	1500 Volts
Anode No. 1 Voltage for Focus	300 to 515 Volts
Grid No. 1 Voltage Required for Cutoff ³	-34 to -56 Volts
Deflection Factor	
Deflecting Plates 1-2 ⁴	40 to 50 Volts d c/Inch
Deflecting Plates 3-4 ⁵	30.5 to 37.5 Volts d c/Inch
Modulation ⁶	
with Anode No. 3 Current = 25 μ a	45 Volts Max.
Line Width ⁶	
with Anode No. 3 Current = 25 μ a	.030 Inches Max.
P1 Light Output ⁶	
with Anode No. 3 Current = 25 μ a	15 Ft. L. Min.
Deflection Factor Uniformity ⁶	2 Percent Max.
Pattern Distortion with 75% Useful Scan ⁷	2 1/2 Percent Max.
Undelected Spot Position ⁸	Within a 5/16 Inch Radius Circle
Useful Scan	\pm 2 Inches From Tube Face Center or a Total 4 Inches Min.

CIRCUIT VALUES

Grid No. 1 Circuit Resistance	1.5 Megohms Max.
Deflection Circuit Resistance ⁹	5 Megohms Max.

NOTES:

1. Deflecting Plate 1 is Pin No. 11.
Deflecting Plate 2 is Pin No. 10.
Deflecting Plate 3 is Pin No. 7.
Deflecting Plate 4 is Pin No. 8.
2. The product of the Anode No. 2 Voltage and the Average Anode No.2 Current should be limited to 6 watts.
3. Visual extinction of undeflected focused spot.
4. Deflecting Plates 1-2 are nearer the screen.
5. Deflecting Plates 3-4 are nearer the base.
6. Measured in accordance with MIL-E-1C.
7. All edges of a raster, pattern adjusted so its widest points just touch the sides of a 3.075 inch square, will fall within the area bounded by the 3.075 inch square and an inscribed 2.925 inch square.
8. Centered on tube face with the tube shielded and with all deflection plates connected to Anode No. 2.
9. It is recommended that the deflecting electrode circuit resistances be approximately equal.

WARNING:

X-ray radiation shielding may be necessary to protect against possible danger of personal injury from prolonged exposure at close range if this tube is operated at higher than the manufacturer's Maximum Rated Anode Voltage or 16,000 volts, whichever is less.

SYLVANIA TYPE 5AHP4A 5AHP*

SPECIAL PURPOSE TUBE

5" Direct Viewed
Round Glass Type
Magnetic Deflection

Electrostatic Focus
High Resolution
"A" Types Aluminized

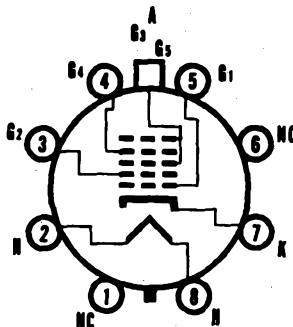
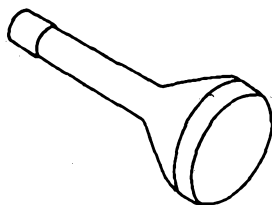

8EF

CHARACTERISTICS

GENERAL DATA

Focusing Method.....	Electrostatic
Deflecting Method.....	Magnetic
Deflection Angle (approx.).....	53 Degrees
Types*	
	5AHP4A 5AHP4
	5AHP7A 5AHP7
	5AHP14A 5AHP14
	5AHP19A 5AHP19
Fluorescence.....	White
Phosphorescence.....	Blue
Persistence.....	Short-Med.
Faceplate.....	Clear
Types 5AHP4A, 5AHP7A, 5AHP14A and 5AHP19A have aluminized screens.	
*In addition to the types shown, the 7ABP can be supplied with several other screen phosphors.	

ELECTRICAL DATA

Heater Voltage.....	6.3 Volts
Heater Current (approx.).....	0.6 Ampere
Direct Interelectrode Capacitances (approx.)	
Cathode to All Other Electrodes.....	5 μ f
Grid No. 1 to All Other Electrodes.....	6 μ f

MECHANICAL DATA

Minimum Useful Screen Diameter.....	4 1/4 Inches
Nominal Overall Length.....	11 1/2 Inches
Bulb Contact (Recessed Small Ball Cap).....	J1-22
Base (Medium Shell Octal 8-Pin).....	B8-11 or B8-65
Basing.....	8EF
Bulb Contact Aligns with Pin No. 5.....	± 10 Degrees

RATINGS

MAXIMUM RATINGS (Absolute Maximum Values)

Anode Voltage.....	11,000 Volts d c
Grid No. 4 (Focusing Electrode) Voltage.....	-550 to +1100 Volts d c
Grid No. 2 Voltage.....	770 Volts d c
Grid No. 1 Voltage.....	
Negative Bias Value.....	200 Volts d c
Positive Bias Value ¹	0 Volts d c
Positive Peak Value.....	0 Volts
Peak Heater-Cathode Voltage.....	
Heater Negative with Respect to Cathode.....	200 Volts
Heater Positive with Respect to Cathode.....	200 Volts

TYPICAL OPERATING CONDITIONS

Anode Voltage ¹	7000 Volts d c
Grid No. 4 Voltage for Focus ⁴	0 to +250 Volts d c
Grid No. 2 Voltage.....	300 Volts d c
Grid No. 1 Voltage ¹	-33 to -77 Volts d c
Line Width ⁴	0.40 MM Max.

CIRCUIT VALUES

Grid No. 1 Circuit Resistance.....	1.5 Megohms Max.
------------------------------------	------------------

SYLVANIA PICTURE TUBES

SYLVANIA TYPE 5AHP4A, 5AHP* (Cont'd)

NOTES:

1. At or near this rating, the effective resistance of the anode supply should be adequate to limit the anode input power to 6 watts. The screen of the 5AHP19 and 5AHP19A can be permanently damaged should the current density be permitted to rise too high. To prevent burning, minimum beam current densities should be employed.
2. Brilliance and definition decrease with decreasing anode voltage. In general, anode voltage should not be less than 4000 volts, except for the 5AHP19 and 5AHP19A. For these types the anode voltage should not be less than 7000 volts.
3. Visual extinction of undeflected focused spot.
4. With E_{g1} adjusted for $I_b = 100 \mu a$ and beam focused for minimum width of individual lines at center of screen.
5. Measured by compressed raster method, using a 35 to 105 line pattern.

SYLVANIA TYPE 5AQP1 5AQP*

OSCILLOSCOPE TUBE

5" Direct Viewed
Round Glass Type
Electrostatic Deflection

Electrostatic Focus
Flat Face
Clear Faceplate

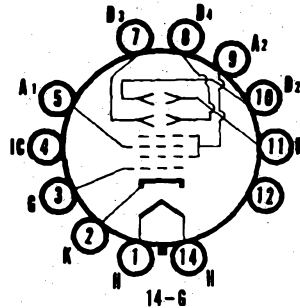
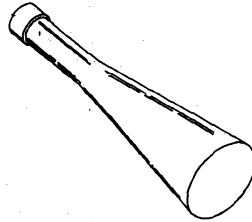

CHARACTERISTICS

GENERAL DATA

Focusing Method.....	Electrostatic			
Deflection Method.....	Electrostatic			
Types*	5AQP1	5AQP2	5AQP7	5AQP11
Fluorescence.....	Green	Blue-Green	Blue	Blue
Phosphorescence.....	Green	Green	Yellow	Short
Persistence.....	Medium	Long	Long	Short
Faceplate.....	Clear			

*In addition to the types shown, the 5AQP— can be supplied with several other screen phosphors.

ELECTRICAL DATA

Heater Voltage.....	6.3 Volts	
Heater Current.....	0.6 ± 10% Ampere	
Direct Interelectrode Capacitances		
	Min.	Max.
Cathode to All Other Electrodes.....	2.7	5.0 μf
Grid No. 1 to All Other Electrodes.....	3.7	6.9 μf
Between Deflecting Plates 1-2 ¹	2.4	4.5 μf
Between Deflecting Plates 3-4 ¹	0.8	1.6 μf
Deflecting Plate 1 ¹ to All Other Electrodes.....	5.0	9.3 μf
Deflecting Plate 2 ¹ to All Other Electrodes.....	5.0	9.3 μf
Deflecting Plate 3 ¹ to All Other Electrodes.....	3.3	6.3 μf
Deflecting Plate 4 ¹ to All Other Electrodes.....	3.3	6.3 μf

MECHANICAL DATA

Minimum Useful Screen Dimensions (Diameter)...	4 1/2 Inches
Nominal Overall Length.....	16 3/4 Inches
Base (Medium Shell Diheptal 12-Pin).....	B12-37
Basing.....	14G
Base Alignment	
D1-D2 trace aligns with Pin No. 5 and Tube Axis.....	± 10 Degrees
Angle Between D1-D2 and D3-D4 Traces.....	90 ± 1 Degree

RATINGS

MAXIMUM RATINGS (Absolute Maximum Values)

Anode No. 2 Voltage ²	4400 Volts d c
Anode No. 1 Voltage for Focus.....	1650 Volts d c
Grid No. 1 Voltage	
Negative Bias Value.....	220 Volts d c
Positive Bias Value.....	0 Volts d c
Positive Peak Value.....	2 Volts
Peak Heater Cathode Voltage	
Heater Negative with Respect to Cathode.....	200 Volts
Heater Positive with Respect to Cathode.....	200 Volts
Peak Voltage Between Anode No. 2 and Any Deflecting Plate.....	1320 Volts

SYLVANIA TYPE 5AQP1, 5AQP* (Cont'd)

TYPICAL OPERATING CONDITIONS

Anode No. 2 Voltage.....	2500 Volts d c
Anode No. 1 Voltage for Focus.....	0 to 300 Volts d c
Grid No. 1 Voltage Required for Cutoff ³	-34 to -56 Volts d c
Deflection Factor ⁴	
Deflecting Plates 1-2.....	40 to 50 Volts d c/Inch
Deflecting Plates 3-4.....	31.5 to 38.5 Volts d c/Inch
P1 Light Output ⁵	15 Ft. L. Min.
Modulation ⁵	40 Volts d c Max.
Line Width A ⁵030 Inches Max.
Anode No. 2 Current ⁵	400 μ d c Max.
Deflection Factor Uniformity ⁶	1 Percent Max.
Pattern Distortion ⁷	2 Percent Max.
Spot Position ⁸	Within a $\frac{3}{16}$ inch Radius Circle
Useful Scan.....	± 2 Inches From Tube Face Center—Total 4 x 4 Inches

CIRCUIT VALUES

Grid No. 1 Circuit Resistance.....	1.5 Megohms Max.
Deflection Circuit Resistance ⁹	1.0 Megohms Max.

NOTES:

1. Deflecting Plate 1 is Pin No. 11.
Deflecting Plate 2 is Pin No. 10.
Deflecting Plate 3 is Pin No. 7.
Deflecting Plate 4 is Pin No. 8.
2. The product of acceleration voltage and average acceleration current should be limited to 6.0 watts.
3. Visual extinction of undeflected focused spot.
4. Positive voltage on D1 deflects beam approximately toward Pin No. 5.
Positive voltage on D3 deflects beam approximately toward Pin No. 2.
5. At a grid drive to produce 15 Ft. L. on a raster size of 2 x 2 inches on P1 screen.
6. The deflection factors of 75% of useful scan and at 25% of useful scan shall not differ by more than the indicated value.
7. All edges of a raster pattern, adjusted so its widest points just touch the sides of a 3.075 inch square, will fall within the area bounded by the 3.075 inch square and an inscribed 2.925 inch square.
8. Centered on the tube face with the tube shielded and with all deflection plates connected to anode No. 2.
9. It is recommended that the deflecting electrode circuit resistances be approximately equal.

SYLVANIA

TELEVISION PICTURE TUBES

SYLVANIA TYPE 5AXP4

TELEVISION RECEIVER CHECK TUBE

5" Direct Viewed Magnetic Deflection
 Round, Glass Type Self Focusing (Electrostatic)
 No Ion Trap Required

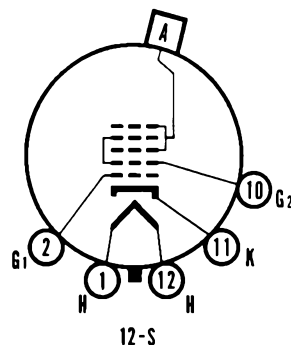
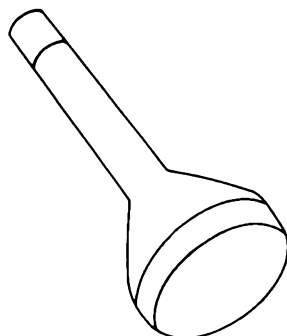

CHARACTERISTICS

GENERAL DATA

Focusing Method	Self Focusing (Electrostatic)
Deflecting Method	Magnetic
Deflecting Angle (approx.)	53 Degrees
Phosphor	P4
Fluorescence	White
Persistence	Medium
Faceplate	Clear Glass

ELECTRICAL DATA

Heater Voltage	6.3 Volts
Heater Current	0.6 Ampere
Direct Interelectrode Capacitances	
Cathode to All Other Electrodes	5 μ f
Grid No. 1 to All Other Electrodes	6 μ f

MECHANICAL DATA

Overall Length	10 $\frac{3}{8}$ \pm $\frac{8}{16}$ Inches
Maximum Diameter	4 $\frac{15}{16}$ \pm $\frac{3}{32}$ Inches
Minimum Useful Screen Diameter	4 $\frac{1}{4}$ Inches
Bulb Contact (Recessed Small Cavity Cap)	J1-21
Base (Small Shell Duodecal 5-Pin)	B5-57
Basing	12S

RATINGS

MAXIMUM RATINGS (Design Center Values)

Anode Voltage	18,000 Volts d c
Grid No. 2 (and Grid No. 4) Voltage	500 Volts d c
Grid No. 1 Voltage	
Negative Bias Value	125 Volts d c
Positive Bias Value	0 Volts d c
Positive Peak Value	2 Volts
Peak Heater-Cathode Voltage	
Heater Negative with Respect to Cathode	
During Warm-up Not to Exceed 15 Seconds	410 Volts
After Equipment Warm-up	180 Volts
Heater Positive with Respect to Cathode	180 Volts

TYPICAL OPERATING CONDITIONS

Anode Voltage	14,000 Volts d c
Grid No. 2 (and Grid No. 4) Voltage	300 Volts d c
Grid No. 1 Voltage for Cutoff	-28 to -72 Volts d c

CIRCUIT VALUES

Grid No. 1 Circuit Resistance	1.5 Megohms Max.
-------------------------------	------------------

5AXP4 (Cont'd)

NOTE:

1. Visual extinction of raster.

WARNING

X-ray radiation shielding may be necessary to protect against possible danger of personal injury from prolonged exposure at close range if this tube is operated at higher than the manufacturer's Maximum Rated Anode Voltage or 16,000 volts, whichever is less.

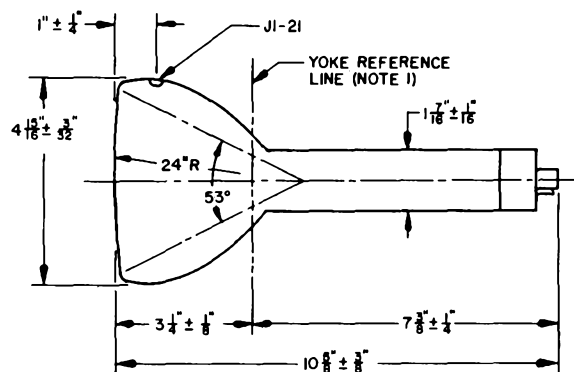

S52032B

DIAGRAM NOTES:

1. The yoke reference line is determined by the plane C-C' of JETEC gauge 116 with the gauge resting against the bulb cone.
2. Anode contact (J1-21) aligns with vacant base pin position No. 6 \pm 30 degrees.

APPLICATION NOTES

The 5AXP4 is a universal test picture tube which may be used in almost any electromagnetically deflected receiver, regardless of the deflection angle of the tube used in the set. When the Check Tube is used in a 90 degree deflection set, the picture will probably extend over the edges of the tube, but the visible portion of the picture will still enable checks to be made.

To save the serviceman's time and make the 5AXP4 a versatile "service tool" the following additional features are incorporated:

1. Automatic self focusing
Convenient in servicing.
2. No ion trap necessary
Saves time in servicing.
3. No external conductive coating
Safety in repeated installation and removal.

FINAL TOUCH-UP ADJUSTMENTS SHOULD ALWAYS BE MADE WITH THE REGULAR PICTURE TUBE INSTALLED IN THE TV SET.

Additional application information on Type 5AXP4 was published in SYLVANIA NEWS, Technical Section, February, 1955. Copies may be obtained from Sylvania Electric Products Inc., 1100 Main St., Buffalo 9, New York.

SYLVANIA TYPE 5BNP16

TELEVISION PICTURE TUBE

Flying Spot Scanner Tube
5" Round Glass Type
Spherical Faceplate
Clear Faceplate

Magnetic Deflection
Electrostatic Focus
No Ion Trap
Aluminized Screen

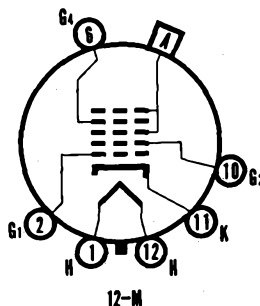
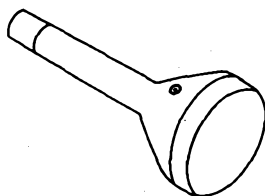

CHARACTERISTICS

GENERAL DATA

Focusing Method.....	Electrostatic
Deflecting Method.....	Magnetic
Deflection Angle (approx.).....	53 degrees
Phosphor.....	Aluminized P16
Fluorescence.....	Violet and near Ultra-Violet
Persistence.....	Extremely Short
Faceplate.....	Clear

ELECTRICAL DATA

Heater Voltage.....	6.3 Volts
Heater Current.....	0.6 Amperes
Direct Interelectrode Capacitances (approx.)	
Cathode to All Other Electrodes.....	5 μ fd
Grid No. 1 to All Other Electrodes.....	6 μ fd
Ion Trap.....	No Ion Trap Required

MECHANICAL DATA

Minimum Useful Screen Diameter (Max. Assured).....	4 $\frac{1}{8}$ Inches
Nominal Overall Length.....	10 $\frac{3}{8}$ Inches
Bulb Contact (Recessed Small Ball Cap).....	J1-22
Base (Small Shell Duo Decal 6 Pin).....	B6-63
Basing.....	12M
Bulb.....	J39 $\frac{1}{2}$ L

RATINGS

MAXIMUM RATINGS (Absolute Maximum Values)

Anode Voltage.....	19,800 Volts d c
Grid No. 4 Voltage (Focusing Electrode).....	-550 to +1100 Volts d c
Grid No. 2 Voltage.....	550 Volts d c
Grid No. 1 Voltage.....	
Negative Bias Value.....	155 Volts d c
Negative Peak Value.....	220 Volts
Positive Bias Value.....	0 Volts d c
Positive Peak Value.....	2 Volts
Peak Heater Cathode Voltage.....	
Heater Negative with Respect to Cathode	
During Warm-up Period Not to	
Exceed 15 Seconds.....	450 Volts
After Equipment Warm-up Period.....	200 Volts
Heater Positive with Respect to Cathode.....	200 Volts

TYPICAL OPERATING CONDITIONS

Anode Voltage.....	14,000 Volts d c
Grid No. 4 Voltage for Focus.....	-50 to +350 Volts d c
Grid No. 2 Voltage.....	300 Volts d c
Grid No. 1 Voltage for Cutoff ¹	-28 to -72 Volts d c

CIRCUIT VALUES

Grid No. 1 Circuit Resistance.....	1.5 Megohms Max.
------------------------------------	------------------

SYLVANIA TYPE 5BNP16 (Cont'd)

NOTE:

1. Visual Extinction of Raster.

WARNING:

X-ray radiation shielding may be necessary to protect against possible danger of personal injury from prolonged exposure at close range if this tube is operated at higher than the manufacturer's Maximum Rated Anode Voltage or 16,000 volts, whichever is less.

SYLVANIA TYPE 5BP1A 5BP-A*

OSCILLOSCOPE TUBE

5" Direct Viewed
Round Glass Type

Electrostatic Deflection
Electrostatic Focus

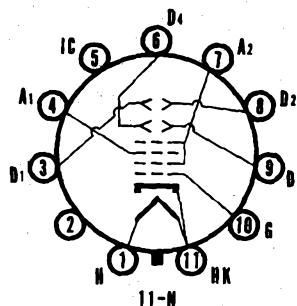
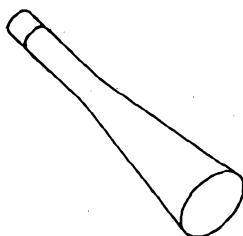

CHARACTERISTICS

GENERAL DATA

Focusing Method	Electrostatic
Deflecting Method	Electrostatic
Phosphor	P1
Fluorescence	Green
Persistence	Medium
Faceplate	Clear

*In addition to the type shown, the 5BP-A can be supplied with several other screen phosphors.

ELECTRICAL DATA

Heater Voltage	6.3 Volts
Heater Current (approx.)	0.6 Ampere
Direct Interelectrode Capacitances (approx.)	
Grid No. 1 to All Other Electrodes	8.0 μ f
Between Deflecting Plates 1-2 ¹	1.3 μ f
Between Deflecting Plates 3-4 ¹	1.2 μ f
Deflecting Plate 1 to All Other Electrodes	9.5 μ f
Deflecting Plate 3 to All Other Electrodes	12 μ f
Deflecting Plate 1 ² to All Other Electrodes	
Except D2	8.0 μ f
Deflecting Plate 2 ² to All Other Electrodes	
Except D1	7.5 μ f
Deflecting Plate 3 ² to All Other Electrodes	
Except D4	10 μ f
Deflecting Plate 4 ² to All Other Electrodes	
Except D3	7.5 μ f

MECHANICAL DATA

Minimum Useful Screen Diameter	4 1/4 Inches
Nominal Overall Length	16 3/4 Inches
Base	Medium Shell Magnal 11 Pin
Basing	11N

RATINGS

MAXIMUM RATINGS (Absolute Maximum Values)

Anode No. 2 Voltage	2200 Volts d c
Anode No. 1 Voltage	1100 Volts d c
Grid Voltage	
Negative Value	125 Volts
Positive Value	0 Volts
Peak Voltage Between Anode No. 2 and Any Deflection Plate	550 Volts

TYPICAL OPERATING CONDITIONS

Anode No. 2 Voltage ³	2000 Volts d c
Anode No. 1 Voltage for Focus	315 to 562 Volts d c
Grid Voltage Required for Cutoff ⁴	-20 to -60 Volts d c
Deflection Factor	
Deflecting Plates 1-2 ⁵	70 to 98 Volts d c/Inch
Deflecting Plates 3-4 ⁶	63 to 90 Volts d c/Inch

SYLVANIA PICTURE TUBES

SYLVANIA TYPE 5BP1A, 5BP-A* (Cont'd)

CIRCUIT VALUES

Grid No. 1 Circuit Resistance..... 1.5 Megohms Max.
Deflection Circuit Resistance..... 5.0 Megohms Max.

NOTES:

1. Deflecting Plate 1 is Pin No. 3.
Deflecting Plate 2 is Pin No. 8.
Deflecting Plate 3 is Pin No. 9.
Deflecting Plate 4 is Pin No. 6.
2. With D1 positive with respect to D2, the spot is deflected toward Pin No. 4;
with D3 positive with respect to D4, the spot is deflected toward Pin No. 1.
3. Brilliance and definition decrease with decreasing Anode No. 2 Voltage. In
general, Anode No. 2 Voltage should not be less than 1500 volts.
4. Visual extinction of undeflected focused spot.
5. Deflecting Plates 1-2 are nearer the screen.
6. Deflecting Plates 3-4 are nearer the base.

5BP1

Sylvania Type 5BP1A replaces Type 5BP1.

SYLVANIA TYPE 5CP1A 5CP7A 5CP11A 5CP12

SPECIAL PURPOSE TUBE

5" Direct Viewed
Round Glass Type
Electrostatic Deflection

Electrostatic Focus
Post Deflection Accelerator
Clear Faceplate

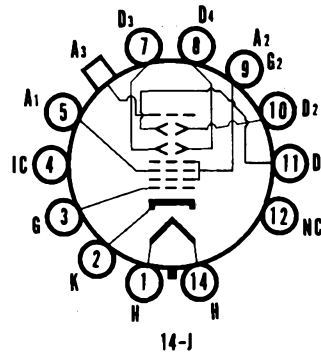

CHARACTERISTICS

GENERAL DATA

Focusing Method	Electrostatic
Deflecting Method	Electrostatic
Phosphor	P1
Fluorescence	Green
Persistence	Medium
Faceplate	Clear

ELECTRICAL DATA

Heater Voltage	6.3 Volts
Heater Current (approx.)	0.6 Ampere
Direct Interelectrode Capacitances (approx.)	
Cathode to All Other Electrodes	9 μ f
Grid No. 1 to All Other Electrodes	8 μ f
Between Vertical Deflecting Plates	2 μ f
Between Horizontal Deflecting Plates	2 μ f
Deflecting Plate 1 to All Other Electrodes	9 μ f
Deflecting Plate 2 to All Other Electrodes	9 μ f
Deflecting Plate 3 to All Other Electrodes	7 μ f
Deflecting Plate 4 to All Other Electrodes	8 μ f

MECHANICAL DATA

Minimum Useful Screen Dimension (Diameter)	4 1/2 Inches
Bulb Contact (Recessed Small Ball Cap)	J1-22
Base (Medium Shell Diheptal 12-Pin)	B12-37
Basing	14J

RATINGS

MAXIMUM RATINGS (Design Center Values)

Anode No. 3 Voltage	4000 Volts d c
Anode No. 2 Voltage	2000 Volts d c
Anode No. 1 Voltage	1000 Volts d c
Grid No. 1 Voltage	
Negative Bias Value	200 Volts d c
Positive Bias Value	0 Volts d c
Positive Peak Value	2 Volts
Peak Heater Cathode Voltage	
Heater Negative with Respect to Cathode	125 Volts
Heater Positive with Respect to Cathode	125 Volts
Peak Voltage Between Anode No. 2 And Any Deflecting Plate	500 Volts

SYLVANIA PICTURE TUBES

SYLVANIA TYPE 5CP1A (Cont'd)

5CP7A

5CP11A

5CP12

RECOMMENDED OPERATING CONDITIONS

Anode No. 3 Voltage.....	4000 Volts d c
Anode No. 2 Voltage.....	2000 Volts d c
Anode No. 1 Voltage.....	375 to 690 Volts d c
Grid No. 1 Voltage Required for Cutoff ¹	-30 to -90 Volts d c
Deflection Factor	
Vertical Plates ²	92 Volts d c/Inch
Horizontal Plates ³	78 Volts d c/Inch

CIRCUIT VALUES

Grid No. 1 Circuit Resistance.....	1.5 Megohms Max.
Deflection Circuit Resistance.....	5.0 Megohms Max.

NOTES:

1. Visual extinction of undeflected focused spot.
2. Pins 10 and 11.
3. Pins 7 and 8.

5CP1

The Sylvania Type 5CP1A is a direct replacement for the Type 5CP1.

5CP7

The Sylvania Type 5CP7A is a direct replacement for the Type 5CP7.

5CP7A

The Sylvania Type 5CP7A is identical to the Type 5CP1A except it has a blue-white fluorescence, yellow phosphorescence, long persistence phosphor.

5CP11A

The Sylvania Type 5CP11A is identical to the Type 5CP1A except it has blue phosphor and a short persistence.

5CP12

The Sylvania Type 5CP12 is identical to the Type 5CP1A except it has an orange phosphor and a medium long persistence.

SYLVANIA TYPE 5UP1 5UP*

TELEVISION PICTURE TUBE

Special Purpose Tube
5" Direct Viewed

Round Glass Type
Electrostatic Deflection
Electrostatic Focus

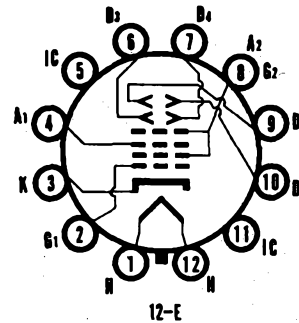
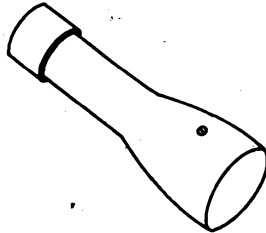

CHARACTERISTICS

GENERAL DATA

Focusing Method	Electrostatic
Deflection Method	Electrostatic
Types*	5UP1 5UP7 5UP11
Fluorescence	Green Blue-White Blue
Phosphorescence	Yellow Yellow Blue
Persistence	Medium Long Short
Faceplate	Clear

*In addition to the types shown, the 5UP can be supplied with several other screen phosphors.

ELECTRICAL DATA

Heater Voltage	6.3 Volts
Heater Current	0.6 ± 10% Ampere
Direct Interelectrode Capacitances (approx.)	
Grid to All Other Electrodes	8.0 μmf
Between Deflecting Plates 1-2	2.5 μmf
Between Deflecting Plates 3-4	2.5 μmf
Deflecting Plate 1 ¹ to All Other Electrodes	11.0 μmf
Deflecting Plate 2 ¹ to All Other Electrodes	8.0 μmf
Deflecting Plate 3 ¹ to All Other Electrodes	7.0 μmf
Deflecting Plate 4 ¹ to All Other Electrodes	8.0 μmf

MECHANICAL DATA

Minimum Useful Screen Diameter	4½ Inches
Nominal Overall Length	14¾ Inches
Base (Small-Shell Duodecal 10-Pin)	B10-75
or (Small-Shell Duodecal 12-Pin)	B12-43
Basing	12E

RATINGS

MAXIMUM RATINGS (Absolute Maximum Values)

Anode No. 2 Voltage	2750 Volts d c
Anode No. 1 Voltage	1100 Volts d c
Grid Voltage	
Negative Bias Value	220 Volts d c
Positive Bias Value	0 Volts d c
Positive Peak Value	2 Volts
Peak Heater-Cathode Voltage	
Heater Negative with Respect to Cathode	140 Volts
Heater Positive with Respect to Cathode	140 Volts
Peak Voltage Between Anode No. 2 and Any Deflection Plate	550 Volts

TYPICAL OPERATING CONDITIONS

Anode No. 2 Voltage ¹	2000 Volts d c
Anode No. 1 Voltage for Focus	340 to 640 Volts d c
Maximum Grid Voltage Required for Cutoff ¹	-90 Volts d c
Deflection Factor ^{2,3}	
Deflecting Plates 1-2 ¹	56 to 77 Volts d c/Inch
Deflecting Plates 3-4 ¹	46 to 62 Volts d c/Inch

SYLVANIA PICTURE TUBES

SYLVANIA TYPE 5UP1, 5UP* (Cont'd)

CIRCUIT VALUES

Grid Circuit Resistance 1.5 Megohms Max.
Deflection Circuit Resistance 5.0 Megohms Max.

NOTES:

1. Positive voltage on Pin No. 10 will move spot approximately in direction of Pin No. 4. Positive voltage on Pin No. 6 will move spot approximately in direction of Pin No. 1.
2. Brilliance and definition decrease with decreasing Anode No. 2 Voltage. In general, Anode No. 2 Voltage should not be less than 1000 volts for the Type 5UP1 and not less than 1500 volts for the Types 5UP7 and 5UP11.
3. Visual extinction of undeflected focused spot.
4. Angle between trace produced by plates D1-D2 and the plane through the tube axis and Pin No. 4 does not exceed 10° .
5. Angle between D1-D2 trace and D3-D4 trace is $90^\circ \pm 30^\circ$.
6. Deflecting Plates 1-2 are nearer the screen.
7. Deflecting Plates 3-4 are nearer the base.

SYLVANIA TYPE 5ZP15 5ZP*

FLYING SPOT SCANNER TUBE

5" Round Glass Type	Acceleration Type Electrostatic Focus
Flat Faceplate	Clear, Non-Browning Faceplate
No Ion Trap	External Conductive Coating on Neck
Magnetic Deflection	External Insulating Coating on Bulb
	Aluminized Screen

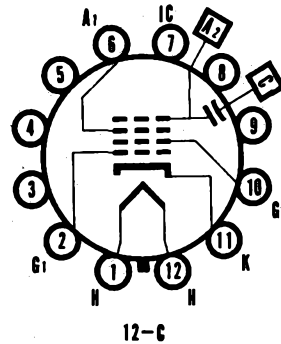
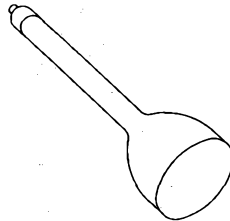

CHARACTERISTICS

GENERAL DATA

Focusing Method.....	Electrostatic
Deflection Method.....	Magnetic
Deflection Angle (approx.).....	40 Degrees
Types*	5ZP15 5ZP16 5ZP24
Fluorescence.....	Blue Green Violet and Near Ultraviolet Blue Green
Persistence.....	Extremely Short Extremely Short Extremely Short
Screen.....	Aluminized
Faceplate.....	Clear, Non-Browning

*In addition to the types shown, the 5ZP— can be supplied with several other screen phosphors.

ELECTRICAL DATA

Heater Voltage.....	6.3 Volts
Heater Current.....	0.6 ± 10% Ampere
Direct Interelectrode Capacitances (approx.)	
Cathode to All Other Electrodes.....	5 μmf
Grid No. 1 to All Other Electrodes.....	8 μmf
External Conductive Neck Coating to Anode ¹	500 μmf Max. 100 μmf Min.

MECHANICAL DATA

Minimum Useful Screen Diameter.....	4 1/4 Inches
Nominal Overall Length.....	14 3/8 Inches
Bulb Contact (Recessed Small Cavity Cap).....	J1-21
Base (Small Shell Duodecal 7-Pin).....	B7-51
Basing.....	12C
Bulb Contact Aligns with Vacant Pin	
Position No. 3.....	± 10 Degrees

RATINGS

MAXIMUM RATINGS (Absolute Maximum Values)

Anode No. 2 Voltage.....	30,000 Volts d c
Anode No. 1 Voltage (Focusing Electrode).....	7700 Volts d c
Grid No. 2 Voltage.....	385 Volts d c
Grid No. 1 Voltage	
Negative Bias Value.....	165 Volts d c
Positive Bias Value.....	0 Volts d c
Positive Peak Value.....	2 Volts
Peak Heater-Cathode Voltage	
Heater Negative with Respect to Cathode	
During Warm-up Period Not to Exceed	
15 Seconds.....	450 Volts
After Equipment Warm-up Period.....	165 Volts
Heater Positive with Respect to Cathode.....	165 Volts

SYLVANIA TYPE 5ZP15, 5ZP* (Cont'd)

TYPICAL OPERATING CONDITIONS

Anode Voltage	27,000 Volts d c
Anode No. 1 Voltage for Focus at $I_b = 15 \mu a$	5550 to 7050 Volts d c
Grid No. 2 Voltage	200 Volts d c
Grid No. 1 Voltage Required for Cutoff	-42 to -98 Volts d c
Anode Current	15 μa d c
Maximum Anode No. 1 Current at $I_b = 15 \mu a$	25 μa d c
Grid No. 2 Current	-15 to +15 μa d c

CIRCUIT VALUES

Grid No. 1 Circuit Resistance	1.5 Megohms Max.
-------------------------------	------------------

NOTES:

1. External conductive neck coating must be grounded.
2. Brilliance and definition decrease with decreasing anode voltage. In general, the anode voltage should not be less than 20,000 volts.
3. Visual extinction of undeflected focused spot.

WARNING:

X-ray radiation shielding may be necessary to protect against possible danger of personal injury from prolonged exposure at close range if this tube is operated at higher than the manufacturer's Maximum Rated Anode Voltage or 16,000 volts, whichever is less.

SYLVANIA TYPE 7ABP4 7ABP*

Special Purpose Tube

7" Direct Viewed
Round Glass Type
Electrostatic Focus

Magnetic Deflection
High Resolution
"A" Types Aluminized

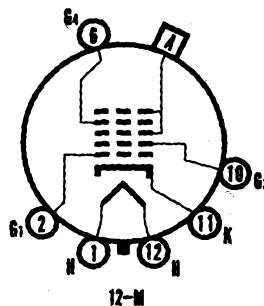
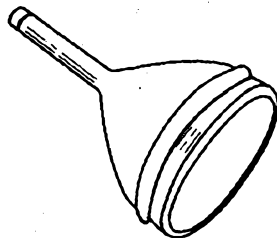

CHARACTERISTICS

GENERAL DATA

Focusing Method.....Self Focusing (Electrostatic)
Deflection Method.....Magnetic
Deflection Angle (approx.).....50 Degrees

Types*	7ABP4	7ABP7A 7ABP7	7ABP14A 7ABP14	7ABP19A 7ABP19
Fluorescence.....	White	Blue-White	Purple	Orange
Phosphorescence.....	White	Yellow	Orange	Yellow
Persistence.....	Short-Med.	Long	Med.-Long	Long
Faceplate.....				Clear

Types 7ABP4A, 7ABP14A and 7ABP19A have aluminized screens.

*In addition to the types shown, the 7ABP can be supplied with several other screen phosphors.

ELECTRICAL DATA

Heater Voltage.....6.3 Volts
Heater Current.....0.6 ± 5% Ampere
Direct Interelectrode Capacitances (approx.)
Cathode to All Other Electrodes.....5 μf
Grid No. 1 to All Other Electrodes.....6 μf

MECHANICAL DATA

Minimum Useful Screen Diameter.....6 Inches
Nominal Overall Length.....13 1/4 Inches
Bulb Contact (Recessed Small Cavity Cap).....J1-21
Base (Small Shell Duodecal 6-Pin).....B6-63
Basing.....12M
Bulb Contact Aligns with Pin No. 3.....± 10 Degrees

RATINGS

MAXIMUM RATINGS (Absolute Maximum Values)

Anode Voltage.....11,000 Volts d c
Grid No. 4 (Focusing Electrode) Voltage.....-550 to +1100 Volts d c
Grid No. 2 Voltage.....770 Volts d c
Grid No. 1 Voltage
Negative Bias Value.....200 Volts d c
Positive Bias Value¹.....0 Volts d c
Positive Peak Value.....0 Volts
Peak Heater-Cathode Voltage
Heater Negative with Respect to Cathode.....200 Volts
Heater Positive with Respect to Cathode.....200 Volts

TYPICAL OPERATING CONDITIONS

Anode Voltage².....7000 Volts d c
Grid No. 4 Voltage for Focus³.....0 to 250 Volts d c
Grid No. 2 Voltage.....300 Volts d c
Grid No. 1 Voltage⁴.....-28 to -72 Volts d c

CIRCUIT VALUES

Grid No. 1 Circuit Resistance.....1.5 Megohms Max.

SYLVANIA TYPE 7ABP4, 7ABP* (Cont'd)

NOTES:

1. At or near this rating, the effective resistance of the anode supply should be adequate to limit the anode input power to 6 watts. The screen of the 7ABP19 and 7ABP19A can be permanently damaged should the current density be permitted to rise too high. To prevent burning, minimum beam current densities should be employed.
2. Brilliance and definition decrease with decreasing anode voltage. In general, anode voltage should not be less than 5000 volts, except for the 7ABP19 and 7ABP19A. For these types the anode voltage should not be less than 7000 volts.
3. With E_{g1} adjusted for $I_b = 100 \mu\text{a}$ and beam focused for minimum width of individual lines at center of screen.
4. Visual extinction of undeflected focused spot.

**SYLVANIA TYPE 7JP1
7JP4
7JP7**

TELEVISION PICTURE TUBE

7" Direct Viewed
Round Glass Type
Clear Faceplate

Electrostatic Deflection
Electrostatic Focus
Spherical Faceplate

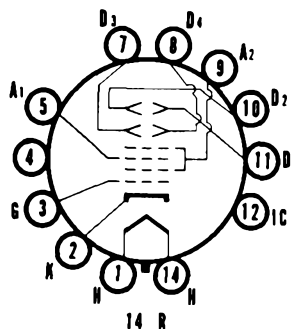
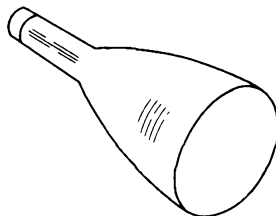

CHARACTERISTICS

GENERAL DATA

Focusing Method.....	Electrostatic
Deflecting Method.....	Electrostatic
Phosphor.....	P4
Fluorescence.....	White
Persistence.....	Medium
Faceplate.....	Clear

ELECTRICAL DATA

Heater Voltage.....	6.3 Volts
Heater Current (approx.).....	0.6 Ampere
Direct Interelectrode Capacitances (approx.)	
Cathode to All Other Electrodes.....	5.0 μf
Grid No. 1 to All Other Electrodes.....	6.0 μf
Between Vertical Deflecting Plates.....	3.0 μf
Between Horizontal Deflecting Plates.....	2.0 μf
Either Vertical Deflecting Plate to All Other Electrodes Except Other Vertical Plate.....	6.0 μf
Either Horizontal Deflecting Plate to All Other Electrodes Except Other Horizontal Plate.....	5.0 μf

MECHANICAL DATA

Minimum Useful Screen Diameter.....	6 Inches
Base (Medium Shell Diheptal 12-Pin).....	B12-37
Basing.....	14R

RATINGS

MAXIMUM RATINGS (Design Center Values)

Anode Voltage.....	6,000 Volts d c
Focusing Anode Voltage.....	2,800 Volts d c
Grid No. 1 Voltage	
Negative Bias Value.....	200 Volts d c
Positive Bias Value.....	0 Volts d c
Positive Peak Value.....	2 Volts
Peak Heater-Cathode Voltage	
Heater Negative with Respect to Cathode During Warm-up Period Not to Exceed 15 Seconds.....	410 Volts
After Equipment Warm-up Period.....	125 Volts
Heater Positive with Respect to Cathode.....	125 Volts
Peak Voltage Between High Voltage Anode and Any Deflecting Plates.....	750 Volts

RECOMMENDED OPERATING CONDITIONS

Anode Voltage.....	6,000 Volts d c
Focusing Anode Voltage.....	1,620-2,400 Volts d c
Grid No. 1 Voltage Required for Cutoff ¹	-72 to -168 Volts d c
Deflection Factor	
Vertical Plates ²	216 Volts d c/Inch
Horizontal Plates ³	177 Volts d c/Inch

7JP1, 7JP4, 7JP7 (Cont'd)

CIRCUIT VALUES

Grid No. 1 Circuit Resistance.....	1.5 Megohms Max
Deflection Circuit Resistance.....	5.0 Megohms Max

NOTES:

1. Visual extinction of undeflected focused spot.
2. Pins 10 and 11.
3. Pins 7 and 8.

The Type 7JP4 may be used as a direct replacement for Type 7GP4 provided no connections are made to the socket connections for Pins 4 and 12.

7JP1

The Type 7JP1 is identical to the Type 7JP4 except it has a green phosphor.

7JP7

The Type 7JP7 is identical to the Type 7JP4 except it has a blue-white, long persistence phosphor and a screen diameter of 5½ inches.

WARNING

X-ray radiation shielding may be necessary to protect against possible danger of personal injury from prolonged exposure at close range if this tube is operated at higher than the manufacturer's Maximum Rated Anode Voltage or 16,000 Volts, whichever is less.

SYLVANIA TYPE 8CP1 8CP4

8" Direct Viewed
Round Glass Type
Clear Faceplate

Electrostatic Deflection
Electrostatic Focus
Spherical Faceplate
Post Deflection Acceleration

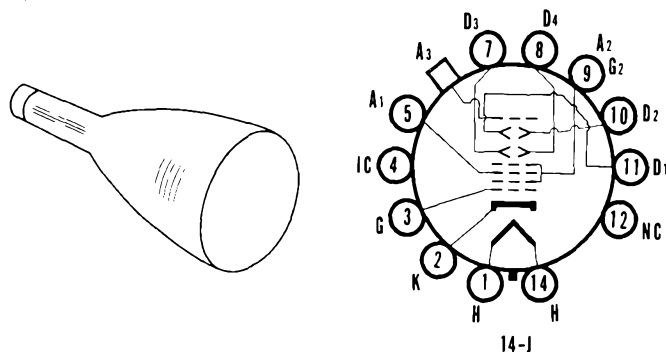

CHARACTERISTICS

GENERAL DATA

Focusing Method.....	Electrostatic
Deflecting Method.....	Electrostatic
Phosphor.....	P4
Fluorescence.....	White
Persistence.....	Medium
Faceplate.....	Clear

8CP1 (Cont'd)

8CP4

ELECTRICAL DATA

Heater Voltage	6.3 Volts
Heater Current (approx.)	0.6 Ampere
Direct Interelectrode Capacitances (approx.)	
Cathode to All Other Electrodes	10 μf
Grid No. 1 to All Other Electrodes	8 μf
Between Vertical Deflecting Plates	4 μf
Between Horizontal Deflecting Plates	2 μf
Either Vertical Deflecting Plate to All Other Electrodes Except Other Vertical Plate	8 μf
Either Horizontal Deflecting Plate to All Other Electrodes Except Other Horizontal Plate	6 μf

MECHANICAL DATA

Bulb Contact (Recessed Small Ball)	J1-22
Base (Medium Shell Diheptal 12-Fin)	B12-37
Basing	14J
Bulb Contact Aligns on Same Side as Pin No. 5	

RATINGS

MAXIMUM RATINGS (Design Center Values)

Anode No. 3 Voltage	6000 Volts d c
Anode No. 2 Voltage	6000 Volts d c
Anode No. 1 Voltage	2500 Volts d c
Grid No. 1 Voltage	
Negative Bias Value	200 Volts d c
Positive Bias Value	0 Volts d c
Positive Peak Value	2 Volts
Peak Heater-Cathode Voltage	
Heater Negative with Respect to Cathode	125 Volts
Heater Positive with Respect to Cathode	125 Volts
Peak Voltage Between Anode No. 2 and Any Deflecting Plates	500 Volts

RECOMMENDED OPERATING CONDITIONS

Anode No. 3 Voltage	4000 Volts d c
Anode No. 2 Voltage	2000 Volts d c
Anode No. 1 Voltage	540 to 800 Volts d c
Grid No. 1 Voltage Required for Cutoff ¹	24 to 56 Volts d c
Deflection Factor	
Vertical Plates ²	58 to 81 Volts d c/Inch
Horizontal Plates ³	49 to 68 Volts d c/Inch

CIRCUIT VALUES

Grid No. 1 Circuit Resistance	1.5 Megohms Max.
Deflection Circuit Resistance	5.0 Megohms Max.

NOTES:

1. Visual extinction of undeflected focused spot.
2. Pins 10 and 11.
3. Pins 7 and 8.

8CP1

The Type 8CP1 is identical to the Type 8CP4 except that it has a green phosphor.

WARNING:

X-ray radiation shielding may be necessary to protect against possible danger of personal injury from prolonged exposure at close range if this tube is operated at higher than the manufacturer's Maximum Rated Anode Voltage or 16,000 volts, whichever is less.

SYLVANIA TYPE 8XP4

TELEVISION RECEIVER CHECK TUBE

8" Direct Viewed Magnetic Deflection
 Rectangular Glass Type Self Focusing (Electrostatic)
 Gray Filter Glass No Ion Trap Required

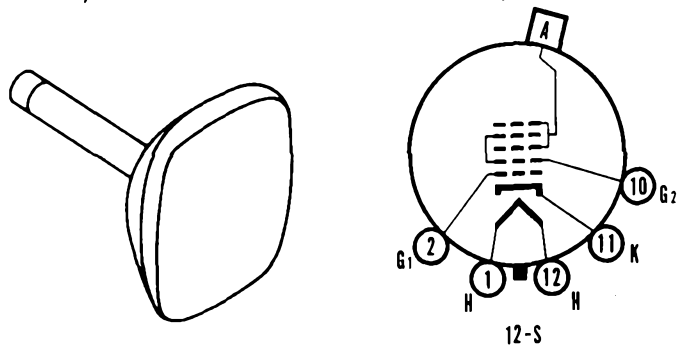

CHARACTERISTICS

GENERAL DATA

Focusing Method	Self Focusing (Electrostatic)
Deflecting Method	Magnetic
Deflecting Angle (approx.)	
Vertical	68 Degrees
Horizontal	85 Degrees
Diagonal	90 Degrees
Phosphor	P4
Fluorescence	White
Persistence	Short to Medium
Faceplate	Gray Filter Glass
Light Transmittance (approx.)	80 Percent

ELECTRICAL DATA

Heater Voltage	6.3 Volts
Heater Current	0.6 Ampero
Direct Interelectrode Capacitances	
Cathode to All Other Electrodes	5 μ f
Grid No. 1 to All Other Electrodes	6 μ f

MECHANICAL DATA

Overall Length	11 $\frac{1}{16}$ \pm $\frac{1}{16}$ Inches
Minimum Useful Screen Dimensions	7 $\frac{3}{16}$ x 5 $\frac{3}{16}$ Inches
Bulb Contact (Recessed Small Cavity Cap.)	J1-21
Base (Small Shell Duodecal 5-Pin)	B5-57
Basing	12S

RATINGS

MAXIMUM RATINGS (Absolute Maximum Values)

Anode Voltage	22,000 Volts d c
Grid No. 2 (and Grid No. 4) Voltage	550 Volts d c
Grid No. 1 Voltage	
Negative Bias Value	155 Volts d c
Negative Peak Value	220 Volts
Positive Bias Value	0 Volts d c
Positive Peak Value	2 Volts
Peak Heater-Cathode Voltage	
Heater Negative with Respect to Cathode	
During Warm-up Not to Exceed 15 Seconds	450 Volts
After Equipment Warm-up	200 Volts
Heater Positive with Respect to Cathode	200 Volts

TYPICAL OPERATING CONDITIONS

Anode Voltage	16,000 Volts d c
Grid No. 2 (and Grid No. 4) Voltage	300 Volts d c
Grid No. 1 Voltage Required for Cutoff	-28 to -72 Volts d c

CIRCUIT VALUES

Grid No. 1 Circuit Resistance	1.5 Megohms Max.
-------------------------------	------------------

NOTES:

1. Visual extinction of raster.

WARNING:

X-ray radiation shielding may be necessary to protect against possible danger of personal injury from prolonged exposure at close range if this tube is operated at higher than the manufacturer's Maximum Rated Anode Voltage or 16,000 volts, whichever is less.

SYLVANIA TYPE 8YP4

TELEVISION RECEIVER CHECK TUBE

8" Rectangular, All Glass No Ion Trap
 Self Focusing (Electrostatic) 110° Magnetic Deflection
 Gray Filter Glass

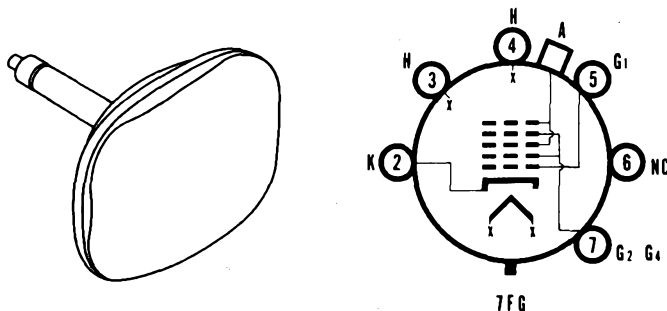

CHARACTERISTICS

GENERAL DATA

Focusing Method	Self Focusing (Electrostatic)
Deflecting Method	Magnetic
Deflection Angles (approx.)	
Vertical	87 Degrees
Horizontal	105 Degrees
Diagonal	110 Degrees
Phosphor	P4
Fluorescence	White
Persistence	Short to Medium
Faceplate	Gray Filter Glass
Light Transmittance (approx.)	80 Percent

ELECTRICAL DATA

Heater Voltage	6.3 Volts
Heater Current (approx.)	0.6 Ampere
Direct Interelectrode Capacitances (approx.)	
Cathode to All Other Electrodes	4 μ f
Grid No. 1 to All Other Electrodes	6 μ f

MECHANICAL DATA

Minimum Useful Screen Dimensions	7½ x 5⅞ Inches
Nominal Overall Length	8⅞ Inches
Bulb Contact (Recessed Small Cavity Cap)	J1-21
Base	B6-185
Basing	7FG
Weight (approx.)	2 Pounds

RATINGS

MAXIMUM RATINGS (Absolute Maximum Values)

Anode Voltage	22,000 Volts d c
Grid No. 2 (and Grid No. 4) Voltage	550 Volts d c
Grid No. 1 Voltage	
Negative Bias Value	155 Volts d c
Negative Peak Value	220 Volts
Positive Bias Value	0 Volts d c
Positive Peak Value	2 Volts
Peak Heater-Cathode Voltage	
Heater Negative with Respect to Cathode	
During Warm-up Period Not to Exceed 15 Seconds	450 Volts
After Equipment Warm-up Period	200 Volts
Heater Positive with Respect to Cathode	200 Volts

TYPICAL OPERATING CONDITIONS

Anode Voltage	16,000 Volts d c
Grid No. 2 (and Grid No. 4) Voltage	300 Volts d c
Grid No. 1 Voltage Required for Cutoff	-35 to -72 Volts d c

CIRCUIT VALUES

Grid No. 1 Circuit Resistance	1.5 Megohms Max.
-------------------------------	------------------

SYLVANIA PICTURE TUBES

Issued as a supplement to the manual in Sylvania News for March, 1958

SYLVANIA TYPE 8YP4 (Cont'd)

NOTE:

1. Visual extinction of raster.

WARNING:

X-ray radiation shielding may be necessary to protect against possible danger of personal injury from prolonged exposure at close range if this tube is operated at higher than the manufacturer's Maximum Rated Anode Voltage or 16,000 volts, whichever is less.

**SYLVANIA TYPE 10ABP4
10ABP4A
10ABP4B
10ABP4C**

TELEVISION PICTURE TUBE

10" Direct Viewed Magnetic Deflection
Rectangular Glass Type Electrostatic Focus
Spherical Face Plate Single Field Ion Trap
External Conductive Coating

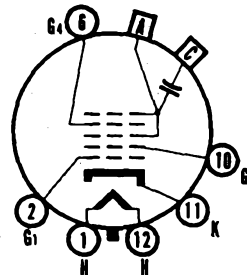
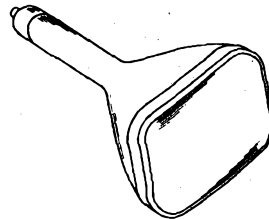

12-L

CHARACTERISTICS

GENERAL DATA

Focusing Method.....		Electrostatic
Deflection Method.....		Magnetic
Deflection Angle (approx.)		
Horizontal.....		85 Degrees
Diagonal.....		90 Degrees
		10ABP4C*
		10ABP4B
Phosphor.....	10ABP4A* 10ABP4	P4 P4
Fluorescence.....		White
Persistence.....	Medium	Medium
Faceplate.....	Clear	Gray Filter
Light Transmittance (approx.).....	91	81 Percent

*Types 10ABP4A and 10ABP4C have aluminized screens.

ELECTRICAL DATA

Heater Voltage.....	6.3 Volts
Heater Current.....	0.6 ± 5% Amperes
Direct Interelectrode Capacitances (approx.)	
Cathode to All Other Electrodes.....	5 μf
Grid No. 1 to All Other Electrodes.....	6 μf
External Conductive Coating to Anode.....	850 μf Max. 400 μf Min.

MECHANICAL DATA

Minimum Useful Screen Dimensions (Maximum Assured).....	8 7/8 x 6 9/16 Inches
Nominal Overall Length.....	11 1/8 Inches
Minimum Useful Screen Area.....	53 1/2 Square Inches
Bulb Contact.....	J1-21
Base.....	B6-63
Basing.....	12L
Bulb Contact Alignment	
J1-21 Contact Aligns with Pin Position No. 6.....	± 30 Degrees
Weight.....	4.5 Pounds

MAXIMUM RATINGS (Absolute Maximum Values)

Anode Voltage.....	13,200 Volts d c
Grid No. 4 Voltage ¹	-550 to +1100 Volts d c
Grid No. 2 Voltage.....	550 Volts d c
Grid No. 1 Voltage.....	
Negative Peak Value.....	220 Volts
Negative Bias Value.....	154 Volts d c
Positive Bias Value.....	0 Volts d c
Positive Peak Value.....	2 Volts
Peak Heater-Cathode Voltage	
Heater Negative with Respect to Cathode	
During Warm-up Period Not to Exceed	
15 Seconds.....	450 Volts
After Equipment Warm-up.....	200 Volts
Heater Positive with Respect to Cathode.....	200 Volts

SYLVANIA PICTURE TUBES

SYLVANIA TYPE 10ABP4, 10ABP4A, 10ABP4B, 10ABP4C (Cont'd)

TYPICAL OPERATING CONDITIONS

Anode Voltage.....	7500 Volts d c
Grid No. 4 Voltage ²	0 to 500 Volts d c
Grid No. 2 Voltage.....	300 Volts d c
Grid No. 1 Voltage ⁴	-38 to -62 Volts d c
Field Strength of PM Ion Trap Magnet ⁴	32 Gaussess Min.

CIRCUIT VALUES

Grid No. 1 Circuit Resistance.....	1.5 Megohms Max.
------------------------------------	------------------

NOTES:

1. Grid No. 4 in this tube is the focus control electrode.
2. With the combined Grid No. 1 bias voltage and video signal adjusted to produce an anode current of 100 μ a on a 8 $\frac{1}{8}$ x 6 $\frac{1}{8}$ inch picture adjusted for best overall focus. For other anode voltages, the focus voltage will be from 0 percent to 5.5 percent.
3. Visual extinction of focused raster.
4. For the specimen PM ion trap magnet such as the Heppner Model No. E437 or equivalent, positioned to give maximum brightness for a given equipment application, the tolerance range for the strength of the PM ion magnet should be added to the minimum value. The maximum strength of the magnet should not exceed the specified minimum value by more than 6 gaussess. This procedure will insure use of the PM ion trap magnet allowing adequate adjustment to permit satisfactory performance without loss of highlight brightness.

SYLVANIA TYPE 10BP4 10BP4A

TELEVISION PICTURE TUBE

10" Direct Viewed	Magnetic Deflection
Round Glass Type	Magnetic Focus
Clear Faceplate	Spherical Faceplate
External Conductive Coating	Double Field Ion Trap
10BP4A has Gray Filter	Glass Faceplate

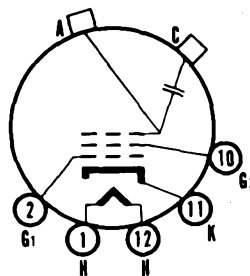
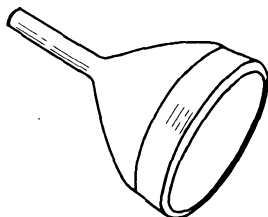

12-N

CHARACTERISTICS

GENERAL DATA

Focusing Method.....	Magnetic
Deflecting Method.....	Magnetic
Deflecting Angle.....	50 Degrees
Phosphor.....	P4
Fluorescence.....	White
Persistence.....	Medium
Faceplate.....	Clear

ELECTRICAL DATA

Heater Voltage.....	6.3 Volts
Heater Current (approx.).....	0.6 Ampere
Direct Interelectrode Capacitances (approx.)	
Cathode to All Other Electrodes.....	5.0 μf
Grid No. 1 to All Other Electrodes.....	6.0 μf
External Conductive Coating to Anode.....	2500 μf Max
	500 μf Min
Ion Trap Magnet.....	External, Double Field Type

MECHANICAL DATA

Minimum Useful Screen Diameter.....	9 $\frac{1}{8}$ Inches
Bulb Contact (Recessed Small Cavity Cap).....	J1-21
Base (Small Shell Duodecal 5-Pin).....	B5-57
Basing.....	12N
Bulb Contact Aligns with Vacant Pin	
Position No. 3.....	± 10 Degrees

RATINGS

MAXIMUM RATINGS (Design Center Values)

Anode Voltage.....	10000 Volts d c
Grid No. 2 Voltage.....	410 Volts d c
Grid No. 1 Voltage	
Negative Bias Value.....	125 Volts d c
Positive Bias Value.....	0 Volts d c
Positive Peak Value.....	2 Volts
Peak Heater-Cathode Voltage	
Heater Negative with Respect to Cathode	
During Warm-up Period Not to Exceed 15 Seconds.....	410 Volts
After Equipment Warm-up Period.....	140 Volts
Heater Positive with Respect to Cathode.....	140 Volts

RECOMMENDED OPERATING CONDITIONS

Anode Voltage.....	9000 Volts d c
Grid No. 2 Voltage.....	250 Volts d c
Grid No. 1 Voltage Required for Cutoff ²	-27 to -63 Volts d c
Focusing Coil Current (approx.) ³	100 Ma d c
Ion Trap Magnet Strength (approx.).....	35 Gauss

10BP4, 10BP4A (Cont'd)

NOTES:

1. External conductive coating must be grounded.
2. Visual extinction of undeflected focused spot.
3. For JET EC focusing coil 106 or equivalent three and one quarter inches from reference line.

10BP4A

Sylvania 10BP4A is identical to Type 10BP4 except for having the gray filter glass faceplate.

WARNING

X-ray radiation shielding may be necessary to protect against possible danger of personal injury from prolonged exposure at close range if this tube is operated at higher than the manufacturer's Maximum Rated Anode Voltage or 16,000 volts, whichever is less.

SYLVANIA TYPE 10HP4

TELEVISION PICTURE TUBE

10" Direct Viewed
Round Glass Type
Clear Faceplate

Electrostatic Deflection
Electrostatic Focus
Spherical Faceplate

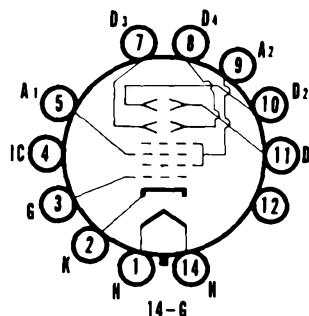
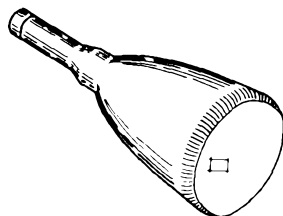

CHARACTERISTICS

GENERAL DATA

Focusing Method.....	Electrostatic
Deflecting Method.....	Electrostatic
Phosphor.....	P4
Fluorescence.....	White
Persistence.....	Medium
Faceplate.....	Clear

ELECTRICAL DATA

Heater Voltage.....	6.3 Volts
Heater Current (approx.).....	0.6 Ampere
Direct Interelectrode Capacitances (approx.)	
Cathode to All Other Electrodes.....	9.5 μf
Grid No. 1 to All Other Electrodes.....	8.5 μf
Between Vertical Deflecting Plates.....	3.5 μf
Between Horizontal Deflecting Plates.....	2.0 μf
Either Vertical Deflecting Plate to All Other Electrodes Except Other Vertical Plate.....	7.5 μf
Either Horizontal Deflecting Plate to All Other Electrodes Except Other Horizontal Plate.....	6.0 μf

10HP4 (Cont'd)

MECHANICAL DATA

Minimum Useful Screen Diameter.....	8¾ Inches
Base (Medium Shell Diheptal 12-Pin).....	B12-37
Basing.....	14G

RATINGS

MAXIMUM RATINGS (Design Center Values)

Anode Voltage.....	5000 Volts d c
Focusing Anode Voltage.....	2000 Volts d c
Grid No. 1 Voltage	
Negative Bias Value.....	200 Volts d c
Positive Bias Value.....	0 Volts d c
Positive Peak Value.....	2 Volts
Peak Heater-Cathode Voltage	
Heater Negative with Respect to Cathode	
During Warm-up Period Not to	
Exceed 15 Seconds.....	410 Volts
After Equipment Warm-up Period.....	125 Volts
Heater Positive with Respect to Cathode.....	125 Volts
Peak Voltage Between High Voltage Anode and	
Any Deflecting Plates.....	600 Volts

RECOMMENDED OPERATING CONDITIONS

Anode Voltage.....	5000 Volts d c
Focusing Anode Voltage.....	1200 to 1800 Volts d c
Grid No. 1 Voltage Required for Cutoff ¹	-60 to -140 Volts d c
Deflection Factor	
Vertical Plates ²	130 Volts d c/Inch
Horizontal Plates ³	100 Volts d c/Inch

CIRCUIT VALUES

Grid No. 1 Circuit Resistance.....	1.5 Megohms Max
Deflection Circuit Resistance.....	5.0 Megohms Max

NOTES:

1. Visual extinction of undeflected focused spot.
2. Pins 10 and 11.
3. Pins 7 and 8.

WARNING

X-ray radiation shielding may be necessary to protect against possible danger of personal injury from prolonged exposure at close range if this tube is operated at higher than the manufacturer's Maximum Rated Anode Voltage or 16,000 volts, whichever is less.

SYLVANIA TYPE 10MP4 10MP4A

TELEVISION PICTURE TUBE

10" Direct Viewed Magnetic Deflection
 Round Glass Type Magnetic Focus
 Clear Faceplate Spherical Faceplate
 External Conductive Coating Double Field Ion Trap
 10MP4A has a Gray Filter Glass Faceplate

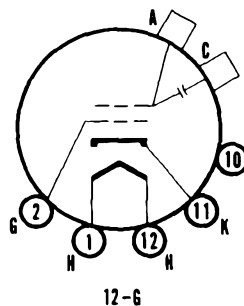
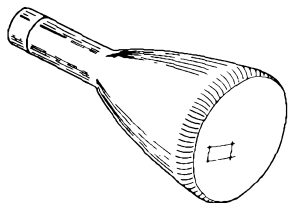

CHARACTERISTICS

GENERAL DATA

Focusing Method.....	Magnetic
Deflecting Method.....	Magnetic
Deflecting Angle (approx.).....	52 Degrees
Phosphor.....	P4
Fluorescence.....	White
Persistence.....	Medium
Faceplate.....	Clear
Light Transmittance (approx.).....	66 Percent

ELECTRICAL DATA

Heater Voltage.....	6.3 Volts
Heater Current (approx.).....	0.6 Ampere
Direct Interelectrode Capacitances (approx.)	
Cathode to All Other Electrodes.....	5 μ f
Grid to All Other Electrodes.....	6 μ f
External Conductive Coating to Anode ¹	2500 μ f Max 500 μ f Min
Ion Trap Magnet.....	External, Double Field Type

MECHANICAL DATA

Minimum Useful Screen Diameter.....	9 $\frac{1}{8}$ Inches
Bulb Contact (Recessed Small Cavity Cap).....	J1-21
Base (Small Shell Duodecal 5-Pin).....	B5-57
Basing.....	12G

RATINGS

MAXIMUM RATINGS (Design Center Values)

Anode Voltage.....	10000 Volts	d c
Grid Voltage.....		
Negative Bias Value.....	125 Volts	d c
Positive Bias Value.....	0 Volts	d c
Positive Peak Value.....	2 Volts	
Peak Heater-Cathode Voltage.....		
Heater Negative with Respect to Cathode		
During Warm-up Period Not to Exceed 15 Seconds.....	410 Volts	
After Equipment Warm-up Period.....	125 Volts	
Heater Positive with Respect to Cathode.....	125 Volts	

RECOMMENDED OPERATING CONDITIONS

Anode Voltage.....	9000 Volts	d c
Grid Voltage Required for Cutoff ²	-27 to -63 Volts	d c
Ion Trap Magnet Strength (approx.).....	35 Gauss	

10MP4, 10MP4A (Cont'd)

CIRCUIT VALUES

Grid Circuit Resistance..... 1.5 Megohms
Max

NOTES:

1. External conductive coating must be grounded.
2. Visual extinction of undeflected focused spot.

10MP4A

The Sylvania Type 10MP4A is identical to Type 10MP4 except for having the gray filter glass faceplate.

WARNING

X-ray radiation shielding may be necessary to protect against possible danger of personal injury from prolonged exposure at close range if this tube is operated at higher than the manufacturer's Maximum Rated Anode Voltage or 16,000 volts, whichever is less.

SYLVANIA TYPE 12KP4 Silver Screen "85" → 12KP4A

TELEVISION PICTURE TUBE

12" Direct Viewed	Magnetic Deflection
Round Glass Type	Magnetic Focus
Clear Faceplate	Spherical Faceplate
External Conductive Coating	Aluminized Screen
No Ion Trap Magnet Required	
12KP4A has a Gray Filter Glass Faceplate	

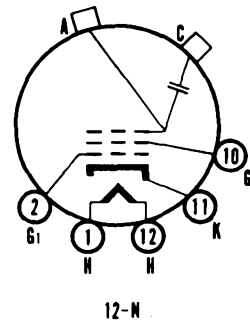
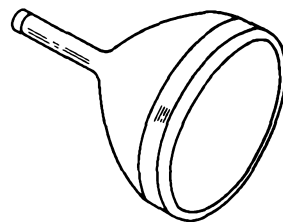

CHARACTERISTICS

GENERAL DATA

Focusing Method.....	Magnetic
Deflecting Method.....	Magnetic
Deflecting Angle (approx.).....	54 Degrees
Phosphor.....	Aluminized, P4
Fluorescence.....	White
Persistence.....	Medium
Faceplate.....	Gray Filter Glass
Light Transmittance (approx.).....	72 Percent

12KP4, 12KP4A (Cont'd)

ELECTRICAL DATA

Heater Voltage.....	6.3 Volts
Heater Current (approx.).....	0.6 Amperes
Direct Interelectrode Capacitances (approx.)	
Cathode to All Other Electrodes.....	5 $\mu\mu\text{f}$
Grid No. 1 to All Other Electrodes.....	6 $\mu\mu\text{f}$
External Conductive Coating to Anode ¹	2500 $\mu\mu\text{f}$ Max 500 $\mu\mu\text{f}$ Min

MECHANICAL DATA

Minimum Useful Screen Diameter.....	11 $\frac{1}{4}$ Inches
Bulb Contact (Recessed Small Cavity Cap).....	J1-21
Base (Small Shell Duodecal 5-Pin).....	B5-57
Basing.....	12N

RATINGS

MAXIMUM RATINGS (Design Center Values)

Anode Voltage.....	12000 Volts d c
Grid No. 2 Voltage.....	410 Volts d c
Grid No. 1 Voltage	
Negative Bias Value.....	125 Volts d c
Positive Bias Value.....	0 Volts d c
Positive Peak Value.....	2 Volts
Peak Heater-Cathode Voltage	
Heater Negative with Respect to Cathode	
During Warm-up Period Not to Exceed 15 Seconds....	410 Volts
After Equipment Warm-up Period.....	140 Volts
Heater Positive with Respect to Cathode.....	140 Volts

RECOMMENDED OPERATING CONDITIONS

Anode Voltage.....	11000 Volts d c
Grid No. 2 Voltage.....	250 Volts d c
Grid No. 1 Voltage Required for Cutoff ²	-27 to -63 Volts d c
Focusing Coil Current (approx.) ³	135 Ma d c

CIRCUIT VALUES

Grid No. 1 Circuit Resistance.....	1.5 Megohms Max
------------------------------------	--------------------

NOTES:

1. External conductive coating must be grounded.
2. Visual extinction of undeflected focused spot.
3. For JETEC focusing coil 106 or equivalent three and one quarter inches from reference line, bias adjusted to 35 foot lamberts on a 7 $\frac{1}{2}$ x 10 inch picture area.

12KP4A

The Sylvania Type 12KP4A is identical to Type 12KP4 except for having the gray filter glass faceplate.

WARNING

X-ray radiation shielding may be necessary to protect against possible danger of personal injury from prolonged exposure at close range if this tube is operated at higher than the manufacturer's Maximum Rated Anode Voltage or 16,000 volts, whichever is less.

SYLVANIA TYPE 10NP11

VIDEO RECORDING TUBE

10" Direct Viewed Magnetic Deflection
 Round Glass Type Magnetic Focus
 Aluminized Screen External Conductive Coating
 Triode Construction

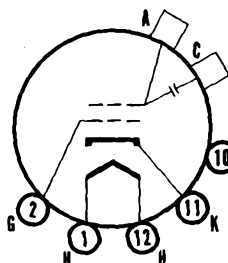
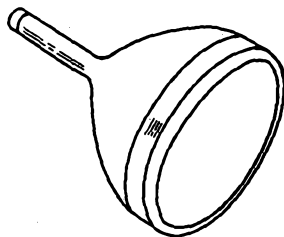

12-G

CHARACTERISTICS

GENERAL DATA

Focusing Method	Magnetic
Deflecting Method	Magnetic
Deflection Angle (approx.)	52 Degrees
Phosphor	P11
Fluorescence	Blue
Persistence	Short
Faceplate	Clear, or Gray Filter Glass
Light Transmittance (approx.)	76 Percent

ELECTRICAL DATA

Heater Voltage	6.3 Volts
Heater Current	0.6 Ampere
Direct Interelectrode Capacitances (approx.)	
Cathode to All Other Electrodes	4 μ f
Grid No. 1 to All Other Electrodes	5 μ f
External Conductive Coating to Anode	1500 μ f Max. 500 μ f Min.

MECHANICAL DATA

Minimum Useful Screen Diameter ¹	9 $\frac{1}{8}$ Inches
Nominal Overall Length	17 $\frac{5}{8}$ Inches
Bulb Contact (Recessed Small Ball Cap)	J1-21
Base (Small Shell Duodecal 5-Pin)	B5-57
Basing	12G
Bulb Contact Aligns with Pin Position No. 3 (Vacant)	\pm 30 Degrees

RATINGS

MAXIMUM RATINGS (Absolute Maximum Values)

Anode Voltage	27,500 Volts d c
Grid No. 1 Voltage	
Negative Bias Value	385 Volts d c
Positive Bias Value	0 Volts d c
Positive Peak Value	2 Volts
Peak Heater Negative with Respect to Cathode	
During Warm-up Period not to Exceed 15 Seconds	450 Volts
Heater Negative with Respect to Cathode	165 Volts
Heater Positive with Respect to Cathode	165 Volts

TYPICAL OPERATING CONDITIONS

Anode Voltage	18,000 Volts d c
Grid No. 1 Voltage ²	-65 to -125 Volts d c
Focusing Coil Current (approx.) ³	110 Ma d c

NOTES:

- For film recording it is recommended that the pattern be confined within the 7 inch diameter circle centered on the tube face to minimize its curvature and to insure best screen quality.
- Visual extinction of undeflected focused spot.
- For JETEC focusing coil 109 or equivalent, with the distance from reference line to the center of the air gap equal to 3 $\frac{1}{4}$ inches.

1870
1871
1872
1873
1874
1875
1876
1877
1878
1879
1880
1881
1882
1883
1884
1885
1886
1887
1888
1889
1890
1891
1892
1893
1894
1895
1896
1897
1898
1899
1900
1901
1902
1903
1904
1905
1906
1907
1908
1909
1910
1911
1912
1913
1914
1915
1916
1917
1918
1919
1920
1921
1922
1923
1924
1925
1926
1927
1928
1929
1930
1931
1932
1933
1934
1935
1936
1937
1938
1939
1940
1941
1942
1943
1944
1945
1946
1947
1948
1949
1950
1951
1952
1953
1954
1955
1956
1957
1958
1959
1960
1961
1962
1963
1964
1965
1966
1967
1968
1969
1970
1971
1972
1973
1974
1975
1976
1977
1978
1979
1980
1981
1982
1983
1984
1985
1986
1987
1988
1989
1990
1991
1992
1993
1994
1995
1996
1997
1998
1999
2000
2001
2002
2003
2004
2005
2006
2007
2008
2009
2010
2011
2012
2013
2014
2015
2016
2017
2018
2019
2020
2021
2022
2023
2024
2025

SYLVANIA TYPE 10SP4

Monitor Tube
10" Direct Viewed
Round Glass Type
Spherical Faceplate
Gray Filter Glass

Aluminized Screen
Magnetic Deflection
No Ion Trap
Acceleration Type
Electrostatic Focus

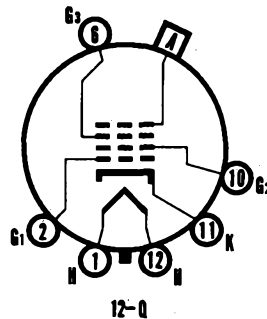
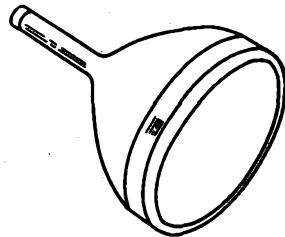

CHARACTERISTICS

GENERAL DATA

Focusing Method.....	Electrostatic
Deflecting Method.....	Magnetic
Deflection Angle (approx.).....	60 Degrees
Phosphor.....	P4
Fluorescence.....	White
Persistence.....	Short to Medium
Faceplate.....	Gray Filter Glass
Light Transmittance.....	76 Percent

ELECTRICAL DATA

Heater Voltage.....	6.3 Volts
Heater Current.....	0.6 Ampere
Direct Interelectrode Capacitances (approx.)	
Cathode to All Other Electrodes.....	5 μ f
Grid No. 1 to All Other Electrodes.....	6 μ f

MECHANICAL DATA

Minimum Useful Screen Diameter.....	9 1/4 Inches
Nominal Overall Length.....	16 1/2 Inches
Bulb Contact (Recessed Small Cavity Cap).....	J1-21
Base (Small Shell Duodecal 6-Pin).....	B6-63
Basing.....	12Q
Bulb Contact Aligns with Pin No. 6.....	\pm 10 Degrees

RATINGS

MAXIMUM RATINGS (Absolute Maximum Values)

Anode Voltage.....	22,000 Volts d c
Grid No. 3 Voltage.....	3300 Volts d c
Grid No. 2 Voltage.....	450 Volts d c
Grid No. 1 Voltage.....	
Negative Bias Value.....	140 Volts d c
Positive Bias Value.....	0 Volts d c
Positive Peak Value.....	2 Volts
Peak Heater-Cathode Voltage.....	
Heater Negative with Respect to Cathode	
During Warm-up Period Not to Exceed	
15 Seconds.....	450 Volts
After Warm-up Period.....	200 Volts
Heater Positive with Respect to Cathode.....	200 Volts

TYPICAL OPERATING CONDITIONS

Anode Voltage ¹	14,000 Volts d c
Grid No. 3 Voltage for Focus with	
I _b = 100 μ amps.....	1640 to 2225 Volts d c
Alignment Magnet Field Strength.....	0 to 8 Gauss
Grid No. 2 Voltage.....	200 Volts d c
Grid No. 1 Voltage Required for Cutoff ²	-18 to -48 Volts d c
Grid No. 3 Current at I _b = 100 μ amps.....	25 μ a Max.

SYLVANIA TYPE 1OSP4 (Cont'd)

CIRCUIT VALUES

Grid No. 1 Circuit Resistance..... 1.5 Megohms Max.

NOTES:

1. Brilliance and definition decrease with decreasing anode voltage. In general, anode voltage should not be less than 10,000 volts.
2. Visual extinction of focused raster. Extinction of stationary focused spot will require that these values be about 5 volts more negative.

WARNING:

X-ray radiation shielding may be necessary to protect against possible danger of personal injury from prolonged exposure at close range if this tube is operated at higher than the manufacturer's Maximum Rated Anode Voltage or 16,000 volts, whichever is less.

SYLVANIA TYPE 12LP4 12LP4A

TELEVISION PICTURE TUBE

12" Direct Viewed	Magnetic Deflection
Round Glass Type	Magnetic Focus
Clear Faceplate	Spherical Faceplate
External Conductive Coating	Double Field Ion Trap

12LP4A has a Gray Filter Glass Faceplate

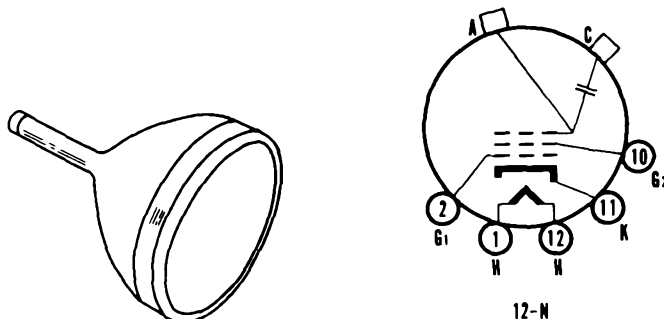

CHARACTERISTICS

GENERAL DATA

Focusing Method.....	Magnetic
Deflecting Method.....	Magnetic
Deflecting Angle (approx.).....	54 Degrees
Phosphor.....	P4
Fluorescence.....	White
Persistence.....	Medium
Faceplate.....	Clear

ELECTRICAL DATA

Heater Voltage.....	6.3 Volts
Heater Current (approx.).....	0.6 Amperes
Direct Interelectrode Capacitances (approx.).....	
Cathode to All Other Electrodes.....	5 μf
Grid No. 1 to All Other Electrodes.....	6 μf
External Conductive Coating to Anode ¹	3000 μf Max 750 μf Min
Ion Trap Magnet.....	External, Double Field Type

MECHANICAL DATA

Minimum Useful Screen Diameter.....	11 Inches
Bulb Contact (Recessed Small Cavity Cap).....	J1-21
Base (Small Shell Duodecal 5-Pin).....	B5-57
Basing.....	12N
Bulb Contact Aligns with Vacant Pin	
Position No. 3.....	± 10 Degrees

RATINGS

MAXIMUM RATINGS (Design Center Values)

Anode Voltage.....	12000 Volts d c
Grid No. 2 Voltage.....	410 Volts d c
Grid No. 1 Voltage.....	
Negative Bias Value.....	125 Volts d c
Positive Bias Value.....	0 Volts d c
Positive Peak Value.....	2 Volts
Peak Heater-Cathode Voltage.....	
Heater Negative with Respect to Cathode	
During Warm-up Period Not to Exceed 15 Seconds.....	410 Volts
After Equipment Warm-up Period.....	140 Volts
Heater Positive with Respect to Cathode.....	140 Volts

12LP4, 12LP4A (Cont'd)

RECOMMENDED OPERATING CONDITIONS

Anode Voltage.....	11000 Volts d c
Grid No. 2 Voltage.....	250 Volts d c
Grid No. 1 Voltage Required for Cutoff ²	-27 to -63 Volts d c
Focusing Coil Current (approx.) ³	110 Ma d c
Ion Trap Magnet Strength (approx.).....	35 Gaussess

CIRCUIT VALUES

Grid No. 1 Circuit Resistance.....	1.5 Megohms Max
------------------------------------	--------------------

NOTES:

1. External conductive coating must be grounded.
2. Visual extinction of undeflected focused spot.
3. For JETEC focusing coil 106 or equivalent three and one quarter inches from reference line, bias adjusted to 20 foot lamberts on a 7½ x 10 inch picture area.

12LP4A

The Sylvania Type 12LP4A is identical to Type 12LP4 except for having the gray filter glass faceplate.

WARNING

X-ray radiation shielding may be necessary to protect against possible danger of personal injury from prolonged exposure at close range if this tube is operated at higher than the manufacturer's Maximum Rated Anode Voltage or 16,000 volts, whichever is less.

SYLVANIA TYPE 12VP4 12VP4A

TELEVISION PICTURE TUBE

12" Direct Viewed	Magnetic Deflection
Round Glass Type	Magnetic Focus
Clear Faceplate	Spherical Faceplate
External Conductive Coating	Double Field Ion Trap
12VP4A has a Gray Filter Glass Faceplate	

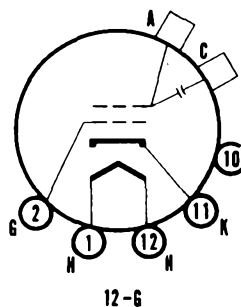
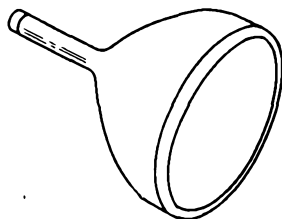

12VP4, 12VP4A (Cont'd)

CHARACTERISTICS

GENERAL DATA

Focusing Method.....	Magnetic
Deflecting Method.....	Magnetic
Deflecting Angle (approx.).....	55 Degrees
Phosphor.....	P4
Fluorescence.....	White
Persistence.....	Medium
Faceplate.....	Clear
Light Transmittance (approx.).....	66 Percent

ELECTRICAL DATA

Heater Voltage.....	6.3 Volts
Heater Current (approx.).....	0.6 Ampere
Direct Interelectrode Capacitances (approx.).....	
Cathode to All Other Electrodes.....	5 μf
Grid to All Other Electrodes.....	6 μf
External Conductive Coating to Anode.....	3000 μf Max
	750 μf Min
Ion Trap Magnet.....	External, Double Field Type

MECHANICAL DATA

Minimum Useful Screen Diameter.....	11 Inches
Bulb Contact (Recessed Small Cavity Cap).....	J1-21
Base (Small Shell Duodecal 5-Pin).....	B5-57
Basing.....	12G

RATINGS

MAXIMUM RATINGS (Design Center Values)

Anode Voltage.....	12000 Volts d c
Grid Voltage.....	
Negative Bias Value.....	125 Volts d c
Positive Bias Value.....	0 Volts d c
Positive Peak Value.....	2 Volts
Peak Heater-Cathode Voltage.....	
Heater Negative with Respect to Cathode.....	
During Warm-up Period Not to Exceed 15 Seconds.....	410 Volts
After Equipment Warm-up Period.....	125 Volts
Heater Positive with Respect to Cathode.....	125 Volts

RECOMMENDED OPERATING CONDITIONS

Anode Voltage.....	11000 Volts d c
Grid Voltage Required for Cutoff.....	-33 to -77 Volts d c
Ion Trap Magnet Strength (approx.).....	35 Gauss

CIRCUIT VALUES

Grid Circuit Resistance.....	1.5 Megohms
	Max

NOTES:

1. External conductive coating must be grounded.
2. Visual extinction of undeflected focused spot.

12VP4A

The Sylvania Type 12VP4A is identical to Type 12VP4 except for having the gray filter glass faceplate.

WARNING

X-ray radiation shielding may be necessary to protect against possible danger of personal injury from prolonged exposure at close range if this tube is operated at higher than the manufacturer's Maximum Rated Anode Voltage or 16,000 volts, whichever is less.

SYLVANIA TYPE 14BP4

TELEVISION PICTURE TUBE

14" Direct Viewed	Magnetic Deflection
Rectangular Glass Type	Magnetic Focus
Gray Filter Glass	Spherical Faceplate
External Conductive Coating	Single Field Ion Trap

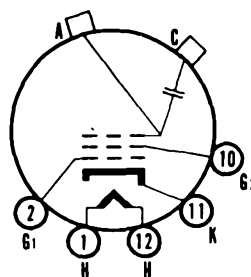
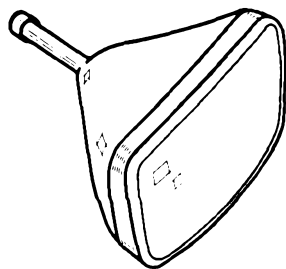

12-N

CHARACTERISTICS

GENERAL DATA

Focusing Method.....	Magnetic
Deflecting Method.....	Magnetic
Deflecting Angle (approx.).....	
Horizontal.....	70 Degrees
Diagonal.....	65 Degrees
Phosphor.....	P4
Fluorescence.....	White
Persistence.....	Medium
Faceplate.....	Gray Filter Glass
Light Transmittance (approx.).....	70 Percent

ELECTRICAL DATA

Heater Voltage.....	6.3 Volts
Heater Current (approx.).....	0.6 Ampere
Direct Interelectrode Capacitances (approx.).....	
Cathode to All Other Electrodes.....	5 μ f
Grid No. 1 to All Other Electrodes.....	6 μ f
External Conductive Coating to Anode ¹	2000 μ f Max
	500 μ f Min
Ion Trap Magnet.....	External, Single Field Type

MECHANICAL DATA

Minimum Useful Screen Dimensions.....	8 ² / ₃₂ x 11 ⁷ / ₁₆ Inches
Bulb Contact (Recessed Small Cavity Cap).....	J1-21
Base (Small Shell Duodecal 5-Pin).....	B5-57
Basing.....	12N

RATINGS

MAXIMUM RATINGS (Design Center Values)

Anode Voltage.....	12000 Volts d c
Grid No. 2 Voltage.....	410 Volts d c
Grid No. 1 Voltage.....	
Negative Bias Value.....	125 Volts d c
Positive Bias Value.....	0 Volts d c
Positive Peak Value.....	2 Volts
Peak Heater-Cathode Voltage.....	
Heater Negative with Respect to Cathode.....	
During Warm-up Period Not to Exceed 15 Seconds....	410 Volts
After Equipment Warm-up Period.....	125 Volts
Heater Positive with Respect to Cathode.....	125 Volts

RECOMMENDED OPERATING CONDITIONS

Anode Voltage.....	11000 Volts d c
Grid No. 2 Voltage.....	250 Volts d c
Grid No. 1 Voltage Required for Cutoff ²	-27 to -63 Volts d c
Focusing Coil Current (approx.) ³	110 Ma d c
Ion Trap Magnet Strength (approx.).....	35 Gauss

14BP4 (Cont'd)

CIRCUIT VALUES

Grid No. 1 Circuit Resistance..... 1.5 Megohms
Max

NOTES:

- External conductive coating must be grounded.
- Visual extinction of undeflected focused spot.
- For JETEC focusing coil 106 or equivalent three and one quarter inch from reference line, bias adjusted to 20 foot lamberts on a $8\frac{2}{32} \times 11\frac{1}{16}$ inch picture area.

WARNING

X-ray radiation shielding may be necessary to protect against possible danger of personal injury from prolonged exposure at close range if this tube is operated at higher than the manufacturer's Maximum Rated Anode Voltage or 16,000 volts, whichever is less.

SYLVANIA TYPE 14CP4

TELEVISION PICTURE TUBE

14" Direct Viewed	Magnetic Deflection
Rectangular Glass Type	Magnetic Focus
Gray Filter Glass	Spherical Faceplate
External Conductive Coating	Single Field Ion Trap

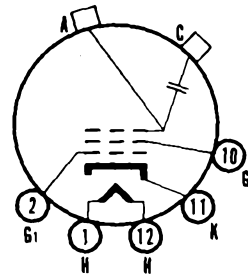
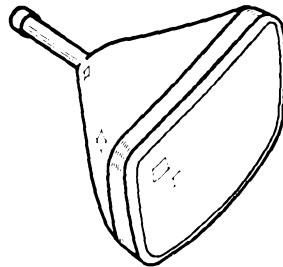

12-N

CHARACTERISTICS

GENERAL DATA

Focusing Method.....	Magnetic
Deflecting Method.....	Magnetic
Deflecting Angle (approx.)	
Horizontal.....	65 Degrees
Diagonal.....	70 Degrees
Phosphor.....	P4
Fluorescence.....	White
Persistence.....	Medium
Faceplate.....	Gray Filter Glass
Light Transmittance (approx.).....	66 Percent

ELECTRICAL DATA

Heater Voltage.....	6.3 Volts
Heater Current (approx.).....	0.6 Ampere
Direct Interelectrode Capacitances (approx.)	
Cathode to All Other Electrodes.....	5 $\mu\mu\text{f}$
Grid No. 1 to All Other Electrodes.....	6 $\mu\mu\text{f}$
External Conductive Coating to Anode ¹	2000 $\mu\mu\text{f}$ Max
	750 $\mu\mu\text{f}$ Min
Ion Trap Magnet.....	External, Single Field Type

14CP4 (Cont'd)

MECHANICAL DATA

Minimum Useful Screen Dimensions.....	8½ x 11⅜	Inches
Bulb Contact (Recessed Small Cavity Cap).....	J1-21	
Base (Small Shell Duodecal 5-Pin).....	B5-57	
Basing.....	12N	
Bulb Contact Aligns with Vacant Pin		
Position No. 6.....	±30	Degrees

RATINGS

MAXIMUM RATINGS (Design Center Values)

Anode Voltage.....	14000	Volts d c
Grid No. 2 Voltage.....	410	Volts d c
Grid No. 1 Voltage.....		
Negative Bias Value.....	125	Volts d c
Positive Bias Value.....	0	Volts d c
Positive Peak Value.....	2	Volts
Peak Heater-Cathode Voltage		
Heater Negative with Respect to Cathode		
During Warm-up Period Not to Exceed 15 Seconds.....	410	Volts
After Equipment Warm-up Period.....	150	Volts
Heater Positive with Respect to Cathode.....	150	Volts

RECOMMENDED OPERATING CONDITIONS

Anode Voltage.....	12000	Volts d c
Grid No. 2 Voltage.....	300	Volts d c
Grid No. 1 Voltage Required for Cutoff ²	-33 to -77	Volts d c
Focusing Coil Current (approx.) ³	92	Ma d c
Ion Trap Magnet Strength (approx.).....	32	Gausses

CIRCUIT VALUES

Grid No. 1 Circuit Resistance.....	1.5	Megohms
		Max

NOTES:

1. External conductive coating must be grounded.
2. Visual extinction of undeflected focused spot.
3. For JETEC focusing coil 109 or equivalent three inches from reference line, bias adjusted to 35 foot lamberts on an 8½ x 11⅜ inch picture area sharply focused at center of screen.

WARNING

X-ray radiation shielding may be necessary to protect against possible danger of personal injury from prolonged exposure at close range if this tube is operated at higher than the manufacturer's Maximum Rated Anode Voltage or 16,000 volts, whichever is less.

SYLVANIA TYPE 14GP4

TELEVISION PICTURE TUBE

14" Direct Viewed
Rectangular Glass Type
Gray Filter Glass
External Conductive Coating

Magnetic Deflection
Electrostatic Focus
Spherical Faceplate
Single Field Ion Trap

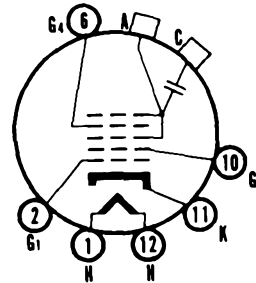
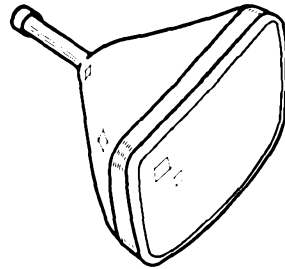

12-L

CHARACTERISTICS

GENERAL DATA

Focusing Method.....	Electrostatic
Deflecting Method.....	Magnetic
Deflecting Angle (approx.).....	
Horizontal.....	65 Degrees
Diagonal.....	70 Degrees
Phosphor.....	P4
Fluorescence.....	White
Persistence.....	Medium
Faceplate.....	Gray Filter Glass
Light Transmittance (approx.).....	66 Percent

ELECTRICAL DATA

Heater Voltage.....	6.3 Volts
Heater Current (approx.).....	0.6 Ampere
Direct Interelectrode Capacitances (approx.).....	
Cathode to All Other Electrodes.....	5 μf
Grid No. 1 to All Other Electrodes.....	6 μf
External Conductive Coating to Anode ¹	2000 μf Max
	750 μf Min
Ion Trap Magnet.....	External, Single Field Type

MECHANICAL DATA

Minimum Useful Screen Dimensions.....	8½ x 11¾ Inches
Bulb Contact (Recessed Small Cavity Cap).....	J1-21
Base (Small Shell Duodecal 6-Pin).....	B6-63
Basing.....	12L

RATINGS

MAXIMUM RATINGS (Design Center Values)

Anode Voltage.....	14000 Volts d c
Grid No. 4 Voltage (Focusing Electrode).....	5000 Volts d c
Grid No. 2 Voltage.....	410 Volts d c
Grid No. 1 Voltage.....	
Negative Bias Value.....	125 Volts d c
Positive Bias Value.....	0 Volts d c
Positive Peak Value.....	2
Peak Heater-Cathode Voltage.....	
Heater Negative with Respect to Cathode.....	
During Warm-up Period Not to Exceed 15 Seconds.....	410 Volts
After Equipment Warm-up Period.....	150 Volts
Heater Positive with Respect to Cathode.....	150 Volts

RECOMMENDED OPERATING CONDITIONS

Anode Voltage.....	12000 Volts d c
Grid No. 4 Voltage.....	2170 to 2940 Volts d c
Grid No. 2 Voltage.....	300 Volts d c
Grid No. 1 Voltage Required for Cutoff ²	-33 to -77 Volts d c
Ion Trap Magnet Strength (approx.).....	35 Gauss

14GP4 (Cont'd)

CIRCUIT VALUES

Grid No. 1 Circuit Resistance..... 1.5 Megohms
Max

NOTES:

1. External conductive coating must be grounded.
2. Visual extinction of undeflected focused spot.

WARNING

X-ray radiation shielding may be necessary to protect against possible danger of personal injury from prolonged exposure at close range if this tube is operated at higher than the manufacturer's Maximum Rated Anode Voltage or 16,000 volts, whichever is less.

SYLVANIA TYPE 16AP4 16AP4A

TELEVISION PICTURE TUBE

16" Direct Viewed Magnetic Deflection
Round Metal Type Magnetic Focus
Clear Faceplate Spherical Faceplate
Double Field Ion Trap
16AP4A has Gray Filter Glass Faceplate

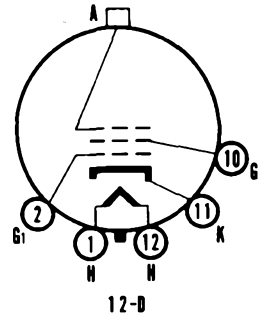
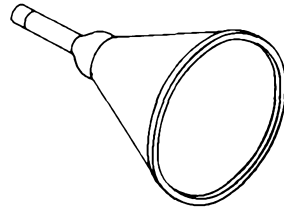

CHARACTERISTICS

GENERAL DATA

Focusing Method.....	Magnetic
Deflecting Method.....	Magnetic
Deflecting Angle (approx.).....	53 Degrees
Phosphor.....	P4
Fluorescence.....	White
Persistence.....	Medium
Faceplate.....	Clear

ELECTRICAL DATA

Heater Voltage.....	6.3 Volts
Heater Current (approx.).....	0.6 Ampere
Direct Interelectrode Capacitances (approx.)	
Cathode to All Other Electrodes.....	5 $\mu\mu\text{f}$
Grid No. 1 to All Other Electrodes.....	6 $\mu\mu\text{f}$
Ion Trap Magnet.....	External, Double Field Type

MECHANICAL DATA

Minimum Useful Screen Diameter.....	14 $\frac{3}{8}$ Inches
Bulb Contact.....	Metal Cone Lip
Base (Small Shell Duodecal 5-Pin).....	B5-57
Basing.....	12D

SYLVANIA TYPE 14RP4

Silver Screen "85" → 14RP4A

TELEVISION PICTURE TUBE

14" Direct Viewed Magnetic Deflection
 Rectangular Glass Type Electrostatic Focus
 Gray Filter Glass Spherical Faceplate
 External Conductive Coating Single Field Ion Trap
 14RP4A has Aluminized Screen

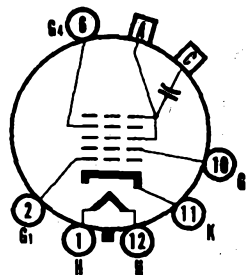
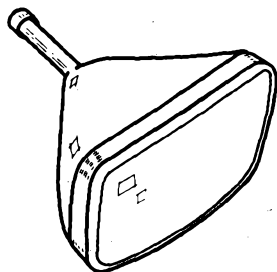

12-1

CHARACTERISTICS

GENERAL DATA

Focusing Method.....	Electrostatic
Deflection Method.....	Magnetic
Deflection Angles (approx.)	
Vertical.....	68 Degrees
Horizontal.....	85 Degrees
Diagonal.....	90 Degrees
Phosphor	
14RP4.....	P4
14RP4A.....	Aluminized P4
Fluorescence.....	White
Persistence.....	Short to Medium
Faceplate.....	Gray Filter Glass
Light Transmittance (approx.).....	78 Percent

ELECTRICAL DATA

Heater Voltage.....	6.3 Volts
Heater Current.....	0.600 ± 5% Ampere
Direct Interelectrode Capacitance (approx.)	
Cathode to All Other Electrodes.....	5 μmf
Grid No. 1 to All Other Electrodes.....	6 μmf
External Conductive Coating to Anode.....	1200 μmf Max.
	800 μmf Min.
Ion Trap Magnet.....	External, Single Field Type

MECHANICAL DATA

Overall Length.....	14 1/2 ± 1/8 Inches
Minimum Useful Screen Dimensions.....	12 1/2 x 9 1/2 Inches
Bulb Contact (Recessed Small Cavity Cap).....	J1-21
Base (Small Shell Duodeal 6-Pin).....	B6-63
Basing.....	12L
Weight (approx.).....	8.5 Pounds

RATINGS

MAXIMUM RATINGS (Absolute Maximum Values)

Anode Voltage.....	15,400 Volts d c
Grid No. 4 Voltage.....	-550 to +550 Volts d c
Grid No. 2 Voltage.....	440 Volts d c
Grid No. 1 Voltage	
Negative Bias Value.....	120 Volts d c
Negative Peak Value.....	175 Volts
Positive Bias Value.....	0 Volts
Positive Peak Value.....	2 Volts
Peak Heater-Cathode Voltage	
Heater Negative with Respect to Cathode.....	200 Volts
Heater Positive with Respect to Cathode.....	200 Volts

SYLVANIA PICTURE TUBES

Issued as a supplement to the manual in Sylvania News for May 1957

14RP4, 14RP4A (Cont'd)

TYPICAL OPERATING CONDITIONS

Anode Voltage.....	12,000 Volts d c
Grid No. 4 Voltage for Focus.....	-50 to +350 Volts d c
Grid No. 2 Voltage.....	300 Volts d c
Grid No. 1 Voltage Required for Cutoff ²	-26 to -70 Volts d c
Ion Trap Magnet Strength approx.	40 ± 3 Gausses Min.

CIRCUIT VALUES

Grid No. 1 Circuit Resistance.....	1.5 Megohms Max.
------------------------------------	------------------

NOTES:

1. External conductive coating must be grounded.
2. Visual extinction of focused raster. Extinction of stationary focused spot will require that these values be about 5 volts more negative.

14RP4A

The Sylvania Type 14RP4A is identical to Type 14RP4 except it has an aluminized screen.

WARNING:

X-ray radiation shielding may be necessary to protect against possible danger of personal injury from prolonged exposure at close range if this tube is operated at higher than the manufacturer's Maximum Rated Anode Voltage or 16,000 volts, whichever is less.

16AP4, 16AP4A (Cont'd)

RATINGS

MAXIMUM RATINGS (Design Center Values)

Anode Voltage	14000 Volts d c
Grid No. 2 Voltage	410 Volts d c
Grid No. 1 Voltage	
Negative Bias Value	125 Volts d c
Positive Bias Value	0 Volts d c
Positive Peak Value	2 Volts
Peak Heater-Cathode Voltage	
Heater Negative with Respect to Cathode	
During Warm-up Period Not to Exceed 15 Seconds	410 Volts
After Equipment Warm-up Period	150 Volts
Heater Positive with Respect to Cathode	150 Volts

RECOMMENDED OPERATING CONDITIONS

Anode Voltage	12000 Volts d c
Grid No. 2 Voltage	300 Volts d c
Grid No. 1 Voltage Required for Cutoff ¹	-33 to -77 Volts d c
Focusing Coil Current (approx.) ²	90 Ma d c
Ion Trap Magnet Current (approx.) ³	200 Ma d c

CIRCUIT VALUES

Grid No. 1 Circuit Resistance	1.5 Megohms Max
-------------------------------	--------------------

NOTES:

1. Visual extinction of undeflected focused spot.
2. For JETEC focusing coil 109 or equivalent three inches from reference line, bias adjusted to 30 foot lamberts on a 10 x 13¼ inch picture area.
3. For JETEC ion trap magnet 108 or equivalent.

16AP4A

The Sylvania Type 16AP4A is identical to the Type 16AP4 except for having the gray filter glass faceplate.

WARNING

X-ray radiation shielding may be necessary to protect against possible danger of personal injury from prolonged exposure at close range if this tube is operated at higher than the manufacturer's Maximum Rated Anode Voltage or 16,000 volts, whichever is less.

**SYLVANIA TYPE 16EP4
16EP4A
16EP4B**

TELEVISION PICTURE TUBE

16" Direct Viewed	Magnetic Deflection
Round Metal Type	Magnetic Focus
Clear Faceplate	Spherical Faceplate
Double Field Ion Trap	
16EP4A has a Gray Filter Glass Faceplate	
16EP4B has a Frosted Gray Filter Glass Faceplate	

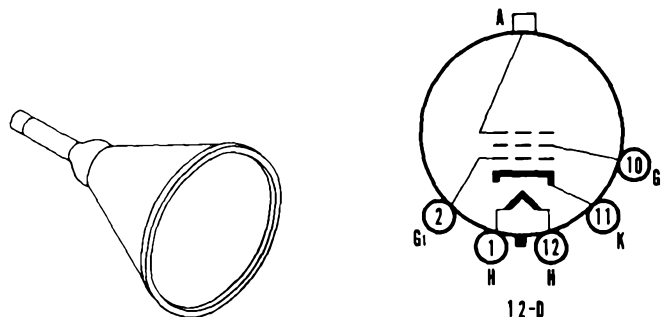

CHARACTERISTICS

GENERAL DATA

Focusing Method.....	Magnetic
Deflecting Method.....	Magnetic
Deflecting Angle (approx.).....	60 Degrees
Phosphor.....	P4
Fluorescence.....	White
Persistence.....	Medium
Faceplate.....	Clear

ELECTRICAL DATA

Heater Voltage.....	6.3 Volts
Heater Current (approx.).....	0.6 Ampere
Direct Interelectrode Capacitances (approx.)	
Cathode to All Other Electrodes.....	5 μ f
Grid No. 1 to All Other Electrodes.....	7 μ f
Ion Trap Magnet.....	External, Double Field Type

MECHANICAL DATA

Minimum Useful Screen Diameter.....	14 3/4 Inches
Bulb Contact.....	Metal Cone Lip
Base (Small Shell Duodecal 5-Pin).....	B5-57
Basing.....	12D

RATINGS

MAXIMUM RATINGS (Design Center Values)

Anode Voltage.....	14000 Volts d c
Grid No. 2 Voltage.....	410 Volts d c
Grid No. 1 Voltage.....	
Negative Bias Value.....	125 Volts d c
Positive Bias Value.....	0 Volts d c
Positive Peak Value.....	2 Volts
Peak Heater-Cathode Voltage.....	
Heater Negative with Respect to Cathode	
During Warm-up Period Not to	
Exceed 15 Seconds.....	410 Volts
After Equipment Warm-up Period.....	140 Volts
Heater Positive with Respect to Cathode.....	140 Volts

16EP4, 16EP4A, 16EP4B (Cont'd)

RECOMMENDED OPERATING CONDITIONS

Anode Voltage.....	12000 Volts d c
Grid No. 2 Voltage.....	300 Volts d c
Grid No. 1 Voltage Required for Cutoff!.....	-33 to -77 Volts d c
Focusing Coil Current (approx.) ²	105 Ma d c
Ion Trap Magnet Strength (approx.).....	35 Gausses

CIRCUIT VALUES

Grid No. 1 Circuit Resistance.....	1.5 Megohms Max
------------------------------------	--------------------

NOTES:

1. Visual extinction of undeflected focused spot.
2. For JETEC focusing coil 109 or equivalent three inches from reference line, bias adjusted to 30 foot lamberts on a 10 x 13¼ inch picture area.

16EP4A

The Sylvania Type 16EP4A is identical to the Type 16EP4 except for having a gray filter glass faceplate.

16EP4B

The Sylvania Type 16EP4B is identical to the Type 16EP4 except for having a frosted gray filter glass faceplate.

WARNING

X-ray radiation shielding may be necessary to protect against possible danger of personal injury from prolonged exposure at close range if this tube is operated at higher than the manufacturer's Maximum Rated Anode Voltage or 16,000 volts, whichever is less.

SYLVANIA TYPE 16GP4 16GP4A 16GP4B

TELEVISION PICTURE TUBE

16" Direct Viewed Magnetic Deflection
Round Metal Type Magnetic Focus
Single Field Ion Trap Spherical Faceplate
Gray Filter Glass
16GP4A has Clear Glass Faceplate
16GP4B has Frosted Gray Filter Glass Faceplate

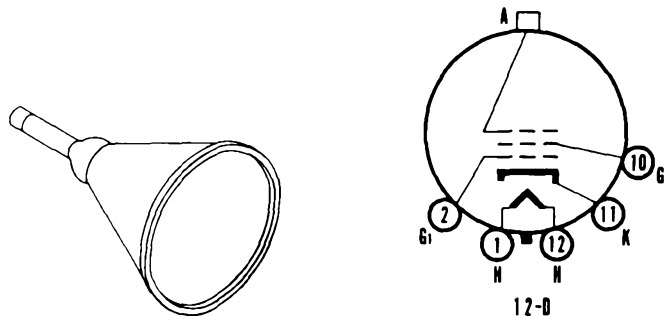

16GP4, 16GP4A, 16GP4B (Cont'd)

CHARACTERISTICS

GENERAL DATA

Focusing Method.....	Magnetic
Deflecting Method.....	Magnetic
Deflecting Angle (approx.).....	70 Degrees
Phosphor.....	P4
Fluorescence.....	White
Persistence.....	Medium
Faceplate.....	Gray Filter Glass

ELECTRICAL DATA

Heater Voltage.....	6.3 Volts
Heater Current (approx.).....	0.6 Ampere
Direct Interelectrode Capacitances (approx.).....	
Cathode to All Other Electrodes.....	5 $\mu\mu\text{f}$
Grid No. 1 to All Other Electrodes.....	6 $\mu\mu\text{f}$
Ion Trap Magnet.....	External, Single Field Type

MECHANICAL DATA

Minimum Useful Screen Diameter.....	14 $\frac{3}{8}$ Inches
Bulb Contact.....	Metal Cone Lip
Base (Small Shell Duodecal 5-Pin).....	B5-57
Basing.....	12D

RATINGS

MAXIMUM RATINGS (Design Center Values)

Anode Voltage.....	14000 Volts d c
Grid No. 2 Voltage.....	410 Volts d c
Grid No. 1 Voltage.....	
Negative Bias Value.....	125 Volts d c
Positive Bias Value.....	0 Volts d c
Positive Peak Value.....	3 Volts
Peak Heater-Cathode Voltage.....	
Heater Negative with Respect to Cathode.....	
During Warm-up Period Not to Exceed 15 Seconds.....	410 Volts
After Equipment Warm-up Period.....	150 Volts
Heater Positive with Respect to Cathode.....	150 Volts

RECOMMENDED OPERATING CONDITIONS

Anode Voltage.....	12000 Volts d c
Grid No. 2 Voltage.....	300 Volts d c
Grid No. 1 Voltage Required for Cutoff.....	-33 to -77 Volts d c
Focusing Coil Current (approx.) ²	100 Ma d c
Ion Trap Magnet Strength (approx.).....	35 Gauss

CIRCUIT VALUES

Grid No. 1 Circuit Resistance.....	1.5 Megohms Max
------------------------------------	--------------------

NOTES:

1. Visual extinction of undeflected focused spot.
2. For JETEC focusing coil 109 or equivalent three inches from reference line, bias adjusted to 30 foot lamberts on a 10 x 13 $\frac{1}{2}$ inch picture area.

16GP4A

The Sylvania Type 16GP4A is identical to the Type 16GP4 except for having the clear glass faceplate.

16GP4B

The Sylvania Type 16GP4B is identical to the Type 16GP4 except for having the frosted gray filter glass faceplate.

WARNING

X-ray radiation shielding may be necessary to protect against possible danger of personal injury from prolonged exposure at close range if this tube is operated at higher than the manufacturer's Maximum Rated Anode Voltage or 16,000 volts, whichever is less.

SYLVANIA TYPE 16JP4 16JP4A

TELEVISION PICTURE TUBE

16" Direct Viewed	Magnetic Deflection
Round Glass Type	Magnetic Focus
Clear Faceplate	Spherical Faceplate
External Conductive Coating	Double Field Ion Trap
16JP4A has Gray Filter	Glass Faceplate

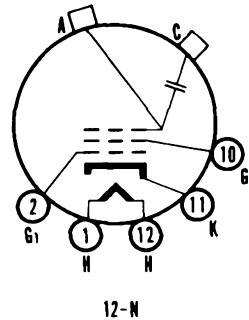
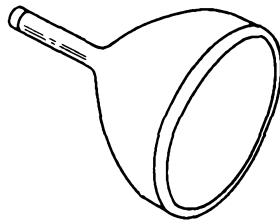

CHARACTERISTICS

GENERAL DATA

Focusing Method	Magnetic
Deflecting Method	Magnetic
Deflecting Angle (approx.)	60 Degrees
Phosphor	P4
Fluorescence	White
Persistence	Medium
Faceplate	Clear
Light Transmittance (approx.)	66 Percent

ELECTRICAL DATA

Heater Voltage	6.3 Volts
Heater Current (approx.)	0.6 Ampere
Direct Interelectrode Capacitances (approx.)	
Cathode to All Other Electrodes	5 $\mu\mu\text{f}$
Grid No. 1 to All Other Electrodes	6 $\mu\mu\text{f}$
External Conductive Coating to Anode	2000 $\mu\mu\text{f}$ Max
	750 $\mu\mu\text{f}$ Min
Ion Trap Magnet	External, Double Field Type

MECHANICAL DATA

Minimum Useful Screen Diameter	15 Inches
Bulb Contact (Recessed Small Cavity Cap)	J1-21
Base (Small Shell Duodecal 5-Pin)	B5-57
Basing	12N

RATINGS

MAXIMUM RATINGS (Design Center Values)

Anode Voltage	14000 Volts d c
Grid No. 2 Voltage	410 Volts d c
Grid No. 1 Voltage	
Negative Bias Value	125 Volts d c
Positive Bias Value	0 Volts d c
Positive Peak Value	2 Volts
Peak Heater-Cathode Voltage	
Heater Negative with Respect to Cathode	
During Warm-up Period Not to Exceed 15 Seconds	410 Volts
After Equipment Warm-up Period	125 Volts
Heater Positive with Respect to Cathode	125 Volts

16JP4, 16JP4A (Cont'd)

RECOMMENDED OPERATING CONDITIONS

Anode Voltage.....	11000 Volts d c
Grid No. 2 Voltage.....	250 Volts d c
Grid No. 1 Voltage Required for Cutoff ²	-27 to -63 Volts d c
Focusing Coil Current (approx.) ³	115 Ma d c
Ion Trap Magnet Current (approx.) ⁴	120 Ma d c

CIRCUIT VALUES

Grid No. 1 Circuit Resistance.....	1.5 Megohms Max
------------------------------------	--------------------

NOTES:

1. External conductive coating must be grounded.
2. Visual extinction of undeflected focused spot.
3. For JETEC focusing coil 106 or equivalent three inches from reference line, bias adjusted to 30 foot lamberts.
4. For JETEC ion trap magnet 108 or equivalent.

16JP4A

The Sylvania Type 16JP4A is identical to the Type 16JP4 except for having the gray filter glass faceplate.

WARNING

X-ray radiation shielding may be necessary to protect against possible danger of personal injury from prolonged exposure at close range if this tube is operated at higher than the manufacturer's Maximum Rated Anode Voltage or 16,000 volts, whichever is less.

SYLVANIA TYPE 16KP4 Silver Screen "85" → 16KP4A

TELEVISION PICTURE TUBE

16" Direct Viewed	Magnetic Deflection
Rectangular Glass Type	Magnetic Focus
Gray Filter Glass	Spherical Faceplate
External Conductive Coating	Single Field Ion Trap
16KP4A has an Aluminized Screen	

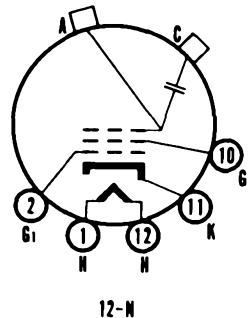
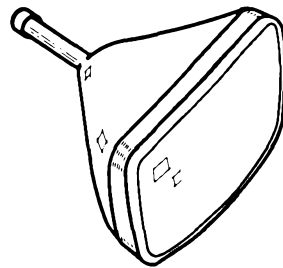

16KP4, 16KP4A (Cont'd)

CHARACTERISTICS

GENERAL DATA

Focusing Method.....	Magnetic
Deflecting Method.....	Magnetic
Deflecting Angle (approx.)	
Horizontal.....	65 Degrees
Diagonal.....	70 Degrees
Phosphor.....	P4
Fluorescence.....	White
Persistence.....	Medium
Faceplate.....	Gray Filter Glass
Light Transmittance (approx.).....	66 Percent

ELECTRICAL DATA

Heater Voltage.....	6.3 Volts
Heater Current (approx.).....	0.6 Ampere
Direct Interelectrode Capacitances (approx.)	
Cathode to All Other Electrodes.....	5 $\mu\mu\text{f}$
Grid No. 1 to All Other Electrodes.....	6 $\mu\mu\text{f}$
External Conductive Coating to Anode ¹	1500 $\mu\mu\text{f}$ Max
	750 $\mu\mu\text{f}$ Min
Ion Trap Magnet.....	External, Single Field Type

MECHANICAL DATA

Minimum Useful Screen Dimensions.....	10 $\frac{1}{8}$ x 13 $\frac{1}{2}$ Inches
Bulb Contact (Recessed Small Cavity Cap).....	J1-21
Base (Small Shell Duodecal 5-Pin).....	B5-57
Basing.....	12N

RATINGS

MAXIMUM RATINGS (Design Center Values)

Anode Voltage.....	16000 Volts d c
Grid No. 2 Voltage.....	410 Volts d c
Grid No. 1 Voltage	
Negative Bias Value.....	125 Volts d c
Positive Bias Value.....	0 Volts d c
Positive Peak Value.....	2 Volts
Peak Heater Cathode Voltage	
Heater Negative with Respect to Cathode	
During Warm-up Period Not to Exceed 15 Seconds.....	410 Volts
After Equipment Warm-up Period.....	150 Volts
Heater Positive with Respect to Cathode.....	150 Volts

RECOMMENDED OPERATING CONDITIONS

Anode Voltage.....	14000 Volts d c
Grid No. 2 Voltage.....	300 Volts d c
Grid No. 1 Voltage Required for Cutoff ²	-33 to -77 Volts d c
Focusing Coil Current (approx.) ³	108 Ma d c
Ion Trap Magnet Strength (approx.).....	35 Gausses

NOTES:

1. External conductive coating must be grounded.
2. Visual extinction of undeflected focused spot.
3. For JETEC focusing coil 109 or equivalent three inches from reference line, bias adjusted to 20 foot lamberts on a 10 $\frac{1}{8}$ x 13 $\frac{1}{2}$ inch picture area.

16KP4A

The Sylvania Type 16KP4A is identical to the Type 16KP4 except for having an aluminized screen.

WARNING

X-ray radiation shielding may be necessary to protect against possible danger of personal injury from prolonged exposure at close range if this tube is operated at higher than the manufacturer's Maximum Rated Anode Voltage or 16,000 volts, whichever is less.

SYLVANIA TYPE 16LP4 16LP4A

TELEVISION PICTURE TUBE

16" Direct Viewed Magnetic Deflection
 Round Glass Type Magnetic Focus
 Clear Faceplate Spherical Faceplate
 External Conductive Coating Double Field Ion Trap
 16LP4A has a Gray Filter Glass Faceplate

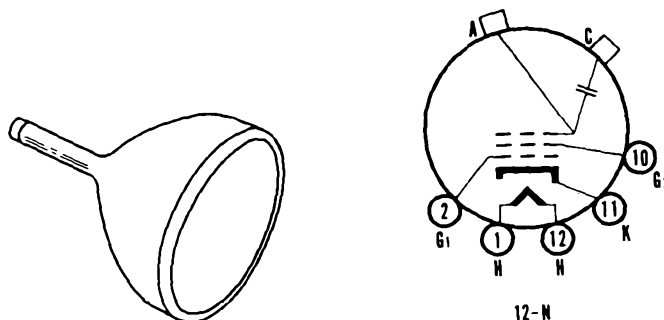

CHARACTERISTICS

GENERAL DATA

Focusing Method.....	Magnetic
Deflecting Method.....	Magnetic
Deflecting Angle (approx.).....	52 Degrees
Phosphor.....	P4
Fluorescence.....	White
Persistence.....	Medium
Faceplate.....	Clear
Light Transmittance (approx.).....	70 Percent

ELECTRICAL DATA

Heater Voltage.....	6.3 Volts
Heater Current (approx.).....	0.6 Ampere
Direct Interelectrode Capacitances (approx.)	
Cathode to All Other Electrodes.....	5 μ f
Grid No. 1 to All Other Electrodes.....	6 μ f
External Conductive Coating to Anode.....	2000 μ f Max
Ion Trap Magnet.....	750 μ f Min
	External, Double Field Type

MECHANICAL DATA

Minimum Useful Screen Diameter.....	14½ Inches
Bulb Contact (Recessed Small Cavity Cap).....	J1-21
Base (Small Shell Duodecal 5-Pin).....	B5-57
Basing.....	12N

RATINGS

MAXIMUM RATINGS (Design Center Values)

Anode Voltage.....	14000 Volts d c
Grid No. 2 Voltage.....	410 Volts d c
Grid No. 1 Voltage	
Negative Bias Value.....	125 Volts d c
Positive Bias Value.....	0 Volts d c
Positive Peak Value.....	2 Volts
Peak Heater-Cathode Voltage	
Heater Negative with Respect to Cathode	
During Warm-up Period Not to Exceed 15 Seconds.....	410 Volts
After Equipment Warm-up Period.....	125 Volts
Heater Positive with Respect to Cathode.....	125 Volts

RECOMMENDED OPERATING CONDITIONS

Anode Voltage.....	12000 Volts d c
Grid No. 2 Voltage.....	300 Volts d c
Grid No. 1 Voltage Required for Cutoff ²	-33 to -77 Volts d c
Focusing Coil Current (approx.) ³	110 Ma d c
Ion Trap Magnet Current (approx.) ⁴	120 Ma d c

16LP4, 16LP4A (Cont'd)

CIRCUIT VALUES

Grid No. 1 Circuit Resistance 1.5 Megohms
Max

NOTES:

1. External conductive coating must be grounded.
2. Visual extinction of undeflected focused spot.
3. For JETEC focusing coil 106 or equivalent three and one quarter inches from reference line, bias adjusted to 20 foot lamberts on a 14½ x 10¼ inch picture area.
4. For JETEC ion trap magnet 108 or equivalent.

16LP4A

The Sylvania Type 16LP4A is identical to Type 16LP4 except for having the gray filter glass faceplate.

WARNING

X-ray radiation shielding may be necessary to protect against possible danger of personal injury from prolonged exposure at close range if this tube is operated at higher than the manufacturer's Maximum Rated Anode Voltage or 16,000 volts, whichever is less.

SYLVANIA TYPE 16RP4

TELEVISION PICTURE TUBE

16" Direct Viewed	Magnetic Deflection
Rectangular Glass Type	Magnetic Focus
Gray Filter Glass	Spherical Faceplate
External Conductive Coating	Single Field Ion Trap

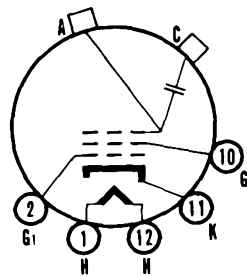
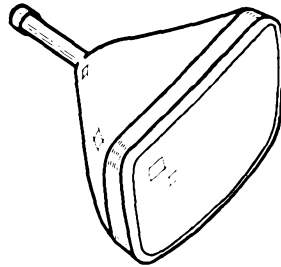

CHARACTERISTICS

GENERAL DATA

Focusing Method	Magnetic
Deflecting Method	Magnetic
Deflecting Angle (approx.)	
Horizontal	65 Degrees
Diagonal	70 Degrees
Phosphor	P4
Fluorescence	White
Persistence	Medium
Faceplate	Gray Filter Glass
Light Transmittance (approx.)	66 Percent

16RP4 (Cont'd)

ELECTRICAL DATA

Heater Voltage.....	6.3 Volts
Heater Current (approx.).....	0.6 Ampere
Direct Interelectrode Capacitances (approx.)	
Cathode to All Other Electrodes.....	5 $\mu\mu\text{f}$
Grid No. 1 to All Other Electrodes.....	6 $\mu\mu\text{f}$
External Conductive Coating to Anode ¹	1500 $\mu\mu\text{f}$ Max
	750 $\mu\mu\text{f}$ Min
Ion Trap Magnet.....	External, Single Field Type

MECHANICAL DATA

Minimum Useful Screen Dimensions.....	10 $\frac{1}{8}$ x 13 $\frac{1}{2}$ Inches
Bulb Contact (Recessed Small Cavity Cap).....	J1-21
Base (Small Shell Duodecal 5-Pin).....	B5-57
Basing.....	12N

RATINGS

MAXIMUM RATINGS (Design Center Values)

Anode Voltage.....	16000 Volts d c
Grid No. 2 Voltage.....	410 Volts d c
Grid No. 1 Voltage	
Negative Bias Value.....	125 Volts d c
Positive Bias Value.....	0 Volts d c
Positive Peak Value.....	2 Volts
Peak Heater-Cathode Voltage	
Heater Negative with Respect to Cathode	
During Warm-up Period Not to Exceed 15 Seconds.....	410 Volts
After Equipment Warm-up Period.....	150 Volts
Heater Positive with Respect to Cathode.....	150 Volts

RECOMMENDED OPERATING CONDITIONS

Anode Voltage.....	14000 Volts d c
Grid No. 2 Voltage.....	300 Volts d c
Grid No. 1 Voltage Required for Cutoff ²	-33 to -77 Volts d c
Focusing Coil Current (approx.) ³	108 Ma d c
Ion Trap Magnet Strength (approx.).....	35 Gausses

CIRCUIT VALUES

Grid No. 1 Circuit Resistance.....	1.5 Megohms Max
------------------------------------	-----------------

NOTES:

1. External conductive coating must be grounded.
2. Visual extinction of undeflected focused spot.
3. For JETEC focusing coil 109 or equivalent three and one half inches from reference line, bias adjusted to 30 foot lamberts on a 10 $\frac{1}{8}$ x 13 $\frac{1}{2}$ inch picture area.

WARNING

X-ray radiation shielding may be necessary to protect against possible danger of personal injury from prolonged exposure at close range if this tube is operated at higher than the manufacturer's Maximum Rated Anode Voltage or 16,000 volts, whichever is less.

SYLVANIA TYPE 16TP4

TELEVISION PICTURE TUBE

16" Direct Viewed	Magnetic Deflection
Rectangular Glass Type	Magnetic Focus
Gray Filter Glass	Spherical Faceplate
External Conductive Coating	Single Field Ion Trap

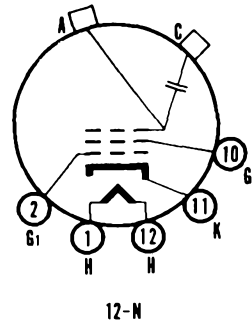
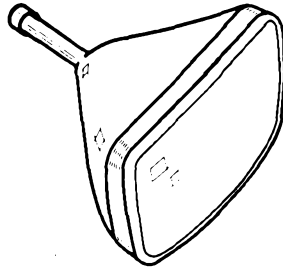

CHARACTERISTICS

GENERAL DATA

Focusing Method	Magnetic
Deflecting Method	Magnetic
Deflecting Angle (approx.)	
Horizontal	65 Degrees
Diagonal	70 Degrees
Phosphor	P4
Fluorescence	White
Persistence	Medium
Faceplate	Gray Filter Glass
Light Transmittance (approx.)	66 Percent

ELECTRICAL DATA

Heater Voltage	6.3 Volts
Heater Current (approx.)	0.6 Ampere
Direct Interelectrode Capacitances (approx.)	
Cathode to All Other Electrodes	5 μ f
Grid No. 1 to All Other Electrodes	6 μ f
External Conductive Coating to Anode	2000 μ f Max 750 μ f Min
Ion Trap Magnet	External, Single Field Type

MECHANICAL DATA

Minimum Useful Screen Dimensions	10 $\frac{1}{8}$ x 13 $\frac{1}{2}$ Inches
Bulb Contact (Recessed Small Cavity Cap)	J1-21
Base (Small Shell Duodecal 5-Pin)	B5-57
Basing	12N

RATINGS

MAXIMUM RATINGS (Design Center Values)

Anode Voltage	14000 Volts d c
Grid No. 2 Voltage	410 Volts d c
Grid No. 1 Voltage	
Negative Bias Value	125 Volts d c
Positive Bias Value	0 Volts d c
Positive Peak Value	2 Volts
Peak Heater-Cathode Voltage	
Heater Negative with Respect to Cathode	
During Warm-up Period Not to Exceed 15 Seconds	410 Volts
After Equipment Warm-up Period	150 Volts
Heater Positive with Respect to Cathode	150 Volts

RECOMMENDED OPERATING CONDITIONS

Anode Voltage	12000 Volts d c
Grid No. 2 Voltage	300 Volts d c
Grid No. 1 Voltage Required for Cutoff ²	-33 to -77 Volts d c
Focusing Coil Current (approx.) ³	100 Ma d c
Ion Trap Magnet Strength (approx.)	35 Gauss

16TP4 (Cont'd)

CIRCUIT VALUES

Grid No. 1 Circuit Resistance..... 1.5 Megohms
Max

NOTES:

1. External conductive coating must be grounded.
2. Visual extinction of undeflected focused spot.
3. For JETEC focus coil 109 or equivalent three inches from reference line, bias adjusted to 30 foot lamberts on a $10\frac{1}{8} \times 13\frac{1}{2}$ inch picture area.

WARNING

X-ray radiation shielding may be necessary to protect against possible danger of personal injury from prolonged exposure at close range if this tube is operated at higher than the manufacturer's Maximum Rated Anode Voltage or 16,000 volts, whichever is less.

SYLVANIA TYPE 16WP4 16WP4A

TELEVISION PICTURE TUBE

16" Direct Viewed Magnetic Deflection
Round Glass Type Magnetic Focus
Gray Filter Glass Spherical Faceplate
Double Field Ion Trap
16WP4A has an External Conductive Coating

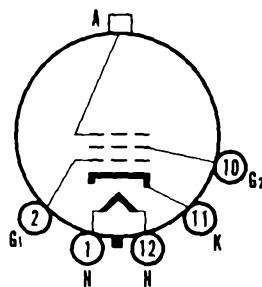
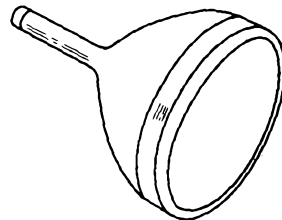

12-D

16WP4

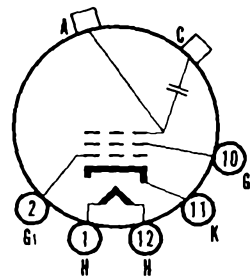

12-N

16WP4A

16WP4, 16WP4A (Cont'd)

CHARACTERISTICS

GENERAL DATA

Focusing Method.....	Magnetic
Deflecting Method.....	Magnetic
Deflecting Angle (approx.).....	70 Degrees
Phosphor.....	
Fluorescence.....	White
Persistence.....	Medium
Faceplate.....	Gray Filter Glass
Light Transmittance (approx.).....	70 Percent

ELECTRICAL DATA

Heater Voltage.....	6.3 Volts
Heater Current.....	0.6 Ampere
Direct Interelectrode Capacitances (approx.).....	
Cathode to All Other Electrodes.....	5 μf
Grid No. 1 to All Other Electrodes.....	6 μf
Ion Trap Magnet.....	External, Double Field Type

MECHANICAL DATA

Minimum Useful Screen Diameter.....	14½ Inches
Bulb Contact (Recessed Small Cavity Cap).....	J1-21
Base (Small Shell Duodecal 5-Pin).....	B5-57
Basing.....	12D

RATINGS

MAXIMUM RATINGS (Design Center Values)

Anode Voltage.....	16000 Volts d c
Grid No. 2 Voltage.....	410 Volts d c
Grid No. 1 Voltage.....	
Negative Bias Value.....	125 Volts d c
Positive Bias Value.....	0 Volts d c
Positive Peak Value.....	2 Volts
Peak Heater-Cathode Voltage.....	
Heater Negative with Respect to Cathode.....	
During Warm-up Period Not to Exceed 15 Seconds.....	410 Volts
After Equipment Warm-up Period.....	125 Volts
Heater Positive with Respect to Cathode.....	125 Volts

RECOMMENDED OPERATING CONDITIONS

Anode Voltage.....	12000 Volts d c
Grid No. 2 Voltage.....	250 Volts d c
Grid No. 1 Voltage Required for Cutoff ¹	-27 to -63 Volts d c
Focusing Coil Current (approx.) ²	110 Ma d c
Ion Trap Magnet Current (approx.) ³	120 Ma d c

CIRCUIT VALUES

Grid No. 1 Circuit Resistance.....	1.5 Megohms Max
------------------------------------	--------------------

NOTES:

1. Visual extinction of undeflected focused spot.
2. For JETEC focusing coil 109 or equivalent three and one quarter inches from reference line, bias adjusted to 30 foot lamberts on a 14½ x 10¼ inch picture area.
3. For JETEC ion trap magnet 108 or equivalent.

16WP4A

The Sylvania Type 16WP4A is identical to the Type 16WP4 except for the addition of an external conductive coating which should be grounded.

External Conductive Coating to Anode Capacitance.....	
Maximum.....	1500 μf
Minimum.....	750 μf
Basing.....	12N

WARNING

X-ray radiation shielding may be necessary to protect against possible danger of personal injury from prolonged exposure at close range if this tube is operated at higher than the manufacturer's Maximum Rated Anode Voltage or 16,000 volts, whichever is less.

SYLVANIA TYPE 16ZP4

TELEVISION PICTURE TUBE

16" Direct Viewed	Magnetic Deflection
Round Glass Type	Magnetic Focus
Gray Filter Glass	Spherical Faceplate
External Conductive Coating	Double Field Ion Trap

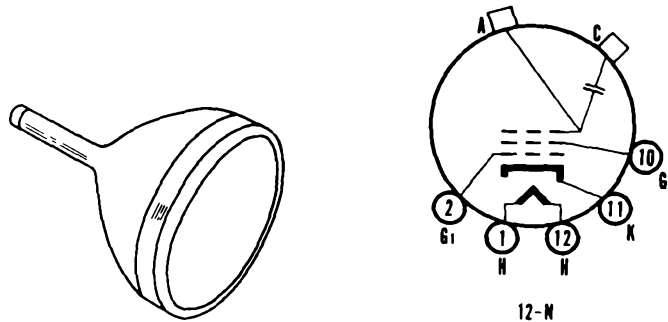

CHARACTERISTICS

GENERAL DATA

Focusing Method.....	Magnetic
Deflecting Method.....	Magnetic
Deflecting Angle (approx.).....	52 Degrees
Phosphor.....	P4
Fluorescence.....	White
Persistence.....	Medium
Faceplate.....	Gray Filter Glass
Light Transmittance (approx.).....	66 Percent

ELECTRICAL DATA

Heater Voltage.....	6.3 Volts
Heater Current (approx.).....	0.6 Ampere
Direct Interelectrode Capacitances (approx.)	
Cathode to All Other Electrodes.....	5 μ f
Grid No. 1 to All Other Electrodes.....	6 μ f
External Conductive Coating to Anode ¹	1500 μ f Max
Ion Trap Magnet.....	750 μ f Min
	External, Double Field Type

MECHANICAL DATA

Minimum Useful Screen Diameter.....	14½ Inches
Bulb Contact (Recessed Small Cavity Cap).....	J1-21
Base (Small Shell Duodecal 5-Pin).....	B5-57
Basing.....	12N

RATINGS

MAXIMUM RATINGS (Design Center Values)

Anode Voltage.....	16000 Volts d c
Grid No. 2 Voltage.....	410 Volts d c
Grid No. 1 Voltage.....	
Negative Bias Value.....	125 Volts d c
Positive Bias Value.....	0 Volts d c
Positive Peak Value.....	2 Volts
Peak Heater-Cathode Voltage.....	
Heater Negative with Respect to Cathode	
During Warm-up Period Not to Exceed 15 Seconds.....	410 Volts
After Equipment Warm-up Period.....	125 Volts
Heater Positive with Respect to Cathode.....	125 Volts

RECOMMENDED OPERATING CONDITIONS

Anode Voltage.....	12000 Volts d c
Grid No. 2 Voltage.....	300 Volts d c
Grid No. 1 Voltage Required for Cutoff ²	-33 to -77 Volts d c
Focusing Coil Current (approx.) ³	110 Ma d c
Ion Trap Magnet Current (approx.) ⁴	120 Ma d c

16ZP4 (Cont'd)

CIRCUIT VALUES

Grid No. 1 Circuit Resistance..... 1.5 Megohms
Max

NOTES:

1. External conductive coating must be grounded.
2. Visual extinction of undeflected focused spot.
3. For JETEC focusing coil 106 or equivalent three and one quarter inches from reference line, bias adjusted to 30 foot lamberts.
4. For JETEC ion trap magnet 108 or equivalent.

WARNING

X-ray radiation shielding may be necessary to protect against possible danger of personal injury from prolonged exposure at close range if this tube is operated at higher than the manufacturer's Maximum Rated Anode Voltage or 16,000 volts, whichever is less.

SYLVANIA TYPE 17AP4

TELEVISION PICTURE TUBE

17" Direct Viewed	Magnetic Deflection
Rectangular Glass Type	Magnetic Focus
Gray Filter Glass	Spherical Faceplate
External Conductive Coating	Single Field Ion Trap

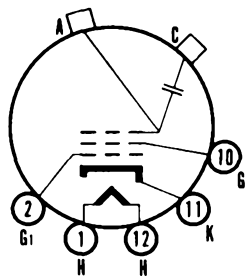
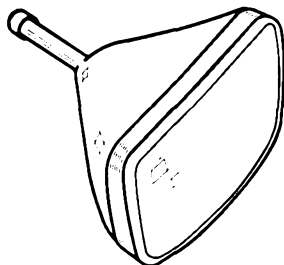

CHARACTERISTICS

GENERAL DATA

Focusing Method.....	Magnetic
Deflecting Method.....	Magnetic
Deflecting Angle (approx.)	
Horizontal.....	65 Degrees
Diagonal.....	70 Degrees
Phosphor.....	P4
Fluorescence.....	White
Persistence.....	Medium
Faceplate.....	Gray Filter Glass
Light Transmittance (approx.).....	72 Percent

ELECTRICAL DATA

Heater Voltage.....	6.3 Volts
Heater Current (approx.).....	0.6 Ampere
Direct Interelectrode Capacitances (approx.)	
Cathode to All Other Electrodes.....	5 μ mf
Grid No. 1 to All Other Electrodes.....	5 μ mf
External Conductive Coating to Anode.....	2000 μ mf Max
	750 μ mf Min
Ion Trap Magnet.....	External, Single Field Type

17AP4 (Cont'd)

MECHANICAL DATA

Minimum Useful Screen Dimensions.....	10 $\frac{3}{4}$ x 14 $\frac{1}{4}$ Inches
Bulb Contact (Recessed Small Cavity Cap).....	J1-21
Base (Small Shell Duodecal 5-Pin).....	B5-57
Basing.....	12N

RATINGS

MAXIMUM RATINGS (Design Center Values)

Anode Voltage.....	16000 Volts d c
Grid No. 2 Voltage.....	410 Volts d c
Grid No. 1 Voltage.....	
Negative Bias Value.....	125 Volts d c
Positive Bias Value.....	0 Volts d c
Positive Peak Value.....	2 Volts
Peak Heater-Cathode Voltage.....	
Heater Negative with Respect to Cathode	
During Warm-up Period Not to	
Exceed 15 Seconds.....	410 Volts
After Equipment Warm-up Period.....	150 Volts
Heater Positive with Respect to Cathode.....	150 Volts

RECOMMENDED OPERATING CONDITIONS

Anode Voltage.....	12000 Volts d c
Grid No. 2 Voltage.....	300 Volts d c
Grid No. 1 Voltage Required for Cutoff ²	-33 to -77 Volts d c
Focusing Coil Current (approx.) ³	115 Ma d c
Ion Trap Magnet Strength (approx.).....	35 Gauss

CIRCUIT VALUES

Grid No. 1 Circuit Resistance.....	1.5 Megohms
	Max

NOTES:

1. External conductive coating must be grounded.
2. Visual extinction of undeflected focused spot.
3. For JETEC focusing coil 109 or equivalent three inches from reference line, bias adjusted to 30 foot lamberts on a 10 $\frac{3}{4}$ x 14 $\frac{1}{4}$ inch picture area.

WARNING

X-ray radiation shielding may be necessary to protect against possible danger of personal injury from prolonged exposure at close range if this tube is operated at higher than the manufacturer's Maximum Rated Anode Voltage or 16,000 volts, whichever is less.

SYLVANIA TYPE 17AVP4

TELEVISION PICTURE TUBE

17" Direct Viewed	Magnetic Deflection
Rectangular Glass Type	Electrostatic Focus
Gray Filter Glass	Spherical Faceplate
External Conductive Coating	Single Field Ion Trap

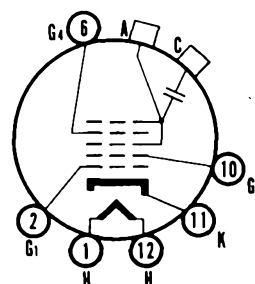
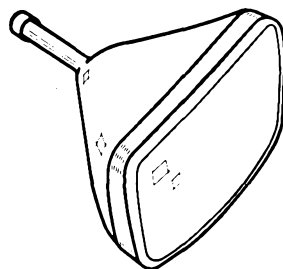

12-L

17AVP4 (Cont'd)

CHARACTERISTICS

GENERAL DATA

Focusing Method.....	Electrostatic
Deflecting Method.....	Magnetic
Deflecting Angle (approx.)	
Horizontal.....	85 Degrees
Diagonal.....	90 Degrees
Phosphor.....	P4
Fluorescence.....	White
Persistence.....	Medium
Faceplate.....	Gray Filter Glass

ELECTRICAL DATA

Heater Voltage.....	6.3 Volts
Heater Current (approx.).....	0.6 Ampere
Direct Interelectrode Capacitances (approx.)	
Cathode to All Other Electrodes.....	5 μ f
Grid No. 1 to All Other Electrodes.....	6 μ f
External Conductive Coating to Anode ¹	1500 μ f Max 750 μ f Min
Ion Trap Magnet.....	External, Single Field Type

MECHANICAL DATA

Bulb Contact (Recessed Small Cavity Type).....	J1-21
Base (Small Shell Duodecal 6-Pin).....	B6-63
Basing.....	12L

RATINGS

MAXIMUM RATINGS (Design Center Values)

Anode Voltage.....	16000 Volts d c
Grid No. 4 Voltage (Focusing Electrode).....	-500 to +1000 Volts d c
Grid No. 2 Voltage.....	500 Volts d c
Grid No. 1 Voltage	
Negative Bias Value.....	125 Volts d c
Positive Bias Value.....	0 Volts d c
Positive Peak Value.....	2 Volts
Peak Heater-Cathode Voltage	
Heater Negative with Respect to Cathode	
During Warm-up Period Not to	
Exceed 15 Seconds.....	410 Volts
After Equipment Warm-up Period.....	180 Volts
Heater Positive with Respect to Cathode.....	180 Volts

RECOMMENDED OPERATING CONDITIONS

Anode Voltage.....	12000 Volts d c
Grid No. 4 Voltage.....	-50 to +350 Volts d c
Grid No. 2 Voltage.....	300 Volts d c
Grid No. 1 Voltage Required for Cutoff ²	-28 to -72 Volts d c
Ion Trap Magnet Field Strength (approx.).....	35 Gauss

CIRCUIT VALUES

Grid No. 1 Circuit Resistance.....	1.5 Megohms Max
------------------------------------	--------------------

NOTES:

1. External conductive coating must be grounded.
2. Visual extinction of focused raster. Extinction of stationary focused spot will require that these values be about 5 volts more negative.

WARNING

X-ray radiation shielding may be necessary to protect against possible danger of personal injury from prolonged exposure at close range if this tube is operated at higher than the manufacturer's Maximum Rated Anode Voltage or 16,000 volts, whichever is less.

SYLVANIA TYPE 17AVP4A

Silver Screen "85"

TELEVISION PICTURE TUBE

17" Direct Viewed	Magnetic Deflection
Rectangular Glass Type	Electrostatic Focus
Gray Filter Glass	Spherical Faceplate
External Conductive Coating	Single Field Ion Trap
Aluminized Screen	

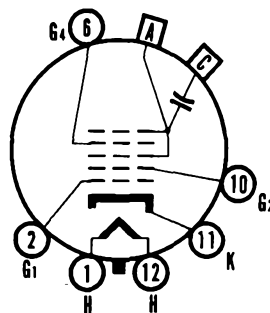
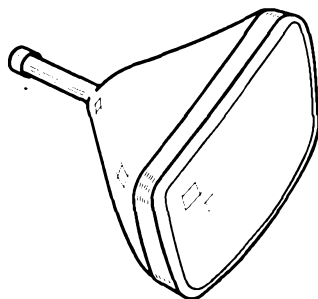

12-L

CHARACTERISTICS

GENERAL DATA

Focusing Method	Electrostatic
Deflecting Method	Magnetic
Deflecting Angle (approx.)	
Horizontal	85 Degrees
Diagonal	90 Degrees
Phosphor	P4
Fluorescence	White
Persistence	Medium
Faceplate	Gray Filter Glass

ELECTRICAL DATA

Heater Voltage	6.3 Volts
Heater Current (approx.)	0.6 Ampere
Direct Interelectrode Capacitances (approx.)	
Cathode to All Other Electrodes	5 μ mf
Grid No. 1 to All Other Electrodes	6 μ mf
External Conductive Coating to Anode	1500 μ mf Max.
	1200 μ mf Min.
Ion Trap Magnet	External, Single Field Type

MECHANICAL DATA

Bulb Contact (Recessed Small Cavity Type)	J1-21
Base (Small Shell Duodecal 6-Pin)	B6-63
Basing	12L

RATINGS

MAXIMUM RATINGS (Design Center Values)

Anode Voltage	16,000 Volts d c
Grid No. 4 Voltage (Focusing Electrode)	-500 to +1000 Volts d c
Grid No. 2 Voltage	500 Volts d c
Grid No. 1 Voltage	
Negative Bias Value	125 Volts d c
Positive Bias Value	0 Volts d c
Positive Peak Value	2 Volts
Peak Heater-Cathode Voltage	
Heater Negative with Respect to Cathode	
During Warm-up Period not to Exceed 15 Seconds	410 Volts
After Equipment Warm-up Period	180 Volts
Heater Positive with Respect to Cathode	180 Volts

17AVP4A (Cont'd)

RECOMMENDED OPERATING CONDITIONS

Anode Voltage.....	12,000 Volts d c
Grid No. 4 Voltage.....	-50 to +350 Volts d c
Grid No. 2 Voltage.....	300 Volts d c
Grid No. 1 Voltage Required for Cutoff.....	-28 to -72 Volts d c
Ion Trap Magnet Strength (approx.).....	35 Gausses

CIRCUIT VALUES

Grid No. 1 Circuit Resistance.....	1.5 Megohms Max.
------------------------------------	------------------

NOTES:

1. External conductive coating must be grounded.
2. Visual extinction of focused raster. Extinction of stationary focused spot will require that these values be about 5 volts more negative.

WARNING:

X-ray radiation shielding may be necessary to protect against possible danger of personal injury from prolonged exposure at close range if this tube is operated at higher than the manufacturer's Maximum Rated Anode Voltage or 16,000 volts, whichever is less.

SYLVANIA TYPE 17BP4
17BP4A
Silver Screen "85" → 17BP4B
17BP4C

TELEVISION PICTURE TUBE

17" Direct Viewed Magnetic Deflection
 Rectangular Glass Type Magnetic Focus
 Gray Filter Glass Spherical Faceplate
 Single Field Ion Trap

17BP4A has an External Conductive Coating
 17BP4B has an External Conductive Coating and
 an Aluminized Screen
 17BP4C has an External Conductive Coating and
 a Frosted Faceplate

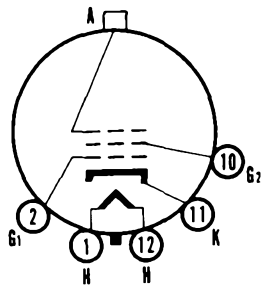
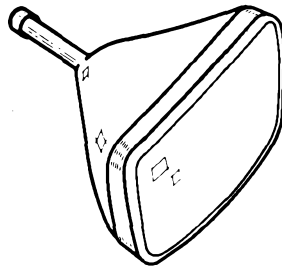

12-D

17BP4

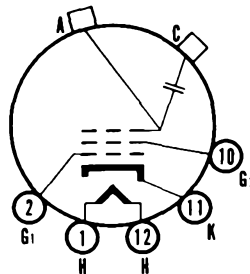

12-N

17BP4A
 17BP4B
 17BP4C

CHARACTERISTICS

GENERAL DATA

Focusing Method.....	Magnetic
Deflecting Method.....	Magnetic
Deflecting Angle (approx.)	
Horizontal.....	65 Degrees
Diagonal.....	70 Degrees
Phosphor.....	P4
Fluorescence.....	White
Persistence.....	Medium
Faceplate.....	Gray Filter Glass
Light Transmittance (approx.).....	72 Percent

17BP4, 17BP4A, 17BP4B, 17BP4C (Cont'd)

ELECTRICAL DATA

Heater Voltage.....	6.3 Volts
Heater Current (approx.).....	0.6 Ampere
Direct Interelectrode Capacitances (approx.)	
Cathode to All Other Electrodes.....	5 μf
Grid No. 1 to All Other Electrodes.....	6 μf
Ion Trap Magnet.....	External, Single Field Type

MECHANICAL DATA

Minimum Useful Screen Dimensions.....	10 $\frac{3}{4}$ x 14 $\frac{1}{4}$ Inches
Bulb Contact (Recessed Small Cavity Cap).....	J1-21
Base (Small Shell Duodecal 5-Pin).....	B5-57
Basing.....	12D

RATINGS

MAXIMUM RATINGS (Design Center Values)

Anode Voltage.....	16000 Volts d c
Grid No. 2 Voltage.....	410 Volts d c
Grid No. 1 Voltage	
Negative Bias Value.....	125 Volts d c
Positive Bias Value.....	0 Volts d c
Positive Peak Value.....	2 Volts
Peak Heater-Cathode Voltage	
Heater Negative with Respect to Cathode	
During Warm-up Period Not to	
Exceed 15 Seconds.....	410 Volts
After Equipment Warm-up Period.....	150 Volts
Heater Positive with Respect to Cathode.....	150 Volts

RECOMMENDED OPERATING CONDITIONS

Anode Voltage.....	14000 Volts d c
Grid No. 2 Voltage.....	300 Volts d c
Grid No. 1 Voltage Required for Cutoff ¹	-28 to -72 Volts d c
Focusing Coil Current (approx.) ²	110 Ma d c
Ion Trap Magnet Strength (approx.).....	30 Gauss

CIRCUIT VALUES

Grid No. 1 Circuit Resistance.....	1.5 Megohms Max
------------------------------------	--------------------

NOTES:

1. Visual extinction of focused raster. Extinction of stationary focused spot will require that these values be about 5 volts more negative.
2. For JETEC focusing coil 109 or equivalent three and one quarter inches from reference line, bias adjusted to 20 foot lamberts on a 10 $\frac{3}{4}$ x 14 $\frac{1}{4}$ inch picture area.

17BP4A

The Sylvania Type 17BP4A is identical to the Type 17BP4 except for having an External Conductive Coating which must be grounded.

External Conductive Coating to Anode Capacitance	
Maximum.....	1500 μf
Minimum.....	750 μf
Basing.....	12N

17BP4B

The Sylvania Type 17BP4B is identical to the Type 17BP4A except for having an aluminized screen.

17BP4C

The Sylvania Type 17BP4C is identical to the Type 17BP4 except for having an External Conductive Coating which must be grounded and a frosted faceplate.

External Conductive Coating to Anode Capacitance	
Maximum.....	1500 μf
Minimum.....	750 μf
Basing.....	12N

WARNING

X-ray radiation shielding may be necessary to protect against possible danger of personal injury from prolonged exposure at close range if this tube is operated at higher than the manufacturer's Maximum Rated Anode Voltage or 16,000 volts, whichever is less.

SYLVANIA TYPE 17CP4

TELEVISION PICTURE TUBE

17" Direct Viewed Magnetic Deflection
 Rectangular Metal Type Magnetic Focus
 Frosted Gray Filter Glass Spherical Faceplate
 Single Field Ion Trap

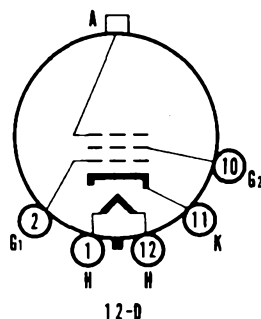
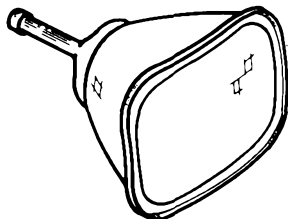

CHARACTERISTICS

GENERAL DATA

Focusing Method.....	Magnetic
Deflecting Method.....	Magnetic
Deflecting Angle (approx.)	
Horizontal.....	66 Degrees
Diagonal.....	70 Degrees
Phosphor.....	P4
Fluorescence.....	White
Persistence.....	Medium
Faceplate.....	Frosted Gray Filter Glass
Light Transmittance (approx.).....	66 Percent

ELECTRICAL DATA

Heater Voltage.....	6.3 Volts
Heater Current (approx.).....	0.6 Ampere
Direct Inter-electrode Capacitances (approx.)	
Cathode to All Other Electrodes.....	5 μ f
Grid No. 1 to All Other Electrodes.....	6 μ f
Ion Trap Magnet.....	External, Single Field Type

MECHANICAL DATA

Minimum Useful Screen Dimensions.....	10 $\frac{1}{16}$ x 14 $\frac{3}{8}$ Inches
Bulb Contact.....	Metal Cone Lip
Base (Small Shell Duodecal 5-Pin).....	B5-57
Basing.....	12D

RATINGS

MAXIMUM RATINGS (Design Center Values)

Anode Voltage.....	16000 Volts d c
Grid No. 2 Voltage.....	410 Volts d c
Grid No. 1 Voltage	
Negative Bias Value.....	125 Volts d c
Positive Bias Value.....	0 Volts d c
Positive Peak Value.....	2 Volts
Peak Heater-Cathode Voltage	
Heater Negative with Respect to Cathode	
During Warm-up Period Not to	
Exceed 15 Seconds.....	410 Volts
After Equipment Warm-up Period.....	180 Volts
Heater Positive with Respect to Cathode.....	180 Volts

RECOMMENDED OPERATING CONDITIONS

Anode Voltage.....	14000 Volts d c
Grid No. 2 Voltage.....	300 Volts d c
Grid No. 1 Voltage Required for Cutoff.....	-33 to -77 Volts d c
Focusing Coil Current (approx.) ²	104 Ma d c
Ion Trap Magnet Strength (approx.).....	50 Gauss

17CP4 (Cont'd)

CIRCUIT VALUES

Grid No. 1 Circuit Resistance 1.5 Megohms
Max

NOTES:

1. Visual extinction of undeflected focused spot.
2. For JETEC focusing coil 109 or equivalent three inches from reference line, bias adjusted to 30 foot lamberts on a $14\frac{3}{8} \times 10\frac{1}{8}$ inch picture area.

WARNING

X-ray radiation shielding may be necessary to protect against possible danger of personal injury from prolonged exposure at close range if this tube is operated at higher than the manufacturer's Maximum Rated Anode Voltage or 16,000 volts, whichever is less.

SYLVANIA TYPE 17FP4

TELEVISION PICTURE TUBE

17" Direct Viewed	Magnetic Deflection
Rectangular Glass Type	Electrostatic Focus
Gray Filter Glass	Spherical Faceplate
External Conductive Coating	Single Field Ion Trap

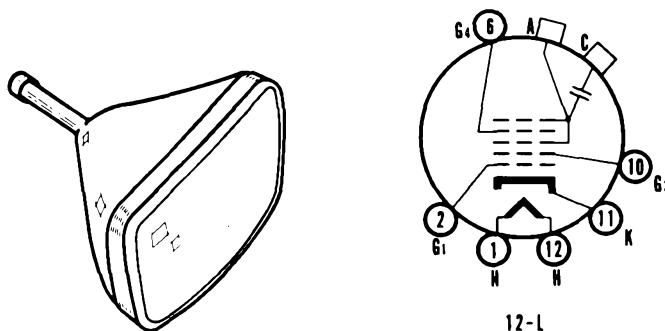

CHARACTERISTICS

GENERAL DATA

Focusing Method	Electrostatic
Deflecting Method	Magnetic
Deflecting Angle (approx.)	
Horizontal	65 Degrees
Diagonal	70 Degrees
Phosphor	P4
Fluorescence	White
Persistence	Medium
Faceplate	Gray Filter Glass
Light Transmittance (approx.)	66 Percent

ELECTRICAL DATA

Heater Voltage	6.3 Volts
Heater Current (approx.)	0.6 Ampere
Direct Interelectrode Capacitances (approx.)	
Cathode to All Other Electrodes	5 μf
Grid No. 1 to All Other Electrodes	6 μf
External Conductive Coating to Anode ¹	750 μf Max
Ion Trap Magnet	500 μf Min
	External, Single Field Type

17FP4 (Cont'd)

MECHANICAL DATA

Minimum Useful Screen Dimensions	10 $\frac{3}{4}$ x 14 $\frac{1}{4}$ Inches
Bulb Contact (Recessed Small Cavity Cap)	J1-21
Base (Small Shell Duodecal 6-Pin)	B6-63
Basing	12L

RATINGS

MAXIMUM RATINGS (Design Center Values)

Anode Voltage	18000 Volts d c
Grid No. 4 Voltage (Focusing Electrode)	5000 Volts d c
Grid No. 2 Voltage	410 Volts d c
Grid No. 1 Voltage	
Negative Bias Value	125 Volts d c
Positive Bias Value	0 Volts d c
Positive Peak Value	2 Volts
Peak Heater-Cathode Voltage	
Heater Negative with Respect to Cathode	
During Warm-up Period Not to	
Exceed 15 Seconds	410 Volts
After Equipment Warm-up Period	150 Volts
Heater Positive with Respect to Cathode	150 Volts

RECOMMENDED OPERATING CONDITIONS

Anode Voltage	16000 Volts d c
Grid No. 3 Voltage	3100 to 4100 Volts d c
Grid No. 2 Voltage	300 Volts d c
Grid No. 1 Voltage Required for Cutoff ²	-33 to -77 Volts d c
Ion Trap Magnet Strength (approx.)	35 Gauss

CIRCUIT VALUES

Grid No. 1 Circuit Resistance	1.5 Megohms
	Max

NOTES:

1. External conductive coating must be grounded.
2. Visual extinction of undeflected focused spot.

WARNING

X-ray radiation shielding may be necessary to protect against possible danger of personal injury from prolonged exposure at close range if this tube is operated at higher than the manufacturer's Maximum Rated Anode Voltage or 16,000 volts, whichever is less.

SYLVANIA TYPE 17GP4

TELEVISION PICTURE TUBE

17" Direct Viewed	Magnetic Deflection
Rectangular Metal Type	Electrostatic Focus
Frosted Gray Filter Glass	Spherical Faceplate
	Single Field Ion Trap

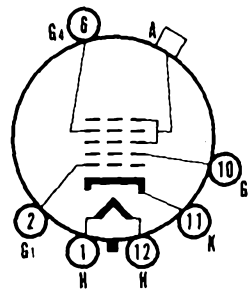
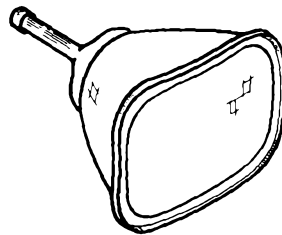

12-M

SYLVANIA TYPE 17BJP4

"Silver Screen 85"

TELEVISION PICTURE TUBE

17" Direct Viewed Magnetic Deflection
 Rectangular Glass Type Electrostatic Focus
 Spherical Faceplate No Ion Trap
 Gray Filter Glass External Conductive Coating
 Aluminized Screen

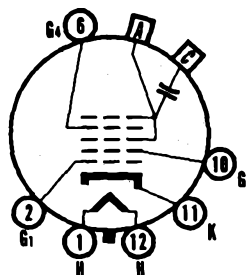
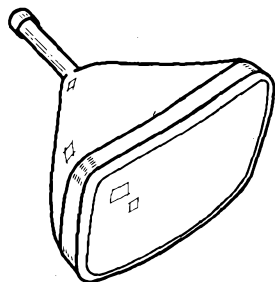

12-L

CHARACTERISTICS

GENERAL DATA

Focusing Method	Electrostatic
Deflection Method	Magnetic
Deflection Angles (approx.)	
Horizontal	85 Degrees
Diagonal	90 Degrees
Phosphor	Aluminized P4
Fluorescence	White
Persistence	Short to Medium
Faceplate	Gray Filter Glass
Light Transmittance (approx.)	74 Percent

ELECTRICAL DATA

Heater Voltage	6.3 Volts
Heater Current	0.6 ± 5% Ampere
Heater Warm-up Time ¹	11 Seconds
Direct Interelectrode Capacitance (approx.)	
Cathode to All Other Electrodes	5 μμf
Grid No. 1 to All Other Electrodes	6 μμf
External Conductive Coating to Anode ²	1500 μμf Max. 1000 μμf Min.

MECHANICAL DATA

Minimum Useful Screen Dimensions	14 $\frac{1}{8}$ x 11 $\frac{1}{4}$ Inches
Nominal Over-all Length	14 $\frac{1}{8}$ Inches
Minimum Useful Screen Area	149 Square Inches
Bulb Contact (Recessed Small Cavity Cap)	J1-21
Base (Small Shell Duodecal 6-Pin)	B6-63
Basing	12L

RATINGS

MAXIMUM RATINGS (Absolute Maximum Values)

Anode Voltage	17,600 Volts d c
Grid No. 4 Voltage	
(Focusing Electrode)	-550 to +1100 Volts d c
Grid No. 2 Voltage	550 Volts d c
Grid No. 1 Voltage	
Negative Bias Value	155 Volts d c
Negative Peak Value	220 Volts
Positive Bias Value	0 Volts d c
Positive Peak Value	2 Volts
Peak Heater-Cathode Voltage	
Heater Negative with Respect to Cathode	
During Warm-up Period Not to Exceed	
15 Seconds	450 Volts
After Equipment Warm-up Period	200 Volts
Heater Positive with Respect to Cathode	200 Volts

SYLVANIA PICTURE TUBES

SYLVANIA TYPE 17BJP4 (Cont'd)

TYPICAL OPERATING CONDITIONS

Anode Voltage	14,000 Volts d c
Grid No. 4 Voltage	-50 to +300 Volts d c
Grid No. 2 Voltage	300 Volts d c
Grid No. 1 Voltage Required for Cutoff ¹	-28 to -72 Volts d c

CIRCUIT VALUES

Grid No. 1 Circuit Resistance	1.5 Megohms Max.
-------------------------------	------------------

NOTES:

1. Heater Warm-up Time is defined as the time required for the voltage across the heater to reach 80% of its rated value after applying four (4) times rated heater voltage to a circuit consisting of the tube heater in series with a resistance equal to three (3) times rated heater voltage divided by rated heater current.
2. External conductive coating must be grounded.
3. Visual extinction of focused raster. Extinction of stationary focused spot will require that these values be about 5 volts more negative.

WARNING:

X-ray radiation shielding may be necessary to protect against possible danger of personal injury from prolonged exposure at close range if this tube is operated at higher than the manufacturer's Maximum Rated Anode Voltage or 16,000 volts, whichever is less.

SYLVANIA TYPE 17BRP4

Silver Screen "85"

TELEVISION PICTURE TUBE

17" Direct Viewed	Aluminized Screen
Rectangular Glass Type	Electrostatic Focus
Lightweight Tube	110° Magnetic Deflection
Spherical Face Plate	1 1/8" Neck Diameter
Gray Filter Glass	Single Field Ion Trap
External Conductive Coating	

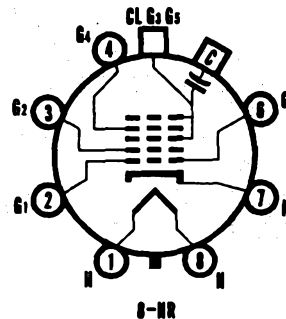
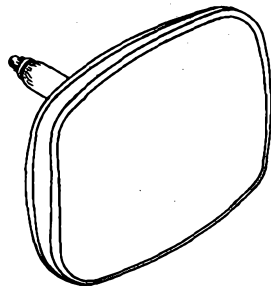

CHARACTERISTICS

GENERAL DATA

Focusing Method.....	Electrostatic
Deflection Method.....	Magnetic
Deflection Angles (approx.)	
Horizontal.....	105 Degrees
Diagonal.....	110 Degrees
Vertical.....	87 Degrees
Phosphor.....	Aluminized P4
Fluorescence.....	White
Persistence.....	Short to Medium
Faceplate.....	Gray Filter Glass
Light Transmittance (approx.).....	77 Percent

ELECTRICAL DATA

Heater Voltage.....	6.3 Volts
Heater Current.....	0.6 ± 5% Ampere
Heater Warm-up Time ¹	11 Seconds
Direct Interelectrode Capacitances (approx.)	
Cathode to All Other Electrodes.....	5 μuf
Grid No. 1 to All Other Electrodes.....	6 μuf
External Conductive Coating to Anode ²	1500 μuf Max. 1000 μuf Min.
Ion Trap Magnet.....	External, Single Field Type

MECHANICAL DATA

Minimum Useful Screen Dimensions (Maximum Assured).....	14 3/4 x 11 1/4
Nominal Overall Length.....	12 3/4 Inches
Minimum Useful Screen Area.....	155 Sq. Inches
Bulb Contact (Recessed Small Cavity Cap).....	J1-21
Base.....	B7-183
Basing.....	8HR
Weight.....	10 1/2 Pounds Approx.

RATINGS

MAXIMUM RATINGS (Absolute Maximum Values)

Anode Voltage.....	16,500 Volts d c
Grid No. 4 Voltage (Focusing Electrode).....	-550 to +1100 Volts d c
Grid No. 2 Voltage.....	550 Volts d c
Grid No. 1 Voltage.....	
Negative Bias Value.....	154 Volts d c
Negative Peak Value.....	220 Volts
Positive Bias Value.....	0 Volts d c
Positive Peak Value.....	2 Volts
Peak Heater-Cathode Voltage.....	
Heater Negative with Respect to Cathode	
During Warm-up Period Not to	
Exceed 15 Seconds.....	450 Volts
After Equipment Warm-up Period.....	200 Volts
Heater Positive with Respect to Cathode.....	200 Volts

SYLVANIA PICTURE TUBES

SYLVANIA TYPE 17BRP4 (Cont'd)

TYPICAL OPERATING CONDITIONS

Anode Voltage	14,000 Volts d c
Grid No. 4 Voltage for Focus	0 to 500 Volts d c
Grid No. 4 Current	-15 to +25 μ a d c
Grid No. 2 Voltage	300 Volts d c
Grid No. 1 Voltage Required for Cutoff ¹	-28 to -72 Volts d c
Ion Trap Field Intensity ⁴	37 Gaussess Min.

CIRCUIT VALUES

Grid No. 1 Circuit Resistance	1.5 Megohms Max.
Grid No. 2 Circuit Resistance	0.1 Megohm Min.
Grid No. 4 Circuit Resistance	0.1 Megohm Min.

NOTES:

1. Heater warm-up time is defined as the time required for the voltage across the heater to reach 80% of its rated value after applying four (4) times rated heater voltage to a circuit consisting of the tube heater in series with a resistance equal to three (3) times rated heater voltage divided by rated heater current.
2. External conductive coating must be grounded.
3. Visual extinction of focused raster. Extinction of stationary focused spot will require that these values be about 5 volts more negative.
4. For a Heppner PM ion trap magnet or equivalent located in optimum position and rotated to give maximum brightness.

WARNING:

X-ray radiation shielding may be necessary to protect against possible danger of personal injury from prolonged exposure at close range if this tube is operated at higher than the manufacturer's Maximum Rated Anode Voltage or 16,000 volts, whichever is less.

SYLVANIA TYPE 17BVP4

TELEVISION PICTURE TUBE

17" Direct Viewed	Aluminized Screen
Rectangular Glass Type	Electrostatic Focus
Lightweight Tube	110° Magnetic Deflection
Spherical Faceplate	1 1/8" Neck Diameter
Gray Filter Glass	Single Field Ion Trap
External Conductive Coating	

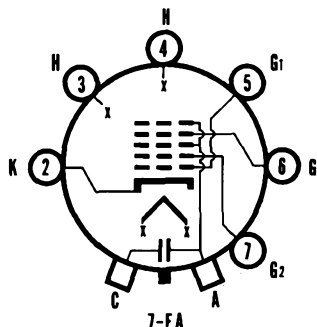
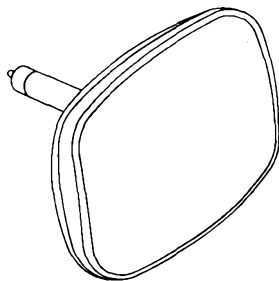

CHARACTERISTICS

GENERAL DATA

Focusing Method.....	Electrostatic
Deflection Method.....	Magnetic
Deflection Angles (approx.)	
Horizontal.....	105 Degrees
Diagonal.....	110 Degrees
Vertical.....	87 Degrees
Phosphor.....	Aluminized P4
Fluorescence.....	White
Persistence.....	Short to Medium
Faceplate.....	Gray Filter Glass
Light Transmittance (approx.).....	79 Percent

ELECTRICAL DATA

Heater Voltage.....	6.3 Volts
Heater Current.....	0.6 ± 5% Ampere
Heater Warm-up Time ¹	11 Seconds
Direct Interelectrode Capacitances (approx.)	
Cathode to All Other Electrodes.....	5 μmf
Grid No. 1 to All Other Electrodes.....	6 μmf
External Conductive Coating to Anode ²	1500 μmf Max. 1000 μmf Min.
Ion Trap Magnet.....	External, Single Field Type

MECHANICAL DATA

Overall Length.....	13 1/4 ± 1/8 Inches
Minimum Useful Screen Dimensions.....	14 1/4 x 11 1/8 Inches
Bulb.....	J132 1/2 A1
Bulb Contact (Recessed Small Cavity Cap).....	J1-21
Base.....	B6-185
Basing.....	7FA
Weight (approx.).....	10 Pounds

RATINGS

MAXIMUM RATINGS (Absolute Maximum Values)

Anode Voltage.....	17,600 Volts d c
Grid No. 4 Voltage.....	-550 to +1100 Volts d c
Grid No. 2 Voltage.....	550 Volts d c
Grid No. 1 Voltage.....	
Negative Bias Value.....	154 Volts d c
Negative Peak Value.....	220 Volts
Positive Bias Value.....	0 Volts d c
Positive Peak Value.....	2 Volts
Peak Heater-Cathode Voltage.....	
Heater Negative with Respect to Cathode.....	
During Warm-up Period not to Exceed	
15 Seconds.....	450 Volts
After Equipment Warm-up Period.....	200 Volts
Heater Positive with Respect to Cathode.....	200 Volts

SYLVANIA PICTURE TUBES

Issued as a supplement to the manual in Sylvania News for March 1957

17BVP4 (Cont'd)

TYPICAL OPERATING CONDITIONS

Anode Voltage.....	14,000 Volts d c
Grid No. 4 Voltage for Focus.....	-50 to +350 Volts d c
Grid No. 2 Voltage.....	300 Volts d c
Grid No. 1 Voltage Required for Cutoff.....	-35 to -72 Volts d c
Ion Trap Magnet Strength.....	33 ± 3 Gaussess Min.

CIRCUIT VALUES

Grid No. 1 Circuit Resistance.....	1.5 Megohms Max.
------------------------------------	------------------

NOTES:

1. Heater warm-up time is the time required for the voltage across the heater terminals to increase to 5.0 volts in the JETEC test circuit, with E = 25 volts and series R = 31.5 ohms.
2. External conductive coating must be grounded.
3. Visual extinction of focused raster. Extinction of stationary focused spot will require that these values be about 5 volts more negative.

WARNING:

X-ray radiation shielding may be necessary to protect against possible danger of personal injury from prolonged exposure at close range if this tube is operated at higher than the manufacturer's Maximum Rated Anode Voltage or 16,000 volts, whichever is less.

SYLVANIA TYPE 17BWP4

Silver Screen "85"

TELEVISION PICTURE TUBE

17" Direct Viewed	Aluminized Screen
Rectangular Glass Type	Electrostatic Focus
Lightweight Tube	110° Magnetic Deflection
Spherical Faceplate	1 1/8" Neck Diameter
Gray Filter Glass	No Ion Trap
External Conductive Coating	

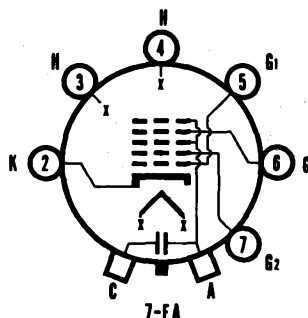
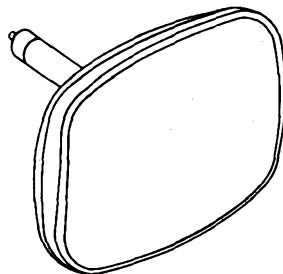

CHARACTERISTICS

GENERAL DATA

Focusing Method.....	Electrostatic
Deflection Method.....	Magnetic
Deflection Angles (approx.)	
Diagonal.....	105 Degrees
Horizontal.....	110 Degrees
Vertical.....	87 Degrees
Phosphor.....	Aluminized P4
Fluorescence.....	White
Persistence.....	Short to Medium
Faceplate.....	Gray Filter Glass
Light Transmittance (approx.).....	79 Percent

ELECTRICAL DATA

Heater Voltage.....	6.3 Volts
Heater Current.....	0.6 ± 5% Ampere
Heater Warm-up Time ¹	11 Seconds
Direct Interelectrode Capacitances (approx.)	
Cathode to All Other Electrodes.....	5 μf
Grid No. 1 to All Other Electrodes.....	6 μf
External Conductive Coating to Anode ²	1500 μf Max. 1000 μf Min.

MECHANICAL DATA

Minimum Useful Screen Dimensions (Maximum Assured).....	14 3/4 x 11 1/4 Inches
Nominal Overall Length.....	12 1/2 Inches
Minimum Useful Screen Area.....	155 Sq. Inches
Bulb.....	J132 1/2A1
Bulb Contact (Recessed Small Cavity Cap).....	J1-21
Base.....	B6-185
Basing.....	7FA
Weight (approx.).....	10 Pounds

RATINGS

MAXIMUM RATINGS (Absolute Maximum Values)

Anode Voltage.....	17,600 Volts d c
Grid No. 4 Voltage (Focusing Electrode).....	-550 to +1100 Volts d c
Grid No. 2 Voltage.....	550 Volts d c
Grid No. 1 Voltage.....	
Negative Bias Value.....	154 Volts d c
Negative Peak Value.....	220 Volts
Positive Bias Value.....	0 Volts d c
Positive Peak Value.....	2 Volts
Peak Heater-Cathode Voltage	
Heater Negative with Respect to Cathode	
During Warm-up Period Not to Exceed	
15 Seconds.....	450 Volts
After Equipment Warm-up Period.....	200 Volts
Heater Positive with Respect to Cathode.....	200 Volts

SYLVANIA PICTURE TUBES

SYLVANIA TYPE 17BWP4 (Cont'd)

TYPICAL OPERATING CONDITIONS

Anode Voltage.....	14,000 Volts d c
Grid No. 4 Voltage for Focus.....	-50 to +350 Volts d c
Grid No. 2 Voltage.....	300 Volts d c
Grid No. 1 Voltage Required for Cutoff ¹	-35 to -72 Volts d c

CIRCUIT VALUES

Grid No. 1 Circuit Resistance.....	1.5 Megohms Max.
------------------------------------	------------------

NOTES:

1. Heater warm-up time is defined as the time required for the voltage across the heater to reach 80% of the rated heater voltage after applying four (4) times rated heater voltage to a circuit consisting of the tube heater in series with a resistance equal to three (3) times the rated heater voltage divided by the rated heater current.
2. External conductive coating must be grounded.
3. Visual extinction of focused raster. Extinction of stationary focused spot will require that these values be about 5 volts more negative.

WARNING:

X-ray radiation shielding may be necessary to protect against possible danger of personal injury from prolonged exposure at close range if this tube is operated at higher than the manufacturer's Maximum Rated Anode Voltage or 16,000 volts, whichever is less.

SYLVANIA TYPE 17BZP4

Silver Screen "85"

TELEVISION PICTURE TUBE

17" Direct Viewed	Aluminized Screen
Rectangular Glass Type	Electrostatic Focus
Lightweight Tube	110° Magnetic Deflection
Spherical Faceplate	1 1/8" Neck Diameter
Gray Filter Glass	No Ion Trap
External Conductive Coating	

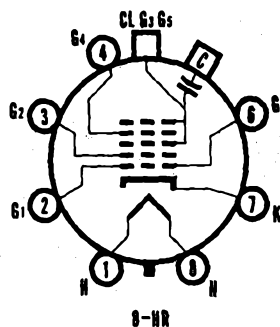
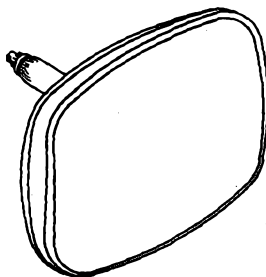

CHARACTERISTICS

GENERAL DATA

Focusing Method	Electrostatic
Deflection Method	Magnetic
Deflection Angles (approx.)	
Horizontal	105 Degrees
Diagonal	110 Degrees
Vertical	87 Degrees
Phosphor	Aluminized P4
Fluorescence	White
Persistence	Short to Medium
Faceplate	Gray Filter Glass
Light Transmittance (approx.)	77 Percent

ELECTRICAL DATA

Heater Voltage	6.3 Volts
Heater Current	0.6 ± 5% Ampere
Heater Warm-up Time	11 Seconds
Direct Interelectrode Capacitances (approx.)	
Cathode to All Other Electrodes	5 μf
Grid No. 1 to All Other Electrodes	6 μf
External Conductive Coating to Anode	1500 μf Max. 1000 μf Min.

MECHANICAL DATA

Minimum Useful Screen Dimensions (Maximum Assured)	14 3/4 x 11 1/2 Inches
Nominal Overall Length	12 5/8 Inches
Minimum Useful Screen Area	155 Square Inches
Bulb	J132 1/2-A1 or equivalent
Bulb Contact (Recessed Small Cavity Cap)	J1-21
Base	B7-183
Basing	8HR
Weight (approx.)	10 Pounds

RATINGS

MAXIMUM RATINGS (Absolute Maximum Values)

Anode Voltage	17,600 Volts d c
Grid No. 4 Voltage (Focusing Electrode)	-550 to +1100 Volts d c
Grid No. 2 Voltage	550 Volts d c
Grid No. 1 Voltage	
Negative Bias Value	154 Volts d c
Negative Peak Value	220 Volts
Positive Bias Value	0 Volts d c
Positive Peak Value	2 Volts
Peak Heater-Cathode Voltage	
Heater Negative with Respect to Cathode	
During Warm-up Period Not to Exceed 15 Seconds	450 Volts
After Equipment Warm-up Period	200 Volts
Heater Positive with Respect to Cathode	200 Volts

SYLVANIA PICTURE TUBES

SYLVANIA TYPE 17BZP4 (Cont'd)

TYPICAL OPERATING CONDITIONS

Anode Voltage.....	14,000 Volts d c
Grid No. 4 Voltage for Focus.....	0 to 400 Volts d c
Grid No. 2 Voltage.....	300 Volts d c
Grid No. 1 Voltage Required for Cutoff ¹	-35 to -72 Volts d c

CIRCUIT VALUES

Grid No. 1 Circuit Resistance.....	1.5 Megohms Max.
------------------------------------	------------------

NOTES:

1. Heater warm-up time is defined as the time required for the voltage across the heater to reach 80% of the rated heater voltage after applying four (4) times rated heater voltage to a circuit consisting of the tube heater in series with a resistance equal to three (3) times the rated heater voltage divided by the rated heater current.
2. External conductive coating must be grounded.
3. Visual extinction of focused raster. Extinction of stationary focused spot will require that these values be about 5 volts more negative.

WARNING:

X-ray radiation shielding may be necessary to protect against possible danger of personal injury from prolonged exposure at close range if this tube is operated at higher than the manufacturer's Maximum Rated Anode Voltage or 16,000 volts, whichever is less.

SYLVANIA TYPE 17CAP4

Silver Screen "85"

TELEVISION PICTURE TUBE

17" Direct Viewed	Aluminized Screen
Rectangular Glass Type	Electrostatic Focus
Lightweight Tube	110° Magnetic Deflection
Spherical Faceplate	1 1/8" Neck Diameter
Gray Filter Glass	No Ion Trap
External Conductive Coating	

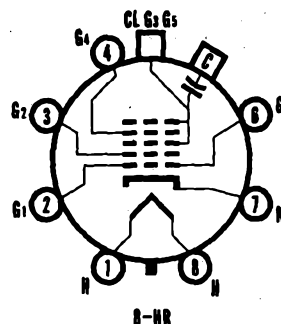
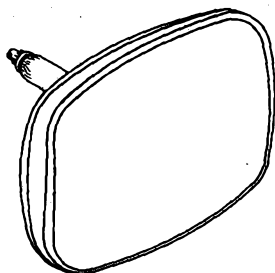

CHARACTERISTICS

GENERAL DATA

Focusing Method	Electrostatic
Deflection Method	Magnetic
Deflection Angles (approx.)	
Horizontal	105 Degrees
Diagonal	110 Degrees
Vertical	87 Degrees
Phosphor	Aluminized P4
Fluorescence	White
Persistence	Short to Medium
Faceplate	Gray Filter Glass
Light Transmittance (approx.)	79 Percent

ELECTRICAL DATA

Heater Voltage	6.3 Volts
Heater Current	0.6 ± 5% Amperes
Heater Warm-up Time ¹	11 Seconds
Direct Interelectrode Capacitances (approx.)	
Cathode to All Other Electrodes	5 μμf
Grid No. 1 to All Other Electrodes	6 μμf
External Conductive Coating to Anode ²	1500 μμf Max. 1000 μμf Min.

MECHANICAL DATA

Minimum Useful Screen Dimensions (Maximum Assured)	14 1/4 x 11 1/2 Inches
Nominal Overall Length	12 3/4 Inches
Minimum Useful Screen Area	155 Sq. Inches
Bulb	J132 1/2 A1 or Equivalent
Bulb Contact (Recessed Small Cavity Cap)	J1-21
Base	B7-183
Basing	8HR
Weight	10 Pounds Approx.

RATINGS

MAXIMUM RATINGS (Absolute Maximum Values)

Anode Voltage	17,600 Volts d c
Grid No. 4 Voltage (Focusing Electrode)	-550 to +1100 Volts d c
Grid No. 2 Voltage	550 Volts d c
Grid No. 1 Voltage	
Negative Bias Value	154 Volts d c
Negative Peak Value	220 Volts
Positive Bias Value	0 Volts d c
Positive Peak Value	2 Volts
Peak Heater-Cathode Voltage	
Heater Negative with Respect to Cathode	
During Warm-up Period Not to Exceed 15 Seconds	450 Volts
After Equipment Warm-up Period	200 Volts
Heater Positive with Respect to Cathode	200 Volts

SYLVANIA TYPE 17CAP4 (Cont'd)

TYPICAL OPERATING CONDITIONS

Anode.....	14,000 Volts d c
Grid No. 4 Voltage for Focus.....	-50 to +350 Volts d c
Grid No. 2 Voltage.....	300 Volts d c
Grid No. 1 Voltage Required for Cutoff.....	-35 to -72 Volts d c

CIRCUIT VALUES

Grid No. 1 Circuit Resistance.....	1.5 Megohms Max.
------------------------------------	------------------

NOTES:

1. Heater warm-up time is defined as the time required for the voltage across the heater to reach 80% of its rated value after applying four (4) times rated heater voltage to a circuit consisting of the tube heater in series with a resistance equal to three (3) times rated heater voltage divided by rated heater current.
2. External conductive coating must be grounded.
3. Visual extinction of focused raster. Extinction of stationary focused spot will require that these values be about 5 volts more negative.

SYLVANIA TYPE 17CFP4

Silver Screen "85"

TELEVISION PICTURE TUBE

17" Direct Viewed	Aluminized Screen
Rectangular Glass Type	Electrostatic Focus
Lightweight Tube	90° Magnetic Deflection
Spherical Faceplate	Short Neck Tube
Gray Filter Glass	No Ion Trap
External Conductive Coating	

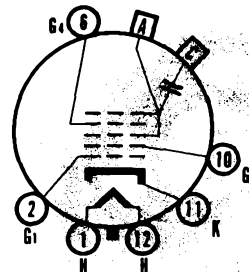
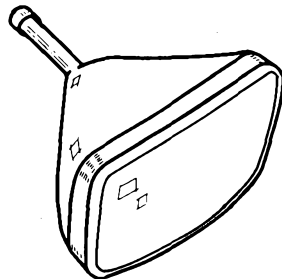

12-L

CHARACTERISTICS

GENERAL DATA

Focusing Method	Electrostatic
Deflection Method	Magnetic
Deflection Angles (approx.)	
Horizontal	85 Degrees
Diagonal	90 Degrees
Phosphor	Aluminized P4
Fluorescence	White
Persistence	Short to Medium
Faceplate	Gray Filter Glass
Light Transmittance (approx.)	77 Percent

ELECTRICAL DATA

Heater Voltage	6.3 Volts
Heater Current	0.6 ± 5% Ampere
Heater Warm-up Time ¹	11 Seconds
Direct Interelectrode Capacitances (approx.)	
Cathode to All Other Electrodes	5 μμf
Grid No. 1 to All Other Electrodes	6 μμf
External Conductive Coating to Anode ²	1500 μμf Max. 1200 μμf Min.

MECHANICAL DATA

Minimum Useful Screen Dimensions (Maximum Assured)	14¾ x 11½ Inches
Nominal Overall Length	15 Inches
Minimum Useful Screen Area	155 Square Inches
Bulb Contact (Recessed Small Cavity Cap)	J1-21
Base	B6-63
Basing	12L
Weight (approx.)	10½ Pounds

RATINGS

MAXIMUM RATINGS (Absolute Maximum Values)

Anode Voltage	17,600 Volts d c
Grid No. 4 Voltage (Focusing Electrode)	-550 to +1100 Volts d c
Grid No. 2 Voltage	550 Volts d c
Grid No. 1 Voltage	
Negative Bias Value	155 Volts d c
Negative Peak Value	220 Volts
Positive Bias Value	0 Volts d c
Positive Peak Value	2 Volts
Peak Heater-Cathode Voltage	
Heater Negative with Respect to Cathode	
During Warm-up Period Not to Exceed	
15 Seconds	450 Volts
After Equipment Warm-up Period	200 Volts
Heater Positive with Respect to Cathode	200 Volts

SYLVANIA PICTURE TUBES

Issued as a supplement to the manual in Sylvania News for February 1958

17CFP4 (Cont'd)

TYPICAL OPERATING CONDITIONS

Anode Voltage.....	14,000 Volts d c
Grid No. 4 Voltage for Focus.....	-50 to +350 Volts d c
Grid No. 2 Voltage.....	300 Volts d c
Grid No. 1 Voltage Required for Cutoff.....	-35 to -72 Volts d c

CIRCUIT VALUES

Grid No. 1 Circuit Resistance.....	1.5 Megohms Max.
------------------------------------	------------------

NOTES:

1. Heater warm-up time is defined as the time required for the voltage across the heater to reach 80% of its rated value after applying four (4) times rated heater voltage to a circuit consisting of the tube heater in series with a resistance equal to three (3) times rated heater voltage divided by rated heater current.
2. External conductive coating must be grounded.
3. Visual extinction of focused raster. Extinction of stationary focused spot will require that these values be about 5 volts more negative.

WARNING:

X-ray radiation shielding may be necessary to protect against possible danger of personal injury from prolonged exposure at close range if this tube is operated at higher than the manufacturer's Maximum Rated Anode Voltage or 16,000 volts, whichever is less.

SYLVANIA TYPE 17CLP4

Silver Screen "85"

Television Picture Tube

17" Direct Viewed	Aluminized Screen
Rectangular Glass Type	Electrostatic Focus
Spherical Faceplate	90° Magnetic Deflection
Gray Filter Glass	Short Neck Tube
External Conductive Coating	

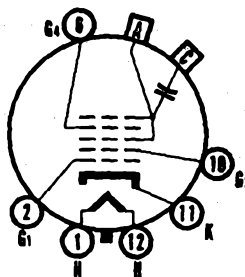
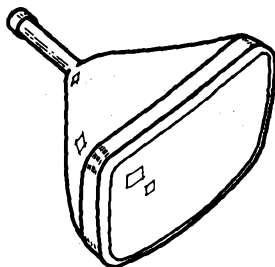

12-L

CHARACTERISTICS

GENERAL DATA

Focusing Method	Electrostatic
Deflection Method	Magnetic
Deflection Angles (approx.)	
Horizontal	85 Degrees
Diagonal	90 Degrees
Phosphor	Aluminized P4
Fluorescence	White
Persistence	Short to Medium
Faceplate	Gray Filter Glass
Light Transmittance (approx.)	74 Percent

ELECTRICAL DATA

Heater Voltage	6.3 Volts
Heater Current	0.6 ± 5% Ampere
Heater Warm-up Time ¹	11 Seconds
Direct Interelectrode Capacitances (approx.)	
Cathode to All Other Electrodes	5 μuf
Grid No. 1 to All Other Electrodes	6 μuf
External Conductive Coating to Anode ²	2300 μuf Max. 1800 μuf Min.
Ion Trap Magnet	External, Single Field Type

MECHANICAL DATA

Minimum Useful Screen Dimensions (Maximum Assured)	14 $\frac{5}{16}$ x 11 $\frac{1}{8}$ Inches
Nominal Overall Length	15 $\frac{1}{2}$ Inches
Minimum Useful Screen Area	149 Sq. Inches
Bulb Contact (Recessed Small Cavity Cap)	J1-21
Base	B6-63
Basing	12L

RATINGS

MAXIMUM RATINGS (Absolute Maximum Values)

Anode Voltage	17,600 Volts d c
Grid No. 4 Voltage (Focusing Electrode)	-550 to +1100 Volts d c
Grid No. 2 Voltage	550 Volts d c
Grid No. 1 Voltage	
Negative Bias Value	155 Volts d c
Negative Peak Value	220 Volts
Positive Bias Value	0 Volts d c
Positive Peak Value	2 Volts
Peak Heater-Cathode Voltage	
Heater Negative with Respect to Cathode	
During Warm-up Period Not to Exceed	
15 Seconds	450 Volts
After Equipment Warm-up Period	200 Volts
Heater Positive with Respect to Cathode	200 Volts

SYLVANIA PICTURE TUBES

SYLVANIA TYPE 17CLP4 (Cont'd)

TYPICAL OPERATING CONDITIONS

Anode Voltage.....	14,000 Volts d c
Grid No. 4 Voltage for Focus.....	-48 to +264 Volts d c
Grid No. 2 Voltage.....	300 Volts d c
Grid No. 1 Voltage Required for Cutoff ³	-35 to -72 Volts d c
Ion Trap Magnet Strength (approx.).....	35 Gauss

CIRCUIT VALUES

Grid No. 1 Circuit Resistance.....	1.5 Megohms Max.
------------------------------------	------------------

NOTES:

1. Heater warm-up time is defined as the time required for the voltage across the heater to reach 80% of its rated value after applying four (4) times rated heater voltage to a circuit consisting of the tube heater in series with a resistance equal to three (3) times rated heater voltage divided by rated heater current.
2. External conductive coating must be grounded.
3. Visual extinction of focused raster. Extinction of stationary focused spot will require that these values be about 5 volts more negative.

WARNING:

X-ray radiation shielding may be necessary to protect against possible danger of personal injury from prolonged exposure at close range if this tube is operated at higher than the manufacturer's Maximum Rated Anode Voltage or 16,000 volts, whichever is less.

SYLVANIA TYPE 17CNP4

Silver Screen "85"

TELEVISION PICTURE TUBE

17" Direct Viewed	Electrostatic Focus
Rectangular Glass Type	90° Magnetic Deflection
Lightweight Tube	Short Neck Tube
Spherical Faceplate	No Ion Trap
Gray Filter Glass	External Conductive Coating
Aluminized Screen	Cathode Drive Design

Low Grid No. 2 Voltage

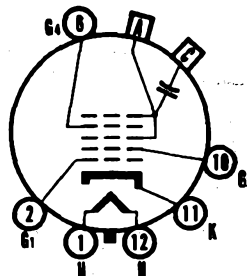
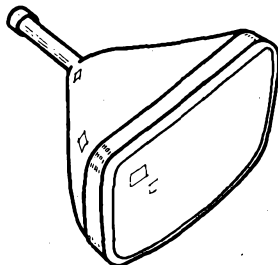

12-L

CHARACTERISTICS

GENERAL DATA

Focusing Method	Electrostatic
Deflection Method	Magnetic
Deflection Angles (approx.)	
Horizontal	85 Degrees
Diagonal	90 Degrees
Phosphor	Aluminized P4
Fluorescence	White
Persistence	Short to Medium
Faceplate	Gray Filter Glass
Light Transmittance (approx.)	77 Percent

ELECTRICAL DATA

Heater Voltage	6.3 Volts
Heater Current	0.6 ± 5% Amperes
Heater Warm-up Time	11 Seconds
Direct Interelectrode Capacitances (approx.)	
Cathode to All Other Electrodes	5 μf
Grid No. 1 to All Other Electrodes	6 μf
External Conductive Coating to Anode ²	1500 μf Max. 1000 μf Min.

MECHANICAL DATA

Minimum Useful Screen Dimensions (Maximum Assured)	14 1/4 x 11 1/2 Inches
Nominal Overall Length	15 Inches
Minimum Useful Screen Area	155 Square Inches
Bulb	J132 1/2 C or Equivalent
Bulb Contact (Recessed Small Cavity Cap)	J1-21
Base (Small Shell Duodecal 6-Pin)	B6-63
Basing	12L
Weight (approx.)	10 1/2 Pounds

RATINGS

MAXIMUM RATINGS (Absolute Maximum Values)³

Anode Voltage	17,600 Volts d c
Grid No. 4 Voltage (Focusing Electrode)	-550 to +1100 Volts d c
Grid No. 2 Voltage	70 Volts d c
Cathode Voltage	
Positive Bias Value	150 Volts d c
Negative Peak Value	0 Volts
Peak Heater-Cathode Voltage	
Heater Negative with Respect to Cathode	
During Warm-up Period Not to Exceed	
15 Seconds	450 Volts
After Equipment Warm-up Period	200 Volts
Heater Positive with Respect to Cathode	200 Volts

SYLVANIA PICTURE TUBES

SYLVANIA TYPE 17CNP4 (Cont'd)

TYPICAL OPERATING CONDITIONS¹

Anode Voltage.....	14,000 Volts d c
Grid No. 4 Voltage for Focus.....	0 to +400 Volts d c
Grid No. 2 Voltage.....	50 Volts d c
Cathode Voltage Required for Cutoff ⁴	35 to 50 Volts d c

CIRCUIT VALUES

Grid No. 1 Circuit Resistance.....	1.5 Megohms Max.
------------------------------------	------------------

NOTES:

1. Heater warm-up time is defined as the time required for the voltage across the heater to reach 80% of its rated value after applying four (4) times rated heater voltage to a circuit consisting of the tube heater in series with a resistance equal to three (3) times rated heater voltage divided by rated heater current.
2. External conductive coating must be grounded.
3. This type is designed for cathode-drive service. All voltages shown are positive with respect to Grid No. 1 Voltage, unless otherwise indicated.
4. For visual extinction of focused raster. Extinction of stationary focused spot will require that these values increase approximately 5 volts.

WARNING:

X-ray radiation shielding may be necessary to protect against possible danger of personal injury from prolonged exposure at close range if this tube is operated at higher than the manufacturer's Maximum Rated Anode Voltage or 16,000 volts, whichever is less.

17CP4 (Cont'd)

CIRCUIT VALUES

Grid No. 1 Circuit Resistance 1.5 Megohms
Max

NOTES:

1. Visual extinction of undeflected focused spot.
2. For JETEC focusing coil 109 or equivalent three inches from reference line, bias adjusted to 30 foot lamberts on a $14\frac{3}{8} \times 10\frac{1}{16}$ inch picture area.

WARNING

X-ray radiation shielding may be necessary to protect against possible danger of personal injury from prolonged exposure at close range if this tube is operated at higher than the manufacturer's Maximum Rated Anode Voltage or 16,000 volts, whichever is less.

SYLVANIA TYPE 17FP4

TELEVISION PICTURE TUBE

17" Direct Viewed	Magnetic Deflection
Rectangular Glass Type	Electrostatic Focus
Gray Filter Glass	Spherical Faceplate
External Conductive Coating	Single Field Ion Trap

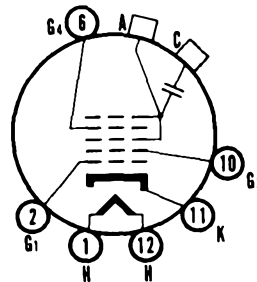
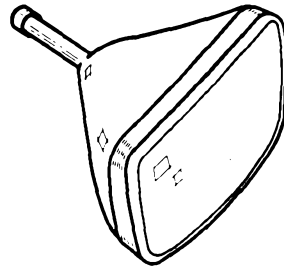

12-L

CHARACTERISTICS

GENERAL DATA

Focusing Method	Electrostatic
Deflecting Method	Magnetic
Deflecting Angle (approx.)	
Horizontal	65 Degrees
Diagonal	70 Degrees
Phosphor	P4
Fluorescence	White
Persistence	Medium
Faceplate	Gray Filter Glass
Light Transmittance (approx.)	66 Percent

ELECTRICAL DATA

Heater Voltage	6.3 Volts
Heater Current (approx.)	0.6 Ampere
Direct Interelectrode Capacitances (approx.)	
Cathode to All Other Electrodes	5 $\mu\mu\text{f}$
Grid No. 1 to All Other Electrodes	6 $\mu\mu\text{f}$
External Conductive Coating to Anode ¹	750 $\mu\mu\text{f}$ Max
	500 $\mu\mu\text{f}$ Min
Ion Trap Magnet	External, Single Field Type

17FP4 (Cont'd)

MECHANICAL DATA

Minimum Useful Screen Dimensions.....	10 $\frac{3}{4}$ x 14 $\frac{1}{4}$ Inches
Bulb Contact (Recessed Small Cavity Cap).....	J1-21
Base (Small Shell Duodecal 6-Pin).....	B6-63
Basing.....	12L

RATINGS

MAXIMUM RATINGS (Design Center Values)

Anode Voltage.....	18000 Volts d c
Grid No. 4 Voltage (Focusing Electrode).....	5000 Volts d c
Grid No. 2 Voltage.....	410 Volts d c
Grid No. 1 Voltage.....	
Negative Bias Value.....	125 Volts d c
Positive Bias Value.....	0 Volts d c
Positive Peak Value.....	2 Volts
Peak Heater-Cathode Voltage.....	
Heater Negative with Respect to Cathode	
During Warm-up Period Not to	
Exceed 15 Seconds.....	410 Volts
After Equipment Warm-up Period.....	150 Volts
Heater Positive with Respect to Cathode.....	150 Volts

RECOMMENDED OPERATING CONDITIONS

Anode Voltage.....	16000 Volts d c
Grid No. 3 Voltage.....	3100 to 4100 Volts d c
Grid No. 2 Voltage.....	300 Volts d c
Grid No. 1 Voltage Required for Cutoff.....	-33 to -77 Volts d c
Ion Trap Magnet Strength (approx.).....	35 Gauss

CIRCUIT VALUES

Grid No. 1 Circuit Resistance.....	1.5 Megohms
	Max

NOTES:

- External conductive coating must be grounded.
- Visual extinction of undeflected focused spot.

WARNING

X-ray radiation shielding may be necessary to protect against possible danger of personal injury from prolonged exposure at close range if this tube is operated at higher than the manufacturer's Maximum Rated Anode Voltage or 16,000 volts, whichever is less.

SYLVANIA TYPE 17GP4

TELEVISION PICTURE TUBE

17" Direct Viewed	Magnetic Deflection
Rectangular Metal Type	Electrostatic Focus
Frosted Gray Filter Glass	Spherical Faceplate
Single Field Ion Trap	

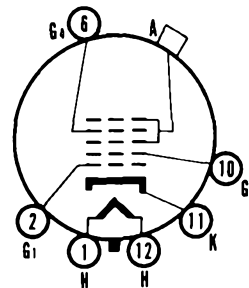
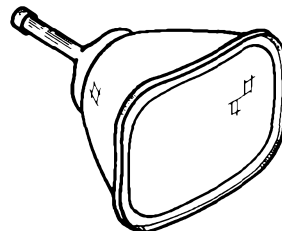

12-M

17GP4 (Cont'd)

CHARACTERISTICS

GENERAL DATA

Focusing Method.....	Electrostatic
Deflecting Method.....	Magnetic
Deflecting Angle (approx.)	
Horizontal.....	66 Degrees
Diagonal.....	70 Degrees
Phosphor.....	P4
Fluorescence.....	White
Persistence.....	Medium
Faceplate.....	Frosted Gray Filter Glass
Light Transmittance (approx.).....	66 Percent

ELECTRICAL DATA

Heater Voltage.....	6.3 Volts
Heater Current (approx.).....	0.6 Ampere
Direct Interelectrode Capacitances (approx.)	
Cathode to All Other Electrodes.....	5 $\mu\mu\text{f}$
Grid No. 1 to All Other Electrodes.....	6 $\mu\mu\text{f}$
Ion Trap Magnet.....	External, Single Field Type

MECHANICAL DATA

Minimum Useful Screen Dimensions.....	14 $\frac{3}{8}$ x 10 $\frac{1}{16}$ Inches
Bulb Contact.....	Metal Cone Lip
Base (Small Shell Duodecal 6-Pin).....	B6-63
Basing.....	12M

RATINGS

MAXIMUM RATINGS (Design Center Values)

Anode Voltage.....	16000 Volts d c
Grid No. 4 Voltage (Focusing Electrode).....	5000 Volts d c
Grid No. 2 Voltage.....	500 Volts d c
Grid No. 1 Voltage	
Negative Bias Value.....	125 Volts d c
Positive Bias Value.....	0 Volts d c
Positive Peak Value.....	2 Volts
Peak Heater-Cathode Voltage	
Heater Negative with Respect to Cathode	
During Warm-up Period Not to	
Exceed 15 Seconds.....	410 Volts
After Equipment Warm-up Period.....	180 Volts
Heater Positive with Respect to Cathode.....	180 Volts

RECOMMENDED OPERATING CONDITIONS

Anode Voltage.....	14000 Volts d c
Grid No. 4 Voltage.....	2670 to 3620 Volts d c
Grid No. 2 Voltage.....	300 Volts d c
Grid No. 1 Voltage Required for Cutoff.....	-33 to -77 Volts d c
Ion Trap Magnet Strength (approx.).....	40 Gauss

CIRCUIT VALUES

Grid No. 1 Circuit Resistance.....	1.5 Megohms
	Max

NOTE:

1. Visual extinction of undeflected focused spot.

WARNING

X-ray radiation shielding may be necessary to protect against possible danger of personal injury from prolonged exposure at close range if this tube is operated at higher than the manufacturer's Maximum Rated Anode Voltage or 16,000 volts, whichever is less.

SYLVANIA TYPE 17HP4/17RP4

Silver Screen "85" → 17HP4B

TELEVISION PICTURE TUBE

17" Direct Viewed Magnetic Deflection
 Rectangular Glass Type Electrostatic Focus
 Gray Filter Glass Spherical Faceplate
 External Conductive Coating Single Field Ion Trap
 17HP4A has a Frosted Faceplate
 17HP4B has an Aluminized Screen

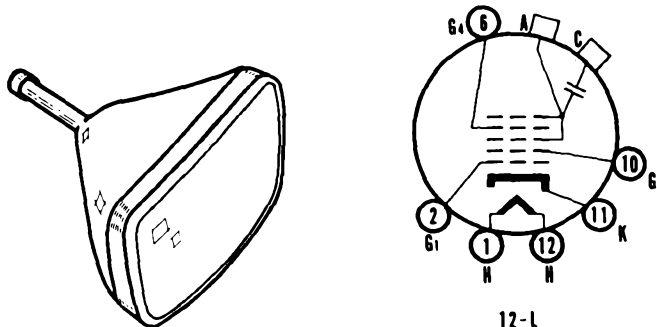

CHARACTERISTICS

GENERAL DATA

Focusing Method.....	Electrostatic
Deflecting Method.....	Magnetic
Deflecting Angle (approx.)	
Horizontal.....	65 Degrees
Diagonal.....	70 Degrees
Phosphor.....	P4
Fluorescence.....	White
Persistence.....	Medium
Faceplate.....	Gray Filter Glass
Light Transmittance (approx.).....	72 Percent

ELECTRICAL DATA

Heater Voltage.....	6.3 Volts
Heater Current (approx.).....	0.6 Amperes
Direct Interelectrode Capacitances (approx.)	
Cathode to All Other Electrodes.....	5 μ f
Grid No. 1 to All Other Electrodes.....	6 μ f
External Conductive Coating to Anode ¹	1500 μ f Max 750 μ f Min
Ion Trap Magnet.....	External, Single Field Type

MECHANICAL DATA

Minimum Useful Screen Dimensions.....	10 $\frac{3}{4}$ x 14 $\frac{1}{4}$ Inches
Bulb Contact (Recessed Small Cavity Cap).....	J1-21
Base (Small Shell Duodecal 6-Pin).....	B6-63
Basing.....	12L

RATINGS

MAXIMUM RATINGS (Design Center Values)

Anode Voltage.....	16000 Volts d c
Grid No. 4 (Focusing Electrode) Voltage.....	-500 to +1000 Volts d c
Grid No. 2 Voltage.....	500 Volts d c
Grid No. 1 Voltage	
Negative Bias Value.....	125 Volts d c
Positive Bias Value.....	0 Volts d c
Positive Peak Value.....	2 Volts
Peak Heater-Cathode Voltage	
Heater Negative with Respect to Cathode	
During Warm-up Period Not to	
Exceed 15 Seconds.....	410 Volts
After Equipment Warm-up Period.....	180 Volts
Heater Positive with Respect to Cathode.....	180 Volts

17HP4/17RP4, 17HP4B (Cont'd)

RECOMMENDED OPERATING CONDITIONS

Anode Voltage	14000 Volts d c
Grid No. 4 Voltage	-56 to +310 Volts d c
Grid No. 2 Voltage	300 Volts d c
Grid No. 1 Voltage Required for Cutoff ²	-28 to -72 Volts d c
Ion Trap Magnet Field Strength (approx.)	30 Gauss

CIRCUIT VALUES

Grid No. 1 Circuit Resistance	1.5 Megohms
	Max

NOTES:

1. External conductive coating must be grounded.
2. Visual extinction of focused raster. Extinction of stationary focused spot will require that these values be about 5 volts more negative.

17HP4A

The Sylvania Type 17HP4A is identical to Type 17HP4 except for having a frosted faceplate.

17HP4B

The Sylvania Type 17HP4B is identical to Type 17HP4 except for having an aluminized screen.

17RP4

The Sylvania Type 17RP4 is identical to Type 17HP4.

WARNING

X-ray radiation shielding may be necessary to protect against possible danger of personal injury from prolonged exposure at close range if this tube is operated at higher than the manufacturer's Maximum Rated Anode Voltage or 16,000 volts, whichever is less.

SYLVANIA TYPE 17JP4

TELEVISION PICTURE TUBE

17" Direct Viewed	Magnetic Deflection
Rectangular Glass Type	Magnetic Focus
Gray Filter Glass	Spherical Faceplate
External Conductive Coating	Single Field Ion Trap

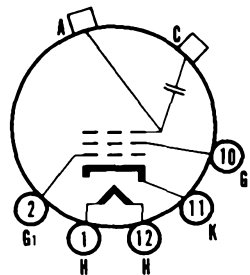
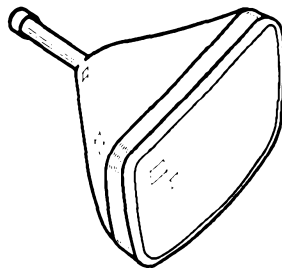

17JP4 (Cont'd)

CHARACTERISTICS

GENERAL DATA

Focusing Method.....	Magnetic
Deflecting Method.....	Magnetic
Deflecting Angle.....	
Horizontal.....	65 Degrees
Diagonal.....	70 Degrees
Phosphor.....	P4
Fluorescence.....	White
Persistence.....	Medium
Faceplate.....	Gray Filter Glass
Light Transmittance (approx.).....	66 Percent

ELECTRICAL DATA

Heater Voltage.....	6.3 Volts
Heater Current (approx.).....	0.6 Ampere
Direct Interelectrode Capacitances (approx.).....	
Cathode to All Other Electrodes.....	5 μ mf
Grid No. 1 to All Other Electrodes.....	6 μ mf
External Conductive Coating to Anode ¹	750 μ mf Max
	500 μ mf Min
Ion Trap Magnet.....	External, Single Field Type

MECHANICAL DATA

Minimum Useful Screen Dimensions.....	14 $\frac{1}{4}$ x 10 $\frac{3}{4}$ Inches
Bulb Contact (Recessed Small Cavity Cap).....	J1-21
Base (Small Shell Duodecal 5-Pin).....	B5-57
Basing.....	12N

RATINGS

MAXIMUM RATINGS (Design Center Values)

Anode Voltage.....	18000 Volts d c
Grid No. 2 Voltage.....	410 Volts d c
Grid No. 1 Voltage.....	
Negative Bias Value.....	125 Volts d c
Positive Bias Value.....	0 Volts d c
Positive Peak Value.....	2 Volts
Peak Heater-Cathode Voltage.....	
Heater Negative with Respect to Cathode.....	
During Warm-up Period Not to Exceed 15 Seconds.....	410 Volts
After Equipment Warm-up Period.....	150 Volts
Heater Positive with Respect to Cathode.....	150 Volts

RECOMMENDED OPERATING CONDITIONS

Anode Voltage.....	16000 Volts d c
Grid No. 2 Voltage.....	300 Volts d c
Grid No. 1 Voltage Required for Cutoff ²	-33 to -77 Volts d c
Focusing Coil Current (approx.) ³	100 Ma d c
Ion Trap Magnet Field Strength (approx.).....	35 Gauss

CIRCUIT VALUES

Grid No. 1 Circuit Resistance.....	1.5 Megohms Max
------------------------------------	-----------------

NOTES:

1. External conductive coating must be grounded.
2. Visual extinction of undeflected focused spot.
3. For JETEC focusing coil 109 or equivalent three inches from reference line, bias adjusted to 20 foot lamberts on a 10 $\frac{3}{4}$ x 14 $\frac{1}{4}$ inch picture area.

WARNING

X-ray radiation shielding may be necessary to protect against possible danger of personal injury from prolonged exposure at close range if this tube is operated at higher than the manufacturer's Maximum Rated Anode Voltage or 16,000 volts, whichever is less.

SYLVANIA TYPE 17LP4/17VP4

Silver Screen "85" → 17LP4A

TELEVISION PICTURE TUBE

17" Direct Viewed	Magnetic Deflection
Rectangular Glass Type	Electrostatic Focus
Gray Filter Glass	Cylindrical Faceplate
External Conductive Coating	Single Field Ion Trap

17LP4A has an Aluminized Screen

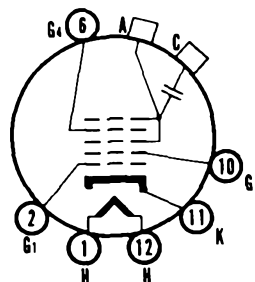
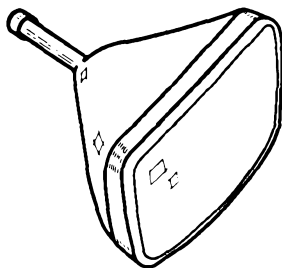

12-L

CHARACTERISTICS

GENERAL DATA

Focusing Method	Electrostatic
Deflecting Method	Magnetic
Deflecting Angle (approx.)	
Horizontal	65 Degrees
Diagonal	70 Degrees
Phosphor	P4
Fluorescence	White
Persistence	Medium
Faceplate	Gray Filter Glass
Light Transmittance (approx.)	72 Percent

ELECTRICAL DATA

Heater Voltage	6.3 Volts
Heater Current (approx.)	0.6 Ampere
Direct Interelectrode Capacitances (approx.)	
Cathode to All Other Electrodes	5 μf
Grid No. 1 to All Other Electrodes	6 μf
External Conductive Coating to Anode	1500 μf Max
Ion Trap Magnet	750 μf Min
Ion Trap Magnet	External, Single Field Type

MECHANICAL DATA

Minimum Useful Screen Dimensions	10 $\frac{3}{4}$ x 14 $\frac{1}{4}$ Inches
Bulb Contact (Recessed Small Cavity Cap)	J1-21
Base (Small Shell Duodecal 6-Pin)	B6-63
Basing	12L

RATINGS

MAXIMUM RATINGS (Design Center Values)

Anode Voltage	16000 Volts d c
Grid No. 4 (Focusing Electrode) Voltage	-500 to +1000 Volts d c
Grid No. 2 Voltage	500 Volts d c
Grid No. 1 Voltage	
Negative Bias Value	125 Volts d c
Positive Bias Value	0 Volts d c
Positive Peak Value	2 Volts
Peak Heater-Cathode Voltage	
Heater Negative with Respect to Cathode	
During Warm-up Period Not to	
Exceed 15 Seconds	410 Volts
After Equipment Warm-up Period	180 Volts
Heater Positive with Respect to Cathode	180 Volts

17LP4/17VP4, 17LP4A (Cont'd)

RECOMMENDED OPERATING CONDITIONS

Anode Voltage.....	14000	Volts d c
Grid No. 4 Voltage.....	-56 to +310	Volts d c
Grid No. 2 Voltage.....	300	Volts d c
Grid No. 1 Voltage Required for Cutoff ²	-28 to -72	Volts d c
Ion Trap Magnet Strength (approx.).....	30	Gausses

CIRCUIT VALUES

Grid No. 1 Circuit Resistance.....	1.5	Megohms
		Max

NOTES:

1. External conductive coating must be grounded.
2. Visual extinction of focused raster. Extinction of stationary focused spot will require that these values be about 5 volts more negative.

17LP4A

The Sylvania Type 17LP4A is identical to the Type 17LP4 except for having an aluminized screen.

17VP4

The Sylvania Type 17VP4 is identical to Type 17LP4.

WARNING

X-ray radiation shielding may be necessary to protect against possible danger of personal injury from prolonged exposure at close range if this tube is operated at higher than the manufacturer's Maximum Rated Anode Voltage or 16,000 volts, whichever is less.

SYLVANIA TYPE 17QP4 17QP4A

TELEVISION PICTURE TUBE

17" Direct Viewed	Magnetic Deflection
Rectangular Glass Type	Magnetic Focus
Gray Filter Glass	Cylindrical Faceplate
External Conductive Coating	Single Field Ion Trap

17QP4A has an Aluminized Screen

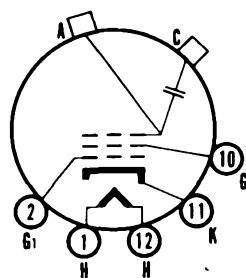
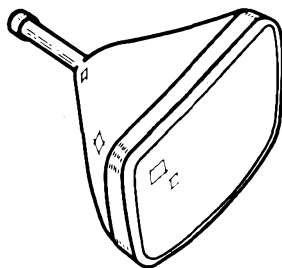

12-N

17QP4, 17QP4A (Cont'd)

CHARACTERISTICS

GENERAL DATA

Focusing Method.....	Magnetic
Deflecting Method.....	Magnetic
Deflecting Angle (approx.)	
Horizontal.....	65 Degrees
Diagonal.....	70 Degrees
Phosphor.....	P4
Fluorescence.....	White
Persistence.....	Medium
Faceplate.....	Gray Filter Glass
Light Transmittance (approx.).....	72 Percent

ELECTRICAL DATA

Heater Voltage.....	6.3 Volts
Heater Current (approx.).....	0.6 Ampere
Direct Interelectrode Capacitances (approx.)	
Cathode to All Other Electrodes.....	5 μf
Grid No. 1 to All Other Electrodes.....	6 μf
External Conductive Coating to Anode.....	1500 μf Max
	750 μf Min
Ion Trap Magnet.....	External, Single Field Type

MECHANICAL DATA

Minimum Useful Screen Dimensions.....	10 $\frac{3}{4}$ x 14 $\frac{1}{4}$ Inches
Bulb Contact (Recessed Small Cavity Cap).....	J1-21
Base (Small Shell Duodecal 5-Pin).....	B5-57
Basing.....	12N

RATINGS

MAXIMUM RATINGS (Design Center Values)

Anode Voltage.....	16000 Volts d c
Grid No. 2 Voltage.....	500 Volts d c
Grid No. 1 Voltage.....	
Negative Bias Value.....	125 Volts d c
Positive Bias Value.....	0 Volts d c
Positive Peak Value.....	2 Volts
Peak Heater-Cathode Voltage.....	
Heater Negative with Respect to Cathode	
During Warm-up Period Not to	
Exceed 15 Seconds.....	410 Volts
After Equipment Warm-up Period.....	150 Volts
Heater Positive with Respect to Cathode.....	150 Volts

RECOMMENDED OPERATING CONDITIONS

Anode Voltage.....	14000 Volts d c
Grid No. 2 Voltage.....	300 Volts d c
Grid No. 1 Voltage Required for Cutoff.....	-28 to -72 Volts d c
Focusing Coil Current (approx.).....	95 Ma d c
Ion Trap Magnet Strength (approx.).....	30 Gauss

CIRCUIT VALUES

Grid No. 1 Circuit Resistance.....	1.5 Megohms
	Max

NOTES:

1. External conductive coating must be grounded.
2. Visual extinction of focused raster. Extinction of stationary focused spot will require that these values be about 5 volts more negative.
3. For JETEC focusing coil 109 or equivalent three inches from reference line, bias adjusted to 20 foot lamberts on a 10 $\frac{3}{4}$ x 14 $\frac{1}{4}$ inch picture area.

17QP4A

The Sylvania Type 17QP4A is identical to the Type 17QP4 except for having an aluminized screen, and a maximum anode voltage rating of 18,000 volts instead of 16,000 volts.

WARNING

X-ray radiation shielding may be necessary to protect against possible danger of personal injury from prolonged exposure at close range if this tube is operated at higher than the manufacturer's Maximum Rated Anode Voltage or 16,000 volts, whichever is less.

SYLVANIA TYPE 17TP4

TELEVISION PICTURE TUBE

17" Direct Viewed Magnetic Deflection
 Rectangular Metal Type Electrostatic Focus
 Frosted Gray Filter Glass Spherical Faceplate
 Single Field Ion Trap

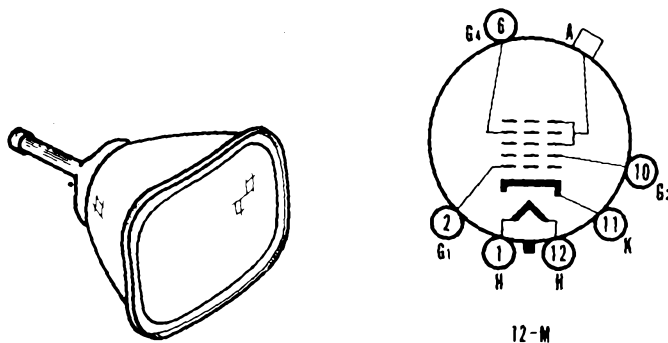

CHARACTERISTICS

GENERAL DATA

Focusing Method.....	Electrostatic
Deflecting Method.....	Magnetic
Deflecting Angle (approx.)	
Horizontal.....	66 Degrees
Diagonal.....	70 Degrees
Phosphor.....	P4
Fluorescence.....	White
Persistence.....	Medium
Faceplate.....	Frosted Gray Filter Glass
Light Transmittance (approx.).....	66 Percent

ELECTRICAL DATA

Heater Voltage.....	6.3 Volts
Heater Current (approx.).....	0.6 Ampere
Direct Interelectrode Capacitances (approx.)	
Cathode to All Other Electrodes.....	5 $\mu\mu\text{f}$
Grid No. 1 to All Other Electrodes.....	6 $\mu\mu\text{f}$
Ion Trap Magnet.....	External, Single Field Type

MECHANICAL DATA

Minimum Useful Screen Dimensions.....	14 $\frac{3}{8}$ x 10 $\frac{1}{16}$ Inches
Bulb Contact.....	Metal Cone Lip
Base (Small Shell Duodecal 6-Pin).....	B6-63
Basing.....	12M

RATINGS

MAXIMUM RATINGS (Design Center Values)

Anode Voltage.....	16000 Volts d c
Grid No. 4 Voltage (Focusing Voltage).....	-500 to +1000 Volts d c
Grid No. 2 Voltage.....	500 Volts d c
Grid No. 1 Voltage	
Negative Bias Value.....	125 Volts d c
Positive Bias Value.....	0 Volts d c
Positive Peak Value.....	2 Volts
Peak Heater-Cathode Voltage	
Heater Negative with Respect to Cathode	
During Warm-up Period Not to	
Exceed 15 Seconds.....	410 Volts
After Equipment Warm-up Period.....	180 Volts
Heater Positive with Respect to Cathode.....	180 Volts

RECOMMENDED OPERATING CONDITIONS

Anode Voltage.....	14000 Volts d c
Grid No. 4 Voltage.....	-55 to +300 Volts d c
Grid No. 2 Voltage.....	300 Volts d c
Grid No. 1 Voltage Required for Cutoff!.....	33 to 77 Volts d c
Ion Trap Magnet Strength (approx.).....	45 Gauss

17TP4 (Cont'd)

CIRCUIT VALUES

Grid No. 1 Circuit Resistance..... 1.5 Megohms
Max

NOTE:

1. Visual extinction of undeflected focused spot.

WARNING

X-ray radiation shielding may be necessary to protect against possible danger of personal injury from prolonged exposure at close range if this tube is operated at higher than the manufacturer's Maximum Rated Anode Voltage or 16,000 volts, whichever is less.

SYLVANIA TYPE 17YP4

TELEVISION PICTURE TUBE

17" Direct Viewed	Magnetic Deflection
Rectangular Glass Type	Magnetic Focus
Gray Filter Glass	Cylindrical Faceplate
External Conductive Coating	Single Field Ion Trap

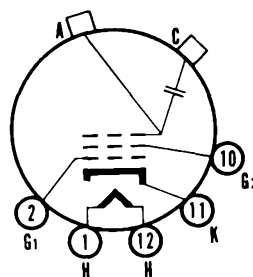
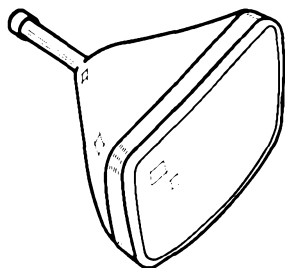

12-N

CHARACTERISTICS

GENERAL DATA

Focusing Method.....	Magnetic
Deflecting Method.....	Magnetic
Deflecting Angle (approx.)	
Horizontal.....	65 Degrees
Diagonal.....	70 Degrees
Phosphor.....	P4
Fluorescence.....	White
Persistence.....	Medium
Faceplate.....	Gray Filter Glass
Light Transmittance (approx.).....	72 Percent

ELECTRICAL DATA

Heater Voltage.....	6.3 Volts
Heater Current (approx.).....	0.6 Ampere
Direct Interelectrode Capacitances (approx.)	
Cathode to All Other Electrodes.....	5 μmf
Grid No. 1 to All Other Electrodes.....	6 μmf
External Conductive Coating to Anode ¹	750 μmf Max
	500 μmf Min
Ion Trap Magnet.....	External, Single Field Type

MECHANICAL DATA

Minimum Useful Screen Dimensions.....	10 $\frac{3}{4}$ x 14 $\frac{1}{4}$ Inches
Bulb Contact (Recessed Small Cavity Cap).....	J1-21
Base (Small Shell Duodecal 5-Pin).....	B5-57
Basing.....	12N

17YP4 (Cont'd)

RATINGS

MAXIMUM RATINGS (Design Center Values)

Anode Voltage	18000 Volts d c
Grid No. 2 Voltage	500 Volts d c
Grid No. 1 Voltage	
Negative Bias Value	125 Volts d c
Positive Bias Value	0 Volts d c
Positive Peak Value	2 Volts
Peak Heater-Cathode Voltage	
Heater Negative with Respect to Cathode	
During Warm-up Period Not to	
Exceed 15 Seconds	410 Volts
After Equipment Warm-up Period	150 Volts
Heater Positive with Respect to Cathode	150 Volts

RECOMMENDED OPERATING CONDITIONS

Anode Voltage	16000 Volts d c
Grid No. 2 Voltage	300 Volts d c
Grid No. 1 Voltage Required for Cutoff ²	-33 to -77 Volts d c
Focusing Coil Current (approx.) ³	100 Ma d c
Ion Trap Magnet Strength (approx.)	35 Gauss

CIRCUIT VALUES

Grid No. 1 Circuit Resistance	1.5 Megohms Max
-------------------------------	--------------------

NOTES:

1. External conductive coating must be grounded.
2. Visual extinction of undeflected focused spot.
3. For JETEC focusing coil 109 or equivalent three inches from reference line, bias adjusted to 20 foot lamberts on a 10 $\frac{1}{4}$ x 14 $\frac{1}{4}$ inch picture area.

WARNING

X-ray radiation shielding may be necessary to protect against possible danger of personal injury from prolonged exposure at close range if this tube is operated at higher than the manufacturer's Maximum Rated Anode Voltage or 16,000 volts, whichever is less.

SYLVANIA TYPE 19AP4
19AP4A
19AP4B
19AP4C
19AP4D

TELEVISION PICTURE TUBE

19" Direct Viewed Magnetic Deflection
 Round Metal Type Magnetic Focus
 Clear Faceplate Spherical Faceplate

Single Field Ion Trap

19AP4A has a Gray Filter Glass Faceplate

19AP4B has a Frosted Gray Filter Glass Faceplate

19AP4C has a Frosted Gray Filter Glass Faceplate
and an Aluminized Screen

19AP4D has a Frosted Faceplate

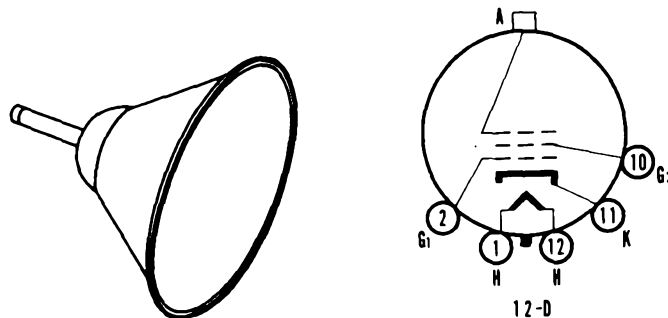

CHARACTERISTICS

GENERAL DATA

Focusing Method.....	Magnetic
Deflecting Method.....	Magnetic
Deflecting Angle (approx.).....	66 Degrees
Phosphor.....	P4
Fluorescence.....	White
Persistence.....	Medium
Faceplate.....	Clear

ELECTRICAL DATA

Heater Voltage.....	6.3 Volts
Heater Current (approx.).....	0.6 Amperes
Direct Interelectrode Capacitances (approx.).....	
Cathode to All Other Electrodes.....	5 μ f
Grid No. 1 to All Other Electrodes.....	7 μ f
Ion Trap Magnet.....	External, Single Field Type

MECHANICAL DATA

Minimum Useful Screen Diameter.....	17 $\frac{1}{2}$ Inches
Bulb Contact.....	Metal Cone Lip
Base (Small Shell Duodecal 5-Pin).....	B5-57
Basing.....	12D

19AP4, 19AP4A, 19AP4B, 19AP4C, 19AP4D (Cont'd)

RATINGS

MAXIMUM RATINGS (Design Center Values)

Anode Voltage.....	19000 Volts d c
Grid No. 2 Voltage.....	410 Volts d c
Grid No. 1 Voltage	
Negative Bias Value.....	125 Volts d c
Positive Bias Value.....	0 Volts d c
Positive Peak Value.....	2 Volts
Peak Heater-Cathode Voltage	
Heater Negative with Respect to Cathode	
During Warm-up Period Not to	
Exceed 15 Seconds.....	410 Volts
After Equipment Warm-up Period.....	150 Volts
Heater Positive with Respect to Cathode.....	150 Volts

RECOMMENDED OPERATING CONDITIONS

Anode Voltage.....	14000 Volts d c
Grid No. 2 Voltage.....	300 Volts d c
Grid No. 1 Voltage Required for Cutoff!.....	-33 to -77 Volts d c
Focusing Coil Current (approx.) ²	115 Ma d c
Ion Trap Magnet Strength (approx.).....	35 Gauss

CIRCUIT VALUES

Grid No. 1 Circuit Resistance.....	1.5 Megohms
	Max

NOTES:

1. Visual extinction of undeflected focused spot.
2. For JETEC focusing coil 106 or equivalent three inches from reference line, bias adjusted to 20 foot lamberts on a 15 $\frac{1}{2}$ x 11 $\frac{1}{4}$ inch picture area.

19AP4A

The Sylvania Type 19AP4A is identical to the Type 19AP4 except for having a gray filter glass faceplate.

19AP4B

The Sylvania Type 19AP4B is identical to the Type 19AP4 except for having a frosted gray filter glass faceplate.

19AP4C

The Sylvania Type 19AP4C is identical to the Type 19AP4 except for having a frosted gray filter glass faceplate and an aluminized screen.

19AP4D

The Sylvania Type 19AP4D is identical to the Type 19AP4 except for having a frosted faceplate.

WARNING

X-ray radiation shielding may be necessary to protect against possible danger of personal injury from prolonged exposure at close range if this tube is operated at higher than the manufacturer's Maximum Rated Anode Voltage or 16,000 volts, whichever is less.

SYLVANIA TYPE 20CP4
20CP4A
Silver Screen "85" → 20CP4B
20CP4C
Silver Screen "85" → 20CP4D

TELEVISION PICTURE TUBE

20" Direct Viewed Magnetic Deflection
 Rectangular Glass Type Magnetic Focus
 Gray Filter Glass Spherical Faceplate
 Single Field Ion Trap

20CP4A has an External Conductive Coating
 20CP4B has an Aluminized Screen
 20CP4C has a Frosted Faceplate
 20CP4D has an External Conductive Coating and
 an Aluminized Screen

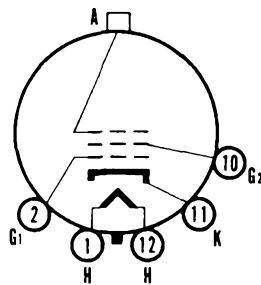
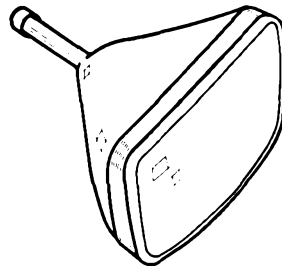

12-D

20CP4
 20CP4B
 20CP4C

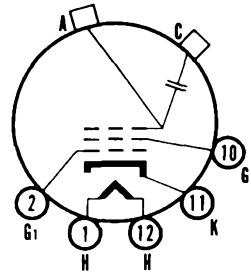

12-N

20CP4A
 20CP4D

CHARACTERISTICS

GENERAL DATA

Focusing Method.....	Magnetic
Deflecting Method.....	Magnetic
Deflecting Angle (approx.)	
Horizontal.....	66 Degrees
Diagonal.....	70 Degrees
Phosphor.....	P4
Fluorescence.....	White
Persistence.....	Medium
Faceplate.....	Gray Filter Glass
Light Transmittance (approx.).....	73 Percent

20CP4, 20CP4A, 20CP4B 20CP4C, 20CP4D (Cont'd)

ELECTRICAL DATA

Heater Voltage.....	6.3 Volts
Heater Current (approx.).....	0.6 Ampere
Direct Interelectrode Capacitances (approx.)	
Cathode to All Other Electrodes.....	5 μf
Grid No. 1 to All Other Electrodes.....	6 μf
Ion Trap Magnet.....	External, Single Field Type

MECHANICAL DATA

Minimum Useful Screen Dimensions.....	12 $\frac{3}{4}$ x 17 Inches
Bulb Contact (Recessed Small Cavity Cap).....	J1-21
Base (Small Shell Duodecal 5-Pin).....	B5-57
Basing.....	12D

RATINGS

MAXIMUM RATINGS (Design Center Values)

Anode Voltage.....	18000 Volts d c
Grid No. 2 Voltage.....	410 Volts d c
Grid No. 1 Voltage.....	
Negative Bias Value.....	125 Volts d c
Positive Bias Value.....	0 Volts d c
Positive Peak Value.....	2 Volts
Heater Negative with Respect to Cathode	
During Warm-up Period Not to	
Exceed 15 Seconds.....	410 Volts
After Equipment Warm-up Period.....	150 Volts
Heater Positive with Respect to Cathode.....	150 Volts

RECOMMENDED OPERATING CONDITIONS

Anode Voltage.....	16,000 Volts d c
Grid No. 2 Voltage.....	300 Volts d c
Grid No. 1 Voltage Required for Cutoff ¹	-33 to -77 Volts d c
Focusing Coil Current (approx.) ²	110 Ma d c
Ion Trap Magnet Strength (approx.).....	35 Gauss

CIRCUIT VALUES

Grid No. 1 Circuit Resistance.....	1.5 Megohms
	Max

NOTES:

1. Visual extinction of undeflected focused spot.
2. For JETEC focusing coil 109 or equivalent three inches from reference line, bias adjusted to 20 foot lamberts on a 12 $\frac{3}{4}$ x 17 inch picture area.

20CP4A

The Sylvania Type 20CP4A is identical to the Type 20CP4 except for having an external conductive coating which must be grounded.

External Conductive Coating to Anode Capacitance	
Maximum.....	750 μf
Minimum.....	500 μf
Basing.....	12N

20CP4B

The Sylvania Type 20CP4B is identical to the Type 20CP4 except for having an aluminized screen.

20CP4C

The Sylvania Type 20CP4C is identical to the Type 20CP4 except for having a frosted faceplate.

20CP4D

The Sylvania Type 20CP4D is identical to the Type 20CP4 except for having an external conductive coating which must be grounded, and an aluminized screen.

External Conductive Coating to Anode Capacitance	
Maximum.....	750 μf
Minimum.....	500 μf
Basing.....	12N

WARNING

X-ray radiation shielding may be necessary to protect against possible danger of personal injury from prolonged exposure at close range if this tube is operated at higher than the manufacturer's Maximum Rated Anode Voltage or 16,000 volts, whichever is less.

**SYLVANIA TYPE 20DP4
20DP4A
Silver Screen "85" → 20DP4B
Silver Screen "85" → 20DP4C**

TELEVISION PICTURE TUBE

20" Direct Viewed Magnetic Deflection
 Rectangular Glass Type Magnetic Focus
 Gray Filter Glass Spherical Faceplate
 Single Field Ion Trap
 20DP4A has an External Conductive Coating
 20DP4B has an Aluminized Screen
 20DP4C has an External Conductive Coating and
 an Aluminized Screen

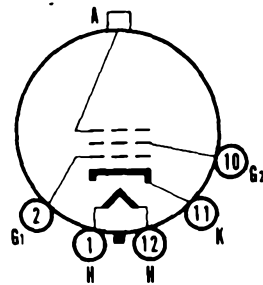
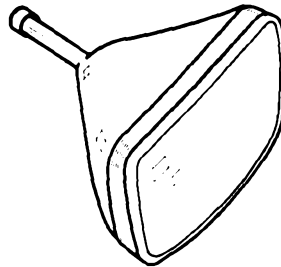

12-D

20DP4
20DP4B

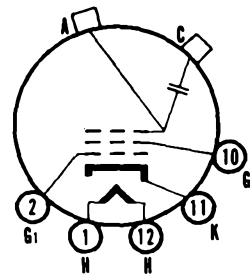

12-N

20DP4A
20DP4C

CHARACTERISTICS

GENERAL DATA

Focusing Method.....	Magnetic
Deflecting Method.....	Magnetic
Deflecting Angle (approx.)	
Horizontal.....	66 Degrees
Diagonal.....	70 Degrees
Phosphor.....	P4
Fluorescence.....	White
Persistence.....	Medium
Faceplate.....	Gray Filter Glass
Light Transmittance (approx.).....	73 Percent

20DP4, 20DP4A, 20DP4B, 20DP4C (Cont'd)

ELECTRICAL DATA

Heater Voltage.....	6.3 Volts
Heater Current (approx.).....	0.6 Ampere
Direct Interelectrode Capacitances (approx.).....	
Cathode to All Other Electrodes.....	5 $\mu\mu\text{f}$
Grid No. 1 to All Other Electrodes.....	6 $\mu\mu\text{f}$
Ion Trap Magnet.....	External, Single Field Type

MECHANICAL DATA

Minimum Useful Screen Dimensions.....	12 $\frac{3}{4}$ x 17 Inches
Bulb Contact (Recessed Small Cavity Cap).....	J1-21
Base (Small Shell Duodecal 5-Pin).....	B5-57
Basing.....	12D

RATINGS

MAXIMUM RATINGS (Design Center Values)

Anode Voltage.....	18000 Volts d c
Grid No. 2 Voltage.....	410 Volts d c
Grid No. 1 Voltage.....	
Negative Bias Value.....	125 Volts d c
Positive Bias Value.....	0 Volts d c
Positive Peak Value.....	2 Volts
Peak Heater-Cathode Voltage.....	
Heater Negative with Respect to Cathode.....	
During Warm-up Period Not to Exceed 15 Seconds.....	410 Volts
After Equipment Warm-up Period.....	180 Volts
Heater Positive with Respect to Cathode.....	180 Volts

RECOMMENDED OPERATING CONDITIONS

Anode Voltage.....	16000 Volts d c
Grid No. 2 Voltage.....	300 Volts d c
Grid No. 1 Voltage Required for Cutoff.....	-28 to -72 Volts d c
Focusing Coil Current (approx.) ²	95 Ma d c
Ion Trap Magnet Strength (approx.).....	35 Gauss

CIRCUIT VALUES

Grid No. 1 Resistance.....	1.5 Megohms Max
----------------------------	--------------------

NOTES:

1. Visual extinction of focused raster. Extinction of stationary focused spot will require that these values be about 5 volts more negative.
2. For JETEC focusing coil 109 or equivalent three inches from reference line, bias adjusted to 20 foot lamberts on a 12 $\frac{3}{4}$ x 17 inch picture area.

20DP4A

The Sylvania Type 20DP4A is identical to Type 20DP4 except for the addition of an External Conductive Coating which must be grounded.

External Conductive Coating to Anode Capacitance.....	
Maximum.....	750 $\mu\mu\text{f}$
Minimum.....	500 $\mu\mu\text{f}$
Basing.....	12N

20DP4B

The Sylvania Type 20DP4B is identical to Type 20DP4 except for having an aluminized screen.

20DP4C

The Sylvania Type 20DP4C is identical to Type 20DP4 except for the addition of an External Conductive Coating which must be grounded, and an aluminized screen.

External Conductive Coating to Anode Capacitance.....	
Maximum.....	750 $\mu\mu\text{f}$
Minimum.....	500 $\mu\mu\text{f}$
Basing.....	12N

WARNING

X-ray radiation shielding may be necessary to protect against possible danger of personal injury from prolonged exposure of close range if this tube is operated at higher than the manufacturer's Maximum Anode Rated Voltage or 16,000 volts, whichever is less.

SYLVANIA TYPE 20HP4
20HP4A/20LP4
20HP4B

Silver Screen "85" → 20HP4C

Silver Screen "85" → 20HP4D

TELEVISION PICTURE TUBE

20" Direct Viewed Magnetic Deflection
Rectangular Glass Type Electrostatic Focus
Gray Filter Glass Spherical Faceplate
Single Field Ion Trap

20HP4A has an External Conductive Coating

20HP4B has a Frosted Faceplate

20HP4C has an Aluminized Screen

20HP4D has an External Conductive Coating and
an Aluminized Screen

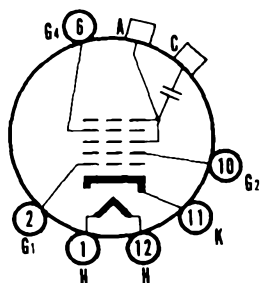
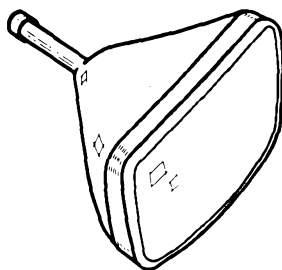

12-L

20HP4A/20LP4
20HP4D

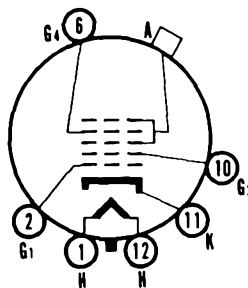

12-M

20HP4
20HP4B
20HP4C

CHARACTERISTICS

GENERAL DATA

Focusing Method.....	Electrostatic
Deflecting Method.....	Magnetic
Deflecting Angle (approx.).....	
Horizontal.....	66 Degrees
Diagonal.....	70 Degrees
Phosphor.....	P4
Fluorescence.....	White
Persistence.....	Medium
Faceplate.....	Gray Filter Glass
Light Transmittance (approx.).....	73 Percent

20HP4, 20HP4A/20LP4, 20HP4B, 20HP4C, 20HP4D (Cont'd)

ELECTRICAL DATA

Heater Voltage.....	6.3 Volts
Heater Current (approx.).....	0.6 Ampere
Direct Interelectrode Capacitances (approx.)	
Cathode to All Other Electrodes.....	5 $\mu\mu f$
Grid No. 1 to All Other Electrodes.....	6 $\mu\mu f$
Ion Trap Magnet.....	External, Single Field Type

MECHANICAL DATA

Minimum Useful Screen Dimensions.....	12 $\frac{3}{4}$ x 17 Inches
Bulb Contact (Recessed Small Cavity Cap).....	J1-21
Base (Small Shell Duodecal 6-Pin).....	B6-63
Basing.....	12M

RATINGS

MAXIMUM RATINGS (Design Center Values)

Anode Voltage.....	16000 Volts d c
Grid No. 4 (Focusing Electrode) Voltage.....	-500 to +1000 Volts d c
Grid No. 2 Voltage.....	500 Volts d c
Grid No. 1 Voltage	
Negative Bias Value.....	125 Volts d c
Positive Bias Value.....	0 Volts d c
Positive Peak Value.....	2 Volts
Peak Heater-Cathode Voltage	
Heater Negative with Respect to Cathode	
During Warm-up Period Not to	
Exceed 15 Seconds.....	410 Volts
After Equipment Warm-up Period.....	180 Volts
Heater Positive with Respect to Cathode.....	180 Volts

RECOMMENDED OPERATING CONDITIONS

Anode Voltage.....	14000 Volts d c
Grid No. 4 Voltage.....	-56 to +310 Volts d c
Grid No. 2 Voltage.....	300 Volts d c
Grid No. 1 Voltage Required for Cutoff.....	-28 to -72 Volts d c
Ion Trap Magnet Strength (approx.).....	30 Gauss

CIRCUIT VALUES

Grid No. 1 Circuit Resistance.....	1.5 Megohms Max
------------------------------------	--------------------

NOTE:

1. Visual extinction of focused raster. Extinction of stationary focused spot will require that these values be about 5 volts more negative.

20HP4A/20LP4

The Sylvania Type 20HP4A is identical to Type 20HP4 except for having an external conductive coating which must be grounded. The Sylvania Type 20LP4 is identical to the Sylvania Type 20HP4A.

External Conductive Coating to Anode Capacitance	
Maximum.....	1500 $\mu\mu f$
Minimum.....	750 $\mu\mu f$
Basing.....	12L

20HP4B

The Sylvania Type 20HP4B is identical to Type 20HP4 except for having a frosted faceplate.

20HP4C

The Sylvania Type 20HP4C is identical to Type 20HP4 except for having an aluminized screen.

20HP4D

The Sylvania Type 20HP4D is identical to the Type 20HP4 except for having an external conductive coating which must be grounded, and an aluminized screen.

External Conductive Coating to Anode Capacitance	
Maximum.....	1500 $\mu\mu f$
Minimum.....	750 $\mu\mu f$
Basing.....	12L

WARNING

X-ray radiation shielding may be necessary to protect against possible danger of personal injury from prolonged exposure at close range if this tube is operated at higher than the manufacturer's Maximum Rated Anode Voltage or 16,000 volts, whichever is less.

SYLVANIA TYPE 20MP4

TELEVISION PICTURE TUBE

20" Direct Viewed	Magnetic Deflection
Rectangular Glass Type	Electrostatic Focus
Gray Filter Glass	Spherical Faceplate
External Conductive Coating	Single Field Ion Trap

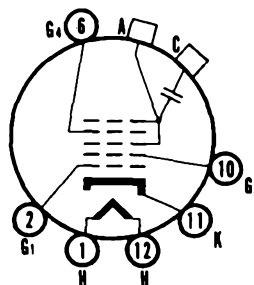
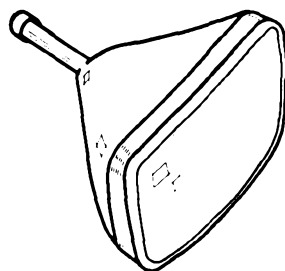

12-1

CHARACTERISTICS

GENERAL DATA

Focusing Method.....	Electrostatic
Deflecting Method.....	Magnetic
Deflecting Angle (approx.)	
Horizontal.....	66 Degrees
Diagonal.....	70 Degrees
Phosphor.....	P4
Fluorescence.....	White
Persistence.....	Medium
Faceplate.....	Gray Filter Glass
Light Transmittance (approx.).....	66 Percent

ELECTRICAL DATA

Heater Voltage.....	6.3 Volts
Heater Current (approx.).....	0.6 Ampere
Direct Interelectrode Capacitances (approx.)	
Cathode to All Other Electrodes.....	5 μ f
Grid No. 1 to All Other Electrodes.....	6 μ f
External Conductive Coating to Anode ¹	750 μ f Max
Ion Trap Magnet.....	500 μ f Min
	External, Single Field Type

MECHANICAL DATA

Minimum Useful Screen Dimensions.....	12 $\frac{3}{4}$ x 17 Inches
Bulb Contact (Recessed Small Cavity Cap).....	J1-21
Base (Small Shell Duodecal 6-Pin).....	B6-63
Basing.....	12L

RATINGS

MAXIMUM RATINGS (Design Center Values)

Anode Voltage.....	16000 Volts d c
Grid No. 4 Voltage (Focusing Voltage).....	-500 to +1000 Volts d c
Grid No. 2 Voltage.....	500 Volts d c
Grid No. 1 Voltage	
Negative Bias Value.....	125 Volts d c
Positive Bias Value.....	0 Volts d c
Positive Peak Value.....	2 Volts
Peak Heater-Cathode Voltage	
Heater Negative with Respect to Cathode	
During Warm-up Period Not to	
Exceed 15 Seconds.....	410 Volts
After Equipment Warm-up Period.....	180 Volts
Heater Positive with Respect to Cathode.....	180 Volts

RECOMMENDED OPERATING CONDITIONS

Anode Voltage.....	14000 Volts d c
Grid No. 4 Voltage.....	-55 to +300 Volts d c
Grid No. 2 Voltage.....	300 Volts d c
Grid No. 1 Voltage Required for Cutoff ²	-33 to -77 Volts d c
Ion Trap Magnet Strength (approx.).....	45 Gauss

20MP4 (Cont'd)

CIRCUIT VALUES

Grid No. 1 Circuit Resistance 1.5 Megohms
Max

NOTES:

1. External conductive coating must be grounded.
2. Visual extinction of undeflected focused spot.

WARNING

X-ray radiation shielding may be necessary to protect against possible danger of personal injury from prolonged exposure at close range if this tube is operated at higher than the manufacturer's Maximum Rated Anode Voltage or 16,000 volts, whichever is less.

SYLVANIA TYPE 21ACP4/21AMP4
Silver Screen "85" → 21ACP4A/21AMP4A

TELEVISION PICTURE TUBE

21" Direct Viewed Magnetic Deflection
Rectangular Glass Type Magnetic Focus
Gray Filter Glass Spherical Faceplate
External Conductive Coating Single Field Ion Trap
21ACP4A/21AMP4A has an Aluminized Screen

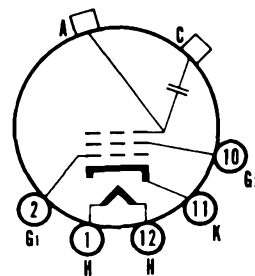
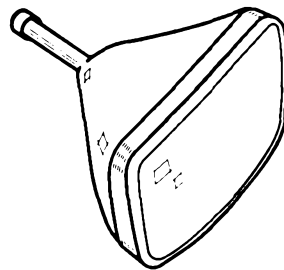

12-N

CHARACTERISTICS

GENERAL DATA

Focusing Method	Magnetic
Deflecting Method	Magnetic
Deflecting Angle (approx.)	
Horizontal	85 Degrees
Diagonal	90 Degrees
Phosphor	P4
Fluorescence	White
Persistence	Medium
Faceplate	Gray Filter Glass
Light Transmittance (approx.)	71 Percent

ELECTRICAL DATA

Heater Voltage	6.3 Volts
Heater Current (approx.)	0.6 Ampere
Direct Interelectrode Capacitances (approx.)	
Cathode to All Other Electrodes	5 μ f
Grid No. 1 to All Other Electrodes	6 μ f
External Conductive Coating to Anode	750 μ f Max
Ion Trap Magnet	500 μ f Min
Ion Trap Magnet	External, Single Field Type

21ACP4/21AMP4 21ACP4A/21AMP4A (Cont'd)

MECHANICAL DATA

Minimum Useful Screen Dimensions.....	19 $\frac{1}{8}$ x 15 Inches
Bulb Contact (Recessed Small Cavity Cap).....	J1-21
Base (Small Shell Duodecal 5-Pin).....	B5-57
Basing.....	12N

RATINGS

MAXIMUM RATINGS (Design Center Values)

Anode Voltage.....	18000 Volts d c
Grid No. 2 Voltage.....	500 Volts d c
Grid No. 1 Voltage.....	
Negative Bias Value.....	125 Volts d c
Positive Bias Value.....	0 Volts d c
Positive Peak Value.....	2 Volts
Peak Heater-Cathode Voltage.....	
Heater Negative with Respect to Cathode	
During Warm-up Period Not to	
Exceed 15 Seconds.....	410 Volts
After Equipment Warm-up Period.....	180 Volts
Heater Positive with Respect to Cathode.....	180 Volts

RECOMMENDED OPERATING CONDITIONS

Anode Voltage.....	16000 Volts d c
Grid No. 2 Voltage.....	300 Volts d c
Grid No. 1 Voltage Required for Cutoff ²	-28 to -72 Volts d c
Focusing Coil Current (approx.) ³	100 \pm 20% Ma d c
Ion Trap Magnet Strength (approx.).....	35 Gauss

CIRCUIT VALUES

Grid No. 1 Circuit Resistance.....	1.5 Megohms
	Max

NOTES:

1. External conductive coating must be grounded.
2. Visual extinction of focused raster. Extinction of the stationary focused spot will require that these values be about 5 volts more negative.
3. For JETEC focusing coil 109 or equivalent three inches from reference line, bias adjusted to 20 foot lamberts on a 19 $\frac{1}{8}$ x 15 inch picture area.

21ACP4A/21AMP4A

The Sylvania Type 21ACP4A/21AMP4A is identical to the Type 21ACP4/21AMP4 except for having an aluminized screen.

WARNING

X-ray radiation shielding may be necessary to protect against possible danger of personal injury from prolonged exposure at close range if this tube is operated at higher than the manufacturer's Maximum Rated Anode Voltage or 16,000 volts, whichever is less.

**SYLVANIA TYPE 21AFP4
21YP4
Silver Screen "85" → 21YP4A**

TELEVISION PICTURE TUBE

21" Direct Viewed Magnetic Deflection
 Rectangular Glass Type Electrostatic Focus
 Gray Filter Glass Spherical Faceplate
 Single Field Ion Trap
 21YP4 has an External Conductive Coating
 21YP4A has an External Conductive Coating and
 an Aluminized Screen

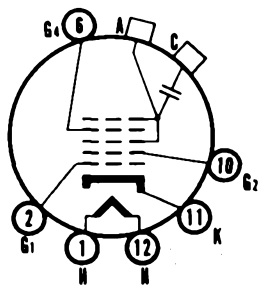
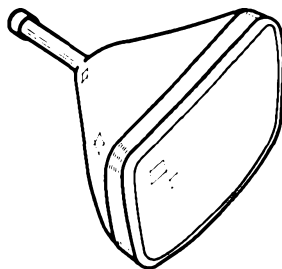

12-L

21YP4
21YP4A

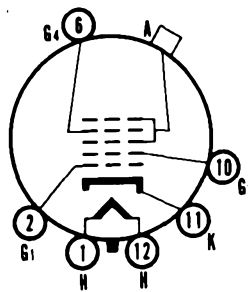

12-M

21AFP4

CHARACTERISTICS

GENERAL DATA

Focusing Method.....	Electrostatic
Deflecting Method.....	Magnetic
Deflecting Angle (approx.)	
Horizontal.....	65 Degrees
Diagonal.....	70 Degrees
Phosphor.....	P4
Fluorescence.....	White
Persistence.....	Medium
Faceplate.....	Gray Filter Glass
Light Transmittance (approx.).....	72 Percent

ELECTRICAL DATA

Heater Voltage.....	6.3 Volts
Heater Current (approx.).....	0.6 Ampere
Direct Interelectrode Capacitances (approx.)	
Cathode to All Other Electrodes.....	5 $\mu\mu\text{f}$
Grid No. 1 to All Other Electrodes.....	6 $\mu\mu\text{f}$
Ion Trap Magnet.....	External, Single Field Type

21AFP4, 21YP4, 21YP4A (Cont'd)

MECHANICAL DATA

Minimum Useful Screen Dimensions.....	19 $\frac{1}{8}$ x 14 $\frac{3}{8}$ Inches
Bulb Contact (Recessed Small Cavity Cap).....	J1-21
Base (Small Shell Duodecal 6-Pin).....	B6-63
Basing.....	12M

RATINGS

MAXIMUM RATINGS (Design Center Values)

Anode Voltage.....	18000 Volts d c
Grid No. 4 (Focusing Electrode) Voltage.....	-500 to +1000 Volts d c
Grid No. 2 Voltage.....	500 Volts d c
Grid No. 1 Voltage.....	
Negative Bias Value.....	125 Volts d c
Positive Bias Value.....	0 Volts d c
Positive Peak Value.....	2 Volts
Peak Heater-Cathode Voltage.....	
Heater Negative with Respect to Cathode	
During Warm-up Period Not to	
Exceed 15 Seconds.....	410 Volts
After Equipment Warm-up Period.....	180 Volts
Heater Positive with Respect to Cathode.....	180 Volts

RECOMMENDED OPERATING CONDITIONS

Anode Voltage.....	16000 Volts d c
Grid No. 4 Voltage.....	-64 to +350 Volts d c
Grid No. 2 Voltage.....	300 Volts d c
Grid No. 1 Voltage Required for Cutoff!.....	-28 to -72 Volts d c
Ion Trap Magnet Strength (approx.).....	35 Gaussess

CIRCUIT VALUES

Grid No. 1 Circuit Resistance.....	1.5 Megohms
	Max

NOTES:

1. Visual extinction of focused raster. Extinction of the stationary focused spot will require that these values be about 5 volts more negative.

21YP4

The Sylvania Type 21YP4 is identical to Type 21AFP4 except for having an external conductive coating, which must be grounded.

External Conductive Coating to Anode Capacitance	
Maximum.....	750 μ f
Minimum.....	500 μ f
Basing.....	12L

21YP4A

The Sylvania Type 21YP4A is identical to Type 21AFP4 except for having an external conductive coating which must be grounded, and an aluminized screen.

External Conductive Coating to Anode Capacitance	
Maximum.....	750 μ f
Minimum.....	500 μ f
Basing.....	12L

WARNING

X-ray radiation shielding may be necessary to protect against possible danger of personal injury from prolonged exposure at close range if this tube is operated at higher than the manufacturer's Maximum Rated Anode Voltage or 16,000 volts, whichever is less.

SYLVANIA TYPE 21ALP4
Silver Screen "85" → 21ALP4A

TELEVISION PICTURE TUBE

21" Direct Viewed	Magnetic Deflection
Rectangular Glass Type	Electrostatic Focus
Gray Filter Glass	Spherical Faceplate
External Conductive Coating	Single Field Ion Trap

21ALP4A has an Aluminized Screen

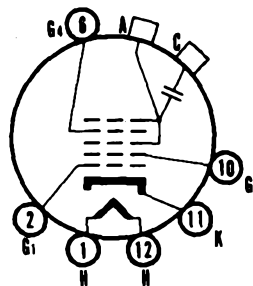
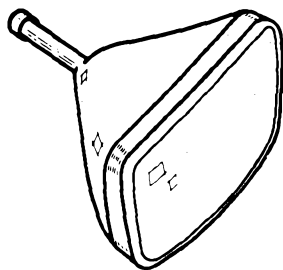

12-L

CHARACTERISTICS

GENERAL DATA

Focusing Method.....	Electrostatic
Deflecting Method.....	Magnetic
Deflecting Angle (approx.)	
Horizontal.....	85 Degrees
Diagonal.....	90 Degrees
Phosphor.....	P4
Fluorescence.....	White
Persistence.....	Medium
Faceplate.....	Gray Filter Glass
Light Transmittance (approx.).....	71 Percent

ELECTRICAL DATA

Heater Voltage.....	6.3 Volts
Heater Current (approx.).....	0.6 Ampere
Direct Interelectrode Capacitances (approx.)	
Cathode to All Other Electrodes.....	5 μ f
Grid No. 1 to All Other Electrodes.....	6 μ f
External Conductive Coating to Anode.....	750 μ f Max
Ion Trap Magnet.....	500 μ f Min
	External, Single Field Type

MECHANICAL DATA

Minimum Useful Screen Dimensions.....	19 $\frac{1}{8}$ x 15 Inches
Bulb Contact (Recessed Small Cavity Cap).....	J1-21
Base (Small Shell Duodecal 6-Pin).....	B6-63
Basing.....	12L

RATINGS

MAXIMUM RATINGS (Design Center Values)

Anode Voltage.....	18000 Volts d c
Grid No. 4 Voltage (Focusing Electrode).....	-500 to +1000 Volts d c
Grid No. 2 Voltage.....	500 Volts d c
Grid No. 1 Voltage.....	
Negative Bias Value.....	125 Volts d c
Positive Bias Value.....	0 Volts d c
Positive Peak Value.....	2 Volts
Peak Heater-Cathode Voltage	
Heater Negative with Respect to Cathode	
During Warm-up Period Not to	
Exceed 15 Seconds.....	410 Volts
After Equipment Warm-up Period.....	180 Volts
Heater Positive with Respect to Cathode.....	180 Volts

21ALP4, 21ALP4A (Cont'd)

RECOMMENDED OPERATING CONDITIONS

Anode Voltage	16000 Volts d c
Grid No. 4 Voltage	-64 to +352 Volts d c
Grid No. 2 Voltage	300 Volts d c
Grid No. 1 Voltage Required for Cutoff ²	-28 to -72 Volts d c
Ion Trap Magnet Strength (approx.)	35 Gauss

CIRCUIT VALUES

Grid No. 1 Circuit Resistance	1.5 Megohms Max
-------------------------------	--------------------

NOTES:

- External conductive coating must be grounded.
- Visual extinction of focused raster. Extinction of stationary focused spot will require that these values be about 5 volts more negative.

21ALP4A

The Sylvania Type 21ALP4A is identical to the Type 21ALP4 except it has an aluminized screen.

WARNING

X-ray radiation shielding may be necessary to protect against possible danger of personal injury from prolonged exposure at close range if this tube is operated at higher than the manufacturer's Maximum Rated Anode Voltage or 16,000 volts, whichever is less.

SYLVANIA TYPE 21ALP4B

Silver Screen "85"

TELEVISION PICTURE TUBE

21" Direct Viewed	Magnetic Deflection
Rectangular Glass Type	Electrostatic Focus
Gray Filter Glass	Spherical Faceplate
External Conductive Coating	Single Field Ion Trap
Aluminized Screen	

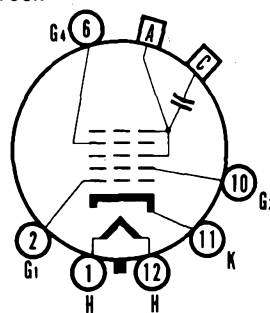
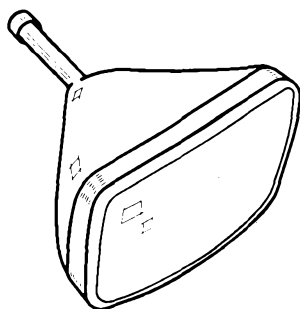

12-L

CHARACTERISTICS

GENERAL DATA

Focusing Method	Electrostatic
Deflecting Method	Magnetic
Deflecting Angle (approx.)	
Horizontal	85 Degrees
Diagonal	90 Degrees
Phosphor	P4
Fluorescence	White
Persistence	Medium
Faceplate	Gray Filter Glass
Light Transmittance (approx.)	71 Percent

21ALP4B (Cont'd)

ELECTRICAL DATA

Heater Voltage	6.3 Volts
Heater Current (approx.)	0.6 Ampere
Direct Interelectrode Capacitances (approx.)	
Cathode to All Other Electrodes	5 μmf
Grid No. 1 to All Other Electrodes	6 μmf
External Conductive Coating to Anode	750 μmf Max. 500 μmf Min.
Ion Trap Magnet	External, Single Field Type

MECHANICAL DATA

Minimum Useful Screen Dimensions	19 $\frac{1}{8}$ x 15 Inches
Bulb Contact (Recessed Small Cavity Cap)	J1-21
Base (Small Shell Duodecal 6-Pin)	B6-63
Basing	12L

RATINGS

MAXIMUM RATINGS (Design Center Values)

Anode Voltage	20000 Volts d c
Grid No. 4 Voltage (Focusing Electrode)	500 to +1000 Volts d c
Grid No. 2 Voltage	500 Volts d c
Grid No. 1 Voltage	
Negative Bias Value	125 Volts d c
Positive Bias Value	0 Volts d c
Positive Peak Value	2 Volts
Peak Heater-Cathode Voltage	
Heater Negative with Respect to Cathode	
During Warm-up Period Not to Exceed 15 Seconds	410 Volts
After Equipment Warm-up Period	180 Volts
Heater Positive with Respect to Cathode	180 Volts

RECOMMENDED OPERATING CONDITIONS

Anode Voltage	16000 Volts d c
Grid No. 4 Voltage	-64 to +352 Volts d c
Grid No. 2 Voltage	300 Volts d c
Grid No. 1 Voltage Required for Cutoff?	-28 to -72 Volts d c
Ion Trap Magnet Strength (approx.)	35 Gauss

CIRCUIT VALUES

Grid No. 1 Circuit Resistance	1.5 Megohms Max.
-------------------------------	------------------

NOTES:

- External conductive coating must be grounded.
- Visual extinction of focused raster. Extinction of stationary focused spot will require that these values be about 5 volts more negative.

WARNING:

X-ray radiation shielding may be necessary to protect against possible danger of personal injury from prolonged exposure at close range if this tube is operated at higher than the manufacturers Maximum Rated Anode Voltage or 16,000 volts, whichever is less.

SYLVANIA TYPE 21ANP4 21ANP4A

TELEVISION PICTURE TUBE

21" Direct Viewed Magnetic Deflection
Rectangular Glass Type Electrostatic Focus
Gray Filter Glass Spherical Faceplate
Single Field Ion Trap
21ANP4A has an Aluminized Screen

21ANP4, 21ANP4A (Cont'd)

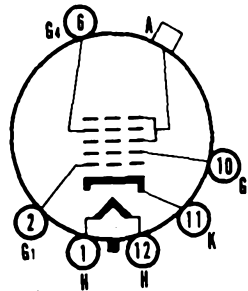
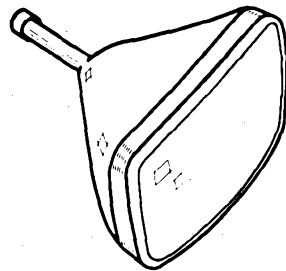

12-M

CHARACTERISTICS

GENERAL DATA

Focusing Method.....	Electrostatic
Deflecting Method.....	Magnetic
Deflecting Angle (approx.)	
Horizontal.....	85 Degrees
Diagonal.....	90 Degrees
Phosphor.....	P4
Fluorescence.....	White
Persistence.....	Medium
Faceplate.....	Gray Filter Glass
Light Transmittance (approx.).....	71 Percent

ELECTRICAL DATA

Heater Voltage.....	6.3 Volts
Heater Current (approx.).....	0.6 Ampere
Direct Interelectrode Capacitances (approx.)	
Cathode to All Other Electrodes.....	5 μ f
Grid No. 1 to All Other Electrodes.....	6 μ f
Ion Trap Magnet.....	External, Single Field Type

MECHANICAL DATA

Minimum Useful Screen Dimensions.....	19 $\frac{1}{8}$ x 15 Inches
Bulb Contact (Recessed Small Cavity Cap).....	J1-21
Base (Small Shell Duodecal 6-Pin).....	B6-63
Basing.....	12M

RATINGS

MAXIMUM RATINGS (Design Center Values)

Anode Voltage.....	18000 Volts d c
Grid No. 4 Voltage (Focusing Electrode).....	-500 to +1000 Volts d c
Grid No. 2 Voltage.....	500 Volts d c
Grid No. 1 Voltage	
Negative Bias Value.....	125 Volts d c
Positive Bias Value.....	0 Volts d c
Positive Peak Value.....	2 Volts
Peak Heater-Cathode Voltage	
Heater Negative with Respect to Cathode	
During Warm-up Period Not to	
Exceed 15 Seconds.....	410 Volts
After Equipment Warm-up Period.....	180 Volts
Heater Positive with Respect to Cathode.....	180 Volts

RECOMMENDED OPERATING CONDITIONS

Anode Voltage.....	16000 Volts d c
Grid No. 4 Voltage.....	-64 to +352 Volts d c
Grid No. 2 Voltage.....	300 Volts d c
Grid No. 1 Voltage Required for Cutoff.....	-28 to -72 Volts d c
Ion Trap Magnet Strength (approx.).....	35 Gauss

CIRCUIT VALUES

Grid No. 1 Circuit Resistance.....	1.5 Megohms
	Max

NOTES:

1. Visual extinction of focused raster. Extinction of the stationary focused spot will require that these values be about 5 volts more negative.

21ANP4A

The Sylvania Type 21ANP4A is identical to the Type 21ANP4 except it has an aluminized screen.

WARNING

X-ray radiation shielding may be necessary to protect against possible danger of personal injury from prolonged exposure at close range if this tube is operated at higher than the manufacturer's Maximum Rated Anode Voltage or 16,000 volts, whichever is less.

SYLVANIA TYPE 21AP4

TELEVISION PICTURE TUBE

21" Direct Viewed
Rectangular Metal Type
Gray Filter Glass
Frosted Faceplate

Magnetic Deflection
Magnetic Focus
Spherical Faceplate
Single Field Ion Trap

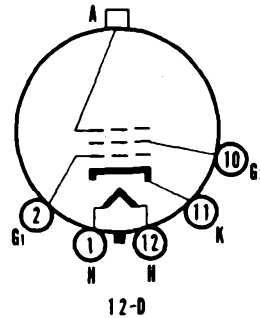
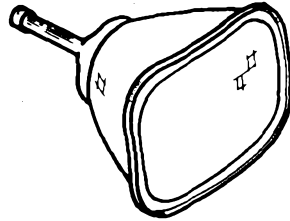

CHARACTERISTICS

GENERAL DATA

Focusing Method.....	Magnetic
Deflecting Method.....	Magnetic
Deflecting Angle (approx.)	
Horizontal.....	66 Degrees
Diagonal.....	70 Degrees
Phosphor.....	P4
Fluorescence.....	White
Persistence.....	Medium
Faceplate.....	Frosted Gray Filter Glass
Light Transmittance (approx.).....	66 Percent

ELECTRICAL DATA

Heater Voltage.....	6.3 Volts
Heater Current (approx.).....	0.6 Ampere
Direct Interelectrode Capacitances (approx.)	
Cathode to All Other Electrodes.....	5 μ f
Grid No. 1 to All Other Electrodes.....	6 μ f
Ion Trap Magnet.....	External, Single Field Type

MECHANICAL DATA

Minimum Useful Screen Dimensions.....	18 $\frac{1}{8}$ x 13 $\frac{11}{16}$ Inches
Bulb Contact.....	Metal Cone Lip
Base (Small Shell Duodecal 5-Pin).....	B5-57
Basing.....	12D

RATINGS

MAXIMUM RATINGS (Design Center Values)

Anode Voltage.....	18000 Volts d c
Grid No. 2 Voltage.....	500 Volts d c
Grid No. 1 Voltage.....	
Negative Bias Value.....	125 Volts d c
Positive Bias Value.....	0 Volts d c
Positive Peak Value.....	2 Volts
Peak Heater-Cathode Voltage	
Heater Negative with Respect to Cathode	
During Warm-up Period Not to	
Exceed 15 Seconds.....	410 Volts
After Equipment Warm-up Period.....	180 Volts
Heater Positive with Respect to Cathode.....	180 Volts

RECOMMENDED OPERATING CONDITIONS

Anode Voltage.....	16000 Volts d c
Grid No. 2 Voltage.....	300 Volts d c
Grid No. 1 Voltage Required for Cutoff ¹	-33 to -77 Volts d c
Focusing Coil Current (approx.) ²	110 Ma d c
Ion Trap Magnet Strength (approx.).....	50 Gauss

CIRCUIT VALUES

Grid No. 1 Circuit Resistance.....	1.5 Megohms
	Max

21AP4 (Cont'd)

NOTES:

1. Visual extinction of undeflected focused spot.
2. For JETEC focusing coil 109 or equivalent three inches from reference line, bias adjusted to 30 foot lamberts on an $18\frac{3}{8} \times 13\frac{5}{16}$ inch picture area.

WARNING

X-ray radiation shielding may be necessary to protect against possible danger of personal injury from prolonged exposure at close range if this tube is operated at higher than the manufacturer's Maximum Rated Anode Voltage or 16,000 volts, whichever is less.

SYLVANIA TYPE 21AQP4 21AQP4A

TELEVISION PICTURE TUBE

21" Direct Viewed Magnetic Deflection
 Rectangular Glass Type Magnetic Focus
 Gray Filter Glass Spherical Faceplate
 Single Field Ion Trap
 21AQP4A has an Aluminized Screen

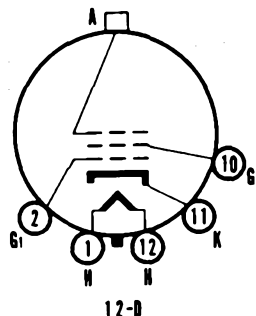
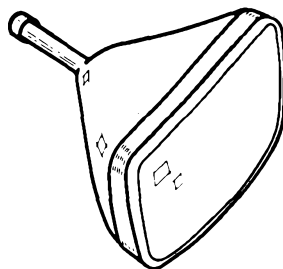

CHARACTERISTICS

GENERAL DATA

Focusing Method.....	Magnetic
Deflecting Method.....	Magnetic
Deflecting Angle (approx.)	
Horizontal.....	85 Degrees
Diagonal.....	90 Degrees
Phosphor.....	P4
Fluorescence.....	White
Persistence.....	Medium
Faceplate.....	Gray Filter Glass
Light Transmittance (approx.).....	71 Percent

ELECTRICAL DATA

Heater Voltage.....	6.3 Volts
Heater Current (approx.).....	0.6 Amperes
Direct Interelectrode Capacitances (approx.)	
Cathode to All Other Electrodes.....	5 $\mu\mu\text{f}$
Grid No. 1 to All Other Electrodes.....	6 $\mu\mu\text{f}$
Ion Trap Magnet.....	External, Single Field Type

MECHANICAL DATA

Minimum Useful Screen Dimensions.....	19 $\frac{1}{4}$ x 15 Inches
Bulb Contact (Recessed Small Cavity Cap).....	J1-21
Base (Small Shell Duodecal 5-Pin).....	B5-57
Basing.....	12D

21AQP4, 21AQP4A (Cont'd)

RATINGS

MAXIMUM RATINGS (Design Center Values)

Anode Voltage	18000	Volts d c
Grid No. 2 Voltage	500	Volts d c
Grid No. 1 Voltage		
Negative Bias Value	125	Volts d c
Positive Bias Value	0	Volts d c
Positive Peak Value	2	Volts
Peak Heater-Cathode Voltage		
Heater Negative with Respect to Cathode		
During Warm-up Period Not to Exceed 15 Seconds	410	Volts
After Equipment Warm-up Period	180	Volts
Heater Positive with Respect to Cathode	180	Volts

RECOMMENDED OPERATING CONDITIONS

Anode Voltage	16000	Volts d c
Grid No. 2 Voltage	300	Volts d c
Grid No. 1 Voltage Required for Cutoff ¹	-28 to -72	Volts d c
Focusing Coil Current ²	100 ±20%	Ma d c
Ion Trap Magnet Strength (approx.)	35	Gausses

CIRCUIT VALUES

Grid No. 1 Circuit Resistance	1.5	Megohms
		Max

NOTES:

1. Visual extinction of focused raster. Extinction of the stationary focused spot will require that these values be about 5 volts more negative.
2. For JETEC focusing coil 109 or equivalent three inches from reference line, bias adjusted to 20 foot lamberts on a 19 $\frac{1}{8}$ x 15 inch picture area.

21AQP4A

The Sylvania Type 21AQP4A is identical to the Type 21AQP4 except for having an aluminized screen.

WARNING

X-ray radiation shielding may be necessary to protect against possible danger of personal injury from prolonged exposure at close range if this tube is operated at higher than the manufacturer's Maximum Rated Anode Voltage or 16,000 volts, whichever is less.

21ATP4 (Cont'd)

CIRCUIT VALUES

Grid No. 1 Circuit Resistance 1.5 Megohms
Max

NOTES:

- External conductive coating must be grounded.
- Visual extinction of focused raster. Extinction of stationary focused spot will require that these values be about 5 volts more negative.

WARNING

X-ray radiation shielding may be necessary to protect against possible danger of personal injury from prolonged exposure at close range if this tube is operated at higher than the manufacturer's Maximum Rated Anode Voltage or 16,000 volts, whichever is less.

SYLVANIA TYPE 21ATP4A

Silver Screen "85"

TELEVISION PICTURE TUBE

21" Direct Viewed	Magnetic Deflection
Rectangular Glass Type	Electrostatic Focus
Gray Filter Glass	Spherical Faceplate
External Conductive Coating	Single Field Ion Trap
Aluminized Screen	

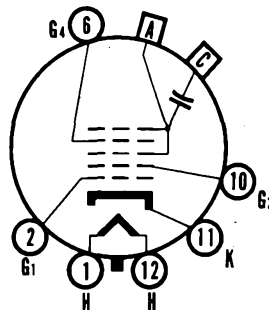
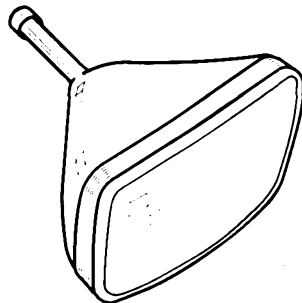

12-L

CHARACTERISTICS

GENERAL DATA

Focusing Method	Electrostatic
Deflecting Method	Magnetic
Deflecting Angle (approx.)	
Horizontal	85 Degrees
Diagonal	90 Degrees
Phosphor	P4
Fluorescence	White
Persistence	Medium
Faceplate	Gray Filter Glass
Light Transmittance (approx.)	71 Per cent

ELECTRICAL DATA

Heater Voltage	6.3 Volts
Heater Current (approx.)	0.6 Ampere
Direct Interelectrode Capacitances (approx.)	
Cathode to All Other Electrodes	5 μf
Grid No. 1 to All Other Electrodes	6 μf
External Conductive Coating to Anode	1500 μf Max.
	1200 μf Min.
Ion Trap Magnet	External, Single Field Type

MECHANICAL DATA

Minimum Useful Screen Dimensions	19 $\frac{1}{8}$ x 15 Inches
Bulb Contact (Recessed Small Cavity Cap)	J1-21
Base (Small Shell Duodecal 6-Pin)	B6-63
Basing	12L

21ATP4A (Cont'd)

RATINGS

MAXIMUM RATINGS (Design Center Values)

Anode Voltage.....	20,000 Volts d c
Grid No. 4 Voltage (Focusing Electrode).....	500 to +1000 Volts d c
Grid No. 2 Voltage.....	500 Volts d c
Grid No. 1 Voltage.....	
Negative Bias Value.....	125 Volts d c
Positive Bias Value.....	0 Volts d c
Positive Peak Value.....	2 Volts
Peak Heater-Cathode Voltage.....	
Heater Negative with Respect to Cathode	
During Warm-up Period Not to	
Exceed 15 Seconds.....	410 Volts
After Equipment Warm-up Period.....	180 Volts
Heater Positive with Respect to Cathode.....	180 Volts

RECOMMENDED OPERATING CONDITIONS

Anode Voltage.....	16,000 Volts d c
Grid No. 4 Voltage.....	-64 to +352 Volts d c
Grid No. 2 Voltage.....	300 Volts d c
Grid No. 1 Voltage Required for Cutoff.....	-28 to -72 Volts d c
Ion Trap Magnet Strength (approx.).....	35 Gauss

CIRCUIT VALUES

Grid No. 1 Circuit Resistance.....	1.5 Megohms Max.
------------------------------------	------------------

NOTES:

1. External conductive coating must be grounded.
2. Visual extinction of focused raster. Extinction of stationary focused spot will require that these values be about 5 volts more negative.

WARNING:

X-ray radiation shielding may be necessary to protect against possible danger of personal injury from prolonged exposure at close range if this tube is operated at higher than the manufacturer's Maximum Rated Anode Voltage or 16,000 volts, whichever is less.

SYLVANIA TYPE 21AUP4

Silver Screen "85" → 21AUP4A

TELEVISION PICTURE TUBE

21" Direct Viewed	Magnetic Deflection
Rectangular Glass Type	Electrostatic Focus
Gray Filter Glass	Spherical Faceplate
External Conductive Coating	Single Field Ion Trap

21AUP4A has an Aluminized Screen

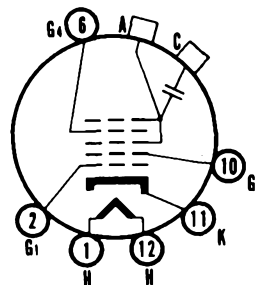
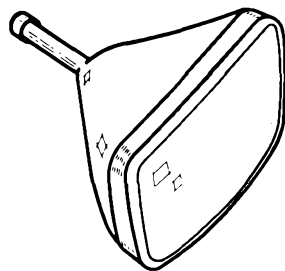

12-L

CHARACTERISTICS

GENERAL DATA

Focusing Method.....	Electrostatic
Deflecting Method.....	Magnetic
Deflection Angle	
Horizontal.....	67 Degrees
Diagonal.....	72 Degrees
Phosphor.....	P4
Fluorescence.....	White
Persistence.....	Medium
Faceplate.....	Gray Filter Glass
Light Transmittance (approx.).....	71 Percent

ELECTRICAL DATA

Heater Voltage.....	6.3 Volts
Heater Current (approx.).....	0.6 Amperes
Direct Interelectrode Capacitances (approx.)	
Cathode to All Other Electrodes.....	5 μf
Grid No. 1 to All Other Electrodes.....	6 μf
External Conductive Coating to Anode.....	750 μf Max
	500 μf Min
Ion Trap Magnet.....	External, Single Field Type

MECHANICAL DATA

Minimum Useful Screen Dimensions.....	19 $\frac{1}{8}$ x 15 Inches
Bulb Contact (Recessed Small Cavity Cap).....	J1-21
Base (Small Shell Duodecal 6-Pin).....	B6-63
Basing.....	12L

RATINGS

MAXIMUM RATINGS (Design Center Values)

Anode Voltage.....	1800 Volts d c
Grid No. 4 Voltage (Focusing Electrode).....	-500 to +1000 Volts d c
Grid No. 2 Voltage.....	500 Volts d c
Grid No. 1 Voltage	
Negative Bias Value.....	125 Volts d c
Positive Bias Value.....	0 Volts d c
Positive Peak Value.....	2 Volts
Peak Heater-Cathode Voltage	
Heater Negative with Respect to Cathode	
During Warm-up Period Not to	
Exceed 15 Seconds.....	410 Volts
After Equipment Warm-up Period.....	180 Volts
Heater Positive with Respect to Cathode.....	180 Volts

21AUP4, 21AUP4A (Cont'd)

RECOMMENDED OPERATING CONDITIONS

Anode Voltage.....	16000	Volts d c
Grid No. 4 Voltage.....	-64 to +352	Volts d c
Grid No. 2 Voltage.....	300	Volts d c
Grid No. 1 Voltage Required for Cutoff ²	-28 to -72	Volts d c
Ion Trap Magnet Strength (approx.).....	35	Gausses

CIRCUIT VALUES

Grid No. 1 Circuit Resistance.....	1.5	Megohms
		Max

NOTES:

- External conductive coating must be grounded.
- Visual extinction of focused raster. Extinction of stationary focused spot will require that these values be about 5 volts more negative.

21AUP4A

The Sylvania Type 21AUP4A is identical to Type 21AUP4 except for having an aluminized screen.

WARNING

X-ray radiation shielding may be necessary to protect against possible danger of personal injury from prolonged exposure at close range if this tube is operated at higher than the manufacturer's Maximum Rated Anode Voltage or 16,000 volts, whichever is less.

SYLVANIA TYPE 21AUP4B

Silver Screen "85"

TELEVISION PICTURE TUBE

21" Direct Viewed	Magnetic Deflection
Rectangular Glass Type	Electrostatic Focus
Gray Filter Glass	Spherical Faceplate
External Conductive Coating	Single Field Ion Trap
Aluminized Screen	

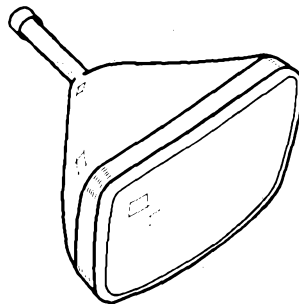

12-L

CHARACTERISTICS

GENERAL DATA

Focusing Method.....	Electrostatic
Deflecting Method.....	Magnetic
Deflecting Angle (approx.).....	
Horizontal.....	67 Degrees
Diagonal.....	72 Degrees
Phosphor.....	P4
Fluorescence.....	White
Persistence.....	Medium
Faceplate.....	Gray Filter Glass
Light Transmittance (approx.).....	71 Per cent

21AUP4B (Cont'd)

ELECTRICAL DATA

Heater Voltage	6.3 Volts
Heater Current (approx.)	0.6 Ampere
Direct Interelectrode Capacitances (approx.)	
Cathode to All Other Electrodes	5 μf
Grid No. 1 to All Other Electrodes	6 μf
External Conductive Coating to Anode	750 μf Max. 500 μf Min.
Ion Trap Magnet	External, Single Field Type

MECHANICAL DATA

Minimum Useful Screen Dimensions	19 ¹ / ₈ x 15 Inches
Bulb Contact (Recessed Small Cavity Cap)	J1-21
Base (Small Shell Duodecal 6-Pin)	B6-63
Basing	12L

RATINGS

MAXIMUM RATINGS (Design Center Values)

Anode Voltage	20,000 Volts d c
Grid No. 4 Voltage (Focusing Electrode)	500 to +1000 Volts d c
Grid No. 2 Voltage	500 Volts d c
Grid No. 1 Voltage	
Negative Bias Value	125 Volts d c
Positive Bias Value	0 Volts d c
Positive Peak Value	2 Volts
Peak Heater-Cathode Voltage:	
Heater Negative with Respect to Cathode	
During Warm-up Period Not to	
Exceed 15 Seconds	410 Volts
After Equipment Warm-up Period	180 Volts
Heater Positive with Respect to Cathode	180 Volts

RECOMMENDED OPERATING CONDITIONS

Anode Voltage	16,000 Volts d c
Grid No. 4 Voltage	-64 to +352 Volts d c
Grid No. 2 Voltage	300 Volts d c
Grid No. 1 Voltage Required for Cutoff	28 to -72 Volts d c
Ion Trap Magnet Strength (approx.)	35 Gauss

CIRCUIT VALUES

Grid No. 1 Circuit Resistance	1.5 Megohms Max.
-------------------------------	------------------

NOTES:

- External conductive coating must be grounded.
- Visual extinction of focused raster. Extinction of stationary focused spot will require that these values be about 5 volts more negative.

WARNING:

X-ray radiation shielding may be necessary to protect against possible danger of personal injury from prolonged exposure at close range if this tube is operated at higher than the manufacturer's Maximum Rated Anode Voltage or 16,000 volts, whichever is less.

SYLVANIA TYPE 21AVP4
Silver Screen "85" → 21AVP4A

TELEVISION PICTURE TUBE

21" Direct Viewed	Magnetic Deflection
Rectangular Glass Type	Electrostatic Focus
Gray Filter Glass	Spherical Faceplate
External Conductive Coating	Single Field Ion Trap
21AVP4A has an Aluminized Screen	

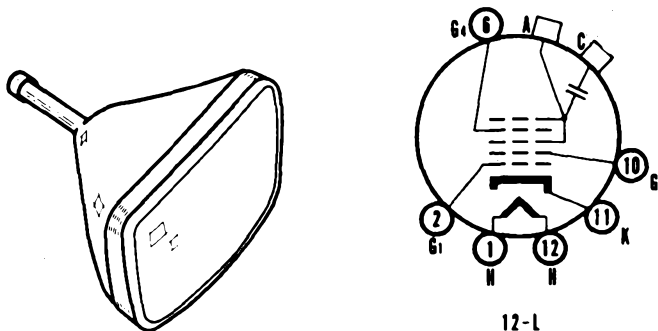

CHARACTERISTICS

GENERAL DATA

Focusing Method.....	Electrostatic
Deflecting Method.....	Magnetic
Deflection Angle	
Horizontal.....	67 Degrees
Diagonal.....	72 Degrees
Phosphor.....	P4
Fluorescence.....	White
Persistence.....	Medium
Faceplate.....	Gray Filter Glass
Light Transmittance (approx.).....	71 Percent

ELECTRICAL DATA

Heater Voltage.....	6.3 Volts
Heater Current (approx.).....	0.6 Ampere
Direct Interelectrode Capacitances (approx.)	
Cathode to All Other Electrodes.....	5 μ f
Grid No. 1 to All Other Electrodes.....	6 μ f
External Conductive Coating to Anode ¹	1500 μ f Max
	1200 μ f Min
Ion Trap Magnet.....	External, Single Field Type

MECHANICAL DATA

Minimum Useful Screen Dimensions.....	19 $\frac{1}{8}$ x 15 Inches
Bulb Contact (Recessed Small Cavity Cap).....	J1-21
Base (Small Shell Duodecal 6-Pin).....	B6-63
Basing.....	12L

RATINGS

MAXIMUM RATINGS (Design Center Values)

Anode Voltage.....	18000 Volts d c
Grid No. 4 Voltage (Focusing Electrode).....	-500 to +1000 Volts d c
Grid No. 2 Voltage.....	500 Volts d c
Grid No. 1 Voltage	
Negative Bias Value.....	125 Volts d c
Positive Bias Value.....	0 Volts d c
Positive Peak Value.....	2 Volts
Peak Heater-Cathode Voltage	
Heater Negative with Respect to Cathode	
During Warm-up Period Not to	
Exceed 15 Seconds.....	410 Volts
After Equipment Warm-up Period.....	180 Volts
Heater Positive with Respect to Cathode.....	180 Volts

21AVP4, 21AVP4A (Cont'd)

RECOMMENDED OPERATING CONDITIONS

Anode Voltage	16000	Volts d c
Grid No. 4 Voltage	-64 to +352	Volts d c
Grid No. 2 Voltage	300	Volts d c
Grid No. 1 Voltage Required for Cutoff ²	-28 to -72	Volts d c
Ion Trap Magnet Strength (approx.)	35	Gausses

CIRCUIT VALUES

Grid No. 1 Circuit Resistance	1.5	Megohms
-------------------------------------	-----	---------

Max

NOTES:

- External conductive coating must be grounded.
- Visual extinction of focused raster. Extinction of stationary focused spot will require that these values be about 5 volts more negative.

21AVP4A

The Sylvania Type 21AVP4A is identical to Type 21AVP4 except for having an aluminized screen.

WARNING

X-ray radiation shielding may be necessary to protect against possible danger of personal injury from prolonged exposure at close range if this tube is operated at higher than the manufacturer's Maximum Rated Anode Voltage or 16,000 volts, whichever is less.

SYLVANIA TYPE 21AVP4B

Silver Screen "85"

TELEVISION PICTURE TUBE

21" Direct Viewed	Magnetic Deflection
Rectangular Glass Type	Electrostatic Focus
Gray Filter Glass	Spherical Faceplate
External Conductive Coating	Single Field Ion Trap
Aluminized Screen	

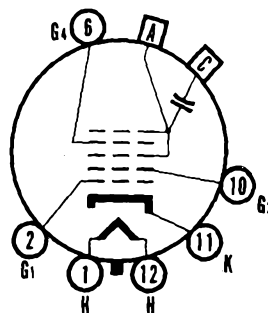
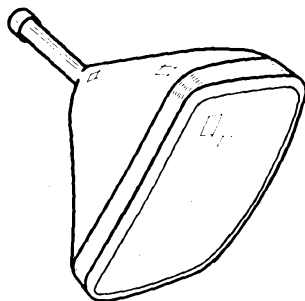

12-1

CHARACTERISTICS

GENERAL DATA

Focusing Method	Electrostatic
Deflecting Method	Magnetic
Deflection Angle	
Horizontal	67 Degrees
Diagonal	72 Degrees
Phosphor	P4
Fluorescence	White
Persistence	Medium
Faceplate	Gray Filter Glass
Light Transmittance (approx.)	71 Percent

21AVP4B (Cont'd)

ELECTRICAL DATA

Heater Voltage	6.3 Volts
Heater Current (approx.)	0.6 Ampere
Direct Interelectrode Capacitances (approx.)	
Cathode to All Other Electrodes	5 μf
Grid No. 1 to All Other Electrodes	6 μf
External Conductive Coating to Anode	1500 μf Max. 1200 μf Min.
Ion Trap Magnet	External, Single Field Type

MECHANICAL DATA

Minimum Useful Screen Dimensions	19 $\frac{1}{4}$ x 15 Inches
Bulb Contact (Recessed Small Cavity Cap)	J1-21
Base (Small Shell Duodecal 6-Pin)	B6-63
Basing	12L

RATINGS

MAXIMUM RATINGS (Design Center Values)

Anode Voltage	20,000 Volts d c
Grid No. 4 Voltage (Focusing Electrode)	500 to +1000 Volts d c
Grid No. 2 Voltage	500 Volts d c
Grid No. 1 Voltage	
Negative Bias Value	125 Volts d c
Positive Bias Value	0 Volts d c
Positive Peak Value	2 Volts
Peak Heater-Cathode Voltage:	
Heater Negative with Respect to Cathode	
During Warm-up Period not to Exceed 15 Secs.	410 Volts
After Equipment Warm-up Period	180 Volts
Heater Positive with Respect to Cathode	180 Volts

RECOMMENDED OPERATING CONDITIONS

Anode Voltage	16,000 Volts d c
Grid No. 4 Voltage	-64 to +352 Volts d c
Grid No. 2 Voltage	300 Volts d c
Grid No. 1 Voltage Required for Cutoff	-28 to -72 Volts d c
Ion Trap Magnet Strength (approx.)	35 Gauss

CIRCUIT VALUES

Grid No. 1 Circuit Resistance	1.5 Megohms Max.
-------------------------------	------------------

NOTES:

- External conductive coating must be grounded.
- Visual extinction of focused raster. Extinction of stationary focused spot will require that these values be about 5 volts more negative.

WARNING:

X-ray radiation shielding may be necessary to protect against possible danger of personal injury from prolonged exposure at close range if this tube is operated at higher than the manufacturer's Maximum Rated Anode Voltage or 16,000 volts, whichever is less.

SYLVANIA TYPE 21AWP4

Silver Screen "85"

TELEVISION PICTURE TUBE

21" Direct Viewed	Magnetic Deflection
Rectangular Glass Type	Magnetic Focus
Gray Filter Glass	Spherical Faceplate
External Conductive Coating	Single Field Ion Trap
Aluminized Screen	

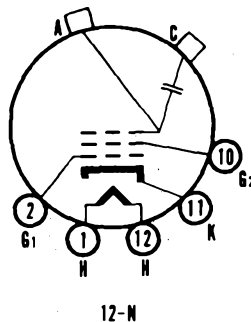
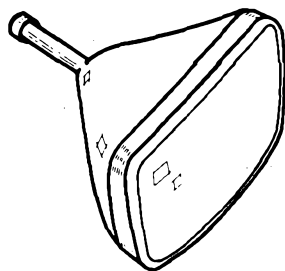

CHARACTERISTICS

GENERAL DATA

Focusing Method	Magnetic
Deflecting Method	Magnetic
Deflecting Angle (approx.)	
Horizontal	67 Degrees
Diagonal	72 Degrees
Phosphor	P4
Fluorescence	White
Persistence	Medium
Faceplate	Gray Filter Glass
Light Transmittance (approx.)	71 Percent

ELECTRICAL DATA

Heater Voltage	6.3 Volts
Heater Current (approx.)	0.6 Amperes
Direct Interelectrode Capacitances (approx.)	
Cathode to All Other Electrodes	5 μf
Grid No. 1 to All Other Electrodes	6 μf
External Conductive Coating to Anode	1500 μf Max
	1200 μf Min
Ion Trap Magnet	External, Single Field Type

MECHANICAL DATA

Minimum Useful Screen Dimensions	19 $\frac{1}{8}$ x 15 Inches
Bulb Contact (Recessed Small Cavity Cap)	J1-21
Base (Small Shell Duodecal 5-Pin)	B5-57
Basing	12N

RATINGS

MAXIMUM RATINGS (Design Center Values)

Anode Voltage	18000 Volts d c
Grid No. 2 Voltage	500 Volts d c
Grid No. 1 Voltage	
Negative Bias Value	125 Volts d c
Positive Bias Value	0 Volts d c
Positive Peak Value	2 Volts
Peak Heater-Cathode Voltage	
Heater Negative with Respect to Cathode	
During Warm-up Period Not to Exceed 15 Seconds	410 Volts
After Equipment Warm-up Period	180 Volts
Heater Positive with Respect to Cathode	180 Volts

21AWP4 (Cont'd)

RECOMMENDED OPERATING CONDITIONS

Anode Voltage.....	16000	Volts d c
Grid No. 2 Voltage.....	300	Volts d c
Grid No. 1 Voltage Required for Cutoff ²	-28 to -72	Volts d c
Focusing Coil Current (approx.) ³	108 ± 20%	Ma d c
Ion Trap Magnet Strength (approx.).....	35	Gausses

CIRCUIT VALUES

Grid No. 1 Circuit Resistance.....	1.5	Megohms Max
------------------------------------	-----	----------------

NOTES:

1. External conductive coating must be grounded.
2. Visual extinction of focused raster. Extinction of stationary focused spot will require that these values be about 5 volts more negative.
3. For JETEC focusing coil 109 or equivalent three inches from reference line, bias adjusted to 20 foot lamberts on a 19½ x 15 inch picture area sharply focused at center of screen.

WARNING

X-ray radiation shielding may be necessary to protect against possible danger of personal injury from prolonged exposure at close range if this tube is operated at higher than the manufacturer's Maximum Rated Anode Voltage or 16,000 volts, whichever is less.

SYLVANIA TYPE 21AYP4

TELEVISION PICTURE TUBE

21" Direct Viewed	Magnetic Deflection
Rectangular Glass Type	Electrostatic Focus
Gray Filter Glass	Spherical Faceplate
External Conductive Coating	Single Field Ion Trap

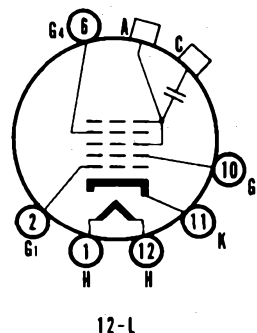
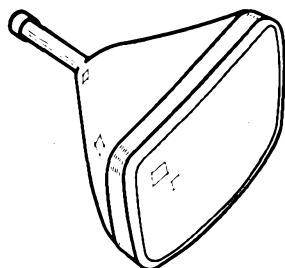

CHARACTERISTICS

GENERAL DATA

Focusing Method.....	Electrostatic
Deflecting Method.....	Magnetic
Deflecting Angle (approx.)	
Horizontal.....	66 Degrees
Diagonal.....	70 Degrees
Phosphor.....	P4
Fluorescence.....	White
Persistence.....	Medium
Faceplate.....	Gray Filter Glass
Light Transmittance (approx.).....	72 Percent

ELECTRICAL DATA

Heater Voltage.....	6.3 Volts
Heater Current (approx.).....	0.6 Ampere
Direct Interelectrode Capacitances (approx.)	
Cathode to All Other Electrodes.....	5 μf
Grid No. 1 to All Other Electrodes.....	6 μf
External Conductive Coating to Anode.....	1500 μf Max
	750 μf Min
Ion Trap Magnet.....	External, Single Field Type

MECHANICAL DATA

Minimum Useful Screen Dimensions.....	17 x 12 $\frac{3}{4}$ Inches
Bulb Contact (Recessed Small Cavity Cap).....	J1-21
Base (Small Shell Duodecal 6-Pin).....	B6-63
Basing.....	12L

RATINGS

MAXIMUM RATINGS (Design Center Values)

Anode Voltage.....	18000 Volts d c
Grid No. 4 Voltage (Focusing Electrode).....	-500 to +1000 Volts d c
Grid No. 2 Voltage.....	500 Volts d c
Grid No. 1 Voltage	
Negative Bias Value.....	125 Volts d c
Positive Bias Value.....	0 Volts d c
Positive Peak Value.....	2 Volts
Peak Heater-Cathode Voltage	
Heater Negative with Respect to Cathode	
During Warm-up Period Not to	
Exceed 15 Seconds.....	410 Volts
After Equipment Warm-up Period.....	180 Volts
Heater Positive with Respect to Cathode.....	180 Volts

RECOMMENDED OPERATING CONDITIONS

Anode Voltage.....	16000 Volts d c
Grid No. 4 Voltage.....	-64 to +352 Volts d c
Grid No. 2 Voltage.....	300 Volts d c
Grid No. 1 Voltage Required for Cutoff.....	-28 to -72 Volts d c
Ion Trap Magnet Strength (approx.).....	35 Gaussses

21AYP4 (Cont'd)

CIRCUIT VALUES

Grid No. 1 Circuit Resistance 1.5 Megohms
Max

NOTES:

1. External conductive coating must be grounded.
2. Visual extinction of focused raster. Extinction of stationary focused spot will require that these values be about 5 volts more negative.

WARNING

X-ray radiation shielding may be necessary to protect against possible danger of personal injury from prolonged exposure at close range if this tube is operated at higher than the manufacturer's Maximum Rated Anode Voltage or 16,000 volts, whichever is less.

SYLVANIA TYPE 21EP4 21EP4A Silver Screen "85" → 21EP4B

TELEVISION PICTURE TUBE

21" Direct Viewed Magnetic Deflection
Rectangular Glass Type Magnetic Focus
Gray Filter Glass Cylindrical Faceplate
Single Field Ion Trap

21EP4A has an External Conductive Coating
21EP4B has an External Conductive Coating and
an Aluminized Screen

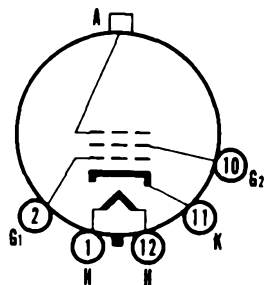
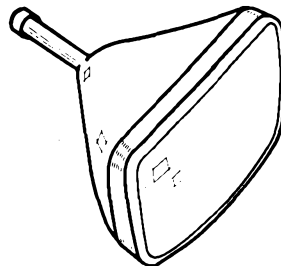

21EP4

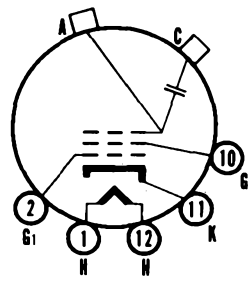

12-N

21EP4A
21EP4B

21EP4, 21EP4A, 21EP4B (Cont'd)

CHARACTERISTICS

GENERAL DATA

Focusing Method.....	Magnetic
Deflecting Method.....	Magnetic
Deflecting Angle (approx.)	
Horizontal.....	65 Degrees
Diagonal.....	70 Degrees
Phosphor.....	P4
Fluorescence.....	White
Persistence.....	Medium
Faceplate.....	Gray Filter Glass
Light Transmittance (approx.).....	72 Percent

ELECTRICAL DATA

Heater Voltage.....	6.3 Volts
Heater Current (approx.).....	0.6 Ampere
Direct Interelectrode Capacitances (approx.)	
Cathode to All Other Electrodes.....	5 μf
Grid No. 1 to All Other Electrodes.....	6 μf
Ion Trap Magnet.....	External, Single Field Type

MECHANICAL DATA

Minimum Useful Screen Dimensions.....	19 $\frac{1}{8}$ x 13 $\frac{7}{8}$ Inches
Bulb Contact (Recessed Small Cavity Cap).....	J1-21
Base (Small Shell Duodecal 5-Pin).....	B5-57
Basing.....	12D

RATINGS

MAXIMUM RATINGS (Design Center Values)

Anode Voltage.....	18000 Volts d c
Grid No. 2 Voltage.....	500 Volts d c
Grid No. 1 Voltage	
Negative Bias Value.....	125 Volts d c
Positive Bias Value.....	0 Volts d c
Positive Peak Value.....	2 Volts
Peak Heater-Cathode Voltage	
Heater Negative with Respect to Cathode	
During Warm-up Period Not to	
Exceed 15 Seconds.....	410 Volts
After Equipment Warm-up Period.....	180 Volts
Heater Positive with Respect to Cathode.....	180 Volts

RECOMMENDED OPERATING CONDITIONS

Anode Voltage.....	16000 Volts d c
Grid No. 2 Voltage.....	300 Volts d c
Grid No. 1 Voltage Required for Cutoff ¹	-28 to -72 Volts d c
Focusing Coil Current (approx.) ²	95 Ma d c
Ion Trap Magnet Strength (approx.).....	35 Gauss

CIRCUIT VALUES

Grid No. 1 Circuit Resistance.....	1.5 Megohms Max
------------------------------------	--------------------

NOTES:

1. Visual extinction of focused raster. Extinction of the stationary focused spot will require that these values be about 5 volts more negative.
2. For JETEC focusing coil 109 or equivalent three inches from reference line, bias adjusted to 20 foot lamberts on a 19 $\frac{1}{8}$ x 13 $\frac{7}{8}$ inch picture area.

21EP4A

The Sylvania Type 21EP4A is identical to Type 21EP4 except for having an external conductive coating, which must be grounded.

External Conductive Coating to Anode Capacitance	
Maximum.....	750 μf
Minimum.....	500 μf
Basing.....	12N

21EP4B

The Sylvania 21EP4B is identical to Type 21EP4 except for having an external conductive coating which must be grounded, and an aluminized screen.

External Conductive Coating to Anode Capacitance	
Maximum.....	750 μf
Minimum.....	500 μf
Basing.....	12N

WARNING

X-ray radiation shielding may be necessary to protect against possible danger of personal injury from prolonged exposure at close range if this tube is operated at higher than the manufacturer's Maximum Rated Anode Voltage or 16,000 volts, whichever is less.

SYLVANIA TYPE 21ACP4A/21AMP4A/21BSP4

Silver Screen "85"

TELEVISION PICTURE TUBE

21" Direct Viewed	Magnetic Deflection
Rectangular Glass Type	Magnetic Focus
Gray Filter Glass	Spherical Faceplate
External Conductive Coating	Single Field Ion Trap
Aluminized Screen	

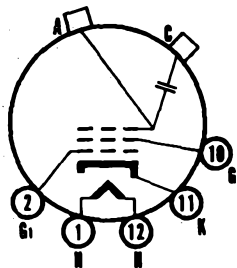
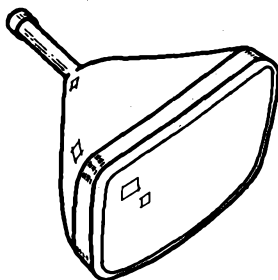

12-N

CHARACTERISTICS

GENERAL DATA

Focusing Method.....	Magnetic
Deflecting Method.....	Magnetic
Deflection Angles (approx.)	
Horizontal.....	85 Degrees
Diagonal.....	90 Degrees
Phosphor.....	Aluminized P4
Fluorescence.....	White
Persistence.....	Short to Medium
Faceplate.....	Gray Filter Glass
Light Transmittance (approx.).....	74 Per cent

ELECTRICAL DATA

Heater Voltage.....	6.3 Volts
Heater Current.....	0.6 ± 5% Amperes
Direct Interelectrode Capacitances (approx.)	
Cathode to All Other Electrodes.....	5 μf
Grid No. 1 to All Other Electrodes.....	6 μf
External Conductive Coating to Anode.....	2500 μf Max. 2000 μf Min.
Ion Trap Magnet.....	External, Single Field Type

MECHANICAL DATA

Minimum Useful Screen Dimensions.....	19 1/2 x 15 1/2 Inches
Bulb Contact (Recessed Small Cavity Cap).....	J1-21
Base (Small Shell Duodecal 5-Pin).....	B5-57
Basing.....	12N

RATINGS

MAXIMUM RATINGS (Absolute Maximum Values)

Anode Voltage.....	22,000 Volts d c
Grid No. 2 Voltage.....	550 Volts d c
Grid No. 1 Voltage.....	
Negative Bias Value.....	155 Volts d c
Negative Peak Value.....	220 Volts
Positive Bias Value.....	0 Volts d c
Positive Peak Value.....	2 Volts
Peak Heater-Cathode Voltage	
Heater Negative with Respect to Cathode	
During Warm-up Period not to Exceed	
15 Seconds.....	450 Volts
After Equipment Warm-up Period.....	200 Volts
Heater Positive with Respect to Cathode.....	200 Volts

TYPICAL OPERATING CONDITIONS

Anode Voltage.....	16,000 Volts d c
Grid No. 2 Voltage.....	300 Volts d c
Grid No. 1 Voltage Required for Cutoff ¹	-28 to -72 Volts d c
Focusing Coil Current ²	116 ± 15% Ma d c
Ion Trap Magnet Strength (approx.).....	33 ± 3 Gauss

SYLVANIA PICTURE TUBES

Issued as a supplement to the manual in Sylvania News for February 1957

21ACP4A/21AMP4A/21BSP4

(Cont'd)

CIRCUIT VALUES

Grid No. 1 Circuit Resistance..... 1.5 Megohms Max.

NOTES:

1. External conductive coating must be grounded.
2. Visual extinction of focused raster. Extinction of stationary focused spot will require that these values be about 5 volts more negative.
3. For JETEC focusing coil 109 or equivalent three inches from reference line, bias adjusted to 20 foot lamberts on a $19\frac{1}{8}$ x $15\frac{1}{8}$ inch picture area sharply focused at center of screen.

WARNING

X-ray radiation shielding may be necessary to protect against possible danger of personal injury from prolonged exposure at close range if this tube is operated at higher than the manufacturer's Maximum Rated Anode Voltage or 16,000 volts, whichever is less.

SYLVANIA PICTURE TUBES

SYLVANIA TYPE 21BTP4

Silver Screen "85"

TELEVISION PICTURE TUBE

21" Direct Viewed Magnetic Deflection
 Rectangular Glass Type Electrostatic Focus
 Gray Filter Glass Spherical Faceplate
 External Conductive Coating Single Field Ion Trap
 Aluminized Screen

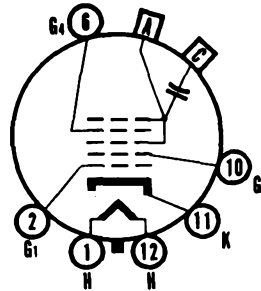
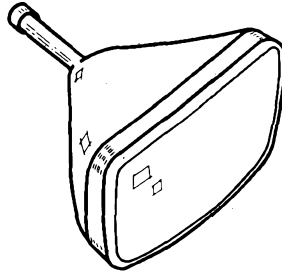

12-L

CHARACTERISTICS

GENERAL DATA

Focusing Method	Electrostatic
Deflection Method	Magnetic
Deflection Angles (approx.)	
Horizontal	85 Degrees
Diagonal	90 Degrees
Phosphor	Aluminized P4
Fluorescence	White
Persistence	Short to Medium
Faceplate	Gray Filter Glass
Light Transmittance (approx.)	74 Percent

ELECTRICAL DATA

Heater Voltage	6.3 Volts
Heater Current	0.6 ± 5% Ampere
Heater Warm-up Time ¹	11 Seconds
Direct Interelectrode Capacitances (approx.)	
Cathode to All Other Electrodes	5 μmf
Grid No. 1 to All Other Electrodes	6 μmf
External Conductive Coating to Anode ²	2500 μmf Max. 2000 μmf Min.
Ion Trap Magnet	External, Single Field Type

MECHANICAL DATA

Minimum Useful Screen Dimensions	19 1/8 x 15 1/8 Inches
Bulb Contact (Recessed Small Cavity Cap)	J1-21
Base (Small Shell Duodecal 6-Pin)	B6-63
Basing	12L

RATINGS

MAXIMUM RATINGS (Absolute Maximum Values)

Anode Voltage	22,000 Volts d c
Grid No. 4 Voltage	-550 to +1100 Volts d c
Grid No. 2 Voltage	550 Volts d c
Grid No. 1 Voltage	
Negative Bias Value	155 Volts d c
Negative Peak Value	220 Volts
Positive Bias Value	0 Volts d c
Positive Peak Value	2 Volts
Peak Heater-Cathode Voltage	
Heater Negative with Respect to Cathode	
During Warm-up Period not to Exceed	
15 Seconds	450 Volts
After Equipment Warm-up Period	200 Volts
Heater Positive with Respect to Cathode	200 Volts

SYLVANIA PICTURE TUBES

Issued as a supplement to the manual in Sylvania News for June 1957

21BTP4 (Cont'd)

TYPICAL OPERATING CONDITIONS

Anode Voltage.....	16,000 Volts d c
Grid No. 4 Voltage for Focus.....	-64 to +352 Volts d c
Grid No. 2 Voltage.....	300 Volts d c
Grid No. 1 Voltage Required for Cutoff.....	-28 to -72 Volts d c
Ion Trap Magnet Strength.....	33 ± 3 Gausses Min.

CIRCUIT VALUES

Grid No. 1 Circuit Resistance.....	1.5 Megohms Max.
------------------------------------	------------------

NOTES:

1. Heater warm-up time is the time required for the voltage across the heater terminals to increase to 5.0 volts in the JETEC test circuit, with E = 25 volts and series R = 31.5 ohms.
2. External conductive coating must be grounded.
3. Visual extinction of focused raster. Extinction of stationary focused spot will require that these values be about 5 volts more negative.

WARNING:

X-ray radiation shielding may be necessary to protect against possible danger of personal injury from prolonged exposure at close range if this tube is operated at higher than the manufacturer's Maximum Rated Anode Voltage or 16,000 volts, whichever is less.

SYLVANIA TYPE 21CBP4 21CBP4A

Silver Screen "85"

TELEVISION PICTURE TUBE

21" Direct Viewed Magnetic Deflection
 Rectangular Glass Type Electronic Focus
 Spherical Faceplate No Ion Trap
 Gray Filter Glass External Conductive Coating
 Aluminized Screen

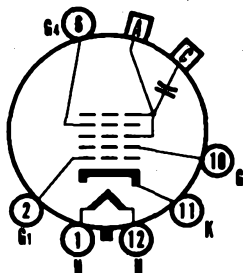
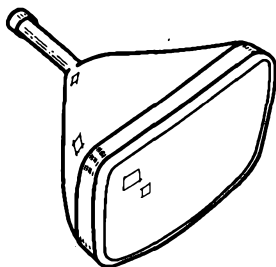

12-L

CHARACTERISTICS

GENERAL DATA

Focusing Method.....	Electrostatic
Deflection Method.....	Magnetic
Deflection Angles (approx.)	
Horizontal.....	85 Degrees
Diagonal.....	90 Degrees
Phosphor.....	Aluminized P4
Fluorescence.....	White
Persistence.....	Short to Medium
Faceplate.....	Gray Filter Glass
Light Transmittance (approx.).....	74 Percent

ELECTRICAL DATA

Heater Voltage.....	6.3 Volts
Heater Current.....	0.6 ± 5% Ampere
Heater Warm-up Time ¹	11 Seconds
Direct Interelectrode Capacitances (approx.)	
Cathode to All Other Electrodes.....	5 μmf
Grid No. 1 to All Other Electrodes.....	6 μmf
External Conductive Coating to Anode ²	2500 μmf Max. 2000 μmf Min.

MECHANICAL DATA

Minimum Useful Screen Dimensions.....	19 1/8 x 15 1/8 Inches
Nominal Overall Length.....	18 Inches
Minimum Useful Screen Area.....	262 Square Inches
Bulb Contact (Recessed Small Cavity Cap).....	J1-21
Base (Small Shell Duodecal 6-Pin).....	B6-63
Basing.....	12L

RATINGS

MAXIMUM RATINGS (Absolute Maximum Values)

Anode Voltage.....	22,000 Volts d c
Grid No. 4 Voltage (Focusing Electrode).....	-550 to +1100 Volts d c
Grid No. 2 Voltage.....	550 Volts d c
Grid No. 1 Voltage.....	
Negative Bias Value.....	155 Volts d c
Negative Peak Value.....	220 Volts
Positive Bias Value.....	0 Volts d c
Positive Peak Value.....	2 Volts
Peak Heater-Cathode Voltage	
Heater Negative with Respect to Cathode	
During Warm-up Period Not to Exceed	
15 Seconds.....	450 Volts
After Equipment Warm-up Period.....	200 Volts
Heater Positive with Respect to Cathode.....	200 Volts

SYLVANIA PICTURE TUBES

Issued as a supplement to the manual in Sylvania News for April, 1958

SYLVANIA TYPE 21CBP4 (Cont'd)
21CBP4A

TYPICAL OPERATING CONDITIONS

Anode Voltage.....	16,000 Volts d c
Grid No. 4 Voltage.....	-50 to +350 Volts d c
Grid No. 2 Voltage.....	300 Volts d c
Grid No. 1 Voltage Required for Cutoff.....	-28 to -72 Volts d c

CIRCUIT VALUES

Grid No. 1 Circuit Resistance.....	1.5 Megohms Max.
------------------------------------	------------------

NOTES:

1. Heater warm-up time is defined as the time required for the voltage across the heater to reach 80% of the rated heater voltage after applying four (4) times rated heater voltage to a circuit consisting of the tube heater in series with a resistance equal to three (3) times the rated heater voltage divided by the rated heater current.
2. External conductive coating must be grounded.
3. Visual extinction of focused raster. Extinction of stationary focused spot will require that these values be about 5 volts more negative.

WARNING:

X-ray radiation shielding may be necessary to protect against possible danger of personal injury from prolonged exposure at close range if this tube is operated at higher than the manufacturer's Maximum Rated Anode Voltage or 16,000 volts, whichever is less.

SYLVANIA TYPE 21CEP4

TELEVISION PICTURE TUBE

21" Direct Viewed	Aluminized Screen
Very Short Length	Electrostatic Focus
Rectangular Glass Type	110° Magnetic Deflection
Spherical Faceplate	1 1/8" Neck Diameter
Gray Filter Glass	No Ion Trap
External Conductive Coating	

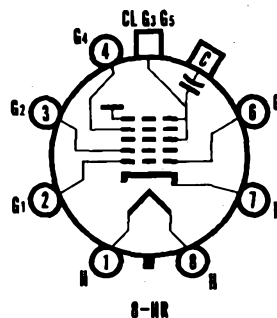
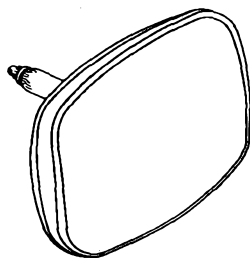

CHARACTERISTICS

GENERAL DATA

Focusing Method.....	Electrostatic
Deflecting Method.....	Magnetic
Deflection Angles (approx.)	
Horizontal.....	105 Degrees
Diagonal.....	110 Degrees
Vertical.....	87 Degrees
Phosphor.....	Aluminized P4
Fluorescence.....	White
Persistence.....	Short to Medium
Faceplate.....	Gray Filter Glass
Light Transmittance (approx.).....	74 Percent

ELECTRICAL DATA

Heater Voltage.....	6.3 Volts
Heater Current.....	0.6 ± 5% Ampere
Heater Warm-up Time ¹	11 Seconds
Direct Interelectrode Capacitance (approx.)	
Cathode to All Other Electrodes.....	5 μmf
Grid No. 1 to All Other Electrodes.....	6 μmf
External Conductive Coating to Anode ²	2500 μmf Max. 2000 μmf Min.

MECHANICAL DATA

Minimum Useful Screen Dimensions (Maximum Assured).....	19 1/8 x 15 1/2 Inches
Nominal Over-all Length.....	14 1/2 Inches
Minimum Useful Screen Area.....	262 Square Inches
Bulb.....	J 171 H1 or Equivalent
Bulb Contact (Recessed Small Cavity Cap).....	J1-21
Base.....	B7-183
Basing.....	8HR
Weight (approx.).....	21 Pounds

RATINGS

MAXIMUM RATINGS (Absolute Maximum Values)

Anode Voltage ³	19,800 Volts dc Max. 11,000 Volts dc Max.
Grid No. 4 Voltage (Focusing Electrode).....	-550 to +1100 Volts dc Max.
Grid No. 2 Voltage.....	550 Volts dc Max.
Grid No. 1 Voltage	
Negative Bias Value.....	154 Volts dc Max.
Negative Peak Value.....	220 Volts Max.
Positive Bias Value.....	0 Volts dc Max.
Positive Peak Value.....	2 Volts Max.

SYLVANIA PICTURE TUBES

Issued as a supplement to the manual in Sylvania News for Nov.-Dec. 1957

SYLVANIA TYPE 21CEP4 (Cont'd)

Peak Heater-Cathode Voltage	
Heater Negative with Respect to Cathode During Warm-up Period	
Not to Exceed 15 Seconds	450 Volts Max.
After Equipment Warm-up Period	200 Volts Max.
Heater Positive with Respect to Cathode	200 Volts Max.

TYPICAL OPERATING CONDITIONS

Anode Voltage	16,000 Volts dc Max.
Grid No. 4 Voltage for Focus	0 to 400 Volts dc Max.
Grid No. 2 Voltage	300 Volts dc Max.
Grid No. 1 Voltage Required for Cutoff	-35 to -72 Volts dc Max.

CIRCUIT VALUES

Grid No. 1 Circuit Resistance	1.5 Megohms Max.
-------------------------------	------------------

NOTES:

1. Heater Warm-up Time is defined as the time required for the voltage across the heater to reach 80% of its rated value after applying four (4) times rated heater voltage to a circuit consisting of the tube heater in series with a resistance equal to three (3) times rated heater voltage divided by rated heater current.
2. External conductive coating must be grounded.
3. Operation outside the limits shown will impair the serviceability of the tube from the viewpoint of life and satisfactory performance.
4. Visual extinction of focused raster. Extinction of stationary focused spot will require that these values be about 5 volts more negative.

WARNING:

X-ray radiation shielding may be necessary to protect against possible danger of personal injury from prolonged exposure at close range if this tube is operated at higher than the manufacturer's Maximum Rated Anode Voltage or 16,000 volts, whichever is less.

SYLVANIA TYPE 21CMP4

Silver Screen "85"

TELEVISION PICTURE TUBE

21" Direct Viewed	Magnetic Deflection
Rectangular Glass Type	Electrostatic Focus
Spherical Faceplate	Single Field Ion Trap
Gray Filter Glass	External Conductive Coating
Aluminized Screen	

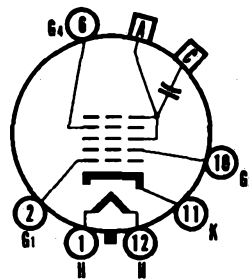
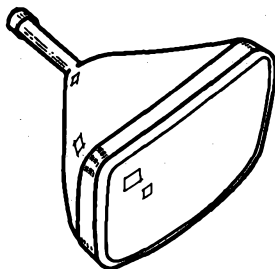

12-L

CHARACTERISTICS

GENERAL DATA

Focusing Method.....	Electrostatic
Deflection Method.....	Magnetic
Deflection Angles (approx.)	
Horizontal.....	85 Degrees
Diagonal.....	90 Degrees
Phosphor.....	Aluminized P4
Fluorescence.....	White
Persistence.....	Short to Medium
Faceplate.....	Gray Filter Glass
Light Transmittance (approx.).....	74 Percent

ELECTRICAL DATA

Heater Voltage.....	6.3 Volts
Heater Current.....	0.6 ± 5% Ampere
Heater Warm-up Time.....	11 Seconds
Direct Interelectrode Capacitances (approx.)	
Cathode to All Other Electrodes.....	5 μmf
Grid No. 1 to All Other Electrodes.....	6 μmf
External Conductive Coating to Anode ²	2500 μmf Max. 2000 μmf Min.
Ion Trap Magnet.....	External, Single Field Type

MECHANICAL DATA

Minimum Useful Screen Dimensions (Maximum Assured).....	19 1/8 x 15 1/8 Inches
Nominal Overall Length.....	19 Inches
Minimum Useful Screen Area.....	262 Square Inches
Bulb Contact (Recessed Small Cavity Cap).....	J1-21
Base (Small Shell Duodecal 6-Pin).....	B6-63
Basing.....	12L

RATINGS

MAXIMUM RATINGS (Absolute Maximum Values)

Anode Voltage.....	22,000 Volts d c
Grid No. 4 Voltage (Focusing Electrode).....	-550 to +1100 Volts d c
Grid No. 2 Voltage.....	550 Volts d c
Grid No. 1 Voltage.....	
Negative Bias Value.....	155 Volts d c
Negative Peak Value.....	220 Volts
Positive Bias Value.....	0 Volts d c
Positive Peak Value.....	2 Volts
Peak Heater-Cathode Voltage	
Heater Negative with Respect to Cathode	
During Warm-up Period Not to	
Exceed 15 Seconds.....	450 Volts
After Equipment Warm-up Period.....	200 Volts
Heater Positive with Respect to Cathode.....	200 Volts

SYLVANIA PICTURE TUBES

SYLVANIA TYPE 21CMP4 (Cont'd)

TYPICAL OPERATING CONDITIONS

Anode Voltage	16,000 Volts d c
Grid No. 4 Voltage for Focus	-64 to +352 Volts d c
Grid No. 2 Voltage	300 Volts d c
Grid No. 1 Voltage Required for Cutoff ¹	-35 to -72 Volts d c
Ion Trap Magnet Current (Average) ²	30 Ma d c
Field Strength of PM Ion Trap Magnet ³	33 Gaussess Min.

CIRCUIT VALUES

Grid No. 1 Circuit Resistance	1.5 Megohms Max.
-------------------------------	------------------

NOTES:

1. Heater warm-up time is defined as the time required for the voltage across the heater to reach 80% of its rated value after applying four (4) times rated heater voltage to a circuit consisting of the tube heater in series with a resistance equal to three (3) times rated heater voltage divided by rated heater current.
2. External conductive coating must be grounded.
3. Visual extinction of focused raster. Extinction of stationary focused spot will require that these values be about 5 volts more negative.
4. For JETEC Ion Trap Magnet No. 117 with pole pieces centered over Grid No. 2 on mount, and rotated for maximum brightness.
5. For typical PM ion trap magnet with field strength tolerance of ± 3 gaussess.

WARNING:

X-ray radiation shielding may be necessary to protect against possible danger of personal injury from prolonged exposure at close range if this tube is operated at higher than the manufacturer's Maximum Rated Anode Voltage of 16,000 volts, whichever is less.

SYLVANIA TYPE 21CQP4

TELEVISION PICTURE TUBE

21" Direct Viewed	Aluminized Screen
Rectangular Glass Type	Electrostatic Focus
Lightweight Tube	110° Magnetic Deflection
Spherical Faceplate	1 1/8" Neck Diameter
Gray Filter Glass	No Ion Trap
External Conductive Coating	

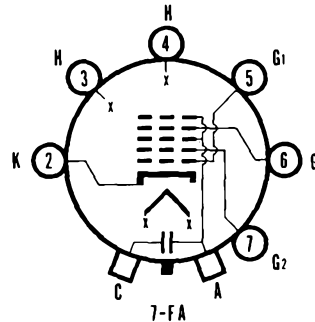
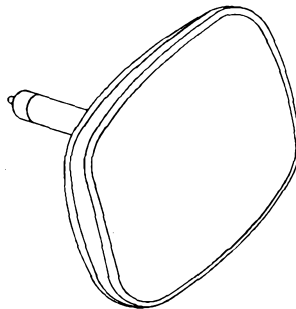

CHARACTERISTICS

GENERAL DATA

Focusing Method	Electrostatic
Deflection Method	Magnetic
Deflection Angles (approx.)	
Horizontal	105 Degrees
Diagonal	110 Degrees
Vertical	87 Degrees
Phosphor	Aluminized P4
Fluorescence	White
Persistence	Short to Medium
Faceplate	Gray Filter Glass
Light Transmittance (approx.)	73 Percent

ELECTRICAL DATA

Heater Voltage	6.3 Volts
Heater Current	0.6 ± 5% Amperes
Heater Warm-up Time ¹	11 Seconds
Direct Interelectrode Capacitances (approx.)	
Cathode to All Other Electrodes	5 μf
Grid No. 1 to All Other Electrodes	6 μf
External Conductive Coating to Anode ²	2500 μf Max. 2000 μf Min.

MECHANICAL DATA

Minimum Useful Screen Dimensions (Maximum Assured)	19 1/8 x 15 1/8 Inches
Minimum Useful Screen Area	262 Sq. Inches
Bulb Contact (Recessed Small Cavity Cap)	J1-21
Bulb	C171 Exp. 19
Base	B6-1B5
Heating	7FA
Weight (approx.)	20 Pounds

RATINGS

MAXIMUM RATINGS (Absolute Maximum Values)

Anode Voltage	19,800 Volts d c
Grid No. 4 Voltage (Focusing Electrode)	-550 to +1100 Volts d c
Grid No. 2 Voltage	550 Volts d c
Grid No. 1 Voltage	
Negative Bias Value	154 Volts d c
Negative Peak Value	220 Volts
Positive Bias Value	0 Volts d c
Positive Peak Value	2 Volts
Peak Heater-Cathode Voltage	
Heater Negative with Respect to Cathode	
During Warm-up Period not to Exceed	
15 Seconds	450 Volts
After Equipment Warm-up Period	200 Volts
Heater Positive with Respect to Cathode	200 Volts

SYLVANIA PICTURE TUBES

SYLVANIA TYPE 21CQP4 (Cont'd)

TYPICAL OPERATING CONDITIONS

Anode Voltage.....	16,000 Volts d c
Grid No. 4 Voltage for Focus.....	-50 to +350 Volts d c
Grid No. 2 Voltage.....	300 Volts d c
Grid No. 1 Voltage Required for Cutoff ¹	-35 to -72 Volts d c

CIRCUIT VALUES

Grid No. 1 Circuit Resistance.....	1.5 Megohms Max.
------------------------------------	------------------

NOTES:

1. Heater warm-up time is defined as the time required for the voltage across the heater to reach 80% of the rated heater voltage after applying four (4) times rated heater voltage to a circuit consisting of the tube heater in series with resistance equal to three (3) times the rated heater voltage divided by rated heater current.
2. External conductive coating must be grounded.
3. Visual extinction of focused raster. Extinction of stationary focused spot will require that these values be about 5 volts more negative.

WARNING:

X-ray radiation shielding may be necessary to protect against possible danger of personal injury from prolonged exposure at close range if this tube is operated at higher than the manufacturer's Maximum Rated Anode Voltage or 16,000 volts, whichever is less.

SYLVANIA TYPE 21CUP4

Silver Screen "85"

TELEVISION PICTURE TUBE

21" Direct Viewed	Magnetic Deflection
Rectangular Glass Type	Magnetic Focus
Spherical Faceplate	Single Field Ion Trap
Gray Filter Glass	External Conductive Coating
Aluminized Screen	

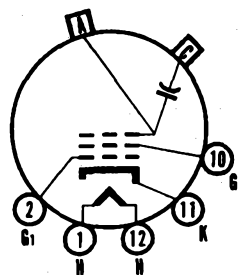
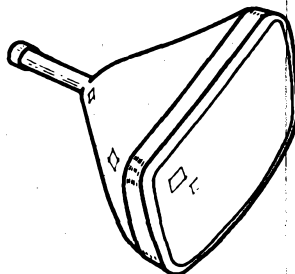

12-N

CHARACTERISTICS

GENERAL DATA

Focusing Method	Magnetic
Deflecting Method	Magnetic
Deflection Angles (approx.)	
Horizontal	85 Degrees
Diagonal	90 Degrees
Phosphor	Aluminized P4
Fluorescence	White
Persistence	Short to Medium
Faceplate	Gray Filter Glass
Light Transmittance (approx.)	74 Percent

ELECTRICAL DATA

Heater Voltage	6.3 Volts
Heater Current	0.6 ± 5% Amperes
Heater Warm-up Time ¹	11 Seconds
Direct Interelectrode Capacitances (approx.)	
Cathode to All Other Electrodes	5 μf
Grid No. 1 to All Other Electrodes	6 μf
External Conductive Coating to Anode ²	2500 μf Max. 2000 μf Min.
Ion Trap Magnet	External, Single Field Type

MECHANICAL DATA

Minimum Useful Screen Dimensions (Maximum Assured)	19 1/8 x 15 1/8 Inches
Nominal Overall Length	20 Inches
Minimum Useful Screen Area	262 Square Inches
Bulb Contact (Recessed Small Cavity Cap)	J1-21
Base (Small Shell Duodecal 5-Pin)	B5-57
Basing	12N

RATINGS

MAXIMUM RATINGS (Absolute Maximum Values)

Anode Voltage	22,000 Volts d c
Grid No. 2 Voltage	550 Volts d c
Grid No. 1 Voltage	
Negative Bias Value	155 Volts d c
Negative Peak Value	220 Volts
Positive Bias Value	0 Volts d c
Positive Peak Value	2 Volts
Peak Heater-Cathode Voltage	
Heater Negative with Respect to Cathode	
During Warm-up Period Not to Exceed	
15 Seconds	450 Volts
After Equipment Warm-up Period	200 Volts
Heater Positive with Respect to Cathode	200 Volts

SYLVANIA TYPE 21CUP4 (Cont'd)

TYPICAL OPERATING CONDITIONS

Anode Voltage.....	16,000 Volts d c
Grid No. 2 Voltage.....	300 Volts d c
Grid No. 1 Voltage Required for Cutoff ³	-28 to -72 Volts d c
Focusing Coil Current ⁴	117 Ma d c
Field Strength of PM Ion Trap Magnet ⁵	40 Gaussess

CIRCUIT VALUES

Grid No. 1 Circuit Resistance.....	1.5 Megohms Max.
------------------------------------	------------------

NOTES:

1. Heater warm-up time is defined as the time required for the voltage across the heater to reach 80% of its rated value after applying four (4) times rated heater voltage to a circuit consisting of the tube heater in series with a resistance equal to three (3) times rated heater voltage divided by rated heater current.
2. External conductive coating must be grounded.
3. Visual extinction of focused raster. Extinction of stationary focused spot will require that these values be about 5 volts more negative.
4. For JETEC focusing coil 109 or equivalent. Distance from yoke reference line to center of air gap to be $3\frac{1}{4}$ inches (approx.).
5. For typical PM ion trap magnet with field strength tolerance of ± 3 gaussess.

WARNING:

X-ray radiation shielding may be necessary to protect against possible danger of personal injury from prolonged exposure at close range if this tube is operated at higher than the manufacturer's Maximum Rated Anode Voltage or 16,000 volts, whichever is less.

SYLVANIA TYPE 21CXP4

Silver Screen "85"

TELEVISION PICTURE TUBE

21" Direct Viewed	90° Magnetic Deflection
Rectangular Glass Type	Cathode Drive Design
Spherical Faceplate	Low Grid No. 2 Voltage
Gray Filter Glass	No Ion Trap
Aluminized Screen	Short Neck Tube
Electrostatic Focus	External Conductive Coating

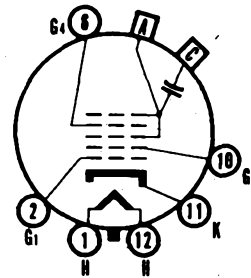
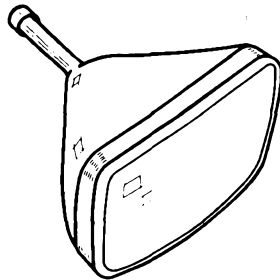

12-1

CHARACTERISTICS

GENERAL DATA

Focusing Method	Electrostatic
Deflecting Method	Magnetic
Deflection Angles (approx.)	
Horizontal	85 Degrees
Diagonal	90 Degrees
Phosphor	Aluminized P4
Fluorescence	White
Persistence	Short to Medium
Faceplate	Gray Filter Glass
Light Transmittance (approx.)	74 Percent

ELECTRICAL DATA

Heater Voltage	6.3 Volts
Heater Current	0.6 ± 5% Ampere
Heater Warm-up Time	11 Seconds
Direct Interelectrode Capacitances (approx.)	
Cathode to All Other Electrodes	5 µµf
Grid No. 1 to All Other Electrodes	6 µµf
External Conductive Coating to Anode	2500 µµf Max. 2000 µµf Min.

MECHANICAL DATA

Minimum Useful Screen Dimensions (Maximum Assured)	19 1/8 x 15 1/8 Inches
Nominal Overall Length	18 Inches
Minimum Useful Screen Area	262 Square Inches
Bulb	J171 D2 or J171 E1
Bulb Contact (Recessed Small Cavity Cap)	J1-21
Base (Small Shell Duodecal 6-Pin)	B6-63
Basing	12L

RATINGS

MAXIMUM RATINGS¹ (Absolute Maximum Values)

Anode Voltage	22,000 Volts dc
Grid No. 4 Voltage (Focusing Electrode)	-550 to +1100 Volts dc
Grid No. 2 to Grid No. 1 Voltage	70 Volts dc
Cathode to Grid No. 1 Voltage	
Positive Bias Value	150 Volts
Negative Peak Value	0 Volts
Peak Heater-Cathode Voltage	
Heater Negative with Respect to Cathode	
During Warm-up Period	
Not to Exceed 15 Seconds	450 Volts
After Equipment Warm-up Period	200 Volts
Heater Positive with Respect to Cathode	200 Volts

SYLVANIA PICTURE TUBES

Issued as a supplement to the manual in Sylvania News for May, 1958

SYLVANIA TYPE 21CXP4 (Cont'd)

TYPICAL OPERATING CONDITIONS (Cathode Drive Service)

Anode Voltage.....	18,000 Volts dc
Grid No. 4 to Grid No. 1 Voltage for Focus at 100 μ a Cathode Current.....	0 to 350 Volts dc
Grid No. 2 to Grid No. 1 Voltage.....	50 Volts dc
Cathode to Grid No. 1 Voltage for Cutoff.....	35 to 50 Volts dc

CIRCUIT VALUES

Grid No. 1 Circuit Resistance.....	1.5 Megohms Max.
------------------------------------	------------------

NOTES:

1. Heater Warm-Up Time is defined as the time required for the voltage across the heater to reach 80% of its rated value after applying four (4) times rated heater voltage to a circuit consisting of the tube heater in series with a resistance equal to three (3) times rated heater voltage divided by rated heater current.
2. External conductive coating must be grounded.
3. This type is designed for cathode-drive service. Voltages shown are with respect to Grid No. 1 Voltage unless otherwise indicated.
4. For visual extinction of the undeflected focused spot. The cutoff voltage will change by approximately 2 percent with 1 kilovolt change of anode voltage.

WARNING:

X-ray radiation shielding may be necessary to protect against possible danger of personal injury from prolonged exposure at close range if this tube is operated at higher than the manufacturer's Maximum Rated Anode Voltage or 16,000 volts, whichever is less.

SYLVANIA TYPE 21CWP4 (Cont'd)

TYPICAL OPERATING CONDITIONS

Anode Voltage.....	16,000 Volts d c
Grid No. 4 Voltage for Focus.....	-64 to +352 Volts d c
Grid No. 2 Voltage.....	300 Volts d c
Grid No. 1 Voltage Required for Cutoff ³	-28 to -72 Volts d c
Field Strength of PM Ion Trap Magnet ⁴	40 Gausses

CIRCUIT VALUES

Grid No. 1 Circuit Resistance.....	1.5 Megohms Max.
------------------------------------	------------------

NOTES:

1. Heater warm-up time is defined as the time required for the voltage across the heater to reach 80% of its rated value after applying four (4) times rated heater voltage to a circuit consisting of the tube heater in series with a resistance equal to three (3) times rated heater voltage divided by rated heater current.
2. External Conductive Coating must be grounded.
3. Visual extinction of focused raster. Extinction of stationary focused spot will require that these values be about 5 volts more negative.
4. For typical PM Ion Trap Magnet with field strength tolerance of ± 3 gaussess.

WARNING:

X-ray radiation shielding may be necessary to protect against possible danger of personal injury from prolonged exposure at close range if this tube is operated at higher than the manufacturer's Maximum Rated Anode Voltage or 16,000 volts, whichever is less.

SYLVANIA TYPE 21CWP4

Silver Screen "85"

TELEVISION PICTURE TUBE

21" Direct Viewed	Magnetic Deflection
Rectangular Glass Type	Electrostatic Focus
Spherical Faceplate	Single Field Ion Trap
Gray Filter Glass	External Conductive Coating
Aluminized Screen	

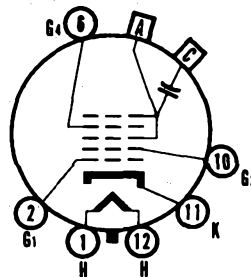
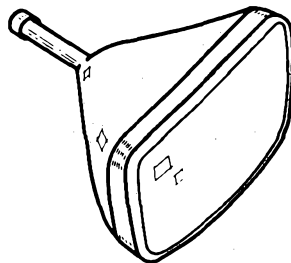

12-1

CHARACTERISTICS

GENERAL DATA

Focusing Method	Electrostatic
Deflection Method	Magnetic
Deflection Angle (approx.)	
Horizontal	85 Degrees
Diagonal	90 Degrees
Phosphor	Aluminized P4
Fluorescence	White
Persistence	Short to Medium
Faceplate	Gray Filter Glass
Light Transmittance (approx.)	74 Percent

ELECTRICAL DATA

Heater Voltage	6.3 Volts
Heater Current	0.6 ± 5% Ampere
Heater Warm-up Time ¹	11 Seconds
Direct Interelectrode Capacitances (approx.)	
Cathode to All Other Electrodes	5 μμf
Grid No. 1 to All Other Electrodes	6 μμf
External Conductive Coating to Anode ²	2500 μμf Max. 2000 μμf Min.
Ion Trap Magnet	External, Single Field Type

MECHANICAL DATA

Minimum Useful Screen Dimensions (Maximum Assured)	19 1/8 x 15 1/4 Inches
Nominal Overall Length	20 Inches
Minimum Useful Screen Area	262 Square Inches
Bulb Type	J171 D2 or J171 E1
Bulb Contact (Recessed Small Cavity Cap)	J1-21
Base (Small Shell Duodecal 6-Pin)	B6-63
Basing	12L

RATINGS

MAXIMUM RATINGS (Absolute Maximum Values)

Anode Voltage	22,000 Volts d c
Grid No. 4 Voltage (Focusing Electrode)	-550 to +1100 Volts d c
Grid No. 2 Voltage	550 Volts d c
Grid No. 1 Voltage	
Negative Bias Value	155 Volts d c
Negative Peak Value	220 Volts
Positive Bias Value	0 Volts d c
Positive Peak Value	2 Volts
Peak Heater-Cathode Voltage	
Heater Negative with Respect to Cathode	
During Warm-up Period Not to Exceed	
15 Seconds	450 Volts
After Equipment Warm-up Period	200 Volts
Heater Positive with Respect to Cathode	200 Volts

SYLVANIA PICTURE TUBES

SYLVANIA TYPE 21DAP4

Silver Screen "85"

TELEVISION PICTURE TUBE

21" Direct Viewed	Aluminized Screen
Rectangular Glass Type	Electrostatic Focus
Lightweight Tube	110° Magnetic Deflection
Spherical Faceplate	1 1/8" Neck Diameter
Gray Filter Glass	No Ion Trap
External Conductive Coating	

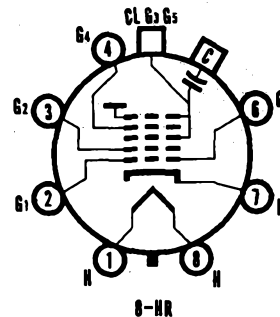
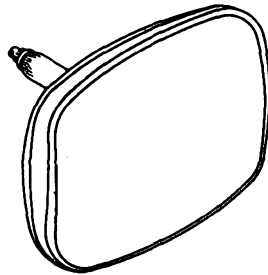

CHARACTERISTICS

GENERAL DATA

Focusing Method	Electrostatic
Deflection Method	Magnetic
Deflection Angles (approx.)	
Horizontal	105 Degrees
Diagonal	110 Degrees
Vertical	87 Degrees
Phosphor	Aluminized P4
Fluorescence	White
Persistence	Short to Medium
Faceplate	Gray Filter Glass
Light Transmittance (approx.)	73 Percent

ELECTRICAL DATA

Heater Voltage	6.3 Volts
Heater Current	0.6 ± 5% Ampere
Heater Warm-up Time ¹	11 Seconds
Direct Interelectrode Capacitances (approx.)	
Cathode to All Other Electrodes	5 μmf
Grid No. 1 to All Other Electrodes	6 μmf
External Conductive Coating to Anode ²	2500 μmf Max. 2000 μmf Min.

MECHANICAL DATA

Minimum Useful Screen Dimensions (Maximum Assured)	19 1/8 x 15 1/8 Inches
Nominal Overall Length	14 1/2 Inches
Minimum Useful Screen Area	262 Sq. Inches
Bulb Contact (Recessed Small Cavity Cap)	J1-21
Bulb	J171-G1 or Equivalent
Base	B7-183
Basing	8HR
Weight (approx.)	20 Pounds

RATINGS

MAXIMUM RATINGS (Absolute Maximum Values)

Anode Voltage	19,800 Volts d c
Grid No. 4 Voltage (Focusing Electrode)	-550 to +1100 Volts d c
Grid No. 2 Voltage	550 Volts d c
Grid No. 1 Voltage	
Negative Bias Value	154 Volts d c
Negative Peak Value	220 Volts
Positive Bias Value	0 Volts d c
Positive Peak Value	2 Volts
Peak Heater-Cathode Voltage	
Heater Negative with Respect to Cathode	
During Warm-up Period Not to Exceed 15 Seconds	450 Volts
After Equipment Warm-up Period	200 Volts
Heater Positive with Respect to Cathode	200 Volts

SYLVANIA PICTURE TUBES

SYLVANIA TYPE 21DAP4 (Cont'd)

TYPICAL OPERATING CONDITIONS

Anode Voltage.....	16,000 Volts d c
Grid No. 4 Voltage for Focus.....	0 to 400 Volts d c
Grid No. 2 Voltage.....	300 Volts d c
Grid No. 1 Voltage Required for Cutoff ¹	-35 to -72 Volts d c

CIRCUIT VALUES

Grid No. 1 Circuit Resistance.....	1.5 Megohms Max.
------------------------------------	------------------

NOTES:

1. Heater warm-up time is defined as the time required for the voltage across the heater to reach 80% of its rated value after applying four (4) times rated heater voltage to a circuit consisting of the tube heater in series with a resistance equal to three (3) times rated heater voltage divided by rated heater current.
2. External conductive coating must be grounded.
3. Visual extinction of focused raster. Extinction of stationary focused spot will require that these values be about 5 volts more negative.

WARNING:

X-ray radiation shielding may be necessary to protect against possible danger of personal injury from prolonged exposure at close range if this tube is operated at higher than the manufacturer's Maximum Rated Anode Voltage or 16,000 volts, whichever is less.

SYLVANIA TYPE 21DEP4

Silver Screen "85"

TELEVISION PICTURE TUBE

21" Direct Viewed	Aluminized Screen
Rectangular Glass Type	Electrostatic Focus
Lightweight Tube	110° Magnetic Deflection
Spherical Faceplate	1 1/8" Neck Diameter
Gray Filter Glass	No Ion Trap
External Conductive Coating	

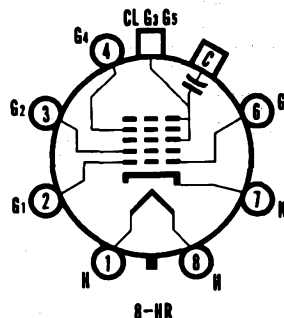
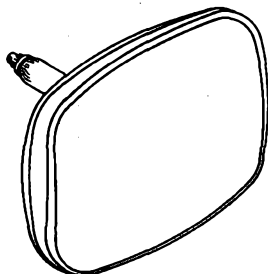

CHARACTERISTICS

GENERAL DATA

Focusing Method	Electrostatic
Deflection Method	Magnetic
Deflection Angles (approx.)	
Horizontal	105 Degrees
Diagonal	110 Degrees
Vertical	87 Degrees
Phosphor	Aluminized P4
Fluorescence	White
Persistence	Short to Medium
Faceplate	Gray Filter Glass
Light Transmittance (approx.)	76 Percent

ELECTRICAL DATA

Heater Voltage	6.3 Volts
Heater Current	0.6 ± 5% Ampere
Heater Warm-up Time ¹	11 Seconds
Direct Interelectrode Capacitances (approx.)	
Cathode to All Other Electrodes	5 μmf
Grid No. 1 to All Other Electrodes	6 μmf
External Conductive Coating to Anode ²	2500 μmf Max. 2000 μmf Min.

MECHANICAL DATA

Minimum Useful Screen Dimensions (Maximum Assured)	19 1/8 x 15 1/2 Inches
Nominal Overall Length	14 1/2 Inches
Minimum Useful Screen Area	262 Sq. Inches
Bulb Contact (Recessed Small Cavity Cap)	J1-21
Bulb	J171 G1 or Equivalent
Base	B7-183
Basing	8HR
Weight (approx.)	20 Pounds

RATINGS

MAXIMUM RATINGS (Absolute Maximum Values)

Anode Voltage	19,800 Volts d c
Grid No. 4 Voltage (Focusing Electrode)	-550 to +1100 Volts d c
Grid No. 2 Voltage	550 Volts d c
Grid No. 1 Voltage	
Negative Bias Value	154 Volts d c
Negative Peak Value	220 Volts
Positive Bias Value	0 Volts d c
Positive Peak Value	2 Volts
Peak Heater-Cathode Voltage	
Heater Negative with Respect to Cathode	
During Warm-up Period Not to Exceed 15 Seconds	450 Volts
After Equipment Warm-up Period	200 Volts
Heater Positive with Respect to Cathode	200 Volts

SYLVANIA TYPE 21DEP4 (Cont'd)

TYPICAL OPERATING CONDITIONS

Anode Voltage.....	17,000 Volts d c
Grid No. 4 Voltage for Focus.....	0 to 400 Volts d c
Grid No. 2 Voltage.....	300 Volts d c
Grid No. 1 Voltage Required for Cutoff.....	-35 to -72 Volts d c

CIRCUIT VALUES

Grid No. 1 Circuit Resistance.....	1.5 Megohms Max.
------------------------------------	------------------

NOTES:

1. Heater warm-up time is defined as the time required for the voltage across the heater to reach 80% of the rated heater voltage after applying four (4) times rated heater voltage to a circuit consisting of the tube heater in series with a resistance equal to three (3) times the rated heater voltage divided by the rated heater current.
2. External conductive coating must be grounded.
3. Visual extinction of focused raster. Extinction of stationary focused spot will require that these values be about 5 volts more negative.

WARNING:

X-ray radiation shielding may be necessary to protect against possible danger of personal injury from prolonged exposure at close range if this tube is operated at higher than the manufacturer's Maximum Rated Anode Voltage or 16,000 volts, whichever is less.

**SYLVANIA TYPE 21FP4
21FP4A
Silver Screen "85" → 21FP4C**

TELEVISION PICTURE TUBE

21" Direct Viewed Magnetic Deflection
 Rectangular Glass Type Electrostatic Focus
 Gray Filter Glass Cylindrical Faceplate
 Single Field Ion Trap
 21FP4A has an External Conductive Coating
 21FP4C has an External Conductive Coating and
 an Aluminized Screen

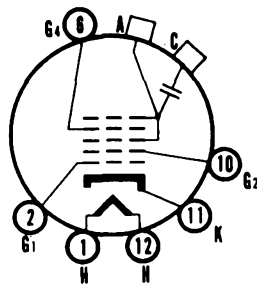
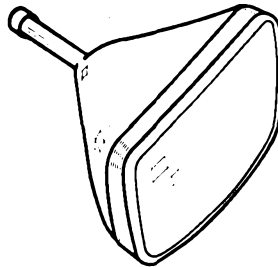

12-L

21FP4A
21FP4C

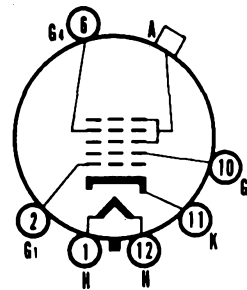

12-M

21FP4

CHARACTERISTICS

GENERAL DATA

Focusing Method.....	Electrostatic
Deflecting Method.....	Magnetic
Deflecting Angle (approx.)	
Horizontal.....	65 Degrees
Diagonal.....	70 Degrees
Phosphor.....	P4
Fluorescence.....	White
Persistence.....	Medium
Faceplate.....	Gray Filter Glass
Light Transmittance (approx.).....	72 Percent

ELECTRICAL DATA

Heater Voltage.....	6.3 Volts
Heater Current (approx.).....	0.6 Amperes
Direct Interelectrode Capacitances (approx.)	
Cathode to All Other Electrodes.....	5 $\mu\mu\text{f}$
Grid No. 1 to All Other Electrodes.....	6 $\mu\mu\text{f}$
Ion Trap Magnet.....	External, Single Field Type

MECHANICAL DATA

Minimum Useful Screen Dimensions.....	19 $\frac{1}{8}$ x 13 $\frac{3}{8}$ Inches
Bulb Contact (Recessed Small Cavity Cap).....	J1-21
Base (Small Shell Duodecal 6-Pin).....	B6-63
Basing.....	12M

21FP4, 21FP4A, 21FP4C (Cont'd)

RATINGS

MAXIMUM RATINGS (Design Center Values)

Anode Voltage.....	18000 Volts d c
Grid No. 4 Voltage (Focusing Electrode).....	-500 to +1000 Volts d c
Grid No. 2 Voltage.....	500 Volts d c
Grid No. 1 Voltage.....	
Negative Bias Value.....	125 Volts d c
Positive Bias Value.....	0 Volts d c
Positive Peak Value.....	2 Volts
Peak Heater-Cathode Voltage.....	
Heater Negative with Respect to Cathode	
During Warm-up Period Not to	
Exceed 15 Seconds.....	410 Volts
After Equipment Warm-up Period.....	180 Volts
Heater Positive with Respect to Cathode.....	180 Volts

RECOMMENDED OPERATING CONDITIONS

Anode Voltage.....	16000 Volts d c
Grid No. 4 Voltage.....	-64 to +350 Volts d c
Grid No. 2 Voltage.....	300 Volts d c
Grid No. 1 Voltage Required for Cutoff.....	-28 to -72 Volts d c
Ion Trap Magnet Strength (approx.).....	35 Gauss

CIRCUIT VALUES

Grid No. 1 Circuit Resistance.....	1.5 Megohms
	Max

NOTE:

1. Visual extinction of focused raster. Extinction of the stationary focused spot will require that these values be about 5 volts more negative.

21FP4A

The Sylvania Type 21FP4A is identical to Type 21FP4 except for having an external conductive coating, which must be grounded.

External Conductive Coating to Anode Capacitance	
Maximum.....	750 μ f
Minimum.....	500 μ f
Basing.....	12L

21FP4C

The Sylvania Type 21FP4C is identical to Type 21FP4 except for having an external conductive coating which must be grounded, and an aluminized screen.

External Conductive Coating to Anode Capacitance	
Maximum.....	750 μ f
Minimum.....	500 μ f
Basing.....	12L

WARNING

X-ray radiation shielding may be necessary to protect against possible danger of personal injury from prolonged exposure at close range if this tube is operated at higher than the manufacturer's Maximum Rated Anode Voltage or 16,000 volts, whichever is less.

SYLVANIA TYPE 21MP4

TELEVISION PICTURE TUBE

21" Direct Viewed
Rectangular Metal Type
Gray Filter Glass
Frosted Faceplate

Magnetic Deflection
Electrostatic Focus
Spherical Faceplate
Single Field Ion Trap

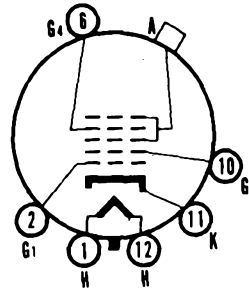
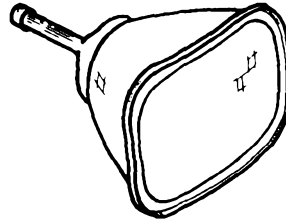

12-M

CHARACTERISTICS

GENERAL DATA

Focusing Method	Electrostatic
Deflecting Method	Magnetic
Deflecting Angle (approx.)	
Horizontal	66 Degrees
Diagonal	70 Degrees
Phosphor	P4
Fluorescence	White
Persistence	Medium
Faceplate	Frosted Gray Filter Glass
Light Transmittance (approx.)	66 Percent

ELECTRICAL DATA

Heater Voltage	6.3 Volts
Heater Current (approx.)	0.6 Ampere
Direct Interelectrode Capacitances (approx.)	
Cathode to All Other Electrodes	5 $\mu\mu\text{f}$
Grid No. 1 to All Other Electrodes	6 $\mu\mu\text{f}$
Ion Trap Magnet	External, Single Field Type

MECHANICAL DATA

Minimum Useful Screen Dimensions	18 $\frac{1}{8}$ x 13 $\frac{1}{16}$ Inches
Bulb Contact	Metal Cone Lip
Base (Small Shell Duodeca: 6-Pin)	B6-63
Basing	12M

RATINGS

MAXIMUM RATINGS (Design Center Values)

Anode Voltage	16000 Volts d c
Grid No. 4 Voltage (Focusing Electrode)	-500 to +1000 Volts d c
Grid No. 2 Voltage	500 Volts d c
Grid No. 1 Voltage	
Negative Bias Value	125 Volts d c
Positive Bias Value	0 Volts d c
Positive Peak Value	2 Volts
Peak Heater-Cathode Voltage	
Heater Negative with Respect to Cathode	
During Warm-up Period Not to Exceed 15 Seconds	410 Volts
After Equipment Warm-up Period	180 Volts
Heater Positive with Respect to Cathode	180 Volts

RECOMMENDED OPERATING CONDITIONS

Anode Voltage	16000 Volts d c
Grid No. 4 Voltage	-64 to +350 Volts d c
Grid No. 2 Voltage	300 Volts d c
Grid No. 1 Voltage Required for Cutoff ¹	-28 to -72 Volts d c
Ion Trap Magnet Strength (approx.)	30 Gaussess

21MP4 (Cont'd)

CIRCUIT VALUES

Grid No. 1 Circuit Resistance 1.5 Megohms
Max

NOTE:

1. Visual extinction of undeflected focused spot.

WARNING

X-ray radiation shielding may be necessary to protect against possible danger of personal injury from prolonged exposure at close range if this tube is operated at higher than the manufacturer's Maximum Rated Anode Voltage or 16,000 volts, whichever is less.

SYLVANIA TYPE 21WP4 Silver Screen "85" → 21WP4A

TELEVISION PICTURE TUBE

21" Direct Viewed	Magnetic Deflection
Rectangular Glass Type	Magnetic Focus
Gray Filter Glass	Spherical Faceplate
External Conductive Coating	Single Field Ion Trap

21WP4A has an Aluminized Screen

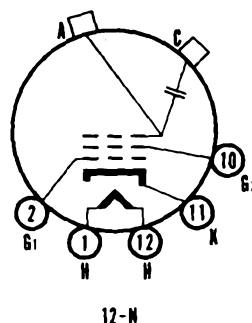
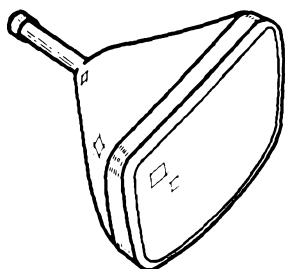

CHARACTERISTICS

GENERAL DATA

Focusing Method.....	Magnetic
Deflecting Method.....	Magnetic
Deflecting Angle (approx.)	
Horizontal.....	66 Degrees
Diagonal.....	70 Degrees
Phosphor.....	P4
Fluorescence.....	White
Persistence.....	Medium
Faceplate.....	Gray Filter Glass
Light Transmittance (approx.).....	72 Percent

ELECTRICAL DATA

Heater Voltage.....	6.3 Volts
Heater Current (approx.).....	0.6 Ampere
Direct Interelectrode Capacitances (approx.)	
Cathode to All Other Electrodes.....	5 μ f
Grid No. 1 to All Other Electrodes.....	6 μ f
External Conductive Coating to Anode.....	750 μ f Max
	500 μ f Min
Ion Trap Magnet.....	External, Single Field Type

21WP4, 21WP4A (Cont'd)

MECHANICAL DATA

Minimum Useful Screen Dimensions.....	17 x 12 $\frac{3}{4}$ Inches
Bulb Contact (Recessed Small Cavity Cap).....	J1-21
Base (Small Shell Duodecal 5-Pin).....	B5-57
Basing.....	12N

RATINGS

MAXIMUM RATINGS (Design Center Values)

Anode Voltage.....	18000 Volts d c
Grid No. 2 Voltage.....	500 Volts d c
Grid No. 1 Voltage.....	
Negative Bias Value.....	125 Volts d c
Positive Bias Value.....	0 Volts d c
Positive Peak Value.....	2 Volts
Peak Heater-Cathode Voltage.....	
Heater Negative with Respect to Cathode	
During Warm-up Period Not to	
Exceed 15 Seconds.....	410 Volts
After Equipment Warm-up Period.....	180 Volts
Heater Positive with Respect to Cathode.....	180 Volts

RECOMMENDED OPERATING CONDITIONS

Anode Voltage.....	16000 Volts d c
Grid No. 2 Voltage.....	300 Volts d c
Grid No. 1 Voltage Required for Cutoff ²	-28 to -72 Volts d c
Focusing Coil Current (approx.) ³	100 +20% Ma d c
Ion Trap Magnet Strength (approx.).....	35 Gausses

CIRCUIT VALUES

Grid No. 1 Circuit Resistance.....	1.5 Megohms
	Max

NOTES:

1. External conductive coating must be grounded.
2. Visual extinction of focused raster. Extinction of stationary focused spot will require that these values be about 5 volts more negative.
3. For JETEC focusing coil 109 or equivalent three and one quarter inches from reference line, bias adjusted to 30 foot lamberts on a 17 x 12 $\frac{3}{4}$ inch picture area.

21WP4A

The Sylvania Type 21WP4A is identical to Type 21WP4 except for having an aluminized screen.

WARNING

X-ray radiation shielding may be necessary to protect against possible danger of personal injury from prolonged exposure at close range if this tube is operated at higher than the manufacturer's Maximum Rated Anode Voltage or 16,000 volts, whichever is less.

SYLVANIA TYPE 21XP4

Silver Screen "85" → 21XP4A

TELEVISION PICTURE TUBE

21" Direct Viewed	Magnetic Deflection
Rectangular Glass Type	Electrostatic Focus
Gray Filter Glass	Spherical Faceplate
External Conductive Coating	Single Field Ion Trap

21XP4A has an Aluminized Screen

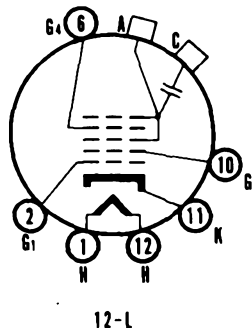
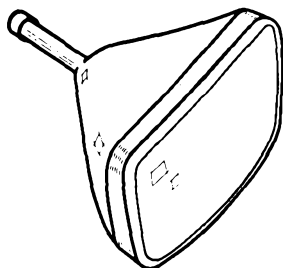

CHARACTERISTICS

GENERAL DATA

Focusing Method	Electrostatic
Deflecting Method	Magnetic
Deflecting Angle (approx.)	
Horizontal	66 Degrees
Diagonal	70 Degrees
Phosphor	P4
Fluorescence	White
Persistence	Medium
Faceplate	Gray Filter Glass
Light Transmittance (approx.)	72 Percent

ELECTRICAL DATA

Heater Voltage	6.3 Volts
Heater Current (approx.)	0.6 Ampere
Direct Interelectrode Capacitances (approx.)	
Cathode to All Other Electrodes	5 μf
Grid No. 1 to All Other Electrodes	6 μf
External Conductive Coating to Anode	750 μf Max
Ion Trap Magnet	500 μf Min
	External, Single Field Type

MECHANICAL DATA

Minimum Useful Screen Dimensions	17 x 12 $\frac{3}{4}$ Inches
Bulb Contact (Recessed Small Cavity Cap)	J1-21
Base (Small Shell Duodecal 6-Pin)	B6-63
Basing	12L

RATINGS

MAXIMUM RATINGS (Design Center Values)

Anode Voltage	18000 Volts d c
Grid No. 4 Voltage (Focusing Electrode)	-500 to +1000 Volts d c
Grid No. 2 Voltage	500 Volts d c
Grid No. 1 Voltage	
Negative Bias Value	125 Volts d c
Positive Bias Value	0 Volts d c
Positive Peak Value	2 Volts
Peak Heater-Cathode Voltage	
Heater Negative with Respect to Cathode	
During Warm-up Period Not to	
Exceed 15 Seconds	410 Volts
After Equipment Warm-up Period	180 Volts
Heater Positive with Respect to Cathode	180 Volts

21XP4, 21XP4A (Cont'd)

RECOMMENDED OPERATING CONDITIONS

Anode Voltage.....	16000	Volts d c
Grid No. 4 Voltage.....	-64 to +352	Volts d c
Grid No. 2 Voltage.....	300	Volts d c
Grid No. 1 Voltage Required for Cutoff.....	-28 to -72	Volts d c
Ion Trap Magnet Strength (approx.).....	35	Gausses

CIRCUIT VALUES

Grid No. 1 Circuit Resistance.....	1.5	Megohms
		Max

NOTES:

1. External conductive coating must be grounded.
2. Visual extinction of focused raster. Extinction of stationary focused spot will require that these values be about 5 volts more negative.

21XP4A

The Sylvania Type 21XP4A is identical to Type 21XP4 except for having an aluminized screen.

WARNING

X-ray radiation shielding may be necessary to protect against possible danger of personal injury from prolonged exposure at close range if this tube is operated at higher than the manufacturer's Maximum Rated Anode Voltage or 16,000 volts, whichever is less.

SYLVANIA TYPE 21ZP4 21ZP4A *Silver Screen "85"* → 21ZP4B

TELEVISION PICTURE TUBE

21" Direct Viewed	Magnetic Deflection
Rectangular Glass Type	Magnetic Focus
Gray Filter Glass	Spherical Faceplate

Single Field Ion Trap

21ZP4A has an External Conductive Coating
21ZP4B has an External Conductive Coating and
an Aluminized Screen

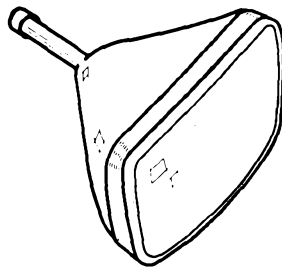

21ZP4, 21ZP4A, 21ZP4B (Cont'd)

CHARACTERISTICS

GENERAL DATA

Focusing Method.....	Magnetic
Deflecting Method.....	Magnetic
Deflecting Angle (approx.)	
Horizontal.....	65 Degrees
Diagonal.....	70 Degrees
Vertical.....	50 Degrees
Phosphor.....	P4
Fluorescence.....	White
Persistence.....	Medium
Faceplate.....	Gray Filter Glass
Light Transmittance (approx.).....	72 Percent

ELECTRICAL DATA

Heater Voltage.....	6.3 Volts
Heater Current (approx.).....	0.6 Ampere
Direct Interelectrode Capacitances (approx.)	
Cathode to All Other Electrodes (approx.).....	5 $\mu\mu\text{f}$
Grid No. 1 to All Other Electrodes.....	6 $\mu\mu\text{f}$
Ion Trap Magnet.....	External, Single Field Type

MECHANICAL DATA

Minimum Useful Screen Dimensions.....	19 $\frac{1}{8}$ x 14 $\frac{3}{16}$ Inches
Bulb Contact (Recessed Small Cavity Cap).....	J1-21
Base (Small Shell Duodecal 5-Pin).....	B5-57
Basing.....	12D

RATINGS

MAXIMUM RATINGS (Design Center Values)

Anode Voltage.....	18000 Volts d c
Grid No. 2 Voltage.....	500 Volts d c
Grid No. 1 Voltage.....	
Negative Bias Value.....	125 Volts d c
Positive Bias Value.....	0 Volts d c
Positive Peak Value.....	2 Volts
Peak Heater-Cathode Voltage	
Heater Negative with Respect to Cathode	
During Warm-up Period Not to	
Exceed 15 Seconds.....	410 Volts
After Equipment Warm-up Period.....	180 Volts
Heater Positive with Respect to Cathode.....	180 Volts

RECOMMENDED OPERATING CONDITIONS

Anode Voltage.....	16000 Volts d c
Grid No. 2 Voltage.....	300 Volts d c
Grid No. 1 Voltage Required for Cutoff ¹	-28 to -72 Volts d c
Focusing Coil Current (approx.) ²	95 \pm 20% Ma d c
Ion Trap Magnet Strength (approx.).....	35 Gaussess

CIRCUIT VALUES

Grid No. 1 Circuit Resistance.....	1.5 Megohms
	Max

NOTES:

1. Visual extinction of focused raster. Extinction of the stationary focused spot will require that these values be about 5 volts more negative.
2. For JETEC focusing coil 109 or equivalent three inches from reference line, bias adjusted to 20 foot lamberts on a 19 $\frac{1}{8}$ x 14 $\frac{3}{16}$ inch picture area.

21ZP4A

The Sylvania Type 21ZP4A is identical to Type 21ZP4 except for having an external conductive coating, which must be grounded.

External Conductive Coating to Anode Capacitance	
Maximum.....	750 $\mu\mu\text{f}$
Minimum.....	500 $\mu\mu\text{f}$
Basing.....	12N

21ZP4B

The Sylvania Type 21ZP4B is identical to Type 21ZP4 except for having an external conductive coating which must be grounded, and an aluminized screen.

External Conductive Coating to Anode Capacitance	
Maximum.....	750 $\mu\mu\text{f}$
Minimum.....	500 $\mu\mu\text{f}$
Basing.....	12N

WARNING

X-ray radiation shielding may be necessary to protect against possible danger of personal injury from prolonged exposure at close range if this tube is operated at higher than the manufacturer's Maximum Rated Anode Voltage or 16,000 volts, whichever is less.

SYLVANIA TYPE 24AEP4

Silver Screen "85"

TELEVISION PICTURE TUBE

24" Direct Viewed	Electrostatic Focus
Rectangular Glass Type	90° Magnetic Deflection
Spherical Faceplate	Short Neck Tube
Gray Filter Glass	No Ion Trap
Aluminized Screen	External Conductive Coating

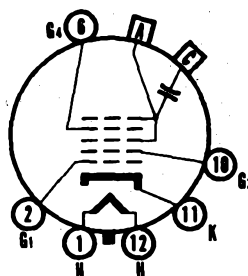
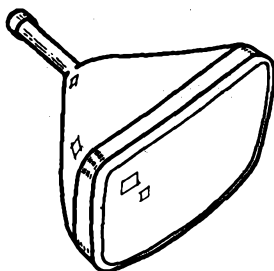

12-L

CHARACTERISTICS

GENERAL DATA

Focusing Method	Electrostatic
Deflection Method	Magnetic
Deflection Angles (approx.)	
Horizontal	85 Degrees
Diagonal	90 Degrees
Phosphor	Aluminized P4
Fluorescence	White
Persistence	Short to Medium
Faceplate	Gray Filter Glass
Light Transmittance (approx.)	74 Percent

ELECTRICAL DATA

Heater Voltage	6.3 Volts
Heater Current	0.6 ± 5% Amperes
Heater Warm-up Time	11 Seconds
Direct Interelectrode Capacitances (approx.)	
Cathode to All Other Electrodes	5 μmf
Grid No. 1 to All Other Electrodes	6 μmf
External Conductive Coating to Anode ²	2500 μmf Max. 2000 μmf Min.

MECHANICAL DATA

Minimum Useful Screen Dimensions (Maximum Assured)	21 ¹ / ₄ x 16 ¹ / ₈ Inches
Nominal Overall Length	19 ¹ / ₄ Inches
Minimum Useful Screen Area	332 Sq. Inches
Bulb Contact (Recessed Small Cavity Cap)	J1-21
Base	B6-63
Basing	12L

RATINGS

MAXIMUM RATINGS (Absolute Maximum Values)

Anode Voltage	22,000 Volts d c
Grid No. 4 Voltage (Focusing Electrode)	-550 to +1100 Volts d c
Grid No. 2 Voltage	550 Volts d c
Grid No. 1 Voltage	
Negative Bias Value	155 Volts d c
Negative Peak Value	220 Volts
Positive Bias Value	0 Volts d c
Positive Peak Value	2 Volts
Peak Heater-Cathode Voltage	
Heater Negative with Respect to Cathode	
During Warm-up Period Not to	
Exceed 15 Seconds	450 Volts
After Equipment Warm-up Period	200 Volts
Heater Positive with Respect to Cathode	200 Volts

SYLVANIA TYPE 24AEP4 (Cont'd)

TYPICAL OPERATING CONDITIONS

Anode Voltage.....	18,000 Volts d c
Grid No. 4 Voltage for Focus.....	-50 to +350 Volts d c
Grid No. 2 Voltage.....	300 Volts d c
Grid No. 1 Voltage Required for Cutoff ¹	-35 to -72 Volts d c

CIRCUIT VALUES

Grid No. 1 Circuit Resistance.....	1.5 Megohms Max.
------------------------------------	------------------

NOTES:

1. Heater warm-up time is defined as the time required for the voltage across the heater to reach 80% of its rated value after applying four (4) times rated heater voltage to a circuit consisting of the tube heater in series with a resistance equal to three (3) times rated heater voltage divided by rated heater current.
2. External conductive coating must be grounded.
3. Visual extinction of focused raster. Extinction of stationary focused spot will require that these values be about 5 volts more negative.

WARNING:

X-ray radiation shielding may be necessary to protect against possible danger of personal injury from prolonged exposure at close range if this tube is operated at higher than the manufacturer's Maximum Rated Anode Voltage or 16,000 volts, whichever is less.

SYLVANIA TYPE 24AHP4

Silver Screen "85"

TELEVISION PICTURE TUBE

24" Direct Viewed	Aluminized Screen
Rectangular Glass Type	Electrostatic Focus
Lightweight Tube	110° Magnetic Deflection
Spherical Faceplate	1 1/8" Neck Diameter
Gray Filter Glass	No Ion Trap
External Conductive Coating	

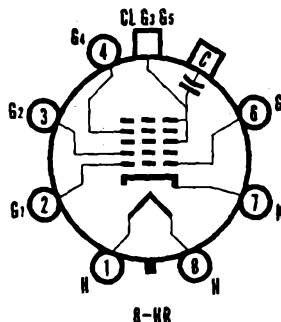
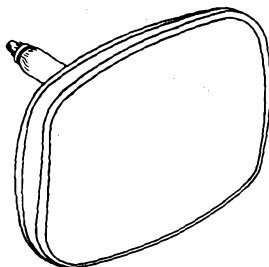

CHARACTERISTICS

GENERAL DATA

Focusing Method.....	Electrostatic
Deflection Method.....	Magnetic
Deflection Angles (approx.)	
Horizontal.....	105 Degrees
Diagonal.....	110 Degrees
Vertical.....	87 Degrees
Phosphor.....	Aluminized P4
Fluorescence.....	White
Persistence.....	Short to Medium
Faceplate.....	Gray Filter Glass
Light Transmittance (approx.).....	76 Percent

ELECTRICAL DATA

Heater Voltage.....	6.3 Volts
Heater Current.....	0.6 ± 5% Ampere
Heater Warm-up Time ¹	11 Seconds
Direct Interelectrode Capacitances (approx.)	
Cathode to All Other Electrodes.....	5 μmf
Grid No. 1 to All Other Electrodes.....	6 μmf
External Conductive Coating to Anode ²	2500 μmf Max. 2000 μmf Min.

MECHANICAL DATA

Minimum Useful Screen Dimensions (Maximum Assured).....	21 1/4 x 16 1/4 Inches
Nominal Overall Length.....	15 1/4 Inches
Minimum Useful Screen Area.....	332 Square Inches
Bulb.....	J192C1 or Equivalent
Bulb Contact (Recessed Small Cavity Cap).....	J1-21
Base.....	B7-183
Basing.....	8HR
Weight (approx.).....	26 1/2 Pounds

RATINGS

MAXIMUM RATINGS (Absolute Maximum Values)

Anode Voltage.....	22,000 Volts d c
Grid No. 4 Voltage (Focusing Electrode).....	-550 to +1100 Volts d c
Grid No. 2 Voltage.....	550 Volts d c
Grid No. 1 Voltage.....	
Negative Bias Value.....	154 Volts d c
Negative Peak Value.....	220 Volts
Positive Bias Value.....	0 Volts d c
Positive Peak Value.....	2 Volts
Peak Heater-Cathode Voltage	
Heater Negative with Respect to Cathode	
During Warm-up Period Not to	
Exceed 15 Seconds.....	450 Volts
After Equipment Warm-up Period.....	200 Volts
Heater Positive with Respect to Cathode.....	200 Volts

SYLVANIA PICTURE TUBES

SYLVANIA TYPE 24AHP4 (Cont'd)

TYPICAL OPERATING CONDITIONS

Anode Voltage.....	16,000 Volts d c
Grid No. 4 Voltage for Focus.....	-50 to +350 Volts d c
Grid No. 2 Voltage.....	300 Volts d c
Grid No. 1 Voltage Required for Cutoff.....	-35 to -72 Volts d c

CIRCUIT VALUES

Grid No. 1 Circuit Resistance.....	1.5 Megohms Max.
------------------------------------	------------------

NOTES:

1. Heater warm-up time is defined as the time required for the voltage across the heater to reach 80% of the rated heater voltage after applying four (4) times rated heater voltage to a circuit consisting of the tube heater in series with a resistance equal to three (3) times the rated heater voltage divided by the rated heater current.
2. External conductive coating must be grounded.
3. Visual extinction of focused raster. Extinction of stationary focused spot will require that these values be about 5 volts more negative.

WARNING:

X-ray radiation shielding may be necessary to protect against possible danger of personal injury from prolonged exposure at close range if this tube is operated at higher than the manufacturer's Maximum Rated Anode Voltage or 16,000 volts, whichever is less.

21ZP4, 21ZP4A, 21ZP4B (Cont'd)

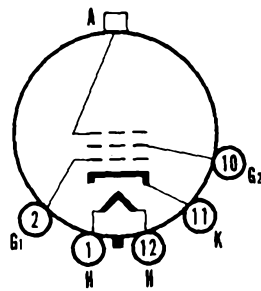

12-D

21ZP4

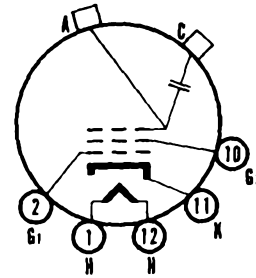

12-N

21ZP4A
21ZP4B

SYLVANIA TYPE 24CP4 Silver Screen "85" → 24CP4A

TELEVISION PICTURE TUBE

24" Direct Viewed	Magnetic Deflection
Rectangular Glass Type	Magnetic Focus
Gray Filter Glass	Spherical Faceplate
External Conductive Coating	Single Field Ion Trap

24CP4A has an Aluminized Screen

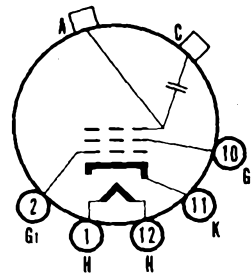
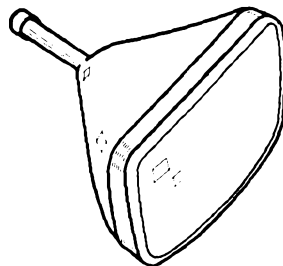

12-N

CHARACTERISTICS

GENERAL DATA

Focusing Method	Magnetic
Deflecting Method	Magnetic
Deflecting Angle (approx.)	
Horizontal	85 Degrees
Diagonal	90 Degrees
Phosphor	P4
Fluorescence	White
Persistence	Medium
Faceplate	Gray Filter Glass
Light Transmittance (approx.)	68 Percent

24CP4, 24CP4A (Cont'd)

ELECTRICAL DATA

Heater Voltage.....	6.3 Volts
Heater Current (approx.).....	0.6 Ampere
Direct Interelectrode Capacitances (approx.)	
Cathode to All Other Electrodes.....	5 μ f
Grid No. 1 to All Other Electrodes.....	6 μ f
External Conductive Coating to Anode ¹	750 μ f Max
Ion Trap Magnet.....	500 μ f Min
	External, Single Field Type

MECHANICAL DATA

Minimum Useful Screen Dimensions.....	21¼ x 16¾ Inches
Bulb Contact (Recessed Small Cavity Cap).....	J1-21
Base (Small Shell Duodecal 5-Pin).....	B5-57
Basing.....	12N

RATINGS

MAXIMUM RATINGS (Design Center Values)

Anode Voltage.....	20000 Volts d c
Grid No. 2 Voltage.....	500 Volts d c
Grid No. 1 Voltage	
Negative Bias Value.....	125 Volts d c
Positive Bias Value.....	0 Volts d c
Positive Peak Value.....	2 Volts
Peak Heater-Cathode Voltage	
Heater Negative with Respect to Cathode	
During Warm-up Period Not to	
Exceed 15 Seconds.....	410 Volts
After Equipment Warm-up Period.....	180 Volts
Heater Positive with Respect to Cathode.....	180 Volts

RECOMMENDED OPERATING CONDITIONS

Anode Voltage.....	18000 Volts d c
Grid No. 2 Voltage.....	300 Volts d c
Grid No. 1 Voltage Required for Cutoff ²	-28 to -72 Volts d c
Focusing Coil Current (approx.) ³	125 \pm 20% Ma d c
Ion Trap Magnet Strength (approx.).....	40 Gauss

CIRCUIT VALUES

Grid No. 1 Circuit Resistance.....	1.5 Megohms
	Max

NOTES:

1. External conductive coating must be grounded.
2. Visual extinction of focused raster. Extinction of stationary focused spot will require that these values be about 5 volts more negative.
3. For JETEC focusing coil 109 or equivalent three inches from reference line, bias adjusted to 30 foot lamberts on a 21¼ x 16¾ inch picture area.

24CP4A

The Sylvania Type 24CP4A is identical to Type 24CP4 except it has an aluminumized screen.

WARNING

X-ray radiation shielding may be necessary to protect against possible danger of personal injury from prolonged exposure at close range if this tube is operated at higher than the manufacturer's Maximum Rated Anode Voltage or 16,000 volts, whichever is less.

SYLVANIA TYPE 24DP4

Silver Screen "85" → 24DP4A

TELEVISION PICTURE TUBE

24" Direct Viewed	Magnetic Deflection
Rectangular Glass Type	Electrostatic Focus
Gray Filter Glass	Spherical Faceplate
External Conductive Coating	Single Field Ion Trap

24DP4A has an Aluminized Screen

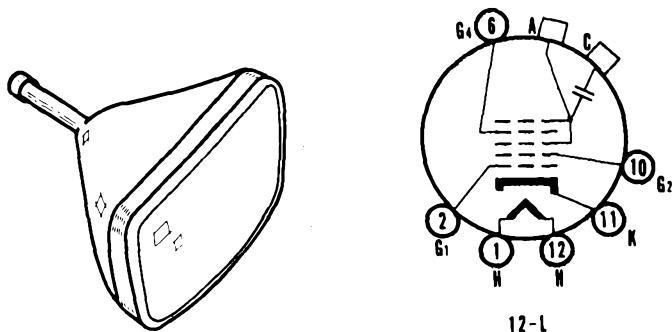

CHARACTERISTICS

GENERAL DATA

Focusing Method.....	Electrostatic
Deflecting Method.....	Magnetic
Deflecting Angle.....	
Horizontal.....	85 Degrees
Diagonal.....	90 Degrees
Phosphor.....	P4
Fluorescence.....	White
Persistence.....	Medium
Faceplate.....	Gray Filter Glass
Light Transmittance (approx.).....	68 Percent

ELECTRICAL DATA

Heater Voltage.....	6.3 Volts
Heater Current (approx.).....	0.6 Ampere
Direct Interelectrode Capacitances (approx.).....	
Cathode to All Other Electrodes.....	5 $\mu\mu\text{f}$
Grid No. 1 to All Other Electrodes.....	6 $\mu\mu\text{f}$
External Conductive Coating to Anode.....	750 $\mu\mu\text{f}$ Max
Ion Trap Magnet.....	500 $\mu\mu\text{f}$ Min
	External, Single Field Type

MECHANICAL DATA

Minimum Useful Screen Dimensions.....	21 $\frac{1}{4}$ x 16 $\frac{3}{4}$ Inches
Bulb Contact (Recessed Small Cavity Cap).....	J1-21
Base (Small Shell Duodecal 6-Pin).....	B6-63
Basing.....	12L

RATINGS

MAXIMUM RATINGS (Design Center Values)

Anode Voltage.....	20000 Volts d c
Grid No. 4 Voltage (Focusing Electrode).....	-500 to +1000 Volts d c
Grid No. 2 Voltage.....	500 Volts d c
Grid No. 1 Voltage.....	
Negative Bias Value.....	125 Volts d c
Positive Bias Value.....	0 Volts d c
Positive Peak Value.....	2 Volts
Peak Heater-Cathode Voltage.....	
Heater Negative with Respect to Cathode	
During Warm-up Period Not to	
Exceed 15 Seconds.....	410 Volts
After Equipment Warm-up Period.....	180 Volts
Heater Positive with Respect to Cathode.....	180 Volts

24DP4, 24DP4A (Cont'd)

RECOMMENDED OPERATING CONDITIONS

Anode Voltage.....	18000	Volts d c
Grid No. 4 Voltage.....	-72 to +396	Volts d c
Grid No. 2 Voltage.....	300	Volts d c
Grid No. 1 Voltage Required for Cutoff.....	-28 to -72	Volts d c
Ion Trap Magnet Strength (approx.).....	40	Gausses

CIRCUIT VALUES

Grid No. 1 Circuit Resistance.....	1.5	Megohms
		Max

NOTES:

- External conductive coating must be grounded.
- Visual extinction of focused raster. Extinction of stationary focused spot will require that these values be about 5 volts more negative.

24DP4A

The Sylvania Type 24DP4A is identical to the Type 24DP4 except it has an aluminized screen.

WARNING

X-ray radiation shielding may be necessary to protect against possible danger of personal injury from prolonged exposure at close range if this tube is operated at higher than the manufacturer's Maximum Rated Anode Voltage or 16,000 volts, whichever is less.

SYLVANIA TYPE 24VP4 Silver Screen "85" → 24VP4A

TELEVISION PICTURE TUBE

24" Direct Viewed	Magnetic Deflection
Rectangular Glass Type	Magnetic Focus
Gray Filter Glass	Spherical Faceplate
External Conductive Coating	Single Field Ion Trap
24VP4A has an Aluminized Screen	

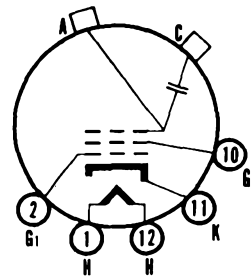
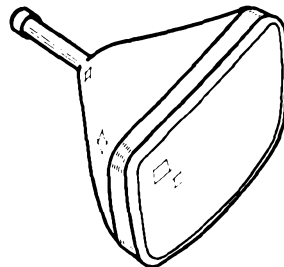

12-H

CHARACTERISTICS

GENERAL DATA

Focusing Method.....	Magnetic
Deflecting Method.....	Magnetic
Deflecting Angle (approx.)	
Horizontal.....	85 Degrees
Diagonal.....	90 Degrees
Phosphor.....	P4
Fluorescence.....	White
Persistence.....	Medium
Faceplate.....	Gray Filter Glass
Light Transmittance (approx.).....	68 Percent

24VP4, 24VP4A (Cont'd)

ELECTRICAL DATA

Heater Voltage.....	6.3 Volts
Heater Current (approx.).....	0.6 Ampere
Direct Interelectrode Capacitances (approx.)	
Cathode to All Other Electrodes.....	5 μf
Grid No. 1 to All Other Electrodes.....	6 μf
External Conductive Coating to Anode ¹	1500 μf Max
	750 μf Min
Ion Trap Magnet.....	External, Single Field Type

MECHANICAL DATA

Minimum Useful Screen Dimensions.....	21 $\frac{3}{8}$ x 16 $\frac{1}{16}$ Inches
Bulb Contact (Recessed Small Cavity Cap).....	J1-21
Base (Small Shell Duodecal 5-Pin).....	B5-57
Basing.....	12N

RATINGS

MAXIMUM RATINGS (Design Center Values)

Anode Voltage.....	22000 Volts d c
Grid No. 2 Voltage.....	600 Volts d c
Grid No. 1 Voltage	
Negative Bias Value.....	125 Volts d c
Positive Bias Value.....	0 Volts d c
Positive Peak Value.....	2 Volts
Peak Heater-Cathode Voltage	
Heater Negative with Respect to Cathode	
During Warm-up Period Not to	
Exceed 15 Seconds.....	410 Volts
After Equipment Warm-up Period.....	180 Volts
Heater Positive with Respect to Cathode.....	180 Volts

RECOMMENDED OPERATING CONDITIONS

Anode Voltage.....	18000 Volts d c
Grid No. 2 Voltage.....	300 Volts d c
Grid No. 1 Voltage Required for Cutoff ²	-28 to -72 Volts d c
Focusing Coil Current (approx.) ³	125 Ma d c
Ion Trap Magnet Strength (approx.).....	40 Gaussess

CIRCUIT VALUES

Grid No. 1 Circuit Resistance.....	1.5 Megohms
	Max

NOTES:

1. External conductive coating must be grounded.
2. Visual extinction of focused raster. Extinction of stationary focused spot will require that these values be about 5 volts more negative.
3. For JETEC focusing coil 109 or equivalent three inches from reference line, bias adjusted to 20 foot lamberts on a 21 $\frac{3}{8}$ x 16 $\frac{1}{16}$ inch picture area.

24VP4A

The Sylvania Type 24VP4A is identical to the Type 24VP4 except for having an aluminized screen.

WARNING

X-ray radiation shielding may be necessary to protect against possible danger of personal injury from prolonged exposure at close range if this tube is operated at higher than the manufacturer's Maximum Rated Anode Voltage or 16,000 volts, whichever is less.

SYLVANIA TYPE 24XP4

TELEVISION PICTURE TUBE

24" Direct Viewed Magnetic Deflection
 Rectangular Glass Type Magnetic Focus
 Gray Filter Glass Spherical Faceplate
 Single Field Ion Trap

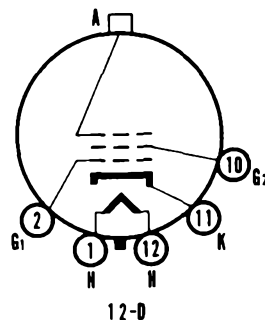
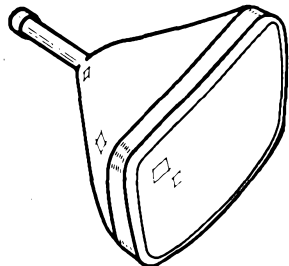

CHARACTERISTICS

GENERAL DATA

Focusing Method.....	Magnetic
Deflecting Method.....	Magnetic
Deflecting Angle (approx.)	
Horizontal.....	85 Degrees
Diagonal.....	90 Degrees
Phosphor.....	P4
Fluorescence.....	White
Persistence.....	Medium
Faceplate.....	Gray Filter Glass
Light Transmittance (approx.).....	68 Percent

ELECTRICAL DATA

Heater Voltage.....	6.3 Volts
Heater Current (approx.).....	0.6 Ampere
Direct Interelectrode Capacitances (approx.)	
Cathode to All Other Electrodes.....	5 μ f
Grid No. 1 to All Other Electrodes.....	6 μ f
Ion Trap Magnet.....	External, Single Field Type

MECHANICAL DATA

Minimum Useful Screen Dimensions.....	16 $\frac{3}{4}$ x 21 $\frac{1}{4}$ Inches
Bulb Contact (Recessed Small Cavity Cap).....	J1-21
Base (Small Shell Duodecal 5-Pin).....	B5-57
Basing.....	12D

RATINGS

MAXIMUM RATINGS (Design Center Values)

Anode Voltage.....	20000 Volts d c
Grid No. 2 Voltage.....	500 Volts d c
Grid No. 1 Voltage.....	
Negative Bias Value.....	125 Volts d c
Positive Bias Value.....	0 Volts d c
Positive Peak Value.....	2 Volts
Peak Heater-Cathode Voltage.....	
Heater Negative with Respect to Cathode	
During Warm-up Period Not to	
Exceed 15 Seconds.....	410 Volts
After Equipment Warm-up Period.....	180 Volts
Heater Positive with Respect to Cathode.....	180 Volts

RECOMMENDED OPERATING CONDITIONS

Anode Voltage.....	18000 Volts d c
Grid No. 2 Voltage.....	300 Volts d c
Grid No. 1 Voltage Required for Cutoff ¹	-28 to -72 Volts d c
Focusing Coil Current (approx.) ²	125 Ma d c
Ion Trap Magnet Strength (approx.).....	40 Gauss

24XP4 (Cont'd)

CIRCUIT VALUES

Grid No. 1 Circuit Resistance 1.5 Megohms
Max

NOTES:

1. Visual extinction of focused raster. Extinction of stationary focused spot will require that these values be about 5 volts more negative.
2. For JETEC focusing coil 109 or equivalent three inches from reference line, bias adjusted to 20 foot lamberts on a 21¼ x 16¾ inch picture area.

WARNING

X-ray radiation shielding may be necessary to protect against possible danger of personal injury from prolonged exposure at close range if this tube is operated at higher than the manufacturer's Maximum Rated Anode Voltage or 16,000 volts, whichever is less.

SYLVANIA TYPE 24YP4

Silver Screen "85"

TELEVISION PICTURE TUBE

24" Direct Viewed	Magnetic Deflection
Rectangular Glass Type	Electrostatic Focus
Gray Filter Glass	Spherical Faceplate
External Conductive Coating	Single Field Ion Trap
Aluminized Screen	

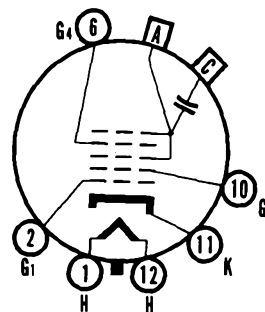
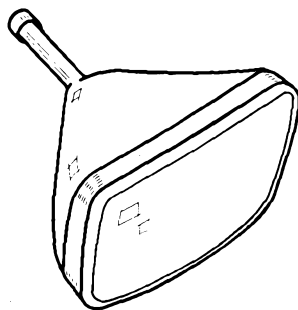

12-L

CHARACTERISTICS

GENERAL DATA

Focusing Method	Electrostatic
Deflecting Method	Magnetic
Deflecting Angle (approx.)	
Horizontal	85 Degrees
Diagonal	90 Degrees
Phosphor	P4
Fluorescence	White
Persistence	Medium
Faceplate	Gray Filter Glass
Light Transmittance (approx.)	68 Per cent

ELECTRICAL DATA

Heater Voltage	6.3 Volts
Heater Current (approx.)	0.6 Ampere
Direct Interelectrode Capacitances (approx.)	
Cathode to All Other Electrodes	5 μf
Grid No. 1 to All Other Electrodes	6 μf
External Conductive Coating to Anode!	1500 μf Max.
	1200 μf Min.
Ion Trap Magnet	External, Single Field Type

24YP4 (Cont'd)

MECHANICAL DATA

Minimum Useful Screen Dimensions	21½ x 16¾	Inches
Bulb Contact (Recessed Small Cavity Cap)	J1-21	
Base (Small Shell Duodecal 6-Pin)	B6-63	
Basing	12L	

RATINGS

MAXIMUM RATINGS (Design Center Values)

Anode Voltage	20,000	Volts d c
Grid No. 4 Voltage (Focusing Electrode)	-500 to +1000	Volts d c
Grid No. 2 Voltage	500	Volts d c
Grid No. 1 Voltage		
Negative Bias Value	125	Volts d c
Positive Bias Value	0	Volts d c
Positive Peak Value	2	Volts
Peak Heater-Cathode Voltage:		
Heater Negative with Respect to Cathode		
During Warm-up Period Not to		
Exceed 15 Seconds	410	Volts
After Equipment Warm-up Period	180	Volts
Heater Positive with Respect to Cathode	180	Volts

RECOMMENDED OPERATING CONDITIONS

Anode Voltage	18,000	Volts d c
Grid No. 4 Voltage	-72 to +396	Volts d c
Grid No. 2 Voltage	300	Volts d c
Grid No. 1 Voltage Required for Cutoff ¹	-28 to -72	Volts d c
Ion Trap Magnet Strength (approx.)	40	Gausses

CIRCUIT VALUES

Grid No. 1 Circuit Resistance	1.5	Megohms Max.
-------------------------------	-----	--------------

NOTES:

1. External conductive coating must be grounded.
2. Visual extinction of focused raster. Extinction of stationary focused spot will require that these values be about 5 volts more negative.

WARNING:

X-ray radiation shielding may be necessary to protect against possible danger of personal injury from prolonged exposure at close range if this tube is operated at higher than the manufacturer's Maximum Rated Anode Voltage or 16,000 volts, whichever is less.

SYLVANIA TYPE 27EP4 27RP4

Silver Screen "85"

TELEVISION PICTURE TUBE

27" Direct Viewed Magnetic Deflection
 Rectangular Glass Type Magnetic Focus
 Gray Filter Glass Spherical Faceplate
 Aluminized Screen Single Field Ion Trap
 27RP4 has an External Conductive Coating

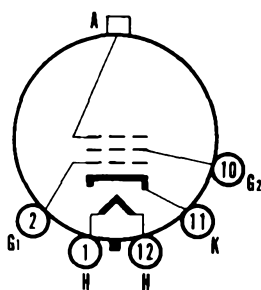
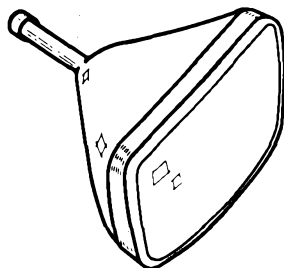

12-D

27EP4

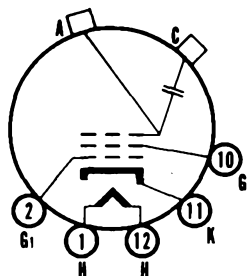

12-N

27RP4

CHARACTERISTICS

GENERAL DATA

Focusing Method.....	Magnetic
Deflecting Method.....	Magnetic
Deflecting Angle (approx.)	
Horizontal.....	85 Degrees
Diagonal.....	90 Degrees
Phosphor.....	P4
Fluorescence.....	White
Persistence.....	Medium
Faceplate.....	Gray Filter Glass
Light Transmittance (approx.).....	68 Percent

ELECTRICAL DATA

Heater Voltage.....	6.3 Volts
Heater Current (approx.).....	0.6 Ampere
Direct Interelectrode Capacitances (approx.).....	
Cathode to All Other Electrodes.....	5 μ f
Grid No. 1 to All Other Electrodes.....	6 μ f
Ion Trap Magnet.....	External, Single Field Type

27EP4, 27RP4 (Cont'd)

MECHANICAL DATA

Minimum Useful Screen Dimensions.....	24 x 18½ Inches
Bulb Contact (Recessed Small Cavity Cap).....	J1-21
Base (Small Shell Duodecal 5-Pin).....	B5-57
Basing.....	12D

RATINGS

MAXIMUM RATINGS (Design Center Values)

Anode Voltage.....	20000 Volts d c
Grid No. 2 Voltage.....	500 Volts d c
Grid No. 1 Voltage.....	
Negative Bias Value.....	125 Volts d c
Positive Bias Value.....	0 Volts d c
Positive Peak Value.....	2 Volts
Peak Heater-Cathode Voltage.....	
Heater Negative with Respect to Cathode.....	
During Warm-up Period Not to Exceed 15 Seconds.....	410 Volts
After Equipment Warm-up Period.....	180 Volts
Heater Positive with Respect to Cathode.....	180 Volts

RECOMMENDED OPERATING CONDITIONS

Anode Voltage.....	20000 Volts d c
Grid No. 2 Voltage.....	300 Volts d c
Grid No. 1 Voltage Required for Cutoff.....	-28 to -72 Volts d c
Focusing Coil Current (approx.) ²	125 ±20% Ma d c
Ion Trap Magnet Strength (approx.).....	40 Gauss

CIRCUIT VALUES

Grid No. 1 Circuit Resistance.....	1.5 Megohms Max
------------------------------------	--------------------

NOTES:

1. Visual extinction of focused raster. Extinction of the stationary focused spot will require that these values be about 5 volts more negative.
2. For JETEC focusing coil 109 or equivalent three inches from reference line, bias adjusted to 20 foot lamberts on a 24 x 18½ inch picture area.

27RP4

The Sylvania Type 27RP4 is identical to Type 27EP4 except for having an external conductive coating which must be grounded.

External Conductive Coating to Anode Capacitance.....	
Maximum.....	750 μμf
Minimum.....	500 μμf
Basing.....	12N

WARNING

X-ray radiation shielding may be necessary to protect against possible danger of personal injury from prolonged exposure at close range if this tube is operated at higher than the manufacturer's Maximum Rated Anode Voltage or 16,000 volts, whichever is less.

SYLVANIA TYPE 27GP4

TELEVISION PICTURE TUBE

27" Direct Viewed Magnetic Deflection
 Rectangular Glass Type Magnetic Focus
 Gray Filter Glass Spherical Faceplate
 Single Field Ion Trap

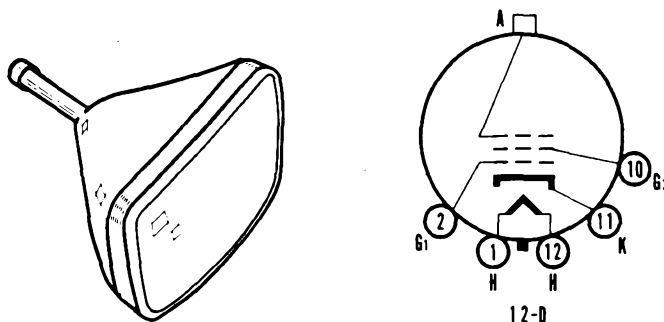

CHARACTERISTICS

GENERAL DATA

Focusing Method.....	Magnetic
Deflecting Method.....	Magnetic
Deflecting Angle (approx.).....	
Horizontal.....	85 Degrees
Diagonal.....	90 Degrees
Phosphor.....	P4
Fluorescence.....	White
Persistence.....	Medium
Faceplate.....	Gray Filter Glass
Light Transmittance (approx.).....	68 Percent

ELECTRICAL DATA

Heater Voltage.....	6.3 Volts
Heater Current (approx.).....	0.6 Ampere
Direct Interelectrode Capacitances (approx.).....	
Cathode to All Other Electrodes.....	5 $\mu\mu\text{f}$
Grid No. 1 to All Other Electrodes.....	6 $\mu\mu\text{f}$
Ion Trap Magnet.....	External, Single Field Type

MECHANICAL DATA

Minimum Useful Screen Dimensions.....	24 $\frac{1}{4}$ x 18 $\frac{1}{2}$ Inches
Bulb Contact (Recessed Small Cavity Cap).....	J1-21
Base (Small Shell Duodecal 5-Pin).....	B5-57
Basing.....	12D

RATINGS

MAXIMUM RATINGS (Design Center Values)

Anode Voltage.....	22500 Volts d c
Grid No. 2 Voltage.....	500 Volts d c
Grid No. 1 Voltage.....	
Negative Bias Value.....	125 Volts d c
Positive Bias Value.....	0 Volts d c
Positive Peak Value.....	2 Volts
Peak Heater-Cathode Voltage.....	
Heater Negative with Respect to Cathode.....	
During Warm-up Period Not to Exceed 15 Seconds.....	410 Volts
After Equipment Warm-up Period.....	180 Volts
Heater Positive with Respect to Cathode.....	180 Volts

RECOMMENDED OPERATING CONDITIONS

Anode Voltage.....	20000 Volts d c
Grid No. 2 Voltage.....	300 Volts d c
Grid No. 1 Voltage Required for Cutoff ¹	-28 to -72 Volts d c
Focusing Coil Current (approx.) ²	125 \pm 20% Ma d c
Ion Trap Magnet Strength (approx.).....	40 Gauss

CIRCUIT VALUES

Grid No. 1 Circuit Resistance.....	1.5 Megohms Max
------------------------------------	--------------------

27GP4 (Cont'd)

NOTES:

1. Visual extinction of focused raster. Extinction of the stationary focused spot will require that these values be about 5 volts more negative.
2. For JETEC focusing coil No. 109 or equivalent 3 inches from reference line bias adjusted to 20 foot lamberts on a 24¼ x 18½ inch picture area.

WARNING

X-ray radiation shielding may be necessary to protect against possible danger of personal injury from prolonged exposure at close range if this tube is operated at higher than the manufacturer's Maximum Rated Anode Voltage or 16,000 volts, whichever is less.

SYLVANIA TYPE 27LP4

Silver Screen "85"

TELEVISION PICTURE TUBE

27" Direct Viewed	Magnetic Deflection
Rectangular Glass Type	Magnetic Focus
Gray Filter Glass	Spherical Faceplate
External Conductive Coating	Single Field Ion Trap
Aluminized Screen	

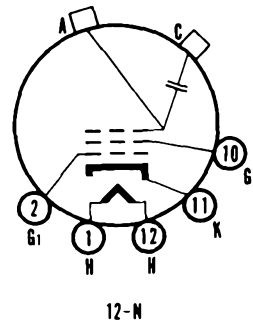
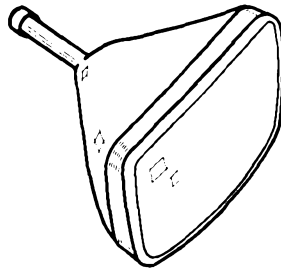

CHARACTERISTICS

GENERAL DATA

Focusing Method.....	Magnetic
Deflecting Method.....	Magnetic
Deflecting Angle (approx.)	
Horizontal.....	85 Degrees
Diagonal.....	90 Degrees
Phosphor.....	P4
Fluorescence.....	White
Persistence.....	Medium
Faceplate.....	Gray Filter Glass

ELECTRICAL DATA

Heater Voltage.....	6.3 Volts
Heater Current (approx.).....	0.6 Ampere
Direct Interelectrode Capacitances (approx.)	
Cathode to All Other Electrodes.....	5.0 $\mu\mu\text{f}$
Grid No. 1 to All Other Electrodes.....	6.0 $\mu\mu\text{f}$
External Conductive Coating to Anode ¹	400 $\mu\mu\text{f}$ Max 250 $\mu\mu\text{f}$ Min
Ion Trap Magnet.....	External, Single Field Type

MECHANICAL DATA

Minimum Useful Screen Dimensions.....	23 ¹ / ₃₂ x 18 ¹ / ₃₂ Inches
Bulb Contact (Recessed Small Cavity Cap).....	J1-21
Base (Small Shell Duodecal 5-Pin).....	B5-57
Basing.....	12N

27LP4 (Cont'd)

RATINGS

MAXIMUM RATINGS (Design Center Values)

Anode Voltage.....	22000 Volts d c
Grid No. 2 Voltage.....	600 Volts d c
Grid No. 1 Voltage.....	
Negative Bias Value.....	125 Volts d c
Positive Bias Value.....	0 Volts d c
Positive Peak Value.....	2 Volts
Peak Heater-Cathode Voltage.....	
Heater Negative with Respect to Cathode.....	
During Warm-up Period Not to Exceed 15 Seconds.....	410 Volts
After Equipment Warm-up Period.....	180 Volts
Heater Positive with Respect to Cathode.....	180 Volts

RECOMMENDED OPERATING CONDITIONS

Anode Voltage.....	20000 Volts d c
Grid No. 2 Voltage.....	300 Volts d c
Grid No. 1 Voltage Required for Cutoff ²	-28 to -72 Volts d c
Focusing Coil Current (approx.) ³	148 Ma d c
Ion Trap Magnet Strength (approx.).....	40 Gauss

CIRCUIT VALUES

Grid No. 1 Circuit Resistance.....	1.5 Megohms Max
------------------------------------	--------------------

NOTES:

1. Conductive coating must be grounded.
2. Visual extinction of focused raster. Extinction of the stationary focused spot will require that these values be about 5 volts more negative.
3. For JETEC focusing coil No. 109 or equivalent.

WARNING

X-ray radiation shielding may be necessary to protect against possible danger of personal injury from prolonged exposure at close range if this tube is operated at higher than the manufacturer's Maximum Rated Anode Voltage or 16,000 volts, whichever is less.

SYLVANIA TYPE 27NP4

TELEVISION PICTURE TUBE

27" Direct Viewed	Magnetic Deflection
Rectangular Glass Type	Magnetic Focus
Gray Filter Glass	Spherical Faceplate
External Conductive Coating	Single Field Ion Trap

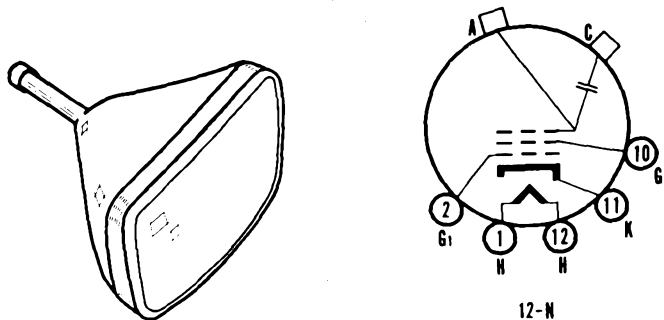

27NP4 (Cont'd)

CHARACTERISTICS

GENERAL DATA

Focusing Method.....	Magnetic
Deflecting Method.....	Magnetic
Deflecting Angle (approx.).....	
Horizontal.....	85 Degrees
Diagonal.....	90 Degrees
Phosphor.....	P4
Fluorescence.....	White
Persistence.....	Medium
Faceplate.....	Gray Filter Glass
Light Transmittance (approx.).....	68 Percent

ELECTRICAL DATA

Heater Voltage.....	6.3 Volts
Heater Current (approx.).....	0.6 Ampere
Direct Interelectrode Capacitances (approx.).....	
Cathode to All Other Electrodes.....	5 μf
Grid No. 1 to All Other Electrodes.....	6 μf
External Conductive Coating to Anode ¹	750 μf Max
	500 μf Min
Ion Trap Magnet.....	External, Single Field Type

MECHANICAL DATA

Minimum Useful Screen Dimensions.....	24 $\frac{1}{4}$ x 18 $\frac{1}{2}$ Inches
Bulb Contact (Recessed Small Cavity Cap).....	J1-21
Base (Small Shell Duodecal 5-Pin).....	B5-57
Basing.....	12N

RATINGS

MAXIMUM RATINGS (Design Center Values)

Anode Voltage.....	18000 Volts d c
Grid No. 2 Voltage.....	500 Volts d c
Grid No. 1 Voltage.....	
Negative Bias Value.....	125 Volts d c
Positive Bias Value.....	0 Volts d c
Positive Peak Value.....	2 Volts
Peak Heater-Cathode Voltage.....	
Heater Negative with Respect to Cathode.....	
During Warm-up Period Not to Exceed 15 Seconds.....	410 Volts
After Equipment Warm-up Period.....	180 Volts
Heater Positive with Respect to Cathode.....	180 Volts

RECOMMENDED OPERATING CONDITIONS

Anode Voltage.....	16000 Volts d c
Grid No. 2 Voltage.....	300 Volts d c
Grid No. 1 Voltage Required for Cutoff ²	-28 to -72 Volts d c
Focusing Coil Current (approx.) ³	95 \pm 20% Ma d c
Ion Trap Magnet Strength (approx.).....	35 Gauss

CIRCUIT VALUES

Grid No. 1 Circuit Resistance.....	1.5 Megohms
	Max

NOTES:

1. Conductive coating must be grounded.
2. Visual extinction of focused raster. Extinction of the stationary focused spot will require that these values be about 5 volts more negative.
3. For JETEC focusing coil 109 or equivalent 3 inches from reference line, bias adjusted to 20 foot lamberts on a 24 $\frac{1}{4}$ x 18 $\frac{1}{2}$ inch picture area.

WARNING

X-ray radiation shielding may be necessary to protect against possible danger of personal injury from prolonged exposure at close range if this tube is operated at higher than the manufacturer's Maximum Rated Anode Voltage or 16,000 volts, whichever is less.

SYLVANIA TYPE 27SP4

TELEVISION PICTURE TUBE

27" Direct Viewed	Magnetic Deflection
Rectangular Glass Type	Electrostatic Focus
Gray Filter Glass	Spherical Faceplate
External Conductive Coating	Single Field Ion Trap
Aluminized Screen	

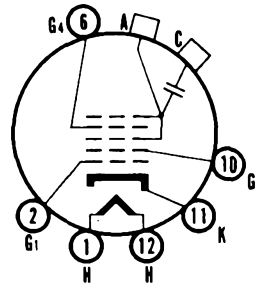
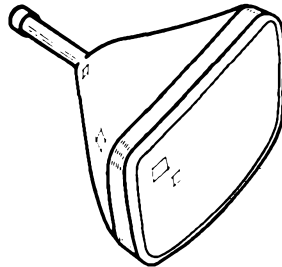

12-L

CHARACTERISTICS

GENERAL DATA

Focusing Method.....	Electrostatic
Deflecting Method.....	Magnetic
Deflecting Angle (approx.)	
Horizontal.....	85 Degrees
Diagonal.....	90 Degrees
Phosphor.....	P4
Fluorescence.....	White
Persistence.....	Medium
Faceplate.....	Gray Filter Glass
Light Transmittance (approx.).....	68 Percent

ELECTRICAL DATA

Heater Voltage.....	6.3 Volts
Heater Current (approx.).....	0.6 Ampere
Direct Interelectrode Capacitances (approx.)	
Cathode to All Other Electrodes.....	5 μ f
Grid No. 1 to All Other Electrodes.....	6 μ f
External Conductive Coating to Anode ¹	750 μ f Max 500 μ f Min
Ion Trap Magnet.....	External, Single Field Type

MECHANICAL DATA

Minimum Useful Screen Dimensions.....	24 x 18½ Inches
Bulb Contact, (Recessed Small Cavity Cap).....	J1-21
Base (Small Shell Duodecal 6-Pin).....	B6-63
Basing.....	12L

RATINGS

MAXIMUM RATINGS (Design Center Values)

Anode Voltage.....	20000 Volts d c
Grid No. 4 Voltage (Focusing Electrode).....	-500 to +1000 Volts d c
Grid No. 2 Voltage.....	500 Volts d c
Grid No. 1 Voltage.....	
Negative Bias Value.....	125 Volts d c
Positive Bias Value.....	0 Volts d c
Positive Peak Value.....	2 Volts
Peak Heater-Cathode Voltage	
Heater Negative with Respect to Cathode	
During Warm-up Period Not to	
Exceed 15 Seconds.....	410 Volts
After Equipment Warm-up Period.....	180 Volts
Heater Positive with Respect to Cathode.....	180 Volts

27SP4 (Cont'd)

RECOMMENDED OPERATING CONDITIONS

Anode Voltage	18000 Volts d c
Grid No. 4 Voltage.....	-72 to +396 Volts d c
Grid No. 2 Voltage.....	300 Volts d c
Grid No. 1 Voltage Required for Cutoff ²	-28 to -72 Volts d c
Ion Trap Magnet Strength (approx.).....	40 Gausses

CIRCUIT VALUES

Grid No. 1 Circuit Resistance.....	1.5 Megohms Max
------------------------------------	--------------------

NOTES:

1. External conductive coating must be grounded.
2. Visual extinction of focused raster. Extinction of the stationary focused spot will require that these values be about 5 volts more negative.

WARNING

X-ray radiation shielding may be necessary to protect against possible danger of personal injury from prolonged exposure at close range if this tube is operated at higher than the manufacturer's Maximum Rated Anode Voltage or 16,000 volts, whichever is less.

"SILVER SCREEN 85"

CROSS REFERENCE CHART

This cross reference chart is designed to tabulate the features of 30 types of "Silver Screen 85" Aluminized Television Picture Tubes which will replace 98 popular types. Only minor changes, if any, are required in making the replacement.

These Silver Screen 85 Types	Replace These Original Types	SILVER SCREEN 85 TYPES HAVE						Replacement Note See Below
		Ion Trap N-None S-Single	External Conductive Coating	Spherical Face Plate	Cylindrical Face Plate	Magnetic Focus	Electrostatic Focus	
12KP4A	12KP4 12KP4A 12QP4 12QP4A 12RP4	N	X	X		X		1 1 2 2 2
16KP4A	16KP4 16KP4A 16QP4 16RP4 16TP4 16XP4	S	X	X		X		1 1 4 3 8 4
17AVP4A	17AVP4 17AVP4A	S	X	X			X	1 1
17BP4B	17BP4 17BP4A 17BP4B 17BP4C 17JP4	S	X	X		X		5 1 1 1 1 6
17HP4B	17HP4 17HP4A 17HP4B 17RP4	S	X	X			X	1 1 1 1 1
17LP4A	17LP4 17LP4A 17VP4	S	X		X		X	1 1 1
20CP4B	20CP4 20CP4B 20CP4C	S		X		X		1 1 1
20CP4D	20CP4A 20CP4D	S	X	X		X		1 1
20DP4B	20DP4 20DP4B	S		X		X		1 1
20DP4C	20DP4A 20DP4C	S	X	X		X		1 1
20HP4C	20HP4 20HP4B 20HP4C	S		X			X	1 1 1
20HP4D	20HP4A 20HP4D 20MP4 20LP4	S	X	X			X	1 1 1 1
21ACP4A/ 21AMP4A	21ACP4 21ACP4A 21AMP4 21AMP4A 21AQP4 21AQP4A	S	X	X		X		1 1 1 1 5 5

- NOTES:—1. Usual Installation Adjustments. 5. Ground Conductive Coating.
 2. Ground Conductive Coating, Remove Ion Trap. 6. Do Not Exceed Voltage Rating.
 3. Check Contact To Conductive Coating. 7. Add Filter Capacitor.
 4. Ground Conductive Coating, Change Ion Trap. 8. If Physical Space Permits.

Chart Continued—Over

"SILVER SCREEN 85"

CROSS REFERENCE CHART

This cross reference chart is designed to tabulate the features of 30 types of "Silver Screen 85" Aluminized Television Picture Tubes which will replace 98 popular types. Only minor changes, if any, are required in making the replacement.

These Silver Screen 85 Types	Replace These Original Types	SILVER SCREEN 85 TYPES HAVE						Replacement Note See Below
		Ion Trap N-None S-Single	External Conductive Coating	Spherical Face Plate	Cylindrical Face Plate	Magnetic Focus	Electrostatic Focus	
21ALP4A/B	21ALP4 21ALP4A 21ALP4B 21ANP4 21ANP4A	S	X	X			X	1 1 5 5
21ATP4	21ATP4	S	X	X			X	1
21AUP4A/B	21AUP4 21AUP4A 21AUP4B	S	X	X			X	1 1 1
21AVP4A/B	21AVP4 21AVP4A 21AVP4B	S	X	X			X	1 1 1
21AWP4	21AWP4	S	X	X		X		1
21EP4B	21EP4 21EP4A 21EP4B	S	X		X	X		5 1 1
21FP4C	21FP4 21FP4A 21FP4C	S	X		X		X	5 1 1
21WP4A	21WP4 21WP4A	S	X	X		X		1 1
21XP4A	21ASP4 21AYP4 21XP4 21XP4A	S	X	X			X	5 1 1 1
21YP4A	21AFP4 21YP4 21YP4A	S	X	X			X	5 1 1
21ZP4B	21ZP4 21ZP4A 21ZP4B	S	X	X		X		5 1 1
24CP4A	24CP4 24CP4A 24QP4 24TP4 24XP4	S	X	X		X		1 1 1 1 5
24DP4A	24DP4 24DP4A	S	X	X			X	1 1
24VP4A	24VP4 24VP4A	S	X	X		X		1 1
24YP4	24YP4	S	X	X			X	1
27EP4	27EP4 27GP4 27NP4	S		X		X		1 1 7
27RP4	27GP4 27NP4 27RP4	S	X	X		X		5 1 1

- NOTES:—1. Usual Installation Adjustments. 5. Ground Conductive Coating.
 2. Ground Conductive Coating, Remove Ion Trap. 6. Do Not Exceed Voltage Rating.
 3. Check Contact To Conductive Coating. 7. Add Filter Capacitor.
 4. Ground Conductive Coating, Change Ion Trap. 8. If Physical Space Permits.

SYLVANIA PICTURE TUBES

INDEX FOR SPECIAL PURPOSE SECTION

Crystal Diodes	1-5
Crystal Diode Replacement Guide	6-7
Gas Control Types	9
Industrial Types	20-21
Receiving and Miscellaneous Types	13-15
Subminiature Receiving Types	10-12
Transmitting Types	16-19
Voltage Regulators	8

Types	Pages	Types	Pages	Types	Pages
OA2	8S	1N110	7S	807	16S
OA3/VR75	8S	1N111	3S,7S	807W	16S
OA4G	9S	1N112	4S,7S	807Y	17S
OA5	9S	1N113	4S,7S	810	17S
OB2	8S	1N114	4S,7S	811A	17S
OB3/VR90	8S	1N115	4S,7S	812A	17S
OC3/VR105	8S	1N116	7S	813	17S,20S
OD3/VR150	8S	1N119	4S,7S	815	18S
1AC5	10S	1N120	4S,7S	816	18S
1AD5	10S	1N124	7S	829B	18S,20S
1C8	10S	1N124A	7S	832A	18S
1D3	10S	1N126	7S	866A	18S
1E8	10S	1N127	7S	872A	18S
1N34	1S,6S	1N128	7S	884	9S
1N34A	1S,6S	1N132	4S,7S	885	9S
1N35	1S,6S	1N133	7S	892	20S
1N38	1S,6S	1N135	7S	1222	14S
1N38A	1S,6S	1N147	7S	1229	14S
1N39	1S,6S	1N172	4S,7S	1236A	8S
1N39A	1S,6S	1N193	4S	1247	11S
1N40	1S,6S	1N194	4S	1265	8S
1N41	1S,6S	1N195	5S	1273	14S
1N42	1S,6S	1N196	5S	1280	14S
1N43	6S	1S6	10S	2050	9S,21S
1N44	6S	1T6	10S	5550/681	20S
1N45	6S	1V5	10S	5551A	20S
1N46	6S	1W5	10S	5552A	20S
1N47	6S	2A4G	9S	5553B/655	20S
1N48	6S	2B5	10S	5636	11S
1N51	6S	2D21	9S	5639	11S
1N52	6S	2E24	16S	5641	11S
1N54	1S,6S	2E26	16S	5642	11S
1N54A	2S,6S	2E30	16S	5643	11S
1N55	2S,6S	2X2A	13S	5644	11S
1N55A	2S,6S	3A4	13S,16S	5647	11S
1N55B	6S	3A5	13S,16S	5654/6AK5W	14S
1N56	2S,6S	5R4GY	13S	5679	14S
1N56A	2S,6S	6AD4	10S	5685	21S
1N57	6S	6AJ5	13S	5718	11S
1N58	2S,6S	6AK4	10S	5719	11S
1N58A	2S,6S	6AN6	13S	5722	14S
1N59	2S,6S	6AS6	13S	5726/6AL5W	14S
1N59A	2S	6AS7G	13S	5749/6BA6W	15S
1N60	2S,6S	6AZ5	11S	5751	15S
1N63	2S,6S	6BA5	11S	5763	18S
1N64	6S	6BF7W	11S	5796	21S
1N65	2S,6S	6D4	9S	5814A	15S
1N66	6S	6J4	13S	5840	11S
1N67	3S,6S	6J7WGT	13S	5845	15S
1N67A	6S	6L6GAY	13S	5896	11S
1N68	6S	6SA7GT	13S	5899	12S
1N68A	6S	6SK7GT	13S	5902	12S
1N69	3S,6S	6SL7WGT	13S	5906	12S
1N70	3S,6S	6SN7WGT	13S	5931	15S
1N71	3S,6S	6SS7GT	13S	5932	15S
1N72	6S	6V6GT	13S	5933	19S
1N73	6S	6X5WGT	13S	5977	12S
1N74	6S	7AK7	14S	5987	12S
1N75	6S	12AY7	14S	6021	12S
1N77	6S	25A7GT	14S	6110	12S
1N77A	3S,6S	26D6	14S	6111	12S
1N81	3S,6S	28D7	14S	6112	12S
1N82	3S,6S	28D7W	14S	6146	19S
1N82A	3S,6S	579B	21S	6159	19S
1N86	7S	632B	21S	6205	12S
1N87	7S	672A	21S	6206	12S
1N88	7S	676	21S	9001	15S
1N89	7S	677	21S	9002	15S
1N90	7S	678	21S	9003	15S
1N105	3S,7S	801A	16S	X6030	15S
1N109	3S,7S				

SPECIAL PURPOSE TUBES

(We suggest that you place this divider between the last picture tube page and the first special purpose tube page.)

APPENDIX

FUNDAMENTAL PROPERTIES OF VACUUM TUBES

The major dynamic operating characteristics of a vacuum tube can be expressed in terms of the amplification factor (μ), the dynamic plate resistance (r_p) and the transconductance (g_m). When they are known, quantitative calculations may be made of tube performance under many conditions.

These properties are interrelated as follows:

$$\mu = r_p g_m$$

The **amplification factor** is defined as the ratio of a small change in plate voltage to a corresponding change in grid voltage necessary to keep the plate current constant.

$$\text{Then: } \Delta E_b = \mu \Delta E_g$$

The **dynamic plate resistance** (r_p) may be defined as the ratio of a small change in plate voltage to a corresponding small change in plate current produced, with grid voltage remaining constant. It represents the resistance between cathode and plate to alternating current.

The **transconductance** (g_m) is the ratio of a change in plate current with respect to a change in grid voltage when the other voltages remain constant. The unit of transconductance is the mho (ohm spelled backward), but as this is a large unit for application to vacuum tubes, the one millionth part of a mho, or μmho , is generally used.

Direct Interelectrode Capacitances are measured in vacuum tubes rather than total capacitances which are the sum of two or more direct capacitances, so that their effect on circuit operation may be estimated.

It is standard practice to connect all metal parts except input and output electrodes to the cathode unless otherwise specified. These parts include external and internal shields, base sleeves, unused pins, etc., but do not include inactive section(s) of multiplex tubes—these are connected to ground.

**TABLE OF CONNECTIONS OF ELECTRODES OF TUBE
SECTIONS FOR MEASURING DIRECT INTER-
ELECTRODE CAPACITANCES**

Capacitance	Measure Between	Ground
INDIRECTLY HEATED CATHODE TYPES		
Heater-Cathode	Heater and Cathode	All other electrodes
DIODE TYPES		
Input	Plate and (cathode + fil. + shields, etc.)	Other Sections
TRIODE, TETRODE PENTODE TYPES		
Grid-Plate	Grid and plate (C _{gp})	All other electrodes
Input	Grid and (cathode + fil. + screen + shields, etc.)	Plates, diodes, inactive section
Output	Plate and (cathode + fil. + screen + shields, etc.)	Grid, diode, inactive section(s)
Input (Grounded Grid) (Receiving Tubes ONLY)	Cathode and (grid + fil. + screen + shields, etc.)	Plate, diodes inactive section(s)
Output (Grounded Grid) (Receiving Tubes ONLY)	Plate and (Grid + fil. + screen + shields, etc.)	Cathode, diode inactive section(s)

TABLE OF CONNECTIONS OF ELECTRODES OF TUBE SECTIONS FOR MEASURING DIRECT INTER-ELECTRODE CAPACITANCES

Capacitance	Measure Between	Ground
CONVERTER TYPES		
R F Input	Signal grid and all other electrodes	
Mixer Output	Mixer plate and all other electrodes	
Osc. Input	Osc. grid and (Cathode + fil. + shields, etc.)	Osc. plate + other section(s)
Osc. Output	Osc. plate and (cathode + fil. + shields, etc.)	Osc. grid and other section(s)

Useful References

- IRE 7. S1 Standards on Electron Tubes:
Definition of Terms, 1950
- ASA C60.6-1952 and RETMA ET-109A Direct Interelectrode Capacitance, Measurement of
- ASA C60.5-1952 and IRE 7. S2 Electron Tubes, Methods of Testing

VACUUM TUBE RATINGS

At the present time, there are two general types of ratings used in the field of receiving type vacuum tubes. These ratings are normally referred to as Design Center and Absolute Maximum ratings. Commercial receiving types normally carry a Design Center rating, while government and some special purpose types may carry an Absolute Maximum rating.

A rating is a statement giving the limiting value of a tube parameter beyond which the performance and/or life of a tube will be deleteriously affected; or it is a statement giving the value of a tube parameter under certain operating conditions.

In the **Design Center system**, the maximum rating is based on the performance of a homogeneous lot (at center supply voltage) of tubes operating so that a tube having centered characteristics will be run at the rated maximum. This, of course, means that some tubes will be operating under the rating while others will be operating above the rating. The data substantiating the rating must, of course, include all tubes from the minimum to the maximum. Providing the circuit parameters are so adjusted as to assure that the average tube does not exceed the allowable maximum under nominal line conditions, satisfactory tube life may, in general, be expected. For more detailed information, see RETMA Engineering Standard M8-210.

The **Absolute Maximum system** makes no allowance for the normal spread of tube characteristics and merely states that under no circumstances should any tube exceed the rating. This puts the burden of proof on the circuit designer to make certain that the maximum is not exceeded for any tube under any circumstance.

Vacuum tube specifications set forth the allowable characteristic spreads and inspection instructions, of which the best known are the military services' MIL-E-1B specifications for JAN tubes. The most desirable situation would be one where each tube was tested in all applications and accepted or rejected upon its operational function. As this is impossible, the tube is tested to a specification which, to the specification engineer's best knowledge, will assure satisfactory performance in the majority of applications and is still realistic from a tube production standpoint.

Useful References

- RETMA Engineering Standard M8-210,
- RETMA Engineering Standard ET-107:
Test Methods and Procedures for Radio Receiving Tubes
- IRE 7. S2 Standards on Electron Tubes:
Methods of Testing, 1950.
- MIL-E-1B Specifications—Basic Section.

VACUUM TUBE RATINGS FOR TELEVISION APPLICATIONS

Television receiver sweep circuits require classes of tube operation and ratings uncommon to other applications. These ratings and their relationship to the ratings established for Class A operation are outlined below.

I. HORIZONTAL DEFLECTION AMPLIFIERS

- (a) **Maximum D C Plate Voltage.** This rating is generally expressed as the sum of the d c power supply voltage and boost voltage.
- (b) **Maximum Peak Positive Pulse Plate Voltage.** This rating is based on actual voltage breakdown considerations at the frequency, duty cycle and supply impedances of the horizontal amplifier stage. This value is expressed as an absolute maximum.
- (c) **Maximum Peak Negative Pulse Plate Voltage.** This rating is intended to protect the tube from failure caused by plate emission at the time the plate swings negative with respect to cathode.
- (d) **Maximum Peak Negative Grid No. 1 Voltage.** The peak negative grid No. 1 voltage rating is based upon grid to cathode leakage considerations and application requirements.
- (e) **Maximum Plate Dissipation.** The maximum plate dissipation rating is determined on the same basis used for establishing the plate dissipation rating for Class A service. The measurement of plate dissipation when the tube is used as a horizontal deflection amplifier is difficult. Comparison methods are considered acceptable. Comparison methods are defined as those in which the temperature of the plate or a factor which is a function of the temperature of the plate is first measured operationally. The plate dissipation is then determined by the static power input to the plate necessary to duplicate temperature, or other factors so measured holding other elements and ambient temperature at the operational value.
- (f) **Maximum Average Cathode Current.** This rating is based on the same considerations as those used in establishing the maximum average cathode current for Class A service.
- (g) **Maximum Peak Cathode Current.** This rating is a multiple of the average cathode current rating, based on application requirements, with due consideration given to cathode capabilities at the typical duty cycle and the repetition rate encountered in this service.
- (h) **Maximum Grid No. 1 Circuit Resistance.** The value of Grid No. 1 circuit resistance is based upon the requirements of the application and limitations of the tube with respect to gas and grid emission.

II. VERTICAL DEFLECTION AMPLIFIERS

- (a) **Maximum D C Plate Voltage.** The maximum d c plate voltage rating is determined on the same basis as used for establishing the maximum d c plate voltage rating for Class A service.
- (b) **Maximum Peak Positive Pulse Plate Voltage.** This rating is

based on actual voltage breakdown, considerations at the typical duty cycle and supply impedances of the vertical amplifier stage. This rating is expressed as an absolute maximum.

- (c) **Maximum Peak Negative Pulse Grid No. 1 Voltage.** This rating is based upon grid-cathode leakage and application requirements.
- (d) **Maximum Plate Dissipation.** This rating is determined on the same basis as used for establishing plate dissipation ratings for Class A service as defined under l(e).
- (e) **Maximum Average Cathode Current.** This rating is based on the same considerations as those used in establishing the maximum average cathode current for Class A service.
- (f) **Maximum Peak Cathode Current.** This rating is based on application requirements with due consideration being given to the limitations of the cathode at the duty cycle and repetition rate encountered in this service.
- (g) **Maximum Grid No. 1 Circuit Resistance.** The maximum grid No. 1 circuit resistance rating is based on the requirements of the application and the limitations of the tube with respect to gas and grid emission.

III. HORIZONTAL AND VERTICAL DEFLECTION OSCILLATORS

- (a) **Maximum D C Plate Voltage.** The maximum d c plate voltage rating is determined on the same basis as used for establishing the maximum d c plate voltage rating for Class A service.
- (b) **Maximum Plate Dissipation.** This rating is determined on the same basis as used for establishing plate dissipation ratings for Class A service as defined under l(e).
- (c) **Maximum Average Cathode Current.** This rating is based on the same considerations as those used in establishing the maximum average cathode current for Class A service.
- (d) **Maximum Peak Cathode Current.** This rating is a multiple of the average cathode current rating based on application requirements with due consideration given to cathode capabilities at the typical duty cycle and repetition rate encountered in this service.
- (e) **Maximum Grid No. 1 Circuit Resistance.** The value of Grid No. 1 circuit resistance is based upon the requirements of the application and limitations of the tube with respect to gas and grid emission.

IV. DAMPERS

- (a) **Maximum Peak Inverse Plate Voltage Rating.** This rating is based on actual voltage breakdown at the typical duty cycle frequency and supply impedances encountered in the horizontal deflection circuit. This rating is shown as an absolute maximum value.
- (b) **Maximum Heater Cathode Voltage.** When the heater is operated negative with respect to cathode, most damping diodes are capable of withstanding high voltages between the heater and cathode. The values shown for heater negative with re-

spect to cathode include the d c, and total d c and peak values based on actual breakdown considerations.

For heater positive with respect to cathode the permissible heater-cathode voltage is comparative in magnitude to that of other types.

- (c) **Maximum D C Plate Current.** This rating is based on capabilities of the cathode.
- (d) **Maximum Peak Plate Current.** This rating is based on cathode capabilities for this service.
- (e) **Maximum Plate Dissipation Rating** The maximum plate dissipation rating is based on the physical limitations of the tube and is determined in application by comparison methods as outlined in 1(e).

NOTE: Power rectifier ratings are not included for damping diodes. The high plate supply impedance required to limit steady state peak plate current and the plate dissipation to rated values makes such usage impractical.

RECEIVING TUBE SCREEN VOLTAGE RATINGS*

The voltage for the screen of a tube may be obtained from either a fixed source or through a screen dropping resistor. A voltage source is considered "fixed" if the regulation is such that no significant change in voltage takes place with variations in current.

The tube data sheets may show a maximum screen voltage, or a maximum screen supply voltage. When a maximum screen voltage is shown, the voltage measured at the screen terminal should not exceed such value under any circuit operating condition. When a maximum screen supply voltage is shown the screen voltage may be permitted to reach the rated supply voltage provided that the screen dissipation (screen current in amperes multiplied by the voltage appearing directly at the screen terminal) is held within certain specified values as indicated in Chart A.

CHART A

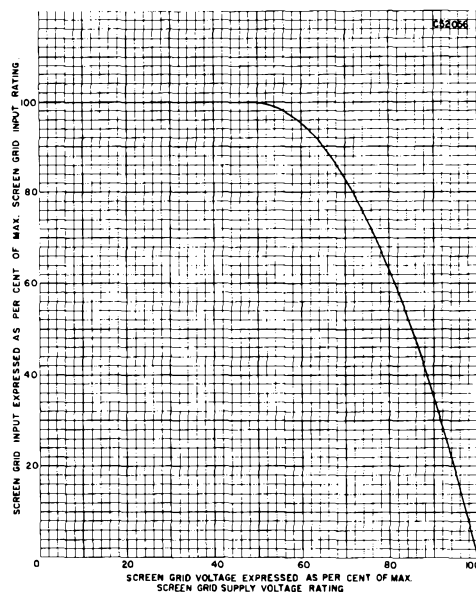

The chart represents the maximum permissible screen dissipation (as a percent of the maximum screen dissipation rating) at any screen voltage operating point. The chart shows that full rated screen dissipation is permissible up to 50% of the maximum rated screen supply voltage. From the 50% point to the full value of rated supply voltage the decrease in the allowable screen dissipation follows a curve of the parabolic form. The chart is of universal use for cases where either a fixed screen voltage or a series screen dropping resistor is used.

In the case where fixed screen applied voltage is desired it is necessary only to determine that the screen dissipation is within the boundary of the chart at the screen voltage to be used. In the case where a screen voltage dropping resistor is to be used it is necessary to determine the resistor value such that the dissipation in the screen grid is again within the same boundary of the chart. It is to be noted that the minimum value of the voltage dropping resistor is given by the factor.

$$\frac{E_{cc2}^2}{4 P_{g2}}$$

where E_{cc2} is the selected screen supply voltage and P_{g2} is the maximum screen dissipation rating for the type.

To illustrate the use of the chart, let it be assumed that the tube data for a type stipulate ratings of 300 volts maximum screen supply voltage, and 1.0 watt maximum screen dissipation. If it is desired to operate the tube at 200 volts (66 $\frac{2}{3}$ % of the maximum screen supply voltage rating) applied directly to the screen, the maximum allowable screen dissipation at this point (refer to Chart A) is 88% of the maximum screen dissipation, or 0.88 watt.

On the other hand, if it is desired to operate the same tube with a screen dropping resistor, the maximum screen voltage must not exceed the 300 volt rating, and the dropping resistor must be selected to hold the dissipation within the safe ratings. To assure that the tube will operate within the rating curve the dropping resistor can be determined from the formula

$$R_{c2} \geq \frac{E_{cc2}^2}{4 P_{g2}}$$

where R_{c2} is the screen dropping resistor (ohms),
 E_{cc2} is the selected screen supply voltage (volts),
 P_{g2} is the maximum screen dissipation rating (watts).

For example, if a screen supply voltage of 250 volts were selected for the above cited tube type

$$R_{c2} \geq \frac{250^2}{4 \times 1.0} = \frac{62500}{4} = 15625 \text{ ohms}$$

**This material was formulated by the Committee on Receiving Tubes of the Joint Election Tube Engineers Council and approved by the Council as JETEC Data.*

RECEIVING TUBE RECTIFIER RATINGS*

Ratings of rectifier tubes are based upon fundamental limitations in the operation of the tubes. In general, the limitations are peak inverse plate voltage, transient peak plate current, steady state peak plate current, D C output current, and (for types with indirectly heated cathodes) heater-cathode voltage. Maximum ratings for such parameters are included in the JETEC Tube Data. The various maximum ratings are generally not attainable simultaneously.

Certain of the limitations of operation are interrelated so that operation more lenient for one parameter will permit more severe conditions of operation in other respects. In order to define the boun-

daries of permissible operation, the JETEC Data for a rectifier type include a chart of the allowable DC load current per plate for values of RMS supply volts per plate up to the maximum rated value, for operation under conditions of either capacitor or choke input.

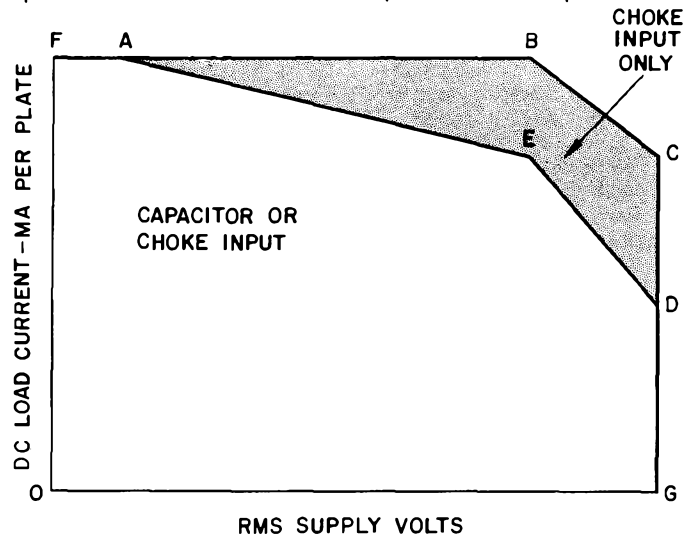

Where the tube is operated with choke input to the filter, the permissible DC Load Current vs RMS Supply Voltage operating point must fall within the area OFABCDGO. If capacitor input to the filter is used, the permissible DC Load Current vs RMS Supply Voltage operating point must fall within the area OFAEDGO.

**This material was formulated by the Committee on Receiving Tubes of the Joint Election Tube Engineers Council and approved by the Council as JETEC Data.*

SERIES STRING TELEVISION

Sylvania provides the set manufacturer with a complete line of tubes specifically designed for series string operation in television receivers.

As with radio receivers, the advantages of series heater operation include elimination of a transformer winding for the heater supply, with probable substitution of a voltage doubler rectifier circuit for the low voltage B supply winding. Thus, the power transformer can be eliminated altogether, if desired.

All the types included in the series string line incorporate 600 ma heaters, permitting series string operation without parallel networks.

To insure proper steady-state operating voltages, heater current production tolerances have been reduced from ± 50 ma for standard receiving tubes to ± 25 ma for all series string types. Slight variations in individual heater voltages will still be present in series strings. However, the magnitude of these variations should be relatively unimportant in properly designed circuits.

At present, the generally accepted method of controlling thermal characteristics in production is by a "heater warm-up time" test. In this test, the measured time is that required for a heater, originally at room temperature, to reach 80% of its rated heater voltage after four times the rated voltage is applied to the heater in series with a fixed resistor. The fixed resistor is specified as three times the hot resistance of the tube's heater. For all types included in the new line of 600 ma tubes, the heater warm-up time in the test described is approximately 11 seconds. This figure should not be confused with the time required for the receiver to become operative.

With respect to receiver warm-up time, tests on experimental models

employing new series string tubes and a fixed series resistor in place of a thermistor, have shown that a normal raster will appear 45 to 55 seconds after power is applied. This time is still somewhat longer than that required by a transformer type receiver. However, it represents approximately one-third the time required for stable operation of a receiver utilizing a thermistor.

Picture tubes for series heater strings have not been introduced as a separate line. Television picture tubes intended for transformer operation incorporate a design center heater current rating of 600 ma and have relatively high heater-cathode voltage ratings. Narrowing of heater current limits, in agreement with the newly developed receiving tubes (600 ± 25 ma) and control of thermal characteristics in production, provide the necessary protection against failure due to surge voltages or improper steady state voltage distribution.

Heater warm-up time is defined as the time required in the circuit shown below for the voltage across the heater terminals to increase from zero to the heater test voltage (V1). The conditions used in conjunction with the test circuit depend upon the rated heater voltage and current of the tube under test as indicated in the table which follows.

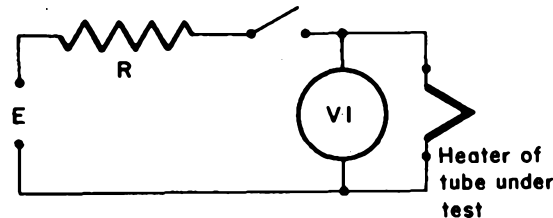

- E — Applied Voltage, R M S or D C
 R — Total Series Resistance
 V1 — Heater Test Voltage, R M S or D C ($V1 = 80\%$ of E_f)
 E_f — Rated Heater Voltage of Tube Under Test
 I_f — Rated Heater Current of Tube Under Test
 T — Approximate Warm-up Time in Seconds

TABLE I

E_f Volts	I_f Amperes	E Volts	R Ohms	V1 Volts	T
2.35	0.6	9.4	11.8	1.9	11.0
3.15	0.6	12.5	15.8	2.5	11.0
3.5	0.6	14.0	17.5	2.8	11.0
4.2	0.6	16.8	21.0	3.33	11.0
4.7	0.6	18.8	23.6	3.75	11.0
6.3	0.6	25.0	31.5	5.0	11.0
8.4	0.6	33.6	42.0	6.72	11.0
12.6	0.6	50.0	63.0	10.0	11.0
18.9	0.6	75.6	94.5	15.1	11.0
25.0	0.6	100.0	125.0	20.0	11.0
28.0	0.6	112.0	140.0	22.4	11.0

AMPLIFIER CLASSIFICATION

All radio receiving tubes except the rectifiers may be conveniently considered as amplifiers. Oscillators and detectors or frequency converters may be thought of as special cases of amplifiers in which use is made of the non-linear relations between the input voltages and output currents of the tube under consideration.

There are three major classes of amplifier service. Definitions describing these have been standardized by the Institute of Radio Engineers.

Class A Amplifier

A Class A, or Class A1, amplifier is one in which the grid bias and signal voltages are such that plate current in the tube, or in each tube of a push-pull stage flows at all times.

This is accomplished by operating at the center point of the plate current vs. grid voltage curve and using signal voltages which do not drive the grid into either the positive region or into the sharp bend near cut-off voltage.

Class A2 Amplifier

A Class A2 amplifier is the same as a Class A1 amplifier except that the signal may drive the grid into the positive region. This is accomplished by operating at a lower bias than the center point which would have been selected for class A operation.

Class B Amplifier

A Class B amplifier is an amplifier in which the grid bias is approximately equal to the cut-off value, so that the plate current is approximately zero when no signal voltage is applied and so that plate current in the tube or in each tube of a push-pull stage, flows for approximately one-half of each cycle when an alternating grid voltage is applied.

An important characteristic is that the grid circuit draws appreciable power which prevents it from being used with ordinary resistance coupled driver tubes.

Class AB1 Amplifier

A Class AB1 amplifier permits greater output to be obtained from small tubes, but requires push-pull operation to reduce distortion. It is characterized by operation at a higher bias than for Class A and uses a signal large enough to drive the grid into the cut-off region but not into the positive region.

Class AB2 Amplifier

A Class AB2 amplifier is the same as a Class AB1 above except that additional bias may be used, and the signal drives the grid into both the cut-off and grid current regions.

Class C Amplifier

A Class C amplifier is one in which the tubes operate at a bias much greater than cut-off voltage so that plate power is drawn only on the peaks of the signal voltage. It is not used in audio amplifiers because the distortion is too high but is the most efficient circuit for R. F. power amplifiers where the harmonics can be reduced by use of resonant circuits.

USE OF CURVES

The plate characteristic: The plate characteristic curves of a typical beam power tube are shown below in Fig. 1. These curves represent plate current plotted against plate voltage for specific values of grid bias and screen grid voltages. A group of such curves with various grid bias voltages is called a plate family. Plate characteristics are the most widely used since most of the other important tube characteristics may be derived from such a family of curves.

Curves shown in the tube manual represent average values and since variations occur from tube to tube during manufacturing processes, it is always advisable to leave a safety margin when using the curves for calculations.

In general, the plate characteristic is shown for only one value of screen grid voltage and various values of grid bias, although in some cases the curves are plotted using one value of grid bias for several different values of screen grid voltages. In the former case, if any other value of screen voltage is to be used then a new plate family must be plotted. Use of the tube manual curves necessitates applying the screen voltage shown on the graph.

An example will be shown here involving the use of plate character-

For Class A₁ Amplifier type of operation, it is not advisable to use a peak-to-peak grid driving signal greater than twice the bias at the operating point, otherwise the grid will be driven positive resulting in excessive distortion. The following calculations, therefore, will be based upon maximum signal conditions, or, in other words, the grid will be driven to zero but not beyond. The load line on the plate characteristic of Fig. 1 then is shown to extend from the $E_{c1} = 0$ Volts curve (Point A) down to the curve where $E_{c1} = -25$ V. (Point D). The range over which the tube operates is indicated and the values for $E_{min.}$, $E_{max.}$, and $I_{min.}$, $I_{max.}$ are located. These are the instantaneous minimum and maximum values of plate voltage and plate current reached over the complete cycle.

A simple but approximate means for calculating power output and second and third harmonic distortion is to use the five selected ordinate method. This method uses only five points on the load line and for the example here, three have already been located (A, O and D). The other two necessary points (B and C) are determined by formula (3).

$$(3) E_{c1} \text{ for } I_1 = 0.293 \text{ V.}$$

$$E_{c1} \text{ for } I_2 = 1.707 \text{ V.}$$

Where $V = E_{c1}$ at operating point

Formulas (4) to (8) may be used for calculating power output, distortion, and plate efficiency.

$$(4) \text{ Power Output} = \frac{R_L}{32} \left[\sqrt{2} (I_1 - I_2) + I_{max.} - I_{min.} \right]^2$$

$$(5) \% \text{ 2nd Harmonic Distortion} = \frac{I_{max.} + I_{min.} - 2 I_b}{I_{max.} - I_{min.} + \sqrt{2} (I_1 - I_2)} \times 100$$

$$(6) \% \text{ 3rd Harmonic Distortion} = \frac{I_{max.} - I_{min.} - \sqrt{2} (I_1 - I_2)}{I_{max.} - I_{min.} + \sqrt{2} (I_1 - I_2)} \times 100$$

$$(7) \% \text{ Total Harmonic Distortion} = \sqrt{(\% \text{ 2nd})^2 + (\% \text{ 3rd})^2}$$

$$(8) \text{ Plate Efficiency} = \frac{P_o}{P_{in}} \times 100 \text{ where } P_{in} = E_b I_b$$

The value of power output obtained from the formula given will be less than the published value since it does not include power supplied from the 3rd harmonic content.

By using the values from Figure 1 and the above formulas the following results are obtained:

$$\text{From (4) } P_o = 4.3 \text{ watts}$$

$$\text{From (5) } \% \text{ 2nd Harmonic Distortion} = 4.8\%$$

$$\text{From (6) } \% \text{ 3rd Harmonic Distortion} = 5.7\%$$

$$\text{Where } \begin{array}{ll} E_{max.} = 425 \text{ V.} & E_{min.} = 38 \text{ V.} \\ I_{max.} = 88 \text{ Ma.} & I_{min.} = 10 \text{ Ma.} \\ I_1 = 78 \text{ Ma.} & I_2 = 16 \text{ Ma.} \end{array}$$

The illustration on use of curves presented here assumes that (1) fixed bias is used, (2) the load is resistive, (3) that good screen and plate regulation are used, (4) that rectification effects are negligible, (5) that a high efficiency output transformer is used and has been selected to present the proper load to the tube, (6) that the voltage drop in the primary of the output transformer is negligible, (7) the applied signal is sinusoidal. Despite these assumptions, reasonably good approximations may be obtained about the performance of the tube described as Class A₁ audio power output amplifier. Figure 2 shows one possible power amplifier circuit that could be used for a beam power tube applicable to the example given. The power supplied to the speaker will be less than that calculated by the amount of transformer efficiency.

R_L = effective impedance of the load R_1 which is reflected back to the primary of the transformer and its value is:

$$(9) R_L = R_1 \left(\frac{N_1}{N_2} \right)^2$$

Where $\frac{N_1}{N_2}$ is the transformer (T) primary to secondary turns ratio, and R_1 is the loudspeaker load.

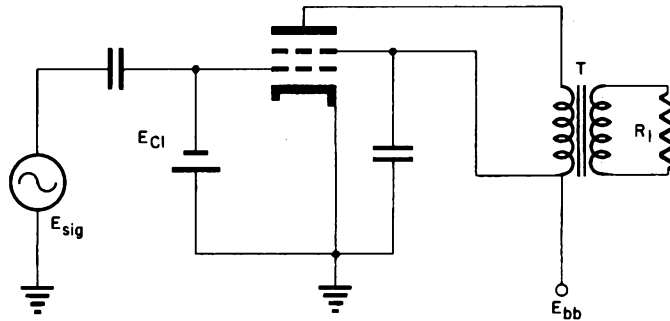

FIGURE 2

This illustration represents only one of the many possible uses for calculating tube performance with characteristic curves.

When it is desirable to use a cathode resistor for bias this may be computed from knowledge of the bias value and the sum of the plate and screen currents (given under Typical Operation).

$$(10) R_k = \frac{E_{c1}}{I_{c2} + I_b}$$

For the 6V6GT the bias at the operating point is known to be -12.5 V. and the sum of plate and screen currents is 49.5 Ma (total cathode current) at the operating point.

$$\text{From (10) } R_k = \frac{12.5 \text{ V.}}{49.5} = 250 \text{ ohms}$$

For more exact calculations of power output, the cathode resistance voltage drop should be subtracted from the power supply voltage to give the correct plate supply voltage.

TUBE AND BASE DIAGRAM SYMBOLS

A —Anode	IS —Internal Shield
Dp —Diode Plate	J —Jumper
F —Filament	K —Cathode
Fc —Filament Center Tap	NC—No Connection
G —Grids numbered according to their position from the cathode	P —Plate
H —Heater	S —Metal Shell
Hc —Heater Center Tap	SA —Starter Anode
Ht —Heater Tap	T —Target
IC —Internal Connection	XS —External Shield
	□ —Top Cap
	■ —Locating Key

INSTALLATION AND HANDLING OF TELEVISION PICTURE TUBES AND LARGE CATHODE RAY TUBES

The installation and handling of television picture tubes and other large cathode ray tubes must be undertaken with considerable care. Picture tubes are large structures made up very largely of glass and inclosing an evacuated space. They should be handled carefully and protected from severe shock. The normal precautions used when working with any high voltage circuits should be observed. The proper procedures and precautions are presented below.

Mechanical Handling

1. Protective face shield or goggles and gloves should be worn, for personal safety, whenever handling large picture tubes.

2. Picture tubes should be removed from the shipping carton face up and supported by the sides of the large portion of the tube. Handling of large picture tubes by the neck is unsafe and should be avoided at all times. It is obviously the weakest part of the tube and most easily injured. Therefore, the neck should always be kept free of strain and protected from striking other objects.

3. Picture tubes should be inserted into sockets by supporting the tube at the large end and holding the neck only for guiding the base pins into the socket.

4. The tubes should be removed from their sockets in the same manner as they are inserted, supported at the large end.

5. When not installed in a television receiver or other equipment, picture tubes should be stored in shipping cartons with the covers closed.

6. Avoid placing picture tubes on a table or bench where there is any possibility of the tube rolling off. This is very important.

7. Scratching the surface of a picture tube weakens the glass and may be the cause of the tube imploding. If it is necessary to place a tube elsewhere than in its shipping carton, a piece of felt or other soft material should be placed under it.

8. Picture tubes should be used for display purposes only after the vacuum seal has been broken. Economy dictates that only wornout, or otherwise worthless, tubes be used for this purpose. The vacuum seal may be broken in the following manner.

A. Place the tube in a shipping carton, face down, with enough soft packing material underneath so that the base will extend above the closed cover.

B. Drill a 1/4-inch hole in the end of the locating lug or break off the lug entirely with a sharp blow or with pliers.

C. Using a small file or cutting pliers, make a small hole at the tip of the exhaust tube. Care should be used to make a small hole in the tip so that air will enter the tube slowly and not disturb the screen coating. In tubes using a metal exhaust tube a small three-cornered file may be used to make a small hole. The bright getter deposit on the neck should change color almost immediately. As a precaution, some time after the small hole has been made, it is well to break off the tip completely. The tube cannot implode after the vacuum seal has been broken, but it should still be handled as carefully as any other glassware of equal weight.

9. Discretion should be exercised in the disposal of tubes which are no longer useful to avoid possible legal liability. A safe method of breaking up a tube for disposal is to place it in a carton, seal the carton, and drive a metal rod through the carton into the face of the side of the tube. The broken parts may then be disposed of in the usual manner.

10. If a tube does break causing small cuts in the skin, such cuts should be washed carefully to be certain that all dirt and other small particles are removed. While the materials used for coating Sylvania picture tubes are not considered to be toxic, there is the possibility of an unusual personal sensitivity or allergy in some persons.

Handling High Voltage Circuits

1. Stand on dry wood, a rubber mat, linoleum or other dry insulating material when working on any electrical circuit.
2. One hand should be kept in a pocket to reduce the effects of accidental shock.
3. Respect all safety interlock switches and be certain that they are in good working condition.
4. Be certain that high voltage condensers are discharged before working on the circuit. Bleeder resistors may be open.
5. Some picture tubes have a conductive coating on both the inside and outside surfaces to form a condenser. This condenser should be discharged before the tube is handled. Even a slight unexpected shock might cause a tube to be dropped.
6. In some circuits where the picture tube operates with a voltage on its second anode higher than its specified maximum rating, or higher than 16,000 volts whichever is less, it is possible that low intensity X-rays may be emitted. Therefore, X-ray radiation shielding may be necessary to protect against possible danger of personal injury from prolonged exposure at close range if the tube is operated at such high voltages.
7. Take the time to be safe.

TUBE OUTLINES

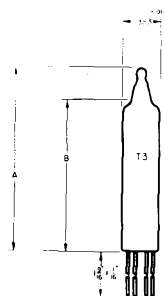

RETMA OUTLINE NUMBER	DIMENSIONS	
	A MAX	B $\pm 0.60''$
3-1	1.375	1.075
3-2	1.500	1.200
3-3	1.750	1.450
3-4	2.000	1.700
3-8	1.625	1.325
3-11	1.250	.950

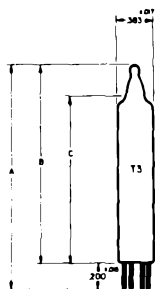

RETMA OUTLINE NUMBER	DIMENSIONS		
	A MAX	B MAX	C $\pm 0.60''$
3-5	1.750	1.500	1.200
3-9	1.620	1.375	1.075
3-10	2.000	1.750	1.450
3-12	1.500	1.250	.950
3-13	1.875	1.625	1.325
3-14	2.125	1.875	1.575
3-15	2.250	2.000	1.700

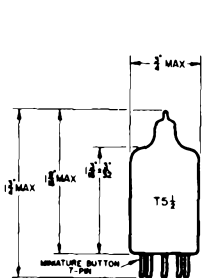

5-1

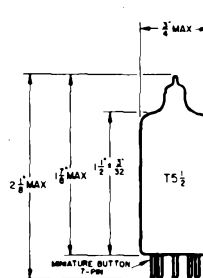

5-2

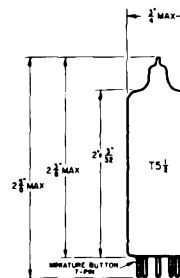

5-3

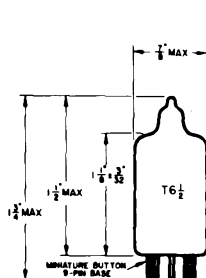

6-1

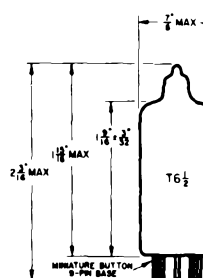

6-2

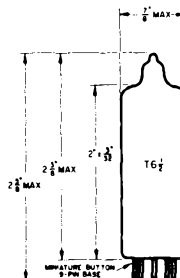

6-3

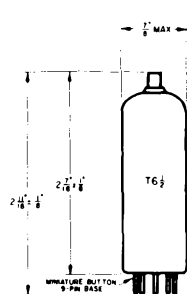

6A-2

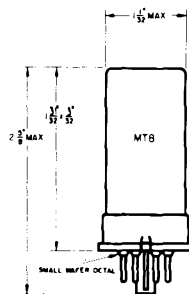

8-1

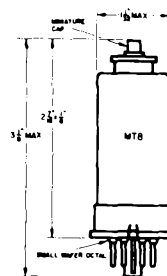

8-2

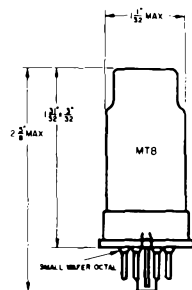

8-3

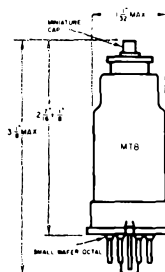

8-4

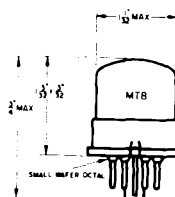

8-5

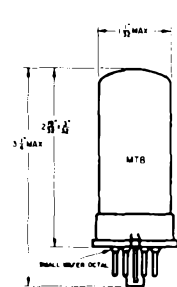

8-6

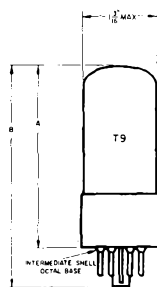

RETMA OUTLINE NUMBER	DIMENSIONS	
	A MAX	B MAX
9-1	1 3/4	2 3/16
9-3	2 5/16	2 3/8
9-5	2 7/16	3"
9-7	2 1/2	3 1/16
9-9	2 11/16	3 1/4
9-11	2 3/4	3 3/8
9-13	2 13/16	3 3/8
9-15	2 3/8	3 1/16
9-33	3 1/4	3 13/16

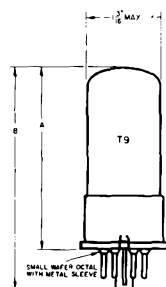

RETMA OUTLINE NUMBER	DIMENSIONS	
	A MAX	B MAX
9-2	1 3/4	2 5/16
9-4	2 3/8	2 3/8
9-6	2 7/16	3"
9-8	2 1/2	3 1/16
9-10	2 11/16	3 1/4
9-12	2 3/4	3 3/8
9-14	2 13/16	3 3/8
9-16	2 3/8	3 1/16

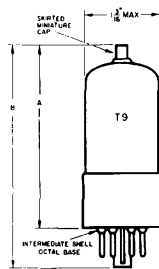

RETMA OUTLINE NUMBER	DIMENSIONS		
	A		B MAX
	MIN	MAX	
9-17	$2\frac{5}{16}$ "	$2\frac{3}{4}$ "	$3\frac{5}{16}$ "
9-19	$2\frac{5}{16}$ "	$2\frac{7}{8}$ "	$3\frac{7}{16}$ "
9-21	$2\frac{5}{16}$ "	$2\frac{13}{16}$ "	$3\frac{1}{2}$ "
9-23	$2\frac{5}{16}$ "	3"	$3\frac{9}{16}$ "
9-50	$2\frac{7}{8}$ "	$3\frac{5}{16}$ "	$3\frac{7}{8}$ "

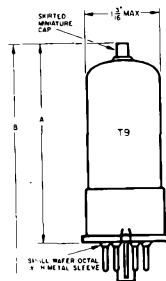

RETMA OUTLINE NUMBER	DIMENSIONS		
	A		B MAX
	MIN	MAX	
9-18	$2\frac{5}{16}$ "	$2\frac{3}{4}$ "	$3\frac{5}{16}$ "
9-20	$2\frac{5}{16}$ "	$2\frac{7}{8}$ "	$3\frac{7}{16}$ "
9-22	$2\frac{5}{16}$ "	$2\frac{13}{16}$ "	$3\frac{1}{2}$ "
9-24	$2\frac{5}{16}$ "	3"	$3\frac{9}{16}$ "

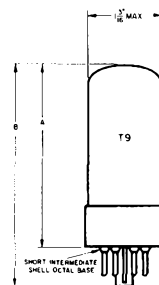

RETMA OUTLINE NUMBER	DIMENSIONS	
	A MAX	B MAX
9-36	$1\frac{1}{4}$ "	$2\frac{1}{16}$ "
9-37	$2\frac{3}{16}$ "	$2\frac{1}{8}$ "
9-38	$2\frac{1}{16}$ "	3"
9-39	$2\frac{1}{2}$ "	$3\frac{1}{16}$ "
9-40	$2\frac{11}{16}$ "	$3\frac{1}{4}$ "
9-41	$2\frac{1}{4}$ "	$3\frac{5}{16}$ "
9-42	$2\frac{13}{16}$ "	$3\frac{3}{8}$ "
9-43	$2\frac{1}{8}$ "	$3\frac{7}{16}$ "
9-44	$3\frac{1}{4}$ "	$3\frac{13}{16}$ "

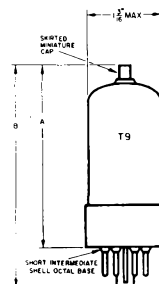

RETMA OUTLINE NUMBER	DIMENSIONS		
	A		B MAX
	MIN	MAX	
9-45	$2\frac{3}{16}$ "	$2\frac{3}{4}$ "	$3\frac{3}{16}$ "
9-46	$2\frac{5}{16}$ "	$2\frac{7}{8}$ "	$3\frac{1}{16}$ "
9-47	$2\frac{3}{16}$ "	$2\frac{13}{16}$ "	$3\frac{1}{2}$ "
9-48	$2\frac{5}{16}$ "	3"	$3\frac{9}{16}$ "
9-49	$2\frac{7}{8}$ "	$3\frac{5}{16}$ "	$3\frac{7}{8}$ "

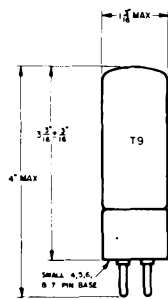

9-25

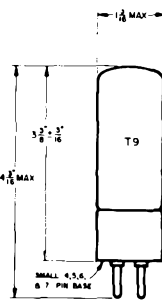

9-26

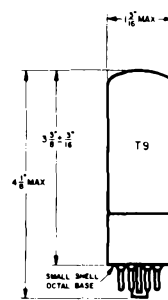

9-27

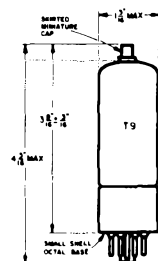

9-28

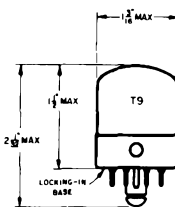

9-29

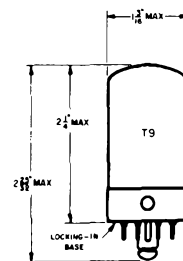

9-30

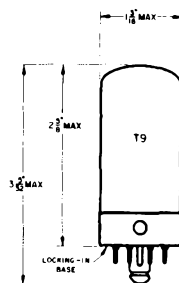

9-31

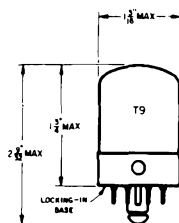

9-32

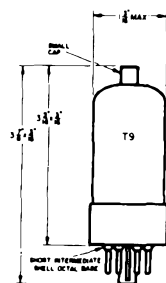

9-51

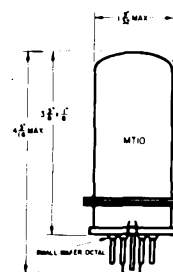

10-1

RETMA OUTLINE NUMBER	DIMENSIONS		
	A	B	C
12-1	$4 \frac{19}{32}$ MAX	$3 \frac{23}{32} \pm \frac{3}{16}$	$1 \frac{5}{16}$
12-5	$4 \frac{3}{16}$ MAX	$3 \frac{3}{8} \pm \frac{3}{16}$	$1 \frac{1}{4}$
12-2	$4 \frac{15}{16}$ MAX	$4 \frac{3}{16} \pm \frac{1}{8}$	$1 \frac{5}{16}$
12-6	$4 \frac{17}{32}$ MAX	$3 \frac{23}{32} \pm \frac{1}{8}$	$1 \frac{1}{4}$
12-3	$4 \frac{17}{32}$ MAX	$3 \frac{23}{32} \pm \frac{3}{16}$	$1 \frac{5}{16}$
12-7	$4 \frac{1}{8}$ MAX	$3 \frac{3}{8} \pm \frac{3}{16}$	$1 \frac{1}{4}$
12-4	$4 \frac{7}{8}$ MAX	$4 \frac{5}{8} \pm \frac{3}{32}$	$1 \frac{5}{16}$
12-8	$4 \frac{15}{32}$ MAX	$3 \frac{3}{4} \pm \frac{3}{32}$	$1 \frac{1}{4}$

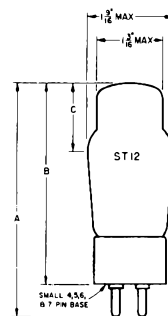

12-1
12-5

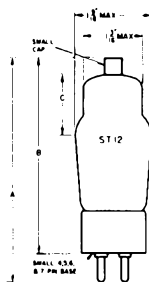

12-2
12-6

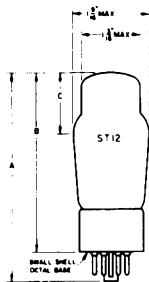

12-3
12-7

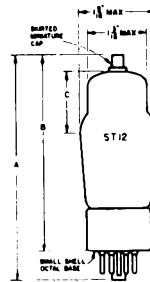

12-4
12-8

RETMA OUTLINE NUMBER	DIMENSIONS		
	A $\pm \frac{3}{16}$	A MAX	B MAX
12-101		$3 \frac{5}{16}$	$3 \frac{7}{8}$
12-102		$3 \frac{13}{16}$	$4 \frac{1}{8}$
12-103		$4 \frac{1}{16}$	$4 \frac{3}{8}$
12-104		$4 \frac{3}{16}$	$4 \frac{3}{4}$
12-105	$3 \frac{9}{16}$		$4 \frac{1}{4}$
12-106	$4 \frac{1}{4}$		5

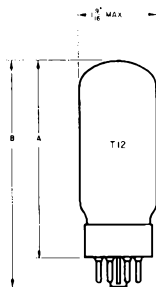

12-101
12-102
12-103
12-104

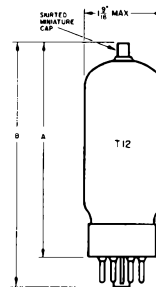

12-105
12-106

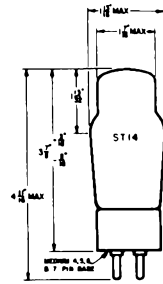

14-1

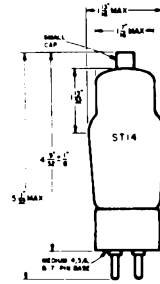

14-2

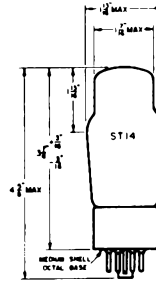

14-3

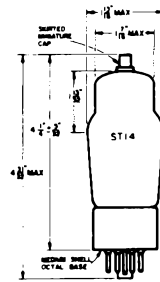

14-4

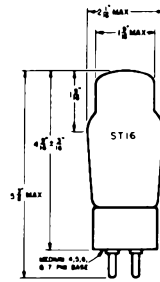

16-1

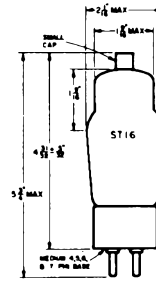

16-2

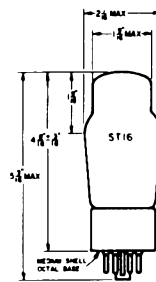

16-3

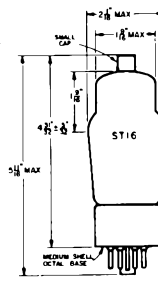

16-5

INDEX FOR RESISTANCE COUPLED AMPLIFIER SECTION

Sylvania Type	Chart Number	Sylvania Type	Chart Number
1L4	I	6ST7	XIII
1S5	II	6SU7GT	XIV
1SA6GT	III	6SZ7	VII
1U4	III	6T8	VII
1U5	II	6U8	XXII
2A6	XI	6W7GT	XII
6AD5GT	X	7A4	IX
6AN8	XX	7AJ7	XII
6AQ6	VII	7B4	X
6AQ7GT	XIV	7B6	XI
6AT6	VII	7C7	XII
6AU6	XXI	7E6	XIII
6AV6	X	7F7	XIV
6B6G	XI	7K7	XIV
6BF6	XIII	7N7	IX
6BH6	XIX	12AT6	VII
6BK6	XV	12AT7	XVII
6C4	IV	12AU7	IV
6C5GT	V	12AU7A	IV
6C6	XII	12AV6	X
6F5GT	X	12AV7	XVIII
6F8G	IX	12AX7	XV
6J5GT	IX	12AY7	XVI
6J7GT	XII	12BF6	XIII
6K5G	VII	12BK6	XV
6N7GT	VI	12SJ7GT	VIII
6Q7GT	VII	12SW7	XIII
6R7GT	XIII	12SX7GT	IX
6S8GT	XI	14C7	XII
6SC7	XIV	19T8	VII
6SF5GT	X	26BK6	XV
6SJ7GT	VIII	26C6	XIII
6SL7GT	XIV	57	XII
6SN7GTA	IX	75	XI
6SQ7GT	XI	954	XII
6SR7GT	XIII	1273	XII
		1280	XII

RESISTANCE COUPLED AMPLIFIER DATA

On the following pages are given the necessary data for the construction of resistance coupled amplifiers using the types of tubes commonly employed for this purpose. The data are necessarily quite condensed but with the aid of the five reference diagrams and the equations given on the following page for determining the size by-pass and coupling condensers, any serviceman should be able to build a good amplifier or check the design of one under repair.

Notice that data are given for use under all the B supply voltages commonly used with a given type. Values of gain are given for two different values of applied signal; the first a typical small signal likely to be found for the type and the second is the maximum which can be used without exceeding the 5% distortion limit.

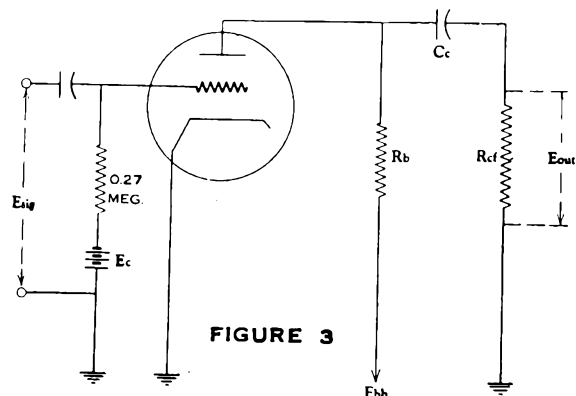
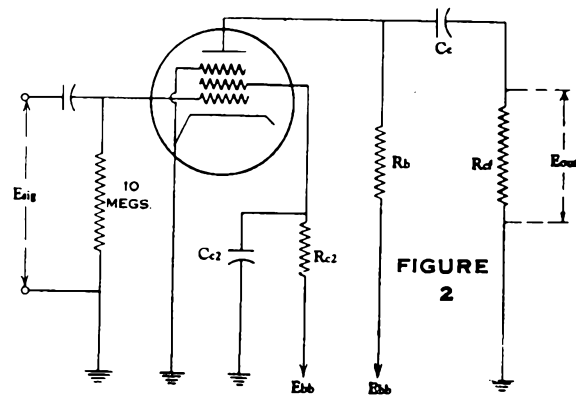
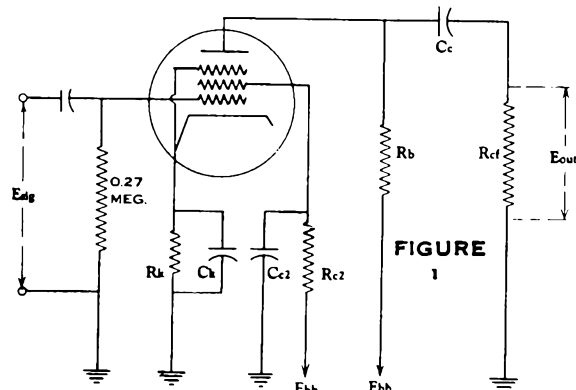

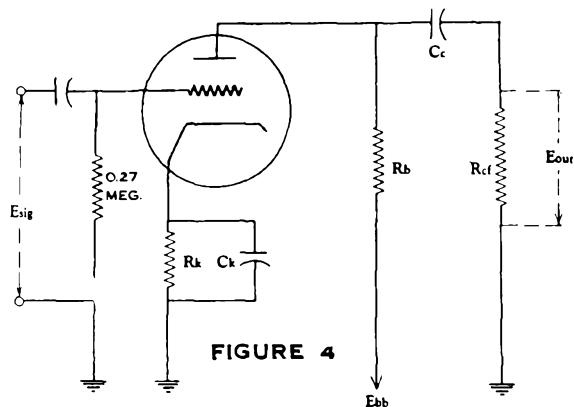

FIGURE 4

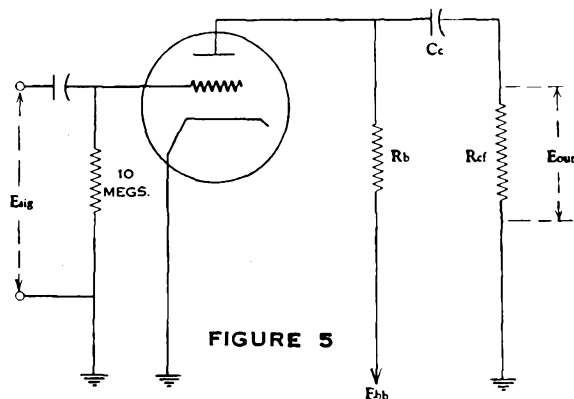

FIGURE 5

SYMBOLS USED

Symbol	Function	Unit
Rb	Plate Load Resistor	Megohms
Rc2	Screen Dropping Resistor	Megohms
Rcf	Grid Resistor of following Tube	Megohms
Ebb	Plate Supply Voltage	Volts
Eb	Plate Voltage at Plate	Volts
Ec or Ecl	Grid to Neg. Fil. Voltage	Volts
Ec2	Screen Grid Voltage	Volts
Esig	Input Signal	RMS Volts
Eout	Output to following Grid	RMS Volts
Ib	Plate Current	Ma.
Ic2	Screen Grid Current	Ma.
Cc	Coupling Condenser	mfd.
Cc2	Screen By-pass Condenser	mfd.

Values of capacity are not specified since these are dependent mostly on the frequency characteristic required in each individual case.

For low frequency limit = f_1

$$C_c = \frac{1.6 \times 10^6}{f_1 R_{cf}} \text{ mfd.}$$

$$C_k = \frac{1.6 \times 10^6}{f_1 R_k} \text{ mfd.}$$

$$C_{c2} = \frac{1.6 \times 10^6}{f_1 R_{c2}} \text{ mfd.}$$

Some text books show a more complicated method for calculating these by-pass condensers, but this method is quite rapid and gives conservative values. The loss due to incomplete by-passing will be less than 1% except for the cathode by-pass where it will be about 3%. The size condenser may be halved where economy is essential unless stages are cascaded and highest quality is required.

CHART I RESISTANCE COUPLED AMPLIFIER DATA

Zero Bias Operation

Rb	Ebb = 45 VOLTS									Ebb = 67.5 VOLTS									Ebb = 90 VOLTS								
	0.27			0.47			1.0			0.27			0.47			1.0			0.27			0.47			1.0		
	0.68			1.2			2.2			0.68			1.2			2.2			0.68			1.2			2.2		
Rc ₁	0.47	1.0	4.7	1.0	4.7	10	2.2	4.7	10	0.47	1.0	4.7	1.0	4.7	10	2.2	4.7	10	0.47	1.0	4.7	1.0	4.7	10	2.2	4.7	10
Rc ₂	0.72	0.72	0.72	.043	.043	.043	.023	.023	.023	.134	.134	.134	.078	.078	.078	.041	.041	.041	.20	.20	.20	.116	.116	.116	.06	.06	.06
E _b	25.6	25.6	25.6	24.8	24.8	24.8	22.0	22.0	22.0	31.3	31.3	31.3	30.8	30.8	30.8	26.5	26.5	26.5	35.9	35.9	35.9	35.5	35.5	35.5	30.0	30.0	30.0
I _{c₁}	.042	.042	.042	.025	.025	.025	.0146	.0146	.0146	.07	.07	.07	.0421	.0421	.0421	.024	.024	.024	.101	.101	.101	.06	.06	.06	.034	.034	.034
E _{c₂}	16.5	16.5	16.5	15.0	15.0	15.0	12.9	12.9	12.9	20.0	20.0	20.0	17.0	17.0	17.0	14.6	14.6	14.6	21.3	21.3	21.3	18.0	18.0	18.0	15.0	15.0	15.0
E _{sig}	0.05	0.05	0.05	0.05	0.05	0.05	0.05	0.05	0.05	0.1	0.1	0.1	0.1	0.1	0.1	0.1	0.1	0.1	0.1	0.1	0.1	0.1	0.1	0.1	0.1	0.1	0.1
E _{out}	1.64	1.94	2.30	2.05	2.67	2.80	2.77	3.27	3.58	4.58	5.5	6.45	6.08	7.8	8.1	7.85	9.25	9.8	5.5	6.67	8.0	7.5	10.0	10.4	10.0	11.4	12.2
Gain	32.8	38.8	46.0	41.0	53.4	56.0	55.5	65.5	71.7	45.8	55.0	64.5	60.8	78.0	81.0	78.5	92.5	98.0	55.0	66.7	80.0	75.0	100	104	100	114	122
% Distortion	2.70	2.40	3.30	3.00	2.80	2.80	3.10	2.80	2.50	2.60	2.10	1.70	4.20	3.60	3.00	3.80	3.00	2.80	1.60	1.20	1.20	2.40	1.70	1.70	2.40	2.50	2.90
E _{sig} (1)	0.09	0.10	0.11	0.08	0.09	0.09	0.07	0.09	0.09	0.16	0.18	0.20	0.12	0.15	0.15	0.12	0.13	0.14	0.24	0.26	0.27	0.17	0.19	0.20	0.16	0.16	0.16
E _{out}	2.85	3.75	4.97	4.13	4.76	4.90	3.83	5.65	6.05	7.0	9.6	11.9	7.2	11.1	11.5	9.3	11.3	12.8	12.5	1.59	19.4	12.3	17.7	19.0	14.9	17.2	18.4
Gain	31.7	37.5	45.2	39.1	52.8	54.5	54.8	62.7	67.2	43.7	53.2	59.5	60.0	74.0	76.6	77.5	87.0	91.5	52.0	61.2	71.9	72.3	93.1	95.0	93.1	107	115
% Distortion	4.60	4.70	4.50	5.00	4.70	4.50	4.20	4.90	4.60	4.70	4.70	4.80	5.00	4.90	4.80	4.80	4.50	4.70	4.90	4.90	4.90	5.0	4.30	4.70	4.50	4.70	4.90

Note (1) Maximum signal for 5.0% Distortion.

FOR CIRCUIT SEE FIGURE 2

CHART II RESISTANCE COUPLED AMPLIFIER DATA

Zero Bias Operation

	Ebb = 45 VOLTS									Ebb = 67.5 VOLTS									Ebb = 90 VOLTS								
	0.27			0.47			1.0			0.27			0.47			1.0			0.27			0.47			1.0		
Rb																											
Rc ₂	1.0			1.8			3.9			1.0			1.8			3.9			1.0			1.8			3.9		
Rcf	0.47	1.0	4.7	1.0	4.7	10	2.2	4.7	10	0.47	1.0	4.7	1.0	4.7	10	2.2	4.7	10	0.47	1.0	4.7	1.0	4.7	10	2.2	4.7	10
Ib	.080	.080	.080	.050	.050	.050	.025	.025	.025	.145	.145	.145	.087	.087	.087	.045	.045	.045	.22	.22	.22	.13	.13	.13	.065	.065	.065
Eb	23.4	23.4	23.4	21.5	21.5	21.5	20.0	20.0	20.0	28.3	28.3	28.3	26.6	26.6	26.6	22.5	22.5	22.5	30.5	30.5	30.5	29.0	29.0	29.0	25.0	25.0	25.0
Ic ₂	.0232	.0232	.0232	.0146	.0146	.0146	.0077	.0077	.0077	.041	.041	.041	.025	.025	.025	.013	.013	.013	.061	.061	.061	.036	.036	.036	.0187	.0187	.0187
Ec ₂	21.8	21.8	21.8	18.7	18.7	18.7	15.0	15.0	15.0	26.5	26.5	26.5	22.5	22.5	22.5	16.8	16.8	16.8	29.0	29.0	29.0	25.0	25.0	25.0	17.0	17.0	17.0
Esig	0.05	0.05	0.05	0.05	0.05	0.05	0.05	0.05	0.05	0.1	0.1	0.1	0.1	0.1	0.1	0.1	0.1	0.1	0.1	0.1	0.1	0.1	0.1	0.1	0.1	0.1	0.1
Eout	1.55	1.94	2.25	2.15	2.75	2.85	2.80	3.25	3.50	4.10	5.0	5.7	5.5	6.8	7.0	7.1	8.2	8.65	4.9	6.0	6.9	6.65	8.35	8.7	9.0	10.4	11.0
Gain	31.0	38.8	45.0	43.0	55.0	57.0	56.0	65.0	70.0	41.0	50.0	57.0	55.0	68.0	70.0	71.0	82.0	86.5	49.0	60.0	69.0	66.5	83.5	87.0	90.0	104	110
% Distortion	2.10	1.90	1.20	2.00	1.70	1.60	2.90	2.40	2.0	1.80	1.30	1.60	1.70	2.0	2.1	2.30	2.50	2.70	.80	1.40	2.0	1.70	3.10	3.50	3.0	3.30	3.60
Esig (1)	0.13	0.17	0.19	0.12	0.15	0.15	0.1	0.11	0.11	0.26	0.28	0.30	0.21	0.23	0.24	0.15	0.17	0.17	0.34	0.34	0.34	0.28	0.28	0.28	0.18	0.18	0.17
Eout	3.95	6.0	7.55	5.0	7.40	7.6	5.60	6.50	6.90	9.85	12.6	15.2	10.4	13.9	14.8	10.0	12.8	13.4	14.4	17.5	20.0	16.5	20.3	21.0	15.1	17.4	17.6
Gain	30.4	35.3	39.7	41.6	49.3	50.6	56.0	59.0	62.7	37.9	45.0	50.6	49.6	60.3	61.8	66.8	75.3	78.8	42.4	51.5	58.9	59.0	72.5	75.0	84.0	96.8	103.5
% Distortion	4.90	4.60	4.70	4.60	4.90	4.60	4.70	4.80	4.70	4.80	4.60	4.80	4.50	4.50	4.90	4.40	4.90	4.60	4.40	4.50	5.0	4.60	4.50	4.80	4.70	4.90	4.80

Note (1) Maximum signal for 5.0% distortion.

FOR CIRCUIT SEE FIGURE 2

CHART III RESISTANCE COUPLED AMPLIFIER DATA

Zero Bias Operation

Sylvania Type 1U4

1U4 SYLVANIA TYPE
1SA6GT

Rb	Ebb = 45 VOLTS (See Note 2)									Ebb = 67.5 VOLTS									Ebb = 90 VOLTS								
	0.27			0.47			1.0			0.27			0.47			1.0			0.27			0.47			1.0		
	1.0			1.5			3.3			1.0			1.5			3.3			1.0			1.5			3.3		
Rc ₁	1.0			1.5			3.3			1.0			1.5			3.3			1.0			1.5			3.3		
Rcf	0.47	1.0	4.7	1.0	4.7	10.0	2.2	4.7	10.0	0.47	1.0	4.7	1.0	4.7	10.0	2.2	4.7	10.0	0.47	1.0	4.7	1.0	4.7	10.0	2.2	4.7	10.0
Ib	.048	.048	.048	.034	.034	.034	.0175	.0175	.0175	.101	.101	.101	.070	.070	.070	.035	.035	.035	.156	.156	.156	.11	.11	.11	.054	.054	.054
Eb	32.14	32.14	32.14	29.12	29.12	29.12	28.5	28.5	28.5	40.2	40.2	40.2	34.6	34.6	34.6	32.5	32.5	32.5	47.9	47.9	47.9	38.3	38.3	38.3	36.0	36.0	36.0
Ic ₁	.0165	.0165	.0165	.012	.012	.012	.006	.006	.006	.033	.033	.033	.0235	.0235	.0235	.0115	.0115	.0115	.049	.049	.049	.036	.036	.036	.017	.017	.017
Ec ₁	28.5	28.5	28.5	27.0	27.0	27.0	25.2	25.2	25.2	34.5	34.5	34.5	32.25	32.25	32.25	29.6	29.6	29.6	41.0	41.0	41.0	36.0	36.0	36.0	33.5	33.5	33.5
Eaig	.05	.05	.05	.05	.05	.05	.04	.04	.05	.05	.05	.05	.05	.05	.05	.05	.05	.05	.05	.05	.05	.05	.05	.05	.05	.05	.05
Eout	1.46	1.75	2.10	2.00	2.55	2.68	2.25	2.52	3.45	2.3	2.75	3.3	3.3	4.25	4.45	4.35	5.2	5.55	2.92	3.60	4.25	4.20	5.40	5.60	5.70	6.80	7.40
Gain	38.3	35	42	40	51	53.6	56.3	63.1	69.0	46	55	66	66	85.0	89	87	104	111	58.4	72.0	85.0	84.0	108	112	113	136	148
% Distortion	3.4	3.4	3.9	4.2	4.3	4.0	4.1	4.4	4.9	2.0	2.0	2.0	2.3	2.3	1.9	3.8	3.6	3.3	1.4	1.2	1.3	1.3	1.1	0.9	2.5	2.2	1.8
Eaig (1)	.06	.06	.06	.05	.05	.06	.04	.04	.05	.10	.11	.11	.09	.10	.10	.06	.07	.07	0.13	0.15	0.15	0.13	0.15	0.16	0.09	0.09	0.11
Eout	1.70	2.08	2.50	2.00	2.55	3.20	2.25	2.52	3.45	4.45	5.9	7.0	5.8	8.35	8.60	5.20	7.15	7.6	7.35	10.3	12.0	10.4	15	16.5	10	11.8	15.1
Gain	28.3	34.8	41.7	40	51	53.4	56.3	63.1	69.0	44.5	53.5	63.5	64.5	83.5	86.0	86.8	102	108	56.5	68.8	80	80	100	103	111	131	138
% Distortion	4.4	4.3	4.5	4.2	4.3	4.9	4.1	4.4	4.9	4.6	5.0	4.8	4.8	4.9	4.1	4.6	5.0	4.6	4.4	5.0	4.8	4.8	4.9	5.0	4.9	4.4	4.6

Note (1) Maximum signal for 5.0% distortion. Note (2) Operation at Ebb = 45 volts is not recommended. Above 45 volts data is shown only to assist in determining end of life performance with 67.5 volt supply.

FOR CIRCUIT SEE FIGURE 2

CHART IV

RESISTANCE COUPLED AMPLIFIER DATA

Self Bias Operation

Rb	Ebb = 100 VOLTS						Ebb = 250 VOLTS					
	0.047		0.1		0.27		0.047		0.1		0.27	
	0.1	0.27	0.1	0.47	0.27	0.47	0.1	0.27	0.1	0.47	0.27	0.47
Rcf	1200	1200	2200	2700	6800	8200	1000	1000	1500	1800	4700	6800
Rk	1.22	1.22	.66	.628	.259	.246	3.2	3.2	1.78	1.72	.684	.63
lb	1.465	1.465	1.45	1.695	1.76	2.02	3.2	3.2	2.67	3.10	3.21	4.28
Ec	42.7	42.7	34	37.2	30	33.6	150.5	150.5	72	78	65	80
Esig	0.5	0.5	0.5	0.5	0.5	0.5	1.0	1.0	1.0	1.0	1.0	1.0
Eout	6.25	6.6	6.35	6.75	6.3	6.3	13.5	14.1	13.8	14.3	13.4	13.2
Gain	12.5	13.2	12.7	13.5	12.6	12.6	13.5	14.1	13.8	14.3	13.4	13.2
% Distortion	4.0	3.6	4.3	2.9	3.0	2.5	3.3	3.1	3.8	2.8	2.5	2.0
Esig (%)	0.65	0.65	0.57	0.77	0.71	0.98	1.70	1.70	1.34	1.70	1.80	2.52
Eout	8.1	8.6	7.2	10.4	8.9	12.4	23.0	24.0	18.5	24.5	24.1	33.1
Gain	12.5	13.2	12.6	13.5	12.5	12.6	13.5	14.1	13.8	14.3	13.4	13.1
% Distortion	4.8	4.4	4.8	4.6	4.6	5.0	4.9	4.6	5.0	5.0	4.9	5.0

(1) At grid current point, less than 1/2 microampere grid current.

FOR CIRCUIT SEE FIGURE 4

SYLVANIA TYPE 6C4
 12AU7
 12AU7A

CHART V

RESISTANCE COUPLED AMPLIFIER DATA

Self Bias Operation

Rb	Ebb = 100 VOLTS						Ebb = 250 VOLTS					
	0.047		0.1		0.27		0.047		0.1		0.27	
	0.1	0.27	0.1	0.47	0.27	0.47	0.1	0.27	0.1	0.47	0.27	0.47
Rk	1800	2200	2700	3900	6800	8200	1800	1800	2700	3900	6800	8200
Ib	0.98	0.90	0.58	0.51	0.24	0.227	2.50	2.50	1.45	1.28	0.60	0.57
Ect	-1.765	-1.98	-1.565	-1.99	-1.63	-1.86	-4.50	-4.50	-3.92	-4.99	-4.08	-4.67
Eb	54	57.7	42	49	35.2	38.7	132.5	132.5	105	122	88	96
Esig	0.5	0.5	0.5	0.5	0.5	0.5	1.0	1.0	1.0	1.0	1.0	1.0
Eout	5.75	6.0	6.15	6.65	6.5	6.7	12.6	13.45	13.2	14.25	13.6	14.1
Gain	11.5	12.0	12.3	13.3	13.0	13.4	12.6	13.45	13.2	14.25	13.6	14.1
% Distortion	2.0	1.7	2.4	1.7	2.3	1.9	1.5	1.2	1.9	1.3	1.9	1.6
Fsig (1)	0.92	1.1	0.8	1.1	0.86	1.0	3.07	3.07	2.5	3.3	2.58	3.0
Eout	10.55	13.2	9.8	14.6	11.1	13.3	38.4	41.2	32.6	46.8	35.0	42.0
Gain	11.5	12.0	12.25	13.3	12.9	13.3	12.5	13.4	13.05	14.2	13.55	14.0
% Distortion	4.0	4.0	4.1	4.1	4.5	4.1	5.0	4.0	5.0	4.8	5.0	5.0

Note (1) At grid current point, less than $\frac{1}{2}$ microampere grid current.

FOR CIRCUIT SEE FIGURE 4

CHART VI

RESISTANCE COUPLED AMPLIFIER DATA

Self Bias Operation
Single Section of Type 6N7GT

Rb	Ebb - 100 VOLTS						Ebb - 250 VOLTS					
	0.047		0.1		0.27		0.047		0.1		0.27	
	0.10	.27	.10	.47	.27	.47	.10	.27	.10	.47	.27	.47
Rof	1800	1800	2700	3300	6800	6800	1000	1200	1500	1800	3300	3900
Ib	.81	.81	.51	.469	.225	.225	2.36	2.21	1.45	1.36	.64	.61
Ec	1.46	1.46	1.38	1.55	1.53	1.53	2.36	2.65	2.18	2.45	2.11	2.38
Eb	61.9	61.9	49	53.1	39.2	39.2	139	146	105	114	77	85.5
Esig	.10	.10	.10	.10	.10	.10	.50	.50	.50	.50	.50	.50
Eout	1.74	1.93	1.93	2.2	2.23	2.38	10.0	10.9	10.9	12.5	12.8	13.0
Gain	17.4	19.3	19.3	22.6	22.3	23.8	20.0	21.8	21.8	25.0	25.6	26.0
% Distortion	1.2	1.0	1.3	1.0	1.3	1.1	1.8	1.8	2.6	2.2	2.7	2.4
Esig (1)	.40	.40	.30	.50	.42	.42	1.20	1.40	1.00	1.22	.90	1.1
Eout	6.85	7.65	5.76	10.9	9.34	10.0	23.8	30.4	21.8	30.5	23.0	28.8
Gain	17.1	19.1	19.2	21.8	22.0	23.8	19.8	21.7	21.8	25.0	25.6	26.2
% Distortion	4.7	3.7	3.7	4.8	5.0	4.2	4.5	4.9	4.8	4.7	4.7	5.0

Note (1) At grid current point, less than 1/2 microampere grid current.

FOR CIRCUIT SEE FIGURE 4

CHART VII

RESISTANCE COUPLED AMPLIFIER DATA

6AQ6 SYLVANIA TYPE
 6AT6
 6K5G
 6Q7GT
 6SZ7
 6T8
 12AT6
 19T8

Self Bias Operation

Zero Bias Operation

Rb	Ebb = 100 VOLTS							Ebb = 250 VOLTS						
	0.1		0.27			0.47		0.1		0.27			0.47	
	0.27	0.47	0.27	0.47	1.0	0.47	1.0	0.27	0.47	0.27	0.47	1.0	0.47	1.0
Rcf	0.27	0.47	0.27	0.47	1.0	0.47	1.0	0.27	0.47	0.27	0.47	1.0	0.47	1.0
Rk	3300	3300	5600	5600	6800	8200	10,000	1800	2200	3300	3900	4700	5600	6800
Ib	288	288	161	161	146	108	099	95	88	476	46	425	31	29
Ec	.95	.95	.9	.9	.99	.89	.99	1.71	1.94	1.57	1.79	2.0	1.73	1.97
Eb	71.2	71.2	56.5	56.5	60.6	49.2	53.5	155	162	121.5	125.8	135.2	104.4	113.7
Esig.	0.1	0.1	0.1	0.1	0.1	0.1	0.1	0.1	0.1	0.1	0.1	0.1	0.1	0.1
Eout	3.53	3.82	4.1	4.53	4.73	4.63	4.9	4.23	4.4	4.9	5.2	5.4	5.3	5.7
Gain	35.3	38.2	41.	45.3	47.3	46.3	49.	42.3	44.	49.	52	54.	53.	57.
% Dist.	55	0.9	1.6	1.2	1.1	1.5	1.2	3	.3	.25	3	.3	2	25
Esig. (%)	.23	24	19	2	25	19	25	.79	.89	63	.77	91	71	.86
Eout	8.	8.9	7.75	8.93	11.8	8.7	12.2	33.3	38.5	30.8	39.6	49.	37.5	48.6
Gain	34.8	37.1	40.8	44.6	47.2	45.8	48.8	42.2	43.3	48.9	51.4	53.9	52.8	56.6
% Dist.	3.6	3.4	3.95	3.4	4.15	3.9	4.6	3.67	4.28	3.4	4.3	4.75	4.8	4.95

Note (1) For self bias operation this is taken at the grid current point with less than 1/2 Microampere grid current.

FOR CIRCUIT SEE FIGURE 4

Rb	Ebb = 100 VOLTS							Ebb = 250 VOLTS						
	0.1		0.27			0.47		0.1		0.27			0.47	
	0.27	0.47	0.27	0.47	1.0	0.47	1.0	0.27	0.47	0.27	0.47	1.0	0.47	1.0
Rcf	0.27	0.47	0.27	0.47	1.0	0.47	1.0	0.27	0.47	0.27	0.47	1.0	0.47	1.0
Rk
Ib	0.325	0.325	0.17	0.17	0.17	0.1125	0.1125	1.35	1.35	0.65	0.65	0.65	0.385	0.385
Ec
Eb	67.5	67.5	54.1	54.1	54.1	47.1	47.1	115	115	74.5	74.5	74.5	69	69
Esig.	0.1	0.1	0.1	0.1	0.1	0.1	0.1	0.1	0.1	0.1	0.1	0.1	0.1	0.1
Eout	3.7	3.8	4.35	4.6	4.83	4.6	5.2	4.5	4.75	5.2	5.8	5.8	5.7	6.2
Gain	37.0	38.0	43.5	46.0	48.3	46.0	52.0	45.0	47.5	52.0	58.0	58.0	57.0	62.0
% Dist.	0.806	0.72	1.58	1.17	0.88	1.56	0.985	0.583	0.61	0.53	0.65	0.65	0.5	0.64
Esig. (%)	0.26	0.28	0.21	0.24	0.28	0.21	0.26	0.9	0.96	0.76	0.87	0.97	0.74	0.88
Eout	8.8	9.8	8.25	10.5	12.5	9.2	12.5	37.0	41.7	36.5	44.2	53.0	39.3	50.0
Gain	33.8	35.0	39.3	43.7	44.6	43.8	48.1	41.2	43.4	48.0	50.8	54.6	53.1	56.8
% Dist.	4.71	4.9	4.96	4.79	4.96	4.8	4.78	4.8	4.88	4.86	4.96	4.88	4.89	4.89

Note (1) Maximum signal for 5.0% Distortion.

FOR CIRCUIT SEE FIGURE 5

CHART VIII RESISTANCE COUPLED AMPLIFIER DATA Self Bias Operation

	Ebb - 100 VOLTS						Ebb - 250 VOLTS							
	0.1		0.27		0.47		0.1		0.27		0.47			
Rb														
Rc ₁	0.39		1.2		1.8		0.39		1.2		2.2			
Rc _f	0.27	0.47	0.27	0.47	1.0	0.47	1.0	0.27	0.47	0.27	0.47	1.0	0.47	1.0
Rk	1200	1200	2700	2700	2700	4700	4700	560	560	1200	1200	1200	1800	1800
Ib	0.645	0.645	0.259	0.259	0.259	0.165	0.165	1.77	1.77	0.675	0.675	0.675	0.402	0.402
Ic ₁	0.18	0.18	0.068	0.068	0.068	0.045	0.045	0.50	0.50	0.183	0.183	0.183	0.102	0.102
Ec ₁	0.99	-0.99	0.882	-0.882	-0.882	-0.99	-0.99	-1.27	-1.27	-1.03	-1.03	-1.03	-0.908	-0.908
Ec ₂	29.8	29.8	18.5	18.5	18.5	19.0	19.0	55	55	30.5	30.5	30.5	25.5	25.5
Eb	35.5	35.5	30.2	30.2	30.2	22.5	22.5	73	73	67.8	67.8	67.8	61.2	61.2
E _{rig}	0.1	0.1	0.1	0.1	0.1	0.1	0.1	0.1	0.1	0.1	0.1	0.1	0.1	0.1
E _{out}	6.85	7.8	8.2	10.2	12.5	10.2	13.1	10.2	11.5	13.6	17.9	21.6	19.5	25.6
Gain	68.5	78.0	82	102	125	102	131	102	115	136	179	216	195	256
% Distortion	0.6	0.7	3.4	2.6	2.3	2.8	3.2	0.7	0.8	2.2	1.8	1.5	3.1	2.4
E _{aig} (¹)	0.2	0.2	0.14	0.14	0.14	0.13	0.13	0.5	0.5	0.25	0.25	0.25	0.15	0.15
E _{out}	13.15	14.9	11.1	13.9	17.2	12.8	16.6	47	54	33	41.8	50	28	37
Gain	65.8	74.5	79.4	99.5	123	98.5	128	94	108	132	167.5	200	187	247
% Distortion	3.0	2.9	5.1	4.3	3.7	4.6	5.0	4.2	5.0	5.2	4.4	4.7	4.5	3.7

Note (¹) At grid current point, less than $\frac{1}{4}$ microampere grid current.

FOR CIRCUIT SEE FIGURE 1

CHART IX

RESISTANCE COUPLED AMPLIFIER DATA

Self Bias Operation
Type 7A4 or Single Section of Type 7N7

6F8G PENNSYLVANIA TYPE
 6J5GT
 6SN7GT
 7A4
 7N7
 12SX7GT

Rb	Ebb = 100 VOLTS						Ebb = 250 VOLTS					
	0.047		0.10		0.27		0.047		0.10		0.27	
	0.1	0.27	0.1	0.47	0.27	0.47	0.1	0.27	0.1	0.47	0.27	0.47
R _k	1800	2200	3300	4700	8200	10,000	1500	2200	2700	3900	6800	8200
I _b	1.05	0.97	0.57	0.50	0.24	0.22	2.79	2.4	1.49	1.31	0.61	0.58
E _c	-1.89	-2.13	-1.90	-2.35	-1.93	-2.19	-4.18	-5.28	-4.03	-5.11	-4.15	-4.74
E _b	50.6	54.4	43.0	50.0	36.5	40.9	119	137	101	119	85	94
E _{sig}	0.5	0.5	0.5	0.5	0.5	0.5	1.0	1.0	1.0	1.0	1.0	1.0
E _{out}	6.6	7.1	6.8	7.4	7.3	7.4	14.8	15.0	15.2	16.2	15.9	16.2
Gain	13.2	14.2	13.6	14.8	14.6	14.8	14.8	15.0	15.2	16.2	15.9	16.2
% Distortion	1.9	1.8	2.4	2.0	2.0	1.7	1.4	1.4	1.8	1.3	1.6	1.3
E _{sig} (1)	0.95	1.13	0.95	1.3	0.95	1.20	2.70	3.50	2.55	3.10	2.64	3.05
E _{out}	12.5	15.5	12.9	19.2	13.7	17.7	39.9	52.5	38.4	53.0	42.0	49.4
Gain	13.1	13.9	13.6	14.7	14.4	14.7	14.7	15.0	15.0	16.1	15.9	16.2
% Distortion	3.9	4.2	4.9	4.7	4.4	4.5	4.1	4.9	4.9	4.6	4.7	4.5

Note (1) For self bias operation this is taken at the grid current point with less than 1/2 microampere grid current.

FOR CIRCUIT SEE FIGURE 4

CHART X RESISTANCE COUPLED AMPLIFIER DATA

Zero Bias Operation

Rb	Ebb = 100 VOLTS								Ebb = 250 VOLTS													
	0.1		0.27		0.47		0.1		0.27		0.47		0.1		0.27		0.47					
	0.27	0.47	0.27	0.47	1.0	0.47	1.0	0.27	0.47	0.27	0.47	1.0	0.47	1.0	0.27	0.47	0.27	0.47	1.0	0.47	1.0	
Rcf	0.27	0.47	0.27	0.47	1.0	0.47	1.0	0.27	0.47	0.27	0.47	1.0	0.47	1.0	0.27	0.47	0.27	0.47	1.0	0.47	1.0	
Rk
Ib	0.223	0.223	0.126	0.126	0.126	0.89	0.89	1.1	1.1	0.54	0.54	0.54	0.34	0.34	
Ec
Eb	77.7	77.7	66.0	66.0	66.0	58.2	58.2	140	140	104	104	104	90	90	
Esig	6.1	0.1	0.1	0.1	0.1	0.1	0.1	0.1	0.1	0.1	0.1	0.1	0.1	0.1	0.1	0.1	0.1	0.1	0.1	0.1	0.1	
Eout	3.85	4.15	4.32	4.9	5.45	5.0	5.8	6.0	6.3	7.0	7.5	8.2	7.7	8.5	
Gain	38.5	41.5	43.2	49.0	54.5	50.0	58.0	60.0	63.0	70.0	75.0	82.0	77.0	85.0	
% Dist.	4.6	4.3	5.0	4.2	3.3	4.5	3.4	0.8	0.8	1.1	1.0	0.9	1.3	1.1	
Esig (1)	0.1	0.11	0.1	0.11	0.14	0.1	0.14	0.46	0.46	0.35	0.40	0.48	0.36	0.45	
Eout	3.85	4.55	4.32	5.35	7.4	5.0	7.84	25.3	26.0	22.5	28.0	35.3	25.1	34.2	
Gain	38.5	41.4	43.2	48.6	53.0	50.0	56.0	55.0	56.5	64.4	70.0	74.0	70.0	76.0	
% Dist.	4.6	4.9	5.0	4.7	5.0	4.5	5.0	4.8	4.7	4.9	4.8	4.8	5.0	4.8	

Note (1) Maximum signal for 5% Distortion.

FOR CIRCUIT SEE FIGURE 5

Self Bias Operation

Rb	Ebb = 100 VOLTS								Ebb = 250 VOLTS												
	0.1		0.27		0.47		0.1		0.27		0.47		0.1		0.27		0.47				
	0.27	0.47	0.27	0.47	1.0	0.47	1.0	3900	3900	5600	5600	6800	8200	10.000	1500	800	2700	2700	2700	3900	4700
Rcf	0.27	0.47	0.27	0.47	1.0	0.47	1.0	0.27	0.47	0.27	0.47	1.0	0.47	1.0	0.27	0.47	0.27	0.47	1.0	0.47	1.0
Rk	3900	3900	5600	5600	6800	8200	10.000	1500	800	2700	2700	2700	3900	4700
Ib	0.22	0.22	0.144	0.144	0.13	0.10	0.091	0.84	0.76	0.443	0.443	0.443	0.295	0.271
Ec	-0.86	-0.86	-0.81	-0.81	-0.88	-0.82	-0.91	-1.26	-1.37	-1.19	-1.19	-1.19	-1.15	-1.27
Eb	78	78	61.1	61.1	64.9	53	57.2	166	174	131	131	131	111.5	123
Esig	0.1	0.1	0.1	0.1	0.1	0.1	0.1	0.1	0.1	0.1	0.1	0.1	0.1	0.1	0.1	0.1	0.1	0.1	0.1	0.1	0.1
Eout	4.25	4.3	4.8	5.35	5.62	5.4	6.4	5.65	5.8	6.5	7.15	7.65	7.3	7.65
Gain	42.5	43.0	48.0	53.5	56.2	54.0	64.0	56.5	58.0	65.0	71.5	76.5	73.0	76.5
% Dist.	4.1	4.1	4.3	3.7	3.2	4.1	3.6	0.9	0.9	1.0	1.0	1.0	1.3	1.2
Esig (1)	0.12	0.12	0.1	0.1	0.13	0.1	0.15	0.47	0.54	0.39	0.39	0.39	0.33	0.45
Eout	5.1	5.15	4.8	5.35	7.25	5.4	9.0	26.5	30.5	24.5	27.5	29.2	23.5	34.0
Gain	42.5	43.0	48	53.5	55.8	54.0	60.0	56.4	56.5	63.0	70.5	75.0	71.3	75.5
% Dist.	5.1	5.0	4.3	3.7	4.6	4.1	5.0	4.5	5.3	5.1	4.2	3.9	5.2	5.3

Note (1) For self bias operation this is taken at the grid current point with less than 1/4 microampere grid current.

FOR CIRCUIT SEE FIGURE 4

6AV6
 6F5GT
 6SF5GT
 7B4

SYLVANIA TYPE 6AD5GT

CHART XI

RESISTANCE COUPLED AMPLIFIER DATA

Zero Bias Operation

Self Bias Operation

 2A6 SYLVANIA TYPE
 6B6G
 6S8GT
 6SQ7GT
 7B6
 7S

Rb	Ebb = 100 VOLTS						Ebb = 250 VOLTS							
	0.1		0.27			0.47	0.1		0.27			0.47		
Ref	0.27	0.47	0.27	0.47	1.0	0.47	1.0	0.27	0.47	0.27	0.47	1.0	0.47	1.0
Rk
Ib	0.228	0.228	0.132	0.132	0.132	0.09	0.09	1.0	1.0	0.52	0.52	0.52	0.34	0.34
Ec
Eb	77.2	77.2	64.4	64.4	64.4	57.7	57.7	150	150	110	110	110	90	90
Esig	0.1	0.1	0.1	0.1	0.1	0.1	0.1	0.1	0.1	0.1	0.1	0.1	0.1	0.1
Eout	3.3	3.55	3.95	4.48	5.05	4.63	5.4	4.63	5.0	5.6	6.1	6.7	6.43	7.15
Gain	33.0	35.5	39.5	44.8	50.5	46.3	54.0	46.3	50.0	56.0	61.0	67.0	64.3	71.5
% Dist	3.0	2.9	3.8	3.2	2.6	3.6	2.6	0.8	0.7	0.9	0.8	0.7	0.8	0.7
Esig (1)	0.15	0.16	0.12	0.14	0.17	0.13	0.17	0.55	0.6	0.5	0.57	0.65	0.5	0.6
Eout	4.73	5.4	4.65	6.12	8.3	5.9	8.8	23.4	26.6	25.5	31.8	39.0	29.5	39.5
Gain	31.5	33.8	38.7	43.8	49.0	45.4	51.7	42.5	44.5	51.0	56.0	60.0	59.0	66.0
% Dist	4.9	5.0	4.9	4.8	5.0	5.0	5.0	4.7	4.9	5.0	4.9	4.9	5.0	5.0

Note (1) Maximum Signal for 5.0% Distortion

FOR CIRCUIT SEE FIGURE 5

Rb	Ebb = 100 VOLTS						Ebb = 250 VOLTS							
	0.1		0.27			0.47	0.1		0.27			0.47		
Ref	0.27	0.47	0.27	0.47	1.0	0.47	1.0	0.27	0.47	0.27	0.47	1.0	0.47	1.0
Rk	3900	3900	5600	6800	6800	8200	10,000	1800	1800	2700	3300	3900	3900	4700
Ib	0.214	0.214	0.138	0.126	0.126	0.095	0.086	0.725	0.725	0.43	0.395	0.365	0.288	0.261
Ec	-0.835	-0.835	-0.774	-0.857	-0.857	-0.78	-0.86	-1.31	-1.31	-1.16	-1.30	-1.42	-1.12	-1.25
Eb	78.6	78.6	62.8	66.0	66.0	55.3	59.6	177.5	177.5	134	143.5	151.5	114.5	124.5
Esig	0.1	0.1	0.1	0.1	0.1	0.1	0.1	0.1	0.1	0.1	0.1	0.1	0.1	0.1
Eout	3.3	3.5	4.1	4.5	5.0	4.9	5.2	4.37	4.78	5.50	5.92	6.13	6.24	6.75
Gain	33.0	35.0	41.0	45.0	50.0	49.0	52.0	43.7	47.8	55.0	59.2	61.3	62.4	67.5
% Dist	2.7	2.6	3.2	3.0	2.5	3.1	2.6	0.8	0.7	0.8	0.8	0.7	0.8	0.7
Esig (1)	0.16	0.16	0.10	0.17	0.17	0.12	0.19	0.55	0.55	0.40	0.53	0.61	0.40	0.53
Eout	5.15	5.5	4.1	7.3	8.2	5.75	9.7	23.9	26.0	21.8	31.2	37.0	25.0	36.0
Gain	32.2	34.4	41.0	43.0	48.1	48.0	51.0	43.5	47.4	54.5	59.0	60.6	62.4	67.5
% Dist	4.5	4.0	3.2	5.0	4.5	4.0	5.0	4.5	4.0	3.3	4.0	4.5	3.3	3.8

Note (1) For self bias operation this is taken at the grid current point with less than 1/2 Microampere grid current.

FOR CIRCUIT SEE FIGURE 4

CHART XII

RESISTANCE COUPLED AMPLIFIER DATA

Self Bias Operation

Rb	Ebb = 100 VOLTS							Ebb = 250 VOLTS						
	0.1		0.27			0.47		0.1		0.27			0.47	
	Rc2							Rc2						
	0.47		1.2			1.8		0.47		1.2			2.2	
Rcf	0.27	0.47	0.27	0.47	1.0	0.47	1.0	0.27	0.47	0.27	0.47	1.0	0.47	1.0
Rk	1000	1000	2200	2200	2200	3900	3900	470	470	1000	1000	1000	1500	1500
Ib	0.62	0.62	0.27	0.27	0.27	0.168	0.168	1.76	1.76	0.75	0.75	0.75	0.44	0.44
Ic1	0.145	0.145	0.064	0.064	0.064	0.465	0.465	0.41	0.41	0.177	0.177	0.177	0.10	0.10
Ec1	-0.765	-0.765	-0.735	-0.735	-0.735	-0.622	-0.622	-1.02	-1.02	-0.927	-0.927	-0.927	-0.81	-0.81
Ec2	31.9	31.9	23.3	23.3	23.3	16.3	16.3	57.2	57.2	37.5	37.5	37.5	30	30
Eb	38	38	27.2	27.2	27.2	21	21	74	74	47.5	47.5	47.5	43.5	43.5
Esig	0.1	0.1	0.1	0.1	0.1	0.1	0.1	0.1	0.1	0.1	0.1	0.1	0.1	0.1
Eout	7.0	8.05	8.0	10.0	12.0	9.8	12.5	10.6	12.0	13.0	17.0	20.4	18.8	24.5
Gain	70.0	80.5	80	100	120	98	125	106	120	130	170	204	188	245
% Distortion	2.7	2.4	3.7	2.7	2.3	3.2	1.9	1.6	1.4	1.5	1.6	2.4	2.0	2.8
Esig (1)	0.18	0.18	0.14	0.14	0.14	0.14	0.14	0.4	0.4	0.27	0.27	0.27	0.18	0.18
Eoutt	12.3	13.9	10.8	13.8	16.7	13.2	17.0	40.3	45.2	33.0	41.6	49.5	32	41.5
Gain	68.5	77.2	77.2	98.7	119	94.5	121.5	101	113	122	154	183.5	178	230
% Distortion	4.7	4.1	5.5	4.6	3.8	4.9	5.0	4.3	4.4	5.0	5.0	5.9	4.3	4.9

Note (1) For self bias operation this is taken at the grid current point with less than 1/3 microampere grid current.

FOR CIRCUIT SEE FIGURE 1

SYLVANIA TYPE 6C6
 6J7GT
 6W7G
 7A17
 7C7
 14C7
 57
 954
 1273
 1280

CHART XIII RESISTANCE COUPLED AMPLIFIER DATA

Self Bias Operation

Rb	Ebb = 100 VOLTS						Ebb = 250 VOLTS					
	0.047		0.1		0.27		0.047		0.1		0.27	
	0.1	0.27	0.1	0.47	0.27	0.47	0.1	0.27	0.1	0.47	0.27	0.47
Rcf	1800	2200	2700	3900	6800	8200	1500	1800	2200	3300	5600	8200
Rk	1.07	1.0	0.62	0.56	0.256	0.240	2.85	2.69	1.63	1.46	0.661	0.60
Ib	-1.93	-2.2	-1.67	-2.18	-1.74	-1.97	-4.27	-4.84	-3.59	-4.82	-3.70	-4.92
Ec	49.6	53.0	38	44	31	35.2	116	123.8	87	104	71.8	88
Esig	0.5	0.5	0.5	0.5	0.5	0.5	1.0	1.0	1.0	1.0	1.0	1.0
Eout	5.3	5.4	5.6	5.8	5.7	5.8	11.2	11.8	11.8	12.4	12.1	12.2
Gain	10.6	10.8	11.2	11.6	11.4	11.6	11.2	11.8	11.8	12.4	12.1	12.2
% Distortion	2.1	1.9	2.0	1.8	2.2	1.8	1.3	1.2	1.8	1.3	1.8	1.3
Esig (1)	1.02	1.24	0.87	1.23	0.97	1.10	2.80	3.25	2.23	3.27	2.40	3.32
Eout	10.6	13.2	9.5	14.2	11.0	12.8	31.2	38.0	26.0	40.4	28.5	40.6
Gain	10.4	10.6	10.9	11.5	11.3	11.6	11.1	11.7	11.7	12.3	12.1	12.2
% Distortion	4.5	4.9	4.7	4.8	4.9	4.3	4.5	4.6	4.4	4.5	4.5	4.9

Note (1) For self bias operation this is taken at the grid current point with less than $\frac{1}{8}$ microampere grid current

FOR CIRCUIT SEE FIGURE 4

6BF6 PENNSYLVANIA TYPE
 6R7GT
 6SR7GT
 6ST7
 7E6
 12BF6
 12SW7
 26C6

CHART XIV RESISTANCE COUPLED AMPLIFIER DATA

Self Bias Operation—All Values Per Single Section

Zero Bias Operation—All Values Per Single Section

Rb	Ebb = 100 VOLTS						Ebb = 250 VOLTS							
	0.10		0.27		0.47		0.10		0.27		0.47			
	0.27	0.47	0.27	0.47	1.0	4.7	1.0	0.27	0.47	0.27	0.47	1.0	4.7	1.0
Rcf	3300	3300	5600	5600	6800	6800	8200	1800	2200	3300	3900	3900	4700	5600
Rk	0.30	0.30	0.169	0.169	0.152	0.1240	0.112	0.917	0.83	0.475	0.44	0.44	0.312	0.29
Ib	-0.99	-0.99	-0.948	-0.948	-1.03	-0.844	-0.92	-1.65	-1.83	-1.57	-1.72	-1.72	-1.47	-1.62
Ec	70	70	54.3	54.3	59.9	41.7	47.3	158.3	167	122	131	131	103	113.5
Esig	0.1	0.1	0.1	0.1	0.1	0.1	0.1	0.1	0.1	0.1	0.1	0.1	0.1	0.1
Eout	3.2	3.23	3.7	4.15	4.5	4.28	4.65	4.0	4.1	4.5	5.0	5.25	5.25	5.55
Gain	32.0	32.3	37.0	41.5	45.0	42.8	46.5	40.0	41.0	45.0	50.0	52.5	52.5	55.5
% Dist.	1.3	1.3	1.8	1.5	1.4	1.8	1.4	0.6	0.5	0.6	0.5	0.4	0.5	0.4
Esig (1)	0.33	0.33	0.21	0.21	0.34	0.2	0.3	0.87	1.03	0.83	0.97	0.97	0.77	0.90
Eout	10.3	10.4	7.7	8.6	14.8	8.5	13.5	33.6	41.5	36.3	46.6	48.8	38.8	48.5
Gain	31.2	31.5	36.6	41.0	43.5	42.5	45.0	38.6	40.2	43.7	48.0	50.4	50.4	54.0
% Dist.	4.9	4.8	4.0	3.1	5.0	3.4	4.4	4.0	4.8	4.5	4.8	3.8	3.9	3.7

Rb	Ebb = 100 VOLTS						Ebb = 250 VOLTS							
	0.1		0.27		0.47		0.1		0.27		0.47			
	0.27	0.47	0.27	0.47	1.0	0.47	1.0	0.27	0.47	0.27	0.47	1.0	0.47	1.0
Rcf
Rk	0.40	0.40	0.202	0.202	0.202	0.13	0.13	1.36	1.36	0.64	0.64	0.64	0.40	0.40
Ib
Ec	60.0	60.0	45.5	45.5	45.5	38.6	38.6	114	114	77.0	77.0	77.0	62.0	62.0
Esig	0.1	0.1	0.1	0.1	0.1	0.1	0.1	0.1	0.1	0.1	0.1	0.1	0.1	0.1
Eout	3.4	3.6	3.95	4.35	4.7	5.1	4.95	4.1	4.32	4.7	5.1	5.5	5.25	5.75
Gain	34.0	36.0	39.5	43.5	47.0	51.0	49.5	41.0	43.2	47.0	51.0	56.0	52.5	57.5
% Dist.	1.1	1.0	1.1	1.0	1.0	1.0	0.9	0.4	0.4	0.5	0.4	0.4	0.4	0.4
Esig (1)	0.33	0.34	0.25	0.3	0.34	0.25	0.32	1.0	1.07	.86	.97	1.09	.83	1.03
Eout	10.3	11.2	9.25	11.8	14.7	10.4	14.7	37.0	41.5	37.3	45.4	53.6	40.0	53.0
Gain	31.2	33.0	37.0	39.4	43.4	41.6	46.0	37.0	38.8	43.4	46.8	49.3	48.3	51.5
% Dist.	5.0	4.8	4.9	5.0	5.0	5.0	5.0	4.9	5.0	5.0	5.0	4.8	5.0	5.0

Note (1) For self bias operation this is taken at the grid current point with less than 1/4 Microampere grid current.

Note (1) Maximum gain for 5.0% Distortion.

FOR CIRCUIT SEE FIGURE 4

FOR CIRCUIT SEE FIGURE 5

CHART XV

RESISTANCE COUPLED AMPLIFIER DATA

6BK6 SYLVANIA TYPE
12AX7
12BK6
26BK6

Self Bias Operation

Zero Bias Operation

Rb	Ebb = 100 VOLTS						Ebb = 250 VOLTS							
	0.1		0.27		0.47		0.1		0.27		0.47			
Ref	0.27	0.47	0.27	0.47	1.0	0.47	1.0	0.27	0.47	0.27	0.47	1.0	0.47	1.0
Rk	4700	5600	8200	10,000	10,000	12,000	15,000	1800	1800	3300	3300	3900	4700	5600
Ib	.23	.204	.132	.117	.117	.092	.08	.84	.84	.45	.45	.41	.30	.28
Ec	-1.08	-1.143	-1.03	-1.17	-1.17	-1.10	-1.2	-1.51	-1.51	-1.49	-1.49	-1.59	-1.41	-1.57
Eb	77.0	79.6	64.4	88.4	68.4	56.8	82.4	166.	166.	128.	128.	139.	109.	118.5
Esig.	0.1	0.1	0.1	0.1	0.1	0.1	0.1	0.1	0.1	0.1	0.1	0.1	0.1	0.1
Eout	3.6	3.8	4.2	4.35	5.0	4.7	5.2	5.4	5.7	6.1	6.6	6.9	6.6	7.1
Gain	38.0	38.0	42.0	43.5	50.0	47.0	52.0	54.0	57.0	61.0	66.0	69.0	66.0	71.0
% Dist.	3.4	3.4	3.6	3.2	2.6	3.2	2.6	0.3	0.5	0.2	0.2	0.4	0.2
Esig. (1)	.14	.14	.11	.14	.17	.13	.17	.5	.5	.41	.45	.54	.38	.48
Eout	5.0	5.2	4.6	6.0	8.3	6.1	8.5	26.5	28.5	24.5	29.0	37.0	25.0	33.5
Gain	35.7	37.2	41.8	42.9	48.8	46.9	50.0	53.0	52.0	59.8	64.4	68.5	65.8	69.8
% Dist.	5.0	5.1	4.1	4.9	5.1	4.4	5.0	5.0	4.4	4.95	4.4	4.8	4.1	4.2

(1) At grid current point, less than 1/2 Microampere grid current through 0.27 megohm grid resistor.

FOR CIRCUIT SEE FIGURE 4

Rb	Ebb = 100 VOLTS						Ebb = 250 VOLTS							
	0.1		0.27		0.47		0.1		0.27		0.47			
Ref	0.27	0.47	0.27	0.47	1.0	0.47	1.0	0.27	0.47	0.27	0.47	1.0	0.47	1.0
Rk
Ib	.255	.255	.146	.146	.146	.100	.100	1.16	1.16	.57	.57	.57	.355	.355
Ec
Eb	74.5	74.5	60.6	60.6	60.6	53	53	134.	134.	123.	123.	123.	83.	83.
Esig.	0.1	0.1	0.1	0.1	0.1	0.1	0.1	0.1	0.1	0.1	0.1	0.1	0.1	0.1
Eout	3.9	4.2	4.35	5.0	5.5	4.85	5.7	6.0	6.3	6.6	7.2	7.7	7.3	8.0
Gain	39	42	43.5	50	55	48.5	57	60	63	66	72	77	73	80
% Dist.	3.0	2.7	3.4	2.6	2.0	2.9	2.0	0.3
Esig. (1)	.14	.15	.13	.15	.18	.14	.18	.52	.56	.43	.5	.57	.42	.53
Eout	5.3	6.1	5.6	7.2	9.3	6.7	8.5	28.5	32.0	26.5	33.0	40.5	29.0	39.0
Gain	37.9	40.7	43	48	51.7	47.8	47.2	54.8	57.1	61.6	66	71.1	69.	73.6
% Dist.	4.8	4.8	4.8	4.7	4.9	4.7	4.8	4.8	5.0	4.9	5.0	4.9	4.8	4.8

(1) Maximum signal for 5.0% distortion.

FOR CIRCUIT SEE FIGURE 5

CHART XVI

RESISTANCE COUPLED AMPLIFIER DATA

Zero Bias Operation

Self Bias Operation

Rb	Ebb = 100 Volts						Ebb = 250 Volts							
	0.1		0.27		0.47		0.1		0.27		0.47			
	0.27	0.47	0.27	0.47	1.0	0.47	1.0	0.27	0.47	0.27	0.47	1.0	0.47	1.0
Rcf
Rk
Ib	0.55	0.55	0.25	0.25	0.25	0.16	0.16	1.75	1.75	0.74	0.74	0.74	0.45	0.45
Ec
Eb	45.0	45.0	32.5	32.5	32.5	25.0	25.0	75	75	50	50	50	38	38
Esig	0.1	0.1	0.1	0.1	0.1	0.1	0.1	0.1	0.1	0.1	0.1	0.1	0.1	0.1
Eout	2.55	2.62	2.55	2.75	2.87	2.65	2.85	3.15	3.25	3.20	3.35	3.45	3.25	3.36
Gain	25.5	26.2	25.5	27.5	28.7	26.5	28.5	31.5	32.5	32.0	33.5	34.5	32.5	33.6
% Dist.	1.1	1.1	1.4	1.2	1.0	1.4	1.1	0.6	0.6	0.7	0.7	0.6	0.7	0.7
Esig ⁽¹⁾	0.42	0.46	0.35	0.40	0.47	0.38	0.47	1.15	1.20	0.86	1.00	1.16	0.87	1.16
Eout	9.7	11.0	8.3	9.8	12.1	9.2	12.0	31.5	33.5	24.5	29.0	35.0	25.0	31.7
Gain	23.1	23.9	23.7	24.5	26.8	24.2	25.5	27.3	27.9	28.5	29.0	30.1	28.7	28.8
% Dist.	5.0	4.9	4.9	4.8	4.8	4.9	4.9	5.0	4.8	4.8	4.8	4.9	4.9	4.9

(¹) Maximum Signal For 5.0% Distortion

FOR CIRCUIT SEE FIGURE 5

Rb	Ebb = 100 Volts						Ebb = 250 Volts							
	0.1		0.27		0.47		0.1		0.27		0.47			
	0.27	0.47	0.27	0.47	1.0	0.47	1.0	0.27	0.47	0.27	0.47	1.0	0.47	1.0
Rcf	0.27	0.47	0.27	0.47	1.0	0.47	1.0	0.27	0.47	0.27	0.47	1.0	0.47	1.0
Rk	1800	2200	3900	3900	4700	6800	8200	1200	1200	2200	2700	3300	3900	4700
Ib	0.48	0.45	0.23	0.23	0.22	0.14	0.14	1.39	1.39	0.64	0.61	0.58	0.39	0.38
Ec ₁	-9	-1.0	-9	-9	-1.0	-1.0	1.2	-1.7	-1.7	-1.4	-1.7	-1.9	-1.5	-1.8
Eb	51	54	37	37	40	33	33	100	109	76	83	91	60	65
Esig	0.1	0.1	0.1	0.1	0.1	0.1	0.1	0.1	0.1	0.1	0.1	0.1	0.1	0.1
Eout	2.43	2.48	2.46	2.68	2.75	2.45	2.60	2.80	2.90	2.81	3.00	2.98	2.90	2.05
Gain	24.3	24.8	24.6	26.8	27.5	24.5	26.0	28.0	29.0	28.1	30.0	29.8	29.0	29.5
% Dist.	1.3	1.3	1.5	1.3	1.2	1.5	1.2	0.5	0.6	0.7	0.7	0.6	0.8	0.5
Esig ⁽¹⁾	0.35	0.45	0.32	0.32	0.43	0.36	0.46	1.02	1.02	0.79	0.95	1.16	0.83	0.99
Eout	8.4	11.0	7.9	8.4	11.6	8.7	11.7	28.1	29.2	22.2	28.0	33.8	24.1	29.5
Gain	24.0	24.4	24.6	26.2	27.0	24.1	25.4	27.5	28.6	28.1	29.4	29.1	29.0	29.8
% Dist.	3.9	4.8	4.4	3.7	4.4	4.7	4.9	4.5	4.0	4.3	4.6	4.9	4.6	4.5

Note (¹) For Self Bias Operation This is Taken at the Grid Current Point With Less Than $\frac{1}{2}$ Microampere Grid Current.

FOR CIRCUIT SEE FIGURE 4

CHART XVII

RESISTANCE COUPLED AMPLIFIER DATA

Self Bias Operation

Zero Bias Operation

Rb	Ebb = 100 Volts						Ebb = 250 Volts							
	0.1		0.27		0.47		0.1		0.27		0.47			
Ref	0.27	0.47	0.27	0.47	1.0	0.47	1.0	0.27	0.47	0.27	0.47	1.0	0.47	1.0
Rk	1500	1800	3900	3900	4700	5600	6800	680	680	1800	1800	2200	3300	3900
Ib	0.54	0.51	0.23	0.23	0.22	0.150	0.141	1.62	1.62	0.69	0.69	0.65	0.41	0.40
Ec ₁	-0.81	-0.92	-0.90	-0.90	-1.04	-0.840	-0.960	-1.10	-1.10	-1.24	-1.24	-1.43	-1.35	-1.56
Eb	45.2	48.1	37.1	37.1	39.6	28.7	32.7	86.9	86.9	62.3	62.3	75.6	55.7	59.9
Esig	0.1	0.1	0.1	0.1	0.1	0.1	0.1	0.1	0.1	0.1	0.1	0.1	0.1	0.1
Eout	3.0	3.0	2.8	3.0	3.1	2.95	3.0	3.90	4.10	3.55	3.70	3.65	3.50	3.60
Gain	30.0	30.0	28.0	30.0	31.0	29.5	30.0	39.0	41.0	35.5	37.0	36.5	35.0	36.0
% Dist.	1.9	1.7	1.9	1.7	1.4	1.8	1.4	.54	1.0	1.0	.92	.79	.89	.75
Esig(1)	0.54	0.29	0.30	0.29	0.38	0.22	0.34	0.61	0.49	0.54	0.56	0.71	0.64	0.77
Eout	6.6	8.7	8.4	8.4	11.5	6.5	10.0	23.0	19.7	19.0	20.6	25.5	22.1	27.0
Gain	30.0	30.0	28.0	28.9	30.3	29.5	29.4	37.0	40.2	35.2	36.8	35.9	34.5	35.1
% Dist.	3.9	4.7	5.0	4.5	4.9	3.6	4.1	4.4	4.2	4.7	4.2	4.6	4.8	4.6

Note (1) For Self Bias Operation This is Taken at the Grid Current Point With Less Than $\frac{1}{2}$ Microampere Grid Current.

FOR CIRCUIT SEE FIGURE 4

Rb	Ebb = 100 Volts						Ebb = 250 Volts							
	0.1		0.27		0.47		0.1		0.27		0.47			
Ref	0.27	0.47	0.27	0.47	1.0	0.47	1.0	0.27	0.47	0.27	0.47	1.0	0.47	1.0
Rk
Ib	0.590	0.590	0.262	0.262	0.262	0.160	0.160	1.82	1.82	0.75	0.75	0.75	0.44	0.44
Ec ₁
Eb	41.0	41.0	29.3	29.3	29.3	24.8	24.8	68.0	68.0	48.0	48.0	48.0	43.0	43.0
Esig	0.1	0.1	0.1	0.1	0.1	0.1	0.1	0.1	0.1	0.1	0.1	0.1	0.1	0.1
Eout	3.0	3.3	3.1	3.3	3.5	3.1	3.3	4.3	4.4	4.0	4.1	4.2	3.85	4.1
Gain	30	33.0	31.0	33.0	35.0	31.0	33.0	43.0	44.0	40.0	41.0	42.0	38.5	41.0
% Dist.	2.0	1.7	2.06	1.8	1.6	1.9	1.6	1.3	1.25	1.30	1.22	1.19	1.25	1.20
Esig(1)	0.28	0.31	0.27	0.33	0.38	0.30	0.40	0.58	0.63	0.57	0.70	0.80	0.63	0.79
Eout	8.3	9.3	7.9	10.0	12.0	8.8	12.0	22.0	24.0	20.5	25.0	29.0	21.0	28.0
Gain	29.6	30.0	29.2	30.3	31.5	29.3	30.0	38.0	38.1	35.9	35.7	36.3	33.3	35.5
% Dist.	5.0	5.0	4.9	5.0	4.8	4.9	5.0	5.0	5.0	4.9	5.0	4.9	5.0	5.0

Note (1) Maximum Signal For 5.0% Distortion.

FOR CIRCUIT SEE FIGURE 5

CHART XVIII

RESISTANCE COUPLED AMPLIFIER DATA

Self Bias Operation

Zero Bias Operation

Rb	Ebb = 100 Volts							Ebb = 250 Volts						
	0.1		0.27			0.47		0.1		0.27			0.47	
Ref	0.27	0.47	0.27	0.47	1.0	0.47	1.0	0.27	0.47	0.27	0.47	1.0	0.47	1.0
Rk	2200	2700	5600	5600	6800	10000	12000	1000	1200	2700	3300	3900	5600	6800
Ib	0.61	0.56	0.250	0.250	0.235	0.150	0.140	1.79	1.72	0.70	0.68	0.65	0.41	0.39
Eci	-1.3	-1.5	-1.4	-1.4	-1.6	-1.5	-1.7	-1.8	-2.1	-1.9	-2.2	-2.5	-2.3	-2.7
Eb	38	43	31	31	35	28	33	69	76	59	64	72	55	63
Esig	0.1	0.1	0.1	0.1	0.1	0.1	0.1	0.1	0.1	0.1	0.1	0.1	0.1	0.1
Eout	2.05	1.96	1.83	2.00	1.95	1.90	1.93	2.42	2.40	2.20	2.24	2.22	2.12	2.12
Gain	20.5	19.6	18.3	20.0	19.5	19.0	19.3	24.2	24.0	22.0	22.4	22.2	21.2	21.2
% Dist.	1.0	0.9	1.0	0.9	0.8	0.8	0.7	0.7	0.6	0.6	0.5	0.5	0.5	0.5
Esig ⁽¹⁾	0.42	0.61	0.54	0.55	0.71	0.62	0.76	0.93	1.13	1.01	1.26	1.48	1.28	1.52
Eout	8.5	11.7	9.9	10.7	13.5	11.5	14.3	22.5	27.0	22.2	28.0	32.5	26.5	31.5
Gain	20.2	19.2	18.3	19.5	19.0	18.6	18.8	24.2	23.9	21.8	22.2	22.0	20.7	20.7
% Dist.	3.9	5.0	4.9	4.1	4.4	4.8	4.5	4.7	4.8	4.7	4.7	4.6	4.9	4.5

Note (1) For Self Bias Operation This is Taken at the Grid Current Point With Less Than 1/4 Microampere Grid Current.

FOR CIRCUIT SEE FIGURE 4

Rb	Ebb = 100 Volts						Ebb = 250 Volts							
	0.1		0.27		0.47		0.1		0.27		0.47			
Ref	0.27	0.47	0.27	0.47	1.0	0.47	1.0	0.27	0.47	0.27	0.47	1.0	0.47	1.0
Rk
Ib	0.730	0.730	0.300	0.300	0.300	0.181	0.181	2.08	2.08	0.82	0.82	0.82	0.49	0.49
Eci
Eb	27.0	27.0	19.0	19.0	19.0	15.0	15.0	42.0	42.0	28.0	28.0	28.0	20.0	20.0
Esig	0.1	0.1	0.1	0.1	0.1	0.1	0.1	0.1	0.1	0.1	0.1	0.1	0.1	0.1
Eout	2.15	2.3	2.05	2.05	2.10	1.95	2.0	2.81	2.85	2.38	2.50	2.55	2.3	2.40
Gain	21.5	23.1	20.5	20.5	21.0	19.5	20.0	28.1	28.5	23.8	25.0	25.5	23.0	24.0
% Dist.	1.3	1.5	1.5	1.4	1.3	1.4	1.4	1.3	1.3	1.3	1.2	1.1	1.2	1.1
Esig ⁽¹⁾	0.44	0.46	0.41	0.47	0.57	0.47	0.58	0.71	0.74	0.68	0.80	0.90	0.75	0.97
Eout	7.60	9.50	7.50	8.30	10.30	8.20	10.3	18.2	19.0	14.5	17.8	20.0	15.0	21.0
Gain	17.3	20.6	18.3	17.7	18.1	17.5	17.8	25.6	25.7	21.3	22.1	22.2	20.0	21.7
% Dist.	5.0	4.9	5.0	5.0	5.0	5.0	5.0	5.0	5.0	5.0	5.0	4.9	5.0	5.0

Note (1) Maximum Signal For 5.0 % Distortion

FOR CIRCUIT SEE FIGURE 5

CHART XIX

RESISTANCE COUPLED AMPLIFIER DATA

Self Bias Operation

	Ebb = 100 Volts						Ebb = 250 Volts							
	0.1		0.27		0.47		0.1		0.27		0.47			
Rb	0.1		0.27		0.47		0.1		0.27		0.47			
Rc ₂	0.27		0.68		1.2		0.27		0.82		1.2			
Rcf	0.27	0.47	0.27	0.47	1.0	0.47	1.0	0.27	0.47	0.27	0.47	1.0	0.47	1.0
Rk	1000	1000	2200	2200	2200	3900	3900	330	330	820	820	820	1200	1500
Ib	.510	.510	.234	.234	.234	.141	.141	1.09	1.09	0.64	0.64	0.64	0.44	0.42
Ie ₂	.205	.205	.095	.095	.095	.057	.057	0.67	0.67	0.25	0.25	0.23	0.173	0.170
Ec ₁	-.72	-.72	-.72	-.72	-.72	-.77	-.77	-.78	-.78	-.73	-.73	-.73	-.74	-.88
Ec ₂	45	45	35	35	35	31	31	69	69	45	45	45	42	46
Eb	49	49	37	37	37	34	34	81	81	77	77	77	43	53
Esig	.05	.05	.05	.05	.05	.05	.05	.05	.05	.05	.05	.05	.05	.05
Eout	4.6	5.2	4.8	6.0	7.5	5.7	7.5	8.9	10.0	9.4	12.0	15.0	12.0	15.5
Gain	92	104	96	120	150	114	150	178	203	188	240	300	240	310
% Dist.	3.6	3.8	4.2	3.8	3.1	4.4	3.3	1.9	1.9	3.6	3.3	3.4	3.0	2.4
Esig ⁽¹⁾	.07	.07	.06	.07	.08	.06	.09	.15	.20	.08	.08	.08	.12	0.2
Eout	6.4	7.3	5.7	8.4	11.5	6.7	13.0	25.0	38.0	15	19	23.5	27.0	52.0
Gain	92	104	95	120	144	112	145	167	190	188	238	294	225	260
% Dist.	5.0	5.0	4.8	4.9	3.8	5.2	5.1	5.0	5.3	5.3	5.2	4.9	4.4	4.8

Note (1) For Self Bias Operation This is Taken at the Grid Current Point With Less Than $\frac{1}{2}$ Microampere Grid Current.

FOR CIRCUIT SEE FIGURE 1

CHART XX RESISTANCE COUPLED AMPLIFIER DATA

Self Bias Operation

	Ebb = 100 Volts						Ebb = 250 Volts					
	.047		0.1		0.27		.047		0.1		0.27	
Rb	.1	.27	.1	.47	.27	.47	.1	.27	.1	.47	.27	.47
Rk	1200	1200	2200	3300	6800	8200	560	560	1000	1200	3900	3900
Ib	1.33	1.33	0.70	0.64	.275	.260	3.84	3.84	1.98	1.95	0.76	0.76
Ec ₁	-1.6	-1.6	-1.5	-2.1	-1.9	-2.1	-2.2	-2.2	-2.0	-2.3	-3.0	-3.0
Eb	36	36	29	34	24	28	66	66	50	53	42	42
Esig	.1	.1	.1	.1	.1	.1	.1	.1	.1	.1	.1	.1
Eout	1.25	1.27	1.13	1.22	1.10	1.12	1.45	1.50	1.37	1.44	1.25	1.28
Gain	12.5	12.7	11.3	12.2	11.0	11.2	14.5	15.0	13.7	14.4	12.5	12.8
% Dist.	0.9	0.9	0.9	0.7	0.6	0.6	0.7	0.7	0.7	0.7	0.5	0.5
Esig ⁽¹⁾	0.60	0.63	.60	.98	.88	1.07	1.17	1.17	1.02	1.28	1.65	1.65
Eout	7.4	8.0	6.8	11.5	9.7	12.0	17.0	17.5	14.0	18.5	20.7	21.1
Gain	12.3	12.7	11.3	11.7	11.0	11.2	14.5	15.0	13.7	14.4	12.5	12.8
% Dist.	4.7	4.5	4.6	4.9	4.7	4.3	5.2	5.0	5.0	4.6	4.8	4.2

Note ⁽¹⁾ For Self Bias Operation This is Taken at the Grid Current Point With Less Than $\frac{1}{6}$ Microampere Grid Current.

FOR CIRCUIT SEE FIGURE 4

CHART XXI

RESISTANCE COUPLED AMPLIFIER DATA

Self Bias Operation

	Ebb = 100 Volts							Ebb = 250 Volts						
	.1		.27			.47		.1		.27			.47	
Rb														
Rc2	.27		.68			1.2		.27		.68			1.2	
Ref	.27	.47	.27	.47	1.0	.47	1.0	.27	.47	.27	.47	1.0	.47	1.0
Rk	1200	1200	2700	2700	2700	4700	4700	470	470	1000	1000	1200	1500	1800
1b	.57	.57	.246	.246	.246	.143	.143	1.74	1.74	.74	.74	.72	.44	.42
Ic2	.24	.24	.106	.106	.106	.063	.063	.68	.68	.30	.30	.29	.18	.175
Ee1	-1.0	-1.0	-1.0	-1.0	-1.0	-1.0	-1.0	-1.1	-1.1	-1.0	-1.0	-1.2	-0.9	-1.1
Ee2	41	41	28	28	28	25	25	66	66	46	46	52	34	40
Eb	46	46	34	34	34	33	33	76	76	50	50	55	43	52
Esig	.05	.05	.05	.05	.05	.05	.05	0.1	0.1	0.1	0.1	0.1	0.1	0.1
Eout	5.8	6.0	5.6	6.9	8.3	6.4	8.5	19.0	20.0	20.5	25.0	29.8	25.1	31.0
Gain	116	120	112	138	166	128	170	190	200	205	250	298	251	310
% Dist.	3.6	3.7	3.9	3.3	2.4	4.7	3.5	2.7	2.5	3.4	1.1	0.8	2.2	0.7
Esig ⁽¹⁾	.07	.07	.06	.09	.11	.05	.07	.32	.32	.26	.22	.29	.14	.22
Eout	8.0	8.3	6.6	12.0	16.5	6.4	11.5	54.0	56.0	37.0	47.7	67.0	34.0	57.5
Gain	114	119	110	133	150	128	164	169	185	185	217	231	243	261
% Dist.	5.1	4.9	4.7	4.9	3.5	4.7	4.7	4.9	3.3	5.1	2.6	3.3	3.5	3.7

Note (1) For Self Bias Operation This is Taken at the Grid Current Point With Less Than $\frac{1}{2}$ Microampere Grid Current.

FOR CIRCUIT SEE FIGURE 1

CHART XXII RESISTANCE COUPLED AMPLIFIER DATA

Triode Section Self Bias Operation

Rb	Ebb = 100 Volts						Ebb = 250 Volts					
	.047		0.1		0.27		.047		0.1		0.27	
Ref	0.1	0.27	0.1	0.47	0.27	0.47	0.1	0.27	0.1	0.47	0.27	0.47
Rk	1000	1200	1800	2700	4700	5600	470	470	820	1200	2700	3300
Ib	1.2	1.1	0.64	0.56	0.26	0.25	3.5	3.5	1.86	1.73	0.72	0.68
Ec	-1.2	-1.3	-1.2	-1.5	-1.2	-1.4	-1.6	-1.6	-1.5	-2.1	-1.9	-2.2
Eb	43	47	35	43	29	32	84	84	63	75	54	64
Esig	0.1	0.1	0.1	0.1	0.1	0.1	0.1	0.1	0.1	0.1	0.1	0.1
Eout	2.0	2.10	1.98	2.05	1.96	2.00	2.45	2.63	2.38	2.45	2.25	2.25
Gain	20.0	21.0	19.8	20.5	19.6	20.0	24.5	26.3	23.8	24.5	22.5	22.5
% Dist.	1.4	1.2	1.5	1.0	1.2	1.0	0.8	0.8	0.9	0.7	0.7	0.6
Esig(°)	.37	.49	.35	.62	.40	.53	.78	.78	.66	1.04	1.02	1.25
Eout	7.4	10.0	6.9	12.5	7.7	10.5	19.1	20.3	15.7	25.5	22.5	28.0
Gain	20.0	20.4	19.7	20.1	19.2	19.8	24.5	26.1	23.8	24.5	22.1	22.4
% Dist.	4.6	5.1	4.5	5.1	4.2	4.1	4.8	4.4	4.5	4.7	4.9	4.7

(1) At Grid Current Point. Less Than ¼ Microampere Grid Current Through 0.27 Megohm Grid Resistor.

FOR CIRCUIT SEE FIGURE 4

Pentode Section Self Bias Operation

Rb	Ebb = 100 Volts						Ebb = 250 Volts							
	0.1		0.27		0.47		0.1		0.27		0.47			
Rc ₂	.27		.68		1.2		.33		.82		1.2			
Ref	.27	.47	.27	.47	1.0	.47	1.0	.27	.47	.27	.47	1.0	.47	1.0
Rk	1000	1000	2200	2200	2700	3300	3900	390	470	820	1000	1200	1800	1800
Ib	.65	.65	.28	.28	.27	.17	.16	1.75	1.70	.74	.73	.72	.46	.46
Ic ₂	.26	.26	.12	.12	.11	.07	.07	.62	.61	.270	.265	.260	.183	.183
Ec ₁	-9	-9	-9	-9	-1.0	-8	-9	-9	-1.0	-8	-1.0	-1.0	-1.2	-1.2
Ec ₂	30	30	18	18	25	16	16	46	49	29	33	37	30	30
Eb	35	35	24	24	27	20	25	75	80	50	53	55	34	34
Esig	.1	.1	.1	.1	.1	.1	.1	.1	.1	.1	.1	.1	.1	.1
Eout	7.9	9.0	8.2	9.8	11.5	9.9	12.4	14.2	15.3	15.7	18.9	22.0	16.7	25.0
Gain	79	90	82	98	115	99	124	142	153	157	189	220	167	250
% Dist.	2.7	2.1	2.9	1.0	.46	2.3	.80	2.4	2.2	2.2	1.5	.82	1.9	2.8
Esig(°)	.18	.18	.14	.14	.23	.12	.17	.27	.38	.18	.27	.35	.30	.35
Eour	13.5	15.0	11.2	13.5	22.6	11.6	19.3	36.2	52.0	27.1	45	63	43.8	67
Gain	75	83.2	80	96.5	98.3	96.6	113	134	137	150	167	180	146	191
% Dist.	4.2	2.9	4.1	1.7	4.0	3.2	2.7	4.3	4.5	3.9	3.9	4.8	5.0	4.5

Note (1) For Self Bias Operation This is Taken at the Grid Current Point With Less Than ¼ Microampere Grid Current.

FOR CIRCUIT SEE FIGURE 1

SYLVANIA ELECTRIC PRODUCTS INC.

PRODUCT DIRECTORY

RADIO TUBE DIVISION

Emporium, Pennsylvania

Receiving Tubes • Test Equipment

TELEVISION PICTURE TUBE DIVISION

Seneca Falls, New York

Cathode Ray Tubes • Television Picture Tubes

RADIO & TELEVISION DIVISION

254 Rano Street, Buffalo 7, New York

Radio Receivers • Television Receivers

ELECTRONICS DIVISION

100 Sylvan Rd., Woburn, Massachusetts

Specialized Electronics Equipment • Germanium and Silicon Diodes — Magnetrons — Thyratrons — TR Tubes

PHOTOFLASH DIVISION

Broad Street, Mountoursville, Pennsylvania

Photoflash Lamps • Photoflood Lamps

LIGHTING DIVISION

60 Boston Street, Salem, Massachusetts

Fluorescent & Incandescent Lamps • Sign Tubing
Lamp Fixtures & Accessories

TUNGSTEN & CHEMICAL DIVISION

Towanda, Pennsylvania

Tungsten Products • Fluorescent Chemicals

PARTS DIVISION

208 East Street, Warren, Pennsylvania

Wire Parts, Welds • Plastics

ELECTRONIC SYSTEMS DIVISION

100 First Street, Waltham, Massachusetts

Special Electronic Equipment

For information on specific products, address inquiries to the appropriate division.

SYLVANIA PLANTS, LABORATORIES, AND OFFICES LOCATED IN—

Alexandria, Va.	Fullerton, Cal.	Point Pleasant, W. Va.
Altoona, Pa.	Hatboro, Pa.	Salem, Mass.
Atlanta, Ga.	Hicksville, N. Y.	San Francisco, Cal.
Batavia, N. Y.	High Point, N. C.	Seattle, Wash.
Bayside, N. Y.	Houtzdale, Pa.	Seneca Falls, N. Y.
Boston, Mass.	Huntington, W. Va.	Shawnee, Okla.
Brookville, Pa.	Ipswich, Mass.	Smethport, Pa.
Buffalo, N. Y.	Kansas City, Kansas	St. Louis, Mo.
Burlington, Iowa	Kew Gardens, N. Y.	St. Marys, Pa.
Charlotte, N. C.	Los Angeles, Cal.	Teterboro, N. J.
Cincinnati, Ohio	Melrose Park, Ill.	Toronto, Ontario, Canada
Cleveland, Ohio	Mill Hall, Pa.	Towanda, Pa.
Dallas, Texas	Milwaukee, Wis.	Troy, Pennsylvania
Danvers, Mass.	Minneapolis, Minn.	Union City, N. J.
Dayton, Ohio	Montoursville, Pa.	Waldoboro, Maine
Denver, Colorado	Montreal, P. Q., Canada	Waltham, Mass.
Detroit, Mich.	Mountain View, Cal.	Warren, Pa.
Drummondville, P. Q., Canada	Naugatuck, Conn.	Washington, D. C.
DuBois, Pa.	Nelsonville, Ohio	Wheeling, W. Va.
Dunnville, Ontario	New York, New York	Williamsport, Pa.
Emeryville, Cal.	Newton, Mass.	Winchester, Kentucky
Emporium, Pa.	Ottawa, Ohio	Woburn, Mass.
Flushing, N. Y.	Philadelphia, Pa.	York, Pa.
	Pittsburgh, Pa.	

INDEX FOR APPENDIX

Fundamental Properties of Vacuum Tubes	1
Vacuum Tube Ratings	2
Receiving Tube Screen Voltage Ratings	5
Receiving Tube Rectifier Ratings	6
Series String Television	7
Amplifier Classification	8
Use of Curves	9
Tube and Base Diagram Symbols	12
Handling of Picture Tubes	13
Tube Outlines Section	15
Resistance Coupled Amplifier Section	21
Sylvania Product Directory	46
Sylvania Aids for Servicemen	47

(We suggest that you place this divider between the last
special purpose tube page and the first appendix page.)