

PHILIPS

Data handbook



Electronic
components
and materials

Electron tubes

Part 3 March 1972

Special Quality tubes

Miscellaneous devices

ELECTRON TUBES

Part 3

March 1972

DATA HANDBOOK SYSTEM

Special Quality tubes

Miscellaneous devices

BLUE

ELECTRON TUBES (7 parts)

RED

SEMICONDUCTORS AND INTEGRATED CIRCUITS (6 parts)

GREEN

COMPONENTS AND MATERIALS (7 parts)

The several parts contain all pertinent data available at the time of publication, and each is revised and reissued annually; the contents of each series are illustrated on the following pages.

We have made every effort to ensure that each series is as accurate, comprehensive and up-to-date as possible, and we hope you will find it to be a valuable source of reference. Wherever ranges or specifications proved difficult to publish in the preceding edition they will be pointed out by arrows. You will understand that we can not guarantee that all products listed in any edition of the handbook will remain available, or that their specifications will not be changed, before the next edition is published. If you need confirmation that the published data cover any other products and the latest available, may we ask that you contact our representative. He is available to answer your inquiries.



DATA HANDBOOK SYSTEM

To provide you with a comprehensive source of information on electronic components, subassemblies and materials, our Data Handbook System is made up of three series of handbooks, each comprising several parts.

The three series, identified by the colours noted, are:

ELECTRON TUBES (9 parts)	BLUE
SEMICONDUCTORS AND INTEGRATED CIRCUITS (6 parts)	RED
COMPONENTS AND MATERIALS (7 parts)	GREEN

The several parts contain all pertinent data available at the time of publication, and each is revised and reissued annually; the contents of each series are summarized on the following pages.

We have made every effort to ensure that each series is as accurate, comprehensive and up-to-date as possible, and we hope you will find it to be a valuable source of reference. Where ratings or specifications quoted differ from those published in the preceding edition they will be pointed out by arrows. You will understand that we can not guarantee that all products listed in any one edition of the handbook will remain available, or that their specifications will not be changed, before the next edition is published. If you need confirmation that the published data about any of our products are the latest available, may we ask that you contact our representative. He is at your service and will be glad to answer your inquiries.

ELECTRON TUBES (BLUE SERIES)

This series consists of the following parts, issued on the dates indicated.

Part 1 Transmitting tubes (Tetrodes, Pentodes)	January 1972 Amplifier circuit assemblies
Part 2 Tubes for microwave equipment	February 1972
Part 3 Special Quality tubes	March 1972 Miscellaneous devices
Part 4 Receiving tubes	April 1971
Part 5 Cathode-ray tubes Photo tubes Camera tubes	May 1971 Associated accessories
Part 6 Photomultiplier tubes Channel electron multipliers Scintillators Photoscintillators	June 1971 Radiation counter tubes Semiconductor radiation detectors Neutron generator tubes Photo diodes Associated accessories
Part 7 Voltage stabilizing and reference tubes Counter, selector, and indicator tubes Trigger tubes Switching diodes	July 1971 Thyratrons Ignitrons Industrial rectifying tubes High-voltage rectifying tubes
Part 8 T. V. Picture tubes	August 1971
Part 9 Transmitting tubes (Triodes) Tubes for R. F. heating (Triodes)	December 1971 Associated accessories

March 1972

SEMICONDUCTORS AND INTEGRATED CIRCUITS (RED SERIES)

This series consists of the following parts, issued on the dates indicated.

Part 1 Diodes and Thyristors September 1971

General
Signal diodes
Variable capacitance diodes
Voltage regulator diodes
Rectifier diodes

Thyristors, diacs, triacs
Rectifier stacks
Accessories
Heatsinks

Part 2 Low frequency; Deflection October 1971

General
Low frequency transistors (low power)
Low frequency power transistors

Deflection transistors
Accessories

Part 3 High frequency; Switching November 1971

General
High frequency transistors

Switching transistors
Accessories

Part 4 Special types December 1971

General
Transmitting transistors
Microwave devices
Field effect transistors
Dual transistors
Microminiature devices for
thick- and thin-film circuits

Photoconductive devices
Photodiodes
Phototransistors
Light emitting diodes
Infra-red sensitive devices
Accessories

Part 5 Linear Integrated Circuits February 1972

General

Linear integrated circuits

Part 6 Digital integrated circuits March 1972

General
DTL (FC family)
TTL (FJ family)
TTL (GJ family)

MOS (FD family)
HNIL (FZ family)
CML (GH family)

COMPONENTS AND MATERIALS (GREEN SERIES)

This series consists of the following parts, issued on the dates indicated.

Part 1 Circuit Blocks, Input/Output Devices, Electro-mechanical Components *), Peripheral Devices **October 1971**

Circuit blocks 40-Series	Input/output devices
Counter modules 50-Series	Electro-mechanical components *)
Norbits 60-Series, 61-Series	Peripheral devices
Circuit blocks 90-Series	

Part 2 Resistors, Capacitors **December 1971**

Fixed resistors	Paper capacitors and film capacitors
Variable resistors	Electrolytic capacitors
Non-linear resistors	Variable capacitors
Ceramic capacitors	

Part 3 Radio, Audio, Television **February 1972**

FM tuners	Audio and mains transformers
Coil assemblies	Television tuners, aerial input assemblies
Piezoelectric ceramic resonators and filters	Components for black and white television
Loudspeakers	Components for colour television
	Deflection assemblies for camera tubes

Part 4 Magnetic Materials, Piezoelectric Ceramics **April 1971**

Ferrites for radio, audio and television	Ferroxcube potcores and square cores
Small coils, assemblies and assembling parts	Ferroxcube transformer cores
	Piezoxide
	Permanent magnet materials

Part 5 Memory Products, Magnetic Heads, Quartz Crystals, Microwave Devices, Variable Transformers **June 1971**

Ferrite memory cores	Quartz crystal units, crystal filters
Matrix planes, matrix stacks	Isolators, circulators
Complete memories	Variable mains transformers
Magnetic heads	

Part 6 Electric Motors and Accessories, Timing and Control Devices **August 1971**

Stepper motors	Small d.c. motors
Small synchronous motors	Tachogenerators and servomotors
Asynchronous motors	Indicators for built-in test equipment

Part 7 Circuit Blocks **September 1971**

Circuit blocks 100kHz Series	Circuit blocks for ferrite core memory drive
Circuit blocks 1-Series	
Circuit blocks 10-Series	

*) From October 1971 published in Part 1 instead of Part 5.

February 1972

Melincué 2594
Tel. 50-9941/8155
BUENOS AIRES

Australia
Philips Industries Ltd.
Elcoma Division
95-99 York Street
Tel. 20223
SYDNEY, N.S.W. 2000

Austria
WIVEG
Zieglergasse 6
Tel. 93 26 22
A1072 VIENNA

Belgium
M.B.L.E.
80, rue des Deux Gares
Tel. 23 00 00
1070 BRUSSELS

Brazil
IBRAPE S.A.
Av. Paulista 2073-S/Loja
Tel. 278-1111
SAO PAULO, SP

Canada
Philips Electron Devices
116, Vanderhoof Ave.
Tel. 425-5161
TORONTO 17, Ontario

Chile
Philips Chilena S.A.
Av. Santa Maria 0760
Tel. 39-40 01
SANTIAGO

Colombia
SADAPE S.A.
Calle 19, No. 5-51
Tel. 422-175
BOGOTA D.E. 1

Denmark
Miniwatt A/S
Emdrupvej 115A
Tel. (01) 69 16 22
DK-2400 KØBENHAVN NV

Finland
Oy Philips Ab
Elcoma Division
Kaivokatu 8
Tel. 65 80 33
SF-00100 HELSINKI 10

France
R.T.C.
La Radiotechnique-Compelec
Avenue Ledru Rollin 130
Tel. 357-69-30
PARIS 11

Germany
Valvo G.m.b.H.
Valvo Haus
Burchardstrasse 19,
Tel. (0411) 3296-1
2 HAMBURG 1

Greece
Philips S.A. Hellénique
Elcoma Division
52, Av. Syngrou
Tel. 915 311
ATHENS

Philips Hong Kong Ltd.
Components Dept.
St. George's Building, 21st Fl.
Tel. K-42 82 05
HONG KONG

India
IMBELEC Div. of
Philips India Ltd.
Band Box House
254-D, Dr. Annie Besant Road
Tel. 475 311 to 15
Worli, BOMBAY 18 (WB)

Indonesia
P.T. Philips-Ralin Electronics
Elcoma Division
Djalan Gadjah Mada 18
Tel. 44 163
DJAKARTA

Ireland
Philips Electrical (Ireland) Ltd.
Newstead, Clonskeagh
Tel. 69 33 55
DUBLIN 14

Italy
Philips S.p.A.
Sezione Elcoma
Piazza IV Novembre 3
Tel. 69 94
MILANO

Japan
NIHON PHILIPS
32nd Fl. World Trade Center Bldg.
5, 3-chome, Shiba Hamamatsu-cho
Minato-ku
Tel. (435) 5204-5
TOKYO

Mexico
Electrónica S.A. de C.V.
Varsovia No. 36
Tel. 5-33-11-80
MEXICO 6, D.F.

Netherlands
Philips Nederland N.V.
Afd. Elonco
Boschdijk, VB
Tel. (040) 43 33 33
EINDHOVEN

New Zealand
EDAC Ltd.
70-72 Kingsford Smith Street
Tel. 873 159
WELLINGTON

Norway
Electronica A/S
Middelthunsgate 27
Tel. 46 39 70
OSLO 3

Peru
CADESA
Jr. Ilo, No. 216
Appartado 10132
Tel. 27 7317
LIMA

Portugal
Philips Portuguesa S.A.R.L.
Rua Joaquim Antonio de Aguiar 66
Tel. 68 31 21/9
LISBOA

EDAC (Pty.) Ltd.
South Park Lane
New Doornfontein
Tel. 24/6701-2
JOHANNESBURG

Spain
COPRESA S.A.
Balmas 22
Tel. 232 66 80
BARCELONA 7

Sweden
ELCOMA A.B.
Lidingövägen 50
Tel. 08/67 97 80
10250 STOCKHOLM 27

Switzerland
Philips A.G.
Edenstrasse 20
Tel. 051/44 22 11
CH-8027 ZUERICH

Taiwan
Philips Taiwan Ltd.
San Min Building, 3rd Fl.
57-1, Chung Shan N. Road
Section 2
Tel. 553101-5
TAIPEI

Turkey
Turk Philips Ticaret A.S.
EMET Department
Gümüşsuyu Cad. 78-80
Tel. 45.32.50
Beyoğlu, ISTANBUL

United Kingdom
Mullard Ltd.
Mullard House
Torrington Place
Tel. 01-580 6633
LONDON WC1E 7HD

United States
North American Philips
Electronic Component Corp.
230, Duffy Avenue
Tel. (516) 931-6200
HICKSVILLE, N.Y. 11802

Uruguay
Luzilectron S.A.
Rondeau 1567, piso 5
Tel. 9 43 21
MONTEVIDEO

Venezuela
C.A. Philips Venezolana
Elcoma Department
Colinas de Bello Monte
Tel. 72.01.51
CARACAS

Special Quality tubes



SPECIAL QUALITY TUBES APPLICATION DIRECTIONS

CONTENTS

1. General
2. Nominal- and spread values of tube characteristics
3. Spread and variation of operating conditions
4. Limiting values
5. Electrode voltage
6. Electrode current
7. Electrode dissipation
8. Heater voltage
9. Supply voltage
10. Resistance values
11. Heater cathode circuit
12. Suppressor grid circuit
13. Control grid circuit
14. Shock and vibration
15. Life
16. Hum
17. Microphony
18. Environmental conditions
19. Mounting and wiring

SPECIAL QUALITY TUBES APPLICATION DIRECTIONS

CONTENTS

1. General
2. Nominal and spread values of tube characteristics
3. Spread and variation of operating conditions
4. Heating values
5. Electrode voltage
6. Electrode current
7. Electrode dissipation
8. Heater voltage
9. Supply voltage
10. Resistance values
11. Heater cathode circuit
12. Suppressor grid circuit
13. Control grid circuit
14. Shock and vibration
15. Life
16. Hum
17. Microphony
18. Environmental conditions
19. Mounting and wiring

GENERAL OPERATIONAL RECOMMENDATIONS SPECIAL QUALITY TUBES

1. GENERAL

Deviations from these directives will be stated on the individual data sheets. If applications are considered not referred to in the data of the relevant tube type extra care should be taken with circuit design to avoid that the tube is overloaded due to unfavourable operating conditions.

Also in the circuit design use might be made of tube characteristics not controlled by the manufacturer. When at a later date batches of tubes are delivered which show different values for these characteristics this may result in unsatisfactory performance of the equipment.

2. NOMINAL AND SPREAD VALUES OF TUBE CHARACTERISTICS

Tube data not stated as maximum or minimum values apply to a nominal tube. Equipment design should be based on the characteristics as stated in the data sheets.

With measurements carried out with a small number of tubes and in particular with new tube types it should be taken into account that average and spread values may differ from those obtained at larger quantities.

3. SPREAD AND VARIATION OF OPERATING CONDITIONS

Parameter values which define the operating conditions may be subject to spread and/or variation.

3.1 Spread. Spread of a parameter value will result in individual values permanently deviating from the average value. The nominal value is the average of such a number of individual values taken at random that an increase of the number will have a negligible influence on the average value.

3.2 Variation. Variation of a parameter value is the change of value occurring as a function of time.

The nominal value is the average value calculated over a period such that a prolongation of that period will have a negligible influence on the average value.

4. LIMITING VALUES

Limiting values should be used in accordance with the applicable rating system as defined by I. E. C. publication 134.

Reference may be made to one of the following 3 rating systems.

- 4.1 Absolute maximum rating system. Absolute maximum ratings are limiting values of operating and environmental conditions applicable to any electronic device of a specified type as defined by its published data, and should not be exceeded under the worst probable conditions.

These values are chosen by the device manufacturer to provide acceptable serviceability of the device, taking no responsibility for equipment variations, environmental variations, and the effects of changes in operating conditions due to variations in the characteristics of the device under consideration and of all other electronic devices in the equipment.

The equipment manufacturer should design so that, initially and throughout life, no absolute-maximum value for the intended service is exceeded with any device under the worst probable operating conditions with respect to supply voltage variation, equipment components variation, equipment control adjustment, load variations, signal variation, environmental conditions, and variations in characteristics of the device under consideration and of all other electronic devices in the equipment.

- 4.2 Design-maximum rating system. Design-maximum ratings are limiting values of operating and environmental conditions applicable to a bogey electronic device of a specified type as defined by its published data, and should not be exceeded under the worst probable conditions.

These values are chosen by the device manufacturer to provide acceptable serviceability of the device, taking responsibility for the effects of changes in operating conditions due to variations in the characteristics of the electronic device under consideration.

The equipment manufacturer should design so that, initially and throughout life, no design-maximum value for the intended service is exceeded with a bogey device under the worst probable operating conditions with respect to supply-voltage variation, equipment component variation, variation in characteristics of all other devices in the equipment, equipment control adjustment, load variation, signal variation and environmental conditions.

- 4.3 Design-centre rating system. Design-centre ratings are limiting values of operating and environmental conditions applicable to a bogey electronic device of a specified type as defined by its published data, and should not be exceeded under normal conditions.

These values are chosen by the device manufacturer to provide acceptable serviceability of the device in average applications, taking responsibility for normal changes in operating conditions due to rated supply-voltage variation, equipment component variation, equipment control adjustment, load variation, signal variation, environmental conditions, and variations in the characteristics of all electronic devices.

The equipment manufacturer should design so that, initially, no design-centre value for the intended service is exceeded with a bogey electronic device in equipment operating at the stated normal supply-voltage.

- 4.4 In addition to the limiting values given in the individual data sheets the directives in the following paragraphs should be observed.

5. ELECTRODE VOLTAGE

Two limiting values of electrode voltage are given

- a) V_{a0} , V_{g20} etc.

These values are continuously permitted at zero anode current and with cold cathode. They are also permitted as peak voltage during operation when a D.C. voltage in combination with a superimposed A.C. voltage are present at the electrode provided that the peak value coincides with approx. zero electrode current.

- b) V_a , V_{g2} etc.

These values are D.C. components of the electrode voltages and are continuously permitted.

In circuits with automatic gain control the D.C. component may exceed the published limiting value with 20% provided that the increase of voltage is solely resulting from the gain control and that the maximum voltage coincides with approximately zero electrode current.

6. ELECTRODE CURRENT

The limiting values I_a , I_{g2} etc. are the D.C. components of the electrode currents calculated over 20 ms.

If no specific pulse ratings apply a peak value $2xI_a$, I_{g2} etc. is permitted for 10 ms maximum.

7. ELECTRODE DISSIPATION

The limiting values W_a , W_{g2} etc. are the average values at an averaging time of 1 s. If for audio output tubes a limiting value W_{g2p} is given this value applies to operation with speech and music excitation and should not be exceeded if measured with a sinusoidal signal and at maximum output. If load values vary during operation care should be taken not to exceed the limiting values of W_a and W_{g2} .

8. HEATER VOLTAGE

The average heater voltage should be the specified nominal value. Variation of the heater voltage exceeding the range of $V_f \text{ nom.} \pm 5\%$ will shorten the tube life.

9. SUPPLY VOLTAGE

If design centre ratings apply the variation of supply voltage should not exceed the range of the nominal value $\pm 10\%$.

10. RESISTANCE VALUES

If design centre ratings apply the spread of resistance values should be limited such that with all other conditions nominal no electrode voltages or currents will exceed the range of their nominal values $\pm 5\%$.

11. HEATER CATHODE CIRCUIT

Limiting values of V_{kf} apply to the positive and negative D.C. component of the voltage between the cathode and any of the heater terminals.

The limiting peak value is 2 times the rated D.C. value with a maximum of 315 V.

At the published values only the risk of breakdown is considered. No conclusions with respect to hum should be drawn from this figure.

To minimise the influence of variation and spread of the leakage current between heater and cathode the resistance of the external heater to cathode circuit should not exceed 20 k Ω in R.F. circuits where frequency stability or preservation of wave form is required and in A.F. circuits with low signal level.

However, when the D.C. value of V_{kf} is at least 3 times the RMS value of the heater voltage an external resistance between heater and cathode of maximum 220 k Ω can be used provided that the hum voltage which may then occur across the cathode resistor can be accepted for the application considered.

12. SUPPRESSOR GRID CIRCUIT

The voltage of the suppressor grid with respect to the cathode should not be positive and should not exceed 35 V.

The external resistance in the suppressor grid circuit should not exceed 5 k Ω .

13. CONTROL GRID CIRCUIT

In the interest of low hum and noise the resistance in the control grid circuit should be as low as possible.

The limiting value of the grid resistance given in the data sheets is chosen so that the negative grid current which may occur during life will not result in unacceptable tube operation.

If only the limiting value of the resistance for fixed bias operation is given and stabilizing elements are used in the circuit, this limiting value may be multiplied by the D.C. feedback factor obtained by these stabilizing elements to a maximum of 20 M Ω .

14. SHOCK AND VIBRATION

The conditions specified under "shock and vibration resistance" are test conditions applied to assess the mechanical quality of the tube.

These conditions are not intended to be used as normal operating conditions.

15. LIFE

In the interest of a satisfactory life performance and especially where long life is required the tube should be operated under the conditions quoted under "operating conditions". Spread and variation of operating conditions should be limited as much as possible. In this respect the operation with high cathode resistor values and positive grid bias is to be preferred.

Variation of heater voltage should not exceed the limits indicated in item 8 or if applicable, the limiting values specified in the individual tube data sheets.

16. HUM

A.F. application. If in the data an equivalent hum voltage on the control grid is given this value applies to the following conditions:

1. The frequency of the heater voltage is 50 c/s + 3% harmonics 500 c/s.
2. The hum voltage is measured as the equivalent RMS value with a filter of 45-550 c/s with a straight response curve.
3. The value of the impedance in the control grid circuit (Z_{g1}) does not exceed the value published with respect to hum.
4. The impedance in the cathode circuit is as specified with respect to hum. If no value is given the hum voltage across the cathode resistor is considered to be negligible.
5. The heater terminals and supply leads are screened with respect to the other electrode terminals unto the tube bottom.
6. The A.C. voltage between cathode and heater does not exceed the value corresponding with the method of earthing of the heater circuit specified with respect to hum.

17. MICROPHONY

The performance of an equipment with respect to microphony is defined by the following conditions:

1. The microphony performance of the relevant tube type.
2. The acceleration applied to the tube during operation.
3. The A.F. amplification between the input of the tube and the output of the applied circuit.

In many applications a tube is subject to accelerations applied via the tube socket or, however to a less extent, via the surrounding air.

The acceleration may be produced by a loudspeaker or by the operation of a motor or of a switch.

Measurements to reduce the acceleration should be directed to mechanical or acoustical isolation of the tube.

If mechanical isolation is required the application of a flexible tube holder is advised.

18. ENVIRONMENTAL CONDITIONS

- 18.1 Atmospheric pressure. Ratings apply to operation at normal atmospheric pressure at altitudes below 3000 m.

In order to avoid the risk of external flashovers it is advised to consult us if tubes have to be operated at lower pressures.

- 18.2 Bulb and base temperature. The bulb and the base temperature are defined as the highest temperature at any place on the bulb or the base.

The base temperature should not exceed 165 °C.

If the maximum permitted base or bulb temperature is exceeded life performance may deteriorate. Adequate cooling should therefore be observed and may be obtained by convection, radiation or conduction.

A tube mounted in free air may be cooled by convection and by radiation. In order to obtain the most efficient cooling a free circulation of air should be assured around the tube and neighbouring bodies should be maintained at low temperature.

These neighbouring bodies should preferably approach the condition of a perfect black body.

With the design of screening- or retaining devices free circulation of cooling air should be permitted and reflection of heat back on to the bulb must be avoided.

Where the forementioned requirements cannot be met due to mechanical limitation or high altitude or where the temperature of the air available for circulation is too high, forced air cooling or conduction can be adopted. In some cases it may be necessary to reduce the electrode dissipation.

If a good thermal contact can be maintained between the glass surface of the tube and the heat conducting mass on which it is mounted and if this mass is at a sufficiently low temperature, cooling by air circulation may not be necessary. This method is particularly suitable for tubes with flying leads when the mechanical arrangements are not likely to allow free air cooling.

- 18.3 Flashover. To avoid insulation breakdown due to ionization or tracking at high electrode voltages adequate ventilation is required. High voltage terminals should not have sharp or pointed edges.

19. MOUNTING AND WIRING

- 19.1 Mounting position. A tube may be mounted in any position. The vertical position however, is recommended.
- 19.2 Pins and sockets. Subminiature tubes employ semi-rigid pins. To ensure that these pins are straight before insertion into the tube socket use may be made of a pin straightening tool. It is recommended both in wired and in printed circuits to use sockets with floating contacts. The connections to these floating contacts should be as flexible as possible. Where the floating contacts are rigidly attached to the contact tags, a wiring jig should be used to ensure that the socket contacts are in the correct position to receive a tube after the socket has been wired. The use of too stiff wiring will destroy the advantage provided by the float of the contacts and may hold the contact so far out of position as to result in damage of the tube base. No connections should be made to a pin marked i.c.
- 19.3 Flexible leads. Where tubes with flexible leads are employed without plug in sockets and are held in position by means of the envelope, such support should not cause undue stress on the leads.
- 19.4 Soldering. Where the leads are connected by soldering they should not be sharply bent close to the glass. It should also be avoided that the glass to metal seal is overheated. The leads therefore should not be soldered nearer than 5 mm to the glass and use may be made of a thermal shunt between the glass and the soldering point.
- 19.5 Magnetic and electrostatic fields. To avoid unwanted effects of magnetic or electrostatic fields a tube should be positioned or shielded as to reduce such effects to a minimum.
- 19.6 Retaining devices. If measures are required to prevent a tube being shaken out of the holder a retaining device may be used. Care should then be taken not to exceed the maximum permitted bulb temperature.
- 19.7 Floating electrodes. All tube electrodes should have a D.C. connection to the cathode. An interruption of the D.C. connection between cathode and earth or heater and earth may introduce heater-cathode breakdown and should be avoided.

19.7 Floating electrodes. All tube electrodes should have a D.C. connection to the cathode. An interruption of the D.C. connection between cathode and earth or heater and earth may introduce heater-cathode breakdown and should be avoided.

19.6 Retaining devices. If measures are required to prevent a tube being shaken out of the holder a retaining device may be used. Care should also be taken not to exceed the maximum permitted tube temperature.

19.5 Magnetic and electrostatic fields. To avoid unwanted effects of magnetic or electrostatic fields a tube should be positioned or shielded so to reduce such effects to a minimum.

19.4 Soldering. Where the leads are connected by soldering they should not be sharply bent close to the glass. It should also be avoided that the glass metal seal is overstressed. The leads therefore should not be soldered nearer than 5 mm to the glass and use may be made of a thermal shunt between the glass and the soldering point.

19.3 Flexible leads. Where tubes with flexible leads are employed without plug sockets and are held in position by means of the envelope, such supports should not cause undue stress on the leads.

19.2 Connections should be made to a pin marked i.e. tube base.

19.1 Mounting position. A tube may be mounted in any position. The vertical position however, is recommended.

19.0 Fine and sockets. Subminiature tubes employ semi-rigid pins. To ensure that these pins are straight before insertion into the tube socket use may be made of a pin straightening tool. It is recommended both in use and in printed circuits to use sockets with floating contacts. The connections to these floating contacts should be as flexible as possible. Where the floating contacts are rigidly attached to the contact tape, a wire tag should be used to ensure that the socket contacts are in the correct position to receive a tube after the socket has been wired. The use of too stiff wiring will destroy the advantage provided by the float of the contacts and may hold the contact so far out of position as to result in damage of the tube base.

19. MOUNTING AND WIRING

18.3. However, To avoid insulation breakdown due to ionization or heating of high electrode voltages adequate ventilation is required. High voltage terminals should not have sharp or pointed edges.

18.2. However, To avoid insulation breakdown due to ionization or heating of

S.Q. TUBE

Special quality pentode designed for use as A.F. and R.F. amplifier, output tube, oscillator a.o.

QUICK REFERENCE DATA

Life test	10 000 hours
Base	Loctal
Heating	Indirect A.C. or D.C. Series or parallel supply
Heater voltage	V_f 20 V
Heater current	I_f 125 mA
Anode current	I_a 16 mA
Mutual conductance	S 6.5 mA/V
Equivalent noise resistance	R_{eq} 1200 Ω
Hum voltage	V_{geq} 10 μV_{RMS}

DIMENSIONS AND CONNECTIONS

Dimensions in mm

Base: Loctal

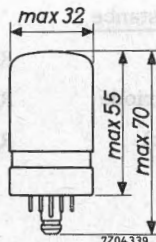
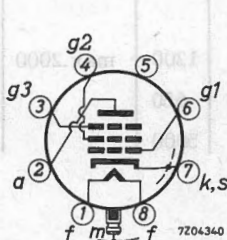

CHARACTERISTICS

Column I Nominal value or setting of the tube

II Range values for equipment design: Initial spread

III Range values for equipment design: End of life

		I	II	III	
Heater voltage	V_f	20			V
Heater current	I_f	125	120 - 130		mA
Anode supply voltage	V_{ba}	225			V
Grid No. 2 supply voltage	V_{bg2}	155			V
Grid No. 3 voltage	V_{g3}	0			V
Cathode resistor	R_k	250			Ω
Anode current	I_a	16	13.5 - 19	min. 11.5	mA
Grid No. 2 current	I_{g2}	3	2 - 4		mA
Mutual conductance	S	6.5	5.5 - 7.8	min. 4.5	mA/V
Internal resistance	R_i	250	min. 200		$k\Omega$
Amplification factor	μ_{g2g1}	19			
<u>Negative grid current</u>	$-I_g$		max. 0.5	max. 1.0	μA
<u>Output power</u>	W_o	1.5			W
Anode load resistance $R_{a\sim} = 10 k\Omega$					
Total distortion $d_{tot} = 10 \%$					
<u>Cathode heating time</u>		26	19 - 33		sec
Anode current $I_a = 4 \text{ mA}$					
<u>Equivalent noise resistance</u>					
R. F.	R_{eq}	1200	max. 2000		Ω
R. F. connected as triode	R_{eq}	650			Ω
A. F. (500 - 3000 Hz)	R_{eq}	5000			Ω

CHARACTERISTICS (continued)

		II	III	
<u>Insulation between cathode and heater</u>	I_{kf}	max. 0.5	max. 1.0	μA
Voltage between cathode and heater $V_{kf} = 50$ V (cathode positive)				
<u>Insulation between two electrodes</u>	R_{ins}	min. 1000	min. 300	$M\Omega$
Voltage between electrodes $V = 50$ V				
<u>Hum voltage</u>	$V_{g_{eq}}$	max. 10		μV_{RMS}
Grid No. 1 resistor $R_{g_1} = 500$ k Ω				
Cathode by-pass capacitor $C_k = 100$ μF				
Heater centre earthed				

CAPACITANCES

		I	II	
Grid No. 1 to grid No. 2, grid No. 3, cathode, heater and screen	C_{g_1/g_2g_3kfs}	8.5	7.5 - 9.5	pF
Grid No. 1 to grid No. 2, grid No. 3, cathode, heater and screen	C_{g_1/g_2g_3kfs}	10.5		pF
Cathode current $I_k = 19$ mA				
Anode to grid No. 2, grid No. 3, cathode, heater and screen	C_{a/g_2g_3kfs}	6.0	4.5 - 7.7	pF
Grid No. 1 and anode to grid No. 3, grid No. 2, cathode, heater and screen	C_{g_1a/g_3g_2kfs}		max. 16	pF
Anode to grid No. 1	C_{ag_1}	14	max. 18	mpF
Grid No. 1 to grid No. 2	$C_{g_1g_2}$	3		pF
Grid No. 2 to grid No. 3	$C_{g_2g_3}$	2.2		pF
Grid No. 1 to cathode and screen	$C_{g_1/ks}$	4.5		pF
Anode to grid No. 3	C_{ag_3}	1.2		pF
Grid No. 1 to heater	C_{g_1f}	20	max. 40	mpF
Anode to heater	C_{af}	120		mpF
Cathode and screen to heater	$C_{ks/f}$	7		pF

CAPACITANCES (continued)

As triode (Grid No. 2 and grid No. 3 connected to anode)

		I	II	
Grid No. 1 to cathode, heater and screen	C_{g1}/kfs	5	max. 6	pF
Anode, grid No. 2 and grid No. 3 to cathode, heater and screen	C_{ag2g3}/kfs	7.5	max. 9	pF
Anode, grid No. 2 and grid No. 3 to grid No. 1	$C_{ag2g3/g1}$	3.2	max. 4	pF

LIFE

Production samples are tested to be within the end of life values (column III) under the following conditions during 10 000 hours.

Heater voltage	V_f	20 V
Anode supply voltage	V_{ba}	225 V
Grid No. 2 supply voltage	V_{bg2}	155 V
Grid No. 3 voltage	V_{g3}	0 V
Cathode resistor	R_k	250 Ω

LIMITING VALUES Design centre rating system.

Anode voltage	V_{a0}	max. 550 V
	V_a	max. 300 V
Anode dissipation	W_a	max. 4 W
Grid No. 3 voltage	V_{g30}	max. 550 V
	V_{g3}	max. 300 V
Grid No. 3 dissipation	W_{g3}	max. 1 W
Grid No. 2 voltage	V_{g20}	max. 550 V
	V_{g2}	max. 300 V
Grid No. 2 dissipation	W_{g2}	max. 1 W
Dissipation of anode, grid No. 2 and grid No. 3 (triode connected)	$W_{a+g2+g3}$	max. 5 W
Grid No. 1 voltage	$-V_{g1}$	max. 100 V
Grid No. 1 dissipation	W_{g1}	max. 50 mW
Cathode current	I_k	max. 30 mA

LIMITING VALUES (continued)

Grid No.1 resistor Anode dissipation > 1.5 W	R_{g1}	max.	0.5 $M\Omega$
Grid No.1 resistor Anode dissipation < 1.5 W	R_{g1}	max.	3 $M\Omega$
Voltage between cathode and heater	V_{kf}	max.	120 V
Bulb temperature (Metal envelope)	t_{bulb}	max.	120 $^{\circ}C$

Heater voltage: The average heater voltage should be 20 V.

Variations of the heater voltage exceeding the range of 19 V to 21 V will shorten the tube life.

The tolerance of heater current (column II) should be taken into account.

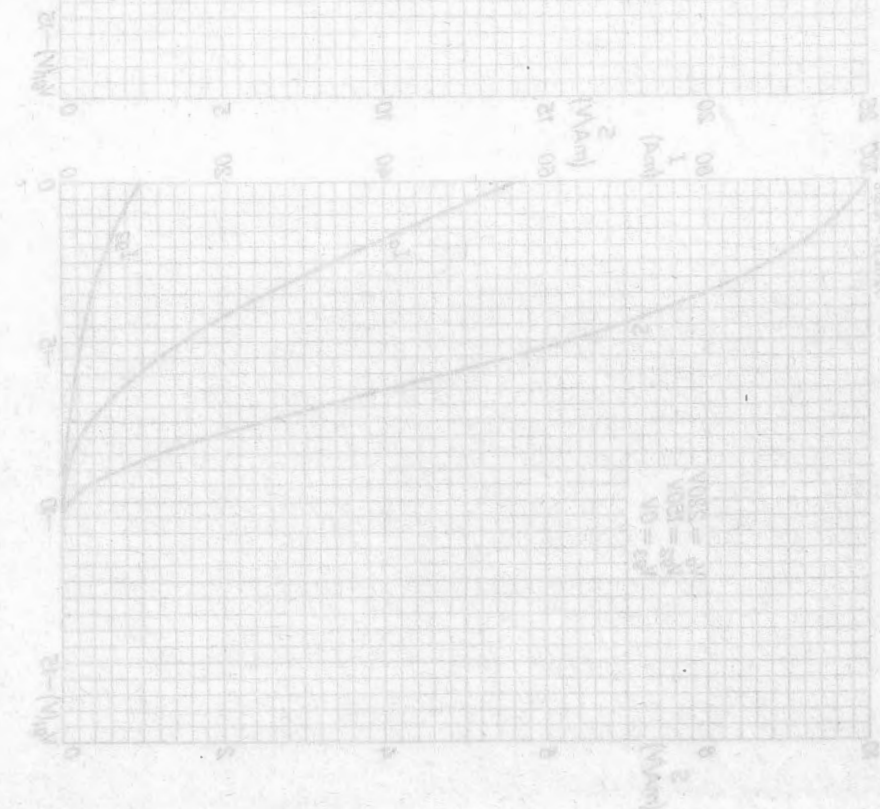

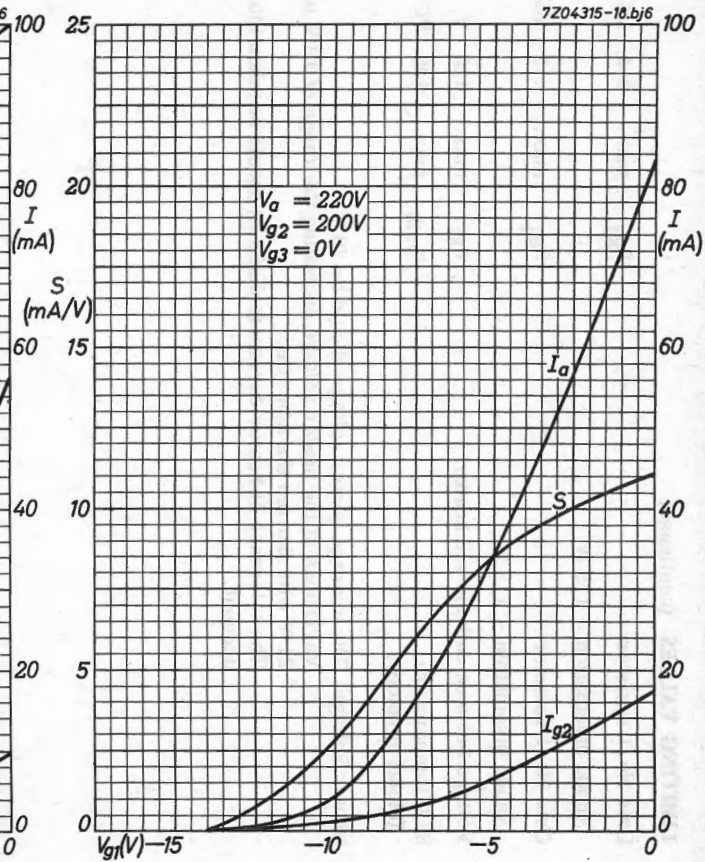
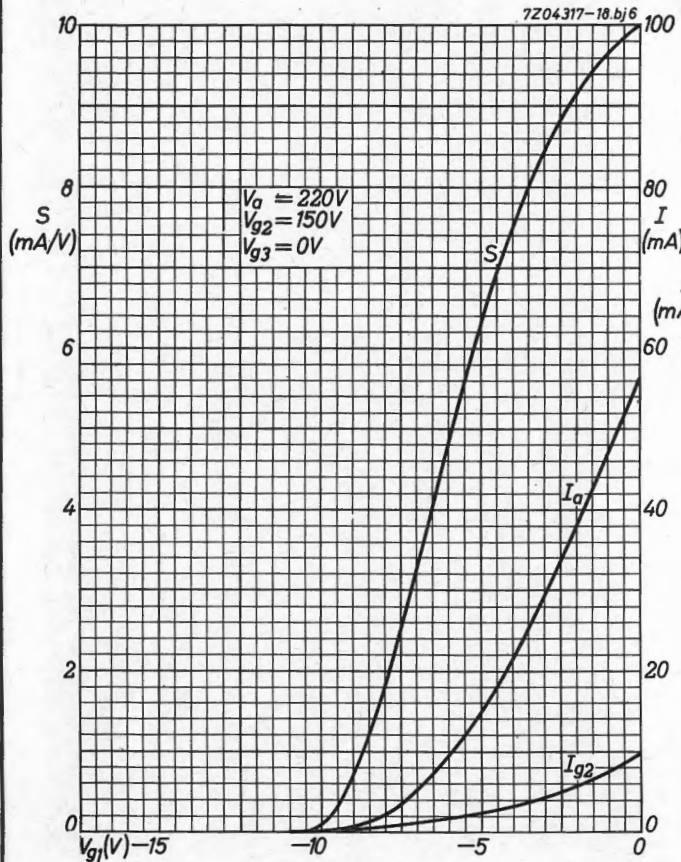

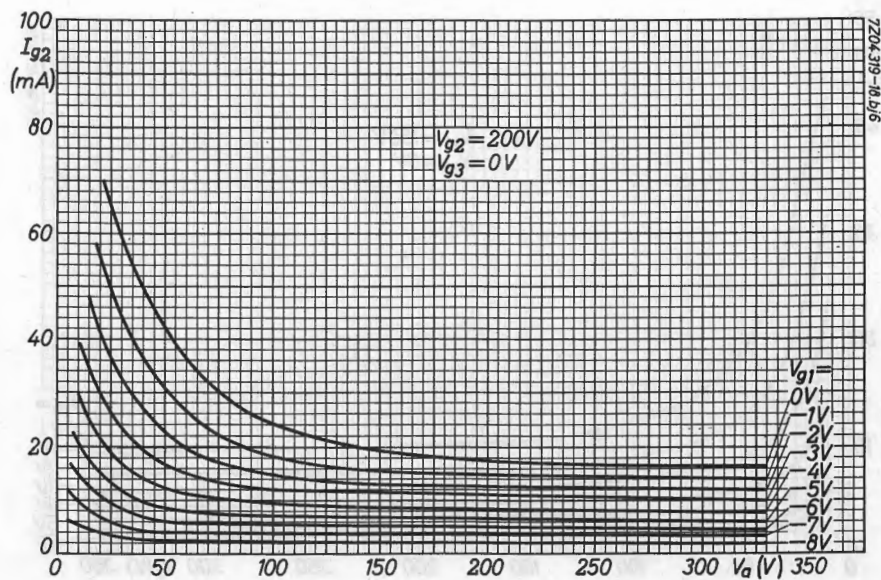
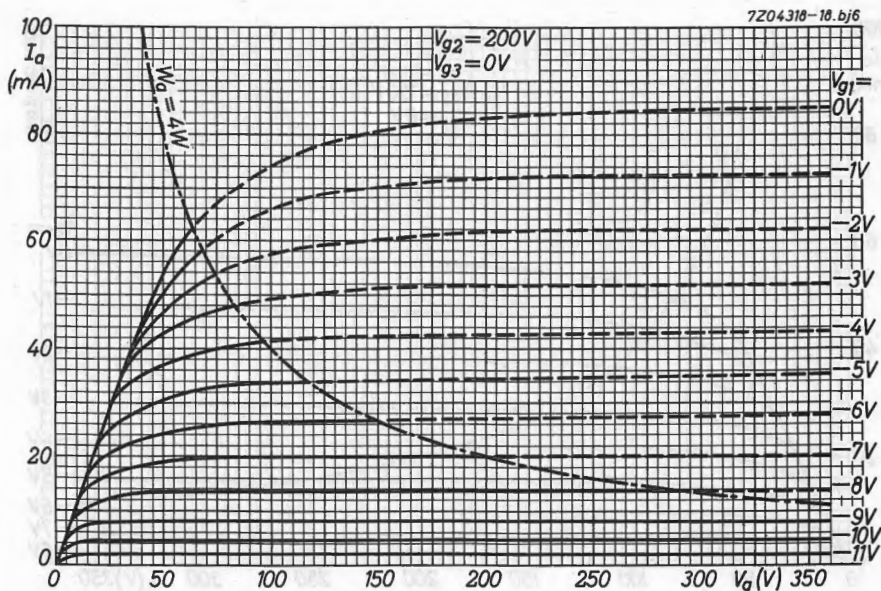

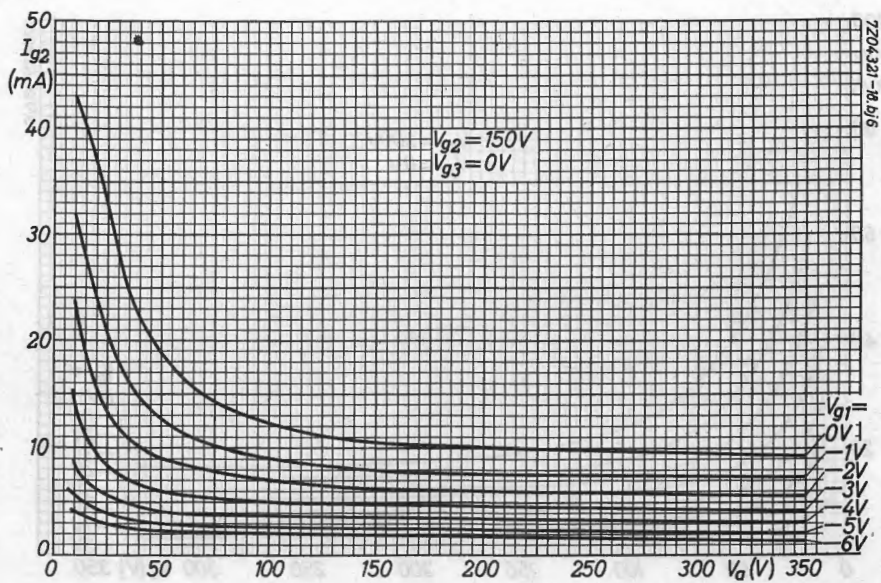
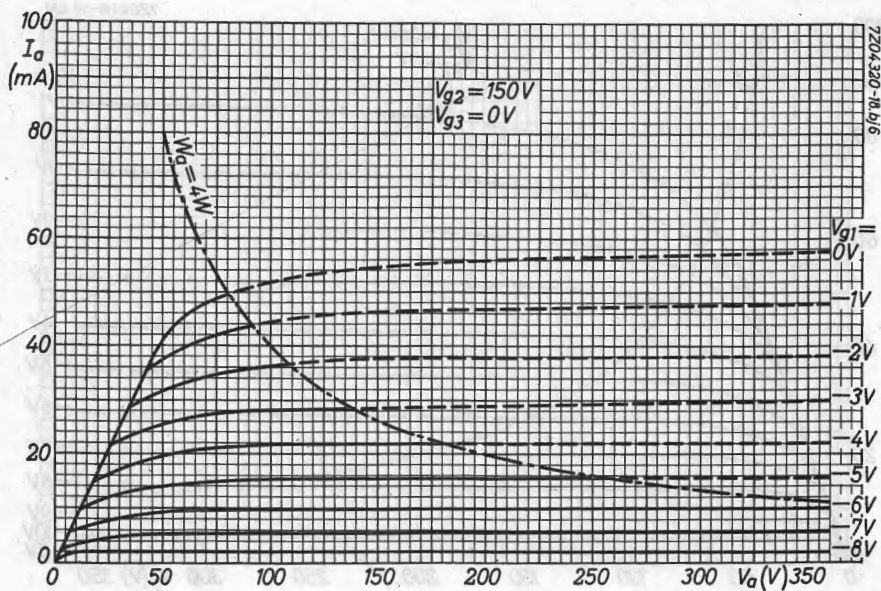

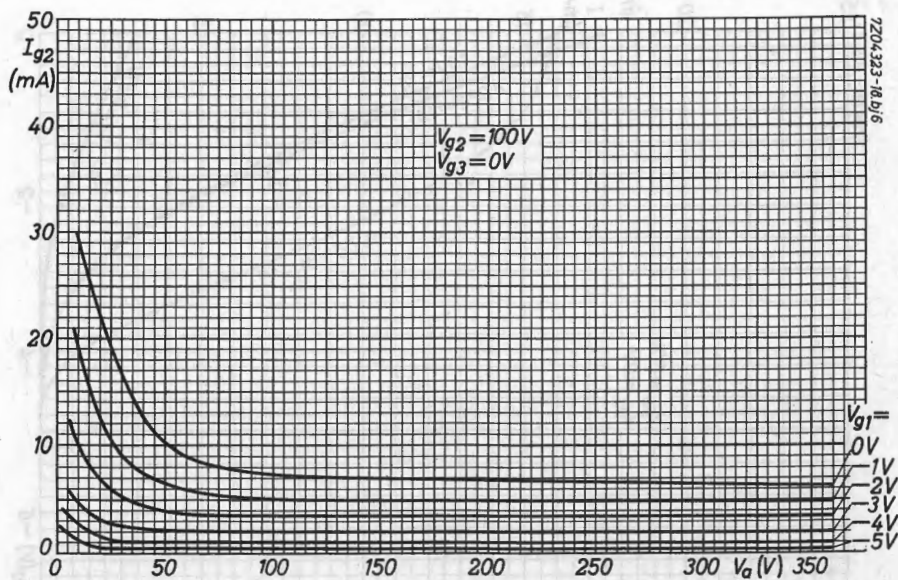
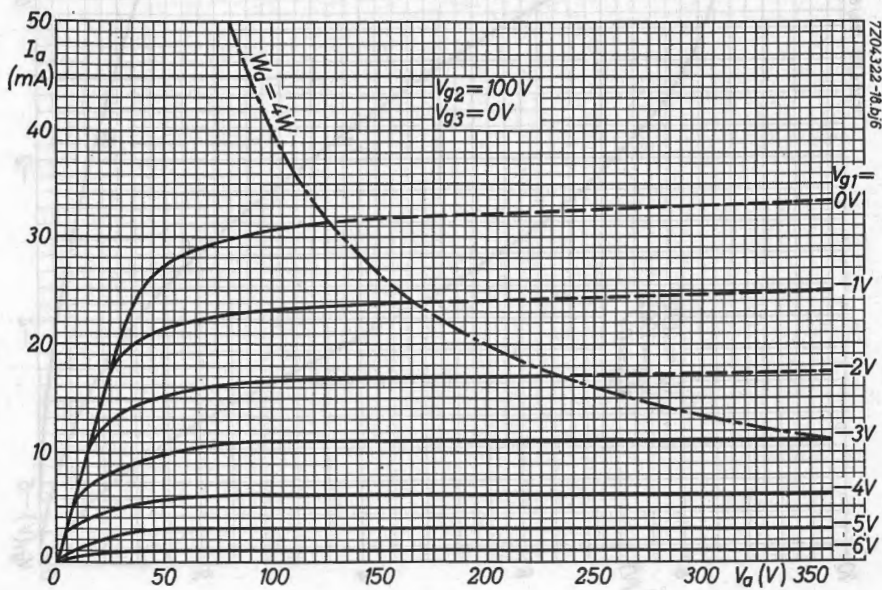

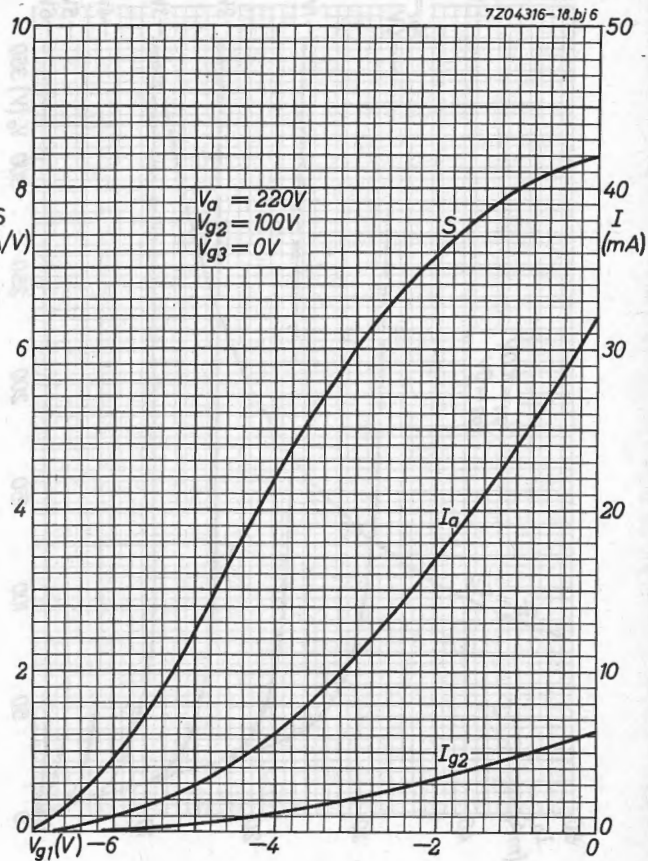
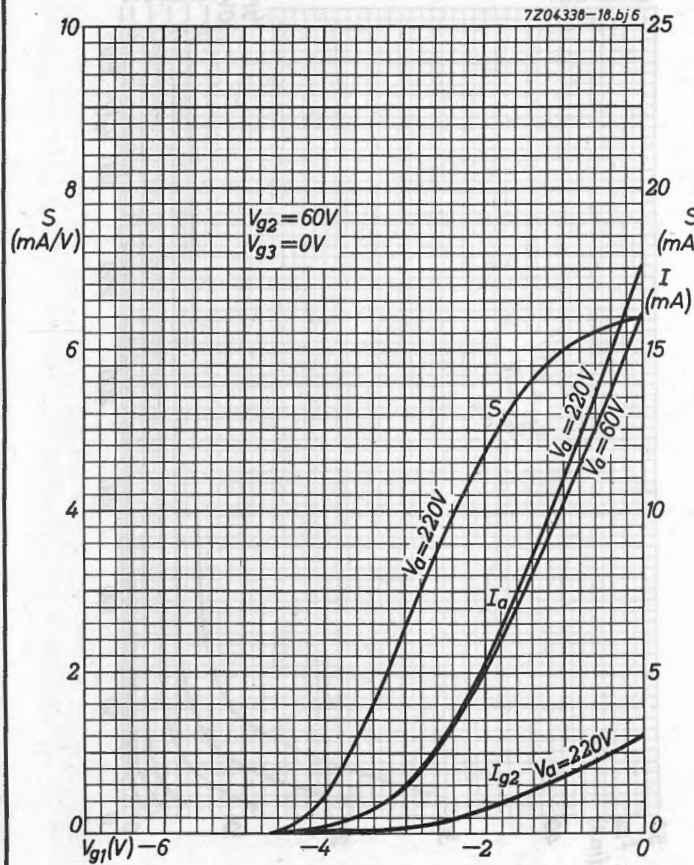

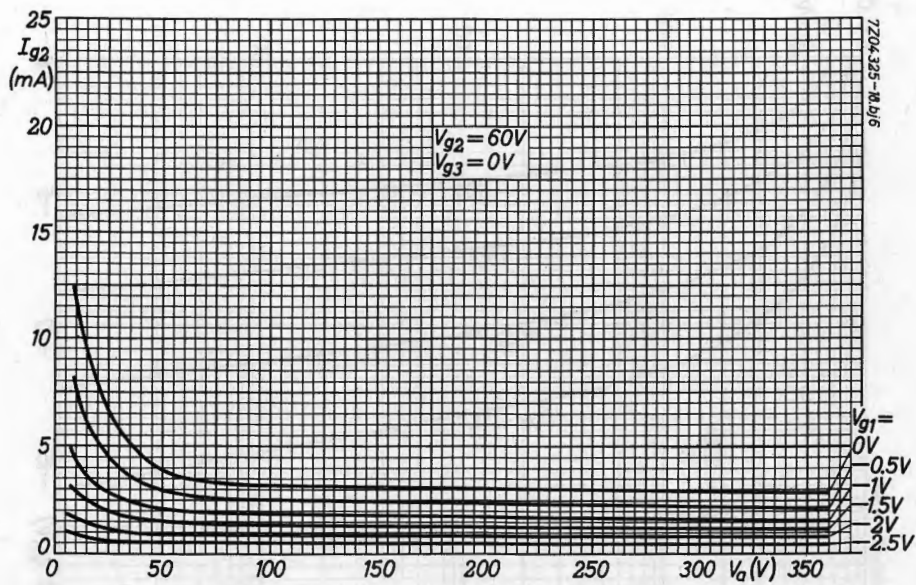
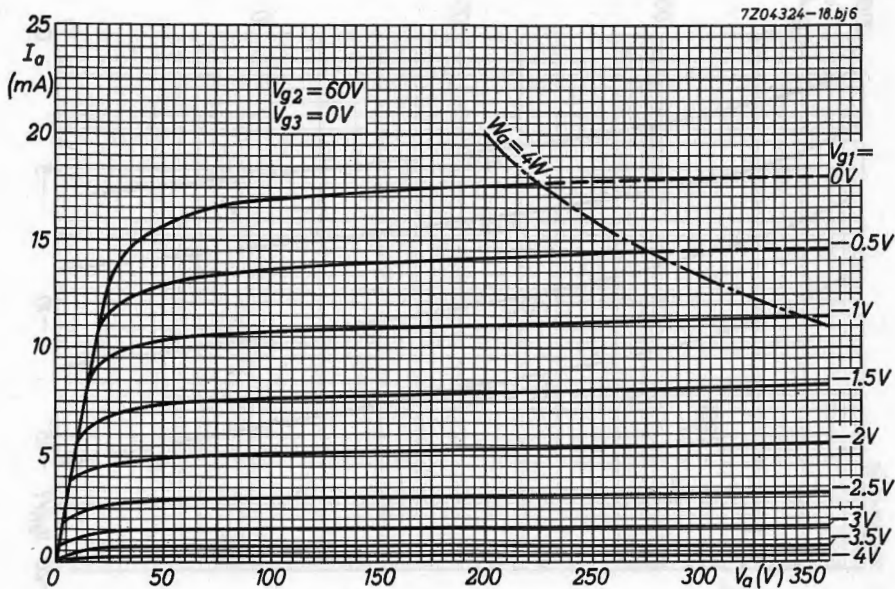

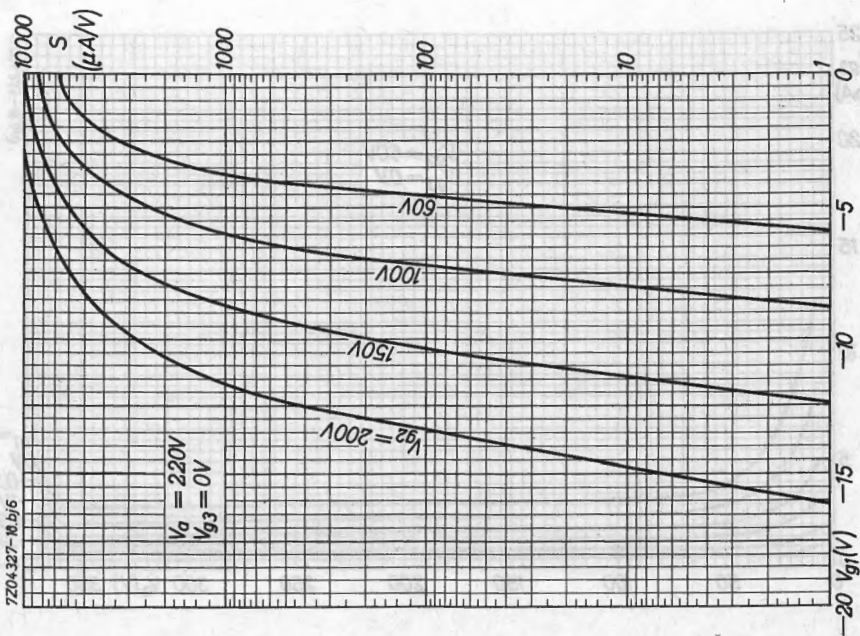
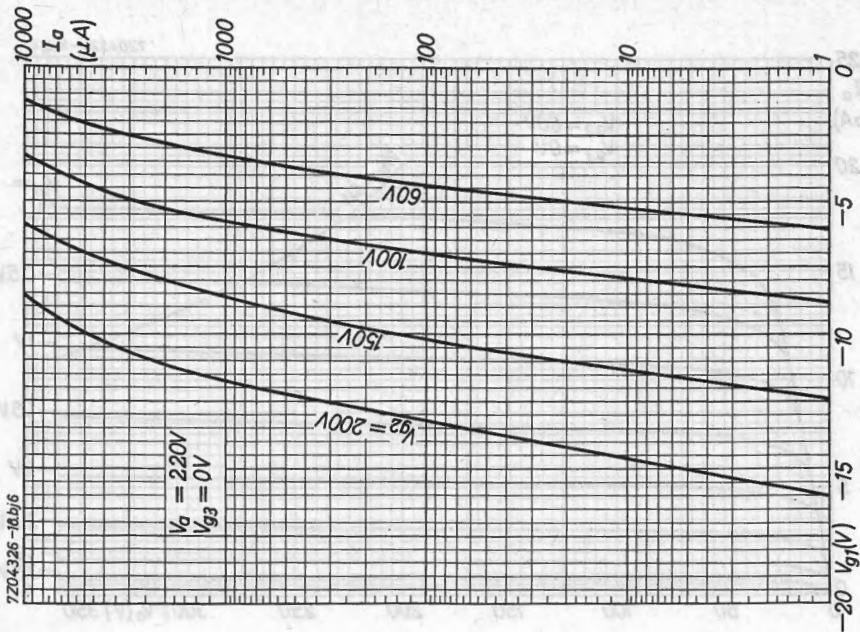

7204329-18.bj6

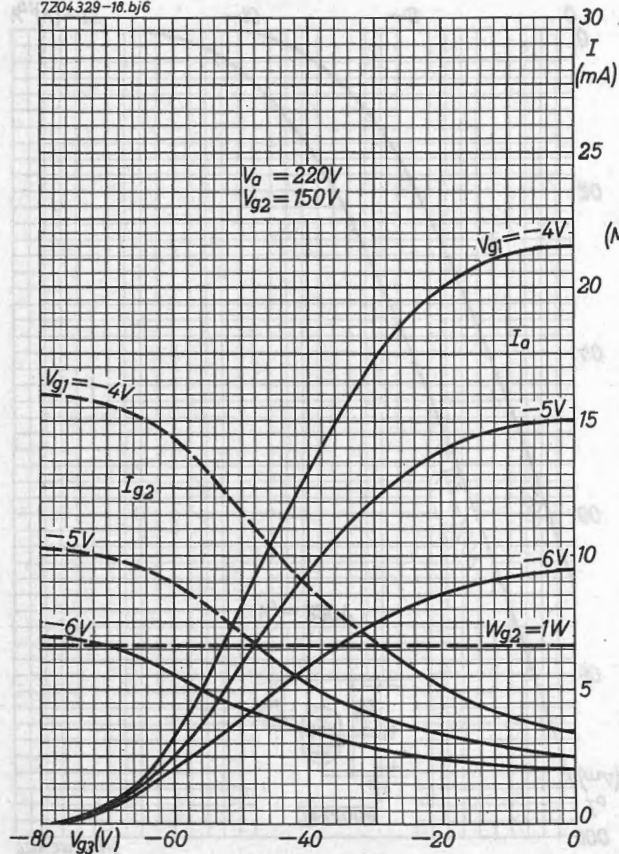

7204328-18.bj6

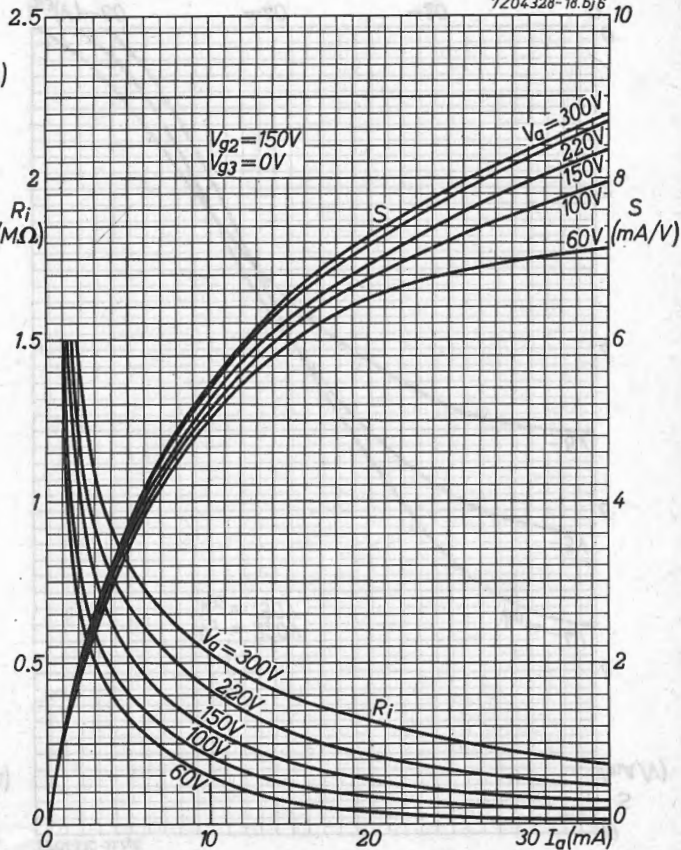

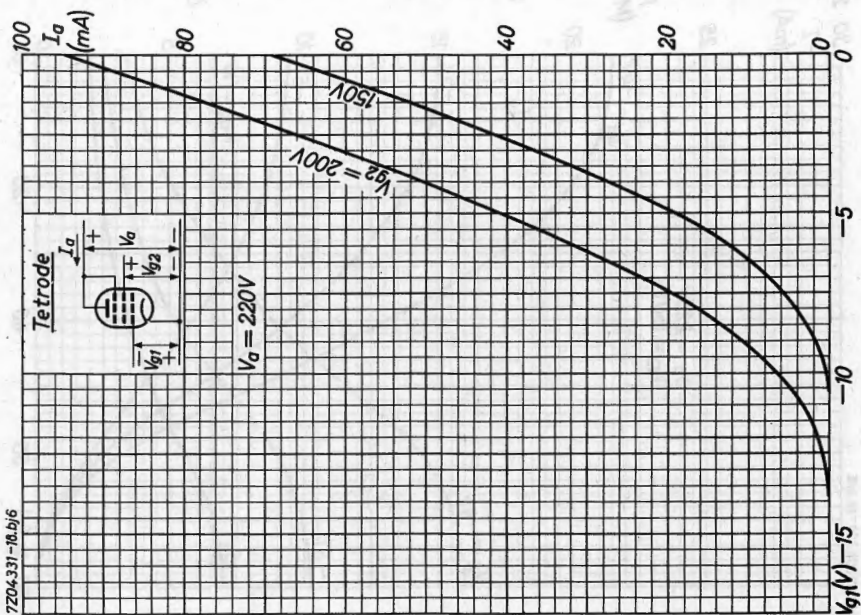
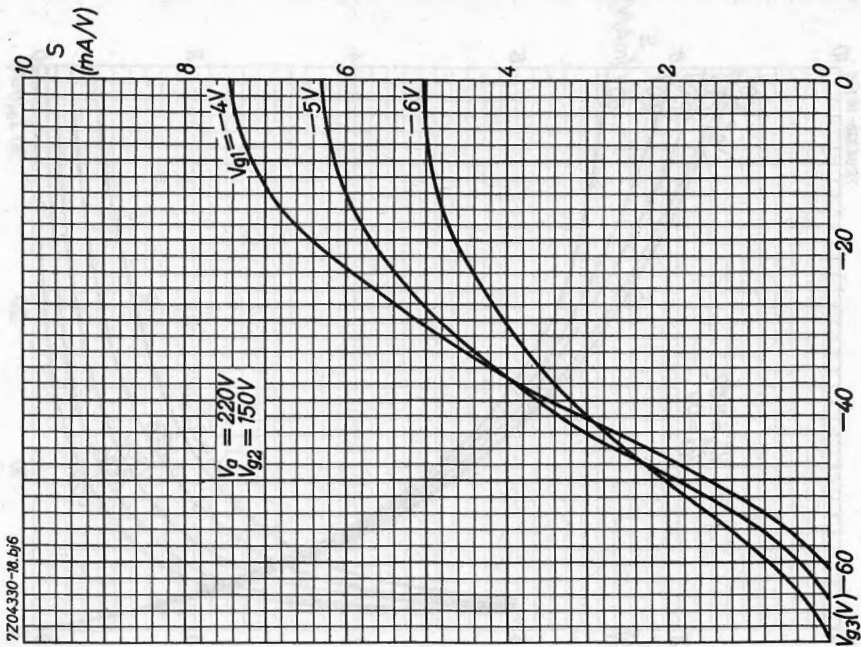

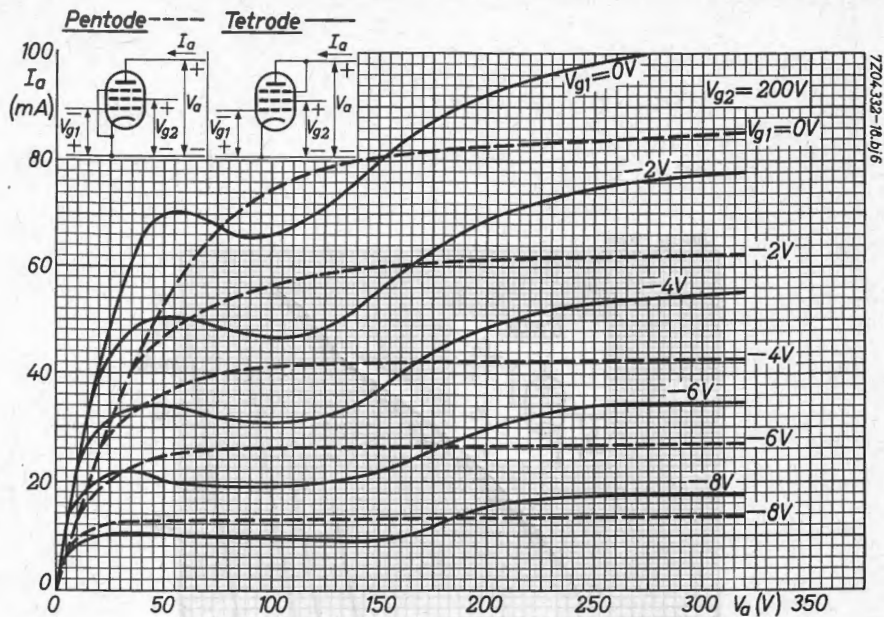

7204-333-14.0/6

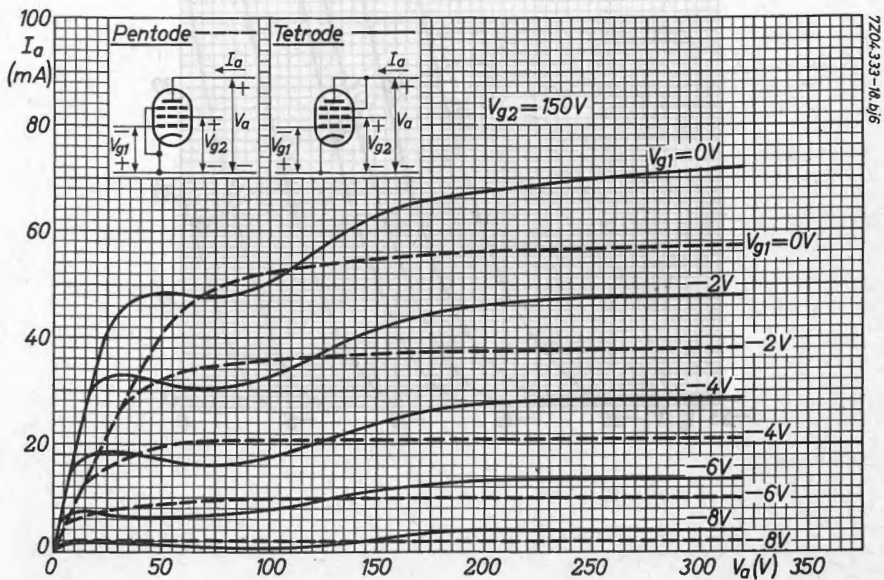

7204-333-14.0/6

7Z04-334-16.b/6

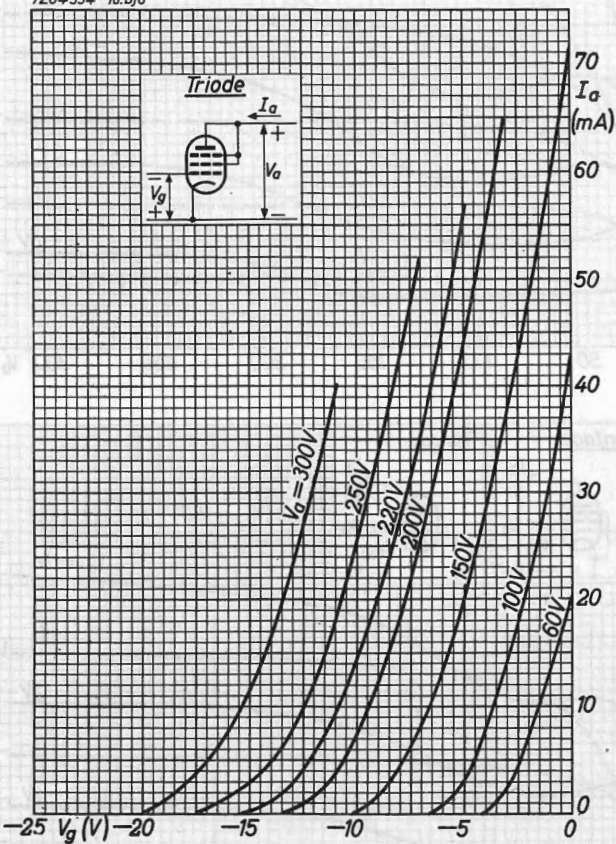

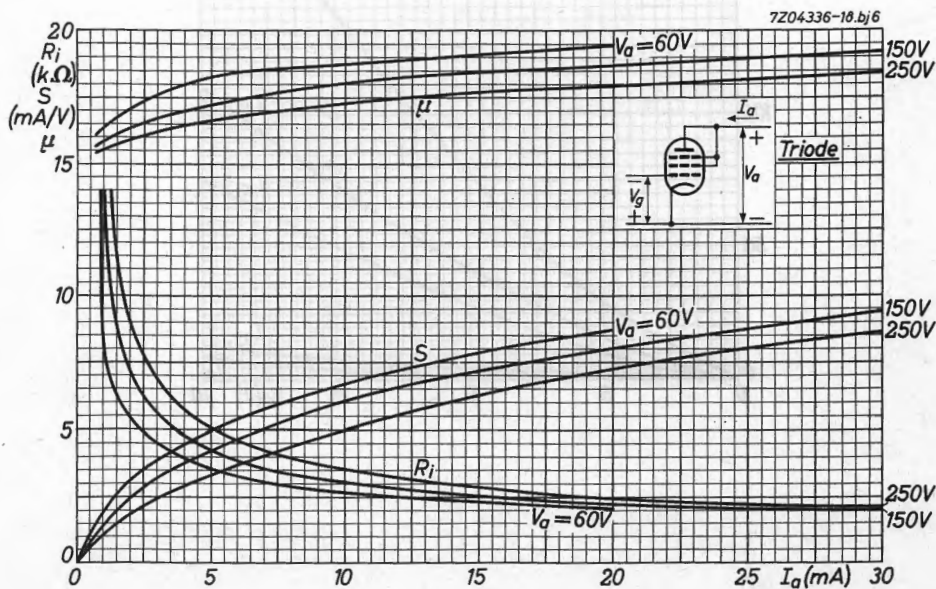
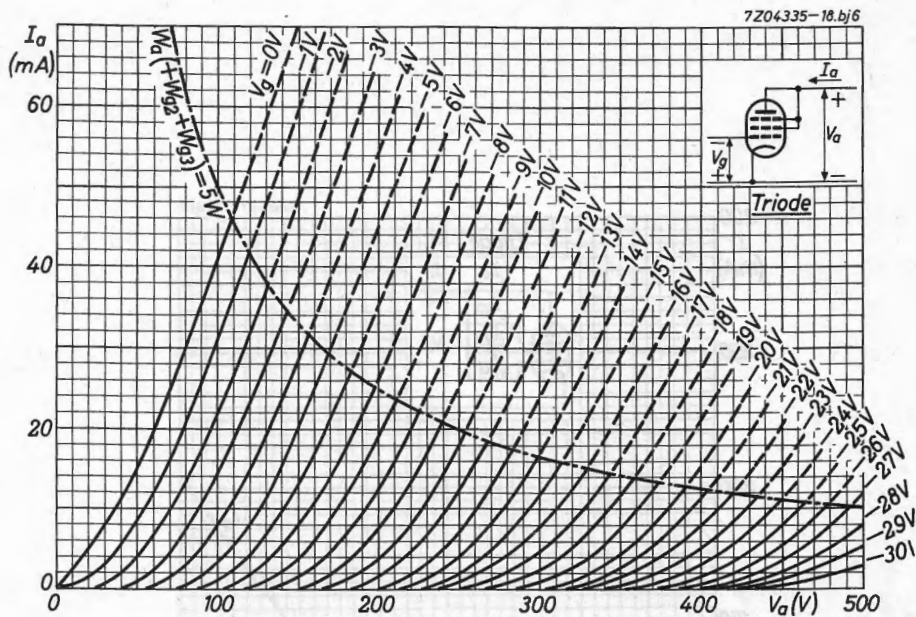

7204337-10.bj6

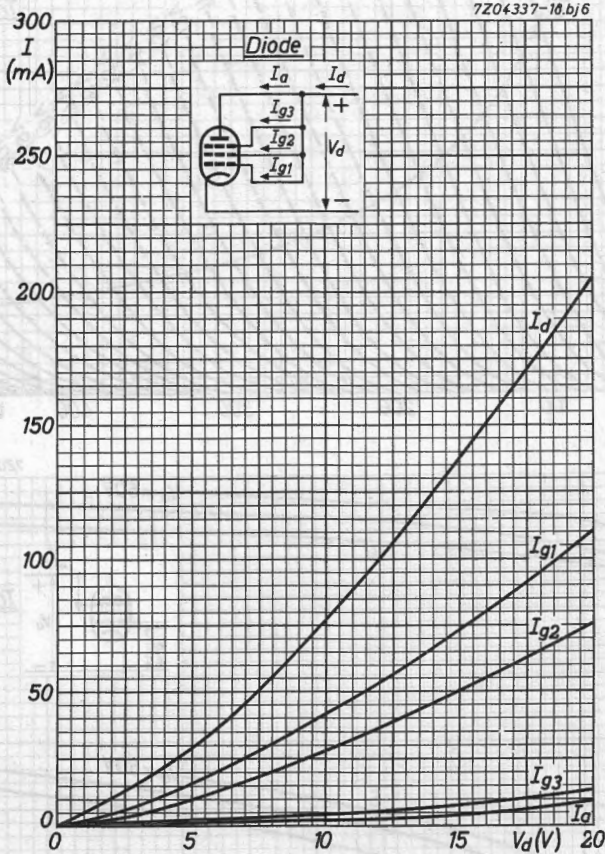

S.Q. TUBE

Special quality pentode designed for use as wide band amplifier

QUICK REFERENCE DATA

Life test	10 000 hours
Low interface resistance	
Base	Noval. Gold plated pins
Heating	Indirect A.C. or D.C.; Parallel supply
Heater voltage	V_f 6.3 V
Heater current	I_f 315 mA
Anode current	I_a 22 mA
Mutual conductance	S 35 mA/V
Equivalent noise resistance	R_{eq} 150 Ω

DIMENSIONS AND CONNECTIONS

Dimensions in mm

Base: Noval

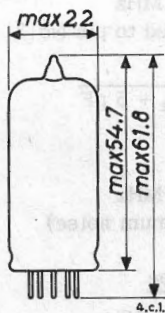
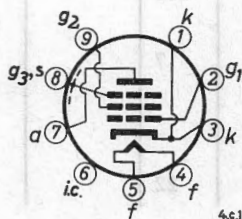

CHARACTERISTICS

Column I Nominal value or setting of the tube

II Range values for equipment design: Initial spread

III Range values for equipment design: End of life

		I	II	III	
Heater voltage	V_f	6.3			V
Heater current	I_f	315	299	331	mA
Anode supply voltage	V_{ba}	190			V
Grid No.2 supply voltage	V_{bg2}	160			V
Grid No.3 voltage	V_{g3}	0			V
Grid No.1 supply voltage	$+V_{bg1}$	10			V
Cathode resistor	R_k	400			Ω
Anode current	I_a	22	21 - 23	min. 20	mA
Grid No.2 current	I_{g2}	6.0	5.4 - 6.6		mA
Internal resistance	R_i	120			k Ω
Mutual conductance	S	35	30 - 40	min. 24.5	mA/V
Amplification factor	μ_{g2g1}	80			
<u>Negative grid current</u>	$-I_{g1}$		max. 0.3	max. 1.0	μA
<u>Equivalent noise resistance</u>	R_{eq}	150			Ω
<u>Input resistance</u>	R_{g1}	1			k Ω
Frequency = 100 MHz pin No.1 connected to pin No.3					
$\frac{S}{2\pi} \cdot \frac{1}{C_{g1}(\text{hot}) + C_a + 5 \text{ pF}}$		230			MHz
<u>Noise factor</u>	F	7			dB
Frequency = 100 MHz (Adapted to minimum noise)					
<u>Phase angle of slope</u>	φ_s	22			$^\circ$
Frequency = 100 MHz					

CHARACTERISTICS (continued)As triode (grid No. 2 connected to anode)

		I	II	
Anode supply voltage	V_{ba}	160		V
Grid No. 3 voltage	V_{g3}	0		V
Grid No. 1 supply voltage	$+V_{bg1}$	10		V
Cathode resistor	R_k	470		Ω
Anode current	I_a	24		mA
Mutual conductance	S	41		mA/V
Amplification factor	μ	77		
Internal resistance	R_i	1.9		k Ω
<u>Equivalent noise resistance</u>	R_{eq}	65		Ω

Insulation resistance between anode and other electrodes R_{ins} min. 500 M Ω

Voltage between electrodes = 300 V

Insulation resistance between grid No. 1 and other electrodes R_{ins} min. 200 M Ω

Voltage between electrodes = 50 V

Leakage current between cathode and heater I_{kf} max. 5 μ A

Voltage between cathode and heater = 100 V

CAPACITANCESWithout external shield.

Grid No. 1 to grid No. 2, grid No. 3, cathode, heater and screen

 $C_{g1/g2g3kfs}$ 10 9- 11 pFGrid No. 1 to grid No. 2, grid No. 3, cathode, heater and screen
Cathode current = 28 mA $C_{g1/g2g3kfs}$ 17 pF

Anode to grid No. 2, grid No. 3, cathode, heater and screen

 $C_{a/g2g3kfs}$ 2.1 1.8- 2.4 pF

CAPACITANCES (continued)

		I	II	
Anode to grid No. 1	C_{ag_1}		max. 40	mpF
Anode to cathode	C_{ak}		max. 50	mpF
Anode to cathode and grid No. 2	C_{a/kg_2}	0.32	0.28-0.36	pF
Anode to cathode, grid No. 2 and grid No. 3	C_{a/kg_2g_3}	2.0	1.7- 2.3	pF
Anode to heater	C_{af}		max. 100	mpF
Grid No. 1 to cathode	C_{g_1k}	6.8	6.1- 7.5	pF
Grid No. 1 to cathode and grid No. 2	C_{g_1/kg_2}	9.5	8.5-10.5	pF
Grid No. 1 to cathode, grid No. 2 and grid No. 3	C_{g_1/kg_2g_3}	10	9- 11	pF
<u>With external shield</u>				
Grid No. 1 to grid No. 2, grid No. 3, cathode, heater and screen	C_{g_1/g_2g_3kfs}	10.1	9.1-11.1	pF
Grid No. 1 to grid No. 2, grid No. 3, cathode, heater and screen Cathode current = 28 mA	C_{g_1/g_2g_3kfs}	17.1		pF
Anode to grid No. 2, grid No. 3, cathode, heater and screen	C_{a/g_2g_3kfs}	3.3	2.9- 3.7	pF
Anode to grid No. 1	C_{ag_1}		max. 35	mpF
<u>As triode. Without external shield.</u>				
Grid No. 3 connected to cathode				
Grid No. 1 to grid No. 3, cathode, heater and screen	C_{g_1/g_3kfs}	7.3		pF
Anode and grid No. 2 to grid No. 3, cathode, heater and screen	C_{ag_2/g_3kfs}	3.1		pF
Anode and grid No. 2 to grid No. 1	C_{ag_2/g_1}	2.7		pF
<u>As triode. Without external shield</u>				
Grid No. 3 connected to anode				
Grid No. 1 to cathode, heater and screen	$C_{g_1/kfs}$	6.7		pF
Anode, grid No. 2 and grid No. 3 to cathode, heater and screen	$C_{ag_2g_3/kfs}$	1.0		pF
Anode, grid No. 2 and grid No. 3 to grid No. 1	$C_{ag_2g_3/g_1}$	3.3		pF

LIFE

Production samples are tested to be within the end of life values (column III) during 10 000 hours.

LIMITING VALUES (Design centre rating system, if not otherwise specified)

Anode voltage		V_{a0}	max.	400 V
		V_a	max.	220 V
Anode dissipation	Des. centre	W_a	max.	4.2 W
	Abs. max.	W_a	max.	4.5 W
Grid No.2 voltage		V_{g20}	max.	400 V
		V_{g2}	max.	180 V
Grid No.2 dissipation	Des. centre	W_{g2}	max.	1.0 W ¹⁾
	Abs. max.	W_{g2}	max.	1.1 W ¹⁾
Anode plus grid No.2 dissipation (triode connected)		W_{a+g2}	max.	4.5 W
Grid No.1 voltage		$-V_{g1}$	max.	30 V
		$+V_{g1}$	max.	0 V
Cathode current	Des. centre	I_k	max.	30 mA
	Abs. max.	I_k	max.	33 mA
Grid resistor (Automatic bias)		R_{g1}	max.	0.5 M Ω
Voltage between cathode and heater	cathode positive	V_{kf}	max.	120 V
	cathode negative	V_{kf}	max.	60 V
Bulb temperature	Abs. max.	t_{bulb}	max.	190 °C

Heater voltage: The average heater voltage should be 6.3 V.

Variations of the heater voltage exceeding the range of 6.0 V to 6.6 V will shorten the tube life.

The tolerance of heater current (column II) should be taken into account.

1) Care should be taken not to exceed the rated W_{g2} values due to switching of positive supply voltages.

If the cathode is shunted by a capacitance $> 10 \mu\text{F}$ a series resistor of minimum 1 k Ω should be inserted in the grid No.1 lead.

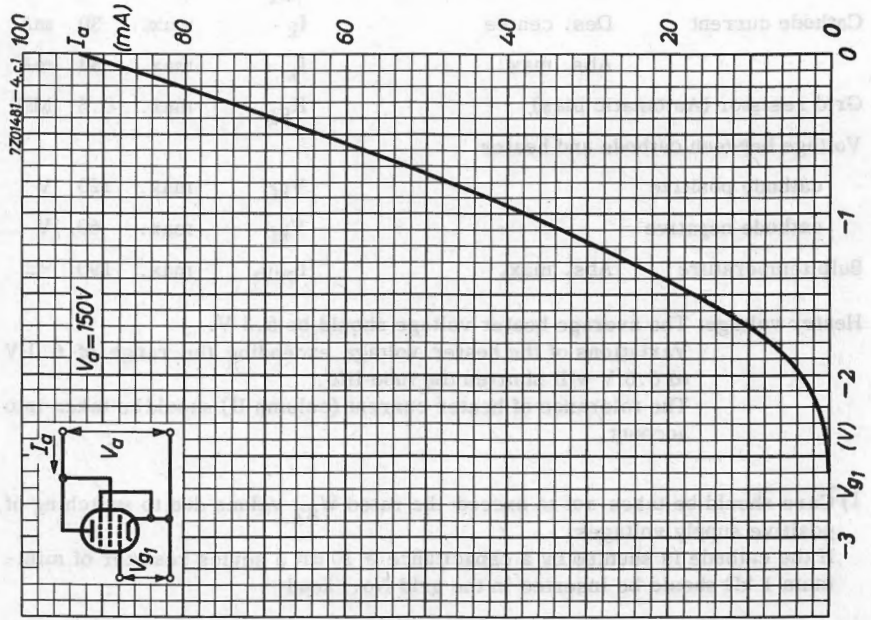
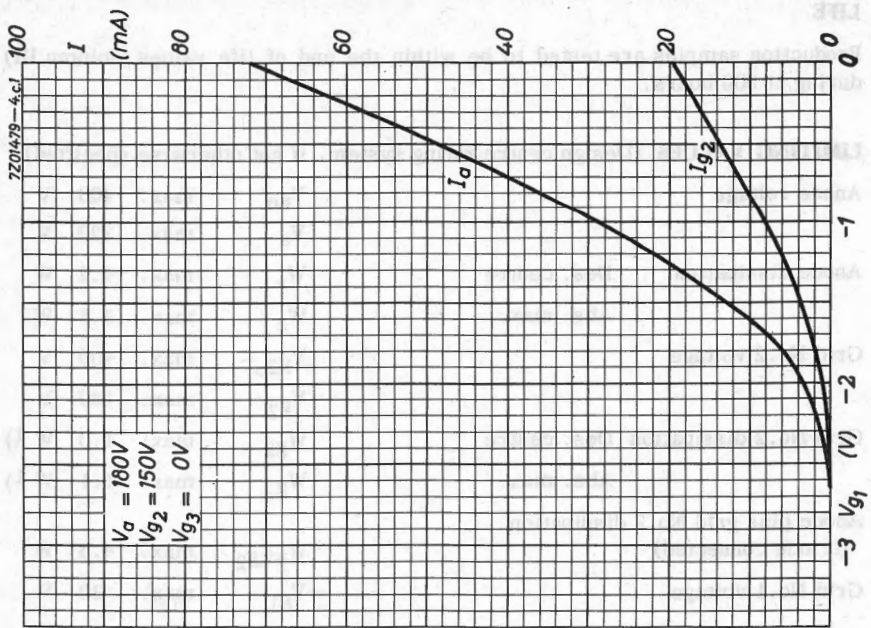

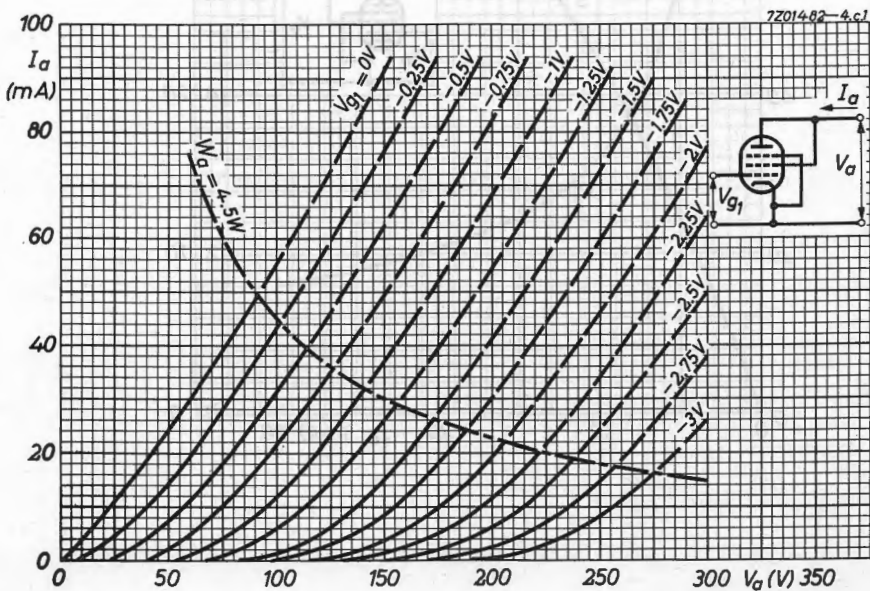
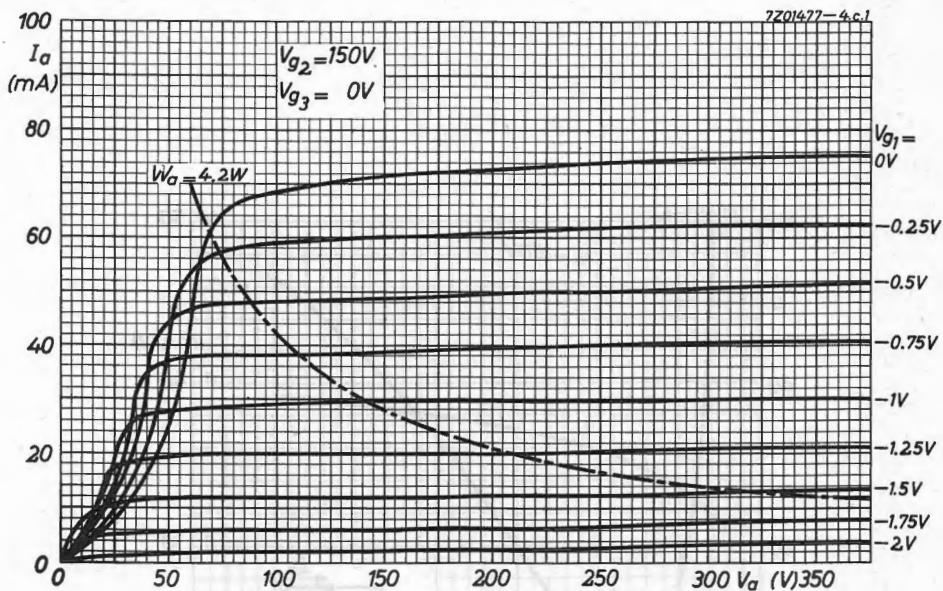

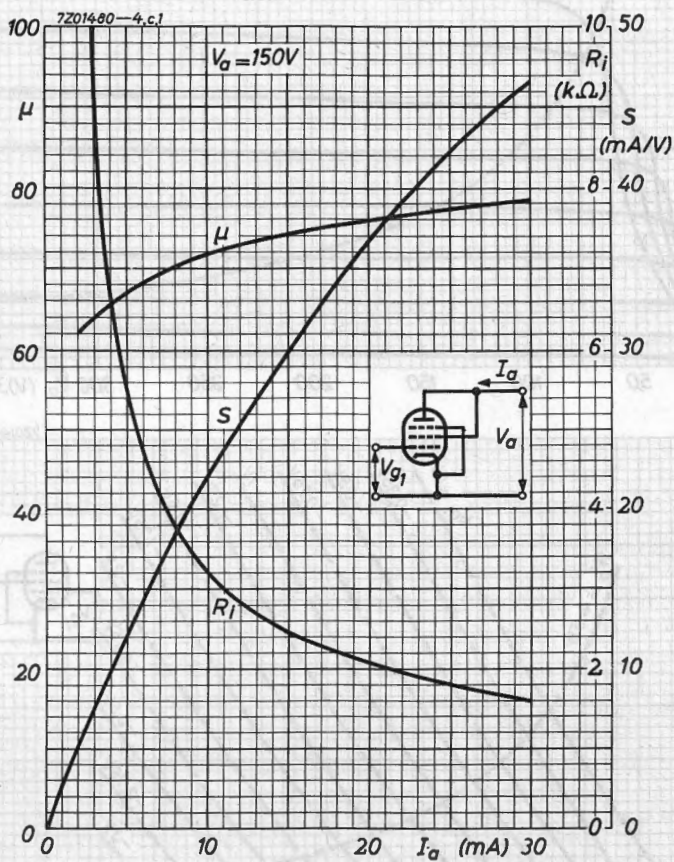

POWER PENTODE

Pentode intended for use as power amplifier.

QUICK REFERENCE DATA

Life test	500 hours
Base	Subminiature
Heating	Direct Battery supply
Heater voltage	V_f 1.25 V
Heater current	I_f 25 mA

DIMENSIONS AND CONNECTIONS

Dimensions in mm

Base: Subminiature

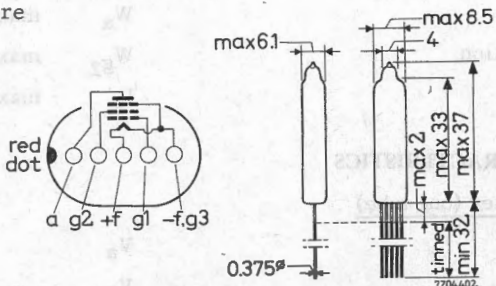

Leads should not be soldered nearer than 5 mm to the seal.
Leads should not be bent nearer than 1.5 mm to the seal.

CHARACTERISTICS

Anode voltage	V_a	22.5 V
Grid No.2 voltage	V_{g2}	22.5 V
Anode current	I_a	600 μ A
Grid No.2 current	I_{g2}	150 μ A
Grid No.1 voltage	$-V_{g1}$	2.2 V
Mutual conductance	S	430 μ A/V
Internal resistance	R_i	100 $k\Omega$
Amplification factor	μ_{g2g1}	5

CAPACITANCE

Anode to grid No.1	C_{ag1}	max. 0.15 pF
--------------------	-----------	--------------

LIMITING VALUES (Design centre rating system)

Anode voltage	V_a	max. 45 V
Grid No.2 voltage	V_{g2}	max. 45 V
Anode dissipation	W_a	max. 100 mW
Grid No.2 dissipation	W_{g2}	max. 25 mW
Cathode current	I_k	max. 2.3 mA

OPERATING CHARACTERISTICS

As class A amplifier (one tube)

Anode voltage	V_a	22.5 V
Grid No.2 voltage	V_{g2}	22.5 V
Grid No.1 voltage	$-V_{g1}$	2.2 V
Anode resistance	$R_{a\sim}$	37.5 $k\Omega$
Anode current ($V_i = \text{zero}$)	I_a	600 μ A
Grid No.1 current ($V_i = \text{zero}$)	I_{g2}	150 μ A
Input voltage	V_i	1.3 V_{RMS}
Output power	W_o	5 mW
Distortion	d	10 %

S.Q. INDICATOR TUBE

High-input impedance, special-quality indicator tube for indication of the output level of flip flops in computer circuits etc.

QUICK REFERENCE DATA

Life test	10000 hours
Mechanical quality	Shock and vibration resistant
Base	Subminiature
Heating	Direct
	A. C. or D. C.; parallel supply
Filament voltage	V_f 1.0 V
Filament current	I_f 30 mA
"On" - "off" control voltage	ΔV min. 1.4 V

DIMENSIONS AND CONNECTIONS

Dimensions in mm

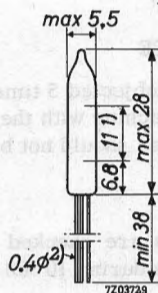
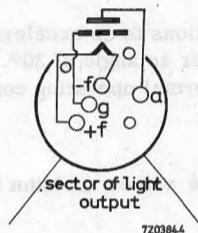

Connections should not be soldered nearer than 5 mm from the seal.

Leads should not be bent nearer than 1.5 mm from the seal.

1) Length of the light bar.

2) Leads without letter indication are cut at the outer surface of the seal.

CHARACTERISTICS

Column I Nominal value or setting of the tube

II Range values for equipment design: Initial spread

III Range values for equipment design: End of life

		I	II	III	
Filament voltage	V_f	1.0			V
Filament current	I_f	30	24-36		mA
Anode voltage	V_a	50			V
Grid resistor	R_g	100			k Ω
Grid supply voltage ¹⁾ (maximum light output)	V_{bg}	0			V
Anode current	I_a	585	430-740	min. 250	μ A
Zero light output is ensured when grid supply voltage ^{1) 2)} is below	V_{bg}	-3	-3	-3	V
Anode current at $V_{bg} = -3$ V ²⁾	I_a		max. 5	max. 5	μ A
Insulation resistance between two electrodes Voltage between two electrodes = 50 V	R_{ins}		min.100		M Ω

SHOCK RESISTANCE

The tube has been subjected 5 times in each of 4 positions to an acceleration of 500 g in an NRL shock machine with the hammer lifted over an angle of 30°.

These test conditions should not be considered as normal operating conditions.

LIFE

Production samples are checked for the end of life values (column III) under the following conditions during 10 000 hours:

Filament voltage	V_f	1.0	V_{RMS}
Anode voltage	V_a	50	V
Grid supply voltage	V_{bg}	0	V ¹⁾
Grid resistor	R_g	100	k Ω

1) Voltage with respect to the midtap of the filament transformer.

2) The residual electron current may be concentrated on one spot which then may be visible in dark surroundings. This effect cannot be mistaken for the indicator being in the "on" condition.

LIMITING VALUES (Absolute max. rating system)

Anode voltage	V_{a0}	max.	100 V
	V_a	max.	65 V
Anode current	I_a	max.	850 μ A
Grid supply voltage, $R_g = 100 \text{ k}\Omega \pm 10\%$	V_{bg}	max.	0 V
$R_g = 1 \text{ M}\Omega \pm 10\%$	V_{bg}	max.	6 V
Grid voltage	$-V_g$	max.	50 V
Grid resistor	R_g	max.	1.1 $\text{M}\Omega$
		min.	0.09 $\text{M}\Omega$

Filament voltage: The average filament voltage should be 1.0 V. Variations exceeding 0 or -10% from nominal will shorten tube life.

APPLICATION NOTE

The visibility of the phosphorescent light produced by the anode when the indicator tube is "on" depends on the grid voltage prevailing in that condition and the illumination level of the surroundings. With $V_g = -3$ V for zero light output ("off" condition of the tube), the visibility is best when $\Delta V = 3$ V (ΔV is the difference between the "high" and "low" voltages of the flip-flop) but an unambiguous indication is still obtained at $\Delta V = 1.4$ V under nominal conditions and a low level of ambient light. With still smaller values of drive voltage a pre-amplifier is required. Figs. 1 and 2 show typical arrangements for negative and positive logic, respectively.

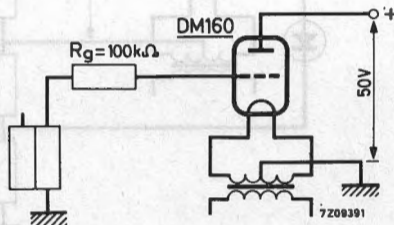

Fig. 1 Digital read-out circuit with DM160 connected to negative logic circuit which uses flip-flops equipped with p-n-p transistors. This circuit can be used for all types of flip-flops with p-n-p transistors with the "high" level near zero volt and a "low" level below -3 volt.

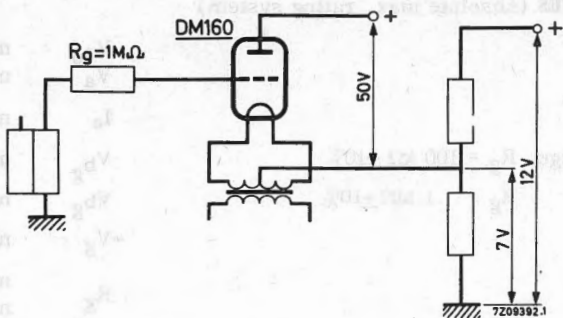

Fig. 2 Digital read-out circuit with DM160 connected to positive logic circuit which uses a type of flip-flops equipped with n-p-n transistors and of which the "high" output level may be above +7.5 V and the "low" level near 0 V. R_g protects the tube against too large anode currents and too large positive grid currents when the grid supply voltage exceeds the cathode potential.

When the minimum of ΔV lies below 3 V the spread in the "high" level of the flip-flop will give rise to an extra spread in the brightness of the phosphorescent light. When undesirable this spread may be reduced by clamping the grid voltage, see Fig. 3.

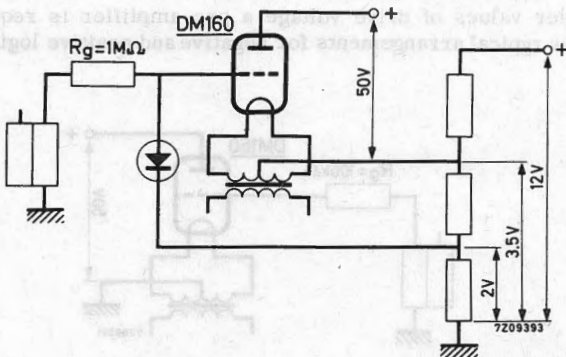
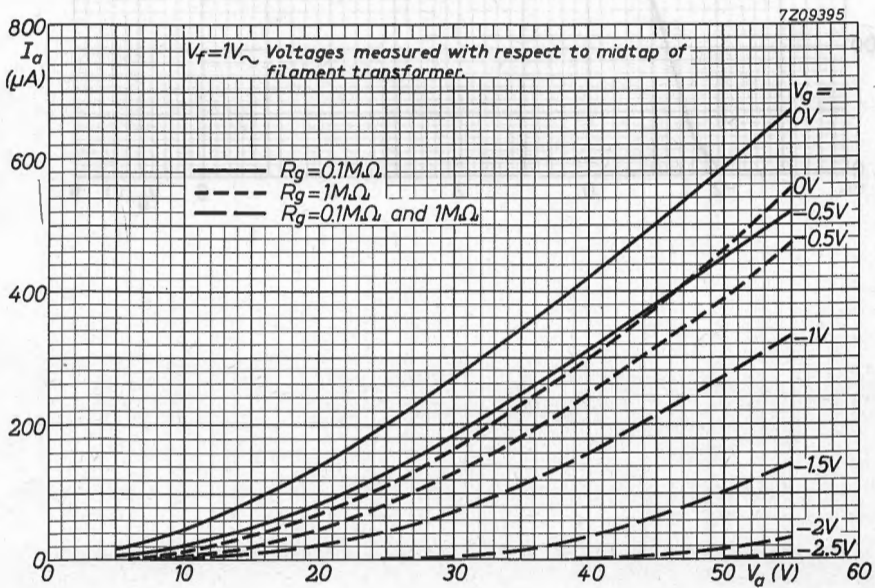
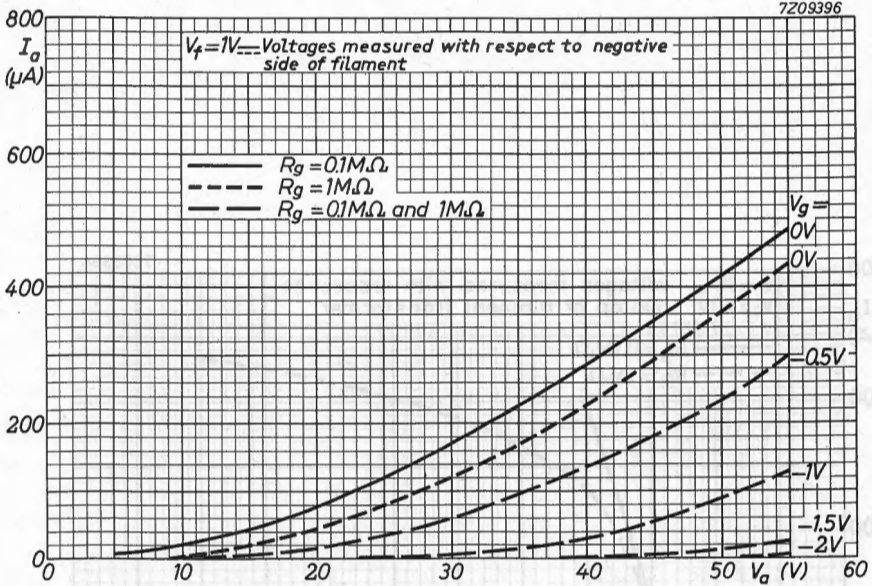
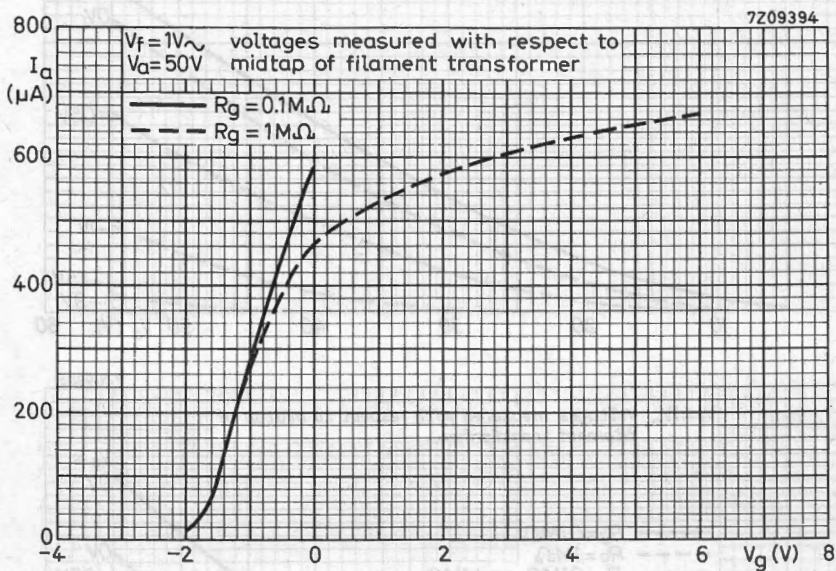

Fig. 3 As Fig. 2; but for a type of flip-flop with a "high" voltage level between +2.0 V and +7.0 V and "low" level between 0 V and +0.5 V; with clamping of the grid voltage.





APPLICATION DIRECTIONS

Ambient illumination

To obtain a clear reading the ambient illumination should range from 40-100 lux. The illumination should be placed in vertical position. This illumination range incorporates the best compromise between the visibility of the uses of the mask and the business picture.

Special quality decade counter tube.

QUICK REFERENCE DATA

Life test	10 000 hours
Base	Duodecal (12 pins)
Heating	Indirect
Heater voltage	A.C. or D.C.;
Heater current	Series or parallel supply
	V_f 6.3 V
	I_f 300 mA

DIMENSIONS AND CONNECTIONS

Base: Duodecal

Dimensions in mm

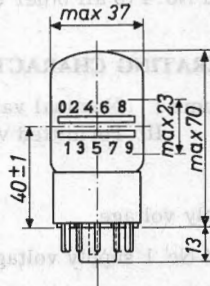
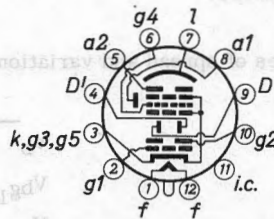
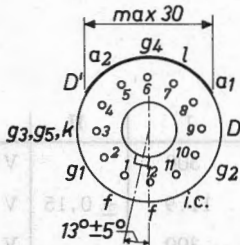

APPLICATION DIRECTIONS

Mounting

Any mounting position, except horizontal with screen down, is permitted.

Sensitivity to magnetic fields

To prevent interference by magnetic fields the flux density of these fields should not exceed 2×10^{-4} Wb/m² (= 2 Gauss) in any direction.

APPLICATION DIRECTIONS

Ambient illumination

To obtain a clear reading the ambient illumination should range from 40-400 lux measured with an illumination-meter placed in vertical position. This illumination range incorporates the best compromise between the visibility of the figures of the mask and the luminescent picture.

CHARACTERISTICS

Heater voltage	V_f	6.3 V
Heater current	I_f	300 mA

CAPACITANCES

Anode No.2 to all other electrodes	$C_{a_2/R}$	10.5 pF
Deflection plate to all other electrodes	$C_{D/R}$	3.5 pF
Deflection plate to all other electrodes	$C_{D'/R}$	3.8 pF
Anode No.1 to all other electrodes	$C_{a_1/R}$	4.9 pF
Grid No.1 to all other electrodes	$C_{g_1/R}$	6.8 pF
Grid No.4 to all other electrodes	$C_{g_4/R}$	7.7 pF

OPERATING CHARACTERISTICS

Column I Nominal value
 II Permitted values of spread and variation

		I	II	
Supply voltage	V_b	300		V
Grid No.1 supply voltage	V_{bg_1}	11.9	± 0.15	V
Grid No.2 supply voltage	V_{bg_2}	300		V
Deflection plate supply voltage	V_D	156	± 1.5	V
Luminescent screen voltage	V_l	300		V
Cathode current	I_k	0.95		mA
Grid No.2 current	I_{g_2}	0.1		mA
Cathode resistor	R_k	15	$\pm 1\%$	$k\Omega$
Grid No.4 resistor	R_{g_4}	47	$\pm 5\%$	$k\Omega$
Anode No.1 resistor	R_{a_1}	39	$\pm 10\%$	$k\Omega$
Anode No.2 resistor	R_{a_2}	1	$\pm 1\%$	$M\Omega$

OPERATING CHARACTERISTICS (continued)

Note

The tube should be used in the circuit of fig.2.

Provided the ratio of the supply voltages V_{bg1} and V_D is strictly maintained the supply voltage V_b is allowed to vary within the range of V_b nom. $\pm 10\%$.

This condition can be realised by using a voltage divider R_1, R_2, R_3 with 1% precision resistors as indicated in the diagram fig.2.

A max. counting speed of 30 000 count/s can be obtained with this circuit.

The input pulse at D should have a positive value of $13.6 \text{ V} \pm 15\%$. The slope of the leading edge should be at least $20 \times 10^6 \text{ V/s}$. The slope of the trailing edge should not exceed $1.2 \times 10^6 \text{ V/s}$.

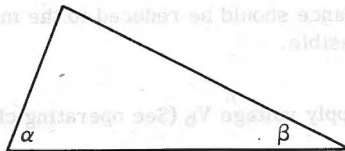
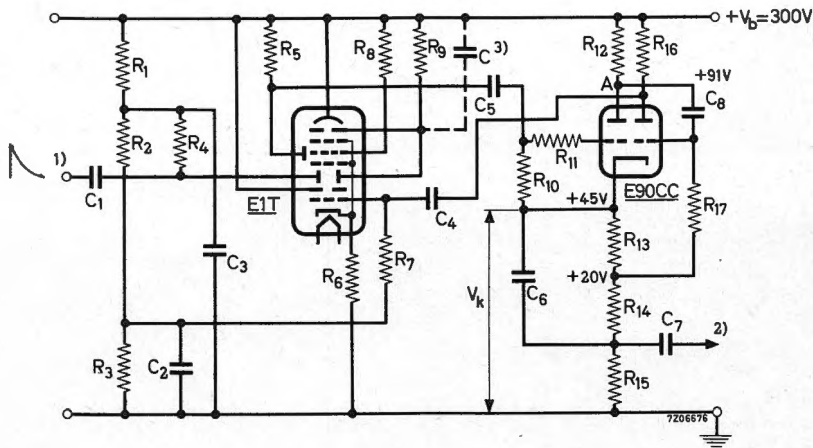

Fig.1

$$\tan \alpha > 20 \times 10^6 \text{ V/s}$$

$$\tan \beta < 1.2 \times 10^6 \text{ V/s}$$



R ₁	68 k Ω \pm 1%	R ₁₀	0.56 M Ω \pm 10%	C ₁	1)
R ₂	68 k Ω \pm 1%	R ₁₁	5.6 k Ω \pm 10%	C ₂	0.39 μ F \pm 20%
R ₃	5.6 k Ω \pm 1%	R ₁₂	39 k Ω \pm 2%	C ₃	0.15 μ F \pm 20%
R ₄	15 k Ω \pm 2%	R ₁₃	4.7 k Ω \pm 2%	C ₄	6800 pF \pm 10%
R ₅	39 k Ω \pm 10%	R ₁₄	2.7 k Ω \pm 2%	C ₅	220 pF \pm 10%
R ₆	15 k Ω \pm 1%	R ₁₅	1 k Ω \pm 1%	C ₆	68 pF \pm 2%
R ₇	0.33 M Ω \pm 10%	R ₁₆	3.3 k Ω \pm 2%	C ₇	680 pF \pm 5%
R ₈	47 k Ω \pm 5%	R ₁₇	0.15 M Ω \pm 2%	C ₈	68 pF \pm 2%
R ₉	1 M Ω \pm 1%				

1. Connected to the preceding E90CC pulse shaper (C₁ = 6800 pF \pm 10%) or the preceding E90CC interstage pulse shaper (C₁ = 680 pF \pm 5%).
2. Connected to deflection plate D of next counter tube.
3. This parasitic capacitance should be reduced to the minimum by keeping the wiring as short as possible.

LIMITING VALUE of supply voltage V_b (See operating characteristics):

$$V_b = \text{max. } 400 \text{ V}$$

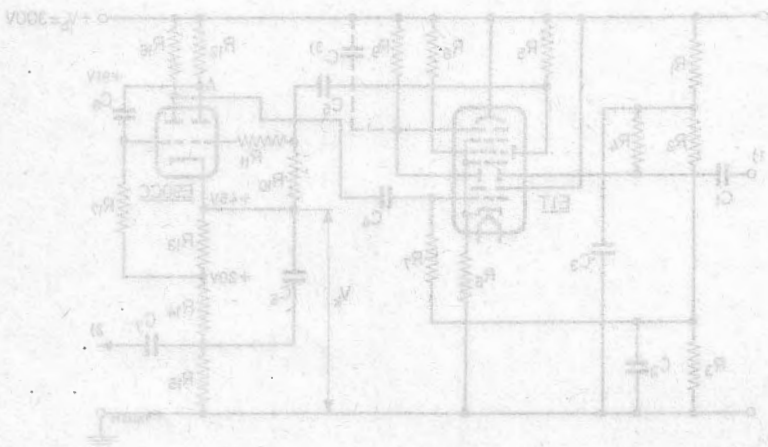

S.Q. TUBE

Special quality pentode designed for use as wide band output tube.

QUICK REFERENCE DATA	
Life test	10 000 hours
Low interface resistance	
Mechanical quality	Shock and vibration resistant
Base	Magnoval. Gold plated pins
Heating	Indirect A.C. or D.C.; Parallel supply
Heater voltage	V_f 6.3 V \pm 5%
Heater current	I_f 600 mA
Anode current	I_a 50 mA
Mutual conductance	S 45 mA/V

DIMENSIONS AND CONNECTIONS

Dimensions in mm

Base: Magnoval

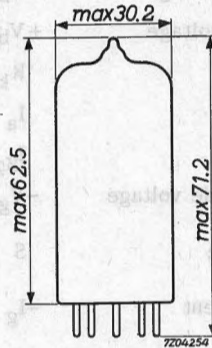
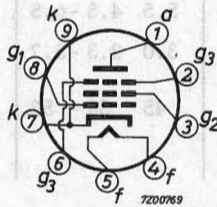

CHARACTERISTICS

Column I Nominal value or setting of the tube

II Range values for equipment design: Initial spread

III Range values for equipment design: End of life

		I	II	III	V
Heater voltage	V_f	6.3 ⁻			V
Heater current	I_f	600			mA
Anode voltage	V_a	125			V
Grid No.3 voltage	V_{g3}	0			V
Grid No.2 voltage	V_{g2}	125			V
Grid No.1 voltage	$-V_{g1}$	3			V
Anode current	I_a	50			mA
Grid No.2 current	I_{g2}	5.5			mA
Mutual conductance	S	45			mA/V
Internal resistance	R_i	20			k Ω
Amplification factor	μ_{g2g1}	30			
Input resistance	R_{g1}	1			k Ω
Frequency = 50 MHz					
Anode supply voltage	V_{ba}	140			V
Grid No.3 voltage	V_{g3}	0			V
Grid No.2 supply voltage	V_{bg2}	140			V
Grid No.1 supply voltage	$+V_{bg1}$	12			V
Cathode resistor	R_k	270			Ω
Anode current	I_a	50	48 - 52		mA
Grid No.2 current	I_{g2}	5.5	4.5 - 6.5		mA
Grid No.1 to cathode voltage	$-V_{g1k}$	3.0	2.3 - 3.7	1.8	V
Mutual conductance	S	45	38 - 52	$\Delta S =$ max.25%	mA/V
Negative grid current	$-I_g$			2	μA

CHARACTERISTICS (continued)

As triode (grid No.2 connected to anode)

		I	
Anode voltage	V_a	125	V
Grid No.1 voltage	$-V_{g_1}$	3	V
Anode current	I_a	55.5	mA
Mutual conductance	S	50	mA/V
Internal resistance	R_i	600	Ω
Amplification factor	μ	30	

CAPACITANCESPentode connected

		I		II		
		With shield	Without shield	With shield	Without shield	
Anode to grid No.3, grid No.2, cathode and heater	C_{a/g_3g_2kf}	6.5	5.8- 7.2	4.0	3.6- 4.4	pF
Grid No.1 to grid No.3, grid No.2, cathode and heater	C_{g_1/g_3g_2kf}	18	15- 21	18	15- 20	pF
Grid No.1 to grid No.3, grid No.2, cathode and heater	C_{g_1/g_3g_2kf}	28		28		pF
Cathode current	$I_k = 55.5$ mA					
Anode to grid No.1	C_{ag_1}	80	max. 120	110	max. 150	mpF

Triode connected (grid No.2 connected to anode)

Anode to grid No.3, cathode and heater	C_{a/g_3kf}	10.5	9.4-11.6	7.8	7.0- 8.6	pF
Grid No.1 to grid No.3, cathode and heater	C_{g_1/g_3kf}	11.8	10-13.6	11.8	10-13.6	pF
Anode to grid No.1	C_{ag_1}	6.2	5.5- 6.9	6.3	5.6- 7.0	pF
Cathode to heater	C_{kf}	6.0		6.0		pF

OPERATING CONDITIONS

Anode supply voltage	V_{ba}	140 V
Grid No.2 supply voltage	V_{bg_2}	140 V
Grid No.3 voltage	V_{g_3}	0 V
Grid No.1 supply voltage	$+V_{bg_1}$	12 V
Cathode resistor	R_k	270 Ω
Anode current	I_a	50 mA
Grid No.2 current	I_{g_2}	5.5 mA
Mutual conductance	S	45 mA/V

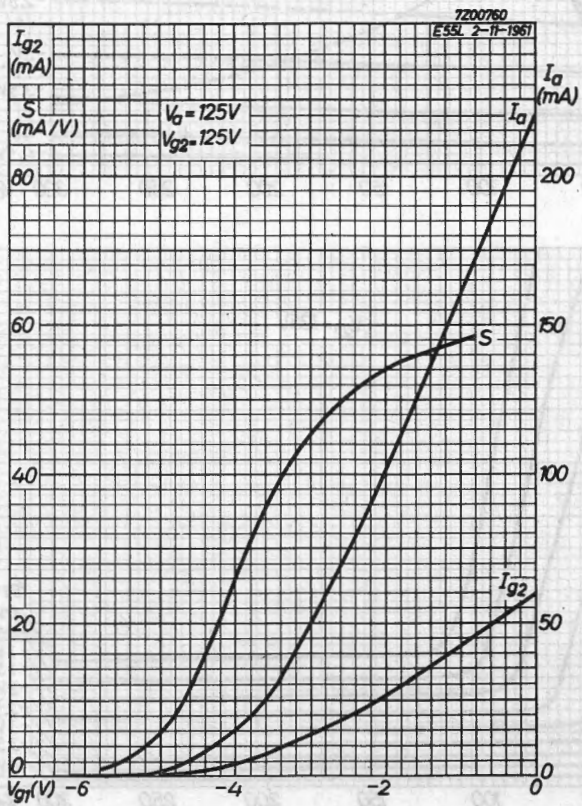

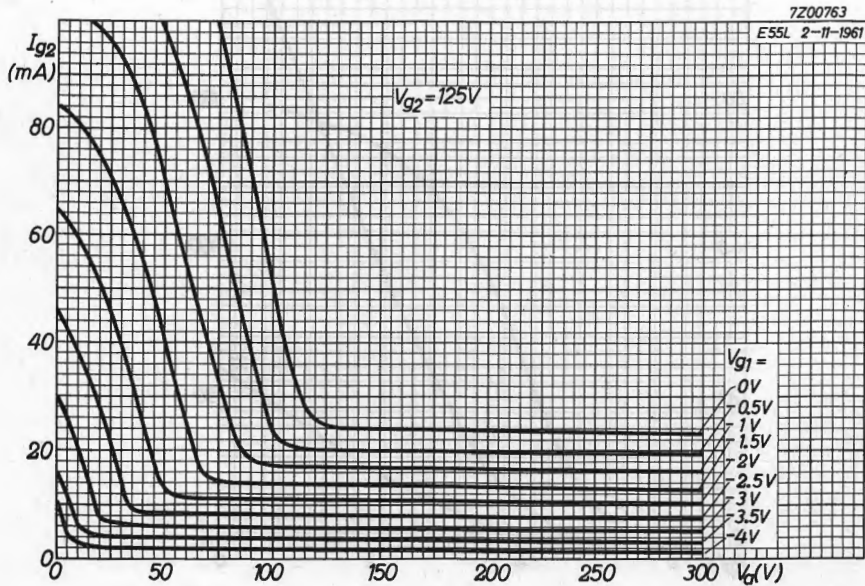
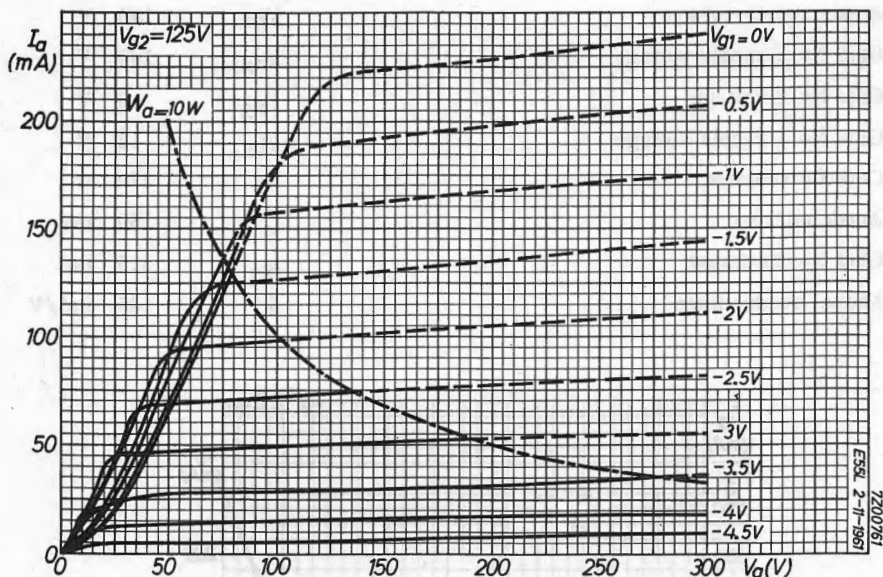

7Z04-432-5, rev. 12

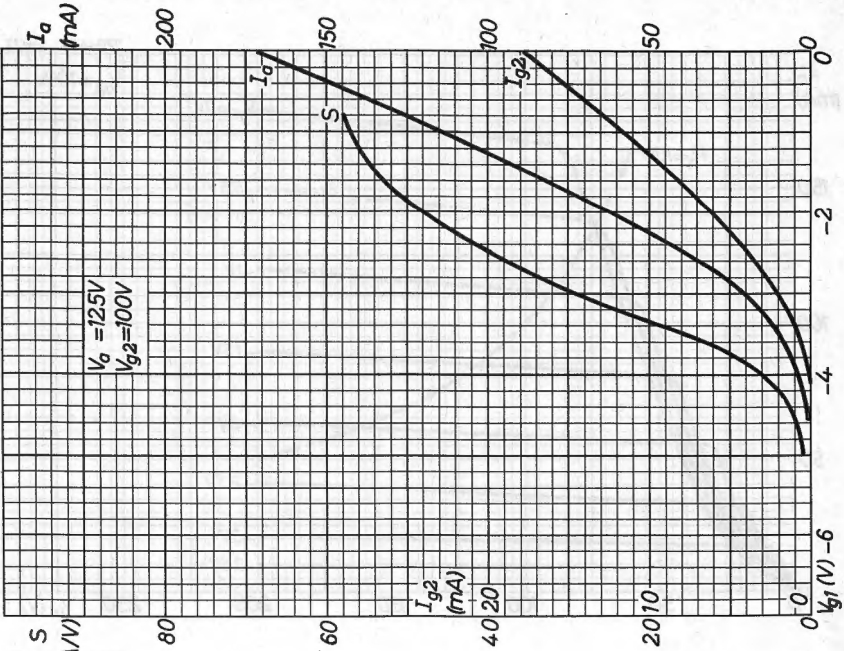

7Z00768

E55L 2-11-1961

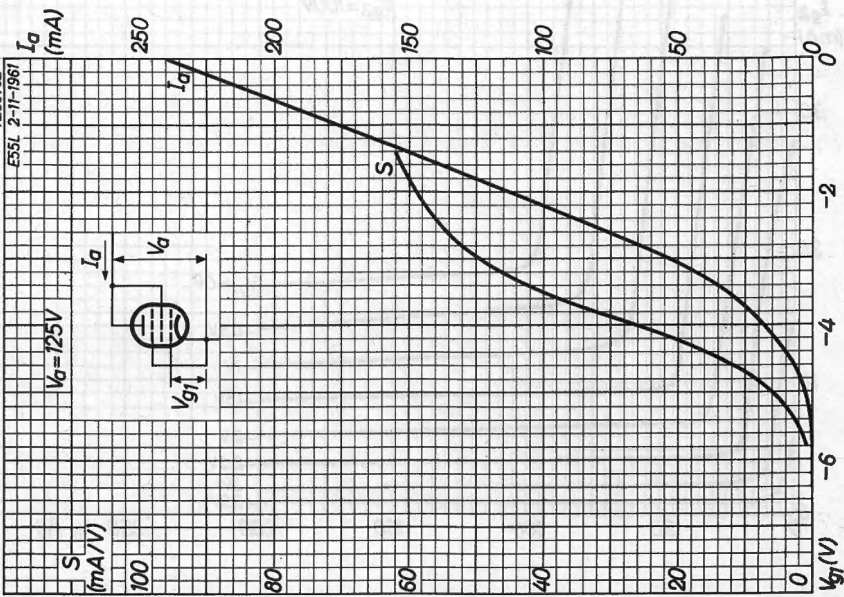

7204434-5.ee.12

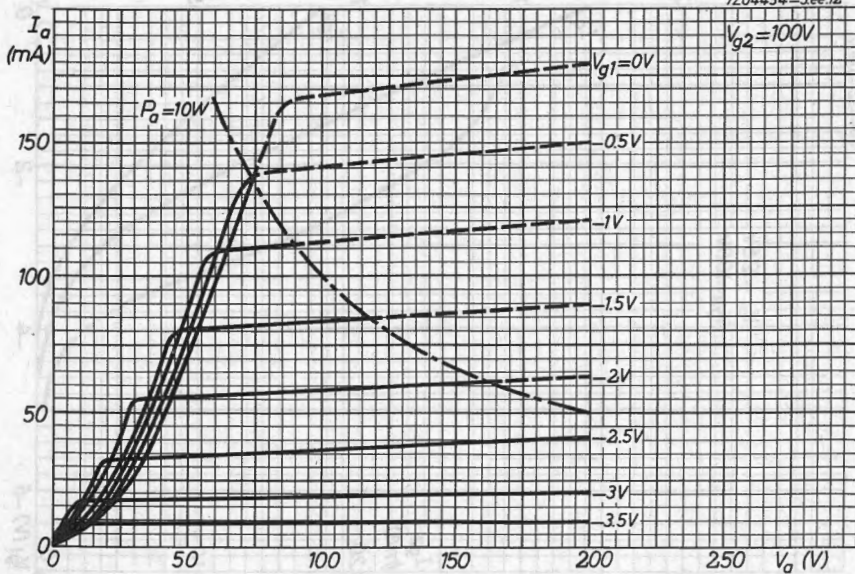

7204433-5.ee.12

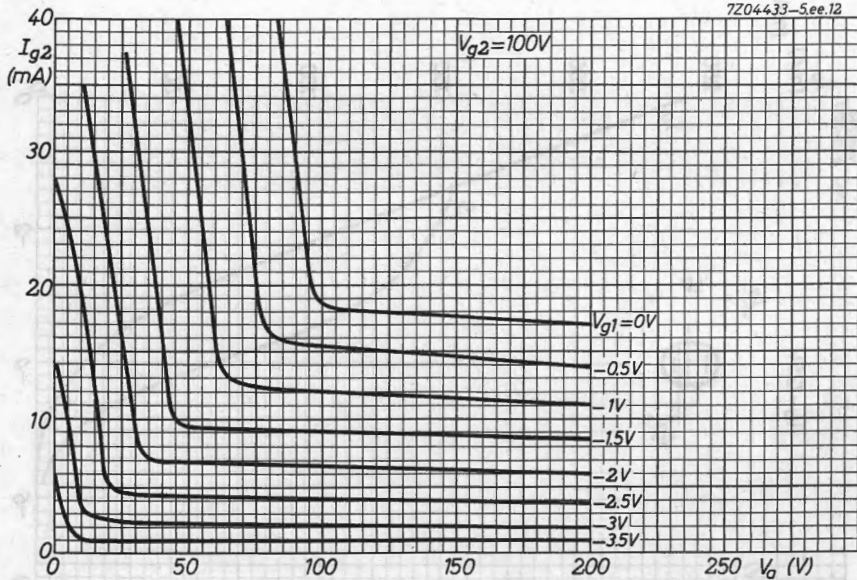

7Z06713-5.see.12

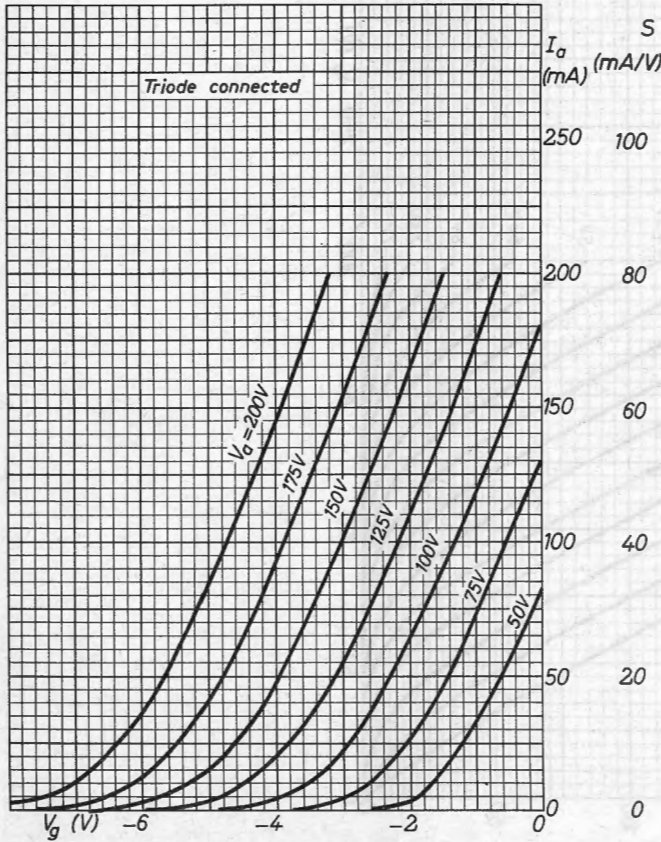

7Z04435-5.see.12

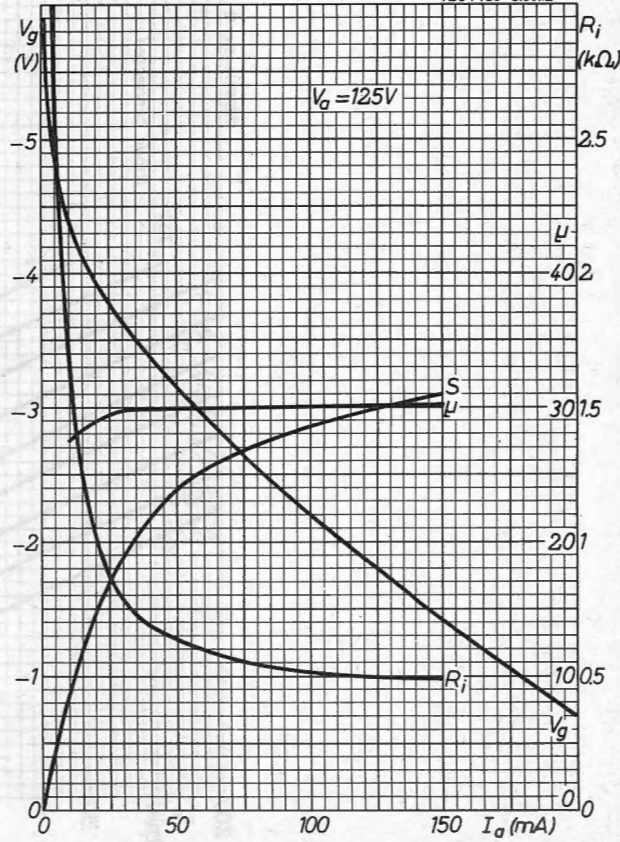

7206714-5.ee.12

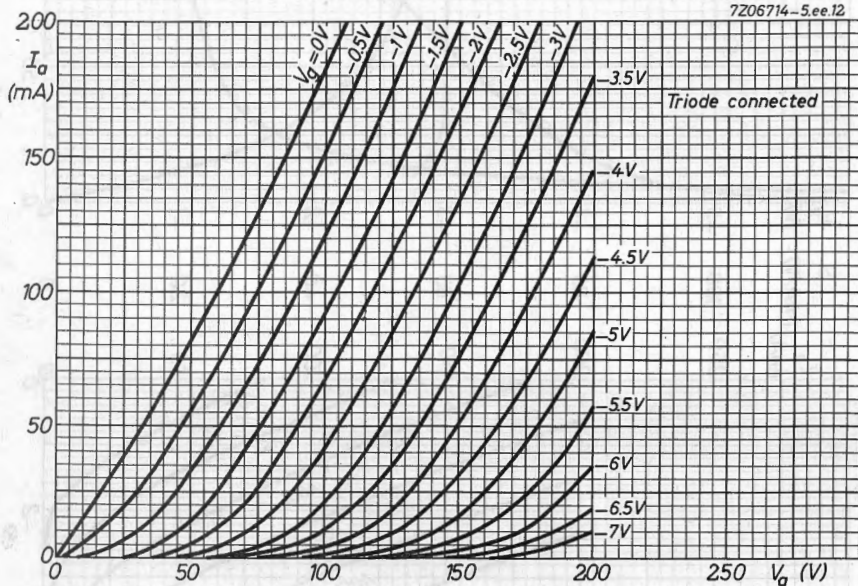

S.Q. TUBE

Special quality double triode designed for use as A.F. and D.C. amplifier.

QUICK REFERENCE DATA

Life test	10 000 hours	
	Low interface resistance after long periods of operation under cut-off conditions	
Mechanical quality	Shock and vibration resistant	
Base	Noval. Gold plated pins	
Heating	Indirect A.C. or D.C. Series or parallel supply	
Heater voltage	V_f	12.6 6.3 V
Heater current	I_f	0.3 0.6 A
Anode voltage	V_a	250 V
Grid voltage	V_g	-5.5 V
Mutual conductance	S	2.7 mA/V

DIMENSIONS AND CONNECTIONS

Dimensions in mm

Base: Noval

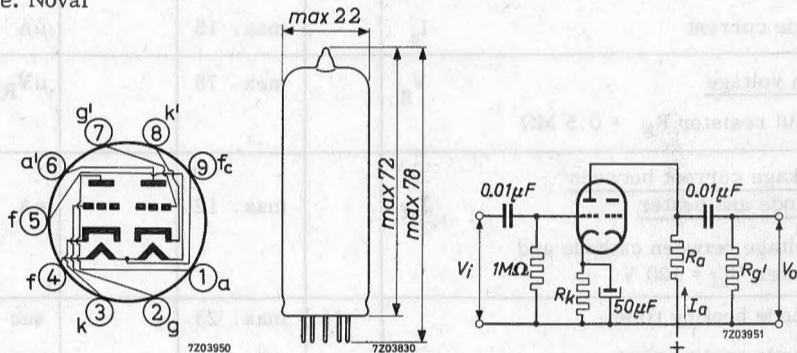

Fig. 1

CHARACTERISTICS

Column I Nominal value or setting of the tube

II Range values for equipment design: Initial spread

III Range values for equipment design: End of life

		I	II	III	
Heater voltage	V_f	12.6			V
Heater current	I_f	300	285 - 315		mA
Anode voltage	V_a	250			V
Cathode resistor	R_k	920			Ω
Anode current	I_a	6.0	5.4 - 6.6	min. 4.3	mA
Transconductance	S	2.7	2.2 - 3.2	min. 1.8	mA/V
Amplification factor	μ	27			
Internal resistance	R_i	10	min. 7		k Ω
Negative grid current	$-I_g$		max. 0.5	max. 1.0	μ A
<u>Difference in anode current of two sections</u>	$ I_a - I_a' $		max. 3.0		mA
Anode voltage	V_a	250			V
Negative grid voltage	$-V_g$	5.5			V
<u>Cut-off voltage</u>	$-V_g$	17			V
Anode voltage	V_a	250			V
Anode resistor	R_a	1			M Ω
Anode current	I_a		max. 15		μ A
<u>Hum voltage</u>	V_g		max. 75		μ V _{RMS}
Grid resistor $R_g = 0.5$ M Ω					
<u>Leakage current between cathode and heater</u>	I_{kf}		max. 12		μ A
Voltage between cathode and heater $V_{kf} = 120$ V					
Cathode heating time		16	max. 23		sec
Cathode cooling time			min. 13		sec

CAPACITANCES

		External screen		Without external screen		
		I	II	I	II	
Anode to cathode and heater	$C_{a/kf}$	3.5	2.8 - 4.2	0.45		pF
Grid to cathode and heater	$C_{g/kf}$	2.6	1.9 - 3.3	2.4		pF
Anode to grid	C_{ag}	3.0	2.4 - 3.6	3.1		pF
Grid to heater	C_{gf}		max. 0.23		max. 0.23	pF
Cathode to heater	C_{kf}	4.8		4.8		pF
Anode to cathode and heater	$C_{a'/k'f}$	3.0	2.3 - 3.7	0.55		pF
Grid to cathode and heater	$C_{g'/k'f}$	2.6	1.9 - 3.3	2.4		pF
Anode to grid	$C_{a'g'}$	3.0	2.4 - 3.6	3.0		pF
Grid to heater	$C_{g'f}$		max. 0.23		max. 0.23	pF
Cathode to heater	$C_{k'f}$	4.8		4.8		pF
Anode to anode other section	$C_{aa'}$	1.3	0.9 - 1.7	1.45		pF
Grid to grid other section	$C_{gg'}$		max. 13		max. 13	mpF
Anode to grid other section	$C_{ag'}$		max. 0.1		max. 0.1	pF
Grid to anode other section	$C_{ga'}$		max. 65		max. 65	mpF

SHOCK AND VIBRATION RESISTANCE

The following test conditions are applied to assess the mechanical quality of the tube. These conditions are not intended to be used as normal operating conditions.

Shock

The tube is subjected 5 times in each of 4 positions to an acceleration of 500 g supplied by an NRL shock machine with the hammer lifted over an angle of 30°.

Vibration

The tube is subjected during 32 hours in each of 3 positions to a vibration frequency of 50 Hz with an acceleration of 2.5 g.

LIFE

Production samples are tested to be within the end of life values (column III) under the following conditions during 10 000 hours.

Heater voltage	V_f	6.3 V
Anode voltage	V_a	250 V
Cathode resistor	R_k	920 Ω

LIMITING VALUES (Absolute max. rating system)

Anode voltage	V_{a0}	max. 600 V
	V_a	max. 300 V
Anode dissipation	W_a	max. 2 W
Cathode current	I_k	max. 12 mA
Cathode current peak value	I_{kp}	max. 150 mA
Grid current peak value max. 30 mA		
Duty factor max. 0.005		
Pulse duration max. 10 μ s		
Cathode current peak value	I_{kp}	max. 30 mA
Grid current peak value max. 2 mA		
Duty factor max. 0.2		
Pulse duration max. 400 μ s		
Grid voltage	$-V_g$	max. 200 V
Grid current, average value	I_g	max. 0.3 mA
peak value	I_{gp}	max. 30 mA
Voltage between cathode and heater	V_{kf}	max. 120 V
Bulb temperature	t_{bulb}	max. 170 $^{\circ}$ C
Grid resistor (automatic bias)	R_g	max. 1 M Ω
Grid resistor (fixed bias)	R_g	max. 0.5 M Ω

Heater voltage. The average heater voltage should be 6.3 V or 12.6 V. Variations of the heater voltage exceeding the range of 6.0 V to 6.6 V or 12.0 to 13.2 V will shorten the tube life. The tolerance of heater current (column II) should be taken into account.

OPERATING CHARACTERISTICS

Resistance coupled A.F. amplifier. Fig.1 page 1

Anode supply voltage	V_{b_a}	200	250	300	350	400	V
Anode resistor	R_a	47	47	47	47	47	k Ω
Cathode resistor	R_k	1.2	1.2	1.2	1.2	1.2	k Ω
Grid resistor	$R_{g'}$	0.15	0.15	0.15	0.15	0.15	M Ω
Anode current	I_a	1.86	2.45	3.15	3.80	4.40	mA
Voltage gain	V_o/V_i	18.5	18.5	18.5	18.5	18.5	
Output voltage at $+I_g = 0.3 \mu A$	V_o	20	30	40	50	60	V_{RMS}
Total distortion 1)	d_{tot}	3.3	3.8	4.0	4.1	4.2	%

Anode supply voltage	V_{b_a}	200	250	300	350	400	V
Anode resistor	R_a	100	100	100	100	100	k Ω
Cathode resistor	R_k	2.2	2.2	2.2	2.2	2.2	k Ω
Grid resistor	$R_{g'}$	0.33	0.33	0.33	0.33	0.33	M Ω
Anode current	I_a	1.00	1.30	1.65	1.95	2.30	mA
Voltage gain	V_o/V_i	20	20	20	20	20	
Output voltage at $+I_g = 0.3 \mu A$	V_o	22	32	42	52	63	V_{RMS}
Total distortion 1)	d_{tot}	3.1	3.4	3.5	3.6	3.7	%

Anode supply voltage	V_{b_a}	200	250	300	350	400	V
Anode resistor	R_a	220	220	220	220	220	k Ω
Cathode resistor	R_k	3.9	3.9	3.9	3.9	3.9	k Ω
Grid resistor	$R_{g'}$	0.68	0.68	0.68	0.68	0.68	M Ω
Anode current	I_a	0.52	0.67	0.83	0.99	1.15	mA
Voltage gain	V_o/V_i	21	21	21	21	21	
Output voltage at $+I_g = 0.3 \mu A$	V_o	19	29	38	47	58	V_{RMS}
Total distortion 1)	d_{tot}	2.3	2.6	3.0	3.1	3.2	%

1) At lower output voltages the distortion is proportionally lower.

Measurments conducted at 25°C ambient temperature.

7203953-5.h.j.3.3

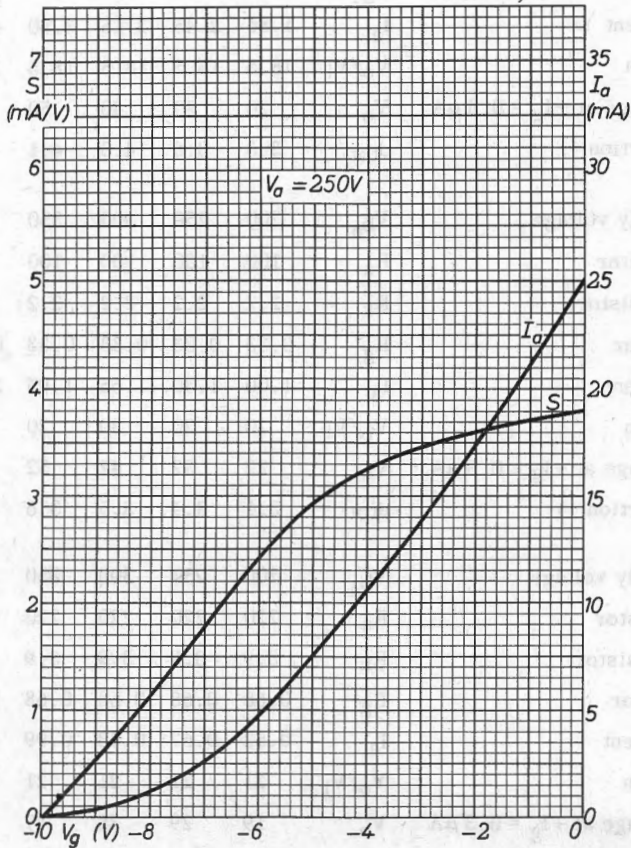

At lower output voltages the distortion is proportionally lower.

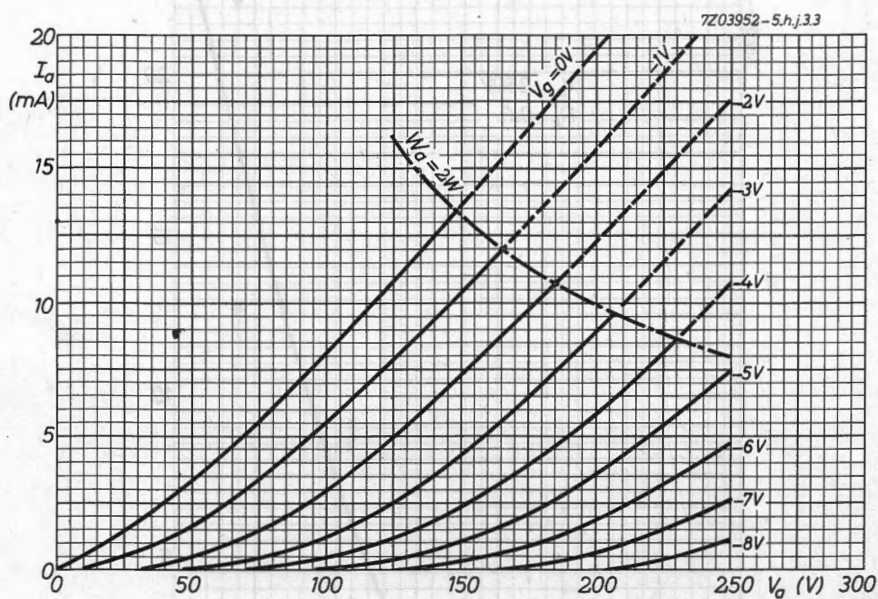

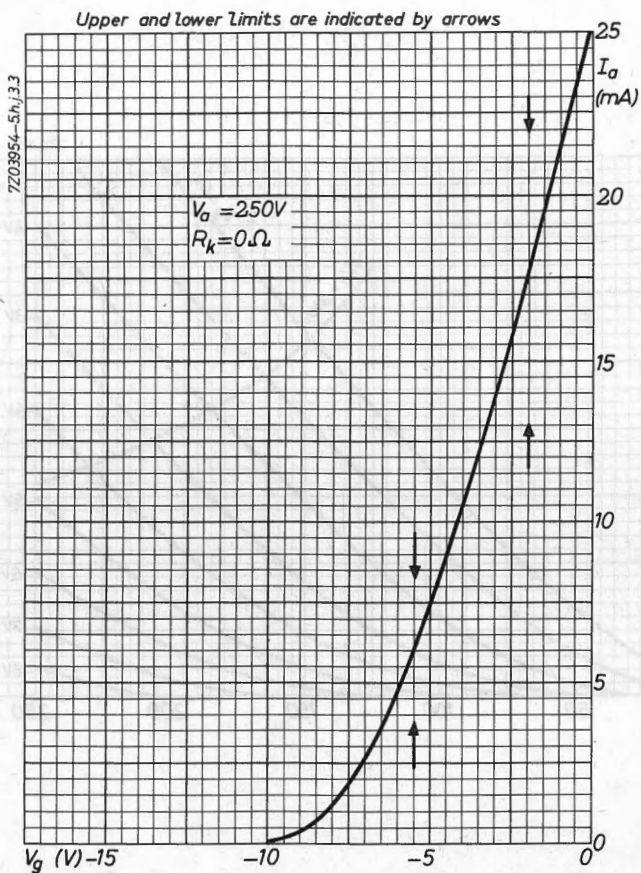

S.Q. TUBE

Special quality triode-pentode

The pentode section is designed for use as mixer and R.F. or A.F. amplifier. The triode section is designed for use as oscillator (max. freq. 300 MHz) multivibrator or blocking oscillator.

QUICK REFERENCE DATA

Life test	10 000 hours
Low interface resistance	
Mechanical quality	Shock and vibration resistant
Base	Noval. Gold plated pins
Heating	Indirect A.C. or D.C.; parallel supply
Heater voltage	V_f 6.3 V
Heater current	I_f 330 mA
Pentode: Anode current	I_a 10 mA
Mutual conductance	S 6.2 mA/V
Amplification factor	μ 40
Triode: Anode current	I_a 14 mA
Mutual conductance	S 5 mA/V
Amplification factor	μ 18

DIMENSIONS AND CONNECTIONS

Dimensions in mm

Base: Noval

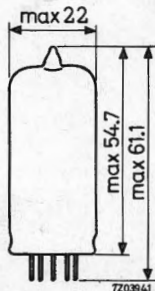
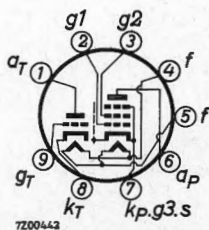

CHARACTERISTICS

Column I Nominal value or setting of the tube

II Range values for equipment design: Initial spread

III Range values for equipment design: End of life

		I	II	III	
Heater voltage	V_f	6.3			V
Heater current	I_f	330	313 - 347		mA
<u>Pentode section</u>					
Anode supply voltage	V_{ba}	170			V
Grid No.2 supply voltage	V_{bg_2}	170			V
Cathode resistor	R_k	155			Ω
Anode current	I_a	10	7.5 - 12.5	min. 6	mA
Grid No.2 current	I_{g_2}	2.8	1.55 - 4.05		mA
Mutual conductance	S	6.2	5.2 - 7.2	min. 4.3	mA/V
Amplification factor grid No.2 to grid No.1	$\mu_{g_2g_1}$	40			
Internal resistance	R_i	0.4	min. 0.26		M Ω
Negative grid No.1 current	$-I_{g_1}$		max. 0.5	max. 1.0	μA
<u>Triode section</u>					
Anode supply voltage	V_{ba}	100			V
Cathode resistor	R_k	120			Ω
Anode current	I_a	14	10 - 18	min. 8.4	mA
Mutual conductance	S	5.0	4 - 6	min. 3.5	mA/V
Amplification factor	μ	18			
Negative grid current	$-I_g$		max. 0.5	max. 1.0	μA



CAPACITANCES Without external shield

<u>Pentode</u>		I	II	
Grid No.1 to grid No.2, grid No.3 cathode, heater and screen	$C_{g1/g2g3kfs}$	5.6	5.2 - 6	pF
Anode to grid No.2, grid No.3 cathode, heater and screen	$C_{a/g2g3kfs}$	3.4	3 - 3.8	pF
Anode to grid No.1	C_{ag1}		max. 25	mpF
Grid No.1 to heater	C_{g1f}		max.0.16	pF
<u>Triode</u>				
Grid to cathode (triode), cathode (pentode) grid No.3, heater and screen	C_{g/k_Tkp_g3fs}	2.5	2.2 - 2.8	pF
Anode to cathode (triode), cathode (pentode) grid No.3, heater and screen	C_{a/k_Tkp_g3fs}	1.5	1.2 - 1.8	pF
Anode to grid	C_{ag}	1.5	1.2 - 1.8	pF
Grid to heater	C_{gf}		max.0.22	pF
<u>Pentode to triode</u>				
Anode (pentode) to anode (triode)	C_{aP-aT}		max.0.07	pF
Anode (pentode) to grid (triode)	C_{aP-gT}		max.0.02	pF
Grid No.1 (pentode) to anode (triode)	C_{g1P-aT}		max.0.16	pF

MICROPHONY

The pentode section can be used without special precautions against microphony in circuits where an input voltage of more than 50 mV is required for an output of 50 mW.

SHOCK AND VIBRATION RESISTANCE

The following test conditions are applied to assess the mechanical quality of the tube. These conditions are not intended to be used as normal operating conditions.

Shock

The tube is subjected 5 times in each of 4 positions to an acceleration of 500 g supplied by an NRL shock machine with the hammer lifted over an angle of 30°.

Vibration

The tube is subjected during 32 hours in each of 3 positions to a vibration frequency of 50 Hz with an acceleration of 2.5 g.

LIFE

Production samples are tested to be within the end of life values (column III) under the following conditions during 10 000 hours.

Pentode section

$$V_{ba} = 170 \text{ V}$$

$$V_{bg_2} = 170 \text{ V}$$

$$R_k = 155 \Omega$$

Triode section

$$V_{ba} = 100 \text{ V}$$

$$R_k = 120 \Omega$$

LIMITING VALUES (Absolute max. rating system)Pentode section

Anode voltage	V_{a_0}	max. 550 V
	V_a	max. 275 V
Anode dissipation	W_a	max. 2.15 W
Grid No.2 voltage	$V_{g_{20}}$	max. 550 V
Grid No.2 voltage:		
Cathode current > 10 mA	V_{g_2}	max. 200 V
Cathode current < 10 mA	V_{g_2}	max. 225 V
Grid No.2 dissipation:		
Anode dissipation > 1.2 W	W_{g_2}	max. 0.7 W
Anode dissipation < 1.2 W	W_{g_2}	max. 0.8 W
Grid No.1 dissipation	W_{g_1}	max. 0.1 W
Negative grid No.1 voltage	$-V_{g_1}$	max. 100 V
Cathode current	I_k	max. 18 mA
Voltage between cathode and heater	V_{kf}	max. 100 V
Grid resistor (fixed bias)	R_{g_1}	max. 0.5 M Ω

LIMITING VALUES (Absolute max. rating system) (continued)Triode section

Anode voltage	V_{a0}	max.	550 V
	V_a	max.	275 V
Anode dissipation	W_a	max.	1.75 W
Grid dissipation	W_g	max.	0.1 W
Grid, voltage, peak value	V_{gp}	max.	30 V
Duty factor max. 0.04			
Pulse duration max. 0.8 ms			
Grid voltage	$-V_g$	max.	100 V
Cathode current	I_k	max.	18 mA
Cathode current peak value	I_{kp}	max.	100 mA
Duty factor max. 0.04			
Pulse duration max. 0.8 ms			
Voltage between cathode and heater	V_{kf}	max.	100 V
Grid resistor (fixed bias)	R_g	max.	0.5 M Ω
Bulb temperature	t_{bulb}	max.	170 °C

Heater voltage: The average heater voltage should be 6.3 V.

Variation of the heater voltage exceeding the range of 6.0 V to 6.6 V will shorten the tube life.

The tolerance of heater current (column II) should be taken into account.

OPERATING CHARACTERISTICS

Pentode section as R.F. amplifier

Anode supply voltage	V_{ba}	170 V
Grid No.2 supply voltage	V_{bg_2}	170 V
Cathode resistor	R_k	155 Ω
Anode current	I_a	10 mA
Grid No.2 current	I_{g_2}	2.8 mA
Mutual conductance	S	6.2 mA/V
Amplification factor grid No.2 to grid No.1	$\mu_{g_2g_1}$	40
Internal resistance	R_i	0.4 M Ω
Input resistance at 50 MHz	r_{g_1}	10 k Ω
Equivalent noise resistance	R_{eq}	1.5 k Ω

Pentode section as mixer

Anode supply voltage	V_{ba}	170 V
Grid No.2 supply voltage	V_{bg_2}	170 V
Grid No.1 resistor	R_{g_1}	0.1 M Ω
Cathode resistor	R_k	330 Ω
Oscillator voltage	V_{osc}	3.5 V _{RMS}
Anode current	I_a	8 mA
Grid No.2 current	I_{g_2}	2.5 mA
Grid No.1 current	I_{g_1}	12 μ A
Conversion conductance	S_c	2.4 mA/V
Internal resistance	R_i	0.5 M Ω

Triode as oscillator

Operation in Colpitts circuit is recommended.

Operation in Hartley circuit is not recommended.

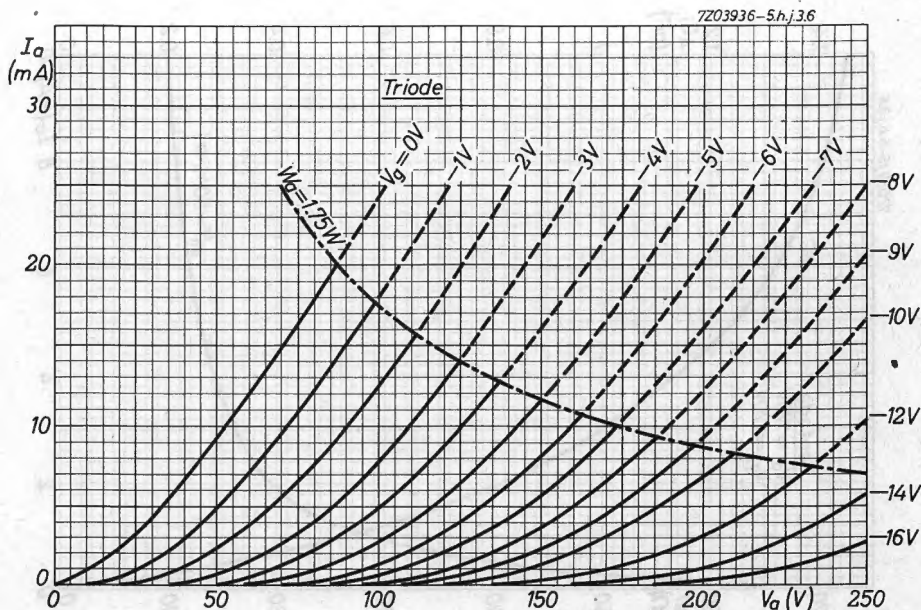
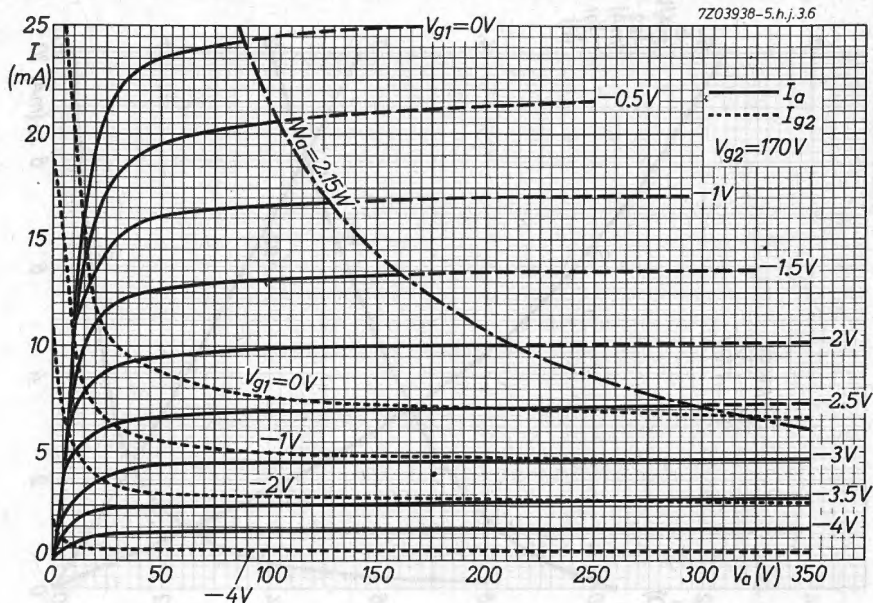

7Z03935-5.h.j.3.6

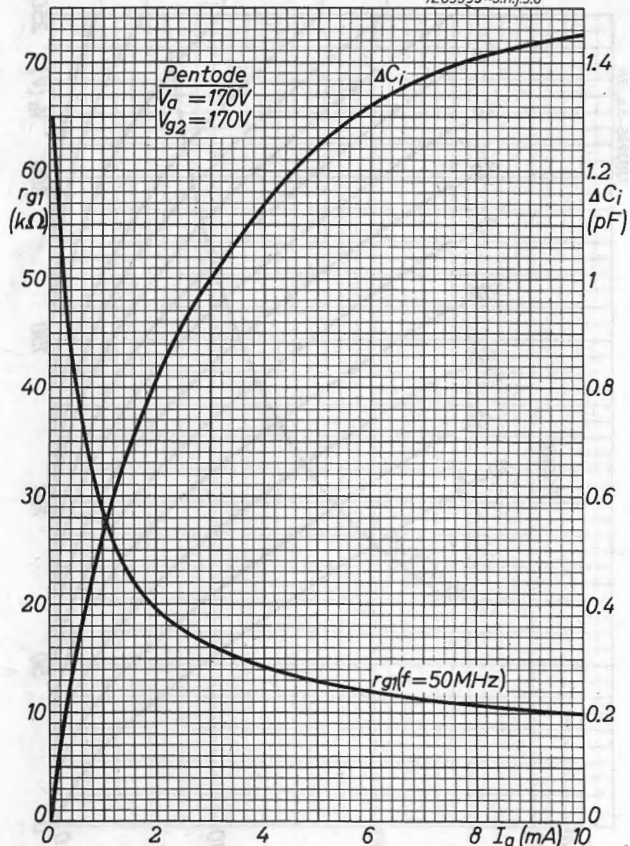

7Z03939-5.h.j.3.6

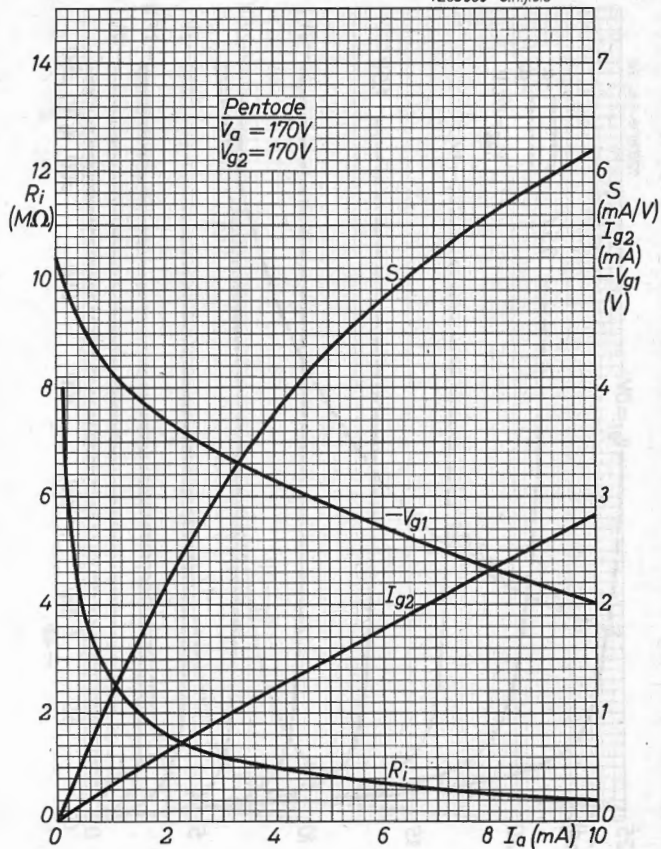

7Z03937-5A,j.36

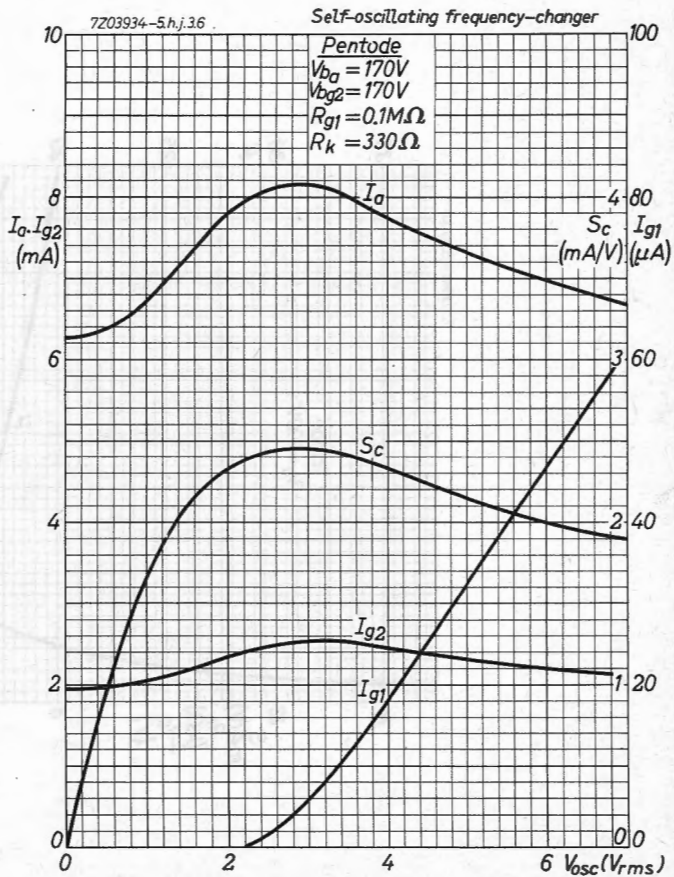
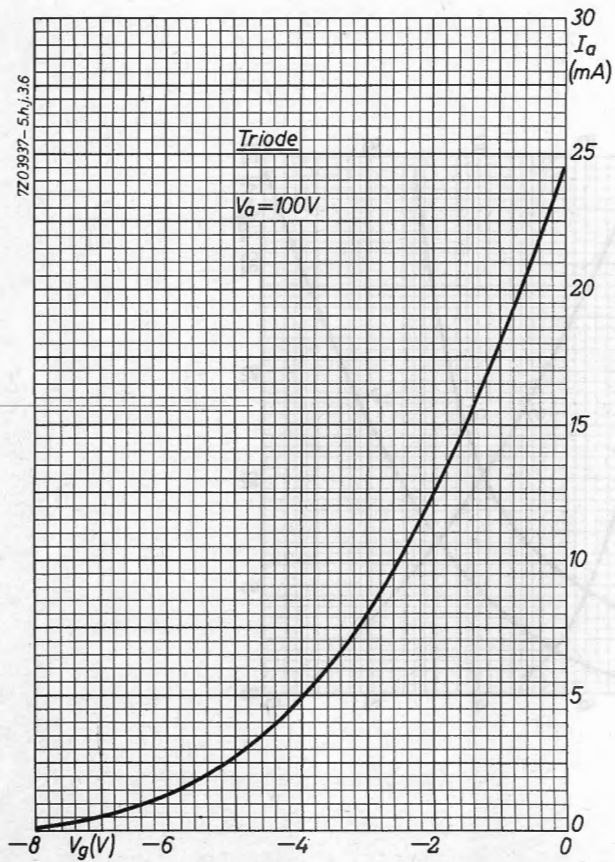

7Z03940-5.h.j.36

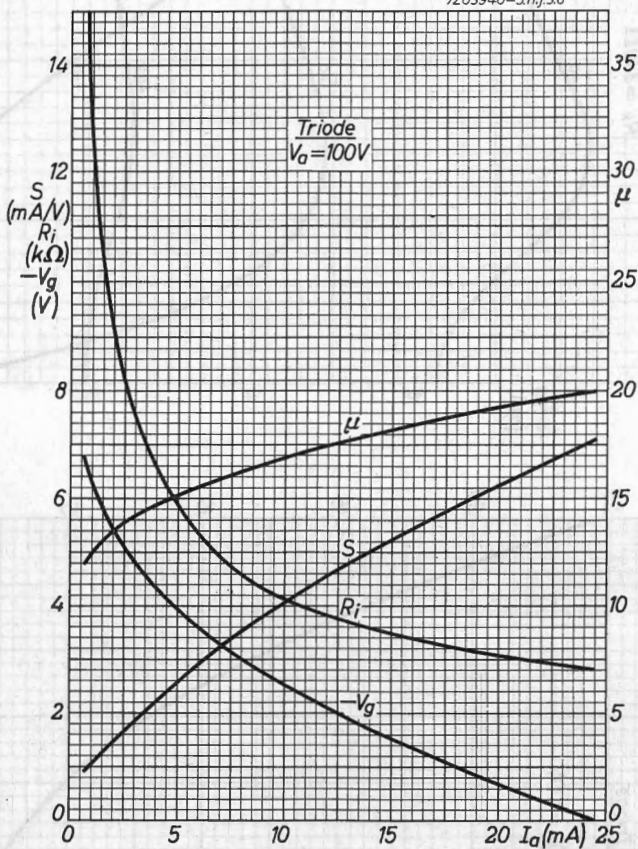

S.Q. TUBE

Special quality pentode designed for use as amplifier.

QUICK REFERENCE DATA

Life test	10 000 hours
Low interface resistance	
Mechanical quality	Shock and vibration resistant
Base	Noval. Gold plated pins
Heating	Indirect A.C. or D.C. Series or parallel supply
Heater voltage	V_f 6.3 V
Heater current	I_f 300 mA
Anode current	I_a 3 mA
Mutual conductance	S 1.85 mA/V
Equivalent noise resistance (A.F.)	R_{eq} 40 k Ω
Hum voltage	V_{g1} max. 5 μ V _{RMS}

DIMENSIONS AND CONNECTIONS

Dimensions in mm

Base: Noval

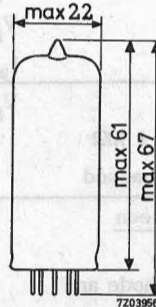
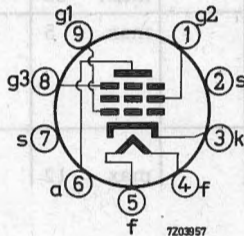

CHARACTERISTICS

Column I Nominal value or setting of the tube

II Range values for equipment design; Initial spread

III Range values for equipment design; End of life

		I	II	III	
Heater voltage	V_f	6.3			V
Heater current	I_f	300	285- 315		mA
Anode voltage	V_a	250			V
Grid No.3 voltage	V_{g3}	0			V
Grid No.2 voltage	V_{g2}	100			V
Cathode resistor	R_k	550			Ω
Anode current	I_a	3	2.5- 3.5	min. 2.0	mA
Grid No.2 current	I_{g2}	0.65	0.45-0.85	min. 0.35	mA
Mutual conductance	S	1.85	1.5- 2.2	min. 1.2	mA/V
Internal resistance	R_i	1.5	min. 1.0		M Ω
Amplification factor grid No.2 to grid No.1	μ_{g2g1}	25			
Equivalent noise resistance Frequency 0-10 kHz Grid No.1 resistor $R_{g1} = 0 \Omega$	R_{eq}		max. 40		k Ω
Negative grid No.1 current	$-I_{g1}$		max. 0.1	max. 0.2	μA
Cut off voltage	$-V_{g1}$	7.5			V
Anode voltage	V_a	250			V
Grid No.3 voltage	V_{g3}	0			V
Grid No.2 voltage	V_{g2}	100			V
Anode current	I_a		max. 20		mA
Hum voltage Grid resistor $R_{g1} = 1 M\Omega$ Cathode resistor bypassed	V_{g1}		max. 5		μV_{RMS}
Leakage current between cathode and heater Voltage between cathode and heater $V_{kf} = 120 V$			max. 12		μA

CAPACITANCES With external shield

		I	II	
Anode to grid No.2, grid No.3, cathode and heater	C_{a/g_2g_3kf}	7.3	6.8-7.8	pF
Grid No.1 to grid No.2, grid No.3, cathode and heater	C_{g_1/g_2g_3kf}	5.0	4.5-5.5	pF
Anode to grid No.1	C_{ag_1}		max. 25	mpF
Grid No.1 to heater	C_{g_1f}		max. 2	mpF
Cathode to heater	C_{kf}	3.7		pF

SHOCK AND VIBRATION RESISTANCE

The following test conditions are applied to assess the mechanical quality of the tube. These conditions are not intended to be used as normal operating conditions.

Shock

The tube is subjected 5 times in each of 4 positions to an acceleration of 500 g supplied by an NRL shock machine with the hammer lifted over an angle of 30°.

Vibration

The tube is subjected during 32 hours in each of 3 positions to a vibration frequency of 50 Hz with an acceleration of 2.5 g.

LIFE

Production samples are tested to be within the end of life values (column III) under the following conditions during 10 000 hours.

Anode voltage	V_a	250	V
Grid No.3 voltage	V_{g_3}	0	V
Grid No.2 voltage	V_{g_2}	100	V
Cathode resistor	R_k	550	Ω

LIMITING VALUES (Absolute max. rating system)

Anode voltage	V_{a_0}	max. 600 V
	V_a	max. 300 V
Anode dissipation	W_a	max. 1.3 W
Grid No.2 voltage	$V_{g_2^0}$	max. 600 V
	V_{g_2}	max. 200 V
Grid No.2 dissipation	W_{g_2}	max. 0.4 W
Negative grid No.3 voltage	$-V_{g_3}$	max. 100 V
Negative grid No.1 voltage	$-V_{g_1}$	max. 100 V
Cathode current	I_k	max. 9 mA
Voltage between cathode and heater		
Cathode positive	V_{kf} (k pos)	max. 120 V
Cathode negative	V_{kf} (k neg)	max. 60 V
Grid No.1 resistor	R_{g_1}	See curve on page G
Bulb temperature		max. 170 °C

Heater voltage: The average heater voltage should be 6.3 V.

Variations of the heater voltage exceeding the range of 6.0 V to 6.6 V will shorten the tube life.

The tolerance of heater current (column II) should be taken into account.

OPERATING CHARACTERISTICS

Resistance coupled A.F. amplifier

Anode supply voltage	V_{ba}	100	200	250	300	400	V
Grid No.2 supply voltage	V_{bg_2}	100	200	250	300	400	V
Anode resistor	R_a	0.22	0.22	0.22	0.22	0.22	M Ω
Grid No.2 resistor	R_{g_2}	1.0	1.2	1.2	1.2	1.2	M Ω
Cathode resistor	R_k	3.3	1.8	1.5	1.2	1.0	k Ω
Grid No.1 resistor	R_{g_1}	1	1	1	1	1	M Ω
Grid resistor next stage	$R_{g_1'}$	0.68	0.68	0.68	0.68	0.68	M Ω
Anode current	I_a	0.29	0.61	0.80	0.98	1.37	mA
Grid No.2 current	I_{g_2}	0.07	0.13	0.17	0.20	0.28	mA
Gain	V_o/V_i	120	165	175	190	200	
Output voltage at $+I_g = 0.3 \mu A$	V_o	8	20	25	30	40	V _{RMS}
Total distortion	d_{tot}	1.7	1.6	1.4	1.1	0.9	%

Electrometer pentode

Heater voltage	V_f	4.5	V
Anode voltage	V_a	40	V
Grid No.3 voltage	V_{g_3}	0	V
Grid No.2 voltage	V_{g_2}	40	V
Negative grid No.1 voltage	$-V_{g_1}$	2.15	V
Anode current	I_a	40	μA
Grid No.2 current	I_{g_2}	9	μA
Negative grid No.1 current	$-I_{g_1}$	max. 10^{-10}	A

7203962-5.h.j.6

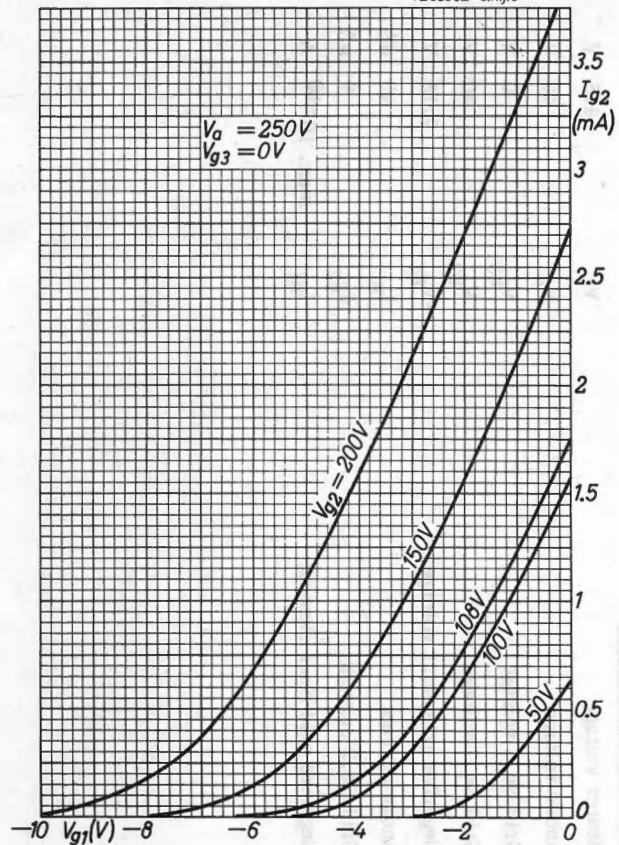

7203965-5.h.j.6

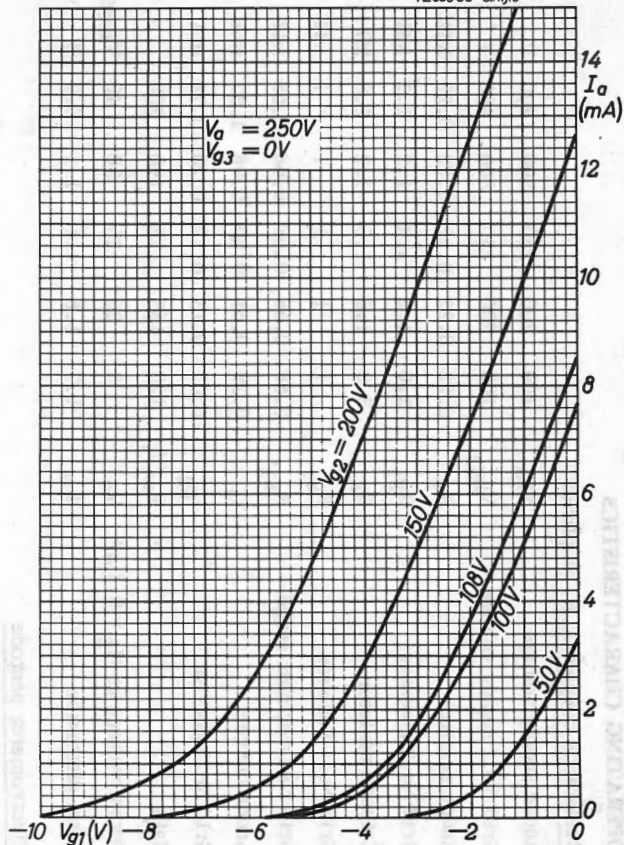

7Z03964-5.h.j.6

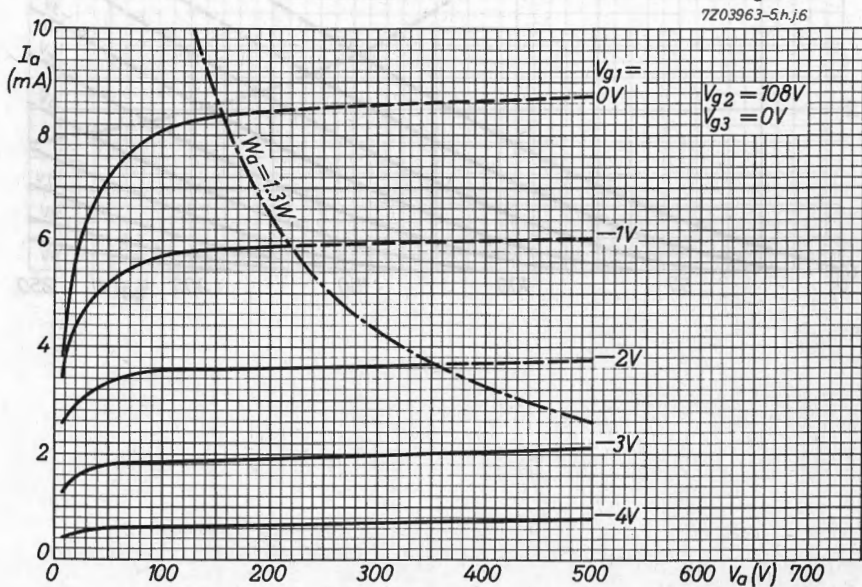
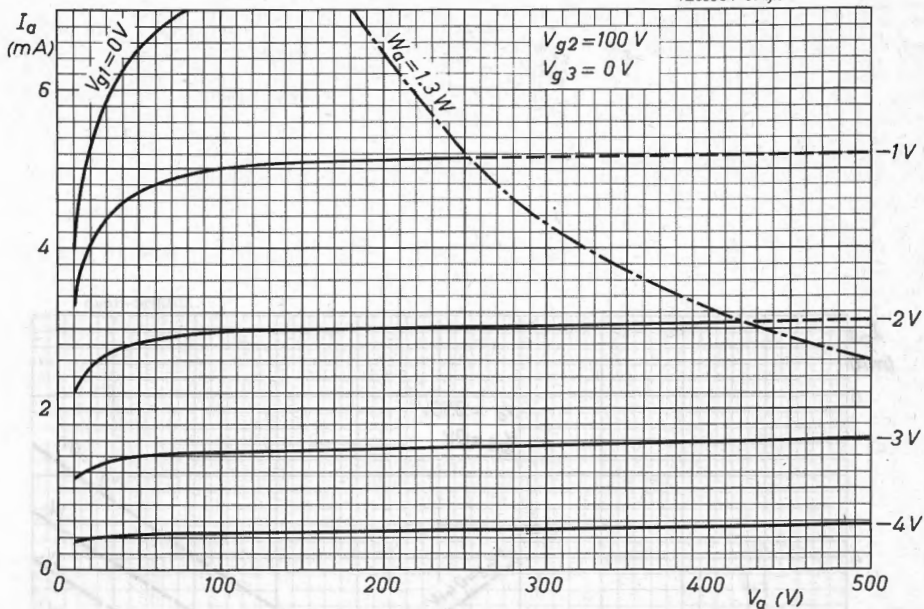

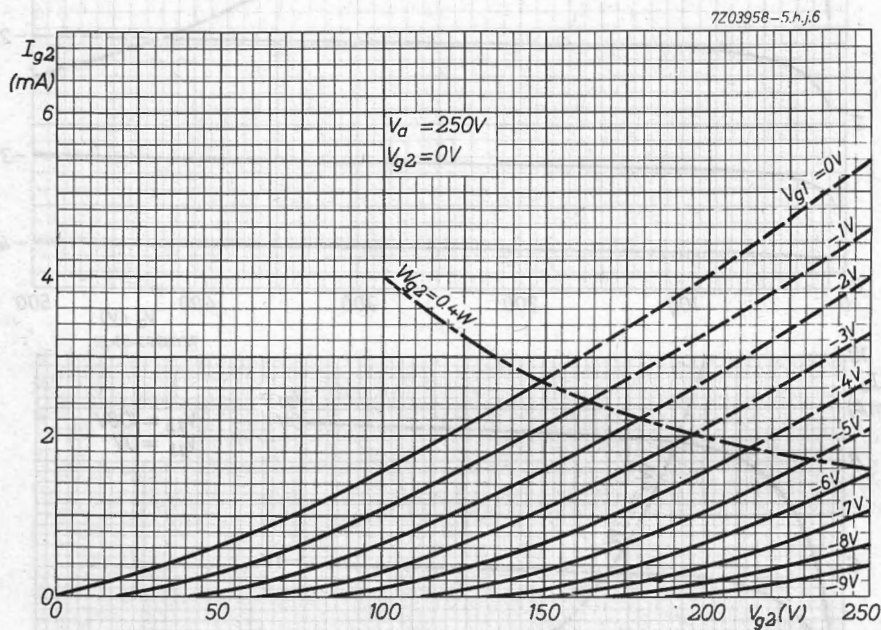

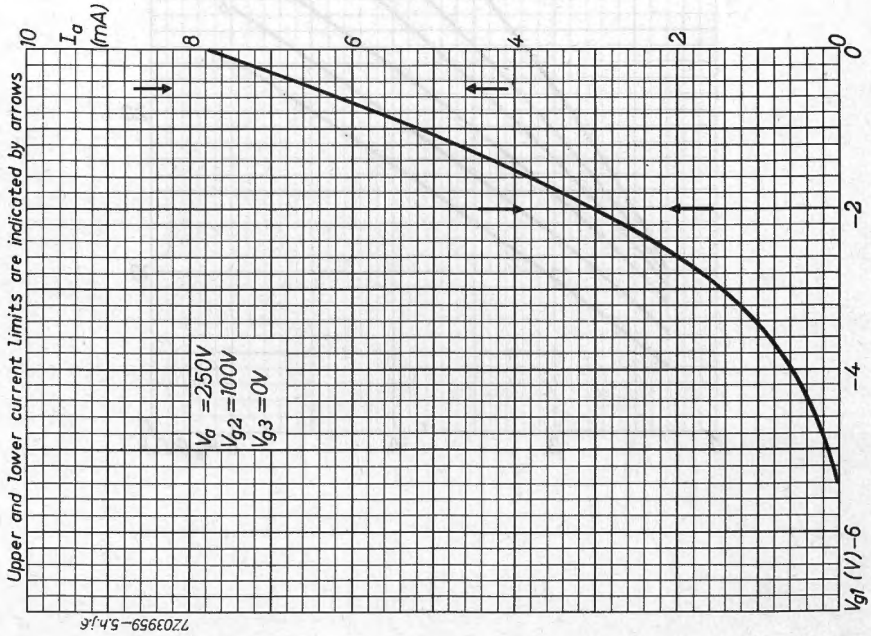
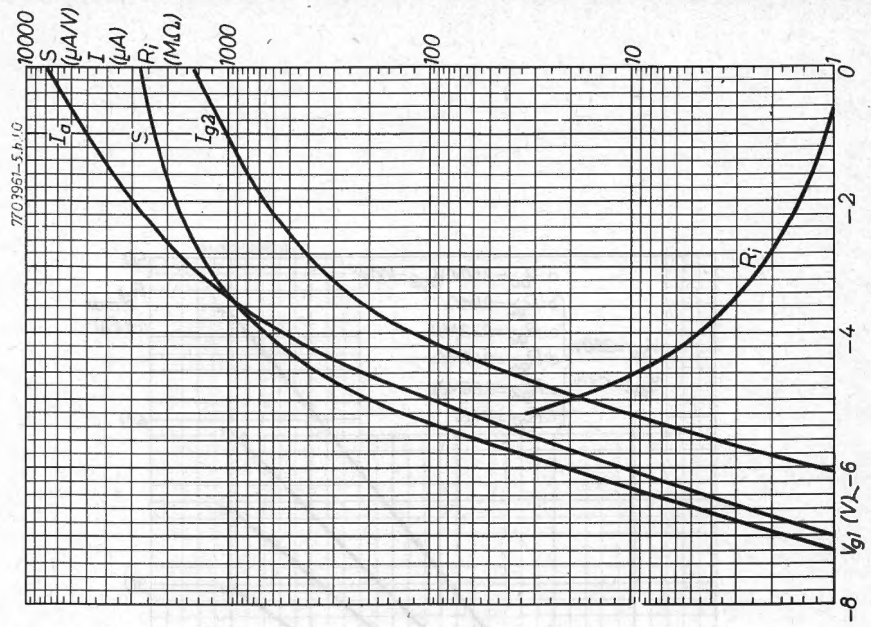

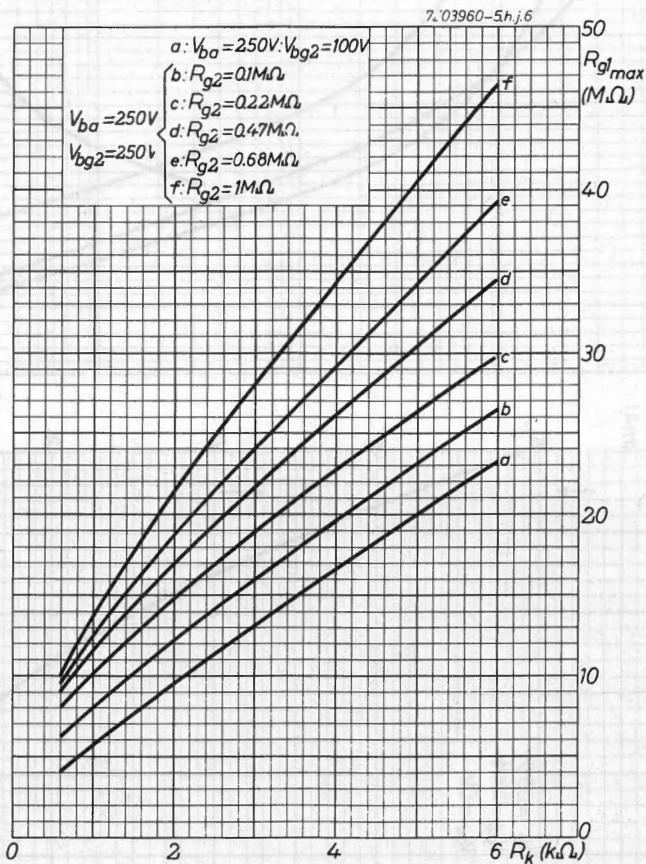

S.Q. TUBE

Special quality output pentode

QUICK REFERENCE DATA

Life test	10 000 hours
Low interface resistance	
Mechanical quality	Shock and vibration resistant
Base	Noval. Gold plated pins
Heating	Indirect A. C. or D. C. Series or parallel supply
Heater voltage	V_f 6.3 V
Heater current	I_f 700 mA
Anode current	I_a 30 mA
Output power, one tube	W_o 2.7 W
two tubes class AB	W_o 5.7 W

DIMENSIONS AND CONNECTIONS

Dimensions in mm

Base: Noval

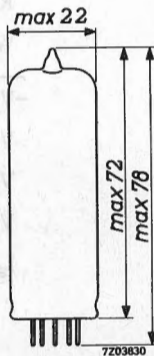
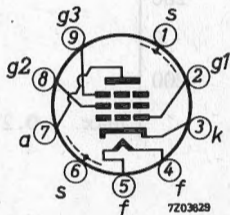

CHARACTERISTICS

- Column I Nominal value or setting of the tube
 II Range values for equipment design: Initial spread
 III Range values for equipment design: End of life

		I	II	III	
Heater voltage	V_f	6.3			V
Heater current	I_f	700	665 - 735		mA
Anode voltage	V_a	200			V
Grid No.3 voltage	V_{g3}	0			V
Grid No.2 voltage	V_{g2}	200			V
Cathode resistor	R_k	130			Ω
Anode current	I_a	30	26.5 - 33.5	min. 21	mA
Grid No.2 current	I_{g2}	4.1	2.7 - 5.5	min. 2.0	mA
Mutual conductance	S	9.0	7.4 - 10.6	min. 6.0	mA/V
Amplification factor grid No.2 to grid No.1	μ_{g2g1}	21.5			
Negative grid No.1 current	$-I_{g1}$		max. 0.5	max. 1.0	μA
Anode voltage	V_a	200			V
Grid No.3 voltage	V_{g3}	0			V
Grid No.2 voltage	V_{g2}	200			V
Anode current	I_a	30			mA
Load resistance	$R_{a\sim}$	7			$k\Omega$
Output power	W_o	2.7	min. 2.0		W
Cut-off voltage	$-V_{g1}$	14			V
Anode voltage	V_a	200			V
Grid No.3 voltage	V_{g3}	0			V
Grid No.2 voltage	V_{g2}	200			V
Anode current	I_a		max. 0.2		mA

CHARACTERISTICS (continued)

	I	II	III	
<u>Hum voltage</u> Grid No.1 resistor $R_{g1} = 0.5 \text{ M}\Omega$ Cathode resistor by-passed	V_{g1}	max. 0.25		mVRMS
<u>Leakage current between cathode and heater</u> Voltage between cathode and heater $V_{kf} = 120 \text{ V}$	I_{kf}	max. 15	max. 20	μA
<u>Insulation resistance between two electrodes</u> Voltage between electrodes = 300 V	R	min. 50	min. 10	$\text{M}\Omega$

CAPACITANCES

	I	II	
Grid No.1 to grid No.3, grid No.2, cathode heater and screen	$C_{g1/g3g2kfs}$	10	9.2 - 10.8 pF
Anode to grid No.3, grid No.2, cathode heater and screen	$C_{a/g3g2kfs}$	6.8	6.3 - 7.3 pF
Anode to grid No.1	C_{ag1}		max. 0.15 pF
Grid No.1 to heater	C_{g1f}		max. 0.25 pF
Cathode to heater	C_{kf}	7.0	pF

SHOCK AND VIBRATION RESISTANCE

The following test conditions are applied to assess the mechanical quality of the tube. These conditions are not intended to be used as normal operating conditions.

Shock

The tube is subjected 5 times in each of 4 positions to an acceleration of 500 g supplied by an NRL shock machine with the hammer lifted over an angle of 30°.

Vibration

The tube is subjected during 32 hours in each of 3 positions to a vibration frequency of 50 Hz with an acceleration of 2.5 g.

LIFE

Production samples are tested to be within the end of life values (column III) under the following conditions during 10 000 hours.

Anode voltage	V_a	200	V
Grid No.3 voltage	V_{g_3}	0	V
Grid No.2 voltage	V_{g_2}	200	V
Cathode resistor	R_k	130	Ω

LIMITING VALUES (Absolute max. rating system)

Anode voltage	V_{a_0}	max.	600	V
	V_a	max.	300	V
Anode dissipation	W_a	max.	8	W
Negative grid No.3 voltage	$-V_{g_3}$	max.	100	V
Grid No.2 voltage	$V_{g_{2_0}}$	max.	600	V
	V_{g_2}	max.	300	V
Grid No.2 dissipation	W_{g_2}	max.	2.6	W
Grid No.1 voltage	$-V_{g_1}$	max.	100	V
Cathode current	I_k	max.	50	mA
Voltage between cathode and heater	V_{kf}	max.	120	V
Bulb temperature	t_{bulb}	max.	225	$^{\circ}\text{C}$
Grid No.1 resistor (automatic bias)	R_{g_1}	max.	1	$\text{M}\Omega$

Heater voltage: The average heater voltage should be 6.3 V.

Variations of the heater voltage exceeding the range of 6.0 V to 6.6 V will shorten the tube life.

The tolerance of heater current (column II) should be taken into account.

OPERATING CHARACTERISTICS

Output tube class A

Anode voltage	V_a	200	250 V
Grid No.3 voltage	V_{g3}	0	0 V
Grid No.2 voltage	V_{g2}	200	250 V
Grid No.2 resistor	R_{g2}		1 k Ω
Cathode resistor	R_k	130	270 Ω
Anode current	I_a	30	24 mA
Grid No.2 current	I_{g2}	4.1	3.3 mA
Mutual conductance	S	9	- mA/V
Internal resistance	R_i	52	- k Ω
Load resistance	$R_{a\sim}$	7	10 k Ω
Output power	W_o	2.7	2.8 W
Total distortion	d_{tot}	10	10 %

Output tube class AB (two tubes)

Anode voltage	V_a	200	V
Grid No.3 voltage	V_{g3}	0	V
Grid No.2 voltage	V_{g2}	200	V
Cathode resistor	R_k	130	Ω
Load resistance	$R_{aa\sim}$	9	k Ω
Input voltage	V_i	0 0.31	5.2 V _{RMS}
Anode current	I_a	2x20.6 -	2x24.6 mA
Grid No.2 current	I_{g2}	2x2.8 -	2x4.9 mA
Output power	W_o	0 0.05	5.7 W
Total distortion	d_{tot}	- -	3.0 %

OPERATING CHARACTERISTICS (continued)

Output tube class AB (two tubes)

Anode voltage	V_a	250	V
Grid No.3 voltage	V_{g3}	0	V
Grid No.2 voltage	V_{g2}	250	V
Cathode resistor	R_k	150	Ω
Load resistance	$R_{aa\sim}$	9	k Ω
Input voltage	V_i	0 0.32 7.8	V_{RMS}
Anode current	I_a	2x23.5 - 2x29.5	mA
Grid No.2 current	I_{g2}	2x3.2 - 2x6.6	mA
Output power	W_o	0 0.05 9	W
Total distortion	d_{tot}	- 4.5	%

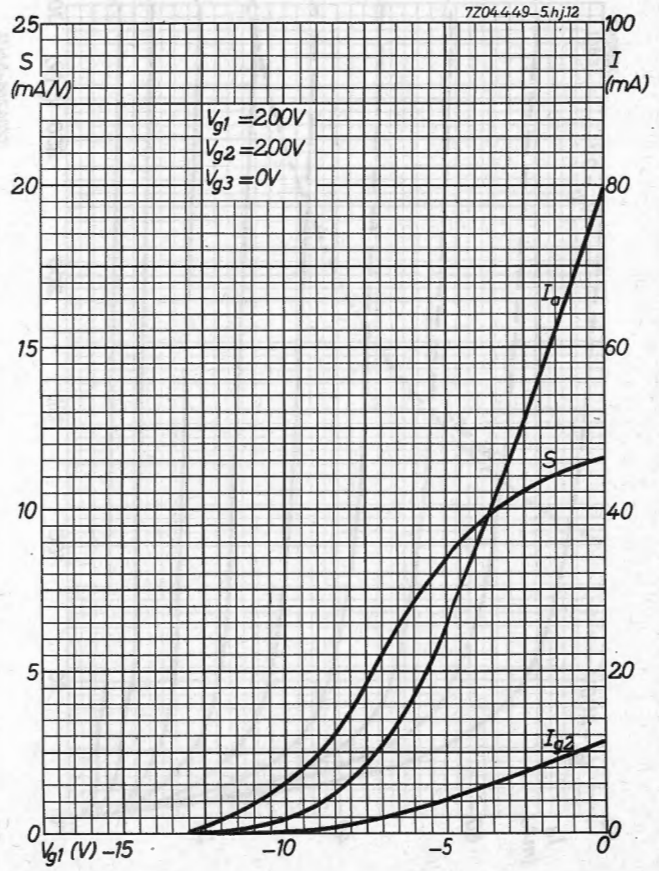
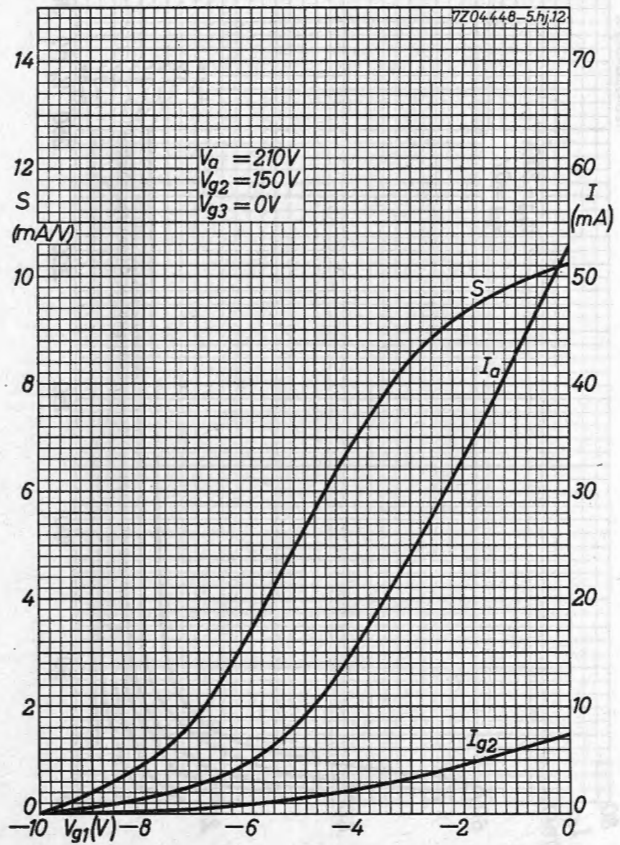

7Z01249
E80L

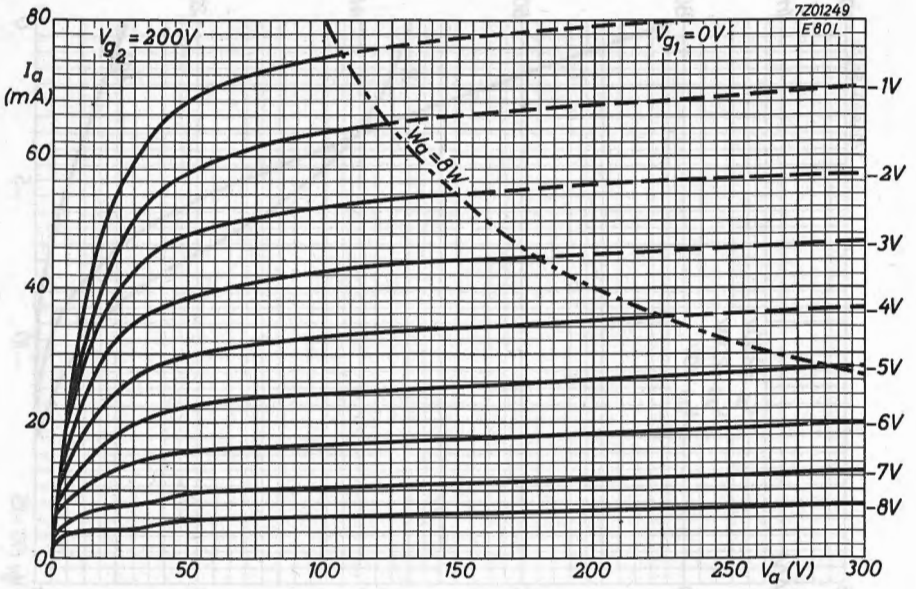

7Z04-286-5.hj.12

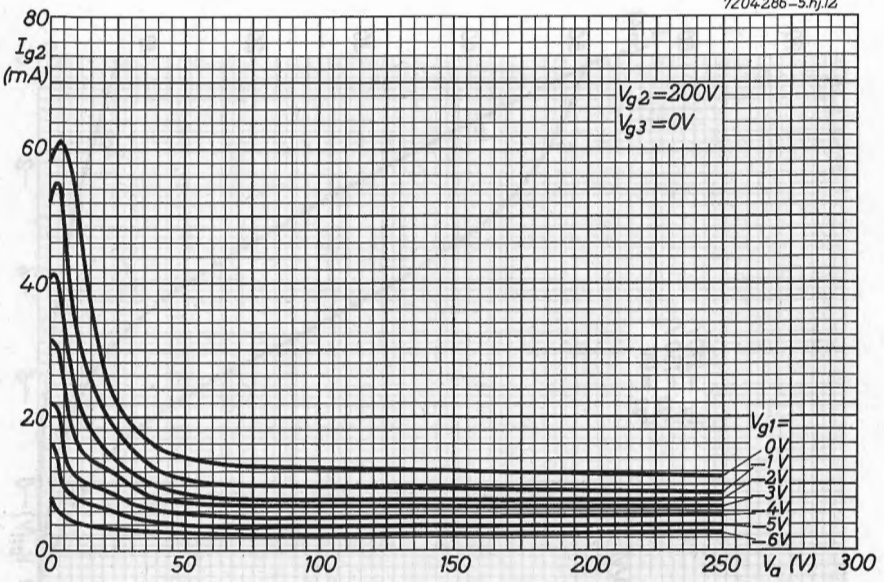

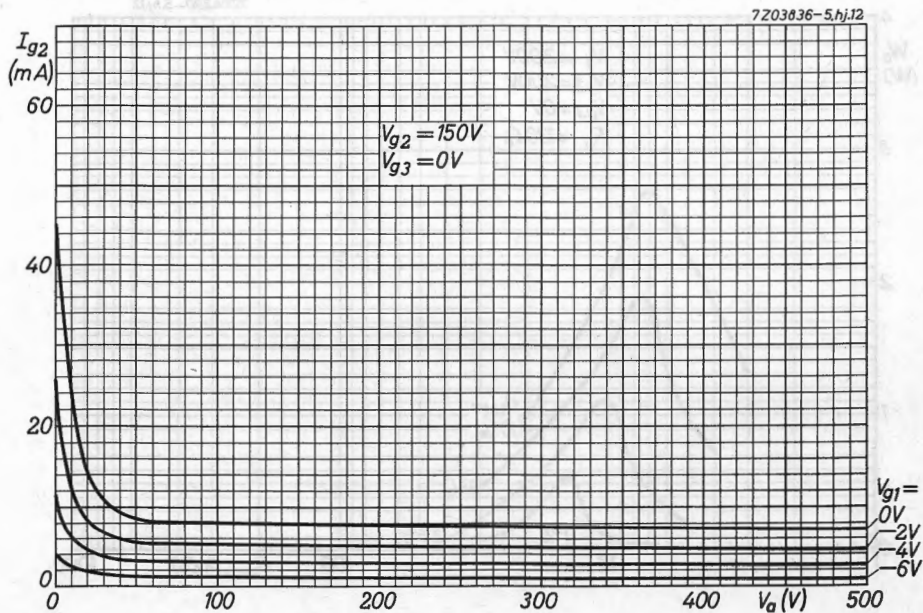
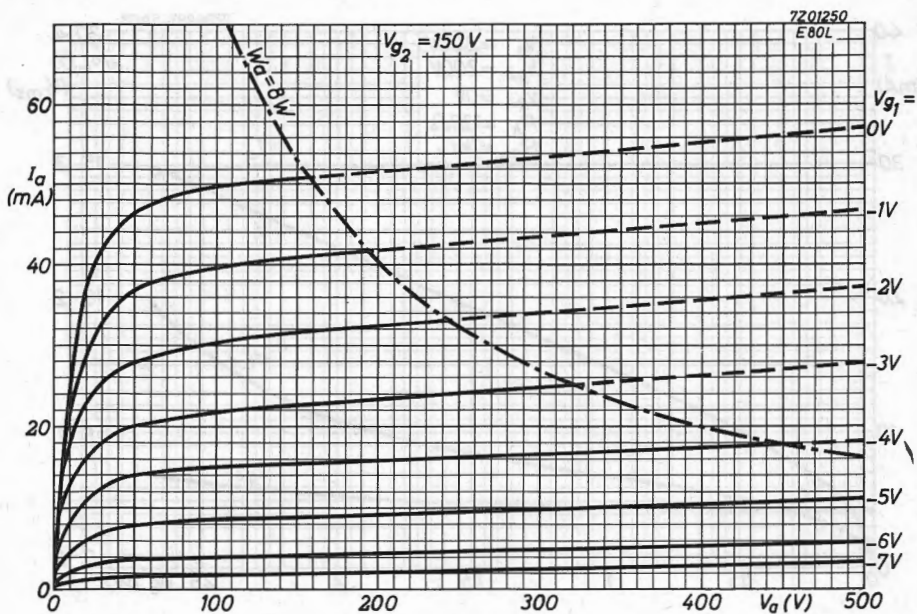

7204-293-5.hj12

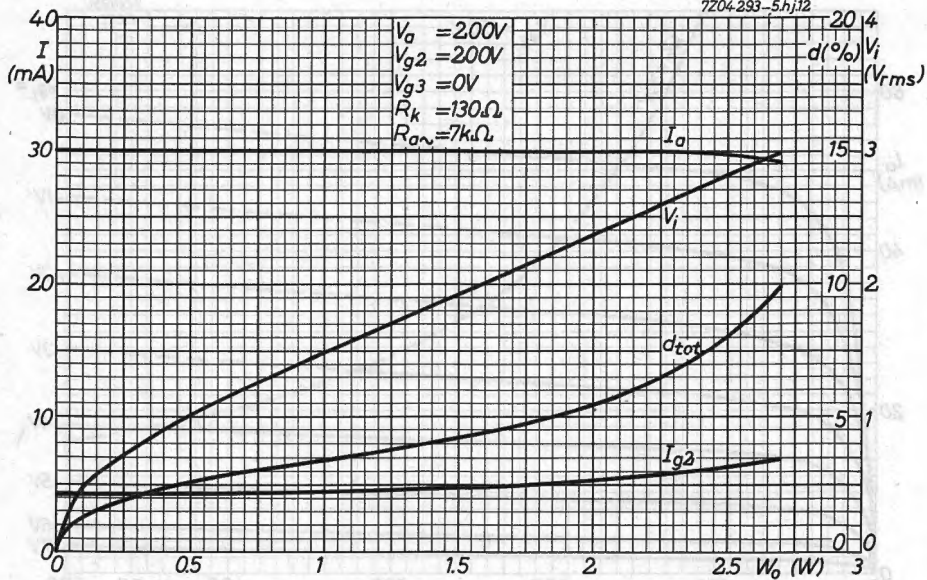

7204-290-5.hj12

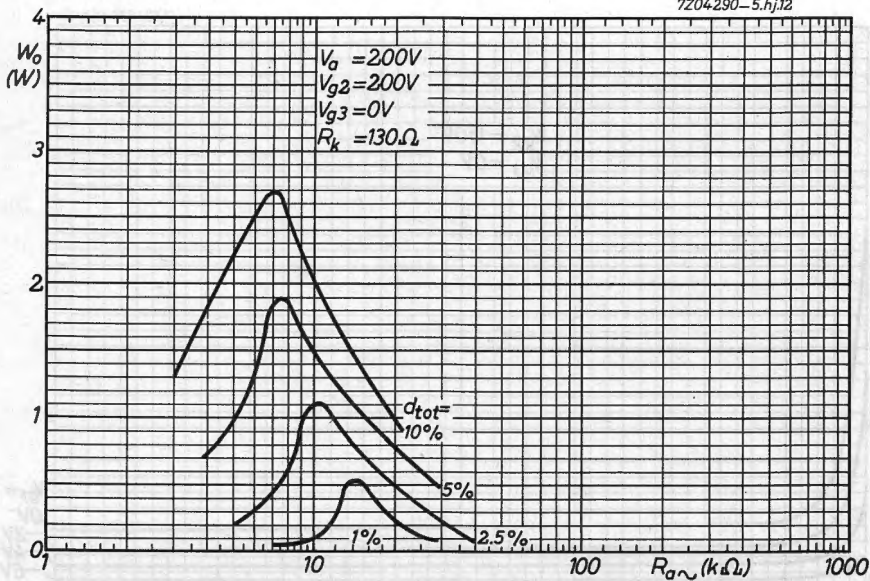

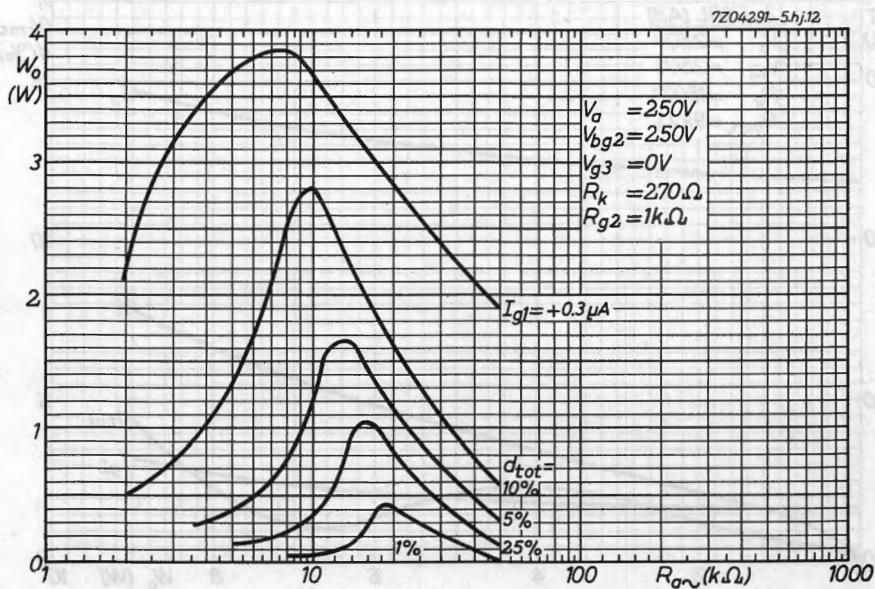
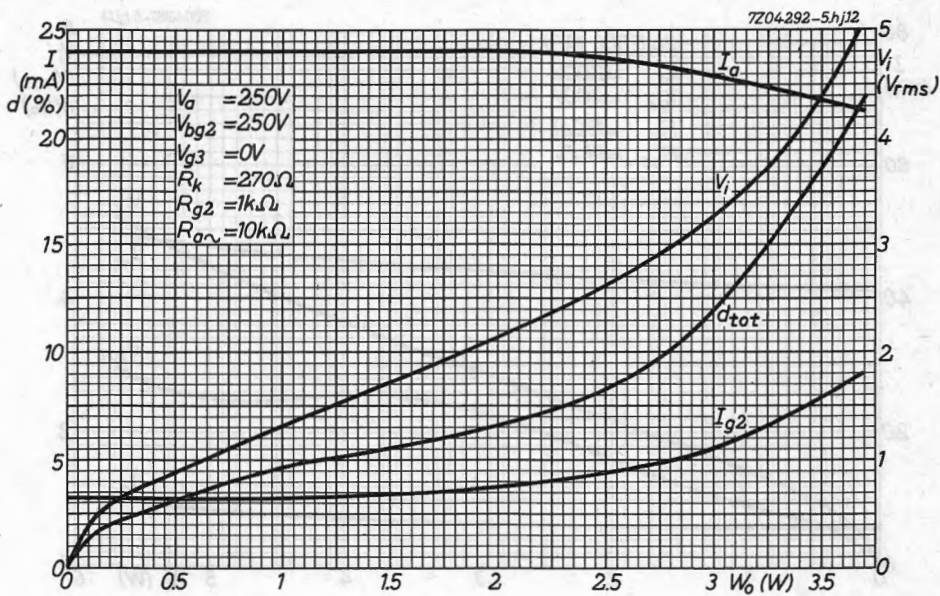

7204-287-5.hj:12

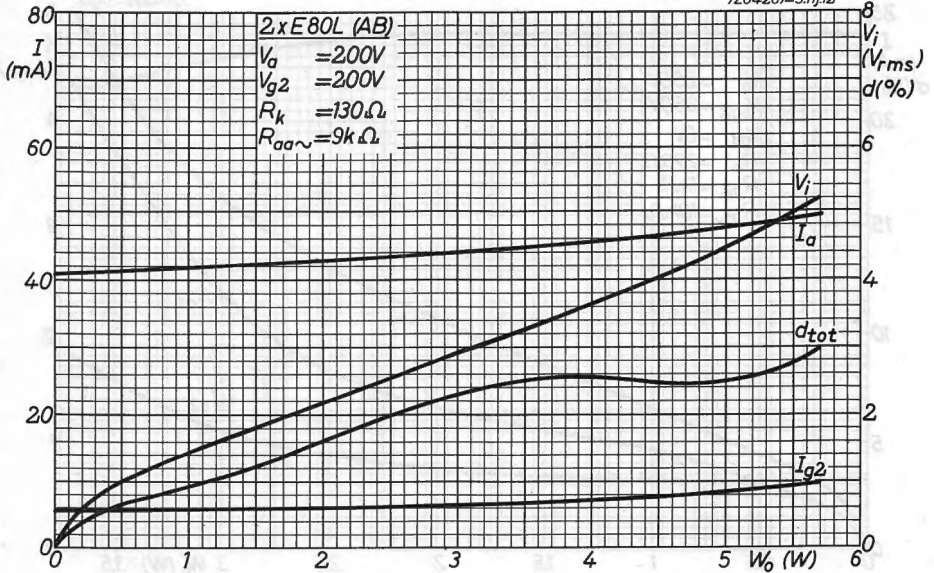

7204-288-5.hj:12

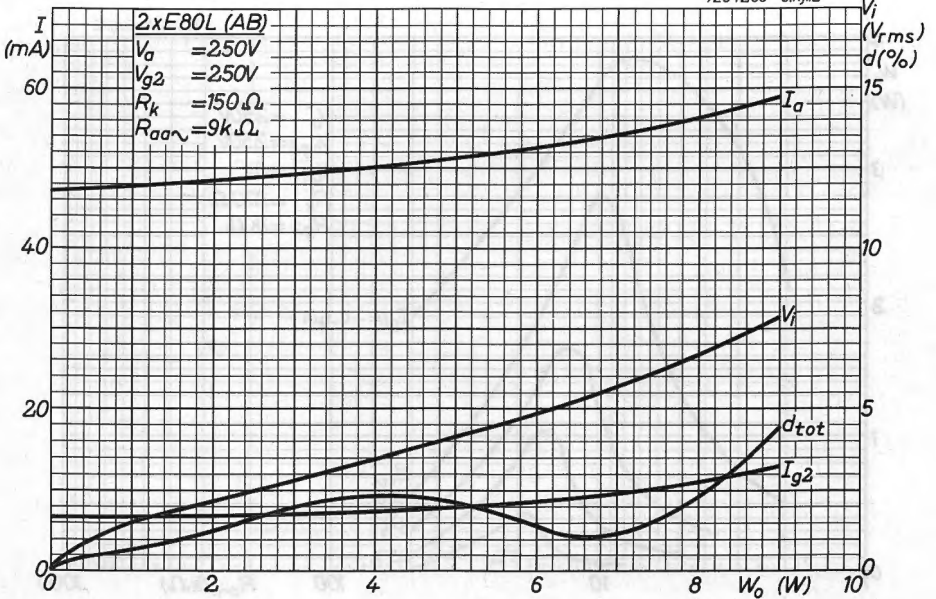

S.Q. TUBE

Special quality output pentode designed for use in telephone equipment.

QUICK REFERENCE DATA

Life test	10 000 hours
Base	Noval. Gold plated pins
Heating	Indirect a. c. or d. c. Series or parallel supply
Heater voltage	V_f 6.3 V
Heater current	I_f 375 mA
Anode current	I_a 20 mA
Output power	W_o 1 W

DIMENSIONS AND CONNECTIONS

Dimensions in mm

Base: Noval

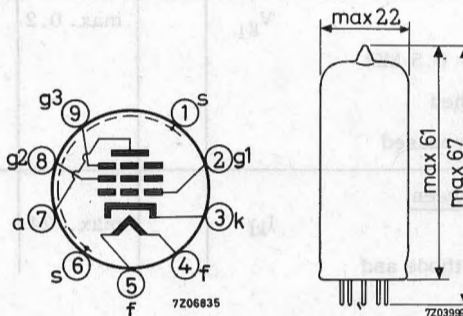

CHARACTERISTICS

Column I Nominal value or setting of the tube

II Range values for equipment design: Initial spread

III Range values for equipment design: End of life

		I	II	III	
Heater voltage	V_f	6.3			V
Heater current	I_f	375	355- 395		mA
Anode voltage	V_a	210			V
Grid No.3 voltage	V_{g3}	0			V
Grid No.2 voltage	V_{g2}	210			V
Cathode resistor	R_k	120			Ω
Anode current	I_a	20	17- 23	min. 13.5	mA
Grid No.2 current	I_{g2}	5.3	4.1- 6.5	min. 3.1	mA
Mutual conductance	S	11	9.5-12.5	min. 7.8	mA/V
Internal resistance	R_i	0.3	min. 0.2		M Ω
Amplification factor grid No:2 to grid No.1	μ_{g2g1}	36			
Equivalent noise resistance	R_{eq}	1.2			k Ω
<u>Negative grid current</u>	$-I_{g1}$		max. 0.5	max. 1.0	μ A
<u>Hum voltage</u>	V_{g1}		max. 0.2		mV _{RMS}
Grid resistor $R_{g1} = 0.5$ M Ω					
Heater centre earthed					
Cathode resistor bypassed					
<u>Leakage current between cathode and heater</u>	I_{kf}		max. 24		μ A
Voltage between cathode and heater $V_{kf} = 120$ V					

CAPACITANCES

	I	II		
Anode to grid No. 3, grid No. 2 cathode heater and screen	C_{a/g_3g_2kfs}	6.5	5.9 - 7.1	pF
Grid No. 1 to grid No. 3, grid No. 2 cathode heater and screen	C_{g_1/g_3g_2kfs}	11.2	10.4 - 12	pF
Grid No. 1 to grid No. 3, grid No. 2 cathode heater and screen Measured with cathode current $I_k = 25$ mA	C_{g_1/g_3g_2kfs}	14.3		pF
Anode to grid No. 1	C_{ag_1}		max. 0.02	pF
Grid No. 1 to heater	C_{g_1f}		max. 0.2	pF
Cathode to heater	C_{kf}	4.2		pF

SHOCK AND VIBRATION RESISTANCE

The following test conditions are applied to assess the mechanical quality of the tube. These conditions are not intended to be used as normal operating conditions.

Shock

The tube is subjected 5 times in each of 4 positions to an acceleration of 500 g supplied by an NRL shock machine with the hammer lifted over an angle of 30°.

Vibration

The tube is subjected during 32 hours in each of 3 positions to a vibration frequency of 50 Hz with an acceleration of 2.5 g.

LIFE

Production samples are tested to be within the end of life values (column III) under the following conditions during 10,000 hours.

Anode voltage	V_a	210	V
Grid No. 3 voltage	V_{g_3}	0	V
Grid No. 2 voltage	V_{g_2}	210	V
Cathode resistor	R_k	120	Ω

LIMITING VALUES (Design centre rating system)

Anode voltage	V_{a0}	max.	550 V
	V_a	max.	210 V
Anode dissipation	W_a	max.	4.5 W
Grid No.2 voltage	V_{g20}	max.	550 V
	V_{g2}	max.	210 V
Grid No.2 dissipation	W_{g2}	max.	1.2 W
Cathode current	I_k	max.	30 mA
Grid No.1 resistor:			
automatic bias	R_{g1}	max.	0.5 M Ω
fixed bias	R_{g1}	max.	0.25 M Ω
Voltage between cathode and heater	V_{kf}	max.	120 V
Bulb temperature	t_{bulb}	max.	170 °C

Heater voltage: The average heater voltage should be 6.3 V. Variations of the heater voltage exceeding the range of 6.0 V to 6.6 V will shorten the tube life. The tolerance of heater current (column II) should be taken into account.

OPERATING CHARACTERISTICSOutput tube. Class A

Anode voltage	V_a	210 V
Grid No.3 voltage	V_{g3}	0 V
Grid No.2 voltage	V_{g2}	210 V
Cathode resistor	R_k	120 Ω
Load resistance	$R_{a\sim}$	15 k Ω
Anode current	I_a	20 mA
Grid No.2 current	I_{g2}	5.3 mA
Output power	W_o	1 W
Total distortion	dt_{tot}	5 %

OPERATING CHARACTERISTICS (continued)

Amplifier

Anode voltage	V_a	210 V
Grid No.3 voltage	V_{g3}	0 V
Grid No.2 voltage	V_{g2}	210 V
Cathode resistor	R_k	180 Ω
Load resistance	$R_{a\sim}$	20 k Ω
Anode current	I_a	15 mA
Grid No.2 current	I_{g2}	4 mA
Voltage gain	V_o/V_i	5.15 N

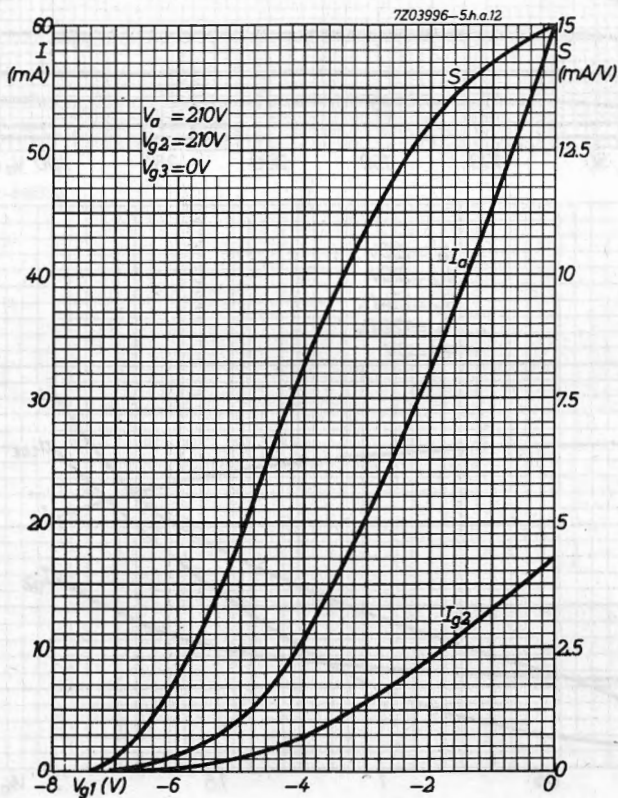

7203993-5.h.a.12

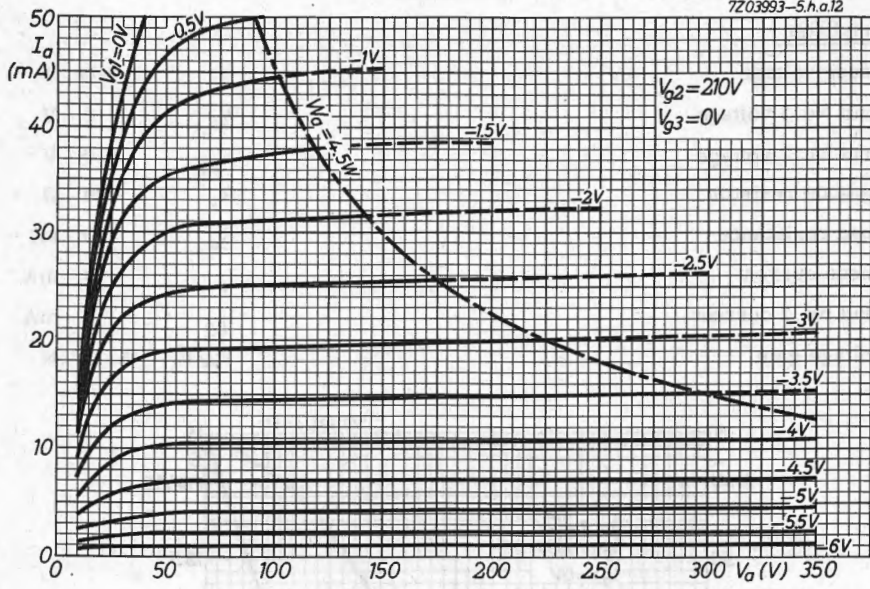

7203995-5.h.a.12

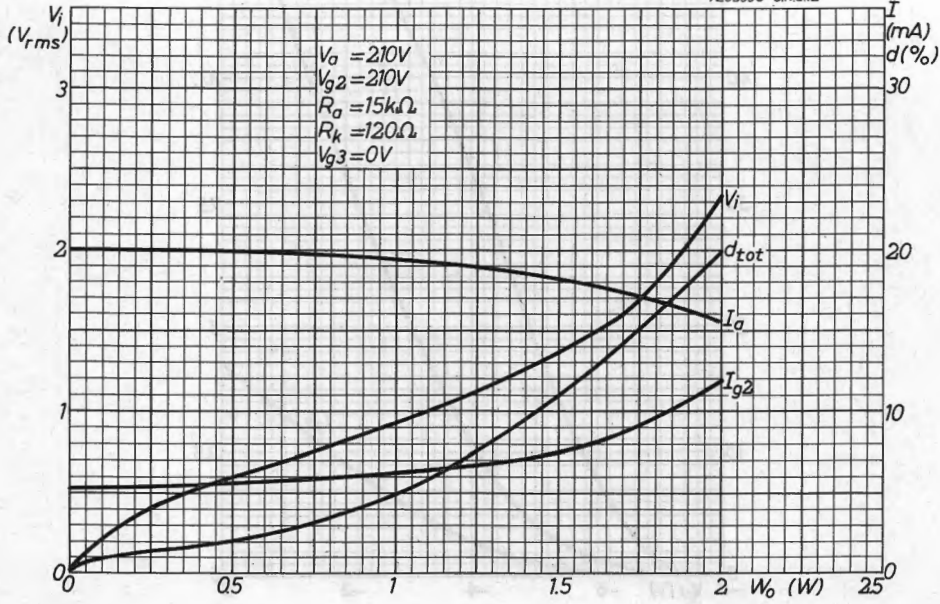

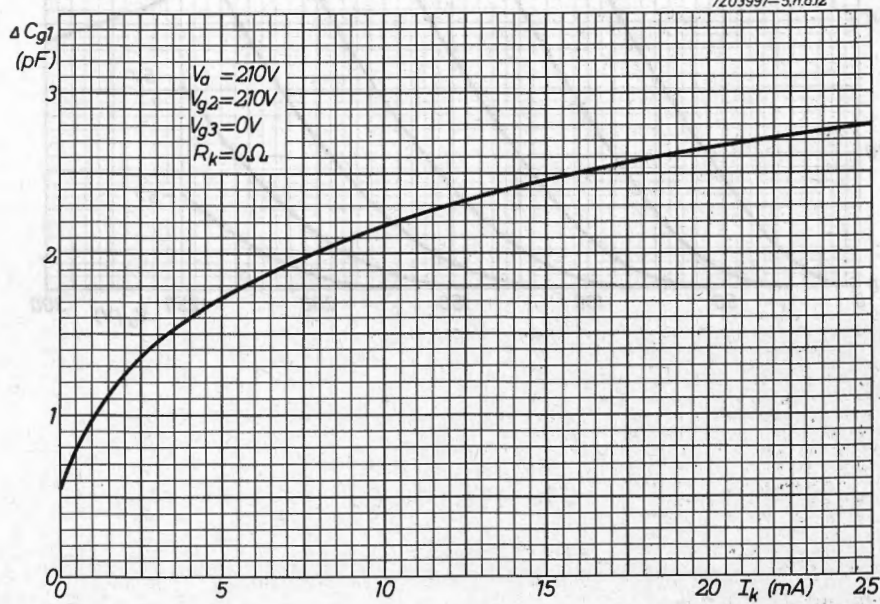
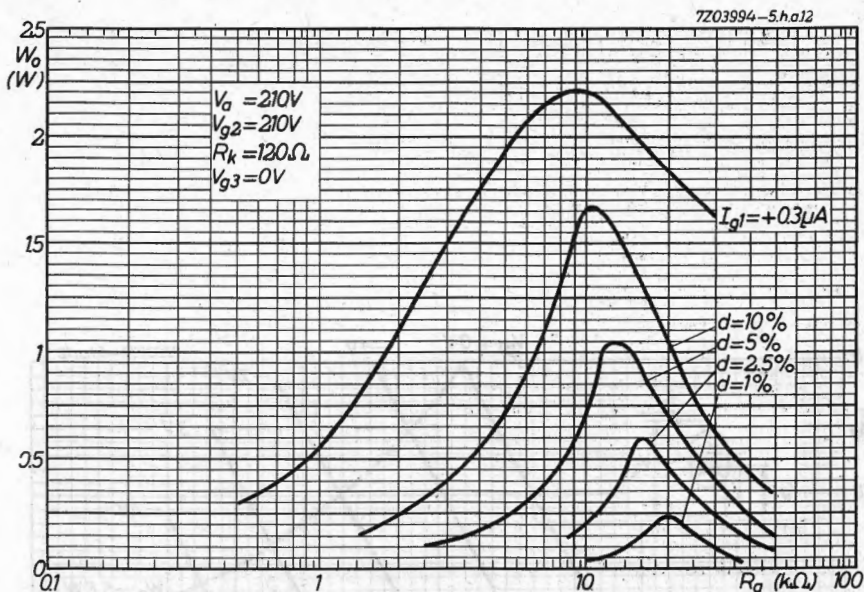

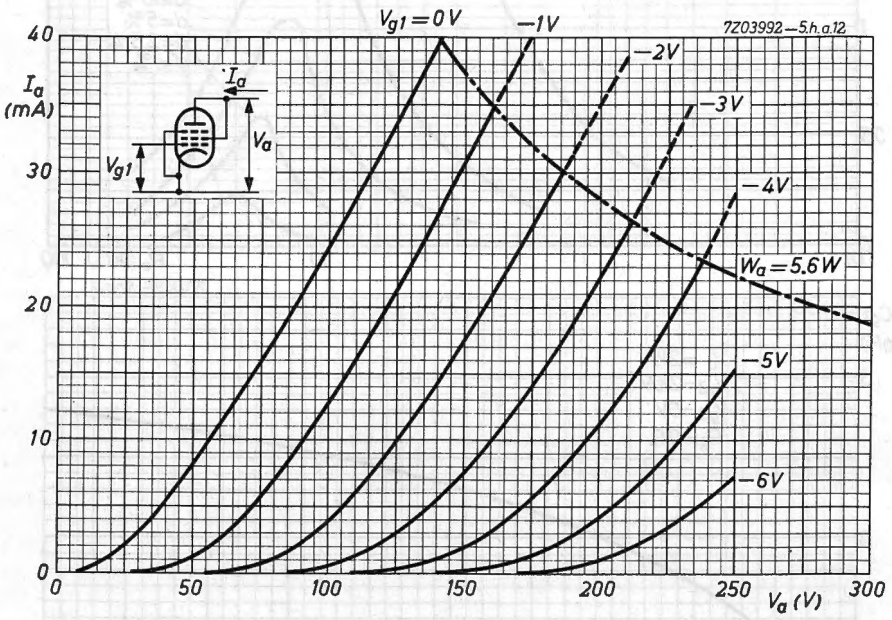

S.Q. TUBE

Special quality double triode designed for use as amplifier oscillator, multivibrator and blocking oscillator.

QUICK REFERENCE DATA

Life	10 000 hours	
Low interface resistance		
Mechanical quality	Shock and vibration resistant	
Base	Noval	
Heating	Indirect	
	A.C. or D.C.; Parallel supply	
Heater voltage	V_f	6.3 or 12.6 V
Heater current	I_f	300 or 150 mA
Anode current	I_a	10.5 mA
Mutual conductance	S	2.2 mA/V

DIMENSIONS AND CONNECTIONS

Dimensions in mm

Base: Noval

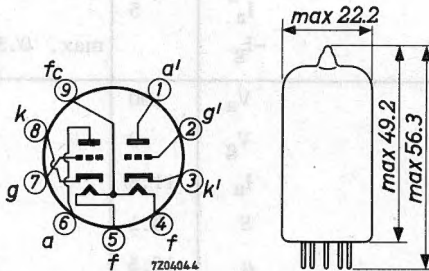

CHARACTERISTICS (Both sections if applicable)

Column I Nominal value or setting of the tube

II Range values for equipment design: Initial spread

III Range values for equipment design: End of life

		I	II	III	
Heater voltage, pin 9 and 4 + 5	V_f	6.3			V
Heater current	I_f	300	285- 315		mA
Heater voltage, pin 4 and 5	V_f	12.6			V
Heater current	I_f	150			mA
Anode voltage	V_a	250			V
Cathode resistor	R_k	800			Ω
Anode current	I_a	10.5	8.7-12.3	min. 7.0	mA
Difference in anode current of both systems	$I_a - I_a'$		max. 1.6		mA
Mutual conductance	S	2.2	1.8- 2.6	min. 1.5	mA/V
Amplification factor	μ	17.0	15.7-18.3		
Internal resistance	R_i	7.7			k Ω
<u>Cut-off voltage</u>					
Grid voltage	$-V_g$	22			V
Anode current	I_a	10			μ A
Grid voltage	$-V_g$		max. 30		V
Anode current	I_a	20			μ A
Grid voltage	$-V_g$		min. 18		V
Anode current	I_a	5			μ A
<u>Negative grid current</u>	$-I_g$		max. 0.5	max. 1.0	μ A
Anode voltage	V_a	100			V
Grid voltage	V_g	0			V
Anode current	I_a	11.8			mA
Mutual conductance	S	3.1			mA/V
Amplification factor	μ	19.5			
Internal resistance	R_i	6.25			k Ω

CHARACTERISTICS (continued)

		I	II	
<u>Leakage current between cathode and heater</u>	I_{kf}		max. 6.5	μA
<u>Insulation resistance:</u>				
Between grid and other electrodes	R_{ins}		min. 500	$M\Omega$
Voltage between electrodes = 100 V				
Between anode and other electrodes	R_{ins}		min. 500	$M\Omega$
Voltage between electrodes = 300 V				
<u>Vibrational noise output (20 to 5000 Hz)</u>	V_o		max. 100	mVRMS
Anode voltage $V_a = 250$ V				
Grid voltage $-V_g = 8.5$ V				
Anode resistor $R_a = 2$ k Ω				
Vibration frequency = 40 Hz				
Acceleration = 10 g				
Units in parallel				
CAPACITANCES				
Anode to cathode and heater	C_a/kf	0.5	0.3 - 0.7	pF
	$C_a'/k'f$	0.4	0.2 - 0.6	pF
Grid to cathode and heater	C_g/kf	1.6	1.25 - 1.95	pF
Anode to grid	C_{ag}	1.5	1.2 - 1.8	pF

SHOCK AND VIBRATION RESISTANCE

The following test conditions are applied to assess the mechanical quality of the tube. These conditions are not intended to be used as normal operating conditions.

Shock

The tube is subjected 5 times in each of 4 positions to an acceleration of 500 g supplied by an NRL shock machine with the hammer lifted over an angle of 30°.

Vibration

The tube is subjected during 32 hours in each of 3 positions to a vibration frequency of 50 Hz with an acceleration of 2.5 g.

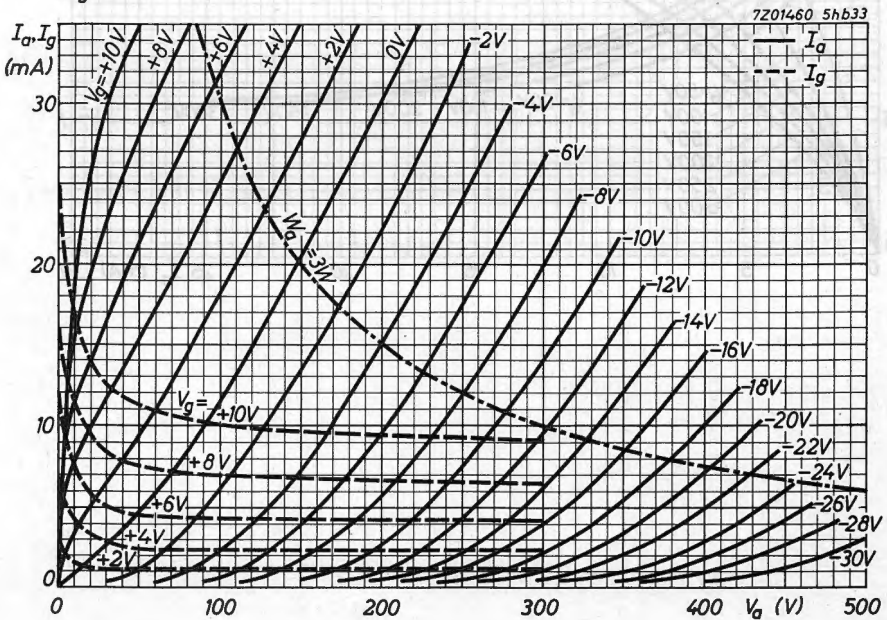
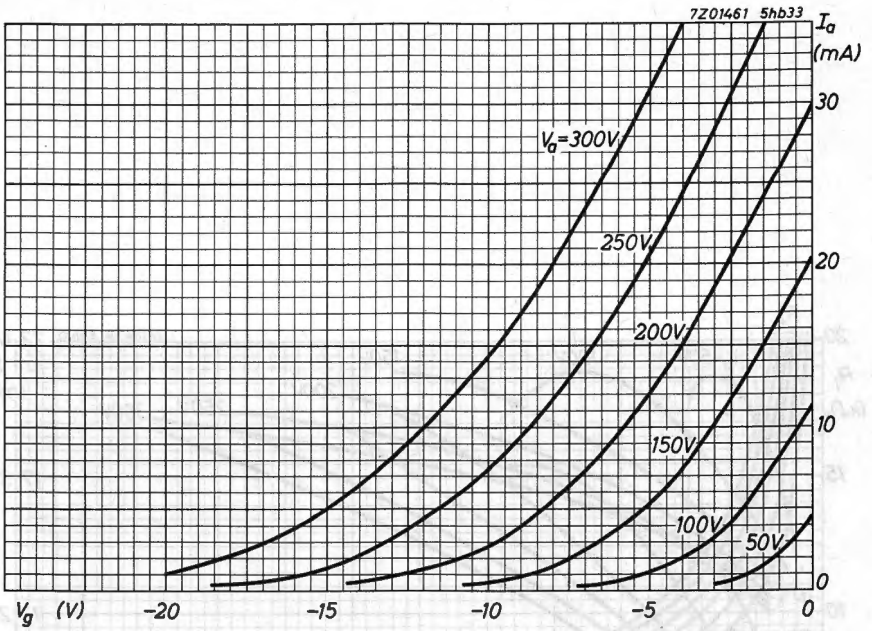

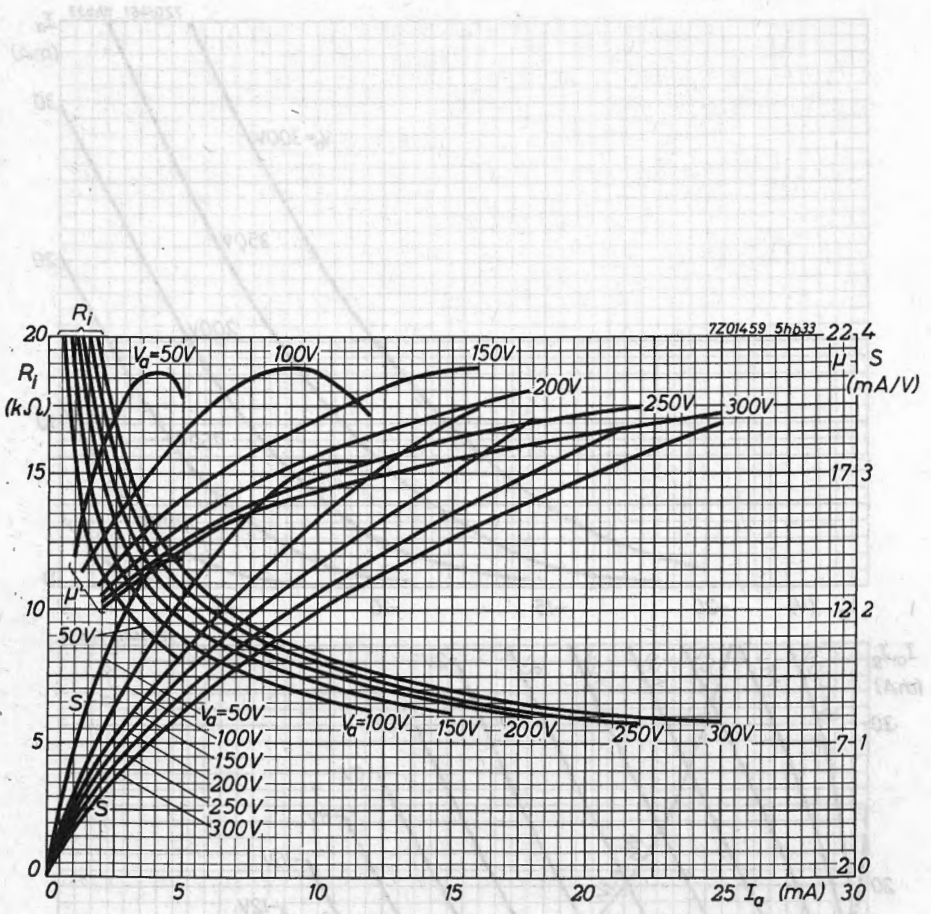

S.Q. TUBE

Special quality double triode designed for use as A.F. amplifier, phase inverter and amplifier in measuring equipment.

QUICK REFERENCE DATA

Life test	10 000 hours
Low interface resistance	
Low microphony level	
Mechanical quality	Shock and vibration resistant
Base	Noval
Heating	Indirect A.C. or D.C.; parallel supply
Heater voltage	V_f 6.3 V or 12.6 V
Heater current	I_f 300 mA or 150 mA
Anode current	I_a 1.25 mA
Mutual conductance	S 1.6 mA/V
Amplification factor	μ 100

DIMENSIONS AND CONNECTIONS

Dimensions in mm

Base: Noval

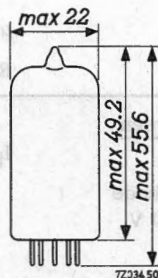
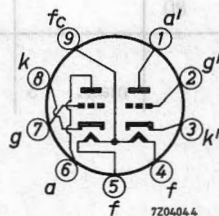

CHARACTERISTICS (Both systems if applicable)

Column I Nominal value or setting of the tube

II Range values for equipment design: Initial spread

III Range values for equipment design: End of life

		I	II	III	
Heater voltage pin 9 and 4 + 5	V_f	6.3			V
Heater current	I_f	300	285 - 315		mA
Heater voltage pin 4 and 5	V_f	12.6			V
Heater current	I_f	150			mA
Anode voltage	V_a	250			V
Cathode resistor	R_k	1.6			k Ω
Anode current	I_a	1.25	1.1 - 1.4	min. 0.8	mA
Mutual conductance	S	1.6	1.3 - 1.95	min. 1.05	mA/V
Amplification factor	μ	100			
Internal resistance	R_i	62.5			k Ω
<u>Negative grid current</u>	$-I_g$		max. 0.2	max. 0.5	μ A
<u>Cut-off voltage</u>	$-V_g$		max. 4		V
Anode current $I_a = 20 \mu$ A					
Anode voltage	V_a	100			V
Anode current	I_a	0.5			mA
Cathode resistor	R_k	2			k Ω
Mutual conductance	S	1.25			mA/V
Amplification factor	μ	100			
Internal resistance	R_i	80			k Ω
<u>Leakage current between cathode and heater</u>	I_{kf}		max. 5		μ A
Voltage between cathode and heater $V_{kf} = 100$ V					

CHARACTERISTICS (continued)Insulation resistance:

Between grid and other electrodes

	I	II	
R_{ins}		max. 300	$M\Omega$

Voltage between electrodes = 100 V

Between anode and other electrodes

R_{ins}		max. 300	$M\Omega$
-----------	--	----------	-----------

Voltage between electrodes = 300 V

Vibrational noise output (20 to 5000 Hz)

V_o		max. 10	mV _{RMS}
-------	--	---------	-------------------

Anode supply voltage $V_{ba} = 250$ VAnode resistor $R_a = 5$ k Ω Grid voltage $-V_g = 2$ V

Vibration frequency = 25 Hz

Acceleration = 2.5 g

Units in parallel

CAPACITANCES

Grid to cathode and heater

C_g/kf	1.6		pF
----------	-----	--	----

Anode to cathode and heater

C_a/kf	0.46		pF
----------	------	--	----

$C_{a'}/kf$	0.34		pF
-------------	------	--	----

Anode to grid

C_{ag}	1.7		pF
----------	-----	--	----

Grid to heater

C_{gf}		max. 0.15	pF
----------	--	-----------	----

Anode to anode other system

$C_{aa'}$		max. 0.6	pF
-----------	--	----------	----

Grid to grid other system

$C_{gg'}$		max. 10	mpF
-----------	--	---------	-----

Anode to grid other system

$C_{ag'}$		max. 60	mpF
-----------	--	---------	-----

$C_{ga'}$		max. 60	mpF
-----------	--	---------	-----

LIMITING VALUES (Absolute max. rating system) (Each unit)

Anode voltage

V_{a0}	max. 600	V
----------	----------	---

V_a	max. 330	V
-------	----------	---

Anode dissipation

W_a	max. 1.2	W
-------	----------	---

Grid voltage

$-V_g$	max. 55	V
--------	---------	---

$+V_g$	max. 0.5	V
--------	----------	---

Cathode current

I_k	max. 9	mA
-------	--------	----

LIMITING VALUES (continued)

Grid resistor: fixed bias	R_g	max. 1.2 M Ω
automatic bias	R_g	max. 2.2 M Ω
grid current bias	R_g	max. 25 M Ω
Voltage between cathode and heater	V_{kf}	max. 200 V
Resistance in cathode heater circuit in case of phase inverter circuit	R_{kf}	max. 135 k Ω
Bulb temperature	t_{bulb}	max. 170 °C
Microphony:		
Input voltage required for 50 mW output	V_i	min. 0.5 mV
Heater voltage: The average heater voltage should be 6.3 V Variations of the heater voltage exceeding the range of 6.0 V to 6.6 V will shorten the tube life. The tolerance of the heater current (column II) should be taken into account.		

OPERATING CHARACTERISTICS

A.F. amplifier - circuit fig. 1

Anode supply voltage	V_{ba}	200	250	300	350	400	V
Anode resistor	R_a	47	47	47	47	47	k Ω
Cathode resistor	R_k	1500	1200	1000	820	680	Ω
Grid resistor next stage	$R_{g'}$	150	150	150	150	150	k Ω
Anode current	I_a	0.86	1.18	1.55	1.98	2.45	mA
Output voltage (Grid current = 0.3 μ A)	V_o	18	23	26	33	37	V _{RMS}
Voltage gain	V_o/V_i	34.0	37.5	40.0	42.5	44.0	
Total distortion	d_{tot}	8.5	7.0	5.0	4.4	3.6	%

OPERATING CHARACTERISTICS (continued)

A.F. amplifier - circuit fig.1 (continued)

Anode supply voltage	V_{ba}	200	250	300	350	400	V
Anode resistor	R_a	100	100	100	100	100	k Ω
Cathode resistor	R_k	1800	1500	1200	1000	820	Ω
Grid resistor next stage	R_g'	330	330	330	330	330	k Ω
Anode current	I_a	0.65	0.86	1.11	1.40	1.72	mA
Output voltage (Grid current = 0.3 μ A)	V_o	20	26	30	36	38	V _{RMS}
Voltage gain	V_o/V_i	50	54.5	57.0	61.0	63.0	
Total distortion	d_{tot}	4.8	3.9	3.7	2.2	1.7	%

Anode supply voltage	V_{ba}	200	250	300	350	400	V
Anode resistor	R_a	220	220	220	220	220	k Ω
Cathode resistor	R_k	3300	2700	2200	1500	1200	Ω
Grid resistor next stage	R_g'	680	680	680	680	680	k Ω
Anode current	I_a	0.36	0.48	0.63	0.85	1.02	mA
Output voltage (Grid current = 0.3 μ A)	V_o	24	28	36	37	38	V _{RMS}
Voltage gain	V_o/V_i	56	66.5	72.0	75.5	76.5	
Total distortion	d_{tot}	4.6	3.4	2.6	1.6	1.1	%

A.F. amplifier - circuit fig.2.

Anode supply voltage	V_{ba}	200	250	300	350	400	V
Anode resistor	R_a	47	47	47	47	47	k Ω
Grid resistor next stage	R_g'	150	150	150	150	150	k Ω
Anode current	I_a	1.02	1.45	2.02	2.50	3.10	mA
Output voltage	V_o	18	23	26	33	37	V _{RMS}
Voltage gain	V_o/V_i	37	39	41	44	45	
Total distortion	d_{tot}	5.6	4.2	2.9	2.7	2.5	%

OPERATING CHARACTERISTICS (continued)

A.F. amplifier - circuit fig.2. (continued)

Anode supply voltage	V_{ba}	200	250	300	350	400	V
Anode resistor	R_a	100	100	100	100	100	$k\Omega$
Grid resistor next stage	$R_{g'}$	330	330	330	330	330	$k\Omega$
Anode current	I_a	0.70	1.00	1.29	1.62	1.95	mA
Output voltage	V_o	20	26	30	36	38	V_{RMS}
Voltage gain	V_o/V_i	50	51	54	56	58	
Total distortion	d_{tot}	3.9	2.6	2.0	1.8	1.6	%

Anode voltage	V_{ba}	200	250	300	350	400	V
Anode resistor	R_a	220	220	220	220	220	$k\Omega$
Grid resistor next stage	$R_{g'}$	680	680	680	680	680	$k\Omega$
Anode current	I_a	0.39	0.56	0.75	0.88	1.09	mA
Output voltage	V_o	24	28	36	37	38	V
Voltage gain	V_o/V_i	58	62	66	67	68	
Total distortion	d_{tot}	4.6	2.7	2.2	1.7	1.4	%

A.F. amplifier - circuit fig.3.

Anode supply voltage	V_{ba}	100	150	200	250	300	350	400	V
Anode resistor	R_a	47	47	47	47	47	47	47	$k\Omega$
Grid resistor next stage	$R_{g'}$	150	150	150	150	150	150	150	$k\Omega$
Anode current	I_a	0.35	0.84	1.40	1.95	2.52	3.19	3.80	mA
Voltage gain	V_o/V_i	25	33	34	36	38	40	41	
Total distortion:									
at $V_o = 2 V_{RMS}$	d_{tot}	1.7	2.5	2.4	2.3	2.2	2.2	2.1	%
at $V_o = 4 V_{RMS}$	d_{tot}	2.1	4.6	4.7	4.6	4.5	4.2	4.2	%
at $V_o = 6 V_{RMS}$	d_{tot}	6.0	5.2	5.6	5.6	5.5	5.5	5.4	%

OPERATING CHARACTERISTICS (continued)

A.F. amplifier - circuit fig.3. (continued)

Anode supply voltage	V_{ba}	100	150	200	250	300	350	400	V
Anode resistor	R_a	100	100	100	100	100	100	100	k Ω
Grid resistor next stage	$R_{g'}$	330	330	330	330	330	330	330	k Ω
Anode current	I_a	0.24	0.56	0.88	1.23	1.58	1.92	2.29	mA
Voltage gain	V_o/V_i	34	43	46	48	50	51	52	
Total distortion:									
at $V_o = 2 V_{RMS}$	d_{tot}	1.6	1.9	1.9	1.8	1.8	1.8	1.7	%
at $V_o = 4 V_{RMS}$	d_{tot}	2.3	3.0	3.8	3.8	3.6	3.6	3.5	%
at $V_o = 6 V_{RMS}$	d_{tot}	2.6	4.7	5.1	5.1	5.0	4.9	4.8	%

Anode supply voltage	V_{ba}	100	150	200	250	300	350	400	V
Anode resistor	R_a	220	220	220	220	220	220	220	k Ω
Grid resistor next stage	$R_{g'}$	680	680	680	680	680	680	680	k Ω
Anode current	I_a	0.14	0.32	0.49	0.67	0.85	1.05	1.23	mA
Voltage gain	V_o/V_i	42	51	54	57	58	59	60	
Total distortion:									
at $V_o = 2 V_{RMS}$	d_{tot}	1.6	1.7	1.7	1.6	1.6	1.6	1.6	%
at $V_o = 4 V_{RMS}$	d_{tot}	2.5	3.0	3.0	2.9	2.9	2.8	2.7	%
at $V_o = 6 V_{RMS}$	d_{tot}	3.2	4.4	4.4	4.4	4.4	4.3	4.2	%

Phase inverter - circuit fig.4

Supply voltage	V_b	250	350	V		
Anode voltage	V_a	65	90	V		
Anode resistor	$R_a, R_{a'}$	100	150	k Ω		
Cathode resistor	R_k	68	82	k Ω		
Anode current	$I_a + I_{a'}$	1.0	1.2	mA		
Voltage gain	V_o/V_i	25	27			
Output voltage (Grid current = 0.3 μ A)	V_o	7	20	10	35	V_{RMS}
Total distortion	d_{tot}	0.6	1.8	0.5	1.8	%

V_a should be adjusted to the specified value for $I_a + I_{a'}$.

OPERATING CHARACTERISTICS (continued)

Phase inverter - circuit fig.5.

Supply voltage	V_b	250	350	V
Cathode resistor	R_k	1200	820	Ω
Anode current	$I_a + I_{a'}$	1.08	1.7	mA
Voltage gain	V_o/V_i	58		
Output voltage	V_o	7	35	V _{RMS}
(Grid current = 0.3 μ A)		9	45	
Total distortion	d_{tot}	1.1	5.5	0.7 3.5 %

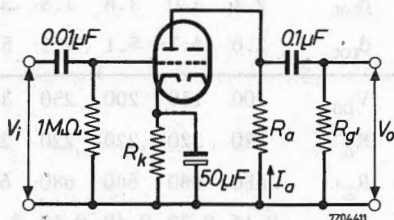

Fig. 1

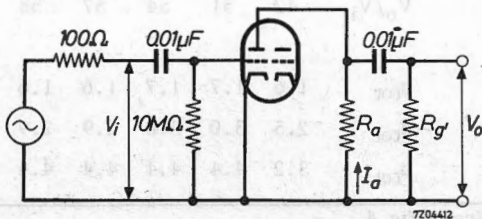

Fig. 2

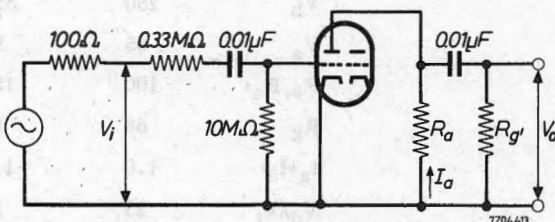

Fig. 3

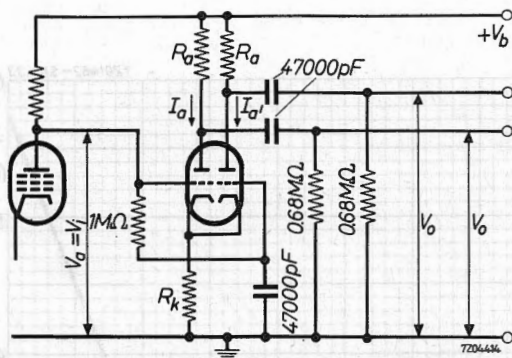

Fig. 4

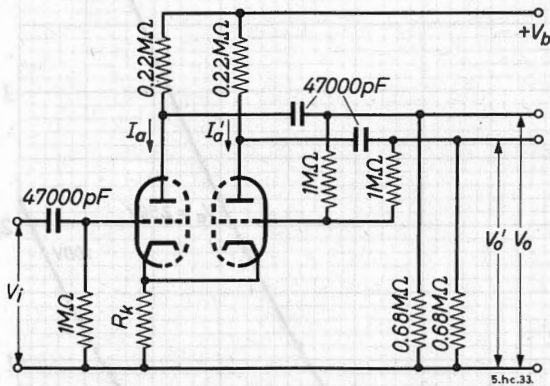
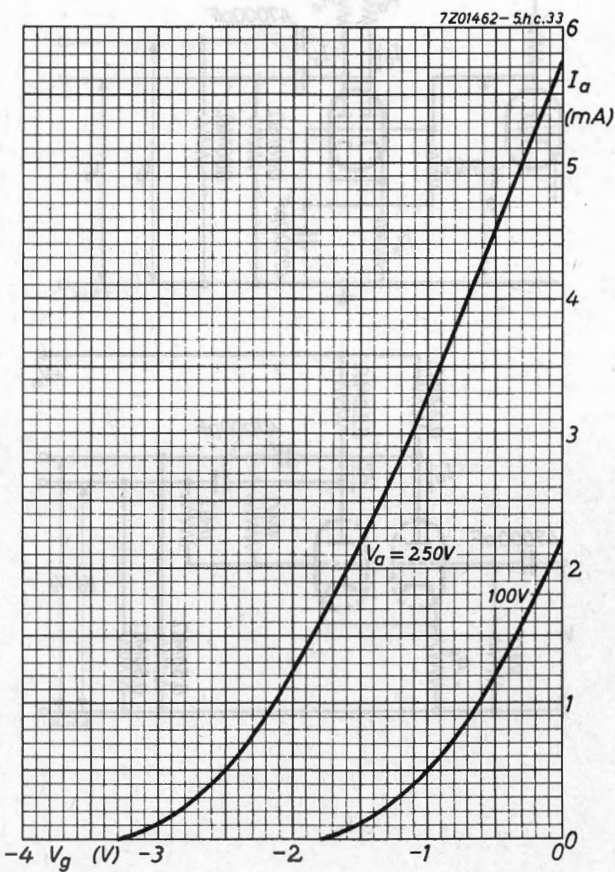
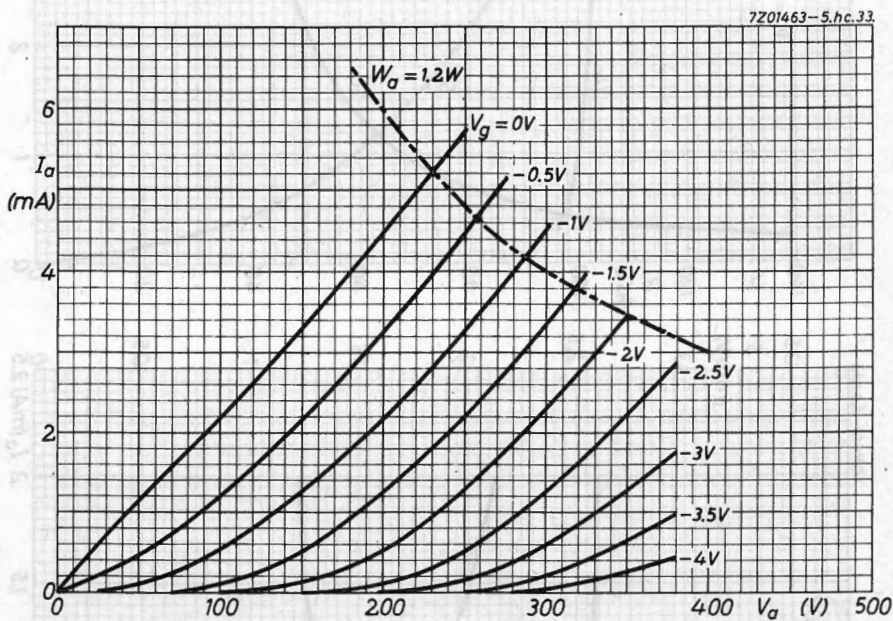
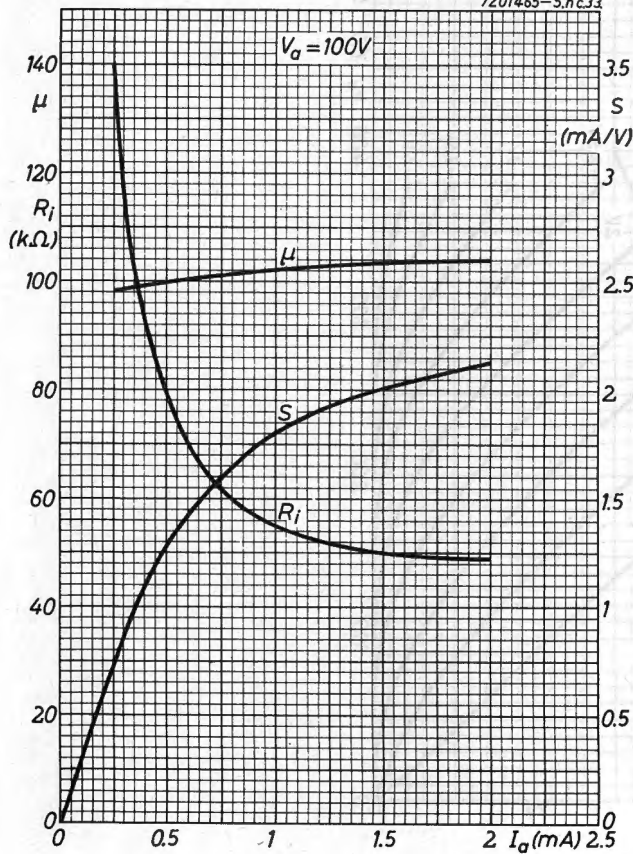

Fig. 5





7Z01465-5, hc.33



7Z01464-5, hc.33

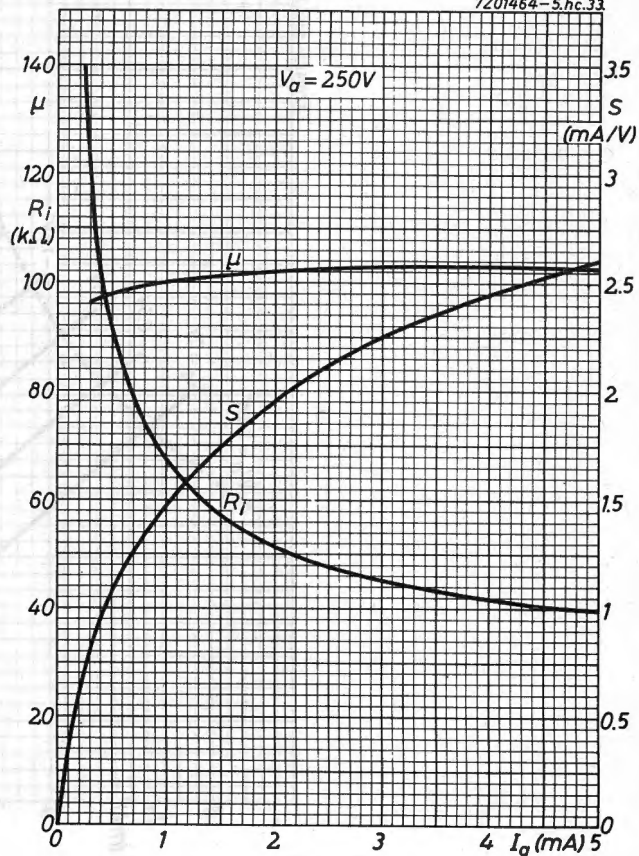

S.Q. TUBE

Special quality pentode designed for use in telephone equipment.

QUICK REFERENCE DATA

Life expectancy	10 000 hours
Low interface resistance	
Base	Noval. Gold plated pins
Heating	Indirect A.C. or D.C. Series or parallel supply
Heater voltage	V_f 6.3 V
Heater current	I_f 0.3 A
Anode current	I_a 10 mA
Mutual conductance	S 9 mA/V

DIMENSIONS AND CONNECTIONS

Dimensions in mm

Base: Noval

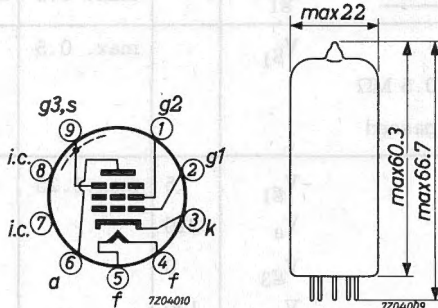

CHARACTERISTICS

Column I Nominal value or setting of the tube.

II Range values for equipment design: Initial spread

III Range values for equipment design: End of life

		I	II	III	
Heater voltage	V_f	6.3			V
Heater current	I_f	300	285 - 315		mA
Anode voltage	V_a	210			V
Grid No.3 voltage	V_{g3}	0			V
Grid No.2 voltage	V_{g2}	120			V
Cathode resistor	R_k	165			Ω
Anode current	I_a	10	8.7 - 11.3	7	mA
Grid No.2 current	I_{g2}	2.1	1.7 - 2.5	1.25	mA
Mutual conductance	S	9	7.8 - 10.2	6.4	mA/V
Internal resistance	R_i	0.5	min. 0.3		M Ω
Amplification factor grid No.2 to grid No.1	μ_{g2g1}	38			
Equivalent noise resistance (R.F.)	R_{eq}	750	max. 1000		Ω
Equivalent noise resistance (A.F.)	R_{eq}		max. 36		k Ω
Negative grid No.1 current	$-I_{g1}$		max. 0.5	max. 1.0	μ A
Hum voltage	V_{g1}		max. 0.5		mVRMS
Grid resistor $R_{g1} = 0.5$ M Ω					
Cathode resistor by passed					
Cut off voltage	$-V_{g1}$	5	max. 5.25		V
Anode voltage	V_a	210			V
Grid No.3 voltage	V_{g3}	0			V
Grid No.2 voltage	V_{g2}	120			V
Anode current	I_a	0.5			mA

CHARACTERISTICS (continued)

	I	II	III	
<u>Leakage current between cathode and heater</u>	I_{kf}	max. 15		μA
Voltage between heater and cathode $V_{kf} = 100 V$				
<u>Insulation resistance between two arbitrary electrodes</u>	R	min. 100		$M\Omega$
Voltage between electrodes $V = 250 V$				

CAPACITANCES

Radiation capacitances measured to a surrounding cylinder, internal diameter 52 mm, height 98 mm.

	I	II	
Grid No.1 to grid No.2, grid No.3, cathode, heater and screen	C_{g_1/g_2g_3kfs}	8	8.7 pF
Grid No.1 to grid No.2, grid No.3, cathode, heater and screen Cathode current = 12.1 mA	C_{g_1/g_2g_3kfs}	10.8	pF
Anode to grid No.2, grid No.3, cathode, heater and screen	C_{a/g_2g_3kfs}	3.5	max. 4.1 pF
Anode to grid No.1	C_{ag_1}		max. 15 mpF
Grid No.1 to heater	C_{g_1f}		max. 0.15 pF
Cathode to heater	C_{kf}	4	pF
Grid No.1 radiation capacitance	C_{rg_1}	max. 25	mpF
Anode radiation capacitance	C_{ra}	max. 25	mpF

LIFE EXPECTANCY

When the tube is operated under the following conditions the range values of the characteristics in column III may be expected not to be exceeded during an operation period of 10 000 hours.

Anode voltage	V_a	210 V
Grid No.3 voltage	V_{g_3}	0 V
Grid No.2 voltage	V_{g_2}	120 V
Cathode resistor	R_k	165 Ω

LIMITING VALUES (Design centre rating system)

Anode voltage	V_{a0}	max.	550 V
	V_a	max.	210 V
Anode dissipation	W_a	max.	2.1 W
Grid No.2 voltage	V_{g20}	max.	550 V
	V_{g2}	max.	210 V
Grid No.2 dissipation	W_{g2}	max.	0.35 W
Grid No.1 voltage	$-V_{g1}$	max.	100 V
Grid No.1 voltage, peak	$-V_{g1p}$	max.	200 V
Duty factor max. 0.1			
Pulse duration max. 200 μ s			
Grid No.1 dissipation	W_{g1}	max.	50 mW
Grid No.1 resistor (automatic bias)	R_{g1}	max.	1 M Ω
Cathode current	I_k	max.	16 mA
Cathode current peak value	I_{kp}	max.	80 mA
Duty factor max. 0.1			
Pulse duration max. 200 μ s			
Voltage between heater and cathode	V_{kf}	max.	100 V
Bulb temperature (absolute maximum)	t_{bulb}	max.	170 $^{\circ}$ C

OPERATING CHARACTERISTICS

Output tube. Class A

Anode voltage	V_a	120	210	V				
Grid No.3 voltage	V_{g3}	0	0	V				
Grid No.2 supply voltage	V_{bg2}	120	120	V				
Grid No.2 resistor	R_{g2}	5.6	5.6	k Ω				
Cathode resistor	R_k	180	180	Ω				
Anode current	I_a	8.3	8.3	mA				
Grid No.2 current	I_{g2}	1.7	1.7	mA				
Mutual conductance	S	8.2	8.2	mA/V				
Internal resistance	R_i	0.42	0.44	M Ω				
Load resistance	$R_{a\sim}$	10	20	k Ω				
Input voltage	V_i	0.35	1.1	-	0.25	1.1	-	V _{RMS}
Grid No.1 current	$+I_{g1}$	-	-	0.3	-	-	0.3	μ A
Grid No.1 resistor	R_{g1}	-	-	0.33	-	-	0.33	M Ω
Total distortion	dt_{tot}	-	10	-	-	10	-	%
Output power	W_o	50	340	400	50	660	870	mW

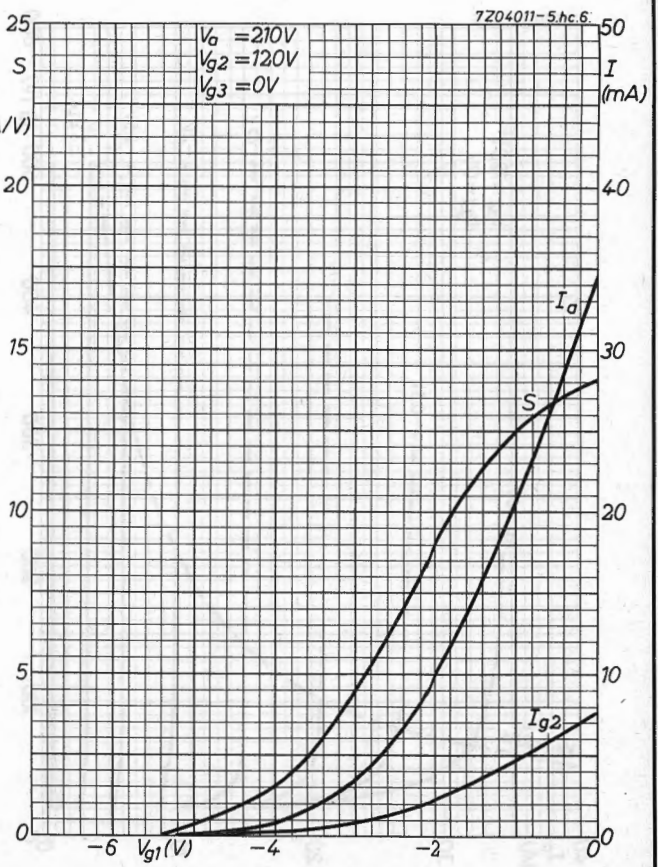
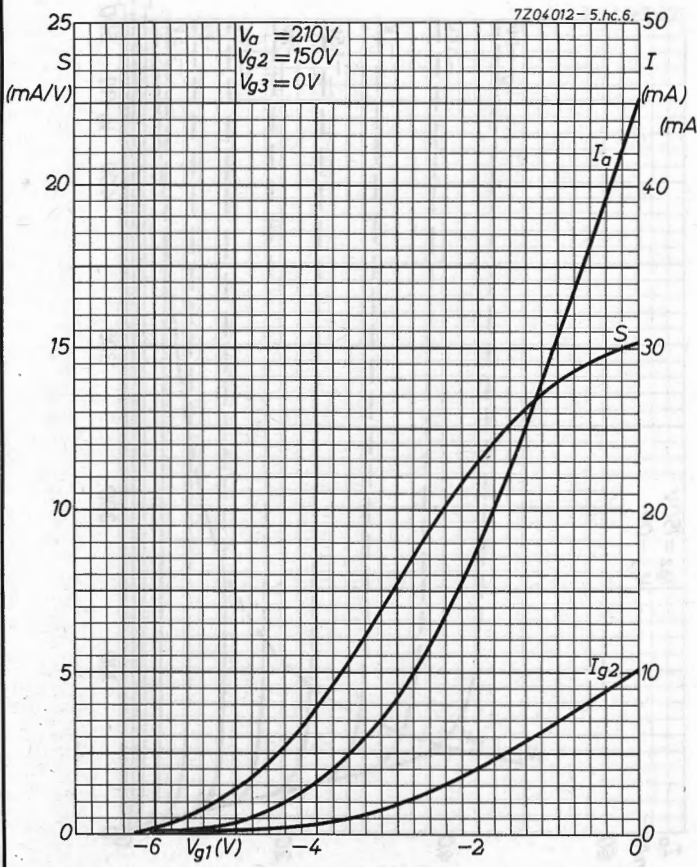

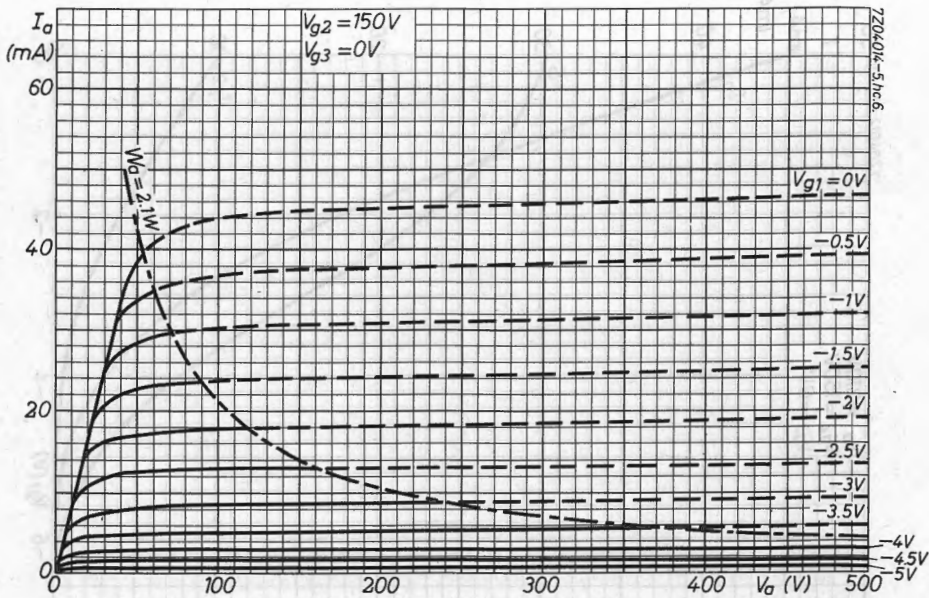
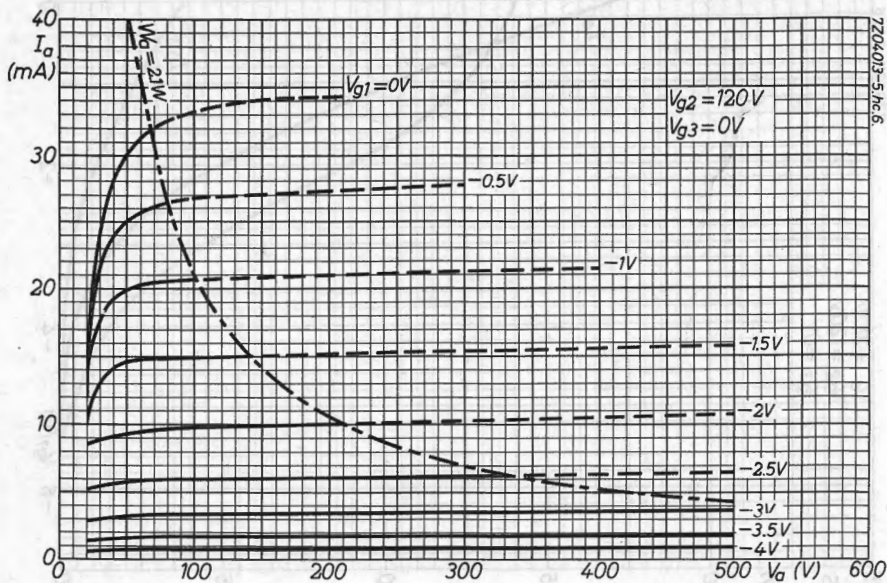

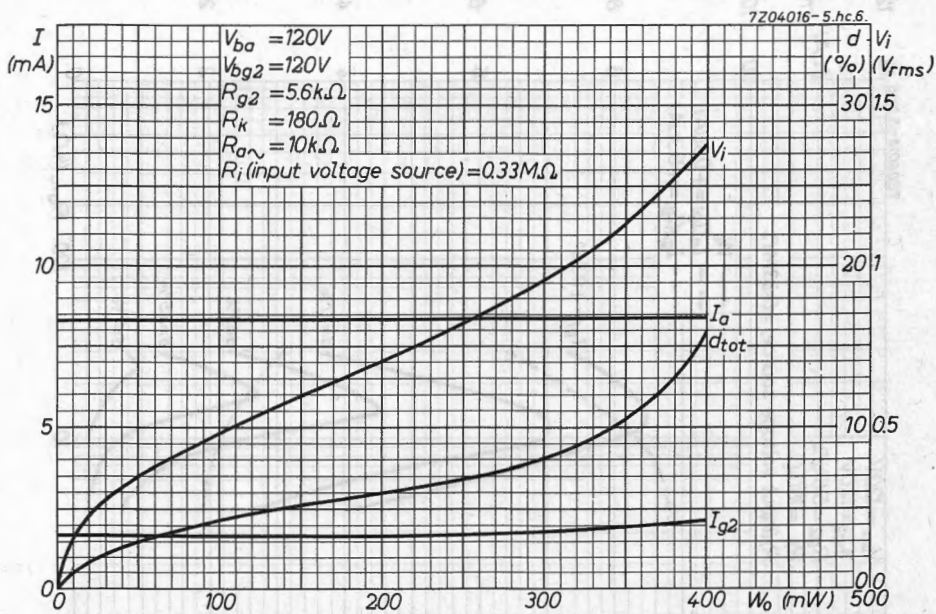
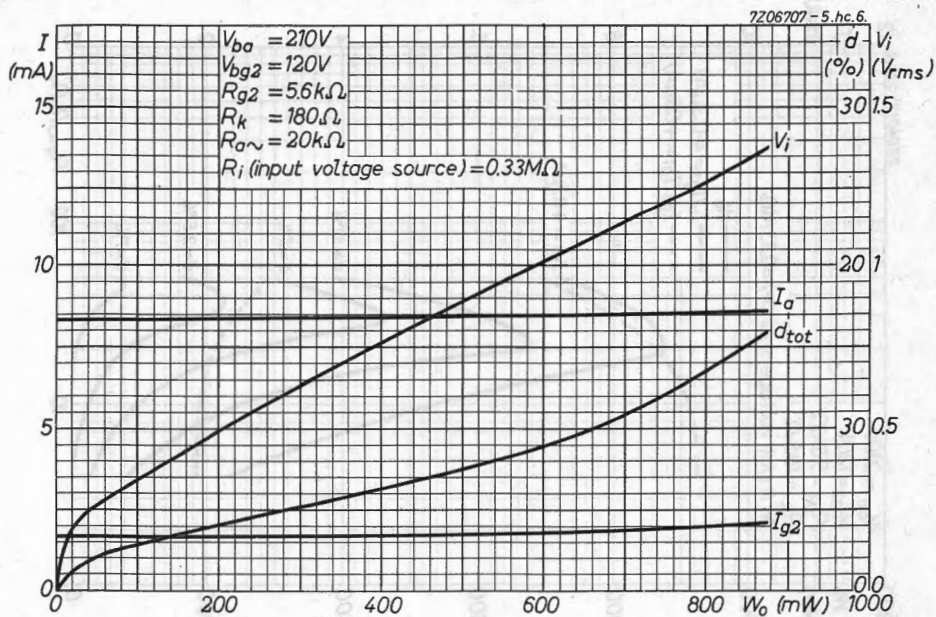

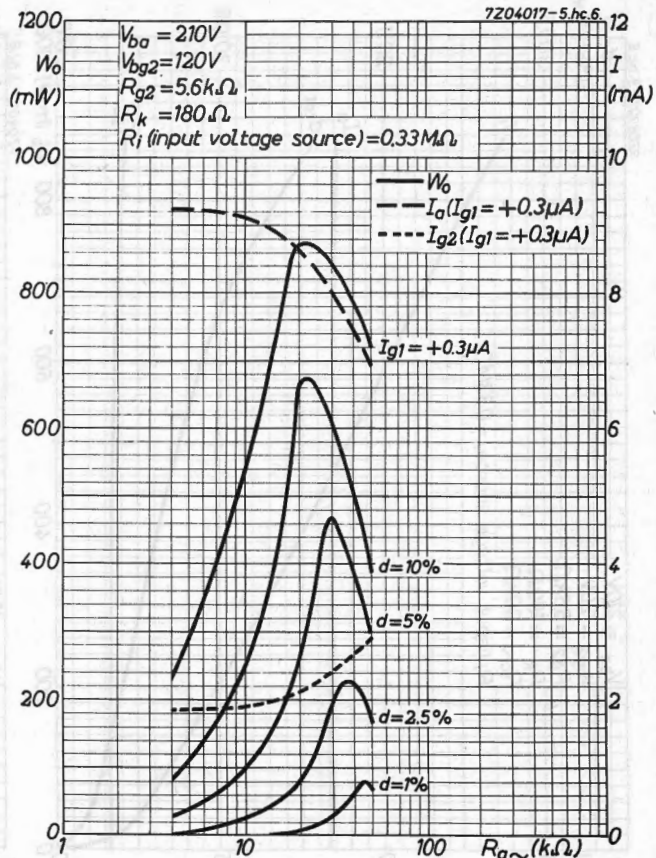
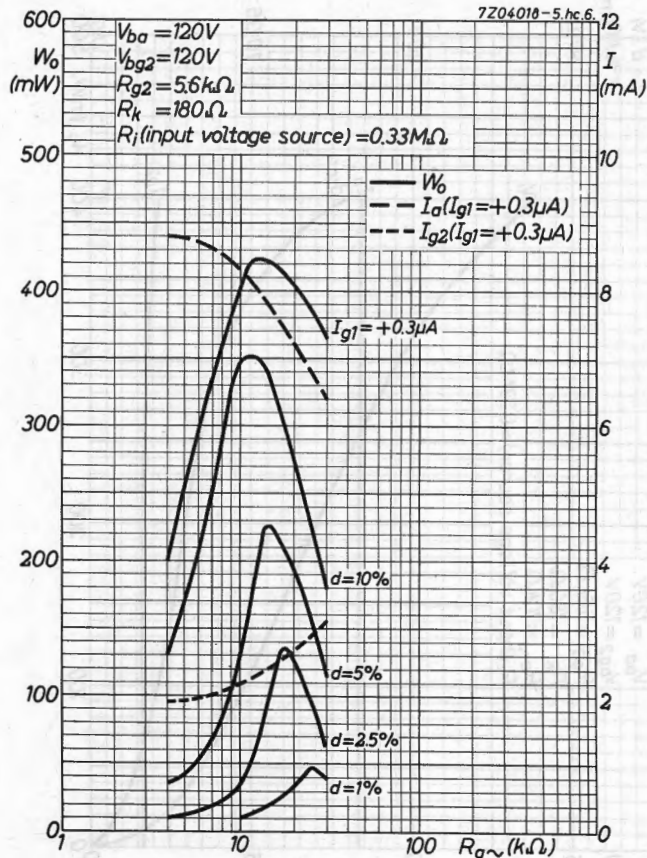

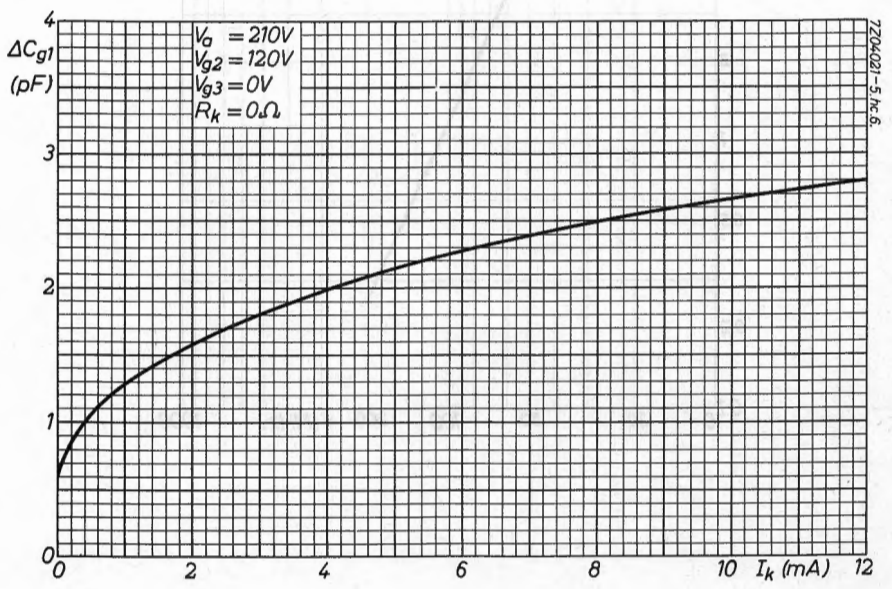
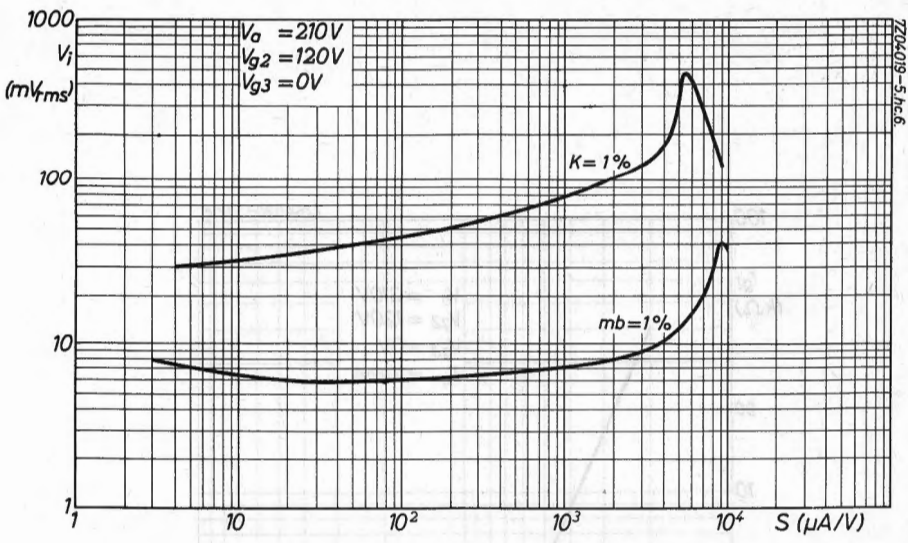

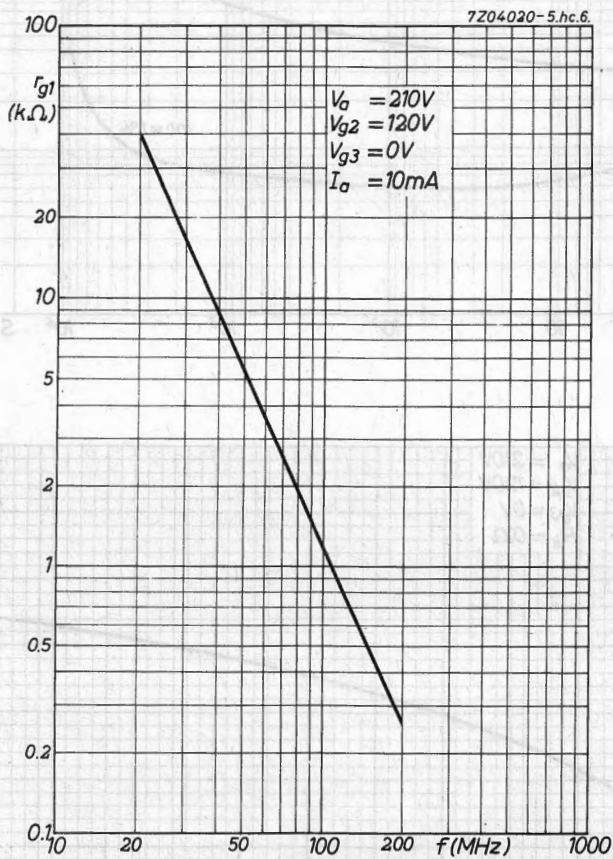

S.Q. TUBE

Special quality output pentode designed for use as wide band amplifier, series regulator tube and power output tube.

QUICK REFERENCE DATA

Life test	10 000 hours
Low interface resistance	
Mechanical quality	Shock and vibration resistant
Base	Noval
Heating	Indirect A. C. or D. C.; parallel supply
Heater voltage	V_f 6.3 V
Heater current	I_f 760 mA
Anode current	I_a 48 mA
Mutual conductance	S 11.3 mA/V
Output power, one tube	W_o 6 W

DIMENSIONS AND CONNECTIONS

Dimensions in mm

Base: Noval

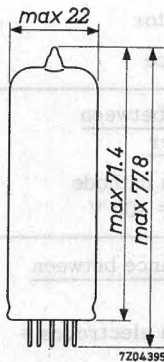
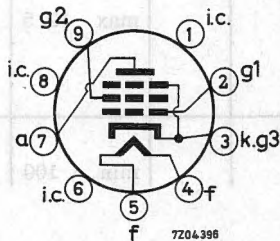

CHARACTERISTICS

- Column I Nominal values or setting of the tube
 II Range values for equipment design: Initial spread
 III Range values for equipment design: End of life

		I	II	III	
Heater voltage	V_f	6.3			V
Heater current	I_f	760	720 - 800		mA
Anode voltage	V_a	250			V
Grid No. 2 voltage	V_{g2}	250			V
Cathode resistor	R_k	135			Ω
Anode current	I_a	48	42 - 54	min. 32	mA
Grid No. 2 current	I_{g2}	5.5	4 - 7		mA
Mutual conductance	S	11.3	9.2 - 13.4	min. 7.5	mA/V
Amplification factor	μ_{g2g1}	19			
Internal resistance	R_i	40			k Ω
Negative grid current	$-I_{g1}$		max. 0.5	max. 1.0	μ A
<u>As triode</u>					
Anode voltage	V_a	250			V
Cathode resistor	R_k	270			Ω
Anode current	I_a	34			mA
Mutual conductance	S	10.2			mA/V
Amplification factor	μ	18.5			
Internal resistance	R_i	1.8			k Ω
<u>Leakage current between cathode and heater</u>					
	I_{kf}		max. 12.5		μ A
Voltage between cathode and heater $V_{kf} = 100$ V					
<u>Insulation resistance between electrodes</u>					
	R		min. 100		M Ω
Voltage between electrodes = 300 V					

CAPACITANCES

	I	II	
Anode to grid No. 2, grid No. 3 cathode and heater	C_{a/g_2g_3kf}	6.0	5.2 - 6.8 pF
Grid No. 1 to grid No. 2, grid No. 3 cathode and heater	C_{g_1/g_2g_3kf}	10	9 - 11 pF
Anode to grid No. 1	C_{ag_1}		max. 0.5 pF
Grid No. 1 to heater	C_{g_1f}		max. 0.25 pF

SHOCK AND VIBRATION RESISTANCE

The following test conditions are applied to assess the mechanical quality of the tube. These conditions are not intended to be used as normal operating conditions.

Shock

The tube is subjected 5 times in each of 4 positions to an acceleration of 500 g supplied by an NRL shock machine with the hammer lifted over an angle of 30°.

Vibration

The tube is subjected during 32 hours in each of 3 positions to a vibration frequency of 50 Hz with an acceleration of 2.5 g.

LIFE

Production samples are tested to be within the end of life values (column III) during 10 000 hours

LIMITING VALUES (Absolute max. rating system)

Anode voltage	V_{a_0}	max.	600 V
	V_a	max.	450 V
Anode dissipation	W_a	max.	13.5 W
Grid No. 2 voltage	$V_{g_{2_0}}$	max.	600 V
	V_{g_2}	max.	450 V
Grid No. 2 dissipation			
Continuously	W_{g_2}	max.	2.2 W
Peak value in case of excitation by speech and music	$W_{g_{2p}}$	max.	4.4 W

LIMITING VALUES (continued)

Grid No.1 dissipation	W_{g1}	max.	0.5 W
Grid No.1 voltage	$-V_{g1}$	max.	100 V
Cathode current	I_k	max.	75 mA
Grid resistor			
Fixed bias	R_{g1}	max.	0.5 M Ω
Automatic bias	R_{g1}	max.	1.0 M Ω
Voltage between cathode and heater	V_{kf}	max.	100 V
Bulb temperature	t_{bulb}	max.	225 °C

Heater voltage: The average heater voltage should be 6.3 V.

Variations of the heater voltage exceeding the range of 6.0 V to 6.6 V will shorten the tube life.

The tolerance of heater current (column II) should be taken into account.

OPERATING CHARACTERISTICS

Output tube class A (one tube) 2³)

Anode voltage	V_a	250	V
Grid No.2 voltage	V_{g2}	250	V
Cathode resistor	R_k	135	Ω
Load resistance	$R_{a\sim}$	4.5	k Ω
Input voltage	V_i	0 0.3 3.5 4.4 (4.8 ¹)	V _{RMS}
Anode current	I_a	48	50.5 50.5 mA
Grid No.2 current	I_{g2}	5.5	10.0 11.0 mA
Output power	W_o	0 0.05 4.5 5.7 6.0	W
Total distortion	d_{tot}		7.5 10 %
Second harmonic	d_2		5.7 5.0 %
Third harmonic	d_3		4.5 8.0 %

OPERATING CHARACTERISTICS (continued)

Output tube class A (one tube) 2)3)

Anode voltage	V_a	250	V
Grid No. 2 voltage	V_{g2}	250	V
Cathode resistance	R_k	135	Ω
Load resistance	$R_{a\sim}$	5.2	$k\Omega$
<hr/>			
Input voltage	V_i	0 0.3 3.4 4.3 4.7 ¹⁾	V_{RMS}
Anode current	I_a	48 49.5 49.2	mA
Grid No. 2 current	I_{g2}	5.5 10.8 11.6	mA
Output power	W_o	0 0.05 4.5 5.7 6.0	W
Total distortion	d_{tot}	6.8 10	%
Second harmonic	d_2	3.0 2.0	%
Third harmonic	d_3	5.8 9.5	%
<hr/>			
Anode voltage	V_a	250	V
Grid No. 2 voltage	V_{g2}	250	V
Cathode resistance	R_k	210	Ω
Load resistance	$R_{a\sim}$	7.0	$k\Omega$
<hr/>			
Input voltage	V_i	0 0.3 3.5 5.5 ¹⁾	V_{RMS}
Anode current	I_a	36 36.8 36	mA
Grid No. 2 current	I_{g2}	4.1 8.5 14.6	mA
Output power	W_o	0 0.05 4.2 5.6	W
Total distortion	d_{tot}	10	%
Second harmonic	d_2	1.7	%
Third harmonic	d_3	8.7	%

OPERATING CHARACTERISTICS (continued)

Output tube class A (one tube) 2)

Anode voltage	V_a	250	V
Grid No.2 voltage	V_{g2}	210	V
Cathode resistor	R_k	160	Ω
Load resistance	$R_{a\sim}$	7.0	$k\Omega$
Input voltage	V_i	0 0.3	3.4 3.8 ¹⁾ V_{RMS}
Anode current	I_a	36	36.6 36.5 mA
Grid No.2 current	I_{g2}	3.9	7.3 8.0 mA
Output power	W_o	0 0.05	4.3 4.7 W
Total distortion	d_{tot}		10 %
Second harmonic	d_2		1.8 %
Third harmonic	d_3		9.3 %

Output tube class AB (two tubes) 2)

Anode voltage	V_a	250	300	V
Grid No.2 voltage	V_{g2}	250	300	V
Cathode resistor	R_k	130	130	Ω
Load resistance	$R_{aa\sim}$	8	8	$k\Omega$
Input voltage	V_i	0 8	0 10 ³⁾ V_{RMS}	
Anode current	I_a	2x31 2x37.5	2x36 2x46 mA	
Grid No.2 current	I_{g2}	2x3.5 2x7.5	2x4 2x11 mA	
Output power	W_o	0 11	0 17 W	
Total distortion	d_{tot}		3 4 %	

OPERATING CHARACTERISTICS (continued)

Output tube class B (two tubes)

Anode voltage	V_a	250	300	V	
Grid No. 2 voltage	V_{g2}	250	300	V	
Grid No. 1 voltage	$-V_{g1}$	11.6	14.7	V	
Load resistance	$R_{aa\sim}$	8	8	$k\Omega$	
Input voltage	V_i	0	8	0	$10^3 V_{RMS}$
Anode current	I_a	2×10	2×37.5	2×7.5	2×46 mA
Grid No. 2 current	I_{g2}	2×1.1	2×7.5	2×0.8	2×11 mA
Output power	W_o	0	11	0	17 W
Total distortion	d_{tot}		3		4 %

As triodeOutput tube class A (one tube)

Anode voltage	V_a	250	V	
Cathode resistor	R_k	270	Ω	
Load resistance	$R_{a\sim}$	3.5	$k\Omega$	
Input voltage	V_i	0	1.0	6.7 V_{RMS}
Anode current	I_a	34	36	mA
Output power	W_o	0	0.05	1.95 W
Total distortion	d_{tot}			9.0 %

Output tube class AB (2 tubes)

Anode voltage	V_a	250	300	V			
Cathode resistor	R_k	270	270	Ω			
Load resistance	$R_{aa\sim}$	10	10	$k\Omega$			
Input voltage	V_i	0	0.95	8.3	0	0.9	10 V_{RMS}
Anode current	I_a	2×20	2×21.7	2×24	2×26	mA	
Output power	W_o	0	0.05	3.4	0	0.05	5.2 W
Total distortion	d_{tot}			2.5			2.5 %

1) Grid No. 1 current $I_{g1} = 0.3 \mu A$

2) Measured with fixed bias

3) With speech and music signal

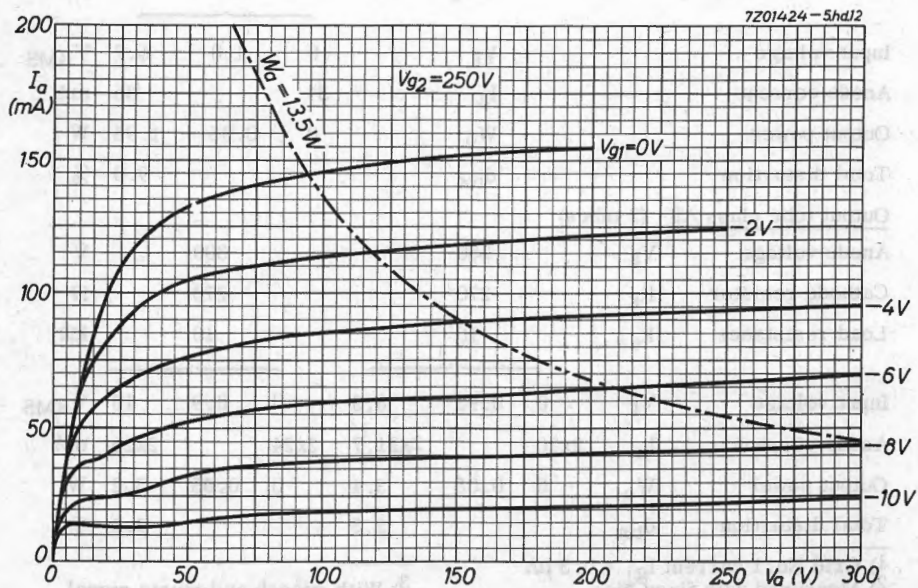
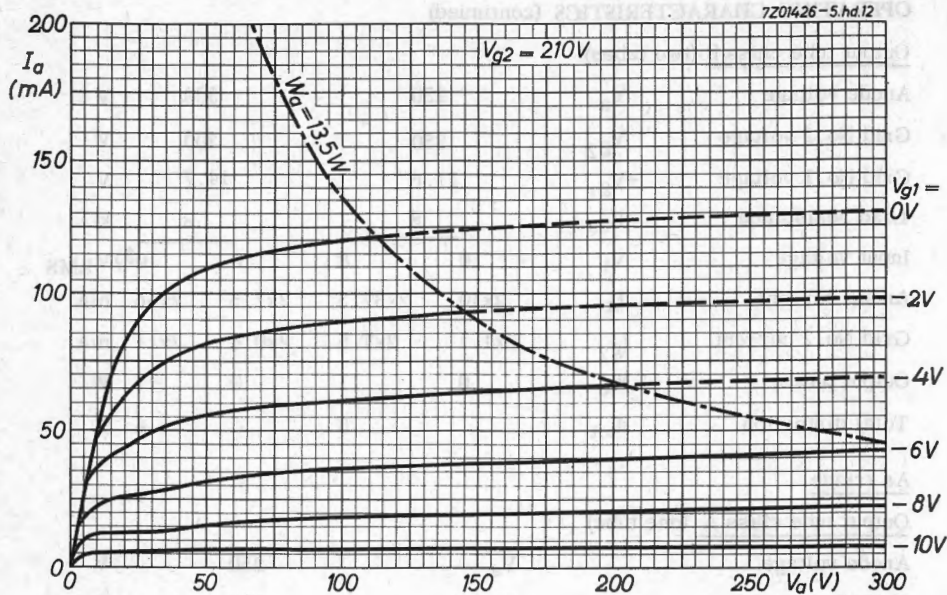

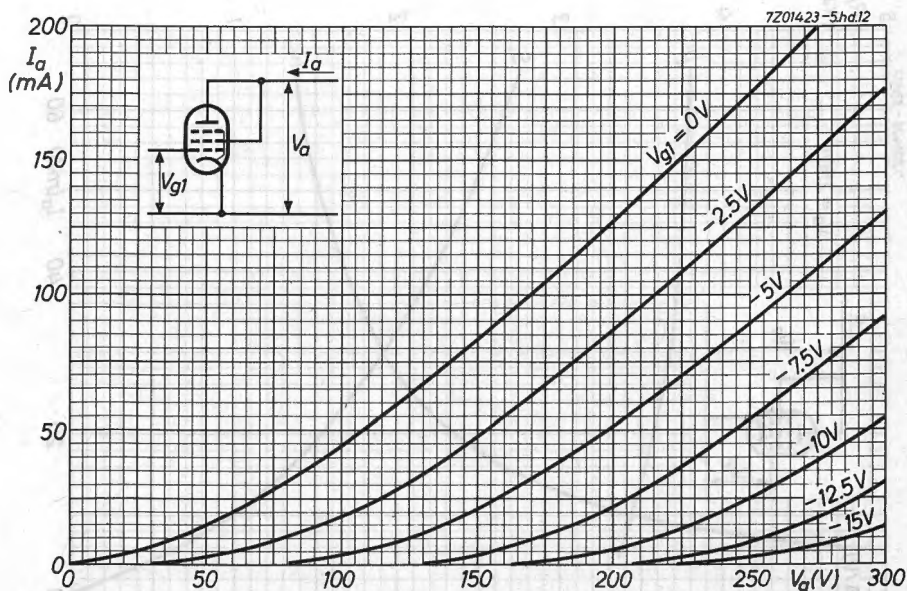
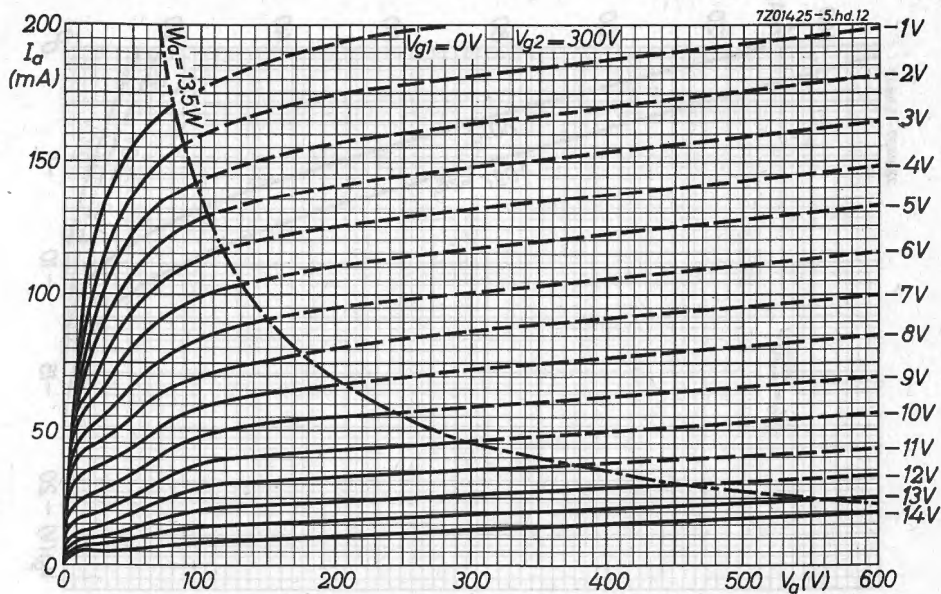

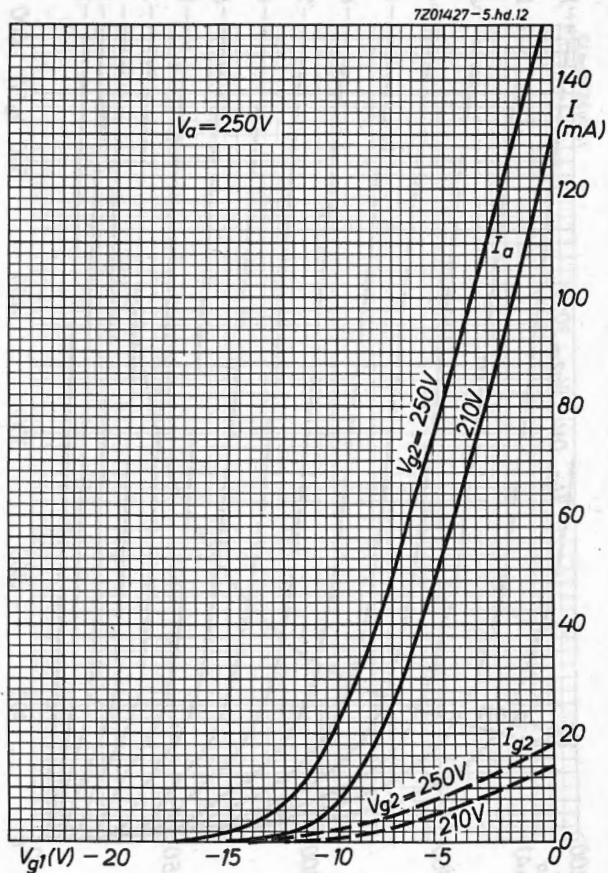
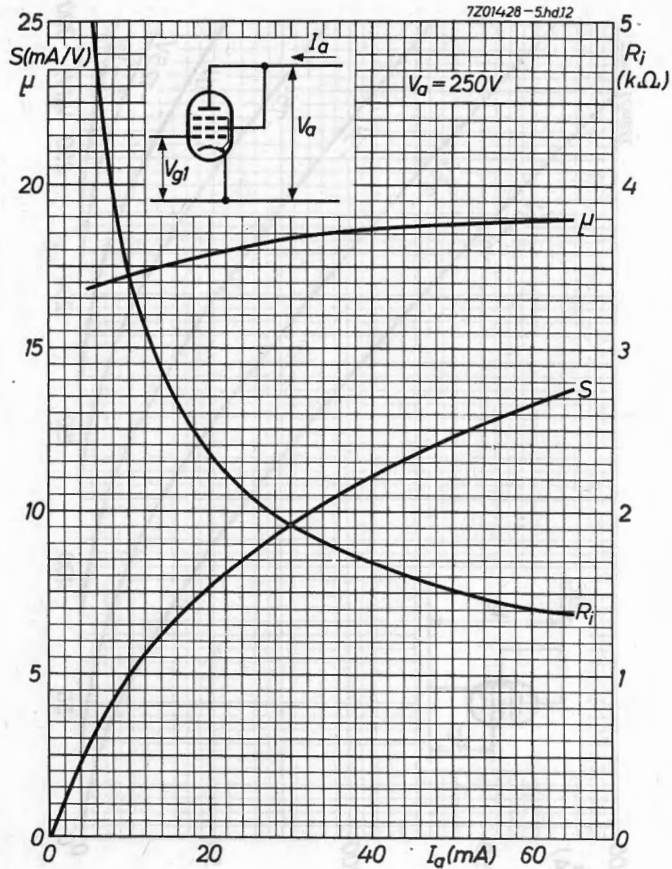

S.Q. TUBE

Special quality U.H.F. triode designed for use as oscillator, amplifier and self-oscillating mixer (max. frequency 800 MHz).

QUICK REFERENCE DATA

Life	10 000 hours
Low interface resistance	
Mechanical quality	Shock and vibration resistant
Base	Noval. Gold plated pins.
Heating	Indirect A.C. or D.C.; Parallel supply
Heater voltage	V_f 6.3 V
Heater current	I_f 165 mA
Anode current	I_a 12 mA
Mutual conductance	S 14 mA/V

DIMENSIONS AND CONNECTIONS

Dimensions in mm.

Base: Noval

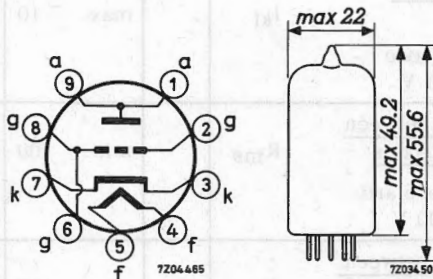

CHARACTERISTICS

Column I Nominal value or setting of the tube

II Range values for equipment design: Initial spread

III Range values for equipment design: End of life

		I	II	III	
Heater voltage	V_f	6.3			V
Heater current	I_f	165	155 - 175		mA
Anode supply voltage	V_{ba}	185			V
Grid supply voltage	$+V_{bg}$	8			V
Cathode resistor	R_k	800			Ω
Anode current	I_a	12	11.2 - 12.8	min. 10.5	mA
Mutual conductance	S	14	11.5 - 17	min. 9.5	mA/V
Amplification factor	μ	68			
<u>Negative grid current</u>	$-I_g$		max. 0.5	max. 1.0	μA
<u>Cut-off voltage</u>	$-V_g$		max. 5		V
Anode current $I_a = 0.1$ mA					
<u>Equivalent noise resistance</u>	R_{eq}	250			Ω
<u>Input resistance</u>	r_g	2			k Ω
Frequency = 100 MHz					
<u>Phase angle of slope</u>	φ_s	-7			$^\circ$
Frequency = 100 MHz					
<u>Leakage current between cathode and heater</u>	I_{kf}		max. 10		μA
Voltage between cathode and heater $V_{kf} = 100$ V					
<u>Insulation resistance between anode and other electrodes</u>	R_{ins}		min. 100		M Ω
Voltage between anode and other electrode = 300 V					
<u>Insulation resistance between grid and other electrode</u>	R_{ins}		min. 100		M Ω
Voltage between grid and other electrode = 100 V					

CAPACITANCES

		I	II	
Anode to grid	C_{ag}	2	1.7 - 2.3	pF
Anode to cathode	C_{ak}	0.2	0.16 - 0.24	pF
Grid to cathode	C_{gk}	3.6	3.0 - 4.2	pF
Grid to heater	C_{gf}		max. 0.3	pF
Cathode to grid and heater	$C_{k/gf}$	6.6	5.5 - 7.7	pF
Anode to grid and heater	$C_{a/gf}$	2.1	1.75 - 2.45	pF
Grid to cathode and heater	$C_{g/kf}$	3.9	3.3 - 4.5	pF
Anode to cathode and heater	$C_{a/kf}$	0.3	0.25 - 0.35	pF
Grid to cathode	C_{gk}	5.6		pF

Anode current $I_a = 12$ mA

With external shield

Anode to grid and shield	$C_{a/gs}$	3.1	2.8 - 3.4	pF
Grid and shield to cathode and heater	$C_{gs/kf}$	4.2	3.6 - 4.8	pF
Anode to cathode and heater	$C_{a/kf}$	0.25	0.2 - 0.3	pF

SHOCK AND VIBRATION RESISTANCE

The following test conditions are applied to assess the mechanical quality of the tube. These conditions are not intended to be used as normal operating conditions.

Shock

The tube is subjected 5 times in each of 4 positions to an acceleration of 500 g supplied by an NRL shock machine with the hammer lifted over an angle of 30° .

Vibration

The tube is subjected during 32 hours in each of 3 positions to a vibration frequency of 50 Hz with an acceleration of 2.5 g.

LIFE

Production samples are tested to be within the end of life values (column III) during 10 000 hours.

Heater voltage: The average heater voltage should be 6.3 V. Variations of the heater voltage exceeding the range of 6.0 V to 6.6 V will shorten the tube life. The tolerance of heater current (column II) should be taken into account.

LIMITING VALUES (Absolute max. rating system)

Anode voltage	V_{a0}	max. 440	V
	V_a	max. 250	V
Anode dissipation	W_a	max. 2.4	W
Grid voltage	$-V_g$	max. 50	V
Grid dissipation	W_g	max. 20	mW
Grid resistor	R_g	max. 1.2	M Ω
Cathode current	I_k	max. 20	mA
Voltage between cathode and heater	V_{kf}	max. 100	V
Bulb temperature	t_{bulb}	max. 165	$^{\circ}\text{C}$
Frequency (as amplifier)	f	up to 800	MHz

OPERATING CHARACTERISTICSAs R.F. amplifier, grounded grid

Anode supply voltage	V_{ba}	185	175	V
Grid supply voltage	V_{bg}	8	0	V
Cathode resistor	R_k	800	125	Ω
Anode current	I_a	12	12	mA
Mutual conductance	S	14	14	mA/V

As mixer

Anode supply voltage	V_{ba}	220	V
Anode resistor	R_a	5.6	k Ω
Grid resistor	R_g	47	k Ω
Anode current	I_a	12	mA
Grid current	I_g	50	μA

7201688-5.hf.3

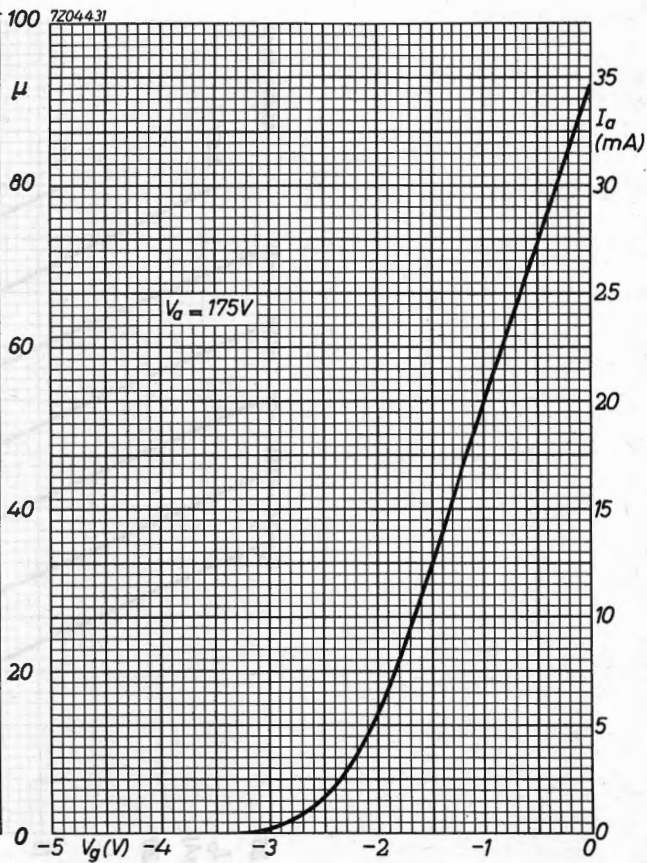
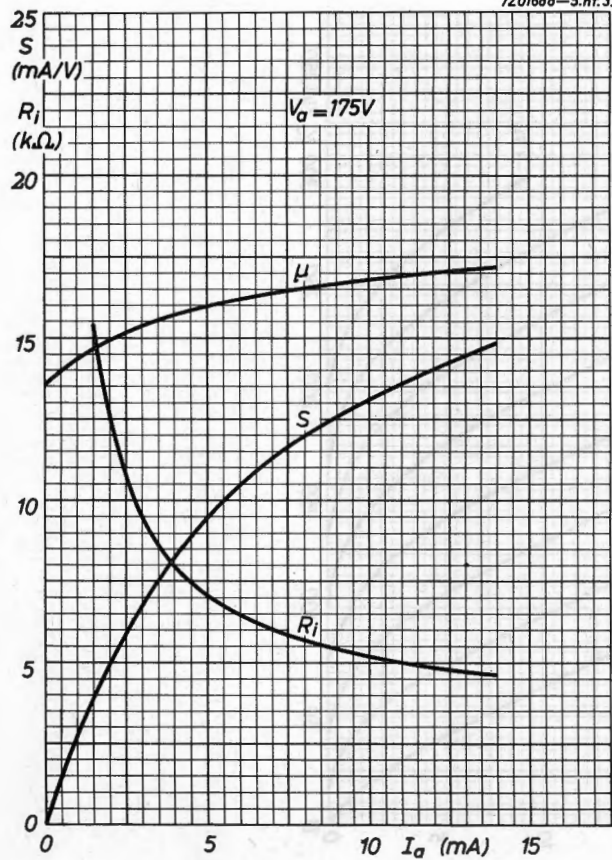

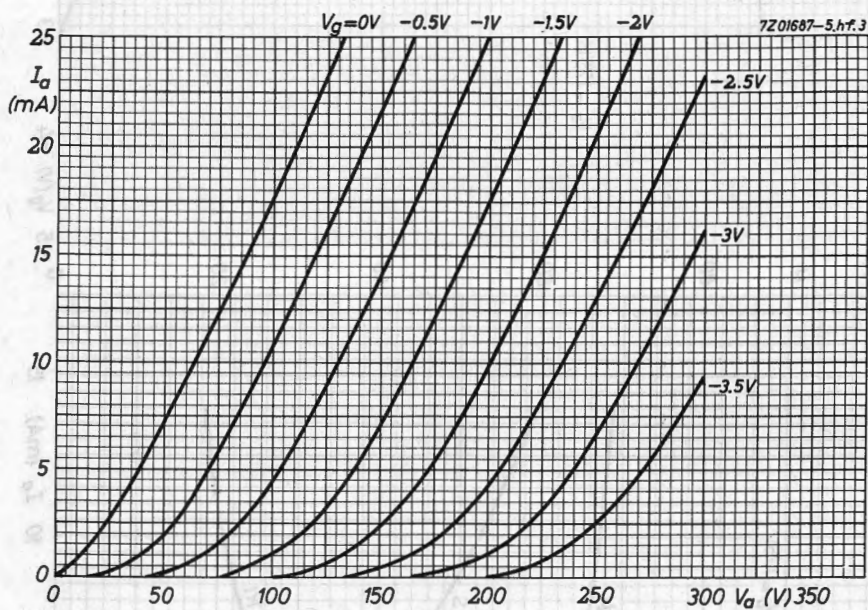

S.Q. TUBE

Special quality triode. Designed for use as grounded grid aerial amplifier for band IV and V.

QUICK REFERENCE DATA

Life test	10 000 hours
Low interface resistance	
Mechanical quality	Shock and vibration resistant
Base	Noval. Gold plated pins
Heating	Indirect A.C. or D.C.; parallel supply
Heater voltage	V_f 6.3 V
Heater current	I_f 165 mA
Anode current	I_a 12.5 mA
Mutual conductance	S 13.5 mA/V
Noise figure at 850 MHz	F 9.6 dB
Equivalent noise resistance	R_{eq} 240 Ω

DIMENSIONS AND CONNECTIONS

Dimensions in mm

Base: Noval

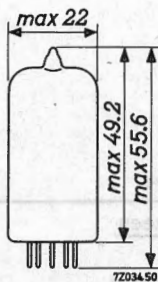
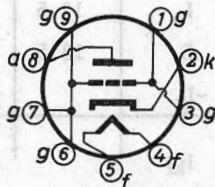

CHARACTERISTICS

Column I Nominal value

II Range values for equipment design: Initial spread

		I	II	
Heater voltage	V_f	6.3		V
Heater current	I_f	165	157-173	mA
Anode voltage	V_a	160		V
Grid voltage	$-V_g$	1.25		V
Anode current	I_a	12.5		mA
Mutual conductance	S	13.5		mA/V
Amplification factor	μ	70		
Internal resistance	R_i	5.2		k Ω
Equivalent noise resistance	R_{eq}	240		Ω
Noise figure	F	9.6		dB
Frequency 850 MHz				
Bandwidth 15 MHz				
Anode supply voltage	V_{ba}	170		V
Cathode resistor	R_k	820		Ω
Grid supply voltage	$+V_{bg}$	9		V
Anode current	I_a	12.5		mA
Mutual conductance	S	13.5	10.5-16.5	mA/V
Anode supply voltage	V_{ba}	161		V
Cathode resistor	R_k	100		Ω
Grid supply voltage	V_{bg}	0		V
Anode current	I_a	12.5	9.5-16.1	mA
Mutual conductance	S	13.5		mA/V
Grid current, negative	$-I_g$		max. 0.1	μ A
<u>Leakage current between cathode and heater</u>	I_{kf}		max. 15	μ A

Voltage between cathode and heater $V_{kf} = 125$ V

CHARACTERISTICS (continued)

	I	
Input series resonance frequency ¹⁾	f_{inp}	1700 MHz
Output series resonance frequency ¹⁾	f_{outp}	1000 MHz

CAPACITANCES

		With screen		Without screen		
		I	II	I	II	
Anode to cathode and heater	C_a/kf	50	35- 65			mpF
Grid to cathode and heater	C_g/kf	3.8	3.2-4.4			pF
Anode to grid	C_{ag}	1.7	1.4-2.0	1.1	0.9 - 1.3	pF

SHOCK AND VIBRATION RESISTANCE

The following test conditions are applied to assess the mechanical quality of the tube. These conditions are not intended to be used as normal operating conditions.

Shock

The tube is subjected 5 times in each of 4 positions to an acceleration of 500 g supplied by an NRL shock machine with the hammer lifted over an angle of 30°.

Vibration

The tube is subjected during 32 hours in each of 3 positions to a vibration frequency of 50 Hz with an acceleration of 2.5 g.

LIFE

Production samples are tested during 10 000 hours under the following conditions:

Anode supply voltage	V_{ba}	170 V
Grid supply voltage	$+V_{bg}$	9 V
Cathode resistor	R_k	820 Ω

- ¹⁾ Measured between the tube pin connected to the relevant electrode and a metal reference plane placed against the tube bottom. The relevant pin and the reference plane are connected to the measuring device so that the minimum distance is obtained between these two connecting points. The remaining tube pins are connected to the reference plane with a negligible impedance. The tube is screened by a cylinder with an internal diameter of 23 mm placed on the reference plane.

LIMITING VALUES (Absolute max. rating system)

Anode voltage	V_{a0}	max.	400 V
	V_a	max.	200 V
Anode dissipation	W_a	max.	2.6 W
Cathode current	I_k	max.	16.5 mA
Grid voltage	$-V_g$	max.	50 V
Grid dissipation	W_g	max.	50 mW
Grid resistor	R_g	max.	1 M Ω
Cathode resistor $R_k = 100 \Omega$			
Voltage between cathode and heater			
Cathode positive	$V_{kf(k+)}$	max.	125 V
Cathode negative	$V_{kf(k-)}$	max.	60 V
Bulb temperature	t_{bulb}	max.	170 °C

Heater voltage: The average heater voltage should be 6.3 V.

Variation of the heater voltage exceeding the range of 6.0 V to 6.6 V will shorten the tube life.

OPERATING CHARACTERISTICSDriver or output tube (circuit fig. 1)

Frequency	f	800	MHz
Bandwidth		8	MHz
Anode supply voltage	V_{ba}	200	V
Anode resistor	R_a	1.5	k Ω
Cathode resistor	R_k	150	Ω
Input voltage	V_i	0 0.5 1.65	VRMS
Anode current	I_a	11.4 12.8	mA
Output voltage	V_o	0 2.0 6.0	VRMS ¹⁾
Inter modulation ratio			min. 26 dB
Sync. impuls compression			max. 30 %

¹⁾ Value of the sync. level with video modulation according to CCIR and with $Z = 60 \Omega$.

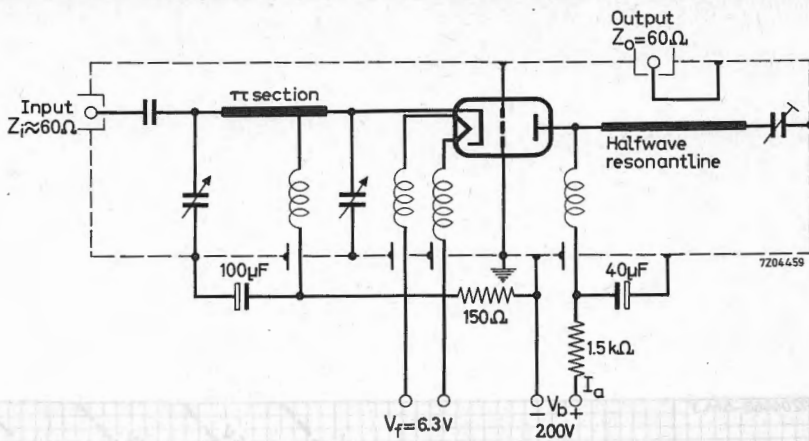
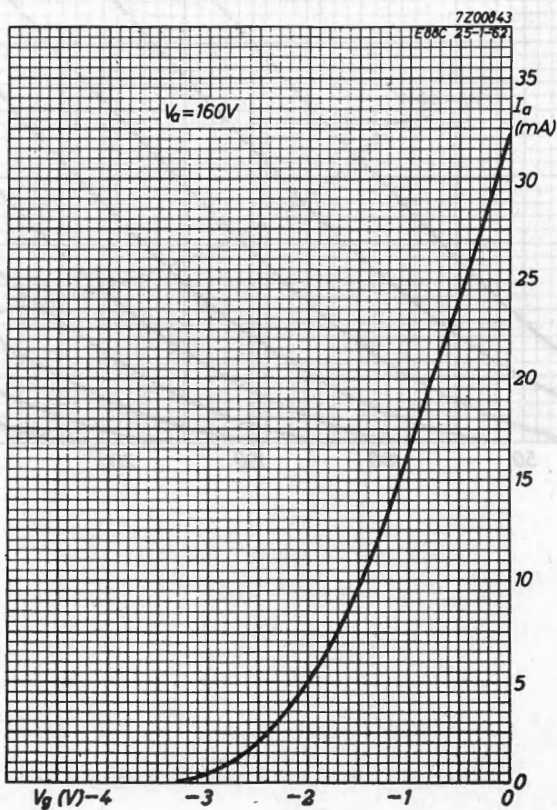
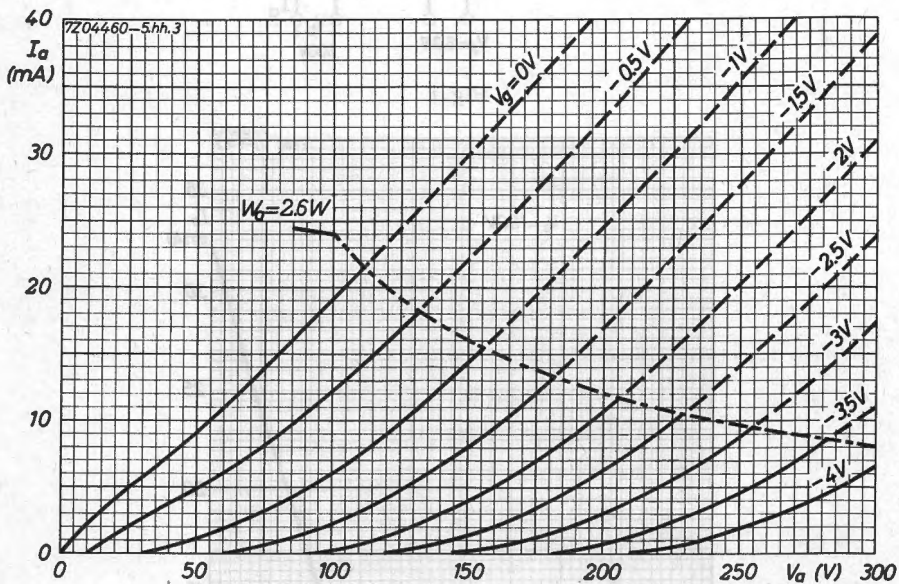
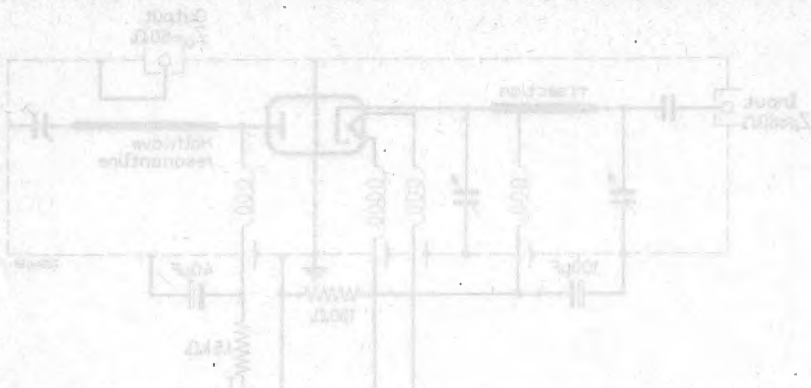

Fig. 1





S.Q. TUBE

Special quality double triode designed for
 Cascode circuits
 H.F. or I.F. amplifiers
 Mixer or phase inverter stages
 Multivibrator and cathode follower in computers

QUICK REFERENCE DATA

Life	10 000 hours
Low interface resistance	
Mechanical quality	Shock and vibration resistant
Base	Noval. Gold plated pins
Heating	Indirect A. C. or D. C.; parallel supply
Heater voltage	V_f 6.3 V
Heater current	I_f 300 mA
Anode current	I_a 15 mA
Mutual conductance	S 12.5 mA/V
Equivalent noise resistance	R_{eq} 300 Ω
Noise factor ($f = 200$ MHz)	F 4.6 dB

DIMENSIONS AND CONNECTIONS

Dimensions in mm

Base: Noval

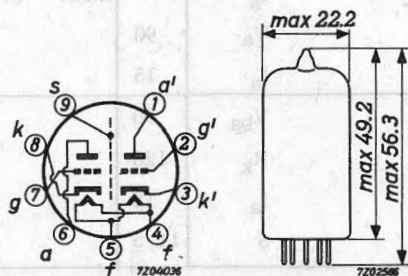

CHARACTERISTICS

- Column I Nominal value or setting of the tube
 II Range values for equipment design: Initial spread
 III Range values for equipment design: End of life

		I	II	III	
Heater voltage	V_f	6.3			V
Heater current	I_f	300	285 - 315		mA
Anode supply voltage	V_{ba}	100			V
Grid supply voltage	$+V_{bg}$	9			V
Cathode resistor	R_k	680			Ω
Anode current	I_a	15	14.2 - 15.8	min. 13.5	mA
Mutual conductance	S	12.5	10.5 - 15	min. 9	mA/V
Amplification factor	μ	33			
<u>Equivalent noise resistance</u>	R_{eq}	300			Ω
Frequency = 45 MHz					
<u>Noise figure</u>	F	4.6			dB
Frequency = 200 MHz					
In cascode circuit adapted to minimum noise					
<u>Input resistance</u>	r_g	3			k Ω
Frequency = 100 MHz					
<u>Start of grid current</u>	V_g	0.75			V_{RMS}
<u>Negative grid current</u>	$-I_g$		max. 0.1	max. 1	μA
Anode voltage	V_a	90			V
Anode current	I_a	15			mA
Anode supply voltage	V_{ba}	90			V
Cathode resistor	R_k	120			Ω
Anode current	I_a	12			mA
Mutual conductance	S	11.5			mA/V

CHARACTERISTICS (continued)

		I	II	III	
<u>Cut-off voltage</u>	$-V_g$	6.5	5 - 8.5		V
Anode voltage	V_a	150			V
Anode current	I_a	0.1			mA
<u>Difference in grid voltage of two sections</u>	$ V_g - V_g' $		max. 2	max. 2	V
Anode voltage	$V_a = V_a'$	150			V
Anode current	$I_a = I_a'$	0.1			mA
Anode supply voltage	V_{ba}	150			V
Negative grid voltage	$-V_g$	15			V
Anode current	I_a		max. 5		μA
<u>In circuit fig.1 "pag.7"</u>					
Anode supply voltage	V_{ba}	150			V
Anode current (not permitted continuously)	I_a	33	28 - 38		mA
Anode supply voltage	V_{ba}	60			V
Anode current	I_a		max. 9		mA
<u>Leakage current between cathode and heater</u>	I_{kf}		max. 6	max. 12	μA
Voltage between cathode and heater = 90 V, cath.neg.					
Voltage between cathode and heater = 120 V, cath.pos.					
<u>Insulation resistance between two electrodes</u>	R_{ins}		min.100	min. 20	$M\Omega$
Voltage between electrodes = 200 V					
<u>Hum voltage</u>	V_g		max. 50		μV_{RMS}
Centre heater transformer earthed					
Grid resistor $R_g = 0.5 M\Omega$					

CAPACITANCES Both sections if applicable

		I	II	
Anode to cathode, heater and screen	$C_{a/kfs}$	1.75	1.55 - 1.95	pF
	$C_{a'/k'fs}$	1.65	1.45 - 1.85	pF
Anode to cathode and heater	$C_{a/kf}$	0.5	0.4 - 0.6	pF
	$C_{a'/k'f}$	0.4	0.3 - 0.5	pF
Grid to cathode, heater and screen	$C_{g/kfs}$	3.3	2.7 - 3.9	pF
	$C_{g/kf}$	3.3	2.7 - 3.9	pF
Anode to grid	C_{ag}	1.4	1.2 - 1.6	pF
Anode to cathode	C_{ak}	0.18	0.14 - 0.22	pF
Cathode to heater	C_{kf}	2.6		pF
	$C_{k'f}$	2.7		pF
Anode to screen	C_{as}	1.3	1.1 - 1.5	pF
Anode to grid, heater and screen	$C_{a/gfs}$	3.0	2.7 - 3.3	pF
	$C_{a'/g'fs}$	2.9	2.6 - 3.2	pF
Cathode to grid, heater and screen	$C_{k/gfs}$	6.0	5.1 - 6.9	pF
Anode to anode other section	$C_{aa'}$		max. 0.045	pF
Grid to grid other section	$C_{gg'}$		max. 0.005	pF
Anode to grid other section	$C_{ag'}, C_{a'g}$		max. 0.005	pF
Grid to cathode other section	$C_{gk'}, C_{g'k}$		max. 0.005	pF

SHOCK AND VIBRATION RESISTANCE

The following test conditions are applied to assess the mechanical quality of the tube. These conditions are not intended to be used as normal operating conditions.

Shock

The tube is subjected 5 times in each of 4 positions to an acceleration of 500 g supplied by an NRL shock machine with the hammer lifted over an angle of 30°.

Vibration

The tube is subjected during 32 hours in each of 3 positions to a vibration frequency of 50 Hz with an acceleration of 2.5 g.

LIFE

Production samples are tested to be within the end of life values (column III) during 10 000 hours under the following conditions:

Anode supply voltage	V_{ba}	100 V
Grid supply voltage	$+V_{bg}$	9 V
Cathode resistor	R_k	680 Ω
Grid resistor	R_g	47 k Ω
Voltage between cathode and heater (cath. neg.)	V_{kf}	60 V
Anode current	I_a	15 mA

LIMITING VALUES Design centre rating system

Anode voltage	V_{a0}	max. 550 V
Anode voltage (Zero cathode current)	V_a	max. 400 V
Anode voltage	V_a	max. 220 V
Anode voltage (Max. anode dissipation 0.8 W)	V_a	max. 250 V
Anode dissipation	W_a	max. 1.5 W
Anode dissipation (Max. anode dissipation of section 1 plus section 2 = 2 W)	W_a	max. 1.8 W
Grid dissipation	W_g	max. 30 mW
Grid voltage	$-V_g$	max. 100 V
Grid peak voltage Max. pulse duration 200 μ sec Max. duty factor 0.1	$-V_{gp}$	max. 200 V
Cathode current	I_k	max. 20 mA
Cathode peak current Max. pulse duration 200 μ sec Max. duty factor 0.1	I_{kp}	max. 100 mA

LIMITING VALUES (continued)

Voltage between cathode and heater

Cathode positive	V_{kf}	max.	150 V
Cathode negative	V_{kf}	max.	100 V
Bulb temperature (Absolute max.)	t_{bulb}	max.	170 °C
Grid resistor (Anode current < 5 mA)	R_g	max.	1 M Ω

Heater voltage: The average heater voltage should be 6.3 V.

Variations of the heater voltage exceeding the range of 6.0 V to 6.6 V will shorten the tube life.

The tolerance of heater current (column II) should be taken into account.

OPERATING CHARACTERISTICS

Output tube class A

Anode voltage	V_a	220	V
Load resistance	$R_{a\sim}$	20	k Ω
Grid voltage	$-V_g$	6.5	V
Input voltage	V_i	0 1.5 4.5	VRMS
Anode current	I_a	6.5 9.2	mA
Output power	W_o	0.05 0.5	W
Total distortion	d_{tot}	7	%

Output tube class B (two tubes)

Continuous single tone input signal

Anode voltage	V_a	200	V
Load resistance	$R_{aa\sim}$	22	k Ω
Grid voltage	$-V_g$	6	V
Input voltage	V_i	0 0.9 4.0	VRMS
Anode current	I_a	2x5 2x9	mA
Output power	W_o	0.05 1.2	W
Total distortion	d_{tot}	3	%

OPERATING CHARACTERISTICS (continued)

Output tube class B (two tubes)

Speech and music input signal

Anode voltage	V_a	200	V
Load resistance	$R_{a-a\sim}$	10	$k\Omega$
Grid voltage	$-V_{g1}$	6	V
Input voltage	V_i	0 0.9 4.0	V_{RMS}
Anode current	I_a	2x5 2x13.5	mA
Output power	W_o	0.05 1.5	W
Total distortion	d_{tot}		4 %

Mixer

Anode supply voltage	V_{ba}	60 90 150	V
Anode resistor	R_a	0 1	3.9 $k\Omega$
Grid resistor	R_g	1 1	1 $M\Omega$
Oscillator voltage	V_{osc}	2 2.5 3	V_{RMS}
Anode current	I_a	4.7 7.7	11 mA
Conversion conductance	S_c	2.9 3.5	4.1 mA/V
Internal resistance	R_i	8.3 7	6.1 $k\Omega$

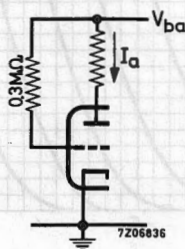
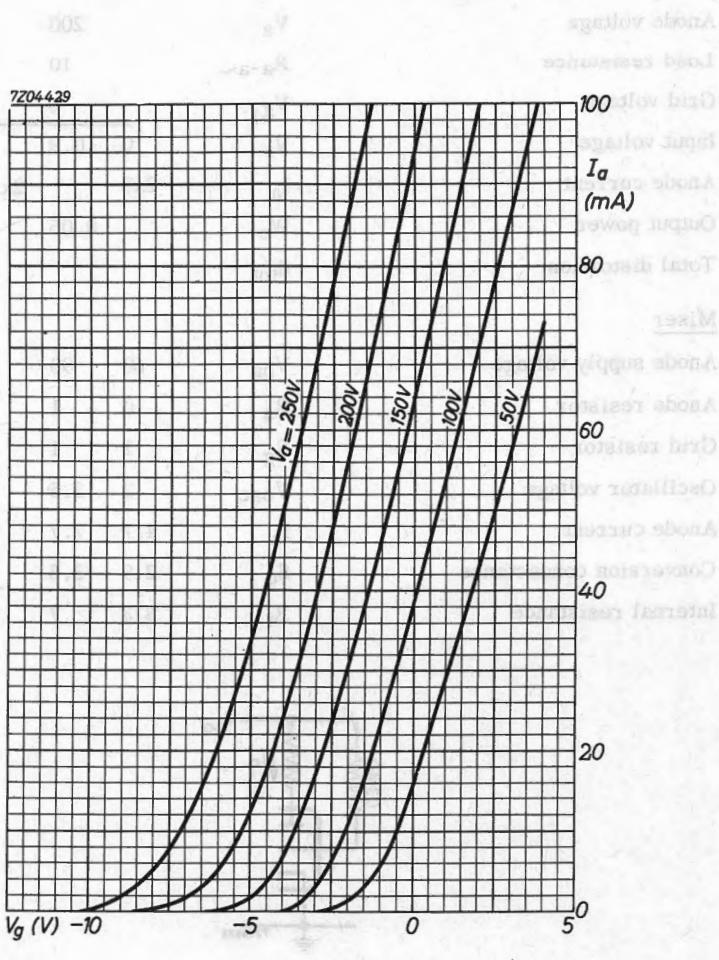
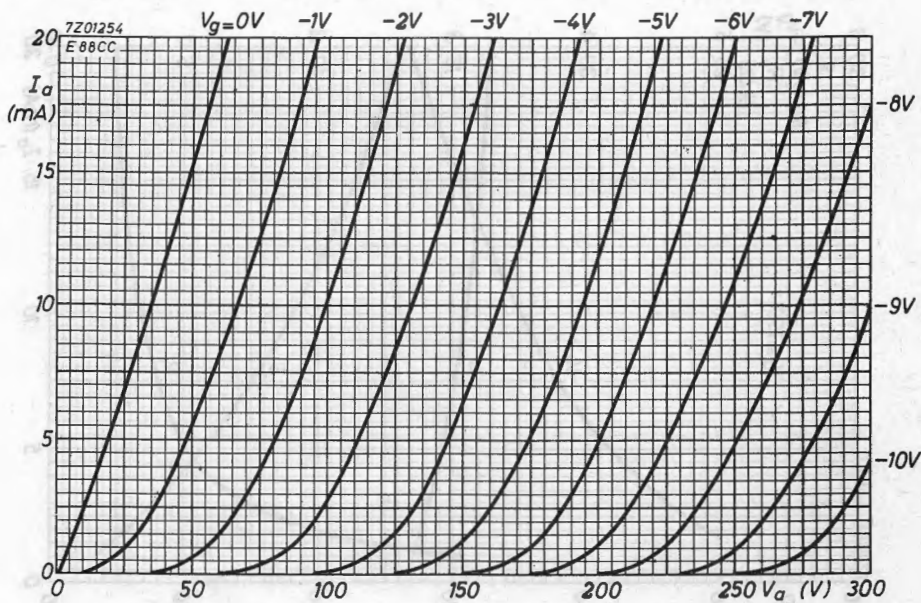
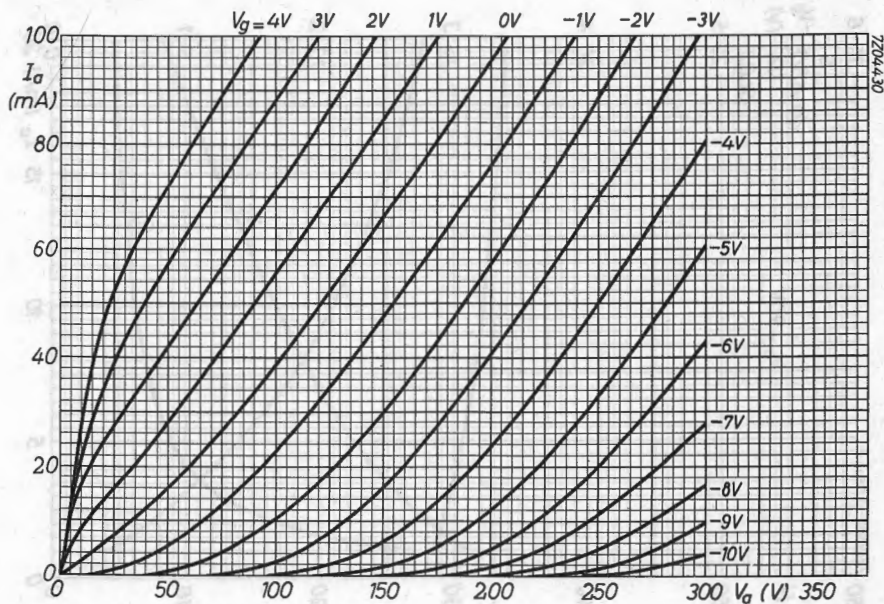
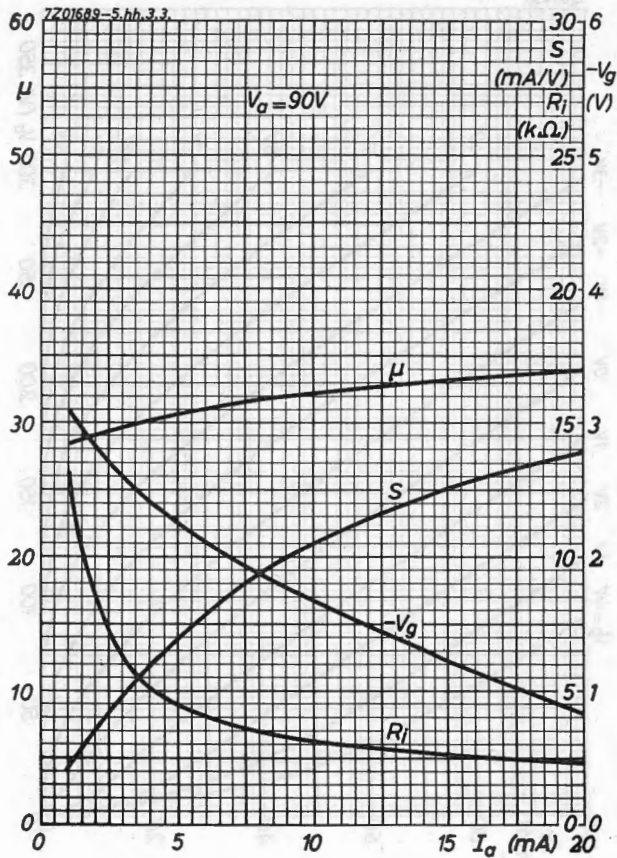
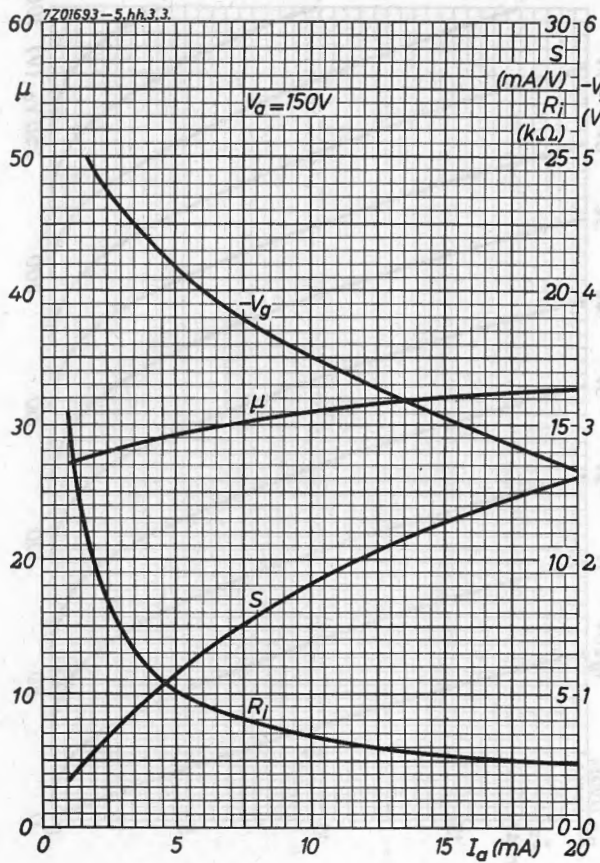

Fig.1

OPERATING CHARACTERISTICS (continued)
 Output tube class B (two tubes)
 Speech and music input signal







7204035-5, Ah. 3.3.

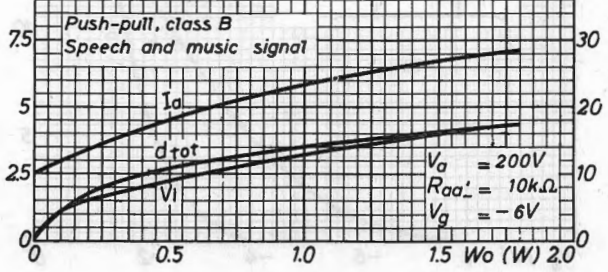
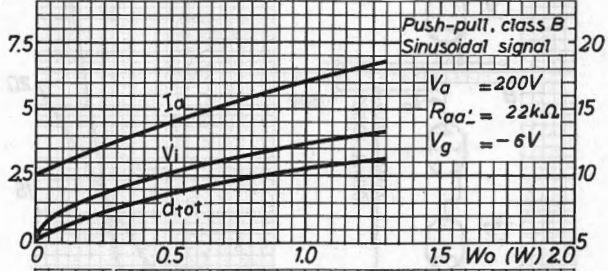
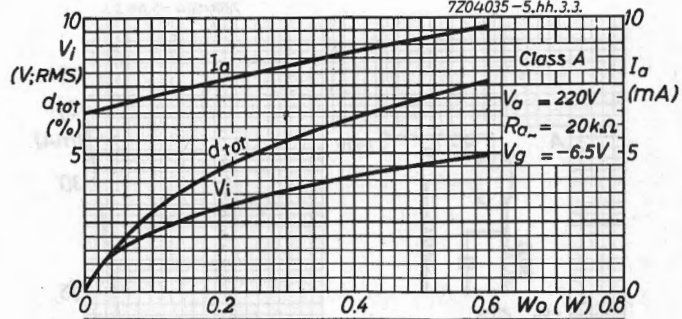

7204-034-5.hh.3.3

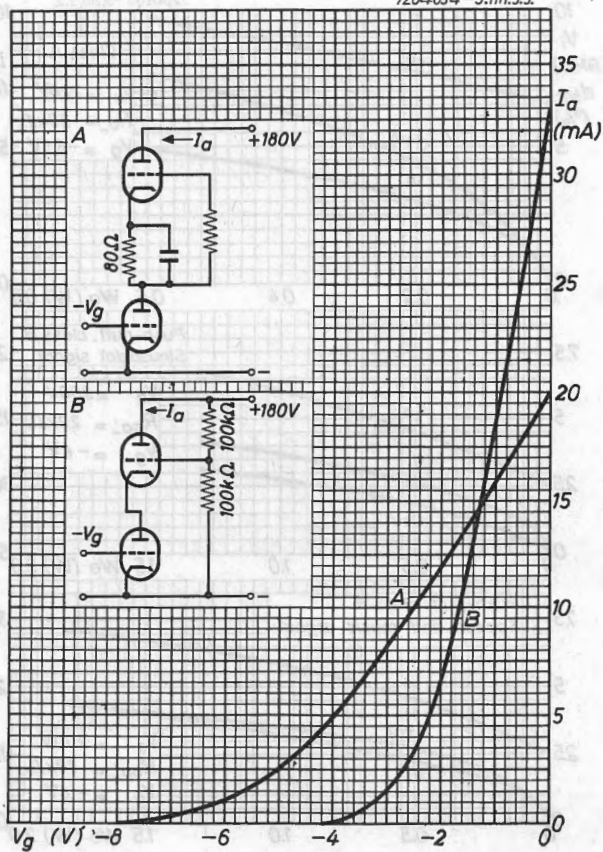

S.Q. TUBE

Special quality double triode designed for use in computer circuits.

QUICK REFERENCE DATA

Life expectancy	10 000 hours
Low interface resistance	
Base	Miniature, 7 pin
Heating	Direct A.C. or D.C. Series or parallel supply
Heater voltage	V_f 6.3 V
Heater current	I_f 400 mA

DIMENSIONS AND CONNECTIONS

Dimensions in mm

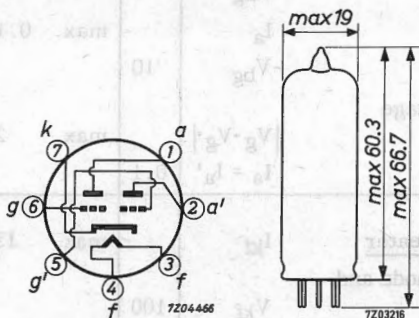

CHARACTERISTICS

- Column I Nominal value or setting of the tube
 II Range values for equipment design: Initial spread
 III Range values for equipment design: End of life

		I	II	III	
Heater voltage	V_f	6.3			V
Heater current	I_f	400	380 - 420		mA
Anode voltage	V_a	100			V
Negative grid voltage	$-V_g$	2.1			V
Anode current	I_a	8.5	4.5 - 12.5		mA
Mutual conductance	S	6.0			mA/V
Amplification factor	μ	27			
Anode voltage	V_a	100			V
Cathode resistor	R_k	250			Ω
Mutual conductance	S	6.0	4.5 - 7.5	min. 3.0	mA/V
<u>Negative grid current</u>	$-I_{g1}$		max. 0.2	max. 1.0	μ A
Anode supply voltage	V_{ba}	150			V
Anode resistor	R_a	20			k Ω
Grid resistor	R_g	47			k Ω
Anode current	I_a	5.6	5.0 - 6.2	min. 4.5	mA
Grid supply voltage	V_{bg}	0			V
Anode current	I_a		max. 0.1	max. 0.1	mA
Grid supply voltage	$-V_{bg}$	10			V
Difference in grid voltage of two sections	$ V_g - V_{g'} $		max. 2	max. 2	V
Anode current	$I_a = I_a'$	0.1			V
<u>Leakage current</u> <u>between cathode and heater</u>	I_{kf}		max. 15	max. 30	μ A
Voltage between cathode and heater	V_{kf}	100			V
<u>Insulation between two electrodes</u>	R_{ins}		min. 100	min. 20	M Ω
Voltage between electrodes	V	300			V

CAPACITANCES Each system if applicable.

	I	II	
Anode to cathode and heater	$C_{a/kf}$	0.35	0.25 - 0.45 pF
	$C_{a' / k' f}$	0.4	0.3 - 0.5 pF
Grid to cathode and heater	$C_{g/kf}$	3.4	2.9 - 3.9 pF
Anode to grid	C_{ag}	2.5	2.0 - 3.0 pF
Grid to heater	C_{gf}		max. 0.15 pF
	$C_{g'f}$		max. 0.3 pF
Anode to anode other section	$C_{aa'}$		max. 1.4 pF
Grid to grid other section	$C_{gg'}$		max. 0.22 pF
Anode to grid other section	$C_{ag'}$		max. 0.35 pF
Grid to anode other section	$C_{ga'}$		max. 0.15 pF
Cathode to heater	C_{kf}	6.5	pF

LIFE

Production samples are tested to be within the end of life values (column III) under the following conditions during 10 000 hours:

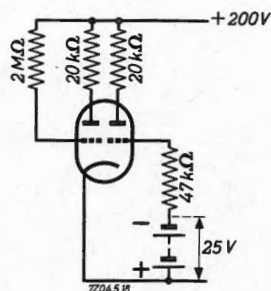

$$I_a = 8 \text{ mA}$$

$$I_{a'} = 0 \text{ mA}$$

$$V_{kf} = 100 \text{ V (k pos)}$$

LIMITING VALUES (Absolute max. rating system)

Anode voltage	V_{a0}	max.	600 V
	V_a	max.	300 V
Anode dissipation	W_a	max.	2.0 W
Grid voltage	$+V_g$	max.	0 V
	$-V_g$	max.	100 V
Grid peak voltage	$-V_{gp}$	max.	200 V
Grid current	I_g	max.	250 μ A
Grid, peak current	I_{gp}	max.	1 mA
max. pulse duration 2.5 msec			
Cathode current	I_k	max.	15 mA
Cathode peak current	I_{kp}	max.	75 mA
max. pulse duration 2 msec			
Voltage between cathode and heater	V_{kf}	max.	100 V
Grid resistor, automatic bias	R_g	max.	1 $M\Omega$
	R_g	max.	0.5 $M\Omega$
fixed bias			
Bulb temperature	t_{bulb}	max.	170 $^{\circ}$ C

Heater voltage: The average heater should be 6.3 V.

Variations of the heater voltage exceeding the range of 6.0 V to 6.6 V will shorten the tube life.

The tolerance of heater current (column II) should be taken into account.

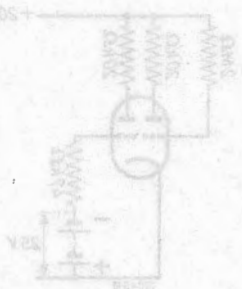

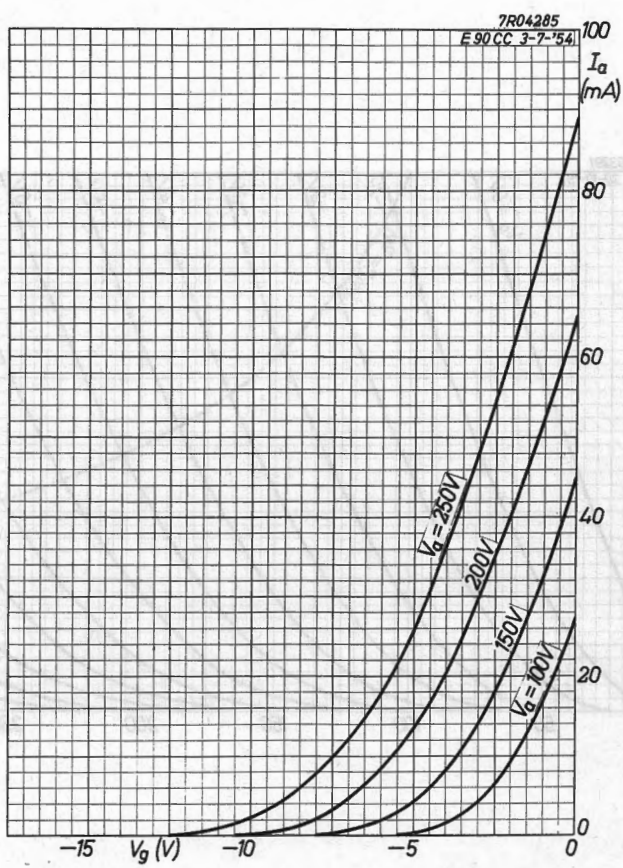

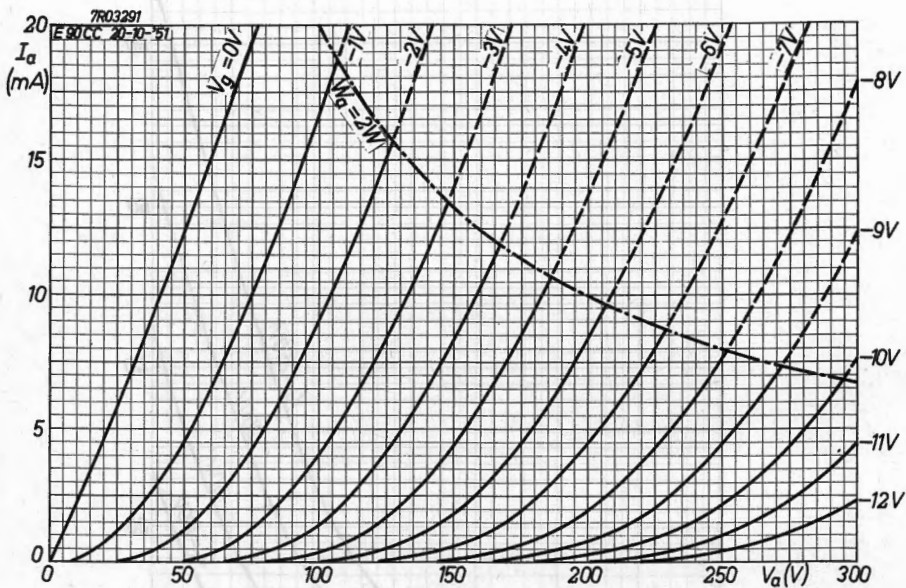

S.Q. TUBE

Special quality tube designed for use as wide band amplifier, cathode follower, series regulator tube for stabilised d.c. supply and output tube.

QUICK REFERENCE DATA

Life test	10 000 hours
Mechanical quality	Shock and vibration resistant
Base	Octal
Heating	Indirect A.C. or D.C.; parallel supply
Heater voltage	V_f 6.3 V
Heater current	I_f 1.7 A
Anode current	I_a 100 mA
Mutual conductance	S 27.5 mA/V
Output power, one tube	W_o 11.5 W
two tubes, class AB	W_o 60 W

DIMENSIONS AND CONNECTIONS

Dimensions in mm

Base: Octal

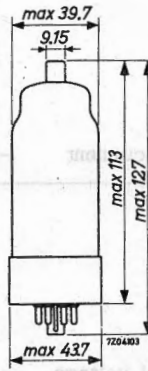
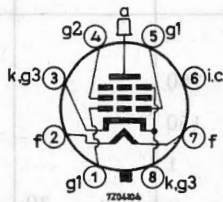

CHARACTERISTICS

Column I Nominal value or setting of the tube

II Range values for equipment design: Initial spread

III Range values for equipment design: End of life

		I	II	III	
Heater voltage	V_f	6.3			V
Heater current	I_f	1.7	1.62 - 1.78		A
Anode voltage	V_a	250			V
Grid No.2 voltage	V_{g2}	150			V
Grid No.1 voltage	$-V_{g1}$	15.5			V
Anode current	I_a	100			mA
Grid No.2 current	I_{g2}	4			mA
Mutual conductance	S	27.5			mA/V
Amplification factor	μ_{g2g1}	6.5			
Internal resistance	R_i	10			k Ω
Anode supply voltage	V_{ba}	275			V
Grid No.2 supply voltage	V_{bg2}	180			V
Positive grid No.1 supply voltage	V_{bg1}	15.7			V
Cathode resistor	R_k	300			Ω
Anode current	I_a	100	85 - 115	decrease max.40%	mA
Grid No.2 current	I_{g2}	4	max. 6		mA
Mutual conductance	S	27.5	22.5 - 32.5	decrease max.30%	mA/V
Negative grid No.1 current	$-I_{g1}$		max. 0.5	max. 1	μ A
<u>Cut off voltage</u>					
Anode voltage	V_a	250			V
Grid No.2 voltage	V_{g2}	150			V
Anode current	I_a	1			mA
Negative grid No.1 voltage	$-V_{g1}$		max. 30		V

CHARACTERISTICS (continued)

Insulation resistance
between one electrode and all
other electrodes measured
with $V = 400\text{ V}$

	II	III	
R_{isol}	min. 100	min. 20	$M\Omega$

CAPACITANCES Without external shield

Grid No.1 to grid No.3, grid No.2,
cathode and heater

	I	II	
C_{g_1/g_3g_2kf}	35		pF
Anode to grid No.3, grid No.2, cathode and heater	C_{a/g_3g_2kf}	17	pF
Anode to grid No.1	C_{ag_1}	max. 2	pF

SHOCK AND VIBRATION RESISTANCE

The following test conditions are applied to assess the mechanical quality of the tube. These conditions are not intended to be used as normal operating conditions.

Shock

The tube is subjected 5 times in each of 4 positions to an acceleration of 500 g supplied by an NRL shock machine with the hammer lifted over an angle of 30° .

Vibration

The tube is subjected during 32 hours in each of 3 positions to a vibration frequency of 50 Hz with an acceleration of 2.5 g.

LIFE

Production samples are tested to be within the end of life values (column III) under the following conditions during 10000 hours.

Anode supply voltage	V_{ba}	275	V
Grid No.2 supply voltage	V_{bg_2}	180	V
Grid No.1 supply voltage	$+V_{bg_1}$	15.7	V
Cathode resistor	R_k	300	Ω
Grid No.1 resistor	R_{g_1}	47	$k\Omega$
Voltage between cathode and heater cathode positive	V_{kf} (k pos)	100	V

LIMITING VALUES (Absolute max. rating system)

Anode voltage	V_{a0}	max. 2000 V
	V_a	max. 900 V
Anode and grid No.2 voltage (triode connection)	V_{a+g2}	max. 250 V
Anode peak voltage	$+V_{ap}$	max. 8000 V
Pulse duration: 18% of a cycle		
Anode peak voltage	$-V_{ap}$	max. 2000 V
Anode dissipation	W_a	max. 27.5 W
Anode plus grid No.2 dissipation (triode connection)	W_{a+g2}	max. 27.5 W
Grid No.2 voltage	V_{g20}	max. 550 V
	V_{g2}	max. 250 V
Grid No.2 dissipation	W_{g2}	max. 5 W
Grid No.1 voltage	$-V_{g1}$	max. 150 V
	$+V_{g1}$	max. 15 V
Grid No.1 dissipation	W_{g1}	max. 0.1 W
Grid No.1 resistor with fixed bias	R_{g1}	max. 0.5 M Ω
with automatic bias	R_{g1}	max. 1.0 M Ω
Cathode current	I_k	max. 300 mA
Cathode peak current	I_{kp}	max. 1.5 A
Pulse duration max. 4 ms		
Average value max. 150 mA		
Cathode peak current	I_{kp}	max. 4.6 A
Pulse duration max. 1.5 μ s		
Average value max. 14 mA		
Voltage between cathode and heater		
Cathode positive	V_{kf} (k pos)	max. 200 V
Cathode negative	V_{kf} (k neg)	max. 100 V
Bulb temperature	t_{bulb}	max. 225 $^{\circ}$ C

LIMITING VALUES (continued)

Heater voltage: The average heater voltage should be 6.3 V.

Variations of the heater voltage exceeding the range of 6.0 V to 6.6 V will shorten the tube life. The tolerance of the heater current (column II) should be taken into account.

OPERATING CHARACTERISTICSOutput tube class A

Anode voltage	V_a	250	V
Grid No.2 voltage	V_{g2}	150	V
Grid No.1 voltage	$-V_{g1}$	15.5	V
Load resistance	$R_{a\sim}$	2.7	$k\Omega$
Input voltage	V_i	3.82	V_{RMS}
Anode current	I_a	100	mA
Grid No.2 current	I_{g2}	18	mA
Output power	W_o	11.5	W
Total distortion	d_{tot}	10	%

Output tube class AB (2 tubes)

Anode voltage	V_a	300	V
Grid No.2 voltage	V_{g2}	150	V
Grid No.1 voltage	$-V_{g1}$	17	V
Load resistance	$R_{aa\sim}$	1.6	$k\Omega$
Input voltage	V_i	0 0.24 9.0	V_{RMS}
Anode current	I_a	2x80 - 2x182	mA
Grid No.2 current	I_{g2}	2x2.5 - 2x22	mA
Output power	W_o	0 0.05 60	W
Total distortion	d_{tot}	- - 5	%

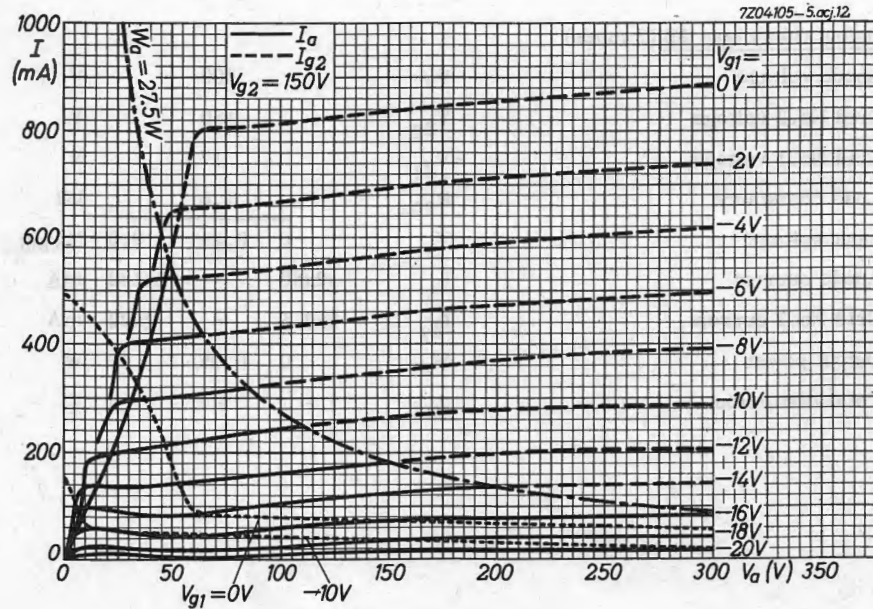
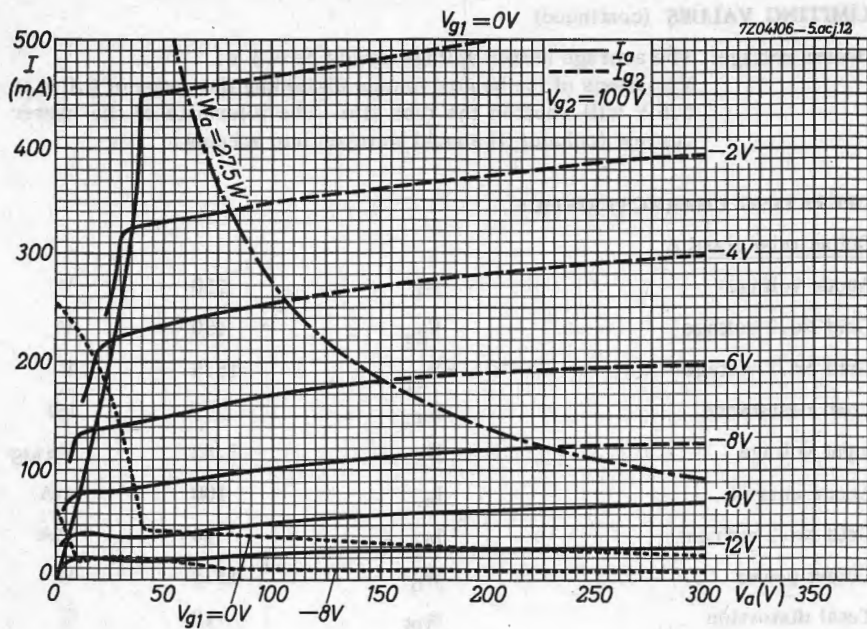

7Z04108-5.acj12

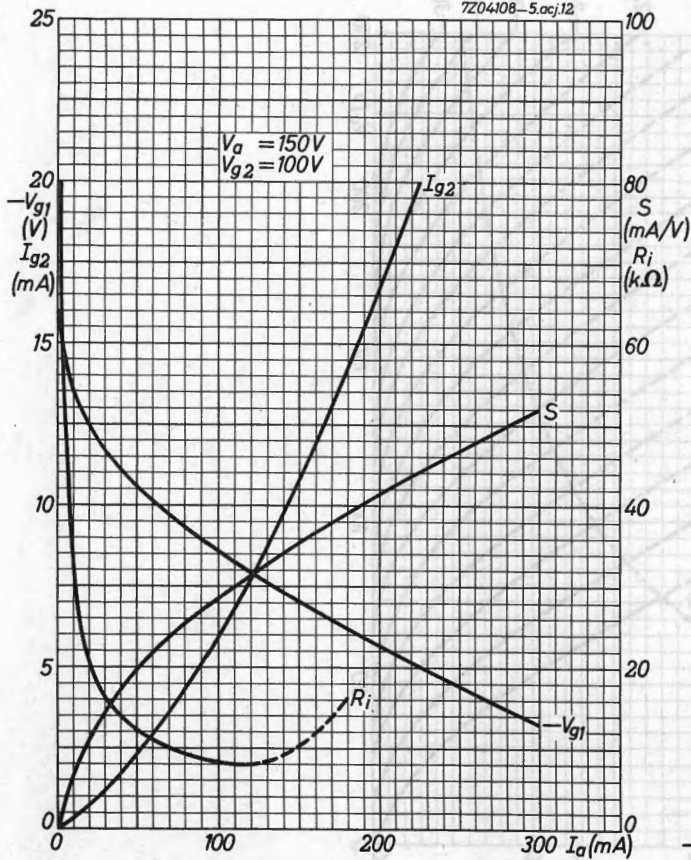

7Z04107-5.acj12

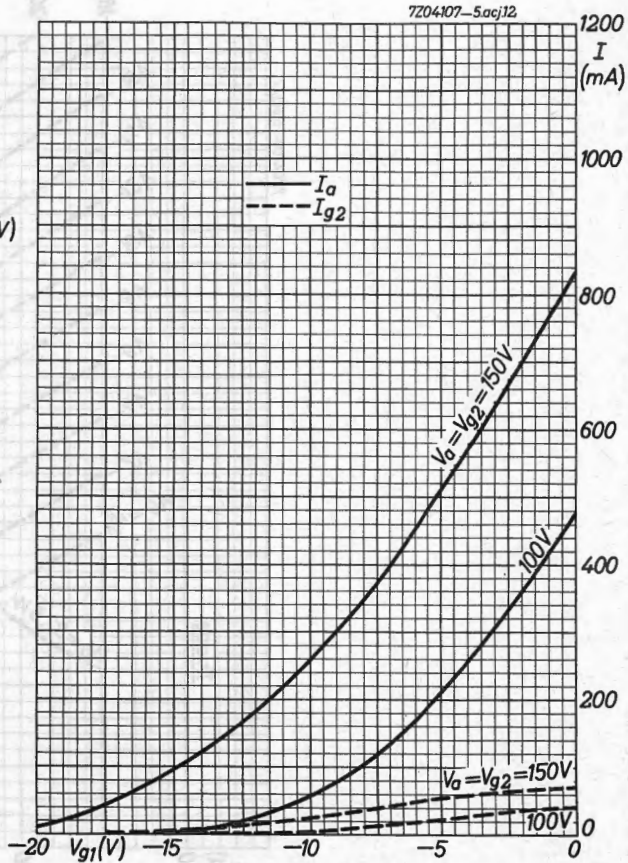

7Z04109-5.ac.12

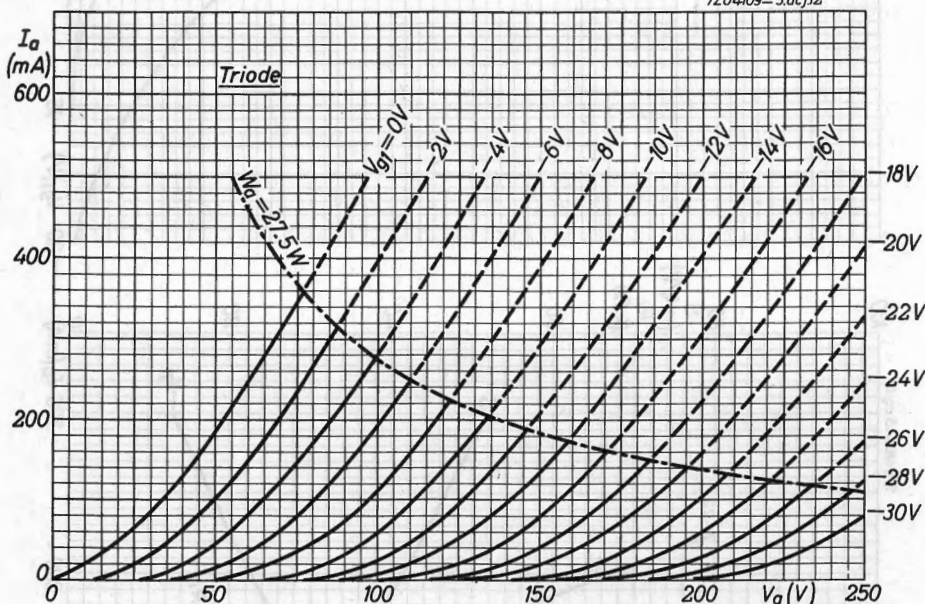

S.Q. TUBE

Special quality double triode designed for use in computer circuits.

QUICK REFERENCE DATA

Life test	10 000 hours	
Low interface resistance		
Base	Noval	
Heating	Indirect	
	A.C. or D.C.; parallel supply	
Heater voltage	V_f	6.3 or 12.6 V
Heater current	I_f	400 or 200 mA

DIMENSIONS AND CONNECTIONS

Dimensions in mm

Base: Noval

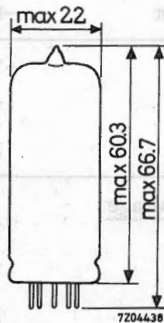
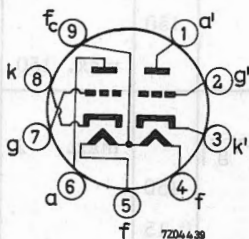

CHARACTERISTICS

Column I Nominal value or setting of the tube

II Range values for equipment design: Initial spread

III Range values for equipment design: End of life

		I	II	III	
Heater voltage (pin 9 and 4 and 5)	V_f	6.3			V
Heater current	I_f	400	380 - 420		mA
Heater voltage (pin 4 and 5)	V_f	12.6			V
Heater current	I_f	200			mA
Anode voltage	V_a	150			V
Grid voltage	$-V_g$	1.85			V
Anode current	I_a	8.5			mA
Mutual conductance	S	6.4			mA/V
Amplification factor	μ	46			
Internal resistance	R_i	7.2			k Ω
Anode voltage	V_a	150			V
Cathode resistor	R_k	220			Ω
Anode current	I_a	8.5	6.3 - 10.7	min. 5.0	mA
Mutual conductance	S	6.4	5.3 - 8.1	min. 4.0	mA/V
Negative grid current	$-I_g$		max. 0.2	max. 1.0	μ A
Cut off voltage	$-V_g$	7.5			V
Anode voltage	V_a	150			V
Anode current	I_a		max. 150	max. 150	μ A
<u>Difference in grid voltage</u> of 2 sections	$ V_g - V_g' $		max. 2	max. 2	V
Anode voltage	V_a	150			V
Anode current	I_a	0.15			mA

CHARACTERISTICS (continued)

		I	II	III	
Anode voltage	V_a	100			V
Grid voltage	$-V_g$	0.8			V
Anode current	I_a	8.5			mA
Mutual conductance	S	7.8			mA/V
Amplification factor	μ	50			
Internal resistance	R_i	6.4			k Ω
Anode voltage	V_a	100			V
Grid supply voltage	$+V_{bg}$	100			V
Grid resistor	R_g	0.5			M Ω
Anode current	I_a	17.8	13.6 - 22.0	min. 9.5	mA
<u>Leakage current between cathode and heater</u>	I_{kf}		max. 15	max. 30	μ A
Voltage between cathode and heater $V_{kf} = 200$ V					
Series resistor = 1 M Ω					
<u>Insulation resistance between two electrodes</u>			min. 100	min. 20	M Ω
Voltage between electrodes V = 275 V					

CAPACITANCES Without external screen

Each system if applicable		I	II	
Anode to cathode and heater	$C_{a/kf}$	0.5	0.3 - 0.7	pF
Anode to cathode and heater	$C_{a'/k'f}$	0.45	0.25 - 0.65	pF
Grid to cathode and heater	$C_{g/kf}$	3.5	3.0 - 4.0	pF
Anode to grid	C_{ag}	2.2	1.8 - 2.6	pF
Anode to grid	$C_{a'g'}$	2.3	1.9 - 2.7	pF
Cathode to heater	C_{kf}	3.5		pF
Anode to anode other section	$C_{aa'}$		max. 1.3	pF
Grid to grid other section	$C_{gg'}$		max. 0.06	pF

LIFE

Production samples are tested to be within the end of life values (column III) under the following conditions during 10 000 hours.

Anode supply voltage	V_{ba}	150 V
Grid supply voltage	V_{bg}	150 V
Anode resistor	R_a	2.6 k Ω
Grid resistor	R_g	1.5 M Ω ($I_g = 100 \mu A$)
Voltage between cathode and heater (k pos)	V_{kf}	200 V

LIMITING VALUES (Absolute max. rating system)

Anode voltage	V_{a0}	max. 600 V
	V_a	max. 275 V
Anode dissipation	W_a	max. 2.0 W
Grid, voltage	$-V_g$	max. 100 V
Grid, peak voltage	$-V_{gp}$	max. 200 V
Max. pulse duration = 10 μs		
Max. duty factor = 0.01		
Grid voltage	$+V_g$	max. 1 V
Grid current	I_g	max. 2 mA
Grid, peak current	I_{gp}	max. 50 mA
Max. pulse duration = 10 μs		
Max. duty factor = 0.01		
Cathode current	I_k	max. 20 mA
Cathode, peak current	I_{kp}	max. 200 mA
Max. pulse duration = 10 μs		
Max. duty factor = 0.01		

LIMITING VALUES (continued)

Voltage between cathode and heater,

Cathode positive (k pos.)

 V_{kf} max. 200 V

Cathode negative (k neg.)

 V_{kf} max. 100 V

Grid resistor with fixed bias

 R_g max. 0.5 M Ω

with automatic bias

 R_g max. 1.0 M Ω

Bulb temperature

 t_{bulb} max. 170 $^{\circ}\text{C}$

Heater voltage: The average heater voltage should be 6.3 V.

Variations of the heater voltage exceeding the range of 6.0 V to 6.6 V will shorten the tube life.

The tolerance of the heater current (column II) should be taken into account.

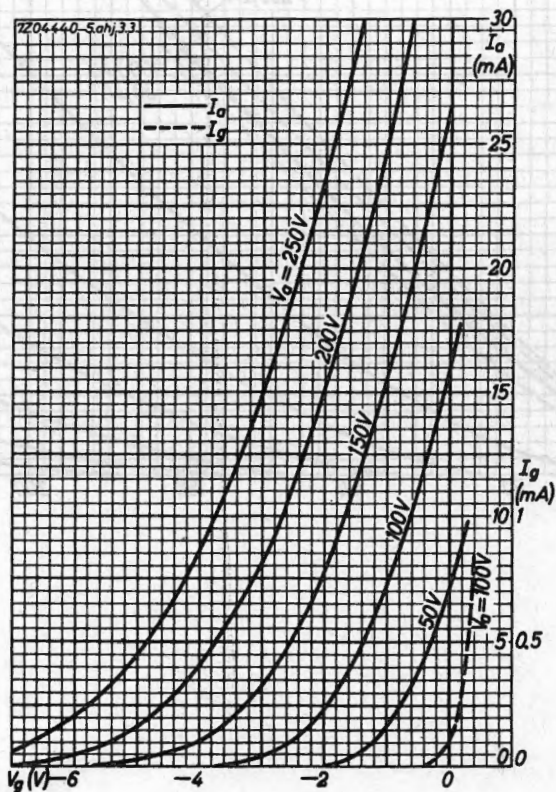

LIMITING VALUES (continued)
 Voltage between cathode and heater
 Cathode positive (+ pos.)
 Cathode negative (- neg.)
 Grid resistor with fixed bias
 with automatic bias
 Ball temperature

max. 300 V
 max. 100 V
 max. 0.2 MΩ
 max. 1.0 MΩ
 max. 170 °C

The average heater voltage should be 6.3 V.
 Variation of the heater voltage exceeding the range of 5.5 V.

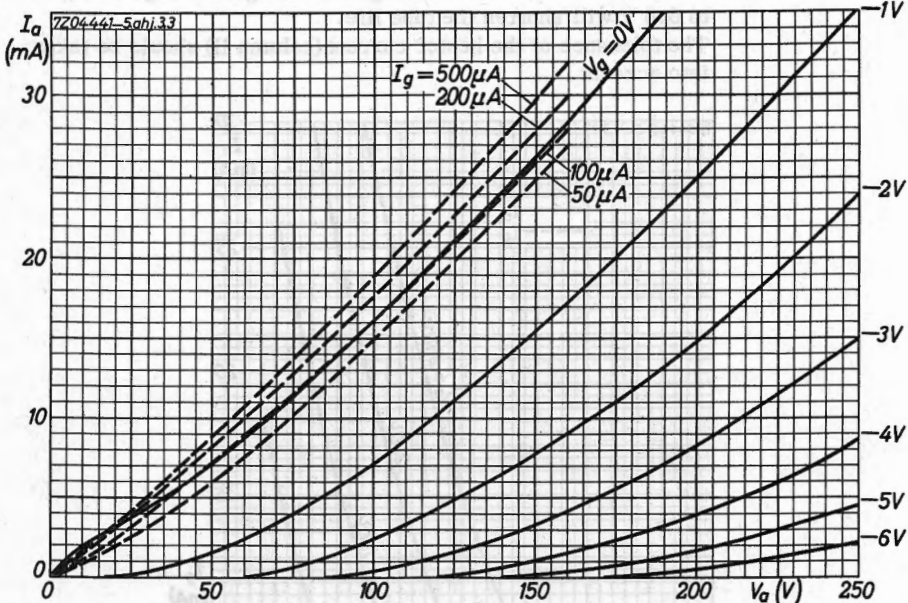

S.Q. TUBE

Special quality pentode designed for use as wide band amplifier.

QUICK REFERENCE DATA

Life test	10 000 hours
Low interface resistance	
Mechanical quality	Shock and vibration resistant
Base	Noval. Gold plated pins
Heating	Indirect A. C. or D. C.; parallel supply
Heater voltage	V_f 6.3 V
Heater current	I_f 300 mA
Anode current	I_a 13 mA
Mutual conductance	S 16.5 mA/V
Equivalent noise resistance	R_{eq} 330 Ω
Hum voltage	V_{g1} max. 100 μ V

DIMENSIONS AND CONNECTIONS

Dimensions in mm

Base: Noval

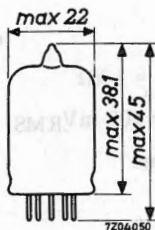
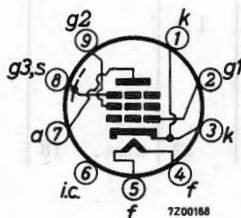

CHARACTERISTICS

- Column I Nominal value or setting of the tube
 II Range values for equipment design: Initial spread
 III Range values for equipment design: End of life

		I	II	III	
Heater voltage	V_f	6.3			V
Heater current	I_f	300	285- 315		mA
Anode supply voltage	V_{ba}	190			V
Grid No.3 voltage	V_{g3}	0			V
Grid No.2 supply voltage	V_{bg2}	160			V
Grid No.1 supply voltage	V_{bg1}	9			V
Cathode resistor	R_k	630			Ω
Anode current	I_a	13	12.2-13.8	min.11.5	mA
Grid No.2 current	I_{g2}	3.3	2.9- 3.7		mA
Mutual conductance	S	16.5	14.2-18.8	min. 11	mA/V
Amplification factor grid No.2 to grid No.1	μ_{g2g1}	50			
Internal resistance	R_i	90	min. 45		k Ω
Equivalent noise resistance	R_{eq}	330	max. 650		Ω
Negative grid No.1 current	$-I_{g1}$		max. 0.5	max. 1.0	μA
<u>Equivalent grid hum voltage</u>	V_{g1}		max. 100		μV_{RMS}
Grid resistor $R_{g1} = 0.5 M\Omega$ Centre tap of heater trans- former grounded					
<u>Distortion</u>	d_2	1.6			%
Load resistor $R_a = 1 k\Omega$ Input voltage $V_i = 100 mV_{RMS}$					
Cathode heating time		12	max. 18		sec

CHARACTERISTICS (continued)

		I	II	
Anode supply voltage	V_{ba}	180		V
Grid No.3 voltage	V_{g3}	0		V
Grid No.2 supply voltage	V_{bg2}	150		V
Cathode resistor	R_k	100		Ω
Anode current	I_a	11.5		mA
Grid No.2 current	I_{g2}	2.9		mA
Mutual conductance	S	15.5		mA/V
<u>Cut-off voltage</u>	$-V_{g1}$		max. 4.5	V
Anode voltage	V_a	180		V
Grid No.2 voltage	V_{g2}	150		V
Grid No.3 voltage	V_{g3}	0		V
Anode current	I_a	0.8		mA
<u>Start of grid No.1 current</u>	$-V_{g1}$		max. 0.5	V
Grid No.1 current $I_{g1} = 0.3 \mu A$				
<u>Input resistance</u>	r_{g1}	2000		Ω
Frequency = 100 MHz				
<u>Phase angle of the slope</u>		9		$^\circ$
Frequency = 50 MHz				
Pin 1 connected to pin 3				
<u>Leakage current between cathode and heater</u>	I_{kf}		max. 15	μA
Voltage between cathode and heater $V_{kf} = 60 V$				
<u>Insulation resistance between two electrodes</u>			min. 20	M Ω

CHARACTERISTICS AS TRIODE

(g₂ connected to anode)

		I	II
Anode supply voltage	V _{ba}	160	V
Grid No.3 voltage	V _{g3}	0	V
Grid No.1 voltage	+V _{bg1}	9	V
Cathode resistor	R _k	620	Ω
Anode current	I _a	16.5	mA
Mutual conductance	S	21	mA/V
Amplification factor	μ	50	
Internal resistance	R _i	2.4	kΩ
Equivalent noise resistance	R _{eq}	225	Ω

CAPACITANCES . With external shield

Anode to grid No.3, grid No.2, cathode and heater	C _{a/g3g2kf}	3	2.5 - 3.5	pF ¹⁾
Grid No.1 to grid No.3, grid No.2, cathode and heater				
(I _k = 0 mA) :	C _{g1/g3g2kf}	7.5	6.6 - 8.4	pF ¹⁾
(I _k = 16.3 mA, f = 100 MHz) :	C _{g1/g3g2kf}	11.1		pF ¹⁾
Anode to grid No.1	C _{ag1}	0.018	max. 0.03	pF
Anode to cathode	C _{ak}		max. 0.1	pF
Grid No.1 to heater	C _{g1f}		max. 0.1	pF

SHOCK AND VIBRATION RESISTANCE

The following test conditions are applied to assess the mechanical quality of the tube. These conditions are not intended to be used as normal operating conditions.

Shock

The tube is subjected 5 times in each of 4 positions to an acceleration of 500 g supplied by an NRL shock machine with the hammer lifted over an angle of 30°.

Vibration

The tube is subjected during 32 hours in each of 3 positions to a vibration frequency of 50 Hz with an acceleration of 2.5 g.

¹⁾ Pin No.6 left floating

LIFE

Production samples are tested to be within the end of life values (column III) under the following conditions during 10 000 hours.

Anode supply voltage	V_{ba}	190	V
Grid No. 3 voltage	V_{g3}	0	V
Grid No. 2 supply voltage	V_{bg2}	160	V
Grid No. 1 supply voltage	$+V_{bg1}$	9	V
Cathode resistor	R_k	630	Ω

LIMITING VALUES (Absolute max. rating system)

Anode voltage	V_{a0}	max.	400	V
	V_a	max.	210	V
Anode dissipation	W_a	max.	3	W
	V_{g20}	max.	400	V
Grid No. 2 voltage	V_{g2}	max.	175	V
	W_{g2}	max.	0.9	W
Grid No. 2 dissipation	I_k	max.	25	mA
Cathode current	$+V_{g1}$	max.	0	V
	$-V_{g1}$	max.	50	V
Grid No. 1 voltage	$-V_{g1p}$	max.	100	V
	R_{g1}	max.	0.25	$M\Omega$
Grid resistor, fixed bias	R_{g1}	max.	0.5	$M\Omega$
	V_{kf}	max.	60	V
Voltage between cathode and heater	t_{bulb}	max.	155	$^{\circ}C$
Bulb temperature				

Heater voltage: The average heater voltage should be 6.3 V.

Variations of the heater voltage exceeding the range of 6.0 V to 6.6 V will shorten the tube life.

The tolerance of heater current (column II) should be taken into account.

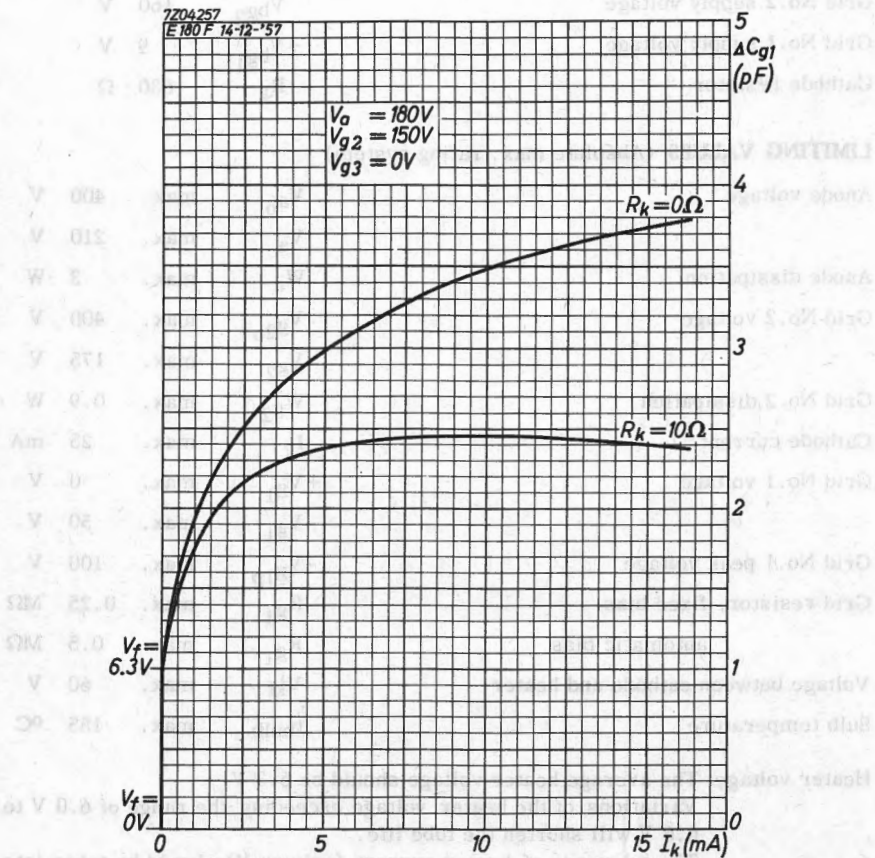

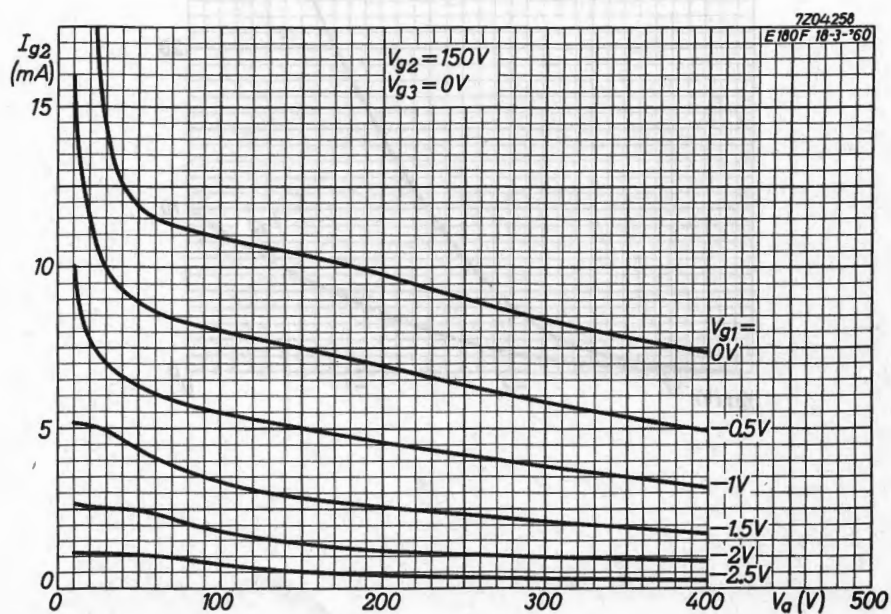
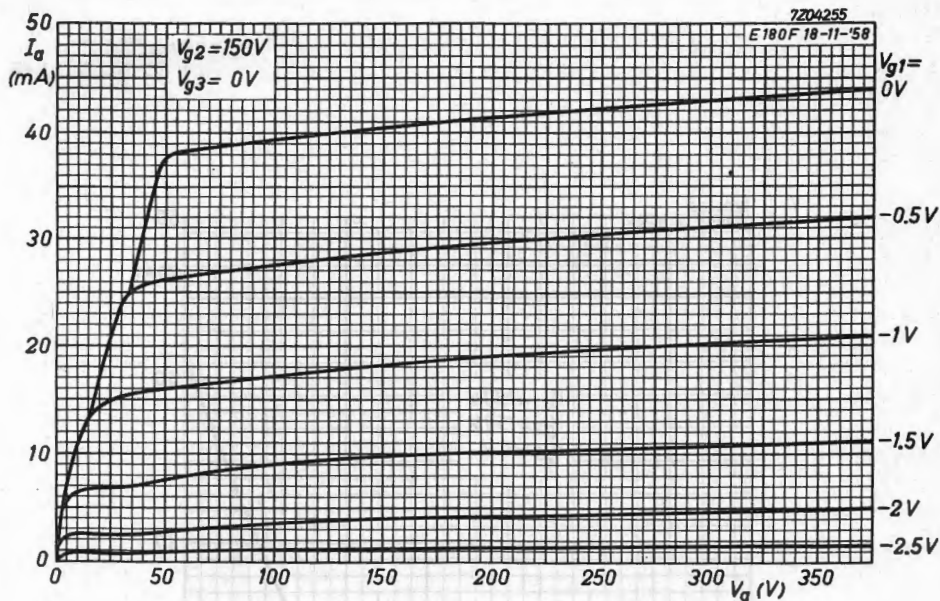

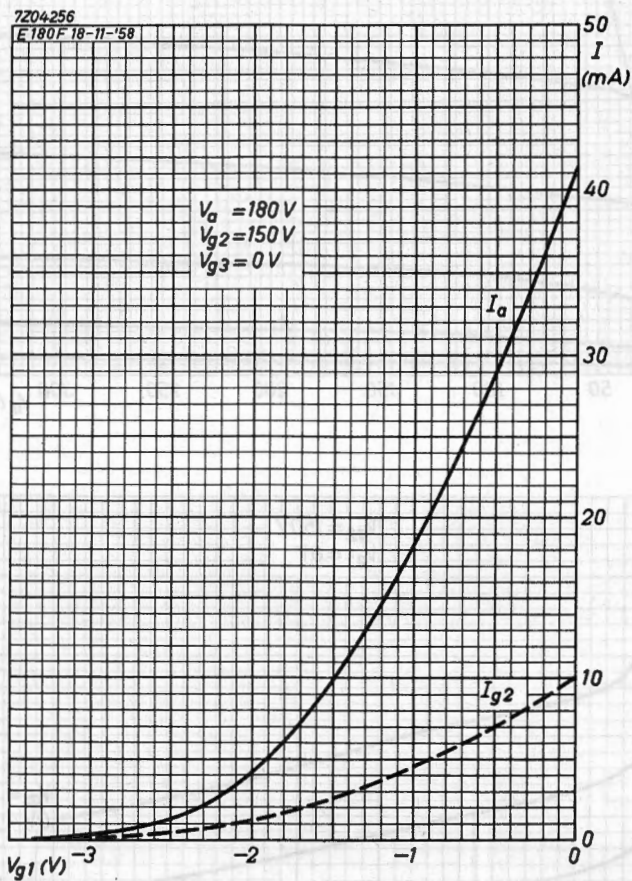

S.Q. TUBE

Special quality double triode designed for use in computer circuits.

QUICK REFERENCE DATA

Life test	10 000 hours	
Low interface resistance		
Base	Noval	
Heating	Indirect	
	A.C. or D.C.; Parallel supply	
Heater voltage	V_f	6.3 or 12.6 V
Heater current	I_f	640 or 320 mA
Anode current	I_a	36 mA
Mutual conductance	S	15 mA/V

DIMENSIONS AND CONNECTIONS

Dimensions in mm

Base: Noval

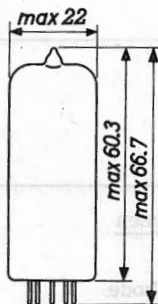
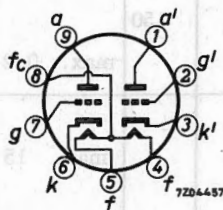

CHARACTERISTICS

Column I Nominal value or setting of the tube

II Range values for equipment design: Initial spread

III Range values for equipment design: End of life

		I	II	III	
Heater voltage (pin 8 and 4 + 5)	V_f	6.3			V
Heater current	I_f	640	605- 675		mA
Heater voltage (pin 4 and 5)	V_f	12.6			V
Heater current	I_f	320			mA
Anode voltage	V_a	120			V
Grid voltage	$-V_g$	2			V
Anode current	I_a	36	26- 45		mA
Mutual conductance	S	15			mA/V
Amplification factor	μ	24			
Negative grid current	$-I_g$		max. 0.2	max.1.0	μ A
Anode voltage	V_a	120			V
Cathode resistor	R_k	55			Ω
Mutual conductance	S	15	11.2-18.8	min. 8	mA/V
Anode voltage	V_a	90			V
Grid current	I_g	250			μ A
Anode current	I_a		41- 62	min. 24	mA
<u>Cut-off voltage</u>	$-V_g$	14			V
Anode voltage	V_a	150			V
Anode current	I_a		max. 0.2		mA
<u>Leakage current between cathode and heater</u>	I_{kf}		max. 15	max. 30	μ A
Voltage between cathode and heater = 200 V					
<u>Insulation resistance between two electrodes</u>			min. 100	min. 20	M Ω

CAPACITANCES Each system if applicable

		I	II	
Anode to cathode and heater	$C_{a/kf}$	1.1	0.75-1.45	pF
	$C_{a'/'kf}$	1.0	0.65-1.35	pF
Grid to cathode and heater	$C_{g/kf}$	6.0	5.3- 6.7	pF
Anode to grid	C_{ag}	4.0	3.4- 4.6	pF
	$C_{a'g'}$	4.4	3.4- 4.8	pF
Cathode to heater	C_{kf}	4.0		pF
Anode to anode other section	$C_{aa'}$	0.6	max. 0.8	pF
Grid to grid other section	$C_{gg'}$		max. 0.15	pF
Anode to grid other section	$C_{ag'}$		max. 0.1	pF

LIFE

Production samples are tested to be within the end of life values (column III) during 10 000 hours under the following conditions.

Anode supply voltage	V_{ba}	150 V
Anode resistor	R_a	1.5 k Ω
Grid supply voltage	V_{bg}	150 V
Grid resistor	R_g	62 k Ω
Voltage between cathode and heater (cath. neg.)	V_{kf}	120 V

LIMITING VALUES (Absolute max. rating system)

Anode voltage	V_{a0}	max. 600 V
	V_a	max. 300 V
Anode dissipation	W_a	max. 4.5 W
Anode dissipation (both sections)	$W_{a+a'}$	max. 8.0 W
Grid voltage	$-V_g$	max. 100 V
	$+V_g$	max. 1 V

LIMITING VALUES (continued)

Grid voltage, peak	$+V_{gp}$	max.	30 V
	$-V_{gp}$	max.	200 V
Pulse duration max. 10 μ s			
Duty factor max. 0.01			
Grid current	I_g	max.	8 mA
Grid peak current	I_{gp}	max.	200 mA
Pulse duration max. 10 μ s			
Duty factor max. 0.01			
Cathode current	I_k	max.	60 mA
Cathode peak current	I_{kp}	max.	400 mA
Pulse duration max. 10 μ s			
Duty factor max. 0.01			
Voltage between cathode and heater d.c. component	V_{kf}	max.	200 V
	V_{kf}	max.	120 V
Bulb temperature	t_{bulb}	max.	160 °C
Grid resistor with automatic bias	R_g	max.	1 M Ω
Grid resistor with fixed bias	R_g	max.	0.5 M Ω

Heater voltage: The average heater voltage should be 6.3/12.6 V.

Variations of the heater voltage exceeding the range of 6.0/12.0 V to 6.6/13.2 V will shorten the tube life.

The tolerance of heater current (column II) should be taken into account.

7204454-5.ahb33

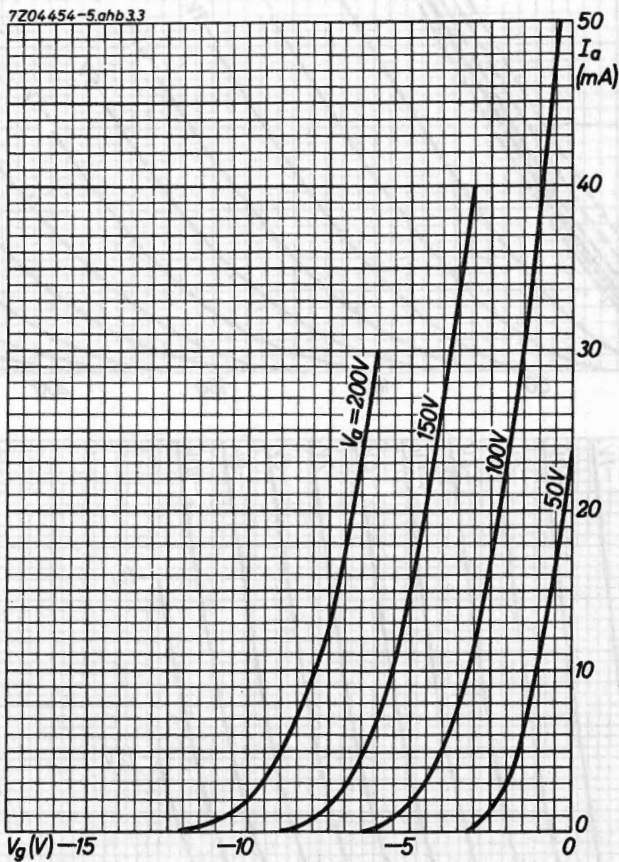

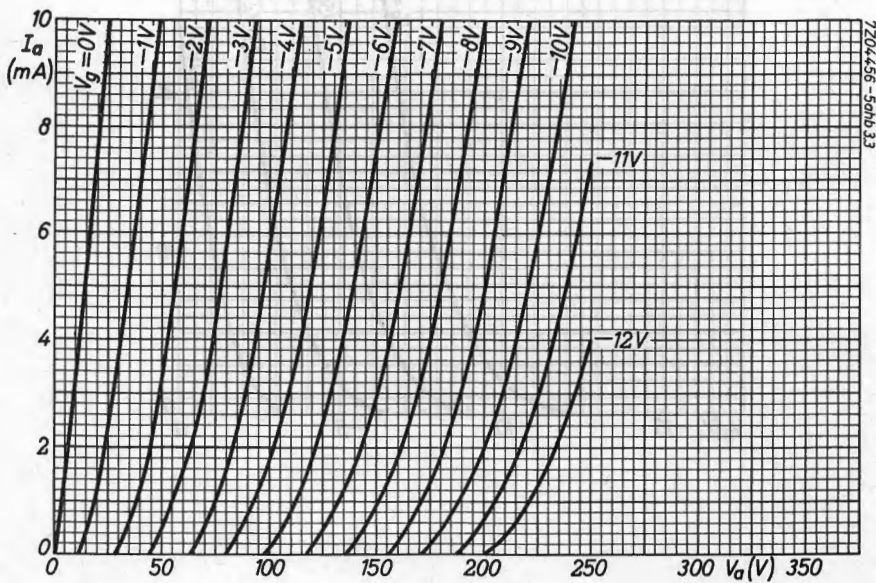
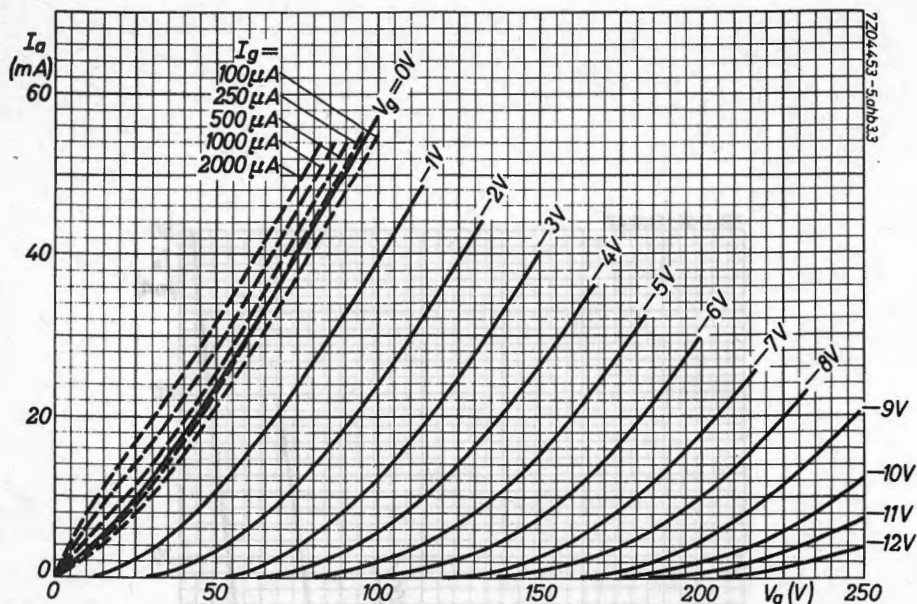

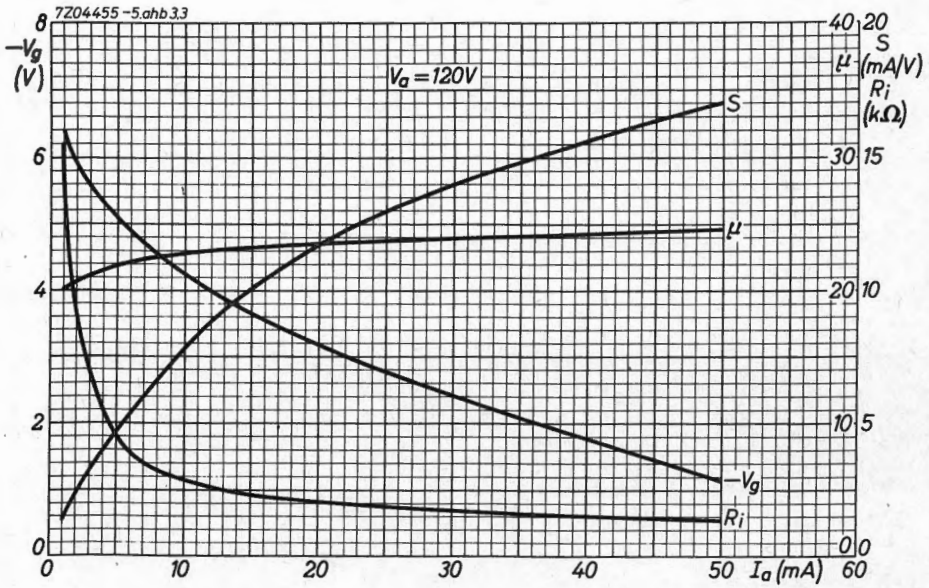

S.Q. TUBE

Special quality pentode designed for use as broad band amplifier.

QUICK REFERENCE DATA

Life test	10 000 hours
Mechanical quality	Shock and vibration resistant
Low microphony level	
Base	Noval
Heating	Indirect a. c. or d. c. ; parallel supply
Heater voltage	V_f 6.3 V
Heater current	I_f 320 mA
Anode current	I_a 13 mA
Mutual conductance	S 16.5 mA/V
Equivalent noise resistance	R_{eq} 330 Ω
Hum voltage	V_{g1} <100 μ V

DIMENSIONS AND CONNECTIONS

Dimensions in mm

Base: Noval

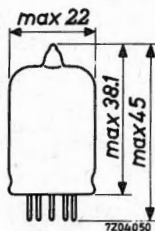
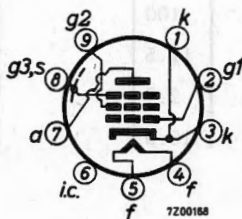

CHARACTERISTICS

Column I Nominal value or setting of the tube

II Range values for equipment design: Initial spread

III Range values for equipment design: End of life

		I	II	III	
Heater voltage	V_f	6.3			V
Heater current	I_f	320	300- 340		mA
Anode supply voltage	V_{ba}	190			V
Grid No.3 voltage	V_{g3}	0			V
Grid No.2 supply voltage	V_{bg2}	160			V
Grid No.1 supply voltage	$+V_{bg1}$	9			V
Cathode resistor	R_k	630			Ω
Anode current	I_a	13	12.2-13.8	min.11.5	mA
Grid No.2 current	I_{g2}	3.3	2.9- 3.7		mA
Mutual conductance	S	16.5	14.2-18.6	min. 11	mA/V
Amplification factor grid No.2 to grid No.1	μ_{g2g1}	53			
Internal resistance	R_i	100			k Ω
<u>Equivalent noise resistance</u> frequency 45 MHz	R_{eq}	330			Ω
<u>Negative grid No.1 current</u>	$-I_{g1}$		max. 0.2	max.0.5	μA
Anode supply voltage	V_{ba}	180			V
Grid No.3 voltage	V_{g3}	0			V
Grid No.2 supply voltage	V_{bg2}	150			V
Cathode resistor	R_k	100			Ω
Anode current	I_a	11.5			mA
Grid No.2 current	I_{g2}	2.9			mA
Mutual conductance	S	15.5			mA/V

CHARACTERISTICS (continued)

	I	II	III
<u>Cut-off voltage</u>	$-V_{g1}$	4.5	V
<u>Anode voltage</u>	V_a	180	V
<u>Grid No.3 voltage</u>	V_{g3}	0	V
<u>Grid No.2 voltage</u>	V_{g2}	150	V
<u>Anode current</u>	I_a	max.0.8	mA
<u>Leakage current between cathode and heater</u>	I_{kf}	max. 10	max. 20 μ A
Voltage between cathode and heater $V_{kf} = 100$ V			
<u>Insulation resistance between two electrodes</u>	R_{ins}	min. 100	min. 50 $M\Omega$
Voltage between electrodes = 100 V			
<u>Hum voltage</u>	V_{g1}	max. 100	μ V
Grid No.1 resistor $R_{g1} = 0.5 M\Omega$			
Centre tapping of heater transformer grounded			
Cathode resistor by-passed			
<u>Vibrational noise output</u>			
With vibration frequency = 50-2000 Hz	V_{g1}	max. 500	mV_{RMS}
With vibration frequency = 50 Hz	V_{g1}	max. 200	mV_{RMS}
Anode supply voltage $V_{b_a} = 216$ V			
Anode resistor $R_a = 2 k\Omega$			
Grid No.2 supply voltage $V_{b_{g2}} = 160$ V			
Grid No.3 voltage $V_{g3} = 0$ V			
Cathode resistor $R_k = 630 \Omega$ (not by-passed)			
Grid No.1 supply voltage $+V_{b_{g1}} = 9$ V			
Acceleration (peak value) = 10 g			

CAPACITANCES . With external shieldAnode to grid No.3, grid No.2
cathode, heater and screenGrid No.1 to grid No.3, grid No.2
cathode, heater and screen

Anode to grid No.1

	I	II	
C_{a/g_3g_2kfs}	3.45		pF
C_{g_1/g_3g_2kfs}	7.6		pF
C_{ag_1}		max.0.03	pF

SHOCK AND VIBRATION RESISTANCE

The following test conditions are applied to assess the mechanical quality of the tube. These conditions are not intended to be used as normal operating conditions.

Shock

The tube is subjected 5 times in each of 4 positions to an acceleration of 500 g supplied by an NRL shock machine with the hammer lifted over an angle of 30°.

Vibration

The tube is subjected during 32 hours in each of 3 positions to a vibration frequency of 50 Hz with an acceleration of 2.5 g.

LIFE

Production samples are tested to be within the end of life values (column III) under the following conditions during 10000 hours.

Anode supply voltage

 V_{ba} 190 V

Grid No.3 voltage

 V_{g_3} 0 V

Grid No.2 voltage

 V_{g_2} 160 V

Grid No.1 supply voltage

 $+V_{bg_1}$ 9 V

Cathode resistor

 R_k 630 Ω Voltage between cathode and
heater (cathode negative) V_{kf} 70 V

LIMITING VALUES (Absolute max. rating system)

Anode voltage	V_{a0}	max.	400 V
	V_a	max.	210 V
Anode dissipation	W_a	max.	3 W
Grid No.2 dissipation	W_{g2}	max.	0.7 W
Grid No.2 voltage	V_{g20}	max.	400 V
	V_{g2}	max.	175 V
Grid No.1 voltage	positive	$+V_{g1}$	max. 0 V
	negative	$-V_{g1}$	max. 50 V
	negative peak	$-V_{g1p}$	max. 100 V
Grid No.1 resistor	fixed bias	R_{g1}	max. 0.25 M Ω
	automatic bias	R_{g1}	max. 0.5 M Ω
Cathode current	I_k	max.	25 mA
Voltage between cathode and heater	V_{kf}	max.	60 V
Bulb temperature	t_{bulb}	max.	165 °C

Heater voltage: The average heater voltage should be 6.3 V.

Variation of the heater voltage exceeding the range of 6.0 V to 6.6 V will shorten the tube life.

The tolerance of heater current (column II) should be taken into account.

7Z04052-5.chf.6.

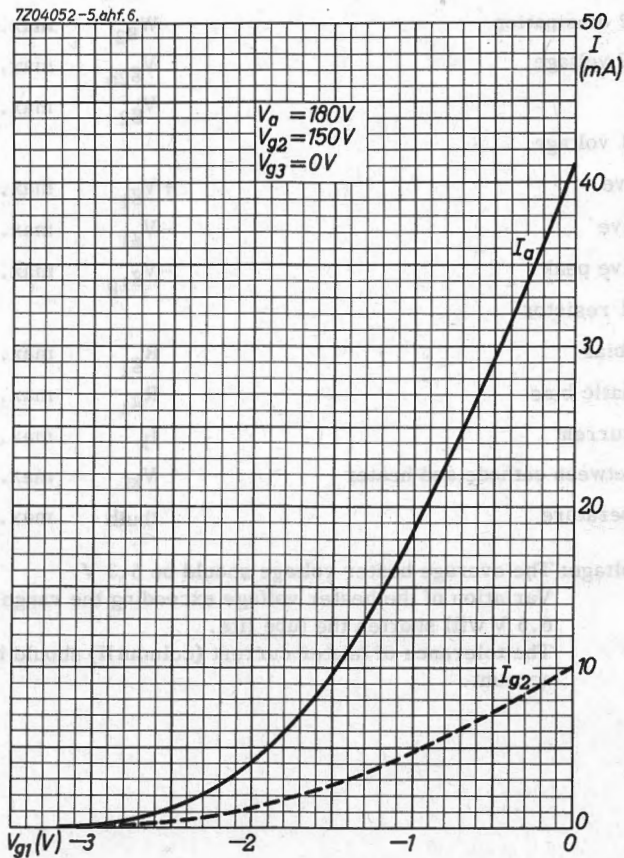

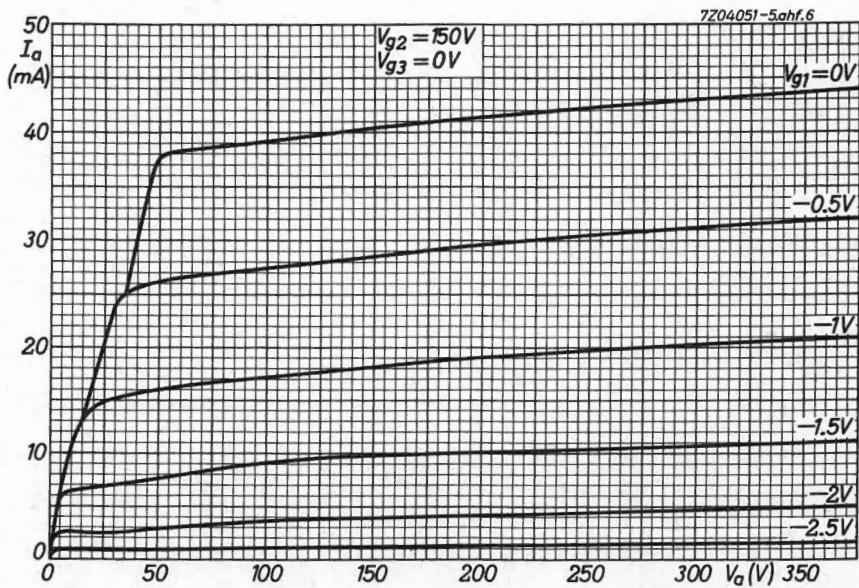

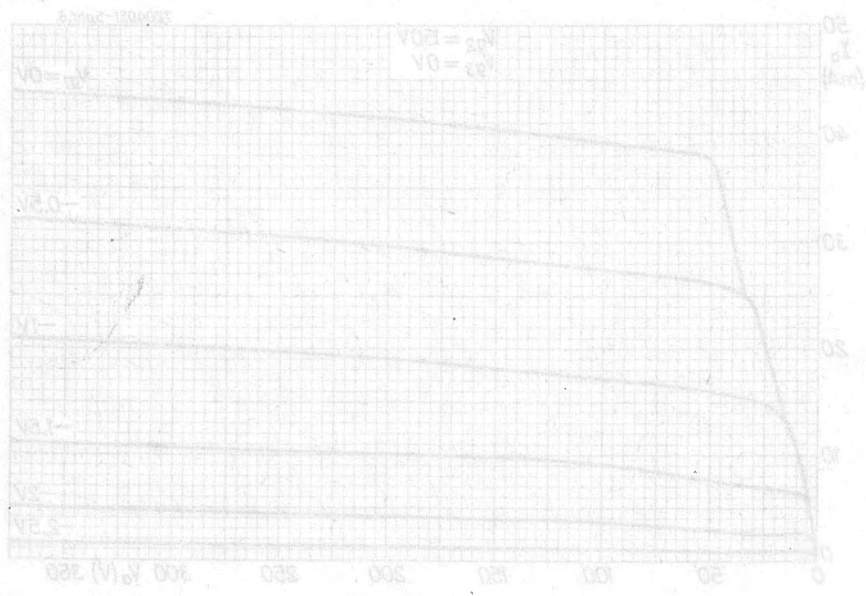

S.Q. TUBE

Special quality double triode designed for use as cascode amplifier, cathode follower etc. in R.F. and A.F. circuits.

QUICK REFERENCE DATA

Life test	10 000 hours
Low interface resistance	
Mechanical quality	Shock and vibration resistant
Base	Noval. Gold plated pins
Heating	Indirect A.C. or D.C.; parallel supply
Heater voltage	V_f 6.3 V
Heater current	I_f 335 mA
Anode current	I_a 15 mA
Mutual conductance	S 12.5 mA/V
Equivalent noise resistance	R_{eq} 250 Ω
Noise factor ($f = 200$ MHz)	F 4.6 dB
Hum voltage	V_g max. 50 μV_{RMS}

DIMENSIONS AND CONNECTIONS

Base: Noval

Dimensions in mm

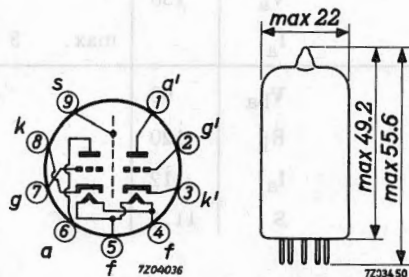

CHARACTERISTICS

Column I Nominal value or setting of the tube

II Range values for equipment design: Initial spread

III Range values for equipment design: End of life

		I	II	III	
Heater voltage	V_f	6.3			V
Heater current	I_f	335	318- 352		mA
Anode supply voltage	V_{ba}	100			V
Grid supply voltage	$+V_{bg}$	9			V
Cathode resistor	R_k	680			Ω
Anode current	I_a	15	14.2-15.8	min. 13.5	mA
Mutual conductance	S	12.5	10.5-14.5	min. 9	mA/V
Amplification factor	μ	33			
<u>Negative grid current</u>	$-I_g$		max. 0.1	max. 1.0	μA
<u>Equivalent noise resistance</u>	R_{eq}	250			Ω
Frequency $f = 45$ MHz					
<u>Noise factor in cascode circuit, adapted to minimum noise</u>	F	4.6.			dB
Frequency $f = 200$ MHz					
<u>Input resistance</u>	r_g	3			k Ω
Frequency $f = 100$ MHz					
<u>Cut off voltage</u>	$-V_{g1}$	15			V
Anode voltage	V_a	150			V
Anode current	I_a		max. 5		mA
Anode supply voltage	V_{ba}	90			V
Cathode resistor	R_k	120			Ω
Anode current	I_a	12			mA
Mutual conductance	S	11.5			mA/V

CHARACTERISTICS (continued)

	I	II	III	
<u>Leakage current between cathode and heater</u> Voltage between cathode and heater $V_{kf} = 60$ V (k neg) or = 120 V (k pos)	I_{kf}	max. 6	max. 12	μA
<u>Insulation resistance between two electrodes</u> Voltage between electrodes $V = 200$ V	R	min. 100	min. 20	$M\Omega$
<u>Hum voltage</u> Grid resistor $R_{g1} = 0.5$ $M\Omega$	V_g	max. 50		μV_{RMS}
<u>Vibrational noise output</u> Anode supply voltage $V_{ba} = 100$ V Anode resistor $R_a = 2$ $k\Omega$ Grid supply voltage + $V_{bg} = 9$ V Cathode resistor $R_k = 680$ Ω (by passed) Vibration frequency $f = 10-50$ Hz Acceleration = 2.5 g	V_g	max. 100		mV
<u>Vibrational noise output</u> Anode supply voltage $V_{ba} = 270$ V Anode resistor $R_a = 18$ $k\Omega$ Grid resistor $R_g = 1$ $M\Omega$ Cathode resistor $R_k = 180$ Ω By pass capacitor $C_k = 50$ μF Vibration frequency $f = 50-5000$ Hz Acceleration = 0.5 g	V_g	max. 140		mV

CAPACITANCES. Both sections if not otherwise indicated.

		I,	II	
Anode to cathode, heater and screen	C_a/kfs	1.75	1.55 - 1.95	pF
	$C_a'/k'fs$	1.65	1.45 - 1.85	pF
Anode to cathode and heater	C_a/kf	0.5	0.4 - 0.6	pF
	$C_a'/k'f$	0.4	0.3 - 0.5	pF
Grid to cathode, heater and screen	C_g/kfs	3.3	2.7 - 3.9	pF
Grid to cathode and heater	C_g/kf	3.3	2.7 - 3.9	pF
Anode to grid	C_{ag}	1.4	1.2 - 1.6	pF
Anode to cathode	C_{ak}	0.18	0.14 - 0.22	pF
Cathode to heater	C_{kf}	2.6		pF
	$C_{k'f}$	2.7		pF
Anode to screen	C_{as}	1.3	1.1 - 1.5	pF
Anode to grid, heater and screen	C_a/gfs	3.0	2.7 - 3.3	pF
	C_a'/gfs	2.9	2.6 - 3.2	pF
Cathode to grid, heater and screen	C_k/gfs	6.0	5.1 - 6.9	pF
Anode to anode other section	$C_{aa'}$	0.025	max.0.045	pF
Grid to grid other section	$C_{gg'}$		max.0.005	pF
Anode to grid other section	$C_{ag'}$		max.0.005	pF
Grid to anode other section	$C_{ga'}$		max.0.005	pF
Grid to cathode other section	$C_{gk'}$		max.0.005	pF
Cathode to grid other section	$C_{kg'}$		max.0.005	pF

SHOCK AND VIBRATION RESISTANCE

The following test conditions are applied to assess the mechanical quality of the tube. These conditions are not intended to be used as normal operating conditions.

Shock

The tube is subjected 5 times in each of 4 positions to an acceleration of 500 g supplied by an NRL shock machine with the hammer lifted over an angle of 30°.

Vibration

The tube is subjected during 32 hours in each of 3 positions to a vibration frequency of 50 Hz with an acceleration of 2.5 g.

LIFE

Production samples are tested to be within the end of life values (column III) under the following conditions during 10 000 hours.

Anode supply voltage	V_{ba}	100 V
Grid supply voltage	$+V_{bg}$	9 V
Cathode resistor	R_k	680 Ω
Grid resistor	R_g	47 k Ω
Cathode to heater voltage (k neg)	V_{kf}	60 V

LIMITING VALUES (Absolute max. rating system)

Anode voltage	V_{a0}	max. 550 V
	V_a	max. 250 V
Anode voltage (Zero anode current)	$V_a(I_a = 0)$	max. 400 V
Anode dissipation	W_a	max. 1.65 W
	W_a'	max. 2.0 W
Both sections	$W_{a+a'}$	max. 2.2 W
Grid dissipation	W_g	max. 30 mW
Grid voltage	$-V_g$	max. 110 V
Grid peak voltage	$-V_{gp}$	max. 200 V
Pulse duration max.		200 μ s
Duty factor max.		0.1
Cathode current	I_k	max. 22 mA
Cathode peak current	I_{kp}	max. 110 mA
Pulse duration max.		200 μ s
Duty factor max.		0.1%
Voltage between cathode and heater		
cathode positive	$V_{kf}(k \text{ pos})$	max. 150 V
cathode negative	$V_{kf}(k \text{ neg})$	max. 100 V
Bulb temperature	t_{bulb}	max. 165 $^{\circ}$ C
Grid resistor with fixed bias	R_g	max. 0.5 M Ω
with automatic bias	R_g	max. 1.0 M Ω

LIMITING VALUES (continued)

Heater voltage: The average heater voltage should be 6.3 V. Variations of the heater voltage exceeding the range of 6.0 V to 6.6 V will shorten the tube life. The tolerance of heater current (column II) should be taken into account.

OPERATING CHARACTERISTICS

Additive mixer

Anode supply voltage	V_{ba}	60	90	150	V
Anode resistor	R_a	0	1	3.9	k Ω
Grid resistor	R_g	1	1	1	M Ω
Grid oscillator voltage	V_{osc}	2	2.5	3	V _{RMS}
Anode current	I_a	4.7	7.7	11	mA
Conversion conductance	S_c	2.9	3.5	4.1	mA/V
Internal resistance	R_i	8.3	7	6.1	k Ω

Output tube class A

Anode voltage	V_a		220		V
Load resistance	$R_{a\sim}$		20		k Ω
Negative grid voltage	$-V_g$		6.5		V
Input voltage	V_i	0	1.5	4.5	V _{RMS}
Anode current	I_a	6.5	-	9.2	mA
Output power	W_o	-	0.05	0.5	W
Total distortion	dt_{tot}			7	%

Output tube class B (two units). Constant sinusoidal input voltage (single tone).

Anode voltage	V_a		200		V
Load resistance	$R_{aa\sim}$		22		k Ω
Negative grid voltage	$-V_g$		6		V
Input voltage	V_i	0	0.9	4.0	V _{RMS}
Anode current	I_a	2x5	-	2x9	mA
Output power	W_o	-	0.05	1.2	W
Total distortion	dt_{tot}	-	-	3	%

OPERATING CHARACTERISTICS (continued)

Output tube class B (two units). Speech and music input voltage

Anode voltage	V_a	200	V
Load resistance	$R_{aa\sim}$	10	$k\Omega$
Negative grid voltage	$-V_g$	6 V	
Input voltage	V_i	0 0.9 4.0	V_{RMS}
Anode current	I_a	2x5 - 2x13.5	mA
Output power	W_o	- 0.05 1.5	W
Total distortion	d_{tot}	- -	4 %

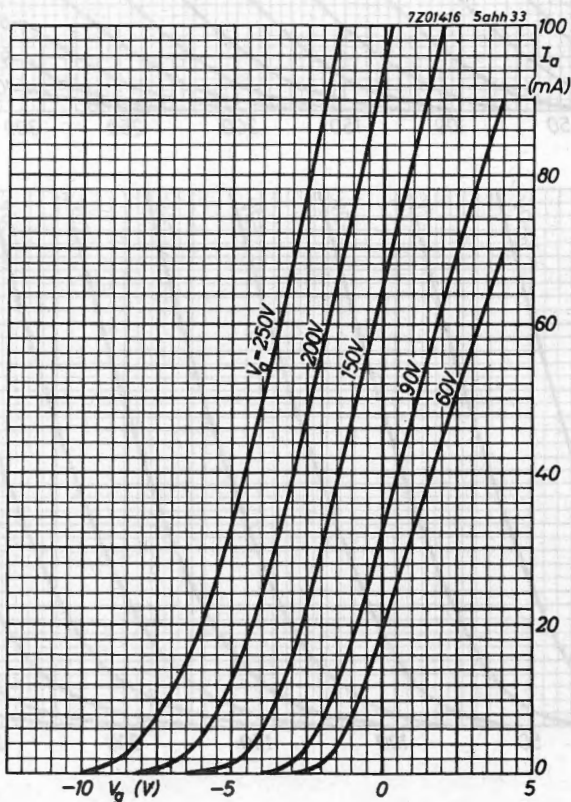

7201415 5ahh33

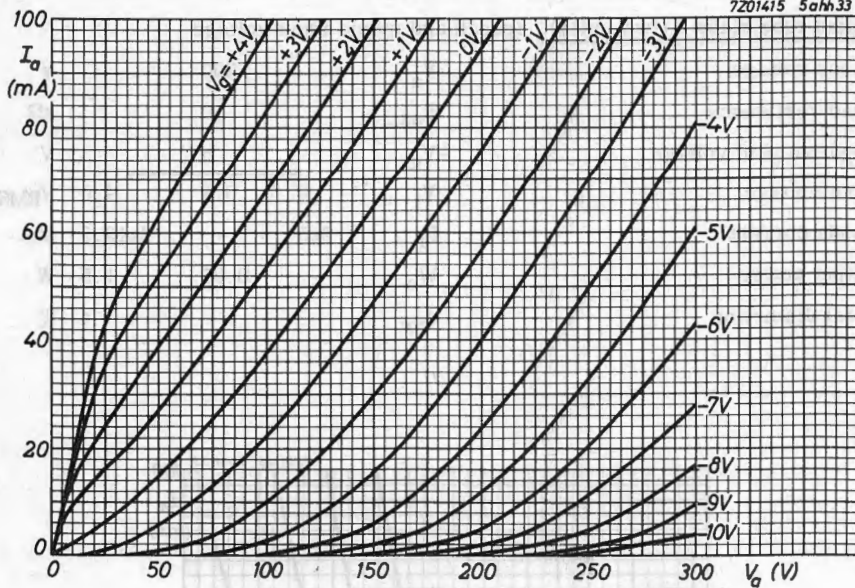

7201417 5ahh33

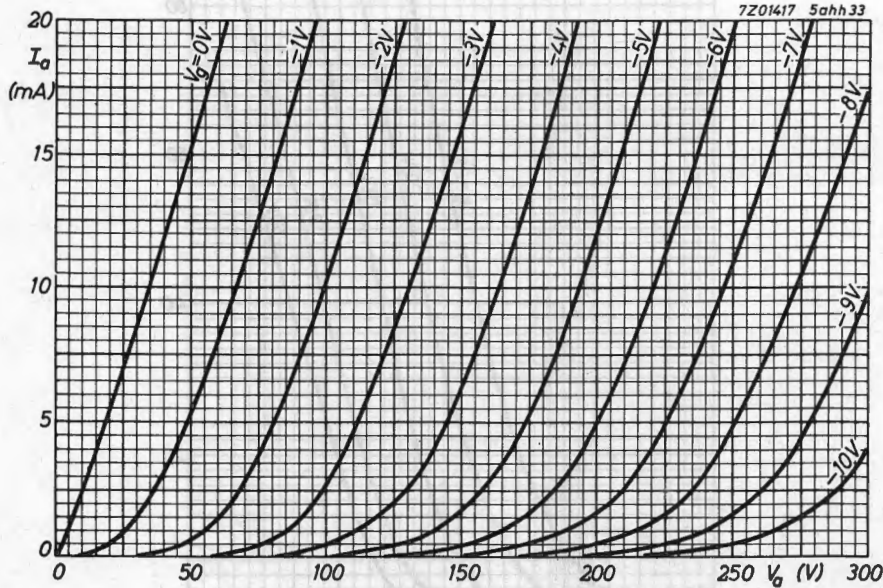

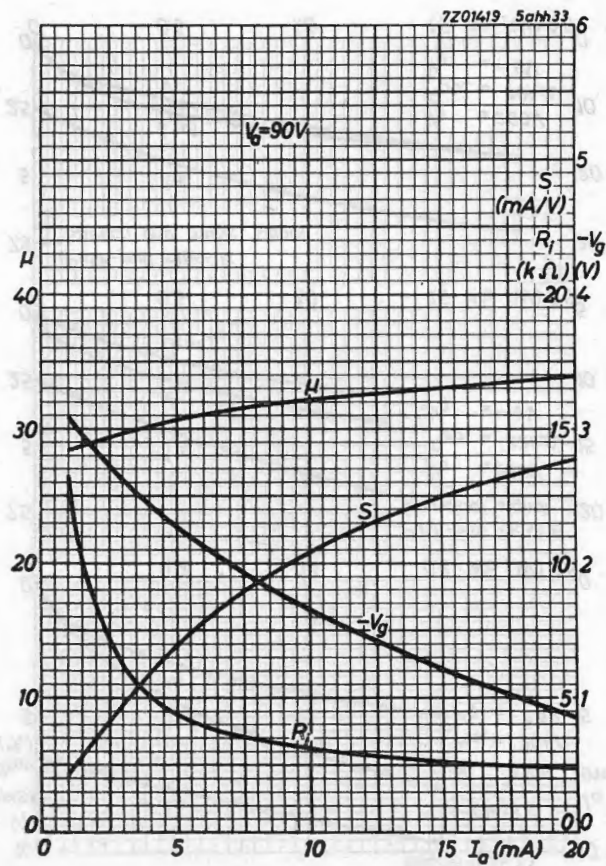
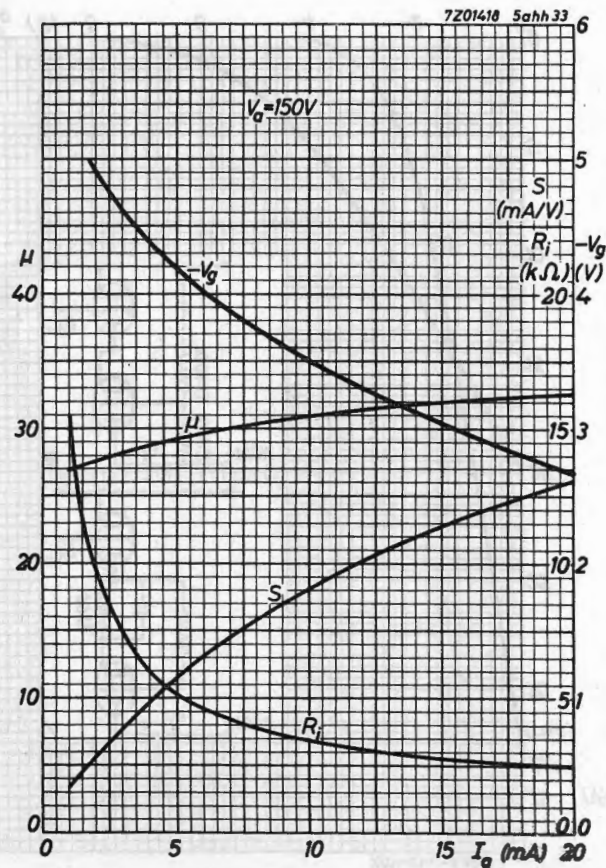

7204034-5, hh.3.3.

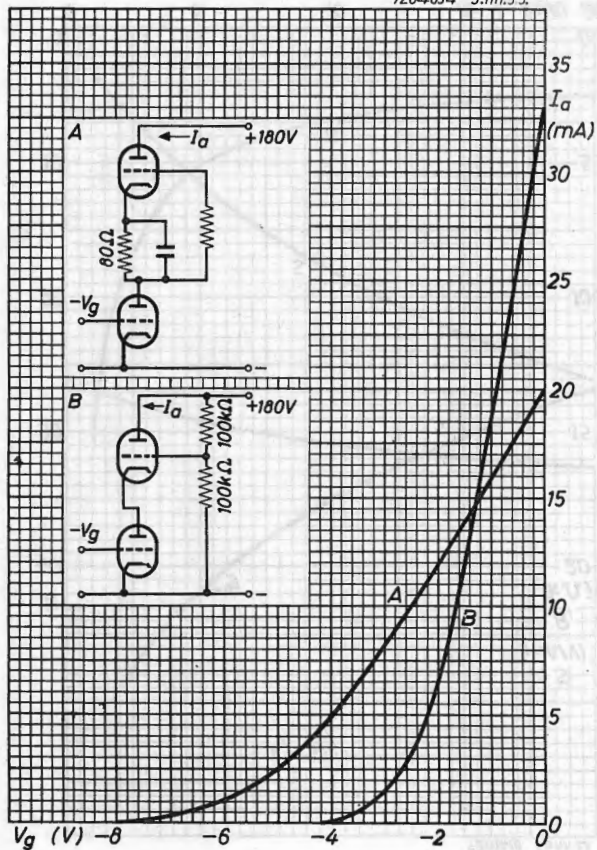

7204035-5, hh.3.3.

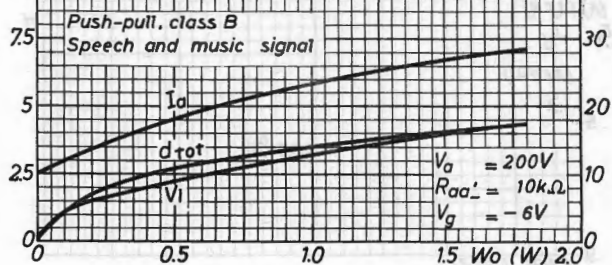
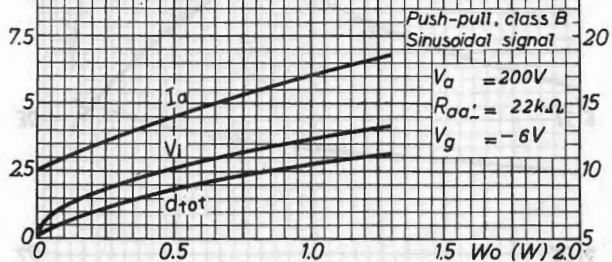
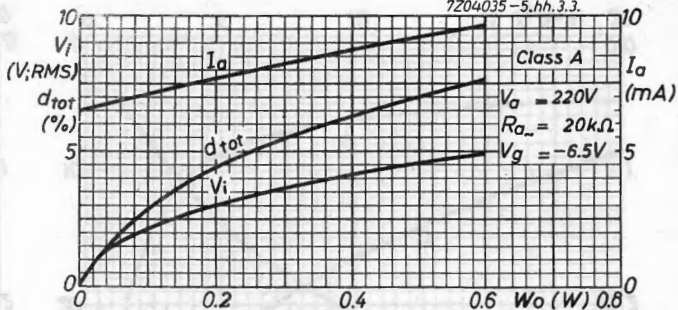

S.Q. TUBE

Special quality tube designed for use as wide band amplifier, power output tube and series regulator tube.

QUICK REFERENCE DATA

Life test	10 000 hours
Low interface resistance	
Mechanical quality	Shock and vibration resistant
Base	Octal
Heating	Indirect
	A.C. or D.C.; Parallel supply
Heater voltage	V_f 6.3 V
Heater current	I_f 1.2 A
Anode current	I_a 100 mA
Mutual conductance	S 14 mA/V
Output power. Class B (two tubes)	W_o 30 W

DIMENSIONS AND CONNECTIONS

Dimensions in mm

Base: Octal

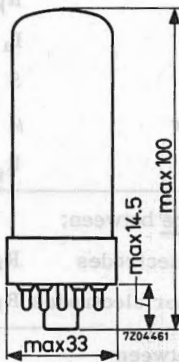
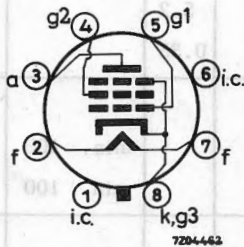

CHARACTERISTICS

Column I Nominal value or setting of the tube

II Range values for equipment design: Initial spread

III Range values for equipment design: End of life

		I	II	III	
Heater voltage	V_f	6.3			V
Heater current	I_f	1.2	1.12-1.28		A
Anode voltage	V_a	100			V
Grid No.2 voltage	V_{g2}	100			V
Cathode resistor	R_k	75			Ω
Anode current	I_a	100	85- 118	min. 65	mA
Grid No.2 current	I_{g2}	5.2	4.0- 6.5		mA
Mutual conductance	S	14	11.5-16.5	min. 9.5	mA/V
Amplification factor	μ_{g2g1}	5.6			
Internal resistance	R_i	5.0			k Ω
<u>Cut off voltage</u>	$-V_{g1}$	35			V
Anode current	I_a	0.1			mA
<u>Negative grid current</u>	$-I_{g1}$		max. 1	max. 2	μ A
<u>As triode.</u> (Grid No.2 connected to anode)					
Anode voltage	V_a	100			V
Cathode resistor	R_k	85			Ω
Anode current	I_a	100			mA
Mutual conductance	S	14			mA/V
Amplification factor	μ	5.2			
Internal resistance	R_i	0.35			k Ω
<u>Insulation resistance between;</u>					
Anode and other electrodes	R_{ins}		min. 100		M Ω
Grid No.1 and other electrodes	R_{ins}		min. 100		M Ω
<u>Leakage current between cathode and heater</u>	I_{kf}		max. 20		μ A

CAPACITANCES

Anode to grid No.2, grid No.3,
cathode and heater

	I	II	
C_{a/g_2g_3kf}	9	8- 10	pF
C_{g_1/g_2g_3kf}	18	16.5-19.5	pF
C_{ag_1}		max. 1.2	pF

Grid No.1 to grid No.2, grid No.3,
cathode and heater

Anode to grid No.1

SHOCK AND VIBRATION RESISTANCE

The following test conditions are applied to assess the mechanical quality of the tube. These conditions are not intended to be used as normal operating conditions.

Shock

The tube is subjected 5 times in each of 4 positions to an acceleration of 500 g supplied by an NRL shock machine with the hammer lifted over an angle of 30°.

Vibration

The tube is subjected during 32 hours in each of 3 positions to a vibration frequency of 50 Hz with an acceleration of 2.5 g.

LIFE

Production samples are tested to be within the end of life values (column III) during 10 000 hours

LIMITING VALUES (Absolute max. rating system)

Anode voltage	V_{a0}	max. 650 V
	V_a	max. 400 V
Anode dissipation	W_a	max. 15 W
Anode + grid No.2 dissipation	W_{a+g_2}	max. 16 W
Grid No.2 voltage	$V_{g_{20}}$	max. 650 V
	V_{g_2}	max. 300 V
Grid No.2 dissipation	W_{g_2}	max. 5.5 W
Grid No.1 resistor	R_{g_1}	max. 0.5 M Ω
Cathode current	I_k	max. 220 mA
$T_{av} = 10$ ms		

LIMITING VALUES (continued)

Cathode peak current	I_{kp}	max. 1.2 A
Voltage between cathode and heater		
cathode positive	$V_{kf}(k\text{ pos})$	max. 250 V
cathode negative	$V_{kf}(k\text{ neg})$	max. 200 V
Bulb temperature	t_{bulb}	max. 220 °C

Heater voltage: The average heater value should be 6.3 V.
 Variation of the heater voltage exceeding the range of 6.0 V to 6.6 V will shorten the tube life.
 The tolerance of heater current should be taken into account.

OPERATING CHARACTERISTICS

Output tube. Class B (two tubes). Excitation up to maximum output is continuously permitted.

Anode voltage	V_a	250	V
Grid No.2 voltage	V_{g2}	170	V
Grid No.1 voltage	$-V_{g1}$	34	V
Load resistor	R_{aa}	3	k Ω
Grid No.2 resistor	R_{g2}	2x0.5	k Ω 1)
Input voltage	V_i	0	22 VRMS
Anode current	I_a	2x12	2x94 mA
Grid No.2 current	I_{g2}	2x1	2x28 mA
Output power	W_o	0	30 W
Total distortion	d_{tot}	-	6 %

1) To avoid overloading of grid No.2 this resistor should not be by-passed.

7Z06715-5 bce12

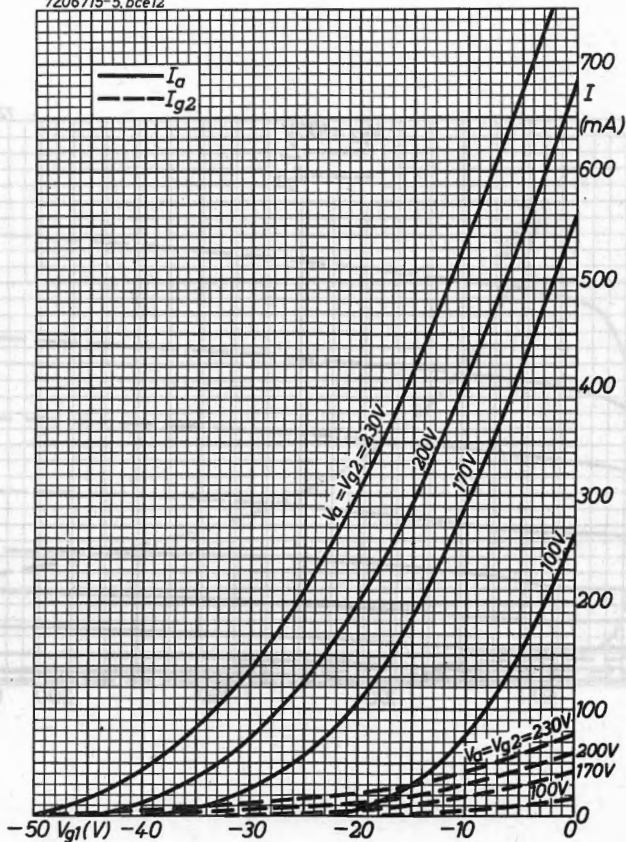

7204753-5bce12

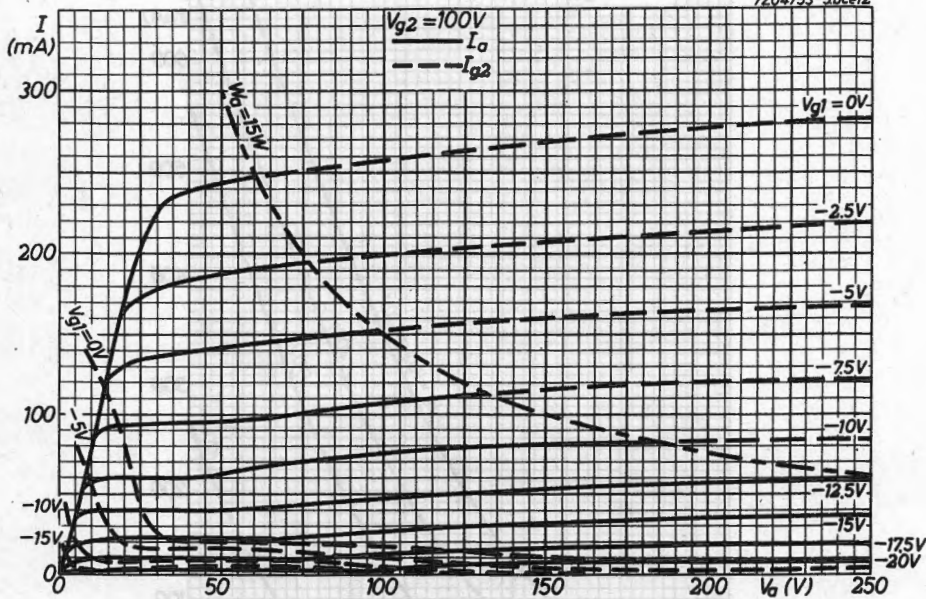

S.Q. TUBE

Special quality output pentode designed for use as line output tube, power output tube, wide band amplifier and series regulator tube.

QUICK REFERENCE DATA

Life test	10 000 hours
Low interface resistance	
Mechanical quality	Shock and vibration resistant
Base	Octal
Heating	Indirect A. C. or D. C. ; parallel supply
Heater voltage	V_f 6.3 V
Heater current	I_f 1.2 A
Anode current	I_a 100 mA
Mutual conductance	S 14 mA/V
Output power. Class B (2 tubes)	W_o 30 W

DIMENSIONS AND CONNECTIONS

Dimensions in mm

Base: Octal

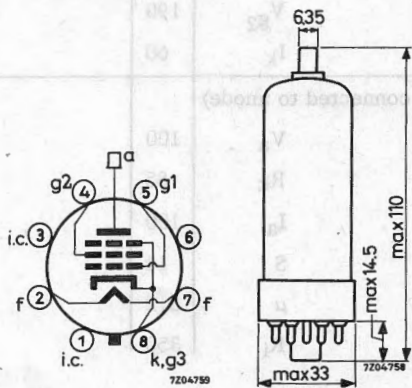

CHARACTERISTICS

- Column I Nominal value or setting of the tube
 II Range values for equipment design: Initial spread
 III Range values for equipment design: End of life

		I	II	III	
Heater voltage	V_f	6.3			V
Heater current	I_f	1.2	1.12 - 1.28		A
Anode voltage	V_a	100			V
Grid No. 2 voltage	V_{g2}	100			V
Cathode resistor	R_k	75			Ω
Anode current	I_a	100	85 - 118	min. 65	mA
Grid No. 2 current	I_{g2}	5.2	4.0 - 6.5		mA
Mutual conductance	S	14	11.5 - 16.5	min. 9.5	mA/V
Amplification factor	μ_{g2g1}	5.6			
Internal resistance	R_i	5.0			$k\Omega$
<u>Cut-off voltage</u>	$-V_{g1}$	35			V
Anode current	I_a	0.1			mA
<u>Negative grid No. 1 current</u>	$-I_{g1}$		max. 1	max. 2	μA
<u>Cut-off voltage</u>	$-V_{g1}$		max. 120		V
Anode voltage	V_a	7			kV_p
Grid No. 2 voltage	V_{g2}	190			V
Cathode current	I_k	60			μA
<u>As triode (grid No. 2 connected to anode)</u>					
Anode voltage	V_a	100			V
Cathode resistor	R_k	85			Ω
Anode current	I_a	100			mA
Mutual conductance	S	14			mA/V
Amplification factor	μ	5.2			
Internal resistance	R_i	350			Ω

CHARACTERISTICS (continued)Insulation resistance between:

Anode and other electrodes

 R_{ins}

min. 100

 $M\Omega$

Grid No. 1 and other electrodes

 R_{ins}

min. 100

 $M\Omega$ Leakage current between cathode and heater I_{kf}

max. 20

 μA **CAPACITANCES**Anode to grid No. 2, grid No. 3,
cathode and heater C_{a/g_2g_3kf}

10

9 - 11

pF

Grid No. 1 to grid No. 2, grid No. 3,
cathode and heater C_{g_1/g_2g_3kf}

19

17.5 - 20.5

pF

Anode to grid No. 1

 C_{ag_1}

max. 1.1

pF

SHOCK AND VIBRATION RESISTANCE

The following test conditions are applied to assess the mechanical quality of the tube. These conditions are not intended to be used as normal operating conditions.

Shock

The tube is subjected 5 times in each 4 positions to an acceleration of 500 g supplied by an NRL shock machine with the hammer lifted over an angle of 30°.

Vibration

The tube is subjected during 32 hours in each of 3 positions to a vibration frequency of 50 Hz with an acceleration of 2.5 g.

LIFE

Production samples are tested to be within the end of life values (column III) during 10 000 hours.

LIMITING VALUES (Absolute max. rating system)

Anode voltage	V_{a_0}	max.	650 V
	V_a	max.	400 V
Anode peak voltage	$+V_{a_p}$	max.	7 kV
	$-V_{a_p}$	max.	1.5 kV
Pulse duration = max. 18 μ sec			
Duty factor = max. 0.22			
Anode dissipation	W_a	max.	15 W
Anode + grid No. 2 dissipation	W_{a+g_2}	max.	16 W
Grid No. 2 voltage	$V_{g_{2o}}$	max.	650 V
	V_{g_2}	max.	300 V
Grid No. 2 dissipation	W_{g_2}	max.	5.5 W
Grid No. 2 dissipation during heating up of EHT diode	W_{g_2}	max.	7.0 W
Grid No. 1 peak voltage	$-V_{g_{1p}}$	max.	1 kV
Pulse duration = max. 18 μ sec			
Duty factor = max. 0.22			
Grid No. 1 resistor	R_{g_1}	max.	0.5 $M\Omega$
Grid No. 1 resistor in line output circuits	R_{g_1}	max.	2.2 $M\Omega$
Cathode current	I_k	max.	220 mA
Cathode peak current	I_{k_p}	max.	1.2 A
Averaging time = max. 10 msec			
Voltage between cathode and heater			
Cathode positive	V_{kf} (k pos)	max.	250 V
Cathode negative	V_{kf} (k neg)	max.	200 V
Bulb temperature	t_{bulb}	max.	220 $^{\circ}C$

Heater voltage: The average heater value should be 6.3 V.

Variation of the heater voltage exceeding the range of 6.0 V to 6.6 V will shorten the tube life.

The tolerance of heater current should be taken into account.

OPERATING CHARACTERISTICS

Output tube class B (2 tubes) Excitation to maximum output is continuously permitted.

Anode voltage	V_a	250	V
Grid No.2 voltage	V_{g2}	170	V
Grid No.1 voltage	$-V_{g1}$	34	V
Load resistance	$R_{aa} \sim$	3	$k\Omega$
Grid No.2 resistor	R_{g2}	2×0.5	$k\Omega$ ¹⁾
Input voltage	V_i	0	22 V_{RMS}
Anode current	I_a	2×12	2×94 mA
Grid No.2 current	I_{g2}	2×1	2×28 mA
Output power	W_o	0	30 W
Total distortion	d_{tot}		6 %

¹⁾ To avoid overloading of grid No.2 this resistor should not be by-passed.

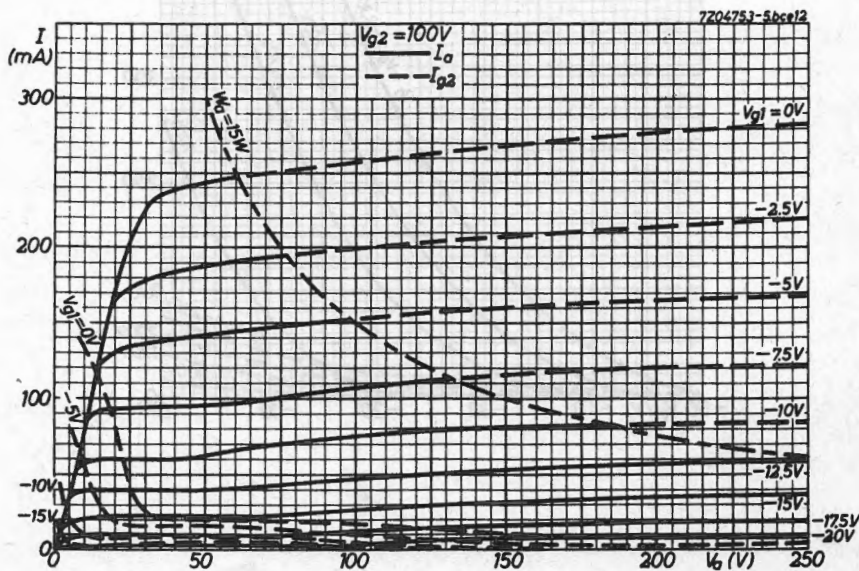

7Z06715-5.bce12

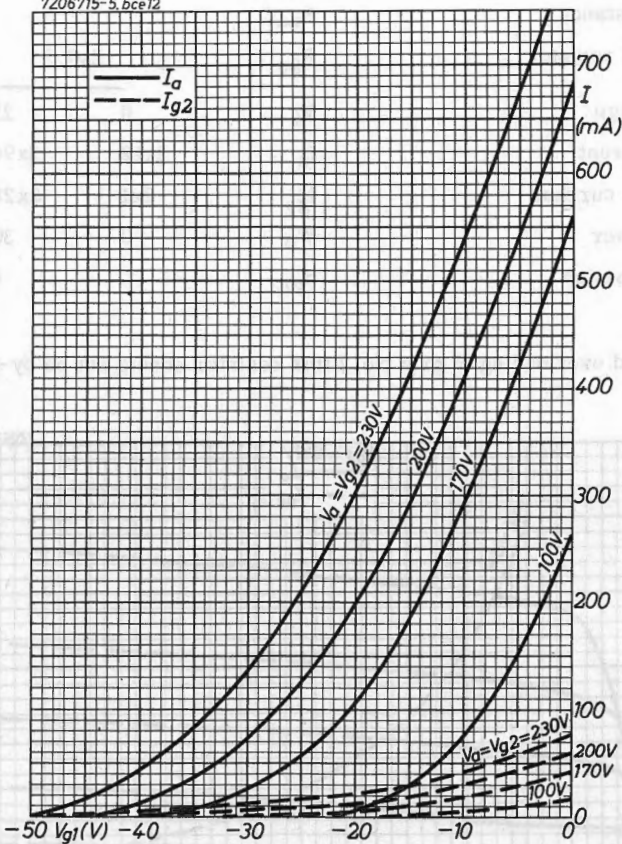

S.Q. TUBE

Special quality pentode designed for use as wide band amplifier.

QUICK REFERENCE DATA

Life test	10 000 hours
Low interface resistance	
Mechanical quality	Shock and vibration resistant
Base	Noval. Gold plated pins
Heating	Indirect A.C. or D.C.; Parallel supply
Heater voltage	V_f 6.3 V
Heater current	I_f 315 mA
Anode current	I_a 20 mA
Transconductance	S 26 mA/V
Equivalent noise resistance	R_{eq} 220 Ω

DIMENSIONS AND CONNECTIONS

Dimensions in mm

Base: Noval

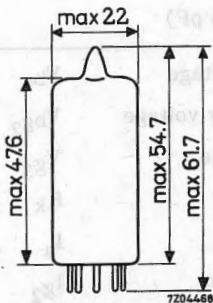
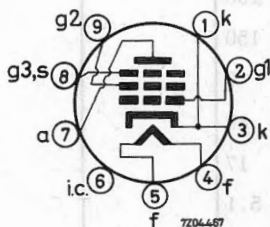

CHARACTERISTICS

Column I Nominal value or setting of the tube

II Range values for equipment design: Initial spread

III Range values for equipment design: End of life

		I	II	III	
Heater voltage	V_f	6.3			V
Heater current	I_f	315	299- 331		mA
Anode supply voltage	V_{ba}	190			V
Grid No.2 supply voltage	V_{bg2}	160			V
Grid No.3 voltage	V_{g3}	0			V
Grid No.1 supply voltage	$+V_{bg1}$	8			V
Cathode resistor	R_k	370			Ω
Anode current	I_a	20	18.8-21.2	min. 17	mA
Grid No.2 current	I_{g2}	6	5.3- 6.7		mA
Mutual conductance	S	26	22- 30	min.17.5	mA/V
Internal resistance	R_i	100			k Ω
Amplification factor	μ_{g2g1}	60			
Negative grid current	$-I_{g1}$		max. 0.3	max. 1.0	μA
Equivalent noise resistance	R_{eq}	220			Ω
Input resistance	r_{g1}	1.4			k Ω
Pin 1 connected to pin 3					
Frequency 100 MHz					
S/C		2.2			mA/V/pF
$S/2\pi(C_g + C_a + 5 \text{ pF})$		180			MHz
Anode supply voltage	V_{ba}	180			V
Grid No.2 supply voltage	V_{bg2}	150			V
Grid No.3 voltage	V_{g3}	0			V
Cathode resistor	R_k	80			Ω
Anode current	I_a	17			mA
Grid No.2 current	I_{g2}	5.1			mA
Mutual conductance	S	24.5			mA/V

CHARACTERISTICS (continued)

As triode (grid No.2 connected to anode,
grid No.3 connected to cathode)

Anode supply voltage	V_a	160	V
Grid No.1 supply voltage	$+V_{bg_1}$	8	V
Cathode resistor	R_k	400	Ω
Anode current	I_a	24	mA
Mutual conductance	S	33	mA/V
Internal resistance	R_i	1.8	k Ω
Amplification factor	μ	60	
Equivalent noise resistance	R_{eq}	100	Ω

CAPACITANCES

		Without external shield		With external shield		
		I	II	I	II	
Grid No.1 to grid No.2, grid No.3, cathode, heater and screen	C_{g_1/g_2g_3kfs}	9.3	8.3-10.3	9.4	8.4-10.4	pF
Anode to grid No.2, grid No.3, cathode, heater and screen	C_{a/g_2g_3kfs}	2.6	2.3- 2.9	3.6	3.2- 4.0	pF
Anode to grid No.1	C_{ag_1}		max. 35		max. 30	mpF
Grid No.1 to grid No.2, grid No.3, cathode, heater and screen	C_{g_1/g_2g_3kfs}	15.5		15.6		pF
Cathode current						
$I_k = 26$ mA						

SHOCK AND VIBRATION RESISTANCE

The following test conditions are applied to assess the mechanical quality of the tube. These conditions are not intended to be used as normal operating conditions.

Shock

The tube is subjected 5 times in each of 4 positions to an acceleration of 500 g supplied by an NRL shock machine with the hammer lifted over an angle of 30°.

Vibration

The tube is subjected during 32 hours in each of 3 positions to a vibration frequency of 50 Hz with an acceleration of 2.5 g.

LIFE

Production samples are tested to be within the end of life values (column III) during 10 000 hours.

LIMITING VALUES (Absolute max. rating system)

Anode voltage	V_{a0}	max.	400 V
	V_a	max.	220 V
Anode dissipation	W_a	max.	4 W
Grid No. 2 voltage	V_{g20}	max.	400 V
	V_{g2}	max.	180 V
Grid No. 2 dissipation	W_{g2}	max.	1.1 W
Cathode current	I_k	max.	30 mA
Grid No. 1 current	I_{g1}	max.	5 mA
Grid No. 1 voltage negative	$-V_{g1}$	max.	50 V
positive	$+V_{g1}$	max.	2 V
Grid No. 1 resistor	R_{g1}	max.	0.5 M Ω
Voltage between cathode and heater			
cathode positive	$V_{kf}(k \text{ pos})$	max.	120 V
cathode negative	$V_{kf}(k \text{ neg})$	max.	60 V
Bulb temperature	t_{bulb}		180 °C

Heater voltage: The average heater voltage should be 6.3 V.

Variation of the heater voltage exceeding the range of 6.0 V to 6.6 V will shorten the tube life.

The tolerance of heater current should be taken into account.

OPERATING CHARACTERISTICS

Anode supply voltage	V_{ba}	190	190	190	190	190	V
Grid No.3 voltage	V_{g_3}	0	0	0	0	0	V
Grid No.2 supply voltage	V_{bg_2}	160	160	160	160	120	V
Grid No.1 supply voltage	$+V_{bg_1}$	8	8	8	9	8	V
Cathode resistor	R_k	370	500	780	630	730	Ω
Anode current	I_a	20	15	10	13.5	10	mA
Grid No.2 current	I_{g_2}	6	4.5	3	4	2.8	mA
Mutual conductance	S	26	23	19	22	20	mA/V
Internal resistance	R_i	100	120	155	130	155	k Ω
Amplification factor	$\mu_{g_2g_1}$	60	58	56	58	56	
Equivalent noise resistance	R_{eq}	220	230	250	240	220	Ω
<u>Input resistance</u>	r_{g_1}	1.4	1.5	1.7	1.6	1.6	k Ω
Pin No.1 connected to pin No.3							
Frequency = 100 MHz							
<u>Capacitance</u> grid No.1 to grid No.2, grid No.3, cathode, heater and screen (no external shield)							
	C_{g_1/g_2g_3kfs}	15.5	15	14.3	14.8	14.8	pF
	$S/2\pi(C_g + C_a + 5 \text{ pF})$	180	162	138	156	142	MHz
	S/C	2.2	1.9	1.6	1.85	1.7	mA/V/pF

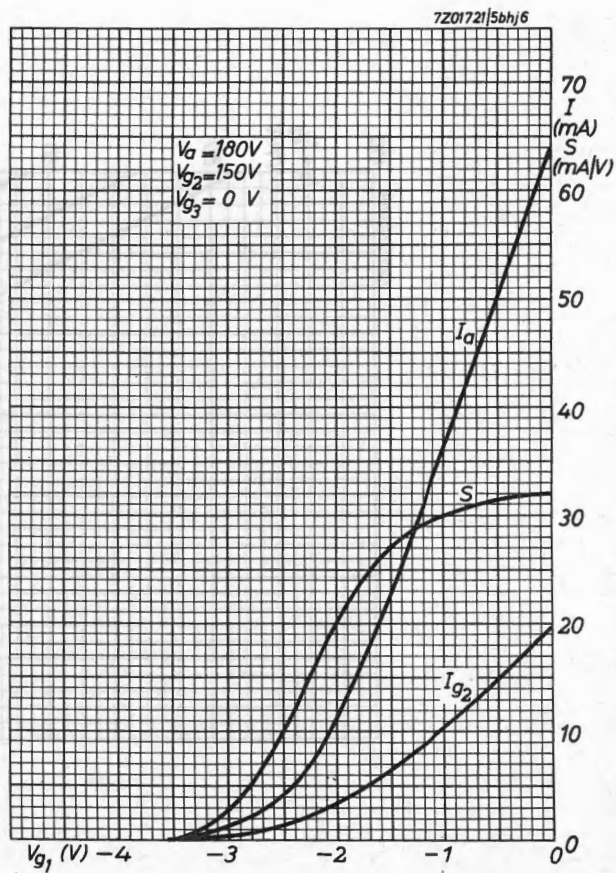
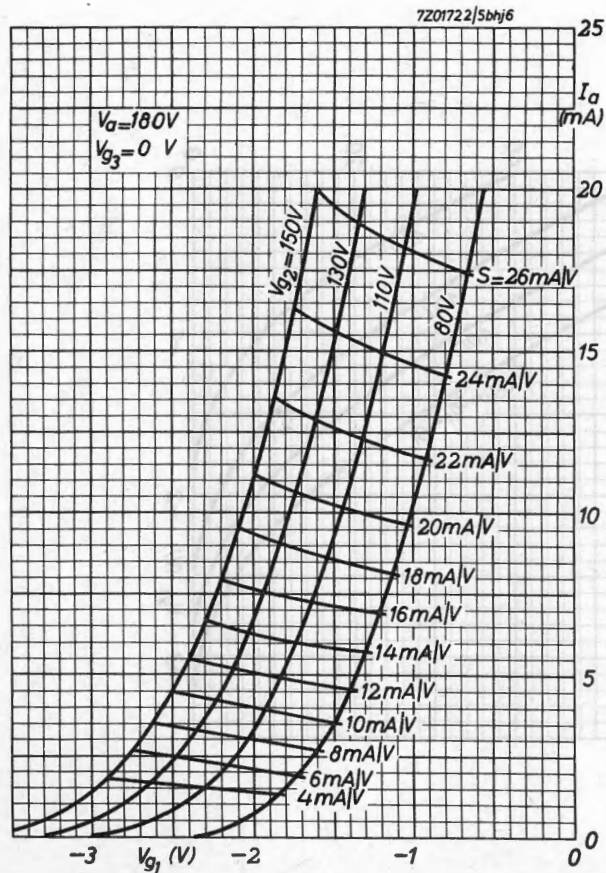

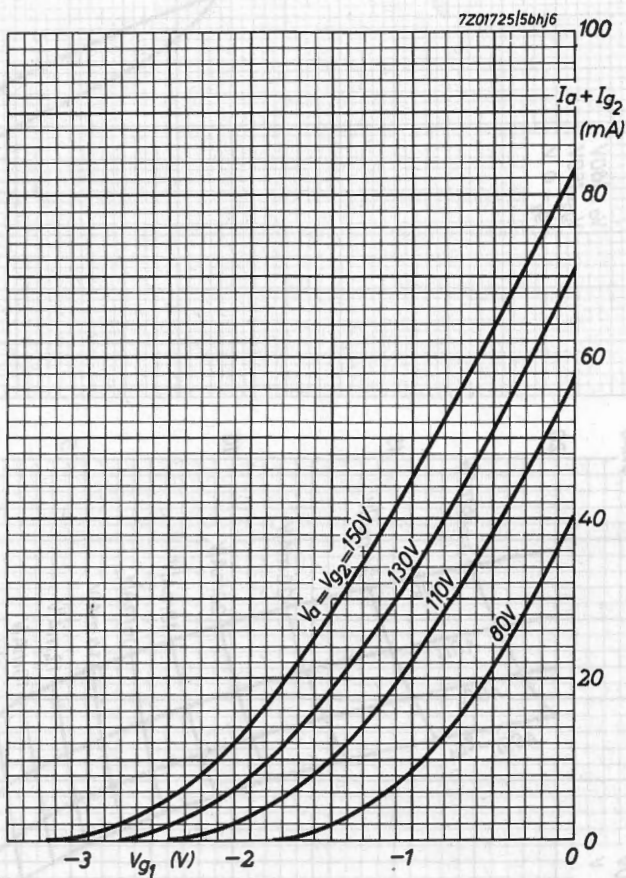

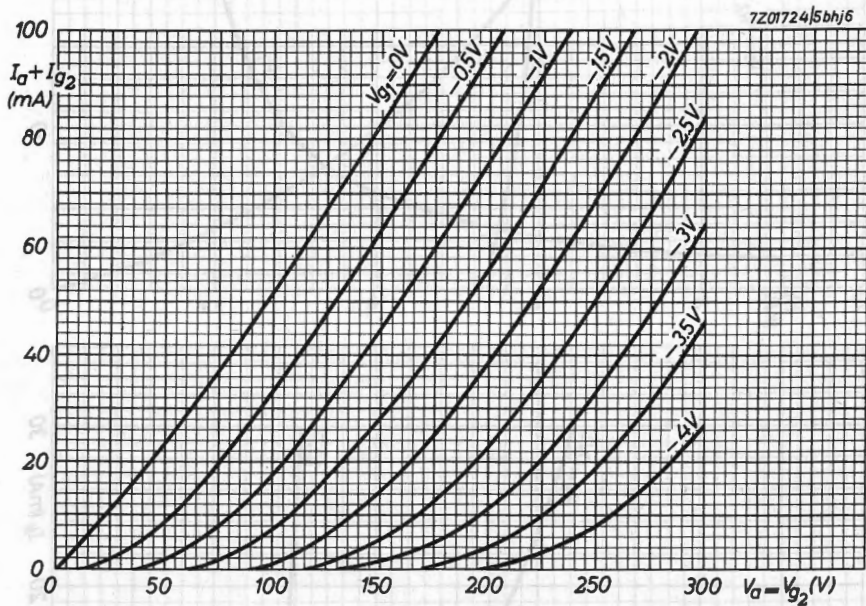

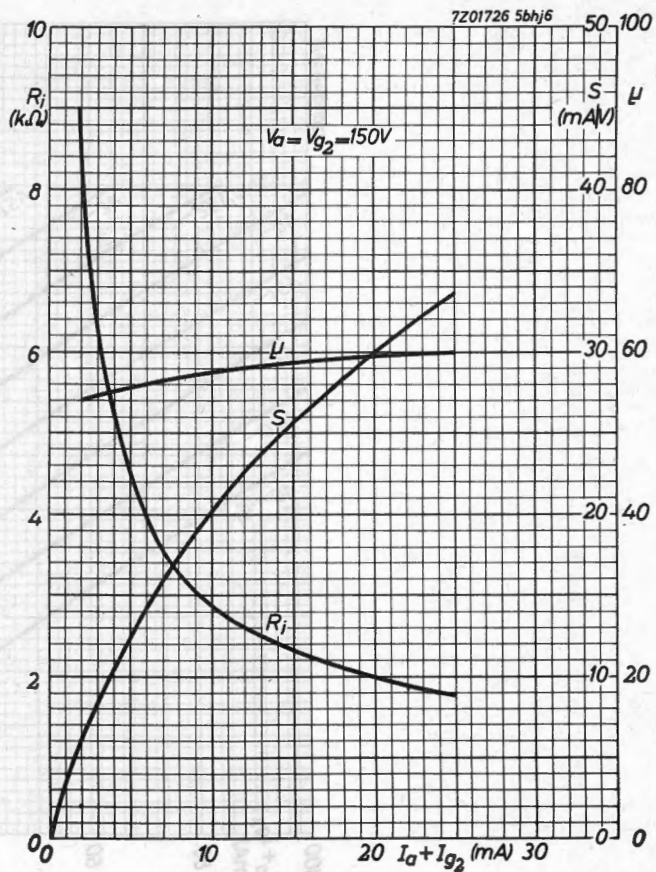
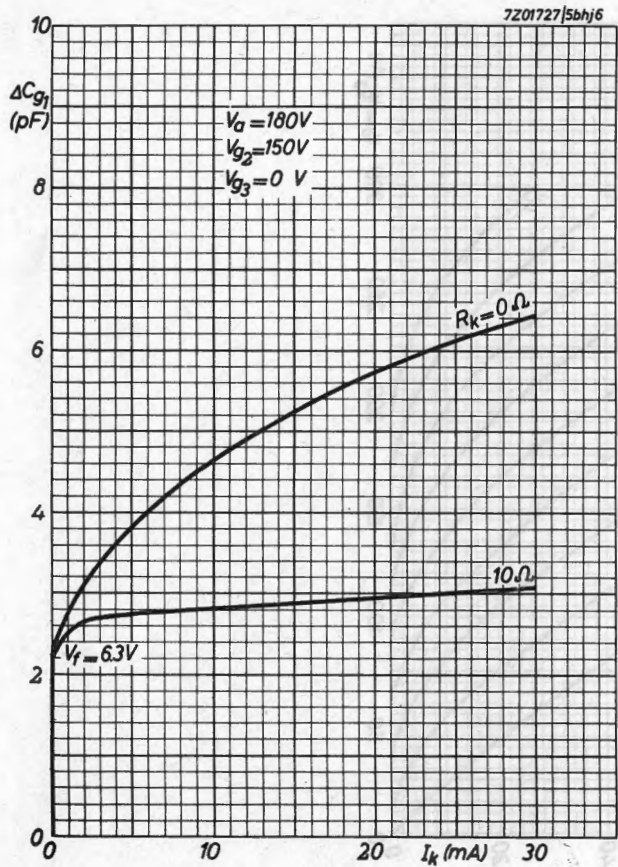

S.Q. TUBE

Special quality pentode designed for use as wide band amplifier for frequencies up to 250 MHz

QUICK REFERENCE DATA

Life test	10 000 hours
Low interface resistance	
Mechanical quality	Shock and vibration resistant
Base	Noval. Gold plated pins
Heating	Indirect A.C. or D.C.; parallel supply
Heater voltage	V_f 6.3 V
Heater current	I_f 350 mA
Anode current	I_a 35 mA
Mutual conductance	S 26 mA/V
Equivalent noise resistance	R_{eq} 200 Ω
Noise factor at 100 MHz	F 7 dB

DIMENSIONS AND CONNECTIONS

Dimensions in mm

Base: Noval

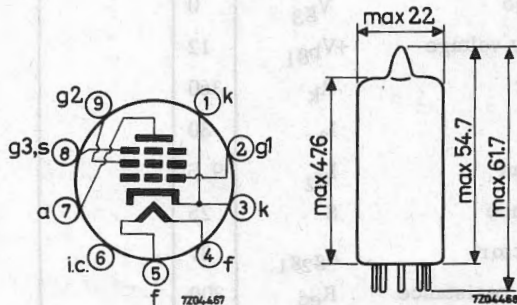

CHARACTERISTICS

- Column I Nominal value or setting of the tube
 II Range values for equipment design: Initial spread
 III Range values for equipment design: End of life

		I	II	III	
Heater voltage	V_f	6.3			V
Heater current	I_f	350			mA
Anode supply voltage	V_{ba}	125			V
Grid No.2 supply voltage	V_{bg2}	125			V
Grid No.3 voltage	V_{g3}	0			mA/V
Grid No.1 supply voltage	$+V_{bg1}$	12			V
Cathode resistor	R_k	300			Ω
Anode current	I_a	35	33 - 37	min. 31	mA
Grid No.2 current	I_{g2}	11	9.9 - 12.1		mA
Mutual conductance	S	26	22 - 30	min. 17.5	mA/V
Amplification factor	μ_{g2g1}	27			
Equivalent noise resistance	R_{eq}	200			Ω
Noise factor at 100 MHz	F	7			dB
Adapted to minimum noise					
Negative grid current	$-I_{g1}$		max. 0.3	max. 1.0	μA
Anode supply voltage	V_{ba}	135			V
Grid No.2 supply voltage	V_{bg2}	125			V
Grid No.3 voltage	V_{g3}	0			V
Grid No.1 supply voltage	$+V_{bg1}$	12			V
Cathode resistor	R_k	360			Ω
Anode current	I_a	30			mA
Grid No.2 current	I_{g2}	9.5			mA
Mutual conductance	S	25			mA/V
Amplification factor	μ_{g2g1}	27			
Equivalent noise resistance	R_{eq}	200			Ω

CHARACTERISTICS (continued)

As triode (grid No. 2 connected to anode)
(grid No. 3 connected to cathode)

		I	II	
Anode supply voltage	V_{ba}	125		V
Grid No. 3 supply voltage	V_{bg3}	0		V
Grid No. 1 supply voltage	$+V_{bg1}$	12		V
Cathode resistor	R_k	350		Ω
Anode current	I_a	40		mA
Mutual conductance	S	32		mA/V
Amplification factor	μ	25.5		
Internal resistance	R_i	800		Ω
Equivalent noise resistance	R_{eq}	100		Ω
<u>Leakage current between cathode and heater</u>				
	I_{kf}		max. 5	μA
Voltage between cathode and heater $V_{kf} = 100$ V				
<u>Insulation resistance</u>				
Anode to other electrodes (V = 300 V)	R		min. 100	M Ω
Grid No. 1 to other electrodes (V = 50 V)	R		min. 100	M Ω
CAPACITANCES				
Grid No. 1 to grid No. 2, grid No. 3 cathode, heater and screen	$C_{g1/g2g3kfs}$	10		pF
Grid No. 1 to grid No. 2, grid No. 3 cathode, heater and screen	$C_{g1/g2g3kfs}$	16		pF
Cathode current $I_k = 46$ mA				
Anode to grid No. 2, grid No. 3 cathode, heater and screen	$C_{a/g2g3kfs}$	2.6		pF
Anode to grid No. 1	C_{ag1}		max. 50	mpF
Anode to cathode	C_{ak}		max. 50	mpF
Cathode to heater	C_{kf}	4.7		pF
Grid No. 1 to heater	C_{g1f}		max. 50	mpF
Anode to heater	C_{af}		max. 100	mpF

SHOCK AND VIBRATION RESISTANCE

The following test conditions are applied to assess the mechanical quality of the tube. These conditions are not intended to be used as normal operating conditions.

Shock

The tube is subjected 5 times in each of 4 positions to an acceleration of 500 g supplied by an NRL shock machine with the hammer lifted over an angle of 30°.

Vibration

The tube is subjected during 32 hours in each of 3 positions to a vibration frequency of 50 Hz with an acceleration of 2.5 g.

LIFE

Production samples are tested to be within the end of life values (column III) during 10 000 hours.

LIMITING VALUES (Absolute max. rating system)

Anode voltage	V_{a_0}	max.	400	V
	V_a	max.	200	V
Anode dissipation	W_a	max.	4.2	W
Grid No. 2 voltage	$V_{g_{2_0}}$	max.	400	V
	V_{g_2}	max.	150	V
Grid No. 2 dissipation ¹⁾	W_{g_2}	max.	1.4	W
Grid voltage	$-V_g$	max.	50	V
Grid resistor, automatic bias	R_{g_1}	max.	0.5	M Ω
Cathode current	I_k	max.	50	mA
Voltage between cathode and heater	V_{kf}	max.	100	V
Bulb temperature	t_{bulb}	max.	180	°C

Heater voltage: The average heater voltage should be 6.3 V.

Variations of the heater voltage exceeding the range of 6.0 V to 6.6 V will shorten the tube life.

The tolerance of heater current should be taken into account.

¹⁾ Grid No. 2 dissipation: Care should be taken not to exceed the limiting value during switching in of positive voltages. If the cathode resistor is shunted by more than 10 μ F a grid No. 1 series resistor of minimum 1 k Ω should be applied.

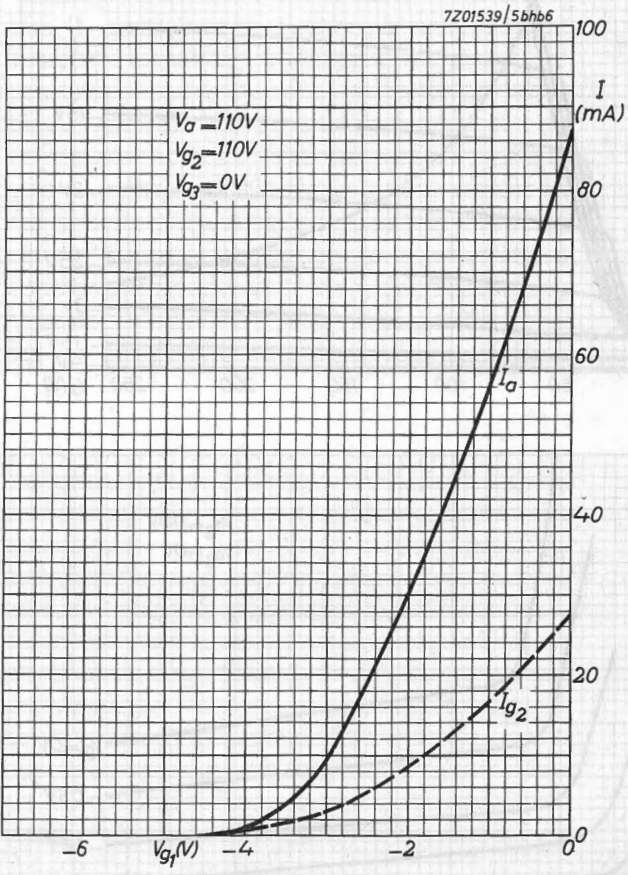

7Z01537/5bhb6

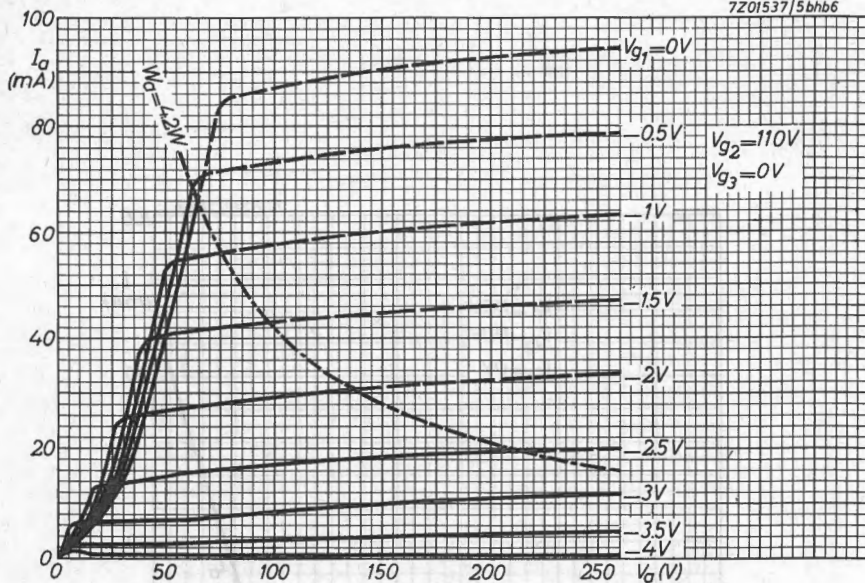

7Z01538/5bhb6

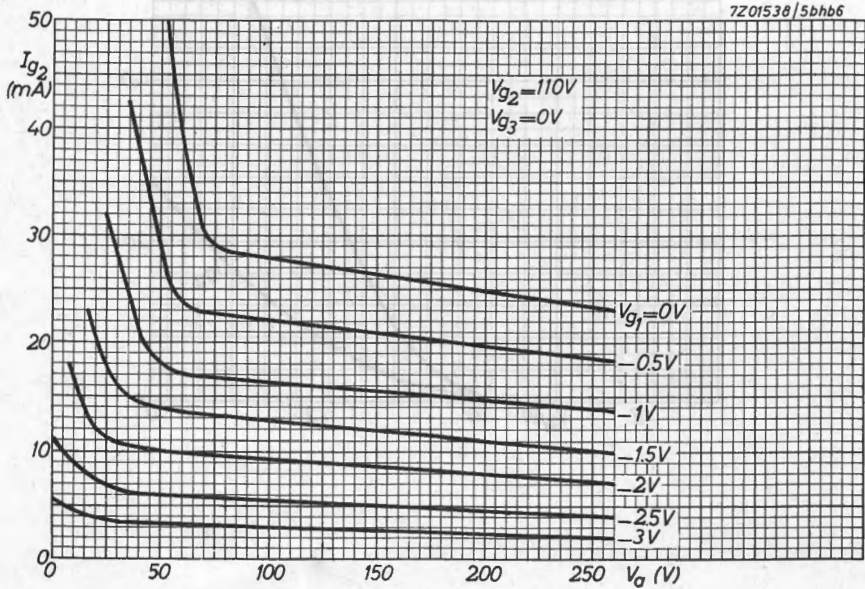

720154-1/5bhb6

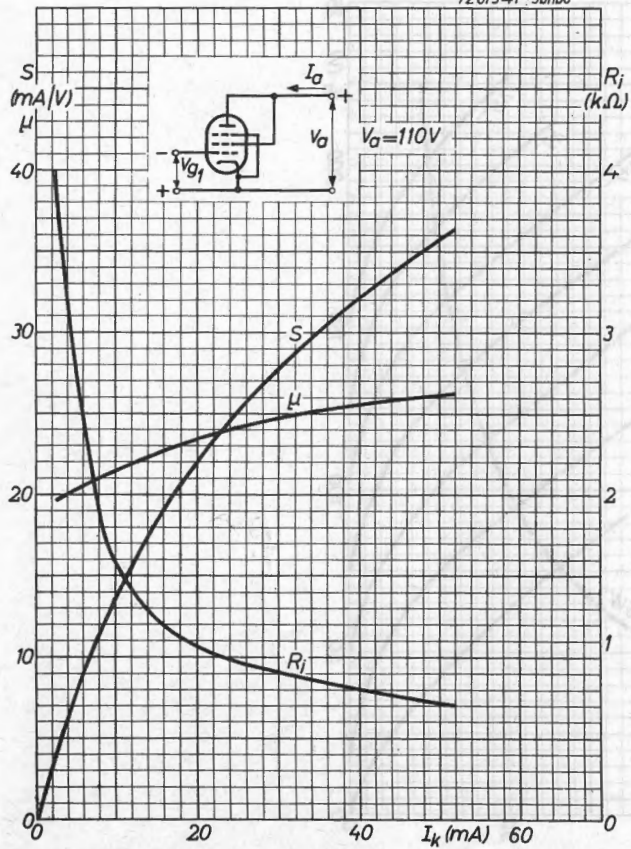

720154-2/5bhb6

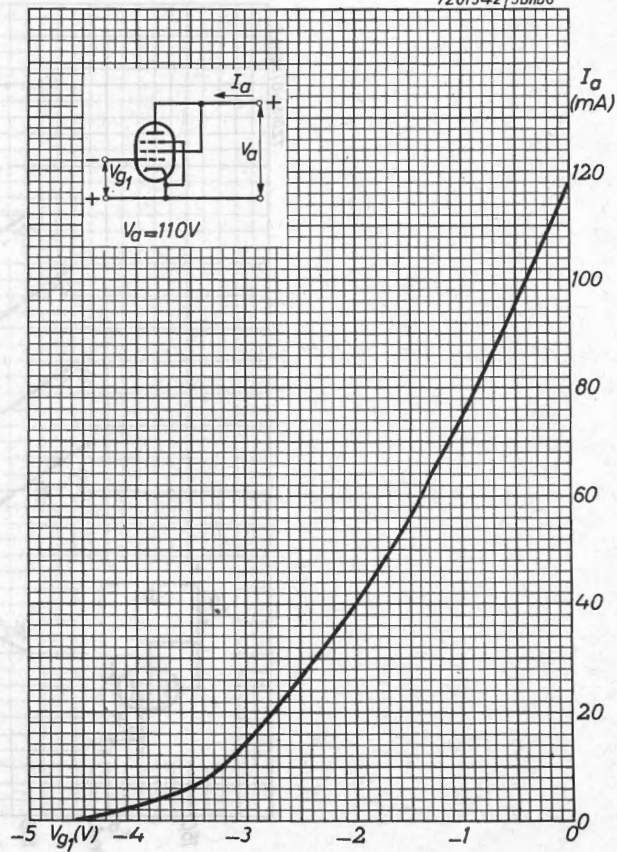

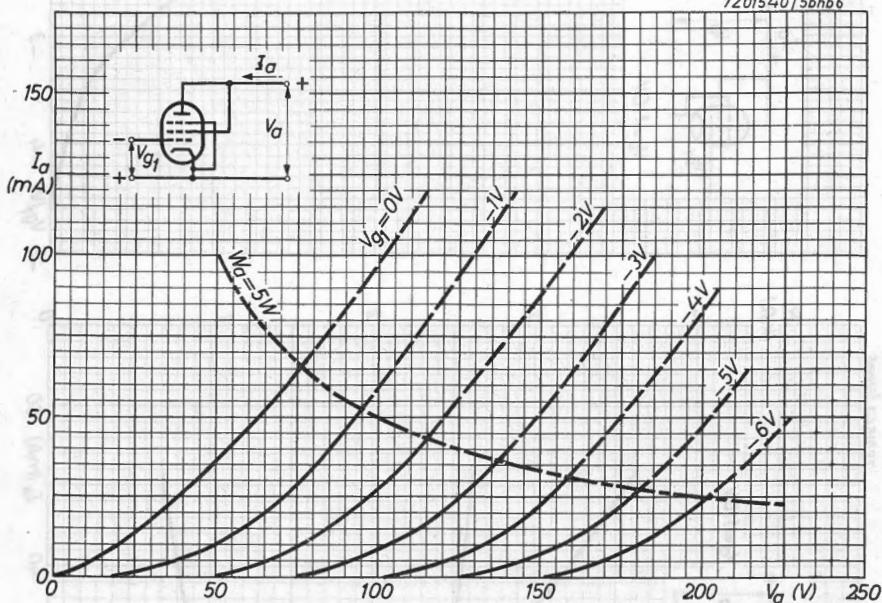

S.Q. TUBE

Special quality double triode designed for use as A.F. amplifier.

QUICK REFERENCE DATA

Life test	10 000 hours
Low interface resistance	
Mechanical quality	Shock and vibration resistant
Base	Noval
Heating	Indirect A.C. or D.C.; parallel supply
Heater voltage	V_f 6.3 V
Heater current	I_f 330 mA
Anode current	I_a 1.25 mA
Mutual conductance	S 1.6 mA/V
Amplification factor	μ 100
Hum voltage Section 1	V_g max. 5 μ V _{RMS}
Section 2	V_g max. 15 μ V _{RMS}

DIMENSIONS AND CONNECTIONS

Dimensions in mm

Base: Noval

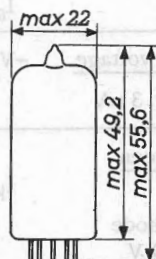

CHARACTERISTICS

- Column I Nominal value or setting of the tube
 II Range values for equipment design: Initial spread
 III Range values for equipment design: End of life

		I	II	III	
Heater voltage	V_f	6.3			V
Heater current	I_f	330	313 - 347		mA
Anode voltage	V_a	250			V
Cathode resistor	R_k	1.6			$k\Omega$
Anode current	I_a	1.25	1.1 - 1.4	min. 0.8	mA
Mutual conductance	S	1.6	1.3 - 1.95	min. 1.05	mA/V
Amplification factor	μ	100			
Internal resistance	R_i	62.5			$k\Omega$
<u>Negative grid current</u>	$-I_g$		max. 0.2	max. 0.5	μA
Anode voltage	V_a	100			V
Cathode resistor	R_k	2			$k\Omega$
Anode current	I_a	0.5			mA
Mutual conductance	S	1.25			mA/V
Amplification factor	μ	100			
Internal resistance	R_i	80			$k\Omega$
<u>Cut-off voltage</u>	$-V_g$		max. 4		V
Anode voltage	V_a	250			V
Anode current	I_a	20			μA
<u>Grid current starting voltage</u>	$-V_g$		max. 1		V
Grid current $+I_g = 0.3 \mu A$					
<u>Leakage current between cathode and heater</u>	I_{kf}		max. 5		μA
Voltage between cathode and heater $V_{kf} = 100 V$					

CHARACTERISTICS (continued)Insulation resistance between electrodes

Anode to all other electrodes

R

II

min. 300

 $M\Omega$

(Voltage between electrodes 300 V)

Grid to all other electrodes

R

min. 300

 $M\Omega$

(Voltage between electrodes 100 V)

Hum voltage Section 1 V_g

max. 5

 μV_{RMS}

Section 2

 $V_{g'}$

max. 15

 μV_{RMS} Anode supply voltage $V_{ba} = 250$ VAnode resistor $R_a = 100$ k Ω Grid resistor $R_g = 1$ M Ω Vibrational noise V_g

max. 10

mV

Anode voltage $V_a = 250$ VGrid voltage $-V_g = 2$ VAnode resistor $R_a = 5$ k Ω Frequency $f = 25$ Hz

Acceleration = 2.5 g

Microphony

The sensitivity of the amplifier circuit for 50 mW should not exceed 0.5 mV.

CAPACITANCES Each system if applicable

Grid to cathode heater and screen

 C_g/kfs

2.0 pF

Anode to cathode and screen

 C_a/kfs

2.0 pF

Anode to grid

 C_{ag}

1.2 pF

Grid to heater

 C_{gf}

max. 0.01 pF

 $C_{g'f}$

max. 0.02 pF

Grid to grid other section

 $C_{gg'}$

max. 0.01 pF

Anode to anode other section

 $C_{aa'}$

max. 0.1 pF

Anode to grid other section

 $C_{ag'}$

max. 0.06 pF

 $C_{a'g}$

max. 0.01 pF

OPERATING CHARACTERISTICS

A.F. amplifier Fig. 1 see page 8

Anode supply voltage	V_{ba}	200	250	300	350	400	V
Anode resistor	R_a	47	47	47	47	47	k Ω
Cathode resistor	R_k	1500	1200	1000	820	680	Ω
Grid resistor next stage	R_o	150	150	150	150	150	k Ω
Anode current	I_a	0.86	1.18	1.55	1.98	2.45	mA
Output voltage at $+H_g = 0.3 \mu A$	V_o	18	23	26	33	37	V _{RMS}
Voltage gain	V_o/V_i	34	37.5	40	42.5	44	
Total distortion 1)	d_{tot}	8.5	7.0	5.0	4.4	3.6	%
Anode voltage	V_{ba}	200	250	300	350	400	V
Anode resistor	R_a	100	100	100	100	100	k Ω
Cathode resistor	R_k	1800	1500	1200	1000	820	Ω
Grid resistor next stage	R_o	330	330	330	330	330	k Ω
Anode current	I_a	0.65	0.86	1.11	1.40	1.72	mA
Output voltage at $+H_g = 0.3 \mu A$	V_o	20	26	30	36	38	V _{RMS}
Voltage gain	V_o/V_i	50	54.5	57	61	63	
Total distortion 1)	d_{tot}	4.8	3.9	2.7	2.2	1.7	%
Anode supply voltage	V_{ba}	200	250	300	350	400	V
Anode resistor	R_a	220	220	220	220	220	k Ω
Cathode resistor	R_k	3300	2700	2200	1500	1200	Ω
Grid resistor next stage	R_o	680	680	680	680	680	k Ω
Anode current	I_a	0.36	0.48	0.63	0.85	1.02	mA
Output voltage at $+H_g = 0.3 \mu A$	V_o	24	28	36	37	38	V _{RMS}
Voltage gain	V_o/V_i	56	66.5	72	75.5	76.5	
Total distortion 1)	d_{tot}	4.6	3.4	2.6	1.6	1.1	%

1) The distortion is about proportional to the output voltage.

OPERATING CHARACTERISTICS (continued)

A. F. amplifier Fig. 2 see page 9 Input source resistance = 100 Ω

Anode supply voltage	V_{ba}	200	250	300	350	400	V
Anode resistor	R_a	47	47	47	47	47	$k\Omega$
Grid resistor next stage	R_o	150	150	150	150	150	$k\Omega$
Anode current	I_a	1.02	1.45	2.02	2.50	3.10	mA
Output voltage	V_o	18	23	26	33	37	V_{RMS}
Voltage gain	V_o/V_i	37	39	41	44	45	
Total distortion ¹⁾	d_{tot}	5.6	4.2	2.9	2.7	2.5	%

Anode supply voltage	V_{ba}	200	250	300	350	400	V
Anode resistor	R_a	100	100	100	100	100	$k\Omega$
Grid resistor next stage	R_o	330	330	330	330	330	$k\Omega$
Anode current	I_a	0.7	1.00	1.29	1.62	1.95	mA
Output voltage	V_o	20	26	30	36	38	V_{RMS}
Voltage gain	V_o/V_i	50	51	54	56	58	
Total distortion ¹⁾	d_{tot}	3.9	2.6	2.0	1.8	1.6	%

Anode supply voltage	V_{ba}	200	250	300	350	400	V
Anode resistor	R_a	220	220	220	220	220	$k\Omega$
Grid resistor next stage	R_o	680	680	680	680	680	$k\Omega$
Anode current	I_a	0.39	0.56	0.74	0.88	1.09	mA
Output voltage	V_o	24	28	36	37	38	V_{RMS}
Voltage gain	V_o/V_i	58	62	66	67	68	
Total distortion ¹⁾	d_{tot}	4.6	2.7	2.2	1.7	1.4	%

¹⁾ The distortion is about proportional to the output voltage.

OPERATING CHARACTERISTICS (continued)

A.F. amplifier Fig. 3 see page 9 Input source resistance = 330 k Ω

Anode supply voltage	V_{ba}	100	150	200	250	300	350	400	V
Anode resistor	R_a	47	47	47	47	47	47	47	k Ω
Grid resistor next stage	R_o	150	150	150	150	150	150	150	k Ω
Anode current	I_a	0.35	0.84	1.40	1.95	2.52	3.19	3.80	mA
Voltage gain	V_o/V_i	25	33	34	36	38	40	41	
Total distortion at:									
$V_o = 2$ V	d_{tot}	1.7	2.5	2.4	2.3	2.2	2.2	2.1	%
$V_o = 4$ V	d_{tot}	2.1	4.6	4.7	4.6	4.5	4.2	4.2	%
$V_o = 6$ V	d_{tot}	6.0	5.2	5.6	5.6	5.5	5.5	5.4	%

Anode supply voltage	V_{ba}	100	150	200	250	300	350	400	V
Anode resistor	R_a	100	100	100	100	100	100	100	k Ω
Grid resistor next stage	R_o	330	330	330	330	330	330	330	k Ω
Anode current	I_a	0.24	0.56	0.88	1.23	1.58	1.92	2.29	mA
Voltage gain	V_o/V_i	34	43	46	48	50	51	52	
Total distortion at:									
$V_o = 2$ V	d_{tot}	1.6	1.9	1.9	1.8	1.8	1.8	1.7	%
$V_o = 4$ V	d_{tot}	2.3	3.0	3.8	3.8	3.6	3.6	3.5	%
$V_o = 6$ V	d_{tot}	2.5	4.7	5.1	5.1	5.0	4.9	4.8	%

Anode supply voltage	V_{ba}	100	150	200	250	300	350	400	V
Anode resistor	R_a	220	220	220	220	220	220	220	k Ω
Grid resistor next stage	R_o	680	680	680	680	680	680	680	k Ω
Anode current	I_a	0.14	0.32	0.49	0.67	0.85	1.05	1.23	mA
Voltage gain	V_o/V_i	42	51	54	57	58	59	60	
Total distortion at:									
$V_o = 2$ V	d_{tot}	1.6	1.7	1.7	1.6	1.6	1.6	1.6	%
$V_o = 4$ V	d_{tot}	2.5	3.0	3.0	2.9	2.9	2.8	2.7	%
$V_o = 6$ V	d_{tot}	3.2	4.4	4.4	4.4	4.4	4.3	4.2	%

OPERATING CHARACTERISTICS (continued)

Phase inverter Fig.4 see page 9

Anode supply voltage	V_{ba}	250	350	V
Anode voltage	V_a	65	90	V
Cathode resistor	R_k	68	82	k Ω
Anode resistor	R_a, R_a'	100	150	k Ω
Anode current	$I_a + I_a'$	1.0	1.2	mA
Voltage gain	V_o/V_i	25		27
Output voltage ($H_g = 0.3 \mu A$)	V_o	7	20	10 35 V _{RMS}
Total distortion 1)	d_{tot}	0.6	1.8	0.5 1.8 %

V_a should be adjusted to the specified value of $I_a + I_a'$

Phase inverter Fig.5 see page 9

Anode supply voltage	V_{ba}	250	350	V
Cathode resistor	R_k	1200	820	Ω
Anode current	$I_a + I_a'$	1.08	1.7	mA
Voltage gain	V_o/V_i	58		62
Output voltage ($H_g = 0.3 \mu A$)	V_o	7.0	35	9 45 V _{RMS}
Total distortion 1)	d_{tot}	1.1	5.5	0.7 3.5 %

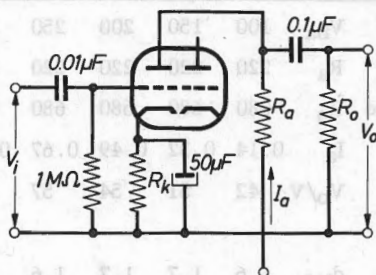

Fig.1

1) The distortion is about proportional to the output voltage.

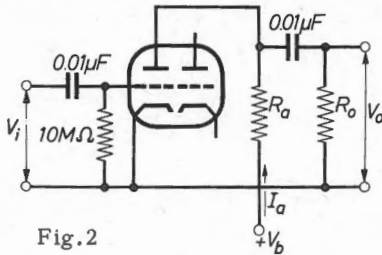

Fig. 2

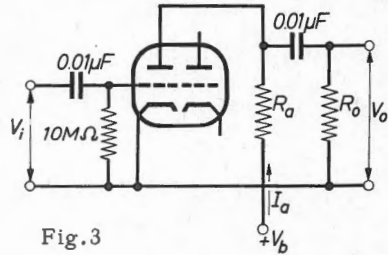

Fig. 3

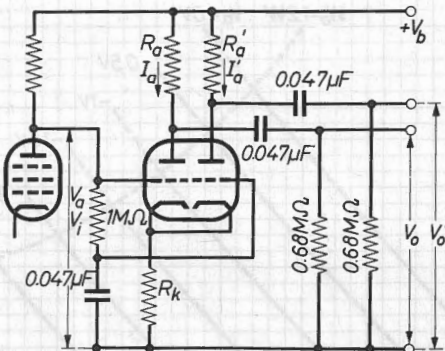

Fig. 4

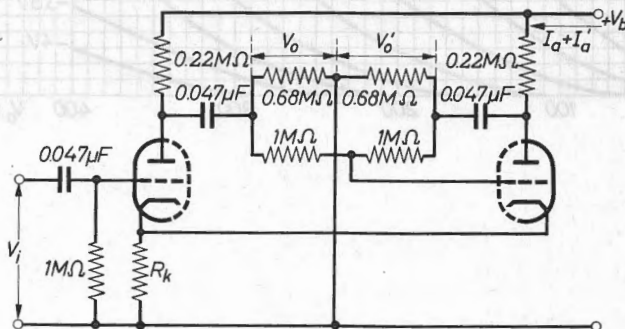
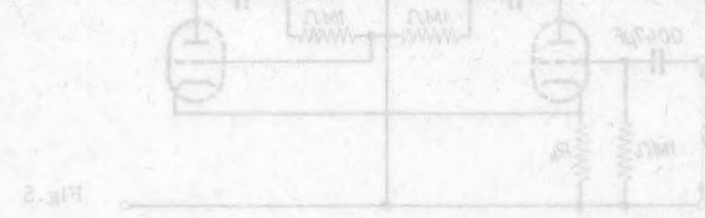
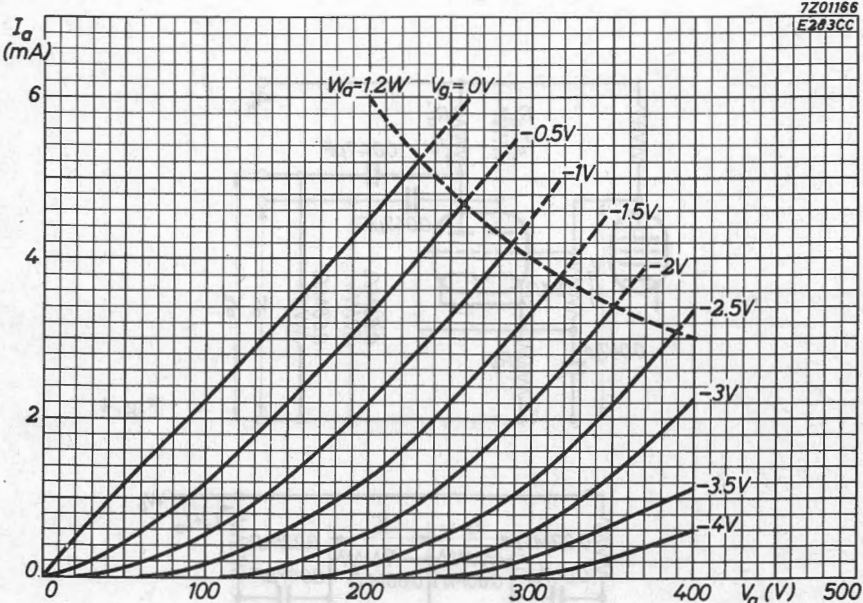
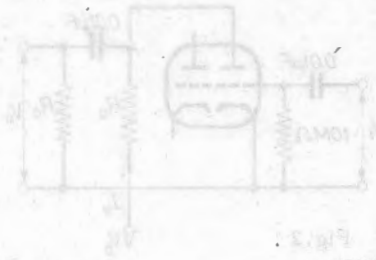
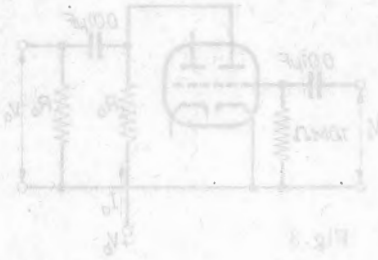
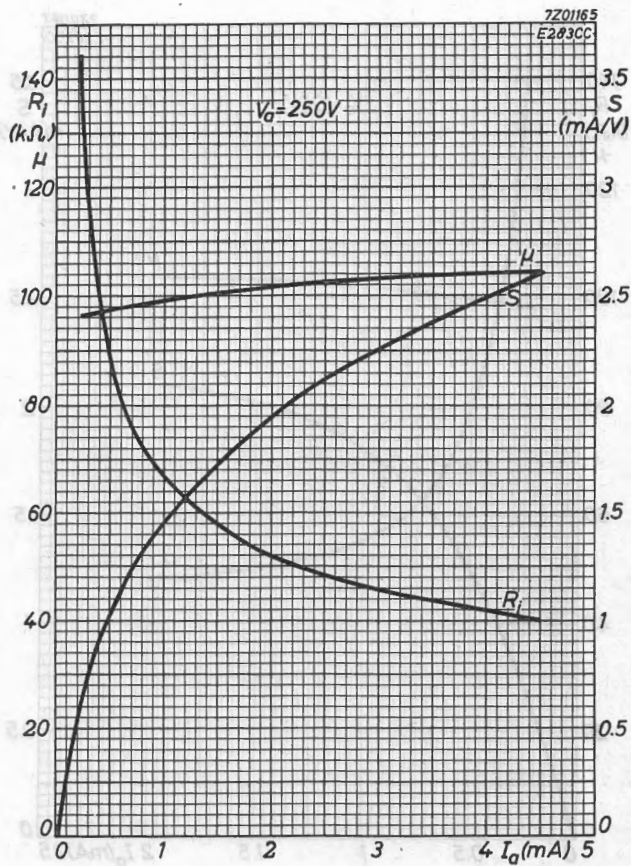
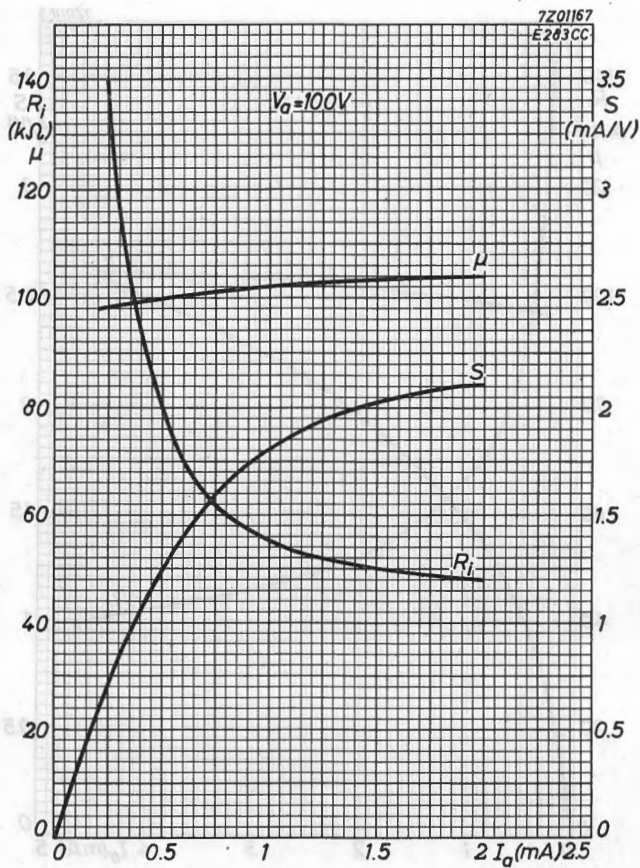

Fig. 5







S.Q. TUBE

Special quality double triode designed for use in cascode circuits and as R.F. or I.F. amplifier.

QUICK REFERENCE DATA

Life test	10 000 hours
Low interface resistance	
Mechanical quality	Shock and vibration resistant
Base	Noval. Gold plated pins
Heating	Indirect A.C. or D.C.; parallel supply
Heater voltage	V_f 6.3 V
Heater current	I_f 475 mA
Anode current	I_a 30 mA
Mutual conductance	S 20 mA/V
Equivalent noise resistance (R.F.)	R_{eq} 200 Ω
Noise figure	F 5.7 dB

DIMENSIONS AND CONNECTIONS

Dimensions in mm

Base: Noval

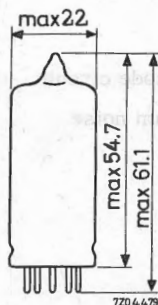
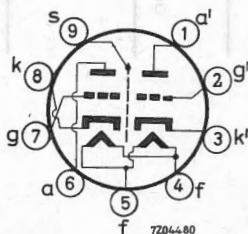

CHARACTERISTICS

Column I Nominal value or setting of the tube

II Range values for equipment design: Initial spread

III Range values for equipment design: End of life

		I	II	III	
Heater voltage	V_f	6.3			V
Heater current	I_f	475	450 - 500		mA
Anode supply voltage	V_{ba}	100			V
Grid supply voltage	$+V_{bg}$	9			V
Cathode resistor	R_k	350			Ω
Anode current	I_a	30	28 - 32	min. 26.5	mA
Mutual conductance	S	20	17 - 22.5	min. 14.5	mA/V
Amplification factor	μ	25			
Internal resistance	R_i	1.25			k Ω
Equivalent noise resistance	R_{eq}	200			Ω
Noise figure in cascode circuit	F	5.7			dB
Adapted to minimum noise					
Negative grid current	$-I_g$		max. 0.2	max. 1	μ A
Anode supply voltage	V_{ba}	60			V
Cathode resistor	R_k	80			Ω
Anode current	I_a	1.5			mA
Mutual conductance	S	15.5			mA/V
Amplification factor	μ	25			
Internal resistance	R_i	1.85			k Ω
Noise figure in cascode circuit	F	5			dB
Adapted to minimum noise					

CAPACITANCES Each system if applicable

Grid to cathode heater and screen	$C_{g/kfs}$	4.7 pF
Anode to cathode heater and screen	$C_{a/kfs}$	1.9 pF
Anode to grid	$C_{a'/k'fs}$	1.8 pF
Cathode to grid heater and screen	C_{ag}	1.8 pF
Anode to grid heater and screen	$C_{k/gfs}$	7.8 pF
	$C_{a/gfs}$	3.5 pF
	$C_{a'/gfs}$	3.4 pF
Anode to cathode	C_{ak}	0.25 pF
Anode to anode other section	$C_{aa'}$	max. 0.05 pF
Grid to grid other section	$C_{gg'}$	max. 0.005 pF

SHOCK AND VIBRATION RESISTANCE

The following test conditions are applied to assess the mechanical quality of the tube. These conditions are not intended to be used as normal operating conditions.

Shock

The tube is subjected 5 times in each of 4 positions to an acceleration of 500 g supplied by an NRL shock machine with the hammer lifted over an angle of 30°.

Vibration

The tube is subjected during 32 hours in each of 3 positions to a vibration frequency of 50 Hz with an acceleration of 2.5 g.

LIFE

Production samples are tested during 10 000 hours.

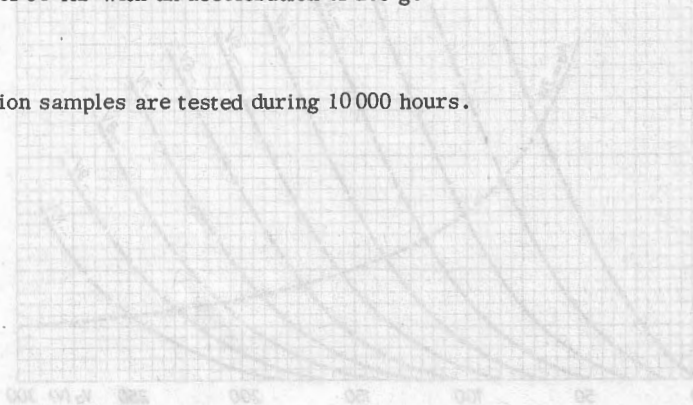

LIMITING VALUES (Absolute max. rating system)

Anode voltage	V_{a0}	max. 400 V
	V_a	max. 250 V
Anode dissipation	W_a	max. 3 W
Grid voltage	$-V_g$	max. 50 V
Grid peak voltage	$-V_{gp}$	max. 150 V
Max. pulse duration 10 μ sec		
Max. duty factor 0.01		
Grid resistor with automatic bias	R_g	max. 1 M Ω
Cathode current	I_k	max. 40 mA
Cathode peak current	I_{kp}	max. 400 mA
Max. pulse duration 10 μ sec		
Max. duty factor 0.01		
Voltage between cathode and heater	V_{kf}	max. 150 V
Bulb temperature	t_{bulb}	max. 190 $^{\circ}$ C

Heater voltage: The average heater voltage should be 6.3 V.

Variations of the heater voltage exceeding the range of 6.0 V to 6.6 V will shorten the tube life.

The tolerance of heater current (column II) should be taken into account.

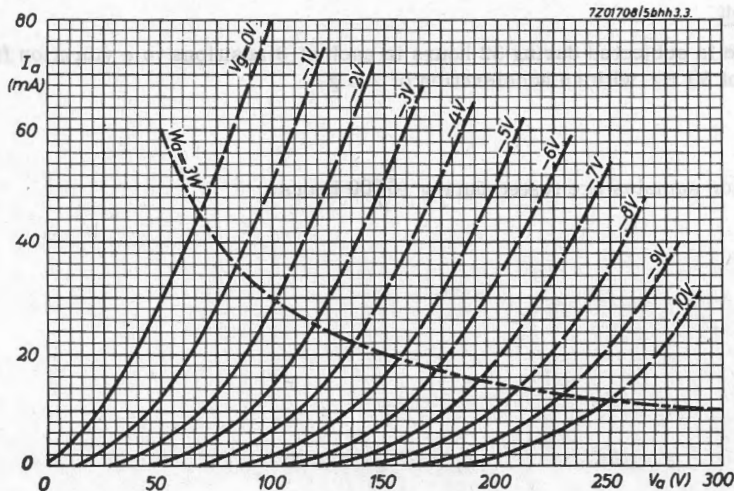

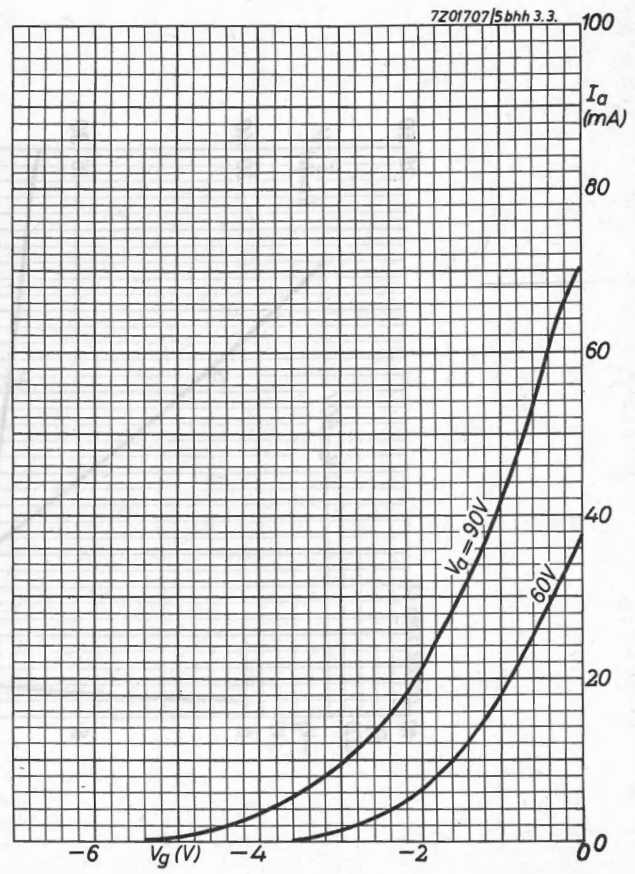
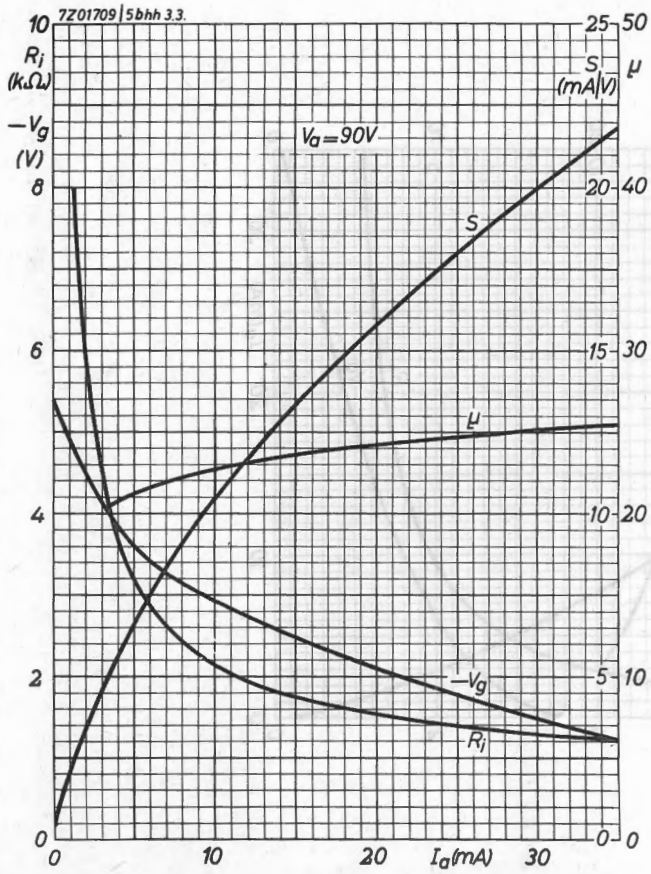

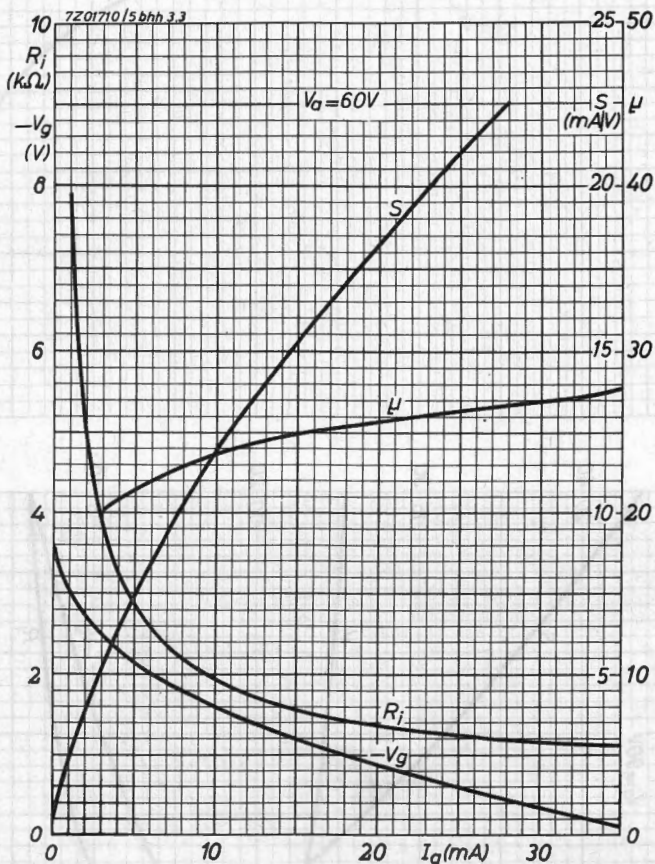

S.Q. TUBE

Special quality pentode designed for use as wide band amplifier.

QUICK REFERENCE DATA

Life test	0	10 000 hours
Low interface resistance	185	
Mechanical quality	11.5	Shock and vibration resistant
Base	380	Noval. Gold plated pins
Heating	37	Indirect A.C. or D.C.; Parallel supply
Heater voltage	6.3	V_f 6.3 V
Heater current	30	I_f 340 mA
Anode current	43	I_a 35 mA
Mutual conductance	57	S 50 mA/V
Equivalent noise resistance	110	R_{eq} 110 Ω
Quality factor	$\frac{S}{2\pi(C_{g1}+C_a+5)}$	250 MHz

DIMENSIONS AND CONNECTIONS

Dimensions in mm

Base: Noval

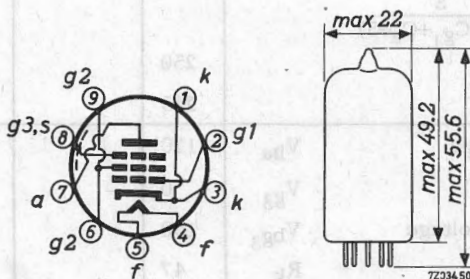

CHARACTERISTICS

Column I Nominal value or setting of the tube

II Range values for equipment design: Initial spread

III Range values for equipment design: End of life

		I	II	III	
Heater voltage	V_f	6.3			V
Heater current	I_f	340	320 - 360		mA
Anode supply voltage	V_{ba}	135			V
Grid No.3 voltage	V_{g3}	0			V
Grid No.2 supply voltage	V_{bg2}	165			V
Grid No.1 supply voltage	$+V_{bg1}$	12.5			V
Cathode resistor	R_k	360			Ω
Anode current	I_a	35	(negligible spread)		mA
Grid No.2 current	I_{g2}	5.0	4.4 - 5.6		mA
Mutual conductance	S	50	42 - 58	min. 35	mA/V
Internal resistance	R_i	42			k Ω
Amplification factor of grid No.2 to grid No.1	μ_{g2g1}	57			
Negative grid current	$-I_{g1}$		max. 0.1	max. 0.2	μA
Equivalent noise resistance	R_{eq}	110			Ω
Frequency = 45 MHz					
Input resistance	r_{g1}	415			Ω
Frequency = 100 MHz					
Quality factor	$\frac{S}{2\pi(C_{g1}+C_a+5)}$				
a) without shield		250			MHz
b) with shield		245			MHz
Anode supply voltage	V_{ba}	120			V
Grid No.3 voltage	V_{g3}	0			V
Grid No 2 supply voltage	V_{bg3}	150			V
Cathode resistor	R_k	47			Ω
Anode current	I_a	35	31 - 39		mA

CHARACTERISTICS (continued)

		II	III	
<u>Hum voltage</u>	V_{g_1}	max. 150		μV
Grid No.1 resistor $R_{g_1} = 0.5 M\Omega$				
Midtap heater transformer grounded				
Cathode resistor decoupled				
<u>Leakage current between cathode and heater</u>	I_{kf}	max. 10	max. 20	μA
Voltage between cathode and heater $V_{kf} = 100 V$				
<u>Insulation resistance between anode and other electrodes</u>	R	min. 100	min. 40	$M\Omega$
Measured with $V = 250 V$				

CAPACITANCES

		Without external shield		With external shield		
		I	II	I	II	
Anode to grid No.3, grid No.2, cathode, heater and screen	C_{a/g_3g_2kfs}	3.5	3.2-3.8	4.1	3.9-4.3	pF
Grid No.1 to grid No.3, grid No.2, cathode, heater and screen	C_{g_1/g_3g_2kfs}	14.5	13- 16	14.5	13- 16	pF
($I_k = 0 mA$)	C_{g_1/g_3g_2kfs}	24	22- 26	24	22- 26	pF
($I_k = 40 mA; f = 100 Mc/s$)	C_{g_1/g_3g_2kfs}					
Anode to grid No.1	C_{ag_1}		max. 36		max. 32	mpF
Anode to cathode	C_{ak}	60	53- 67	33	26- 40	mpF
Anode to heater	C_{af}	31	26- 36	20	12- 28	mpF
Grid No.1 to heater	C_{g_1f}	60	40- 80	55	35- 75	mpF
Cathode to heater	C_{kf}			5.2	4.2-6.2	pF

SHOCK AND VIBRATION RESISTANCE

The following test conditions are applied to assess the mechanical quality of the tube. These conditions are not intended to be used as normal operating conditions.

Shock

The tube is subjected 5 times in each of 4 positions to an acceleration of 500 g supplied by an NRL shock machine with the hammer lifted over an angle of 30°.

Vibration

The tube is subjected during 32 hours in each of 3 positions to a vibration frequency of 50 Hz with an acceleration of 2.5 g.

LIFE

Production samples are tested to be within the end of life values (column III) under the following conditions during 10 000 hours.

Anode supply voltage	V_{ba}	165 V
Anode resistor	R_a	820 Ω
Grid No.3 voltage	V_{g3}	0 V
Grid No.2 supply voltage	V_{bg2}	165 V
Grid No.1 supply voltage	$+V_{bg1}$	12.5 V
Cathode resistor	R_k	360 Ω
Anode current	I_a	35 mA
Voltage between cathode and heater	V_{kf}	100 V

LIMITING VALUES (Absolute max. rating system)

Anode voltage	V_{a0}	max. 400 V
	V_a	max. 250 V
Anode dissipation	W_a	max. 5 W
Grid No.2 voltage	V_{g20}	max. 400 V
	V_{g2}	max. 200 V
Grid No.2 dissipation	W_{g2}	max. 1 W ¹⁾
Grid No.1 voltage	$-V_{g1}$	max. 25 V
Grid No.1 peak voltage	$-V_{g1p}$	max. 50 V
	$+V_{g1p}$	max. 50 V
Grid No.1 dissipation	W_{g1}	max. 10 mW

Maximum averaging time = 1 s

¹⁾ Care should be taken not to exceed the rated W_{g2} value due to switching of positive supply voltages.

LIMITING VALUES (Absolute max. rating system) (continued)

Grid No. 1 resistor

With fixed bias

 R_{g1} max. 0.2 M Ω With automatic bias $R_k = 47 \Omega$ R_{g1} max. 0.6 M Ω $R_k = 360 \Omega$ R_{g1} max. 3.5 M Ω

Cathode current

 I_k max. 50 mA

Cathode current

 I_k max. 65 mA

(Life expectancy 1000 hours)

Voltage between cathode and heater

 V_{kf} max. 100 V

Bulb temperature

 t_{bulb} max. 200 °C

Bulb temperature

 t_{bulb} max. 220 °C

(Life expectancy 1000 hours)

Heater voltage: The average heater voltage should be 6.3 V.

Variations of the heater voltage exceeding the range of 6.0 V to 6.6 V will shorten the tube life.

The tolerance of heater current (column II) should be taken into account.

OPERATING CHARACTERISTICSOutput tube class A

Anode supply voltage

 V_{ba} 155 V

Grid No. 3 voltage

 V_{g3} 0 V

Grid No. 2 supply voltage

 V_{bg2} 165 V

Grid No. 1 supply voltage

 $+V_{bg1}$ 12.5 V

Cathode resistor

 R_k 360 Ω

Cathode capacitor

 C_k 1000 μF

Anode resistor

 $R_{a\sim}$ 560 Ω

Anode current

 I_a 35 mA

Anode current, peak to peak

 I_{ap} 40 mA

Total distortion

 d_{tot} 7.5 %

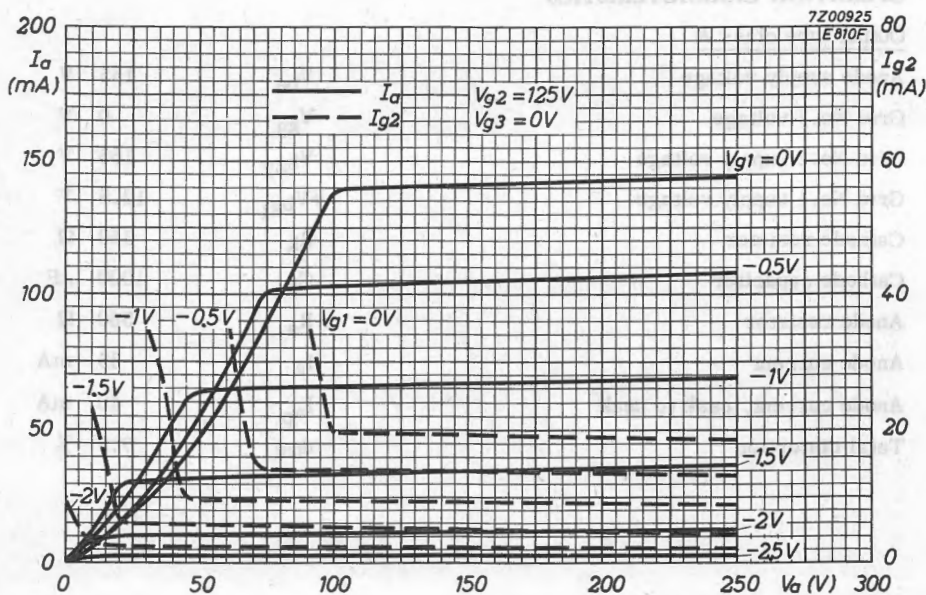
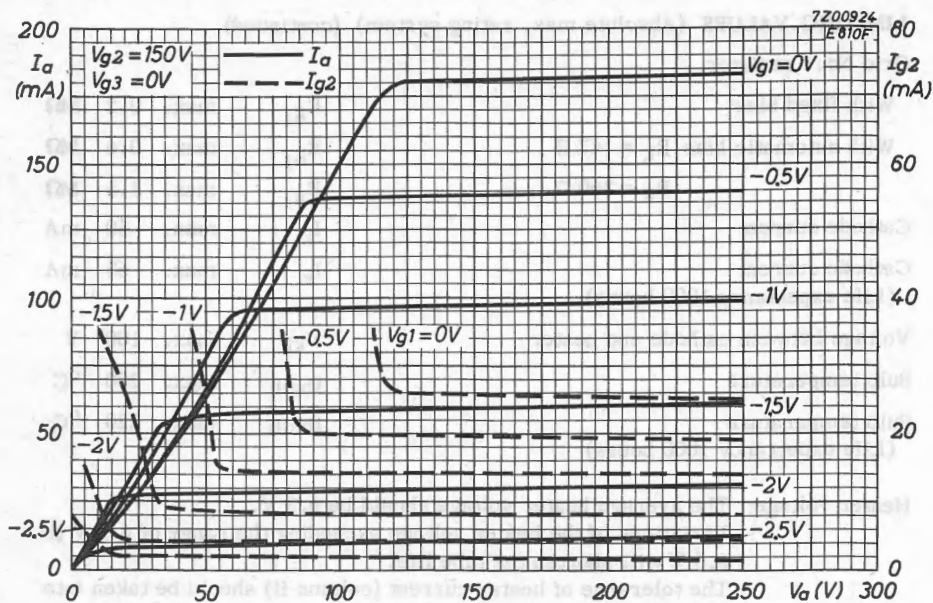

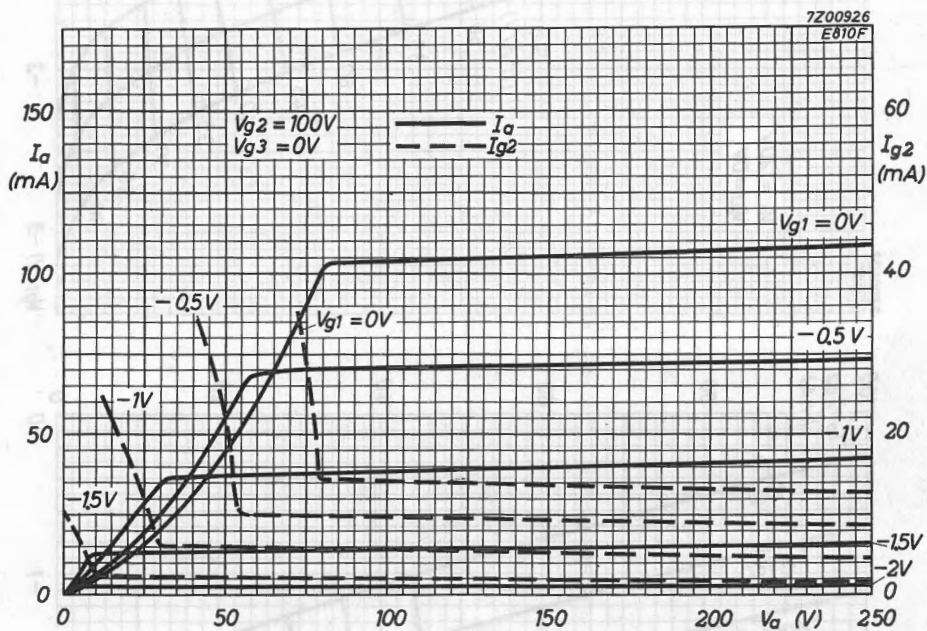

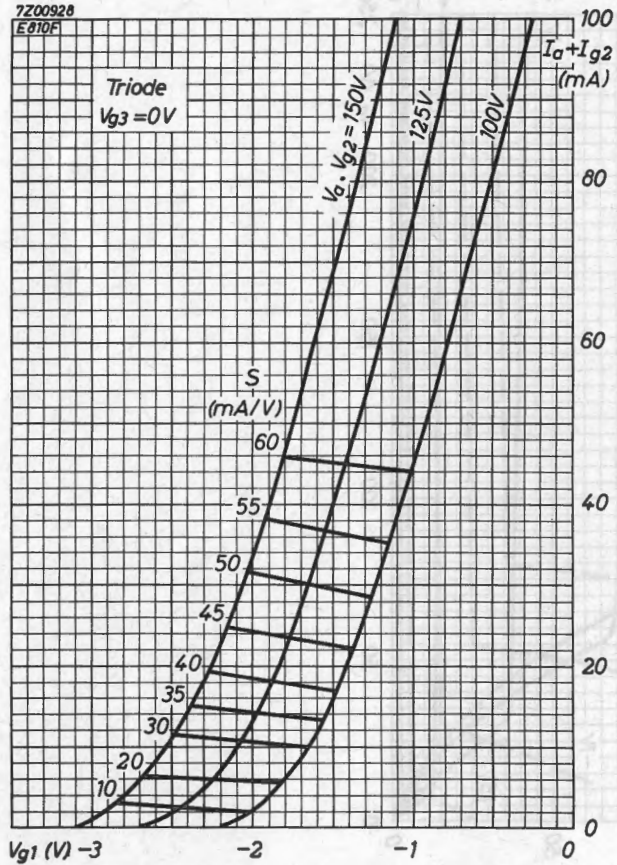
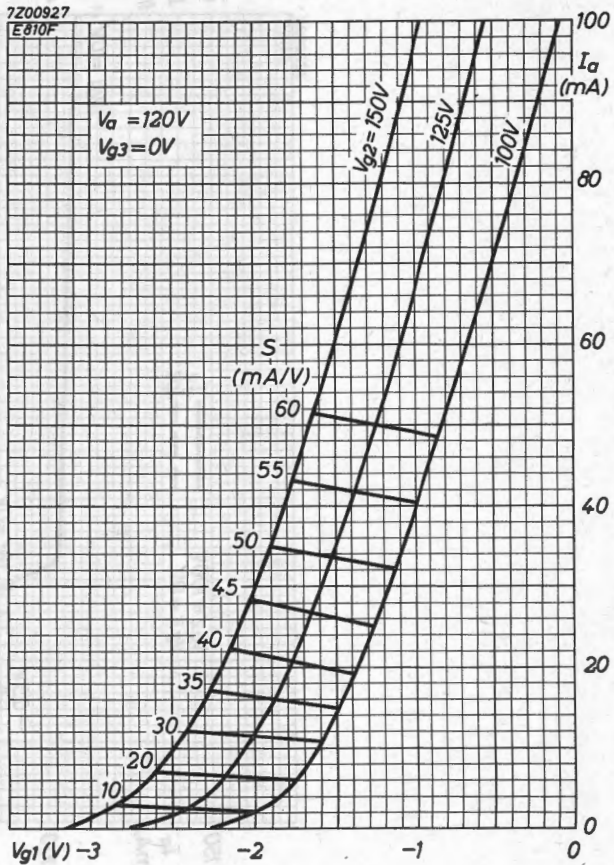
7Z00928
E810F7Z00927
E810F

S.Q. TUBE

Triode designed for use as grounded grid U.H.F. amplifier for frequencies up to 500 MHz.

QUICK REFERENCE DATA

Life test	500 hours	
Base	Noval. Gold plated pins	
Heating	Indirect A.C. or D.C.; parallel supply	
Heater voltage	V_f	6.3 V
Heater current	I_f	430 mA
Mutual conductance	S	12 mA/V

DIMENSIONS AND CONNECTIONS

Dimensions in mm

Base: Noval

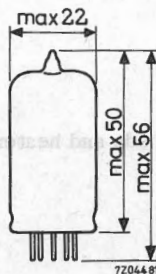
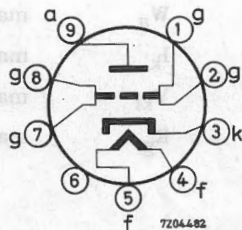

CHARACTERISTICS

Anode voltage	V_a	250 V
Grid voltage	$-V_g$	1.5 V
Anode current	I_a	15 mA
Mutual conductance	S	12 mA/V
Amplification factor	μ	80

CAPACITANCES

Grid and pin No.6 to cathode and heater	$C_{gp6/kf}$	5.1 pF
Grid, heater and pin No.6 to cathode	$C_{gfp6/k}$	9.3 pF
Anode to cathode	C_{ak}	max. 0.075 pF
Anode to cathode and heater	$C_{a/kf}$	max. 0.08 pF
Anode to grid and pin No.6	$C_{a/gp6}$	3.4 pF
Anode to grid, heater and pin No.6	$C_{a/gfp6}$	3.4 pF
Cathode to heater	C_{kf}	max. 8 pF

LIFE

Production samples are tested during 500 hours.

LIMITING VALUES (Design centre rating system)

Anode voltage	V_{a0}	max.	550 V
	V_a	max.	300 V
Anode dissipation	W_a	max.	4 W
Cathode current	I_k	max.	15 mA
Voltage between cathode and heater	V_{kf}	max.	100 V
Grid resistor	R_g	max.	0.3 M Ω

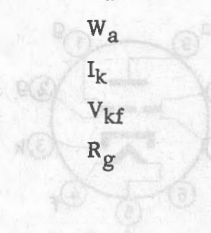
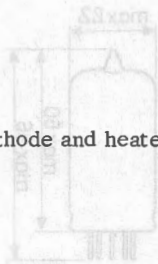

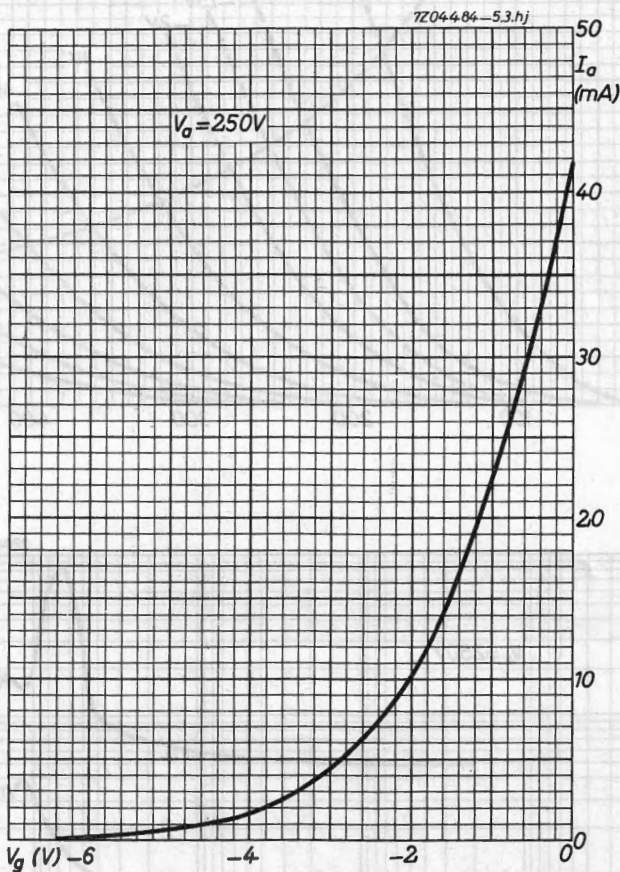

72044-83-5.3.hj

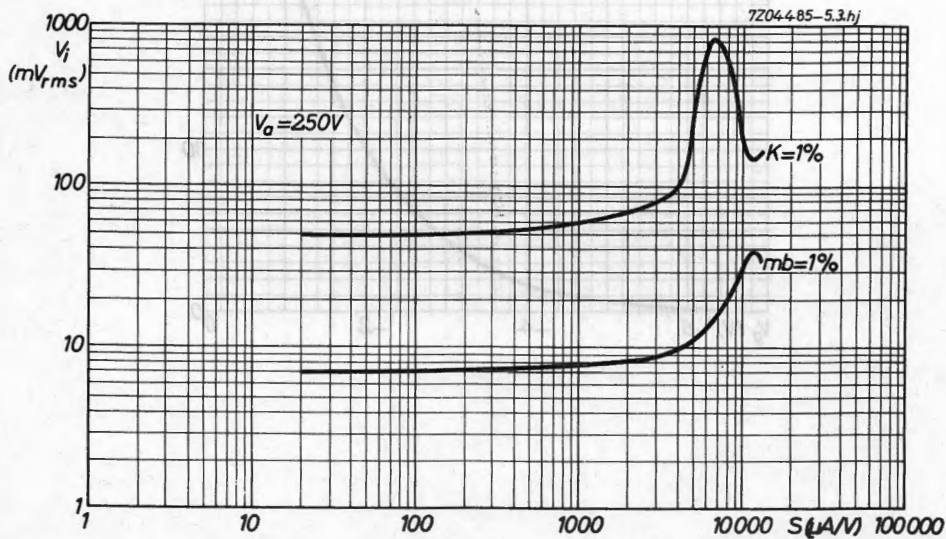
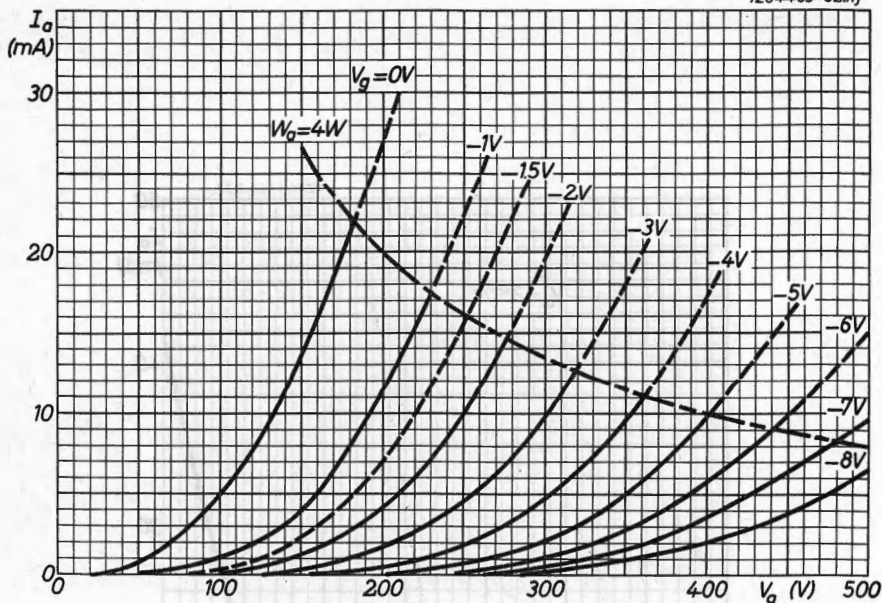

S.Q. TUBE

U.H.F. oscillator triode for frequencies up to 750 MHz.

QUICK REFERENCE DATA

Base	Noval. Gold plated pins
Heating	Indirect A.C. or D.C.; parallel supply
Heater voltage	V_f 6.3 V
Heater current	I_f 175 mA
Anode current	I_a 30 mA
Mutual conductance	S 5.5 mA/V

DIMENSIONS AND CONNECTIONS

Dimensions in mm

Base: Noval

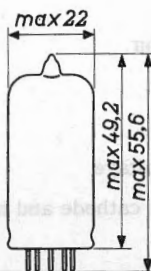
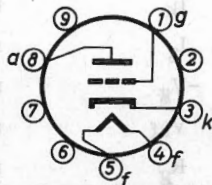

CAPACITANCES

Grid to all except anode	$C_{g(a)}$	1.8 pF
Anode to all except grid	$C_{a(g)}$	0.7 pF
Anode to grid	C_{ag}	1.6 pF
Grid to heater	C_{gf}	max. 0.25 pF
Cathode to heater	C_{kf}	2.3 pF

CHARACTERISTICS

Heater voltage	V_f	6.3	V	
Heater current	I_f	175	mA	
Anode voltage	V_a	120	150	V
Grid voltage	$-V_g$	2	2	V
Anode current	I_a	20	30	mA
Mutual conductance	S	4	5.5	mA/V
Amplification factor	μ	16	16	

OPERATING CHARACTERISTICS AND LIMITING VALUES

Operation as U.H.F. oscillator

A) Heater supply voltage	V_f	6.3	V
Series resistor in heater circuit	R	3	Ω
Wave length	λ	40 — 80	cm
Anode voltage	V_a	220 — 275	V
Anode current	I_a	18.6 — 17.2	mA
Grid current	$+I_g$	1.5 — 2.8	mA
Output power	W_o	0.6 — 2.1	W

LIMITING VALUES Design centre rating system

Anode voltage	V_{a_o}	max. 550	V
Anode voltage	V_a	max. 275	V
Anode dissipation	W_a	max. 3.5	W
Cathode current	I_k	max. 20	mA
Grid current	I_g	max. 7.5	mA
Negative grid voltage	$-V_g$	max. 100	V
Voltage between cathode and heater	V_{kf}	max. 100	V
Grid resistor	R_g	max. 1	M Ω

B) Heater supply voltage	V_f	6.3	V
Series resistor in heater circuit	R	3	Ω
Wave length	λ	40 — 80	cm
Anode voltage	V_a	290 — 300	V
Anode current	I_a	19.6 — 18.6	mA
Grid current	$+I_g$	0.4 — 1.5	mA
Output power	W_o	0.7 — 2.2	W

With these operating conditions the following limiting values should be strictly adhered to

LIMITING VALUES Design centre rating system unless otherwise specified.

Anode voltage	V_{a_0}	max.	550	V
Anode voltage (stabilized $\pm 1\%$)	V_a	max.	300	V
Anode dissipation (Abs. max.)	W_a	max.	5	W
Cathode current	I_k	max.	20	mA
Grid current	I_g	max.	7.5	mA
Negative grid voltage	$-V_g$	max.	100	V
Voltage between cathode and heater	V_{kf}	max.	100	V
Grid resistor	R_g	max.	1	$M\Omega$

C) Heater voltage	V_f	6.3		V
Wave length	λ	40	80	cm
Anode voltage	V_a	220	300	V
Anode current	I_a	27.7	26.3	mA
Grid current	I_g	2.3	4	mA
Output power	W_o	1.1	3.8	W

LIMITING VALUES Design centre rating system unless otherwise specified.

Anode voltage	V_{a_0}	max.	550	V
Anode voltage (stabilized $\pm 1\%$)	V_a	max.	300	V
Anode dissipation (Abs. max.)	W_a	max.	5	W
Cathode current (Abs. max.)	I_k	max.	30	mA
Grid current	$+I_g$	max.	7.5	mA
Grid voltage	$-V_g$	max.	100	V
Voltage between cathode and heater	V_{kf}	max.	100	V
Grid resistor	R_g	max.	1	$M\Omega$

Heater voltage: The average heater voltage should be 6.3 V

Variation of the heater voltage should not exceed the range the range of $6.3 \text{ V} \pm 3\%$.

7209921

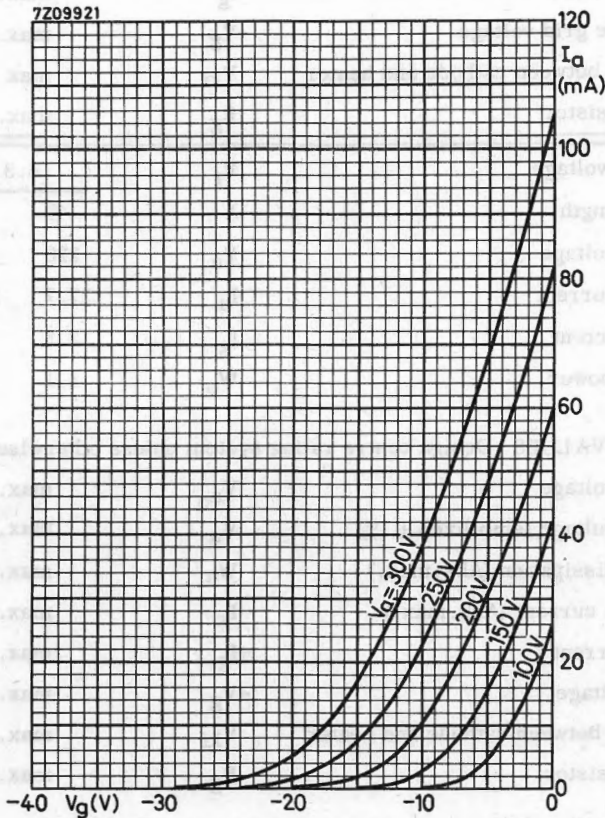

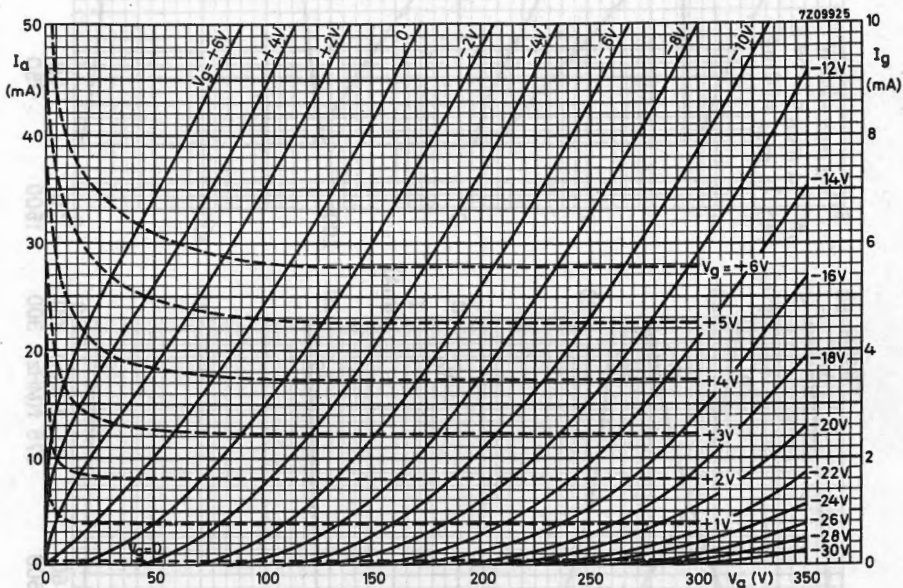

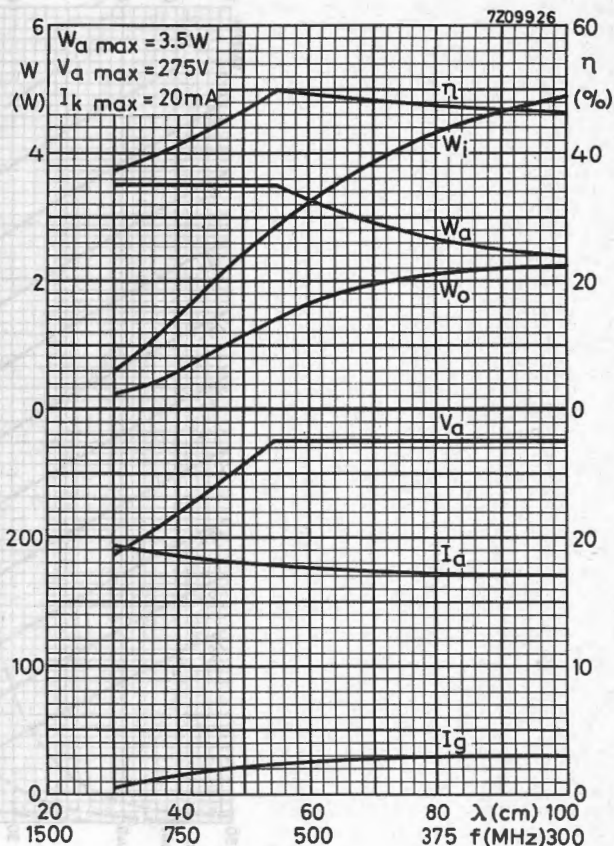
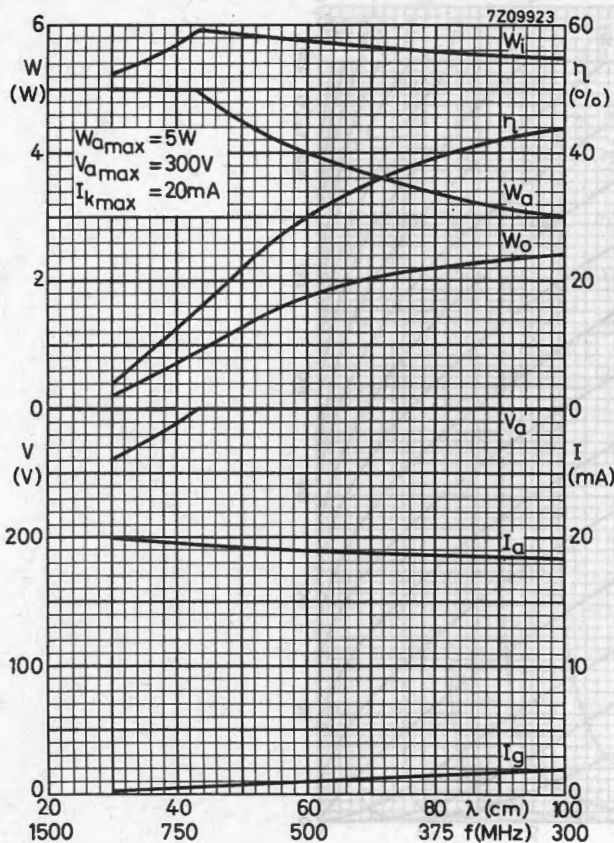

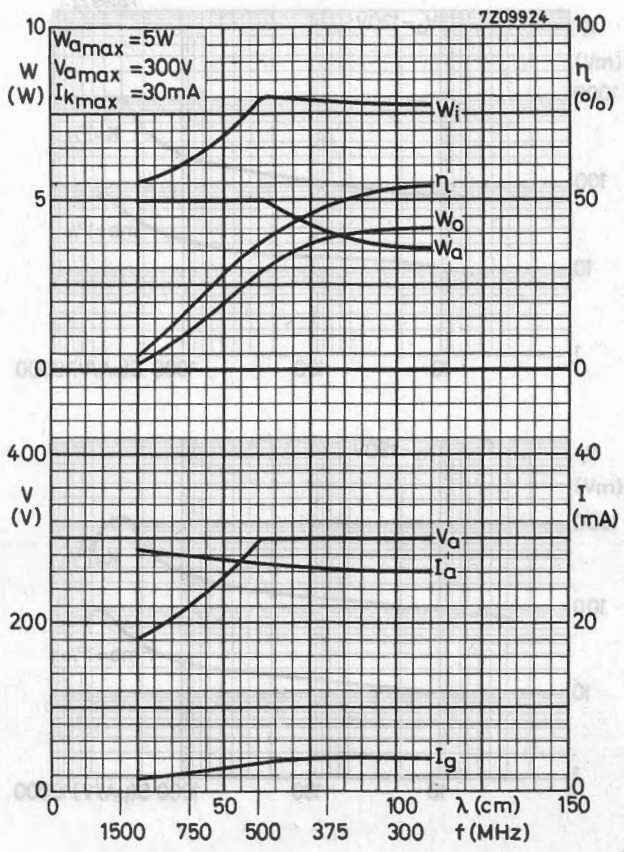

7Z09922.1

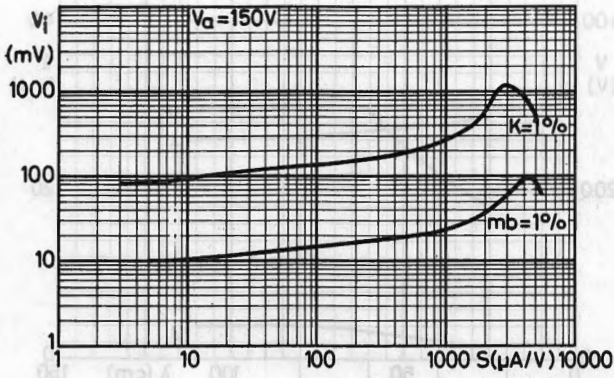
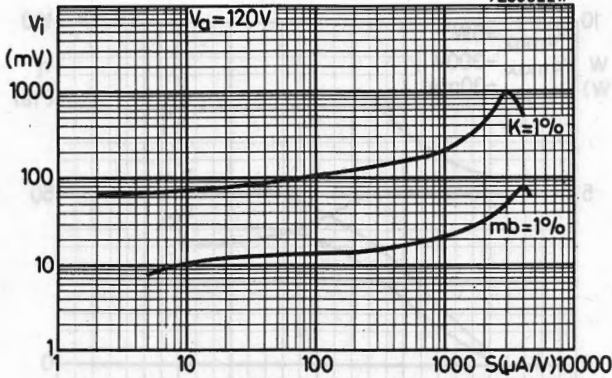

S.Q. TUBE

Triode designed for use as R.F. power amplifier or oscillator for frequencies up to 150 MHz.

QUICK REFERENCE DATA

Life test	500 hours
Base	Miniature
Heating	Indirect A.C. or D.C.
Heater voltage	V_f 6.3 V
Heater current	I_f 150 mA
Output power $f = 50$ MHz	W_o 3.6 W
$f = 100$ MHz	W_o 3.3 W

DIMENSIONS AND CONNECTIONS

Dimensions in mm

Base: Miniature

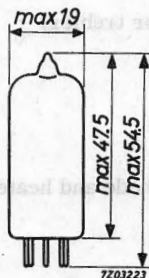
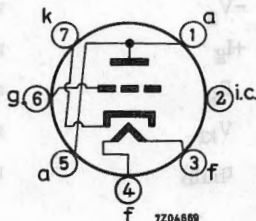

CHARACTERISTICS

Heater voltage	V_f	6.3	V
Heater current	I_f	150	mA
Anode voltage	V_a	100	250 V
Grid voltage	$-V_g$	0	8.5 V
Anode current	I_a	11.8	10.5 mA
Mutual conductance	S	3.25	2.2 mA/V
Amplification factor	μ	21.5	17
Internal resistance	R_i	6.6	7.7 k Ω

CAPACITANCES

		Without shield	With shield
Anode to grid	C_{ag}	1.4	1.3 pF
Grid to cathode and heater	$C_{a/kf}$	1.5	1.7 pF
Anode to cathode and heater	$C_{g/kf}$	1.2	2.6 pF

LIMITING VALUES (Design centre rating system)

Anode voltage	V_{a0}	max.	550 V
	V_a	max.	300 V
Anode dissipation	W_a	max.	3.5 W
Cathode current:			
(as R.F. oscillator or amplifier)	I_k	max.	30 mA
(as R.F. doubler or trebler)	I_k	max.	20 mA
Grid voltage	$-V_g$	max.	100 V
Grid current	$+I_g$	max.	5.0 mA
Grid resistor	R_g	max.	250 k Ω
Voltage between cathode and heater	V_{kf}	max.	150 V
Bulb temperature	t_{bulb}	max.	180 °C

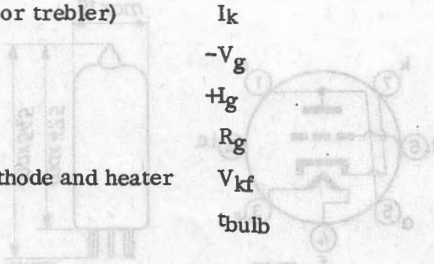

OPERATING CHARACTERISTICS

As R.F. amplifier or oscillator

Class C telegraphy or F.M.

Frequency	f	50	100	MHz
Anode voltage	V_a	300	300	V
Grid voltage	$-V_g$	27	27	V
Anode current	I_a	16.2	17.1	mA
Grid current	$+I_g$	3.8	2.9	mA
Output power	W_o	3.6	3.3	W
Efficiency	η	67	55	%

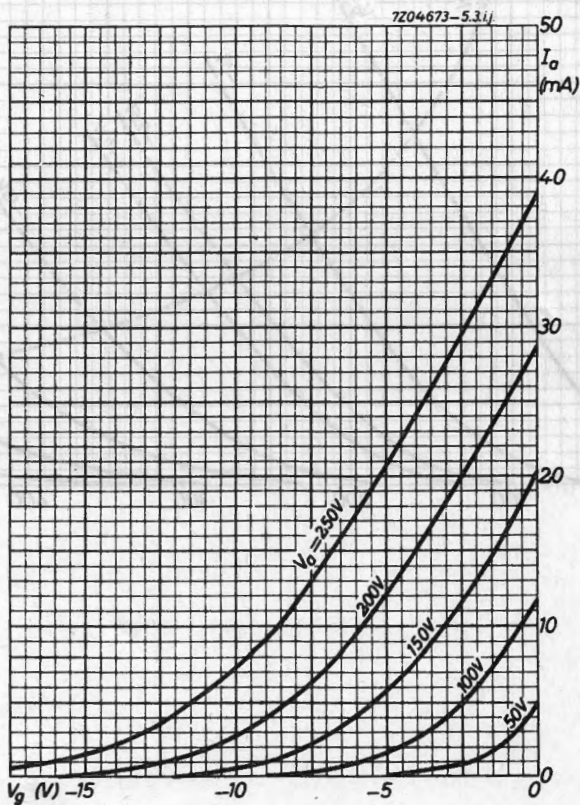

OPERATING CHARACTERISTICS

As R.F. amplifier or oscillator

Class C telephony or F.M.

Frequency

Anode voltage

Grid voltage

Anode current

Grid current

7204670-5.3ij

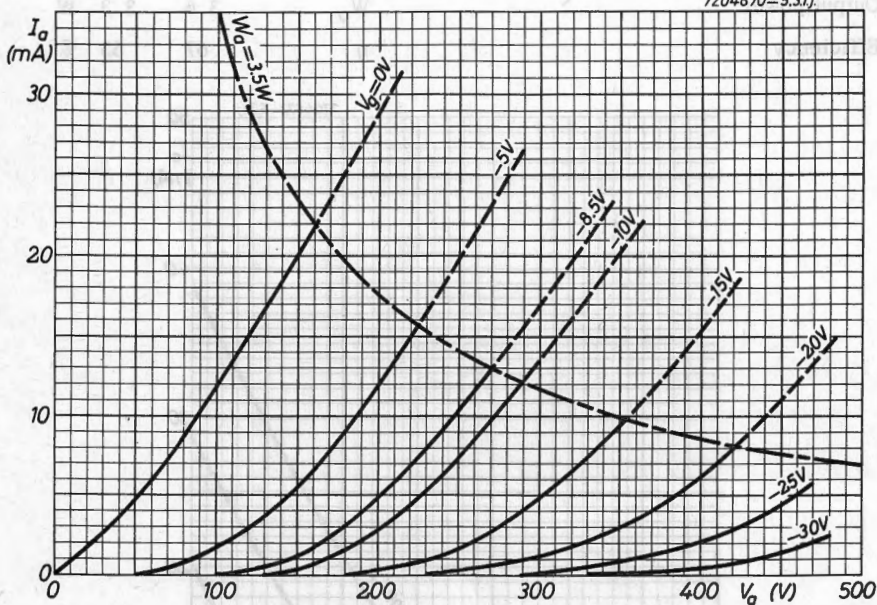

S.Q. TUBE

Triode designed for use as grounded grid-U.H.F. amplifier for frequencies up to 250 MHz.

QUICK REFERENCE DATA

Life test	500 hours
Base	Miniature 7 pin
Heating	Indirect A.C. or D.C. Series or parallel supply
Heater voltage	V_f 6.3 V
Heater current	I_f 300 mA
Mutual conductance	S 8.5 mA/V

DIMENSIONS AND CONNECTIONS

Dimensions in mm

Base: Miniature 7 pin

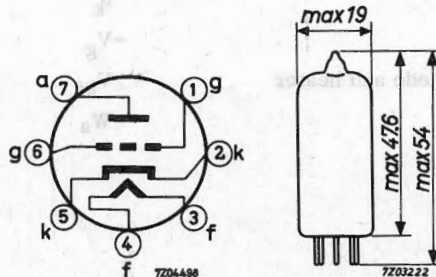

CHARACTERISTICS

Anode voltage	V_a	250 V
Grid voltage	$-V_g$	1.5 V
Cathode resistor	R_k	150 Ω
Anode current	I_a	10 mA
Mutual conductance	S	8.5 mA/V
Amplification factor	μ	100

Internal resistance	R_i	12 k Ω
Equivalent noise resistance	R_{eq}	400 Ω

CAPACITANCES

Grid to cathode and heater	$C_{g/kf}$	8.5 pF
Anode to cathode and heater	$C_{a/kf}$	max. 0.2 pF
Anode to grid	C_{ag}	2.5 pF

LIFE

Production samples are tested during 500 hours.

LIMITING VALUES (Absolute max. rating system)

Anode voltage	V_{a0}	max. 550 V
	V_a	max. 250 V
Cathode current	I_k	max. 15 mA
Grid voltage	$-V_g$	max. 100 V
Voltage between cathode and heater	V_{kf}	max. 150 V
Anode dissipation	W_a	max. 2.5 W

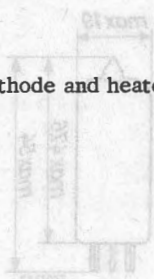

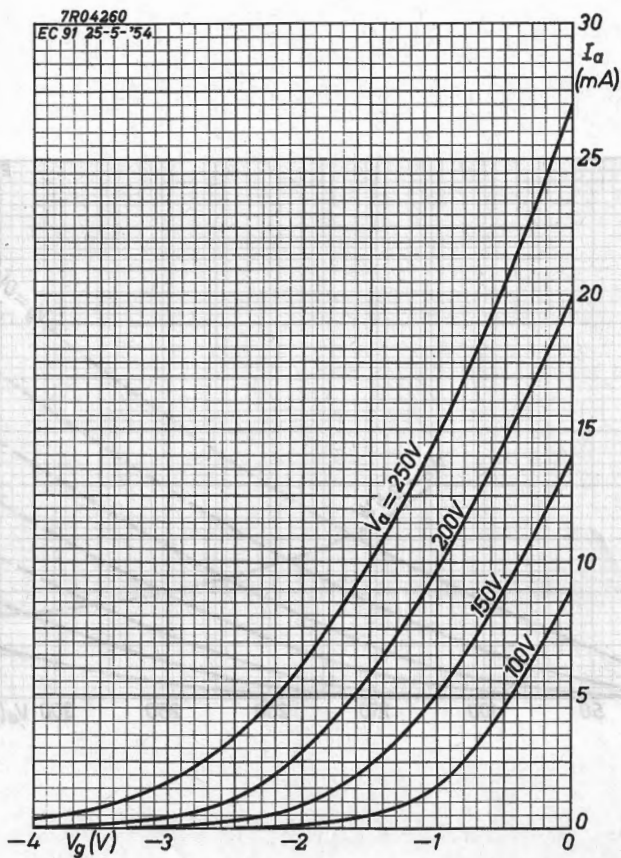

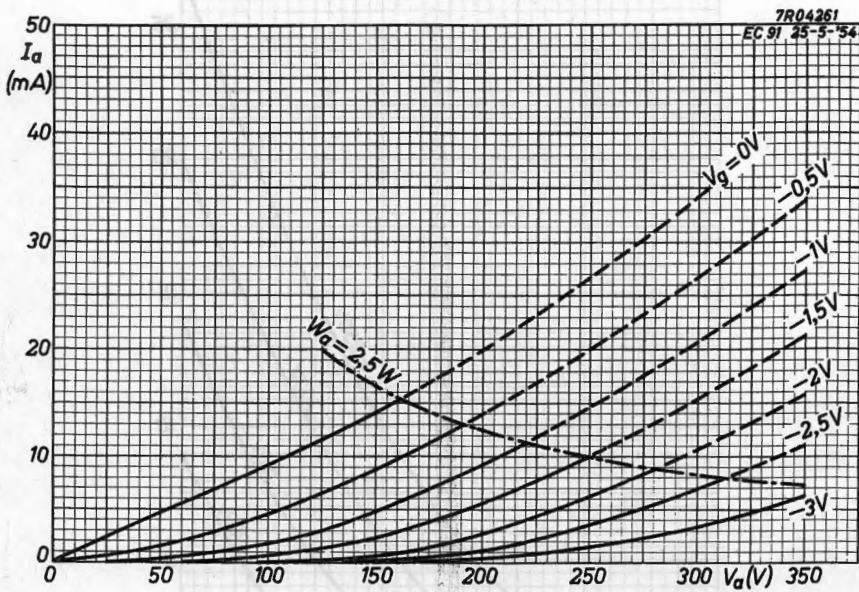

S.Q. TUBE

Special quality triode, designed for use as amplifier in measuring probes.

QUICK REFERENCE DATA

Life test	1000 hours
Envelope	Subminiature
Low interface resistance	
Mechanical quality	Shock and vibration resistant
Heating	Indirect
	A. C. or D. C.; parallel supply
Heater voltage	V_f 6.3 V
Heater current	I_f 185 mA
Equivalent grid noise voltage	V_n max. 1 mV
Anode current	I_a 14 mA
Mutual conductance	S 14.5 mA/V

DIMENSIONS AND CONNECTIONS

Envelope: Subminiature

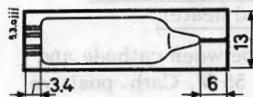
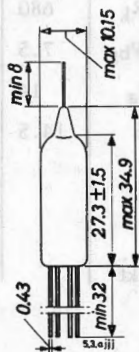
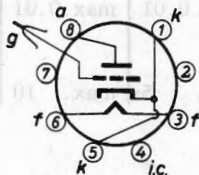

Leads should not be soldered nearer than 5 mm to the seal.

Leads should not be bent nearer than 2 mm to the seal.

Method of shielding. See fig. 1.

Dimensions in mm

CHARACTERISTICS

- Column I Nominal value or setting of the tube
 II Range values for equipment design: Initial spread
 III Range values for equipment design: End of life

		I	II	III	
Heater voltage	V_f	6.3			V
Heater current	I_f	185	175-195		mA
Anode voltage	V_a	80			V
Grid voltage	$-V_g$	2			V
Anode current	I_a	14			mA
Mutual conductance	S	14.5			mA/V
Amplification factor	μ	27.5			
Input resistance	r_g	300			Ω
Frequency = 250 MHz					
Input resonance frequency	f	400			MHz
Anode supply voltage	V_{ba}	82			V
Cathode resistor	R_k	143			Ω
Anode current	I_a	14.0	11.2-16.8	min. 8.2	mA
Mutual conductance	S	14.5			mA/V
Anode supply voltage	V_{ba}	90			V
Cathode resistor	R_k	680			Ω
Grid supply voltage	$+V_{bg}$	7.5			V
Anode current	I_a	14			mA
Mutual conductance	S	14.5	12.9-16.1	min. 9.2	mA/V
<u>Negative grid current</u>	$-I_g$		max. 0.01	max. 0.01	μA
<u>Leakage current between cathode and heater</u>	I_{kf}		max. 5	max. 10	μA

Voltage between cathode and heater = 55 V. Cath. positive

CHARACTERISTICS (continued)Equivalent grid microphony voltage

Peak acceleration = 4 g

Frequency = 50 Hz

Equivalent grid hum voltageGrid resistor = 0.5 M Ω Cathode resistor = 100 Ω

Heater centre grounded

	I	II	
V_g		max. 1.0	mV _{RMS}
V_g		max. 1.0	mV _{RMS}
C_{gk}	3.5	2.9 - 4.1	pF
C_{ag}	1.7	1.4 - 2.0	pF
C_{gf}	33	23 - 43	mpF
C_{ak}	450	325 - 575	mpF
C_{af}	270	185 - 355	mpF

CAPACITANCES

Grid to cathode

Anode to grid

Grid to heater

Anode to cathode

Anode to heater

SHOCK AND VIBRATION RESISTANCE

The following test conditions are applied to assess the mechanical quality of the tube. These conditions are not intended to be used as normal operating conditions.

Shock

The tube is subjected 5 times in each of 4 positions to an acceleration of 500 g supplied by an NRL shock machine with the hammer lifted over an angle of 30°.

Vibration

The tube is subjected during 32 hours in each of 3 positions to a vibration frequency of 50 Hz with an acceleration of 2.5 g.

LIFE

Production samples are tested to be within the end of life values during 1000 hours.

LIMITING VALUES (Absolute max. rating system)

Anode voltage	V_{a0}	max.	275	V
	V_a	max.	110	V
Anode dissipation	W_a	max.	1.5	W
Grid voltage	$-V_g$	max.	55	V
Cathode current	I_k	max.	22	mA
Voltage between cathode and heater	V_{kf}	max.	55	V
Bulb temperature	t_{bulb}	max.	170	°C

Grid resistor: The grid resistance should be restricted to a value such that no limiting values are exceeded at $-I_g = 0.01 \mu A$.

The D.C. feed back factor of the operating circuit may be taken into account.

The R_g value will also be limited by the required current stability and the permissible hum level.

Heater voltage: The average heater voltage should be 6.3 V.

Variations of the heater voltage exceeding the range of 6.0 V to 6.6 V will shorten the tube life.

SHOCK AND VIBRATION RESISTANCE

The following test conditions are applied to assess the mechanical quality of the tube. These conditions are not intended to be used as normal operating conditions.

Shock

The tube is subjected 2 times in each of 4 positions to an acceleration of 300 g applied by an M.R.I. shock machine with the tamper lifted over an angle of 30°.

Vibration

The tube is subjected during 33 hours in each of 3 positions to a vibration frequency of 30 Hz with an acceleration of 2.5 g.

LIFE

Production samples are tested to be within the end of life values during 1000 hours.

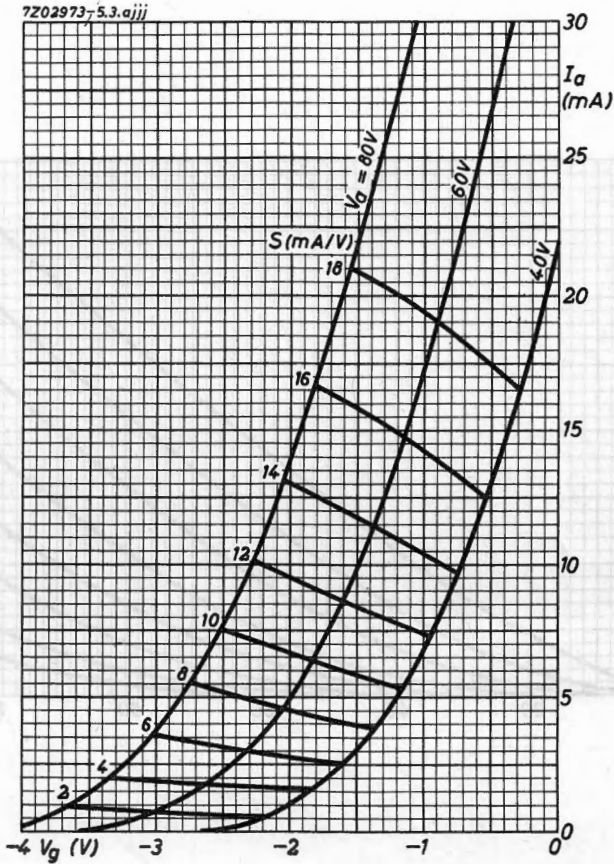

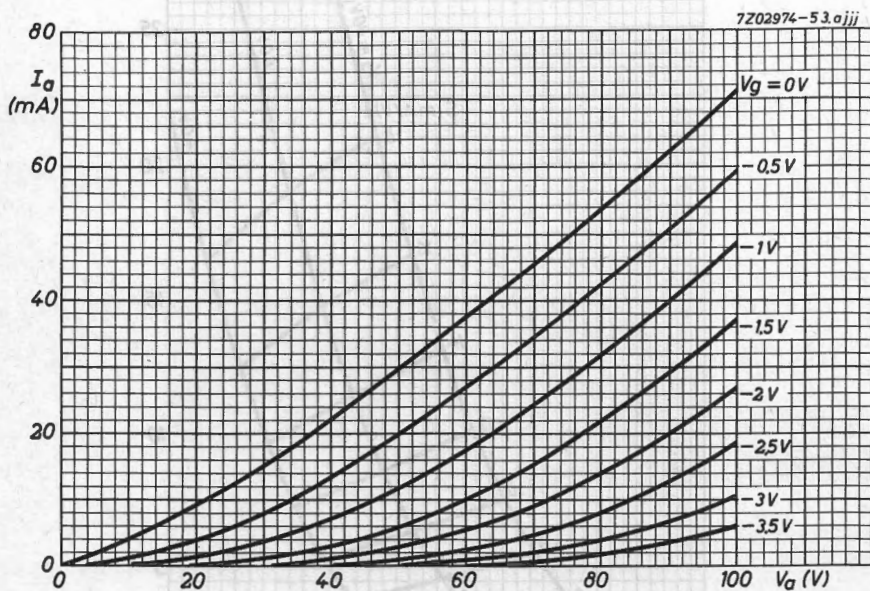

S.Q. TUBE

Special quality U.H.F. triode designed for use as R.F. amplifier and oscillator (max. frequency 1000 MHz).

QUICK REFERENCE DATA

Life test	10 000 hours
Low interface resistance	
Mechanical quality	Shock and vibration resistant
Base	Noval
Heating	Indirect A.C. or D.C.; parallel supply
Heater voltage	V_f 6.3 V
Heater current	I_f 280 mA
Anode current	I_a 25 mA
Mutual conductance	S 28 mA/V

DIMENSIONS AND CONNECTIONS

Dimensions in mm

Base: Noval

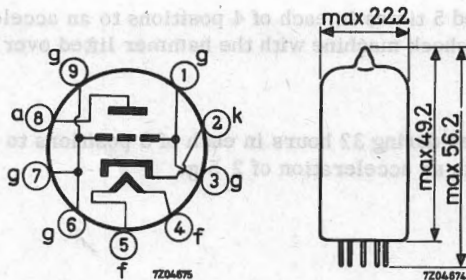

CHARACTERISTICS

Anode supply voltage	V_{ba}	200 V
Anode resistor	R_a	2.4 k Ω
Cathode resistor	R_k	47 Ω
Anode current	I_a	25 mA
Mutual conductance	S	28 mA/V
Amplification factor	μ	60

CAPACITANCESWithout shield

Anode to cathode and heater	$C_{a/kf}$	0.1 pF
Grid to cathode and heater	$C_{g/kf}$	7 pF
Anode to grid	C_{ag}	1.4 pF

With external shield

Anode to cathode and heater	$C_{a/kf}$	0.09 pF
Grid and screen to cathode and heater	$C_{gs/kf}$	7.5 pF
Anode to grid and shield	$C_{a/gS}$	1.9 pF

SHOCK AND VIBRATION RESISTANCE

The following test conditions are applied to assess the mechanical quality of the tube. These conditions are not intended to be used as normal operating conditions.

Shock

The tube is subjected 5 times in each of 4 positions to an acceleration of 500 g supplied by an NRL shock machine with the hammer lifted over an angle of 30°.

Vibration

The tube is subjected during 32 hours in each of 3 positions to a vibration frequency of 50 Hz with an acceleration of 2.5 g.

LIMITING VALUES (Absolute max. rating system)

Anode voltage	V_{a0}	max. 400 V
	V_a	max. 200 V
Anode dissipation	W_a	max. 4.5 W
Grid voltage	$-V_g$	max. 20 V
Cathode current	I_k	max. 35 mA
Grid resistor	R_g	max. 500 k Ω
Voltage between cathode and heater	V_{kf}	max. 100 V

Heater voltage: The average heater voltage should be 6.3 V.
 Variations of the heater voltage exceeding the range of 6.0 V to 6.6 V will shorten the tube life.

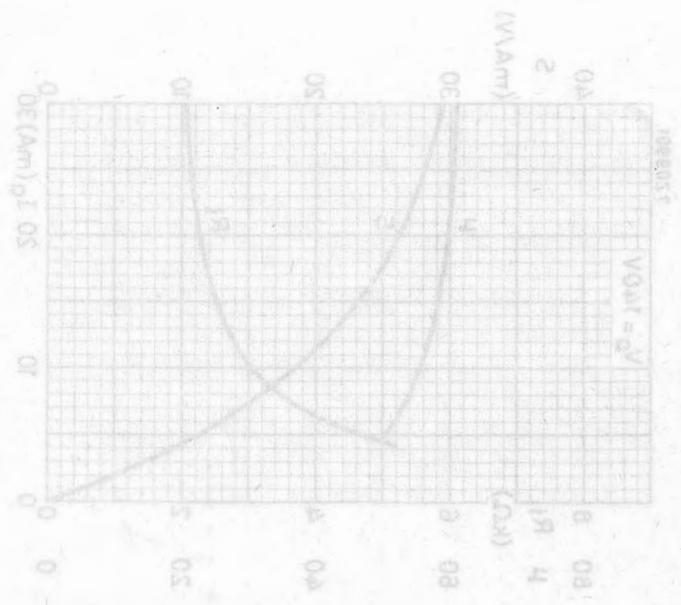
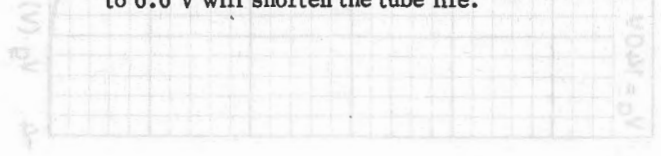

LIMITING VALUES (Special max. rating system)

max. 400 V
300 V
4.5 W
30 V
35 mA
500 kΩ
100 V
2 of 8.0 V

Anode voltage
Anode diss.
Grid voltage
Cathode current
Grid resistor
Voltage base
Heater voltage

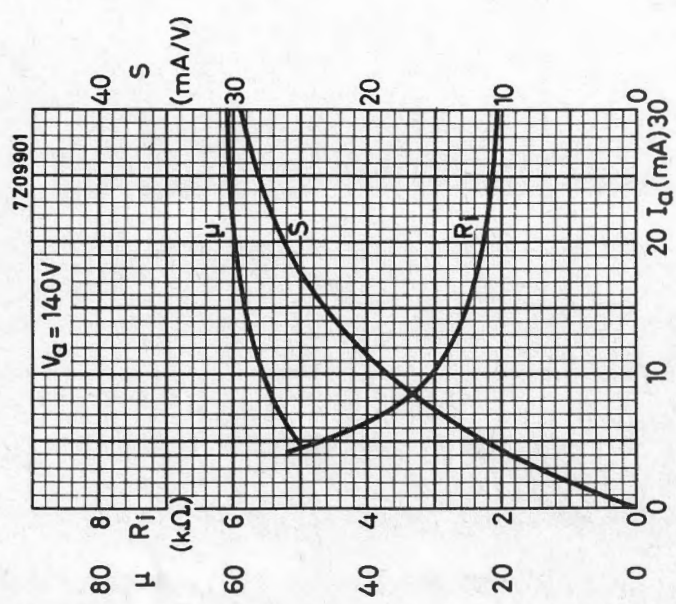
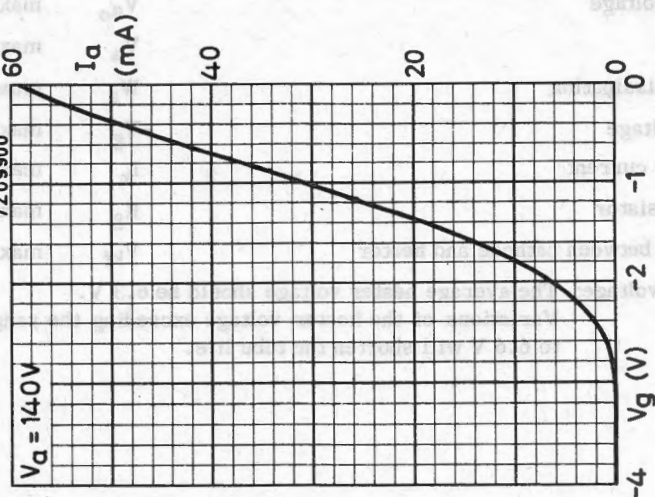

S.Q. TUBE

Special quality double triode with neutralisation screen, designed for use as V.H.F. amplifier (max. freq. 300 MHz) in a cascode circuit without external neutralisation, e.g. aerial amplifier for band III and frequency multiplier.

QUICK REFERENCE DATA

Life test	10 000 hours			
Low interface resistance				
Mechanical quality	Shock and vibration resistant			
Base	10 pin miniature with gold plated pins			
Heating	Indirect A.C. or D.C.; parallel supply			
Heater voltage	V_f	6.3 V		
Heater current	I_f	335 mA		
Anode voltage	Input section		Output section	
	90	90	90	90 V
Anode current	15	27	15	27 mA
	13	17.5	17	22 mA/V
Mutual conductance				

DIMENSIONS AND CONNECTIONS

Base: 10 pin miniature

Dimensions in mm

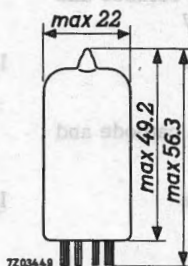
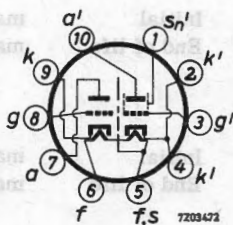

CHARACTERISTICS

Heater voltage	V_f	6.3		V
Heater current	I_f	335		mA
<u>Input section (unit a', g', k')</u>				
Anode voltage	$V_{a'}$	90	90	V
Neutralization screen voltage	$V_{Sn'}$	0	0	V
Grid voltage	$-V_{g'}$	2.1	1.4	V
Anode current	$I_{a'}$	15	27	mA
Mutual conductance	S	13	17.5	mA/V
Amplification factor	μ	27	27	
Equivalent noise resistance	R_{eq}	250	200	Ω
<u>Output section (unit a, g, k)</u>				
Anode voltage	V_a	90	90	V
Grid voltage	$-V_g$	2.0	1.4	V
Anode current	I_a	15	27	mA
Mutual conductance	S	17	22	mA/V
Amplification factor	μ	28	28	
Equivalent noise resistance	R_{eq}	200	150	Ω
<u>Insulation resistance between electrodes</u>	R_{ins}	Initial	min. 100	M Ω
		End of life	min. 20	M Ω

Leakage current between cathode and heater

Voltage between cathode and heater $V = 150$ V

Cathode positive

I_{kf}	Initial	max. 15	μ A
	End of life	max. 20	μ A

Voltage between cathode and heater $V = 50$ V

Cathode negative

I_{kf}	Initial	max. 15	μ A
	End of life	max. 20	μ A

CAPACITANCES**Input system (unit a', g', k')**

Grid to cathode, filament and neutralisation screen	$C_{g'}/k'f_{sn}'$	5.1 pF
---	--------------------	--------

Anode to cathode, filament and neutralisation screen	$C_{a'}/k'f_{sn}'$	5.0 pF
--	--------------------	--------

Grid to neutralisation screen	$C_{g'sn}'$	1.4 pF
-------------------------------	-------------	--------

Anode to grid	$C_{a'g}'$	0.45 pF
---------------	------------	---------

Anode to neutralisation screen	$C_{a'sn}'$	3.4 pF
--------------------------------	-------------	--------

Output system (unit a, g, k)

Cathode to grid and filament	$C_{k/gf}$	6.5 pF
------------------------------	------------	--------

Anode to grid and filament	$C_{a/gf}$	3.2 pF
----------------------------	------------	--------

Anode to cathode	C_{ak}	180 mpF
------------------	----------	---------

Anode to grid	C_{ag}	1.5 pF
---------------	----------	--------

SHOCK AND VIBRATION RESISTANCE

The following test conditions are applied to assess the mechanical quality of the tube. These conditions are not intended to be used as normal operating conditions.

Shock

The tube is subjected 5 times in each of 4 positions to an acceleration of 500 g supplied by an NRL shock machine with the hammer lifted over an angle of 30°.

Vibration

The tube is subjected during 32 hours in each of 3 positions to a vibration frequency of 50 Hz with an acceleration of 2.5 g.

LIFE

Production samples are tested under the following conditions during 10000 hours: (each unit)

Heater voltage	V_f	6.3 V
----------------	-------	-------

Anode supply voltage	V_{ba}	110 V
----------------------	----------	-------

Grid supply voltage	V_{bg}	17 V
---------------------	----------	------

Cathode resistor	R_k	680 Ω
------------------	-------	--------------

LIMITING VALUES (Absolute max. rating system)

(Each unit)

Anode voltage	V_{a0}	max. 450 V
	V_a	max. 250 V
Anode dissipation	W_a	max. 2.7 W
Grid voltage	$-V_g$	max. 50 V
Grid peak voltage	$-V_{gp}$	max. 150 V
Duty factor max.		1%
Pulse duration max.		10 μ s
Cathode current	I_k	max. 40 mA
Cathode peak current	I_{kp}	max. 400 mA
Duty factor max.		10%
Pulse duration max.		200 μ s
Grid resistor	R_g	max. 1 M Ω
Automatic bias		
Voltage between cathode and heater		
Cathode positive	$V_{kf}(k+)$	max. 150 V
Cathode negative	$V_{kf}(k-)$	max. 50 V
Bulb temperature		max. 225 $^{\circ}$ C

OPERATING CHARACTERISTICS

Cascode circuit, Frequency 200 MHz

Supply voltage	V_b	200	200 V
Cathode resistor	R_k'	1200	680 Ω
Anode current	I_a	15.5	26.5 mA
Input resistance	$r_{g'}$	910	670 Ω
Input capacitance	C_i	11	12 pF
Noise figure	F	2.5	2.5 kT_0

Adapted to minimum noise

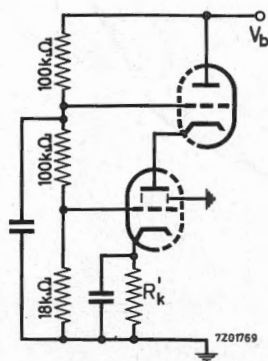

S.Q. TUBE

Special quality double triode designed for use as A.F. amplifier, oscillator and multivibrator.

QUICK REFERENCE DATA

Life test	1000 hours
Low interface resistance	
Mechanical quality	Shock and vibration resistant
Base	Noval
Heating	Indirect A.C. or D.C.; Parallel supply
Heater voltage	V_f 6.3 or 12.6 V
Heater current	I_f 300 or 150 mA
Anode current	I_a 1.2 mA
Mutual conductance	S 1.6 mA/V
Amplification factor	μ 100

DIMENSIONS AND CONNECTIONS

Dimensions in mm

Base: Noval

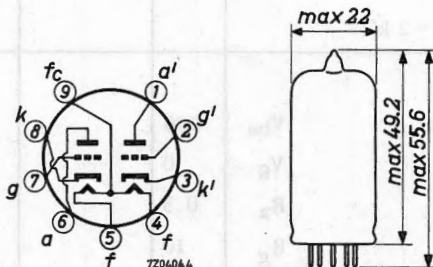

CHARACTERISTICS Each system if applicable.

Column I Nominal value or setting of the tube

II Range values for equipment design: Initial spread

III Range values for equipment design: End of life

		I	II	III	
Heater voltage	V_f	6.3			V
Heater current	I_f	300	276- 324		mA
Anode voltage	V_a	250			V
Grid voltage	$-V_g$	2			V
Anode current	I_a	1.2	0.75-1.75		mA
Mutual conductance	S	1.6	1.25-2.05	min. 1.12	mA/V
Amplification factor	μ	100			
Internal resistance	R_i	62.5			k Ω
Difference in anode current of both systems	$ I_a - I_a' $		max. 0.6		mA
Negative grid current	$-I_g$		max. 0.5	max. 0.5	μ A
Vibrational noise output (units connected parallel)	V_o		max. 25		mVRMS
Anode supply voltage $V_{ba} = 250$ V					
Grid voltage $-V_g = 2$ V					
Frequency $f = 25$ Hz					
Acceleration 2.5 g					
Anode resistor $R_a = 2$ k Ω					
<u>Amplification</u>					
Anode supply voltage	V_{ba}	100			V
Grid voltage	V_g	0			V
Anode resistor	R_a	0.5			M Ω
Grid resistor	R_g	10			M Ω
Input voltage	V_i	0.2			VRMS
Output voltage	V_o		min. 8.4		VRMS

CHARACTERISTICS (continued)

		I	II	III	
Anode voltage	V_a	100			V
Grid voltage	$-V_g$	1			V
Anode current	I_a	0.5			mA
Mutual conductance	S	1.25			mA/V
Amplification factor	μ	100			
Internal resistance	R_i	80			$k\Omega$
<u>Insulation resistance between electrodes</u>	R_{ins}		min. 100	min. 50	$M\Omega$
Voltage between electrodes $V = 100$ V					
<u>Leakage current between cathode and heater</u>	I_{kf}		max. 10	max. 20	μA
Voltage between cathode and heater $V_{kf} = 100$ V					

CAPACITANCES. Without external screen.
Each system if applicable.

Anode to grid, cathode and heater	$C_{a/gkf}$	3.9 pF
Anode to cathode and heater	$C_{a/kf}$	0.4 pF
	$C_{a'/k'f}$	0.3 pF
Grid to anode, cathode and heater	$C_{g/akf}$	3.7 pF
Grid to cathode and heater	$C_{g/kf}$	1.6 pF
Anode to grid	C_{ag}	1.7 pF

SHOCK AND VIBRATION RESISTANCE

The following test conditions are applied to assess the mechanical quality of the tube. These conditions are not intended to be used as normal operating conditions.

Shock

The tube is subjected 5 times in each of 4 positions to an acceleration of 500 g supplied by an NRL shock machine with the hammer lifted over an angle of 30° .

SHOCK AND VIBRATION RESISTANCE (continued)

Vibration

The tube is subjected during 32 hours in each of 3 positions to a vibration frequency of 50 Hz with an acceleration of 2.5 g.

LIFE

Production samples are tested to be within the end of life values (column III)

LIMITING VALUES (Absolute max. rating system)

Anode voltage	V_a	max. 330 V
Anode dissipation	W_a	max. 1.1 W
Cathode current	I_k	max. 20 mA
Grid resistor with fixed bias	R_g	max. 1 M Ω
Voltage between cathode and heater	V_{kf}	max. 100 V
Bulb temperature	t_{bulb}	max. 165 °C

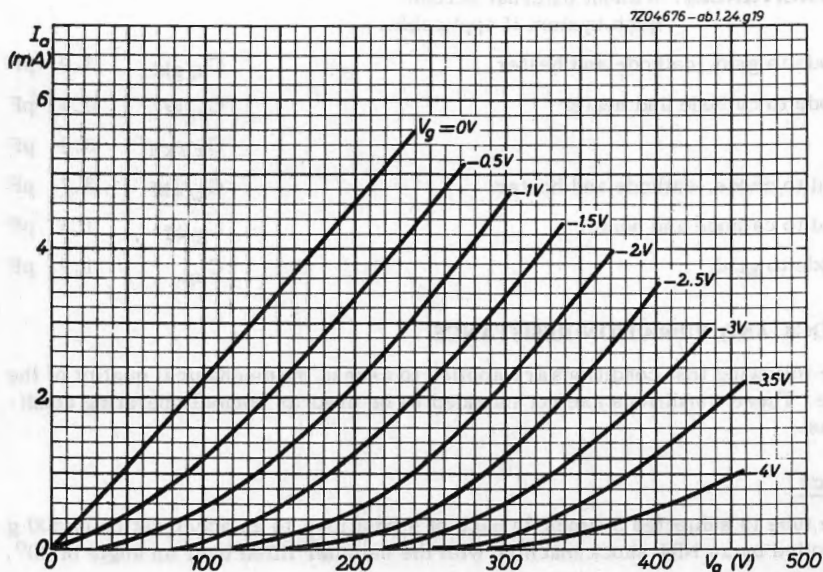

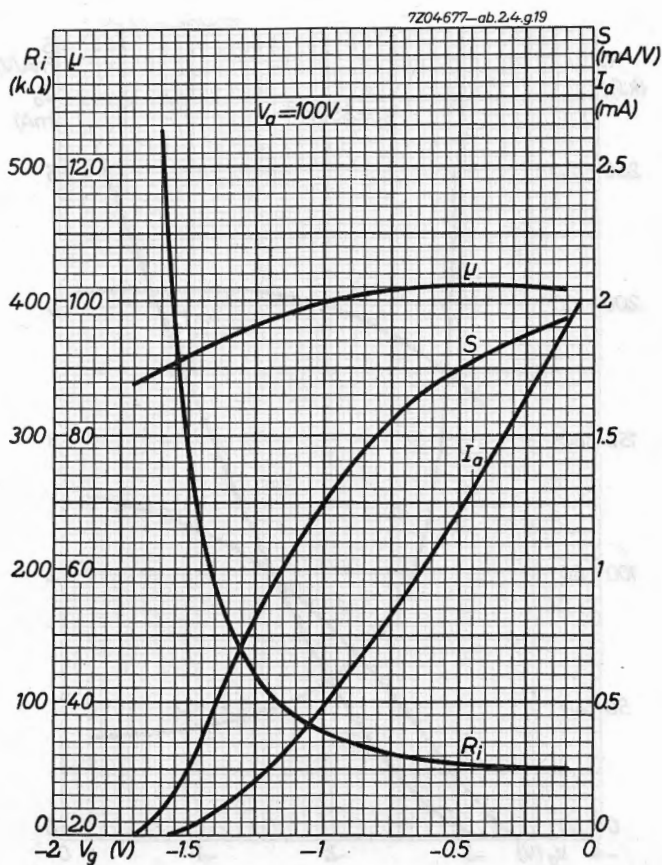

7204678-ob.2.4.g.19

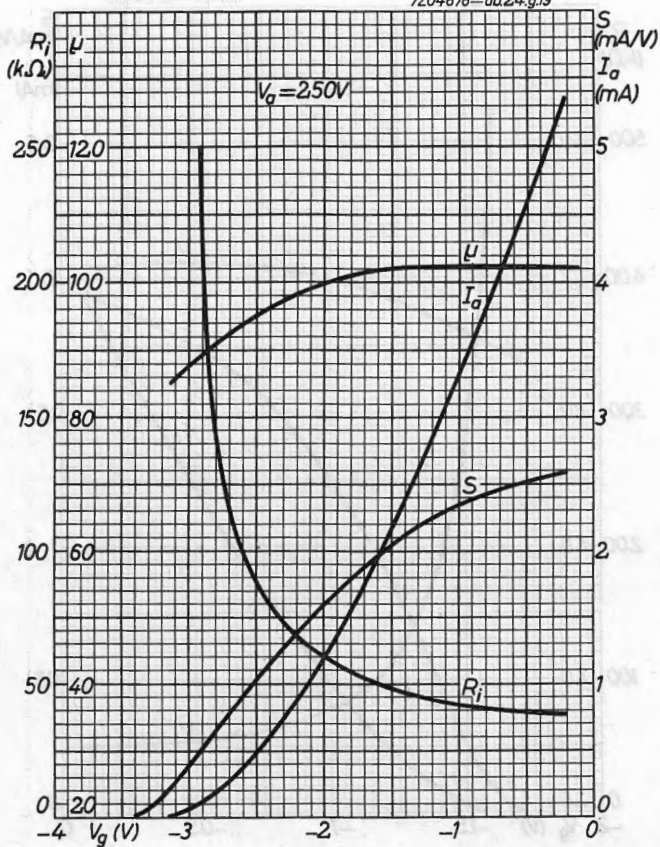

S.Q. DUAL CONTROL PENTODE

Special quality dual control pentode designed for use as amplifier and mixer.

QUICK REFERENCE DATA

Life test	1000 hours
Mechanical quality	Shock and vibration resistant
Base	Subminiature
Heating	Indirect
Heater voltage	V_f 6.3 V
Heater current	I_f 150 mA
Mutual conductance anode to grid No.1	S_{ag1} 3.2 mA/V
Mutual conductance anode to grid No.3	S_{ag3} 0.5 mA/V

DIMENSIONS AND CONNECTIONS

Base: Subminiature

Dimensions in mm

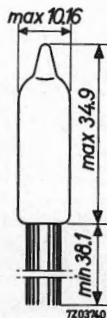
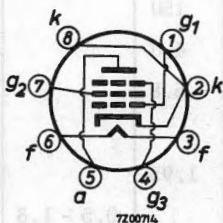

Connections should not be soldered nearer than 5 mm to the seal.

Leads should not be bent nearer than 1.5 mm to the seal.

CHARACTERISTICS

Column I Nominal value or setting of the tube

II Range values for equipment design: Initial spread

III Range values for equipment design: End of life

		I	II	III	
Heater voltage	V_f	6.3			V
Heater current	I_f	150	140 - 160		mA
Anode voltage	V_a	100			V
Grid No.2 voltage	V_{g2}	100			V
Grid No.3 voltage	V_{g3}	0			V
Cathode resistor	R_k	150			Ω
Anode current	I_a	5.3	3.7 - 6.9		mA
Grid No.2 current	I_{g2}	4.0	2.8 - 5.4		mA
Mutual conductance;					
anode to grid No.1	S_{ag1}	3.2	2.7 - 4.0	ΔS : max. 20 %	mA/V
anode to grid No.3	S_{ag3}	0.5			mA/V
Internal resistance	R_i	110			k Ω
<u>Negative grid No.1 current</u>	$-I_{g1}$		max. 0.3	max. 1.0	μA
Grid No.1 resistor $R_{g1} = 1 M\Omega$					
Anode voltage	V_a	100			V
Grid No.2 voltage	V_{g2}	100			V
Grid No.3 voltage	V_{g3}	-1			V
Cathode resistor	R_k	150			Ω
Anode current	I_a	4.0			mA
Grid No.2 current	I_{g2}	5.8			mA
Mutual conductance;					
anode to grid No.1	S_{ag1}	1.95			mA/V
anode to grid No.3	S_{ag3}		0.5 - 1.8		mA/V
Internal resistance	R_i	50			k Ω

CHARACTERISTICS (continued)

		I	II	III	
<u>Grid No. 1 cut-off voltage</u>	$-V_{g1}$		max. 7.5		V
Anode voltage	V_a	100			V
Grid No. 2 voltage	V_{g2}	100			V
Anode current	I_a	100			μA
<u>Grid No. 3 cut-off voltage</u>	$-V_{g3}$		max. 8.0		V
Anode voltage	V_a	100			V
Grid No. 2 voltage	V_{g2}	100			V
Anode current	I_a	100			μA
<u>Leakage current between cathode and heater</u>	I_{kf}		max. 5	max. 10	μA
Voltage between cathode and heater $V_{kf} = 100$ V					
<u>Insulation resistance between two electrodes</u>	R_{ins}		min. 100	min. 50	M Ω
Voltage between electrodes = 100 V					
<u>Vibrational noise output</u>	V_o		max. 40		mV
Anode supply voltage	V_{ba}	100			V
Anode resistor	R_a	10			k Ω
Grid No. 2 voltage	V_{g2}	100			V
Grid No. 3 voltage	V_{g3}	0			V
Cathode by pass capacitor $C = 1000 \mu F$					
Cathode resistor $R_k = 150 \Omega$					
Vibration frequency 40 Hz					
Acceleration 15 g					

CAPACITANCES; With external shield

		I	II	
Grid No.1 to grid No.2, grid No.3, cathode and heater	$C_{g1/g2g3}$ kf	4.0	3.5 - 4.5	pF
Grid No.3 to grid No.1, grid No.2, cathode and heater	$C_{g3/g2g1}$ kf	4.0	3.5 - 4.5	pF
Anode to grid No.2, grid No.3, cathode and heater	$C_{a/g2g3}$ kf	3.4	2.9 - 3.9	pF
Anode to grid No.1	C_{ag1}		max. 0.02	pF
Anode to grid No.3	C_{ag3}		max. 1.1	pF
Grid No.1 to grid No.3	C_{g1g3}		max. 0.15	pF

SHOCK AND VIBRATION RESISTANCE

The following test conditions are applied to assess the mechanical quality of the tube. These conditions are not intended to be used as normal operating conditions.

Shock

The tube is subjected 5 times in each of 4 positions to an acceleration of 500 g supplied by an NRL shock machine with the hammer lifted over an angle of 30°.

Vibration

The tube is subjected during 32 hours in each of 3 positions to a vibration frequency of 25 Hz with an acceleration of 2.5 g.

LIFE

Production samples are tested to be within the end of life values (column III) during 1000 hours.

LIMITING VALUES (Absolute max. rating system)

Anode voltage	V_{a_0}	max.	330 V
Anode voltage	V_a	max.	165 V
Anode dissipation	W_a	max.	1.1 W
Grid No.3 voltage	V_{g_3}	max.	30 V
Grid No.3 negative voltage	$-V_{g_3}$	max.	55 V
Grid No.2 voltage	V_{g_2}	max.	155 V
Grid No.2 dissipation	W_{g_2}	max.	0.7 W
Grid No.1 voltage	V_{g_1}	max.	0 V
Grid No.1 negative voltage	$-V_{g_1}$	max.	55 V
Grid No.1 resistor	R_{g_1}	max.	1.2 M Ω
Cathode current	I_k	max.	16 mA
Voltage between cathode and heater;			
D.C. component	V_{kf}	max.	200 V
peak value	V_{kfp}	max.	200 V
Bulb temperature	t_{bulb}	max.	220 °C

Heater voltage: The average heater voltage should be 6.3 V.

Variations of the heater voltage exceeding the range of 6.0 V to 6.6 V will shorten the tube life.

The tolerance of heater current (column II) should be taken into account.

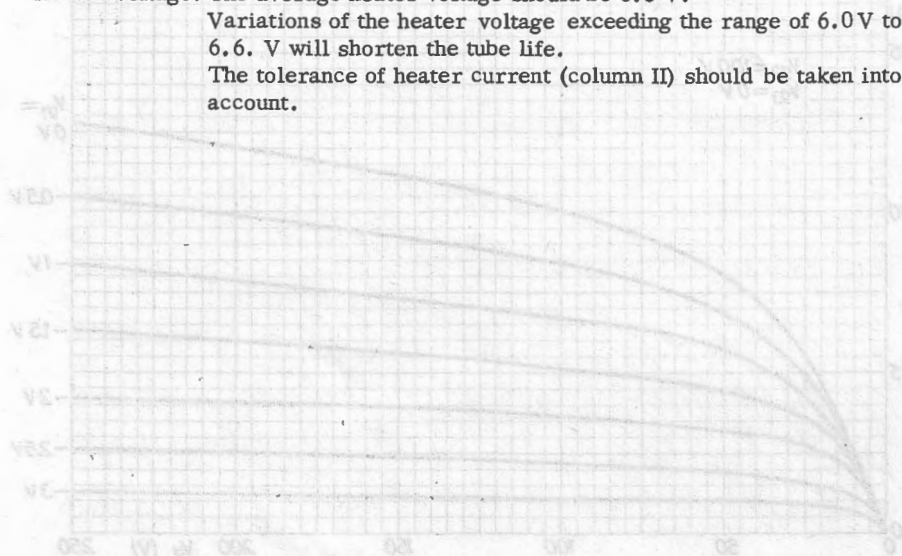

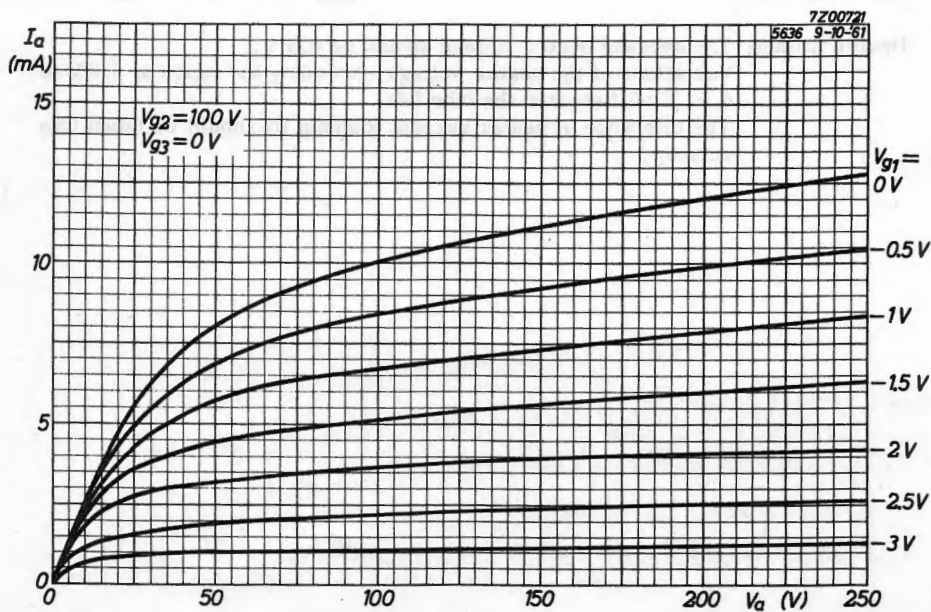
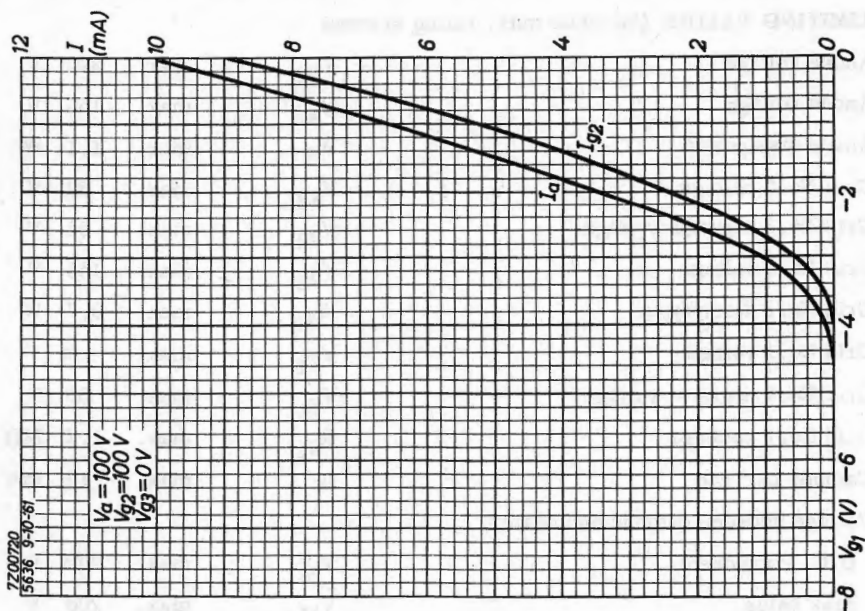

S.Q. OUTPUT PENTODE

Special quality pentode designed for use as output tube and video amplifier.

QUICK REFERENCE DATA

Life test	1000 hours	
Mechanical quality	Shock and vibration resistant	
Base	Subminiature	
Heating	Indirect	
	A.C. or D.C., parallel supply	
Heater voltage	V_f	6.3 V
Heater current	I_f	450 mA
Mutual conductance	S	9 mA/V
Anode current	I_a	21 mA

DIMENSIONS AND CONNECTIONS

Base: Subminiature

Dimensions in mm

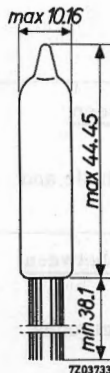
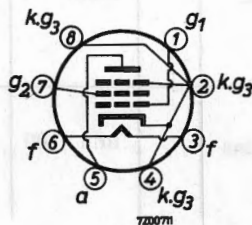

Connections should not be soldered nearer than 5 mm to the seal.
Leads should not be bent nearer than 1.5 mm to the seal.

CHARACTERISTICS

Column I Nominal value or setting of the tube

II Range values for equipment design: Initial spread

III Range values for equipment design: End of life value

		I	II	III	
Heater voltage	V_f	6.3			V
Heater current	I_f	450	420-480		mA
Anode voltage	V_a	150			V
Grid No. 2 voltage	V_{g2}	100			V
Cathode resistor	R_k	100			Ω
Anode current	I_a	21	14-28		mA
Grid No. 2 current	I_{g2}	4.0	2-6		mA
Mutual conductance	S	9.0	7.5-10.5	ΔS : max. 20%	mA/V
Internal resistance	R_i	50			k Ω
<u>Negative grid No. 1 current</u>	$-I_{g1}$		max. 1.0	max. 2.0	μA
Grid No. 1 resistor $R_{g1} = 1 M\Omega$					
<u>Grid No. 1 cut-off voltage</u>	$-V_{g1}$	14			
Anode voltage	V_a	150			V
Grid No. 2 voltage	V_{g2}	100			V
Anode current	I_a		max. 75		μA
<u>Leakage current between cathode and heater</u>	I_{kf}		max. 15	max. 60	μA
Voltage between cathode and heater $V_{kf} = 100 V$					
<u>Insulation resistance between two electrodes</u>	R_{ins}		min. 100	min. 50	$M\Omega$
Voltage between electrodes $V = 100 V$					

CHARACTERISTICS (continued)

	I	II	III	
<u>Vibrational noise output</u>	V_o	max. 100		mV_{eff}
Anode supply voltage	V_{ba}	150		V
Anode resistor	R_a	2		$k\Omega$
Grid No.2 voltage	V_{g2}	100		V
Cathode resistor	R_k	100		Ω
Cathode by pass capacitor $C_k = 1000 \mu F$				
Grid No.1 resistor $R_{g1} = 0.1 M\Omega$				
Vibration frequency = 40 Hz				
Acceleration = 15 g				

CAPACITANCES With external shield, inside diameter 10.3 mm

	I	II		
Grid No.1 to grid No.2, grid No.3, cathode and heater	$C_{g1/g2} k_{g3f}$	9	8-10	pF
Anode to grid No.2, grid No.3, cathode and heater	$C_a/g2 k_{g3f}$	8	7-9	pF
Anode to grid No.1	C_{ag1}		max.0.13	pF

SHOCK AND VIBRATION RESISTANCE

The following test conditions are applied to assess the mechanical quality of the tube. These conditions are not intended to be used as normal operating conditions.

Shock

The tube is subjected 5 times in each of 4 positions to an acceleration of 500 g supplied by an NRL shock machine with the hammer lifted over an angle of 30° .

Vibration

The tube is subjected during 32 hours in each of 3 positions to a vibration frequency of 50 Hz with an acceleration of 2.5 g.

LIFE

Production samples are tested to be within the end of life values (column III) during 1.000 hours.

LIMITING VALUES (Absolute max. rating system)

Anode voltage	V_{a_0}	max. 330 V
Anode voltage	V_a	max. 165 V
Anode dissipation	W_a	max. 4 W
Grid No. 2 voltage	V_{g_2}	max. 155 V
Grid No. 2 dissipation	W_{g_2}	max. 1 W
Grid No. 1 voltage	V_{g_1}	max. 0 V
Grid No. 1 negative voltage	$-V_{g_1}$	max. 55 V
Grid No. 1 resistor with fixed bias	R_{g_1}	max. 100 k Ω
with automatic bias	R_{g_1}	max. 500 k Ω
Cathode current	I_k	max. 40 mA
Voltage between cathode and heater, d.c. component	V_{kf}	max. 200 V
peak value	V_{kfp}	max. 200 V
Bulb temperature	t_{bulb}	max. 220 °C

Heater voltage: The average heater voltage should be 6.3 V
Variations of the heater voltage exceeding the range of 6.0 to 6.6 V will shorten the tube life.

OPERATING CHARACTERISTICSOutput tube class A

Anode voltage	V_a	150 V
Grid No. 2 voltage	V_{g_2}	100 V
Cathode resistor	R_k	100 Ω
Load resistance	$R_{a\sim}$	9 k Ω
Input voltage	V_i	2 V_{RMS}
Output power	W_o	1 W

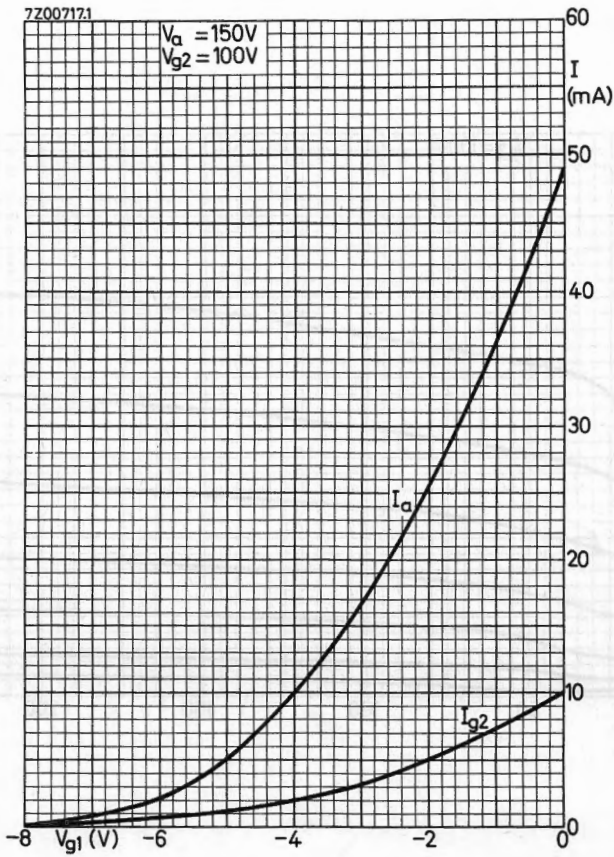

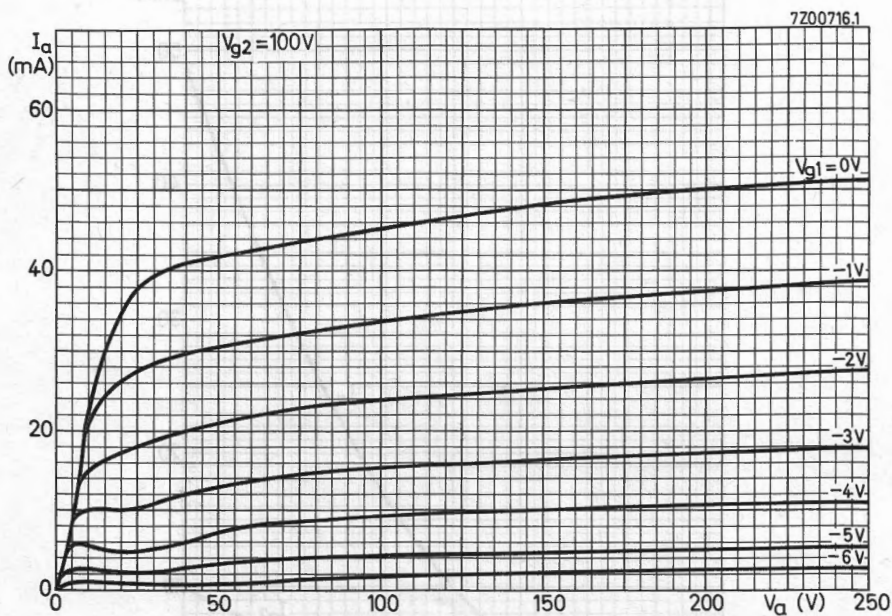

S.Q. TUBE

Single anode rectifier for use in the E.H.T. supply of oscilloscopes.

QUICK REFERENCE DATA

Life test	500 hours
Heater voltage	V_f 1.25 V
Heater current	I_f 200 mA
Heating	Direct A.C. or D.C.
Peak inverse voltage	$V_{a\text{inv}p}$ 10 kV
Anode current	I_a 250 μ A

DIMENSIONS AND CONNECTIONS

Dimensions in mm

Connections: Flying leads

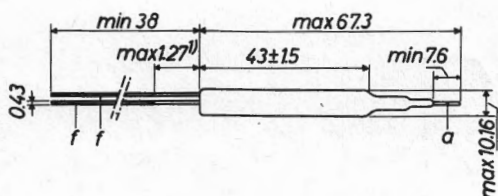

CAPACITANCES

Anode to filament

 C_{af}

0.6 pF

1) Not tinned

LIMITING VALUES Design centre rating system

Anode peak inverse voltage	V_{ainvp}	max.	10 kV
Anode current	I_a	max.	250 μ A
Anode peak current	I_{ap}	max.	5 mA
Pulse duration max. 10 μ sec			
Duty factor max. 0.15			

Anode peak current	I_{ap}	max.	1.5 mA
--------------------	----------	------	--------

Sine wave input

Frequency min. 5 kHz

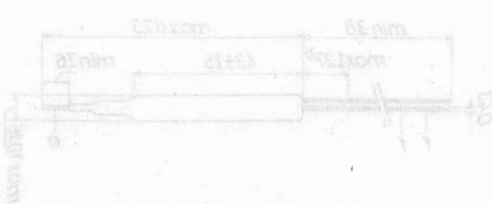

CAPACITANCES
Anode to filament

S.Q. TUBE

Special quality pentode designed for use as wide-band amplifier.

QUICK REFERENCE DATA

Life test	1000 hours
Mechanical quality	Shock and vibration resistant
Base	Miniature 7 pin
Heating	Indirect
Heater voltage	V_f 6.3 V
Heater current	I_f 175 mA
Mutual conductance	S 5 mA/V
Sharp cut off	

DIMENSIONS AND CONNECTIONS

Dimensions in mm

Base: Miniature 7 pin

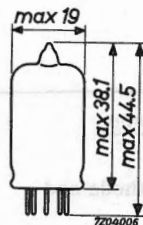
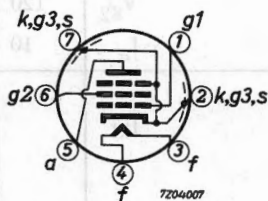

CHARACTERISTICS

Column I Nominal value or setting of the tube

II Range values for equipment design: Initial spread

		I	II	
Heater voltage	V_f	6.3		V
Heater current	I_f	175	160 - 190	mA
Anode voltage	V_a	120		V
Grid No.2 voltage	V_{g2}	120		V
Grid No.1 voltage	$-V_{g1}$	2		V
Anode current	I_a	7.5	5 - 11	mA
Grid No.2 current	I_{g2}	2.5	0.8 - 4.0	mA
Mutual conductance	S	5	3.8 - 6.2	mA/V
Internal resistance	R_i	0.34		$M\Omega$
Negative grid current	$-I_{g1}$		max. 0.1	μA
Anode supply voltage	V_{ba}	120		V
Grid No.2 voltage	V_{g2}	120		V
Anode resistor	R_a	0.1		$M\Omega$
Grid No.1 voltage	$-V_{g1}$	10		V
Anode current	I_a		max. 200	μA
<u>Grid No.1 cut off voltage</u>	$-V_{g1}$	8.5		V
Anode voltage	V_a	120		V
Grid No.2 voltage	V_{g2}	120		V
Anode current	I_a	10		μA
<u>Leakage current between cathode and heater</u>	I_{kf}		max. 10	μA
Voltage between cathode and heater $V_{kf} = 100$ V				
<u>Insulation resistance between two electrodes</u>	R		min. 100	$M\Omega$

CAPACITANCES. With external shieldGrid No.1 to grid No.2, grid No.3
cathode and heater

	I	II	
C_{g_1/g_2g_3kf}	4.0	3.4 - 4.6	pF

Anode to grid No.2, grid No.3
cathode and heater

C_{a/g_2g_3kf}	2.85	2.45 - 3.25	pF
------------------	------	-------------	----

Anode to grid No.1

C_{ag_1}		max. 0.02	pF
------------	--	-----------	----

Grid No.1 to grid No.2

$C_{g_1g_2}$	1.4		pF
--------------	-----	--	----

SHOCK AND VIBRATION RESISTANCE

The following test conditions are applied to assess the mechanical quality of the tube. These conditions are not intended to be used as normal operating conditions.

Shock

The tube is subjected 5 times in each of 4 positions to an acceleration of 500 g supplied by an NRL shock machine with the hammer lifted over an angle of 30°.

Vibration

The tube is subjected during 32 hours in each of 3 positions to a vibration frequency of 50 Hz with an acceleration of 2.5 g.

LIFE

Production samples are tested to be within the end of life values (column III) during 1000 hours.

LIMITING VALUES (Absolute max. rating system)

Anode voltage	V_{a_0}	max.	600 V
	V_a	max.	200 V
Grid No.2 voltage	$V_{g_{20}}$	max.	600 V
	V_{g_2}	max.	155 V
Grid No.1 voltage	$-V_{g_1}$	max.	50 V
	$+V_{g_1}$	max.	0 V
Anode dissipation	W_a	max.	1.65 W
Grid No.2 dissipation	W_{g_2}	max.	0.55 W
Cathode current	I_k	max.	20 mA
Grid No.1 current	I_{g_1}	max.	1 mA
Grid No.1 resistor	R_{g_1}	max.	0.1 M Ω
Voltage between cathode and heater	V_{kf}	max.	135 V
Bulb temperature	t_{bulb}	max.	165 °C ¹⁾

Heater voltage: The average heater voltage should be 6.3 V.

Variations of the heater voltage exceeding the range of 5.7 V to 7.0 V will shorten the tube life.

The tolerance of heater current (column II) should be taken into account.

¹⁾ Tube life and reliability of performance will be enhanced by operation at lower temperatures.

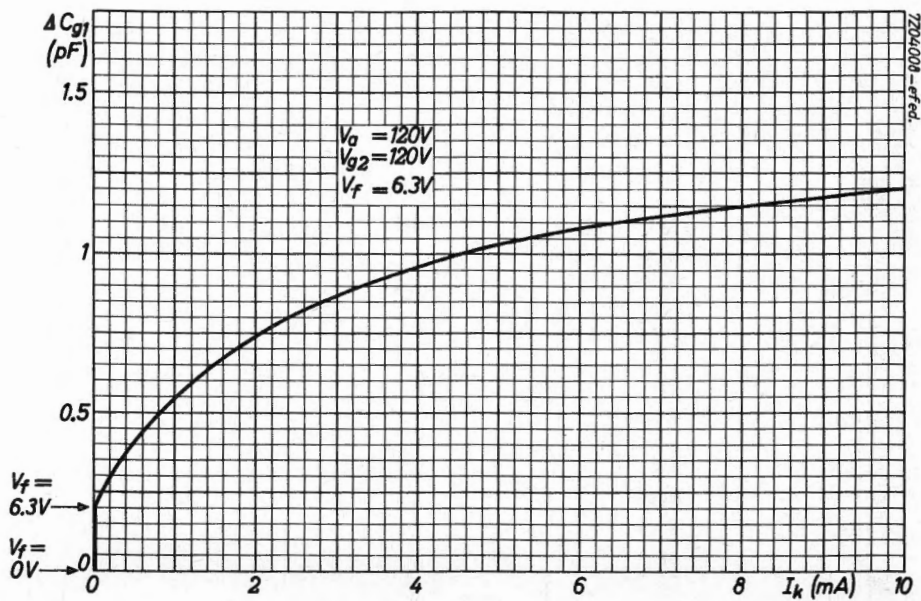

S.Q. TRIODE

Special quality triode designed for use as R.F. amplifier, oscillator (max. frequency 1000 MHz), and AF amplifier.

QUICK REFERENCE DATA

Life test	500 hours	
Mechanical quality	Shock and vibration resistant	
Base	Subminiature	
Heating	Indirect	
	A. C. or D. C., Parallel supply	
Heater voltage	V_f	6.3 V
Heater current	I_f	150 mA
Anode current	I_a	13 mA
Mutual conductance	S	6.5 mA/V

DIMENSIONS AND CONNECTIONS

Base : Subminiature

Dimensions in mm

Socket: B1 506 81

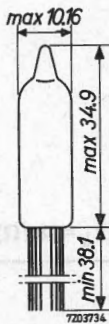
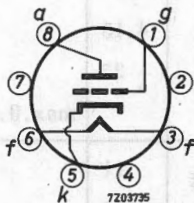

Connections should not be soldered nearer than 5 mm to the seal.

Leads should not be bent nearer than 1.5 mm to the seal.

On request the tube can also be delivered with shortened leads of 4.7-5.4 mm.

CHARACTERISTICS

Column I Nominal value or setting of the tube

II Range values for equipment design: Initial spread

III Range values for equipment design: End of life

		I	II	III	
Heater voltage	V_f	6.3			V
Heater current	I_f	150	138 - 162		mA
Anode voltage	V_a	100			V
Cathode resistor	R_k	150			Ω
Anode current	I_a	8.5	6 - 11		mA
Mutual conductance	S	5.8	4.8 - 6.8	$\Delta S: \text{max. } 20\%$	mA/V
Internal resistance	R_i	4.65			k Ω
Amplification factor	μ	27	23 - 31		-
Anode voltage	V_a	100			V
Negative grid voltage	$-V_g$		max. 7		V
Anode current	I_a	100			μA
Cut off voltage	$-V_g$	7			V
Anode voltage	V_a	100			V
Anode current	I_a	10			μA
Anode voltage	V_a	150			V
Cathode resistor	R_k	180			Ω
Anode current	I_a	13			mA
Mutual conductance	S	6.5			mA/V
Internal resistance	R_i	4.15			k Ω
Amplification factor	μ	27			-
Negative grid current ($R_k = 380 \Omega$)	$-I_g$		max. 0.4	max. 0.6	μA
Cut off voltage	$-V_g$	11			V
Anode voltage	V_a	150			V
Anode current	I_a	10			μA

CHARACTERISTICS (continued)

		I	II	III	
<u>Leakage current between cathode and heater</u>	I_{kf}			max. 10	μA
Voltage between cathode and heater = 100 V					
<u>Insulation between two electrodes</u>	R_{ins}			min. 50	$M\Omega$

CAPACITANCES

		With external shield		Without shield		
		I	I	II		
Anode to cathode and heater	C_a/kf	2.4	0.7	0.5 - 0.9		pF
Grid to cathode and heater	C_g/kf	2.4	2.2	1.6 - 2.8		pF
Anode to grid	C_{ag}	1.3	1.45	1.1 - 1.8		pF

SHOCK AND VIBRATION RESISTANCE

The following test conditions are applied to assess the mechanical quality of the tube. These conditions are not intended to be used as normal operating conditions.

Shock

The tube is subjected 5 times in each of 4 positions to an acceleration of 500 g supplied by an NRL shock machine with the hammer lifted over an angle of 30°.

Vibration

The tube is subjected during 32 hours in each of 3 positions to a vibration frequency of 50 Hz with an acceleration of 2.5 g.

LIFE

Production samples are tested to be within the end of life values (column III) under the following conditions during 500 hours:

Anode voltage	V_a	=	100 V
Cathode resistor	R_k	=	150 Ω
Grid resistor	R_g	=	1 $M\Omega$
Voltage between cathode and heater (cath.neg.)	V_{kf}	=	200 V

LIMITING VALUES (Absolute max. rating system)

Anode voltage	V_a	max.	165 V
Grid voltage	$-V_g$	max.	55 V
Anode dissipation	W_a	max.	3.3 W
Anode current	I_a	max.	22 mA
Grid current	I_g	max.	5.5 mA
Grid resistor	R_g	max.	1.2 M Ω
Voltage between cathode and heater	V_{kf}	max.	200 V
Bulb temperature ¹⁾	t_{bulb}	max.	250 °C

Heater voltage: The average heater voltage should be 6.3 V.

Variations of the heater voltage exceeding the range of 6.0 V to 6.6 V will shorten the tube life.

The tolerance of heater current (column II) should be taken into account.

OPERATING CHARACTERISTICSAs R.F. amplifier

Anode voltage	V_a	100	150 V
Cathode resistor	R_k	150	180 Ω
Anode current	I_a	8.5	13 mA
Mutual conductance	S	5.8	6.5 mA/V

As oscillator

Anode voltage	V_a	150	V
Anode current	I_a	20	mA
Output power	W_o	0.9	W
Frequency	f	500	MHz

¹⁾ In the interest of optimum life performance it is recommended to reduce the bulb temperature by fixing the bulb directly to the chassis with a metal clamp. (ZE1100)

OPERATING CHARACTERISTICS (continued)

As A.F. amplifier Fig. 1

Anode supply voltage	V_b	100	200	100	200	100	200	V
Anode resistor	R_a	47	47	100	100	270	270	$k\Omega$
Grid resistor	R_g	270	270	270	270	270	270	$k\Omega$
Grid resistor next stage	R_g	100	100	270	270	470	470	$k\Omega$
Cathode resistor	R_k	1.0	0.82	2.2	1.8	8.2	5.6	$k\Omega$
Input voltage	V_i	0.5	1.0	0.5	1.0	0.5	1.0	V_{RMS}
Voltage gain	V_o/V_i	16.4	19.0	16.4	18.6	14.8	16.2	-
Total distortion	d_{tot}	3.9	4.0	3.0	3.2	2.8	3.2	%

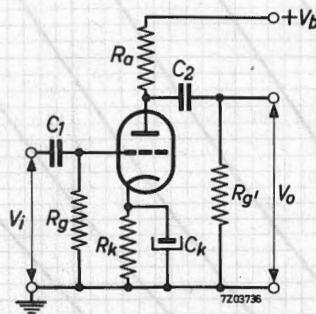
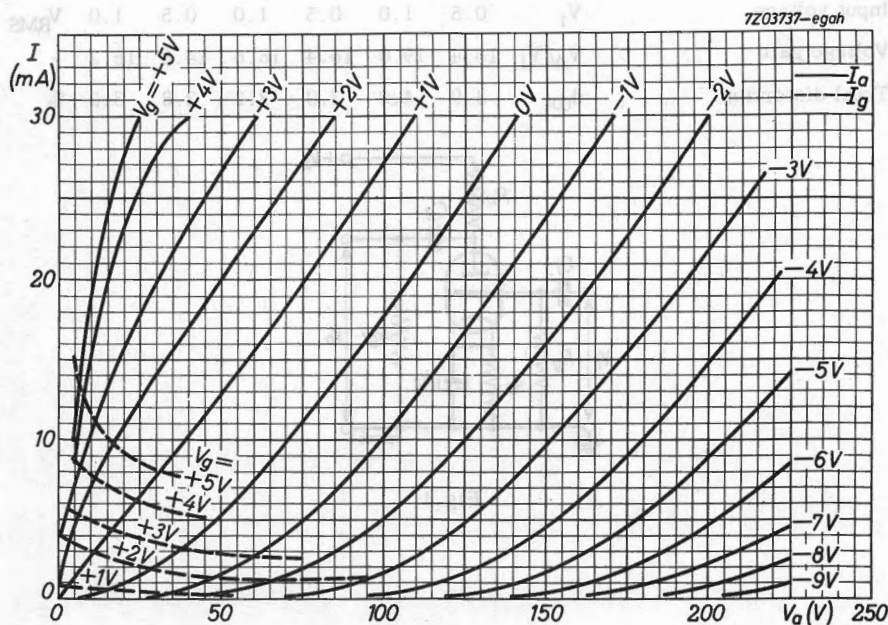

Fig. 1

OPERATING CHARACTERISTICS (Continued)

As a F. amplifier, Fig. 1.



S.Q. TUBE

Special quality triode designed for use as A.F. amplifier

QUICK REFERENCE DATA		
Life test	1000	1000 hours
Mechanical quality		Shock and vibration resistant
Base		Subminiature
Heating		Indirect A.C. or D.C.; parallel supply
Heater voltage	V_f	6.3 V
Heater current	I_f	150 mA
Mutual conductance	S	2.3 mA/V
Amplification factor	μ	70

DIMENSIONS AND CONNECTIONS

Base: Subminiature

Dimensions in mm

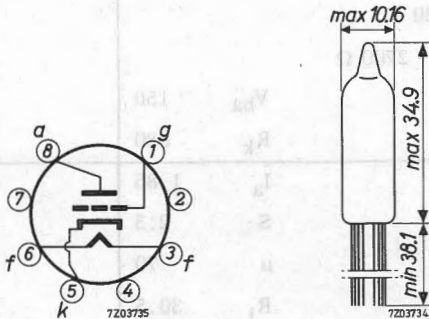

Leads should not be soldered nearer than 5 mm to the seal.
Leads should not be bent nearer than 2 mm to the seal.

CHARACTERISTICS

Column I Nominal value or setting of the tube

II Range values for equipment design: Initial spread

III Range values for equipment design: End of life

		I	II	III	
Heater voltage	V_f	6.3			V
Heater current	I_f	150	140 - 160		mA
Anode supply voltage	V_{ba}	100			V
Cathode resistor	R_k	1500			Ω
Anode current	I_a	0.73	0.5 - 0.9		mA
Mutual conductance	S	1.7	1.4 - 2.0	min. 1.1	mA/V
Internal resistance	R_i	41			k Ω
Amplification factor	μ	70	60 - 80		
<u>Cut-off voltage</u>	$-V_g$	2.5			V
Anode current	I_a		max. 50		μ A
Grid voltage	$-V_g$	1.8			V
Anode current	I_a		min. 5		μ A
<u>Negative grid current</u>	$-I_g$		max. 0.3	max. 0.6	μ A
Anode supply voltage $V_{ba} = 150$ V					
Cathode resistor $R_k = 2700 \Omega$					
Anode supply voltage	V_{ba}	150			V
Cathode resistor	R_k	680			Ω
Anode current	I_a	1.85			mA
Mutual conductance	S	2.3			mA/V
Amplification factor	μ	70			
Internal resistance	R_i	30.5			k Ω
<u>Leakage current between cathode and heater</u>	I_{kf}		max. 5		μ A
Voltage between cathode and heater $V_{kf} = 100$ V.					

CHARACTERISTICS (continued)**Insulation resistance
between electrodes**

	I	II	III	
R_{ins}		min. 100	min. 25	M Ω
Voltage between electrodes = 100 V				
V_o		max. 25		mV

Vibrational noise outputAnode supply voltage $V_{ba} = 100$ VAnode resistor $R_a = 10$ k Ω Cathode by-pass capacitor $C_k = 1000$ pF

Vibration frequency = 40 Hz

Acceleration = 15 g

CAPACITANCES

Anode to cathode and heater

Grid to cathode and heater

Anode to grid

	I	II	
C_a/kf	0.6	0.4 - 0.8	pF
C_g/kf	1.7	1.2 - 2.2	pF
C_{ag}	0.8	0.6 - 1.0	pF

SHOCK AND VIBRATION RESISTANCE

The following test conditions are applied to assess the mechanical quality of the tube. These conditions are not intended to be used as normal operating conditions.

Shock

The tube is subjected 5 times in each of 4 positions to an acceleration of 500 g supplied by an NRL shock machine with the hammer lifted over an angle of 30°.

Vibration

The tube is subjected during 32 hours in each of 3 positions to a vibration frequency of 50 Hz with an acceleration of 2.5 g.

LIFE

Production samples are tested to be within the end of life values (column III) under the following conditions during 1000 hours.

Anode supply voltage	V_{ba}	150 V
Cathode resistor	R_k	680 Ω
Grid resistor	R_g	1 M Ω
Voltage between cathode and heater (k pos)	V_{kf}	200 V

LIMITING VALUES (Absolute max. rating system)

Anode voltage	V_{a0}	max. 330 V
	V_a	max. 165 V
Grid voltage	$-V_g$	max. 55 V
	$+V_g$	max. 0 V
Anode dissipation	W_a	max. 0.55 W
Anode current	I_a	max. 3.3 mA
Peak voltage between cathode and heater	V_{kfp}	max. 200 V
	t_{bulb}	max. 220 $^{\circ}\text{C}$
Bulb temperature		
Heater voltage	V_f	min. 6.0 V
		max. 6.6 V

OPERATING CHARACTERISTICS

Anode supply voltage	V_{ba}	100	100	100	100	100	100	V
Cathode resistor	R_k	2.7	2.7	5.6	6.8	10	10	k Ω
Anode resistor	R_a	0.1	0.1	0.27	0.27	0.47	0.47	M Ω
Grid resistor	R_g	1.0	1.0	1.0	1.0	1.0	1.0	M Ω
Grid resistor next stage	R_g'	0.27	0.47	0.47	1.0	0.47	1.0	M Ω
Voltage gain	V_o/V_i	37	39	41	42	40	43	
Total distortion	d_{tot}	2.4	2.1	2.1	1.8	2.4	1.7	%

OPERATING CHARACTERISTICS

Anode supply voltage	V_{ba}	200	200	200	200	200	200	V
Cathode resistor	R_k	1.5	1.8	3.3	3.9	5.6	6.8	$k\Omega$
Anode resistor	R_a	0.1	0.1	0.27	0.27	0.47	0.47	$M\Omega$
Grid resistor	R_g	1.0	1.0	1.0	1.0	1.0	1.0	$M\Omega$
Grid resistor next stage	$R_{g'}$	0.27	0.47	0.47	1.0	0.47	1.0	$M\Omega$
Voltage gain	V_o/V_i	44	46	49	50	48	50	
Total distortion	d_{tot}	0.7	0.7	0.9	0.7	0.9	0.7	%

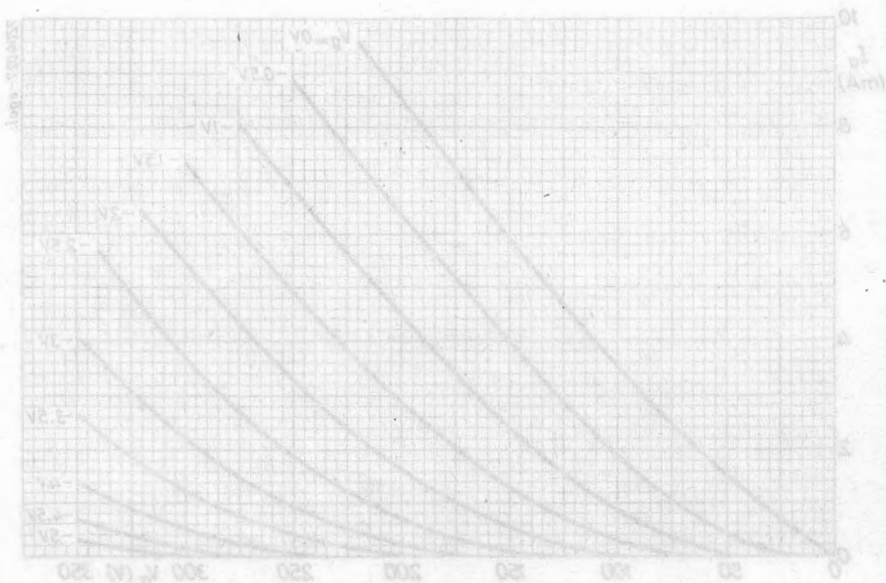

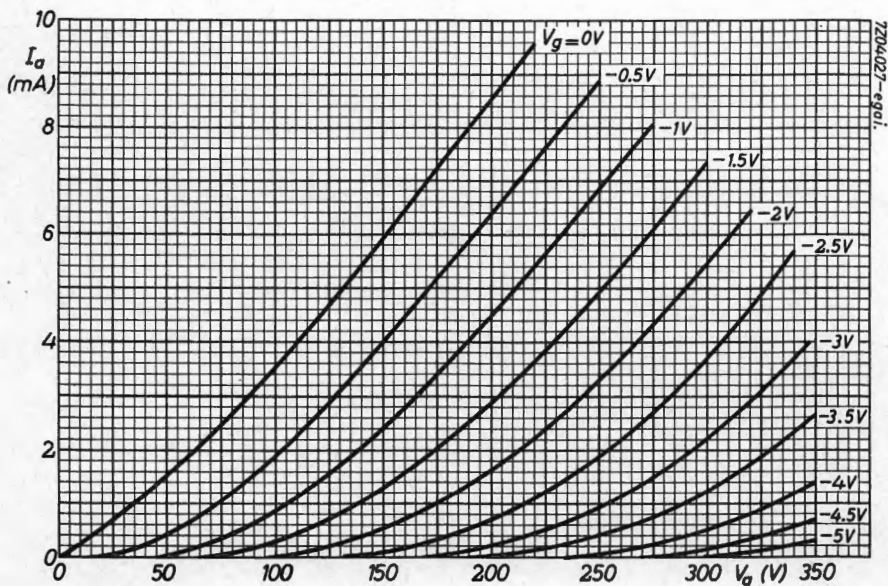
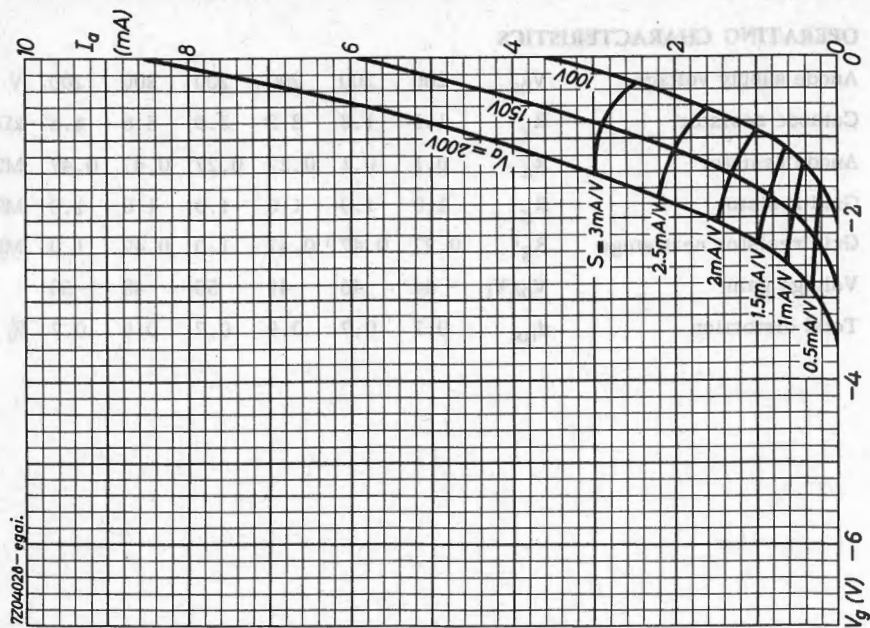

S.Q. TUBE

Special quality pentode designed for use as R.F. amplifier.

QUICK REFERENCE DATA

Life test	1000 hours
Mechanical quality	Shock and vibration resistant
Base	Miniature 7 pin
Heating	Indirect
Heater voltage	A.C. or D.C.; parallel supply
Heater current	V_f 6.3 V
Sharp cut-off	I_f 175 mA
Double control	

DIMENSIONS AND CONNECTIONS

Base: Miniature 7 pin

Dimensions in mm

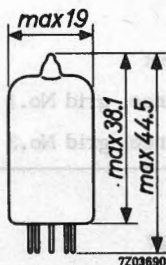
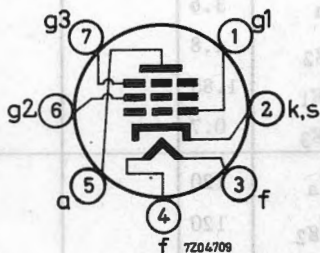

CHARACTERISTICS

Column I Nominal value or setting of the tube

II Range values for equipment design: Initial spread

III Range values for equipment design: End of life

		I	II	III	
Heater voltage	V_f	6.3			V
Heater current	I_f	175	160 - 190		mA
Anode voltage	V_a	120			V
Grid No.2 voltage	V_{g2}	120			V
Grid No.3 voltage	V_{g3}	0			V
Grid No.1 voltage	$-V_{g1}$	2			V
Anode current	I_a	5.2	2.5 - 9.0		mA
Grid No.2 current	I_{g2}	3.5	max.5.5		mA
Mutual conductance, grid No.1	S_{g1}	3.2	2.5 - 4.5	ΔS max.20%	mA/V
Mutual conductance, grid No.3	S_{g3}	0.47			mA/V
Internal resistance	R_i	150			k Ω
Negative grid No.1 current	$-I_{g1}$		max.0.1	max.0.2	μA
Anode voltage	V_a	120			V
Grid No.2 voltage	V_{g2}	120			V
Grid No.3 voltage	$-V_{g3}$	3			V
Grid No.1 voltage	$-V_{g1}$	2			V
Anode current	I_a	3.6			mA
Grid No.2 current	I_{g2}	4.8			mA
Mutual conductance, grid No.1	S_{g1}	1.85			mA/V
Mutual conductance, grid No.3	S_{g3}	0.7			mA/V
Anode voltage	V_a	120			V
Grid No.2 voltage	V_{g2}	120			V
Grid No.3 voltage	$-V_{g3}$	5			V
Grid No.1 voltage	$-V_{g1}$	2			V
Mutual conductance, grid No.3	S_{g3}	1.2	0.7 - 1.7		mA/V

CHARACTERISTICS (continued)

		I	II	III	
<u>Cut-off voltage</u>	$-V_{g1}$	8			V
Anode voltage	V_a	120			V
Grid No.2 voltage	V_{g2}	120			V
Grid No.3 voltage	V_{g3}	0			V
Anode current	I_a		max. 50		μA
<u>Cut-off voltage</u>	$-V_{g1}$	6			V
Anode voltage	V_a	120			V
Grid No.2 voltage	V_{g2}	120			V
Grid No.3 voltage	V_{g3}	0			V
Anode current	I_a		min. 5		μA
<u>Cut-off voltage</u>	$-V_{g1}$	3			V
	$-V_{g3}$	5.5			V
Anode voltage	V_a	120			V
Grid No.2 voltage	V_{g2}	120			V
Anode current	I_a		min. 5		μA
<u>Cut-off voltage</u>	$-V_{g1}$	3			V
	$-V_{g3}$	10			V
Anode voltage	V_a	120			V
Grid No.2 voltage	V_{g2}	120			V
Anode current	I_a		max. 50		μA
<u>Cut-off voltage</u>	$-V_{g1}$	2			V
	$-V_{g2}$	15			V
Anode voltage	V_a	120			V
Grid No.2 voltage	V_{g2}	120			V
Anode current	I_a	10			μA
<u>Leakage current between cathode and heater</u>	I_{kf}		max. 10	max. 10	μA
Voltage between cathode and heater $V_{kf} = 100$ V					
Cathode negative					

CHARACTERISTICS (continued)

Vibrational noiseAnode voltage $V_a = 120$ VGrid No.2 voltage $V_{g_2} = 120$ VGrid No.1 voltage $-V_{g_1} = 2$ VGrid No.3 voltage $V_{g_3} = 0$ VAnode resistor $R_a = 10$ k Ω

Vibration frequency = 50 Hz

Acceleration = 10 g

 V_o

I

II

max.150 mV

CAPACITANCES With external screenAnode to grid No.3, grid No.2,
cathode, heater and screen C_{a/g_3g_2kfs}

3.0

2.6 - 3.4

pF

Grid No.1 to grid No.3, grid No.2,
cathode, heater and screen C_{g_1/g_3g_2kfs}

4.0

3.5 - 4.5

pF

Grid No.1 to grid No.3

 $C_{g_1g_3}$

max.150

mpF

Anode to grid No.1

 C_{ag_1}

max. 20

mpF

Grid No.1 to grid No.3, grid No.2,
cathode, heater and screen C_{g_1/g_3g_2kfs}

5.5

pF

Cathode current $I_k = 12$ mA

Frequency = 100 MHz

SHOCK AND VIBRATION RESISTANCE

The following test conditions are applied to assess the mechanical quality of the tube. These conditions are not intended to be used as normal operating conditions.

Shock

The tube is subjected 5 times in each of 4 positions to an acceleration of 500 g supplied by an NRL shock machine with the hammer lifted over an angle of 30°.

Vibration

The tube is subjected during 32 hours in each of 3 positions to a vibration frequency of 50 Hz with an acceleration of 2.5 g.

LIFE

Production samples are tested to be within the end of life values (column III) during 1000 hours.

LIMITING VALUES (Absolute max. rating system)

Anode voltage	V_a	max.	200 V
Grid No.2 voltage	V_{g_2}	max.	155 V
Grid No.3 voltage	V_{g_3}	max.	30 V
Anode dissipation	W_a	max.	1.85 W
Grid No.2 dissipation	W_{g_2}	max.	0.85 W
Cathode current	I_k	max.	20 mA
Voltage between cathode and heater	V_{kf}	max.	100 V
Grid resistor with fixed bias	R_{g_1}	max.	1 M Ω
Bulb temperature	t_{bulb}	max.	165 °C



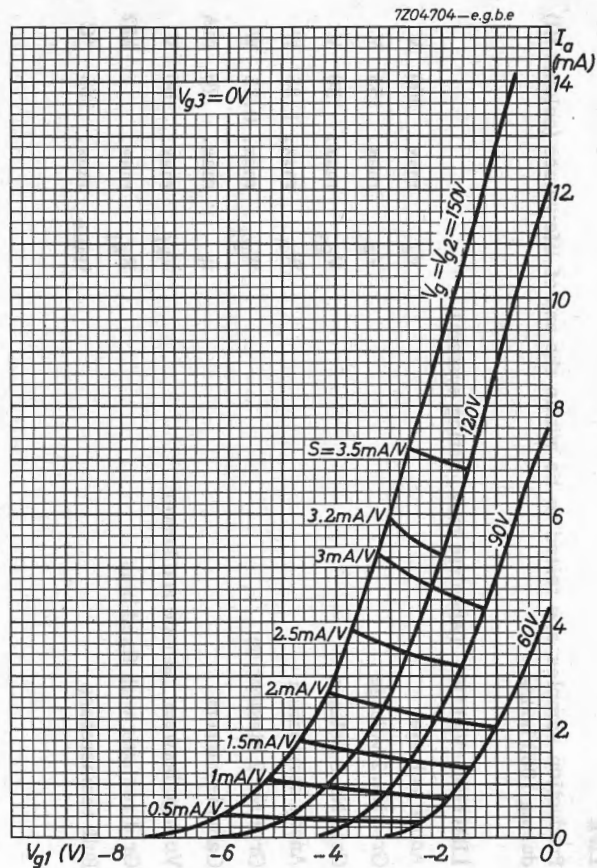
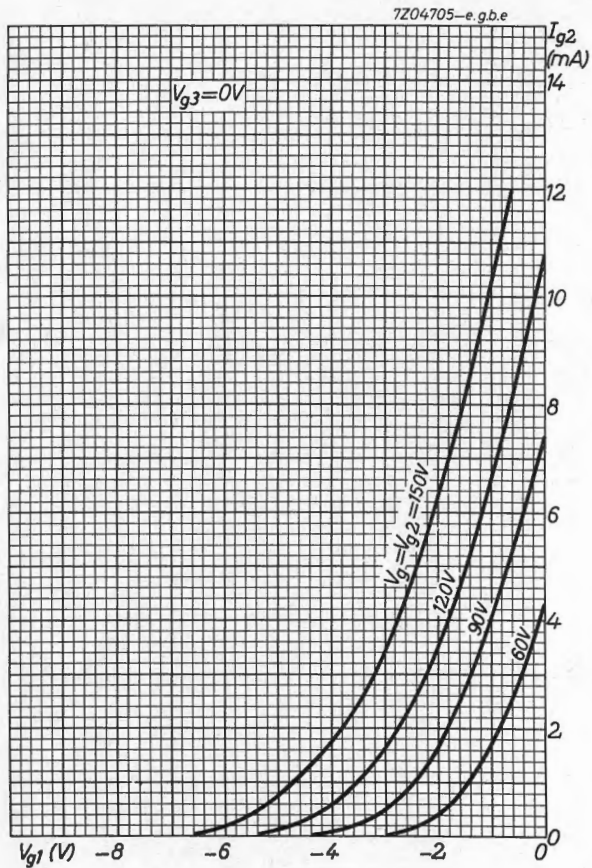

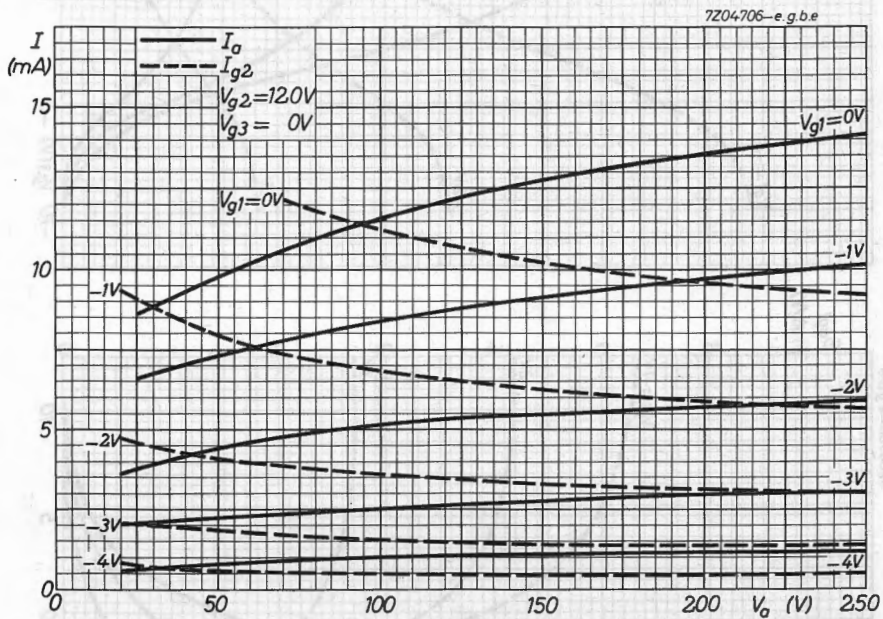

7204708-e.g.b.e

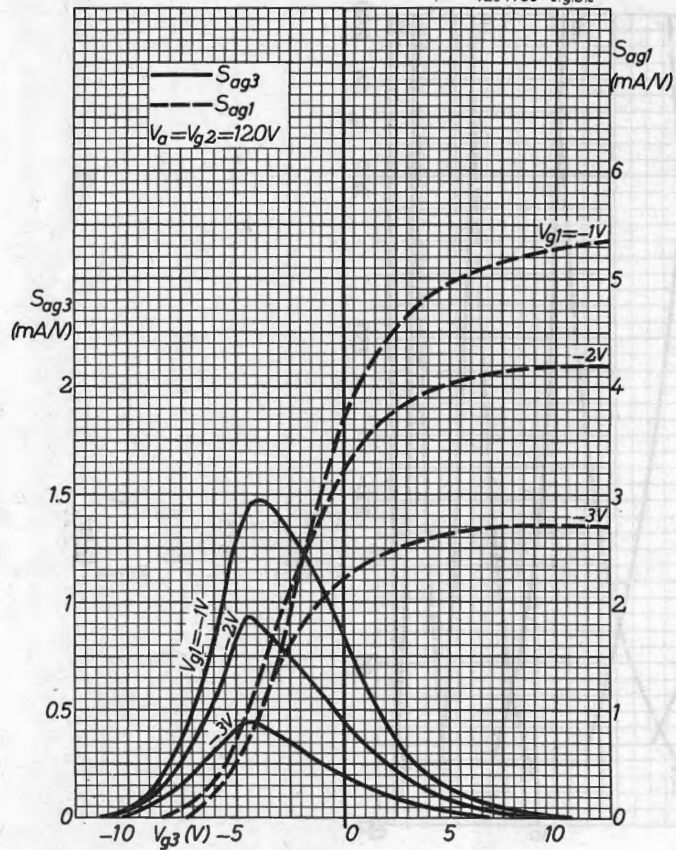

7204707-e.g.b.e

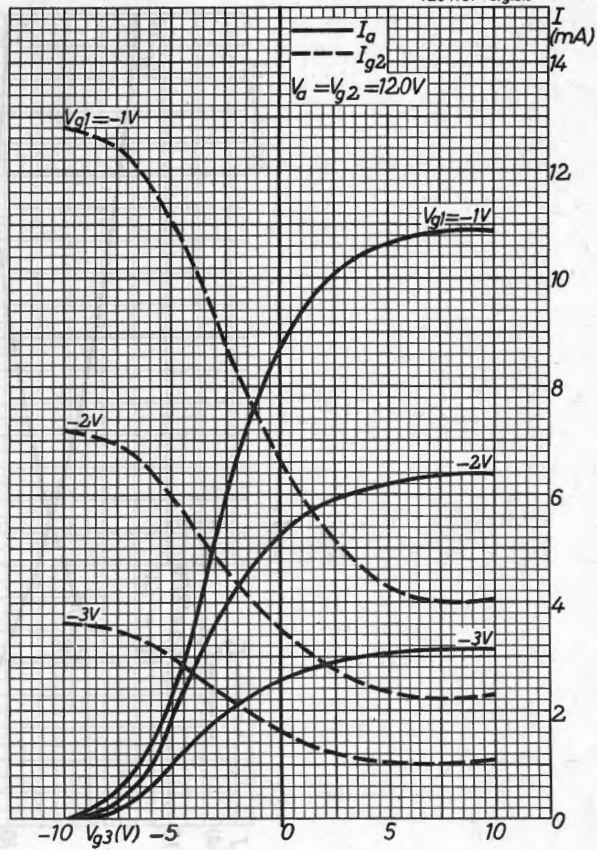

S.Q. DOUBLE DIODE

Special quality double diode designed for use as detector or low-current power rectifier.

QUICK REFERENCE DATA

Life test	1000 hours
Mechanical quality	Shock and vibration resistant
Base	Miniature 7 pin
Heating	Indirect
	A.C. or D.C.
	Series or parallel supply
Heater voltage	V_f 6.3 V
Heater current	I_f 300 mA
Diode current	I_d 10 mA
Inverse peak voltage	V_{invP} 360 V

DIMENSIONS AND CONNECTIONS

Base: Miniature 7 pin

Dimensions in mm

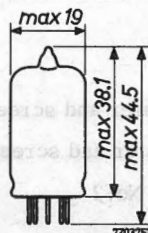
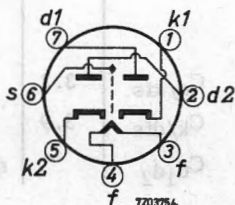

CHARACTERISTICS (both systems if applicable)

Column I Nominal value or setting of the tube

II Range values for equipment design: Initial spread

		I	II	
Heater voltage	V_f	6.3		V
Heater current	I_f	300	275 - 325	mA
<u>Diode current</u>	I_d		min. 40	mA
Diode voltage	V_d	10		V
<u>Diode current</u>	I_{do}		2 - 20	μ A
Diode voltage	V_d	0		V
Series resistor	R	40		k Ω
<u>Difference in diode current</u>	$ I_d - I_d' $		max. 5	μ A
Diode voltage	V_d	0		V
Series resistor	R	40		k Ω
<u>Leakage current between cathode and heater</u>	I_{kf}		max. 10	μ A
Voltage between cathode and heater $V_{kf} = 100$ V				
<u>Insulation resistance between two electrodes</u>	R_{ins}		min. 100	M Ω
Voltage between electrodes = 300 V				
<u>Resonant frequency</u>		700		MHz
CAPACITANCES				
Diode to cathode heater and screen	C_d/kfs	3.2	2.4 - 4	pF
Cathode to diode heater and screen	C_k/dfs	3.9	3.1 - 4.7	pF
Diode No.1 to diode No.2	$C_{d_1d_2}$		max. 0.026	pF

SHOCK AND VIBRATION RESISTANCE

The following test conditions are applied to assess the mechanical quality of the tube. These conditions are not intended to be used as normal operating conditions.

Shock

The tube is subjected 5 times in each of 4 positions to an acceleration of 700g supplied by an NRL shock machine with the hammer lifted over an angle of 45°.

Vibration

The tube is subjected during 32 hours in each of 3 positions to a vibration frequency of 50 Hz with an acceleration of 2.5 g.

LIFE

Production samples are tested during 1000 hours.

LIMITING VALUES (Absolute max. rating system) (Per system if applicable)

Inverse peak voltage	V_{invp}	max.	360 V
Diode current	I_d	max.	10 mA
Diode peak current	I_{dp}	max.	60 mA
Peak voltage between cathode and heater	V_{kf_p}	max.	360 V
Bulb temperature	t_{bulb}	max.	165 °C

Heater voltage: The average heater voltage should be 6.3 V.

Variations of the heater voltage exceeding the range of 5.7 V to 7.0 V will shorten the tube life.

OPERATING CHARACTERISTICSAs full wave power rectifier

A.C. supply voltage	V_{tr}	2 x 165	V_{RMS}
Capacitance	C	8	μF
Series resistor per diode	R_s	300	Ω
Load resistor	R_l	11	k Ω
D.C. current	I_o	min. 16	mA

As half wave rectifier (per system)

A.C. supply voltage	V_{tr}	117	V_{RMS}
Capacitance	C	8	μF
Series resistor	R_s	300	Ω
D.C. current	I_o	9	mA

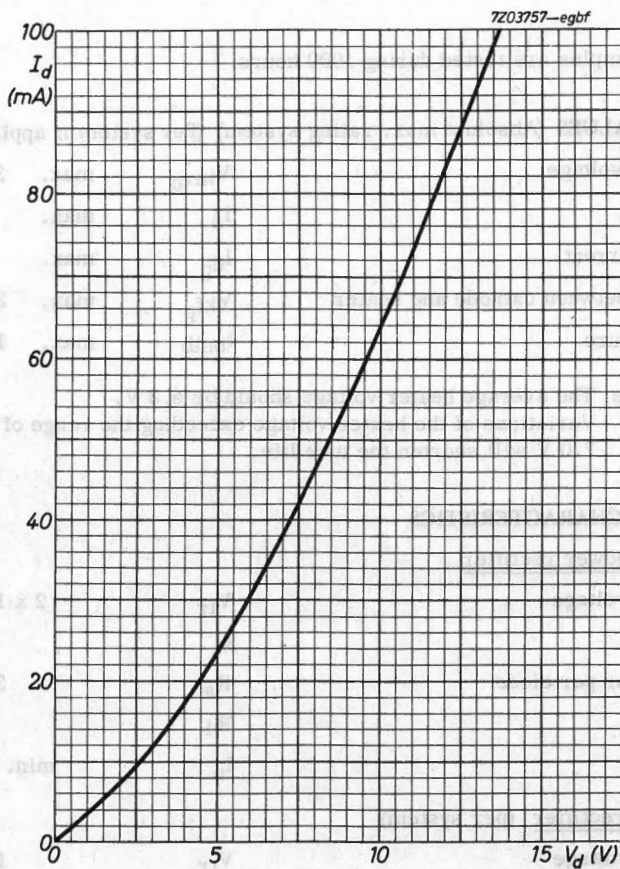

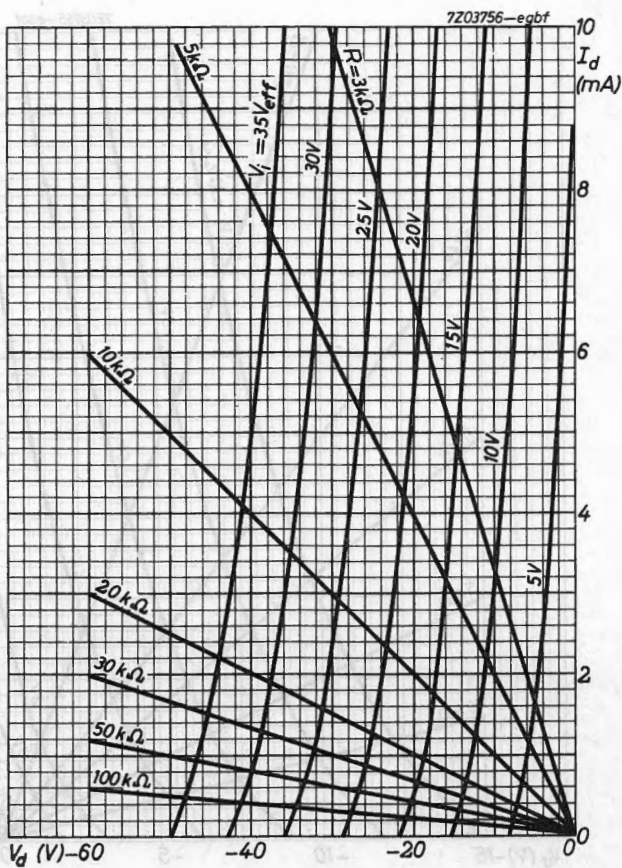

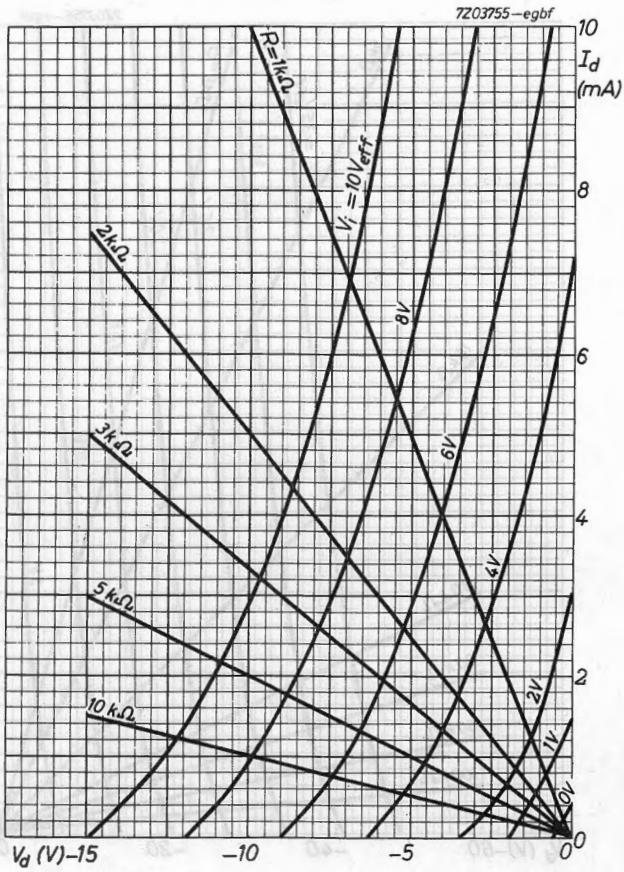

S.Q. TUBE

Special quality pentode designed for use A.F. and R.F. amplifier (max. frequency 400 MHz)

QUICK REFERENCE DATA

Life test	1000 hours
Mechanical quality	Shock and vibration resistant
Base	Subminiature
Heating	Indirect A.C. or D.C.; parallel supply
Heater voltage	V_f 6.3 V
Heater current	I_f 150 mA
Mutual conductance	S 5 mA/V
Anode current	I_a 7.5 mA

DIMENSIONS AND CONNECTIONS

Dimensions in mm

Base: Subminiature

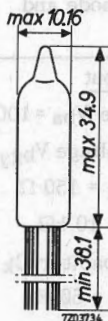
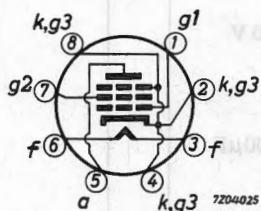

Leads should not be soldered nearer than 5 mm to the seal

Leads should not be bent nearer than 2 mm to the seal.

CHARACTERISTICS

Column I Nominal value or setting of the tube

II Range values for equipment design: Initial spread

III Range values for equipment design: End of life

		I	II	III	
Heater voltage	V_f	6.3			V
Heater current	I_f	150	140 - 160		mA
Anode supply voltage	V_{ba}	100			V
Grid No.2 supply voltage	V_{bg2}	100			V
Cathode resistor	R_k	150			Ω
Anode current	I_a	7.5	5.5 - 9.5		mA
Grid No.2 current	I_{g2}	2.4	1.5 - 3.3		mA
Mutual conductance	S	5	4.2 - 5.8	min. 3.5	mA/V
Internal resistance	R_i	260	min. 175		k Ω
Negative grid No.1 current	$-I_{g1}$		max. 0.3	max. 0.8	μ A
<u>Cut-off voltage</u>	$-V_{g1}$	9			V
Anode voltage	V_a	100			V
Grid No.2 voltage	V_{g2}	100			V
Anode current	I_a	10	max. 50		mA
<u>Leakage current between cathode and heater</u>	I_{kf}		max. 5	max. 10	μ A
Voltage between cathode and heater $V_{kf} = 100$ V					
<u>Vibrational noise output</u>	V_o		max. 60		mV _{RMS}
Anode supply voltage $V_{ba} = 100$ V					
Grid No.2 supply voltage $V_{bg2} = 100$ V					
Cathode resistor $R_k = 150 \Omega$					
Anode resistor $R_a = 10$ k Ω					
Cathode by-pass capacitor $C_k = 1000 \mu$ F					
Vibration frequency = 50 Hz					
Acceleration = 15 g					
Insulation resistance					
a to all at V = 300 V	R_{ins}		min. 100		M Ω
g_1 to all at V = 100 V	R_{ins}		min. 100		M Ω

CAPACITANCES

		With external screen		Without external shield		
		I	II	I	II	
Anode to grid No. 2, cathode, heater and screen	C_{a/g_2kfs}	3.4	2.9-3.9	1.9		pF
Grid No. 1 to grid No. 2, cathode, heater and screen	C_{g_1/g_2kfs}	4.2	3.5-4.9	4.0		pF
Anode to grid No. 1	C_{ag_1}		max. 15		max. 30	mpF

SHOCK AND VIBRATION RESISTANCE

The following test conditions are applied to assess the mechanical quality of the tube. These conditions are not intended to be used as normal operating conditions.

Shock

The tube is subjected 5 times in each of 4 positions to an acceleration of 500 g supplied by an NRL shock machine with the hammer lifted over an angle of 30°.

Vibration

The tube is subjected during 32 hours in each of 3 positions to a vibration frequency of 50 Hz with an acceleration of 2.5 g.

LIFE

Production samples are tested to be within the end of life values (column III) under the following conditions during 1000 hours.

Anode supply voltage	V_{ba}	100 V
Grid No. 2 supply voltage	V_{bg_2}	100 V
Cathode resistor	R_k	150 Ω

LIMITING VALUES (Absolute max. rating system)

Anode voltage	V_{a_0}	max. 330 V
	V_a	max. 165 V
Grid No. 2 voltage	$V_{g_2_0}$	max. 330 V
	V_{g_2}	max. 155 V
Anode dissipation	W_a	max. 1.1 W
Grid No. 2 dissipation	W_{g_2}	max. 0.55 W

LIMITING VALUES (continued)

Cathode current	I_k	max. 16.5 mA
Grid No.1 voltage	$-V_{g1}$	max. 55 V
Voltage between cathode and heater	V_{kf}	max. 200 V
Grid No.1 resistor	R_{g1}	max. 1.1 M Ω
Bulb temperature	tbulb	max. 220 $^{\circ}$ C

OPERATING CHARACTERISTICS Fig. 1

Supply voltage	V	100	150	100	150	100	150	V
Anode resistor	R_a	100	100	270	270	470	470	k Ω
Grid No.2 resistor	R_{g2}	0.22	0.27	0.68	0.82	1.2	1.5	k Ω
Grid No.1 resistor	R_{g1}	0.27	0.27	0.47	0.47	1.0	1.0	M Ω
Total distortion ($V_i = 0.1$ VRMS)	d_{tot}	2.8	1.5	2.5	2.4	2.3	3.0	%
Voltage gain ($V_i = 0.1$ VRMS)	V_o/V_i	82	115	95	132	117	167	
Total distortion ($+I_{g1} = 0.3$ μ A)	d_{tot}	4.9	4.8	4.7	4.9	5.0	4.8	%
Voltage gain ($+I_{g1} = 0.3$ μ A)	V_o/V_i	77	109	91	128	114	159	
Input voltage ($+I_{g1} = 0.3$ μ A)	V_i	0.23	0.2	0.15	0.16	0.14	0.14	V _{RMS}

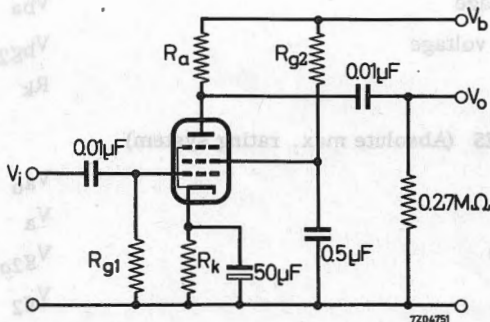
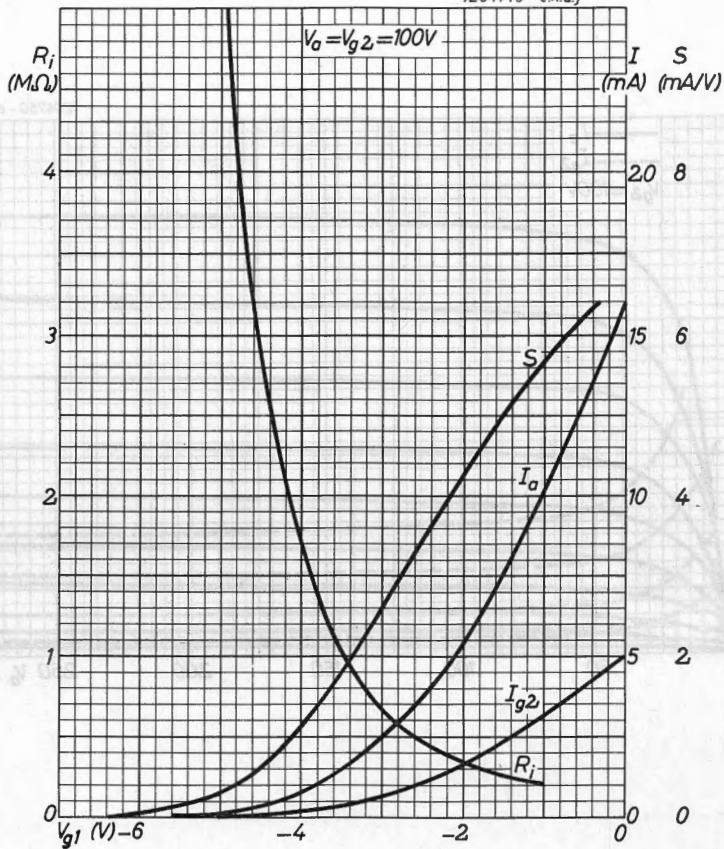
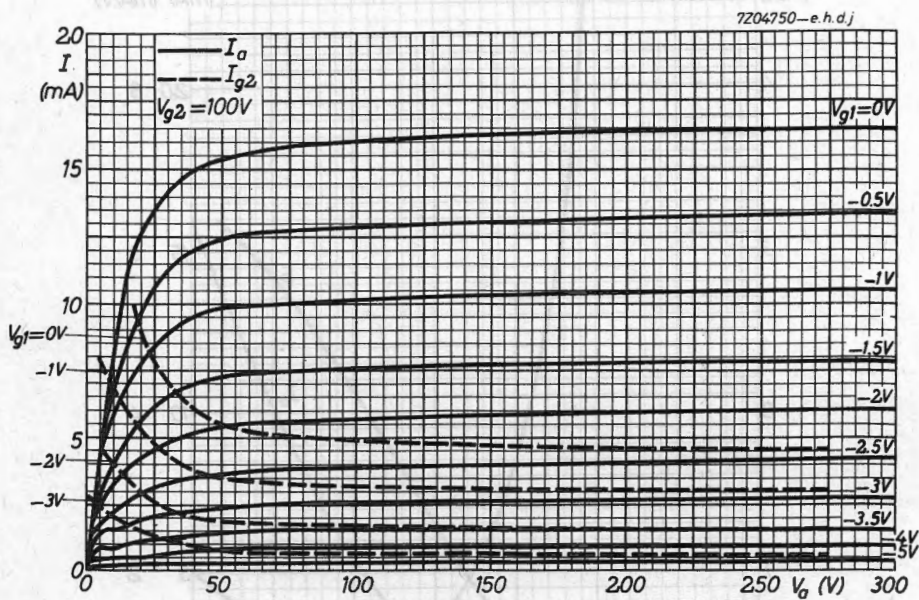

Fig. 1

7Z04749—e.h.d.j





S.Q. TUBE

Special quality triode designed for use as grounded grid H.F. and I.F. wide band amplifier.

QUICK REFERENCE DATA

Life test	1000 hours	
Low interface resistance		
Mechanical quality	Shock and vibration resistant	
Base	Noval	
Heating	Indirect	
	A.C. or D.C.; Parallel supply	
Heater voltage	V_f	6.3 V
Heater current	I_f	300 mA
Anode current	I_a	26 mA
Transconductance	S	24 mA/V

DIMENSIONS AND CONNECTIONS

Dimensions in mm

Base: Noval

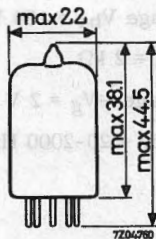
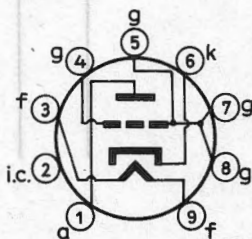

CHARACTERISTICS

Column I Nominal value or setting of the tube

II Range values for equipment design: Initial spread

		I	II	
Heater voltage	V_f	6.3		V
Heater current	I_f	300	280 - 320	mA
Anode supply voltage	V_a	150		V
Cathode resistor	R_k	60		Ω
Anode current	I_a	26	19 - 33	mA
Mutual conductance	S	24	19 - 29	mA/V
Amplification factor	μ	50		
Negative grid current	$-I_g$		max. 0.2	μA
<u>Cut-off voltage</u>	$-V_g$	10		V
Anode current $I_a = \text{max. } 100 \mu A$				
<u>Leakage current between cathode and heater</u>	I_{kf}		max. 15	μA
Voltage between cathode and heater $V_{kf}(\text{cath. pos.}) = 100 \text{ V}$				
<u>Insulation resistance between electrodes</u>	R_{ins}		min. 100	M Ω
Voltage between electrodes = 300 V				
<u>Vibrational noise output</u>	V_o		max. 100	mV
Anode supply voltage $V_{ba} = 150 \text{ V}$				
Anode resistor $R_a = 2 \text{ k}\Omega$				
Negative grid voltage $-V_g = 2 \text{ V}$				
Vibration frequency = 20-2000 Hz				
Acceleration = 4 g				

CAPACITANCES

	I	II	
Anode to cathode and heater	C_a/kf	max. 0.55	pF
Cathode to grid and heater	C_k/gf	8 - 10	pF
Anode to grid and heater	C_a/gf	1.5 - 1.95	pF

SHOCK AND VIBRATION RESISTANCE

The following test conditions are applied to assess the mechanical quality of the tube. These conditions are not intended to be used as normal operating conditions.

Shock

The tube is subjected 5 times in each of 4 positions to an acceleration of 500 g supplied by an NRL shock machine with the hammer lifted over an angle of 30°.

Vibration

The tube is subjected during 32 hours in each of 3 positions to a vibration frequency of 50 Hz with an acceleration of 2.5 g.

LIFE

Production samples are tested during 1000 hours.

LIMITING VALUES Absolute maximum rating system

Anode voltage	V_{a0}	max.	400	V
	V_a	max.	200	V
Anode dissipation	W_a	max.	4.5	W
Grid voltage	$-V_g$	max.	50	V
Grid peak voltage	$-V_{gp}$	max.	100	V
Cathode current	I_k	max.	38	mA
Voltage between cathode and heater	V_{kf}	max.	60	V
Bulb temperature	t_{bulb}	max.	160	°C
Grid resistor: fixed bias	R_g	max.	0.15	MΩ
automatic bias	R_g	max.	0.3	MΩ

Heater voltage: The average heater voltage should be 6.3 V.

Variations of the heater voltage exceeding the range of 6.0 to 6.6 V will shorten the tube life.

The tolerance of heater current (column II) should be taken into account.

CAPACITANCES

	I	II	
Anode to cathode and heater	CaM	max 0.25	pF
Cathode to grid and heater	CaG1	8 - 10	pF
Anode to grid and heater	CaG2	1.5 - 1.95	pF

SHOCK AND VIBRATION RESISTANCE

The following test conditions are applied to assess the mechanical quality of the tube. These conditions are not intended to be used as normal operating conditions.

Shock

The tube is subjected 5 times in each of 4 positions to an acceleration of 50g supplied by an NRL shock machine with the hammer lifted over an angle of 30°.

Vibration

The tube is subjected during 32 hours in each of 3 positions to a vibration frequency of 50 Hz with an acceleration of 2 g.

Life

Production samples are tested during 1000 hours.

LIMITING VALUES Absolute maximum rating system

Anode voltage:	V_{a0}	max. 400 V
	V_a	max. 300 V
Anode dissipation	W_a	max. 4.5 W
Grid voltage	$-V_g$	max. 50 V
Grid peak voltage	$-V_{gp}$	max. 100 V
Cathode current	I_k	max. 38 mA
Voltage between cathode and heater	V_{KH}	max. 60 V
Bulb temperature	temp	max. 160 °C
Grid resistor: fixed bias	R_g	max. 0.15 MΩ
automatic bias	R_g	max. 0.3 MΩ

Heater voltage: The average heater voltage should be 0.3 V. Variations of the heater voltage exceeding the range of 0.0 to 0.5 V will shorten the tube life. The tolerance of heater current (column II) should be taken into account.

S.Q. TUBE

Special quality pentode designed for use as controlled R.F. or I.F. amplifier (max. freq. 400 MHz).

QUICK REFERENCE DATA

Life test	1000 hours
Mechanical quality	Shock and vibration resistant
Base	Subminiature
Heating	Indirect A.C. or D.C.; parallel supply
Heater voltage	V_f 6.3 V
Heater current	I_f 150 mA
Anode current	I_a 7.2 mA
Mutual conductance	S 4.5 mA/V

DIMENSIONS AND CONNECTIONS

Dimensions in mm

Base: Subminiature

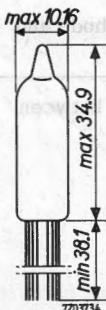
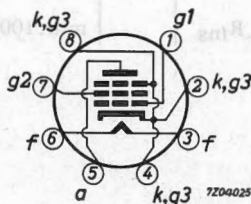

Leads should not be soldered nearer than 5 mm to the seal
Leads should not be bent nearer than 2 mm to the seal

CHARACTERISTICS

- Column I Nominal value or setting of the tube
 II Range values for equipment design; Initial spread
 III Range values for equipment design; End of life

		I	II	III	
Heater voltage	V_f	6.3			V
Heater current	I_f	150	140-160		mA
Anode voltage	V_a	100			V
Grid No.2 voltage	V_{g_2}	100			V
Cathode resistor	R_k	120			Ω
Anode current	I_a	7.2	5.2-9.2		mA
Grid No.2 current	I_{g_2}	2.0	1.0-3.0		mA
Mutual conductance	S	4.5	3.8-5.2	ΔS max. 25%	mA/V
Internal resistance	R_i	260	min.175		k Ω
Negative grid No.1 current	$-I_{g_1}$		max.0.3	max. 0.8	μA
Mutual conductance	S	25	1- 75		$\mu A/V$
Grid No.1 voltage	$-V_{g_1}$	14			V
<u>Leakage current between cathode and heater</u>	I_{kf}		max. 5	max. 10	μA
Voltage between cathode and heater $V_{kf} = 100$ V					
Insulation resistance between electrodes	R_{ins}		min.100		M Ω

CHARACTERISTICS (continued)

	I	II	
<u>Vibrational noise output</u>	V_o	max. 60	mVRMS
Anode supply voltage			
$V_{ba} = 100$ V			
Grid No.2 supply voltage			
$V_{bg_2} = 100$ V			
Cathode resistor $R_k = 120$ Ω			
Anode resistor $R_a = 10$ k Ω			
Grid No.1 resistor $R_{g_1} = 1$ M Ω			
Cathode bypass capacitor			
$C_k = 1000$ μ F			
Vibration frequency = 50 Hz			
Acceleration = 15 g			

CAPACITANCES With external shield

Anode to grid No.2, cathode heater and screen	C_{a/g_2} kfs	3.4	2.9 - 3.9	pF
Grid No.1 to grid No.2, cathode heater and screen	C_{g_1/g_2} kfs	4.2	3.8 - 4.8	pF
Anode to grid No.1	C_{ag_1}		max. 15	mpF

SHOCK AND VIBRATION RESISTANCE

The following test conditions are applied to assess the mechanical quality of the tube. These conditions are not intended to be used as normal operating conditions.

Shock

The tube is subjected 5 times in each of 4 positions to an acceleration of 500 g supplied by an NRL shock machine with the hammer lifted over an angle of 30°.

Vibration

The tube is subjected during 32 hours in each of 3 positions to a vibration frequency of 50 Hz with an acceleration of 2.5 g.

LIFE

Production samples are tested to be within the end of life values (column III) under the following conditions during 1000 hours.

Anode voltage	V_a	100	V
Grid No.2 voltage	V_{g2}	100	V
Cathode resistor	R_k	120	Ω

LIMITING VALUES (Absolute max. rating system)

Anode voltage	V_a	max.	165	V
Grid No.2 voltage	V_{g2}	max.	155	V
Anode dissipation	W_a	max.	1.1	W
Grid No.2 dissipation	W_{g2}	max.	0.55	W
Cathode current	I_k	max.	16.5	mA
Voltage between cathode and heater	V_{kf}	max.	200	V
Grid No.1 resistor	R_{g1}	max.	1.2	$M\Omega$
Bulb temperature	t_{bulb}	max.	220	$^{\circ}C$

7Z04-296-ehii

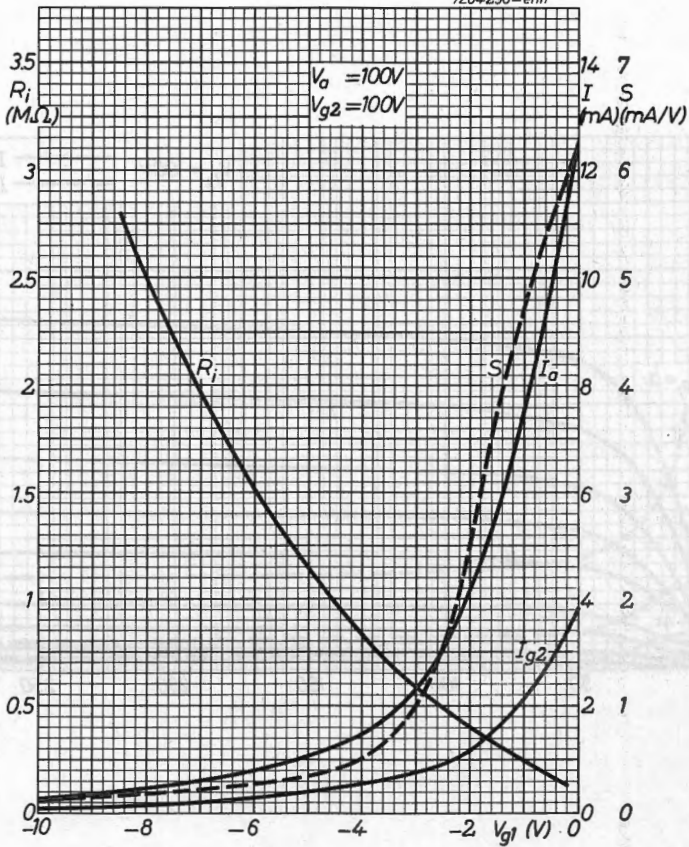

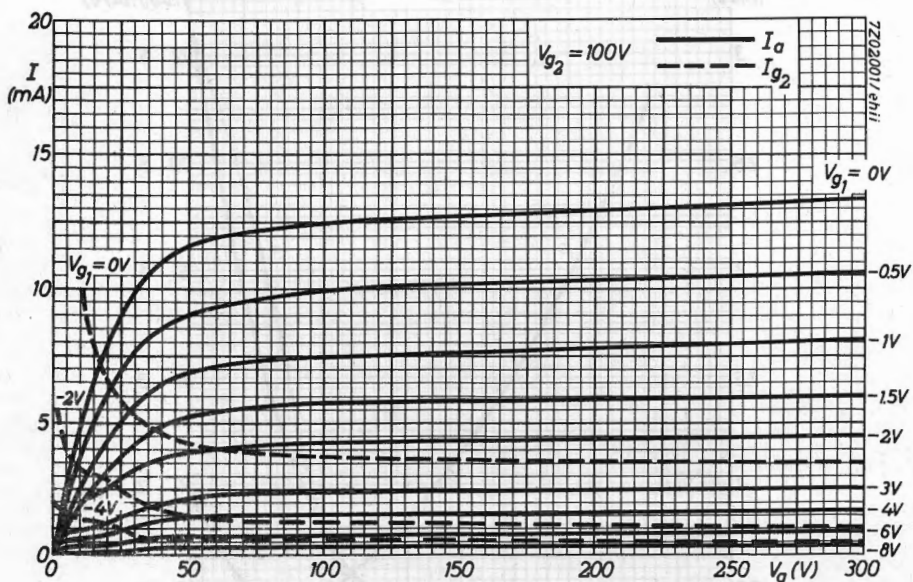

S.Q. TUBE

Special quality pentode designed for use as A. F. power output tube.

QUICK REFERENCE DATA

Life test	1000 hours
Mechanical quality	Shock and vibration resistant
Base	Subminiature
Heating	Indirect A. C. or D. C. ; parallel supply
Heater voltage	V_f 6.3 V
Heater current	I_f 450 mA
Anode current	I_a 30 mA
Output power	W_o 1.0 W

DIMENSIONS AND CONNECTIONS

Dimensions in mm

Base: Subminiature

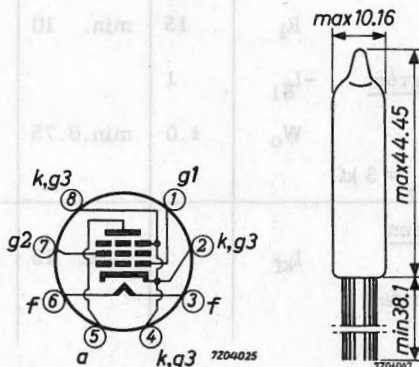

The leads should not be soldered nearer than 5 mm to the seal and should not be bent nearer than 1.5 mm to the seal.

CHARACTERISTICS

- Column I Nominal value or setting of the tube
 II Range values for equipment design: Initial spread
 III Range values for equipment design: End of life

		I	II	III	
Heater voltage	V_f	6.3			V
Heater current	I_f	450	420 - 480		mA
Anode voltage	V_a	100			V
Grid No.2 voltage	V_{g2}	100			V
Grid No.1 voltage	$-V_{g1}$	9			V
Anode current	I_a	30			mA
Grid No.2 current	I_{g2}	2.2			mA
Mutual conductance	S	4.2			mA/V
Anode supply voltage	V_{ba}	109			V
Grid No.2 supply voltage	V_{bg2}	109			V
Cathode resistor	R_k	270			Ω
Anode current	I_a	30	23 - 37		mA
Grid No.2 current	I_{g2}	2.2	max. 4.0		mA
Mutual conductance	S	4.2	3.5 - 4.9		mA/V
Internal resistance	R_i	15	min. 10		$k\Omega$
<u>Negative grid No.1 current</u>	$-I_{g1}$	1		2	μA
<u>Output power</u>	W_o	1.0	min. 0.75	ΔW_o : max. 25%	W
Load resistance $R_{a\sim} = 3 k\Omega$					
<u>Leakage current between cathode and heater</u>	I_{kf}		max. 15	max. 60	μA
Voltage between cathode and heater $V_{kf} = 100 V$					

CHARACTERISTICS (continued)

Vibrational noise outputAnode supply voltage $V_{ba} = 110$ VGrid No. 2 supply voltage $V_{bg_2} = 110$ VCathode resistor $R_k = 270 \Omega$ Cathode by-pass capacitor $C_k = 1000$ pFAnode resistor $R_a = 2$ k Ω

Vibration frequency = 50 Hz

Acceleration = 15 g

	I	II
V_o		max. 100

CAPACITANCES

Anode to grid No. 2, cathode,
heater and screenGrid No. 1 to grid No. 2 cathode,
heater and screen

Anode to grid No. 1

	I	II	
C_{a/g_2kfs}	7.2	6.5 - 8.5	pF
C_{g_1/g_2kfs}	6.5	5.5 - 7.5	pF
C_{ag_1}		max. 0.2	pF

SHOCK AND VIBRATION RESISTANCE

The following test conditions are applied to assess the mechanical quality of the tube. These conditions are not intended to be used as normal operating conditions.

Shock

The tube is subjected 5 times in each of 4 positions to an acceleration of 500 g supplied by an NRL shock machine with the hammer lifted over an angle of 30°.

Vibration

The tube is subjected during 32 hours in each of 3 positions to a vibration frequency of 50 Hz with an acceleration of 2.5 g.

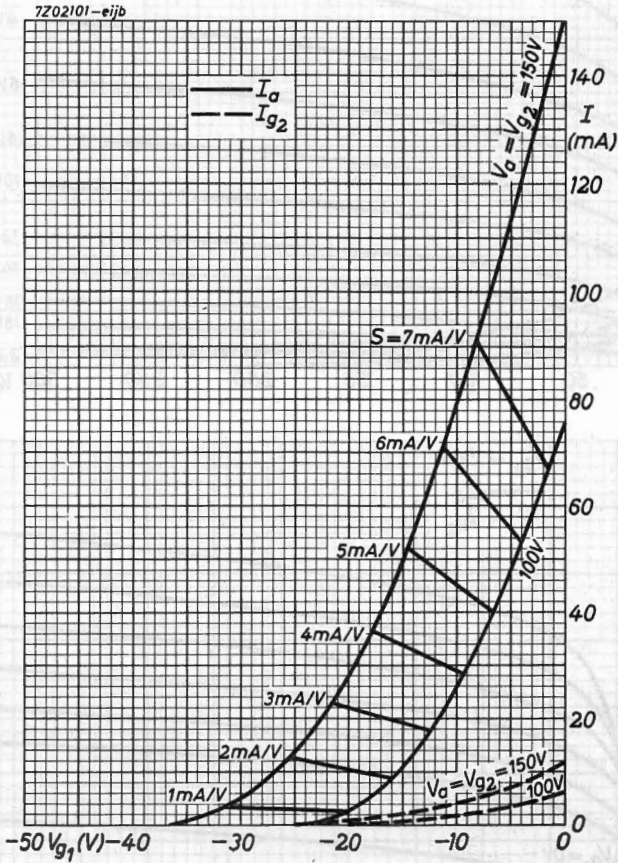

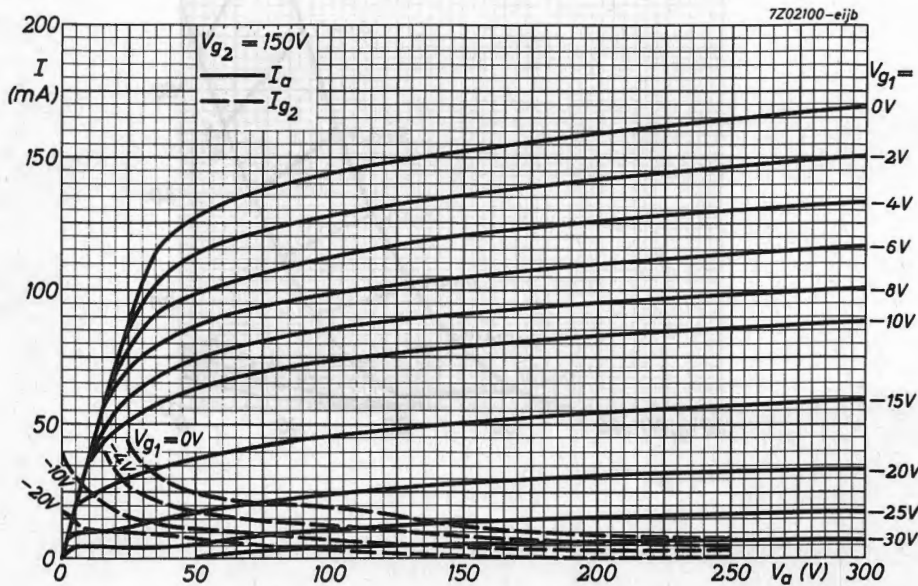
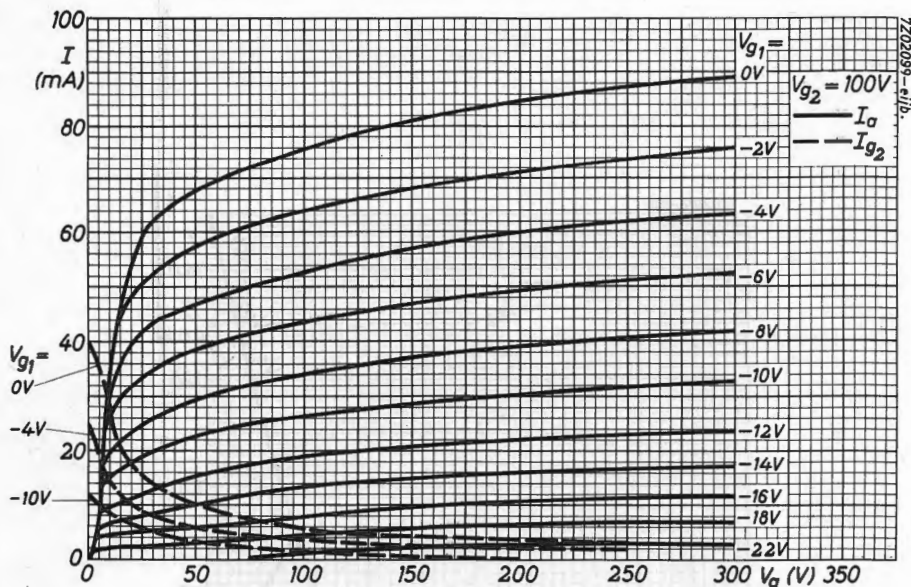

S.Q. TUBE

Special quality double triode designed for use as R. F. amplifier and oscillator.

QUICK REFERENCE DATA	
Life test	1000 hours
Mechanical quality	Shock and vibration resistant
Base	Subminiature
Heating	Indirect
	A. C. or D. C.; parallel supply
Heater voltage	V_f 6.3 V
Heater current	I_f 300 mA
Anode current	I_a 6.5 mA
Mutual conductance	S 5.4 mA/V

DIMENSIONS AND CONNECTIONS

Dimensions in mm

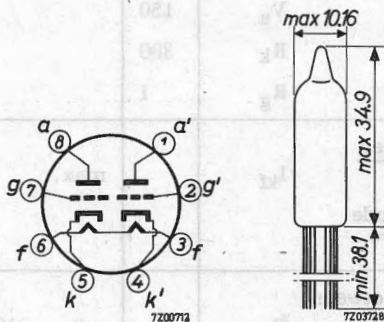

Connections should not be soldered nearer than 5 mm to the seal.

Leads should not be bent nearer than 1.5 mm to the seal.

CHARACTERISTICS (both sections if applicable)

Column I Nominal value or setting of the tube

II Range values for equipment design: Initial spread

III Range values for equipment design: End of life

		I	II	III	
Heater voltage	V_f	6.3			V
Heater current	I_f	300	280 - 320		mA
Anode voltage	V_a	100			V
Cathode resistor	R_k	150			Ω
Anode current	I_a	6.5	4.5 - 8.5		mA
Difference in anode current of both systems	$ I_a - I_a' $		max. 1.6		mA
Mutual conductance	S	5.4	4.45 - 6.35	ΔS : max. 25%	mA/V
Amplification factor	μ	35	30 - 40		
Internal resistance	R_i	6.5			k Ω
<u>Cut-off voltage</u>	$-V_g$		max. 6.5		V
Anode voltage	V_a	100			V
Anode current	I_a	100			μ A
<u>Negative grid current</u>	$-I_g$		max. 0.3	max. 1.0	μ A
Anode voltage	V_a	150			V
Cathode resistor	R_k	300			Ω
Grid resistor	R_g	1			M Ω
<u>Leakage current between cathode and heater</u>	I_{kf}		max. 5	max. 10	μ A
Voltage between cathode and heater $V_{kf} = 100$ V					
<u>Insulation resistance between two electrodes</u>	R_{ins}		min. 100	min. 50	M Ω
Voltage between electrodes = 100 V					

CHARACTERISTICS (continued)

		I	II	III	
<u>Vibrational noise output</u>	V_o		max. 35		mV _{RMS}
Anode supply voltage V_{ba}					100 V
Anode resistor R_a					10 k Ω
Cathode resistor R_k					150 Ω
Cathode bypass capacitor C					1000 μ F
Vibration frequency					40 Hz
Acceleration					15 g
CAPACITANCES					
Grid to cathode and heater	$C_{g/kf}$	2.4	1.8 - 3.0		pF
Anode to cathode and heater	$C_{a/kf}$	0.28	0.20 - 0.36		pF
	$C_{a'/k'f}$	0.32	0.22 - 0.42		pF
Anode to grid	C_{ag}	1.5	1.2 - 1.8		pF
Grid to grid other section	$C_{gg'}$		max. 0.013		pF
Anode to anode other section	$C_{aa'}$		max. 0.52		pF

SHOCK AND VIBRATION RESISTANCE

The following test conditions are applied to assess the mechanical quality of the tube. These conditions are not intended to be used as normal operating conditions.

Shock

The tube is subjected 5 times in each of 4 positions to an acceleration of 500 g supplied by an NRL shock machine with the hammer lifted over an angle of 30°.

Vibration

The tube is subjected during 32 hours in each of 3 positions to a vibration frequency of 50 Hz with an acceleration of 2.5 g.

LIFE

Production samples are tested to be within the end of life values (column III) under the following conditions during 1000 hours:

Anode voltage $V_a = 100$ V

Cathode resistor $R_k = 150$ Ω

Voltage between
cathode and heater $V_{kf} = 200$ V

LIMITING VALUES (Absolute max. rating system)

Anode voltage	V_{a0}	max.	330 V
Anode voltage	V_a	max.	165 V
Anode dissipation	W_a	max.	0.7 W
Anode current	I_a	max.	22 mA
Grid voltage	$-V_g$	max.	55 V
Grid current	I_g	max.	5.5 mA
Grid resistor	R_g	max.	1.1 M Ω
Voltage between cathode and heater d.c. or peak value	V_{kf}	max.	200 V
Bulb temperature	t_{bulb}	max.	220 $^{\circ}$ C

Heater voltage: The average heater voltage should be 6.3 V.

Variations of the heater voltage exceeding the range of 6.0 V to 6.6 V will shorten the tube life.

The tolerance of heater current (column II) should be taken into account.

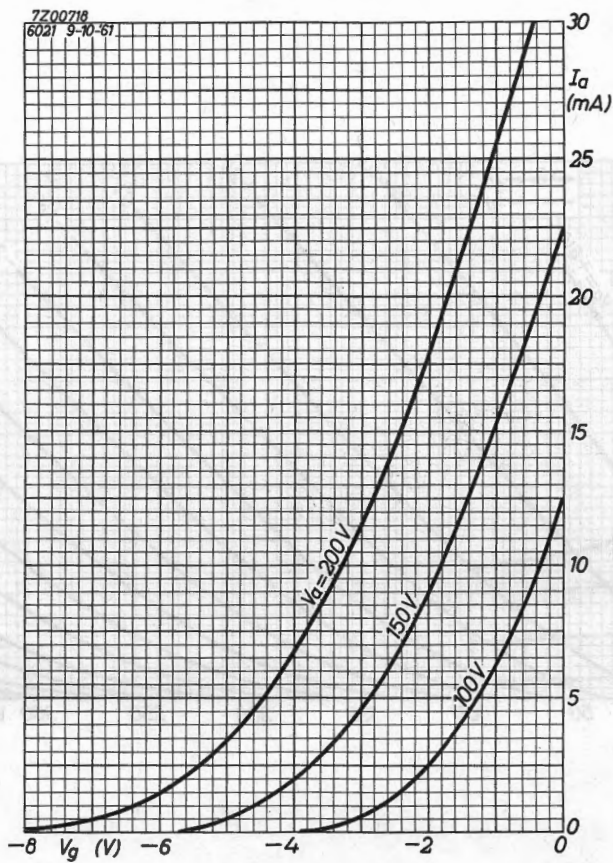

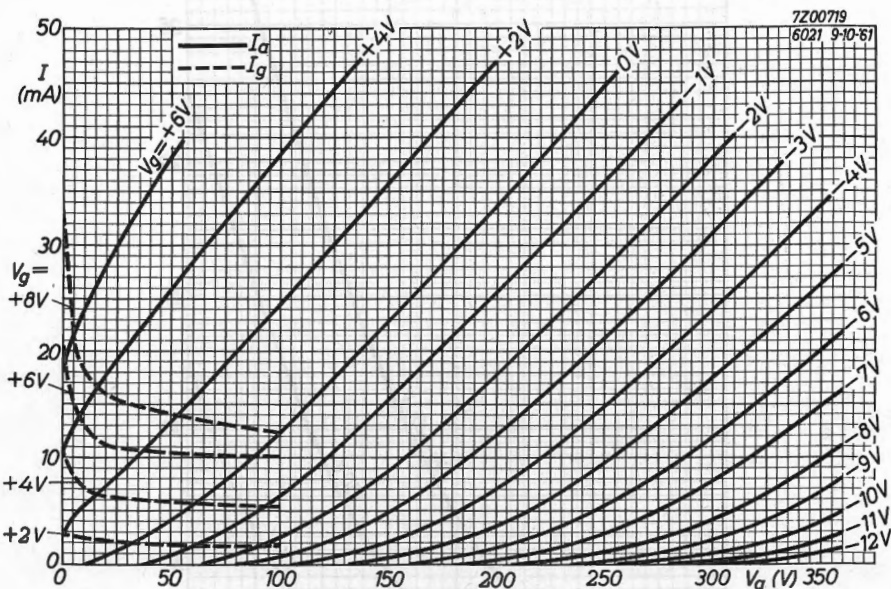

S.Q. TUBE

Special quality double triode designed for use as series regulator tube in d.c. power supplies, in servo application and as booster triode.

QUICK REFERENCE DATA

Life test	500 hours
Mechanical quality	Shock and vibration resistant
Base	Octal
Heating	Indirect A.C. or D.C.; parallel supply
Heater voltage	V_f 6.3 V
Heater current	I_f 2.5 A
Anode current	I_a 100 mA (each section)
Mutual conductance	S 6.5 mA/V
Internal resistance	R_i 300 Ω

DIMENSIONS AND CONNECTIONS

Dimensions in mm

Base: Octal

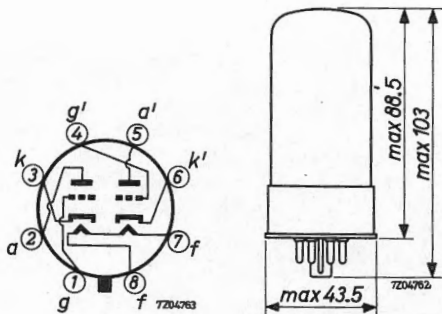

CHARACTERISTICS

Each section if applicable

Column I Nominal value or setting of the tube

II Range values for equipment design; Initial spread

		I	II	
Heater voltage	V_f	6.3		V
Heater current	I_f	2.5	2.26 - 2.74	A
Anode voltage	V_a	100		V
Cathode resistor	R_k	300		Ω
Anode current	I_a	100		mA
Mutual conductance	S	6.5		mA/V
Amplification factor	μ	2		
Internal resistance	R_i	300		Ω
Anode supply voltage	V_{ba}	135		V
Cathode resistor	R_k	250		Ω
Anode current	I_a 1)	125	100 - 150	mA
Mutual conductance	S	7.0	5.8 - 8.2	mA/V
Amplification factor	μ	2.0	1.4 - 2.6	
Internal resistance	R_i	280		Ω
Negative grid current (g connected to g')	$-I_g$		max. 4.0	μA



1) Max. duration 1 s

Operation with W_a and I_a at the absolute maximum limiting values.

CHARACTERISTICS (continued)**Vibrational noise output** V_o

max. 0.2

 V_{RMS}

Two sections in parallel

Anode supply voltage $V_{ba} = 135$ VGrid voltage $-V_g = 7$ VAnode resistor $R_a = 2$ k Ω

Vibration frequency = 25 Hz

Acceleration = 2.5 g

CAPACITANCES Each system if applicable

Anode to grid

 C_{ag}

8.6

pF

Anode to cathode and heater

 $C_{a/kf}$

2.5

pF

Grid to cathode and heater

 $C_{g/kf}$

5.5

pF

Cathode to heater

 C_{kf}

7

pF

Anode to anode other section

 $C_{aa'}$

2.2

pF

Grid to grid other section

 $C_{gg'}$

0.5

pF

SHOCK AND VIBRATION RESISTANCE

The following test conditions are applied to assess the mechanical quality of the tube. These conditions are not intended to be used as normal operating conditions.

Shock

The tube is subjected 5 times in each of 4 positions to an acceleration of 500 g supplied by an NRL shock machine with the hammer lifted over an angle of 30°.

Vibration

The tube is subjected during 32 hours in each of 3 positions to a vibration frequency of 25 Hz with an acceleration of 2.5 g.

LIFE

Production samples are tested during 500 hours.

LIMITING VALUES (Absolute max. rating system)

Anode voltage	V_{a0}	max. 550 V
	V_a	max. 250 V
Anode inverse peak voltage	$V_a \text{ inv}_p$	max. 3 kV
Duty factor max. 0.15		
Pulse duration max. 10 μsec		
Cathode current	I_k	max. 125 mA
Grid peak voltage	$-V_{gp}$	max. 2.3 kV
Duty factor max. 0.15		
Pulse duration max. 10 μsec		
Anode dissipation	W_a	max. 13 W
Voltage between cathode and heater, peak	V_{kfp}	max. 300 V
Grid resistor	Automatic bias	R_g max. 1.0 $M\Omega$
	Fixed bias	R_g max. 0.1 $M\Omega$ ¹⁾
Bulb temperature	t_{bulb}	max. 260 °C

1) With fixed bias the anode circuit should contain a protective resistance to provide a minimum drop of 15 V d.c. at the normal operating conditions. When two or more sections are used in parallel at dissipations approaching the rated maximum, separate anode and cathode resistors must be used to assist load sharing.

When combined fixed and automatic bias is used, the cathode bias portion should have a minimum value of 7.5 V d.c. at the normal operating conditions. R_g should then not exceed 0.1 $M\Omega$.

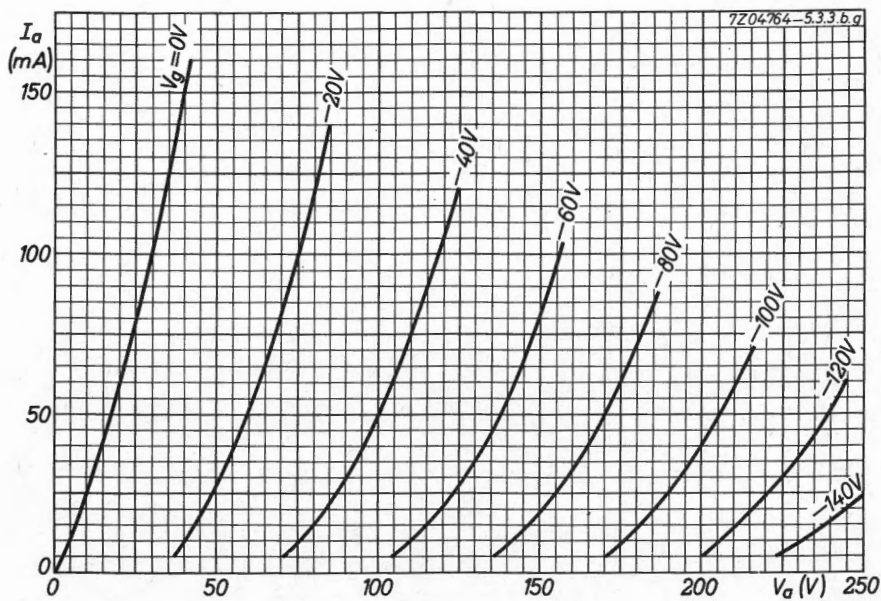

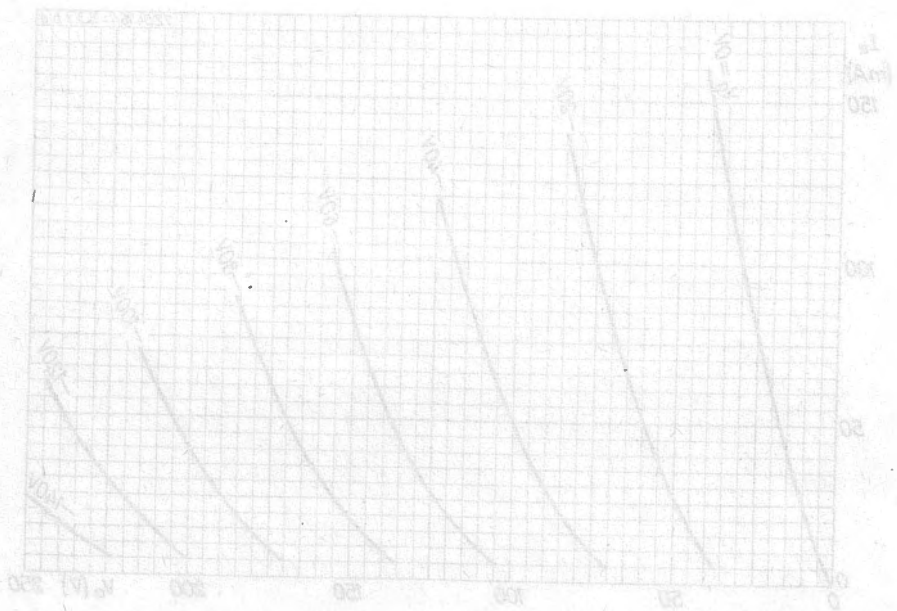

S.Q. TUBE

Special quality double triode designed for use as amplifier mixer and oscillator.

QUICK REFERENCE DATA

Life test	1000 hours
Mechanical quality	Shock and vibration resistant
Base	Subminiature
Heating	Indirect
	A.C. or D.C.; parallel supply
Heater voltage	V_f 6.3 V
Heater current	I_f 300 mA
Anode current	I_a 8.5 mA
Mutual conductance	S 5 mA/V

DIMENSIONS AND CONNECTIONS

Dimensions in mm

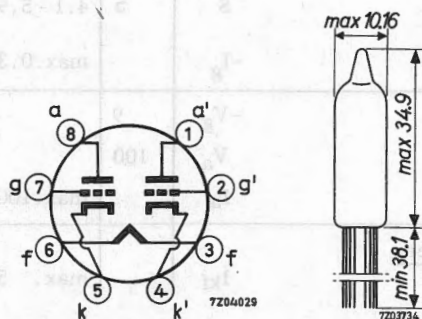

The leads should not be soldered nearer than 5 mm to the seal and should not be bent nearer than 1.5 mm to the seal.

CHARACTERISTICS (Each system if applicable)

Column I Nominal values or setting of the tube

II Range values for equipment design: Initial spread

III Range values for equipment design: End of life

		I	II	III	
Heater voltage	V_f	6.3			V
Heater current	I_f	300	280 - 320		mA
Anode voltage	V_a	100			V
Grid voltage	$-V_g$	1.9			V
Anode current	I_a	8.5			mA
Mutual conductance	S	5			mA/V
Amplification factor	μ	20	17 - 23		
Internal resistance	R_i	4			k Ω
Anode voltage	V_a	100			V
Cathode resistor	R_k	220			Ω
Anode current	I_a	8.5	6.0 - 11		mA
Difference in anode current of two sections	$ I_a - I_a' $		max. 2		mA
Mutual conductance	S	5	4.1 - 5.9	min. 3.5	mA/V
<u>Negative grid current</u>	$-I_g$		max. 0.3	max. 1.0	μ A
<u>Cut-off voltage</u>	$-V_g$	9			V
Anode voltage	V_a	100			V
Anode current	I_a		max. 100		μ A
<u>Leakage current between cathode and heater</u>	I_{kf}		max. 5	max. 10	μ A

Voltage between cathode and heater $V_{kf} = 100$ V

CHARACTERISTICS (continued)**Vibrational noise output**

	I	II	
V_o		max. 50	mVRMS

Anode supply voltage $V_{ba} = 100$ VCathode resistor $R_k = 220 \Omega$ Anode resistor $R_a = 10 \text{ k}\Omega$ Grid resistor $R_g = 0.1 \text{ M}\Omega$ Cathode by-pass capacitor $C_k = 1000 \mu\text{F}$

Vibration frequency = 50 Hz

Acceleration = 15 g

CAPACITANCES

Anode to cathode and heater

 $C_{a/kf}$ 0.28 0.2-0.36 pF $C_{a'/k'f}$ 0.32 0.22-0.42 pF

Grid to cathode and heater

 $C_{g/kf}$ 1.9 1.4- 2.4 pF

Anode to grid

 C_{ag} 1.5 1.2- 1.8 pF

Grid to grid other section

 $C_{gg'}$ max. 13.0 mpF

Anode to anode other section

 $C_{aa'}$ max. 0.5 pF**SHOCK AND VIBRATION RESISTANCE**

The following test conditions are applied to assess the mechanical quality of the tube. These conditions are not intended to be used as normal operating conditions.

Shock

The tube is subjected 5 times in each of 4 positions to an acceleration of 500 g supplied by an NRL shock machine with the hammer lifted over an angle of 30°.

Vibration

The tube is subjected during 32 hours in each of 3 positions to a vibration frequency of 50 Hz with an acceleration of 2.5 g.

LIFE

Production samples are tested to be within the end of life values (column III) under the following conditions during 1000 hours.

Anode voltage V_a 100 VCathode resistor R_k 220 Ω

LIMITING VALUES (Absolute max. rating system)

Anode voltage	V_{a_0}	max. 330 V
	V_a	max. 165 V
Grid voltage	$+V_g$	max. 0 V
	$-V_g$	max. 55 V
Grid current	I_g	max. 5.5 mA
Anode dissipation	W_a	max. 1.1 W
Cathode current	I_k	max. 22 mA
Peak voltage between cathode and heater	V_{kfP}	max. 200 V
Grid resistor	R_g	max. 1 M Ω
Bulb temperature	t_{bulb}	max. 220 °C

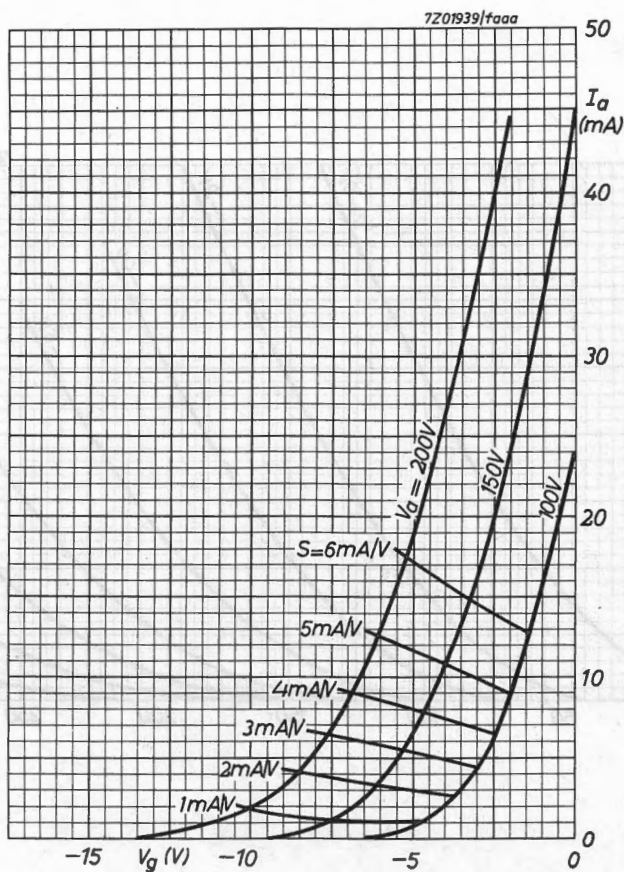

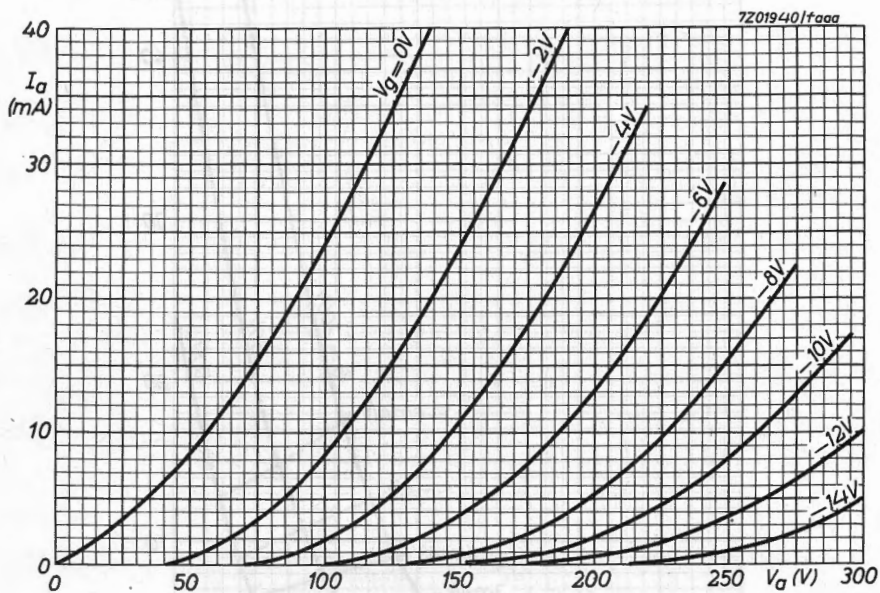

S.Q. TUBE

Special quality double triode designed for use as A.F. amplifier and multi-vibrator.

QUICK REFERENCE DATA

Life test	1000 hours	
Mechanical quality	Shock and vibration resistant	
Base	Subminiature e	
Heating	Indirect A.C. or D.C.; parallel supply	
Heater voltage	V_f	6.3 V
Heater current	I_f	300 mA
Anode current	I_a	0.8 mA
Mutual conductance	S	1.8 mA/V

DIMENSIONS AND CONNECTIONS

Dimensions in mm

Base: Subminiature

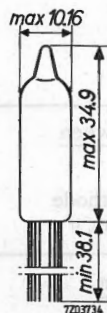
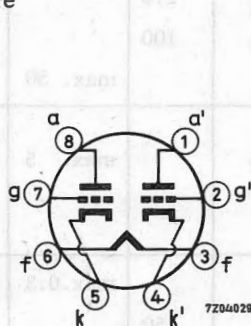

The leads should not be soldered nearer than 5 mm to the seal and should not be bent nearer than 1.5 mm to the seal.

CHARACTERISTICS

- Column I Nominal values or setting of the tube
 II Range values for equipment design: Initial spread
 III Range values for equipment design: End of life

		I	II	III	
Heater voltage	V_f	6.3			V
Heater current	I_f	300	280 - 320		mA
Anode voltage	V_a	100			V
Grid voltage	$-V_g$	1.2			V
Anode current	I_a	0.8			mA
Mutual conductance	S	1.8			mA/V
Amplification factor	μ	70			
Internal resistance	R_i	38.8			k Ω
Anode voltage	V_a	100			V
Cathode resistor	R_k	1500			Ω
Anode current	I_a	0.8	0.5 - 1.1		mA
Mutual conductance	S	1.8	1.5 - 2.1		mA/V
Amplification factor	μ	70	60 - 80		
<u>Cut off voltage</u>	$-V_g$	2.8			V
Anode voltage	V_a	100			V
Anode current	I_a		max. 50		μ A
<u>Leakage current between cathode and heater</u>	I_{kf}		max. 5	max. 10	μ A
Voltage between cathode and heater $V_{kf} = 100$ V					
<u>Negative grid current</u>	$-I_g$		max. 0.3	max. 0.9	μ A
Anode voltage	V_a	150			V
Cathode resistor	R_k	820			Ω

CHARACTERISTICS (continued)

		I	II	
<u>Vibrational noise output</u>	V_o		max. 25	mVRMS
Anode supply voltage $V_{ba} = 100$ V				
Cathode resistor $R_k = 1500$ Ω				
Anode resistor $R_a = 10$ k Ω				
Grid resistor $R_g = 0.1$ M Ω				
Cathode bypass capacitor $C_k = 1000$ μ F				
Vibration frequency 50 Hz				
Acceleration 15 g				

CAPACITANCES

Anode to cathode and heater	$C_{a/kf}$	0.23	0.16 - 0.30	pF
	$C_{a'/k'f}$	0.28	0.21 - 0.35	pF
Grid to cathode and heater	$C_{g/kf}$	1.7	1.3 - 2.1	pF
Anode to anode other section	$C_{aa'}$		max. 0.8	pF
Grid to grid other section	$C_{gg'}$		max. 14.0	mpF
Anode to grid	C_{ag}	1.0	0.8 - 1.2	pF

SHOCK AND VIBRATION RESISTANCE

The following test conditions are applied to assess the mechanical quality of the tube. These conditions are not intended to be used as normal operating conditions.

Shock

The tube is subjected 5 times in each of 4 positions to an acceleration of 500 g supplied by an NRL shock machine with the hammer lifted over an angle of 30°.

Vibration

The tube is subjected during 32 hours in each of 3 positions to a vibration frequency of 50 Hz with an acceleration of 2.5 g.

LIFE

Production samples are tested to be within the end of life values (column III) under the following conditions during 1000 hours.

Anode supply voltage	V_{ba}	100 V
Cathode resistor	R_k	1500 Ω

LIMITING VALUES (Absolute max. rating system)

Anode voltage	V_{a0}	max. 330 V
	V_a	max. 165 V
Grid voltage	$+V_g$	max. 0 V
	$-V_g$	max. 55 V
Anode dissipation	W_a	max. 0.55 W
Anode current	I_a	max. 3.3 mA
Peak voltage between cathode and heater	V_{kfP}	max. 200 V
Grid resistor	R_g	max. 1 M Ω
Bulb temperature	t_{bulb}	max. 220 °C

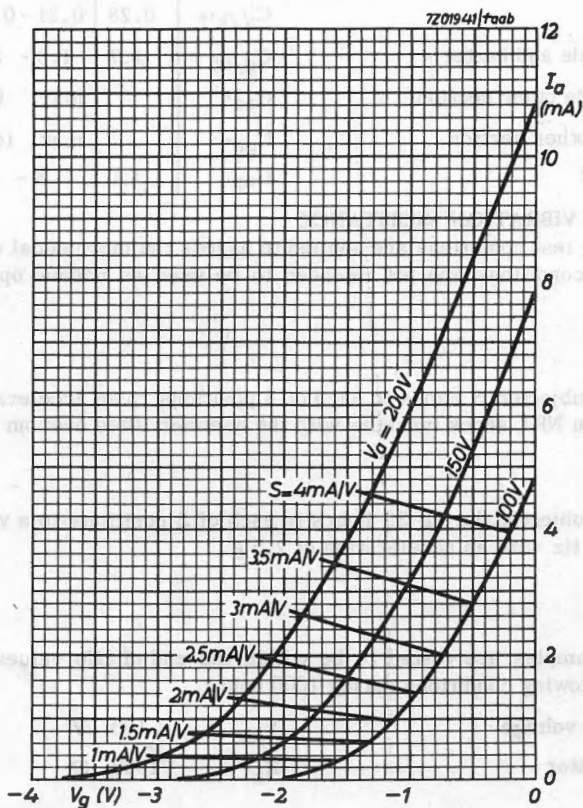

S.Q. TUBE

Special quality double triode designed for use as A.F. amplifier.

QUICK REFERENCE DATA

Life test	1000 hours
Mechanical quality	Shock and vibration resistant
Base	Noval
Heating	Indirect
	A.C. or D.C.; Parallel supply
Heater voltage	V_f 6.3 or 12.6 V
Heater current	I_f 300 or 150 mA
Anode current	I_a 11.8 mA
Mutual conductance	S 3.2 mA/V

DIMENSIONS AND CONNECTIONS

Base: Noval

Dimensions in mm

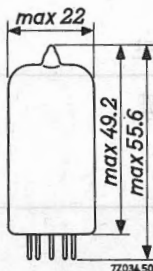
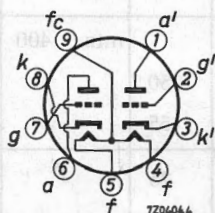

CHARACTERISTICS (Both sections if applicable)

Column I Nominal values or setting of the tube

II Range values for equipment design: Initial spread

III Range values for equipment design: End of life

		I	II	III	
Heater voltage (pin 9 and 4+5)	V_f	6.3			V
Heater current	I_f	300	276- 324		mA
Heater voltage (pin 4 and 5)	V_f	12.6			V
Heater current	I_f	150			mA
Anode voltage	V_a	100			V
Grid voltage	$-V_g$	0			V
Anode current	I_a	11.8			mA
Mutual conductance	S	3.2	2.5- 4.0		mA/V
Amplification factor	μ	19.5			
Internal resistance	R_i	6.25			k Ω
Anode voltage	V_a	250			V
Grid voltage	$-V_g$	8.5			V
Anode current	I_a	10.5	6.5-14.5		mA
Mutual conductance	S	2.2	1.8- 2.6	min. 1.5	mA/V
Amplification factor	μ	17	15.5-18.5		
Internal resistance	R_i	7.7			k Ω
<u>Negative grid current</u>	$-I_g$		max. 0.5	max. 0.5	μ A
<u>Cathode peak current</u>	I_{kp}		min. 400		mA
Anode voltage	V_a	250			V
Grid voltage	V_g	55			V
<u>Cut-off voltage</u>	$-V_g$	25			V
Anode voltage	V_a	250			V
Anode current	I_a		max. 20		μ A

CHARACTERISTICS (continued)

		I	II	III	
<u>Leakage current between cathode and heater</u>	I_{kf}		max. 5	max. 5	μA
Voltage between cathode and heater $V_{kf} = 100 V$					
<u>Vibrational noise output</u>	V_o		max. 100		mV_{RMS}
Anode voltage $V_a = 250 V$					
Grid voltage $-V_g = 8.5 V$					
Anode resistor $R_a = 2 k\Omega$					
Grid resistor $R_g = 0.1 M\Omega$					
Vibration frequency = 50 Hz					
Acceleration = 10 g					
CAPACITANCES					
Anode to cathode and heater	$C_{a/kf}$	0.5	0.3- 0.7		pF
	$C_{a'}/k'f$	0.4	0.2- 0.6		pF
Grid to cathode and heater	$C_{g/kf}$	1.6	1.25-1.95		pF
Anode to grid	C_{ag}	1.5	1.2- 1.8		pF

SHOCK AND VIBRATION RESISTANCE

The following test conditions are applied to assess the mechanical quality of the tube. These conditions are not intended to be used as normal operating conditions.

Shock

The tube is subjected 5 times in each of 4 positions to an acceleration of 500 g supplied by an NRL shock machine with the hammer lifted over an angle of 30°.

Vibration

The tube is subjected during 32 hours in each of 3 positions to a vibration frequency of 50 Hz with an acceleration of 2.5 g.

LIFE

Production samples are tested to be within the end of life values (column III) under the following conditions during 1000 hours.

Anode voltage	V_a	250	V
Grid voltage	$-V_g$	8.5	V

LIMITING VALUES (Absolute max. rating system)

Anode voltage	V_a	max.	330	V
Anode dissipation	W_a	max.	3	W
Cathode current	I_k	max.	22	mA
Grid resistor: fixed bias	R_{g1}	max.	0.5	M Ω
	R_{g1}	max.	1.0	M Ω
Voltage between cathode and heater	V_{kf}	max.	110	V
	t_{bulb}	max.	165	$^{\circ}\text{C}$
Bulb temperature				

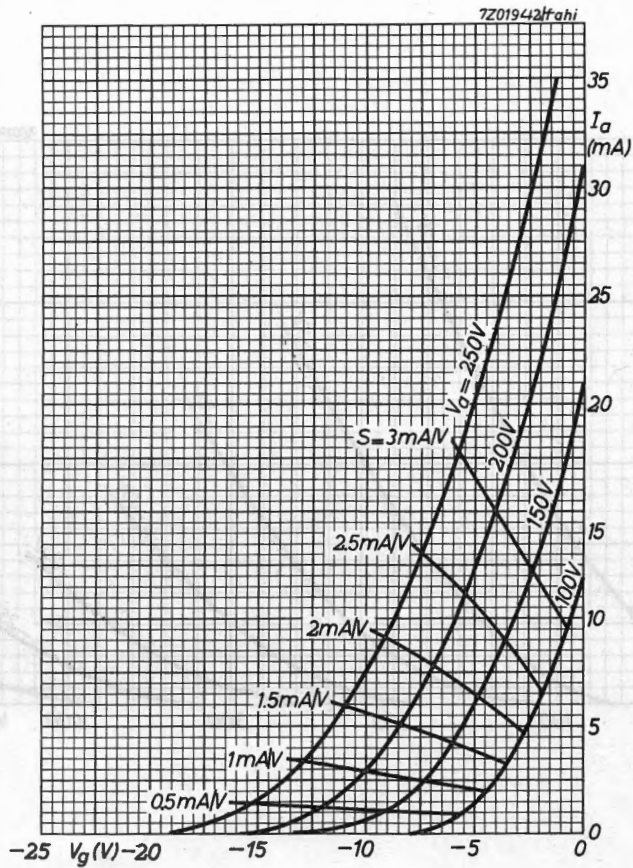

7Z01943|fahi

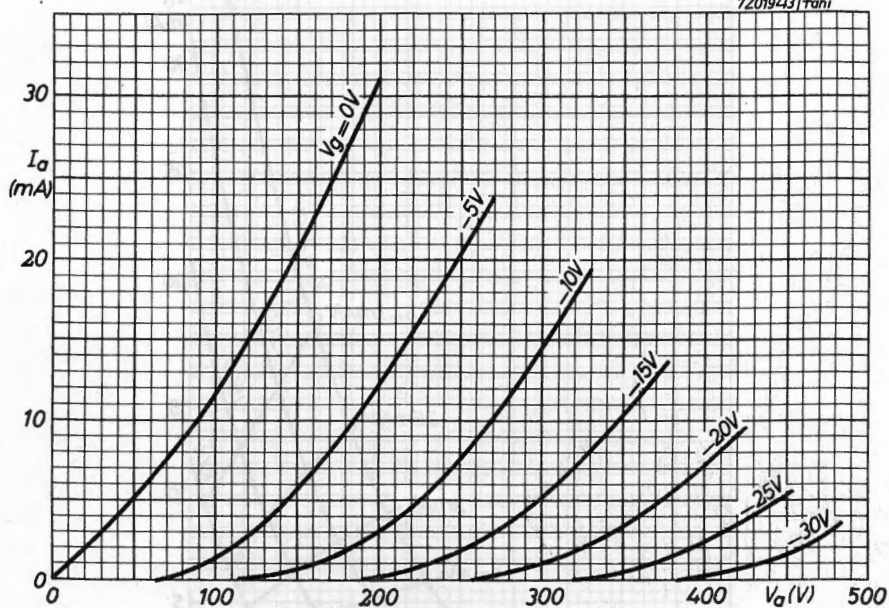

S.Q. TUBE

Special quality double triode designed for use as R.F. amplifier in grounded grid circuits, frequency changer (max. freq. 300 MHz) in mobile and industrial equipment with intermittent operation, and on-off control applications where operation under cut-off conditions is required.

QUICK REFERENCE DATA

Life test	500 hours
Low interface resistance	
Mechanical quality	Shock and vibration resistant
Base	Noval. Gold plated pins
Heating	Indirect A.C. or D.C. Parallel or series supply
Heater voltage	V_f 6.3 or 12.6 V
Heater current	I_f 300 or 150 mA
Anode current	I_a 10 mA
Mutual conductance	S 5.5 mA/V

DIMENSIONS AND CONNECTIONS

Dimensions in mm

Base: Noval

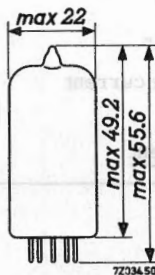
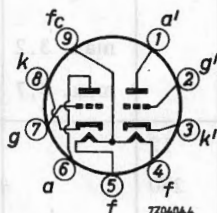

CHARACTERISTICS

- Column I Nominal value or setting of the tube
 II Range values for equipment design: Initial spread
 III Range values for equipment design: End of life

		I	II	III	
Heater voltage (pin 9 and 4 + 5)	V_f	6.3			V
Heater current	I_f	300			mA
Heater voltage (pin 4 and 5)	V_f	12.6			V
Heater current	I_f	150	138 - 162		mA
Anode voltage	V_a	100			V
Cathode resistor	R_k	270			Ω
Anode current	I_a	3.3			mA
Mutual conductance	S	4.0			mA/V
Internal resistance	R_i	14.3			$k\Omega$
Amplification factor	μ	57			
<u>Cut-off voltage</u>	$-V_g$	5			V
Anode voltage	V_a	100			V
Anode current	I_a	10			μA
Anode voltage	V_a	250			V
Cathode resistor	R_k	200			Ω
Anode current	I_a	10	7 - 14		mA
Mutual conductance	S	5.5	4.5 - 6.5	min. 3.8	mA/V
Internal resistance	R_i	10.9			$k\Omega$
Amplification factor	μ	60	50 - 70		
Difference in anode current of two systems	$ I_a - I_a' $		max. 3.2		mA
<u>Negative grid current</u>	$-I_g$		max. 0.7	max. 0.7	μA
<u>Cut-off voltage</u>	$-V_g$	12			V
Anode voltage	V_a	250			V
Anode current	I_a	10			μA

CHARACTERISTICS (continued)

	I	II	III	
<u>Cut-off voltage</u>	$-V_g$	20		V
Anode supply voltage $V_a = 250$ V	V_a	250		V
Anode resistor $R_a = 0.1$ M Ω	R_a	0.1		M Ω
Anode current $I_a = \text{max. } 100$ μ A	I_a		max. 100	μ A
<u>Vibrational noise output</u>	V_o		max. 100	mVRMS
Anode supply voltage $V_{ba} = 200$ V				
Grid voltage $-V_g = 3$ V				
Anode resistor $R_a = 2$ k Ω (two sections in parallel)				
Vibration frequency 25 Hz				
Acceleration 2.5 g				
<u>Leakage current between cathode and heater</u>	I_{kf}	max. 10	max. 10	μ A
Voltage between cathode and heater $V_{kf} = 100$ V				
<u>Insulation resistance between grid and cathode ($V = 100$ V)</u>	R_{ins}	min. 100	min. 50	M Ω
anode and cathode ($V = 300$ V)	R_{ins}	min. 100	min. 50	M Ω

CAPACITANCES (Both sections if applicable)

Without external shield

	I	II	
Anode to grid	C_{ag}	1.6	1.3 - 1.9 pF
Grid to cathode and heater	$C_{g/kf}$	2.5	2.0 - 3.0 pF
Anode to cathode and heater	$C_{a/kf}$	0.45	0.2 - 0.7 pF
	$C_{a'/k'f}$	0.38	0.16 - 0.60 pF
Cathode to heater	C_{kf}	2.8	2.1 - 3.5 pF
Anode to anode other section	$C_{aa'}$	0.24	0.15 - 0.33 pF
Cathode to grid and heater	$C_{k/gf}$	5.0	pF
Anode to grid and heater	$C_{a/gf}$	1.9	pF
	$C_{a'/g'f}$	1.8	pF
Anode to cathode	C_{ak}	0.2	pF
	$C_{a'k'}$	0.24	pF

CAPACITANCES (Both sections if applicable) (continued)With external shield connected to the applicable cathode

Anode to grid	C_{ag}	1.6 pF
Grid to cathode and heater	$C_{g/kf}$	2.5 pF
Anode to cathode and heater	$C_{a/kf}$	1.2 pF
	$C_{a' / k' f}$	1.3 pF
Cathode to heater	C_{kf}	2.8 pF

With external shield connected to the applicable grid

Cathode to grid and heater	$C_{k/gf}$	5.0 pF
Anode to grid and heater	$C_{a/gf}$	2.7 pF
Anode to cathode	C_{ak}	0.18 pF
	$C_{a' k'}$	0.2 pF

SHOCK AND VIBRATION RESISTANCE

The following test conditions are applied to assess the mechanical quality of the tube. These conditions are not intended to be used as normal operating conditions

Shock

The tube is subjected 5 times in each of 4 positions to an acceleration of 600 g supplied by an NRL shock machine with the hammer lifted over an angle of 42°

Vibration

The tube is subjected during 32 hours in each of 3 positions to a vibration frequency of 25 Hz with an acceleration of 2.5 g

LIFE

Production samples are tested to be within the end of life values (column III) under the following conditions during 500 hours

Anode supply voltage	V_{ba}	= 250 V
Cathode resistor	R_k	= 200 Ω

LIMITING VALUES (Absolute max. rating system)

Anode voltage	V_{a0}	max.	600 V
	V_a	max.	330 V
Anode dissipation	W_a	max.	2.8 W
Grid voltage	$-V_g$	max.	55 V
Grid current	I_g	max.	250 μ A
Grid resistor, fixed bias	R_g	max.	0.25 M Ω
	R_g	max.	1.0 M Ω
Cathode current	I_k	max.	18 mA
Voltage between cathode and heater	V_{kf}	max.	100 V
Bulb temperature	t_{bulb}	max.	200 $^{\circ}$ C 1)

Heater voltage: The average heater voltage should be 6.3 V.

Variations of the heater voltage exceeding the range of 5.7 to 7.0 V will shorten the tube life.

OPERATING CHARACTERISTICS

Fig. 1

1) Tube life and reliability of performance will be enhanced by operation at lower temperatures.

OPERATING CHARACTERISTICS

As A.F. amplifier

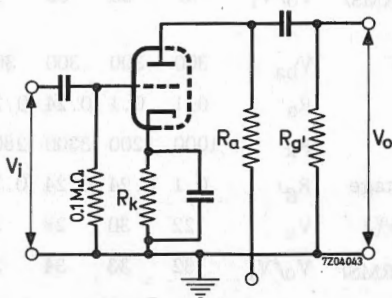
Resistance of voltage source = 200 Ω

Anode supply voltage	V_{ba}	90	90	90	90	90	90	V
Anode resistor	R_a	0.1	0.1	0.24	0.24	0.51	0.51	$M\Omega$
Cathode resistor	R_k	1600	1800	3800	4200	8000	9600	Ω
Grid resistor of next stage	$R_{g'}$	0.1	0.24	0.24	0.51	0.51	1.0	$M\Omega$
Output voltage ($d_{tot} = 5\%$)	V_o	5.3	7.8	7.2	9.4	8.3	10	V_{RMS}
Voltage gain ($V_o = 2 V_{RMS}$)	V_o/V_i	26	29	28	30	28	29	
Anode supply voltage	V_{ba}	180	180	180	180	180	180	V
Anode resistor	R_a	0.1	0.1	0.24	0.24	0.51	0.51	$M\Omega$
Cathode resistor	R_k	1100	1400	2800	3300	5600	6700	Ω
Grid resistor of next stage	$R_{g'}$	0.1	0.24	0.24	0.51	0.51	1.0	$M\Omega$
Output voltage ($d_{tot} = 5\%$)	V_o	12	17	16	20	18	23	V_{RMS}
Voltage gain ($V_o = 2 V_{RMS}$)	V_o/V_i	31	33	32	33	31	32	
Anode voltage	V_{ba}	300	300	300	300	300	300	V
Anode resistor	R_a	0.1	0.1	0.24	0.24	0.51	0.51	$M\Omega$
Cathode resistor	R_k	1000	1200	3300	2800	4900	6000	Ω
Grid resistor of next stage	$R_{g'}$	0.1	0.24	0.24	0.51	0.51	1.0	$M\Omega$
Output voltage ($d_{tot} = 5\%$)	V_o	22	30	28	35	31	38	V_{RMS}
Voltage gain ($V_o = 2 V_{RMS}$)	V_o/V_i	32	33	34	33	33	33	

OPERATING CHARACTERISTICS (continued)

Resistance of voltage source 100 k Ω

Anode supply voltage	V_{ba}	90	90	90	90	90	90 V
Anode resistor	R_a	0.1	0.1	0.24	0.24	0.51	0.51 M Ω
Cathode resistor	R_k	2000	2400	4700	5300	9300	11000 Ω
Grid resistor of next stage	$R_{g'}$	0.1	0.24	0.24	0.51	0.51	1.0 M Ω
Output voltage ($d_{tot} = 5\%$)	V_o	9.9	13	12	15	13	16 V _{RMS}
Voltage gain ($V_o = 2$ V _{RMS})	V_o/V_i	25	27	27	28	27	28
Anode supply voltage	V_{ba}	180	180	180	180	180	180 V
Anode resistor	R_a	0.1	0.1	0.24	0.24	0.51	0.51 M Ω
Cathode resistor	R_k	1200	1400	2900	3600	6000	7100 Ω
Grid resistor of next stage	$R_{g'}$	0.1	0.24	0.24	0.51	0.51	1.0 M Ω
Output voltage ($d_{tot} = 5\%$)	V_o	17	28	25	31	27	33 V _{RMS}
Voltage gain ($V_o = 2$ V _{RMS})	V_o/V_i	31	33	32	33	31	32
Anode supply voltage	V_{ba}	300	300	300	300	300	300 V
Anode resistor	R_a	0.1	0.1	0.24	0.24	0.51	0.51 M Ω
Cathode resistor	R_k	900	1200	2300	2900	5000	6400 Ω
Grid resistor of next stage	$R_{g'}$	0.1	0.24	0.24	0.51	0.51	1.0 M Ω
Output voltage ($d_{tot} = 5\%$)	V_o	35	47	42	52	45	55 V _{RMS}
Voltage gain ($V_o = 2$ V _{RMS})	V_o/V_i	33	33	34	34	33	34



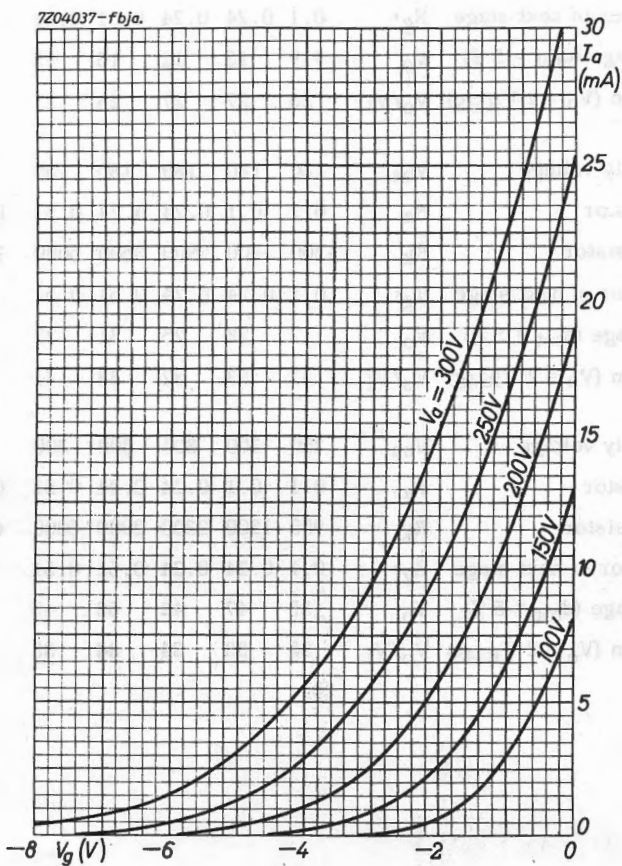

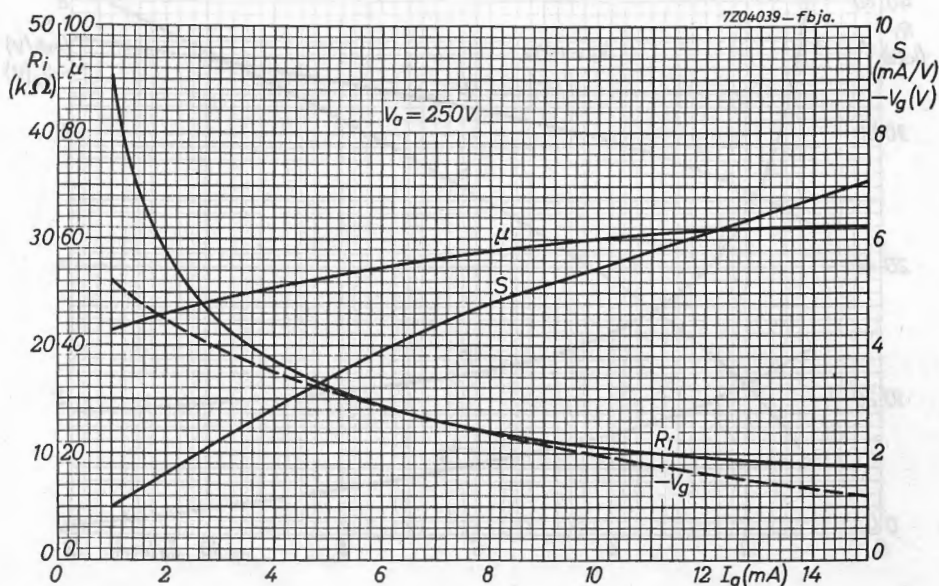
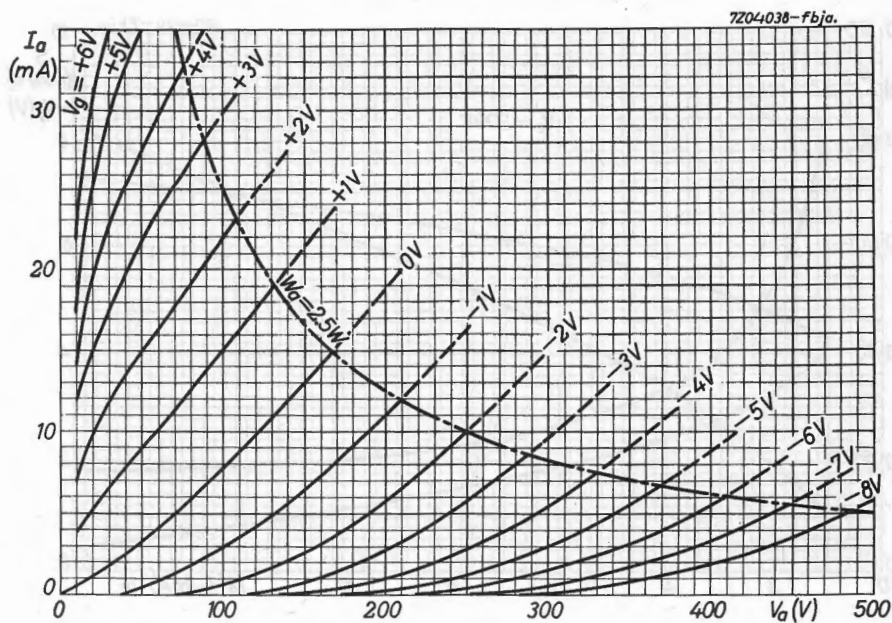

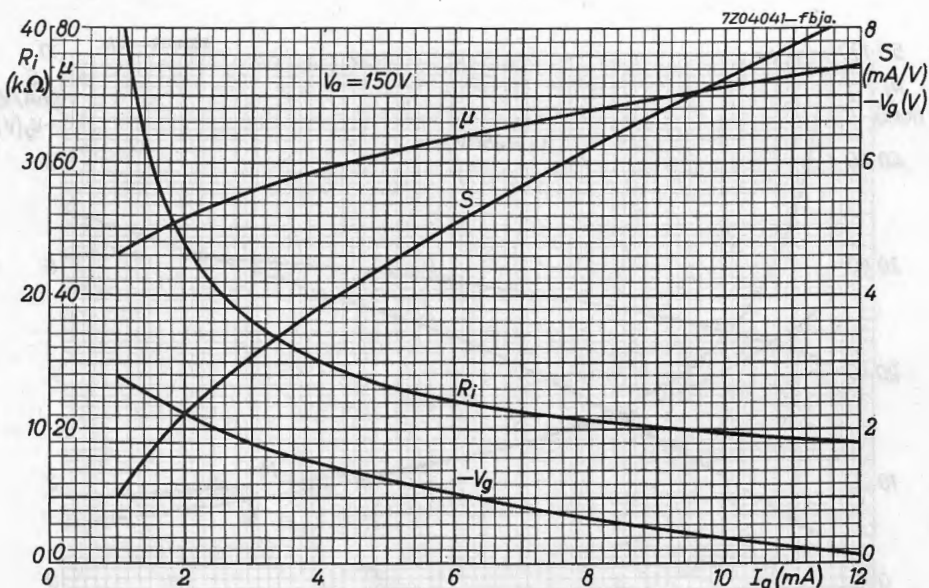
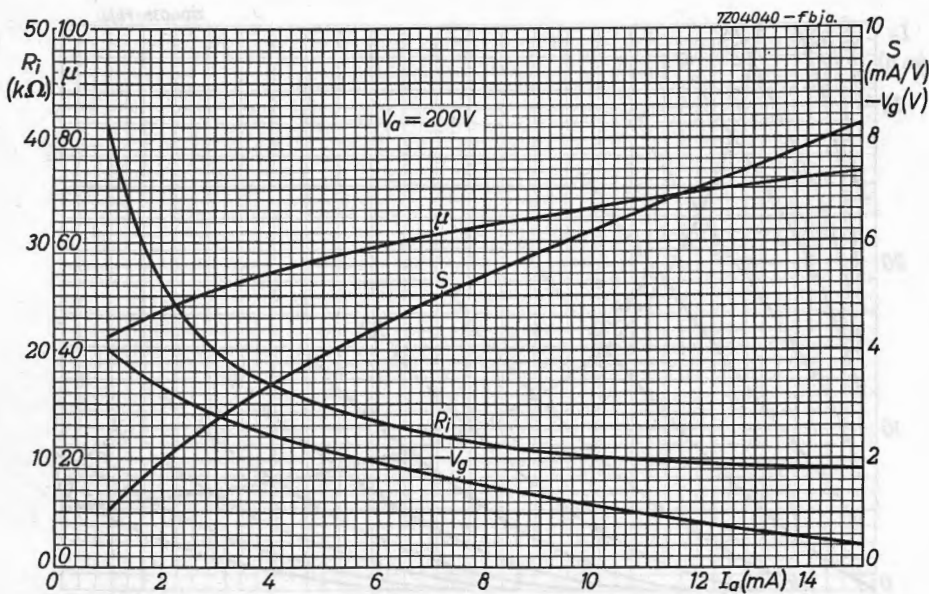

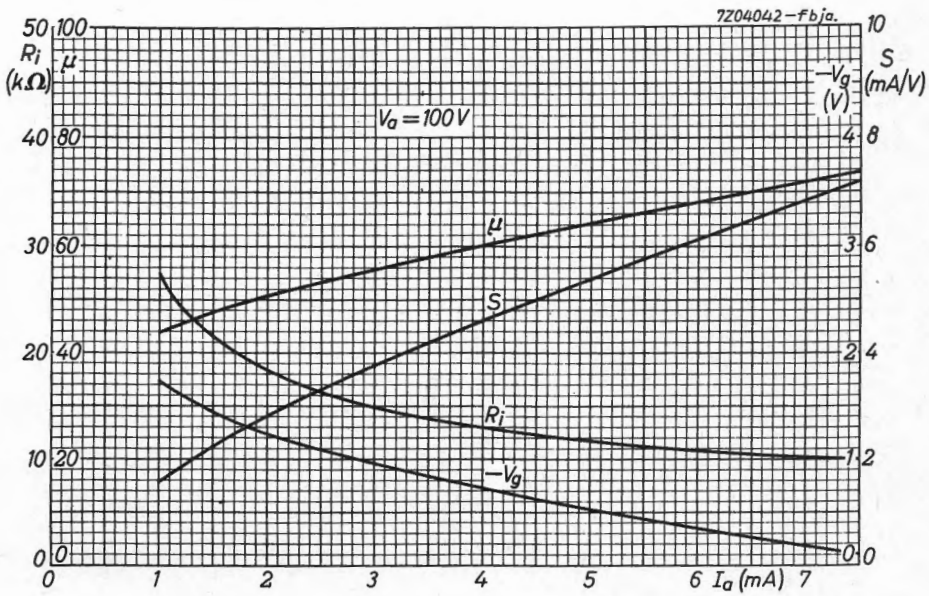

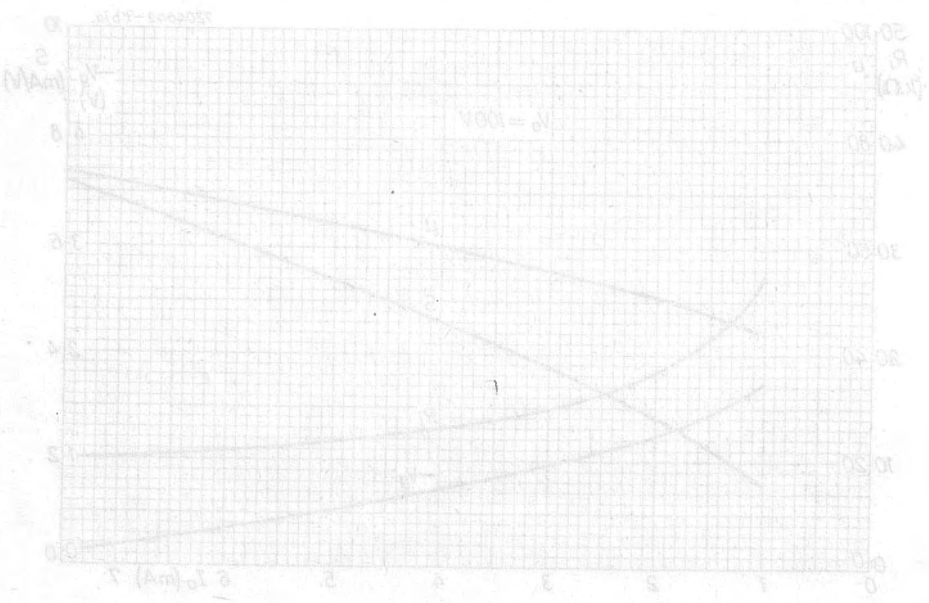

S.Q. TUBE

Pentode designed for use in telephone equipment.

QUICK REFERENCE DATA

Life test	10 000 hours
Low interface resistance	
Base	Noval
Heating	Indirect A.C. or D.C. Series or parallel supply
Heater voltage	V_f 18 V
Heater current	I_f 100 mA
Anode current	I_a 10 mA
Mutual conductance	S 9 mA/V

DIMENSIONS AND CONNECTIONS

Dimensions in mm

Base: Noval

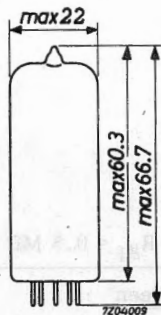
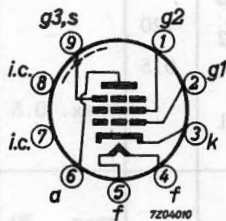

CHARACTERISTICS

Column I Nominal value or setting of the tube

II Range values for equipment design: Initial spread

III Range values for equipment design: End of life

		I	II	III	
Heater voltage	V_f	18			V
Heater current	I_f	100	95 - 105		mA
Anode voltage	V_a	210			V
Grid No.3 voltage	V_{g3}	0			V
Grid No.2 voltage	V_{g2}	120			V
Cathode resistor	R_k	165			Ω
Anode current	I_a	10	8.7 - 11.3	min. 7	mA
Grid No.2 current	I_{g2}	2.1	1.7 - 2.5	min. 1.25	mA
Mutual conductance	S	9	7.8 - 10.2	min. 6.4	mA/V
Internal resistance	R_i	0.5	min. 0.3		$M\Omega$
Amplification factor	μ_{g2g1}	38			
Equivalent noise resistance					
R.F.	R_{eq}	750	max. 1000		Ω
A.F. (0 - 10 kHz)	R_{eq}		max. 36		k Ω
Negative grid current	$-I_{g1}$		max. 0.5	max. 1.0	μA
<u>Cut-off voltage</u>	$-V_g$		max. 5.25		V
Anode voltage	V_a	210			V
Grid No.3 voltage	V_{g3}	0			V
Grid No.2 voltage	V_{g2}	120			V
Anode current	I_a	0.5			mA
<u>Hum voltage</u>	V_{g1}		max. 0.5		mV _{RMS}
Grid No.1 resistor $R_{g1} = 0.5 M\Omega$					
<u>Leakage current between cathode and heater</u>	I_{kf}		max. 20		μA
Voltage between cathode and heater $V_{kf} = 100 V$					

CAPACITANCES

		I	II	
Anode to grid No.2, grid No.3, cathode and heater	C_{a/g_2g_3kfs}	3.5	max. 4.1	pF
Grid No.1 to grid No.2, grid No.3, cathode, heater and screen	C_{g_1/g_2g_3kfs}	8.0	max. 8.7	pF
Anode to grid No.1	C_{ag_1}		max.0.015	pF
Grid No.1 to heater	C_{g_1f}		max. 0.15	pF
Cathode to heater	C_{kf}	4		pF
Grid No.1 to grid No.2, grid No.3, cathode, heater and screen	C_{g_1/g_2g_3kfs}	11.3		pF
Cathode current = 12.1 mA				
Radiation capacitance:				
Anode to surrounding box, inner diam. 52 mm, height 98 mm	C_{ra}		max.0.025	pF
Grid No.1 to surrounding box, inner diam. 52 mm, height 98 mm	C_{rg_1}		max.0.025	pF

LIFE

Production samples are tested to be within the end of life values (column III) during 10 000 hours.

LIMITING VALUES Design centre rating system

Anode voltage	V_{a_0}	max.	550	V
	V_a	max.	210	V
Anode dissipation	W_a	max.	2.1	W
Grid No.2 voltage	$V_{g_{2_0}}$	max.	550	V
	V_{g_2}	max.	210	V
Grid No.2 dissipation	W_{g_2}	max.	0.35	W
Cathode current	I_k	max.	16	mA
Grid No.1 resistor (automatic bias)	R_{g_1}	max.	1	M Ω
Voltage between cathode and heater	V_{kf}	max.	100	V
Bulb temperature	t_{bulb}	max.	170	$^{\circ}C$

LIMITING VALUES (continued)

Heater voltage: The average heater voltage should be 18 V.

Variations of the heater voltage exceeding the range of 17.1 to 18.9 V will shorten the tube life.

The tolerance of heater current (column II) should be taken into account.

OPERATING CHARACTERISTICSOutput tube class A

Anode voltage	V_a	120		210		V		
Grid No.3 voltage	V_{g3}	0		0		V		
Grid No.2 supply voltage	V_{bg2}	120		120		V		
Grid No.2 resistor	R_{g2}	5.6		5.6		k Ω		
Cathode resistor	R_k	180		180		Ω		
Anode current	I_a	8.3		8.3		mA		
Grid No.2 current	I_{g2}	1.7		1.7		mA		
Mutual conductance	S	8.2		8.2		mA/V		
Internal resistance	R_i	0.42		0.44		M Ω		
Load resistance	$R_{a\sim}$	10			20		k Ω	
Output power	W_o	340	400	50	660	870	50	mW
Input voltage	V_i	1.1	-	0.35	1.1	-	0.25	V _{RMS}
Total distortion	d_{tot}	10	-	-	10	-	-	%
Grid No.1 current	$+I_g$	-	0.3	-	-	0.3	-	μ A
Grid No.1 resistor	R_{g1}	-	0.33	-	-	0.33	-	M Ω

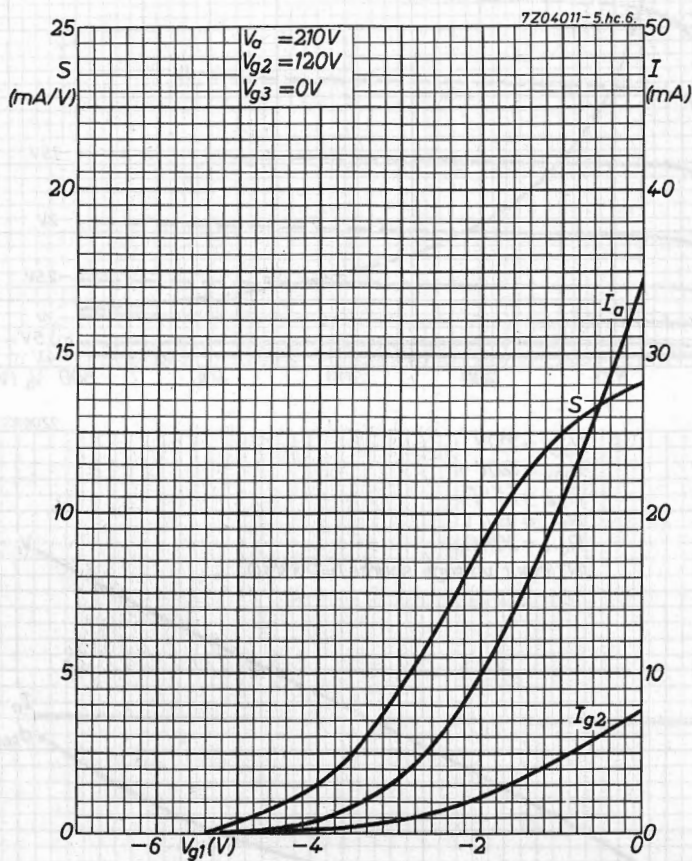

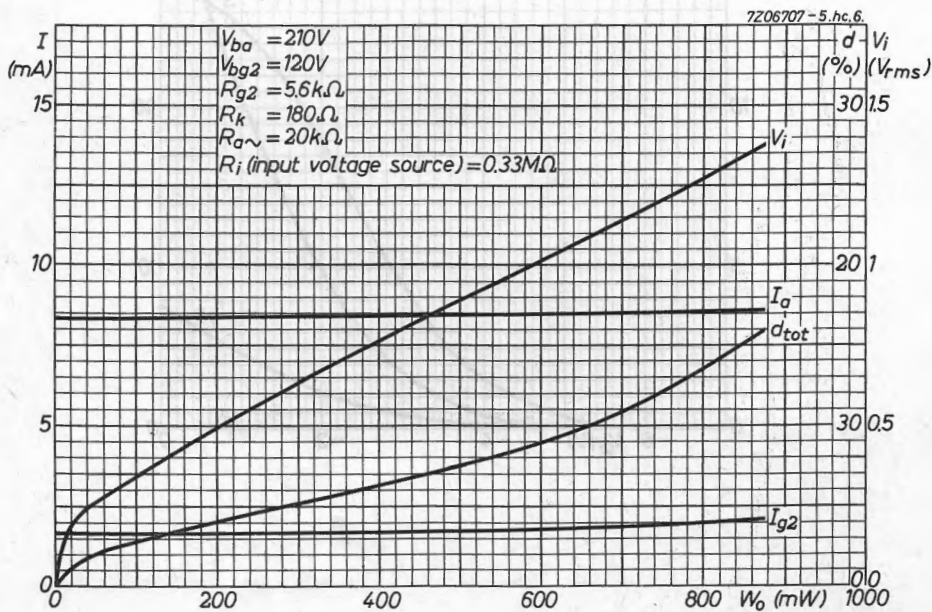
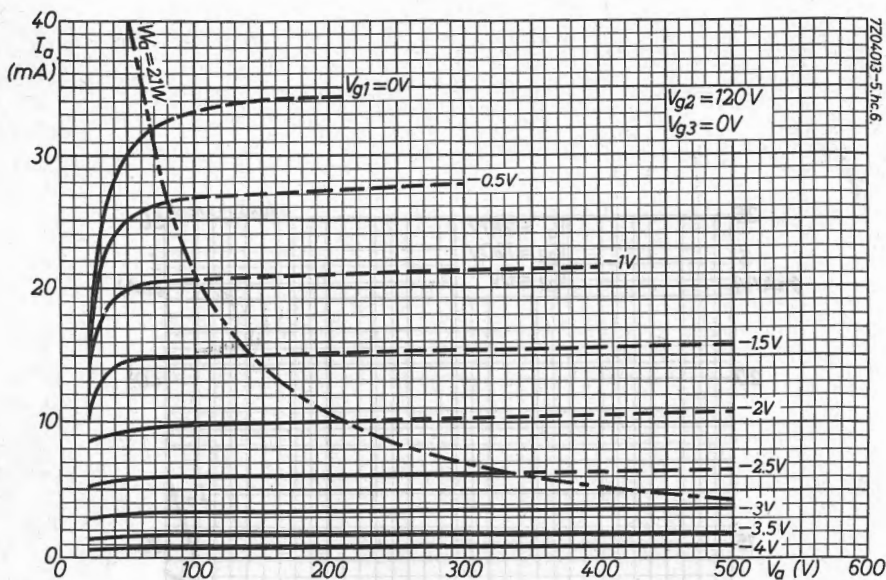

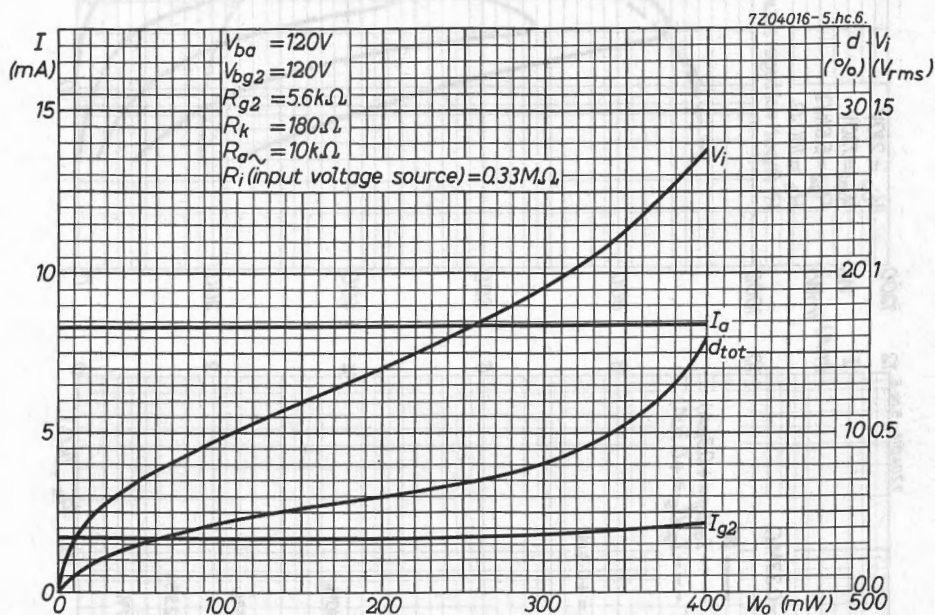

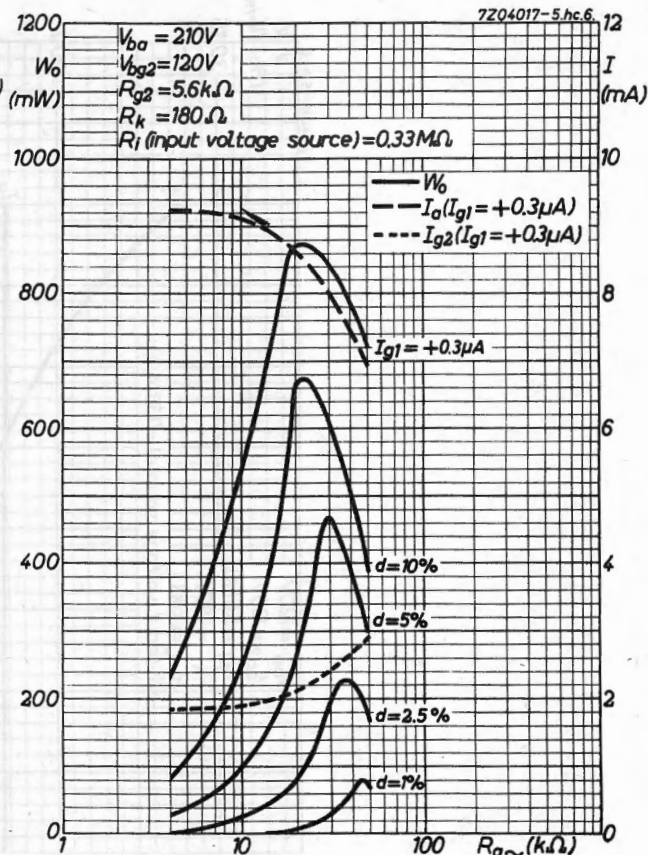
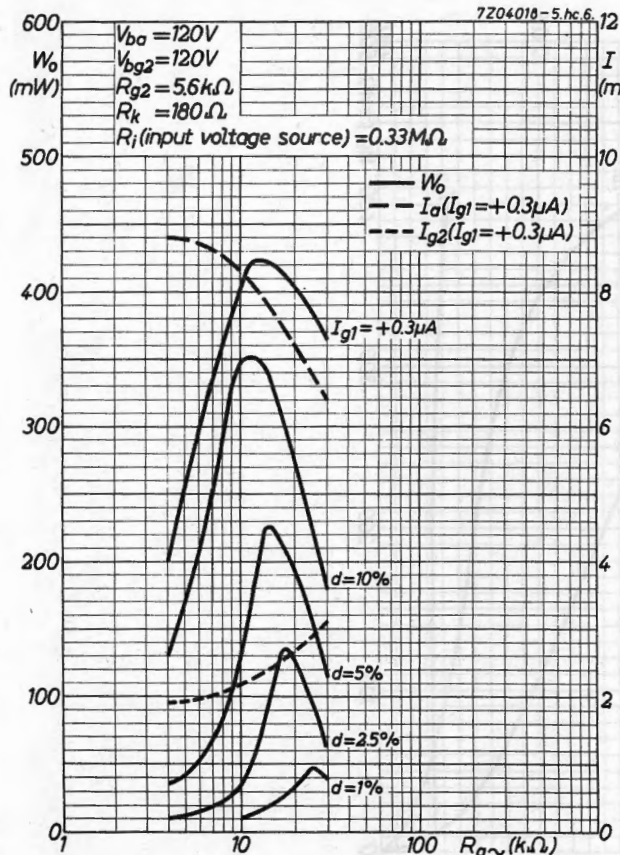

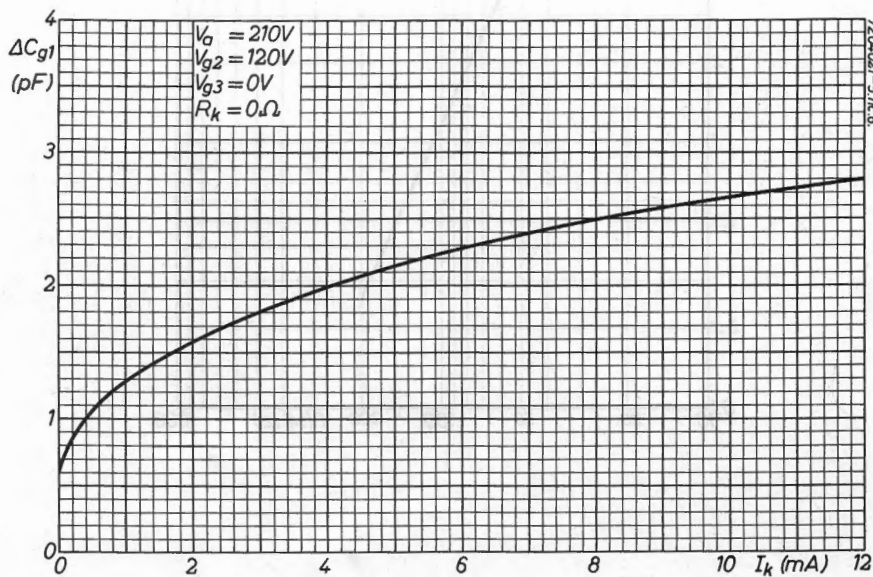
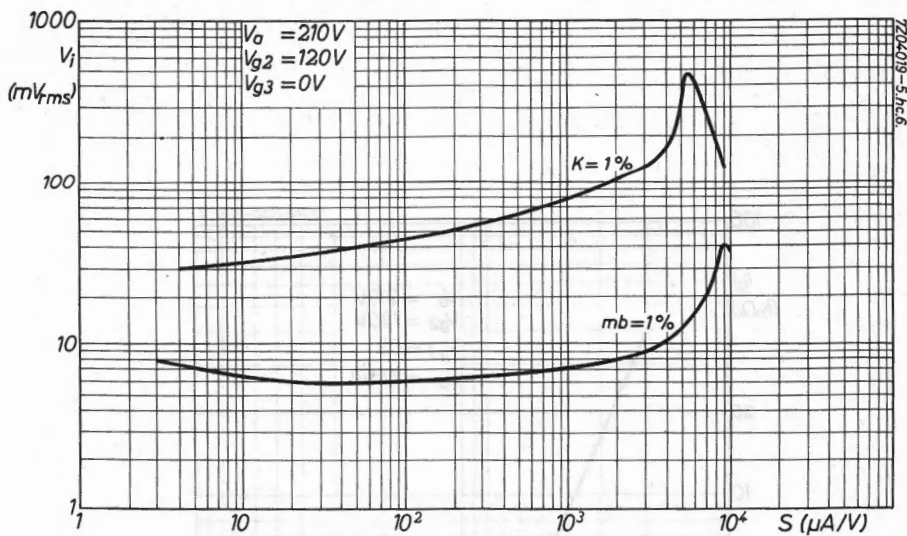

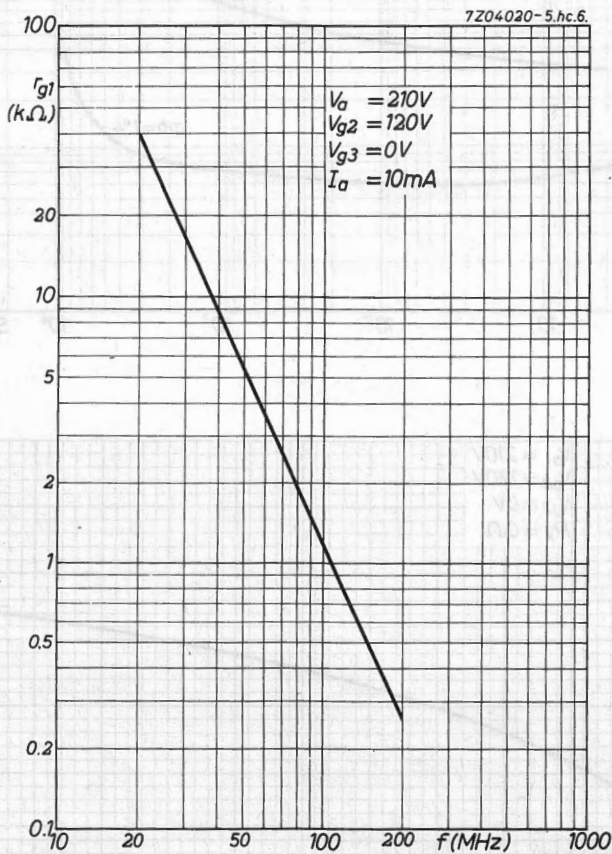

S.Q. TUBE

Output pentode designed for use in telephone equipment.

QUICK REFERENCE DATA

Life test	10 000 hours
Base	Noval
Heating	Indirect A.C. or D.C. Series or parallel supply
Heater voltage	V_f 18 V
Heater current	I_f 130 mA
Anode current	I_a 20 mA
Output power, Class A	W_o 1 W

DIMENSIONS AND CONNECTIONS

Dimensions in mm

Base: Noval

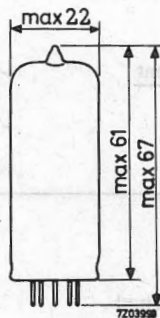
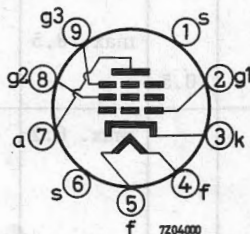

CHARACTERISTICS

Column I Nominal value or setting of the tube

II Range values for equipment design: Initial spread

III Range values for equipment design: End of life

		I	II	III	
Heater voltage	V_f	18			V
Heater current	I_f	130	123 - 137		mA
Anode voltage	V_a	210			V
Grid No.3 voltage	V_{g3}	0			V
Grid No.2 voltage	V_{g2}	210			V
Cathode resistor	R_k	120			Ω
Anode current	I_a	20	17 - 23	min. 13.5	mA
Grid No.2 current	I_{g2}	5.3	4.1 - 6.5	min. 3.1	mA
Mutual conductance	S	11	9.5 - 12.5	min. 7.8	mA/V
Internal resistance	R_i	0.3	min. 0.2		M Ω
Output power	W_o	1.0	min. 0.7		W
Load resistance $R_{a\sim} = 15 \text{ k}\Omega$					
Total distortion $d_{\text{tot}} = 5\%$					
Total distortion at $W_o = 0.1 \text{ W}$	d_{tot}	1.2	max. 2		%
Amplification factor	μ_{g2g1}	36			
Equivalent noise resistance (R.F.)	R_{eq}	1.2			k Ω
<u>Negative grid current</u>	$-I_{g1}$		max. 0.5	max. 1.0	μA
<u>Cut-off voltage</u>	$-V_{g1}$		max. 8.5		V
Anode current	I_a	0.5			mA
<u>Hum voltage</u>	V_{g1}		max. 0.2		mV _{RMS}
$R_{g1} = 0.5 \text{ M}\Omega$					
Heater centre earthed					
<u>Insulation resistance between two electrodes</u>	R_{ins}		min. 100		M Ω

CHARACTERISTICS (continued)

Leakage current between
cathode and heater

Voltage between cathode and
heater $V_{kf} = 120$ V

Cathode heating time

Cathode cooling time

CAPACITANCES

Anode to grid No.2, grid No.3,
cathode, heater and screen

Grid No.1 to grid No.2, grid No.3,
cathode, heater and screen

Grid No.1 to grid No.2, grid No.3,
cathode, heater and screen

Cathode current $I_k = 25$ mA

Anode to grid No.1

Grid No.1 to heater

Cathode to heater

Radiation capacitance: Anode to
surrounding box, inner dia. 52 mm,
height 98 mm

Radiation capacitance: Grid No.1 to
surrounding box, inner dia. 52 mm,
height 98 mm

LIFE

Production samples are tested to be within the end of life values (column III)
during 10 000 hours.

	I	II	
I_{kf}		max. 24	μA
	16	max. 22	sec
	15	min. 7	sec
C_{a/g_2g_3kfs}	6.5	5.8 - 7.2	pF
C_{g_1/g_2g_3kfs}	11.2	10 - 12.4	pF
C_{g_1/g_2g_3kfs}	14.3		pF
C_{ag_1}		max.0.02	pF
C_{g_1f}		max. 0.2	pF
C_{kf}	4.2		pF
C_{ra}		max.0.06	pF
C_{rg_1}		max.0.12	pF

LIMITING VALUES (Design centre rating system)

Anode voltage	V_{a0}	max. 550 V
	V_a	max. 210 V
Anode dissipation	W_a	max. 4.5 W
Grid No.2 voltage	V_{g20}	max. 550 V
	V_{g2}	max. 210 V
Grid No.2 dissipation	W_{g2}	max. 1.2 W
Cathode current	I_k	max. 30 mA
Voltage between cathode and heater	V_{kf}	max. 120 V
Bulb temperature	t_{bulb}	max. 170 °C
Grid resistor, automatic bias	R_{g1}	max. 0.5 M Ω
fixed bias	R_{g1}	max. 0.25 M Ω

OPERATING CHARACTERISTICSAs pre-amplifier

Anode voltage	V_a	210 V
Grid No.3 voltage	V_{g3}	0 V
Grid No.2 voltage	V_{g2}	210 V
Cathode resistor	R_k	180 Ω
Anode resistance	$R_{a\sim}$	20 k Ω
Anode current	I_a	15 mA
Grid No.2 current	I_{g2}	4 mA
Mutual conductance	S	10 mA/V
Internal resistance	R_i	0.4 M Ω
Voltage gain	g	5.15 Neper

OPERATING CHARACTERISTICS (continued)

As output tube class A

Anode voltage	V_a	210 V
Grid No.3 voltage	V_{g3}	0 V
Grid No.2 voltage	V_{g2}	210 V
Cathode resistor	R_k	120 Ω
Anode current	I_a	20 mA
Grid No.2 current	I_{g2}	5.3 mA
Mutual conductance	S	11 mA/V
Internal resistance	R_i	0.3 $M\Omega$
Anode resistance	$R_{a\sim}$	15 $k\Omega$
Input voltage	V_i	0.95 V_{RMS}
Output power	W_o	1 W
Total distortion	d_{tot}	5 %

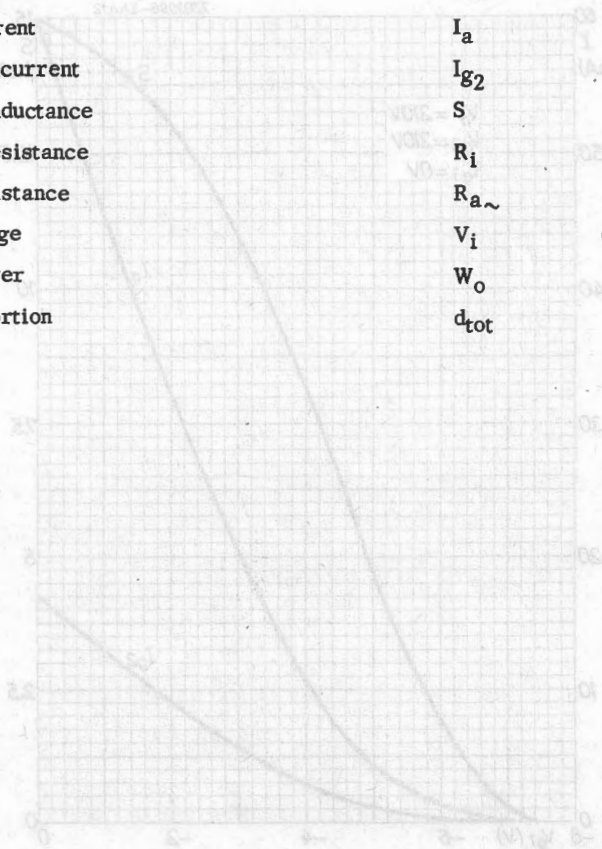

OPERATING CHARACTERISTICS (continued)

As output tube class A

Grid No. 3 voltage
Grid No. 2 voltage
Grid No. 1 voltage
Control 1 selector
Anode current
Grid No. 2 current
Internal resistance
Anode resistance
Input voltage
Output power
Tube diameter

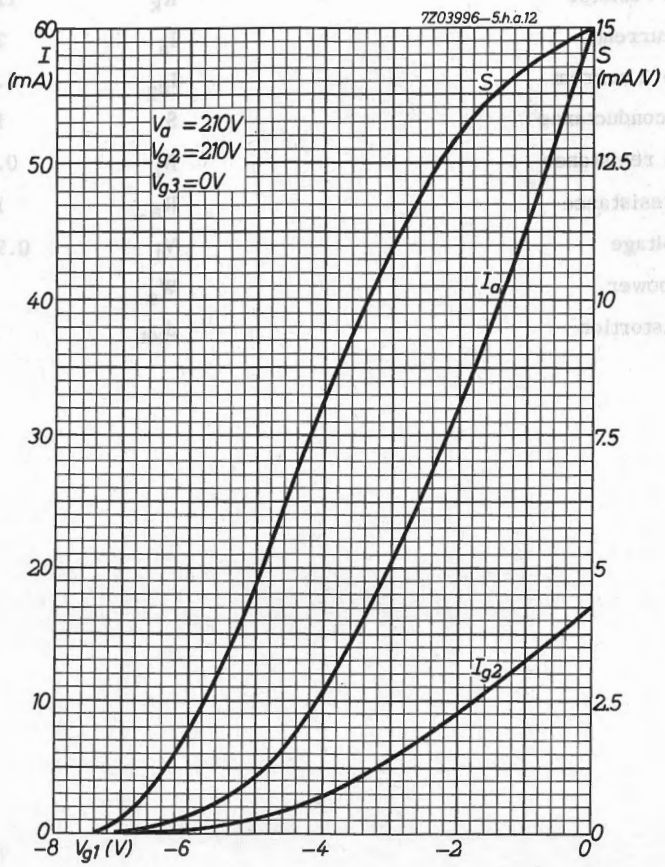

7Z03993-5.h.a.12

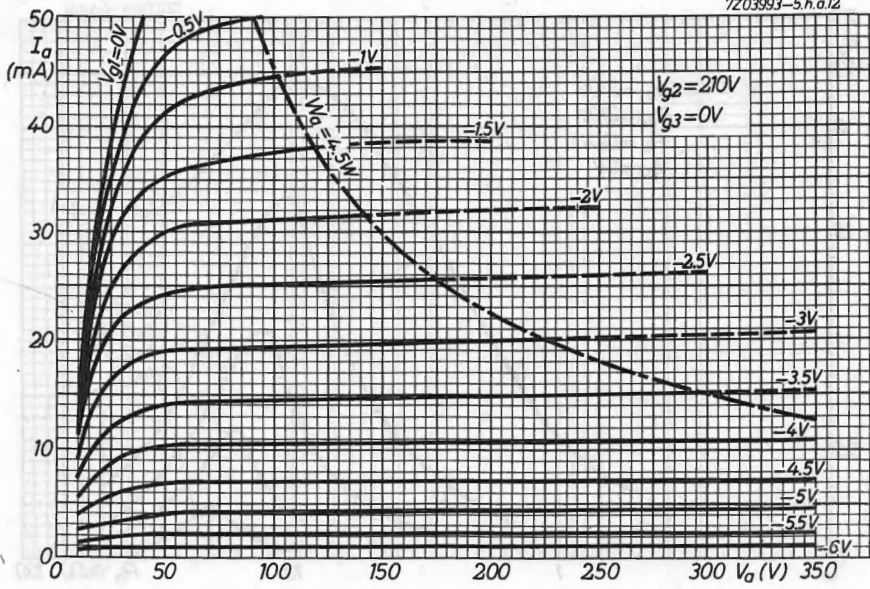

7Z03995-5.h.a.12

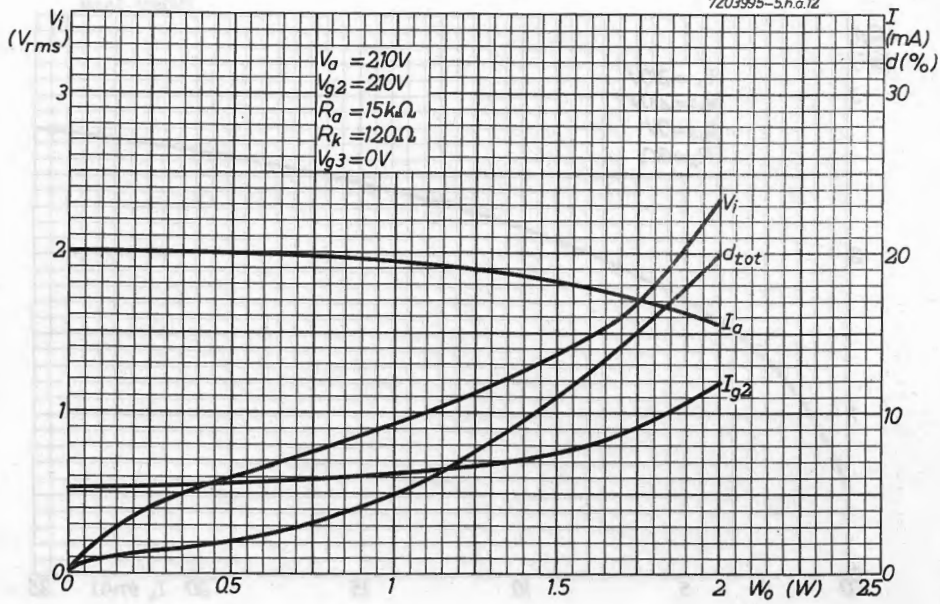

7203994-5.ha12

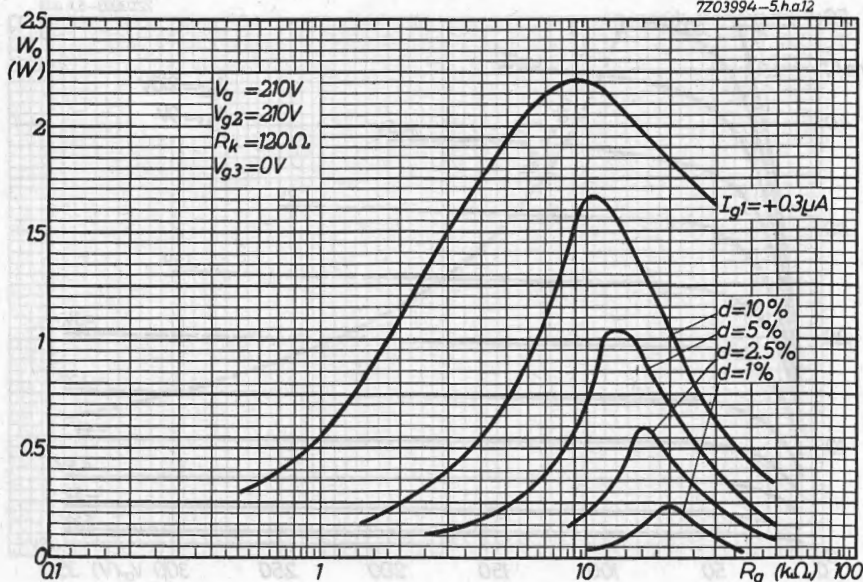

7203997-5.ha12

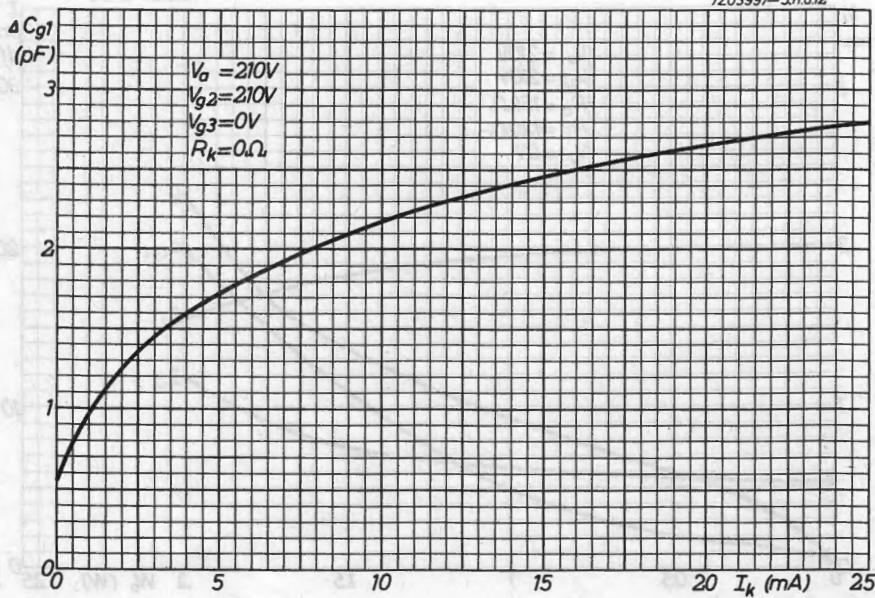

Miscellaneous devices



Miscellaneous devices

VACUUM GAUGE HEAD, PENNING TYPE

Glass envelope, high vacuum gauge head of the Penning type (cold-cathode, ionisation type). Pressure range 2×10^{-3} torr to 10^{-5} torr.

CHARACTERISTICS

Pressure range	2×10^{-3} to 10^{-5} torr
Sensitivity	see page 3

Notes:

1. The graph on page 3 is correct within a factor two for air, hydrogen, argon and carbon dioxide. The inaccuracy can be reduced to plus or minus 5% by calibrating for the gas composition in question.
2. Water vapour contamination of the gauge head may cause misreadings; in this case it is advisable to take readings some minutes after application of the anode supply voltage.

TYPICAL OPERATING CONDITIONS

CIG-22 combined with magnet type 95380

Anode supply voltage	V_{ba}	2000 V d.c.
Anode resistor	R_a	1 M Ω

LIMITING VALUES

CIG-22 combined with magnet type 95380

Anode voltage	max. 2500 V
Anode current	max. 2 mA

MECHANICAL DATA

Dimensions in mm

Material of tubulation: 01 soft glass

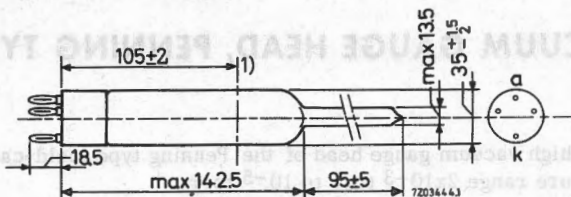

1) Line through the centres of the cathode plates and axis of the magnetic flux lines.

Mounting position: any

Note: When in operation the gauge has a pumping effect; to prevent misreadings due to pressure losses in the connecting tubulation, the connection to the vacuum chamber should be wide and short. Recommended dimensions are: diameter min. 10 mm and length max. 100 mm.

ASSOCIATED COMPONENTS

Magnet 95380

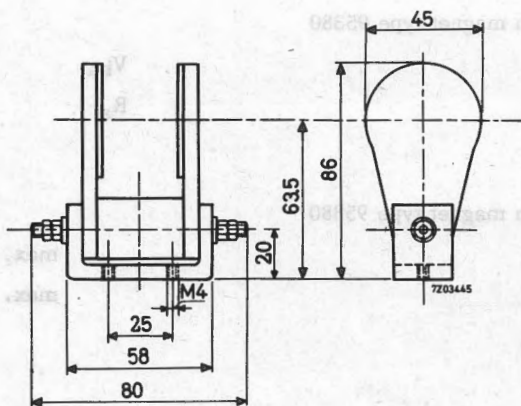

Magnet type 95380

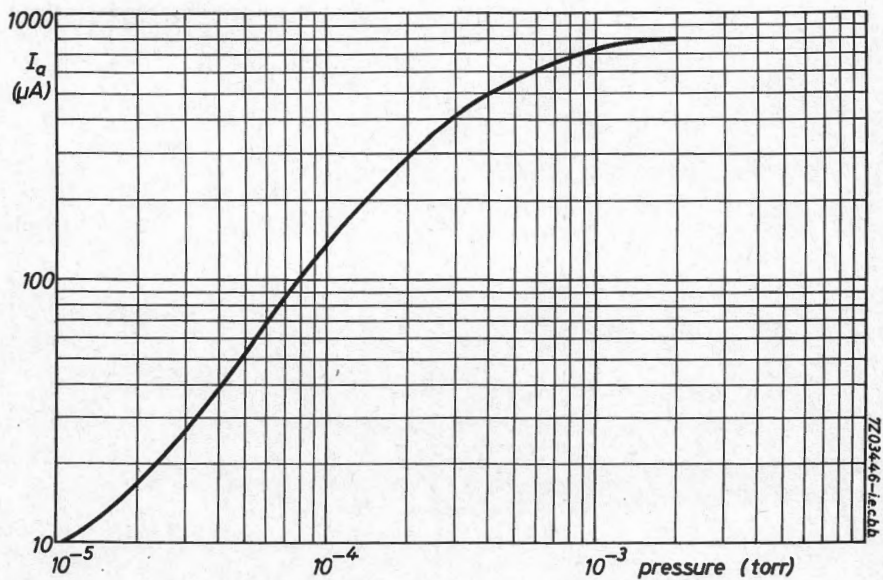

VACUUM GAUGE HEAD, PENNING TYPE EXTRA SENSITIVE

Glass envelope, high vacuum gauge head of the Penning type (cold-cathode, ionization type). Pressure range 10^{-4} torr to 5×10^{-8} torr.

CHARACTERISTICS

Pressure range

10^{-4} to 5×10^{-8} torr

Sensitivity

see page 3

Notes:

1. The graph on page 3 is correct within a factor two for air, hydrogen, argon and carbon dioxide. The inaccuracy can be reduced to plus or minus 5% by calibrating for the gas composition in question.
2. Water vapour contamination of the gauge head may cause misreadings; in this case it is advisable to take readings some minutes after application of the anode supply voltage.

TYPICAL OPERATING CONDITIONS

CIG-82 combined with magnet type 95380

Anode voltage

V_{ba} 2000 V d.c.

Anode resistor

R_a 1 $M\Omega$

LIMITING VALUES

CIG-82 combined with magnet type 95380

Anode supply voltage

max. 2500 V

Anode current

max. 2 mA

MECHANICAL DATA

Dimensions in mm

Material of tubulation: G28 hard glass

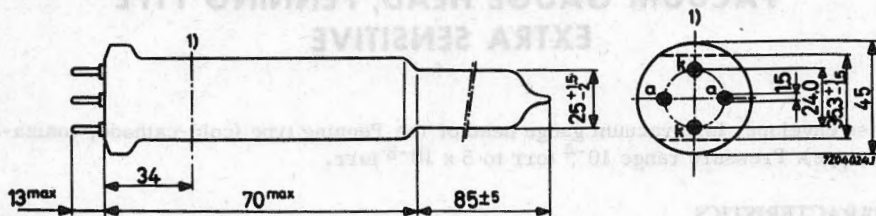

Mounting position: any

Note: When in operation the gauge has a pumping effect; to prevent misreadings due to pressure losses in the connecting tubulation, the connection to the vacuum chamber should be wide and short. Recommended dimensions are diameter min. 10 mm and length max. 100 mm.

ASSOCIATED COMPONENTS

Magnet 95380

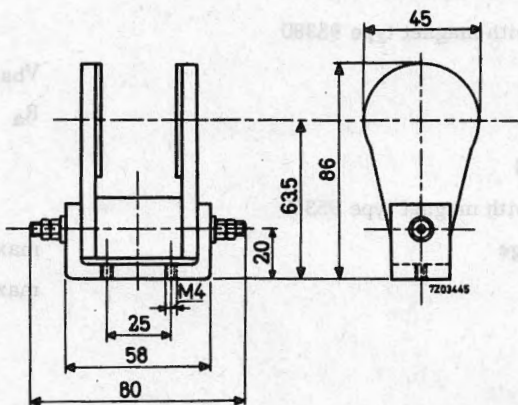

Magnet type 95380

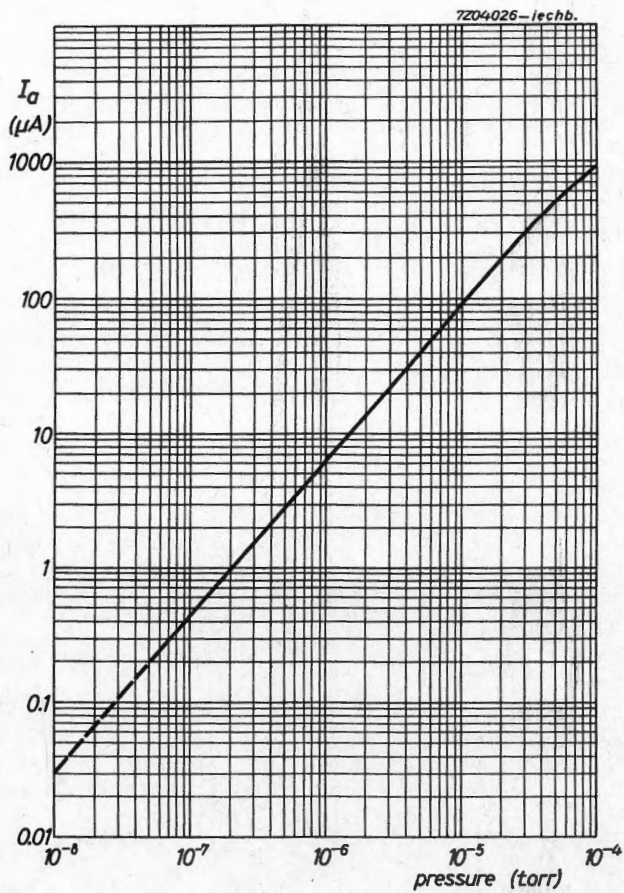

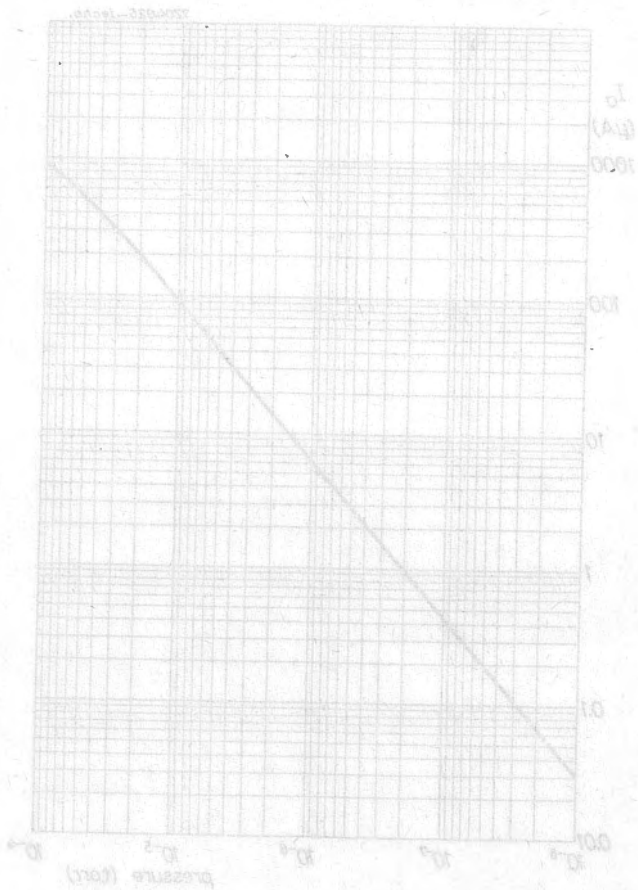

EVAPORATION ION PUMP

One-shot evaporation ion pump, consisting of a Bayard-Alpert gauge with the addition of a zirconium getter filament. The getter is evaporated from the getter filament, the pumping speed being enhanced by the ionising action of the gauge. The Bayard-Alpert gauge can be used independently for measuring purposes.

CHARACTERISTICS

Pressure range, pumping measurement	10^{-3} to 10^{-11} torr 10^{-3} to 10^{-10} torr
Pumping speed average (for nitrogen) at 10 mA emission current	0.4 l/s
Gauge sensitivity (for nitrogen)	approx. 12 per torr
Gauge filament characteristics	see page 3
Gauge emission current range	$1 \mu\text{A}$ to 75 mA
Insulation resistance before pumping	
Collector to other electrodes	min. $10^{14} \Omega$
Grid to other electrodes	min. $10^{12} \Omega$

TYPICAL OPERATING CONDITIONS

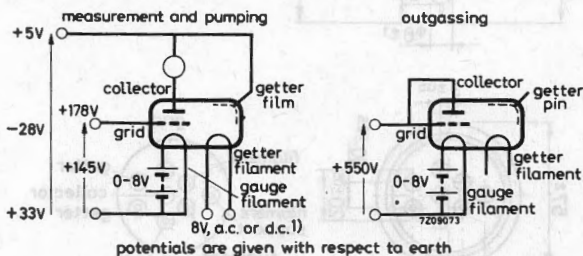

Gauge emission current (see also page 2)	
measurement	$100 \mu\text{A}$, 1 mA or 10 mA
outgassing	75 mA

1) Getter filament current at the given supply voltage

8 A

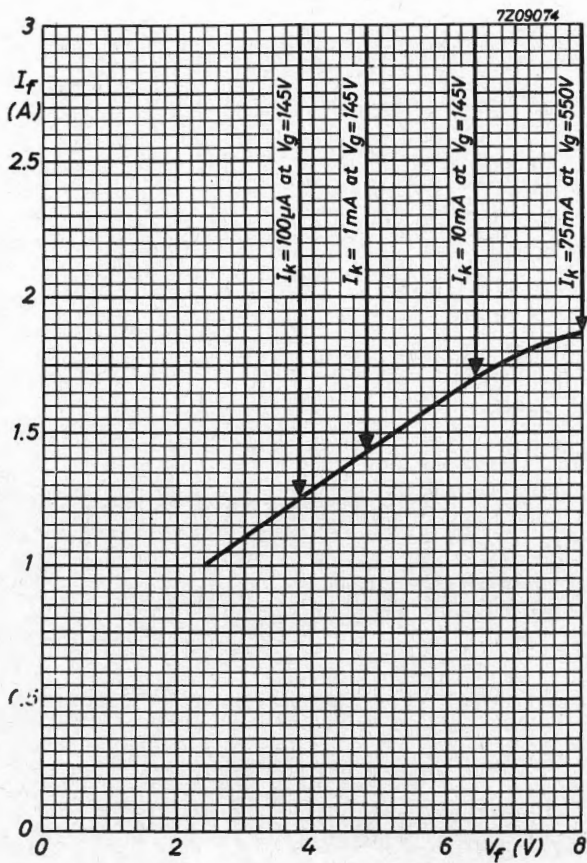

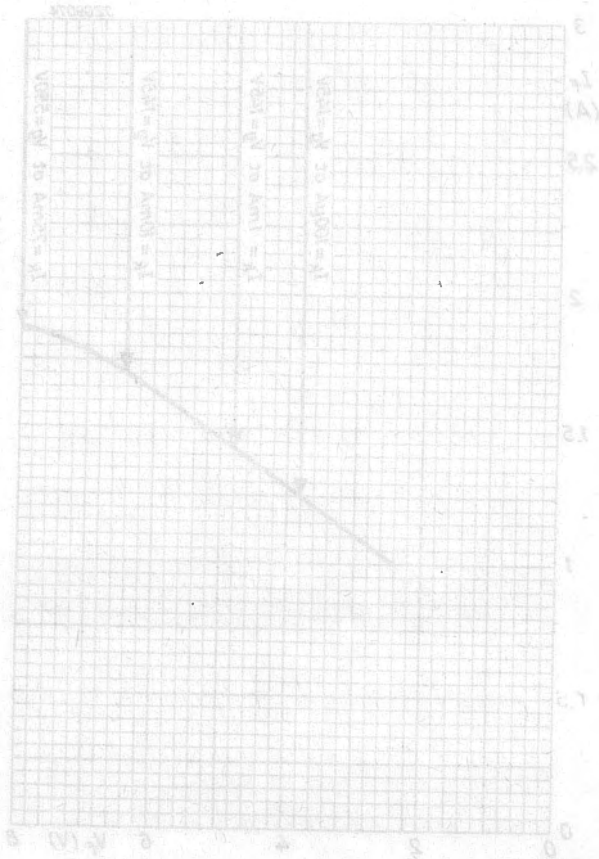

VACUUM GAUGE HEAD , BAYARD-ALPERT TYPE

Glass envelope, ultra-high vacuum gauge head of the Bayard-Alpert type. Measuring range 10^{-3} torr to 10^{-10} torr; sensitivity approx. 12 per torr.

The gauge head is provided with an electrically conductive layer deposited on the inside of the glass envelope. By applying a fixed potential to the layer, excess primary electrons are attracted directly to the envelope rather than oscillating around the collector thereby leading to very stable measurements of low pressure.

Moreover the gauge head features a low thermal inertia and a low filament power consumption.

CHARACTERISTICS

Pressure range	10 ⁻³ to 10 ⁻¹⁰ torr
Sensitivity (for nitrogen)	approx. 12 per torr
Emission current range	1 μ A to 75 mA
Filament characteristics	see page 3
Insulation resistance	
Collector to other electrodes	min. 10 ¹⁴ Ω
Grid to other electrodes	min. 10 ¹² Ω

TYPICAL OPERATING CONDITIONS

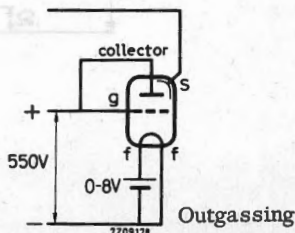
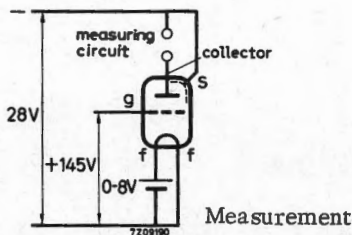

Emission current (see also page 3)

measurement

100 μ A, 1 mA or 10 mA

outgassing

75 mA

LIMITING VALUES

Pressure (filament litt)	max. 10^{-3} torr
Filament voltage	max. 8 V
Emission current	max. 75 mA
Grid input power	max. 40 W
Bulb temperature during operation	max. 100 °C
Bake-out temperature	max. 450 °C

MECHANICAL DATA

Material tubulation G28 glass

Filament Tungsten

Dimensions in mm

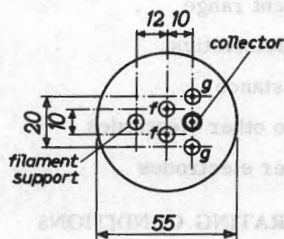
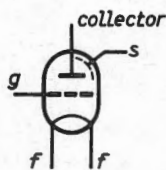
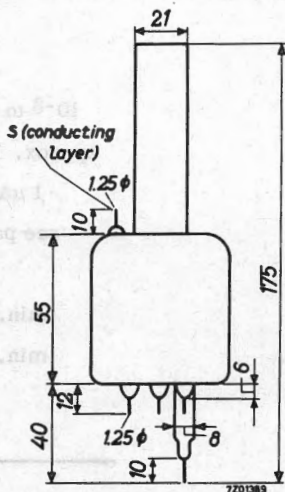

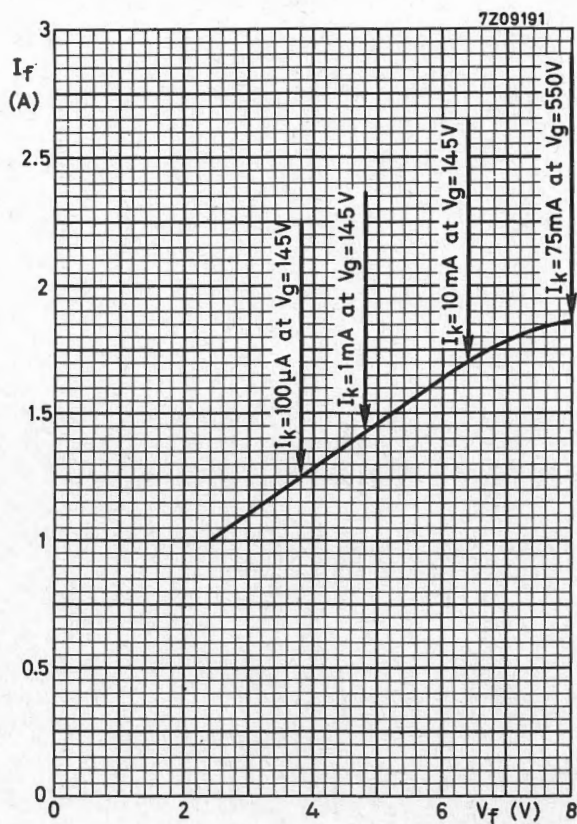

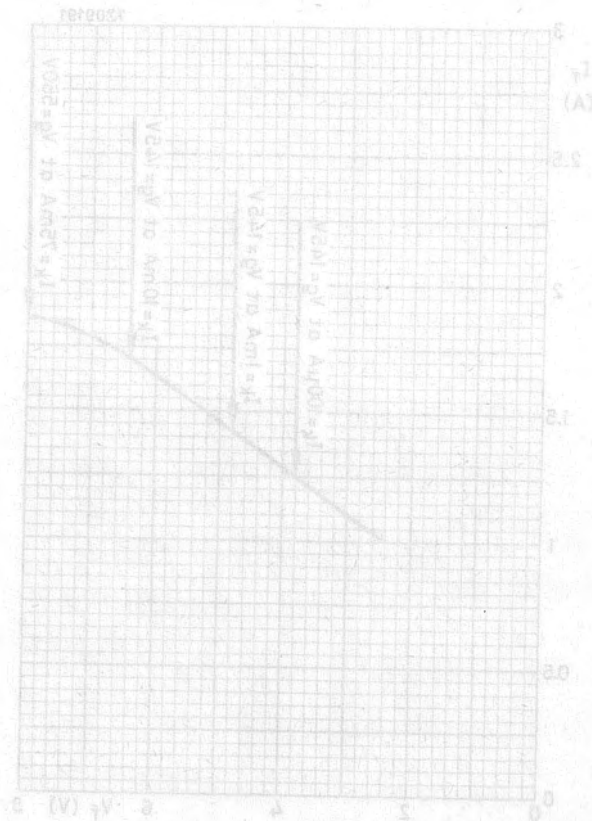

VACUUM GAUGE HEAD, BAYARD-ALPERT TYPE

Nude, ultra-high vacuum gauge head of the Bayard-Alpert type.
Measuring range 10^{-3} torr to 10^{-10} torr; sensitivity approx. 12 per torr.

Type IOG-13T has a fernico skirt, prepared for easy welding.
The gauge head features a low thermal inertia and a low filament power consumption.

FOR THE ELECTRICAL DATA SEE TYPE IOG-12

MECHANICAL DATA

Dimensions in mm

Material

Filament

Tungsten

Skirt

Fernico

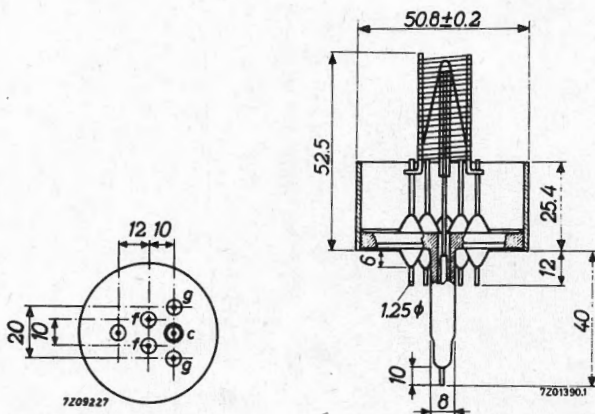

Mounting position: any

VACUUM GAUGE HEAD, BAYARD-ALPERT TYPE

Glass envelope, ultra-high vacuum gauge head of the Bayard-Alpert type. Measuring range 10^{-3} torr to 10^{-10} torr; sensitivity approx. 12 per torr.

The gauge head is provided with two filaments, one of tungsten and one of lanthanum hexaboride.

CHARACTERISTICS

Pressure range	10^{-8} to 10^{-10} torr
Sensitivity (for nitrogen)	approx. 12 per torr
Emission current range	1 μ A to 75 mA
Filament characteristics	see page 3
Insulation resistance	
collector to other electrodes	min. 10^{14} Ω
grid to other electrodes	min. 10^{12} Ω

TYPICAL OPERATING CONDITIONS

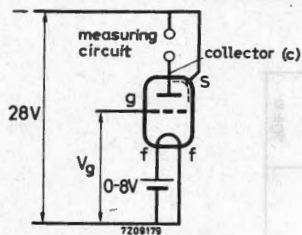

Measurement

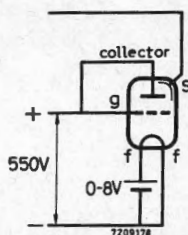

Outgassing

Grid voltage, in combination with fil. 1	V_g +145 V
in combination with fil. 2	+178 V
Emission current (see also page 3)	
measurement	100 μ A, 1 mA or 10 mA
outgassing	75 mA

LIMITING VALUES

Pressure (filament litt)	max.	10 ⁻³	torr
Filament voltage	max.	8	V
Emission current	max.	75	mA
Grid input power	max.	40	W
Bulb temperature during operation	max.	100	°C
Bake-out temperature	max.	450	°C

MECHANICAL DATA

Dimensions in mm

Material

Tubulation	W1 glass
Filament 1	Tungsten
Filament 2	Lanthanum hexaboride (La Br 6)

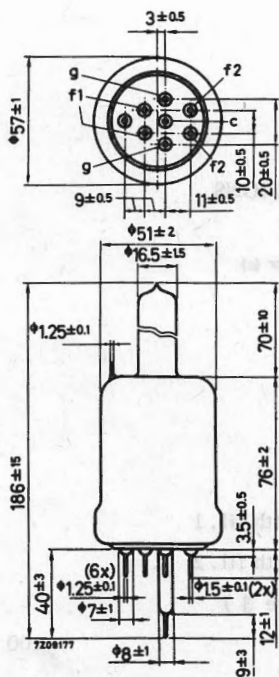

Mounting position: any

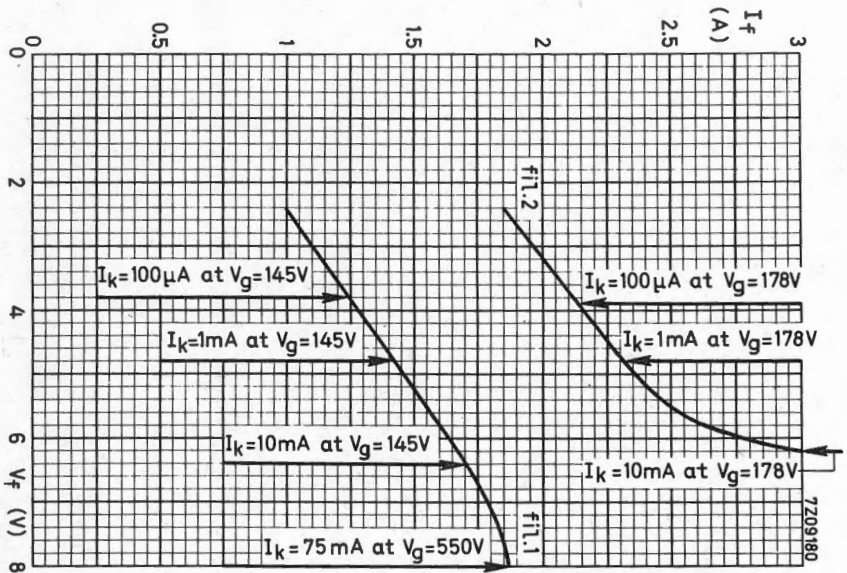

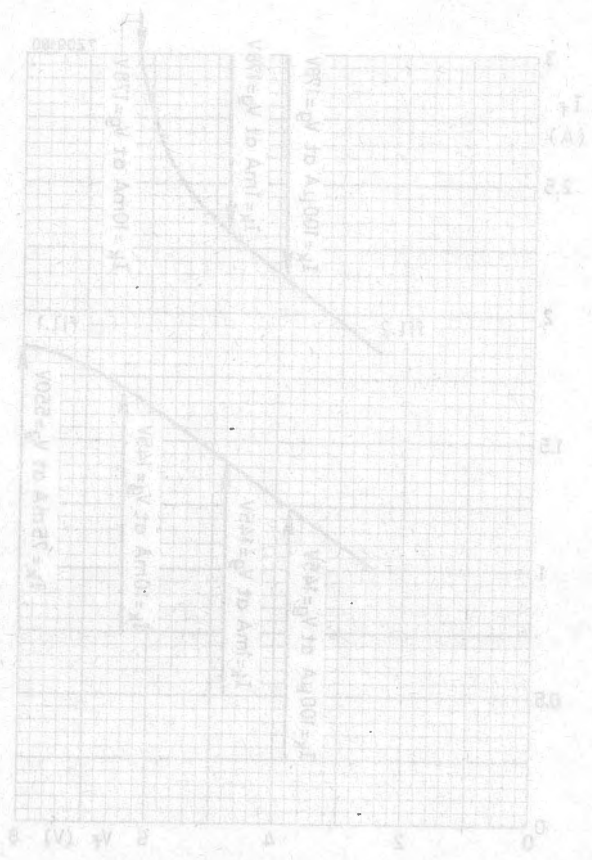

LIMITING VALUES

Pressure (filament litt)	max. 10 ⁻³ torr
Filament voltage	max. 8 V
Emission current	max. 50 mA
Grid input power, type IOG-18	max. 30 W
type IOG-18N	max. 20 W
Bulb temperature during operation	max. 100 °C
Bake-out temperature	max. 450 °C

MECHANICAL DATA

Dimensions in mm

Material

Filament	Tungsten
Tubulation (with type IOG-18)	Kodial
Skirt (with type IOG-18N)	Fernico

Mounting position: any

IOG-18

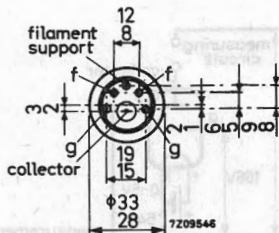
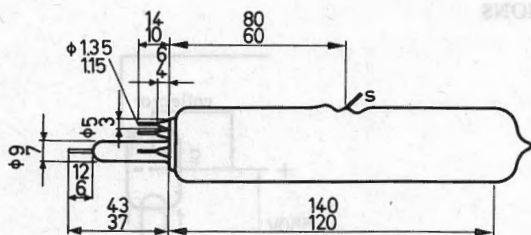

100 μA, 1 mA or 10 mA
50 mA
30 mA

Emission current (see also page 4)
measurement
type IOG-18
type IOG-18N

MECHANICAL DATA (continued)

IOG-18N

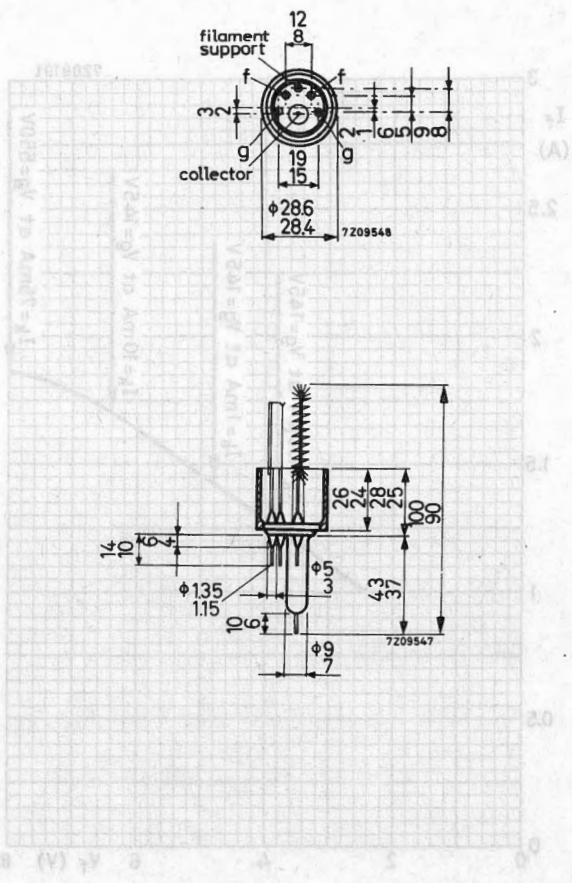

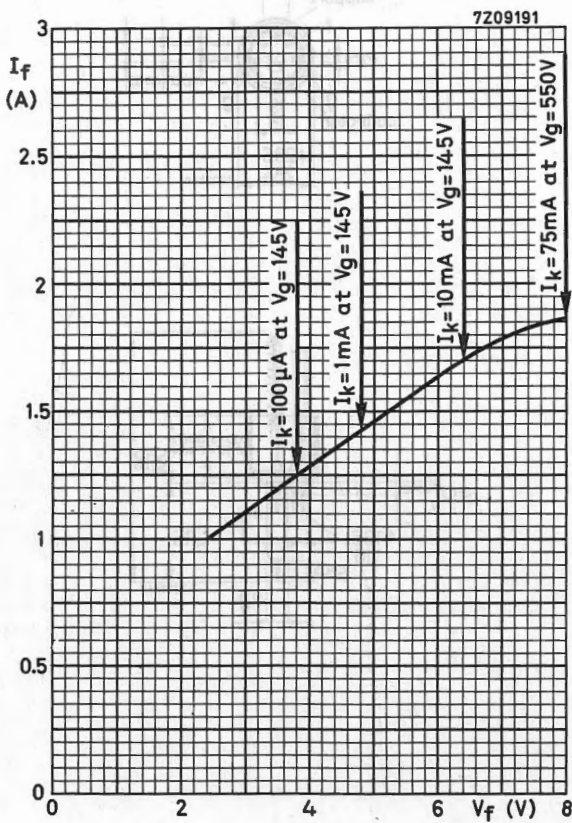

VACUUM GAUGE HEAD, BAYARD-ALPERT TYPE

Ultra-high vacuum gauge head of the Bayard-Alpert type. Measuring range 10^{-3} torr to 4×10^{-11} torr; sensitivity approx. 12 per torr.

Type IOG-19N has a fernico skirt, prepared for easy welding.

The gauge head features a low thermal inertia and a low filament power consumption.

FOR THE ELECTRICAL DATA SEE TYPE IOG-18

MECHANICAL DATA

Material

Filament

Tungsten

Skirt

Fernico

Mounting position: any

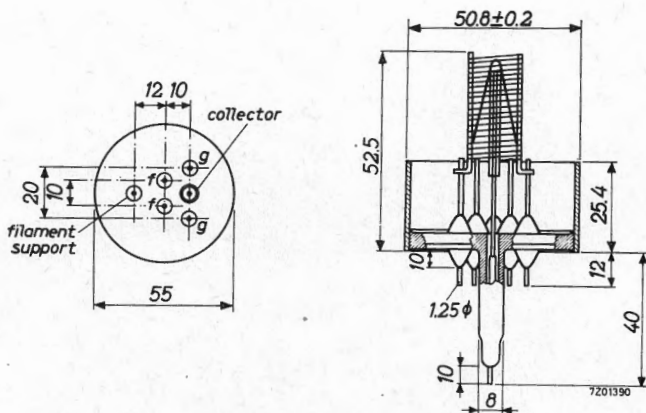

VACUUM GAUGE HEAD, BAYARD-ALPERT TYPE

Ultra-high vacuum gauge head of the Bayard-Alpert type. Measuring range 10^{-4} torr to 4×10^{-11} torr; sensitivity approx. 1% per torr.
 Type IOC-18N has a tantalum skirt, prepared for easy welding.
 The gauge head features a low thermal inertia and a low filament power consumption.

FOR THE ELECTRICAL DATA SEE TYPE IOC-18

MECHANICAL DATA

Material

Filament

Skirt

Tungsten

Tantalum

Mounting position: any

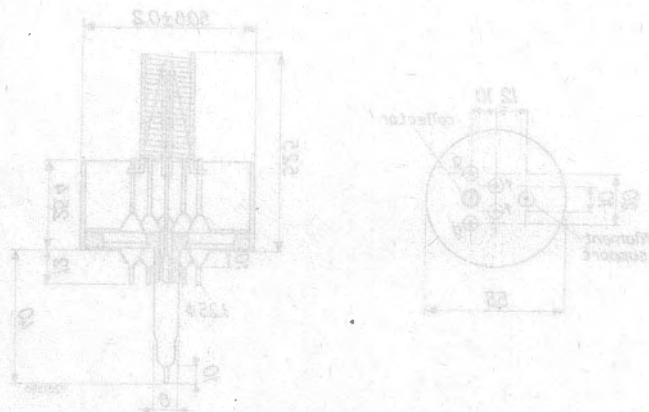

VACUUM GAUGE HEAD, TRIODE TYPE

Glass envelope, high vacuum gauge head of the triode type (hot-cathode, ionization type). Measuring range 10^{-3} to 5×10^{-8} torr, sensitivity 20 per torr.

CHARACTERISTICS

Pressure range

10^{-3} to 5×10^{-8} torr

Sensitivity (for dry air)

20 per torr

TYPICAL OPERATING CONDITIONS

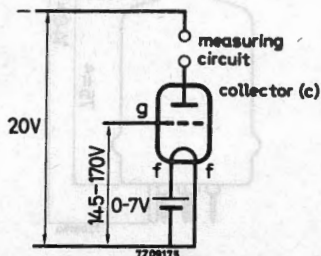

Grid current

above 10^{-4} torr

5 mA

below 10^{-4} torr

10 mA

LIMITING VALUES

Pressure (filament litted)

max. 5×10^{-3} torr

Filament voltage

max. 10 V

Bake-out temperature

max. 450 °C

MECHANICAL DATA

Dimensions in mm

Material: W1 glass

foot made to B7A spec.

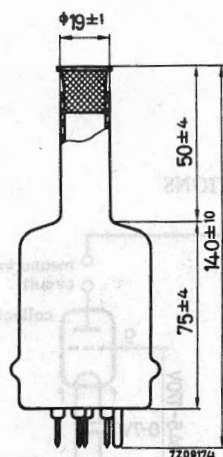
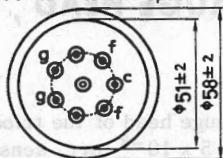

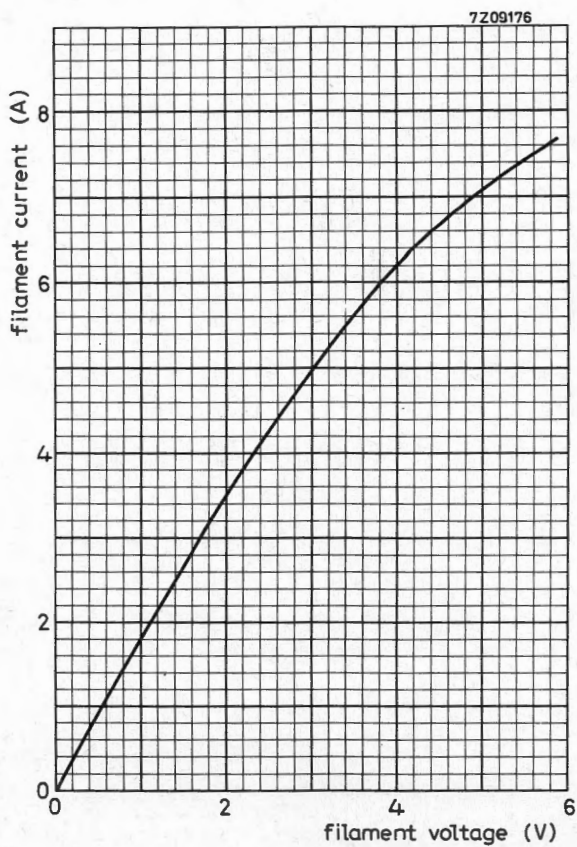

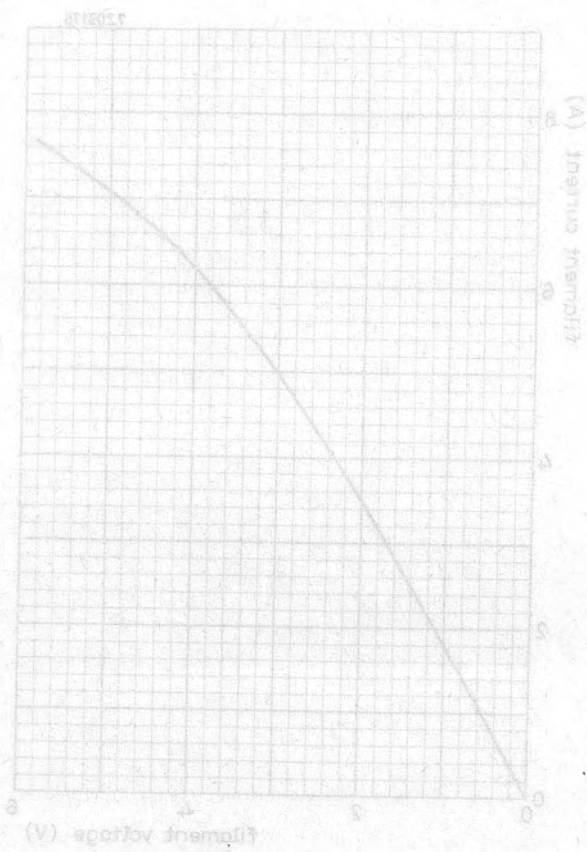

DRY REED SWITCH

Miniature dry reed switch hermetically sealed in a glass-filled glass capsule. Single-pole, single-throw type, having normally open contacts, and containing two magnetically actuated reeds. The switch is of the double-ended type and may be actuated by means of either an electromagnet or a permanent magnet or combinations of both. The switch is intended for use in telephone equipment and other applications where exceptional reliability is required.

QUICK REFERENCE DATA

Contact	S.P.S.T. normally open
Switched power	max. 5 W
Switched voltage	max. 65 V
Switched current	max. 100 mA
Failure rate	$< 5 \times 10^{-8}$

MECHANICAL DATA

Contact material	gold
Contact arrangement	normally open
Terminal finish	tinned
Resonant frequency of single reed	approx. 1650 Hz
Net weight	approx. 0.6 g
Mounting position	any

Dimensions in mm

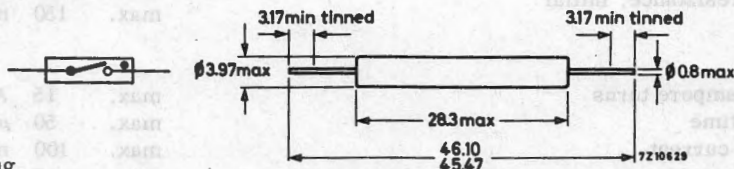

Mounting

The leads should not be bent nearer than 2 mm to the glass-to-metal seals. Stress on the glass-to-metal seals should be avoided.

The robustness of terminations is tested according to IEC Publication 68-2-21. test Ua (load 2.75 kg), Ub (load 1 kg, 2 bends), and Uc.

Care must be taken to prevent stray magnetic fields from influencing the operating and measuring conditions.

Soldering

The switch may be soldered direct into the circuit but heat conducted to the glass-to-metal seals should be kept to a minimum by the use of a thermal shunt.

Dip-soldering is permitted to a minimum of 4 mm from the seals at a solder temperature of 240 °C during maximum 10 s.

Solderability

Solderability is tested according to IEC Publication 68-2-20, test T, solder globule method.

CHARACTERISTICS

Non-operative

Breakdown voltage	min.	1000 V
Insulation resistance, initial (V = 100 V)	min.	10 ⁵ MΩ
Capacitance without test coil		0.70 pF
with earthed test coil		0.35 pF
Non-operative ampere turns	max.	30 A.T. ¹⁾

Operative

Operating ampere turns	max.	58 A.T. ¹⁾
Operating time, including bounce	av.	0.6 ms ¹⁾²⁾
	max.	1.0 ms ¹⁾²⁾
Switched current	max.	100 mA

Hold

Hold ampere turns	min.	27 A.T. ¹⁾
Current through closed contacts	max.	1 A
Contact resistance, initial	min.	60 mΩ ¹⁾³⁾
	max.	150 mΩ ¹⁾³⁾

Release

Release ampere turns	max.	15 A.T. ¹⁾
Release time	max.	50 μs ¹⁾²⁾
Switched current	max.	100 mA
Switched power	max.	5 W

1) Measured in a standard coil of 5000 turns of 42 SWG single enamelled copper wire on a coil former of 25.4 mm winding length and a core diameter of 8.75 mm.

2) Measured with 80 A.T.

3) Measured with 40 A.T.

LIMITING VALUES (Absolute max. rating system)

See also "Life expectancy and reliability"

Switched power	max.	5	W
Switched voltage	max.	65	V
Switched current	max.	100	mA
surge (T = max. 100 ns)	max.	1.5	A
Temperature, operating	min.	-55	°C
	max.	+80	°C

LIFE EXPECTANCY AND RELIABILITY

End of life is assumed to be reached when:

- the contact resistance exceeds 1Ω for no load conditions or 2.5Ω for loaded conditions
- the release time exceeds 2.5 ms (latching or contact sticking)

No load conditions

Life expectancy min. 10^7 operations with a failure rate of less than 5.5×10^{-9} with 90% confidence level.

Loaded conditions

Life expectancy min. 5×10^6 operations with a failure rate of less than 10^{-8} with 90% confidence level.

If inductive loads are to be interrupted, contact protection is recommended (diode or RC network).

Reliability - testing conditions

Capacitive loading resulting in a peak current of 0.8 A $i_1/i_2 = 1.4$, $T = 80$ ns to 100 ns, see Fig. 1. Nominal switched voltage 50 V, nominal switched current 100 mA.

Under these conditions a life of more than 5×10^6 operations can be reached with a failure rate of less than 8.5×10^{-9} .

Remark

Higher loads may be switched if a reduced life expectancy and reliability are acceptable. The manufacturer should be consulted before doing so.

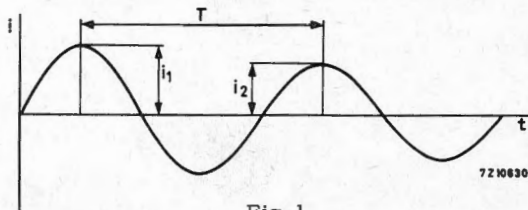

Fig. 1

SHOCK AND VIBRATION

Impact : Acceleration 50 g during 11 ms, due to a force perpendicular to the flat sides of the reeds.

Such an impact will not cause an open contact (no magnetic field present) to close, nor a contact kept closed by an 80 A. T. coil to open.

Vibration: Frequency range 50 Hz to 1500 Hz, acceleration 20 g due to a force perpendicular to the flat side of the reed.

Such a vibration will not cause an open contact (no magnetic field present) to close, nor a contact kept closed by an 80 A. T. coil to open.

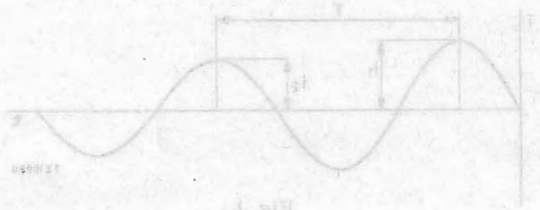
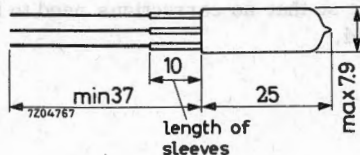
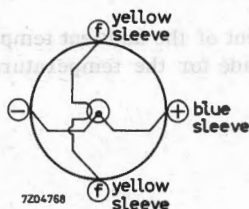

Fig. 1

THERMOCOUPLES

Indirectly heated thermocouples in subminiature construction.

DIMENSIONS AND CONNECTIONS



CHARACTERISTICS AND LIMITING VALUES (Absolute max. rating system)

		TH71	TH73	TH75	
Heater current	I_f	0 to 15	0 to 75	0 to 300	mA
Heater current 1)	I_f	0 to 5	0 to 20	0 to 100	mA
Heater current at $E = 12 \text{ mV}$	I_f	10	40	200	mA
Heater current ($T = \text{max. } 1 \text{ m}$)	I_f	max. 20	100	350	mA
Heater resistance	R_f	68	7.0	1.2	Ω
Resistance of thermocouple	R_{TH}	6.0	3.5	3.5	Ω
Response time 2)	T	10	10	10	s
at heater current $I_f =$		10	40	200	mA
Heater to thermocouple voltage	V_f/TH	max. 100	100	100	V

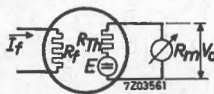
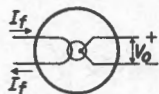

- 1) In approximately this range V_o is proportional to the square of I_f
- 2) Time between the moment of switching on of I_f and the moment of reaching max. voltage (See page 4).

REMARK

The electrical characteristics of the types TH71, TH73 and TH75 are identical to those of the types TH1, TH3, TH5 and TH91, TH93 and TH95 respectively and therefore can be used as replacement for these types.

GENERAL INFORMATION

The "hot" weld of the thermocouple consists of an iron constantan junction.

The "cold" welds are iron to copper and constantan to copper junctions inside the vacuum envelope.

The tube has copper leads.

The measuring results are practically independent of the ambient temperature of the tube so that no corrections need to be made for the temperature of the "cold" weld.

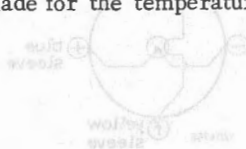
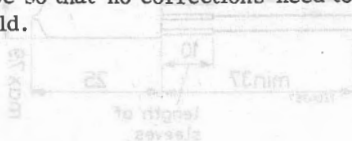

CHARACTERISTICS AND LIMITING VALUES (absolute max. rating system)

	TH75	TH73	TH71	
Heater current	0 to 300 mA	0 to 75	0 to 15	I_H
Heater current (1)	0 to 100 mA	0 to 20	0 to 5	$I_H^{(1)}$
Heater current at $E = 12$ mV	300 mA	40	10	I_H
Heater current (T-max. 1 m)	350 mA	100	20	I_H
Heater resistance	1.2 Ω	7.0	68	R_H
Resistance of thermocouple	3.5 Ω	3.5	0.0	R_{TC}
Response time τ_0	10 s	10	10	τ
Heater current I_H at heater voltage V_{HT}	300 mA	40	10	
Heater to thermocouple voltage	100 V	100	100	V_{HT} max.



(1) In approximately the range $\sqrt{I_H}$ is proportional to the square of I_H .
 (2) Time between the moment of switching on of I_H and the moment of reaching max. voltage (see page 4).

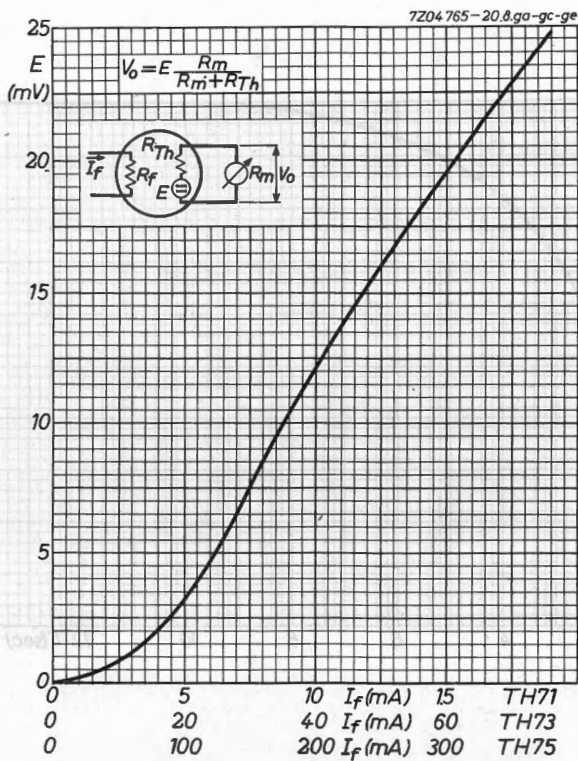

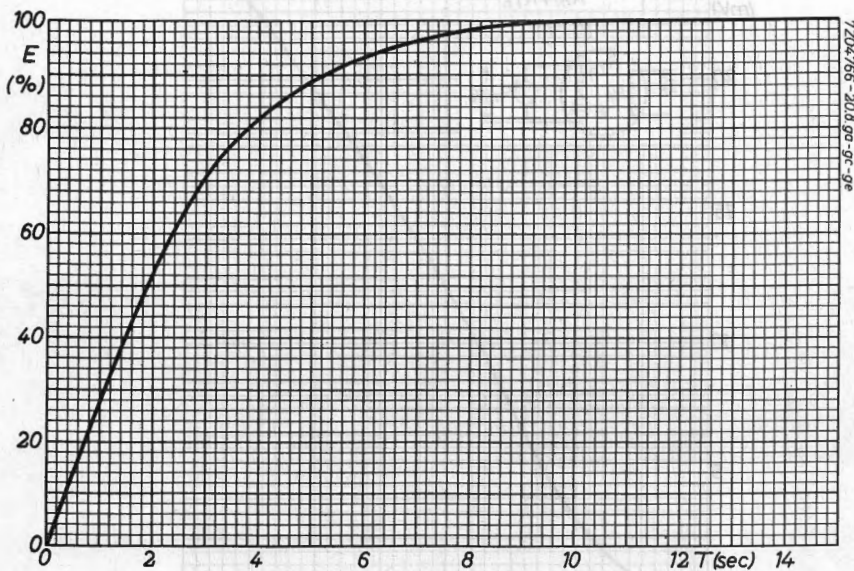

TH71 25 (Ampl) 01 2 0
 TH73 08 (Ampl) 04 05 0
 TH75 00E (Ampl) 100C 00E 0

VIBRATING CAPACITOR

Vibrating membrane capacitor in evacuated envelope to be driven by a high-frequency electric field.

Application: D.C. to A.C. converter, e.g. in dosimeters, pH meters and electrometer equipment, where a very high input resistance is of paramount importance.

Equipment measuring currents of 500 electrons per second have been realised.

QUICK REFERENCE DATA

Contact potential	-50 to +50 mV
Short term drift of contact potential	< 100 μ V
Insulation	> 10^{15} Ω
Outline dimensions:	
overall length	max. 64.7 mm
diameter	max. 30.2 mm

MECHANICAL DATA

Base: Magnoval, gold plated pins

C_m = measuring capacitor

C_{dr} = driving capacitor

Operating position: any

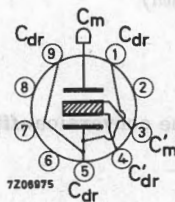

Dimensions in mm

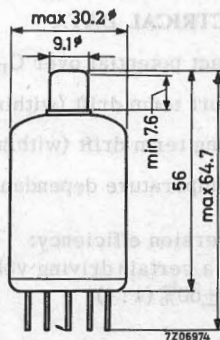

PRINCIPLE OF OPERATION

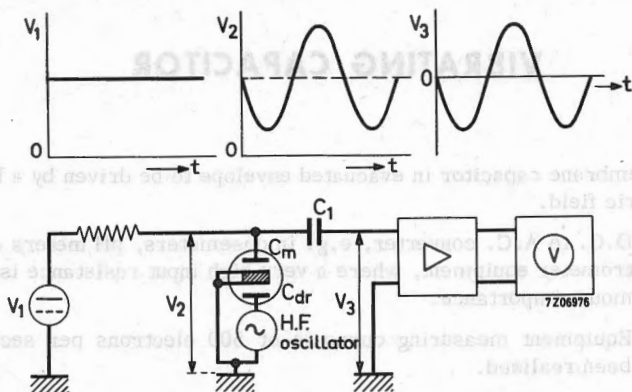

The D.C. voltage to be measured is connected to capacitor C_m . The earthed membrane vibrates in its own resonance frequency as a result of an H.F. electrical field between the electrodes of capacitor C_{dr} . So the D.C. voltage on capacitor C_m is modulated in the resonance frequency of the membrane. Capacitor C_1 insulates the D.C. source from the A.C. amplifier.

LIMITING VALUES (Absolute max. rating system)

D.C. voltage on C_m max. 25 V

Conversion efficiency

$$\frac{\text{R.M.S. output voltage}}{\text{D.C. input voltage}} \quad \text{max. } 40 \% \text{ } ^1)$$

ELECTRICAL DATA

Contact potential over C_m

-50 to +50 mV

Short term drift (within 1 day)

0.1 mV

Long term drift (within 1 month)

1 mV

Temperature dependance

20 $\mu\text{V}/^\circ\text{C}$

Conversion efficiency:

At a certain driving voltage the conversion efficiency will show a max. spread of $\pm 60\%$ (1 : 4)

¹⁾ Above 40 % it is possible that two capacitor plates will touch each other and will be damaged.

ELECTRICAL DATA (continued)**Driving voltage:**

There can always be found a value of the H.F. driving voltage at which all capacitors have a conversion efficiency between 10% and 40%.¹⁾

Insulation resistance between any two capacitor terminals

$> 10^{15} \Omega^2)$

Resonance frequency of the membrane

5.3 to 6.3 kHz

Drift

1.5 %

Temperature dependance

± 1 Hz/°C

Capacitances of C_m and C_{dr}

35 pF

Temperature dependance between -10 and $+60$ °C

ΔC 1 pF

SHOCK AND VIBRATION RESISTANCE

The following test conditions are applied to assess the mechanical quality of the tube. These conditions are not intended to be used as normal operating conditions.

Shock

The tube is subjected 5 times in each of 4 positions to an acceleration of 500 g supplied by an NRL shock machine with the hammer lifted over an angle of 30° .

Vibration

The tube is subjected to a vibration of 15 to 1500 Hz with an acceleration of 2.5 g.

APPLICATION NOTES

The capacitive drive opens the possibility to use as driving signal for the membrane a high frequency signal amplitude-modulated with the resonance frequency of the vibrating membrane.

Since in that case there is a great difference between the frequency of the driving signal and the modulation frequency of the voltage to be measured, the stray influences of the driving signal can easily be kept away from the measuring amplifier. In addition, a high frequency drive simplifies design and execution of the driving oscillator.

1) For instance in an apparatus realised with the circuit shown in Fig.2, it turned out that all capacitors have a conversion efficiency between 10 and 40% at a voltage over L_1 of 1 VRMS.

2) Under standard atmospheric conditions as defined in I.E.C. publication 68-1, i.e. any combination of temperature, humidity and pressure within the following limits:

Temperature
Relative humidity
Air pressure

+15 to +35 °C
45 to 75 %
860 to 1060 mbar

EXAMPLE OF A DRIVING OSCILLATOR

Operating principle

Fig. 1

The driving capacitor (C_{dr}) is incorporated in an impedance bridge that determines the feedback to the amplifier transistor. Capacitance C_1 has been given a slightly larger value than that of capacitor C_{dr} in its quiescent state. Due to this the fed-back A.C. voltage V_1 has the proper phase and amplitude to cause the circuit to oscillate in a frequency that is mainly determined by the circuit $L_2 C_1 C_{dr}$.

The electric attractive force between the capacitor plates of C_{dr} makes the membrane move towards the fixed plate of C_{dr} as a result of which its capacitance increases, the transistor receives less feedback and the oscillator voltage decreases.

The phases and amplitudes of the electrical and the mechanical forces on the membrane and of the feedback factor are such that the membrane begins to vibrate in its resonance frequency, while the H.F. voltage is modulated in amplitude with this frequency.

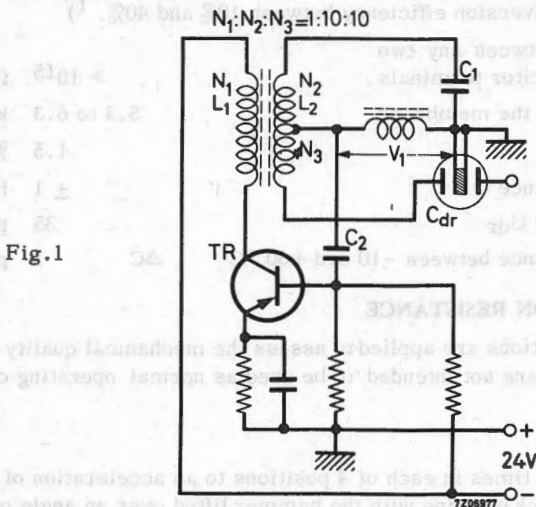
Since it is very difficult to realize this circuit in such a way that a stable operation is ensured, it is advisable to add some components for automatic adjustment of the capacitance C_1 .

See the following circuit.

EXAMPLE OF A DRIVING OSCILLATOR (continued)

Practical circuit

Fig.2

$C_1 = 12 \text{ pF mica}$

$C_2 = 1500 \text{ pF}$

$C_3 = 10 \text{ pF mica}$

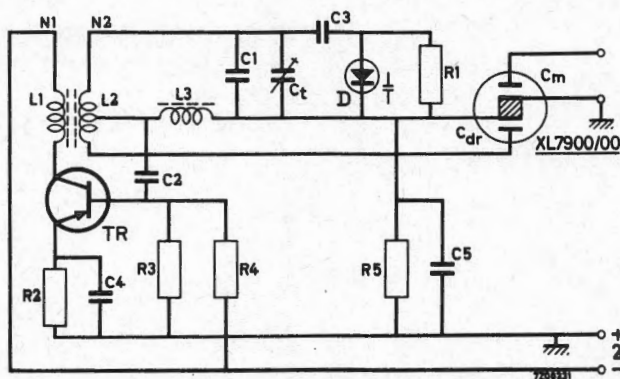
$C_4 = 2200 \text{ pF}$

$C_5 = 0.1 \mu\text{F}$

$C_t = 25 \text{ pF max.}$

$R_1 = 68 \text{ k}\Omega$

$R_2 = 3.3 \text{ k}\Omega$

$R_3 = 4.7 \text{ k}\Omega$

$R_4 = 1 \text{ k}\Omega$

$R_5 = 1 \text{ M}\Omega$

$L_2 = 1.3 \text{ mH}$

$L_3 = 1.3 \text{ mH R.F. choke}$

$N_2/N_1 = 20$

TR = BCY70

D = BA102

ELECTROMETER TUBE

Subminiature electrometer triode

QUICK REFERENCE DATA

Filament voltage	V_f	1.25 V
Anode voltage	V_a	9 V
Anode current	I_a	100 μ A
Grid current	$-I_g$	$< 12.5 \times 10^{-14}$ A

DIMENSIONS AND CONNECTIONS

Dimensions in mm

Base: Subminiature

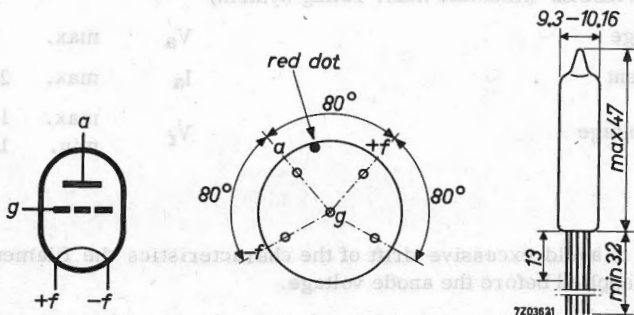

Directly soldered connections to the leads of this tube must be at least 13 mm from the seals and any bending of the leads must be at least 1.5 mm from the seals

HEATING: Direct by D.C.

Filament voltage	V_f	1.25 V
Filament current	I_f	13 mA

CHARACTERISTICS AND RANGE VALUES

Anode voltage	V_a	9	V
Grid voltage	V_g	-2.5	-2 to -3.75 V
Anode current	I_a	100	μA
Transconductance	S	80	70 to 90 $\mu\text{A/V}$
Amplification factor	μ	2.0	1.7 to 2.7
Grid current	$-I_g$	8.5×10^{-14}	$< 12.5 \times 10^{-14}$ A ¹⁾
Crossover point ²⁾	V_g	-1.3	< -1.6 V
Anode current at crossover point	I_a	-	$> 160 \mu\text{A}$

LIMITING VALUES (Absolute max. rating system)

Anode voltage	V_a	max.	25 V
Anode current	I_a	max.	250 μA
Filament voltage	V_f	max.	1.5 V
		min.	1.1 V

REMARKS

1. In order to avoid excessive drift of the characteristics the filament voltage must be applied before the anode voltage.
2. To avoid contamination of the glass, the tube should not be removed from its protective envelope until it is mounted into the equipment.

¹⁾ Valid only in darkness

²⁾ The "crossover point" is the point at which the direction of the grid current is reversed

7Z03619-djfe

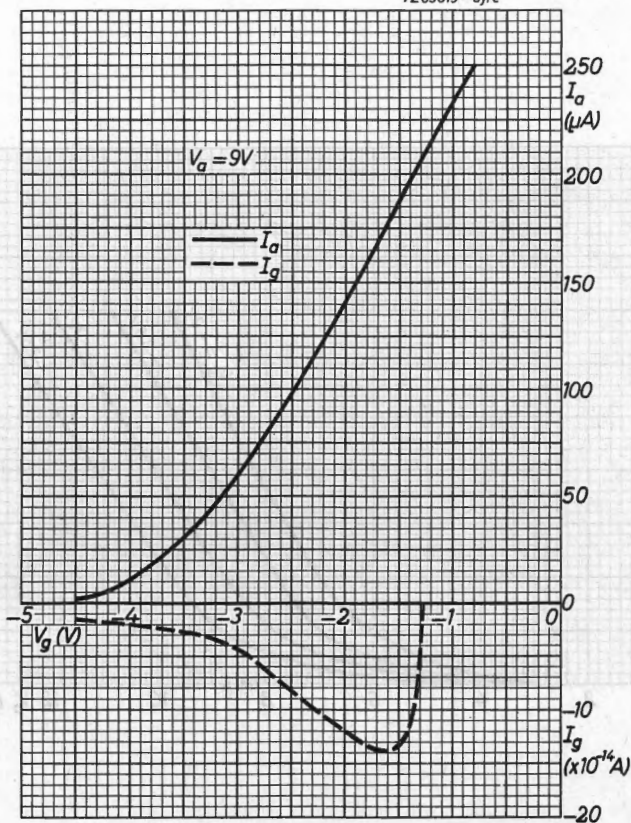

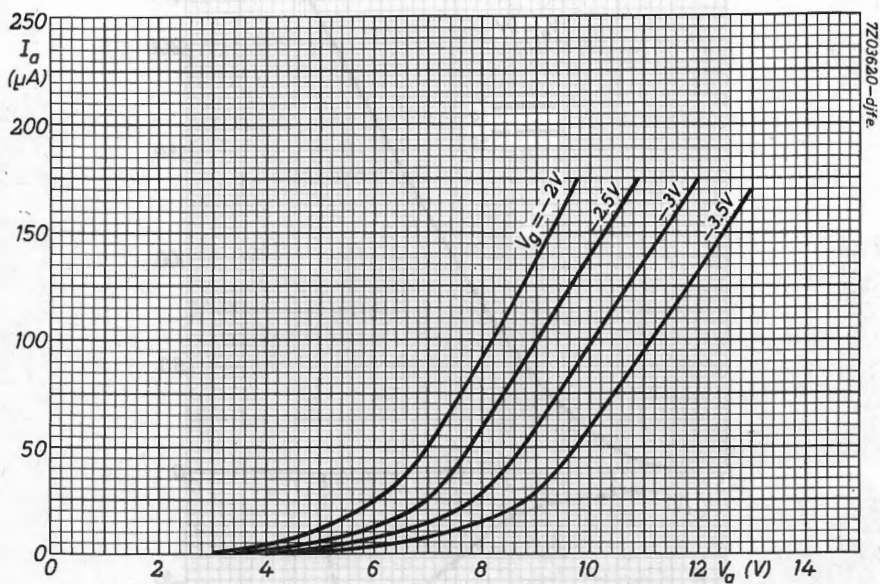

Z20362A0-d/1e

ELECTROMETER TUBE

Subminiature electrometer tetrode

QUICK REFERENCE DATA

Filament voltage	V_f	1.25 V
Anode voltage	V_a	4.5 V
Grid No. 2 voltage	V_{g2}	-3.2 V
Anode current	I_a	20 μ A
Grid No. 2 current	I_{g2}	$< 6 \times 10^{-15}$ A

DIMENSIONS AND CONNECTIONS

Dimensions in mm

Base: Subminiature

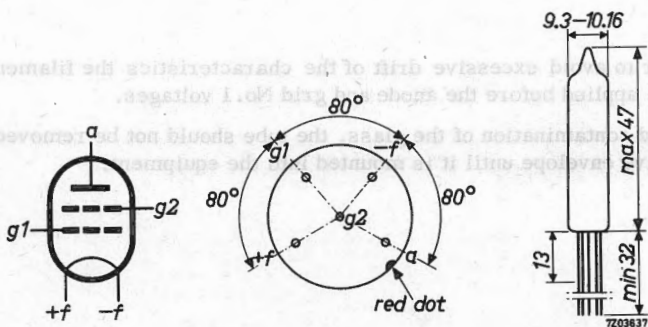

Directly soldered connections to the leads of this tube must be at least 13 mm from the seal and any bending of the leads must be at least 1.5 mm from the seal.

HEATING: Direct by D.C.

Filament voltage

 V_f 1.25 V

Filament current

 I_f 13 mA

CHARACTERISTICS AND RANGE VALUES

Anode voltage	V_a	4.5	V
Grid No.2 voltage	V_{g2}	-3.2	-2 to -4.5 V
Grid No.1 voltage	V_{g1}	3.0	2 to 4 V
Anode current	I_a	20	μA
Grid No.2 current	$-I_{g2}$	2.5×10^{-15}	$< 6 \times 10^{-15}$ A
Transconductance	S_{ag2}	17	10 to 24 $\mu A/V$
Grid No.1 current ¹⁾	I_{g1}	250	μA
Grid No.2 voltage at crossover point ²⁾	V_{g2}	-1.75	V

LIMITING VALUES (Absolute max. rating system)

Anode voltage	V_a	max.	10 V
Cathode current	I_k	max.	300 μA
Filament voltage	V_f	max.	1.5 V
		min.	1.1 V

REMARKS

- In order to avoid excessive drift of the characteristics the filament voltage must be applied before the anode and grid No.1 voltages.
- To avoid contamination of the glass, the tube should not be removed from its protective envelope until it is mounted into the equipment.

1) Only valid in darkness

2) "Crossover point" is the point at which the direction of I_{g2} is reversed
At this point, V_{g2} is at least 0.5 V less negative than its value at $I_a = 20 \mu A$

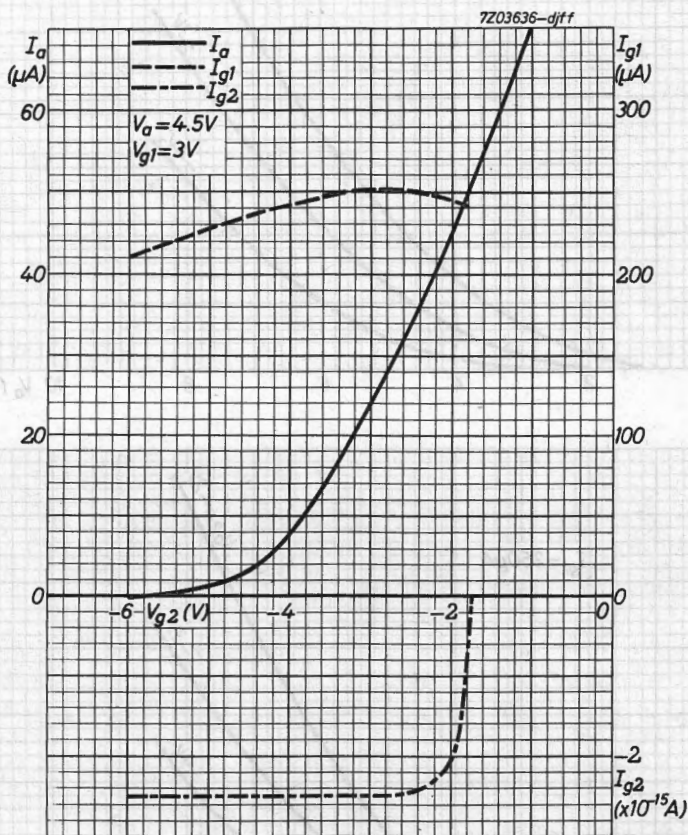

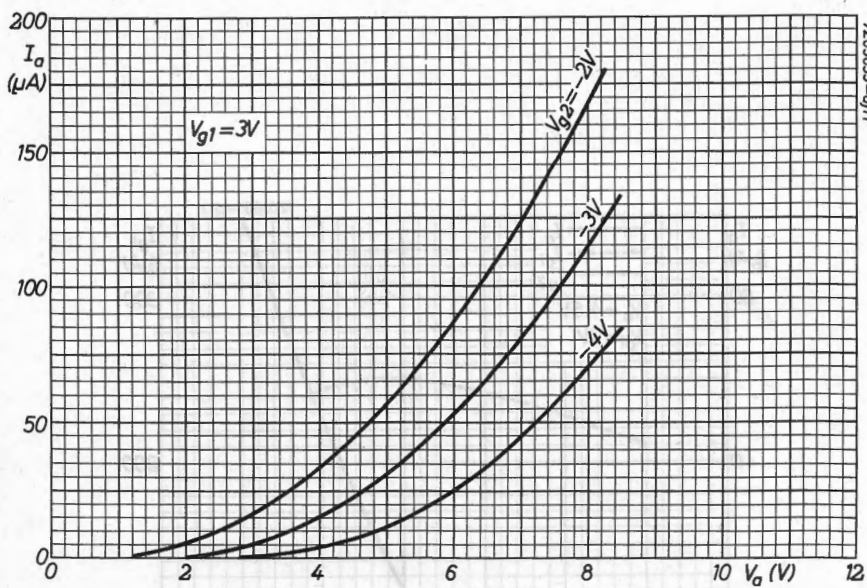

7203635-DIT

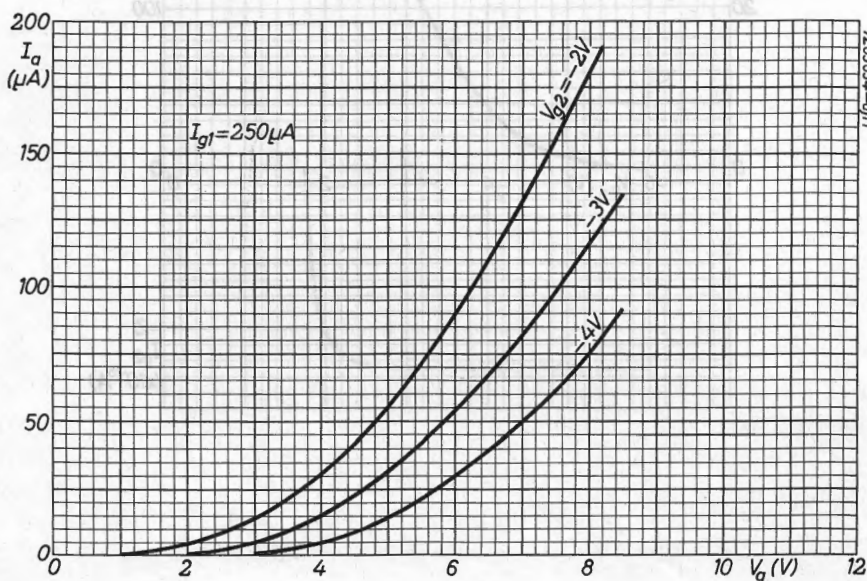

7203634-DIT

ELECTROMETER TUBE

Subminiature electrometerpentode

QUICK REFERENCE DATA

Filament voltage	V_f	1.25 V
Anode voltage	V_a	10 V
Anode current	I_a	5.0 μ A
Grid No. 1 current	$-I_{g1}$	$< 8 \times 10^{-15}$ A

DIMENSIONS AND CONNECTIONS

Dimensions in mm

Base: Subminiature

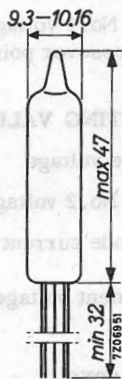
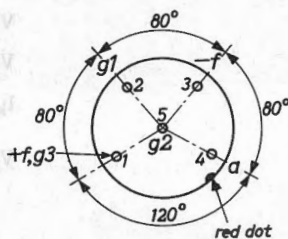
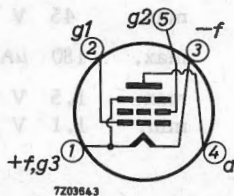

Directly soldered connections to the leads of this tube must be at least 13 mm from the seal and any bending of the leads must be at least 1.5 mm from the seal.

HEATING: Direct by D. C.

Filament voltage

 V_f 1.25 V

Filament current

 I_f 8.2 mA

CAPACITANCES

Anode to all	C_a	4.0 pF
Grid No. 1 to all	C_{g_1}	3.0 pF
Anode to grid No. 1	C_{ag_1}	0.2 pF

CHARACTERISTICS AND RANGE VALUES

Anode voltage	V_a	10	V
Grid No. 2 voltage	V_{g_2}	6.5	5.0 to 7.5 V
Grid No. 1 voltage	V_{g_1}	-2.5	V
Anode current	I_a	5.0	μA
Grid No. 2 current	I_{g_2}	2.2	1.5 to 3.0 μA
Grid No. 1 current ¹⁾	$-I_{g_1}$	3×10^{-15}	$< 8 \times 10^{-15}$ A
Transconductance	S	10.5	8.0 to 15 $\mu A/V$
Internal resistance	R_i	10.5	M Ω
Amplification factor	μ_{ag_1}	110	> 80
Grid No. 1 voltage at crossover point ²⁾	V_{g_1}	-1.15	V ³⁾

LIMITING VALUES (Absolute max. rating system)

Anode voltage	V_a	max.	45 V
Grid No. 2 voltage	V_{g_2}	max.	45 V
Cathode current	I_k	max.	180 μA
Filament voltage	V_f	max.	1.5 V
		min.	1.1 V

REMARKS

- In order to avoid excessive drift of the characteristics the filament voltage must be applied before the anode and grid No. 2 voltages.
- To avoid contamination of the glass, the tube should not be removed from its protective envelope until it is mounted into the equipment.

1) Valid only in darkness.

2) The crossover point is the value of V_{g_1} at which the direction of I_{g_1} is reversed.

3) Measured at $V_f = 1.25$ V, $V_a = 10$ V, V_{g_2} = the value at which $I_a = 5 \mu A$ when $V_{g_1} = -2.5$ V.

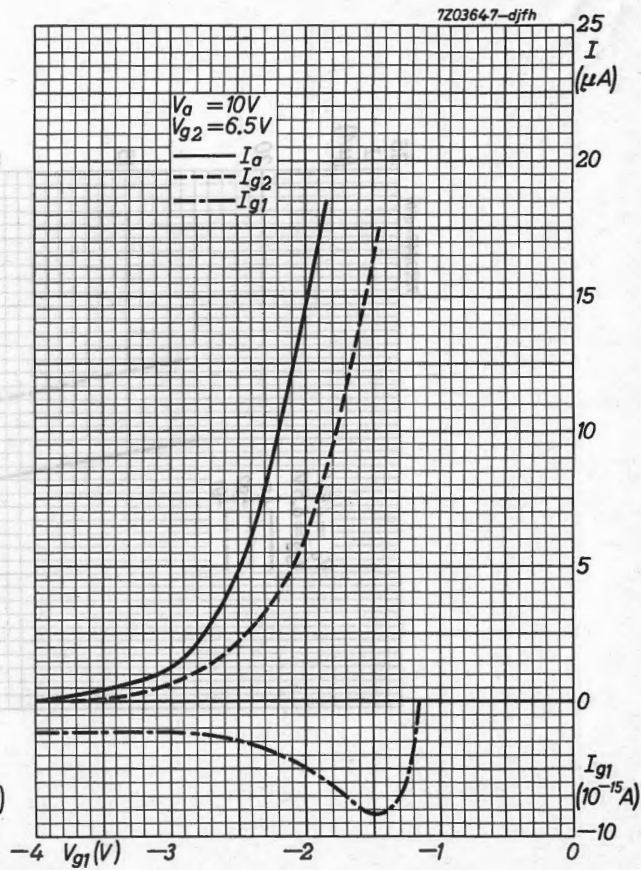
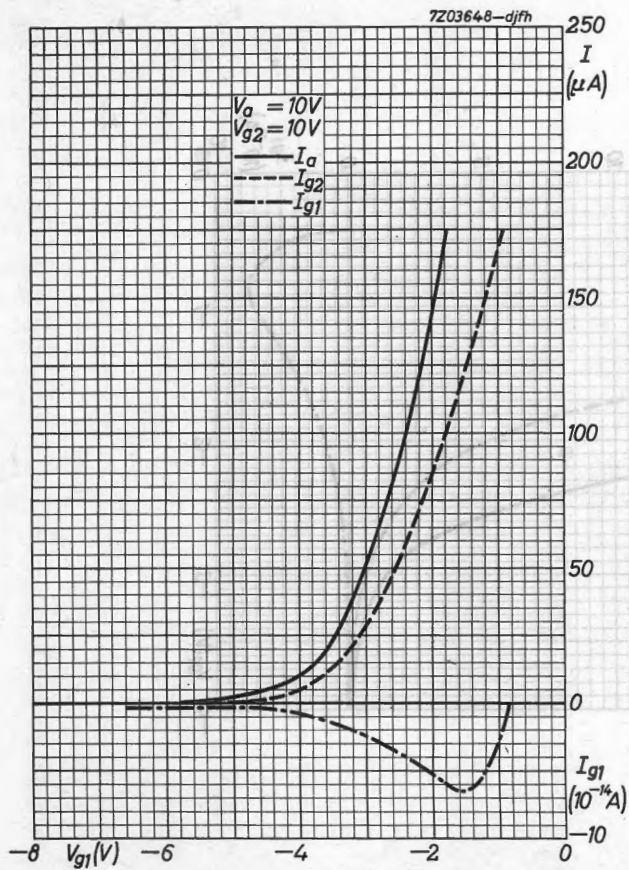

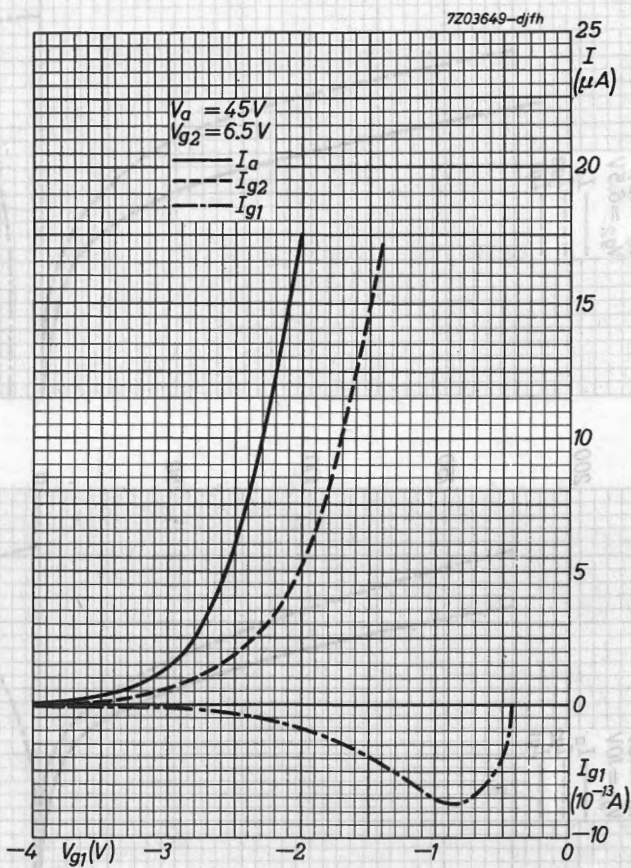

7Z03645-djfh

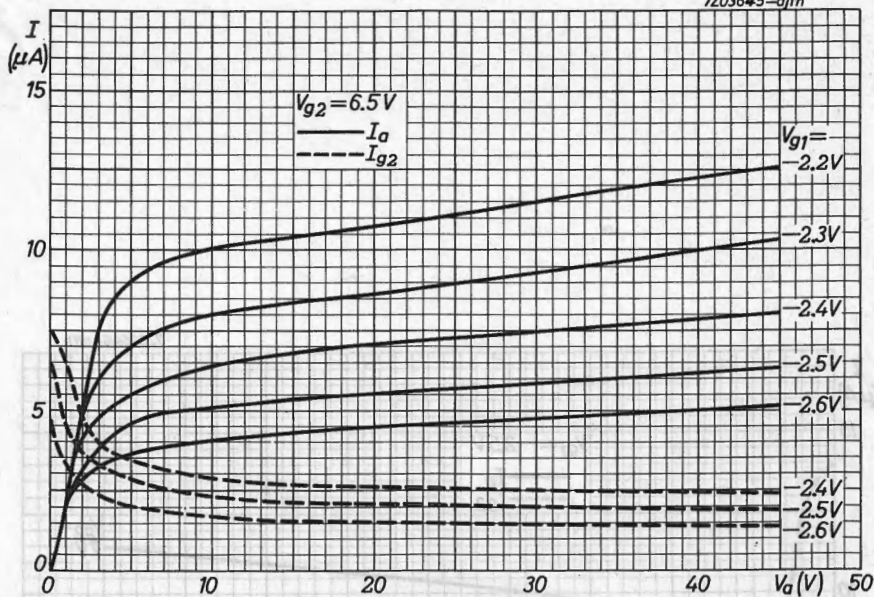

7Z03644-djfh

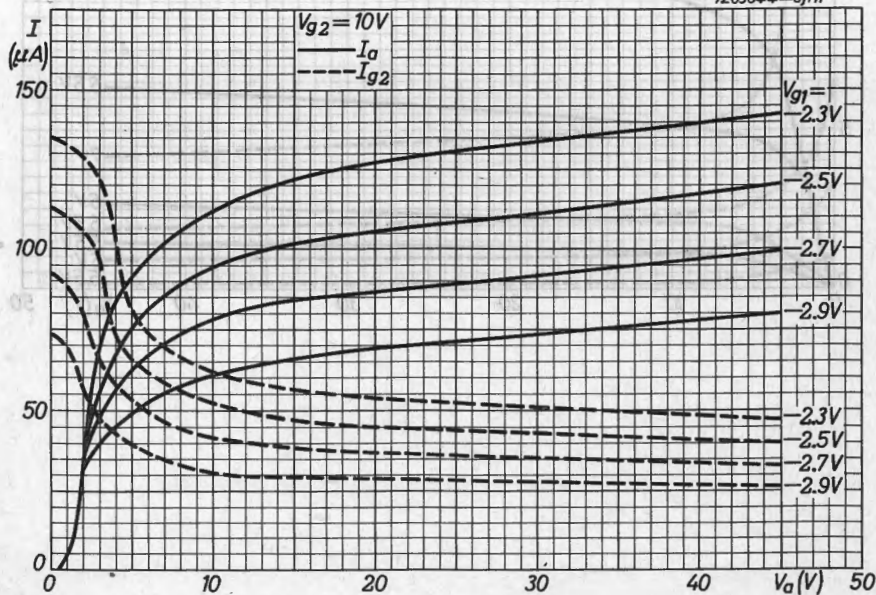

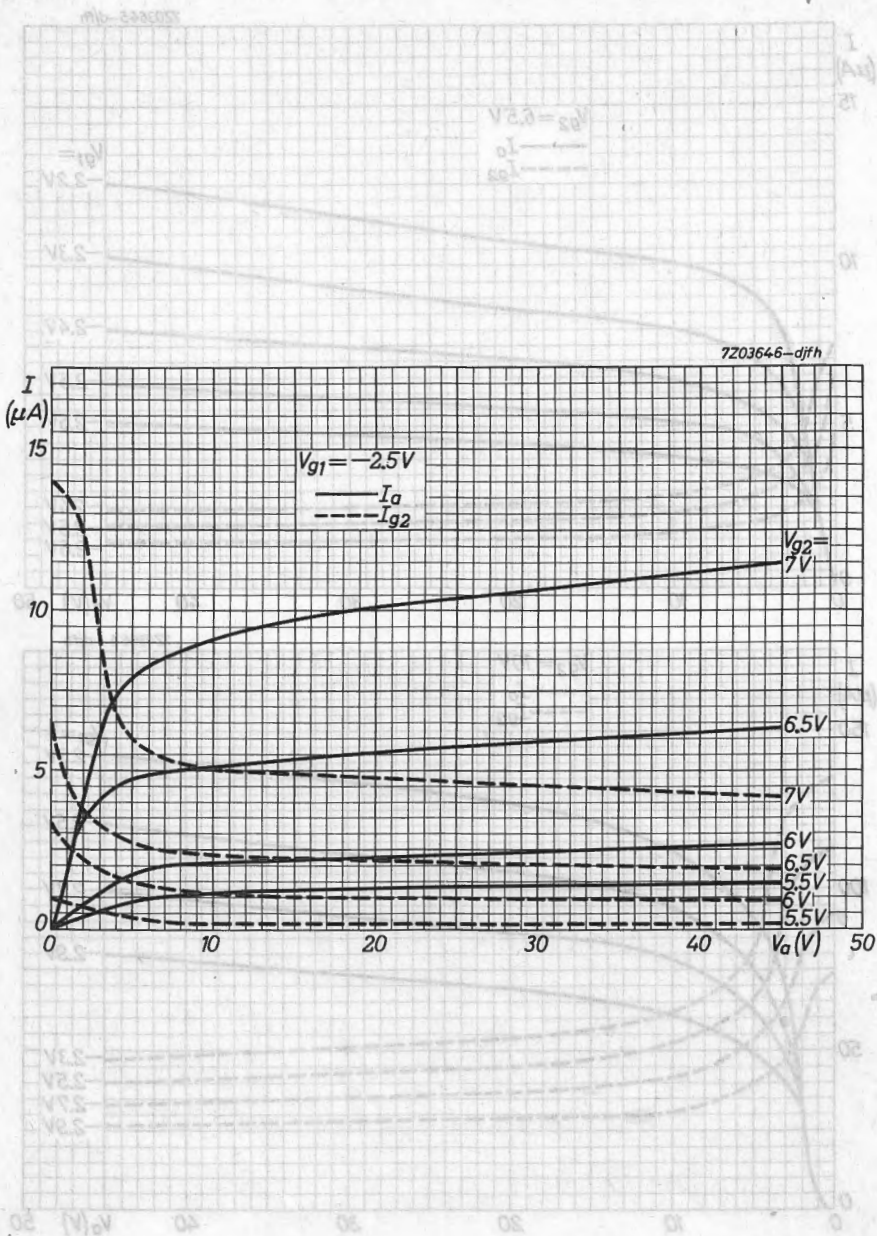

ELECTROMETER TUBE

Subminiature electrometer triode for linear and logarithmic use with a controlled logarithmic relationship between positive grid current and anode current.

QUICK REFERENCE DATA

Filament voltage	V_f	1.25 V
Anode voltage	V_a	9.0 V
Anode current	I_a	100 μ A
Grid current	$-I_g$	< 10 ⁻¹² A

DIMENSIONS AND CONNECTIONS

Base: Subminiature

Dimensions in mm

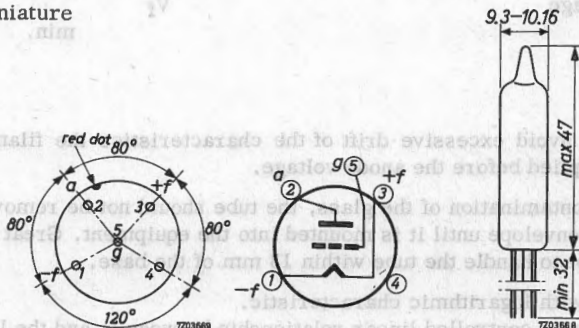

Directly soldered connections to the leads of this tube must be at least 13 mm from the seal and any bending of the leads must be at least 1.5 mm from the seals.

HEATING: direct by D.C.

Filament voltage	V_f	1.25 V
Filament current	I_f	14 mA

CAPACITANCES

Anode to all except grid	$C_{a(g)}$	0.8 pF
Grid to all except anode	$C_{g(a)}$	0.5 pF
Anode to grid	C_{ag}	2.0 pF

CHARACTERISTICS AND RANGE VALUES

Anode voltage	V_a	9.0	V
Grid voltage	V_g	-2.7	-2.0 to 3.75 V
Anode current	I_a	100	μA
Grid current	$-I_g$	1.6×10^{-13}	$< 10^{-12}$ A 1)
Transconductance	S	80	60 to 90 $\mu\text{A/V}$
Amplification factor	μ	2.0	1.6 to 2.7
Grid voltage at crossover point 2) ($I_a = 145 \mu\text{A}$)	V_g	-1.4	< 1.7 V

LIMITING VALUES (Absolute max. rating system)

Anode voltage	V_a	max.	25 V
Anode current	I_a	max.	250 μA
Filament voltage	V_f	max.	1.5 V
		min.	1.1 V

REMARKS

- In order to avoid excessive drift of the characteristics the filament voltage must be applied before the anode voltage.
- To avoid contamination of the glass, the tube should not be removed from its protective envelope until it is mounted into the equipment. Great care should be taken not to handle the tube within 13 mm of the base.
- Operation with logarithmic characteristic.

The tube has a controlled linear relationship between I_a and the logarithm of the positive I_g , which holds good over a range of I_g from 3×10^{-12} to 3×10^{-9} A. With $+I_g = 3 \times 10^{-9}$ A, V_a can be set to some value within the range from 3 to 6 V (nominal 4.4 V) such that I_a falls by $50 \mu\text{A}$ when $+I_g$ is reduced to 3×10^{-12} A. The initial value of I_a will be found in the range from 65 to 100 μA .

1) Only valid in darkness.

2) The crossover point is the point at which the direction of I_g is reversed.

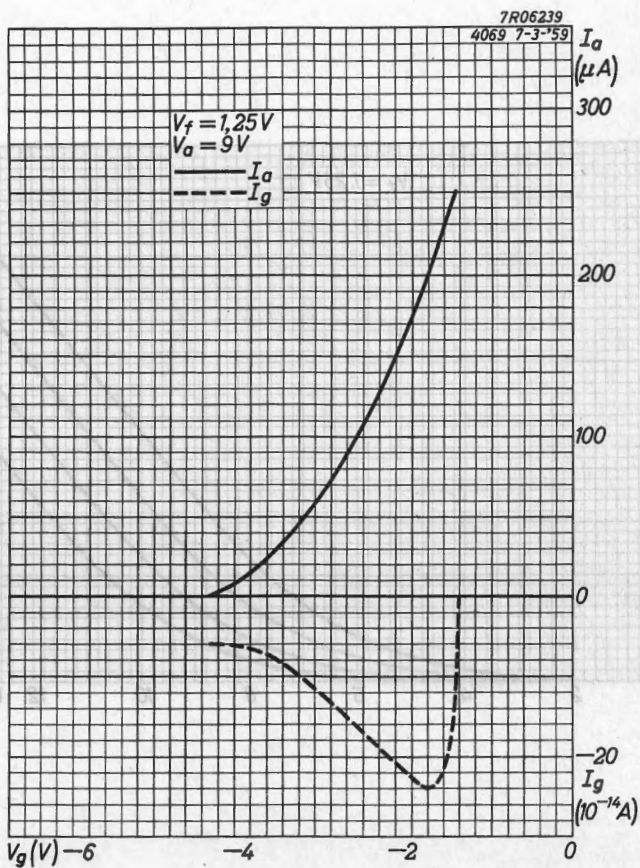

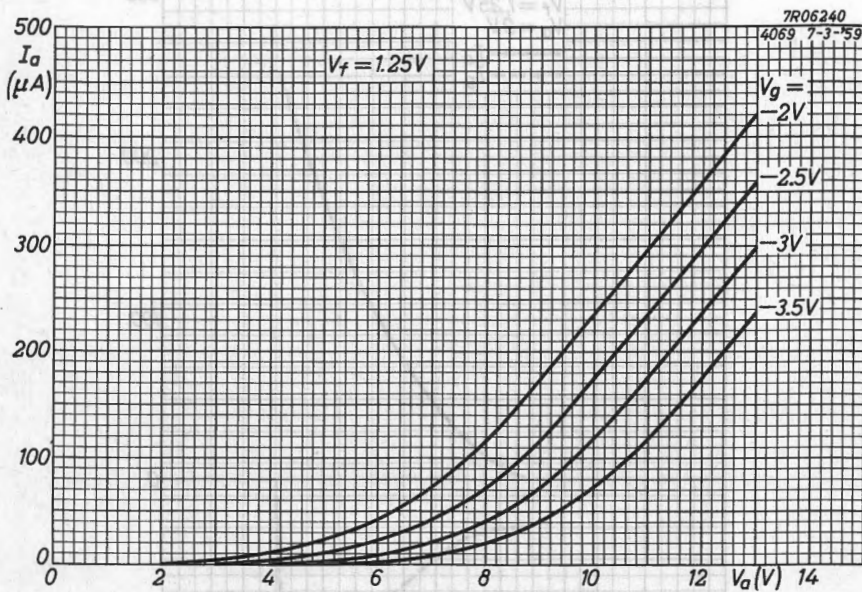

OMEGATRON MASS-SPECTROMETER TUBE

Mass-spectrometer tube with platinum electrodes and tungsten cathode to be used for gasanalysis. Used with comparatively simple equipment, with this tube masses 32 and 33 can be completely separated.

Its sensitivity is large enough to make measurements possible at partial pressures of 10^{-10} to 10^{-11} torr.

By using platinum electrodes, the measuring qualities of this tube stay excellent also after repeated use. When cold, the tungsten cathode is insensitive to air of room temperature and atmospheric pressure.

The risk of damage during transport from factory to user is too large when the filament has been operated in the factory. For that reason the tube cannot be tested in operation before leaving the factory. The user, therefore, should test the tube immediately on receipt.

OPERATING PRINCIPLE (see fig. 1)

Electrons emitted by the cathode are concentrated into a beam by a magnetic field and collimated by circular holes in the grids g_1 and g_2 and in the box D. The beam traverses box D, passes through a second hole in box D and is collected by the electron collector T.

While traversing box D, the electron beam ionises gas molecules. The magnetic field forces the ions thus formed into helical paths around the axis of the electron beam. Most of them will escape from the box along the electron beam or be neutralised on the wall of the box D.

There are, however, ions with a mass such that their angular velocity around the axis of the electron beam is in resonance with the frequency of the electric field which results from the radio frequency voltage between box D and electrode H. These ions will spiral out of the electron beam so far that they will strike and be neutralised by the ion collector P and cause a current from ion collector P to earth, which is amplified and measured.

Note: By choosing a suitable d.c. current meter it should be avoided that the voltage difference between ion collector P and electrode D is becoming too high. Values of 100 mV often have no appreciable influence on measuring results, but 10 mV is a safe voltage under any circumstances.

The relation connecting the frequency of the electric field between electrodes D and H, the mass of the ions that will strike collector P and the magnetic induction in the gap of the magnet is:

$$f_T = 15.33 \times 10^6 \times \frac{B}{M}$$

where: f_T is the resonance frequency in Hz

B is the induction Wb/m^2

M is the ion mass in mass units.

Ions of different masses can be selected from the collision area by adjusting the frequency of the radio frequency voltage applied to electrode H; the resulting current is a measure of the rate of formation of ions having a particular mass.

Thus by progressively varying the frequency, a mass spectrum can be recorded.

The resolution of the omegatron is given by:

$$\frac{M}{\Delta M} = 6450 \times \frac{B^2}{V_{HD} M}$$

where B = magnetic induction in Wb/m^2

V_{HD} = R.M.S. value of the radio-frequency voltage between electrodes H and D in volts

M = ion mass in mass units

For $B = 0.4 \text{ Wb/m}^2$, $V_{HD} = 1 \text{ V}$ and $M = 32$ the resolution $\frac{M}{\Delta M} = 32$

Thus a system equipped with a 0.4 Wb/m^2 magnet will allow complete separation over an interval of at least one mass unit of masses up to and including 33 mass units.

When no spurious effects are encountered, the curve which shows the values of current I_p plotted against the R.M.S. value of the R.F. frequency voltage V_{HD} (all other values constant) will be practically horizontal for values of V_{HD} between 1 V and $2 V_{RMS}$.

The value attained by current I_p in the horizontal part of the curve has the following relation to the gas pressure and the electron current I_T :

$$I_p = c \cdot p \cdot I_T$$

where p = partial pressure of the particular gas in torr.

I_T = current to electron collector T in amperes.

c = sensitivity constant depending on kind of gas and of mass number.

An indication of the absolute value of this constant for the mass number with the highest peak of each gas is displayed on page 6 for 12 common gases. The relative values with regard to the highest peak are given there for other mass numbers for each gas.

The validity of the above relation, and hence also the method of measurement, is limited to pressures below 10^{-5} torr.

2. D.C. current meter, full scale deflection between 2×10^{-10} A and at least 10^{-13} A, preferably 2×10^{-14} A.

This measuring equipment should be designed so that during measurement the voltage difference between electrodes P and D will not exceed 10 mV. The meter should preferably have a response time below 2 seconds.

3. Radio frequency signal-generator:

Output voltage 1 to 5 V_{RMS}

Frequency range $60 \times 10^3 \times B < f < 16000 \times 10^3 \times B$ Hz

for the masses 1 to 250

B being the magnetic induction in Wb/m^2 in the gap of the magnet.

4. Power supply for the omegatron.

D.C. voltages required (fig. 1)

$$V_{kD} = -90 \text{ V}$$

$$V_{g1D} = -80 \text{ V}$$

$$V_f \quad \text{variable from 0 to + 2 V}$$

$$V_{sD} = V_{s'D} \quad \text{variable from 0 to - 60 V}$$

$$V_{TD} \quad \text{variable from 0 to + 40 V}$$

Note: The operation of the equipment is much simplified and often measurements are more exact if the power supply is equipped with a possibility for automatic regulation of V_{g1D} or I_f to keep the current to electron collector T constant at a required value. (I_f should never be allowed to become larger than 3.5 A corresponding to a V_f of approx. 2 V).

OPERATIONAL NOTES

- Affix filament leads to filament pins and place the omegatron between the magnet poles.
- Bring the pressure down to below 10^{-5} torr.
- Connect all electrodes except P to their supply voltages as shown in fig. 1, adjust V_{TD} to 10 V, $V_{sD} = V_{s'D}$ to -10 V and adjust the filament current I_f so that a current I_D of 1 μA flows to box D.
- Without changing the filament current I_f , the position of the omegatron in the magnetic field is so adjusted that current I_D attains a minimum value which should be below 10^{-8} A. Current I_T should now be 1 μA .
- Connect the amplifier to the ion collector P.
- Bring I_T on the value required by adjusting I_f . Usually, for measurements on gases with a partial pressure over 10^{-9} torr, a value of 1 μA will be chosen. For partial pressures below 10^{-9} the values for I_T will be progressively larger. At 10^{-11} torr a value of 30 μA will often be most convenient.

7. Tune the generator to the resonant frequency of a heavy mass, e.g. 28 and make $V_{HD} = 1.5 V_{RMS}$

By adjusting $V_{sD} = V_s'D$ and V_{TD} the ion current I_P is maximized, I_T being kept on the same value. b

8. The optimum adjustment thus obtained for heavy masses has to be checked now for light masses. This more critical adjustment is carried out by tuning the generator to the resonant frequency of a light mass, e.g. mass 2, and again maximizing the ion current I_P by adjusting $V_{sD} = V_s'D$ and V_{TD} . The deviation from the optimum ion current has to be made as small as possible for all masses (< 10%).

9. It is advisable not to exceed the following operating limits:

$$+5 < V_{TD} < +30 \text{ V}$$

$$0 < V_{sD} = V_s'D < -60 \text{ V}$$

$$I_f < 3.5 \text{ A}$$

BAKING

To clean the glass, baking temperatures up to 450 °C are allowed.

The platinum electrodes are not ordinarily subject to contamination, but if necessary they can under a pressure below 10^{-6} torr, be cleaned by heating up to 800 °C in a high frequency magnetic field.

WARNINGS

1. Operation of the tube at pressures above 10^{-2} torr will damage the filament.
2. Inhomogeneities in the radio frequency electric field between electrodes D and H may give rise to higher harmonics resulting in indications at mass numbers $\frac{M}{2}$, $\frac{M}{3}$, etc. There will be individual, but also day to day difference in the occurrence of these harmonics.

The higher harmonics are liable to interfere with the accuracy of the measurements. However, the spurious effect can easily be recognized and it can be eliminated at the cost of some sensitivity. Peaks whose height alter considerably when the value of V_{HD} is changed contain a higher harmonic component, and this can be removed by lowering that voltage or the gas pressure, or both. A further method ... which is also likely to reduce the sensitivity of the measurement ... is to add a negative bias of a few tenth of a volt to the radio-frequency voltage on electrode H. Conversely, it should be noted that liability to higher-harmonic interference is increased by raising V_{HD} and the gas pressure in the tube.

SOME MASS SPECTRA MEASURED WITH OMEGATRON

	1	2	4	12	13	14	15	16	17	18	19	20	24	25	26	27	28	29	30	31	32	33	34	35	36	37	38	39	40	41	43	44	c
H ₂	100																															4.0	
N ₂						7.4	0.03										100	0.75															11
CO				3.3	0.04	0.55		1.3									100	0.88	0.2		0.02												11.8
CO ₂				3.5	0.03	0.08		7.8									11.5	0.1			0.4										100	14	
H ₂ O	1							1.8	21	100	14	0.23										0.13										10.5	
He	100																															1.8	
A												14.2													0.38	0.06	100					13	
CH ₄			1.8	5.7	12.5	81	100	2.7																								7.4	
C ₂ H ₂	3.5	1.4	4.0	0.3									5.1	19	100	3.2																15.5	
C ₂ H ₄			0.6	1.0	2.3	0.3	0.4						2.0	6.8	47	51.5	100	3.3														11.6	
C ₂ H ₆			0.2	0.55	2.0	3.1	0.15						0.5	2.7	18.1	27.6	100	20.5	25.9	0.54												14	
C ₃ H ₈			0.18	0.36	1.13	3.8	0.12						0.13	0.64	8.2	39.1	60.3	100	2.1							0.64	4.1	5.8	20	16	30.8	44.9	9

INDEX OF TYPENUMBERS

Type No.	Section	Type No.	Section	Type No.	Section
C3m	SQ	EC81	SQ	5718	SQ
CIG-22	M	EC90	SQ	5719	SQ
CIG-82	M	EC91	SQ	5725	SQ
D3a	SQ	EC1000	SQ	5726	SQ
DL68	SQ	EC8010	SQ	5840	SQ
DM160	SQ	ECC2000	SQ	5842	SQ
E1T	SQ	EIP-12	M	5899	SQ
E55L	SQ	IOG-12	M	5902	SQ
E80CC	SQ	IOG-13T	M	5920	See E90CC
E80CF	SQ	IOG-17	M	6021	SQ
E80F	SQ	IOG-18	M	6080	SQ
E80L	SQ	IOG-18N	M	6084	See E80F
E81L	SQ	IOG-19N	M	6085	See E80CC
E82CC	SQ	IOG-71	M	6086	See 18042
E83CC	SQ			6111	SQ
E83F	SQ	RI-12	M	6112	SQ
E84L	SQ	TH71	M	6189	SQ
E86C	SQ	TH73	M	6201	SQ
E88C	SQ	TH75	M	6227	See E80L
E88CC	SQ			6370	See E1T
E90CC	SQ			6681	See E83CC
E130L	SQ	XL7900	M	6686	See E81L
E180CC	SQ	6AQ4	See EC91	6688	See E180F
E180F	SQ	6C4	See EC90	6689	See E83F
E182CC	SQ	6Q4	See EC80	6922	See E88CC
E186F	SQ	6R4	See EC81	6977	See DM160
E188CC	SQ	12AX7S	SQ	7062	See E180CC
E235L	SQ	4065	M	7119	See E182CC
E236L	SQ	4066	M	7308	See E188CC
E280F	SQ	4068	M	7320	See E84L
E282F	SQ	4069	M	7534	See E130L
E283CC	SQ	5636	SQ	7643	See E80CF
E288CC	SQ	5639	SQ	7721	See D3a
E810F	SQ	5642	SQ	7722	See E280F
EC80	SQ	5654	SQ	7737	See E186F

SQ = Special Quality Tubes

M = Miscellaneous

SQ = Special Quality Tubes
M = Miscellaneous

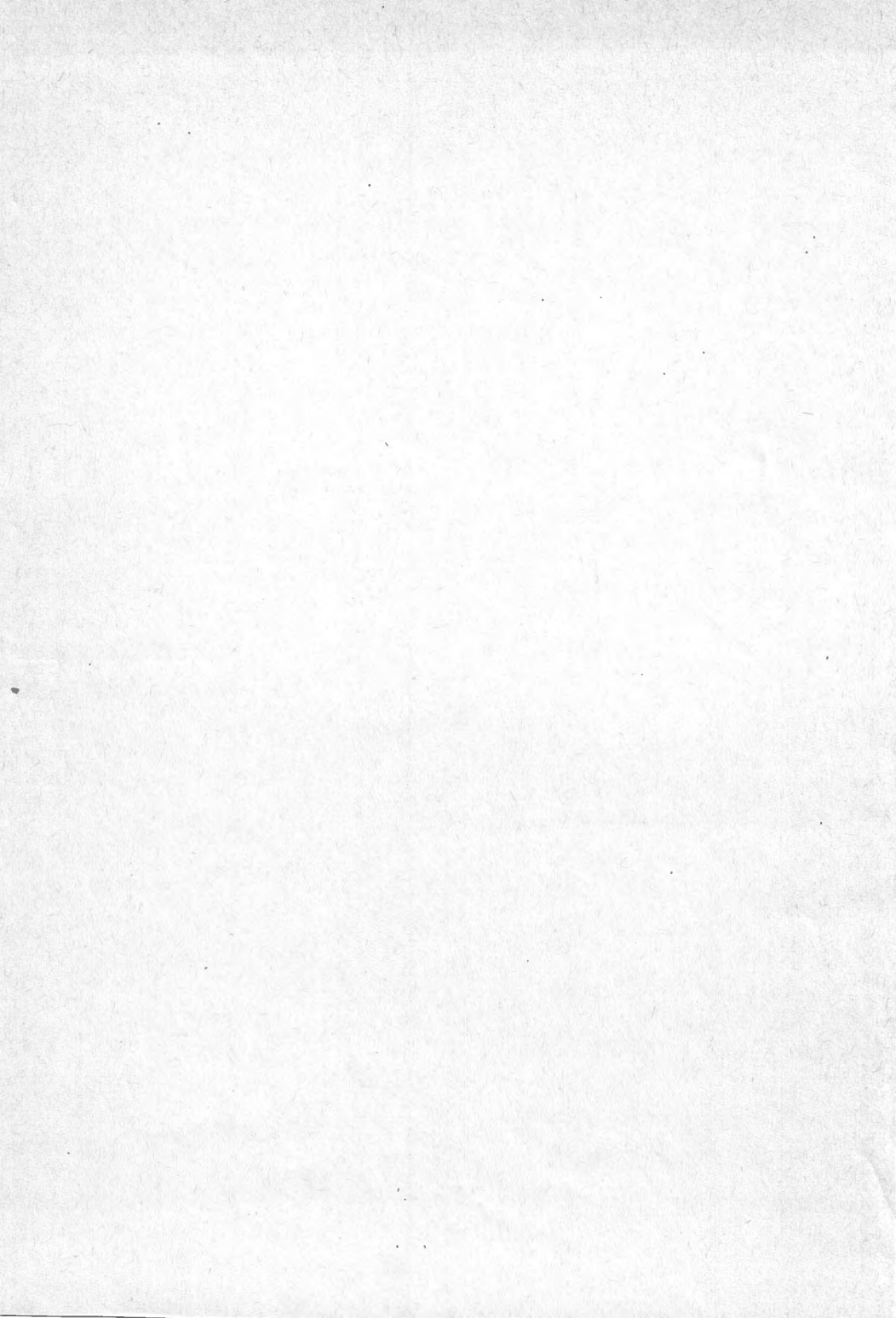

Special Quality tubes

Miscellaneous devices

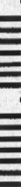

Special Quality tubes

Miscellaneous devices

