

# Foreword

This abridged catalogue is issued with the object of presenting in handy and compact form the essential particulars of the comprehensive range of Mullard Master Valves.

The valves are grouped in seven ranges, and each section is prefaced by an index sheet giving the application and prices of each valve in the range. Receiving valves are listed in decreasing order of impedance, and output valves in increasing order of dissipation.

Attention is called to the technical appendix on pages 65 to 77, wherein will be found much useful information and many circuit diagrams.

## CONTENTS

	—	PAGES
Mullard 2-volt range	- -	3-15
Mullard 4-volt range	- -	16-23
Mullard 6-volt range	- -	24-33
Mullard Indirectly-heated A.C.		
Mains range	- - -	34-43
Mullard Directly-heated A.C.		
Mains Output range	- -	44-53
Mullard A.C. Mains Pentode		
range	- - - -	54-58
Mullard Full-wave Rectifier		
range	- - - -	59-64
Technical Appendix	- -	65-77

# MULLARD RECEIVING VALVES

for use with

## 2-VOLT L.T. ACCUMULATOR

Type.	Application.	For particulars see page	PRICE.	
			In Gt. Britain	In I.F.S.
PM.12	Screened-grid high frequency amplifier ..	4	20/-	22/-
PM.1DG	Combined oscillator and first detector in super-heterodyne receivers .. ..	5	20/-	22/-
PM.1A	High frequency amplifier or detector followed by resistance-capacity coupling ..	6	8/6	9/6
PM.1HF	High frequency amplifier in stages not employing screened-grid valves. Detector or L.F. amplifier followed by transformer coupling .. ..	7	8/6	9/6
PM.1HL	High frequency amplifier in stages not employing screened-grid valves. Detector followed by transformer or certain R.C. couplings .. ..	8	8/6	9/6
PM.1LF	Detector or L.F. amplifier followed by transformer coupling	9	8/6	9/6
PM.2DX	Super detector or L.F. amplifier followed by transformer coupling	10	8/6	9/6
PM.2	Small power output valve .. ..	11	10/6	11/9
PM.2A	Small power output valve .. ..	12	10/6	11/9
PM.202	Super-power valve ..	13	13/6	15/-
PM.252	Super-power valve ..	14	13/6	15/-
PM.22	Pentode output valve..	15	20/-	22/-

**Mullard the Master Valve**

# Type P.M.12



## SCREENED GRID VALVE

Price 20/-

(In I.F.S. 22/-)

### Application.

Screened-grid high frequency amplifying stages.

### Operating Data.

Max. Filament Voltage	2.0 volts
Filament Current	0.15 amp.
Max. Anode Voltage	150 volts
Positive Screen Voltage	75 volts

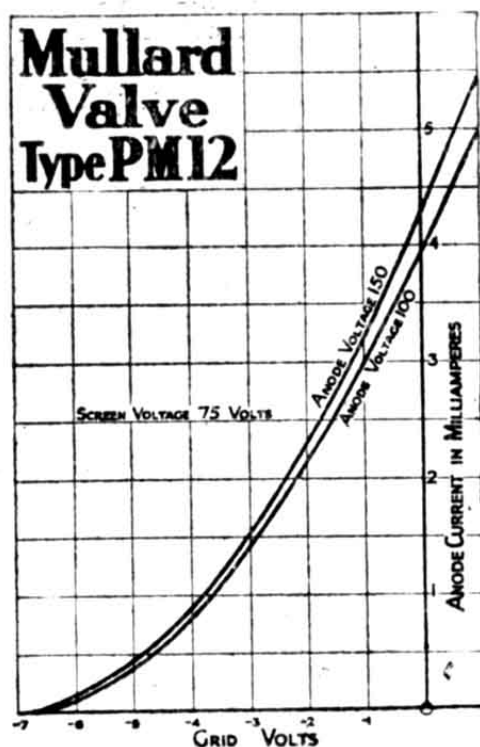

### Characteristics.

*Anode Impedance	.. .. .	180,000 ohms
Amplification Factor	.. .. .	200
*Mutual Conductance	.. .. .	1.1 mA./volt

\*At Anode Volts 100 ; Screen Volts 75 ; Grid Volts, Zero.

## Mullard the Master Valve

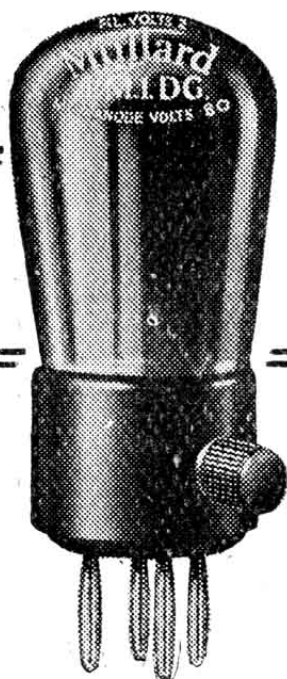

# Type P.M.1DG.

## DOUBLE GRID VALVE

Price 20/-  
(In I.F.S. 22/-)

### Application.

Combined oscillator and first detector in super-heterodyne receivers.

### Operating Data.

Max. Filament Voltage 2.0 volts  
 Filament Current 0.1 amp.  
 Max. Anode Voltage 80 volts  
 Max. Auxiliary Grid Voltage 20 volts

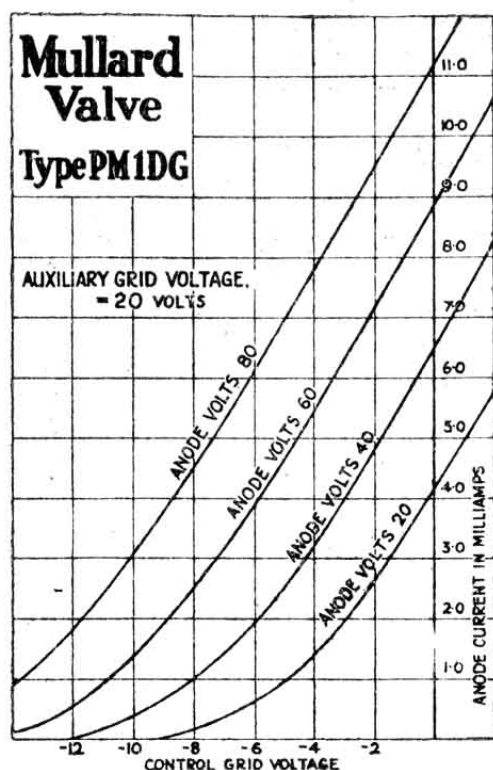

### Characteristics.

- \*Mutual Conductance .. .. 0.8 mA./volt
- \*At Anode Volts 20 ; Auxiliary Grid Volts 20 ; Control Grid Volts, Zero.

**Mullard the Master Valve**

# Type P.M.1A.

## HIGH IMPEDANCE VALVE

Price 8/6  
(In I.F.S. 9/6)

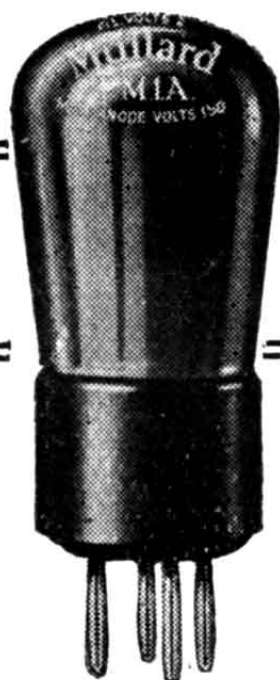

### Application.

High frequency amplifier or detector followed by resistance - capacity coupling.

### Operating Data.

Max. Filament Voltage  
2.0 volts

Filament Current 0.1 amp.

Max. Anode Voltage  
150 volts

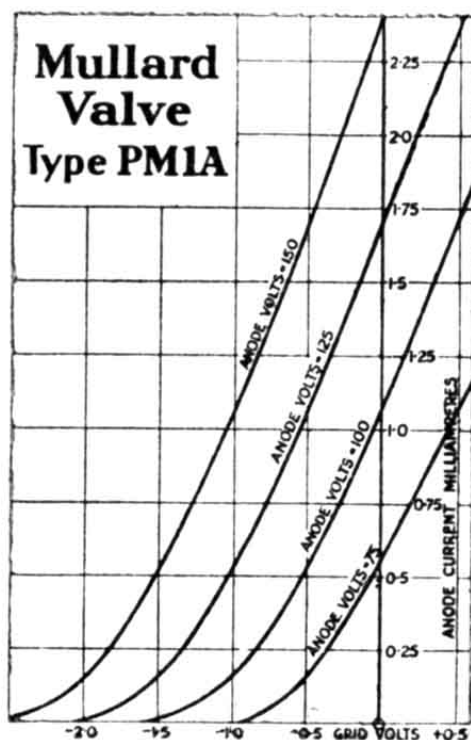

### Characteristics.

*Anode Impedance	..	..	..	41,600 ohms
*Amplification Factor	..	..	..	50
*Mutual Conductance	..	..	..	1.2 mA./volt

\*At Anode Volts 100 ; Grid Volts, Zero.

**Mullard the Master Valve**

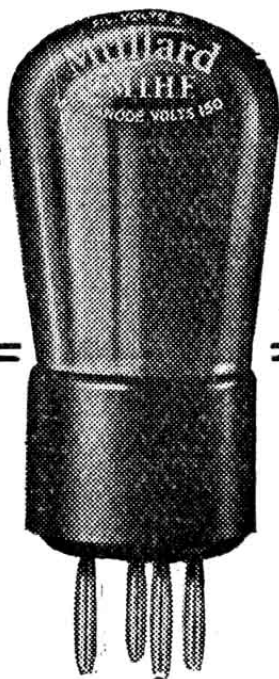

## Type P.M.1 H.F.

### MEDIUM IMPEDANCE VALVE

Price 8/6  
(In I.F.S. 9/6)

#### Application.

High frequency amplifier in stages not employing screened-grid valves. Detector or l.f. amplifier followed by transformer coupling.

#### Operating Data.

Max. Filament Voltage  
2.0 volts  
Filament Current 0.1 amp.  
Max. Anode Voltage  
150 volts

#### Characteristics.

\*Anode Impedance  
22,500 ohms  
\*Amplification Factor 18  
\*Mutual Conductance  
0.8 mA./volt  
\*At Anode Volts 100; Grid  
Volts, Zero.

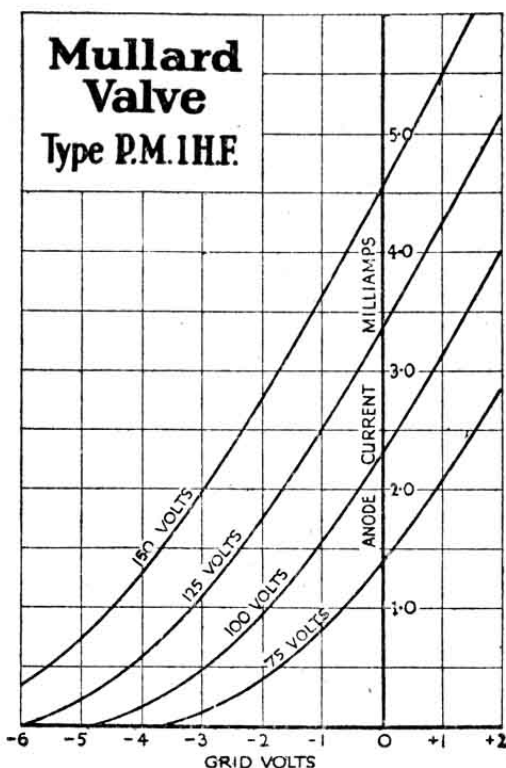

#### Grid Bias Table.

Anode Voltage.	Approx. Neg. Grid Bias Voltage.	Approx. Anode Current (mA).
75	1.5	0.6
100	1.5 to 3.0	0.9
125	3.0	1.2
150	3.0 to 4.5	1.5

**Mullard the Master Valve**

# Type P.M.1 H.L.

## MEDIUM IMPEDANCE VALVE

Price 8/6  
(In I.F.S. 9/6)

### Application.

High frequency amplifier in stages not employing screened-grid valves—particularly choke-coupled stages. Detector followed by transformer or certain R.C. couplings.

### Operating Data.

Max. Filament Voltage 2.0 volts  
Filament Current 0.1 amp.  
Max. Anode Voltage 150 volts

### Characteristics.

- \*Anode Impedance 18,500 ohms
- \*Amplification Factor 28
- \*Mutual Conductance 1.5 mA./volt
- \*At Anode Volts 100; Grid Volts, Zero.

### Grid Bias Table.

Anode Voltage.	Approx. Neg. Grid Bias Voltage.	Approx. Anode Current (mA).
100	1.5	1.0
125	1.5 to 3.0	1.2
150	3.0	1.4

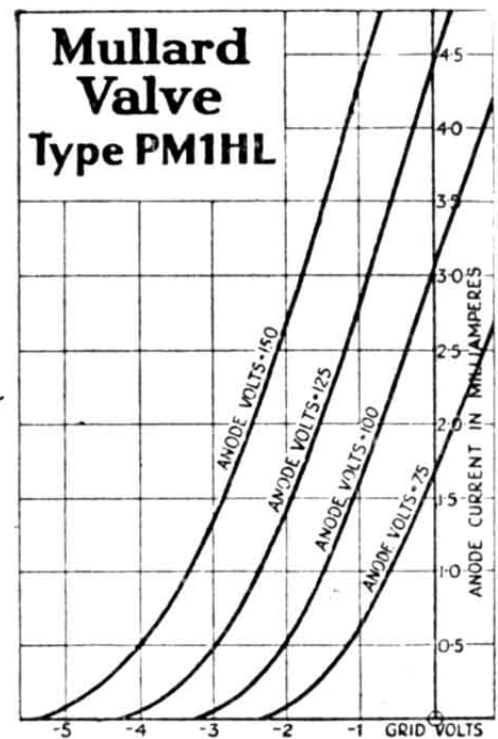
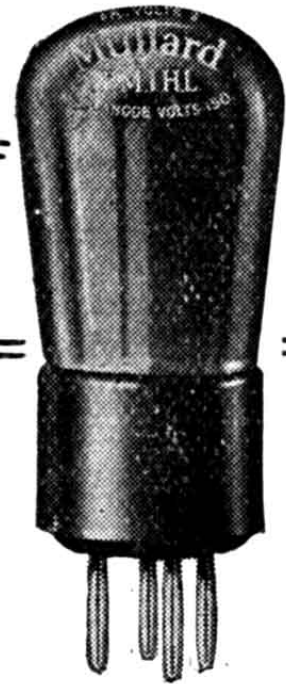

**Mullard the Master Valve**



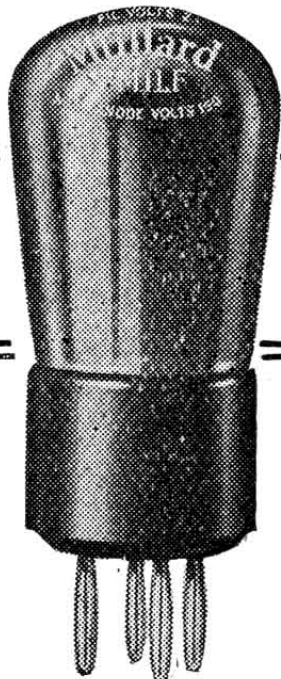

# Type P.M.1 L.F.

## MEDIUM IMPEDANCE VALVE

Price 8/6  
(In I.F.S. 9/6)

### Application.

Detector or l.f. amplifier followed by transformer coupling.

### Operating Data.

Max. Filament Voltage 2.0 volts  
Filament Current 0.1 amp.  
Max. Anode Voltage 150 volts

### Characteristics.

\*Anode Impedance 12,000 ohms  
\*Amplification Factor 11  
\*Mutual Conductance 0.9 mA./volt

\*At Anode Volts 100; Grid Volts, Zero.

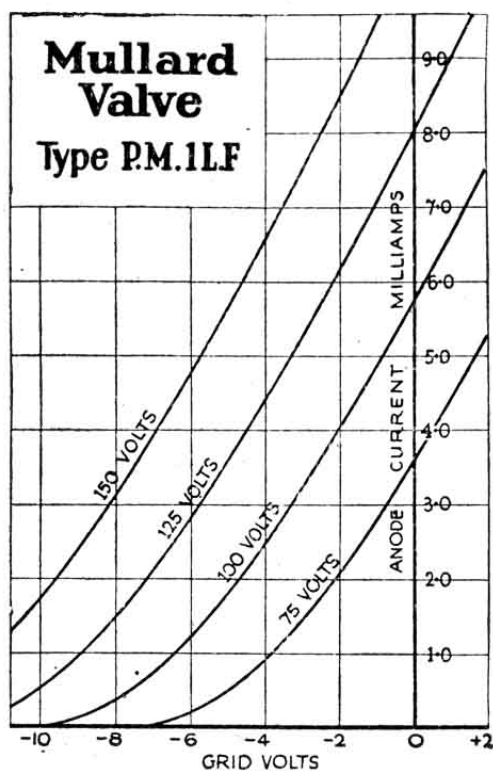

### Grid Bias Table.

Anode Voltage.	Approx. Neg. Grid Bias Voltage.	Approx. Anode Current (mA).
75	3.0	1.6
100	4.5	2.2
125	6.0	2.8
150	7.5	3.4

**Mullard the Master Valve**

# Type P.M. 2D.X.

## SUPER DETECTOR VALVE

Price 8/6  
(In I.F.S. 9/6)

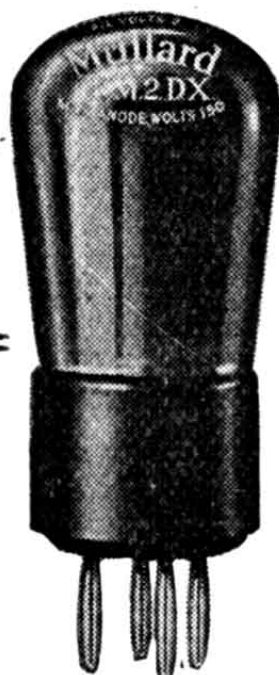

### Application.

Detector or l.f. amplifier followed by transformer coupling.

### Operating Data.

Max. Filament Voltage 2.0 volts  
Filament Current 0.1 amp.  
Max. Anode Voltage 150 volts

### Characteristics.

- \*Anode Impedance 10,000 ohms
- \*Amplification Factor 17
- \*Mutual Conductance 1.7 mA./volt
- \*At Anode Volts 100; Grid Volts, Zero.

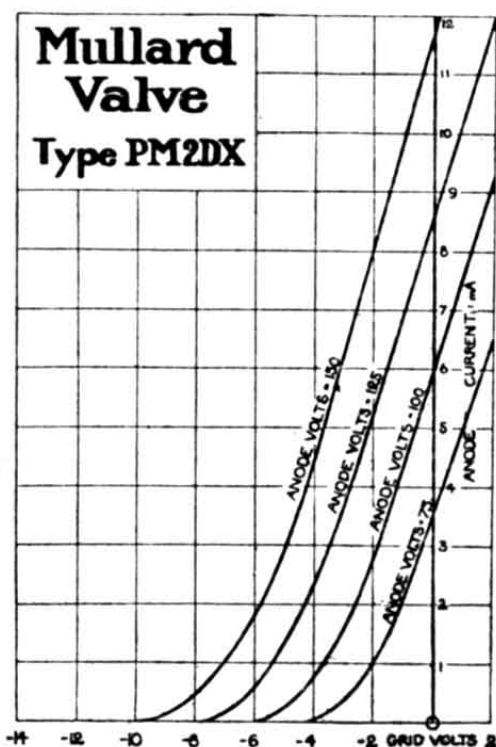

### Grid Bias Table.

Anode Voltage.	Approx. Neg. Grid Bias Voltage.	Approx. Anode Current (mA).
100	3.0	1.25
125	4.5	2.0
150	4.5 to 6.0	2.5

**Mullard the Master Valve**

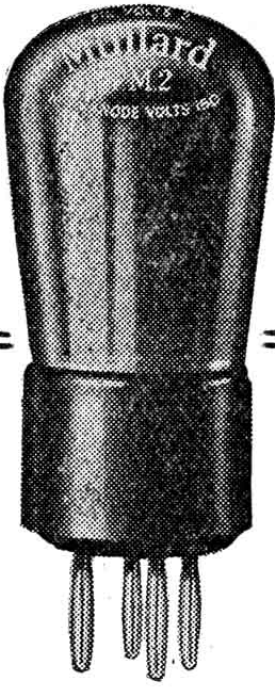

## Type P.M.2.

### “ POWER ” OUTPUT VALVE

Price 10/6  
(In I.F.S. 11/9)

#### Application.

Small power output valve.

#### Characteristics.

- \*Anode Impedance 4,400 ohms
- \*Amplification Factor 7.5
- \*Mutual Conductance 1.7 mA./Volt
- \*At Anode Volts 100 ; Grid Volts, Zero.

#### Operating Data.

Max. Filament Voltage 2.0 volts  
 Filament Current 0.2 amp.  
 Max. Anode Voltage 150 volts

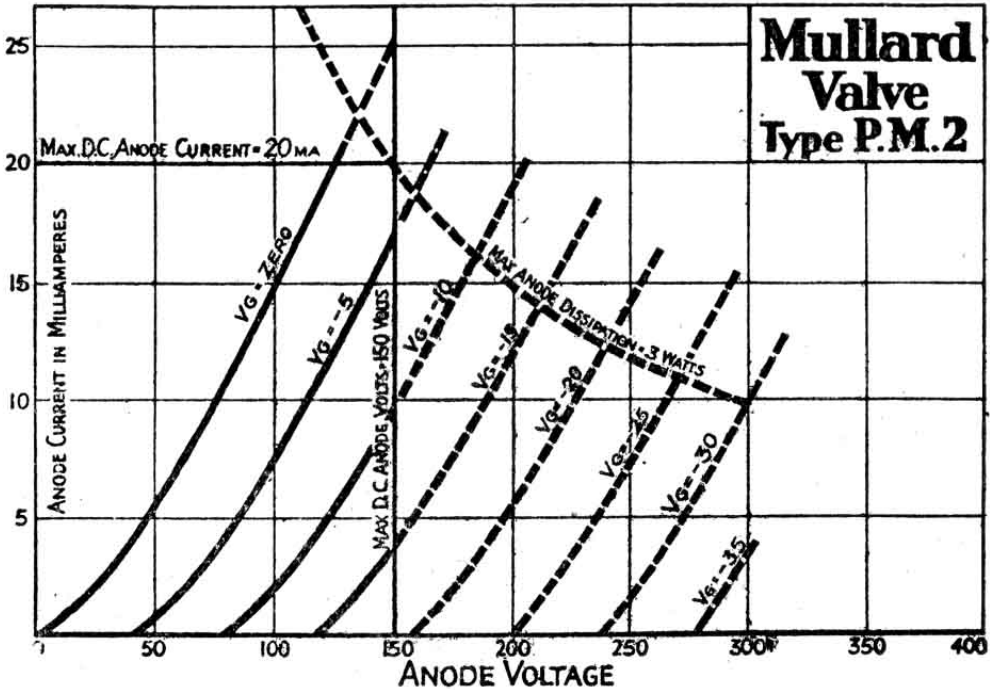

#### Grid Bias Table.

Anode Voltage.	Approx. Neg. Grid Bias Voltage.	Approx. Anode Current (mA).
100	7.5	4.0
125	9.0 to 10.5	5.3
150	12.0	6.6

**Mullard the Master Valve**

# Type P.M.2A.

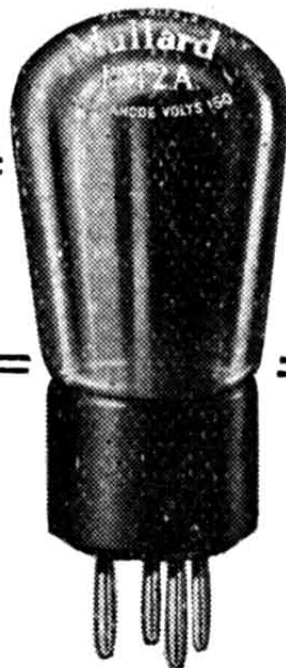

## “POWER” OUTPUT VALVE

Price 10/6  
(In I.F.S. 11/9)

### Application.

Small power output valve

### Characteristics.

- \*Anode Impedance 3,600 ohms
- \*Amplification Factor 12.5
- \*Mutual Conductance 3.5 mA./volt
- \*At Anode Volts 100 ; Grid Volt, Zero.

### Operating Data.

- Max. Filament Voltage 2.0 volts
- Filament Current 0.2 amp.
- Max. Anode Voltage 150 volts

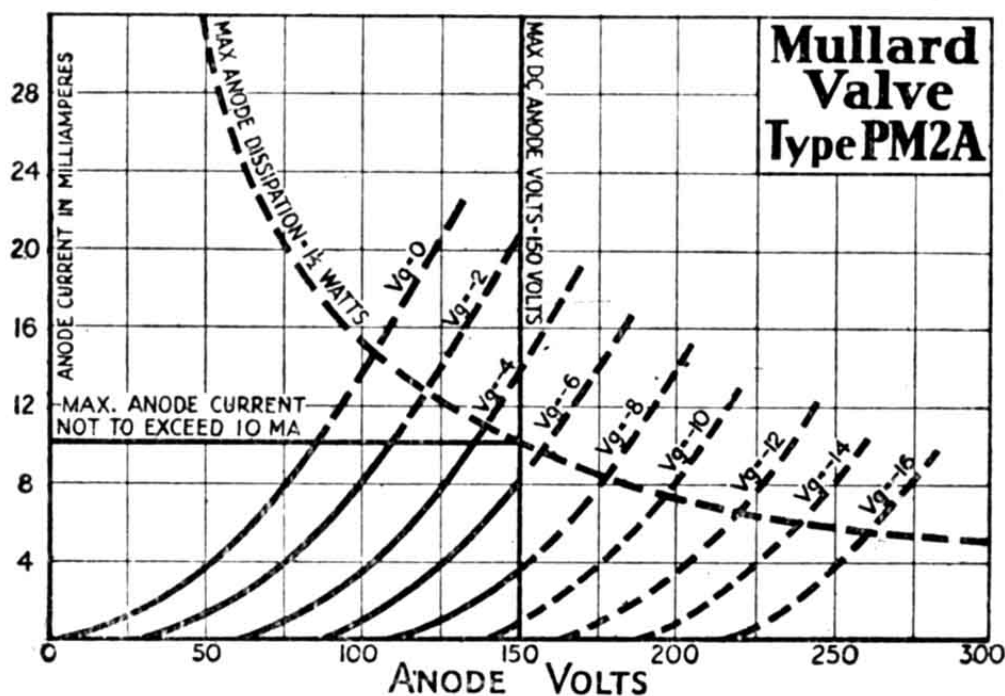

### Grid Bias Table.

Anode Voltage.	Approx. Neg. Grid Bias Voltage.	Approx. Anode Current (mA).
100	3.0	5.0
125	4.5	6.5
150	6.0	8.0

**Mullard the Master Valve**

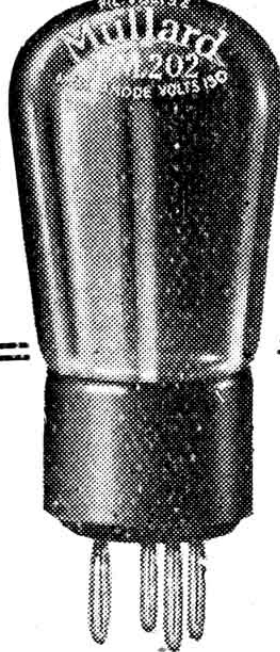

# Type P.M.202

**“ SUPER POWER ”  
OUTPUT VALVE**

Price 13/6  
(In I.F.S. 15/-)

### Application.

Super-power valve.

### Characteristics.

- \*Anode Impedance 2,000 ohms
- \*Amplification Factor 7
- \*Mutual Conductance 3.5 mA./volt
- \*At Anode Volts 100 ; Grid Volts, Zero.

### Operating Data.

- Max. Filament Voltage 2.0 volts
- Filament Current 0.2 amp.
- Max. Anode Voltage 150 volts

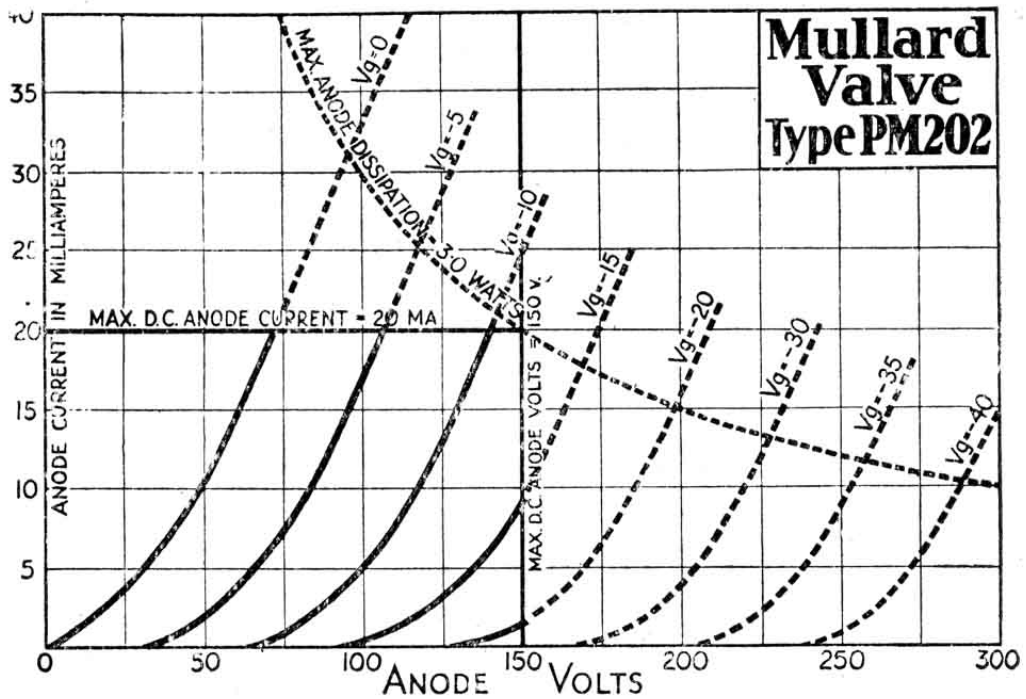

**Mullard  
Valve  
Type PM202**

### Grid Bias Table.

Anode Voltage.	Approx. Neg. Grid Bias Voltage.	Approx. Anode Current (mA).
75	4.5	8.0
100	7.5	10.0
125	9.0 to 10.5	14.0
150	12.0 to 15.0	14.0

**Mullard the Master Valve**

# Type P.M.252

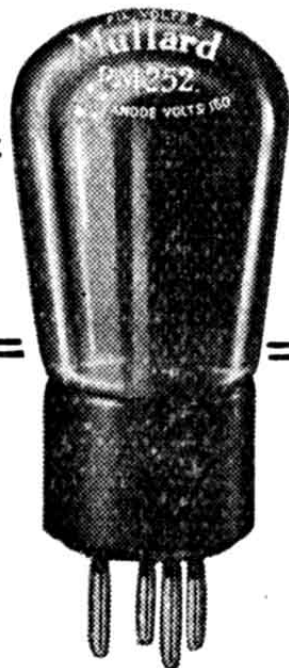

## “ SUPER-POWER ” OUTPUT VALVE

Price 13/6  
(In I.F.S. 15/-)

### Application.

Super-power valve.

### Characteristics.

- \*Anode Impedance 1,900 ohms
- \*Amplification Factor 7.0
- \*Mutual Conductance 3.7 mA./volt
- \*At Anode Volts 100; Grid Volts, Zero.

### Operating Data.

- Max. Filament Voltage 2.0 volts
- Filament Current 0.4 amp.
- Max. Anode Voltage 150 volts

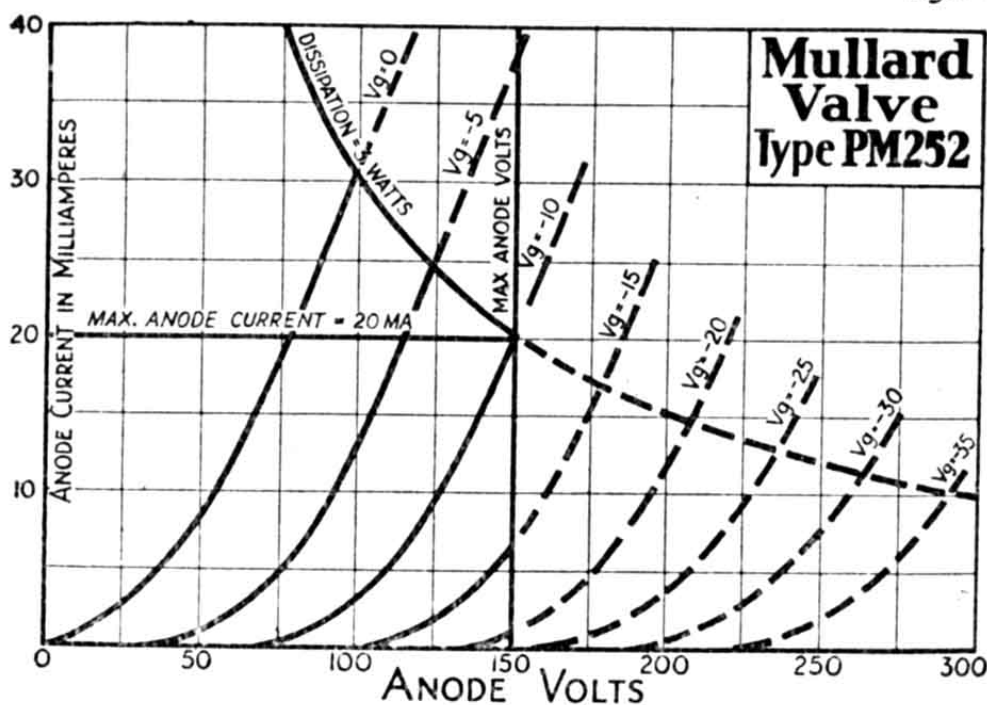

### Grid Bias Table.

Anode Voltage.	Approx. Neg. Grid Bias Voltage.	Approx. Anode Current (mA).
100	6.0	11.0
125	7.5 to 10.5	14.0
150	9.0 to 12.0	17.0

**Mullard the Master Valve**

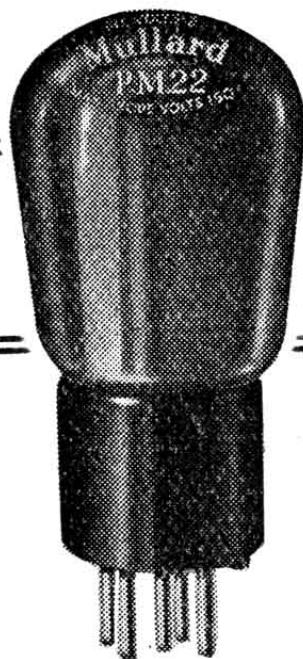

# Type P.M.22.

## PENTODE OUTPUT VALVE

Price 20/-  
(In I.F.S. 22/-)

### Application.

Five-electrode output valve  
(Pentode).

### Characteristics.

\*Mutual Conductance 1.3 mA./volt  
\*At Anode Volts 100 ;  
Auxiliary Grid Volts 100 ;  
Control Grid Volts, Zero.

### Operating Data.

Max. Filament Voltage 2.0 volts  
Filament Current 0.3 amp.  
Max. Anode Voltage 150 volts  
Max. Auxiliary Grid Voltage 150 volts

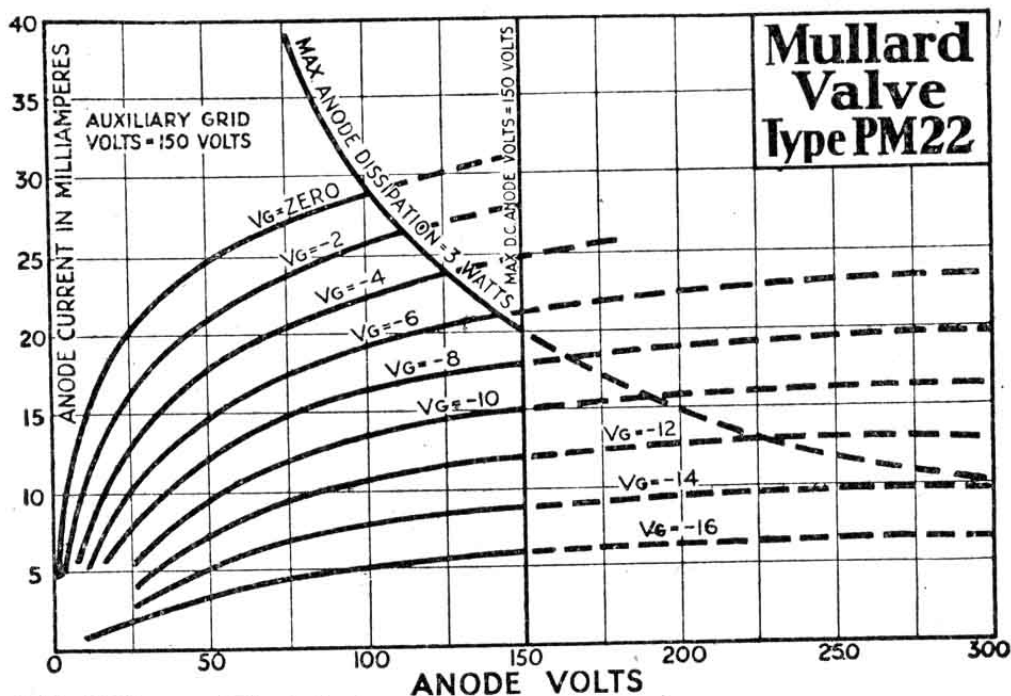

### Grid Bias Table.

Auxiliary Grid Voltage.	Approx. Neg. Grid Bias Voltage.	Approx. Anode Current (mA).
100	6.0	9.0
125	8.0	12.0
150	10.0	15.0

**Mullard the Master Valve**

# MULLARD RECEIVING VALVES

## for use with

### 4-VOLT L.T. ACCUMULATOR

Type.	Application.	For particulars see page	PRICE	
			In Gt. Britain	In I.F.S.
PM.14	Screened-grid high frequency amplifier ..	17	20/-	22/-
PM.3A	High frequency amplifier or detector followed by resistance capacity coupling ..	18	8/6	9/6
PM.3	Detector or low frequency amplifier followed by transformer coupling .. ..	19	8/6	9/6
PM.4D X	Super detector or low frequency amplifier followed by transformer coupling ..	20	8/6	9/6
PM.4	Small power valve ..	21	10/6	11/9
PM.254	Super-power valve ..	22	13/6	15/-
PM.24	Pentode output valve	23	20/-	22/-

## Mullard the Master Valve





# Type P.M.14

## SCREENED GRID VALVE

Price 20/-  
(In I.F.S. 22/-)

### Application.

Screened-grid high frequency amplifying stages.

### Operating Data.

Max. Filament Voltage  
4.0 volts  
Filament Current  
0.075 amp.  
Max. Anode Voltage  
150 volts  
Positive Screen Voltage  
75 volts

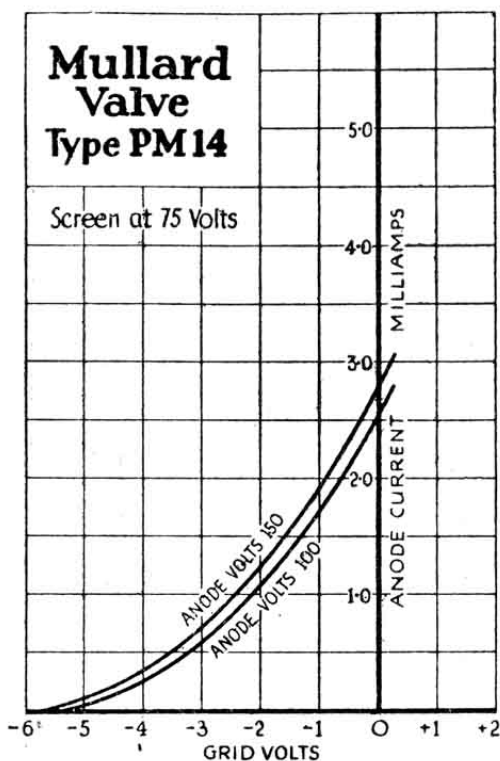

### Characteristics.

\*Anode Impedance .. .. . 230,000 ohms  
\*Amplification Factor .. .. . 200  
\*Mutual Conductance .. .. . 0.87 mA./volt  
\*At Anode Volts 100 ; Screen Volts 75 ; Grid Volts, Zero.

**Mullard the Master Valve**

# Type P.M.3A.

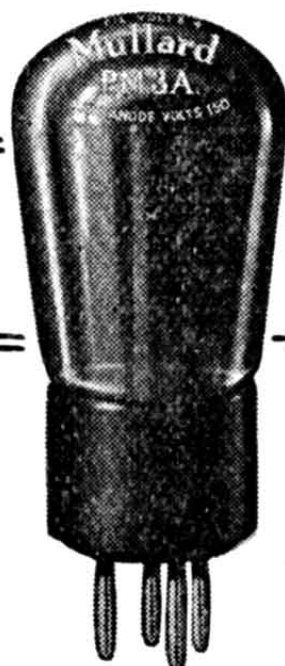

## HIGH IMPEDANCE VALVE

Price 8/6  
(In I.F.S. 9/6)

### Application.

High frequency amplifier or detector followed by resistance-capacity coupling.

### Operating Data.

Max. Filament Voltage 4.0 volts  
Filament Current 0.075 amp.  
Max. Anode Voltage 150 volts

### Characteristics.

\*Anode Impedance 55,000 ohms  
\*Amplification Factor 38  
\*Mutual Conductance 0.66 mA./volt  
\*At Anode Volts 100; Grid Volts, Zero.

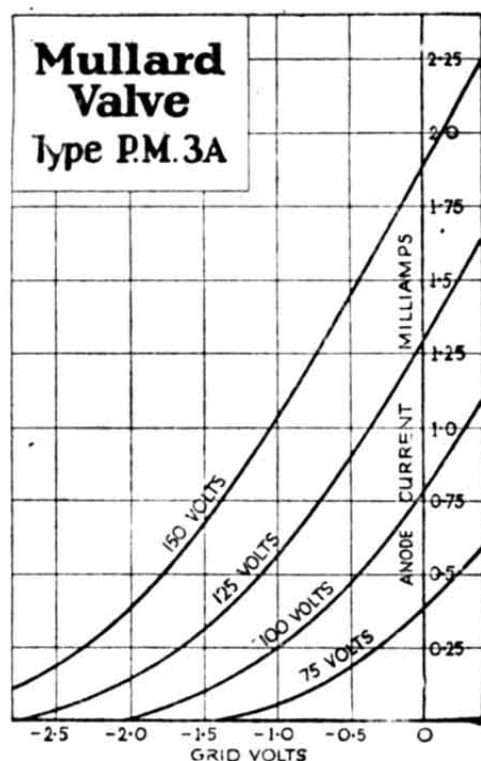

### Grid Bias Table.

Anode Voltage.	Approx. Neg. Grid Bias Voltage.	Approx. Anode Current (mA).
75	0	0.35
100	0 to 1.5	0.45
125	0 to 1.5	0.55
150	1.5	0.65

**Mullard the Master Valve**

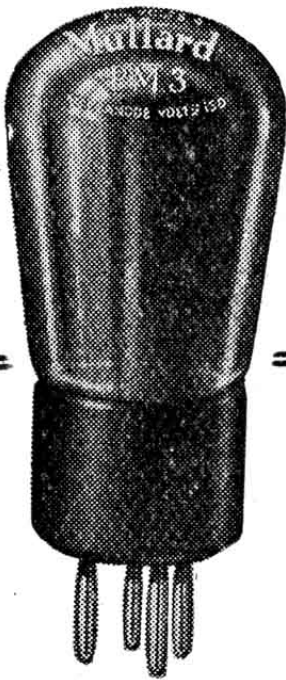

## Type P.M.3

### MEDIUM IMPEDANCE VALVE

Price 8/6  
(In I.F.S. 9/6)

#### Application.

Detector or low frequency amplifier followed by transformer coupling.

#### Operating Data.

Max. Filament Voltage  
4.0 volts  
Filament Current  
0.075 amp.  
Max. Anode Voltage  
150 volts

#### Characteristics.

\*Anode Impedance  
13,000 ohms  
\*Amplification Factor 14  
\*Mutual Conductance  
1.05 mA./volt  
\*At Anode Volts 100; Grid  
Volts, Zero.

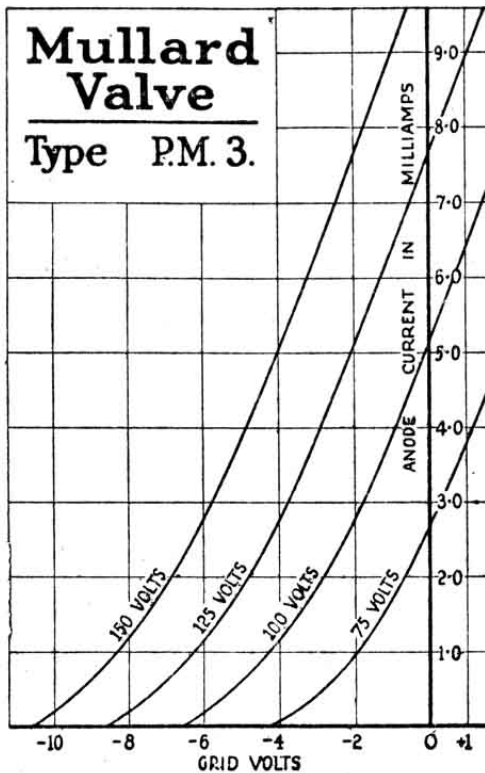

#### Grid Bias Table.

Anode Voltage.	Approx. Neg. Grid Bias Voltage.	Approx. Anode Current (mA).
75	1.5	1.0
100	3.0	1.6
125	4.5	2.2
150	6.0	2.8

**Mullard the Master Valve**

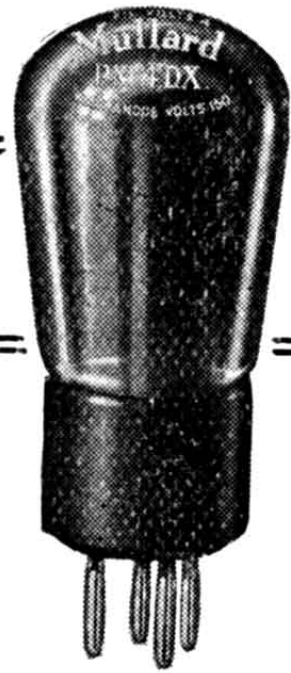

# Type P.M.4D.X.

## SUPER DETECTOR VALVE

Price 8/6  
(In I.F.S. 9/6)

### Application.

Detector or low frequency amplifier followed by transformer coupling.

### Operating Data.

Max. Filament Voltage 4.0 volts  
Filament Current 0.1 amp.  
Max. Anode Voltage 150 volts

### Characteristics.

\*Anode Impedance 7,500 ohms  
\*Amplification Factor 15  
\*Mutual Conductance 2.0 mA./volt  
\*At Anode Volts 100; Grid Volts, Zero.

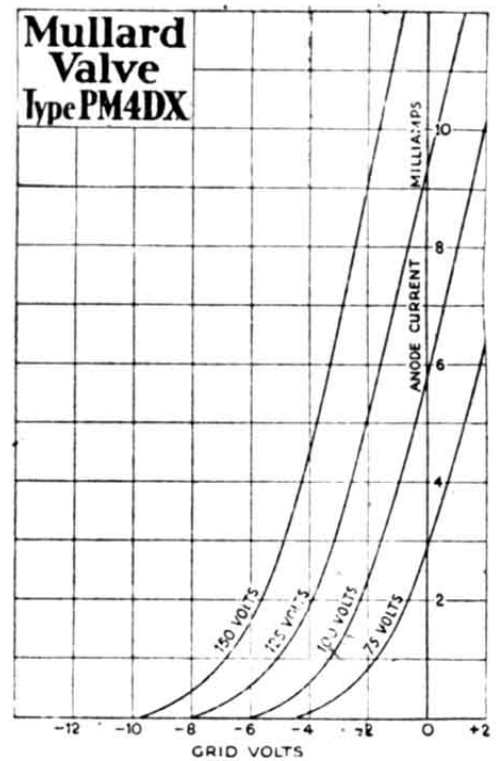

### Grid Bias Table.

Anode Voltage.	Approx. Neg. Grid Bias Voltage.	Approx. Anode Current (mA).
75	0 to 1.5	1.0
100	1.5 to 3.0	1.5
125	3.0 to 4.5	2.0
150	4.5 to 6.0	2.5

**Mullard the Master Valve**

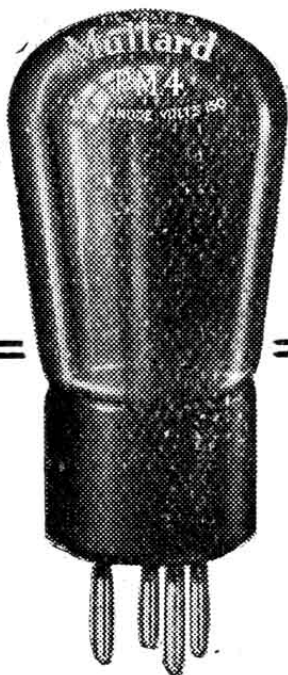

## Type P.M.4

### POWER OUTPUT VALVE

Price 10/6  
(In I.F.S. 11/9)

#### Application.

Small power output valve.

#### Characteristics.

- \*Anode Impedance 4,000 ohms
- \*Amplification Factor 8.0
- \*Mutual Conductance 2.0 mA./volt
- \*At Anode Volts 100; Grid Volts, Zero.

#### Operating Data.

Max. Filament Voltage 4.0 volts  
 Filament Current 0.1 amp.  
 Max. Anode Voltage 150 volts

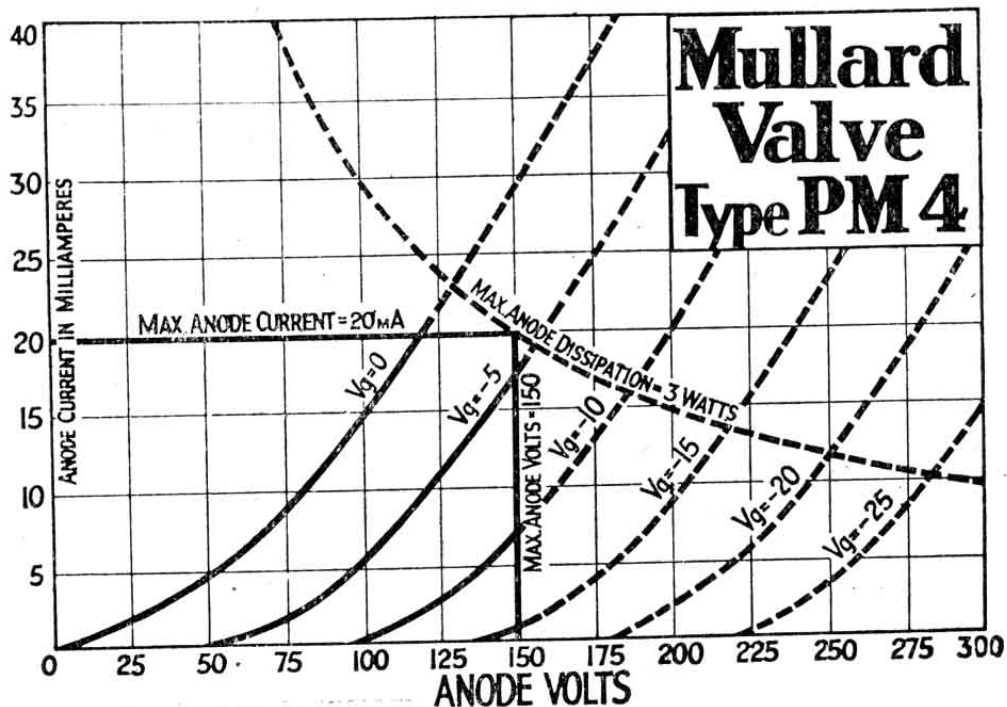

#### Grid Bias Table.

Anode Voltage.	Approx. Neg. Grid Bias Voltage.	Approx. Anode Current (mA).
75	3.0	4.0
100	5.0	5.5
125	7.0	7.5
150	8.0	10.0

**Mullard the Master Valve**

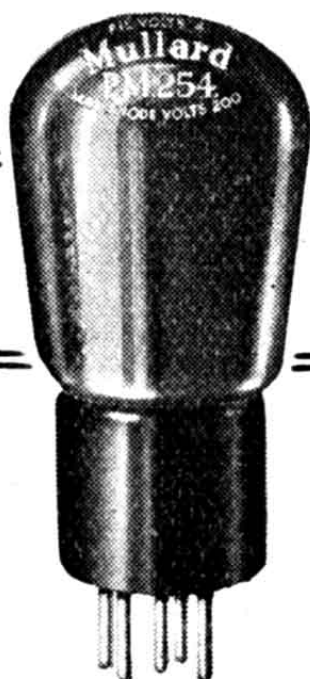

# Type P.M.254

## SUPER-POWER OUTPUT VALVE

Price 13/6  
(In I.F.S. 15/-)

### Application.

Super power output valve.

### Characteristics.

- \*Anode Impedance 2,150 ohms
- \*Amplification Factor 6.5
- \*Mutual Conductance 3.0 mA./volt
- \*At Anode Volts 100 ; Grid Volts, Zero.

### Operating Data.

- Max. Filament Voltage 4.0 volts
- Filament Current 0.2 amp.
- Max. Anode Voltage 200 volts

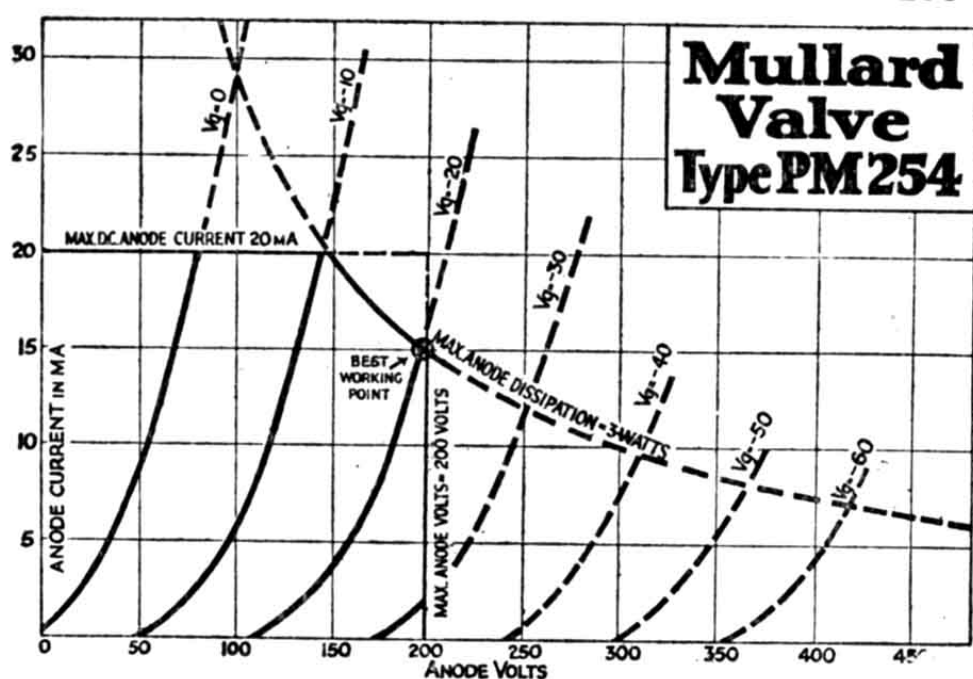

### Grid Bias Table.

Anode Voltage.	Approx. Neg. Grid Bias Voltage.	Approx. Anode Current (mA).
100	9.0	6.0
150	15.0	10.0
200	21.0	15.0

**Mullard the Master Valve**

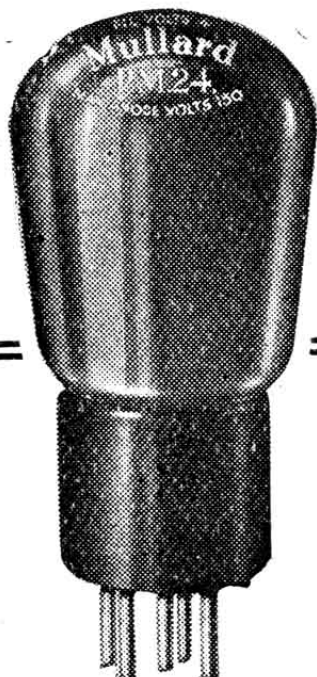

# Type P.M.24.

## FIVE ELECTRODE OUTPUT VALVE

Price 20/-  
(In I.F.S. 22/-)

### Application.

Five electrode output valve (Pentode).

### Operating Data.

Max. Filament Voltage 4.0 volts  
 Filament Current 0.15 amp.  
 Max. Anode Voltage 150 volts  
 Max. Auxiliary Grid Voltage 150 volts

### Characteristics.

\*Mutual Conductance 1.75 mA./volt  
 \*At Anode Volts 100 ; Auxiliary Grid Volts 100 ; Control Grid Volts, Zero.

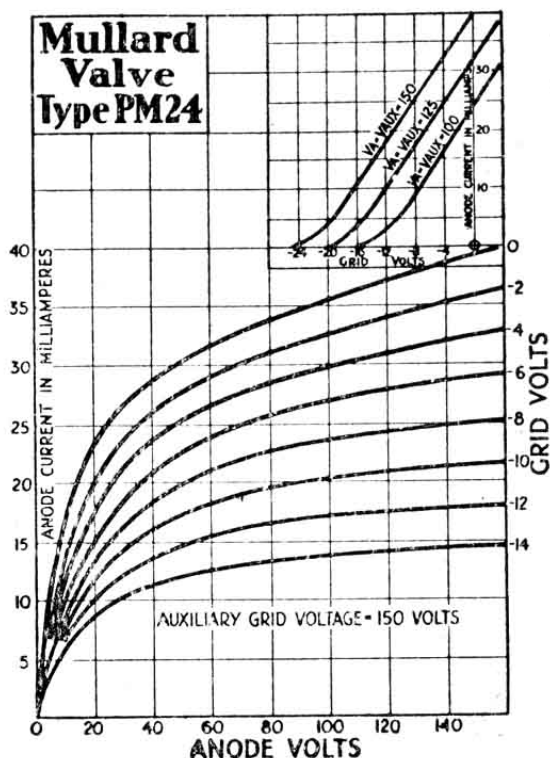

### Grid Bias Table.

Auxiliary Grid Voltage.	Approx. Neg. Grid Bias Voltage.	Approx. Anode Current (mA).
75	3	8
100	6	12
125	9	16
150	12	20

**Mullard the Master Valve**

# MULLARD RECEIVING VALVES

## for use with

### 6-VOLT L.T. ACCUMULATOR

Type.	Application.	For particulars see page	PRICE	
			In Gt. Britain	In I.F.S.
PM.16	Screened-grid high frequency amplifier ..	25	20/-	22/-
PM.5B	High frequency amplifier or detector followed by resistance-capacity coupling ..	26	8/6	9/6
PM.5D	Detector or low frequency amplifier followed by transformer or resistance-capacity coupling .. ..	27	8/6	9/6
PM.5X	Detector or low frequency amplifier followed by transformer coupling .. ..	28	8/6	9/6
PM.6D	Super detector or low frequency amplifier followed by transformer coupling ..	29	8/6	9/6
PM.6	Small power valve ..	30	10/6	11/9
PM.256	Super power valve ..	31	13/6	15/-
PM.256A	Super power valve ..	32	13/6	15/-
PM.26	Pentode output valve	33	20/-	22/-

## Mullard the Master Valve





# Type P.M.16

## SCREENED GRID VALVE

Price 20/-  
(In I.F.S. 22/-)

### Application.

Screened-grid high-frequency amplifying stages.

### Operating Data.

Max. Filament Voltage  
6.0 volts

Filament Current  
0.075 amp.

Max. Anode Voltage  
150 volts

Positive Screen Voltage  
75 volts

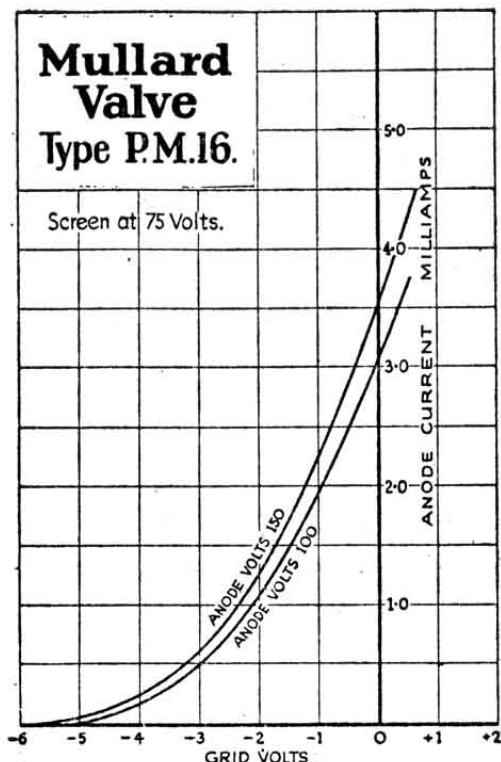

### Characteristics.

- \*Anode Impedance .. .. . 200,000 ohms
  - \*Amplification Factor .. .. . 200
  - \*Mutual Conductance .. .. . 1.0 mA./volt
- \*At Anode Volts 100; Positive Screen Volts 75; Grid Volts, Zero.

**Mullard the Master Valve**

# Type P.M.5B.

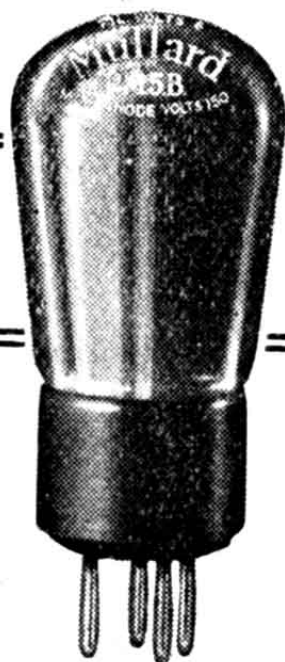

## HIGH IMPEDANCE VALVE

Price 8/6  
(In I.F.S. 9/6)

### Application.

High frequency amplifier or detector followed by resistance-capacity coupling.

### Operating Data.

Max. Filament Voltage 6.0 volts  
Filament Current 0.075 amp.  
Max. Anode Voltage 150 volts

### Characteristics.

- \*Anode Impedance 49,000 ohms
- \*Amplification Factor 40
- \*Mutual Conductance 0.85 mA./volt
- \*At Anode Volts 100; Grid Volts, Zero.

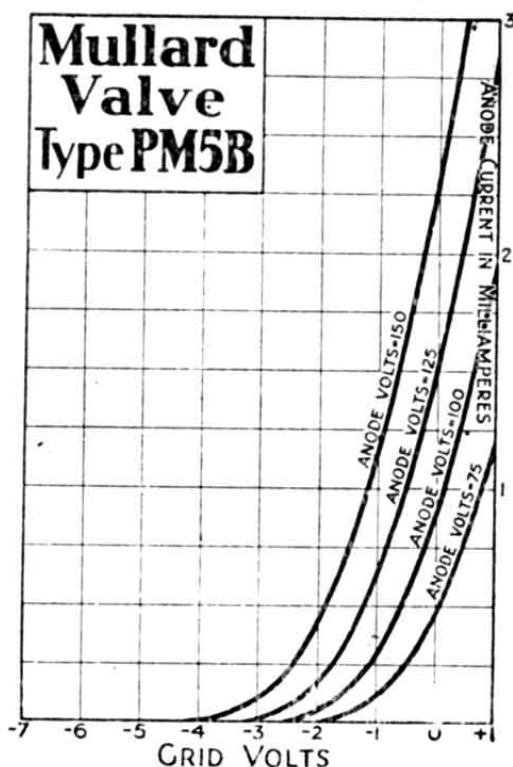

### Grid Bias Table.

Anode Voltage.	Approx. Neg. Grid Bias Voltage.	Approx. Anode Current (mA).
100	0 to 1.5	0.4
125	0 to 1.5	0.5
150	1.5	0.7

**Mullard the Master Valve**

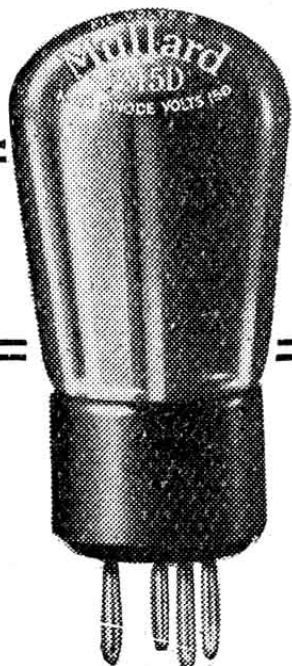

## Type P.M.5D.

### MEDIUM IMPEDANCE VALVE

Price 8/6  
(In I.F.S. 9/6)

#### Application.

Detector or low frequency amplifier followed by transformer or resistance-capacity coupling.

#### Operating Data.

Max. Filament Voltage 6.0 volts  
Filament Current 0.075 amp.  
Max. Anode Voltage 150 volts

#### Characteristics.

\*Anode Impedance 20,000 ohms  
\*Amplification Factor 26  
\*Mutual Conductance 1.3 mA./volt  
\*At Anode Volts 100; Grid Volts, Zero.

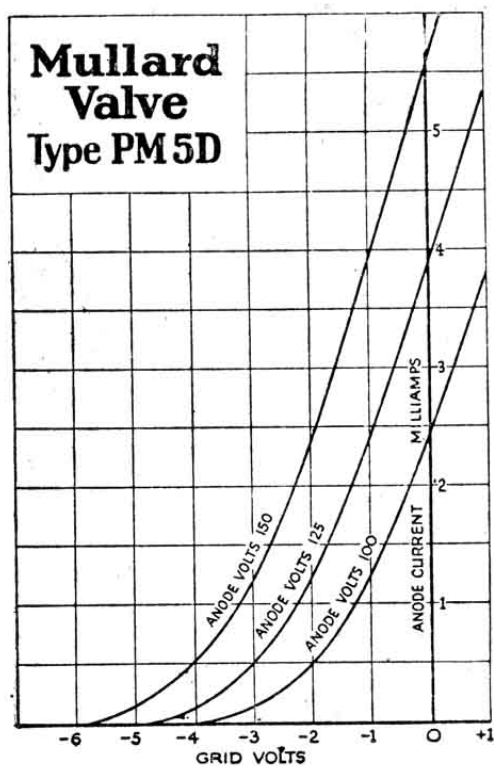

#### Grid Bias Table.

Anode Voltage.	Approx. Neg. Grid Bias Voltage.	Approx. Anode Current (mA).
75	0 to 1.5	0.6
100	1.5	0.8
125	1.5 to 3.0	1.0
150	3.0	1.2

**Mullard the Master Valve**

# Type P.M.5X.

## MEDIUM IMPEDANCE VALVE

Price 8/6  
(In I.F.S. 9/6)

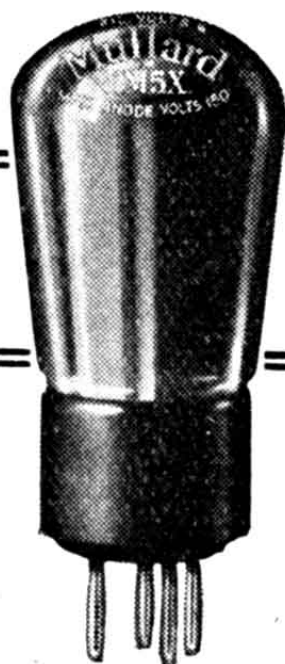

### Application.

Detector or low frequency amplifier followed by transformer coupling.

### Operating Data.

Max. Filament Voltage 6.0 volts  
Filament Current 0.075 amp.  
Max. Anode Voltage 150 volts

### Characteristics.

\*Anode Impedance 14,700 ohms  
\*Amplification Factor 17.5  
\*Mutual Conductance 1.2 mA./volt

\*At Anode Volts 100; Grid Volts, Zero.

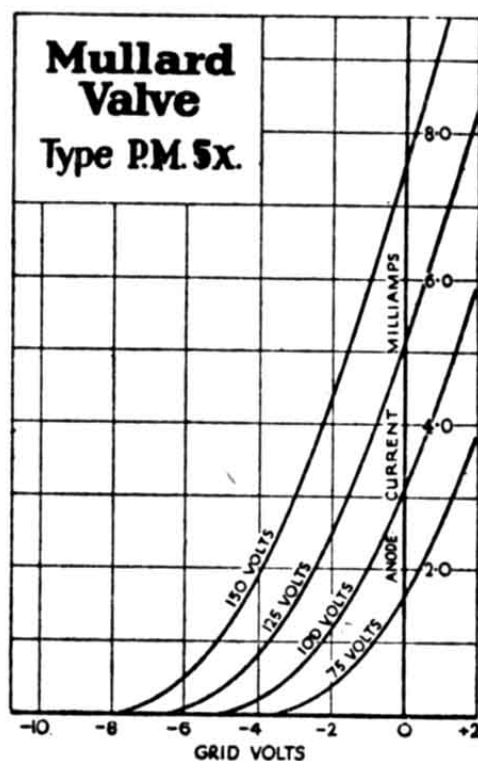

### Grid Bias Table.

Anode Voltage.	Approx. Neg. Grid Bias Voltage.	Approx. Anode Current (mA).
75	1.5	0.8
100	1.5 to 3.0	1.2
125	3.0	1.6
150	3.0 to 4.5	2.0

**Mullard the Master Valve**

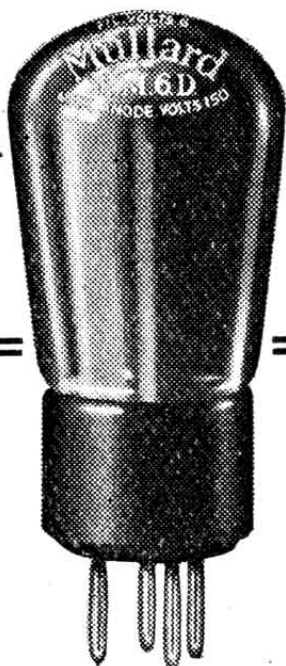

# Type P.M.6D.

## SUPER DETECTOR VALVE

Price 8/6  
(In I.F.S. 9/6)

### Application.

Detector or low frequency amplifier followed by transformer coupling.

### Operating Data.

Max. Filament Voltage 6.0 volts  
Filament Current 0.1 amp.  
Max. Anode Voltage 150 volts

### Characteristics.

- \*Anode Impedance 9,000 ohms
- \*Amplification Factor 18
- \*Mutual Conductance 2.0 mA./volt
- \*At Anode Volts 100; Grid Volts, Zero.

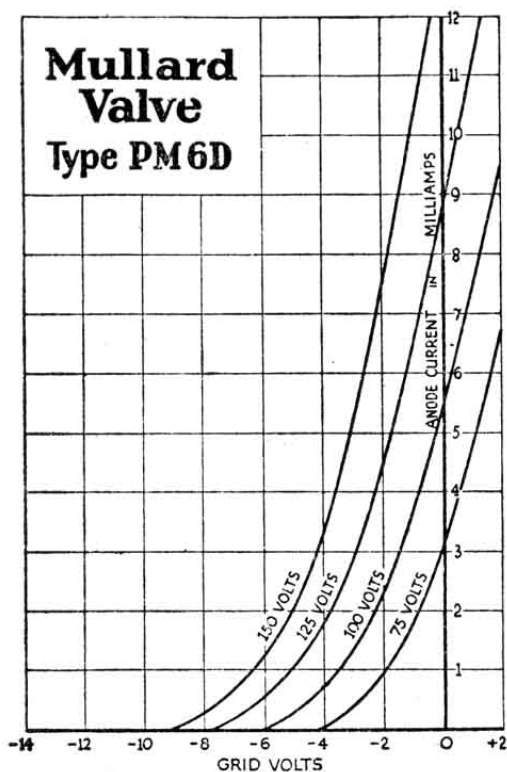

### Grid Bias Table.

Anode Voltage.	Approx. Neg. Grid Bias Voltage.	Approx. Anode Current (mA).
75	0 to 1.5	1.0
100	1.5 to 3	1.5
125	3.0 to 4.5	2.0
150	4.5	2.5

**Mullard the Master Valve**

# Type P.M.6.

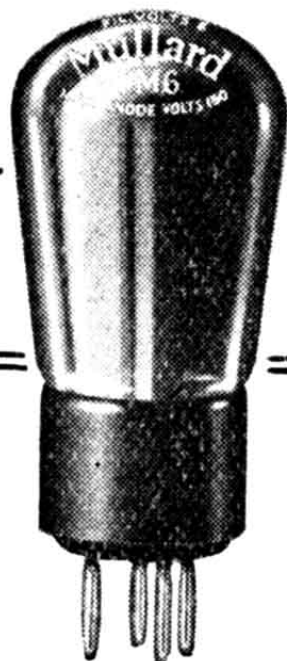

## POWER OUTPUT VALVE

Price 10/6  
(In I.F.S. 11/9)

### Application.

Small power output valve

### Characteristics.

- \*Anode Impedance 3,550 ohms
- \*Amplification Factor 8.0
- \*Mutual Conductance 2.25 mA./volt
- \*At Anode Volts 100 ; Grid Volts, Zero.

### Operating Data.

- Max. Filament Voltage 6.0 volts
- Filament Current 0.1 amp.
- Max. Anode Voltage 150 volts

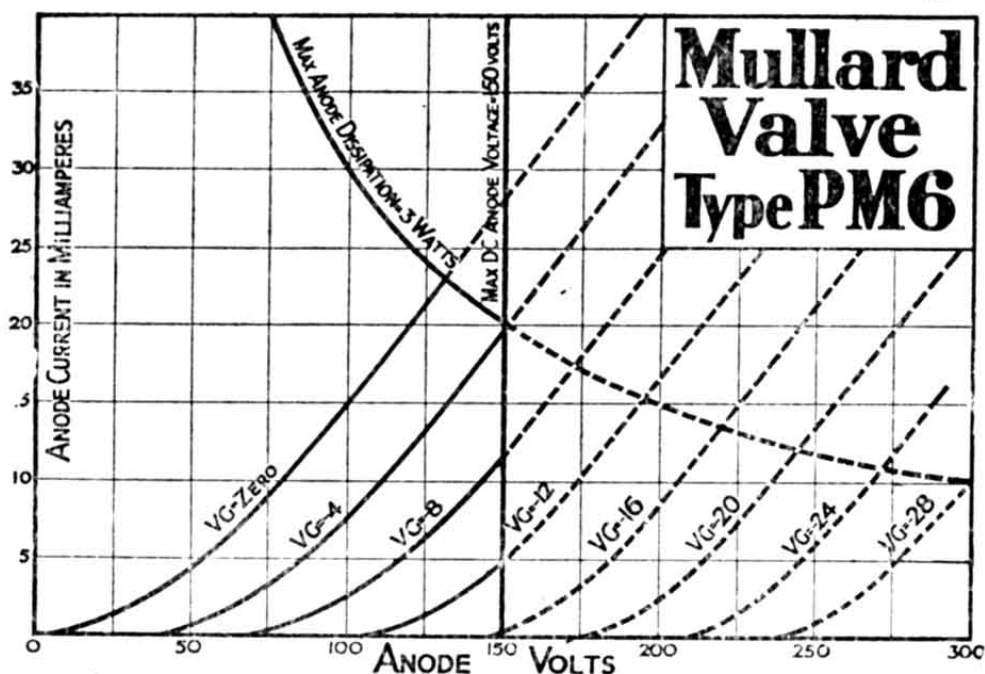

### Grid Bias Table.

Anode Voltage.	Approx. Neg. Grid Bias Voltage.	Approx. Anode Current (mA).
75	4.5	2.5
100	6.0	4.5
125	7.5	7.0
150	9.0	9.5

**Mullard the Master Valve**

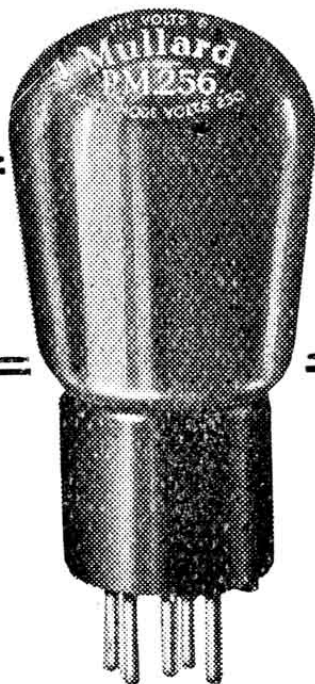

# Type P.M.256.

## OUTPUT VALVE

Price 13/6  
(In I.F.S. 15/-)

### Application.

Super-power output valve.

### Characteristics.

- \*Anode Impedance 1,850 ohms
- \*Amplification Factor 6.0
- \*Mutual Conductance 3.25 mA./volt
- \*At Anode Volts 100 ; Grid Volts, Zero.

### Operating Data.

Max. Filament Voltage 6.0 volts  
 Filament Current 0.25 amp.  
 Max. Anode Voltage 250 volts

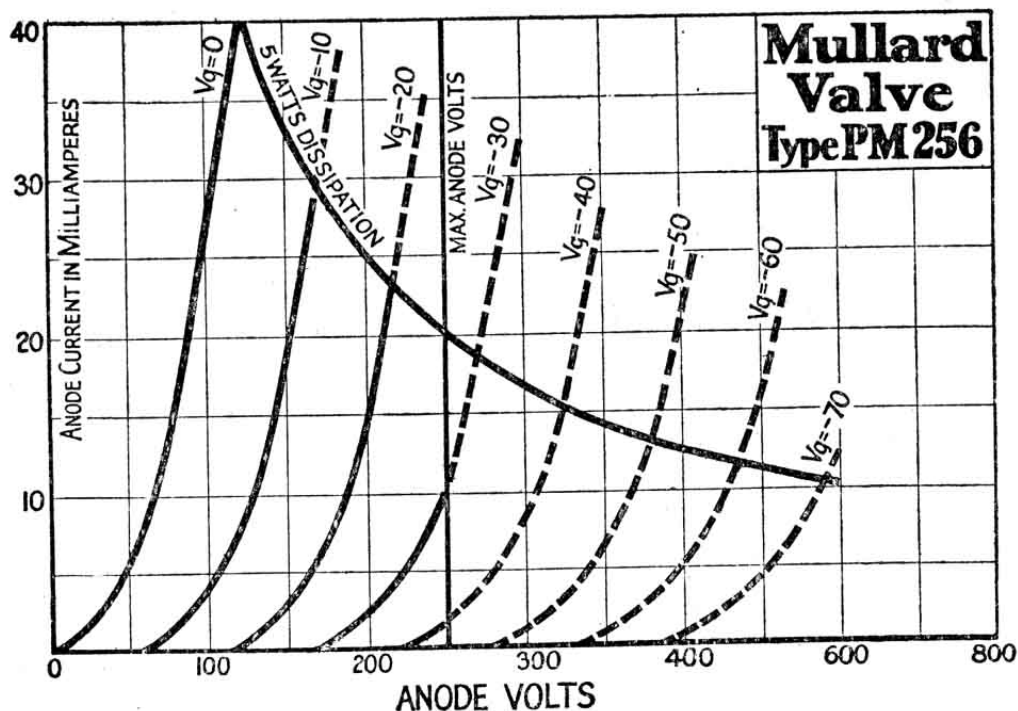

### Grid Bias Table.

Anode Voltage.	Approx. Neg. Grid Bias Voltage.	Approx. Anode Current (mA).
100	7.5 to 9.0	6.0
150	10.5 to 13.5	10.0
200	18.0 to 21.0	15.0
250	27.0	20.0

**Mullard the Master Valve**

# Type P.M.256A

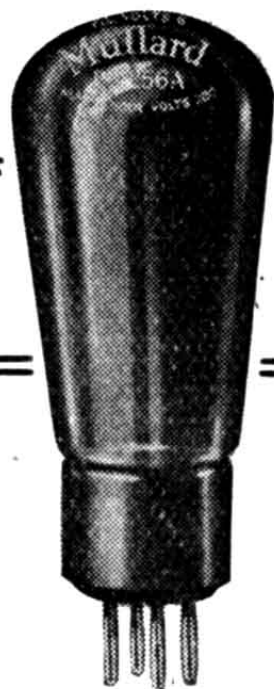

## OUTPUT VALVE

Price 13/6  
(In I.F.S. 15/-)

### Application.

Super-power output valve.

### Characteristics.

- \*Anode Impedance 1,400 ohms.
- \*Amplification Factor 3.6
- \*Mutual Conductance 2.6 mA./volt
- \*At Anode Volts 100 ; Grid Volts, Zero.

### Operating Data.

- Max. Filament Voltage 6.0 volts
- Filament Current 0.25 amp.
- Max. Anode Voltage 200 volts

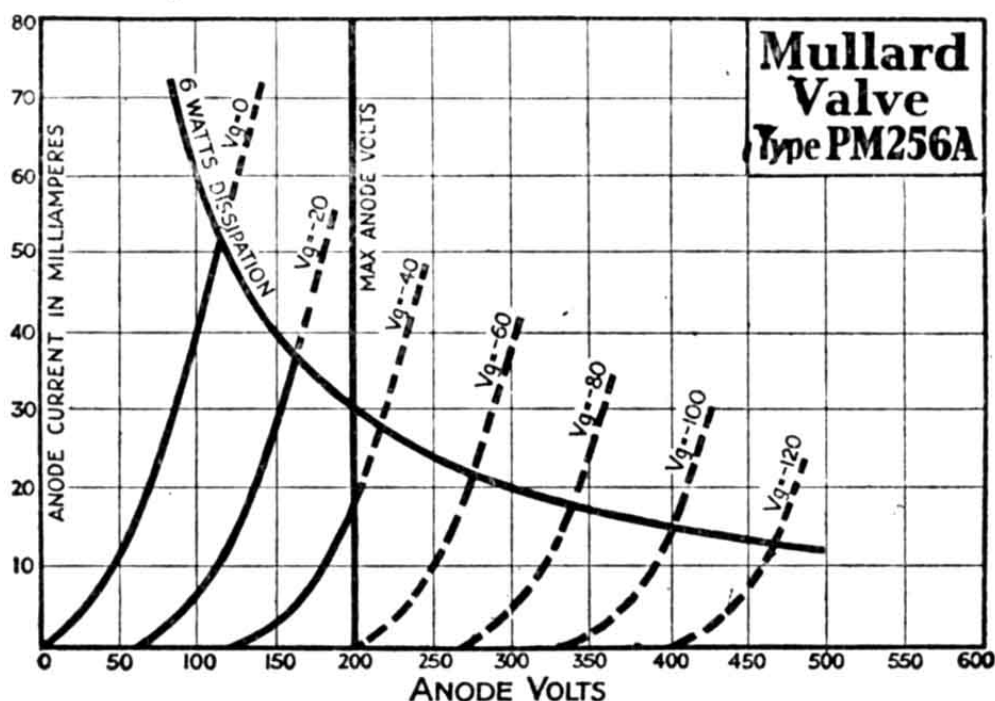

### Grid Bias Table.

Anode Voltage.	Approx. Neg. Grid Bias Voltage.	Approx. Anode Current (mA).
100	12.0	17.0
150	22.5	23.5
200	33.0	30.0

**Mullard the Master Valve**



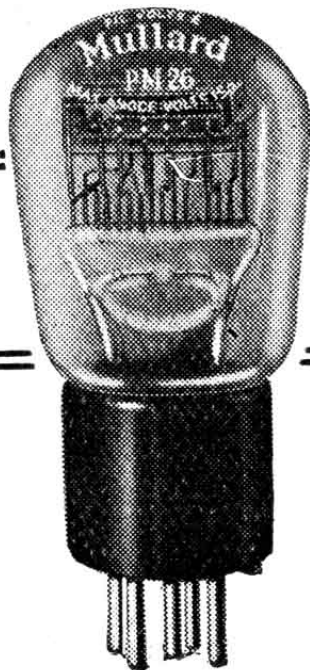

# Type P.M.26

## FIVE-ELECTRODE OUTPUT VALVE

Price 20/-  
(In I.F.S. 22/-)

### Application.

Five-electrode output valve (Pentode).

### Operating Data.

Max. Filament Voltage  
6.0 volts

Filament Current  
0.17 amp.

Max. Anode Voltage  
150 volts

Max. Aux. Grid Voltage  
150 volts

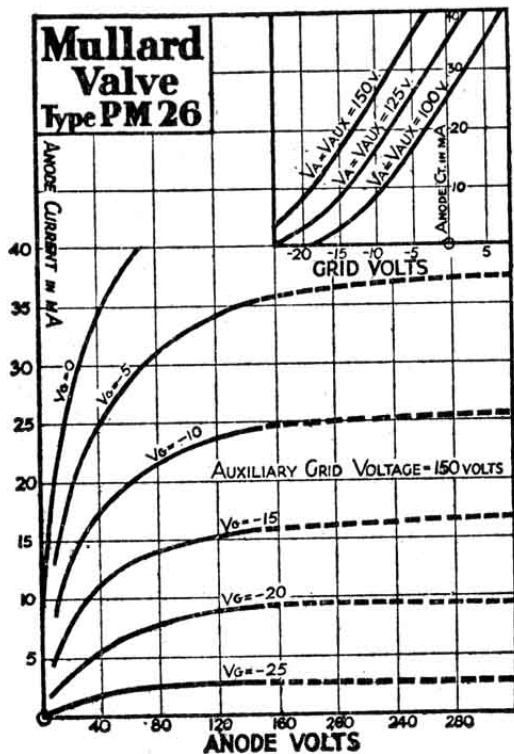

### Characteristics.

\*Mutual Conductance  
2.0 mA./volt

\*At Anode Volts 100 ; Auxiliary  
Grid Volts 100 ; Control Grid  
Volts, Zero.

### Grid Bias Table.

Aux. Grid Voltage.	Approx. Neg. Grid Bias Voltage.	Approx. Anode Current (mA).
75	6.0	7.0
100	9.0	11.0
125	12.0	15.0
150	15.0	19.0

**Mullard the Master Valve**

# MULLARD RECEIVING VALVES

## Indirectly Heated Types

### for use with

## 4-volt A.C. LOW TENSION SUPPLY

Type.	Application.	For particulars see page	PRICE	
			In Gt. Britain	In I.F.S.
S4V	Screened grid high frequency amplifier ..	35	22/6	24/9
S4VA	Screened grid high frequency amplifier ..	36	22/6	24/9
S4VB	Screened grid high frequency amplifier ..	37	22/6	24/9
904V	Detector followed by resistance-capacity or transformer coupling	38	15/-	16/6
354V	Super detector followed by transformer coupling .. .. .	39	15/-	16/6
164V	Low frequency amplifier followed by transformer coupling ..	40	17/6	19/3
104V	Small power valve, 3-electrode output valve	41	17/6	19/3
054V	Super power valve ..	42	20/-	22/-
PEN4V	Pentode output valve..	43	25/-	27/6

## Mullard the Master Valve



## Type S.4V.

### INDIRECTLY HEATED SCREENED GRID VALVE

Price 22/6  
(In I.F.S. 24/9)

#### Application.

Screened-grid high frequency amplifying valve for A.C. all-mains receivers.

#### Operating Data.

Max. Heater Voltage	4.0 volts
Max. Heater Current	1.0 amp.
Max. Anode Voltage	200 volts
Positive Screen Voltage	75 volts

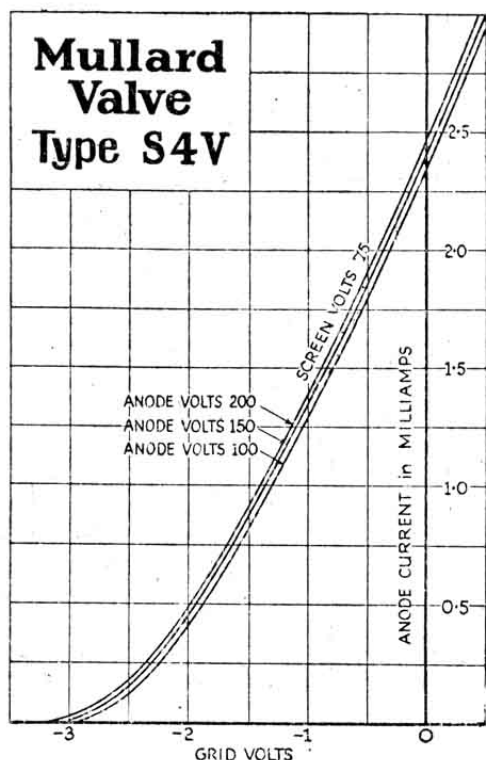

#### Characteristics.

*Anode Impedance .. .. .	909,000 ohms
*Amplification Factor .. .. .	1,000
*Mutual Conductance .. .. .	1.1 mA./volt
*At Anode Volts 100; Grid Volts, Zero; Positive Screen Volts 75.	

**Mullard the Master Valve**

# Type S.4V.A.



## INDIRECTLY HEATED SCREENED GRID VALVE

Price 22/6  
(In I.F.S. 24/9)

### Application.

Screened-grid high frequency amplifying valve for A.C. all-mains receivers.

### Operating Data.

Max. Heater Voltage  
4.0 volts  
Max. Heater Current  
1.0 amp.  
Max. Anode Voltage  
200 volts  
Positive Screen Voltage  
75-100 volts

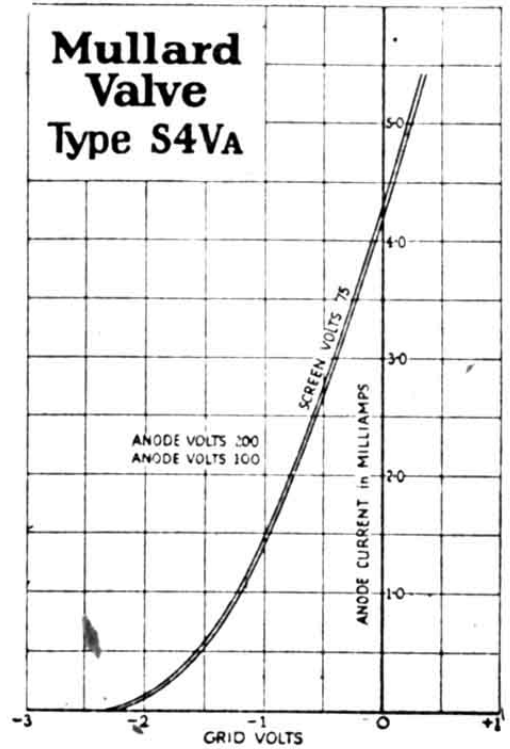

### Characteristics.

\*Anode Impedance .. .. . 430,000 ohms  
\*Amplification Factor .. .. . 1,500  
\*Mutual Conductance .. .. . 3.5 mA./volt

\*At Anode Volts 100; Positive Screen Voltage 75; Grid Volts, Zero.

# Mullard the Master Valve



## Type S.4V.B.

### INDIRECTLY HEATED SCREENED GRID VALVE

Price 22/6  
(In I.F.S. 24/9)

#### Application.

Screened-grid high frequency amplifying valve for A.C. all-mains receivers.

#### Operating Data.

Max. Heater Voltage  
4.0 volts  
Max. Heater Current  
1.0 amp.  
Max. Anode Voltage  
200 volts  
Positive Screen Voltage  
75-100 volts

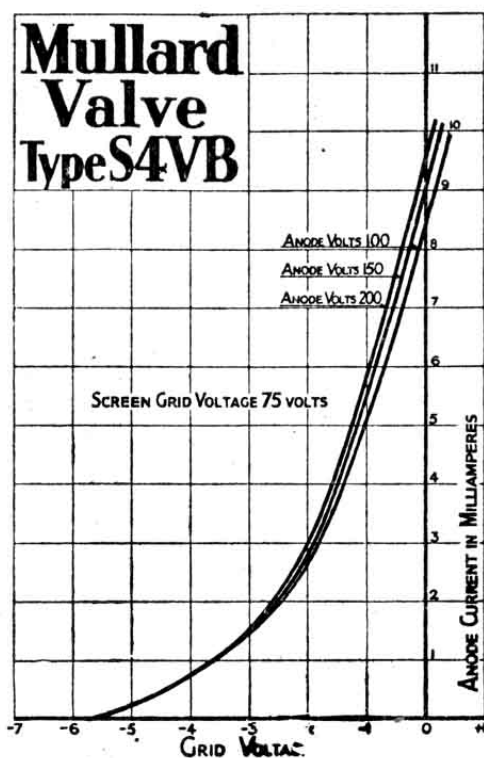

#### Characteristics.

\*Anode Impedance .. .. . 257,000 ohms  
\*Amplification Factor .. .. . 900  
\*Mutual Conductance .. .. . 3.5 mA./volt  
\*Anode Volts 100 ; Positive Screen Volts 75 ; Grid Volts -1

**Mullard the Master Valve**

# Type 904V.

## INDIRECTLY HEATED MEDIUM IMPEDANCE VALVE

Price 15/-  
(In I.F.S. 16/6)

### Application.

Detector or low frequency amplifier in A.C. all-mains receiver, following resistance capacity or transformer coupling.

### Operating Data.

Max. Heater Voltage 4.0 volts  
Heater Current 1.0 amp.  
Max. Anode Voltage 200 volts

### Characteristics.

- \*Anode Impedance 17,000 ohms
- \*Amplification Factor 85
- \*Mutual Conductance 5.0 mA./volt
- \*At Anode Volts 100; Grid Volts, Zero.

### Grid Bias Table.

Anode Voltage.	Approx. Neg. Grid Bias Voltage.	Approx. Anode Current (mA).
100	0.75	2.5
150	1.0	3.5
200	1.5	4.5

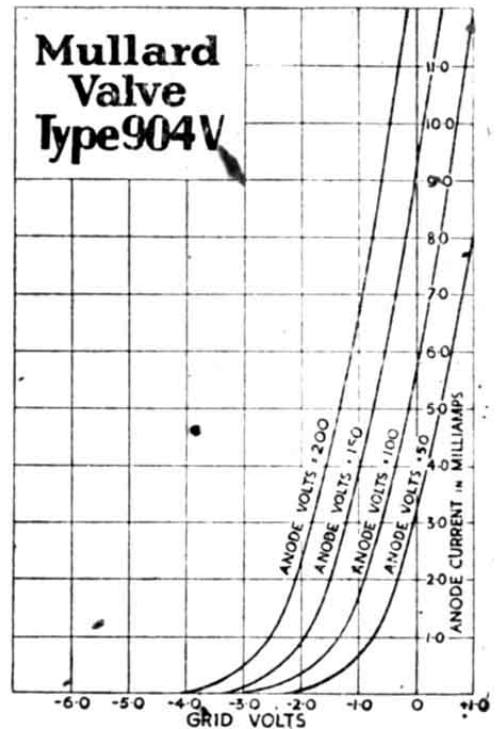
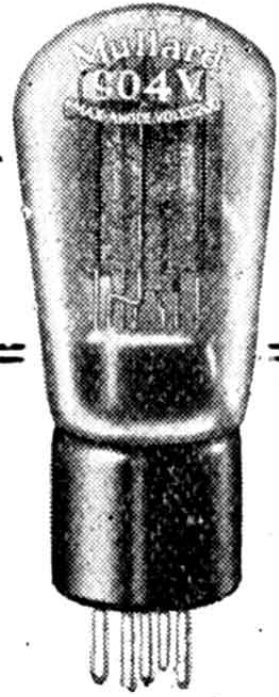

**Mullard the Master Valve**

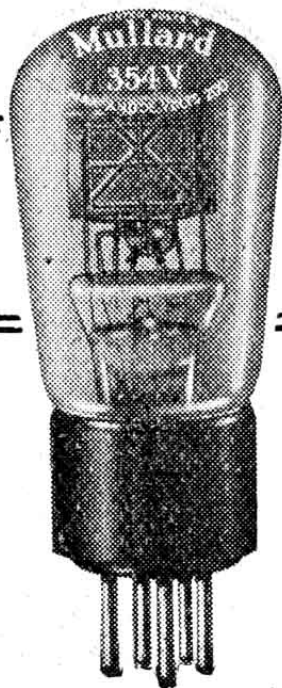

## Type 354V.

### INDIRECTLY HEATED SUPER DETECTOR VALVE

Price 15/-  
(In. I.F.S. 16/6)

#### Application.

Detector or low frequency amplifier in A.C. all-mains receivers, followed by transformer coupling.

#### Operating Data.

Max. Heater Voltage 4.0 volts  
Heater Current 1.0 amp.  
Max. Anode Voltage 200 volts

#### Characteristics.

\*Anode Impedance 10,000 ohms  
\*Amplification Factor 35  
\*Mutual Conductance 3.5 mA./volt  
\*At Anode Volts 100; Grid Volts, Zero.

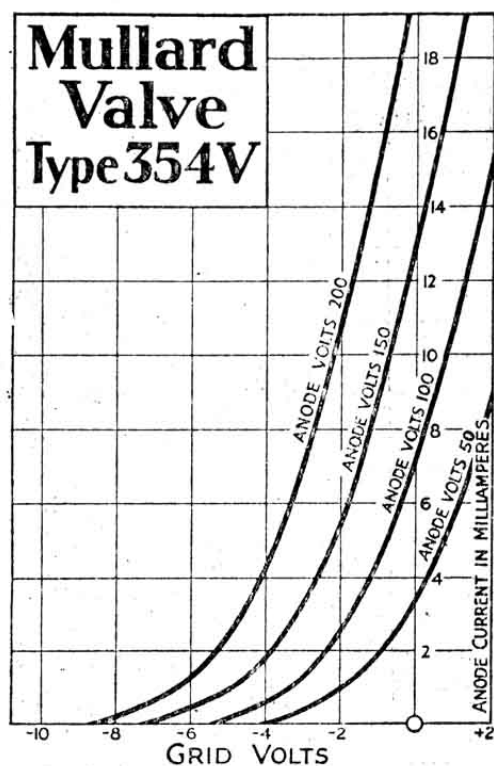

#### Grid Bias Table.

Anode Voltage.	Approx. Neg. Grid Bias Voltage.	Approx. Anode Current (mA).
100	2.0	2.0
150	3.0	3.0
200	4.0	4.0

**Mullard the Master Valve**

# Type 164V.

## INDIRECTLY HEATED MEDIUM IMPEDANCE VALVE

Price 17/6  
(In I.F.S. 19/3)



### Application.

Low frequency amplifier in A.C. all-mains receivers followed by transformer capacity coupling.

### Operating Data.

Max. Heater Voltage 4.0 volts  
Heater Current 1.0 amp.  
Max. Anode Voltage 200 ohms

### Characteristics.

- \*Anode Impedance 4,850 ohms
- \*Amplification Factor 16
- \*Mutual Conductance 3.3 mA./volt
- \*At Anode Volts 100; Grid Volts, Zero.

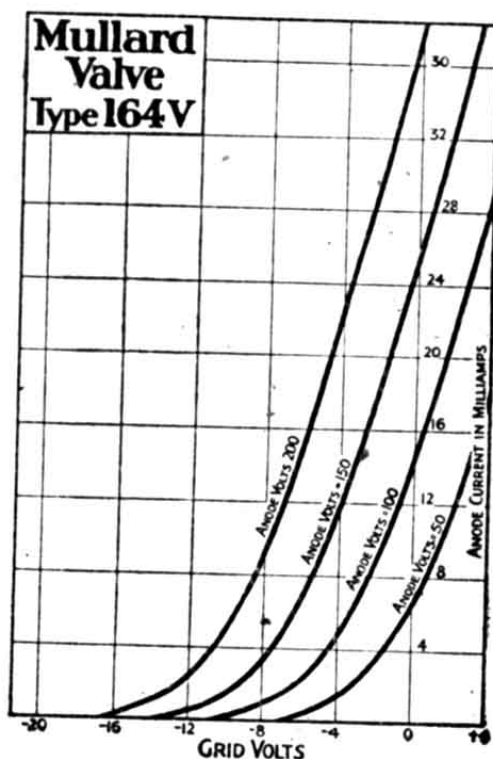

### Grid Bias Table.

Anode Voltage.	Approx. Neg. Grid Bias Voltage.	Approx. Anode Current (mA).
100	4.5	4.5
150	6.5	6.5
200	8.5	8.5

**Mullard the Master Valve**



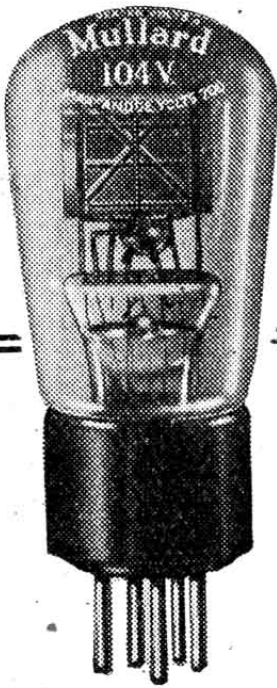

# Type 104V.

## INDIRECTLY HEATED LOW IMPEDANCE VALVE

Price 17/6  
(In I.F.S. 19/3)

### Application.

Small power output valve in A.C. all-mains receivers having no previous low frequency stage.

### Characteristics.

- \*Anode Impedance 2,850 ohms
- \*Amplification Factor 10
- \*Mutual Conductance 3.5 mA./volt
- \*At Anode Volts 100; Grid Volts, Zero.

### Operating Data.

- Max. Heater Voltage 4.0 volts
- Heater Current 1.0 amp.
- Max. Anode Voltage 200 volts

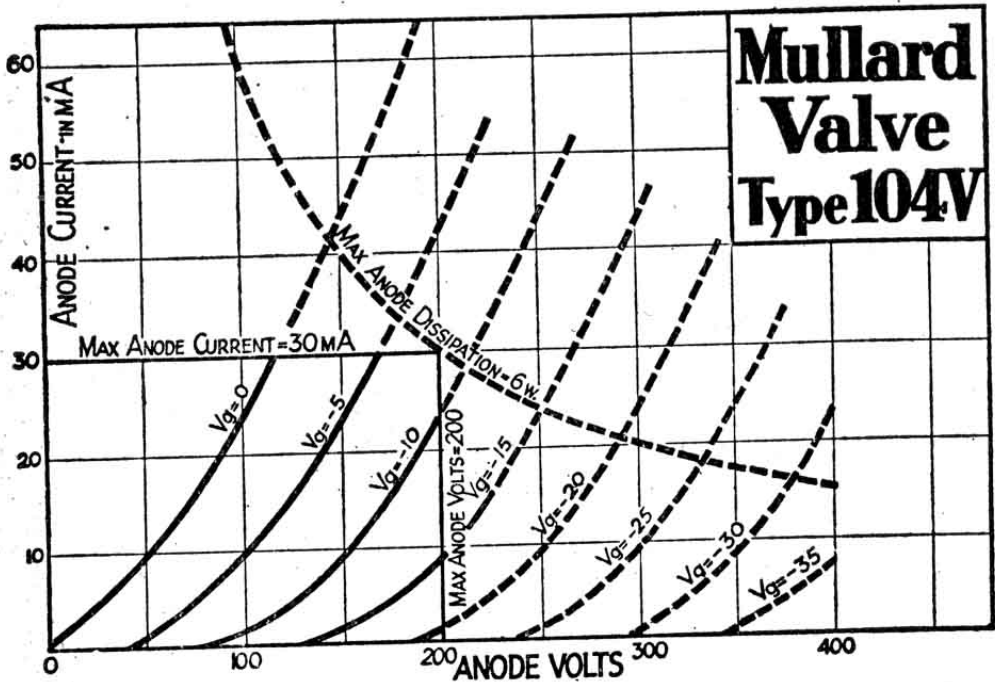

### Grid Bias Table.

Anode Voltage.	Approx. Neg. Grid Bias Voltage.	Approx. Anode Current (mA).
100	5.0	9.0
150	8.5	13.0
200	12.0	17.0

**Mullard the Master Valve**

# Type 054V.

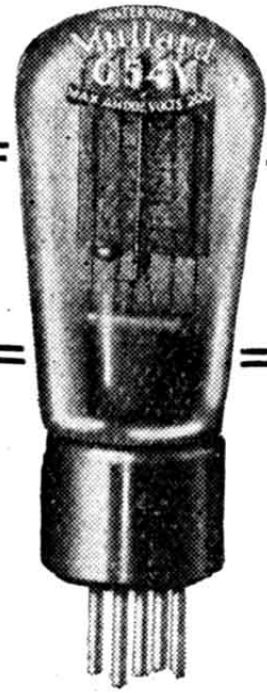

## INDIRECTLY HEATED OUTPUT VALVE

Price 20/-  
(In I.F.S. 22/-)

### Application.

Output valve in A.C. all-mains receivers.

### Characteristics.

- \*Anode Impedance 1,250 ohms
- \*Amplification Factor 5
- \*Mutual Conductance 4.0 mA./volt
- \*At Anode Volts 100 ; Grid Volts, Zero.

### Operating Data.

- Max. Heater Voltage 4.0 volts
- Heater Current 1.0 amp.
- Max. Anode Voltage 200 volts

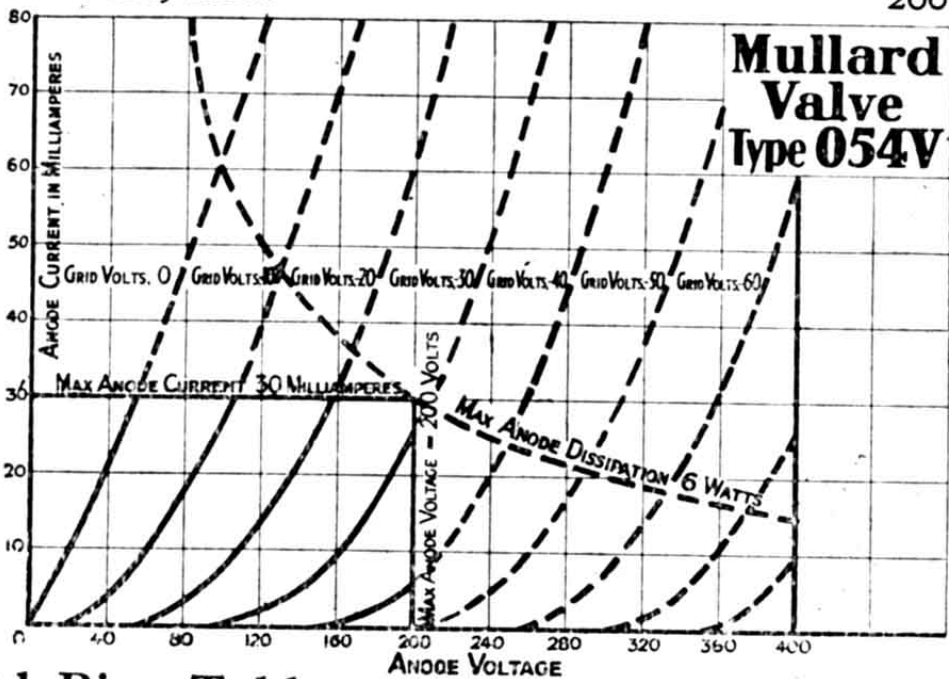

### Grid Bias Table.

Anode Voltage.	Approx. Neg. Grid Bias Voltage.	Approx. Anode Current (mA).
100	14.0	20.0
150	18.0	30.0
200	28.0	30.0

**Mullard the Master Valve**

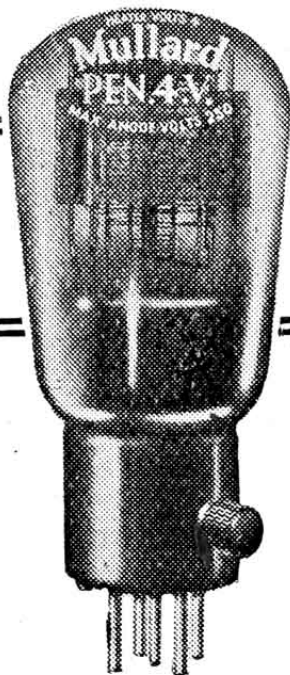

## Type PEN 4V.

### INDIRECTLY HEATED FIVE ELECTRODE OUTPUT VALVE

Price 25/-  
(In I.F.S. 27/6)

#### Application.

Five-electrode output valve (Pentode) in A.C. all-mains receivers.

#### Characteristics.

- \*Mutual Conductance 3.0 mA./volt
- \*At Auxiliary Grid Volts 100; Control Grid Volts, Zero.

#### Operating Data.

Max. Heater Voltage	4.0 volts
Heater Current	1.0 amp.
Max. Anode Voltage	250 volts
Max. Auxiliary Grid Voltage	200 volts

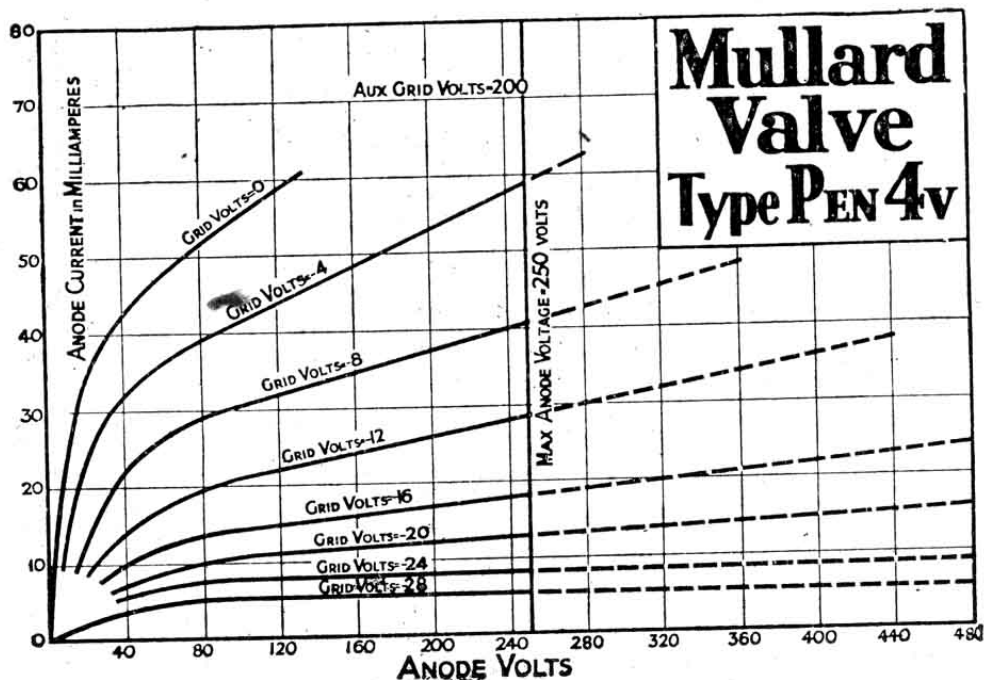

#### Grid Bias Table.

Aux. Grid Voltage.	Approx. Neg. Grid Bias Voltage.	Approx. Anode Current (mA).
200	10.0	35.0

**Mullard the Master Valve**

# MULLARD RECEIVING VALVES

## Directly Heated Output Types

### for use with

## A.C. LOW TENSION SUPPLY

Type.	Application.	For particulars see page	PRICE.	
			In Gt. Britain	In I.F.S.
AC.104	Output valve for receivers having no previous L.F. stage ..	45	16/-	17/9
AC.064	Output valve for A.C. all-mains receivers ..	46	16/-	17/9
AC.044	Output valve for A.C. all-mains receivers ..	47	20/-	22/-
DO.10	Output valve (high anode voltage type) for powerful receivers and amplifiers ..	48	25/-	27/6
DO.20	Output valve (high anode voltage type) for powerful receivers and amplifiers ..	49	30/-	33/-
DO.24	Output valve (high anode voltage type) for powerful receivers and amplifiers ..	50	30/-	33/-
DO.25	Output valve (high anode voltage type) for powerful receivers and amplifiers ..	51	30/-	33/-
DO.60	Output valve (high anode voltage type) for powerful amplifiers .. ..	52	110/-	128/6
DO.75	Output valve (high anode voltage type) for powerful amplifiers .. ..	53	160/-	186/8

## Mullard the Master Valve

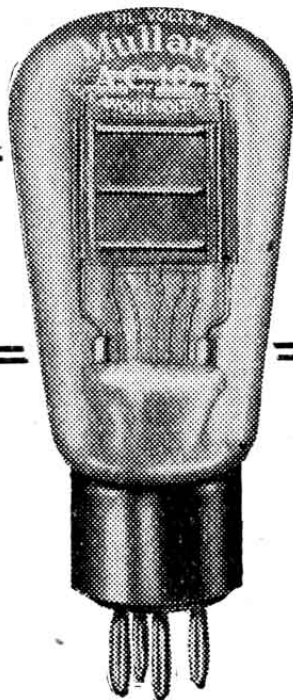

## Type AC.104

### DIRECTLY HEATED OUTPUT VALVE

Price 16/-  
(In I.F.S. 17/9)

#### Application.

Output valve in A.C. all-mains receivers having no previous low frequency stage.

#### Characteristics.

- \*Anode Impedance 2,850 ohms
- \*Amplification Factor 10
- \*Mutual Conductance 2.5 mA./volt
- \*At Anode Volts 100 ; Grid Volts, Zero.

#### Operating Data.

- Max. Filament Voltage 4.0 volts
- Filament Current 1.0 amp.
- Max. Anode Voltage 200 volts

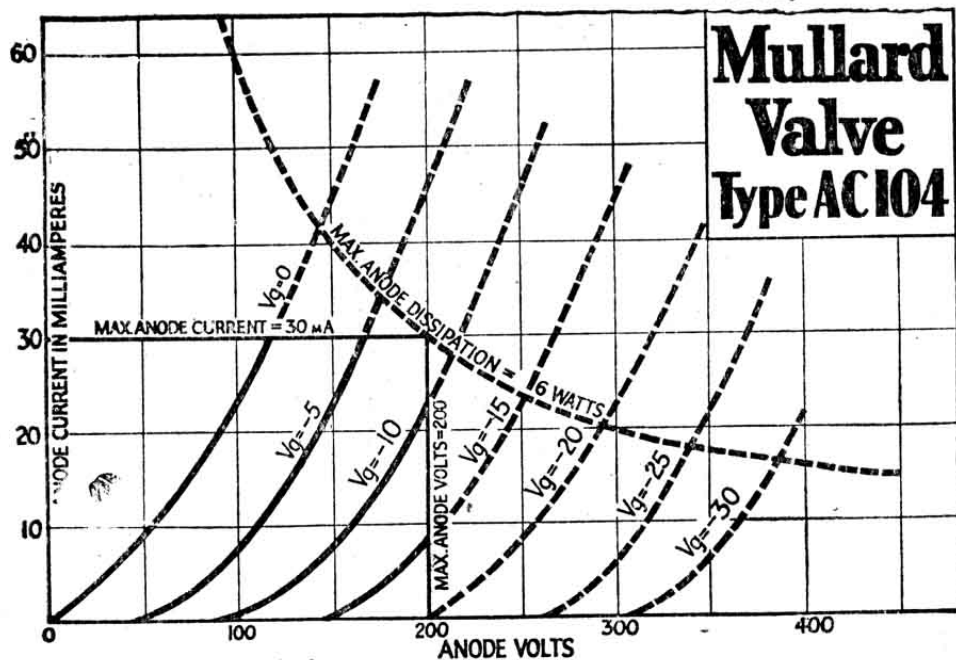

#### Grid Bias Table.

Anode Voltage.	Approx. Neg. Grid Bias Voltage.	Approx. Anode Current (mA).
150	10.0	8.5
175	12.0	9.75
200	14.0	11.0

**Mullard the Master Valve**

# Type A.C.064

## DIRECTLY HEATED OUTPUT VALVE

Price 16/-  
(In I.F.S. 17/9)

### Application.

Output valve in A.C.  
all-mains receivers.

### Characteristics.

- \*Anode Impedance 2,000 ohms
- \*Amplification Factor 6
- \*Mutual Conductance 3.0 mA./volt
- \*At Anode Volts 100 ; Grid Volts, Zero.

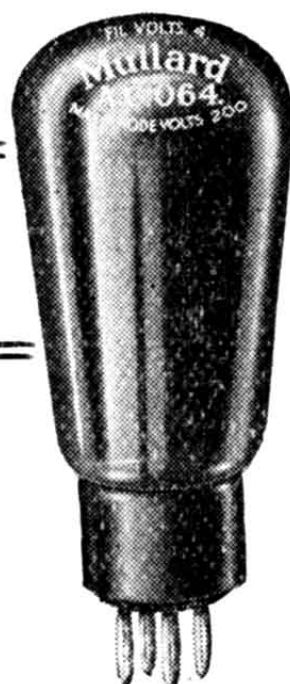

### Operating Data.

- Max. Filament Voltage 4.0 volts
- Filament Current 1.0 amp.
- Max. Anode Voltage 200 volts

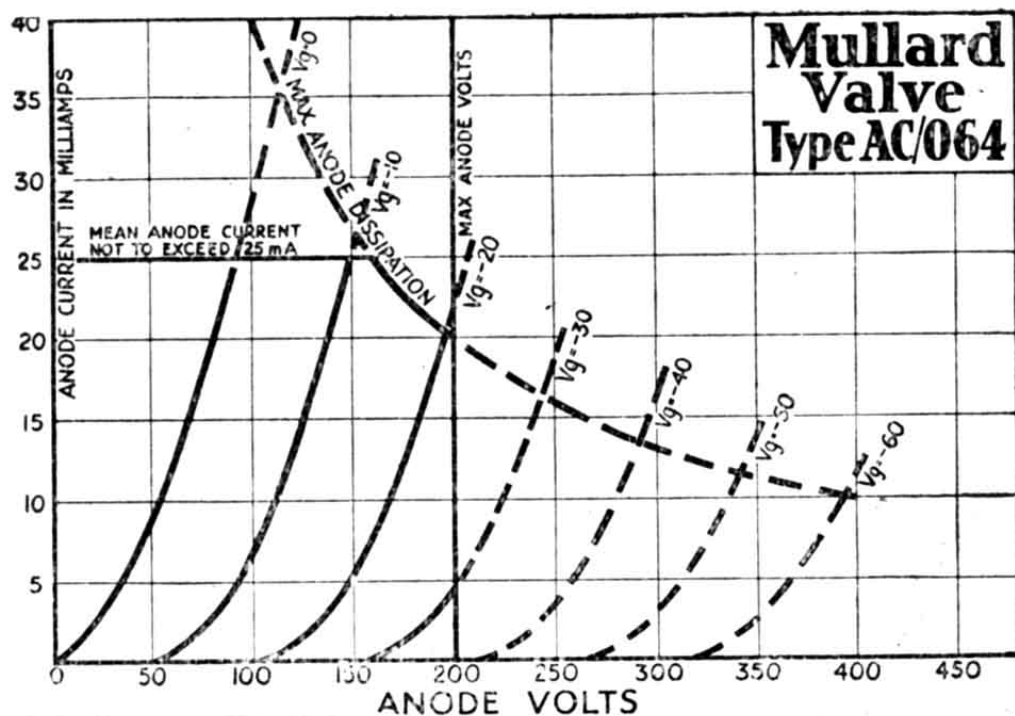

### Grid Bias Table.

Anode Voltage.	Approx. Neg. Grid Bias Voltage.	Approx. Anode Current (mA).
150	14.0	16.0
175	17.5	18.0
200	21.0	20.0

**Mullard the Master Valve**

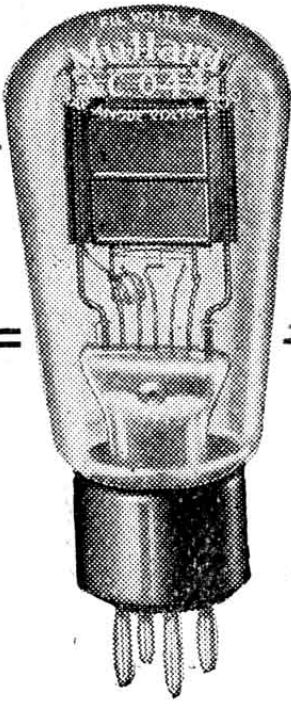

# Type A.C.044

## DIRECTLY HEATED OUTPUT VALVE

Price 20/-  
(In I.F.S. 22/-)

### Application.

Output valve in A.C. all-  
mains receivers.

### Characteristics.

- \*Anode Impedance 1,150 ohms
- \*Amplification Factor 4
- \*Mutual Conductance 3.5 mA./volt
- \*At Anode Volts 100 ; Grid Volts, Zero.

### Operating Data.

Max. Filament Voltage 4.0 volts  
Filament Current 0.7 amp.  
Max. Anode Voltage 200 volts

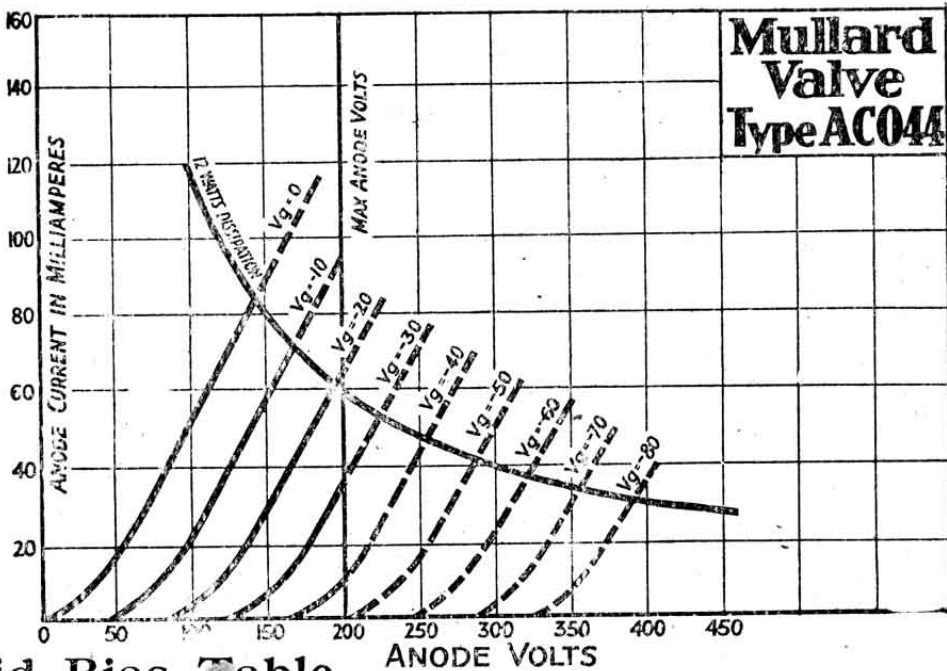

### Grid Bias Table.

Anode Voltage.	Approx. Neg. Grid Bias Voltage.	Approx. Anode Current (mA).
100	14.0	15.0
150	23.0	22.5
200	32.0	30.0

**Mullard the Master Valve**

# Type DO.10

## DIRECTLY HEATED OUTPUT VALVE

Price 25/-  
(In I.F.S. 27/6)

### Application.

Output valve for powerful receivers and amplifiers.

### Characteristics.

- \*Anode Impedance 2.850 ohms
- \*Amplification Factor 2.4
- \*Mutual Conductance 0.85 mA./volt
- \*At Anode Volts 100 ; Grid Volts, Zero.

### Operating Data.

- Filament Voltage 5.0 to 6.0 volts
- Filament Current 0.85 amp.
- Max. Anode Volts 400 volts

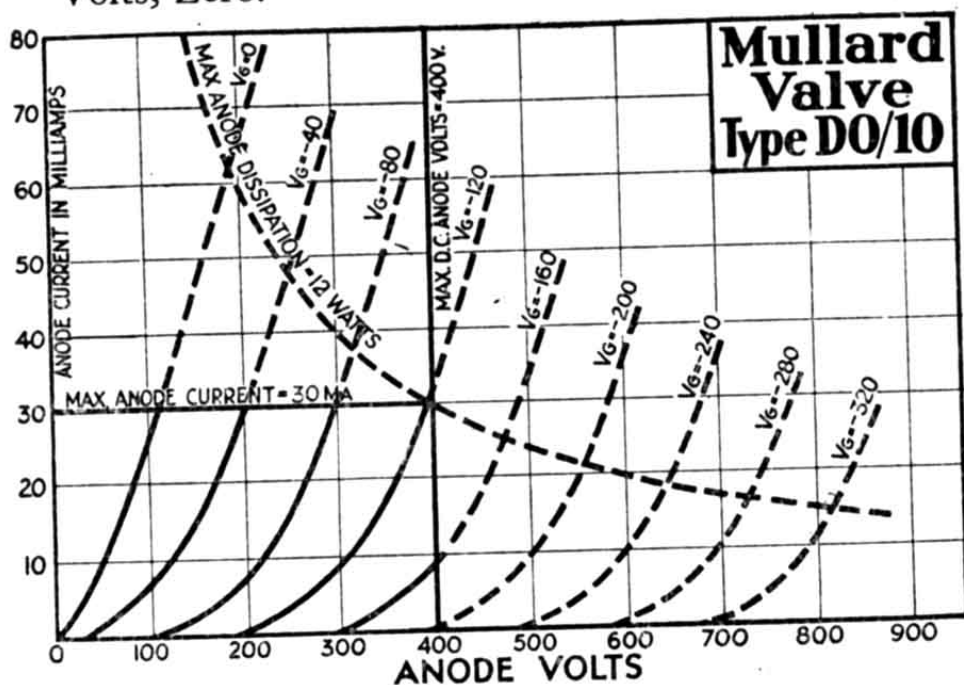
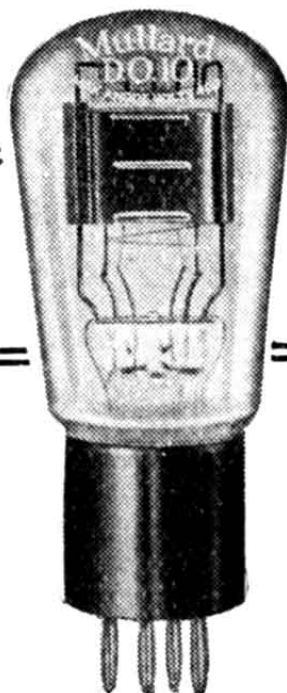

### Grid Bias Table.

Anode Voltage.	Approx. Neg. Grid Bias Voltage.	Approx. Anode Current (mA).
100	30.0	12.0
200	60.0	17.0
300	90.0	25.0
400	130.0	25.0

**Mullard the Master Valve**



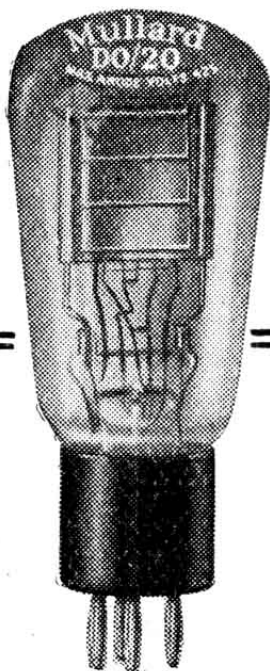

## Type DO.20

### DIRECTLY HEATED OUTPUT VALVE

Price 30/-  
(In I.F.S. 33/-)

### Application.

Output valve for powerful receivers and amplifiers.

### Characteristics.

- \*Anode Impedance 2,000 ohms
- \*Amplification Factor 5
- \*Mutual Conductance 2.5 mA./volt
- \*At Anode Volts 100 ; Grid Volts, Zero.

### Operating Data.

- Max. Filament Voltage 7.5 volts
- Filament Current 1.3 amps.
- Max. Anode Voltage 425 volts

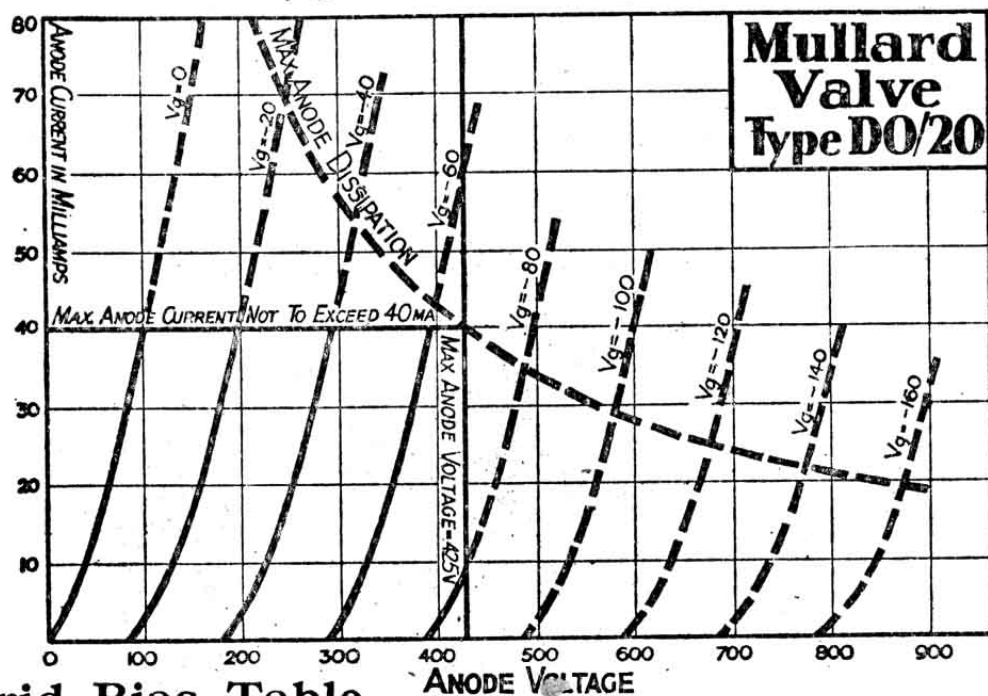

Grid Bias Table.

Anode Voltage.	Approx. Neg. Grid Bias Voltage.	Approx. Anode Current (mA).
325	48.0	32.0
350	52.5	34.0
375	57.0	36.0
400	61.5	38.0
425	66.0	40.0

**Mullard the Master Valve**

# Type DO.24.

## DIRECTLY HEATED OUTPUT VALVE

Price 30/-  
(In I.F.S. 33/-)

### Application.

Output valve for powerful receivers and amplifiers.

### Characteristics.

- \*Anode Impedance 1,670 ohms
- \*Amplification Factor 10
- \*Mutual Conductance 6.0 mA./volt
- \*At Anode Volts 100; Grid Volts, Zero.



### Operating Data.

- Max. Filament Voltage 4.0 volts
- Filament Current 2.0 amp.
- Max. Anode Voltage 400 volts

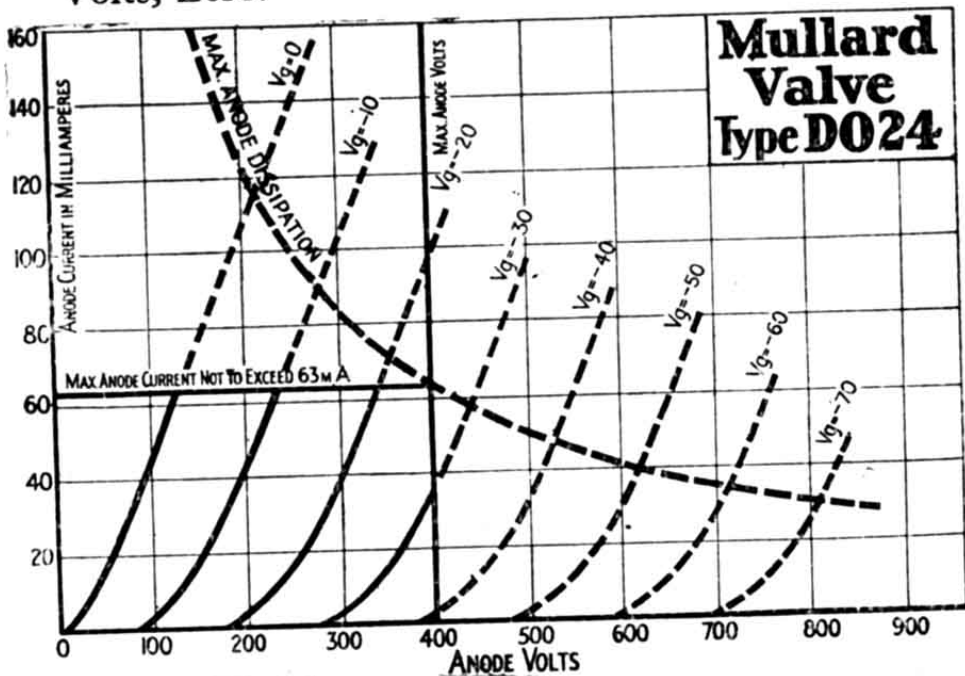

### Grid Bias Table.

Anode Voltage.	Approx. Neg. Grid Bias Voltage.	Approx. Anode Current (mA).
200	12.0	30.0
300	18.0	48.0
400	25.0	63.0

**Mullard the Master Valve**

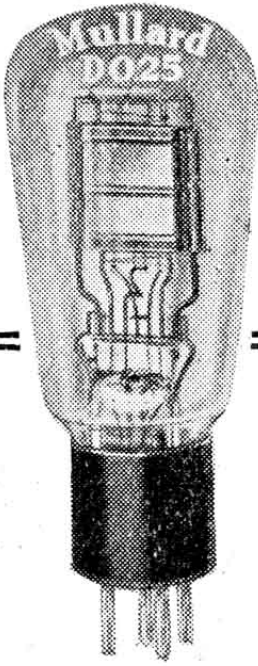

# Type D0.25

## DIRECTLY HEATED OUTPUT VALVE

Price 30/-

(In I.F.S. 33/-)

### Application.

Output valve for powerful receivers and amplifiers.

### Characteristics.

- \*Anode Impedance 1,150 ohms
- \*Amplification Factor 3
- \*Mutual Conductance 2.6 mA./volt
- \*At Anode Volts 100 ; Grid Volts, Zero.

### Operating Data.

- Max. Filament Voltage 6.0 volts
- Filament Current 1.8 amps.
- Max. Anode Voltage 400 volts

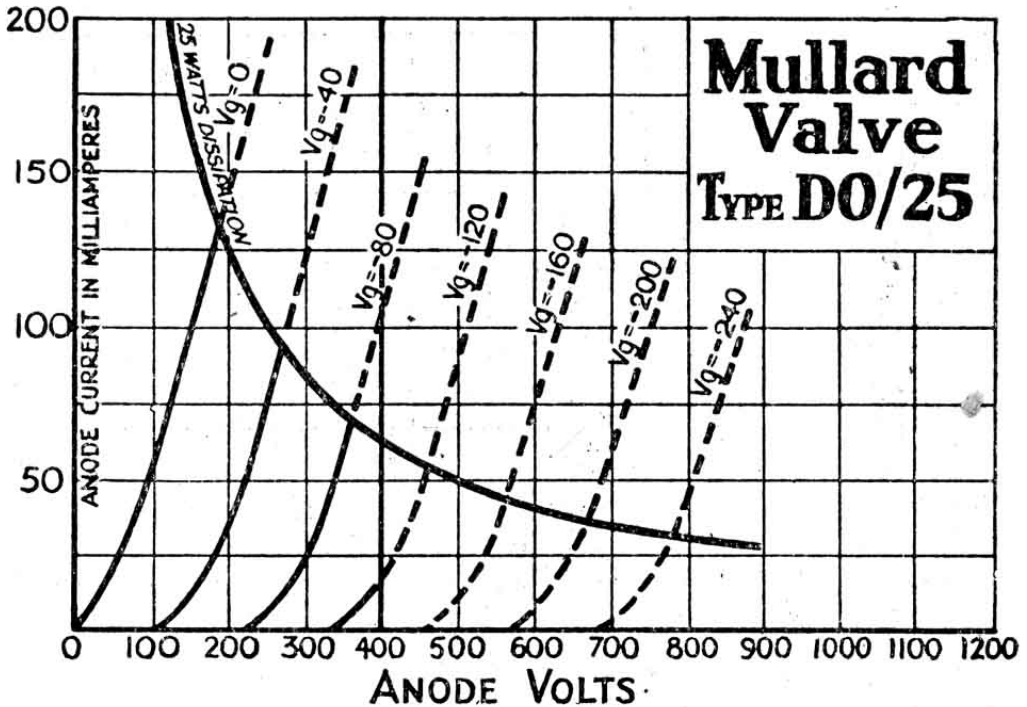

### Grid Bias Table.

Anode Voltage.	Approx. Neg. Grid Bias Voltage.	Approx. Anode Current (mA).
200	40.0	35.0
300	67.5	48.5
400	95.0	63.0

**Mullard the Master Valve**

# Type DO.60

## DIRECTLY HEATED OUTPUT VALVE

Price £5 10 0

(In I.F.S. £6 8 6)

### Application.

Output valve for powerful receivers and amplifiers.

### Characteristics.

- \*Anode Impedance 1,000 ohms.
- \*Amplification Factor 3.5
- \*Mutual Conductance 3.5 mA./volt
- \*Under working conditions, viz., Anode Volts 500, Anode Current 120 mA.



### Operating Data.

- Max. Filament Voltage 6.0 volts
- Filament Current 4.0 amp.
- Max. Anode Voltage 500 volts

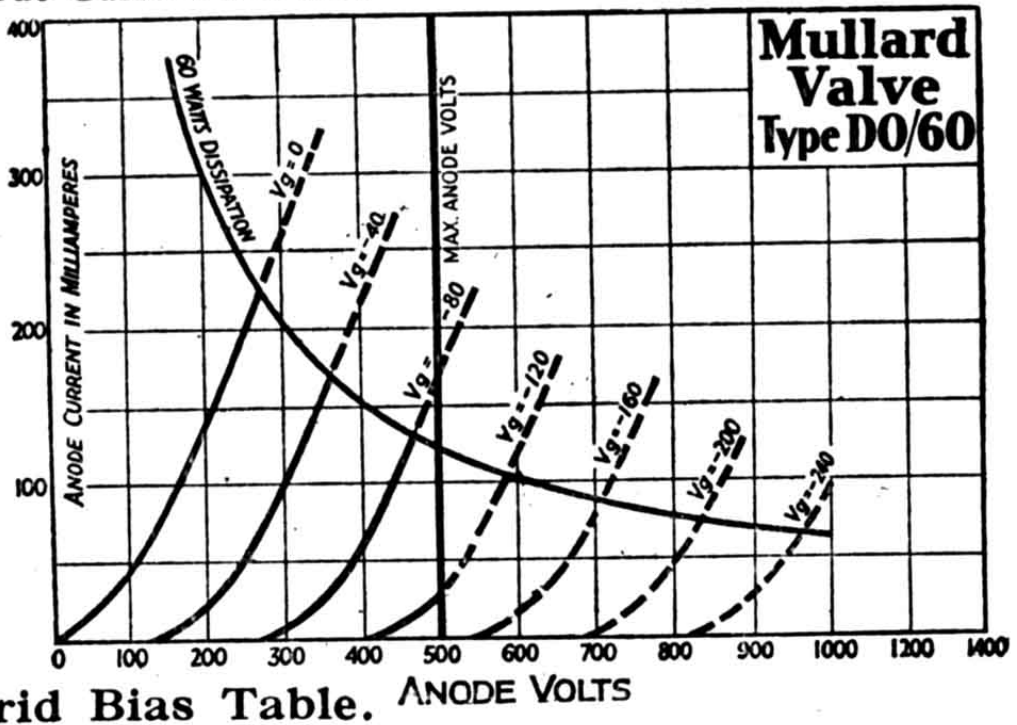

Grid Bias Table. ANODE VOLTS

Anode Voltage.	Approx. Neg. Grid Bias Voltage.	Approx. Anode Current (mA).
300	42.0	82.0
400	65.0	120.0
500	95.0	120.0

**Mullard the Master Valve**



# Type D0.75

## DIRECTLY HEATED OUTPUT VALVE

Price £8 0 0

(In I.F.S. £9 6 8)

Special Holder 12/6 nett

(In I.F.S. 14/6 nett)

### Application.

Output valve for powerful amplifiers.  
**Characteristics.**

\*Anode Impedance 2,000 ohms

\*Amplification Factor 12

\*Mutual Conductance 6.0 mA./volt

\*Under working conditions, viz:

Anode Volts, 1000, Anode Current,  
75 mA.

### Operating Data.

Max. Filament Voltage  
10.0 volts

Filament Current 2.0 amp.

Max. Anode Voltage  
1,000 volts

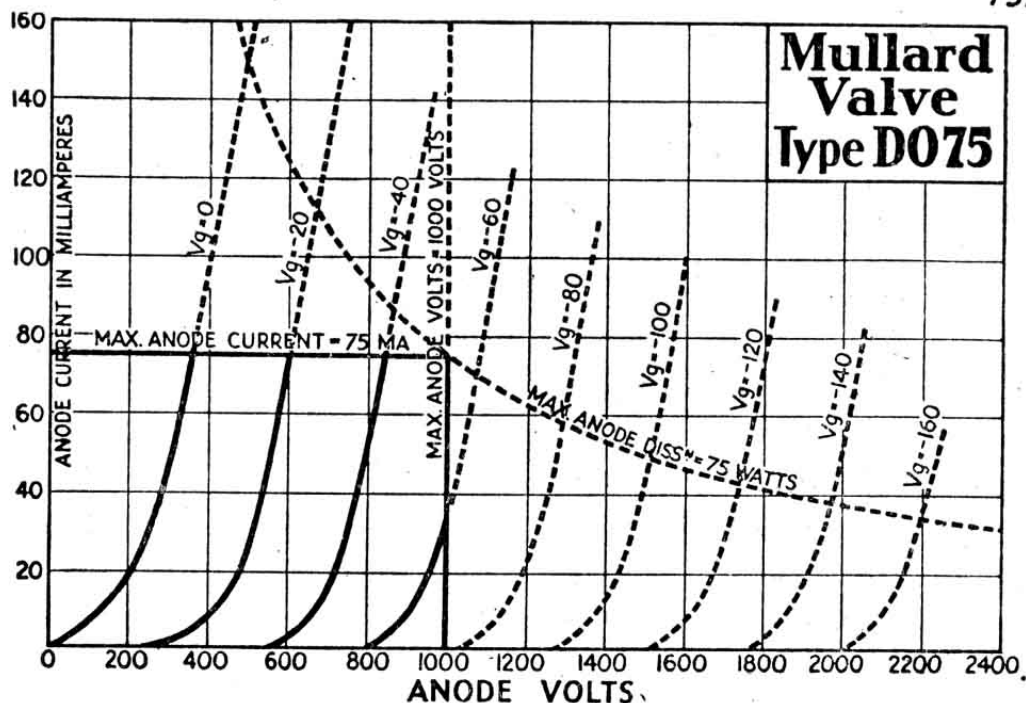

### Grid Bias Table.

Anode Voltage	Approx. Neg. Grid Bias Voltage.	Approx. Anode Current (mA).
600	25.0	45.0
800	40.0	60.0
1,000	55.0	75.0

**Mullard the Master Valve**

# MULLARD RECEIVING VALVES

## Pentodes

for use with

### 4-volt A.C. LOW TENSION SUPPLY

Type.	Application.	For particulars see page	PRICE.	
			In Gt. Britain	In I.F.S.
PM.24A	Output valve for use with anode voltages up to 300 .. ..	55	25/-	27/6
PM.24B	Output valve for use with anode voltages up to 400 .. ..	56	27/6	30/-
PM.24C	Output valve for use with anode voltage up to 400 .. ..	57	27/6	30/-
PM.24D	Output valve for use with anode voltage up to 500 .. ..	58	45/-	49/6

**Mullard the Master Valve**



# Type P.M.24A.

## FIVE ELECTRODE OUTPUT VALVE

Price 25/-  
(In I.F.S. 27/6)

### Application.

Five electrode output valve (pentode).

### Characteristics.

- \*Mutual Conductance 2.0 mA./volt
- \*At Anode Volts 100; Auxiliary Grid Volts 100; Control Grid Volts Zero.

### Operating Data.

- Max. Filament Voltage 4.0 volts
- Filament Current 0.275 amp.
- Max. Anode Voltage 300 volts
- Max. Auxiliary Grid Voltage 200 volts

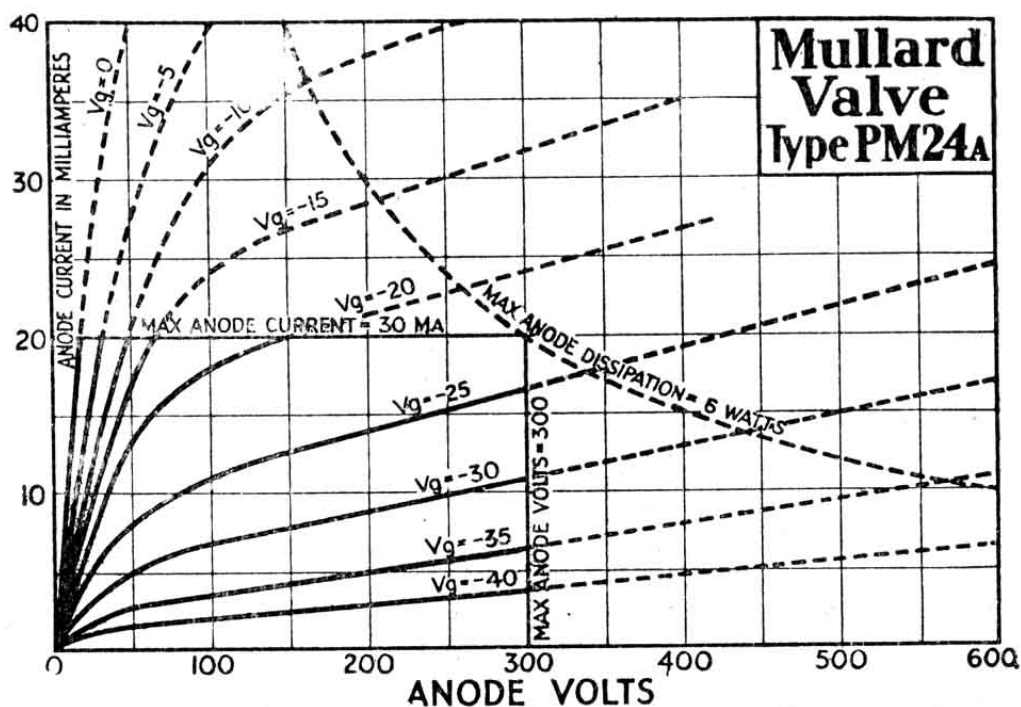

### Grid Bias Table.

Auxiliary Grid Voltage.	Approx. Neg. Grid Bias Voltage.	Approx. Anode Current (mA).
100	9.0	10.0
150	15.0	15.0
200	21.0	21.0

**Mullard the Master Valve**

# Type P.M.24B.

## FIVE ELECTRODE OUTPUT VALVE

Price 27/6  
(In I.F.S. 30/-)

### Application.

Five electrode output valve  
(Pentode).

### Characteristics.

\*Mutual Conductance  
2.1 mA./volt

\*At Anode Volts 100 ;  
Auxiliary Grid Volts 100 ;  
Control Grid Volts, Zero.

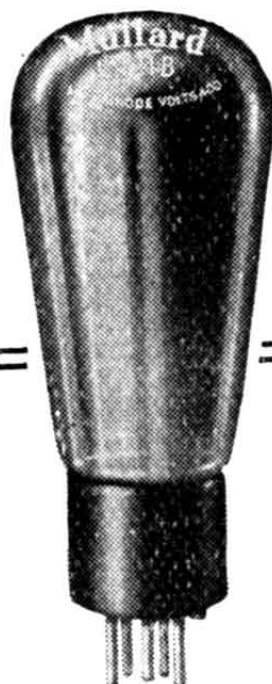

### Operating Data.

Max. Filament Voltage 4.0 volts  
Filament Current 1.0 amp.  
Max. Anode Voltage 400 volts  
Max. Auxiliary Grid Voltage 300 volts

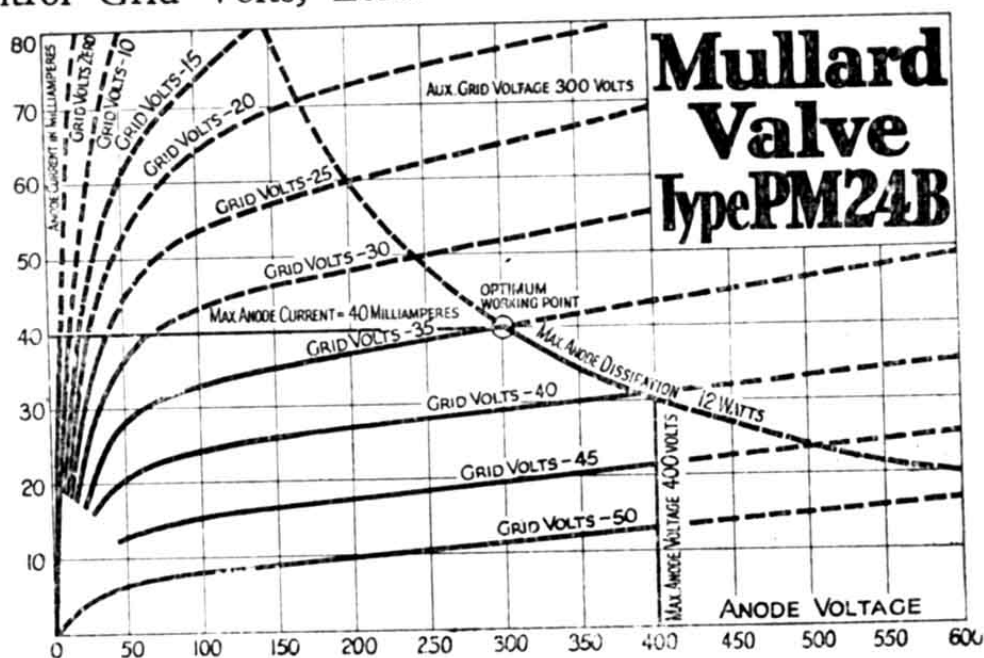

### Grid Bias Table.

Auxiliary Grid Voltage.	Approx. Neg. Grid Bias Voltage.	Approx. Anode Current (mA).
200	26.0	22.0
250	33.0	25.0
300 (At anode volts 300)	35.0	40.0
300 (At anode volts 400)	40.0	30.0

**Mullard the Master Valve**



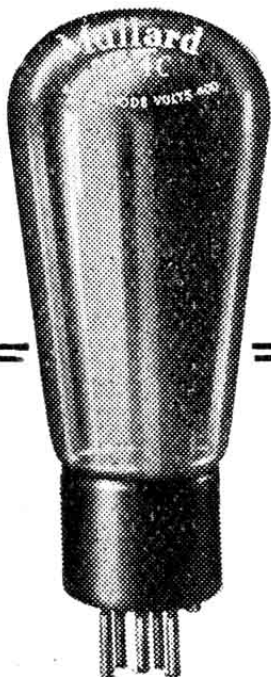

# Type P.M.24C.

## FIVE ELECTRODE OUTPUT VALVE

Price 27/6  
(In I.F.S. 30/-)

### Application.

Five electrode output valve (pentode).

### Characteristics.

\*Mutual Conductance 3.0 mA./volt  
\*At Anode Volts 400 ;  
Auxiliary Grid Volts 200 ;  
Control Grid Volts, -20.

### Operating Data.

Max. Filament Voltage 4.0 volts  
Filament Current 1.0 amp.  
Max. Anode Voltage 400 volts  
Max. Auxiliary Grid Voltage 200 volts

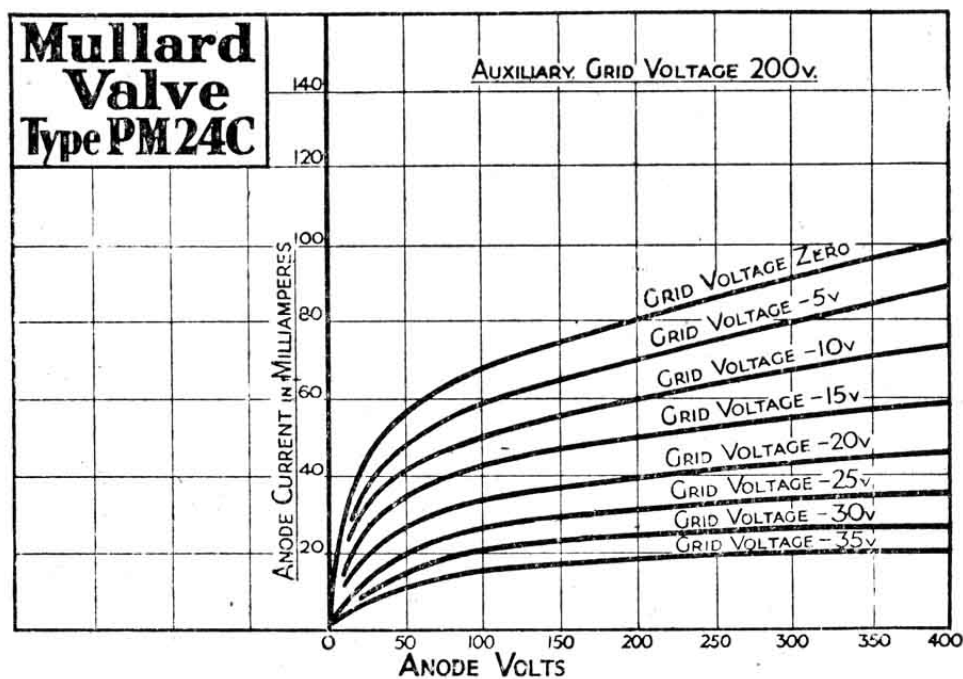

### Grid Bias Table.

Auxiliary Grid Voltage.	Approx. Neg. Grid Bias Voltage.	Approx. Anode Current (mA).
200	28.0	30

**Mullard the Master Valve**

# Type P.M.24D.



## FIVE ELECTRODE OUTPUT VALVE

Price 45/-  
(In I.F.S. 49/6)

### Application.

Five electrode output valve (pentode).

### Characteristics.

- \*Mutual Conductance  $\sim 4.0$  mA./volt
- \*At Anode Volts 100;  
Auxiliary Grid Volts 100;  
Control Grid Volts Zero.

### Operating Data.

- Max. Filament Voltage 4.0 VOLTS
- Filament Current 2.0 amp.
- Max. Anode Voltage 500 volts
- Max. Auxiliary Grid Voltage 200 volts

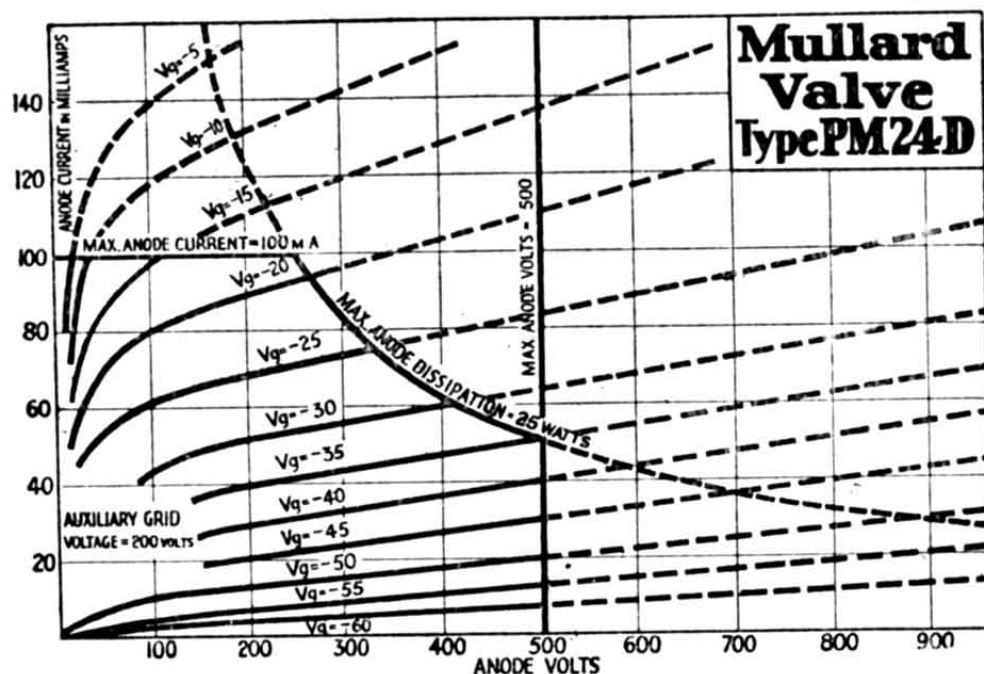

### Grid Bias Table.

Auxiliary Grid Voltage.	Approx. Neg. Grid Bias Voltage.	Approx. Anode Current (mA).
200	35	50

**Mullard the Master Valve**

# MULLARD RECTIFIER VALVES

## FULL WAVE TYPES

Type.	Application.	For particulars see page	PRICE	
			In Gt. Britain	In I.F.S.
DW.2	For outputs up to 60 mA. at 250 volts ..	60	15/-	16/6
DW.3	For outputs up to 120 mA. at 350 volts..	61	17/6	19/3
DW.4	For outputs up to 120 mA. at 500 volts..	62	22/6	24/9
DW.5	For outputs up to 120 mA. at 700 volts..	63	35/-	41/-
DW.6	For outputs up to 120 mA. at 1,000 volts	64	60/-	70/-
			Holder Nett 5/9	Nett 6/9

**Mullard the Master Valve**

# Type D.W.2

## FULL WAVE RECTIFYING VALVE

Price 15/-  
(In I.F.S. 16/6)

### Application.

Full wave rectifier for use in H.T. supply units or battery charging equipments.

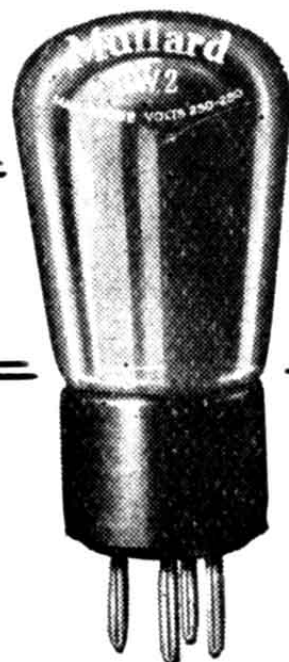

### Operating Data.

Max. Filament Voltage 4.0 volts  
Filament Current 1.0 amp.  
Max. Anode Voltage 250-250 volts R.M.S.

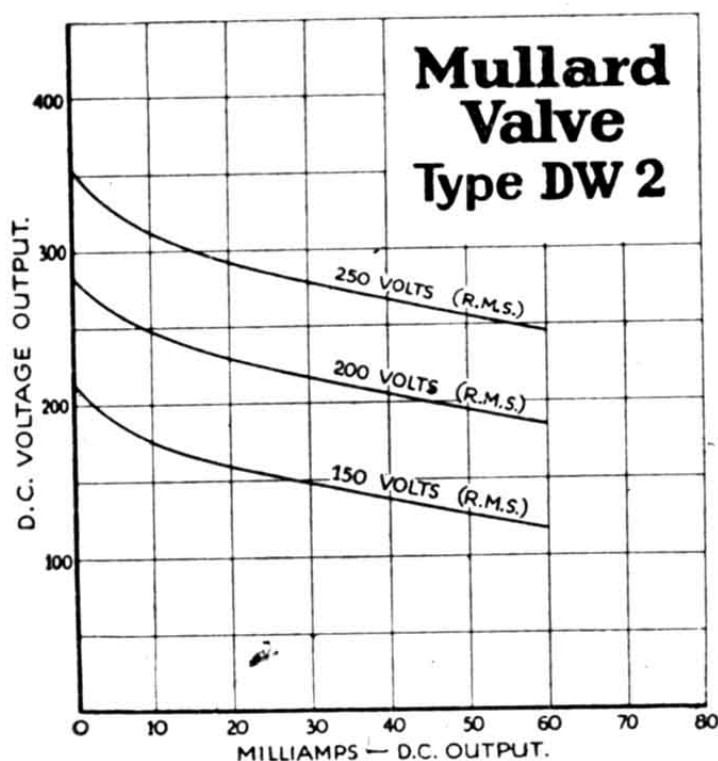

### Output.

Max. Rectified Output .. .. 60 mA. D.C.

**Mullard the Master Valve**

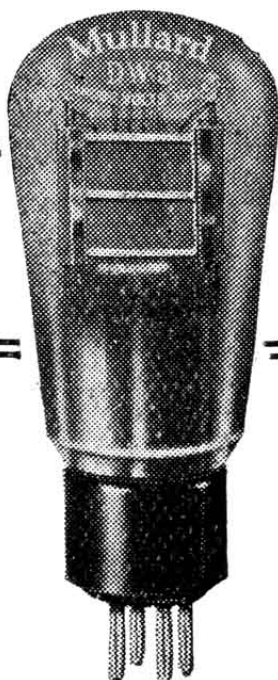

## Type D.W.3

### FULL WAVE RECTIFIER VALVE

Price 17/6

(In I.F.S. 19/3)

#### Operating Data.

Max. Filament Voltage  
4.0 volts  
Filament Current  
1.0 amp.  
Max. Anode Voltage  
350-350 volts R.M.S.

#### Application.

Full wave rectifier for use in H.T. supply units or battery charging equipments.

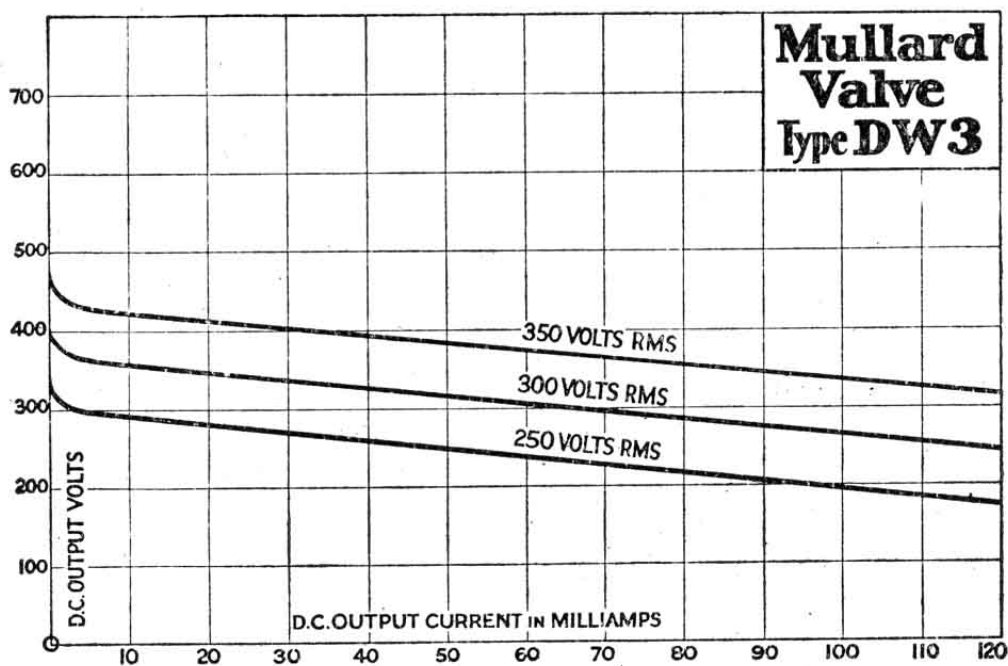

#### Output.

Max. Rectified Output .. .. 120 mA. D.C.

**Mullard the Master Valve**

# Type D.W.4

## FULL WAVE RECTIFIER VALVE

Price 22/6  
(In I.F.S. 24/9)

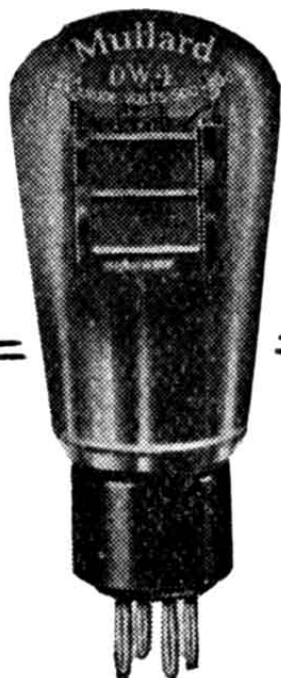

### Application.

Full wave rectifier for use in H.T. supply units or battery charging equipments.

### Operating Data.

Max. Filament Voltage 4.0 volts  
Filament Current 2.0 amps.  
Max. Anode Voltage 500-500 volts R.M.S.

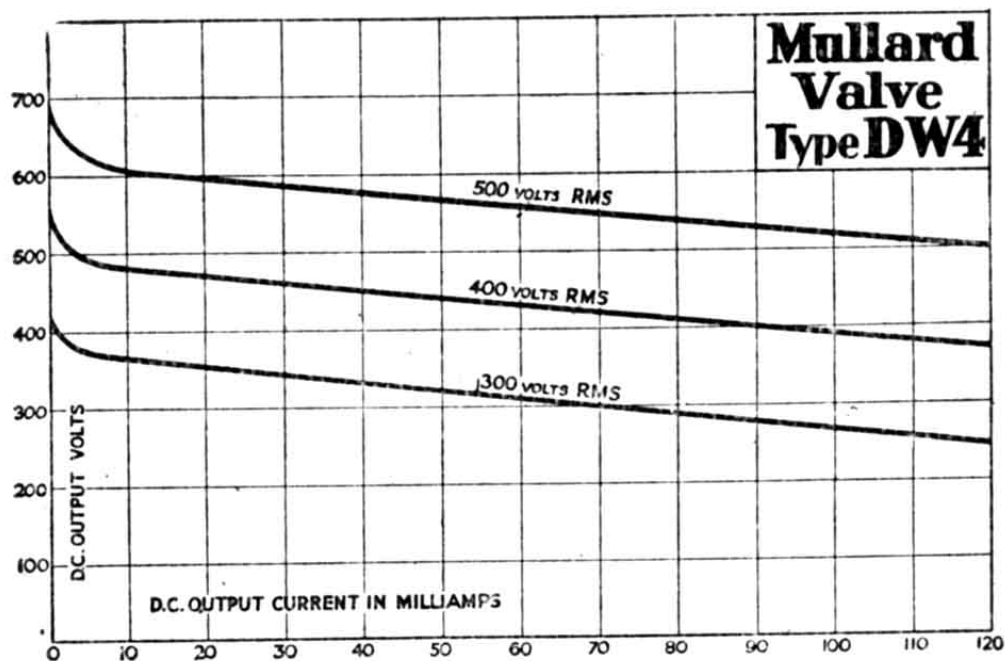

### Output.

Max. Rectified Output .. .. 120 mA. D.C.

**Mullard the Master Valve**

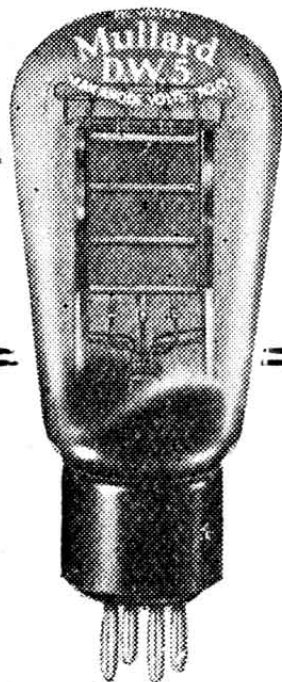

## Type D.W.5

### FULL WAVE RECTIFIER VALVE

Price 35/-

(In I.F.S. 41/-)

#### Operating Data.

Max. Filament Voltage  
4.0 volts

Filament Current  
3.0 amp.

Max. Anode Voltage  
700-700 volts R.M.S.

#### Application.

Full wave rectifier  
for use in H.T. supply  
units or battery charg-  
ing equipments.

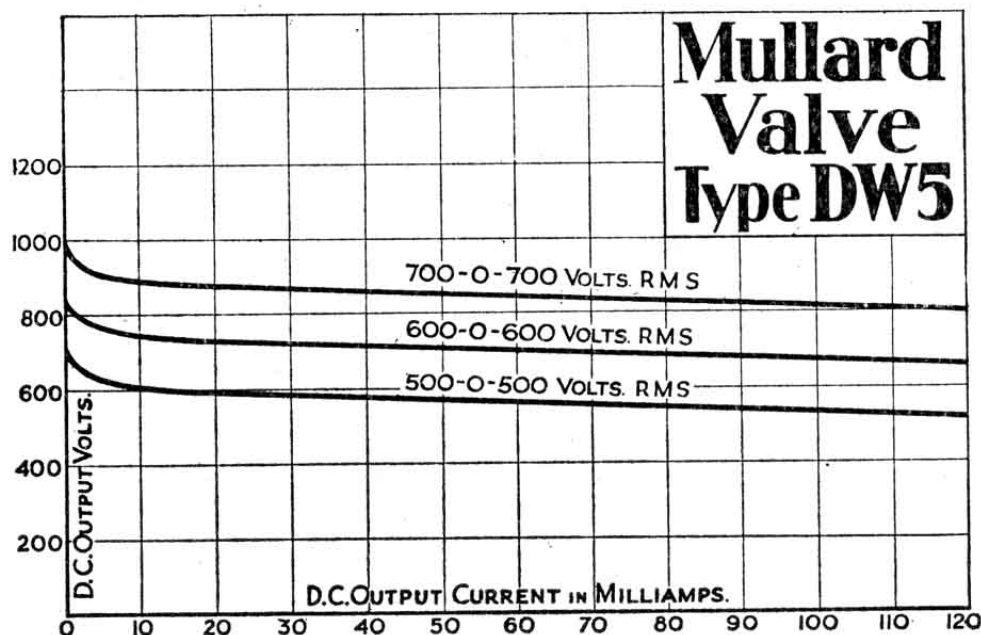

#### Output.

Max. Rectified Output .. .. 120 mA. D.C.

**Mullard the Master Valve**

# Type D.W.6

## FULL WAVE RECTIFIER VALVE

Price 60/-

(In I.F.S. 70/-)

Special Holder 5/9 nett.

(In I.F.S. 6/9 nett)



### Application.

Full wave rectifier for use in H.T. supply units or battery charging equipments.

### Operating Data.

Max. Filament Voltage  
4.0 volts

Filament Current  
4.0 amps.

Max. Anode Voltage  
1,000-1,000 volts

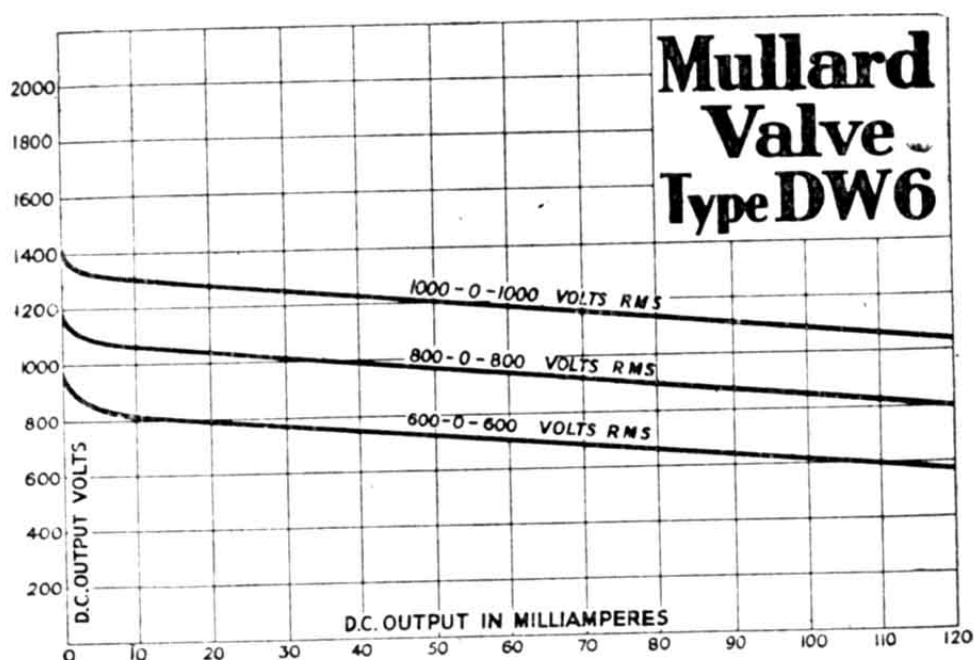

### Output.

Max. Rectified Output .. .. 120 mA. D.C.

**Mullard the Master Valve**



# TECHNICAL APPENDIX

	PAGES
AUTOMATIC GRID BIAS ..	66-70
L.F. AMPLIFIER CIRCUITS ..	71-75
H.F. OSCILLATION IN L.F. AMPLIFIERS — SYMPTOMS, CAUSES AND CURES ..	.. 76-77

# AUTOMATIC GRID BIAS

It is often convenient to obtain grid bias in A.C. all-mains receivers by utilising the voltage drop across a resistance connected between the negative terminal of the H.T. supply and the cathode. This so-called "free" grid bias arrangement has the advantage of automatically controlling the value of the anode current, and, if the biasing resistance is variable, avoids the possibility of a dangerous rise in anode current while adjustment to grid bias is being made.

The accompanying diagrams show recommended automatic bias circuits for various types of valves and suitable values for the decoupling resistance and bypass condensers. Beneath each diagram are given the appropriate values of biasing resistance for each type of Mullard A. C. mains valve.

The resistance should be of the wire-wound type and must be capable of carrying continuously the full anode current of the valve.

## I. Indirectly-heated screened-grid valves.

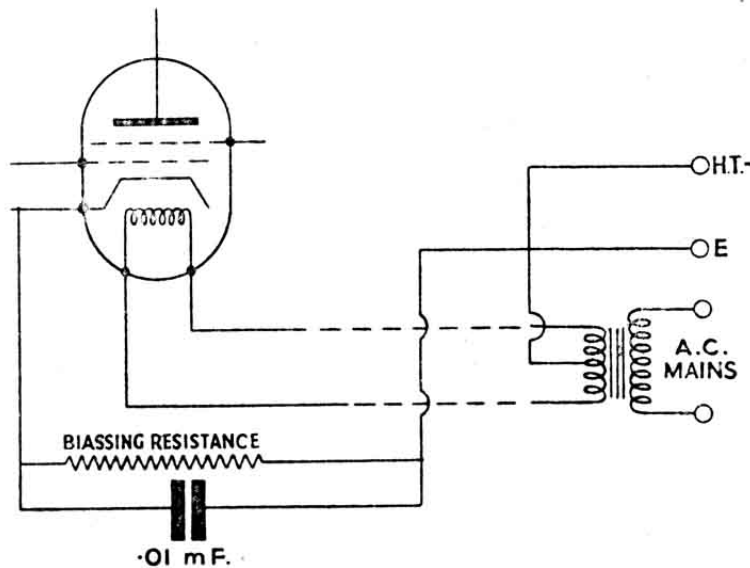

Valve Type.	Value of Biasing Resistance (Ohms).
S.4V	600
S.4VA	300
S.4VB	200

**Mullard the Master Valve**

# AUTOMATIC GRID BIAS—cont.

## II. Indirectly-heated triode as L.F. amplifier.

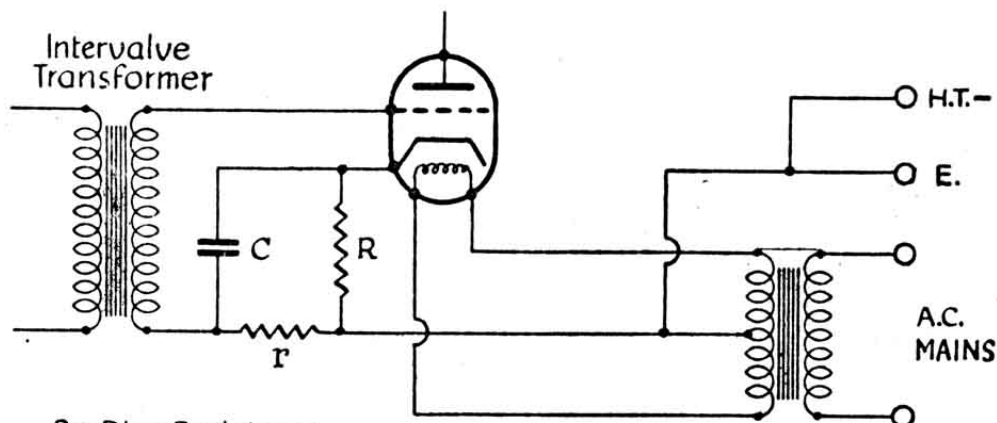

R = Bias Resistance.  
 r = Decoupling resistance - 0.1 Megohm  
 C =  $2\mu\text{F}$  Condenser.

Valve Type.	Value of Biasing Resistance (Ohms).
904V	1000
354V	1000
164V	1000
104V	1000

## III. Indirectly-heated triode as output valve.

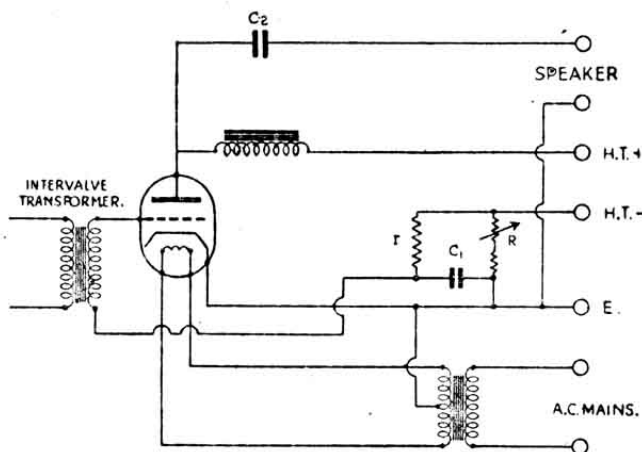

R = Bias Resistance.  
 r = Decoupling resistance  
 (0.1 mega-ohm grid leak)  
 C<sub>1</sub> =  $2\mu\text{F}$  Condenser.  
 C<sub>2</sub> =  $4\mu\text{F}$  Condenser

FILAMENT TRANSFORMER.  
 Method of obtaining automatic Grid Bias for indirectly heated power valve

Valve Type.	Total Value of Biasing Resistance (Ohms).	Fixed Portion of Biasing Resistance (Ohms).	Variable Portion of Biasing Resistance (Ohms).
104V	1000	500	500
054V	1200	700	500

# Mullard the Master Valve

# AUTOMATIC GRID BIAS—cont.

## IV. Directly-heated triode output valve.

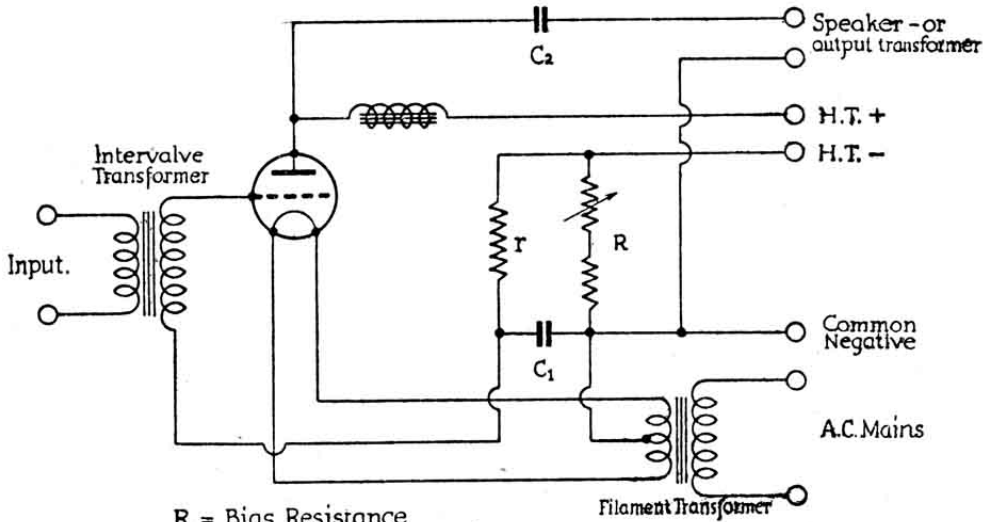

$R$  = Bias Resistance  
 $r$  = Decoupling Resistance (100,000 ohms)  
 $C_1$  = Bypass Condenser ( $2\mu\text{F}$ )  
 $C_2$  = Output Condenser ( $4\mu\text{F}$ )

*If condensers are put in each speaker lead,  
they should both have a value of  $8\mu\text{F}$ .*

Valve Type.	Total Value of Biasing Resistance (Ohms).	Fixed Portion of Biasing Resistance (Ohms).	Variable Portion of Biasing Resistance (Ohms).
PM.254	1000	500	500
PM.256	1500	1000	500
PM.256A	1250	750	500
AC.104	1500	1000	500
AC.064	1250	750	500
AC.044	1250	750	500
DO.10	5500	4500	1000
DO.20	2000	1500	500
DO.24	500	250	250
DO.25	1750	1250	500
DO.60	1000	500	500
DO.75	1000	500	500

# AUTOMATIC GRID BIAS—cont.

## V. Directly-heated pentode.

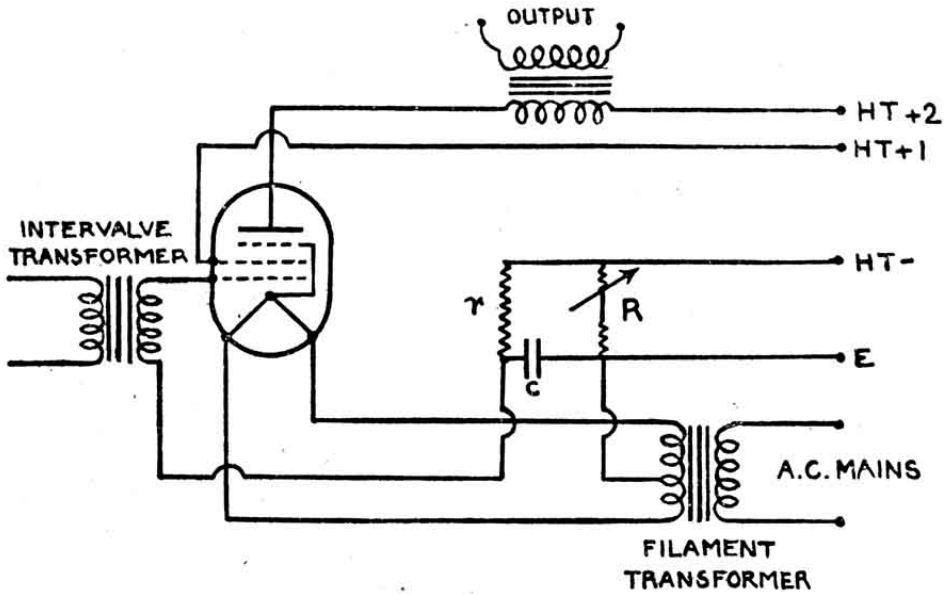

$R$  - Bias Resistance

$r$  - Decoupling Resistance  
(0.1 meg Ohm gridleak)

$C$  - 2 mfd. condenser

METHOD OF OBTAINING  
AUTOMATIC GRID BIAS  
FOR DIRECTLY HEATED PENTODE VALVE

Valve Type.	Total Value of Biasing Resistance (Ohms).	Fixed Portion of Biasing Resistance (Ohms).	Variable Portion of Biasing Resistance (Ohms).
PM.24	650	400	250
PM.24A	1250	750	500
PM.24B	1250	750	500
PM.24C	1250	750	500
PM.24D	1000	500	500

# AUTOMATIC GRID BIAS—cont.

## VI. Indirectly-heated pentode.

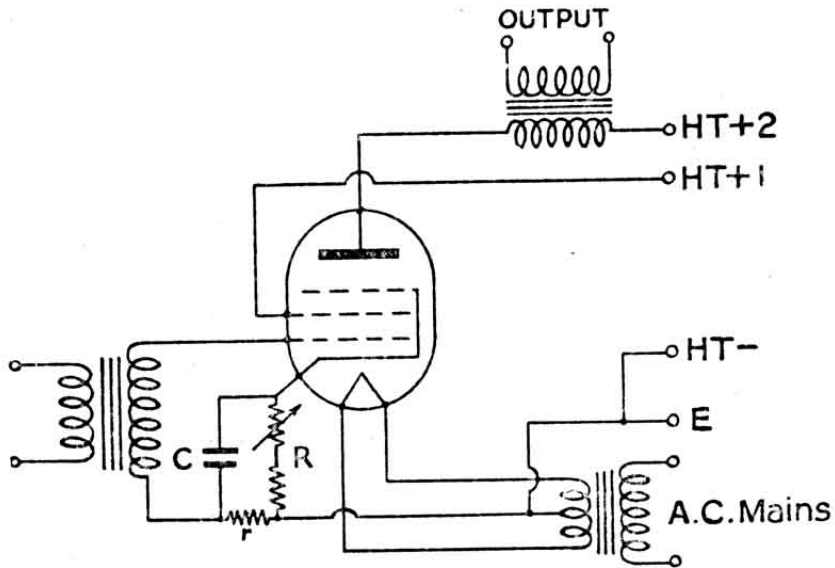

R = Bias Resistance  
 C = 2mfd Condenser  
 r = De-Coupling  
 Resistance-100,000ohms

METHOD OF OBTAINING  
 AUTOMATIC GRID BIAS  
 FOR INDIRECTLY HEATED  
 PENTODE VALVE

Valve Type.	Total Value of Biasing Resistance (Ohms).	Fixed Portion of Biasing Resistance (Ohms).	Variable Portion of Biasing Resistance (Ohms).
PEN.4V	500	250	250

# LOW FREQUENCY AMPLIFIER CIRCUITS

Below and on the following pages are given a number of circuits for amplifiers suitable for gramophone or moderate power public address equipment.

The values of the various components are given below each diagram.

## CIRCUIT No. 1

3-watt Battery-operated Amplifier  
with Triode Output Valve.

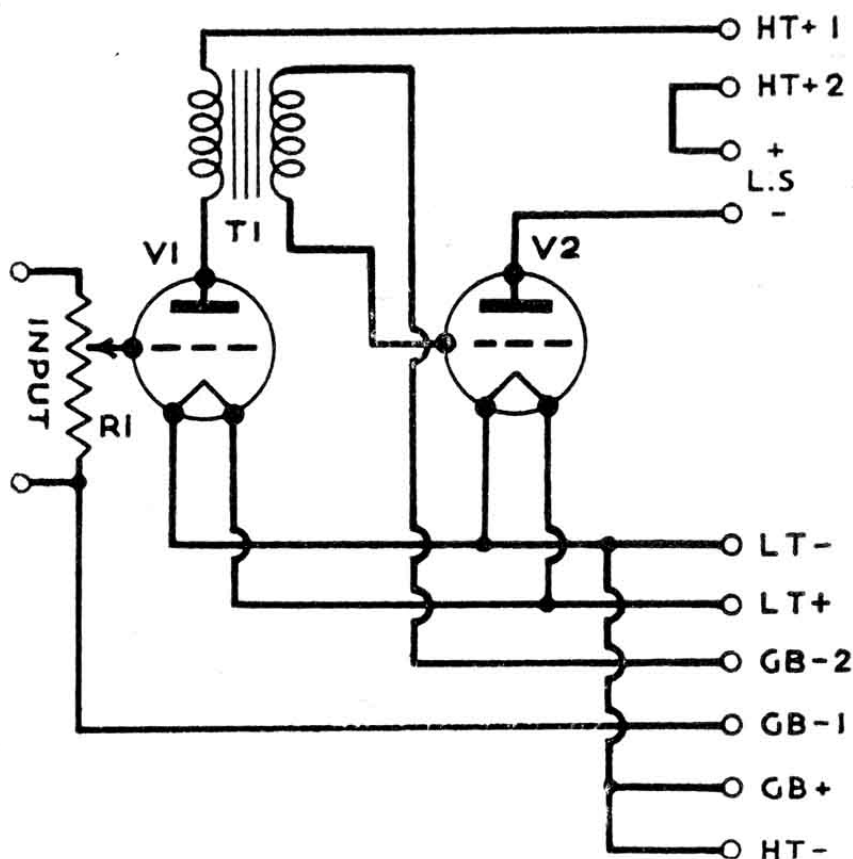

V1 .....PM.2DX.

V2 .....PM.252.

R1 .....250,000 ohm Volume Control

T1 .....Inter-valve Transformer

L.S. ...Loud Speaker

H.T.1...100 volts

H.T.2...150 volts

L.T. ... 2 volts

G.B.1... - 3 volts

G.B.2... - 15 volts

**Mullard the Master Valve**

## LOW FREQUENCY AMPLIFIERS—Contd.

## CIRCUIT No. 2

3-watt Battery-operated Amplifier  
with Pentode Output Valve.

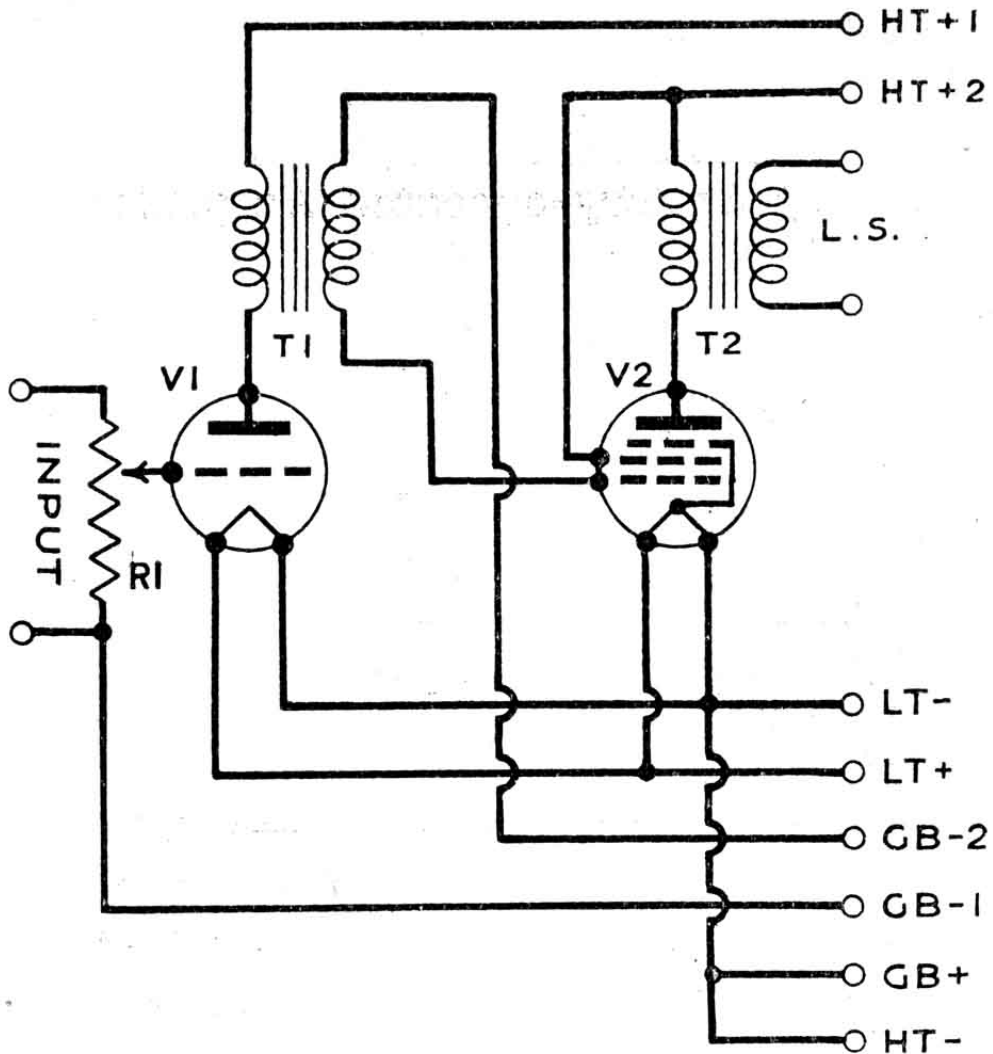

V<sub>1</sub> .....PM.2DX

V<sub>2</sub> .....PM.22

R<sub>1</sub> .....250,000 ohm Volume Control

T<sub>1</sub> .....Inter-valve Transformer

T<sub>2</sub> .....Pentode Output Transformer

L.S. ...Loud Speaker

H.T.1... 100 volts

H.T.2... 150 volts

L.T. ... 2 volts

G.B.1... - 3 volts

G.B.2... - 12 volts



## LOW FREQUENCY AMPLIFIERS—Contd.

## CIRCUIT No. 3

12-watt All-Mains Amplifier  
with Triode Output Valve.

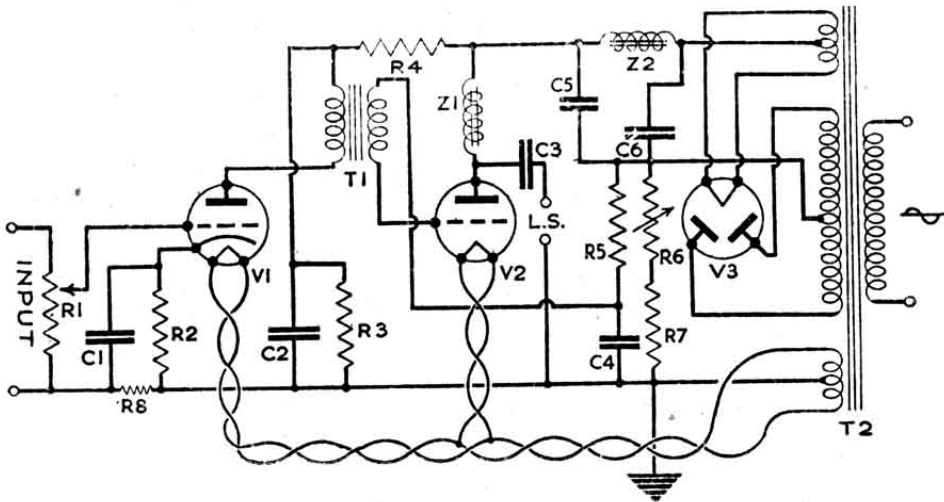

V<sub>1</sub>.....354V

V<sub>2</sub>.....A.C.044

V<sub>3</sub>.....D.W.2

R<sub>1</sub>.....250,000 ohm Volume Control

R<sub>2</sub>.....1,000 ohm Resistance (wire wound)

R<sub>3</sub>.....200,000 ohm Resistance (wire wound)

R<sub>4</sub>.....20,000 ohm Resistance (wire wound)

R<sub>5</sub>.....100,000 ohm Resistance (wire wound)

R<sub>6</sub>.....500 ohm Variable Resistance

R<sub>7</sub>.....750 ohm Fixed Resistance

L.S. ...Loud Speaker

C<sub>1</sub> = C<sub>2</sub> = C<sub>4</sub>...2 mfd.

C<sub>3</sub> = C<sub>6</sub>...4 mfd.

C<sub>5</sub>.....8 mfd.

T<sub>1</sub>.....Inter-valve Transformer

T<sub>2</sub>.....Mains Transformer with 3 secondary windings

(a) 2-0-2 Volts (RMS) to give 2 amps.

(b) 200-0-200 Volts (RMS) to give 40 mA.

(c) 2-0-2 Volts (RMS) to give 1 amp.

Z<sub>1</sub>.....30 henry Choke to carry 30 mA. D.C.

Z<sub>2</sub>.....30 to 60 henry Choke to carry 35 mA. D.C.

**Mullard the Master Valve**

## LOW FREQUENCY AMPLIFIERS—Contd.

**CIRCUIT No. 4**

**12-watt All-Mains Amplifier  
with Pentode Output Valve.**

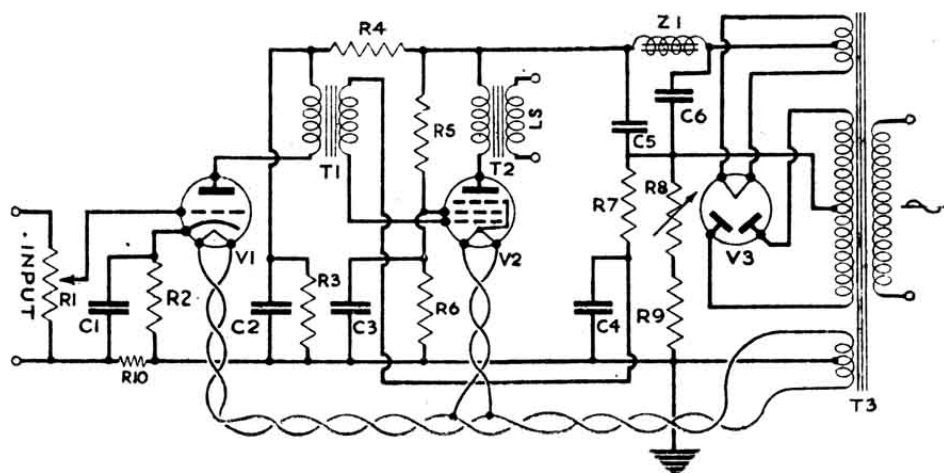

V1.....354V

V2.....PM.24B

V3.....D.W.4

R1.....250,000 ohm Volume Control

R2.....1,000 ohm Resistance (wire wound)

R3.....200,000 ohm Resistance (wire wound)

R4.....50,000 ohm Resistance (wire wound)

R5.....10,000 ohm Resistance (wire wound)

R6.....100,000 ohm Resistance (wire wound)

R7.....100,000 ohm Resistance (wire wound)

R8.....500 ohm Variable Resistance

R9.....1,500 ohm Resistance (wire wound)

C1 = C2 = C3 = C4...2 mfd.

C5.....8 mfd.

C6.....4 mfd.

T1.....Inter-valve Transformer

T2.....Pentode Output Transformer

T3.....Mains Transformer with 3 secondary windings

(a) 2-0-2 volts (RMS) to give 2 amps.

(b) 400-0-400 volts (RMS) to give 45 mA.

(c) 2-0-2 volts (RMS) to give 2 amps.

Z1.....30 to 60 henry Choke to carry 45 mA. D.C.

**Mullard the Master Valve**

## LOW FREQUENCY AMPLIFIERS—Contd.

## CIRCUIT No. 5

### 25-watt All-Mains Amplifier with Triode Output Valve

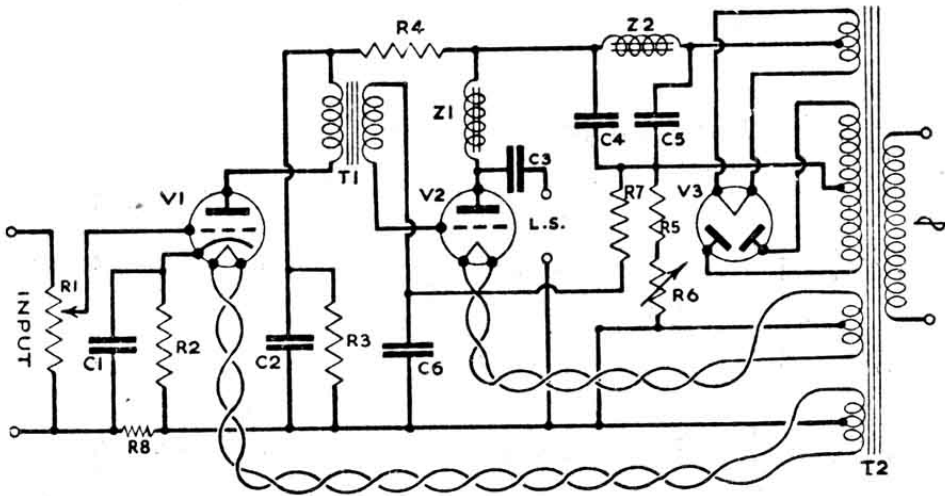

V1...354V

V2...DO.25

V3...DW.4

R1...500,000 ohm Volume Control

R2...1,000 ohm Resistance (wire wound)

R3...200,000 ohm Resistance

R4...50,000 ohm Resistance

R5...1,250 ohm Resistance

R6...500 ohm Variable Resistance

R7...0.1 megohm Decoupling Grid Leak

R8...0.1 megohm Decoupling Grid Leak

C1...2 mfd. Blocking Condenser

C2...2 mfd. Blocking Condenser

C3...4 mfd. Condenser (working voltage 500)

C4...4 mfd. Condenser (working voltage 500)

C5...4 mfd. Condenser (working voltage 500)

C6...2 mfd. Blocking Condenser

T1...Inter-valve Transformer

T2...Mains Transformer with four secondaries

(a) 4-volts, 2.0 amps.

(b) 500-0-500 volts ; 120 mA.

(c) 3-0-3 volts, 1.8 amp.

(d) 2-0-2 volts, 1 amp.

Z1...30 henry Choke to carry 63 mA.

Z2...50 henry Choke to carry 120 mA.

# Mullard the Master Valve

# HIGH FREQUENCY OSCILLATION IN LOW FREQUENCY AMPLIFIERS

Owing to the high mutual conductance of modern output valves, it sometimes happens that trouble arises in low frequency amplifiers due to high frequency oscillation in the power stage. This effect, which is most likely to occur when modern efficient output valves are used in existing gear which does not conform to the most modern practice, or when such valves are used in parallel or push-pull, is not in any way due to faults in the valves, but is a natural result of the increased mutual conductance of up-to-date valves.

High frequency oscillation makes itself apparent as increased anode current and reduced output. In difficult cases it may be traced as follows :

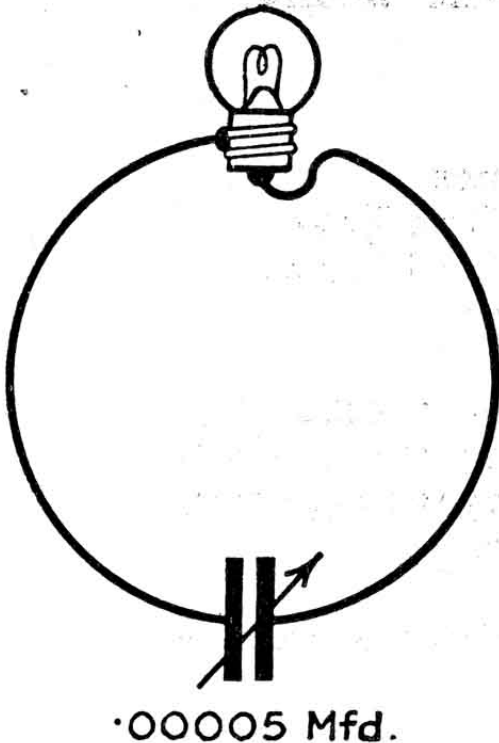

- (1). By lowering a tuned wire loop, connected to a flash lamp bulb, over the valve connections, when the lamp may light due to induced H.F. currents, if the amplifier be oscillating violently.
- (2). By touching the "grid" terminal with the finger or with a piece of metal when the anode feed current will usually show a sudden change if the valve be oscillating.
- (3). By holding a neon lamp to the grid terminal when the lamp will glow if sufficiently powerful oscillations be present. Care must be taken to check that the grid bias potential will not, of itself, make the lamp glow.

The first test, i.e., lighting of a small glow lamp, is the most reliable indication of H.F. oscillation.

---

**Mullard the Master Valve**

## CURES.

It has been found by experience that the following methods may be relied upon to stop "parasitic" H.F. oscillation and should be adopted as precautionary measures when designing power amplifiers :

- (1). Insertion of a wire-wound resistance of 80 to 100 ohms in the anode circuit as close as possible to the anode terminal of the valve holder.
- (2). The inclusion of a 5,000 ohms resistance in the grid circuit close to the grid terminal is useful, but greater values of resistance should not be employed.
- (3). A Neon "gas-gap" discharge tube may be connected across the input terminals of the amplifier (without including the grid bias voltage in cases where this is high enough to discharge through the tube). To any signal of normal strength the neon tube will offer almost infinite impedance, but transients of abnormal strength, which would tend to set the amplifier into oscillation, discharge through the tube and are short-circuited thereby. Gas-gap neon tubes can be obtained having breakdown voltages from 90 volts upwards.
- (4). In extreme cases similar neon tubes (of higher breakdown voltages) may be connected across impedance in the anode circuits.
- (5). In the case of valves connected in pairs, either in "push-pull," "parallel" or both, it should be remembered that symmetrical arrangements of the wiring are favourable to generation of very short waves.