

Mullard passive components 1974/5

Also available companion quick reference guides on valves and tubes & semiconductors

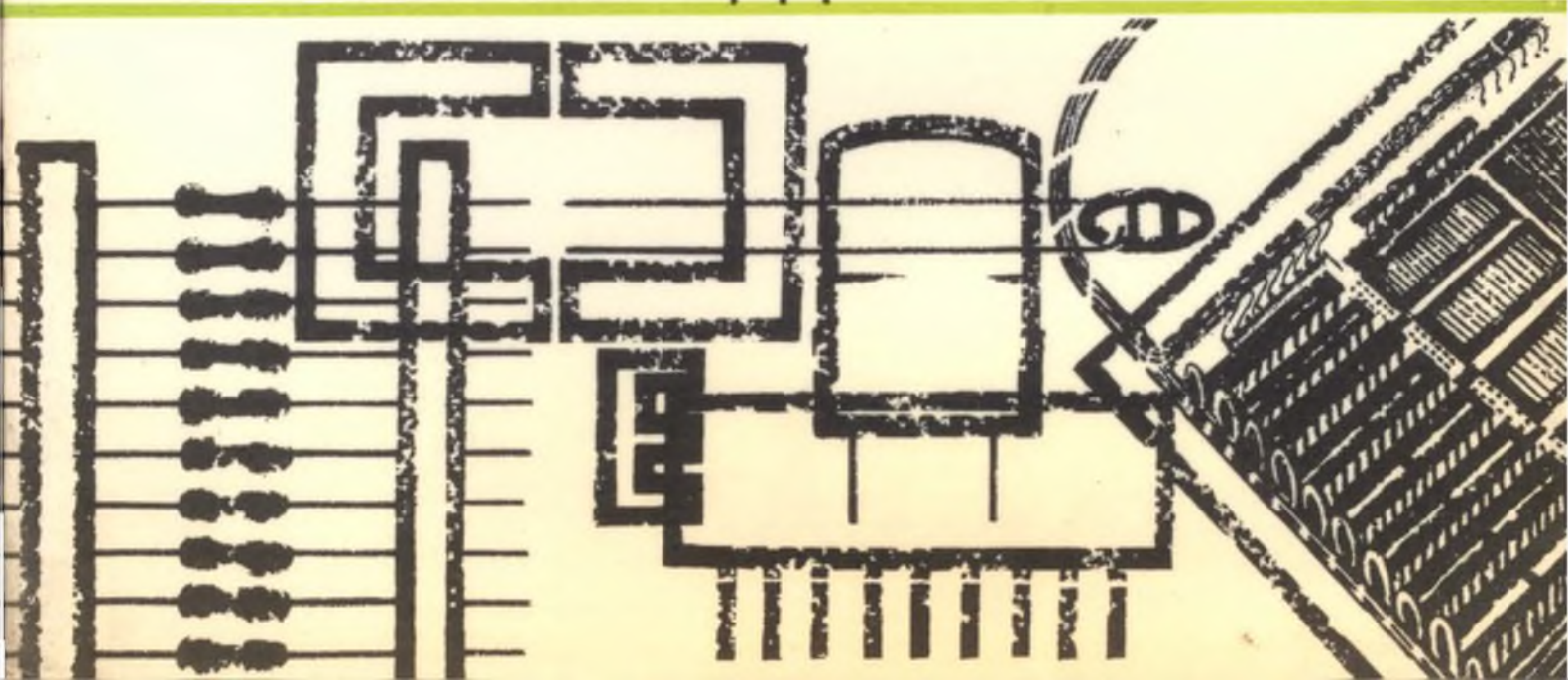
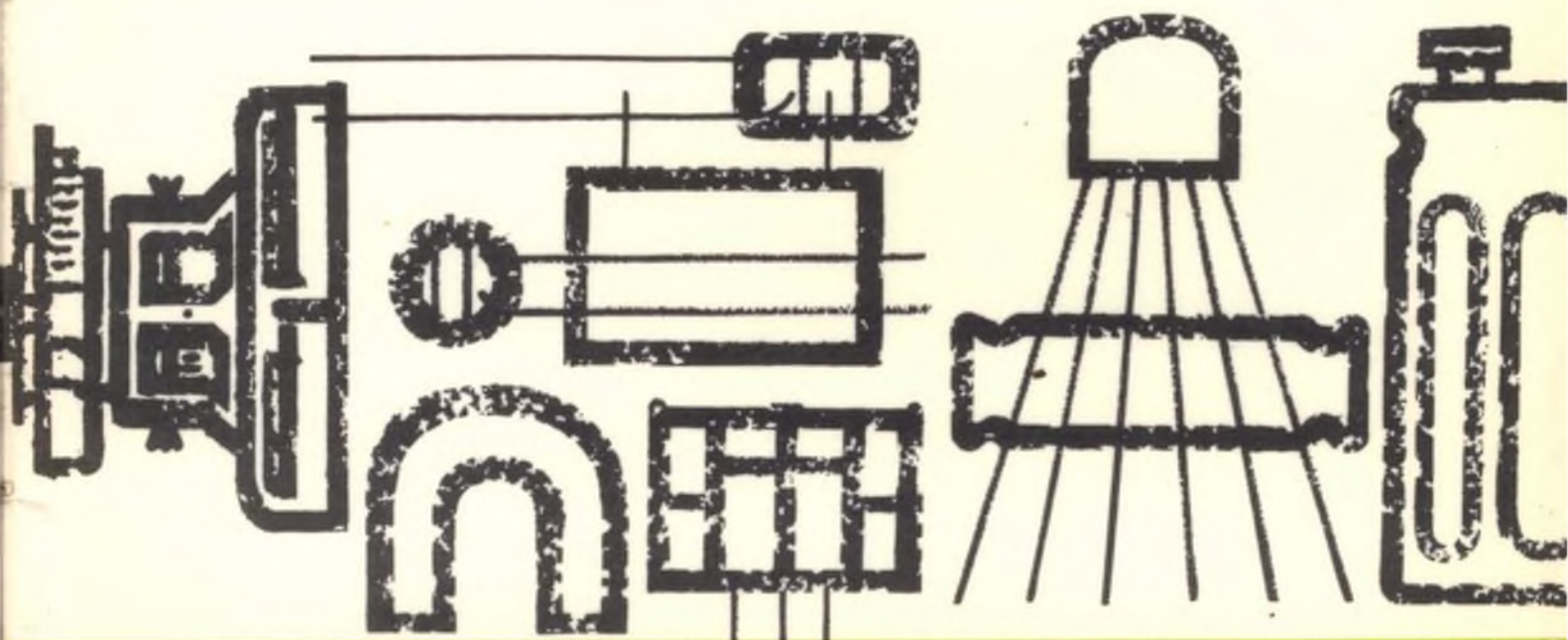

contents

Page
No.

Page
No.

4 Index

6 Code number conversion list

Metallised film capacitors
8 p.e.t.p. and polycarbonate



Film/foil capacitors
11 moulded polystyrene (extended foil)
12 miniature, polystyrene (extended foil)
13 p.e.t.p. (extended foil)
15 polypropylene and paper (extended foil)



Ceramic capacitors
16 miniature, plate (low-K)
17 miniature, plate (high-K)
17 miniature, plate (medium-K)

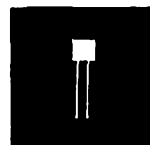

Electrolytic capacitors
18 long life, small
19 general purpose, miniature and small
21 general purpose, large
22 long life, large (computer)
23 long life, small
24 solid electrolyte, aluminium



Variable capacitors
25 tubular ceramic trimmers
25 film dielectric trimmers, miniature

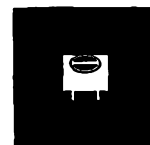

Linear resistors
26 lacquered, carbon film
27 lacquered, metal film
28 metal film, high power
29 metal glaze, high ohmic



Non-linear resistors
30 negative temperature coefficient
32 positive temperature coefficient
32 voltage dependent



Radio and audio modules
34 f.m. tuner modules
34 i.f. modules
34 stereo decoder module
35 stereo pre-amplifier modules
35 audio amplifier modules

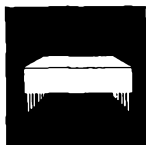

Television modules
36 voltage multiplying modules



Television assemblies
37 tuners (with diode tuning)
37 line linearity control units
37 deflection coils (monochrome)
37 line output transformers (monochrome)
38 deflection coils (90° colour)
38 deflection coils (110° colour)
38 combined deflection coils and convergence units (90° colour)
38 blue lateral units (colour)
39 line output transformers (90° colour)
39 line output transformer (110° colour)
39 raster correction transducers (colour)
39 bridge coil (110° colour)
39 correction adjustment coils (colour)
39 delay line (colour)



Solid state control elements
40 Norbit 2 series
41 thyristor trigger and control modules – 61 series
42 display counters – 50 series
43 input devices



contents continued

Page
No.

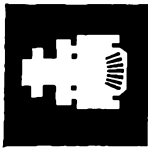

44 Mosaic printers



45 Hybrid v.h.f./u.h.f. wideband amplifiers



Ferroxcube
46 linear ferrite materials
46 cores for power applications :
46 - for use in television
46 - yoke rings
47 - for use in switched-mode power supplies and inverters
48 cores for small signal applications :
48 - E and I cores
48 - H core assemblies
49 - pot and RM transformer cores
49 - cross cores
50 - screening beads
50 - single and double aperture cores
50 - rods
51 - tubes
51 - toroids
52 RM inductor cores
53 Vinkor pot cores (to BS4061 range 1)



PXE piezoelectric ceramic components
54 material properties
55 gas ignition
55 ultrasonic cleaning and welding
55 echo sounder
55 pick-up elements
55 air transducer
55 delay line transducer
55 feedback disc
55 general applications rods, discs, plates



Permanent magnets
56 material properties
56 standard shapes and sizes
57 plasto ferrites
57 Magnadur magnet powder M8



Computer components
58 ferrite core memory systems
59 ferrite core matrix planes and stacks
59 M.O.S. memory systems



Wound components
60 custom-built service
60 miniature pulse transformers
61 thyristor trigger transformers

Passive components quick reference guide 1974/75

This guide presents quick reference data on Mullard passive components.

Product information is deliberately abbreviated to give a rapid appreciation of salient characteristics, and to enable the performance of similar types to be compared quickly.

Full technical data on individual products, and details of the Mullard Technical Handbook, may be obtained from
Central Technical Services
Mullard Limited
New Road
Mitcham Surrey CR4 4XY
Telephone 01-648 3471 Telex 22194

For the convenience of Handbook users, the relevant book and part numbers are indicated at the top of each data table in the guide; data sheets for some new components may still be in preparation.

Mullard technical information service

Quick reference information

The most important characteristics of the current ranges of Mullard passive components are given in this guide.

Full technical data

Individual data sheets, giving full technical data on each product are readily available, and may be obtained by quoting the relevant type number.

In addition, laboratory reports, applications reports and technical publications of many kinds are regularly issued.

Technical Handbook system

The Mullard Technical Handbook system of data is made up of three sets of books, each comprising several parts.

The three sets of books, easily identifiable by the colours of their covers, are as follows:

| | |
|-----------------|---|
| Book 1 (blue) | Semiconductor devices and integrated circuits |
| Book 2 (orange) | Valves and tubes |
| Book 3 (green) | Components materials and assemblies |

New editions are issued at approximately yearly intervals.

New product information

As a further part of the information service, advance details of each new product or technique are published in the Mullard Bulletin, which is sent automatically to people who have asked to be kept informed of new introductions.

index of data pages

| Type No. | Page | Type No. | Page | Type No. | Page | Type No. | Page |
|----------------|------|---------------|--------|----------|--------|----------|--------|
| AT1025/05 | 38 | DT2468 | 52 | FX1169 | 50 | *FX2902 | 50 |
| AT1025/06 | 38 | DT2470 | 52 | *FX1172 | 50 | *FX2917 | 50 |
| AT1025/08 | 38 | DT2477 | 52 | *FX1208 | 51 | FX3008 | 51 |
| AT1027/15 | 38 | DT2480 | 52 | FX1238 | 48 | FX3009 | 51 |
| AT1027/19 | 38 | DT2481 | 52 | FX1239 | 48 | FX3012 | 51 |
| AT1029/15 | 38 | DT2487 | 52 | FX1242 | 50, 51 | FX3160 | 46 |
| AT1029/19 | 38 | DT2496 | 52 | FX1243 | 51 | FX3187 | 46 |
| AT1040/00 | 37 | DT2498 | 52 | FX1272 | 51 | FX3188 | 46 |
| AT1040/15 | 37 | DT2506 | 52 | FX1276 | 51 | FX3225 | 50 |
| AT1062/01 | 38 | DT2517 | 52 | FX1314 | 48 | FX3234 | 47 |
| AT1063/01 | 38 | *DT2522 | 52 | FX1315 | 48 | FX3235 | 47 |
| AT2036/00 | 37 | DT2523 | 52 | *FX1433 | 50 | FX3237 | 51 |
| AT2048/11 | 37 | DT2534 | 52 | FX1447 | 51 | FX3238 | 51 |
| AT2055 | 39 | DT2535 | 52 | FX1483 | 51 | FX3239 | 51 |
| AT2055/02 | 39 | *DT2538 | 52 | FX1516 | 50 | FX3240 | 51 |
| AT2063/00 | 39 | DT2539 | 52 | FX1582 | 51 | *FX3245 | 50 |
| AT4040 Series | 39 | DT2720 | 47 | FX1586 | 51 | FX3251 | 46 |
| AT4041/37 | 39 | DT2730 | 47 | FX1587 | 51 | FX3280 | 49 |
| AT4041/40 | 39 | DT2740 | 47 | FX1588 | 51 | FX3286 | 49 |
| AT4042/02 | 37 | DT2750 | 47 | FX1589 | 51 | FX3287 | 49 |
| AT4042/08 | 37 | | | FX1590 | 51 | FX3288 | 49 |
| AT4042/14 | 37 | E220ZZ Series | 32 | FX1593 | 51 | FX3308 | 46 |
| AT4043/86 | 39 | E295ZZ Series | 33 | FX1594 | 51 | FX3311 | 51 |
| AT4046 Series | 38 | E298 Series | 33 | FX1595 | 51 | FX3312 | 51 |
| | | E299 Series | 33 | FX1598 | 51 | FX3313 | 51 |
| C004 Series | 25 | ECA50 | 42 | FX1652 | 48 | FX3316 | 50 |
| C280AE Series | 8 | ELC1042 | 37 | FX1653 | 48 | FX3391 | 50 |
| C280CF Series | 8 | ELC1043/05 | 37 | *FX1807 | 50 | FX3432 | 49 |
| C281AB Series | 9 | ELC2000S | 37 | FX1818 | 48 | FX3433 | 49 |
| C281CD Series | 9 | EPD60 | 43 | FX1819 | 48 | FX3434 | 49 |
| C281VV Series | 9 | | | FX1886 | 51 | FX3435 | 49 |
| *C295AA Series | 11 | FF90 | 40 | FX1898 | 50 | FX3436 | 49 |
| *C295AC Series | 11 | FI-2 | 58 | FX2049 | 50 | FX3437 | 49 |
| *C295AH Series | 11 | FI-26 | 58 | FX2073 | 51 | FX3438 | 49 |
| C296AA Series | 13 | FI-65 | 58 | *FX2236 | 49 | FX3439 | 49 |
| C296AC Series | 13 | FI-75 | 58 | *FX2238 | 49 | FX3440 | 49 |
| C333 Series | 16 | FI-128 | 58 | *FX2239 | 49 | FX3441 | 49 |
| *C428 Series | 18 | FI-138 | 58 | *FX2240 | 49 | FX3550 | 46, 47 |
| CM64 | 44 | FIC1 to FIC6 | 42 | FX2241 | 49 | FX3558 | 46 |
| CR16 Series | 26 | FX1007 | 48 | FX2242 | 49 | FX3560 | 46, 47 |
| CR25 Series | 26 | FX1052 | 48 | FX2243 | 49 | FX3567 | 46 |
| CR37 Series | 26 | *FX1053 | 48 | FX2249 | 50 | FX3588 | 46 |
| | | FX1054 | 51 | *FX2318 | 48 | FX3720 | 47 |
| DL50 | 39 | *FX1060 | 51 | *FX2343 | 51 | FX3730 | 47 |
| DOA61 | 41 | *FX1068 | 51 | FX2395 | 51 | FX3740 | 47 |
| DT2387 | 52 | FX1073 | 48 | FX2431 | 50 | FX3750 | 47 |
| *DT2391 | 52 | FX1076 | 51 | FX2501 | 49 | | |
| DT2392 | 52 | FX1089 | 50 | *FX2502 | 49 | GLD60 | 40 |
| DT2396 | 52 | FX1098 | 51 | FX2507 | 46 | | |
| DT2398 | 52 | FX1099 | 50 | FX2527 | 46 | | |
| DT2406 | 52 | *FX1099 | 50 | FX2633 | 50 | HPA60 | 40 |
| DT2410 | 52 | FX1105 | 48 | *FX2634 | 50 | H7 | 48 |
| DT2411 | 52 | FX1107 | 48 | FX2691 | 51 | H10 | 48 |
| DT2412 | 52 | FX1115 | 50, 51 | FX2754 | 50 | H20 | 48 |
| DT2415 | 52 | FX1128 | 51 | FX2837 | 50 | | |
| DT2452 | 52 | *FX1130 | 50 | FX2856 | 49 | | |
| DT2453 | 52 | *FX1156 | 51 | FX2857 | 49 | *LA1157 | 53 |
| DT2467 | 52 | *FX1159 | 51 | FX2858 | 49 | *LA1158 | 53 |

*Available for current production ; not intended for new designs

| Type No. | Page | Type No. | Page | Type No. | Page | Type No. | Page | Type No. | Page |
|----------|------|---------------|------|-----------------|------|----------------------|------|----------------|------|
| *LA1161 | 53 | *LA1417 | 53 | LP1185 | 34 | PSR50 | 42 | VSD | 43 |
| *LA1162 | 53 | *LA1418 | 53 | LP1186 | 34 | PSU50 | 42 | WF3500 Series | 60 |
| *LA1163 | 53 | *LA1419 | 53 | LP1193 | 36 | PSU61 | 40 | WF3806 | 61 |
| *LA1164 | 53 | *LA1420 | 53 | LP1194 Series | 36 | PXE | 54 | WF3807 | 61 |
| *LA1165 | 53 | LA1421 | 53 | LP1400 | 34 | PXE rods and discs | 55 | WF3808 | 61 |
| *LA1166 | 53 | LA1422 | 53 | LP1402 | 34 | Q-14 | 58 | WF3809 | 61 |
| *LA1167 | 53 | LA1423 | 53 | LRD50 | 42 | RIC50 | 42 | WF3810 | 61 |
| *LA1168 | 53 | LA1424 | 52 | Magnadur | 56 | RM inductor cores | 52 | WF3811 | 61 |
| *LA1169 | 53 | LA1427 | 52 | M8 | 57 | RM transformer cores | 49 | WF4500 Series | 60 |
| LA1170 | 53 | LA1428 | 52 | MB50 | 42 | RM4/5 clip | 52 | X22 | 49 |
| LA1171 | 53 | LA1429 | 52 | MB1000 | 55 | RM5A13AL100 | 52 | X30 | 49 |
| LA1172 | 53 | LA1430 | 52 | MB1015 | 55 | RM5A13AL160 | 52 | X35 | 49 |
| LA1173 | 53 | LA1431 | 52 | MB1082 | 55 | RM5A13AL250 | 52 | 015 Series | 19 |
| LA1174 | 53 | LA1432 | 52 | MB1086 | 55 | RM5B0BS/S6P | 52 | 016 Series | 19 |
| LA1175 | 53 | LA1433 | 52 | MB1109 | 55 | RSA61 | 41 | 017 Series | 19 |
| LA1210 | 53 | LA1494 | 52 | MB1112 | 55 | SID50 | 42 | 071 Series | 21 |
| LA1211 | 53 | LA1495 | 52 | MB1113 | 55 | Ticonal | 56 | 072 Series | 21 |
| LA1212 | 53 | LA1500 | 52 | MB1114 | 55 | TT61 | 41 | 2IA60 | 40 |
| LA1213 | 53 | LA1501 | 52 | MB1115 | 55 | TU60 | 40 | 2LPA60 | 40 |
| LA1214 | 53 | LA1519 | 52 | MB1116 | 55 | UPA61 | 41 | 2NOR60 | 40 |
| LA1215 | 53 | LA1522 | 49 | MB2019 | 55 | VA1033 | 30 | 2NOR61 | 41 |
| LA1216 | 53 | LA4128 | 52 | MB2021 | 55 | VA1034 | 30 | 2SF60 | 40 |
| LA1217 | 53 | LA4129 | 52 | MB3004 | 55 | VA1037 | 30 | 2TG90 | 40 |
| *LA1218 | 53 | LA4130 | 52 | MB3010 | 55 | VA1038 | 30 | 3NOR50 | 42 |
| *LA1219 | 53 | LA4145 | 52 | MB3011 | 55 | VA1039 | 30 | 4NOR51 | 42 |
| *LA1220 | 53 | LA4146 | 52 | MB3013 | 55 | VA1040 | 30 | 4NOR60 | 40 |
| *LA1221 | 53 | LA4147 | 52 | MB4016 | 55 | VA1053 | 30 | 60SA | 44 |
| *LA1222 | 53 | LA4148 | 52 | MB7007 | 55 | VA1055S | 30 | 60SR | 44 |
| *LA1223 | 53 | LA4228 | 52 | MB7010 | 55 | VA1056S | 30 | 106 Series | 22 |
| *LA1224 | 53 | LA4229 | 52 | MB7012 | 55 | VA1066S | 30 | 107 Series | 22 |
| *LA1225 | 53 | LA4230 | 52 | MB7014 | 55 | VA1067S | 30 | 108 Series | 23 |
| *LA1226 | 53 | LA4245 | 52 | MB8000 | 55 | VA1074 | 30 | 121 Series | 24 |
| *LA1227 | 53 | LA4246 | 52 | MB8001 | 55 | VA1077 | 30 | 278 Series | 15 |
| *LA1228 | 53 | LA4247 | 52 | MB8004 | 55 | VA1086 | 30 | 344 2 Series | 10 |
| *LA1229 | 53 | LA4248 | 52 | MB8009 | 55 | VA1088 | 30 | 344 4 Series | 10 |
| *LA1230 | 53 | LA4328 | 52 | MID50 | 42 | VA1096 | 30 | 347 2 Series | 14 |
| LA1246 | 48 | LA4329 | 52 | MM1507 | 58 | VA1097 | 30 | 347 4 Series | 14 |
| LA1302 | 48 | LA4344 | 52 | MR25 | 27 | VA1098 | 30 | 347 5 Series | 14 |
| LA1366 | 48 | LA4345 | 52 | MR30 | 27 | VA1100 | 30 | 347 6 Series | 14 |
| LA1372 | 53 | LA4346 | 52 | MVSO | 43 | VA1104 | 30 | 424 Series | 12 |
| LA1373 | 53 | LA4347 | 52 | Norbit 2 Series | 40 | VA1106 | 30 | 425 Series | 12 |
| LA1374 | 53 | LA4348 | 52 | NIC50 | 42 | VA1099 | 30 | 427 Series | 12 |
| LA1375 | 53 | LA4528 | 52 | OM175 | 45 | VA1108 | 30 | 629 Series | 17 |
| LA1376 | 53 | LA4529 | 52 | OM180 | 45 | VA1109 | 30 | 630 Series | 17 |
| LA1377 | 53 | LA4543 | 52 | OM185 | 45 | VA1110 | 30 | 632 Series | 16 |
| LA1378 | 53 | LA4544 | 52 | OM190 | 45 | VA1111 | 30 | 802 Series | 25 |
| LA1379 | 53 | LA4545 | 52 | *PA60 | 40 | VA1112 | 30 | 808 Series | 25 |
| LA1380 | 53 | LA4546 | 52 | PDU50A | 42 | VA3100 Series | 31 | *809 05 Series | 25 |
| LA1399 | 52 | LA4547 | 52 | PDU50B | 42 | VA3200 Series | 31 | *809 07 Series | 25 |
| LA1400 | 52 | LP1159 | 34 | PR37 Series | 28 | VA3400 Series | 31 | 809 08 Series | 25 |
| LA1409 | 53 | *LP1162 | 35 | PR52 Series | 28 | VA3700 Series | 31 | 809 09 Series | 25 |
| LA1410 | 53 | LP1164/1 | 34 | PS90 | 40 | VA8650 | 32 | 2322 554 02221 | 33 |
| LA1411 | 53 | LP1170 | 34 | PSD12 | 43 | VR37 Series | 29 | 2322 640 90002 | 31 |
| LA1412 | 53 | LP1173 | 35 | PSD24 | 43 | | | 2322 640 90003 | 31 |
| LA1413 | 53 | LP1179 Series | 34 | | | | | 2322 640 90004 | 31 |
| *LA1414 | 53 | LP1181 | 34 | | | | | | |
| *LA1415 | 53 | LP1183/2 | 35 | | | | | | |
| *LA1416 | 53 | LP1184/2 | 35 | | | | | | |

*Available for current production ; not intended for new designs

conversion list— code numbers to Mullard type numbers

For customers receiving our components under a Mullard code number, a conversion list to type numbers is given.

Capacitors

| Code number | Type number | Code number | Type number |
|----------------|--------------|----------------|--------------|
| 2222 101 12161 | C428AR/B160 | 2222 341 05154 | C281VV/A150K |
| 2222 101 12259 | C428AR/B25 | 2222 341 05155 | C281VV/A1M5 |
| 2222 101 12321 | C428AR/B320 | 2222 341 05223 | C281VV/A22K |
| 2222 101 12509 | C428AR/B50 | 2222 341 05224 | C281VV/A220K |
| 2222 101 12809 | C428AR/B80 | 2222 341 05225 | C281VV/A2M2 |
| 2222 101 13131 | C428AR/C125 | 2222 341 05333 | C281VV/A33K |
| 2222 101 13209 | C428AR/C20 | 2222 341 05334 | C281VV/A330K |
| 2222 101 13251 | C428AR/C250 | 2222 341 05473 | C281VV/A47K |
| 2222 101 13409 | C428AR/C40 | 2222 341 05474 | C281VV/A470K |
| 2222 101 13649 | C428AR/C64 | 2222 341 05683 | C281VV/A68K |
| 2222 101 14101 | C428AR/D100 | 2222 341 05684 | C281VV/A680K |
| 2222 101 14169 | C428AR/D16 | 2222 341 59103 | C281CD/A10K |
| 2222 101 14201 | C428AR/D200 | 2222 341 59104 | C281CD/A100K |
| 2222 101 14329 | C428AR/D32 | 2222 341 59153 | C281CD/A15K |
| 2222 101 14509 | C428AR/D50 | 2222 341 59154 | C281CD/A150K |
| 2222 101 15109 | C428AR/E10 | 2222 341 59223 | C281CD/A22K |
| 2222 101 15131 | C428AR/E125 | 2222 341 59224 | C281CD/A220K |
| 2222 101 15209 | C428AR/E20 | 2222 341 59333 | C281CD/A33K |
| 2222 101 15329 | C428AR/E32 | 2222 341 59334 | C281CD/A330K |
| 2222 101 15649 | C428AR/E64 | 2222 341 59473 | C281CD/A47K |
| 2222 101 16139 | C428AR/F12-5 | 2222 341 59474 | C281CD/A470K |
| 2222 101 16209 | C428AR/F20 | 2222 341 59683 | C281CD/A68K |
| 2222 101 16409 | C428AR/F40 | 2222 341 89103 | C281AB/A10K |
| 2222 101 16648 | C428AR/F6-4 | 2222 341 89105 | C281AB/A1M |
| 2222 101 16809 | C428AR/F80 | 2222 341 89153 | C281AB/A15K |
| 2222 101 17139 | C428AR/G12-5 | 2222 341 89155 | C281AB/A1M5 |
| 2222 101 17259 | C428AR/G25 | 2222 341 89223 | C281AB/A22K |
| 2222 101 17408 | C428AR/G4 | 2222 341 89333 | C281AB/A33K |
| 2222 101 17509 | C428AR/G50 | 2222 341 89473 | C281AB/A47K |
| 2222 101 17808 | C428AR/G8 | 2222 341 89683 | C281AB/A68K |
| 2222 101 18169 | C428AR/H16 | 2222 341 89104 | C281AB/A100K |
| 2222 101 18258 | C428AR/H2-5 | 2222 341 89154 | C281AB/A150K |
| 2222 101 18329 | C428AR/H32 | 2222 341 89224 | C281AB/A220K |
| 2222 101 18508 | C428AR/H5 | 2222 341 89225 | C281AB/A2M2 |
| 2222 101 18808 | C428AR/H8 | 2222 341 89334 | C281AB/A330K |
| | | 2222 341 89474 | C281AB/A470K |
| | | 2222 341 89684 | C281AB/A680K |
| 2222 311 31103 | C296AA/A10K | 2222 342 44103 | C280AE/P10K |
| 2222 311 31104 | C296AA/A100K | 2222 342 44104 | C280AE/P100K |
| 2222 311 31105 | C296AA/A1M | 2222 342 44153 | C280AE/P15K |
| 2222 311 31153 | C296AA/A15K | 2222 342 44154 | C280AE/P150K |
| 2222 311 31154 | C296AA/A150K | 2222 342 44223 | C280AE/P22K |
| 2222 311 31223 | C296AA/A22K | 2222 342 44224 | C280AE/P220K |
| 2222 311 31224 | C296AA/A220K | 2222 342 44333 | C280AE/P33K |
| 2222 311 31333 | C296AA/A33K | 2222 342 44473 | C280AE/P47K |
| 2222 311 31334 | C296AA/A330K | 2222 342 44683 | C280AE/P68K |
| 2222 311 31473 | C296AA/A47K | 2222 342 45105 | C280AE/A1M |
| 2222 311 31474 | C296AA/A470K | 2222 342 45155 | C280AE/A1M5 |
| 2222 311 31683 | C296AA/A68K | 2222 342 45225 | C280AE/A2M2 |
| 2222 311 31684 | C296AA/A680K | 2222 342 45334 | C280AE/A330K |
| 2222 311 51102 | C296AC/A1K | 2222 342 45474 | C280AE/A470K |
| 2222 311 51103 | C296AC/A10K | 2222 342 45684 | C280AE/A680K |
| 2222 311 51104 | C296AC/A100K | 2222 342 54103 | C280CF/P10K |
| 2222 311 51152 | C296AC/A1K5 | 2222 342 54104 | C280CF/P100K |
| 2222 311 51153 | C296AC/A15K | 2222 342 54153 | C280CF/P15K |
| 2222 311 51154 | C296AC/A150K | 2222 342 54154 | C280CF/P150K |
| 2222 311 51222 | C296AC/A2K2 | 2222 342 54223 | C280CF/P22K |
| 2222 311 51223 | C296AC/A22K | 2222 342 54224 | C280CF/P220K |
| 2222 311 51224 | C296AC/A220K | 2222 342 54333 | C280CF/P33K |
| 2222 311 51332 | C296AC/A3K3 | 2222 342 54473 | C280CF/P47K |
| 2222 311 51333 | C296AC/A33K | 2222 342 54683 | C280CF/P68K |
| 2222 311 51334 | C296AC/A330K | 2222 342 55105 | C280CF/A1M |
| 2222 311 51472 | C296AC/A4K7 | 2222 342 55334 | C280CF/A330K |
| 2222 311 51473 | C296AC/A47K | 2222 342 55474 | C280CF/A470K |
| 2222 311 51474 | C296AC/A470K | 2222 342 55684 | C280CF/A680K |
| 2222 311 51682 | C296AC/A6K8 | | |
| 2222 311 51683 | C296AC/A68K | | |
| 2222 341 05103 | C281VV/A10K | 2222 435 41004 | C295AH/D100K |
| 2222 341 05104 | C281VV/A100K | 2222 435 41104 | C295AH/D110K |
| 2222 341 05105 | C281VV/A1M | 2222 435 41204 | C295AH/D120K |
| 2222 341 05153 | C281VV/A15K | 2222 435 41304 | C295AH/D130K |

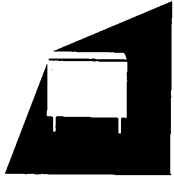

Metallised film capacitors

*p.e.t.p. book 3 part 1

C280AE (342) Series 250V d.c. working

| Type No. | Code No. | Capacitance | | Dimensions mm | | | | | | Colour code† | | |
|--------------|-----------|---------------|------|---------------|------|------|-----|--------|--------|--------------|--------|--|
| | | μF | S | L | T | H | d | ϕ | Band 1 | Band 2 | Band 3 | |
| C280AE/P10K | 342 44103 | 0.01 | 10.2 | 12.5 | 4 | 9 | 0.6 | 16 | Brown | Black | Orange | |
| C280AE/P15K | 342 44153 | 0.015 | 10.2 | 12.5 | 4 | 9 | 0.6 | 16 | Brown | Green | Orange | |
| C280AE/P22K | 342 44223 | 0.022 | 10.2 | 12.5 | 4 | 9 | 0.6 | 16 | Red | Red | Orange | |
| C280AE/P33K | 342 44333 | 0.033 | 10.2 | 12.5 | 4 | 9 | 0.6 | 16 | Orange | Orange | Orange | |
| C280AE/P47K | 342 44473 | 0.047 | 10.2 | 12.5 | 4 | 9 | 0.6 | 16 | Yellow | Violet | Orange | |
| C280AE/P68K | 342 44683 | 0.068 | 10.2 | 12.5 | 5 | 10 | 0.6 | 16 | Blue | Grey | Orange | |
| C280AE/P100K | 342 44104 | 0.1 | 10.2 | 12.5 | 6 | 11 | 0.6 | 16 | Brown | Black | Yellow | |
| C280AE/P150K | 342 44154 | 0.15 | 15.3 | 17.5 | 6 | 11 | 0.8 | 18 | Brown | Green | Yellow | |
| C280AE/P220K | 342 44224 | 0.22 | 15.3 | 17.5 | 7 | 12 | 0.8 | 18 | Red | Red | Yellow | |
| C280AE/A330K | 342 45334 | 0.33 | 20.3 | 22.5 | 6.5 | 11.5 | 0.8 | 21 | Orange | Orange | Yellow | |
| C280AE/A470K | 342 45474 | 0.47 | 20.3 | 22.5 | 7.5 | 12.5 | 0.8 | 21 | Yellow | Violet | Yellow | |
| C280AE/A680K | 342 45684 | 0.68 | 20.3 | 22.5 | 9.5 | 14.5 | 0.8 | 21 | Blue | Grey | Yellow | |
| C280AE/A1M | 342 45105 | 1 | 27.9 | 30 | 9.5 | 14.5 | 0.8 | 21 | Brown | Black | Green | |
| C280AE/A1M5 | 342 45155 | 1.5 | 27.9 | 30 | 10.5 | 18 | 0.8 | 21 | Brown | Green | Green | |
| C280AE/A2M2 | 342 45225 | 2.2 | 27.9 | 30 | 12.5 | 20.5 | 0.8 | 21 | Red | Red | Green | |

*p.e.t.p. book 3 part 1

C280CF (342) Series 400V d.c. working

| Type No. | Code No. | Capacitance | | Dimensions mm | | | | | | Colour code† | | |
|--------------|-----------|---------------|------|---------------|-----|------|-----|--------|--------|--------------|--------|--|
| | | μF | S | L | T | H | d | ϕ | Band 1 | Band 2 | Band 3 | |
| C280CF/P10K | 342 54103 | 0.01 | 10.2 | 12.5 | 4 | 9 | 0.6 | 16 | Brown | Black | Orange | |
| C280CF/P15K | 342 54153 | 0.015 | 10.2 | 12.5 | 4 | 9 | 0.6 | 16 | Brown | Green | Orange | |
| C280CF/P22K | 342 54223 | 0.022 | 10.2 | 12.5 | 4 | 9 | 0.6 | 16 | Red | Red | Orange | |
| C280CF/P33K | 342 54333 | 0.033 | 10.2 | 12.5 | 5 | 10 | 0.6 | 16 | Orange | Orange | Orange | |
| C280CF/P47K | 342 54473 | 0.047 | 10.2 | 12.5 | 6 | 11 | 0.6 | 16 | Yellow | Violet | Orange | |
| C280CF/P68K | 342 54683 | 0.068 | 15.3 | 17.5 | 6 | 11 | 0.8 | 18 | Blue | Grey | Orange | |
| C280CF/P100K | 342 54104 | 0.1 | 15.3 | 17.5 | 7 | 12 | 0.8 | 18 | Brown | Black | Yellow | |
| C280CF/P150K | 342 54154 | 0.15 | 20.3 | 22.5 | 6.5 | 11.5 | 0.8 | 21 | Brown | Green | Yellow | |
| C280CF/P220K | 342 54224 | 0.22 | 20.3 | 22.5 | 7.5 | 12.5 | 0.8 | 21 | Red | Red | Yellow | |
| C280CF/A330K | 342 55334 | 0.33 | 20.3 | 22.5 | 9.5 | 14.5 | 0.8 | 21 | Orange | Orange | Yellow | |
| C280CF/A470K | 342 55474 | 0.47 | 27.9 | 30 | 9.5 | 14.5 | 0.8 | 21 | Yellow | Violet | Yellow | |
| C280CF/A680K | 342 55684 | 0.68 | 27.9 | 30 | 10 | 18 | 0.8 | 21 | Blue | Grey | Yellow | |
| C280CF/A1M | 342 55105 | 1 | 27.9 | 30 | 12 | 20 | 0.8 | 21 | Brown | Black | Green | |

*Polyethylene terephthalate

Packing quantity: Multiples of 1000 pieces

†Colour code reads from the top of the component.

Fourth band denotes tolerance: White $\pm 10\%$ Black $\pm 20\%$

Fifth band denotes working voltage: Red 250V Yellow 400V

Capacitance tolerance

for $C \leq 0.22 \mu\text{F} \pm 20\%$

for $C \geq 0.33 \mu\text{F} \pm 10\%$

$\tan \delta < 75 \times 10^{-4}$

Losses (at 1kHz)

Insulation resistance at 20°C for $C \leq 0.33 \mu\text{F}$ $R > 30\,000\ \text{M}\Omega$

for $C \geq 0.47 \mu\text{F}$ $RC > 10\,000\ \text{M}\Omega\mu\text{F}$

Temperature range

-40 to +85°C

C280 Series capacitors are also available with crimped and cropped leads to suit 2.54 mm (0.1 in) printed wiring grid, these are supplied under C280 (352) Series.

C280 (342)

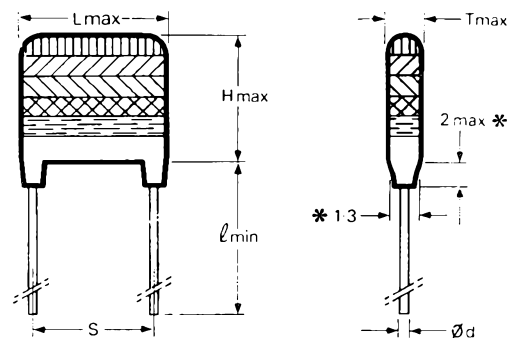
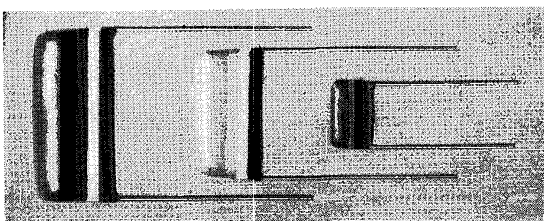

*Lacquer extends 2 max from position where diameter is 1.3

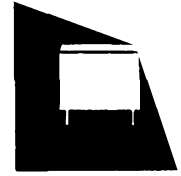

Metallised film capacitors

*p.e.t.p. book 3 part 1

C281VV and C281AB (341) Series 250V d.c. working

| Post Office | | Commercial | | Capacitance μF | Dimensions mm | | | | |
|--------------|-----------|--------------|-----------|------------------------------|---------------|------|------|-----|--------|
| Type No. | Code No. | Type No. | Code No. | | L | T | H | d | ϕ |
| C281VV/A10K | 341 05103 | C281AB/A10K | 341 89103 | 0.01 | 14.6 | 4.8 | 8.8 | 0.8 | 40 |
| C281VV/A15K | 341 05153 | C281AB/A15K | 341 89153 | 0.015 | 14.6 | 4.8 | 8.8 | 0.8 | 40 |
| C281VV/A22K | 341 05223 | C281AB/A22K | 341 89223 | 0.022 | 14.6 | 4.8 | 8.8 | 0.8 | 40 |
| C281VV/A33K | 341 05333 | C281AB/A33K | 341 89333 | 0.033 | 14.6 | 4.8 | 8.8 | 0.8 | 40 |
| C281VV/A47K | 341 05473 | C281AB/A47K | 341 89473 | 0.047 | 14.6 | 4.8 | 8.8 | 0.8 | 40 |
| C281VV/A68K | 341 05683 | C281AB/A68K | 341 89683 | 0.068 | 14.6 | 5.6 | 9.5 | 0.8 | 40 |
| C281VV/A100K | 341 05104 | C281AB/A100K | 341 89104 | 0.1 | 14.6 | 6.6 | 10.5 | 0.8 | 40 |
| C281VV/A150K | 341 05154 | C281AB/A150K | 341 89154 | 0.15 | 18.1 | 6.6 | 10.5 | 0.8 | 40 |
| C281VV/A220K | 341 05224 | C281AB/A220K | 341 89224 | 0.22 | 18.1 | 7.7 | 11.6 | 0.8 | 40 |
| C281VV/A330K | 341 05334 | C281AB/A330K | 341 89334 | 0.33 | 23.6 | 7.5 | 11.6 | 0.8 | 40 |
| C281VV/A470K | 341 05474 | C281AB/A470K | 341 89474 | 0.47 | 23.6 | 8.8 | 12.9 | 0.8 | 40 |
| C281VV/A680K | 341 05684 | C281AB/A680K | 341 89684 | 0.68 | 23.6 | 10.5 | 14.5 | 0.8 | 40 |
| C281VV/A1M | 341 05105 | C281AB/A1M | 341 89105 | 1 | 31.1 | 10.5 | 14.7 | 1 | 49 |
| C281VV/A1M5 | 341 05155 | C281AB/A1M5 | 341 89155 | 1.5 | 31.1 | 12.5 | 19.6 | 1 | 49 |
| C281VV/A2M2 | 341 05225 | C281AB/A2M2 | 341 89225 | 2.2 | 31.1 | 15.1 | 22.1 | 1 | 49 |

C281VV are approved to Post Office specification D2283 and marked with Post Office type number 8017B
 RRE approved to DEF5041
 *Polyethylene terephthalate

polycarbonate book 3 part 1

C281CD (341) Series 400V d.c. working

| Type No. | Code No. | Capacitance μF | Dimensions mm | | | | |
|--------------|-----------|------------------------------|---------------|------|------|-----|--------|
| | | | L | T | H | d | ϕ |
| C281CD/A10K | 341 59103 | 0.01 | 14.6 | 4.8 | 8.8 | 0.8 | 40 |
| C281CD/A15K | 341 59153 | 0.015 | 14.6 | 4.8 | 8.8 | 0.8 | 40 |
| C281CD/A22K | 341 59223 | 0.022 | 14.6 | 4.8 | 8.8 | 0.8 | 40 |
| C281CD/A33K | 341 59333 | 0.033 | 14.6 | 5.6 | 9.5 | 0.8 | 40 |
| C281CD/A47K | 341 59473 | 0.047 | 14.6 | 6.6 | 10.5 | 0.8 | 40 |
| C281CD/A68K | 341 59683 | 0.068 | 18.1 | 6.6 | 10.5 | 0.8 | 40 |
| C281CD/A100K | 341 59104 | 0.1 | 18.1 | 7.7 | 11.6 | 0.8 | 40 |
| C281CD/A150K | 341 59154 | 0.15 | 23.6 | 7.5 | 11.6 | 0.8 | 40 |
| C281CD/A220K | 341 59224 | 0.22 | 23.6 | 8.8 | 12.9 | 0.8 | 40 |
| C281CD/A330K | 341 59334 | 0.33 | 23.6 | 10.5 | 14.5 | 0.8 | 40 |
| C281CD/A470K | 341 59474 | 0.47 | 31.1 | 10.5 | 14.7 | 1 | 49 |

Packing quantity : Multiples of 1000 pieces

Capacitance tolerance $\pm 10\%$
 Losses (at 1kHz) $\tan \delta$ (C281VV and AB Series) $< 75 \times 10^{-4}$
 (C281CD Series) $< 30 \times 10^{-4}$
 Insulation resistance at 20°C for $C < 0.33 \mu\text{F}$ $R > 30\,000\ \text{M}\Omega$
 for $C \geq 0.47 \mu\text{F}$ $R_C > 10\,000\ \text{M}\Omega \mu\text{F}$
 Temperature range -55 to $+85^\circ\text{C}$

C281 (341)

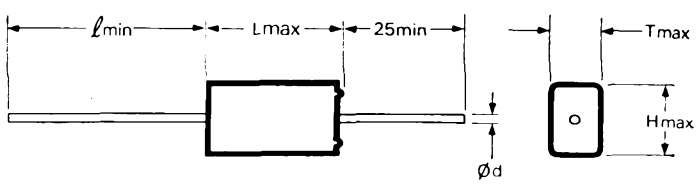
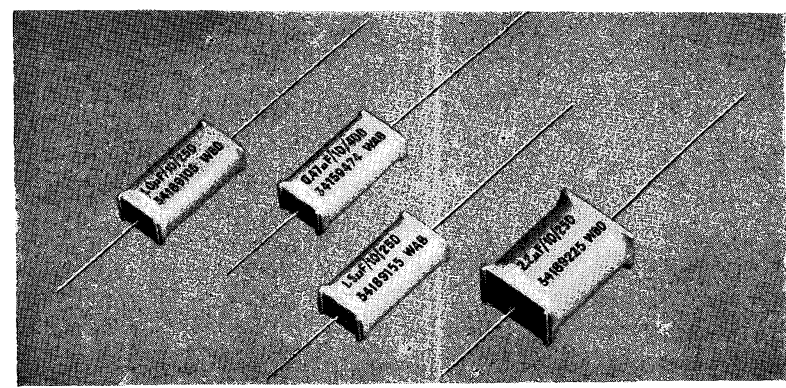

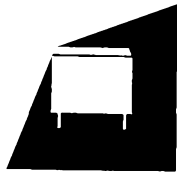

Metallised film capacitors

*p.e.t.p. or polycarbonate book 3 part 1

344 2 Series 100V d.c. working

| Type No. | | Capacitance μF | Dimensions mm | | | |
|-----------|---------------|------------------------------|---------------|------|------|------|
| P.E.T.P. | Polycarbonate | | S | L | T | H |
| 344 25473 | 344 21473 | 0.047 | 10 | 13 | 4.5 | 10 |
| 344 25683 | 344 21683 | 0.068 | 10 | 13 | 4.5 | 10 |
| 344 25104 | 344 21104 | 0.1 | 10 | 13 | 4.5 | 10 |
| 344 25154 | 344 21154 | 0.15 | 10 | 13 | 4.5 | 10 |
| 344 25224 | 344 21224 | 0.22 | 10 | 13 | 5 | 11 |
| 344 25334 | 344 21334 | 0.33 | 15 | 17.5 | 5 | 11 |
| 344 25474 | 344 21474 | 0.47 | 15 | 17.5 | 6 | 11.5 |
| 344 25684 | 344 21684 | 0.68 | 15 | 17.5 | 7 | 13 |
| 344 25105 | 344 21105 | 1 | 15 | 17.5 | 8.5 | 14.5 |
| 344 25155 | 344 21155 | 1.5 | 22.5 | 26 | 7.5 | 16.5 |
| 344 25225 | 344 21225 | 2.2 | 22.5 | 26 | 8.5 | 18 |
| 344 25335 | 344 21335 | 3.3 | 22.5 | 26 | 9.5 | 19 |
| 344 25475 | 344 21475 | 4.7 | 27.5 | 30 | 11 | 20.5 |
| 344 25685 | 344 21685 | 6.8 | 27.5 | 30 | 13.5 | 22 |

*p.e.t.p. book 3 part 1

344 4 Series 250V d.c. working

| Type No. | Capacitance μF | Dimensions mm | | | |
|---------------------------|------------------------------|---------------|------|------|------|
| | | S | L | T | H |
| 344 41103 | 0.01 | 10 | 13 | 4.5 | 10 |
| 344 41153 | 0.015 | 10 | 13 | 4.5 | 10 |
| 344 41223 | 0.022 | 10 | 13 | 4.5 | 10 |
| 344 41333 | 0.033 | 10 | 13 | 4.5 | 10 |
| 344 41473 | 0.047 | 10 | 13 | 4.5 | 10 |
| 344 41683 | 0.068 | 10 | 13 | 5 | 11 |
| 344 41104 | 0.1 | 15 | 17.5 | 5 | 11 |
| 344 41154 | 0.15 | 15 | 17.5 | 6 | 11.5 |
| 344 41224 | 0.22 | 15 | 17.5 | 7 | 13 |
| 344 41334 | 0.33 | 15 | 17.5 | 8.5 | 14.5 |
| 344 41474 | 0.47 | 22.5 | 26 | 6.5 | 15.5 |
| 344 41684 | 0.68 | 22.5 | 26 | 7.5 | 16.5 |
| 344 41105 | 1 | 22.5 | 26 | 9.5 | 19 |
| 344 41155 | 1.5 | 27.5 | 30 | 11 | 20.5 |
| 344 41225 | 2.2 | 27.5 | 30 | 13.5 | 22 |
| 344 90901 P.O. type 8019A | 0.9 $\pm 10\%$ | 22.5 | 26 | 9.5 | 19 |
| 344 90108 P.O. type 8022A | 1.8 $\pm 15\%$ | 27.5 | 30 | 13.5 | 22 |

*Polyethylene terephthalate
Packing quantity: Multiples of 1000 pieces

The 344 2 and 344 4 Series have Post Office approval and are RRE recommended

Capacitance tolerance $\pm 10\%$ unless otherwise stated
 Temperature range -55 to $+85^\circ\text{C}$
 Losses (at 1kHz) $\tan \delta < 30 \times 10^{-4}$ (344 21... only)
 $< 75 \times 10^{-4}$ (remainder)
 Insulation resistance at 20°C for $C \leq 0.33 \mu\text{F}$ $R > 30\,000\ \text{M}\Omega$
 for $C > 0.47 \mu\text{F}$ $RC > 10\,000\ \text{M}\Omega\mu\text{F}$

344

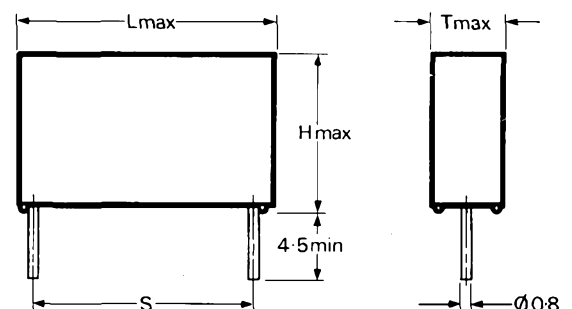
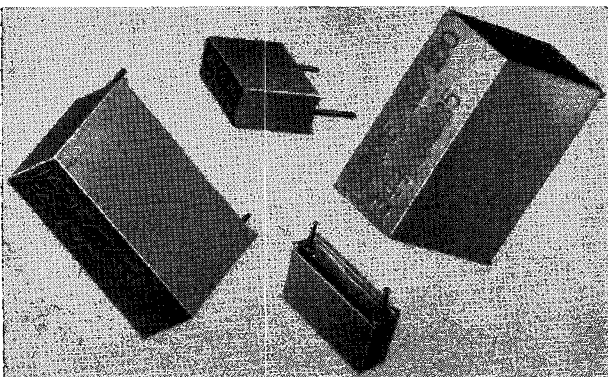

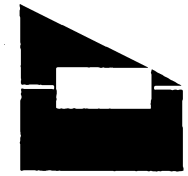

Film/foil capacitors moulded polystyrene (extended foil) book 3 part 1

C295AH (435) Series 63V d.c. working

| Type No. | Code No. | Capacitance nF | Dimensions mm | |
|-------------|-----------|-------------------|---------------|----|
| | | | D | L |
| C295AH/D18K | 435 41803 | 18 | 10.1 | 15 |
| C295AH/D20K | 435 42003 | 20 | 10.1 | 15 |
| C295AH/D22K | 435 42203 | 22 | 10.1 | 15 |
| C295AH/D24K | 435 42403 | 24 | 10.1 | 15 |
| C295AH/D27K | 435 42703 | 27 | 12.6 | 15 |
| C295AH/D30K | 435 43003 | 30 | 12.6 | 15 |
| C295AH/D33K | 435 43303 | 33 | 12.6 | 15 |
| C295AH/D36K | 435 43603 | 36 | 12.6 | 15 |

| Type No. | Code No. | Capacitance nF | Dimensions mm | |
|--------------|-----------|-------------------|---------------|----|
| | | | D | L |
| C295AH/D39K | 435 43903 | 39 | 12.6 | 15 |
| C295AH/D91K | 435 49103 | 91 | 12.6 | 25 |
| C295AH/D100K | 435 41004 | 100 | 15.1 | 25 |
| C295AH/D110K | 435 41104 | 110 | 15.1 | 25 |
| C295AH/D120K | 435 41204 | 120 | 15.1 | 25 |
| C295AH/D130K | 435 41304 | 130 | 15.1 | 25 |
| C295AH/D150K | 435 41504 | 150 | 15.1 | 25 |
| C295AH/D160K | 435 41604 | 160 | 15.1 | 25 |

C295AA (436) Series 125V d.c. working

| | | | | |
|-------------|-----------|-----|------|----|
| C295AA/D4K3 | 436 44302 | 4.3 | 7.6 | 15 |
| C295AA/D4K7 | 436 44702 | 4.7 | 9.1 | 15 |
| C295AA/D5K1 | 436 45102 | 5.1 | 9.1 | 15 |
| C295AA/D5K6 | 436 45602 | 5.6 | 9.1 | 15 |
| C295AA/D6K2 | 436 46202 | 6.2 | 9.1 | 15 |
| C295AA/D6K8 | 436 46802 | 6.8 | 9.1 | 15 |
| C295AA/D7K5 | 436 47502 | 7.5 | 9.1 | 15 |
| C295AA/D8K2 | 436 48202 | 8.2 | 10.1 | 15 |
| C295AA/D9K1 | 436 49102 | 9.1 | 10.1 | 15 |
| C295AA/D10K | 436 41003 | 10 | 10.1 | 15 |
| C295AA/D11K | 436 41103 | 11 | 12.6 | 15 |
| C295AA/D12K | 436 41203 | 12 | 12.6 | 15 |
| C295AA/D13K | 436 41303 | 13 | 12.6 | 15 |
| C295AA/D15K | 436 41503 | 15 | 12.6 | 15 |

| | | | | |
|-------------|-----------|----|------|----|
| C295AA/D16K | 436 41603 | 16 | 12.6 | 15 |
| C295AA/D27K | 436 42703 | 27 | 12.6 | 25 |
| C295AA/D30K | 436 43003 | 30 | 12.6 | 25 |
| C295AA/D33K | 436 43303 | 33 | 12.6 | 25 |
| C295AA/D36K | 436 43603 | 36 | 12.6 | 25 |
| C295AA/D39K | 436 43903 | 39 | 12.6 | 25 |
| C295AA/D43K | 436 44303 | 43 | 12.6 | 25 |
| C295AA/D47K | 436 44703 | 47 | 12.6 | 25 |
| C295AA/D51K | 436 45103 | 51 | 12.6 | 25 |
| C295AA/D56K | 436 45603 | 56 | 15.1 | 25 |
| C295AA/D62K | 436 46203 | 62 | 15.1 | 25 |
| C295AA/D68K | 436 46803 | 68 | 15.1 | 25 |
| C295AA/D75K | 436 47503 | 75 | 15.1 | 25 |
| C295AA/D82K | 436 48203 | 82 | 15.1 | 25 |

C295AC (438) Series 500V d.c. working

| | | | | |
|-------------|-----------|-----|------|----|
| C295AC/D1K3 | 438 41302 | 1.3 | 9.1 | 15 |
| C295AC/D1K5 | 438 41502 | 1.5 | 9.1 | 15 |
| C295AC/D1K6 | 438 41602 | 1.6 | 9.1 | 15 |
| C295AC/D1K8 | 438 41802 | 1.8 | 9.1 | 15 |
| C295AC/D2K | 438 42002 | 2.0 | 9.1 | 15 |
| C295AC/D2K2 | 438 42202 | 2.2 | 9.1 | 15 |
| C295AC/D2K4 | 438 42402 | 2.4 | 10.1 | 15 |
| C295AC/D2K7 | 438 42702 | 2.7 | 10.1 | 15 |

| | | | | |
|-------------|-----------|-----|------|----|
| C295AC/D3K | 438 43002 | 3.0 | 10.1 | 15 |
| C295AC/D3K3 | 438 43302 | 3.3 | 10.1 | 15 |
| C295AC/D3K6 | 438 43602 | 3.6 | 12.6 | 15 |
| C295AC/D3K9 | 438 43902 | 3.9 | 12.6 | 15 |
| C295AC/D18K | 438 41803 | 18 | 15.1 | 25 |
| C295AC/D20K | 438 42003 | 20 | 15.1 | 25 |
| C295AC/D22K | 438 42203 | 22 | 15.1 | 25 |
| C295AC/D24K | 438 42403 | 24 | 15.1 | 25 |

Packing quantity: Multiples of 25 to 125 pieces according to dimensions
Available for current production; not intended for new designs

C295 (435, 436, 438)

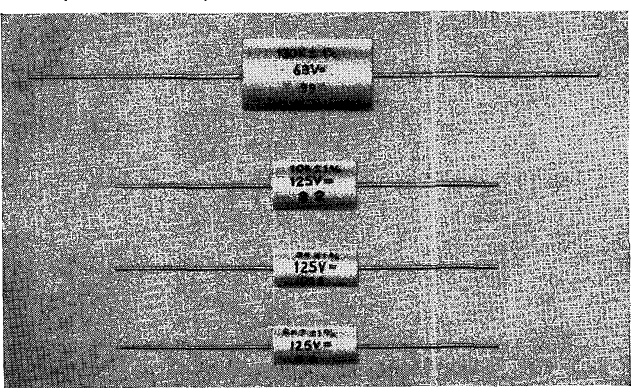

Capacitance tolerance $\pm 1\%$
 Losses (at 1 kHz) $\tan \delta < 2 \times 10^{-4}$
 (at 1 MHz) $< 10 \times 10^{-4}$
 Insulation resistance at 20°C for C < 100nF $> 10^6 \Omega$
 for C ≥ 100 nF $> 10^5 \Omega$
 Temperature range C295AA and AC -40 to $+85^\circ\text{C}$
 C295AH -40 to $+70^\circ\text{C}$

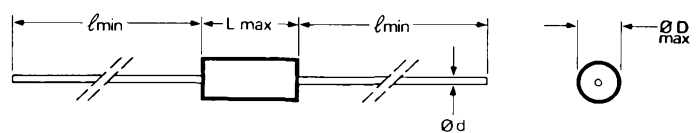

For capacitors of body length L = 15mm $l = 33$ mm and d = 0.7mm dia
 L = 25mm $l = 43$ mm and d = 0.8mm dia

Film/foil capacitors miniature, polystyrene (extended foil) book 3 part 1

424 Series 63V d.c. working

| Type No. | | Capacitance pF | D mm | Type No. | | Capacitance pF | D mm |
|-----------|-----------|-------------------|---------|-----------|-----------|-------------------|---------|
| ±1% | ±5% | | | ±1% | ±5% | | |
| 424 44302 | 424 24302 | 4300 | 4.5 | 424 45602 | 424 25602 | 5600 | 5 |
| 424 44702 | 424 24702 | 4700 | 4.5 | 424 46202 | 424 26202 | 6200 | 5 |
| 424 45102 | 424 25102 | 5100 | 5 | 424 46802 | 424 26802 | 6800 | 5.5 |

425 Series 125V d.c. working

| | | | | | | | |
|-----------|-----------|------|-----|-----------|-----------|------|-----|
| 425 45601 | 425 25601 | 560 | 3.5 | 425 41602 | 425 21602 | 1600 | 4.5 |
| 425 46201 | 425 26201 | 620 | 3.5 | 425 41802 | 425 21802 | 1800 | 4.5 |
| 425 46801 | 425 26801 | 680 | 3.5 | 425 42002 | 425 22002 | 2000 | 4.5 |
| 425 47501 | 425 27501 | 750 | 3.5 | 425 42202 | 425 22202 | 2200 | 5 |
| 425 48201 | 425 28201 | 820 | 3.5 | 425 42402 | 425 22402 | 2400 | 5 |
| 425 49101 | 425 29101 | 910 | 3.5 | 425 42702 | 425 22702 | 2700 | 5 |
| 425 41002 | 425 21002 | 1000 | 3.5 | 425 43002 | 425 23002 | 3000 | 5.5 |
| 425 41102 | 425 21102 | 1100 | 4 | 425 43302 | 425 23302 | 3300 | 5.5 |
| 425 41202 | 425 21202 | 1200 | 4 | 425 43602 | 425 23602 | 3600 | 6 |
| 425 41302 | 425 21302 | 1300 | 4 | 425 43902 | 425 23902 | 3900 | 6 |
| 425 41502 | 425 21502 | 1500 | 4 | | | | |

427 Series 500V d.c. working

| | | | | | | | |
|-----------|-----------|-----|-----|-----------|-----------|-----|-----|
| 427 41001 | 427 21001 | 100 | 3.5 | 427 42401 | 427 22401 | 240 | 3.5 |
| 427 41101 | 427 21101 | 110 | 3.5 | 427 42701 | 427 22701 | 270 | 3.5 |
| 427 41201 | 427 21201 | 120 | 3.5 | 427 43001 | 427 23001 | 300 | 3.5 |
| 427 41301 | 427 21301 | 130 | 3.5 | 427 43301 | 427 23301 | 330 | 4 |
| 427 41501 | 427 21501 | 150 | 3.5 | 427 43601 | 427 23601 | 360 | 4 |
| 427 41601 | 427 21601 | 160 | 3.5 | 427 43901 | 427 23901 | 390 | 4.5 |
| 427 41801 | 427 21801 | 180 | 3.5 | 427 44301 | 427 24301 | 430 | 4.5 |
| 427 42001 | 427 22001 | 200 | 3.5 | 427 44701 | 427 24701 | 470 | 4.5 |
| 427 42201 | 427 22201 | 220 | 3.5 | 427 45101 | 427 25101 | 510 | 5 |

Packing quantity: Multiples of 500 pieces.

| | |
|-------------------------------|----------------------------------|
| Capacitance tolerance | ±1% or ±5% |
| Losses (at 1 kHz) | $\tan \delta < 2 \times 10^{-4}$ |
| (at 1 MHz) | $< 5 \times 10^{-4}$ |
| Insulation resistance at 20°C | $> 10^5 \text{ M}\Omega$ |
| Temperature range 63V | -40 to +70°C |
| 125V | -40 to +85°C |
| 500V | -40 to +85°C |

424/425/427

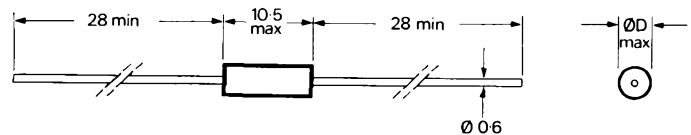
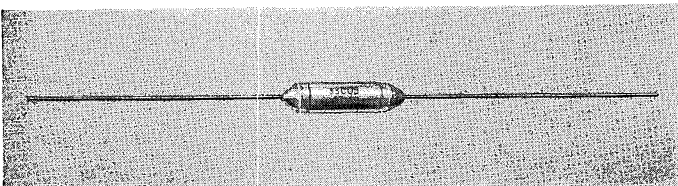

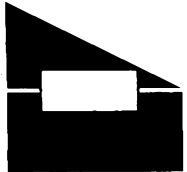

Film/foil capacitors

*p.e.t.p. (extended foil) book 3 part 1

C296AA (311) Series 160V d.c. working

| Type No. | Code No. | Capacitance μF | Dimensions mm | |
|--------------|-----------|------------------------------|---------------|----|
| | | | D | L |
| C296AA/A10K | 311 31103 | 0.01 | 7.5 | 21 |
| C296AA/A15K | 311 31153 | 0.015 | 7.5 | 21 |
| C296AA/A22K | 311 31223 | 0.022 | 7.5 | 21 |
| C296AA/A33K | 311 31333 | 0.033 | 7.5 | 21 |
| C296AA/A47K | 311 31473 | 0.047 | 8 | 21 |
| C296AA/A68K | 311 31683 | 0.068 | 9 | 21 |
| C296AA/A100K | 311 31104 | 0.1 | 10.5 | 21 |

| Type No. | Code No. | Capacitance μF | Dimensions mm | |
|--------------|-----------|------------------------------|---------------|----|
| | | | D | L |
| C296AA/A150K | 311 31154 | 0.15 | 12 | 21 |
| C296AA/A220K | 311 31224 | 0.22 | 10 | 35 |
| C296AA/A330K | 311 31334 | 0.33 | 12 | 35 |
| C296AA/A470K | 311 31474 | 0.47 | 14 | 35 |
| C296AA/A680K | 311 31684 | 0.68 | 16 | 35 |
| C296AA/A1M | 311 31105 | 1 | 18.5 | 35 |

C296AC (311) Series 400V d.c. working

| | | | | |
|-------------|-----------|--------|-----|----|
| C296AC/A1K | 311 51102 | 0.001 | 7.5 | 21 |
| C296AC/A1K5 | 311 51152 | 0.0015 | 7.5 | 21 |
| C296AC/A2K2 | 311 51222 | 0.0022 | 7.5 | 21 |
| C296AC/A3K3 | 311 51332 | 0.0033 | 7.5 | 21 |
| C296AC/A4K7 | 311 51472 | 0.0047 | 7.5 | 21 |
| C296AC/A6K8 | 311 51682 | 0.0068 | 7.5 | 21 |
| C296AC/A10K | 311 51103 | 0.01 | 7.5 | 21 |
| C296AC/A15K | 311 51153 | 0.015 | 7.5 | 21 |
| C296AC/A22K | 311 51223 | 0.022 | 8.5 | 21 |

| | | | | |
|--------------|-----------|-------|------|----|
| C296AC/A33K | 311 51333 | 0.033 | 10 | 21 |
| C296AC/A47K | 311 51473 | 0.047 | 11.5 | 21 |
| C296AC/A68K | 311 51683 | 0.068 | 9.5 | 35 |
| C296AC/A100K | 311 51104 | 0.1 | 11 | 35 |
| C296AC/A150K | 311 51154 | 0.15 | 12.5 | 35 |
| C296AC/A220K | 311 51224 | 0.22 | 14.5 | 35 |
| C296AC/A330K | 311 51334 | 0.33 | 17 | 35 |
| C296AC/A470K | 311 51474 | 0.47 | 19.5 | 35 |

*Polyethylene terephthalate

Packing quantity: Multiples of 1000 pieces

Capacitance tolerance $\pm 10\%$

Losses (at 1kHz) $\tan \delta < 60 \times 10^{-4}$

Insulation resistance at 20°C

for $C < 0.22 \mu\text{F}$ $R > 50\,000\ \text{M}\Omega$

for $C > 0.33 \mu\text{F}$ $RC > 16\,500\ \text{M}\Omega \mu\text{F}$

Temperature range

-40 to +85°C

C296 (311)

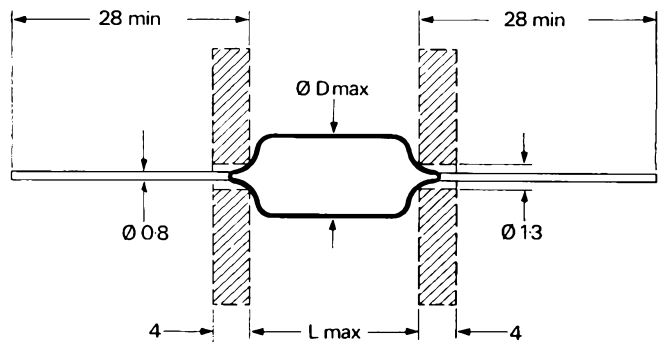
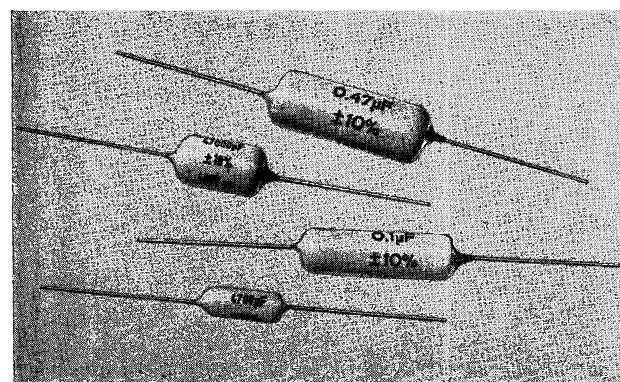

Film/foil capacitors

*p.e.t.p. (extended foil) (cont.) book 3 part 1

| 347 2 Series 100V d.c. working | | | | | | |
|--------------------------------|-------------------|---------------|------|------|------|-----|
| Type No. | Capacitance nF | Dimensions mm | | | | |
| | | S | L | T | H | d |
| 347 21104 | 100 | 15.2 | 19 | 7.5 | 16.5 | 0.8 |
| 347 21154 | 150 | 15.2 | 19 | 8.5 | 17.5 | 0.8 |
| 347 4 Series 250V d.c. working | | | | | | |
| 347 41103 | 10 | 10.2 | 13.5 | 5 | 13 | 0.6 |
| 347 41153 | 15 | 10.2 | 13.5 | 6 | 14 | 0.6 |
| 347 41223 | 22 | 10.2 | 13.5 | 6.5 | 14 | 0.6 |
| 347 41333 | 33 | 15.2 | 19 | 6 | 15 | 0.8 |
| 347 41473 | 47 | 15.2 | 19 | 7 | 16 | 0.8 |
| 347 41683 | 68 | 15.2 | 19 | 8 | 17 | 0.8 |
| 347 41104 | 100 | 22.9 | 27 | 7 | 19 | 0.8 |
| 347 41154 | 150 | 22.9 | 27 | 8.5 | 19.5 | 0.8 |
| 347 41224 | 220 | 22.9 | 27 | 10 | 22 | 0.8 |
| 347 41334 | 330 | 27.9 | 32 | 10.5 | 22.5 | 0.8 |
| 347 41474 | 470 | 27.9 | 32 | 12.5 | 24.5 | 0.8 |
| 347 41684 | 680 | 27.9 | 32 | 15.5 | 27.5 | 0.8 |
| 347 5 Series 400V d.c. working | | | | | | |
| 347 51472 | 4.7 | 10.2 | 13.5 | 4.5 | 12.5 | 0.6 |
| 347 51682 | 6.8 | 10.2 | 13.5 | 5.5 | 13.5 | 0.6 |
| 347 6 Series 630V d.c. working | | | | | | |
| 347 61222 | 2.2 | 10.2 | 13.5 | 4.5 | 12.5 | 0.6 |
| 347 61332 | 3.3 | 10.2 | 13.5 | 5.5 | 13.5 | 0.6 |

*Polyethylene terephthalate

Packing quantity: Multiples of 2000 pieces

Capacitance tolerance $\pm 10\%$
 Losses (at 10kHz) $\tan \delta$ for $C \leq 100\text{nF}$ $< 120 \times 10^{-4}$
 (at 1kHz) for $C > 100\text{nF}$ $< 60 \times 10^{-4}$
 Insulation resistance at 20°C for $C \leq 100\text{nF}$ $R > 10^5 \text{M}\Omega$
 for $C > 100\text{nF}$ $RC > 10\,000\text{s}$
 Temperature range -40 to $+85^\circ\text{C}$

347

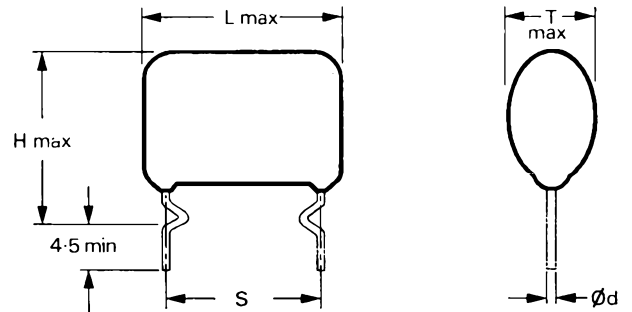
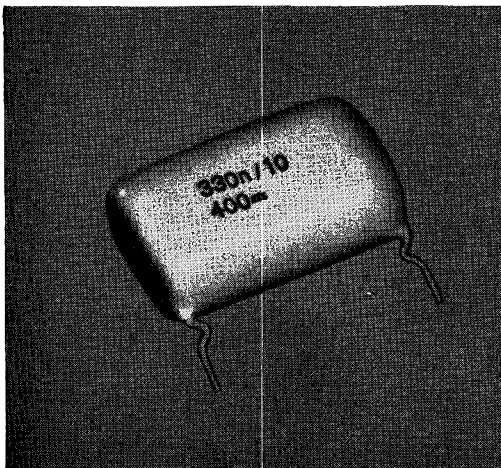



Film/foil capacitors polypropylene and paper (extended foil) book 3 part 1

278 Series 2 kV peak to peak

| Type No. | Capacitance nF | Dimensions mm | |
|------------------|-------------------|---------------|----|
| | | D | L |
| 278 82152 | 1.5 | 13.5 | 36 |
| 278 82182 | 1.8 | 13.5 | 36 |
| 278 82202 | 2 | 13.5 | 36 |

| Type No. | Capacitance nF | Dimensions mm | |
|------------------|-------------------|---------------|----|
| | | D | L |
| 278 82522 | 5.2 | 16.5 | 41 |
| 278 82822 | 8.2 | 16.5 | 41 |
| 278 82103 | 10 | 16.5 | 41 |
| 278 82113 | 11 | 16.5 | 41 |

Packing quantity : Multiples of 600 pieces

Capacitance tolerance $\pm 5\%$
 Losses (at 1kHz) $\tan \delta < 30 \times 10^{-4}$
 (at 10kHz) $< 60 \times 10^{-4}$
 (at 100kHz) $< 150 \times 10^{-4}$
 Insulation resistance at 20°C $> 50\,000\text{M}\Omega$
 Temperature range -25 to $+85^\circ\text{C}$

278

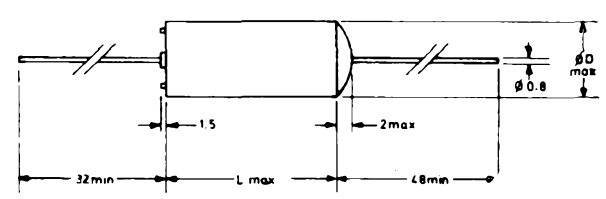
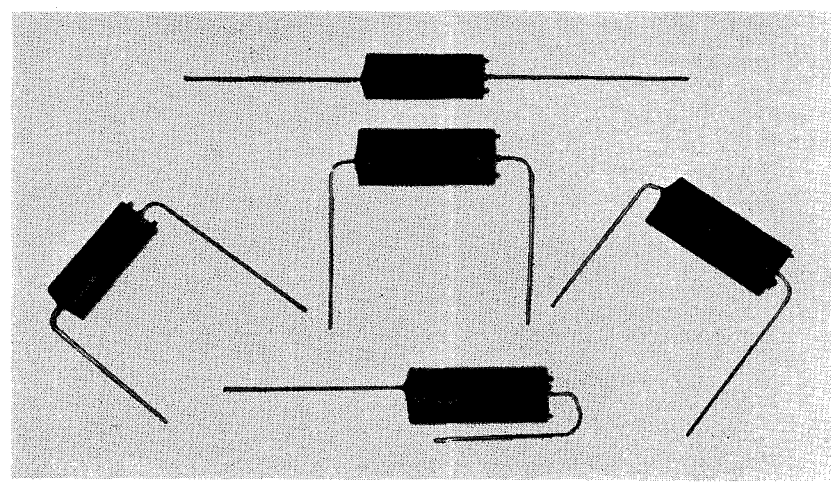

Ceramic capacitors miniature, plate (low-K) book 3 part 1

C333 (632) Series 63V d.c. working

| Type No. | Code No. | Capacitance pF | Capacitance code marking | Size |
|--------------------|-----------|-------------------|--------------------------------|------|
| C333CB/N1E8 | 632 09188 | 1.8 | 1p8 | 1 |
| C333CB/N2E2 | 632 09228 | 2.2 | 2p2 | 1 |
| C333CB/N2E7 | 632 09278 | 2.7 | 2p7 | 1 |
| C333CB/N3E3 | 632 09338 | 3.3 | 3p3 | 1 |
| C333CB/N3E9 | 632 09398 | 3.9 | 3p9 | 1 |
| C333CB/N4E7 | 632 09478 | 4.7 | 4p7 | 1 |
| C333CB/N5E6 | 632 09568 | 5.6 | 5p6 | 1 |
| C333CB/N6E8 | 632 09688 | 6.8 | 6p8 | 1 |
| C333CB/N8E2 | 632 09828 | 8.2 | 8p2 | 1 |
| C333CB/C10E | 632 10109 | 10 | 10p | 1 |
| C333CB/C12E | 632 10129 | 12 | 12p | 1 |
| C333CB/C15E | 632 10159 | 15 | 15p | 1 |
| C333CB/C18E | 632 10189 | 18 | 18p | 1 |
| C333CC/C22E | 632 34229 | 22 | 22p | 1 |

| Type No. | Code No. | Capacitance pF | Capacitance code marking | Size |
|---------------------|-----------|-------------------|--------------------------------|------|
| C333CC/C27E | 632 34279 | 27 | 27p | 2 |
| C333CC/C33E | 632 34339 | 33 | 33p | 2 |
| C333CC/C39E | 632 34399 | 39 | 39 or 39p | 2 |
| C333CC/C47E | 632 34479 | 47 | 47 or 47p | 2 |
| C333CC/C56E | 632 34569 | 56 | 56 or 56p | 3 |
| C333CC/C68E | 632 34689 | 68 | 68 or 68p | 3 |
| C333CC/C82E | 632 34829 | 82 | 82 or 82p | 4 |
| C333CC/C100E | 632 34101 | 100 | 100 or n10 | 4 |
| C333CC/C120E | 632 34121 | 120 | 120 or n12 | 5 |
| C333CC/C150E | 632 34151 | 150 | 150 or n15 | 5 |
| C333CH/C180E | 632 58181 | 180 | 180 or n18 | 4 |
| C333CH/C220E | 632 58221 | 220 | 220 or n22 | 4 |
| C333CH/C270E | 632 58271 | 270 | 270 or n27 | 5 |
| C333CH/C330E | 632 58331 | 330 | 330 or n33 | 5 |

Packing quantity: Multiples of 1000 pieces

| | |
|-------------------------------|---|
| Capacitance tolerance | 1.8 to 8.2 pF ± 0.25 pF 10 to 330 pF $\pm 2\%$ |
| Insulation resistance at 20°C | > 1000 M Ω |
| Temperature range | -55 to +85°C |
| Temperature coefficient | 1.8 to 18 pF = NPO 22 to 150 pF = N150 180 to 330 pF = N750 |

Dimensions mm

| Size | L | H |
|------|-----|------|
| 1 | 3.5 | 4.5 |
| 2 | 4.5 | 5.5 |
| 3 | 5.5 | 6.5 |
| 4 | 6.5 | 7.5 |
| 5 | 6.5 | 10.5 |

C333 (632)

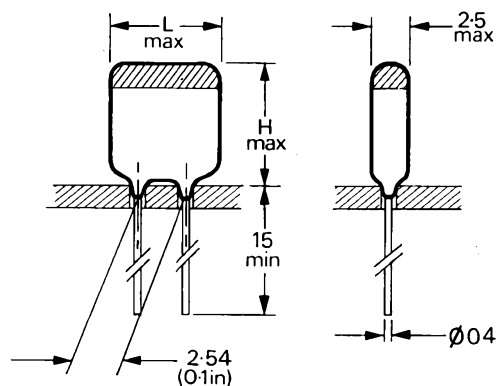
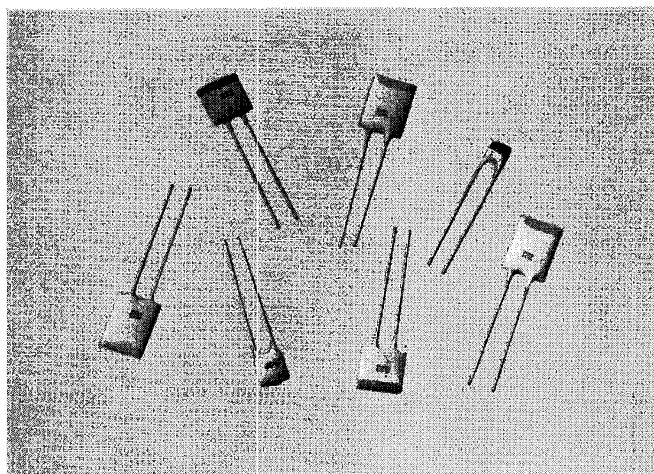



Ceramic capacitors miniature, plate (high-K) book 3 part 1

629 Series 40 V d.c. working (long lead version)

| Type No. | Capacitance nF | Dimensions mm | | |
|-----------|-------------------|---------------|-----|-----|
| | | L | T | H |
| 629 02102 | 1 | 3.5 | 2.1 | 4.5 |
| 629 02222 | 2.2 | 3.5 | 2.1 | 4.5 |
| 629 02472 | 4.7 | 3.5 | 2.1 | 4.5 |
| 629 02103 | 10 | 4.5 | 2.1 | 5.5 |
| 629 02223 | 22 | 6.5 | 2.1 | 7.5 |

Packing quantity : Multiples of 1000 pieces

629 Series 40V d.c. working (cropped lead version)

| Type No. | Capacitance nF | Dimensions mm | | |
|-----------|-------------------|---------------|-----|---|
| | | L | T | H |
| 629 06102 | 1 | 6.5 | 2.1 | 6 |
| 629 06222 | 2.2 | 6.5 | 2.1 | 6 |
| 629 06472 | 4.7 | 6.5 | 2.1 | 6 |
| 629 06103 | 10 | 6.5 | 2.1 | 7 |
| 629 06223 | 22 | 6.5 | 2.1 | 9 |

Capacitance tolerance -20 to +100%
 Insulation resistance at 20°C >1000 M Ω
 Temperature range -10 to +55°C

miniature, plate (medium-K) book 3 part 1

630 Series 100V d.c. working

| Type No. | Capacitance pF | Dimensions mm | | |
|-----------|-------------------|---------------|-----|-----|
| | | L | T | H |
| 630 02391 | 390 | 3.5 | 2.1 | 4.5 |
| 630 02471 | 470 | 3.5 | 2.1 | 4.5 |
| 630 02561 | 560 | 3.5 | 2.1 | 4.5 |
| 630 02681 | 680 | 3.5 | 2.1 | 4.5 |
| 630 02821 | 820 | 3.5 | 2.1 | 4.5 |
| 630 02102 | 1000 | 4.5 | 2.1 | 5.5 |
| 630 02122 | 1200 | 4.5 | 2.1 | 5.5 |

Packing quantity : Multiples of 1000 pieces

| Type No. | Capacitance pF | Dimensions mm | | |
|-----------|-------------------|---------------|-----|-----|
| | | L | T | H |
| 630 02152 | 1500 | 4.5 | 2.1 | 5.5 |
| 630 02182 | 1800 | 4.5 | 2.1 | 5.5 |
| 630 02222 | 2200 | 5.5 | 2.1 | 6.5 |
| 630 02272 | 2700 | 5.5 | 2.1 | 6.5 |
| 630 02332 | 3300 | 6.5 | 2.1 | 7.5 |
| 630 02392 | 3900 | 6.5 | 2.1 | 7.5 |
| 630 02472 | 4700 | 6.5 | 2.1 | 7.5 |

Capacitance tolerance ±10%
 Insulation resistance at 20°C >1000 M Ω
 Temperature range -55 to +85°C

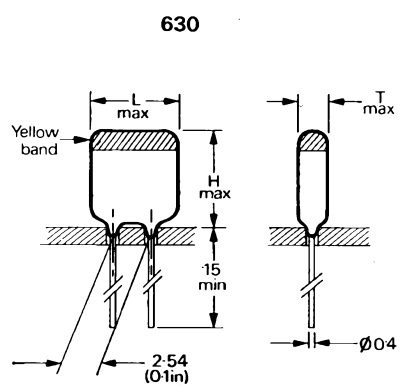
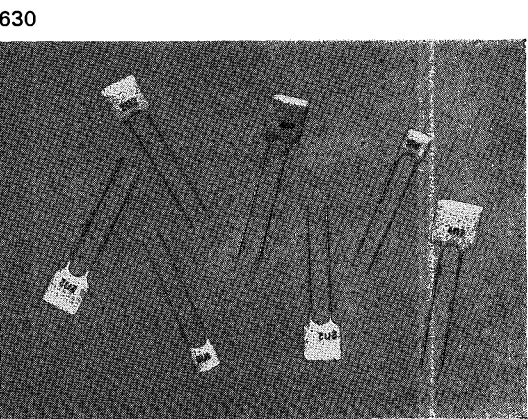
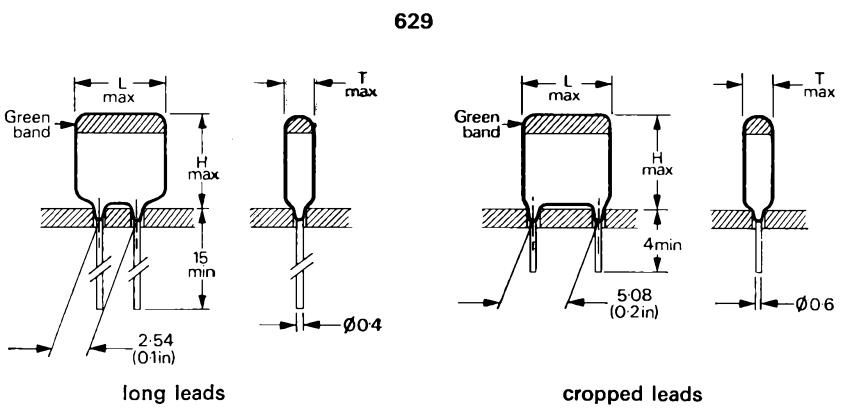
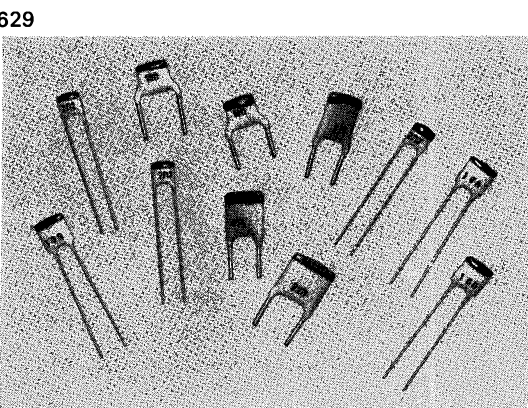

Electrolytic capacitors long life, small book 3 part 1

C428 (101) Series

| Type No. | Code No. | Working voltage Vdc | Capacitance μ F | Can size |
|-------------|-----------|---------------------|---------------------|----------|
| C428AR/B25 | 101 12259 | 4 | 25 | 1 |
| C428AR/B50 | 101 12509 | 4 | 50 | 1 |
| C428AR/B80 | 101 12809 | 4 | 80 | 2 |
| C428AR/B160 | 101 12161 | 4 | 160 | 3 |
| C428AR/B320 | 101 12321 | 4 | 320 | 4 |
| C428AR/C20 | 101 13209 | 6.4 | 20 | 1 |
| C428AR/C40 | 101 13409 | 6.4 | 40 | 1 |
| C428AR/C64 | 101 13649 | 6.4 | 64 | 2 |
| C428AR/C125 | 101 13131 | 6.4 | 125 | 3 |
| C428AR/C250 | 101 13251 | 6.4 | 250 | 4 |
| C428AR/D16 | 101 14169 | 10 | 16 | 1 |
| C428AR/D32 | 101 14329 | 10 | 32 | 1 |
| C428AR/D50 | 101 14509 | 10 | 50 | 2 |
| C428AR/D100 | 101 14101 | 10 | 100 | 3 |
| C428AR/D200 | 101 14201 | 10 | 200 | 4 |
| C428AR/E10 | 101 15109 | 16 | 10 | 1 |
| C428AR/E20 | 101 15209 | 16 | 20 | 1 |
| C428AR/E32 | 101 15329 | 16 | 32 | 2 |

| Type No. | Code No. | Working voltage Vdc | Capacitance μ F | Can size |
|--------------|-----------|---------------------|---------------------|----------|
| C428AR/E64 | 101 15649 | 16 | 64 | 3 |
| C428AR/E125 | 101 15131 | 16 | 125 | 4 |
| C428AR/F6.4 | 101 16648 | 25 | 6.4 | 1 |
| C428AR/F12.5 | 101 16139 | 25 | 12.5 | 1 |
| C428AR/F20 | 101 16209 | 25 | 20 | 2 |
| C428AR/F40 | 101 16409 | 25 | 40 | 3 |
| C428AR/F80 | 101 16809 | 25 | 80 | 4 |
| C428AR/G4 | 101 17408 | 40 | 4 | 1 |
| C428AR/G8 | 101 17808 | 40 | 8 | 1 |
| C428AR/G12.5 | 101 17139 | 40 | 12.5 | 2 |
| C428AR/G25 | 101 17259 | 40 | 25 | 3 |
| C428AR/G50 | 101 17509 | 40 | 50 | 4 |
| C428AR/H2.5 | 101 18258 | 64 | 2.5 | 1 |
| C428AR/H5 | 101 18508 | 64 | 5 | 1 |
| C428AR/H8 | 101 18808 | 64 | 8 | 2 |
| C428AR/H16 | 101 18169 | 64 | 16 | 3 |
| C428AR/H32 | 101 18329 | 64 | 32 | 4 |

Post Office approval to D2186 and RRE recommended

Packing quantity: Multiples of 200 pieces.

Available for current production; not intended for new designs

Capacitance tolerance -10 to +50%
Temperature range -40 to +70°C

Dimensions mm

| Can size | L | D |
|----------|------|------|
| 1 | 22.5 | 8.5 |
| 2 | 22.5 | 10.5 |
| 3 | 30.5 | 10.5 |
| 4 | 30.5 | 13 |

C428 (101)

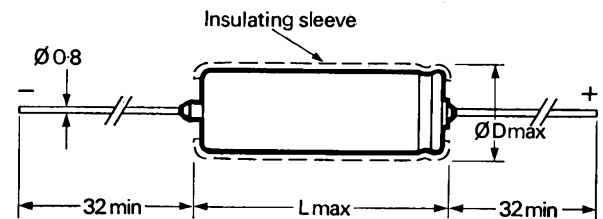
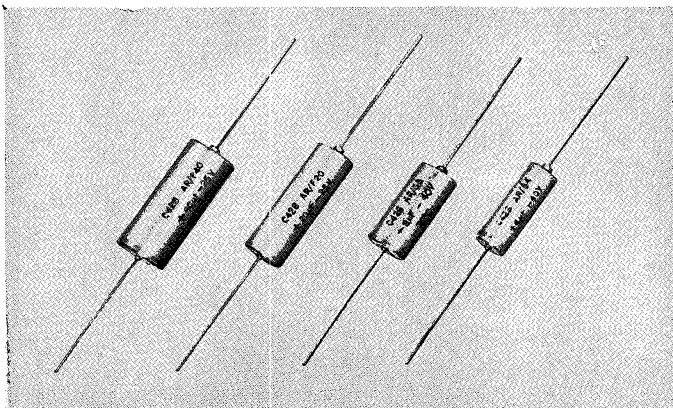



Electrolytic capacitors general purpose, miniature and small book 3 part 1

015, 016, 017 Series – axial version

| Type No. | Working voltage Vdc | Capacitance μF | Can size |
|-----------|---------------------|---------------------------|----------|
| 015 12479 | 4 | 47 | 2 |
| 015 12101 | 4 | 100 | 3 |
| 016 12221 | 4 | 220 | 4 |
| 016 12331 | 4 | 330 | 5 |
| 017 12102 | 4 | 1000 | 00 |
| 017 12472 | 4 | 4700 | 03 |
| 015 13339 | 6.3 | 33 | 2 |
| 015 13689 | 6.3 | 68 | 3 |
| 016 13151 | 6.3 | 150 | 4 |
| 016 13471 | 6.3 | 470 | 6 |
| 017 13681 | 6.3 | 680 | 00 |
| 017 13152 | 6.3 | 1500 | 01 |
| 017 13222 | 6.3 | 2200 | 02 |
| 017 13332 | 6.3 | 3300 | 03 |
| 015 14229 | 10 | 22 | 2 |
| 015 14479 | 10 | 47 | 3 |
| 016 14101 | 10 | 100 | 4 |
| 016 14221 | 10 | 220 | 5 |
| 016 14331 | 10 | 330 | 6 |
| 017 14471 | 10 | 470 | 00 |
| 017 14102 | 10 | 1000 | 01 |
| 017 14152 | 10 | 1500 | 02 |
| 017 14222 | 10 | 2200 | 03 |
| 015 15159 | 16 | 15 | 2 |
| 015 15339 | 16 | 33 | 3 |
| 016 15689 | 16 | 68 | 4 |
| 016 15151 | 16 | 150 | 5 |
| 016 15221 | 16 | 220 | 6 |
| 017 15331 | 16 | 330 | 00 |
| 017 15681 | 16 | 680 | 01 |
| 017 15102 | 16 | 1000 | 02 |
| 017 15152 | 16 | 1500 | 03 |

| Type No. | Working voltage Vdc | Capacitance μF | Can size |
|-----------|---------------------|---------------------------|----------|
| 015 16109 | 25 | 10 | 2 |
| 015 16229 | 25 | 22 | 3 |
| 016 16479 | 25 | 47 | 4 |
| 016 16101 | 25 | 100 | 5 |
| 016 16151 | 25 | 150 | 6 |
| 017 16221 | 25 | 220 | 00 |
| 017 16471 | 25 | 470 | 01 |
| 017 16681 | 25 | 680 | 02 |
| 017 16102 | 25 | 1000 | 03 |
| 015 17688 | 40 | 6.8 | 2 |
| 015 17159 | 40 | 15 | 3 |
| 016 17339 | 40 | 33 | 4 |
| 016 17479 | 40 | 47 | 5 |
| 016 17101 | 40 | 100 | 6 |
| 017 17151 | 40 | 150 | 00 |
| 017 17221 | 40 | 220 | 01 |
| 017 17471 | 40 | 470 | 02 |
| 017 17681 | 40 | 680 | 03 |
| 015 18108 | 63 | 1 | 3 |
| 015 90001 | 63 | 1.5 | 3 |
| 015 18228 | 63 | 2.2 | 3 |
| 015 18338 | 63 | 3.3 | 3 |
| 015 90003 | 63 | 4.7 | 3 |
| 015 18688 | 63 | 6.8 | 3 |
| 016 18109 | 63 | 10 | 4 |
| 016 18159 | 63 | 15 | 4 |
| 016 18229 | 63 | 22 | 5 |
| 016 18479 | 63 | 47 | 6 |
| 017 18689 | 63 | 68 | 00 |
| 017 18101 | 63 | 100 | 01 |
| 017 18151 | 63 | 150 | 01 |
| 017 18221 | 63 | 220 | 02 |
| 017 18331 | 63 | 330 | 03 |

For can sizes see next page

015, 016, 017

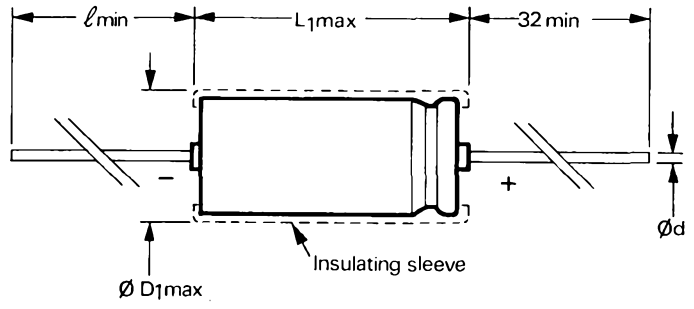
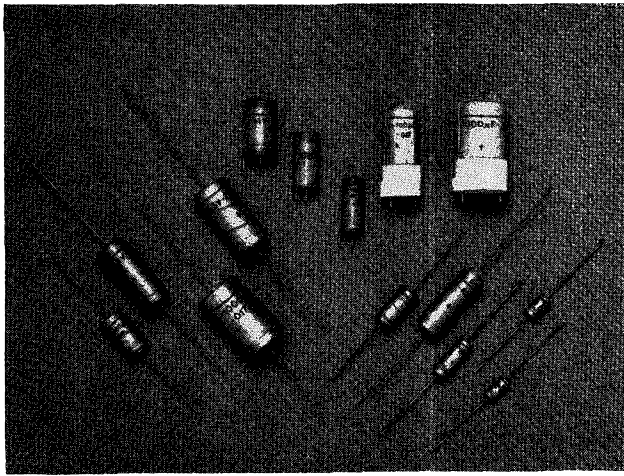

Electrolytic capacitors general purpose, miniature and small (cont.) book 3 part 1

015, 016, 017 Series – printed wiring versions

| Type No. | Working voltage Vdc | Capacitance μ F | Can size | Fig. |
|-----------|---------------------|---------------------|----------|------|
| 016 42221 | 4 | 220 | 4 | 1 |
| 016 42331 | 4 | 330 | 5 | 1 |
| 017 52102 | 4 | 1000 | 00 | 2 |
| 017 52472 | 4 | 4700 | 03 | 2 |
| 016 43151 | 6.3 | 150 | 4 | 1 |
| 016 43471 | 6.3 | 470 | 6 | 1 |
| 017 53681 | 6.3 | 680 | 00 | 2 |
| 017 53152 | 6.3 | 1500 | 01 | 2 |
| 017 53222 | 6.3 | 2200 | 02 | 2 |
| 017 53332 | 6.3 | 3300 | 03 | 2 |
| 016 44101 | 10 | 100 | 4 | 1 |
| 016 44221 | 10 | 220 | 5 | 1 |
| 016 44331 | 10 | 330 | 6 | 1 |
| 017 54471 | 10 | 470 | 00 | 2 |
| 017 54102 | 10 | 1000 | 01 | 2 |
| 017 54152 | 10 | 1500 | 02 | 2 |
| 017 54222 | 10 | 2200 | 03 | 2 |
| 016 45689 | 16 | 68 | 4 | 1 |
| 016 45151 | 16 | 150 | 5 | 1 |
| 016 45221 | 16 | 220 | 6 | 1 |
| 017 55331 | 16 | 330 | 00 | 2 |
| 017 55681 | 16 | 680 | 01 | 2 |
| 017 55102 | 16 | 1000 | 02 | 2 |
| 017 55152 | 16 | 1500 | 03 | 2 |

| Type No. | Working voltage Vdc | Capacitance μ F | Can size | Fig. |
|-----------|---------------------|---------------------|----------|------|
| 016 46479 | 25 | 47 | 4 | 1 |
| 016 46101 | 25 | 100 | 5 | 1 |
| 016 46151 | 25 | 150 | 6 | 1 |
| 017 56221 | 25 | 220 | 00 | 2 |
| 017 56471 | 25 | 470 | 01 | 2 |
| 017 56681 | 25 | 680 | 02 | 2 |
| 017 56102 | 25 | 1000 | 03 | 2 |
| 016 47339 | 40 | 33 | 4 | 1 |
| 016 47479 | 40 | 47 | 5 | 1 |
| 016 47101 | 40 | 100 | 6 | 1 |
| 017 57151 | 40 | 150 | 00 | 2 |
| 017 57221 | 40 | 220 | 01 | 2 |
| 017 57471 | 40 | 470 | 02 | 2 |
| 017 57681 | 40 | 680 | 03 | 2 |
| 016 48109 | 63 | 10 | 4 | 1 |
| 016 48159 | 63 | 15 | 4 | 1 |
| 016 48229 | 63 | 22 | 5 | 1 |
| 016 48479 | 63 | 47 | 6 | 1 |
| 017 58689 | 63 | 68 | 00 | 2 |
| 017 58101 | 63 | 100 | 01 | 2 |
| 017 58151 | 63 | 150 | 01 | 2 |
| 017 58221 | 63 | 220 | 02 | 2 |
| 017 58331 | 63 | 330 | 03 | 2 |

Packing quantity: Multiples of 1000 pieces

Capacitance tolerance

-10 to +50%

Temperature range

015 Series

-25 to +85°C

016, 017 Series

-40 to +85°C

Dimensions mm

| Axial lead version | | | | | Printed wiring versions | | | | | |
|--------------------|-------|-------|--------|-----|-------------------------|-------|-------|--------|-------|-------|
| Can size | | | | | Fig. 1 | | | Fig. 2 | | |
| | L_1 | D_1 | ϕ | d | L_2 | D_2 | S_1 | L_3 | D_3 | S_2 |
| 2 | 12.5 | 4.8 | 32 | 0.6 | - | - | - | - | - | - |
| 3 | 12.5 | 6.1 | 32 | 0.6 | - | - | - | - | - | - |
| 4 | 18.5 | 6.7 | 32 | 0.8 | 23 | 8.5 | 5.1 | - | - | - |
| 5 | 18.5 | 8.3 | 32 | 0.8 | 23 | 10.2 | 5.1 | - | - | - |
| 6 | 18.5 | 10.3 | 32 | 0.8 | 23 | 12.1 | 7.6 | - | - | - |
| 00 | 30.5 | 10.4 | 54 | 0.8 | - | - | - | 39.5 | 12.8 | 10.2 |
| 01 | 30.5 | 12.9 | 54 | 0.8 | - | - | - | 39.5 | 15.2 | 10.2 |
| 02 | 30.5 | 15.4 | 54 | 0.8 | - | - | - | 39.5 | 17.8 | 12.7 |
| 03 | 30.5 | 18.4 | 54 | 0.8 | - | - | - | 39.5 | 20.8 | 15.2 |

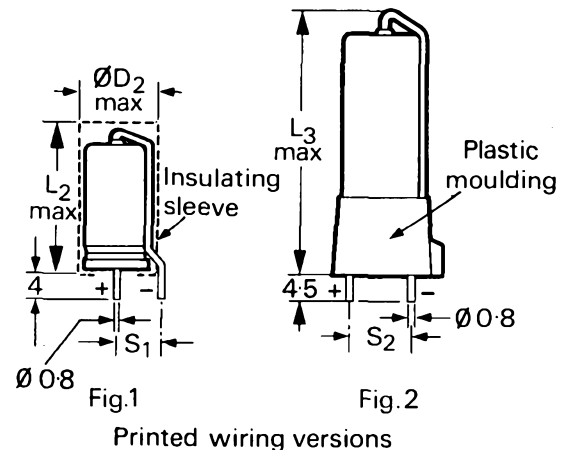
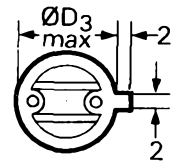



Electrolytic capacitors general purpose, large book 3 part 1

071, 072 Series (to I.E.C. 103 Type 1)

| Type No. | Working voltage Vdc | Capacitance μF | Can size | I, max. at 100Hz (A) | | |
|-----------|------------------------|------------------------------|----------|----------------------|---------|---------|
| | | | | at 50°C | at 70°C | at 85°C |
| 071 14472 | 10 | 4700 | 5 | 2.5 | 1.9 | 1.1 |
| 071 14682 | 10 | 6800 | 6 | 4.0 | 3.1 | 1.8 |
| 071 14103 | 10 | 10 000 | 7 | 6.0 | 4.6 | 2.7 |
| 071 14153 | 10 | 15 000 | 8 | 8.2 | 6.3 | 3.7 |
| 072 14113 | 10 | 11 000+11 000 | 9 | 10.6 | 8.3 | 4.8 |
| 072 14173 | 10 | 16 500+16 500 | 10 | 13.4 | 10.4 | 6.0 |
| 071 15332 | 16 | 3300 | 5 | 2.4 | 1.9 | 1.1 |
| 071 15472 | 16 | 4700 | 6 | 3.9 | 3.0 | 1.7 |
| 071 15682 | 16 | 6800 | 7 | 5.8 | 4.5 | 2.6 |
| 071 15103 | 16 | 10 000 | 8 | 7.9 | 6.1 | 3.5 |
| 072 15752 | 16 | 7500+7500 | 9 | 10.5 | 7.6 | 4.7 |
| 072 15113 | 16 | 11 000+11 000 | 10 | 13.8 | 10.6 | 6.1 |
| 071 16222 | 25 | 2200 | 5 | 2.2 | 1.7 | 1.0 |
| 071 16332 | 25 | 3300 | 6 | 3.7 | 2.8 | 1.7 |
| 071 16472 | 25 | 4700 | 7 | 5.4 | 4.2 | 2.4 |
| 071 16682 | 25 | 6800 | 8 | 7.3 | 5.6 | 3.3 |
| 072 16502 | 25 | 5000+5000 | 9 | 9.6 | 7.4 | 4.3 |
| 072 16752 | 25 | 7500+7500 | 10 | 12.6 | 9.8 | 5.7 |
| 071 17102 | 40 | 1000 | 5 | 2.1 | 1.6 | 1.0 |
| 071 17222 | 40 | 2200 | 6 | 2.9 | 2.2 | 1.3 |
| 071 17332 | 40 | 3300 | 7 | 5.2 | 4.1 | 2.4 |
| 071 17472 | 40 | 4700 | 8 | 7.0 | 5.4 | 3.1 |
| 072 17342 | 40 | 3400+3400 | 9 | 9.1 | 7.1 | 4.1 |
| 072 17502 | 40 | 5000+5000 | 10 | 12.0 | 8.7 | 5.3 |
| 071 18681 | 63 | 680 | 5 | 2.1 | 1.4 | 0.8 |
| 071 18102 | 63 | 1000 | 6 | 2.9 | 2.2 | 1.3 |
| 071 18152 | 63 | 1500 | 7 | 4.3 | 3.4 | 2.0 |
| 071 18222 | 63 | 2200 | 8 | 5.8 | 4.5 | 2.6 |
| 072 18172 | 63 | 1650+1650 | 9 | 7.8 | 6.0 | 3.5 |
| 072 18242 | 63 | 2350+2350 | 10 | 10.0 | 7.8 | 4.5 |

Approved to Post Office D2186

Also available in lower voltage ranges.

Packing quantity: Multiples of 100 pieces.

Tag width: 4mm

Capacitance tolerance -10 to +50%

Temperature range -40 to +85°C

071, 072

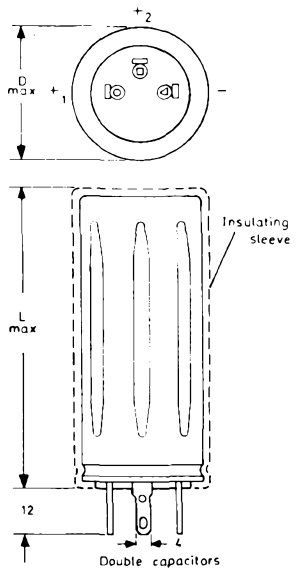
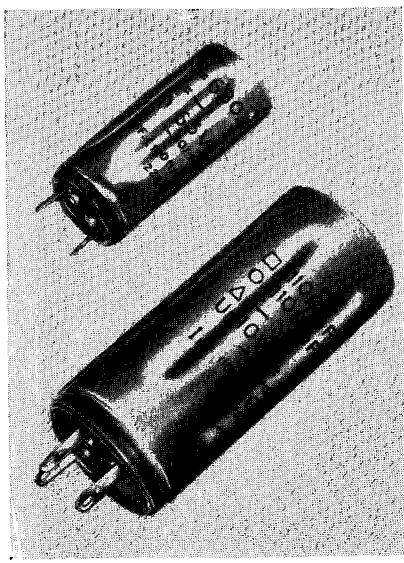

Dimensions mm

| Can size | L | D | Clips |
|----------|------|------|---------|
| 5 | 50.3 | 21.6 | B127121 |
| 6 | 50.3 | 25.6 | B127122 |
| 7 | 81.3 | 25.6 | B127122 |
| 8 | 81.3 | 30.6 | DT2402 |
| 9 | 81.3 | 35.6 | B127124 |
| 10 | 81.3 | 40.8 | B127125 |

Electrolytic capacitors long life, large (computer) book 3 part 1

106, 107 Series (to I.E.C. 103 Type 1)

| Type No. | Working voltage Vdc | Capacitance μ F | Can size | I _r max. at 100 Hz, (A) | | |
|-----------|------------------------|------------------------|----------|------------------------------------|---------|---------|
| | | | | at 50°C | at 70°C | at 85°C |
| 106 15103 | 16 | 10 000 | 11 | 7 | 6.3 | 3.1 |
| 106 15153 | 16 | 15 000 | 12 | 10 | 9 | 4.5 |
| 106 15223 | 16 | 22 000 | 14 | 12 | 11 | 5.4 |
| 106 15333 | 16 | 33 000 | 15 | 17 | 15 | 7.7 |
| 106 15683 | 16 | 68 000 | 16 | 28 | 25 | 12.6 |
| 106 16682 | 25 | 6800 | 11 | 7 | 6.3 | 3.1 |
| 106 16103 | 25 | 10 000 | 12 | 10 | 9 | 4.5 |
| 106 16153 | 25 | 15 000 | 14 | 12 | 11 | 5.4 |
| 106 16223 | 25 | 22 000 | 15 | 17 | 15 | 7.7 |
| 106 16473 | 25 | 47 000 | 16 | 28 | 25 | 12.6 |
| 106 17472 | 40 | 4700 | 11 | 7 | 6.3 | 3.1 |
| 106 17682 | 40 | 6800 | 12 | 10 | 9 | 4.5 |
| 106 17103 | 40 | 10 000 | 14 | 12 | 11 | 5.4 |
| 106 17153 | 40 | 15 000 | 15 | 17 | 15 | 7.7 |
| 106 17333 | 40 | 33 000 | 16 | 28 | 25 | 12.6 |
| 106 18222 | 63 | 2200 | 11 | 7 | 6.3 | 3.1 |
| 106 18332 | 63 | 3300 | 12 | 10 | 9 | 4.5 |
| 106 18472 | 63 | 4700 | 14 | 12 | 11 | 5.4 |
| 106 18682 | 63 | 6800 | 15 | 17 | 15 | 7.7 |
| 106 18153 | 63 | 15 000 | 16 | 28 | 25 | 12.6 |
| 107 10152 | 100 | 1500 | 11 | 7 | 6.3 | 3.1 |
| 107 10222 | 100 | 2200 | 12 | 10 | 9 | 4.5 |
| 107 10332 | 100 | 3300 | 14 | 12 | 11 | 5.4 |
| 107 10472 | 100 | 4700 | 15 | 17 | 15 | 7.7 |
| 107 10103 | 100 | 10 000 | 16 | 28 | 25 | 12.6 |

Approved to Post Office D2186, Min. of Defence (Naval) DEF5134—1 and Min. of Defence (SRDE) 070/8/01

Packing quantity: Multiples of 50 pieces

Capacitance tolerance -10 to +50%
 Temperature range
 106 Series -40 to +85°C
 107 Series -25 to +85°C

106, 107

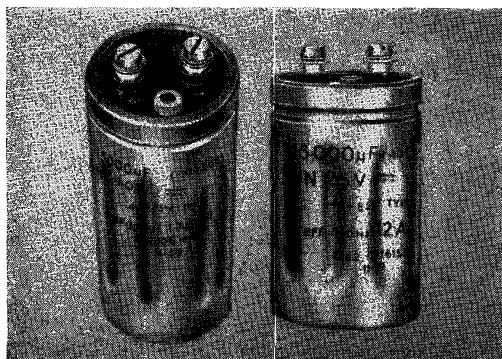

Dimensions mm

| Can size | L | D | S | C | Clips |
|----------|-----|------|----|------|--------|
| 11 | 83 | 36.8 | 15 | 8.4 | DT2401 |
| 12 | 115 | 36.8 | 15 | 8.4 | DT2401 |
| 14 | 83 | 51.8 | 22 | 14.3 | DT2254 |
| 15 | 115 | 51.8 | 22 | 14.3 | DT2254 |
| 16 | 115 | 66.8 | 31 | 19.0 | DT2400 |

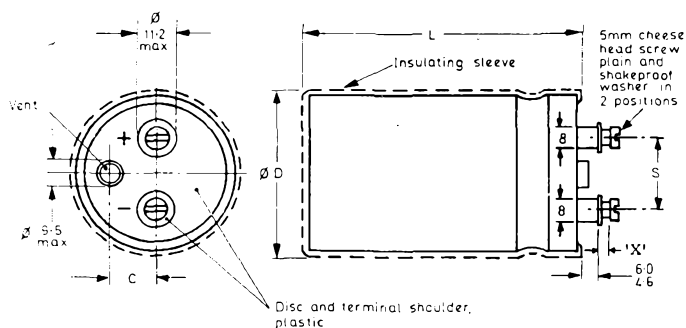



Electrolytic capacitors

long life, small book 3 part 1

108 Series (to I.E.C. 103 Type 1)

| Type No. | Working voltage Vdc | Capacitance μF | Can size | I_r max. at 100Hz, (mA) at 85°C |
|-----------|------------------------|------------------------------|----------|--------------------------------------|
| 108 13151 | 6.3 | 150 | 5 | 130 |
| 108 13331 | 6.3 | 330 | 6 | 220 |
| 108 13471 | 6.3 | 470 | 00 | 325 |
| 108 13102 | 6.3 | 1000 | 01 | 470 |
| 108 13152 | 6.3 | 1500 | 02 | 630 |
| 108 13222 | 6.3 | 2200 | 03 | 920 |
| 108 14101 | 10 | 100 | 5 | 120 |
| 108 14221 | 10 | 220 | 6 | 205 |
| 108 14331 | 10 | 330 | 00 | 325 |
| 108 14681 | 10 | 680 | 01 | 470 |
| 108 14102 | 10 | 1000 | 02 | 630 |
| 108 14152 | 10 | 1500 | 03 | 920 |
| 108 15689 | 16 | 68 | 5 | 110 |
| 108 15151 | 16 | 150 | 6 | 190 |
| 108 15221 | 16 | 220 | 00 | 270 |
| 108 15471 | 16 | 470 | 01 | 360 |
| 108 15681 | 16 | 680 | 02 | 500 |
| 108 15102 | 16 | 1000 | 03 | 650 |
| 108 16339 | 25 | 33 | 5 | 85 |
| 108 16479 | 25 | 47 | 5 | 100 |
| 108 16101 | 25 | 100 | 6 | 170 |
| 108 16151 | 25 | 150 | 00 | 270 |
| 108 16221 | 25 | 220 | 01 | 360 |
| 108 16471 | 25 | 470 | 02 | 500 |
| 108 16681 | 25 | 680 | 03 | 650 |
| 108 17229 | 40 | 22 | 5 | 80 |
| 108 17479 | 40 | 47 | 6 | 130 |
| 108 17689 | 40 | 68 | 00 | 195 |
| 108 17151 | 40 | 150 | 01 | 280 |
| 108 17221 | 40 | 220 | 02 | 360 |
| 108 17331 | 40 | 330 | 03 | 495 |
| 108 18228 | 63 | 2.2 | 5 | 25 |
| 108 18338 | 63 | 3.3 | 5 | 30 |
| 108 18478 | 63 | 4.7 | 5 | 35 |
| 108 18688 | 63 | 6.8 | 5 | 45 |
| 108 18109 | 63 | 10 | 5 | 50 |
| 108 18159 | 63 | 15 | 6 | 75 |
| 108 18339 | 63 | 33 | 00 | 125 |
| 108 18689 | 63 | 68 | 01 | 195 |
| 108 18101 | 63 | 100 | 02 | 275 |
| 108 18151 | 63 | 150 | 03 | 355 |

Approved to Post Office D2186 and Min. of Defence (Naval) DEF5134-1

Packing quantity : Multiples of 250 pieces for cans 00 to 03
100 pieces for cans 5 and 6

Capacitance tolerance -10+50%
Temperature range -40 to +85°C

Dimensions mm

| Can size | L | D |
|----------|------|------|
| 5 | 22.5 | 8.5 |
| 6 | 22.5 | 10.5 |
| 00 | 32.5 | 10.5 |
| 01 | 32.5 | 12.5 |
| 02 | 32.5 | 15.5 |
| 03 | 32.5 | 18.5 |

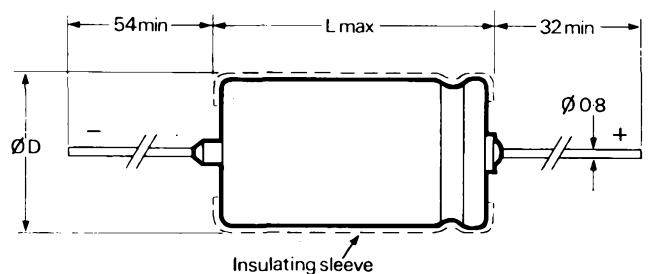

108

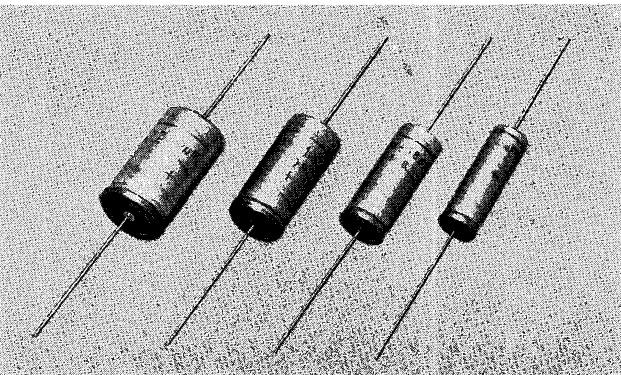



Electrolytic capacitors solid electrolyte, aluminium book 3 part 1

121 Series

| Type No. | Working voltage Vdc | Capacitance μF | Can size |
|-----------|---------------------|---------------------------|----------|
| 121 13229 | 6.3 | 22 | 1 |
| 121 13479 | 6.3 | 47 | 2 |
| 121 13689 | 6.3 | 68 | 3 |
| 121 13151 | 6.3 | 150 | 4 |
| 121 13221 | 6.3 | 220 | 5 |
| 121 13331 | 6.3 | 330 | 6 |
| 121 14159 | 10 | 15 | 1 |
| 121 14339 | 10 | 33 | 2 |
| 121 14479 | 10 | 47 | 3 |
| 121 14101 | 10 | 100 | 4 |
| 121 14151 | 10 | 150 | 5 |
| 121 14221 | 10 | 220 | 6 |
| 121 15109 | 16 | 10 | 1 |
| 121 15159 | 16 | 15 | 2 |
| 121 15339 | 16 | 33 | 3 |

| Type No. | Working voltage Vdc | Capacitance μF | Can size |
|-----------|---------------------|---------------------------|----------|
| 121 15479 | 16 | 47 | 4 |
| 121 15689 | 16 | 68 | 5 |
| 121 15101 | 16 | 100 | 6 |
| 121 16478 | 25 | 4.7 | 1 |
| 121 16109 | 25 | 10 | 2 |
| 121 16229 | 25 | 22 | 3 |
| 121 16339 | 25 | 33 | 4 |
| 121 16479 | 25 | 47 | 5 |
| 121 16689 | 25 | 68 | 6 |
| 121 17228 | 40 | 2.2 | 1 |
| 121 17478 | 40 | 4.7 | 2 |
| 121 17109 | 40 | 10 | 3 |
| 121 17229 | 40 | 22 | 4 |
| 121 17339 | 40 | 33 | 5 |
| 121 17479 | 40 | 47 | 6 |

Post Office approved

Packing quantity: Multiples of 100 pieces

Capacitance tolerance $\pm 20\%$

Temperature range -55 to $+85^\circ\text{C}$
(up to $+125^\circ\text{C}$ with voltage derating)

Dimensions mm

| Can size | L | D | d |
|----------|------|-----|-----|
| 1 | 17.5 | 6.6 | 0.8 |
| 2 | 24 | 6.6 | 0.8 |
| 3 | 24 | 8.3 | 0.8 |

| Can size | L | D | d |
|----------|----|------|-----|
| 4 | 24 | 10.4 | 0.8 |
| 5 | 32 | 10.4 | 0.8 |
| 6 | 32 | 12.9 | 0.8 |

121

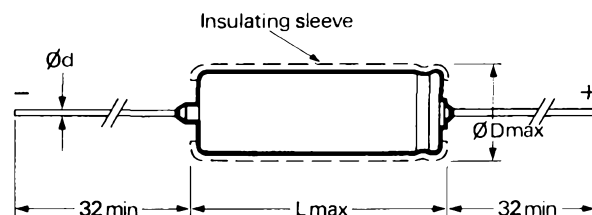
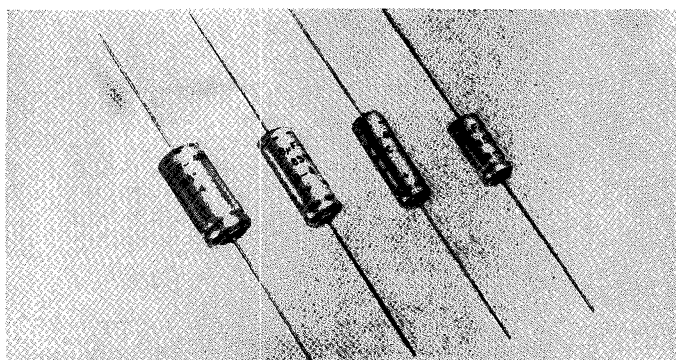

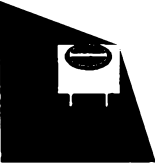

Variable capacitors tubular ceramic trimmers book 3 part 1

C004 (802) Series

| Type No. | Code No. | Capacitance swing pF | Minimum capacitance pF | Temperature coefficient ppm per deg C | Dimensions mm | |
|-------------------|-----------|----------------------|------------------------|---------------------------------------|---------------|----------|
| | | | | | Length* | Diameter |
| C004EA/3E | 802 20001 | 3 | <0.8 | 0 to -400 | 25.5 | 6 |
| C004EA/6E | 802 20002 | 6 | <0.8 | 0 to -400 | 31.5 | 6 |
| C004EA/12E | 802 20004 | 12 | <1 | 0 to -400 | 43.5 | 6 |
| C004EA/18E | 802 20005 | 18 | <1.7 | 0 to -400 | 43.5 | 6 |

*At minimum capacitance

Working voltage 500V d.c. Temperature range -40 to +85°C

Packing quantity: Multiples of 450 pieces

film dielectric trimmers, miniature book 3 part 1

808 Series

| Type No. | Capacitance swing pF | Minimum capacitance pF | Dimensions mm | | |
|------------------|----------------------|------------------------|---------------|-------|--------------------|
| | | | Length | Width | Height above board |
| 808 00004 | 4.1 | 1.4 | 8.8 | 8 | 10 |
| 808 00005 | 8 | 2 | 8.8 | 8 | 10 |
| 808 00006 | 20 | 2 | 8.8 | 8 | 10 |
| 808 01001 | 59.5 | 5.5 | 11.5 | 10.6 | 11 |

Packing quantity: Multiples of 1400 pieces except 808 01001, which is packed in multiple of 800 pieces.

Working voltage 100V d.c. Temperature range -40 to +70°C

809 09 Series

| Type No. | Capacitance swing pF | Minimum capacitance pF | Dimensions mm | | |
|------------------|----------------------|------------------------|---------------|-------|--------------------|
| | | | Length | Width | Height above board |
| 809 09001 | 4.1 | 1.4 | 8.8 | 8 | 10 |
| 809 09002 | 7 | 2 | 8.8 | 8 | 10 |
| 809 09003 | 16 | 2 | 8.8 | 8 | 10 |

Packing quantity: Multiples of 900 pieces

Working voltage 300V d.c. Temperature range -40 to +125°C

809 08 Series

| Type No. | Capacitance swing pF | Minimum capacitance pF | Dimensions mm | | |
|------------------|----------------------|------------------------|---------------|-------|--------------------|
| | | | Length | Width | Height above board |
| 809 08002 | 36 | 4 | 10.9 | 10.5 | 11 |
| 809 08003 | 55 | 5 | 10.9 | 10.5 | 11 |

Packing quantity: Multiples of 450 pieces

Working voltage 300V d.c. Temperature range -40 to +125°C

809 05 and 809 07 Series are still available for current production but are not recommended for the design of new equipment.

C004EA (802)

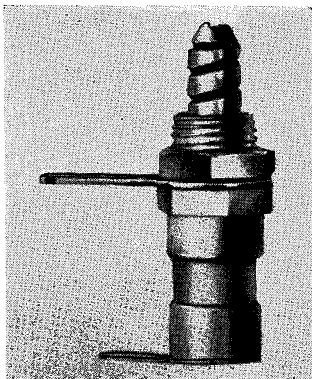

808

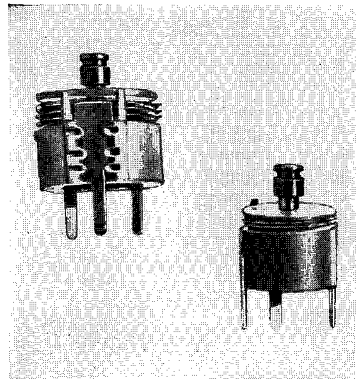

809 08/809 09

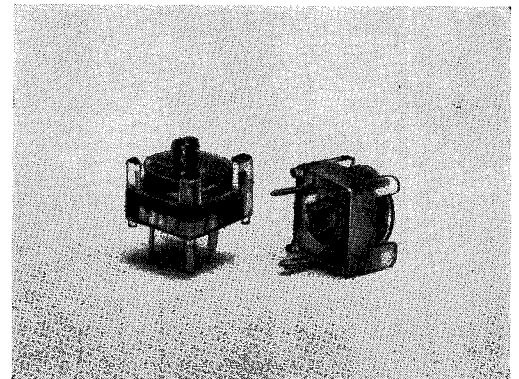

Linear resistors lacquered, carbon film book 3 part 1

| Style | Resistance tolerance | Resistance range | Maximum power dissipation at 70°C W | Preferred value series | Maximum voltage d.c. or rms V |
|-------------|----------------------|-------------------|-------------------------------------|------------------------|-------------------------------|
| CR16 | ±5% | 10 Ω to 220 k Ω | 0.2 | E12 | 150 |
| | ±10% | 270 k Ω to 1 M Ω | | E12 | 150 |
| CR25 | ±5% | 1 Ω to 1 M Ω | 0.33 | E24 | 250 |
| | ±10% | 1.2 M Ω to 10 M Ω | | E12 | 250 |
| CR37 | ±5% | 1 Ω to 1 M Ω | 0.5 | E24 | 350 |
| | ±10% | 1.2 M Ω to 10 M Ω | | E12 | 350 |

Packed in bandoliers of 1000 pieces with dividing marks at intervals of 100.

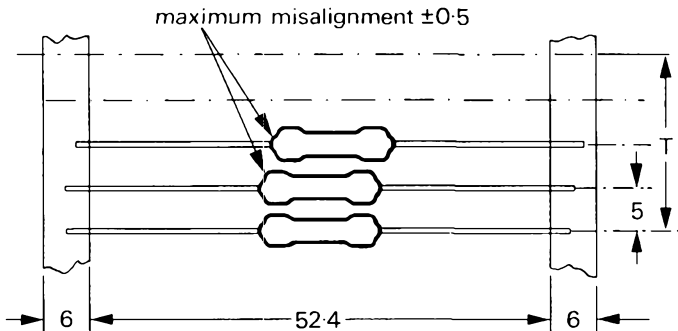

$$T = [5(n-1)] \pm 4$$

This formula is applicable when the number of resistors (n) is between 50 and 100 pieces.

| Dimensions mm | | | |
|---------------|--------|--------|-----|
| Style | D max. | L max. | d |
| CR16 | 1.6 | 4.5 | 0.4 |
| CR25 | 2.5 | 7.5 | 0.6 |
| CR37 | 3.7 | 10 | 0.7 |

CR16/CR25/CR37

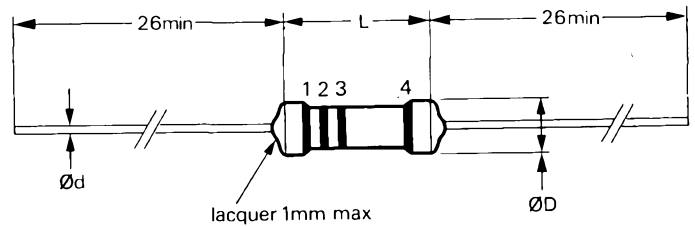
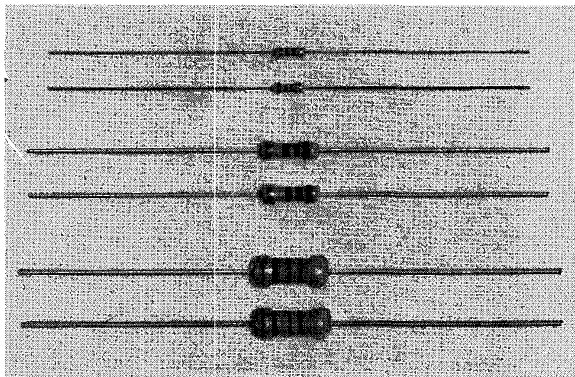

These resistors are coated with a tan coloured lacquer and colour coded in accordance with BS1852.

The four colour bands indicate:— (1) first significant figure (2) second significant figure (3) multiplier and (4) tolerance.

E12 series: 10 12 15 18 22 27 33 39 47 56 68 82

E24 series: 10 11 12 13 15 16 18 20 22 24 27 30 33 36 39 43 47 51 56 62 68 75 82 91

CR16/25/37 resistors are available in the above values and decimal multiples and submultiples thereof.

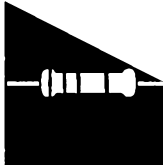

Linear resistors lacquered, metal film book 3 part 1

| Style | Resistance tolerance | Resistance range | Maximum power dissipation at 70°C W | Preferred value series | Temperature coefficient ppm per deg C | Maximum voltage d.c. or rms V |
|-------------|----------------------|------------------|-------------------------------------|------------------------|---------------------------------------|-------------------------------|
| MR25 | ±1% | 4.99 Ω to 301k Ω | 0.4 | E96 | <100 (Typical 60) | 250 |
| | ±2% | 5.1 Ω to 300k Ω | | E24 | | |
| MR30 | ±1% | 4.99 Ω to 1 M Ω | 0.5 | E96 | <100 (Typical 60) | 350 |
| | ±2% | 5.1 Ω to 1 M Ω | | E24 | | |

Packed in bandoliers of 1000 pieces with dividing marks at intervals of 100.

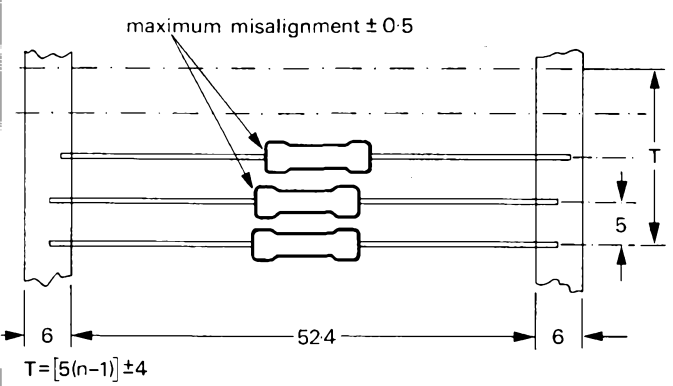

This formula is applicable when the number of resistors (n) is between 50 and 100 pieces.

| Dimensions mm | | | |
|---------------|--------|--------|-----|
| Style | D max. | L max. | d |
| MR25 | 2.5 | 6.5 | 0.6 |
| MR30 | 3 | 10 | 0.6 |

MR25/MR30

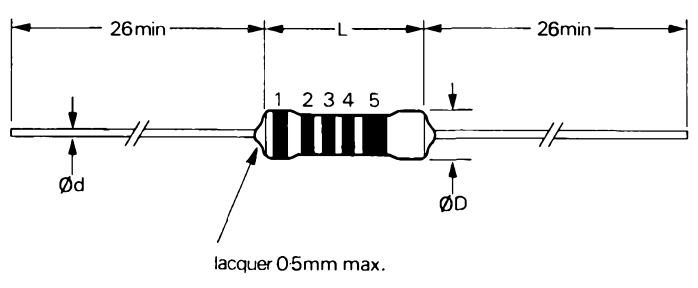
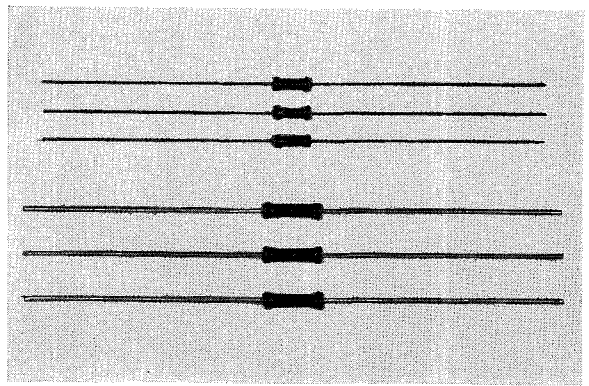

These resistors are coated with a green coloured lacquer and colour coded in accordance with BS1852.

Resistors in the E24 series with a 2% tolerance, are colour coded with 4 bands: (1) first significant figure, (2) second significant figure, (3) multiplier, (4) tolerance.

Resistors in the E96 series with a 1% tolerance are colour coded with 5 bands: (1) first significant figure, (2) second significant figure, (3) third significant figure, (4) multiplier, (5) tolerance.

E24 series: 10 11 12 13 15 16 18 20 22 24 27 30 33 36 39 43 47 51 56 62 68 75 82 91

E96 series: 100 102 105 107 110 113 115 118 121 124 127 130 133 137 140 143 147 150 154 158 162 165 169 174 178
182 187 191 196 200 205 210 215 221 226 232 237 243 249 255 261 267 274 280 287 294 301 309 316 324
332 340 348 357 365 374 383 392 402 412 422 432 442 453 464 475 487 499 511 523 536 549 562 576 590
604 619 634 649 665 681 698 715 732 750 768 787 806 825 845 866 887 909 931 953 976

MR25/30 resistors are available in the above values and decimal multiples and submultiples thereof.

Linear resistors metal film, high power book 3 part 1

| Style | Resistance tolerance | Resistance range | Maximum power dissipation at 70°C W | Preferred value series |
|-------------|----------------------|------------------|-------------------------------------|------------------------|
| PR37 | ±5% | 10 Ω to 10k Ω | 1.6 | E12 |
| PR52 | ±5% | 10 Ω to 27k Ω | 2.5 | E12 |

Packed in bandoliers of 1000 pieces with dividing marks at intervals of 100.

PR52

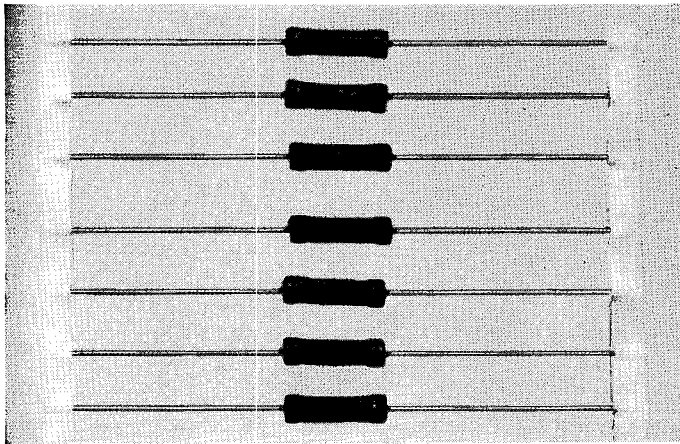

| Dimensions mm | | | |
|---------------|--------|--------|-----|
| Style | D max. | L max. | d |
| PR37 | 3.7 | 10 | 0.6 |
| PR52 | 5.2 | 16.7 | 0.6 |

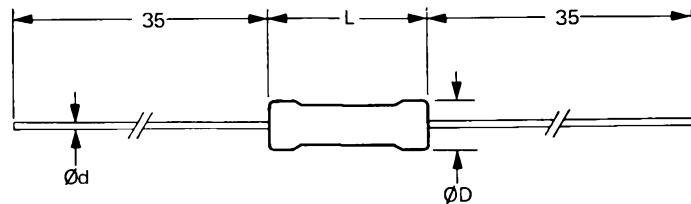

These resistors are coated with a red-brown coloured high temperature silicone paint. The resistance value and tolerance are printed on the resistor body.

E12 Series: 10 12 15 18 22 27 33 39 47 56 68 82

PR37/52 resistors are available in the above values and decimal multiples thereof.



Linear resistors metal glaze, high ohmic book 3 part 1

| Style | Resistance tolerance | Resistance range | Maximum power dissipation at 70°C W | Maximum voltage rms V | Preferred value series |
|-------------|----------------------|------------------|-------------------------------------|-----------------------|------------------------|
| VR37 | ±5% | 1 MΩ to 33 MΩ | 0.5 | 2500 | E24 |

Packed in bandoliers of 1000 pieces with dividing marks at intervals of 100.

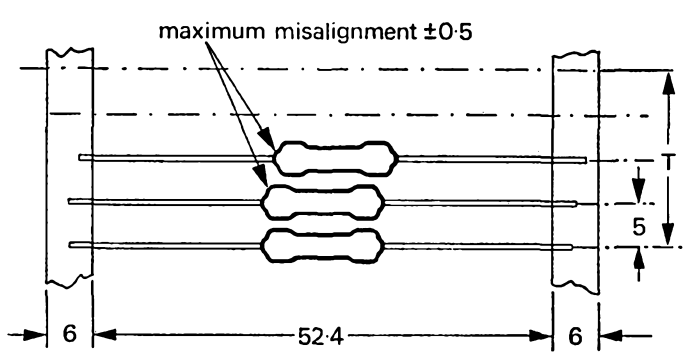

$$T = [5(n-1)] \pm 4$$

This formula is applicable when the number of resistors (n) is between 50 and 100 pieces.

| Dimensions mm | | | |
|---------------|--------|--------|-----|
| Style | D max. | L max. | d |
| VR37 | 3.7 | 10 | 0.7 |

VR37

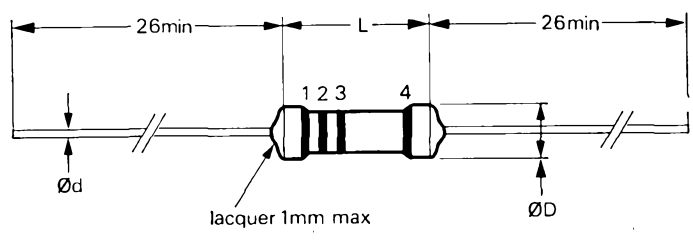
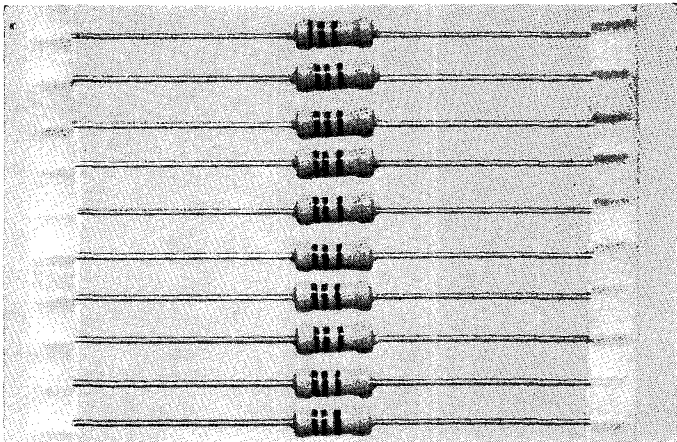

These resistors are coated with a blue coloured lacquer and colour coded in accordance with BS1852.

The four colour bands indicate:— (1) first significant figure (2) second significant figure (3) multiplier (4) tolerance. In this series the ±5% tolerance is indicated by a yellow band.

E24 series: 10 11 12 13 15 16 18 20 22 24 27 30 33 36 39 43 47 51 56 62 68 75 82 91

VR37 resistors are available in the above values and decimal multiples and submultiples thereof.



Non-linear resistors negative temperature coefficient book 3 part 1 rod types

| Type No. | Code No. 2322 ... | Resistance at 25°C (R ₂₅) Ω | B value K | Maximum dissipation W | Approx. resistance at maximum dissipation Ω | Approx. operating current at maximum dissipation mA | Approx. dissipation factor mW per deg C | Dimensions | |
|----------------|----------------------|---|-----------------|-----------------------------|---|--|--|----------------|------------------------------|
| | | | | | | | | Diameter mm | Thickness or length mm |
| VA1066S | 635 01472 | 4.7k | 3250 | 0.6 | 200 | 55 | 5.5 | 3.7 | 12 |
| VA1055S | 635 01153 | 15k | 3550 | 0.6 | 540 | 33 | 5.5 | 3.7 | 12 |
| VA1056S | 635 01473 | 47k | 3925 | 0.6 | 1k | 23 | 5.5 | 3.7 | 12 |
| VA1067S | 635 01154 | 150k | 4075 | 0.6 | 3k | 15 | 5.5 | 3.7 | 12 |

disc and plate types

| | | | | | | | | | |
|---------------|-----------|------|------|-----------------------|------|------|-----|------------------|-----|
| VA1037 | 619 90002 | 1.1 | 2650 | 1 | 0.2 | 2200 | 14 | 21 × 9 rectangle | 5.2 |
| VA1086 | 610 11228 | 2.2 | 2650 | 1 | 0.29 | 1850 | 10 | 9.4 | 5 |
| VA1033 | 610 11408 | 4 | 2800 | 1 | 0.25 | 2000 | 10 | 9.4 | 5 |
| VA1074 | 610 11608 | 6 | 2800 | 1 | 0.45 | 1500 | 10 | 9.4 | 5 |
| VA1053 | 610 11803 | 8 | 2900 | 1 | 0.8 | 1100 | 10 | 9.4 | 5 |
| VA1110 | 610 90043 | 10 | 2950 | 1 | 1 | 1000 | 10 | 9.4 | 5 |
| VA1100 | 610 11159 | 15 | 3000 | 1 | 0.7 | 1200 | 10 | 9.4 | 5 |
| VA1104 | 644 90005 | 15 | 3350 | max. rms current 2.2A | | | 17 | 16 | 5 |
| VA1077 | 619 90003 | 32 | 4200 | 1 | 0.8 | 1200 | 14 | 21 × 9 rectangle | 5.2 |
| VA1034 | 610 11509 | 50 | 3300 | 1 | 2.6 | 600 | 10 | 9.4 | 5 |
| VA1040 | 610 11131 | 130 | 4600 | 1 | 2.6 | 600 | 10 | 9.4 | 5 |
| VA1096 | 642 11151 | 150 | 3275 | 0.6 | 19 | 180 | 8 | 5.5 | 5.5 |
| VA1097 | 642 11471 | 470 | 3425 | 0.6 | 52 | 105 | 8 | 5.5 | 5.5 |
| VA1039 | 610 11501 | 500 | 5200 | 1 | 6.8 | 380 | 10 | 9.4 | 5 |
| VA1038 | 610 11132 | 1.3k | 5450 | 1 | 10.3 | 300 | 10 | 9.4 | 5 |
| VA1098 | 642 11152 | 1.5k | 3700 | 0.6 | 130 | 70 | 8 | 5.5 | 5.5 |
| VA1106 | 642 11222 | 2.2k | 3750 | 0.6 | 280 | 46 | 8 | 5.5 | 5.5 |
| VA1109 | 642 12472 | 4.7k | 4225 | 0.6 | 370 | 40 | 8 | 5.5 | 5.5 |
| VA1108 | 642 11153 | 15k | 4250 | 0.6 | 920 | 25 | 8.5 | 5.5 | 5.5 |
| VA1112 | 642 12223 | 22k | 4300 | 0.6 | 1.2k | 22 | 8.5 | 5.5 | 5.5 |
| VA1111 | 642 12333 | 33k | 4325 | 0.6 | 1.8k | 18 | 8.5 | 5.5 | 5.5 |

Rod, disc and plate n.t.c. thermistors

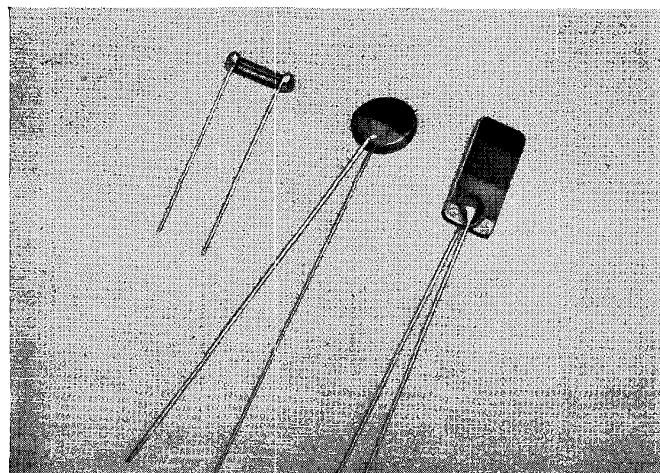

Packing quantity : Multiples of 250 pieces except as follows :
VA1037 and VA1077 – 200 pieces
VA1104 – 100 pieces



Non-linear resistors negative temperature coefficient (cont.) book 3 part 1

miniature bead types

| Plain beads | | Gas filled glass tube | | Glass dipped bead | | Thermometer type | | Resistance at 25°C (R ₂₅) Ω | B value K |
|-------------|-------------------------|-----------------------|-------------------------|-------------------|-------------------------|------------------|-------------------------|---|-----------------|
| Type No. | Code No. 2322 634 .. | Type No. | Code No. 2322 634 .. | Type No. | Code No. 2322 627 .. | Type No. | Code No. 2322 627 .. | | |
| VA3100 | 11102 | VA3200 | 21102 | VA3400 | 21102 | VA3700 | 11102 | 1000 | 2375 |
| VA3102 | 11222 | VA3202 | 21222 | VA3402 | 21222 | VA3702 | 11222 | 2200 | 2600 |
| VA3104 | 11472 | VA3204 | 21472 | VA3404 | 21472 | VA3704 | 11472 | 4700 | 3725 |
| VA3106 | 11103 | VA3206 | 21103 | VA3406 | 21103 | VA3706 | 11103 | 10 000 | 3800 |
| VA3108 | 11223 | VA3208 | 21223 | — | — | VA3708 | 11223 | 22 000 | 3875 |
| VA3110 | 11473 | VA3210 | 21473 | VA3410 | 21473 | VA3710 | 11473 | 47 000 | 3850 |
| VA3112 | 11104 | VA3212 | 21104 | VA3412 | 21104 | VA3712 | 11104 | 100 000 | 3975 |
| VA3114 | 11224 | VA3214 | 21224 | VA3414 | 21224 | VA3714 | 11224 | 220 000 | 4200 |
| VA3116 | 11474 | VA3216 | 21474 | — | — | VA3716 | 11474 | 470 000 | 4350 |

Dimensions (millimetres)

| Type No. Series | Body | | Leads | | Type No. Series | Body | | Leads | |
|--------------------|-----------|-------------|-------|--------|--------------------|-----------|-------------|-------|--------|
| | Dia. max. | Length max. | Dia. | Length | | Dia. max. | Length max. | Dia. | Length |
| VA3100 | 1 | 1 | 0.06 | 4.5 | VA3400 | 1.5 | 5 | 0.2 | 21 |
| VA3200 | 2.5 | 12 | 0.24 | 22 | VA3700 | 2.5 | 33 | 0.3 | 32 |

Packing quantity : Multiples of 100 pieces.

Maximum dissipation

Maximum temperature (T_{max})

Stability ΔR₂₅ after 1000 hours at T max.

60mW

200°C

<1%

Dissipation constant approx :

VA3100 Series 0.1 mW/deg C

VA3200 Series 0.4 mW/deg C

VA3400 Series 0.75 mW/deg C

VA3700 Series 0.7 mW/deg C

plastic encapsulated 'two point' types

| Type No. 2322 ... | Colour code | Temperature range °C | Resistance at | | | | | | |
|----------------------|----------------|----------------------------|-----------------|---------------|---------------|--------|-----------------|----------------|----------------|
| | | | -30°C | -20°C | -10°C | 0°C | +25°C | +100°C | +200°C |
| 640 90002 | blue | -20 to +25 | | 8.6k Ω ±8% | | 3.5k Ω | 1.215k Ω ±7% | | |
| 640 90003 | white | -30 to -10 | 13.35k Ω ±5% | 8k Ω ±4% | 5k Ω ±4.5% | | | | |
| 640 90004 | grey | +25 to +100 | | | | | 12k Ω ±7% | 0.95k Ω ±5% | |
| 640 90005 | black | +100 to +200 | | | | | | 16.7k Ω ±7% | 1.12k Ω ±7% |

Packing quantity : Multiples of 250 pieces.

Maximum dissipation 0.25W

Voltage proof (terminals to heatsink) 350 Vrms

These plastic encapsulated thermistors are specially designed for temperature measurement and control. The body is 4.2 mm max. square, by 2.7 mm max. thick.

Miniature bead n.t.c. thermistors

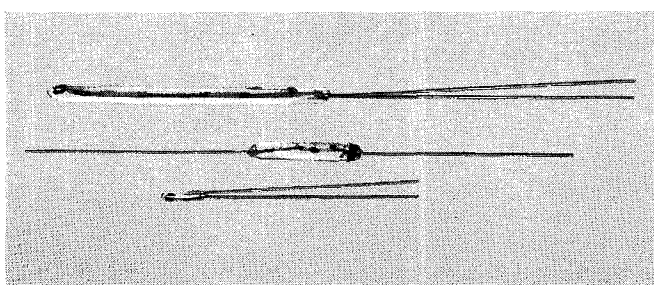

Plastic encapsulated n.t.c. thermistors

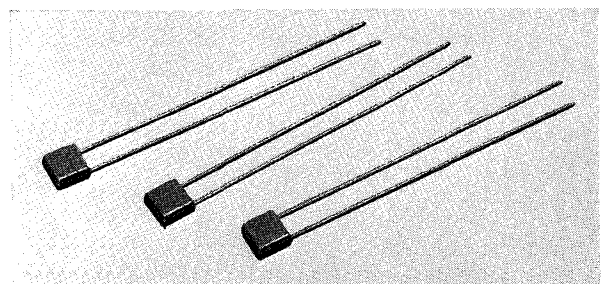



Non-linear resistors positive temperature coefficient book 3 part 1

| Type No. | Code No. 2322 . . . | Resistance at 25°C (R ₂₅) Ω | Switch temp. °C | App. res. at switch temp. Ω | Temp. coef. at switch temp. % per deg C | Dissipation factor mW per deg C | Max. voltage V | Dimensions mm | |
|------------------|------------------------|---|-----------------------|--------------------------------------|--|--|----------------------|---------------|-----------------|
| | | | | | | | | Body | Leads |
| E220ZZ/01 | 661 91005 | 50 | 25 | 50 | + 9 | 6 | 40 | Ø8.5 | Ø0.5 39 long |
| E220ZZ/02 | 661 91004 | 30 | 45 | 60 | +16 | 8.5 | 50 | | |
| E220ZZ/03 | 661 91002 | 50 | 80 | 150 | +18 | 8.5 | 50 | | |
| E220ZZ/04 | 661 91003 | 40 | 110 | 80 | +25 | 8.5 | 50 | | |
| VA8650 | 662 93037 | 80 | 75 | 220 | +23 | 21 | 265 | Ø12.6 | Ø0.8, 30 long |

Packing quantity : Multiples of 250 pieces except VA8650 which is packed in multiples of 100 pieces.
Note : Type VA8650 with VDR type E299DH/P230 is specially designed for degaussing colour tv picture tubes.

P.T.C. thermistors

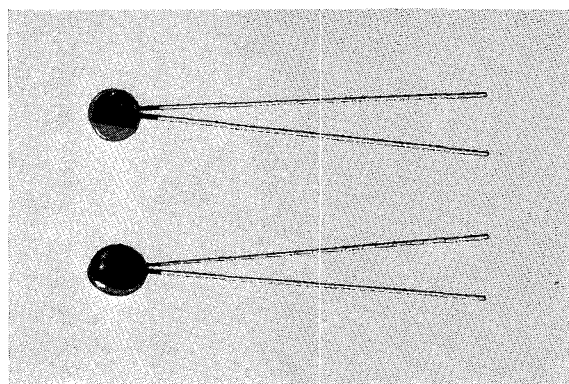

Asymmetric VDRs

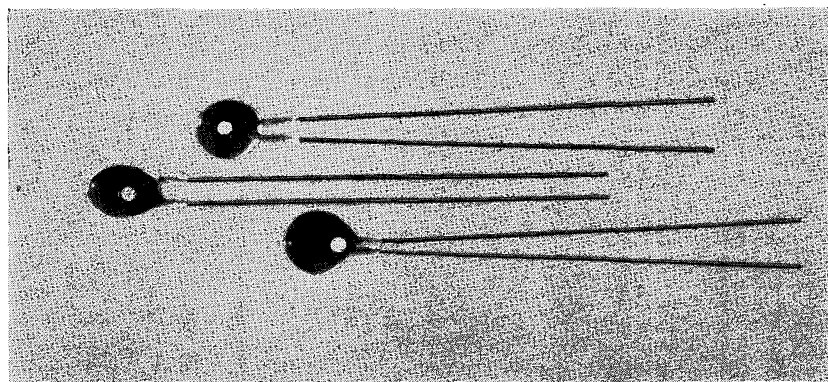

Rod type VDRs

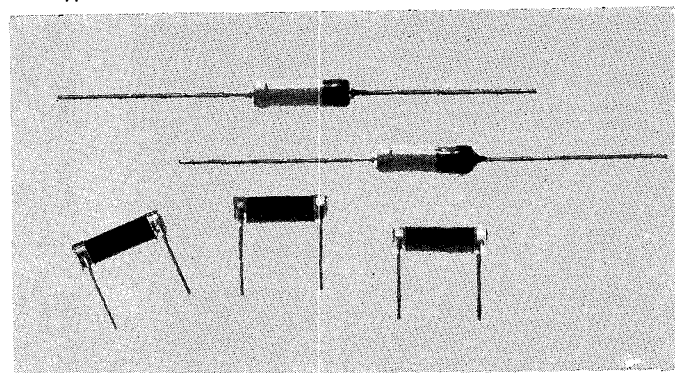

Disc type VDRs

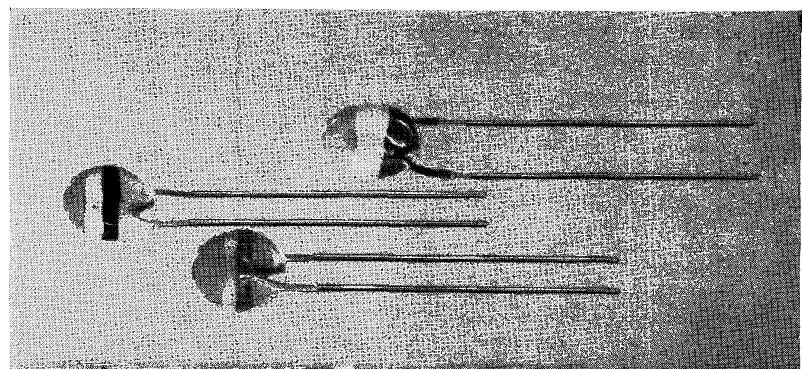

voltage dependent book 3 part 1

Notes

- The reverse characteristics of the asymmetric types are similar to a diode (forward characteristics only shown in the table). In view of the knee voltages, of these two devices (1 and 1.35 volts), they can be used as voltage reference devices to fill the gap left by conventional silicon diodes (0.5 volts) and the lower end of the voltage regulator (zener) diodes (3.3 volts).
- The relationship between applied voltage and current flowing is given by: $E = CI^\beta$, where
E is in volts
I is in amperes
C is the applied voltage for a current of 1 ampere
 β is the slope of the characteristic.
- These devices are not designed to pass 1 ampere. Therefore C and β are derived from measurements made at lower levels.
- Maximum dissipation at 40°C ambient :
E298 Series : 700 mW
E299DD Series : 800 mW
E299DH/P230 : 3 W
2322 554 02221 : 2W
- Maximum temperature at zero power
E295 Series : 70°C
E298 Series : 150°C
E299DD Series : 125°C
E299DH/P230 : 125°C
2322 554 02221 : 125°C



Non-linear resistors voltage dependent (cont.) book 3 part 1

| Type No. | Code No. 2322... | C (approx.) V | β value | Reference current mA | Reference voltage V | Diameter mm V | Thickness or length mm |
|----------|---------------------|---------------------|------------------|----------------------------|---------------------------|---------------------|------------------------------|
|----------|---------------------|---------------------|------------------|----------------------------|---------------------------|---------------------|------------------------------|

asymmetric types

| | | | | | | | |
|------------------|-----------|-----|--------------|---|------|---|-----|
| E295ZZ/01 | 574 90001 | 1.6 | 0.05 to 0.08 | 1 | 1 | 9 | 4.6 |
| E295ZZ/02 | 574 90002 | 2.4 | 0.06 to 0.09 | 1 | 1.35 | 9 | 4.6 |

Packing quantity : Multiples of 250 pieces.

rod types

| | | | | | | | |
|---------------------|-----------|------|--------------|----|------|-----|------|
| E298ED/A258 | 564 02582 | 1550 | 0.20 to 0.25 | 10 | 470 | 5.2 | 28 |
| *E298CD/A258 | 564 22582 | 1550 | 0.20 to 0.25 | 10 | 470 | 7.2 | 16.5 |
| E298ED/A260 | 564 02602 | 1800 | 0.18 to 0.23 | 10 | 560 | 5.2 | 28 |
| E298ED/A262 | 564 02622 | 2200 | 0.18 to 0.23 | 10 | 680 | 5.2 | 28 |
| E298ED/A265 | 564 90014 | 2400 | 0.18 to 0.23 | 10 | 910 | 5.2 | 28 |
| E298ED/P268 | 564 02681 | 3000 | 0.17 to 0.22 | 10 | 1200 | 5.2 | 28 |
| *E298ZZ/05 | 564 90004 | 3020 | 0.16 to 0.21 | 2 | 950 | 7.2 | 16.5 |
| E298ZZ/06 | 564 90005 | 3020 | 0.16 to 0.21 | 2 | 950 | 5.2 | 28 |

Packing quantity : Multiples of 100 pieces.

*Tag ended ; the remainder have axial leads

disc types

| | | | | | | | |
|-----------------------|-----------|------|--------------|-----|-----|------|-----|
| E299DD/P116 | 552 01161 | 14 | 0.25 to 0.4 | 100 | 8 | 15 | 5 |
| E299DD/P118 | 552 01181 | 18 | 0.25 to 0.4 | 100 | 10 | 15 | 5 |
| E299DD/P120 | 552 01201 | 21 | 0.25 to 0.4 | 100 | 12 | 15 | 5 |
| E299DD/P216 | 552 02161 | 25 | 0.25 to 0.4 | 10 | 8 | 15 | 5 |
| E299DD/P218 | 552 02181 | 32 | 0.25 to 0.4 | 10 | 10 | 15 | 5 |
| E299DD/P220 | 552 02201 | 40 | 0.25 to 0.4 | 10 | 12 | 15 | 5 |
| E299DD/P222 | 552 02221 | 48 | 0.25 to 0.4 | 10 | 15 | 15 | 5 |
| E299DD/P224 | 552 02241 | 57 | 0.21 to 0.35 | 10 | 18 | 15 | 5 |
| E299DD/P226 | 552 02261 | 60 | 0.21 to 0.35 | 10 | 22 | 15 | 5 |
| E299DD/P228 | 552 02281 | 70 | 0.21 to 0.35 | 10 | 27 | 15 | 5 |
| E299DD/P230 | 552 02301 | 85 | 0.18 to 0.25 | 10 | 33 | 15 | 5 |
| E299DD/P232 | 552 02321 | 100 | 0.18 to 0.25 | 10 | 39 | 15 | 5 |
| E299DD/P234 | 552 02341 | 130 | 0.18 to 0.25 | 10 | 47 | 15 | 5 |
| E299DD/P236 | 552 02361 | 150 | 0.18 to 0.25 | 10 | 56 | 15 | 5 |
| E299DD/P238 | 552 02381 | 180 | 0.18 to 0.25 | 10 | 68 | 15 | 5 |
| E299DD/P336 | 552 03361 | 190 | 0.14 to 0.23 | 1 | 56 | 15 | 5 |
| E299DD/P338 | 552 03381 | 230 | 0.14 to 0.23 | 1 | 68 | 15 | 5 |
| E299DD/P340 | 552 03401 | 300 | 0.14 to 0.21 | 1 | 82 | 15 | 5 |
| E299DD/P342 | 552 03421 | 350 | 0.14 to 0.21 | 1 | 100 | 15 | 5.5 |
| E299DD/P344 | 552 03441 | 400 | 0.14 to 0.21 | 1 | 120 | 15 | 6 |
| E299DD/P346 | 552 03461 | 500 | 0.14 to 0.21 | 1 | 150 | 15 | 6.5 |
| E299DD/P348 | 552 03481 | 600 | 0.14 to 0.21 | 1 | 180 | 15 | 7 |
| E299DD/P350 | 552 03501 | 750 | 0.14 to 0.21 | 1 | 220 | 15 | 7.5 |
| E299DD/P352 | 552 03521 | 900 | 0.14 to 0.21 | 1 | 270 | 15 | 8 |
| E299DD/P354 | 552 03541 | 1100 | 0.14 to 0.21 | 1 | 330 | 15 | 9 |
| 2322 554 02221 | — | 47 | 0.25 to 0.4 | 10 | 15 | 27.5 | 5 |
| E299DH/P230 | 555 02301 | 84 | 0.18 to 0.25 | 10 | 33 | 42.5 | 5 |

Packing quantity : Multiples of 100 pieces, except as follows :

2322 554 02221 – 50 pieces

E299DH/P230 – 25 pieces

Radio and audio modules

f.m. tuner modules book 3 part 5

| Type No. | Description | Supply voltage V | Frequency tuning range MHz | Power gain (100MHz) dB | Dimensions mm |
|----------------------|---|------------------|----------------------------|------------------------|---------------|
| LP1179 Series | f.m. tuner, mechanically tuned, with a.m. facility | +6.8 | 87.4 to 104.5 | 28 | 85 × 38 × 36 |
| LP1186 | f.m. tuner with diode tuning | +8 | 87.4 to 104.5 | 30 | 62 × 31 × 17 |
| LP1402 | f.m. tuner, mechanically tuned, with a.m. facility, double tuned i.f. | +6.8 | 87.4 to 104.5 | 28 | 85 × 38 × 36 |

i.f. modules book 3 part 5

| Type No. | Description | Supply voltage V | Supply current mA | Dimensions mm |
|-----------------|--|------------------|-------------------|---------------|
| LP1159 | a.m. i.f. ; for medium, long and short wave receivers | -7.6 | 3.3 | 62 × 30 × 16 |
| LP1164/1 | a.m./f.m. i.f. ; a.m. section suitable for medium, long and short wave operation with external oscillator coil | +9.4 | 7 | 83 × 42 × 20 |
| LP1170 | a.m./f.m. i.f. ; a.m. section with oscillator coil, suitable for medium and long wave operation | +9.4 | 7 | 75 × 41 × 20 |
| LP1181 | a.m. i.f. ; for medium, long and short wave operation ; suitable for capacitive or permeability tuning | +7.6 | 5 | 62 × 30 × 16 |
| LP1185 | f.m. i.f. ; for mains or battery operation | +9 | 6.5 | 62 × 30 × 16 |

stereo decoder module book 3 part 5

| Type No. | Description | Supply voltage V | Channel separation dB | Dimensions mm |
|---------------|--|------------------|-----------------------|---------------|
| LP1400 | High performance stereo decoder using frequency multiplex system | 8 to 18 | 40 | 61 × 43 × 31 |

LP1179

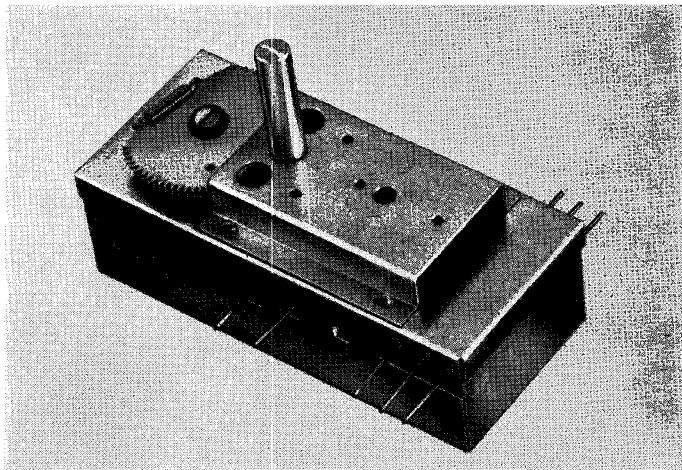

LP1400

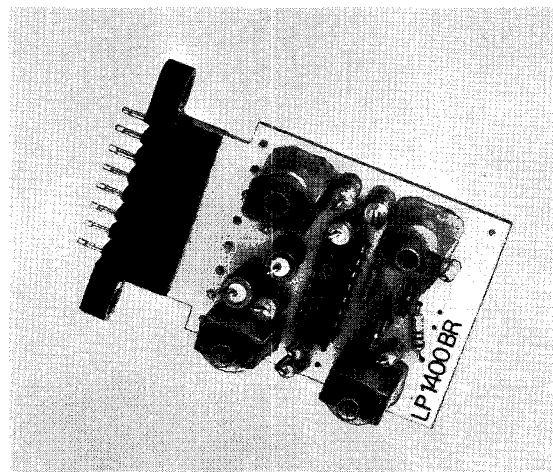

LP1181

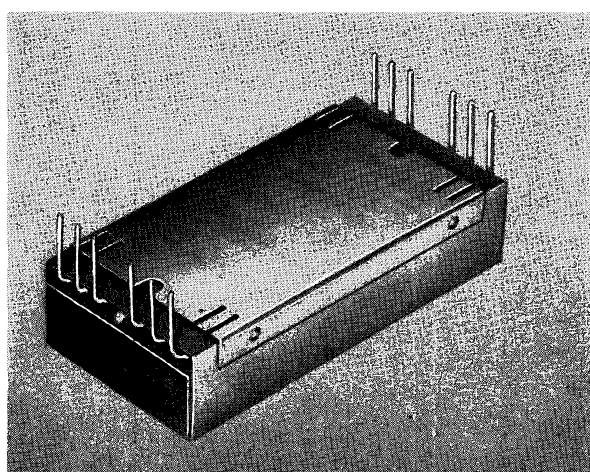



Radio and audio modules

stereo pre-amplifier modules book 3 part 5

| Type No. | Description | Supply voltage V | Supply current mA | Dimensions mm |
|-----------------|---|------------------|-------------------|---------------|
| LP1183/2 | dual input ; for 10W systems, using ceramic or low output crystal pick-up heads | +24 | 0.6 | 84 × 82 |
| LP1184/2 | multi-input ; for 10W systems, incorporating a magnetic pick-up input and featuring very low distortion | +24 | 2.2 | 123 × 100 |

audio amplifier modules book 3 part 5

| Type No. | Description | Supply voltage V | Supply current mA | Dimensions mm |
|----------------|--|------------------|---|---------------|
| *LP1162 | 4/5W capability into 12 or 8 Ω ; for mains radio and record player applications | -24 | 280 (12 Ω load) 340 (8 Ω load) | 111 × 71 × 22 |
| LP1173 | 10W capability into 4 Ω ; for radiogram and unit audio applications | +24 | 770 | 112 × 70 × 29 |

*Available for current production ; not intended for new designs.

LP1183/2

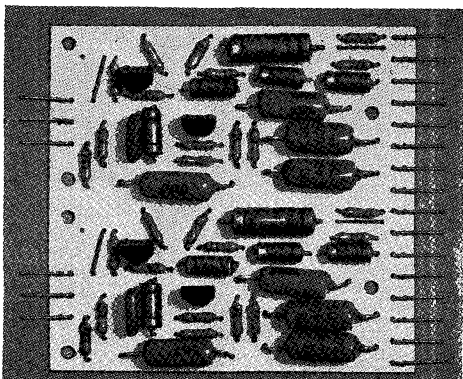

LP1162

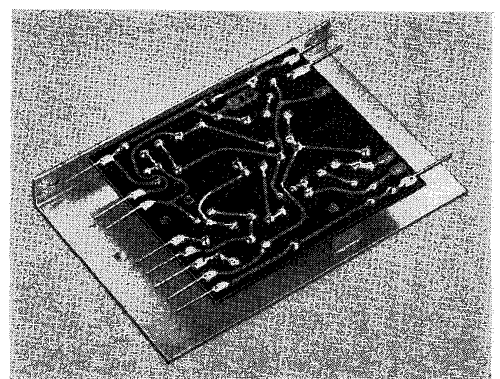

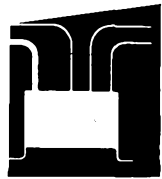

Television modules voltage multiplying modules book 3 part 5

voltage doubler LP1193

Intended for use in transistor line output stages

| | |
|-------------------------|-------------|
| $V_{in(pk)}$ nom. | 10·6kV |
| V_{out} (e.h.t.) nom. | 20kV |
| V_{out} (focus) nom. | 10·6kV |
| I_{out} (e.h.t.) max. | 750 μ A |

voltage triplers LP1194 Series

This series is intended for use in transistor line output stages.

| | |
|------------------|--|
| LP1194/30 | A five capacitor, five diode module with surge limiting resistor |
| LP1194/40 | As LP1194/30, with a clipping diode across the input |
| LP1194/60 | As LP1194/40, with a separate earth return lead for the clipping diode |

| | LP1194/30 | LP1194/40 | LP1194/60 |
|-------------------------|-----------|-----------|-----------|
| $V_{in(pk)}$ nom. | 8·9 kV | 8·3 kV | 8·6 kV |
| V_{out} (e.h.t.) nom. | 25 kV | 25 kV | 25 kV |
| V_{out} (focus) nom. | 7·2 kV | 8·3 kV | 7·7 kV |
| I_{out} (e.h.t.) max. | 1·5 mA | 1·5 mA | 1·5 mA |

LP1194

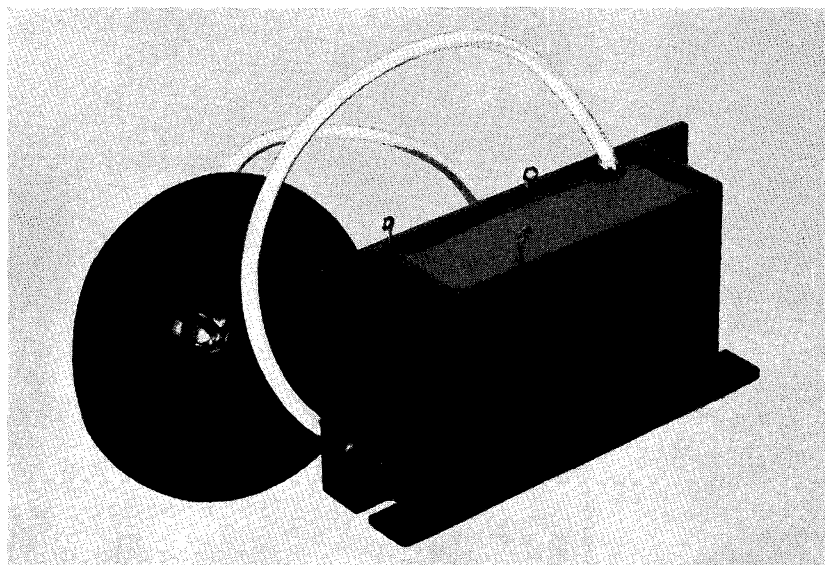



Television assemblies tuners (with diode tuning) book 3 part 5

| Type No. | Channel coverage | | Supply voltage V | | Noise factor dB | Power gain dB |
|-------------------|------------------|--|------------------|---------------|---------------------------------|----------------------------------|
| | | | transistors | tuning diodes | | |
| ELC1042 | v.h.f. | UK: 405, 625 CCIR | +12 | +0.3 to +28 | 7 | 20 |
| ELC1043/05 | u.h.f. | 21 to 69 | +12 | +0.3 to +25 | 7 | 22 |
| ELC2000S | v.h.f./u.h.f. | C.C.I.R. E5 to E12 E2 to C E21 to E69 | +12 | +0.3 to +28 | 6 to 13 depending on channel | 28 to 32 depending on channel |

line linearity control units book 3 part 5

| Type No. | Adjustment range V | Used with deflection coil | Application |
|------------------|--------------------|------------------------------------|---------------------------|
| AT4042/02 | 15 to 26 | AT1040/00 and AT1027/AT1029 Series | Monochrome and 90° colour |
| AT4042/08 | 15 to 25 | AT1062/01, AT1063/01 | 110° colour |
| AT4042/14 | Fixed at 17 | AT1040/15 | Monochrome |

deflection coils (monochrome) book 3 part 5

| Type No. | Line coil inductance mH | Field coil resistance (at 25°C) Ω | Deflection current (Ap-p) at 18kV, 61 cm (24 in.) reference tube | | Used with linearity control | Thermistor (at 25°C) Ω |
|------------------|-------------------------------|--|---|---------------------------------|-----------------------------------|------------------------------|
| | | | line (for 495 mm deviation) | field (for 390 mm deviation) | | |
| AT1040/00 | 2.1 parallel | 30 series | 2.82 | 0.545 | AT4042/02 | 10 |
| AT1040/15 | 3.3 parallel | 7.5 parallel | 2.3 | 1.09 | AT4042/02 or/14 | — |

line output transformers (monochrome) book 3 part 5

| Type No. | Drive | Used with deflection coil | E.H.T. kV | H.T. line V | Mounting |
|------------------|-------|------------------------------|--------------|----------------|---------------|
| AT2036/80 | PL504 | AT1040/00 | 18 | 240 | Printed board |
| AT2048/11 | BU205 | AT1040/15 | 18 | 150 | Printed board |

ELC1043/05

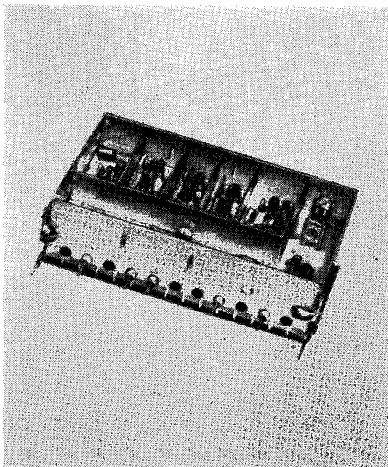

AT1040/15

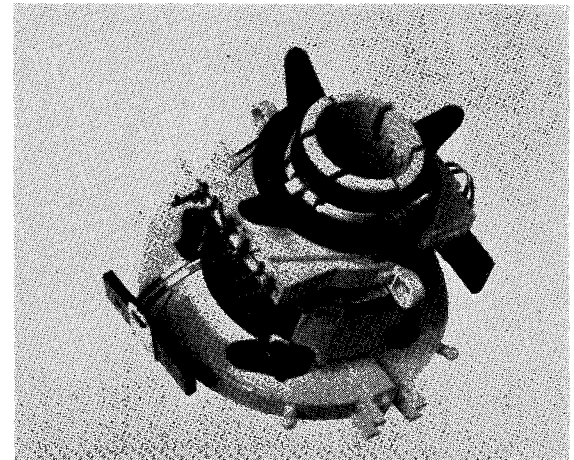

Television assemblies deflection coils (90° colour) book 3 part 5

| Type No. | Picture tube cm | Used with | |
|------------------|--------------------|------------------|-------------------|
| | | convergence unit | linearity control |
| AT1027/19 | 66 (26 in.) | AT4046 Series | AT4042/02 |
| AT1029/19 | 56 (22 in.) | AT4046 Series | AT4042/02 |

Line coil inductance – parallel connected 2.95mH
 Field coil resistance – series connected 56 Ω
 – parallel connected 14 Ω + 6 Ω thermistor in parallel with 12 Ω resistor
 Deflection current with edge to edge scan (at 25 kV)
 – line (parallel) 2.6 A_{p-p}
 – field (parallel) 0.415 A_{p-p}

Note: These deflection coils are normally supplied with integral convergence units (see below).

deflection coils (110° colour) book 3 part 5

| Type No. | Picture tube cm | Used with | |
|------------------|--------------------|------------------|-------------------|
| | | convergence unit | linearity control |
| AT1062/01 | 66 (26 in.) | AT4046 Series | AT4042/08 |
| AT1063/01 | 56 (22 in.) | AT4046 Series | AT4042/08 |

Line coil inductance – parallel connected 1.2mH
 – series connected 4.7mH
 Field coil resistance – series connected 3.6Ω
 – parallel connected 14.2Ω + 2 × 4Ω thermistor
 Deflection current with edge to edge scan (at 25kV)
 – line (parallel) 6 A_{p-p}
 – field (parallel) 2.4 A_{p-p}

combined deflection coils and convergence units (90° colour) book 3 part 5

| Type No. (combination) | Deflection coil | Convergence unit |
|---------------------------|------------------|------------------|
| AT1027/15 | AT1027/19 | AT4046/15 |
| AT1029/15 | AT1029/19 | AT4046/15 |

Details of other deflection coil and convergence unit combinations are available upon request.

blue lateral units (colour) book 3 part 5

| Type No. | Inductance mH | | Resistance Ω | |
|------------------|---------------|--------|--------------|--------|
| | parallel | series | parallel | series |
| AT1025/05 | 0.63 | 3.2 | 9 | 36 |
| AT1025/06 | — | 0.062 | — | 0.5 |
| AT1025/08 | 0.3 | — | 3.2 | — |

AT2048/11

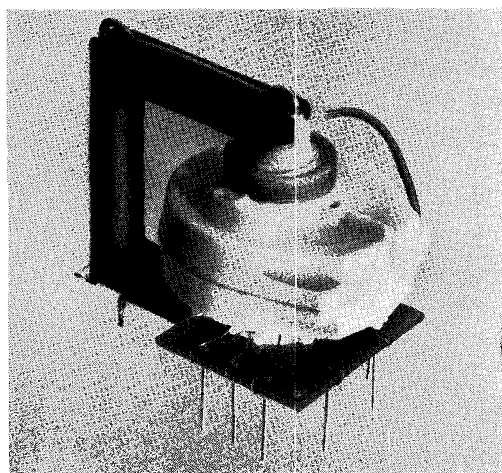

AT1062/01

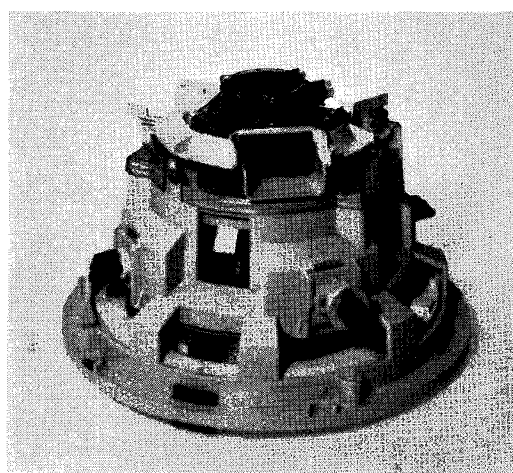

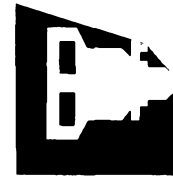

Television assemblies line output transformers (90° colour) book 3 part 5

| Type No. | Drive | E.H.T. kV | E.H.T. generation | H.T. line V | Mounting |
|------------------|-------|--------------|-------------------|----------------|---------------|
| AT2055 | PL509 | 25 | Tripler | 205 | Chassis |
| AT2055/02 | PL509 | 25 | Tripler | 295 | Printed board |

line output transformer (110° colour) book 3 part 5

| Type No. | Drive | E.H.T. kV | E.H.T. generation | H.T. line V | Mounting |
|------------------|-------|--------------|-------------------|----------------|---------------|
| AT2063/00 | BU208 | 25 | Tripler | 185 | Printed board |

raster correction transductors (colour) book 3 part 5

| Type No. | V _{p-p} | | Deflection coil connection | | Used with North-South phase coil | Application |
|------------------|------------------|-------|----------------------------|----------|----------------------------------|-------------|
| | line | field | line | field | | |
| AT4041/37 | 1400 | 55 | parallel | parallel | AT4040/50 | 90° |
| | 1400 | 110 | parallel | series | | |
| AT4041/40 | 400 | 210 | parallel | series | AT4040/87 | 110° |

bridge coil (110° colour) book 3 part 5

| Type No. | Primary inductance μH | Maximum current A _{p-p} |
|------------------|--------------------------|-------------------------------------|
| AT4043/86 | 285 | 6 |

correction adjustment coils (colour) book 3 part 5

AT4040 Series

This range has been designed for use with other Mullard television components and assemblies as correction (waveform realignment) and adjustment (waveform balancing) coils in colour television circuits. Full details may be obtained from the appropriate data sheet in Mullard Technical Handbook. Book 3, Part 5.

delay line (colour) book 3 part 5

| Type No. | Phase delay time μs | Insertion loss dB | Unwanted reflections relative to 1 τ signal (dB) | | Temperature range |
|-------------|------------------------|----------------------|---|---------|-------------------|
| | | | 3τ | others | |
| DL50 | 63.943 | 8 | -22 max | -30 max | -20 to +70°C |

DL50 uses separate coils AT4044/00 (input) and AT4044/01 (output)

AT2055

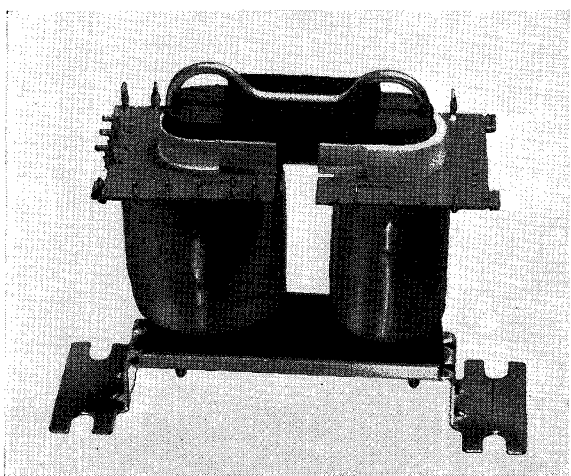

DL50

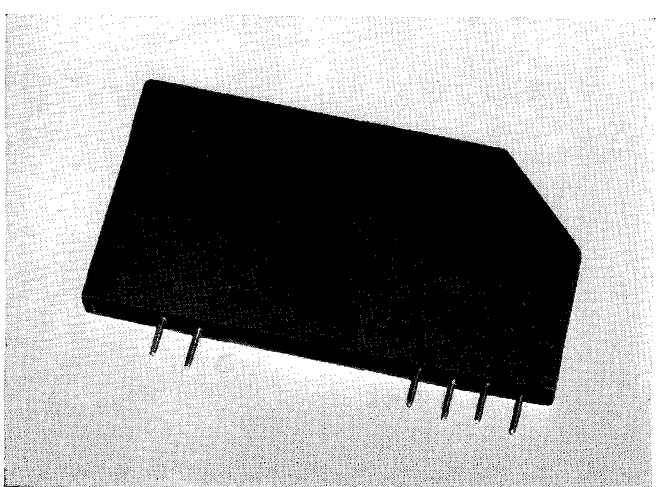

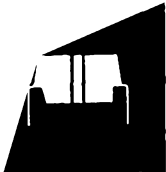

Solid state control elements

Norbit 2 series book 3 part 6

| Type No. | Description | Function | Colour |
|---------------|--|--|--------|
| 2NOR60 | Twin NOR | Basic logic elements | Black |
| 4NOR60 | Quadruple NOR | Basic logic elements | Black |
| 2IA60 | Twin inverter amplifier (or low power output) | High fan-out amplifier (100mA output unit) | Blue |
| 2LPA60 | Twin low power output | 100mA each output | Blue |
| PA60 | Available for current production ; for new designs see HPA60 and UPA61 | | |
| HPA60 | High power output | 2.5A output unit | Black |
| GLD60 | Grounded load driver | Output unit | Black |
| 2SF60 | Twin input switch filter | Interference suppression | Green |
| TU60 | Timer | Time delay | Red |
| PS90 | Pulse shaper | Input unit | Green |
| FF90 | Flip-flop | Counter/shift register | Red |
| 2TG90 | Twin trigger gate | Extends facilities for FF90 | Red |
| PSU61 | Power supply | 500mA at 24V d.c.; 25mA at 100V d.c. 146 × 80 × 76 | |

Dimensions (mm): 50.8 × 25.4 × 14 except PA60 and HPA60 which are 50.8 × 63.5 × 16.5
 Power supply: Single rail un stabilised +24V d.c. ±25% Temperature range: -10 to +85°C Operating speed: 10kHz

All modules except HPA60

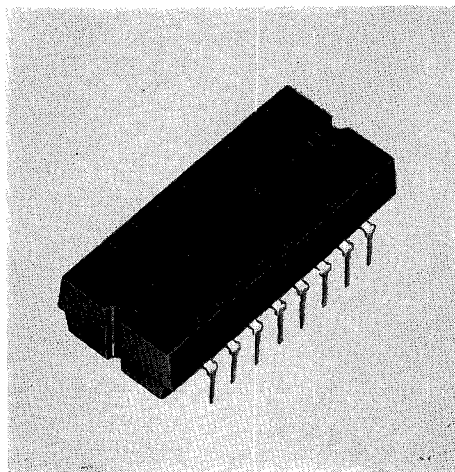

HPA60

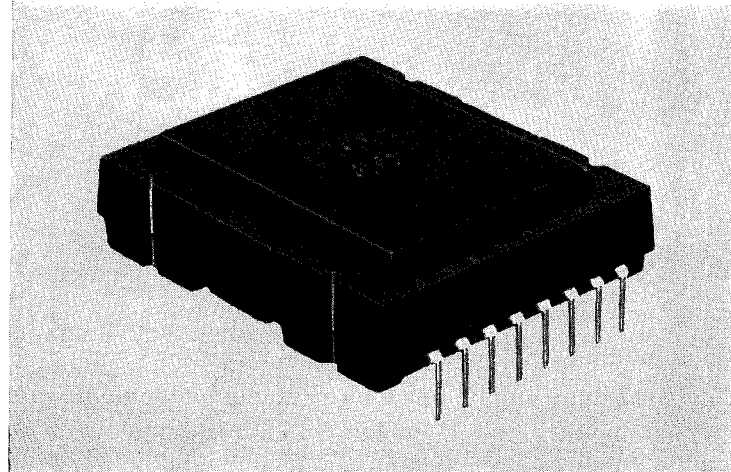

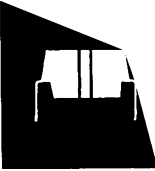

Solid state control elements

thyristor trigger and control modules, 61 series

book 3 part 6

| Type No. | Description | Function |
|---------------|------------------------------------|---|
| TT61 | Trigger transformer | Interface, giving two isolated outputs for use between thyristor or triac gates and control sections. |
| UPA61 | Universal power amplifier | (a) Pulse generator for driving TT61 (b) D.C. driver (c) Other circuit functions. |
| RSA61 | Rectifier and synchroniser | Provides power supplies and synchronising signals. |
| DOA61 | Differential operational amplifier | For use in closed loop control systems. |
| 2NOR61 | Twin NOR | For logic functions. |

Dimensions (mm): 50.8 × 25.4 × 14

Colour: Black

Maximum working temperature: +70°C

For mounting accessories of Norbit 2 and 61 Series, please contact Mullard Ltd.

61 Series

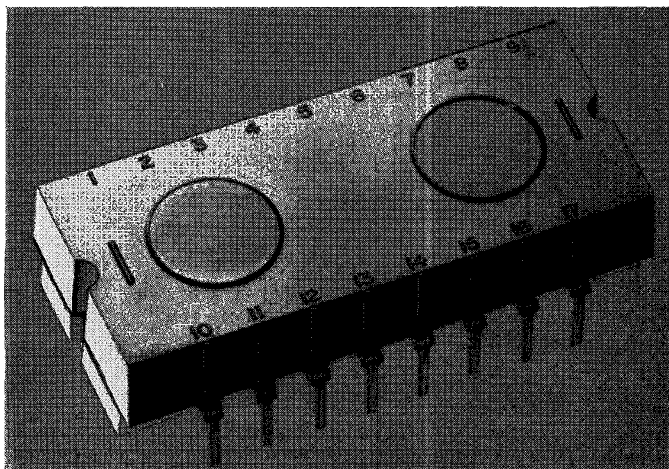

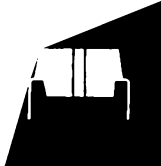

Solid state control elements

display counters, 50 series book 3 part 6

| Type No. | Description | Dimensions mm |
|---------------|-----------------------------------|----------------|
| NIC50 | Decade counter | 89 × 63 × 25.2 |
| RIC50 | Bi-directional counter | 89 × 63 × 25.2 |
| MID50 | Memory indicator | 89 × 63 × 25.2 |
| SID50 | Sign indicator +, -, ~, x, y or z | 89 × 63 × 25.2 |
| PSR50 | Pulse shaper | 52 × 48 × 12.6 |
| 3NOR50 | 3 × NOR gate | 52 × 48 × 12.6 |
| 4NOR51 | 4 × NOR gate | 52 × 48 × 12.6 |
| LRD50 | Lamp/relay driver | 52 × 48 × 12.6 |
| PDU50A | Printer drive unit | 52 × 48 × 12.6 |
| PDU50B | Scan circuit unit | 52 × 48 × 12.6 |

Power supply: +24V d.c. ±10%; 250mA
 Temperature range: -25 to +70°C
 Operating speed: 50kHz max.

Accessories for 50 series

| Type No. | Description | Dimensions mm |
|--------------|--------------------------------|----------------|
| PSU50 | Power supply unit | 170 × 140 × 87 |
| ECA50 | Empty case assembly | 52 × 48 × 12.6 |
| MB50 | Mounting bar | 265 long |
| FIC1 | Facade for one display unit | 66 × 35.4 |
| FIC2 | Facade for two display units | 66 × 60.8 |
| FIC3 | Facade for three display units | 66 × 86.2 |
| FIC4 | Facade for four display units | 66 × 111.6 |
| FIC5 | Facade for five display units | 66 × 137 |
| FIC6 | Facade for six display units | 66 × 162.4 |

NIC 50

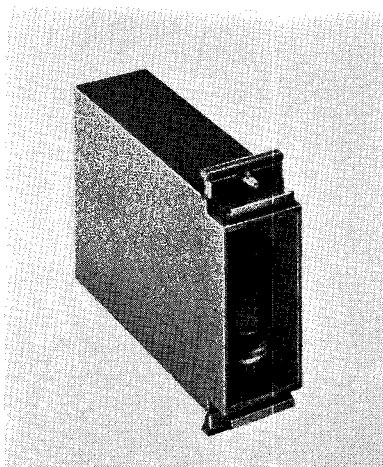

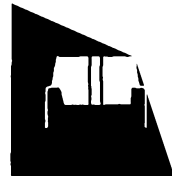

Solid state control elements

input devices book 3 part 6

| Type No. | Description | Temperature range | Speed of operation | Working range | Power supply | Dimensions mm |
|------------------------------|-----------------------------------|-------------------|--------------------|---------------|-----------------------|-----------------|
| VSD | Vane switched detector | -20 to +85°C | 1kHz | — | 12V ± 5% | 92 × 23 × 23 |
| MVSO | Miniature version of VSD | -25 to +85°C | 3kHz | — | 12V ± 5% 24V ± 25% | 41 × 19 × 15 |
| PSD12 PSD24 | Proximity switched detector (PSD) | -25 to +85°C | 100Hz | 10 mm | 12V ± 5% 24V ± 25% | 102.5 × 31 × 31 |
| EPD60 | Miniature version of PSD | -25 to +70°C | 1kHz | — | 12V ± 5% 24V ± 25% | 50 × 30 × 17.6 |

MVSO

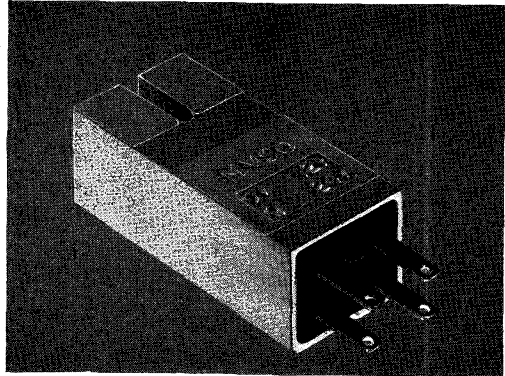

EPD60

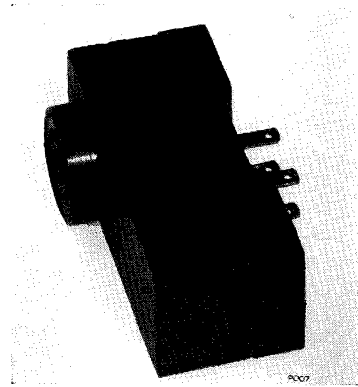

VSD

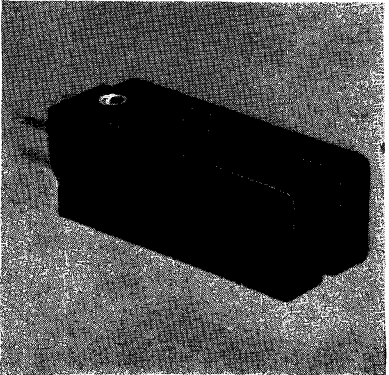

PSD

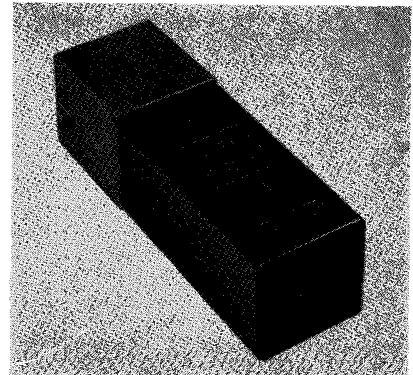

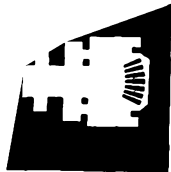

Mosaic printers book 3 part 6

| Type No. | Paper | Columns per line | Printing speed | Dimensions mm |
|-------------|-------------------|------------------|---|----------------|
| 60SA | Self-action | 20 | 50 characters per second 1 line per second | 221 × 148 × 80 |
| 60SR | Plain, ink ribbon | 20 | 50 characters per second 1 line per second | 240 × 148 × 80 |

Either of the above printers should be used with the following character module:

| Type No. | Characters | TTL compatible input | Dimensions mm |
|-------------|---------------------------------------|----------------------|-------------------------|
| CM64 | Full alpha numeric (64 characters) | 6 bits ASCII | Two boards 117 × 110 |

A 7 × 5 dot matrix is used to form characters which must be supplied serially as demanded by the character module. The printer takes 60 mm wide paper rolls.

Mosaic printer

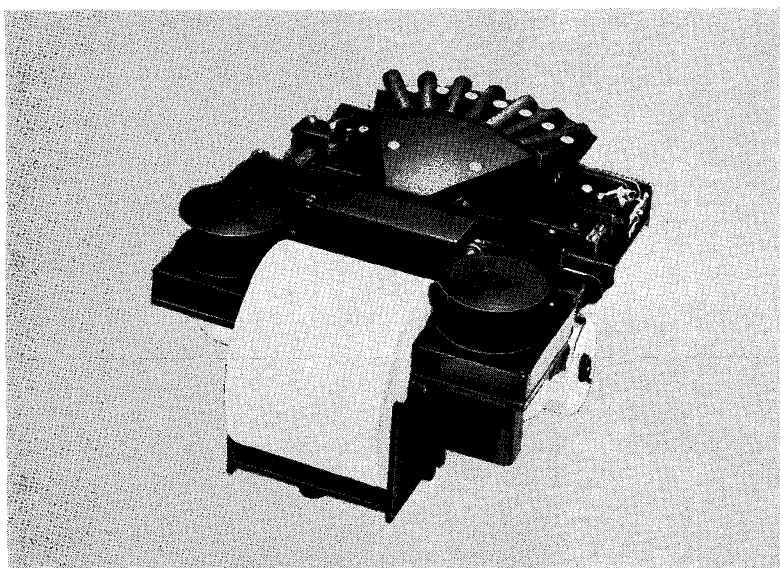

CM 64

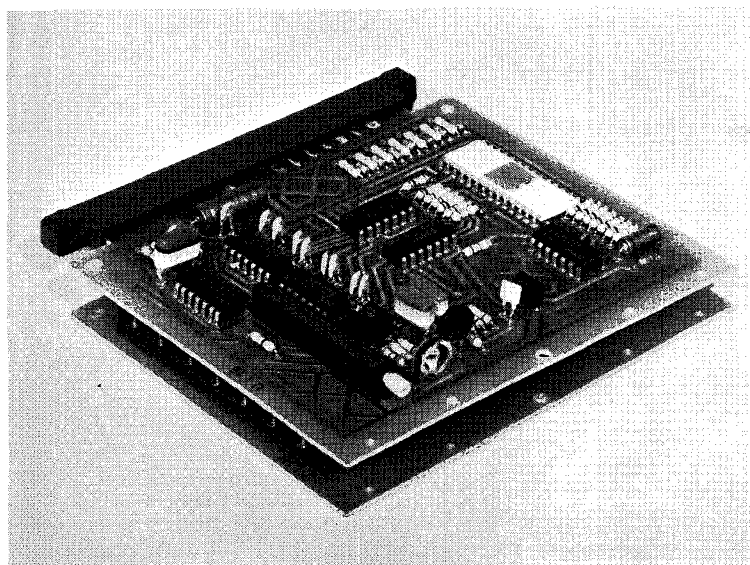

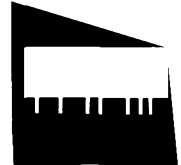

Hybrid v.h.f./u.h.f. wideband amplifiers

A range of hybrid v.h.f./u.h.f. wideband amplifiers designed for use in MATV systems for the frequency range 40 to 860MHz. D.C. power requirements are $24V \pm 10\%$, and source and load impedances are 75Ω .

| Type No. | Description | Transducer gain dB | Flatness of response dB | Noise figure dB | Dimensions mm |
|--------------|--|--------------------|--------------------------|-----------------|---------------|
| OM175 | 2-stage amplifier for use as a distribution amplifier | 15 | 0.5 | 7 | 40 × 22 × 6 |
| OM180 | 2-stage amplifier for use as a booster amplifier and as a preamplifier for OM175 | 16 | 0.2 v.h.f. 1.4 u.h.f. | 5.5 | 30 × 12 × 6 |
| OM185 | 3-stage amplifier for use as a booster amplifier and as a preamplifier for OM175 | 25 | 0.3 v.h.f. 1.6 u.h.f. | 5.5 | 30 × 12 × 6 |
| OM190 | 2-stage amplifier for use as a booster amplifier and as a preamplifier for OM175 | 17 | 0.2 v.h.f. 1.4 u.h.f. | 7 | 30 × 12 × 6 |

Hybrid v.h.f./u.h.f. wideband amplifiers.

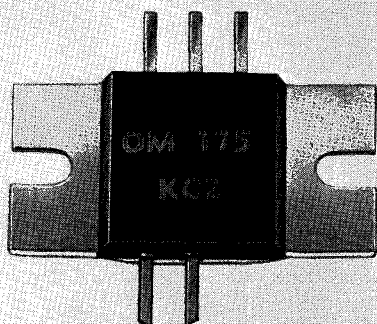

Ferroxcube

linear ferrite materials book 3 part 2

Ferroxcube cores are produced mainly in the following material grades :

For use in pot cores and RM cores :

- Grade A8 A high permeability material suitable for pulse applications, where the pulse repetition frequency is less than about 500kHz, and for wideband applications where the lowest frequency to be transmitted is less than 1 MHz.
- Grade A10 This is a low loss high stability material for use at frequencies between 200kHz and 2MHz.
- Grade A13 A very low loss, high permeability, high stability material. It is used in the form of pot cores for inductors operating at frequencies up to 300kHz and for transformers where the lowest frequency to be transmitted is less than 10MHz.
- Grade B10 A low loss high stability material for use in the frequency range 1 to 15MHz. It is normally available in the form of pot cores for inductor and transformer applications.

For use in television, switched-mode power supplies and inverters :

- Grade A9 Suitable for low frequency power applications where a high operating flux density and low total core loss is required to be maintained at elevated temperatures, e.g. tv line output transformers and inverters. This material can be used at frequencies up to 100kHz and is normally available in U-core form.
- Grade A16 This material has similar properties to grade A9 but has lower losses.

For use in yoke rings in television scanning assemblies :

- Grade A3 Exclusively for the manufacture of yoke rings used in television scanning assemblies.

cores for power applications book 3 part 2

for use in television

| Type No. | Shape | Minimum amplitude permeability (μ_a) for a pair of cores $f < 50\text{Hz}$, $\theta = 25^\circ\text{C}$ | Dimensions mm | | | Other features and applications |
|------------------|---------------------|--|----------------|--------|-------|---------------------------------|
| | | | length | height | width | |
| FX2527 | E core | 1000 at 400mT | 56 | 16 | 19 | Round centre leg |
| FX3560 | E core | 1000 at 420mT | 56 | 18 | 19 | Round centre leg |
| FX3567 | E core | 1000 at 420mT | 44 | 18 | 19 | Round centre leg |
| FX3308 | 30mm pot core | 800 at 340mT | \emptyset 30 | 9.5 | — | |
| FX3550 | RM10 core | 1000 at 330mT | \square 24 | 9.4 | — | |
| FX2507 | U core | 1000 at 400mT | 60 | 29 | 16 | |
| FX3558 | U core | 1000 at 420mT | 60 | 29 | 16 | |
| FX3588 | U core | 1000 at 420mT | 67 | 35 | 19 | |
| FX3187/88 | U and I combination | 1000 at 400mT | 67 | 71 | 19 | μ_a for U and I combination |

yoke rings

| Type No. | Application : For scanning coils in television picture tubes | Dimensions mm | | | |
|---------------|---|---------------|------|--------|------------|
| | | o.d. | i.d. | height | |
| FX3160 | 90° (colour) | 108 | 49 | 50 | Yoke rings |
| FX3251 | 110° (mono) | 57 | 40 | 26 | Yoke rings |

E core

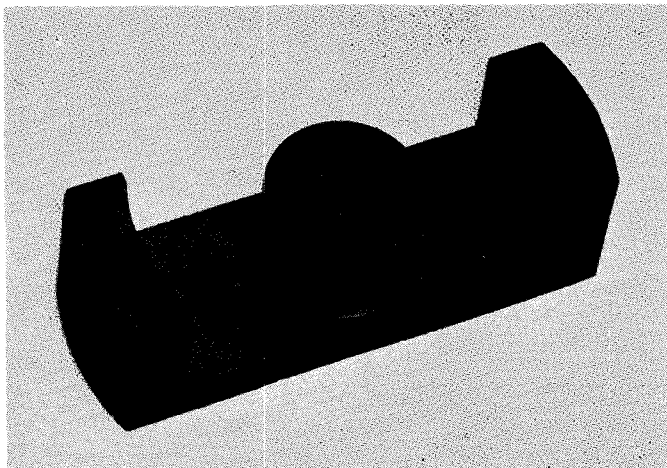



Ferroxcube

cores for power applications (cont.) book 3 part 2

for use in switched-mode power supplies and inverters :

| Type No. | Shape | Coil former type No. | Minimum amplitude permeability (μ_a) for a pair of cores $f < 50\text{Hz}$, $\theta = 25^\circ\text{C}$ | Dimensions mm | | | Other features and applications |
|---------------|-----------|----------------------|--|---------------|--------|-------|---------------------------------|
| | | | | length | height | width | |
| FX3560 | E core | — | 1000 at 420 mT | 56 | 18 | 19 | Round centre leg |
| FX3720 | E core | DT2720 | 1000 at 300mT | 34.5 | 17.3 | 9.5 | Round centre leg |
| FX3730 | E core | DT2730 | 1000 at 300mT | 40.6 | 19.5 | 11.6 | Round centre leg |
| FX3740 | E core | DT2740 | 1000 at 300mT | 52.2 | 24.2 | 13.4 | Round centre leg |
| FX3750 | E core | DT2750 | 1000 at 300mT | 70 | 34.5 | 16.4 | Round centre leg |
| FX3550 | RM10 core | — | 1000 at 330mT | □ 24 | 9.4 | — | — |
| FX3234 | U core | — | 1000 at 400mT | 60 | 35 | 15 | — |
| FX3235 | U core | — | 1000 at 400mT | 60 | 55 | 15 | — |

RM10 cores

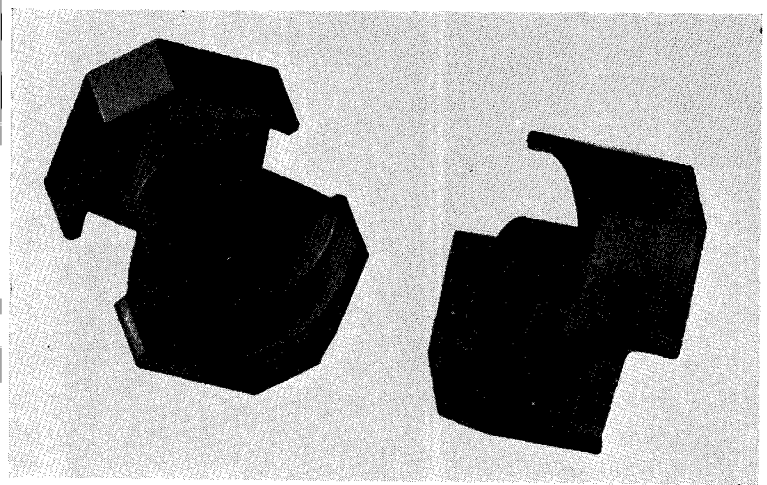

Power U-cores

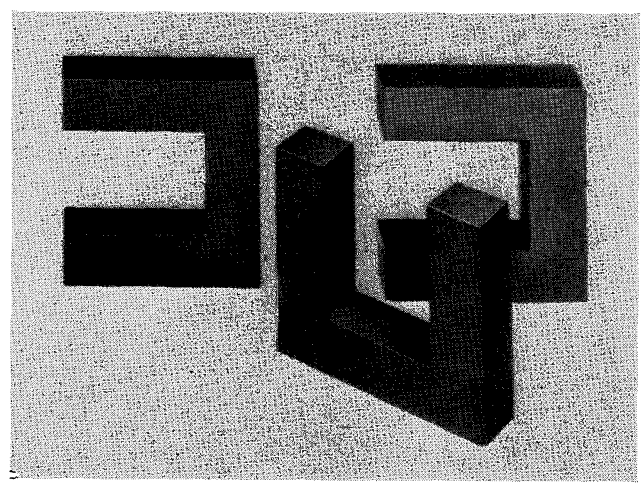

Pot core

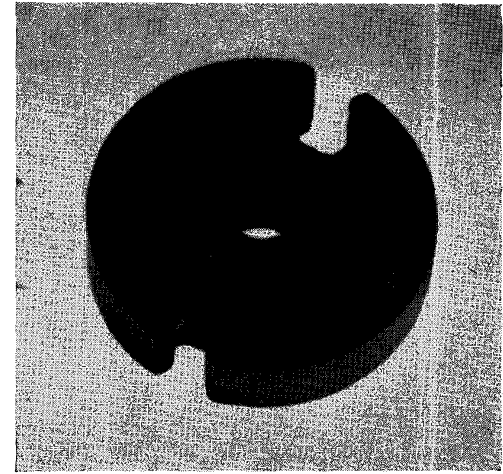

U and I combination

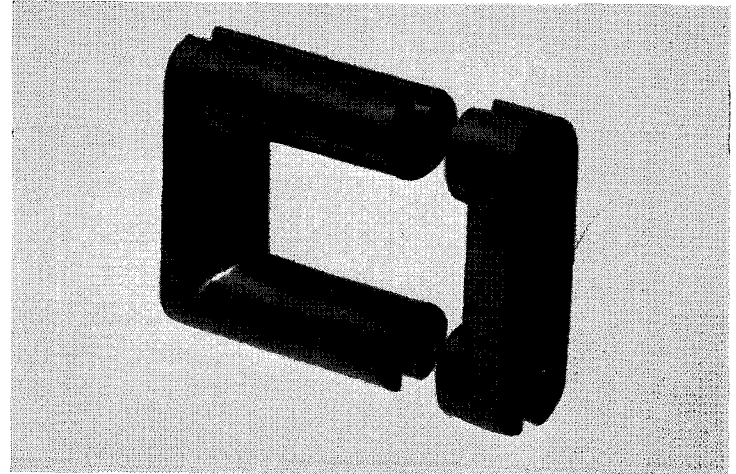

Ferroxcube

cores for small signal applications book 3 part 2

E and I cores

| Type No. | | Minimum effective permeability (μ_e) for two 'E' cores at 25° C | Dimensions mm for two E cores or an E and I combination | | |
|---------------|----------------|---|---|--------------------------|-------|
| E core | I core | | length | height | width |
| FX1052 | *FX1053 | 900 (700 for E and I) | 13 | 13 (2, E's) 10 (E and I) | 3 |
| FX1652 | | 1020 | 20 | 19 | 5 |
| FX1238 | | 1100 | 25 | 19 | 6 |
| FX1007 | FX1107 | 1150 (1150 for E and I) | 41 | 44 (2, E's) 28 (E and I) | 9 |
| FX1239 | | 1150 | 34 | 26 | 8 |
| FX1818 | | 1150 | 42 | 35 | 9 |
| FX1314 | | 1150 | 52 | 60 | 12 |
| FX1819 | *FX2318 | 1150 (1150 for E and I) | 56 | 58 (2, E's) 42 (E and I) | 13 |
| FX1073 | | 1150 | 34 | 20 | 12 |
| FX1105 | | 1150 | 30 | 25 | 12 |
| FX1653 | | 1150 | 90 | 63 | 24 |
| FX1315 | | 1150 | 40 | 48 | 15 |

*Available for current production ; not intended for new designs.

H core assemblies

| Type No. | Minimum effective permeability (μ_e) at 25°C | Dimensions mm | | | No. of pins |
|---------------------|--|---------------|-------|--------|-------------|
| | | length | width | height | |
| LA1366 (H7) | 3000 | 7.5 | 10 | 4.8 | 6 |
| LA1246 (H10) | 3820 | 12.4 | 11.2 | 6.1 | 8 |
| LA1302 (H20) | 3850 | 20 | 20 | 15.2 | 8 |

E cores

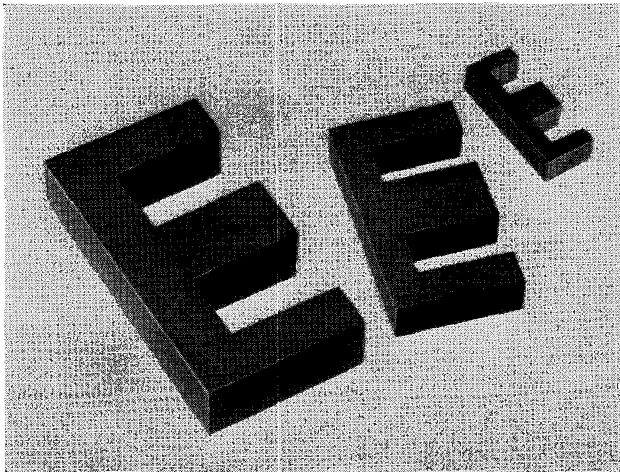

H core assembly

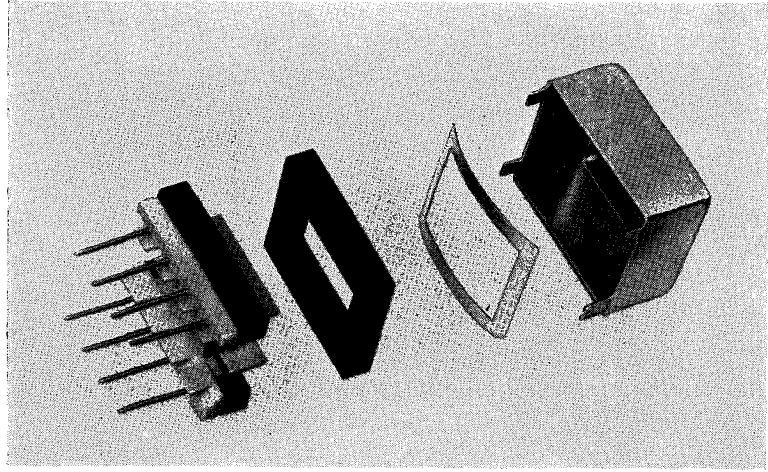



Ferroxcube cores for small signal applications (cont.) book 3 part 2

pot and RM transformer cores

| Designation | Dimensions mm | | Design types | | | | Current types* | |
|-------------|---------------|--------|---------------|---------|---------------|---------|----------------|---------|
| | | | A13 | | A8 | | A5 | |
| | size | height | Type No. | AL min. | Type No. | AL ±25% | Type No. | μe min. |
| 10mm | ∅ 10 | 7 | FX2501 | 1205 | FX3280 | 3325 | — | — |
| 12mm | ∅ 12 | 8 | — | — | — | — | FX2502 | 900 |
| RM6-S | □ 14.4 | 12.4 | FX3432 | 1930 | FX3437 | 4400 | — | — |
| | | | | | LA1522 | 5500 | | |
| RM6-R | □ 14.4 | 12.4 | FX3433 | 2000 | FX3438 | 4750 | — | — |
| 14mm | ∅ 14 | 9 | — | — | — | — | FX2236 | 950 |
| RM7 | □ 16.9 | 13.4 | FX3434 | 2230 | FX3439 | 5600 | — | — |
| 18mm | ∅ 18 | 11 | — | — | — | — | FX2238 | 1150 |
| RM8 | □ 19.4 | 16.4 | FX3435 | 2400 | FX3440 | 6300 | — | — |
| 21mm | ∅ 21 | 14 | — | — | — | — | FX2239 | 1150 |
| RM10 | □ 24.1 | 18.6 | FX3436 | 3260 | FX3441 | 8600 | — | — |
| 25mm | ∅ 25 | 16 | — | — | — | — | FX2240 | 1200 |
| 30mm | ∅ 30 | 19 | FX2241 | 5815 | FX3286 | 15 000 | — | — |
| 35mm | ∅ 35 | 23 | FX2242 | 6950 | FX3287 | 17 800 | — | — |
| 45mm | ∅ 45 | 29 | FX2243 | 8830 | FX3288 | 20 000 | — | — |

*Available for current production ; not intended for new designs.

Accessories: Accessories are available. Please refer to Mullard Technical Handbook for details.

cross cores

| Type No. | Minimum effective permeability (μe) at 25°C | Dimensions mm | | | |
|----------------------|--|---------------|-------|---------------|-------------|
| | | length | width | height (pair) | centre hole |
| FX2856 (X 22) | 1440 | 21.3 | 21.3 | 14.2 | ∅ 3 |
| FX2857 (X 30) | 1525 | 29.6 | 29.6 | 23.6 | ∅ 4.5 |
| FX2858 (X 35) | 1580 | 34.6 | 34.6 | 28 | ∅ 5.5 |

Pot and RM cores

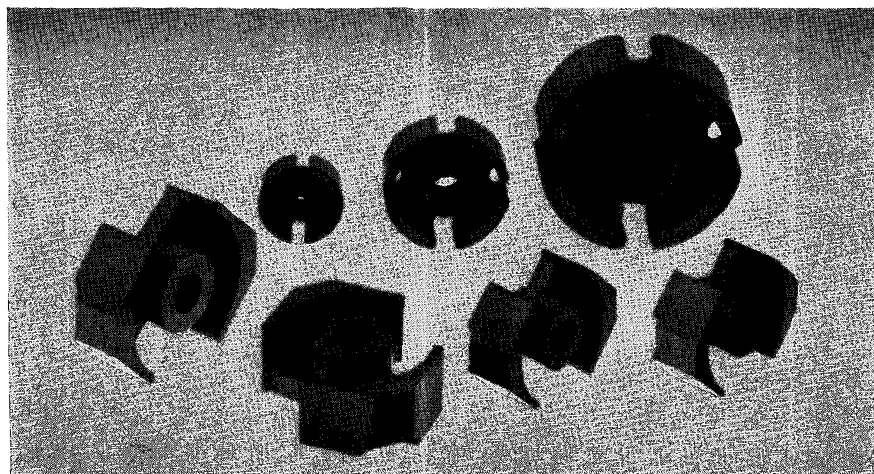

Cross core assembly

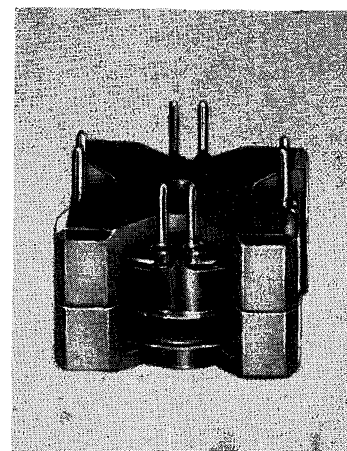



Ferroxcube cores for small signal applications (cont.) book 3 part 2

screening beads

Ferroxcube beads with 1, 2 or 6 holes can be used to introduce, in a simple way, additional impedance for the suppression of unwanted parasitic oscillations, or to provide screening.

| Type No. | No. of holes | Dimensions | | | Minimum suppression frequency MHz | Type No. | No. of holes | Dimensions | | | Minimum suppression frequency MHz |
|---------------|--------------|---------------------|-------------------|--------------------------|-----------------------------------|---------------|--------------|---------------------|-------------------|--------------------------|-----------------------------------|
| | | Maximum diameter mm | Maximum length mm | Minimum hole diameter mm | | | | Maximum diameter mm | Maximum length mm | Minimum hole diameter mm | |
| FX1115 | 1 | 4.2 | 5.5 | 1.8 | 1 | FX1516 | 2 | 5.9 | 12.4 | 0.7 | 10 |
| FX1242 | 1 | 4.1 | 5.7 | 1.3 | 10 | FX1898 | 6 | 6.3 | 10.5 | 0.6 | 10 |

single and double aperture cores

| Type No. | | Minimum effective permeability (μ_e) at 25°C | Colour mark | Dimensions mm | | | | |
|----------------|-----------------|--|-------------|---------------|--------|-------|--------|----------|
| | | | | diameter | length | width | height | aperture |
| FX2431 | Single aperture | 500 | — | 8 | — | — | 6 | ∅2 |
| FX2633 | Single aperture | 1500 | — | 8 | — | — | 6 | ∅2 |
| FX2049 | Double aperture | 200 | white | — | 13 | 8 | 6 | ∅3 |
| FX2249 | Double aperture | 500 | white | — | 10.8 | 5.4 | 10.9 | □2 |
| *FX2634 | Double aperture | 1500 | red | — | 10.8 | 5.4 | 10.9 | □2 |
| FX2754 | Double aperture | 1400 | red | — | 13 | 8 | 6 | ∅3 |
| FX2837 | Double aperture | 3000 | yellow | — | 10.8 | 5.4 | 10.9 | □2 |
| FX3316 | Double aperture | 3000 | — | — | 10.8 | 5.4 | 6 | □2 |
| FX3391 | Double aperture | 1400 | — | — | 10.8 | 5.4 | 6 | □2 |

*Available for current production ; not intended for new designs (replaced by FX3316).

rods

| Type No. | Material grade | Dimensions mm | |
|----------------|----------------|---------------|------|
| | | d | ℓ |
| *FX2902 | B2 | 1.6 | 12 |
| *FX1433 | B5 | 1.6 | 14 |
| *FX2917 | B2 | 1.6 | 17.1 |
| *FX3245 | B5 | 3 | 10 |
| FX3225 | B2 | 6 | 25.4 |
| FX1089 | A4 | 6.4 | 31.8 |
| *FX1099 | A4 | 6.4 | 51.8 |
| *FX1130 | A1 | 6.4 | 25.4 |
| *FX1807 | B2 | 9 | 30.5 |
| FX1169 | A4 | 12.7 | 50.8 |
| *FX1172 | A4 | 12.7 | 76.2 |

*Available for current production ; not intended for new designs.

Single and double aperture cores

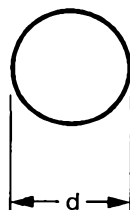
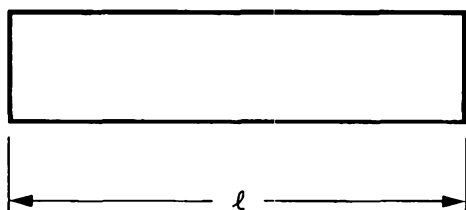
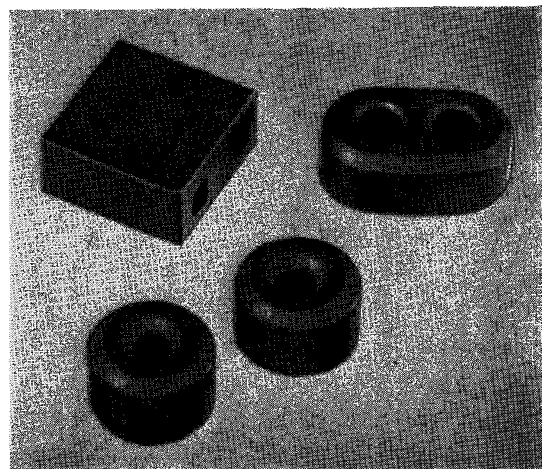



Ferroxcube

cores for small signal applications (cont.) book 3 part 2

tubes

| Type No. | Material grade | Dimensions mm | | |
|----------------|----------------|---------------|------|--------|
| | | o.d. | i.d. | ℓ |
| FX1483 | A1 | 3.6 | 2.5 | 14.3 |
| FX1242 | B2 | 4 | 1.5 | 5.5 |
| *FX1068 | A4 | 4 | 1.5 | 32 |
| *FX1164 | A1 | 4 | 1.5 | 25.4 |
| FX1054 | A4 | 4 | 1.5 | 51 |
| FX1115 | A1 | 4 | 2 | 5 |
| FX1272 | A1 | 4 | 2 | 14 |
| *FX1156 | A1 | 4.1 | 1.5 | 19 |
| *FX1060 | A1 | 4.2 | 2.1 | 7 |
| FX1098 | A4 | 4.2 | 2.3 | 7 |
| *FX2343 | B5 | 4.7 | 2 | 19 |
| *FX1208 | A1 | 5.6 | 1.5 | 31.8 |
| *FX1159 | A4 | 6.4 | 1.5 | 50.8 |
| FX1447 | A4 | 6.4 | 2 | 30 |
| FX1243 | A4 | 7.5 | 4.5 | 17 |
| FX1128 | A1 | 9.5 | 6.5 | 17 |
| FX1276 | A4 | 11 | 9 | 59.7 |

*Available for current production ; not intended for new designs.

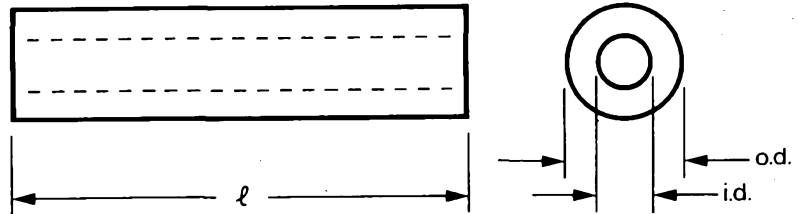

toroids

Uncoated types

| Type No. | Material grade | Dimensions mm | | |
|---------------|----------------|---------------|------|------|
| | | o.d. | i.d. | w |
| FX3237 | A15 | 2 | 1.3 | 0.7 |
| FX2073 | A5 | 5 | 2.9 | 1.2 |
| FX1886 | B5 | 5.2 | 3.1 | 1 |
| FX1593 | A4 | 12.7 | 6.3 | 3.2 |
| FX1594 | B1 | 12.7 | 6.3 | 3.2 |
| FX1595 | B2 | 12.7 | 6.3 | 3.2 |
| FX1598 | B5 | 12.7 | 6.3 | 3.2 |
| FX2691 | A5 | 12.7 | 6.3 | 3.2 |
| FX3311 | A8 | 12.7 | 6.4 | 3.2 |
| FX2395 | A4 | 38.1 | 25.4 | 19 |
| FX1582 | A4 | 25.4 | 19 | 4.8 |
| FX3312 | A8 | 25.4 | 19 | 4.8 |
| FX1586 | A4 | 38.1 | 25.4 | 6.3 |
| FX1587 | B1 | 38.1 | 25.4 | 6.3 |
| FX1588 | B2 | 38.1 | 25.4 | 6.3 |
| FX1589 | B3 | 38.1 | 25.4 | 6.3 |
| FX1590 | B4 | 38.1 | 25.4 | 6.3 |
| FX3313 | A8 | 38.1 | 25.4 | 6.3 |
| FX1076 | A4 | 108 | 70 | 12.7 |

Coated types

| Type No. | Material grade | Uncoated dimensions mm | | |
|---------------|----------------|------------------------|------|-----|
| | | o.d. | i.d. | w |
| FX3238 | A15 | 4 | 2.2 | 1.1 |
| FX3239 | A15 | 6 | 4 | 2 |
| FX3240 | A15 | 9 | 6 | 3 |
| FX3008 | A4 | 12.7 | 6.3 | 3.2 |
| FX3009 | A5 | 12.7 | 6.3 | 3.2 |
| FX3012 | B2 | 12.7 | 6.3 | 3.2 |

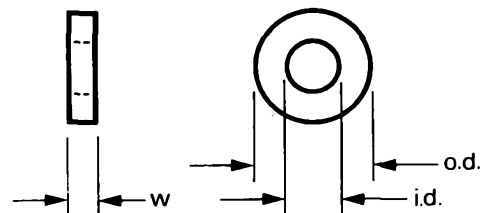



Ferroxcube

RM inductor cores book 3 part 4

| RM5 range | | |
|--------------------|---------------------------------|----------------------|
| Type No. | Violet range | |
| | Inductance factor A_L (nH) | Standard adjuster |
| RM5A13AL250 | 250 | LA1519 |
| RM5A13AL160 | 160 | LA1495 |
| RM5A13AL100 | 100 | LA1494 |

LA4000 Series

The LA4000 'RM' range of high quality inductor cores for direct mounting on printed wiring boards, is designed to achieve a greater packing density and to reduce the time and cost of assembly. Each core consists of two halves, held together by metal clips, thus providing a quick and easy method of assembly on a printed wiring board with a grid spacing of 2.54 mm (0.1 in) by means of pins in the coil former.

| Size | Type No. | Violet range | | Red range | | |
|-------|---------------|---------------------------------|----------------------|---------------|---------------------------------|----------------------|
| | | Inductance factor A_L (nH) | Standard adjuster | Type No. | Inductance factor A_L (nH) | Standard adjuster |
| RM6-R | LA4145 | 400 | LA1501 | LA4128 | 100 | LA1500 |
| | LA4146 | 250 | LA1429 | LA4129 | 63 | LA1500 |
| | LA4147 | 160 | LA1429 | LA4130 | 40 | LA1500 |
| | LA4148 | 100 | LA1500 | — | — | — |
| RM7 | LA4245 | 400 | LA1400 | LA4228 | 100 | LA1427 |
| | LA4246 | 250 | LA1399 | LA4229 | 63 | LA1427 |
| | LA4247 | 160 | LA1399 | LA4230 | 40 | LA1427 |
| | LA4248 | 100 | LA1427 | — | — | — |
| RM8 | LA4344 | 630 | LA1430 | LA4328 | 100 | LA1431 |
| | LA4345 | 400 | LA1424 | LA4329 | 63 | LA1431 |
| | LA4346 | 250 | LA1424 | — | — | — |
| | LA4347 | 160 | LA1431 | — | — | — |
| RM10 | LA4348 | 100 | LA1431 | — | — | — |
| | LA4543 | 1000 | LA1433 | LA4528 | 100 | LA1432 |
| | LA4544 | 630 | LA1428 | LA4529 | 63 | LA1432 |
| | LA4545 | 400 | LA1428 | — | — | — |
| RM10 | LA4546 | 250 | LA1432 | — | — | — |
| | LA4547 | 160 | LA1432 | — | — | — |

Accessories

| Size | Coil formers | | | Clip | Aligning plug | Non-magnetic screwdriver |
|-------|--------------------|-------------|-----------------|---------------------|---------------|-----------------------------|
| | 1 section | No. of pins | 2 section | | | |
| RM5 | RM5B0BS/S6P | 6 | — | † RM4/5 CLIP | — | — |
| RM6-R | DT2467 | 4 | — | DT2398 | DT2415 | DT2452 |
| | DT2517 | 6 | DT2477 | † DT2498 | — | — |
| RM7 | DT2468 | 4 | — | DT2387 | DT2453 | DT2452 |
| | * DT2391 | 5 | * DT2522 | † DT2487 | — | — |
| RM8 | DT2392 | 8 | DT2523 | DT2396 | DT2411 | DT2410 |
| | DT2470 | 4 | — | † DT2496 | — | — |
| RM10 | DT2480 | 8 | DT2481 | DT2406 | DT2412 | DT2410 |
| | DT2534 | 5 | * DT2538 | † DT2506 | — | — |
| | DT2535 | 8 | DT2539 | — | — | — |

*Available for current production, not intended for new designs.

†With earthing tag

RM inductor cores

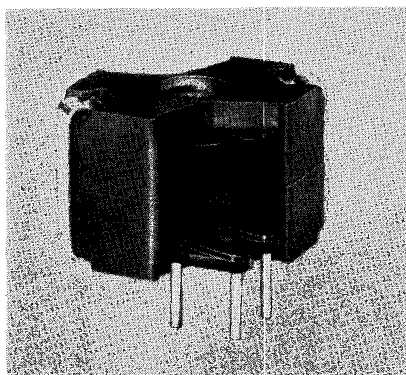

RM inductor cores

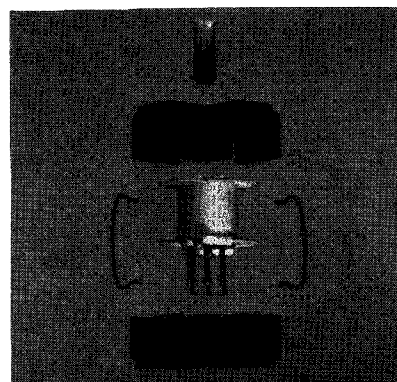

Ferroxcube

Vinkor pot cores (to BS4061 range 1) book 3 part 3

| Size mm | Violet range | | Red range | | Blue range | |
|------------|--------------|--|-----------|--|------------|--------------------------------|
| | Type No. | Effective permeability (μ_e) with adjuster in mid-range position | Type No. | Effective permeability (μ_e) with adjuster in mid-range position | Type No. | Inductance factor (A_L) nH |
| 10 | LA1421 | 100 | | | LA1378 | 33.8 |
| | LA1422 | 63 | | | LA1379 | 32.0 |
| | LA1423 | 40 | | | LA1380 | 30.0 |
| 12 | *LA1418 | 100 | | | | |
| | *LA1419 | 63 | | | | |
| | *LA1420 | 40 | | | | |
| 14 | *LA1228 | 250 | *LA1157 | 63 | LA1375 | 55.0 |
| | *LA1229 | 160 | *LA1158 | 40 | LA1376 | 45.7 |
| | *LA1230 | 100 | | | LA1377 | 37.0 |
| | *LA1417 | 63 | | | | |
| 18 | *LA1225 | 250 | *LA1161 | 63 | LA1372 | 76.2 |
| | *LA1226 | 160 | *LA1162 | 40 | LA1373 | 59.4 |
| | *LA1227 | 100 | *LA1163 | 25 | LA1374 | 45.4 |
| | *LA1416 | 63 | | | | |
| 21 | *LA1222 | 250 | *LA1164 | 63 | | |
| | *LA1223 | 160 | *LA1165 | 40 | | |
| | *LA1224 | 100 | *LA1166 | 25 | | |
| | *LA1415 | 63 | | | | |
| 25 | *LA1218 | 400 | *LA1167 | 63 | | |
| | *LA1219 | 250 | *LA1168 | 40 | | |
| | *LA1220 | 160 | *LA1169 | 25 | | |
| | *LA1221 | 100 | | | | |
| | *LA1414 | 63 | | | | |
| 30 | LA1214 | 400 | LA1170 | 63 | | |
| | LA1215 | 250 | LA1171 | 40 | | |
| | LA1216 | 160 | LA1172 | 25 | | |
| | LA1217 | 100 | | | | |
| | LA1413 | 63 | | | | |
| 35 | LA1210 | 400 | LA1173 | 63 | | |
| | LA1211 | 250 | LA1174 | 40 | | |
| | LA1212 | 160 | LA1175 | 25 | | |
| | LA1213 | 100 | | | | |
| | LA1412 | 63 | | | | |
| 45 | LA1409 | 250 | | | | |
| | LA1410 | 160 | | | | |
| | LA1411 | 100 | | | | |

The Mullard BLUE RANGE is supplied with specially adjusted A_L values to avoid integral turn problems at low inductance values.

*Available for current production, for new designs see RM inductor cores.

Vinkor pot cores

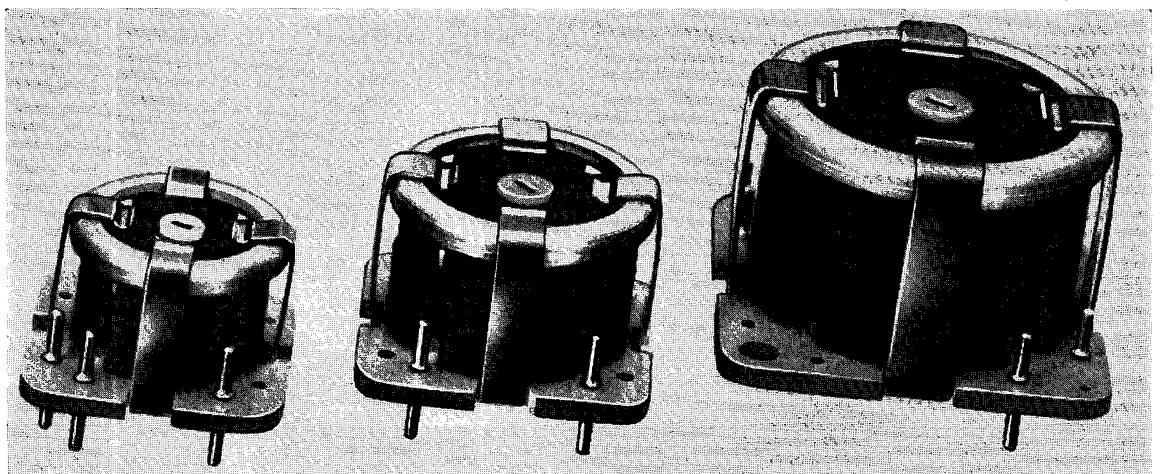

Accessories :
Accessories are available.
Please refer to Technical
Handbook for details.

PXE piezoelectric ceramic components

Piezoelectricity is 'pressure' electricity, a property of certain crystalline materials and of man-made polycrystalline ceramic materials. It provides for the designer, a simple, direct method for electro-mechanical, and reverse, energy transformations. Mullard have introduced into their range of electrical ceramics piezoelectric elements chosen from three main grades of material. These elements are robust and have a high mechanical stiffness. They have the advantage that element shapes and their piezoelectric properties are formed during manufacture, and can be chosen to meet the requirements of particular applications. There are many fields in which modern piezoelectric elements have already been applied, and these materials are now of increasing importance to industry.

material properties book 3 part 2

| Material | PXE4 | PXE5 | PXE6 | PXE7 | PXE11 | PXE21 | PXE22 | PXE41 | *PXE51 | Units | |
|---|----------|------|-------|------|-----------|-------|-------|-------|--------|---------------------|----------------------|
| Mechanical data | | | | | | | | | | | |
| Density | 7.5 | 7.6 | 7.7 | 7.75 | 4.5 | 7.75 | 7.75 | 7.9 | 7.7 | 10^3kg/m^3 | |
| Curie temperature θ_c | 265 | 285 | 370 | 320 | 180, 400† | 270 | 270 | 315 | 220 | °C | |
| Electrical data | | | | | | | | | | | |
| Relative permittivity ϵ_r | 1750 | 1800 | 600 | 700 | 400 | 1750 | 2250 | 1200 | 2300 | — | |
| Dielectric dissipation factor $\tan \delta$ | 6 | 16 | 8 | 20 | 25 | 16 | 16 | 2.5 | 16 | 10^{-3} | |
| Electromechanical data | | | | | | | | | | | |
| Coupling coefficients | k_p | 0.55 | 0.58 | 0.32 | 0.52 | 0.43 | 0.62 | 0.62 | 0.56 | 0.66 | — |
| | k_{31} | 0.32 | 0.34 | 0.19 | 0.31 | 0.25 | 0.37 | 0.37 | 0.33 | 0.39 | — |
| | k_{33} | 0.64 | 0.70 | — | 0.70 | 0.55 | 0.72 | 0.72 | 0.68 | 0.72 | — |
| | k_{15} | — | 0.66 | — | 0.66 | 0.65 | — | — | 0.60 | — | — |
| Piezoelectric charge constants | d_{31} | -138 | -169 | -44 | -86 | -47.5 | -180 | -202 | -119 | -234 | 10^{-12}C/N |
| | d_{33} | 292 | 384 | — | 220 | 100 | 385 | 438 | 268 | 480 | 10^{-12}C/N |
| | d_{15} | — | 515 | — | 370 | 235 | — | — | 335 | — | 10^{-12}C/N |
| Piezoelectric voltage constants | g_{31} | -8.9 | -10.7 | -8.0 | -14.0 | -13.4 | -11.6 | -10.1 | -11.2 | -9.5 | 10^{-3}Vm/N |
| | g_{33} | 18.8 | 24.2 | — | 35.4 | 28.2 | 25 | 22.0 | 25.2 | 19.3 | 10^{-3}Vm/N |
| | g_{15} | — | 32.5 | — | 42.0 | 44.0 | — | — | 33.5 | — | 10^{-3}Vm/N |
| Quality factor | Q_M^E | 500 | 80 | 1000 | 80 | 270 | 80 | 80 | 1000 | 50 | — |
| Frequency constants | N_p^E | 2300 | 2000 | 2460 | 2200 | 3600 | 2000 | 2000 | 2200 | 2050 | Hzm |
| | N_1^E | 1620 | 1460 | 1800 | 1640 | 2650 | — | — | 1620 | — | Hzm |
| | N_3^D | 2050 | 1850 | — | 2000 | 2900 | 1900 | 1900 | 2000 | 1950 | Hzm |
| | N_5^E | — | 930 | — | 970 | 1500 | — | — | 1020 | — | Hzm |

*Tentative figures

†In PXE11 there is a transition from the ferroelectric orthorhombic to the ferroelectric tetragonal phase at 180°C. If the material passes through this temperature in either direction, then it must be repoled.

PXE ceramic components

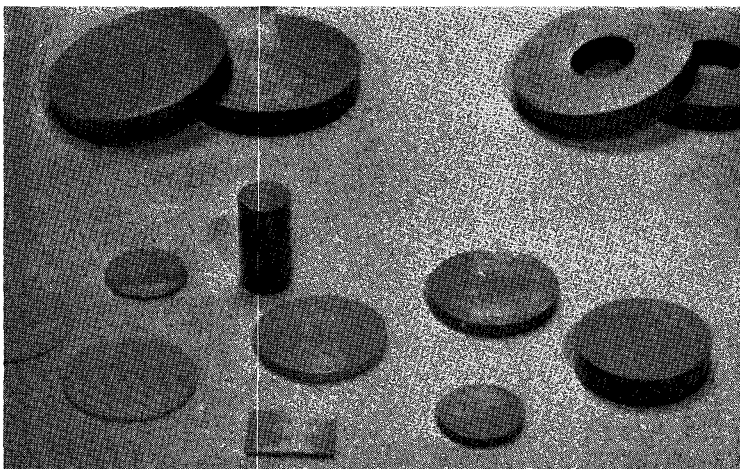

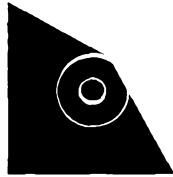

PXE piezoelectric ceramic components preferred types book 3 part 2

| Type No. | PXE | Dimensions mm | |
|-------------------------------|------------|---------------|--------|
| gas ignition | | dia. | length |
| MB1115 | 41 | 3.7 | 5 |
| MB1113 | 41 | 6.35 | 15 |
| MB1086, MB1112, MB1114 | 21, 22, 41 | 6.35 | 16 |

| ultrasonic cleaning and welding | | o.d. | i.d. | thickness |
|--|----|------|------|-----------|
| MB1116 | 41 | 38.1 | — | 6.35 |
| MB2019 | 41 | 38.1 | 12.7 | 6.35 |
| MB2021 | 41 | 38.1 | 19.1 | 6.35 |
| MB1109 | 41 | 50 | — | 3 |

Where more than one MB type number is shown, it indicates that the component is made in more than one material but has the same physical size. Type numbers refer respectively to the materials shown.

| echo sounder | | dia. | length |
|--|----|------|--|
| MB1082 (operating frequency 151kHz) | 41 | 32 | 14 (approx.) dependent on frequency |

| pick-up elements | | length | width | thickness |
|--------------------------|---|--------|-------|-----------|
| MB8009 multimorph | 5 | 9.6 | 1.6 | 0.68 |
| MB8001 multimorph | 5 | 12.7 | 1.6 | 0.68 |
| MB8000 multimorph | 5 | 15.5 | 1.6 | 0.68 |
| MB8004 multimorph | 5 | 70 | 1.6 | 0.68 |
| MB7010 bimorph | 5 | 8 | 8 | 0.6 |
| MB7007 bimorph | 5 | 11.6 | 6.35 | 0.5 |
| MB7012 bimorph | 5 | 12.7 | 1.6 | 0.5 |
| MB7014 bimorph | 5 | 15 | 1.6 | 0.6 |

| air transducer | | dia. | thickness |
|---|---|------|-----------|
| MB4016 (operating frequency 36kHz) | 5 | 25 | 14.5 |

| delay line transducer | | length | width | thickness |
|---|---|--------|-------|--|
| MB3013 (operating frequency 4.1 MHz) | 7 | 25 | 10 | 0.24 (approx.) dependent on frequency |

| feedback disc | | dia. | thickness |
|----------------------|---|------|-----------|
| MB1000 | 5 | 16 | 1.1 |

| general applications | | |
|-----------------------------|----------------------|-----|
| rods and discs | | |
| Dia. mm. | Thickness/length mm. | PXE |
| 3 | 0.5 to 8 | 5 |
| 5 | 0.2 to 2 | 5 |
| 6.35 | 2 | 21 |
| 10 | 0.2 to 20 | 5 |
| 16 | 0.2 to 3 | 5 |
| 25.4 | 0.5 to 2 | 5 |

| plates | | |
|---------------|---------------|-----|
| Type No. | Dimensions mm | PXE |
| MB3011 | 12 × 6 × 0.5 | 5 |
| MB3010 | 12 × 6 × 1 | 5 |
| MB3004 | 16 × 12 × 1 | 5 |



Permanent magnets

Mullard provide a service for the design and manufacture of metal (TICONAL) and ceramic (MAGNADUR) magnets to customers' specialised requirements; a comprehensive range of standard shapes and sizes is also available. Magnets may be supplied in the basic shape, cored, grooved, tapered, etc., and either unmagnetised or magnetised with a choice of magnetic axes (where no choice is available, this is shown on the appropriate outline drawing).

material properties book 3 part 2

| Material | (BH) _{max} | | B _r | | H _{cB} | |
|--------------------|-----------------------------------|-----------------------|----------------|--------|-----------------------|---------|
| | kilojoules/ metre ³ | megagauss -oersted | millitesla | gauss | kiloamperes/ metre | oersted |
| Ticonal 900(XX) | 79.6 | 10.0 | 1080 | 10 800 | 127 | 1600 |
| Ticonal 600(VC-sc) | 47.8 | 6.0 | 1310 | 13 100 | 54.1 | 680 |
| Ticonal 570(C-sc) | 45.4 | 5.7 | 1320 | 13 200 | 51.7 | 650 |
| Ticonal 550(HX) | 43.8 | 5.5 | 900 | 9000 | 123 | 1550 |
| Ticonal 500(C) | 40.6 | 5.1 | 1250 | 12 500 | 52.5 | 660 |
| Ticonal 440(H) | 35.0 | 4.4 | 1160 | 11 600 | 55.7 | 700 |
| Magnadur 2 | 28.7 | 3.6 | 400 | 4000 | 143 | 1800 |
| Magnadur 5 | 25.5 | 3.2 | 370 | 3700 | 239 | 3000 |
| Magnadur 3 | 22.3 | 2.8 | 350 | 3500 | 239 | 3000 |
| Magnadur 4 | 14.3 | 1.8 | 280 | 2800 | 199 | 2500 |
| *Magnadur 1 | 7.56 | 0.95 | 220 | 2200 | 131 | 1650 |
| *Magnadur D55 | 4.78 | 0.60 | 170 | 1700 | 111 | 1400 |
| Magnadur P40 | 3.58 | 0.45 | 145 | 1450 | 95.5 | 1200 |

*These materials, in their unmagnetised state, have no preferred direction of magnetic axis (i.e. isotropic).

Conversion factors: 10 gauss = 1 millitesla (mT)

1 oersted = 79.6 amperes per metre (A/m)

1 gauss-oersted = 79.6 × 10⁻⁴ joules per metre³ (J/m³) which is equivalent to the expression tesla amperes per metre (TA/m)

standard shapes and sizes book 3 part 2

| Shape | Dimensions mm | | | Material | Figure |
|-----------------------------|---------------|------------|-----------|----------|--------|
| | a | b | c | | |
| Rectangular section bars | 5 to 400 | 5 to 50 | 5 to 25 | Ticonal | 1 |
| | 19 to 152 | 16 to 100 | 6 to 25 | Magnadur | |
| Rods and discs | Ø3 to 40 | 5 to 76 | — | Ticonal | 2 |
| | Ø1 to 30 | 4 to 40 | — | Magnadur | |
| Rings and tubes | Ø6 to 190 | 29 to 83 | Ø5 to 140 | Ticonal | 3 |
| | Ø6 to 184 | 6 to 18 | Ø3 to 73 | Magnadur | |
| U-shapes | 6 to 170 | Ø9 to 180 | 8 to 100 | Ticonal | 4 |
| C-shapes | 11 to 84 | 38 to 178 | 8 to 108 | Ticonal | 5 |
| Segments | 40 to 65 | R 23 to 37 | 13 to 45 | Magnadur | 6 |

For outline drawings (figs 1 to 6) see next page.



Permanent magnets standard shapes and sizes book 3 part 2

outline drawings

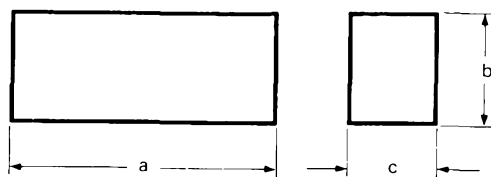

Fig. 1

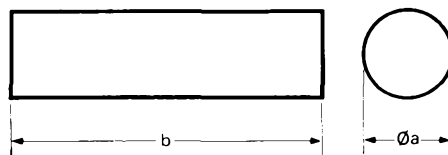

Fig. 2

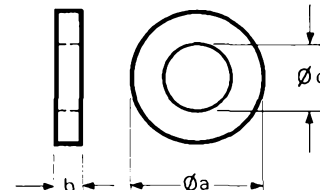

Fig. 3

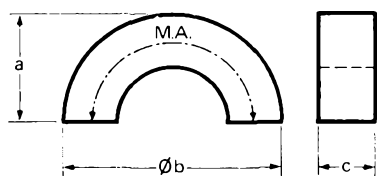

Fig. 4

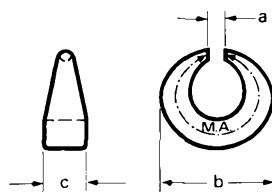

Fig. 5

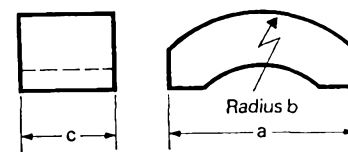

Fig. 6

M.A. = Magnetic axis
For dimensions a, b & c see previous page

plasto ferrites book 3 part 2

Two materials are available:
Magnadur D55 – available in ring form
Magnadur P40 – available in strip form: width 8 to 48 mm, thickness 1 to 4.5 mm., length up to 50 metres

Magnadur magnet powder M8 book 3 part 2

Mainly intended for use in the manufacture of plastic bonded magnetic articles which are extruded or stamped from rolled sheet.

MAGNETIC DATA

The parameters specified below are measured on a test piece.

Typical properties

| | SI units | CGS units | |
|--------------|-----------------------|-----------|----|
| $(BH)_{max}$ | 3180 J/m ³ | 0.4 MGs | Oe |
| B_r | 138 mT | 1380 | Gs |
| H_{cB} | 87.6 kA/m | 1100 | Oe |
| H_{cJ} | 191 kA/m | 2400 | Oe |
| Curie point | 450 °C | 450 | °C |

Magnadur magnets

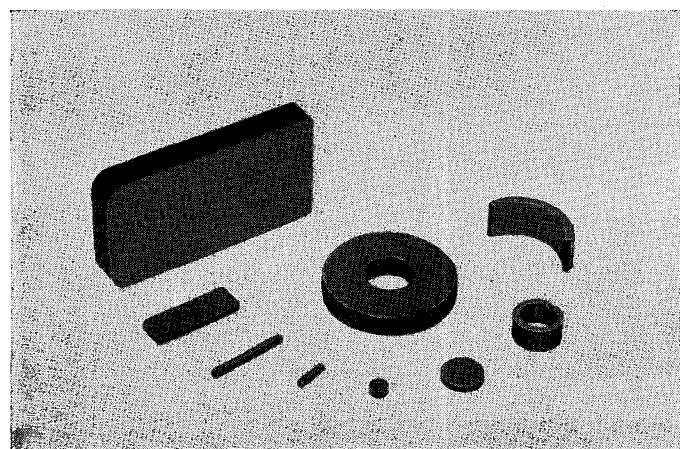

TEST PIECE

The constituents of the test piece are as follows:

| | |
|---|-------|
| M8 powder | 400 g |
| Bakelite resin | 21 ml |
| Acetone solution (70% water, 30% acetone) | 9 ml |

From this material, a cylindrical test piece is made according to the following specifications:

| | |
|-----------------------|----------------------------------|
| Diameter | 30.05/30.00 mm |
| Height | 12.05/11.95 mm |
| Cured pressed density | $3.6 \times 10^3 \text{ kg/m}^3$ |

Ticonal magnets

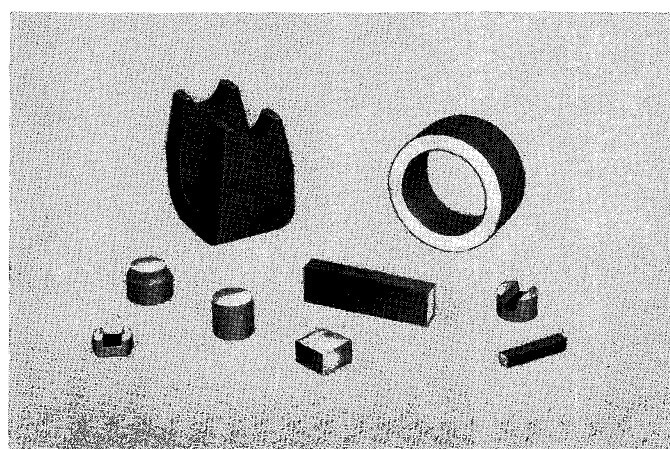

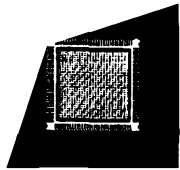

Computer components

ferrite core memory systems book 3 part 2

Mullard are actively engaged in the design and manufacture of ferrite core memory systems, stacks, planes and semiconductor memory systems. Whilst the standard ranges given will be satisfactory for many applications, we welcome the opportunity to discuss with customers details of systems to suit their specific requirements.

| Type No. | Words | Bits per word | Cycle time | Access time |
|----------------|--------------------|---------------|-------------|-------------|
| FI-2 | 1 024 | 8 | 4 μ s | < 700ns |
| MM1507 | 1 024 | 8 | 1.2 μ s | 320ns |
| **FI-26 | 1 024 | 13 | 1 μ s | 500ns |
| *FI-75 | 4 096 | 18 | 750ns | 300ns |
| FI-128 | 4 096 | 8 | 1.5 μ s | 600ns |
| FI-138 | 8 192 | 8 | 1.5 μ s | 600ns |
| *FI-65 | 8 192 or 16 384 | 18 9 | 650ns | 275ns |
| *Q-14 | 16 384 | 36 | 1.4 μ s | 600 μ s |

*Expansion—The capacity of these memory systems may be readily expanded in increments (of the basic capacity given above) up to a maximum of 8, by the addition of extra memory modules.

**Expansion up to 16k13

FI-26

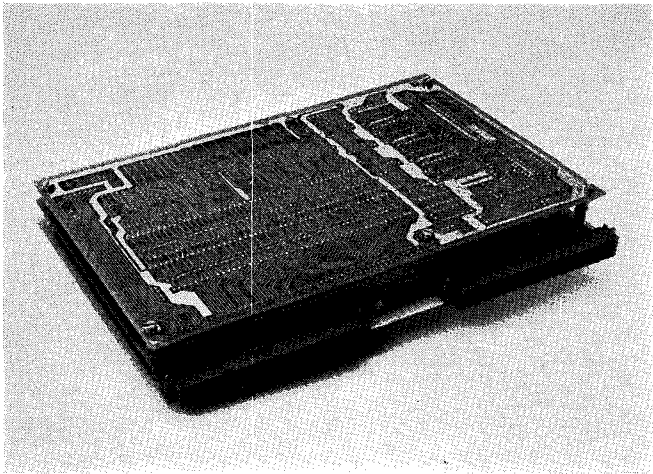

FI-128

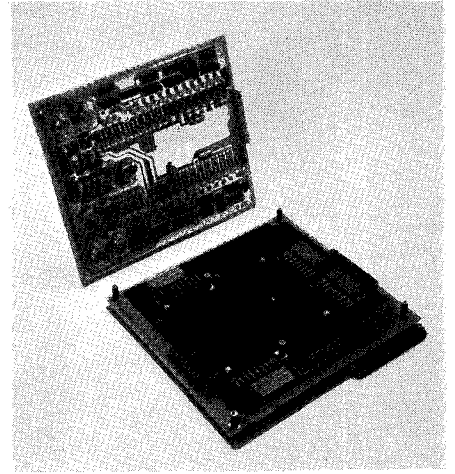

FI-65

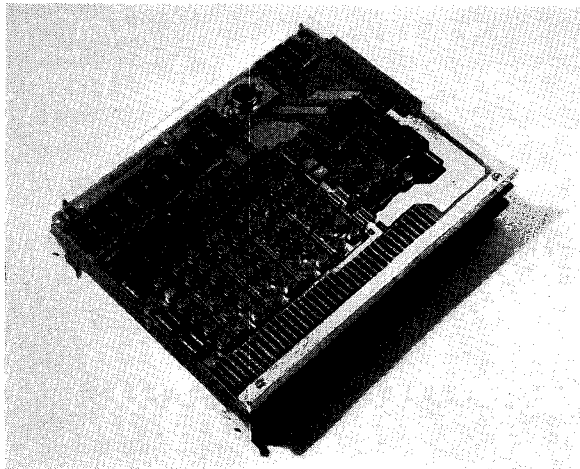

Q-14

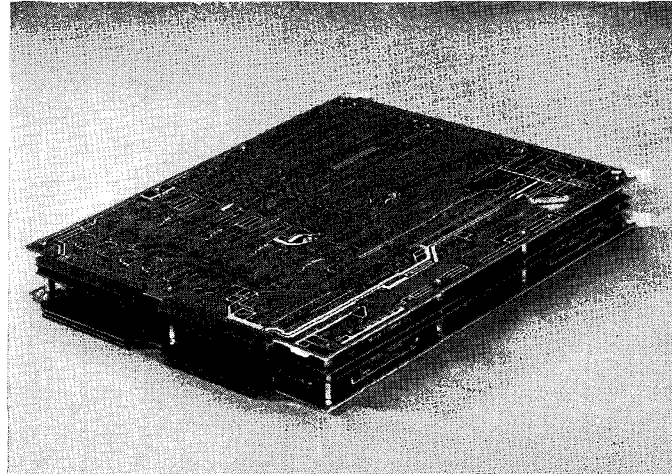

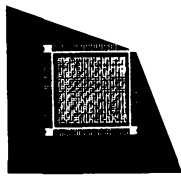

Computer components ferrite core matrix planes and stacks

A wide range of planes and stacks are produced using 3D/3W and 3D/4W techniques, with core sizes from 0.018 in to 0.030 in, and capacities up to 32K26.

4k18 3D/3W planar

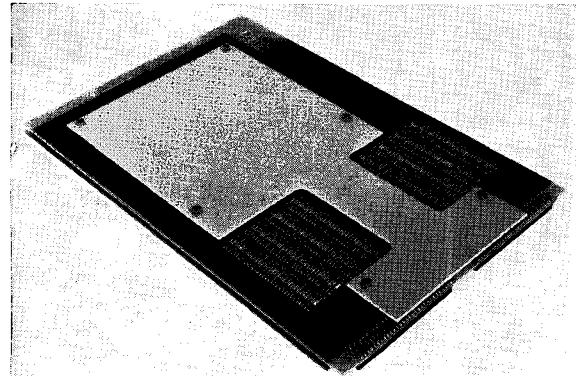

16k18 folded planar 0.018 in cores

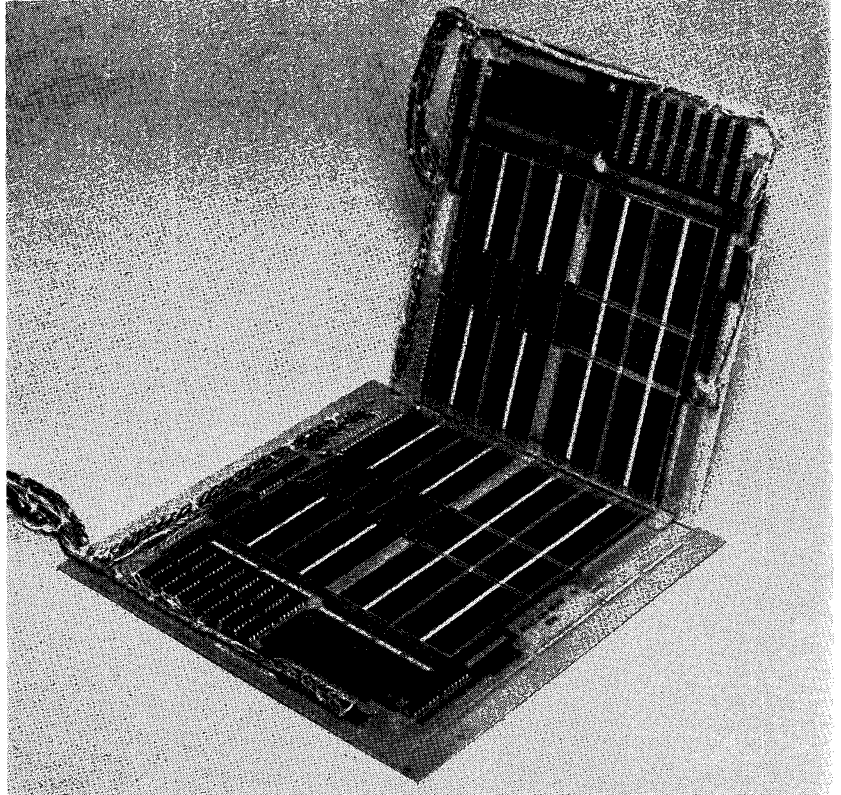

4k16 3D/4W folded planar

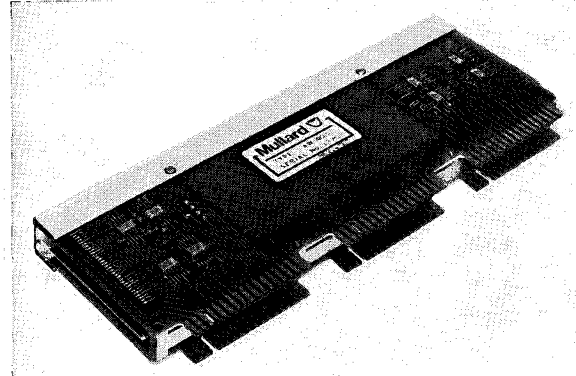

We welcome the opportunity to discuss details of stacks for specific applications and operating environments.

M.O.S. memory systems

We are currently supplying M.O.S. memory systems incorporating the Mullard GYQ101. A brief summary of the system is given below. At the same time we recognise the wide range of possible specifications for such systems, and we are always interested to discuss details of specific requirements.

| | |
|-------------|---|
| Capacity | 4k18 expandable to 16k36 |
| Cycle time | 600ns (refresh interrupt), 1 μ s (hidden refresh) |
| Access time | 450ns (refresh interrupt), 700 ns (hidden refresh) |

M.O.S. memory system

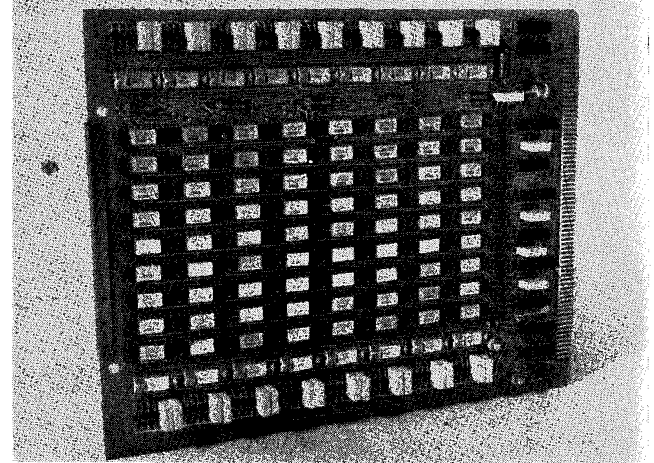



Wound components custom-built service book 3 part 2

Mullard provide a complete service for the design and manufacture of wound inductive components, using ferrite cores. Each component is designed and manufactured to meet customers' individual circuit requirements and thorough testing is applied at all stages of manufacture. Finishes can be supplied to meet various environmental specifications. Wherever possible, adjustment facilities are retained after finishing.

Mechanical arrangements and environmental protection

For inductors and transformers the preferred mechanical arrangements are those used for the miniature pulse transformers, the thyristor trigger transformers, RM-cores, and Vinkors. Stocks of piece parts for these mechanical arrangements are held so that a prompt return of samples, for potential bulk orders, is assured. These types of wound component can be supplied "tropicalised". For inductors and transformers, the normal processes are wax or varnish impregnation under vacuum. These processes can also be applied to L.C. filters which can, if needed, be fitted in hermetically sealed cans.

Inductors

To individual customers' specifications in the range.

Inductance up to 100H
 Inductance tolerance $\pm 0.5\%$
 Q values up to 1000 depending on level and frequency
 Frequency up to 15MHz
 Temperature range -55 to $+85^{\circ}\text{C}$

Transformers

Multi-winding transformers for wide band, pulse and blocking oscillator applications can be manufactured. Close control of matching, leakage inductance and interwinding capacitance is maintained and bifilar windings are used where balanced windings are required.

L.C. filters

L.C. filters, including low pass, high pass and bandpass filters, can be designed to meet customers' specific requirements.

Preferred types

In addition to the custom-built wound components, preferred ranges of miniature pulse transformers and thyristor trigger transformers, as described, are offered.

miniature pulse transformers preferred types book 3 part 2

WF3500 Series

| Type No. | Turns ratio | Min. primary inductance mH | Max. primary ET $V\mu\text{s}$ |
|----------|-------------|----------------------------|--------------------------------|
| WF3500 | 1:1:1 | 0.1 | 4.4 |
| WF3501 | | 0.2 | 6.2 |
| WF3502 | | 0.5 | 9.8 |
| WF3503 | | 1 | 14 |
| WF3504 | | 2 | 20 |
| WF3505 | | 5 | 31 |
| WF3506 | | 10 | 44 |
| WF3507 | 20 | 62 | |
| <hr/> | | | |
| WF3508 | 1:2:2 | 0.1 | 4.4 |
| WF3509 | | 0.2 | 6.2 |
| WF3510 | | 0.5 | 9.8 |
| WF3511 | | 1 | 14 |
| WF3512 | | 2 | 20 |
| WF3513 | | 5 | 31 |
| WF3514 | | 10 | 44 |
| WF3515 | 20 | 62 | |

| Type No. | Turns ratio | Min. primary inductance mH | Max. primary ET $V\mu\text{s}$ |
|----------|-------------|----------------------------|--------------------------------|
| WF3516 | 1:5:5 | 0.1 | 4.4 |
| WF3517 | | 0.2 | 6.2 |
| WF3518 | | 0.5 | 9.8 |
| WF3519 | | 1 | 14 |
| WF3520 | | 2 | 20 |
| WF3521 | | 5 | 31 |

WF4500 Series

| Type No. | Turns ratio | Min. primary inductance mH | Max. primary ET $V\mu\text{s}$ |
|----------|-------------|----------------------------|--------------------------------|
| WF4500 | 1:1 | 0.1 | 2.4 |
| WF4501 | | 0.2 | 3.3 |
| WF4502 | | 0.5 | 5.4 |
| WF4503 | | 1 | 7.5 |
| WF4504 | | 2 | 10 |
| WF4505 | | 5 | 16 |
| WF4506 | | 10 | 23 |
| WF4507 | 20 | 33 | |

Miniature pulse transformer

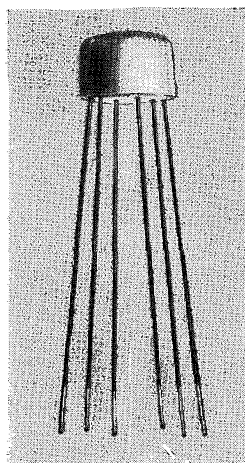

Custom-built wound assemblies

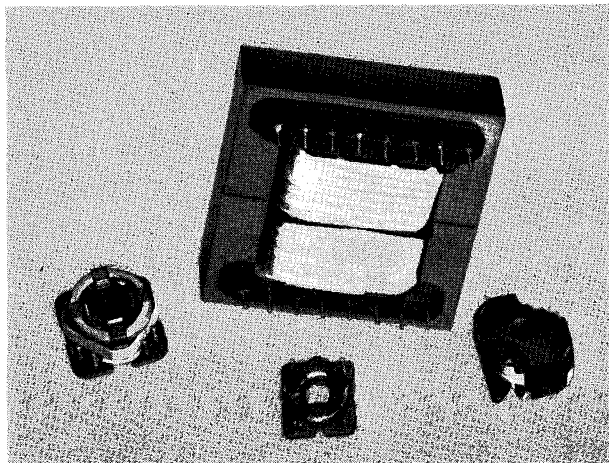

Thyristor trigger transformers

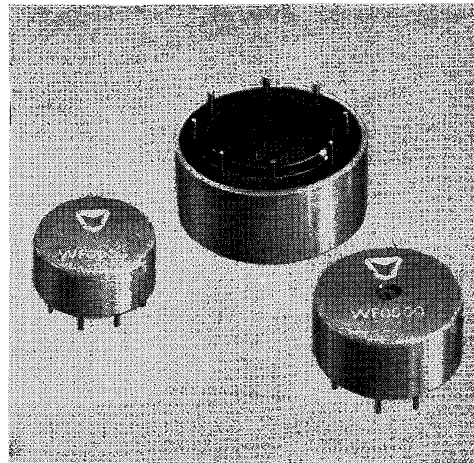

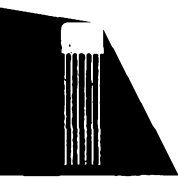

Wound components

miniature pulse transformers (cont.)

preferred types book 3 part 2

NF4500 Series—continued

| Type No. | Turns ratio | Min. primary inductance mH | Max. primary ET V μ s | Type No. | Turns ratio | Min. primary inductance mH | Max. primary ET V μ s |
|----------|-------------|----------------------------|---------------------------|----------|-------------|----------------------------|---------------------------|
| WF4508 | 1:2 | 0.1 | 2.4 | WF4548 | 1:4:4 | 0.1 | 2.4 |
| WF4509 | | 0.2 | 3.3 | WF4549 | | 0.2 | 3.3 |
| WF4510 | | 0.5 | 5.4 | WF4550 | | 0.5 | 5.4 |
| WF4511 | | 1 | 7.5 | WF4551 | | 1 | 7.5 |
| WF4512 | | 2 | 10 | WF4552 | | 2 | 10 |
| WF4513 | | 5 | 16 | WF4553 | | 5 | 16 |
| WF4514 | | 10 | 23 | WF4554 | | 10 | 23 |
| | | | | WF4555 | 20 | 33 | |
| WF4516 | 1:3 | 0.1 | 2.4 | WF4564 | 2:1:1 | 0.1 | 2.4 |
| WF4517 | | 0.2 | 3.3 | WF4565 | | 0.2 | 3.3 |
| WF4518 | | 0.5 | 5.4 | WF4566 | | 0.5 | 5.4 |
| WF4519 | | 1 | 7.5 | WF4567 | | 1 | 7.5 |
| WF4520 | | 2 | 10 | WF4568 | | 2 | 10 |
| WF4521 | | 5 | 16 | WF4569 | | 5 | 16 |
| WF4522 | | 10 | 23 | WF4570 | | 10 | 23 |
| WF4523 | 20 | 33 | WF4571 | 20 | 33 | | |
| WF4524 | 1:4 | 0.1 | 2.4 | WF4572 | 3:1:1 | 0.1 | 2.4 |
| WF4525 | | 0.2 | 3.3 | WF4573 | | 0.2 | 3.3 |
| WF4526 | | 0.5 | 5.4 | WF4574 | | 0.5 | 5.4 |
| WF4527 | | 1 | 7.5 | WF4575 | | 1 | 7.5 |
| WF4528 | | 2 | 10 | WF4576 | | 2 | 10 |
| WF4529 | | 5 | 16 | WF4577 | | 5 | 16 |
| WF4530 | | 10 | 23 | WF4578 | | 10 | 23 |
| WF4531 | 20 | 33 | WF4579 | 20 | 33 | | |
| WF4532 | 1:5 | 0.1 | 2.4 | WF4580 | 4:1:1 | 0.1 | 2.4 |
| WF4533 | | 0.2 | 3.3 | WF4581 | | 0.2 | 3.3 |
| WF4534 | | 0.5 | 5.4 | WF4582 | | 0.5 | 5.4 |
| WF4535 | | 1 | 7.5 | WF4583 | | 1 | 7.5 |
| WF4536 | | 2 | 10 | WF4584 | | 2 | 10 |
| WF4537 | | 5 | 16 | WF4585 | | 5 | 16 |
| | | | | WF4586 | | 10 | 23 |
| | | | WF4587 | 20 | 33 | | |
| WF4540 | 1:3:3 | 0.1 | 2.4 | WF4588 | 5:1:1 | 0.1 | 2.4 |
| WF4541 | | 0.2 | 3.3 | WF4589 | | 0.2 | 3.3 |
| WF4542 | | 0.5 | 5.4 | WF4590 | | 0.5 | 5.4 |
| WF4543 | | 1 | 7.5 | WF4591 | | 1 | 7.5 |
| WF4544 | | 2 | 10 | WF4592 | | 2 | 10 |
| WF4545 | | 5 | 16 | WF4593 | | 5 | 16 |
| WF4546 | | 10 | 23 | WF4594 | | 10 | 23 |
| | | | WF4595 | 20 | 33 | | |

Mechanical details of WF3500 and WF4500 Series:

body diameter 9.6 mm max; body height 6.8 mm max; lead length 38 mm min; climatic group (to DEF 5011) H5, T3, GP2

thyristor trigger transformers book 3 part 2

Wound on Mullard Ferroxcube pot cores. Four windings, primary, feedback and two outputs are provided having turns ratios 2 : 1 : 1 : 1

| Type No. | Core size mm | Min. primary inductance (mH) | Max. primary ET (V μ s) | Type No. | Core size mm | Min. primary inductance (mH) | Max. primary ET (V μ s) |
|----------|--------------|------------------------------|-----------------------------|----------|--------------|------------------------------|-----------------------------|
| WF3806 | 14 | 10 | 400 | WF3809 | 25 | 10 | 1000 |
| WF3807 | 14 | 30 | 700 | WF3810 | 25 | 30 | 1700 |
| WF3808 | 14 | 100 | 1300 | WF3811 | 25 | 100 | 3000 |

For the transformers using 25 mm cores, body diameter 39.6 mm max, seated height 20.3 mm max.

For the transformers using 14 mm cores, body diameter 24.6 mm max, seated height 13.2 mm max.

Mullard

Mullard Limited
Mullard House
Torrington Place
London WC1E 7HD
Tel : 01-580 6633



Birmingham 021-236 8541 : Gothic Electronic Components Ltd., Beacon House, Hampton St., Birmingham 19

Birmingham 021-359 4301 : Hawnt Electronics Ltd., 112/114 Pritchett St., Birmingham B6 4EN

Bristol 0272 294313 : Black Arrow Electronics Ltd., Wirelect House, 122/123 St. Thomas St., Bristol BS1 6JW

Crawley 0293 28700 : SASCO Ltd., P.O. Box 2000, Gatwick Road, Crawley, Sussex RH10 2RU

Leeds 0532 636311 : Farnell Electronic Components Ltd., Canal Road, Leeds LS12 2TU

Leicester 0533 768561 : Townsend-Coates Ltd., Coleman Road, Leicester LE5 4LP

London 01-237 0404 : Edmundson Electronic Components Ltd., Cowley House, 30/50 Ossory Road, London SE1 5AP

Reading 0734 582211 : Celdis Ltd., 37/39 Loverock Road, Reading, Berkshire RG3 1ED

Rochdale 0706 47411 : Swift Hardman Ltd., P.O. Box 23, Hardale House, Baillie St., Rochdale, Lancs. OL16 1JE