

Essential Characteristics

GE Receiving Tubes

Canadian General Electric Company Limited

May 1951

Scanned by VE6BPO January 2007.

ESSENTIAL CHARACTERISTICS—RECEIVING TYPES is especially prepared to provide the Service Technician with a single source of reference containing data on every tube apt to be found in any home receiver—AM, FM, or Television.

Data presented include those characteristics and ratings essential to fast, efficient, trouble-shooting. Basing diagrams for each type are shown on the page with the data.

The electronics engineer, amateur, and experimenter will also find this a valuable quick-reference for tubes currently in use.

Included in the present edition of this handbook are the many new receiving tubes recently announced for use in Television applications; a comprehensive coverage of subminiature tubes; and a new section listing the essential physical and electrical characteristics of Television Picture Tubes.

To aid in the proper evaluation of the information presented in this handbook, a section entitled "Interpretation of Ratings and Technical Data" has been included. Following this section is a chart of "Recommended Types" which will provide the Service Technician with a valuable guide to tubes apt to be found in the late-model receivers.

Requests for additional data on specific uses of individual types will receive prompt attention if addressed to:

**ELECTRONICS DIVISION
CANADIAN GENERAL ELECTRIC COMPANY LTD.
212 KING ST. W. TORONTO, ONT.**

INTERPRETATION OF RATINGS AND TECHNICAL DATA

I. MAXIMUM RATINGS

Unless otherwise specified, the maximum tube ratings in this manual have been prepared in accordance with the RTMA system of Design Center Maximums and should be interpreted as defined in paragraphs 1 and 2 given below.

1. Cathode

The heater or filament voltage is given as a normal value unless stated otherwise. This means that transformers or resistances in the heater or filament circuit should be designed to operate the heater or filament at rated value for full-load operating conditions under average supply-voltage conditions. A reasonable amount of leeway is incorporated in the cathode design so that moderate fluctuations of heater or filament voltage downward will not cause marked falling off in response; also, moderate voltage fluctuations upward will not reduce the life of the cathode to an unsatisfactory degree.

A. 1.4-volt Battery Tube Types

The filament power supply may be obtained from dry-cell batteries, from storage batteries, or from a power line. With dry-cell battery supply the filament may be connected either directly across a battery rated at a terminal potential of 1.5 volts, or in series with the filaments of similar tubes across a power supply consisting of dry cells in series. In either case, the voltage across each 1.4-volt section of filament should not exceed 1.6 volts. With power-line or storage-battery supply, the filament may be operated in series with the filaments of similar tubes. For such operation, design adjustments should be made so that, with tubes of rated characteristics, operating with all electrode voltages applied and on a normal line voltage of 117 volts or on a normal storage-battery voltage of 2.0 volts per cell (without a charger) or 2.2 volts per cell (with a charger), the voltage drop across each 1.4-volt section of filament will be maintained within a range of 1.25 to 1.4 volts with a nominal center of 1.3 volts. In order to meet the recommended conditions for operating filaments in series from dry-battery, storage batteries, or power-line sources it may be necessary to use shunting resistors across the individual 1.4-volt sections of filament.

B. 2.0-volt Battery Tube Types

The 2.0-volt line of tubes is designed to be operated with 2.0 volts across the filament. In all cases the operating voltage range should be maintained within the limits of 1.8 volts to 2.2 volts.

2. Positive Potential Electrodes

The power sources for the operation of radio equipment are subject to variations in their terminal potential. Consequently, the maximum ratings given in this manual have been established for certain Design Center Voltages which experience has shown to be representative. The Design Center Voltages to be used for the various power supplies together with other rating considerations are as given below.

A. A-C or D-C Power-line Service in U.S.A.

The design center voltage for this type of power supply is 117 volts. The maximum ratings of plate voltages, screen-supply voltages, dissipations, and rectifier output currents are design maximums and should not be exceeded in equipment operated at a line voltage of 117 volts.

B. Storage-battery Service

When storage-battery equipment is operated without a charger, it should be so designed that the published maximum values of plate voltages, screen-supply voltages, dissipations, and rectifier output currents are never exceeded for a terminal potential at the battery source of 2.0 volts per cell. When storage-battery equipment is operated with a charger it should be so designed that 90 per cent of the same values are never exceeded for a terminal potential at the battery source of 2.2 volts per cell.

C. B-Battery Service

The design center voltage for B-batteries is the normal voltage rating of the battery block, such as 45 volts, 90 volts, etc. Equipment should be so designed that under no condition of battery voltage will the plate voltages, the screen-supply voltages, or dissipations ever exceed the recommended respective maximum values shown in the data for each tube type by more than 10 per cent.

D. Other Considerations

a. Class A Amplifiers

The maximum plate dissipation occurs at the Zero-signal condition. The maximum screen dissipation usually occurs at the condition where the peak-input signal voltage is equal to the bias voltage.

b. Class B Amplifiers

The maximum plate dissipation theoretically occurs at approximately 63 per cent of the Maximum-signal condition, but practically may occur at any signal-voltage value.

c. Converters

The maximum plate dissipation occurs at the Zero-signal condition and the frequency at which the oscillator-developed bias is a minimum. The screen dissipation for any reasonable variation in signal voltage must never exceed the rated value by more than 10 per cent.

d. Screen Ratings

The maximum screen voltage rating may be exceeded provided that all the following conditions are satisfied:

1. At any operating condition the screen voltage does not exceed the maximum plate voltage rating.
2. At any operating condition the average screen dissipation does not exceed the maximum rating.
3. At the operating condition which results in maximum screen current, the screen voltage does not exceed the value required for maximum screen dissipation. This condition, however, may not represent the maximum dissipation condition.

3. Absolute Maximum Ratings

In some instances, the maximum ratings are specified as Absolute Maximum Ratings. The absolute maximum ratings represent the limiting values above which the serviceability of the tube may be impaired from the viewpoint of life and satisfactory performance. Therefore in order not to exceed these absolute ratings, the equipment designer has the responsibility of determining an average design value for each rating below the absolute value of that rating by an amount such that the absolute values will never be exceeded under any usual condition of supply-voltage variation, manufacturing variations (including components) in the equipment itself, or adjustment of controls.

II. TYPICAL OPERATING CONDITIONS

For many receiving tubes, the data show typical operating conditions in particular services. These typical operating values are given to show concisely some guiding information for the use of each type. They are not to be considered as ratings, because the tube can be used under any suitable conditions within its rating limitations.

III. GENERAL

1. Interelectrode Capacitances

A. Unless otherwise noted, all capacitance values indicated in this manual are average values.

B. Unless otherwise noted, all capacitance values indicated in this manual for glass tubes are measured with a close-fitting metal shield as standardized by RTMA.

2. Use of Pin No. 1 on Octal Types

Pin No. 1 on metal receiving tubes is usually connected to the outer shell of the tube. Certain glass tubes with octal bases have internal shields connected to this pin. In order to obtain correct operation of octal based tubes, Pin No. 1 should never be used as a terminal for any voltage or portion of the electrical circuit, but should be connected to ground whenever possible.

3. Use of GT/G Suffix

The use of the suffix GT/G on small glass receiving tubes has been eliminated and for this reason does not appear in this manual. Data on tubes which have been previously marked as GT/G types may be obtained by referring to the data under the GT listing (for example, characteristics of the 6J5-GT/G will be found under the 6J5-GT listing).

4. Rectifier Characteristics

Unless otherwise noted, all ratings and characteristics, presented for rectifier tubes apply to operation with a capacitor-input filter. In general, operation with a choke-input filter allows the use of a slightly higher RMS supply voltage.

5. Metal Types

Metal tube type designations are shown in boldface type on the following pages to facilitate the location of these types in the tabular material.

6. Miniature Types

The type designations of miniature tubes are shown in italics on the following pages for ease of location in the tabular material.

7. X-Ray Radiation from TV Picture Tubes

Cathode-ray tubes rated at anode voltages in excess of 16,000 volts may require x-ray radiation shielding to avert possible danger of personal injury from prolonged exposure at close range. The protective fore-viewing window of apparatus using tubes of this type may provide such a safeguard. If the radiation measured in contact with this window is not in excess of 6.25 milliroentgens per hour the window will provide adequate protection.

RECOMMENDED TYPES

Filament	Voltage Amplifiers					
	Triodes			Pentodes		
	Single	Twin	With Diodes	Sharp Cutoff	Remote Cutoff	With Diodes
0 thru 2.8 volts				<i>IU4</i>	<i>IT4</i>	<i>IU5</i>
5.0 thru 6.3 volts	<i>6AB4</i> <i>6C4</i>	<i>6J6</i> <i>6SN7-GT</i>	<i>6AV6</i> 6SQ7 <i>6T8</i>	<i>6AU6</i> <i>6BC6</i> <i>6CB6</i>	6BA6 6SK7	
12.6 volts and above		<i>12AT7</i> <i>12AU7</i> <i>12AX7</i>	<i>12AV6</i> 12SQ7 <i>19T8</i>		<i>12BA6</i> 12SK7	

Filament	Thermionic Diodes and Rectifiers	Power Amplifiers		Gated-beam Tubes	Pentagrid Converters	TV Picture Tubes
		Output Amplifiers	TV Deflection Amplifiers			
0 thru 2.8 volts	<i>1B3-GT</i> <i>1X2-A</i>	<i>3S4</i> <i>3V4</i>			<i>IR5</i>	
5.0 thru 6.3 volts	<i>5U4-G</i> <i>5Y3-GT</i> <i>6AL5</i> <i>6W4-GT</i> <i>6X4</i> <i>6X5-GT</i>	<i>6AQ5</i> <i>6K6-GT</i> <i>6V6-GT</i> <i>6W6-GT</i>	<i>6BG6-G</i> <i>6BQ6-GT</i> <i>6CD6-G</i> <i>6S4</i>	<i>6BN6</i>	<i>6BE6</i> 6SA7	<i>10BP4-A</i> <i>12LP4-A</i> <i>14CP4</i> <i>14EP4</i> <i>16KP4</i> <i>17BP4-A</i> <i>20CP4</i>
12.6 volts and above	<i>25W4-GT</i> 35W4 <i>35Z5-GT</i>	<i>25L6-GT</i> 35C5 <i>50C5</i> <i>50L6-GT</i>	<i>25AV5-GT</i> <i>25BQ6-GT</i>		<i>12BE6</i> 12SA7	

Type numbers of metal tubes are shown in bold-face type.
Type numbers of miniature tubes are shown in italics.

NOTE

The information presented in this handbook is industry-wide in scope. Consequently, the inclusion of a tube in this publication does not necessarily imply the availability of that type from the Canadian General Electric Company Ltd.

Tube Type	Classification by Construction	Base Connections	Outline Dwg	Type Cathode	Filament Volts	Filament Amp	Max Plate Volts	Max Screen Volts	Capacitance in Micromicrofarads		
									Input	Output	Grid-plate
OOA	Triode Detector	4D	14-1	Fil	5.0 D-C	0.25	45	—	3.2	2.0	8.5
OA#	Glow-Discharge Diode Voltage Regulator	5B0	5-3	Cold	—	—	Anode supply = 185 volts d-c min				
OA3/ VR-75	Glow-Discharge Diode Voltage Regulator	4AJ	12-7	Cold	—	—	Anode supply = 105 volts d-c min				
OA4-G	Gas Triode	4V	12-7	Cold	—	—					
OB#	Glow-Discharge Diode Voltage Regulator	5B0	5-3	Cold	—	—	Anode supply = 133 volts d-c min				
OB3/ VR-90	Glow-Discharge Diode Voltage Regulator	4AJ	12-7	Cold	—	—	Anode supply = 125 volts d-c min				
OC3/ VR-105	Glow-Discharge Diode Voltage Regulator	4AJ	12-7	Cold	—	—	Anode supply = 133 volts d-c min				
OD3/ VR-150	Glow-Discharge Diode Voltage Regulator	4AJ	12-7	Cold	—	—	Anode supply = 185 volts d-c min				
OY4 OY4-G	Half-Wave Gas Rectifier	4BU	8-1 7A-1	Cold	— —	— —	Pins 7 and 8 must be connected;				
OZ4 OZ4-G	Full-Wave Gas Rectifier	4R	8-3 7A-1	Cold	— —	— —					
O1-A	Low-Mu Triode	4D	14-1	Fil	5.0 D-C	0.25	135	—	3.1	2.2	8.1
1A#	R-F Diode	5AP	5-2	Htr	1.4	0.15					
1A4-p 1A4-t	Remote-Cutoff R-F Pentode	4M 4K	12-6	Fil	2.0 D-C	0.06	180	67.5	5.0▲	11.0▲	0.007
1A5-GT	Power Amplifier Pentode	6X	9-11	Fil	1.4 D-C	0.05	110	110	—	—	—
1A6	Pentagrid Converter	6L	12-6	Fil	2.0 D-C	0.06	180	67.5	Anode = 180 volts thru 20,000 ohms $I_p = 2.3$ ma Anode = 135 volts $I_p = 2.3$ ma		
1A7-G 1A7-GT	Pentagrid Converter	7Z	9-28 9-18	Fil	1.4 D-C	0.05	110	60	Anode = 90 volts $I_p = 1.2$ ma		
1AB5	Remote-Cutoff R-F Pentode	5BF	9-32	Fil	1.2 D-C	0.130	150	150	2.8	4.2	0.25♣
1AC5⊙	Power Amplifier Pentode	8CP	3-5	Fil	1.25 D-C	0.04	67.5	67.5	—	—	—

▲ Without external shield.

§ Approximate.

† Zero signal.

♣ Maximum.

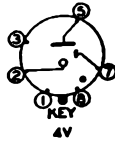
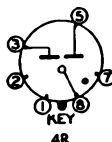
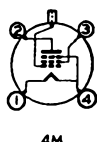
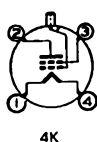
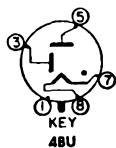
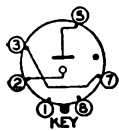

Service	Neg Grid Volts	Screen Volts	Screen Milli-am-peres	Plate Volts	Plate Milli-am-peres	R _p , Ohms	G _m , μmhos	μ Factor	Load for Rated Out-put, Ohms	Power Out-put, Watts	Tube Type
Detector	0.0	—	—	45	1.5	30,000	666	20	—	—	OOA
{ d-c operating current = 5 ma min } Ionization voltage = 155 volts d-c § { d-c operating current = 30 ma max } Operating voltage = 150 volts d-c § Regulation (5 to 30 milliamperes) = 2.0 volts											
{ d-c operating current = 5 ma min } Ionization voltage = 100 volts d-c § { d-c operating current = 40 ma max } Operating voltage = 75 volts d-c § Regulation (5 to 40 milliamperes) = 5.0 volts											
Peak cathode current = 100 ma max; d-c cathode current = 25 ma max; Starter anode drop = 55 volts §; anode drop = 70 volts §											
{ d-c operating current = 5 ma min } Ionization voltage = 115 volts d-c § { d-c operating current = 30 ma max } Operating voltage = 105 volts d-c § Regulation (5 to 30 milliamperes) = 1.0 volts											
{ d-c operating current = 5 ma min } Ionization voltage = 110 volts d-c § { d-c operating current = 40 ma max } Operating voltage = 90 volts d-c § Regulation (5 to 40 milliamperes) = 8.0 volts											
{ d-c operating current = 5 ma min } Ionization voltage = 180 volts d-c § { d-c operating current = 40 ma max } Operating voltage = 105 volts d-c § Regulation (5 to 40 milliamperes) = 2.0 volts											
{ d-c operating current = 5 ma min } Ionization voltage = 160 volts d-c § { d-c operating current = 40 ma max } Operating voltage = 150 volts d-c § Regulation (5 to 40 milliamperes) = 4.0 volts											
peak current = 500 ma max; d-c output current = 75 ma max, 40 ma min; max starting voltage = 95 volts d-c; peak inverse voltage = 300 volts max											
Starter supply voltage per plate = 300 peak volts min; max d-c output = 75 milliamperes; peak current per plate = 200 milliamperes											
Class A Amplifier	9.0	—	—	135	3.0	10,000	800	8	—	—	OY4 OY4-G OZ4 OZ4-G OI-A
Rms plate voltage = 117 volts; peak inverse voltage = 330 volts max; peak plate current = 5.0 ma max; d-c output current = 0.5 ma avg											
Class A Amplifier	3	67.5	0.8	180	2.3	1,000,000	750	—	—	—	1A4-p 1A4-t
Class A Amplifier	4.5 4.5	90 85	0.8† 0.7†	90 85	4.0† 3.5†	300,000 300,000	850 800	— —	25,000 25,000	0.115 0.100	1A5-GT
Converter	3.0	67.5	2.4	180	1.3	500,000	Conversion Trans-conductance = 300		—	—	1A6
Converter	3.0	67.5	2.5	135	1.2	400,000	Conversion Trans-conductance = 275		—	—	
Converter	0.0	45	0.7	90	0.6	600,000	Conversion Trans-conductance = 250		—	—	1A7-G 1A7-GT
Class A Amplifier	1.5 R _g = 1.0 Meg	150 90	2.0 0.8	150 90	6.8 3.5	125,000 275,000	1350 1100	— —	— —	— —	1AB5
Class A Amplifier	4.5 3.0 2.0	67.5 45 30	0.4 0.2 0.1	67.5 45.0 30	2.0 1.0 0.5	150,000§ 170,000§ 200,000§	750 600 450	— — —	25,000 40,000 50,000	0.050 0.015 0.005	1AC5 ●

Type designations of metal tubes are shown in bold-face type
 Type designations of miniature tubes are shown in italics.
 ● Designates sub-miniature types.

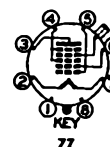
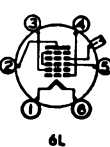
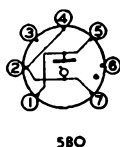
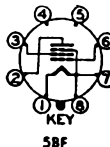
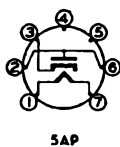

Tube Type	Classification by Construction	Base Connections	Out-line Dwg	Type Cathode	Fila-ment Volts	Fila-ment Amp	Max Plate Volts	Max Screen Volts	Capacitance in Micromicrofarads		
									Input	Out-put	Grid-plate
1AD4 ●	Sharp-Cutoff R-F/A-F Pentode	1AD4	2-1	Fil	1.25 D-C	0.10	45	45	4.5	4.5	0.01 ♣
1AD5 ●	Sharp-Cutoff R-F Pentode	8CP	3-5	Fil	1.25 D-C	0.04	67.5	67.5	1.9	3.0	0.009 ♣
1AE4	Sharp-Cutoff R-F Pentode	6AR	5-2	Fil	1.25 D-C	0.10	90	90	3.6	4.4	0.008 ♣
1AE5 ●	Heptode Mixer	1AE5	2-1	Fil	1.25 D-C	0.06	45	45	G1 injection = 15μa thru 0.2 meg		
1AF4	Sharp-Cutoff Pentode	6AR	5-2	Fil	1.4 D-C	0.025	110	90	3.8	7.6	0.009 ♣
1AF6	Diode, Sharp-Cutoff Pentode	6AU	5-2	Fil	1.4 D-C	0.025	110	110	2.5	4.8	0.17
1B3-GT	Half-Wave High-Voltage Rectifier	3C	9A-5	Fil	1.25	0.2	Max d-c output = 2 ma;				
1B4-p	Sharp-Cutoff R-F Pentode	4M	12-6	Fil	2.0 D-C	0.06	180	67.5	5.0▲	11▲	0.007 ♣
1B5/25-S	Duplex-Diode Triode	6M	12-5 or 9-26	Fil	2.0 D-C	0.06	135	—	1.6▲	1.9▲	3.6▲
1B7-G	Pentagrid Converter	7Z	9-28	Fil	1.4 D-C	0.10	110	65	Anode = 90 volts I _p = 1.6 ma		
1B7-GT			9-18								
1B8-GT	Diode-Triode Power Amplifier Pentode	8AW	9-17	Fil	1.4 D-C	0.10	110	110	Pentode Section		
							110	—	Triode Section		
1C3	Medium-Mu Triode	5CF	5-2	Fil	1.4 D-C	0.05	110	—	0.9	4.2	1.8
1C5-GT	Power Amplifier Pentode	6X	9-11	Fil	1.4 D-C	0.10	110	110	—	—	—
1C6	Pentagrid Converter	6L	12-6	Fil	2.0 D-C	0.12	180	67.5	—	—	—
1C7-G	Pentagrid Converter	7Z	12-8	Fil	2.0 D-C	0.12	180	67.5	—	—	—
1C8 ●	Pentagrid Converter	8CN	3-2	Fil	1.25 D-C	0.040	67.5	45	Osc I _g = 0.070 ma thru 0.1 meg		

▲ Without external shield. § Approximate. † Zero signal. ♣ Maximum.

Service	Neg Grid Volts	Screen Volts	Screen Milli-am-peres	Plate Volts	Plate Milli-am-peres	R _p Ohms	G _m μmhos	μ Factor	Load for Rated Out-put, Ohms	Power Out-put, Watts	Tube Type
Class A Amplifier	R _g = 2 meg	45	0.8	45	3.0	500,000§	2000	—	—	—	1AD4 ●
Class A Amplifier	{ 0.0 0.0	{ 67.5 30	{ 0.75 0.16	{ 67.5 30	{ 1.85 0.45	{ 700,000§ 700,000§	{ 735 430	—	—	—	1AD5 ●
Class A Amplifier	0.0	90	1.2	90	3.5	500,000	1550	—	—	—	1AE4
Mixer	0.0	45	2.0	45	0.9	200,000§	Conversion Trans-conductance = 200		—	—	1AE5 ●
Class A Amplifier	{ 0.0 0.0	{ 90 67.5	{ 0.55 0.32	{ 90 67.5	{ 1.8 1.2	{ 1,800,000§ 2,200,000§	{ 1050 925	—	—	—	1AF4
Class A Amplifier	{ 0.0 0.0	{ 90 67.5	{ 0.4 0.25	{ 90 67.5	{ 1.1 0.7	{ 2,000,000§ 2,800,000§	{ 600 550	—	—	—	1AF6
max peak current = 17 ma; max peak inverse voltage = 30,000 volts											1B3-GT
Class A Amplifier	{ 3.0 3.0	{ 67.5 67.5	{ 0.6 0.7	{ 180 90	{ 1.7 1.6	{ 1,500,000 1,000,000	{ 650 600	—	—	—	1B4-p
Class A Amplifier	3.0	—	—	135	0.8	35,000	575	20	—	—	1B5/25-S
Converter	0.0	45	1.3	90	1.5	350,000	Conversion Trans-conductance = 350		—	—	1B7-G 1B7-GT
Class A Amplifier	6.0	90	1.4†	90	6.3†	—	1,150	—	14,000	0.210	1B8-GT
Class A Amplifier	0.0	—	—	90	0.15	240,000	275	—	—	—	
Class A Amplifier	{ 3.0 0.0	—	—	{ 90 90	{ 1.4 4.5	{ 19,000 11,200	{ 760 1,300	{ 14.5 14.5	—	—	1C3
Class A Amplifier	7.5	90	1.6†	90	7.5†	115,000	1,550	180	8,000	0.240	1C5-GT
Class A Amplifier	7.0	83	1.6†	83	7.0†	110,000	1,500	165	9,000	0.200	
Converter	{ 3.0 3.0	{ 67.5 67.5	{ 2.0 2.5	{ 180 135	{ 1.5 1.3	{ 700,000 600,000	Conversion Trans-conductance = 325 Conversion Trans-conductance = 300		—	—	1C6
Converter	{ 3.0 3.0	{ 67.5 67.5	{ 2.0 2.5	{ 180 135	{ 1.5 1.3	{ 700,000 600,000	Conversion Trans-conductance = 325 Conversion Trans-conductance = 300		—	—	1C7-G
Converter	0.0	67.5†	1.5	67.5	1.0	400,000	Conversion Trans-conductance = 150		—	—	1C8 ●

† Screen supply applied through properly by-passed 20,000 ohm resistor.

Type designations of miniature tubes are shown in italics. ● Designates sub-miniature types.

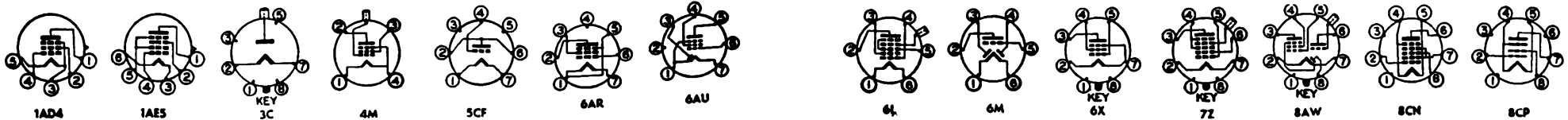

CHARACTERISTICS

Tube Type	Classification by Construction	Base Connections	Out-line Dwg	Type Cathode	Fila-ment Volts	Fila-ment Amp	Max Plate Volts	Max Screen Volts	Capacitance in Micromicrofarads		
									Input	Out-put	Grid-plate
1D3	Low-Mu UHF Triode	8DN	3-2	Fil	1.25 D-C	0.30	110	—	1.0	1.0	2.8
1D5-Gp	Remote-Cutoff R-F Pentode	5Y	12-8	Fil	2.0 D-C	0.06	180	67.5	5.0▲	11.0▲	0.007♣
1D5-Gt	Remote-Cutoff R-F Tetrode	5R	12-8	Fil	2.0 D-C	0.06	180	67.5	—	—	—
1D7-G	Pentagrid Converter	7Z	12-8	Fil	2.0 D-C	0.06	180	67.5	Anode = 180 volts thru 20,000 ohms I _p = 2.3 ma Anode = 135 volts I _p = 2.3 ma		
1D8-GT	Diode-Triode Power Amplifier Pentode	8AJ	9-17	Fil	1.4 D-C	0.10	110	110	Pentode Section		
							110	—	Triode Section		
1E4-G	Medium-Mu Triode	5S	9-25	Fil	1.4 D-C	0.05	110	—	2.4	6.0	2.4
1E5-Gp	Remote-Cutoff R-F Pentode	5Y	12-8	Fil	2.0 D-C	0.06	180	67.5	5.0▲	11.0▲	0.007♣
1E7-G	Twin-Pentode Power Amplifier	8C	14-3	Fil	2.0 D-C	0.24	135	135	Each Section		
1E7-GT			9-11						Push-pull		
1E8	Pentagrid Converter	8CN	3-5	Fil	1.25 D-C	0.04	67.5	45	Osc I _g = 0.07 ma thru 0.1 meg		
1F4	Power Amplifier Pentode	5K	14-1	Fil	2.0 D-C	0.12	180	180	—	—	—
1F5-G	Power Amplifier Pentode	6X	12-7	Fil	2.0 D-C	0.12	180	180	—	—	—
1F6	Duplex-Diode Sharp-Cutoff Pentode	6W	12-6	Fil	2.0 D-C	0.06	180	67.5	4.0▲	9.0▲	0.007♣
1F7-GH 1F7-GV	Duplex-Diode Sharp-Cutoff Pentode	7AD	12-8	Fil	2.0 D-C	0.06	180	67.5	3.8	9.5	0.01♣
1G4-GT	Detector Amplifier Triode	5S	9-11	Fil	1.4 D-C	0.05	110	—	2.2▲	3.4▲	2.8▲
1G5-G	Power Amplifier Pentode	6X	12-7	Fil	2.0 D-C	0.12	135	135	—	—	—
1G6-GT	Twin-Triode Power Amplifier	7AB	9-11	Fil	1.4 D-C	0.10	110	—	—	—	—
1H4-G 1H4-GT	Low-Mu Triode	5S	12-7	Fil	2.0 D-C	0.06	180	—	Single Tube		
			9-11						Two Tubes		
1H5-G 1H5-GT	Diode High-Mu Triode	5Z	9-28	Fil	1.4 D-C	0.05	110	—	1.1	4.6	1.0
			9-18								

▲ Without external shield. § Approximate. † Zero signal. ♣ Maximum. † Undistorted
 □ Absolute maximum rating. ⊕ For both sections. ♠ Per section. ‡ Plate-to-plate.

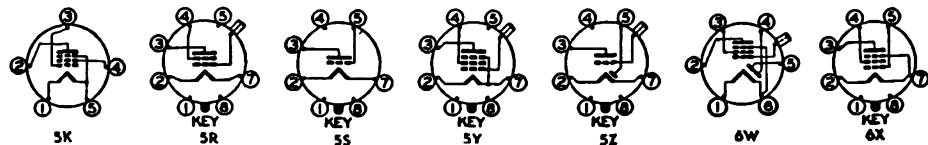

AND RATINGS

Service	Neg Grid Volts	Screen Volts	Screen Milli-am-peres	Plate Volts	Plate Milli-am-peres	R _p , Ohms	G _m , μmhos	# Factor	Load for Rated Out-put, Ohms	Power Out-put, Watts	Tube Type
Class A Amplifier	3.0	67.5	0.8	180	2.3	1,000,000§	750	750	—	—	1D5-Gp
Class A Amplifier	3.0	67.5	0.7	180	2.2	600,000§	650	390	—	—	1D5-Gt
Converter	3.0	67.5	2.4	180	1.3	500,000	Conversion Trans-conductance = 300			—	1D7-G
Converter	3.0	67.5	2.5	135	1.2	400,000	Conversion Trans-conductance = 275			—	
Class A Amplifier	9.0	90	1.0	90	5.0	200,000§	925	—	12,000	0.20	1D8-GT
Class A Amplifier	0.0	—	—	90	1.1	43,500§	575	25	—	—	
Class A Amplifier	0.0	—	—	90	4.5	11,200	1,300	14.5	—	—	1E4-C
	3.0	—	—	90	1.4	19,000	760	—	—	—	
Class A Amplifier	3.0	67.5	0.6	180	1.7	1,500,000	650	1,000	—	—	1E5-Gp
	3.0	67.5	0.7	90	1.6	1,000,000	600	550	—	—	
Class A Amplifier	4.5	135	2.2†	135	7.5†	280,000§	1,425	—	16,000	0.29	1E7-G
Class A Amplifier	7.5	135	2.0†	135	7.0†	—	—	—	24,000†	0.575	1E7-GT
Converter	0.0	67.5‡	1.5	67.5	1.0	400,000§	Conversion Trans-conductance = 150			—	1E8
Class A Amplifier	4.5	135	2.4†	135	8†	200,000§	1,700	340	16,000	0.310†	1F4
	3.0	90	1.1	90	4	240,000§	1,400	336	—	—	
Class A Amplifier	4.5	135	2.4†	135	8†	200,000§	1,700	340	16,000	0.310†	1F5-G
	3.0	90	1.1	90	4	240,000§	1,400	336	—	—	
Class A Amplifier	1.5	67.5	0.7	180	2.2	1,000,000	650	650	—	—	1F6
Class A Amplifier	1.5	67.5	0.7	180	2.2	1,000,000	650	650	—	—	1F7-GH 1F7-GV
Class A Amplifier	6	—	—	90	2.3	10,700	825	8.8	—	—	1G4-GT
Class A Amplifier	13.5	135	2.5†	135	8.7†	160,000	1,550	250	9,000	0.55	1G5-G
	6.0	90	2.5†	90	8.5†	133,000	1,500	—	8,500	0.25	
Class A Amplifier	0.0	—	—	90	1.0	40,000§	825	33	—	—	1G6-GT
Class B Amplifier	0.0	—	—	90	2.0†	—	—	—	12,000†	0.675	
Class A Amplifier	13.5	—	—	180	3.1	10,300	900	9.3	—	—	1H4-G
Class B Amplifier	15.0	—	—	157.5	1.0†	Input Signal = .260 watt			8,000†	2.1	1H4-GT
Class A Amplifier	0.0	—	—	90	0.15	240,000	275	65	—	—	1H5-G 1H5-GT

⊙ Designates subminiature type. Type designations of miniature tubes are shown in italics.
 ‡ Screen supply applied through properly by-passed 20,000 ohm resistor.

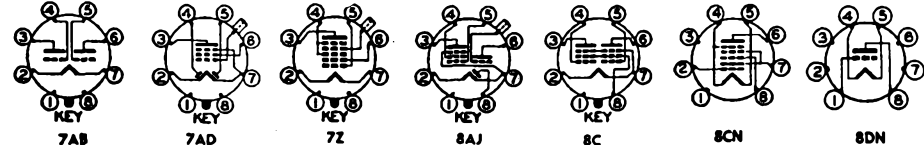

Tube Type	Classification by Construction	Base Connections	Out-line Dwg	Type Cathode	Fila-ment Volts	Fila-ment Amp	Max Plate Volts	Max Screen Volts	Capacitance in Micromicrofarads		
									Input	Out-put	Grid-plate
1H6-G 1H8-GT	Duplex-Diode Triode	7AA	12-7 9-11	Fil	2.0 D-C	0.06	135	—	—	—	—
1J5-G	Power Amplifier Pentode	6X	14-3	Fil	2.0 D-C	0.12	135	135	—	—	—
1J6-G	Power Amplifier Twin Triode	7AB	12-7	Fil	2.0 D-C	0.24	135	—	—	—	—
1J6-GT	Power Amplifier Twin Triode	7AB	9-16	Fil	2.0 D-C	0.24	135	—	—	—	—
1J6-GX	Power Amplifier Twin Triode	7AB	12-7	Fil	2.0 D-C	0.24	135	—	—	—	—
1L4	Sharp-Cutoff R-F Pentode	6AR	5-2	Fil	1.4 D-C	0.05	110	90	3.6▲	7.5▲	0.008▲ ♣
1L8	Pentagrid Converter	7DC	5-2	Fil	1.4 D-C	0.05	110	65	Osc plate = 90 v; Osc I _p = 1.2 ma		
1LA4	Power Amplifier Pentode	5AD	9-30	Fil	1.4 D-C	0.05	110	110	—	—	—
1LA6	Pentagrid Converter	7AK	9-30	Fil	1.4 D-C	0.05	90	55	—	—	—
1LB4	Power Amplifier Pentode	5AD	9-30	Fil	1.4 D-C	0.05	110	110	—	—	—
1LB6	Pentagrid Converter	8AX	9-30	Fil	1.4 D-C	0.05	90	67.5	—	—	—
1LC5	Sharp-Cutoff R-F Pentode	7AO	9-30	Fil	1.4 D-C	0.05	110	45	3.2	7.0	0.007 ♣
1LC6	Pentagrid Converter	7AK	9-30	Fil	1.4 D-C	0.05	90	90	E _{g2} = 45 volts I _{g2} = 1.4 ma I _{g1} = 0.35 ma		
1LD5	Diode Pentode	6AX	9-30	Fil	1.4 D-C	0.05	90	45	3.2	6.0	0.18 ♣
1LE3	Medium-Mu Triode	4AA	9-30	Fil	1.4 D-C	0.05	110	—	1.7	3.0	1.7
1LP3	Medium-Mu Triode	4AA	9-30	Fil	1.4 D-C	0.05	110	—	1.7	3.0	1.7
1LG5	Semi-Remote Cutoff R-F Pentode	7AO	9-30	Fil	1.4 D-C	0.05	110	110	3.2	7.0	0.007 ♣
1LH4	Diode High-Mu Triode	5AG	9-30	Fil	1.4 D-C	0.05	110	—	2.0	2.4	1.2
1LN5	Sharp-Cutoff R-F Pentode	7AO	9-30	Fil	1.4 D-C	0.05	110	110	3.4	8.0	0.007 ♣
1N5-G	Sharp-Cutoff R-F Pentode	5Y	9-28	Fil	1.4 D-C	0.05	110	110	3.0	10.0	0.007 ♣
1N5-GT			9-18								
1N6-G	Diode Power-Amplifier Pentode	7AM	9-27	Fil	1.4 D-C	0.05	110	110	—	—	—
1N6-GT			9-11								

▲Without external shield. §Approximate. †Zero signal. *Minimum ♣Maximum.

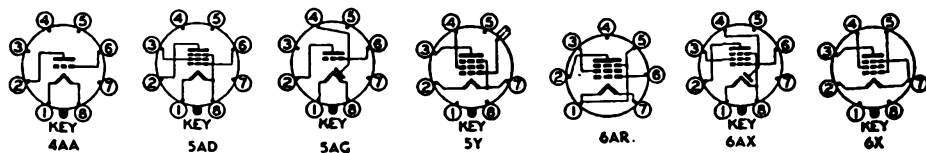

Service	Neg Grid Volts	Screen Volts	Screen Milli-am-peres	Plate Volts	Plate Milli-am-peres	R _p , Ohms	G _m , μmhos	μ Fac-tor	Load for Rated Out-put, Ohms	Power Out-put, Watts	Tube Type
Class A Amplifier	16.5	135	2.0	135	7.0	105,300§	950	100	135,-000	0.45	1J5-G
Class B Amplifier	0.0	—	—	135	5.0†	Input Signal = .170 watt		—	10,-000†	2.1‡	1J6-G
Class B Amplifier	0.0	—	—	135	5.0†	Input Signal = .170 watt		—	10,-000†	2.2‡	1J6-GT
Class B Amplifier	0.0	—	—	135	5.0†	Input Signal = .170 watt		—	10,-000†	2.1‡	1J6-GX
Class A Amplifier	0.0	90	2.0	90	4.5	350,000	1,025	—	—	—	1L4
Converter	0.0	45	0.6	90	0.5	650,000§	Conversion Trans-conductance = 300			—	1L8
Class A Amplifier	4.5 4.5	90 85	0.8† 0.7†	90 85	4.0† 3.5†	300,000 300,000	850 800	255 240	25,000 25,000	0.115 0.100	1LA4
Converter	0.0	45	0.6	90	0.55	750,000	Conversion Trans-conductance = 250			—	1LA6
Class A Amplifier	9.0	90	1.0†	90	5.0†	250,000§	925	—	12,000	0.200	1LB4
Converter	0.0	67.5	2.2	90	0.4	2,000,000§	Conversion Trans-conductance = 100			—	1LB6
Class A Amplifier	0.0	45	0.30	90	1.15	1,000,000*	775	—	—	—	1LC5
Converter	0.0	35	0.7	90	0.75	650,000	Conversion Trans-conductance = 275			—	1LC8
Class A Amplifier	0.0	45	0.1	90	0.6	750,000	575	—	—	—	1LD5
Class A Amplifier	0.0 3.0	—	—	90 90	4.5 1.3	11,200 19,000	1,300 760	14.5 14.5	—	—	1LE3
Class A Amplifier	0.0 3.0	—	—	90 90	4.5 1.4	11,200 19,000	1,300 760	14.5 14.5	—	—	1LP3
Class A Amplifier	0.0	45	0.4	90	1.7	1,000,000§	800	—	—	—	1LG5
Class A Amplifier	0.0	—	—	90	0.15	240,000	275	65	—	—	1LH4
Class A Amplifier	0.0	90	0.35	90	1.6	1,100,000§	800	—	—	—	1LN5
Class A Amplifier	0.0	90	0.30	90	1.2	1,500,000§	750	—	—	—	1N5-G
Class A Amplifier	4.5	90	0.7†	90	3.4†	300,000§	800	—	25,000	0.100	1N6-G
											1N6-GT

†Plate-to-plate.

Type designations of miniature tubes are shown in italics.

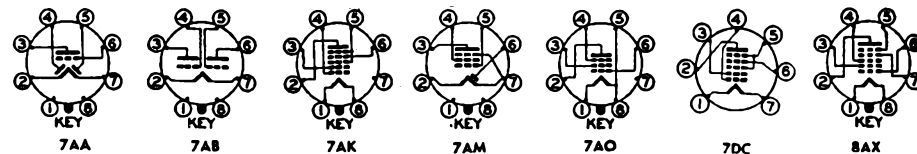

CHARACTERISTICS

Tube Type	Classification by Construction	Base Connections	Out-line Dwg	Type Cathode	Fila-ment Volts	Fila-ment Amp	Max Plate Volts	Max Screen Volts	Capacitance in Micromicrofarads		
									Input	Out-put	Grid-plate
1P5-G	Remote-Cutoff R-F Pentode	5Y	9-28	Fil	1.4 D-C	0.05	110	110	3.0	10.0	0.007
1P5-GT			9-18								♣
1Q5-GT	Beam Power Amplifier	6AF	9-11	Fil	1.4 D-C	0.10	110	110	—	—	—
1Q6	Diode Pentode	8CO	3-2	Fil	1.25 D-C	0.04	100	100	1.8	4.2	0.085
1R4	R-F Diode	4AH	9-30	Htr	1.4	0.15	Max rms plate voltage = 117 volts;				
1R6	Pentagrid Converter	7AT	5-2	Fil	1.4 D-C	0.05	90	67.5	Osc I _g = .25 ma thru 0.1 meg Osc I _g = .25 ma thru 0.1 meg Osc I _g = .25 ma thru 0.1 meg		
1S4	Power Amplifier Pentode	7AV	5-2	Fil	1.4 D-C	0.10	90	67.5	—	—	—
1S6	Sharp-Cutoff Diode Pentode	6AU	5-2	Fil	1.4 D-C	0.05	90	90	—	—	—
1S6	Diode-Pentode	8DA	3-2	Fil	1.25 D-C	0.04	100	100	—	—	—
1SA6-GT	R-F Pentode	6BD	9-12	Fil	1.4 D-C	0.05	90	67.5	5.2	8.6	0.01
1SB6-GT	Diode Pentode	6BE	9-11	Fil	1.4 D-C	0.05	90	67.5	3.2	3.0	0.25
1T4	Remote-Cutoff R-F Pentode	6AR	5-2	Fil	1.4 D-C	0.05	90	90	3.6	7.5	0.01
1T5-GT	Beam Power Amplifier	6X	9-11	Fil	1.4 D-C	0.05	110	110	4.8	8.0	0.5
1T6	Diode-Pentode	8DA	3-5	Fil	1.25 D-C	0.04	67.5	67.5	—	—	—
1U4	Sharp-Cutoff R-F Pentode	6AR	5-2	Fil	1.4 D-C	0.05	110	110	3.6	7.5	0.01
1U6	Sharp-Cutoff Diode Pentode	6BW	5-2	Fil	1.4 D-C	0.05	90	90	—	—	—
1U8	Pentagrid Converter	7DC	5-2	Fil	1.4 D-C	0.025	110	65	Osc plate = 90 v; Osc I _p = 1.1 ma		

†Zero signal. §Approximate. ♣Maximum.

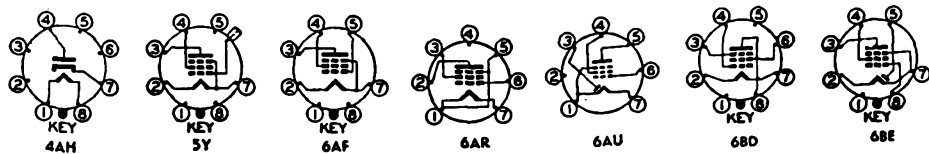

AND RATINGS

Service	Neg Grid Volts	Screen Volts	Screen Milli-am-peres	Plate Volts	Plate Milli-am-peres	R _p , Ohms	G _m , μmhos	μ Fac-tor	Load for Rated Out-put, Ohms	Power Out-put, Watts	Tube Type
Class A Amplifier	0.0	90	0.7	90	2.3	800,000§	750	640§	—	—	1P5-G
											1P5-GT
Class A Amplifier	4.5	90	1.3†	90	9.5†	90,000§	2,200	—	8,000	0.270	1Q5-GT
	5.0	85	0.8†	85	7.0†	70,000§	1,950	—	9,000	0.250	
Class A Amplifier	0.0	67.5	0.40	67.5	1.6	400,000	600	—	—	—	1Q6
Class A Amplifier	0.0	30	0.09	30	0.33	500,000	330	—	—	—	1R4
max d-c output current = 1.0 ma											
Converter	0.0	67.5	3.2	90	1.6	Conversion Trans-conductance = 300		—	—	—	1R6
Converter	0.0	67.5	3.2	67.5	1.4	Conversion Trans-conductance = 280		—	—	—	
Converter	0.0	45	1.9	45	0.7	Conversion Trans-conductance = 235		—	—	—	
Class A Amplifier	7.0	67.5	1.4†	90	7.4†	100,000§	1,575	—	8,000	0.270	1S4
Class A Amplifier	7.0	67.5	1.5†	67.5	7.2†	100,000§	1,550	—	5,000	0.180	
Class A Amplifier	4.5	45.0	0.8†	45	3.8†	100,000§	1,250	—	8,000	0.065	
Class A Amplifier	0.0	67.5	0.4	67.5	1.6	600,000§	625	—	—	—	1S6
Class A Amplifier	0.0	67.5	0.4	67.5	1.6	400,000§	600	—	—	—	1S6
Class A Amplifier	0.0	30	0.10	30	0.33	500,000§	330	—	—	—	1S6
Class A Amplifier	0.0	67.5	0.68	90	2.45	800,000	970	—	—	—	1SA6-GT
Class A Amplifier	0.0	67.5	0.38	90	1.45	700,000	665	—	—	—	1SB6-GT
Class A Amplifier	0.0	67.5	1.4	90	3.5	500,000§	900	—	—	—	1T4
Class A Amplifier	0.0	67.5	1.5	67.5	3.4	250,000§	875	—	—	—	
Class A Amplifier	0.0	45	0.7	45	1.7	350,000§	700	—	—	—	
Class A Amplifier	6.0	90	0.85†	90	6.5†	250,000§	1,150	—	14,000	0.170	1T5-GT
Class A Amplifier	0.0	67.5	0.4	67.5	1.6	400,000§	600	—	—	—	1T6
Class A Amplifier	0.0	30	0.10	30	0.33	500,000§	330	—	—	—	1T6
Class A Amplifier	0.0	90	0.50	90	1.6	1,000,000§	900	—	—	—	1U4
Class A Amplifier	0.0	67.5	0.4	67.5	1.6	600,000§	625	—	—	—	1U6
Converter	0.0	45	0.55	90	0.55	600,000	Conversion Trans-conductance = 275		—	—	1U8

Type designations of miniature tubes are shown in italics. © Designates sub-miniature type.

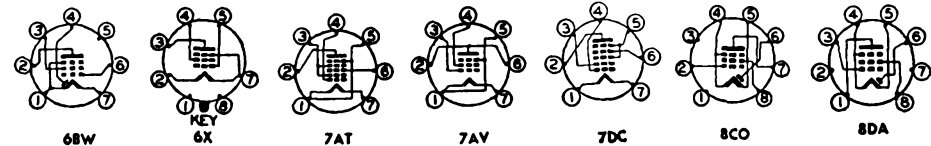

Tube Type	Classification by Construction	Base Connections	Out-line Dwg	Type Cathode	Filament Volts	Filament Amp	Max Plate Volts	Max Screen Volts	Capacitance in Micromicrofarads		
									Input	Output	Grid-plate
1-v	Half-Wave High-Vacuum Rectifier	4G	12-5	Htr	6.3	0.3	Max rms voltage per plate = 325 volts;				
1V \sharp	Half-Wave, High-Voltage Rectifier	9U	6-2	Fil	0.625	0.3	Max d-c output = 0.5 ma;				
1V5 \odot	Power Amplifier Pentode	8CP	3-2	Fil	1.25 D-C	0.04	100	100	—	—	—
1W4	Power Amplifier Pentode	5BZ	5-2	Fil	1.4 D-C	0.05	110	110	3.6	7.0	0.1
1W5 \odot	Sharp-Cutoff R-F Amplifier Pentode	8CP	3-2	Fil	1.25 D-C	0.04	100	100	2.3	3.0	0.009 \clubsuit
1X \sharp	Half-Wave, High-Voltage Rectifier	9Y	1X2	Fil	1.25	0.2	Max d-c output = 1.0 ma;				
1X2-A	Half-Wave, High-Voltage Rectifier	9Y	1X2	Fil	1.25	0.2	Max d-c output \square = 1.1 ma;				
1Y2	Half-Wave High-Vacuum Rectifier	4P	12A-1	Fil	1.5	0.290	Max d-c output current = 2 ma;				
1Z \sharp	Half-Wave Rectifier	7CB	5A-1	Fil	1.5	0.30	Max rms plate voltage = 7.8 kv;				
2A3	Power-Amplifier Triode	4D	16-1	Fil	2.5	2.5	300	—	7.5 \blacktriangle	5.5 \blacktriangle	16.5 \blacktriangle
2A4-G	Gas Triode	5S	12-7	Fil	2.5	2.5	2 tubes, push-pull				
2A5	Power Amplifier Pentode	6B	14-1	Htr	2.5	1.75	375	285	Pentode Connection		
							350	—	Triode Connection		
							375	285	2 Tubes Pentode Connection		
									2 Tubes Triode Connection		
2A6	Duplex-Diode-Hi-Mu Triode	6G	12-6	Htr	2.5	0.8	250	—	1.7	3.8	1.7
2A7	Pentagrid Converter	7C	12-6	Htr	2.5	0.8	300	100	Anode = 250 v thru 20 M Ω , I _p = 4 ma		
2A7-S \star									Anode = 100 v, I _p = 2.0 ma		
2B7	Semi-Remote-Cutoff Duplex-Diode Pentode	7D	12-6	Htr	2.5	0.8	300	125	3.5 \blacktriangle	9.5 \blacktriangle	0.007 \clubsuit
2B7-S \star											
2C21/1642	Medium-Mu Twin Triode	7BH	12-6	Htr	6.3	0.60	250	—	Each Section		

\dagger Zero signal. \S Approximate. \Uparrow Undistorted. \star External shield connected to cathode pin.
 \blacktriangle Without external shield. \clubsuit Maximum. \ddagger Plate-to-plate.



4D



4C



4P



5BZ

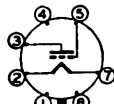

5S



6B



6C

Service	Neg Grid Volts	Screen Volts	Screen Milli-am-peres	Plate Volts	Plate Milli-am-peres	R _p , Ohms	G _m , μmhos	μ Factor	Load for Rated Out-put, Ohms	Power Out-put, Watts	Tube Type
max d-c output = 45 ma; peak current per plate = 270 ma; max peak inverse voltage = 1,000 v											1-v
max peak current = 10 ma; max peak inverse voltage = 7,500 volts											1VZ
Class A Amplifier	4.5	67.5	0.4	67.5	2.0	150,000	750	—	25,000	0.050	1V5⊙
Class A Amplifier	3.0	45	0.2	45	1.0	175,000	600	—	40,000	0.015	
Class A Amplifier	2.0	30	0.1	30	0.5	200,000	450	—	50,000	0.005	
Class A Amplifier	9.0 6.0 4.5	90 67.5 45	1.0† 0.8† 0.3†	90 67.5 45	5.0† 3.8† 1.6†	250,000 300,000 400,000	925 875 650	— — —	12,000 16,000 20,000	0.20 0.10 0.035	1W4
Class A Amplifier	0.0	67.5	0.75	67.5	1.85	700,000‡	735	—	—	—	1W5⊙
Class A Amplifier	0.0	30.0	0.16	30.0	0.45	700,000‡	430	—	—	—	
max peak current = 10 ma; max peak inverse voltage = 15,000 volts											1XZ
max peak current ⊠ = 11 ma; max peak inverse voltage ⊠ = 20,000 volts											1X2-A
max peak plate current = 10 ma; max peak inverse voltage = 50 kv											1Y2
max d-c output current = 2.0 ma; max peak inverse voltage = 20 kv											1ZZ
Class A Amplifier	45	—	—	250	60†	800	5,250	4.2	2,500	3.5	2A3
Class AB ₁ Amplifier	62	—	—	300	80†	—	—	—	3,000†	15	
Peak anode voltage = 200 max volts inverse or forward; peak anode current = 1.25 amp max; average anode current = 0.1 amp max											2A4-G
Class A Amplifier	20.0	285	7.0†	285	38†	78,000‡	2,500	—	7,000	4.8	2A5
Class A Amplifier	20.0	—	—	250	31.0	2,600	2,600	6.8	4,000	0.85¶	
Class AB ₂ Amplifier	26.0	250	5.0†	375	34.0†	—	—	—	10,000†	18.5	
Class AB ₂ Amplifier	38.0	—	—	350	48.0†	—	—	—	6,000†	13.0	
Class A Amplifier	2.0	—	—	250	0.9	91,000	1,100	100	—	—	2A6
Converter	3.0	100	2.7	250	3.5	360,000‡	Conversion Trans-conductance = 550		—	—	2A7
Converter	1.5	50	1.3	100	1.1	600,000‡	Conversion Trans-conductance = 360		—	—	2A7-S *
Class A Amplifier	3.0	125	2.3	250	9.0	600,000‡	1,125	—	—	—	2B7
Class A Amplifier	3.0	100	1.5	250	6.0	800,000	1,000	—	—	—	2B7-S *
Class A Amplifier	16.5	—	—	250	8.3	7,600	1,375	10.4	—	—	2C21/1642

Type designations of miniature tubes are shown in italics.
 ⊙ Designates sub-miniature types.

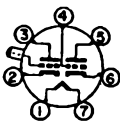

7BM



7C



7CS



7D



8CP

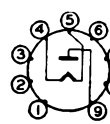

9U



9Y

Tube Type	Classification by Construction	Base Connections	Out-line Dwg	Type Cathode	Filament Volts	Filament Amp	Max Plate Volts	Max Screen Volts	Capacitance in Micromicrofarads		
									Input	Out-put	Grid-plate
2C22	Medium-Mu Triode	4AM	9A-2	Htr	6.3	0.30	300	—	2.2	0.7	3.6
6C61	High-Frequency Twin Triode	8CJ	6-1	Htr	6.3	0.30	300	—	2.2	1.0	1.3
2C52	High-Mu Twin Triode	8BD	9-12	Htr	12.6	0.30	300	—	2.3	0.75	2.7
6D21	Gas Tetrode	7BN	5-2	Htr	6.3	0.6	—	—	—	—	—
2E5	Electron-Ray Tube	6R	9-26	Htr	2.5	0.80	250	—	—	—	—
6E90	Beam Power Amplifier	7CQ	5-3	Fil	(6.0 3.0)	(0.65 1.30)	250	—	9.6	14	0.18 ♣
2E31 ●	Sharp-Cutoff R-F Pentode	2E31	2-1A	Fil	1.25 D-C	0.05	45	45	4.2	4.0	0.018 ♣
2E32 ●	Sharp-Cutoff R-F Pentode	2E31	2-1A	Fil	1.25 D-C	0.05	45	45	4.2	4.0	0.018 ♣
2E35 ●	Power Amplifier Pentode	2E31	2-1	Fil	1.25 D-C	0.03	45	45	2.7	5.7	0.2 ♣
2E36 ●	Power Amplifier Pentode	2E31	2-1	Fil	1.25 D-C	0.03	45	45	2.7	5.7	0.2 ♣
2E41 ●	Diode Pentode	2E41	2-1A	Fil	1.25 D-C	0.03	45	45	2.7	4.3	0.10
2E42 ●	Diode Pentode	2E41	2-1A	Fil	1.25 D-C	0.03	45	45	2.7	4.3	0.10
2G21 ●	Triode-Heptode Converter	2G21	2-3A	Fil	1.25 D-C	0.05	45	45	E _{pt} = 22.5 v I _{pt} = 1.0 ma I _{gt} = 0.03 ma		
2G22 ●	Triode-Heptode Converter	2G21	2-3A	Fil	1.25 D-C	0.05	45	45	E _{pt} = 22.5 v I _{pt} = 1.0 ma I _{gt} = 0.03 ma		
2-S/4-S ★	Twin Diode	5D	—	Htr	2.5	1.35	—	—	—	—	—
6W3	Half-Wave Rectifier	4X	8-6	Fil	2.5	1.50	—	—	—	—	—
2X2-A	Half-Wave Rectifier	4AB	12-6	Htr	2.5	1.75	—	—	—	—	—

†Zero signal.

★External shield connected to cathode pin.

♣Maximum.

■ Absolute maximum rating.

♣ Per section.



2E31



2E41



2G21



4AB



4AM

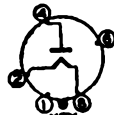

4X

Service	Neg Grid Volts	Screen Volts	Screen Milli-am-peres	Plate Volts	Plate Milli-am-peres	R_p , Ohms	G_m , μ mhos	μ Factor	Load for Rated Out-put, Ohms	Power Out-put, Watts	Tube Type
Class A Amplifier	10.5	—	—	300	11.0	6,600	3,000	20	—	—	2C22
Class A Amplifier \clubsuit	2.0	—	—	150	8.2	—	5,500	35	—	—	2C51
	2.0	—	—	250	1.3	—	1,900	100	—	—	2C52
Peak forward anode voltage \square = 650 volts max; peak inverse voltage \square = 1,300 volts max; max. d-c output \square = 100 ma; max peak current \square = 500 ma										—	2D21
Plate voltage = 250 v thru 1.0 meg. ($E_g = 0$, shadow angle = 90°, $I_p = 0.24$ ma) ($E_g = -8$ v, shadow angle = 0°) Target voltage = 250										—	2E5
Class A Amplifier	20.0	250	3.3†	250	40.0†	63,000	3,700	—	4,500	4.5	2E30
Class A Amplifier	$R_g = 5$ meg	22.5	0.225	45	0.400	1,000,000	525	—	—	—	2E31 ●
Class A Amplifier	$R_g = 5$ meg	30	0.525	30	0.725	270,000	600	—	—	—	
Class A Amplifier	$R_g = 5$ meg	22.5	0.30	22.5	0.40	350,000	500	—	—	—	
Class A Amplifier	$R_g = 5$ meg	22.5	0.225	45	0.400	1,000,000	525	—	—	—	2E32 ●
Class A Amplifier	$R_g = 5$ meg	30	0.525	30	0.725	270,000	600	—	—	—	
Class A Amplifier	$R_g = 5$ meg	22.5	0.30	22.5	0.40	350,000	500	—	—	—	
Class A Amplifier	1.25	45	0.11	45	0.45	250,000	500	—	100000	0.006	2E35 ●
Class A Amplifier	$R_g = 5$ meg	30	0.14	30	0.60	170,000	575	—	150000	0.0027	
Class A Amplifier	$R_g = 5$ meg	22.5	0.07	22.5	0.27	220,000	385	—	150000	0.0012	
Class A Amplifier	1.25	45	0.11	45	0.45	250,000	500	—	100000	0.006	2E36 ●
Class A Amplifier	$R_g = 5$ meg	30	0.14	30	0.60	170,000	575	—	150000	0.0027	
Class A Amplifier	$R_g = 5$ meg	22.5	0.07	22.5	0.27	220,000	385	—	150000	0.0012	
Class A Amplifier	$R_g = 5$ meg	22.5	0.12	22.5	0.35	250,000	375	—	—	—	2E41 ●
Class A Amplifier	$R_g = 5$ meg	22.5	0.12	22.5	0.35	250,000	375	—	—	—	2E42 ●
Converter	$R_g = 5$ meg	22.5	0.30	22.5	0.20	Conversion Trans-conductance = 60		—	—	—	2G21 ●
Converter	$R_g = 5$ meg	22.5	0.30	22.5	0.20	Conversion Trans-conductance = 60		—	—	—	2G22 ●
Plate voltage = 50 volts per plate; cathode current = 80 ma										—	2-S/4-S *
Rms voltage per plate = 350 v; max d-c output = 55 ma										—	2W3
Peak inverse = 12,500 volts; peak plate current = 100 ma, max; d-c output current = 7.5										—	2X2-A

● Designates subminiature types.

Type designations of metal tubes are shown in bold-face type
Type designations of miniature tubes are shown in italics.



5D



6R



7BN

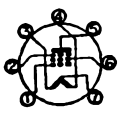

7CQ

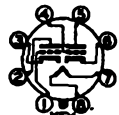

8BD

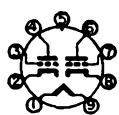

8CJ

Tube Type	Classification by Construction	Base Connections	Out-line Dwg	Type Cathode	Fila-ment Volts	Fila-ment Amp	Max Plate Volts	Max Screen Volts	Capacitance in Micromicrofarads		
									Input	Out-put	Grid-plate
3A4	Power Amplifier Pentode	7BB	5-2	Fil	{2.8 1.4 D-C	{0.1 0.2	150	90	4.8	4.2	0.20 ♣
3A5	High-Frequency Twin Triode	7BC	5-2	Fil	{2.8 1.4 D-C	{0.11 0.22	135	—	0.9	1.0	3.2
3A8-GT	Sharp-Cutoff R-F Amplifier Diode Triode Pentode	8AS	9-17	Fil	{2.8 1.4 D-C	{0.05 0.10	110	—	Triode Section Pentode Section		
3B4	Beam Power Amplifier	7CY	5-2	Fil	1.25 2.50 D-C	0.33 0.16	150	135	4.6▲	7.6▲	0.16▲ ♣
3B5-GT	Beam Power Amplifier	7AQ	9-12	Fil	1.4 2.8 D-C	0.10 0.05	67.5	67.5	Parallel Filaments Series Filaments		
3B7	High-Frequency Twin Triode	7BE	9-30	Fil	1.4 D-C	0.22	180	—	Push-Pull, Two Tubes		
3C5-GT	Power Amplifier Pentode	7AQ	9-12	Fil	1.4 2.8 D-C	0.10 0.05	110	110	Parallel Filaments Series Filaments		
3C6	Medium-Mu Twin Triode	7BW	9-30	Fil	1.4 2.8 D-C	0.10 0.05	110	—	Section 1 {Parallel Section 2 {Filaments Section 1 {Series Section 2 {Filaments		
3D6	Beam Power Amplifier	6BA	9-30	Fil	1.4 D-C	0.22	180	135	7.5	6.5	0.30
3E5	Beam Power Amplifier	6BX	5-2	Fil	1.4 D-C 2.8	0.05 0.025	135	90	Parallel Filaments Series Filaments		
3E6	Sharp-Cutoff R-F Pentode	7CJ	9-30	Fil	2.8 1.4	0.05 0.10	110	110	5.5	8.0	0.007 ♣
3LE4	Power Amplifier Pentode	6BA	9-30	Fil	1.4 2.8 D-C	0.10 0.05	110	110	Parallel Filaments Series Filaments		
3LF4	Beam Power Amplifier	6BB	9-30	Fil	2.8 D-C 1.4 D-C	0.05 0.10	110	110	Series Filaments Parallel Filaments		
3Q4	Power Amplifier Pentode	7BA	5-2	Fil	1.4 2.8 D-C	0.10 0.05	90	90	Parallel Filaments Series Filaments		
3Q5-GT	Beam Power Amplifier	7AP	9-11	Fil	1.4 1.4 2.8 D-C	0.1 0.1 0.05	110	110	Parallel Filaments Parallel Filaments Series Filaments Series Filaments		

‡Zero signal. ♣Maximum. ▲Without external shield. ♠Per section. †Plate-to-plate.

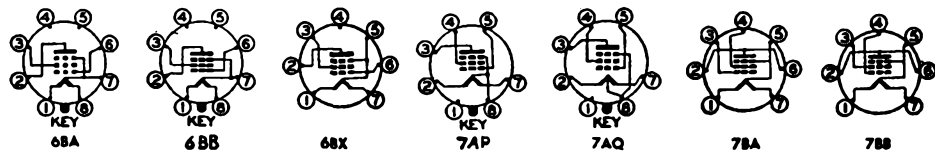

Service	Neg Grid Volts	Screen Volts	Screen Milli-amperes	Plate Volts	Plate Milli-amperes	R _p Ohms	G _m μmhos	μ Factor	Load for Rated Out-put, Ohms	Power Out-put, Watts	Tube Type
Class A Amplifier	8.4	90	2.2†	150	13.3†	100,000	1,900	—	8,000	0.7	3A4
Class A Amplifier ♣	2.5	—	—	90	3.7	8,300	1,800	15	—	—	3A5
Class A Amplifier Class A Amplifier	0.0 0.0	— 90	— 0.5	90 90	0.2 1.5	200,000 800,000	275 750	— —	— —	— —	3A8-GT
Class C Amplifier Class C Amplifier	18 38	90 135	4.8 6.2	90 150	15 25	Input Signal = 0.03 watt Input Signal = 0.07 watt		— —	— —	0.45 1.25	3B4
Class A Amplifier Class A Amplifier	7.0 7.0	67.5 67.5	0.6† 0.5†	67.5 67.5	8.0† 6.7†	100,000 100,000	1,650 1,500	— —	5,000 5,000	0.2 0.18	3B5-GT
Class B Amplifier	0.0	—	—	135	18.2†	—	1,900 ♣	20♣	16,000 ‡	1.5	3B7
Class A Amplifier Class A Amplifier	9.0 9.0	90 90	1.4† 1.4†	90 90	6.0† 6.0†	— —	1,550 1,450	— —	8,000 10,000	0.24 0.26	3C5-GT
{ Class A Amplifier Class A Amplifier Class A Amplifier }	0.0 0.0 0.0	— — —	— — —	90 90 90	4.5 4.5 4.5	11,200 11,200 11,200	1,300 1,300 1,300	14.5 14.5 14.5	— — —	— — —	3C6
Class A Amplifier	4.5	90	1.0†	150	9.8†	—	2,400	—	14,000	0.60	3D6
Class A Amplifier Class A Amplifier Class A Amplifier	{7.0 5.0 7.0 5.0	{90 67.5 90 67.5	{1.6 1.1 1.4 0.9	{90 67.5 90 67.5	{8.0 5.5 6.8 4.4	{100,000 120,000 120,000 130,000	{1,550 1,400 1,450 1,300	{— — — —	{8,000 8,000 9,000 11,000	{0.250 0.125 0.225 0.115	3E5
Class A Amplifier	R _g = 2.0 Meg R _g = 2.0 Meg	90	1.2	90	2.9	325,000§	1,700	—	—	—	3E6
Class A Amplifier	9.0	90	2.0†	90	10.0†	100,000§	1,700	—	6,000	0.325	3LE4
Class A Amplifier Class A Amplifier	9.0 9.0	90 90	1.8† 1.8†	90 90	8.8† 8.8†	110,000§ 110,000§	1,600 1,600	— —	6,000 6,000	0.300 0.300	3LE4
Class A Amplifier Class A Amplifier Class A Amplifier	{6.6 4.5 6.6 4.5	{110 90 110 90	{1.1 1.0 1.4 1.3	{110 90 110 90	{8.5 8.0 10.0 9.5	{110,000§ 80,000§ 100,000§ 90,000§	{2,000 2,000 2,200 2,200	{— — — —	{8,000 8,000 8,000 8,000	{0.33 0.23 0.40 0.27	3LF4
Class A Amplifier Class A Amplifier	4.5 4.5	90 90	2.1† 1.7†	90 90	9.5† 7.7†	100,000§ 120,000§	2,150 2,000	— —	10,000 10,000	0.27 0.24	3Q4
Class A Amplifier Class A Amplifier Class A Amplifier Class A Amplifier	6.6 4.5 6.6 4.5	110 90 110 90	1.4† 1.3† 1.1† 1.1†	110 90 110 8.5†	10.0† 9.5† 8.5† 8.0†	100,000§ 90,000§ 110,000§ 80,000§	2,200 2,200 2,000 2,000	— — — —	8,000 8,000 8,000 8,000	0.400 0.270 0.330 0.230	3Q5-GT

§Approximate.

Type designations of miniature tubes are shown in italics.

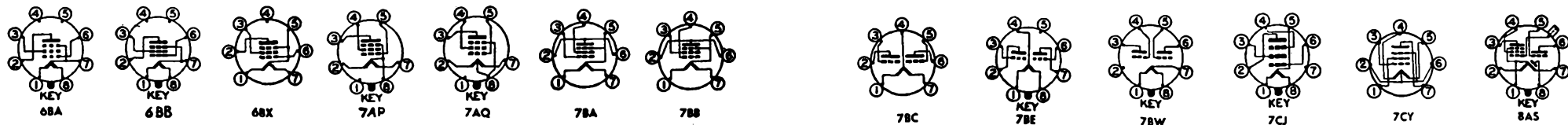

Tube Type	Classification by Construction	Base Connections	Out-line Dwg	Type Cathode	Filament Volts	Filament Amp	Max Plate Volts	Max Screen Volts	Capacitance in Micromicrofarads		
									Input	Out-put	Grid-plate
5S4	Power Amplifier Pentode	7BA	5-2	Fil	1.4	0.1	90	67.5	Parallel Filaments		
					1.4	0.1	90	67.5	Parallel Filaments		
					2.8	0.05	90	67.5	Series Filaments		
					2.8 D-C	0.05	90	67.5	Series Filaments		
5V4	Power Amplifier Pentode	6BX	5-2	Fil	1.4	0.1	90	90	Parallel Filaments		
					2.8 D-C	0.05	90	90	Series Filaments		
4A6-G	Power Amplifier Twin Triode	8L	12-7	Fil	4.0	0.06	90	—	1 Section		
					2.0				0.06	90	2 Sections
					4.0						
					2.0						
					D-C						
5AX4-GT	Full-Wave, High-Vacuum Rectifier	5T	9-13	Fil	5.0	2.5	Rms voltage per plate = 350 volts max; max d-c output = 175 ma;				
5AZ4	Full-Wave High-Vacuum Rectifier	5T	9-31	Fil	5.0	2.0	Rms voltage per plate = 350 volts max; max d-c output = 125 ma				
5R4-GY	Full-Wave High-Vacuum Rectifier	5T	16-3	Fil	5.0	2.0	Rms voltage per plate = 900 volts; Rms voltage per plate = 700 volts;				
5T4	Full-Wave High-Vacuum Rectifier	5T	10-1	Fil	5.0	2.0	Rms volts per plate = 450 volts max; max d-c output = 225 ma				
5U4-G	Full-Wave High-Vacuum Rectifier	5T	16-3	Fil	5.0	3.0	Rms voltage per plate = 450 volts; max d-c output = 225 ma				
5V4-G	Full-Wave High-Vacuum Rectifier	5L	14-3	Htr	5.0	2.0	Rms volts per plate = 375 volts max; max d-c output = 175 ma				
5W4 5W4-GT	Full-Wave High-Vacuum Rectifier	5T	8-6 9-11	Fil	5.0	1.5	Rms volts per plate = 500 volts max; max d-c output = 100 ma				
5X4-G	Full-Wave High-Vacuum Rectifier	5Q	16-3	Fil	5.0	3.0	Rms voltage per plate = 450 volts max; max d-c output = 225 ma				
5Y3-G	Full-Wave High-Vacuum Rectifier	5T	14-3	Fil	5.0	2.0	Rms voltage per plate = 350 volts; max d-c output = 125 ma				
5Y3-GT	Full-Wave High-Vacuum Rectifier	5T	9-11	Fil	5.0	2.0	Rms voltage per plate = 350 volts; max d-c output = 125 ma				
5Y4-G	Full-Wave High-Vacuum Rectifier	5Q	14-3	Fil	5.0	2.0	Rms voltage per plate = 350 volts max; max d-c output = 125 ma				
5Y4-GT	Full-Wave High-Vacuum Rectifier	5Q	9-13	Fil	5.0	2.0	Rms voltage per plate = 350 volts max; max d-c output = 125 ma				
5Z3	Full-Wave High-Vacuum Rectifier	4C	16-1	Fil	5.0	3.0	Rms voltage per plate = 450 volts max; max d-c output = 225 ma				
5Z4	Full-Wave High-Vacuum Rectifier	5L	8-6	Htr	5.0	2.0	Rms voltage per plate = 350 volts max; max d-c output = 125 ma				
5Z4-GT	Full-Wave High-Vacuum Rectifier	5L	9-11	Htr	5.0	2.0	Rms voltage per plate = 350 volts max; max d-c output = 125 ma				
6A3	Power Amplifier Triode	4D	16-1	Fil	6.3	1.0	325	1 tube			
								2 tubes, push-pull			
6A4/LA	Power Amplifier Pentode	5B	14-1	Fil	6.3	0.3	180	180	—	—	—

§Approximate.

¶Undistorted.

‡Plate-to-plate



4C



4D



5B



5L



5T

AND RATINGS

Service	Neg Grid Volts	Screen Volts	Screen Milli-amperes	Plate Volts	Plate Milli-amperes	R _p Ohms	G _m μmhos	μ Factor	Load for Rated Out-put, Ohms	Power Out-put, Watts	Tube Type
Class A Amplifier	7.0	67.5	1.4†	90	7.4†	100,000§	1,575	—	8,000	0.270	5S4
Class A Amplifier	7.0	67.5	1.5†	67.5	7.2†	100,000§	1,550	—	5,000	0.180	
Class A Amplifier	7.0	67.5	1.1†	90	6.1†	100,000§	1,425	—	8,000	0.235	
Class A Amplifier	7.0	67.5	1.2†	67.5	6.0†	100,000§	1,400	—	5,000	0.160	
Class A Amplifier	4.5	90	2.1†	90	9.5†	100,000	2,150	—	10,000	0.27	5V4
Class A Amplifier	4.5	90	1.7†	90	7.7†	120,000	2,000	—	10,000	0.24	
Class A Amplifier	1.5	—	—	90	1.2	28,000	900	25	—	—	4A6-G
Class B Amplifier	1.5	—	—	90	1.1	I _p = 10.8 max signal	—	—	8,000	1.0	
max peak current per plate = 525 ma max; peak inverse voltage = 1400 volts; min plate supply impedance per plate = 50 ohms											5AX4-GT
peak current per plate = 650 ma; peak inverse voltage = 1400 volts max; min. plate supply impedance per plate = 50 ohms											5A24
max d-c output = 150 ma max; peak inverse voltage = 2800 volts max d-c output = 250 ma max; peak inverse voltage = 2100 volts											5R4-GY
peak current per plate = 675 ma max; peak inverse voltage = 1550 volts max; min. plate supply impedance per plate = 150 ohms											5T4
peak current per plate = 675 ma max; peak inverse voltage = 1550 volts max; min plate supply impedance per plate = 75 ohms											5U4-G
peak current per plate = 525 ma max; peak inverse voltage = 1400 volts max; min plate supply impedance per plate = 100 ohms											5V4-G
peak current per plate = 300 ma max; peak inverse voltage = 1400 volts max; min plate supply impedance per plate = 50 ohms											5W4 5W4-GT
peak current per plate = 675 ma max; peak inverse voltage = 1550 volts max; min plate supply impedance per plate = 75 ohms											5X4-G
peak current per plate = 375 ma; peak inverse voltage = 1400 volts max; min plate supply impedance per plate = 50 ohms											5Y3-G
peak current per plate = 400 ma; peak inverse voltage = 1400 volts max; min plate supply impedance per plate = 50 ohms											5Y3-GT
peak current per plate = 375 ma max; peak inverse voltage = 1400 volts max; min plate supply impedance per plate = 50 ohms											5Y4-G
max peak current per plate = 400 ma; peak inverse voltage = 1400 volts max; min plate supply impedance per plate = 50 ohms											5Y4-GT
peak current per plate = 675 ma max; peak inverse voltage = 1500 volts max; min plate supply impedance per plate = 75 ohms											5Z3
peak current per plate = 375 ma max; peak inverse voltage = 1400 volts max; min plate supply impedance per plate = 50 ohms											5Z4
peak current per plate = 375 ma; peak inverse voltage = 1400 volts max; min plate supply impedance per plate = 50 ohms											5Z4-GT
Class A Amplifier	45	—	—	250	60†	800	5,250	4.2	2,500	3.2†	6A3
Class AB ₁ Amplifier	68	—	—	325	80†	—	—	—	3,000‡	15.0†	
Class A Amplifier	12	180	3.9†	180	22.0†	45,400§	2,200	100‡	8,000	1.4	6A4/LA

†Zero signal.

Type designations of metal tubes are shown in bold-face type.
Type designations of miniature tubes are shown in italics.

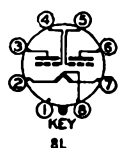
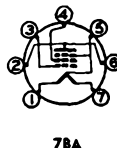
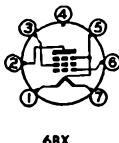

Tube Type	Classification by Construction	Base Connections	Out-line Dwg	Type Cathode	Filament Volts	Filament Amp	Max Plate Volts	Max Screen Volts	Capacitance in Micromicrofarads		
									Input	Output	Grid-plate
6A5-G	Power Amplifier Triode	6T	16-3	Htr	6.3	1.25	250	1 tube 2 tubes, push-pull			
6A6	Twin Triode	7B	14-1	Htr	6.3	0.8	300	— Single Tube Parallel Triodes			
6A7 6A7-S *	Pentagrid Converter	7C	12-6	Htr	6.3	0.3	300	100	{ Anode = 250 volts thru 20M ohms $I_p = 4.0$ ma Anode = 100 volts $I_p = 2.0$ ma		
6A8 6A8-G 6A8-GT	Pentagrid Converter	8A	8-4 12-8 9-18	Htr	6.3	0.3	300	100	{ Anode = 250 volts thru 20M ohms $I_p = 4.0$ ma Anode = 100 volts $I_p = 2.0$ ma		
6AB4	High-Frequency Triode	5CE	5-2	Htr	6.3	0.15	300	—	2.2	1.4	1.5
6AB5/6N5	Electron-Ray Tube	6R	9-26	Htr	6.3	0.15	180				
6AB7/1853	Semi-Remote-Cutoff R-F Pentode	8N	8-1	Htr	6.3	0.45	300	200	8.0	5.0	0.015 ♣
6AC5-GT	High-Mu Power Amplifier Triode	6Q	9-11	Htr	6.3	0.4	250	— 2 tubes			
6AC6-GT	Dynamic-Coupled Power Amplifier	7W	9-11	Htr	6.3	1.1	180	— — —			
6AC7/1852	R-F Pentode	8N	8-1	Htr	6.3	0.45	300	150	11	5	0.015 ♣
6AD4 Ⓞ	High-Mu Triode	6K4	3-2	Htr	6.3	0.15	150	—	2.8	3.2	1.3
6AD6-G	Electron-Ray Twin Indicator	7AG	9-3	Htr	6.3	0.15					
6AD7-G	Triode-Power Amplifier Pentode	8AY	14-3	Htr	6.3	0.85	285 375	— 285	Triode section Pentode section		
6AE5-GT	Amplifier Triode	6Q	9-11	Htr	6.3	0.3	300	— — —			
6AE6-G	Single-Grid Twin-Plate Control Tube	7AH	12-7	Htr	6.3	0.15	250	— Remote-cut-off plate Sharp-cut-off plate			
6AE7-GT	Twin-Triode Amplifier	7AX	9-11	Htr	6.3	0.5	300 300	— Grids and cathodes parallel connected Push-pull dynamic coupled			

§Approximate.

‡Plate-to-plate.

♣Maximum.

★External shield connected to cathode pin.

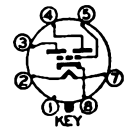
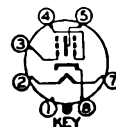
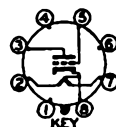
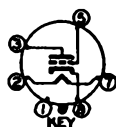
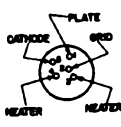

Service	Neg Grid Volts	Screen Volts	Screen Milli-am-peres	Plate Volts	Plate Milli-am-peres	R _p , Ohms	G _m , μmhos	μ Fac-tor	Load for Rated Out-put, Ohms	Power Out-put, Watts	Tube Type
Class A Amplifier	45.0	—	—	250	60†	800	5,250	4.2	2,500	3.75	6A5-G
Class A Amplifier	68.0	—	—	325	80†	—	—	—	3,000	15.0	
Class B Amplifier	0.0	—	—	300	35	Input signal = .350 watt		—	8,000	10.0‡	6A6
Class A Amplifier	6.0	—	—	294	7.0†	11,000	3,200	35	30,000‡	0.400‡	
Converter	3.0	100	2.7	250	3.5	360,000‡	Conversion Transconductance, 550				6A7 6A7-S *
Converter	1.5	50	1.3	100	1.1	600,000‡	Conversion Transconductance, 360				
Converter	3.0	100	2.7	250	3.5	360,000‡	Conversion Transconductance, 550				6A8 6A8-G 6A8-GT
Converter	1.5	50	1.3	100	1.1	600,000‡	Conversion Transconductance, 360				
Class A Amplifier	R _k = 200 R _k = 270	—	—	250	10	10,900	5500	60	—	—	6AB4
		—	—	160	3.7	15,000	4000	60	—	—	
Plate voltage = 135 volts through .25 meg. (E _g = 0, shadow angle = 90°; I _b = 0.5 ma) (E _g = -10 volts, shadow angle = 0°)											6AB5/6N5
Class A Amplifier	3.0	200	3.2	300	12.5	700,000‡	5,000	—	—	—	6AB7/1853
Class B Amplifier	0.0	—	—	250	5.0†	Input signal = .950 watt			10,000‡	8.0	6AC5-GT
Class A Amplifier	0.0	180	7.0	180	45.0	18,000‡	3,000	—	3,500	3.6	6AC6-GT
Class A Amplifier	R _k = 160	150	2.5	300	10.0	1,000,000‡	9,000	—	—	—	6AC7/1852
Class A Amplifier	R _k = 820	—	—	100	1.4	26,000	2700	70	—	—	6AD4 ●
Target voltage = 150 volts max; shadow angle = 0° with control electrode = +75 volts, 90° with +8 volts											6AD6-G
Class A Amplifier	25.0	—	—	250	3.7	19,000‡	325	6.0	—	—	6AD7-G
Class A Amplifier	16.5	250	6.5†	250	34.0†	80,000‡	2,500	—	7,000	3.2	
Class A Amplifier	15.0	—	—	95	7.0	3,500	1,200	4.2	—	—	6AE5-GT
Amplifier	1.5	—	—	250	6.5	25,000‡	1,000	25	—	—	6AE6-G
Amplifier	1.5	—	—	250	4.5	35,000‡	950	33	—	—	
Amplifier	13.5	—	—	250	10.0	4,650	3,000	14	—	—	6AE7-GT
Amplifier	—	—	—	250	10.0	Grid to grid signal 44 volts RMS			10,000‡	9.5	

†Zero signal.

||Input plate.

●Designates subminiature type.

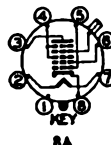
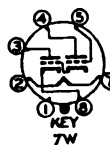
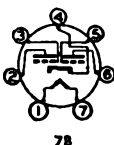
 Type designations of metal tubes are shown in bold-face type.
 Type designations of miniature tubes are shown in *italics*.

Tube Type	Classification by Construction	Base Connections	Out-line Dwg	Type Cathode	Filament Volts	Filament Amp	Max Plate Volts	Max Screen Volts	Capacitance in Micromicrofarads		
									Input	Out-put	Grid-plate
6AF5-G	Low-Mu Triode	6Q	12-7	Htr	6.3	0.3	180	—	—	—	—
6AF6-GT	Electron-Ray Tube	7AG	9-1	Htr	6.3	0.15	135				
6AG6	Sharp-Cutoff R-F Pentode	7BD	5-2	Htr	6.3	0.3	300 300	150 —	Pentode Connection Triode Connection (G ₂ & P tied)		
6AG7	Power Amplifier Pentode	8Y	8-6	Htr	6.3	0.65	300	300	13	7.5	0.06 ♣
6AH6	Sharp-Cutoff R-F Pentode	7BK	5-2	Htr	6.3	0.45	300	150	10.0	3.6	0.02 ♣
6AH7-GT	Medium-Mu Twin-Triode	8BE	9-7	Htr	6.3	0.3	180	—	—	—	—
6AJ5	High-Frequency Pentode	7BD	5-1	Htr	6.3	0.175	180	90	4.0	2.8	0.02 ♣
6AJ7	R-F Pentode	8N	8-1	Htr	6.3	0.45	300	150	11	5	0.015 ♣
6AK5	Sharp-Cutoff R-F Pentode	7BD	5-1	Htr	6.3	0.175	180	140	4.0	2.8	0.02 ♣
6AK6	Power Amplifier Pentode	7BK	5-2	Htr	6.3	0.150	300	250	3.6▲	4.2▲	0.12▲
6AK7	Power Amplifier Pentode	8Y	8-6	Htr	6.3	0.65	300	300	13	7.5	0.06 ♣
6AL5	Twin Diode	6BT	5-1	Htr	6.3	0.3	Rms voltage per plate=117 volts max;				
6AL6-G	Beam Power Amplifier	6AM	16-4	Htr	6.3	0.90	350	300	—	—	—
6AL7-GT	Electron-Ray Tube	8CH	9-7	Htr	6.3	0.15	400				
6AM6	Power Amplifier Pentode	6CH	5-2	Htr	6.3	0.2	250	250	Single Tube 2 tubes, push-pull		
6AM6	Sharp-Cutoff R-F Pentode	7DB	5-2	Htr	6.3	0.3	300	250	Pentode Connection Triode Connection (G ₂ & P tied)		
6AN5	Power Amplifier Pentode	7BD	5-2	Htr	6.3	0.45	120	120	9.0	4.8	0.075 ♣
6AN6	Duplex Twin Diode	7BJ	5-2	Htr	6.3	0.20	—				
6AN7	Triode-Hexode Converter	9Q	6-3	Htr	6.3	0.23	250	250	Osc plate = 250 volts thru 33,000 ohms; Osc I _p = 5.1 ma		

▲ Without external shield.
♣ Per section.

‡ Zero signal.

* Minimum.

‡ Plate-to-plate.

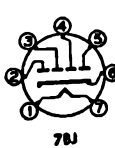
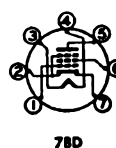
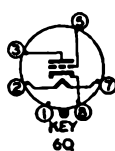
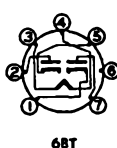
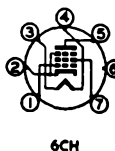

Service	Neg Grid Volts	Screen Volts	Screen Milli-amperes	Plate Volts	Plate Milli-amperes	R _p Ohms	G _m μ mhos	μ Factor	Load for Rated Output, Ohms	Power Output, Watts	Tube Type
Class A Amplifier	18.0	—	—	180	7.0	4,900	1,500	7.4	—	—	6AF5-G
Target voltage = 135 volts max (shadow angle = 0° with control electrode = +75 volts, 90° with +8 volts)											
Class A Amplifier	R _k = 150	150	2.0	250	6.5	800,000§	5,000	—	—	—	<i>6AG5</i>
Class A Amplifier	R _k = 180	—	—	250	5.5	10,000	3,800	42	—	—	<i>6AG6</i>
Class A Amplifier	R _k = 820	—	—	250	5.5	10,000	3,800	42	—	—	<i>6AG7</i>
Class A Amplifier	3.0	150	7.0†	300	30†	130,000	11,000	—	10,000	3.0	6AG7
Class A Pentode	R _k = 150	150	2.5	300	10.0	500,000	9,000	—	—	—	<i>6AH6</i>
Class A Triode	R _k = 160	—	—	150	12.5	3,600	11,000	—	—	—	<i>6AH6</i>
Class A Amplifier	R _k = 160	—	—	150	12.5	3,600	11,000	—	—	—	<i>6AH6</i>
Class A Amplifier \clubsuit	6.5	—	—	180	7.6	8,400	1,900	16	—	—	6AH7-GT
Class A Amplifier	1.0	28	1.0	28	2.7	100,000§	2,500	—	—	—	<i>6AJ6</i>
Class A Amplifier	R _k = 150	150	2.5	300	10	1,000,000§	9,000	—	—	—	6AJ7
Class A Amplifier	R _k = 160	150	2.5	300	10	1,000,000§	9,000	—	—	—	6AJ7
Class A Amplifier	R _k = 180	120	2.4	180	7.7	500,000§	5,100	—	—	—	<i>6AK6</i>
Class A Amplifier	9.0	180	2.5†	180	15.0†	200,000	2,300	—	10,000	1.1	<i>6AK6</i>
Class A Amplifier	3.0	150	7.0†	300	30†	130,000	11,000	—	10,000	3.0	6AK7
max d-c output per plate = 9.0 ma; max peak current per plate = 54 ma; max peak inverse voltage = 330 volts; min plate supply impedance per plate = 300 ohms											
Class A Amplifier	14.0	250	5.0†	250	72.0†	22,500	6,000	—	2,500	6.5	6AL6-G
Outer edge of any of the three illuminated areas displaced 1/16 in. minimum outward with application of +5 volts to its electrode. Similar displacement inward with application of -5 volts. Entire pattern disappears with application of -6 volts to control grid											
Class A Amplifier	13.5	250	2.4	250	16	130,000	2,600	—	16,000	1.4	<i>6AM5</i>
Class AB ₁ Amplifier	19.0	250	1.3†	250	10†	—	—	—	20,000‡	4.8	<i>6AM5</i>
Class A Amplifier	2.0	250	2.5	250	10	1,000,000§	7,500	—	—	—	<i>6AM6</i>
Class A Amplifier	2.0	—	—	250	12.5	7,500§	9,300	70	—	—	<i>6AM6</i>
Class A Amplifier	R _k = 120	120	12	120	35	12,500§	8,000	—	2,500	1.3	6AN5
Rms voltage per plate = 75 volts; d-c output = 3.5 ma with 25,000 ohms and 8 μ f load; peak current per plate = 10 ma; peak inverse voltage = 210 volts											
Converter	2.0	85	3.0	250	3.0	1,000,000*	Conversion Trans-conductance = 750		—	—	6AN7

§ Approximate.
 \clubsuit Maximum.

Type designations of metal tubes are shown in bold-face type.
 Type designations of miniature tubes are shown in italics.

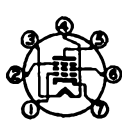

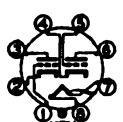
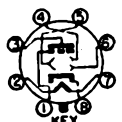
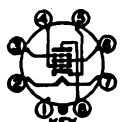
7BK

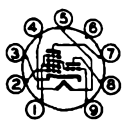
7DB

8BE

8CH

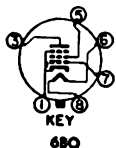
8N

8Y

9Q

Tube Type	Classification by Construction	Base Connections	Out-line Dwg	Type Cathode	Filament Volts	Filament Amp	Max Plate Volts	Max Screen Volts	Capacitance in Micromicrofarads		
									Input	Output	Grid-plate
6AQ6	Beam Power Amplifier	7BZ	5-3	Htr	6.3	0.45	250	250	7.6	6.0	0.35
6AQ6-W	Ruggedized Beam Power Amplifier	7BZ	5-3	Htr	6.3	0.45	250	250	—	—	—
6AQ6	Duplex-Diode Triode	7BT	5-2	Htr	6.3	0.150	300	—	1.7	1.5	1.8
6AQ7-GT	Duplex-Diode Triode	8CK	9-11	Htr	6.3	0.30	250	—	—	—	—
6AR6	Power Amplifier Pentode	6CC	5-3	Htr	6.3	0.4	250	250	—	—	—
6AR6	Beam Power Amplifier	6BQ	9A-3	Htr	6.3	1.20	630	315	11.0▲	7.0▲	0.8▲ ♣
6AR7-GT	Twin-Diode, Remote-Cutoff Pentode	7DE	6AR7-GT	Htr	6.3	0.3	300	125	5.5▲	7.5▲	0.003 ▲♣
6AS6	Beam Power Amplifier	7CV	5-3	Htr	6.3	0.8	150	117	12.0▲	6.2▲	0.6▲
6AS8	Dual-Control R-F Pentode	7CM	5-1	Htr	6.3	0.175	180	140	4.0	3.0	0.02♣
6AS7-G	Low-Mu Twin Triode	8BD	16-3	Htr	6.3	2.5	250	—	—	—	—
6AT6	Duplex-Diode Triode	7BT	5-2	Htr	6.3	0.30	300	—	2.3▲	1.1▲	2.1▲
6AU5-GT	Beam Power Amplifier	6CK	9-11♠	Htr	6.3	1.25	450	200	11.3▲	7.0▲	0.5▲
6AU6	Sharp-Cutoff R-F Pentode	7BK	5-2	Htr	6.3	0.3	300	150 250	Pentode Connection Triode Connection (G ₁ , G ₂ , & P tied)		
6AV5-GT	Beam Power Amplifier	6CK	9-11	Htr	6.3	1.2	550§	200	—	—	—
6AV6	Duplex-Diode High-Mu Triode	7BT	5-2	Htr	6.3	0.3	300	—	2.2	1.2	2.0
6AW7-GT	Duplex-Diode, High-Mu Triode	8CQ	9-16	Htr	6.3	0.3	300	—	—	—	—
6AX5-GT	Full-Wave, High-Vacuum Rectifier	6S	9-11♠	Htr	6.3	1.2	Rms voltage per plate = 350 volts; max d-c output = 125 ma;				
6AX6-G	Full-Wave Rectifier; TV Damping Diode	7Q	14-3	Htr	6.3	2.5	Rms voltage per plate = 350 volts; max d-c output = 250 ma;				

▲ Without external shield. † Zero signal. § Absolute maximum rating. ♠ With short base.
 — The duration of the pulse voltage must not exceed 15 percent of one scanning cycle.

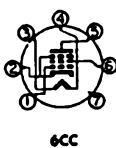

6BQ



6CC

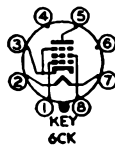

6CK

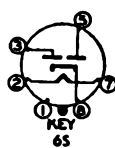

6S

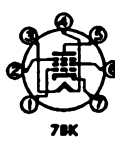

7BK



7BT



7BZ

Service	Neg Grid Volts	Screen Volts	Screen Milli-amperes	Plate Volts	Plate Milli-amperes	R_p , Ohms	G_m , μ mhos	μ Factor	Load for Rated Output, Ohms	Power Output, Watts	Tube Type
Class A Amplifier	8.5	180	3.0†	180	29.0†	58,000§	3,700	—	5,500	2.0	<i>6AQ6</i>
Class A Amplifier	12.5	250	4.5†	250	45.0†	52,000§	4,100	—	5,000	4.5	
Class A Amplifier	{ 12.5 8.5	{ 250 180	{ 4.5† 3.0†	{ 250 180	{ 45† 29†	{ 52,000§ 58,000§	{ 4,100 3,700	{ — —	{ 5,000 5,500	{ 4.5 2.0	<i>6AQ6-W</i>
Class A Amplifier	3.0	—	—	250	1.0	58,000	1,200	70	—	—	<i>6AQ6</i>
Class A Amplifier	2.0	—	—	250	2.3	44,000	1,600	70	—	—	<i>6AQ7-GT</i>
Class A Amplifier	18.0	250	5.5†	250	32.0†	68,000	2,300	—	7,600	3.4	<i>6AR6</i>
Class A Amplifier	36.0	300	4.0	300	58.0	22,000	4,300	—	—	—	<i>6AR6</i>
Class A Amplifier	2.0	100	1.8	250	7.0	200,000	2,500	—	—	—	<i>6AR7-GT</i>
Class A Amplifier	8.5	110	2.0†	150	35.0†	—	5,600	—	4,500	2.2	<i>6AS6</i>
Class A Amplifier	{ 2.0 2.0	{ 120 120	{ 3.5 4.8	{ 120 120	{ 5.2 3.6	{ 110,000§ —	{ 3,200 1,850	$E_{c3} = 0$ volts $E_{c3} = -3$ volts		—	<i>6AS6</i>
D-C Amplifier	$R_k = 250$	—	—	135	125♣	280	7,000	2.0	—	—	<i>6AS7-G</i>
Class A Amplifier	3.0	—	—	250	1.0	58,000	1,200	70	—	—	<i>6AT8</i>
Horizontal Deflection Amplifier	Max positive pulse plate voltage _g = 5,000 volts; max plate dissipation = 10 watts; max screen input = 2.5 watts; max d-c plate current = 100 ma										<i>6AU5-GT</i>
Class A Amplifier	$R_k = 68$	150	4.3	250	10.6	1,000,000§	5,200	—	—	—	<i>6AU6</i>
Class A Amplifier	$R_k = 150$	100	2.1	100	5.0	500,000§	3,900	—	—	—	
Class A Amplifier	$R_k = 330$	—	—	250	12.2	—	4,800	36	—	—	
Class A Amplifier	22.5	150	2.1	250	55	—	5,800	—	—	—	<i>6AV5-GT</i>
Horizontal Deflection Amplifier	Max positive pulse plate voltage _g = 5,500 volts; max plate dissipation = 11 watts; max screen dissipation = 2.5 watts; max d-c plate current = 100 ma										
Class A Amplifier	2.0	—	—	250	1.2	62,500	1,600	100	—	—	<i>6AV6</i>
Class A Amplifier	0.0	—	—	100	1.4	—	1,200	80	—	—	<i>6AW7-GT</i>
max peak current per plate = 375 ma; max peak inverse voltage = 1,250 volts; min plate supply impedance per plate = 50 ohms											<i>6AX5-GT</i>
max peak current per plate = 600 ma; min plate supply impedance per plate = 145 ohms; max peak inverse voltage = 1,250 volts; max peak inverse voltage (damper service) = 2,000 volts											<i>6AX6-G</i>

§ Approximate.

♣ Maximum.

† Plate supply voltage.

♠ Per section.

Type designations of miniature tubes are shown in italics.



7CM



7CV



7DE

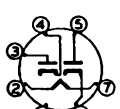

7Q



8BD



8CK

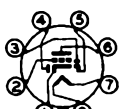

8CQ

Tube Type	Classification by Construction	Base Connections	Out-line Dwg	Type Cathode	Filament Volts	Filament Amp	Max Plate Volts	Max Screen Volts	Capacitance in Micromicrofarads		
									Input	Out-put	Grid-plate
6B4-G	Power Amplifier Triode	5S	16-3	Fil	6.3	1.0	250	—	Single tube 2 tubes, Push-pull		
6B5	Direct-Coupled Power Amplifier	6AS	14-1	Htr	6.3	0.8	300	—	—	—	—
6B6-G	Duplex Diode High-Mu Triode	7V	12-8	Htr	6.3	0.3	250	—	1.7	3.8	1.7
6B7	Semi-Remote-Cutoff Duplex-Diode Pentode	7D	12-6	Htr	6.3	0.3	300	125	3.5▲	9.5▲	.007♣
6B7-S★									—	—	—
6B8	Semi-Remote-Cutoff Duplex-Diode Pentode	8E	8-4	Htr	6.3	0.3	300	125	6.0	9.0	.005
6B8-G			12-8						3.6	9.5	.01
6B8-GT			9-20						4.5	10.0	0.005
6BA5⊙	Sharp-Cutoff Pentode	6BA5	3-2	Htr	6.3	0.15	150	140	4.0	6.5	0.19
6BA6	Remote-Cutoff R-F Amplifier Pentode	7BK	5-2	Htr	6.3	0.3	300	150	5.5	5.0	0.0035♣
6BA7	Pentagrid Converter	8CT	6-3	Htr	6.3	0.3	300	100	Osc I _g = 0.35 ma thru 20,000 ohms Osc I _g = 0.35 ma thru 20,000 ohms		
6BC6	Sharp-Cutoff R-F Pentode	7BD	5-2	Htr	6.3	0.3	300	150	Pentode Connection		
							300	—	Triode Connection (G2 & P tied)		
6BC7	Triple Diode	6BC7	6-2	Htr	6.3	0.45	Max diode operation current per plate = 12.0 ma;				
6BD5-GT	Beam Power Amplifier	6CK	6BD5-GT	Htr	6.3	0.9	325	325	—	—	—
6BD6	Remote-Cutoff R-F Amplifier Pentode	7BK	5-2	Htr	6.3	0.3	300	125	4.3▲	5.0▲	0.005♣▲
6BD7	Duplex-Diode, High-Mu Triode	9Z	6-3	Htr	6.3	0.23	300	—	—	—	—
6BE6	Pentagrid Converter	7CH	5-2	Htr	6.3	0.3	300	100	Osc I _g = 0.5 ma thru 20,000 ohms		
6BE7	Seven-Grid Limiter-Discriminator	9AA	6-3	Htr	6.3	0.2	250	100	E _{c3} = 12 volts RMS E _{c5} = 12 volts RMS		

|| Input plate ★ External shield connected to cathode pin. § Approximate. † Zero signal.
 ‡ Plate-to-plate. ¶ Undistorted. ♣ Maximum. ▲ Without external shield.

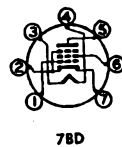
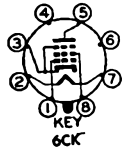
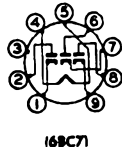
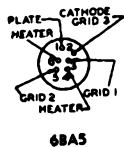
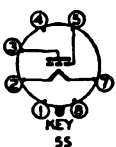

Service	Neg Grid Volts	Screen Volts	Screen Milli-amperes	Plate Volts	Plate Milli-amperes	R _p , Ohms	G _m , μ mhos	μ Factor	Load for Rated Output, Ohms	Power Output, Watts	Tube Type
Class A Amplifier Class AB Amplifier	45	—	—	250	60†	800	5,250	4.2	2,500	3.2†	6B4G
	68	—	—	325	80†	—	—	—	3,000‡	15.0†	
Class A Amplifier	0.0	.300	8.0	300	45.0	24,000§	2,400	—	7,000	4.0†	6B5
Class A Amplifier	2.0	—	—	250	0.9	91,000	1,100	100	—	—	6B6-G
Class A Amplifier	3.0	125	2.3	250	9.0	600,000§	1,125	—	—	—	6B7
											6B7-S*
Class A Amplifier	3.0	125	2.3	250	10.0	600,000§	1,325	—	—	—	6B8 6B8-G 6B8-GT
Class A Amplifier	R _k = 270	100	1.25	100	4.8	150,000	3,300	—	—	—	6BA5 ●
Class A Amplifier	R _k = 68 Ω	100	4.2	250	11.0	1,000,000§	4,400	—	—	—	<i>6BA6</i>
Converter	1.0	100	10.0	250	3.8	1,000,000§	Conversion Transconductance = 950			—	<i>6BA7</i>
Converter	1.0	100	10.2	100	3.6	500,000§	Conversion Transconductance = 900			—	
Class A Amplifier	R _k = 180	150	2.1	250	7.5	800,000§	5,700	—	—	—	6BC6
	R _k = 100	125	2.4	125	8.0	500,000§	6,100	—	—	—	
	R _k = 180	100	1.4	100	4.7	600,000§	4,900	—	—	—	
Class A Amplifier	R _k = 820	—	—	250	6.0	9,000§	4,400	40	—	—	
	R _k = 330	—	—	180	8.0	6,000§	6,000	42	—	—	
max heat.-cathode voltage = 200 volts; average diode current @ 5 volts = 35 ma (diodes 1 & 3)											<i>6BC7</i>
Horizontal Deflection Amplifier	Max positive pulse plate voltage = 4,000 volts; max plate dissipation = 10 watts; max screen dissipation = 3.0 watts; max d-c cathode current = 100 ma										6BD5-GT
Class A Amplifier	3.0	100	3.5	250	9.0	700,000	2,000	—	—	—	6BD6
Class A Amplifier	3.0	—	—	250	1.0	58,000	1,200	70	—	—	6BD7
Converter	1.5	100	6.8	250	2.9	1,000,000§	Conversion Transconductance = 475			—	6BE8
FM Limiter-Discriminator	4.4§	20§	1.5	250§	0.28	5,000,000	—	—	470000	—	6BE7

● Designates subminiature type.
§ Plate supply voltage

Type designations of metal tubes are shown in bold-face type.
Type designations of miniature tubes are shown in italics.

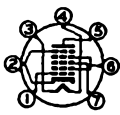

7CH



7D

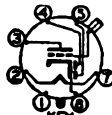

7V

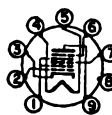

8CT

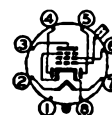

8E



9AA



9Z

Tube Type	Classification by Construction	Base Connections	Out-line Dwg	Type Cathode	Filament Volts	Filament Amp	Max Plate Volts	Max Screen Volts	Capacitance in Micromicrofarads		
									Input	Output	Grid-plate
6BF6	Beam Power Amplifier	7BZ	5-3	Htr	6.3	1.2	250	250	Pentode Connection Triode Connection (G2 & P tied)		
6BF6	Duplex-Diode Triode	7BT	5-2	Htr	6.3	0.3	300	—	1.8▲	1.1▲	2.0▲
6BF7⊙	Twin Triode	8DG	3-2	Htr	6.3	0.3	110	—	2.0	1.6 ₁ 2.0 ₂	1.5
6BG6-G	Beam Power Amplifier	5BT	16A-1	Htr	6.3	0.9	700	350	11▲	6.5▲	0.65▲ ♣
6BG7⊙	Twin Triode	8DG	3-5	Htr	6.3	0.3	110	—	2.0	1.6 ₁ 2.0 ₂	1.5
6BH6	Sharp-Cutoff R-F Pentode	7CM	5-2	Htr	6.3	0.15	300	150	5.4	4.4	0.0035 ♣
6BJ6	Remote-Cutoff R-F Pentode	7CM	5-2	Htr	6.3	0.15	300	150	4.5	5.5	0.0035 ♣
6BK6	Duplex-Diode High-Mu Triode	7BT	5-3	Htr	6.3	0.3	300	—	—	—	—
6BL7-GT	Medium-Mu Twin Triode	8BD	9-11♦	Htr	6.3	1.5	500	—	5.0	3.4 ₁ 3.2 ₂	4.2 ₁ 4.0 ₂
6BN6	Gated-Beam Discriminator	7DF	5-3	Htr	6.3	0.3	300‡	100	E _{c1} = 1.25 volts RMS*		
6BN7	Double Triode	6BN7	6-3	Htr	6.3	0.75	400	—	Section 1		
							400		Section 2		
6BQ6-GT	Beam Power Amplifier	6AM	6BQ6-GT	Htr	6.3	1.2	550‡	200	14▲	9.5▲	0.95▲
6BQ7	High-Frequency Twin Triode	9AJ	6-2	Htr	6.3	0.4	250	—	2.55 ₁	1.30 ₁	1.15
6BT6	Duplex-Diode, High-Mu Triode	7BT	5-3	Htr	6.3	0.3	300	—	—	—	—
6BU6	Duplex-Diode Medium-Mu Triode	7BT	5-3	Htr	6.3	0.3	300	—	—	—	—
6BW6	Beam Power Amplifier	9AM	6-3	Htr	6.3	0.45	315	285	—	—	—

†—Section 1. ⊠—Absolute maximum rating. ‡—Approximate. ♦—With short base.
 ‡—Section 2. ♣—Maximum. ▲—Without external shield. ⊕—For both sections. ‡—Plate supply voltage.
 ‡—The duration of the pulse voltage must not exceed 15 percent of one scanning cycle.

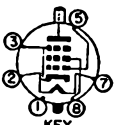

5BT



6AM

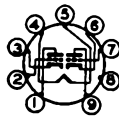

6BN7



7BT

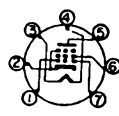

7BZ

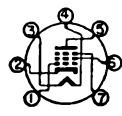

7CM

Service	Neg Grid Volts	Screen Volts	Screen Milli-amperes	Plate Volts	Plate Milli-amperes	R _p Ohms	G _m μmhos	μ Factor	Load for Rated Output, Ohms	Power Output, Watts	Tube Type
Class A Amplifier Vertical Deflection Amplifier	7.5	110	4†	110	49†	10,000	7,500	—	2,500	1.9	6BF6
} Max positive pulse plate voltage ₃ = 700 volts; max plate dissipation = 5.0 watts; max screen dissipation = 1.25 watts											
Class A Amplifier	9.0	—	—	250	9.5	8,500	1,900	16	—	—	6BF6
Class A Amplifier ♦	R _k = 100	—	—	100	8.0	7,000	4,800	35	—	—	6BF7 ©
Horizontal Deflection Amplifier	} Max positive pulse plate voltage ₃ = 6,000 volts; max plate dissipation = 20 watts; max screen dissipation = 3.2 watts; max d-c plate current = 100 ma										
Class A Amplifier ♦	R _k = 100	—	—	100	8.0	7,000	4,800	35	—	—	6BG7 ©
Class A Amplifier	1.0 1.0	100 150	1.4 2.9	100 250	3.6 7.4	700,000\$ 1,400,000\$	3,400 4,600	—	—	—	6BH6
Class A Amplifier	1.0	100	3.3	250	9.2	1,300,000\$	3,600	—	—	—	6BJ6
Class A Amplifier	1.0	100	3.5	100	9.0	250,000\$	3,650	—	—	—	6BK6
Class A Amplifier	{ 2.0 1.0	—	—	250 100	1.2 0.5	62,500 80,000	1,600 1,250	100 100	—	—	6BK6
Class A Amplifier ♦ Vertical Deflection Amplifier ♦	9.0	—	—	250	40	2,150	7,000	15	—	—	6BL7-GT
} Max positive pulse plate voltage ₃ ⊕ = 2000 volts; max plate dissipation = 10 watts; max plate dissipation ⊕ = 12 watts; max d-c cathode current = 60 ma											
FM Limiter-Discriminator	R _k = 200 to 400	100	9.8	285‡	0.49	—	—	—	330000	—	6BN6
Class A Amplifier Vertical Deflection Amplifier Class A Amplifier	15.0	—	—	250	24	2,200	5,500	12	—	—	6BN7
} Max positive pulse plate voltage ₃ = 1,500 volts; max plate dissipation ₁ = 7.5 watts; max plate dissipation ₂ = 1.5 watts											
Class A Amplifier Horizontal Deflection Amplifier	1.0	—	—	120	5	14,000	2,000	28	—	—	6BQ6-GT
Class A Amplifier Horizontal Deflection Amplifier	22.5	150	2.1	250	55	—	5,500	—	—	—	6BQ6-GT
} Max positive pulse plate voltage ₃ ⊕ = 5,500 volts; max plate dissipation = 11 watts; max screen input = 2.5 watts; max d-c plate current = 100 ma											
Class A Amplifier ♦	R _k = 220	—	—	150	9	5,800	6,000	35	—	—	6BQ7
Class A Amplifier	{ 3.0 1.0	—	—	250 100	1.0 0.8	58,000 54,000	1,200 1,300	70 70	—	—	6BT6
Class A Amplifier	9.0	—	—	250	9.5	8,500	1,900	16	10,000	0.30	6BU6
Class A Amplifier	{ 13.0 12.5 8.5	225 250 180	2.2‡ 4.5† 3†	315 250 180	34† 45† 29†	77,000\$ 52,000\$ 58,000\$	3,750 4,100 3,700	— — —	8,500 5,000 5,500	5.5 4.5 2.0	6BW6

♦ Each section.
† Zero signal.
* Minimum

© Designates subminiature type.
Type designations of metal tubes are shown in bold-face type.
Type designations of miniature tubes are shown in italics.

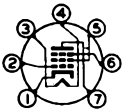

7DF



8BD

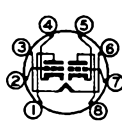

8DG

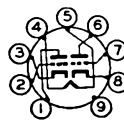

9AJ



9AM

Tube Type	Classification by Construction	Base Connections	Out-line Dwg	Type Cathode	Filament Volts	Filament Amp	Max Plate Volts	Max Screen Volts	Capacitance in Micromicrofarads		
									Input	Output	Grid-plate
6BY5-G	Full-Wave Rectifier; TV Damping Diode	6CN	14-3	Htr	6.3	1.6	RMS voltage per plate = 375 volts; max d-c output = 175 ma;				
6C4	Medium Mu Triode	6BG	5-2	Htr	6.3	0.15	300	—	1.8▲	1.3▲	1.6▲
6C5	Medium Mu Triode	6Q	8-1	Htr	6.3	0.3	300	—	3.0	11.0	2.0
6C5-GT			9-12						4.4	12.0	2.2
6C6	Sharp-Cutoff Pentode	6F	12-2	Htr	6.3	0.3	300	125	5.0▲	6.5▲	0.007
6C7	Duplex-Diode Triode	7G	12-2	Htr	6.3	0.3	250	—	—	—	—
6C8-G	Twin-Triode Amplifier	8G	12-8	Htr	6.3	0.3	250	—	Each triode		
6CB8	Sharp-Cutoff R-F Pentode	7CM	5-2	Htr	6.3	0.3	300	150	6.3▲	1.9▲	0.020▲♣
6CD6-G	Beam Power Amplifier	5BT	16A-1	Htr	6.3	2.5	700	175	26▲	10▲	1.0▲♣
6CG8	Remote-Cutoff Pentode	7BK	5-2	Htr	6.3	0.3	300	150	5.0	5.0	0.008♣
6D4	Gas Triode	5AY	5-2	Htr	6.3	0.25	Max voltage between elements = 450;				
6D6	Remote-Cutoff Pentode	6F	12-2	Htr	6.3	0.3	300	100	4.7▲	6.5▲	0.007♣
6D7	Sharp-Cutoff Pentode	7H	12-2	Htr	6.3	0.3	300	125	5.2▲	6.8▲	0.01▲♣
6D8-G	Pentagrid Converter	8A	12-8	Htr	6.3	0.15	300	100	—	—	—
6E5	Electron-Ray Tube	6R	9-26	Htr	6.3	0.3	250				
6E6	Twin-Triode Power Amplifier	7B	14-1	Htr	6.3	0.6	250	—	—	—	—
6E7	Remote-Cutoff R-F Pentode	7H	12-2	Htr	6.3	0.3	300	100	5.2▲	6.8▲	0.01▲
6F4	Triode Amplifier (Acorn)	7BR	4-2	Htr	6.3	0.225	150	—	1.9▲	0.6▲	1.8▲

*Minimum. §Approximate. ▲Without external shield. ¶Undistorted. ♣Maximum.
 ;—The duration of the pulse voltage must not exceed 15 percent of one scanning cycle.



5AY

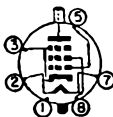

5BT

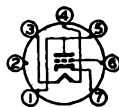

6B6



6CN

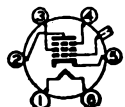

6F

Service	Neg Grid Volts	Screen Volts	Screen Milli-amperes	Plate Volts	Plate Milli-amperes	R_p , Ohms	G_m , μ mhos	μ Factor	Load for Rated Output, Ohms	Power Output, Watts	Tube Type
max peak current per plate = 525 ma; max peak inverse voltage = 1400 volts; min plate supply impedance per plate = 100 ohms; max peak inverse voltage (damper service) = 2,500 volts											6BY5-G
Class A Amplifier	8.5	—	—	250	10.5	7,700	2,200	17	—	—	<i>6C4</i>
Class A Amplifier	8.0	—	—	250	8.0	10,000	2,000	20	—	—	6C5 <i>6C5-GT</i>
Class A Amplifier	3.0	100	0.5	250	2.0	1,000,000*	1,225	—	—	—	6C6
Class A Amplifier	9.0	—	—	250	5.5	16,000	1,250	20	—	—	6C7
Class A Amplifier	4.5	—	—	250	3.2†	22,500	1,600	36	—	—	6C8-G
Class A Amplifier	$R_k = 180$	150	2.8	200	9.5	600,000‡	6,200	—	—	—	<i>6CB6</i>
Horizontal Deflection Amplifier	{ Max positive pulse plate voltage = 6,000 volts; max plate dissipation = 15 watts; max screen input = 3 watts; max d-c plate current = 170 ma									6CD6-G	
Class A Amplifier	8.0	150	2.3	250	9.0	720,000	2,000	—	—	—	<i>6CG6</i>
peak anode current = 100 ma; average anode current = 25 ma; tube voltage drop at 25 ma = 16 volts											6D4
Class A Amplifier	3.0	100	2.0	250	8.2	800,000‡	1,600	—	—	—	6D6
Class A Amplifier	3.0	100	0.5	250	2.0	1,000,000*	1,225	—	—	—	6D7
Converter	3.0	100	2.6	250	3.5	400,000‡	Conversion Trans-conductance = 550		—	—	6D8-G
Plate voltage = 250 through one meg ($E_g = 0$, shadow angle = 90°, $I_p = .24$ ma) ($E_g \approx -8$ volts, shadow angle = 0°) target voltage = 250											6E5
Class A Amplifier	27.5	—	—	250	18.0†	3,500	1,700	6.0	14,000 †	1.6‡	6E6
Class A Amplifier	3.0	100	2.0	250	8.2	800,000	1,600	1,280	—	—	6E7
Class A Amplifier	$R_k = 105\Omega$	—	—	80	13.0	2,900	5,800	17	—	—	6F4

†Zero signal.
‡Plate-to-plate.

Type designations of metal tubes are shown in bold-face type.
Type designations of miniature tubes are shown in italics.

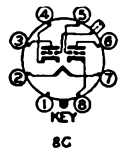
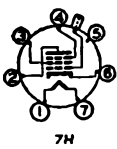
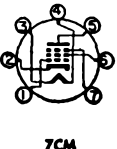
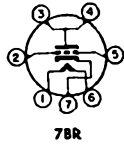
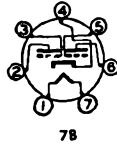
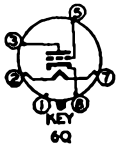

Tube Type	Classification by Construction	Base Connections	Out-line Dwg	Type Cathode	Filament Volts	Filament Amp	Max Plate Volts	Max Screen Volts	Capacitance in Micromicrofarads		
									Input	Output	Grid-plate
6F5 6F5-G 6F5-GT	High-Mu Triode	5M	8-4 12-8 9-17	Htr	6.3	0.3	300	—	—	—	—
6F6 6F6-GT	Power Amplifier Pentode	7S	8-6 9-15	Htr	6.3	0.7	375 350 375 350	285 — 250 —	Pentode connection Triode connection Pentode connection Triode connection		
6F7 6F7-S★	Remote-Cut-Off Amplifier Pentode Triode	7E	12-6	Htr	6.3	0.3	250 100	100 —	Pentode section Triode section		
6F8-G	Twin-Triode	8G	12-8	Htr	6.3	0.6	300	—	Each triode		
6G6-G	Power Amplifier Pentode	7S	12-7	Htr	6.3	0.15	300 300	250 —	Pentode connection Triode connection		
6H4-GT	Diode	5AF	9-11	Htr	6.3	0.15					
6H6 6H6-GT	Twin Diode	7Q	8-5 9-11	Htr	6.3	0.3					
6J4	High-Frequency Triode	7BQ	5-2	Htr	6.3	0.4	150	—	5.5	0.24♣	4.0
6J5 6J5-GT	Medium-Mu Triode	6Q	8-1 9-12	Htr	6.3	0.3	300	—	3.4 —	3.6 4.2	3.4 3.8
6J6	Twin Triode	7BF	5-2	Htr	6.3	0.45	300 300	— —	2.6	1.6 ₁ 1.0 ₂	1.5 Push-pull
6J7 6J7-G 6J7-GT	Sharp-Cutoff Pentode	7R	8-4 12-8 9-18	Htr	6.3	0.3	300 250	125 —	Pentode connected Triode connected		
6J8-G	Triode-Heptode Converter	8H	12-8	Htr	6.3	0.3	300	100	{ Osc Anode = 250 v thru 20,000 ohms; I _p = 5.8 ma }		
6K4⊙	Medium-Mu Triode	6K4	3-2	Htr	6.3	0.15	250	—	2.4▲	0.8▲	2.4▲
6K5-G 6K5-GT	High-Mu Triode	5U	12-8 9-17	Htr	6.3	0.3	250	—	—	—	—

†Zero signal.
♣Maximum.

⊙Both sections.
—Section 1.

*Minimum.
—Section 2.

§Approximate.
¶Undistorted.

♣Per section.
‡Plate-to-plate.

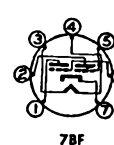
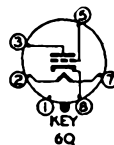
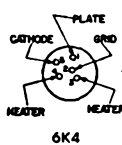
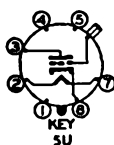
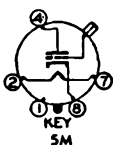

Service	Neg Grid Volts	Screen Volts	Screen Milli-am-peres	Plate Volts	Plate Milli-am-peres	Rp, Ohms	G _m , μmhos	μ Factor	Load for Rated Output, Ohms	Power Output, Watts	Tube Type
Class A Amplifier	2.0	—	—	250	0.9	66,000	1,500	100	—	—	6F6 6F5-G 6F5-GT
Class A Power Amplifier	20.0	285	7.0†	285	38.0†	78,000‡	2,550	—	7,000	4.8	6F6 6F6-GT
Class A Power Amplifier	20.0	—	—	250	31.0†	2,600	2,600	6.8	4,000	0.850 ‡	
Class A Power Amplifier	26.0	250	5.0†	375	34.0†	—	—	—	10,000	18.5	
Class AB Amplifier	38.0	—	—	350	48.0†	—	—	—	6,000 ‡	13.0	
Class A Amplifier	3.0	100	1.5	250	6.5	850,000	1,100	900	—	—	6F7
Class A Amplifier	3.0	—	—	100	3.5	16,000	500	8.0	—	—	6F7-S★
Class A Amplifier	8.0	—	—	250	9.0	7,700‡	2,600 §	20	—	—	6F8-G
Class A Amplifier	9.0	180	2.5†	180	15.0†	175,000	2,300	400	10,000	1.1	6G6-G
Class A Amplifier	12.0	—	—	180	11.0†	4,750	2,000	9.5	12,000	0.25	
Rms voltage = 100 volts max; maximum d-c output = 4 ma											6H4-GT
Max rms voltage per plate = 150 volts; max d-c output per plate = 8 ma; max peak current per plate = 48 ma; max peak inverse voltage = 420 volts											6H6 6H6-GT
Class A Amplifier	R _k = 100	—	—	150	15.0	4,500	12,000	55	—	—	6J4
Class A Amplifier	8.0	—	—	250	9.0	7,700	2,600	20	—	—	6J5 6J5-GT
Class A Amplifier ♠	R _k = 50 ⊕	—	—	100	8.5	7,100	5300	38	—	—	6J6
Class C Amplifier ⊕	10.0	—	—	150	30	Power input = 0.35 watt‡				3.5‡	
Class A Amplifier	3.0	100	0.5	250	2.0	1,000,000*	1,225	—	—	—	6J7
Class A Amplifier	8.0	—	—	250	6.5	10,500	1,900	20	—	—	6J7-G 6J7-GT
Converter	3.0	100	3.5	250	1.3	2,500,000‡	Conversion Trans-conductance = 290			—	6J8-G
Class A Amplifier	R _k = 680	—	—	200	11.5	4,650	3,450	16	—	—	6K4 ⊕
Class A Amplifier	3.0	—	—	250	1.1	50,000‡	1,400	70‡	—	—	6K5-G 6K5-GT

★ External shield connected to cathode pin.
 ▲ Without external shield.

⊕ Designates sub-miniature types.
 Type designations of metal tubes are shown in bold-face type.
 Type designations of miniature tubes are shown in italics.



7E



7Q

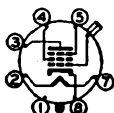

7R

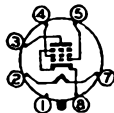

7S

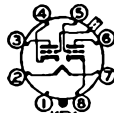

8C



8H

Tube Type	Classification by Construction	Base Connections	Out-line Dwg	Type Cathode	Fila-ment Volts	Fila-ment Amp	Max Plate Volts	Max Screen Volts	Capacitance in Micromicrofarads		
									Input	Out-put	Grid-plate
6K6-GT	Power Amplifier Pentode	7S	9-11	Htr	6.3	0.4	315 315	285 285	Single Tube 2 Tubes, Push-pull		
6K7 6K7-G 6K7-GT	Remote-Cutoff R-F Amplifier Pentode	7R	8-4 12-8 9-18	Htr	6.3	0.3	300	125	7.0 5.0 4.6	12.0 12.0 12.0	0.005 0.007 0.005
6K8 6K8-G 6K8-GT	Triode-Hexode Converter	8K	8-2 12-8 9-24	Htr	6.3	0.3	300	150	{Osc Anode = 100 V} *I _p = 3.8 ma		
6L4	Medium-Mu Triode (Acorn)	7BR	4-2	Htr	6.3	0.225	500	..	0.5▲	1.8▲	1.6▲
6L5-G	Medium-Mu Triode	6Q	12-7	Htr	6.3	0.15	250	—	3.0	5.0	2.7
6L6 6L6-G 6L6-GA	Beam Power Amplifier	7AC	10-1 16-3 14-3	Htr	6.3	0.9	360	270	Single Tube Single Tube 2 Tubes, Push-pull 2 Tubes, Push-pull 2 Tubes, Push-pull		
6L7 6L7-G	Pentagrid Mixer Amplifier	7T	8-4 12-8	Htr	6.3	0.3	300 300	150 100	(E _{cs} = -15 v) (E _{cs} = -3.0 v)		
6M6	Power Amplifier Pentode	9N	6M5	Htr	6.3	0.71	300	300	Single Tube Two Tubes, Push-pull		
6N4	Medium—Mu U-H-F Triode	7CA	5-1	Htr	6.3	0.20	180	—	3.0	1.6	1.1
6N6-G	Direct-Coupled Power Amplifier	7AU	14-3	Htr	6.3	0.8	300	300	Single Tube		
6N7 6N7-G 6N7-GT	Twin Triode	8B	8-6 14-3 9-11	Htr	6.3	0.8	300 300	— —	Single Tube, Push-pull Parallel Triodes		
6N8	Duplex-Diode Pentode	9T	6-3	Htr	6.3	0.3	250	250	—	—	—
6P5-GT	Medium-Mu Triode	6Q	9-11	Htr	6.3	0.3	250	—	3.4	5.5	2.6

‡Zero signal.

♣Maximum.

▲Without external shield.

||Input plate.

†Undistorted.

‡Without external shield.

*Minimum.

♥Grids never driven positive.

§Approximate.

‡Plate-to-plate.

‡Plate-to-plate.

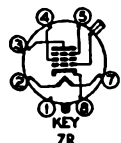
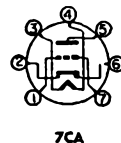
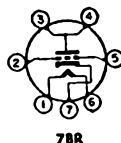
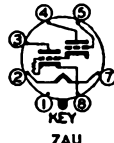
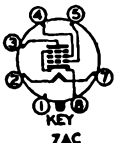
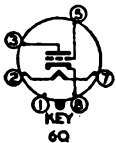

Service	Neg Grid Volts	Screen Volts	Screen Milli-amperes	Plate Volts	Plate Milli-amperes	R_p , Ohms	G_m , μ mhos	μ Factor	Load for Rated Output, Ohms	Power Output, Watts	Tube Type
Class A Amplifier	21.0	250	4.0†	315	25.5†	110,000‡	2,100	—	9,000	4.5	6K6-GT
Class A Amplifier	25.5	285	9.0†	285	55.0†	Peak Grid-to-Grid Voltage = 51 V		12,000‡	10.5		
Class A Amplifier	3.0	125	2.6	250	10.5	600,000‡	1,650	—	—	—	6K7 6K7-G 6K7-GT
Converter	3.0	100	6.0	250	2.5	600,000‡	Conversion Transconductance = 350		—	—	6K8 6K8-G 6K8-GT
Class A Amplifier	$R_k = 150$	—	—	80	9.5	4,400	6400	28	—	—	6L4
Class A Amplifier	9.0	—	—	250	8.0	9,000	1,900	17	—	—	6L5-G
Class A Amplifier	14.0	250	5.0†	250	72.0†	22,500	6,000	—	2,500	6.5	6L6
Class A Amplifier	18.0	250	2.5†	350	54.0†	33,000	5,200	—	4,200	10.8	6L6-G
Class A Amplifier	17.5	270	11.0†	270	134.0†	23,500	5,700	—	5,000	17.5	6L6-GA
Class AB ₁ Amplifier	22.5♥	270	5.0†	360	88.0†	—	—	—	3,800	18.0	
Class AB ₂ Amplifier	22.5	270	5.0†	360	88.0†	—	—	—	3,800	47.0	
Mixer	6.0	150	9.2	250	3.3	1,000,000*	Conversion Transconductance = 350		—	—	6L7
Class A Amplifier	3.0	100	6.5	250	5.3	600,000‡	1,100	670	—	—	6L7-G
Class A Amplifier	$R_k = 170$	250	5.2	250	36	40,000	10,000	—	7,000	3.9	<i>6M5</i>
Class AB ₁ Amplifier	$R_k = 85$	250	16.0	250	79	—	—	—	7,000‡	9.4	
Class A Amplifier	3.5	—	—	180	12.0	5,400‡	6,000	32	—	—	6N4
Class A Amplifier	0.0	300	0.8	300	45	24,000‡	2,400‡	—	7,000‡	4.0¶	6N6-G
Class B Amplifier	0.0	—	—	300	35†	—	—	—	8,000‡	10.0	6N7
Class A Amplifier	6.0	—	—	294	7.0	11,000	3,200	—	—	—	6N7-G 6N7-GT
Class A Amplifier	$R_k = 295$	85	1.75	250	5.0	1,600,000	2,200	—	—	—	6N8
Class A Amplifier	13.5	—	—	250	5.0	9,500	1,450	13.8	—	—	6P5-GT

Type designations of metal tubes are shown in bold-face type.
Type designations of miniature tubes are shown in italics.

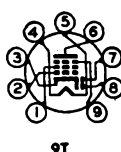
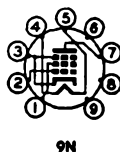
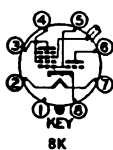
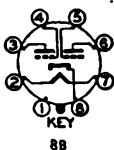
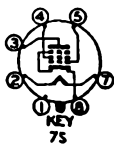

Tube Type	Classification by Construction	Base Connections	Out-line Dwg	Type Cathode	Filament Volts	Filament Amp	Max Plate Volts	Max Screen Volts	Capacitance in Micromicrofarads		
									Input	Out-put	Grid-plate
6P7-G	Remote-Cutoff Pentodé Triode	7U	12-8	Htr	6.3	0.3	250	100	Pentode Section Triode Section		
6Q4	High-Frequency Triode	9S	6-2	Htr	6.3	0.48	300	—	5.4	0.06 ♣	3.4
6Q7 6Q7-G 6Q7-GT	Duplex Diode High-Mu Triode	7V	8-4 12-8 9-18	Htr	6.3	0.3	300	—	5.0 3.2 2.2	3.8 5.0 5.0	1.4 1.5 1.6
6R4	High-Frequency Triode	9R	6-2	Htr	6.3 ₄	0.2	275	—	1.7	0.5	1.5
6R7 6R7-G 6R7-GT	Duplex Diode Triode	7V	8-4 12-8 9-17	Htr	6.3	0.3	250	—	4.8	3.8	2.4
6R8	Triple-Diode, Low-Mu Triode	9E	6-2	Htr	6.3	0.45	250	—	—	—	—
6S4	Medium-Mu Triode	9AC	6-3	Htr	6.3	0.6	500	—	—	—	—
6S7 6S7-G	Remote-Cutoff R-F Amplifier Pentode	7R	8-2 12-8	Htr	6.3	0.15	300	100	6.5 4.4	10.5 8.0	0.005 0.008 ♣
6S8-GT	Triple-Diode Triode	8CB	9-23	Htr	6.3	0.30	300	—	—	—	—
6SA7 6SA7-GT	Pentagrid Converter	8R 8AD	8-1 9-11	Htr	6.3	0.3	300	100	Osc I _g = 0.5 ma thru 20,000 ohms		
6SB7-Y	Pentagrid Converter	8R	8-1	Htr	6.3	0.3	300	100	Osc I _g = 0.5 ma thru 20,000 ohms		
6SC7 6SC7-GT	High-Mu Twin-Triode	8S	8-1 9-11	Htr	6.3	0.3	250	—	Each Triode		
6SD7-GT	Semi-Remote-Cutoff Pentode	8N	9-12	Htr	6.3	0.3	300	125	9.0	7.5	0.0035 ♣
6SE7-GT	Sharp-Cutoff Pentode	8N	9-12	Htr	6.3	0.3	300	125	8.0	7.5	0.005 ♣
6SF5 6SF5-GT	High-Mu Triode	6AB	8-1 9-11	Htr	6.3	0.3	300	—	4.0	3.6	2.4
6SF7	Remote-Cutoff Pentode Diode	7AZ	8-1	Htr	6.3	0.3	300	100	5.5	6.0	0.004 ♣

♠ Approximate. ♣ Maximum
 — The duration of the pulse voltage must not exceed 15 percent of one scanning cycle.
 — A resistor of 3 ohms must be put in series with heater.

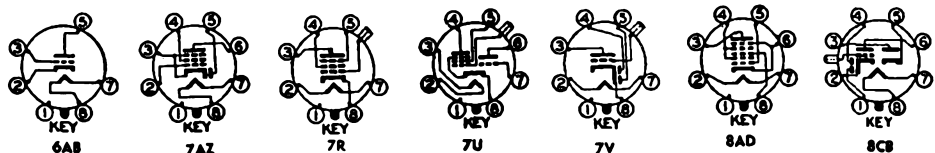

Service	Neg Grid Volts	Screen Volts	Screen Milli-am-peres	Plate Volts	Plate Milli-am-peres	R _p ' Ohms	G _m ' μmhos	μ Factor	Load for Rated Out-put, Ohms	Power Out-put, Watts	Tube Type
Class A Amplifier Class A Amplifier	3.0	100	1.5	250	6.5	850,000	1,100	900	—	—	6P7-G
	3.0	—	—	100	3.5	16,000	500	8.0	—	—	
Class A Amplifier	1.5	—	—	250	15	—	12,000	80	—	—	6Q4
Class A Amplifier	3.0	—	—	250	1.0	58,000	1,200	70	—	—	6Q7 6Q7-G 6Q7-GT
Class A Amplifier	2.0	—	—	150	30	—	5,500	16	—	—	6R4
	2.0	—	—	120	20	—	4,000	16	—	—	
Class A Amplifier	9.0	—	—	250	9.5	8,500	1,900	16	—	—	6R7 6R7-G 6R7-GT
Class A Amplifier	9.0	—	—	250	9.5	8,500	1,900	16	10,000	0.30	6R8
Class A Amplifier Vertical Deflection Amplifier	8.0	—	—	250	26	3,600	4,500	16	—	—	6S4
{ Max positive pulse plate voltage _s = 2,000 volts; max plate dissipation = 7.5 watts; max d-c cathode current = 30 ma											
Class A Amplifier	3.0	100	2.0	250	8.5	1,000,000§	1,750	—	—	—	6S7 6S7-G
Class A Amplifier	2.0	—	—	250	0.9	91,000	1,100	100	—	—	6S8-GT
Converter	2.0	100	8.5	250	3.5	1,000,000§	Conversion Trans-conductance = 450			—	6SA7 6SA7-GT
Converter	1.5	100	8.5	250	4.0	—	Conversion Trans-conductance = 880			—	6SB7-Y
Class A Amplifier	2.0	—	—	250	2.0	53,000§	1,325§	70	—	—	6SC7 6SC7-GT
Class A Amplifier	2.0	125	3.0	250	9.5	700,000	4,250	—	—	—	6SD7-GT
Class A Amplifier	1.5	100	1.5	250	4.5	1,000,000	3,400	—	—	—	6SE7-GT
Class A Amplifier	2.0	—	—	250	0.9	66,000	1,500	100	—	—	6SF5 6SF5-GT
Class A Amplifier	1.0	100	3.3	250	12.4	700,000§	2,050	—	—	—	6SF7

Type designations of metal tubes are shown in bold-face type.
 Type designations of miniature tubes are shown in italics.

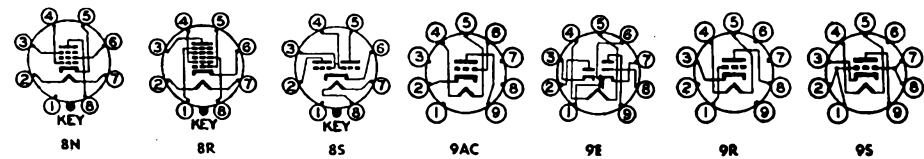

Tube Type	Classification by Construction	Base Connections	Out-line Dwg	Type Cathode	Filament Volts	Filament Amp	Max Plate Volts	Max Screen Volts	Capacitance in Micromicrofarads		
									Input	Out-put	Grid-plate
6SG7 6SG7-GT	Semi-Remote-Cutoff Pentode	8BK	8-1 9-12	Htr	6.3	0.3	300	150	8.5	7.0	0.003 ♣
6SH7 6SH7-GT	Sharp-Cutoff R-F Pentode	8BK	8-1 9-12	Htr	6.3	0.3	300	150	8.5	7.0	0.003 ♣
6SJ7 6SJ7-GT 6SJ7-Y	Sharp-Cutoff Pentode	8N	8-1 9-12 8-1	Htr	6.3	0.3	300 250	125 —	Pentode Connection Triode Connection (G2, G3 & P tied)		
6SK7 6SK7-GT	Remote-Cutoff R-F Pentode	8N	8-1 9-12	Htr	6.3	0.3	300	125	6.0 6.5	7.0 7.5	0.003 ♣ 0.005 ♣
6SL7-GT	High-Mu Twin-Triode	8BD	9-11	Htr	6.3	0.3	300	—	Each Unit		
6SN7-GT	Medium-Mu Twin Triode	8BD	9-11	Htr	6.3	0.6	300	—	2.8 ₁ 3.0 ₂	0.8 ₁ 1.2 ₂	3.8 ₁ 4.0 ₂
6SN7-GTA	Medium-Mu Twin Triode	8BD	9-11	Htr	6.3	0.6	500	—	2.8 ₁ ▲ 3.0 ₂ ▲	0.8 ₁ ▲ 1.2 ₂ ▲	3.8 ₁ ▲ 4.0 ₂ ▲
6SQ7 6SQ7-GT	Duplex-Diode, High-Mu Triode	8Q	8-1 9-12	Htr	6.3	0.3	300	—	3.2 4.2	3.0 3.4	1.6 1.8
6SR7 6SR7-GT	Duplex-Diode Triode	8Q	8-1 9-11	Htr	6.3	0.3	250	—	3.6	2.8	2.4
6SS7	Remote-Cutoff R-F Pentode	8N	8-1	Htr	6.3	0.15	300	100	5.5	7.0	0.004 ♣
6ST7	Duplex Diode Triode	8Q	8-1	Htr	6.3	0.15	250	—	2.8	3.0	1.5
6SU7- GT _Y	High-Mu Twin-Triode	8BD	9-11	Htr	6.3	0.3	250	—	Each Unit		
6SV7	Diode R-F Pentode	7AZ	8-1	Htr	6.3	0.30	300	150	6.5	6.0	0.004 ♣
6SZ7	Duplex-Diode High-Mu Triode	8Q	8-1	Htr	6.3	0.15	300	—	2.6	2.8	1.1
6T5	Electron-Ray Indicator	6R	9-26	Htr	6.3	0.3	250	Plate voltage = 250 through 1 megohm			
6T7-G	Duplex-Diode High-Mu Triode	7V	12-8	Htr	6.3	0.15	250	—	1.8	3.1	1.7
6T8	Triple Diode High-Mu Triode	9E	6-2	Htr	6.3	0.45	300	—	1.5▲	1.1▲	2.4▲
6U4-GT	Half-Wave Rectifier; TV Damping Diode	4CG	9-13	Htr	6.3	1.2	Rms voltage = 350 volts; Max d-c output = 125 ma;				
6U5/6G5	Electron-Ray Indicator	6R	9-26	Htr	6.3	0.3	285	Plate voltage = 250 through 1 megohm			
6U6-GT	Beam Power Amplifier	7AC	9-11	Htr	6.3	0.75	200	135	—	—	—

†Zero signal.
‡—Section 2.

§Approximate.

▲Without external shield.

*Minimum.

1—Section 1.



4CG



6R

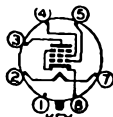

7AC

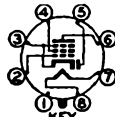

7AZ

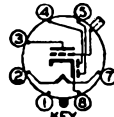

7V

Service	Neg Grid Volts	Screen Volts	Screen Milli-amperes	Plate Volts	Plate Milli-amperes	R _p , Ohms	G _m , μmhos	μ Factor	Load for Rated Output, Ohms	Power Output, Watts	Tube Type
Class A Amplifier	2.5	150	3.4	250	9.2	1,000,000*	4,000	—	—	—	6SG7 6SG7-GT
Class A Amplifier	1.0	150	4.1	250	10.8	900,000§	4,900	—	—	—	6SH7 6SH7-GT
Class A Amplifier	3.0	100	0.8	250	3.0	1,000,000*	1,650	—	—	—	6SJ7
Class A Amplifier	8.5	—	—	250	9.2	7,600	2,500	19	—	—	6SJ7-GT 6SJ7-Y
Class A Amplifier	3.0	100	2.6	250	9.2	800,000§	2,000	—	—	—	6SK7 6SK7-GT
Class A Amplifier	2.0	—	—	250	2.3	44,000	1,600	70	—	—	6SL7-GT
Class A Amplifier ♣	{ 8.0 0.0	—	—	250 90	9.0 10	7,700 6,700	2600 3000	20 20	—	—	6SN7-GT
Class A Amplifier ♣ Vertical Deflection Amplifier ♣	{ 8.0 0.0	—	—	250 90	9.0 10	7,700 6,700	2600 3000	20 20	—	—	6SN7-GTA
Max positive pulse plate voltage = 1250; max plate dissipation = 5.0 watts; max plate dissipation ⊕ = 7.5 watts											
Class A Amplifier	{ 2.0 1.0	—	—	250 100	1.1 0.5	85,000 110,000	1175 925	100 100	—	—	6SQ7 6SQ7-GT
Class A Amplifier	9.0	—	—	250	9.5†	8,500	1,900	16	10,000	0.300	6SR7 6SR7-GT
Class A Amplifier	3.0	100	2.0	250	9.0	1,000,000§	1,850	—	—	—	6SS7
Class A Amplifier	9.0	—	—	250	9.5	8,500	1,900	16	—	—	6ST7
Class A Amplifier	2.0	—	—	250	2.3	44,000	1,600	70	—	—	6SU7-GTY
Class A Amplifier	1.0	150	2.8	250	7.5	1,500,000§	3,600	—	—	—	6SV7
Class A Amplifier	3.0	—	—	250	1.0	58,000	1,200	70	—	—	6SZ7
target voltage = 250 volts; (E _g = 0 for min illumination, I _b = 3 ma; E _g = -22 for max illumination)											
Class A Amplifier	3.0	—	—	250	1.2	62,000	1,050	65	—	—	6T7-G
Class A Amplifier	3.0	—	—	250	1.0	58,000§	1,200	70	—	—	6T8
Class A Amplifier	1.0	—	—	100	0.8	54,000§	1,300	70	—	—	6U4-GT
max peak current = 600 ma; max peak inverse voltage = 1250 volts; min plate supply impedance = 145 ohms; max peak inverse voltage (damper service) ⊞ = 3850 volts											
(E _g = 0, shadow angle = 90°, I _p = .24 ma) (E _g = 22, shadow angle = 0°) target voltage = 250											
Class A Amplifier	14.0	135	3.0†	200	55.0†	20,000	6,200	—	3,000	5.5	6U6-GT

♣ Maximum.

♠ Per section.

Type designations of metal tubes are shown in bold-face type.

⊕ For both sections.

⊞ Absolute maximum rating. Type designations of miniature tubes are shown in italics.

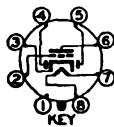
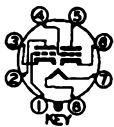

Tube Type	Classification by Construction	Base Connections	Out-line Dwg	Type Cathode	Filament Volts	Filament Amp	Max Plate Volts	Max Screen Volts	Capacitance in Micromicrofarads		
									Input	Out-put	Grid-plate
6U7-G	Remote-Cutoff R-F Pentode	7R	12-4	Htr	6.3	0.3	300	100	5.0	9.0	0.007 ♣
6V4	Full-Wave, High-Vacuum Rectifier	9M	6M5	Htr	6.3	0.6	Rms voltage per plate = 350 volts,				
6V5-GT	Beam Power Amplifier	6AO	9-11	Htr	6.3	0.45	315	285	Single Tube		
6V6	Beam Power Amplifier	7AC	8-6 9-11	Htr	6.3	0.45	315	285	Two Tubes, Push-pull		
6V6-GT									Single Tube 2 Tubes, Push-pull		
6V7-G	Duplex Diode Triode	7V	12-8	Htr	6.3	0.3	250	—	2.0	3.5	1.7
6V8	Triple-Diode, High-Mu Triode	9AH	6-2	Htr	6.3	0.45	300	—	—	—	—
6W4-GT	Half-Wave Rectifier; TV Damping Diode	4CG	9-11	Htr	6.3	1.2	Rms voltage = 350 volts; min plate supply impedance = 145 ohms;				
6W5-G	Full-Wave High-Vacuum Rectifier	6S	12-7	Htr	6.3	0.9	Rms voltage per plate = 325 v; max d-c output = 90 ma;				
6W6-GT	Beam Power Amplifier	7AC	9-11	Htr	6.3	1.2	300	150	Pentode Connection		
									Triode Connection (G ₂ & P tied)		
6W7-G	Sharp-Cutoff Pentode	7R	12-8	Htr	6.3	0.15	300	300	5.0	8.5	0.007 ♣
6X4	Full-Wave High-Vacuum Rectifier	5BS	5-3	Htr	6.3	0.6	Rms voltage per plate = 325 volts max; max d-c output = 70 ma;				
6X5	Full-Wave High-Vacuum Rectifier	6S	8-6 9-11	Htr	6.3	0.6	Rms voltage per plate = 325; max d-c output = 70 ma;				
6X5-GT											
6Y6-G	Beam Power Amplifier	7AC	14-3	Htr	6.3	1.25	200	135	15.0▲	11.0▲	0.7▲
6Y6-GT			9-11						—	—	—
6Y7-G	Twin-Triode Amplifier	8B	12-7	Htr	6.3	0.6	250	—	Single Tube		—
6Z4	Full-Wave High-Vacuum Rectifier	5D	12-5	Htr	6.3	0.5	Rms voltage per plate = 325 v; max d-c output = 60 ma;				
6Z5	Full-Wave High-Vacuum Rectifier	6K	12-5	Htr	{6.3 12.6}	{0.8 0.4}	Rms voltage per plate = 230 v;				
6Z7-G	Twin-Triode Power Amplifier	8B	12-7	Htr	6.3	0.3	180	—	Single Tube		
6ZY5-G	Full-Wave High-Vacuum Rectifier	6S	12-7	Htr	6.3	0.3	Rms voltage per plate = 325 v; max d-c output = 40 ma;				
7A4	Medium-Mu Triode	5AC	9-30	Htr	6.3	0.3	300	—	3.4	3.0	4.0

§ Approximate.

† Zero signal.

‡ Plate-to-plate.

♣ Maximum.

■ Absolute maximum rating.

▲ Without external shield.

♥ Grids never driven positive.

— The duration of the pulse voltage must not exceed 15 percent of one scanning cycle.

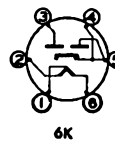
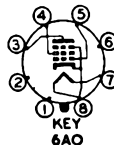
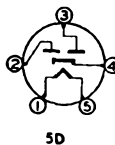
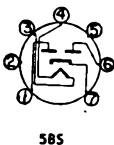
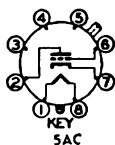
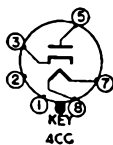

Tube Type	Classification by Construction	Base Connections	Out-line Dwg	Type Cathode	Filament Volts	Filament Amp	Max Plate Volts	Max Screen Volts	Capacitance in Micromicrofarads		
									Input	Output	Grid-plate
7A5	Beam Power Amplifier	6AA	9-31	Htr	6.3	0.75	125	125	—	—	—
7A6	Twin Diode	7AJ	9-30	Htr	6.3	0.15	Rms voltage per plate = 150 v;				
7A7	Remote-Cutoff R-F Pentode	8V	9-30	Htr	6.3	0.3	250	100	6.0	7.0	0.005 ♣
7A8	Octode Converter	8U	9-30	Htr	6.3	0.15	300	100	Anode = 250 v thru 20,000 ohms I _p = 4.0 ma		
7AB7	Sharp-Cutoff R-F Pentode	8BO	9-32	Htr	6.3	0.15	300	150	3.5	4.0	0.06 ♣
7AD7	Power Amplifier Pentode	8V	9-31	Htr	6.3	0.60	300	150	11.5	7.5	0.03 ♣
7AF7	Medium-Mu Twin Triode	8AC	9-30	Htr	6.3	0.3	300	—	2.2	1.6	2.3 ♣
7AG7	Sharp-Cutoff R-F Pentode	8V	9-30	Htr	6.3	0.15	300	300	7.0	6.0	0.005 ♣
7AH7	Remote-Cutoff R-F Pentode	8V	9-30	Htr	6.3	0.15	300	300	7.0	6.5	0.005 ♣
7AJ7	Sharp-Cutoff R-F Pentode	8V	9-30	Htr	6.3	0.3	300	100	6.0	6.5	0.007 ♣
7AK7	Sharp-Cutoff R-F Pentode	8V	9-31	Htr	6.3	0.8	200	100	12.0	9.5	0.7
7B4	High-Mu Triode	5AC	9-30	Htr	6.3	0.3	300	—	3.6	3.4	1.6
7B5	Power Amplifier Pentode	6AE	9-31	Htr	6.3	0.4	315	285	—	—	—
7B6	Duplex Diode High-Mu Triode	8W	9-30	Htr	6.3	0.3	300	—	—	—	—
7B7	Remote-Cutoff R-F Pentode	8V	9-30	Htr	6.3	0.15	250	100	5.0	7.0	0.005 ♣
7B8	Pentagrid Converter	8X	9-30	Htr	6.3	0.3	250	100	Anode = 250 v thru 20,000 ohms I _p = 4.0		
7C4	Diode	4AH	9-30	Htr	6.3	0.150	Rms plate voltage = 117 max;				
7C5	Beam Power Amplifier	6AA	9-31	Htr	6.3	0.4	315	250	—	—	—
7C6	Duplex Diode High-Mu Triode	8W	9-30	Htr	6.3	0.15	300	—	2.4	3.0	1.4
7C7	Sharp-Cutoff Pentode	8V	9-30	Htr	6.3	0.15	300	100	5.5	6.5	0.007 ♣

§ Approximate. † Zero signal. * Minimum. ♣ Per section. ♣ Maximum.

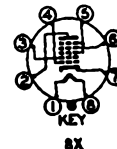
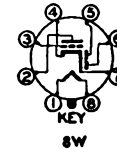
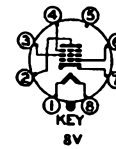
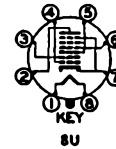
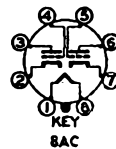
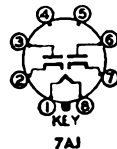
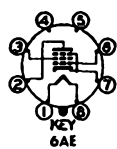
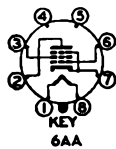
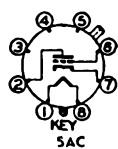
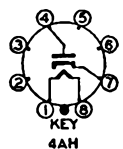

Service	Neg Grid Volts	Screen Volts	Screen Milli-amperes	Plate Volts	Plate Milli-amperes	R _p Ohms	C _m μmhos	μ Factor	Load for Rated Output, Ohms	Power Output, Watts	Tube Type
Class A Amplifier	7.5	110	3.0†	110	40.0†	16,000	5,800	—	2,500	1.5	7A5
max d-c output = 8 ma											
Class A Amplifier	3.0	100	2.6	250	9.2	800,000	2,000	—	—	—	7A6
Converter	3.0	100	3.2	250	3.0	700,000§	Conversion Trans-conductance = 550			—	7A7
Class A Amplifier	2.0	100	1.3	250	4.0	500,000§	1,800	—	—	—	7A8
Class A Amplifier	R _k = 68	150	7.0	300	28.0	300,000	9,500	—	—	—	7AB7
Class A Amplifier ♣	10.0	—	—	250	9.0	7,600	2,100	16	—	—	7AD7
Class A Amplifier	R _k = 250	250	2.0	250	6.0	1,000,000*	4,200	—	—	—	7AF7
Class A Amplifier	R _k = 250	250	1.9	250	6.8	1,000,000	3,300	—	—	—	7AG7
Class A Amplifier	1.0	100	1.8	100	5.7	400,000§	2,275	—	—	—	7AJ7
	3.0	100	0.7	250	2.2	1,000,000§	1,575	—	—	—	
Class A Amplifier	0	90	21.0	150	40.0	11,500§	6,500	—	—	—	7AK7
Class A Amplifier	2.0	—	—	250	0.9	66,000	1,500	100	—	—	7B4
Class A Amplifier	21.0	250	4.0†	315	25.5†	75,000	2,100	—	9,000	4.5	7B5
Class A Amplifier	18.0	250	5.5†	250	32.0†	68,000	2,300	—	7,600	3.4	7B6
Class A Amplifier	2.0	—	—	250	0.9	91,000	1,100	100	—	—	7B7
Class A Amplifier	3.0	100	2.0	250	8.5	700,000	1,700	—	—	—	7B8
Converter	3.0	100	2.7	250	3.5	360,000§	Conversion Trans-conductance = 550			—	7C4
max d-c output = 5 ma											
Class A Amplifier	13.0	225	2.2†	315	34.0†	77,000	3,750	—	8,500	5.5	7C5
Class A Amplifier	8.5	180	3.0†	180	29.0†	58,000	3,700	—	5,500	2.0	7C6
Class A Amplifier	1.0	—	—	250	1.3	100,000	1,000	100	—	—	7C7
Class A Amplifier	3.0	100	0.5	250	2.0	2,000,000§	1,300	—	—	—	7C7

Tube Type	Classification by Construction	Base Connections	Out-line Dwg	Type Cathode	Filament Volts	Filament Amp	Max Plate Volts	Max Screen Volts	Capacitance in Micromicrofarads		
									Input	Output	Grid-plate
7E5	High-Frequency Triode	8BN	9-30	Htr	6.3	0.15	250	—	3.6	2.8	1.5
7E6	Duplex-Diode Triode	8W	9-30	Htr	6.3	0.3	250	—	—	—	—
7E7	Remote-Cutoff Duplex-Diode Pentode	8AE	9-30	Htr	6.3	0.3	250	100	4.6	4.6	0.005
7F7	High-Mu Twin Triode	8AC	9-30	Htr	6.3	0.3	250	—	Each Triode Unit		
7F8	High-Frequency Twin Triode	8BW	9-32	Htr	6.3	0.30	300	—	2.8	1.4	1.2
7G7	Sharp-Cutoff Pentode	8V	9-30	Htr	6.3	0.45	250	100	9.0	7.0	0.007
7G8	Twin Tetrode	8BV	9-32	Htr	6.3	0.30	300	150	3.4	2.6	0.15
7H7	Semi-Remote-Cutoff R-F Pentode	8V	9-30	Htr	6.3	0.3	300	150	8.0	7.0	0.007
7J7	Triode Heptode Converter	8BL	9-30	Htr	6.3	0.3	300	100	Osc. Anode = 250 v thru 20,000 ohms $I_p = 5.4$ ma		
7K7	Duplex-Diode High-Mu Triode	8BF	9-30	Htr	6.3	0.3	250	—	—	—	—
7L7	Sharp-Cutoff Pentode	8V	9-30	Htr	6.3	0.3	300	125	8.0	6.5	0.01
7N7	Medium-Mu Twin Triode	8AC	9-31	Htr	6.3	0.6	300	—	—	—	—
7Q7	Pentagrid Converter	8AL	9-30	Htr	6.3	0.3	300	100	Osc $I_g = 0.5$ ma thru 20,000 ohms		
7R7	Duplex-Diode Pentode	8AE	9-30	Htr	6.3	0.3	250	125	5.6	5.3	0.004
7S7	Triode-Heptode Converter	8BL	9-30	Htr	6.3	0.3	175	100	$E_{pt} = 250$ v thru 20,000 ohms $I_{pt} = 5.0$ ma $I_{gt} = 0.5$ ma		
7T7	R-F Sharp-Cutoff Pentode	8V	9-30	Htr	6.3	0.30	300	150	7.5	5.5	0.005
7V7	Pentode Amplifier	8V	9-30	Htr	6.3	0.45	300	150	$E_{ag} = 300$ v thru 40,000 ohms		
7W7	Amplifier Pentode	8BJ	9-30	Htr	6.3	0.45	300	150	—	—	—
7X6	Full-Wave Rectifier	7AJ	9-31	Htr	6.3	1.2	Rms voltage per plate = 235 volts; max d-c output per plate = 75 ma				
7X7	Duplex-Diode High-Mu Triode	8BZ	9-31	Htr	6.3	0.30	300	—	—	—	—
7Y4	Full-Wave High-Vacuum Rectifier	5AB	9-30	Htr	6.3	0.5	Rms voltage per plate = 325 v; max d-c output = 70 ma;				
7Z4	Full-Wave High-Vacuum Rectifier	5AB	9-31	Htr	6.3	0.9	Rms voltage per plate = 325 v; max d-c output = 100 ma;				

§ Approximate. ♣ Maximum. ♦ Per section.



Service	Neg Grid Volts	Screen Volts	Screen Milli-amperes	Plate Volts	Plate Milli-amperes	R_p , Ohms	G_m , μ mhos	μ Factor	Load for Rated Output, Ohms	Power Output, Watts	Tube Type
Class A Amplifier	3.0	—	—	180	5.5	12,000	3,000	36	—	—	7E5
Class A Amplifier	9.0	—	—	250	9.5	8,500	1,900	16	—	—	7E6
Class A Amplifier	3.0	100	1.6	250	7.5	700,000§	1,300	—	—	—	7E7
Class A Amplifier	2.0	—	—	250	2.3	44,000§	1,600	70	—	—	7F7
Class A Amplifier ♦	$R_k = 500\Omega$	—	—	250	6.0	—	3,300	48	—	—	7F8
Class A Amplifier	2.0	100	2.0	250	6.0	800,000§	4,500	—	—	—	7G7
Class A Amplifier ♦	2.5	100	0.8	250	4.5	225,000§	2,100	—	—	—	7G8
Class A Amplifier	$R_k = 180$	150	3.2	250	10.0	800,000§	4,000	—	—	—	7H7
Converter	3.0	100	2.9	300	1.3	1,500,000	Conversion Trans-conductance = 300		—	—	7J7
Class A Amplifier	2.0	—	—	250	2.3	44,000	1,600	70	—	—	7K7
Class A Amplifier	1.5	100	1.5	250	4.5	1,000,000§	3,100	—	—	—	7L7
Class A Amplifier ♦	8.0	—	—	250	9.0	7,700	2,600	20	—	—	7N7
Converter	2.0	100	8.5	250	3.5	1,000,000§	Conversion Trans-conductance = 550		—	—	7Q7
Class A Amplifier	1.0	100	2.1	250	5.7	1,000,000§	3,200	—	—	—	7R7
Converter	2.0	100	3.0	250	1.8	1,250,000§	Conversion Trans-conductance = 525		—	—	7S7
Class A Amplifier	1.0	150	4.1	250	10.8	900,000	4,900	—	—	—	7T7
Class A Amplifier	$R_k = 160$	—	3.9	300	10	300,000§	5,800	—	—	—	7V7
Class A Amplifier	$R_k = 160$	150	3.9	300	10	300,000	5,800	—	—	—	7W7
max peak current per plate = 450 ma; max peak inverse voltage = 700 volts; min plate supply impedance per plate = 100 ohms											
Class A Amplifier	1.0	—	—	250	1.9	67,000	1,500	100	—	—	7X6
peak current per plate = 180 ma; max peak inverse voltage = 1,250; min plate supply impedance per plate = 150 ohms											
peak current per plate = 300 ma; max peak inverse voltage = 1,250; min plate supply impedance per plate = 75 ohms											
7Y4											
7Z4											

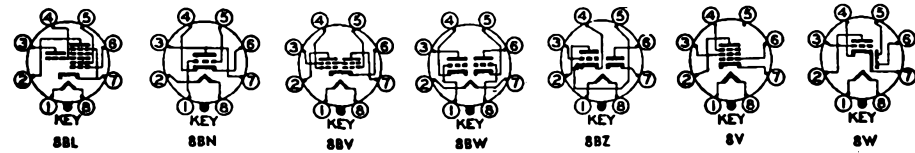

Tube Type	Classification by Construction	Base Connections	Out-line Dwg	Type Cathode	Filament Volts	Filament Amp	Max Plate Volts	Max Screen Volts	Capacitance in Micromicrofarads		
									Input	Output	Grid-plate
10	Power Amplifier Triode	4D	19A-1	Fil	7.5	1.25	425	—	4.0	3.0	7.0
										2 Tubes	
12A	Detector Amplifier Triode	4D	14-1	Fil	5.0 D-C	0.25	180	—	4.0▲	2.0▲	8.5▲
12A4	Medium-Mu Triode	9AG	6-3	Htr	{ 6.3 12.6 }	{ 0.6 0.3 }	450	—	6.7	3.8	4.9
12A5	Power Amplifier Pentode	7F	12-5	Htr	{ 12.6 6.3 }	{ 0.3 0.6 }	180	180	—	—	—
12A6	Beam Power Amplifier	7AC	8-6	Htr	12.6	0.15	250	250	—	—	—
12A6-GT			9-9								
12A7	Diode Pentode	7K	12-6	Htr	12.6	0.3	135	135	Pentode Section		
									Diode Section		
12A8-GT	Pentagrid Converter	8A	9-18	Htr	12.6	0.15	300	100	Anode = 250 volts thru 20,000 ohms I _p = 4.0 ma Anode = 100 volts I _p = 2.0 ma		
12AH7-GT	Twin Triode	8BE	9-7	Htr	12.6	0.15	180	—	Each Triode Section		
12AL6	Twin Diode	6BT	5-1	Htr	12.6	0.15	Max rms voltage per plate = 117;				
12AT6	Duplex-Diode Triode	7BT	5-2	Htr	12.6	0.15	300	—	2.2	1.2	2.0
12AT7	High-Frequency Twin Triode	9A	6-2	Htr	{ 12.6 6.3 }	{ 0.15 0.30 }	300	—	2.2	1.2 ₁ 1.5 ₂	1.5
12AU6	Sharp-Cutoff R-F Pentode	7BK	5-2	Htr	12.6	0.15	300	150	Pentode Connection		
							250	—	Triode Connection (G ₂ , G ₃ , & P tied)		
12AU7	Medium-Mu Twin Triode	9A	6-2	Htr	{ 12.6 6.3 }	{ 0.15 0.30 }	300	—	1.8	2.0	1.5
12AV6	Duplex-Diode High-Mu Triode	7BT	5-2	Htr	12.6	0.15	300	—	2.2	1.2	2.0
12AV7	Twin Triode	9A	6-2	Htr	{ 6.3 12.6 }	{ 0.450 0.225 }	300	—	3.2	1.3 ₁ 1.6 ₂	1.9
12AW6	Sharp-Cutoff R-F Pentode	7CM	5-2	Htr	12.6	0.15	300	150	Pentode Connection		
							300	—	Triode Connection (G ₂ & P tied)		

▲ Without external shield.
† Zero signal.

◆ Per section.

‡ Undistorted.

§ Absolute maximum rating.

‡ Plate-to-plate.

§ Approximate.



4D

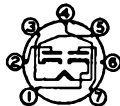

6BT



7AC



7BT



7BK



7CM

Service	Neg Grid Volts	Screen Volts	Screen Milli-amperes	Plate Volts	Plate Milli-amperes	R_p , Ohms	G_m , μ mhos	μ Factor	Load for Rated Output, Ohms	Power Output, Watts	Tube Type
Class A Amplifier Class B \clubsuit Amplifier	40.0	—	—	425	18.0†	5,000	1,600	8.0	10,200	1.6¶	10
	50.0	—	—	425	4.0†	Power Input = 2.5 Watts			8,000‡	25.0	
Class A Amplifier	13.5	—	—	180	7.7†	4,700	1,800	8.5	10,650	0.285¶	12A
Class A Amplifier	9.0	—	—	250	21	—	7,800	20	—	—	12A4
Vertical Deflection Amplifier	{ Max positive pulse plate voltage; \square = 1,000 volts; max plate dissipation \square = 6.5 watts; max d-c cathode current = 30 ma										
Class A Amplifier	25.0	180	8.0†	180	45.0†	35,000‡	2,400	—	3,300	3.4	12A5
Class A Amplifier	12.5	250	3.5†	250	30.0†	70,000‡	3,000	—	7,500	3.4	12A6 12A6-GT
Class A Amplifier Rectifier	13.5	135	2.5†	135	9.0†	102,000	975	—	13,500	0.55	12A7
Rms plate voltage = 125 v max; d-c output current = 30 ma max											
Converter	3.0	100	2.7	250	3.5	360,000‡	Conversion Transconductance = 550		—	—	12A8-GT
Converter	1.5	50	1.3	100	1.1	600,000‡	Conversion Transconductance = 360		—	—	
Class A Amplifier	6.5	—	—	180	7.6	8,400	1,900	16.0	—	—	12AH7-GT
max d-c output per plate = 9 ma; max peak plate current per plate = 54 ma; max peak inverse voltage = 330											12AL5
Class A Amplifier	3.0	—	—	250	1.0	58,000	1,200	70	—	—	12AT6
Class A Amplifier \clubsuit Class A Amplifier \clubsuit	$R_k = 200$	—	—	250	10.0	10,900	5,500	60	—	—	12AT7
	$R_k = 270$	—	—	100	3.7	15,000	4,000	60	—	—	
Class A Amplifier	$R_k = 68$	150	4.3	250	10.6	1,000,000‡	5,200	—	—	—	12AU6
	$R_k = 150$	100	2.1	100	5.0	500,000‡	3,900	—	—	—	
Class A Amplifier	$R_k = 330$	—	—	250	12.2	—	4,800	36	—	—	
Class A Amplifier \clubsuit	8.5	—	—	250	10.5	7,700	2,200	17	—	—	12AU7
Class A Amplifier \clubsuit	0.0	—	—	100	11.8	6,500	3,100	20	—	—	
Class A Amplifier	2.0	—	—	250	1.2	62,500	1,600	100	—	—	12AV6
Class A Amplifier \clubsuit	$R_k = 56$	—	—	150	18	4,800	8,500	41	—	—	12AV7
	$R_k = 120$	—	—	100	9.0	6,100	6,100	37	—	—	
Class A Amplifier Class A Amplifier	$R_k = 200$	150	2.0	250	7.0	800,000‡	5,000	—	—	—	12AW6
	$R_k = 825$	—	—	250	5.5	11,000	3,800	42	—	—	

1—Section 1.

2—Section 2.

3—The duration of the pulse voltage must not exceed 15 percent of one scanning cycle.

Type designations of metal tubes are shown in bold-face type.

Type designations of miniature tubes are shown in italics.

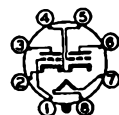
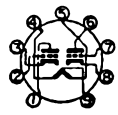
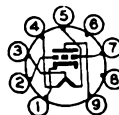

7F

7K

8A

8BE

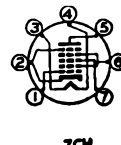
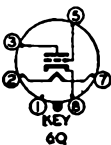
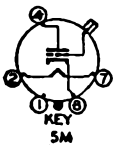
9A

9AG

Tube Type	Classification by Construction	Base Connections	Out-line Dwg	Type Cathode	Fila-ment Volts	Fila-ment Amp	Max Plate Volts	Max Screen Volts	Capacitance in Micromicrofarads		
									Input	Out-put	Grid-plate
12AX7	High-Mu Twin Triode	9A	6-2	Htr	{ 12.6 6.3 }	{ 0.15 0.30 }	300	—	1.8	1.9	1.7
12AY7	Twin Triode	9A	6-2	Htr	{ 6.3 12.6 }	{ 0.3 0.15 }	300	—	1.3▲	0.6▲	1.3▲
12B8-GT	Remote-Cutoff Pentode Triode	8T	9-24	Htr	12.6	0.3	90	90	Pentode Section Triode Section		
12BA6	Remote-Cutoff R-F Pentode	7BK	5-2	Htr	12.6	0.15	300	150	5.5	5.0	0.0035♣
12BA7	Pentagrid Converter	8CT	6-3	Htr	12.6	0.15	300	100	Osc I _g = 0.35 ma thru 20,000 ohms Osc I _g = 0.35 ma thru 20,000 ohms		
12BD6	Remote-Cutoff R-F Pentode	7BK	5-2	Htr	12.6	0.15	300	125	4.3▲	5.0▲	0.005♣▲
12BE6	Pentagrid Converter	7CH	5-2	Htr	12.6	0.15	300	100	Osc I _g = 0.5 ma thru 20,000 ohms		
12BF6	Duplex-Diode Triode	7BT	5-2	Htr	12.6	0.15	300	—	1.8▲	1.1▲	2.0▲
12BH7	Medium-Mu Twin Triode	9A	6-3	Htr	{ 6.3 12.6 }	{ 0.6 0.3 }	300	—	3.0	2.0 ₁ 2.6 ₂	2.4
12BK6	Duplex-Diode, High-Mu Triode	7BT	5-3	Htr	12.6	0.15	300	—	—	—	—
12BN6	Gated-Beam Discriminator	7DF	5-3	Htr	12.6	0.15	300♠	100	E _{ct} = 1.25 volts Rms*		
12BT6	Duplex-Diode High-Mu Triode	7BT	5-3	Htr	12.6	0.15	300	—	—	—	—
12BU6	Duplex-Diode Medium-Mu Triode	7BT	5-3	Htr	12.6	0.15	300	—	—	—	—
12C8 12C8-Y	Semi-Remote-Cutoff Duplex-Diode Pentode	8E	8-4	Htr	12.6	0.15	300	125	6.0	9.0	0.005♣
12E5-GT	Medium-Mu Triode	6Q	9-11	Htr	12.6	0.15	250	—	3.4	5.5	2.6
12F5-GT	High-Mu Triode	5M	9-17	Htr	12.6	0.15	300	—	1.9	3.4	2.4
12H6	Twin Diode	7Q	8-5	Htr	12.6	0.15	Rms voltage per plate = 150 v;				
12J5 12J5-GT	Medium-Mu Triode	6Q	8-1 9-11	Htr	12.6	0.15	300	—	3.4	3.6	3.4
12J7-GT	Sharp-Cutoff Pentode	7R	9-18	Htr	12.6	0.15	300	125	Pentode Connected		
							250	—	Triode Connected		

▲ Without external shield. *Minimum. ♠ Absolute maximum rating.
 § Approximate. ♣ Per section. ♣ Maximum. ♠ Plate supply voltage.
 †— The duration of the pulse voltage must not exceed 15 percent of one scanning cycle.



Service	Neg Grid Volts	Screen Volts	Screen Milli-amperes	Plate Volts	Plate Milli-amperes	R_p , Ohms	G_m , μ mhos	μ Factor	Load for Rated Output, Ohms	Power Output, Watts	Tube Type
Class A Amplifier	1.0	—	—	100	0.5	80,000	1,250	100	—	—	12AX7
	2.0	—	—	250	1.2	62,500	1,600	100	—	—	
Class A Amplifier \clubsuit	4.0	—	—	250	3.0	—	1,750	40	—	—	12AY7
Class A Amplifier	3.0	90	2.0	90	7.0	200,000	1,800	360	—	—	12B8-GT
	0.0	—	—	90	2.8	37,000	2,400	90	—	—	
Class A Amplifier	$R_k = 68\Omega$	100	4.2	250	11.0	1,000,000 \S	4,400	—	—	—	12BA6
Converter	1.0	100	10	250	3.8	1,000,000 \S	Conversion Transconductance = 950 Conversion Transconductance = 900	—	—	—	12BA7
Converter	1.0	100	10.2	100	3.6	500,000 \S		—	—	—	
Class A Amplifier	3.0	100	3.5	250	9.0	700,000	2,000	—	—	—	12BD6
Converter	1.5	100	6.8	250	2.9	1,000,000 \S	Conversion Transconductance = 475		—	—	12BE6
Class A Amplifier	9.0	—	—	250	9.5	8,500	1,900	16	—	—	12BF6
Class A Amplifier \clubsuit Vertical Deflection Amplifier \clubsuit	10.5	—	—	250	11.5	—	3,100	17	—	—	12BH7
Max positive pulse voltage; $\square = 1,500$ volts; max plate dissipation $\square = 5$ watts; max d-c cathode current = 20 ma											
Class A Amplifier	2.0	—	—	250	1.2	62,500	1,600	100	—	—	12BK6
	1.0	—	—	100	0.5	80,000	1,250	100	—	—	
FM Limiter-Discriminator	$R_k = 200$ to 400	100	9.8	285 \S	0.49	—	—	—	330000	—	12BN6
Class A Amplifier	3.0	—	—	250	1.0	58,000	1,200	70	—	—	12BT6
	1.0	—	—	100	0.8	54,000	1,300	70	—	—	
Class A Amplifier	9.0	—	—	250	9.5	8,500	1,900	16	10,000	0.30	12BU6
Class A Amplifier	3.0	125	2.3	250	10.0	600,000 \S	1,325	—	—	—	12C8 12C8-Y
Class A Amplifier	13.0	—	—	250	5.0	9,500	1,450	13.8	—	—	12E5-GT
Class A Amplifier	2.0	—	—	250	0.9	66,000	1,500	100	—	—	12F5-GT
max d-c output per plate = 8 ma; peak current per plate = 48 ma; peak inverse voltage = 420 v											12H6
Class A Amplifier	0.0	—	—	90	10	6,700	3,000	20	—	—	12J5
	8.0	—	—	250	9.0	7,700	2,600	20	—	—	12J5-GT
Class A Amplifier	3.0	100	0.5	250	2.0	1,000,000*	1,225	—	—	—	12J7-GT
Class A Amplifier	8.0	—	—	250	6.5	10,500	1,900	20	—	—	

Section 1.
Section 2.

Type designations of metal tubes are shown in bold-face type.
Type designations of miniature tubes are shown in italics.

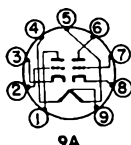
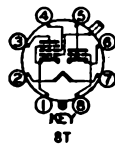
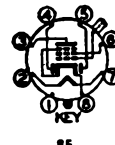
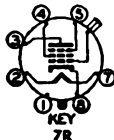

Tube Type	Classification by Construction	Base Connections	Out-line Dwg	Type Cathode	Filament Volts	Filament Amp	Max Plate Volts	Max Screen Volts	Capacitance in Micromicrofarads		
									Input	Out-put	Grid-plate
12K7-GT	Remote-Cutoff R-F Pentode	7R	9-18	Htr	12.6	0.15	300	125	4.6	12.0	0.005♣
12K8 12K8-GT 12K8-Y	Triode Hexode Converter	8K	8-2 9-24 8-2	Htr	12.6	0.15	300	150	Osc Anode = 100 v I _p = 3.8 ma		
12L8-GT	Twin-Pentode Power Amplifier	8BU	9-11	Htr	12.6	0.15	180	180	5.0▲	6.0▲	0.70▲
12Q7-GT	Duplex-Diode High-Mu Triode	7V	9-18	Htr	12.6	0.15	300	—	2.2	5.0	1.6
12S8-GT	Triple-Diode Triode	8CB	9A-4	Htr	12.6	0.15	300	—	1.2	5.0	2.0
12SA7 12SA7-GT	Pentagrid Converter	8R 8AD	8-1 9-11	Htr	12.6	0.15	300	100	Osc I _g = 0.5 ma thru 20,000 ohms		
12SC7	High-Mu Twin Triode	8S	8-1	Htr	12.6	0.15	250	—	Each Triode		
12SF5 12SF5-GT	High-Mu Triode	6AB	8-1 9-11	Htr	12.6	0.15	300	—	4.0	3.6	2.4
12SF7 12SF7-GT	Remote-Cutoff Diode Pentode	7AZ	8-1 9-18	Htr	12.6	0.15	300	150	5.5	6.0	0.004♣
12SG7	Semi-Remote-Cutoff Pentode	8BK	8-1	Htr	12.6	0.15	300	150	8.5	7.0	0.003♣
12SH7	Sharp-Cutoff R-F Pentode	8BK	8-1	Htr	12.6	0.15	300	150	8.5	7.0	0.003♣
12SJ7 12SJ7-GT	Sharp-Cutoff Pentode	8N	8-1 9-12	Htr	12.6	0.15	300	125 250	Pentode Connection Triode Connection (G2, G3 & P tied)		
12SK7 12SK7-GT	Remote-Cutoff R-F Pentode	8N	8-1 9-12	Htr	12.6	0.15	300	125	6.0	7.0	0.003♣
12SL7-GT	High-Mu Twin Triode	8BD	9-11	Htr	12.6	0.15	300	—	Each Unit		
12SN7-GT	Medium-Mu Twin Triode	8BD	9-11	Htr	12.6	0.3	300	—	Each Unit		
12SQ7 12SQ7-GT	Duplex-Diode High-Mu Triode	8Q	8-1 9-12	Htr	12.6	0.15	300	—	3.2 4.2	3.0 3.4	1.6 1.8
12SR7 12SR7-GT	Duplex-Diode Triode	8Q	8-1 9-11	Htr	12.6	0.15	250	—	3.6 3.5	2.8 3.8	2.4 2.3
12SW7	Duplex-Diode Triode	8Q	8-1	Htr	12.6	0.15	250	—	3.0	2.8	2.4

*Minimum. §Approximate. †Zero signal. ▲Without external shield. ♣Maximum.

Service	Neg Grid Volts	Screen Volts	Screen Milli-am-peres	Plate Volts	Plate Milli-am-peres	R _p , Ohms	G _m , μmhos	μ Factor	Load for Rated Out-put, Ohms	Power Out-put, Watts	Tube Type
Converter	3.0	100	6.0	250	2.5	600,000§	Conversion Trans-conductance = 350			—	12K8 12K8-GT 12K8-Y
Class A Amplifier	9.0	180	2.8†	180	13.0†	160,000	2,150	—	10,000	1.0	12L8-GT
Class A Amplifier	3.0	—	—	250	1.0	58,000	1,200	70	—	—	12Q7-GT
Class A Amplifier	2.0	—	—	250	0.9	91,000	1,100	100	—	—	12S8-GT
Converter	2.0	100	8.5	250	3.5	1,000,000§	Conversion Trans-conductance = 450			—	12SA7 12SA7-GT
Class A Amplifier	2.0	—	—	250	2.0	53,000§	1,325§	70	—	—	12SC7
Class A Amplifier	2.0	—	—	250	0.9	66,000	1,500	100	—	—	12SF5
Class A Amplifier	2.0	—	—	250	0.9	66,000	1,500	100	—	—	12SF5-GT
Class A Amplifier	1.0	100	3.3	250	12.4	700,000§	2,050	—	—	—	12SF7 12SF7-GT
Class A Amplifier	2.5	150	3.4	250	9.2	1,000,000*	4,000	—	—	—	12SG7
Class A Amplifier	1.0	150	4.1	250	10.8	900,000§	4,900	—	—	—	12SH7
Class A Amplifier	3.0	100	0.8	250	3.0	1,000,000*	1,650	—	—	—	12SJ7
Class A Amplifier	8.5	—	—	250	9.2	7,600	2,500	19	—	—	12SJ7-GT
Class A Amplifier	3.0	100	2.6	250	9.2	800,000§	2,000	—	—	—	12SK7 12SK7-GT
Class A Amplifier	2.0	—	—	250	2.3	44,000	1,600	70	—	—	12SL7-GT
Class A Amplifier	8.0	—	—	250	9.0	7,700	2,600	20	—	—	12SN7-GT
Class A Amplifier	2.0	—	—	250	1.1	85,000	1,175	100	—	—	12SQ7 12SQ7-GT
Class A Amplifier	9.0	—	—	250	9.5†	8,500	1,900	16	10,000	0.300	12SR7 12SR7-GT
Class A Amplifier	9.0	—	—	250	9.5	8,500	1,900	16	—	—	12SW7
Class A Amplifier	R _g = 2 meg	—	—	26.5	1.1	15,500	1,100	17	—	—	

Type designations of metal tubes are shown in bold-face type.

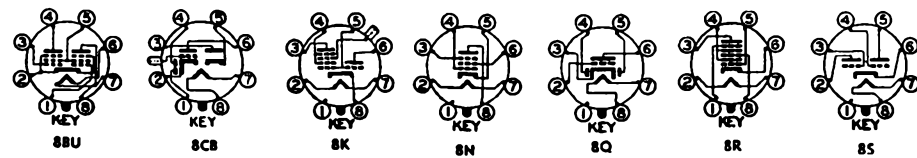
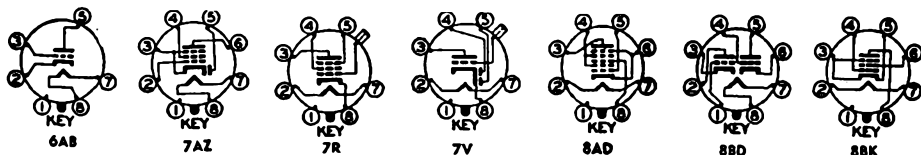

Tube Type	Classification by Construction	Base Connections	Out-line Dwg	Type Cathode	Filament Volts	Filament Amp	Max Plate Volts	Max Screen Volts	Capacitance in Micromicrofarads		
									Input	Output	Grid-plate
12SX7-GT	Medium-Mu Twin Triode	8BD	9-11	Htr	12.6	0.30	300	—	3.0 2.8 ₂	0.8 ₁ 1.2 ₁	3.6
12SY7 12SY7-GT	Heptode Pentagrid Converter	8R 8AD	8-1 9-12	Htr	12.6	0.15	300	100	Osc I _g = 0.5 ma thru 20,000 ohms Osc I _g = 0.1 ma thru 20,000 ohms		
12Z3	Half-Wave High-Vacuum Rectifier	4G	12-5	Htr	12.6	0.3					
14A4	Medium-Mu Triode	5AC	9-30	Htr	12.6	0.15	300	—	3.4	3.0	4.0
14A5	Beam Power Amplifier	6AA	9-30	Htr	12.6	0.15	250	250	—	—	—
14A7/12B7	Remote-Cutoff Pentode	8V	9-30	Htr	12.6	0.15	300	125	6.0	7.0	0.005 ♣
14AF7	Medium-Mu Twin Triode	8AC	9-30	Htr	12.6	0.15	300	—	2.2	1.6	2.3
14B6	Duplex-Diode High-Mu Triode	8W	9-30	Htr	12.6	0.15	300	—	—	—	—
14B8	Pentagrid Converter	8X	9-30	Htr	12.6	0.15	300	100	E _{c2} = 250 v thru 20,000 ohms I _{c2} = 4.0 ma		
14C5	Beam Power Amplifier	6AA	9-31	Htr	12.6	0.225	315	285	—	—	—
14C7	Sharp-Cutoff Pentode	8V	9-30	Htr	12.6	0.15	300	100	6.0	6.5	0.007 ♣
14E6	Duplex-Diode High-Mu Triode	8W	9-30	Htr	12.6	0.15	250	—	—	—	—
14E7	Duplex-Diode Pentode	8AE	9-30	Htr	12.6	0.15	250	100	4.6	5.3	0.005 ♣
14F7	High-Mu Twin Triode	8AC	9-30	Htr	12.6	0.15	250	—	—	—	—
14F8	High-Frequency Twin Triode	8BW	9-32	Htr	12.6	0.15	300	—	2.8	1.4	1.2
14H7	Semi-Remote-Cutoff Pentode	8V	9-30	Htr	12.6	0.15	300	150	8.0	7.0	0.007 ♣
14J7	Triode-Heptode Converter	8BL	9-30	Htr	12.6	0.15	300	100	E _{pt} = 250 v thru 20,000 ohms I _{pt} = 5.0 ma		
14N7	Medium-Mu Twin Triode	8AC	9-31	Htr	12.6	0.30	300	—	—	—	—
14Q7	Pentagrid Converter	8AL	9-30	Htr	12.6	0.15	300	100	Osc I _g = 0.5 ma thru 20,000 ohms		
14R7	Duplex-Diode Pentode	8AE	9-30	Htr	12.6	0.15	250	125	5.6	5.3	0.004 ♣
14S7	Triode-Heptode Converter	8BL	9-30	Htr	12.6	0.15	300	100	E _{pt} = 250 v thru 20,000 ohms I _{pt} = 5.0 ma		

♣ Per section.

§ Approximate.

* Minimum.

† Zero signal.

§ Section 1.
§ Section 2.

♣ Maximum.



4C

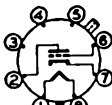

5AC

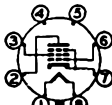

6AA

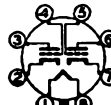

8AC

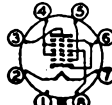

8AD



8AE

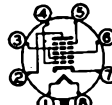

8AL

Service	Neg Grid Volts	Screen Volts	Screen Milli-amperes	Plate Volts	Plate Milli-amperes	R_p , Ohms	G_m , μ mhos	μ Factor	Load for Rated Output, Ohms	Power Output, Watts	Tube Type
Class A Amplifier	8.0	—	—	250	9.0 \clubsuit	7,700	2,600	20	—	—	12SX7-GT
Class A Amplifier	$R_g = .05$ meg	—	—	26.5	1.8 \clubsuit	11,500	1,800	21	—	—	
Converter	2.0	100	8.5	250	3.5	1,000,000 \S	Conversion Trans-conductance = 450				12SY7
Converter	1.0	28	1.8	28	0.5	—	Conversion Trans-conductance = 250				12SY7-GT
Max d-c output = 55 ma; Rms voltage = 235 volts max; max peak current = 330 ma; max peak inverse voltage = 700 v											12Z3
Class A Amplifier	8.0	—	—	250	9.0	7,700	2,600	20	—	—	14A4
Class A Amplifier	12.5	250	3.5 \dagger	250	30.0 \dagger	70,000 \S	3,000	—	7,500	2.8	14A5
Class A Amplifier	3.0	100	2.6	250	9.2	800,000 \S	2,000	—	—	—	14A7/12B
Class A Amplifier \clubsuit	10.0	—	—	250	9.0	7,600	2,100	16	—	—	14AF7
Class A Amplifier	2.0	—	—	250	0.9	91,000	1,100	100	—	—	14B6
Converter	3.0	100	2.7	250	3.5	360,000 \S	Conversion Trans-conductance = 550			—	14B8
Class A Amplifier	13.0	225	2.2 \dagger	315	34.0 \dagger	77,000 \S	3,750	—	8,500	5.5	14C5
Class A Amplifier	3.0	100	0.7	250	2.2	1,000,000 \S	1,575	—	—	—	14C7
Class A Amplifier	9.0	—	—	250	9.5	8,500	1,900	16	—	—	14E6
Class A Amplifier	3.0	100	1.6	250	7.5	700,000 \S	1,300	—	—	—	14E7
Class A Amplifier \clubsuit	2.0	—	—	250	2.3	44,000 \S	1,600	70	—	—	14F7
Class A Amplifier \clubsuit	$R_k = 500\Omega$	—	—	250	6.0	—	3,300	48	—	—	14F8
Class A Amplifier	$R_k = 180$	150	3.2	250	10.0	800,000 \S	4,000	—	—	—	14H7
Converter	3.0	100	2.8	250	1.4	1,500,000 \S	Conversion Trans-conductance = 290 $I_{g1} = 0.4$ ma			—	14J7
Class A Amplifier \clubsuit	8.0	—	—	250	9.0	7,700	2,600	20	—	—	14N7
Converter	2.0	100	8.5	250	3.5	1,000,000 \S	Conversion Trans-conductance = 550			—	14Q7
Class A Amplifier	1.0	100	2.1	250	5.7	1,000,000	3,200	—	—	—	14R7
Converter	2.0	100	3.0	250	1.8	1,250,000 \S	Conversion Trans-conductance = 525			—	14S7

Type designations of metal tubes are shown in bold-face type.

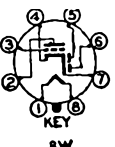
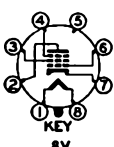
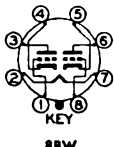
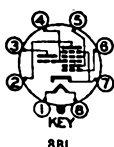
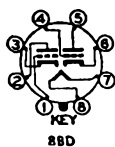

Tube Type	Classification by Construction	Base Connections	Out-line Dwg	Type Cathode	Fila-ment Volts	Fila-ment Amp	Max Plate Volts	Max Screen Volts	Capacitance in Micromicrofarads		
									Input	Out-put	Grid-plate
14W7	Amplifier Pentode	8BJ	9-30	Htr	12.6	0.225	300	150	—	—	—
14X7	Duplex-Diode High-Mu Triode	8BZ	9-31	Htr	12.6	0.15	300	—	—	—	
14Y4	Full-Wave High-Vacuum Rectifier	5AB	9-30	Htr	12.6	0.30	Rms volts per plate = 325 v; max d-c output = 70 ma;				
15	Sharp-Cutoff R-F Pentode	5F	12-6	Htr	2.0 D-C	0.22	135	67.5	2.35▲	7.80▲	0.01
19	Twin-Triode Power Amplifier	6C	12-5	Fil	2.0 D-C	0.26	135	—	Single Tube		
19AQ5	Beam Power Amplifier	7BZ	5-3	Htr	18.9	0.15	250	250	—	—	—
19BG6-G	Beam Power Amplifier	5BT	16A-1	Htr	18.9	0.3	700	350	11▲	6.5▲	0.65▲ ♣
19C8	Triple-Diode, High-Mu Triode	9E	6-2	Htr	18.9	0.15	250	—	—	—	—
19J6	Twin Triode	7BF	5-2	Htr	18.9	0.15	300	—	2.0▲	0.4▲	1.5▲
19T8	Triple-Diode High-Mu Triode	9E	6-2	Htr	18.9	0.15	300	—	1.5▲	1.1▲	2.4▲
19V8	Triple-Diode, High-Mu Triode	9AH	6-2	Htr	18.9	0.15	300	—	—	—	—
20	Power Amplifier Triode	4D	9-25	Fil	3.3 D-C	0.132	135	—	2.0	2.3	4.1
22	R-F Amplifier Tetrode	4K	14-2	Fil	3.3 D-C	0.132	135	67.5	3.5	10.0	0.02 ♣
24A	Sharp-Cut-Off Amplifier Tetrode	5E	14-2	Htr	2.5	1.75	250	90	5.3▲	10.5▲	0.007 ♣
25A6	Power Amplifier Pentode	7S	8-6	Htr	25.0	0.3	160	135	8.5	12.5	0.2
25A6-GT			9-11						—	—	—
25A7-GT	Diode Pentode	8F	9-11	Htr	25.0	0.3	117	117	—	—	—
25AC5-GT	High-Mu Power Amplifier Triode	6Q	9-11	Htr	25.0	0.3	180	Two tubes Dynamic-coupled with 6AE5-GT driver			



4D

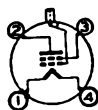

4K



5AB

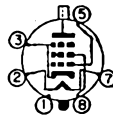

5BT

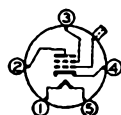

5E



5F



6C

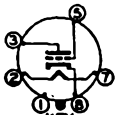

6Q

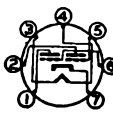

7BF

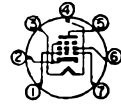

7BZ

Service	Neg Grid Volts	Screen Volts	Screen Milli-am-peres	Plate Volts	Plate Milli-am-peres	R _p , Ohms	G _m , μmhos	μ Factor	Load for Rated Out-put, Ohms	Power Out-put, Watts	Tube Type
Class A Amplifier	R _k = 160	150	3.9	300	10.0	300,000	5,800	—	—	—	14W7
Class A Amplifier	1.0	—	—	250	1.9	67,000	1,500	100	—	—	14X7
max peak current per plate = 210 ma; max peak inverse voltage = 1250; min plate supply impedance per plate = 150 ohms											14Y4
Class A Amplifier	1.5	67.5	0.3	135	1.85	800,000	750	600	—	—	15
Class A Amplifier	1.5	67.5	0.3	67.5	1.85	630,000	710	450	—	—	15
Class B Amplifier	0.0	—	—	135	5.0†	Input Signal = 0.170 watt			10,000‡	2.1‡	19
Class A Amplifier	12.5 8.5	250 180	4.5† 3.0†	250 180	45† 29†	2,000‡ 58,000‡	4,100 3,700	—	5,000 5,500	4.5 2.0	19AQ5
Horizontal Deflection Amplifier	Max positive pulse plate voltage _{pk} = 6,000 volts; max plate dissipation = 20 watts, max screen input = 3.2 watts; max d-c plate current = 100 ma										19BG6-G
Class A Amplifier	1.0	—	—	100	0.5	80,000	1,250	100	—	—	19C8
Class A Amplifier	R _k = 150 ⊕	—	—	100	8.5	7,100	5,300	38	—	—	19J6
Class A Amplifier Class A Amplifier	3.0	—	—	250	1.0	58,000‡	1,200	70	—	—	19T8
	1.0	—	—	100	0.8	54,000‡	1,300	70	—	—	19T8
Class A Amplifier	3.0	—	—	250	1.0	58,000‡	1,200	70	—	—	19V8
	1.0	—	—	100	0.8	54,000‡	1,300	70	—	—	19V8
Class A Amplifier	22.5	—	—	135	6.5†	6,300	525	3.3	6,500	0.110	20
Class A Amplifier	1.5	67.5	1.3♣	135	3.7	325,000	500	160	—	—	22
Class A Amplifier	3.0	90	1.7♣	250	4.0	600,000	1,050	630	—	—	24A
Class A Amplifier	18.0	120	6.5†	160	33.0†	42,000	2,375	—	5,000	2.2	25A6
											25A6-GT
Class A Amplifier	15.0	100	4.0†	100	20.5†	50,000	1,800	90	4,500	0.77	25A7-GT
Class B Amplifier	0.0	—	—	180	4.0†	—	—	—	4,800 †	6.0	25AC5-GT
Class A Amplifier	—	—	—	110	45.0†	Driver I _b = 7.0 ma			2,000	2.0	

†Zero signal. §Approximate. ♣Per section. ♠Maximum. ‡Plate-to-plate.
 ▲Without external shield. ⊕Both sections.

Type designations of metal tubes are shown in bold-face type.
 Type designations of miniature tubes are shown in italics.

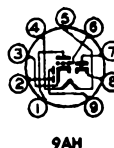
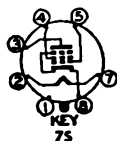

Tube Type	Classification by Construction	Base Connections	Out-line Dwg	Type Cathode	Filament Volts	Filament Amp	Max Plate Volts	Max Screen Volts	Capacitance in Micromicrofarads		
									Input	Out-put	Grid-plate
25AV5-GT	Beam Power Amplifier	6CK	9-11	Htr	25.0	0.3	550‡	200	—	—	—
25B5	Direct-Coupled Power Amplifier	6D	12-1	Htr	25.0	0.30	180	—	—	—	
25B6-G	Power Amplifier Pentode	7S	14-3	Htr	25.0	0.3	200	135	—	—	
25B8-GT	Triode Remote-Cutoff Pentode	8T	9-24	Htr	25.0	0.15	100	100	Pentode Section Triode Section		
25BQ6-GT	Beam Power Amplifier	6AM	6BQ6-GT	Htr	25.0	0.3	550‡	200	14▲	9.5▲	0.95▲
25C6-G	Beam Power Amplifier	7AC	14-3	Htr	25.0	0.3	200	135	—	—	—
25D8-GT	Diode-Triode-Pentode	8AF	9-23	Htr	25.0	0.15	100	100	Pentode Section Triode Section		
25L6	Beam Power Amplifier	7AC	8-6	Htr	25.0	0.3	200	117	16.0	13.5	0.3
25L6-GT	Beam Power Amplifier	7AC	9-11	Htr	25.0	0.3	200	125	15▲	10▲	0.8▲
25N6-G	Direct-Coupled Power Amplifier	7W	12-3	Htr	25.0	0.30	180	—	—	—	
25X6-GT	High-Vacuum Rectifier Doubler	7Q	9-11	Htr	25.0	0.15					
25W4-GT	Half-Wave Rectifier; TV Damping Diode	4CG	9-11	Htr	25.0	0.3	Rms voltage = 350 volts; max d-c output = 125 ma;				
25Y5	High-Vacuum Rectifier Doubler	6E	12-5	Htr	25.0	0.3	Rms voltage per plate = 235 volts max; max d-c output = 75 ma;				
25Z4	Half-Wave High-Vacuum Rectifier	5AA	8-1	Htr	25.0	0.30	Max plate voltage = 235 rms;				
25Z5	High-Vacuum Rectifier Doubler	6E	12-5	Htr	25.0	0.3	Half-wave operation: max voltage = 235 volts rms;				
25Z6	High-Vacuum Rectifier Doubler	7Q	8-6	Htr	25.0	0.3	Half-wave operation: max voltage = 235 volts rms;				
25Z6-GT			9-11								
26	Amplifier Triode	4D	14-1	Fil	1.5	1.05	180	—	2.8	2.5	8.1
26A6	Remote-Cutoff R-F Pentode	7BK	5-2	Htr	26.5	0.07	250	100	6.0	5.0	0.0035

†Zero signal. §Approximate. ▲Without external shield. ‡Plate supply voltage.
 s—The duration of the pulse voltage must not exceed 15 percent of one scanning cycle.

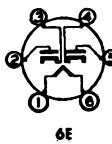
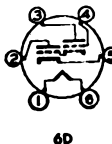
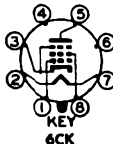
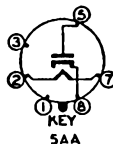
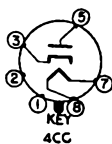

Tube Type	Classification by Construction	Base Connections	Out-line Dwg	Type Cathode	Fila-ment Volts	Fila-ment Amp	Max Plate Volts	Max Screen Volts	Capacitance in Micromicrofarads		
									Input	Out-put	Grid-plate
26A7-GT	Twin-Pentode Power Amplifier	8BU	9A-1	Htr	26.5	0.60	50	50	16.0▲	13.0▲	1.2▲
26C6	Duplex Diode Triode	7BT	5-2	Htr	26.5	0.07	250	—	1.8	1.4	2.0
26CG8	Remote-Cutoff Pentode	7BK	5-2	Htr	26.5	0.07	300	150	5.0	5.0	0.008♣
26D6	Pentagrid Converter	7CH	5-2	Htr	26.5	0.07	300	300	R _{g1} = 20000 I _{g1} = 0.5 R _{g2} = 20000 I _{g2} = 0.5		
27	Detector Amplifier Triode	5A	12-5	Htr	2.5	1.75	275	—	3.1	2.3	3.3
27S★									—	—	—
28D7	Double Beam Power Amplifier	8BS	9-31	Htr	28.0	0.40	100	67.5	—	—	—
28Z5	Full-Wave High-Vacuum Rectifier	5AB	9-31	Htr	28.0	0.24	—	—	—	—	—
30	Detector Amplifier Triode	4D	12-5 or 9-26	Fil	2.0 D-C	0.06	180	—	3.0▲	2.2▲	6.0▲
31	Power Amplifier Triode	4D	12-5	Fil	2.0 D-C	0.130	180	—	3.5	2.7	5.7
32	Sharp-Cutoff R-F Tetrode	4K	14-2	Fil	2.0 D-C	0.06	180	67.5	5.3▲	10.5▲	0.015
32L7-GT	Diode Beam Power Amplifier	8Z	9-11	Htr	32.5	0.3	90	90	—	—	—
33	Power Amplifier Pentode	5K	14-1	Fil	2.0 D-C	0.26	180	180	8.0	12.0	1.0
34	Remote-Cutoff R-F Pentode	4M	14-2	Fil	2.0 D-C	0.06	180	67.5	6.0▲	11.0▲	0.015♣
35/51	Remote-Cutoff R-F Pentode	5E	14-2	Htr	2.5	1.75	275	90	5.3▲	10.5▲	0.007♣
35A5	Beam Power Amplifier	6AA	9-31	Htr	35.0	0.15	200	125	—	—	—
36B6	Beam Power Amplifier	7BZ	5-3	Htr	35.0	0.15	117	117	11▲	6.5▲	0.4▲
36C6	Beam Power Amplifier	7CV	5-3	Htr	35.0	0.15	117	117	11▲	6.5▲	0.4▲
35L6-GT	Beam Power Amplifier	7AC	9-11	Htr	35.0	0.15	200	125	—	—	—
35S/51S★	Remote-Cutoff R-F Pentode	5E	14-2	Htr	2.5	1.75	250	90	—	—	—



4D

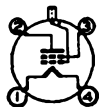

4K

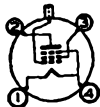

4M



5A



5AB



5E

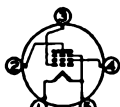

5K

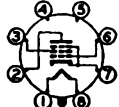

6AA



7AC



7BK

Service	Neg Grid Volts	Screen Volts	Screen Milli-am-peres	Plate Volts	Plate Milli-am-peres	R _p , Ohms	G _m , μmhos	μ Factor	Load for Rated Output, Ohms	Power Output, Watts	Tube Type
Class A Amplifier †	4.5	26.5	1.6†	26.5	20.0†	2,500‡	6,000	—	1,500	0.18	26A7-GT
Class A Amplifier	9.0	—	—	250	9.5	8,500	1,900	16	—	—	<i>26C6</i>
Class A Amplifier	R _g = 2 meg	—	—	26.5	1.1	15,500	1,100	17	—	—	
Class A Amplifier		8.0	150	2.3	250	9.0	720,000	2,000	—	—	<i>26CG8</i>
Converter Converter	1.5 0.5	100 26.5	7.8 1.6	250 26.5	3.0 0.45	Conversion Transconductance = 475 Conversion Transconductance = 270					<i>26D6</i>
Class A Amplifier	21.0	—	—	250	5.2	9,250	975	9.0	—	—	27 27S★
Class A Amplifier †	3.5	28.0	1.0†	28.0	12.5†	4,200	3,400	—	4,000	0.100	28D7
Rms voltage per plate = 450 volt; max d-c output = 100 ma; peak current per plate = 300 ma; peak inverse voltage = 1250 volts									—	—	28Z5
Class A Amplifier	13.5	—	—	180	3.1	10,300	900	9.3	—	—	30
Class A Amplifier	30.0	—	—	180	12.3†	3,600	1,050	3.8	5,700	0.375	31
Class A Amplifier	3.0	67.5	0.4	180	1.7	1,200,000	650	780	—	—	32
Class A Amplifier	7.0	90	2.0†	90	27.0†	17,000	4,800	—	2,600	1.0	32L7-GT
Class A Amplifier	5.0	90	3.0†	90	38.0†	15,000	6,000	—	2,600	0.8	
Class A Amplifier	18.0	180	5.0†	180	22.0†	55,000‡	1,700	90‡	6,000	1.4	33
Class A Amplifier	3.0	67.5	1.0	180	2.8	1,000,000	620	620	—	—	34
Class A Amplifier	3.0	90	2.5♣	250	6.5	400,000	1,050	420	—	—	35/51
Class A Amplifier	R _k = 180 7.5	125	2.0†	200	43.0†	34,000‡	6,100	—	5,000	3.0	35A5
Class A Amplifier		110	3.0†	110	40.0†	14,000‡	5,800	—	2,500	1.5	
Class A Amplifier	7.5	110	3.0†	110	40.0†	—	5,800	—	2,500	1.5	<i>36B5</i>
Class A Amplifier	7.5	110	3.0†	110	40.0†	—	5,800	—	2,500	1.5	<i>36C5</i>
Class A Amplifier	R _k = 180 7.5	125	2.0†	200	43.0†	34,000‡	6,100	—	5,000	3.0	35L6-GT
Class A Amplifier		110	3.0†	110	40.0†	14,000‡	5,800	—	2,500	1.5	
Class A Amplifier	3.0	90	2.5♣	250	6.5	400,000	1,050	420	—	—	35S/51S★

†Zero signal. ♣Maximum. ★External shield connected to cathode pin. §Approximate.
 ▲Without external shield.

*Minimum. ♠Per section. *Type designations of miniature tubes are shown in italics.*



7BT

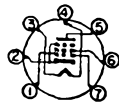

7BZ



7CH



7CV



88S

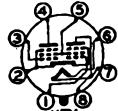

88U

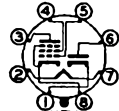

8Z

Tube Type	Classification by Construction	Base Connections	Out-line Dwg	Type Cathode	Filament Volts	Filament Amp	Max Plate Volts	Max Screen Volts	Capacitance in Micromicrofarads		
									Input	Output	Grid-plate
36W4	Half-Wave High-Vacuum Rectifier	5BQ	5-3	Htr	35.0 32.0	0.15 0.15	Without panel lamp: With panel lamp:				
35Y4	Half-Wave High-Vacuum Rectifier	5AL	9-31	Htr	35.0	0.15	Rms voltage per plate = 235 volts;				
35Z3	Half-Wave High-Vacuum Rectifier	4Z	9-31	Htr	35.0	0.15	Rms voltage per plate = 235 volts;				
35Z4-GT	Half-Wave High-Vacuum Rectifier	5AA	9-11	Htr	35.0	0.15	Rms voltage per plate = 235 volts;				
35Z5-GT	Half-Wave High-Vacuum Rectifier	6AD	9-11	Htr	35.0 32.0	0.15 0.15	Without panel lamp: With panel lamp:				
35Z6-G	High-Vacuum Rectifier Doubler	7Q	14-3	Htr	35.0	0.30	Rms voltage per plate = 125 volts;				
36	Sharp-Cutoff R-F Tetrode	5E	12-6	Htr	6.3	0.3	250	90.0	3.8▲	9.0▲	0.007♣
37	Medium-Mu Triode	5A	12-5	Htr	6.3	0.3	250	—	3.5	2.9	2.0
38	Power Amplifier Pentode	5F	12-6	Htr	6.3	0.3	250	250	3.5	7.5	0.30
39/44	Remote-Cutoff R-F Pentode	5F	12-6	Htr	6.3	0.3	250	90	3.8▲	10.0▲	0.007♣
40	Medium-Mu Triode	4D	14-1	Fil	5.0 D-C	0.25	180	—	2.8	2.2	2.0
41	Power Amplifier Pentode	6B	12-5	Htr	6.3	0.4	315	285	Single tube Two tubes, Push-pull		
42	Power Amplifier Pentode	6B	14-1	Htr	6.3	0.7	375 350 375 350	285 — 250 —	Pentode connection Triode connection Pentode connection 2 Tubes Triode connection 2 Tubes		
43	Power Amplifier Pentode	6B	14-1	Htr	25.0	0.3	160	135	8.5	12.5	0.2
45	Power Amplifier Triode	4D	14-1	Fil	2.5	1.5	275	—	4.0	3.0	7.0
									Two tubes		
46Z3	Half-Wave High-Vacuum Rectifier	5AM	5-2	Htr	45.0	0.075	Rms voltage per plate = 117 volts;				
45Z5-GT	Half-Wave High-Vacuum Rectifier	6AD	9-11	Htr	45.0	0.15	Rms voltage per plate = 235 volts;				
46	Power Amplifier Tetrode	5C	16-1	Fil	2.5	1.75	400	—	{ 2 tubes push-pull } { G ₁ & G ₂ tied }		
									{ Single tube } { G ₁ & P tied }		
47	Power Amplifier Pentode	5B	16-1	Fil	2.5	1.75	250	250	8.6	13.0	1.2

†Zero signal.

♣Maximum.

‡Undistorted.

♣Approximate.

▲Without external shield.



4D



4Z



5A

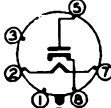

5AA



5AL

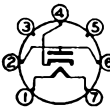

5AM



5B

Service	Neg Grid Volts	Screen Volts	Screen Milli-am-peres	Plate Volts	Plate Milli-am-peres	R _p , Ohms	G _m , μmhos	μ Factor	Load for Rated Out-put, Ohms	Power Out-put, Watts	Tube Type
max d-c output = 100 ma; max peak inverse plate voltage = 330; max peak plate current = 600 ma										—	<i>36W4</i>
max d-c output = 90 ma; max peak inverse plate voltage = 330; max peak plate current = 600 ma										—	
max d-c output = 100 ma; peak current per plate = 600 ma; peak inverse voltage = 700 volts										—	35Y4
max d-c output = 100 ma; peak current per plate = 600 ma; peak inverse voltage = 700 volts										—	35Z3
max d-c output = 100 ma; peak current per plate = 600 ma; peak inverse voltage = 700 volts										—	35Z4-GT
Rms plate voltage = 235 volts; max d-c output = 100 ma; peak plate current = 600 ma; peak inverse voltage = 700 volts										—	35Z5-GT
Rms plate voltage = 235 volts; max d-c output = 90 ma; peak inverse voltage = 700 volts										—	
max d-c output = 110 ma; peak current per plate = 500 ma										—	35Z6-G
Class A Amplifier	3.0	90	1.7♣	250	3.2	550,000	1,080	595	—	—	36
Class A Amplifier	18.0	—	—	250	7.5	8,400	1,100	9.2	—	—	37
Class A Amplifier	25.0	250	3.8	250	22.0	100,000	1,200	120	10,000	2.5	38
Class A Amplifier	3.0*	90	1.4	250	5.8	1,000,000	1,050	1,050	—	—	39/44
Class A Amplifier	3.0	—	—	180	0.2	150,000	200	30	250,000	—	40
Class A Amplifier	21.0	250	4.0†	315	25.5†	75,000§	2,100	—	9,000	4.5	41
Class A Amplifier	25.5	285	9.0†	285	55.0†	Peak grid-to-grid voltage = 51 volts			12,000‡	10.5	
Class A Amplifier	20.0	285	7.0†	285	38.0†	78,000§	2,550	—	7,000	4.8	42
Class A Amplifier	20.0	—	—	250	31.0†	2,600§	2,600	6.8	4,000	0.850	
Class AB ₂ Amplifier	26.0	250	5.0†	375	34.0†	—	—	—	10,000	18.5	
Class AB ₂ Amplifier	38.0	—	—	350	48.0†	—	—	—	6,000‡	13.0	
Class A Amplifier	18.0	120	6.5†	160	33.0†	42,000	2,375	—	5,000	2.2	43
Class A Amplifier	56.0	—	—	275	36.0†	1,700	2,050	3.5	4,600	2.0¶	45
Class AB ₁ Amplifier	68.0	—	—	275	28.0†	—	Power input = 0.656 w		3,200‡	18.0	
max d-c output = 65 ma; peak current per plate = 390 ma; peak inverse voltage = 350 volts										—	<i>46Z3</i>
max d-c output = 100 ma; peak current per plate = 600 ma; peak inverse voltage = 700 volts										—	45Z5-GT
Class B Amplifier	0.0	—	—	400	6.0†	Input signal = .650 watt		5,800‡	20.0§		46
Class A Amplifier	33.0	—	—	250	22.0†	2,380	2,350	5.6	6,400	1.25¶	
Class A Amplifier	16.5	250	6.0†	250	31.0†	60,000	2,500	150	7,000	2.7	47

*Minimum.

†Plate-to-plate.

Type designations of miniature tubes are shown in italics.

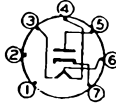

38Q

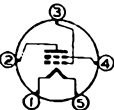

5C

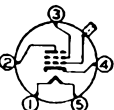

5E



5F

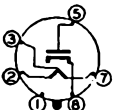

6AD

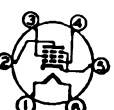

6B



7Q

Tube Type	Classification by Construction	Base Connections	Out-line Dwg	Type Cathode	Filament Volts	Filament Amp	Max Plate Volts	Max Screen Volts	Capacitance in Micromicrofarads		
									Input	Out-put	Grid-plate
48	Power Amplifier Tetrode	6A	16-1	Htr	30.0 D-C	0.4	125 125	100 —	Tetrode connected Single tube Triode connected Single tube Tetrode connected 2 tubes push-pull Triode connection 2 tubes push-pull		
49	Power Amplifier Tetrode	5C	14-1	Fil	2.0 D-C	0.120	180	—	Single tube G ₂ & P tied Two tubes G ₁ & G ₂ tied		
50	Power Amplifier Triode	4D	19A-1	Fil	7.5	1.25	450	—	4.2	3.4	7.1
50A5	Beam Power Amplifier	6AA	9-31	Htr	50.0	0.15	200	125	—	—	—
50AX6-G	Full-Wave Rectifier; TV Damping Diode	7Q	14-3	Htr	50.0	0.3	Rms voltage per plate = 350 volts; max d-c output = 250 ma				
60B6	Beam Power Amplifier	7BZ	5-3	Htr	50.0	0.15	135	117	13.0▲	6.5▲	0.50▲
60C6	Beam Power Amplifier	7CV	5-3	Htr	50.0	0.15	135	117	13.0▲	6.1▲	0.64▲
50C6-G	Beam Power Amplifier	7AC	14-3	Htr	50.0	0.15	200	135	—	—	—
50L6-GT	Beam Power Amplifier	7AC	9-11	Htr	50.0	0.15	200	125	—	—	—
50X6	High-Vacuum Rectifier Doubler	7AJ	9-31	Htr	50.0	0.15					
50Y6-GT	High-Vacuum Rectifier Doubler	7Q	9-11	Htr	50.0	0.15					
50Y7-GT	High-Vacuum Rectifier Doubler	8AN	9-11	Htr	50.0	0.15					
50Z6-G	Full-Wave High-Vacuum Rectifier	7Q	14-3	Htr	50.0	0.30	Rms voltage per plate = 235;				
50Z7-G	High-Vacuum Rectifier Doubler	8AN	12-7	Htr	50.0	0.15	Rms voltage per plate = 235 volts;				
53	Twin Triode	7B	14-1	Htr	2.5	2.0	300 300	— —	Single triode Parallel triodes		
55	Duplex-Diode Triode	6G	12-6	Htr	2.5	1.0	250	—			
55-S★											
56	Medium-Mu Triode	5A	12-5	Htr	2.5	1.0	250	—			
56-AS★ 56-S★											

†Zero signal. ‡Plate-to-plate. §Approximate. ¶Undistorted. ▲Without external shield.
— The duration of the pulse voltage must not exceed 15 percent of one scanning cycle.



4D



5A

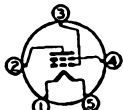

5C

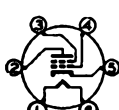

6A

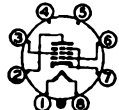

6AA

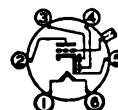

6C

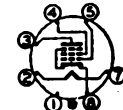

7AC

Service	Neg Grid Volts	Screen Volts	Screen Milli-amperes	Plate Volts	Plate Milli-amperes	R_p , Ohms	G_m , μ mhos	μ Factor	Load for Rated Output, Ohms	Power Output, Watts	Tube Type
Class A Amplifier	20.0	100	9.5	125	56.0	—	3,900	—	1,500	2.5	48
Class A Amplifier	32.5	—	—	125	52.0	675	3,700	2.5	—	—	
Class A Amplifier	20.0	100	—	125	50.0†	—	—	—	3,000	5.0	
Class A Amplifier ♦	32.5	—	—	125	50.0†	—	—	—	1,250	3.0	
Class A Amplifier	20.0	—	—	135	6.0	4,125	1,125	4.7	11,000	0.170	49
Class B Amplifier	0.0	—	—	180	4.0†	—	—	—	12,000	3.5‡	
Class A Amplifier	84.0	—	—	450	55.0	1,800	2,100	3.8	4,350	4.6¶	50
Class A Amplifier	$\left\{ \begin{array}{l} R_k = \\ 180 \\ 7.5 \end{array} \right.$	125	2.2†	200	46.0†	28,000‡	8,000	—	4,000	3.8	50A5
Class A Amplifier		110	4.0†	110	49.0†	13,000‡	8,000	—	2,000	2.1	
max peak current per plate = 600 ma; max peak inverse voltage = 1250 volts; min plate supply impedance per plate = 145 ohms; max peak inverse voltage (damper service) = 2,000 volts											50AX6-G
Class A Amplifier	7.5	110	4.0†	110	49.0†	10,000‡	7,500	—	2,500	1.9	60B6
Class A Amplifier	7.5	110	4.0†	110	49.0†	10,000‡	7,500	—	2,500	1.9	60C6
Class A Amplifier	13.5	135	3.5†	135	58.0†	9,300	7,000	—	2,000	3.6	50C6-G
Class A Amplifier	13.5	135	11.5†	135	60.0†	9,300	7,000	—	2,000	3.6	
Class A Amplifier	$\left\{ \begin{array}{l} R_k = \\ 180 \\ 7.5 \end{array} \right.$	125	2.2†	200	46.0†	28,000‡	8,000	—	4,000	3.8	50L6-GT
Class A Amplifier		110	4.0†	110	49.0†	13,000‡	8,000	—	2,000	2.1	
Half-wave operation: max voltage = 235 volts rms; max d-c output = 75 ma per plate Voltage doubler operation: max voltage = 117 volts rms; max d-c output = 75 ma											50X6
Half-wave operation: max voltage = 235 volts rms; max d-c output = 75 ma per plate Voltage doubler operation: max voltage = 117 volts rms; max d-c output = 75 ma											50Y6-GT
Peak inverse voltage = 700; max d-c output = 75 ma per plate (without panel lamp) Half-wave operation ♦: max voltage = 235 volts rms; max d-c output = 65 ma per plate Minimum total effective plate supply impedance = 100 ohms per plate Voltage doubler operation †: max voltage = 117 volts rms; max d-c output = 65 ma Minimum total effective plate supply impedance = 15 ohms per plate											50Y7-GT
max d-c output = 250 ma; peak current per plate = 750 ma; peak inverse voltage = 700											50Z6-G
max d-c output = 65 ma per plate; peak current per plate = 400 ma; peak inverse voltage = 700 volts											50Z7-G
Class B Amplifier	0.0	—	—	300	17.5†	—	—	—	8,000	10.0	53
Class A Amplifier	6.0	—	—	294	7.0	11,000	3,200	—	—	—	
Class A Amplifier	20.0	—	—	250	8.0†	7,500	1,100	8.3	20,000	0.350 ¶	55
Class A Amplifier	13.5	—	—	250	5.0	9,500	1,450	13.8	—	—	56
											56-AS ★
											56-S ★

★ External shield connected to cathode pin. ♦ Per section. † Both sections.
 Type designations of miniature tubes are shown in italics.

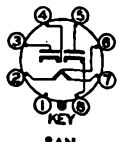
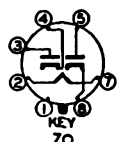
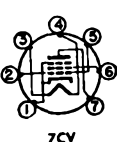
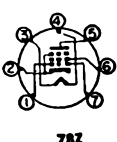
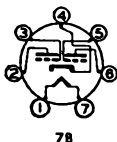
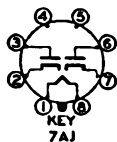

Tube Type	Classification by Construction	Base Connections	Outline Dwg	Type Cathode	Filament Volts	Filament Amp	Max Plate Volts	Max Screen Volts	Capacitance in Micromicrofarads		
									Input	Output	Grid-plate
57	Sharp-Cutoff Pentode	6F	12-2	Htr	2.5	1.0	300	125	Pentode connected		
							250		Triode connected		
57-AS★	Sharp-Cutoff Pentode	6F	12-2	Htr	6.3	0.4	300	125	Pentode connected		
							250	—	Triode connected		
57-S★	Sharp-Cutoff Pentode	6F	12-2	Htr	2.5	1.0	300	125	Pentode connected		
									Triode connected		
58	Remote-Cutoff R-F Pentode	6F	12-2	Htr	2.5	1.0	300	100			
58-AS★											
58-S★											
59	Power Amplifier Pentode	7A	16-1	Htr	2.5	2.0	250	—	{Triode connection G ₁ , G ₂ & P tied Pentode connection		
							250	250			
							400	—			
70A7-GT	Half-Wave Rectifier; Beam Power Amplifier	8AB	9-11	Htr	70.0	0.15	110	110	—	—	—
70L7-GT	Half-Wave Rectifier; Beam Power Amplifier	8AA	9-11	Htr	70.0	0.15	117	117	—	—	—
71-A	Power Amplifier Triode	4D	14-1	Fil	5.0	0.25	180	—	3.2	2.9	7.5
75	Duplex-Diode High-Mu Triode	6G	12-6	Htr	6.3	0.3	250	—	1.7▲	3.8▲	1.7▲
75-S★									—	—	—
76	Detector Amplifier Triode	5A	12-5	Htr	6.3	0.3	250	—	3.5	2.5	2.8
77	Sharp-Cutoff Detector Amplifier Pentode	6F	12-6	Htr	6.3	0.3	300	100	4.7▲	11.0▲	0.007♣
78	Remote-Cutoff R-F Pentode	6F	12-6	Htr	6.3	0.3	300	125	4.5	11.0	0.007♣
79	Twin Triode Power Amplifier	6H	12-6	Htr	6.3	0.6	250	—	Single tube		
80	Full-Wave High-Vacuum Rectifier	4C	14-1	Fil	5.0	2.0	Rms voltage per plate = 350 volts max;				
81	Half-Wave High-Vacuum Rectifier	4B	19A-1	Fil	7.5	1.25	Rms voltage per plate = 700 volts max;				
82	Full-Wave Mercury-Vapor Rectifier	4C	14-1	Fil	2.5	3.0	Rms voltage per plate = 450 volts;				
83	Full-Wave Mercury-Vapor Rectifier	4C	16-1	Fil	5.0	3.0	Rms voltage per plate = 450 volts;				
83-V	Full-Wave High-Vacuum Rectifier	4AD	14-1	Htr	5.0	2.0	Rms voltage per plate = 375 volts;				

†Zero signal. *Minimum.
▲Without external shield.

†Plate-to-plate.
§Approximate.

♣Maximum. ¶Undistorted.
★External shield connected to cathode pin.



4AD



4B



4C



4D



5A

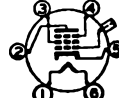

6F

Service	Neg Grid Volts	Screen Volts	Screen Milli-am-peres	Plate Volts	Plate Milli-am-peres	R _p , Ohms	G _m , μmhos	μ Factor	Load for Rated Out-put, Ohms	Power Out-put, Watts	Tube Type
Class A Amplifier	3.0	100	0.5	250	2.0	1,000,000*	1,225	—	—	—	57
Class A Amplifier	8.0	—	—	250	6.5	10,500	1,900	20.0	—	—	57-AS ★
Class A Amplifier	3.0	100	0.5	250	2.0	1,000,000*	1,225	—	—	—	
Class A Amplifier	8.0	—	—	250	6.5	10,500	1,900	20.0	—	—	57-S ★
Class A Amplifier	3.0	100	0.5	250	2.0	1,000,000*	1,225	—	—	—	
Class A Amplifier	8.0	—	—	250	6.5	10,500	1,900	20.0	—	—	
Class A Amplifier	3.0	100	2.0	250	8.2	800,000‡	1,600	—	—	—	58
											58-AS ★
											58-S ★
Class A Amplifier	28.0	—	—	250	26.0	2,300	2,600	6.0	5,000	1.25¶	59
Class A Amplifier	18.0	250	9.0	250	35.0	40,000	2,500	100	6,000	3.0	
Class B Amplifier	0.0	—	—	400	13.0†	Input signal = 1.5 watts			6,000 ‡	20.0	
Class A Amplifier Rectifier	7.5	110	3.0†	110	40.0†	—	5,800	—	2,500	1.5	70A7-GT
	Rms voltage per plate = 125 volts; max d-c output = 60 ma										
Class A Amplifier Rectifier	7.5	110	3.0†‡	110	40.0†	15,000	7,500	—	2,000	1.8	70L7-GT
	Rms voltage per plate = 117 volts; max d-c output = 70 ma; peak current per plate = 420 ma; peak inverse voltage = 350										
Class A Amplifier	40.5	—	—	180	20.0†	1,750	1,700	3.0	4,800	0.790	71-A
Class A Amplifier	2.0	—	—	250	0.9	91,000‡	1,100	100	—	—	75
											75-S ★
Class A Amplifier	13.5	—	—	250	5.0	9,500	1,450	13.8	—	—	76
Class A Amplifier	3.0	100	0.5	250	2.3	1,000,000*	1,250	—	—	—	77
Class A Amplifier	3.0	125	2.6	250	10.5	600,000‡	1,650	—	—	—	78
Class B Amplifier	0.0	—	—	250	5.3†	Input signal = .380 watt		—	14,000 ‡	8.0‡	79
	max d-c output = 125 ma; peak current per plate = 375 ma; peak inverse voltage = 1,400 volts										
	max d-c output = 85 ma; peak current per plate = 500 ma; peak inverse voltage = 2,000 volts										
	max d-c output = 115 ma; peak current per plate = 600 ma; peak inverse voltage = 1,550 volts										
	max d-c output = 225 ma; peak current per plate = 1,000 ma; peak inverse voltage = 1,550 volts										
	max d-c output = 175 ma; peak current per plate = 525 ma; peak inverse voltage = 1,400 volts										
											80
											81
											82
											83
											83-V

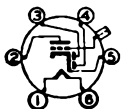

6C



6H

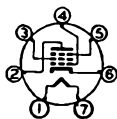

7A



8AA

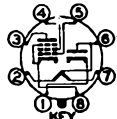

8AB

Tube Type	Classification by Construction	Base Connections	Out-line Dwg	Type Cathode	Filament Volts	Filament Amp	Max Plate Volts	Max Screen Volts	Capacitance in Micromicrofarads		
									Input	Output	Grid-plate
84/6Z4	Full-Wave High-Vacuum Rectifier	5D	12-5	Htr	6.3	0.5	Rms voltage per plate = 325 volts;				
85	Duplex Diode Triode	6G	12-6	Htr	6.3	0.3	250	—	1.5	4.3	1.5
85-AS★									—	—	—
89	Power Amplifier Pentode	6F	12-6	Htr	6.3	0.4	250	—	Triode connection (G ₂ , G ₁ & P tied) Pentode connection Two tubes, G ₁ & G ₂ tied		
							250	250			
							180	—			
V99	Low-Mu Triode	4E	8A-4	Fil	3.3 D-C	0.063	90	—	2.5	2.5	3.3
X99		4D	9-25					—			
117L7/M7-GT	Rectifier Beam Power Amplifier	8AO	9-15	Htr	117	0.09	117	117	—	—	—
117N7-GT	Rectifier Beam Power Amplifier	8AV	9-15	Htr	117	0.09	117	117	—	—	—
117P7-GT	Rectifier Beam Power Amplifier	8AV	9-15	Htr	117	0.09	117	117	—	—	—
117Z5	Half-Wave Rectifier	4CB	5-3	Htr	117	0.04	Max rms plate voltage = 117;				
117Z4-GT	High-Vacuum Half-Wave Rectifier	5AA	9-5	Htr	117	0.04	Rms voltage per plate = 117 volts max;				
117Z6-GT	High-Vacuum Rectifier Doubler	7Q	9-11	Htr	117	0.075	Half-wave rectifier;				
182-B/482B	Power Amplifier Triode	4D	14-1	Fil	5.0	1.25	250	—	—	—	—
183/483	Power Amplifier Triode	4D	14-1	Fil	5.0	1.25	250	—	—	—	—
485	Medium-Mu Triode	5A	12-5	Htr	3.0	1.25	180	—	—	—	—
502-A	Gas Tetrode	6BS	8-1	Htr	6.3	0.6					
807	Beam Power Amplifier	5AW	16-2	Htr	6.3	0.9	400	—	Triode Connection Two Tubes, Push-pull Pentode Connection Two Tubes, Push-pull		
							600	300			
950	Power Amplifier Pentode	5K	14-1	Fil	2.0 D-C	0.12	135	135	—	—	—

§Approximate.

†Zero signal.

‡Undistorted.

★External shield connected to cathode pin.



4CB



4D



4E



5A

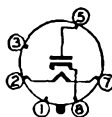

5AA

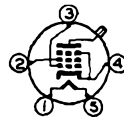

5AW

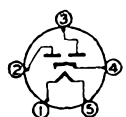

5D

Service	Neg Grid Volts	Screen Volts	Screen Milli-amperes	Plate Volts	Plate Milli-amperes	R _p , Ohms	G _m , μmhos	μ Factor	Load for Rated Output, tor Ohms	Power Output, Watts	Tube Type
max d-c output = 60 ma; peak current per plate = 180 ma; peak inverse voltage = 1,250 volts											84/6Z4
Class A Amplifier	20.0	—	—	250	8.0†	7,500	1,100	8.3	20,000	0.350	85
	9.0	—	—	250	5.5	—	1,250	20.0	—	—	85-AS★
Class A Amplifier	31.0	—	—	250	32.0†	2,600	1,800	4.7	5,500	0.900	89
	25.0	250	5.5†	250	32.0†	70,000	1,800	125.0	6,750	3.4	89
Class A Amplifier	0.0	—	—	180	3.0†	Input signal = 350 watt		—	9,400‡	3.5‡	
Class B Amplifier	4.5	—	—	90	2.5	15,500	425	6.6	—	—	V99
Class A Amplifier	4.5	—	—	90	2.5	15,500	425	6.6	—	—	X99
	5.2	105	4.0†	105	43.0†	17,000‡	5,300	—	4,000	0.85	117L7/M7-GT
Rms voltage per plate = 117 volts max; max d-c output = 75 ma; peak current per plate = 450 ma; peak inverse voltage = 350 volts											
Class A Amplifier	6.0	100	5.0†	100	51.0†	16,000‡	7,000	—	3,000	1.2	117N7-GT
	Rms voltage per plate = 117 volts max; max d-c output = 75 ma; peak current per plate = 450 ma; peak inverse voltage = 350 volts										
Class A Amplifier	5.2	105	4.0†	105	43.0†	17,000‡	5,300	—	4,000	0.85	117P7-GT
	Rms voltage per plate = 117 volts max; max d-c output = 75 ma; peak current per plate = 450 ma; peak inverse voltage = 350 volts										
max d-c output = 90 ma; peak inverse voltage = 330 max											<i>117Z3</i>
max d-c output = 90 ma; peak inverse voltage = 350 volts; peak plate current = 540 ma											117Z4-GT
max rms volts per plate = 235; max d-c output = 60 ma; peak current per plate = 360 ma; peak inverse voltage = 700 volts											117Z6-GT
Class A Amplifier	35.0	—	—	250	18.0	—	1,500	5.0	—	—	182-B/482B
Class A Amplifier	60.0	—	—	250	30.0	1,750	1,700	3.0	—	—	183/483
Class A Amplifier	9.0	—	—	180	5.8	8,900	1,400	12.5	—	—	485
Peak forward anode voltage ⊕ = 650 volts max; peak inverse voltage ⊖ = 1,300 volts max; max d-c output ⊖ = 100 ma; max peak current ⊖ = 1.0 ampere											502-A
Class AB ₁ Amplifier	45.0	—	—	400	60.0†	—	—	—	3,000‡	30‡	807
Class AB ₂ Amplifier	30.0	300	5.0†	600	60.0†	—	—	—	6,400‡	80‡	
Class A Amplifier	16.5	135	2.0†	135	7.0†	105,300	950	100	13,500	0.450	950

†Plate-to-plate.

‡Absolute maximum rating.

Type designations of miniature tubes are shown in italics.

Type designations of metal tubes are shown in bold-face type.

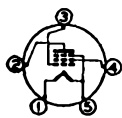

5K

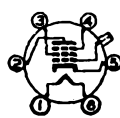
 KEY
6B5

6F

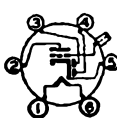

6C

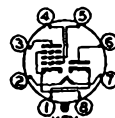
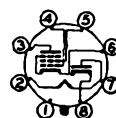
 KEY
7Q

 KEY
8A0

 KEY
8AV

Tube Type	Classification by Construction	Base Connections	Out-line Dwg	Type Cathode	Filament Volts	Filament Amp	Max Plate Volts	Max Screen Volts	Capacitance in Micromicrofarads		
									Input	Output	Grid-plate
954	Detector Amplifier Pentode (Acorn)	5BB	4-3	Htr	6.3	0.15	250	100	3.4	3.0	0.007 ♣
955	Medium-Mu Triode (Acorn)	5BC	4-1	Htr	6.3	0.15	250	—	1.0 ▲	0.4 ▲	1.3 ▲
								250	—	—	—
								250	—	—	—
								180	—	—	—
956	Remote-Cutoff R-F Pentode (Acorn)	5BB	4-3	Htr	6.3	0.15	250	100	3.1	2.5	0.009 ♣
957	Medium-Mu Triode (Acorn)	5BD	4-1	Fil	1.25 D-C	0.05	135	—	0.25	0.5	1.1
958-A	Medium-Mu Triode (Acorn)	5BD	4-1	Fil	1.25 D-C	0.10	135	—	0.45	0.6	2.5
							135	—	—	—	
959	Detector Amplifier Pentode (Acorn)	5BE	4-3	Fil	1.25 D-C	0.05	145	67.5	1.8	2.5	0.015 ♣
1629	Electron-Ray Tube	7AL	9-27	Htr	12.6	0.15	250	Plate voltage = 250 thru 1 meg			
5590	R-F Pentode	7BD	5-1	Htr	6.3	0.150	180	140	3.40	2.90	0.01
5591	R-F Pentode	7BD	5-1	Htr	6.3	0.150	180	140	3.90	2.85	0.01
5608	Sharp-Cutoff R-F Pentode	7BD	5-1	Htr	6.3	0.175	180	140	4.0	2.9	0.02
5608-A	Twin Triode	7B	14-1	Htr	2.5	2.0	350	—	—	—	—
5610	Medium-Mu Triode	6CG	5-2	Htr	6.3	0.15	300	—	—	—	—
5633 ●	Remote-Cutoff R-F Pentode	5633	5633	Htr	6.3	0.15	150	140	4.0 ▲	2.2 ▲	0.015 ♣▲
5634 ●	Remote-Cutoff R-F Pentode	5633	5633	Htr	6.3	0.15	150	140	4.4 ▲	2.2 ▲	0.015 ♣▲
5635 ●	Twin Triode	8DB	3-1	Htr	6.3	0.45	150	—	2.6	1.6	1.2
5636 ●	Dual-Control Pentode	8DC	3-2	Htr	6.3	0.15	150	100	E _{cs} = 15 volts Rms		
5637 ●	High-Mu Triode	5637	3-2	Htr	6.3	0.15	150	—	2.6 ▲	0.7 ▲	1.4 ▲
5638 ●	Amplifier Pentode	5638	3-2	Htr	6.3	0.15	150	140	4.0	6.5	0.19
5639 ●	Ruggedized Video Pentode	8DL	3-3	Htr	6.3	0.45	165 □	155 □	9.5	7.5	0.10 ♣

▲ Without external shield.

♣ Per Section.

* Minimum.

♣ Maximum.

† Zero signal.

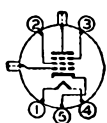

5BB



5BC



5BD

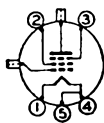

5BE



6CG

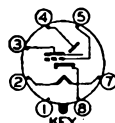

7AL



7B

Service	Neg Grid Volts	Screen Volts	Screen Milli-amperes	Plate Volts	Plate Milli-amperes	R_p , Ohms	G_m , μ mhos	μ Factor	Load for Rated Output, Ohms	Power Output, Watts	Tube Type
Class A Amplifier	3.0	100	0.7	250	2.0	1,000,000*	1,400	—	—	—	954
Class A Amplifier	3.0	90	0.5	90	1.2	1,000,000	1,100	—	—	—	
Class A Amplifier	7.0	—	—	250	6.3	11,400	2,200	25.0	—	—	955
Class A Amplifier	5.0	—	—	180	4.5†	12,500	2,000	25.0	20,000	0.135	
Class A Amplifier	2.5	—	—	90	2.5	14,700	1,700	25.0	—	—	
Class C Amplifier	35.0‡	—	—	180	7.0†	—	—	—	—	0.5	
Class A Amplifier	3.0	100	2.7	250	6.7	700,000‡	1,800	—	—	—	956
Class A Amplifier	5.0	—	—	135	2.0	20,800‡	650	13.5	—	—	957
Class A Amplifier	7.5	—	—	135	3.0	10,000‡	1,200	12	—	—	958-A
Class C Amplifier	20.0	—	—	135	7.0	Power input = 0.035 watt		—	—	0.600	
Class A Amplifier	3.0	67.5	0.4	135	1.7	800,000‡	600	—	—	—	959
($E_g = 0$, shadow angle = 90° , $I_p = 0.24$ ma) ($E_g = -8$ volts, shadow angle = 0°) Target voltage = 250; target current = 4 ma at 90°											1629
Class A Amplifier	$R_k = 820$	90	1.4	90	3.9	300,000	2,000	800	—	—	<i>6690</i>
Class A Amplifier	$R_k = 200$	120	2.4	180	7.7	690,000	5,100	3,500	—	—	<i>6691</i>
Class A Amplifier	12.0	120	2.5	120	7.5	340,000	5,000	—	—	—	<i>6808</i>
Class A Amplifier	6.0	—	—	300	6.0	13,000	2,450	32	—	—	5608-A
Class A Amplifier	1.5	—	—	90	17	3,500	4,000	14	—	—	<i>6610</i>
Class A Amplifier	$R_k = 150$	100	2.8	100	7.0	200,000	3,400	—	—	—	5633
Class A Amplifier	$R_k = 150$	100	2.5	100	6.5	240,000‡	3,500	—	—	—	5634
Class A Amplifier	$R_k = 100$ ⊕	—	—	100	4.8	10,000	3,800	38	—	—	5635
Mixer	$R_k = 150$	100	5.0	100	3.0	160,000	Conversion Trans-conductance = 1,000		—	—	5636
Class A Amplifier	$R_k = 820$	—	—	100	1.4	26,000	2,700	70	—	—	5637
Class A Amplifier	$R_k = 270$	100	1.25	100	4.8	150,000	3,300	—	—	—	5638
Class A Amplifier	$R_k = 100$	100	4.0	150	21	50,000	9,000	—	—	—	5639

‡ Approximate. ⊕ For both sections.
 ⊙ Designates sub-miniature types

⊠ Absolute maximum rating.
 Type designations of miniature tubes are shown in italics.

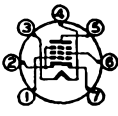

78D

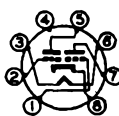

8DB

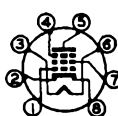

8DC



8DL



5633

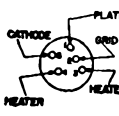

5637

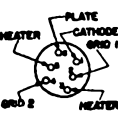

5638

Tube Type	Classification by Construction	Base Connections	Out-line Dwg	Type Cathode	Filament Volts	Filament Amp	Max Plate Volts	Max Screen Volts	Capacitance in Micromicrofarads		
									Input	Output	Grid-plate
5640 ●	Beam Power Amplifier	5640	3-4	Htr	6.3	0.45	150	140	9.0	7.0	0.18
5641 ●	Ruggedized Half-Wave Rectifier	6CJ	3-3	Htr	6.3	0.45	Rms voltage = 250 volts;				
5642 ●	Half-Wave Rectifier	5642	5642	Fil	1.25 D-C	0.14	Rms voltage = 3,600 volts;				
5645 ●	Medium-Mu Triode	5645	5645	Htr	6.3	0.15	150	—	2.2	3.0	1.7
5646 ●	High-Mu Triode	5645	5645	Htr	6.3	0.15	150	—	2.2▲	1.0▲	1.3▲
5647 ●	Ruggedized High-Frequency Diode	5647	5647	Htr	6.3	0.150	Rms plate voltage = 165 volts max; max d-c output = 10 ma;				
6654	High-Reliability Sharp-Cutoff R-F Pentode	7BD	5-1	Htr	6.3	0.175	180	140	4.0	2.9	0.02♣
6670	High-Reliability High-Frequency Triode	8CJ	6-1	Htr	6.3	0.350	300	—	2.2▲	1.0▲	1.3▲
5672 ●	Power Amplifier Pentode	2E31	2-1	Fil	1.25 D-C	0.050	90	90	—	—	—
5675	Medium-Mu Triode (Pencil)	5675	5675	Htr	6.3	0.135	150	—	2.3▲	0.09▲	1.3▲
5676 ●	Medium-Mu Triode	5676	2-1	Fil	1.25 D-C	0.12	135	—	1.3	4.0	2.0
5677 ●	Medium-Mu Triode	5676	2-1	Fil	1.25 D-C	0.06	135	—	1.3	3.8	2.0
5678 ●	Pentode Amplifier	5678	2-1	Fil	1.25 D-C	0.05	90	67.5	3.3	3.8	0.01♣
5679	Twin Diode	7CX	9-30	Htr	6.3	0.15	Rms voltage per plate = 150 volts;				
6686	High-Reliability Power Amplifier Pentode	5686	6-2	Htr	6.3	0.35	250	250	6.5	8.5	0.08♣
6687	General Purpose Twin Triode	9H	6-2	Htr	6.3	0.9	300	—	4.0▲	0.45▲	3.1▲
					12.6	0.45					
5691	High-Mu Twin Triode	8BD	9-3♦	Htr	6.3	0.6	275☐	—	—	—	—
5692	Medium-Mu Twin Triode	8BD	9-3♦	Htr	6.3	0.6	275☐	—	—	—	—
5693	Sharp-Cutoff Pentode	8N	8-1	Htr	6.3	0.3	300☐	125☐	5.3	6.2	0.005♣
5694	Twin Triode	8CS	14-3	Htr	6.3	0.8	300	—	—	—	—



2E31



6CJ



7BD



7CX

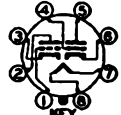

8BD



8CJ



8CS



8N

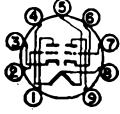

9H

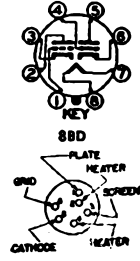

5640

Service	Neg Grid Volts	Screen Volts	Screen Milli-am-peres	Plate Volts	Plate Milli-am-peres	R _p , Ohms	G _m , μmhos	μ Factor	Load for Rated Output, Ohms	Power Output, Watts	Tube Type
Class A Amplifier	9.0	100	2.2†	100	31.0†	15,000	5,000	—	3,000	1.25	5640 ●
max d-c output = 45 ma; peak current = 270 ma; peak inverse voltage = 850 volts; min plate supply impedance = 300 ohms											
d-c output = 2.0 ma; peak plate current = 12 ma; max peak inverse voltage = 10,000 volts; min plate supply impedance = 200,000 ohms											
Class A Amplifier	R _k = 560	—	—	100	5.0	7,400	2,700	20			5645 ●
Class A Amplifier	R _k = 820	—	—	100	1.4	29,000	2,400	70			5646 ●
max peak current = 60 ma; max peak inverse voltage = 460 volts											
Class A Amplifier	R _k = 200	120	2.5	120	7.5	340,000‡	5,000	—			6654
Class A Amplifier ♣	R _k = 240	—	—	150	8.2	—	5,500	35	—	—	6670
Class AB ₁ Amplifier ⊕	R _k = 800	—	—	300	9.8†	—	—	—	27,000 ‡	1.0	
Class A Amplifier	6.5	67.5	1.1	67.5	3.25	—	650	—	20,000	0.065	5672 ●
Class A Amplifier	R _k = 68	—	—	135	24	3,225	6,200	20	—	—	5675
Class A Amplifier	5.0	—	—	135	4.0	—	1,600	15	—	—	5676 ●
Class A Amplifier	6.0	—	—	135	1.9	—	650	13.5	—	—	5677 ●
Class A Amplifier	0.0	67.5	0.48	67.5	1.8	1,000,000	1,100	—	—	—	5678 ●
max d-c output current per plate = 8.0 ma; peak plate current per plate = 45 ma max; max heater-cathode voltage = 330 volts											
Class A Amplifier	12.5	250	5.0	250	27	—	3,100	—	9,000	2.7	6686
Class C Amplifier	50.0	250	10.5	250	40	Input Power = 0.15 watt		—	—	6.5	
Class A ♣ Amplifier	7.0	—	—	180	23.0	2,750	6,400	17.5	—	—	6687
Class A ♣ Amplifier	12.5	—	—	250	16.0	4,000	4,100	16.5	—	—	
Class A ♣ Amplifier	2.0	—	—	250	2.3	44,000	1,600	70	—	—	5691
Class A ♣ Amplifier	9.0	—	—	250	6.5	9,100	2,200	20	—	—	5692
Class A Amplifier	3.0	100	0.85	250	3.0	1,000,000*	1,650	—	—	—	5693
Class A Amplifier ●	6.0 5.0	—	—	294 250	7.0 6.0	11,000 11,300	3,200 3,100	35 35	—	—	5694

♣ With short base.

● Absolute maximum rating.

▲ Without external shield.

♠ Per section.

* Minimum.

† Plate-to-plate.

‡ Zero signal.

§ Approximate.

♣ Maximum.

Type designations of miniature tubes are shown in italics.

● Designates sub-miniature types.

Type designations of metal tubes are shown in bold-face type.

● Sections in parallel.

⊕ For both sections.

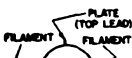

5642

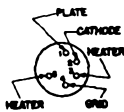

5645

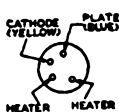

5647

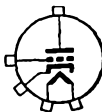

5675

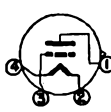

5676



5678



5686

Tube Type	Classification by Construction	Base Connections	Out-line Dwg	Type Cathode	Filament Volts	Filament Amp	Max Plate Volts	Max Screen Volts	Capacitance in Micromicrofarads		
									Input	Out-put	Grid-plate
5697 ●	Low-Mu Triode	5697	2-4	Fil	0.625 D-C	0.02	45	—	—	—	—
5702 ●	Remote-Cutoff R-F Pentode	5702	3-7	Htr	6.3	0.2	180	120	4.4	3.5	0.03 ♣
5703 ●	Medium-Mu Triode	5703	3-6	Htr	6.3	0.2	250	—	2.6	0.7	1.2
5704 ●	Diode	5704	5704	Htr	6.3	0.15	Rms voltage per plate = 150 volts;				
5718 ●	Ruggedized Medium-Mu Triode	5718	3-2	Htr	6.3	0.150	110	—	2.4▲	0.8▲	2.4▲
5719 ●	Ruggedized High-Mu Triode	5718	3-2	Htr	6.3	0.150	110	—	2.6▲	0.7▲	1.4▲
5725	High-Reliability Dual-Control R-F Pentode	7CM	5-1	Htr	6.3	0.175	180	140	3.9	3.0	0.01
5728	High-Reliability Twin Diode	6BT	5-1	Htr	6.3	0.30	Rms voltage per plate = 117 volts; max d-c output per plate = 9 ma;				
5731	Power Amplifier Triode (Acorn)	5BC	4-1	Htr	6.3	0.15	250	—	1.0	0.4	1.3
5744 ●	High-Mu Triode	5744	3-6	Htr	6.3	0.2	250	—	—	—	—
5749	High-Reliability Remote-Cutoff R-F Pentode	7BK	5-2	Htr	6.3	0.3	300	125	5.5	5.5	0.0035
5750	High-Reliability Pentagrid Converter	7CH	5-2	Htr	6.3	0.3	300	100	Osc I _g = 0.5 ma thru 20,000 ohms		
5751	High-Reliability High-Mu Twin Triode	9A	6-2	Htr	{ 6.3 12.6 }	{ 0.350 0.175 }	300	—	—	—	—
5784 ●	Dual-Control R-F Pentode	5702	3-7	Htr	6.3	0.2	180	140	3.9	3.0	0.03♣
5785 ●	High-Voltage Diode	5785	2-3	Fil	1.25 D-C	0.015	Max d-c output = 0.10 ma; max peak current = 0.45 ma;				
5814	High-Reliability Medium-Mu Twin Triode	9A	6-2	Htr	{ 6.3 12.6 }	{ 0.350 0.175 }	300	—	1.6▲	0.50;▲ 0.35;▲	1.5▲
5824	Beam Power Amplifier	7AC	14-3	Htr	25.0	0.3	200	135	—	—	—
5825	Half-Wave High-Voltage Rectifier	4P	5825	Fil	1.6	1.25	Rms voltage = 21,200 volts max; max d-c output @ = 2 ma;				
5840 ●	Ruggedized Sharp-Cutoff R-F Pentode	8DL	3-1	Htr	6.3	0.15	165■	155■	4.2	3.4	0.015 ♣
5842	High-Mu Triode	9V	6-1	Htr	6.3	0.3	180	—	—	—	—



4P



5BC



6BT



7AC



7BK



7CH



7CM



8DL



9A



9V

Service	Neg Grid Volts	Screen Volts	Screen Milli-am-peres	Plate Volts	Plate Milli-am-peres	R_p Ohms	G_m μ mhos	μ Factor	Load for Rated Out-put Ohms	Power Out-put, Watts	Tube Type
Class A Amplifier	3.0	—	—	12.0	0.22	—	135	2.1	—	—	5697 ●
Class A Amplifier	$R_k = 200$	120	2.5	120	7.5	340,000	5,000	—	—	—	5702 ●
Class A Amplifier	$R_k = 220$	—	—	120	9.0	—	5,000	25	—	—	5703 ●
max d-c output current = 9 ma; peak plate current = 54 ma max; peak inverse voltage = 420 volts max											5704 ●
Class A Amplifier	$R_k = 150$	—	—	100	12.0	3,650	5,500	20	—	—	5718 ●
Class A Amplifier	$R_k = 820$	—	—	100	1.4	26,000	2,700	70	—	—	5719 ●
Class A Amplifier	2.0	120	3.5	120	5.2	—	3,200	$E_{c3} = 0.0$ volts	—	—	5725
max peak current per plate = 54 ma; max peak inverse voltage = 330 volts; min. plate supply impedance per plate = 300 ohms											5726
Class A Amplifier	7.0	—	—	250	6.3	11,400	2,200	25	—	—	5731
Class A Amplifier	$R_k = 500$	—	—	250	4.0	—	4,000	70	—	—	5744 ●
Class A Amplifier	$R_k = 68$ $R_k = 68$	100	4.2	250	11.0	1,000,000§	4,400	—	—	—	5749
		100	4.4	100	10.8	250,000§	4,300	—	—	—	
Converter	1.5	100	7.5	250	2.6	1,000,000§	Conversion Trans-conductance = 475		—	—	5750
Class A Amplifier ♣	3.0 1.0	—	—	250	1.0	58,000 58,000	1,200	70	—	—	5751
		100	—	100	0.8		1,200	70	—	—	
Class A Amplifier	2.0 2.0	120	3.5	120	5.2	—	3,200 $E_{c3} = 0.0$ volts			—	5784 ●
		120	4.8	120	3.6		1,850 $E_{c3} = -3.0$ volts				
max peak inverse voltage = 3500 volts with internal impedance of supply = 1 megohm min.											5785 ●
Class A Amplifier ♣	8.5 0.0	—	—	250	10.5	7,700 6,250	2,200	17	—	—	5814
		100	—	100	11.8		3,100	19.5	—	—	
Class A Amplifier	22.0	135	2.5†	135	61.0†	15,000§	5,000	—	1,700	4.3	5824
max peak current ⊕ = 40 ma; max peak inverse voltage ⊕ = 60,000 volts.											5825
Class A Amplifier	$R_k = 150$	100	2.4	100	7.5	230,000	5,000	—	—	—	5840 ●
Class A Amplifier	$R_k = 62$	—	—	150	26.0	1,800	24,000	43	—	—	5848

▲ Without external shield. ♣ Per section. * Minimum. ♠ Maximum. § Approximate.

● Designates sub-miniature tubes.

Type designations of miniature tubes are shown in italics.

1—Section 1

2—Section 2

⊕ Absolute maximum rating.

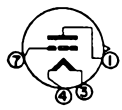

5697



5702



5703



5704

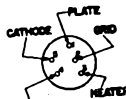

5718



5744



5785

Tube Type	Classification by Construction	Base Connections	Out-line Dwg	Type Cathode	Fila-ment Volts	Fila-ment Amp	Max Plate Volts	Max Screen Volts	Capacitance in Micromicrofarads		
									Input	Out-put	Grid-plate
5847	Sharp-Cutoff R-F Pentode	9X	6-1	Htr	6.3	0.3	180	150	7.1	2.9	0.04
5851	Ruggedized Beam Power Amplifier	6CL	5851	Fil	1.25 2.50 D-C	0.110 0.055	180	135	2.5	3.0	0.055
5871	Ruggedized Beam Power Amplifier	7AC	9-11	Htr	6.3	0.45	315	285	9.5	7.5	0.7
5876	High-Mu Triode (Pencil)	5675	5675	Htr	6.3	0.135	300	—	2.5▲	0.035▲	1.4▲
5879	Sharp-Cutoff A-F Pentode	9AD	6-2	Htr	6.3	0.150	300 250	150 —	Pentode Connection Triode Connection		
5881	Beam Power Amplifier	7AC	9A-3	Htr	6.3	0.9	360	270	Single Tube Two tubes, Push-pull		
5890	Remote-Cutoff Pentode Regulator	12J	5890	Htr	6.3	0.6	30,000 □	450 □	E _{c3} = 5,500 volts E _{c3} = 5,500 volts E _{c3} = 5,500 volts		
5896	Ruggedized High-Frequency Twin Diode	8DJ	3-1	Htr	6.3	0.3	Max d-c output per plate □ = 10 ma;				
5897	Ruggedized UHF Medium-Mu Triode	8DK	3-1	Htr	6.3	0.15	165□	—	2.2	0.7	1.40
5898	Ruggedized UHF High-Mu Triode	8DK	3-1	Htr	6.3	0.15	165□	—	2.40	0.60	0.70
5899	Ruggedized UHF Semi-Remote-Cutoff Pentode	8DL	3-1	Htr	6.3	0.15	165□	155□	4.4	3.4	0.015♣
5900	Ruggedized UHF Semi-Remote-Cutoff Pentode	8DL	3-1	Htr	6.3	0.15	165□	155□	4.4	3.4	0.015♣
5901	Ruggedized UHF Sharp-Cutoff Pentode	8DL	3-1	Htr	6.3	0.15	165□	155□	4.2	3.4	0.015
5902	Ruggedized Beam Power Amplifier	8DL	3-3	Htr	6.3	0.45	165□	120□	6.5	7.5	0.11
5903	Ruggedized UHF Twin Diode	8DJ	3-1	Htr	26.5	0.075	Max d-c output per plate □ = 10 ma;				
5904	Ruggedized UHF Medium-Mu Triode	8DK	3-1	Htr	26.5	0.045	55□	—	2.2	0.8	1.80
5905	Ruggedized UHF Sharp-Cutoff Pentode	8DL	3-1	Htr	26.5	0.045	55□	55□	4.4	3.4	0.015♣
5906	Ruggedized UHF Sharp-Cutoff Pentode	8DL	3-1	Htr	26.5	0.045	165□	155□	4.2	4.0	0.015♣
5907	Ruggedized UHF Remote-Cutoff Pentode	8DL	3-1	Htr	26.5	0.045	55□	55□	4.4	3.4	0.015♣

▲Without external shield.

†Zero signal.

♣Maximum.

□ Absolute maximum rating.



6CL



7AC

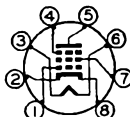

8DC

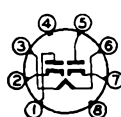

8DJ



8DK

Service	Neg Grid Volts	Screen Volts	Screen Milli-amperes	Plate Volts	Plate Milli-amperes	Rp, Ohms	Gm, mhos	μ Factor	Load for Rated Output, Ohms	Power Output, Watts	Tube Type
Class A Amplifier	$R_k = 110$	150	4.5	150	13	—	12,500	—	—	—	<i>6847</i>
Class A Amplifier	7.5	125	0.9	125	5.5	175,000	1,600	—	—	—	5851 Ⓣ
Class A Amplifier	13.0	225	2.2	315	34.0	77,000	3,750	—	8,500	5.5	5871
Class A Amplifier	$R_k = 75$	—	—	250	18.0	8,625	6,500	56	—	—	5876
Class A Amplifier	3.0	100	0.4	250	1.8	2,000,000	1,000	—	—	—	<i>6879</i>
Class A Amplifier	8.0	—	—	250	5.5	13,700	1,530	21	—	—	
Class A Amplifier	18.0	250	2.5†	350	53.0†	48,000	5,200	—	4,200	11.3	5881
Class AB ₁ Amplifier	14.0	250	4.3†	250	75.0†	30,000	6,100	—	2,500	6.7	
	22.5	270	5.0†	360	88.0†	—	—	—	3,800	18.0	
	22.5	270	5.0†	360	88.0†	—	—	—	6,600	26.5	
Shunt Regulator	60	200	0.0	30,000	0.0	—	—	Peak G ₁ signal = 0.0 volts			5890
	60	200	0.0	30,000	0.06	—	—	Peak G ₁ signal = 20 volts			
	60	200	0.0	30,000	0.50	—	—	Peak G ₁ signal = 45 volts			
max peak current per plate $\square = 60$ ma; max peak inverse voltage $\square = 460$ volts											5896 Ⓣ
Class A Amplifier	$R_k = 150$	—	—	100	8.5	—	5,800	27	—	—	5897 Ⓣ
RF Oscillator	—	—	—	150	20.0	Frequency = 500 mc		—	—	0.9	
Class A Amplifier	$R_k = 680$	—	—	150	1.7	—	2,700	70	—	—	5898 Ⓣ
Class A Amplifier	$R_k = 120$	100	2.2	100	7.2	260,000	4,500	—	—	—	5899 Ⓣ
Class A Amplifier	$R_k = 120$	100	2.2	100	7.2	260,000	4,500	—	—	—	5900 Ⓣ
Class A Amplifier	$R_k = 150$	100	2.4	100	7.5	230,000	5,000	—	—	—	5901 Ⓣ
Class A Amplifier	$R_k = 270$	110	2.2	110	30.0	15,000	4,200	—	3,000	1.0	5902 Ⓣ
max peak current per plate $\square = 60$ ma; max peak inverse voltage $\square = 460$ volts.											5903 Ⓣ
Class A Amplifier	$R_k = 2.2$ Meg	—	—	26.5	3.0	—	5,000	19	—	—	5904 Ⓣ
Class A Amplifier	$R_k = 2.2$ Meg	26.5	0.9	26.5	2.3	110,000	2,850	—	—	—	5905 Ⓣ
Class A Amplifier	$R_k = 150$	100	2.4	100	7.5	230,000	5,000	—	—	—	5906 Ⓣ
Class A Amplifier	$R_k = 2.2$ Meg	26.5	1.1	26.5	2.7	125,000	3,000	—	—	—	5907 Ⓣ

Type designations of miniature tubes are shown in italics.
 Ⓣ Designates sub-miniature types.



8DL



9AD



9X



5675



5675

Tube Type	Classification by Construction	Base Connections	Out-line Dwg	Type Cath-ode	Fila-ment Volts	Fila-ment Amp	Max Plate Volts	Max Screen Volts	Capacitance in Micromicrofarads		
									Input	Out-put	Grid-plate
5908 Ⓞ	Ruggedized UHF Mixer Pentode	8DC	3-1	Htr	26.5	0.045	55 Ⓞ	55 Ⓞ	$E_{c3} = 0$ volts		
5916	Pentagrid Amplifier	7CH	5-2	Htr	6.3	0.3	250 Ⓞ	125 Ⓞ	$E_{c3} = 0.0$ volts $E_{c3} = -10$ volts $E_{c3} = 0.0$ volts		
5916 Ⓞ	Ruggedized Mixer Pentode	8DC	3-1	Htr	26.5	0.045	165 Ⓞ	155 Ⓞ	$E_{c3} = 0$ volts $E_{c3} = -3$ volts		
5961	Ruggedized Pentagrid Converter	8R	8-1	Htr	6.3	0.3	300	100	Osc $I_g = 0.5$ ma thru 20,000 ohms		
5963	Medium-Mu Twin Triode	9A	6-2	Htr	{ 12.6 6.3 }	{ 0.15 0.3 }	250 Ⓞ	—	1.9 ▲	0.5 ₁ ▲ 0.35 ₂ ▲	1.5 ▲
5964	High-Mu Twin Triode	7BF	5-2	Htr	6.3	0.45	250 Ⓞ	—	2.1 ▲	0.4 ▲	1.3 ▲
5977 Ⓞ	Ruggedized Medium-Mu Triode	8DK	3-1	Htr	6.3	0.15	180 Ⓞ	—	1.9	0.6	1.3
9001	Detector Amplifier Pentode	7BD	5-1	Htr	6.3	0.15	250	100	3.6	3.0	0.01 ♣
9002	Medium-Mu Triode	7BS	5-1	Htr	6.3	0.15	250	—	1.2	1.1	1.4
9003	Remote-Cutoff Pentode	7BD	5-1	Htr	6.3	0.15	250	100	3.6	3.0	0.01 ♣
9004	UHF Diode (Acorn)	4BJ	4-1	Htr	6.3	0.15	Max Rms plate voltage = 117;				
9005	UHF Diode (Acorn)	5BG	4-1	Htr	3.6	0.165	Max Rms plate voltage = 117;				
9006	UHF Diode	6BH	5-1	Htr	6.3	0.15	Max Rms plate voltage = 270;				

▲ Without external shield. * Minimum. ♣ Maximum. Ⓞ Absolute maximum rating.

‡ Plate supply voltage. § Approximate. ♠ Per section.



4B1



5BC

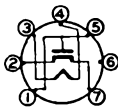

6BH

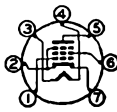

7BD

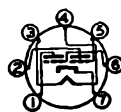

7BF



Service	Neg Grid Volts	Screen Volts	Screen Milli-am-peres	Plate Volts	Plate Milli-am-peres	R _p , Ohms	G _m , mhos	u Factor	Load for Rated Out-put, Ohms	Power Out-put, Watts	Tube Type	
Class A Amplifier	$R_g = 2.2$ Meg	26.5	1.6	26.5	2.3	30,000	1,750	—	—	—	5908 ©	
Gated Amplifier	10.0 0.0 0.0	75 69§ 71§	0.0 14.0 9.0	150§ 150§ 150§	0.0 0.0 5.8	$R_{g1} = R_{g3} = 47,000$ $R_{g1} = R_{g3} = 47,000$ $R_{g1} = R_{g3} = 47,000$	—	—	20,000 20,000 20,000	— — —	5915	
Class A Amplifier	$R_k = 150$ $R_k = 150$	100 100	3.4 4.5	100 100	4.4 2.6	130,000 50,000	3,000 1,600	— —	— —	— —	5916 ©	
Converter	2.0	100	8.5	250	3.5	1,000,000§	Conversion Trans-conductance = 450		—	—	5961	
Class A Amplifier Frequency Halfer	0.0 15.0 0.0	— — —	— — —	67.5 150§ 150§	7 0.0 5.1	7,850 $R_{g1} = 47,000$ $R_{g1} = 47,000$	2,800	22	— 20,000 20,000	— — —	5963	
Class A Amplifier Frequency Halfer	$R_k = 50$ 10.0 0.0	— — —	— — —	100 150§ 150§	9.5 0.0 5.0	6,500 $R_{g1} = 47,000$ $R_{g1} = 47,000$	6,000	39	— 20,000 20,000	— — —	5964	
Class A Amplifier	$R_k = 270$	—	—	100	10.0	—	4,500	16	—	—	5977 ©	
Class A Amplifier	3.0	100	0.7	250	2.0	1,000,000*	1,400	—	—	—	9001	
Class A Amplifier	7.0	—	—	250	6.3	11,400	2,200	25	—	—	9002	
Class A Amplifier	3.0	100	2.7	250	6.7	700,000	1,800	—	—	—	9003	
max d-c output = 5 ma; plate-cathode capacitance = 1.3 μ f; plate-heater capacitance = 0.3 μ f; heater-cathode capacitance = 2.2 μ f.										—	—	9004
max d-c output = 1.0 ma; plate-cathode capacitance = 0.8 μ f; plate-heater capacitance = 0.2 μ f; heater-cathode capacitance = 1.1 μ f.										—	—	9005
max d-c output = 5 ma; peak plate current = 15 ma; peak inverse voltage = 750										—	—	9006

1—Section 1

2—Section 2

Type designations of miniature tubes are shown in italics.

© Designates sub-miniature tubes.

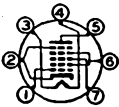

7CH

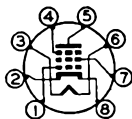

8DC

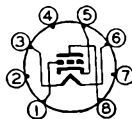

8DK



8R



9A

Type	Base Connections	Construction	Face-plate Shape	Face-plate Color	Outside Conductive Coating	Focus Method	Defl Method	Defl Angle Degrees	Nom Over-all Length Inches	Nom Bulb Diam. Inches
3KP4	11M	Glass	Round	Clear	No	Elec	Elec	—	11 1/4	3
3NP4●	5BV	Glass	Round	Clear°	No	Mag	Mag	42	10	2 1/2
5BP4	11N	Glass	Round	Clear	No	Elec	Elec	—	16 1/4	5 1/4
5FP4-A	5AN	Glass	Round	Clear	No	Mag	Mag	53	11 1/4	4 1/2
5TP4●	12C	Glass	Round	Clear°	No	Elec	Mag	50	11 1/4	5
7AP4	5AJ	Glass	Round	Clear	No	Elec	Mag	55	13 1/4	7
7CP4	6AZ	Glass	Round	Clear	No	Elec	Mag	57	13 1/4	7
7DP4	12C	Glass	Round	Clear	Yes	Elec	Mag	50	14 1/4	7 1/2
7EP4	11N	Glass	Round	Clear	No	Elec	Elec	—	15 1/4	7
7GP4	14G	Glass	Round	Clear		Elec	Elec	—	14 1/4	7
7HP4	12D	Glass	Round	Clear	Yes	Mag	Mag	50	13	7 1/2
7JP4	14G	Glass	Round	Clear	No	Elec	Elec	—	14 1/4	7
8AP4	12H	Metal	Round	Clear	Metal	Mag	Mag	54	14 1/4	8 1/2
8AP4-A	12H	Metal	Round	Filter	Metal	Mag	Mag	54	14 1/4	8 1/2
8BP4	14G	Glass	Round	Clear	No	Elec	Elec	—	16 1/2	8 1/2
9AP4	6AL	Glass	Round	Clear	No	Elec	Mag	40	21	9
10BP4	12D	Glass	Round	Clear	Yes	Mag	Mag	50	17 3/8	10 1/2
10BP4-A	12D	Glass	Round	Filter	Yes	Mag	Mag	50	17 3/8	10 1/2
10CP4	12D	Glass	Round	Clear	Yes	Mag	Mag	50	16 3/8	10 1/2
10FP4	12D	Glass	Round	Clear°	Yes	Mag	Mag	50	17 3/8	10 1/2
10FP4-A	12D	Glass	Round	Filter°	Yes	Mag	Mag	54	17 3/8	10 1/2
10GP4	14G	Glass	Round	Clear	No	Elec	Elec	—	18 1/2	10
10HP4	14G	Glass	Round	Clear	No	Elec	Elec	—	19 1/4	10

● Designates projection type.
° Reflective, metal-backed screen to increase light output.

⚡ Absolute maximum rating.
‡ Plate-to-plate.



Htr Volts/Amps	Max Anode Volts	Max Grid 2 Volts	Typical Operating Conditions						Type
			Anode Volts	Grid 2 Volts ⊠	Neg Grid 1 Volts	RTMA Focus Coil No.	Focus Coil Dist‡	Focus Current in ma	
6.3/0.6	2500 Δ	1000 ⚡	2000 Δ	460 ⚡	38 to 90	D1-D2 ⊕ = 100 to 136 volts/inch D3-D4 ⊕ = 76 to 104 volts/inch			3KP4
6.3/0.6	25000	—	24000	—	60	— 2.78 120 None			3NP4●
6.3/0.6	2000 Δ	1000 ⚡	2000 Δ	425 ⚡	85	D1-D2 ⊕ = 84 volts/inch D3-D4 ⊕ = 76 volts/inch			5BP4
6.3/0.6	8000	300	6000	250	25 to 70	— — 122 None			5FP4-A
6.3/0.6	27000 Δ	350	27000 Δ	200	42 to 98	— — — None			5TP4●
2.5/2.1	3500 Δ	1000 ⚡	3500 Δ	675 ⚡	67.5	— — — None			7AP4
6.3/0.6	8000 Δ	300	6000 Δ	250	22 to 68	— — — None			7CP4
6.3/0.6	2400 ⚡	—	1140 ⚡	—	—	— — — None			7DP4
6.3/0.6	8000 Δ	410	6000 Δ	250	27 to 63	— — — Double			7DP4
6.3/0.6	2400 ⚡	—	1430 ⚡	—	—	— — — Double			7DP4
6.3/0.6	3300 Δ	1500 ⚡	2500 Δ	650 ⚡	36 to 84	D1-D2 ⊕ = 88 to 132 volts/inch D3-D4 ⊕ = 76 to 114 volts/inch			7EP4
6.3/0.6	4000 Δ	1500 ⚡	3000 Δ	1000 ⚡	36 to 84	D1-D2 ⊕ = 93 to 123 volts/inch D3-D4 ⊕ = 75 to 102 volts/inch			7GP4
6.3/0.6	8000	410	6000	250	33 to 77	106 3.5 135 None			7HP4
6.3/0.6	6000 Δ	2800 ⚡	6000 Δ	2010 ⚡	72 to 168	D1-D2 ⊕ = 186 to 246 volts/inch D3-D4 ⊕ = 150 to 204 volts/inch			7JP4
6.3/0.6	9000	—	7000	—	27 to 63	106 3 1/4 115 Single			8AP4
6.3/0.6	9000	—	7000	—	27 to 63	106 3 1/4 115 Single			8AP4-A
6.3/0.6	6600 Δ	3100 ⚡	6000 Δ	2010 ⚡	72 to 168	D1-D2 ⊕ = 146 to 198 volts/inch D3-D4 ⊕ = 124 to 168 volts/inch			8BP4
2.5/2.1	7000 Δ	250	7000 Δ	250	75	— — — None			9AP4
6.3/0.6	2000 ⚡	—	1425 ⚡	—	—	— — — None			9AP4
6.3/0.6	10000	410	9000	250	27 to 63	106 3 1/4 100 Double			10BP4
6.3/0.6	10000	410	9000	250	27 to 63	106 3 1/4 110 Double			10BP4-A
6.3/0.6	11000	410	9000	250	30 to 66	— — — None			10CP4
6.3/0.6	10000	410	9000	250	27 to 63	106 3 1/4 110 None			10FP4
6.3/0.6	12000	410	11000	250	27 to 63	106 3 1/4 110 None			10FP4-A
6.3/0.6	5000 Δ	2000 ⚡	5000 Δ	1550 ⚡	60 to 140	D1-D2 ⊕ = 125 to 165 volts/inch D3-D4 ⊕ = 100 to 135 volts/inch			10GP4
6.3/0.6	5000 Δ	2000 ⚡	5000 Δ	1500 ⚡	60 to 140	D1-D2 ⊕ = 110 to 150 volts/inch D3-D4 ⊕ = 85 to 115 volts/inch			10HP4

⚡ Anode No. 1. Under typical operating conditions center value of anode 1 voltage for focus is shown. Voltage should be adjustable about this value.
Δ Anode No. 2. ⊕ Deflection factor.

TELEVISION PICTURE TUBES

CHARACTERISTICS AND RATINGS

Type	Base Connections	Construction	Faceplate Shape	Faceplate Color	Outside Conductive Coating	Focus Method	Defl Method	Defl Angle Degrees	Nom Over-all Length Inches	Nom Bulb Diam. Inches
10MP4	12G	Glass	Round	Clear	Yes	Mag	Mag	52	17	10 1/2
10MP4-A	12G	Glass	Round	Filter	Yes	Mag	Mag	52	17	10 1/2
12AP4	6AL	Glass	Round	Clear	No	Elec	Mag	35	25	12
12JP4	12D	Glass	Round	Clear	No	Mag	Mag	50	17 1/2	12
12KP4	12D	Glass	Round	Clear°	Yes	Mag	Mag	54	17 1/2	12 1/4
12KP4-A	12D	Glass	Round	Filter°	Yes	Mag	Mag	54	17 1/2	12 1/4
12LP4	12D	Glass	Round	Clear	Yes	Mag	Mag	54	18 1/2	12 1/4
12LP4-A	12D	Glass	Round	Filter	Yes	Mag	Mag	54	18 1/2	12 1/4
12QP4	12D	Glass	Round	Clear	No	Mag	Mag	55	17 1/2	12 1/4
12RP4	12D	Glass	Round	Clear	No	Mag	Mag	56	17 1/2	12
12TP4	12D	Glass	Round	Clear	No	Mag	Mag	54	18 1/2	12 1/4
12UP4	12D	Metal	Round	Clear	Metal	Mag	Mag	54	18 1/2	12 1/4
12UP4-A	12D	Metal	Round	Filter	Metal	Mag	Mag	54	18 1/2	12 1/4
12UP4-B	12D	Metal	Round	Filter+	Metal	Mag	Mag	54	18 1/2	12 1/4
12VP4	12G	Glass	Round	Clear	Yes	Mag	Mag	55	18	12 1/4
12VP4-A	12G	Glass	Round	Filter	Yes	Mag	Mag	55	18	12 1/4
14AP4	12A	Glass	Round	Clear	Yes	Elec	Elec	—	24 1/2	13 1/2
14BP4	12D	Glass	Rect	Filter	Yes	Mag	Mag	Hor 65 Diag 70	16 1/2	13 1/2
14CP4	12D	Glass	Rect	Filter	Yes	Mag	Mag	Hor 65 Diag 70	16 1/2	13 1/2
14DP4	12D	Glass	Rect	Filter	No	Mag	Mag	Hor 65 Diag 70	16 1/2	13 1/2
14EP4	12D	Glass	Rect	Filter	Yes	Mag	Mag	Hor 65 Diag 70	16 1/4	13 1/2
15AP4	12D	Glass	Round	Clear	No	Mag	Mag	52-57	20 1/2	15 1/2
15CP4	12D	Glass	Round	Clear	No	Mag	Mag	50	21 1/2	15 1/2
15DP4	12D	Glass	Round	Clear	No	Mag	Mag	57	20 1/2	15 1/2
16AP4	12D	Metal	Round	Clear	Metal	Mag	Mag	53	22 1/2	15 1/2
16AP4-A	12D	Metal	Round	Filter	Metal	Mag	Mag	53	21 1/2	15 1/2
16CP4	12D	Glass	Round	Clear	No	Mag	Mag	52	21 1/2	15 1/2
16DP4	12D	Glass	Round	Clear	No	Mag	Mag	60	20 1/2	15 1/2
16DP4-A	12D	Glass	Round	Filter	No	Mag	Mag	60	20 1/2	15 1/2
16EP4	12D	Metal	Round	Clear	Metal	Mag	Mag	60	19 1/2	15 1/2
16EP4-A	12D	Metal	Round	Filter	Metal	Mag	Mag	60	19 1/2	15 1/2
16FP4	12D	Glass	Round	Clear	No	Mag	Mag	62	20 1/2	16 1/2

Htr Volts/Amps	Max Anode Volts	Max Grid 2 Volts	Typical Operating Conditions							Type
			Anode Volts	Grid 2 Volts	Neg Grid 1 Volts	RTMA Focus Coil No.	Focus Coil Dist	Focus Current in ma	Ion Trap	
6.3/0.6	10000	—	9000	—	27 to 63	—	—	—	Double	10MP4
6.3/0.6	10000	—	9000	—	27 to 63	—	—	—	Double	10MP4-A
2.5/2.1	7000 Δ 2000 †	250	7000 Δ 1460 †	250	75	—	—	—	None	12AP4
6.3/0.6	12000	410	10000	250	27 to 63	106	3.0	146	None	12JP4
6.3/0.6	12000	410	11000	250	27 to 63	106	3 1/4	135	None	12KP4
6.3/0.6	12000	410	11000	250	27 to 63	106	3 1/4	135	None	12KP4-A
6.3/0.6	12000	410	11000	250	27 to 63	106	3 1/4	110	Double	12LP4
6.3/0.6	12000	410	11000	250	27 to 63	106	3 1/4	110	Double	12LP4-A
6.3/0.6	12000	410	11000	250	27 to 63	106	3.0	135	Single	12QP4
6.3/0.6	12000	410	10000	250	27 to 63	106	3.0	135	Single	12RP4
6.3/0.6	12000	410	11000	250	27 to 63	106	3 1/4	110	Double	12TP4
6.3/0.6	12000	410	11000	250	27 to 63	106	3 1/4	110	Double	12UP4
6.3/0.6	12000	410	11000	250	27 to 63	106	3 1/4	110	Double	12UP4-A
6.3/0.6	12000	410	11000	250	27 to 63	106	3 1/4	130	Double	12UP4-B
6.3/0.6	12000	—	11000	—	33 to 77	—	—	—	Double	12VP4
6.3/0.6	12000	—	11000	—	33 to 77	—	—	—	Double	12VP4-A
2.5/2.1	8000 ◻ 4000 Δ	1800 †	8000 ◻ 4000 Δ	1000 †	40 to 120	D1-D2 ⬢ = 104 to 156 volts/inch D3-D4 ⬢ = 104 to 156 volts/inch				14AP4
6.3/0.6	12000	410	11000	250	27 to 63	106	3 1/4	110	Double	14BP4
6.3/0.6	14000	410	12000	250	27 to 63	109	3 1/4	105	Single	14CP4
6.3/0.6	14000	410	11000	250	27 to 63	109	3.0	100	Double	14DP4
6.3/0.6	14000	410	12000	300	33 to 77	109	2 3/4	110	Single	14EP4
6.3/0.6	15000	410	12000	250	27 to 63	106	3 1/4	159	None	15AP4
6.3/0.6	15000	410	12000	250	27 to 63	106	3.0	115	Double	15CP4
6.3/0.6	15000	410	12000	250	27 to 63	106	3.0	140	Single	15DP4
6.3/0.6	14000	410	12000	300	33 to 77	109	3.0	80	Double	16AP4
6.3/0.6	14000	410	12000	300	33 to 77	109	3.0	80	Double	16AP4-A
6.3/0.6	15000	410	12000	250	27 to 63	106	3 1/4	110	Double	16CP4
6.3/0.6	15000	410	12000	250	27 to 63	106	3 1/4	115	Double	16DP4
6.3/0.6	15000	410	12000	250	27 to 63	109	3 1/4	115	Double	16DP4-A
6.3/0.6	14000	410	12000	300	33 to 77	109	2 3/4	105	Double	16EP4
6.3/0.6	14000	410	12000	300	33 to 77	109	2 3/4	105	Double	16EP4-A
6.3/0.6	16000	410	13000	250	27 to 63	106	3.0	146	Single	16FP4

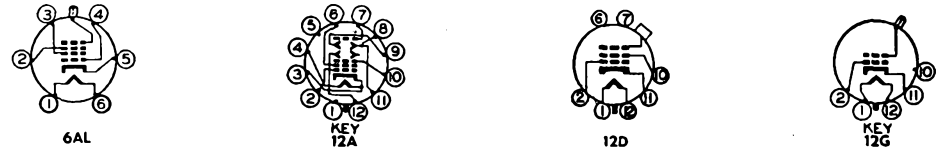

† Anode No. 1 Under typical operating conditions center value of anode 1 voltage for focus is shown. Voltage should be adjustable about this value.
 Δ Anode No. 2. ◻ Deflection factor. ◻ Anode No. 3.
 † Plate-to-plate. † Reflective, metal-backed screen to increase light output.
 ◻ For visual extinction of undeflected focused spot.
 † Special treatment of faceplate to reduce reflection.

Type	Base Connections	Construction	Face-plate Shape	Face-plate Color	Outside Conductive Coating	Focus Method	Defl Method	Defl Angle Degrees	Nom Over-all Length Inches	Nonl Bulb Diam. Inches
16GP4	12D	Metal	Round	Filter	Metal	Mag	Mag	70	17 $\frac{1}{8}$	15 $\frac{3}{8}$
16GP4-B	12D	Metal	Round	Filter +	Metal	Mag	Mag	70	17 $\frac{1}{8}$	15 $\frac{3}{8}$
16HP4	12D	Glass	Round	Clear	Yes	Mag	Mag	60	21 $\frac{1}{4}$	15 $\frac{3}{8}$
16HP4-A	12D	Glass	Round	Filter	Yes	Mag	Mag	60	21 $\frac{1}{4}$	15 $\frac{3}{8}$
16JP4	12D	Glass	Round	Clear	Yes	Mag	Mag	60	20 $\frac{3}{4}$	16 $\frac{1}{4}$
16JP4-A	12D	Glass	Round	Filter	Yes	Mag	Mag	60	20 $\frac{3}{4}$	16 $\frac{1}{4}$
16KP4	12D	Glass	Rect	Filter	Yes	Mag	Mag	Hor 65 Diag 70	18 $\frac{3}{4}$	16 $\frac{3}{8}$
16KP4-A	12D	Glass	Rect	Filter ^o	Yes	Mag	Mag	Hor 65 Diag 70	18 $\frac{3}{4}$	16 $\frac{3}{8}$
16LP4	12D	Glass	Round	Clear	Yes	Mag	Mag	52	22 $\frac{1}{4}$	15 $\frac{3}{8}$
16LP4-A	12D	Glass	Round	Filter	Yes	Mag	Mag	52	22 $\frac{1}{4}$	15 $\frac{3}{8}$
16MP4	12D	Glass	Round	Clear	Yes	Mag	Mag	60	21 $\frac{3}{4}$	16 $\frac{1}{2}$
16MP4-A	12D	Glass	Round	Filter	Yes	Mag	Mag	60	21 $\frac{3}{4}$	16 $\frac{1}{2}$
16QP4	12D	Glass	Rect	Filter	No	Mag	Mag	Hor 64 $\frac{1}{2}$ Diag 70	19 $\frac{1}{2}$	16
16RP4	12D	Glass	Rect	Filter	Yes	Mag	Mag	Hor 65 Diag 70	18 $\frac{3}{4}$	16 $\frac{1}{2}$
16SP4	12D	Glass	Round	Clear	Yes	Mag	Mag	70	17 $\frac{1}{8}$	15 $\frac{3}{8}$
16SP4-A	12D	Glass	Round	Filter	Yes	Mag	Mag	70	17 $\frac{1}{8}$	15 $\frac{3}{8}$
16TP4	12D	Glass	Rect	Filter	Yes	Mag	Mag	Hor 65 Diag 70	18 $\frac{1}{2}$	16 $\frac{1}{2}$
16UP4	12D	Glass	Rect	Filter	No	Mag	Mag	Hor 65 Diag 70	18 $\frac{1}{2}$	16 $\frac{1}{2}$
16VP4	12D	Glass	Round	Filter	No	Mag	Mag	70	17 $\frac{1}{8}$	15 $\frac{3}{8}$
16WP4	12D	Glass	Round	Filter	No	Mag	Mag	70	17 $\frac{3}{4}$	15 $\frac{3}{8}$
16WP4-A	12D	Glass	Round	Filter	Yes	Mag	Mag	70	17 $\frac{3}{4}$	15 $\frac{3}{8}$
16XP4	12D	Glass	Rect	Filter	No	Mag	Mag	Hor 65 Diag 70	18 $\frac{3}{4}$	16 $\frac{1}{2}$
16YP4	12D	Glass	Round	Filter	Yes	Mag	Mag	70	17 $\frac{1}{8}$	15 $\frac{3}{8}$
16ZP4	12D	Glass	Round	Filter	Yes	Mag	Mag	52	22 $\frac{1}{4}$	15 $\frac{3}{8}$
17AP4	12D	Glass	Rect	Filter	Yes	Mag	Mag	Hor 65 Diag 70	18 $\frac{3}{8}$	16 $\frac{1}{2}$
17BP4	12D	Glass	Rect	Filter	No	Mag	Mag	Hor 65 Diag 70	19 $\frac{1}{4}$	16 $\frac{1}{2}$
17BP4-A	12D	Glass	Rect	Filter	Yes	Mag	Mag	Hor 65 Diag 70	19 $\frac{1}{4}$	16 $\frac{1}{2}$
17BP4-B	12D	Glass	Rect	Filter ^o	Yes	Mag	Mag	Hor 65 Diag 70	19 $\frac{1}{4}$	16 $\frac{1}{2}$

Htr Volts/ Amps	Max Anode Volts	Max Grid 2 Volts	Typical Operating Conditions						Type	
			Anode Volts	Grid 2 Volts	Neg Grid 1 Volts	RTMA Focus Coil No.	Focus Coil Dist [†]	Focus Current in ma		Ion Trap
6.3/0.6	14000	410	12000	300	33 to 77	109	3.0	100	Single	16GP4
6.3/0.6	14000	410	12000	300	33 to 77	109	3.0	100	Single	16GP4-B
6.3/0.6	14000	410	12000	300	33 to 77	106	3 $\frac{1}{4}$	110	Double	16HP4
6.3/0.6	14000	410	12000	300	33 to 77	106	3 $\frac{1}{4}$	110	Double	16HP4-A
6.3/0.6	14000	410	11000	250	27 to 63	106	—	115	Double	16JP4
6.3/0.6	14000	410	11000	250	27 to 63	106	—	115	Double	16JP4-A
6.3/0.6	16000	410	14000	250	27 to 63	109	3 $\frac{1}{4}$	108	Single	16KP4
6.3/0.6	16000	410	14000	250	27 to 63	109	3 $\frac{1}{4}$	108	Single	16KP4-A
6.3/0.6	14000	410	12000	300	33 to 77	106	3 $\frac{1}{4}$	110	Double	16LP4
6.3/0.6	14000	410	12000	300	33 to 77	106	3 $\frac{1}{4}$	110	Double	16LP4-A
6.3/0.6	14000	410	12000	300	33 to 77	106	3 $\frac{1}{4}$	110	Double	16MP4
6.3/0.6	14000	410	12000	300	33 to 77	106	3 $\frac{1}{4}$	110	Double	16MP4-A
6.3/0.6	16000	410	14000	250	27 to 63	106	—	150	Double	16QP4
6.3/0.6	16000	410	12000	300	33 to 77	109	3 $\frac{1}{4}$	100	Single	16RP4
6.3/0.6	14000	410	12000	300	33 to 77	109	3 $\frac{1}{4}$	110	Double	16SP4
6.3/0.6	14000	410	12000	300	33 to 77	109	3 $\frac{1}{4}$	110	Double	16SP4-A
6.3/0.6	14000	410	12000	300	33 to 77	109	3.0	115	Single	16TP4
6.3/0.6	15000	410	12000	300	27 to 63	109	3.0	100	Single	16UP4
6.3/0.6	15000	410	12000	250	27 to 63	109	3.0	110	Single	16VP4
6.3/0.6	15000	410	12000	250	27 to 63	109	3.0	110	Double	16WP4
6.3/0.6	16000	410	12000	250	27 to 63	109	3 $\frac{1}{4}$	110	Double	16WP4-A
6.3/0.6	15000	410	12000	250	27 to 63	109	3.0	100	Double	16XP4
6.3/0.6	14000	410	12000	300	33 to 77	109	3 $\frac{1}{4}$	100	Single	16YP4
6.3/0.6	16000	410	12000	300	33 to 77	—	3 $\frac{1}{4}$	110	Double	16ZP4
6.3/0.6	16000	410	12000	300	33 to 77	109	3.0	100	Single	17AP4
6.3/0.6	16000	410	14000	250	27 to 63	109	3 $\frac{1}{4}$	115	Single	17BP4
6.3/0.6	16000	410	14000	250	27 to 63	109	3 $\frac{1}{4}$	115	Single	17BP4-A
6.3/0.6	16000	410	14000	250	27 to 63	109	3 $\frac{1}{4}$	115	Single	17BP4-B



- o Reflective, metal-backed screen to increase light output.
- + Special treatment of faceplate to reduce reflection.
- For visual extinction of undeflected focused spot.
- † Plate-to-plate.
- ⊠ Absolute maximum rating.

Type	Base Connections	Construction	Face-plate Shape	Face-plate Color	Outside Conductive Coating	Focus Method	Defl Method	Defl Angle Degrees	Nom Over-all Length Inches	Nom Bulb Diam. Inches
19AP4	12D	Metal	Round	Clear	Metal	Mag	Mag	66	21 ½	18 ¾
19AP4-A	12D	Metal	Round	Filter	Metal	Mag	Mag	66	21 ½	18 ¾
19AP4-B	12D	Metal	Round	Filter +	Metal	Mag	Mag	66	21 ½	18 ¾
19AP4-C	12D	Metal	Round	Filter ^o	Metal	Mag	Mag	66	21 ½	18 ¾
19AP4-D	12D	Metal	Round	Clear +	Metal	Mag	Mag	66	21 ½	18 ¾
19DP4	12D	Glass	Round	Clear	Yes	Mag	Mag	66	21 ½	18 ¾
19DP4-A	12D	Glass	Round	Filter	Yes	Mag	Mag	66	21 ½	18 ¾
19EP4	12D	Glass	Rect	Filter	Yes	Mag	Mag	Hor 65 Diag 70	21 ½	18 ¾
19FP4	12D	Glass	Round	Gray	No	Mag	Mag	66	22	18 ¾
19GP4	12D	Glass	Round	Filter	No	Mag	Mag	66	21 ¼	18 ¾
19JP4	12D	Glass	Rect	Filter	No	Mag	Mag	Hor 66 Diag 70	20 ½	17 ¼
20AP4	12A	Glass	Round	Clear	No	Elec	Elec	—	27 ¾	20
20BP4	12D	Glass	Round	Clear	No	Mag	Mag	54	28	20
20CP4	12D	Glass	Rect	Filter	No	Mag	Mag	Hor 65 Diag 70	21 ¼	20 ¾
22AP4	12D	Metal	Round	Clear	No	Mag	Mag	70	22 ¾	21 ½
22AP4-A	12D	Metal	Round	Filter	No	Mag	Mag	70	22 ¾	21 ½
MW22-2	5A	Glass	Round	Clear	No	Mag	Mag	50	15 ¾	9 ¾
MW31-3	5A	Glass	Round	Clear	No	Mag	Mag	50	18 ¾	12 ¾
TP400A		Glass	Round	Clear	Yes	Mag	Mag	50	12 ¾	4

♣ Anode No. 1 Under typical operating conditions center value of anode 1 voltage for focus is shown. Voltage should be adjustable about this value.
 △ Anode No. 2. ◀ Anode No. 3. ◆ Deflection factor.

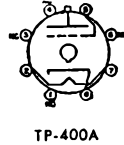
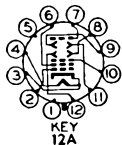
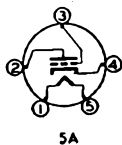

CHARACTERISTICS AND RATINGS

Htr Volts/ Amps	Max Anode Volts	Max Grid 2 Volts	Typical Operating Conditions							Type
			Anode Volts	Grid 2 Volts	Neg Grid 1 Volts ■	RTMA Focus Coil No.	Focus Coil Dist‡	Focus Current in ma	Ion Trap	
6.3/0.6	19000	410	15000	300	33 to 77	109	3 3/4	115	Single	19AP4
6.3/0.6	19000	410	15000	300	33 to 77	109	3 3/4	115	Single	19AP4-A
6.3/0.6	19000	410	15000	300	33 to 77	109	3 3/4	115	Single	19AP4-B
6.3/0.6	19000	410	15000	300	33 to 77	109	3 3/4	115	Single	19AP4-C
6.3/0.6	19000	410	12000	300	33 to 77	106	3.0	140	Single	19AP4-D
6.3/0.6	19000	410	13000	250	26 to 63	106	3 1/4	146	Double	19DP4
6.3/0.6	19000	410	13000	250	26 to 63	106	3 1/4	146	Double	19DP4-A
6.3/0.6	19000	410	13000	250	26 to 63	109	3 1/4	146	Double	19EP4
6.3/0.6	19000	410	13000	250	27 to 63	109	3.0	115	Double	19FP4
6.3/0.6	19000	410	13000	250	27 to 63	109	3.0	120	Single	19GP4
6.3/0.6	18000	410	12000	300	33 to 77	109	3.0	95	Single	19JP4
2.5/2.1	8000 □ 4000 △	1800 †	8000 □ 4000 △	1000 †	40 to 120	D1-D2 ◆ = 88 to 132 volts/inch D3-D4 ◆ = 88 to 132 volts/inch				20AP4
6.3/0.6	20000	410	15000	250	27 to 63	106	3.0	135	None	20BP4
6.3/0.6	18000	410	15000	250	23 to 67	109	3.5	106	Single	20CP4
6.3/0.6	19000	410	14000	300	33 to 77	109	3.0	117	Single	22AP4
6.3/0.6	19000	410	14000	300	33 to 77	109	3.0	117	Single	22AP4-A
6.3/0.6	6000	330	5000	250	100				None	MW22-2
6.3/0.6	6000	330	5000	250	100				None	MW31-3
6.3/0.6	22000		20000		70 to 140			144	No	TP400A

†Special treatment of faceplate to reduce reflection.
 □ Reflective, metal-backed screen to increase light output.
 ■ For visual extinction of undeflected focused spot.

‡Plate-to-plate.

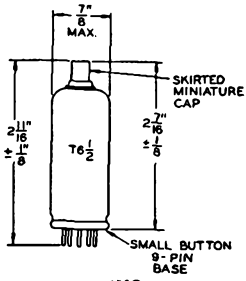

1X2

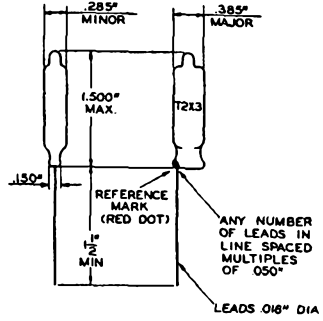

2-1

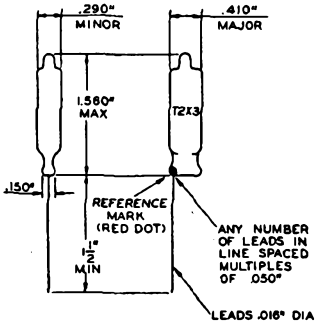

2-3A

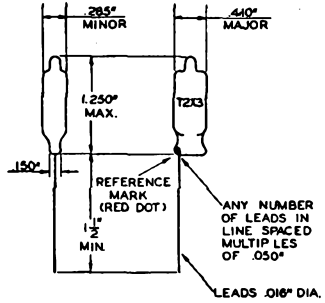

2-4

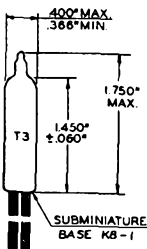

3-3

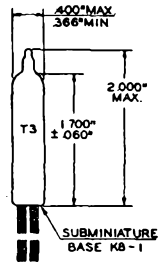

3-4

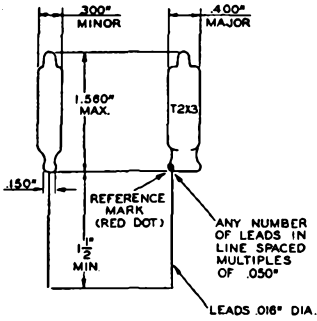

2-1A

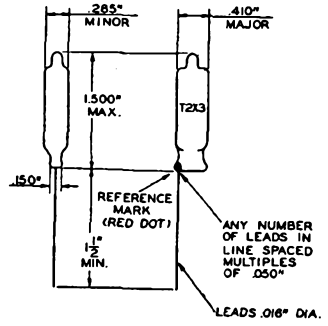

2-3

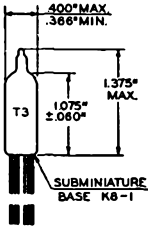

3-1

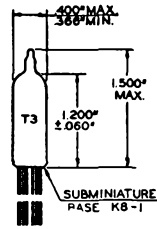

3-2

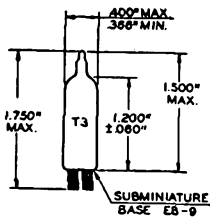

3-5

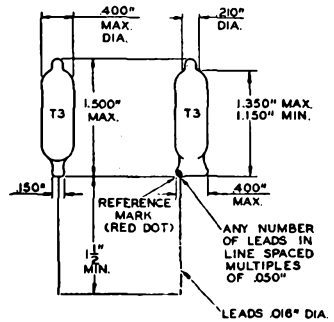

3-6

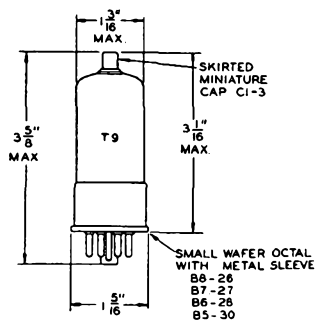
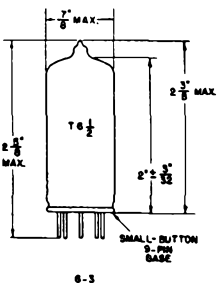
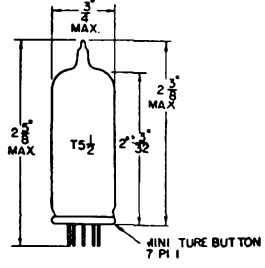
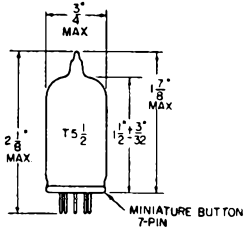
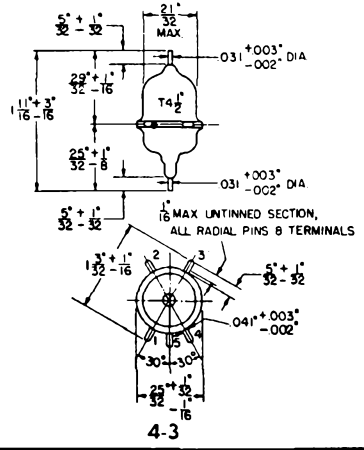
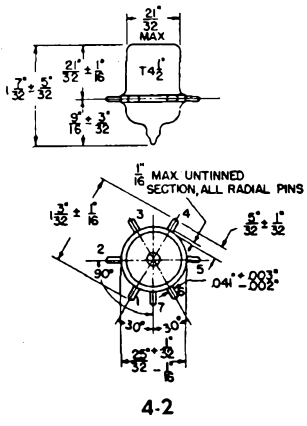

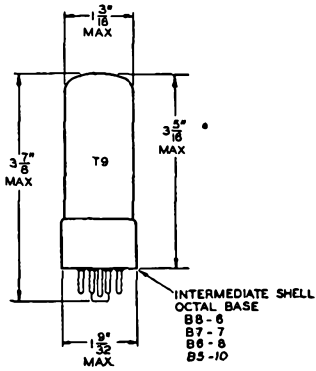

6BD5-GT

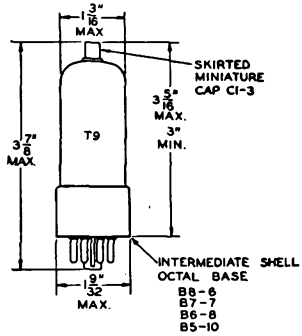

6BQ6-GT

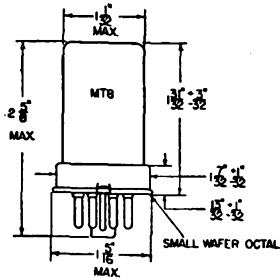

8-1

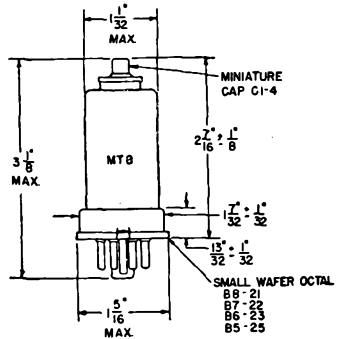

8-2

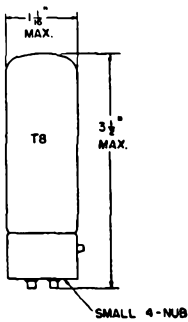

8A-4

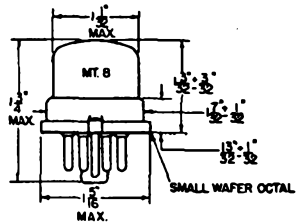

8-5

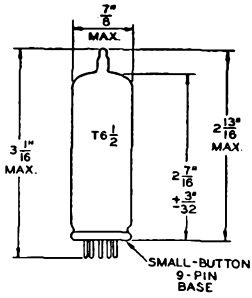

6M5

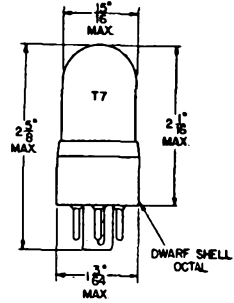

7A-1

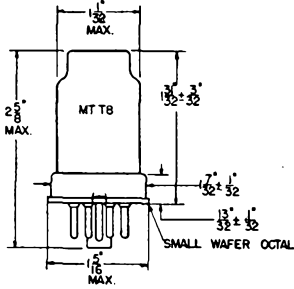

8-3

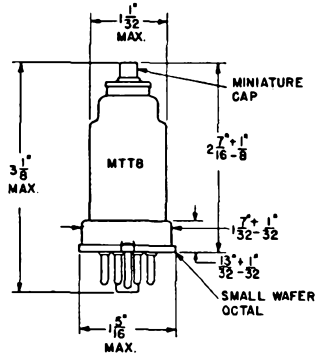

8-4

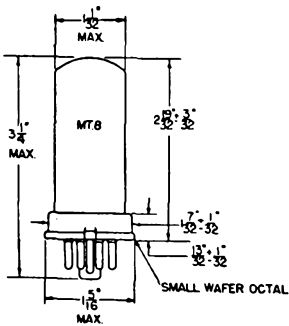

8-6

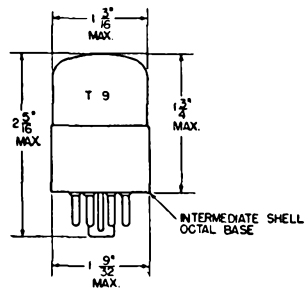

9-1

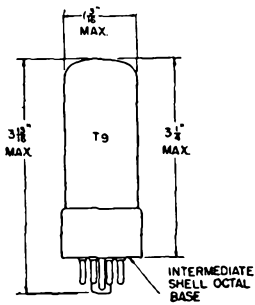

9A-1

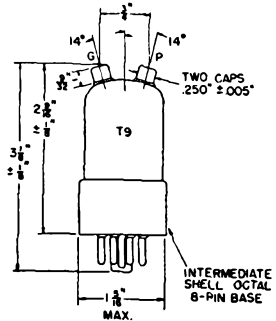

9A-2

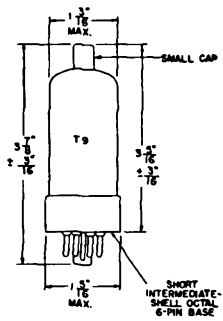

9A-5

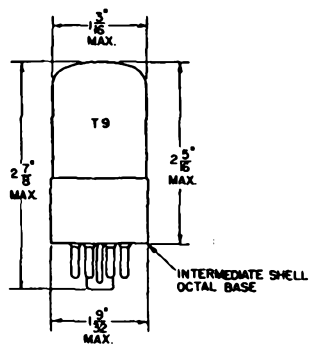

9-3

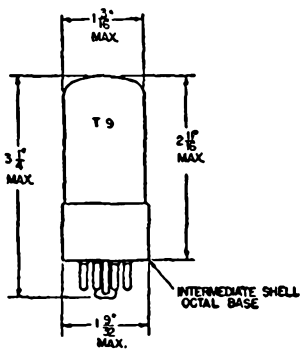

9-9

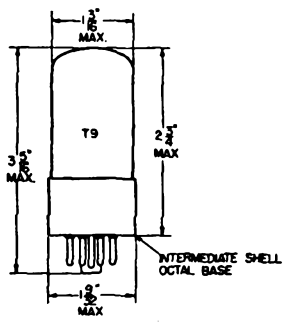

9-11

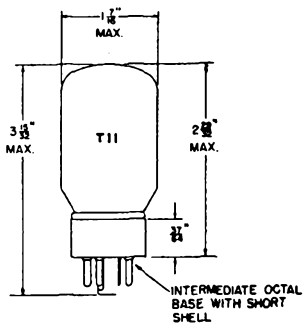

9A-3

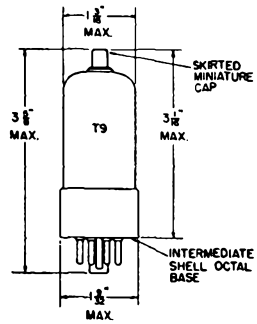

9A-4

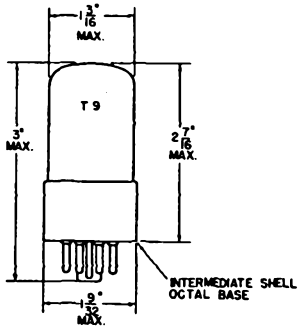

9-5

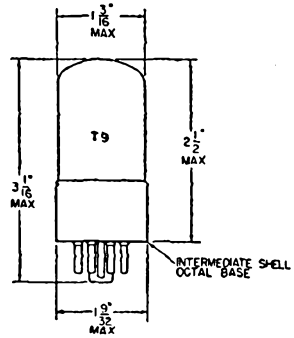

9-7

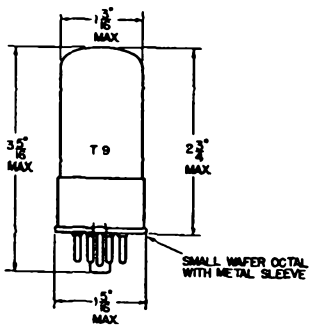

9-12

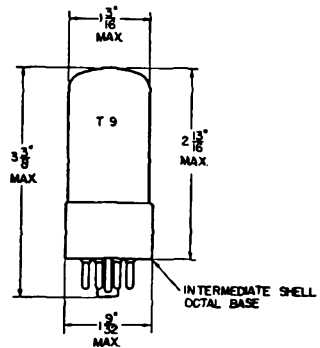

9-13

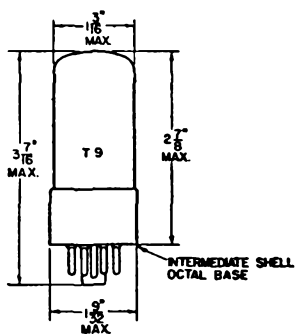

9-15

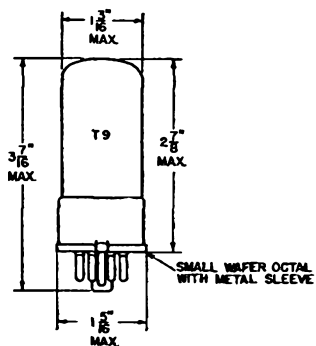

9-16

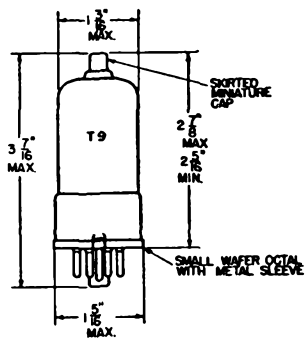

9-20

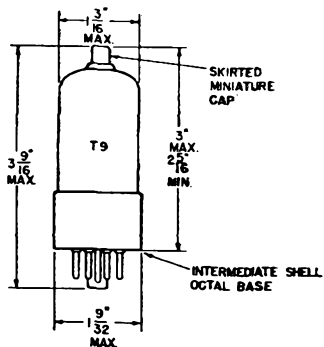

9-23

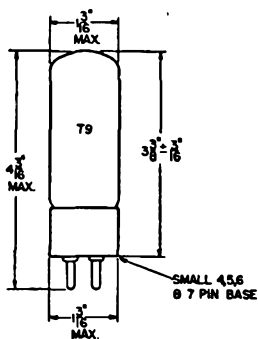

9-26

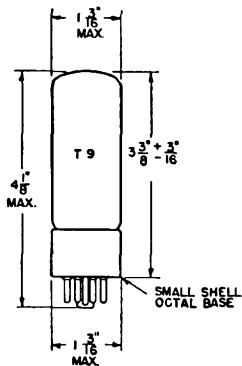

9-27

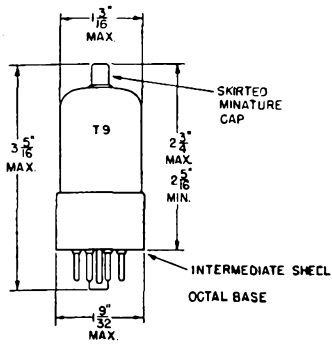

9-17

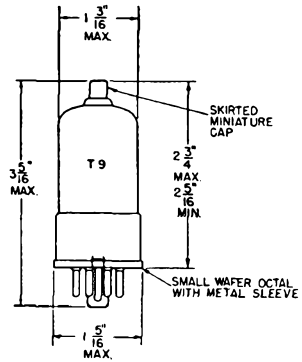

9-18

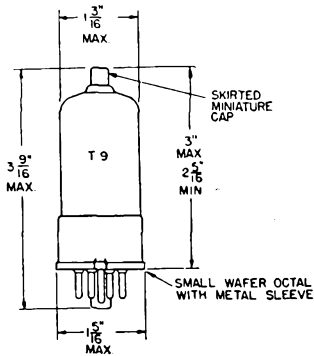

9-24

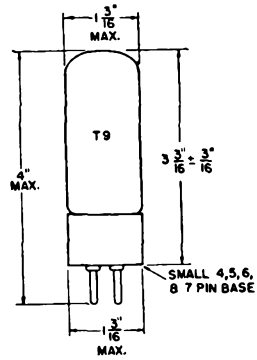

9-25

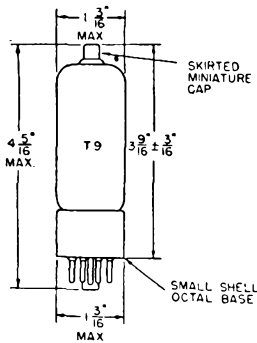

9-28

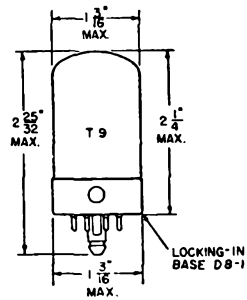

9-30

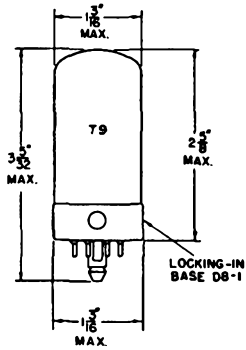

9-31

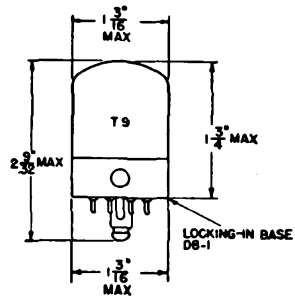

9-32

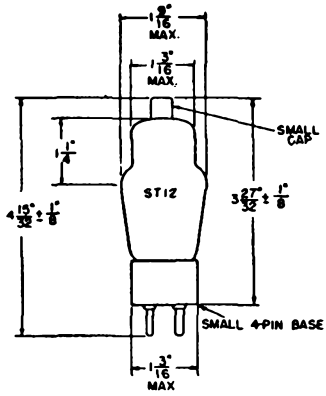

12A-1

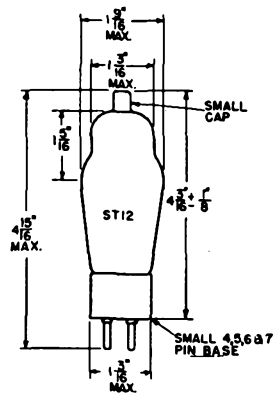

12-2

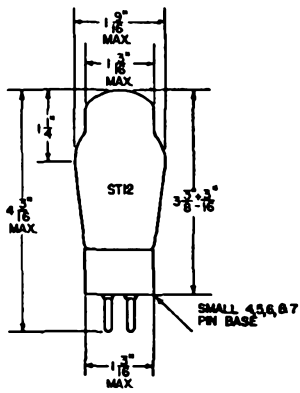

12-5

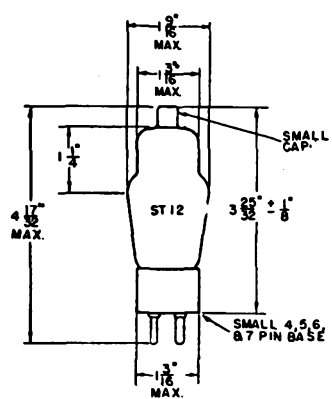

12-6

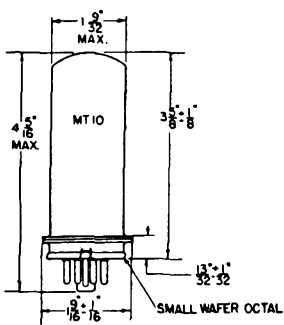

10-1

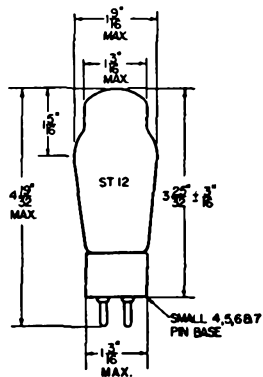

12-1

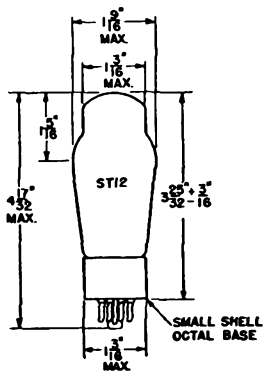

12-3

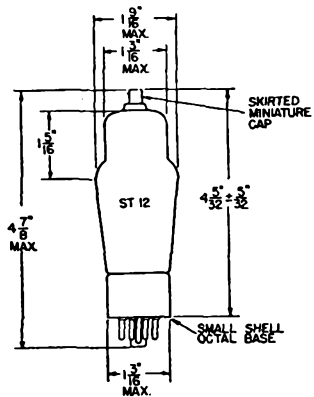

12-4

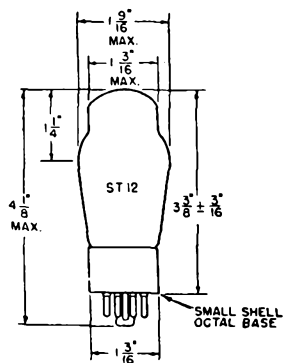

12-7

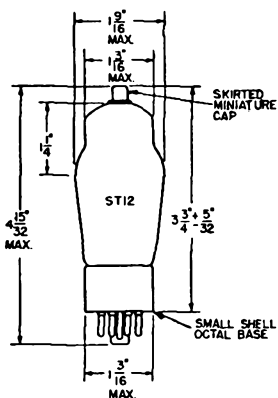

12-8

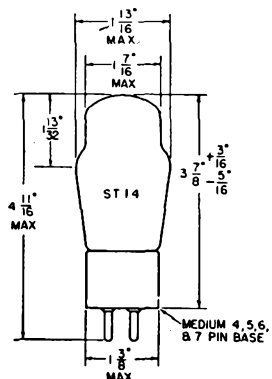

14-1

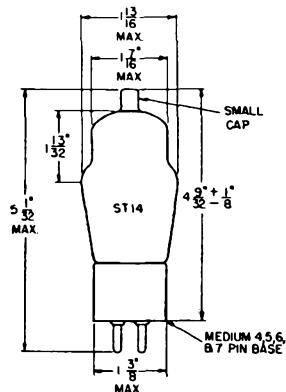

14-2

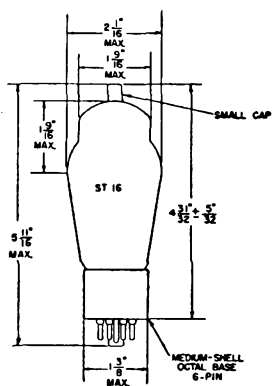

16A-1

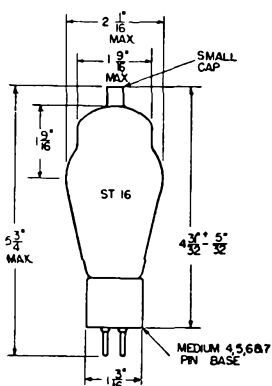

16-2

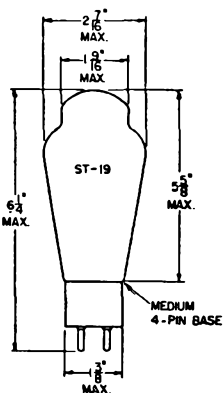

19A-1

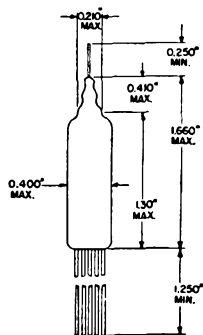

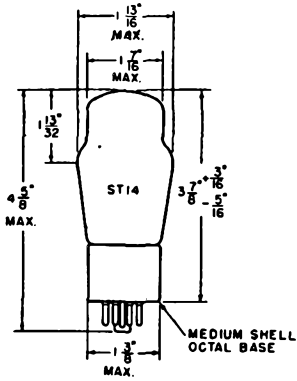

14-3

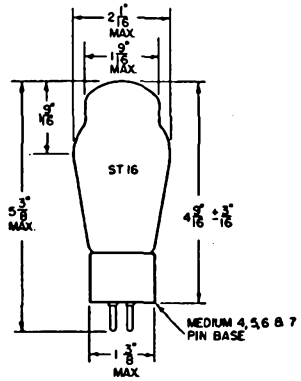

16-1

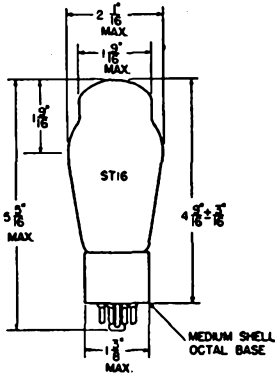

16-3

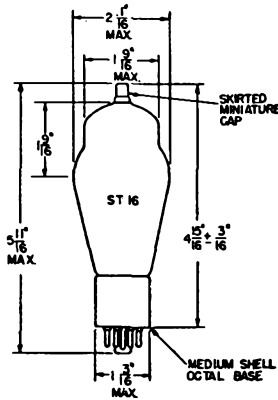

16-4

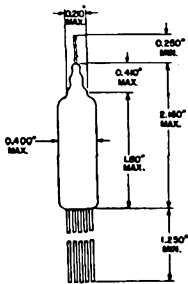

5642

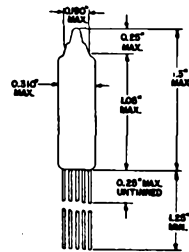

5645

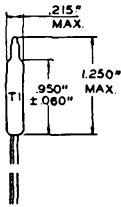

5647

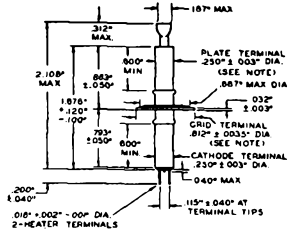

NOTE: MAX ECCENTRICITY OF K AXIS OF PLATE TERMINAL OR GRID-TERMINAL FLANGE WITH RESPECT TO THE X AXIS) OF THE CATHODE TERMINAL IS .000"

5675

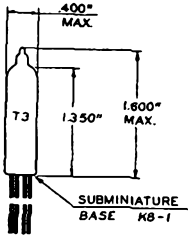

5851

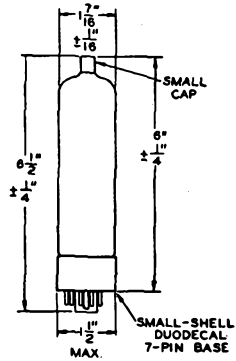

5890

