

# Television Operational Measurements

## Video and RF for NTSC Systems



**TEKTRONIX**

committed to  
technical excellence

# VIDEO FREQUENCY BROADCAST MEASUREMENTS

## CONTENTS

<b>Equipment Requirements</b> .....	<b>3</b>
Equipment Needed	3
Calibration	4
Other Equipment	4
<b>Video Amplitude Measurements</b> .....	<b>6</b>
Overall Amplitude	6
Demodulator Measurements	7
Percentage of Modulation, Modulation Depth	7
Sync Amplitude	8
Burst Amplitude	9
Setup	10
<b>Synchronizing Timing Measurements</b> .....	<b>10</b>
Format Check	10
Horizontal Blanking	10
Sync Pulse Width	12
Front Porch Width	12
Burst	13
Breezeway	13
Rise Time of H Sync	14
Equalizing Pulse Width	15
Vertical Blanking	15
Vertical Sync Pulse	16
Subcarrier Frequency	16
<b>Linear Distortions</b> .....	<b>19</b>
Long Time Distortions	19
Field Time Distortions	21
Line Time Distortions	21
Short Time Distortions	22
Video Signal to Noise Ratio	23
Chrominance to Luminance Gain	24
Chrominance to Luminance Delay	24
<b>Nonlinear Distortions</b> .....	<b>25</b>
Luminance Nonlinear Distortions	25
Differential Gain	26
Differential Phase	27

# RF TV BROADCAST MEASUREMENTS USING THE SPECTRUM ANALYZER

## CONTENTS

<b>Introduction</b> .....	<b>30</b>
<b>Visual Transmitter</b> .....	<b>30</b>
Sideband Response, Out-Of-Service	30
Sideband Response, Low Level In-Service	32
Sideband Response, Keyed in VIT Interval	34
Swept-Differential Gain	35
Peak-to-Peak Variations Due to Noise, Hum, and Field Rate Distortions	36
Harmonic and <i>im</i> Distortions	37
Modulation Monitor Calibration	38
<b>Aural</b> .....	<b>38</b>
Response	38
AM Noise	39
FM Noise	40
Modulation Monitor Calibration	40
<b>Combined</b> .....	<b>40</b>
Effective Power Ratios between -10 and -20% Pattern	41
Out Of Band Spurs and 920 kHz Problem	42
Antenna, Filter, Coupler Evaluation	43
<b>Miscellaneous Tests</b> .....	<b>43</b>

**First Edition**

# VIDEO FREQUENCY BROADCAST MEASUREMENTS

By  
Stu Rasmussen

## Equipment Requirements

### Equipment Needed

In order to make satisfactory measurements of video signals, a certain minimum of equipment is required. For most measurements, a video waveform monitor is all that is needed, but to do a complete analysis of a system requires some additional equipment. The waveform monitor should include provision for making measurements on vertical interval test signals (VITS) and provide filtering to allow separate examination of the luminance and chrominance components of color television signals. The TEKTRONIX 1480 Waveform Monitor is recommended for these measurements. In addition to the waveform monitor, a vectorscope must be used for making certain measurements on color television system, particularly differential phase measurements. The luminance filter and color decoders of the TEKTRONIX 520A Vectorscope make it an excellent tool for evaluating both the luminance and chrominance channels of most video equipment. The waveform monitor and vectorscope are all that are required to accomplish these measurements, but if a greater level of accuracy is desired in timing measurements, a conventional oscilloscope with an associated digital counter/timer would be a great asset. Measuring the output of a television transmitter at baseband requires a demodulator. For greatest accuracy this demodulator should provide a zero carrier reference pulse for determining percentage of modulation, and ideally will use synchronous detection to avoid quadrature distortion.



1480 Series Waveform Monitor.



520A Vectorscope.

## Calibration

Before attempting to make any signal measurement, it would be a good idea to check the calibration of your test equipment. In most cases, modern test equipment is quite accurate to start with, and holds its accuracy for long periods without adjustment. Nevertheless, before making any important measurements, take a few moments to verify the accuracy of your equipment. Most measurement gear provides internally generated calibration signals which can be dialed up to verify the accuracy of the instrument. In addition, some characteristics of a composite television signal can be used to verify the calibration of your equipment.

## Other Equipment

Some of the parameters described here can also be measured on other equipment, such as a conventional oscilloscope or a frequency counter. The wide variety of such equipment makes a detailed description of calibration checks impossible. If you are using other equipment, consult the instruction manual for a method of checking its accuracy before using.

## Waveform Monitor Calibration Check

1. Allow instrument to warm up a few minutes. Depress all gray buttons, and set vertical sensitivity to 1V CALibrated.

## Vertical System

2. To check vertical calibration, depress CALibrator button, and position signal so that upper edge is at 100 IRE.

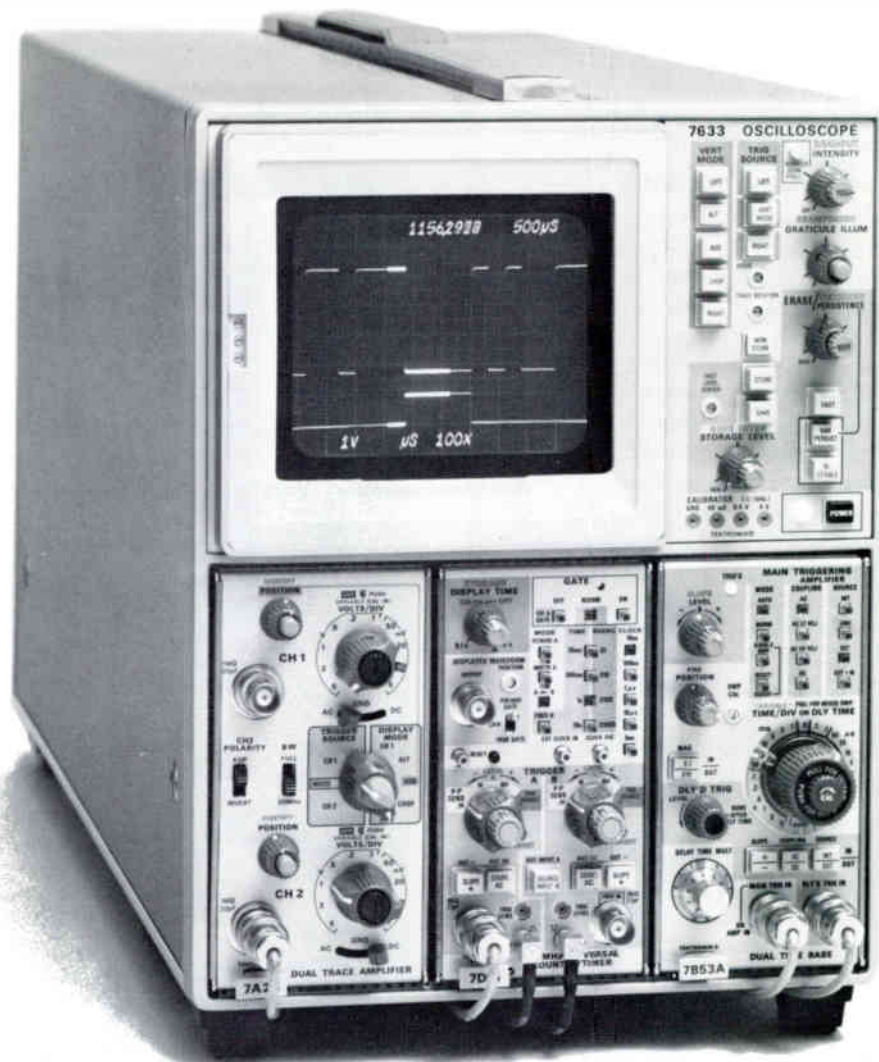

Oscilloscope with counter/timer plug-in.

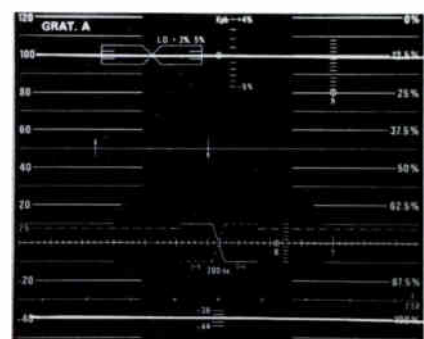
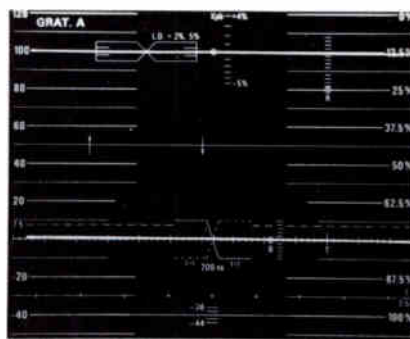

3. Check that calibrator signal is 100 IRE units (0.714 volts).

4. Depress SYNC TIP button, check that display is 140 IRE units (1 Volt).

## Horizontal Deflection

5. Connect a composite color video signal to the waveform monitor A Input.

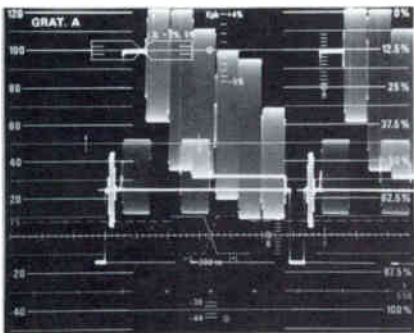

6. Set the time base for 10 microseconds per division, and check that the distance between two sync pulses is about 6.3 divisions ( $\approx 63\mu\text{sec}$ ).

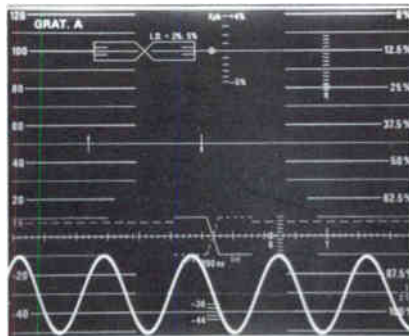

8. Change to  $0.1\mu\text{sec/div}$ , reposition the burst and check that there is  $\frac{1}{2}$  cycle of burst per tic mark. This verifies the  $0.1\mu\text{sec/div}$  timing.

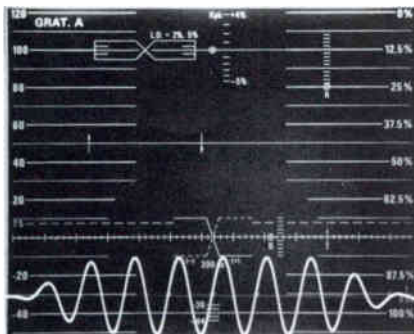

7. Set the Magnifier to  $0.2\mu\text{sec}$  per division, and position the color burst so that it passes through the 3.58 MHz tic marks on the graticule. Check that there is 1 cycle of burst per tic mark. This verifies the  $0.2\mu\text{sec}$  timing accuracy.

## Vectorscope Calibration Check (TEKTRONIX 520A)

1. Allow the instrument to warm up for a few minutes. Set the CHANNEL A, CHANNEL B, and LUMINANCE GAIN controls to their CALIBRATED positions.

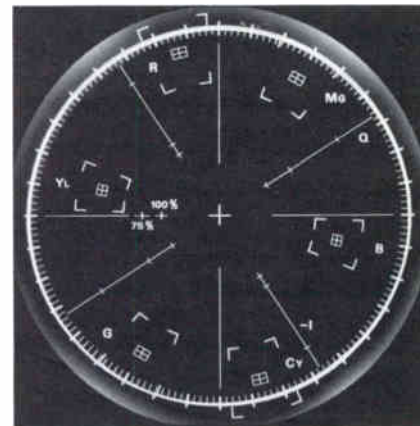

2. Depress the VECTOR pushbutton and the A CAL button. Check that a circle is displayed, centered on the screen and full amplitude. Cancel the A CAL button and repeat this check with the B CAL signal.

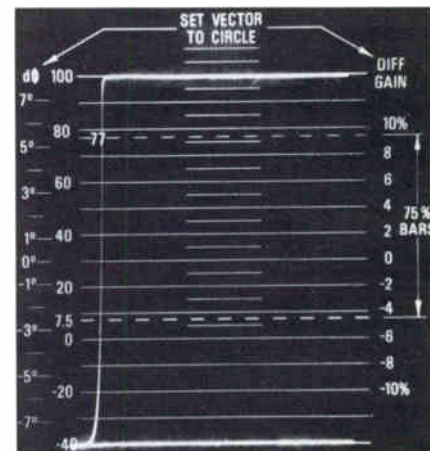

3. Depress the Y, R, G, and B push-buttons, one after the other, and check that there is a 140 IRE units signal displayed in each position. Repeat this check using the A CAL signal.

# Video Amplitude Measurements

At one time or another, just about every component part of a video signal must be measured or adjusted. The overall amplitude of the signal and each of its component parts have strictly defined levels, and the relationship between the parts is also critical. We'll start with the measurement of overall amplitude.

## Overall Amplitude

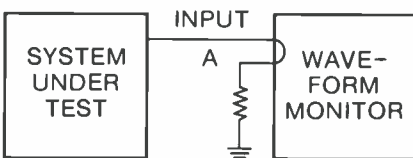

This measurement, also known as insertion gain, is a measurement of the peak-to-peak amplitude of the television signal. The signals that are distributed around the plant are all supposed to be 1 volt peak-to-peak, from sync tip to peak white. Any time the signal amplitude is less than or greater than this level, there is the possibility that some piece of equipment will either overload or possibly not give its best performance. To measure signal level, or insertion gain, set the waveform monitor to display a 1 volt peak-to-peak full scale signal, and then apply the signal to be measured to the video input. If its amplitude is greater or less than 1 volt, there is something amiss somewhere, and the signal should be adjusted to the correct amplitude. There is a chance that the incorrect level is caused by a distortion somewhere in the signal chain, so it

would be well to adjust the variable gain control of the waveform monitor so that the signal amplitude is actually centered correctly between the 100 IRE and -40 IRE limits on the graticule. Once this is done, check to see that the ratio of picture amplitude to sync amplitude is correct. There should be 100 units of picture and 40 units of sync, disregarding any chrominance components that may be present. If the signal is correctly proportioned, but low or high in amplitude, it can be adjusted to the correct level. If there is an imbalance between the picture and sync, the cause of this disturbance should be found and corrected.

As an aid to accurately setting the video amplitude, the TEKTRONIX 1480 Series of waveform monitors provides an accurate comparison between a precise 1 volt calibration signal provided by the waveform monitor and the amplitude of the incoming signal. Feed the signal to be adjusted into the waveform monitor A input, set the DC RESTORER to SYNC TIP, and depress both the OPERate and CALibrate buttons simultaneously. The waveform display will show the video signal twice, with the two signals offset by exactly one volt. Adjust the incoming signal amplitude so that the peak white of the lower trace signal and the sync tip of the upper trace coincide. When this happens, the incoming signal is exactly one volt peak-to-peak. To locate a reference level for peak white, you may have to find a VIT signal that includes a white flag, such as the pulse and bar waveform. For greater accuracy in setting the signal level, increase the vertical gain of the waveform monitor to the 0.2 volt full scale position and fine tweek the signal level to 1 volt.

## Overall Amplitude Measurement

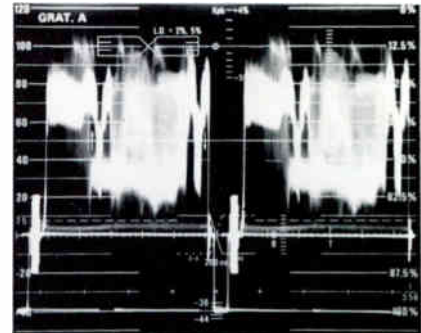

1. Display the signal on the waveform monitor at 5 or 10  $\mu\text{sec/div}$ , with the VOLTS FULL SCALE at 1V CALibrated. Adjust the signal amplitude for 140 units, disregarding chrominance components.

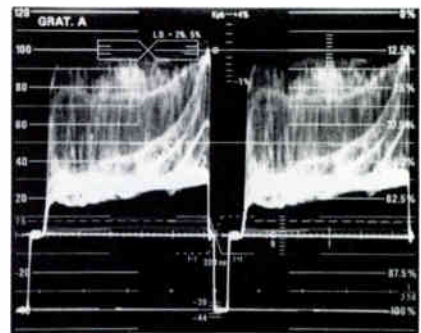

2. The IRE response position can be used to remove chrominance, making this level setting easier.

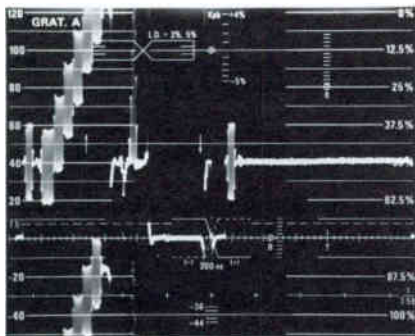
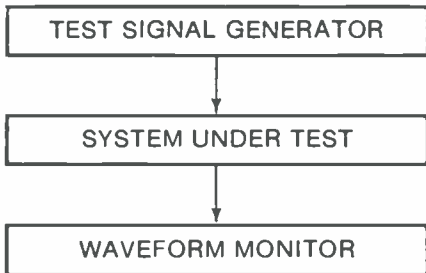

3. For accurate level setting, display a test signal which contains a white reference. A VIT Composite signal is shown here. Select the SYNC TIP DC RESTORER mode.

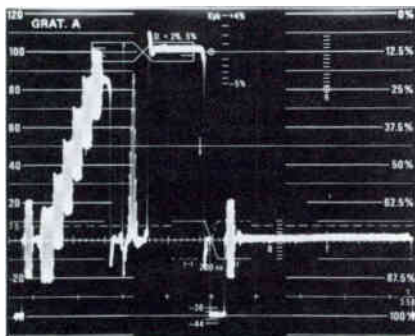

4. Depress both the OPERate and CALibrate buttons simultaneously, and position the display so that the sync tip of the upper trace and the white flag of the lower trace are at the blanking level on the graticule.

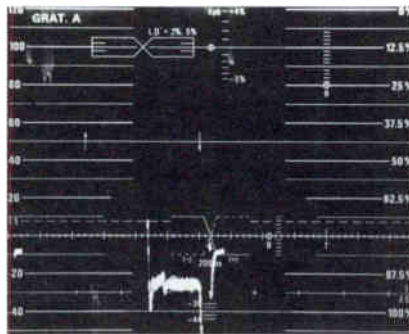

5. Switch to 0.2 Volts/div to increase sensitivity.

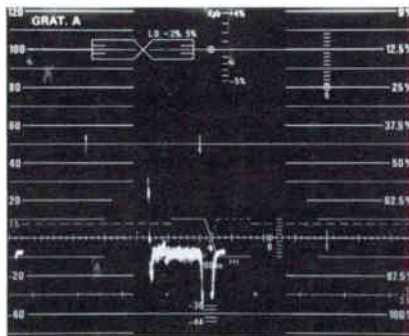

6. Adjust the signal level until the sync tip and white flag are at the same level. This procedure accurately sets the video amplitude to 1 Volt p-p.

7. Check that the sync to picture ratio is correct. 40 units of sync and 100 units of picture.

### Demodulator Measurements

Off the air measurement of video signals imposes some restrictions on the test equipment being used. The waveform monitor and vector-scope will faithfully indicate the output of the demodulator, but there's no way to know if the demodulator is telling the truth. For most measurements, a quality demodulator, incorporating synchronous detection, is a must. The

simple diode demod usually found at a transmitter site just won't do the job. Any signal measurement done at video baseband can be made from a suitable demodulator.

### Percentage of Modulation, Modulation Depth

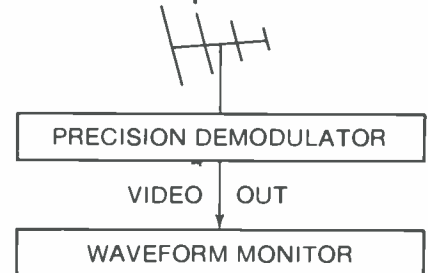

Connect the demodulator output to the waveform monitor, as shown. Locate the zero carrier reference pulse from the demodulator and set the demodulator output level so that the sync tip of the signal is at -40 units, and the zero carrier reference pulse is at +120 units. Now verify that the blanking level is at 0, and peak white of the transmitted signal is 100 IRE. If either blanking or peak white are not correct, there is cause for suspicion that something is amiss in either the demodulator or transmitter. By using the rf spectrum analyzer to examine the carrier signal, the source of trouble can be identified. The right hand scale on the waveform monitor graticule is calibrated in percentage of peak power, from zero at +120 IRE to 100% at sync tip. There is no way to determine transmitter output power using a demodulator, as direct reference to the output stage of the transmitter is necessary. Nevertheless, once power has been determined, the waveform monitor display will indicate percentage of this measured peak power.

## Demodulator Measurements

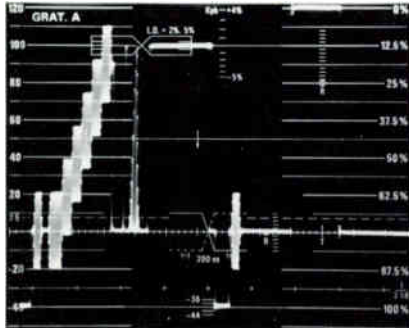

Vertical interval test signal from precision demodulator. The graticule scale at the right is calibrated in percentage of modulation. On a correctly adjusted system, sync tip is 100% power, blanking is 75% peak power, and reference white is 12½% peak power. The zero carrier reference pulse is inserted by the demodulator as an aid in determining carrier rf levels.

## Sync Amplitude

The measured level of sync, from sync tip to blanking, is not as important as the relationship between sync and picture or between sync and zero carrier. 40/140 of the composite video signal should be sync. On a 1 volt signal, the sync amplitude should be 286 millivolts. At the transmitter, the sync amplitude should be equal to 25% of the overall signal amplitude, from sync tip to zero carrier. The relative levels of sync, picture, and zero carrier are shown below.

If gross distortions are introduced in a transmission system, the sync to picture ratio is the most apparent indicator. Some common sources of amplitude non-linearities are

microwave transmission links and high powered visual transmitters. By its very nature, the transmitter is a tremendous source of amplitude distortions. In order to make the transmitter output look better, the signal fed to it is pre-distorted to compensate for the non-linearities introduced during modulation. This pre-distortion, or may we say pre-correction, is dependent on the average picture level of the signal, so there is some compromise on optimum equalization. A better solution to the transmitter distortion problem is to use an interactive corrector which samples the output signal and makes its corrections to the input signal to compensate for the transmitter abnormalities.

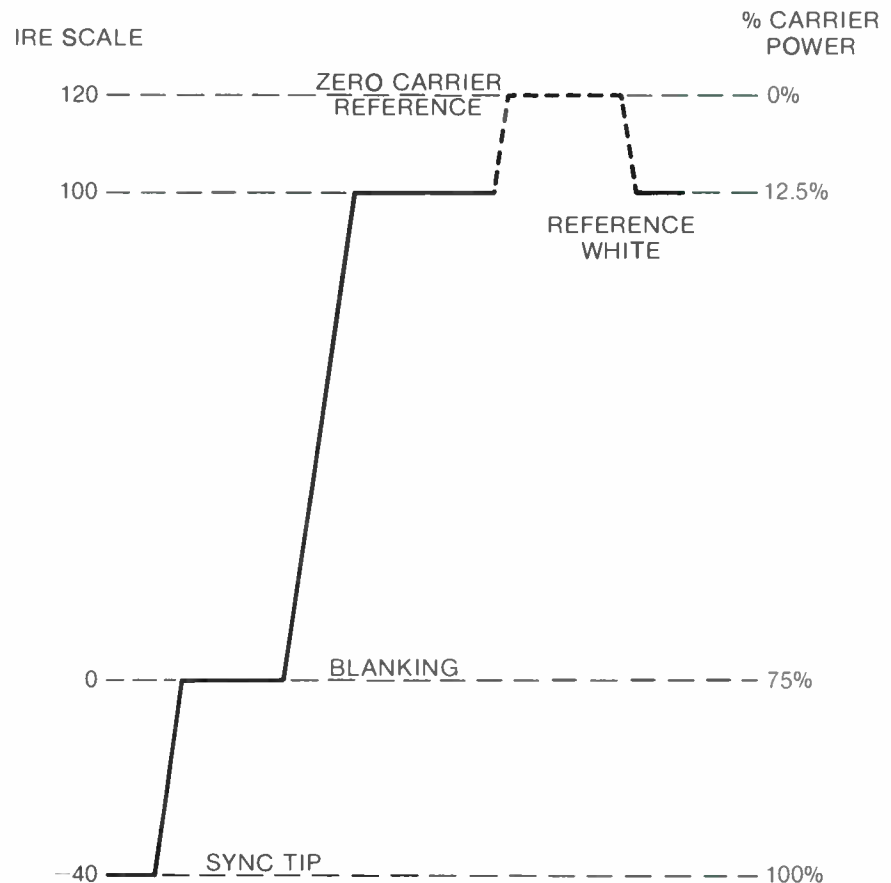

Relative levels of sync, picture and zero carrier.



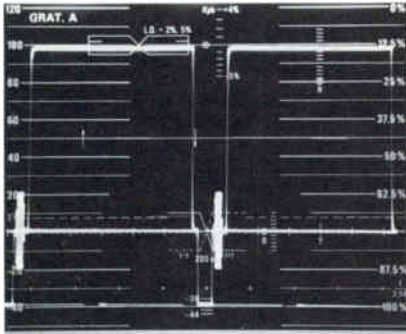

1. Sync should be 40/140 of the composite video signal.

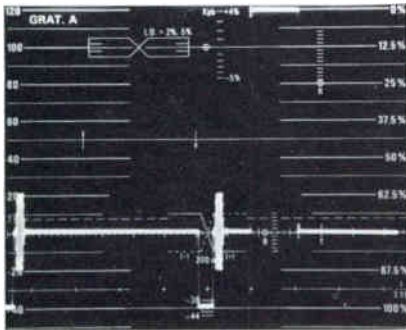

2. Sync amplitude must be equal to 25% of the difference between peak power and zero power. Sync tip is 100% peak power and blanking should be 75% peak power.

### Burst Amplitude

The color burst, from EIA standards, is to be equal in amplitude to the synchronizing signal, and centered on the blanking level. The FCC requires the burst on a transmitted signal to be within 90% to 110% of the amplitude of sync. This measurement can be made at either the transmitter input or from a demodulator. It is well worth considering that the Federal Communications Commission field inspectors make their measurements from an off the air signal, so it would be to your advantage to do likewise. To measure burst amplitude, the signal can be measured directly on the IRE scale of a waveform monitor, and should be 40 units peak to peak. It is easier, however, to compare the amplitude of burst to the sync signal to see if it is within specs. To do this, position the signal and adjust the VOLTS FULL SCALE and VARIABLE control until the sync signal fills the 100 IRE scale from blanking to +100. Now position the signal so

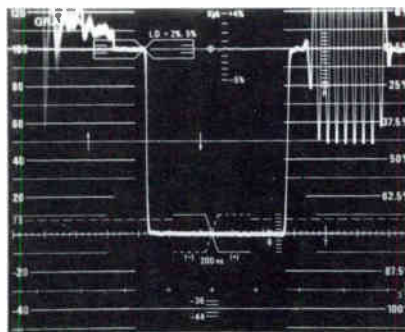

that the burst signal extends upward from blanking. The top of the burst envelope now corresponds to its amplitude relationship to the sync signal. For example, if the burst signal tip were at the 95 IRE unit line, burst is equal to 95% of sync amplitude. Using this technique, bursts must be between 90 and 110 units in height compared to sync at 100 units.

1. Adjust display until sync extends from 0 to 100 IRE.

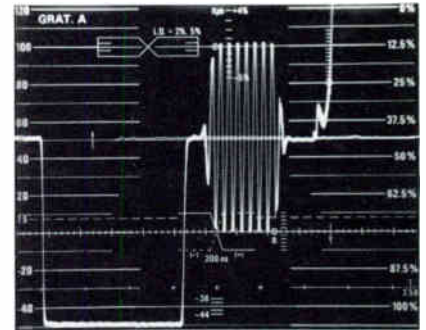

2. Reposition the signal so that burst extends upward from the 0 IRE scale division. Burst amplitude must be between 90 and 110 units on the scale. Burst shown here is about 2% high, which is well within specifications.

## Setup

The FCC requires that the picture video black level be separated from blanking by a setup level of 7.5 ( $\pm 2.5$ ) IRE units. This setup level does not include color subcarrier components which may extend below this level. To measure setup, display a full field picture signal, and measure the level from blanking to the lowest portion of the picture signal. To eliminate chrominance components that may confuse this measurement, use the IRE filter position of the waveform monitor. Setup is measured between blanking and picture black, so if the picture does not have any areas which are black, the result of this measurement is not valid. In this case, wait until black is present in the picture and then perform the measurement.

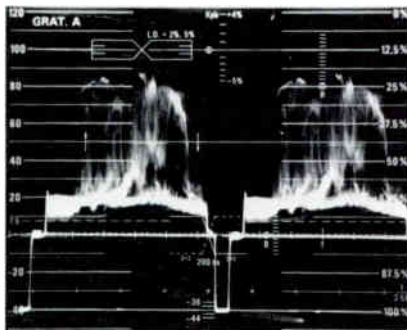

1. Picture black is separated from blanking by 9 IRE. Setup must be within the range of 5 to 10 IRE.

# Synchronizing Timing Measurements

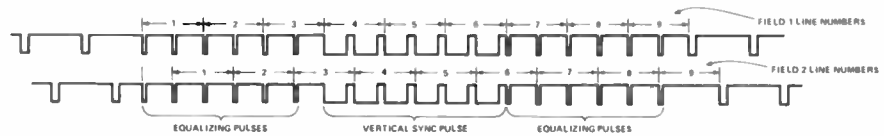

## Format Check

The broadcast television signal must conform to the format diagrammed in FCC 73.699, Figure 6, and shown here in abbreviated form. Before making timing measurements on the signal, verify that the signal format is as shown here. Pay particular attention to the number of equalizing pulses and sync pulses contained in the vertical interval, and be certain that vertical blanking starts three lines before the start of the vertical sync pulse. Verify that the relative widths of the various pulses are approximately correct before proceeding with the actual timing measurements.

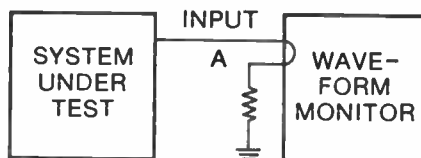

Synchronizing timing measurement setup.

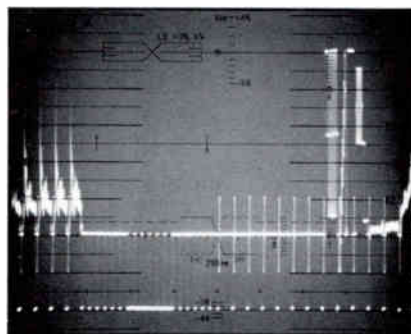

1. Field 1 Blanking interval.

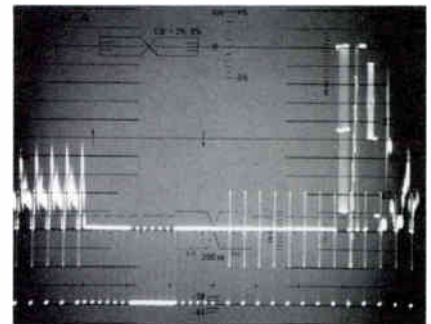

2. Field 2 Blanking interval.

## Horizontal Blanking

Horizontal blanking, as defined by the FCC, is measured between points on the waveform at +4 IRE units. The minimum width for blanking is 10.49 microseconds, and the maximum width permissible by FCC specification is 11.44 microseconds. The maximum width specification applies to a measurement made at 90 IRE units above blanking. It is unlikely that many signals will be found to measure which have video immediately after blanking which reaches to 90 IRE, but if this is the case, the maximum timing applies.

There is currently a group working within the broadcast industry engaged in examining this timing to recommend changes in the timing format to accommodate subcarrier to H sync phasing. The work of this group could result in changes to the blanking width specifications.

## Horizontal Blanking Width



3. To easily locate the + 4 IRE (1/10 sync) level between which blanking is measured, use the vertical gain controls to set the sync pulse height to be 100 Units.

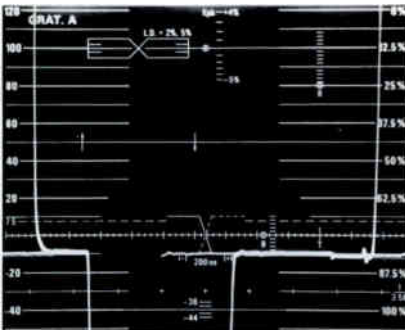

4. Without disturbing the setting of the Volts per Division and Variable controls, move the signal down until the blanking level is at the -10 IRE scale division. Blanking width is now measured where the signal crosses the 0 graticule division. In this photo, there are 10.7 divisions on the 0 IRE line, making blanking 10.7 microseconds.

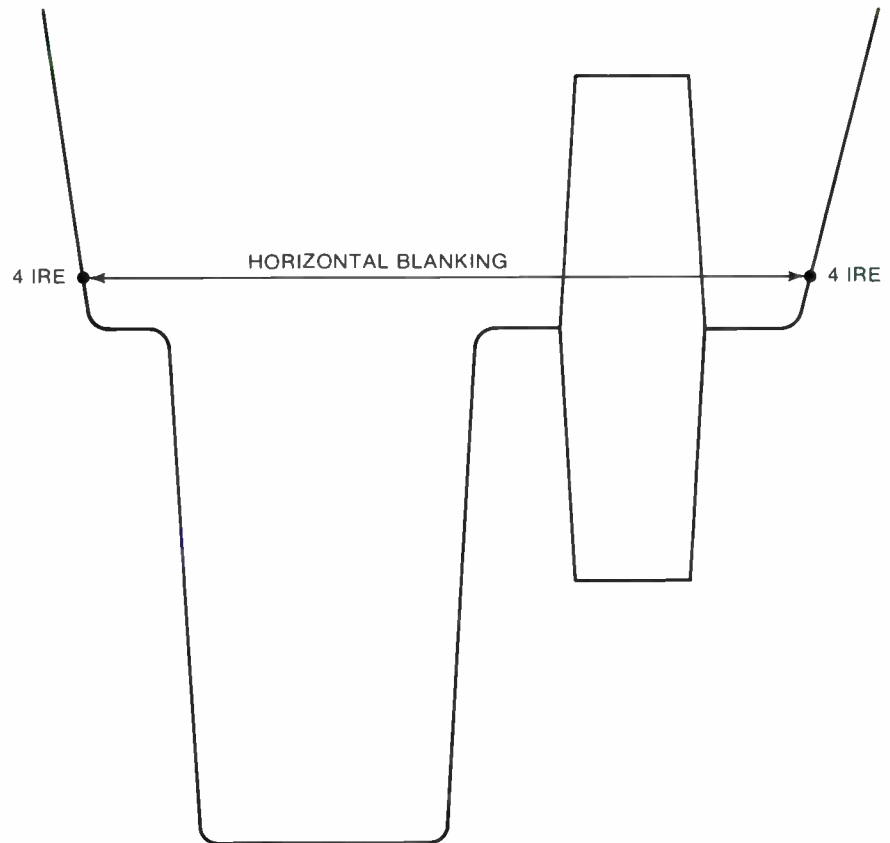

### Sync Pulse Width

The horizontal sync pulse, measured between the points at the -4 IRE level, must be between 4.45 and 5.08 microseconds.

H SYNC WIDTH

-4 IRE

-4 IRE

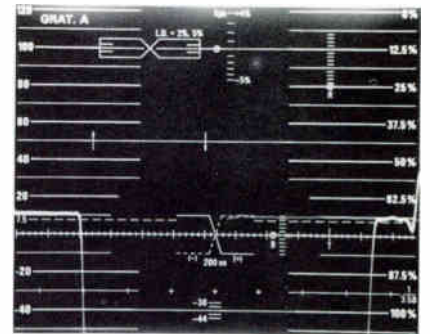

5. Set the sync amplitude to 100 units as for blanking measurements, then reposition the signal to put blanking at the +10 IRE division. Sync width is now measured on the 0 IRE graticule line. In this photo, sync width is 9.4 division, at 0.5 microseconds per division.  $9.4 \text{ division} \times 0.5 \mu\text{sec/div} = 4.7 \text{ microseconds}$ .

### Front Porch Width

The front porch, between blanking and the leading edge of H sync, must be no less than 1.27 microseconds. This is measured from the -4 IRE level at blanking to the -4 IRE level on the leading edge of H sync.

FRONT  
PORCH

+4 IRE

-4 IRE

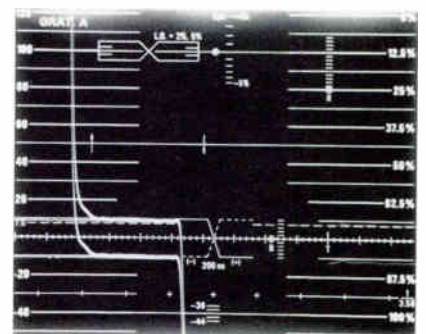

6. After setting sync to 100 units, the blanking level is set to -10 IRE, and the start of the front porch is on the 0 IRE line. The end of front porch is found by moving blanking to +10 IRE. These points are shown here as a double exposure.

**Burst**

The present specification for burst requires a minimum of 8 cycles of burst. This may be revised in the near future to 9. The first cycle of burst is defined as the first cycle of burst, one half cycle of which equals or exceeds 50% of the peak amplitude of burst measured at the center of the signal. This first half cycle determines the start of burst and also its phase. The last cycle of burst is defined the same way at the end of the burst.

FIRST 1/2 CYCLE EXCEEDING 50%

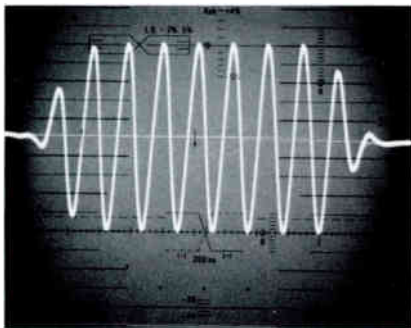
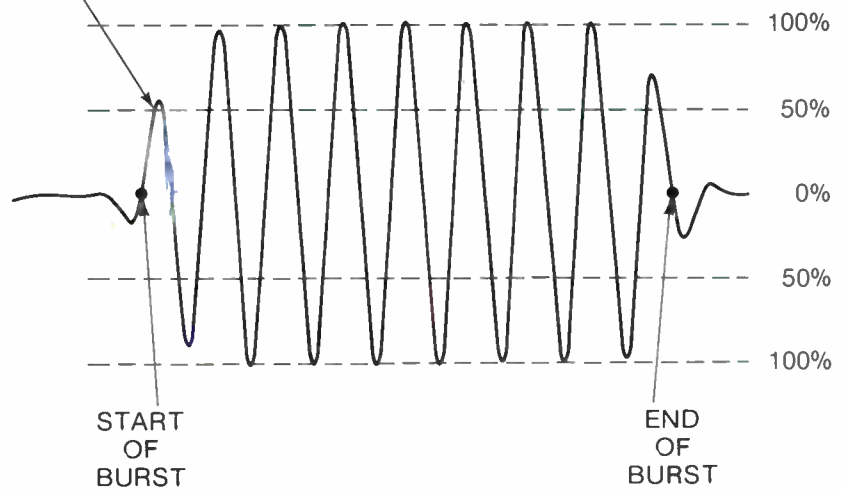

7. FCC standards require a minimum of 8 cycles of color burst. The burst shown here contains 8½ cycles.

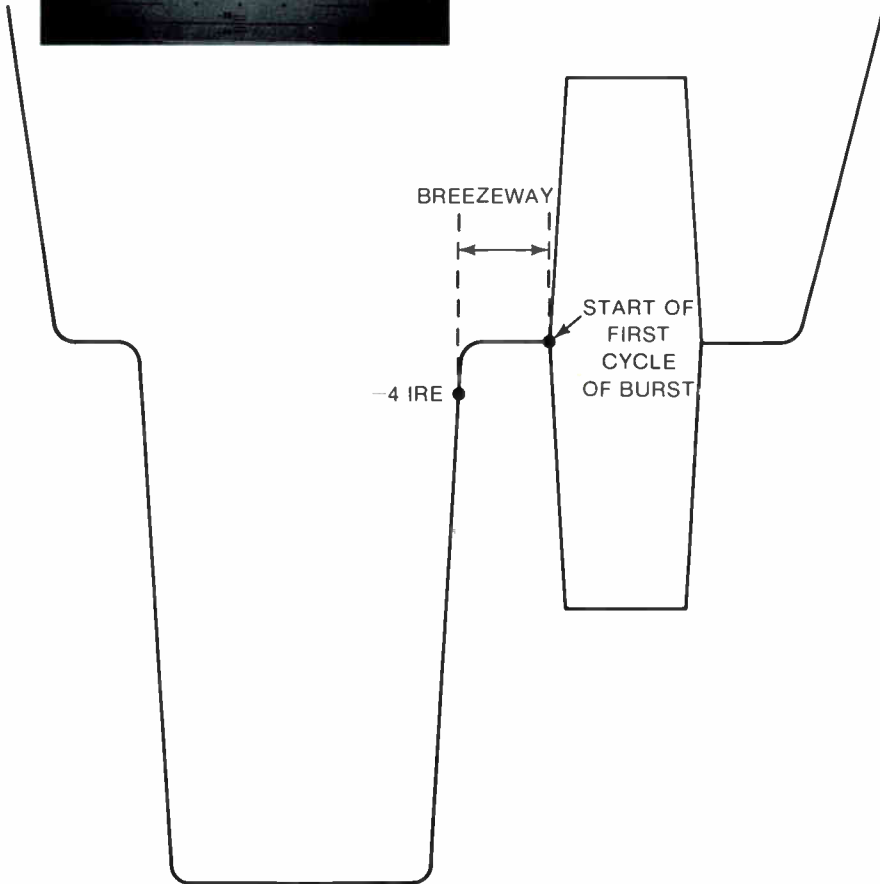

**Breezeway**

The period between the trailing edge of the horizontal sync pulse and the first cycle of color burst must be no less than 381 nanoseconds, or 0.381 microseconds. This period is measured from the -4 IRE level on the trailing edge of H sync to the first zero crossing of the first cycle of the burst packet.

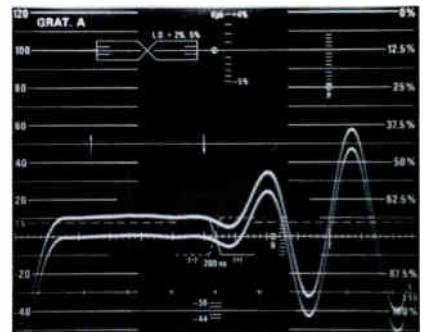

8. Double exposure showing breezeway measurement. Starting point at 1/10 of sync. Shown here, at 0.1 µsec/div, breezeway = 0.620 microseconds.

The period between the end of burst and the leading edge of picture is not specified, since its timing is defined by the other parameters and blanking width requirements.

### Rise Time of H Sync

The rise and fall times of the horizontal sync pulse, measured between the 10 and 90% points on the leading and trailing edges of the pulse, must be less than 0.250 microseconds (250 nanoseconds).

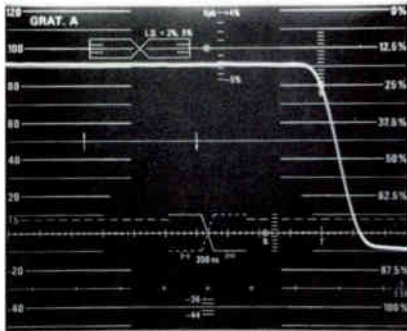

9. Shown here at 0.1  $\mu$ sec/division. Sync pulse leading edge, 0.120  $\mu$ sec, (Figure 9) sync pulse trailing edge 0.125  $\mu$ sec.

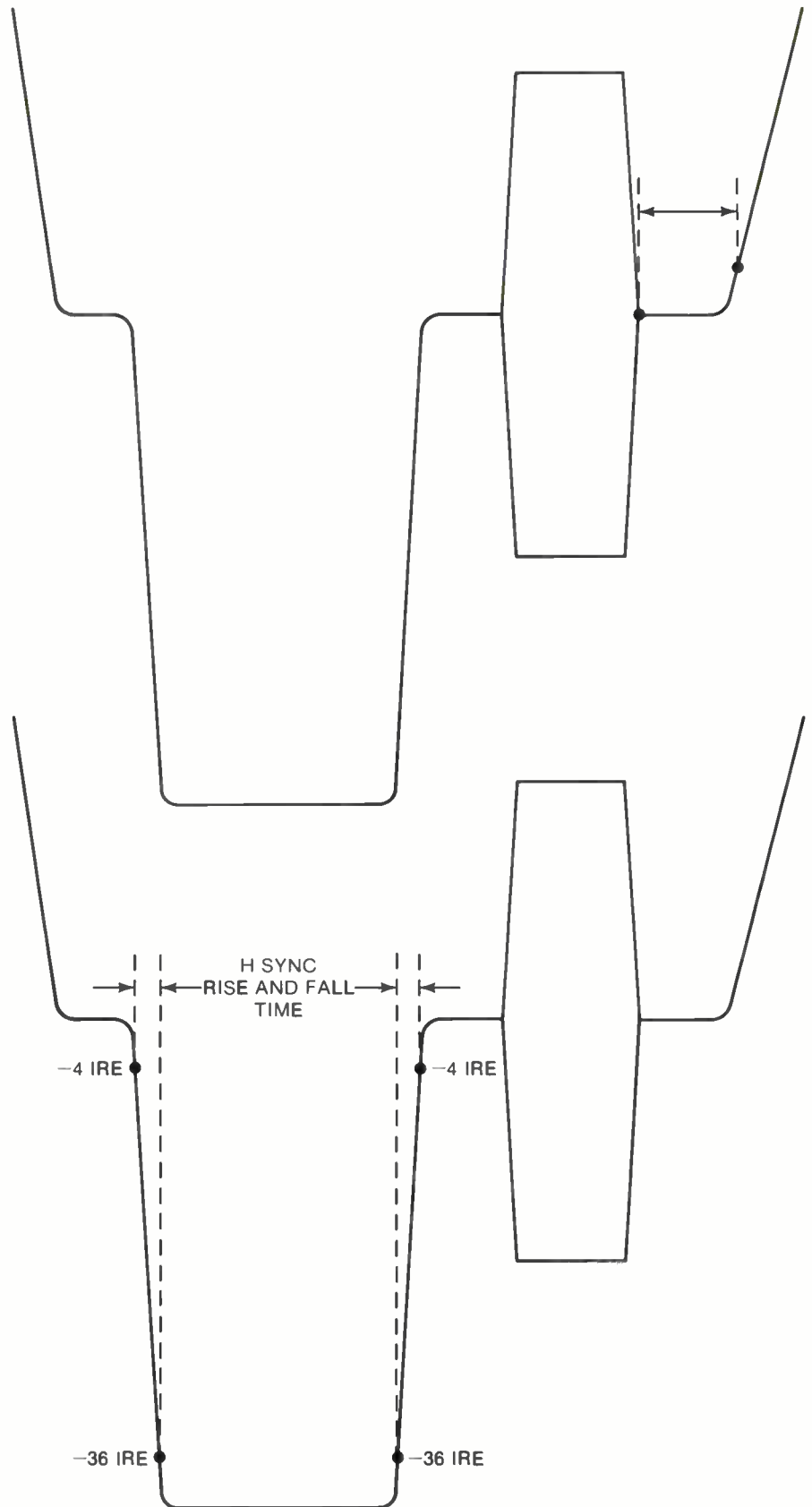
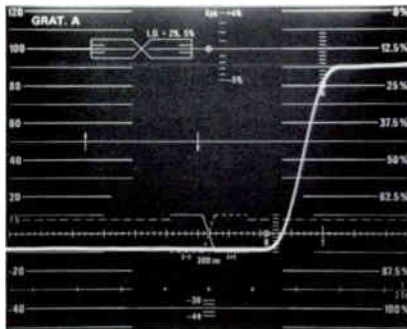



### Vertical Blanking

Vertical blanking is the time between the last picture information at the bottom of one field and the first picture information at the top of the following field. Vertical blanking is measured from the leading edge of the first equalizing pulse. Measured in terms of time, vertical

blanking must be greater than 1.17 milliseconds, but less than 1.33 milliseconds. In terms of scanning lines, the maximum vertical blanking is 21 lines. It is fairly standard in the industry to adhere to 21 lines of blanking, as the vertical interval lines preceding picture are often used for the transmission of vertical interval test signals.

### Equalizing Pulse Width

The width of the equalizing pulses which precede and follow vertical sync should be 2.54 microseconds. The tolerance on equalizing pulses is that the area of the pulse must be between 45 and 50% of the area of a synchronizing pulse. It is a fairly simple matter to compare the relative widths of the pulses and make a valid comparison in that manner. The equalizing pulses can be viewed on a waveform monitor by using the variable line selector to trigger in the vertical interval. Be sure when making this measurement that the vertical interval is correctly formatted as described previously.

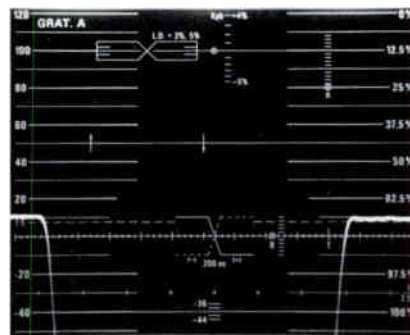
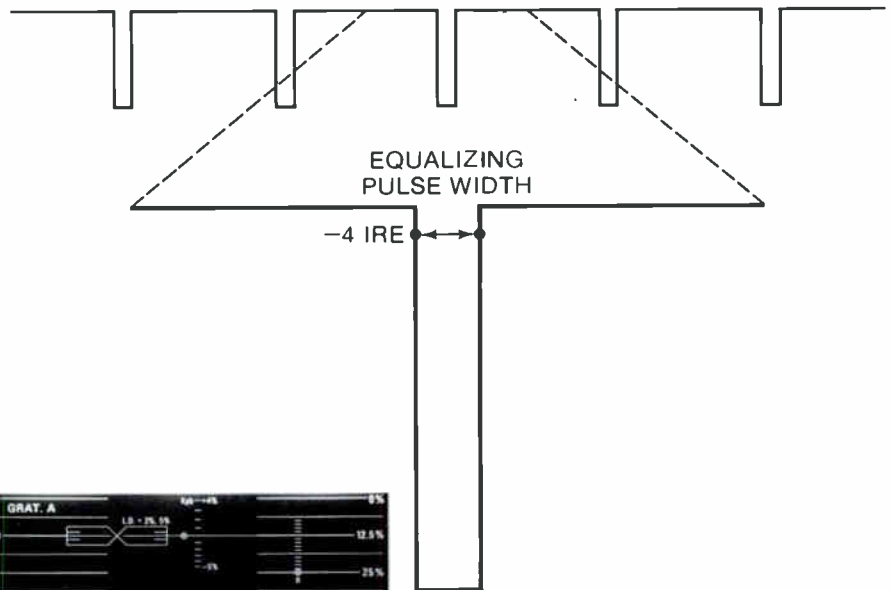

11. Measured between points at the 1/10 sync (-4 IRE) level. Shown here at 0.25  $\mu\text{sec/div}$ : 2.40  $\mu\text{sec}$ . Depending on the width of H sync, equalizers may be between 2.0 and 2.54  $\mu\text{sec}$ .

### Vertical Sync Pulse

The vertical sync pulse should have a total width equal to three horizontal scanning lines. The serrations in the sync pulse must be between 3.8 and 5.1 microseconds, measured at the -4 IRE level. The rise and fall times of the equalizers and serrations must be less than 0.250 microseconds.

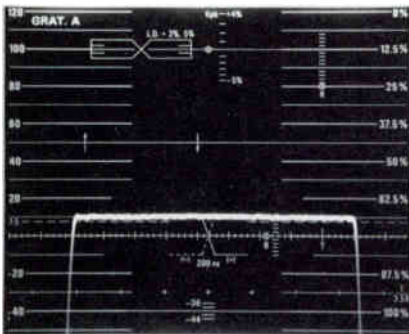
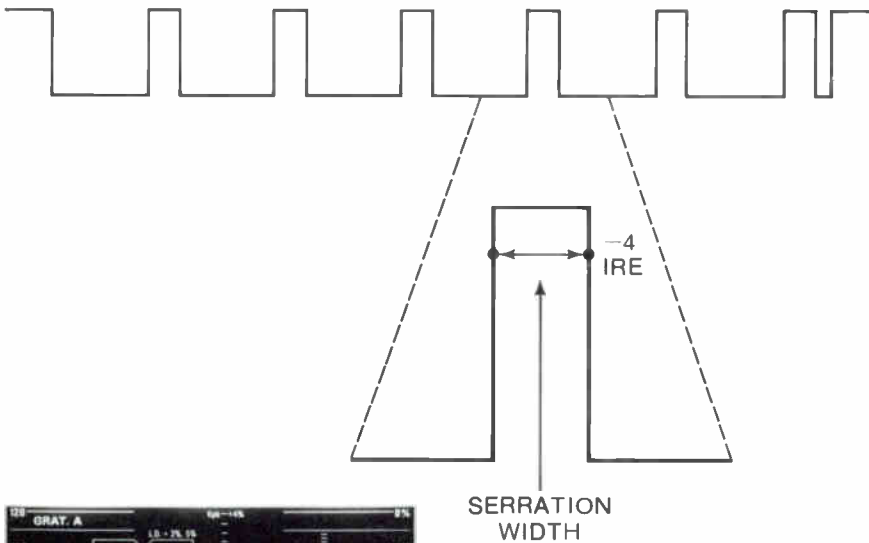

12. 3 full lines in duration, with serrations as shown here. 0.5 μsec/div, serration width = 4.5 μsec.

### Subcarrier Frequency

The frequency of the color subcarrier or burst signal must be held within 10 Hz of 3.579545 MHz. The short time duration of the burst signal makes direct frequency counting quite inaccurate. Depending on the equipment available, burst frequency can be measured or verified in several ways.

### Frequency Counter and Gen-Lock Device

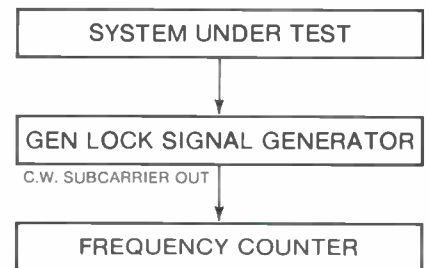

If you have a digital frequency counter and a gen-lock signal generator with a cw subcarrier output, the generator can be locked to the video signal and the subcarrier frequency of the generator can be measured with the frequency counter.



### Vectorscope, Variable Oscillator, and Frequency Counter

If you have a vectorscope and variable oscillator capable of generating 3.58 MHz with fair stability, use the equipment set up as shown. Adjust the signal generator in the range of 3.58 MHz until the vectorscope display rotates very slowly, or not at all. At this time, measure the oscillator frequency with the counter. This measurement should be quite close to the actual subcarrier frequency.

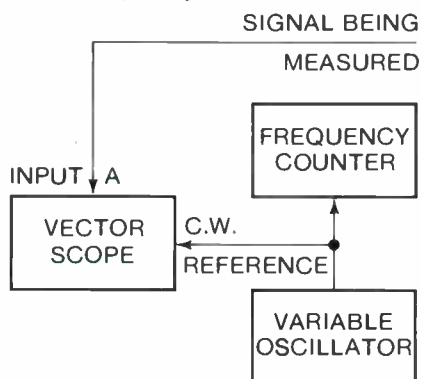

### Vectorscope

If you have only a vectorscope to use for checking subcarrier frequency, lock the vectorscope **cw** reference to a known good source of subcarrier frequency, or feed one channel input with a known good composite video signal, and reference the vectorscope to this source of subcarrier. Select the signal to be measured, and view the vector display. The rate of rotation of the display indicates the difference in frequency between the reference signal and the signal being checked. If the display is rotating faster than your eye can perceive the frequency is probably farther off than 10 Hz. It is not recommended to attempt to adjust subcarrier frequency using this comparison technique.

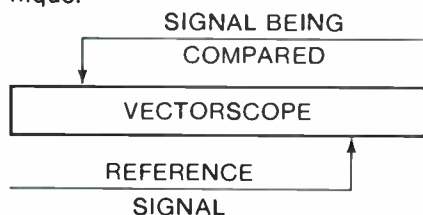

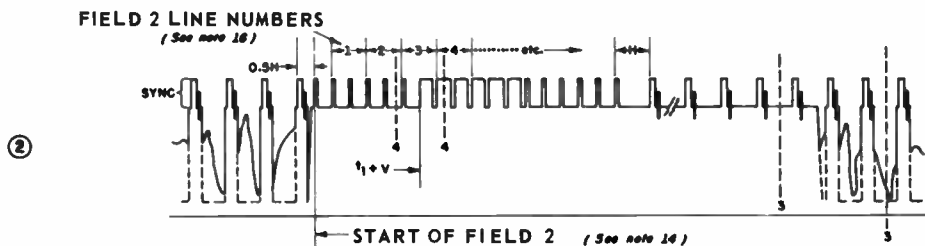
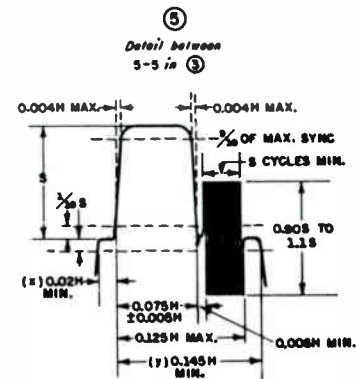
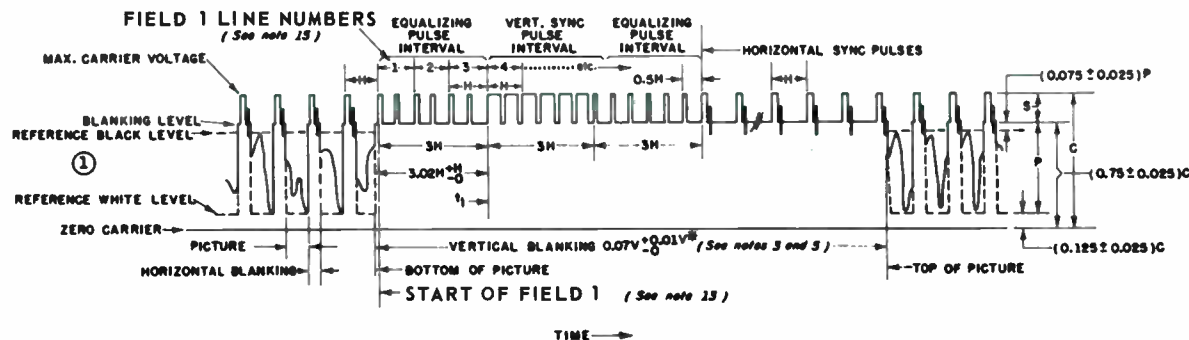

Horizontal dimensions not to scale in 1, 2 and 3

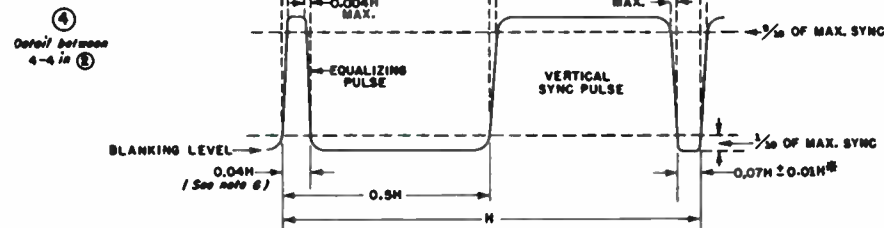
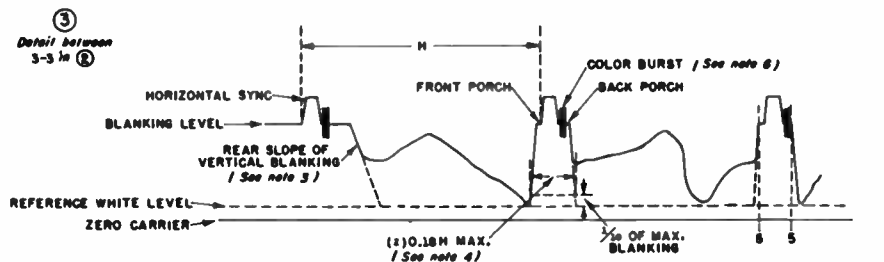

NOTES

- 1 H = Time from start of one line to start of next line.
- 2 V = Time from start of one field to start of next field.
- 3 Leading and trailing edges of vertical blanking should be complete in less than 0.1H.
- 4 Leading and trailing slopes of horizontal blanking must be steep enough to preserve minimum and maximum values of (x+y) and (z) under all conditions of picture content.
- \*5 Dimensions marked with asterisk indicate that tolerances given are permitted only for long time variations and not for successive cycles.
- 6 Equalizing pulse area shall be between 0.45 and 0.5 of area of a horizontal sync pulse.
- 7 Color burst follows each horizontal pulse, but is omitted following the equalizing pulses and during the broad vertical pulses.
- 8 Color bursts to be omitted during monochrome transmission.
- 9 The burst frequency shall be 3.579545 mc. The tolerance on the frequency shall be ±10 cycles with a maximum rate of change of frequency not to exceed 1/20 cycle per second per second.
- 10 The horizontal scanning frequency shall be 1/33 times the burst frequency.
- 11 The dimensions specified for the burst determine the times of starting and stopping the burst, but not its phase. The color burst consists of amplitude modulation of a continuous sine wave.
- 12 Dimension "P" represents the peak excursion of the luminance signal from blanking level, but does not include the chrominance signal. Dimension "S" is the sync amplitude above blanking level. Dimension "C" is the peak carrier amplitude.
- 13 Start of Field 1 is defined by a whole line between first equalizing pulse and preceding H sync pulses.
- 14 Start of Field 2 is defined by a half line between first equalizing pulse and preceding H sync pulses.
- 15 Field 1 line numbers start with first equalizing pulse in Field 1.
- 16 Field 2 line numbers start with second equalizing pulse in Field 2.
- 17 Refer to text for further explanations and tolerances.

## Linear Distortions

There are two broad classifications of signal distortions in television systems, linear and nonlinear. Non-linear distortions vary with the average or instantaneous amplitude of the picture signal, whereas linear distortions manifest themselves independent of the signal level. Linear distortions usually occur in a system as a result of incorrect frequency response.

Linear distortions are divided into four classifications, depending on the time domain in which the distortion is evident. Short time distortions occur in a fractional part of a horizontal line, and generally affect horizontal sharpness or definition. Overshoot, undershoot, and ringing are examples of short time distortions, and indicate incorrect high frequency response. Mid frequency response errors, or line time distortions, cause horizontal streaking or smearing in the received picture. Field time distortions are errors in low frequency response, and introduce undesired vertical shading in the picture. Long time distortions are dc and extremely low frequency signal errors which cause intermittent, abrupt changes or slow variations in picture brightness. The presence of long time distortions may also cause flicker in the received picture.

### Long Time Distortions

Long time distortions of a television signal are those that occur fairly slowly, and which the eye can easily perceive as changes in picture brightness or flicker. Long time distortions can be introduced into a system either from an external source, or by inadequacies in the equipment itself. If a video amplifier cannot tolerate an abrupt change in picture brightness, this intolerance may be evident as an abrupt dc axis shift at the point of the change, with the output level settling back shortly thereafter. This level shift is usually caused by the inability of the sync separator and dc restorer to follow the variation. External sources of long time distortions are power line hum and power supply ripple, and possibly dc currents being inadvertently carried in shield conductors.

To check for the presence of long time distortions, a special test signal is necessary. The bouncing APL signal supplied by several Tektronix test signal generators can be used to evaluate equipment for low frequency disturbances. Using the waveform monitor in its direct coupled mode, the output of the equipment being tested is viewed while it is carrying the bouncing APL signal. A further refinement of this testing procedure is the use of the DC bounce signal provided by the new Tektronix 1410 Test Signal Generator. The output of this generator is direct coupled to the input of the equipment being tested, so an extremely sensitive test of equipment performance results. To make this measurement easier, a slow sweep mode is provided on certain 1480 series waveform monitors which gives a measurement period equal to several cycles of the bounce signal. Any vertical shift of the blanking and sync level seen on the waveform monitor indicates the possibility of long time distortions being introduced.

## Long Time Distortions, Cont.

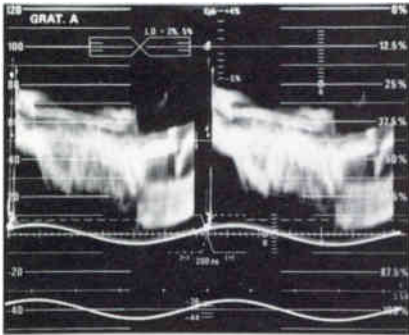

1. Observe the signal with the waveform monitor DC RESTORER OFF and in SLOW clamp mode. Mains hum, if present, will be evident in a 2 field display.

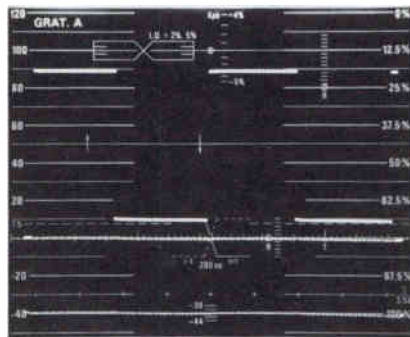

3. Bouncing APL Signal, shown here in slow sweep mode. Video clamping circuits are intended to maintain sync and blanking at constant dc levels despite changes in signal amplitude.

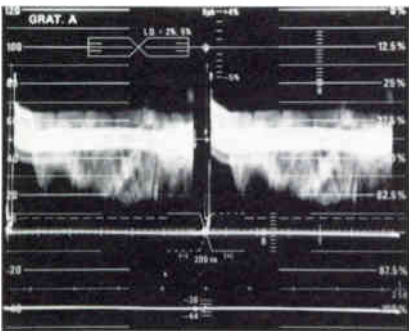

2. The FAST DC RESTORER of the waveform monitor eliminates hum on the display.

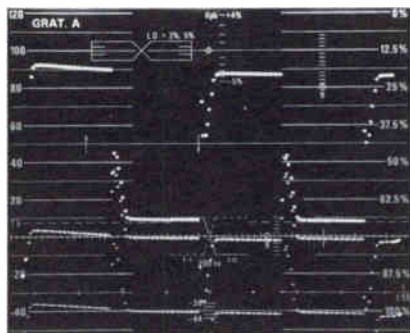

4. System with poor tolerance of level shift. Observe that several lines are required for the blanking and sync levels to settle after a signal transition. To eliminate the effects of the dc restorer in the waveform monitor, the incoming signal should be direct coupled to the input.

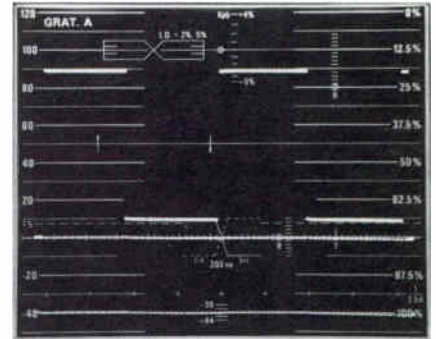

5. Acceptable response. Only a slight variation in sync tip level is visible after each level change.

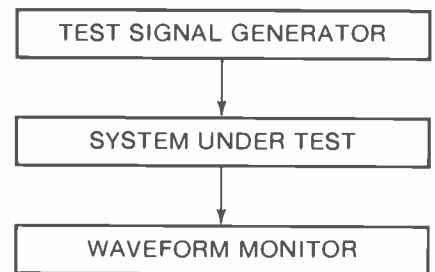

## Field Time Distortions

Incorrect low frequency response, or the introduction of extraneous low frequency components into the system will result in field time distortions. If the coupling between stages of an ac coupled video amplifier is insufficient, low frequency roll-off will be evident in the signal. This appears as a difference in shading from the top to the bottom of the picture. Extraneous signals coupled into the television system, most notably power supply and power line hum, will also be seen as field time distortions, but their effect will be present regardless of the level of the picture signal. With color systems, in which the vertical rate is not locked to the power line frequency, hum will become evident as a long time distortion.

There is no adequate way to measure field time distortion on an in-service basis. A gross check on field time distortion while the system is operating can be made by viewing the blanking level or sync tip, and observing any variation between the vertical blanking interval and the picture level. This is an unsatisfactory test except for emergency troubleshooting. The waveform monitor DC RESTORER should be off for these tests.

Ideally, to test low frequency response, a 60 Hz squarewave would be used for out of service tests. Since some television equipment requires sync pulses to operate satisfactorily, a special 60 Hz square wave with synchronizing pulses is available from the Tektronix Test Signal Generators. This 60 Hz square wave is extremely sensitive to low frequency response errors, or field time distortions.

Other similar signals, such as a window or full field bar signal, may also be used. These signals are, however, much less sensitive to field time distortions than the 60 Hz square wave.



1. 60 Hz modified square wave used in testing for field time distortions.



2. Field time distortion. Notice tilt in square wave. This check is made with the DC Restorer in the waveform monitor turned off.

## Line Time Distortions

Mid-frequency response errors account for the line time distortions present on television signals. Line time distortion is measured by viewing the tilt of the bar waveform on a pulse and bar signal. This measurement can be made on a full field or in-service basis.

In checking for line time distortion, low frequency hum and noise may thicken the trace, making an accurate determination of the amount of distortion difficult. If this is the case, attempt to minimize or eliminate their effect by using the FAST DC RESTORER (clamp) to remove the low frequency components. If this measurement is made on a full field signal, the 15 LINE mode can be used to further reduce hum and low frequency interference. The first and last portions of the bar waveform are not considered when measuring line time distortion, as the presence of any short time distortions will disturb the leading and trailing edges of the bar signal. The graticule supplied on current 1480 Series Waveform Monitors is designed to assist in making measurements of line time distortions.

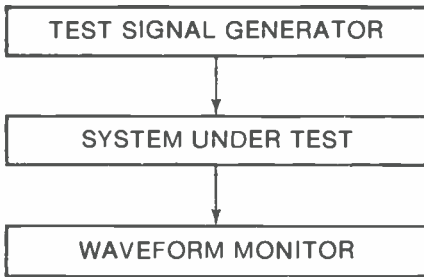

### Short Time Distortions

Errors in high frequency response result in short time distortions. To measure these short time distortions, the pulse and bar test signal is used, either as an in-service test or on a full field basis. By comparing the height of the pulse to the height of the center of the bar, the relative response at low and high frequencies can be compared. The ratio of the height of the pulse to the bar is a measure of the short time distortion present. To make the comparison between pulse and bar amplitude easier, the TEKTRONIX 1480 Series of waveform monitors allows the pulse to be "folded back" under the bar. A small amount of high frequency peaking will actually enhance the received picture by making fine details stand out. Excessive high frequency response, however, will introduce echoes or ghosts.

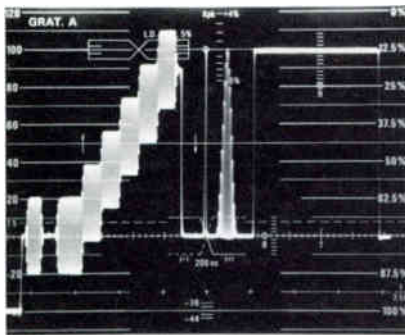

1. The bar portion of this composite test signal may be used to measure line time distortions.

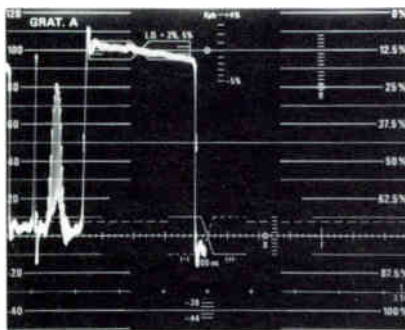

2. 5% line time distortion indicated from off the air measurement.

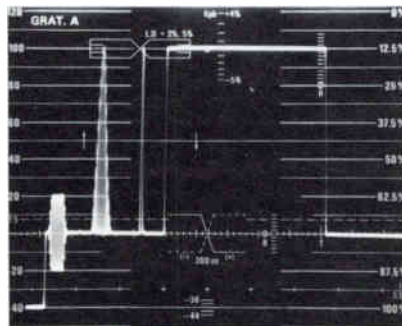

1. Pulse and bar test signal. By comparing the pulse to the bar amplitude short time distortions can be measured.

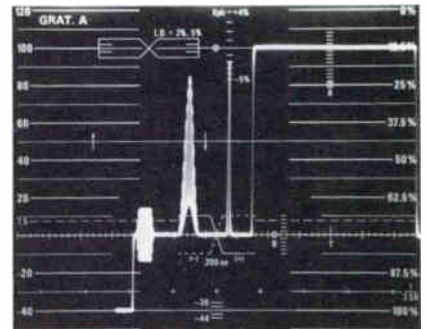

2. Pulse height is down about 8 IRE units. This corresponds to a K factor picture impairment of -2% ( $K_{PB}$ ).

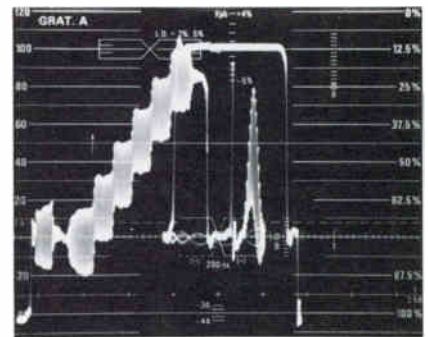

3. The comparison of pulse to bar amplitude is simplified by the sweep foldback feature of the TEKTRONIX 1480 Waveform Monitor.

## Video Signal to Noise Ratio

Noise components on a video signal, if sufficiently large, will degrade the received picture. One objective in system operation, therefore, is to keep these noise components to an absolute minimum. This task is complicated by the fact that each piece of equipment that the signal passes through adds its own little bit of noise to the video signal. System noise is measured and expressed as a ratio between the normal picture signal level, 714 mv, and the rms amplitude of the noise component contained on the signal. This ratio is usually expressed in decibels. The TEKTRONIX 1430 Random Noise Measuring Set and the TEKTRONIX 147A Test Signal Generator both provide facilities for measuring random noise. Because of the response characteristics of the human eye, certain noise frequencies are perceived to cause greater degradation in the viewed picture. To compensate for this visual response characteristic, a weighting filter is used to correlate electrical noise to visually perceived picture degradation.

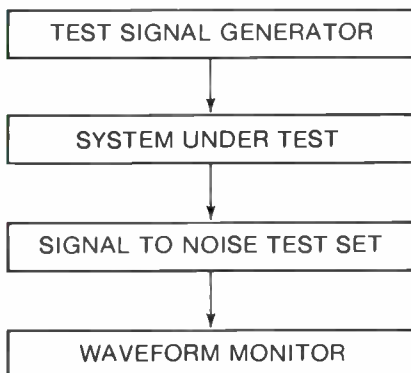

1430 Random Noise Measuring Set.

Signal to noise measurements using the TEKTRONIX 1430 or 147A are made by comparing the signal noise level to a calibrated noise source in the test set. This method is simple to use, accurate, and can be used either in-service or full field.

Many times, the exact signal to noise ratio of a system is not important. Rather, it is merely specified as being greater than or less than some particular figure. If you are comparing to such a specification, set the noise test set to insert this specified noise level, and then simply compare the inserted noise to the signal noise. If the inserted noise is greater than the system noise, the equipment meets or exceeds the spec. This procedure is a great time saver.

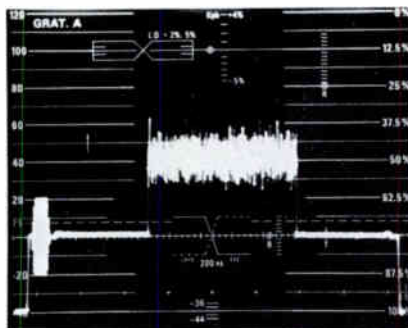

1. In noise measurement, a pedestal signal with noise is inserted by the noise measuring set. By adjusting the pedestal amplitude and noise level to match the video signal noise level, the system noise is measured.

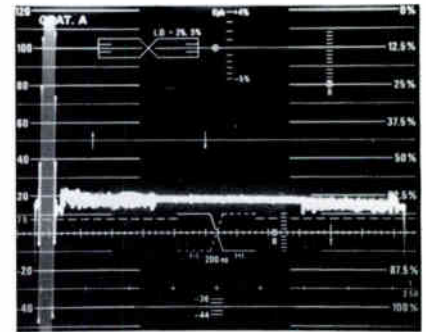

2. Vertical gain expanded, inserted pedestal adjusted to same level as video signal being measured.

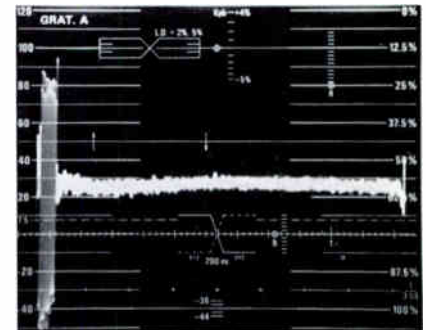

3. Adjustment of noise generator to match noise on signal. When the two signals cannot be differentiated visually, the dials of the noise generator are read to determine relative signal to noise ratio. In this case, SNR = -52 dB.



### Chrominance to Luminance Gain

The luminance and chrominance components of a color television signal should be transferred through a system with their relative amplitudes undistorted. If either signal is attenuated with respect to the other, a relative chroma level error is present which will affect the saturation of the reproduced picture. To measure relative chroma level, or chrominance to luminance gain inequality, a modulated 12.5 T pulse is used. This signal consists of equal peak amplitudes of luminance and chrominance, and is usually transmitted as a part of a composite test signal.

To measure chrominance to luminance gain, set the waveform monitor so that the modulated pulse amplitude goes from blanking to the 100 IRE level. If only a gain inequality is present, the baseline of the pulse will describe a continuous curve. By taking the peak amplitude of this curve and plotting it against the vertical axis of the nomogram in figure 3A, the chrominance to luminance gain inequality, or relative chroma level can be determined.

### Chrominance to Luminance Delay

At the time of signal origination, the luminance and chrominance components of the television signal are correctly timed with respect to one another. If any delay is introduced in one component without an equal delay being introduced in the other, when the signal gets to a picture monitor the luminance and chrominance of the picture will be misregistered. This is most often noticed on red letters smeared to the right into a white or neutral background, or the misregistration may be so bad as to make the received picture appear to have color ghosts.

To measure this delay, the modulated 12.5 T pulse is used. Position the test signal as described for relative chroma gain measurements, and observe the baseline of the waveform. A sinusoidal shape on the baseline of the pulse indicates the presence of chrominance to luminance delay. Measure the peak to peak excursions of the sinusoid, and plot these values on the nomogram shown in figure 3A. The intersection of these points will indicate the chrominance to luminance delay.

This measurement can be considerably simplified by the use of the TEKTRONIX 1478 Calibrated Chrominance Level Corrector, which removes any chrominance gain inequality that may be present. It is then a simple matter to evaluate the delay distortion using the waveform monitor graticule.

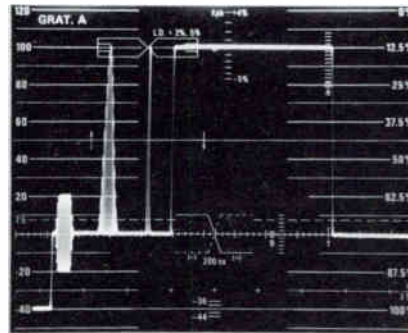

1. Modulated 12.5 T pulse used to measure chrominance to luminance gain and delay, here shown as part of a composite test signal.

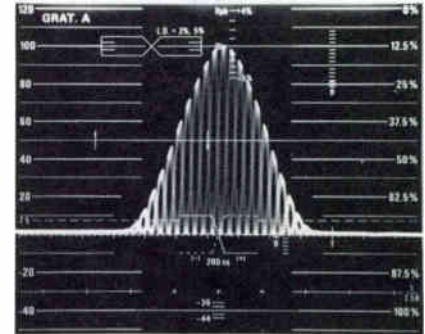

2. Undistorted modulated 12.5 T pulse.

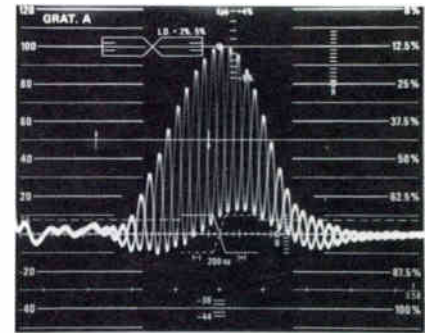

3. Modulated 12.5 T pulse from off the air feed. Pulse amplitude is first set to 100 IRE. Any aberration in the baseline indicates either CIL gain or delay distortion. The distortion can be evaluated by measuring the baseline disturbances and applying these values to the nomogram shown in figure 3A. In this photo, the baseline deviates to -10 IRE and +13 IRE. From the nomogram, chroma gain is -0.6 dB relative to luminance gain, and chroma is 220 nanoseconds ahead of luminance.



Figure 3A

MODULATED SIN<sup>2</sup> PULSE APPLICATION NOMOGRAPH  
 12.5T 1.57 μsec h.o.d. FOR 525/60 STANDARDS

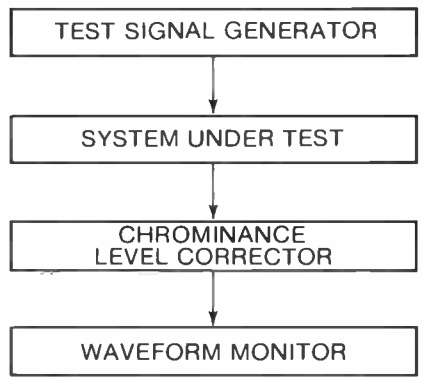
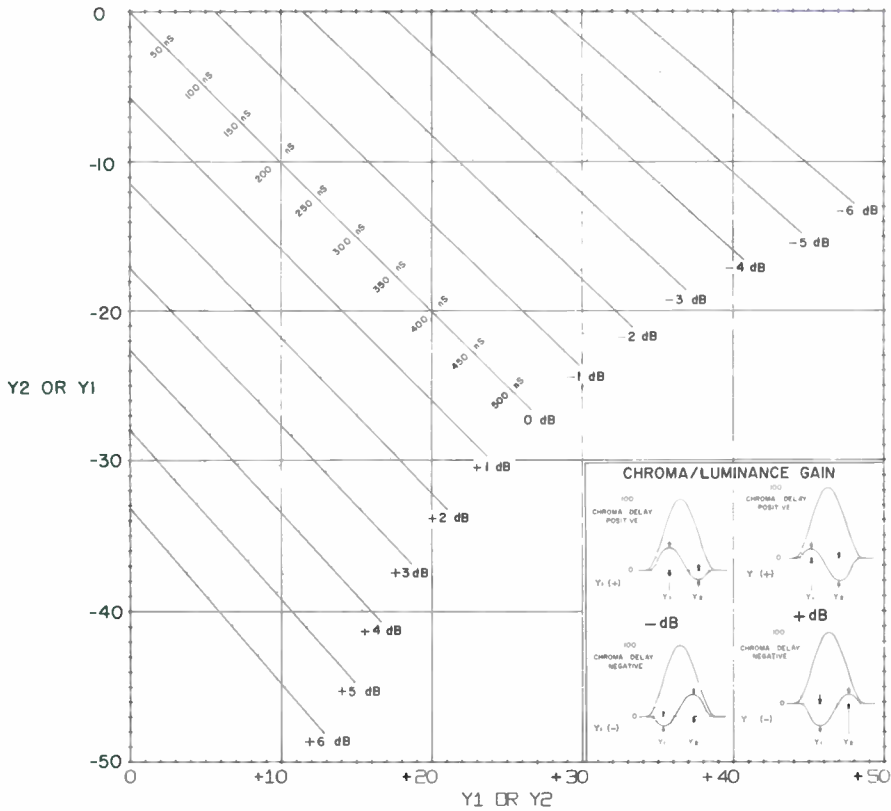

## Nonlinear Distortions

The preceding measurements have been of distortions which are independent of the signal amplitude. If a signal distortion changes with variations in the average or instantaneous picture level, it is said to be a nonlinear distortion. The following measurements are all nonlinear distortions.

Since nonlinear distortions depend upon the Average Picture Level of the signal, measurements of these distortions should be made at several different APL settings to properly evaluate system performance. In most cases, measurements of nonlinear distortions are made at average picture levels of 10%, 50% and 90%.

### Luminance Nonlinear Distortion

If the gain or response of a system varies as the signal level changes from blanking to white, then a nonlinear gain distortion is present. If this manifests itself in the luminance channel, it is luminance nonlinear distortion. To measure luminance non-linear distortion, the staircase signal is connected to the waveform monitor. The signal is passed through a differentiator to provide an indication of each riser amplitude. The tallest spike is set to 100 IRE, and the distortion is evaluated by observing the amplitude of the shortest riser.

The TEKTRONIX 1480 Waveform Monitors provide a built in differentiator to facilitate this measurement.

## Luminance Nonlinear Distortion, Cont.

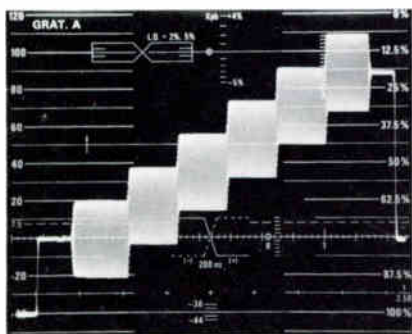
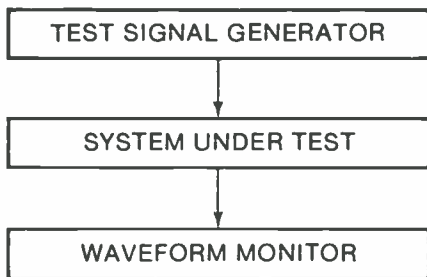

1. The staircase or modulated staircase is used for measuring luminance nonlinear distortion.

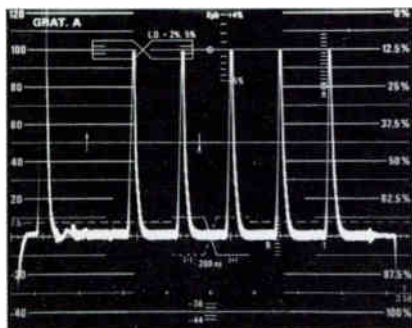

2. After passing through the staircase differentiator and chrominance filter, the CRT display shows spikes in proportion to the amplitude of the staircase risers.

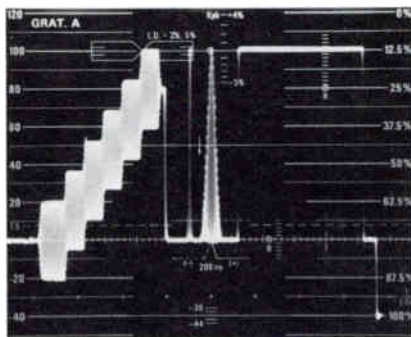

3. The staircase of the composite test signal may also be used for this measurement.

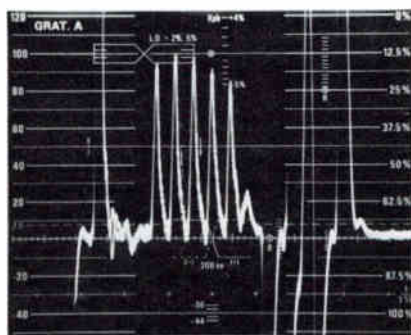

4. Off-air signal showing luminance nonlinear distortion. The tallest spike is set to 100 units, and the shortest spike pictured is down 14 units from 100.

## Differential Gain

Differential gain, or as it is more correctly described, differential chroma gain, is a difference in amplitude response at the color sub-carrier frequency as the signal level changes. The value of differential gain may change as the average picture level or brightness changes, so several measurements of this distortion are necessary to fully evaluate the system response. The test signal used for differential gain measurements is the staircase signal with chroma added to the risers. Any difference in the amplitude of the chrominance component after transmission is differential gain. This parameter can be measured either in service or on a full field basis. To make the measurement, apply the test signal to the equipment to be tested, and monitor the output signal on the waveform monitor. Pass the signal through the chroma bandpass filter in the waveform monitor. Adjust the vertical sensitivity until the largest chroma envelope is 100 IRE peak. The difference in amplitude between this step and the smallest step displayed is a measure of the differential chroma gain. For out of service testing, this measurement is also made at 10% and 90% Average Picture Level to simulate the range of possible transmission parameters.

A vectorscope can also be used for measuring differential gain. The characteristics of the TEKTRONIX 520A Vectorscope allow measurements of differential gain distortion as small as 1%.

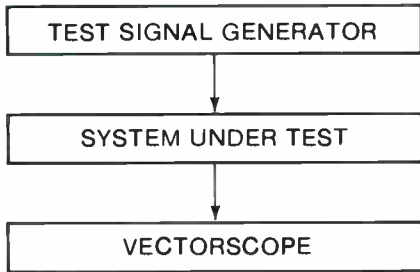

OR

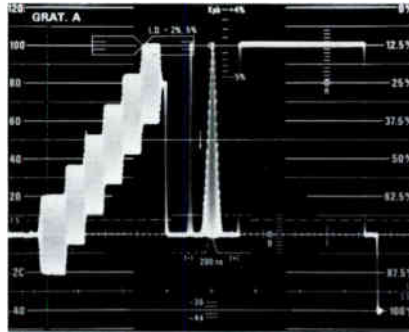
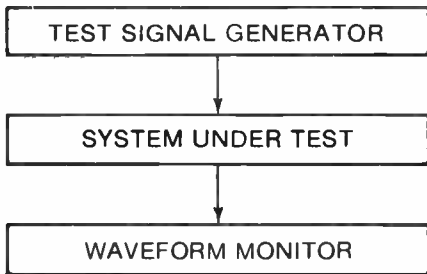

1. The modulated staircase is used to measure differential chroma gain.

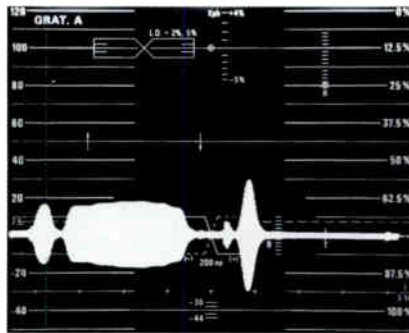

2. Off-air signal viewed with waveform monitor chroma bandpass filter.

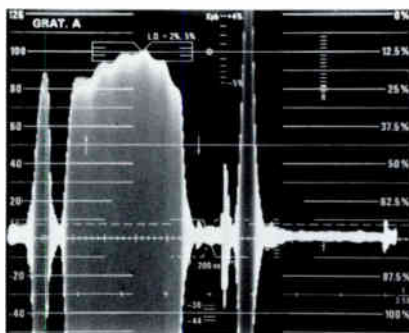

3. Signal expanded so that largest burst packet is 100 IRE peak. The amplitude difference between 100 and the smallest step is the amount of differential gain. Shown here, DG = 21%.

## Differential Phase

If the phase of the color subcarrier changes as a result of changes in the amplitude of the luminance signal, this distortion is known as differential phase. Differential phase is measured by using a staircase signal with constant amplitude chrominance added to the staircase risers. Viewing the subcarrier signal on a vectorscope, any phase difference between the steps indicates differential phase. The difference, in degrees, between the two steps which are farthest apart is a measure of the differential phase.

The TEKTRONIX 520A Vectorscope provides more accurate measurement of differential phase through the use of specially designed circuitry.

There is no FCC specification for differential phase per se, but the phase error of saturated color bars must be less than  $\pm 10$  degrees. More conservative values of differential phase are well within the state of the art, so a tighter specification for your facility might be appropriate.

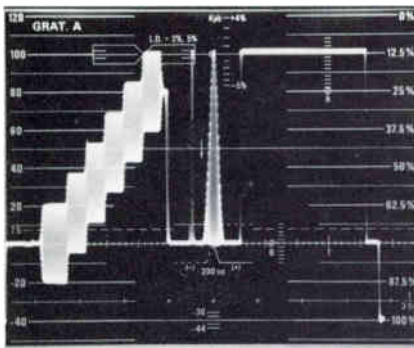

1. The modulated staircase is used to evaluate differential phase. As generated, the chrominance on the staircase is equal in phase and amplitude.

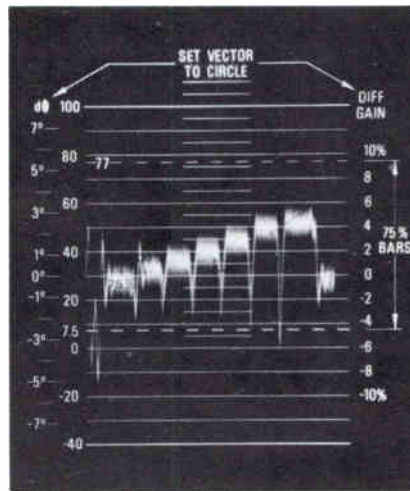

3. Depressing the DIFFERENTIAL PHASE button, the staircase chroma is positioned so that the reference point is on the 0° scale division. The peak of the signal corresponds to the differential phase error. In this photo, differential phase equals about 3°.

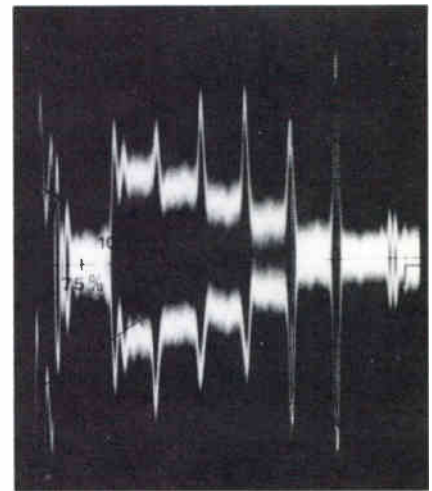

5. The CALIBRATED PHASE control is then adjusted to overlay the step being measured. The CALIBRATED PHASE dial now indicates the differential phase present. This method allows differential phase distortion as small as 0.1° to be measured.

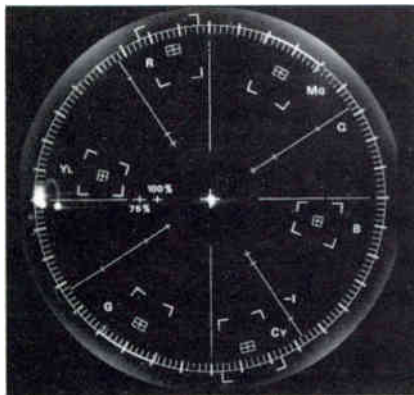

2. Viewed on a vectorscope in the VECTOR mode, the staircase chrominance component is positioned to the 0°-180° axis, and the gain is adjusted to place the staircase chroma at the perimeter of the circle.

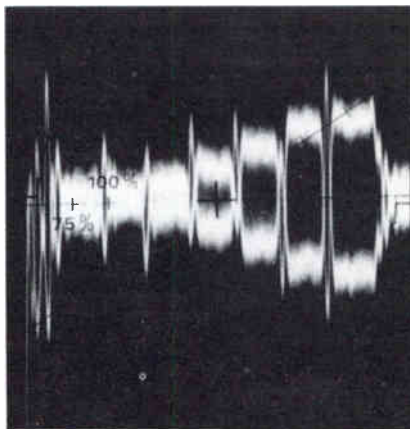

4. For greater accuracy in differential phase measurement, the double trace technique can be used. In this mode, the signal is set up as before, and the CALIBRATED PHASE shifter is set to 0. The CHANNEL A or CHANNEL B PHASE control, as appropriate, is adjusted so that the reference signals are overlaid.



# **RF TV BROADCAST MEASUREMENTS USING THE SPECTRUM ANALYZER**

**By  
Clifford B. Schrock**

# RF TV BROADCAST MEASUREMENTS USING THE SPECTRUM ANALYZER

By  
Clifford B. Schrock

- I. Introduction
- II. Visual Transmitter
  - A. Sideband response, out-of-service
  - B. Sideband response, low level in-service
  - C. Sideband response, keyed in VIT interval
  - D. Swept-differential gain
  - E. Peak to peak variations due to noise, hum, and field rate distortions
  - F. Harmonic and *im* distortions
  - G. Modulation monitor calibration
- III. Aural
  - A. Response
  - B. AM noise
  - C. FM noise
  - D. Modulation monitor calibration
- IV. Combined
  - A. Effective power ratios between -10 and -20%
  - B. Pattern
  - C. Out of band spurs and 920 kHz problem
  - D. Antenna, filter, coupler evaluation
- V. Miscellaneous Tests

## I. Introduction

The modern television plant consists of two distinct sectors; the baseband and the rf, or perhaps the studio and the transmitter.

Baseband measurement techniques are characterized with very precise timing, perfectly shaped pulses, and accurate amplitudes. An impressive array of specialized test equipment exists; monitors, vectorscopes, and waveform monitors.

It is a surprise, to say the least, when most studio engineers see the waveform of a TV signal for the first time after it passes through a transmitter and demodulator. The transmitting of the TV signal within the vestigial sideband system is still quite a mystery to most of us, perhaps because of the inevitable discrepancies that exist between what should happen in theory and what does happen in real life.

The area of rf test equipment is also a mystery in that we are often not certain if the test equipment isn't compounding the problem by lying a little.

A modern spectrum analyzer, with its displays of frequency related information, can remove much of the mystery. The test series presented here is performed with a modern spectrum analyzer. A demodulator is not needed since all measurements are performed directly on the rf carriers. Both visual and aural transmitter test procedures are included.

The Author

## II. Visual Transmitter

### A. Sideband Response, Out-of-Service

Traditionally, sideband response measurements have been performed as out-of-service measurements to facilitate tuning and verification of the transmitter and associated vsb filter assemblies. [\$73.687 (a)]. The test signal consists of a sweeping signal broken by sync pulses, or H rate pulses. The sweeping signal goes from close to 0 MHz to beyond the bandpass of the transmitter (typically 6 MHz or more).

The difficult part of sideband analysis is the receiver. A simple diode detector won't work. Instead a tracking receiver must be used to differentiate between the upper and lower sidebands. Here, the spectrum analyzer is a natural answer, since it is in fact a high quality sweeping receiver. Modern spectrum analyzers, such as the TEKTRONIX 7L12, can tune across the entire TV spectrum from video through vhf and beyond the highest uhf stations used commercially in the world today. In addition to a linear display, the spectrum analyzer can display in LOG modes; 2 dB/div being excellent for flatness checks, and 10 dB/div permitting roll-off and lower sideband evaluation in excess of 70 dB down.

The new TEKTRONIX 1405 Sideband Analyzer Adapter works in conjunction with the spectrum analyzer and provides many of the extra features such as crystal markers and calibrated APL and output controls to make the combination one of the most powerful sideband analyzers available.

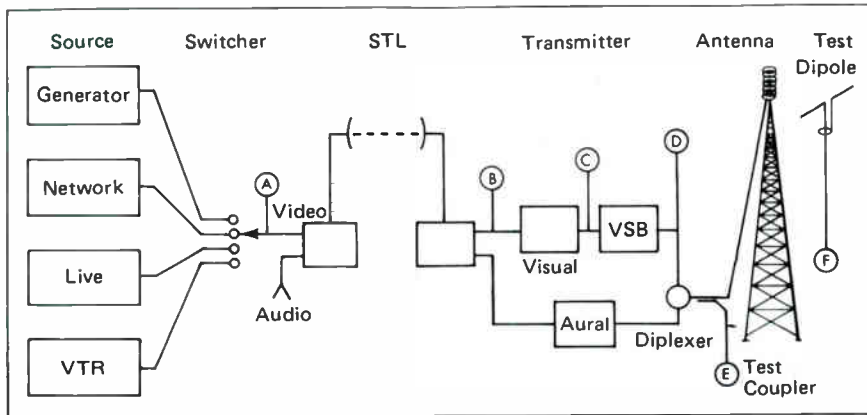

Figure 1. Typical Station Layout Showing Test Points

Any number of possibilities exist for performing sideband analysis out of service. For transmitter tuning, it is desirable to set up the sideband analyzer feeding the input to the transmitter directly (B), and connecting the input of the spectrum analyzer at the output of the vsb filter (D). Other intermediate points can also be probed such as the transmitter if, transmitter output before the vsb filter (C), after the diplexer (E), or even off-the-air using a dipole (F).

Once the transmitter has been correctly set up, you may wish to move the sideband analyzer system to the

studio so that, by using a test antenna, the entire loop (including the microwave link and transmitting antenna) can be verified.

#### Procedure for In-Service Sideband Analysis

1. Calibrate the 7L12 or 7L13 Spectrum Analyzer as described in the Owners Manual.
2. Connect the 1405 Sideband Analyzer to the 7L12 or 7L13 and temporarily connect a BNC to BNC jumper from the output of the 1405 to the input of the spectrum analyzer.
3. Tune both units to zero and verify that the 1405 is working correctly by noting a flat response curve from 0 MHz to at least 15 MHz.

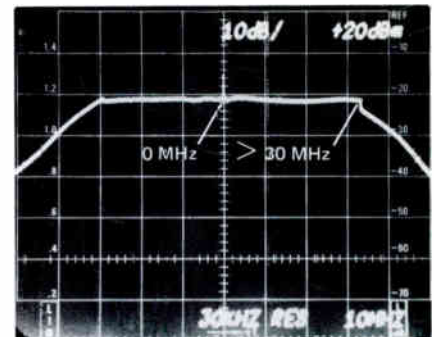

Figure 3. Sideband Analyzer Response at Baseband

4. Make sure that the internal sync on the 1405 is switched ON, and connect the unit to the transmitter input (B). Generally this can be accomplished through the video patch panel. \*See notes for special cases and international standards.

5. Connect the spectrum analyzer to an rf test point after the vsb filter.

#### —CAUTION—

CARE SHOULD BE EXERCISED TO KEEP THE POWER LEVEL INTO THE ANALYZER LOW. ANY OFF-SCREEN SIGNAL CAN DAMAGE THE SPECTRUM ANALYZER. EXTERNAL PADS SHOULD BE USED IF THE INTERNAL ATTENUATOR CANNOT REDUCE SIGNALS TO AN ON-SCREEN CONDITION.

6. Tune the spectrum analyzer in 10 dB/div, 5 MHz/div, until the station carrier is centered upon the screen.
7. Tune the sideband analyzer until the display floor on the spectrum analyzer suddenly rises to indicate the response shape of the TV transmitter. Reduce the span to 2 or 1 MHz/div and rock the FINE control on the sideband

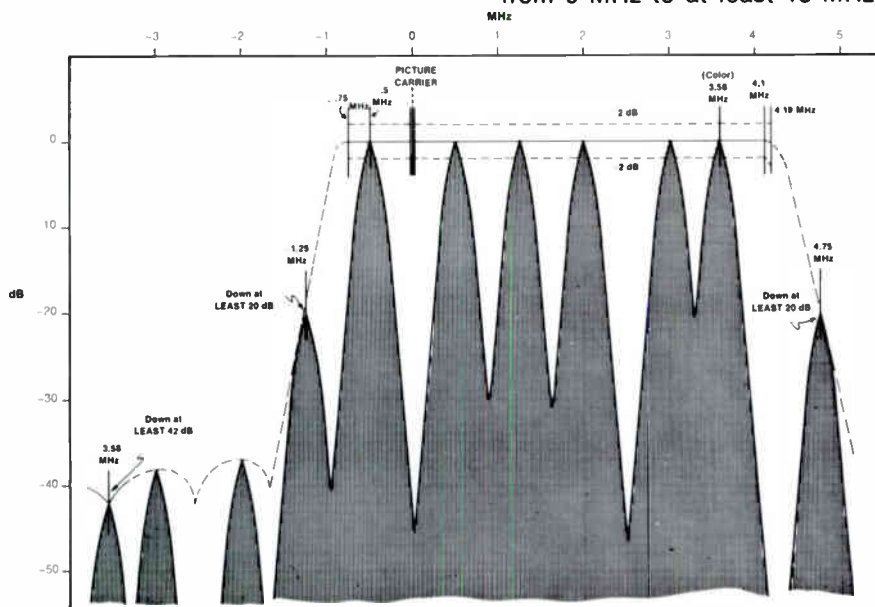

Figure 2. Idealized Color Transmitter Response (NTSC-Multi-burst Superimposed)

analyzer to keep the two units tracking (indicated by maximum amplitude response). A properly adjusted transmitter will appear as in Figures 4 and 5.

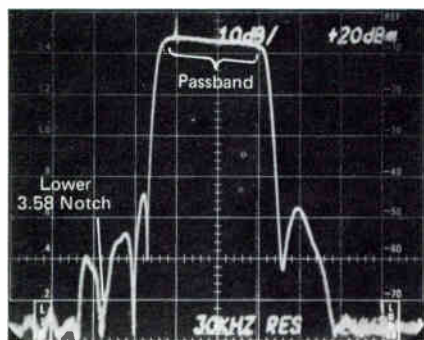

Figure 4. Transmitter Response at 2 MHz/Div and 10 dB/Div

8. Select 2 dB/div to verify the flatness from -0.75 to +4.2 MHz. You should obtain a display similar to Figure 6.

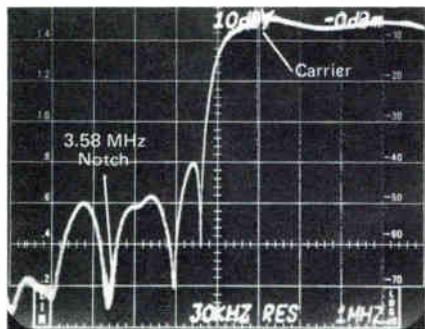

Figure 5. Lower Sideband and 3.58 Trap Tuning

9. Intensity markers can be used by connecting a cable from the z-axis output of the 1405 to the z-axis of the mainframe.

*\*NOTES: For foreign standards where the internal sync rate of 15.75 kHz will not work, or in cases where the transmitter must see vertical or full NTSC sync, sideband analysis can be performed by adding the sideband analyzer cw signal to a studio or generator test signal as shown in Figure 6. The 1405 internal sync can be defeated with the panel switch. Although not necessary, blanking can be supplied to the 1405 to remove the swept signal during the sync interval. When the 1405 is added to composite sync as shown in Figure 8, the transmitter input gain control will have to be increased to make up combining losses of 6 dB (50%).*

### B. Sideband Response, In-Service Using Low Level Techniques

With remote control transmitters and longer transmitting days, it is desirable to check sideband response more often than once before sign-on. Two common in-service techniques are possible with the 1405. One is the insertion of the sideband analyzer signal into the Vertical Interval (described in Section C), and the other is the low level sweep, described below.

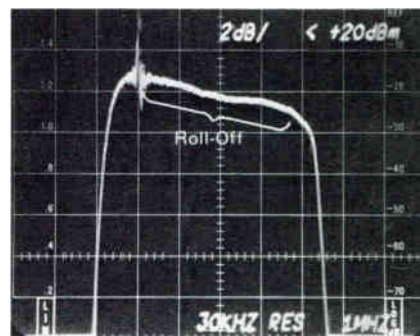

Figure 6. Transmitter Response at 2 dB/Div (Note Response Rolloff of about 2 dB)

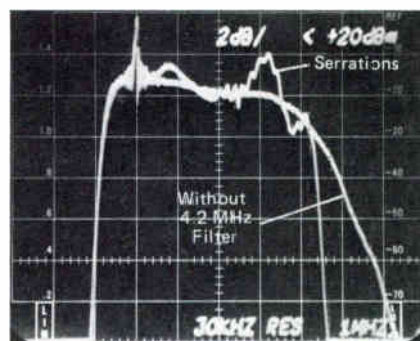

Figure 7. Response with and without 4.2 MHz Filter (Note Serrations Due to Filter)

The low level sweep is attractive because of its simplicity and real time adjustment capabilities. The sweeping signal is combined directly with the TV picture using a resistive combiner so that the sweeping signal is down 30 to 40 dB (or more) below the picture information. Be-

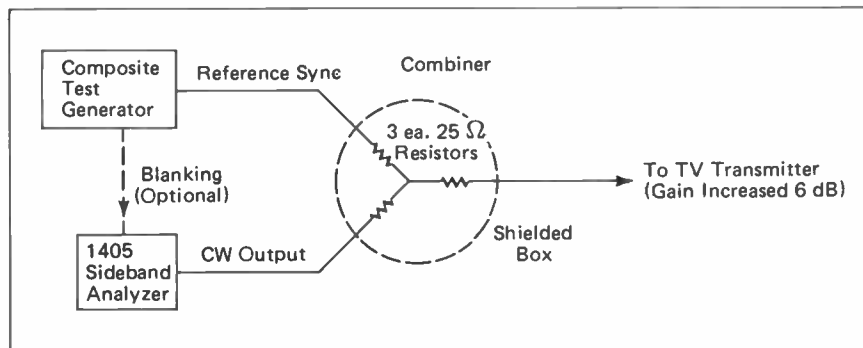

Figure 8. Combining CW Signal with Test Generator for Special Tests (See Text)



cause of the low signal level and repetition rates, interference from in-service testing by this technique is only perceptible to the trained observer. If the station uses the technique for a few sweeps, at different times during the day, or perhaps after a final change for a short period of time, the average customer will not detect the sweeping signals superimposed on the TV signal.

The intentional addition of the swept signal to the picture information might be interpreted by some as illegal [§73.682(a21)] especially since no information is permitted on sync information. However, part (a16) of the same section states that carrier-to-noise and other effects can be up to 5%. This is equivalent to 8 IRE units. We recommend that the sweeping signal be inserted with 2 or 3 IRE units, well within the tolerance of this rule.

This in-service technique can be used from the studio, to verify not only the transmitter, but also the **stl**, processors, and antenna performance.

#### Procedure for In-Service Testing

1. Prepare a test point where the swept signal can be inserted.

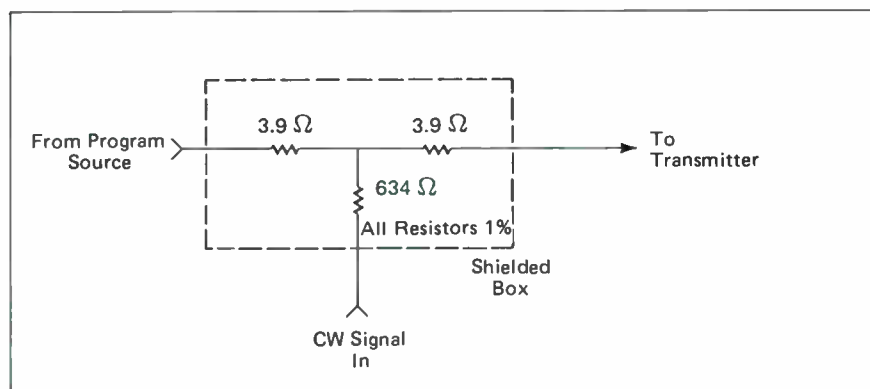

Figure 9. Insertion "T" for In-Service Low Level Testing

This can be a simple T as shown in Figure 9 (supplied with the 1405). Make sure that the internal sync on the 1405 is switched OFF, APL set to 0, and the AMPL control is set to 10 IRE. *Amplitude settings between 10 and 20 (equivalent to 1 and 2 IRE thru the insertion T) will give the most satisfactory results with minimum picture impairment.*

2. Connect the 1405 to the test point, and while watching an off-air color monitor to insure that there is no interference, tune the COARSE TUNING control until the baseline raises. It should be possible to use the FINE control to tune for maximum upward deflection of the display.
3. Connect the spectrum analyzer to an rf test point and carefully tune in the picture carrier at 10 dB/div, 1 or 2 MHz/div and 30 kHz RESOLUTION.
4. By using the VIDEO FILTERS on the spectrum analyzer it should be possible to obtain a display similar to Figure 11.

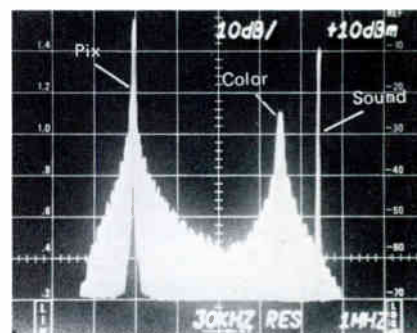

Figure 10. Typical TV Channel with Picture and Color Carriers

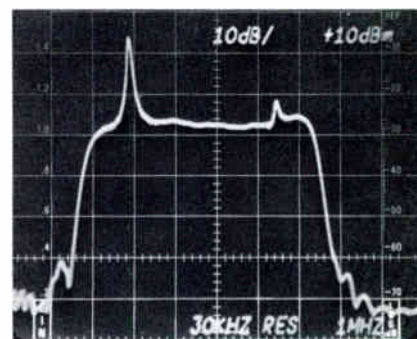

Figure 11. In-Service Low Level Sideband Response

5. Approximately 10 dB more range and finer resolution can be obtained with 3 kHz RESOLUTION. The fine tuning control will be more critical and tend to drift unless both instruments are completely warmed up. Displays similar to Figure 12 should be obtained.



Figure 12. Low Level Sideband Response Using 3 kHz Resolution Bandwidth

6. The 2 dB/div mode can also be used to check the flatness (Figure 13).

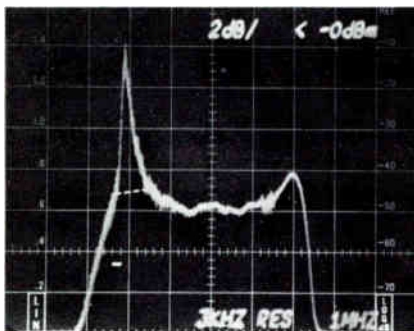

Figure 13. Low Level Sideband Response at 2 dB/Div

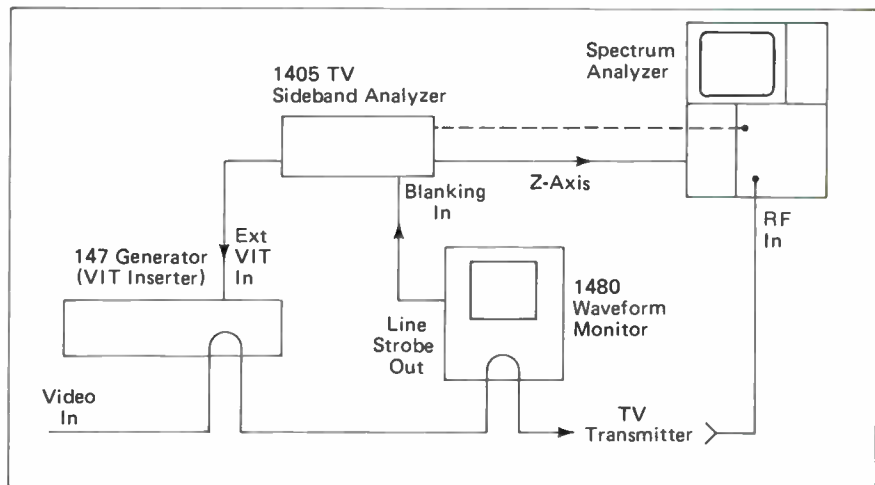

Figure 14. Sideband Analyzer Connections for VIT Insertion

### C. In-Service Sideband Response Using the Vertical Interval

Another in-service technique uses the swept signal, inserted on one line in the Vertical Interval. This technique has an advantage in that it can be used continuously during the day with no picture interference, however, a storage oscilloscope is required to recover the swept display. In addition, the display is not real time. Up to 30 seconds is required after an adjustment to visually verify the result.

The main advantages of this technique are that very fine resolution and accuracy can be obtained continually on an in-service basis.

A number of lines in the VIT area can be used for the sweeping signal [§73.682(a16)]. Line 18, field 2 is sometimes available, and line 20, both fields is also often empty.

The theory of this technique should be understood before attempting to use the procedure. Different VITS insertion devices can be used, other than those shown in the procedure, provided that the same keying can be accomplished.

The spectrum analyzer will receive all the normal picture information, however, the z-axis (intensity) is only turned on during the single line sweep.

### Procedure

1. Set up the equipment as shown in figure 14. Good results can be obtained without the 1480 Waveform Monitor if the intensity on the spectrum analyzer is carefully set. A 529 type waveform monitor can be substituted for the 1480, using the video output, however, the 529 must be modified by lifting one end of R198.
2. Verify with the 1480 (or another waveform monitor) that the sweep signal is inserted on the correct line, and the APL and AMPL controls work correctly.

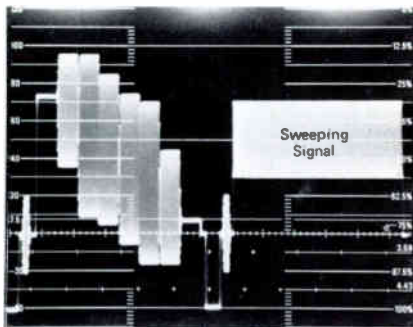

Figure 15. Waveform Monitor Display of VIT Interval Including Sideband Envelope

3. The spectrum analyzer should be tuned to the picture carrier with 1 MHz/div, 300 KHz resolution, and 10 dB/div.
4. Using the storage mode on the spectrum analyzer and a slow sweep speed (approximately 1/2 sec/div) carefully tune the sideband analyzer (1405) for maximum upward deflection of the response curve (Figure 16).

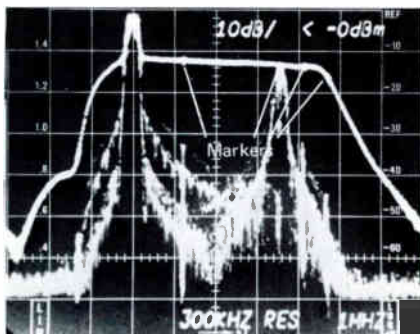

Figure 16. Sideband Response Using VIT Insertion

5. This procedure can be used at the studio location, by using a roof-top high-gain antenna to receive the rf for the spectrum analyzer. On long stl's some delay will occur, and can be compensated for with the fine tuning control on the 1405.
6. The intensity markers will work normally with this technique.

#### D. Swept Differential Gain Measurements on the Television Transmitter

A variety of methods exists at base-band for making differential gain measurements, however, the following technique uses the rf swept signal of the sideband analyzer. This makes it possible to check gain changes with frequency across the passband of the transmitter.

The TV transmitter, being a very high powered, am transmitter, often tends to exhibit a very sloppy differential gain characteristic. A "linearizer" function is generally included to correct most gain effects, however, effects related to frequency remain. The technique described below shows a typical transmitter characteristic with and without the "linearizer" function. Although most of the gain slewing with input APL is controlled, the effects relative to frequency remain.

The TEKTRONIX 1405 TV Sideband Adapter has calibrated steps from 0 to 100 IRE and 0 to 100% swept signal to permit accurate evaluation of the differential gain problem.

#### Procedure for Swept Differential Gain Measurement

1. Set up the sideband analyzer and spectrum analyzer for normal out-of-service testing (Procedure A).

2. With all processing defeated and the transmitter "linearizer" OFF, sweep the transmitter using a 20% AMPL signal with an APL of 10 and 90 IRE. A display similar to Figure 17 will be typical. You may wish to do a series of sweeps from 10 to 90 IRE to determine how the transmitter responds at intermediate levels.

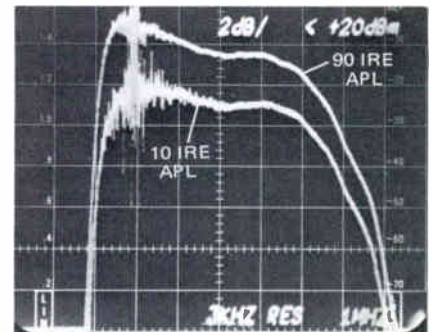

Figure 17. Transmitter Variations with 10 and 90 IRE Test Sweeps

3. With the "linearizer" or other processing equipment, repeat the sweep tests for levels of 10 and 90 IRE. The display in Figure 18 is typical. Note the response changes with APL.

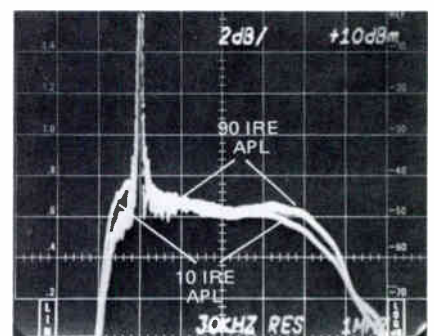

Figure 18. Transmitter Differential Gain Display for 20% Amplitude 0 and 100 IRE Test Sweeps

### E. Variations Due to Noise, Hum, and Field Rate Distortion [§73.682(16)]

The contribution of noise, hum, and field rate distortions by the transmitter or transmitting system is often in question. These parameters can be measured with a demodulator and waveform monitor to some extent, but the question of contribution of the noise in the test equipment, or the clamping of hum and field rate distortions always arises.

The spectrum analyzer can be used directly at rf to measure signal-to-noise ratio, and can also be used in zero span (as a receiver dc coupled to a display) to measure hum and low frequency related distortions.

The signal-to-noise ratio measuring technique described below will display the noise related to frequency. This aids tremendously in diagnosing noise problems since we can readily determine whether the noise has a pre-emphasis type characteristic centered about the picture carrier, which may indicate a microwave problem, or extends beyond the lower sideband limits indicating a high level parasitic problem.

#### Procedure for Measuring Noise, Hum, and Field Rate Distortion

1. Set up the spectrum analyzer at an rf test point or test dipole and tune in the picture carrier at 10 dB/div, 1 MHz/div, using a 300 kHz RESOLUTION. Reduce the input attenuator on the spectrum analyzer so that the picture carrier is within the top graticule blocks as shown in Figure 19.

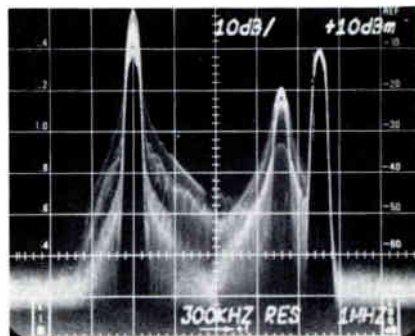

Figure 19. Spectrum Analyzer Display of TV Signal

2. Disable or immobilize any automatic gain circuits or closed loop connection systems.
3. Disconnect the transmitter input momentarily, and using the 300 Hz VIDEO FILTER and a slow sweep speed, a display similar to Figure 20 should be observed.

—CAUTION—

**MOST TRANSMITTERS CAN ONLY REMAIN IN A NO-SIGNAL CONDITION FOR A SHORT PERIOD OF TIME SO THIS PORTION OF THE TEST MUST BE PERFORMED RAPIDLY.**

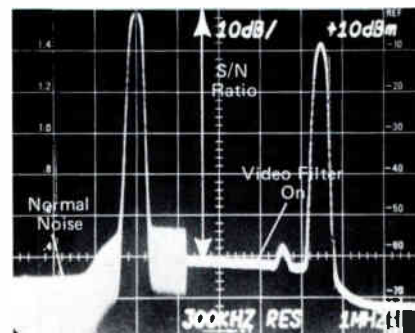

Figure 20. Display of Noise Measurement

4. Signal to noise ratio is calculated by measuring from the peak of the picture carrier (Figure 19) to the average noise floor (Figure 20). To obtain a ratio that can be correlated to video measurements, subtract a correction factor for bandwidth, modulation, sync, and log effects of the spectrum analyzer. The total correction factor is 13.2 dB.

$S/N \text{ 4.2 MHz} = S/N \text{ measured} - 13.2 \text{ dB correction factor}$

5. To measure hum and field rate distortion (tilt), tune the picture carrier at 3 MHz RESOLUTION, ZERO SPAN and fine tune for maximum upward deflection.
6. Using the VAR IF gain control, adjust until the picture sync tips are just touching the top graticule line. Then switch to LIN mode. You should have a display similar to Figure 21.
7. Both hum and field rate distortion are measured as a percentage of full screen as shown in Figure 21.

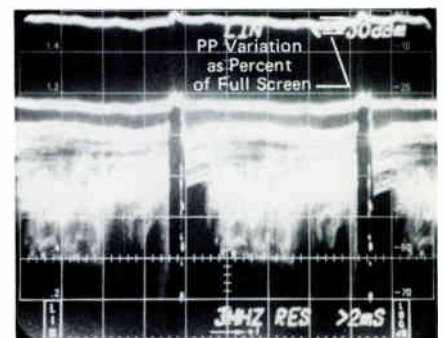

Figure 21. Linear Display of TV Waveform for Hum and Field Time Distortion Measurements

**NOTE:** Signal to noise and hum can be measured on any part of the transmitting chain from the studio through the stl and processing equipment.

## F. Harmonic and Intermodulation Distortions

While there are no actual standards set up for U.S., NTSC transmitters concerning harmonic (second) and intermodulation (second and third) distortions, many things can be learned about a transmitting system by performing some of these tests. Certain international organizations as well as the U.S. cable television rules recognize that distortions less than 36 to 46 dB down from the visual carrier can become visible in the TV picture. Related or coherent forms of distortion tend to cause only shadow or halo effects, or a slight loss of definition in the picture, while noncoherent sum and differences beats (such as sound-color difference) tend to cause bars or moiré type interference.

The two-tone test recommended below is easy to set up and interpret although there are many other variations possible such as three-tone, or multi-tone tests. Many different points in the studio transmitter chain can be checked to pinpoint problem areas. Baseband and microwave equipment can be checked by tuning the spectrum analyzer to zero. If modulated transmitters should be checked both at the if, then the rf test points.

Transmitters should also be checked for spurious products at the diplexer output and off-the-air. (These two tests are covered separately in Part IV Step C.)

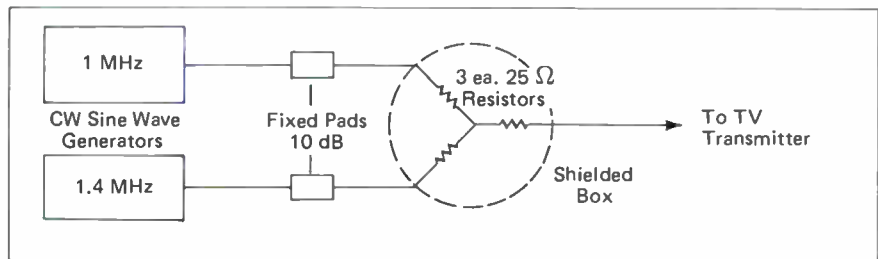

Figure 22. Combining Two CW Sine-wave Generators for Distortion Tests

### Procedure for Distortion Tests

1. Combine two cw sinewave generators (1 MHz and 1.4 MHz) through a resistive combiner as shown in Figure 22.
2. Use the spectrum analyzer, tuned to the baseband to verify the harmonics of the two generators and note these levels. Harmonics ideally should be down further than 50 dB.
3. Insert the test signals into the transmitter and set the level to indicate 80 to 90% on the modulation monitor. Resetting the transmitter bias to mid-range may be necessary before the transmitter will accept sine wave signals.
4. Note the second and third order components when the spectrum analyzer is tuned to the picture carrier (Figure 23). Different mod-

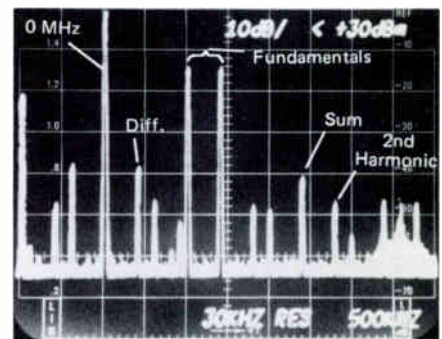

Figure 23. Distortion Measurements on the Spectrum Analyzer

ulation levels from 10 to 90% can be tested. Figure 24 shows all the components commonly generated in this test.

### —CAUTION—

**EXTRA CARE MUST BE EXERCISED TO KEEP THE TRANSMITTER WITHIN ITS OPERATING LIMITS DURING SINE-WAVE TESTING.**

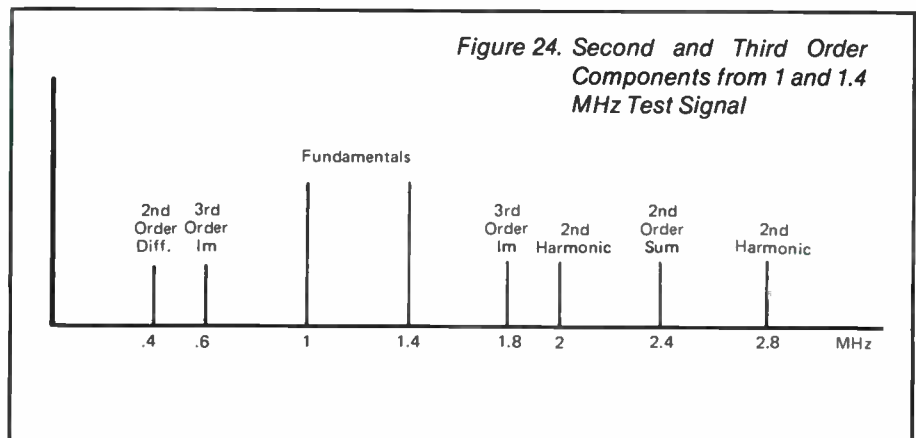

Figure 24. Second and Third Order Components from 1 and 1.4 MHz Test Signal

### G. Modulation Monitor Calibration

Accurate determination of modulation percentage is an important part of the transmitter engineer's duty. Traditionally, either the modulation envelope was monitored (requiring an oscilloscope with a bandwidth close to the transmitting frequency) or more typically, a chopper pulse is used with a diode detector or demodulator and waveform monitor.

The spectrum analyzer, in zero span, is an accurate receiver, DC coupled and calibrated in the LINEAR mode with the baseline representing the ZERO carrier reference point. No chopper pulse is required.

#### Procedure for Modulation Measurements

1. Connect the spectrum analyzer to an rf test point on the transmitter and tune the picture carrier at 3 MHz RESOLUTION, ZERO span. Fine tune for maximum upward deflection.
2. Use the VAR IF gain control to position the sync tips within the top graticule lines, then switch to the LIN mode. When the sync tips are adjusted with the VAR IF gain control to just touch the top graticule line, the picture 'white' should not fall within the bottom row of graticule squares. With this setup, the bottom graticule line is the zero carrier reference and 87.5% modulation (100 IRE) should appear as in Figure 25.

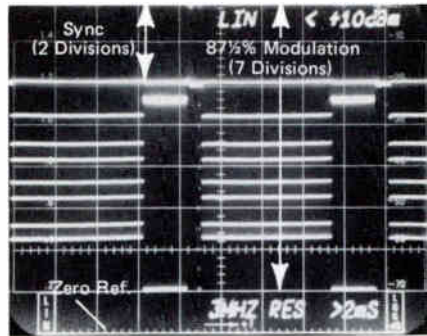

Figure 25. Modulation Adjustments Using the Spectrum Analyzer

## III. Aural

For many TV stations, the aural transmitter is just a black box sitting back in the corner receiving attention (perhaps a kick now and again) only when it quits working. The aural transmitter is capable of performance approaching that of a commercial fm service and should receive at least a minimum of attention.

All initial aural proof measurements are theoretically possible using spectrum analysis, however, most TV stations will not have the luxury of both an audio and an rf spectrum analyzer, so we will only cover those measurements possible with an rf analyzer such as the 7L12 or 7L13.

### A. Response Measurements

The TV transmitter uses a 75  $\mu$ s pre-emphasis curve as shown in Figure 27. Any deviations from this curve will appear as frequency response variations. The spectrum analyzer can be used as a modulation indicator for the 25, 50, 85, and 100% response tests and a gain set attenuator is used to accurately determine the deviations from the pre-emphasis curve.

The spectrum analyzer should be carefully calibrated. If available, use a signal generator modulated with 20 kHz to verify the accuracy of the narrower calibrated spans.

Modulate the aural transmitter with a 1,000 Hz tone through a 600 $\Omega$  step attenuator to indicate a carrier deviation horizontally of 50 kHz using the 300 kHz RESOLUTION BANDWIDTH as indicated in the LIN mode on the spectrum analyzer (Figure 26). The 1000 Hz point is the

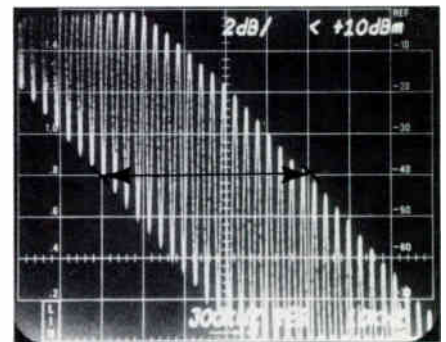

Figure 26. Measuring FM Deviation on the Spectrum Analyzer (5 divisions equals 50 kHz.)

zero reference on the step attenuator. Perform tests for the frequencies of 50, 100, 400, 1000, 5000, 5500, and 10,000 Hz, noting the deviation on the step attenuator from the zero reference established for the 1000 Hz tone. Deviations from the 75  $\mu$ s pre-emphasis curve (Figure 27) indicate frequency response variations. These tests can also be performed for 25% modulation, using 12.5 kHz deviation on the spectrum analyzer, 50% modulation (25 kHz), and 85% modulation (42.5 kHz).

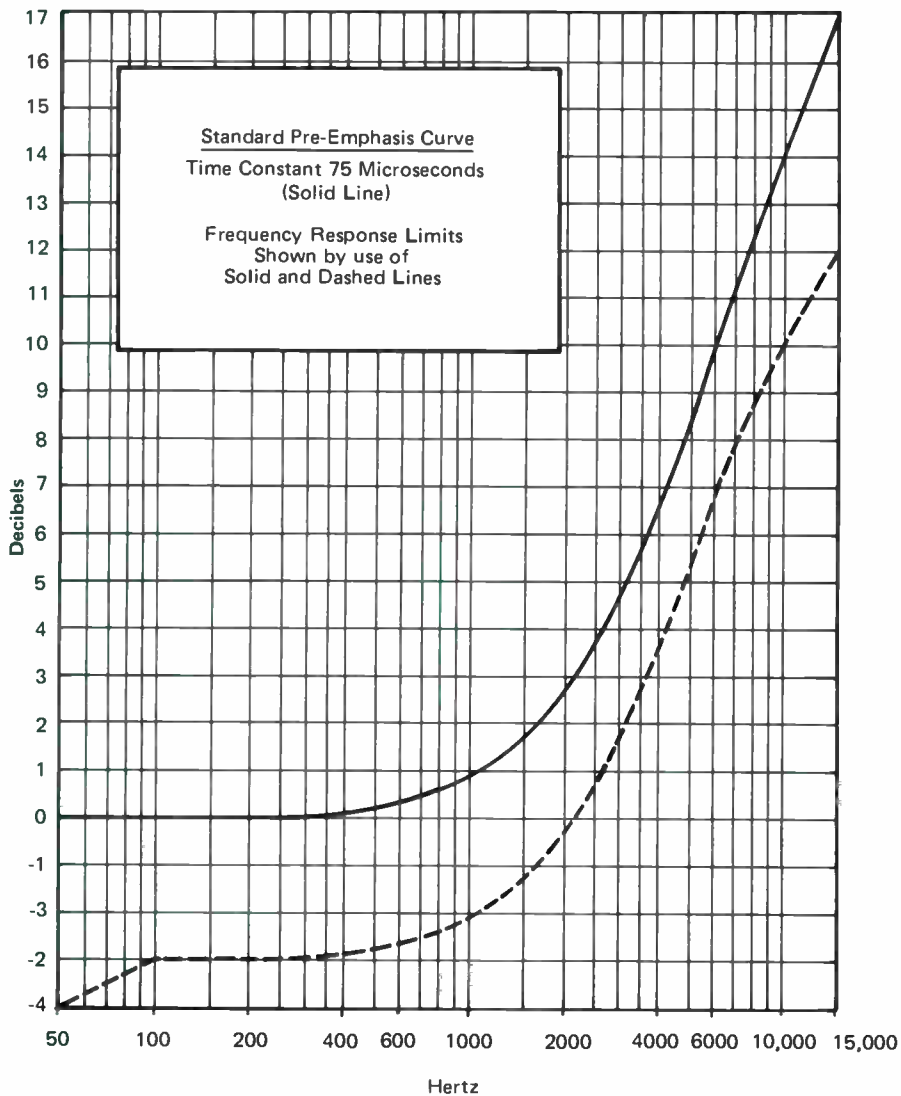

Figure 27. Standard 75  $\mu$ s Pre-Emphasis on the Spectrum Analyzer

### B. AM Noise

Am noise occurs in two manners in the fm transmitter. It can occur in the lower level stages and appear around the unmodulated carrier much as it occurs in the visual transmitter. It can also appear as an effect of improper tuning of the transmitter or antenna system.

Procedures for accurate tuning of the final stages of the transmitter are presented below, since this will determine the best am noise performance.

Check the residual am noise by tuning to the unmodulated AURAL carrier using 10 dB/div and a 3 kHz RESOLUTION. Using the 300 Hz VIDEO FILTER, note any humps in the noise floor around the carrier indicating noisy low level stages in the transmitter as shown in Figure 28.

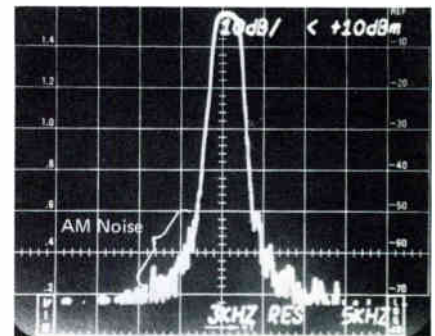

Figure 28. AM Noise on Aural Transmitter Due to Low Level Stages

Then modulate the transmitter to 100% using a low frequency of 50 or 60 Hz. Using the ZERO SPAN mode and 300 kHz RESOLUTION, note any modulation components on the carrier tip as shown in Figure 29. Amplitude modulation components can be minimized by tuning the final and any transmission line traps to be completely flat across the 30 kHz bandpass of the aural channel.

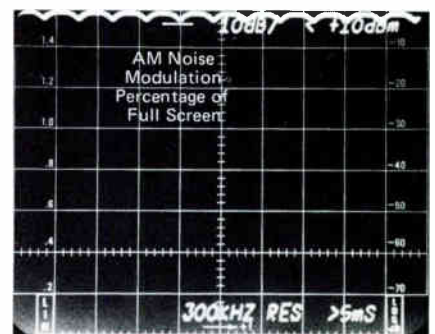

Figure 29. AM Noise on Aural Transmitter from Improper Tuning

### C. FM Noise

Fm noise is simply a measure of the residual fm noise remaining with no modulation present. Due to the pre-emphasis curve employed with fm transmission, the lower frequency noise will have the greatest effect upon reception.

Fm noise is measured with no modulation on the transmitter, by using the spectrum analyzer in a narrow RESOLUTION and SPAN and noting any horizontal (frequency) jitter of the fm as shown in Figure 30. This jitter, if detected can be related as a percentage of the 100% modulation limit of the aural transmitter.

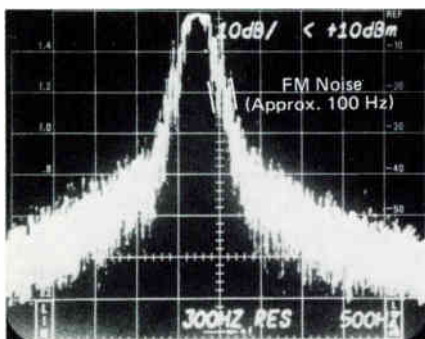

Figure 30. FM Noise on Aural Transmitter

### D. Modulation Monitor Calibration

Two techniques can be employed using the spectrum analyzer, to verify the calibration of the aural modulation monitor.

The Bessel Null technique is the most accurate, wherein a specific frequency (10.396 kHz for 25 kHz deviation) will cause a distinctive and undisputable null at 100% modulation. (Figure 31). The 1405 TV Sideband Adapter contains a convenient crystal-derived source for calibrating the 100% modulation point.

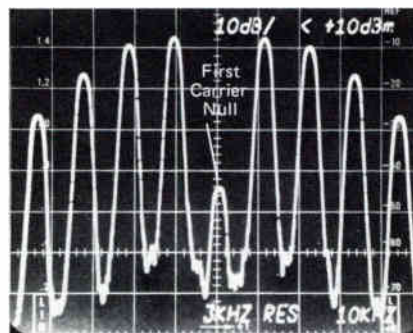

Figure 31. Bessel Null Technique of Determining 100% Modulation

An alternate technique described in the response measurement section (III A) uses the calibrated SPAN/DIV function of the spectrum analyzer to verify any modulation percentage desired. This can also be a very accurate technique.

## IV. Combined

Many parameters can change significantly when the aural and visual transmitters are combined in the diplexer. Tests should be performed both at a test point after the diplexer, and off-the-air to verify the condition of the signals as actually received by the customer.

Sideband analysis, as was discussed, can be performed with a test dipole. Because of the narrow bandwidth, the spectrum analyzer will display the sideband response while the sound carrier is present. Other parameters such as power ratios, field strength, and spurious responses should also be checked off-the-air to insure the best pictures possible, and compliance with the FCC standards.

Off-the-air tests are best performed with some form of a calibrated dipole of known performance. These can be purchased commercially or you may wish to construct one as shown in Figure 33.

### A. Effective Power Ratios

The FCC states that the effective power ratio of the sound carrier shall be -10 to -20% (-7 to -10 dB) of the visual carrier [§73.682(a15)]. This can be easily verified with a dipole and gives good advance warnings of deterioration of the vsb filters, diplexers, or antenna and feedline if problems are beginning to occur.

Set up the spectrum analyzer in the field, and using a test dipole with flat response across the channel, check the ratio between the picture and sound carriers. (Figure 32)



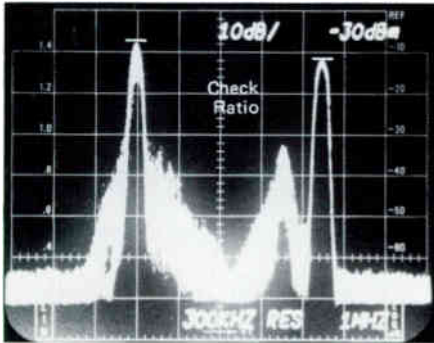

Figure 32. Checking the Picture-to-Sound Ratio

**B. Pattern**

The pattern of a station can be verified by using the test dipole and the conversion chart to  $\mu V/meter$  shown in Figures 33-35. While accuracy can be quite high, we do not recommend that you use this technique for absolute measurements for licensing unless other calibration steps are taken.

The dipole can be constructed with standard 300  $\Omega$  twin line (flat line) to the lengths shown. The 300 to 75  $\Omega$  balun is available through most CATV supply houses. For maximum sensitivity a preamplifier should be used. The TEKTRONIX 7K11 or AM 511 are both available and match the 75  $\Omega$  antenna impedance. To insure maximum accuracy and minimize reflections, it is recommended that a 10 dB pad be used between the dipole and the amplifier input.

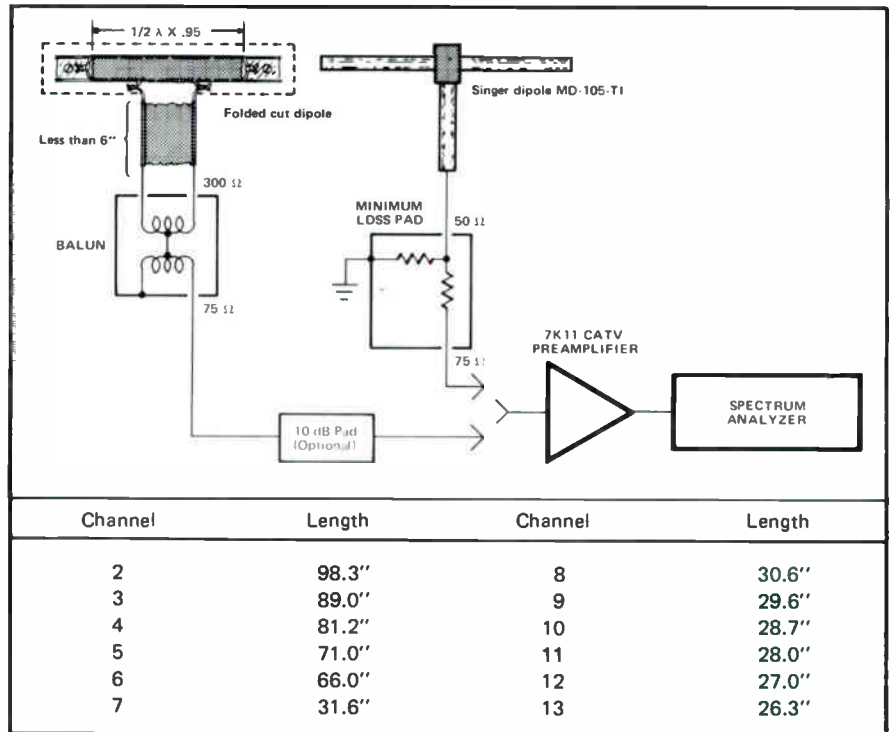

Figure 33. Constructing a Test Dipole

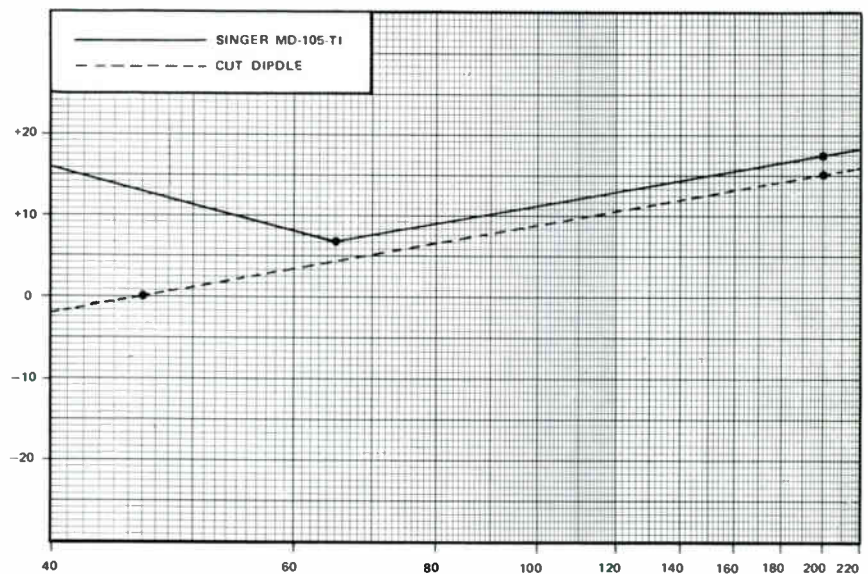

Figure 34. Correction Factors for Test Dipole

CONVERSION TABLE dBmV – Microvolt/m									
Reference Level: 0 dBmV = 1 millivolt/m									
dBmV	$\mu\text{v/m}$	dBmV	$\mu\text{v/m}$	dBmV	$\mu\text{v/m}$	dBmV	$\mu\text{v/m}$	dBmV	$\mu\text{v/m}$
-40	10.00	-20	100.0	0	1 000	21	11 220	41	112 200
-39	11.22	-19	112.2	1	1 122	22	12 590	42	125 900
-38	12.59	-18	125.9	2	1 259	23	14 130	43	141 300
-37	14.13	-17	141.3	3	1 413	24	15 850	44	158 500
-36	15.85	-16	158.5	4	1 585	25	17 780	45	177 800
-35	17.78	-15	177.8	5	1 778	26	19 950	46	199 500
-34	19.95	-14	199.5	6	1 995	27	22 390	47	223 900
-33	22.39	-13	223.9	7	2 239	28	25 120	48	251 200
-32	25.12	-12	251.2	8	2 512	29	28 180	49	281 800
-31	28.18	-11	281.8	9	2 818	30	31 620	50	316 200
-30	31.62	-10	316.2	10	3 162	31	35 480	51	354 800
-29	35.48	-9	354.8	11	3 548	32	39 810	52	398 100
-28	39.81	-8	398.1	12	3 981	33	44 670	53	446 700
-27	44.67	-7	446.7	13	4 467	34	50 120	54	501 200
-26	50.12	-6	501.2	14	5 012	35	56 230	55	562 300
-25	56.23	-5	562.3	15	5 623	36	63 100	56	631 000
-24	63.10	-4	631.0	16	6 310	37	70 790	57	707 900
-23	70.79	-3	707.9	17	7 079	38	79 430	58	794 300
-22	79.43	-2	794.3	18	7 943	39	89 130	59	891 300
-21	89.13	-1	891.3	19	8 913	40	100 000	60	1 000 000
				20	10 000				

Figure 35. Conversion from dBmV to mV/Meter

To measure field strengths with the 7L12/7K11 or similar combination, take readings in the field with the spectrum analyzer, orienting the dipole for maximum output. Measure the carrier power in dBmV, add the correction factor for the channel being measured (Figure 34), add the 10 dB pad value if used, then convert to  $\mu\text{V}/\text{meter}$  using the chart (Figure 35).

### C. Spurious Signals

Spurious signals can either originate within the transmitter, or at the antenna. The most logical place to begin testing for spurious signals is at some distance (one mile or more) from the transmitter using a test dipole. Then, if problems are noted, the interfering signal can be traced back through the transmitting chain and pinpointed.

The technique described will get you started, however, the subject of spurious cures is beyond the scope of this short paper.

Using the spectrum analyzer and a test dipole at a distance from the transmitter, note any in-channel spurious carriers. (Figure 36). There should not be any continuous carriers other than the picture, sound, and color subcarriers. If extra spurious signals are noted, momentarily remove aural and visual carriers to pinpoint whether the problem is internal or off-the-air.

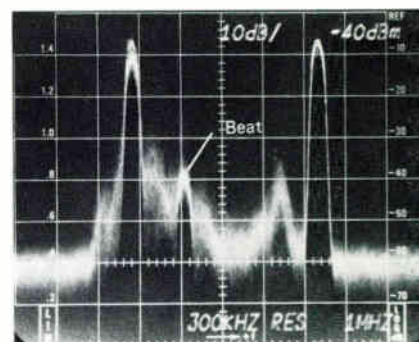

Figure 36. Beats within the Channel

Increase the measuring span to include other local stations, then alternately remove and restore power noting any carrier other than your own channel that may appear as sum and difference beats Figure 37.

Finally, test the harmonics of the picture and sound transmitters Figure 38.

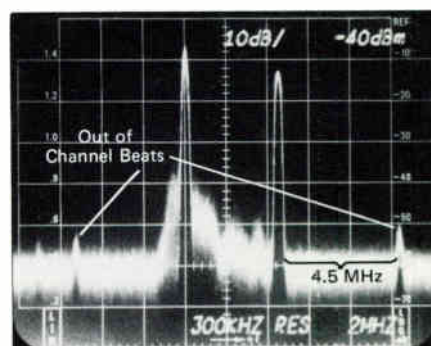

Figure 37. Out-of-Channel Sum and Difference Beats

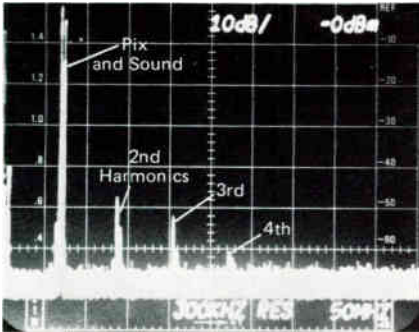

Figure 38. Harmonics of TV Transmitter

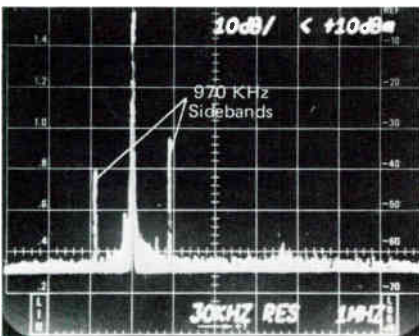

Figure 39. Beats Noted on Carrier Due to Local Broadcast Station

#### D. Antenna, Filter, and Coupler Evaluation

Components of the transmitter system must sometimes be tested out-of-service or disconnected to isolate problems or verify performance. If a signal source such as a sweep or cw generator is available, the performance of most filters, transmission lines, and couplers can be checked. The spectrum analyzer is used in the storage mode (or with a camera if storage is not available) to check the response and insertion loss. With the addition of a bridge, return loss (match) and tuning can also be checked on single port devices such as the transmitter output, or the antenna and feed line. (Figure 40). The inverse of the return loss display of an antenna gives the tuning characteristic. (Figure 41).

—CAUTION—

**DO NOT ATTEMPT ANY MEASUREMENTS WITH THE TRANSMITTER ENERGIZED AS THIS CAN RESULT IN DAMAGE TO THE SPECTRUM ANALYZER. ANTENNA MEASUREMENTS SHOULD BE ATTEMPTED WITH CAUTION IN AREAS WHERE OTHER FM OR TV ANTENNAS ARE LOCATED SINCE THE INDUCED VOLTAGES CAN BE QUITE HIGH.**

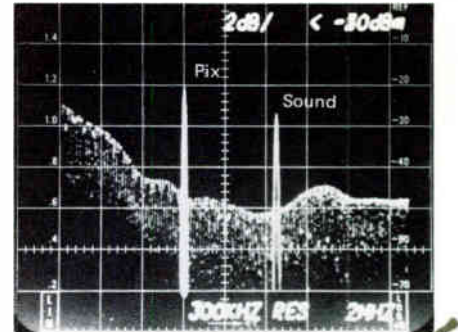

Figure 41. Return Loss (Match) of a TV Antenna

#### V. Miscellaneous Tests

The television engineer is responsible for many other areas besides the transmitter. On the pure engineering end, he may be asked to evaluate new components or design a new system, and day to day, he may have to repair a microwave link or a balky vtr. The spectrum analyzer has many capabilities not already covered, around the studio, and on the microwave and telemetry systems. While it is beyond the scope of this paper to cover these applications in detail, we encourage you to experiment. Look at baseband signals with the spectrum analyzer and sweep VDAs, PDAs, switchers, and other baseband devices with the 1405 Sideband Analyzer. Don't be afraid to stick a probe on the spectrum analyzer and attack the inside of a dead box. You might find the spectrum analyzer is the most valuable test instrument on your bench.

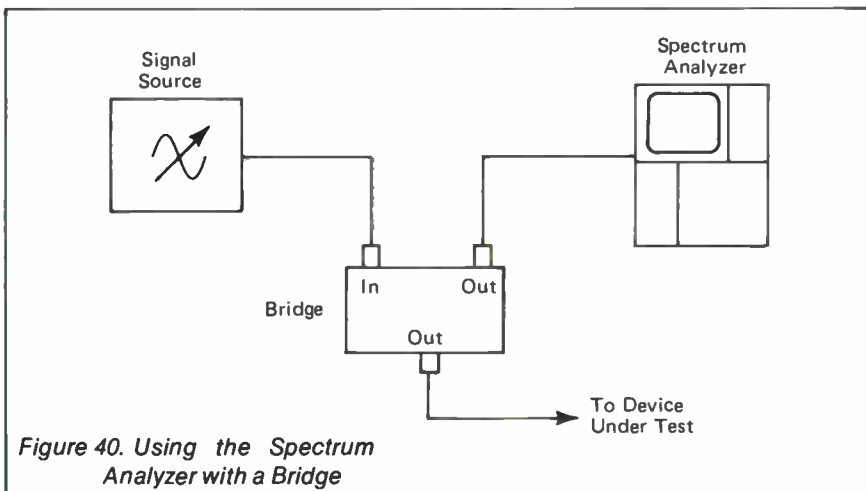



Figure 40. Using the Spectrum Analyzer with a Bridge



Copyright © 1976, Tektronix, Inc. All rights reserved. Printed in U.S.A. Foreign and U.S.A. Products of Tektronix, Inc. are covered by Foreign and U.S.A. Patents and/or Patents Pending. Information in this publication supersedes all previously published material. Specification and price change privileges reserved. TEKTRONIX, TEK, SCOPE-MOBILE, TELEQUIPMENT, and  are registered trademarks of Tektronix, Inc. P. O. Box 500, Beaverton, Oregon 97077, Phone: (Area Code 503) 644-0161, TWX: 910-467-8708, Cable: TEKTRONIX. Overseas Distributors in over 50 Countries.