

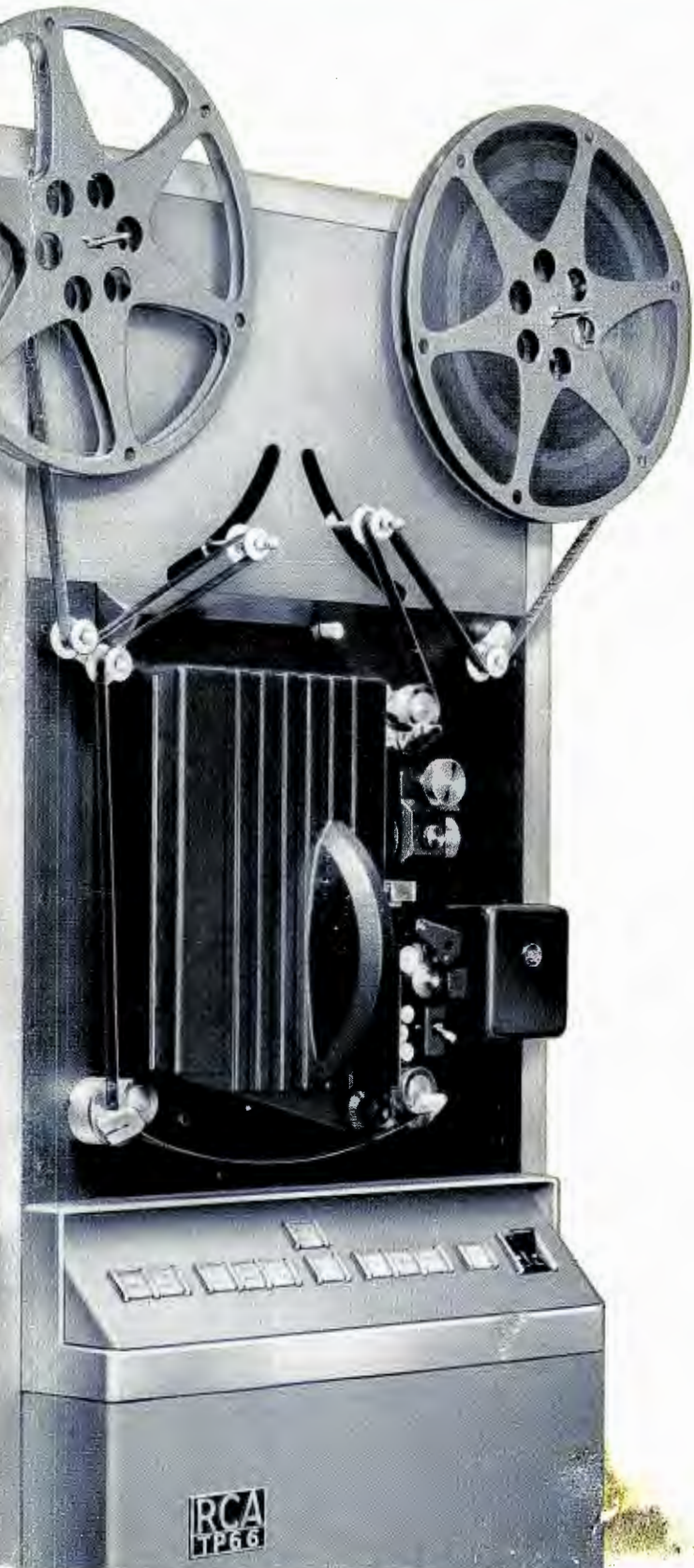

FILM CAMERAS • PROJECTORS • MULTIPLEXERS • ACCESSORIES



TELEVISION  
**film**  
EQUIPMENT





# TELEVISION FILM EQUIPMENT CATALOG

Fifth Edition, Price \$1.00



**THE MOST TRUSTED NAME IN TELEVISION**

## ABOUT THIS CATALOG

This catalog provides information on RCA Television Film Equipment. Other RCA Broadcast Equipment Catalogs supply information on TV camera, TV tape, Terminal and Switching, and Audio equipment; also on AM, FM, VHF, and UHF TV transmitters, antennas, and transmission line.

The information contained in this catalog is intended to serve as a buying guide for the user. Complete specifications and ordering information are supplied. Readers who desire more information or individual bulletins on particular equipment items are invited to write to their RCA Broadcast Representative.

## OTHER RCA TECHNICAL PRODUCTS

RCA also manufactures many other electronic products, including: two-way radio and microwave relay communications equipment; optical and magnetic film recording equipment; sound systems of all types; 16mm projectors and magnetic recorders; industrial inspection and automation equipment; scientific instruments, such as the electron microscope; closed-circuit television systems; and many types of custom-built equipment for industry, the military, educational and medical services. Information describing these products may be obtained from RCA Sales Offices in the United States and Canada or internationally from local RCA Distributors or RCA International Division.

## PRICES

Domestic prices of the equipment shown in this catalog are provided in a separate price list. Equipments are identified by type and MI (Master Item) numbers which are used to identify apparatus on invoices and packing slips. International prices for the various equipment items shown in this catalog are available from RCA Distributors or RCA International Division.

## HOW TO ORDER

The RCA Television Film Equipment shown in this catalog is sold through RCA Broadcast Representatives, who are familiar with broadcast equipment and related problems. These RCA Representatives are located in convenient offices (shown on back cover). Domestic orders for equipment, or requests for additional information, should be directed to the nearest RCA Sales Office. International Readers are invited to contact their local RCA Distributor or the RCA International Division Office.

	Page
<b>TK-22 All Transistor Vidicon Film Camera</b>	<b>5</b>
<b>TK-27 Transistorized Color Film Camera</b>	<b>13</b>
<b>TP-66 16mm TV Film Projector</b>	<b>21</b>
<b>TP-7B TV Slide Projector</b>	<b>29</b>
<b>Light Control Units</b>	<b>33</b>
<b>Projector Control Panels</b>	<b>35</b>
<b>Interlock Motor Drive Kit</b>	<b>38</b>
<b>Unilock</b>	<b>39</b>
<b>TP-15A Universal Multiplexer</b>	<b>43</b>
<b>TP-11D Monochrome Multiplexer</b>	<b>47</b>
<b>TV Film Accessory Equipment</b>	<b>49</b>
<b>TFR-1 Television Film Recorder</b>	<b>53</b>
<b>Index</b>	<b>61</b>





## All-Transistor Vidicon Film Camera, Type TK-22

- Plug-in modular circuits
- Electrostatically focused 1½-inch vidicon
- Only two operating controls
- Built-in test pulses
- Savings in power and space





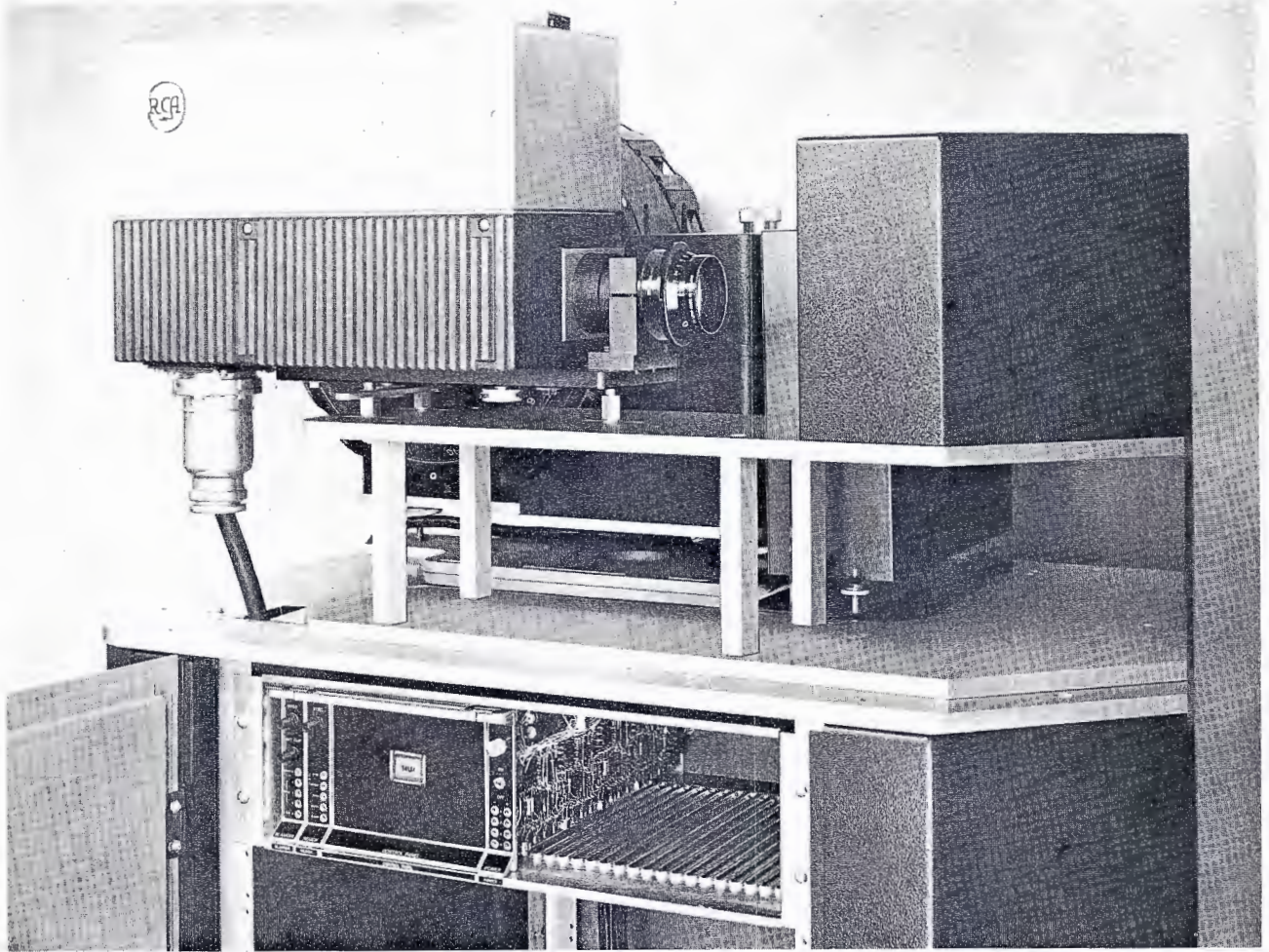

**MATCHES ALL RCA FILM SYSTEMS—COLOR AND MONOCHROME . . .** The TK-22 Vidicon Film Camera complements all RCA TV film systems, and, as shown, is easily mounted on the TP-15 Multiplexer (above) and TP-11 Multiplexer (below). Local indicator panel is shown with modules in rack below camera.

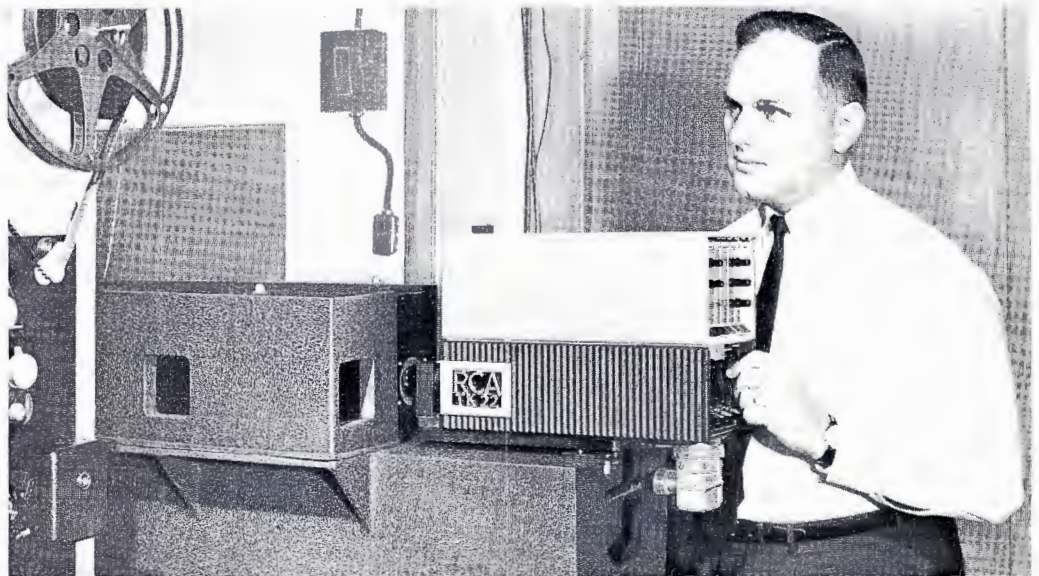



## Analysis: Vidicon Film Camera, Type TK-22

The RCA all-transistor vidicon film camera, TK-22, introduces a new excellence in TV film picture quality and stability. It incorporates important technical advances and operational features to meet the demands of fast paced film and slide programming.

Higher resolution, increased signal-to-noise ratio and utmost picture stability result in exceptionally crisp monochrome pictures. Resolution is 800 lines without aperture correction. Low heat dissipation and technical improvements provide

a camera that requires no day-to-day adjustments nor extensive warm-up before camera is "on air."

Optical sound is standard, but magnetic sound is readily installed as an accessory. A new camera mount permits removal and replacement of the TK-22 on multiplexers without need for any mechanical alignment adjustments. Panels for remote operation are available. Compatible and compact, the TK-22 provides a degree of automatic operation heretofore unknown.

### Description

#### Higher Quality Pictures

A newly designed pickup tube—a larger 1½-inch-diameter vidicon—provides a 50% increase in image size. Picture resolution is boosted to 800 lines—an excellent measure of picture quality . . . a figure obtained without aperture correction. Aperture response is 60% at 400 lines. This means pictures that are extra sharp over the entire film scene.

#### Transistor Reliability

Semiconductors are used throughout, the only tube being the vidicon itself. Transistors provide a degree of reliability never before achieved. Maintenance is reduced. Circuits are stable and free from microphonics. Heat generated is virtually negligible, and power consumption is reduced to new lows.

#### Ultra Stable Performance

Everything in the design of the TK-22 contributes to reduced heat. This is a big factor in the exceptional stability of the camera. Drift caused by temperature variations is virtually eliminated because there is no heat-producing focus coil for the vidicon. Cathode heater power for the tube itself is only 0.6 watt. Extensive use of feed-back techniques provides added stability.

#### Simplified Control

There are only two primary operating controls for the system—sensitivity and black level. And they are independent; adjustment of one has no effect on the other. Illuminated pushbutton switches provide selection of the following: automatic or manual control of sensitivity, video gain and black level; positive or negative film polarity; test pulse on or off.

#### Automatic Operation

The TK-22 features an advanced form of automatic sensitivity control. It is achieved by varying electrode voltages on the vidicon in accordance with a video sensing signal while maintaining a fixed voltage on the target. A control is provided to limit the range of operation during fades to black and to prevent an abnormal increase in sensitivity when no image is projected on the face of the vidicon.

The blackest portion of the video signal is automatically held at a predetermined level established by the setting of the black-level control on the control panel. An automatic white-level control maintains video at a constant peak-to-peak amplitude regardless of variations in the contrast range of film or slides. This combination of ASC, ABL and AWL

provides a degree of automatic operation heretofore unknown.

#### World-Wide Standards

The TK-22 operates on voltages in the ranges of 90 to 130 volts AC, or 180 to 260 volts AC, at line frequencies of 47 to 63 cps. The camera can be operated at 525-line/60 field, or 625-line/50 field scanning standards.

#### Compatible with Other Systems

The TK-22 is compatible with existing RCA systems for both color and monochrome. For the ultimate in film performance, use it with the TP-66 film projectors and TP-15A or TP-11D multiplexer systems.

#### Ease of Installation

A new precision mounting arrangement permits removal and replacement of the camera head without need for mechanical alignment adjustments. Interconnection of units is extremely simple, requiring only a minimum of external wiring.

#### Savings in Power and Space

The power required for the entire camera chain, less monitor, is only 50 watts . . . less than 10 percent of the power requirement of previous film systems. The 5¼-inch depth of the rack-mounted modules amounts to more than a 90 percent reduction in rack space.

# Special Vidicon—Heart of TK-22 Performance

The new vidicon is the RCA-8480, 1½-inch tube developed especially for transistorized circuits. It is electrostatically focused. This eliminates the focus coil normally needed and greatly reduces power requirements. Heater-cathode power of only 0.6 watt further contributes to cool operation and unusually high stability.

Less aperture correction is required with this high resolution tube resulting in extremely high signal-to-noise ratio. The mesh of the tube is separated from the wall electrode. Applying proper potentials to these elements forms a collimating lens causing the electron beam to approach the target perpendicularly. The field of focus of the TK-22 is extremely flat.

## Design Extras

### Camera Control Panels

A local control panel may be mounted in the rack-mounting frame as part of the camera auxiliary when unattended operation is contemplated. If the camera is to be operated from a remote control position, a Remote Control Panel is mounted at the video control console, and an indicator panel replaces the Local Control Panel in the camera auxiliary.

### Compensation for Cable Lengths

Circuits in the camera head automatically advance horizontal pulses to compensate for cable delay, assuring accurate timing regardless of length. In another self-operating circuit, d-c supply voltages are sensed at the camera and the voltage is automatically corrected to compensate for voltage drop in the camera cable.

### Simplified Pulse System

Interconnection of the camera, auxiliary unit and remote control is extremely simple. The TK-22 requires system sync and blanking inputs only. H and V drive pulses are generated within the camera.

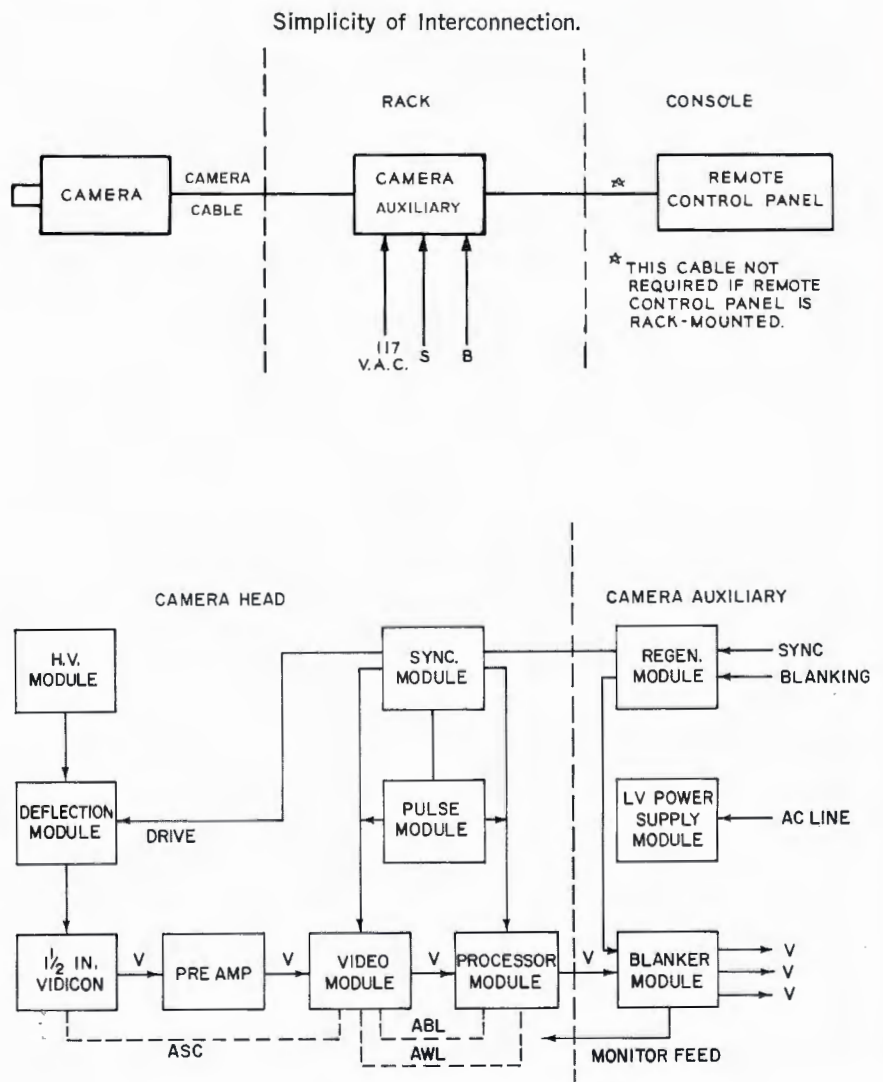



# Bonus Features

Sturdy, Compact, Dust-Free Camera—No Blower Required

Horizontal and Vertical Drive Generated in Camera

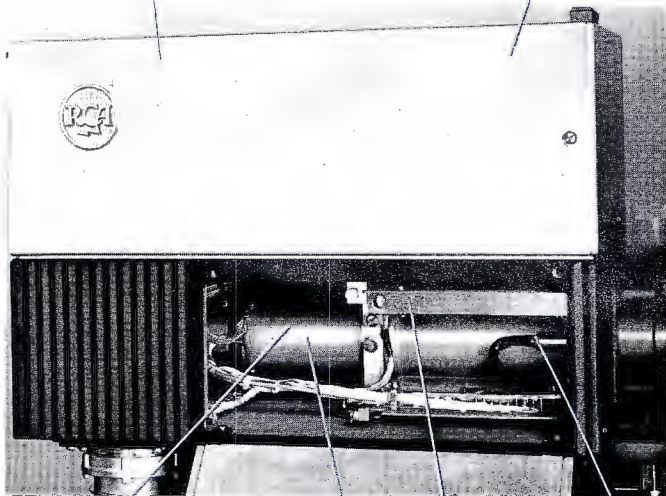

Electrostatic Focus & Magnetic Deflection Vidicon—Only Tube Used in Camera

Self-Aligning Vidicon Tube Mount

High Signal-to-Noise Vidicon Input Amplifier

Preamplifier

Test Points Throughout Equipment

Low Power Vidicon Heater

Utmost Accessibility To All Components and Circuits

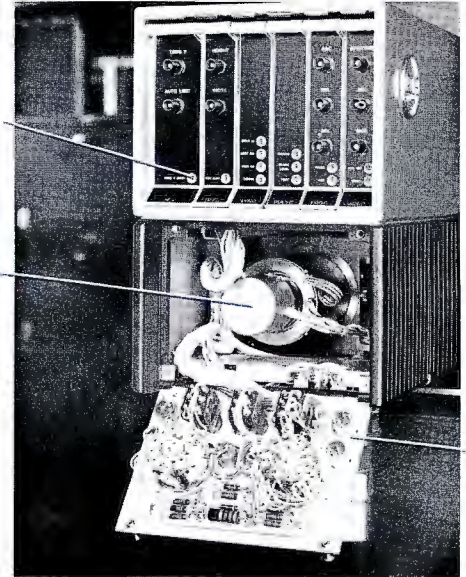

Modular Plug-Ins Throughout—No Matching of Components Required

Monitor Feed and Choice of Four Signal Feeds

Variable Amplitude Aperture Correction

Gamma Control 0.5, 0.7 and 1.0. For Negative Film, 1.2 gamma is automatically provided.

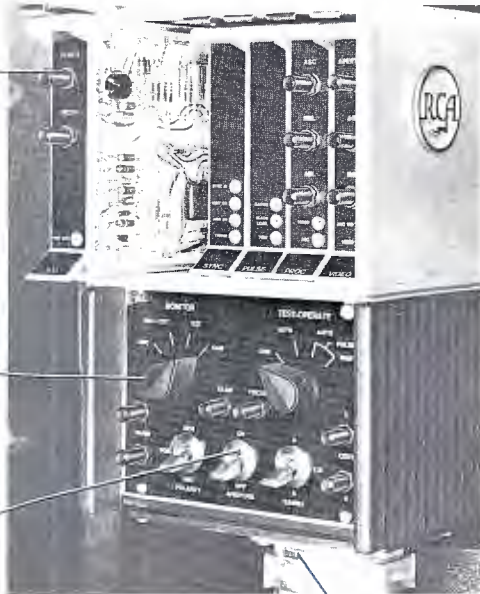

Module Extenders Available for Test

Automatic Functions Switched On and Off Independently

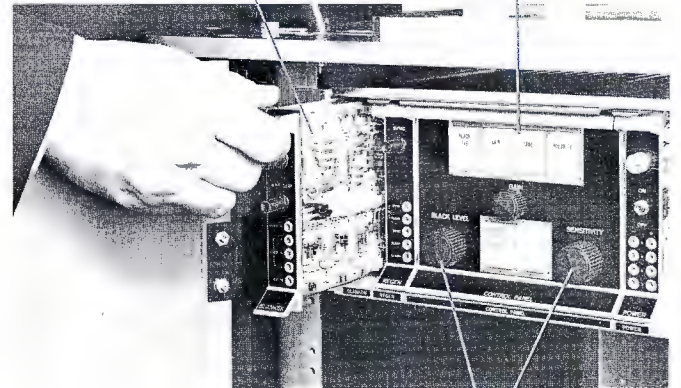

System Power Consumption Less Than 50 Watts

Only Two Operating Controls—may be located at Camera Auxiliary as shown or at Remote Position



# TK-22 Module and Panel . . . Description of Functions

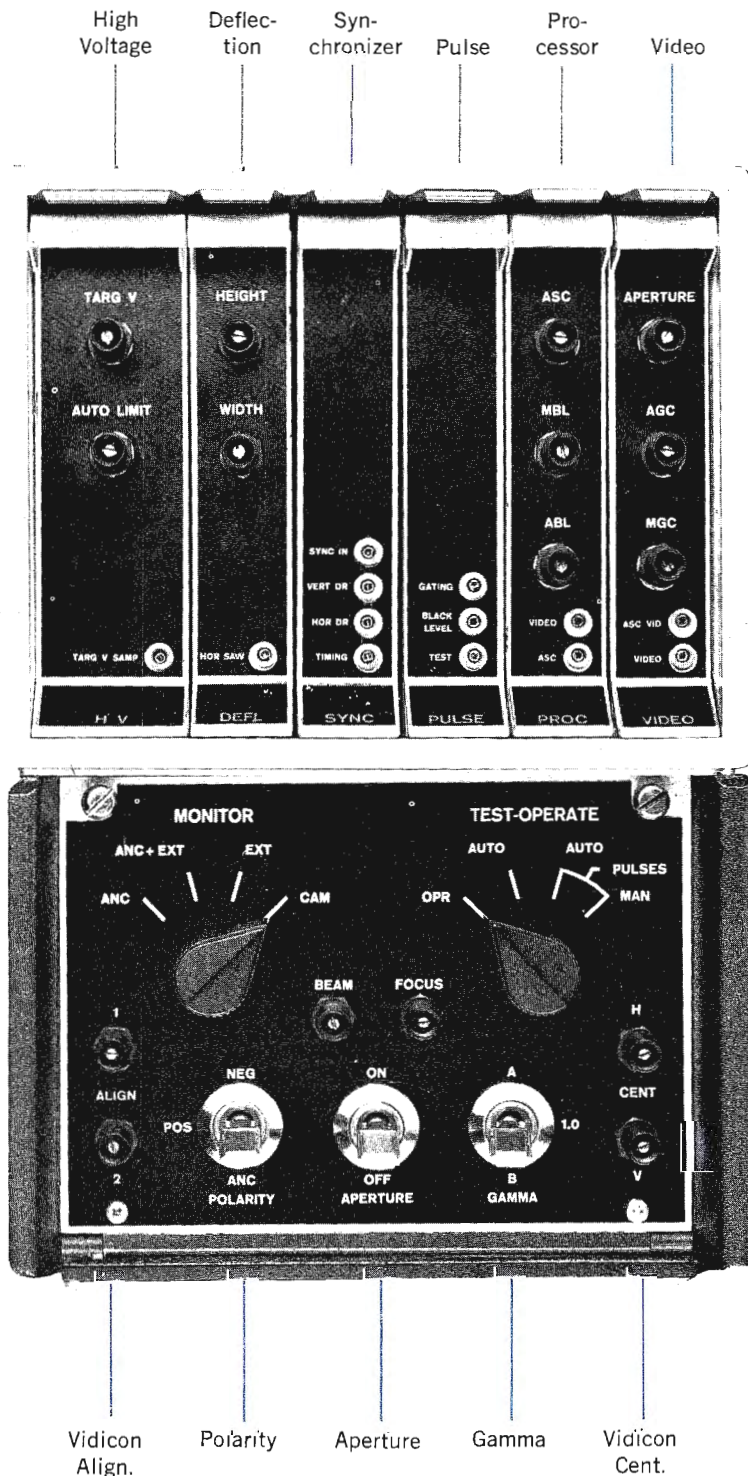

**HIGH VOLTAGE**—Contains circuitry for generation of high voltage, DC filament voltage for the vidicon and a reference voltage to operate transistor decouplers, in other modules. Vidicon blanking and target voltage ranges are set in this module.

**DEFLECTION**—Provides horizontal and vertical deflection signals. Also provides vidicon protection in case of scan failure.

**SYNCHRONIZER**—Takes sync fed to camera head and horizontal drive stop pulse from the pulse module, and generates and distributes vertical gating, vertical drive, timing pulse and horizontal drive. Contains circuitry for automatic time delay compensation and also clips and amplifies sync for use in other modules.

**PULSE**—Generates black level pulse, horizontal drive stop pulse and gating pulses. Also generates test pulses for use in set-up of the camera.

**PROCESSOR**—Clamps the video signal and inserts gamma correction. Contains circuitry for manual and automatic black and automatic sensitivity functions.

**VIDEO**—Amplifies video signal received from the preamplifier and provides aperture compensation.

## Camera

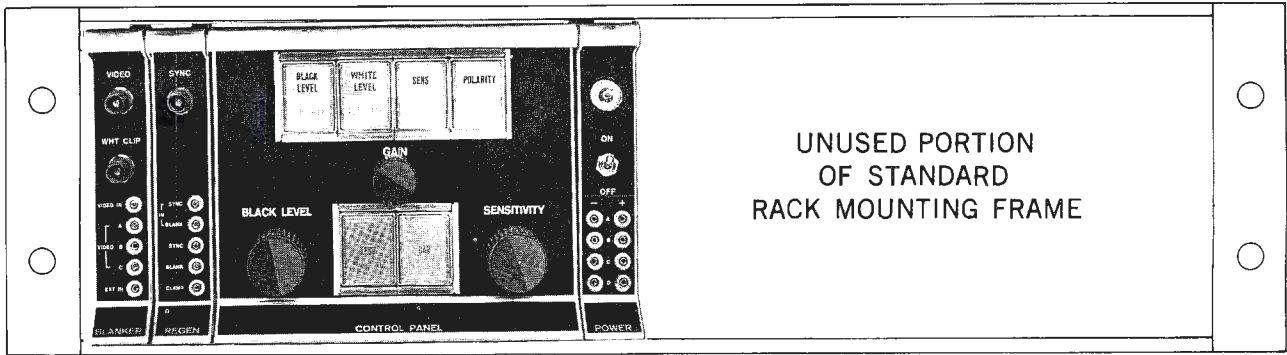

UNUSED PORTION  
OF STANDARD  
RACK MOUNTING FRAME

**COMPACT AND ECONOMICAL . . .** The 5¼-inch depth of the rack mounted modules reduces space requirements by more than 90%. System power consumption is only 50 watts.

### Auxiliary

**BUILT-IN TEST PULSES**—provide a quick check of camera performance and simplifies set up.

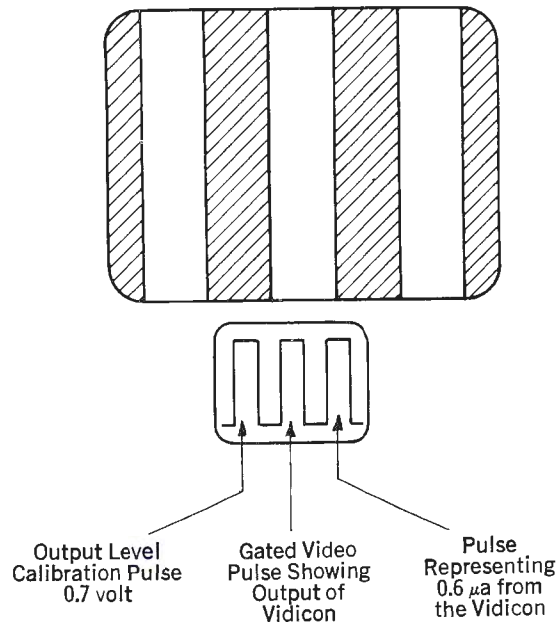

**BLANKER**—Adds final blanking to the video signal. Contains a multiple video output line driver with sending end termination and has switchable sync addition to the output video signals. Also contains a single line driver with sending end termination which can be remotely switched to the line. An external signal coming from a loop-through input or a combination of the line and the external signal.

**REGENERATOR**—Regenerates sync, blanking and clamp pulses. Contains circuitry for horizontal drive advance to compensate for camera cable delays.

**POWER**—Supplies four separate 12.5 volt feeds: two for auxiliary, and two for camera head. Remote sensing of voltage at camera is provided to compensate automatically for voltage drop in camera cable. Outputs short-circuit protected to prevent damage to components.

Remote Control Panels for the TK-22 Vidicon Film Camera. At left, MI-557202 panel to fit 13-inch console housing; at right, MI-557203 remote control panel to fit new 20-inch consoles.

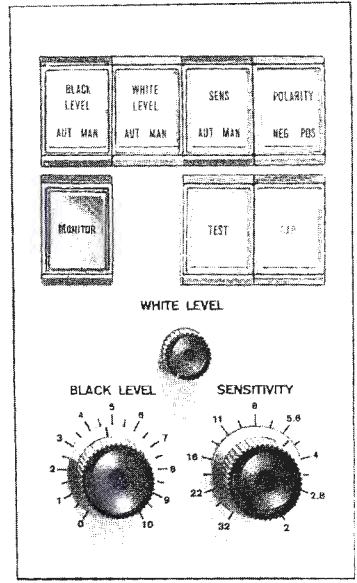
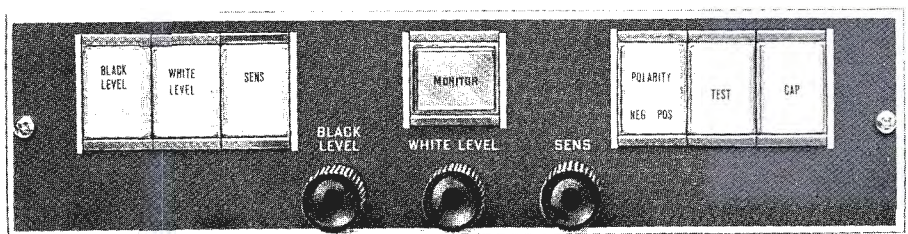

# Specifications

## General

Type of Reproduction.....Monochrome  
 Number of Scanning Lines.....525 or 625  
 Field Repetition Rate.....60 or 50 cps  
 Line Repetition Rate.....15,750 or 15,625/sec.  
 Vidicon.....1¼" electrostatic focus,  
 electromagnetic deflection, type 8480

## Picture Quality

Limiting Horizontal Resolution.....800 TV lines minimum at  
 center, 700 lines minimum in corners  
 Signal-to-Noise Ratio.....Nominal, 46 db peak-to-peak  
 signal/rms noise for bandwidth of 4.5 mc  
 Overall Frequency Response.....±0.5 db to 8 mc,  
 down not more than 3 db at 10 mc  
 Gray Scale.....Reproduces 10 shades of gray from a  
 log-linear gray scale having density range of 1.3  
 Total Raster Distortion.....Within ±1% of picture height

## Operational

Gamma Correction.....Switchable to three preset values:  
 0.5, 0.7 and 1.0 also 1.2 for negative film operation  
 Aperture Correction.....Amplitude continuously adjustable  
 from 0 to 12 db boost at 5.5 mc, no phase distortion

## Electrical

Input Signals:  
 Sync.....2-8 volts, p/p negative  
 Blanking.....2-8 volts, p/p negative  
 Input Impedance.....Bridging  
 Output Signals.....3 video outputs, plus monitor  
 feed, either 1.0 volt p/p composite, or 0.7 volt p/p non-  
 composite, switchable in pairs  
 Output Impedance.....75 ohms, sending end terminated  
 Power Input  
 (Camera & Auxiliary, excluding monitors):  
 Line Voltage.....90-130 volts, or 180-260 volts  
 Line Frequency.....47-63 cps  
 Power Consumption.....50 watts  
 Environmental:  
 Temperature.....-20°C to +55°C  
 Relative Humidity.....Up to 95%

## Mechanical

### Overall Dimensions

	Width	Height	Depth	Weight
Camera Head.....	6¾"	9⅞"	16"	25 lbs
	17.1 cm	24.5 cm	40 cm	11.3 kg
Camera Auxiliary .....	8½"	5¼"	18⅜"	20 lbs
	21.2 cm	13.1 cm	45.7 cm	9 kg
Camera Control Panel.....	11⅛"	2⅝"		2 lbs
	27.5 cm	6.5 cm		.9 kg

# Accessories

Camera Lens for use with TP-11 Multiplexer.....MI-43202-1  
 Camera Lens for use with TP-15 Multiplexer.....MI-43202-2  
 Mounting Adaptor for TP-11 to TP-11C  
 Multiplexers (not needed for TP-11D).....MI-40128  
 Mounting Adaptor for TP-15 Multiplexer (not  
 needed for TP-15A Multiplexer using MI-40130  
 optical assembly) .....MI-40129

Field Lens for TP-11 Multiplexer.....MI-26810-2  
 Field Lens for TP-15 Multiplexer.....MI-40859-6  
 Terminal Extracting Tool.....MI-43226  
 Module Extender .....MI-557301  
 Module Extender (for Preamplifier).....MI-557304  
 Camera Alignment Jig.....MI-40445

TK-22 Camera Head.....MI-557201-B1  
 Type 8480 Vidicon Tube.....MI-557205  
 Camera Auxiliary Equipment.....MI-557200-B1  
 Including the following:  
 Rack Mounting Frame  
 Harness Assembly  
 Regenerator Module  
 Blanker Module  
 Power Supply Module  
 Camera Cable, 50 ft. with connectors.....MI-26725-E5  
 Control Panels:  
 Remote Control Panel (for 13" console).....MI-557202-B1  
 Console Well Adaptor (for MI-557202-B1).....MI-26212  
 Remote Control Panel (for new 20" console).....MI-557203-A1  
 Mounting Frame (for MI-557203-A1).....MI-557306  
 Local Indicator Panel.....MI-557796-B1  
 Local Control Panel.....MI-557797-B1

# Ordering Information

*TK-22 Film Camera Chain, less master monitor.*



## Transistorized Color Film Camera, Type TK-27

- Completely transistorized for superior performance, economy, dependability
- Flawless picture control with unique NAM monitoring
- Brighter, sharper images with 1½-inch electrostatic vidicon



# Unique Features of TK-27 Color Film Camera

Transistor Reliability  
and Economy

Plug-in Module  
Electronics

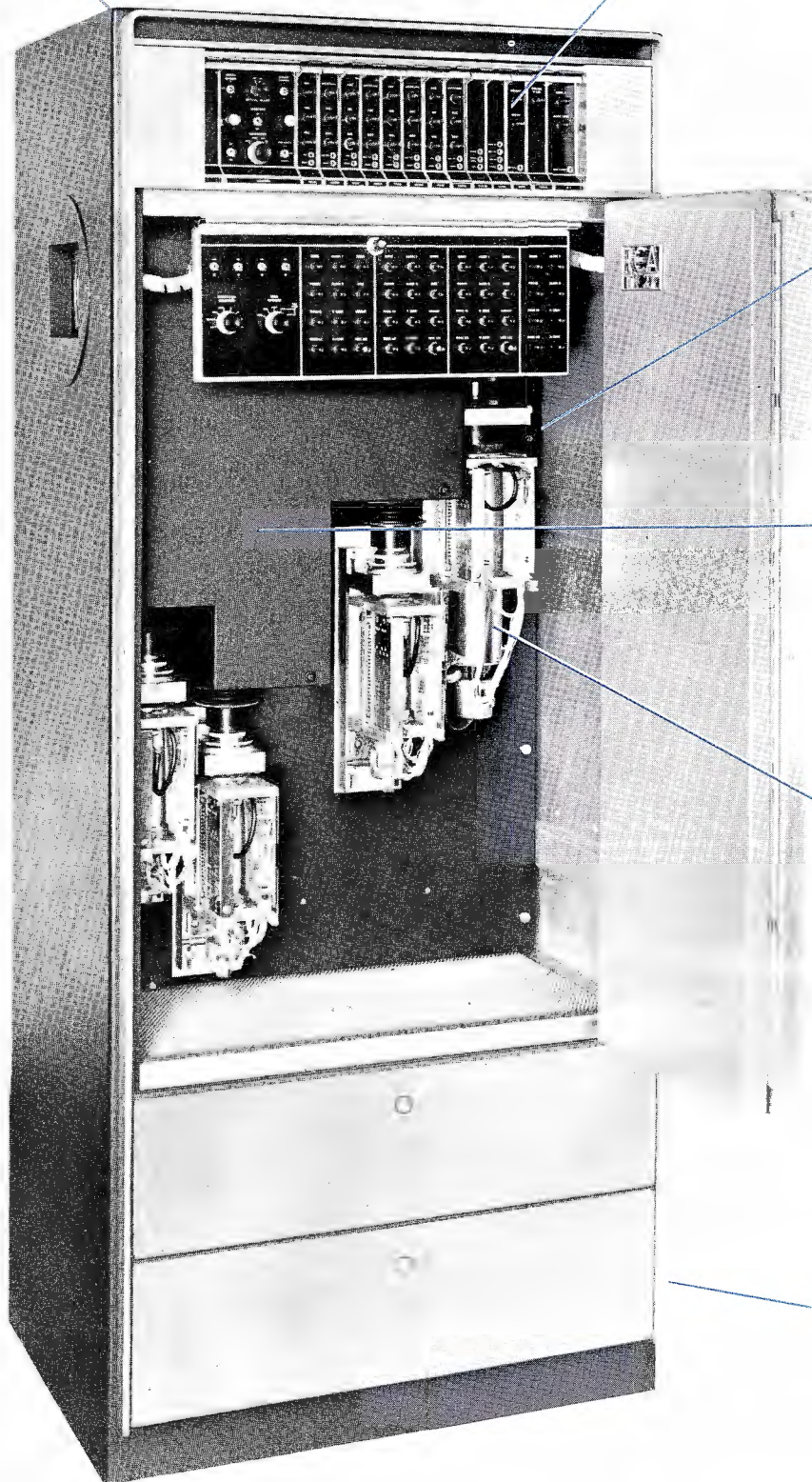

Rigid Optics  
Mounting Structure

Sealed Prism  
Dichroics

Electrostatic Focus  
Pickup Tubes—  
50% Larger  
Luminance Vidicon

Universal TV  
and Power Standards



## Color TV Filming at its Best

The RCA TK-27 Color Film Camera is a completely new system designed for highest quality reproduction of color film and slides. It represents a major breakthrough in camera development, setting new standards of performance, stability and reliability.

There are many new features, such as the larger vidicon, automatic circuitry and sealed prism optics. Moreover, it is more compact, more dependable and costs less to operate than any other color film camera available.

### Description

#### All Solid State

The TK-27 is completely transistorized providing a new order of reliability and greatly reduced maintenance. As a result of the solid state circuits, power consumption is less than 200 watts and the floor space requirement is only three square feet. Other advantages of transistors are lower heat dissipation and freedom from microphonics.

#### Electrostatic Pickup Tubes

The four vidicon pickup tubes are electrostatically focused. This eliminates focus coils and their heat dissipation problems. Power consumption is negligible and performance is independent of voltage variations — *greatly improving stability*. Electrostatic focusing has reduced heat in the camera head—the main cause in all cameras for rise in dark current—by at least 40 percent.

#### Larger Luminance Vidicon

The luminance channel employs the 50 percent larger RCA Type 8480 vidicon. This tube has twice the output of other types. The result is a 6 db gain in S/N ratio. Signal-to-noise ratio is exceptionally high due to its excellent aperture response, minimizing the need for aperture correction. Stable high-peaking is assured by an input transistor

mounted on the vidicon to minimize input capacitance and present a constant impedance to the vidicon.

#### High "Plateau" Resolution

Another advantage of the larger vidicon is the high resolution capability, not only in the center of the picture but also at the corners, providing a relatively flat, "plateau" response curve not found in other cameras and resulting in unusually sharp film and slide reproductions.

#### Revolutionary Single Waveform Monitoring

Unlike other four tube film cameras that require an experienced operator to monitor individual color levels, the TK-27 presents a single waveform that is similar to a standard monochrome signal. The method employs non-additive-mixing (NAM) of receiver type color signals to produce a single waveform that at any instant represents the proper values of color and monochrome in *one presentation*. Advantages are accurate control of picture brightness and hue, and the prevention of transmitter and receiver overload. This is an important consideration in color film operation since other cameras require the operator to continuously monitor all colors in order to minimize the possibility of overmodulation.

#### Plug-In Electronics

Completely transistorized plug-in circuit modules with convenient front panel test jacks provide excellent accessibility for service. Many of the circuit functions in the four vidicon channels are identical. This results in modules that are duplicates and thus interchangeable, offering greater circuit familiarity and easier maintenance. Because of a multiplicity of test points (approximately 100 test jacks) trouble can often be isolated within a module without removing the module from the frame.

#### Automatic Level Control

Automatic circuits in the TK-27 provide means for controlling white level and black level proportionately in all four vidicon channels to compensate for density variations in slides and motion picture film. This automatic control feature applies even in the manual control mode by maintaining the levels of the two signals at the points determined by the settings of the controls.

#### Simplified Interconnection

Horizontal and vertical drive signals for the TK-27 now originate in the film camera itself instead of in the master sync generator as with other color film cameras. This simplifies cabling and reduces the num-



## TK-27 RESOLUTION CAPABILITY

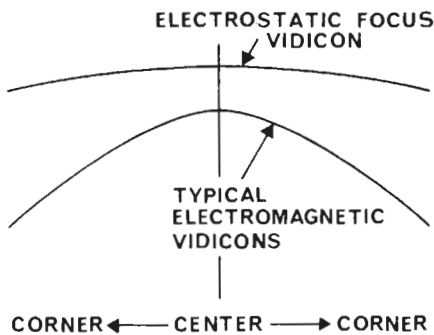

ber of distribution amplifiers required by the system.

### Advanced Camera and Optics

The design of the camera and optical assemblies assure long term life and freedom from secondary reflections. Assemblies are mounted on a 1/2-inch-thick, aluminum base plate. This is rigidly fastened to the structurally reinforced cabinet which is in turn bolted to the floor. Unprecedented accuracy is achieved in superimposing optically the four images on the vidicons. Prisms are employed to separate and direct the light image to each of the four cameras. Dichroic surfaces are sealed within the optical block to eliminate any multiple reflections and to prevent contamination from dust or handling. Prisms, therefore, are maintenance-free, assuring optimum performance at all times. Plug-in design permits quick and easy removal of vidicon assemblies to facilitate tube changing or trouble shooting.

### Minimum Space Requirement

Plug-in transistorized modules associated with the camera circuits are located along the top of the camera unit above the vidicon setup control panel. The plug-in modules comprising the Auxiliary Assembly which combines pulse regeneration, blanking and colorplexing functions are housed in two module frames each only 5 1/4 inches high.

### Ease of Setup and Test

TK-27 camera circuits are designed so that one man can set up and adjust the camera using simple pulse techniques which speed up camera adjustments. Built in and operable by a switch, test pulses determine that pickup tubes and amplifiers are operating at proper levels. A switch on the control panel inserts pulses for checking system stability at any time. Initial adjustment of the TK-27 is made quickly and further touch-up is rarely required. A built-in color bar generator provides full raster R, G and B signals at 75% or 100% level to facilitate setup of the colorplexing function using only an oscilloscope.

### Operating Features

Design of the TK-27 makes it possible to include all the remote controls for the system in three control panels that are mounted side-by-side in a console housing or in a standard rack, occupying only 7 inches of height. Operators will find it easy to maintain consistently high picture quality with minimum attention. There are several unique points about the controls. For ex-

ample, white and black balance controls, used to individually control levels in each chrominance channel to compensate for deficiencies in color film, are completely non-interacting. Chroma level may also be adjusted from the control panel. With NAM monitoring there is no fear of overloading the system since it is always apparent when maximum chroma levels have been reached.

### Universal Standards

The TK-27 operates on either domestic or international TV standards on a switchable basis when equipped with the required accessory filters. The versatile power supply of the TK-27 operates on either 115 or 230 volts at any frequency between 47 and 63 cps.

### Control Versatility

Three control panels mounted side-by-side contain all the controls and illuminated pushbutton indicator switches for operation of the TK-27 color film camera system from a control console or other location. The left-hand and right-hand panels are used for color operation, while the remote control panel in the center contains the main operating controls. Provision is made for "monochrome only" operation of the TK-27. With this mode, operation is similar to that of the RCA TK-22 monochrome camera. Only those circuits required for processing the signal from luminance vidicon are used. For extended periods of monochrome operation, chrominance vidicons may be turned off.

## TK-27 COLOR FILM CAMERA SYSTEM

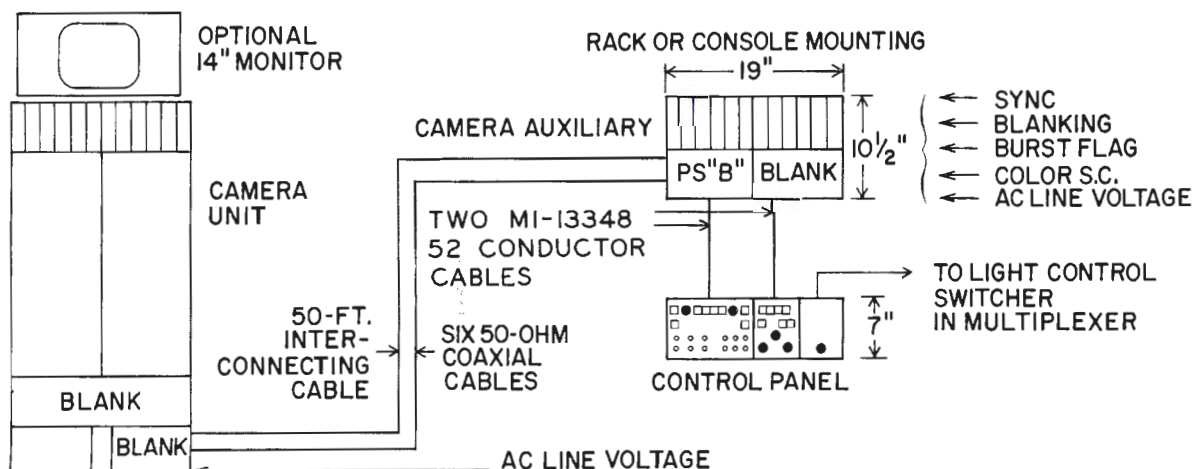



# New Design Advances for Ultimate Picture Quality



**SEALED PRISM DICHOICS** eliminate secondary reflections — are maintenance-free.

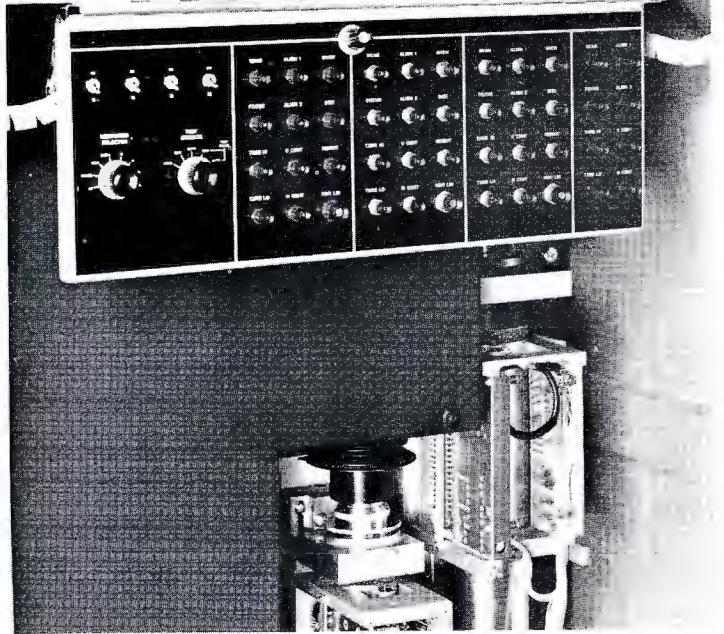
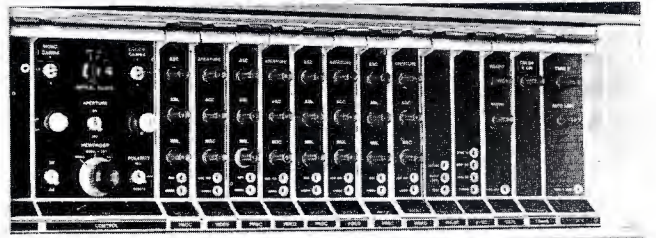

**CENTRALIZED TK-27 CONTROLS** speed camera setup and test adjustments.



**ELECTROSTATIC FOCUS PICK-UP TUBES** — larger, 1½-inch luminance vidicon for brighter, clearer pictures.



## Camera Unit Modules

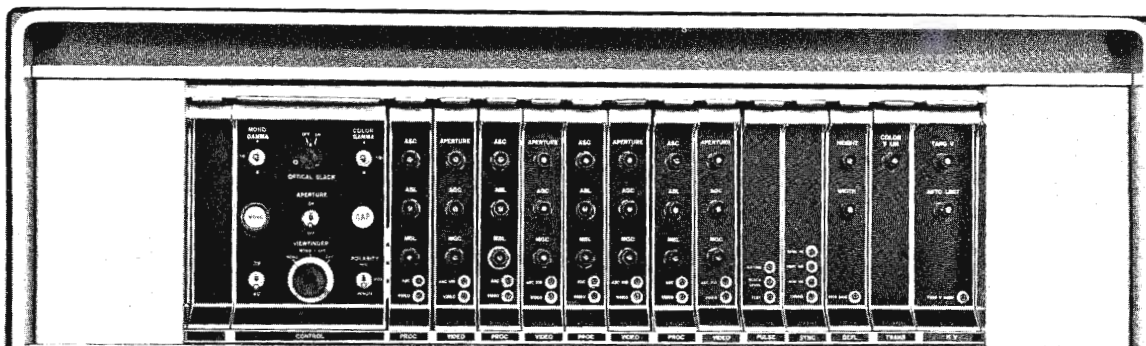

TK-27 Camera Modules.

### Control

Controls monitor feed selection, gamma, monochrome polarity reversal, 3-V/4-V operation and indicates when camera is in mono only mode.

### Proc

Processor clamps video and inserts gamma correction. Contains controls for manual and automatic black and automatic sensitivity. One used for each of four vidicon channels.

### Video

Amplifies video from preamplifier and provides aperture compensation. One used for each of four vidicon channels.

### Pulse

Generates white test pulse, black level pulse, horizontal drive stop pulse, gating pulses and

test pulses for use in setup, testing and automatic circuits.

### Sync

Generates and distributes vertical gating, vertical drive, timing pulse and horizontal drive. Contains circuitry for automatic time delay compensation. Clips and amplifies sync for use in other modules.

### Defl

Deflection provides horizontal and vertical deflection. Provides vidicon protection in case of scan-failure.

### Trans

Transitional—using signals from the DEFL and HV modules. Provides horizontal and vertical deflection for chrominance channel vidicons.

### HV

High Voltage—Generates high voltage, DC filament voltage for the luminance channel vidicon and reference voltage to operate transistor decouplers. Vidicon blanking and target voltage ranges are set in this module.

### Power B

Develops regulated positive and negative low voltage DC for use in camera. Supplies low voltage AC to FIL module.

### Fil

Filament Power—Converts AC low voltage to regulated DC filament voltage for the R, B and G vidicons. Contains switch to turn off this voltage for long term monochrome only operations.

## Camera Auxiliary Modules

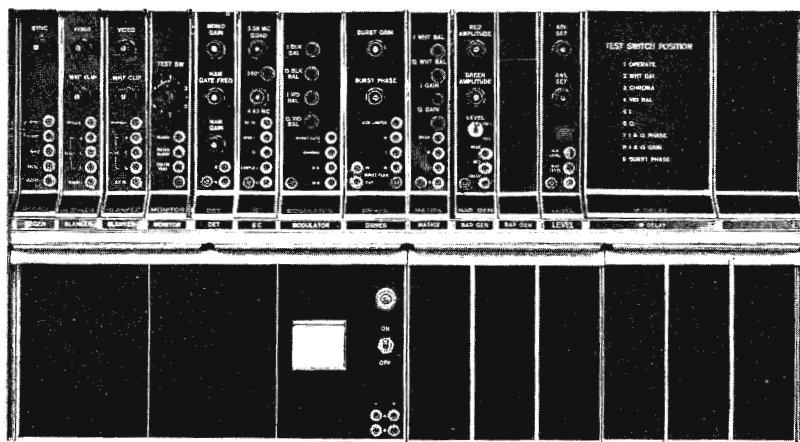

TK-27 Camera Auxiliary Modules.

### Regen

Regenerates sync and blanking and generates clamp pulses. Contains part of circuitry for horizontal drive advance to compensate for cable and encoder delays.

### Blanker

Adds final blanking to video. Contains multiple video output line driver with sending-end termination and has switchable sync addition to output video. Contains single line driver with sending-end termination which can be remotely switched to line, an external signal coming from a loop-through input or combination of line and external test signal.

### Monitor

Contains line driver amplifier for feeds to the CRO and picture monitor. Regenerates blanking and clamp pulses and inserts system blanking on the RGB&M signals. Test switch is included to allow set-up of encoder using only CRO signal.

### Det

Converts monochrome and color difference signals into receiver Rr, Br, and Gr signals. Non-additively mixes signals and switches between NAM white and black to form single NAM signal. (Similar to monochrome camera signal.) Individual NAM white and black signals are used in automatic white and automatic black control systems.

### SC

Subcarrier—Supplies quadrature subcarrier to modulator and generates sampling bursts required by automatic carrier balance detectors.

### Modulator

Modulates the I and Q color difference signals to produce chroma signal with automatic carrier balance. Generates gating signal to ungate blanker module during burst time. Provides color difference signals to Detector module.

### Driver

Band limits I and Q signals, inserts burst flag into I and Q signals for burst generation and feeds these signals to modulator. Amplifies M signal and drives M Delay module. Inserts delay into I signal to match Q filter delay.

### Matrix

Matrixes R, B and G signals into I and Q. Contains relays and amplifiers used in monitoring

individual M, R, B and G signals and has provisions for tying chrominance signals together for white balance adjustment of encoder.

### Bar Gen

Generates R, B and G pulses used to form standard non-split modulated color bar patterns of either 75% or 100% level as selected by switch on front panel.

### Level

Detects NAM white and NAM black signals and forms DC voltages used in feedback loops for automatic white and automatic black level control. Provides gating required for automatic black operation of camera.

### M Delay

Delays M signal to match Q filter delay.

### Power B

Develops regulated positive and negative low voltage DC for use in Camera Auxiliary.



# Controls and Functions

## COLOR CONTROL PANEL

**Bars**  
Connects color bars to colorplexer.

**Monitor**  
Selects monitor display: color output, mono output, NAM, BRGM.

**B, R, G, M**  
Selects outputs seen on monitor or CRO in BRGM position of monitor and CRO switches.

**CRO**  
Selects display for CRO (same choice as on monitor switch).

**Chroma**  
Varies white level in all color channels simultaneously, but not monochrome white level.

**Mono**  
Disables color channels, provides mono signal without burst on all video outputs.

**Chroma**  
Switch turns chroma, but not burst, off.

**H Cent**  
Vernier horizontal centering.

**V Cent**  
Vernier vertical centering.

**White Balance**  
Varies white level of color channels individually.

**Black Balance**  
Varies black level of color channels individually.

## REMOTE CONTROL PANEL

**Black Level**  
Selects manual or automatic black level control.

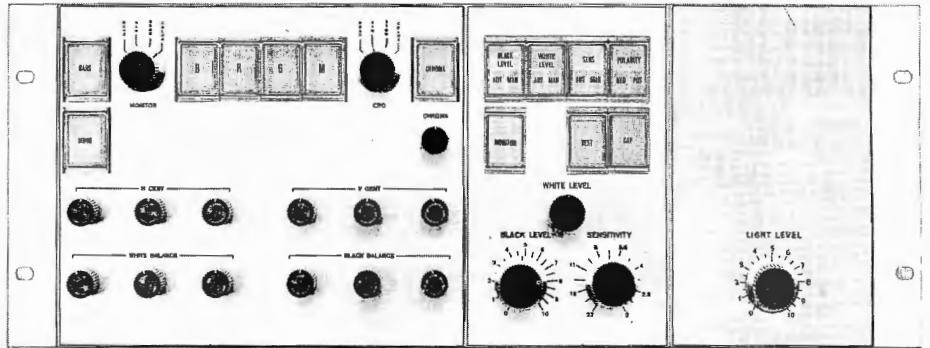

TK-27 Remote Control Facility showing Color Control, Remote Control and Light Control Panels.

**White Level**  
Selects manual or automatic white level control.

**Sensitivity**  
Selects manual or automatic sensitivity control.

**Polarity**  
Selects operation for positive or negative film.

**Monitor**  
Used with studio switcher to connect camera chain output to console monitor.

**Test**  
Energizes test pulses.

**Cap**  
Electronically caps vidicon pickup tubes.

**White Level**  
Controls white level reference pulse when switch is in manual, or sets level to which peak white is held when switch is in automatic.

**Black Level**  
Controls black level reference pulse when switch is in manual, or sets level to which peak black is held when switch is in automatic.

**Sensitivity**  
Controls vidicon sensitivity when switch is in manual, or sets level to which peak sensitivity is held when switch is in automatic.

## LIGHT CONTROL PANEL

**Light Level**  
Manually controls neutral density disc for color operation.

# Functional Diagram

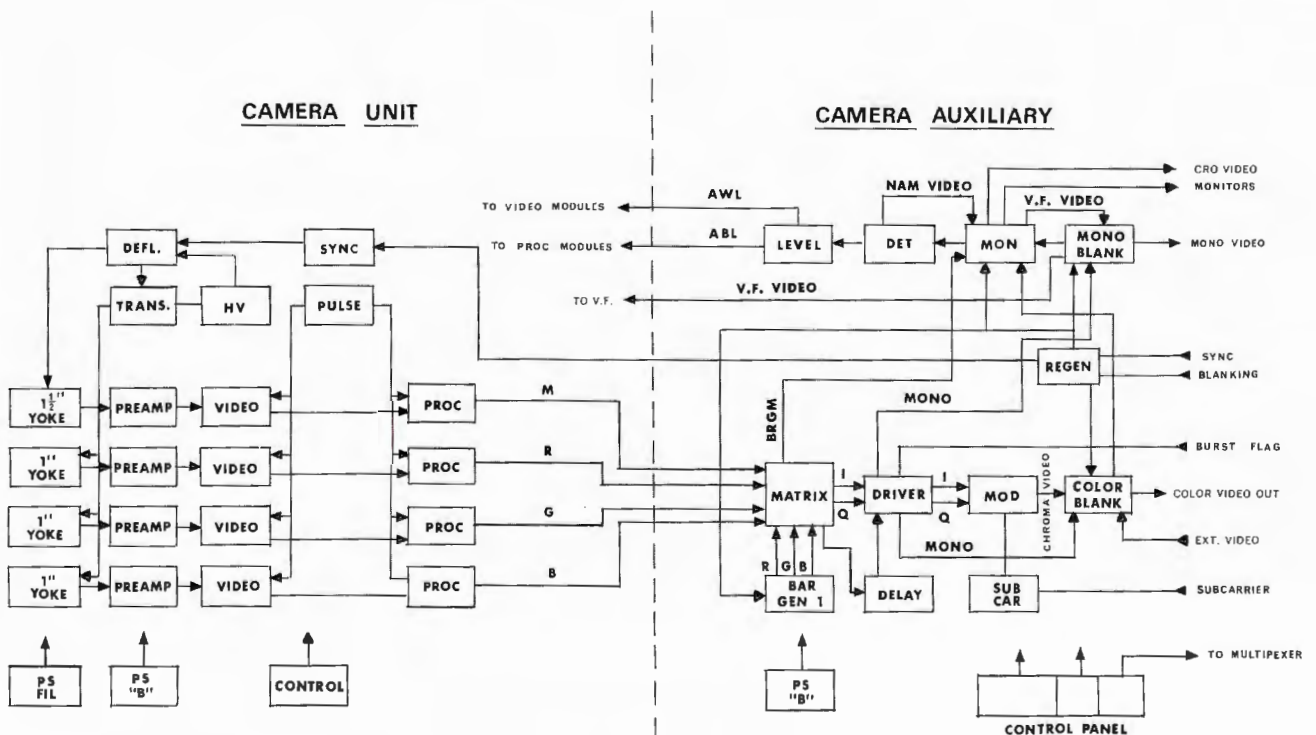

# Specifications

## General

Type of Reproduction.....Color and Monochrome  
 Number of Scanning Lines.....525 or 625  
 Field Repetition Rate.....60 or 50 cps  
 Line Repetition Rate.....15, 750 or 15, 625 cps

## Picture Quality

Limiting Horizontal Resolution  
 Luminance Signal.....700 lines min. at center  
 600 lines min. in corners  
 Signal-to-Noise Ratio, Luminance Signal.....Nominal 46 db  
 peak-to-peak signal/rms noise for bandwidth of 4.5 mc  
 Square Wave Tilt.....Max. 2%, 60 cps square wave  
 Video Bandwidth.....Down not more than 3 db at 8 mc  
 Total Raster Distortion.....Within 2% of picture height

## Operational

Gamma Correction Luminance Channel.....Switchable to three  
 preset values; 0.5, 0.7, 1.0 and 1.2  
 Aperture Correction.....Amplitude continuously adjustable  
 from 0 to +12 db boost at 5.5 mc

## Electrical

Input Signals:  
 Sync.....2 to 8 volts, peak-to-peak, neg.  
 Blanking.....2 to 8 volts, peak-to-peak, neg.  
 Burst Flag.....2 to 8 volts, peak-to-peak  
 Color Sub-Carrier.....2.0 +0.5 volts peak-to-peak  
 3.579545 mc or 4.4296875 mc  
 Input Impedance.....Bridging  
 Output Signals:  
 Program.....2 color and 2 monochrome  
 either 1.0 volt peak-to-peak composite or 0.7 volt peak-  
 to-peak non-composite. One color output required for  
 color monitor.  
 Monitor.....1 color and 1 monochrome  
 for internal picture and waveform monitor through system  
 monitor selector switches plus 1 composite monochrome  
 signal for optional camera position monitor.  
 Output Impedance.....75 ohms, sending end terminated

## Power Input

(Camera and Auxiliary, excluding monitors):  
 Line Voltage.....90-130 volts or 180-260 volts  
 Line Frequency.....47 to 63 cps  
 Power Consumption.....200 watts

## Mechanical

Overall Dimensions:	Wide	High	Deep
Camera Unit .....	24"	58"	18"
	61 cm	147.3 cm	45.7 cm
Camera Auxiliary .....	19"	10½"	16½"
	48.3 cm	26.7 cm	41.9 cm
Control Panel Frame (for Remote Control Panel, Color Control panel and Light Control Panel).....	19"	7"	—
	48.3 cm	17.8 cm	—
Remote Control Panel.....	4¼"	7"	7"
	13.3 cm	17.8 cm	17.8 mc
Color Control Panel.....	8½"	7"	7"
	26.6 cm	17.8 cm	17.8 cm
Light Control Panel.....	4¼"	7"	2"
	13.3 cm	17.8 cm	5 cm
Monochrome Monitor and Rotatable Housing .....	19¼"	12"	18"
	48.9 cm	30.5 cm	45.7 cm
Optical Centerline Height.....	48 inches (122 cm) above floor level, adjustable		

## Weight (approximate)

Camera Unit.....250 lbs. (113 kg.)  
 Camera Auxiliary.....100 lbs. (45 kg.)  
 Control Panels, mounted in frame.....9 lbs. (4 kg.)  
 Monochrome Monitor and Rotatable Housing.....75 lbs. (34 kg.)

# Ordering Information

Qty.	Description	MI-
1	TK-27 Camera Unit.....	557208-A1
1	1½-inch Vidicon, Type 8480-VI.....	557205
3	1-inch Vidicon, Type 8134-VI.....	557206
1	Camera Auxiliary .....	557207-A1
1	Remote Control Panel.....	557203-A1
1	Color Control Panel.....	557204-A1
1	Light Control Panel.....	557322
1	Mounting Frame for Control Panels.....	557306

Qty.	Description	MI-
1	Interconnecting Cable, 50 ft. with connectors to interconnect Camera Unit and Auxiliary .....	557307
1	Waveform Monitor, TO-4.....	556523
1	Connector Assembly for TO-4.....	556525
1	Front Panel for TO-4.....	556524
1	Picture Monitor, 8-inch, TM-19N.....	556526
1	Front Panel for TM-19N.....	556527
1	Mount for TO-4/TM-19N.....	556528
1	TM-27AC Color Monitor, 115 volts, 60 cps.....	40232-A
	or 230 volts, 50 cps.....	40444
1	Color Test Film.....	40846

## Accessory Equipment

Monitor Housing, rotatable, for mounting on top of Camera Unit.....	MI-557209
Monochrome Picture Monitor, 14" (115 volts, 60 cycles).....	MI-557210
Monochrome Picture Monitor, 14" (115/230, 50/60 cps).....	MI-557218

---

## 16 mm TV Film Projector, Type TP-66

---

- Automatic Cueing, Loop Restoring, Lamp Change
- Instant Start . . . Still Frame Projector . . . Film Reversing
- For Color and Monochrome Programming





# OMORROW'S PROJECTOR...TODAY

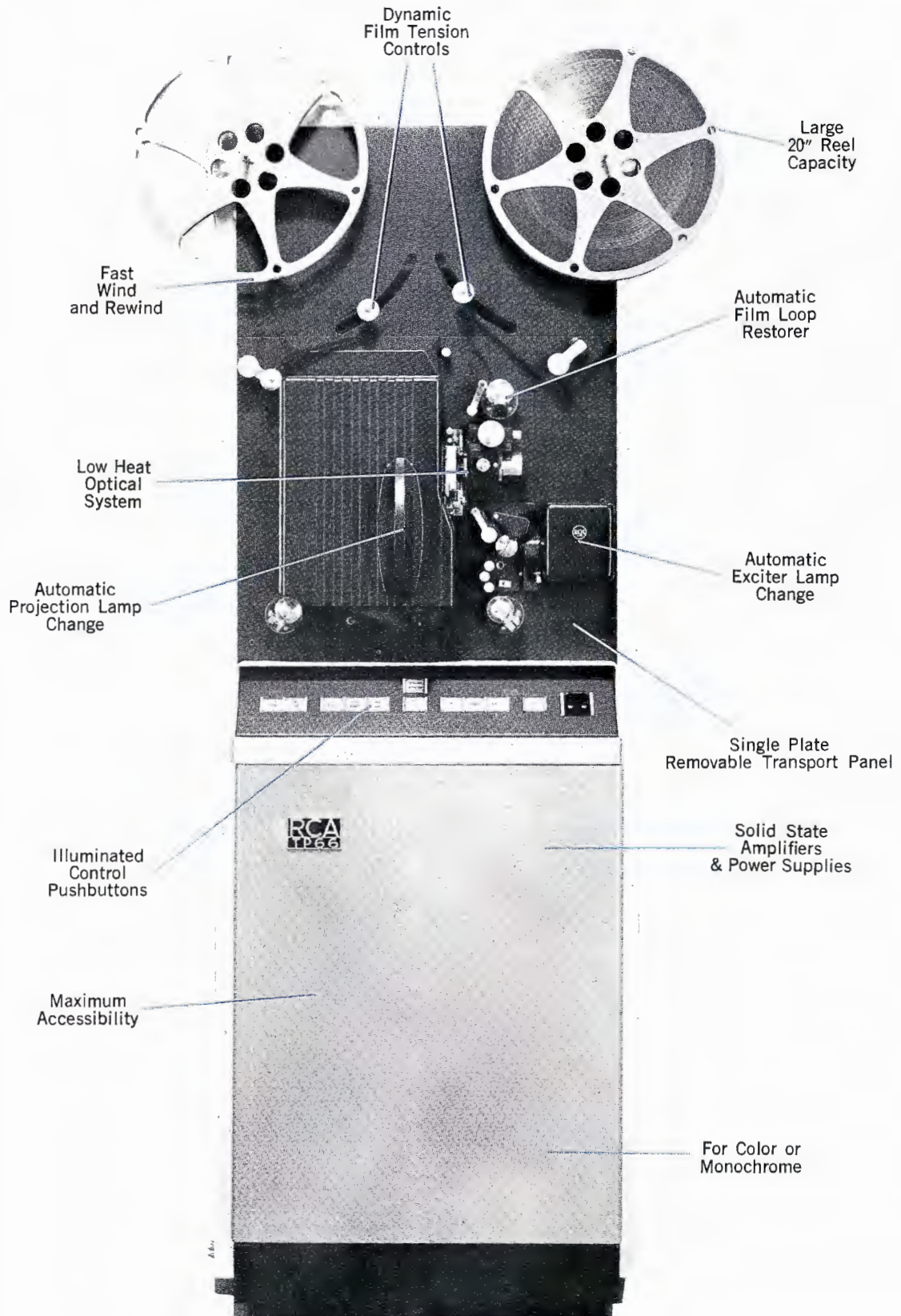

# Advanced 16 mm TV Film Projector, Type TP-66

The TP-66 is a TV Film Projector designed specifically for television. It is built to meet the modern pace of film programming. It is the final result of studying user requirements for TV film projection.

The TP-66 is an advanced projector that offers the reliability and instant reaction of transistorized circuits. It is de-

signed with many automatic features that reduce error. It incorporates new operating features that facilitate program creativity.

Designed for the requirements of color and of automation the TP-66 fulfills the needs of TV film programming for the present and the future.

## Description

### Rapid Start

Starting time is virtually instantaneous. Sound is sufficiently stable for program use within only 0.3 seconds from the start. No longer necessary is the usual pre-roll period prior to switching the projector "on-air." Start and show buttons—for all practical purposes—can be activated in a single operation, eliminating one more source of error during station breaks.

### Reverse Operation

The TP-66 can be operated in reverse, making possible repetition of film segments without the need for rewinding and rethreading.

This time saving feature is particularly useful during rehearsal of "live" or tape shows in which film inserts are incorporated. The TP-66 sound system is automatically disabled when the projector is being operated in the reverse direction.

### Still Frame Projection

A single film frame can be shown at full light level for extended periods of time—a feature that permits the director to preview the first frame of any upcoming film. Attenuation of light level, which is necessary during still frame projection, is

provided by a filter which is automatically placed in the light path. The shutter is indexed to assure that it is held in an open position during still frame projection.

### Large Reel Capacity

The TP-66 accommodates large, 20-inch reels, providing the capacity needed for continuous film programming. Up to one hour and 40 minutes of uninterrupted projection is possible. Film segments can be spliced together on a single large reel to save time and to avoid possible errors.

### Fast Wind and Rewind

Winding and rewinding of film is fast and easy. Film is merely threaded over the two sets of idler rollers. Winding in either direction is then controlled by manual operation of the tensioning arms. Moving either of the arms in an upward direction results in winding the associated reel. A 100-foot reel can be rewound in about 45 seconds . . . the 20-inch reel in approximately  $5\frac{1}{4}$  minutes.

### Automatic Cue

Films can be stopped and cued up automatically on the TP-66, elimi-

nating the need for manual threading and cueing of individual films, and reducing errors that often occur with visual cue marks. Precise, clean program transitions are assured. A feature film can be programmed in advance to cue the beginning as well as any number of stopping points for station breaks or commercials. The TP-66 stops automatically at the end of each film segment, and cues up the next segment within one frame of the desired starting point. The system is activated by small patches of conductive tape attached to the film. A cue defeat switch is mounted on both the local and remote control panels so that cue patches can be overrun without stopping the projector.

### Quiet Operation

Several design features make the TP-66 particularly quiet in operation. The slow speed 1800 rpm drive motor connects sprockets, intermittent and shutter through a system of toothed belts rather than through noisy gears. The 720 rpm shutter is driven directly by the intermittent cam. Even the intermittent itself, using a cycloidal pulldown, runs smoothly and quietly. During standby, only the whisper-quiet, axial flow lamp blower is in operation.



## Easy Threading

Projectionists will appreciate the human engineering that has gone into the design of the TP-66. The entire film path has been placed at stand-up working level to eliminate the need for stooping or bending while threading the projector. The film gate and the projection lens are entirely separate assemblies, the lens remaining stationary when the gate is opened. New design makes the gate area more easily accessible for insertion of film. Film loops are easily and correctly formed by solenoid operated loop setters which act as measuring guides when the projector is being threaded.

## Automatic Loop Restorer

Loss of loop, caused by torn sprocket holes or otherwise seriously damaged film, is instantly recovered by the automatic loop restorer built into the projector. Upon sensing loop loss, the automatic restorer applies a force to cause film slippage to occur at the gate between pull-downs and thus recover enough film for correct loop size. Sufficient compliance has been provided to avoid any possible damage to the film.

## Automatic Projection Lamp Change

When projection lamp failure occurs, a spare lamp automatically moves into place and is activated immediately. Changeover mechanism consists of two projection lamps mounted on a moveable plate so that either of the two lamps can be placed in operating position. Condition of the standby lamp is indicated instantly on the control panel, and lamps can be replaced easily and quickly even while the machine is running.

## Automatic Exciter Lamp Change

A further contribution to the high degree of overall reliability is an automatic exciter lamp change device. An indicator shows when the changer is in its normal position. Removal of a single cover permits rapid replacement of the defective lamp.

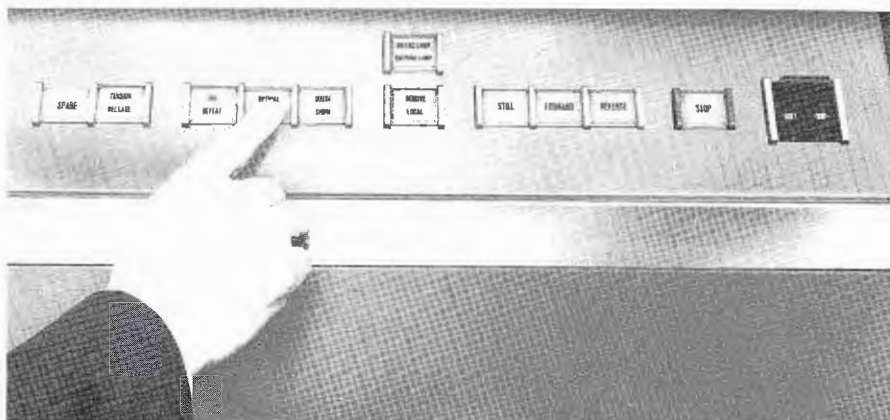

Illuminated control buttons are arranged for easy identification and operation.

## SPECIAL CONSTRUCTION FEATURES

The modules and panels that comprise the TP-66 system are housed in a rugged frame type structure designed to provide a support that is extremely rigid and one that offers utmost accessibility to all areas.

### Precision Intermittent

A high degree of picture stability is achieved through a precision claw type intermittent that uses no gears and very few moving parts. The unique mechanism combines mechanical simplicity with extreme accuracy of film indexing.

A three tooth claw assures uninterrupted passage of film—even worn film with damaged sprocket holes. The center claw is sapphire lined. Claw guides are of hardened tool steel for long trouble-free operation.

The intermittent is easily removable for servicing, and in most cases can be remounted without readjustment, although adjustments are easily made. Design permits utilization of a 50 percent application time shutter to meet color requirements.

### High Efficiency Optics

Because of the high efficiency of the optical system in the TP-66, a projection lamp of 500 watts provides more than adequate light out-

put for either a monochrome or color film camera system. This also contributes to the low heat dissipation of the projector.

### Dynamic Film Tension Controls

Proper reeling tensions for any diameter from 1¼-inch to 20 inches is assured by dynamic film tension controls provided on both projector reels. Tension is decreased as the reeling diameter increases, to prevent cinching.

All film supply and take-up reeling functions for both forward and reverse operation of the projector are provided by two similar but opposed reeling modules, each a closed loop tensioning system. Actual film tension controls the position of a spring-loaded tensioning arm linked to a variable transformer. This transformer varies the voltage to a torque motor, connected to the reel spindle by means of a toothed belt drive. Proper reeling tension is assured at all times.

Since actual film tension directly controls motor torque, the function of each module can be changed from "supply" to "takeup" by control of the direction of film motion alone, as occurs when the projector is reversed.



## Features For Easy Operation



**EYE LEVEL REELS—NEW REEL LOCKS . . .** Eye level reels eliminate stooping or bending. New spring-action reel key and lock simplify placing reel on shaft.

**SEPARATE GATE & LENS MOUNTS . . .** Film pressure shoe moves forward opening gate area for easy threading without disturbing lens position.

**AUTOMATIC LOOP SETTERS . . .** Loop setters (shown in position) act as measuring guides to assure correct loop size.

**SIMPLE FILM PATH . . .** Wide, self-aligning film gate and simple film path make threading easy.

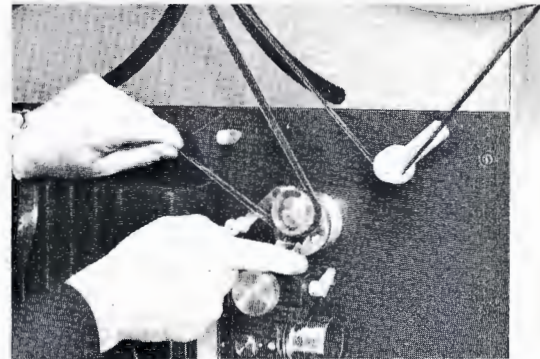

## Dependable Performance

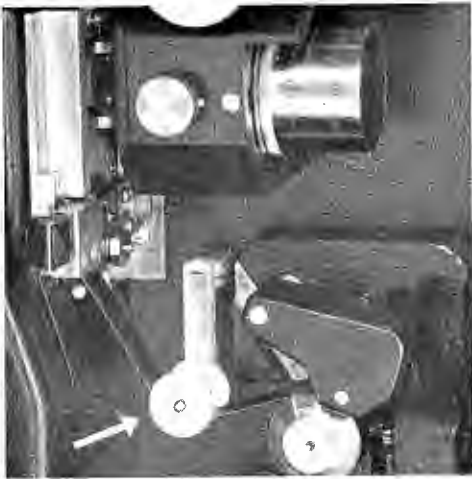

**AUTOMATIC LOOP RESTORER . . .** Loss of loop caused by defective film is instantly recovered by the automatic loop restorer shown at optimum loop position.

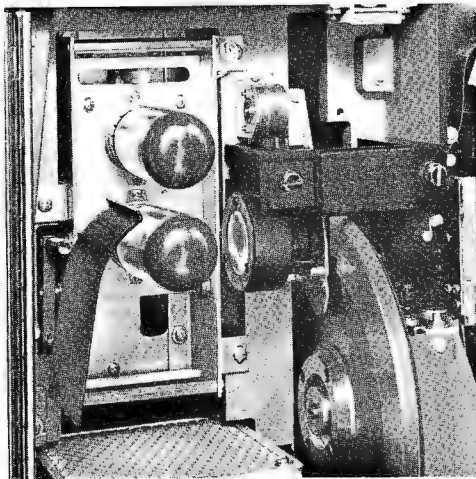

**AUTOMATIC PROJECTION LAMP CHANGE . . .** Automatic lamp change mechanism places new lamp into position within one second of lamp failure.

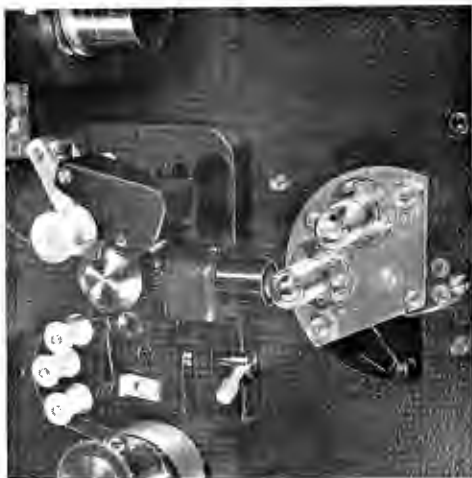

**AUTOMATIC EXCITER LAMP CHANGE . . .** With same speed as projection lamp changer, exciter lamp changer replaces defective exciter lamp automatically.

**LESS CARE AND ATTENTION . . . LONG TERM RELIABILITY . . .** (Left) Magnetically latched cover removed from TP-66 to show module frame (beneath control panel) housing plug-in amplifiers and power supplies.



(Right) full length rear door (also removable) provides complete accessibility for inspection or service.



### Transistorized Components

Dependability is a prime feature of the TP-66 TV Film Projector. Utmost reliability in the sound system is gained through transistorization, which also provides other important benefits such as lower heat dissipation and the elimination of equipment warmup prior to operation.

The TP-66 utilizes a solid state photo transducer. This replaces the conventional photo cell used in other projectors and offers a substantial increase in operating life.

Audio amplifiers are completely transistorized and designed so that electrical shorts at either the input or output line will not cause damage. Silicon transistors are used throughout.

### Minimum Lubrication

Under normal operating conditions lubrication is required only on a semi-annual basis. The intermittent assembly runs in an oil bath. All major rotating shafts use ball bearings for utmost dependability.

### Excellent Accessibility

Quick and easy accessibility to every part of the projector drastically reduces the time required for inspection and maintenance. In keeping with this philosophy, access to the intermittent assembly for inspection, servicing or removal has been made quite simple.

Should major servicing be required, the complete main panel can be removed without affecting optical alignment.

Servicing of plug-in modules during operation is easily accomplished by use of extenders which make the module accessible for service while in operation.

The control panel is hinged and will pivot down and forward for access to the rear of the panel.

The precision optics in the TP-66 are easily cleaned to assure maximum efficiency and performance at all times. The condenser lens assembly

is a plug-in unit, readily removed for cleaning.

### Ease of Installation

The projector is entirely compatible with existing RCA film systems. It can be installed with either TP-6 or TP-16 projectors and integrated with TP-11D or TP-15A multiplexer systems.

Installation is simplified by use of a new alignment and leveling arrangement. Adjustment screws provide ease in leveling and aligning the projector, both transverse and parallel to the optical axis.

The TP-66 is supplied as a completely assembled and system-tested unit ready to be placed in operation.

## ACCESSORIES ENHANCE OPERATION

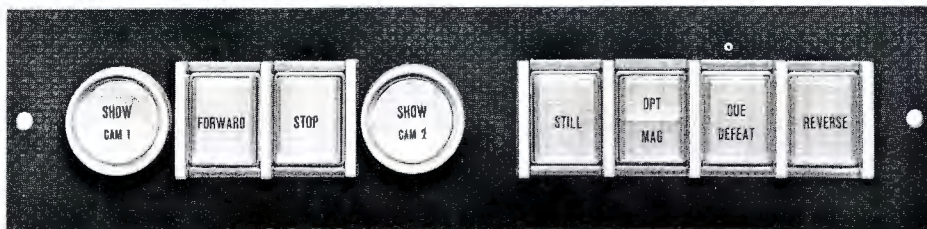

TP-66 Projector Remote Control Panel, MI-40166 for use with either TP-11D or TP-15A Multiplexers.

### Variable Density Light Control

This permits smooth control of light intensity regardless of variations in film density, provides optimum conditions for color or monochrome systems, and is readily integrated into an automatic light control system.

### Magnetic Sound

Permits playback of sound recorded magnetically on pre-stripped film. Utilizes special advantages of magnetic film for local production

of news films and commercials. After installation, either magnetic or optical sound can be selected.

### Remote Control Panels

Two available . . . the MI-40166 provides for "show," "forward," "reverse" and "still" projection, "stop," "optical/magnetic sound" and "automatic cue defeat." Simplified Dual Projector Remote Control Panel, MI-40256, provides "start," "stop" and "show" for two TP-66 projectors and a slide projector.



Dual Projector Remote Control Panel, MI-40256 for use with TP-11D Multiplexer.



## Specifications

### General

Film.....	Standard 16 mm	
Reel Size and Capacity.....	Up to 20" (50.8 cm) diameter (100 minutes running time)	
Optical Center Line.....	Adjustable, 47" (117.5 cm)- 49" (122.5 cm) above floor	
Light Application .....	50%	
	<b>60-Cycle Model</b>	<b>50-Cycle Model</b>
Film Speed .....	24 frames/sec	25 frames/sec
Shutter Speed .....	60 light pulses/sec	50 light pulses/sec.

### Electrical

	<b>60-Cycle Model</b>	<b>50-Cycle Model</b>
Power Requirements	105-125 volts, approx. 1000 W	105-125/210-240 volts, approx. 1000 W
Signal-to-Noise Ratio		
Optical Sound System.....	55 db or better	
Magnetic Sound System.....	52 db or better	
Harmonic Distortion		
(Optical Sound Preamplifier).....	Not to exceed 0.5% over frequency range	

Audio Output Level and Impedance.....	+18 dbm; 150/600 ohms
Frequency Response.....	50-7000 cps within 4 db

### Mechanical

Dimensions.....	.69" (172.5 cm) high (without reels), 24½" (63.2 cm) wide, 14¾" (36.8 cm) deep	
	<b>60-Cycle Model</b>	<b>50-Cycle Model</b>
Weight .....	475 lbs. (215.4 kg)	505 lbs. (229 kg)
Picture Stability.....	Vertical jump and horizontal weave not more than 0.1% of picture width	
Uniformity of Illumination.....	Not less than 90%	
Flutter and Wow.....	Not to exceed 0.3% within 0.3 to 2 seconds after start of projector. After 2 seconds, not to exceed 0.15%	

### Accessories

Light Control System.....	ES-40946
Magnetic Sound Control.....	ES-40940
Remote Control Panel for TP-66 Projector for use with either TP-11D or TP-15A Multiplexers.....	MI-40166
Dual Projector Remote Control Panel for use with TP-11D Multiplexer.....	MI-40256-A

## Ordering Information

The Type TP-66 16 mm Film Projector is available  
for operation on 60-cycle or 50-cycle power sources.

Basic Models:	Specify as:
TP-66 16 mm TV Film Projector for 60-Cycle Power.....	MI-40066
TP-66 16 mm TV Film Projector for 50-Cycle Power.....	MI-557066
Projection Lenses (one required but not supplied with basic projector):	Specify as:
Lens, 3½" f/1.5 for use of projector with TP-11 Multiplexer.....	MI-26325-A
Lens, 2½" f/2.6 for use of projector with TP-15 Multiplexer.....	MI-26799-B

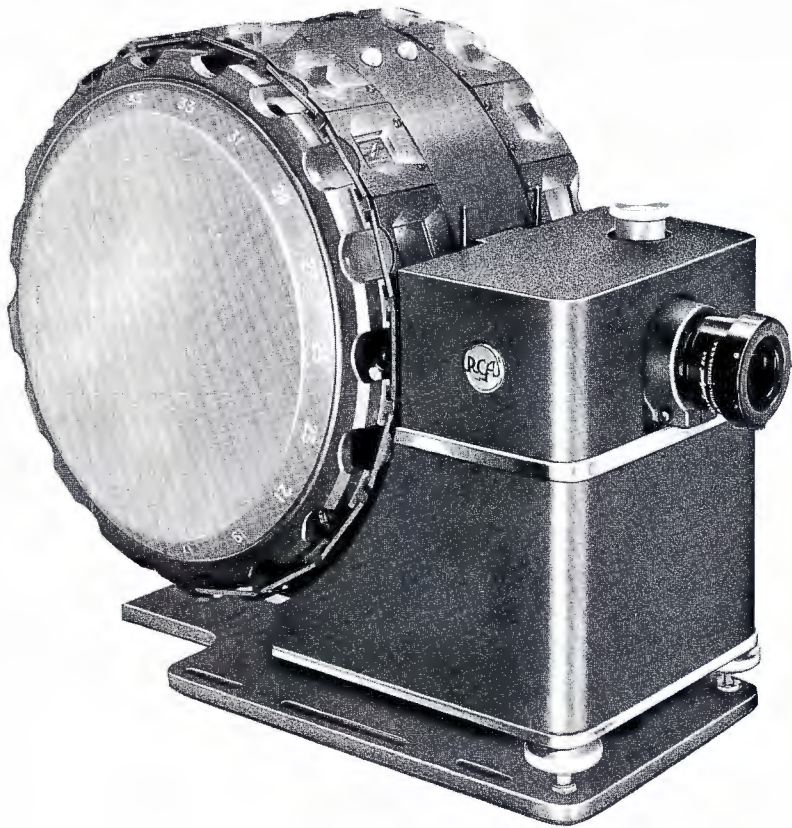

- Dual drum projector for color or monochrome TV use
- Single lamp source provides uniform image brightness
- Large slide capacity
- Instantaneous remote or local slide change

## Television Slide Projector, Type TP-7B

### Application

The Dual Drum Slide Projector, Type TP-7B, provides a ready means of projecting standard 2 by 2-inch slide transparencies into monochrome or color vidicon film cameras. The optical resolution and detail contrast are excellent for any TV pickup application. The machine has adequate light output for color film pickup systems, and it provides uniform brightness over the entire field of the projected image.

The TP-7B is semi-automatic in operation, projecting the slides in a sequential manner on signal from a local or remote location. Dual drums provide a slide capacity of 36 (18 per drum), and the slide change time is practically instantaneous. The slides advance either forward or backward. The operator may gain access to the slides on

the two magazines for inspection or re-scheduling during operation of the projector. It is possible to hold a slide in one channel and show it alternately with a series of slides in the other channel. An emergency projection lamp is available for quick manual change.

The TP-7B is a quality unit for the TV film room. It may be used with any RCA vidicon multiplexer or vidicon film camera chain, using proper mounting facilities and projector lenses. The TP-7B operates on a 115 volt, a-c, 60 cycle, single phase power line. A 230 volt, 50 cycle version of the TP-7B Slide Projector is available. It utilizes a separate step-down transformer to reduce line voltage to 115 volts as required to operate the projector.



## Description

The Type TP-7B Dual Drum Slide Projector is intended to be used in studio color or monochrome television productions for the presentation of any standard mounted 2 by 2-inch slide. Dual condenser lens systems form two optical channels. A drum type magazine associated with each optical channel provides storage for the slides and is so arranged to bring succeeding slides into position for projection without any dark period as the projector drums are rotated. Instantaneous slide change is accomplished by a moving mirror mechanism which multiplexes the two optical channels.

### Single Lamp Source

One projection lamp is used in conjunction with the two sets of condenser optics each of which form an optical channel. Light is collected from both sides of the lamp filament by these optics and directed to each of the two slide gates (one per channel) which are offset from but symmetrically located with respect to the projection axis. Three fixed and one movable front surfaced mirrors located between the slide gates and the single projection lens multiplex the optical channel axes into the centrally located projection lens. Split second movement of this mirror in or out of the optical path switches from one slide channel to the other. A relay type condenser system with four lens elements per channel is used.

### Uniform Screen Illumination

This optical arrangement is the nucleus of the design of the TP-7B. It provides the means of meeting all objectives associated with the optics. Two channels are available to provide the desired continuity of programming. Internal multiplexing of the two channels into one projection lens permits the on-axis projection required on field lens systems. One projection lamp eliminates the possible introduction of color unbalance between the two channels with unmatched lamps. Use of a fully reflective moving mirror in the multiplex system eliminates the need for dichroic or half silvered mirrors which introduce color unbalance with their inherent spectral selectivity. A 300 watt medium pre-focused base down

lamp provides 450 foot candles on a 3.35 by 4.46-inch screen. This is sufficient light for a television color film camera. Uniformity of screen illumination exceeds 90 percent in open gate search measurements.

### Dual Drum Operation

Separate drive motors are used for each drum. As the slide from one drum is being projected the other drum advances to a new slide position. Precision indexing of each slide position on the drum is accomplished by suitable detents.

### Forced Air Cooling

Forced air cooling is provided so that the slides remain cool, even for extended exposure. A centrifugal type blower located under the optical plate shares this space with the moving mirror mechanism. Ample air flow is provided to maintain cool operation with a 500 watt lamp.

### Unitized Construction

Unitized construction of the TP-7B Professional Slide Projector provides easy accessibility for cleaning or servicing. The top front cover which protects the multiplexer mirrors from dust may be removed thus giving access to all optical components on the optical plate. For access to the condenser optics, the drums can be easily removed. Bottom covers and lamphouse are also removable so that access to every component is possible. Dowel pins and other devices reassure automatic alignment on reassembly.

Operating controls for the TP-7B are located at the rear of the projector. The projector also can be controlled from a remote control panel.

### Slide Change Instantaneous

A reversible shaded pole gear-head motor coupled to the mirror through a modified type of geneva movement provides the means for rapid movement of the mirror into and out of the optical paths. The mirror and its mount are pivoted on a shaft which is perpendicular to the reflective surface. This permits mirror motion only in the plane established by its surface. Although the drive motor rotor has low inertia, a friction type override clutch between

the crank and the motor reduces shock when the crank strikes its limit stops. Lever type sensing switches are operated by the crank near each end of its travel. The crank is detented in these positions to prevent spring-back when the motor is de-energized and to maintain proper pressure on the sensing switches. Actual mirror motion time is less than  $\frac{1}{5}$  second, yet the gentle accelerating and decelerating forces inherent in the geneva mechanism gives smooth quiet operation.

### Ease of Operation

Soft illumination of all slides in the top and rear portions of the drums is provided in this projector. This permits visual observation of picture area when loading the slides. It also permits visual checks on orientation, loading sequence, etc. of the slides in the drum at any time without removing them from the drum. Since the drums may be readily rotated by hand, a complete check on every slide in the drum can be accomplished quickly.

A control box, furnished with the Projector may be mounted in a rack or the base of the multiplexer. This box contains all the relays used in the control circuits as well as the larger capacitors associated with the drive motor. All control circuits operate on 24 volts d-c. Interconnection between it and the projector utilizes a 24-conductor cable which is terminated in the projector on two barrier type terminal boards and at the control box by a plug. Separate jacks are supplied on the box for the two power inputs and for two types of remote control connections.

### Remote Control

An accessory remote control panel, MI-40111, provides remote control of four functions: left drum hold, right drum hold, forward-reverse, and slide changer. The panel may be located at any convenient operation point, and mounts either in the well area or, when used with an MI-26252 adaptor, in the hood section of a standard RCA 13-inch console housing. The remote control panel is 2 $\frac{5}{8}$  inches high and 11 $\frac{1}{16}$  inches long. Remote Control Panels, MI-40256 and MI-40167 are also available for limited control of ON-OFF and slide change functions.

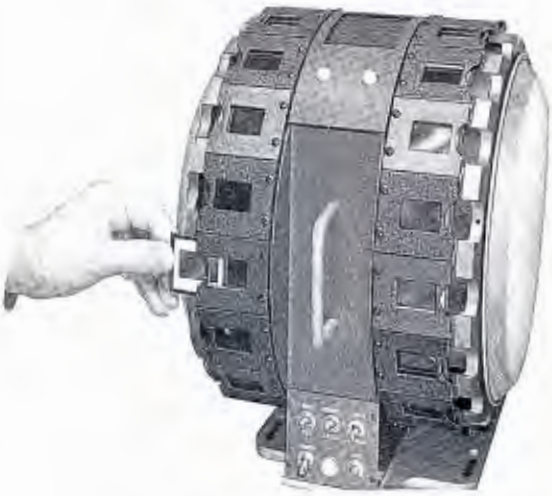

**HIGH SLIDE CAPACITY**—Up to 36 slides may be viewed sequentially in either forward or reverse direction in dual drum, dual channel machine.

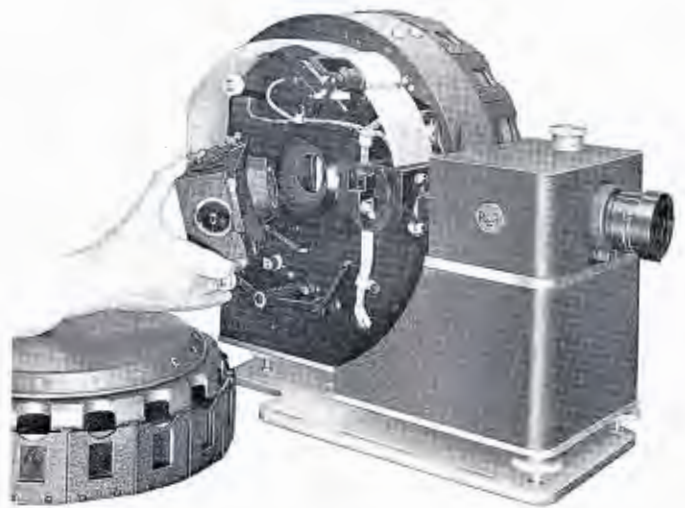

**SINGLE LAMP SOURCE** illuminates both channels, eliminating color balance problem and provides uniform image brightness.

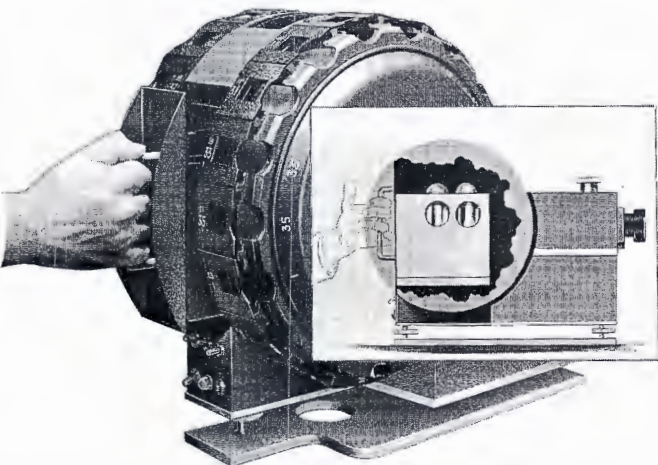

**QUICK LAMP CHANGE** mechanism which allows spare lamp to be moved quickly into place by pulling back handle.

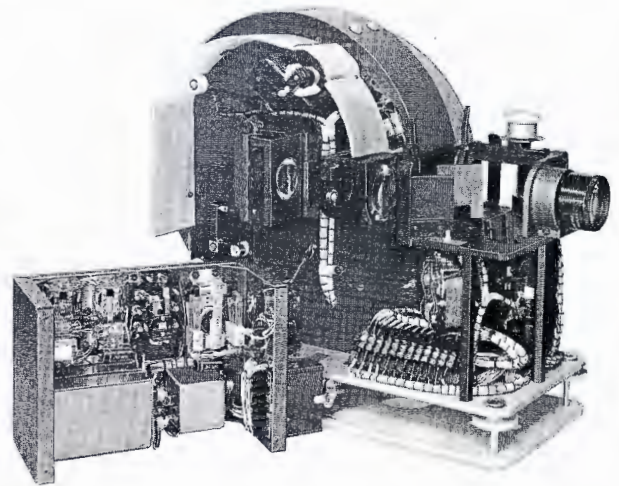

**UNITIZED CONSTRUCTION** allows complete access to control box (left) and projector assemblies.



# Specifications

Slide Size.....	2" x 2"
Lamp Size.....	300 watts (500 wattage available)
Usable Picture Area.....	.844" x 1.25" min. (SMPTE Standard)
Slide Changer Time.....	1/5 second
Slide Cycling Time.....	1 sec. max.
Lenses.....	Either 9"—f/6 or 7.5"—f/4
Operation.....	Dual drums operated by individual motors
Slide Capacity.....	18 per drum, total 36 slides
Control Circuit.....	24 volts, d-c
Power Requirements.....	115 volts, 50/60 cycles, single phase, 7 amps; 24 volts, d-c 1 amp
Fuse.....	10 amps., slo-blo, 3AG
Overall Dimensions:	
Projector.....	23" long, 11" wide, 18" high
Control Box.....	10" long, 6¾" wide, 5¼" high
Weight.....	75 lbs. (approx.)
Finish.....	Midnight Blue and Silver Gray

## ACCESSORY EQUIPMENT

Projection Lens (one required, but not supplied, select as follows):	
Lens, 7½" (for use with TP-11D or TP-15A Multiplexers, where the TP-15A is not used with a TP-16 Projector).....	MI-26335
Lens, 9" (for use with TP-15A Multiplexer when used with a TP-16 Projector).....	MI-26336
Lens Adaptor for MI-26335 Lens when used with TP-11D Multiplexer.....	MI-26340-A
Light Control:	
Neutral Density Disc Type for use with TP-15A Multiplexer on pedestal for color or monochrome (requires Light Control Amplifier).....	MI-40150
Light Control Amplifier.....	MI-40147
Variable Transformer for all Multiplexers to decrease light output to level required for monochrome camera operation.....	MI-26646
Remote Control Panel.....	MI-40167
Step-down Transformer—for operation from 230 volt, 50 cycle power source.....	T-10269
Remote Control Panel (all functions).....	MI-40111

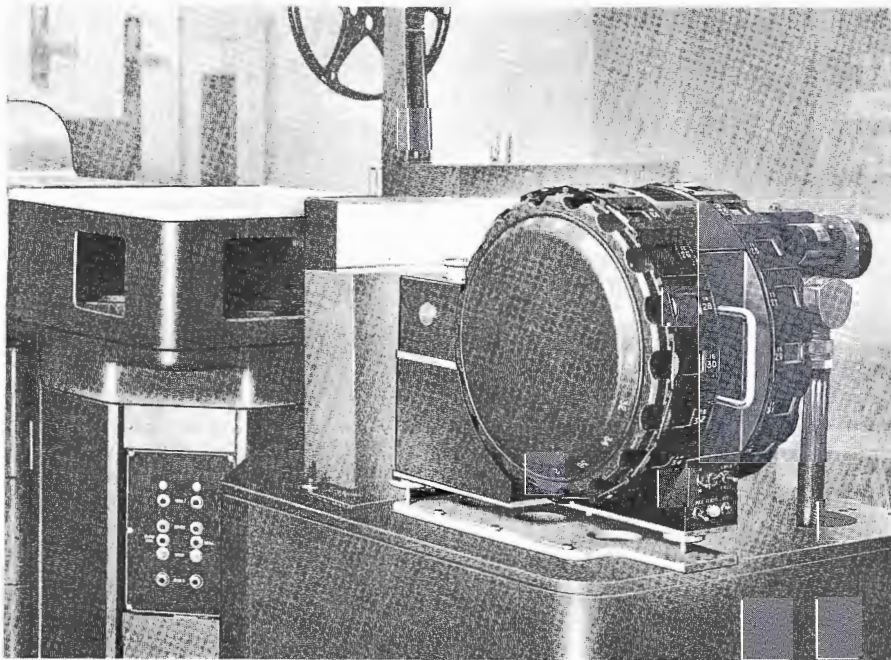

TP-7B Slide Projector offers instantaneous slide change for use with color and monochrome film camera systems.

## Ordering Information

TP-7B Slide Projector and Control Box, less lens, 115 volts, 60 cycle.....	MI-40011-B
---	------------

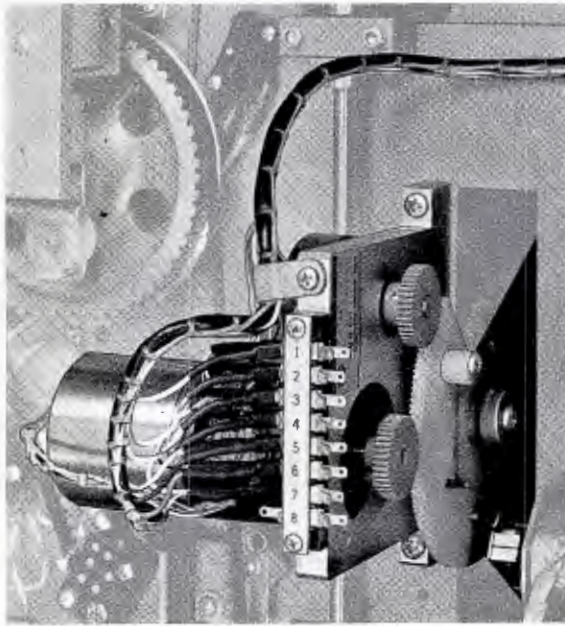

MI-40146 Mounted in TP-66

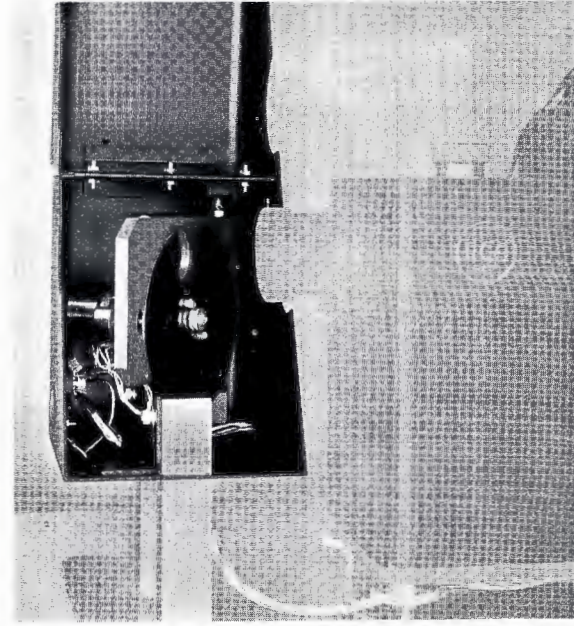

MI-40150 Mounted on TP-7B

- Fully transistorized
- Maintains proper color balance
- Fast response

## Light Control Systems

### Application

The RCA Light Control System provides a means of varying the projected image brightness from TV film and slide projectors. The light intensity is determined by the angular position of a variable neutral density filter that is inserted in

the optical path. This compensates for the varying density of slide and film material and permits optimum operating conditions at all times with no perceptible change in the spectral characteristics of the light.

### Description

The RCA Light Control System is comprised of a light control unit and a servo amplifier. Two light control units are available. The MI-40146 is designed for use with the TP-66 Film Projector, and upon installation, it becomes an integral part of that projector. The MI-40150 Light Control Unit is intended to be mounted in front of the TP-7 TV Slide Projector projection lens. The Light Control Servo Amplifier, MI-40147, is a transistorized unit of modular construction that includes a self-contained power supply. It is designed for mounting in any stand-

ard RCA module frame. When used with the TP-66 Projector it is mounted in the module frame provided in the base of the projector.

The Light Control Units include a servo motor and follower potentiometer that drives the variable density filter through a gear train. The MI-40146 mechanism is easily installed on the rear side of the TP-66 transport panel. In this system the variable density filter wedge is placed in the axis of the optical path in the cross-over region of the relay condenser system. The mechanism in

the MI-40150 Light Control Unit is contained in a housing which is designed for mounting on the multiplexer directly in front of the slide projector lens. This unit utilizes a lightweight variable density disc for maximum speed of response.

### Operation

In the RCA Light Control Systems a potentiometer is coupled to the drive shaft of the filter wheel by a gear train. Another potentiometer is located at the camera control position. These two potentiometers form a bridge circuit. The difference in



electrical potential between the arms of the two potentiometers is fed to an AC servo amplifier and the output of the amplifier, in turn, is fed to one of the two fields of a 2-phase servo motor which drives the neutral density filter wheel. The servo amplifier and two potentiometers form a null-seeking bridge circuit. If a difference between the outputs of the two potentiometers exists, the output of the servo amplifier drives the follower potentiometer that is coupled to the servo motor by a gear train until the potential difference between drive and follower potentiometer becomes zero. Thus the output signal of the servo amplifier also becomes zero, the servo motor develops no torque, and the filter wheel is brought to a stop at a specific point.

The camera operator remotely controls the density of the filter by rotating the driver potentiometer at the camera control position. This can be located anywhere in the studio. The interconnections are made by a conventional two conductor, shielded microphone cable. The servo amplifier is controlled by a variable control on the front panel of the amplifier, or by a potentiometer located at the video control position. A switch is provided on the front panel of the amplifier module for selecting the control position.

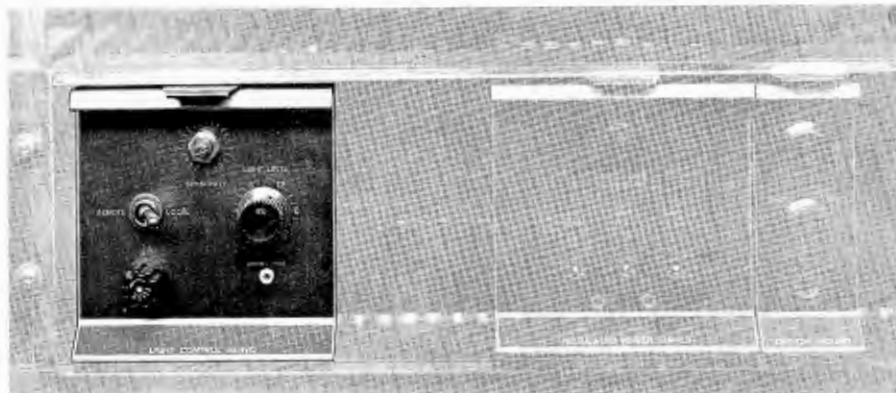

Light Control Servo Amplifier, MI-40147.

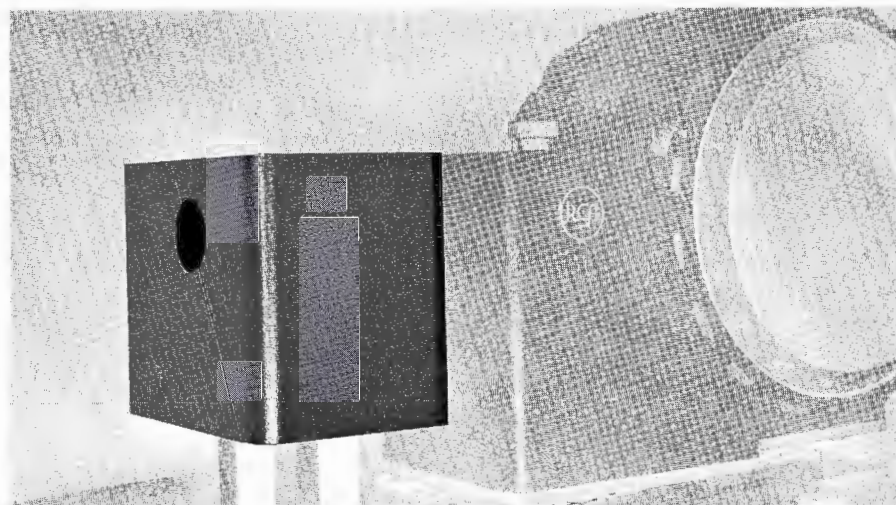

Light Control Unit, MI-40150, shown mounted for use with TP-7 Slide Projector.

## Specifications

Power Requirements.....	105-130 volts, 50/60 cycles, 16 watts, 24 volts, dc, 0.01 amps
Transistor and Diode Complement (Servo Amplifier): 2—2N2270, 2—2N1702, 5—1N3253	
Light Transmission Ratio:	
MI-40146 .....	100 : 1
MI-40150 .....	40 : 1
Operating Time (for maximum change):	
MI-40146 .....	0.3 sec.
MI-40150 .....	0.4 sec.

Overall Dimensions:	
MI-40146.....	Parts mount in TP-66
MI-40150.....	12½" high, 6¾" wide, 13¾" long (31.75 cm x 17.1 cm x 34.9 cm)
MI-40147 (servo amplifier unit).....	5¼" high, 10 module units or 4:56" wide, 12½" long (13.34 cm x 11.582 cm x 30.8 cm)
Weight:	
MI-40146.....	2 lbs. (0.9 kg)
MI-40150.....	13 lbs. (5.9 kg)
MI-40147.....	5 lbs. (2.25 kg)

## Ordering Information

Light Control Unit for TP-66 Film Projector (less filter wedge) .....	ES-40946
Filter Wedge for MI-40146.....	MI-40148
Light Control Unit for TP-7 Slide Projector.....	MI-40150
Light Control Servo Amplifier (mounts in TP-66 Projector or Standard Mounting Frame).....	MI-40147
Mounting Frame for Standard 5½-inch Modules.....	MI-557300
Light Control Panel (Accessory).....	MI-557322

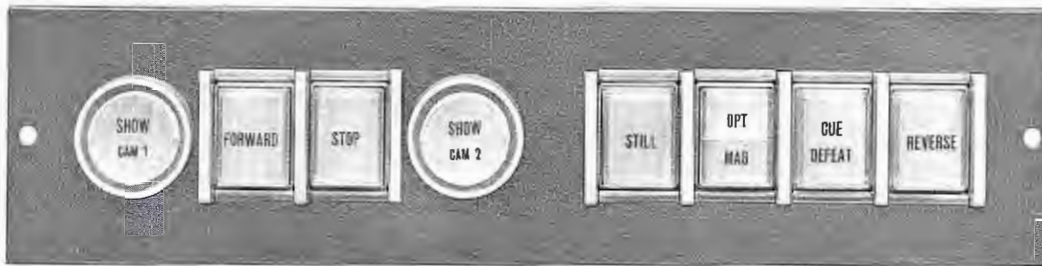

MI-40166 Remote Control Panel for TP-66 Film Projector.

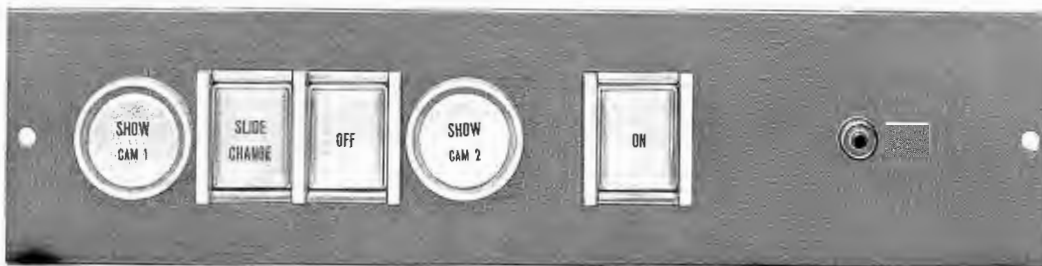

MI-40167 Remote Control Panel for TP-7 Slide Projector.

## Projector Control Panels

### Applications

This new series of control panels is designed as a central control for remotely operating RCA television film projection equipment. Versatile in application, they may be used to accommodate any

combination of RCA TP-66 Film Projectors and TP-7B Slide Projectors in conjunction with either TP-11 or TP-15 series multiplexer systems.

### Description

#### Remote Control Panel for TP-66 Film Projector, MI-40166

The MI-40166 Remote Control Panel provides control of the following projector functions from a remote location: FORWARD, REVERSE, STILL, STOP, OPTICAL/MAGNETIC SOUND, and AUTO CUE DEFEAT.

All switches are of the momentary

contact type and are duplicates of the switches on the local control panel which is part of the TP-66 Film Projector. When the projector is placed in "REMOTE", the 24-volt switching voltage which was present at the local control panel is transferred to the remote point permitting operation of the projector from that location. Under these con-

ditions, the switch indicators on the Remote Control Panel are dimly illuminated, indicating that control of the equipment has been transferred to the remote point. When the projector is placed in a particular condition by actuation of one or more of the control switches, the indicator associated with that control function is lit at full brilliance.



Two additional momentary contact switches are provided. They are marked: SHOW-CAMERA 1, and SHOW-CAMERA 2. These switches control either the operation of multiplexer mirrors or projector doublers depending on the type of multiplexer system in use. One MI-40166 Control Panel is required for each TP-66 Film Projector.

#### Remote Control Panel for TP-7 Slide Projector, MI-40167

The MI-40167 Remote Control Panel provides control of the following projector functions from a remote location: ON, OFF, and SLIDE CHANGE. Operation is similar to the TP-66 film projector control panel, and it is compatible with the arrangement of the film projector controls.

Additional momentary contact switches labeled: SHOW-CAM 1 and SHOW-CAM 2 are also provided on this panel to control the operation of multiplexer mirrors or projector doublers depending on the type of multiplexer system used. One control panel is required for each TP-7B Slide Projector.

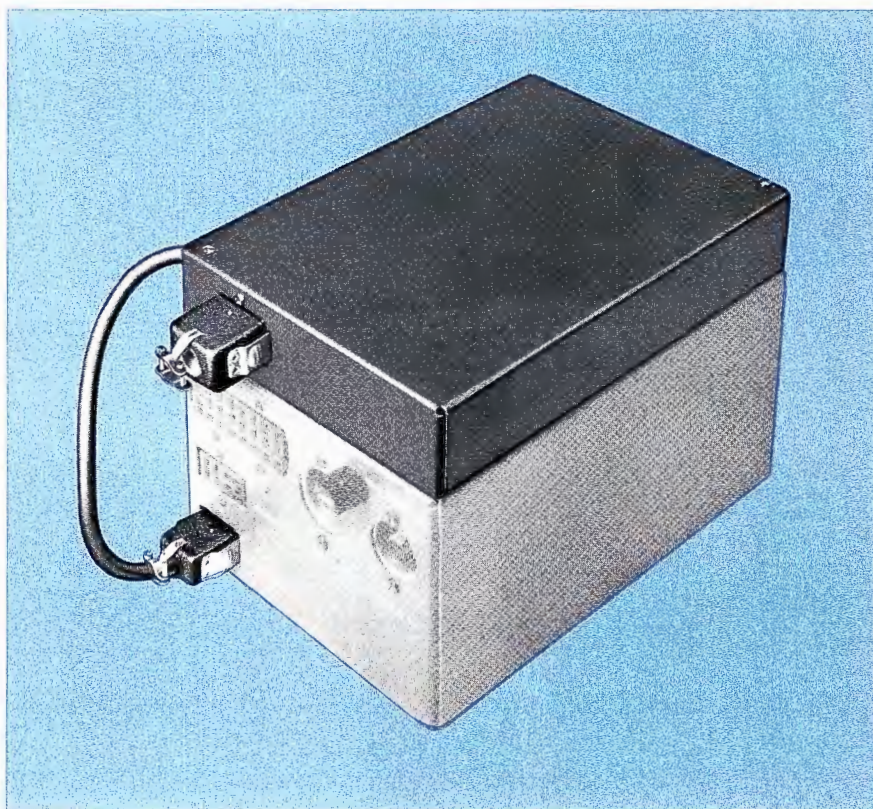

TP-11 Control Accessory, MI-40168, shown mounted on TP-7 Slide Projector Control Box.

#### TP-11 Control Accessory, MI-40168

The TP-11 Control Accessory is designed to operate in a film system using a TP-11 Series Multiplexer in conjunction with the Remote Control Panels for the TP-66 Film Projector and the TP-7 Slide Projector. The chassis contains relays for turning the slide projector on and off. A diode network provides selective control of the doublers of the film pro-

jectors and the slide projector lamp depending on which program source is used. Projectors not in actual operation are thereby automatically doused when the desired picture source is activated.

#### Modification Kit, MI-40169

The MI-40167 Remote Control Panel for the TP-7 Slide Projector

is designed to turn the Slide Projector on and off from a remote position by means of momentarily contact switch closures. The TP-15 Multiplexer contains a relay for remote operation of the ON function only. The MI-40169 Modification Kit provides a relay for the OFF function as well. This kit is not required for the new TP-15A Multiplexer.

## Specifications

Dimensions	High	Wide	Deep
MI-40166	2-21/32" (6.74 cm)	11 1/8" (28.1 cm)	
MI-40167	2-21/32" (6.74 cm)	11 1/8" (28.1 cm)	
MI-40168	2" (5 cm)	6 3/4" (17.15 cm)	10" (25.4 cm)

## Ordering Information

Remote Control Panel (for TP-66 Film Projector).....	MI-40166
Remote Control Panel (for TP-7 Slide Projector).....	MI-40167
TP-11 Control Accessory.....	MI-40168
Modification Kit .....	MI-40169

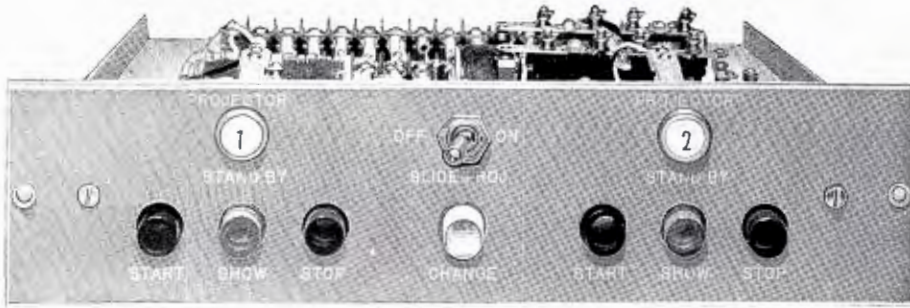

- Convenient remote control for film and slide projectors
- Console or rack mounting
- Illuminated pushbuttons

## Projector Remote Control Panels, MI-26256-A & MI-40256-A

### Description

Projector Control Panels, MI-40256 and MI-26256 are designed as a central control unit for operating television studio film equipment from a remote location. They provide facilities for remotely controlling two film projectors and a single TP-7B Slide Projector when used with the RCA TP-11D Multiplexer system.

MI-40256 is designed for use with the new RCA TP-66 Film Projectors. MI-26256 is available for operation of the earlier TP-6 and TP-16 series projectors.

The Projector Control Panel con-

tains three groups of switches and indicator lamps, one for each of the projectors. It is designed for mounting in a 13-inch console housing section with other remote control equipment. The panel also may be mounted on standard studio racks by use of an adapter.

The center group of panel controls remotely operate the slide projector. They consist of a toggle switch for turning the slide projector lamp on and off, and a momentary contact pushbutton switch for changing slides. A pilot lamp behind the translucent "Change" pushbutton, when lit, indicates that the projector

lamp switch is in the "On" position. The remaining two groups of controls are for remote operation of two motion picture projectors. Each group consists of three momentary contact switches actuated by differently colored translucent pushbuttons. A pilot lamp behind each "Start" and "Show" pushbutton, when lit, indicates the function.

Above each group of three pushbuttons is a numbered "Stand-By" indicator lamp. This lamp lights when the local-remote switch of the projector is in the remote position, thus indicating that the projector is ready for remote operation.

### Specifications

#### Electrical

Control provided for:

- (a) Two motion picture film projectors
- (b) One slide projector
- (c) One external audio switching relay (optional)

Power Requirements.....115 volts, 50/60 cycles

#### Mechanical

Length.....11 $\frac{1}{8}$ " (28.1 cm)  
 Height.....2 $\frac{5}{8}$ " (6.66 cm)  
 Depth.....10 $\frac{1}{8}$ " (25.72 cm)  
 Weight.....4 $\frac{1}{2}$  lbs. (2.04 kg)  
 Finish.....Silver gray

### Ordering Information

Projector Control Panel for TP-66 Projectors.....MI-40256-A  
 Projector Control Panel  
 for TP-6 or TP-16 Projectors.....MI-26256-A

#### Accessories

Console Mounting Adapter for 13" Console.....MI-26252  
 Mounting Adapter for Rack or  
 New 20" Console Housings.....MI-26254  
 Audio Switching Relay.....MI-11729

For 230 volt, 50 cycle operation, the specified input voltage is supplied from the step-down transformer included with the 230 volt, 50 cycle version of the TP-7B Slide Projector.



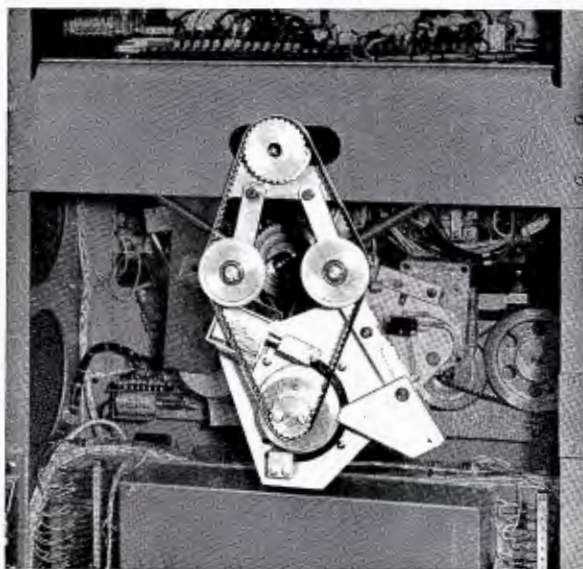

- Permits interlocking TP-66 Projector to other film handling devices for double system operation
- An efficient, moderate cost interlock system
- Compatible with 50/60 cycle systems

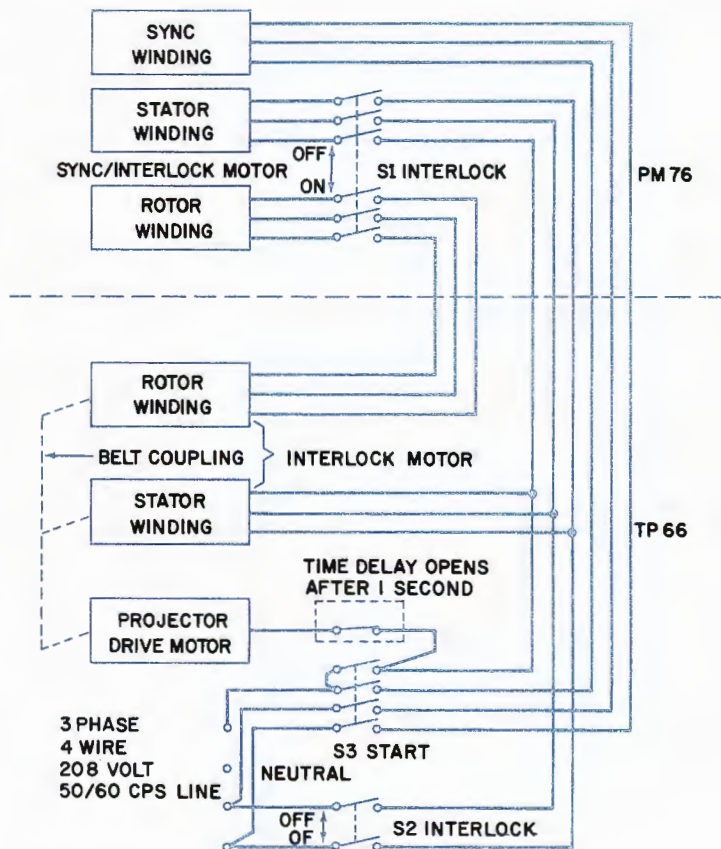

## Interlock Motor Drive Kit, MI-3492

When added to a TP-66 Film Projector, the MI-3492 kit permits interlocking the drive system of the projector with other film handling machines for "double system" operation (sound track separate from picture print). The Interlock Kit provides a means for operating the TP-66 with an RCA Type PM-76 Magnetic Sound Reproducer, or any equivalent equipment, from a standing start to synchronous speed without loss of sound and picture synchronization.

Comprising the MI-3492 Kit are: a 230 volt, 3-phase interlock type motor, mounting bracket assembly, timing belt and associated pulleys, as well as necessary mounting and electrical hardware. The Kit is compatible with 50 or 60 cycle systems. Also included are drawings and instructions for modifying the TP-66 Projector.

The interlock system provided by the MI-3492 kit operates in a forward direction only. Operational control of the interlock motor system

is incorporated in the existing control panel of the TP-66. When the Projector is operated in a conventional (non-interlock) manner, the controls for interlock are electrically locked out.

Since the interlock motor supplied with the MI-3492 kit must operate with a 230 volt, 3-phase interlock motor system, the second machine (sprocket-driven tape reproducer) must be equipped with this type motor, and must additionally have an independent synchronous motor.

### Ordering Information

MI-3492 Interlock Motor Drive Kit, including:

230 volt, 3-phase motor  
Mounting bracket assembly  
Timing belt and pulleys

Mounting and electrical hardware  
Modification drawings and instructions

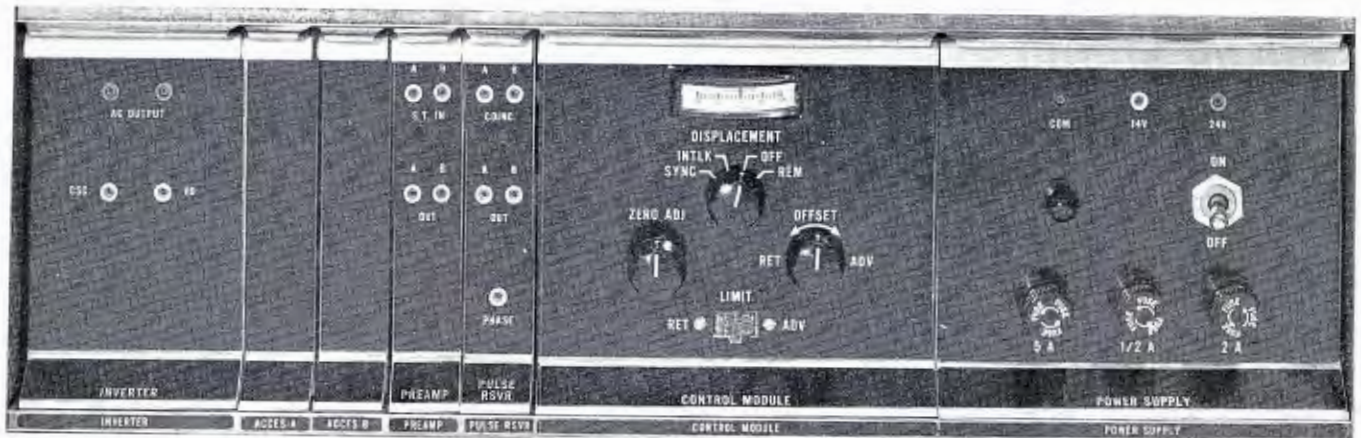

• New electronic means for interlocked playback of two or more tapes or film devices

• Provides the accuracy of reproduction for audio tape and television tape which is normally associated with sprocketed devices

## Unilock (Universal Interlock)

### Description

UNILOCK (universal interlock) is a new electronic means for accomplishing interlocked playback of two or more devices in absolute reference to *each other*. With UNILOCK, the audio tape and television tape media can achieve the same accuracy of reproduction as sprocketed mechanisms. It permits interlocked playback of many types of machines, including audio tape recorders, television tape recorders, sound film reproducers and television film projectors.

It has been common practice to "cue up" two 1/4-inch tape recorders or two television tape recorders to a common start mark and then start both machines simultaneously in the hope of achieving synchronous playback. This procedure involves considerable uncertainty since no reliable means have been available to guarantee that both machines would come up to speed together. Of per-

haps even greater importance has been the problem of maintaining precise synchronization of the two devices throughout the playback interval.

Both problems—interlocked run-up and interlocked playback—are solved by UNILOCK.

The widespread use of 1/4-inch audio magnetic tape for "on location" sound recording has led to the need for equipment which permits interlocked playback. As an example, audio tape is extensively used in newsreel work, usually in conjunction with sprocketed devices such as 35mm, 16mm or 8mm motion picture film. Television tape is also coming into greater use for the same application. The production of some programs depends upon quick, efficient editing of material. This is commonly handled by the simultaneous recording of sync tracks for

synchronizing the 1/4-inch tape to the corresponding picture information. In this pilot-tone system, a "magnetic perforation" is added to the tape during the picture recording of a track offset from the sound recording proper. This pilot-tone is derived directly from the picture-repetition frequency of the motion picture camera. On playback, the pilot recording serves to synchronize the sound tape with the picture. UNILOCK makes it possible for these tape devices to be operated synchronously with the interlocked accuracy of sprocketed reproducers.

UNILOCK utilizes "electronic sprocketholes"—such as the control track on the television tape recorder or the sync signal on the 1/4-inch audio tape recorder—to provide a precise pulse count which permits maintaining a synchronous or locked condition. This is accomplished by comparing two pulse counts on tape



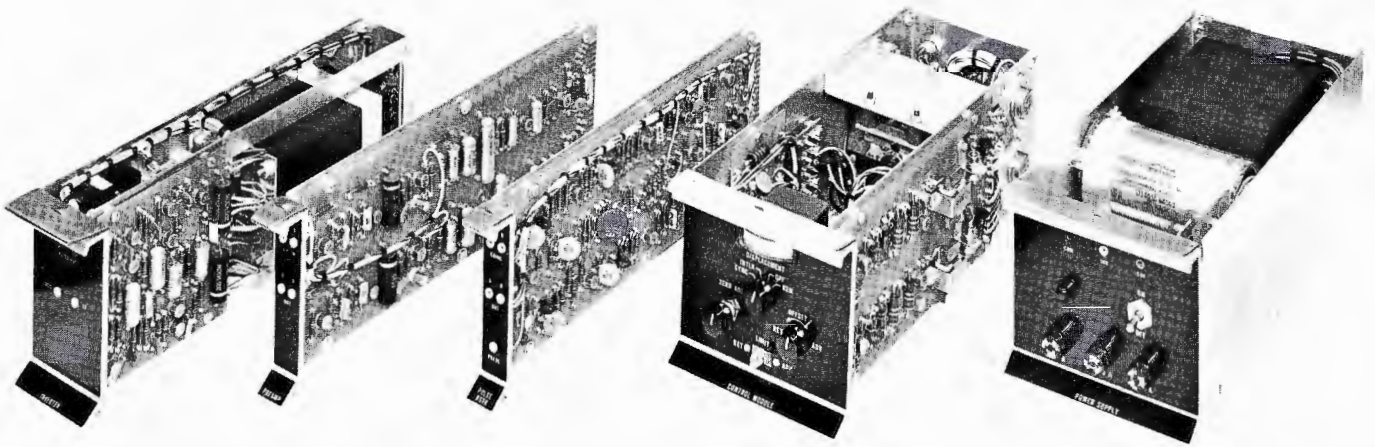

The UNILOCK system consists of the following modules: inverter, preamplifier, pulse resolver, control module and power supply.

mechanisms connected by UNILOCK, obtaining a difference signal (either plus or minus), and making the correction by controlling the speed of one of the machines. After reaching zero or "no pulse difference," UNILOCK becomes a phase sensitive device controlling motor speed by phase comparison much like the capstan servo in a television tape recorder.

In addition to controlling motor speed by phase comparison, UNILOCK has a memory storage feature which permits it to store plus or minus 100 frames in terms of a 24 cps frame rate. UNILOCK memory is non-volatile—it will store an error indefinitely or until reset to zero. Power removal or "start-stop" operation does not affect the error.

### Operation

The UNILOCK system consists of the following modules: preamplifier, pulse resolver, control, inverter, and power supply.

As shown on the block diagram, UNILOCK has two input channels which have sufficient gain to be connected directly to magnetic pilot-tone (sync) heads or other rate generating readout devices. The 60 (or 50) cycle reference information from the two units to be interlocked is fed into the separate channels of the UNILOCK where it is amplified and compared in the pulse resolver for coincidence or partial coincidence. When partial or full coincidence exists, both pulses are eliminated and no error information can be generated. If pulses simply alternate, they are eliminated since their num-

ber will be equal. Any excess pulses are passed to the control module and represent an error to be corrected by UNILOCK.

The basic function of the control module is to convert the error pulses into analog information. The error pulses passed are amplified to drive a stepping motor. Attached to the stepping motor through a 5 to 1 gear train is a ten turn precision potentiometer. The gear ratio in combination with the potentiometer provides the plus-or-minus 100 frame storage.

The output of the potentiometer is used to control the frequency of the voltage controlled oscillator located in the inverter module. The output of the voltage controlled oscillator is amplified and is available at the output of the UNILOCK as two signals:

- a. 115 volts, 50/60 cps, 30 watts for driving a 1/4-inch tape recorder capstan motor,
- b. A vertical drive pulse, 4 volt P-P, 75 ohms, for use with television tape systems or power drive amplifiers.

### Application Examples

As a typical example, consider a UNILOCK system that is operating phase locked with an 8mm, 16mm or 35mm film projector rate generator connected to channel B and a control track of a 1/4-inch audio tape machine connected to channel A. In this example, the inverter output of UNILOCK would be driving the 1/4-inch capstan motor and the system will continue to run phase locked as long as there is no external

influence. If the audio tape recorder connected to channel A should be momentarily held back for ten pulses (which amounts to 4 frames), channel B would count out ten error pulses into the stepping motor. The voltage-controlled oscillator would then run at maximum frequency, thereby speeding up the 1/4-inch capstan until coincidence occurs. Since the tape was only momentarily held back, it will run fast until the ten pulses have been gained, then once more run phase-locked where it is again in its original interlocked position. No frames will have been lost or gained after the correction has been made.

Several diagrams are included to indicate some of the common applications for UNILOCK. The news department of television stations will be interested in the use of UNILOCK to interlock 1/4-inch tape to 8mm or 16mm Television Film Projectors. This permits synchronized playback of 1/4-inch tape with news film and makes it practical for the television station to record the sound over picture in the convenience of the studio rather than in the field.

Another extremely useful application for UNILOCK is for interlocking 1/4-inch tape to television tape recorders. With UNILOCK, double system sound becomes practical for television tape. A UNILOCK unit will provide synchronous operation of an audio tape recorder and will correct for tape slippage so that several audio recorders may be used in a system with complete assurance that timing of each recorder will be identical.

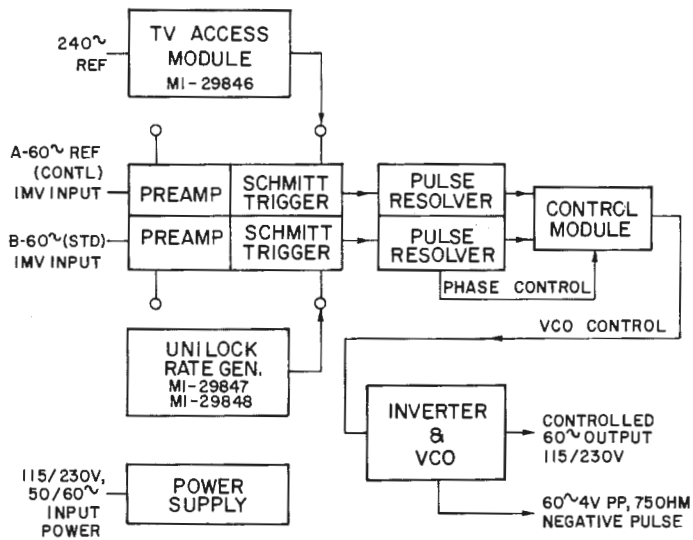

Block Diagram of UNILOCK System, MI-29845

The following show typical system diagrams of UNILOCK in conjunction with Audio Tape Recorders, TV Tape Recorders and Film Projection Equipment.

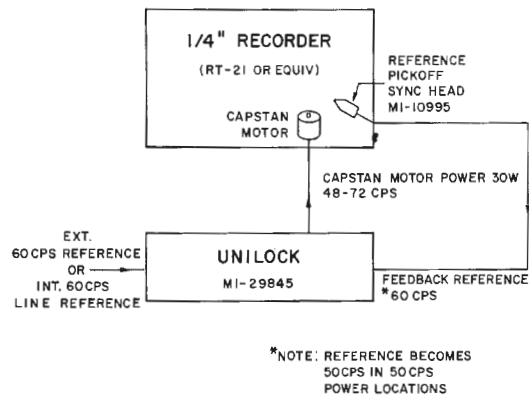

Basic UNILOCK configuration with 1/4-inch Recorders.

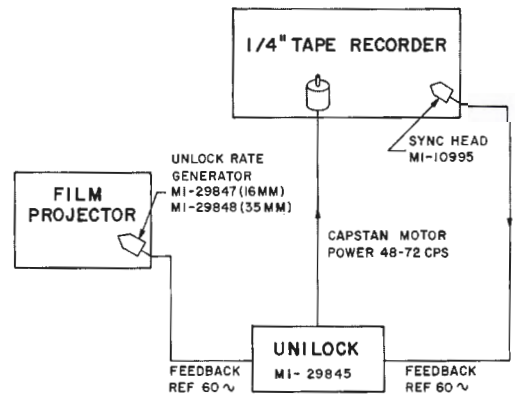

1/4-inch tape recorder interlocked to film projector.

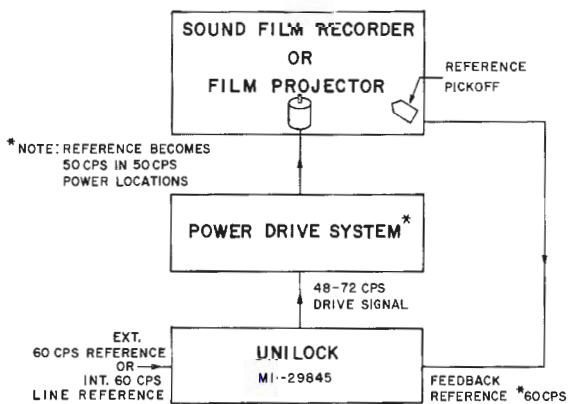

Basic UNILOCK configuration with film recorder or film projector.

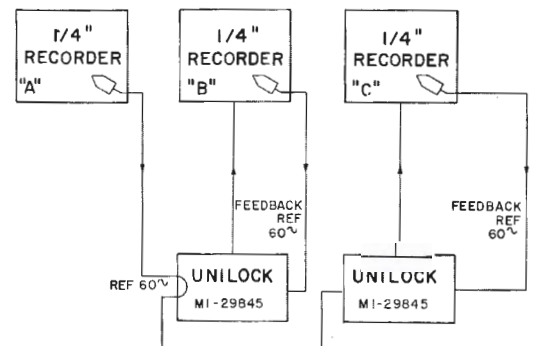

1/4-inch tape recorders interlocked to machine "A".



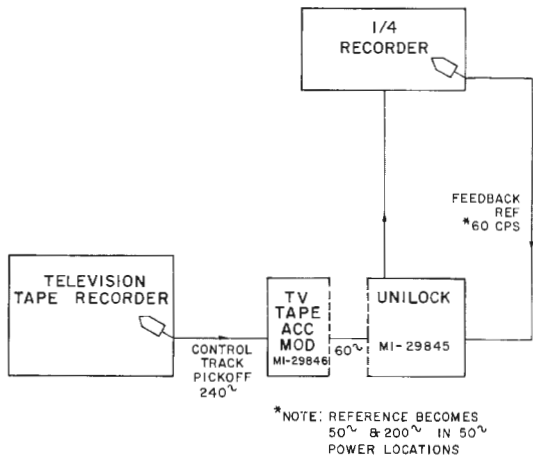

TV Tape Recorder and 1/4-inch recorder interlock system.

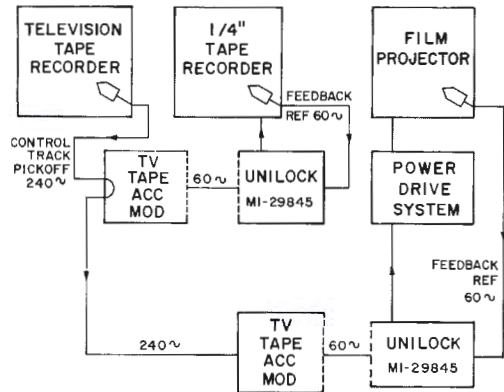

1/4-Inch Tape Recorder and film projector interlocked to Television Tape Recorder.

## Specifications

### Electrical

Input Sensitivity.....0.5 mv  
 Input Impedance.....1000 ohms  
 AC Input Power.....115/230 volts, 50/60 cps, 175 watts  
 Output A.....115/230 volts, 50/60 cps, 30 watts  
 Output B.....4 volt P-P pulse, negative going  
 630 microsecond, 75 ohm terminating, 50/60 cps nominal  
 Maintain Synchronism..... $\pm 1/2$  frame

### Mechanical

Construction.....19" rack modular assembly,  
 14" deep, 5 1/4" high  
 Number of Modules.....5

### Operating Controls

Power Switch  
 Advance/Retard Pushbuttons  
 Advance/Retard Vernier  
 Calibrate/Zero Adjust  
 Line/External Sync Reference/Remote Control/OFF Selector

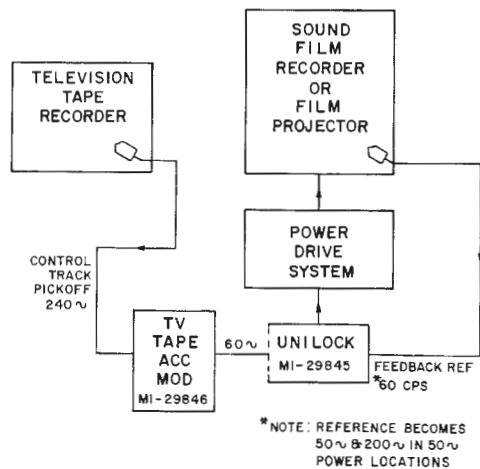

TV Tape Recorder and Film Projector interlock system.

## Ordering Information

### MI-29845 UNILOCK Assembly

(Includes preamplifier, pulse resolver, control, inverter and power supply modules plus rack mounting frame.)

### Accessories

MI-29846 Television Tape Accessory Module

MI-29847 Unilock Rate Generator, 16mm

MI-29848 Unilock Rate Generator, 35mm

- PM-77 1/4" Audio Tape Recorder/Reproducer equipped with sync head and provisions for record and playback of control track for use with UNILOCK System, rack mounting.



exible—complete integration of monochrome and color film

Permits film preview while other is "on-air"

Light efficiency essentially 100 per cent

Remote control of film and slide projectors and dual channel changeover mechanism

## Universal Multiplexer System, Type TP-15A

### Application

The Universal Multiplexer, Type TP-15A is an optical switching system for directing images from film and slide projectors into either of two television film cameras. It thus offers ideal facilities for previewing the picture from the upcoming projector while supplying a program signal

from another projector. This multiplexer allows complete integration of monochrome and color in the same system. Any two of the inputs can be fed to two outputs serving either two monochrome film cameras, or a monochrome and color film camera.



## Description

The Type TP-15A Universal Multiplexer consists of a Multiplexer unit, MI-40015-A, set of mirrors, MI-40114, and a basic control panel, MI-40025-A, together with a 24-volt d-c power supply, power supply shelf and panel. Four moveable mirrors are used to establish a desired light path between a projector and a Vidicon camera. Each mirror is driven by a reversible motor and a limited travel Geneva mechanism. The use of moveable mirrors permit the utilization of the film equipment for maximum program efficiency. Either of two film projectors (16mm or 35mm) or two slide projectors may be switched to either of two multiplexer outputs. The multiplexer base includes mounting space for a local control panel. For ease of assembly and service, the control panel and the associated control

circuits are mounted on a vertical chassis which is supported by a pair of drawer slides to permit withdrawal for service without disturbing the remainder of the system.

### Flexible Program Source

The TP-15A offers program flexibility and standby protection comparable to that of two complete single camera systems. It provides smoothness and continuity in programming without the expense and complexity of duplicated equipment. The TP-15A also requires less valuable projection room space than a two camera system utilizing separate multiplexers and projectors. A further advantage of this multiplexer is that it permits the installation of a monochrome system and later addition of color without discarding any equipment.

### Versatile Accessories

A group of accessory items consisting of a pedestal, optical assembly, set of mirrors and a field lens are required when a Monochrome Film Camera is used with the TP-15A Universal Multiplexer. The pedestal provides mounting for a monochrome camera and a slide projector, and includes 36 inches of rack space to mount such units as a 24-volt d-c power supply, control box for slide projectors or other associated equipment. The optical assembly includes a camera mount that incorporates vernier adjustment for accurate alignment. The mirrors and field lens are mounted on an adjustable bench plate which is covered for protection from stray light and dust. The rugged construction of the entire unit assures stability of operation.

TP-15A Multiplexer (right) and Pedestal (left) with monochrome Vidicon camera and slide projector mounted on it. The light-tight and dust-free covers have been removed to reveal the entire optical assembly.

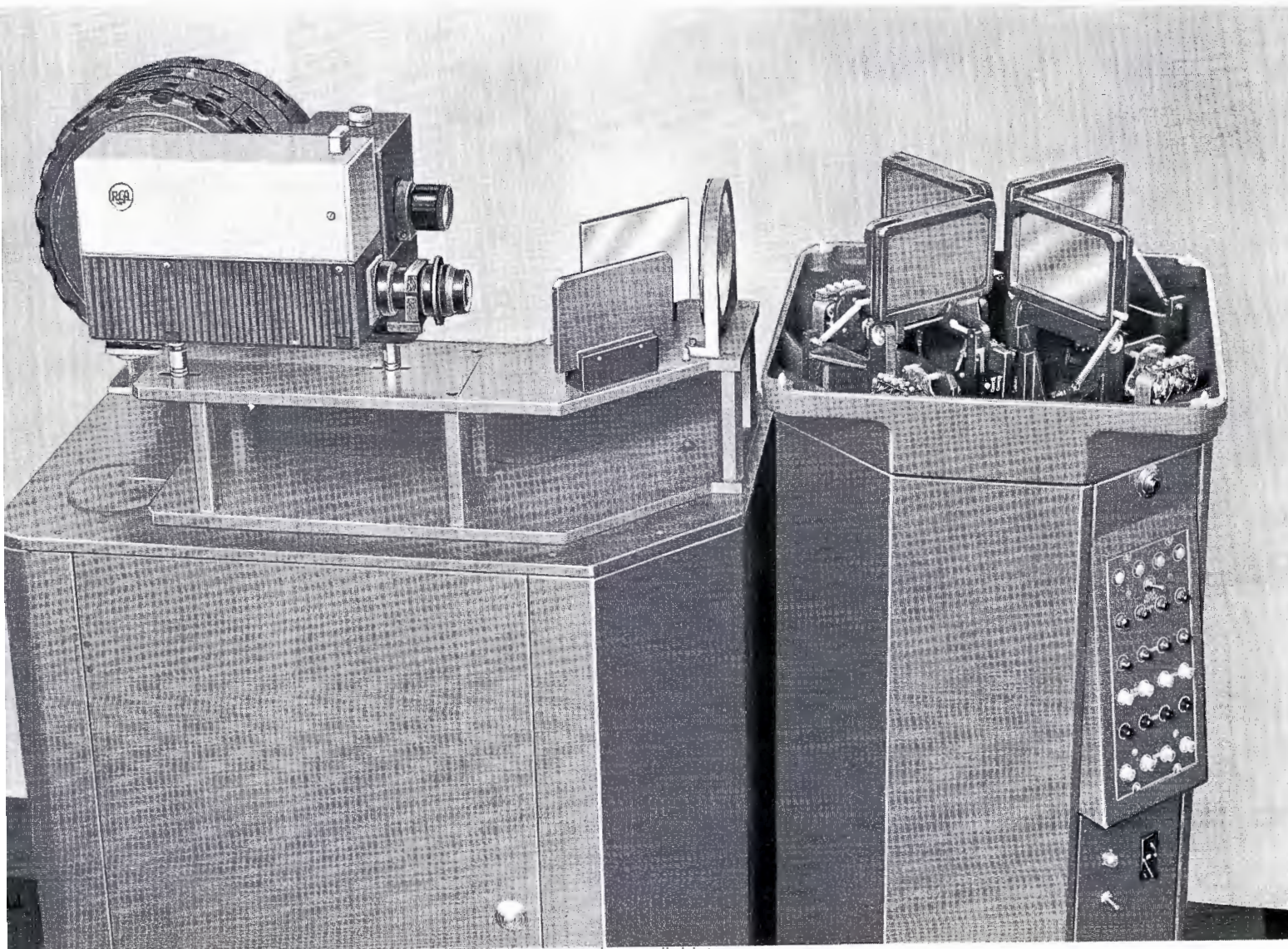



# Four Picture Sources in Multiplexed Use

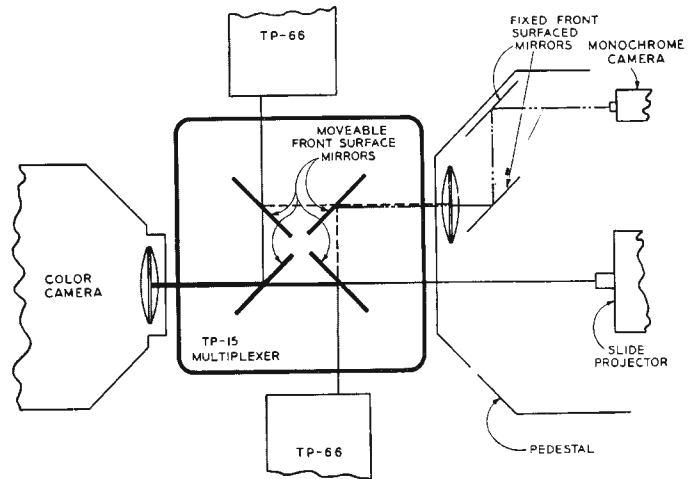
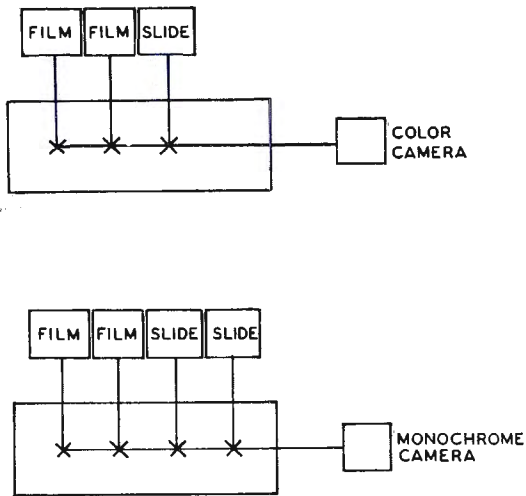

Diagram of light paths between cameras and projectors made possible by TP-15A Multiplexer.

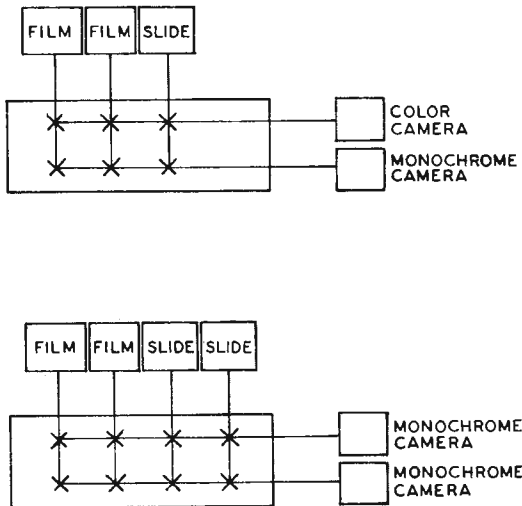
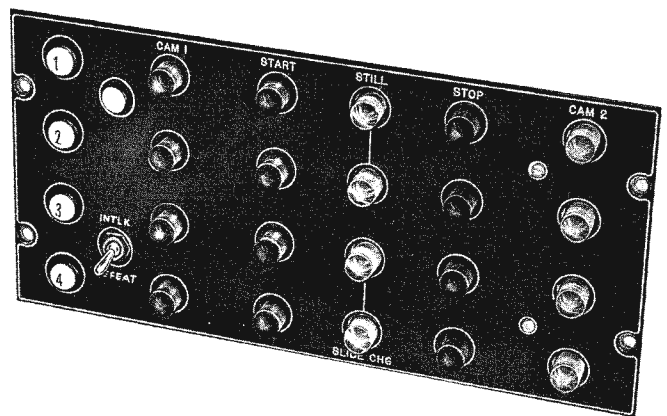

Diagram of possible arrangement of cameras, and film or slide projectors with TP-15A Universal Multiplexer.



Basic Control Panel allows remote control of multiplexer and projector functions.



## Control Panels

Control panels are available to meet a variety of system requirements. The Basic Control Panel provides all facilities for starting, stopping, still projection, slide change and the delegation of any projector to any multiplexer output. This panel may be used at the multiplexer for local control or at a remote location or both. The Auxiliary Control Panel provides limited control of

two projectors and two multiplexer outputs at the multiplexer. Since the operator stands beside the third projector when using this panel he has direct control of this projector. The Auxiliary Control Panel mounts on the multiplexer base opposite the Basic Control Panel and allows convenient access to controls from either side of the multiplexer.

Auxiliary switching voltages are available from the TP-15A Multi-

plexer which may be used to automatically switch audio when the multiplexer is used to switch video.

When ordering, it is necessary to specify the desired control panels as well as bulk cables, field lens and type of cover for the TP-15A Multiplexer. Covers are available for accommodating either two monochrome cameras, or one monochrome and one color Vidicon camera.

## Specifications

Multiplex Inputs.....Three or four  
 Multiplex Outputs .....Two  
 Control.....Local or remote  
 Mirrors (Four).....Three front surface, 1 dual surface  
 Motors (Four).....115 volts, 60-cycle, geared type,  
 gear ratio 29.5:1

Power Requirements.....115 volts, 60-cycle, single-phase  
 and 24 volts d-c  
 Dimensions.....60" long, 54" high, 20" wide  
 (152.4 cm x 137.2 cm x 50.8 cm)  
 Weight.....350 lbs. (approx.) (158.8 kg.)  
 Finish.....Shadow blue and midnight blue

## Ordering Information

TP-15A Universal Multiplexer Consisting of the following:

- 1 Multiplexer Unit, less cover  
 (115 volts, 60 cycles).....MI-40015-A  
 OR
- 1 Multiplexer Unit, less cover  
 (230 volts, 50/60 cycles).....MI-40015-AX
- 1 Set of Mirrors.....MI-40114
- 1 Power Supply (24 volt, d-c).....MI-3537
- 1 Shelf (for power supply).....MI-11597-B

Equipment required for mounting Monochrome camera and slide projector:

- Pedestal .....MI-40115-A
- Optical Assembly (for TK-21 Cameras).....MI-40116-A
- Optical Assembly (for TK-22 Camera).....MI-40130
- Set of Mirrors (for optical assembly).....MI-40113

Field Lens for Monochrome camera (Order one for each camera used in system)

Field Lens (3.14 diopter,  
 for TK-21 Series Cameras).....MI-40859-3

Field Lens (3.0 diopter  
 for TK-22 Series Cameras).....MI-40859-6

TP-15 Multiplexer Cover (select one of the following types)

Standard Cover (for TP-15A, midnight blue).....MI-40119-A

Cover for Dual Monochrome System  
 (four inputs, two outputs).....MI-40120-A

Control Panels (select as required)

Basic Control Panel  
 (for local or remote operation).....MI-40025-A

Auxiliary Control Panel (provides control of two projectors and two multiplexer outputs at multiplexer. MI-40025-A must also be used at multiplexer) .....MI-40024-A

Basic Control Panel for TP-66 Film Projector  
 (one required for each projector).....MI-40166

Basic Control Panel for TP-7 Slide Projector  
 (one required for each projector).....MI-40167

(NOTE: When two monochrome cameras are to be used order two of each of the above items and one Dual Surface Mirror, Stock #217782 for use in the Multiplexer Unit, MI-40015-A.)



## Features

- Precision optics and beam splitting prisms maintain "live" picture quality
- Rugged construction for stability of operation
- Light-tight and dust-free
- Vidicon camera and slide projector mount directly to multiplexer

# Monochrome Multiplexer, Type TP-11D

## Description

The TP-11D Monochrome Multiplexer is designed to provide multiple picture inputs for a single TK-22 Vidicon Film Camera. The unit can reflect images from two 16mm or 35mm film projectors and one slide projector. Thus greater operational simplicity is achieved by eliminating the number of operating controls that would be required if a separate vidicon camera were used for each projector. The TP-11D also greatly simplifies switching from one projector to another.

The TP-11D Monochrome Multi-

plexer employs two beam-splitting cubes for transmitting and reflecting the images from three projector sources onto the photo-conductive surface of the vidicon camera tube. The use of these prisms permits the permanent arrangement of the film equipment for maximum program efficiency. Either of the two motion picture projectors or the slide projector may be switched on or off electrically while the prisms remain in a fixed position.

The equipment is mounted on a rigid pedestal which is provided

with an adjustable supporting shelf for leveling the slide projector. A new precision mounting arrangement for the TK-22 Camera permits removal and replacement of the camera head without the need for optical realignment. The prisms and the field lenses are mounted on an adjustable optical bench plate which provides a means of leveling the optics. The complete optical system is covered so that it is light-tight and dust-free. The rugged construction of the entire unit assures stability of operation.



# Specifications

Length.....	63 $\frac{5}{8}$ " (162.6 cm)	Optical Center Above Floor.....	48" (121.9 cm)
Height.....	56" (142.2 cm)	Weight.....	150 lbs. (68 kg.)
Width .....	18" (45.7 cm)	Finish .....	Midnight blue

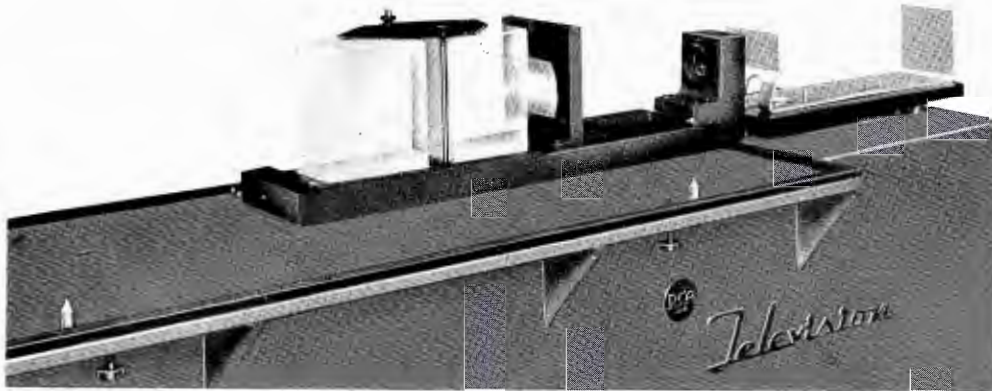

Close-up of the optical system of the TP-11D Monochrome Multiplexer. The optical system is completely covered by a housing to keep it light-tight and dust-free.

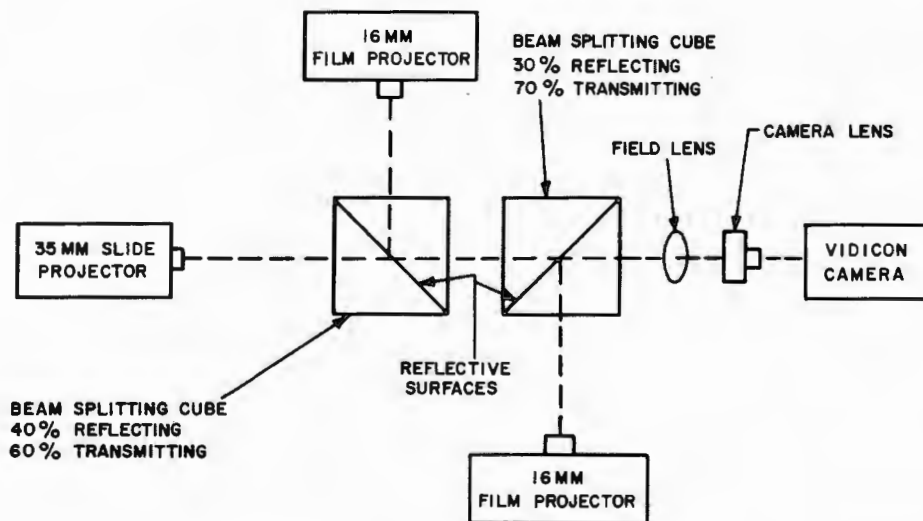

Optical Alignment Diagram, TP-11D Multiplexer.

# Ordering Information

Type TP-11D Monochrome Multiplexer  
(less Prisms) .....MI-26374

Beam Splitting Prisms.....MI-26394  
 Field Lens .....MI-26810-2  
 TP-11 Control Accessory (for use with MI-40166  
 and MI-40167 Control Panels).....MI-40168

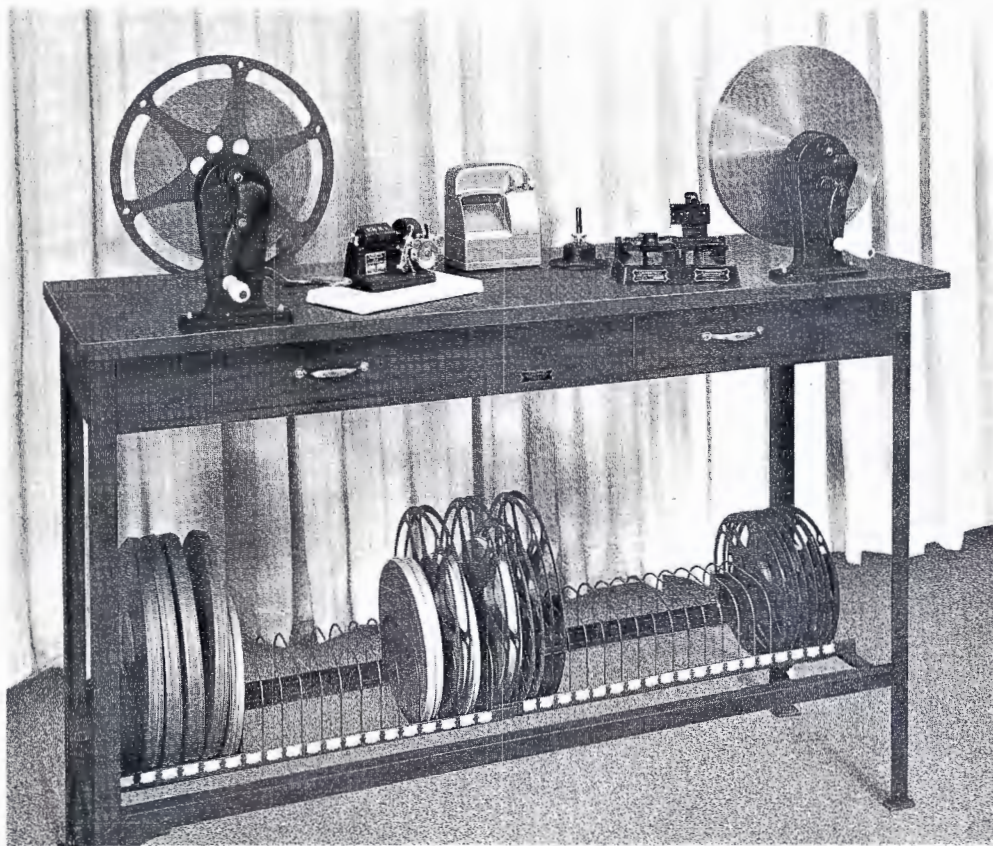

- ⊕ Complete film handling and editing facilities
- ⊕ Provides protection from fire and dust
- ⊕ Ample, orderly storage

## TV Film Accessory Equipment

RCA Film accessories are designed and selected to accommodate practically every editing and film handling need. Although individual TV station requirements will vary, practically every telecaster will find that film is an increasingly vital part of

the overall program structure. Equipment available includes film splicers, rewinds, viewers, measuring machine, editing tables, storage cabinets, reels and cans. Each may contribute to increased efficiency.



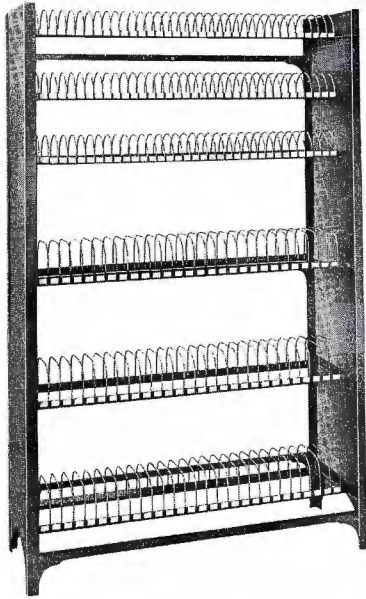

**Film Storage Rack, Model RK-200**

The RK-200 film storage rack provides space for storing film after it has been aired. This model is especially designed to schedule a one week supply of film, and may be located in the projection room, where it will always be handy for the projectionist.

The capacity of the RK-200 is 100-400 foot 16mm reels, and 100 of 800 foot, 1200 foot, or 1600 foot reels. Three tiers above handle 400 foot reels and the three below accommodate the larger reels. Reinforced with cross braces front and back, the RK-200 is drilled for mounting to wall or another unit. Overall size is 48 inches wide, 72 inches high and 16 inches deep.

**16mm Film Splicer, Model R-3**

A sturdy, heavy duty precision built splicer for professional use, exactly duplicating the famous Griswold 35mm model. With the Griswold Model R-3, 16mm sound film need never be "looped around" to splice and either sound or silent can be handled. The splices formed are clean, solid, and square—and stronger than the film itself.

The Griswold Model R-3 is supplied with scraper holder, 3 scraper blades, felt moistener, and complete instructions. The splicer is available in two different overlaps,  $\frac{1}{10}$ -inch for positive— $\frac{1}{16}$ -inch for negative. Overall size of the splicer is  $5\frac{1}{4}$  by  $8\frac{3}{8}$  by  $3\frac{3}{8}$  inches.

**Reel Rack Roller Truck, Model RRT-3**

This handy cart transports daily film from storage to the projection room. When film has been aired it may thus be returned to storage, without the burden of many trips needed when carried by hand. Large, rubber-covered ball bearing wheels (3-inch diam.). Overall size: 30 inches high, 30 inches wide, 9 inches deep.



**Film Storage Rack, Model MM-119**

Clean and orderly storage facilities are vitally important to the TV broadcaster. This filing equipment is a valuable addition to any projection room and protects costly films against damage.

The Neumade Model MM-119 Film Rack permits storage of a varied film library. Individual indexes are provided for reel spaces plus a master index. The door has a key lock and three point latching device. Overall size is 70 inches high, 30 inches wide and 16 inches deep. Capacity is 40-400 foot reels, 20-800 foot reels, 20-1200 foot reels and 20-1600 foot reels. A total of 100 filmstrip cans are accommodated. A utility drawer is supplied in base of cabinet.

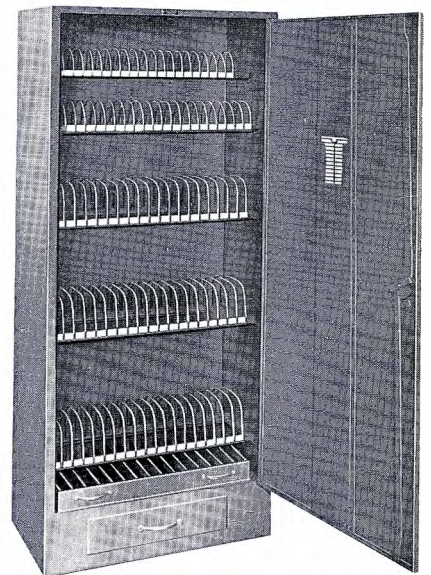

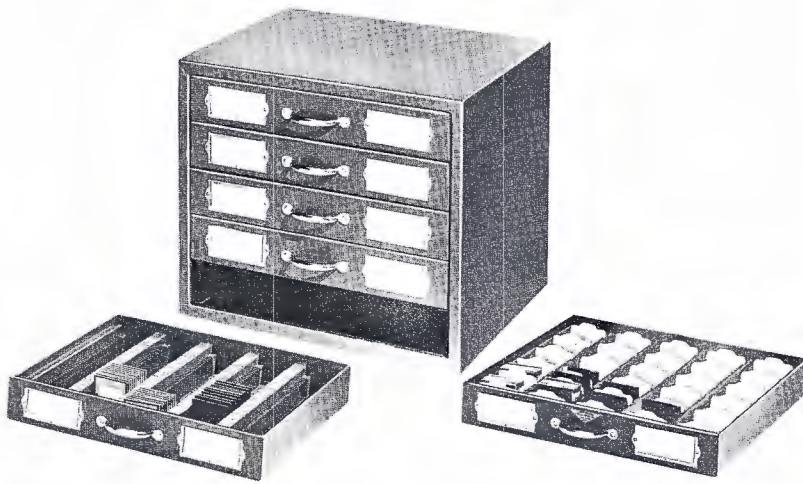

▲  
**Steel Slide Cabinets,  
 Models SF-5 & SF-5S**

TV shows require frequent slide changes and Neumade cabinets shown provide the storage needs. Heavy gauge cabinets are fireproof, welded construction. Cabinet drawers have back stops and permit filing of 2 by 2-inch slides in orderly fashion. Two models available are identical except for type drawer employed. Type SF-5 with five drawers accommodates 1250 slides or 2500 ready-mounts. Type SF-5S is identical but is blocked for sequence filing. Five drawers have 30 adjustable tabbed index dividers. Type SF-5S holds 2500 slides or 5000 ready-mounts. Size of both cabinets is 15 inches wide, 12 inches deep and 13 inches high.



◀ **Commercial Spot Storage Cabinet,  
 Model MM-180-16**

Neumade all-steel cabinets provide maximum storage facilities in a minimum of space. The Model MM-180-16 is an ideal storage cabinet for spot commercials, with a capacity of 625 100 foot 16mm film reels. Each may be housed in its own division with individual index card. Provision has been made for a master index. A humidifier tray on the bottom prevents films from drying out over long periods of time. Double doors with key lock as well as a three-point latching device are provided. The cabinet dimensions are 72 inches high, 48 inches wide, and 11 inches deep overall.

**Film Filing Cabinet, Model MM-12**

Here is a cabinet for bulk storage of "spots" that offers compact design, yet large capacity, to provide maximum utilization of limited space. Each cabinet holds 125 100 foot or 200 16mm reels and is equipped with double doors with key lock and three point latch. May be stacked like sectional bookcases to provide additional space. Overall size: 29 inches wide, 22 inches high, 17 inches deep.

▼

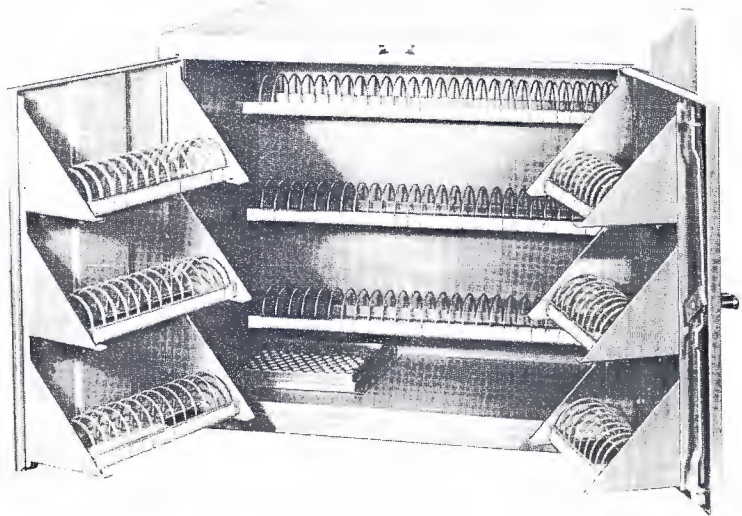

**Large Film Cabinet, MM-216**

For larger film libraries the MM-216 Cabinet (not shown) is available. It holds up to 200 reels of 800, 1200 or 1600 foot length without cans. The reels may be individually indexed and also master indexed. The cabinet is 90 inches high, 47 inches wide, and 16 inches deep overall. For housing reels in cans, the Model MM-216-C should be specified. Its capacity is 160 reels in cans up to the 1600 foot size.





### Projection Table, Model T-134C

Ideal for audition rooms of TV studios, or where the projector is not in permanent position. Table is sturdily built, non-vibrating, heavy gauge steel. Large rubber covered, ball-bearing casters (2 swivel—2 stationary) permits easy transport. Lower utility shelf provides clearance for speaker of all leading 16mm projectors. Top tilts by hand-driven spiral gears to any height to 10-inch rise. Adjustable bar prevents machine slipping. Finish: olive-gray baked enamel. Overall size: 30 inches long, 16 inches wide, 36 inches high.

### Motor Rewind, Model PD-1

TV projectionists will find that these motor driven rewinds save re-winding and inspecting time. Includes ball bearing, motor driven re-winder, with variable six position speed control for foot or hand operation.

### 16mm Rewinds

Neumade rewinds have long been popular because they are highly efficient and designed to give many long years of top service.

Precision ball bearings, machine cut steel gears, 3 point base, 4 to 1 gear ratio, streamlined sturdy gray iron cast housings plus brake arm on left hand unit contribute to efficiency and durability. Finished in fine black crystal morocco with bright yellow, extra full grip handles.

### 16mm BAIA Viewer

The Baia Viewer is used for "quick" editing and is very handy for previewing short sequences, interchanging spots and checking continuity of film strip or show. Has self-threading film track which eliminates sprockets or rollers. Picture is seen in motion on 2¼ by 3-inch ground glass screen. Ventilated low wattage bulb used which prevents film buckling.

### Editing Table, Model T-20

Neumade Editing table designed specifically for film work. The overall size is 42 inches long, 28 inches wide and 30 inches high.

### Footage Counter, Model HM-5-S

With a Neumade measuring machine the TV broadcaster can be assured of proper timing. It is equipped with precision cut gears and a patented counter. Sprocket hubs have teeth on one side only for silent or sound.

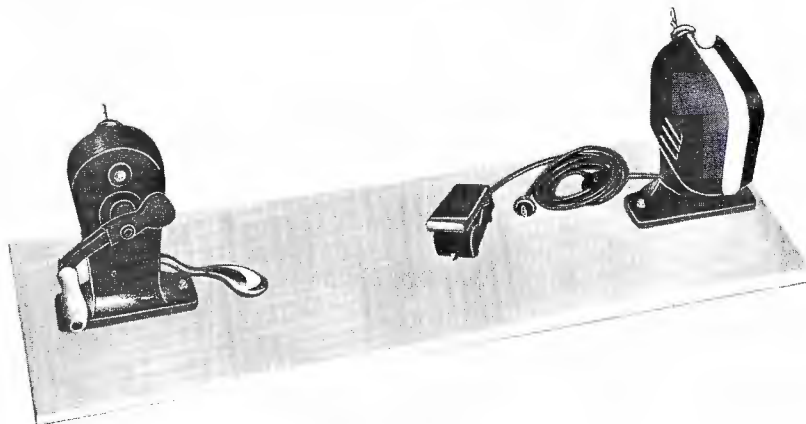

### 16mm Reels

Every well equipped TV studio needs an assortment of sizes of reels in flat steel as well as small plastic reels. These reels are perfectly rigid with just the right "give." They are true running—with perfect alignment. Finished with durable baked enamel. Sizes available for 400, 800, 1200, 1600 and 2000 feet.

### 16mm Flanges, Model DAF-26

TV station operators will find these a necessary item for transferring incoming film from spools to reels. They are smooth running, lightweight and very long lasting. All flanges are fabricated with Duralumin sides and brass hubs. Each has a removable key in the hub to engage bakelite cores.

### Cement Applicator Set, Model AS-16

This handy applicator set insures that film cement is always sealed when not in use and prevents spilling, wasting and deteriorating the cement. Specially designed glass bottle spring dipped into heavy cast base. Aluminum disc lays flat on bottle to keep it air-tight. Fluted brass applicator through disc deposits cement quickly and evenly.

### Fiber Shipping Cases

These sturdy cartons are a "must" for proper shipment of film. They have steel trunk corners, full telescope covers, 1-inch web straps with non-slip buckle, and a patented "Neu-Clip" metal holder with 2 reversible address cards. Large sizes have full-grip cowhide handle. All cases available in sizes for 400, 800, 1200, 1600 and 2000-foot reels, with capacity of from one to four reels per case.

### Large 16mm Steel Cans

These perfectly fitting cans are invaluable for protecting film from dust, abrasion, and atmospheric conditions. Both edges as well as top and bottom are ribbed for extra strength and rigidity. Sizes available for 800, 1200, 1600 and 2000-foot reels.

## Television Film Recorder, Type TFR-1



- New high resolution display tube
- Automated control system for easier operation
- Produces "live" quality film recordings
- Synchronous camera drive system



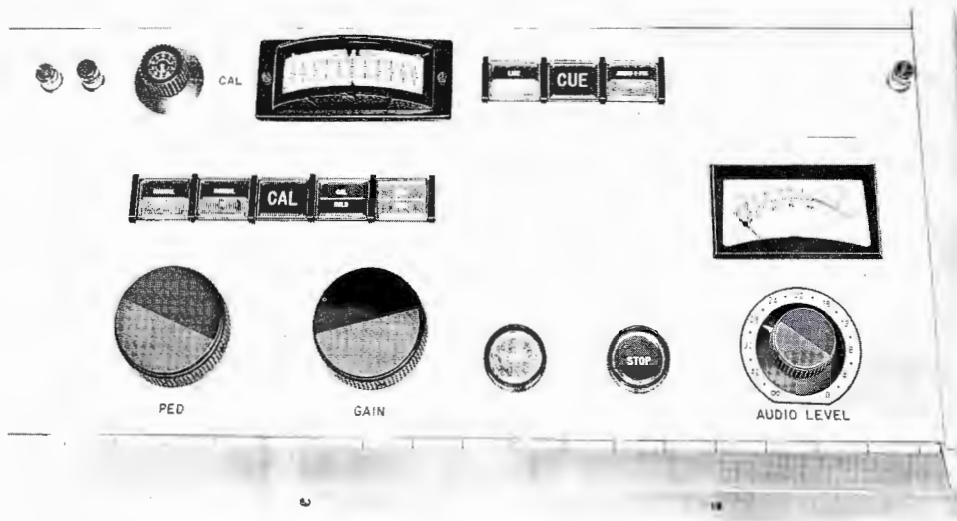

For ease of operation, the control panel of the TFR-1 is divided into three functional areas. Illustrated above is the right hand control panel, located beneath the camera.

The TFR-1 Television Film Recorder is completely self-contained in an air pressurized cabinet.

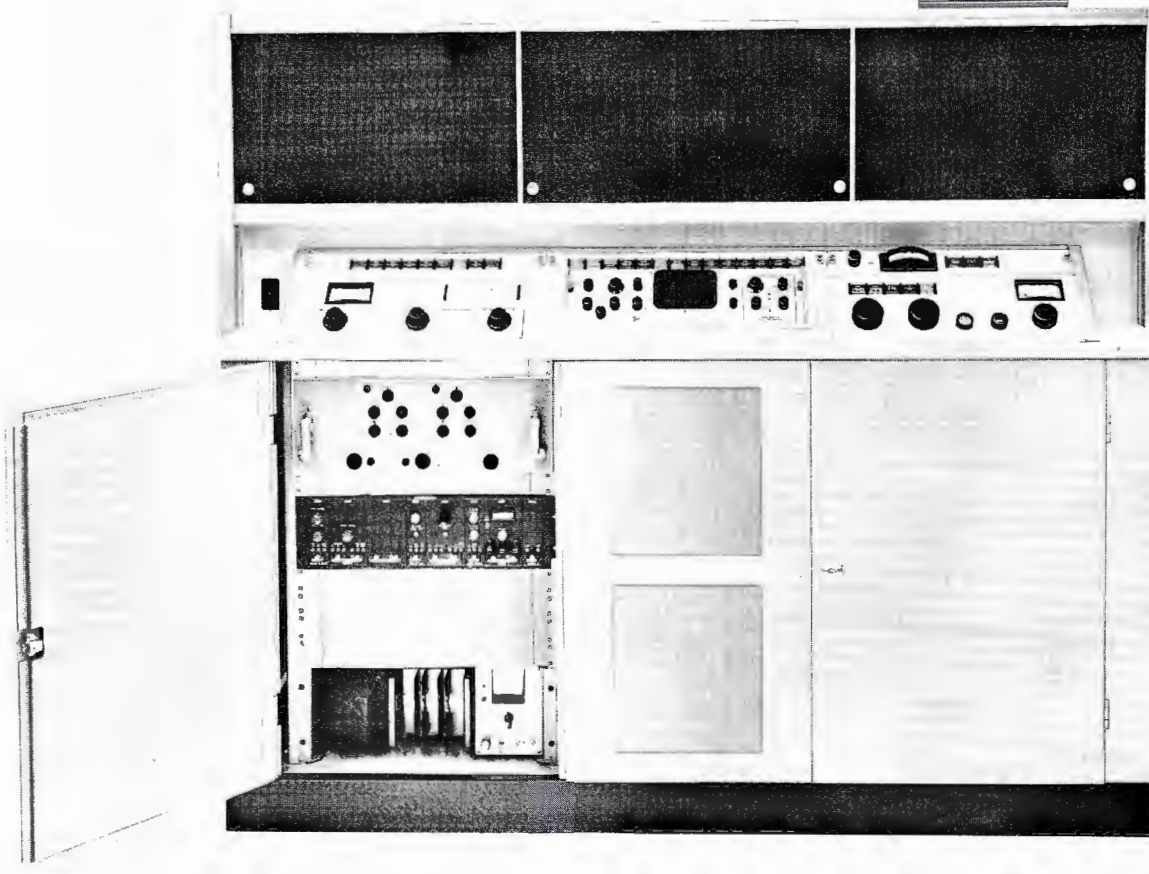
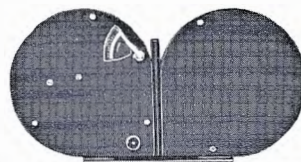

The RCA Type TFR-1 Television Film Recorder produces consistently high quality 16mm motion picture films from television signals. Video signals fed to the equipment appear on a high-resolution image display tube (kinescope), and in turn are recorded on film by the camera. The TFR-1, used in conjunction with a 4½-inch image orthicon camera, can produce a high quality noise-free film recording that is virtually indistinguishable from a "live" pickup.

The TFR-1 offers the opportunity for broadcasters and others with TV studio facilities to establish a film center for the production of commercials, delayed network programs, promotional films, public service films and the like, either for distribution or for library inventory.

Once the information is recorded on film, one, ten, or more copies can be readily obtained at far lower cost than other media to support varying distribution requirements. Recorded material may be easily checked and edited prior to further duplication.

As a result of its automatic preset exposure parameters which can be obtained at the touch of a button, this recorder will produce consistently good quality film transfers. A complete line of accessories, including single or double system optical sound recording channels, enhances its adaptability to a wide range of film recording requirements.

TFR-1 Film Recorders can be furnished to meet CCIR standards and can be equipped with 35mm cameras, if required.

## Description

The Type TFR-1 Television Film Recorder utilizes new design concepts in the image display tube and recording camera which account for a large portion of the improvements in the recording process. These components, together with an electronic system that provides minimum operating controls, optical "feedback" of output and control of both contrast and brightness of the display image, make the TFR-1 the first film recorder in the industry which can be called "automatic."

### Self-Contained Console

The TFR-1 equipment is completely enclosed in an air-pressurized cabinet. It consists basically of the image display tube and camera, together with associated control panel, video amplifiers, deflection circuits and power supplies. Electronics for the system are housed in the base of

the recorder. The sloped control panel includes the waveform monitor and meters, and is divided into three functional areas for operating ease.

Maximum accessibility is afforded by swing-out door panels, plug-in modules and shelves. The top portion of the cabinet houses a floating optical bench on which is mounted the image display tube and the camera. Access to this area is provided by means of sliding panels.

An a-c circuit breaker is provided and power input is by means of a single cable power feed. An ordinary 3-connector twist lock receptacle is used for supplying power.

### Simplified Control System

The TFR-1 is designed for ease of operation and maintenance. The control panel is divided into three

functional areas. The left hand panel contains illuminated push-button indicators and a meter for checking significant voltages, waveform monitor input pushbuttons and centering and focus controls.

The center panel contains the waveform monitor and illuminated function selector pushbuttons. The mode of operation, i.e., positive or negative, aperture compensation for live or tape signals, scan reversal, etc., is selected on this panel.

The right hand control panel, which is located beneath the camera, is the operating panel containing start-stop buttons, calibrate buttons, pedestal and gain controls, VU meter and audio level control. A calibrated dial provides adjustable reference for the light output of the image display tube.



To produce consistently high quality motion picture films, accurate control of exposure is necessary. In the TFR-1 system this is achieved by means of a photo-cell bridge which automatically adjusts both black level and contrast range to preset values at the touch of a button.

### Sub-Screen High Resoluion Display Tube

The TFR-1 utilizes a specially designed image display tube which incorporates a precision aligned electron gun with controlled spot size for optimum resolution at all normal brightness levels. Electrostatic focus with the addition of "Dynamic Beam Focusing"—the mixture of several focusing waveforms—results in optimum resolution capabilities in all raster areas.

This image display tube's high resolution capability (at least 800 lines in the center of the raster and

at least 600 lines in the corners) results from a special electron gun structure which provides a 3 mil spot size (comparable to writing with a fine pencil). The sub-screen tube utilizes a method of phosphor suspension that permits the image to be located a short distance behind the face plate. Dispersion of light caused by the thick face plate is thereby virtually eliminated. This also allows an effective increase in detail contrast ratio.

### Precision Registration Camera

The TFR-1 system includes a 16mm recording camera specifically designed for film recording. This camera features simplicity of operation, virtually vibrationless mechanism, and fixed registration pin for precise frame registration. The pull-down principle employed uses only one reciprocating component. Pull-down is accomplished without the use of claws. The optical shutter is

based upon a "lap-dissolve" action which effectively eliminates shutter bar effects. The TFR-1 camera, combined with the image display tube featuring PTFR-3 phosphor, produces film transfers of consistent excellence.

### Synchronous Camera Drive System

A solid state power drive system driven by the vertical deflection chassis assures synchronous operation of the camera, locked to the incoming video signal at all times.

This is a vital factor in the outstanding flexibility of the TFR-1. Any incoming video signal—color or monochrome, local or remote—can be faithfully recorded without shutter-bar effects that result from non-synchronous operation.

### The Electronic System

The electronic system of the TFR-1 is shown in the block diagram. The first block in the system

Block diagram of TFR-1 Electronics System.

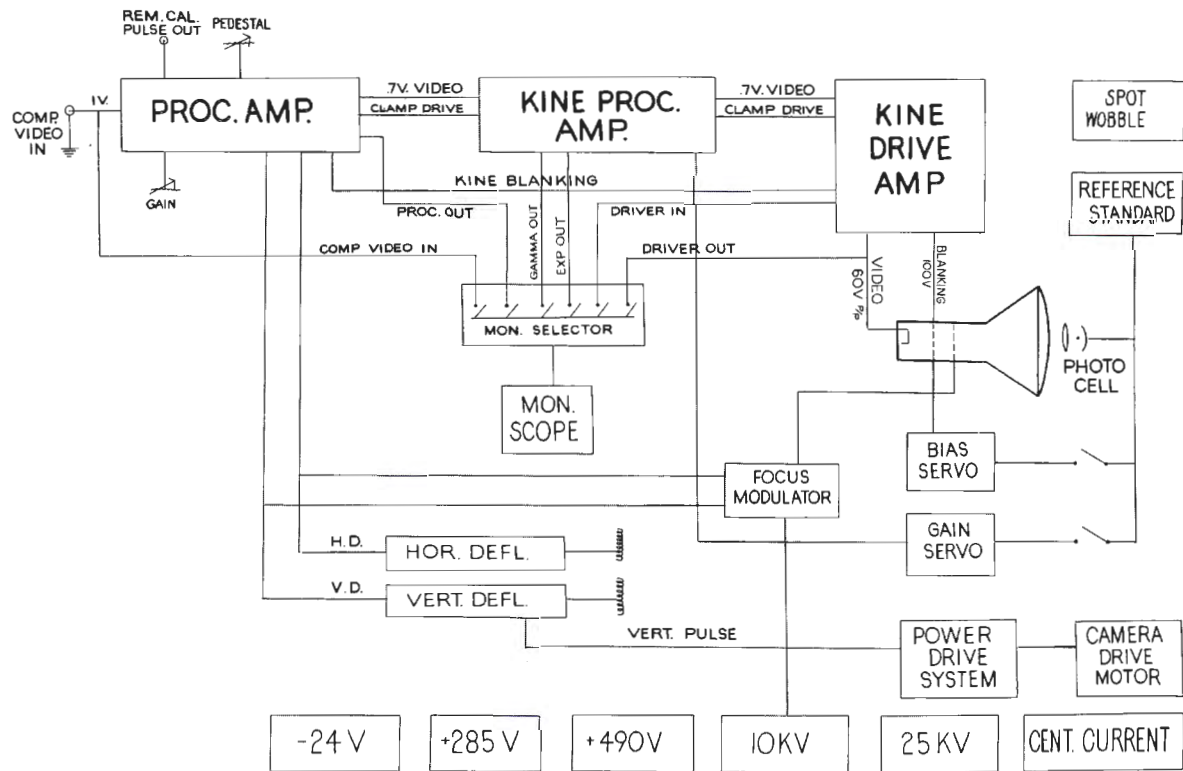

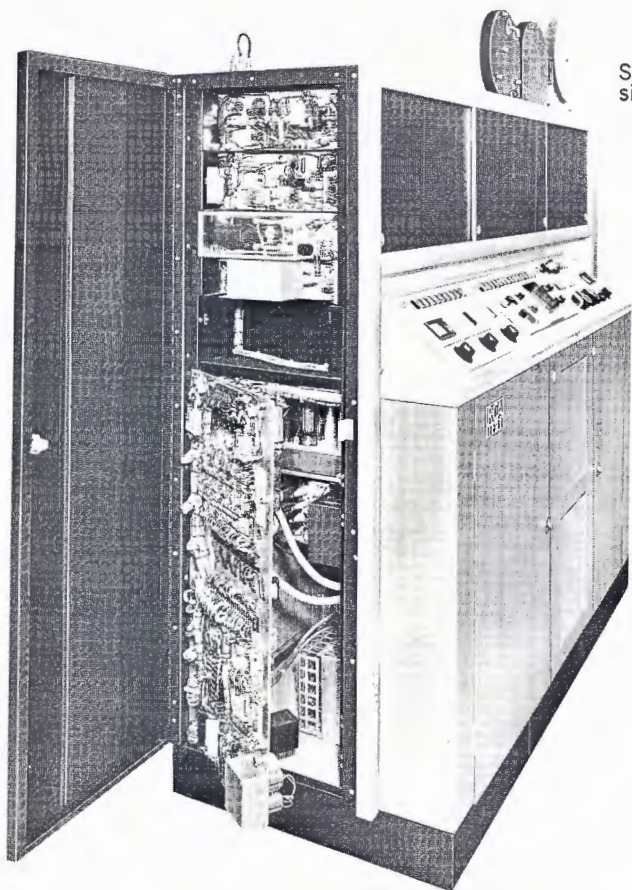

Side view of TFR-1 showing accessibility of electronic components.

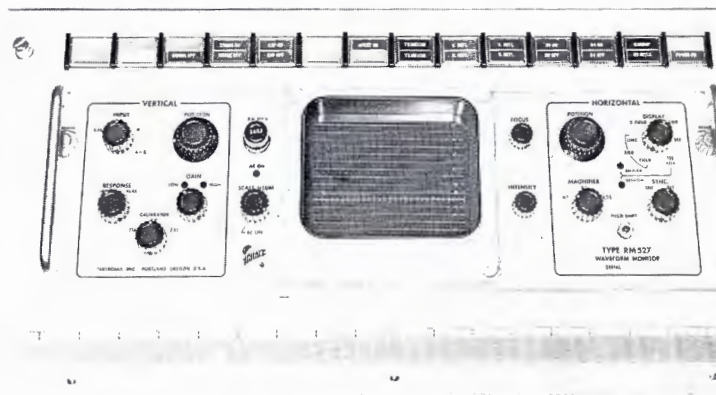

Initial set-up and adjustment of the TFR-1 is available by a built-in waveform monitor with pushbutton input selectors.

is a processing amplifier which separates the sync, drive and blanking information from the composite signal for use throughout the system. Added to the processing amplifier is a calibration pulse generator which plays an important part in the system operation. It produces a half black and half white screen presentation on the display tube which is referenced to an established standard, for automatic adjustment of gain and bias to produce the desired brightness and contrast.

The generator is also used as the signal source to automatically produce a 4 step variable density strip after each set up for laboratory processing guidance. The steps vary in amplitude from zero to the established maximum, with each step representing an equal increment of the total maximum brightness value. Thus a sensitometric reference at the beginning of each film is available for processing laboratory use.

A precision clamp and level reference pulse is generated, always available, mixed with the signal for purposes of clamping and level control during horizontal blanking to a predetermined level on either positive or negative picture presentations. A

clamp driver is added with variable timing to provide clamp on either reference black or reference white depending upon which display is desired—Negative or Positive.

### Kine Processing Amplifier

The kine processing amplifier contributes several essential functions to the systems concept: aperture compensation, exponential correction, gamma correction and system gain. Aperture compensation is variable in amplitude over a range of 10 db, with pushbutton selection for two frequencies (4 and 8 megacycles) for the purpose of tape and live recordings respectively.

Exponential correction ("white" stretch) and gamma correction ("black" stretch) are provided to permit precise control of the video to luminance transfer characteristic. Both negative and positive film recordings can be optimized through the use of continuously adjustable slope and break point controls for exponential and gamma. If desired, both circuits can be by-passed by front panel pushbuttons. The kine processing amplifier also controls the system gain as determined by the automatic calibration circuit.

A kine driver amplifier follows. It is a high gain video amplifier providing 60 volts peak-to-peak from 30 cps to 8 mc within  $\pm 0.5$  db and to 10 mc  $\pm 1.5$  db. The amplifier is directly coupled to the cathode of the display tube, with d-c restoration of the feedback clamp type. The amplifier also increases kine blanking to 100 volts for "super blanking."

### Built-In Waveform Monitor

The TFR-1 Television Film Recorder contains a waveform monitor with pushbutton input selector. The pushbuttons are arranged so that the signal path may be sequentially monitored from input jack to image display tube. This allows a rapid method of initial set-up and adjustment of the system as well as a convenient tool for normal maintenance of the system.

Illuminated pushbutton switches are employed for almost all operating and set-up functions. Critical components, such as the image display tube, are protected by various electrical interlocks to protect these components from accidental damage due to circuit failures or other causes. High voltage interlocks for personnel protection are also provided.





Automatic Film Processor, available as a TFR-1 accessory, produces high quality films in a continuous automatic process without need for mixing chemicals or preparing solutions.

### Automatic Presetting Exposure Control

An important element of the TFR-1 system is the automatic calibration circuit which provides repetitive accurate set-up of the recording channel. During the calibrate interval the calibration pulse generator previously described provides a screen presentation of half white and half black. A photo cell scans the presentation and compares the luminance values observed to the established standard and sequentially causes the bias and gain servos to adjust the brightness (bias) and contrast (gain) to achieve the pre-set operating conditions.

### Dynamic Beam Focusing

The focus modulator provides adjustable amplitude hyperbolic wave forms at horizontal and vertical rates to produce excellent spot focus over the entire face of the display tube. Also, the circuits are designed to compensate for the defocusing effect produced by the wide range of video drive, maintaining the desirable spot size throughout all normal operating conditions.

PM-80 Double System Optical Sound Recorder is available for applications where it is desirable to have separate processing for the sound portion of the film. It includes transistorized amplifiers and employs the proven RCA variable area recording method.



## Solid State Power Supplies

The power drive system for the camera is a solid state device that powers the camera motor, directing its speed and phase in accordance with the timing of the television picture. Thus, it operates independently from the a-c power line frequency. This is most necessary when working at color standards (59.94 cps) and further advantageous for all tape transfer work.

All power supplies including filament supplies are regulated and the horizontal and vertical deflection chassis are also highly stabilized with excellent linearity.

## Line Erase

A "spot wobble" modulator drives an auxiliary yoke winding and is controlled by a front panel push-button. With line erase "on," the raster lines are effectively eliminated from the recorded film by a very high frequency modulation of the kinescope beam. This is accomplished with no discernible loss in picture resolution.

## Automatic Fault Indicator System

A color code is employed on the illuminated buttons so that a "red" indication points out an inoperative circuit or unit. Under normal operation all indicators will show either yellow or green. Secondary circuitry such as aperture compensation, gamma correction, exponential correction, etc. may be bypassed at the touch of a button to prevent a complete loss of the recording in the event of circuit failure.

## Built-In Test and Reference Signal Generator

Three test and reference signals are generated in the TFR-1 to facilitate controlled, automatic operation:

1. A half-black half-white presentation on the image display tube serves as the basis for automatically adjusting gain and bias to pre-determined levels as previously described.
2. A constant amplitude calibration pulse appears in the horizontal blanking interval during normal operation of the recorder and establishes peak video level.
3. A 4 step test signal is generated after each calibration cycle to serve as a reference for film processing.

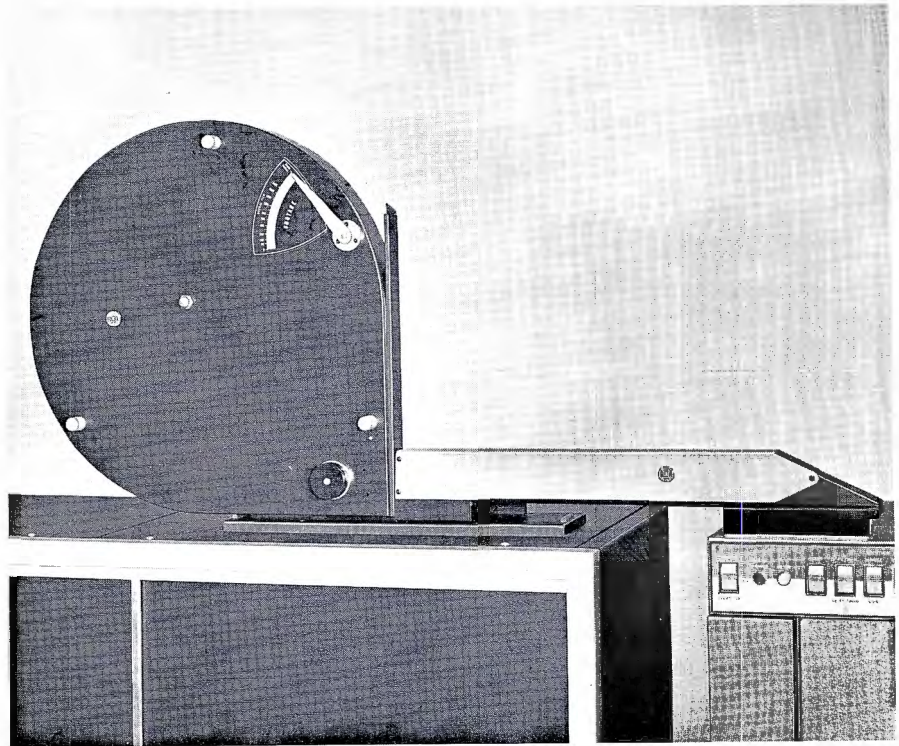

The MI-29733 Coupling Unit, for use between recorder and processor, automatically starts and stops TFR-1 and processor at required time intervals.

## ACCESSORIES

Single System Variable Area (Auricon) Optical Sound Recording Accessory Kit.....	MI-29736-VA
Single System Magnetic Sound Recording Channel....	MI-29738
Single System Variable Area (Maurer) Optical Sound Recording Channel.....	MI-29744
RCA Type PM-80E Double System Optical Sound Recording Channel.....	ES-40968
Power Drive System for PM-80E including Interconnecting Cables and Accessories.....	MI-29737
1200-foot capacity 16mm Film Magazine.....	MI-10770-E
MacBeth Model TD-100 Densitometer	
Eastman Model 30 Viscomat Processor	
Eastman Model 1M, Viscomat Water Temperature Control Unit	
Coupling Unit, with start-stop sequencer (for use between recording camera and viscomat processor) .....	MI-29733



**Electrical**

Input Signals:

Video:

Composite Video Signal.....In accordance with EIA and FCC specified color/monochrome signal standards

Composite Video Signal Level.....0.5 to 1.4 volts peak-to-peak

Audio (optional).....-10 to +8 VU into 600 ohm balanced line matching input

Power.....117 volts ±10%, 60 cycles a-c single phase, 13 amp. (ES-40967)  
230 volts ±10%, 50 cycles a-c single phase, 7 amp. (ES-40967-B)

**Performance**

General:

Recording Medium....16mm double or single perforated blue sensitive film such as Eastman 7374

Film Speed:

ES-40967.....24 frames per second

ES-40967-B.....25 frames per second

Picture—Sound Separation.....26 frames, sound leading

Recording Time.....Nominally 66 minutes

Starting Time.....3 seconds maximum

**Camera**

Fast-film pull-down mechanism

Buckle trip interlock

2400 ft. film capacity

Fixed registration pin

Viewing magnifier for lineup

Separate torque motor for magazine drive

Film footage counter

**Image Display Tube**

Diameter .....9"

Raster Size.....4.2" by 5.6"

Deflection .....Electro-magnetic

Focus .....Electro-static

Phosphor .....PTFR-3

Resolution .....800 lines

Spot Size......003" max.

**General Specifications**

Deflection System.....Linearity deviation 1% max.

High Voltage Supplies.....25 KV ±1%, 10 KV ±1%

Control System:

Exposure Control.....Photocell Bridge coupled to servo potentiometers

Brightness Reference.....Comparison voltage

Contrast Reference.....Selected Wratten Neutral Density Filters

Auxiliary Circuit Selection.....Illuminated Pushbuttons

Metering Selection.....Illuminated Pushbuttons

Mode Selection.....Illuminated Pushbuttons

Calibrate Presets.....Illuminated Pushbuttons

Video Amplifier Bandwidth.....±.5 db to 8 mc

Aperture Correction.....Approx. 4 mc and 8 mc

Boost.....Adjustable to 10 db min.

Gamma Correction.....Two breakpoints, adjustable  
Two slope gain controls

Exponential Correction.....Two breakpoints, adjustable  
Two slope gain controls (Provision for five plug-in units)

**Mechanical Specifications**

Width .....70"

Height (not including film magazine).....60"

Depth .....26"

Shipping Weight.....1200 lbs. (approx.)

Finish.....Two tone blue

**Ordering Information**

Type TFR-1 Television Film Recorder.....ES-40967

525 lines, 60 fields, including:

1 MI-29730 Console Assembly

1 MI-29732 Recording Camera

2 MI-29734 Film Cassette (2400 ft.)

1 MI-29739 Footage Counter

1 MI-29813 Image Display Tube (Subscreen)

1 MI-29814 Image Display Tube

Type TFR-1 Television Film Recorder.....ES-40967-B

625 lines, 50 fields (CCIR) including:

1 MI-29730-B Console Assembly

1 MI-29743 Camera

2 MI-29734 Film Cassette (2400 ft.)

1 MI-29813 Image Display Tube (Subscreen)

1 MI-29814 Image Display Tube

# Index

	MI No.	Page
Alignment Jig (for TK-22) .....	40445	12
Amplifier (for TP-7B/66 Light Control Systems) .....	40147	34
Audio Switching Relay (for Remote Control Panels) .....	11729	37
Audio Tape Recorder/Reproducer .....	PM-77	42
Beam-Splitting Prisms (for TP-11D) .....	26394	48
<b>Cabinet:</b>		
Commercial Spot Storage .....	MM-180-16	51
Film Filing (100-foot spools) .....	MM-12	51
Film Storage (16mm Reels) .....	MM-119	50
Large Film .....	MM-216	51
2-inch by 2-inch Slide File (1250 capacity) .....	SF-5	51
2-inch by 2-inch Slide File (2500 capacity) .....	SF-5S	51
<b>Cable:</b>		
TK-22 Camera .....	26725-E5	12
TK-27 Interconnection (50-foot with connectors) .....	557307	20
<b>Camera:</b>		
TK-22 All-Transistor Vidicon Film (monochrome) .....	TK-22	5
TK-27 Transistorized Color Film .....	TK-27	13
<b>Cans, 16mm Steel:</b>		
1 400-foot reel .....	—	52
1 800-foot reel .....	—	52
1 1200-foot reel .....	—	52
1 1600-foot reel .....	—	52
1 2000-foot reel .....	—	52
<b>Cases, Fiber Shipping:</b>		
1 800-foot 16mm reel .....	—	52
1 1200-foot 16mm reel .....	—	52
1 1600-foot 16mm reel .....	—	52
1 2000-foot 16mm reel .....	—	52
Cement Applicator Set .....	AS-16	52
Color Test Film .....	40846	20
Connector Assembly (for TO-4) .....	556525	20
Console Well Adaptor (for TK-22 Remote Control Panel) .....	26212	12
Control Accessory (for TP-11D) .....	40168	36, 48
<b>Control Panels:</b>		
TK-22 Camera .....	557797-B1	12
TK-22 Remote (fits 13-inch console) .....	557202-B1	12
TK-22 Remote (for 20-inch console) .....	557203-A1	12
TK-27 Color .....	557204-A1	20
TK-27 Light .....	557322	20, 34
TK-27 Remote (for 20-inch console) .....	557203-A1	20
TP-7B Dual Remote .....	26256-A	37
TP-7B Slide Projector (use with TP-11D/15A) .....	40167	32, 36
TP-15 Auxiliary Control Panel .....	40024-A	46
TP-15 Basic Control Panel .....	40025-A	46
TP-66 16mm TV Film Projector (use with TP-11D/15A) .....	40166	28, 36, 46
TP-66 Dual Remote .....	40256-A	28, 37



	MI No.	Page
Coupling Unit (with start-stop sequencer for use between TFR-1 Recording Camera and Viscomat Processor) .....	29733	59
Cover:		
TP-15A Multiplexer, Standard Type .....	40119-A	46
TP-15A Multiplexer, Dual Monochrome Camera System .....	40120-A	46
Densitometer (MacBeth) .....	TD-100	59
Disc, Neutral Density for TP-7B .....	40150	32
Dual Projector Remote Control Panel (For TP-66 Film Projectors) .....	40256	28
Editing Table .....	T-20	52
Film Cameras:		
Monochrome TK-22 .....	—	5
Color TK-27 .....	—	13
Film Cassette (2400 feet for TFR-1) .....	29734	60
Film Magazine, 16mm (1200-foot capacity) .....	10770-E	59
Film Projectors:		
TK-66 16mm, 60 cycle .....	40066	28
TK-66 16mm, 50 cycle .....	557066	28
Film Recorder:		
Television Type TFR-1 (525 line, 60 fields) .....	ES-40967	60
Television Type TFR-1 (625 line, 50 fields) .....	ES-40967-B	60
Film Splicer .....	R-3	50
Film Storage Cabinet .....	MM-119	50
Film Storage Rack .....	RK-200	50
Filter Wedge (for TP-66 Light Control) .....	40148	34
Flanges, 16mm—14-inch .....	DAF-26	52
Footage Counter:		
For 16mm Film .....	HM-5-S	52
Image Display Tube:		
TFR-1 (Subscreen) .....	29813	60
TFR-1 .....	29814	60
Interlock Motor Drive Kit .....	3492	38
Lenses:		
2½-inch, f/2.6 (TP-66 with TP-15A) .....	26799-B	28
3½-inch, f/1.5 (TP-66 with TP-11) .....	26325-A	28
7½-inch, f/1.5 (TP-7B, also TP-15A when not used with TP-16 Projectors) .....	26335	32
9-inch, (TP-7B with TP-15A when used with a TP-16 Projector) .....	26336	32
Camera Lens (for TK-22 when used with TP-11 Multiplexer) .....	43202-1	12
Camera Lens (for TK-22 when used with TP-15 Multiplexer) .....	43202-2	12
Field, 6.3 Diopter (TK-22 with TP-11D) .....	26810-2	12, 44
Field, 3.0 Diopter (TK-22 with TP-15A) .....	40859-6	12, 46
Field, 3.14 Diopter (TP-15A less TP-16) .....	40359-3	46
Lens Adaptor (for MI-26335 Lens when used with TP-11D) .....	26340-A	32
Light Controls:		
For TP-66 .....	ES-40946	34
For TP-7B (Use with Amplifier MI-40147) .....	40150	32
Magnetic Sound Control (for TP-66) .....	ES-40940	28

	MI No.	Page
Measuring Machine (Film Footage Counter) .....	HM-5-S	52
Mirrors:		
Set for TP-15A Multiplexer .....	40114	46
Set for TP-15A Optical Assembly .....	40113	46
Modification Kit (to permit use of MI-40167 with TP-15A) .....	40169	36
Module, TV Tape Accessory .....	29846	42
Module Extender .....	557301	12
Module Extender for Preamplifier .....	557304	12
Monitor:		
Color (115 volts, 60 cycles) Type TM-27AC .....	40232-A	20
Color (230 volts, 50 cycles) Type TM-27AC .....	40444	20
Monochrome, 14-inch Picture (115 volts, 60 cycles) .....	557210	20
Monochrome, 14-inch Picture (115/230 volts, 50/60 cycles) .....	557218	20
Monochrome, 8-inch Picture, Type TM-19N .....	556526	20
Waveform, Type TO-4 .....	556523	20
Monitor Housing, rotatable (for TK-27) .....	557209	20
Mount (for TO-4/TM-19N) .....	556528	20
Mounting Adaptor:		
TK-22 with TP-11/A/B/C Multiplexers .....	40128	12
TK-22 with TP-15 Multiplexer .....	40129	12
Mounting Frame:		
For Standard 5½-inch Modules .....	557300	34
For TK-22/27 Remote Control Panels .....	557306	12
For TP-7B/66 Remote Control Panel in 13-inch Console .....	26252	37
For TP-7B/66 Remote Control Panel in Rack or 20-inch Console .....	26254	37
Multiplexer:		
TP-11D Monochrome (less prisms) .....	26374	48
TP-15A Universal (115 volts, 60 cycles) .....	40015-A	46
TP-15A Universal (230 volts, 50/60 cycles) .....	40015-AX	46
Optical Assembly:		
TP-15A Multiplexer (with TK-21 Camera) .....	40116-A	46
TP-15A Multiplexer (with TK-22 Camera) .....	40130	46
Panels:		
Front (for TM-19A Monitor) .....	556527	20
Front (for TO-4 Waveform Monitor) .....	556524	20
Local Indicator for TK-22 Camera .....	557796-B1	12
(see also under Control Panels)		
Pedestal (for TP-15A Universal Multiplexer) .....	40115-A	46
Prisms, Beam-Splitting (for TP-11D) .....	26394	48
Processor .....	Eastman 30	59
Projector:		
TP-7B 35mm Slide (115 volts, 60 cycles) .....	40011-B	32
TP-66 16mm (60 cycles) .....	40066	28
TP-66 16mm (50 cycles) .....	557066	28
Projection Table .....	T-134C	52
Power Drive System for PM-80E .....	29737	59



	MI No.	Page
Power Supply, 24 volt d-c for TP-15A .....	3537	46
Rack, Film Storage .....	RK-200	50
Recorder, TV Film:		
TFR-1 (525 lines, 60 fields) .....	ES-40967	60
TFR-1 (625 lines, 50 fields, CCIR) .....	ES-40967-B	60
Reels, 16mm:		
1 100-foot plastic .....	---	52
1 400-foot flat steel .....	---	52
1 800-foot flat steel .....	---	52
1 1200-foot flat steel .....	---	52
1 1600-foot flat steel .....	---	52
1 2000-foot flat steel .....	---	52
Reel Rack Roller Truck .....	RRT-3	50
Rewind, Dynamic 16mm:		
Geared End with Brake .....	Neumade	52
Geared End .....	Neumade	52
Rewind, Motor Driven 16mm .....	PD-1	52
Servo Amplifier (for Light Control Systems) .....	40147	34
Shelf (for TP-15A Power Supply) .....	11597-B	46
Slide Projector:		
TP-7B 35mm (115 volts, 60 cycles) .....	40011-B	32
Sound Recording Accessory Kit, variable area, optical .....	29736-VA	59
Sound Recording Channel:		
Single System, magnetic .....	29738	59
Single System, variable area optical .....	29744	59
Double System, optical .....	ES-40968	59
Sound System, Magnetic (for TP-66) .....	ES-40940	28
Splicer, 16mm Film, Griswold .....	R-3	50
Table:		
Editing .....	T-20	52
Projection .....	T-134C	52
Temperature Control, Viscount Water .....	Eastman IM	59
Terminal Extracting Tool .....	43226	12
Transformer:		
Step Down, 230 volts, 50 cycles (for TP-7B) .....	T-10269	32
Variable (for TP-11D/15A light outputs) .....	26646	32
Tube:		
8134-VI (for TK-27 Camera) .....	557206	20
8480-VI (for TK-22/27 Cameras) .....	557205	12, 20
Unilock (Universal Interlock) .....	29845	42
Unilock Rate Generator:		
16mm .....	29847	42
35mm .....	29848	42
Viewer, 16mm .....	BAIA	52







The Most Trusted Name in Television

### RCA BROADCAST SALES OFFICES

Atlanta, Ga. 1121 Rhodes-Haverty Bldg. Tel. 524-7703	30303	Chicago, Ill. 2000 Merchandise Mart Plaza Tel. 467-5900	60654	Kansas City, Mo. 7711 State Line Rd. Tel. 363-6770	64114	San Francisco, Cal. 420 Taylor St. Tel. 673-8027	94102
Austin, Texas 4605 Laurel Canyon Drive Tel. 453-8233	78731	Cleveland, Ohio 1600 Keith Bldg. Tel. 241-3450	44115	Meadow Lands, (Pittsburgh) Penna. Washington County Tel. 341-5296	15347	Seattle, Wash. 2246 First Ave., S. Tel. 622-8350	98134
Birmingham, Ala. Office Park Circle Bldg. #10 Tel. 871-1155	35223	Dallas, Texas 7901 Carpenter Freeway Tel. 631-3050	75210	Memphis, Tenn. 2110 Airways Blvd. Tel. 324-4434	38114	Southfield, (Detroit) Mich. 17000 W. 8-Mile Rd. Rm. A3-300 Tel. 357-0080	48076
Burbank, Calif. 2700 W. Olive Ave. Tel. 849-6741	91505	Denver, Colo. Suite 223, 2785 N. Speer Blvd. Tel. 477-6832	80211	Minneapolis, Minn. 4522 Excelsior Blvd. Tel. 929-3033	55416	Washington, D.C. 1725 "K" St., N.W. Tel. 337-8500	20006
Camden, N.J. Front & Cooper Sts. Tel. 963-8000 Ext. PC 3592.	08102	Indianapolis, Ind. 501 N. LaSalle St. Tel. 636-5321	46201	New York, N.Y. Rm. 1219, 30 Rockefeller Plaza Tel. 689-7200	10020	West Newton, (Boston) Mass. 950 Watertown Street Tel. 969-6010	02165
Charlotte, N.C. 330 Charlottetown Center Tel. 333-3996	28204					West Palm Beach, Fla. 645 S. Military Trail Tel. 683-2219	33401
						RCA International Div. 30 Rockefeller Plaza, N.Y., N.Y. Tel. 689-7200	10020

### RADIO CORPORATION OF AMERICA

BROADCAST AND COMMUNICATIONS PRODUCTS DIVISION, CAMDEN, N.J. 08102 • RCA INTERNATIONAL DIVISION, 30 ROCKEFELLER PLAZA, NEW YORK, N.Y. 10020 U.S.A.