

**TECHNICAL SERIES RC-13
PRICE TWENTY-FIVE CENTS**

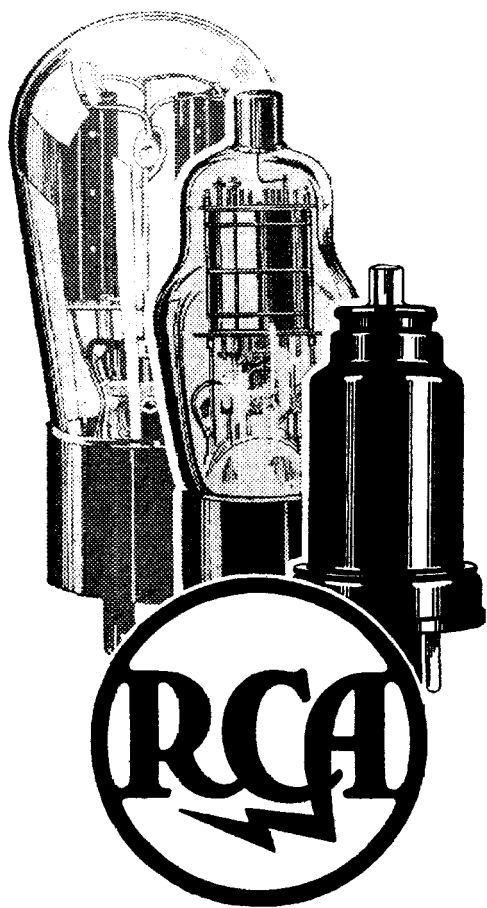

RECEIVING TUBE MANUAL

NON-RECEIVING TUBES

In addition to the Receiving Tube Types described in this Manual,

RCA MANUFACTURING COMPANY, INC.

SUPPLIES TUBES

For Amateur Transmitters
For Cathode-Ray Oscillographs
For Phototube Equipment
For Laboratory Equipment
For Radio Communicating Systems
For Broadcast Transmitters
etc., etc.

For sales information regarding any RCA product, please consult the nearest District Office or write to Sales Department, RCA MANUFACTURING COMPANY, INC., Camden, N. J.

For technical information on RCA Tubes, please write to Commercial Engineering Section, RCA MANUFACTURING COMPANY, INC., Harrison, N. J.

DISTRICT SALES OFFICES

ATLANTA, GEORGIA
492 Peachtree Street, N.E.

BALTIMORE, MARYLAND
Court Square Building
Calvert and Lexington Streets

BOSTON, MASSACHUSETTS
Metropolitan Theater Building
260 Tremont Street

CHICAGO, ILLINOIS
589 East Illinois Street

CINCINNATI, OHIO
Union Trust Building

CLEVELAND, OHIO
Keith Building

DALLAS, TEXAS
2211-13 Commerce Street

DENVER, COLORADO
Midland Savings Building
444 W. 17th Street

DETROIT, MICHIGAN
Book Tower
Washington Blvd. at Grand River

HOLLYWOOD, CALIFORNIA
1016 N. Sycamore Avenue

KANSAS CITY, MISSOURI
Davidson Building
10 E. 17th Street

MEMPHIS, TENNESSEE
60 N. Main Street

MINNEAPOLIS, MINNESOTA
Plymouth Building

NEW YORK, NEW YORK
411 Fifth Avenue

PHILADELPHIA, PENNSYLVANIA
12 South 12th Street

PITTSBURGH, PENNSYLVANIA
Plaza Building

SAN FRANCISCO, CALIFORNIA
170 - 9th Street

SEATTLE, WASHINGTON
Fourth Avenue Building

SYRACUSE, NEW YORK
Loew State Building
S. Salina and W. Jefferson Streets

FOREWORD

The RCA RECEIVING TUBE MANUAL, like its preceding editions, has been prepared especially to assist those who work or experiment with radio tubes and circuits.

The information and technical data presented in this book were selected after careful consideration of their usefulness in the field of radio-tube applications. While the form, in general, follows that of the previous editions, it will be found that many additions and numerous revisions have been made.

Material for the individual All-Metal types and glass-bulb types is arranged in numerical-alphabetical sequence, starting on page 40. Information for octal-base glass-bulb types is given on page 188 and, for recently added All-Metal and Glass types, on page 192.

This Manual will be found valuable by radio service men, radio technicians, experimenters, radio amateurs, and all others technically interested in radio tubes.

RCA MANUFACTURING COMPANY, INC.

Commercial Engineering Section
Harrison, New Jersey

Copyright, 1937
by
RCA MANUFACTURING CO., Inc.

CONTENTS



	PAGE
ELECTRONS AND ELECTRODES	5
Cathodes, Diodes, Triodes, Tetrodes, Pentodes, Multi-Electrode and Multi-Unit Tubes	
RADIO TUBE CHARACTERISTICS	12
Static, Dynamic	
RADIO TUBE APPLICATION	14
Amplification, Rectification, Detection, Automatic Volume Control, Tuning Indication with Electron-Ray Tubes, Oscillation, Frequency Conversion	
RADIO TUBE INSTALLATION	33
Filament and Heater Circuits; Plate Voltage, Grid Voltage, and Screen Voltage Supply; Shielding, Filters; Output Coupling Devices	
RADIO TUBE CLASSIFICATIONS	39
TECHNICAL DESCRIPTION BY TUBE TYPES	40
RADIO TUBE MATERIALS CHART	170
RADIO TUBE TESTING	171
RESISTANCE-COUPLED AMPLIFIER CHART	174
RADIO TUBE CIRCUITS	178
INDEX	186
RADIO TUBES—G TYPES	188
RADIO TUBES—RECENTLY ADDED TYPES	192
READING LIST	Inside Back Cover



The license extended to the purchaser of tubes appears in the License Notice accompanying them. Information contained herein is furnished without assuming any obligations.

STRUCTURE OF AN ALL-METAL RADIO TUBE

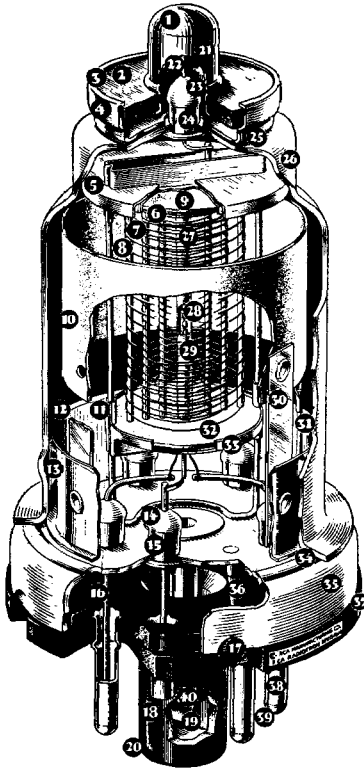

1—SOLDER
2—CAP INSULATOR
3—ROLLED LOCK
4—CAP SUPPORT
5—GRID LEAD SHIELD
6—CONTROL GRID
7—SCREEN
8—SUPPRESSOR
9—INSULATING SPACER
10—PLATE
11—MOUNT SUPPORT
12—SUPPORT COLLAR
13—GETTER TAB
14—GLASS BEAD SEAL
15—EYELET

16—LEAD WIRE
17—CRIMPED LOCK
18—ALIGNING KEY
19—PINCHED SEAL
20—ALIGNING PLUG
21—GRID CAP
22—GRID LEAD WIRE
23—GLASS BEAD SEAL
24—EYELET
25—BRAZED WELD
26—VACUUM-TIGHT STEEL SHELL
27—CATHODE
28—HELICAL HEATER
29—CATHODE COATING

30—PLATE INSULATING SUPPORT
31—PLATE LEAD CONNECTION
32—INSULATING SPACER
33—SPACER SHIELD
34—SHELL-TO-HEADER SEAL WELD
35—HEADER
36—SHELL CONNECTION
37—OCTAL BASE
38—BASE PIN
39—SOLDER
40—EXHAUST TUBE



RECEIVING TUBE MANUAL

Electrons and Electrodes

The radio tube is a marvelous device. It makes possible the performing of operations, amazing in conception, with a precision and a certainty that are astounding. It is an exceedingly sensitive and accurate instrument—the product of coordinated efforts of engineers and craftsmen. Its construction requires materials from every corner of the earth. Its use is world-wide. Its future possibilities, even in the light of present-day accomplishments, are but dimly foreseen, for each development opens new fields of design and application.

ELECTRONS

A radio tube consists of a cathode, which supplies electrons, and one or more additional electrodes, which control and collect these electrons, mounted in an evacuated envelope. The envelope may be a glass bulb, or it may be the more compact and efficient metal shell.

The importance of the radio tube lies in its ability to control almost instantly the flight of the millions of electrons supplied by the cathode. It accomplishes this with a minimum of control energy. Because it is almost instantaneous in its action, the radio tube can operate efficiently and accurately at electrical frequencies much higher than those attainable with rotating machines.

All matter exists in the solid, liquid, or gaseous state. These three forms of matter consist entirely of minute divisions known as molecules. Molecules are assumed to be composed of atoms. According to a present accepted theory, atoms have a nucleus which is a positive charge of electricity. Around this nucleus revolve tiny charges of negative electricity known as electrons. Scientists have estimated that these invisible bits of electricity weigh only 1/46 billion, billion, billion, billionths of an ounce, and that they may travel at speeds of thousands of miles per second.

Electron movement may be accelerated by the addition of energy. Heat is one form of energy which can be conveniently used to speed up the electron. For example, if the temperature of a metal is gradually raised, the electrons in the metal gain velocity. When the metal becomes hot enough to glow, some electrons may acquire sufficient speed to break away from the surface of the metal. This action is utilized in the radio tube to produce the necessary electron supply.

CATHODES

A cathode is an essential part of a radio tube, since it supplies the electrons necessary for tube operation. In general, heat is the form of energy applied to the cathode to release the electrons. The method of heating the cathode may be used to distinguish between the different forms of cathodes. For example, a directly heated cathode, or filament-cathode, is a wire heated by the passage of an electric current. An indirectly heated cathode, or heater-cathode, consists of a filament, or heater, enclosed in a metal sleeve. The sleeve carries the electron-emitting material on its outside surface and is heated by radiation and conduction from the heater.

A filament, or **directly heated cathode**, may be further classified by identifying the filament or electron-emitting material. The materials in regular use are tungsten, thoriated-tungsten, and metals which have been coated with alkaline-earth oxides. Tungsten filaments are made from the pure metal. Since they must operate at high temperatures (a dazzling white) to emit sufficient electrons, a relatively large amount of filament power is required. Thoriated-tungsten filaments are drawn from tungsten slugs which have been impregnated with thoria. Due to the thorium, these filaments liberate electrons at a more moderate temperature (a bright yellow) and are, therefore, much more economical of filament power than are pure tungsten filaments. Alkaline earths are usually applied as a coating on a nickel alloy wire or ribbon. This coating, which is dried in a substantial layer on the filament, requires only a very low temperature (a dull red) to produce a copious supply of electrons. Coated filaments operate very efficiently and require relatively little filament power. However, each of these cathode materials has special advantages which determine the choice for a particular application.

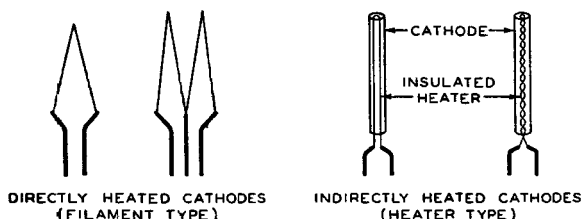

Directly heated filament-cathodes require comparatively little heating power. For that reason, they are used in almost all the tube types designed for battery operation because it is, of course, desirable to impose as small a drain as possible on the batteries. Examples of the battery-operated filament types are the 30, 31, 32, 33, and 34. A-c operated types having directly heated filament-cathodes are the 2A3 and 45.

Heater, or indirectly heated cathodes, comprise an assembly of a thin metal sleeve coated with emitting material and a heater contained within and insulated from the sleeve. The heater is made of tungsten wire and is used only for the purpose of heating the sleeve and its coating to an electron-emitting temperature. The tungsten wire is operated at a moderate temperature and supplies the energy for heating the sleeve.

The heater-cathode construction is well adapted for use in radio tubes intended for operation from a-c power lines. The use of separate parts for emitter and heater functions, the electrical insulation of the heater from the emitter, and the shielding effect of the sleeve may all be utilized in the design of the tube to prevent the a-c heater supply from causing hum. From the viewpoint of circuit design, the heater-cathode construction offers advantages in connection flexibility due to the electrical separation of the heater from the cathode. Another advantage of the heater-cathode construction is that it permits a rectifier tube to be designed with closer spacing between the cathode and plate, and an amplifier tube with closer spacing between the cathode and grid. In a rectifier tube, this results in less voltage drop in the tube and improved regulation; in an amplifier tube, it results in an increase in the gain obtainable from the tube. Because of the advantages of the heater-cathode construction, almost all present-day tubes designed for a-c operation have heater-cathodes.

DIODES

Electrons are of no value in a radio tube unless they can be put to work. A radio tube is designed with the necessary parts to provide and to utilize the electron flow. These parts consist of a cathode and one or more supplementary electrodes. The simplest form of radio tube contains two electrodes, a "cathode" and a "plate," and is often called a "diode," the family name for two-electrode tubes.

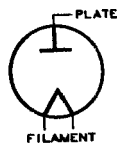

The electrodes are enclosed in an evacuated envelope with the necessary connections brought out through air-tight seals. The air is removed from the envelope to allow free movement of the electrons and to prevent injury to the emitting surface of the cathode. When the cathode is heated, electrons leave the cathode surface and form an invisible cloud in the space around it. Any positive electric potential within the evacuated envelope will offer a strong attraction to the electrons (unlike electric charges attract; like charges repel). In a diode, the positive potential is applied to the second electrode, known as the **anode**, or **plate**. The potential is supplied by a suitable electrical source connected between the plate terminal and a cathode terminal. Under the influence of the positive plate potential, electrons flow from the cathode to the plate and return through the external plate-battery circuit to the cathode, thus completing the circuit. This flow of electrons is known as the plate current and may be measured by a sensitive current-meter.

If a negative potential is applied to the plate, the free electrons in the space surrounding the cathode will be forced back to the cathode, and no plate current will flow. Thus, the tube permits electrons to flow from the cathode to the plate but not from the plate to the cathode. If an alternating voltage is applied to the plate, the plate is alternately made positive and negative. Plate current flows only during the time when the plate is positive. Hence the current through the tube flows in one direction and is said to be rectified. Diode rectifiers are used in a-c receivers to convert a.c. to d.c. for supplying "B," "C," and screen voltages to the other tubes in the receiver. Rectifier tubes may have one plate and one cathode. The 1-V and 12Z3 are of this form and are called **half-wave rectifiers**, since current can flow only during one-half of the alternating-current cycle. When two plates and one or more cathodes are used in the same tube, current may be obtained on both halves of the a-c cycle. The 5Z4, 80, and 5Z3 are examples of this type and are called **full-wave rectifiers**.

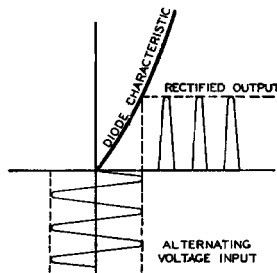

Not all of the electrons emitted by the cathode reach the plate. Some return to the cathode while others remain in the space between the cathode and plate for a brief period to form an effect known as **space-charge**. This charge has a repelling action on other electrons which leave the cathode surface, and impedes their passage to the plate. The extent of this action and the amount of space-charge depend on the cathode temperature and the plate potential. The higher the plate potential, the less is the tendency for electrons to remain in the space-charge region and repel others. This effect may be noted by applying increasingly higher plate voltages to a tube operating at a fixed heater or filament voltage. Under these conditions, the maximum number of available electrons is fixed, but increasingly higher plate voltages will succeed in attracting a greater proportion of the free electrons.

Beyond a certain plate voltage, however, additional plate voltage has little effect in increasing the plate current. The reason is that all of the electrons emitted by the cathode are already being drawn to the plate. This maximum current is called **saturation current**, and because it is an indication of the total number of electrons emitted, it is also known as the **emission current**, or, simply, **emission**. Tubes are

sometimes tested by measurement of their emission current. However, in this test it is generally not feasible to measure the full value of emission because this value would be sufficiently large to cause change in the tube's characteristics, or to damage the tube. For that reason, the test value of current in an emission test is less than the full emission current. However, this test value is larger than the maximum value which will be required from the cathode in the use of the tube. The emission test, therefore, indicates whether the tube's cathode can supply a sufficiently large number of electrons for satisfactory operation of the tube.

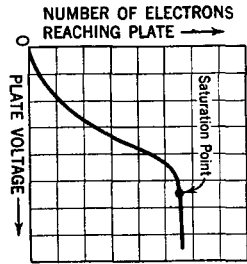

If space charge were not present to repel electrons coming from the cathode, it follows that the same plate current could be produced at a lower plate voltage. One way to make the effect of space charge small is to make the distance between plate and cathode small. This means is used in rectifier types, such as the 83-v and the 25Z5, having heater-cathodes. In these types the radial distance between cathode and plate is only about two hundredths of an inch. Another means for reducing space-charge effect is utilized in the mercury-vapor rectifier types, such as the 83. This tube contains a small amount of mercury, which is partially vaporized when the tube is operated. The mercury vapor consists of mercury atoms permeating the space inside the bulb. These atoms are bombarded by the electrons on their way to the plate. If the electrons are moving at a sufficiently high speed, the collisions will tear off electrons from the mercury atoms. When this happens, the mercury atom is said to be "ionized," that is, it has lost one or more electrons and, therefore, is charged positive. Ionization, in the case of mercury vapor, is made evident by a bluish-green glow between the cathode and plate. When ionization due to bombardment of mercury atoms by electrons leaving the filament occurs, the space-charge is neutralized by the positive mercury ions so that increased numbers of electrons are made available. A mercury-vapor rectifier has a small voltage drop between cathode and plate (about 15 volts). This drop is practically independent of current requirements up to the limit of emission of electrons from the filament, but is dependent to some degree on bulb temperature.

TRIODES

When a third electrode, called the **grid**, is placed between the cathode and plate, the tube is known as a triode, the family name for three-electrode tubes. The grid usually is a winding of wire extending the length of the cathode. The spaces between turns are comparatively large so that the passage of electrons from cathode to plate is practically unobstructed by the turns of the grid. When the tube is used as an amplifier, the grid is usually operated at a negative voltage so that it repels the electrons and therefore does not draw appreciable current.

The purpose of the grid is to control plate current. With a negative voltage on the grid, the grid exerts a force on electrons in the space between cathode and grid. This force drives the electrons back to the cathode. In this way, the negatively charged grid opposes the flow of electrons to the plate. When the voltage on the grid is made more negative, the grid exerts a stronger repelling force on the electrons and plate current is decreased. When the grid voltage is made less negative, there is less repelling force exerted by the grid and plate current increases. Hence, when the voltage on the grid is varied in accordance with a signal, the plate current varies with the signal. Because a small voltage applied to the grid can control a comparatively large amount of plate current, the signal is amplified by the tube. Typical three-electrode tube types are the 6C5, 76, and 2A3.

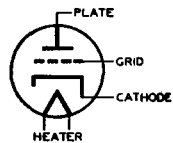

The grid, plate, and cathode of a triode form an electrostatic system, each electrode acting as one plate of a small condenser. The capacitances are those existing between grid and plate, plate and cathode, and grid and cathode. These

capacitances are known as **interelectrode capacitances**. Generally, the capacitance between grid and plate is of the most importance. In high-gain radio-frequency amplifier circuits, this capacitance may act to produce undesired coupling between the **input circuit**, the circuit between grid and cathode, and the **output circuit**, the circuit between plate and cathode. This coupling is undesirable in an amplifier because it may cause instability and unsatisfactory performance.

TETRODES

The capacitance between grid and plate can be made small by mounting an additional electrode, called the screen, in the tube. With the addition of the screen, the tube has four electrodes and is, accordingly, called a tetrode. The screen is mounted between the grid and the plate and acts as an electrostatic shield between them, thus reducing the grid-to-plate capacitance. The effectiveness of this shielding action is increased by connecting a by-pass condenser between screen and cathode. By means of the screen and this by-pass condenser, the grid-plate capacitance of a tetrode is made very small. In practice, the grid-plate capacitance is reduced from an average of 8.0 micromicrofarads ($\mu\mu\text{f}$) for a triode to 0.01 $\mu\mu\text{f}$ or less for a screen-grid tube.

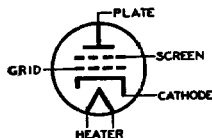

The screen has another desirable effect in that it makes plate current practically independent of plate voltage over a certain range. The screen is operated at a positive voltage and, therefore, attracts electrons from the cathode. But because of the comparatively large space between wires of the screen, most of the electrons drawn to the screen pass through it to the plate. Hence the screen supplies an electrostatic force pulling electrons from the cathode to the plate. At the same time the screen shields the electrons between cathode and screen from the plate so that the plate exerts very little electrostatic force on electrons near the cathode. Hence plate current in a screen-grid tube depends to a great degree on the screen voltage and very little on the plate voltage. This holds true only as long as the plate voltage is higher than the screen voltage. The fact that plate current in a screen-grid tube is largely independent of plate voltage makes it possible to obtain much higher amplification with a tetrode than with a triode. The low grid-plate capacitance makes it possible to obtain this high amplification without plate-to-grid feedback and resultant instability. Representative screen-grid types are the 3Z and 24-A.

PENTODES

In all radio tubes, electrons striking the plate may, if moving at sufficient speed, dislodge other electrons. In two- and three-electrode types, these vagrant electrons usually do not cause any trouble because no positive electrode other than the plate itself is present to attract them. These electrons, therefore, are eventually drawn back to the plate. Emission from the plate caused by bombardment of the plate by electrons from the cathode is called **secondary emission**, because the effect is secondary to the original cathode emission. In the case of screen-grid tubes (tetrodes), the proximity of the positive screen to the plate offers a strong attraction to these secondary electrons and particularly so if the plate voltage swings lower than the screen voltage. This effect lowers the plate current and limits the permissible plate swing for tetrodes.

The plate-current limitation is removed when a fifth electrode, known as the **suppressor**, is placed in the tube between the screen and plate. The family name for five-electrode types is "pentode." The suppressor is usually connected to the cathode. Because of its negative potential with respect to the plate, it retards the flight of secondary electrons and diverts them back to the plate, where they cannot cause trouble.

The suppressor is utilized in pentodes designed for two different functions.

In power output pentodes, the suppressor makes possible a large power output with high gain, due to the fact that the plate swing can be made very large. Tubes of this type are represented by the 6F6, 42, and 33. In radio-frequency amplifier pentodes, the suppressor permits of obtaining a high voltage amplification at moderate values of plate voltage. In fact, the plate voltage may be as low as, or lower than, the screen voltage without serious loss in the gain capabilities of this type. Representative of this type are the 6J7 and 6K7.

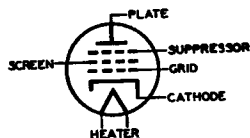

A beam power tube makes use of a different method for suppressing secondary emission. In this tube there are four electrodes, a cathode, grid, screen and plate so spaced that secondary emission from the plate is suppressed without an actual suppressor. Because of the way the electrodes are spaced, electrons traveling to the plate slow down, when plate voltage is low, almost to zero velocity in a certain region between screen and plate. In this region the electrons form a stationary cloud, a space-charge. The effect of this space charge is to repel secondary electrons emitted from the plate and thus cause them to return to the plate. In this way, secondary emission is suppressed.

Another feature of the beam power tube is the low current drawn by the screen. The screen and the grid are spiral wires wound so that each turn of the screen is shaded from the cathode by a grid turn. This alignment of the screen and grid causes the electrons to travel in sheets between the turns of the screen so that very few of them flow to the screen. Because of the effective suppressor action provided by space charge and because of the low current drawn by the screen, the beam power tube has the advantages of high power output, high power sensitivity, and high efficiency. The 6L6 is a beam power tube.

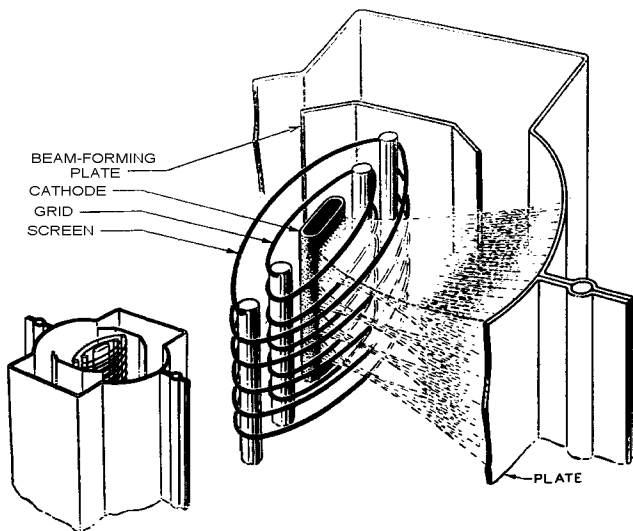

INTERNAL STRUCTURE OF BEAM POWER TUBE

MULTI-ELECTRODE and MULTI-UNIT TUBES

In the initial period of tube development and application, tubes were of the so-called "general purpose type"; that is, a single tube type—a triode—was used as a radio-frequency amplifier, an intermediate-frequency amplifier, an audio-frequency amplifier, an oscillator, or as a detector. Obviously, with this diversity of application, one tube did not meet all requirements to the best advantage.

Later and present trends of tube design are the development of "specialty" types. These types are intended either to give optimum performance in a particular application or to combine in one bulb functions which formerly required two or more tubes. The first class of tubes includes such examples of specialty types as the 6J7, 6L7, 6F6, and 6L6. Types of this class, in general, require more than three electrodes to obtain the desired special characteristics. Thus, they may be broadly classed as multi-electrode types. The 6L7 is an especially interesting type in this class. This tube has an unusually large number of electrodes, seven, exclusive of the heater. Plate current in the tube is varied at two different frequencies at the same time. The tube is designed primarily for use as a mixer in superheterodyne receivers. In this use, the tube mixes the signal frequency with oscillator frequency to give intermediate-frequency output.

Tubes of the multi-electrode class often present interesting possibilities of application besides the one for which they are designed. The 6L7, for instance, can also be used as a variable-gain audio amplifier in such applications as a volume expander for a phonograph amplifier. The 6F6, besides its use as a power output pentode, can also be connected as a triode and used as a driver for a pair of 6L6's.

The second class includes multiple-unit tubes such as the duplex-diode triodes 6Q7 and 6R7, as well as the duplex-diode pentodes 6B8 and 6B7 and the twin Class B amplifier types 6N7 and 6A6. All of these types have two or more separate tube units. Related to this class are the electron-ray types, 6E5 and 6G5, which combine a triode amplifier with a fluorescent target. It is interesting to note that the 80 is one of the earliest illustrations of multi-unit tubes.

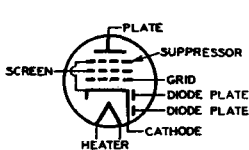

DUPLEX-DIODE PENTODE

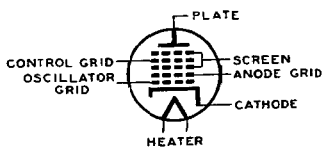

PENTAGRID CONVERTER

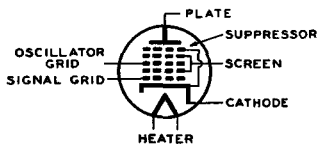

PENTAGRID MIXER

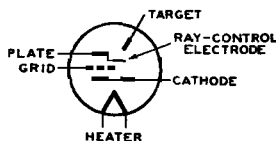

ELECTRON-RAY TUBE

A third class combines features of each of the other two classes. Typical of this third class are the 6A8 and the 6A7 pentagrid-converter types. These tubes are similar to the multi-electrode types in that they have seven electrodes, all of which affect the same electron stream, and are like the multi-unit tubes in that they perform two functions (oscillator and mixer in a superheterodyne receiver) simultaneously.

Radio Tube Characteristics

The term "CHARACTERISTICS" is used to identify the distinguishing electrical features and values of a radio tube. These values may be shown in curve form or they may be tabulated. When given in curve form, they are called characteristic curves and may be used for the determination of tube performance and the calculation of additional tube factors.

Tube characteristics are obtained from electrical measurements of a tube in various circuits under certain definite conditions of voltages. Characteristics may be further described by denoting the conditions of measurements. For example, **Static Characteristics** are the values obtained with different d-c potentials applied to the tube electrodes, while **Dynamic Characteristics** are the values obtained with an a-c voltage on the control grid under various conditions of d-c potentials on the electrodes. The dynamic characteristics, therefore, are indicative of the performance capabilities of a tube under actual working conditions.

Plate characteristic curves and transfer (mutual) characteristic curves both give information on static characteristics. These curves present the same information, but in two different forms to increase its usefulness. The plate characteristic curve is obtained by varying plate voltage and measuring plate current for different control-grid bias voltages, while the transfer-characteristic curve is obtained by varying control-grid bias voltage and measuring plate current for different plate voltages. A plate-characteristic family of curves is illustrated by Fig. 1. Fig. 2 gives the transfer characteristic family of curves for the same tube.

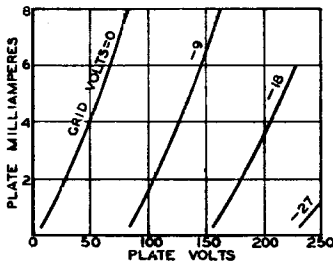

Fig. 1

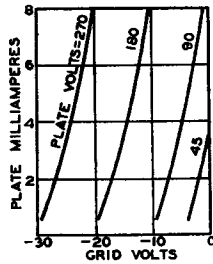

Fig. 2

Dynamic characteristics include amplification factor, plate resistance, control-grid—plate transconductance and certain detector characteristics, and may be shown in curve form for variations in tube operating conditions.

The **amplification factor**, or μ , is the ratio of the change in plate voltage to a change in control-electrode voltage in the opposite direction, under the condition that the plate current remains unchanged. For example, if, when the plate voltage is made 1 volt more positive, the grid voltage must be made 0.1 volt more negative to hold plate current unchanged, the amplification factor is 1 divided by 0.1, or 10. In other words, a small voltage variation in the grid circuit of a tube has the same effect on the plate current as a large plate voltage change—the latter equal to the product of the grid voltage change and amplification factor. The μ of a tube is useful for calculating stage gain, as discussed on page 15.

Plate resistance (r_p) of a radio tube is the resistance of the path between cathode and plate to the flow of alternating current. It is the quotient of a small change in plate voltage by the corresponding change in plate current and is expressed in ohms, the unit of resistance. Thus, if a change of 0.1 milliampere (0.0001 ampere) is produced by a plate voltage variation of 1 volt, the plate resistance is 1 divided by 0.0001, or 10000 ohms.

Control-grid—plate transconductance, or simply **transconductance** (g_m), is a factor which combines in one term the amplification factor and the plate resistance, and is the quotient of the first by the second. This term is also known as mutual

conductance. Transconductance may be more strictly defined as the ratio of a small change in plate current (amperes) to the small change in the control-grid voltage producing it, under the condition that all other voltages remain unchanged. Thus, if a grid-voltage change of 0.5 volt causes a plate-current change of 1 milliamper (0.001 ampere), with all other voltages constant, the transconductance is 0.001 divided by 0.5, or 0.002 mho. A "mho" is the unit of conductance and was named by spelling ohm backwards. For convenience, a millionth of a mho, or a micromho, is used to express transconductance. So, in the example, 0.002 mho is 2000 micromhos.

Conversion transconductance (s_c) is a characteristic associated with the mixer (first detector) function of tubes and may be defined as the quotient of the intermediate-frequency (i-f) current in the primary of the i-f transformer by the applied radio-frequency (r-f) voltage producing it; or more precisely, it is the limiting value of this quotient as the r-f voltage and i-f current approach zero. When the performance of a frequency converter is determined, conversion transconductance is used in the same way as control-grid—plate transconductance is used in single-frequency amplifier computations.

Maximum peak inverse voltage characteristic of a rectifier tube is the highest peak voltage that a rectifier tube can safely stand in the direction opposite to that in which it is designed to pass current. In other words, it is the safe arc-back limit with the tube operating within the specified temperature range. Referring to Fig. 3,

when plate A of a full-wave rectifier tube is positive, current flows from A to C, but not from B to C, because B is negative. At the instant plate A is positive, the filament is positive (at high voltage) with respect to plate B. The voltage between the positive filament and the negative plate B is in inverse relation to that causing current flow. The peak value of this voltage is limited by the resistance and nature of the path between plate B and filament. The maximum value of this voltage at which there is no danger of breakdown of the tube is known as maximum peak-inverse voltage. The relations between peak inverse voltage, rms value of a-c input voltage and d-c output voltage depend largely on the individual characteristics of the rectifier circuit and the power supply.

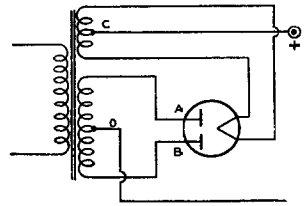

Fig. 3

The presence of line surges or any other transient, or wave-form distortion may raise the actual peak voltage to a value higher than that calculated for sine-wave voltages. Therefore, the actual inverse voltage, and not the calculated value, should be such as not to exceed the rated maximum peak inverse voltage for the rectifier tube. A cathode-ray oscillograph or a spark gap connected across the tube is useful in determining the actual peak inverse voltage. In single-phase, full-wave circuits with sine-wave input and with no condenser across the output, the peak inverse voltage on a rectifier tube is approximately 1.4 times the rms value of the plate voltage applied to the tube. In single-phase, half-wave circuits with sine-wave input and with condenser input to the filter, the peak inverse voltage may be as high as 2.8 times the rms value of the applied plate voltage. In polyphase circuits, mathematical determination of peak inverse voltage requires the use of vectors.

Maximum peak plate current is the highest peak current that a rectifier tube can safely stand in the direction in which it is designed to pass current. The safe value of this peak current in hot-cathode types of rectifiers is a function of the available emission and the duration of the pulsating current flow from the rectifier tube during each half cycle. In a given circuit, the actual value of peak plate current is largely determined by filter constants. If a large choke is used in the filter circuit next to the rectifier tubes, the peak plate current is not much greater than the load current, but if a large condenser is used in the filter next to the rectifier tubes, the peak current is often many times the load current. In order to determine accurately the peak current in any circuit, the best procedure usually is to measure it with a peak-indicating meter or to use an oscillograph.

Radio Tube Applications

The diversified applications of a radio tube may, within the scope of this chapter, be grouped broadly into five kinds of operation. These are: Amplification, rectification, detection, oscillation, and frequency conversion. Although these operations may take place at either radio- or audio-frequencies and may involve the use of different circuits and different supplemental parts, the general considerations of each kind of operation are basic.

AMPLIFICATION

The amplifying action of a radio tube was mentioned under TRIODES, page 8. This action can be utilized in radio circuits in a number of ways, depending upon the results to be achieved. Four classes of amplifier service recognized by engineers are covered by definitions standardized by the Institute of Radio Engineers. This classification depends primarily on the fraction of input cycle during which plate current is expected to flow under rated full-load conditions. The classes are Class A, Class AB, Class B, and Class C. The term, cut-off bias, used in these definitions is the value of grid bias at which plate current is some very small value.

Class A Amplifier. A class A amplifier is an amplifier in which the grid bias and alternating grid voltages are such that plate current in a specific tube flows at all times.

Class AB Amplifier. A class AB amplifier is an amplifier in which the grid bias and alternating grid voltages are such that plate current in a specific tube flows for appreciably more than half but less than the entire electrical cycle.

Class B Amplifier. A class B amplifier is an amplifier in which the grid bias is approximately equal to the cut-off value so that the plate current is approximately zero when no exciting grid voltage is applied, and so that plate current in a specific tube flows for approximately one-half of each cycle when an alternating grid voltage is applied.

Class C Amplifier. A class C amplifier is an amplifier in which the grid bias is appreciably greater than the cut-off value so that the plate current in each tube is zero when no alternating grid voltage is applied, and so that plate current flows in a specific tube for appreciably less than one-half of each cycle when an alternating grid voltage is applied.

NOTE:—To denote that grid current does not flow during any part of the input cycle, the suffix 1 may be added to the letter or letters of the class identification. The suffix 2 may be used to denote that grid current flows during some part of the cycle.

For radio-frequency amplifiers which operate into a selective tuned circuit, as in radio transmitter applications, or under requirements where distortion is not an important factor, any of the above classes of amplifiers may be used, either with a single tube or a push-pull stage. For audio-frequency amplifiers in which distortion is an important factor, only Class A amplifiers permit single-tube operation. In this case, operating conditions are usually chosen so that distortion is kept below the conventional 5% for triodes and the conventional 7 to 10% for tetrodes or pentodes. Distortion can be reduced below these figures by means of special circuit arrangements such as that discussed under **inverse feedback** on page 21. With Class A amplifiers, reduced distortion with improved power performance can be obtained by using a push-pull stage for audio service. With Class AB and Class B amplifiers, a balanced amplifier stage using two tubes is required for audio service.

As a **Class A voltage amplifier**, a radio tube is used to reproduce grid voltage variations across an impedance or a resistance in the plate circuit. These variations are essentially of the same form as the input signal voltage impressed on the grid, but of increased amplitude. This is accomplished by operating the tube at a suitable grid bias so that the applied grid-input voltage produces plate-current variations proportional to the signal swings. Since the voltage variation obtained in the plate circuit is much larger than that required to swing the grid, amplification of the signal is obtained. Fig. 4 gives a graphical illustration of this method of amplification and shows, by means of the grid-voltage vs. plate-current characteristics, the effect of an input signal (S) applied to the grid of a tube. O is the resulting amplified plate-current variation.

The plate current flowing through the load resistance (R) of Fig. 5 causes a voltage drop which varies directly with the plate current. The ratio of this voltage variation produced in the load resistance to the input signal voltage is the voltage

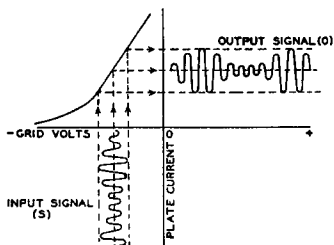

Fig. 4

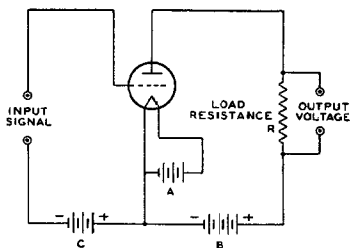

Fig. 5

amplification, or gain, provided by the tube. The voltage amplification due to the tube is expressed by the following convenient formulae:

$$\text{Voltage Amplification} = \text{Amplification factor} \frac{\text{Load resistance}}{\text{Load resistance} + \text{Plate resistance}} \text{ or}$$

$$\frac{\text{Transconductance in micromhos} \times \text{Plate resistance} \times \text{Load resistance}}{1000000 \times (\text{Plate resistance} + \text{Load resistance})}$$

From the first formula, it can be seen that the gain actually obtainable from the tube is less than the tube's amplification factor but that the gain approaches the amplification factor when the load resistance is large compared to the tube's plate resistance. Fig. 6 shows graphically how the gain approaches the mu of the tube as load resistance is increased. From the curve it can be seen that to obtain high gain in a voltage amplifier, a high value of load resistance should be used.

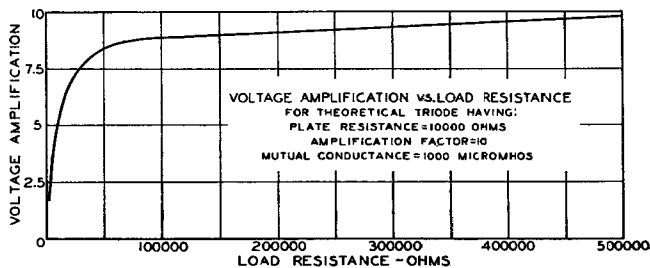

Fig. 6

In a resistance-coupled amplifier, the resistance of the tube's load is approximately equal to the plate resistor in parallel with the grid resistor of the following stage. Hence, to obtain a large value of load resistance, it is necessary to use a plate resistor and a grid resistor of large resistance. However, the plate resistor should not be too large. The flow of plate current through the plate resistor produces a voltage drop which reduces the plate voltage applied to the tube. If the plate resistor is too large, this drop will be too large, the plate voltage on the tube will be too small and the voltage output of the tube will be too small. Also, the grid resistor of the following stage should not be too large because an amplifier tube may become unstable if its grid resistor is too large. The recommended values of plate resistor and grid resistor for the tube types used in resistance-coupled circuits, and the values of gain obtainable, are shown in the RESISTANCE-COUPLED AMPLIFIER SECTION.

The input impedance of a radio tube, that is, the impedance between grid and cathode, is very high at audio frequencies when the tube is operated with a negative grid. Hence in a Class A₁ or Class AB₁ transformer-coupled audio amplifier, the

loading imposed by the grid on the input transformer is negligible. The secondary impedance of a Class A_1 or Class AB_1 input transformer therefore is not limited by the input impedance of the tube; the secondary impedance is limited, however, by other transformer design considerations.

A **super-control amplifier** tube is a modified construction of a pentode or a screen-grid type and is designed to reduce modulation-distortion and cross-modulation in radio-frequency stages. **Cross-modulation** is the effect produced in a radio receiver by an interfering station "riding through" on the carrier of the station to which the receiver is tuned. **Modulation-distortion** is a distortion of the modulated carrier and appears as audio-frequency distortion in the output. This effect is produced by a radio-frequency amplifier stage operating on an excessively curved characteristic when the grid bias has been increased to reduce volume. The offending stage for cross-modulation is usually the first radio-frequency amplifier, while for modulation-distortion, the cause is usually the last intermediate-frequency stage.

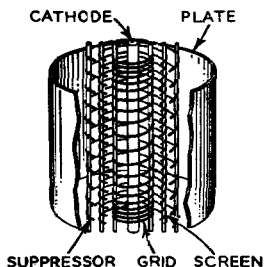
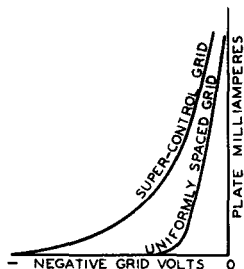

Fig. 7

Fig. 8



The characteristics of super-control types are such as to enable the tube to handle both large and small input signals with minimum distortion over a wide range. A cross-section of the structure of a 6K7, a typical super-control tube, is shown in Fig. 7. The super-control action is due to the structure of the grid which provides a variation in amplification factor with change in grid bias. The grid is wound with coarse spacing at the middle and with close spacing at the ends. When weak signals and low grid bias are applied to the tube, the effect of the non-uniform turn spacing of the grid on cathode emission and tube characteristics is essentially the same as for uniform spacing. As the grid bias is made more negative to handle larger input signals, the electron flow from the sections of the cathode enclosed by the ends of the grid is cut off. The plate current and other tube characteristics are then dependent on the electron flow through the coarse section of the grid. This action changes the gain of the tube so that large signals may be handled with minimum distortion due to cross-modulation and modulation distortion. Fig. 8 shows a typical plate-current vs. grid-voltage curve for a super-control type compared with the curve for a type having a uniformly spaced grid. It will be noted that while the curves are similar at small grid-bias voltages, the plate current of the super-control tube drops quite slowly with large values of bias voltage. This slow change makes it possible for the tube to handle large signals satisfactorily. Since super-control types can accommodate large and small signals, they are particularly suitable for use in sets having automatic volume control. Super-control types also are known as remote cut-off types.

As a **Class A power amplifier**, a radio tube is used in the output stage of radio receivers to supply relatively large amounts of power to the loudspeaker. For this application, large power output is of much greater importance than high voltage amplification, so that gain possibilities are sacrificed in the design of power tubes to obtain power-handling capability. Power tubes of the triode type in Class A service are characterized by low power-sensitivity, low plate-power efficiency, and low distortion. Power tubes of the pentode type are characterized by high power-sensitivity, high plate-power efficiency, and relatively high distortion. The beam power amplifier type 6L6 has a still higher power sensitivity and efficiency and has a higher power output capability than triode or pentode types.

A Class A power amplifier is also used as a driver to supply power to a Class AB or a Class B output stage. It is usually advisable to use a triode type, rather than a pentode, in a driver stage because of the lower distortion of the triode.

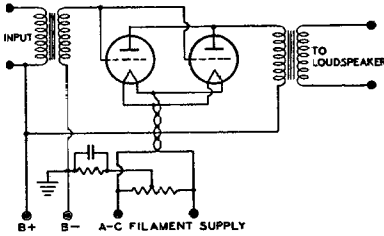

Fig. 9

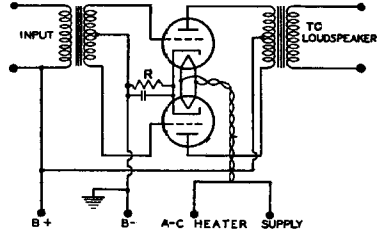

Fig. 10

Either *push-pull* or *parallel operation* of power tubes may be employed with Class A amplifiers to obtain increased output. The parallel connection (Fig. 9) provides twice the output of a single tube with the same value of grid-signal voltage. The push-pull connection (Fig. 10) requires twice the input-signal voltage, but has, in addition to increase in power, a number of important advantages over single-tube operation. Distortion due to even-order harmonics and hum due to plate-supply voltage fluctuations are either eliminated or decidedly reduced through cancellation. Since distortion is less than for single-tube operation, appreciably more than twice single-tube output can be obtained by decreasing the load resistance.

Operation of power tubes so that the grids run positive is inadvisable except under conditions such as are discussed later in this section for Class AB and Class B amplifiers.

Power output for triodes as single-tube Class A amplifiers can be calculated without serious error from the plate family of curves by assuming a resistance load. The proper plate current, grid bias, and optimum load resistance, as well as the per cent second-harmonic distortion, can also be determined. The calculations are made graphically and are illustrated by Fig. 11 for given conditions. The procedure is as follows: A straight line XY is drawn through the point P on the plate family of curves. This point is determined by the tentatively chosen values of plate voltage and plate current. The slope of the line XY corresponds to the value of load resistance tentatively chosen. The slope of XY is determined by adjusting a line through P so that the voltage value (at the intersection of the line with the zero-current axis) divided by the current value (at the intersection of the line with the zero-voltage axis) gives the desired trial load resistance. A more direct method is to draw any convenient line AB having the proper slope, and then to draw XY parallel to it and through P. To draw AB, choose any convenient voltage value on the zero-current axis. A line drawn through this point and given the proper slope must intersect the zero-voltage axis at a current value equal to the chosen voltage divided by the chosen resistance value.

In calculating power output, it is assumed that the peak alternating grid voltage is sufficient to swing the grid from the operating-bias value to zero bias on the positive swing and to a value twice the fixed bias on the negative swing. Identifying the maximum and minimum values of plate voltage and plate current for the grid-voltage swing as E max., E min., I max., I min., the power output is given by the formula:

$$\text{Power Output} = \frac{(I \text{ max.} - I \text{ min.}) \times (E \text{ max.} - E \text{ min.})}{8}$$

If E is in volts and I in milliamperes, power output is in milliwatts.

Per cent second-harmonic distortion is given by the following formula in which I₀ is the trial value of d-c plate current.

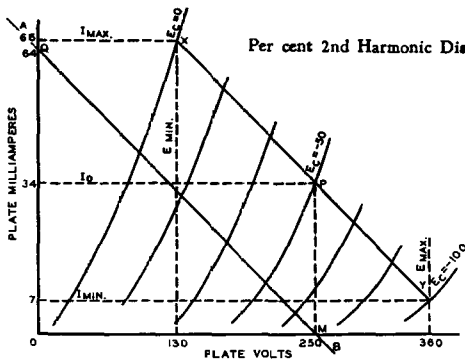

Fig. 11

By substitution of values from curves in above power formula:

$$\text{Power Output} = \frac{(0.066 - 0.007) \times (360 - 130)}{8} = 1.7 \text{ watts}$$

By substitution of values from curves in above distortion formula:

$$\text{2nd Harmonic Distortion} = \frac{\frac{0.066 + 0.007}{2} - 0.034}{0.066 - 0.007} \times 100 = 4.2\%$$

It is customary to make the final selection of load resistance such that the distortion as calculated above does not exceed 5 per cent, a value which experience has shown to be permissible. Several approximations of load resistance may be necessary to obtain the optimum value for the trial value of plate current. Ordinarily, the plate load resistance for optimum conditions is approximately equal to twice the plate resistance.

To check the trial plate current, calculations should be made for d-c plate currents above and below the trial value. The most suitable value with its corresponding grid bias can then be selected, unless the value is higher than that recommended for the tube. In this event the maximum permissible value is chosen.

The proper load for triodes in push-pull power amplifiers may be determined by means of the plate family and the relation $E = 0.6 E_0$, where E_0 is equal to the desired operating plate voltage. The method is to erect a vertical line at $E = 0.6 E_0$ (see Fig. 12), intersecting the $E_c = 0$ curve at the point (I_m). A load line is then drawn through I_m and the E_0 point on the zero-current axis. Four times the resistance corresponding to this load line is the plate-to-plate load for two triodes in a Class A push-pull amplifier.

Fig. 12 illustrates the application of this method to the case of two type 45's operated at $E_0 = 250$ volts. Then

$$\text{Per cent 2nd Harmonic Distortion} = \frac{I_{\text{max.}} + I_{\text{min.}} - I_0}{I_{\text{max.}} - I_{\text{min.}}} \times 100$$

Example: Determine the undistorted power output of a 3-electrode tube at a plate voltage of 250 volts, a plate current of 34 milliamperes, and a plate load of 3900 ohms, given the plate characteristic curves as shown.

Procedure: Draw through point (P) which represents proposed operating conditions, line XY with slope corresponding to 3900-ohm load. This may be done by drawing XY parallel to line AB. The line AB is drawn between point (M) at 250 volts and zero current, and point (Q) at zero volts and current equal to 250 volts divided by plate load of 3900 ohms, i.e., $250 \div 3900 = 0.064$ ampere or 64 milliamperes.

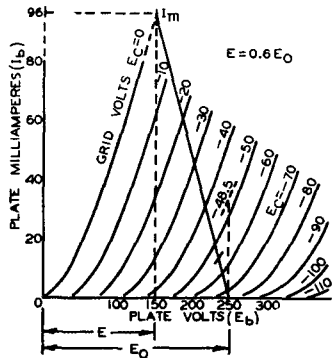

Fig. 12

$$\text{Plate-to-Plate Load} = \frac{E_o - 0.6 E_o}{I_m} \times 4 = \frac{100}{0.096} \times 4 = 4160 \text{ ohms}$$

This simple formula is applicable to all power output triodes. The operating grid-bias voltage can be anywhere between that specified for single-tube operation and that equal to one-half the grid-bias voltage required to produce plate-current cut-off at a plate voltage of 1.4 E_o. Thus, for single-tube operation of the type 45, the grid-bias voltage is recommended as -50 volts for 250 volts on the plate. Plate-current cut-off at 1.4 E_o, or 350 volts, occurs at -110 volts on the grid. One-half of this value is -55 volts, which is the most negative value permissible without departing from Class A conditions. Operation beyond this point will be accompanied by rectification and will no longer be representative of a Class A amplifier.

The power output for push-pull triodes may be determined by the following formula:

$$\text{Power Output} = \frac{I_m E_o}{5}$$

If I_m is expressed in amperes and E_o in volts, power is obtained in watts. Thus, for Fig. 12, power output = 0.096 × 250 ÷ 5, or 4.8 watts.

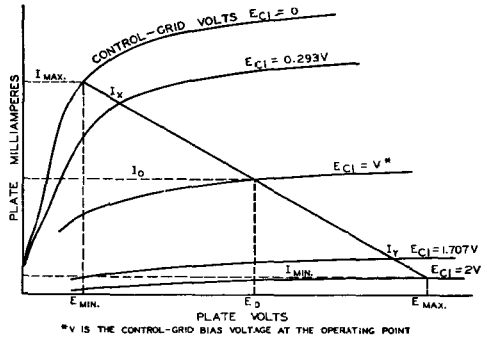

Fig. 13

Power output for pentodes and for beam power tubes as Class A amplifiers can be calculated in much the same way as for triodes by means of the following formulas and a special plate characteristic family of curves, illustrated in Fig. 13.

$$\text{Power Output} = \frac{[I_{\text{max.}} - I_{\text{min.}} + 1.41 (I_x - I_y)]^2 R_p}{32}$$

If I is in amperes and E in volts, then

$$R_p = \frac{E_{\text{max.}} - E_{\text{min.}}}{I_{\text{max.}} - I_{\text{min.}}} \text{ in ohms.}$$

and power output is obtained in watts.

$$\text{Per cent 2nd Harmonic Distortion} = \frac{I_{\text{max.}} + I_{\text{min.}} - 2 I_o}{I_{\text{max.}} - I_{\text{min.}} + 1.41 (I_x - I_y)} \times 100$$

$$\text{Per cent 3rd Harmonic Distortion} = \frac{I_{\text{max.}} - I_{\text{min.}} - 1.41 (I_x - I_y)}{I_{\text{max.}} - I_{\text{min.}} + 1.41 (I_x - I_y)} \times 100$$

$$\text{Per cent total (2nd and 3rd) Harmonic Distortion} = \sqrt{(\% \text{ 2nd Har. Dist.})^2 + (\% \text{ 3rd Har. Dist.})^2}$$

The conversion curves given in Fig. 14 apply to radio tubes in general but are particularly useful for power tubes. These curves can be used for calculating approximate operating conditions for a plate voltage which is not included in the published data on operating conditions. For instance, suppose it is desired to operate two 6L6's in Class A₁ push-pull, fixed bias, with a plate voltage of 200 volts. The published operating conditions for this class of service are for a plate voltage of 250 volts. The operating conditions for the new plate voltage can be determined as follows: First compute the ratio of the new plate voltage to the plate voltage of the published data. In the example, this ratio is 200/250=0.8. This figure is the Voltage Conversion Factor, F_v. Multiply by this factor to obtain the new values of grid bias and screen voltage. This gives a grid bias of -16×0.8=-12.8 volts, and a screen voltage of 250×0.8=200 volts for the new conditions. To obtain

the rest of the new conditions, multiply the published values by factors shown on the chart as corresponding to a voltage conversion factor of 0.8. In this chart,

F_i applies to plate current and to screen current,

F_p applies to power output,

F_r applies to load resistance and plate resistance.

F_{gm} applies to transconductance.

Thus, to find the power output for the new conditions, determine the value of F_p for a voltage conversion factor of 0.8. The chart shows that this value of F_p is 0.6. Multiplying the published value of power output by 0.6, the power output for the new conditions is $14.5 \times 0.6 = 8.7$ watts.

A class AB power amplifier employs two tubes connected in push-pull with a higher negative grid bias than is used in a Class A stage. With this higher negative bias, the plate and screen voltages can usually be made higher than for Class A because the increased negative bias holds plate current within the limit of the tube's plate dissipation rating. As a result of these higher voltages, more power output can be obtained from Class AB operation.

Class AB amplifiers are subdivided into Class AB₁ and Class AB₂. In Class AB₁ there is no flow of grid current. That is, the peak signal voltage applied to each grid is not greater than the negative grid-bias voltage. The grids therefore are not driven to a positive potential and do not draw grid current. In Class AB₂, the peak signal voltage is greater than the bias so that the grids are driven positive and draw grid current.

Because of the flow of grid current in a Class AB₂ stage there is a loss of power in the grid circuit. The sum of this loss and the loss in the input transformer is the total driving power required by the grid circuit. The driver stage should be capable of a power output considerably larger than this required power in order that distortion introduced in the grid circuit be kept low. The input transformer used in a Class AB₂ amplifier usually has a step-down turns ratio.

Because of the large fluctuations of plate current in a Class AB₂ stage, it is important that the power supply should have good regulation. Otherwise the fluctuations in plate current cause fluctuations in the voltage output of the power supply, with the result that power output is decreased and distortion is increased. To obtain satisfactory regulation it is usually advisable to use a choke-input filter. It is sometimes advisable to use a mercury-vapor rectifier tube rather than a vacuum type because of the better regulation of the mercury-vapor type. In all cases, the resistance of the filter chokes and power transformer should be as low as possible.

A Class B power amplifier employs two tubes connected in push-pull, so biased that plate current is almost zero when no signal voltage is applied to the grids. Because of this low value of no-signal plate current, Class B amplification has the same advantage as Class AB, that large power output can be obtained without excessive plate dissipation. The difference between Class B and Class AB is that, in Class B, plate current is cut off for a larger portion of the negative grid swing.

There are several tube types designed especially for Class B amplification. The characteristic common to all these types is high amplification factor. With this high amplification factor, plate current is small when grid voltage is zero. These tubes,

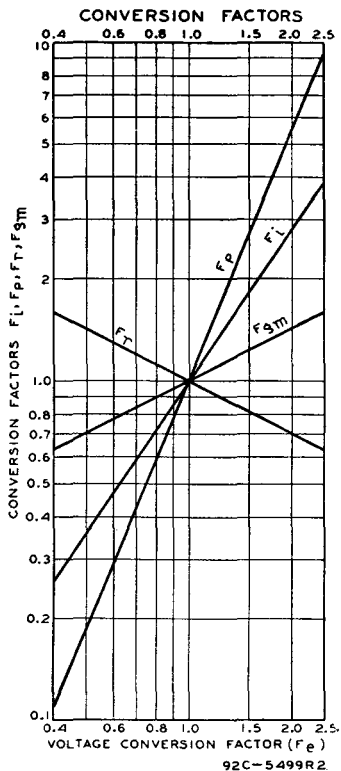

Fig. 14

therefore, can be operated in Class B at a bias of zero volts, so that a bias supply is not required. A number of the Class B amplifier tube types consist of two triode units mounted in one tube. The two triode units can be connected in push-pull, so that only one tube is required for a Class B stage. Examples of these Class B twin triode types are the 6N7, 6A6, and 19.

Because a Class B amplifier is usually operated at zero bias, each grid is at a positive potential during the positive half-cycle of its signal swing and consequently draws considerable grid current. There is, therefore, a loss of power in the grid circuit. This imposes the same requirement on the driver stage as in a Class AB₂ stage; that is, the driver should be capable of considerably more power output than the power required for the Class B grid circuit in order that distortion be low. The interstage transformer between the driver and Class B stage usually has a step-down turns ratio.

The fluctuations in plate current in a Class B stage are large so that it is important that the power supply have good regulation. The discussion of the power supply for a Class AB₂ stage, therefore, also applies to the power supply for a Class B amplifier.

Inverse feedback is used in audio amplifiers to reduce distortion in the output stage where the load impedance on the tube is a loudspeaker. Because the impedance of a loudspeaker is not constant for all audio frequencies, the load impedance on the output tube varies with frequency. When the output tube is a pentode or beam power tube having high plate resistance, this variation in plate load impedance can, if not corrected, produce considerable frequency distortion. Such frequency distortion can be corrected by means of inverse feedback.

The application of inverse feedback to a power output stage using a single 6L6 is illustrated by Fig. 16. In this circuit, R₁, R₂, and C are connected across the output of the 6L6 as a voltage divider. The secondary of the grid-input transformer is returned to a point on this voltage divider. Condenser C blocks the d-c plate voltage from the grid. However, a portion of the tube's a-f output voltage, approximately equal to the output voltage multiplied by the fraction $R_2 / (R_1 + R_2)$, is applied to the grid. There results a decrease in distortion which can be explained by the curves of Fig. 17.

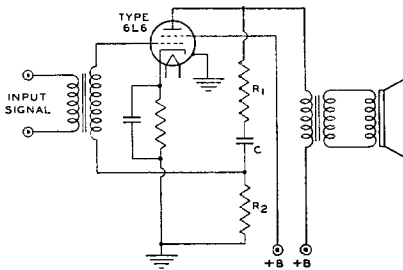

Fig. 16

Consider first the amplifier as being without inverse feedback. Suppose that when a signal voltage e_s is applied to the grid the a-f plate current i_p has an irregularity in its positive half-cycle. This irregularity represents a departure from the waveform of the input signal and is, therefore, distortion. For this plate-current waveform, the a-f plate voltage has a waveform shown by e'_p . The plate-voltage waveform is inverted compared to the plate-current waveform because a plate-current increase produces an increase in the drop across the plate load. The voltage at the plate is the difference between the drop across the load and the supply voltage; thus, when plate current goes up, plate voltage goes down; when plate current goes down, plate voltage goes up.

Now suppose that inverse feedback is applied to the amplifier. The distortion irregularity in plate current is corrected in the following manner. With an inverse feedback arrangement, the voltage fed back to the grid has the same waveform and phase as the plate voltage, but is smaller in magnitude. Hence, with a plate voltage of waveform shown by e'_p , the feed-back voltage appearing on the grid is as shown by e'_{gr} . This voltage applied to the grid produces a component of plate current i'_{pr} . It is evident that the irregularity in the waveform of this component of plate current would act to cancel the original irregularity and thus reduce distortion.

After the correction of distortion has been applied by inverse feedback, the

relations are as shown in the curve for i_p . The dotted curve shown by $i_{p'}$ is the component of plate current due to the feedback voltage on the grid. The dotted curve shown by i_p' is the component of plate current due to the signal voltage on the grid. The sum of these two components gives the resultant plate current shown

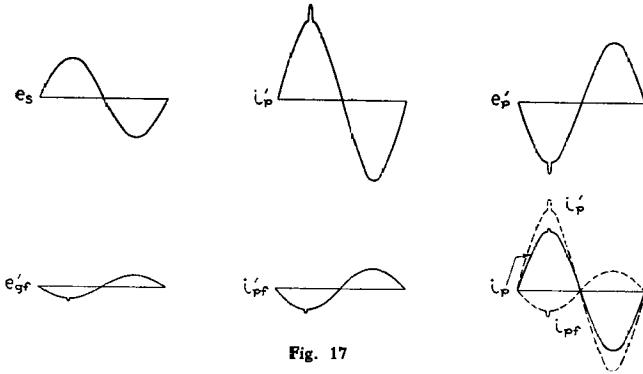

Fig. 17

by the solid curve of i_p . Since $i_{p'}$ is the plate current that would flow without inverse feedback, it can be seen that the application of inverse feedback has reduced the irregularity in the output current. In this manner, inverse feedback acts to correct any component of plate current that does not correspond to the input signal voltage, and thus reduces distortion.

From the curve for i_p , it can be seen that, besides reducing distortion, inverse feedback also reduces the amplitude of the output current. It follows that when inverse feedback is applied to an amplifier, there is a decrease in power output as well as a decrease in distortion. However, by means of an increase in signal voltage, the power output can be brought back to its full value. Hence, the application of inverse feedback to an amplifier means that more driving voltage must be applied to obtain full power output but that this full power output is obtained with less distortion.

The inverse-feedback method shown in Fig. 16 can also be applied to Class A_1 or Class AB_1 push-pull amplifiers as shown in Fig. 18. The method requires that the input transformer have a separate secondary winding for each grid. The method is not recommended for use in amplifiers drawing grid current because of the resistances introduced in the grid circuit.

Inverse feedback can be applied to any Class A_1 or Class AB_1 power amplifier tube but is especially applicable to a beam power tube. It is not generally applied to a triode power amplifier, such as the 2A3, because the variation in speaker impedance with frequency does not produce much distortion in a triode stage having low plate resistance. It is sometimes applied in a pentode stage but is not always convenient. As

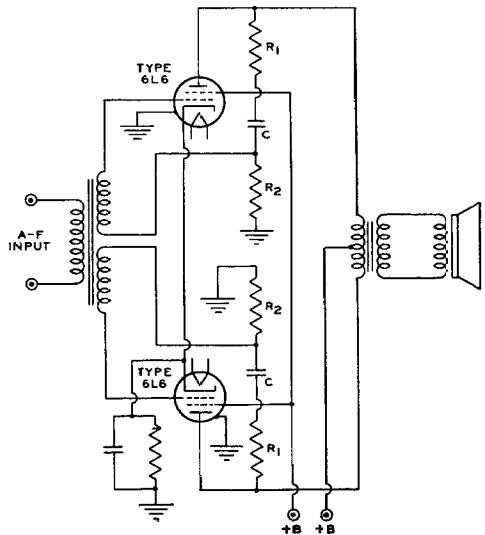

Fig. 18

has been shown, when inverse feedback is used in an amplifier, the driving voltage must be increased in order to give full power output. When inverse feedback is used with a pentode, the total driving voltage required for full power output may be inconveniently large. Because a beam power tube gives full power output on a comparatively small driving voltage, inverse feedback is especially applicable to beam power tubes. By means of inverse feedback, the high efficiency and high power output of the beam power tube can be combined with freedom from the effects of varying speaker impedance.

A **corrective filter** can be used to improve the frequency characteristic of an output stage, using a beam power tube or a pentode, when inverse feedback is not applicable. The filter consists of a resistor and a condenser connected in series across the primary of the output transformer. Connected in this way, the filter is in parallel with the plate-load impedance reflected from the voice-coil by the output transformer. The magnitude of this reflected impedance increases with increasing frequency in the middle and upper audio range. The impedance of the filter, however, decreases with increasing frequency. It follows that by use of the proper values for the resistance and the capacitance in the filter, the effective load impedance on the output tubes can be made practically constant for all frequencies in the middle and upper audio range. The result is an improvement in the frequency characteristic of the output stage.

The resistance to be used in the filter for a push-pull stage is 1.3 times the recommended plate-to-plate load resistance; or, for a single-tube stage, is 1.3 times the recommended plate load resistance. The capacitance in the filter should have a value such that the voltage gain of the output stage at a frequency of 1000 cycles or higher is equal to the voltage gain at 400 cycles. A method of determining the proper value of capacitance for the filter is to make two measurements on the output voltage across the primary of the output transformer: first, when a 400-cycle signal is applied to the input, and second, when a 1000-cycle signal of the same voltage as the 400-cycle signal is applied to the input. The correct value of capacitance is the one which gives equal output voltages for the two signal inputs. In practice, this value is usually found to be on the order of 0.05 μ f.

A **volume expander** can be used in a phonograph amplifier to make more natural the reproduction of music which has a very large volume range. For instance, in the music of a symphony orchestra, the sound intensity of the loud passages is very much higher than that of the soft passages. When this music is recorded, it is not feasible to make the ratio of maximum amplitude to minimum amplitude as large on the record as it is in the original music. The recording process is therefore monitored so that the volume range of the original is compressed on the record. To compensate for this compression, a volume-expander amplifier has a variable gain which is greater for a high-amplitude signal than for a low-amplitude signal. The volume expander therefore amplifies loud passages more than soft passages and thus can restore to the music reproduced from the record the volume range of the original.

A volume expander circuit is shown in **CIRCUIT SECTION**. The action of this circuit depends on the fact that the gain of the 6L7 as an audio amplifier can be varied by variation of the bias on the No. 3 grid. When the bias on the No. 3 grid is made less negative, the gain of the 6L7 increases. In the circuit, the signal to be amplified is applied to the No. 1 grid of the 6L7 and is amplified by the 6L7. The signal is also applied to the grid of the 6C5, is amplified by the 6C5, and is rectified by the 6H6. The rectified voltage developed across R8, the load resistor of the 6H6, is applied as a positive bias voltage to the No. 3 grid of the 6L7. Then, when the amplitude of the signal input increases, the voltage across R8 increases, and the bias on the No. 3 grid of the 6L7 is made less negative. Because this increases the gain of the 6L7, the gain of the amplifier increases with increase in signal amplitude and thus produces volume expansion of the signal.

The No. 1 grid of the 6L7 is a variable-mu grid and therefore will produce distortion if the input signal voltage is too large. For that reason, the signal input to the 6L7 should not exceed a peak value of 1 volt. This value is of the same order as the voltage obtainable from the usual magnetic phonograph pick-up. The no-signal bias voltage on the No. 3 grid is controlled by adjustment of

contact P. This contact should be adjusted initially to give a no-signal plate current of 0.15 milliamperes in the 6L7. No further adjustment of contact P is required if the same 6L7 is always used. If it is desired to delay volume expansion until the signal input reaches a certain amplitude, the delay voltage can be inserted as a negative bias on the 6H6 plates at the point marked X in the diagram.

A phase inverter is used to provide resistance coupling between the output of a single-tube stage and the input of a push-pull stage. The necessity for a phase inverter arises because the signal-voltage inputs to the grids of a push-pull stage must be 180 degrees out of phase, and equal in amplitude. That is, when the signal voltage input to a push-pull stage swings one of the push-pull grids in the positive direction, it should swing the other grid in the negative direction by an equal amount. When transformer coupling is used, the out-of-phase input voltages can be obtained from the output of a single-tube stage by means of a center-tapped secondary. When resistance coupling is to be used, the out-of-phase input voltages can be obtained by means of a phase inverter.

Figure 15 shows a simple phase inverter circuit in which phase inversion is provided by triode T_2 . In this circuit, the voltage output of T_1 is applied to one of the push-pull grids. A portion of the voltage output of T_1 also is applied from the tap on R_3 to the grid of T_2 . The voltage output of T_2 is applied to the other push-pull grid. When the voltage output of T_1 swings the grid of T_2 in the

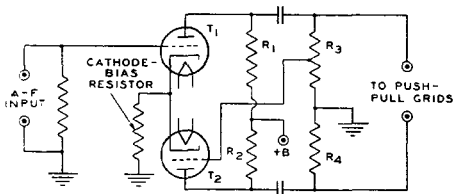

Fig. 15

positive direction, the plate current of T_2 increases. This increases the voltage drop across the plate resistor R_2 and therefore swings the plate of T_2 in the negative direction. Hence, when the voltage output of T_1 swings positive, the voltage output of T_2 swings negative. In other words, the voltage output of T_2 is 180 degrees out of phase with the voltage output of T_1 . The voltage output of T_2 is made equal to the voltage output of T_1 by adjustment of the tap on R_3 . For example, if the voltage amplification of T_2 is 20, the tap on R_3 is adjusted to supply one-twentieth of the a-f voltage across R_3 to the grid of T_2 . The a-f voltage across R_4 is thus made equal in amplitude to the a-f voltage across R_3 . The signal voltage inputs to the push-pull grids are then equal in amplitude and 180 degrees out of phase.

In the practical application of this circuit, it is convenient to use a twin-triode tube combining T_1 and T_2 . Operating conditions can be taken from the chart in RESISTANCE-COUPLED AMPLIFIER SECTION. The adjustment of the tap on R_3 is not critical.

Another form of phase inverter is shown in CIRCUIT SECTION. In this circuit, when the grid of the 6F5 swings in the positive direction, plate current through the tube increases and the voltage drops across R_5 and R_6 increase. The plate of the 6F5 therefore swings in the negative direction, while the cathode swings in the positive direction. The input voltages to the push-pull grids are thus supplied 180 degrees out of phase. The push-pull input voltages are equal in amplitude because R_5 is equal to R_6 . It should be noted that this circuit is not to be used in a t-r-f receiver where the diode circuit is grounded by the mounting of the tuning-condenser rotor shaft on the chassis. A ground connection to the condenser would lower the impedance across R_6 and would thus unbalance the input voltages to the push-pull grids.

RECTIFICATION

The rectifying action of a diode finds an important application in supplying

a receiver with d-c power from an a-c line. A typical arrangement for this application includes a rectifier tube, a filter, and a voltage divider. The rectifying action of the tube is explained briefly under DIODES, page 7. The filter's action is explained on page 37; its function is to smooth out the ripple of the tube output, as indicated in Fig. 20. The voltage divider is used to cut down the output voltage to the values required by the plates, screens, and grids of the tubes in the receiver.

A half-wave rectifier and a full-wave rectifier circuit are shown in Figs. 21 and 22, respectively. In the half-wave circuit, current flows through the rectifier tube to the filter on every other half-cycle of the a-c input voltage when the plate is positive with respect to the cathode. In the full-wave circuit, current flows to the filter on every half-cycle, through plate No. 1 on one half-cycle when plate No. 1 is positive with respect to the cathode, and through plate No. 2 on the next half-cycle when plate No. 2 is positive with respect to the cathode. Because the current flow to the filter is more uniform in the full-wave circuit than in the half-wave circuit, the output of the full-wave circuit requires less filtering. Rectifier operating information and circuits are given under each rectifier tube type and in the CIRCUIT SECTION

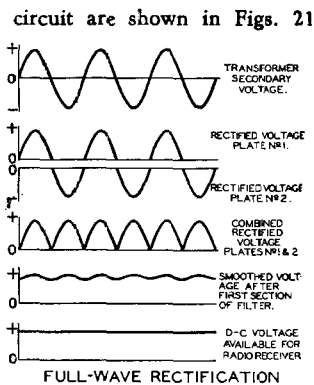

FULL-WAVE RECTIFICATION
Fig. 20

A voltage-doubler rectifier circuit of simple form is shown in Fig. 23. The circuit derives its name from the fact that its d-c voltage output can be as high as twice the peak value of the a-c input. The action of this circuit is briefly as follows. On the positive half-cycle of the a-c input, that is, when the upper side of the a-c input line is positive with respect to the lower side, the upper diode passes current and feeds positive charge into the upper condenser. As positive charge accumulates on the upper plate of the condenser, a positive voltage builds up across the condenser. On the next half-cycle of the a-c input, when the upper side of the line is negative with respect to the lower side, the lower diode passes current so that a negative voltage builds up across the lower condenser. As long as no

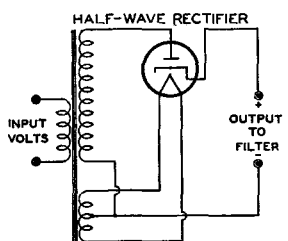

Fig. 21

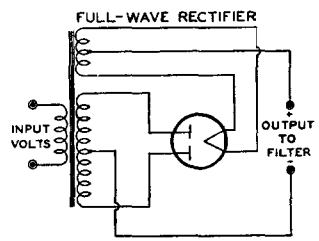
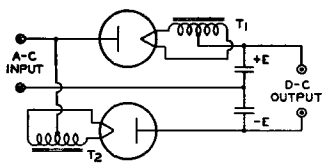

Fig. 22

current is drawn at the output terminals from the condensers, each condenser can charge up to a voltage of magnitude E , the peak value of the a-c input. It can be seen from the diagram that with a voltage of $+E$ on one condenser and $-E$ on the other, the total voltage across the condensers is $2E$. Thus the voltage doubler supplies a no-load d-c output voltage twice as large as the peak a-c input voltage. When current is drawn at the output terminals by the load, the output voltage drops below $2E$ by an amount that depends on the magnitude of the load current and the capacitance of the condensers.

Two rectifier types especially designed for use as voltage doublers are the all-metal 25Z6 and the glass 25Z5. These tubes combine two separate diodes in one tube. As voltage doublers the tubes are used in "transformerless" receivers. In these receivers, the heaters of all tubes in the set are connected in series with



T₁, T₂ = SEPARATE FILAMENT TRANSFORMER WINDINGS.

Fig. 23

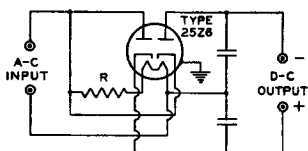

R = HEATERS OF OTHER TUBES IN SERIES WITH VOLTAGE-DROPPING RESISTOR

Fig. 24

a voltage-dropping resistor across the line. The connections for the heater supply and the voltage-doubling circuit are shown in Fig. 24.

DETECTION

When speech or music is transmitted from a radio station, the station radiates a radio-frequency wave whose amplitude varies in accordance with the audio-frequency signal being transmitted. The r-f wave is said to be modulated by the a-f wave. The effect of modulation on the waveform of the r-f wave is shown in Fig. 25.

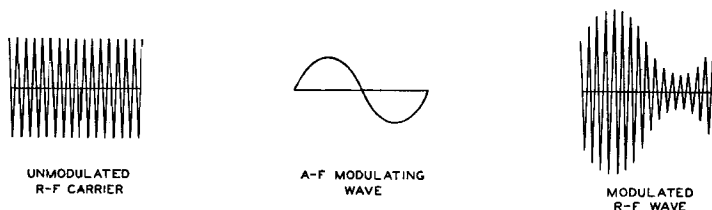

Fig. 25

In the receiver it is desired to reproduce the original a-f modulating wave from the modulated r-f wave. In other words, it is desired to demodulate the r-f wave. The receiver stage which performs this demodulation is called the demodulator or detector stage. There are three different detector circuits in general use, the diode detector, the grid-bias detector, and the grid-leak detector. These detector circuits are alike in that they eliminate, either partially or completely, alternate half-cycles of the r-f wave. With the alternate half-cycles eliminated, the audio variations of the other half of the r-f wave can be amplified to drive a loudspeaker or headphones.

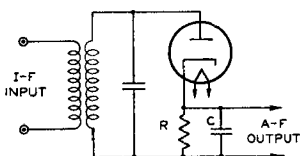

Fig. 26

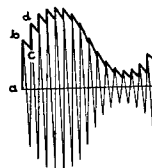

Fig. 27

A diode-detector circuit is shown in Fig. 26. The action of this circuit when a modulated r-f wave is applied is illustrated by Fig. 27. The r-f voltage applied to the circuit is shown in light line, the output voltage across the condenser C is shown in heavy line. Between points a and b on the first positive half-cycle of the applied r-f voltage, the condenser C charges up to the peak value of the r-f voltage. Then as the applied r-f voltage falls away from its peak value, the condenser holds the cathode at a potential more positive than the voltage applied to the anode. The condenser thus temporarily cuts off current through the diode. While the diode current is cut off, the condenser discharges, from b to c, through the diode load resistor R. When the r-f voltage on the anode rises high enough to exceed

the potential at which the condenser holds the cathode, current flows again and the condenser charges up to the peak value of the second positive half-cycle at d. In this way, the voltage across the condenser follows the peak value of the applied r-f voltage and thus reproduces the a-f modulation. The curve for voltage across the condenser, as drawn in Fig. 27, is somewhat jagged. However, this jaggedness, which represents an r-f component in the voltage across the condenser, is exaggerated in the drawing. In an actual circuit the r-f component of the voltage across the condenser is negligible. Hence, when the voltage across the condenser is amplified, the output of the amplifier reproduces the speech or music originating at the transmitting station.

It is helpful, in order to understand the diode detector better, to consider the circuit as a half-wave rectifier. Considered this way, the diode is the half-wave rectifier tube, the r-f signal voltage is the a-c input, the r-f by-pass condenser C is the filter condenser, and the resistor R is the load resistance. Because the d-c output voltage of a rectifier depends on the voltage of the a-c input, the d-c voltage across C varies with the amplitude of the r-f carrier and thus reproduces the a-f signal. On the basis of this analogy, it can be seen that the condenser C should be large enough to smooth out r-f or i-f variations, but should not be so large as to affect the audio variations. Also, on the basis of this analogy, it can be seen that two diodes can be connected in a circuit similar to a full-wave rectifier to give full-wave detection. However, in practice, the advantages of this connection generally do not justify the extra circuit complication.

The diode method of detection has the advantage over other methods in that it produces less distortion. The reason is that its dynamic characteristic can be made more linear than that of other detectors. It has the disadvantages that it does not amplify the signal, and that it draws current from the input circuit and therefore reduces the selectivity of the input circuit. However, because the diode method of detection produces less distortion and because it permits the use of simple a-c circuits without the necessity for an additional voltage supply, the diode method of detection is most widely used in broadcast receivers.

A typical diode-detector circuit using a duplex-diode triode tube is shown in Fig. 28. In this circuit, R_1 is the diode load resistor. A portion of the a-f voltage developed across this resistor is applied to the triode grid through the volume control R_3 . In a typical circuit, resistor R_1 may be tapped so that five-sixths of the total a-f voltage across R_1 is applied to the volume control. This tapped connection not only reduces the voltage output of the detector circuit but also reduces audio distortion and improves the r-f filtering. D-c bias for the triode section is provided by the cathode-bias resistor R_2 and the audio by-pass condenser C_3 . The function of condenser C_2 is to block the d-c bias of the cathode from the grid. The function of condenser C_4 is to by-pass any r-f voltage on the grid to cathode. A duplex-diode pentode may also be used in this circuit. With a pentode, the a-f output should be resistance-coupled rather than transformer-coupled.

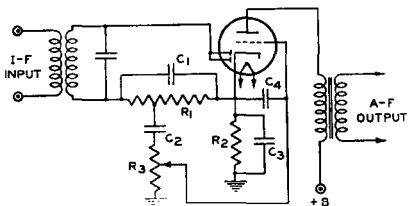

Fig. 28

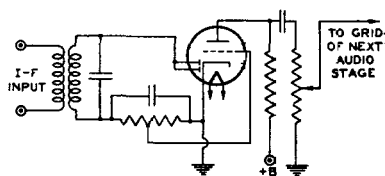

Fig. 29

Another diode detector circuit, called a diode-biased circuit, is shown in Fig. 29. In this circuit, the triode grid is connected directly to a tap on the diode load resistor. When an r-f signal voltage is applied to the diode, the d-c voltage at the tap supplies bias to the triode grid. When the r-f signal is modulated, the a-f voltage at the tap is applied to the grid and is amplified by the triode. The advantage of this circuit over the self-biased arrangement shown in Fig. 28 is that the diode-biased circuit does not employ a condenser between the grid and the

diode load resistor, and consequently does not produce as much distortion of a signal having a high percentage of modulation.

However, there are restrictions on the use of the diode-biased circuit. Because the bias voltage on the triode depends on the average amplitude of the r-f voltage applied to the diode, the average amplitude of the voltage applied to the diode should be constant for all values of signal strength at the antenna. Otherwise there will be different values of bias on the triode grid for different signal strengths and the triode will produce distortion. This restriction means, in practice, that the receiver should have a separate-channel avc system. With such an avc system, the average amplitude of the signal voltage applied to the diode can be held within very close limits for all values of signal strength at the antenna. The tube used in a diode-biased circuit should be one which operates at a fairly large value of bias voltage. The variations in bias voltage are then a small percentage of the total bias and hence produce small distortion. Tubes taking a fairly large bias voltage are types such as the 6R7 or 85 having a medium- μ triode. Tube types having a high- μ triode or a pentode should not be used in a diode-biased circuit. Since there is no bias applied to the diode-biased triode when no r-f voltage is applied to the diode, sufficient resistance should be included in the plate circuit of the triode to limit its zero-bias plate current to a safe value.

A grid-bias detector circuit is shown in Fig. 30. In this circuit, the grid is biased almost to cut-off, i.e., operated so that the plate current with zero signal is practically zero. The bias voltage can be obtained from a cathode-bias resistor, a C battery, or a bleeder tap. Because of the high negative bias, only the positive half cycles of the r-f signal are amplified by the tube. The signal is therefore detected in the plate circuit. The advantages of this method of detection are that it amplifies the signal, besides detecting it, and that it does not draw current from the input circuit and therefore does not lower the selectivity of the input circuit.

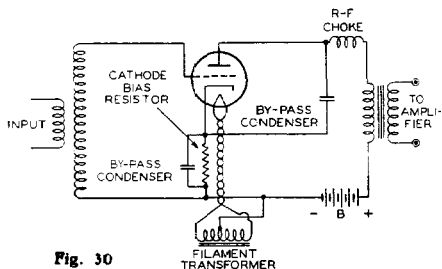

Fig. 30

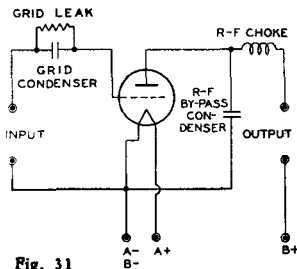

Fig. 31

The grid-leak and condenser method, illustrated by Fig. 31, is somewhat more sensitive than the grid-bias method and gives its best results on weak signals. In this circuit, there is no negative d-c bias voltage applied to the grid. Hence, on the positive half-cycles of the r-f signal, current flows from grid to cathode. The grid and cathode thus act as a diode detector, with the grid-leak resistor as the diode load resistor and the grid condenser as the r-f by-pass condenser. The voltage across the condenser then reproduces the a-f modulation in the same manner as has been explained for the diode detector. This voltage appears between the grid and cathode and is therefore amplified in the plate circuit. The output voltage thus reproduces the original a-f signal.

In this detector circuit, the use of a high-resistance grid leak increases selectivity and sensitivity. However, improved a-f response and stability are obtained with lower values of grid-leak resistance. This detector circuit has the advantage that it amplifies the signal but has the disadvantage that it draws current from the input circuit and therefore lowers the selectivity of the input circuit.

AUTOMATIC VOLUME CONTROL

The chief purposes of automatic volume control in a receiver are to prevent fluctuations in loudspeaker volume when the signal at the antenna is fading in and

out, and to prevent an unpleasant blast of loud volume when the set is tuned from a weak signal, for which the volume control has been turned up high, to a strong signal. To accomplish these purposes, an automatic volume control circuit regulates the receiver's r-f and i-f gain so that this gain is less for a strong signal than for a weak signal. In this way, when the signal strength at the antenna changes, the avc circuit reduces the resultant change in the voltage output of the last i-f stage and consequently reduces the change in the speaker's output volume.

The avc circuit reduces the r-f and i-f gain for a strong signal usually by increasing the negative bias of the r-f, i-f, and frequency-mixer stages when the signal increases. A simple avc circuit is shown in Fig. 32. On each positive half-cycle of the signal voltage, when the diode plate is positive with respect to the cathode, the diode passes current. Because of the flow of diode current through R_1 , there is a voltage drop across R_1 which makes the left end of R_1 negative with respect to ground. This voltage drop across R_1 is applied, through the filter R_2 and C , as negative bias on the grids of the preceding stages. Then, when the signal strength at the antenna increases, the signal applied to the avc diode increases, the voltage drop across R_1 increases, the negative bias voltage applied to the r-f and i-f stages increases, and the gain of the r-f and i-f stages is decreased. Thus the increase in signal strength at the antenna does not produce as much increase in the output of the last i-f stage as it would produce without avc. When the signal strength at the antenna decreases from a previous steady value, the avc circuit acts, of course, in the reverse direction, applying less negative bias, permitting the r-f and i-f gain to increase, and thus reducing the decrease in the signal output of the last i-f stage. In this way, when the signal strength at the antenna changes, the avc circuit acts to prevent change in the output of the last i-f stage, and thus acts to prevent change in loudspeaker volume.

The function of the filter, C and R_2 , is to prevent the avc voltage from varying at audio frequency. This filter is necessary because the voltage drop across R_1 varies with the modulation of the carrier being received. If avc voltage were taken directly from R_1 without filtering, the audio variations in avc voltage would vary the receiver's gain so as to smooth out the modulation of the carrier. To avoid this effect, the avc voltage is taken from the condenser C . Because of the resistance R_2 in series with C , the condenser C can charge and discharge at only a comparatively slow rate. The avc voltage therefore cannot vary at a frequency high enough to be in the audio range. However, the avc voltage can vary at frequencies below the audio range and, at these frequencies, can compensate for most fading. Thus the filter permits the avc circuit to smooth out variations in signal due to fading, but prevents the circuit from smoothing out audio modulation.

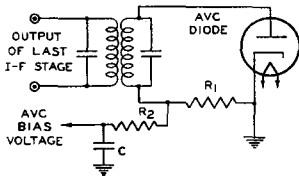

Fig. 32

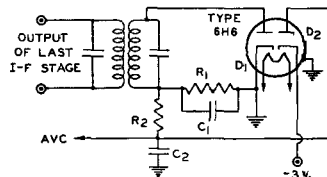

Fig. 33

It will be seen that an avc circuit and a diode detector circuit are much alike. It is therefore convenient in a receiver to combine the detector and the avc diode in a single stage. Examples of how these functions are combined in receivers are shown in **CIRCUIT SECTION**.

In the circuit shown in Fig. 32, a certain amount of avc negative bias is applied to the preceding stages on a weak signal. Since it may be desirable to maintain the receiver's r-f and i-f gain at the maximum possible value for a weak signal, avc circuits are designed in some cases to apply no avc bias until the signal strength exceeds a certain value. These avc circuits are known as delayed avc, or davg, circuits. A davg circuit is shown in Fig. 33. In this circuit, the diode section D_1 of the 6H6 acts as detector and avc diode, R_1 is the diode load resistor, and R_2 and C_2 are the avc filter. Because the cathode of diode D_2 is returned to -3

volts, a d-c current flows through R_1 and R_2 in series with D_2 . The voltage drop of this current places the avc lead at approximately -3 volts potential. As long as the average amplitude of the rectified signal voltage developed across R_1 does not exceed 3 volts, the avc lead remains at -3 volts. Hence, for signals not strong enough to develop 3 volts across R_1 , the bias applied to the controlled tubes stays constant at a value giving high sensitivity. However, when the average amplitude of rectified signal voltage across R_1 exceeds 3 volts, the plate of diode D_2 becomes more negative than the cathode of D_2 and current flow in diode D_2 ceases. The potential of the avc lead is then controlled by the voltage developed across R_1 . Therefore, with further increase in signal strength, the avc circuit applies an increasing avc bias voltage to the controlled stages. In this way, the circuit regulates the receiver's gain for strong signals, but permits the gain to stay constant at a maximum value for weak signals.

It can be seen in Fig. 33 that a portion of the -3 volts delay voltage is applied to the plate of the detector diode D_1 , this portion being approximately equal to $R_1/(R_1 + R_2)$ times -3 volts. Hence, with the circuit constants as shown, the detector plate is made negative with respect to its cathode by approximately one-half volt. However, this voltage does not interfere with detection because it is not large enough to prevent current flow in the tube.

TUNING INDICATION WITH ELECTRON-RAY TUBES

In the electron-ray types 6E5 and 6G5, a triode is mounted in a glass bulb, with a fluorescent target in the dome of the bulb, as shown in Fig. 34. The target is operated at a positive voltage and therefore attracts electrons from the cathode. Electrons striking the target produce a glow in a fluorescent coating on the target. When electrons are flowing to the whole circumference of the target, the target has the appearance of a ring of light.

An electrode, the ray-control electrode, is mounted between the cathode and target. When the potential of this electrode is less positive than the target, electrons flowing to the target are repelled by the electrostatic field of the electrode, and do not reach that portion of the target behind the electrode. Because the target does not glow where it is shielded from electrons, the control electrode casts a shadow on the glowing target. The extent of this shadow varies from approximately 100 degrees of the target, when the control electrode is much more negative than the target, to zero degrees when the control electrode is at approximately the same potential as the target.

In the application of the electron-ray tube, the potential of the control electrode is determined by the voltage on the grid of the triode section, as can be seen in Fig. 35. The flow of the triode's plate current through resistor R produces a voltage drop which determines the potential of the control electrode. When the voltage of the triode grid changes in the positive direction, plate current increases, the potential of the control electrode goes down because of the increased drop across R , and the shadow angle widens. When the potential of the triode grid changes in the negative direction, the shadow angle narrows.

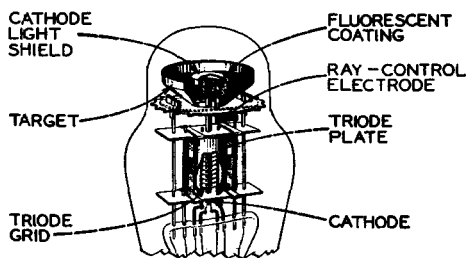

Fig. 34

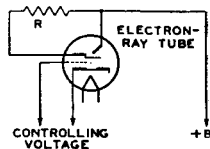

Fig. 35

Electron-ray tubes are widely used as tuning indicators in radio receivers. In this use, avc voltage is applied to the grid of the triode. Since avc voltage is at a

maximum when the set is tuned to give maximum response to the station, the shadow angle is at a minimum when the set is tuned exactly to the desired station. Thus the electron-ray tube gives a convenient visual indication of correct tuning. The choice between the electron-ray types 6E5 and 6G5 for a receiver depends on the receiver's avc characteristic. The 6E5 has a sharp cut-off triode which closes the shadow angle on a comparatively small value of avc voltage. The 6G5 has a remote cut-off triode which closes the shadow angle on a larger value of avc voltage than the 6E5.

Electron-ray tubes are also used as indicators in vacuum-tube voltmeters. In this application, an electron-ray tube has the advantage that it does not draw current from the circuit connected to its input terminals.

OSCILLATION

As an oscillator, a radio tube can be employed to generate a continuously alternating voltage. In present-day radio broadcast receivers, this application is limited practically to superheterodyne receivers for supplying the heterodyning frequency. Several circuits (represented in Figs. 36A and 36B) may be utilized, but they all depend on feeding more energy from the plate circuit to the grid circuit than is required to equal the power loss in the grid circuit. Feed-back may be

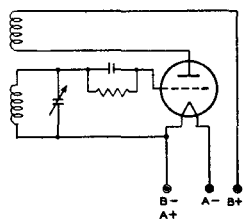

Fig. 36A

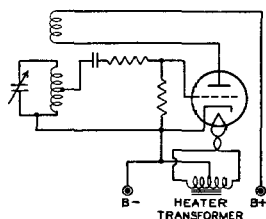

Fig. 36B

produced by electrostatic or electromagnetic coupling between the grid and plate circuits. When sufficient energy is fed back to more than equal the loss in the grid circuit, the tube will oscillate. The action consists of regular surges of power between the plate and the grid circuit at a frequency dependent on the circuit constants of inductance and capacity. By proper choice of these values, the frequency may be adjusted over a very wide range.

FREQUENCY CONVERSION

Frequency conversion is used in superheterodyne receivers to change the frequency of the r-f signal to an intermediate frequency. To perform this change in frequency, a frequency-converting device consisting of an oscillator and a frequency mixer is employed. In such a device, shown diagrammatically in Fig. 37, two voltages of different frequency, the r-f signal voltage and the voltage generated by the oscillator, are applied to the input of the frequency mixer. These voltages beat, or heterodyne, within the mixer tube to produce a plate current having, in addition to the frequencies of the input voltages, numerous sum and difference frequencies. The output circuit of the mixer stage is provided with a tuned circuit which is adjusted to select only one beat frequency, i.e., the frequency equal to the difference between the signal frequency and the oscillator frequency. The selected output frequency is known as the intermediate



FREQUENCY CONVERTER

Fig. 37

frequency, or i.f. The output frequency of the mixer tube is kept constant for all values of signal frequency by tuning the oscillator to the proper frequency.

Important advantages gained in a receiver by the conversion of signal frequency to a fixed intermediate frequency are high selectivity with few tuning stages and a high, as well as stable, overall gain for the receiver.

Three methods of frequency conversion for superheterodyne receivers are of interest. These methods are alike in that they employ a frequency-mixer tube in which plate current is varied at a combination of the signal frequency and the oscillator frequency. These variations in plate current produce across the tuned plate load a voltage of the desired intermediate frequency. The three methods differ in the types of tubes employed and in the means of supplying input voltages to the mixer tube.

A method widely used before the availability of tubes especially designed for frequency-conversion service, employs as mixer tube either a triode, a tetrode, or a pentode, in which oscillator voltage and signal voltage are applied to the same grid. In this method, coupling between the oscillator and mixer circuits is obtained by means of inductance or capacitance.

A second method employs a tube especially designed for frequency-converter service, in which the oscillator and the frequency mixer are combined in one tube. With this tube, called a pentagrid converter, coupling between the oscillator and mixer circuits is obtained by means of the electron stream within the tube. The arrangement of electrodes in a pentagrid converter tube is shown in Fig. 38A. Grids No. 1 and No. 2 and the cathode are connected to an external circuit to act as a triode oscillator. Grid No. 1 is the grid of this oscillator and grid No. 2 is

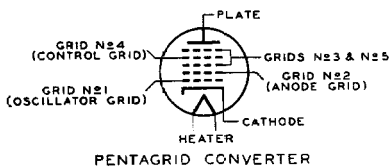

Fig. 38A

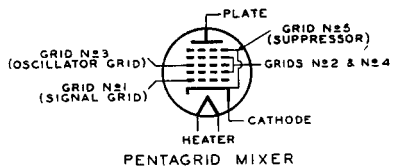

Fig. 38B

the anode. These two grids and the cathode can be considered to be a composite cathode which supplies to the rest of the tube an electron stream that varies at oscillator frequency. This varying electron stream is also controlled by the r-f voltage on grid No. 4. Thus, the variations in plate current are due to the combination of the oscillator and the signal frequencies. The purpose of grids No. 3 and No. 5, which are connected together within the tube, is to accelerate the electron stream and to shield grid No. 4 electrostatically from the other electrodes. The 6A8 and 1C6 are examples of the pentagrid-converter types.

A third method employs a tube particularly designed for short-wave reception. This tube, called a pentagrid mixer, has two independent control grids and is used with a separate oscillator tube. R-f signal voltage is applied to one of the control grids and oscillator voltage is applied to the other. It follows that the variations in plate current are due to the combination of the oscillator and signal frequencies. The arrangement of electrodes in a pentagrid-mixer tube is shown in Fig. 38B. The two control grids are No. 1 and No. 3. The r-f signal voltage is applied to No. 1. This grid is a remote cut-off grid and is, therefore, suited for control by avc bias voltage. The oscillator voltage is applied to No. 3 grid. This grid is a sharp cut-off grid and, therefore, produces a comparatively large effect on plate current for a small amount of oscillator voltage. Grids No. 2 and No. 4 are tied together within the tube. They serve to accelerate the electron stream and to shield grid No. 3 electrostatically from the other electrodes. Grid No. 5 functions similarly to the suppressor in a pentode. The 6L7 is a pentagrid-mixer tube.

Radio Tube Installation

The installation of radio tubes requires care if high-quality performance is to be obtained from the associated radio circuits. Installation suggestions and precautions which are generally common to all types of tubes are covered in this section. Careful observance of these suggestions will do much in helping the experimenter and radio technician to obtain the full performance capabilities of radio tubes and circuits. Additional and pertinent information is given under each tube type and in the **CIRCUIT SECTION**.

FILAMENT AND HEATER POWER SUPPLY

The design of radio tubes allows for some variation in the voltage and current supplied to the filament or heater, but most satisfactory results are obtained from operation at the rated values. When the voltage is low, the temperature of the cathode is below normal, with the result that electron emission is limited. This may cause unsatisfactory operation and reduced tube life. On the other hand, high cathode voltage causes rapid evaporation of cathode material and shortened life. To insure proper tube operation, the filament or heater voltage should be checked at the socket terminals by means of an accurate voltmeter while the receiver is in operation. In the case of series operation of heaters, correct adjustment can be checked by means of an ammeter in the heater circuit.

The filament or heater voltage supply may be a direct-current source (a battery or a d-c power line) or an alternating-current power line, depending on the type of service and type of tube. Frequently, a resistor (either variable or fixed) is used with a d-c supply to permit compensation for battery voltage variations or to adjust the tube voltage at the socket terminals to the correct value. Ordinarily, a step-down transformer is used with an a-c supply to provide the proper filament or heater voltage. Receivers, however, intended for operation on both d-c and a-c power lines have the heaters connected in series with a suitable resistor and supplied directly from the power line.

D-c filament or heater operation should be considered on the basis of the source of power. In the case of dry-battery supply, a variable resistor in series with the filament and the battery is required to compensate for battery variations. It is also recommended that an accurate voltmeter or milliammeter be permanently installed in the receiver to insure operation of the tubes at their rated filament voltage. Turning the set on and off by means of the rheostat is advised to prevent over-voltage conditions after an off-period. The voltage of dry-cells rises during off-periods. In the case of storage-battery supply, air-cell-battery supply, or d-c power supply, a non-adjustable resistor of suitable value may be used. It is well, however, to check initial operating conditions, and thus the resistor value, by means of a voltmeter or ammeter. A resistor is not required in some types of service, such as in the operation of the 2-volt series of tubes on a single storage-cell, and the 6.3-volt series of tubes from a 6-volt storage battery.

The **filament or heater resistor** required when heaters and/or filaments are operated in parallel can be determined easily by a simple formula derived from Ohm's law.

$$\text{Required Resistance (ohms)} = \frac{\text{Supply volts} - \text{Rated volts of tube type}}{\text{Total rated filament current (amperes)}}$$

Thus, if a receiver using three 32's, two 30's, and two 31's is to be operated from dry batteries, the series resistor is equal to 3 volts (the voltage from two dry cells in series) minus 2 volts (voltage rating for these tubes) divided by 0.56 ampere (the sum of 5×0.060 ampere + 2×0.130 ampere), i.e., approximately 1.8 ohms. Since this resistor should be variable to allow adjustment for battery depreciation, it is advisable to obtain the next larger commercial size, although any value between 2 and 3 ohms will be quite satisfactory. Where much power is dissipated in the resistor, the wattage rating should be sufficiently large to prevent overheating. The power dissipation in watts is equal to the voltage drop in the resistor multiplied by the total filament current in amperes. Thus, for the example above, $1 \times 0.56 = 0.56$ watts. In this case, the value is so small that any commercial rheostat with suitable resistance will be adequate.

For the case where the heaters and/or filaments of several tubes are operated in series, the resistor value is calculated by the following formula, also derived from Ohm's law.

$$\text{Required Resistance (ohms)} = \frac{\text{Supply volts} - \text{Total rated volts of tubes}}{\text{Rated amperes of tubes}}$$

Thus, if a receiver having one 6A8, one 6K7, one 6B8, one 25A6, and one 25Z6 is to be operated from a 120-volt power line, the series resistor is equal to 120 volts (the supply voltage) minus 68.9 volts (the sum of 3×6.3 volts + 2×25 volts) divided by 0.3 ampere (current rating of these tubes), i.e., approximately 170 ohms. The wattage dissipation in the resistor will be 120 volts minus 68.9 volts times 0.3 ampere, or approximately 15.3 watts. A resistor having a wattage rating in excess of this value should be chosen. It will be noted in the example for series operation that all tubes have the same current rating. If it is desired to connect in series tubes having different current ratings, tubes of the lower ratings should have shunt resistors placed across their heater terminals to pass the excess current. The required series resistor is then calculated on the basis of the tubes having the highest current rating.

A-c filament or heater operation should be considered on the basis of either a parallel or a series arrangement of filaments and/or heaters. In the case of the parallel arrangement, a step-down transformer is employed. Precautions should be taken to see that the line voltage is the same as that for which the primary of the transformer is designed. The line voltage may be determined by measurement with an a-c voltmeter (0-150 volts).

If the line voltage measures in excess of that for which the transformer is designed, a resistor should be placed in series with the primary to reduce the line voltage to the rated value of the transformer primary. Unless this is done, the excess input voltage will cause proportionally excessive voltage to be applied to the tubes. Any radio tube may be damaged or made inoperative by excessive operating voltages.

If the line voltage is consistently below that for which the primary of the transformer is designed, it may be necessary to install a booster transformer between the a-c outlet and the transformer primary. Before such a transformer is installed, the a-c line fluctuations should be very carefully noted. Some radio sets are equipped with a line-voltage switch which permits adjustment of the power transformer primary to the line voltage. When this switch is properly adjusted, the series-resistor or booster-transformer method of controlling line voltage is seldom required.

In the case of the series arrangements of filaments and/or heaters, a voltage-dropping resistance in series with the heaters and the supply line is usually required. This resistance should be of such value that, for normal line voltage, tubes will operate at their rated heater or filament current. The method for calculating the resistor value is given above.

HEATER-TO-CATHODE CONNECTION

The cathodes of heater-type tubes, when operated from a.c., should be connected either to the mid-tap on the heater-supply winding or to the mid-tap of a 50-ohm (approximate) resistor shunted across the winding. This practice follows the general recommendation that the potential difference between heater and cathode be kept low. In high-gain resistance-coupled circuits, the use of 10 volts is suggested to minimize hum. If a large resistor is used between heater and cathode, it should be by-passed by a suitable filter network or objectionable hum may develop. In the case of the 6.3-volt heater-cathode types when operated from a storage battery, the cathodes are connected either directly or through biasing resistors to the negative battery terminal. When a series-heater arrangement is used, the cathode circuits should be connected either directly or through biasing resistors to the negative side of the d-c plate supply, which is furnished either by the d-c power line or by the a-c power line through a rectifier.

PLATE VOLTAGE SUPPLY

The plate voltage for radio tubes is obtained from batteries, devices for rectifying a.c., direct-current power lines, and small local generators. Auto radios have caused the commercial development of a number of devices for obtaining a high-voltage d-c supply either from the car storage-battery or from a generator driven by the car engine.

The maximum plate voltage value for any tube type should not be exceeded if most satisfactory performance is to be obtained. Plate voltage should not be applied to a tube unless the corresponding recommended grid voltage is also supplied to the grid.

GRID VOLTAGE SUPPLY

The recommended grid voltages for different operating conditions have been carefully determined to give the most satisfactory performance. Grid voltage may be obtained from a separate C-battery, a tap on the voltage divider of the high-voltage d-c supply, or from the voltage drop across a resistor in the cathode circuit. This last is called the "self-bias" method, since the cathode current of the tube is utilized to produce the bias voltage. In any case, the object of the connection is to make the grid negative with respect to the cathode by the specified voltage. With C-battery supply, the negative battery terminal is connected to the grid return. The positive battery terminal is connected to the negative filament socket terminal, or to the cathode terminal if the tube is of the heater-cathode type. If the filament is supplied with alternating current, this connection is usually made to the center-tap of a low resistance (20-50 ohms) shunted across the filament terminals. This method reduces hum disturbances caused by the a-c supply. If bias voltages are obtained from the voltage divider of a high-voltage d-c supply, the grid return is connected to a more negative tap than the cathode.

The self-biasing method utilizes the voltage drop produced by the cathode current flowing through a resistor (Fig. 39) connected between the cathode and the negative terminal of the B-supply. The cathode current is, of course, equal to the plate current in the case of a triode, or to the sum of the plate and screen current in the case of a tetrode, pentode, or beam power tube. Since the voltage drop along the resistance is increasingly negative with respect to the cathode, the required negative grid-bias voltage can be obtained by connecting the grid return to the negative end of the resistance.

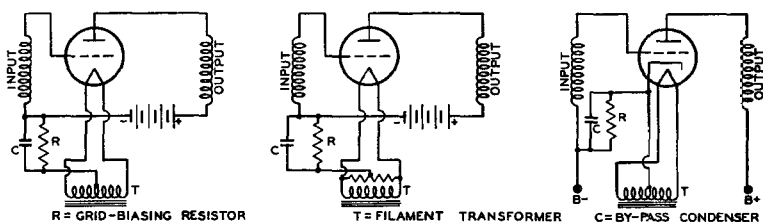

Fig. 39

The size of the resistance for self-biasing a single tube can be determined from the following formula:

$$\text{Resistance (ohms)} = \frac{\text{Desired grid - bias voltage} \times 1000}{\text{Rated cathode current in milliamperes}}$$

Thus, the resistance required to produce 9 volts bias for a triode which operates at 3 milliamperes plate current is $9 \times 1000 / 3 = 3000$ ohms. If the cathode current of more than one tube passes through the resistor, the size of the resistor will be determined by the total current. As indicated above, for tetrodes, pentodes, or beam power tubes, the cathode current is the sum of the screen and the plate current.

Grid voltage variation for the r-f amplifier stages is a convenient and frequently used method for controlling receiver volume. The variable voltage supplied to the grid is obtained from a bleeder circuit by means of a potentiometer; by the self-bias method using a variable resistor; or, with automatic volume control (avc), from a bleeder circuit by means of changes in bleeder current caused by the avc tube. In any case, it is important that the control be arranged so that less than the minimum recommended grid-bias voltage cannot be applied to the grid. This requirement may be met by a stop on the potentiometer, by a fixed resistance in series with the variable section, or by a fixed cathode resistance in addition to the regulating resistor. See Figs. 40 to 42.

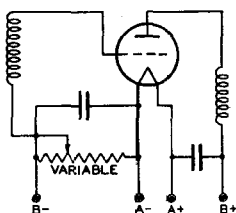

Fig. 40

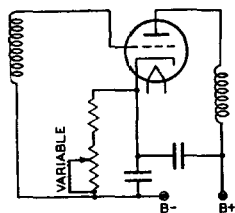

Fig. 41

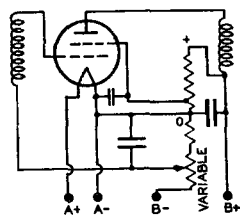

Fig. 42

SCREEN VOLTAGE SUPPLY

The positive voltage for the screen of a radio tube is usually obtained from a tap on the B-supply. For screen grid types of the four-electrode (or tetrode) construction, the screen voltage should be obtained by connecting the screen either directly to the proper voltage tap or through a potentiometer connected across the B-supply, but never through a series resistance to a high-voltage supply. This latter arrangement will not usually be satisfactory because of screen-current variations. Pentodes and beam power tubes, however, may utilize the series-resistor arrangement because tubes having suppressor action provide greater uniformity of the screen-current characteristic. Fig. 43 shows a pentode with screen voltage supplied through a series resistor.

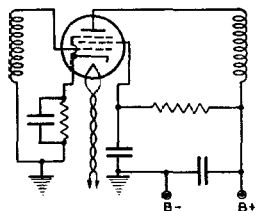

Fig. 43

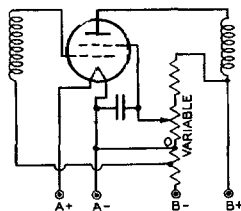

Fig. 44

Screen voltage variation for the r-f amplifier stages is sometimes used for volume control of the receiver. Reduced screen voltage lowers the mutual conductance of the tube and results in decreased gain per stage. The voltage variation is obtained by means of a potentiometer shunted across the screen voltage supply. See Fig. 44.

SHIELDING

In high-frequency stages having high gain, the output circuit of each stage must be shielded from the input circuit of that stage. Each high-frequency stage also must be shielded from the other high-frequency stages. Unless shielding is employed, undesired feedback may occur and may produce many harmful effects on receiver performance. To prevent this feedback, it is a widely followed practice

to shield separately each unit of the high-frequency stages. For instance, in a superheterodyne receiver, each i-f and r-f coil may be mounted in a separate shield can. Baffle plates may be mounted on the ganged tuning condenser to shield each section of the condenser from the other sections. The oscillator coil may be especially well-shielded by being mounted under the chassis. The shielding precautions required in a receiver depend on the design of the receiver and the layout of the parts. However, in all receivers having high-gain high-frequency stages, it is necessary to shield separately each tube in the high-frequency stages. With all-metal tubes, complete shielding of each tube is provided by the metal shell of the tube.

FILTERS

Feed-back effects also are caused in radio receivers by coupling between stages through common voltage-supply circuits. Filters find an important use in minimizing such effects. They should be placed in voltage-supply leads to each tube in order to return the signal current through a low-impedance path direct to the tube cathode rather than by way of the voltage-supply circuit. Fig. 45 illustrates several forms of filter circuits. In these, the condenser forms the low-impedance path, while the choke or resistor assists in diverting the signal through the condenser by offering a high-impedance to the power-supply circuit.

The choice between a resistor and a choke depends chiefly upon the permissible d-c voltage drop through the filter. In circuits where the current is small (a few milliamperes) resistors are practical; where the current is large, or regulation important, chokes are more suitable.

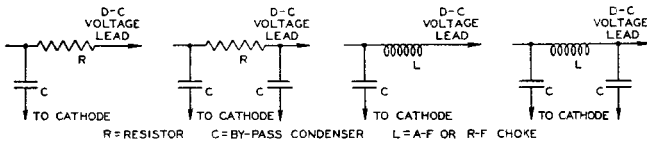

Fig. 45

The minimum practical size of the condensers may be estimated in most cases by the following rule: The impedance of the condenser at the lowest frequency amplified should not be more than one-fifth of the impedance of the filter choke or resistor at that frequency. Better results will be obtained in special cases if the ratio is not more than one-tenth. Radio-frequency circuits, particularly at high frequencies, require high-quality condensers. Mica condensers are preferable. Where stage shields are employed, filters should be placed within the shield.

Another important application of filters is to smooth the output of a rectifier tube. See RECTIFICATION. A smoothing filter usually consists of condensers and iron-core chokes, as in Fig. 46. In any filter design problem, the load impedance must be considered as an integral part of the filter because the load is an important factor in filter performance. Smoothing effect is obtained from the chokes because they are in series with the load and offer a high impedance to the ripple voltage. Smoothing effect is obtained from the condensers because they are in parallel with the load and store energy on the voltage peaks; this energy is released on the voltage dips and serves to maintain the voltage at the load substantially constant.

Smoothing filters are classified as choke-input or condenser-input according to whether a choke or condenser is placed next to the rectifier tube. See Fig. 46.

The **CIRCUIT SECTION** gives a number of examples of rectifier circuits with recommended filter constants.

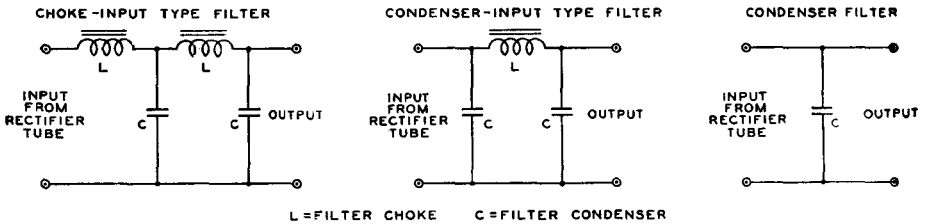

Fig. 46

If an input condenser is used, consideration must be given to the instantaneous peak value of the a-c input voltage. This peak value is about 1.4 times the RMS value as measured by an a-c voltmeter. Filter condensers, therefore, especially the input condenser, should have a rating high enough to withstand the instantaneous peak value, if breakdown is to be avoided. When the input-choke method is used, the available d-c output voltage will be somewhat lower than with the input-condenser method for a given a-c plate voltage. However, improved regulation together with lower peak current will be obtained.

OUTPUT-COUPLING DEVICES

An output-coupling device is used in the plate circuit of a power output tube to keep the comparatively high d-c plate current from the winding of an electro-magnetic speaker and, also, to transfer power efficiently from the output stage to a loudspeaker of either the electro-magnetic or dynamic type.

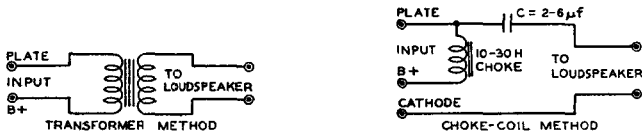

Fig. 47

Output-coupling devices are of two types, (1) choke-condenser and (2) transformer. The choke-condenser type consists of an iron-core choke with an inductance of not less than 10 henrys which is placed in series with the plate and B-supply. The choke offers a very low resistance to the d-c plate current component of the signal voltage but opposes the flow of the fluctuating component. A by-pass condenser of 2 to 6 μf supplies a path to the speaker winding for the signal voltage. The transformer type is constructed with two separate windings, a primary and a secondary, wound on an iron core. This construction permits of designing each winding to meet the requirements of its position in the circuit. Typical arrangements of each type of coupling device are shown in Fig. 47. Examples of transformers for push-pull stages are shown in several of the circuits given in the **CIRCUIT SECTION**.

RCA RADIO TUBE CLASSIFICATIONS

The following table classifies RCA tubes according to their functions and cathode voltages. It is intended to assist the tube user in identifying type numbers and in choosing a tube type for an application. As new tubes have been made available, the importance of certain earlier types for new equipment designs has decreased. This decrease in importance to the designer is indicated in the table by showing these types in small light face. The new All-Metal types are identified by large bold face.

Cathode Volts	1.1	1.5	2.0	2.5	3.3	5.0	6.3	7.5	12.6	25	30
DIODES											
Detector (twin)							6H6				
Rectifier (half-wave)							1-v	81	12Z3		
Rectifier (full-wave, vacuum)						5W4, 5Z4, 5Z3 80, 83-v	6X5, 84				
Rectifier (full-wave, mercury)				82	83						
Rectifier-Doubler										25Z6 25Z5	
TRIODES											
Voltage amplifier (medium mu)	11, 12	26	30	27, 56	99	00-A, 01-A, 40	6C5, 76, 37				
Voltage amplifier (high mu)							6F5				
Power amplifier			31	2A3, 45	20	71-A, 112-A			10, 50		
Class B amplifier (twin)			19	53			6N7, 6A6, 79				
Class B amplifier (dual grid)			49	46							
TETRODES											
Voltage amplifier (sharp cut-off)			32	24-A	22		36				
Voltage amplifier (remote cut-off)				35							
Power amplifier											48
BEAM POWER TUBES							6L6			25L6	
PENTODES											
Voltage amplifier (sharp cut-off)			1B4, 15	57			6J7, 6C6, 77				
Voltage amplifier (remote cut-off)			1A4, 34	58			6K7, 6D6, 78 39/44				
Power amplifier			1F4, 33	2A5, 47 59			6F6, 38, 41 42, 6A4, 39			25A6 43	
PENTAGRID CONVERTERS			1A6, 1C6	2A7			6A8, 6A7				
PENTAGRID MIXER							6L7				
DUPLEX-DIODE TYPES											
With medium-mu triode			1B5, 25S	55			6R7, 85				
With high mu triode				2A6			6Q7, 75				
With pentode			1F6	2B7			6B8, 6B7				
TRIODE-PENTODE							6F7				
ELECTRON-RAY TUBES											
With sharp cut-off triode							6E5				
With remote cut-off triode							6G5				

KEY TO TERMINAL DESIGNATIONS OF SOCKETS

Alphabetical subscripts **D**, **P**, and **T** indicate, respectively, diode unit, pentode unit, and triode unit in multi-unit types.

Numerical subscripts are used (1) in multi-grid types to indicate relative position of grids to cathode or filament, and (2) in multi-unit types to differentiate between two identical electrodes which would otherwise have the same designation.

BP = Bayonet Pin

H = Heater

P_{BF} = Beam-Forming Plates

F = Filament

K = Cathode

S = Shell

G = Grid

NC = No Connection

TA = Target

P = Plate

Bottom views of sockets are shown throughout this book.

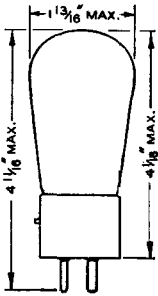

RCA-00-A

DETECTOR

The 00-A is a three-electrode storage-battery tube of the gas-filled type for use as a sensitive grid-leak detector.

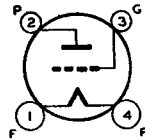

RCA-01-A

DETECTOR, AMPLIFIER

The 01-A is a three-electrode storage-battery tube for use as a detector and as an amplifier. Base connections are same as for the 00-A.

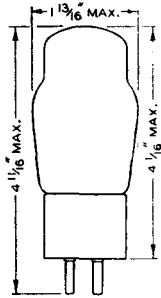

CHARACTERISTICS

	00-A	01-A	
FILAMENT VOLTAGE (D. C.)	5.0	5.0	Volts
FILAMENT CURRENT	0.25	0.25	Ampere
PLATE VOLTAGE	45 max.	90 135 max.	Volts
GRID VOLTAGE	0	-4.5 -9	Volts
PLATE CURRENT	1.5	2.5 3.0	Milliamperes
PLATE RESISTANCE	30000	11000 10000	Ohms
AMPLIFICATION FACTOR	20	8 8	
TRANSCONDUCTANCE	666	725 800	Micromhos
GRID-PLATE CAPACITANCE	8.5	8.1	$\mu\mu\text{f}$
GRID-FILAMENT CAPACITANCE	3.2	3.1	$\mu\mu\text{f}$
PLATE-FILAMENT CAPACITANCE	2.0	2.2	$\mu\mu\text{f}$
BULB	S-14	ST-14	
BASE	Medium 4-Pin Bayonet	Medium 4-Pin Bayonet	

INSTALLATION AND APPLICATION

The base pins of the 00-A and 01-A fit the standard four-contact socket which should be installed to hold the tube in a vertical position.

As a detector, the 01-A may be operated either with conventional grid leak and condenser or with grid bias. For grid-bias detection, plate voltages up to the maximum value of 135 volts may be used with the corresponding negative grid-bias voltage (13.5 volts approximately, at 135 volts).

These two types are used principally for renewal purposes.

RCA-1A4

SUPER-CONTROL R-F AMPLIFIER PENTODE

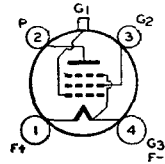
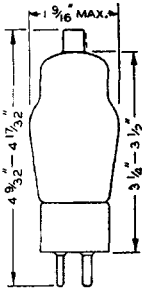

The 1A4 is a super-control pentode of the filament type. It is useful as a radio-frequency amplifier or intermediate-frequency amplifier in battery-operated receivers. The 1A4, although similar in application to type 34, is constructed in a smaller bulb and, because of its less remote cut-off characteristic, requires less B-battery power.

CHARACTERISTICS

FILAMENT VOLTAGE (D. C.)	2.0	Volts
FILAMENT CURRENT	0.060	Ampere
PLATE VOLTAGE	90 180 max.	Volts
SCREEN VOLTAGE (Grid No. 2)	67.5 max. 67.5 max.	Volts
GRID VOLTAGE (Grid No. 1)	-3 min. -3 min.	Volts
PLATE CURRENT	2.2 2.3	Milliamperes
SCREEN CURRENT	0.9 0.8	Milliamperes
PLATE RESISTANCE (Approx.)	0.6 1.0	Megohm
AMPLIFICATION FACTOR	425 750	
TRANSCONDUCTANCE	720 750	Micromhos
TRANSCONDUCTANCE (At -15 volts bias)	15 15	Micromhos
GRID-PLATE CAPACITANCE (With shield-can)	0.007 max.	μmf
INPUT CAPACITANCE	5	μmf
OUTPUT CAPACITANCE	11	μmf
BULB		ST-12
CAP		Small Metal
BASE		Small 4-Pin

INSTALLATION AND APPLICATION

For INSTALLATION and APPLICATION, refer to type 34.

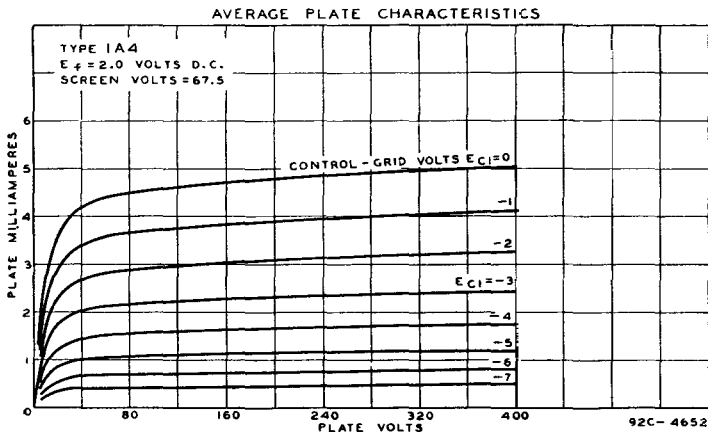

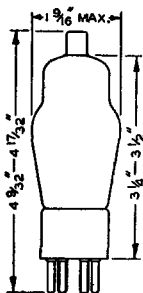

RCA-1A6

PENTAGRID CONVERTER

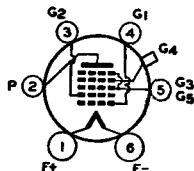

The 1A6 is a multi-electrode type of vacuum tube designed to perform simultaneously the function of a mixer tube and of an oscillator tube in superheterodyne circuits. Through its use, the independent control of each function is made possible within a single tube. The 1A6 is designed especially for use in battery-operated receivers. In such service, this tube replaces the two tubes required in conventional circuits and gives improved performance. For general discussion of pentagrid types, see Frequency Conversion, page 31.

CHARACTERISTICS

FILAMENT VOLTAGE (D. C.).....	2.0	Volts
FILAMENT CURRENT	0.060	Ampere
DIRECT INTERELECTRODE CAPACITANCES (Approx.)		
Grid No. 4 to Plate (With shield-can).....	0.25	μf
Grid No. 4 to Grid No. 2 (With shield-can).....	0.2	μf
Grid No. 4 to Grid No. 1 (With shield-can).....	0.1	μf
Grid No. 1 to Grid No. 2.....	0.8	μf
Grid No. 4 to All Other Electrodes (R-F Input)...	10.5	μf
Grid No. 2 to All Other Electrodes (Osc. Output)...	6	μf
Grid No. 1 to All Other Electrodes (Osc. Input)...	5	μf
Plate to All Other Electrodes (Mixer Output).....	9	μf
BULB		ST-12
CAP		Small Metal
BASE		Small 6-Pin

Converter Service

PLATE VOLTAGE	180 max.	Volts	
SCREEN VOLTAGE (Grids No. 3 and 5).....	67.5 max.	Volts	
ANODE-GRID VOLTAGE (Grid No. 2).....	135 max.	Volts	
ANODE-GRID VOLTAGE SUPPLY*.....	180 max.	Volts	
CONTROL-GRID VOLTAGE (Grid No. 4).....	-3 min.	Volts	
TOTAL CATHODE CURRENT.....	9 max.	Milliamperes	
TYPICAL OPERATION			
Plate Voltage	135	180	Volts
Screen Voltage	67.5	67.5	Volts
Anode-Grid Voltage	135	135	Volts
Anode-Grid Voltage Supply.....	135	180*	Volts
Control-Grid Voltage	-3	-3	Volts
Oscillator-Grid Resistor (Grid No. 1).....	50000	50000	Ohms
Plate Current	1.2	1.3	Milliamperes
Screen Current	2.5	2.4	Milliamperes
Anode-Grid Current	2.3	2.3	Milliamperes
Oscillator-Grid Current	0.2	0.2	Milliampere
Total Cathode Current.....	6.2	6.2	Milliamperes
Plate Resistance	0.4	0.5	Megohm
Conversion Conductance	275	300	Micromhos
Conversion Conductance (At -22.5 volts on Grid No. 4).....	4	4	Micromhos

* Applied through 20000-ohm dropping resistor, by-passed by 0.1 μf condenser.

The transconductance of the oscillator portion (not oscillating) of the 1A6 is 425 micromhos under the following conditions: Plate voltage, 135 to 180 volts; screen voltage, 67.5 volts; anode-grid voltage (no voltage-dropping resistor), 135 volts; and zero oscillator grid volts. Under these same conditions the anode-grid current is 2.3 milliamperes.

INSTALLATION

The base pins of the 1A6 require the use of a standard six-contact socket which should be installed to hold the tube in a vertical position.

The coated filament of the 1A6 may be operated conveniently from dry-cells, from a single lead storage-cell, or from an air-cell battery. For dry-cell operation, a filament rheostat may be used together with a permanently installed voltmeter to insure the proper filament voltage. For operation from a 2-volt lead storage-cell, the 1A6 requires no filament resistor. Operation from an air-cell battery requires a fixed resistor in the filament circuit. This resistor should have a value such that with a new air-cell battery, the voltage applied across the filament terminals will not initially exceed 2.15 volts.

Series operation of the filament of the 1A6 with those of other two-volt battery types is permissible provided certain precautions are observed. It is essential that shunt resistors be employed across certain filaments to carry the plate current returning from other tubes through these filaments. The shunt resistors should be adjusted to maintain the filament voltage of each tube at its rated value of 2.0 volts under operating conditions. It is obvious that the shunt resistor can also be used to adjust for a difference in filament current ratings. Series-parallel operation of two-volt types is not recommended because failure of one tube may cause excessive voltage across other tubes. Socket terminal No. 1 (see socket connections) should be connected to the positive battery terminal.

Complete shielding of the 1A6 is generally necessary to prevent intercoupling between its circuit and those of other stages.

APPLICATION

As a frequency converter in superheterodyne circuits, the 1A6 can supply the local oscillator frequency and at the same time mix it with the radio-input frequency to provide the desired intermediate frequency. For this service, design information is given under CHARACTERISTICS. It is important to note that the anode-grid voltage and the plate voltage must each be higher than the screen voltage.

For the oscillator circuit, the coils may be constructed according to conventional design, since the tube is not particularly critical for frequencies up to 10 megacycles. For higher frequencies the 1C6 should be used. However, it should be noted that the 1C6 requires additional filament current. The voltage applied to the anode-grid (No. 2) of the 1A6 should not exceed the maximum value of 135 volts, but should always be higher than the screen (grids No. 3 and No. 5) voltage. The anode-grid voltage may be obtained from a suitable tap on the B battery or from the plate-supply tap through a voltage-dropping resistor of 20000 ohms shunted by a by-pass condenser of 0.1 μf . The size of the resistor in the grid circuit of the oscillator is not critical but requires design adjustment, depending upon the values of the anode-grid voltage and of the screen voltage. Adjustment of the circuit should be such that the cathode current is approximately 6 milliamperes. *Under no condition of adjustment should the cathode current exceed the recommended maximum value of 9 milliamperes.*

The bias voltage applied to grid No. 4 can be varied over relatively wide limits to control the translation gain of the tube. For example, with 67.5 volts on the screen (grids No. 3 and No. 5), the bias voltage may be varied from -3 to plate current cut-off (approximately -25 volts). With lower screen voltages, the cut-off point is proportionately less. The extended cut-off feature of the 1A6 in combination with the similar characteristics of super-control tubes can be utilized advantageously to adjust receiver sensitivity.

Since the capacity between grid No. 4 and plate is in a parallel path with the capacity and inductance of the plate load, it is important to use a load capacity of sufficient size to limit the magnitude of the r-f voltage built up across the load. If this is not done, r-f voltage feed-back will occur between plate and grid No. 4 to produce degenerative effects. For this reason, the size of the load condenser in the plate circuit should be not less than 50 μf .

Converter circuits employing the 1A6 may easily be designed to have a translation gain of approximately 40. A typical circuit which provides exceptionally uniform oscillator output over the entire grid-bias range is shown under type 1C6. For details of oscillator coil assemblies, refer to type 2A7.

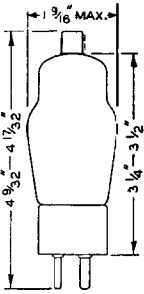

RCA-1B4

R-F AMPLIFIER PENTODE

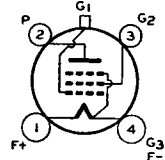

The 1B4 is a pentode of the filament type. It is recommended for use primarily as a radio-frequency amplifier or detector in battery-operated receivers. The 1B4 is similar in application to type 32 but is constructed in a smaller bulb.

CHARACTERISTICS

FILAMENT VOLTAGE (D. C.)	2.0	Volts
FILAMENT CURRENT	0.060	Ampere
PLATE VOLTAGE	90 180 max.	Volts
SCREEN VOLTAGE (Grid No. 2)	67.5 max. 67.5 max.	Volts
GRID VOLTAGE (Grid No. 1)	-3 -3	Volts
PLATE CURRENT	1.6 1.7	Milliamperes
SCREEN CURRENT	0.7 0.6	Milliamperes
PLATE RESISTANCE	1 1.5	Megohms
AMPLIFICATION FACTOR	550 1000	
TRANSCONDUCTANCE	600 650	Micromhos
GRID VOLTAGE* (Approx.)	-8 -8	Volts
GRID-PLATE CAPACITANCE (With shield-can)	0.007 max.	$\mu\mu\text{f}$
INPUT CAPACITANCE	5	$\mu\mu\text{f}$
OUTPUT CAPACITANCE	11	$\mu\mu\text{f}$
BULB		ST-12
CAP		Small Metal
BASE		Small 4-Pin

* For plate current cut-off.

INSTALLATION AND APPLICATION

For INSTALLATION, refer to type 34; for APPLICATION, refer to type 32.

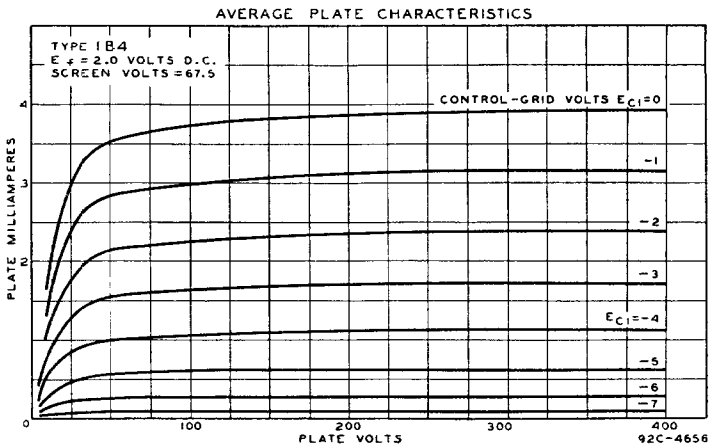

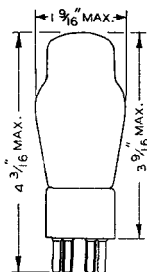

RCA-1B5/25S

DUPLEX-DIODE TRIODE

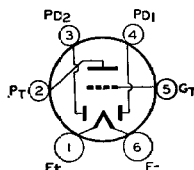

The 1B5/25S is a filament type of tube containing *two diodes* and a *triode* in a single bulb. It is recommended for use as a combined detector, amplifier, and automatic-volume-control tube in battery-operated receivers. For diode-detector considerations, refer to page 26.

CHARACTERISTICS

FILAMENT VOLTAGE (D. C.)	2.0	Volts
FILAMENT CURRENT	0.06	Ampere
GRID-TRIODE PLATE CAPACITANCE	3.6	μmf
GRID-FILAMENT CAPACITANCE	1.6	μmf
TRIODE PLATE-FILAMENT CAPACITANCE	1.9	μmf
BULB		ST-12
BASE		Small 6-Pin

Triode Unit—As Class A₁ Amplifier

PLATE VOLTAGE	135 max.	Volts
GRID VOLTAGE	-3	Volts
PLATE CURRENT	0.8	Milliampere
PLATE RESISTANCE	35000	Ohms
AMPLIFICATION FACTOR	20	
TRANSCONDUCTANCE	575	Micromhos

Diode Units

The two diodes and the triode are independent of each other except for the common filament. Diode plate No. 1 is located at the negative end of the filament; diode plate No. 2 is located at the positive end. Because of this arrangement, diode plate No. 1, when the diodes are used for different purposes, should be used for detection to avoid signal delay effects. Operation curves for the diode units are given under type 6B7.

INSTALLATION AND APPLICATION

The base pins of the 1B5/25S require the use of a standard six-contact socket which should be installed to hold the tube in a vertical position.

For filament operation and shielding, refer to 1A6.

The 1B5/25S is similar in application to the type 6R7.

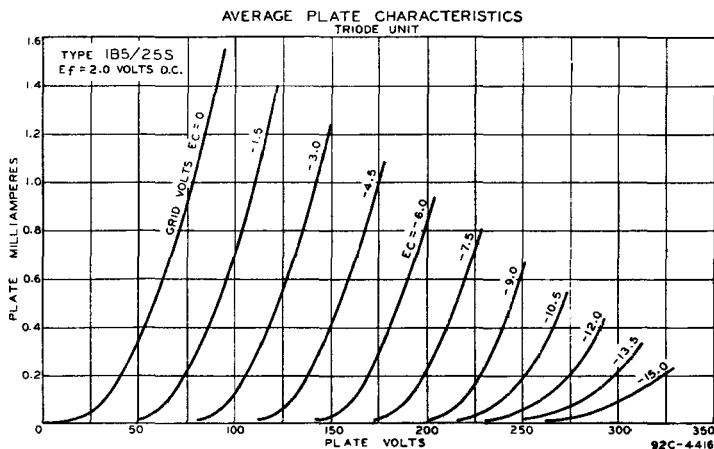

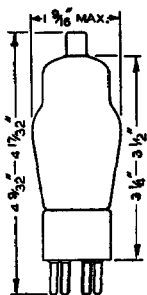

RCA-1C6

PENTAGRID CONVERTER

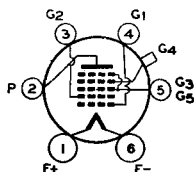

The 1C6 is a multi-electrode type of vacuum tube designed to perform simultaneously the function of a mixer tube and of an oscillator tube in superheterodyne circuits. Through its use, the independent control of each function is made possible within a single tube. The 1C6 is designed especially for use in battery-operated receivers. In such service, this tube replaces the two tubes required in conventional circuits and gives improved performance. It is especially useful in multi-range receivers which are often designed to cover frequencies as high as 20 megacycles. For general discussion of pentagrid types, see FREQUENCY CONVERSION, page 31.

CHARACTERISTICS

FILAMENT VOLTAGE (D. C.).....	2.0	
FILAMENT CURRENT	0.120	Volts
DIRECT INTERELECTRODE CAPACITANCES (Approx.):		Ampere
Grid No. 4 to Plate (With shield-can).....	0.3	$\mu\mu\text{f}$
Grid No. 4 to Grid No. 2 (With shield-can).....	0.3	$\mu\mu\text{f}$
Grid No. 4 to Grid No. 1 (With shield-can).....	0.15	$\mu\mu\text{f}$
Grid No. 1 to Grid No. 2.....	1.5	$\mu\mu\text{f}$
Grid No. 4 to All Other Electrodes (R-F Input)...	10	$\mu\mu\text{f}$
Grid No. 2 to All Other Electrodes (Osc. Output)..	6	$\mu\mu\text{f}$
Grid No. 1 to All Other Electrodes (Osc. Input)..	6	$\mu\mu\text{f}$
Plate to All Other Electrodes (Mixer Output).....	10	$\mu\mu\text{f}$
BULB		ST-12
CAP		Small Metal
BASE		Small 6-Pin

Converter Service

PLATE VOLTAGE	180 max.		Volts
SCREEN VOLTAGE (Grids No. 3 and 5).....	67.5 max.		Volts
ANODE-GRID VOLTAGE (Grid No. 2).....	135 max.		Volts
ANODE-GRID VOLTAGE SUPPLY*.....	180 max.		Volts
CONTROL-GRID VOLTAGE (Grid No. 4).....	-3 min.		Volts
TOTAL CATHODE CURRENT.....	9 max.		Milliamperes
TYPICAL OPERATION			
Plate Voltage	135	180	Volts
Screen Voltage	67.5	67.5	Volts
Anode-Grid Voltage Supply.....	135*	180*	Volts
Control-Grid Voltage	-3	-3	Volts
Oscillator Grid-Resistor (Grid No. 1).....	50000	50000	Ohms
Plate Current	1.3	1.5	Milliamperes
Screen Current (Approximate)	2	2	Milliamperes
Anode-Grid Current	2.6	3.3	Milliamperes
Oscillator-Grid Current	0.2	0.2	Milliamperes
Total Cathode Current (Approx.).....	6.5	7	Milliamperes
Plate Resistance	0.55	0.75	Megohm
Conversion Conductance	300	325	Micromhos
Conversion Conductance (At -14 volts on Grid No. 4).....	4	4	Micromhos

The transconductance of the oscillator portion (not oscillating) of the 1C6 is 1000 micromhos under the following conditions: Plate voltage, 135 to 180 volts; screen voltage, 67.5 volts; anode-grid voltage (no voltage-dropping resistor), 135 volts; and zero oscillator grid volts. Under these same conditions, the anode-grid current is 4.9 milliamperes.

* Applied through 20000-ohm dropping resistor, by-passed by 0.1 μf condenser.

INSTALLATION

Refer to INSTALLATION on type 1A6.

APPLICATION

As a frequency converter in superheterodyne circuits, the 1C6 can supply the local oscillator frequency and at the same time mix it with the radio-input frequency to provide the desired intermediate frequency. For this service, design information is given under CHARACTERISTICS. It is important to note that the anode-grid voltage and the plate voltage must each be higher than the screen voltage.

For oscillator circuit information, refer to APPLICATION on type 1A6. Final adjustment of the 1C6 circuit should be such that the cathode current is approximately 6.5 milliamperes. The cathode current should never exceed 9 milliamperes under any condition of adjustment.

This tube, which is similar to the 1A6 although not directly interchangeable with it, requires twice the filament current of the latter, but offers the feature of an extended operating range at the higher frequencies. This feature is of particular value in the design of multi-range receivers, since the oscillator section of the 1C6 has sufficient mutual conductance to function at frequencies as high as 25 megacycles. In order to cover this same range of operation, the 1A6 requires the use of a triode connected in parallel with the oscillator section for frequencies above 10 megacycles.

The maximum conversion transconductance is obtained with an oscillator-grid current of slightly less than 0.2 milliampere. The size, inductance, and coupling of the oscillator-grid and plate coils will determine this value. The coupling of these coils should be adjusted to make the oscillator-grid current the proper value (approximately 0.2 milliampere) when a grid condenser of 250 μf and a grid leak of 50000 ohms are used. For details of oscillator-coil assemblies, refer to type 2A7.

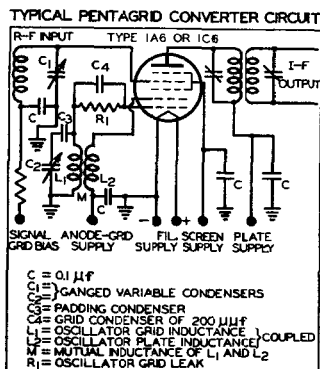
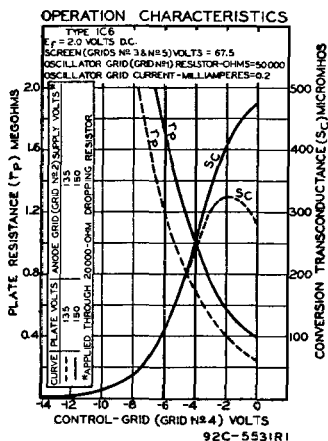

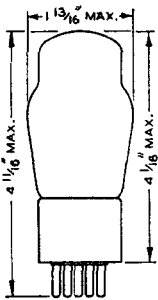

RCA-1F4

POWER AMPLIFIER PENTODE

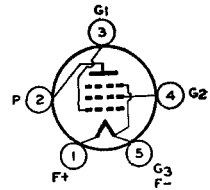

The 1F4 is a power-amplifier pentode for use in the output stage of battery-operated receivers. This tube has low filament- and plate-current requirements, high power sensitivity,

and will deliver a considerable amount of audio output with low distortion.

CHARACTERISTICS

FILAMENT VOLTAGE (D. C.)	2.0	Volts
FILAMENT CURRENT	0.12	Ampere
PLATE VOLTAGE	90	135 max. Volts
SCREEN VOLTAGE (Grid No. 2)	90	135 max. Volts
GRID VOLTAGE (Grid No. 1)	-3	-4.5 Volts
PLATE CURRENT	4	8 Milliampere
SCREEN CURRENT	1.3	2.6 Milliampere
PLATE RESISTANCE	240000	200000 Ohms
AMPLIFICATION FACTOR	340	340
TRANSCONDUCTANCE	1400	1700 Micromhos
LOAD RESISTANCE	20000	16000 Ohms
SELF-BIAS RESISTOR	566	425 Ohms
POWER OUTPUT*	120	340 Milliwatts
BULB		ST-14
BASE		Medium 5-Pin

* 5% total harmonic distortion.

INSTALLATION AND APPLICATION

For INSTALLATION and APPLICATION, refer to type 33.

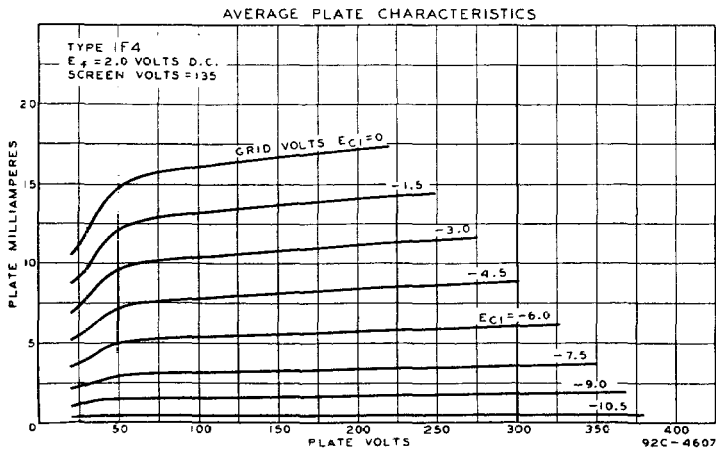

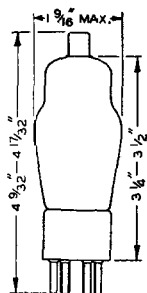

RCA-1F6

DUPLEX-DIODE PENTODE

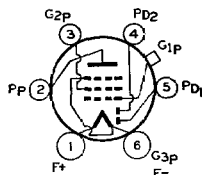

The 1F6 is a duplex-diode pentode consisting of two diodes and a pentode in a single bulb. It is recommended for service as a combined detector, amplifier (radio-frequency, intermediate-frequency or audio-frequency), and automatic-volume-control tube in battery-operated receivers. For diode-detector considerations, refer to page 26.

CHARACTERISTICS

FILAMENT VOLTAGE (D. C.)	2.0	Volts
FILAMENT CURRENT	0.06	Ampere
GRID-PENTODE PLATE CAPACITANCE (With shield-can)	0.007 max.	μf
INPUT CAPACITANCE	4	μf
OUTPUT CAPACITANCE	9	μf
BULB		ST-12
CAP		Small Metal
BASE		Small 6-Pin

Pentode Unit—As Class A R-F or I-F Amplifier

PLATE VOLTAGE	180 max.	Volts
SCREEN VOLTAGE (Grid No. 2)	67.5 max.	Volts
GRID VOLTAGE (Grid No. 1)	-1.5	Volts
PLATE CURRENT	2.0	Milliamperes
SCREEN CURRENT	0.6	Milliampere
PLATE RESISTANCE (Approx.)	1	Megohm
AMPLIFICATION FACTOR (Approx.)	650	
TRANSCONDUCTANCE	650	Micromhos
TRANSCONDUCTANCE (At -12 volts bias)*	15	Micromhos

Pentode Unit—As Resistance-Coupled A-F Amplifier

PLATE-SUPPLY VOLTAGE	135	135	Volts		
SCREEN-SUPPLY VOLTAGE	135	135	Volts		
D-C GRID VOLTAGE	-1.0	-2.0	Volts		
PEAK A-F GRID VOLTAGE	0.64	0.62	Volt		
ZERO-SIGNAL D-C PLATE CURRENT	0.42	0.42	Milliampere		
MAX-SIGNAL D-C PLATE CURRENT	0.34	0.34	Milliampere		
PLATE RESISTOR	0.25	0.25	Megohm		
SCREEN RESISTOR	1	0.8	Megohm		
LOAD RESISTANCE	**	**			
GRID RESISTOR†	1.0	0.5	1.0	0.5	Megohm
VOLTAGE AMPLIFICATION	48	43	46	41	
TOTAL HARMONIC DISTORTION	5	5	5	5	Per cent
PEAK VOLTAGE OUTPUT	30.8	28	28	25.2	Volts

** The load resistance across which the output voltage is developed, consists of the plate resistor, coupling condenser, and grid resistor of the following tube.

† For the following tube.

* For cathode current cut-off.

Diode Units

The two diodes and the pentode are independent of each other except for the common filament. The two diode units are placed at the negative end of the filament. Operation curves for diode units are given under type 6B7.

INSTALLATION AND APPLICATION

Refer to INSTALLATION of type 1A6. The 1F6 is similar in application to type 6B8. The maximum value of resistance in the grid circuit of this tube should not exceed 1.0 megohm for any condition of operation. A family of plate characteristic curves is given on page 61.

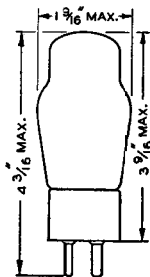

RCA-1-v

HALF-WAVE RECTIFIER

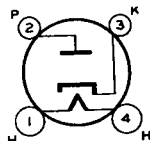

The 1-v is a half-wave, high-vacuum rectifier tube employing a heater cathode. It is intended for use in radio equipment of either the "universal" or the automobile type designed for its characteristics. The low voltage drop of this tube makes it uniquely adapted to such service. The 1-v is interchangeable with type 1.

CHARACTERISTICS

HEATER VOLTAGE (A. C. or D. C.).....	6.3	Volts
HEATER CURRENT	0.3	Ampere
A-C PLATE VOLTAGE (RMS).....	350 max.	Volts
PEAK INVERSE VOLTAGE.....	1000 max.	Volts
D-C OUTPUT CURRENT.....	50 max.	Milliamperes
BULB		ST-12
BASE		Small 4-Pin

INSTALLATION

The base pins of the 1-v fit the standard four-contact socket which may be installed to hold the tube in any position.

For heater operation, refer to type 6A8. The d-c potential between heater and cathode should never exceed 500 volts.

APPLICATION

The filter may be either of the condenser-input or the choke-input type provided the recommended maximum plate voltage and output current ratings given under CHARACTERISTICS are not exceeded.

If the condenser-input type of filter is used, consideration must be given to the instantaneous peak value of the a-c input voltage which, for a sinusoidal wave, is about 1.4 times the RMS value as measured with an a-c voltmeter. It is important, therefore, that the filter condensers (especially the input condenser) have a sufficiently high breakdown rating to withstand this instantaneous peak value. Particular attention must be given to this point when the waveshape input to the plates of the rectifier tube is non-sinusoidal.

When the input-choke method is used, the available d-c output voltage will be somewhat lower than with the input-condenser method for a given a-c plate voltage. However, improved regulation, together with lower peak current, will be obtained.

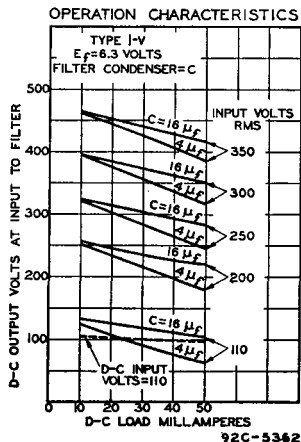

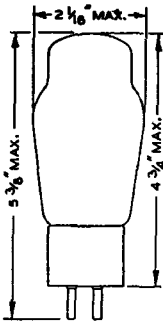

RCA-2A3

POWER AMPLIFIER TRIODE

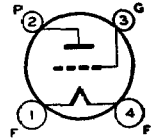

The 2A3 is a three-electrode, high-vacuum type of power amplifier tube for use in the power-output stage of a-c operated receivers. The exceptionally large power-handling ability of the 2A3 is the result of its design features. Among these are its extremely high transconductance and its large effective cathode area.

CHARACTERISTICS

FILAMENT VOLTAGE (A. C. or D. C.)	2.5	Volts
FILAMENT CURRENT	2.5	Amperes
GRID-PLATE CAPACITANCE	16.5	μmf
GRID-FILAMENT CAPACITANCE	7.5	μmf
PLATE-FILAMENT CAPACITANCE	5.5	μmf
BULB		ST-16
BASE		Medium 4-Pin

As Single-Tube Class A₁ Amplifier

FILAMENT VOLTAGE (A. C.)	2.5	Volts
PLATE VOLTAGE	250 <i>max.</i>	Volts
GRID VOLTAGE*	-45	Volts
PLATE CURRENT	60	Milliamperes
PLATE RESISTANCE	800	Ohms
AMPLIFICATION FACTOR	4.2	
TRANSCONDUCTANCE	5250	Micromhos
LOAD RESISTANCE	2500	Ohms
SELF-BIAS RESISTOR	750	Ohms
UNDISTORTED POWER OUTPUT	3.5	Watts

As Push-Pull Class AB₁ Amplifier (Two Tubes)

	<i>Fixed Bias</i>	<i>Self-Bias</i>	
FILAMENT VOLTAGE (A. C.)	2.5	2.5	Volts
PLATE VOLTAGE (Maximum)	300	300	Volts
GRID VOLTAGE*	-62	—	Volts
SELF-BIAS RESISTOR	—	780	Ohms
ZERO-SIGNAL PLATE CURRENT (Per tube)	40	40	Milliamperes
EFFECTIVE LOAD RESISTANCE (Plate-to-plate)	3000	5000	Ohms
TOTAL HARMONIC DISTORTION	2.5	5	Per cent
POWER OUTPUT	15	10	Watts

* Grid volts measured from mid-point of a-c operated filament.

INSTALLATION

The base pins of the 2A3 fit the standard four-contact socket which may be installed to hold the tube either in a vertical or in a horizontal position. For horizontal operation, the socket should be positioned with the filament-pin openings one vertically above the other. Sufficient ventilation should be provided to prevent overheating.

APPLICATION

As a power amplifier (Class A_1), the 2A3 is usable either singly or in push-pull combination in the power-output stage of a-c receivers. Recommended operating conditions are given under CHARACTERISTICS.

The values recommended for push-pull operation are different than the conventional ones usually given on the basis of characteristics for a single tube. The values shown for Push-Pull Class AB_1 operation cover operation with fixed bias and with self-bias, and have been determined on the basis of no grid current flow during the most positive swing of the input signal and of cancellation of second-harmonic distortion by virtue of the push-pull circuit. The self-bias resistor should preferably be shunted by a suitable filter network to minimize grid-bias variations produced by current surges in the self-bias resistor.

When 2A3's are operated in push-pull, it is desirable to provide means for adjusting independently the bias on each tube. This requirement is a result of the very high transconductance of these tubes—5250 micromhos. This very high value makes the 2A3 somewhat critical as to grid-bias voltage, since a very small bias-voltage change produces a very large change in plate current. It is obvious, therefore, that the difference in plate current between two tubes may be sufficient to unbalance the system seriously. To avoid this possibility, simple methods of independent self-bias adjustment may be used, such as (1) input transformer with two independent secondary windings, or (2) filament transformer with two independent filament windings. With either of these methods, each tube can be biased separately so as to obtain circuit balance.

Any conventional type of input coupling may be used provided the resistance added to the grid circuit by this device is not too high. Transformers or impedances are recommended. When self-bias is used, the d-c resistance in the grid circuit should not exceed 0.5 megohm. With fixed-bias, however, the d-c resistance should not exceed 50000 ohms.

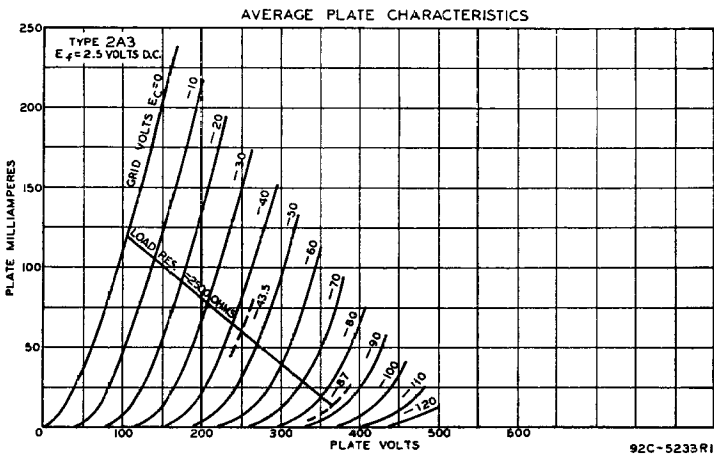

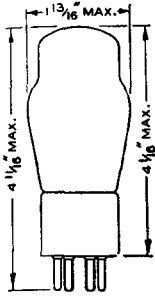

RCA-2A5

POWER AMPLIFIER PENTODE

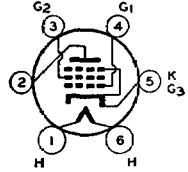

The 2A5 is a heater-cathode type of power-amplifier pentode for use in the audio-output stage of a-c receivers. It is capable of giving large power output with a relatively small input-signal voltage. Because of the heater-cathode construction, a uniformly low hum-level is attainable in power-amplifier design.

CHARACTERISTICS

HEATER VOLTAGE (A. C. or D. C.)	2.5
HEATER CURRENT	1.75
BULB	
BASE	

Volts
Amperes
ST-14
Medium 6-Pin

Other characteristics of this type are the same as for type 42.

INSTALLATION

The base pins of the 2A5 fit the standard six-contact socket which may be installed to hold the tube in any position.

The bulb of this tube will become very hot under certain conditions of operation. Sufficient ventilation should be provided to prevent overheating.

The heater is designed to operate at 2.5 volts. The transformer winding supplying the heater circuit should be designed to operate the heater at this recommended value for full-load operating conditions at average line voltage.

The cathode should preferably be connected directly to a mid-tap on the heater winding or to a center-tapped resistor across the heater winding. If this practice is not followed, the potential difference between heater and cathode should be kept as low as possible.

APPLICATION

Refer to APPLICATION on type 6F6. Additional curve information is given under type 42.

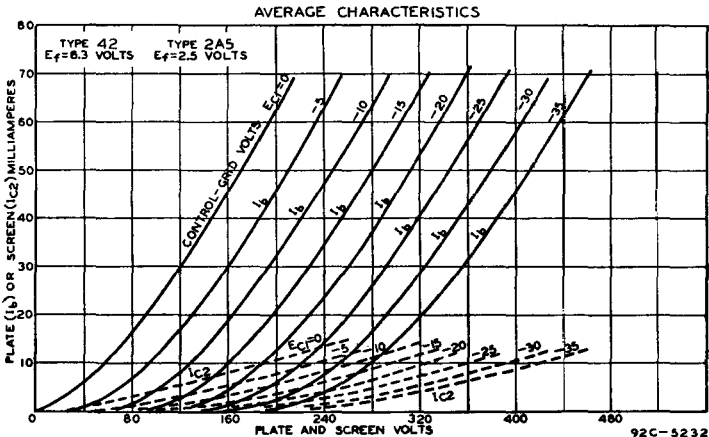

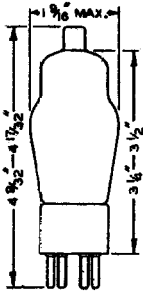

RCA-2A6

DUPLEX-DIODE HIGH-MU TRIODE

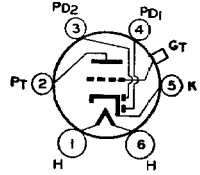

The 2A6 is a heater type of tube consisting of two diodes and a high-mu triode in a single bulb. It is for use as a combined detector, amplifier, and automatic-volume-control tube in radio receivers designed for its characteristics. For diode-detector considerations, refer to page 26.

CHARACTERISTICS

HEATER VOLTAGE (A. C. or D. C.)	2.5	Volts
HEATER CURRENT	0.8	Ampere
BULB		ST-12
CAP		Small Metal
BASE		Small 6-Pin

Other characteristics of this type are the same as for the type 75.

INSTALLATION

The base pins of the 2A6 fit the standard six-contact socket which may be installed to hold the tube in any position.

Heater operation and cathode connection are the same as for the 2A5.

APPLICATION

Refer to APPLICATION on the type 75.

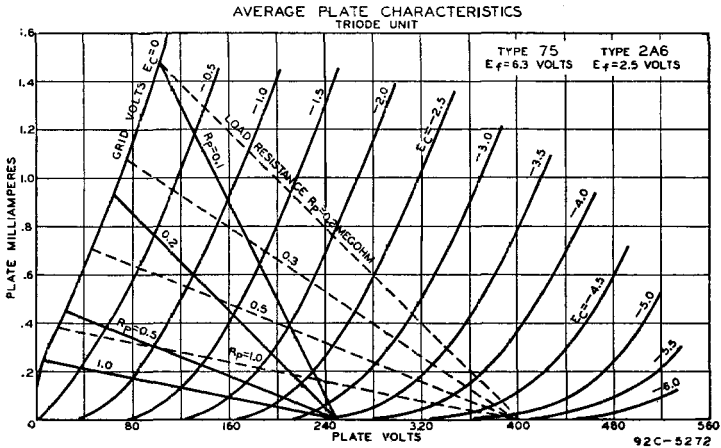

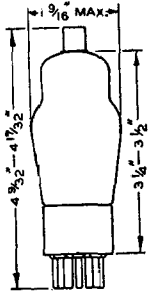

RCA-2A7

PENTAGRID CONVERTER

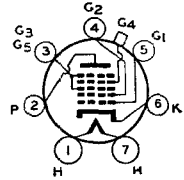

The 2A7 is a multi-electrode type of vacuum tube designed to perform simultaneously the functions of a mixer (first detector) tube and of an oscillator tube in superheterodyne circuits. Through the use of this type, the independent control of each function is made possible within a single tube. The 2A7 is intended especially for use in a-c receivers having a 2.5-volt heater supply. For general discussion of pentagrid types, see FREQUENCY CONVERSION, page 31.

CHARACTERISTICS

HEATER VOLTAGE (A. C. or D. C.).....	2.5	Volts
HEATER CURRENT	0.8	Ampere

Other characteristics of this type are the same as for type 6A7.

INSTALLATION AND APPLICATION

The base pins of the 2A7 fit the seven-contact (0.75-inch pin-circle diameter) socket which may be installed to hold the tube in any position. For heater operation and cathode connection, refer to the type 2A5. Complete shielding of the 2A7 is generally necessary to prevent intercoupling between its circuit and the circuits of other stages. Refer to APPLICATION on type 6A8.

Since the capacity between grid No. 4 and plate is in a parallel path with the capacity and inductance of the plate load, it is important to use a load capacity of sufficient size to limit the magnitude of the r-f voltage built up across the load. If this is not done, r-f voltage feed-back will occur between plate and grid No. 4 to produce degenerative effects. For this reason, the size of the load condenser in the plate circuit should be not less than 50 μf .

TYPICAL PENTAGRID CONVERTER CIRCUIT

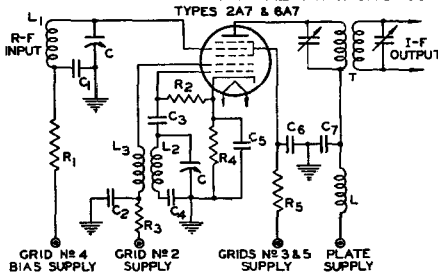

- C = GANGED TUNING CONDENSER (40 TO 350 μf)
- $C_1, C_2, C_5, C_6, C_7 = 0.1 \mu\text{f}$
- $C_3 = 0.00025 \mu\text{f}$
- $C_4 =$ SEE TABLE BELOW
- $R_1 = 250,000$ OHMS, 0.1 WATT
- $R_2 = 10,000 - 50,000$ OHMS, 0.1 WATT
- $R_3 =$ OSCILLATOR-ANODE (GRID NO. 2) VOLTAGE-DROPPING RESISTOR
- $R_4 = 150 - 300$ OHMS, 0.1 WATT
- $R_5 =$ SCREEN (GRIDS NO. 3 & 5) FILTER RESISTOR
- L = 60-MILLIHENRY R-F CHOKE
- T = 465-KC I-F TRANSFORMER

COIL-DESIGN DETAILS

FREQUENCY BAND MEGACYCLES	0.15 TO 0.40		0.55 TO 1.5		1.5 TO 4.0		4.0 TO 10		10 TO 25	
	ASSEMBLY NO. 1		ASSEMBLY NO. 2		ASSEMBLY NO. 2		ASSEMBLY NO. 3		ASSEMBLY NO. 3	
	TURNS	WIRE #	TURNS	WIRE #	TURNS	WIRE #	TURNS	WIRE #	TURNS	WIRE #
R-F COIL (L ₁)	422	36 SSE	118	30 SSE	146	32 ENAM	36.2	30 ENAM	10.1	30 ENAM
OSC. GRID COIL (L ₂)	198	36 SSE	80	30 SSE	92	32 ENAM	30.9	30 ENAM	9.7	30 ENAM
OSC. PLATE COIL (L ₃)	60	36 SSE	30	30 SSE	20	32 ENAM	12	30 ENAM	12	36 ENAM
OSC. TRACKING COND. (C ₄)	117 μf		400 μf		1070 μf		2900 μf		7300 μf	

NO. 1		NO. 2		NO. 3	
MULTI-LAYER COILS		SINGLE-LAYER COILS		SINGLE-LAYER COILS	

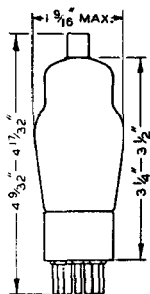

RCA-2B7

DUPLEX-DIODE PENTODE

The 2B7 is a heater type of tube consisting of two diodes and a pentode in a single bulb. It is recommended for service as a combined detector, amplifier (radio-frequency, intermediate-frequency or audio-frequency), and automatic-volume-control tube in radio receivers. The 2B7 is intended especially for use in a-c receivers having 2.5-volt heater supply. For diode-detector considerations, refer to page 26.

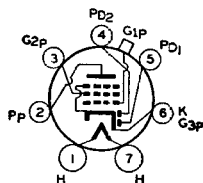

CHARACTERISTICS

HEATER VOLTAGE (A. C. or D. C.)	2.5
HEATER CURRENT	0.8
BULB	
CAP	
BASE	

Volts
Ampere
ST-12
Small Metal
Small 7-Pin

Other characteristics of this type are the same as for type 6B7.

Diode Units

Two diode plates are placed around a cathode, the sleeve of which is common to the pentode unit. Each diode plate has its own base pin. Operation curves for the diode units are given under type 6B7.

INSTALLATION AND APPLICATION

The base pins of the 2B7 fit the seven-contact (0.75-inch pin-circle diameter) socket which may be installed to hold the tube in any position.

For heater operation and cathode connection, refer to type 2A5.

Complete shielding of detector circuits employing the 2B7 is generally necessary to prevent r-f or i-f coupling between the diode circuits and the circuits of other stages.

Refer to APPLICATION on type 6B8. Typical duplex-diode pentode circuits are shown under type 6B7.

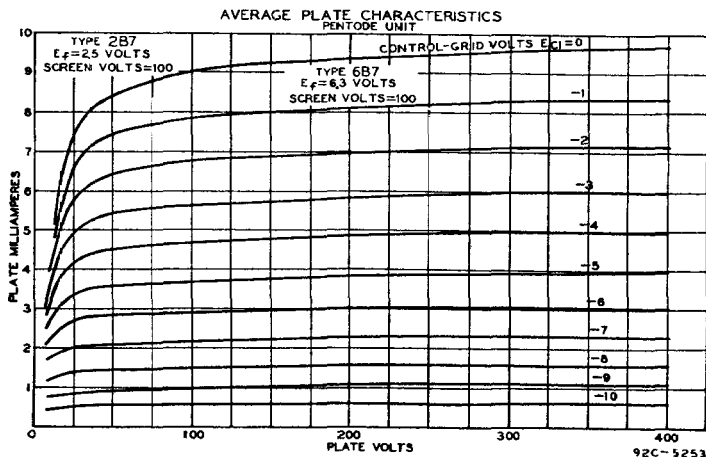

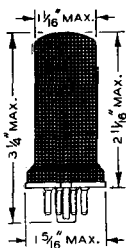

RCA-5W4

FULL-WAVE RECTIFIER

The 5W4 is a full-wave high-vacuum rectifying tube of the All-Metal type for use in a-c receivers of low current requirements.

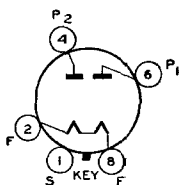

CHARACTERISTICS

FILAMENT VOLTAGE (A. C.).....	5.0	Volts
FILAMENT CURRENT	1.5	Amperes
A-C PLATE VOLTAGE PER PLATE.....	350 max.	Volts
PEAK INVERSE VOLTAGE.....	1000 max.	Volts
D-C OUTPUT CURRENT.....	110 max.	Milliamperes
BASE	Small Wafer Octal 5-Pin	

INSTALLATION

The base pins of the 5W4 fit the standard octal socket which should be installed to hold the tube in a vertical position with the base down. Provision should be made for adequate ventilation to prevent overheating.

The coated filament of the 5W4 is designed to operate from the a-c line through a step-down transformer. The voltage applied to the filament terminals should be the rated value of 5.0 volts under operating conditions and average line voltage.

APPLICATION

As a full-wave rectifier, the 5W4 may be operated as shown under CHARACTERISTICS. The recommended maximum values of plate voltage and d-c output current must not be exceeded. For a given value of a-c input voltage, the choke-input type filter will give somewhat less d-c output voltage than that obtained with a condenser-input filter, but has the advantage of reducing the peak plate current and improving the voltage regulation. Filter circuits are discussed on page 37.

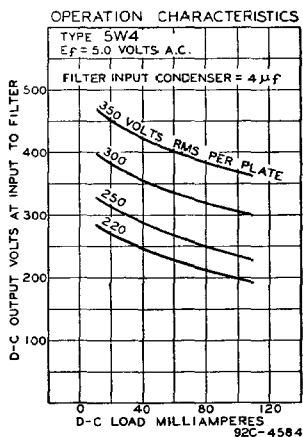

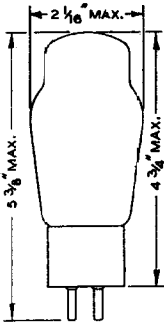

RCA-5Z3

FULL-WAVE RECTIFIER

The 5Z3 is a high-vacuum rectifier of the full-wave type intended for supplying rectified power to radio equipment having very large direct-current requirements.

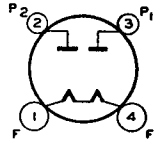

CHARACTERISTICS

FILAMENT VOLTAGE (A. C.).....	5.0	Volts
FILAMENT CURRENT	3.0	Amperes
A-C PLATE VOLTAGE PER PLATE (RMS).....	500 max.	Volts
PEAK INVERSE VOLTAGE.....	1400 max.	Volts
D-C OUTPUT CURRENT.....	250 max.	Milliamperes
BULB		ST-16
BASE		Medium 4-Pin

INSTALLATION

The base pins of the 5Z3 fit the standard four-contact socket which should be mounted preferably to hold the tube in a vertical position with the base down. If it is necessary to place the tube in a horizontal position the socket should be mounted with the filament-pin openings either at the top or at the bottom so that the plane of each filament is vertical. Only a socket making very good filament contact and capable of carrying three amperes continuously should be used with the 5Z3. Provision should be made for adequate ventilation to prevent overheating.

The coated filament of the 5Z3 is intended to operate from the a-c line through a step-down transformer. The voltage applied to the filament terminals should be the rated value of 5.0 volts under operating conditions and average line voltage. The high current taken by the filament makes it imperative that all connections in the filament circuit be of low resistance and of adequate current-carrying capacity.

APPLICATION

As a full-wave rectifier, the 5Z3 may be operated with condenser-input or choke-input filter under conditions not to exceed the rating given under CHARACTERISTICS. Filter circuits are discussed on page 37.

As a half-wave rectifier, one or more 5Z3's may be operated with plates connected in parallel. For example, two 5Z3's so arranged in a full-wave circuit can supply twice the output current of a single tube. In this service, the plates of each 5Z3 are tied together at the socket. The allowable voltage and load conditions per tube are the same as for full-wave service.

OPERATION CHARACTERISTICS

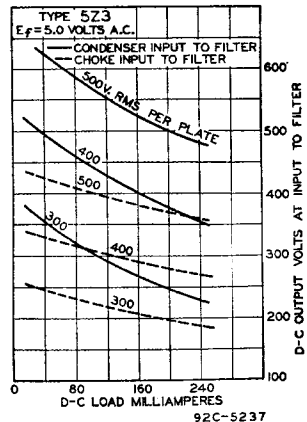

RCA-5Z4

FULL-WAVE RECTIFIER

The 5Z4 is a full-wave high-vacuum rectifying tube of the All-Metal type intended for use in d-c power-supply devices which operate from the a-c supply line.

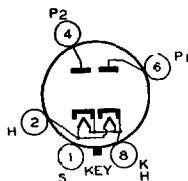
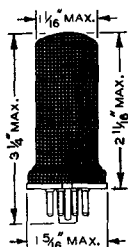

CHARACTERISTICS

HEATER VOLTAGE (A. C.).....	5.0	Volts
HEATER CURRENT	2.0	Amperes
A-C PLATE VOLTAGE PER PLATE.....	400 <i>max.</i>	Volts
PEAK INVERSE VOLTAGE.....	1100 <i>max.</i>	Volts
D-C OUTPUT CURRENT.....	125 <i>max.</i>	Milliamperes
BASE	Small Wafer Octal 5-Pin	

INSTALLATION AND APPLICATION

The base pins of the 5Z4 fit the standard octal socket which should be installed to hold the tube in any position. Provision should be made for adequate ventilation to prevent overheating.

The heater of the 5Z4 is designed to operate from the a-c line through a step-down transformer. The voltage applied to the heater should be the rated value of 5.0 volts under operating conditions and average line voltage.

As a full-wave rectifier, the 5Z4 may be operated with condenser-input or choke-input filter under conditions not to exceed the ratings given under CHARACTERISTICS.

As a half-wave rectifier, two 5Z4's may be operated in a full-wave circuit with reasonable serviceability to deliver more d-c output current than can be obtained from one tube. For this use, the plates of each 5Z4 are tied together at the socket. The allowable voltage and load conditions per tube are the same as for full-wave service.

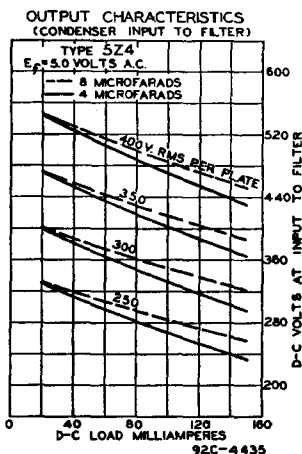
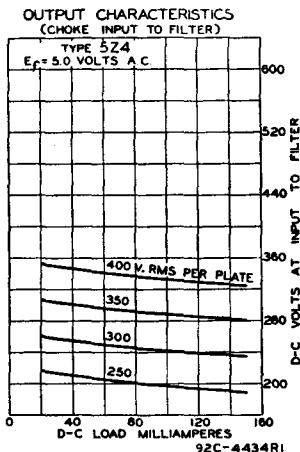

RCA-6A4

POWER-AMPLIFIER PENTODE

The 6A4 is a power-amplifier pentode of the 6.3-volt filament type for use in receivers employing a six-volt storage-battery filament supply. The 6A4 is interchangeable with type LA.

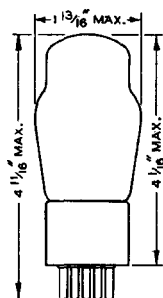
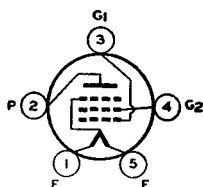

CHARACTERISTICS

FILAMENT VOLTAGE (A. C. or D. C.)	6.3				Volts
FILAMENT CURRENT	0.3				Ampere
PLATE VOLTAGE	100	135	165	180 max.	Volts
SCREEN VOLTAGE (Grid No. 2)	100	135	165	180 max.	Volts
GRID VOLTAGE* (Grid No. 1)	-6.5	-9	-11	-12	Volts
PLATE CURRENT	9	14	20	22	Milliamperes
SCREEN CURRENT	1.6	2.5	3.5	3.9	Milliamperes
PLATE RESISTANCE (Approx.)	83250	52600	48000	45500	Ohms
AMPLIFICATION FACTOR (App.)	100	100	100	100	
TRANSCONDUCTANCE	1200	1900	2100	2200	Micromhos
LOAD RESISTANCE	11000	9500	8000	8000	Ohms
SELF-BIAS RESISTOR	615	545	470	465	Ohms
POWER OUTPUT†	0.31	0.7	1.2	1.4	Watts
BULB					ST-14
BASE					Medium 5-Pin

* Grid volts measured from negative end of d-c operated filament. If the filament is a-c operated, the tabulated values of grid bias should each be increased by 4.0 volts and be referred to the mid-point of filament.

† 9 per cent total harmonic distortion.

INSTALLATION AND APPLICATION

The base pins of the 6A4 fit the standard five-contact socket which should be mounted preferably to hold the tube in a vertical position. If it is necessary to place the tube in a horizontal position, the socket should be mounted with its filament-pin openings one vertically above the other. The coated filament of the 6A4 is primarily intended for operation from a six-volt storage battery. Socket terminal No. 1 should be connected to the positive battery terminal.

For the power amplifier stage, the 6A4 is recommended either singly or in push-pull combination. Transformer or impedance input-coupling devices are recommended. If, however, resistance coupling is employed, the grid resistor should not exceed 0.5 megohm. A family of plate characteristics for the 6A4 is shown on the following page.

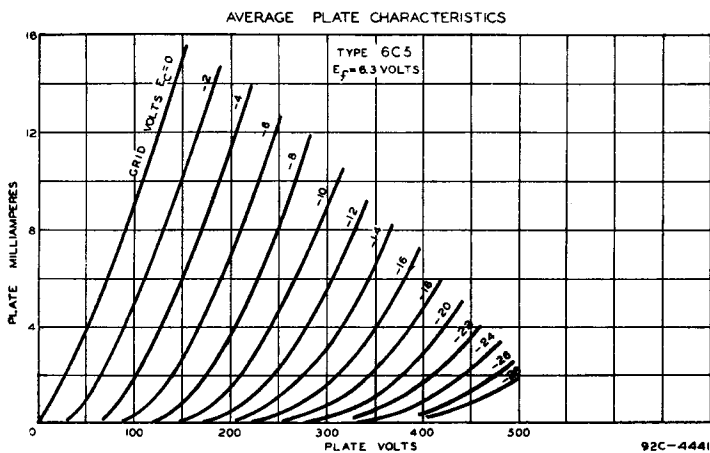
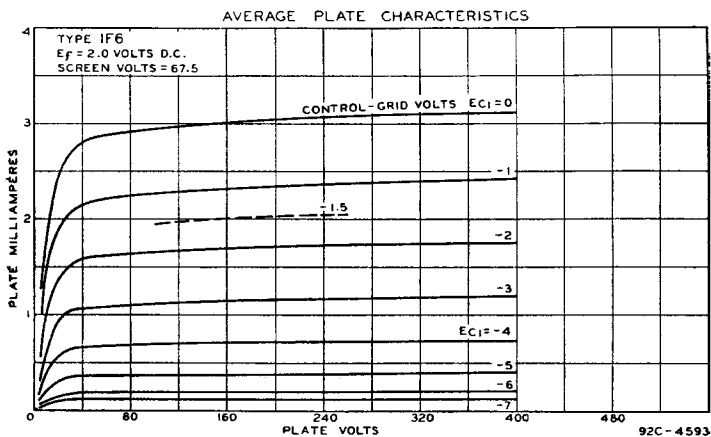
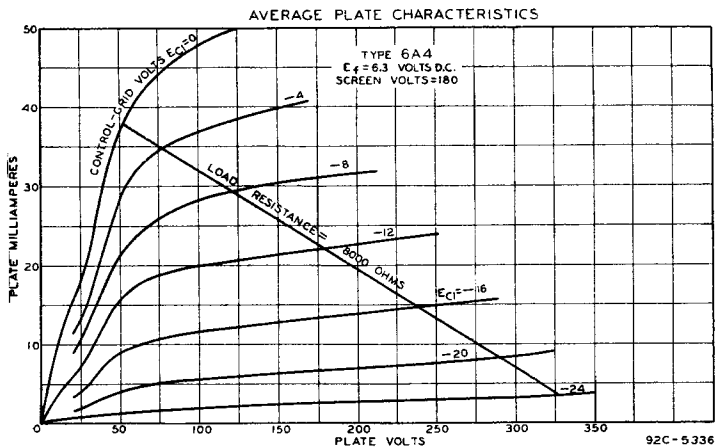

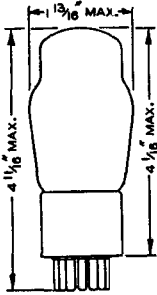

RCA-6A6

CLASS B TWIN AMPLIFIER

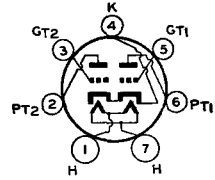

The 6A6 is a heater-cathode type of tube combining in one bulb two high- μ triodes designed for Class B operation. The triode units have separate external terminals for all

electrodes except the cathodes and heaters, so that circuit design is similar to that of Class B amplifiers utilizing two tubes in the output stage. The 6A6 may also be used as a Class A₁ amplifier (with triode units connected in parallel) to drive a 6A6 as a Class B amplifier in the output stage.

CHARACTERISTICS

HEATER VOLTAGE (A. C. or D. C.).....	6.3	Volts
HEATER CURRENT	0.8	Ampere
BULB		ST-14
BASE		Medium 7-Pin

Other characteristics of this type are the same as for type 6N7.

INSTALLATION AND APPLICATION

The base pins of the 6A6 fit the seven-contact (0.855-inch pin-circle diameter) socket which may be installed to hold the tube in any position. Sufficient ventilation should be provided to prevent overheating.

The heater is designed to operate at 6.3 volts. In a series-heater circuit employing several 6.3-volt types and one or more 6A6's, the heaters of the 6A6's should be placed on the positive side. Furthermore, since most 6.3-volt types have 0.3-ampere heaters, a bleeder circuit across these heaters is required to take care of the additional 0.5-ampere heater current of the 6A6's. Each 6.3-volt tube of the 0.3-ampere type in the series circuit should, therefore, be shunted by a bleeder resistance of 13 ohms.

Refer to APPLICATION on type 6N7, and additional curve under type 53.

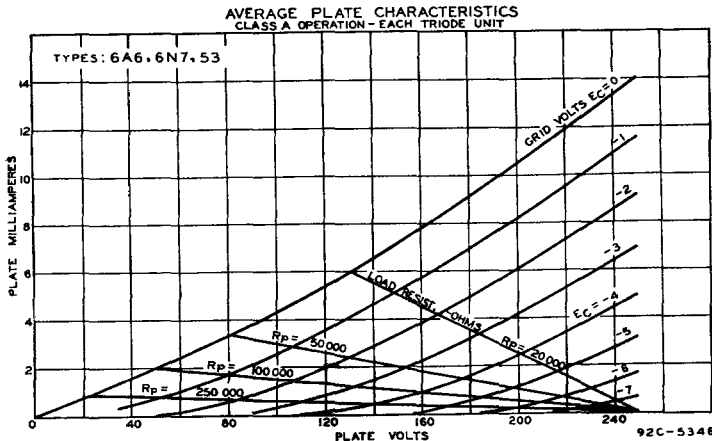

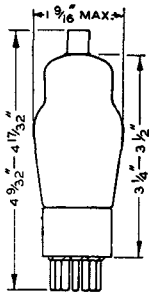

RCA-6A7

PENTAGRID CONVERTER

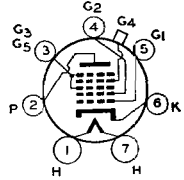

The 6A7 is a multi-electrode type of vacuum tube designed to perform simultaneously the functions of a mixer tube and of an oscillator tube in superheterodyne circuits.

For discussion of pentagrid types, see **FREQUENCY CONVERSION**, page 31.

CHARACTERISTICS

HEATER VOLTAGE (A. C. or D. C.).....	6.3	Volts
HEATER CURRENT	0.3	Ampere
DIRECT INTERELECTRODE CAPACITANCES (Approx.):		
Grid No. 4 to Plate (With shield-can).....	0.3	$\mu\mu\text{f}$
Grid No. 4 to Grid No. 2 (With shield-can).....	0.15	$\mu\mu\text{f}$
Grid No. 4 to Grid No. 1 (With shield-can).....	0.15	$\mu\mu\text{f}$
Grid No. 1 to Grid No. 2.....	1.0	$\mu\mu\text{f}$
Grid No. 4 to All Other Electrodes (R-F Input)...	8.5	$\mu\mu\text{f}$
Grid No. 2 to All Other Electrodes (Osc. Output)..	5.5	$\mu\mu\text{f}$
Grid No. 1 to All Other Electrodes (Osc. Input)..	7.0	$\mu\mu\text{f}$
Plate to All Other Electrodes (Mixer Output).....	9.0	$\mu\mu\text{f}$
BULB		ST-12
CAP		Small Metal
BASE		Small 7-Pin

As Frequency Converter

PLATE VOLTAGE	250 max.	Volts
SCREEN VOLTAGE (Grids No. 3 and 5).....	100 max.	Volts
ANODE-GRID VOLTAGE (Grid No. 2).....	200 max.	Volts
ANODE-GRID VOLTAGE SUPPLY (Grid No. 2)*.....	250 max.	Volts
CONTROL-GRID VOLTAGE (Grid No. 4).....	-3 min.	Volts
TOTAL CATHODE CURRENT	14 max.	Milliamperes

TYPICAL OPERATION

Plate Voltage	100	250	Volts
Screen Voltage	50	100	Volts
Anode-Grid Voltage	100	200	Volts
Control-Grid Voltage (Minimum).....	-1.5	-3	Volts
Oscillator-Grid Resistor (Grid No. 1).....	10000	50000	Ohms
Plate Current	1.3	3.5	Milliamperes
Screen Current	2.5	2.2	Milliamperes
Anode-Grid Current	3.3	4.0	Milliamperes
Oscillator-Grid Current	1.2	0.7	Milliamperes
Total Cathode Current	8.3	10.4	Milliamperes
Cathode Resistor	150	300	Ohms
Plate Resistance	0.6	0.36	Megohm
Conversion Conductance	350	520	Micromhos

Control-Grid Voltage, Approximate
(Conversion Conductance—2 μmhos)... -20 -45 Volts

* Voltages in excess of 200 volts require use of 20000-ohm voltage-dropping resistor by-passed by 0.1 μf condenser.

INSTALLATION AND APPLICATION

The base pins of the 6A7 fit the seven-contact (0.75-inch pin-circle diameter) socket which may be installed to hold the tube in any position. For heater and cathode operation, refer to type 6A8. Complete shielding of the 6A7 is generally necessary to prevent intercoupling between its circuit and the circuits of other stages. Refer to APPLICATION of types 6A8 and 2A7. A typical circuit is shown under type 2A7.

RCA-6A8

PENTAGRID CONVERTER

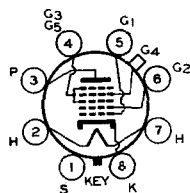
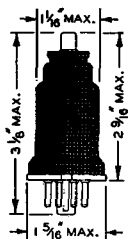

The 6A8 is a multi-electrode vacuum tube of the metal type designed to perform simultaneously the functions of a mixer (first detector) tube and of an oscillator tube in super-

heterodyne circuits. Through the use of this type, the independent control of each function is made possible within a single tube. For general discussion of pentagrid types, refer to FREQUENCY CONVERSION, page 31.

CHARACTERISTICS

HEATER VOLTAGE (A. C. or D. C.).....	6.3	Volts
HEATER CURRENT	0.3	Ampere
DIRECT INTERELECTRODE CAPACITANCES (Approx.):*		
Grid No. 4 to Plate.....	0.03	$\mu\mu\text{f}$
Grid No. 4 to Grid No. 2.....	0.1	$\mu\mu\text{f}$
Grid No. 4 to Grid No. 1.....	0.09	$\mu\mu\text{f}$
Grid No. 1 to Grid No. 2.....	0.8	$\mu\mu\text{f}$
Grid No. 4 to All Other Electrodes (R-F Input)...	12.5	$\mu\mu\text{f}$
Grid No. 2 to All Other Electrodes (Osc. Output).	5	$\mu\mu\text{f}$
Grid No. 1 to All Other Electrodes (Osc. Input)..	6.5	$\mu\mu\text{f}$
Plate to All Other Electrodes (Mixer Output).....	12.5	$\mu\mu\text{f}$
CAP		Miniature
BASE		Small Wafer Octal 8-Pin

* With shell connected to cathode.

As Frequency Converter

PLATE VOLTAGE	250 max.	Volts	
SCREEN VOLTAGE (Grids No. 3 and 5).....	100 max.	Volts	
ANODE-GRID VOLTAGE (Grid No. 2).....	200 max.	Volts	
ANODE-GRID SUPPLY VOLTAGE (Grid No. 2)†.....	250 max.	Volts	
CONTROL-GRID VOLTAGE (Grid No. 4).....	-3 min.	Volts	
TOTAL CATHODE CURRENT.....	14 max.	Milliamperes	
TYPICAL OPERATION			
Plate Voltage	100	250	Volts
Screen Voltage	50	100	Volts
Anode-Grid Voltage	100	250†	Volts
Control-Grid Voltage (Minimum).....	-1.5	-3	Volts
Oscillator-Grid Resistor (Grid No. 1).....	50000	50000	Ohms
Plate Current	1.2	3.3	Milliamperes
Screen Current	1.5	3.2	Milliamperes
Anode-Grid Current	1.6	4.0	Milliamperes
Oscillator-Grid Current	0.25	0.5	Milliamperes
Plate Resistance	0.6	0.36	Megohm
Conversion Conductance	350	500	Micromhos
Control-Grid Voltage, Approximate (Conversion Conductance = 2 μmhos)..	-20	-45	Volts

† Anode-grid supply voltages in excess of 200 volts require the use of 20000-ohm voltage-dropping resistor by-passed by 0.1 μf condenser.

INSTALLATION

The base pins of the 6A8 fit the standard octal socket, which may be installed to hold the tube in any position.

The heater of the 6A8 is designed to operate on either d-c or a-c. For operation on a-c with a transformer, the winding which supplies the heater circuit

should operate the heater at its recommended value for full-load operating conditions at average line voltage. For service in automobile receivers, the heater terminals of the 6A8 should be connected directly across a 6-volt battery. In receivers that employ a series-heater connection, the heater of the 6A8 may be operated in series with the heater of other types having a 0.3-ampere rating. The current in the heater circuit should be adjusted to 0.3 ampere for the normal supply-line voltage.

The cathode of the 6A8, when operated from a transformer, should preferably be connected directly to the electrical mid-point of the heater circuit. When it is operated in receivers employing a 6-volt storage battery for the heater supply, the cathode circuit is tied in either directly or through bias resistors to the negative side of the d-c plate supply which is furnished either by the d-c power line or the a-c line through a rectifier. In circuits where the cathode is not directly connected to the heater, the potential difference between them should be kept as low as possible. If the use of a large resistor is necessary between the heater and cathode of the 6A8 in some circuit designs, it should be by-passed by a suitable filter network or objectionable hum may develop.

APPLICATION

As a frequency converter in superheterodyne circuits, the 6A8 can supply the local oscillator frequency and at the same time mix it with radio-input frequency to provide the desired intermediate frequency. For this service, design information is given under CHARACTERISTICS.

For the oscillator circuit, the coils may be constructed according to conventional design, since the tube is not particularly critical. The supply voltage applied to the anode-grid No. 2 should not exceed the maximum value of 250 volts. In fact, from a performance standpoint, a lower value is to be preferred, because it will be adequate to provide for optimum translation gain. Under no condition of adjustment should the cathode current exceed a recommended maximum value of 14 milliamperes.

The bias voltage applied to grid No. 4 can be varied from -3 volts to cut-off to control the translation gain of the tube. With lower screen voltages, the cut-off point is less remote. The extended cut-off feature of this tube in combination with the similar characteristic of super-control tubes can be utilized advantageously to adjust receiver sensitivity.

Refer to type 2A7 for typical circuit and coils. When the 6A8 is used in this circuit, its shell should be connected to ground.

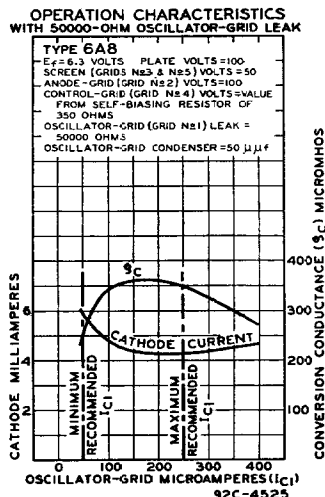
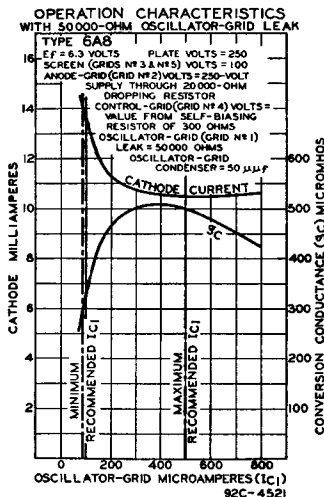

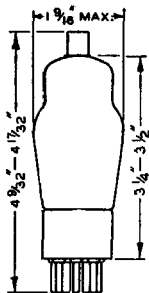

RCA-6B7

DUPLEX-DIODE PENTODE

The 6B7 is a heater type of tube consisting of two diodes and a pentode in a single bulb. It is recommended for service as combined detector, amplifier (radio-frequency, intermediate-frequency or audio-frequency), and automatic-volume-control tube in radio receivers. For diode-detector considerations, refer to page 26.

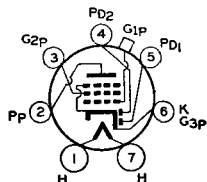

CHARACTERISTICS

HEATER VOLTAGE (A. C. or D. C.).....	6.3	Volts
HEATER CURRENT	0.3	Ampere
GRID-PLATE CAPACITANCE (With shield-can).....	0.007 <i>max.</i>	$\mu\mu\text{f}$
INPUT CAPACITANCE	3.5	$\mu\mu\text{f}$
OUTPUT CAPACITANCE	9.5	$\mu\mu\text{f}$
BULB		ST-12
CAP		Small Metal
BASE		Small 7-Pin

Pentode Unit—As Class A₁ Amplifier

PLATE VOLTAGE	100	180	250	250 <i>max.</i>	Volts
SCREEN VOLTAGE (Grid No. 2)	100	75	100	125 <i>max.</i>	Volts
GRID VOLTAGE† (Grid No. 1).	-3	-3	-3	-3	Volts
PLATE CURRENT	5.8	3.4	6.0	9.0	Milliamperes
SCREEN CURRENT	1.7	0.9	1.5	2.3	Milliamperes
PLATE RESISTANCE	0.3	1.0	0.8	0.65	Megohm
AMPLIFICATION FACTOR	285	840	800	730	
TRANSCONDUCTANCE	950	840	1000	1125	Micromhos
GRID BIAS VOLT. (Approx.)*.	-17	-13	-17	-21	Volts

* For cathode current cut-off.

† The total resistance in the grid circuit of the 6B7 should be limited to 1.0 megohm.

Diode Units

Two diode plates are placed around a cathode, the sleeve of which is common to the pentode unit. Each diode plate has its own base pin. Operation curves for the diode units are given under type 6B7.

INSTALLATION AND APPLICATION

The base pins of the 6B7 fit the standard seven-pin (0.75-inch pin-circle diameter) socket which may be installed to hold the tube in any position.

For heater and cathode operation, refer to type 6A8.

Complete shielding of detector circuits employing the 6B7 is generally necessary to prevent r-f or i-f coupling between the diode circuits and the circuits of other stages.

Refer to APPLICATION on the type 6B8. Plate characteristics of pentode unit are shown under type 2B7.

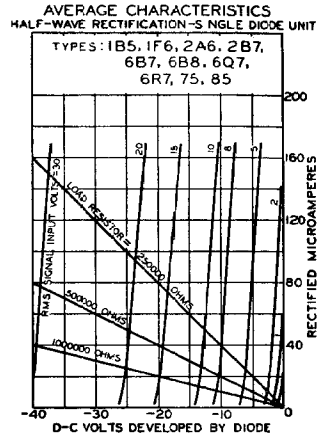
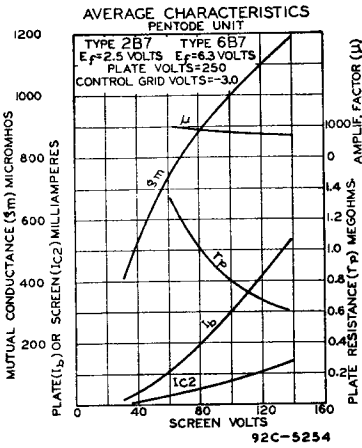

**TYPICAL DUPLEX-DIODE PENTODE CIRCUITS
USING TYPES 2B7 OR 6B7**

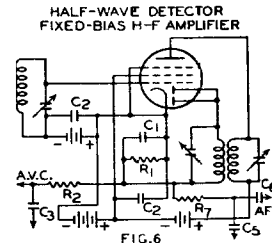
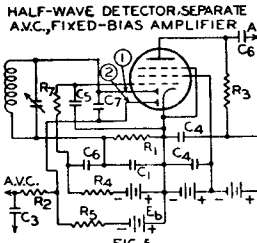
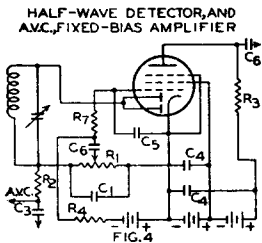
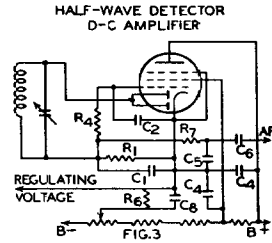
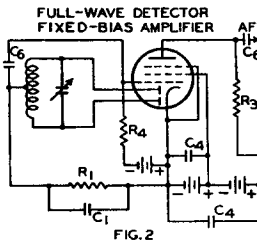
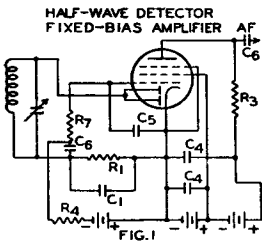

APPROXIMATE VALUES

- $R_1=0.5-1.0$ MEGOHM
- $R_2=1.0-1.5$ MEGOHMS
- $R_3=0.1-0.2$ MEGOHM
- $R_4=0.5-1.0$ MEGOHM
- $R_5=1.0$ MEGOHM
- $R_6=30000-100000$ OHMS
- $R_7=0.1-0.2$ MEGOHM
- $E_b=$ VOLTAGE FOR SENSITIVITY CONTROL

- $C_1=$ 150 $\mu\mu\text{F}$ FOR 500-1500 KC.
 450 $\mu\mu\text{F}$ FOR 175 KC.
- $C_2=0.1$ μF
- $C_3=0.1$ μF
- $C_4=0.5$ μF OR LARGER
- $C_5=0.0001$ μF OR SMALLER
- $C_6=0.01-0.1$ μF
- $C_7=0.0005-0.001$ μF
- $C_8=0.1$ μF OR LARGER

NOTE: Suppressor connected to cathode within bulb.

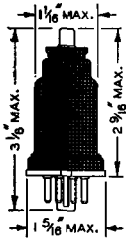

RCA-6B8

DUPLEX-DIODE PENTODE

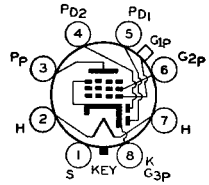

The 6B8 is an All-Metal type of tube consisting of two diodes and a pentode in a single envelope. It is recommended for service as combined detector, amplifier (radio-frequency, intermediate-frequency or audio-frequency), and automatic-volume-control tube in radio receivers. For diode-detector considerations, refer to page 26.

CHARACTERISTICS

HEATER VOLTAGE (A. C. or D. C.)	6.3	Volts
HEATER CURRENT	0.3	Ampere
GRID-PLATE CAPACITANCE*	0.007 ^{max.}	μf
INPUT CAPACITANCE*	6	μf
OUTPUT CAPACITANCE*	9	μf
CAP		Miniature
BASE		Small Wafer Octal 8-Pin

* With shell connected to cathode.

Pentode Unit—As Class A₁ Amplifier

PLATE VOLTAGE	250 max.	Volts
SCREEN VOLTAGE (Grid No. 2)	125 max.	Volts
GRID VOLTAGE (Grid No. 1)**	-3	Volts
PLATE CURRENT	10.0	Milliamperes
SCREEN CURRENT	2.3	Milliamperes
PLATE RESISTANCE	0.6	Megohm
AMPLIFICATION FACTOR	800	
TRANSCONDUCTANCE	1325	Micromhos
GRID BIAS VOLTAGE (Approx.)†	-21	Volts

† For cathode current cut-off.
 ** The value of the resistance in the grid circuit should not exceed a maximum of 1.0 megohm.

Diode Units

Two diode plates are placed around a cathode, the sleeve of which is common to the pentode unit. Each diode plate has its own base pin. Operation curves for the diode units are given under type 6B7.

INSTALLATION

Refer to INSTALLATION on the type 6A8.

APPLICATION

The 6B8 is recommended for performing the simultaneous functions of automatic-volume-control, detection, and amplification.

For detection, the diodes of this tube may be utilized in a full-wave circuit or in a half-wave circuit. In the latter case, one plate only or the two plates in parallel may be employed. The use of the half-wave arrangement will provide approximately twice the rectified voltage as compared with the full-wave arrangement.

For automatic-volume-control, a rectified voltage which is dependent on the r-f or i-f carrier is usually employed. This voltage may be utilized to regulate the gain of the r-f and/or i-f amplifier stages so as to maintain essentially constant-carrier input to the audio detector. Refer to discussion of automatic-volume-control methods on page 28.

The complex structure of the 6B8 permits of obtaining automatic-volume-control voltage in a number of ways. In one case, the required voltage is obtained from the detector circuit by utilizing the voltage drop caused by the rectified current flowing through a resistor in the detector circuit. In another case, the required voltage is obtained by utilizing one diode for the sole purpose of automatic-volume-control. This latter method is of particular interest since it confines the sensitivity and time-delay function to the avc circuit. Time-delay action is determined by the use of a resistance and condenser combination having the desired time constant. The avc action may be postponed by applying a negative voltage to the avc diode plate. Another avc arrangement capable of various adaptations is to use the pentode as a d-c amplifier to supply the regulating voltage.

For r-f or i-f amplification, the pentode unit of the 6B8 may be employed in conventional circuit arrangements. It is designed so that its cut-off is somewhat extended to permit of moderate gain control by grid-bias variation without introducing cross-modulation effects. The cut-off point and the ability to handle the larger signals may be altered by choice of screen voltage to suit the requirements of the circuit. To assist in making this choice, different operating conditions for representative screen voltages are given under CHARACTERISTICS.

For many types of circuits a convenient and practical method of obtaining the desired benefit of the extended cut-off is to supply the screen voltage from a high-voltage tap through a series resistor. This arrangement provides automatically an increase in the voltage applied to the screen as the grid-bias is made more negative, with the result that the maximum signal-handling ability is obtained. When this method is used, the voltage applied to the screen should be limited to 125 volts for -3 volts grid-bias and to 200 volts for more negative values of grid-bias.

For a-f amplification, the pentode unit of the 6B8 may be used in a resistance-coupled circuit arrangement to provide high gain under operating conditions given in the Resistance-Coupled A-F Amplifier Section.

Typical duplex-diode pentode circuits are shown under type 6B7. When the 6B8 is used in these circuits, its shell should be connected to ground.

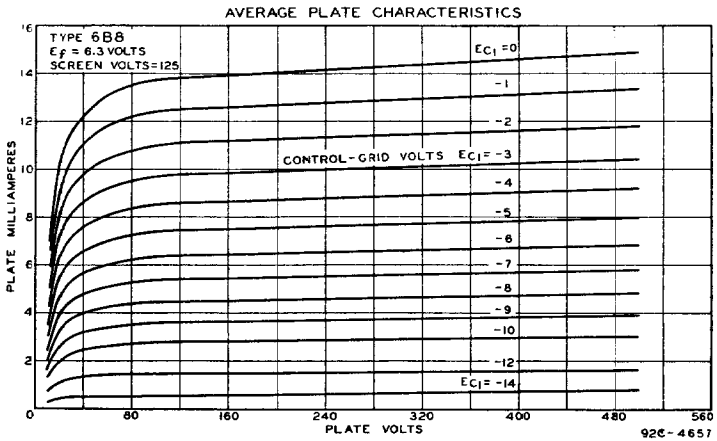

RCA-6C5

DETECTOR AMPLIFIER TRIODE

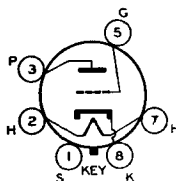
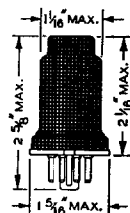

The 6C5 is a three-electrode tube of the metal type recommended for use as a detector, amplifier, or oscillator. This tube has a high transconductance together with a comparatively high amplification factor.

CHARACTERISTICS

HEATER VOLTAGE (A. C. or D. C.)	6.3	Volts
HEATER CURRENT	0.3	Ampere
GRID-PLATE CAPACITANCE*	1.8	μf
GRID-CATHODE CAPACITANCE*	4	μf
PLATE-CATHODE CAPACITANCE*	13	μf
BASE	Small Wafer Octal 6-Pin	

* With shell connected to cathode.

As Class A₁ Amplifier

	Transformer-Coupled	Resistance-Coupled	
PLATE VOLTAGE	250 max.	250*	Volts
GRID VOLTAGE**	-8	-5 approx.	Volts
PLATE CURRENT	8	1 to 2	Milliamperes
PLATE RESISTANCE	10000	—	Ohms
AMPLIFICATION FACTOR	20	—	
TRANSCONDUCTANCE	2000	—	Micromhos
VOLTAGE OUTPUT (5 per cent second harmonic)	—	42 RMS	Volts
VOLTAGE AMPLIFICATION	—	14	

* This is a plate-supply voltage value.

** If a grid-coupling resistor is used, its maximum value should not exceed 1.0 megohm.

INSTALLATION

The base pins of the 6C5 fit the standard octal socket which may be installed to hold the tube in any position.

For heater operation and cathode connection, refer to INSTALLATION for type 6A8.

APPLICATION

As an amplifier, the 6C5 is applicable to radio-frequency or audio-frequency circuits. Recommended operating conditions for service using transformer coupling and resistance coupling are given under CHARACTERISTICS.

As a detector, the 6C5 may be of the grid-leak and condenser or grid-bias type. The plate voltage for the grid leak and condenser method should be 45 to 100 volts. A grid leak from 0.1 to 1.0 megohm with a grid condenser of 0.00005 to 0.0005 μf is satisfactory. For the grid-bias method of detection, a plate-supply voltage of 250 volts may be used together with a negative grid-bias voltage of approximately 17 volts. The plate current should be adjusted to 0.2 milliamperes with no input signal voltage. The grid-bias voltage may be supplied from the voltage drop in a resistor between cathode and ground. A plate family for this type is given on page 61.

Operating conditions as a resistance-coupled A-F amplifier are given in the Resistance-Coupled A-F Amplifier Section.

RCA-6C6

TRIPLE-GRID DETECTOR AMPLIFIER

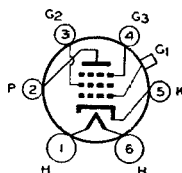
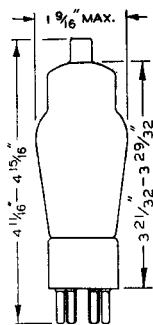

The 6C6 is a triple-grid tube of the heater-cathode type recommended for service as a biased detector in radio receivers designed for its characteristics. This tube is capable of delivering a large audio-frequency output voltage with relatively small input voltage. Significant among its electrical features are its sharp plate current "cut-off" with respect to grid voltage. The 6C6 is constructed with an internal shield connected to the cathode within the tube.

CHARACTERISTICS

HEATER VOLTAGE (A. C. or D. C.).....	6.3	Volts
HEATER CURRENT	0.3	Ampere
GRID-PLATE CAPACITANCE (With shield-can).....	0.007 max.	$\mu\mu\text{f}$
INPUT CAPACITANCE	5.0	$\mu\mu\text{f}$
OUTPUT CAPACITANCE	6.5	$\mu\mu\text{f}$
BULB		ST-12
CAP		Small Metal
BASE		Small 6-Pin

Other characteristics of this type are the same as for type 6J7.

INSTALLATION AND APPLICATION

The base pins of the 6C6 fit the standard six-contact socket which may be installed to hold the tube in any position.

For heater operation and cathode connection, refer to INSTALLATION for type 6A8.

The screen voltage may be obtained from a potentiometer or bleeder circuit across the B-supply source. Due to the screen-current characteristics of the 6C6, the use of a resistor in series with the high-voltage supply may be employed for obtaining the screen voltage provided the cathode-resistor method of bias control is used. This method, however, is not recommended if the high-voltage B-supply exceeds 250 volts.

Complete shielding of detector circuits employing the 6C6 is generally necessary, since considerable voltage at carrier frequency is usually present in the plate circuit even though the latter is by-passed with a low impedance condenser. Two-section filters in the plate circuit are frequently necessary to prevent radio-frequency feed-back to the input of the detector.

In receivers employing a built-in loudspeaker, acoustic shielding may be necessary to prevent microphonic feed-back when a strong radio-frequency carrier voltage is present on the tube electrodes. It should be noted also that condenser plates may cause an audio howl due to mechanical feed-back from the speaker.

The application of this type is similar to that of type 6J7.

As an audio-frequency amplifier triode, the 6C6 should have its screen and suppressor connected to the plate. Operating conditions for triode service in transformer- or impedance-coupled circuits are: Plate voltage, 250 volts; grid voltage, -8 volts; and plate current, 7 milliamperes, approximate. Operating conditions as a resistance-coupled A-F amplifier are given in the Resistance-Coupled A-F Amplifier Section.

A plate family of curves is given under type 6J7.

RCA-6D6

TRIPLE-GRID SUPER-CONTROL AMPLIFIER

The 6D6 is a triple-grid super-control amplifier tube recommended for service in the radio-frequency and intermediate-frequency stages of radio receivers designed for its character-

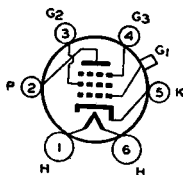
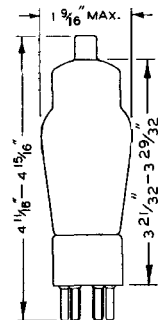

istics. The ability of this tube to handle the usual signal voltages without cross-modulation and modulation-distortion makes it adaptable to the r-f and i-f stages of receivers employing automatic volume control. The 6D6 is constructed with an internal shield connected to the cathode within the tube.

CHARACTERISTICS

HEATER VOLTAGE (A. C. or D. C.)	6.3	Volts
HEATER CURRENT	0.3	Ampere
PLATE VOLTAGE	100 250 max.	Volts
SCREEN VOLTAGE	100 100 max.	Volts
GRID VOLTAGE (Minimum)	-3 -3	Volts
SUPPRESSOR	Connected to cathode at socket	
PLATE CURRENT	8 8.2	Milliamperes
SCREEN CURRENT	2.2 2.0	Milliamperes
PLATE RESISTANCE	0.25 0.8	Megohm
AMPLIFICATION FACTOR	375 1280	
TRANSCONDUCTANCE	1500 1600	Micromhos
TRANSCONDUCTANCE (At -50 volts bias)	2 2	Micromhos
GRID-PLATE CAPACITANCE (With shield-can)	0.007 max.	μmf
INPUT CAPACITANCE	4.7	μmf
OUTPUT CAPACITANCE	6.5	μmf
BULB		ST-12
CAP		Small Metal
BASE		Small 6-Pin

INSTALLATION AND APPLICATION

The base pins of the 6D6 fit the standard six-contact socket which may be installed to hold the tube in any position.

For heater operation and cathode connection, refer to INSTALLATION for type 6A8.

For control-grid bias, screen voltage, and suppressor connection, refer to INSTALLATION on type 6K7. Shielding requirements are similar to those for type 6C6.

Refer to APPLICATION on type 6K7. A plate family of curves is given under type 58.

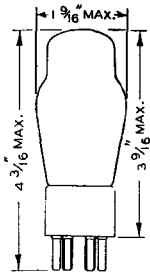

RCA-6E5

ELECTRON-RAY TUBE

(Indicator Type)

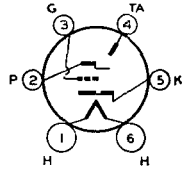

The 6E5 is a high-vacuum, heater-cathode type of tube designed to indicate visually, by means of a fluorescent target, the effects of a change in the controlling voltage.

The tube, therefore, is essentially a voltage indicator and as such is particularly useful as a convenient and non-mechanical means to indicate accurate tuning of a receiver to the desired station. The 6E5 is similar to the 6G5 except that the 6G5 triode unit is designed with a remote plate-current cut-off characteristic. For discussion of Electron-Ray Tube considerations, refer to page 30.

CHARACTERISTICS

HEATER VOLTAGE (A. C. or D. C.).....	6.3	Volts		
HEATER CURRENT	0.3	Ampere		
PLATE-SUPPLY VOLTAGE	250 max.	Volts		
TARGET VOLTAGE*	250 max.	Volts		
TYPICAL OPERATION				
Plate- and Target-Supply Voltage..	100	200	250	Volts
Series Triode-Plate Resistor.....	0.5	1	1	Megohm
Target Current (Approx.).....	4.5	4.5	4.5	Milliamperes
Triode-Plate Current (For zero triode-grid voltage)	0.19	0.19	0.24	Milliampere
Triode-Grid Voltage (For shadow angle of 0°) (Approx.).....	-3.3	-6.5	-8.0	Volts
Triode-Grid Voltage (For shadow angle of 90°) (Approx.).....	0	0	0	Volts
BULB				ST-12
BASE				Small 6-Pin

* Minimum target voltage should not be less than 90 volts.

INSTALLATION

The base pins of the 6E5 fit the standard six-contact socket which may be installed to hold the tube in any position. For convenience, the tube is usually mounted horizontally so that the fluorescent screen is readily visible when the receiver circuit is tuned. A small hood, placed over the dome and fluorescent target, will help to eliminate external light reflections.

For heater operation and cathode connection, refer to type 6A8. The bulb of this tube becomes hot under certain conditions of operation. Sufficient ventilation should be provided to prevent overheating.

APPLICATION

The visible effect is observed on the fluorescent target located in the dome of the bulb. The pattern on the target varies from a shaded angle of 90° with zero bias (off tune) to a shaded angle of approximately 0° at resonance with a strong carrier. Exact tuning is indicated by the narrowest shaded angle that can be obtained. The stronger the carrier, the narrower is the shadow.

The diagrams on the next page show typical tuning-indicator circuits employing the 6E5. If the strongest carrier received produces sufficient AVC voltage to exceed the cut-off bias value of -8 volts, the shadow area of the fluorescent target will overlap. To overcome this effect, resistor R₃ should be connected, as shown, between the triode-unit grid and cathode in order to reduce the control voltage.

The value of R_5 may easily be determined by applying a strong signal and adjusting R_5 until the shadow-angle is nearly zero. If the resultant value of R_5 is so low as to reduce the avc voltage appreciably, the d-c controlling voltage for the 6E5 should be obtained from a tap on the diode load resistor as shown in the diagram at the right.

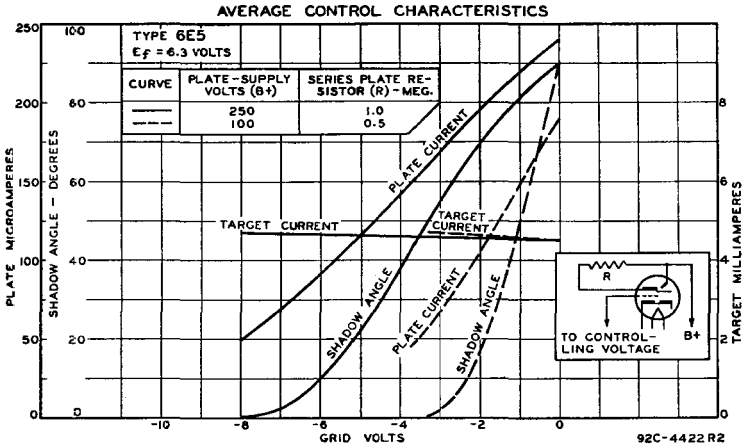

TYPICAL ELECTRON-RAY TUBE CIRCUITS

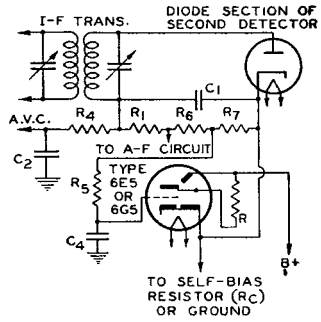
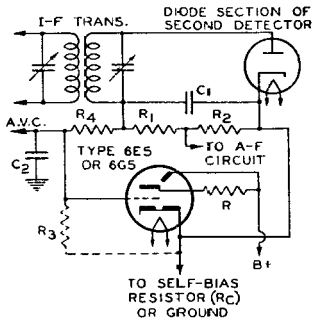

- $R = \begin{cases} 1.0 \text{ MEGOHM FOR } B_+ = 250 \text{ VOLTS} \\ 0.5 \text{ MEGOHM FOR } B_+ = 100 \text{ VOLTS} \end{cases}$
- $R_1 = 0.05 \text{ MEGOHM (R-F FILTER)}$
- $R_2 = 0.2 \text{ MEGOHM}$
- $R_3 = \text{DETERMINED BY TEST. SEE TEXT.}$
- $R_4 = \text{AVC FILTER RESISTOR}$

- $R_5 = R_4$
- $R_6 + R_7 = 0.2 \text{ MEGOHM}$
- $C_1 = 100 \text{ TO } 200 \mu\text{f}$
- $C_2 = \text{AVC FILTER CONDENSER}$
- $C_3 = 0.05 \text{ TO } 1.0 \mu\text{f}$
- $C_4 = C_2$

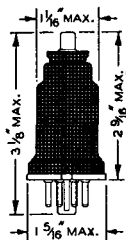

RCA-6F5

HIGH-MU TRIODE

The 6F5 is a high-mu triode of the All-Metal type. It is particularly suitable for use in resistance-coupled amplifier circuits.

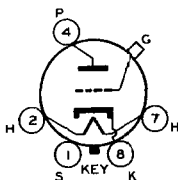

CHARACTERISTICS

HEATER VOLTAGE (A. C. or D. C.)	6.3	Volts
HEATER CURRENT	0.3	Ampere
PLATE VOLTAGE	250 max.	Volts
GRID VOLTAGE	-2	Volts
PLATE CURRENT	0.9	Milliampere
PLATE RESISTANCE	66000	Ohms
AMPLIFICATION FACTOR	100	
TRANSCONDUCTANCE	1500	Micromhos
GRID-PLATE CAPACITANCE*	2	μf
GRID-CATHODE CAPACITANCE*	6	μf
PLATE-CATHODE CAPACITANCE*	12	μf
CAP		Miniature
BASE	Small Wafer Octal 5-Pin	

* With shell connected to cathode.

INSTALLATION AND APPLICATION

The base pins of the 6F5 fit the standard octal socket which may be mounted to hold the tube in any position. For heater operation and cathode connection, refer to INSTALLATION for type 6A8.

As an amplifier in resistance-coupled a-f circuits, the 6F5 may be operated under conditions given in the Resistance-Coupled A-F Amplifier Section.

In resistance-coupled circuits, the d-c resistance in the grid circuit of the 6F5 should not exceed 1.0 megohm.

When a 6F5 is used to amplify the output of the 6H6 diode, it is recommended that fixed grid bias be employed. Diode-biasing of the 6F5 is not suitable because of the probability of plate-current cut-off, even with relatively small signal voltages applied to the diode circuit.

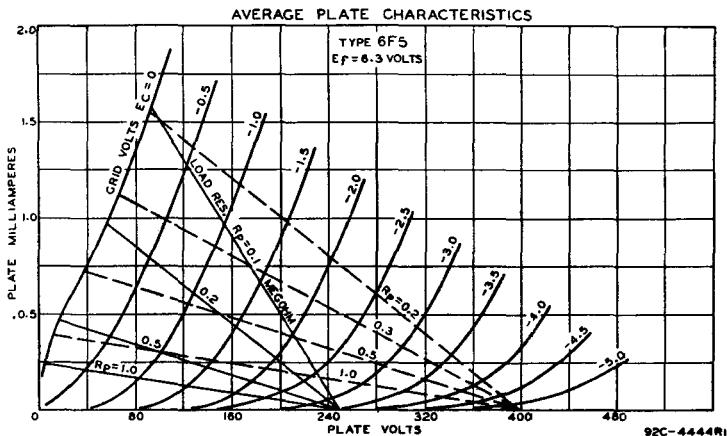

RCA-6F6

POWER-AMPLIFIER PENTODE

The 6F6 is a heater-cathode power-amplifier pentode of the All-Metal type for use in the audio-output stage of a-c receivers. It is capable of giving large power output with a

relatively small input voltage. Because of the heater-cathode construction, uniformly low hum-level is attainable in power-amplifier design.

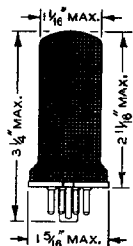
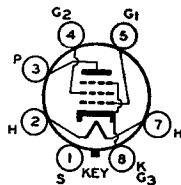

CHARACTERISTICS

HEATER VOLTAGE (A. C. or D. C.)	6.3	Volts
HEATER CURRENT	0.7	Ampere
BASE	Small Wafer Octal 7-Pin	

As Single-Tube Class A₁ Amplifier—Pentode Connection

PLATE VOLTAGE	250	315* max.	Volts
SCREEN VOLTAGE (Grid No. 2)	250	315* max.	Volts
GRID VOLTAGE (Grid No. 1)	-16.5	-22	Volts
PLATE CURRENT	34	42	Milliamperes
SCREEN CURRENT	6.5	8	Milliamperes
PLATE RESISTANCE (Approximate)	80000	75000	Ohms
AMPLIFICATION FACTOR (Approx.)	200	200	
TRANSCONDUCTANCE	2500	2650	Micromhos
LOAD RESISTANCE	7000	7000	Ohms
TOTAL HARMONIC DISTORTION	7	7	Per cent
POWER OUTPUT	3	5	Watts

As Single-Tube Class A₁ Amplifier—Triode Connection (Screen tied to plate)

PLATE VOLTAGE†	250	Volts
GRID VOLTAGE	-20	Volts
PLATE CURRENT	31	Milliamperes
PLATE RESISTANCE	2600	Ohms
AMPLIFICATION FACTOR	7	
TRANSCONDUCTANCE	2700	Micromhos
LOAD RESISTANCE	4000	Ohms
TOTAL HARMONIC DISTORTION	5	Per cent
POWER OUTPUT	0.85	Watt

Under the above maximum voltage conditions, transformer or impedance input-coupling devices are recommended. If resistance-coupling is used, refer to last paragraph of APPLICATION.

* Not recommended for automobile service or other similar services where heater voltage can rise more than 10% above rated value.

† Maximum plate voltage=315 volts.

As Push-Pull Class AB₂ Amplifier—Pentode Connection

Unless otherwise specified, values are for two tubes.

	Fixed Bias	Self-Bias	
PLATE VOLTAGE	375 max.	375 max.	Volts
SCREEN VOLTAGE	250 max.	250 max.	Volts
GRID VOLTAGE	-26 min.	—	Volts
SELF-BIAS RESISTOR	—	340 min.	Ohms
PEAK A-F GRID-TO-GRID VOLTAGE	82	94	Volts

ZERO-SIGNAL PLATE CURRENT.....	34	54	Milliamperes
ZERO-SIGNAL SCREEN CURRENT.....	5	8	Milliamperes
LOAD RESISTANCE (Per Tube).....	2500	2500	Ohms
EFFECTIVE LOAD RESISTANCE (Plate-to-plate).....	10000	10000	Ohms
TOTAL HARMONIC DISTORTION.....	5	5	Per cent
POWER OUTPUT (Approx.).....	19*	19†	Watts

Under the above maximum voltage conditions, transformer or impedance input-coupling devices must be used.

* With one triode-connected 6F6 as driver operated at plate volts of 250, grid volts of -20, and with a minimum plate load of approximately 10000 ohms: input transformer ratio, primary to one-half secondary, is 3.32. The plate, screen and grid supply have negligible resistance.

† With one triode-connected 6F6 as driver operated at plate volts of 250, grid volts of -20, and with a minimum plate load of approximately 10000 ohms: input transformer ratio, primary to one-half secondary, is 2.5. The plate and screen supply have negligible resistance. The value given for the self-bias resistor is determined for a minimum grid bias of -21 volts.

As Push-Pull Class AB₂ Amplifier—Triode Connection
(Screen tied to plate)

Unless otherwise specified, values are for two tubes.

	Fixed Bias	Self-Bias	
PLATE VOLTAGE	350 max.	350 max.	Volts
GRID VOLTAGE	-38	—	Volts
SELF-BIAS RESISTOR	—	730 min.	Ohms
PEAK A-F GRID-TO-GRID VOLTAGE.....	123	132	Volts
ZERO-SIGNAL PLATE CURRENT.....	45	50	Milliamperes
LOAD RESISTANCE (Per Tube).....	1500	2500	Ohms
EFFECTIVE LOAD RESISTANCE (Plate-to-plate).....	6000	10000	Ohms
TOTAL HARMONIC DISTORTION.....	7	7	Per cent
POWER OUTPUT (Approx.).....	18°	14‡	Watts

Under the above maximum voltage conditions, transformer or impedance input-coupling devices must be used.

° With one triode-connected 6F6 as driver operated at plate volts of 250, grid volts of -20, and with a minimum plate load of approximately 10000 ohms: input transformer ratio, primary to one-half secondary, is 1.67. The plate and grid supply have negligible resistance.

‡ With one triode-connected 6F6 as driver operated at plate volts of 250, grid volts of -20, and with a minimum plate load of approximately 10000 ohms: input transformer ratio, primary to one-half secondary, is 1.29. The plate supply has negligible resistance. The value given for the self-bias resistor is determined for a minimum grid bias of -36.5 volts.

INSTALLATION

The base pins of the 6F6 fit the standard octal socket which may be installed to hold the tube in any position.

For heater operation and cathode connection, refer to type 42.

APPLICATION

As a Class A power-amplifier pentode, the 6F6 may be used either singly or in push-pull. Recommended operating conditions are given under CHARACTERISTICS. If a single 6F6 is operated at a plate voltage of 250 volts, the self-bias resistor should have a value of approximately 410 ohms; at 315 volts, 440 ohms. For two tubes in the same stage, the value of the self-bias resistor should be approximately one-half that for a single tube.

As a Class A power-amplifier triode, the 6F6 may be used either singly or in push-pull. For this service the screen is connected to the plate. Recommended operating conditions are given under CHARACTERISTICS. When a single 6F6 is operated as a Class A triode at a plate voltage of 250 volts, the self-bias resistor should have a value of approximately 650 ohms. For two tubes in the same stage, the value of the self-bias resistor should be approximately one-half that for a single tube.

As a Class AB power-amplifier triode or pentode, the 6F6 should be operated as shown under the CHARACTERISTICS. The values shown cover operation with fixed-bias and with self-bias, and have been determined on the basis of some

grid-current flow during the most positive swing of the input signal and of cancellation of second-harmonic distortion by virtue of the push-pull circuit.

The type of input coupling used should not introduce too much resistance in the grid circuit. Transformer or impedance-coupling devices are recommended. When the grid circuit has a resistance not higher than 0.05 megohm, fixed bias may be used; for higher values, self-bias is required. With self-bias, the grid circuit may have a resistance as high as, but not greater than, 0.5 megohm provided the heater voltage is not allowed to rise more than 10% above rated value under any condition of operation.

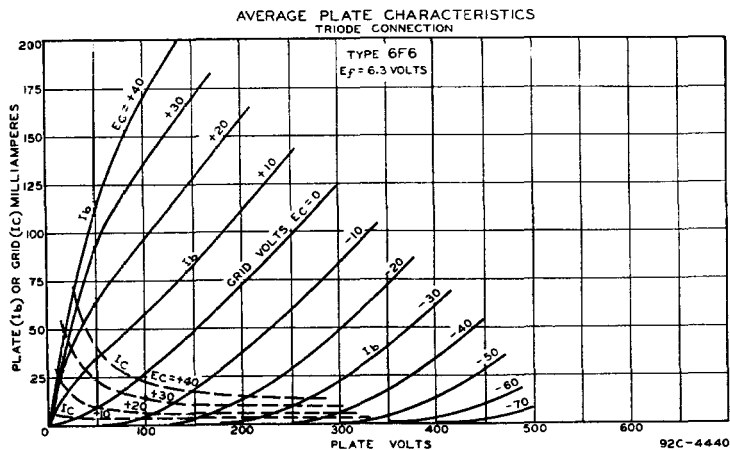
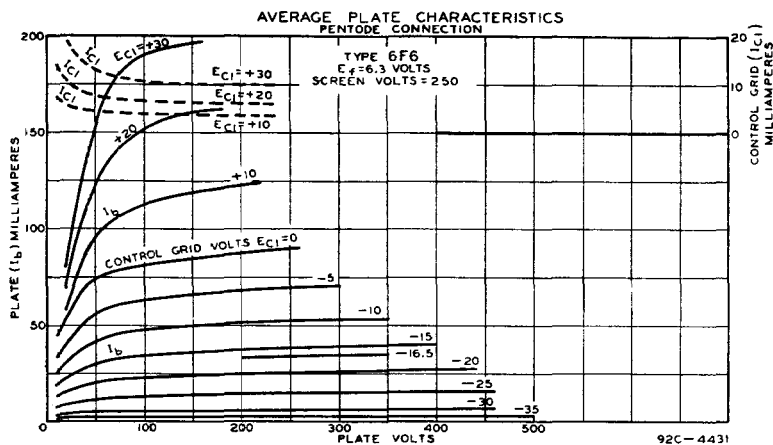

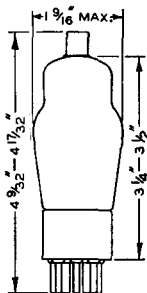

RCA-6F7

TRIODE-PENTODE

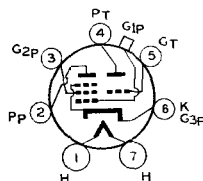

The 6F7 is a heater type of tube combining in one bulb a triode and an r-f pentode of the remote cut-off type. Since these two units are independent of each other except for

the common cathode, the 6F7 may be adapted to circuit design in several ways.

CHARACTERISTICS

HEATER VOLTAGE (A. C. or D. C.).....	6.3	Volts
HEATER CURRENT	0.3	Ampere
DIRECT INTERELECTRODE CAPACITANCES		
Triode Unit—Grid to Plate.....	2.0	μf
Grid to Cathode.....	2.5	μf
Plate to Cathode.....	3.0	μf
Pentode Unit—Grid to Plate (With shield-can) ..	0.008 max.	μf
Input	3.2	μf
Output	12.5	μf
BULB		ST-12
CAP		Small Metal
BASE		Small 7-Pin

As Amplifier

	Triode Unit	Pentode Unit	
PLATE VOLTAGE	100 max.	100	250 max. Volts
SCREEN VOLTAGE (Grid No. 2)	—	100	100 max. Volts
GRID VOLTAGE (Grid No. 1) ..	-3 min.	-3 min.	-3 min. Volts
PLATE CURRENT	3.5	6.3	6.5 Milliamperes
SCREEN CURRENT	—	1.6	1.5 Milliamperes
AMPLIFICATION FACTOR	8	300	900
PLATE RESISTANCE	16000	290000	850000 Ohms
TRANSCONDUCTANCE	500	1050	1100 Micromhos
TRANSCONDUCTANCE (At -35 volts bias).....	—	9	10 Micromhos

As Frequency Converter

TYPICAL OPERATION	Triode Unit	Pentode Unit	
Plate Voltage (Maximum).....	100°	250	Volts
Screen Voltage	—	100	Volts
Grid Voltage	†	-10*	Volts
Oscillator Peak Voltage Input.....	—	7	Volts
D-C Grid Current.....	0.15	0	Milliampere
D-C Plate Current.....	2.4††	2.8	Milliamperes
Screen Current	—	0.6	Milliampere
Plate Resistance	—	2.0	Megohms
Conversion Transconductance	—	300	Micromhos

* May be obtained from 250-volt source through 60000-ohm dropping resistor.

* Obtained by means of 1700-ohm self-biasing (cathode) resistor.

† Obtained by 100000-ohm grid-leak resistor returned directly to cathode.

†† Oscillator conditions should be adjusted so that plate current does not exceed maximum of 4 milliamperes.

INSTALLATION

Refer to INSTALLATION on type 6A8.

APPLICATION

Being of the multi-unit type, the 6F7 is suitable for diversified applications. The triode unit and the pentode unit can be utilized independently of each other for performing any of the functions expected of single-unit types with similar characteristics. Circuit design for the 6F7, therefore, will follow conventional practice.

As a frequency converter, the 6F7 is used by employing the triode unit as oscillator and the pentode unit as mixer (first detector). The circuit should be adjusted so that the grid-bias voltage is approximately 3 volts greater than the peak oscillator voltage. In operation, the plate current of the oscillator should not exceed 4 milliamperes.

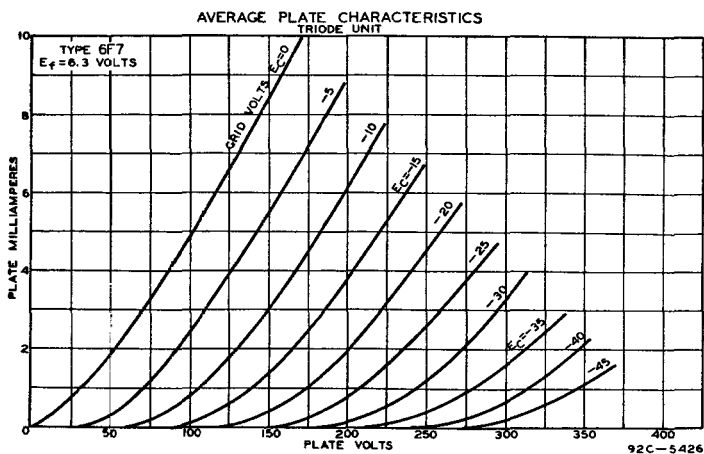
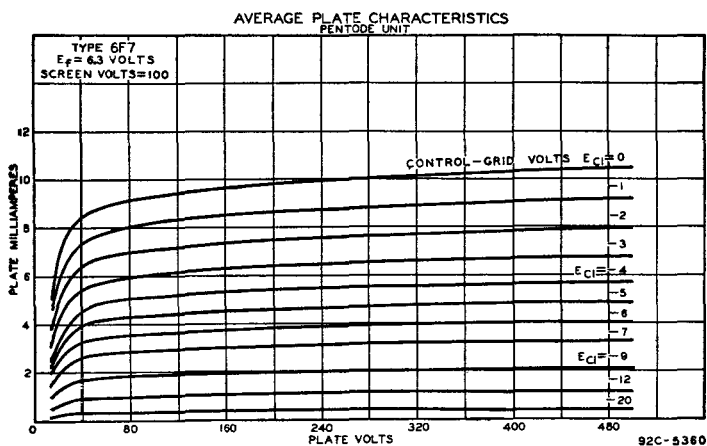

RCA-6G5

ELECTRON-RAY TUBE

(Indicator Type)

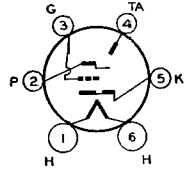
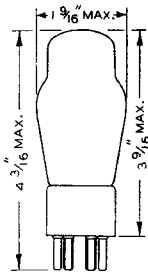

The 6G5 is a high-vacuum, heater-cathode type of tube designed to indicate visually, by means of a fluorescent target, the effects of change in the controlling voltage.

The tube, therefore, is essentially a voltage indicator and as such is particularly useful as a convenient and non-mechanical means to indicate accurate tuning of a receiver to the desired station. For a discussion of Electron-Ray Tube considerations, refer to page 30.

CHARACTERISTICS

HEATER VOLTAGE (A. C. or D. C.).....	6.3	Volts		
HEATER CURRENT	0.3	Ampere		
PLATE-SUPPLY VOLTAGE	250 max.	Volts		
TARGET VOLTAGE*	250 max.	Volts		
TYPICAL OPERATION				
Plate- and Target-Supply Voltage..	100	200	250	Volts
Series Triode-Plate Resistor.....	0.5	1	1	Megohm
Target Current (Approx.).....	4.5	4.5	4.5	Milliamperes
Triode-Plate Current (For zero triode-grid voltage)	0.19	0.19	0.24	Milliampere
Triode-Grid Voltage (For shadow angle of 0°) (Approx.).....	-8	-18.5	-22	Volts
Triode-Grid Voltage (For shadow angle of 90°) (Approx.).....	0	0	0	Volts
BULB				ST-12
BASE				Small 6-Pin

* Minimum target voltage should not be less than 90 volts.

INSTALLATION AND APPLICATION

For **INSTALLATION**, refer to type 6E5. The **APPLICATION** of the 6G5 is similar to that of the 6E5. Typical circuits are shown under the latter type. The essential difference between type 6E5 and type 6G5 is that the 6G5 has a remote plate-current cut-off characteristic.

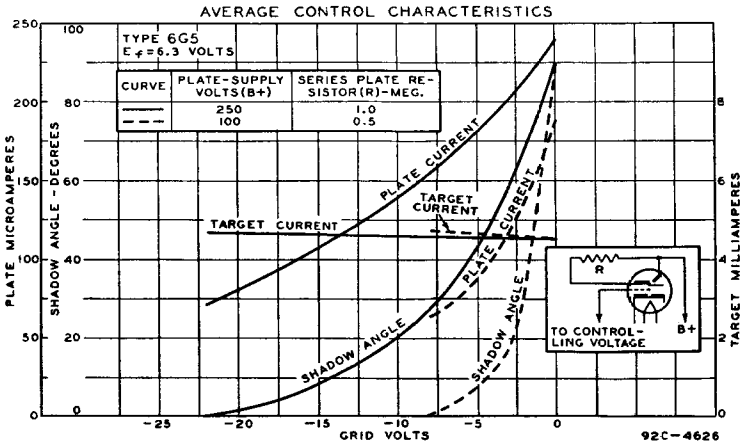

RCA-6H6

TWIN DIODE

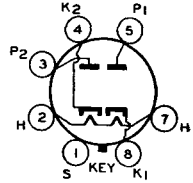
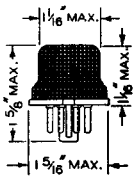

The 6H6 is a heater-cathode type of All-Metal tube combining two diodes in one shell. Each diode has its own separate cathode and corresponding base pin. This arrangement offers flexibility in the design of circuits employing the 6H6 for detection, for low-voltage low-current rectification, or for automatic volume control. For diode-detector considerations, refer to page 26.

CHARACTERISTICS

HEATER VOLTAGE (A. C. or D. C.).....	6.3	Volts
HEATER CURRENT	0.3	Ampere
PLATE NO. 1 TO PLATE NO. 2 CAPACITANCE*.....	0.02 max.	μ mf
A-C PLATE VOLTAGE PER PLATE (RMS).....	100 max.	Volts
D-C OUTPUT CURRENT.....	4 max.	Milliamperes
BASE	Small Wafer Octal 7-Pin	

* With shell connected to cathode.

INSTALLATION

The base pins of the 6H6 fit the standard octal socket which may be installed to hold the tube in any position. For heater operation and cathode connection, refer to INSTALLATION for type 6A8.

APPLICATION

For detection, the diodes may be utilized in a full-wave circuit or in a half-wave circuit. In the latter case, one plate only, or the two plates in parallel, may be employed. The use of the half-wave arrangement will provide approximately twice the rectified voltage as compared with the full-wave arrangement.

For automatic-volume control, the 6H6 may be used in circuits similar to those employed for any of the duplex-diode types of tubes. The only difference is that the 6H6 is more adaptable due to the fact that each diode has its own separate cathode.

Since the diodes by themselves do not provide any amplification, it is usually necessary to provide gain by means of a supplementary tube. Types such as the 6C5, 6F5, 6J7, and 6K7 are very suitable for this purpose. Their use in combination with the 6H6 is similar to that of the amplifier sections of duplex-diode triode or pentode types, such as the 6R7, 6Q7 and 6B8. The amplifier sections of these types have somewhat the same characteristics as the 6C5, 6F5 and 6J7, respectively.

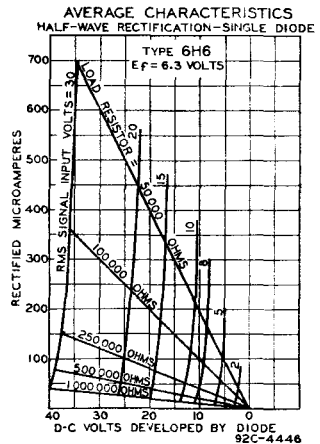

RCA-6J7

TRIPLE-GRID DETECTOR AMPLIFIER

The 6J7 is a triple-grid type of All-Metal tube recommended especially for service as a biased detector in radio receivers designed for its characteristics. In such service, this

tube is capable of delivering a large audio-frequency output voltage with relatively small input voltage. Other applications of the 6J7 include its use as a high-gain amplifier tube.

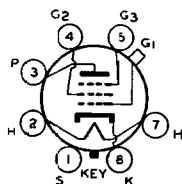

CHARACTERISTICS

HEATER VOLTAGE (A. C. or D. C.)	6.3	Volts
HEATER CURRENT	0.3	Ampere
PLATE VOLTAGE	100 250 max.	Volts
SCREEN VOLTAGE	100 100**	Volts
GRID VOLTAGE*	-3 -3	Volts
SUPPRESSOR	Connected to cathode at socket	
PLATE CURRENT	2 2	Milliamperes
SCREEN CURRENT	0.5 0.5	Milliampere
PLATE RESISTANCE	1.0 Greater than 1.5	Megohm
AMPLIFICATION FACTOR	1185 Greater than 1500	
TRANSCONDUCTANCE	1185 1225	Micromhos
GRID VOLTAGE (Approximate)†	-7 -7	Volts
GRID-PLATE CAPACITANCE°	0.005 max.	μf
INPUT CAPACITANCE°	7	μf
OUTPUT CAPACITANCE°	12	μf
CAP		Miniature
BASE		Small Wafer Octal 7-Pin

* The d-c resistance in the grid circuit should not exceed 1.0 megohm.

** Maximum Screen Volts = 125. † For cathode current cut-off. ° With shell connected to cathode.

INSTALLATION

The base pins of the 6J7 fit the standard octal socket which may be installed to hold the tube in any position. For heater operation and cathode connection, refer to INSTALLATION for type 6A8.

The screen voltage may be obtained from a potentiometer or bleeder circuit across the B-supply source. Due to the screen-current characteristics of the 6J7, a resistor in series with the high-voltage supply may be employed for obtaining the screen voltage, provided the cathode-resistor method of bias control is used. This method, however, is not recommended if the high-voltage B-supply exceeds 250 volts.

APPLICATION

As a biased detector, the 6J7 can deliver a large audio-frequency output voltage of good quality with a fairly small radio-frequency signal input. Typical recommended conditions for the 6J7 as a biased detector are as follows:

Plate Supply*	100 100 250 250	Volts
Screen Voltage	12 30 50 100	Volts
Grid Voltage	-1.16 -1.83 -2 -4.3	Volts
Cathode Resistor	18000 10000 3000 10000	Ohms
Suppressor	Connected to cathode at socket	
Cathode Cur. (Zero Signal)	0.63 0.183 0.65 0.43	Milliampere

Plate Resistor	1.0	0.25	0.25	0.50	Megohm
Blocking Condenser	0.01	0.01	0.03	0.03	μ f
Grid Resistor†	1.0	0.5	0.25	0.25	Megohm
R-F Signal (RMS)**	1.05	1.6	1.18	1.37	Volts

* Voltage at plate will be PLATE-SUPPLY voltage less voltage drop in plate resistor caused by plate current.

† For the following amplifier tube.

** With these signal voltages modulated 20%, the voltage output under each set of operating conditions is 17 peak volts at the grid of the following amplifier, a value sufficient to insure full audio output from a type 6F6 at 250 volts on plate.

Detector bias may be obtained from a bleeder circuit, from a resistor in the cathode circuit, or from a partial self-biasing circuit. The cathode-resistor method permits of higher output at low percentage modulation, since the input signal may be increased almost in inverse proportion to the modulation without resulting in objectionable distortion.

As an audio-frequency amplifier pentode in resistance-coupled circuits, the 6J7 may be operated as shown in the tables given in the Resistance-Coupled A-F Amplifier Section.

As a radio-frequency amplifier pentode, the 6J7 may be used particularly in applications where the r-f signal applied to the grid is relatively low, that is, of the order of a few volts. In such cases either screen or control-grid voltage (or both) may be varied to control the receiver volume. When larger signals are involved, a super-control amplifier tube should be employed to prevent the occurrence of excessive cross-modulation and modulation-distortion. Recommended operating conditions for amplifier services are given under CHARACTERISTICS.

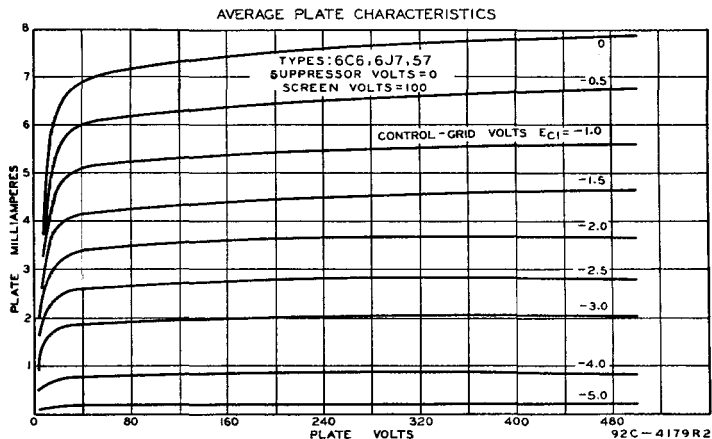

RCA-6K7

TRIPLE-GRID SUPER-CONTROL AMPLIFIER

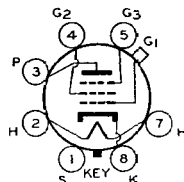
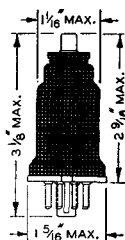

The 6K7 is a triple-grid super-control amplifier tube of the All-Metal type recommended for service in the radio-frequency and intermediate-frequency stages of radio receivers designed for its characteristics. The ability of this tube to handle unusual signal voltages without cross-modulation and modulation-distortion makes it adaptable to the r-f and i-f stages of receivers employing automatic volume control.

CHARACTERISTICS

HEATER VOLTAGE (A. C. or D. C.)				6.3	Volts
HEATER CURRENT				0.3	Ampere
PLATE VOLTAGE	90	180	250	250 max.	Volts
SCREEN VOLTAGE	90	75	100	125 max.	Volts
GRID VOLTAGE (Minimum)	-3	-3	-3	-3	Volts
SUPPRESSOR	Connected to cathode at socket				
PLATE CURRENT	5.4	4.0	7.0	10.5	Milliamperes
SCREEN CURRENT	1.3	1.0	1.7	2.6	Milliamperes
PLATE RESISTANCE	0.315	1.0	0.8	0.6	Megohm
AMPLIFICATION FACTOR	400	1100	1160	990	
TRANSCONDUCTANCE	1275	1100	1450	1650	Micromhos
GRID VOLTAGE*	-38.5	-32.5	-42.5	-52.5	Volts
GRID-PLATE CAPACITANCE°				0.005 max.	μμf
INPUT CAPACITANCE°				7	μμf
OUTPUT CAPACITANCE°				12	μμf
CAP					Miniature
BASE					Small Wafer Octal 7-Pin

* For transconductance = 2 micromhos.

° With shell connected to cathode.

INSTALLATION

The base pins of the 6K7 fit the standard octal socket which may be installed to hold the tube in any position.

For heater operation and cathode connection, refer to INSTALLATION for type 6A8.

Control-grid bias variation will be found effective in changing the volume of the receiver. In order to obtain adequate volume control, an available grid-bias voltage of approximately 50 volts will be required. The exact value will depend upon the circuit design and operating conditions. This voltage may be obtained, depending on the receiver requirements, from a potentiometer across a fixed supply voltage or by the use of a variable self-bias resistor in the cathode circuit.

The screen voltage may be obtained from a potentiometer or bleeder circuit across the B-supply source. Due to the screen current characteristics of the 6K7, a resistor in series with the high-voltage supply may be employed for obtaining the screen voltage provided the cathode-resistor method of bias control is used. This method, however, is not recommended if the high-voltage B-supply exceeds 250 volts. Furthermore, it should be noted that the use of a resistor in the screen circuit will have an effect on the change in plate resistance with variation in suppressor voltage in case the suppressor is utilized for control purposes.

The suppressor may be connected directly to the cathode or it may be made negative with respect to the cathode. For the latter condition, the suppressor voltage may be obtained from a potentiometer or bleeder circuit for manual volume- and selectivity-control, or from the drop in a resistor in the plate circuit of the automatic volume-control tube.

APPLICATION

As a radio-frequency amplifier, the 6K7 is especially applicable to radio receiver design because of its ability to reduce cross-modulation effects, its remote "cut-off" feature, and its flexible adaptability to circuit combinations and to receiver design. Recommended conditions for the 6K7 as an amplifier are given under CHARACTERISTICS.

To realize the maximum benefit of the long "cut-off" feature of this tube, it is necessary to apply a variable grid bias and to maintain the screen at a constant potential with respect to the cathode. Good results, however, may be obtained by using a variable cathode resistance. Such a resistance, of course, reduces the screen potential by the amount that the bias is increased and thus hastens the "cut-off." Therefore, the ability of the tube to handle large signals is somewhat impaired. This effect may be nullified by means of a series resistor in the screen circuit.

The use of series resistors for obtaining satisfactory control of screen voltage in the case of four-electrode tubes is usually impossible because of secondary emission phenomena. In the 6K7, however, the suppressor practically removes these effects and it is therefore possible to obtain satisfactorily the screen voltage from the plate supply or from some high intermediate voltage providing these sources do not exceed 250 volts. With this method, the screen-to-cathode voltage will fall off very little from minimum to maximum value of cathode-control resistor. In some cases, it may actually rise. This rise of screen-to-cathode voltage above the normal maximum value is allowable because the screen and the plate current are reduced simultaneously by a sufficient amount to prevent damage to the tube. It should be recognized in general that the series-resistor method of obtaining screen voltage from a higher voltage supply necessitates the use of the variable cathode-resistor method of controlling volume in order to prevent too high a voltage on the screen. When screen and control-grid voltage are obtained in this manner, the remote "cut-off" advantage of the 6K7 may be fully realized.

As a mixer in superheterodyne circuits, the 6K7 may be used although a pentagrid mixer or pentagrid converter type is generally preferable. The 6K7 as a mixer is capable of producing, under the proper conditions of grid and local oscillator voltage, a gain of about one-third that which can be obtained in an intermediate-frequency amplifier stage. This gain can be controlled by varying the grid bias either from a separate supply or from a variable resistor in the cathode circuit. This is a desirable feature in receivers employing automatic volume-control, because it enables a much lower threshold input to be received without loss of amplification and permits the reception of high input voltages without loss of control. Recommended conditions for the 6K7 as a superheterodyne mixer follow: Plate voltage, 250 volts; screen voltage, 100 volts; suppressor connected to cathode at socket; and grid-bias voltage, -10 volts approximate (with 7-volt oscillator peak swing).

A plate family of curves is given under type 78.



RCA-6L6

BEAM POWER AMPLIFIER

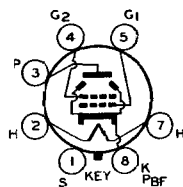

The 6L6 is a power-amplifier tube of the All-Metal type for use in the output stage of radio receivers, especially those designed to have ample reserve of power-delivering ability.

The 6L6 provides high power output sensitivity and high efficiency. The power output at all levels has low third and negligible higher-order harmonic distortion. When operated at maximum ratings, this tube will give over 11 watts output in single-ended operation and as much as 60 watts in push-pull. When the push-pull connection is used with a 6600-ohm load, the 6L6 will give 34 watts of audio power without the need of grid-driving power. For discussion of beam power amplifier considerations, refer to page 10.

CHARACTERISTICS

HEATER VOLTAGE (A. C. or D. C.)	6.3	Volts
HEATER CURRENT	0.9	Ampere
AVERAGE CHARACTERISTICS		
Plate Voltage	250	Volts
Screen Voltage	250	Volts
Grid Voltage	-14	Volts
Plate Current	72	Milliamperes
Screen Current	5	Milliamperes
Plate Resistance	22500	Ohms
Amplification Factor	135	
Transconductance	6000	Micromhos
BASE	Small Wafer	Octal 7-Pin

As Single-Tube Class A₁ Amplifier—With Self-bias

PLATE VOLTAGE	375 max.	Volts		
SCREEN VOLTAGE	250 max.	Volts		
SCREEN DISSIPATION	3.5 max.	Watts		
PLATE AND SCREEN DISSIPATION	24 max.	Watts		
TYPICAL OPERATION				
Plate Voltage	375	250	300	Volts
Screen Voltage	125	250	200	Volts
Self-Bias Resistor	365	170	220	Ohms
Peak A-F Grid Voltage	8.5	14	12.5	Volts
Zero-Signal Plate Current	24	75	51	Milliamperes
Max.-Signal Plate Current	24.3	78	54.5	Milliamperes
Zero-Signal Screen Current	0.7	5.4	3	Milliamperes
Max.-Signal Screen Current	1.8	7.2	4.6	Milliamperes
Load Resistance	14000	2500	4500	Ohms
Total Harmonic Distortion	9	10	11	Per cent
Second Harmonic Distortion	8	9.7	10.7	Per cent
Third Harmonic Distortion	4	2.5	2.5	Per cent
Max.-Signal Power Output	4	6.5	6.5	Watts

As Single-Tube Class A₁ Amplifier—Fixed Bias

PLATE VOLTAGE	375 max.	Volts
SCREEN VOLTAGE	250 max.	Volts
SCREEN DISSIPATION	3.5 max.	Watts
PLATE AND SCREEN DISSIPATION (Total)	24 max.	Volts

TYPICAL OPERATION

Plate Voltage	375	250	300	375	Volts
Screen Voltage	125	250	200	250	Volts
D-C Grid Voltage	-9	-14	-12.5	-17.5	Volts
Peak A-F Grid Voltage.....	8	14	12.5	17.5	Volts
Zero-Signal Plate Current...	24	72	48	57	Milliamperes
Max.-Signal Plate Current...	26	79	55	67	Milliamperes
Zero-Signal Screen Current..	0.7	5	2.5	2.5	Milliamperes
Max.-Signal Screen Current..	2	7.3	4.7	6	Milliamperes
Load Resistance	14000	2500	4500	4000	Ohms
Total Harmonic Distortion..	9	10	11	14.5	Per cent
Second Harmonic Distortion..	8	9.7	10.7	11.5	Per cent
Third Harmonic Distortion..	4	2.5	2.5	4.2	Per cent
Max.-Signal Power Output..	4.2	6.5	6.5	11.5	Watts

As Push-Pull Class A₁ Amplifier

PLATE VOLTAGE	375 max.	Volts
SCREEN VOLTAGE	250 max.	Volts
SCREEN DISSIPATION	3.5 max.	Watts
PLATE AND SCREEN DISSIPATION (Total).....	24 max.	Watts

TYPICAL OPERATION Values are for two tubes.

Fixed Bias Self-Bias

Plate Voltage	250	250	Volts
Screen Voltage	250	250	Volts
D-C Grid Voltage	-16	—	Volts
Self-Bias Resistor	—	125	Ohms
Peak A-F Grid-to-Grid Voltage.....	32	35.6	Volts
Zero-Signal Plate Current.....	120	120	Milliamperes
Max.-Signal Plate Current.....	140	130	Milliamperes
Zero-Signal Screen Current.....	10	10	Milliamperes
Max.-Signal Screen Current.....	16	15	Milliamperes
Load Resistance (Plate-to-plate).....	5000	5000	Ohms
Total Harmonic Distortion.....	2	2	Per cent
Third Harmonic Distortion.....	2	2	Per cent
Max.-Signal Power Output.....	14.5	13.8	Watts

As Push-Pull Class AB₁ Amplifier

PLATE VOLTAGE	400 max.	Volts
SCREEN VOLTAGE	300 max.	Volts
SCREEN DISSIPATION	3.5 max.	Watts
PLATE AND SCREEN DISSIPATION (Total).....	24 max.	Watts

TYPICAL OPERATION Values are for two tubes.

Self-Bias Fixed Bias

Plate Voltage	400	400	400	400	Volts
Screen Voltage	250	300	250	300	Volts
D-C Grid Voltage.....	—	—	-20	-25	Volts
Self-Bias Resistor	190	200	—	—	Ohms
Peak A-F Grid-to-Grid Volt.	43.8	57	40	50	Volts
Zero-Signal Plate Current..	96	112	88	102	Milliamperes
Max.-Signal Plate Current..	110	128	124	152	Milliamperes
Zero-Signal Screen Current.	4.6	7	4	6	Milliamperes
Max.-Signal Screen Current.	10.8	16	12	17	Milliamperes
Load Resist. (Plate-to-plate)..	8500	6600	8500	6600	Ohms
Total Harmonic Distortion..	2	2	2	2	Per cent
Third Harmonic Distortion..	2	2	2	2	Per cent
Max.-Signal Power Output..	24	32	26.5	34	Watts

As Push-Pull Class AB₂ Amplifier—Fixed Bias

PLATE VOLTAGE	400 max.	Volts
---------------------	----------	-------

SCREEN VOLTAGE	300 max.	Volts
SCREEN DISSIPATION	3.5 max.	Watts
PLATE AND SCREEN DISSIPATION (Total).....	24 max.	Watts
TYPICAL OPERATION <i>Values are for two tubes.</i>		
Plate Voltage	400	400 Volts
Screen Voltage	250	300 Volts
D-C Grid Voltage	-20	-25 Volts
Peak A-F Grid-to-Grid Voltage.....	57	80 Volts
Zero-Signal Plate Current.....	88	102 Milliampères
Max.-Signal Plate Current.....	168	230 Milliampères
Zero-Signal Screen Current.....	4	6 Milliampères
Max.-Signal Screen Current.....	13	20 Milliampères
Load Resistance (Plate-to-plate).....	6000	3800 Ohms
Peak Grid-Input Power†.....	0.18	0.35 Watt
Max.-Signal Power Output*.....	40	60 Watts

* With zero-impedance driver and perfect regulation, plate-circuit distortion does not exceed 2%. In practice, plate-voltage regulation, screen-voltage regulation, and grid-bias regulation, should not be greater than 5%, 5%, and 3%, respectively.

† Driver stage should be capable of supplying the grids of the Class AB stage with the specified peak values at low distortion. The effective resistance per grid circuit of the Class AB stage should be kept below 500 ohms and the effective impedance at the highest desired response frequency should not exceed 700 ohms.

INSTALLATION

The base pins of the 6L6 fit the standard octal socket which may be installed to hold the tube in any position.

The heater is designed to operate at 6.3 volts. The transformer supplying this voltage should be designed to operate the heater at this recommended value for full-load operating conditions at average line voltage. Under the maximum screen and plate dissipation conditions, the heater voltage should never fluctuate so that it exceeds 7.0 volts. For cathode connection, refer to type 6A8.

In all services precautions should be taken to insure that the dissipation rating is not exceeded with expected line-voltage variations, especially in the cases of fixed-bias operation. When the push-pull connection is used, fixed-bias values up to 10% of each typical screen voltage can be used without increasing distortion.

APPLICATION

As a Class A₁ power amplifier, the 6L6 should be operated as shown under CHARACTERISTICS. The values cover self- and fixed-bias operation and have been determined on the basis that no grid current flows during any part of the input signal swing. The second harmonics can easily be eliminated by the use of push-pull circuits. In single-tube, resistance-coupled circuits, the second-harmonics can be minimized by generating out-of-phase second harmonics in the pre-amplifier.

As a push-pull Class AB₁ power amplifier, the 6L6 may be operated as shown under CHARACTERISTICS. The values shown cover self- and fixed-bias operation and have been determined on the basis that no grid current flows during any part of the input signal swing.

The type of input coupling used in Class A₁ and Class AB₁ service should not introduce too much resistance in the grid-circuit. Transformer- or impedance-coupling devices are recommended. When the grid circuit has a resistance not higher than 0.1 megohm fixed-bias may be used; for higher values, self-bias is required. With self-bias, the grid circuit may have a resistance as high as, but not greater than, 0.5 megohm provided the heater voltage is not allowed to rise more than 10% above the rated value under any condition of operation.

As a push-pull Class AB₂ power amplifier, the 6L6 may be operated as shown under CHARACTERISTICS. The values cover operation with fixed-bias and have been determined on the basis that some grid current flows during the most positive swing of the input signal.

Refer to Circuit Section for circuits employing the 6L6, and to page 21 for discussion of inverse-feedback arrangements. A family of plate characteristics curves is given on page 96.

RCA-6L7



PENTAGRID MIXER AMPLIFIER

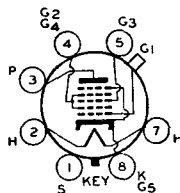

The 6L7 is a multi-electrode vacuum tube of the All-Metal type designed with two separate control grids shielded from each other. This design permits each control grid to

act independently on the electron stream. This tube, therefore, is especially useful as a mixer in superheterodyne circuits having a separate oscillator stage, as well as in other applications where dual control is desirable in a single stage. The design of the tube is such that coupling effects between oscillator and signal circuits are made very small. This feature enables the 6L7 to give high gain in high-frequency circuits. For general discussion of pentagrid types, see Frequency Conversion on page 31.

CHARACTERISTICS

HEATER VOLTAGE (A. C. or D. C.).....	6.3	Volts
HEATER CURRENT	0.3	Ampere
DIRECT INTERELECTRODE CAPACITANCES:*		
Grid No. 1 to Grid No. 3.....	0.12	μmf
Grid No. 1 to Plate.....	0.0005 max.	μmf
Grid No. 3 to Plate.....	0.025	μmf
Grid No. 1 to All Other Electrodes.....	8.5	μmf
Grid No. 3 to All Other Electrodes.....	11.5	μmf
Plate to All Other Electrodes.....	12.5	μmf
CAP		Miniature
BASE		Small Wafer Octal 7-Pin

As Mixer

PLATE VOLTAGE	250 max.	Volts	
SCREEN (Grids No. 2 and No. 4) VOLTAGE.....	150 max.	Volts	
TYPICAL OPERATION:			
Plate Voltage	250	250†	Volts
Screen Voltage	100	150†	Volts
Signal-Grid (Grid No. 1) Voltage.....	-3 min.	-6 min.†	Volts
Oscillator-Grid (Grid No. 3) Voltage**....	-10	-15	Volts
Peak Oscillator Voltage			
Applied to Grid No. 3 (Minimum).....	12	18	Volts
Plate Current	2.4	3.3	Milliamperes
Screen Current	7.2	9.2	Milliamperes
Plate Resistance	Greater than 1		Megohm
Conversion Conductance	350	350	Micromhos
Signal-Grid (Grid No. 1) Voltage			
for Conver. Cond. of 5 Micromhos.....	-30	-45	Volts

** The d-c resistance in oscillator-grid-No. 3 circuit should be limited to 50000 ohms.

† Recommended values for all-wave receivers. * With shell connected to cathode.

As Amplifier

PLATE VOLTAGE	250 max.	Volts
SCREEN (Grids No. 2 and No. 4) VOLTAGE.....	100 max.	Volts
CONTROL-GRID (Grid No. 1) VOLTAGE.....	-3 min.	Volts
CONTROL-GRID (Grid No. 3) VOLTAGE.....	-3	Volts
PLATE CURRENT	5.3	Milliamperes
SCREEN CURRENT	6.5	Milliamperes
AMPLIFICATION FACTOR	880	

PLATE RESISTANCE	0.8	Megohm
TRANSCONDUCTANCE	1100	Micromhos
TRANSCONDUCTANCE {	5	Micromhos
-15 volts bias on Grid No. 1 } -15 volts bias on Grid No. 3 }		

INSTALLATION

The base pins of the 6L7 fit the standard octal socket which may be installed to hold the tube in any position. For heater operation and cathode connection, refer to INSTALLATION for type 6A8.

APPLICATION

As a mixer in superheterodyne circuits, the 6L7 can mix the input from an external oscillator with the radio-input frequency to provide the desired intermediate frequency. For this service, design information is given under CHARACTERISTICS.

As a radio-frequency or intermediate-frequency amplifier, the 6L7 should be operated as shown under CHARACTERISTICS. In this application, the 6L7 has the advantage that avc bias can be applied to both the No. 1 grid and the No. 3 grid. With avc bias applied to the two grids, a small change in avc voltage produces a large change in the gain provided by the tube. For this reason the 6L7 as an r-f or i-f amplifier provides a flatter avc characteristic than a conventional pentode.

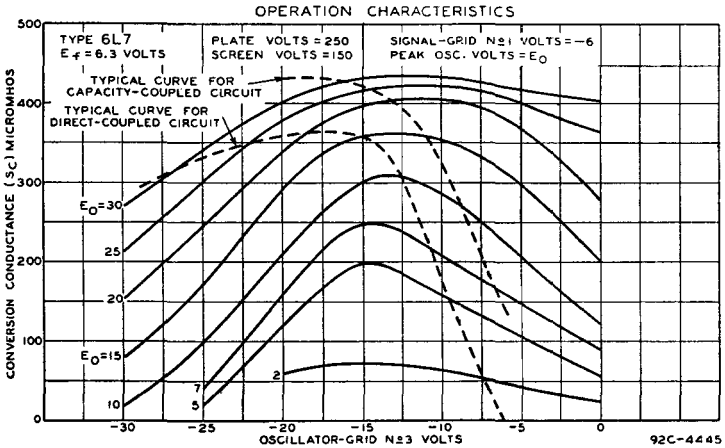

AVERAGE CHARACTERISTICS FOR TYPE 6L7

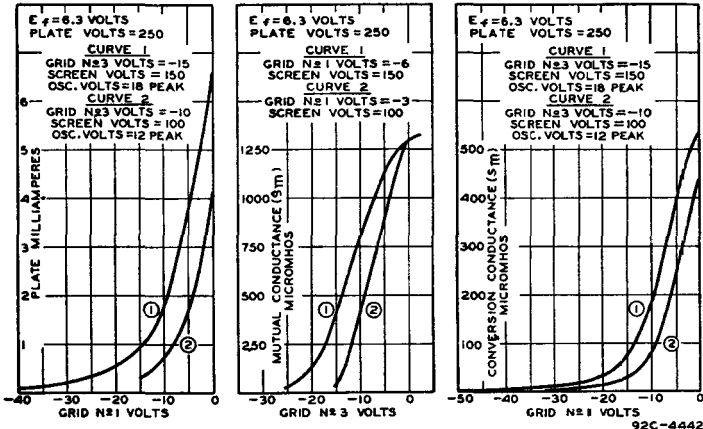

RCA-6N7

CLASS B TWIN TRIODE

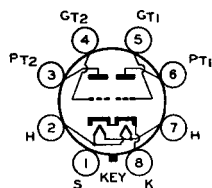
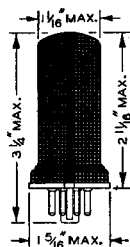

The 6N7 is an All-Metal tube containing in one envelope two high-mu triodes designed for Class B operation. The triode units have separate external terminals for all

electrodes except the cathodes and heaters. The 6N7 may also be used as a Class A₁ amplifier (with triode units connected in parallel) to drive a single 6N7 as a Class B amplifier in the output stage.

CHARACTERISTICS

HEATER VOLTAGE (A. C. or D. C.).....	6.3	Volts
HEATER CURRENT	0.8	Ampere
BASE	Small Wafer Octal 8-Pin	

As Class B Power Amplifier

PLATE VOLTAGE	300 max.	Volts	
PEAK PLATE CURRENT (Per Plate).....	125 max.	Milliamperes	
AVERAGE PLATE DISSIPATION.....	10 max.	Watts	
TYPICAL OPERATION			
Plate Voltage	250	300	Volts
Grid Voltage	0	0	Volts
Zero-Signal Plate Current (Per Plate).....	14	17.5	Milliamperes
Effective Load Resistance (Plate-to-plate) .	8000	10000	Ohms
Power Output (Approximate)*.....	8	10	Watts

As Driver—Class A₁ Amplifier

(Both grids connected together at socket; likewise both plates.)

PLATE VOLTAGE†	250	294	Volts
GRID VOLTAGE	-5	-6	Volts
AMPLIFICATION FACTOR	35	35	
PLATE RESISTANCE	11300	11000	Ohms
TRANSCONDUCTANCE	3100	3200	Micromhos
PLATE CURRENT	6	7	Milliamperes

* With average input of 350 milliwatts applied between grids.

† Maximum plate voltage = 300 volts.

INSTALLATION

Refer to INSTALLATION on the type 6A6.

APPLICATION

As a Class B power amplifier, the 6N7 is used in circuits similar in design to those utilizing individual tubes in the output stage. It requires no grid-bias, since the high-mu feature of the triode units reduces the steady plate current at zero bias to a relatively low value. Refer to page 20 for general Class B amplifier design considerations.

Two 6N7's can be operated in a Class B output stage with the two triode units of each 6N7 connected in parallel to give a power output of 20 watts, approximate, under conditions of 300 volts on the plates and of a 5000-ohm plate-to-plate load.

As a Class A₁ amplifier triode, the 6N7 may be employed in the driver stage of Class B amplifier circuits, and thus reduce the number of tube types necessary in a receiver. When operated in this way with a plate supply of 300 volts and corresponding grid-bias, the 6N7 is capable of supplying a power output upwards of 400 milliwatts. The load into which the driver works will depend largely on the design factors of the Class B amplifier. In general, however, the load will be between 20000 and 40000 ohms. The d-c resistance in the grid circuit of the 6N7, when operated as a Class A amplifier, may be as high as 0.5 megohm with self bias. With fixed bias, however, the resistance should not exceed 0.1 megohm. Typical operating values as a resistance-coupled amplifier are given in the Resistance-Coupled Amplifier Section.

Among other and less conventional applications of the 6N7 are its use as (1) biased detector and one-stage a-f amplifier, (2) two-stage a-f amplifier, (3) amplifier and phase-inverter to supply resistance-coupled, push-pull output tubes, (4) two-tube oscillator, and (5) oscillator and amplifier.

Additional curves are given under types 6A6 and 53.

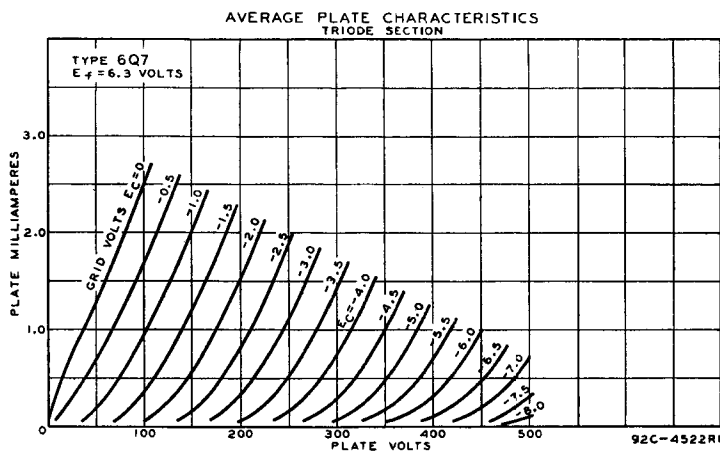
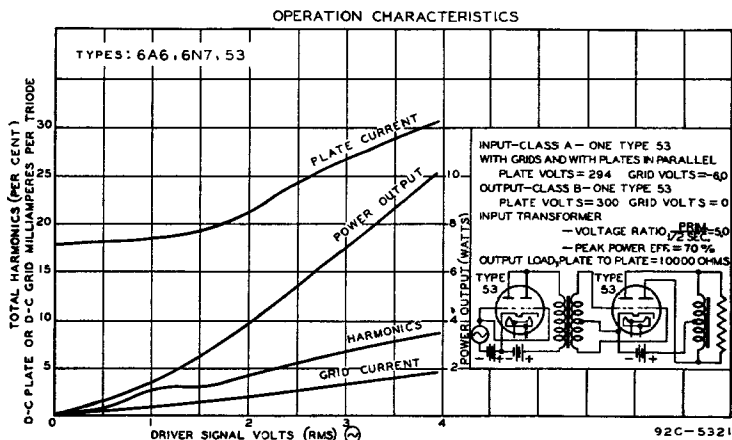

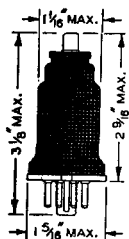

RCA-6Q7

HIGH-MU TRIODE DUPLEX-DIODE

The 6Q7 is an All-Metal tube consisting of two diodes and a high-mu triode in one envelope. It is for use as a combined detector, amplifier, and automatic-volume-control tube in

radio receivers designed for its characteristics. For diode-detector considerations, refer to page 26.

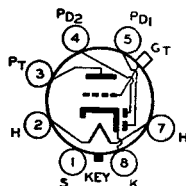

CHARACTERISTICS

HEATER VOLTAGE (A. C. or D. C.)	6.3	Volts
HEATER CURRENT	0.3	Ampere
GRID-PLATE CAPACITANCE*	1.5	$\mu\mu\text{f}$
GRID-CATHODE CAPACITANCE*	5.5	$\mu\mu\text{f}$
PLATE-CATHODE CAPACITANCE*	5	$\mu\mu\text{f}$
CAP		Miniature
BASE		Small Wafer Octal 7-Pin

Triode Unit—As Class A Amplifier

PLATE VOLTAGE	100	250 max.	Volts
GRID VOLTAGE	-1.5	-3	Volts
AMPLIFICATION FACTOR	70	70	
PLATE RESISTANCE	87500	58000	Ohms
TRANSCONDUCTANCE	800	1200	Micromhos
PLATE CURRENT	0.35	1.1	Milliamperes

* With shell connected to cathode.

Diode Units

The two diode plates are placed around a cathode, the sleeve of which is common to the triode unit. Each diode plate has its own base pin. Operation curves for the diode units are given under type 6B7.

INSTALLATION AND APPLICATION

The base pins of the 6Q7 fit the standard octal socket which may be installed to hold the tube in any position. Heater and cathode considerations are the same as for the 6A8.

The 6Q7 is, in many respects, similar to the 75 except that it has a lower amplification factor which permits of handling somewhat larger input driving voltage without overloading. The triode unit is recommended for use only in resistance-coupled circuits. Typical recommended operating conditions are given in the Resistance-Coupled Amplifier Section.

Grid bias for the triode unit of the 6Q7 may be obtained from a fixed source, such as a fixed-voltage tap on the d-c power supply or from a cathode-bias resistor. It should not be obtained by the diode-biasing method because of the probability of plate-current cut-off, even with relatively small signal voltages applied to the diode circuit.

A family of plate characteristic curves is given on the preceding page.

RCA-6R7

DUPLEX-DIODE TRIODE

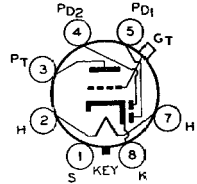
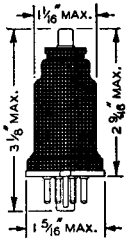

The 6R7 is an All-Metal tube consisting of two diodes and a triode in a single envelope. It is for use as a combined detector, amplifier, and automatic-volume-control tube in radio receivers designed for its characteristics. For diode-detector considerations refer to page 26.

CHARACTERISTICS

HEATER VOLTAGE (A. C. or D. C.)	6.3	Volts
HEATER CURRENT	0.3	Ampere
GRID-PLATE CAPACITANCE	2.5	μf
GRID-CATHODE CAPACITANCE	5.5	μf
PLATE-CATHODE CAPACITANCE	4.0	μf
CAP		Miniature
BASE		Small Wafer Octal 7-Pin

Triode Unit—As Class A Amplifier

PLATE VOLTAGE	250 max.	Volts
GRID VOLTAGE	-9	Volts
AMPLIFICATION FACTOR	16	
PLATE RESISTANCE	8500	Ohms
TRANSCONDUCTANCE	1900	Micromhos
PLATE CURRENT	9.5	Milliamperes
LOAD RESISTANCE	10000	Ohms
UNDISTORTED POWER OUTPUT	280	Milliwatts

Diode Units

The two diode plates are placed around a cathode, the sleeve of which is common to the triode unit. Each diode plate has its own base pin. Operation curves for the diode units are given under type 6B7.

INSTALLATION AND APPLICATION

The base pins of the 6R7 fit the standard octal socket which may be installed to hold the tube in any position. Heater and cathode considerations are the same as those for type 6A8.

As a transformer-coupled amplifier, the triode unit of the 6R7 may be employed in conventional circuit arrangements. Operating conditions are shown under CHARACTERISTICS.

As a resistance-coupled amplifier, the triode unit may be used under conditions given in the Resistance-Coupled Amplifier Section.

Grid bias for the triode unit of the 6R7 may be obtained from a fixed source, such as a fixed-voltage tap on the d-c power supply or from a cathode-bias resistor. It should not be obtained by the diode-biasing method because of the probability of plate-current cut-off, even with relatively small signal voltages applied to the diode circuit.

A family of plate characteristic curves is given on page 98.

RCA-6X5

FULL-WAVE RECTIFIER

The 6X5 is a full-wave, high-vacuum rectifier of the All-Metal type. It is intended for use in automobile-radio receivers or in a-c operated receivers designed for its characteristics.

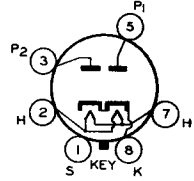
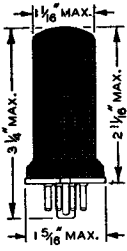

CHARACTERISTICS

HEATER VOLTAGE (A. C. or D. C.).....	6.3	Volts
HEATER CURRENT	0.6	Ampere
A-C PLATE VOLTAGE PER PLATE (RMS).....	350 max.	Volts
PEAK INVERSE VOLTAGE.....	1250 max.	Volts
D-C OUTPUT CURRENT.....	75 max.	Milliamperes
BASE	Small Wafer Octal 6-Pin	

INSTALLATION

The base pins of the 6X5 fit the standard octal socket which may be installed to hold the tube in any position.

The heater should be operated at 6.3 volts. Under no condition should the heater voltage ever fluctuate so that it exceeds 7.5 volts. The d-c potential between heater and cathode should be limited to 400 volts.

APPLICATION

As a full-wave rectifier, the 6X5 may be operated with condenser-input or choke-input filter under conditions not to exceed the ratings given under CHARACTERISTICS. For discussion of rectifiers and filter circuits, refer to page 24 and 37, respectively.

OPERATION CHARACTERISTICS

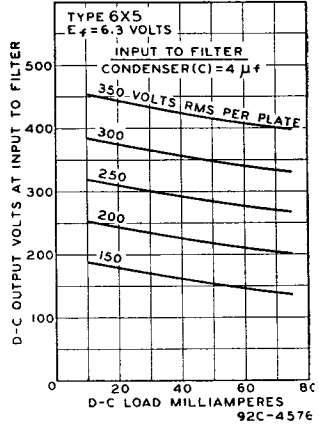

AVERAGE PLATE CHARACTERISTICS WITH E_{C1} AS VARIABLE

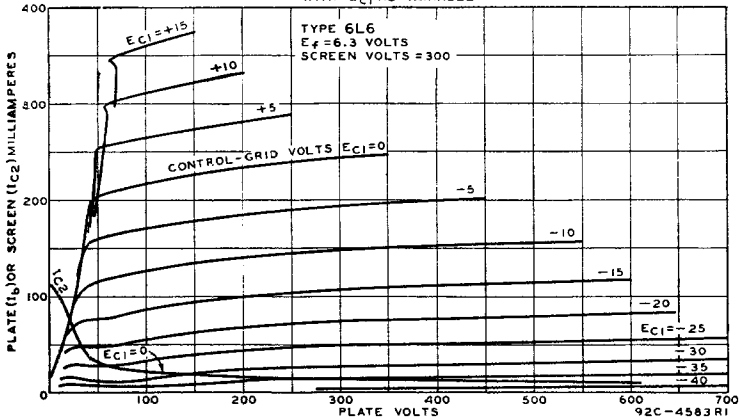

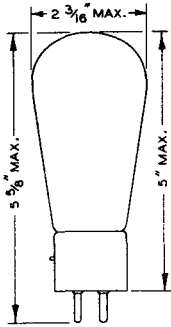

RCA-10

POWER AMPLIFIER OSCILLATOR

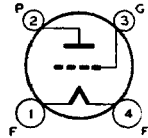

The 10 is a three-electrode, high-vacuum tube suitable for use as an audio-frequency amplifier in equipment designed for its characteristics.

CHARACTERISTICS

FILAMENT VOLTAGE (A. C. or D. C.)	7.5	Volts
FILAMENT CURRENT	1.25	Amperes
PLATE VOLTAGE	250 350 425 max.	Volts
GRID VOLTAGE*	-23.5 -32 -40	Volts
PLATE CURRENT	10 16 18	Milliamperes
PLATE RESISTANCE	6000 5150 5000	Ohms
AMPLIFICATION FACTOR	8 8 8	
TRANSCONDUCTANCE	1330 1550 1600	Micromhos
LOAD RESISTANCE	13000 11000 10200	Ohms
SELF-BIAS RESISTOR	2350 2000 2220	Ohms
UNDISTORTED POWER OUTPUT	0.4 0.9 1.6	Watts
GRID-PLATE CAPACITANCE	7	$\mu\mu\text{f}$
GRID-FILAMENT CAPACITANCE	4	$\mu\mu\text{f}$
PLATE-FILAMENT CAPACITANCE	3	$\mu\mu\text{f}$
BULB		S-17
BASE		Medium 4-Pin Bayonet

* Grid voltages are given with respect to the mid-point of filament operated on a. c. If d. c. is used, each stated value of grid voltage should be decreased by 5.0 volts and should be referred to the negative end of the filament.

INSTALLATION AND APPLICATION

The base pins of the 10 fit the standard four-contact socket which should be installed to hold the tube in a vertical position with the base down. The filament of this type is usually operated on a-c, see page 33. As an audio power amplifier, the 10 should be operated under conditions as given under CHARACTERISTICS.

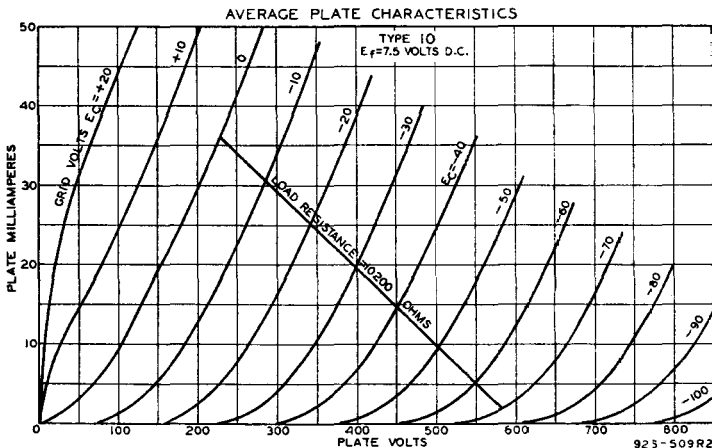

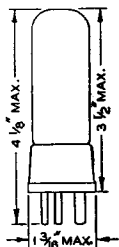

RCA-11

RCA-11, RCA-12

DETECTOR, AMPLIFIER

The 11 and 12 are three-electrode tubes for use as detector and amplifier in dry-cell operated receivers designed for their characteristics. Their electrical characteristics are identical.

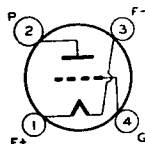

RCA-11

CHARACTERISTICS

FILAMENT VOLTAGE (D. C.)	1.1	Volts	
FILAMENT CURRENT	0.25	Ampere	
PLATE VOLTAGE	90	135 max.	Volts
GRID VOLTAGE	-4.5	-10.5	Volts
PLATE CURRENT	2.5	3	Milliamperes
PLATE RESISTANCE	15500	15000	Ohms
AMPLIFICATION FACTOR	6.6	6.6	
TRANSCONDUCTANCE	425	440	Micromhos
GRID-PLATE CAPACITANCE		3.3	$\mu\mu\text{f}$
GRID-FILAMENT CAPACITANCE		2.5	$\mu\mu\text{f}$
PLATE-FILAMENT CAPACITANCE		2.5	$\mu\mu\text{f}$

Volts
Ampere
Volts
Volts
Milliamperes
Ohms
Micromhos
 $\mu\mu\text{f}$
 $\mu\mu\text{f}$
 $\mu\mu\text{f}$

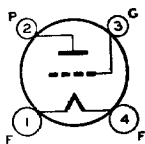

RCA-12

RCA-11 RCA-12

BULB T-8 T-10
BASE WD-4-Pin Med. 4-Pin Bayonet

These two types are used principally for renewal purposes.

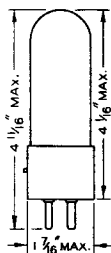

RCA-12

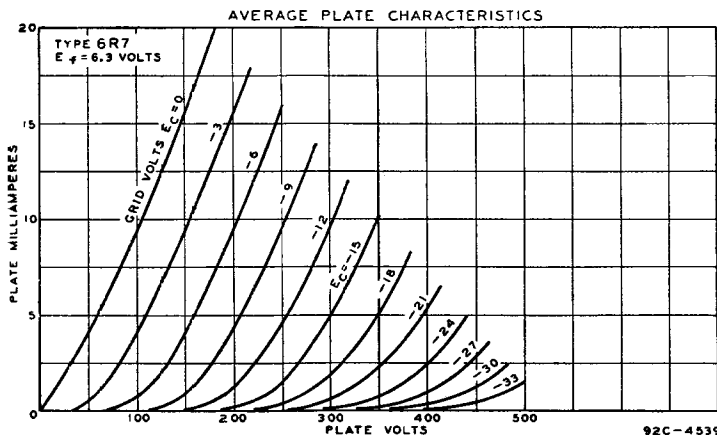

RCA-12Z3

HALF-WAVE RECTIFIER

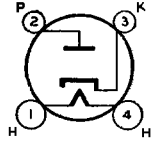
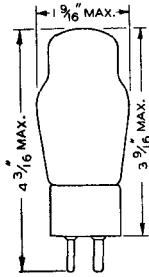

The 12Z3 is a half-wave, high-vacuum rectifier of the heater-cathode type for use in suitable circuits designed to supply d-c power from an a-c power line. It is intended for use in "transformerless" receivers of the "universal" (a.c.-d.c.) type. The adaptability of the 12Z3 to such receivers is facilitated by the heater design which permits of convenient series operation with other tube types.

CHARACTERISTICS

HEATER VOLTAGE (A. C. or D. C.).....	12.6	Volts
HEATER CURRENT	0.3	Ampere
A-C PLATE VOLTAGE (RMS).....	250 max.	Volts
PEAK INVERSE VOLTAGE.....	700 max.	Volts
D-C OUTPUT CURRENT.....	60 max.	Milliamperes
BULB		ST-12
BASE		Small 4-Pin

INSTALLATION

The base pins of the 12Z3 fit the standard four-contact socket which may be installed to hold the tube in any position. Sufficient ventilation should be provided to circulate air freely around the tube to prevent overheating.

The 12.6-volt heater of the 12Z3 is designed to operate under the normal conditions of line-voltage variation without materially affecting the performance or serviceability of this tube. For operation of the 12Z3 in series with the heaters of other types having 0.3 ampere rating, the current in the heater circuit should be adjusted to 0.3 ampere for the normal supply voltage. The d-c potential difference between heater and cathode should be limited to 350 volts.

APPLICATION

As a half-wave rectifier, the 12Z3 is particularly useful in "transformerless" receivers of the "universal" type. Conditions for this service are given under CHARACTERISTICS.

A filter of the condenser-input type is recommended for use with this tube in order to obtain a d-c output voltage as high as possible. A large input capacitance in the order of 16 μ f is desirable. Typical output curves for several values of input condensers are shown in the accompanying diagram. As a supplement to the curves with an a-c input voltage, a dashed curve is included to show the output when the receiver is operated from a d-c power line.

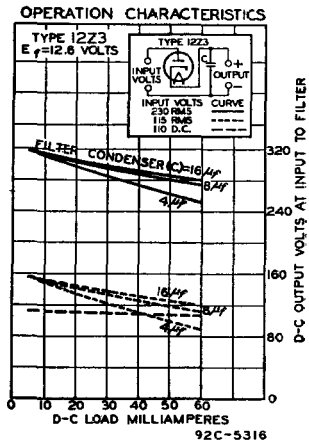

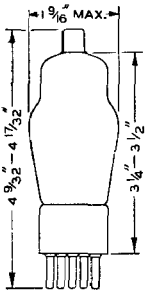

RCA-15

R-F AMPLIFIER PENTODE

The 15 is a heater-cathode pentode of the 2.0-volt type for use in battery-operated receivers that require a separate cathode connection.

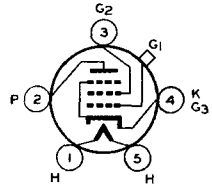

CHARACTERISTICS

HEATER VOLTAGE (D. C.)	2.0	Volts
HEATER CURRENT	0.22	Ampere
PLATE VOLTAGE	67.5	135 max. Volts
SCREEN VOLTAGE (Grid No. 2)	67.5	67.5 max. Volts
GRID VOLTAGE (Grid No. 1)	-1.5	-1.5 Volts
PLATE CURRENT	1.85	1.85 Milliampere
SCREEN CURRENT	0.3	0.3 Milliampere
PLATE RESISTANCE	0.63	0.8 Megohm
AMPLIFICATION FACTOR	450	600
TRANSCONDUCTANCE	710	750 Micromhos
GRID-PLATE CAPACITANCE (With shield-can)		0.01 μ f
INPUT CAPACITANCE		2.35 μ f
OUTPUT CAPACITANCE		7.80 μ f
BULB		ST-12
CAP		Small Metal
BASE		Small 5-Pin

INSTALLATION AND APPLICATION

The base pins of the 15 fit the standard five-pin socket which may be installed to hold the tube in any position.

The potential difference between heater and cathode should be kept as low as possible. In no event should it exceed 22.5 volts.

The APPLICATION of the 15 is similar to that of type 32. The heater-cathode construction permits operation where a separate cathode connection is required.

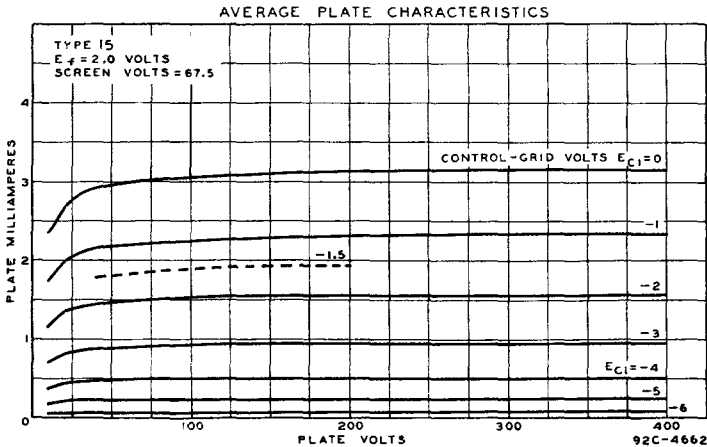

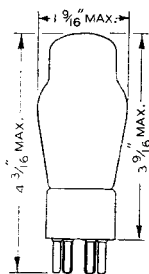

RCA-19

CLASS B TWIN AMPLIFIER

The 19 combines in one bulb two high- μ triodes designed for Class B operation. It is intended for use in the output stage of battery-operated receivers and is capable of supplying approximately 2 watts of audio power. The triode units have separate external terminals for all electrodes except the filaments, so that circuit design is similar to that of Class B amplifiers utilizing individual tubes in the output stage.

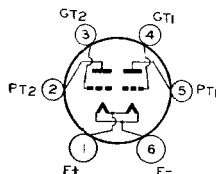

CHARACTERISTICS

FILAMENT VOLTAGE (D. C.).....	2.0	Volts
FILAMENT CURRENT	0.26	Ampere
BULB		ST-12
BASE		Small 6-Pin

As Class B Power Amplifier

PLATE VOLTAGE		135 max.	Volts	
MAXIMUM SIGNAL PLATE CURRENT (Per plate).....		50 max.	Milliamperes	
TYPICAL OPERATION				
Plate Voltage	135	135	135	Volts
Grid Voltage	-6	-3	0	Volts
Zero-Signal Plate Current (Per plate)	0.5	2	5	Milliamperes
Effective Load Resistance				
(Plate-to-plate)	10000	10000	10000	Ohms
Average Power Input (Approx.)*..	95	130	170	Milliwatts
Power Output (Approximate).....	1.6	1.9	2.1	Watts

* Applied between grids to give indicated values of power output.

INSTALLATION

The base pins of the 19 fit the standard six-contact socket. The socket should be installed to hold the tube in a vertical position. In some cases, cushioning of the socket may be found desirable.

For filament operation, refer to INSTALLATION for type 1A6.

APPLICATION

As a Class B power amplifier in the output stage of battery-operated receivers, the 19 should be operated as shown under CHARACTERISTICS. In such service, it may be operated either with zero grid bias or with negative grid bias. The latter method may be of advantage in cases where plate-battery drain must be conserved, even at some sacrifice in power output.

The type of driver tube chosen to precede the 19 should be capable of handling enough power to operate the Class B amplifier stage. Allowance should be made for transformer efficiency. It is most important, if low distortion is desired, that the driver tube be worked well below its Class A undistorted output rating, since distortion produced by the driver stage and the power stage will be present in the output. A discussion of Class B amplifier features is given on page 20.

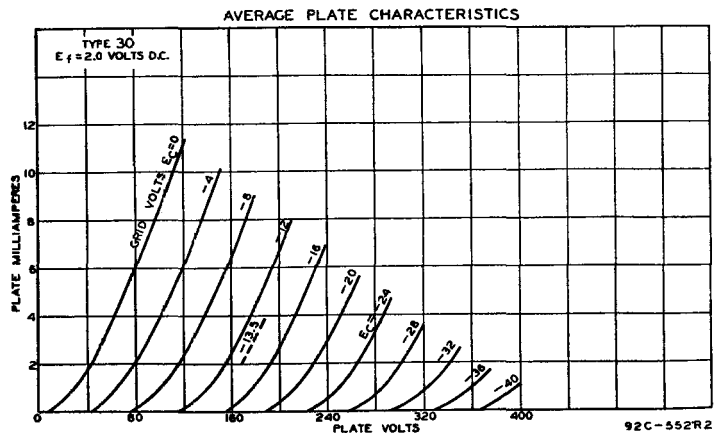
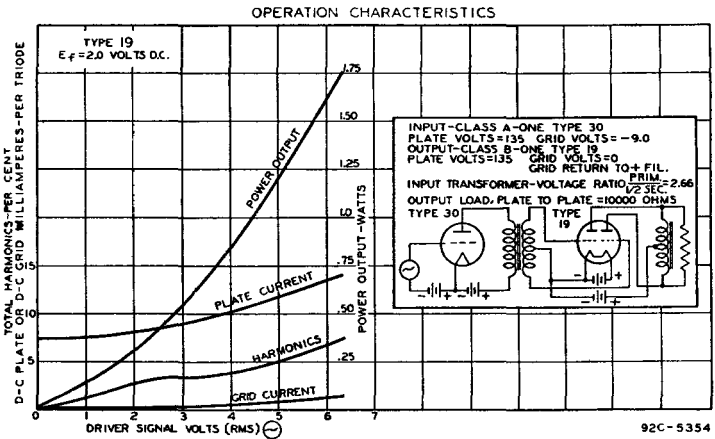
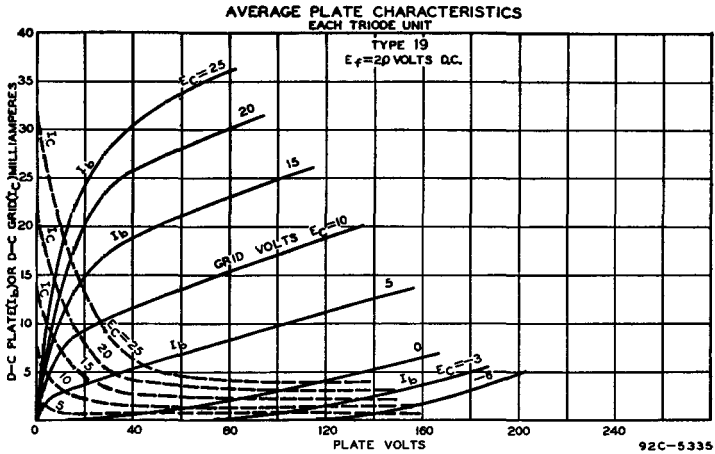

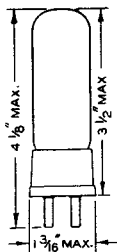

RCA-20

POWER AMPLIFIER

The 20 is a power amplifier triode for use in dry-battery operated receivers employing 3.3-volt filament tubes.

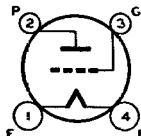

CHARACTERISTICS

FILAMENT VOLTAGE (D.C.)	3.0- 3.3	Volts
FILAMENT CURRENT	0.125-0.132	Ampere
PLATE VOLTAGE	90 135 max.	Volts
GRID VOLTAGE	-16.5 -22.5	Volts
PLATE CURRENT	3 6.5	Milliamperes
PLATE RESISTANCE	8000 6300	Ohms
AMPLIFICATION FACTOR	3.3 3.3	
TRANSCONDUCTANCE	415 525	Micromhos
LOAD RESISTANCE	9600 6500	Ohms
UNDISTORTED POWER OUTPUT	45 110	Milliwatts
GRID-PLATE CAPACITANCE	4.1	μf
GRID-FILAMENT CAPACITANCE	2.0	μf
PLATE-FILAMENT CAPACITANCE	2.3	μf
BULB		T-8
BASE		Small 4-Pin

This type is used principally for renewal purposes.

—o00o—

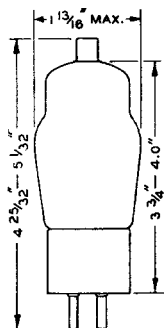

RCA-22

SCREEN-GRID RADIO-FREQUENCY AMPLIFIER

The 22 is a screen grid tube designed particularly for radio-frequency amplification in dry-battery-operated receivers employing 3.3-volt filament tubes.

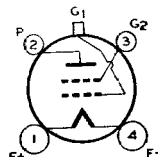

CHARACTERISTICS

FILAMENT VOLTAGE (D. C.)	3.3	Volts
FILAMENT CURRENT	0.132	Ampere
PLATE VOLTAGE	135 135 max.	Volts
SCREEN VOLTAGE (Grid No. 2)	45* 67.5† max.	Volts
GRID VOLTAGE (Grid No. 1)	-1.5 -1.5	Volts
PLATE CURRENT	1.7 3.7	Milliamperes
SCREEN CURRENT (Maximum)	0.6 1.3	Milliamperes
PLATE RESISTANCE	725000 325000	Ohms
AMPLIFICATION FACTOR	270 160	
TRANSCONDUCTANCE	375 500	Micromhos
GRID-PLATE CAPACITANCE (With shield-can)	0.02 max.	μf
INPUT CAPACITANCE	4.0	μf
OUTPUT CAPACITANCE	10	μf
BULB		ST-14
CAP		Small Metal
BASE		Medium 4-Pin

* Maximum value of grid resistor is 5.0 megohms. † Maximum value of grid resistor is 1.0 megohm.

This type is used principally for renewal purposes.

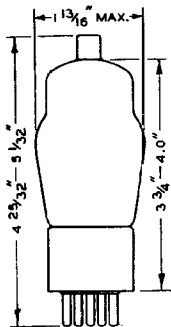

RCA-24-A

SCREEN-GRID RADIO-FREQUENCY AMPLIFIER

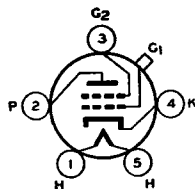

The 24-A is a screen-grid amplifier tube of the heater-cathode type for use primarily as a radio-frequency amplifier in a-c receivers. The 24-A may also be used as a screen-grid detector or audio amplifier.

CHARACTERISTICS

HEATER VOLTAGE (A. C. or D. C.)	2.5	Volts
HEATER CURRENT	1.75	Amperes
PLATE VOLTAGE*	180	250
SCREEN VOLTAGE (Grid No. 2)	90 max.	90 max.
GRID VOLTAGE (Grid No. 1)	-3	-3
PLATE CURRENT	4	4
SCREEN CURRENT (Maximum)	1.7	1.7
PLATE RESISTANCE	0.4	0.6
AMPLIFICATION FACTOR	400	630
TRANSCONDUCTANCE	1000	1050
GRID-PLATE CAPACITANCE (With shield-can)	0.007 max.	μf
INPUT CAPACITANCE		5.3 μf
OUTPUT CAPACITANCE		10.5 μf
BULB		ST-14
CAP		Small Metal
BASE		Medium 5-Pin

* Maximum plate voltage = 275 volts.

INSTALLATION AND APPLICATION

The base pins of the 24-A fit the standard five-contact socket. The socket may be installed to hold the tube in any position. For heater operation and cathode connection, refer to type 2A5. The screen voltage for the 24-A may be obtained from a fixed or variable tap on a voltage divider across the high-voltage supply, or across a portion of the supply. Complete shielding in all stages of the circuit is necessary if maximum gain per stage is to be obtained.

AVERAGE PLATE CHARACTERISTICS

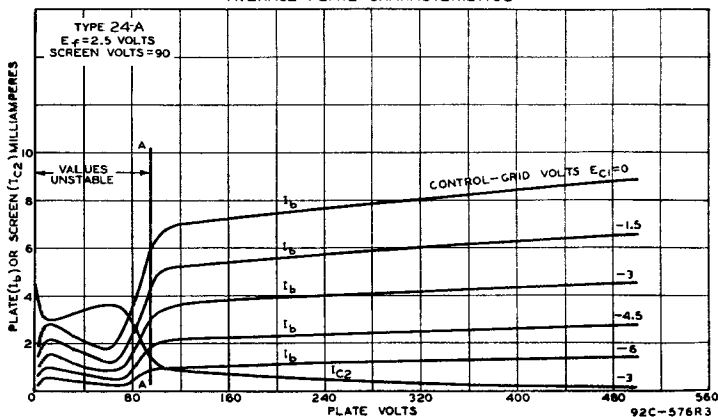

RCA-25A6

POWER-AMPLIFIER PENTODE

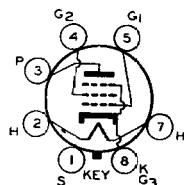
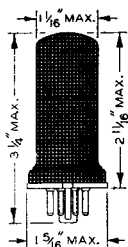

The 25A6 is a power-amplifier pentode of the All-Metal type for use in the output stage of radio receivers, especially those of the "d-c power line" or "universal" type. In

such applications, the 25A6 is capable of handling relatively large audio power.

CHARACTERISTICS

HEATER VOLTAGE (A. C. or D. C.).....			25	Volts
HEATER CURRENT			0.3	Ampere
PLATE VOLTAGE	95	135	180 <i>max.</i>	Volts
SCREEN VOLTAGE (Grid No. 2).....	95	135	135 <i>max.</i>	Volts
GRID VOLTAGE (Grid No. 1).....	-15	-20	-20	Volts
PLATE CURRENT	20	37	38	Milliamperes
SCREEN CURRENT	4	8	7.5	Milliamperes
PLATE RESISTANCE (Approximate)...	45000	35000	40000	Ohms
AMPLIFICATION FACTOR (Approx.)...	90	85	100	
TRANSCONDUCTANCE	2000	2450	2500	Micromhos
LOAD RESISTANCE	4500	4000	5000	Ohms
SELF-BIAS RESISTOR	625	440	440	Ohms
POWER OUTPUT	0.9*	2‡	2.75‡	Watts
BASE	Small Wafer Octal 7-Pin			

* 11% total harmonic distortion.

‡ 10% total harmonic distortion.

† 9% total harmonic distortion.

INSTALLATION

The **base** pins of the 25A6 fit the standard octal socket which may be installed to hold the tube in any position.

The 25-volt **heater** of the 25A6 is designed to operate under the normal conditions of line-voltage variation without materially affecting the performance or serviceability of this tube. For operation of the 25A6 in series with the heaters of other types having 0.3-ampere rating, the current in the heater circuit should be adjusted to 0.3 ampere for the normal supply voltage.

In a series-heater circuit of the "d-c power line" type employing several 0.3-ampere (6.3-volt) types and one or two 25A6's, the heaters of the 25A6's should be placed on the positive side of the line. Under these conditions, heater-cathode voltage of the 25A6 must not exceed the value given under **cathode**. In a series-heater circuit of the "universal" type employing rectifier tube 25Z6, one or two 25A6's, and several 0.3-ampere (6.3-volt) types, it is recommended that the heater(s) of the 25A6(s) be placed in the circuit so that the higher values of heater-cathode bias will be impressed on the 25A6(s) rather than on the 6.3-volt types. This is accomplished by arranging the 25A6(s) on the side of the supply line which is connected to the cathode of the rectifier, i.e., the positive terminal of the rectified voltage supply. Between this side of the line and the 25A6(s), any necessary auxiliary resistance and the heater of the 25Z6 are connected in series.

The **cathode** circuit in "d-c power line" or "universal" receivers is tied in either directly or through biasing resistors to the negative side of the d-c plate supply which is furnished either by the d-c power line or by the a-c line by means of a rectifier. The potential difference thus introduced between heater and cathode of the 25A6 should not exceed 90 volts d.c., as measured between the negative heater terminal and the cathode.

APPLICATION

As a power amplifier (Class A), the 25A6 is recommended for use either singly or in push-pull combination in the power output stages of "d-c power line" and "universal" receivers. Recommended operating conditions are given under CHARACTERISTICS.

The self-bias resistor should be shunted by a suitable filter network to avoid degenerative effects at low audio frequencies. The use of two 25A6's in push-pull eliminates the necessity for shunting the resistor. The self-bias resistor for two 25A6's in the same stage is approximately one-half the value given for single-tube operation.

The total d-c resistance in the grid circuit should not exceed 0.5 megohm with self-bias; or 0.5 megohm for the 95-volt condition and 50000 ohms for the 135-volt and 180-volt conditions with fixed bias.

An additional plate family for this type is shown under type 43.

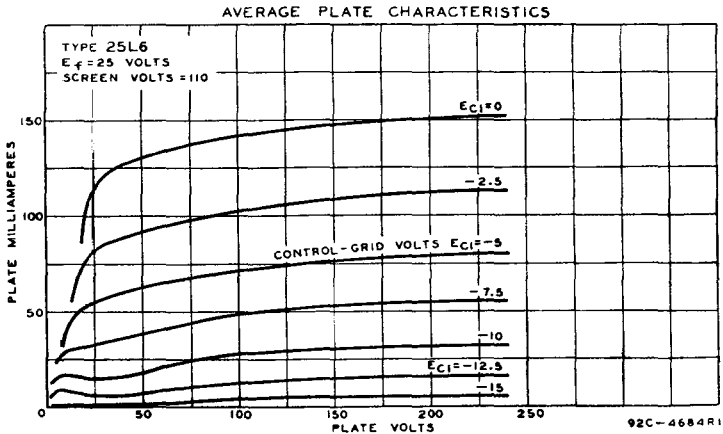
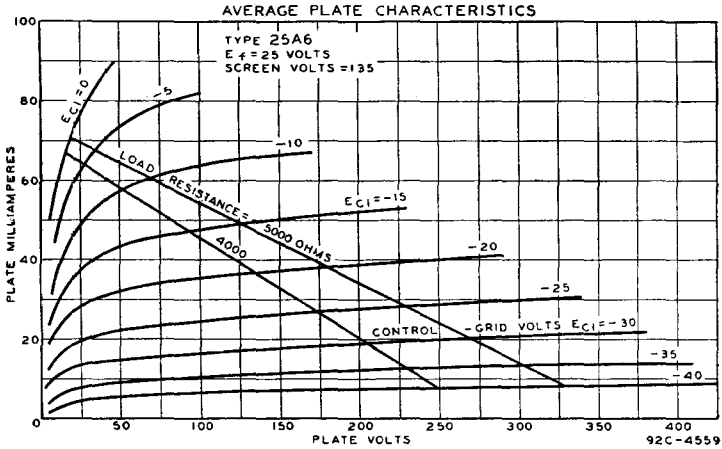

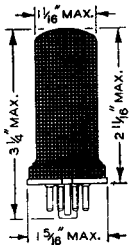

RCA-25L6

BEAM POWER AMPLIFIER

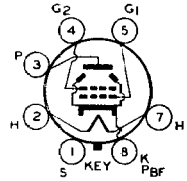

The 25L6 is a power-amplifier tube of the All-Metal type for use in the output stage of "transformerless" (a.c.-d.c.) radio receivers, especially those designed to have ample reserve of power-delivering ability. The new tube provides high power output at the relatively low plate and screen voltages available for transformerless receivers. The high power output is obtained with high power sensitivity and high efficiency.

These distinctive features have been made possible by the application of directed-electron-beam principles in the design of the 25L6. The design is similar to that of the RCA-6L6 with the difference that the 25L6 is intended for operation in a.c.-d.c. receivers.

TENTATIVE CHARACTERISTICS

HEATER VOLTAGE (A. C. or D. C.).....	25.0	Volts
HEATER CURRENT	0.3	Ampere
BASE	Small Wafer	Octal 7-Pin

As Single-Tube Class A₁ Amplifier

PLATE VOLTAGE	110	110	Volts
SCREEN VOLTAGE (Grid No. 2).....	110	110	Volts
GRID VOLTAGE (Grid No. 1).....	-7.5	-7.5	Volts
PEAK A-F GRID VOLTAGE.....	7.5	7.5	Volts
ZERO-SIGNAL PLATE CURRENT.....	49	49	Milliamperes
MAX.-SIGNAL PLATE CURRENT.....	54	50	Milliamperes
ZERO-SIGNAL SCREEN CURRENT.....	4	4	Milliamperes
MAX.-SIGNAL SCREEN CURRENT.....	9	11	Milliamperes
PLATE RESISTANCE (Approx.).....	10000	10000	Ohms
TRANSCONDUCTANCE	8200	8200	Micromhos
LOAD RESISTANCE	1500	2000	Ohms
DISTORTION:			
Total Harmonic	11	10	Per cent
Second Harmonic	10	3.5	Per Cent
Third Harmonic	4	8.5	Per cent
POWER OUTPUT	2.1	2.2	Watts

INSTALLATION

The base pins of the 25L6 fit the standard octal-base socket which may be installed to hold the tube in any position. For heater operation and cathode connection, refer to type 25A6.

APPLICATION

The 25L6 should be operated as shown under CHARACTERISTICS. The values have been determined on the basis that grid current does not flow during any part of the input cycle. The type of input coupling used should not introduce too much resistance in the grid circuit. Transformer- or impedance-coupling devices are recommended. When the grid circuit has a d-c resistance not higher than 0.1 megohm, fixed bias may be used; for higher values, self-bias is required. With self-bias, the grid circuit may have a d-c resistance as high as, but not greater than 0.5 megohm. A family of plate characteristic curves is given on the preceding page.

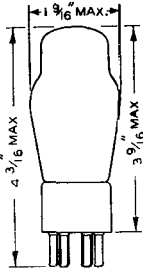

RCA-25Z5

RECTIFIER-DOUBLER

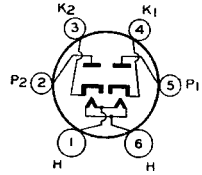

The 25Z5 is a full-wave, high-vacuum rectifier of the heater-cathode type for use in suitable circuits designed to supply d-c power from an a-c power line. This tube is well

suited for "transformerless" receivers of either the "universal (a.c.-d.c.)" type or the "a-c operated" type. In "universal" receivers, the 25Z5 may be used as a half-wave rectifier, while in the "a-c operated" type, it may be used as a voltage doubler to provide about twice the d-c output voltage obtainable from the half-wave arrangement. This two-fold application is made possible by the use of a separate base pin for each of the two cathodes. For voltage-doubler considerations, see page 25.

CHARACTERISTICS

HEATER VOLTAGE (A. C. or D. C.).....	25	Volts
HEATER CURRENT	0.3	Ampere
BULB		ST-12
BASE		Small 6-Pin

As Voltage Doubler

A-C PLATE VOLTAGE PER PLATE (RMS).....	125 max.	Volts
PEAK PLATE CURRENT.....	500 max.	Milliamperes
D-C OUTPUT CURRENT.....	100 max.	Milliamperes

As Half-Wave Rectifier

A-C PLATE VOLTAGE PER PLATE (RMS)...	125 max.	250* max.	Volts
PEAK PLATE CURRENT (per plate).....	500 max.	500 max.	Milliamperes
D-C OUTPUT CURRENT (per plate).....	85	85 max.	Milliamperes

* On a-c input voltage above 125 volts, it is necessary to connect a 100 ohm resistor in series with each plate lead, or a 100 ohm resistor common to both plates (giving somewhat poorer regulation) may be used.

INSTALLATION AND APPLICATION

The base pins of the 25Z5 fit the standard six-contact socket which may be installed to hold the tube in any position. The bulb of this tube will become quite hot under certain conditions of operation. Sufficient ventilation should be provided to circulate air freely around the tube to prevent overheating. For heater operation, filter considerations, and APPLICATION, refer to type 25Z6.

Operation curves and circuits are given on the following page.

OPERATION CHARACTERISTICS
HALF-WAVE RECTIFIER

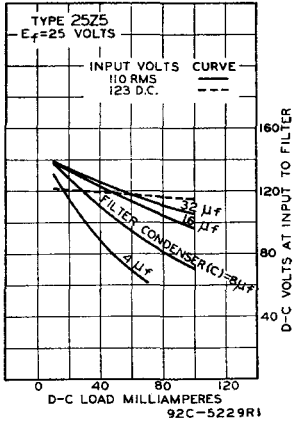

OPERATION CHARACTERISTICS
VOLTAGE DOUBLER

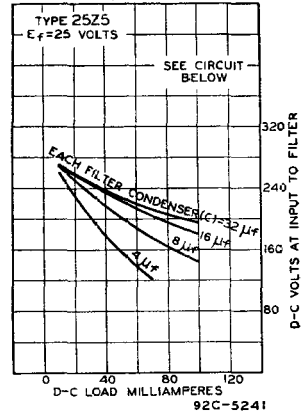

OPERATION CHARACTERISTICS
HALF-WAVE RECTIFIER

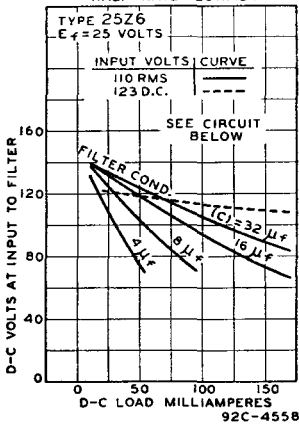

OPERATION CHARACTERISTICS
VOLTAGE DOUBLER

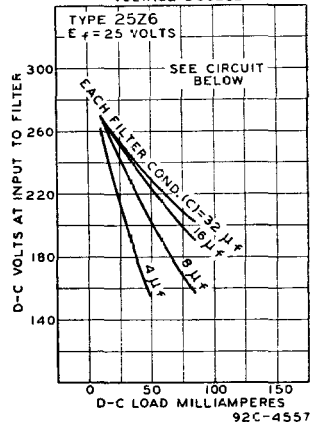

HALF-WAVE RECTIFIER CIRCUIT

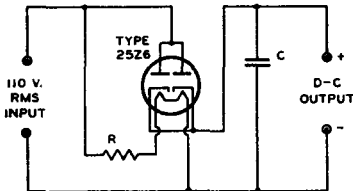

R = HEATER VOLTAGE-DROPPING RESISTOR
C = FILTER CONDENSER

VOLTAGE-DOUBLER CIRCUIT

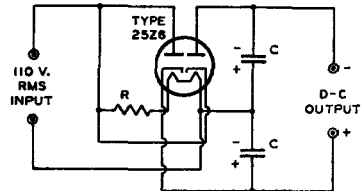

R = HEATER VOLTAGE-REDUCING RESISTOR
C = FILTER CONDENSER

RCA-25Z6

RECTIFIER-DOUBLER

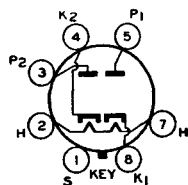
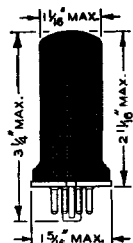

The 25Z6 is a full-wave, high-vacuum rectifier of the heater-cathode type for use in suitable circuits designed to supply d-c power from an a-c power line. This tube is well

suited for "transformerless" receivers of either the "universal (a.c.-d.c.)" type or the "a-c operated" type. In "universal" receivers, the 25Z6 may be used as a half-wave rectifier, while in the "a-c operated" type, it may be used as a voltage doubler to provide about twice the d-c output voltage obtainable from the half-wave arrangement. For voltage-doubler considerations, see page 25.

CHARACTERISTICS

HEATER VOLTAGE (A. C. or D. C.).....	25	Volts
HEATER CURRENT	0.3	Ampere
BASE	Small Wafer Octal 7-Pin	

As Voltage Doubler

A-C PLATE VOLTAGE PER PLATE (RMS).....	125 max.	Volts
PEAK PLATE CURRENT.....	500 max.	Milliamperes
D-C OUTPUT CURRENT.....	85 max.	Milliamperes

As Half-Wave Rectifier

A-C PLATE VOLTAGE PER PLATE (RMS)...	125 max.	250* max.	Volts
PEAK PLATE CURRENT PER PLATE.....	500 max.	500 max.	Milliamperes
D-C OUTPUT CURRENT PER PLATE.....	85 max.	85 max.	Milliamperes

* An a-c input voltage greater than 125 volts requires the use of a series resistor or resistors. A 100-ohm resistor in each plate lead or a 100-ohm resistor common to both plates (giving somewhat poorer regulation) may be used.

INSTALLATION

The base pins of the 25Z6 fit the standard octal socket which may be installed to hold the tube in any position.

The heater is designed to operate under the normal conditions of line voltage variation without materially affecting the performance or serviceability of this tube. The current in the heater circuit should be adjusted to 0.3 ampere for the normal supply voltage.

A filter of the condenser-input type is recommended for use with this tube in order to obtain a d-c output voltage as high as possible. A large input capacitance in the order of 16 μ f is desirable for half-wave rectifier service, while a higher value is advantageous for voltage-doubler circuits.

APPLICATION

As a half-wave rectifier, the 25Z6 is designed for service in "transformerless" receivers of the "universal" type. In such service, the two plates are connected together at the socket in order to act as a single plate; likewise, the cathodes are connected as a unit. Conditions for this method of operation are given under CHARACTERISTICS. Typical output curves for several values of input condensers are shown on page 109. As a supplement to the curves with a-c input voltage, a dotted curve is included to show the output when the receiver is operated from a d-c power line.

As a voltage doubler, the 25Z6 is useful in "transformerless" receivers of the "a-c operated" type and is capable of supplying approximately twice the d-c output voltage of the half-wave circuit. In voltage-doubling service, the two diode units of the tube are arranged as shown in the voltage-doubler circuit, below. Circuits are given on the preceding page.

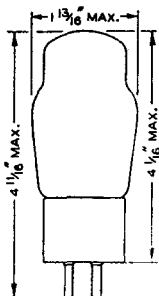

RCA-26

AMPLIFIER

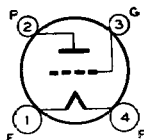

The 26 is an amplifier tube containing a filament designed for operation on alternating current. This tube is for use as an r-f or a-f amplifier in equipment designed for

its characteristics. The 26 is not ordinarily suitable for use as a detector or power output tube.

CHARACTERISTICS

FILAMENT VOLTAGE (A. C. or D. C.)	1.5	Volts
FILAMENT CURRENT	1.05	Amperes
PLATE VOLTAGE	90 135 180 <i>max.</i>	Volts
GRID VOLTAGE*	-7 -10 -14.5	Volts
PLATE CURRENT	2.9 5.5 6.2	Milliamperes
PLATE RESISTANCE	8900 7600 7300	Ohms
AMPLIFICATION FACTOR	8.3 8.3 8.3	
TRANSCONDUCTANCE	935 1100 1150	Micromhos
GRID-PLATE CAPACITANCE	8.1	$\mu\mu\text{f}$
GRID-FILAMENT CAPACITANCE	2.8	$\mu\mu\text{f}$
PLATE-FILAMENT CAPACITANCE	2.5	$\mu\mu\text{f}$
BULB		ST-14
BASE		Medium 4-Pin

* Grid voltage measured from mid-point of a-c operated filament.

INSTALLATION AND APPLICATION

The base pins of the 26 fit the standard four-contact socket, which should be installed to hold the tube in a vertical position.

The coated filament of the 26 should be operated at the rated voltage of 1.5 volts from the a-c line through a step-down transformer.

As an amplifier, the 26 should be operated as shown under CHARACTERISTICS.

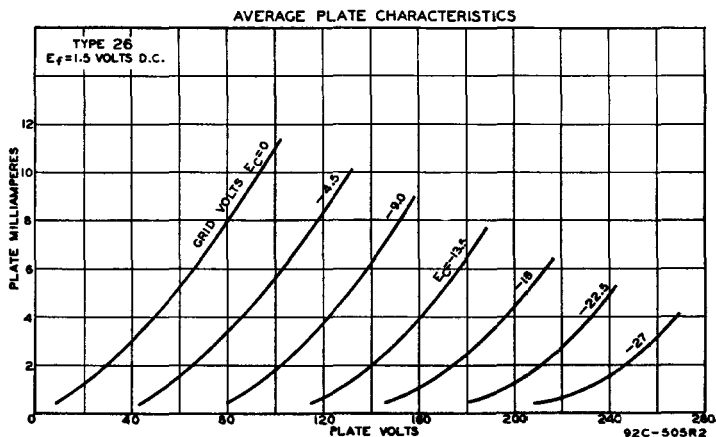

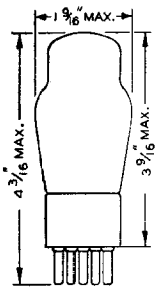

RCA-27

DETECTOR, AMPLIFIER

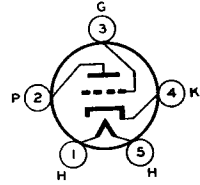

The 27 is a three-electrode general purpose tube of the heater-cathode type for use as an amplifier and detector in a-c receivers.

CHARACTERISTICS

HEATER VOLTAGE (A. C. or D. C.)					2.5	Volts
HEATER CURRENT					1.75	Amperes
PLATE VOLTAGE*	90	135	180		250	Volts
GRID VOLTAGE†	-6	-9	-13.5		-21	Volts
PLATE CURRENT	2.7	4.5	5.0		5.2	Milliamperes
PLATE RESISTANCE	11000	9000	9000		9250	Ohms
AMPLIFICATION FACTOR	9	9	9		9	
TRANSCONDUCTANCE	820	1000	1000		975	Micromhos
GRID-PLATE CAPACITANCE					3.3	$\mu\mu\text{f}$
GRID-CATHODE CAPACITANCE					3.1	$\mu\mu\text{f}$
PLATE-CATHODE CAPACITANCE					2.3	$\mu\mu\text{f}$
BULB						ST-12
BASE						Small 5-Pin

* Maximum plate voltage = 275 volts.

† Maximum value of d-c resistance in grid circuit is 1.0 megohm.

INSTALLATION AND APPLICATION

The base pins of the 27 fit the standard five-contact socket. The socket may be installed to hold the tube in any position.

For heater operation and cathode connection, refer to type 2A5.

As an amplifier, the 27 is applicable to the audio- or the radio-frequency stages of a receiver. Recommended plate and grid voltages are shown under CHARACTERISTICS.

As a detector, the 27 may be operated either with grid leak and condenser or with grid bias. The plate voltage for grid leak and condenser detection is 45 volts. A grid leak of from 1 to 5 megohms used with a grid condenser of 0.00025 μf is suitable. For grid-bias detection, a plate voltage of 275 volts or less may be used. The corresponding grid bias should be adjusted so that the plate current, when no signal is being received, is approximately 0.2 milliamperes. For the condition of 250 volts on plate and transformer coupling, the grid bias will be approximately -30 volts.

AVERAGE PLATE CHARACTERISTICS

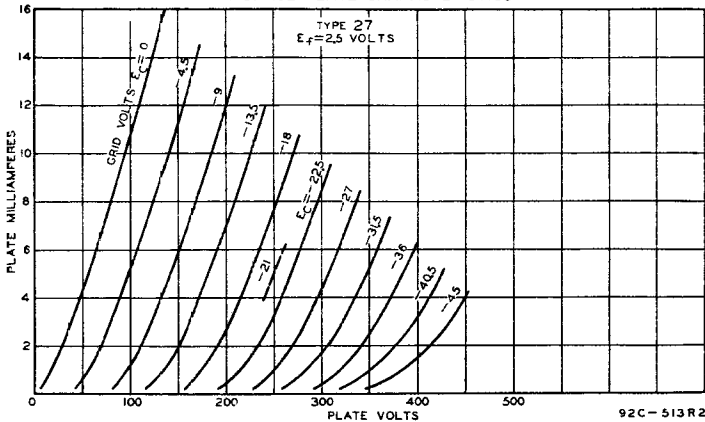

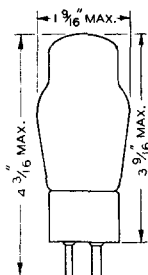

RCA-30

DETECTOR, AMPLIFIER

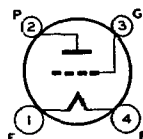

The 30 is a detector and amplifier tube of the three-electrode type for battery-operated radio receivers where economy of filament-current drain is important.

CHARACTERISTICS

FILAMENT VOLTAGE (D. C.)	2.0	Volts
FILAMENT CURRENT	0.060	Ampere
GRID-PLATE CAPACITANCE	6.0	μf
GRID-FILAMENT CAPACITANCE	3.0	μf
PLATE-FILAMENT CAPACITANCE	2.1	μf
BULB		ST-12
BASE		Small 4-Pin

As Class A₁ Amplifier

PLATE VOLTAGE	90	135	180 max.	Volts
GRID VOLTAGE	-4.5	-9	-13.5	Volts
PLATE CURRENT	2.5	3.0	3.1	Milliamperes
PLATE RESISTANCE	11000	10300	10300	Ohms
AMPLIFICATION FACTOR	9.3	9.3	9.3	
TRANSCONDUCTANCE	850	900	900	Micromhos

As Class B Amplifier

PLATE VOLTAGE	180 max.	Volts
MAXIMUM-SIGNAL PLATE CURRENT	50 max.	Milliamperes
ZERO-SIGNAL PLATE CURRENT (Per tube)	1.5 max.	Milliamperes
TYPICAL OPERATION (2 tubes)		

Values are for two tubes.

Plate Voltage	157.5	Volts
Grid Voltage	-15	Volts
Zero-Signal Plate Current (Per tube)	1.0	Milliampere
Effective Load Resistance (Plate-to-plate)	8000	Ohms
Maximum-Signal Driving Power	260	Milliwatts
Power Output, Approximate*	2.1	Watts

* With one type 30 as driver operated under the following conditions: Plate voltage, 157.5 volts, negative grid bias voltage, 11.3 volts; plate load of approximately 18000 ohms; and input transformer ratio (primary to one-half secondary), 1.165: Total distortion is 6 to 7%.

INSTALLATION AND APPLICATION

The base pins of the 30 fit the standard four-contact socket which should be installed to hold the tube in a vertical position. Cushioning of the socket in the detector stage may be desirable if microphonic disturbances are encountered. For filament operation, refer to INSTALLATION on type 1A6.

As a detector, the 30 may be operated either with grid leak and condenser or with grid-bias. The plate voltage for the former method should not be more than 45 volts. A grid leak of from 1 to 5 megohms used with a grid condenser of 0.00025 μf is satisfactory. The grid return should be connected to the positive filament socket terminal. For grid-bias detection, plate voltages up to the maximum value of 180 volts may be used. The corresponding grid-bias should be adjusted so that the plate current is about 0.2 milliampere when no signal is being received.

In resistance-coupled service, the maximum d-c resistance in the grid circuit should not exceed 2 megohms.

A family of plate characteristic curves is given on page 102.

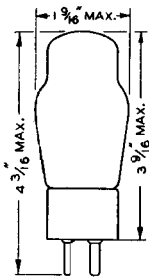

RCA-31

POWER AMPLIFIER

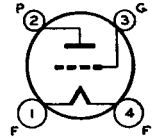

The 31 is a power-amplifier tube of the three-electrode type for battery-operated radio receivers where economy of filament-current drain is important.

CHARACTERISTICS

FILAMENT VOLTAGE (D. C.).....	2.0	Volts
FILAMENT CURRENT	0.130	Ampere
PLATE VOLTAGE	135 180 <i>max.</i>	Volts
GRID VOLTAGE	-22.5 -30	Volts
PLATE CURRENT	8.0 12.3	Milliamperes
PLATE RESISTANCE	4100 3600	Ohms
AMPLIFICATION FACTOR	3.8 3.8	
TRANSCONDUCTANCE	925 1050	Micromhos
LOAD RESISTANCE	7000 5700	Ohms
SELF-BIAS RESISTOR	2815 2440	Ohms
UNDISTORTED POWER OUTPUT.....	0.185 0.375	Watt
GRID-PLATE CAPACITANCE	5.7	$\mu\mu\text{f}$
GRID-FILAMENT CAPACITANCE	3.5	$\mu\mu\text{f}$
PLATE-FILAMENT CAPACITANCE	2.7	$\mu\mu\text{f}$
BULB		ST-12
BASE		Small 4-Pin

INSTALLATION

Refer to INSTALLATION on type 30.

APPLICATION

As a **power amplifier**, the 31 should be operated as shown under CHARACTERISTICS. Grid voltage may be obtained from a C-battery, or by means of a self-bias resistor connected in the negative plate-return lead. The latter method is required where a grid resistor (maximum value 1 megohm) is used. If more output is desired than can be obtained from a single 31, two 31's may be operated either in parallel or **push-pull connection**.

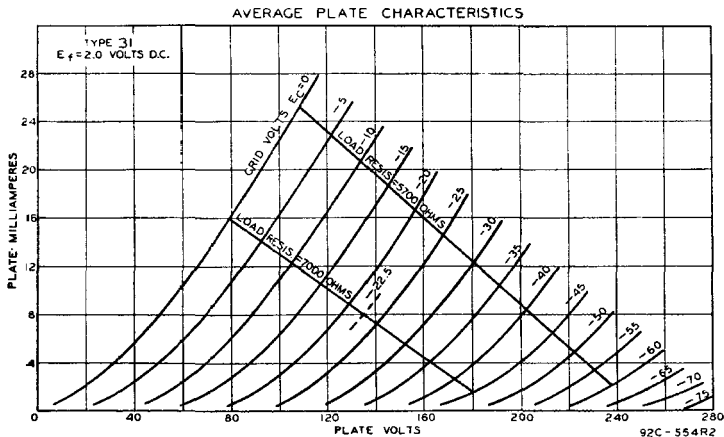

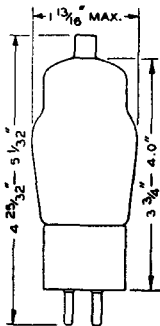

RCA-32

RADIO-FREQUENCY AMPLIFIER

The 32 is a screen-grid tube recommended primarily for use as a radio-frequency amplifier in battery-operated radio receivers where economy of filament-current drain is important.

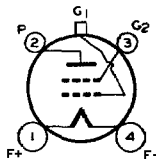

CHARACTERISTICS

FILAMENT VOLTAGE (D. C.)	2.0	Volts
FILAMENT CURRENT	0.060	Ampere
PLATE VOLTAGE	135	180 max. Volts
SCREEN VOLTAGE (Grid No. 2)	67.5 max.	67.5 max. Volts
GRID VOLTAGE (Grid No. 1)	-3	-3 Volts
PLATE CURRENT	1.7	1.7 Milliampere
SCREEN CURRENT (Maximum)	0.4	0.4 Milliampere
PLATE RESISTANCE	0.95	1.2 Megohms
AMPLIFICATION FACTOR	610	780
TRANSCONDUCTANCE	640	650 Micromhos
GRID-PLATE CAPACITANCE (With shield-can)	0.015 max.	μ mf
INPUT CAPACITANCE		5.3 μ mf
OUTPUT CAPACITANCE		10.5 μ mf
BULB		ST-14
CAP		Small Metal
BASE		Medium 4-Pin

INSTALLATION AND APPLICATION

For **socket mounting** and **filament operation**, refer to **INSTALLATION** for type 30.

The **screen voltage** may be obtained from a tap on the plate battery or a bleeder circuit across the supply battery in whole or in part. Never attempt to obtain the screen voltage for the 32 by connecting the screen through a series resistor to a high-voltage source. The results will not be satisfactory because of voltage-drop variation produced by the different screen currents of individual tubes. **Volume control** may be effected by variation of the screen voltage between 0 and 67.5 volts. The variation must, however, be made by a potentiometer shunted across the screen-voltage supply and not by a high-resistance rheostat.

Complete **shielding** of all stages is recommended if maximum gain per stage is to be obtained.

As a **detector**, the 32 may be operated either with grid leak and condenser or with grid bias. For grid bias detection, suitable operating conditions are: Plate-supply voltage, 180 volts applied through a plate-coupling resistance of 0.1 megohm or an equivalent impedance; screen voltage, 67.5 volts; and a negative grid bias (approximately 6 volts) adjusted so that a plate current of 0.2 milliampere is obtained with no input signal. In designing circuits to use the 32 as a detector, it is desirable to work from the detector stage directly into the power-output stage.

The d-c resistance in the grid circuit of the 32 should not exceed 2 megohms.

A family of plate characteristic curves is given on page 118.

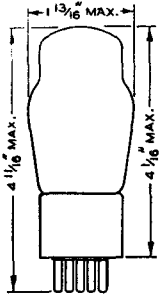

RCA-33

POWER-AMPLIFIER PENTODE

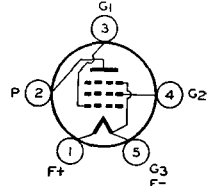

The 33 is a power-amplifier pentode for use in the output stage of battery-operated receivers where economy of battery consumption is important.

CHARACTERISTICS

FILAMENT VOLTAGE (D. C.)	2.0	Volts
FILAMENT CURRENT	0.260	Ampere
PLATE VOLTAGE	135	180 max. Volts
SCREEN VOLTAGE (Grid No. 2)	135	180 max. Volts
GRID VOLTAGE (Grid No. 1)	-13.5	-18 Volts
PLATE CURRENT	14.5	22 Milliamperes
SCREEN CURRENT	3	5 Milliamperes
PLATE RESISTANCE	50000	55000 Ohms
AMPLIFICATION FACTOR (Approx.)	70	90
TRANSCONDUCTANCE	1450	1700 Micromhos
LOAD RESISTANCE	7000	6000 Ohms
SELF-BIAS RESISTOR	770	670 Ohms
POWER OUTPUT (7% total harmonic distort.)	0.7	1.4 Watts
BULB		ST-14
BASE		Medium 5-Pin

INSTALLATION AND APPLICATION

The base pins of the 33 fit the standard five-contact socket. The socket should be installed to hold the tube in a vertical position. In some cases, cushioning of the socket may be found desirable. For filament operation, refer to INSTALLATION for type 1A6.

For the power amplifier stage of radio receivers, the 33 is recommended either singly or in push-pull combination. More than one audio stage preceding the 33 is undesirable because of the possibility of microphonic disturbances resulting from the high level of amplification. Transformer or impedance coupling devices are preferable. If resistance coupling is employed, the d-c resistance in the grid circuit should not exceed 1.0 megohm under self-bias conditions; without self-bias, the maximum value is 0.5 megohm.

AVERAGE PLATE CHARACTERISTICS

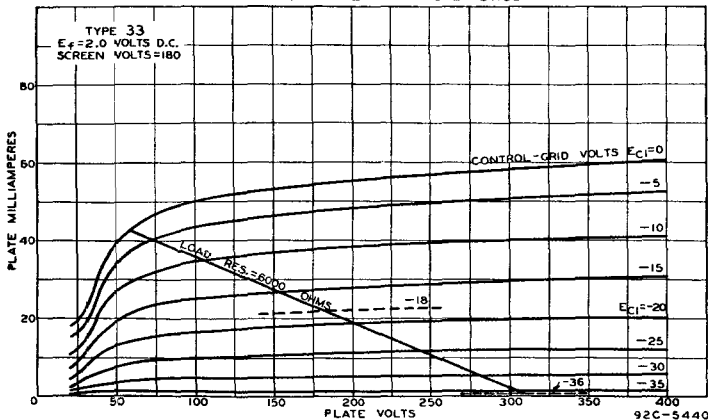

RCA-34

SUPER-CONTROL R-F AMPLIFIER PENTODE

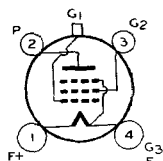
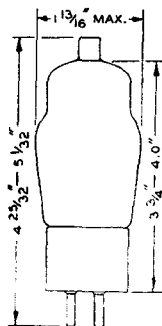

The 34 is a super-control pentode recommended for use primarily as a radio-frequency amplifier and intermediate-frequency amplifier in battery-operated receivers where economy of filament-current drain is important. The 34 is very effective in reducing cross-modulation and modulation-distortion over the usual range of signal voltages without the use of antenna potentiometers or auxiliary volume-control switches. (See Super-Control amplifier, page 16.) This super-control characteristic makes the tube uniquely adaptable to the r-f and i-f stages of receivers employing automatic volume control.

CHARACTERISTICS

FILAMENT VOLTAGE (D. C.)	2.0	Volts
FILAMENT CURRENT	0.060	Ampere
PLATE VOLTAGE	67.5† 135 180 max.	Volts
SCREEN VOLTAGE (Grid No. 2)*	67.5 max. 67.5 max. 67.5 max.	Volts
GRID VOLTAGE, Variable (Grid No. 1)	-3 min. -3 min. -3 min.	Volts
PLATE CURRENT	2.7 2.8 2.8	Milliamperes
SCREEN CURRENT	1.1 1.0 1.0	Milliamperes
PLATE RESISTANCE	0.4 0.6 1.0	Megohm
AMPLIFICATION FACTOR	224 360 620	
TRANSCONDUCTANCE	560 600 620	Micromhos
TRANSCONDUCTANCE (At -22.5 volts bias)	15 15 15	Micromhos
GRID-PLATE CAPACITANCE (With shield-can)	0.015 max.	μμf
INPUT CAPACITANCE	6.0	μμf
OUTPUT CAPACITANCE	11.5	μμf
BULB		5L-14
CAP		Small Metal
BASE		Medium 4-Pin

* Under conditions of maximum plate current.

† Recommended values for use in portable receivers.

INSTALLATION

The base pins of the 34 fit the standard four-contact socket which should be installed to hold the tube in a vertical position. Although this tube is quite free from microphonic disturbances, cushioning of its socket may sometimes be desirable.

For filament operation, refer to INSTALLATION for type 1A6.

The screen voltage may be obtained from a tap on the B-supply battery or from a bleeder circuit across the battery, as a whole or in part. Due to the screen current characteristics of the 34, a resistor in series with the B-supply may be employed, if desired, for obtaining the screen voltage, provided the maximum voltage between screen and filament does not exceed 100 volts under conditions of reduced plate current.

Stage shielding enclosing all the components of each stage is, in general, necessary for multi-stage amplifier circuits.

APPLICATION

As an r-f or i-f amplifier, the 34 is applicable in receivers designed for it. Plate, screen, and minimum grid voltages are given under CHARACTERISTICS for a number of operating conditions.

Volume control of the receiver is accomplished effectively by variation of the negative voltage applied to the grid. In order to obtain adequate volume control, an available grid-bias voltage of approximately -22.5 volts will be required. The exact value will depend upon the circuit design and operating conditions. This voltage may be obtained from a potentiometer, a bleeder circuit, or a separate source, depending on receiver requirements.

Owing to the fact that the super-control feature of the 34 requires a comparatively large grid-bias change, the screen and plate voltage may vary considerably for various volume settings, depending on receiver design. It is recommended, therefore, that design features be incorporated in the receiver so that the screen voltage will not exceed 67.5 volts under conditions of minimum grid bias and maximum plate current. With a design arrangement of this kind, the screen voltage at decreased values of plate current may reach a value higher than 67.5 volts but should not exceed 100 volts. It should be recognized that under the condition of screen voltage above 67.5 volts at low plate current, an increase in the grid-bias voltage supply must be provided for adequate volume control.

As the mixer in superheterodyne circuits, the 34 may be utilized to advantage. It should be noted that by varying the grid bias on the mixer in conjunction with that on the radio-frequency and/or the intermediate-frequency stages, additional control of volume may be accomplished. Recommended conditions are: Plate voltage, 67.5 to 180 volts; screen voltage, 67.5 volts; grid-bias voltage, -5 volts approximately (with 4 -volt oscillator peak swing).

AVERAGE PLATE CHARACTERISTICS

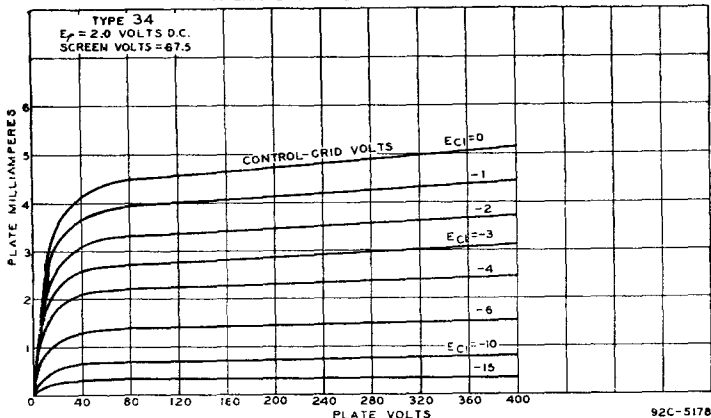

AVERAGE PLATE CHARACTERISTICS

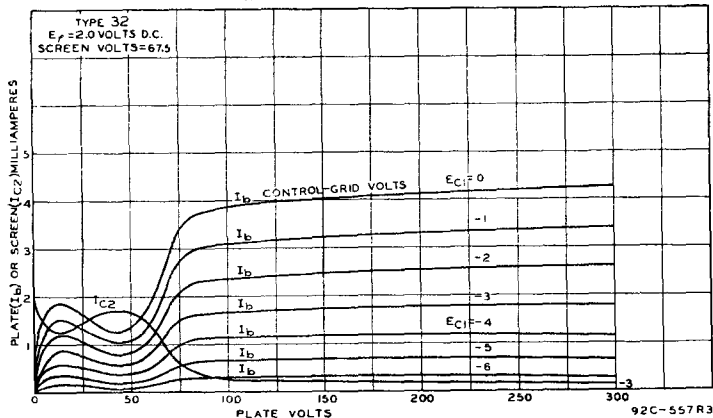

RCA-35

SUPER-CONTROL R-F AMPLIFIER

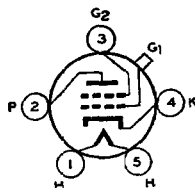
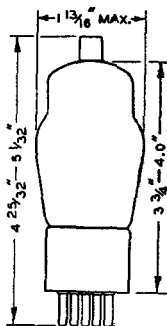

The 35 is a super-control screen grid amplifier tube of the heater-cathode type recommended as an r-f amplifier and an i-f amplifier in a-c receivers. The 35 is very effective

in reducing cross-modulation and modulation-distortion over the entire range of received signals. Its design is such as to permit easy control of a large range of signal voltages without the use of local-distance switches or antenna potentiometers. This super-control feature makes the tube adaptable to circuits incorporating automatic volume control. See page 16 for Super-Control feature. The 35 is interchangeable with type 51.

CHARACTERISTICS

HEATER VOLTAGE (A. C. or D. C.).....	2.5	Volts
HEATER CURRENT	1.75	Amperes
PLATE VOLTAGE*	180 250	Volts
SCREEN VOLTAGE (Maximum).....	90 90	Volts
GRID VOLTAGE, Variable (Minimum).....	-3 -3	Volts
PLATE CURRENT	6.3 6.5	Milliamperes
SCREEN CURRENT (Maximum).....	2.5 2.5	Milliamperes
PLATE RESISTANCE	0.3 0.4	Megohm
AMPLIFICATION FACTOR	305 420	
TRANSCONDUCTANCE	1020 1050	Micromhos
TRANSCONDUCTANCE (At -40 volts bias)....	15 15	Micromhos
GRID-PLATE CAPACITANCE (With shield-can).....	0.007 max.	$\mu\mu\text{f}$
INPUT CAPACITANCE	5.3	$\mu\mu\text{f}$
OUTPUT CAPACITANCE	10.5	$\mu\mu\text{f}$
BULB		ST-14
CAP		Small Metal
BASE		Medium 5-Pin

* Maximum plate voltage = 275 volts.

INSTALLATION

The base pins of the 35 fit the standard five-contact socket which may be installed to hold the tube in any position.

For heater operation and cathode connection, refer to type 2A5.

The screen voltage for the 35 may be obtained from a fixed or variable tap on a voltage divider across the supply voltage or from a portion of the supply.

Complete shielding for all stages of the circuit is necessary if maximum gain and the volume-control-range capabilities of this tube are to be realized.

APPLICATION

As a radio-frequency and intermediate-frequency amplifier, the 35 should be operated as shown under CHARACTERISTICS. In general, properly designed radio-frequency transformers are preferable to interstage coupling impedances, especially in cases where a high-impedance B-supply may cause oscillation below radio frequencies.

Volume control of receivers designed for the 35 may be accomplished by variation of the negative grid bias of this tube. In order to utilize the full volume-control range of the 35, an available grid-bias voltage of approximately 50 volts will be required, depending on the circuit design and operating conditions. This voltage may be obtained from a potentiometer, a bleeder circuit, or from an adjustable cathode resistor.

As a mixer in superheterodyne receivers, the 35 may be used under the following conditions: Plate voltage, 250 volts; screen voltage, 90 volts; and grid bias, -7 volts with a 6-volt peak swing from the oscillator. By varying the grid bias on the mixer in conjunction with that on the radio-frequency and/or the intermediate-frequency stages, additional control of volume may be accomplished.

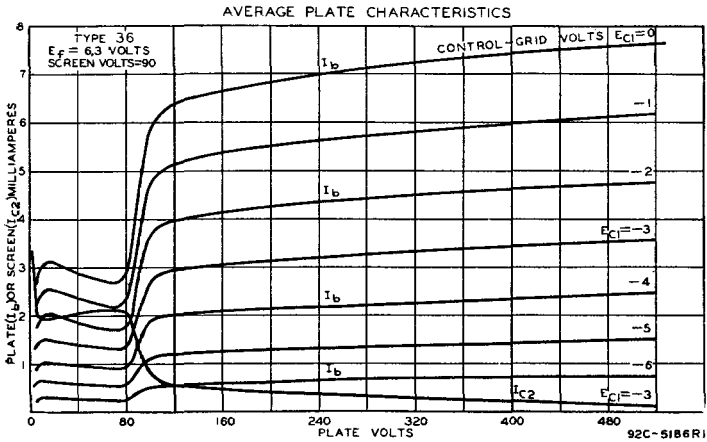
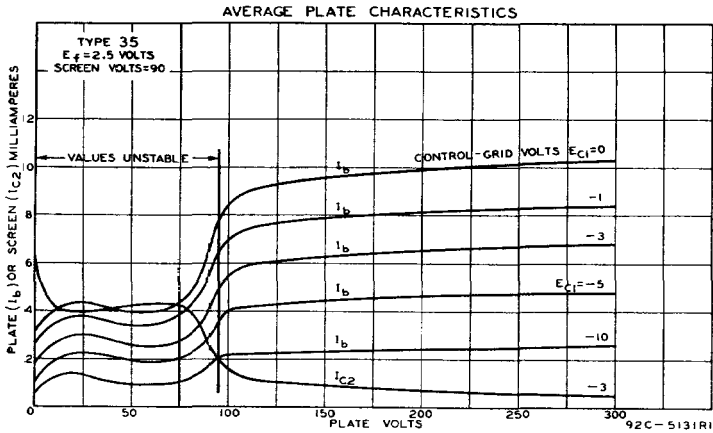

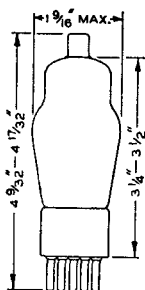

RCA-36

RADIO-FREQUENCY AMPLIFIER

The 36 is a heater-cathode type of screen grid tube intended for use as a radio-frequency amplifier, intermediate-frequency amplifier, and detector.

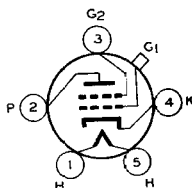

CHARACTERISTICS

HEATER VOLTAGE (A. C. or D. C.).....	6.3	Volts
HEATER CURRENT	0.3	Ampere
PLATE VOLTAGE	100 135 180 250 <i>max.</i>	Volts
SCREEN VOLTAGE	55 67.5 90 <i>max.</i> 90 <i>max.</i>	Volts
GRID VOLTAGE	-1.5 -1.5 -3 -3	Volts
PLATE CURRENT	1.8 2.8 3.1 3.2	Milliamperes
SCREEN CURRENT	— — — 1.7 <i>max.</i>	Milliamperes
PLATE RESISTANCE	0.55 0.475 0.5 0.55	Megohm
AMPLIFICATION FACTOR	470 475 525 595	
TRANSCONDUCTANCE	850 1000 1050 1080	Micromhos
GRID-PLATE CAPACITANCE (With shield-can).....	0.007 <i>max.</i>	μ f
INPUT CAPACITANCE	3.7	μ f
OUTPUT CAPACITANCE	9.2	μ f
BULB		ST-12
CAP		Small Metal
BASE		Small 5-Pin

INSTALLATION AND APPLICATION

The base pins of the 36 fit the standard five-contact socket which may be installed to hold the tube in any position. For heater operation and cathode connection, refer to INSTALLATION for type 6A8. For screen voltage and shielding, refer to INSTALLATION for type 35.

As a radio-frequency amplifier, the 36 should be operated as shown under CHARACTERISTICS.

As a detector, the 36 may be operated either with grid leak and condenser or with grid bias. For grid-bias detection, suitable operating conditions are: Plate-supply voltage, 180 volts applied through a plate-coupling resistor of 0.25 megohm or an equivalent impedance; screen voltage, 67.5 volts; and negative grid bias, 6 volts (approx.) so adjusted that a plate current of 0.1 milliamperes is obtained with no input signal.

A plate family of characteristics is given on the preceding page.

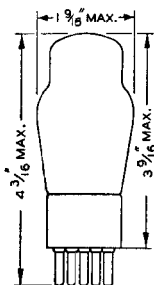

RCA-37

DETECTOR, AMPLIFIER

The 37 is a three-electrode general-purpose tube of the heater-cathode type for use as amplifier and detector.

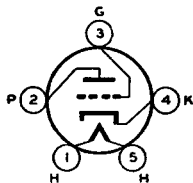

CHARACTERISTICS

HEATER VOLTAGE (A. C. or D. C.).....				6.3	Volts
HEATER CURRENT				0.3	Ampere
PLATE VOLTAGE	90	135	180	250 <i>max.</i>	Volts
GRID VOLTAGE*	-6	-9	-13.5	-18	Volts
PLATE CURRENT	2.5	4.1	4.3	7.5	Milliamperes
PLATE RESISTANCE	11500	10000	10200	8400	Ohms
AMPLIFICATION FACTOR	9.2	9.2	9.2	9.2	
TRANSCONDUCTANCE	800	925	900	1100	Micromhos
GRID-PLATE CAPACITANCE				2.0	$\mu\mu\text{f}$
GRID-CATHODE CAPACITANCE				3.5	$\mu\mu\text{f}$
PLATE-CATHODE CAPACITANCE				2.9	$\mu\mu\text{f}$
BULB				ST-12	
BASE				Small 5-Pin	

* The d-c resistance in the grid circuit should not exceed 1.0 megohm.

INSTALLATION AND APPLICATION

The base pins of the 37 fit the standard five-contact socket which may be installed to hold the tube in any position. For heater operation and cathode connection, refer to INSTALLATION for type 6A8.

As an amplifier, the 37 is applicable to the audio or the radio-frequency stages of a receiver. Recommended plate and grid voltages are shown under CHARACTERISTICS.

As a detector, the 37 may be operated with either grid leak and condenser or with grid bias. The plate voltage for the grid leak and condenser method is 45 volts. A grid leak of from 1 to 5 megohms used with a grid condenser of 0.00025 μf is suitable. For grid-bias detection a plate voltage of 250 volts, together with a negative grid bias of approximately 28 volts, may be used. The plate current should be adjusted to 0.2 milliampere with no input signal.

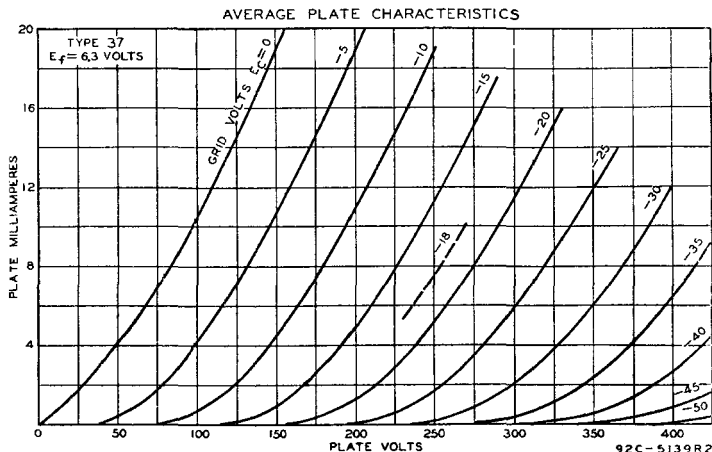

RCA-38

POWER-AMPLIFIER PENTODE

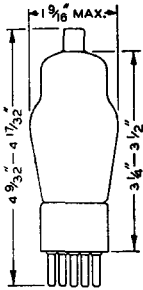

The 38 is a power-amplifier pentode of the heater-cathode type. The relatively low heater current of this type makes it suitable for automobile receivers and for power-line-operated sets, particularly those with a series-heater arrangement.

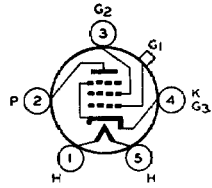

CHARACTERISTICS

HEATER VOLTAGE (A. C. or D. C.)					6.3	Volts
HEATER CURRENT					0.3	Ampere
PLATE VOLTAGE	100	135	180	250 max.	Volts	
SCREEN VOLTAGE	100	135	180	250 max.	Volts	
GRID VOLTAGE	-9	-13.5	-18	-25	Volts	
PLATE CURRENT	7	9	14	22	Milliamperes	
SCREEN CURRENT	1.2	1.5	2.4	3.8	Milliamperes	
PLATE RESISTANCE	0.14	0.13	0.115	0.10	Megohm	
AMPLIFICATION FACTOR	120	120	120	120		
TRANSCONDUCTANCE	875	925	1050	1200	Micromhos	
LOAD RESISTANCE	15000	13500	11600	10000	Ohms	
SELF-BIAS RESISTOR	1100	1100	1100	970	Ohms	
POWER OUTPUT	0.27*	0.55†	1.0*	2.5*	Watts	
GRID-PLATE CAPACITANCE					0.30	μf
INPUT CAPACITANCE					3.5	μf
OUTPUT CAPACITANCE					7.5	μf
BULB						ST-12
CAP						Small Metal
BASE						Small 5-Pin

* 8% total harmonic distortion.

† 10% total harmonic distortion.

INSTALLATION AND APPLICATION

The base pins of the 38 fit the standard five-contact socket which may be installed to hold the tube in any position. For heater operation and cathode connection, refer to INSTALLATION for type 6A8.

For the power amplifier stage of radio receivers, the 38 is recommended either singly or in push-pull combination. Transformer or impedance-coupling devices are preferable. If, however, resistance coupling is used, the d-c resistance in the grid circuit should be limited to 1.0 megohm with plate voltages up to 250 volts, provided the heater voltage does not rise more than 10% above the rated value under any condition of operation.

A plate family of characteristics is given on page 125.

RCA-39/44

SUPER-CONTROL R-F AMPLIFIER PENTODE

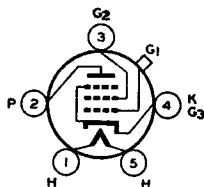
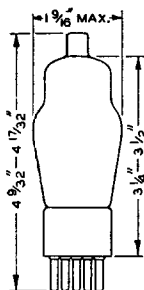

The 39/44 is a heater-cathode tube of the remote cut-off type suitable for use primarily as a radio-frequency amplifier, intermediate-frequency amplifier, and mixer in receivers

designed for its characteristics. The 39/44 is effective in reducing cross-modulation and modulation-distortion over the usual range of signal voltages without the use of antenna potentiometers or auxiliary volume-control switches. An explanation of the Super-Control feature is given on page 16.

CHARACTERISTICS

HEATER VOLTAGE (A. C. or D. C.).....	6.3	Volts
HEATER CURRENT	0.3	Ampere
PLATE VOLTAGE	90 180 250 max.	Volts
SCREEN VOLTAGE	90 90 90 max.	Volts
GRID VOLTAGE (Minimum).....	-3 -3 -3	Volts
PLATE CURRENT	5.6 5.8 5.8	Milliamperes
SCREEN CURRENT	1.6 1.4 1.4	Milliamperes
PLATE RESISTANCE	0.375 0.75 1.0	Megohm
AMPLIFICATION FACTOR	360 750 1050	
TRANSCONDUCTANCE	960 1000 1050	Micromhos
TRANSCONDUCTANCE (At -42.5 volts bias)	2 2 2	Micromhos
GRID-PLATE CAPACITANCE (With shield-can).....	0.007 max.	$\mu\mu\text{f}$
INPUT CAPACITANCE	3.5	$\mu\mu\text{f}$
OUTPUT CAPACITANCE	10	$\mu\mu\text{f}$
BULB		ST-12
CAP		Small Metal
BASE		Small 5-Pin

INSTALLATION

The base pins of the 39/44 fit the standard five-contact socket. The socket may be installed to hold the tube in any position.

For heater operation and cathode connection, refer to INSTALLATION for type 6A8.

The screen voltage for the 39/44 may be obtained from a section of the B-battery, from a fixed or variable tap on a voltage divider across the supply voltage, or from a portion of the supply. Care should be taken to keep the impedance between the screen and cathode as low as possible.

When the 39/44 is self-biased, a resistor in series with the high-voltage supply may be used for obtaining the screen voltage. This is possible because of the stable screen-current characteristic of the 39/44 pentode. The resistor method of securing the screen voltage is limited to circuits where the screen-voltage supply does not exceed 180 volts as a maximum. The value of this resistance should be such that under the conditions of minimum grid bias and maximum plate current the screen voltage will not exceed 90 volts. A resistance of approximately 80000 ohms will be suitable.

Complete shielding of all stages is necessary if maximum gain per stage is to be obtained.

APPLICATION

As a radio-frequency and intermediate-frequency amplifier, the 39/44 should be operated as shown under CHARACTERISTICS. In general, properly designed radio-frequency transformers are preferable to interstage coupling impedances, especially in cases where a high impedance B-supply may cause oscillation below radio frequencies.

Volume control of receivers designed for the 39/44 may be accomplished by variation of the negative grid bias of this tube. In order to obtain adequate volume control, an available grid-bias voltage of approximately 45 volts will be required. The exact value will depend upon the circuit design and operating conditions. This voltage may be obtained from a potentiometer, a bleeder circuit, a variable resistor in the cathode circuit, or from a separate source.

As a detector mixer in superheterodyne receivers, the 39/44 may be utilized. Suitable operating voltages for such service are: Plate voltage, 90 to 250 volts; screen voltage, 90 volts; grid voltage, -7 volts (approx.), with a 6-volt peak swing from the oscillator. By varying the grid bias on the mixer in conjunction with that on the r-f and/or the i-f stages, additional control of volume may be accomplished.

AVERAGE PLATE CHARACTERISTICS

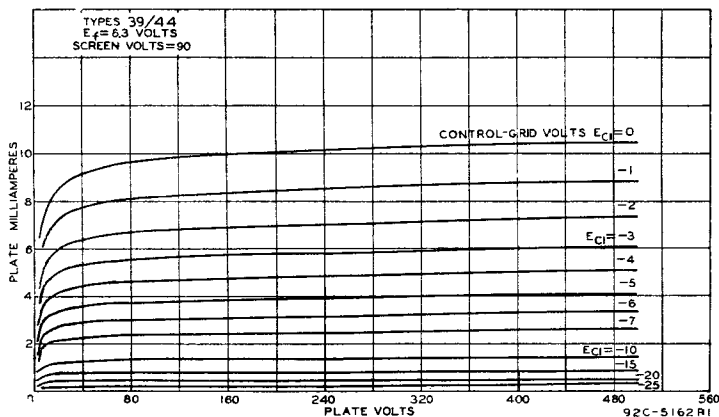

AVERAGE PLATE CHARACTERISTICS

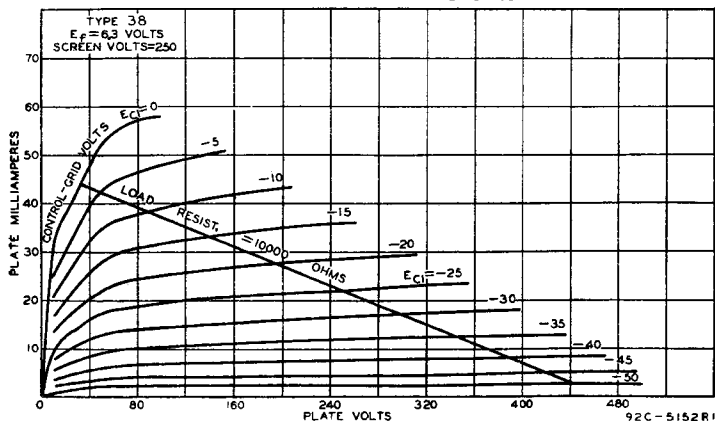

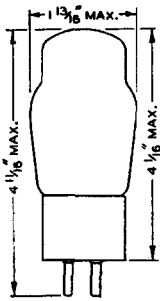

RCA-40

VOLTAGE AMPLIFIER

The 40 is a high-mu triode of the storage-battery type for use in resistance-coupled or impedance-coupled amplifier or detector circuits.

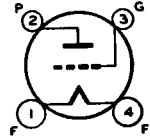

CHARACTERISTICS

FILAMENT VOLTAGE (D. C.)	5.0	Volts
FILAMENT CURRENT	0.25	Ampere
PLATE VOLTAGE*	135 180	Volts
GRID VOLTAGE	-1.5 -3	Volts
PLATE CURRENT	0.2 0.2	Milliampere
PLATE RESISTANCE	150000 150000	Ohms
AMPLIFICATION FACTOR	30 30	
TRANSCONDUCTANCE	200 200	Micromhos
BULB		ST-14
BASE	Medium 4-Pin Bayonet	

* Effective voltage at plate will be plate supply voltage minus voltage drop in load of 0.25 megohm caused by plate current; the effective value should not exceed 180 volts.

This type is used principally for renewal purposes.

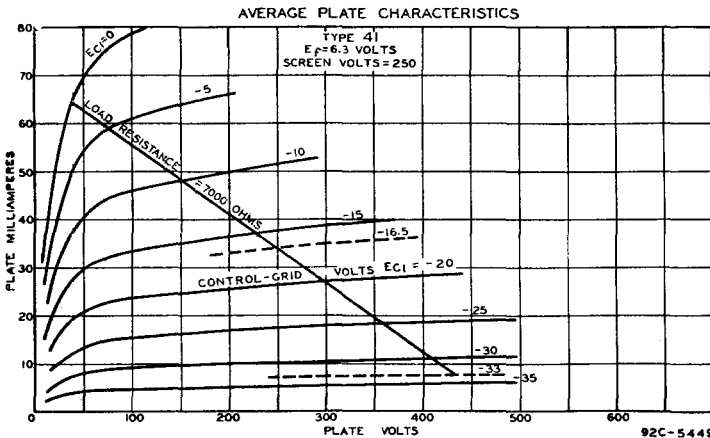

RCA-41

POWER-AMPLIFIER PENTODE

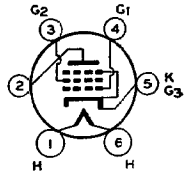
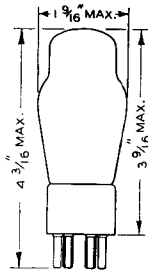

The 41 is a power-amplifier pentode of the heater-cathode type for use in the audio-output stage of radio receivers with 6.3-volt heater supply. The tube is capable of giving a large power output with a relatively small input-signal voltage.

CHARACTERISTICS

HEATER VOLTAGE (A. C. or D. C.)	6.3	Volts
HEATER CURRENT	0.4	Ampere
PLATE VOLTAGE	100 135 180	250 max. Volts
SCREEN VOLTAGE	100 135 180	250 max. Volts
GRID VOLTAGE	-7 -10 -13.5 -18	Volts
PLATE CURRENT	9.0 12.5 18.5	32 Milliamperes
SCREEN CURRENT	1.6 2.2 3.0	5.5 Milliamperes
PLATE RESISTANCE (Approx.)	103500 94000 81000 68000	Ohms
AMPLIF. FACTOR (Approx.)	150 150 150 150	
TRANSDUCANCE	1450 1600 1850 2200	Micromhos
LOAD RESISTANCE	12000 10400 9000 7600	Ohms
SELF-BIAS RESISTOR	660 680 630 480	Ohms
POWER OUTPUT*	0.33 0.75 1.5 3.4	Watts
BULB		ST-12
BASE		Medium 6-Pin

* 10% total harmonic distortion.

INSTALLATION AND APPLICATION

The base pins of the 41 fit the standard six-contact socket which may be installed to hold the tube in any position. For heater operation and cathode connection, refer to INSTALLATION on type 6A8.

For the power amplifier stage of receivers, the 41 may be used either singly or in push-pull combination. More than one audio stage preceding the 41 is undesirable because of the possibility of microphonic disturbances resulting from the high level of amplification.

If a single 41 is operated self-biased, the self-bias resistor should be shunted by a suitable filter network to avoid degenerative effects at low audio frequencies. The use of two 41's in push-pull eliminates the necessity for shunting the resistor. The self-bias resistor required for two 41's in the same stage is one-half that for a single stage.

Any conventional type of input coupling may be used provided the resistance added to the grid circuit by this device is not too high. Transformer or impedance coupling devices are recommended. If, however, resistance coupling is employed, the grid resistor should not exceed one megohm with self-bias, provided the heater voltage does not rise more than 10% above the rated value under any condition of operation. When self-bias is not used, the value should be limited to 100000 ohms.

An output transformer should be used to supply power to the winding of the reproducing unit. The optimum value of load resistance for a single tube is given under CHARACTERISTICS. For push-pull operation, the plate-to-plate load resistance should be twice that for a single tube. For best results, the impedance in the plate circuit of the 41 should be as uniform as possible over the entire audio-frequency range.

A family of plate characteristic curves is given on the preceding page.

RCA-42

POWER-AMPLIFIER PENTODE

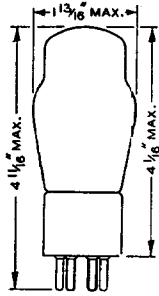
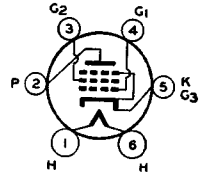

The 42 is a heater-cathode type of power-amplifier pentode for use in the audio-output stage of receivers. It is capable of giving large power output with a relatively small input-signal

voltage. Because of the heater-cathode construction, a uniformly low hum-level is attainable in power amplifier design.

CHARACTERISTICS

HEATER VOLTAGE (A. C. or D. C.).....	6.3	Volts
HEATER CURRENT	0.7	Ampere
BULB		ST-14
BASE		Medium 6-Pin

As Single-Tube Class A₁ Amplifier

	Pentode Connection		Triode Connection Screen tied to plate	
PLATE VOLTAGE	250	315	max. 250°	Volts
SCREEN VOLTAGE (Grid No. 2).....	250	315	max. —	Volts
GRID VOLTAGE (Grid No. 1).....	-16.5	-22	-20	Volts
PLATE CURRENT	34	42	31	Milliamperes
SCREEN CURRENT	6.5	8	—	Milliamperes
PLATE RESISTANCE (Approx.).....	80000	100000	2700	Ohms
AMPLIFICATION FACTOR (Approx.)...	190	260	6.2	
TRANSCONDUCTANCE	2350	2600	2300	Micromhos
LOAD RESISTANCE	7000	7000	3000	Ohms
TOTAL HARMONIC DISTORTION.....	7	7	5	Per cent
POWER OUTPUT	3	5	0.65	Watts

Under the above maximum voltage conditions, transformer or impedance input-coupling devices are recommended. If resistance coupling is used, refer to last paragraph of APPLICATION under type 6F6.

° Maximum plate volts = 315.

As Push-Pull Class AB₂ Amplifier—Pentode Connection

Values are for two tubes.

	Fixed Bias	Self-Bias	
PLATE VOLTAGE	375 max.	375 max.	Volts
SCREEN VOLTAGE (Grid No. 2).....	250 max.	250 max.	Volts
GRID VOLTAGE (Grid No. 1).....	-26 min.	—	Volts
SELF-BIAS RESISTOR	—	340 min.	Ohms
ZERO-SIGNAL PLATE CURRENT.....	34	54	Milliamperes
ZERO-SIGNAL SCREEN CURRENT.....	5	8	Milliamperes
LOAD RESISTANCE (Plate-to-plate).....	10000	10000	Ohms
TOTAL HARMONIC DISTORTION.....	5	5	Per Cent
POWER OUTPUT	19*	19‡	Watts

* With one triode-connected 42 as driver operated at plate volts of 250, grid volts of -20, and with a minimum plate load of approximately 10000 ohms: input transformer ratio, primary to one-half secondary, is 3.32. The plate, screen and grid supply have negligible resistance.

‡ With one triode-connected 42 as driver operated at plate volts of 250, grid volts of -20, and with a minimum plate load of approximately 10000 ohms: input transformer ratio, primary to one-half secondary, is 2.5. The plate and screen supply have negligible resistance. The value given for the self-bias resistor is determined for a minimum grid bias of -21 volts.

Under the above maximum voltage conditions, transformer or impedance input-coupling devices must be used.

A₁ Push-Pull Class AB₂ Amplifier—Triode Connection
Screen Tied to Plate

Values are for two tubes.

	Fixed Bias	Self-Bias	
PLATE VOLTAGE	350 max.	350 max.	Volts
GRID VOLTAGE	-38 min.	—	Volts
SELF-BIAS RESISTOR	—	730 min.	Ohms
ZERO-SIGNAL PLATE CURRENT.....	45	50	Milliamperes
LOAD RESISTANCE (Plate-to-plate).....	6000	10000	Ohms
TOTAL HARMONIC DISTORTION.....	7	7	Per cent
POWER OUTPUT	18†	14**	Watts

† With one triode-connected 42 as driver operated at plate volts of 250, grid volts of -20, and with a minimum plate load of approximately 10000 ohms: input transformer ratio, primary to one-half secondary, is 1.67. The plate and grid supply have negligible resistance.

** With one triode-connected 42 as driver operated at plate volts of 250, grid volts of -20, and with a minimum plate load of approximately 10000 ohms: input transformer ratio, primary to one-half secondary, is 1.29. The plate supply has negligible resistance. The value given for the self-bias resistor is determined for a minimum grid bias of -36.5 volts.

Under the above maximum voltage conditions, transformer or impedance input-coupling devices must be used

INSTALLATION AND APPLICATION

The base pins of the 42 fit the standard six-contact socket which may be installed to hold the tube in any position. Sufficient ventilation should be provided to prevent overheating.

The heater is designed to operate at 6.3 volts. In a series-heater circuit employing several 6.3-volt types and one or more 42's, the heaters of the 42's should be placed on the positive side. Furthermore, since most 6.3-volt types have 0.3-ampere heaters, a bleeder circuit across these heaters is required to take care of the additional 0.4-ampere heater current of the 42. Each 6.3-volt tube of the 0.3-ampere type in the series circuit should, therefore, be shunted by a bleeder resistance of 16 ohms.

The cathode should preferably be connected directly to a mid-tap on the heater winding or to a center-tapped resistor across the heater winding. If this practice is not followed, the potential difference between heater and cathode should be kept as low as possible.

For application, refer to type 6F6.

Additional curve data is given under type 2A5.

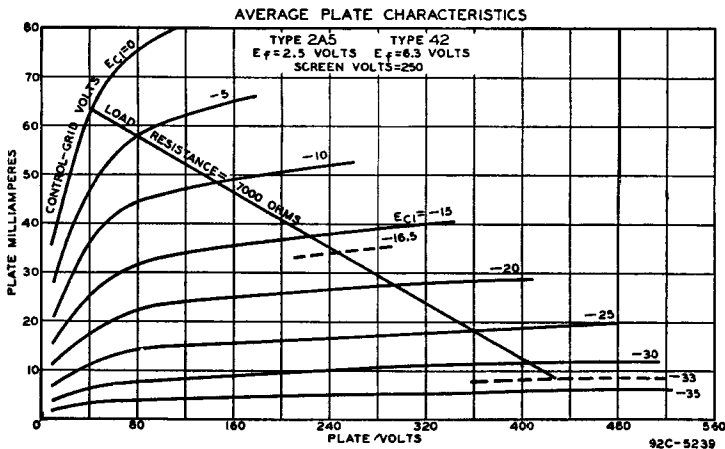

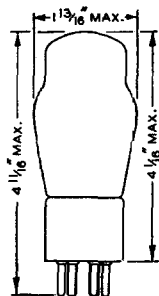

RCA-43

POWER-AMPLIFIER PENTODE

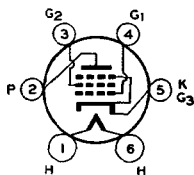

The 43 is a power-amplifier pentode of the heater-cathode type for use in the output stage of radio receivers, especially those of the "d-c power line" type and the "universal (a.c.-d.c.)" type. In such applications, the 43 is capable of handling relatively large audio power at the low plate and screen voltage available. A single 43 in the output stage operating with 100 volts on plate and screen can deliver nearly one watt of audio power, while two 43's in push-pull arrangement with the same voltages can supply approximately two watts.

CHARACTERISTICS

HEATER VOLTAGE (A. C. or D. C.)	25	Volts
HEATER CURRENT	0.3	Ampere
BULB		ST-14
BASE		Medium 6-Pin

Other characteristics of this type are the same as for the type 25A6.

INSTALLATION AND APPLICATION

The base pins of the 43 fit the standard six-contact socket which may be installed to hold the tube either in a vertical or in a horizontal position. Sufficient ventilation should be provided to circulate air freely around the tube to prevent overheating.

For heater operation and cathode connection, refer to type 25A6.

For APPLICATION, refer to type 25A6.

An additional family of plate characteristic curves which applies to type 43 is given under type 25A6.

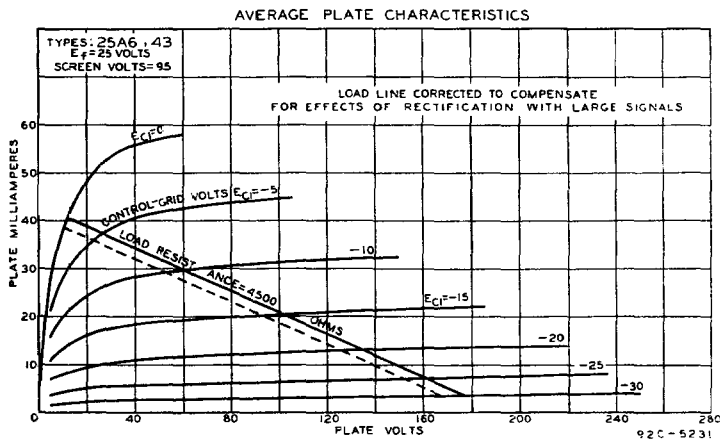

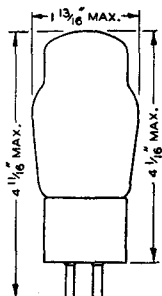

RCA-45

POWER AMPLIFIER

The 45 is a power-amplifier triode of the filament type capable of supplying large undistorted output in a-c operated receivers.

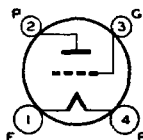

CHARACTERISTICS

FILAMENT VOLTAGE (A. C. or D. C.)	2.5	Volts
FILAMENT CURRENT	1.5	Amperes
GRID-PLATE CAPACITANCE	7	$\mu\mu\text{f}$
GRID-FILAMENT CAPACITANCE	4	$\mu\mu\text{f}$
PLATE-FILAMENT CAPACITANCE	3	$\mu\mu\text{f}$
BULB		ST-14
BASE		Medium 4-Pin

As Single-Tube Class A₁ Amplifier

FILAMENT VOLTAGE (A. C.)	2.5	Volts
PLATE VOLTAGE	180 250 275 max.	Volts
GRID VOLTAGE*	-31.5 -50 -56	Volts
PLATE CURRENT	31 34 36	Milliamperes
PLATE RESISTANCE	1650 1610 1700	Ohms
AMPLIFICATION FACTOR	3.5 3.5 3.5	
TRANSCONDUCTANCE	2125 2175 2050	Micromhos
LOAD RESISTANCE	2700 3900 4600	Ohms
SELF-BIAS RESISTOR	1020 1470 1550	Ohms
UNDISTORTED POWER OUTPUT	0.825 1.6 2.0	Watts

* Grid volts measured from midpoint of a-c operated filament. Self-bias is advisable in all cases, required if grid d-c resistance (max. value of 1.0 megohm) is used in grid circuit.

As Push-Pull Class AB₂ Amplifier (Two Tubes)

Values are for two tubes.

	Fixed Bias	Self-Bias	
FILAMENT VOLTAGE (A. C.)	2.5	2.5	Volts
PLATE VOLTAGE (Maximum)	275	275	Volts
GRID VOLTAGE	-68	—	Volts
SELF-BIAS RESISTOR	—	775	Ohms
ZERO-SIGNAL PLATE CURRENT	28	72	Milliamperes
MAXIMUM-SIGNAL PLATE CURRENT	138	90	Milliamperes
LOAD RESISTANCE (Plate-to-plate)	3200	5060	Ohms
TOTAL HARMONIC DISTORTION	5	5	Per cent
POWER OUTPUT	18	12	Watts

INSTALLATION AND APPLICATION

For installation refer to **INSTALLATION** on type 2A3.

As a power amplifier (Class A₁), the 45 may be used either singly or in push-pull. Typical operating conditions are given under **CHARACTERISTICS**.

In a push-pull Class AB₂ stage, the 45 is operated under conditions such that a small amount of grid current flows during the most positive swing of the input signal and the second harmonic distortion is cancelled by virtue of the push-pull circuit. A driver stage, consisting of one 56 operated at 250 volts on the plate, will drive two 45's in push-pull (fixed-bias or self-bias) to the stated output values. A step-down interstage transformer of suitable design is required.

A family of plate characteristic curves is given on page 143.

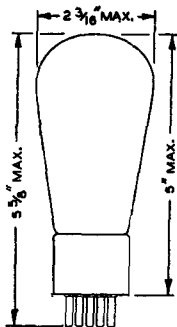

RCA-46

DUAL-GRID POWER AMPLIFIER

The 46 is a double-grid power-amplifier tube recommended especially for service in Class B amplifier circuits of suitable design.

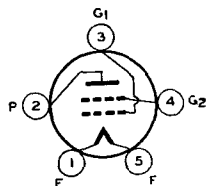

CHARACTERISTICS

FILAMENT VOLTAGE (A. C. or D. C.).....	2.5	Volts
FILAMENT CURRENT	1.75	Amperes
BULB		S-17
BASE		Medium 5-Pin

As Class B Amplifier

(Grid No. 1 and No. 2 connected together at socket)

PLATE VOLTAGE	400 max.	Volts
PEAK PLATE CURRENT.....	200 max.	Milliamperes
AVERAGE PLATE DISSIPATION.....	10 max.	Watts
TYPICAL OPERATION (2 tubes)		

Values are for two tubes.

Plate Voltage	300	400	Volts
Grid Voltage	0	0	Volts
Zero-Signal Plate Current.....	8	12	Milliamperes
Effective Load Resistance (Plate-to-plate) ..	5200	5800	Ohms
Power Output (Approximate).....	16*	20†	Watts

* With average power input of 950 milliwatts applied between grids.

† With average power input of 650 milliwatts applied between grids.

As Class A₁ Amplifier

(Grid No. 2 connected to plate at socket)

PLATE VOLTAGE	250 max.	Volts
GRID VOLTAGE	-33	Volts
PLATE CURRENT	22	Milliamperes
PLATE RESISTANCE	2380	Ohms
AMPLIFICATION FACTOR	5.6	
TRANSCONDUCTANCE	2350	Micromhos
LOAD RESISTANCE (For max. undistorted power)††...	6400	Ohms
UNDISTORTED POWER OUTPUT.....	1.25	Watts

†† Approximately twice this value is recommended for load of this tube as driver for Class B stage.

INSTALLATION

The base pins of the 46 fit the standard five-contact socket which may be installed to hold the tube either in a vertical or in a horizontal position. For horizontal operation, the socket should be positioned with the filament-pin openings one vertically above the other. Sufficient ventilation should be provided around the tube to prevent overheating.

The filament is designed to operate at 2.5 volts. The transformer winding supplying the filament circuit should operate the filament at this recommended value for full-load operating conditions at average line voltage. The filament wiring should, insofar as possible, be isolated from the input circuit of the driver stage in order to avoid the possibility of hum caused by electrostatic induction from this wiring.

The grid- and the plate-return lead for the Class B stage should be connected to the mid-tap of the filament winding or to the center-tap of a 20-ohm resistor across the winding. The grid- and plate-return for the driver stage should be made

to a variable center-tapped resistor across the filament supply for minimum hum adjustment. The use of a push-pull driver stage with either equi-potential or filament-type tubes will reduce hum resulting from the filament supply, but is required only in special applications.

APPLICATION

In Class B audio power-amplifier service, the 46 is recommended because the two grids in the tube are connected together and, thus, the signal voltage is applied to both simultaneously. Consideration of general Class B amplifier design features is given on page 20.

For Class A₁ operation of the 46, the grid adjacent to the plate is connected to the plate. The intended application of the 46 as a Class A amplifier is for driving two 46's in a Class B amplifier circuit. The tube has been constructed for this dual service in order to reduce the number of tube types necessary in a receiver. The tabulated values for Class A operation of this type, as given under CHARACTERISTICS, are for its operation as a power output tube.

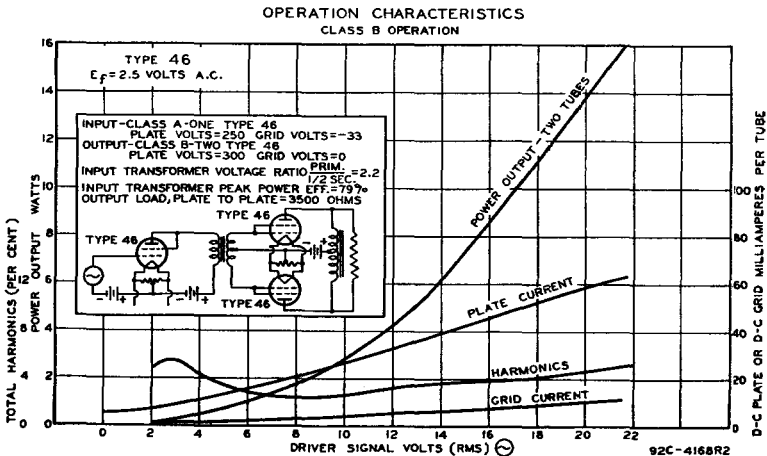
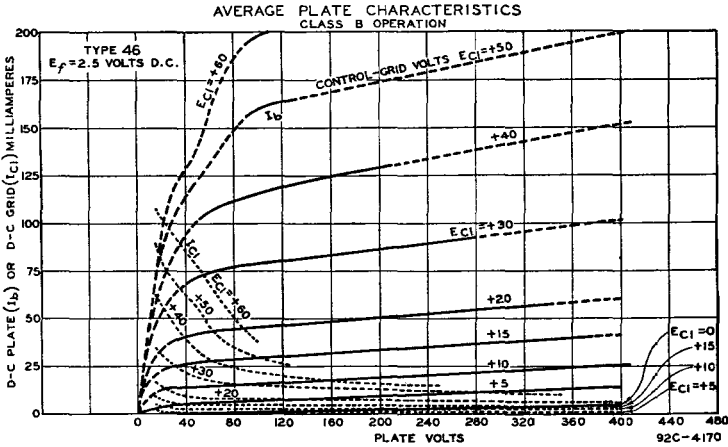

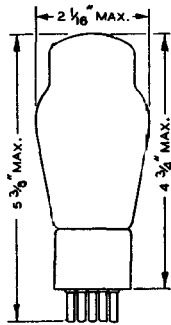

RCA-47

POWER-AMPLIFIER PENTODE

The 47 is a power-amplifier pentode for use in the audio output stage of a-c receivers. In comparison with three-electrode Class A power amplifiers of the same plate dissipation, the

47 is capable of greater output with the additional feature of higher amplification.

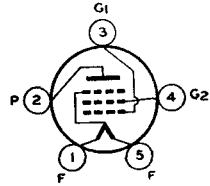

CHARACTERISTICS

FILAMENT VOLTAGE (A. C. or D. C.)	2.5	Volts
FILAMENT CURRENT	1.75	Amperes
PLATE VOLTAGE	250 <i>max.</i>	Volts
SCREEN VOLTAGE	250 <i>max.</i>	Volts
GRID VOLTAGE*	-16.5	Volts
PLATE CURRENT	31	Milliamperes
SCREEN CURRENT	6	Milliamperes
PLATE RESISTANCE	60000	Ohms
AMPLIFICATION FACTOR	150	
TRANSCONDUCTANCE	2500	Micromhos
LOAD RESISTANCE	7000	Ohms
SELF-BIAS RESISTOR	450	Ohms
POWER OUTPUT (6% total harmonic distortion)	2.7	Watts
GRID-PLATE CAPACITANCE	1.2	μf
INPUT CAPACITANCE	8.6	μf
OUTPUT CAPACITANCE	13.0	μf
BULB		ST-16
BASE		Medium 5-Pin

* If filament is operated on d-c, grid bias should be -15.3 volts.

INSTALLATION AND APPLICATION

The base pins of the 47 fit the standard five-contact socket which should be installed preferably to hold the tube in a vertical position. If it is necessary to place the tube in a horizontal position, the socket should be mounted with its filament-pin openings one vertically above the other. Sufficient ventilation should be provided around the tube to prevent overheating.

For the power amplifier stage of radio receivers, the 47 is recommended either singly or in push-pull combination. More than one audio stage preceding the 47 is undesirable because of the possibility of microphonic disturbances resulting from the high level of amplification.

Any conventional type of input coupling may be used, provided the resistance added to the grid circuit by this device is not too high. Transformer or impedance-coupling devices are preferable. If resistance coupling is used, the d-c resistance in the grid circuit should not exceed 0.5 megohm with self-bias, or 50000 ohms with fixed bias.

The blue glow which frequently appears on the inner surface of the 47 bulb is due to fluorescence caused by stray electrons from the filament which strike the interior of the getter-coated bulb. This fluorescence is a natural effect and is in no manner an indication of the performance of the tube.

A family of plate characteristic curves is given at the bottom of page 138.

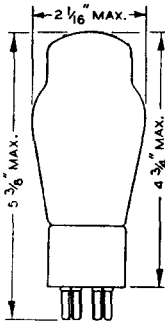

RCA-48

POWER-AMPLIFIER TETRODE

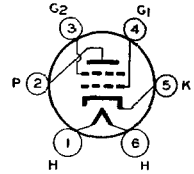

The 48 is a power-amplifier tetrode which has pentode characteristics when operated at the recommended screen and plate voltage. It is for use in the audio-output stage of receivers designed to operate from 115-volt d-c power lines. The 48 is exceptional in its ability to deliver power at the low plate and screen voltage obtainable in such service.

The large power-delivering ability of the 48 is made practical by the unique features of its electrical and structural design. Among these are the big cathode with its large emitting surface, the control-grid structure with its heat radiator, and the plate with a rib structure fastened to its inner surface. The rib structure serves to suppress the effects of secondary emission which limit the power output of four-electrode screen grid types.

CHARACTERISTICS

HEATER VOLTAGE (D. C.)	30	Volts
HEATER CURRENT	0.4	Ampere
BULB		ST-16
BASE		Medium 6-Pin

As Single-Tube Class A Amplifier

	Tetrode Connection		Triode Connection		
	96	125 max.	80	125 max.	
PLATE VOLTAGE	96	125 max.	80	125 max.	Volts
SCREEN VOLTAGE (Grid No. 2)	96	100 max.	—	—	Volts
GRID VOLTAGE (Grid No. 1) ..	-19	-20	-20	-32.5	Volts
PLATE CURRENT	52	56	31	52	Milliamperes
SCREEN CURRENT	9	9.5	—	—	Milliamperes
PLATE RESISTANCE	Subject to considerable variation.		760	675	Ohms
AMPLIFICATION FACTOR			2.5	2.5	
TRANSCONDUCTANCE	3800	3900	3300	3700	Micromhos
LOAD RESISTANCE	1500	1500	—	—	Ohms
SELF-BIAS RESISTOR	310	310	—	—	Ohms
POWER OUTPUT*	2	2.5	—	—	Watts

* 9% total harmonic distortion.

As Push-Pull Class A Amplifier

Values are for two tubes

	Tetrode Connection		Triode Connection		
	125 max.	125 max.	125 max.	125 max.	
PLATE VOLTAGE	125 max.	125 max.	125 max.	125 max.	Volts
SCREEN VOLTAGE (Grid No. 2)	100 max.	—	—	—	Volts
GRID VOLTAGE (Grid No. 1)	—	-20	-20	-32.5	Volts
ZERO-SIGNAL PLATE CURRENT	100	100	100	100	Milliamperes
LOAD RESISTANCE (Plate-to-Plate)	3000	1250	—	—	Ohms
TOTAL HARMONIC DISTORTION	9	2	9	2	Per cent
POWER OUTPUT	5	3	5	3	Watts

INSTALLATION AND APPLICATION

The base pins of the 48 fit the standard six-contact socket which may be installed to hold the tube either in a vertical or in a horizontal position. For horizontal operation, the socket should be positioned with the plate-pin opening at the top and the cathode-pin opening at the bottom, or vice versa. Sufficient ventilation should be provided around the tube to prevent overheating.

The heater of the 48 is designed to operate at approximately 30 volts d. c. Due to the heater-cathode design, the heater voltage may range between 26 and 34 volts during line-voltage fluctuations without greatly affecting the performance or serviceability of the tube.

In a series-heater circuit employing several 6.3-volt types and one or more 48's, the heaters of the 48's should be placed on the positive side of the line. Furthermore, since the 6.3-volt types have 0.3-ampere heaters, a bleeder circuit across these heaters is required to take care of the additional 0.1-ampere heater current of the 48. Each 6.3-volt tube in the series circuit should, therefore, be shunted by a bleeder resistance of 63 ohms.

The cathode circuit in d-c receivers is tied in either directly or through biasing resistors to the negative side of the heater circuit. The potential difference thus introduced between heater and cathode of the 48 should not exceed 90 volts, as measured between the negative heater terminal and the cathode.

As a Single Class A power-amplifier tetrode the 48 should be operated as shown under CHARACTERISTICS.

Any conventional type of input coupling may be used, provided the resistance added to the grid circuit by this device is not too high. Transformer or impedance-coupling devices are preferable. In any case, the d-c resistance in the grid circuit should not exceed 10000 ohms.

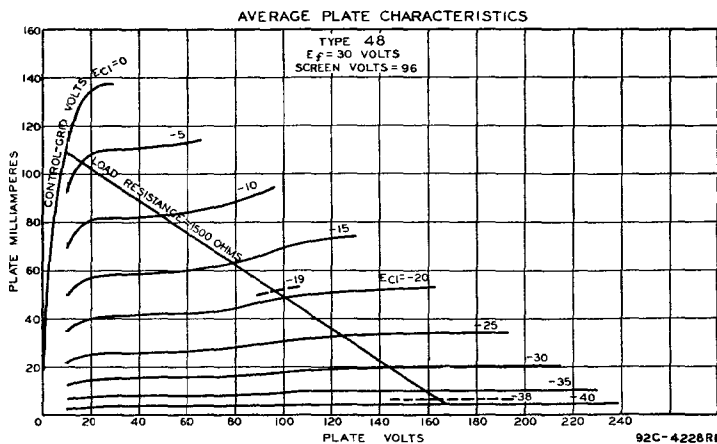

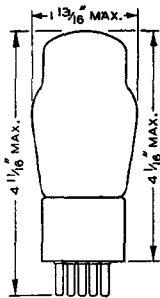

RCA-49

DUAL-GRID POWER AMPLIFIER

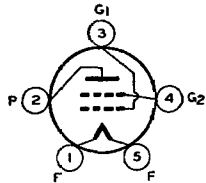

The 49 is a double-grid power-amplifier tube designed for use in battery-operated receivers employing 2-volt tubes. In such service, it may be used either as a Class B output tube or, by a change in socket connections, as a Class A driver tube.

CHARACTERISTICS

FILAMENT VOLTAGE (D. C.).....	2.0	Volts
FILAMENT CURRENT	0.12	Ampere
BULB		ST-14
BASE		Medium 5-Pin

As Class B Power Amplifier

(Grids No. 1 and No. 2 connected together at socket)

PLATE VOLTAGE	180 max.	Volts
PEAK PLATE CURRENT.....	50 max.	Milliamperes
TYPICAL OPERATION (2 tubes)		

Values are for two tubes.

Plate Voltage	135	180	Volts
Grid Voltage	0	0	Volts
Zero-Signal Plate Current.....	2.6	4	Milliamperes
Effective Load Resistance (Plate-to-plate)..	8000	12000	Ohms
Power Output Approximate.....	2.3	3.5	Watts

As Driver—Class A₁ Amplifier

(Grid No. 2 connected to plate at socket)

PLATE VOLTAGE	135 max.	Volts
GRID VOLTAGE	-20	Volts
PLATE CURRENT	6.0	Milliamperes
PLATE RESISTANCE	4175	Ohms
AMPLIFICATION FACTOR	4.7	
TRANSCONDUCTANCE	1125	Micromhos
LOAD RESISTANCE	11000*	Ohms
POWER OUTPUT (Approximate).....	0.170	Watt

* Approximately twice this value is recommended for load of this tube as driver for Class B stage.

INSTALLATION AND APPLICATION

The base pins of the 49 fit the standard five-contact socket which should be installed to hold the tube in a vertical position. In some cases, cushioning of the socket may be found desirable. For filament operation, refer to INSTALLATION on type 1A6. Refer to APPLICATION for type 46. Plate characteristics curves are given on the following page.

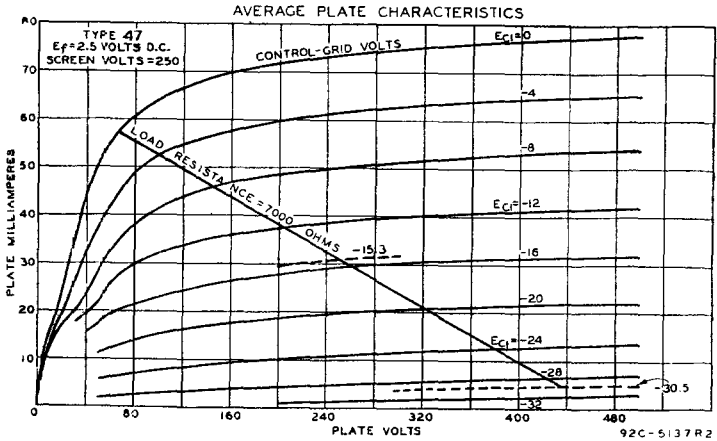
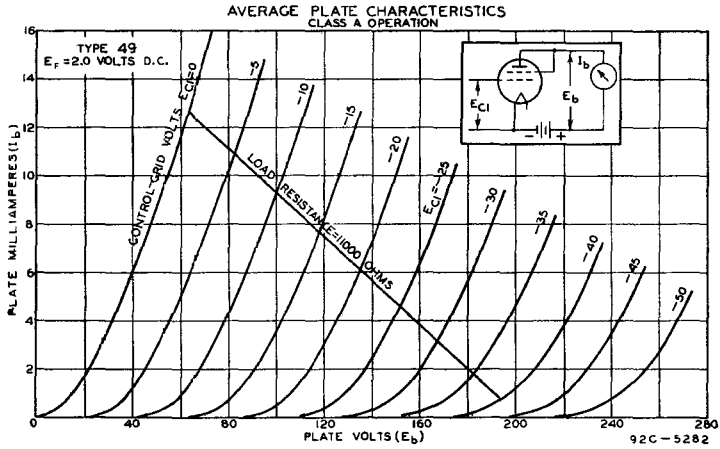
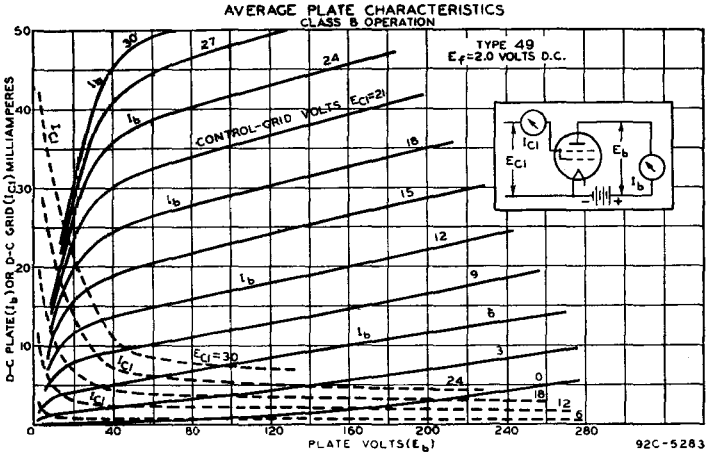

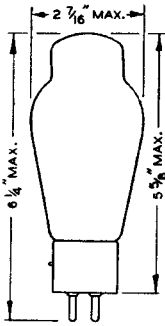

RCA-50

POWER AMPLIFIER

The 50 is a power-amplifier tube designed for use primarily in the output stage of an audio-frequency amplifier employing transformer coupling. It is capable of delivering large undistorted power.

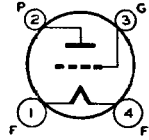

CHARACTERISTICS

FILAMENT VOLTAGE (A. C. or D. C.)				7.5	Volts
FILAMENT CURRENT				1.25	Amperes
PLATE VOLTAGE	350	400	450	<i>max.</i>	Volts
GRID VOLTAGE*	-63	-70	-84		Volts
PLATE CURRENT	45	55	55		Milliamperes
PLATE RESISTANCE	1900	1800	1800		Ohms
AMPLIFICATION FACTOR	3.8	3.8	3.8		
TRANSCONDUCTANCE	2000	2100	2100		Micromhos
LOAD RESISTANCE	4100	3670	4350		Ohms
SELF-BIAS RESISTOR	1400	1275	1530		Ohms
UNDISTORTED POWER OUTPUT	2.4	3.4	4.6		Watts
BULB					ST-19
BASE					Medium 4-Pin Bayonet

* Measured from mid-point of a-c operated filament.

INSTALLATION AND APPLICATION

Refer to INSTALLATION and APPLICATION on type 10. Any conventional type of input coupling may be used provided the resistance added to the grid circuit by this device does not exceed 10000 ohms.

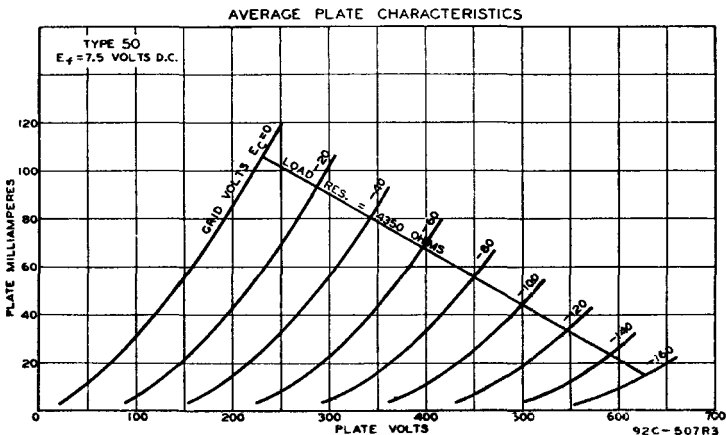

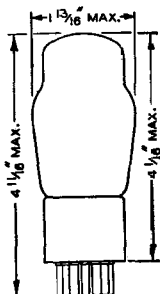

RCA-53

CLASS B TWIN AMPLIFIER

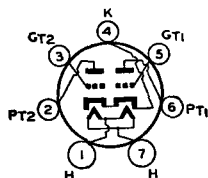

The 53 is a heater-cathode type of tube combining in one bulb two high- μ triodes designed for Class B operation. It is intended primarily for use in the output stage of a-c operated radio receivers. The triode units have separate external terminals for all electrodes except the cathodes and heaters, so that circuit design is similar to that of Class B amplifiers utilizing individual tubes in the output stage. The 53 may be used as a Class A₁ amplifier (with triode units connected in parallel) to drive a 53 as a Class B amplifier in the output stage.

CHARACTERISTICS

HEATER VOLTAGE (A. C. or D. C.).....	2.5	Volts
HEATER CURRENT	2.0	Amperes
BULB		ST-14
BASE		Medium 7-Pin

Other characteristics of this type are the same as for type 6N7.

INSTALLATION

The base pins of the 53 fit the seven-contact (0.855 inch pin-circle diameter) socket which may be installed to hold the tube in any position. Sufficient ventilation should be provided to circulate air freely around the tube to prevent overheating.

For heater operation and cathode connection, refer to type 2A5.

APPLICATION

For APPLICATION refer to type 6N7. Additional curves are shown under types 6A6 and 6N7.

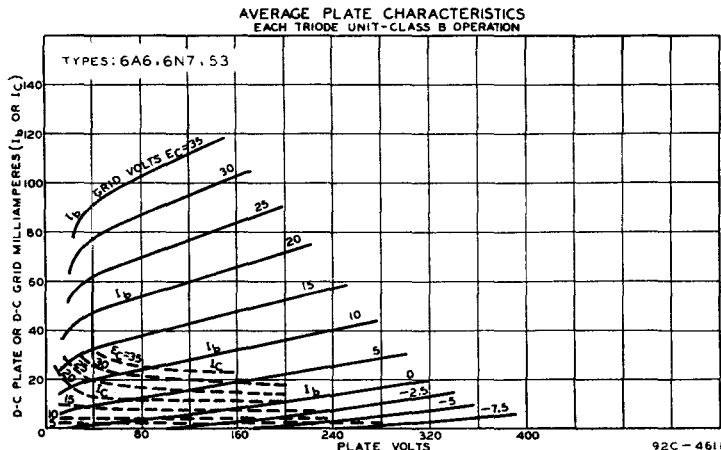

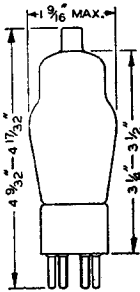

RCA-55

DUPLEX-DIODE TRIODE

The 55 is an a-c heater type of tube consisting of two diodes and a triode in a single bulb. It is recommended for service as a combined detector, amplifier and automatic-volume-control tube.

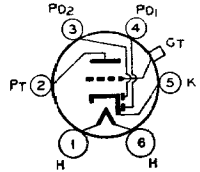

CHARACTERISTICS

HEATER VOLTAGE (A. C. or D. C.).....	2.5
HEATER CURRENT	1.0
BULB	
CAP	
BASE	

Volts
Ampere
ST-12
Small Metal
Small 6-Pin

Other characteristics of this type are the same as for type 85.

Diode Units

Two diode plates are placed around a cathode, the sleeve of which is common to the triode unit. Each diode plate has its own base pin. Operation curves for the diode units are given under type 6B7.

INSTALLATION AND APPLICATION

The base pins of the 55 fit the standard six-contact socket, which may be installed to hold the tube in any position. For heater operation and cathode connection, refer to INSTALLATION under type 2A5. Complete shielding of detector circuits employing the 55 is generally necessary to prevent r-f or i-f coupling between the diode circuits and the circuits of other stages.

For APPLICATION, refer to type 85, and to the chart of the Resistance-Coupled Amplifier Section. Circuits using the 55 are given under type 85.

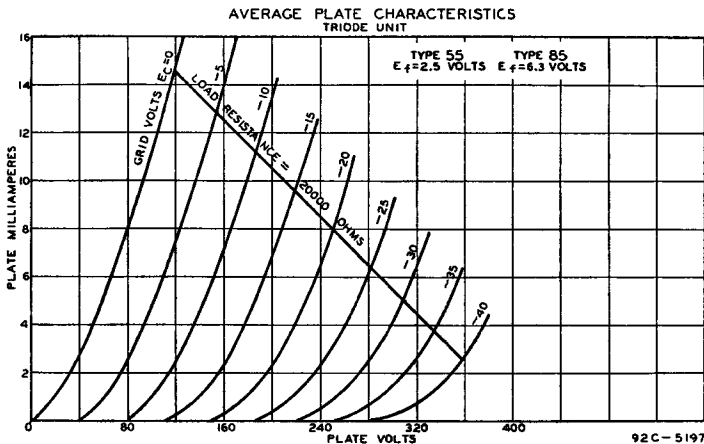

RCA-56

SUPER-TRIODE AMPLIFIER DETECTOR

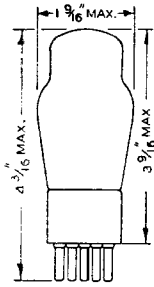
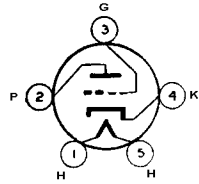

The 56 is a three-electrode tube of the heater-cathode type recommended for use as detector, amplifier, or oscillator in a-c receivers designed for it. This tube is characterized by its high

mutual conductance, and its comparatively high amplification factor. The 56 is useful in resistance-coupled audio-frequency amplifiers.

CHARACTERISTICS

HEATER VOLTAGE (A. C. or D. C.)	2.5	Volts
HEATER CURRENT	1.0	Ampere
PLATE VOLTAGE	100 250 max.	Volts
GRID VOLTAGE*	-5 -13.5	Volts
PLATE CURRENT	2.5 5	Milliamperes
PLATE RESISTANCE	12000 9500	Ohms
AMPLIFICATION FACTOR	13.8	
TRANSCONDUCTANCE	1150 1450	Micromhos
GRID-PLATE CAPACITANCE	3.2	$\mu\mu\text{f}$
GRID-CATHODE CAPACITANCE	3.2	$\mu\mu\text{f}$
PLATE-CATHODE CAPACITANCE	2.2	$\mu\mu\text{f}$
BULB		ST-12
BASE		Small 5-Pin

* If a grid-coupling resistor is used, its maximum value should not exceed 1.0 megohm.

INSTALLATION

The base pins of the 56 fit the standard five-contact socket which may be installed to hold the tube in any position.

The bulb of this tube will become very hot under certain conditions of operation. Sufficient ventilation should be provided to prevent overheating.

The heater is designed to operate at 2.5 volts. The transformer winding supplying the heater circuit should be designed to operate the heater at this recommended value for full-load operating conditions at average line voltage.

The cathode should preferably be connected directly to a mid-tap on the heater winding or to a center-tapped resistor across the heater winding. If this practice is not followed, the potential difference should be kept as low as possible.

APPLICATION

As an amplifier, the 56 is applicable either to radio-frequency or audio-frequency circuits. Recommended operating conditions for service using transformer coupling are given under CHARACTERISTICS. For operation as a resistance-coupled amplifier, refer to the Resistance-Coupled Amplifier Section.

As a detector, the 56 may be of the grid leak and condenser or grid-bias type. The plate voltage for the grid leak and condenser method should be about 45 volts. A grid leak of from 1 to 5 megohms with a grid condenser of 0.00025 μf is satisfactory. For the grid-bias method of detection, a plate-supply voltage of 250 volts may be used together with a negative grid-bias voltage of approximately 20 volts. The plate current should be adjusted to 0.2 milliamperes, with no input signal voltage. The grid-bias voltage may be supplied from the voltage drop in a resistor between cathode and ground. The value of this self-bias resistor is not critical, 30000 to 150000 ohms being suitable. The higher value will permit the application of a larger input signal.

A plate family for this type is given under type 76.

RCA-57

TRIPLE-GRID DETECTOR AMPLIFIER

The 57 is a triple-grid tube recommended especially for service as a biased detector in a-c receivers designed for its characteristics. The 57 is constructed with an internal shield connected to the cathode within the tube.

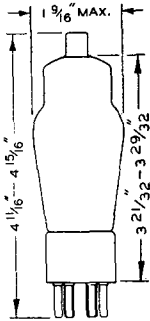
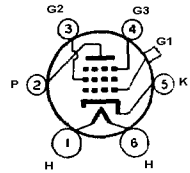

CHARACTERISTICS

HEATER VOLTAGE (A. C. or D. C.).....	2.5	Volts
HEATER CURRENT	1.0	Ampere
GRID-PLATE CAPACITANCE (With shield-can).....	0.007 max.	$\mu\mu\text{f}$
INPUT CAPACITANCE	5.0	$\mu\mu\text{f}$
OUTPUT CAPACITANCE	6.5	$\mu\mu\text{f}$
BULB		ST-12
CAP		Small Metal
BASE		Small 6-Pin

Other characteristics of this type are the same as for type 6J7.

INSTALLATION AND APPLICATION

The base pins of the 57 fit the standard six-contact socket which may be installed to hold the tube in any position. For heater operation and **cathode** connection, refer to **INSTALLATION** for type 2A5.

For **screen** voltage and **shielding** requirements, see **INSTALLATION** on type 6C6.

Refer to **APPLICATION** on type 6J7. The curve shown under 6J7 also applies to the 57.

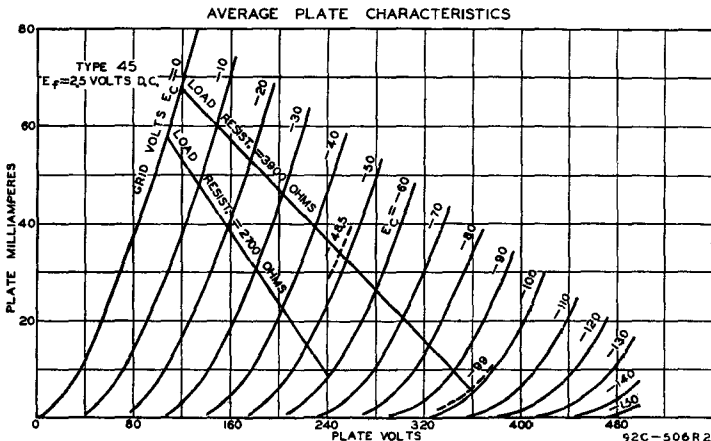

RCA-58

TRIPLE-GRID SUPER-CONTROL AMPLIFIER

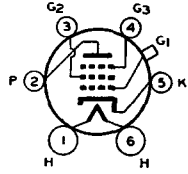
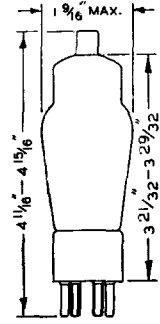

The 58 is a triple-grid super-control amplifier tube recommended especially for service in the radio-frequency and intermediate-frequency stages of a-c receivers designed for its characteristics. The 58 is constructed with an internal shield connected to the cathode within the tube.

CHARACTERISTICS

HEATER VOLTAGE (A. C. or D. C.)	2.5	Volts
HEATER CURRENT	1.0	Ampere
GRID-PLATE CAPACITANCE	0.007 <i>max.</i>	$\mu\mu\text{f}$
INPUT CAPACITANCE	4.7	$\mu\mu\text{f}$
OUTPUT CAPACITANCE	6.3	$\mu\mu\text{f}$
BULB		ST-12
CAP		Small Metal
BASE		Small 6-Pin

Other characteristics of this type are the same as for type 6D6. The curve shown under the 6D6 also applies to the 58.

INSTALLATION AND APPLICATION

The base pins of the 58 fit the standard six-contact socket which may be installed to hold the tube in any position. For heater operation and cathode connection, refer to INSTALLATION for type 2A5.

For control-grid bias variation, screen voltage, and suppressor connection, refer to INSTALLATION on type 6K7. Shielding requirements are similar to those for type 6C6. Refer to APPLICATION on type 6K7.

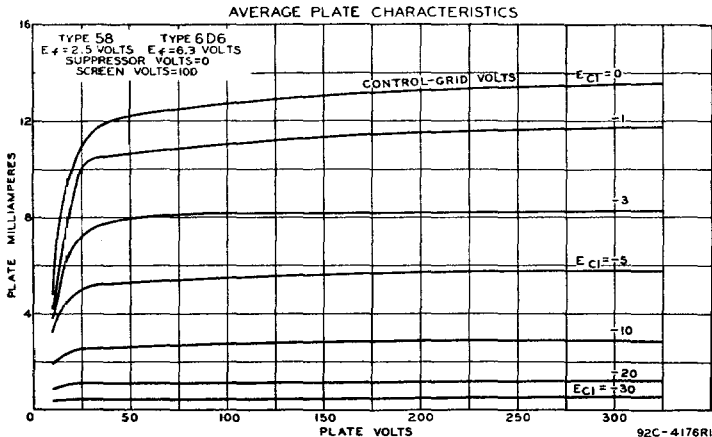

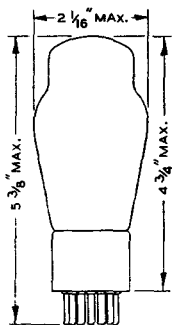

RCA-59

TRIPLE-GRID POWER AMPLIFIER

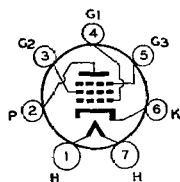

The 59 is a triple-grid power-amplifier tube of the heater-cathode type for use in the output stage of a-c operated receivers. The triple-grid construction of this tube, with

external connections for each grid, makes possible its application as (1) a Class A Power-Amplifier Triode, (2) a Class A Power-Output Pentode, and (3) a Class B Power-Output Triode.

CHARACTERISTICS

HEATER VOLTAGE (A. C. or D. C.)	2.5	Volts
HEATER CURRENT	2.0	Amperes
BULB		ST-16
BASE		Medium 7-Pin

As Class A₁ Power Amplifier

	Triode°	Pentode°°	
PLATE VOLTAGE	250 max.	250 max.	Volts
SCREEN VOLTAGE (Grid No. 2)	—	250 max.	Volts
GRID VOLTAGE (Grid No. 1)	-28	-18	Volts
PLATE CURRENT	26	35	Milliamperes
SCREEN CURRENT	—	9	Milliamperes
AMPLIFICATION FACTOR	6	100	
PLATE RESISTANCE	2300	40000	Ohms
TRANSCONDUCTANCE	2600	2500	Micromhos
LOAD RESISTANCE	5000*	6000	Ohms
SELF-BIAS RESISTOR	1080	410	Ohms
POWER OUTPUT	1.25	3†	Watts

As Class B Power Amplifier—Triode Connection

(Grids No. 1 and No. 2 tied together; grid No. 3 tied to plate)

PLATE VOLTAGE	400 max.	Volts
PEAK PLATE CURRENT	200 max.	Milliamperes
AVERAGE PLATE DISSIPATION	10 max.	Watts
AVERAGE GRID DISSIPATION (Grids No. 1 and No. 2)	1.5 max.	Watts

Values are for two tubes.

Plate Voltage	300	400	Volts
Grid Voltage	0	0	Volts
Zero-Signal Plate Current	20	26	Milliamperes
Effective Load Resistance (Plate-to-plate)	4600	6000	Ohms
Power Output, Approximate	15	20	Watts

* Grids No. 2 and No. 3 tied to plate; grid No. 1 is control grid.

** Grid No. 3 tied to cathode; grid No. 1 is control grid; grid No. 2 is screen.

† Optimum for maximum undistorted power output of 1.25 watts. Approximately twice this value is recommended for load of this type as driver for Class B stage.

‡ 7% total harmonic distortion.

INSTALLATION

The base pins of the 59 fit the seven-contact (0.855-inch pin-circle diameter) socket which may be installed to hold the tube in any position.

The bulb of this tube may become very hot under certain conditions of operation. Sufficient ventilation, therefore, should be provided to prevent overheating.

For heater operation and cathode connection, refer to INSTALLATION for type 2A5.

APPLICATION

For Class A₁ Triode Operation of the 59, the two grids (No. 2 and No. 3) immediately adjacent to the plate are connected to the plate, while the third (No. 1) is employed for control purposes. Operation of the tube is then similar to any Class A power-amplifier triode. The tabulated values for Class A operation of this type as given under CHARACTERISTICS, are for its operation as a power-output tube. When it is used as the driver for a Class B stage, the load requirements are changed, as indicated in the note under CHARACTERISTICS. This change is recommended in order to minimize distortion due to the driver stage.

The d-c resistance in the grid circuit of the 59, operating as a Class A amplifier (either with triode or pentode connection) should not exceed 0.5 megohm if self-bias is used. Without self-bias, the resistance should not exceed 10000 ohms. The use of resistances higher than these may cause the tube to lose bias due to grid current, with the result that the plate current will rise to a value sufficiently high to damage the tube.

For Class A₁ Pentode Operation of the 59, the grid (No. 3) adjacent to the plate is tied to the cathode and thus serves as the suppressor, while the other two grids (No. 2 and No. 1) serve as the screen grid and control grid respectively. Operation of the tube is then similar to any Class A power-output pentode.

For either method of Class A operation, the self-bias resistor should be shunted by a suitable filter network to avoid degenerative effects at low audio frequencies. The use of the two 59's in push-pull eliminates the necessity for shunting the resistor. The value of the self-bias resistor required for two tubes in the same stage is approximately one-half that for a single tube.

For Class B Triode Operation of the 59, the grid (No. 3) adjacent to the plate is tied to the plate, while the other grids (No. 1 and No. 2) are connected together to serve as a single control-grid. No grid bias is necessary with this connection. This feature is particularly important because it prevents the variation of bias with applied signal which would otherwise exist if any self-bias arrangement were employed. A discussion of Class B design features is given on page 20.

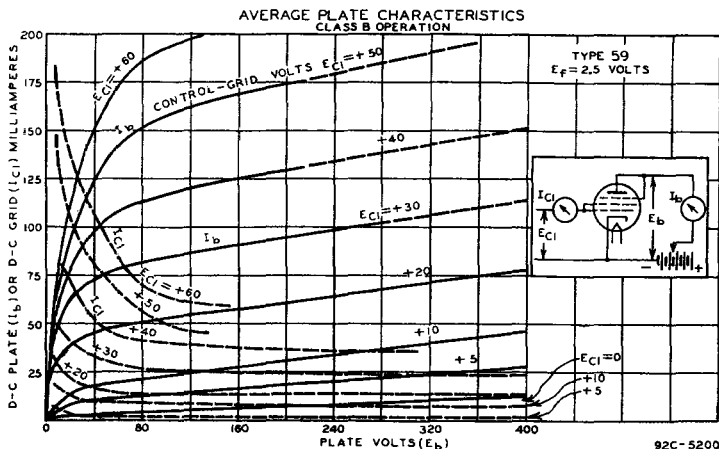

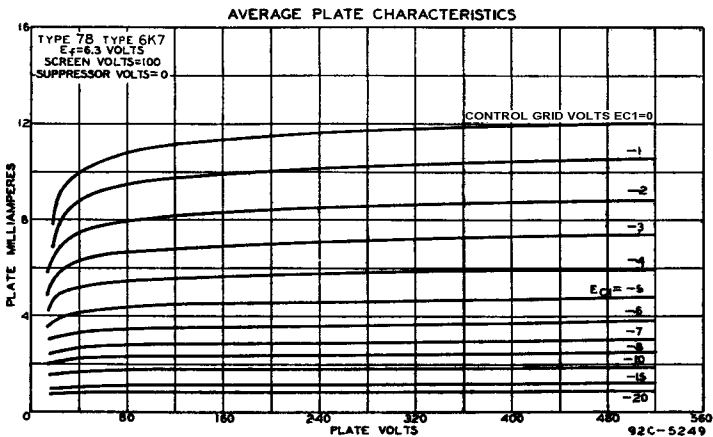
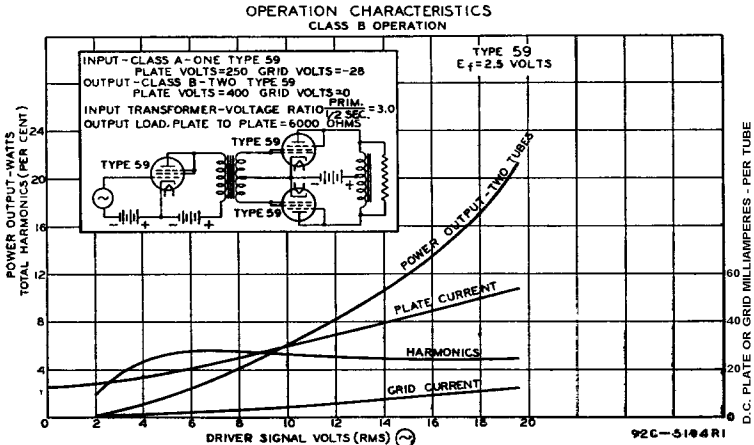
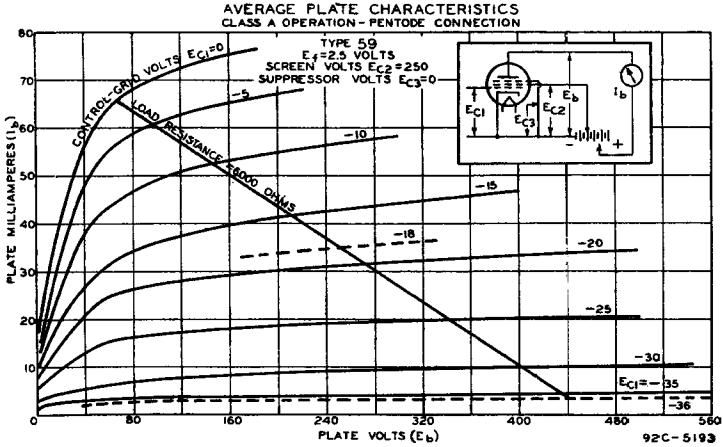

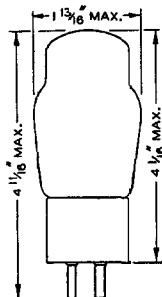

RCA-71-A

POWER AMPLIFIER

The 71-A is a power-amplifier tube of low-output impedance for use in the output stage of audio-frequency amplifiers.

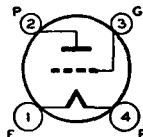

CHARACTERISTICS

FILAMENT VOLTAGE (A. C. or D. C.)	5.0	Volts
FILAMENT CURRENT	0.25	Ampere
PLATE VOLTAGE	90 135 180 <i>max.</i>	Volts
GRID VOLTAGE*	-16.5 -27 -40.5	Volts
PLATE CURRENT	10 17.3 20	Milliamperes
PLATE RESISTANCE	2170 1820 1750	Ohms
AMPLIFICATION FACTOR	3 3 3	
TRANSCONDUCTANCE	1400 1650 1700	Micromhos
LOAD RESISTANCE	3000 3000 4800	Ohms
SELF-BIAS RESISTOR	1600 1700 2150	Ohms
UNDISTORTED POWER OUTPUT	0.125 0.4 0.79	Watt
GRID-PLATE CAPACITANCE	7.5	$\mu\mu\text{f}$
GRID-FILAMENT CAPACITANCE	3.2	$\mu\mu\text{f}$
PLATE-FILAMENT CAPACITANCE	2.9	$\mu\mu\text{f}$
BULB		ST-14
BASE		Medium 4-Pin Bayonet

* For operation on a-c filament supply, increase grid-bias voltage 2.5 volts. The d-c resistance in the grid circuit should not exceed 0.5 megohm.

INSTALLATION AND APPLICATION

The base pins of this tube fit the standard four-contact socket which should be installed to hold the tube in a vertical position.

The coated filament of the 71-A may be operated from a storage battery or from the a-c line through a step-down transformer. For operation of this tube from a storage battery, a fixed or variable resistor of suitable value is required to reduce the battery voltage to 5.0 volts across the filament terminals at the socket.

Operating conditions are given under CHARACTERISTICS for the use of this tube in the power output stage.

An output device should be used to transfer power to the winding of the reproducing unit.

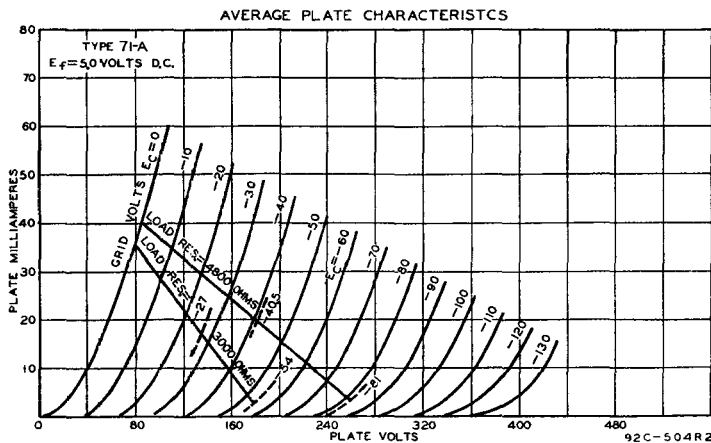

RCA-75

DUPLEX-DIODE HIGH-MU TRIODE

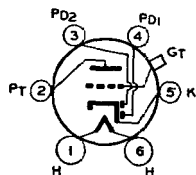
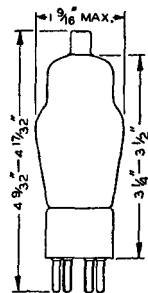

a-c receivers designed for its characteristics. For diode-detector considerations, refer to page 26.

CHARACTERISTICS

HEATER VOLTAGE (A. C. or D. C.)	6.3	Volts
HEATER CURRENT	0.3	Ampere
GRID-TRIODE-PLATE CAPACITANCE	1.7	μmf
GRID-CATHODE CAPACITANCE	1.7	μmf
TRIODE PLATE-CATHODE CAPACITANCE	3.8	μmf
BULB		ST-12
CAP		Small Metal
BASE		Small 6-Pin

Triode Unit—As Class A₁ Amplifier

PLATE VOLTAGE	250 <i>max.</i>	Volts
GRID VOLTAGE	-2	Volts
AMPLIFICATION FACTOR	100	
PLATE RESISTANCE	91000	Ohms
TRANSCONDUCTANCE	1100	Micromhos
PLATE CURRENT	0.8	Milliampere

Diode Units

The two diode plates are placed around a cathode, the sleeve of which is common to the triode unit. Each diode plate has its own base pin. Operation curves for the diode units are given under type 6B7.

INSTALLATION

The base pins of the 75 fit the standard six-contact socket which may be installed to hold the tube in any position.

Heater operation and cathode connection are the same as for the type 6A8.

APPLICATION

The 75 in many respects is similar in application to the 6Q7. The outstanding difference, however, is that the 75 has a high-mu triode. For this reason, the tube is recommended for use only in resistance-coupled circuits. Furthermore, diode-biasing of the triode unit is not suitable because of the probability of triode plate-current cut-off, even with relatively small signal voltages applied to the diode circuit.

As an amplifier in resistance-coupled a-f circuits, the 75 may be operated under the conditions given in the Resistance-Coupled Amplifier Section. A family of average plate characteristic curves applicable to this type will be found under type 2A6.

RCA-76

SUPER-TRIODE AMPLIFIER DETECTOR

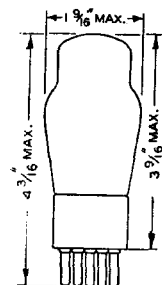
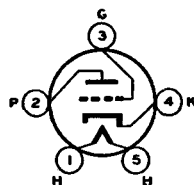

The 76 is a three-electrode tube of the heater-cathode type recommended for use as detector, amplifier, or oscillator with either a-c or d-c heater supply. This tube is characterized by

its high mutual conductance and its comparatively high amplification factor. The 76 is useful in resistance-coupled audio-frequency amplifiers.

CHARACTERISTICS

HEATER VOLTAGE (A. C. or D. C.)	6.3	Volts
HEATER CURRENT	0.3	Ampere
PLATE VOLTAGE	100 250 max.	Volts
GRID VOLTAGE*	-5 -13.5	Volts
PLATE CURRENT	2.5 5	Milliamperes
PLATE RESISTANCE	12000 9500	Ohms
AMPLIFICATION FACTOR	13.8 13.8	
TRANSCONDUCTANCE	1150 1450	Micromhos
GRID-PLATE CAPACITANCE	2.8	μmf
GRID-CATHODE CAPACITANCE	3.5	μmf
PLATE-CATHODE CAPACITANCE	2.5	μmf
BULB		ST-12
BASE		Small 5-Pin

* If a grid-coupling resistor is used, its maximum value should not exceed 1.0 megohm.

INSTALLATION AND APPLICATION

The base pins of the 76 fit the standard five-contact socket which may be installed to hold the tube in any position. For heater operation and cathode connection, refer to INSTALLATION for type 6A8. Refer to APPLICATION for the type 56.

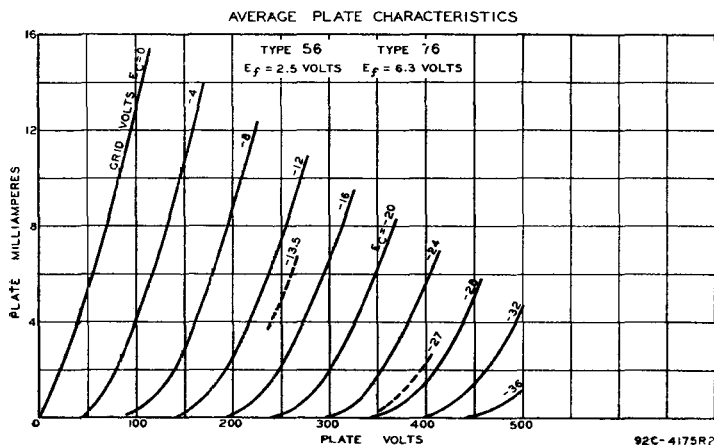

RCA-77

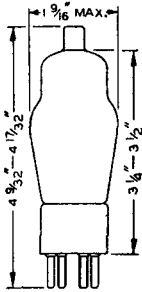

TRIPLE-GRID DETECTOR AMPLIFIER

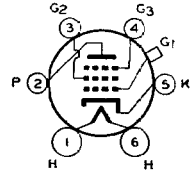

The 77 is a triple-grid tube recommended especially for service as a biased detector in radio receivers designed for its characteristics. In such service, this tube is capable of deliv-

ering a large audio-frequency output voltage with relatively small input voltage. Other applications of the 77 include its use as a low-signal-input screen-grid amplifier tube and as an automatic-volume-control tube.

CHARACTERISTICS

HEATER VOLTAGE (A. C. or D. C.).....	6.3	Volts
HEATER CURRENT	0.3	Ampere
PLATE VOLTAGE	100	250 <i>max.</i> Volts
SCREEN VOLTAGE (Grid No. 2).....	60	100 <i>max.</i> Volts
GRID VOLTAGE* (Grid No. 1).....	-1.5	-3 Volts
SUPPRESSOR (Grid No. 3).....	Connected to cathode at socket	
PLATE CURRENT	1.7	2.3 Milliampere
SCREEN CURRENT	0.4	0.5 Milliampere
PLATE RESISTANCE (Approximate).....	0.65	1.5 Megohms
AMPLIFICATION FACTOR	715	1500
TRANSCONDUCTANCE	1100	1250 Micromhos
GRID VOLTAGE (Approximate)†.....	-5.5	-7.5 Volts
GRID-PLATE CAPACITANCE (With shield-can).....	0.007	<i>max.</i> μf
INPUT CAPACITANCE	4.7	μf
OUTPUT CAPACITANCE	11.0	μf
BULB		ST-12
CAP		Small Metal
BASE		Small 6-Pin

* The d-c resistance in the grid circuit should not exceed 1.0 megohm.

† For cathode current cut-off.

INSTALLATION

The base pins of the 77 fit the standard six-contact socket which may be installed to hold the tube in any position. For heater operation and cathode connection, refer to INSTALLATION under type 6A7. Shielding and screen voltage requirements are similar to those for the type 6C6.

APPLICATION

As a radio-frequency amplifier pentode, the 77 may be used particularly in applications where the r-f signal applied to the grid is relatively low, that is, of the order of a few volts. In such cases either screen or control grid voltage (or both) may be varied to control the receiver volume. When larger signals are involved, a super-control amplifier tube should be employed to prevent the occurrence of excessive cross-modulation and modulation-distortion. Recommended operating conditions for amplifier service are given under CHARACTERISTICS.

As a biased detector, the 77 is particularly recommended because of its ability to deliver a large audio-frequency output voltage of good quality with a fairly small radio-frequency signal input. Recommended conditions for the 77 as a biased detector are as follows:

PLATE SUPPLY*	100	250	250	Volts
SCREEN VOLTAGE	36	50	100max.	Volts
GRID VOLTAGE	-2	-2	-4.3	Volts
CATHODE RESISTOR	12500	3000	10000	Ohms
SUPPRESSOR	Connected to cathode at socket			
CATHODE CURRENT (No signal)	0.16	0.65	0.43	Milliamperes
PLATE RESISTOR	0.25	0.25	0.50	Megohm
BLOCKING CONDENSER	0.01	0.03	0.03	μ f
GRID RESISTOR†	0.25	0.25	0.25	Megohm
R-F SIGNAL (RMS)**	1.88	1.18	1.37	Volts

* Voltage at plate will be PLATE SUPPLY voltage minus voltage drop in plate resistor caused by plate current.

† For the following amplifier tube.

** With these signal voltages modulated 20%, the voltage output for the 100-volt plate supply is 14 peak volts at the grid of the following amplifier, a value sufficient to insure full audio output from a type 43; likewise for the 250-volt conditions, 17 peak volts, a value sufficient to insure full audio output from a type 2A5.

Detector bias may be obtained from a bleeder circuit, from a resistor in the cathode circuit, or from a partial self-bias circuit. The cathode-resistor method permits of higher output at lower percentage modulation since the input signal may be increased almost in inverse proportion to the modulation without resulting in objectionable distortion.

As an audio-frequency amplifier pentode in resistance-coupled circuits, the 77 may be operated as shown in the Resistance-Coupled Amplifier Section.

As an audio-frequency amplifier triode, the 77 should have its screen and suppressor connected to the plate. Operating conditions for triode service in transformer- or impedance-coupled circuits are: Plate voltage, 250 volts; grid voltage, -8 volts; and plate current, 8 milliamperes, approximate. If resistance coupling is used, a plate-supply voltage of 250 volts may be applied through a plate-coupling resistor of 0.1 to 0.25 megohm.

As a mixer in superheterodyne circuits, the 77 can be employed, but a tube having super-control characteristics is to be preferred, especially if signals of large magnitude are to be received, and if supplementary volume control is to be obtained in this stage.

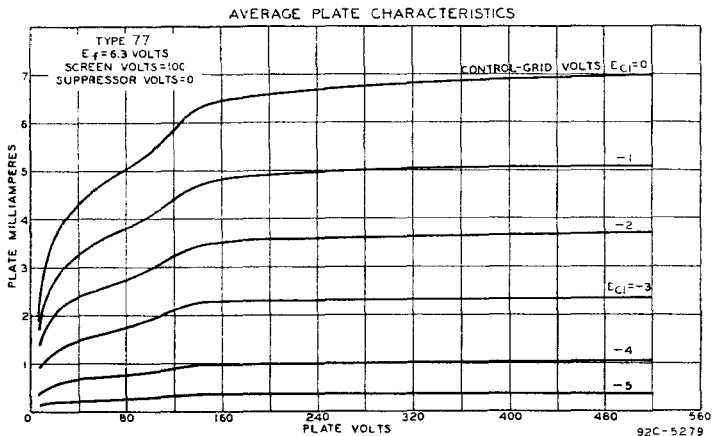

RCA-78

TRIPLE-GRID SUPER-CONTROL AMPLIFIER

The 78 is a triple-grid super-control amplifier tube recommended for service in the radio-frequency and intermediate-frequency stages of radio receivers designed for its character-

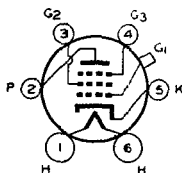
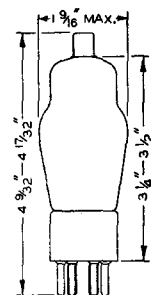

istics. The ability of this tube to handle usual signal voltages without cross-modulation and modulation-distortion makes it adaptable to the r-f and i-f stages of receivers employing automatic volume-control. The internal shield around the plate of the 78 is connected to the cathode within the tube.

CHARACTERISTICS

HEATER VOLTAGE (A. C. or D. C.)	6.3	Volts
HEATER CURRENT	0.3	Ampere
PLATE VOLTAGE	90 180 250 <i>max.</i> 250 <i>max.</i>	Volts
SCREEN VOLTAGE	90 75 100 125 <i>max.</i>	Volts
GRID VOLTAGE (Minimum)	-3 -3 -3 -3	Volts
SUPPRESSOR	Connected to cathode at socket	
PLATE CURRENT	5.4 4.0 7.0 10.5	Milliamperes
SCREEN CURRENT	1.3 1.0 1.7 2.6	Milliamperes
PLATE RESISTANCE	0.315 1.0 0.8 0.6	Megohm
AMPLIFICATION FACTOR	400 1100 1160 990	
TRANSCONDUCTANCE	1275 1100 1450 1650	Micromhos
GRID VOLTAGE*	-38.5 -32.5 -42.5 -52.5	Volts
GRID-PLATE CAPACITANCE (With shield-can)	0.007 <i>max.</i>	$\mu\mu\text{f}$
INPUT CAPACITANCE	4.5	$\mu\mu\text{f}$
OUTPUT CAPACITANCE	11.0	$\mu\mu\text{f}$
BULB		ST-12
CAP		Small Metal
BASE		Small 6-Pin

* For transconductance = 2 micromhos.

INSTALLATION AND APPLICATION

The base pins of the 78 fit the standard six-contact socket which may be installed to hold the tube in any position. Heater operation and cathode connection are the same as for the type 6A8. Control-grid bias variation, screen voltage supply, and suppressor connection follow the methods given under INSTALLATION for the type 6D6. Shielding requirements are similar to those of the type 6C6. Refer to APPLICATION on the type 6K7.

A plate family of characteristic curves is given at the bottom of page 147.

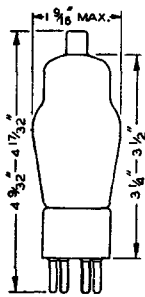

RCA-79

CLASS B TWIN AMPLIFIER

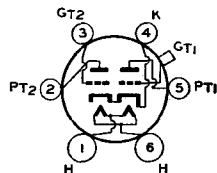

The 79 is a heater-cathode type of tube combining in one bulb two high- μ triodes designed for Class B operation. It is intended for use in the audio-output stage of radio receivers with 6.3-volt heater supply. The triode units have separate external terminals for all electrodes except the cathode and heater so that circuits employing the 79 are similar to those of Class B amplifiers utilizing individual tubes in the output stage.

CHARACTERISTICS

HEATER VOLTAGE (A. C. or D. C.).....	6.3	Volts
HEATER CURRENT	0.6	Ampere
BULB		ST-12
CAP		Small Metal
BASE		Small 6-Pin

As Class B Power Amplifier

PLATE VOLTAGE	250 max.	Volts	
PEAK PLATE CURRENT (Per Plate).....	90 max.	Milliamperes	
AVERAGE PLATE DISSIPATION.....	11.5 max.	Watts	
TYPICAL OPERATION			
Plate Voltage	180	250	Volts
Grid Voltage	0	0	Volts
Zero-Signal Plate Current (Per plate)....	3.8	5.3	Milliamperes
Effective Load Resistance (Plate-to-plate)..	7000	14000	Ohms
Power Output (Approximate)*.....	5.5	8.0	Watts

* With average power input of 380 milliwatts applied between grids.

INSTALLATION AND APPLICATION

The base pins of the 79 fit the standard six-contact socket which may be installed to operate the tube either in a vertical or in a horizontal position. Sufficient ventilation should be provided to circulate air freely around the tube to prevent overheating.

For heater operation and cathode connection, refer to INSTALLATION on type 6A8.

As a Class B power amplifier, the 79 is used in circuits similar in design to those utilizing individual tubes in the output stage. It requires no grid-bias, since the high- μ feature of the triode units reduces the steady plate current at zero bias to only a few milliamperes. Refer to page 20 for general Class B amplifier design considerations.

As a Class A amplifier, the 79 may be used with grid-bias voltage for small input signals. Such applications include circuits employing the two triode units either in parallel or in push-pull connection.

In other applications, the two triode units of the 79 may be used in various circuits to combine the functions of oscillation, detection and/or amplification.

A family of plate characteristic curves is given on page 156.

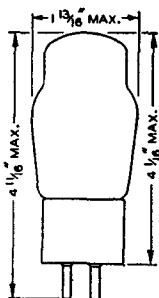

RCA-80

FULL-WAVE RECTIFIER

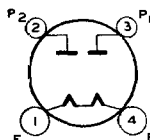

The 80 is a full-wave rectifying tube intended for use in d-c power supply devices which operate from the a-c supply line.

CHARACTERISTICS

FILAMENT VOLTAGE (A. C.).....	5.0	Volts
FILAMENT CURRENT	2.0	Amperes
1 { A-C PLATE VOLTAGE PER PLATE (RMS).....	350	Volts
{ D-C OUTPUT CURRENT.....	125 max.	Milliamperes
2 { A-C PLATE VOLTAGE PER PLATE (RMS).....	400 max.	Volts
{ D-C OUTPUT CURRENT.....	110 max.	Milliamperes
3* { A-C PLATE VOLTAGE PER PLATE (RMS).....	550 max.	Volts
{ D-C OUTPUT CURRENT.....	135 max.	Milliamperes
BULB		ST-14
BASE		Medium 4-Pin

* This rating is permissible only with filter circuits having an input choke of at least 20 henries

INSTALLATION

The base pins of the 80 fit the standard four-contact socket which should be mounted preferably to hold the tube in a vertical position. If it is necessary to place the tube in a horizontal position, the socket should be mounted with both of the filament-pin openings, either at the top or at the bottom. This precaution locates the filament-plane vertical for most satisfactory performance. Provision should be made for free circulation of air around the bulb since it becomes quite hot during operation.

The coated filament of the 80 is designed to operate from the a-c line through a step-down transformer. The voltage applied to the filament terminals should be the rated value of 5.0 volts under operating conditions and average line voltage.

The approximate d-c output voltage of the 80 for various values of a-c input voltage may be obtained from the curves, page 156. For the d-c voltage available at the radio set, it is necessary to subtract the voltage drop across the filter from the value read from the curves.

APPLICATION

As a full-wave rectifier, the 80 may be operated with condenser-input or choke-input filter under conditions not to exceed the ratings given under CHARACTERISTICS.

As a half-wave rectifier, two 80's may be operated in a full-wave circuit with reasonable serviceability to deliver more d-c output current than can be obtained from one tube. For this use, the plates of each 80 are tied together at the socket. The allowable voltage and load conditions per tube are the same as for full-wave service.

The filter may be of either the condenser-input or choke-input type. If an input condenser is used, consideration must be given to the instantaneous peak value of the a-c input voltage. The peak voltage is about 1.4 times the RMS value as measured by most a-c voltmeters. Filter condensers, therefore, especially the input condenser, should have a rating high enough to withstand the instantaneous peak value, if breakdown is to be avoided. When the input-choke method is used, the available d-c output voltage will be somewhat lower than with the input condenser method for a given a-c plate voltage. However, improved regulation, together with lower peak current, will be obtained.

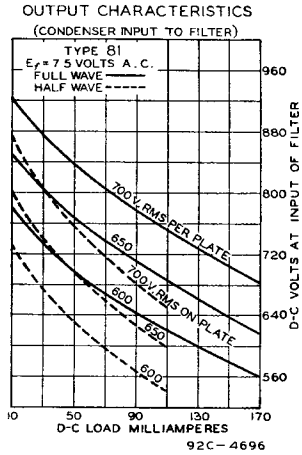
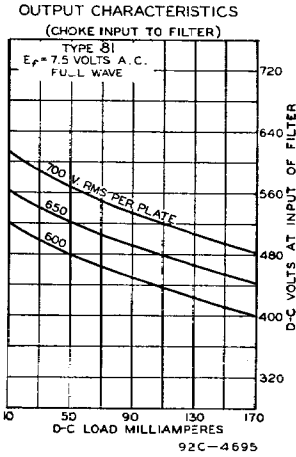
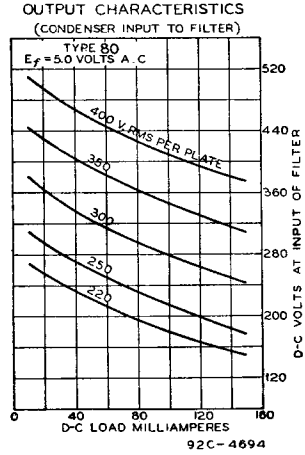
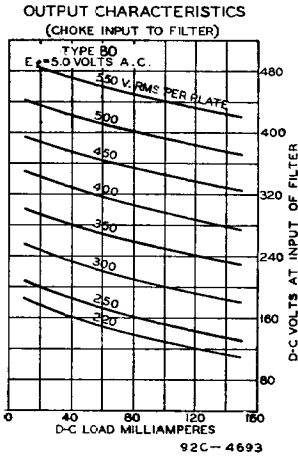

AVERAGE PLATE CHARACTERISTICS
EACH TRIODE UNIT

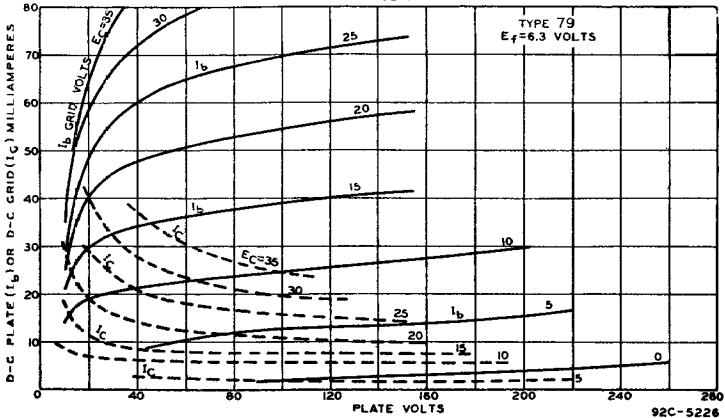

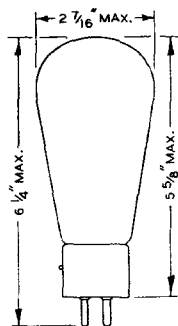

RCA-81

HALF-WAVE RECTIFIER

The 81 is a half-wave rectifier tube of the high-vacuum type for use in d-c power-supply devices operating from the alternating-current supply line. Full-wave rectification may be accomplished by two 81's.

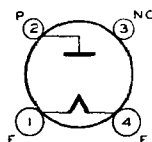

CHARACTERISTICS

FILAMENT VOLTAGE (A. C.).....	7.5	Volts
FILAMENT CURRENT	1.25	Amperes
A-C PLATE VOLTAGE (RMS).....	700 <i>max.</i>	Volts
D-C OUTPUT CURRENT.....	85 <i>max.</i>	Milliamperes
BULB		S-19
BASE	Medium	4-Pin Bayonet

INSTALLATION

The **base** pins of the 81 fit the standard four-contact socket which should be mounted to hold the tube in a vertical position. Provision should be made for free circulation of air around the bulb since it becomes quite hot during operation.

The coated **filament** of the 81 is designed to operate from the a-c line through a step-down transformer. The voltage applied to the filament terminals should be the rated value of 7.5 volts under operating conditions and average line voltage.

The approximate **d-c output voltage** of the 81 in half-wave and full-wave connection, for various values of a-c input voltage, may be obtained from the curves on the preceding page. For the d-c voltage available at the radio set, it is necessary to subtract the voltage drop across the filter from the value read from the curves.

APPLICATION

As a **half-wave rectifier**, the 81 may be operated under conditions not to exceed those given under CHARACTERISTICS.

In **full-wave** circuits, two 81's are required to rectify both halves of the a-c voltage. Operating voltages per tube are the same as for the half-wave circuit, but twice the d-c output current may be obtained.

The **filter** may be of either the condenser-input or choke-input type. If an input condenser is used, consideration must be given to the instantaneous peak value of the a-c input voltage. The peak value is about 1.4 times the RMS value as measured by most a-c voltmeters. For this reason, filter condensers, especially the input condenser, should have a rating high enough to withstand the instantaneous peak value, if breakdown is to be avoided. When the input-choke method is used, the available d-c output voltage will be somewhat lower than with the input-condenser method for a given a-c plate voltage. However, improved regulation, together with lower peak current, will be obtained.

For **special applications**, it is possible to obtain a d-c output voltage approximately double that to be expected from conventional rectifier circuits, without exceeding the recommended maximum a-c input-voltage per tube. This is accomplished by means of a voltage-doubling system designed for each particular application. See page 25.

RCA-82

FULL-WAVE MERCURY-VAPOR RECTIFIER

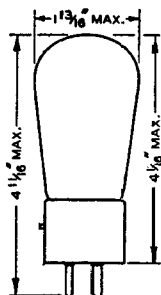
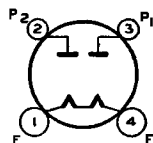

The 82 is a full-wave mercury-vapor rectifier tube of the hot-cathode type for use in suitable rectifying devices designed to supply d-c power of uniform voltage to receivers in

which the direct-current requirements are subject to considerable variation. The excellent voltage-regulation characteristic of the 82 is due to its low and practically constant tube voltage drop (only about 15 volts) for any current drain up to the full emission of the filament (see page 8).

CHARACTERISTICS

FILAMENT VOLTAGE (A. C.).....	2.5	Volts
FILAMENT CURRENT	3.0	Amperes
A-C VOLTAGE PER PLATE (RMS).....	500 <i>max.</i>	Volts
PEAK INVERSE VOLTAGE.....	1400 <i>max.</i>	Volts
D-C OUTPUT CURRENT (Continuous).....	125 <i>max.</i>	Milliamperes
PEAK PLATE CURRENT.....	400 <i>max.</i>	Milliamperes
TUBE VOLTAGE DROP (Approximate).....	15	Volts
BULB		S-14
BASE		Medium 4-Pin

MERCURY-VAPOR RECTIFIER CONSIDERATIONS

The 82 has very low internal resistance, so that the current it delivers depends on the resistance of the load and the regulation of the power transformer. Sufficient protective resistance or reactance must always be used with this tube to limit its current to the recommended maximum value. If this value is exceeded, the tube voltage drop will increase rapidly and may permanently damage the filaments.

It is characteristic of mercury-vapor rectifiers that no appreciable plate current will flow until the plate voltage reaches a certain critical positive value. At this point the plate current rises steeply to a high value in a small fraction of a second. This surge of current re-occurring each time either plate becomes positive may excite circuits in the vicinity of the tube to damped oscillation and thus cause noisy radio receiver operation. It is usually necessary, therefore, to provide small radio-frequency chokes in series with each plate lead so that the slope of the current wave front to the filter is reduced sufficiently to eliminate impact excitation.

INSTALLATION

The base pins of the 82 fit the standard four-contact socket, which should be installed to hold the tube in a vertical position with the base down. Only a socket making very good filament contact and capable of carrying 3 amperes continuously should be used. Poor contact at the filament pins will cause overheating at the pins and socket, lowered filament voltage, and high internal tube drop with consequent injury to the tube.

The bulb becomes hot during continuous operation. Provision should be made for adequate natural ventilation to prevent overheating, especially if shielding is employed.

The coated filament is intended for a-c operation from one of the secondary windings of a power transformer. This winding, provided with a center-tap or center-tap resistor, should supply at the filament terminals the rated operating voltage of 2.5 volts when average rated voltage is applied to the primary. The high current taken by the filament and the possibility of damage caused by applying plate voltage to the tube with its filament insufficiently heated make it imperative that all connections in the filament circuit be of low resistance and of adequate current-carrying capacity.

The plate supply is obtained from a center-tapped high-voltage winding designed so that the maximum a-c input voltage per plate will not exceed 500 volts RMS under varying conditions of supply-line voltage. The resistance of the transformer windings should, of course, be low if full advantage of the excellent regulation capabilities of this mercury-vapor rectifier is to be obtained. Since the drop through the tube is practically constant, any reduction in rectified voltage when the load is increased is due to the drop in the transformer and/or the filter windings. The return-lead from the plates, i.e., the positive bus of the filter and load circuit, should be connected to the center-tap of the filament winding.

Shielding of this tube, particularly in sensitive receivers, may be necessary to eliminate objectionable noise. Radio-frequency choke coils, connected in series with each plate lead and placed within the shielding if used, are usually necessary in receivers having high sensitivity. The inductance of the chokes should be one millihenry or more.

A fuse having a rating approximately 50% in excess of normal load requirements should be inserted in the primary of the power transformer to prevent damage in case of excessive current which may flow under abnormal conditions.

It is recommended that the entire equipment be disconnected from the a-c power supply whenever the 82 is removed from or installed in its socket.

APPLICATION

As a full-wave rectifier, the 82 is recommended for supplying d-c power to receivers, particularly those in which the direct-current requirements cause considerable variation in the load impressed on the rectifier tube.

As a half-wave rectifier, the 82 may be operated with plates connected in parallel. For example, two 82's so arranged in a full-wave circuit can supply twice the output current of a single tube. When the 82's plates are operated in parallel, a resistor of not less than 100 ohms should be connected in series with each plate in order that each plate will carry its proper share of the total load.

Filter circuits (page 37) of either the condenser-input or the choke-input type may be employed provided the maximum voltages and currents tabulated under CHARACTERISTICS are not exceeded. The choke-input type of circuit is to be preferred from the standpoint of obtaining the maximum continuous d-c output current from the 82 under the most favorable conditions.

Under operating conditions, the 82 has a bluish-white glow filling the space within the plates and extending to some degree into the surrounding space outside the plates. This glow, caused by the mercury vapor, is an inherent operating characteristic of the 82.

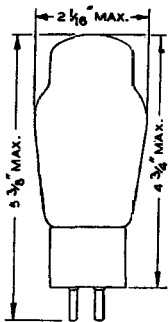

RCA-83

FULL-WAVE MERCURY-VAPOR RECTIFIER

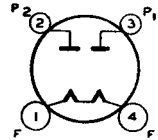

The 83 is a heavy-duty, full-wave, mercury-vapor rectifier tube of the hot-cathode type. It is intended for use in suitable rectifying devices designed to supply d-c power of uniform voltage to receivers. The excellent voltage regulation characteristic of the 83 is due to its low and practically constant tube voltage drop (only about 15 volts) for any current drain up to the full emission of its filaments. For mercury-vapor rectifier considerations, refer to page 8 and to type 82.

CHARACTERISTICS

FILAMENT VOLTAGE (A. C.).....	5.0	Volts
FILAMENT CURRENT	3.0	Amperes
A-C PLATE VOLTAGE PER PLATE (RMS).....	500 <i>max.</i>	Volts
PEAK INVERSE VOLTAGE.....	1400 <i>max.</i>	Volts
D-C OUTPUT CURRENT (Continuous).....	250 <i>max.</i>	Milliamperes
PEAK PLATE CURRENT.....	800 <i>max.</i>	Milliamperes
TUBE VOLTAGE DROP (Approximate).....	15	Volts
BULB		ST-16
BASE		Medium 4-Pin

INSTALLATION

Installation of the 83 is similar to that of the type 82.

APPLICATION

As a **full-wave rectifier**, the 83 is intended for supplying large amounts of d-c power to receivers whose requirements are in excess of the rating of the 82. The 83 is recommended for heavy-drain receivers in which the direct-current requirements cause considerable variation in the load impressed on the rectifier tube.

As a **half-wave rectifier**, the 83 may be operated with plates connected in parallel. For example, two 83's so arranged in a full-wave circuit can supply twice the output current of a single tube. When the 83's plates are operated in parallel, a resistor of not less than 50 ohms should be connected in series with each plate in order that each plate will carry its proper share of the total load. If the load is less than 75% of the total maximum current rating of the tube(s), the series plate resistors should be increased to 100 ohms each.

Filter circuits (page 37) of either the condenser-input or the choke-input type may be employed, provided the maximum voltages and currents tabulated under CHARACTERISTICS are not exceeded. The choke-input type of circuit is to be preferred from the standpoint of obtaining the maximum continuous d-c output current from the 83 under the most favorable conditions.

Under operating conditions, the 83 has a bluish-white glow filling the space within the plates and extending to some degree into the surrounding space outside the plates. This glow, caused by the mercury-vapor, is an inherent operating characteristic of the tube.

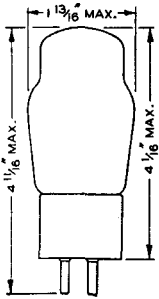

RCA-83-v

FULL-WAVE RECTIFIER

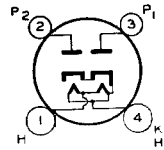

The 83-v is a high-vacuum, full-wave rectifier tube of the heater-cathode type. It is intended for use in suitable rectifying devices designed to supply d-c power to receivers having large d-c requirements. The excellent voltage regulation characteristic of the 83-v is due to the close spacing of the cathode and plate.

CHARACTERISTICS

HEATER VOLTAGE (A. C.).....	5.0	Volts
HEATER CURRENT	2.0	Amperes
A-C PLATE VOLTAGE PER PLATE.....	400 max.	Volts
PEAK INVERSE VOLTAGE.....	1100 max.	Volts
D-C OUTPUT CURRENT.....	200 max.	Milliamperes
BULB		ST-14
BASE		Medium 4-Pin

INSTALLATION

The **base** pins of the 83-v fit the standard four-contact socket which may be mounted to hold the tube in any position.

The **bulb** becomes hot during continuous operation. Provision should be made for adequate natural ventilation to prevent overheating.

The **heater** is designed to operate from the a-c line through a step-down transformer. The voltage applied to the heater should be the rated value of 5.0 volts under operating conditions and average line voltage. The heater leads should have as low resistance as practical.

The **cathode** of the 83-v is connected to the heater **within** the tube.

APPLICATION

As a **full-wave rectifier**, the 83-v is useful for supplying large amounts of d-c power to receivers, particularly those in which the d-c requirements cause considerable variation in the load impressed on the rectifier tube.

Filter circuits of either the choke-input or the condenser-input type may be employed, provided the maximum voltages and currents tabulated under **CHARACTERISTICS** are not exceeded. The choke-input type of circuit is to be preferred from the standpoint of obtaining the maximum continuous d-c output current from the 83-v under the most favorable conditions.

For discussion of rectifiers and filter circuits, refer to pages 24 and 37, respectively.

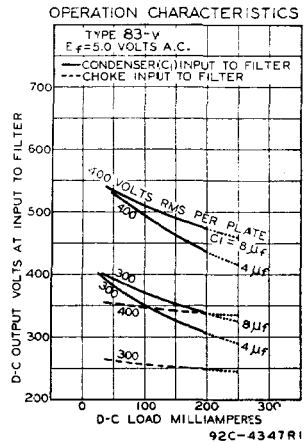

RCA-84

FULL-WAVE RECTIFIER

The 84 is a high-vacuum rectifier of the heater-cathode type, intended for supplying rectified power to automobile-radio equipment designed for its characteristics. This type is interchangeable with the 6Z4.

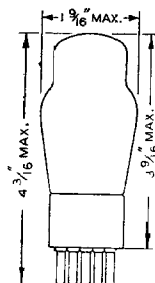
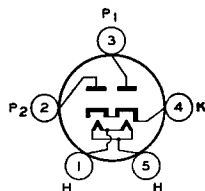

CHARACTERISTICS

HEATER VOLTAGE (A. C. or D. C.).....	6.3	Volts
HEATER CURRENT	0.5	Ampere
A-C PLATE VOLTAGE PER PLATE (RMS).....	350 max.	Volts
PEAK INVERSE VOLTAGE.....	1000 max.	Volts
D-C OUTPUT CURRENT.....	50 max.	Milliamperes
BULB		ST-12
BASE		Small 5-Pin

INSTALLATION

The base pins of the 84 fit the standard five-contact socket which may be mounted to hold the tube in any position.

The bulb of this tube will become very hot under certain conditions of operation. Adequate ventilation should be provided for cooling the tube by the use of chassis enclosures designed to radiate heat efficiently.

The heater is designed so that the normal voltage variation of 6-volt automobile batteries during charge and discharge will not materially affect the performance or serviceability of this tube. Under no condition of operation should the normal operating heater voltage of this tube fluctuate to exceed a maximum of 7.5 volts. The d-c potential difference heater and cathode should be limited to 500 volts.

APPLICATION

As a full-wave rectifier, the 84 may be operated with condenser-input or choke-input filter under conditions not to exceed the ratings given under CHARACTERISTICS.

As a half-wave rectifier, the 84 may be used by connecting the two plate terminals together at the socket. With this arrangement, the maximum d-c output current is 75 milliamperes, while other values are the same as for full-wave service.

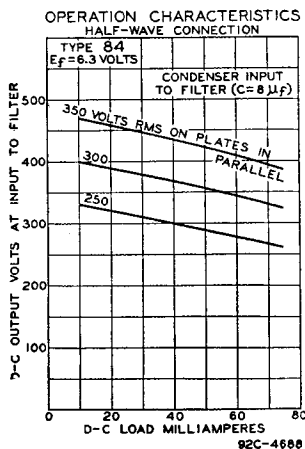
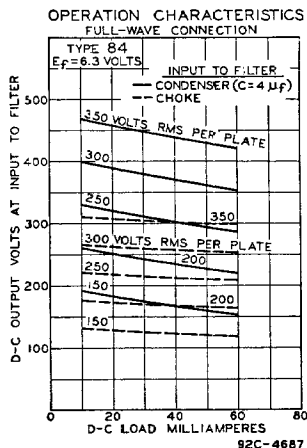

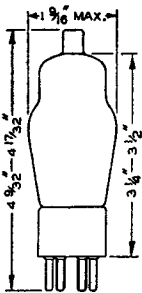

RCA-85

DUPLEX-DIODE TRIODE

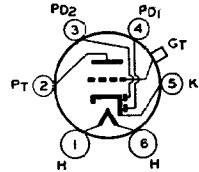

The 85 is a heater type of tube consisting of two diodes and a triode in a single bulb. It is for use as a combined detector, amplifier, and automatic-volume-control tube in radio receivers designed for its characteristics. The two diodes and the triode are independent of each other except for a common cathode sleeve, which has one emitting surface for the diodes and another for the triode. The separate tube units permit of unusual flexibility in circuit arrangement and design. For example, the diodes of this tube can perform the functions of detection and of automatic volume-control; while, at the same time, the triode may be used as an amplifier under its own optimum conditions. For diode-detector considerations, refer to page 26.

CHARACTERISTICS

HEATER VOLTAGE (A. C. or D. C.).....	6.3	Volts
HEATER CURRENT	0.3	Ampere
GRID-PLATE CAPACITANCE	1.5	μmf
GRID-CATHODE CAPACITANCE	1.5	μmf
PLATE-CATHODE CAPACITANCE	4.3	μmf
BULB		ST-12
CAP		Small Metal
BASE		Small 6-Pin

Triode Unit—As Class A Amplifier

PLATE VOLTAGE	135	180	250 max.	Volts
GRID VOLTAGE	-10.5	-13.5	-20	Volts
AMPLIFICATION FACTOR	8.3	8.3	8.3	
PLATE RESISTANCE	11000	8500	7500	Ohms
TRANSCONDUCTANCE	750	975	1100	Micromhos
PLATE CURRENT	3.7	6.0	8.0	Milliamperes
LOAD RESISTANCE	25000	20000	20000	Ohms
POWER OUTPUT	0.075	0.16	0.35	Watt

Diode Units

The two diode plates are placed around a cathode, the sleeve of which is common to the triode unit. Each diode plate has its own base pin. Operation curves for the diode units are given under type 6B7.

INSTALLATION

The base pins of the 85 fit the standard six-contact socket, which may be installed to hold the tube in any position. For heater operation and cathode connection, refer to INSTALLATION under type 6A8. Complete shielding of detector circuits employing the 85 is generally necessary to prevent r-f or i-f coupling between the diode circuits and the circuits of other stages.

APPLICATION

The 85 is recommended for performing the simultaneous functions of automatic volume-control, detection, and amplification.

For detection, the diodes may be utilized in a full-wave circuit or in a half-wave circuit. In the latter case, one plate only, or the two plates in parallel, may be employed. The use of the half-wave arrangement will provide approximately twice the rectified voltage as compared with the full-wave arrangement.

For automatic volume-control, a rectified voltage which is dependent on the r-f or i-f carrier, is usually employed. This voltage is utilized to regulate the gain of the r-f and/or i-f amplifier stages so as to maintain essentially constant-carrier input to the audio detector. The regulation of amplifier gain by means of the rectified voltage may be accomplished by a number of methods, differing chiefly in

the means of applying the voltage to the various electrodes of the amplifier tubes. As is well known, the regulating voltage may be applied to the control grids of the amplifier tubes. On the other hand, by less familiar methods, the voltage may, depending on the requirements of the designer, be applied to other electrodes. For example, the voltage may be applied to suppressor, plate and/or screen of an r-f pentode.

The complex structure of the 85 permits of obtaining automatic-volume-control voltage in a number of ways. In one case, the required voltage is obtained from the detector circuit by utilizing the voltage drop caused by the rectified current flowing through a resistor in the detector circuit. In another case, the required voltage is obtained by utilizing one diode for the sole purpose of automatic volume-control (a.v.c.). This latter method is of particular interest since it confines the sensitivity and time-delay function to the a.v.c. circuit. Time-delay action is, of course, determined by the use of a resistance and condenser combination having the desired time constant. The a.v.c. action may be postponed by applying a negative voltage to the a.v.c. diode plate. Another a.v.c. arrangement capable of various adaptations is to use the triode as a d-c amplifier to supply the regulating voltage. Additional information on automatic volume-control is given on page 28.

For amplification, the triode may be employed in conventional circuit arrangements. Representative conditions for resistance-coupled amplifier applications are given in the Resistance-Coupled Amplifier Section. Grid bias for the triode, depending upon circuit design, may be obtained from a fixed-voltage tap on the d-c power supply or may be obtained by utilizing the variable voltage drop caused by the rectified current flowing through a resistor in the detector circuit. In this connection, it should be noted that the circuits shown below designate this latter arrangement as "Diode-Biased Amplifier." Diode biasing of the triode unit may be employed only when at least 20000 ohms resistance is used in the triode plate circuit.

A plate family of characteristics for the triode unit is given under type 55.

TYPICAL DUPLEX-DIODE TRIODE CIRCUITS

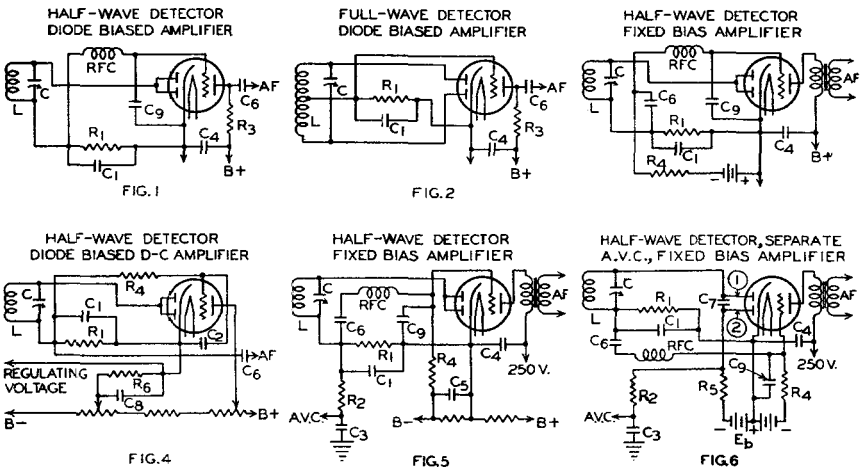

APPROXIMATE VALUES

- $C_1 = \begin{cases} 150 \mu\mu\text{f} & \text{FOR } 500-1500 \text{ KC.} \\ 450 \mu\mu\text{f} & \text{FOR } 175 \text{ KC.} \end{cases}$
- $C_2 = 0.1 \mu\text{f}$
- $C_3 = 0.1 \mu\text{f}$
- $C_4 = 0.5 \mu\text{f}$ OR LARGER
- $C_5 = 0.5 \mu\text{f}$ OR LARGER
- $C_6 = 0.01 - 0.1 \mu\text{f}$
- $C_7 = 0.0005 - 0.001 \mu\text{f}$
- $C_8 = 0.1 \mu\text{f}$ OR LARGER
- $C_9 = 0.0001 \mu\text{f}$ OR SMALLER
- $R_1 = 0.5 - 1.0 \text{ MEGOHM}$
- $R_2 = 1.0 - 1.5 \text{ MEGOHMS}$
- $R_3 = 0.1 \text{ MEGOHM}$
- $R_4 = 0.5 - 1.0 \text{ MEGOHM}$
- $R_5 = 1.0 \text{ MEGOHM}$
- $R_6 = 25000 - 75000 \text{ OHMS}$
- $E_b = \text{VOLTAGE FOR SENSITIVITY CONTROL}$

RCA-89

TRIPLE-GRID POWER AMPLIFIER

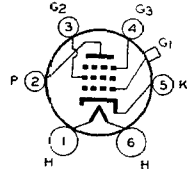
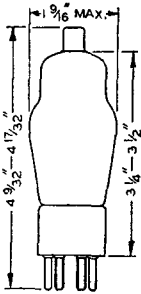

The 89 is a triple-grid power-amplifier tube of the heater-cathode type recommended for use in receivers with 6.3-volt heater supply. The triple-grid construction of this tube, with external connections for each grid, makes possible its application as (1) a Class A Power-Amplifier Triode, (2) a Class A Power-Output Pentode, and (3) a Class B Power-Output Triode.

CHARACTERISTICS

HEATER VOLTAGE (A. C. or D. C.).....	6.3	Volts
HEATER CURRENT	0.4	Ampere
BULB		ST-12
CAP		Small Metal
BASE		Small 6-Pin

Class A₁ Power Amplifier—Triode Connection (Grids No. 2 and No. 3 tied to plate)

PLATE VOLTAGE	160	180	250 max.	Volts
GRID VOLTAGE (Grid No. 1).....	-20	-22.5	-31	Volts
PLATE CURRENT	17	20	32	Milliamperes
AMPLIFICATION FACTOR	4.7	4.7	4.7	
PLATE RESISTANCE	3300	3000	2600	Ohms
TRANSCONDUCTANCE	1425	1550	1800	Micromhos
LOAD RESISTANCE*	7000	6500	5500	Ohms
SELF-BIAS RESISTOR	1180	1125	970	Ohms
UNDISTORTED POWER OUTPUT.....	0.3	0.4	0.9	Watt

* Optimum for maximum undistorted power output. Approximately twice the value or any given set of conditions is recommended for load of this tube when used as driver for Class B stage.

Class A₁ Power Amplifier—Pentode Connection (Grid No. 3 tied to cathode)

PLATE VOLTAGE	100	135	180	250 max.	Volts
SCREEN VOLTAGE (Grid No. 2).....	100	135	180	250 max.	Volts
GRID VOLTAGE (Grid No. 1).....	-10	-13.5	-18	-25	Volts
PLATE CURRENT	9.5	14	20	32	Milliamperes
SCREEN CURRENT	1.6	2.2	3.0	5.5	Milliamperes
AMPLIFICATION FACTOR	125	125	125	125	
PLATE RESISTANCE	104000	92500	80000	70000	Ohms
TRANSCONDUCTANCE	1200	1350	1550	1800	Micromhos
LOAD RESISTANCE	10700	9200	8000	6750	Ohms
SELF-BIAS RESISTOR	900	830	785	670	Ohms
POWER OUTPUT*	0.33	0.75	1.5	3.4	Watts

* 9% total harmonic distortion.

Class B Power Amplifier—Triode Connection (Grids No. 1 and No. 2 tied together, grid No. 3 tied to plate)

PLATE VOLTAGE	250 max.	Volts
PEAK PLATE CURRENT.....	90 max.	Milliamperes
AVERAGE GRID DISSIPATION (Grids No. 1 and No. 2).....	0.35 max.	Watt
TYPICAL OPERATION Values are for two tubes.		
Plate Voltage	180	Volts
Grid Voltage	0	Volts

Zero-Signal Plate Current.....	6	Milliamperes
Effective Load Resistance (Plate-to-plate).....	9400	Ohms
Power Output (Approximate).....	3.5	Watts

INSTALLATION AND APPLICATION

The base pins of the 89 fit the standard six-contact socket which may be installed to hold the tube in any position. Sufficient ventilation should be provided to circulate air freely around the tube to prevent overheating.

For heater operation and cathode connection, refer to type 6A8.

For Class A₁ Triode Operation of the 89, the two grids (No. 2 and No. 3), immediately adjacent to the plate, are connected to the plate, while the third (No. 1) is employed for control purposes. Operation of the tube is then similar to any Class A Power-Amplifier Triode. When it is used as the driver for a Class B stage, the load requirements are changed as indicated in the note under CHARACTERISTICS. This change is recommended in order to minimize distortion due to the driver stage.

For Class A₁ Pentode Operation of the 89, the grid (No. 3) adjacent to the plate is tied to the cathode and thus serves as the suppressor, while the other two grids (No. 1 and No. 2) serve as the screen-grid and control-grid respectively. Operation of the tube is then similar to any Class A power-output pentode.

When the 89 is operated as a Class A Amplifier (triode or pentode), input transformer or impedance-coupling devices are recommended. If, however, resistance coupling is used, a resistance of 1.0 megohm may be employed, provided the heater voltage does not rise more than 10 per cent above rated value under any condition of operation.

For Class B Triode Operation of the 89, the grid (No. 3) adjacent to the plate is tied to the plate, while the other two grids (No. 1 and No. 2) are connected together to serve as a single control grid. A discussion of Class B design features is given on page 20.

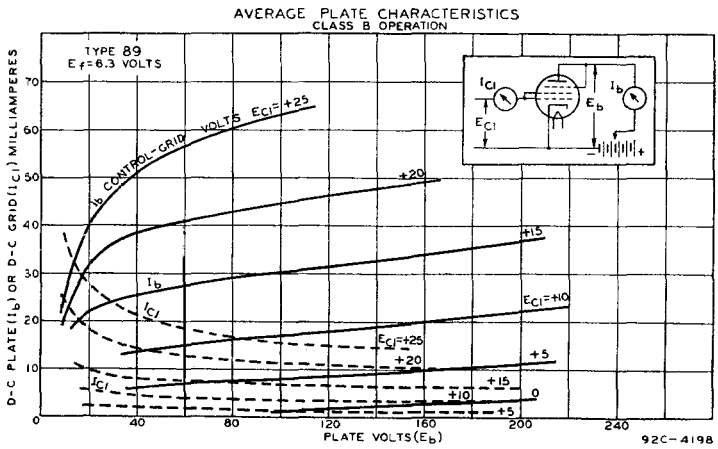
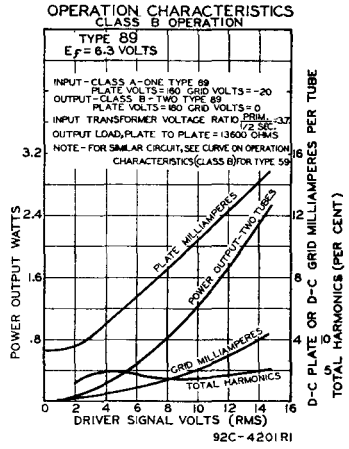

RCA-V99 and RCA-X99

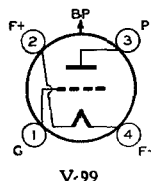
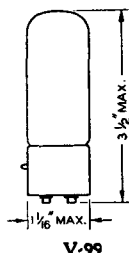

DETECTORS, AMPLIFIERS

The 99 types are three-electrode, general-purpose tubes designed for dry-cell operation. The low power consumption of these tubes makes them applicable to portable receivers and services where power economy is important. The two types have different bases.

CHARACTERISTICS

FILAMENT VOLTAGE (D. C.)	3.0- 3.3	Volts
FILAMENT CURRENT	0.060-0.063	Ampere
PLATE VOLTAGE	90 max.	Volts
GRID VOLTAGE	-4.5	Volts
PLATE CURRENT	2.5	Milliamperes
PLATE RESISTANCE	15500	Ohms
AMPLIFICATION FACTOR	6.6	
TRANSCONDUCTANCE	425	Micromhos
GRID-PLATE CAPACITANCE	3.3	μf
GRID-FILAMENT CAPACITANCE	2.5	μf
PLATE-FILAMENT CAPACITANCE	2.5	μf
BULB	Type V99	Type X99
BASE	T-8	T-9
	Small 4-Nub	Small 4-Pin

INSTALLATION

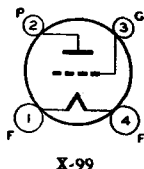

X-99

The base pins of the X99 fit the standard four-contact socket; the V99 fits only the small shell socket with bayonet slot. The sockets should be installed so that the tubes will operate in a vertical position. Cushioning of the sockets in the detector stage may be desirable if microphonic disturbances are encountered.

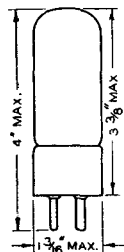

X-99

APPLICATION

As detectors, 99's may be operated either with grid leak and condenser or with grid bias. The recommended plate voltage for the former method is 45 volts. A grid leak of from 1 to 5 megohms used with a grid condenser of 0.00025 μf is satisfactory. The grid-circuit return should be connected to the positive filament terminal. For grid-bias detection the maximum plate voltage of 90 volts may be used with the corresponding negative grid bias of 10.5 volts. The grid bias should be adjusted so that the plate current is 0.2 milliampere with no input signal.

As amplifiers, the 99's are applicable to the audio or the radio-frequency stages of a receiver. Recommended plate and grid voltages are shown under CHARACTERISTICS.

These two types are used principally for renewal purposes.

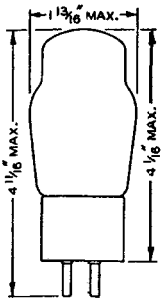

RCA-112-A

DETECTOR, AMPLIFIER

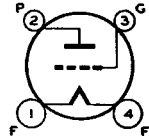

The 112-A is a three-electrode storage-battery tube for use as a detector and as an amplifier.

CHARACTERISTICS

FILAMENT VOLTAGE (D. C.)	5.0	Volts
FILAMENT CURRENT	0.25	Ampere
PLATE VOLTAGE	90 135 180 <i>max.</i>	Volts
GRID VOLTAGE*	-4.5 -9 -13.5	Volts
PLATE CURRENT	5.0 6.2 7.7	Milliamperes
PLATE RESISTANCE	5400 5100 4700	Ohms
AMPLIFICATION FACTOR	8.5 8.5 8.5	
TRANSCONDUCTANCE	1575 1650 1800	Micromhos
LOAD RESISTANCE	5000 9000 10650	Ohms
UNDISTORTED POWER OUTPUT	0.035 0.13 0.285	Watt
GRID-PLATE CAPACITANCE	8.5	μ f
GRID-FILAMENT CAPACITANCE	4.0	μ f
PLATE-FILAMENT CAPACITANCE	2.0	μ f
BULB	ST-14	
BASE	Medium 4-Pin Bayonet	

* The d-c resistance in the grid circuit should not exceed one megohm.

INSTALLATION AND APPLICATION

The base pins of the 112-A fit the standard four-contact socket which should be installed to hold the tube in a vertical position.

As a detector, the 112-A may be operated either with grid leak and condenser or with grid bias. For grid-bias detection, plate voltages up to the maximum value of 180 volts may be used with the corresponding negative grid-bias voltage (21 volts approximately, at 180 volts).

As an amplifier, the 112-A should be operated as shown under CHARACTERISTICS.

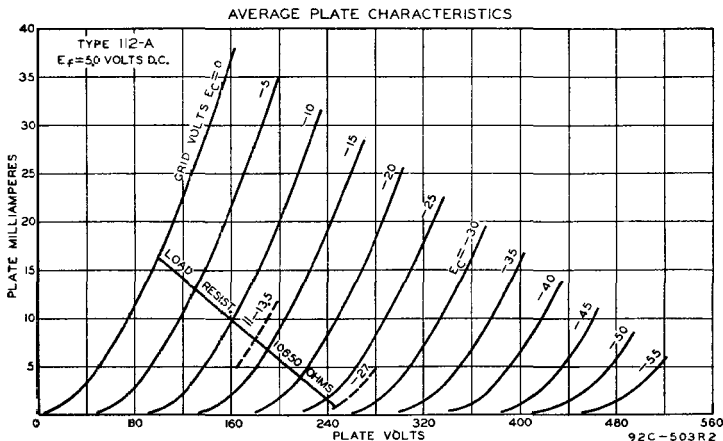

RCA-874

VOLTAGE REGULATOR

The 874 is a voltage regulator tube designed to maintain constant d-c output from rectifier devices for varying values of d-c load current.

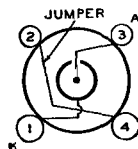

CHARACTERISTICS

STARTING SUPPLY VOLTAGE (D. C.).....	125 min.	Volts
OPERATING VOLTAGE (D. C.).....	90	Volts
OPERATING CURRENT (D. C.).....	10 to 50	Milliamperes
CONTINUOUS CURRENT (D. C.).....	50 max.	Milliamperes
MAXIMUM OVERALL LENGTH.....	55/8	Inches
MAXIMUM DIAMETER.....	29/16	Inches
BULB.....		S-17
BASE.....	Medium	4-Pin Bayonet

INSTALLATION AND APPLICATION

The base pins of the 874 fit the standard four-contact socket. Pins No. 2 and No. 4 are connected together within the base; the connection is used as a link in the primary circuit of the power transformer to prevent the application of voltage when the 874 is removed from its socket.

Sufficient resistance must always be used in series with the 874 to limit the current to 50 milliamperes when no load current is being drawn from the rectifier.

This type is used principally for renewal purposes.

RCA-876, RCA-886

CURRENT REGULATORS

The 876 and 886 are, within their ranges of operation, constant-current regulating devices.

CHARACTERISTICS

	Type 876	Type 886	
VOLTAGE RANGE.....	40 to 60	40 to 60	Volts
OPERATING CURRENT.....	1.7	2.05	Amperes
AMBIENT TEMPERATURE (Fahrenheit)....	150	150	Degrees
MAXIMUM OVERALL LENGTH.....	8	8	Inches
MAXIMUM DIAMETER.....	2 1/16	2 1/16	Inches
BULB.....	T-16	T-16	
BASE.....	Mogul Screw	Mogul Screw	

INSTALLATION AND APPLICATION

The bases of these types fit the standard mogul screw socket which may be installed to hold the tubes in any position. These tubes operate at a high bulb temperature and must be surrounded by a metal ventilating stack.

Either type may be used in series with the primary of a suitably designed transformer (or with a resistive load) to maintain essentially constant input voltage to the primary (or load) over a range of line voltage variation of 20 volts. The primary of the transformer should be designed for a voltage input equal to the average line voltage minus 50 volts. The primary current of the transformer should be 1.7 amperes for the 876 and 2.05 amperes for the 886. If less than this current is drawn, adjustment to the rated value must be made either by a shunt resistor or increased load on the secondary. Two or more of these tubes are required if the current drawn is more than the rated values.

These two types are used principally for renewal purposes.

MISCH METAL · NIGROSINE · PORCELAIN · PETROLEUM JELLY · ZINC
 CALCIUM ALUMINUM FLUORIDE · RESIN (SYNTHETIC) · ETHYL ALCOHOL

MATERIALS USED IN RCA RADIO TUBES

LEAD ACETATE · MALACHITE GREEN · GLYCERINE · ZINC CHLORIDE · IRON
 MARBLE DUST · WOOD FIBER · STRONTIUM NITRATE · LEAD OXIDE · ZINC OXIDE
 LAVA · MICA · TIN · SODIUM CARBONATE · SODIUM NITRATE · SILVER OXIDE

BARIUM CARBONATE
 ARSENIC TRIOXIDE
 STRONTIUM CARBONATE

CALCIUM CARBONATE
 AMMONIUM CHLORIDE
 POTASSIUM CARBONATE

ISOLANTITE
 MOLYBDENUM

BAKELITE
 PHOSPHORUS

ALUMINA
 BORAX
 BARIUM
 COPPER
 CARBON
 CHROMIUM
 CALCIUM
 CAESIUM
 COBALT
 IRIIDIUM
 MONE L
 MERCURY
 CALCIUM
 OXIDE
 BARIUM
 NITRATE

SILICON
 SHELLAC
 TUNGSTEN
 TITANIUM
 SILICA
 GLASS
 MAGNESIA
 PLATINUM
 STRONTIUM
 MAGNESIUM
 ROSIN
 NICKEL
 COBALT
 OXIDE
 THORIUM
 NITRATE

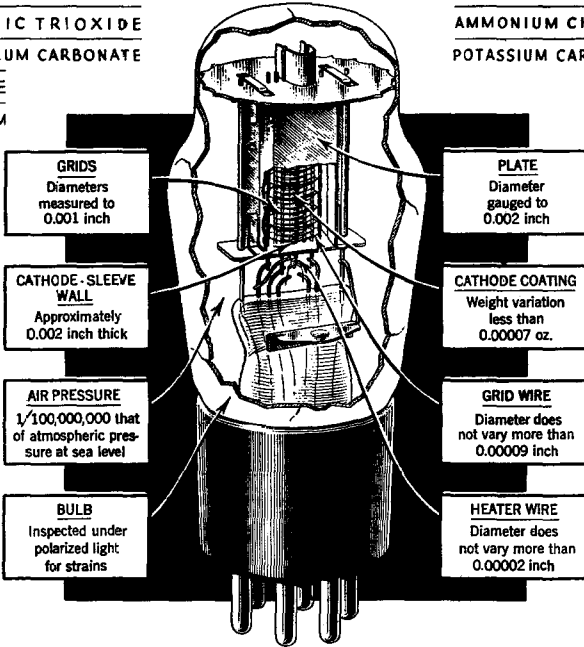

Gases Used in Manufacture

NEON — HYDROGEN — CARBON DIOXIDE — ILLUMINATING GAS
 HELIUM — ARGON — NATURAL GAS — NITROGEN — OXYGEN

Elements Entering into the Manufacture

ARGON — ALUMINUM — BORON — BARIUM — CAESIUM — CALCIUM — COPPER — CARBON — CHROMIUM — CHLORINE
 COBALT — HYDROGEN — HELIUM — IRIIDIUM — IRON — LEAD — MAGNESIUM — MERCURY — MOLYBDENUM
 NICKEL — NEON — NITROGEN — OXYGEN — POTASSIUM — PHOSPHORUS — PLATINUM — SODIUM — SILVER
 SILICON — STRONTIUM — TUNGSTEN — THORIUM — TANTALUM — TITANIUM — TIN — ZINC — RARE EARTHS

Radio Tube Testing

The radio tube user—service man, experimenter, and non-technical radio listener—is interested in knowing the condition of his tubes, since they govern the performance of the device in which they are used. In order to determine the condition of a tube, some method of test is necessary. Because the operating capabilities and design features of a tube are indicated and described by its electrical characteristics, a tube is tested by measuring its characteristics and comparing them with representative values established as standard for that type. Tubes which read abnormally high with respect to the standard for the type are subject to criticism just the same as tubes which are too low.

Certain practical limitations are placed on the accuracy with which a tube test can be correlated with actual tube performance. These limitations make it unnecessary for the service man and dealer to employ complex and costly testing equipment having laboratory accuracy. Because the accuracy of the tube-testing device need be no greater than the accuracy of the correlation between test results and receiver performance, and since certain fundamental characteristics are virtually fixed by the manufacturing technique of leading tube manufacturers, it is possible to employ a relatively simple test in order to determine the serviceability of a tube.

In view of these factors, dealers and service men will find it economically expedient to obtain adequate accuracy and simplicity of operation by employing a device which indicates the status of a single characteristic. Whether the tube is satisfactory or unsatisfactory is judged from the test result of this single characteristic. Consequently, it is very desirable that the characteristic selected for the test be one which is truly representative of the tube's overall condition.

SHORT CIRCUIT TEST

The fundamental circuit of a short-circuit tester is shown in Fig. 48. While this circuit is suitable for tetrodes and types having less than four electrodes, tubes of more electrodes may be tested by adding more indicator lamps to the circuit. Voltages are applied between the various electrodes with lamps in series with the electrode leads. Any two shorted electrodes complete a circuit and light one or more lamps. Since two electrodes may be just touching to give a high-resistance short, it is desirable that the indicating lamps operate on very low current. It is also desirable to maintain the filament or heater of the tube at its operating temperature during the short-circuit test, because short-circuits in a tube may sometimes occur only when the electrodes are heated.

SELECTION OF A SUITABLE CHARACTERISTIC FOR TEST

Some characteristics of a tube are far more important in determining its operating worth than are others. The cost of building a device to measure any one of the more important characteristics may be considerably higher than that of a device which measures a less representative characteristic. Consequently, three methods of test will be discussed, ranging from relatively simple and inexpensive equipment to more elaborate, more accurate, and more costly devices.

An emission test is perhaps the simplest method of indicating a tube's condition. (Refer to DIODES, page 7, for a discussion of electronic emission.) Since emission falls off as the tube wears out, low emission is indicative of the end of tube serviceability. However, the emission test is subject to limitations because it tests the tube under static conditions and does not take into account the actual operation of the tube. On the one hand, coated filaments, or cathodes, often develop active spots from which the emission is so great that the relatively small grid area adjacent to these spots cannot control the electron stream. Under these conditions, the total emission may indicate the tube to be normal although the tube is unsatisfactory. On the other hand, coated types of filaments are capable of such large emission that the tube will often operate satisfactorily after the emission has fallen far below the original value.

Fig. 49 shows the fundamental circuit diagram for an emission test. All of the electrodes of the tube, except the cathode, are connected to the plate. The filament, or heater, is operated at rated voltage; after the tube has reached constant temperature, a low positive voltage is applied to the plate and the electronic emission is read on the meter. Readings which are well below the average for a particular tube type indicate that the total number of available electrons has been so reduced that the tube is no longer able to function properly.

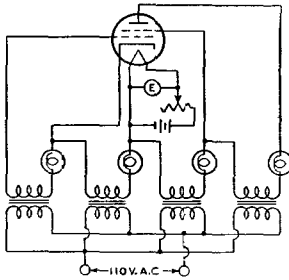

Fig. 48

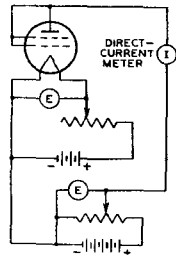

Fig. 49

A **transconductance test** takes into account a fundamental operating principle of the tube. (This will be seen from the definition of Transconductance on page 12.) It follows that transconductance tests, when properly made, permit better correlation between test results and actual performance than does a straight emission test.

There are two forms of transconductance test which can be utilized in a tube tester. In the first form (illustrated by Fig. 50, giving a fundamental circuit with a tetrode under test), appropriate operating voltages are applied to the electrodes of the tube. A plate current, depending upon the electrode voltages, will then be indicated by the meter. If the bias on the grid is then shifted by the application of a different grid voltage, a new plate-current reading is obtained. The difference between the two plate-current readings is indicative of the transconductance of the tube. This method of transconductance testing is commonly called the "grid-shift" method, and depends on readings under static conditions. The fact that this form of test is made under static conditions imposes limitations not encountered in the second form of test made under dynamic conditions.

The dynamic transconductance test illustrated in Fig. 51 gives a fundamental circuit with a tetrode under test. This method is superior to the static transconductance test in that a-c voltage is applied to the grid. Thus, the tube is tested

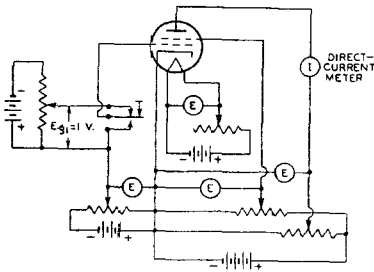

Fig. 50

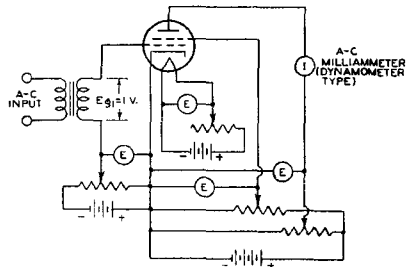

Fig. 51

under conditions which approximate actual operating conditions. The alternating component of the plate current is read by means of an a-c ammeter of the dynamometer type. The transconductance of the tube is equal to the a-c plate current divided by the input-signal voltage. If a one-volt RMS signal is applied to the

grid, the plate-current-meter reading in milliamperes multiplied by one thousand is the value of transconductance in micromhos.

The **power output test** probably gives the best correlation between test results and actual operating performance of a tube. In the case of voltage amplifiers, the power output is indicative of the amplification and output voltages obtainable from the tube. In the case of power output tubes, the performance of the tube is closely checked. Consequently, although more complicated to set up, the power output test will give closer correlation with actual performance than any other single test.

Fig. 52 shows the fundamental circuit of a power output test for Class A operation of tubes. The diagram illustrates the method for a pentode. The a-c output voltage developed across the plate-load impedance (L) is indicated by the current meter. The current meter is isolated as far as the d-c plate current is concerned by the condenser (C). The power output can be calculated from the current reading and known load resistance. In this way, it is possible to determine the operating condition of the tube quite accurately.

Fig. 53 shows the fundamental circuit of a power output test for Class B operation of tubes. With a-c voltage applied to the grid of the tube, the current in the plate circuit is read on a d-c milliammeter. The power output of the tube is approximately equal to:

$$\text{Power Output (watts)} = \frac{(\text{D-c current in amperes})^2 \times \text{Load resistance in ohms}}{0.405}$$

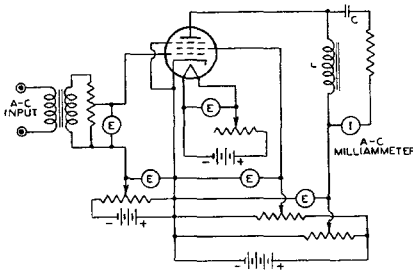

Fig. 52

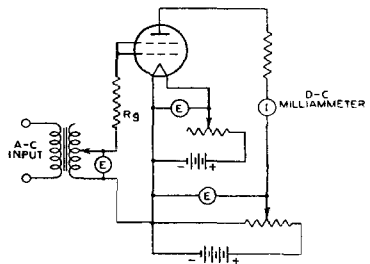

Fig. 53

ESSENTIAL TUBE TESTER REQUIREMENTS

1. It is desirable that the tester provide for a short-circuit test to be made prior to measurement of the tube's characteristics.
2. It is important that some means of controlling the voltages applied to the electrodes of the tube be provided. If the tester is a-c operated, a line-voltage control will permit of supplying proper electrode voltages.
3. It is essential that the rated voltage applied to the filament or heater be maintained accurately.
4. It is suggested that the characteristics test follow one of the methods described. The method selected and the quality of the parts used in the tester will depend upon the requirements of the user.

TUBE TESTER LIMITATIONS

A tube testing device can only indicate the difference between a given tube's characteristics and those which are standard for that particular type. Since the operating conditions imposed upon a tube of a given type may vary within wide limits, it is impossible for a tube testing device to evaluate tubes in terms of performance capabilities for all applications. The tube tester, therefore, cannot be looked upon as a final authority in determining whether or not a tube is always satisfactory. Actual operating test in the equipment in which the tube is to be used will give the best possible indication of a tube's worth. Nevertheless, the tube tester is a most helpful device for indicating the serviceability of a tube.

RESISTANCE - COUPLED AMPLIFIER CHART

C = BLOCKING CONDENSER (μ f) **Cd** = SCREEN BY-PASS CONDENSER (μ f) **E_o** = VOLTAGE OUTPUT (Peak Volts) **Rd** = SCREEN RESISTOR (Megohms) **RL** = PLATE RESISTOR (Megohms)
Cc = CATHODE BY-PASS CONDENSER (μ f) **Ebb** = PLATE-SUPPLY VOLTAGE (Volts) **Rc** = CATHODE RESISTOR (Ohms) **Rg** = GRID RESISTOR (Megohms) **V.G.** = VOLTAGE GAIN

DUPLX-DIODE TRIODE TYPES: 2A6, 75

Ebb ¹	90									180									300									Ebb ¹
	0.1			0.25			0.5			0.1			0.25			0.5			0.1			0.25			0.5			
Rg ²	0.1	0.25	0.5	0.25	0.5	1	0.5	1	2	0.1	0.25	0.5	0.25	0.5	1	0.5	1	2	0.1	0.25	0.5	0.25	0.5	1	0.5	1	2	Rg ²
Rc	6500	6600	6700	10000	11000	11500	16200	16600	17400	2600	2900	3000	4300	4800	5300	7000	8000	8800	1900	2200	2300	3300	3600	4200	5300	6100	7000	Rc
Cc	2.2	1.7	1.7	1.24	1.07	0.9	0.75	0.7	0.65	3.3	2.9	2.7	2.1	1.8	1.5	1.3	1.1	0.9	4	3.5	3	2.7	2	1.8	1.6	1.3	1.2	Cc
C	0.02	0.01	0.006	0.01	0.006	0.003	0.005	0.003	0.0015	0.025	0.015	0.007	0.015	0.007	0.004	0.007	0.004	0.002	0.03	0.015	0.007	0.015	0.007	0.004	0.007	0.004	0.002	C
E _o ³	3	5	6	5	7	10	7	10	13	16	22	25	21	28	33	25	33	38	31	41	45	42	51	60	47	62	67	E _o ³
V.G. ⁴	23 ^d	29 ^b	31 ^c	34 ^b	40 ^c	40	39	44	48	29	36	37	43	50	53	52	57	58	31	39	42	48	53	56	58	60	63	V.G. ⁴

TRIODE TYPE 6F5

Ebb ¹	90									180									300									Ebb ¹
	0.1			0.25			0.5			0.1			0.25			0.5			0.1			0.25			0.5			
Rg ²	0.1	0.25	0.5	0.25	0.5	1	0.5	1	2	0.1	0.25	0.5	0.25	0.5	1	0.5	1	2	0.1	0.25	0.5	0.25	0.5	1	0.5	1	2	Rg ²
Rc	4400	4800	5000	8000	8800	9000	12200	13500	14700	1800	2000	2200	3500	4100	4500	6100	6900	7700	1300	1600	1700	2600	3200	3500	4500	5400	6100	Rc
Cc	2.5	2.1	1.8	1.33	1.18	0.9	0.76	0.67	0.58	4.4	3.5	2.9	2.3	1.8	1.7	1.3	0.9	0.85	5	3.7	3.2	2.5	2.1	2	1.5	1.2	0.93	Cc
C	0.02	0.01	0.005	0.01	0.005	0.003	0.005	0.003	0.0015	0.025	0.015	0.006	0.01	0.006	0.004	0.006	0.003	0.0015	0.025	0.01	0.006	0.01	0.007	0.004	0.006	0.004	0.002	C
E _o ³	4	5	6	6	7	10	8	10	12	16	23	25	21	26	32	24	33	37	33	43	48	41	54	63	50	62	70	E _o ³
V.G. ⁴	28 ^d	34 ^b	35 ^c	39 ^b	43 ^c	44	43	46	48	37	44	46	48	53	57	53	63	66	42	49	52	56	63	67	65	70	70	V.G. ⁴

TWIN-TRIODE TYPES: 6A6, 6N7, 53 (ONE TRIODE UNIT)

Ebb ¹	90									180									300									Ebb ¹
	0.1			0.25			0.5			0.1			0.25			0.5			0.1			0.25			0.5			
Rg ²	0.1	0.25	0.5	0.25	0.5	1	0.5	1	2	0.1	0.25	0.5	0.25	0.5	1	0.5	1	2	0.1	0.25	0.5	0.25	0.5	1	0.5	1	2	Rg ²
Rc	1900	2250	2500	4050	4950	5400	7000	8500	9650	1300	1700	1950	2950	3800	4300	5250	6600	7650	1150	1500	1750	2650	3400	4000	4850	6100	7190	Rc
C	0.025	0.01	0.006	0.01	0.006	0.003	0.006	0.003	0.0015	0.03	0.015	0.007	0.015	0.007	0.0035	0.007	0.0035	0.002	0.03	0.015	0.007	0.015	0.0075	0.003	0.0075	0.003	0.0015	C
E _o ³	13	19	20	16	20	24	18	23	26	35	46	50	40	50	57	44	54	61	60	83	86	75	87	100	76	94	104	E _o ³
V.G. ⁴	16	19	20	20	22	23	22	23	23	19	21	22	23	24	24	24	25	25	20	22	23	23	24	24	23	24	24	V.G. ⁴

TWIN-TRIODE TYPE 79 (ONE TRIODE UNIT)

Ebb ¹	90									180									300									Ebb ¹
	0.1			0.25			0.5			0.1			0.25			0.5			0.1			0.25			0.5			
Rg ²	0.1	0.25	0.5	0.25	0.5	1	0.5	1	2	0.1	0.25	0.5	0.25	0.5	1	0.5	1	2	0.1	0.25	0.5	0.25	0.5	1	0.5	1	2	Rg ²
Rc	2050	2200	2350	4000	4250	4650	6150	6850	7500	1050	1250	1350	2050	2450	2750	3450	4100	4650	800	1000	1100	1650	2050	2350	2850	3600	4450	Rc
C	0.04	0.015	0.009	0.015	0.006	0.004	0.006	0.004	0.002	0.04	0.02	0.009	0.02	0.01	0.005	0.009	0.0035	0.002	0.025	0.01	0.006	0.01	0.0055	0.003	0.0055	0.003	0.0015	C
E _o ³	5.8	8.4	9.5	7.1	9.7	12	8.8	12	15	21	27	31	26	34	40	30	39	44	40	57	60	56	66	77	61	75	82	E _o ³
V.G. ⁴	23 ^b	29 ^c	29	31 ^c	33	35	34	38	40	27	31	34	37	41	42	42	44	45	29	34	36	39	42	43	44	46	46	V.G. ⁴

TRIODE TYPES: 56, 76

Ebb ¹	90						180						300						Ebb ¹									
	0.05		0.1		0.25		0.05		0.1		0.25		0.05		0.1		0.25			RL								
Rg ²	0.05	0.1	0.25	0.1	0.25	0.5	0.25	0.5	1	0.05	0.1	0.25	0.1	0.25	0.5	0.25	0.5	1	0.05	0.1	0.25	0.1	0.25	0.5	0.25	0.5	1	Rg ²
Rc	2500	3200	3800	4500	6500	7500	11100	15100	18300	2400	3000	3700	4500	6500	7600	10700	14700	17700	2400	3100	3800	4500	6400	7500	11100	15200	18300	Rc
Cc	2	1.6	1.25	1.05	0.82	0.68	0.48	0.36	0.32	2.5	1.9	1.65	1.45	0.97	0.8	0.6	0.45	0.4	2.8	2.2	1.8	1.6	1.2	0.98	0.69	0.5	0.4	Cc
C	0.06	0.03	0.015	0.03	0.015	0.007	0.015	0.007	0.0035	0.06	0.035	0.015	0.035	0.015	0.008	0.015	0.007	0.0045	0.08	0.045	0.02	0.04	0.02	0.009	0.02	0.009	0.005	C
Eo ³	16	21	23	19	23	25	21	24	28	36	48	55	45	55	57	49	59	64	65	80	95	74	95	104	82	96	108	Eo ³
V.G. ⁴	7	7.7	8.1	8.1	8.9	9.3	9.4	9.7	9.8	7.7	8.2	9	9.3	9.5	9.8	9.7	10	10	8.3	8.9	9.4	9.5	10	10	10	10	10	V.G. ⁴

TYPES: 6C5 (TRIODE), AND 6C6, 6J7, 57 (AS TRIODES)

Ebb ¹	90						180						300						Ebb ¹									
	0.05		0.1		0.25		0.05		0.1		0.25		0.05		0.1		0.25			RL								
Rg ²	0.05	0.1	0.25	0.1	0.25	0.5	0.25	0.5	1	0.05	0.1	0.25	0.1	0.25	0.5	0.25	0.5	1	0.05	0.1	0.25	0.1	0.25	0.5	0.25	0.5	1	Rg ²
Rc	2800	3400	3800	4800	6400	7500	11400	14900	17300	2200	2700	3100	3900	5300	6200	9500	12300	14700	2100	2600	3100	3800	5300	6000	9600	12300	14000	Rc
Cc	2	1.62	1.3	1.12	0.84	0.66	0.52	0.4	0.33	2.2	2.1	1.85	1.7	1.25	1.2	0.74	0.55	0.47	3.16	2.3	2.2	1.7	1.3	1.17	0.9	0.59	0.37	Cc
C	0.05	0.025	0.01	0.025	0.01	0.005	0.01	0.006	0.004	0.055	0.03	0.015	0.035	0.015	0.008	0.015	0.008	0.004	0.075	0.04	0.015	0.035	0.015	0.008	0.015	0.008	0.003	C
Eo ³	14	17	20	16	22	23	18	23	26	34	45	54	41	54	55	44	52	59	57	70	83	65	84	88	73	85	97	Eo ³
V.G. ⁴	9	9	10	10	11	12	12	12	13	10	11	11	12	12	13	13	13	13	11	11	12	12	13	13	13	14	14	V.G. ⁴

DUPLEX-DIODE TRIODE TYPE 6Q7

Ebb ¹	90						180						300						Ebb ¹									
	0.1		0.25		0.5		0.1		0.25		0.5		0.1		0.25		0.5			RL								
Rg ²	0.1	0.25	0.5	0.25	0.5	1	0.5	1	2	0.1	0.25	0.5	0.25	0.5	1	0.5	1	2	0.1	0.25	0.5	0.25	0.5	1	0.5	1	2	Rg ²
Rc	4000	4200	4300	7200	7600	8000	11500	12300	13700	1600	1900	2100	3400	4000	4500	6000	7100	7900	1200	1500	1700	2600	3000	3600	4600	5500	6200	Rc
Cc	2.07	1.7	1.5	1.17	1.2	0.9	0.72	0.6	0.45	3	2.5	2.3	1.6	1.3	1.05	0.86	0.76	0.63	4.4	3.6	3.05	2.4	1.66	1.45	1.2	0.9	0.9	Cc
C	0.02	0.01	0.005	0.01	0.006	0.003	0.006	0.003	0.0015	0.02	0.01	0.005	0.01	0.005	0.003	0.006	0.003	0.002	0.03	0.015	0.007	0.015	0.007	0.004	0.007	0.004	0.002	C
Eo ³	5	8	9	8	11	13	9	13	17	19	26	29	25	31	37	30	36	41	35	52	53	43	52	62	47	60	66	Eo ³
V.G. ⁴	23 ^a	28 ^b	29 ^c	31 ^b	32	33	31	33	37	28	33	35	36	38	40	39	40	41	34	39	40	42	45	45	45	46	47	V.G. ⁴

DUPLEX-DIODE TRIODE TYPE 6R7

Ebb ¹	90						180						300						Ebb ¹									
	0.05		0.1		0.25		0.05		0.1		0.25		0.05		0.1		0.25			RL								
Rg ²	0.05	0.1	0.25	0.1	0.25	0.5	0.25	0.5	1	0.05	0.1	0.25	0.1	0.25	0.5	0.25	0.5	1	0.05	0.1	0.25	0.1	0.25	0.5	0.25	0.5	1	Rg ²
Rc	2300	2600	2900	3500	4400	5000	7600	9800	11300	1700	2100	2500	3000	4100	4600	6700	8800	10000	1600	2000	2400	2900	3800	4400	6300	8400	10600	Rc
Cc	2	1.7	1.27	1.2	0.9	0.77	0.54	0.42	0.38	2.3	1.9	1.5	1.3	0.9	0.8	0.54	0.4	0.33	2.6	2	1.6	1.4	1.1	1	0.7	0.5	0.44	Cc
C	0.05	0.03	0.01	0.03	0.01	0.006	0.015	0.007	0.003	0.05	0.03	0.01	0.03	0.01	0.006	0.01	0.006	0.003	0.055	0.03	0.015	0.03	0.015	0.007	0.015	0.007	0.004	C
Eo ³	14	18	20	15	19	21	15	18	21	31	40	45	35	43	46	33	40	47	50	62	71	52	68	71	54	62	74	Eo ³
V.G. ⁴	8	9	10	10	10	11	10	10	11	9	9	10	10	10	10	10	10	11	9	9	10	10	10	10	10	10	11	V.G. ⁴

DUPLEX-DIODE TRIODE TYPES: 55, 85

Ebb ¹	90						180						300						Ebb ¹									
	0.05		0.1		0.25		0.05		0.1		0.25		0.05		0.1		0.25			RL								
Rg ²	0.05	0.1	0.25	0.1	0.25	0.5	0.25	0.5	1	0.05	0.1	0.25	0.1	0.25	0.5	0.25	0.5	1	0.05	0.1	0.25	0.1	0.25	0.5	0.25	0.5	1	Rg ²
Rc	3800	4600	5400	6620	9000	10300	15100	20500	24400	3200	4100	5000	6200	8700	10000	14500	20000	24000	3200	4100	5100	5900	8300	9600	14300	19400	23600	Rc
Cc	1.4	1.1	0.86	0.7	0.55	0.5	0.31	0.25	0.2	1.8	1.6	1.2	0.9	0.7	0.57	0.43	0.29	0.24	1.9	1.5	1.2	0.8	0.54	0.45	0.3	0.22	0.2	Cc
C	0.06	0.03	0.015	0.04	0.015	0.007	0.015	0.007	0.004	0.06	0.045	0.02	0.04	0.015	0.008	0.015	0.008	0.004	0.08	0.045	0.015	0.03	0.015	0.006	0.01	0.006	0.003	C
Eo ³	16	19	23	17	22	25	18	23	26	33	44	49	37	47	50	40	48	53	50	74	85	64	82	88	71	84	94	Eo ³
V.G. ⁴	4.5	4.9	5.1	5.1	5.4	5.5	5.3	5.9	5.6	4.9	5.2	5.3	5.3	5.5	5.5	5.6	5.7	5.7	5.2	5.5	5.6	5.9	5.7	5.8	5.7	5.7	5.8	V.G. ⁴

DUPLEX-DIODE PENTODE TYPES: 2B7, 6B7, 6B8

E _{bb} ¹	90									180									300									E _{bb} ²
	0.1			0.25			0.5			0.1			0.25			0.5			0.1			0.25			0.5			
R _g ²	0.1	0.25	0.5	0.25	0.5	1	0.5	1	2	0.1	0.25	0.5	0.25	0.5	1	0.5	1	2	0.1	0.25	0.5	0.25	0.5	1	0.5	1	2	R _g ²
R _d	0.37	0.5	0.6	1.18	1.1	1.35	2.6	2.8	2.9	0.44	0.5	0.6	1.18	1.2	1.5	2.6	2.8	3	0.5	0.55	0.6	1.2	1.2	1.5	2.7	2.9	3.4	R _d
R _c	2000	2200	2000	3500	3500	3500	5000	6000	6200	1000	1200	1200	1900	2100	2200	3300	3500	3500	950	1100	900	1500	1600	1800	2400	2500	2800	R _c
C _d	0.07	0.07	0.06	0.04	0.04	0.04	0.04	0.04	0.04	0.08	0.08	0.07	0.05	0.06	0.05	0.04	0.04	0.04	0.09	0.09	0.08	0.06	0.06	0.08	0.05	0.05	0.05	C _d
C _c	3	3	2.8	1.9	2.1	1.9	1.5	1.55	1.5	4.4	4.4	4	2.7	3.2	3	2.1	2	2.2	4.6	5	4.8	3.2	3.5	4	2.5	2.3	2.8	C _c
C	0.02	0.01	0.006	0.008	0.007	0.003	0.004	0.003	0.003	0.02	0.015	0.008	0.01	0.007	0.003	0.005	0.003	0.002	0.025	0.015	0.009	0.015	0.008	0.004	0.006	0.003	0.0025	C
E _o ³	19	28	29	26	33	32	22	29	27	30	52	53	39	55	53	47	55	53	60	89	86	70	100	95	80	120	90	E _o ³
V _G ⁴	24	33	37	43	55	65	63	85	100	30	41	46	55	69	83	81	115	116	36	47	54	64	79	100	96	150	145	V _G ⁴

PENTODE TYPES: 6C6, 6J7, 57

E _{bb} ¹	90									180									300									E _{bb} ²
	0.1			0.25			0.5			0.1			0.25			0.5			0.1			0.25			0.5			
R _g ²	0.1	0.25	0.5	0.25	0.5	1	0.5	1	2	0.1	0.25	0.5	0.25	0.5	1	0.5	1	2	0.1	0.25	0.5	0.25	0.5	1	0.5	1	2	R _g ²
R _d	0.37	0.44	0.44	1.1	1.18	1.4	2.18	2.6	2.7	0.44	0.5	0.5	1.1	1.18	1.4	2.45	2.9	2.7	0.44	0.5	0.55	1.18	1.18	1.45	2.45	2.9	2.95	R _d
R _c	1200	1100	1300	2400	2600	3600	4700	5900	5500	1000	750	800	1200	1600	2000	2600	3100	3500	500	450	600	1100	1200	1300	1700	2200	2300	R _c
C _d	0.05	0.05	0.05	0.03	0.03	0.025	0.02	0.05	0.02	0.05	0.05	0.05	0.04	0.04	0.04	0.03	0.025	0.02	0.07	0.07	0.06	0.04	0.04	0.05	0.04	0.04	0.04	C _d
C _c	5.2	5.3	4.8	3.7	3.2	2.5	2.3	2	2	6.5	6.7	6.7	5.2	4.3	3.8	3.2	2.5	2.8	8.5	8.3	8	5.5	5.4	5.8	4.2	4.1	4	C _c
C	0.02	0.01	0.006	0.008	0.005	0.003	0.005	0.0025	0.0015	0.02	0.01	0.006	0.008	0.005	0.0035	0.005	0.0025	0.0015	0.02	0.01	0.006	0.008	0.005	0.005	0.005	0.003	0.0025	C
E _o ³	17	22	33	23	32	33	28	29	27	42	52	59	41	60	60	45	56	60	55	81	96	81	104	110	75	97	100	E _o ³
V _G ⁴	41	55	66	70	85	92	93	120	140	51	69	83	93	118	140	135	165	165	61	82	94	104	140	185	161	350	240	V _G ⁴

¹ Voltage at plate equals Plate-Supply Voltage minus voltage drop in R_L and R_c. For other supply voltages differing by as much as 50% from those listed, the values of resistors, condensers, and gain are approximately correct. The value of voltage output, however, for any of these other supply voltages equals the listed voltage output multiplied by the new plate-supply voltage divided by the plate-supply voltage corresponding to the listed voltage output.

² For following stage (see Circuit Diagrams).

³ Voltage across R_g at grid-current point.

⁴ Voltage Gain at 5 volts (RMS) output unless index letter indicates otherwise.

^a At 2 volts (RMS) output.

^b At 3 volts (RMS) output.

^c At 4 volts (RMS) output.

^d At 2.2 volts (RMS) output.

PENTODE DIAGRAM WITH LEGEND

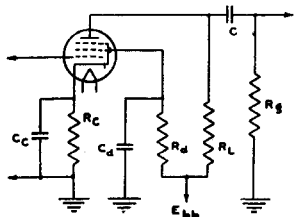

TRIODE DIAGRAM WITH LEGEND

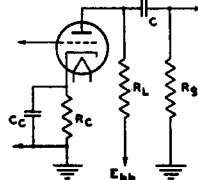

TWIN-TRIODE DIAGRAM WITH LEGEND

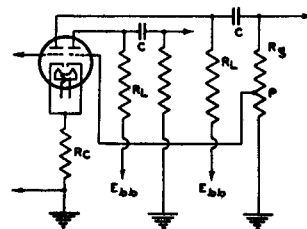

FREQUENCY CHARACTERISTIC OF SINGLE-STAGE RESISTANCE-COUPLED PENTODE AMPLIFIER

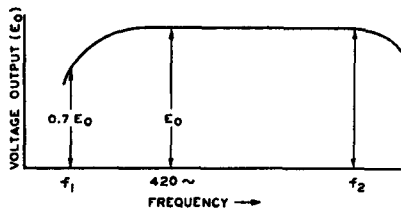

NOTES

- A. Condensers C, Cc, and Cd have been chosen to give output voltages equal to 0.7 Eo for f₂ of 100 cycles. For any other value of f₁, multiply values of C, Cc, and Cd by 100/f₁.

In the case of condenser Cc, the values shown are for an amplifier with d-c heater excitation. When a-c is used, depending on the character of the associated circuits, the gain, and the value of f₁, it may be necessary to increase the value of Cc to minimize hum disturbances. It may also be desirable to have a d-c potential difference of approximately 10 volts between heater and cathode.

- B. f₂ = frequency at which high-frequency response begins to fall off.
 C. The voltage output at f₁ for n like stages equals (0.7 Eo)ⁿ.
 D. Decoupling filters are not necessary for two stages or less.
 E. For an amplifier of typical construction, approximate values of f₂ for different values of RL are:

RL	f ₂
0.1 Meg.	2000 cps
0.25 "	10000 "
0.5 "	5000 "

- F. Always use highest permissible value of Rg.
 G. A variation of ± 10% in values of resistors and condensers has only slight effect on performance.

FREQUENCY CHARACTERISTIC OF SINGLE-STAGE RESISTANCE-COUPLED TRIODE AMPLIFIER

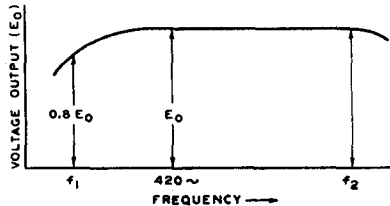

NOTES

- A. Condensers C and Cc have been chosen to give output voltages equal to 0.8 Eo for f₁ of 100 cycles. For any other value of f₁, multiply values of C and Cc by 100/f₁.

In the case of condenser Cc, the values shown are for an amplifier with d-c heater excitation. When a-c is used, depending on the character of the associated circuits, the gain, and the value of f₁, it may be necessary to increase the value of Cc to minimize hum disturbances. It may also be desirable to have a d-c potential difference of approximately 10 volts between heater and cathode.

- B. f₂ = frequency at which high-frequency response begins to fall off.
 C. The voltage output at f₁ for n like stages equals (0.8 Eo)ⁿ.
 D. Decoupling filters are not necessary for two stages or less.
 E. For an amplifier of typical construction, the value of f₂ is well above the audio-frequency range for any value of RL.
 F. Always use highest permissible value of Rg.
 G. A variation of ± 10% in values of resistors and condensers has only a slight effect on performance.

FREQUENCY CHARACTERISTIC OF RESISTANCE-COUPLED TWIN-TRIODE AMPLIFIER

SEE INFORMATION UNDER TRIODE AMPLIFIER WHICH IN GENERAL APPLIES ALSO TO THIS CASE.

NOTES

The diagram given above is for Phase-Inverter Service. The signal input is supplied to the grid of the left-hand triode unit. The grid of the right-hand unit obtains its signal from a tap (P) on the grid resistor (Rg) in the output circuit of the left-hand triode unit. The tap (P) is chosen so as to make the voltage output of the right-hand unit equal to that of the left-hand unit. Its location is determined from the voltage gain values given in the Chart. For example, if the value of voltage gain is 20 (from the Chart), (P) is chosen so as to supply 1/20 of the voltage across (Rg) to the grid of the right-hand triode.

For phase-inverter service, the cathode resistor (Rc) should not be by-passed by a condenser. Omission of the condenser in this service assists in balancing the output voltages. The value of (Rc) is specified on the basis that both units are operating simultaneously at the same values of plate load and plate voltage.

Circuit Section

The circuit diagrams given on the following pages have been carefully chosen, not necessarily to illustrate commercial practice, but rather to show many different uses of radio tubes. All of the circuits are conservatively designed to give reliable and satisfactory performance. Although relatively few circuits are given, it is often practical to use a portion of one circuit in combination with portions of other circuits to obtain a design meeting the desired requirements. Tuned-circuit constants are omitted from the receiver diagrams because inductance and condenser values are usually subject to the individual requirements of the set builder. In addition, suitable, well-made tuned-circuit parts can generally be purchased at very reasonable cost. Information on the characteristics and the application features of each tube, given under each tube type, will prove of assistance in understanding and utilizing the circuits.

(A)

SUPERHETERODYNE RECEIVER FOR A-C OPERATION
WITH SINGLE-TUBE INVERSE FEEDBACK POWER AMPLIFIER

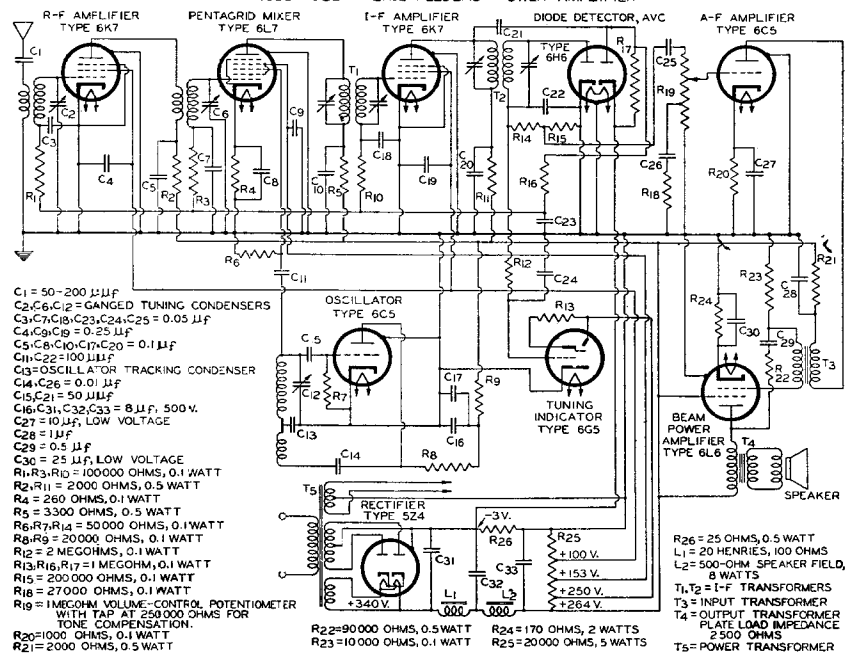

(B)

TUNED R-F RECEIVER WITH AVC AND INVERSE FEEDBACK POWER AMPLIFIER
CLASS AB1 6L6'S, OUTPUT 32 WATTS

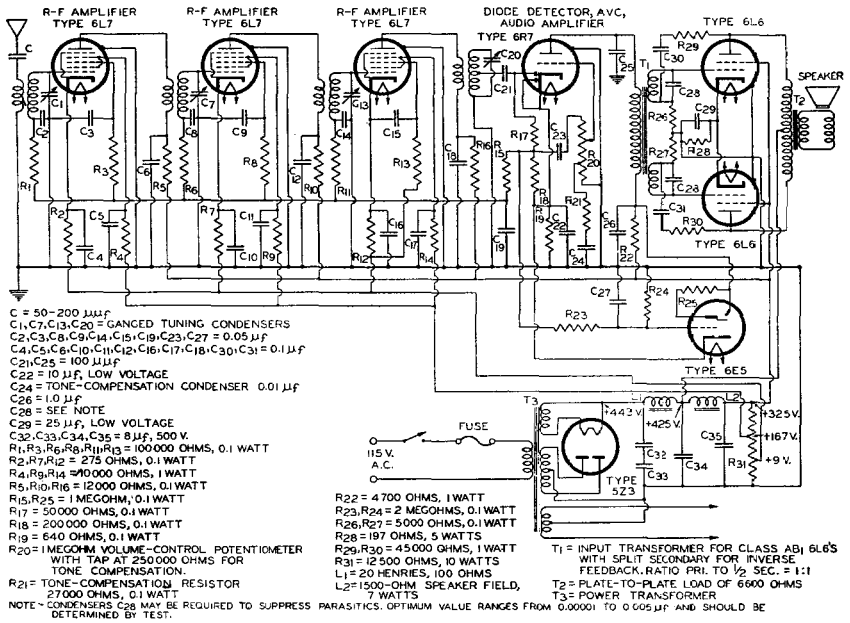

(C)

SUPERHETERODYNE AUTOMOBILE RECEIVER

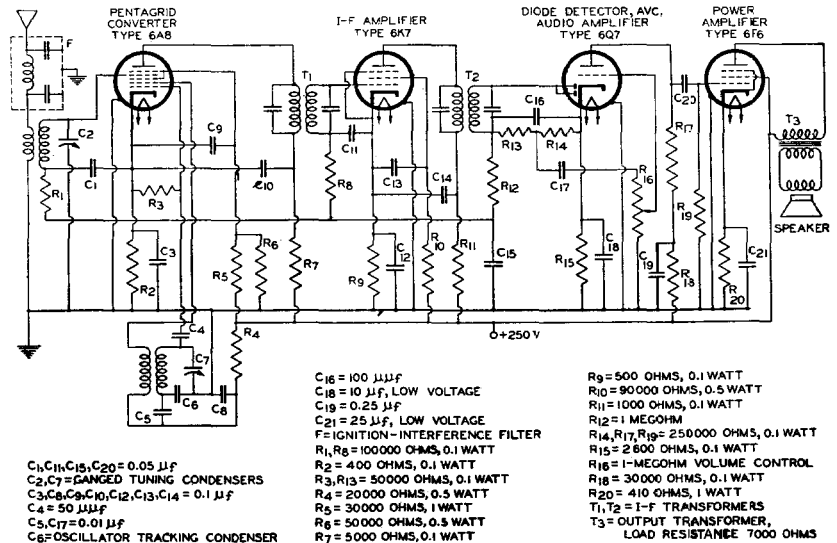

(D)

A-C AND D-C SUPERHETERODYNE RECEIVER POWER OUTPUT 2 WATTS

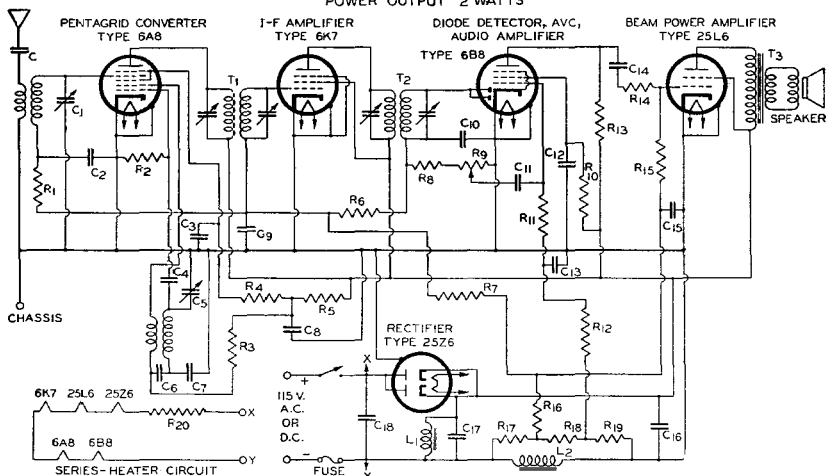

$C = 50 - 200 \mu\text{f}$
 $C_1, C_5 = \text{GANGED TUNING CONDENSERS}$
 $C_2, C_3, C_9, C_{14} = 0.05 \mu\text{f}$
 $C_4 = 50 \mu\text{f}$
 $C_6, C_{11} = 0.01 \mu\text{f}$
 $C_7 = \text{OSCILLATOR PADDING CONDENSER}$
 $C_8 = 8 \mu\text{f}, 200 \text{ V.}$
 $C_{10} = 100 \mu\text{f}$
 $C_{12} = 0.07 \mu\text{f}$

$C_{13}, C_{15} = 0.5 \mu\text{f}$
 $C_{16}, C_{17} = 40 \mu\text{f}, 200 \text{ V.}$
 $C_{18} = 0.01 \mu\text{f}$
 $R_1, R_3, R_{15}, R_{16} = 100,000 \text{ OHMS}, 0.1 \text{ WATT}$
 $R_2, R_4, R_{14} = 50,000 \text{ OHMS}, 0.1 \text{ WATT}$
 $R_3, R_4 = 15,000 \text{ OHMS}, 0.1 \text{ WATT}$
 $R_5 = 10,000 \text{ OHMS}, 0.5 \text{ WATT}$
 $R_6, R_7, R_{11}, R_{12} = 1 \text{ MEGOHM}$
 $R_9 = 200,000 \text{ OHMS VOLUME CONTROL}$

$R_{10} = 500,000 \text{ OHMS}, 0.1 \text{ WATT}$
 $R_{17}, R_{18} = 250,000 \text{ OHMS}, 0.1 \text{ WATT}$
 $R_{19} = 125,000 \text{ OHMS}, 0.1 \text{ WATT}$
 $R_{20} = 150 \text{ OHMS}, 15 \text{ WATTS}$
 $L_1 = \text{SPEAKER FIELD}, 3,000 \text{ OHMS}, 100 \text{ V.}$
 $L_2 = \text{FILTER CHOKE, RESIST. } 200 \text{ OHMS, INDUCT. AS LARGE AS PRACTICAL.}$
 $T_1, T_2 = \text{I-F TRANSFORMERS}$
 $T_3 = \text{OUTPUT TRANSFORMER}$

(E)

BATTERY-OPERATED SUPERHETERODYNE RECEIVER WITH DELAYED AVC - FOR DRY-BATTERY A- AND B-SUPPLY

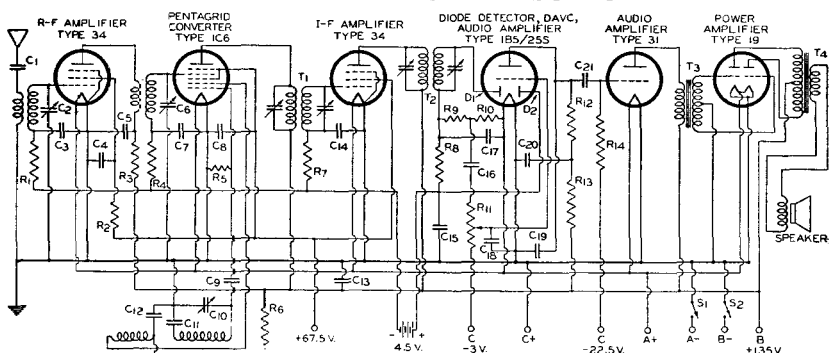

$C_1 = 50 - 200 \mu\text{f}$
 $C_2, C_6, C_{10} = \text{GANGED TUNING CONDENSERS}$
 $C_3, C_7, C_{14}, C_{15}, C_{16}, C_{21} = 0.05 \mu\text{f}$
 $C_4, C_5, C_8, C_{12} = 0.1 \mu\text{f}$
 $C_9 = 0.00005 \mu\text{f}$
 $C_{11} = \text{OSCILLATOR PADDING CONDENSER}$
 $C_{13} = 1.0 \mu\text{f}$
 $C_{17}, C_{18} = 100 \mu\text{f}$
 $C_{19} = 250 \mu\text{f}$

$C_{20} = 0.25 \mu\text{f}$
 $R_1, R_4, R_7 = 100,000 \text{ OHMS}, 0.1 \text{ WATT}$
 $R_2 = 5,000 \text{ OHMS}, 0.1 \text{ WATT}$
 $R_3 = 10,000 \text{ OHMS}, 0.1 \text{ WATT}$
 $R_5, R_9, R_{12}, R_{13} = 50,000 \text{ OHMS}, 0.1 \text{ WATT}$
 $R_6 = 20,000 \text{ OHMS}, 0.1 \text{ WATT}$
 $R_8 = 2 \text{ MEGOHMS}, 0.1 \text{ WATT}$
 $R_{10} = 200,000 \text{ OHMS}, 0.1 \text{ WATT}$

$R_{11} = 1 \text{ MEGOHM VOLUME CONTROL}$
 $R_{14} = 1 \text{ MEGOHM}, 0.1 \text{ WATT}$
 $S_1, S_2 = \text{D.P.S.T. SWITCH ON VOLUME CONTROL}$
 $T_1, T_2 = \text{I-F TRANSFORMERS}$
 $T_3 = \text{DRIVER TRANSFORMER}$
 $\text{RATIO PRI. TO } \frac{1}{2} \text{ SEC.} = 1.53:1$
 $T_4 = \text{OUTPUT TRANSFORMER}$

(F)

BATTERY-OPERATED SHORT-WAVE RECEIVER
2.0-VOLT TYPES

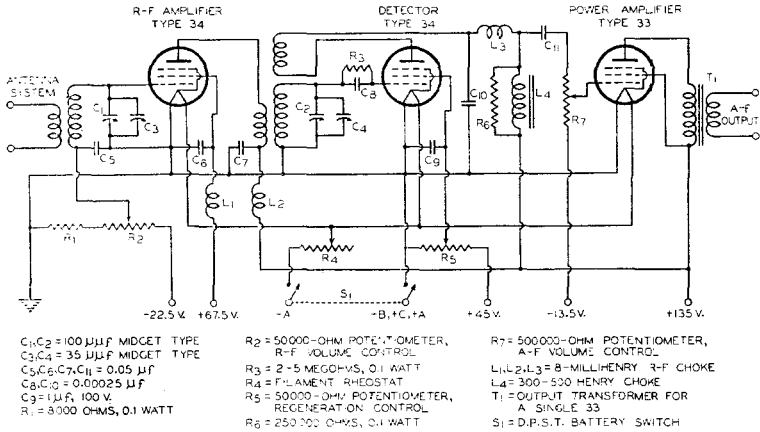

(G)

BATTERY-OPERATED SUPERHETERODYNE RECEIVER
FOR VIBRATOR B-SUPPLY

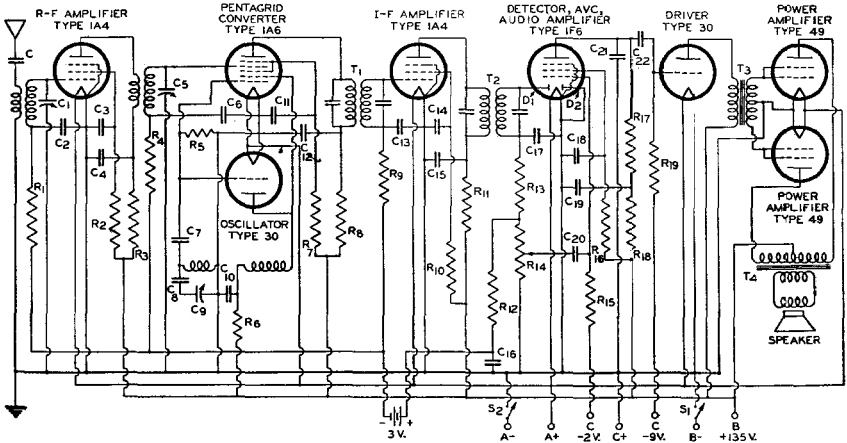

H)

HIGH-POWER AUDIO-FREQUENCY AMPLIFIER
CLASS AB₂ 6L6'S, OUTPUT 55 WATTS

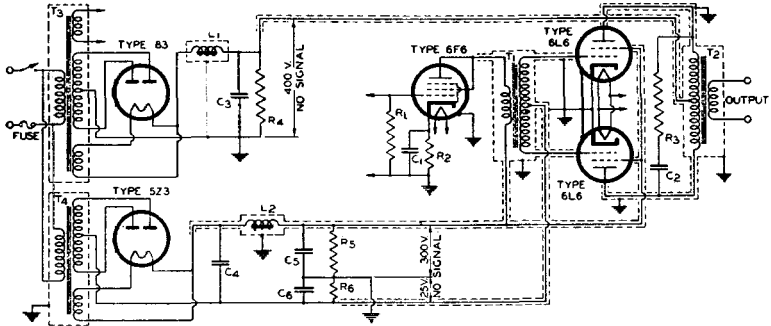

C₁, C₆ = 25 μF, 25 V.
C₂ = 0.035 μF, 1000 V.
C₃ = 14 μF, 450 V.
C₄, C₅ = 8 μF, 450 V.
R₁ = 0.5 MEGOHM

H₂ = 650 OHMS, 0.1 WATT
R₃ = 5000 OHMS, 20 WATTS
R₄ = 50000 OHMS, 5 WATTS
R₅ = 3500 OHMS, 30 WATTS
R₆ = 200 OHMS, 5 WATTS

L₁ = 5 HENRIES AT 220 MA., 50 OHMS OR LESS
L₂ = 20 HENRIES AT 150 MA., 100 OHMS OR LESS
T₁ = INPUT TRANSFORMER FOR CLASS AB₂ 6L6'S
T₂ = OUTPUT TRANSFORMER
'PLATE-TO-PLATE LOAD 3800 OHMS'
T₃, T₄ = POWER TRANSFORMERS

J)

NON-RADIATING REGENERATIVE SHORT-WAVE RECEIVER

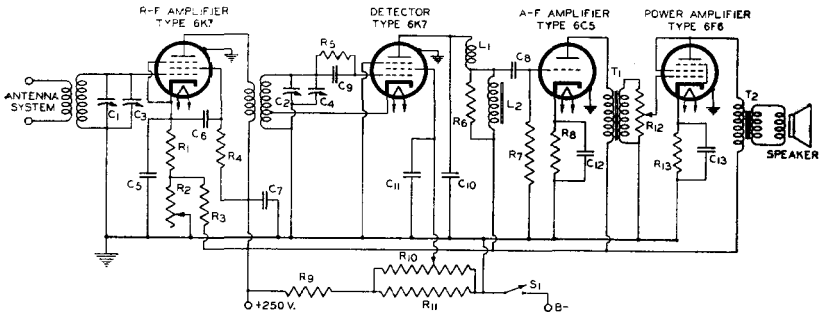

C₁, C₂ = 35 μMF MIDGET TYPE
C₃, C₄ = 100 μMF W DGET TYPE
C₅, C₆, C₇ = 0.01 μF MICA TYPE
C₈ = 0.1 μF
C₉, C₁₀ = 0.00025 μF MICA TYPE
C₁₁ = 1 μF, 200 V.
C₁₂, C₁₃ = 2-25 μF ELECTROLYTIC, 25 V.
R₁ = 230 OHMS, 0.1 WATT
R₂ = 10000-OHM WIRE-WOUND
PCTENTIOMETER

R₃ = 100000 OHMS, 1 WATT
R₄ = 50000 OHMS, 1 WATT
R₅ = 2-5 MEGOHMS, 0.1 WATT
R₆ = 250000 OHMS, 1 WATT
R₇ = 1 MEGOHM, 0.1 WATT
R₈ = 1000 OHMS, 1 WATT
R₉ = 15 000 OHMS, 5 WATTS
R₁₀ = 50000-OHM POTENTIOMETER,
REGENERATION CONTROL

R₁₁ = 5000 OHMS, 1 WATT
R₁₂ = 100000-OHM VOLUME CONTROL
R₁₃ = 670 OHMS, 1 WATT
S₁ = S.P.S.T. SWITCH
L₁ = 8-MILLIHENRY R-F CHOKE
L₂ = 300-500 HENRY A-F CHOKE
T₁ = INTERSTAGE TRANSFORMER,
3:1 STEP-UP TURNS RATIO
T₂ = OUTPUT TRANSFORMER

(K)

VOLUME EXPANDER USING TYPE 6L7
FOR USE IN A PHONOGRAPH AMPLIFIER

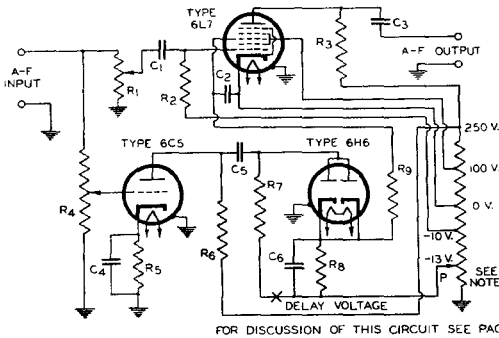

- C₁, C₃, C₅ = 0.1 μF
- C₂, C₄, C₆ = 0.5 μF
- R₁ = 1-MEGOHM POTENTIOMETER
VOLUME-LEVEL CONTROL
- R₂ = 1 MEGOHM
- R₃, R₆ = 10000 OHMS, 1 WATT
- R₄ = 1-MEGOHM POTENTIOMETER
EXPANSION CONTROL
- R₅ = 10 300 OHMS, 0.1 WATT
- R₇ = 100 000 OHMS, 0.1 WATT
- R₈ = 250 000 OHMS, 0.1 WATT
- R₉ = 500 000 OHMS, 0.1 WATT

NOTE - ALL TERMINAL POINTS ON POWER UNIT SHOULD BE ADEQUATELY BY-PASSED.

FOR DISCUSSION OF THIS CIRCUIT SEE PAGE 23

(L)

NON-MOTORBOATING RESISTANCE-COUPLED AMPLIFIER
VOLTAGE GAIN = 9000

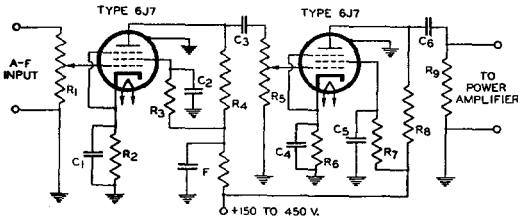

- C₁, C₄ = 8 μF, LOW VOLTAGE
- C₂, C₅ = 0.05 μF, VOLTAGE RATING AS HIGH AS VOLTAGE SUPPLY
- C₃, C₆ = 0.005 μF, VOLTAGE RATING AS HIGH AS VOLTAGE SUPPLY
- R₁ = VOLUME-CONTROL POTENTIOMETER
- R₂, R₆ = 600 OHMS, 0.1 WATT
- R₃, R₇, R₉ = 500 000 OHMS, 0.5 WATT
- R₄, R₈ = 100 000 OHMS, 0.1 WATT
- R₅ = 500 000-OHM VOLUME-CONTROL POTENTIOMETER GANGED WITH R₁
- F = DECOUPLING FILTER

NOTE—Values of resistance and capacitance shown in this circuit are taken from the Chart in the Resistance-Coupled Amplifier Section. The values in this chart are chosen to give a sharp low-frequency cut-off and, thus, to minimize tendency of multiple stages to motorboat. Three or more stages, including power stage, operated from a common B supply may require a decoupling filter in the plate-supply leads of one or more of the voltage amplifier stages. The constants of decoupling filters depend on the design requirements of the amplifier.

(M)

AUDIO AMPLIFIER FOR USE ON 115-VOLT D-C LINE
CLASS A₁ - POWER OUTPUT, 4 WATTS*

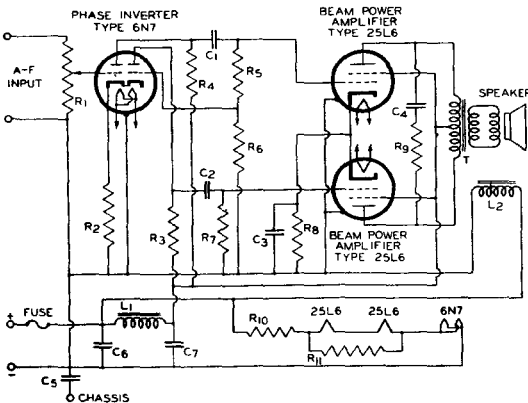

- C₁, C₂ = 0.005 μF
- C₃ = 25 μF, LOW VOLTAGE
- C₄ = 0.035 μF
- C₅, C₆ = 2 μF, 150 V.
- C₇ = 4 μF, 150 V.
- R₁ = 500 000-OHM VOLUME CONTROL
- R₂ = 5000 OHMS, 0.1 WATT
- R₃, R₄ = 250 000 OHMS, 0.1 WATT
- R₅ = 475 000 OHMS, 0.1 WATT
- R₆ = 23 000 OHMS, 0.1 WATT
- R₇ = 500 000 OHMS, 0.1 WATT
- R₈ = 70 OHMS, 1 WATT
- R₉ = 4000 OHMS, 2 WATTS
- R₁₀ = 75 OHMS, 50 WATTS
- R₁₁ = 100 OHMS, 25 WATTS
- L₁ = FILTER CHOK, 10 HENRIES
AT 125 MA., 60 OHMS
- L₂ = SPEAKER FIELD, 110 VOLTS D.C.
- T = OUTPUT TRANSFORMER,
PLATE-TO-PLATE LOAD 3000 OHMS

*SIGNAL VOLTAGE INPUT FOR FULL POWER OUTPUT = 0.34 VOLTS PEAK.

(N)

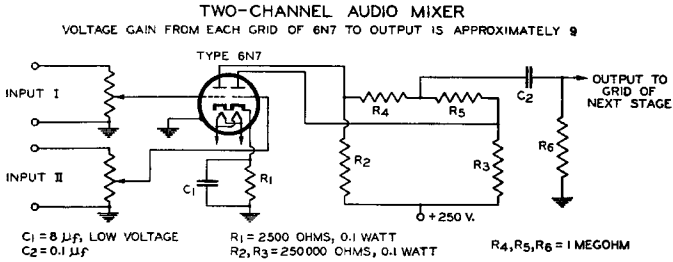

(P)

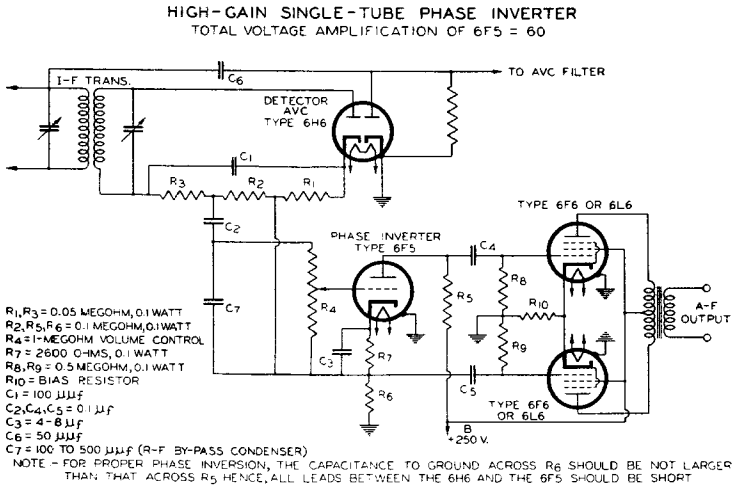

(Q)

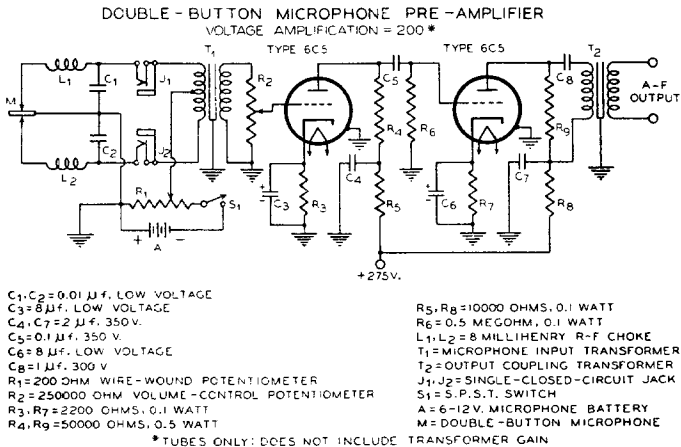

(R)

CLASS B AMPLIFIER FOR PORTABLE USE
POWER OUTPUT 10 WATTS

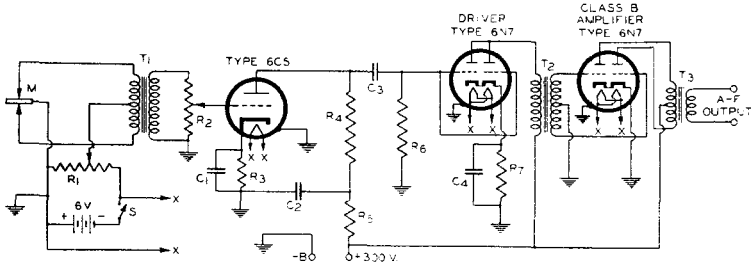

- C1 = 1.3 μ f, LOW VOLTAGE
- C2 = 0.5 μ f
- C3 = 0.016 μ f
- C4 = 25 μ f, LOW VOLTAGE
- R1 = 500-OHM WIRE-WOUND POTENTIOMETER
- R2 = 500,000-OHM VOLUME-CONTROL POTENTIOMETER
- R3 = 5,000 OHMS, 0.1 WATT
- R4 = 100,000 OHMS, 0.5 WATT
- R5 = 50,000 OHMS, 0.5 WATT

- R6 = 250,000 OHMS, 0.1 WATT
- R7 = 900 OHMS, 0.1 WATT
- M = DOUBLE-THROW MICROPHONE SWITCH
- S = MICROPHONE AND HEATER SWITCH
- T1 = MICROPHONE INPUT TRANSFORMER
- T2 = CLASS B INPUT TRANSFORMER
- T3 = CLASS B OUTPUT TRANSFORMER

(S)

CLASS A AUDIO-FREQUENCY AMPLIFIER
OUTPUT 12 WATTS

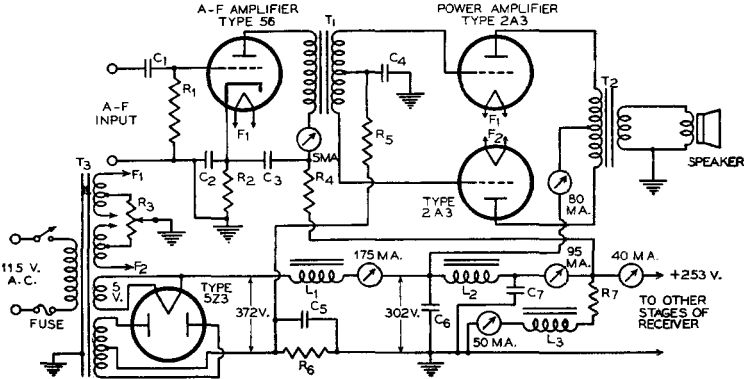

- C1 = 0.1 μ f
- C2 = 5 μ f, 25 V.
- C3 = 2 μ f, 350V.
- C4 = 0.5 μ f
- C5 = 25 μ f, 75 V.
- C6 = 10 μ f, 400V.
- C7 = 8 μ f, 350V.
- R1 = 0.5-1 MEGOHM
- R2 = 2,200 OHMS, 1 WATT
- R3 = 100-OHM POTENTIOMETER
- R4 = 5,000 OHMS, 1 WATT
- R5 = 50,000 OHMS, 1 WATT
- R6 = 345 OHMS, 15 WATTS
- R7 = 2,560 OHMS, 10 WATTS

- L1 = FILTER CHOKE; 12 HENRIES AT 175 MA., 60 OHMS
- L2 = FILTER CHOKE; 30 HENRIES AT 95 MA., 515 OHMS
- L3 = SPEAKER FIELD; 2,500 OHMS, 125 V.
- T1 = PLATE-TO-PUSH-PULL-GRID INPUT TRANSFORMER
- T2 = OUTPUT TRANSFORMER
- T3 = POWER TRANSFORMER HAVING GOOD VOLTAGE-REGULATION CHARACTERISTICS

NOTE: A SPEAKER SPECIALLY DESIGNED FOR HIGH POWER IS RECOMMENDED. CIRCUIT CONSTANTS SHOULD CLOSELY APPROXIMATE THOSE GIVEN ABOVE.

INDEX

	Page		Page
Amplification Factor	12	inverse feedback	21, 22, 178, 179
Amplifier:		microphone pre-amplifier	184
audio-frequency	14, 16	oscillator	31
audio mixer	184	pentagrid converter	47, 55
Class A	14, 16	phase inverter	24, 184
Class AB	14, 20	power amplifier	182, 183, 185
Class B	14, 20	power output test	173
Class C	14	resistance-coupled amplifier	183
inverse-feedback	14, 21, 178, 179	short-circuit test	171
parallel	17	short-wave receiver	181, 182
phase-inverter	24, 184	superheterodyne	
push-pull	17	receiver	178, 179, 180, 181
radio-frequency	14, 16	transconductance test	172
resistance-coupled a-f conditions	174	tuned r-f receiver	179
super-control	16	voltage-doubler rectifier	26
volume-expander	23, 183	volume expander	183
Anode	7	Condenser-Input Filter	37
Anode-Grid	32	Conversion Curve, Use of	19
Arc-Back Limit	13	Conversion Transconductance	13
Automatic Volume Control (AVC)	28	Corrective Filter	23
Beam Power Tube Considerations	10	Cross-Modulation	16
Bias:		Current:	
battery	35	cathode	35
diode	27	grid	20, 21
self	35	peak plate	13
		plate	7
Calculation of:		Cut-off	14
amplification factor	12	Delayed Automatic Vol. Control	
filament resistor power dissipation	33	(DAVC)	29
filament (or heater) resistor value	33	Demodulation	26
harmonic distortion, 2nd	18, 19	Detection:	
load resistance	17, 18	diode	26
operating conditions from		grid-bias	28
conversion curves	19	grid leak and condenser	28
plate resistance	12	Diode:	
power output (push-pull triodes,		biasing	27
Class A)	19	considerations	7
power output (single pentode and		detection	26
beam power tube)	19	load resistor	26
power output (single triode)	17	Driver Tube	20, 21
self-bias resistor	35	Duplex Diode:	
transconductance	12	pentode	11
voltage amplification (gain)	15	triode	11
Carrier Wave	26	Dynamic Characteristics	12
Cathode:		Electron:	
coating	5	considerations	5
connection	34	secondary	9, 10
current	35	Electron-Ray Tubes	11, 30, 73, 81
directly heated	5	Emission:	
indirectly heated	6	current	7
resistor	35	secondary	9, 10
Center-Tap Resistor	35	test	7, 171
Characteristics:		Feedback:	
amplification factor	12	inverse	21, 179, 180
control-grid—		undesired	36, 37
plate transconductance	12	Filament (see Heater and Cathode):	
conversion transconductance	13	operation	33
dynamic	12	resistor, power dissipation of	33
mutual conductance	12	resistor, value of	33, 34
plate resistance	12	series operation	34
static	12	supply voltage	33
Choke-Input Filter	37	Filter:	
Circuit Diagram of:		choke-input	37
audio mixer	184	condenser-input	37
avc	28	corrective	23
dave	29	radio-frequency	37
duplex-diode pentode	27, 67	resistor	37
duplex-diode triode	27, 164		
emission test	171		
full-wave rectifier	25		
half-wave rectifier	25		
high-gain a-f amplifier	183		

INDEX (Continued)

	Page		Page
Formulas (see Calculation)		plate-to-plate load resistance	
Frequency Conversion	31	(triodes)	18
Gain	15	resistance	12
Grid:		voltage supply	35
anode	32	Power Output:	
bias	35	calculation of	17, 19
bias detection	28	Class A test for	173
considerations	8	Class B test for	173
current	20, 21	Push-Pull Operation of Tubes	17
input impedance	15	Radio-Frequency:	
leak and condenser detection	28	amplifier	14, 16
resistor	15, 28, 174	filter	37
voltage supply	35	Reading List	Inside back cover
Grid-Plate Capacity	9	Rectifier:	
Grid-Plate Transconductance	12	full-wave	7, 25
Harmonic Distortion:		half-wave	7, 25
cancellation of 2nd	17	voltage-doubler	25
determination of	18, 19	Resistance Coupling	15
Heater:		Resistance-Coupled Amplifier	174, 183
cathode	5	Resistor:	
cathode bias	34	cathode	35
cathode connection	34	center-tap	35
parallel operation	33, 34	filament	33, 34
resistor power dissipation	33, 34	filter	37
resistor value determination	33, 34	grid	15, 28, 174
series operation	34	plate load	15, 174
shunt resistor	34	screen	36
supply voltage	33	self-biasing	35
Interelectrode Capacity	9	Saturation Current	8
Input Filter-Choke	38	Screen:	
Input Filter-Condenser	38	considerations	9, 10
Instantaneous Peak Voltage	38	voltage supply	36
Intermediate Frequency,		Secondary Emission	9, 10
production of	31	Self-Bias	35
Inverse-Feedback Circuits	21, 178, 179	Shielding	36
Ionization	8	Short-Circuit Test	171
Load:		Space Charge	7, 8
line	17	Static Characteristics	12
resistance	15, 18	Super-Control Tube	16
Mercury-Vapor Rectifier	8	Suppressor	9, 10
Mho	13	Testing Radio Tubes	171
Micromho	13	Tetrode Considerations	9
Mixer, audio	184	Transconductance:	
Mixer, pentagrid	32	conversion	13
Modulation	26	dynamic test for	172
Modulation Distortion	16	grid-plate	12
Multi-Electrode Tubes	10	grid-shift test for	172
Multi-Unit Tubes	10	Triode Considerations	8
Mutual Conductance		Tube:	
(see Transconductance)		classification by use and by	
Oscillator	31	cathode voltage	39
Output:		testing	171
coupling	38	Tube Materials Chart	170
plate load	15, 18	Tube Types:	
power	17	all-metal, and glass types	40
Parallel Operation of Tubes	17	octal-base, glass-bulb types	
Peak Inverse Voltage	13	(G types)	188
Peak Plate Current	13	Tuning Indicator	30, 73, 81
Pentagrid Converter	32	Voltage:	
Pentagrid Mixer	32	amplification	14
Pentode Considerations	9	doubler rectifier	25
Phase Inverter Circuits	24, 184	peak inverse	13
Plate:		Voltage Conversion Factor	20
current	7	Volume Control:	
load	15, 18	automatic	28
		by grid-voltage variation	36
		by screen-voltage variation	36
		Volume-Expander Circuit	23, 183

RCA G-TYPE RADIO TUBES

(OCTAL-BASE, GLASS-BULB TYPES)

In addition to the types of tubes shown on the preceding pages, the following octal-base, glass-bulb types are also available. These types are identified by the letter "G" following the type number. For each of these types, the corresponding glass or metal types are indicated below, together with socket connections and overall dimensions. Characteristics data for the G-types, except for some differences in capacity values, are the same as those for the corresponding types. Socket connection diagrams are shown on page 191.

NOTE: Certain G-types have an internal shield which is brought out to Pin No. 1. Socket connections for such types designate Pin No. 1 as SHIELD. For G-types without SHIELD connections, Pin No. 1 is marked NC. Other symbols on socket diagrams are explained in the KEY TO TERMINAL DESIGNATIONS OF SOCKET CONNECTIONS on page 39.

G-Series Type	Corresponding Glass Type	Corresponding Metal Type	Socket Connections	Max. Overall Dimensions Length x Diam.
1C7-G	1C6	—	G-7Z	4 ¹⁵ / ₃₂ " x 1 ⁹ / ₁₆ "
1D5-G	1A4	—	G-5Y	4 ¹⁵ / ₃₂ " x 1 ⁹ / ₁₆ "
1D7-G	1A6	—	G-7Z	4 ¹⁵ / ₃₂ " x 1 ⁹ / ₁₆ "
1E5-G	1B4	—	G-5Y	4 ¹⁵ / ₃₂ " x 1 ⁹ / ₁₆ "
1E7-G	§	—	G-8C	4 ¹ / ₈ " x 1 ⁹ / ₁₆ "
1F5-G	1F4	—	G-6X	4 ⁵ / ₈ " x 1 ¹³ / ₁₆ "
1F7-G	1F6	—	G-7AD	4 ¹⁵ / ₃₂ " x 1 ⁹ / ₁₆ "
1H4-G	30	—	G-5S	4 ¹ / ₈ " x 1 ⁹ / ₁₆ "
1H6-G	1B5/25S	—	G-7AA	4 ¹ / ₈ " x 1 ⁹ / ₁₆ "
1J6-G	19*	—	G-7AB	4 ¹ / ₈ " x 1 ⁹ / ₁₆ "
5U4-G	5Z3	—	G-5T	5 ⁵ / ₁₆ " x 2 ¹ / ₁₆ "
5V4-G	83-v	—	G-5L	4 ³ / ₈ " x 1 ¹³ / ₁₆ "
5X4-G	5Z3	—	G-5Q	5 ⁵ / ₁₆ " x 2 ¹ / ₁₆ "
5Y3-G	80	—	G-5T	4 ³ / ₈ " x 1 ¹³ / ₁₆ "
5Y4-G	80	—	G-5Q	4 ⁵ / ₈ " x 1 ¹³ / ₁₆ "
6A8-G	—	6A8	G-8A	4 ¹⁵ / ₃₂ " x 1 ⁹ / ₁₆ "
6B8-G	—	6B8	See bottom page 192	4 ¹⁵ / ₃₂ " x 1 ⁹ / ₁₆ "
6C5-G	—	6C5	G-6Q	4 ¹ / ₈ " x 1 ⁹ / ₁₆ "
6D8-G	See data on page 189	—	G-8A	4 ¹⁵ / ₃₂ " x 1 ⁹ / ₁₆ "
6F5-G	—	6F5	G-5M	4 ¹⁵ / ₃₂ " x 1 ⁹ / ₁₆ "
6F6-G	—	6F6	G-7S	4 ⁵ / ₈ " x 1 ¹³ / ₁₆ "
6H6-G	—	6H6	G-7Q	4 ¹ / ₈ " x 1 ⁹ / ₁₆ "
6J3-G	See 6J5, page 192	—	G-6Q (6J5-G)‡	4 ¹ / ₈ " x 1 ⁹ / ₁₆ "
6J7-G	—	6J7	G-7R (6J7-G)	4 ¹⁵ / ₃₂ " x 1 ⁹ / ₁₆ "
6K5-G	See data on page 189	—	G-5U	4 ¹⁵ / ₃₂ " x 1 ⁹ / ₁₆ "
6K6-G	41	—	G-7S	4 ¹ / ₈ " x 1 ⁹ / ₁₆ "
6K7-G	—	6K7	G-7R (6K7-G)	4 ¹⁵ / ₃₂ " x 1 ⁹ / ₁₆ "
6L5-G	See data on page 189	—	G-6Q	4 ¹ / ₈ " x 1 ⁹ / ₁₆ "
6L6-G	—	6L6	G-7AC	5 ⁵ / ₁₆ " x 2 ¹ / ₁₆ "
6L7-G	—	6L7	G-7T	4 ¹⁵ / ₃₂ " x 1 ⁹ / ₁₆ "

*. §. †. ‡: see next page.

R C A R E C E I V I N G T U B E M A N U A L

G-Series Type	Corresponding Class Type	Metal Type	Socket Connections	Max. Overall Dimensions Length x Diam.
6N7-G	—	6N7	G-8B	4 $\frac{5}{8}$ " x 1 $\frac{13}{16}$ "
6Q7-G	—	6Q7	G-7V	4 $\frac{15}{32}$ " x 1 $\frac{9}{16}$ "
6R7-G	—	6R7	G-7V	4 $\frac{15}{32}$ " x 1 $\frac{9}{16}$ "
6S7-G	See data on page 189		G-7R (6K7-G)	4 $\frac{7}{8}$ " x 1 $\frac{9}{16}$ "
6T7-G	See data on page 190		G-7V	4 $\frac{15}{32}$ " x 1 $\frac{9}{16}$ "
6V6-G	See data on page 190		G-7AC	4 $\frac{5}{8}$ " x 1 $\frac{13}{16}$ "
6X5-G	—	6X5	G-6S	4 $\frac{1}{8}$ " x 1 $\frac{9}{16}$ "
25A6-G	—	25A6	G-7S	4 $\frac{5}{8}$ " x 1 $\frac{13}{16}$ "
25B6-G	See data on page 190		G-7S	4 $\frac{5}{8}$ " x 1 $\frac{13}{16}$ "
25L6-G	—	25L6	G-7AC	4 $\frac{5}{8}$ " x 1 $\frac{13}{16}$ "
25Z6-G	—	25Z6	G-7Q#	4 $\frac{1}{8}$ " x 1 $\frac{9}{16}$ "

* Except that filament current is 0.24 ampere. † Two 1F4's in the same bulb, with a common screen connection.

‡ Same as G-6Q except that Pin No. 1 has no connection.

Pin No. 1 has no connection.

RCA-6D8-G:

Heater Voltage	6.3 a-c or d-c	Volts
Heater Current	0.15	Ampere
Plate Voltage 135	250 max.	Volts
Screen Voltage (Grids No. 3 and 5) 67.5	100 max.	Volts
Anode-Grid Supply Voltage (Grid No. 2) 135	250† max.	Volts
Control-Grid Voltage (Grid No. 4) -3	-3 min.	Volts
Oscillator-Grid Resistor (Grid No. 1) 50000	50000	Ohms
Cathode Current 8	13	Milliamperes
Plate Resistance 0.4	0.32	Megohm
Conversion Conductance 325	500	Micromhos
Control-Grid Voltage, Approximate (Conversion Conductance = 10 μ mhos) -25	-38.5	Volts

† Anode-grid supply voltages in excess of 200 volts require the use of 20000-ohm voltage-dropping resistor by-passed by 0.1- μ f condenser.

RCA-6K5-G: Similar to triode section of 6Q7.

Heater Voltage 6.3	6.3 a-c or d-c	Volts
Heater Current 0.3	0.3	Ampere
Plate Voltage 100	250	Volts
Grid Voltage -1.5	-3	Volts
Amplification Factor 70	70 approx.	
Plate Resistance 78000	50000 approx.	Ohms
Transconductance 900	1400	Micromhos
Plate Current 0.35	1.1	Milliamperes

RCA-6L5-G:

Heater Voltage 6.3	6.3 a-c or d-c	Volts
Heater Current 0.15	0.15	Ampere
Plate Voltage 135	250	Volts
Grid Voltage -5	-9	Volts
Amplification Factor 17	17	
Plate Resistance 11300	9000	Ohms
Transconductance 1500	1900	Micromhos
Plate Current 3.5	8	Milliamperes
Grid Bias (for cut-off) -11	-20	Volts

RCA-6S7-G:

Heater Voltage 6.3	6.3 a-c or d-c	Volts
Heater Current 0.15	0.15	Ampere
Plate Voltage 135	250 max.	Volts
Screen Voltage 67.5	100 max.	Volts
Grid Voltage -3	-3	Volts
Suppressor	Connected to cathode at socket	

R C A R E C E I V I N G T U B E M A N U A L

Amplification Factor (Approx.)	850	1100	
Transconductance	1250	1750	Micromhos
Plate Current	3.7	8.5	Milliamperes
Screen Current	0.9	2.0	Milliamperes
Grid Voltage (For transconductance = 10 micromhos)	-25	-38.5	Volts

RCA-6T7-G:

Heater Voltage	6.3	a-c or d-c	Volts
Heater Current	0.15		Ampere
Plate Voltage	135	250	Volts
Grid Voltage	-1.5	-3	Volts
Amplification Factor	65	65	
Plate Resistance	65000	62000	Ohms
Transconductance	1000	1050	Micromhos
Plate Current	0.9	1.2	Milliamperes

The two diodes of this type are similar to those of other duplex-diode triode types. Plate biasing of this type is not recommended.

RCA-6V6-G:

Heater Voltage	6.3	a-c or d-c	Volts
Heater Current	0.45		Ampere

As Single-Tube Class A₁ Amplifier (With Fixed Bias):

Maximum Ratings:

Plate Voltage	250 max.	Volts
Screen Voltage	250 max.	Volts
Plate and Screen Dissipation (Total)#	12.5 max.	Watts

Typical Operation:

Plate Voltage	250	Volts
Screen Voltage	250	Volts
Grid Voltage§	-12.5	Volts
Peak A-F Grid Voltage	12.5	Volts
Zero-Signal D-C Plate Current	45	Milliamperes
Max.-Signal D-C Plate Current	47	Milliamperes
Zero-Signal D-C Screen Current	4.5	Milliamperes
Max.-Signal D-C Screen Current	6.5	Milliamperes
Load Resistance	5000	Ohms
Total Harmonic Distortion	6	Per cent
Second Harmonic Distortion	4.5	Per cent
Third Harmonic Distortion	3.5	Per cent
Max.-Signal Power Output	4.25	Watts

As Push-Pull Class AB₁ Amplifier (With Fixed Bias):

Maximum Ratings:

Plate Voltage	300 max.	Volts
Screen Voltage	300 max.	Volts
Plate and Screen Dissipation (Total)#	12.5 max.	Watts

Typical Operation (Two Tubes) Values are for two tubes:

Plate Voltage	250	300	Volts
Screen Voltage	250	300	Volts
Grid Voltage§	-15	-20	Volts
Peak A-F Grid-to-Grid Voltage	30	40	Volts
Zero-Signal Plate Current	70	78	Milliamperes
Max.-Signal Plate Current	79	90	Milliamperes
Zero-Signal Screen Current	5	5	Milliamperes
Max.-Signal Screen Current	12	13.5	Milliamperes
Load Resist. (Plate-to-Plate)	10000	8000	Ohms
Total Harmonic Distortion	4	4	Per cent
Third Harmonic Distortion	3.5	3.5	Per cent
Max.-Signal Power Output	8.5	13	Watts

Dissipation rating should not be exceeded with expected line-voltage fluctuation, especially in case of fixed-bias operation.

§ Transformer- or impedance-coupling devices are recommended. Fixed bias may be used when the grid-circuit resistance does not exceed 0.05 megohm; with self-bias, the resistance may be as high as 0.5 megohm provided the heater voltage does not fluctuate to exceed 7.0 volts.

RCA-25B6-G:

Heater Voltage	25.0	a-c or d-c	Volts
Heater Current	0.3		Ampere
Plate Voltage	95		Volts
Screen Voltage	95		Volts
Grid Voltage	-15		Volts
Plate Current	45		Milliamperes
Screen Current	4		Milliamperes
Plate Resistance	Subject to considerable variation		
Transconductance	4000		Micromhos
Load Resistance	2000		Ohms
Power Output (10% Distortion)	1.75		Watts

RCA G-TYPE SOCKET CONNECTIONS

BOTTOM VIEWS

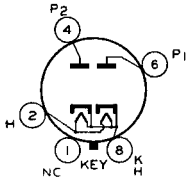

G-5L

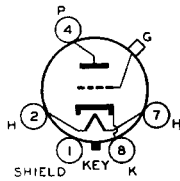

G-5M

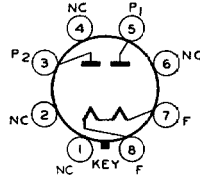

G-5Q

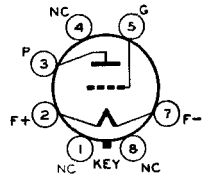

G-5S

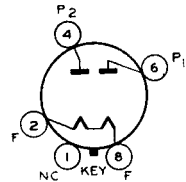

G-5T

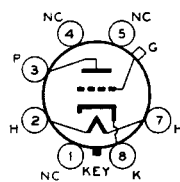

G-5U

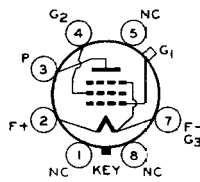

G-5Y

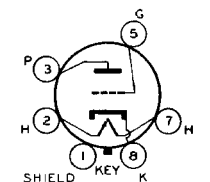

G-6Q

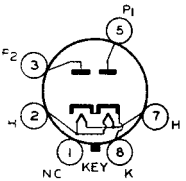

G-6S

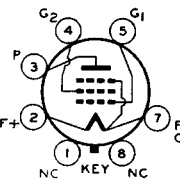

G-6X

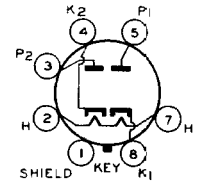

G-7Q

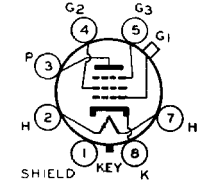

G-7R (6J7-G)

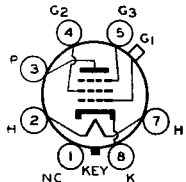

G-7R (6K7-G)

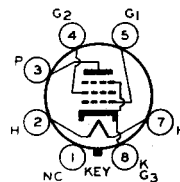

G-7S

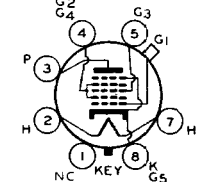

G-7T

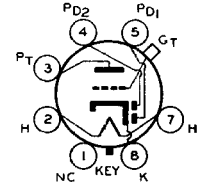

G-7V

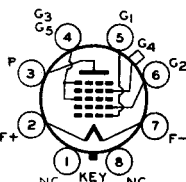

G-7Z

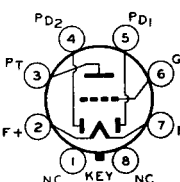

G-7AA

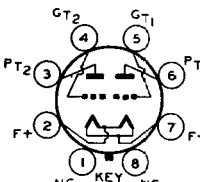

G-7AB

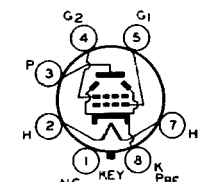

G-7AC

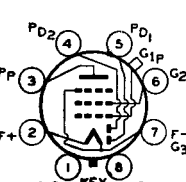

G-7AD

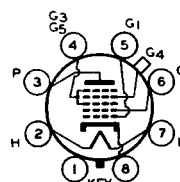

G-8A

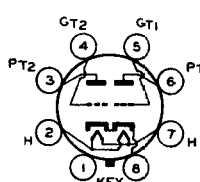

G-8B

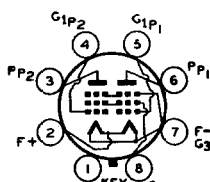

G-8C

ADDITIONAL RCA GLASS and ALL-METAL TUBES

Type	Description	Socket Connections	Max. Overall Dimensions Length x Diameter
5T4	All-Metal Full-Wave Rectifier	Same as 5W4, p. 57	4-1/4" x 1-23/32"
6J5	All-Metal Detector Amplifier Triode	Same as 6C5, p. 70	2-5/8" x 1- 5/16"
6N5	Electron-Ray Tube.....	Same as 6G5, p. 81	4-3/16" x 1- 9/16"
6U5	Electron-Ray Tube.....	Same as 6G5, p. 81	4-3/16" x 1- 3/16"

RCA-5T4:

Filament Voltage	5.0 a-c	Volts
Filament Current	2.0	Amperes
1 {	A-C Plate Voltage Per Plate (RMS)	450 max. Volts
	Peak Inverse Voltage.....	1250 max. Volts
2 {	D-C Output Current.....	250 max. Milliampere
	A-C Plate Voltage Per Plate (RMS)	550 max. Volts
2* {	Peak Inverse Voltage.....	1550 max. Volts
	D-C Output Current.....	250 max. Milliampere
Base	Large Wafer Octal 5-Pin	

* Permissible only with filter circuits having an input choke of at least 10 henrys.

RCA-6J5:

Heater Voltage	6.3 a-c or d-c	Volts
Heater Current	0.3	Ampere
Plate Voltage	250 max.	Volts
Grid Voltage ^o	-8	Volts
Amplification Factor.....	20	
Plate Resistance.....	7700	Ohms
Transconductance.....	2600	Micromhos
Plate Current.....	9	Milliamperes
Grid-Plate Capacitance (shell tied to cathode)	3.4	μmf
Grid-Cathode Capacitance.....	3.4	μmf
Plate-Cathode Capacitance.....	3.6	μmf
Base	Small Wafer Octal 6-Pin	

^o The d-c resistance in the grid circuit should not exceed 1.0 megohm.

RCA-6N5:

Heater Voltage	6.3	Volts
Heater Current	0.15	Ampere
Plate- and Target-Supply Voltage....	135 max.	Volts
Series Triode-Plate Resistor.....	0.25	Megohm
Triode-Plate Current (For zero triode-grid voltage).....	0.5	Milliampere
Triode-Grid Voltage (For shadow angle of 0°).....	-12	Volts
Triode-Grid Voltage (For shadow angle of 90°).....	0	Volts
Bulb	ST-12	
Base	Small 6-Pin	

RCA-6U5: The electrical characteristics of this type are identical with those of type 6G5. The 6U5 has a tubular (T-9) bulb and small 6-pin base.

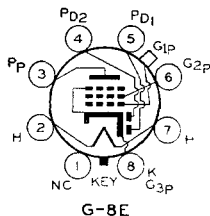

READING LIST

The following list of radio references gives texts of both elementary and advanced character. Obviously, the list is not inclusive, but it will guide the reader to other references.

- CHAFFEE, E. L. *Theory of Thermionic Vacuum Tubes*. McGraw-Hill Book Co., Inc.
- DUNCAN AND DREW. *Radio Telegraphy and Telephony*. John Wiley and Sons, Inc.
- GHIRARDI, ALFRED A. *Modern Radio Servicing*. Radio and Technical Publishing Co., Inc.
- GULLIKSEN AND VEDDER. *Industrial Electronics*. John Wiley and Sons, Inc.
- HENNEY, KEITH. *Electron Tubes in Industry*. McGraw-Hill Book Co., Inc.
- HENNEY, KEITH. *Principles of Radio*. John Wiley and Sons, Inc.
- HENNEY, KEITH. *Radio Engineering Handbook*. McGraw-Hill Book Co., Inc.
- JONES, FRANK C. *Jones Radio Handbook*. Pacific Radio Publishing Co., Inc.
- LAUER AND BROWN. *Radio Engineering Principles*. McGraw-Hill Book Co., Inc.
- McILWAIN AND BRAINERD. *High-Frequency Alternating Currents*. John Wiley and Sons, Inc.
- MORECROFT, J. H. *Electron Tubes and Their Applications*. John Wiley and Sons, Inc.
- MORECROFT, J. H. *Principles of Radio Communication*. John Wiley and Sons, Inc.
- MOYER AND WOSTREL. *Radio Handbook*. McGraw-Hill Book Co., Inc.
- MOYER AND WOSTREL. *Radio Receiving Tubes*. McGraw-Hill Book Co., Inc.
- PENDER, HAROLD. *Handbook for Electrical Engineers—Communications and Electronics*. John Wiley and Sons, Inc.
- PETERS, LEO J. *Thermionic Vacuum Tube Circuits*. McGraw-Hill Book Co., Inc.
- Proceedings of the Institute of Radio Engineers* (a monthly publication).
- RAMSEY, R. R. *Fundamentals of Radio*. Ramsey Publishing Co.
- TERMAN, FREDERICK E. *Radio Engineering*. McGraw-Hill Book Co., Inc.
- The Radio Amateur's Handbook*. American Radio Relay League.
- UNDERSHILL, C. R. *Electrons at Work*. McGraw-Hill Book Co., Inc.
- VAN DER BIJL, H. J. *Thermionic Vacuum Tubes*. McGraw-Hill Book Co., Inc.
- ZWORYKIN AND WILSON. *Photocells and Their Application*. John Wiley and Sons, Inc.

