

**BROADCAST  
EQUIPMENT  
AND TELEVISION**

catalog

# BROADCAST EQUIPMENT CATALOG

## AM, FM AND TELEVISION 1948

*Price . . . One Dollar*



ENGINEERING PRODUCTS DEPARTMENT

**RADIO CORPORATION OF AMERICA**

RCA VICTOR DIVISION.....CAMDEN, N. J.

RCA INTERNATIONAL DIVISION.....N. Y. C.

COPYRIGHTED • PRINTED IN U. S. A.

BROADCAST AUDIO EQUIPMENT	5
AM TRANSMITTING EQUIPMENT	91
FM TRANSMITTING EQUIPMENT	119
TELEVISION STUDIO EQUIPMENT	145
TELEVISION FIELD AND RELAY EQUIPMENT	173
TELEVISION TRANSMITTING EQUIPMENT	191
TEST AND MEASURING EQUIPMENT	201
DATA SECTION	231
INDEX	247

## FOREWORD

This Broadcast Equipment Catalog is intended to serve as a buying guide to the user of this type of equipment. An attempt has been made to present a clear and concise picture covering: features, uses, description and specifications for each item of broadcast equipment.

RCA manufactures a complete line of broadcast equipment from microphone to antenna inclusive—for FM, AM and Television. This line includes not only the operating units but also such necessary accessories as monitoring and test equipment. RCA is equipped to furnish custom built studio equipment and antenna phasing equipments. RCA designs and manufactures the components for its broadcast equipment whenever necessary or desirable to insure maximum performance and reliability. Major items of such components are tubes, inductance coils, mica capacitors, crystals and transformers.

RCA is the leader in the field of broadcast equipment. This is evidenced by the fact that for fifteen years RCA equipment has outsold all other manufactures. This record includes large and small stations—among them a large proportion of the most notable installations made during this period. RCA has been and will continue to be an active leader in FM development. RCA pioneered the development of electronic television. Twenty-five years of progress in the radio field plus vast wartime experience has given RCA an engineering background for the production of the most advanced and highest quality broadcasting apparatus.

Readers of this catalog are invited to communicate with the nearest RCA Regional Office for additional information or individual bulletins on the equipment shown herein. Separate catalogs or descriptive bulletins are available on other lines of RCA equipment such as Sound, Theatre, Aviation, Communications, Electronic Heating, Scientific Instruments, Records and Radio Receivers.

# **POLICIES AND INFORMATION**

## **Covering the Direct Sale of**

### **BROADCAST EQUIPMENT**

#### **Foreword**

RCA Broadcast Equipment is sold directly to the station through RCA's regional offices. Regional representatives are conveniently located to render service to broadcast stations and are familiar with broadcast equipment and broadcast problems.

The following outline is intended to convey to the purchaser the policies applicable to the sale of RCA Television Equipment. Policies for the sale of tubes and other RCA products are described on separate sheets. RCA is setting forth this statement so that all purchasers will clearly understand the terms and conditions of our sales so that transactions may be carried forward fairly and promptly.

#### **Contracts**

RCA Transmitters, Antennas and all custom-built or special apparatus are sold by means of a standard agreement form.

#### **Prices**

All prices are subject to change or withdrawal without notice. Prices on Broadcast Transmitters, Antennas and Television equipment are firm prices, subject to the limitations included in the agreements covering these sales. Broadcast Audio and Measuring equipment prices are subject to revision to prices in effect on date of delivery. All prices are net f.o.b. factory or warehouse. Prices do not include Federal Excise Tax or any Federal, State or Local taxes based upon or measured by sales or use.

#### **Terms**

Terms of payment are subject to approval of RCA's Credit Department.

#### **Delivery**

RCA will furnish an estimate of delivery but assumes no responsibility for delays in delivery. Customers are requested to specify, at the time the order is placed, the method of transportation desired, such as motor freight, express, consolidated freight, etc. In the absence of any specific shipping instructions, RCA will use its best judgment in the selection of the carrier and will generally ship by the method which results in the lowest transportation cost.

#### **Warranty**

RCA will repair or replace, at its expense, f.o.b. factory, any parts of equipment manufactured by RCA or sold under RCA's name, which parts show defects of workmanship or material when used in the normal manner under normal conditions, and when used for the intended purposes. This is provided that, at RCA's option, such parts are returned to RCA's factory for inspection, properly packed and all expenses prepaid, within one year from date of delivery, and providing that inspection indicates the defects to RCA's reasonable satisfaction. Equipment manufactured by others and listed in this catalog as

products of other manufacturers shall bear only the guarantee as may be given by the manufacturer. Electron tubes are covered by a separate warranty.

RCA makes no warranties other than those above described.

#### **Patent Protection**

RCA agrees to defend any suit which may be brought against purchaser for infringement of United States patents arising out of purchaser's use of the equipment for the purposes and in the manner contemplated by this agreement, and to pay any judgment for damages or costs which may be finally awarded in such suit against the purchaser by a court of last resort. This is upon the condition that the purchaser will give RCA prompt notice of any such suit and full right and opportunity to conduct its defense, together with full information and all reasonable cooperation. The purchaser agrees that this does not apply to any infringement arising by reason of combination of the equipment with other apparatus. The purchaser also agrees that RCA shall have the right to substitute for the equipment or any parts of it which are claimed to infringe the patent rights of others, other equally suitable apparatus or parts, without altering the conditions of the sale, or obtain for the purchaser the right to continue to use such parts, or in the event RCA is unable to do so, take back the equipment, refunding any sums the purchaser has paid, less a reasonable allowance for use.

#### **Installation**

RCA's prices do not include installation, unless specifically mentioned in a letter of quotation. The purchaser assumes responsibility for installation and operation of the equipment as well as obtaining all necessary licenses, permits, etc. RCA maintains a staff of trained factory engineers who are specialists in the tuneup of transmitters. Orders for this engineering service are arranged through the RCA Service Company, Inc.

#### **Changes**

RCA reserves the right to modify the specifications of equipment described in this catalog, without notice and to supply such equipment providing that the modifications will not materially affect the performance.

#### **Acceptance of Orders**

It is requested that all orders be forwarded to RCA's regional offices. Regional offices will forward orders promptly to RCA's Camden, N. J. office for acceptance.

#### **Repairs and Returned Apparatus**

Write to the nearest regional office for shipping instructions and identifying number before returning apparatus for repair or adjustment. This will enable RCA to render you better service. RCA receives many shipments daily and without proper identification, delays may occur. RCA can assume no responsibility for unauthorized returns.

**You Can Locate Your Nearest RCA  
Representative from This List of  
FIELD OFFICES**

•  
36 W. 49th Street  
NEW YORK 20, NEW YORK  
Telephone: Circle 6-4030

•  
718 Keith Building  
CLEVELAND 15, OHIO  
Telephone: Cherry 3450

•  
666 N. Lake Shore Drive  
CHICAGO 11, ILLINOIS  
Telephone: Delaware 0700

•  
502 Citizens and Southern Bank Bldg.  
ATLANTA 3, GEORGIA  
Telephone: Walnut 5946

•  
1907-11 McKinney Avenue  
DALLAS 1, TEXAS  
Telephone: Riverside 1371, 72, 73

•  
621 South Hope Street  
LOS ANGELES 14, CALIFORNIA  
Telephone: Mutual 1103

•  
1355 Market Street  
SAN FRANCISCO 3, CALIFORNIA  
Telephone: Hemlock 8-300

•  
221 West 18th Street  
KANSAS CITY 8, MISSOURI  
Telephone: Victor 6410

•  
1625 K Street, N. W.  
WASHINGTON 6, D. C.  
Telephone: District 1260

# **BROADCAST AUDIO EQUIPMENT**

	<b>Page</b>
<b>MICROPHONES</b>	<b>10</b>
<b>CUSTOM BUILT EQUIPMENT</b>	<b>27</b>
<b>CONSOLETTES &amp; SWITCHING</b>	<b>30</b>
<b>AUDIO AMPLIFIERS</b>	<b>37</b>
<b>REMOTE EQUIPMENT</b>	<b>47</b>
<b>RACKS &amp; RACK EQUIPMENT</b>	<b>52</b>
<b>POWER SUPPLIES</b>	<b>68</b>
<b>TURNTABLES</b>	<b>70</b>
<b>RECORDERS</b>	<b>73</b>
<b>LOUDSPEAKERS</b>	<b>85</b>

# Recommended Equipment Lists

The following equipment lists have been prepared as an aid to the selection of broadcast audio equipment required for an average studio installation and for audio and monitoring equipment required for use with a transmitter at the transmitter location. These lists should be used only as a guide in the selection of equipment since the individual requirements of each station must be considered carefully before the proper equipment selection can be made.

Equipment listed for the studio will successfully handle an average installation where not more than two studios are required. For more than two studios consideration should be given to the more extensive equipment requirements such as master control switching with individual studio control. RCA broadcast audio engineers will gladly assist in planning master control installations when these are required.

Transmitter monitoring equipment lists suggest typical equipment for use when the transmitter is located at a point remote from the studio and for use when the transmitter and studio are at the same location. An equipment list is given also for use where MI-11623 transmitter control rack is to be used with control desks which are supplied as standard equipment with RCA BTA-5F, BTA-10F, BTA-50F and BTF-50A Transmitters.

The equipment lists include:

1. AM or FM Studio Equipment
2. AM and FM Studio Equipment
3. AM and FM Remote Equipment
4. Professional Type Recording Equipment
5. Standard Type Recording Equipment
6. AM or FM Transmitter Audio and Monitoring Equipment
  - A Transmitter and Studio at Same Location
  - B Transmitter at Location Remote from Studio
  - C Transmitter at Location Remote from Studio, where MI-11623 Rack is desired to be used with transmitter control desk.

## 1. AM or FM Studio Equipment

Suggested apparatus list for handling two studios, an announce booth, control room microphone, two turntables and equalization for remote lines.

Item No.	Qty.	Description	MI No.
1	1	76-B4 consolette and power supply	11613-C/ 11301-B
2	1	Set of tubes for consolette and power supply	11252

Item No.	Qty.	Description	MI No.
3	4	Relays for studio lights	11702
4	2	"On Air" lights	11706-1
5	2	"Audition" lights	11706-3
6	1	Speaker relay for announce booth	11703-A
7	2	Type 70-D turntables U/G	11801
8	2	Type BA-2C booster amplifiers	11226-B
9	2	Tube kits for BA-2C	11287
10	2	Type 44-BX velocity microphones (one for each studio)	4027-D
11	2	Type 77-D polydirectional microphones (one for each studio)	4045-A
12	1	Type 88-A pressure microphone (one for announce booth)	4048-D
13	1	Type KB-2C "Bantam" velocity microphone (for control room)	11001
14	2	Type 90-A deluxe program stands	11050
15	1	Type KS-1A floor stand	12065
16	1	Type KS-3A boom stand	4094-B
17	1	Type 91-B desk stand	4092-C
18	1	Desk stand for KB-2C	12066
19	6	Microphone connectors	4630-B
20	6	Wall receptacles	4624-A
21	1	Type BR-84B cabinet rack	30951-B84
22	2	Single trim strip	30566-G84
23	1	Terminal board mounting bracket	4570-A
24	1	Power terminal strip	4568
25	1	Audio terminal block	4569
26	2	Type 33-A jack strip	4645-A
27	1	Double jack mat	11502-A
28	4	2' patch cord	4652-2B
29	1	Type BE-1B variable line equalizer	4196-B
30	1	Type BA-4C monitor amplifier (for house speakers)	11223-B
31	2	Tube kits for BA-4C	11267
32	2	Type LC-1A loudspeaker	11411/11401
33	1	Type BR-2A panel and shelf	11598/11599
34	3	Studio accordion edge speaker (for talk-back in studios)	12435/13225
35	1000'	Interconnecting cable (Rack wiring)	63-A
36	500'	Interconnecting cable (speaker circuits)	64
37	500'	Interconnecting cable (filament circuits)	65

## 2. AM and FM Studio Equipment

Suggested apparatus for separate programming of AM and FM channels. The suggested equipment list assumes four studios, two announce booths, four turntables and equalization for remote lines.

Item No.	Qty.	Description	MI No.
1	2	Type 76-C studio consolette and power supply	11624 11301-B
2	2	Sets of tubes for 76-C consolette and power supply	11628-B
3	*1	BCS-2A switching system	11622
4	2	Console supervisory kits (one for each consolette)	11714
5	6	"On Air" light	11706-1
6	4	"Audition" light	11706-3
7	10	Relay for studio light	11702
8	2	Speaker relays (for announce booth)	11703-A
9	4	Turntables 70-D	11801
10	4	Type 44-BX velocity microphone (one for each studio)	4027-D
11	4	Type 77-D polydirectional microphones (one for each studio)	4045-A
12	2	Type 88-A pressure microphone (for announce booth)	4048-D
13	2	Type KB-2C "Bantam" velocity microphone (for control rooms)	11001
14	4	Type 90-A deluxe program floor stand	11050
15	2	Type KS-1A floor stands	12065
16	1	Type KS-3A boom stand	4094-B
17	1	Type KS-4A Magic Lock Boom Stand	11052
18	2	91-B desk stand	4092-C
19	2	Stands for KB-2C "Bantam" velocity microphone	12066
20	12	Microphone connector	4630-B
21	12	Microphone wall receptacles	4624-A
22	1	Type BR-84-B cabinet rack	30951-B84
23	2	Single trim strip	30566-G84
24	1	Terminal board mounting bracket	4570-A
25	1	Power terminal strip	4568
26	1	Audio terminal block	4569
27	2	Type 33-A jack strip	4645-A
28	1	Double jack mat (for 33-A)	11502-A
29	3	2' patch cord	4652-2B
30	2	Type BE-1B variable line equalizer	4196-B
31	2	Type BA-4C monitoring amplifiers (for house speakers)	11223-B
32	2	Tube kits for BA-4C	11267
33	2	Type BR-2A panel and shelf	11598/11599

\* If more than two consolettes are needed, substitute the BCS-1A switching system.

Item No.	Qty.	Description	MI No.
34	2	Type LC-1A loudspeaker (for control rooms)	11411/11401
35	6	Accordion edge speakers for talk-back in studios, etc.	12435/13225
36	2000'	Interconnecting cable (rack wiring)	63-A
37	1000'	Interconnecting cable (speaker circuits)	64
38	500'	Interconnecting cable (filament circuits)	65

## 3. AM and FM Remote Equipment

Suggested equipment for handling average remote requirements.

Item No.	Qty.	Description	MI No.
1	2	Type OP-6 remote amplifiers	11202-A
2	2	Tube kits for OP-6 (one each)	11253
3	2	VU meter kits for OP-6 (one each)	11251
4	2	Cover for OP-6	11256
5	1	OP-7 portable mixer-preamplifier	11213
6	1	Tube kit for OP-7	11254
7	1	Cover for OP-7	11257
8	1	Battery box for OP-6 and/or OP-7	11214
9	1	Cover for battery box	11258
10	3	Type 88-A microphones	4048-D
11	5	Microphone cable plug	4630-B
12	2	59-B portable microphone stand	4093-B
13	1	Collapsible banquet stand	4095-A
14	2	Microphone carrying case	4085
15	100'	Microphone extension cable	42
16	2	Extension cable plugs	4620-B

## 4. Professional Type Recording Equipment

Suggested apparatus for producing high quality recordings using Type 73-B professional recording equipment.

Item No.	Qty.	Description	MI No.
1	2	Type 73-B professional recorders	11825/11850-C
2	3	Sapphire styli	4842
3	1	Orthacoustic recording filter	4916-A
4	1	Type BA-5A Recording amplifier	11227
		or	
	1	Type BA-4C Monitoring amplifier	11223-B
5	1	Set of tubes for BA-5A	11290
		or	
	1	Set of tubes for BA-4C	11267
6	1	Type BR-2A panel and shelf (for BA-4C amplifier if used)	11598/11599
7	1	Limiting amplifier Type 86-A1 (complete with tubes)	11216-C



<i>Item No.</i>	<i>Qty.</i>	<i>Description</i>	<i>MI No.</i>
*3	1	36-B panel and shelf (for limiting amplifier)	4682-B
9	1	Type 33-A jack strip	4645-A
10	1	Double jack mat (for 33-A)	11502-A
11	4	2' patch cord	4652-2B
12	1	VU meter panel	11265
13	1	Filament transformer, 6.3 V for VU meter panel lamp	11606
14	1	Type BR-84-B cabinet rack	30951-B84
15	2	Single trim strip	30566-G84
16	1	Terminal board mounting bracket	4570-A
17	1	Terminal power strip	4568
18	1	Terminal audio block	4569
19	1	Type 57-C switch and fuse panel	4395-B
20	3	Blank panels 8¾"	4594-B
21	1	Blank panel 7"	4593-A
22	1	Blank panel 3½"	4591-B
23	1	Type RS-1A suction equipment	11857
24	1	Chip collector and hose assembly	11858
25	*2	Automatic equalizer for 73-B recorder	11100

\* Please refer to recording charts.

<i>Item No.</i>	<i>Qty.</i>	<i>Description</i>	<i>MI No.</i>
*8	1	36-B panel and shelf (for limiting amplifier)	4682-B
9	1	Type 33-A jack strip	4645-A
10	1	Double jack mat (for 33-A)	11502-A
11	4	2' patch cord	4652-2B
12	1	VU meter panel	11265
13	1	Filament transformer, 6.3 V for VU meter panel lamp	11606
14	1	Type BR-84-B cabinet rack	30951-B84
15	2	Single trim strip	30566-G84
16	1	Terminal board mounting bracket	4570-A
17	1	Terminal power strip	4568
18	1	Terminal audio block	4569
19	1	Type 57-C switch and fuse panel	4395-B
20	1	Type RS-1A suction equipment	11857
21	1	Chip collector and hose assembly	11858
22	2	Automatic equalizers for 72-D recorder	11101
23	3	Blank panel 8¾"	4594-B
24	1	Blank panel 7"	4593-A
25	1	Blank panel 3½"	4591-B

\* Please refer to recording charts.

## 5. Standard Type Recording Equipment

Suggested apparatus for making high quality recordings by using recording attachments for the 70-D transcription turntables.

<i>Item No.</i>	<i>Qty.</i>	<i>Description</i>	<i>MI No.</i>
1	2	Type 72-D recording attachments with standard recording head	11901
2	3	Sapphire cutting styli	4842
3	1	*Orthoacoustic recording filter	4916-A
4	1	Type BA-5A Recording amplifier or Type BA-4C Monitoring amplifier	11227 11223-B
5	1	Set of tubes for BA-5A	11290
		or	
	1	Set of tubes for BA-4C	11267
6	1	Type BR-2A panel and shelf for BA-4C amplifier (if used)	11598/11599
7	1	Type 86-A1 limiting amplifier (complete with tubes)	11216-C

## 6. AM or FM Transmitter Audio and Monitoring Equipment

TRANSMITTER AND STUDIO AT SAME LOCATION

<i>Item No.</i>	<i>Qty.</i>	<i>Description</i>	<i>MI No.</i>
1	1	BR-84 cabinet rack	30951-B84
2	2	Single trim strips (cabinet rack)	30566-G84
*3	1	Type WF-48A frequency monitor (AM)	
*4	1	Type WM-43A modulation monitor (AM)	
5	1	Type 86-A1 limiting amplifier (complete with tubes)	11216-C
6	1	Type 36-B panel and shelf (for limiting amplifier)	4682-B
7	2	Type 33-A jack strip	4645-A
8	1	Double jack mat (for 33-A)	11502-A
9	2	Blank panel 8¾"	4594-B
10	2	Blank panel 5¼"	4592-B

Item No.	Qty.	Description	MI No.
11	1	Blank panel 3½"	4591-B
12	1	Blank panel 1¾"	4590-B
13	1	Type 57-C switch and fuse panel	1395-B
14	1	Terminal block mounting bracket	4570-A
15	1	Terminal power strip	4568
16	1	Terminal audio block	4569
17	1000'	Interconnecting cable (rack wiring)	63-A
18	1000'	Interconnecting cable (filament circuits)	65

#### TRANSMITTER AT LOCATION REMOTE FROM STUDIO

1	1	BR-84 cabinet rack	30951-B84
2	2	Single trim strip (cabinet rack)	30566-G84
**3	1	Type WF-18A frequency monitor (AM)	
**4	1	Type WM-43A modulation monitor (AM)	
5	1	Type 86-A1 limiting amplifier (complete with tubes)	11216-C
6	1	36-B panel and shelf (for limiting amplifier)	1682-B
7	1	Type BA-4C monitoring amplifier	11223-B
8	1	Set of tubes for BA-4C	11267
9	2	BA-2C booster amplifiers (for microphone and turntable)	11226-B
10	2	Sets of tubes for BA-2C	11287
11	2	BR-2A panel and shelf (for monitor and booster amplifiers)	11598/11599
12	1	Type 33-A jack strip	4615-A
13	1	Double jack mat (for 33-A)	11502-A
14	1	Type BE-1B variable line equalizer	4196-B
15	1	VU meter panel	11265
16	1	Filament transformer, 6.3 V for VU meter panel lamp	11606
17	1	Blank panel 7"	4593-A
18	1	Terminal board mounting bracket	4570-A
19	1	Terminal power strip	4568
20	1	Terminal audio block	4569
21	1	Type 57-C switch and fuse panel	4395-B
22	3	2' patch cord	4652-2B
23	1	Type 88-A pressure microphone	4048-D
24	1	Type 91-B desk stand for microphone	4092-B
25	1	Microphone cable plug	4630-B
26	1	Microphone wall receptacle	4624-A
27	1	Type 70-D turntable	11801
28	1	Type LC-1A monitoring speaker	11411/11401
29	1000'	Interconnecting cable (rack wiring)	63-A
30	1000'	Interconnecting cable (filament circuits)	65

\*\* When used for FM, space occupied will be utilized for FM frequency and modulation monitor Type WF-5A.

## Transmitter Location Remote From Studio Where MI-11623 Transmitter Control rack Is Desired to Be Used With Control Desk Supplied With RCA Transmitters BTA-5F, 10-F, 50-F, and BTF-50A

The MI-11623 Transmitter Monitor and Amplifier Cabinet Rack has been designed to operate with the Control Desks supplied with the BTA-5F, 10-F, 50-F and BTF-50A Transmitters to provide a complete and flexible system of controls and monitors.

Item No.	Qty.	Description	MI No.
1	1	Transmitter monitor and amplifier cabinet rack	11623

This cabinet rack is supplied with the following equipment:

2	Type 33-A jack strip complete with mat
1	Type BA-4C monitoring amplifier and tubes
1	Type 86-A1 limiting amplifier and tubes
1	Type 36-B panel and shelf for limiting amplifier
1	Type 57-C switch and fuse panel
2	*Type BR-2A panel and shelf

#### MOUNTINGS AND WIRING ARE ALSO PROVIDED FOR THE FOLLOWING ACCESSORY EQUIPMENT:

2	Type 56-C fixed line equalizers	
2	Type 15-KC high frequency compensators (to be used in the 56-C)	
1	FM pre-emphasis equalizer	4926-A
1	Power reduction panel	4309-B
1	Hum equalizer	7264-E
3	Type BA-1A amplifiers	11218-A
1	Type BX-1C pre-amplifier power supply	11305-B
1	Blank panel drilled and tapped for mounting 3 MI-10253 line transformers	
1	VU meter panel	11265
1	Filament transformer (for VU meter)	11606
1	Sola voltage regulator	11280

#### Notes:

1. Space and wiring are available at the top of all MI-11623 racks for mounting the Frequency Monitor WF-18A and Modulation Monitor WM-43A, or combination FM Frequency and Modulation Monitor Type WF-5A.

2. Side panels and trim strips for cabinets are available at the customer's specific requirements.

\* One shelf contains the BA-4C amplifier and the other is wired to accommodate 3 BA-1A pre-amplifiers and 1 BX-1C power supply for the pre-amplifiers.

# RCA Microphones

<i>Type No.</i>	<i>Directional Characteristic</i>	<i>Use</i>	<i>Effective Output Level dbm*</i>	<i>Output Impedance Ohms</i>	<i>Frequency Response cps</i>	<i>Hum Pick-up Level db**</i>	<i>Finish</i>	<i>Fitting</i>
44-BX	Bi-directional	Studio	-55	50/250	30-15,000	-112	Satin Chrome and Umber Gray	1/2" Pipe Thread
77-D	Poly-directional	Studio or Stage	-57	50/250/600	50-15,000	-118	Satin Chrome and Umber Gray	1/2" Pipe Thread
88-A	Non-directional	Remotes	-56	50/250	60-10,000	-109	Satin Chrome and Umber Gray	1/2" Pipe Thread
KB-2C	Bi-directional	Studio	-56	30/150/250	80-8,000	-108	Satin Chrome	5/8"—27 Thread
74-B	Bi-directional	Studio	-56	50/250/15,000	50-9000	-100	Satin Chrome and Umber Gray	1/2" Pipe Thread
MI-6203-C	Poly-directional	Stage or Studio	-58	50/250/600	70-10,000	-111	Umber Gray	1/2" Pipe Thread
MI-6206-G	Non-directional	Talkback	-56	250	80-8000	-109	Umber Gray	1/8" Pipe Thread
KN-1A	Non-directional	Talkback	-57	250	100-8000	-109	Satin Chrome and Umber Gray	5/8"—27 Thread

\* See "Microphones General." Reference level is one milliwatt and a sound pressure of 10 dynes/cm<sup>2</sup>.  
 \*\* Level referred to a hum field of 10<sup>-3</sup> gauss.

# Microphones General Information

RCA Microphones are the product of years of intensive research and development by outstanding engineers. Several types of microphones are available, some having wide fields of application and some for specific services.

## High Quality Broadcast Microphones

Broadcast Type Microphones, such as the Types 44-BX, 77-D and 88-A have characteristics which suit them for high quality pickup work. They have good frequency response curves, well shielded output transformers to prevent hum pickup, and are very well shock mounted to reduce low frequency noises caused by building rumble. The 44-BX and 77-D Microphones are particularly suitable for high quality indoor pickups while the 88-A is recommended for outside pickups where rough handling and wind may be experienced.

## Public Address Microphones for Broadcast Use

Public address types of microphones such as the Types KB-2C and 74-B Velocity Microphone, and the MI-6203-C Varacoustic Microphones have been designed as economy microphones for public address and industrial sound use. These microphones, however, are suitable for use in broadcast applications within their limitations. The 74-B may be used in place of the 44-BX in applications where the frequency response, shielding and shock mounting of the 44-BX is not required. Likewise the MI-6203-C may be used in place of the 77-D for pickups where the frequency response, transformer shielding and shock mounting of the 77-D are not required. Where an extremely small microphone is desired, the Type KB-2C will give excellent results.

## Unloaded Transformer Input

RCA Broadcast Microphones are designed to work into a microphone preamplifier whose input transformer is unloaded. Under this condition of operation the full generated voltage

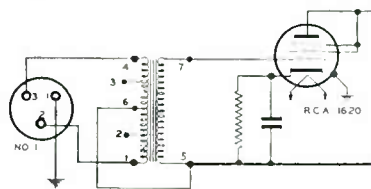

No. 1 Input Channel of OP-7 Portable Preamplifier showing unloaded transformer input

of the microphone appears at the grid of the first tube resulting in a gain in signal to noise ratio of between 3 and 6 db depending on whether the major source of noise is in the microphone amplifier or in the input resistance of the microphone.

## Microphone Resistance Loading

Microphones which are relatively inefficient or in which there is a great deal of damping associated with the moving system will in general have their frequency response characteristics little changed by loading. The 88-A and 77-D (in the pressure position) are examples of this.

Highly efficient microphones, particularly those in which the moving system is mass controlled usually show impedance variations for a constant generated voltage. Such microphones will have their response characteristics adversely affected by resistance loading because the mechanical constants of the moving system will be disturbed by the reflected resistance load. The Type 44-BX, and 77-D (in the bi-directional and uni-directional positions) are examples of this. Resistance loading will generally result in a loss in low frequency response.

The frequency response curves for all microphones listed in this catalogue were taken with the microphone working into an unloaded input transformer of a preamplifier and it is recommended that the microphones be so operated in practice.

## Effective Output Level

When a microphone is effectively working into an open circuit its output cannot be expressed in terms of dbm power level as no appreciable power is consumed by the open circuit termination. As a result of this condition the microphone output ratings are given as *Effective Output Level*. The effective level is so calculated that when the amplifier gain in db is added to the microphone output level in db the correct output level from the amplifier will be obtained. To do this the effective output level rating is based upon the assumption that the microphone works into a load impedance which is equal to its own rated output impedance. The voltage corresponding to this effective output level is actually 6 decibels below that which is obtained when the microphone is worked into an "open circuit" preamplifier input. This 6 db difference is brought about by the fact that the high input impedance of a preamplifier does not offer a load to the output of the microphone. Thus the 6 db apparent increase in gain is a function of the preamplifier input termination and not of the microphone itself. The "gain" ratings of preamplifiers takes into account this 6 db increase in gain so that it becomes necessary to rate the microphone output at its effective level for purposes of computing the overall gain of the system as noted above. The term dbm means the power level expressed in db resulting from a single frequency sine wave voltage, referred to 1 milliwatt. For the same peak voltage this will be about 10 db higher than the indication obtained with a normal signal of complex wave shape.

## Hum Pick-up Level

An arbitrary standard a-c field of  $10^{-3}$  gauss has been established as the reference level. It is representative of fields measured at typical microphone locations in an average studio. The sound pressure reference is the standard microphone sound pressure of 10 dynes/cm<sup>2</sup>. The hum pick-up level is given for all microphones which permits comparison between an available unit as compared with other types.

## Microphones Shipped Less Plug

RCA Microphones are supplied less microphone plugs. Although Cannon Type "P" plugs and receptacles are recommended, and stocked by RCA, many stations use other types of plugs and prefer to supply their own. For this reason, RCA supplies the microphone with cord, and, if the Cannon Plug is desired, it should be ordered as an accessory.

## Why 1/2" Pipe Thread

RCA has standardized on the rugged 1/2" pipe thread for microphone mounting. A recent questionnaire which we sent to broadcasting stations indicated that the 1/2" pipe thread was by far the most popular microphone thread size. This size pipe thread makes it easy to add microphone stand extensions, booms, etc. for they may be easily made up locally from standard 1/2" pipe and fittings.

Suitable microphone stands and adapters are available and shown in this catalogue for all RCA Microphones.

# Polydirectional Microphone Type 77-D



## Features

- High fidelity.
- Adjustable directional characteristic, continuously variable, provides non-directional, bi-directional or uni-directional operation.
- Three position "voice-music" switch allows selection of best operating characteristic for voice or music.
- Well shielded output transformer assures low hum pick-up.
- Reduced reverberation pick-up through selection of proper directional characteristic.
- Efficient shock mounting reduces building vibrations.
- Small size—light weight.
- Attractive appearance.

## Uses

The RCA 77-D is a high-fidelity microphone for use in broadcast studios. With this one microphone a variety of directional patterns may be obtained by operating a screw-driver adjustment which is conveniently located on the back of the microphone. The 77-D combines the best features of the velocity and pressure microphones. The polydirectional characteristics of this microphone aid materially in obtaining a better balance, clarity, naturalness and selectivity in studio pickups. It is also of considerable value where difficulties are encountered in reverberant locations since the undesired sound reflections may be reduced by a choice of the proper directional pattern.

## Description

The 77-D is similar in appearance to the previous Type 77-C1 Microphone but differs in operating principle. The 77-D consists of a single ribbon placed in the air gap formed by the pole pieces of a permanent magnet, a variable acoustic network, a well-shielded matching transformer with low hum pickup and a perforated metal case housing. Effective shock-mounting is used between the microphone and stand to reduce building rumble.

One side of the microphone ribbon is completely closed by a connector tube which in turn is coupled to a damped pipe or labyrinth. An aperture, placed in the connector tube directly behind the ribbon, is made variable in size by a rotating shutter. The directional characteristics of the microphone are controlled by varying the area of the aperture in the labyrinth connector. When the aperture is so large that the back of the ribbon is effectively open to the atmosphere, as in a velocity microphone, the acoustic impedance is zero and a bi-directional characteristic pattern is obtained. When the aperture is completely closed, the acoustic impedance is infinite and the characteristic pattern is non-directional which is typical of a pressure operated microphone. As the area of the aperture is varied, a critical value introduces a phase shift which results in a uni-directional characteristic. Other positions of the shutter result in patterns varying between bi-directional and non-directional.

On the back side of the 77-D wind screen (upper shell) is a slotted shaft control adjustment which is brought out flush with a designation plate mounted on the screen. The plate is marked "U", "N", and "B", as designations for the uni-directional, non-directional and bi-directional response curves. A special uni-directional plate, marked with a large "U", is provided with the microphone. When fastened over the designation plate, it fixes the directional pattern control shaft in the uni-directional position; thereby identifying the microphone as a uni-directional microphone, when this plate is attached.

The lower half of the case contains the acoustical labyrinth, output transformer and a selector switch for voice or music. This switch will attenuate the low frequencies below 300 cycles for voice pickup and has three positions designated as "M", "V<sub>1</sub>" and "V<sub>2</sub>". The switch is operated by a screw driver and is accessible from the bottom of the lower cylindrical shell. A protective cloth bag is shipped with each Type 77-D Microphone. The bag can also be used with Type 77-D and 77-C Microphones and ordered separately as MI-4087.

## Specifications

Directional Characteristic (adjustable)	Bi-directional, uni-directional and non-directional
Output Impedances (tapped transformer)	50/250/600 ohms
Effective Output Level	—57 dbm*
Hum Pickup Level	—118 dbm**
Frequency Response	See curves
Finish	Satin chrome and umber gray
Mounting	1/2" pipe thread
Dimensions, overall	
Height	11 1/2"
Width	3 3/4"
Depth	2 1/2"
Weight (unpacked including mountings)	3 lbs.
Cable (MI-43 3 conductor shielded)	30' less plug
Stock Identification	MI-4045-A

## Accessories

Microphone Plug	MI-4630-B
Protective Cloth Bag	MI-4087

\* Referred to one milliwatt and a sound pressure of 10 dynes/cm<sup>2</sup>.

\*\* Level referred to a hum field of  $1 \times 10^{-3}$  gauss.

**Directional Response Patterns**

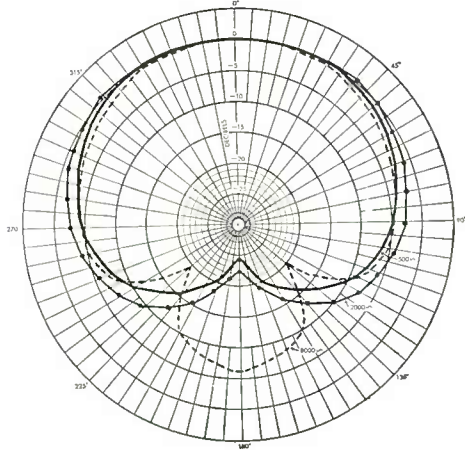

*Uni-Directional Position*

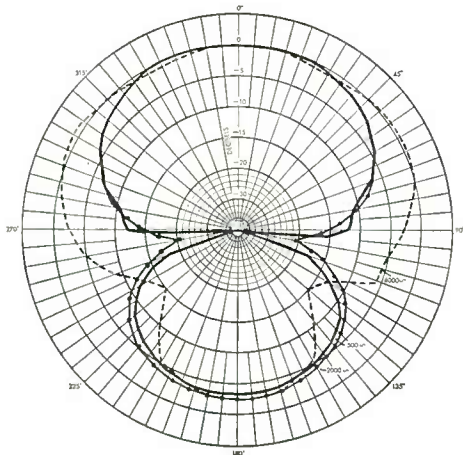

*Bi-Directional Position*

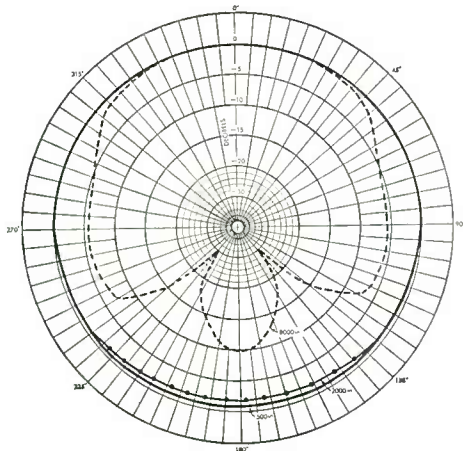

*Non-Directional Position*

**Frequency Response Curves**

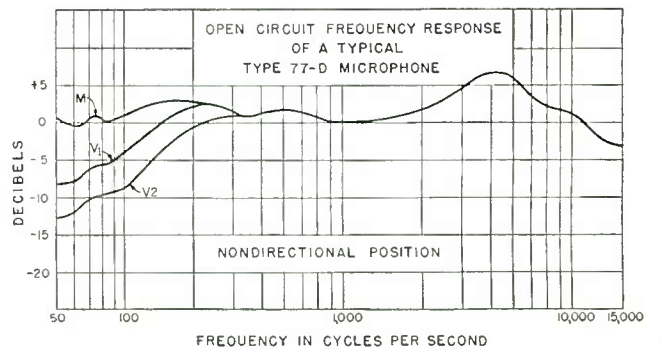
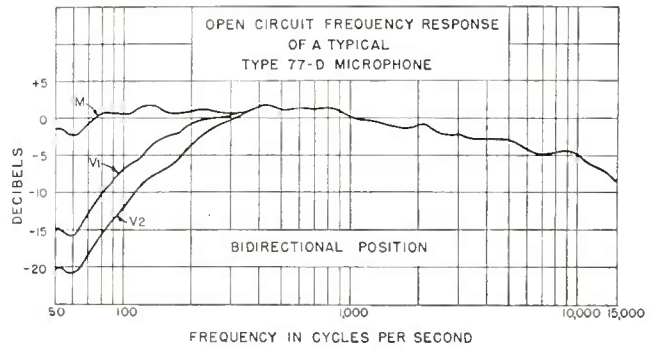
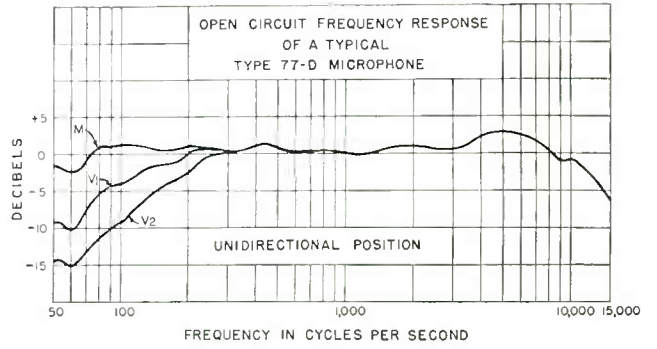

# Velocity Microphone Type 44-BX

## Features

- Sensitive ribbon element for faithful reproduction.  
Free from cavity or diaphragm resonance and pressure doubling.
- Uniform and smooth reproduction over the entire audio range.
- Response adjustment to provide the best possible frequency characteristics for either vocal or musical pickup.
- Bi-directional "figure eight" type pattern which allows placing of artists on both sides of the microphone and greatly reduces reflection pickup from side walls.
- Unaffected by temperature, humidity or changes in air pressure.
- Ruggedly built for hard usage.
- Shock mounted.
- Attractive in appearance.

## Uses

The 44-BX is primarily intended for studio use where a microphone of the highest quality of reproduction is desired. It can be used with practically any audio facilities system and lends itself readily to unusual or difficult studio problems. The 44-BX is also well suited for high quality remote work. The 44-BX is found in almost all of the leading studios in the country and has become a recognized symbol of broadcasting.

## Description

The bi-directional pattern of the Type 44-BX Microphone is of the familiar "figure eight" type. Unlike other types of microphones, it has no diaphragm—the moving element being, instead, a thin metallic ribbon so suspended as to be able to vibrate freely between the poles of a permanent magnet. Because of its lightness, the motion of this ribbon corresponds exactly to the velocity of the air particles and the voltage generated in it is, therefore, an exact reproduction of the sound waves which traverse it. Moreover, since it has no diaphragm and is open in construction so that air flows freely through it, the Type 44-BX Velocity Microphone is free from the effects of cavity resonance, diaphragm resonance and pressure doubling, which cause undesirable peaks in the response of all pressure type microphones.

The 44-BX is attractively designed in satin chromium and umber gray to harmonize with practically any modern studio interior. The yoke mounting permits a wide range of tilting angles. The shock mounting reduces undesirable pick-up from floor vibrations, etc.

## Specifications

Directional Characteristic	Bi-directional
Output Impedances (tapped transformer)	50/250 ohms
Effective Output Level	-55 dbm*
Hum Pickup Level	-112 dbm**
Frequency Response (see curves)	30-15,000 cycles
Finish	Umer gray and satin chromium
Mounting	1/2" pipe thread
<b>Dimensions, overall</b>	
Height (including cushion mounting)	12"
Width	4 3/4"
Depth	3 3/8"
Weight (unpacked, including mountings)	8 1/2 lbs.
Cable (MI-62 2 conductor, shielded)	30' less plug
Stock Identification	MI-4027-D

\* Referred to one milliwatt and a sound pressure of 10 dynes/cm<sup>2</sup>.

\*\* Level referred to a hum field of 1 x 10<sup>-3</sup> gauss.

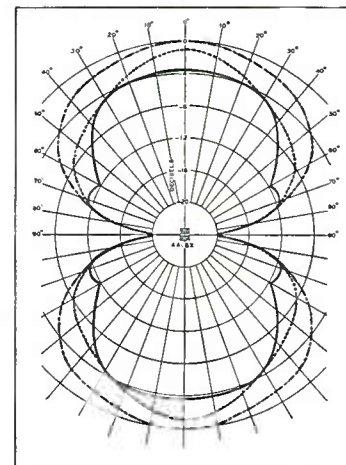

Directional characteristic of a typical 44-BX Velocity Microphone

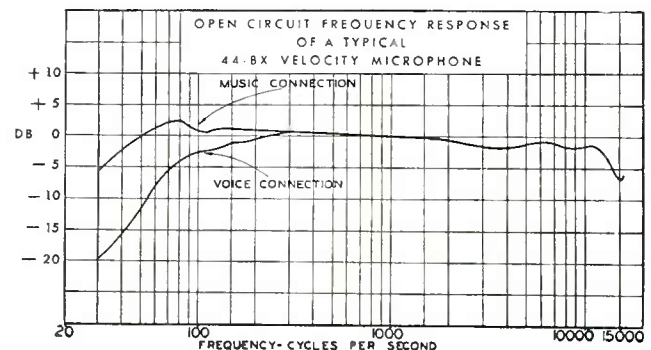

# Pressure Microphone Type 88-A

## Features

- Good frequency response.
- Light weight.
- Small size.
- Rugged construction.
- Low cost.
- Minimum effects from wind and moisture.
- High output providing unusually good signal-to-noise ratio.
- Adaptable for use with any stand or may be carried in the hand for street interview programs.
- Output cord protected by spring.

## Uses

The Type 88-A is the ideal microphone for general remote pickup use. It has been specially designed to provide small size, light weight, good frequency response and relative freedom from the effects of wind and moisture. In spite of its light weight and small size, it is extremely rugged and well-suited to stand the hard usage to which a remote microphone is put. The characteristics of the 88-A also make it adaptable for many types of studio use where a non-directional microphone is desired.

## Description

The Type 88-A Microphone is of the pressure-actuated type. The moving system consists of a thin molded diaphragm to which an annular coil assembly is attached. Coupled to the diaphragm is an acoustic circuit so proportioned that the diaphragm velocity will remain essentially constant for a constant sound pressure over the frequency range of 60-10,000 cycles. The coil is placed in the air gap of a magnetic structure and the ends connected to a transformer which provides output impedances of 50 or 250 ohms.

This microphone is styled and finished in umber gray and satin chrome to present a very pleasing appearance. A ball and socket joint with a thumbscrew clamp permits operation in either a vertical or horizontal position.

## Specifications

Directional Characteristics	Non-directional
Output Impedances (tapped transformer)	50/250 ohms
Effective Output Level	56 dbm*
Hum Pickup Level	109 dbm**
Frequency Response (see curves)	60-10,000 cycles
Finish	Umbur gray and satin chrome
Mounting	1/2" pipe thread
<b>Dimensions, overall</b>	
Height (including mounting)	4 1/2"
Diameter	2 1/8"
Length	3 3/8"
Weight (unpacked)	1 lb.
Cable (MI-43 three conductor shielded)	30' less plug
Stock Identification	MI-4048-D

\* Referred to one milliwatt and a sound pressure of 10 dynes/cm<sup>2</sup>.

\*\* Level referred to a hum field of 1 x 10<sup>-3</sup> gauss.

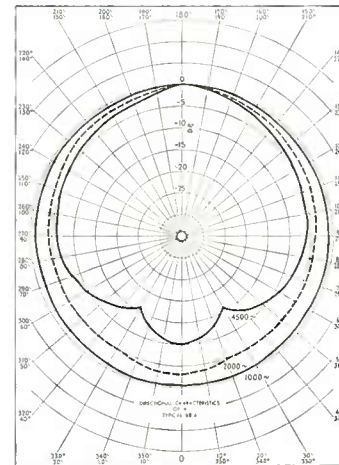

Directional characteristic of a typical 88-A Pressure Microphone

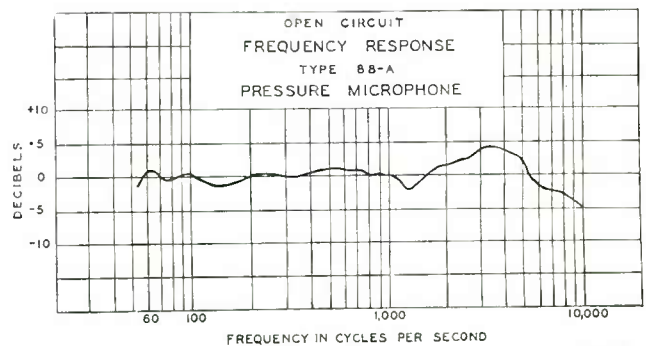

5-8860360



# Microphones MI-6203-C, MI-6206-G, KN-1A

## Varacoustic MI-6203-C

### Uses

The Varacoustic Microphone is ideally suited for public address use under high reverberatory conditions and for stage pickups where auditorium noises are to be kept to a minimum. As an economy microphone it may also be used for similar broadcast applications when shock mounting is not required and the ruggedness of broadcast types is not required. Compared to the original MI-6203, the MI-6203-C has an improved transformer, and impedances of 50, 250 and 600 ohms. 1/2" pipe thread fitting is also used.

### Description

This microphone is of entirely new design. A slide adjustment which changes the physical characteristics of the labyrinth permits a choice of non-directional, bi-directional or uni-directional operation. In addition, three variations between the uni-directional and bi-directional pattern may be obtained.



### Features

- Low cost.
- Good frequency response.
- Reduced reverberation pickup.
- Adjustable directional characteristics.

### Specifications

Directional Characteristics	Adjustable for non-directional, bi-directional or uni-directional
Output Impedance	50/250/600 ohms
Effective Output Level	-58 dbm*
Hum Pick-up Level	-111 dbm**
Frequency Response	70-10,000 cycles
Finish	Umber gray
Mounting	1/2" pipe thread (Supplied with adaptor 1/2" to 5/8"-27 fixture thread)
Dimensions, overall	
Length	6 7/8"
Width	2 1/2"
Depth	6 7/8"
Weight (unpacked)	3 1/2 lbs.
Cable (MI-42 two conductor shielded)	30' less plug
Stock Identification	MI-6203-C

## Aeropressure MI-6206-G

### Uses

The MI-6206-G offers outstanding performance as a public address microphone. Its relatively wide frequency response, high sensitivity and attractive appearance also readily adapt it for use as a "talk back" microphone in broadcast studios. It is well suited to the requirements of a program director's microphone or it may be used for emergency announce purposes.

### Description

Like other pressure operated microphones, the MI-6206-G is relatively non-directional at the lower frequencies and directional at the higher frequencies. The reversible paracoustic baffle supplied with this microphone will change the high frequency directional characteristics. This baffle either sharpens or broadens the directional characteristic, depending upon whether its concave surface faces toward or away from the microphone grille. This microphone is supplied with a clevis mounting bracket and a short six inch cable and female plug, or as indicated.



### Features

- Low cost.
- Good frequency response.
- Baffle for directional or non-directional application.

### Specifications

Directional Characteristics	Non-directional
Output Impedance	250 ohms
Effective Output Level	-56 dbm*
Hum Pick-up Level	109 dbm**
Frequency Response	80-8,000 cycles
Finish	Two tone umber gray
Mounting	1/8" pipe thread (Supplied with adaptor 1/8" to 5/8"-27 fixture thread. MI-12051 Adaptor required for 1/2" pipe thread.)
Dimensions, overall	
Length	5"
Diameter	2 1/8"
Weight (unpacked)	2 1/4 lbs.
Stock Identification:	
With 6 in. Cable and Female Plug	MI-6206-G
With 15 ft. Cable and Male Plug	MI-12077-B
With 30 ft. Cable and Male Plug	MI-12077-C

## Announce Microphone, Type KN-1A

### Uses

The KN-1A is an excellent microphone of the dynamic pressure type, ideally suited for announcing and "talkback" purposes in broadcasting.

### Description

This microphone is of an entirely new design with modernistic lines. The shank fitting is a standard 5/8"-27 thread for public address use. 5/8"-27 to 1/2" adaptor, MI-12053, is used to attach it to the broadcast standard 1/2" pipe thread stand fitting. The microphone is mounted on the adjustable swivel and may be moved through an arc of 80° in the vertical plane. The shank accommodates the cable with the new type "XL" female plug which is inserted in the microphone male plug. A hinge cover protecting the connectors is snapped closed.



### Specifications

Directional Characteristic	Semi-directional
Effective Output Level	-57 dbm*

Hum Pick-up Level	109 dbm**
Frequency Response	100-8,000 cycles
Output Impedance	30/150/250 ohms
Finish	Umber gray
Dimensions:	
Length	9 3/4"
Width	1 1/2"
Depth	2"
Weight Less Cable (unpacked)	2 lbs.
Mounting	5/8"-27 fixture thread
Stock Identification:	
With 15' Cable	MI-12081-B
With 30' Cable	MI-12081-C

### Accessories

Cable Only (2 conductor)	MI-42
Desk Stand (gray metalustre)	MI-12066
Desk Stand (black)	MI-12066-A

\* Referred to one milliwatt and a sound pressure 10 dynes/cm<sup>2</sup>.

\*\* Level referred to a hum field of 1 x 10<sup>-3</sup> gauss.

# Microphone Plugs and Receptacles

RCA Microphones are sold without plugs in order that the purchaser may use any type desired. The Cannon Type "P" Series are recommended for their reliability and ruggedness. This series of Cannon Plugs is used in all RCA remote amplifiers. The Cannon Type "P" Plugs and Receptacles stocked by RCA have steel jackets, which are preferred to the die cast type, for their increased ruggedness. All fittings are finished in satin chrome.

A miniature size plug was developed to obtain a cable connection that could be housed in the stem of the KB-2C Microphone. This size of microphone plug is identified in the Cannon XL-3 Series. The versions stocked by RCA for broadcast use have satin chrome finish and use steel jackets to reduce possible mechanical damage. A split gland type of cable clamp will accommodate cable diameters up to 1/4 inch. Although features preferred by broadcasters have been incorporated into this plug, its smaller size and restricted space for making connections to the contact pins may make it less acceptable than the larger Cannon "P" Series for general use. The XL-3 Series of Plugs and Receptacles has been accepted by RMS as standard for public address use.

### CANNON "P" SERIES OF PLUGS

<i>Description</i>	<i>Cannon Stock No.</i>	<i>RCA Stock Identification</i>
Male Plug for Microphone Cords	P3-CG-12S	MI-4630-B
Wall Receptacle for Above Plug	P3-35	MI-4624-A
Note: The MI-4624-A Receptacle will fit in a standard a-e outlet box.		
Extension Cord—Female Connector	P3-CG-11S	MI-4620-B

### CANNON "XL" SERIES OF PLUGS

<i>Description</i>	<i>Cannon Stock No.</i>	<i>RCA Stock Identification</i>
Male Plug for Microphone Cords	XL-3-12SC	MI-11089
Female Connectors—Extension Cord	XL-3-11SC	MI-11090
Wall Receptacle for Microphone Plug	None	MI-11096
Female Receptacle—for Amplifiers	XL-3-13N	MI-11088

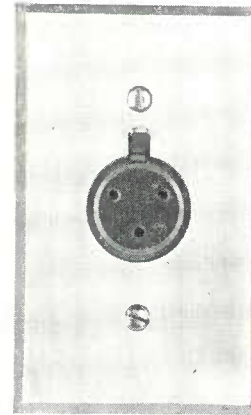

MI-4624-A Wall Receptacle

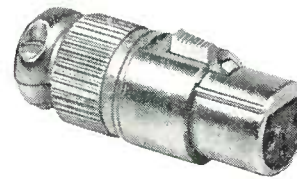

MI-11090 Cord Connector



MI-4630-B Microphone Plug

MI-11089 Microphone Plug

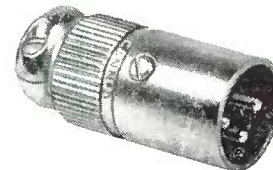

MI-4620-B Cord Connector

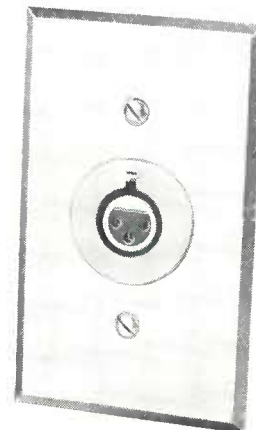

MI-11096 Wall Receptacle

# Microphone Stands

## Banquet Stand MI-4095-A

### Features

- Compact and convenient for portable use.
- Rugged construction.
- Easy to assemble or take apart.
- Attractive finish.

### Uses

This newly designed stand is the ideal for banquets or other occasions where a sturdy, attractive and truly portable stand is required.

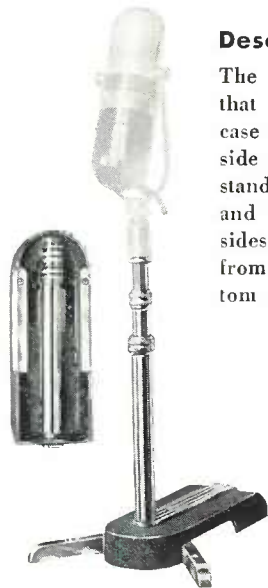

### Description

The MI-4095-A is of novel construction in that its base forms a compact carrying case for the entire stand. The hollow under side of the base casting accommodates the stand's three telescoping tubular sections and two fin type legs fold into the base sides. When unfolded the legs extend  $5\frac{1}{4}$ " from center of the vertical rod. The bottom of the base is covered with felt.

### Specifications

Height—Adjustable  $10\frac{3}{4}$ " to  $24\frac{3}{4}$ "  
 Base Dimensions  $3\frac{5}{8}$ "x $10\frac{1}{2}$ "x $1\frac{5}{8}$ "  
 Microphone Mounting  $\frac{1}{2}$ " pipe thread  
 Weight \_\_\_\_\_ 5 lbs.  
 Finish—Umber gray and chromium  
 Stock Identification —MI-4095-A

## Desk Stand Type 91-B

### Features

- Small size.
- Heavy base with felt covered bottom.
- Adjustable height.
- Attractive appearance.

### Uses

The 91-B is a heavy-based desk stand designed especially for studio or announce use. It is attractive in appearance and easily mounts the heaviest of studio microphones.



### Description

The 91-B is finished in the new RCA umber gray metalustre with polished chromium trim. The base is felt covered to prevent marring the table or desk on which it may be placed.

The stand has a base size of  $4\frac{1}{2}$ " and is provided with a choice of two mounting fittings. The shorter one with a  $\frac{3}{4}$ " extension is intended for use with the 77-D, 44-BX, and 74-B microphones. The longer extension with a  $1\frac{3}{4}$ " extension is intended for use with the 88-A microphone.

### Specifications

Microphone Mounting \_\_\_\_\_  $\frac{1}{2}$ " pipe thread  
 Base Dimensions \_\_\_\_\_  $4\frac{1}{2}$ " x  $6\frac{5}{8}$ " x  $\frac{3}{4}$ "  
 Finish \_\_\_\_\_ Umber gray with polished chromium trim  
 Weight \_\_\_\_\_ 4 lbs.  
 Stock Identification \_\_\_\_\_ MI-4092-C

## Desk Stand Type KS-5A

The desk stand, Type KS-5A, is a neatly designed stand primarily for use with the KB-2C and KN-1A microphones. It is of cast metal and attractively finished in two glossy finishes, gray metalustre or black. The microphone is held rigidly in position by  $\frac{5}{8}$ "—27 thread bolt. The bottom is cushioned by a strip of rubber, giving adequate protection to any finely finished surface.

### Specifications

Dimensions:  
 Length \_\_\_\_\_  $4\frac{1}{8}$ "  
 Width \_\_\_\_\_  $5\frac{3}{8}$ "  
 Height \_\_\_\_\_  $\frac{3}{4}$ "  
 Weight \_\_\_\_\_  $1\frac{1}{4}$  lbs.  
 Fitting Size (of mike extension) \_\_\_\_\_  $\frac{5}{8}$ "—27 thread  
 Stock Identification:  
 Gray Metalustre \_\_\_\_\_ MI-12066  
 Glossy Black \_\_\_\_\_ MI-12066-A



## Announce Stand Type 91-A For 44-BX Only

The 91-A is a simple but attractive desk stand for 44-BX Microphones. It is finished in dark umber gray metalustre and its base rests on three felt buttons. Height of the 44-BX Center above desk is  $8\frac{3}{8}$ ". Base diameter, 7". Use only with Type 44-BX Microphone.

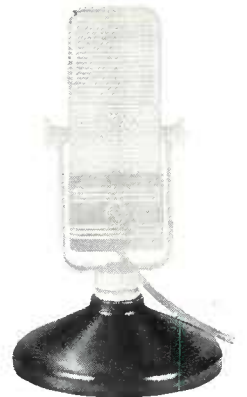

### Specifications

Weight (npacked) \_\_\_\_\_  $3\frac{1}{2}$  lbs.  
 Stock Identification \_\_\_\_\_ MI-4058-C

**Desk Stand MI-12063**

The MI-12063 is a special light weight 6" desk stand with a 5/8"-27 pipe thread fitting. It is especially suited for use with the RCA Aeropressure and Aerodynamic Microphones. It is attractively finished in dark amber gray metallure and has a heavy 6" felted base.

Weight (unpacked) \_\_\_\_\_ 1 1/4 lbs.

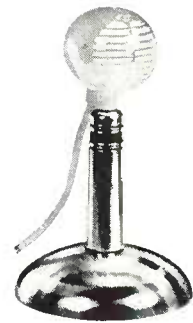

**Announce Stand MI-4096**

This attractively-designed announce stand is adjustable from 8 to 10 1/2", making it ideal for use on a desk or table. It is finished in chromium and black and features a 7 1/2" base. The microphone mounting is for a standard 1/2" pipe thread.

Weight (unpacked) \_\_\_\_\_ 4 lbs.



**Pushmike Stand MI-6427**



This smartly designed table stand features a built-in microphone switch and is suitable for use with all RCA pressure type microphones. The switch is of the D.P.D.T. long leaf anti-capacity type and permits turning the microphone on and off right at the microphone stand. It may also be used for "push-to-talk" operation or lock-in "Talk" position.

The stand is 4 3/4" high with 5 3/4" base and is attractively finished in chromium. The microphone mounting is for a 5/8"-27 male or female thread. Stock #33543 Adaptor is available on separate order for microphone with 1/2" pipe thread.

Weight (unpacked) \_\_\_\_\_ 1 1/8" lbs.  
 Stock Identification \_\_\_\_\_ MI-6427  
 (Includes MI-6425 Stand and MI-6426 Base)

**Pushmike Adaptor MI-6425**

An adaptor with a built-in microphone switch of the D.P.D.T. long leaf anti-capacity type. The switch permits "push-to-talk" operation or locked-in "talk" position and may be used with any floor or table stand having 5/8"-27 fixture threads. The adaptor is an extremely light compact unit finished in chromium. It is 4 3/4" long, 1 3/16" in diameter and weight is 3/4 lbs. unpacked.



Fitting \_\_\_\_\_ Bottom 5/8"-27 fixture thread (female)  
 Top \_\_\_\_\_ 5/8"-27 fixture thread (female) with added  
 5/8"-27 thread, male nipple  
 Weight (unpacked) \_\_\_\_\_ 3/4 lb.  
 Stock Identification \_\_\_\_\_ MI-6425

**Microphone Adaptors**

RCA offers a comprehensive stock of microphone adaptors suitable for microphones and stands, etc., used in the broadcast field. A recent questionnaire confirmed that for its simplicity in procurement and availability, the 1/2" standard pipe

thread was infinitely more popular than any other pipe size. For this reason, RCA has standardized on the 1/2" standard pipe thread, and avails broadcasters of adaptors to suit any application.

Stand Thread	Microphone Thread	Stock Identification
1/8" pipe thread	1/2" pipe thread	Stock No. 32212
1/2" pipe thread	1/8" pipe thread	MI-12051
1/2" pipe thread	3/8"-27	MI-12053
1/2" pipe thread	5/8"-24 (W.E.)	MI-12057
5/8"-24 (W.E.)	1/2" pipe thread	MI-12057-A
5/8"-27	1/8" pipe thread	MI-6229
5/8"-27	1/2" pipe thread	Stock No. 33543



Stock #33543



MI-12051



MI-6229

## Program Stand Type 90-A

### Uses

The 90-A Program Stand is the standard unit at leading Station and Network Studios. With its attractive finish and sturdy construction this stand will improve the appearance and operation of any studio set-up. It may be used with all RCA Broadcast Type microphones or with any other microphone which may be adapted to a 1/2" pipe thread mounting. The 1/2" fitting may be removed to expose a 3/8"—27 thread.

### Description

The 90-A floor stand is equipped with a simple clamping device which permits height adjustments to be made easily and quietly *without operating any release mechanism*. The up and down operation is smooth and the locking operation positive. The patented clamp is mechanically simple and is ruggedly constructed to give years of service. The weighted base of the 90-A is equipped with equalizing projections to assure a firm position on an uneven floor. The stand is finished in satin chrome to harmonize with any studio decoration. Cable guides are included to hold the microphone cord in proper position.

### Features

- Hundreds giving excellent performance in leading broadcast studios.
- Suitable for use with all RCA Microphones.
- Large heavy base with equalizing projections assure sturdy support of microphone.
- Simple non-slide, trouble free clamping device.
- Attractively finished in satin chrome.

### Specifications

Height of Stand \_\_\_\_\_ Adjustable from 3'8" to 6'2"  
 Microphone Mounting \_\_\_\_\_ Standard 1/2" or 3/8"—27 pipe thread  
 Diameter of Base \_\_\_\_\_ 12 1/4"  
 Weight (unpacked) \_\_\_\_\_ 33 lbs.  
 Finish \_\_\_\_\_ Satin Chrome  
 Stock Identification \_\_\_\_\_ MI-11050  
 Accessory Item—Cable Hook \_\_\_\_\_ MI-11099



## Floor Stand Type KS-1A

### Uses

The KS-1A is an attractive light-weight floor stand specially designed to provide the superior qualities of the Type 90-A Program Stand in a light-weight model. This stand may be used with all RCA microphones and is particularly recommended for applications where the heavier construction of the 90-A Stand is not required.

### Description

The KS-1A, like all RCA Floor Stands, features the patented clamping device that permits smooth height adjustment without the operation of any release mechanism. The clamping arrangement is positive in operation and is ruggedly constructed to give years of trouble-free service. The telescoping tube sections are stainless steel and the weighted base is finished in dark umber gray wrinkle. A cable clamp is provided in the base to hold the cable in position.

### Features

- Suitable for use with all RCA Microphones.
- Low price.
- Smooth operation with automatic clamping and release device.
- Light weight.
- Heavy ten inch base.
- Sturdy construction.
- Attractively finished.



### Specifications

Height of Stand \_\_\_\_\_ Adjustable from 3' 2" to 5' 5 1/2"  
 Microphone Mounting \_\_\_\_\_ 1/2" pipe thread  
 Diameter of Lower Tube \_\_\_\_\_ 1"  
 Diameter of Base \_\_\_\_\_ 11"  
 Weight (unpacked) \_\_\_\_\_ 14 lbs.  
 Finish  
 Base \_\_\_\_\_ Dark umber gray  
 Stand \_\_\_\_\_ Satin chrome  
 Stock Identification \_\_\_\_\_ MI-12065

## Cable Hook MI-11099

### Uses

Attached to the 90-A or any other 1 1/4" round tube stand the MI-11099 provides a convenient method of holding the cable when it is not in use.

### Description

The Cable Hook is simple to install, and may be easily adjusted to the proper height. Merely tightening a smooth locking nut holds it in position.

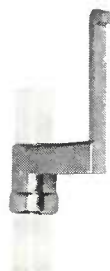

### Features

- Can be attached or removed in a few seconds.
- Saves wear on the cable.
- Keeps cable out of the way when not in use.

### Specifications

Weight \_\_\_\_\_ 15 oz.  
 Finish \_\_\_\_\_ Satin chromium  
 Hole Diameter \_\_\_\_\_ 1/4"

### Three-section Microphone Stand MI-6208

**Description**

The MI-6208 is a convenient and attractive stand for floor or banquet use. It is especially suitable for portable use since it may be taken apart into three sections for easy packing or carrying. The stand has a heavy ten-inch gray crackle base which is trimmed with satin-silver stripes. The stand finish is chromium.

**Features**

- Utility stand for floor or banquet use.
- Three sections for easy packaging or carrying.
- Heavy ten-inch base.
- Attractive appearance.

**Specifications**

Height (for floor use—3 sections)  
Adjustable from 3' 11" to 5'  
Height (for banquet use—2 sections)  
Adjustable from 1' 6" to 2' 7"  
Microphone Mounting— $\frac{1}{2}$ " pipe thread  
Finish  
Stand \_\_\_\_\_ Polished chromium  
Base \_\_\_\_\_ Gun metal crackle with  
satin-silver stripes  
Weight (unpacked) \_\_\_\_\_ 11 lbs.  
Stock Identification \_\_\_\_\_ MI-6208



### Floor Stand MI-4068-D

**Description**

The MI-4068-D is a lightweight microphone floor stand with a twelve-inch base. It may be used with any RCA Microphone where a stand of heavier structure is not required.

**Features**

- Heavy twelve-inch base.
- Modern appearance.
- Finish harmonizes with all colors.

**Specifications**

Height \_\_\_\_\_ Adjustable from 2' 11" to 5' 7"  
Microphone Mounting— $\frac{5}{8}$ "—27 pipe thread  
fitted with  $\frac{1}{2}$ " pipe thread adaptor. (For  
microphones with  $\frac{1}{8}$ " pipe thread use  
MI-6229 Adaptor.)  
Finish \_\_\_\_\_ Chromium and black  
Weight (unpacked) \_\_\_\_\_ 14½ lbs.  
Stock Identification \_\_\_\_\_ MI-4068-D



### Boom Stand Type KS-3A

**Description**

The KS-3A is a studio type stand which is especially suited for piano pickups and arrangements where it is desirable to locate a microphone close to the source of sound. It is also ideal for picking up large orchestra groups where the microphone must be elevated above the height attained with a Type 90-A Stand.

Adjustments are easily made with large knurled and polished handwheels. The boom is adjustable and counterbalanced. Smooth-rolling, rubber-tired casters eliminate noise and facilitate movement. Foot operated locks are located on all casters. The boom stand is finished in satin aluminum and umber gray wrinkle. Cable supports are provided for the microphone cord.

**Features**

- Sturdy construction, strong tubing and casting.
- Large base with rubber tired casters.
- Easily adjusted over wide range of heights and boom length.
- Positive locking adjustments.
- Air cushion lowering brake.



**Specifications**

Height of Stand  
Adjustable from 4½' to 8'  
Horizontal Arm Adjustment  
4' 11" to 7' 6"  
Microphone Mounting  
Standard  $\frac{1}{2}$ " pipe thread  
Weight (unpacked) \_\_\_\_\_ 62 lbs.  
Finish \_\_\_\_\_ Satin aluminum and black  
Stock Identification \_\_\_\_\_ MI-4094-B

### Portable Stand Type 59-B

**Description**

The 59-B is a collapsible, lightweight and rugged stand which is unexcelled for field use. It features a tripod base and a patented clutch arrangement which permits height adjustments to be quickly made without the operation of a mechanical release.

**Specifications**

Height \_\_\_\_\_ Adjustable from 3' to 5'  
Weight (unpacked) \_\_\_\_\_ 3½ lbs.  
Finish \_\_\_\_\_ Satin chrome  
Microphone Mounting  $\frac{1}{2}$ " pipe thread  
Stock Identification \_\_\_\_\_ MI-4093-B

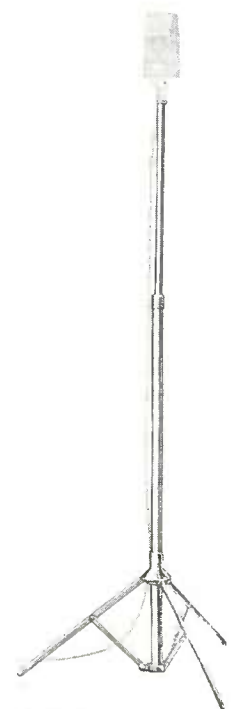

# “Magic Lock” Boom Stand Type KS-4-A



**Features**

- Remarkable dimensional flexibility—a 13' arc extending to 21' high.
- One arm universal action.
- “Magic Lock”, insuring positive and instantaneous action.
- Microphonic noises reduced to a minimum.
- Mobility—base will pass through any door.
- All steel construction—satin chrome finish.
- Low operating expense—no maintenance required.
- Suitable for catwalks, etc., with mounting bracket.

**Uses**

The “Magic Lock” Boom Stand is another addition to the series of microphone stands employing the “magic lock” principle. The ingenuity of this patented device is unexcelled by any other type of mechanism produced. It allows a one hand movement of the boom without operation of screws or release mechanisms and will retain a positive position without any possibility of slipping.

The stand’s flexibility embraces a wide variety of positions with various types of microphones, and presents a boom stand of universal action that will find an infinite number of applications in any broadcast or television studio.

**Description**

The “Magic Lock” Boom Stand is of all steel construction with a satin chrome finish throughout except for the low gravity cast iron base, which is dark umber gray. The main

shaft of the stand utilizes one main “magic lock” which constitutes an instantaneous and positive action in the vertical plane. The securing screw brake controls and locks the boom movement in azimuth.

The boom, with two telescoping 4' sections, has a controllable arc of approximately 180° by virtue of another “magic lock”. The microphone may be elevated and rotated in azimuth to any point by a one arm operation of counter balance. The base has a radius of 26", giving it great mobility, and allowing it to pass through any standard door. The stand and base are supported by three large, heavy-duty ball bearing casters, rubber covered to insure a smooth and silent operation. The microphone cable is guided at six locations and thus eliminates any possibility of fouling apparatus or instruments. If desired, the boom’s vertical shaft may be removed from the housing and used on a catwalk or a wall fitting bracket.

**Specifications**

Dimensions:

<i>Weight of Microphone</i>	<i>Radius of Arc</i>	<i>Height</i>
1 lb.	13'	21'
4 lbs.	9'	17'
8 lbs.	6'	14'

Counter Balance \_\_\_\_\_ 2' from center yoke  
 Boom When Closed \_\_\_\_\_ 5' radius  
 Adjustable Height Above Floor \_\_\_\_\_ 6' to 9'  
 Finish \_\_\_\_\_ Satin chrome  
 Weight \_\_\_\_\_ Approx 200 lbs.  
 Microphone Thread \_\_\_\_\_ Standard 5/8"—27 with adaptor to 1/2"  
 Stock Identification \_\_\_\_\_ MI-11052

# Microphone Boom & Perambulator MI-26574

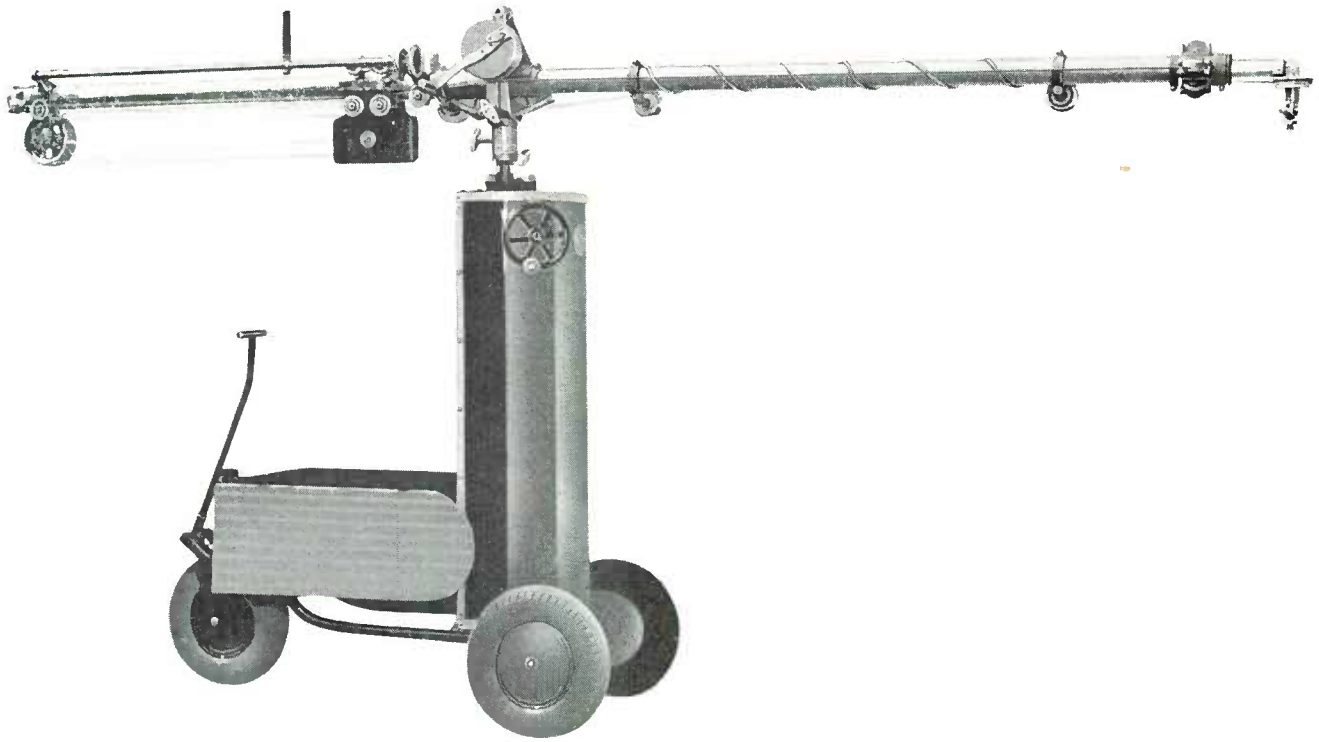

## Features

- Boom and perambulator can be passed through narrow doorways.
- Duraluminum tubing for boom assures rigidity and light weight.
- "Gunning" device revolves directional microphones through 280°.
- Radius of boom can be extended to 17 feet—retracted to 7 feet, 4 inches.
- Boom fitted with adjustable counterbalance for different microphones.
- Quiet in operation.

## Use

The MI-26574 Microphone Boom and Perambulator is designed for use in broadcast or television studios. It enables the operator to quickly place the microphone with respect to the sound source. He can closely follow the sound, or move from one source of sound to another easily and quietly.

## Description

The perambulator is constructed of steel tubing with drop-rim type wheels and pneumatic tires. The steering wheel swivels 180° and can be clamped to hold a given radius. The tiller when pushed back operates a toggle brake on the steering wheel. It is also provided with steps which aid the operator in mounting the platform when it is elevated. Operated by a

hand wheel, the elevating column raises the boom from a height of 6 feet, 5 inches to 9 feet, 5 inches. The operating platform raises with the boom. The wheel tread of the perambulator can be narrowed to 27 inches and the leaf portions of the table can be lowered to permit passing the perambulator through a 30-inch door.

A hand crank governs extension and retraction of the boom, and a hand rail controls elevation and horizontal traversal. As the boom is retracted, the microphone cable is received on take-up sheaves. The movement of the telescoping member is counterbalanced by weights which can be adjusted to properly balance different microphones. Since many microphones are directional, the boom is fitted with a "microphone gunning" device which revolves the microphone through 280°.

## Specifications

### Dimensions:

Maximum Height (with boom pedestal elevated)	9' 5"
Maximum Height (with pedestal lowered)	6' 5"
Length of Boom:	
Extended	17'
Retracted	7' 4½"

### Weight:

Boom (with gunning device)	66¾ lbs.
Counterweights for Boom	35¼ lbs.
Perambulator	421 lbs.



## Microphone Cables

### Cable MI-41

Use \_\_\_\_\_ High impedance microphone cable  
 Type \_\_\_\_\_ Single conductor stranded equiv. #25 AWG  
 Insulation \_\_\_\_\_ Special rubber compound  
 Shield \_\_\_\_\_ Tinned copper  
 Outer Covering \_\_\_\_\_ Special durable black rubber compound  
 Overall Diameter \_\_\_\_\_ Approximately 0.245"  
 Capacity \_\_\_\_\_ Does not exceed 26 mmf per ft. at 1000 cycles  
 Stock Identification (specify length in feet) \_\_\_\_\_ MI-41

### Cable MI-42

Use \_\_\_\_\_ Low impedance microphone cable  
 For Use with Microphones \_\_\_\_\_ 74-B, 88-A, MI-6203-C  
 Type \_\_\_\_\_ Stranded two-conductor shielded equiv. #20 AWG  
 Insulation \_\_\_\_\_ Special rubber compound  
 Shield \_\_\_\_\_ Tinned copper  
 Outer Covering \_\_\_\_\_ Special durable black rubber compound  
 Overall Diameter \_\_\_\_\_ Approximately 0.280"  
 Stock Identification (specify length in feet) \_\_\_\_\_ MI-42

### Cable MI-43

Use \_\_\_\_\_ Low impedance microphone cable  
 For Use with Microphones \_\_\_\_\_ 77 Series KB-2C  
 Type \_\_\_\_\_ Stranded three-conductor shielded equiv. #20 AWG  
 Insulation \_\_\_\_\_ Special rubber compound  
 Shield \_\_\_\_\_ Tinned copper  
 Outer Covering \_\_\_\_\_ Special durable black rubber compound  
 Overall Diameter \_\_\_\_\_ Approximately 0.280"  
 Stock Identification (specify length in feet) \_\_\_\_\_ MI-43

### Cable MI-62

Use \_\_\_\_\_ Low impedance microphone cable  
 For Use with Microphones \_\_\_\_\_ 44-BX  
 (Extra flexible lightweight construction for portable use)  
 Type \_\_\_\_\_ Twisted two-conductor shielded, 41 strands #34 wire  
 \_\_\_\_\_ Equiv. #18 AWG  
 Insulation \_\_\_\_\_ Special rubber compound  
 Shield \_\_\_\_\_ Tinned copper  
 Outer Covering \_\_\_\_\_ Special durable black rubber compound  
 Overall Diameter \_\_\_\_\_ Approximately 0.285"  
 Stock Identification (specify length in feet) \_\_\_\_\_ MI-62

## Interconnecting Cables

The majority of cables required to interconnect the various components of a broadcast audio assembly are of a special type and cannot be readily purchased from the local electrical dealer. In order to avoid unnecessary installation delays, RCA carries in stock five of the generally used special type cables.

### Stranded Conductor Cable MI-49

Use \_\_\_\_\_ Especially recommended for audio circuits  
 \_\_\_\_\_ and general rack wiring  
 Type \_\_\_\_\_ Shielded, twisted pair, stranded, composed of 10 .010  
 \_\_\_\_\_ tinned copper conductors equivalent to #16 AWG  
 \_\_\_\_\_ Outside covering of cotton braid.  
 Insulation \_\_\_\_\_ Varnished cambric covered with a serving of cotton  
 Shield \_\_\_\_\_ Tinned copper braid  
 Overall Diameter \_\_\_\_\_ Approx. 0.25"  
 Color Code \_\_\_\_\_ Red and black  
 Rating \_\_\_\_\_ 600 volts  
 Stock Identification (stocked in 1000' rolls) \_\_\_\_\_ MI-49

### Solid Conductor Cable MI-63

Use \_\_\_\_\_ General rack wiring  
 Type \_\_\_\_\_ Shielded, twisted pair, solid copper #19 AWG  
 Insulation \_\_\_\_\_ Silk wrapping and cotton braid  
 Shield \_\_\_\_\_ Tinned copper braid  
 Overall Diameter \_\_\_\_\_ Approx. 0.24"  
 Color Code \_\_\_\_\_ Red and black  
 Rating \_\_\_\_\_ 600 volts  
 Stock Identification (stocked in 1000 ft. rolls) \_\_\_\_\_ MI-63

### Solid Conductor Cable MI-63-A

Use \_\_\_\_\_ General purpose audio transmission line  
 Type \_\_\_\_\_ Twisted two-conductor, solid copper, shielded,  
 \_\_\_\_\_ tinned #19 AWG  
 Insulation \_\_\_\_\_ Varnished cambric covered with a serving of cotton  
 Shield \_\_\_\_\_ Tinned copper braid  
 Overall Diameter \_\_\_\_\_ Approx. 0.25"  
 Color Code \_\_\_\_\_ Red and black  
 Rating \_\_\_\_\_ 600 volts  
 Stock Identification (stocked in 1000' rolls) \_\_\_\_\_ MI-63-A

### Stranded Conductor Cable MI-64

Use \_\_\_\_\_ Recommended for power circuits particularly where  
 \_\_\_\_\_ extra flexibility is required  
 Type \_\_\_\_\_ Shielded, twisted pair, stranded, composed of 10 .010  
 \_\_\_\_\_ tinned copper conductors equivalent to #19 AWG  
 Insulation \_\_\_\_\_ Varnished cambric covered with a serving of cotton  
 Shield \_\_\_\_\_ Tinned copper braid  
 Overall Diameter \_\_\_\_\_ Approx. 0.28"  
 Color Code \_\_\_\_\_ Red and black  
 Rating \_\_\_\_\_ 600 volts  
 Stock Identification (stocked in 1000' rolls) \_\_\_\_\_ MI-64

### Stranded Conductor Cable MI-65

Use \_\_\_\_\_ Especially recommended for 110 volt supply  
 \_\_\_\_\_ and filament circuits  
 Type \_\_\_\_\_ Shielded, twisted pair, stranded, composed of 26 .010  
 \_\_\_\_\_ tinned copper conductors equivalent to #16 AWG  
 Insulation \_\_\_\_\_ Varnished cambric covered with a serving of cotton  
 Shield \_\_\_\_\_ Tinned copper braid  
 Overall Diameter \_\_\_\_\_ Approx. 0.275"  
 Color Code \_\_\_\_\_ Red and black  
 Rating \_\_\_\_\_ 600 volts  
 Stock Identification (stocked in 1000' rolls) \_\_\_\_\_ MI-65

## CUSTOM BUILT EQUIPMENT

RCA "Custom-Built" equipments are complete speech input systems designed according to the requirements and specifications of individual stations. RCA engineers have worked closely with the country's leading broadcast and network engineers in the design, production and installation of many such equipments, a few of which are shown in the accompanying photographs.

No two broadcast studio layouts are just alike, and never, except perhaps in the smaller stations, are the equipment requirements exactly the same. Moreover, the larger the installation, the more specialized the equipment problem. But, however large or however modern may be the requirements,

RCA "Custom-Built" equipments can be furnished to meet them.

Moreover, the "Custom-Built" service means more than just so many racks or pieces of equipment,—it includes, in fact, the services of the whole RCA engineering organization. In some cases, for instance, the station or network engineers may wish to lay out the system themselves, complete with specifications. In such instances, RCA engineers will assemble standard units and, where necessary, specially-built units to meet these specifications in every detail. On the other hand, where stations so desire, RCA engineers will study the requirements of the station, make overall and detailed layouts, and draw up specifications for the needed equipment.



*A completely RCA equipped master control console and associated audio equipment installed at WFAA, Dallas, Texas.*

**CUSTOM BUILT**

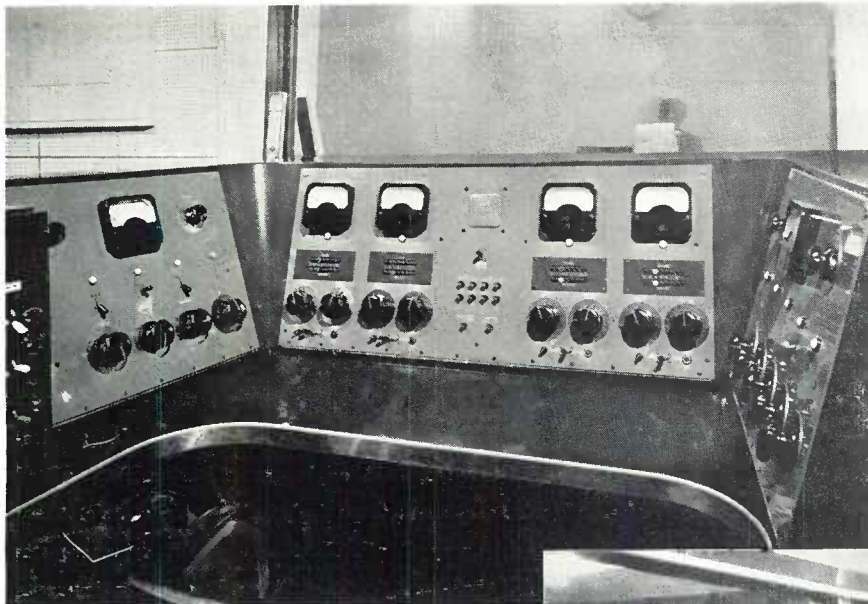

*Master control console installed at WCAO, Baltimore, Md.*

*View of a studio control console at WNEW, New York City.*



*Deluxe, custom-built installation, completely RCA equipped, at WNEW, New York City.*

*A studio control console designed especially for installation at WJBP, Baton Rouge, La.*

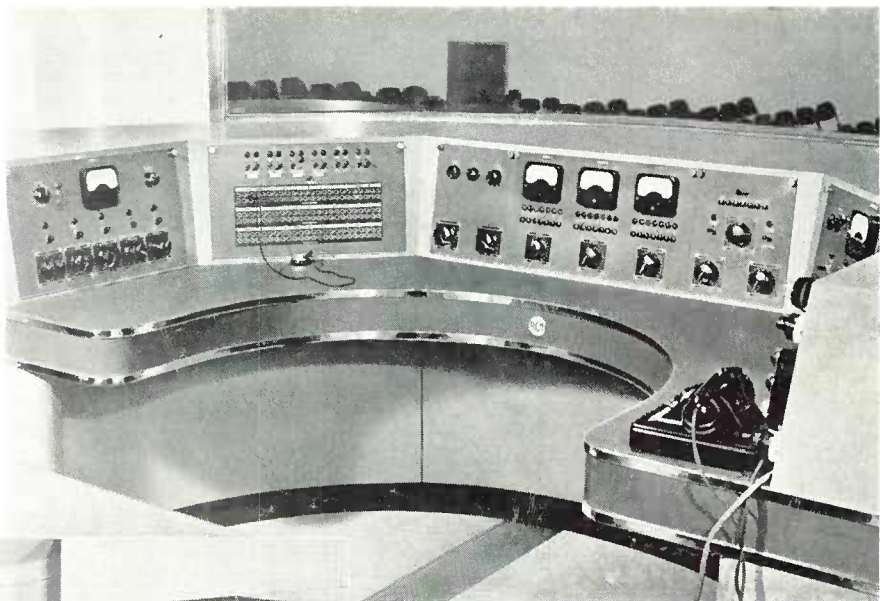

*A partial view of the master control installation at WCAO, Baltimore, Md., showing the rack-mounted audio equipment. This is companion equipment to that shown on the opposite page top view.*

*Master control desk, transcription turntable, and associated audio racks as installed at WISH, Indianapolis, Ind.*



# Studio Consolette Type 76-B4



## Features

- Complete high fidelity speech input system for two studios, announce booth, turntables and remotes.
- Excellent frequency response—low distortion for FM or AM.
- No broadcast time lost from amplifier or power supply failures. Duplicate equipment may be quickly connected by means of switches.
- 8-watt monitoring and audition amplifier with interlocked relay circuits for three loudspeakers.
- Full facilities for simultaneous audition and broadcast.
- Push button selector switches—six channel mixer.
- Large vu meter connected to rotary selector switch permits accurate program monitoring and checks plate currents of all tubes in program channel.
- Talk-back system independent of program channel—interlocked switching prevents feed-back.
- Easy access for maintenance.
- Heavy duty power supply for external mounting allows space for full-sized components in small sized console.

## Uses

The 76-B4 provides a completely flexible and high quality speech input system for FM as well as standard broadcasting. The new design supersedes the type 76-B2 and is advantageous by its increased flexibility in the switching of the 4th mixer position from Studio B to the Announce Booth or control room. This model also uses push button switches of an improved design.

The 76-B4 provides all the amplifying control and monitoring equipment required to handle successfully two studios, an announce booth microphone, a control-room announce microphone, two transcription turntables and six remote lines. Full facilities are provided for simultaneously auditioning and broadcasting from any combination of the studios, turntables or remote lines.

## Description

All the amplifying and control equipment is mounted in a single metal console and the power supplies are located in a metal box designed for wall mounting.

The standardized, illuminated volume indicator meter is furnished calibrated in "vu's." This meter is also used to measure the plate current of all the tubes in the program channel. The meter is switched to the various tubes by means of the rotary switch which is mounted to the left of the meter. An adjustable attenuator at the right of the meter allows the 100% mark on the scale to be calibrated for +4, +8, +12, and +16 vu.

The console contains four pre-amplifiers, one high-gain program amplifier and one high-gain 8-watt monitoring amplifier. A six position mixer is utilized with the pre-amplifiers connected to four of the mixers and banks of mechanically inter-

locked push-keys connected to the remaining two. The output of each mixer connects to lever keys so it may be switched to the input of the program amplifier for broadcasting or to the monitor amplifier for auditioning. These key switches are interlocked to disconnect the studio loudspeakers and operate "On Air" light relays. A three position key switch in the input of the fourth pre-amplifier permits it to operate from a microphone in the studio, announce booth, or local control room. The push-keys on the fifth and sixth mixer positions allow any one of six remote lines and two turntables to be instantly connected to the input of either of the two mixers. Additional push-key sets provide circuits for feeding cue to remote lines and for bringing in monitoring circuits such as transmitter or master control outputs. A monitoring headset jack is supplied and the headphones may be connected to the output of the program channel, the remote line push-keys, or the incoming network by means of a three-position lever switch. Lever-keys permit using monitoring amplifier for program amplifier in emergencies. Talkback facilities are included and separate push-keys permit talking back to either of the two studios or to the remote lines. The talk-back circuits are interlocked to prevent feed-back or program interruption.

An "Over-ride-Record" switch is provided which permits the remote operator to call in on any of the six remote lines and over-ride the program on the control room speaker. The "Record" position of the switch furnishes a signal source for

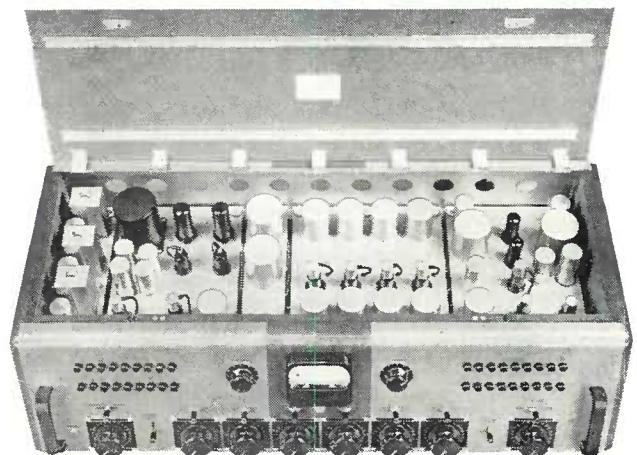

76-B4 with top raised

an external recording amplifier. Two remote line repeating coils and attenuator pads are provided.

The console is constructed of metal with wooden style plates on each end. A lid is provided for access to tubes, etc. from the top and is equipped with sturdy concealed hinges. The entire console chassis is hinged across the back to permit quick and easy access to every component and all the wiring. Handles on the front panel facilitate opening the chassis for inspection. When the chassis is opened, all the mixers are made accessible for servicing.

The metal power supply box is equipped with a hinged front door and a hinged chassis. Two separate rectifier and filter units provide power for the program amplifier—preamplifiers, monitoring amplifier, three speaker interlocking relays and up to 4 external 12 volt relays for studio signal lights. A switch permits feeding the preamplifiers from the monitor supply in emergencies.

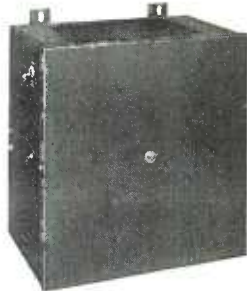

*Wall Mounting  
Power Supply*

**Specifications**

Source Impedance	
Microphones	30/50 or 250 ohms
Remote Lines	150, 300 or 600 ohms
Turntables	250 ohms
Monitor Cue	20,000 ohms
Load Impedance	
Line	500/600 ohms
Speaker (total of four speakers)	each 15 ohms

**OUTPUT LEVEL**

Line (distortion less than 0.5% 50-7500 cycles)	+ 18 dbm
Maximum Line Output Level	+ 26 dbm
(With 1.0% rms distortion at frequencies 50-7,000 cycles)	
Speaker (distortion less than 3% 50-7500 cycles)	8 watts
Gain (maximum microphone to line)	112 db

Transcription Input to Line	81 db
Frequency Response (to line or speaker)	±2 db 30-15,000 cycles
Noise Level (below +18 db output, 68 db gain)	-68 db
Power Input: 105/125 volts, 50/60 cycles	225 watts
Dimensions	<i>Console</i> <i>Power Supply</i>
Length	39"     15"
Height	10½"     15"
Depth	17"     8"
Finish	Two-tone Umber Grey     Dark Umber Grey
Weight, unpacked (less tubes)	135 lbs.     60 lbs.
Stock Identification	MI-11613-C     MI-11301-B

**Accessories**

- BA-2C Booster Amplifier (one required for each 70-D turntable) \_\_\_\_\_ MI-11226-B
- Tube Kit (complete tube complement for 76-B4) \_\_\_\_\_ MI-11252-E
  - 11 RCA-1620     1 RCA-5R4GT
  - 2 RCA-1621     2 RCA-1622     1 RCA-5R4GT
- Emergency Tube Kit (complete tube complement) MI-11252-D
  - 11 RCA-6J7     1 RCA-5R4GT
  - 2 RCA-6F6     2 RCA-6L6     1 RCA-5Y3G
- On-Air Light Relay (one required for each studio on air or audition light) \_\_\_\_\_ MI-11702
- Speaker Relay (not required unless an interlocked speaker is desired in Announce Booth) \_\_\_\_\_ MI-11703-A

*Components Easily  
Accessible with this  
Hinged Feature*

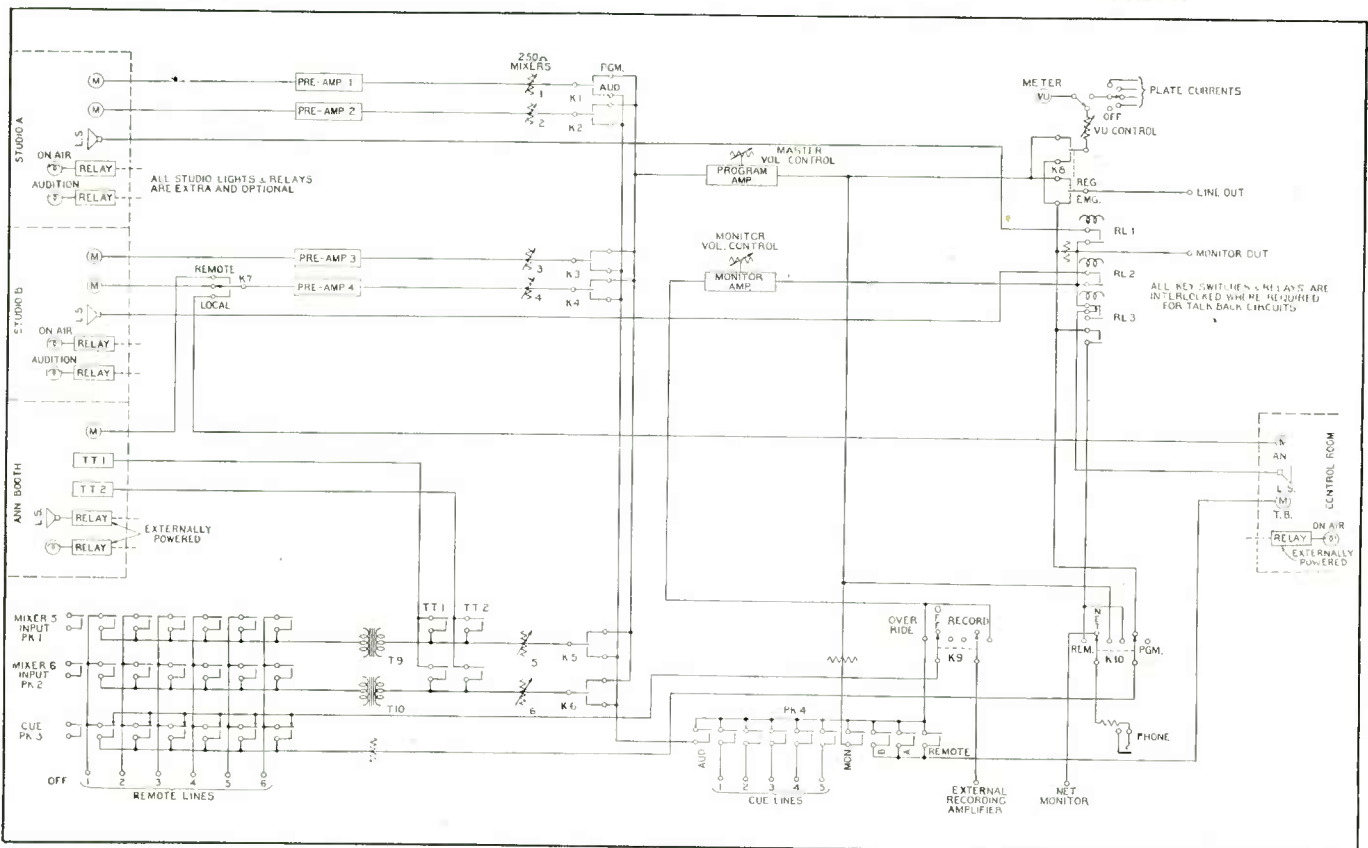
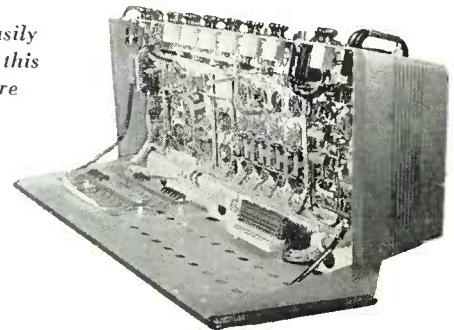

*Simplified block diagram of 76-B4 Consolelette*

# Studio Consolette Type 76-C

## Features

- Complete AM, FM studio system for large and small stations.
- Six microphone inputs, six mixers, six pre-amplifiers, eight watt monitoring and auditioning facilities.
- Offers maximum flexibility for large or small stations.

## Uses

The 76-C Studio Consolette offers a complete and flexible control system for AM and FM broadcasting. This new design has resulted from a desire expressed by many broadcasters for a consolette possessing six pre-amplifiers and additional flexibility on the fifth and sixth mixer positions. The consolette is versatile in operation and is admirably suited for single studio use in a large station or as a complete control unit for a small station.

## Description

The 76-C provides all the amplifying control and monitoring equipment required to operate efficiently a control room, two studios and announce booth, two transcription turntables, four remote lines and five cue circuits. The consolette contains six pre-amplifiers, six mixer positions, a high gain program amplifier and eight watt monitoring amplifier which may be utilized to feed an external recording amplifier terminals—67 db gain. All amplifier inputs and outputs are terminated in terminal strips, thereby allowing intermediate jack facilities for patching, etc. The fifth and sixth mixer positions are flexible and may be used as microphone inputs (giving each channel a 112 db gain) or switched to serve four remote lines and two turntables. Turntables 1 and 2 have their respective cueing keys which allow cueing signal to be fed to an external amplifier. Full facilities are provided for simultaneously auditioning and broadcasting for any combination of studios, turntables, or remote lines. Monitoring facilities are provided for all auditioning channels, turntables, remote and cue lines. The 76-C is attractively finished and in all respects similar to the 76-B series consolettes. The chassis is hinged at the rear, permitting ready accessibility for maintenance. The MI-11301-B power supply contains two separate rectifiers and filter units supplying power for the amplifiers, speaker relays and four studio signal lights.



## Specifications

Source Impedance:  
 Microphones \_\_\_\_\_ 30/50 or 250 ohms  
 Remote Lines \_\_\_\_\_ 150, 300 or 600 ohms  
 Turntables \_\_\_\_\_ 250 ohms  
 Monitor Cue \_\_\_\_\_ 20,000 ohms

Load Impedance:  
 Line \_\_\_\_\_ 500/600 ohms  
 Speaker (total of three speakers) \_\_\_\_\_ Each 15 ohms  
 Headphone Output \_\_\_\_\_ 2 to 5000 ohms

Output Level:  
 Line (distortion less than 0.5% 50 to 7500 cycles) \_\_\_\_\_ +18 db  
 Maximum Line Output Level  
 (distortion less than 1% at 50 to 7500 cycles) \_\_\_\_\_ +26 dbm  
 Speaker (distortion less than 3%, 50 to 7500 cycles) \_\_\_\_\_ 8 watts  
 Gain (maximum microphone to line output) \_\_\_\_\_ 112 db  
 Transcription Inputs Line to Line Output \_\_\_\_\_ 81 db  
 Frequency Response \_\_\_\_\_ ±2 db 30 to 15,000 kc  
 (to line or speaker)  
 Noise Level (68 db gain, +18 dbm output) \_\_\_\_\_ -68 db  
 Power Input (105/125 volts, 50/60 cycles) \_\_\_\_\_ 125 watts

## Dimensions:

	Consolette	Power Supply
Length _____	39 inches	15 inches
Height _____	10½ inches	15 inches
Depth _____	17 inches	8 inches
Weight _____	140 lbs.	60 lbs.
Finish _____	Two-tone U/G	Dark U/G
Stock Identification _____	MI-11624	MI-11301-B

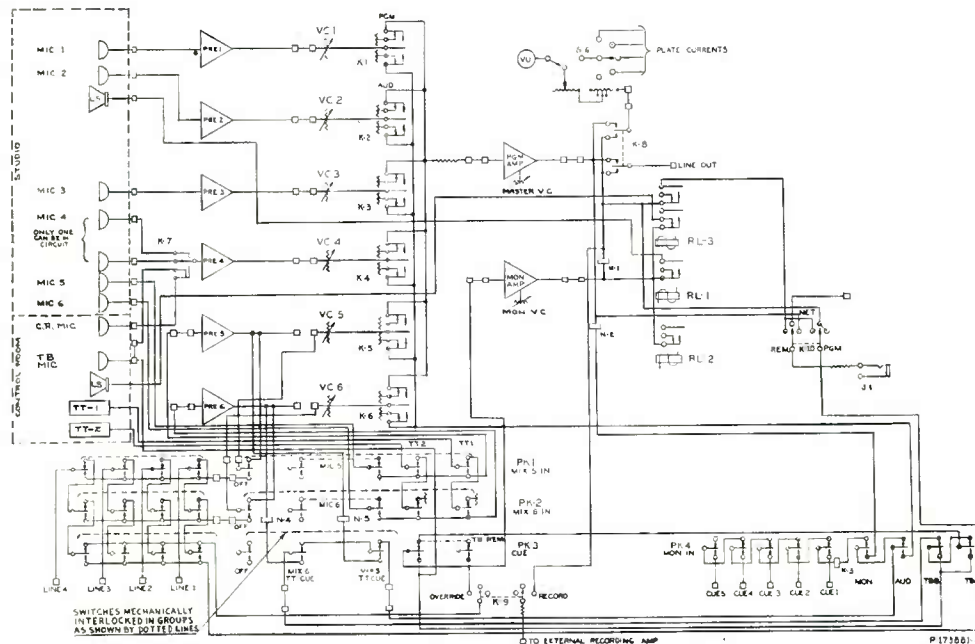

# Switching System Type BCS-2A

## Features

- Economically priced.
- Control of two consolettes for two outgoing lines.
- Independent or simultaneous switching of inputs to outgoing channels.
- Attractive styling blends with all RCA consolettes and equipments.
- AM, FM, or other desired outgoing channel combinations.
- Nine possible combinations of switching.
- Mechanically interlocked.

## Uses

The BCS-2A switching console has been developed to meet the demands of many stations now operating both AM and FM transmitters, or one transmitter and a utility channel for feeding network, recording studio, etc. The addition of this extra channel adds many complications to programming, unless a switching system is evolved providing adequate flexibility and protection from erroneous switching. This is accomplished in the design of the BCS-2A.



## Description

The BCS-2A switching console is used in conjunction with the 76 series or any general consolette, and enables two console outputs to be switched independently to either of the two outgoing lines such as AM and FM or other combinations including recording, audition, and network feed. If desired, either of the two consolettes will feed both outgoing lines simultaneously, however, push button switches are mechanically interlocked and prevent both consolettes feeding the same outgoing line. If the program necessitates material from two different studios, this may be accomplished through the originating consolette's remote facilities. Switch contacts are provided to operate signal lights that may be located on or near the input consolettes to indicate if outgoing channel A or B or both are being fed. The 76 series consolettes have holes with plug buttons in place on either side of the VU meter in which the signal lights may be located. Signal light kits are available as MI-11714. Power for the signal lights is obtainable from 6.3 volt filament supply.

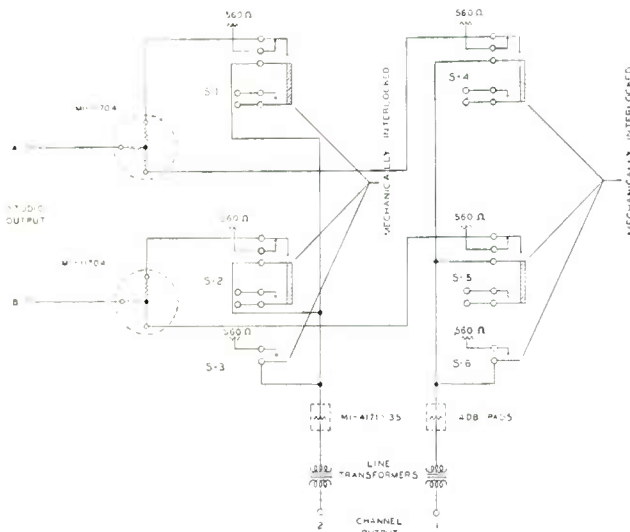

Simplified schematic diagram of BCS-2A

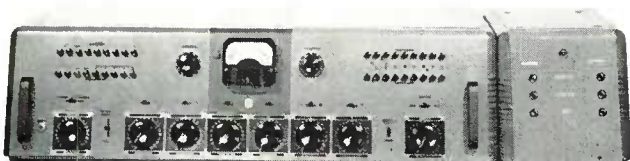

BCS-2A with 76-B4 Consolette

## Specifications

### Dimensions:

- Length \_\_\_\_\_ 10½"
- Height \_\_\_\_\_ 10½"
- Depth \_\_\_\_\_ 17"
- Weight \_\_\_\_\_ Approx. 30 lbs.
- Finish \_\_\_\_\_ Two tone number gray
- Stock Identification \_\_\_\_\_ MI-11622

### Accessories

- Console Signal Light Kit \_\_\_\_\_ MI-11714



# Switching System Type BCS-1A

## Features

- Facilities comparable with custom-built equipment.
- Control of 5 consolettes to 3 outgoing lines.
- Attractive styling blends with all RCA consolettes and equipment.
- Eliminates any possibility of 2 programs feeding one outgoing line.
- AM, FM and utility, or any desired combination.
- Monitoring facilities for all channels, networks, etc.

## Uses

The BCS-1A switching system has evolved after numerous requests from broadcasters to develop a "fool-proof" system of flexible switching for stations operating several studios to more than one outgoing channel. With the addition of FM to many stations, it has become apparent that a separate system for AM and FM transmitter channels is desirable. This feature decreases the possibility of inadvertent switching and also enables the operator to satisfactorily adhere to switching functions as assigned.

## Description

The BCS-1A is a relay operated system consisting of a master switching console, usually installed in the main control room, and a studio console for each control room. The complete system provides the master switching console with handling capacity for one to five studio consoles, with each studio console handling two studios and one announce booth. This system will switch the output of five consoles to three outgoing lines. The unique design of the relay interlocking feature prevents the feeding of more than one program to an outgoing line, or lines, although supporting program material may be handled as remotes by the originating studio.

The Master Switching Console (see photograph) has three groups of lights and switches and an associated VU meter for each of the three outgoing channels. In each group the top row of lights indicates which of the five studio switching consoles is feeding the outgoing channel. The associated switches for each studio are immediately below the lights. A studio release switch for each outgoing channel is on the next row. "Studio Controls" are on the lower two rows. A monitoring

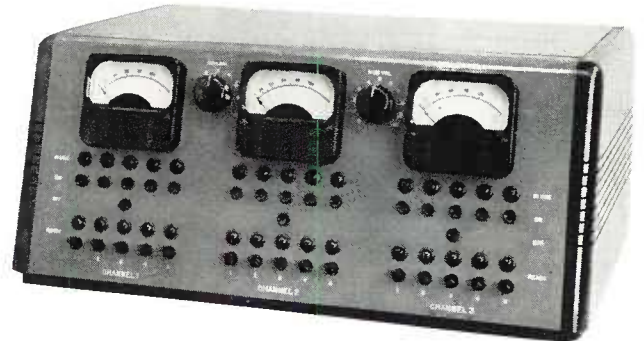

Master Switching Console

toring amplifier input selector switch is placed on the left of the center VU meter to provide a cue check on monitoring of programs on any of the three outgoing lines, any one of the five originating consolettes and two spare positions for user's choice, such as networks, remotes and recording, etc. A step-by-step bridging type volume control on the right hand side controls the level of the monitoring amplifiers.

The Studio Switching Console (see photograph) has three vertical rows of lights and switches, each vertical being associated with an outgoing channel. Reading from top to bottom, the horizontal rows are the "On-Air" lights which light only in the program originating control room and indicate which outgoing channel or channels the originating control room is feeding. The next row is "In Use". These are operated when the originating studio, or any other studio, is feeding program to the channel. The "On" switch which controls each channel is on the next row. The "Off" switch and the "Studio Control" lights are the bottom two rows.

Some operating features are as follows:

- The master control switching unit can put any studio on or off the air at any time. It is the only unit which has unqualified control.
- The master switching control can extend control to any studio control and any outgoing bus or buses that are desired. This is accomplished by the operation of the studio control switch on the master switching console, the status of this control is indicated by the lower signal light row on each control box.
- The studio control feature prevents unauthorized switching from occurring in control rooms not in use.
- A studio control set up for the next program as indicated by the studio control light cannot interrupt the originating studio using the channel. Only the studio feeding or the master control can release the channel. This is a very important feature. The new originating studio is advised of the channel availability by the extinguishing of the "In Use" signal light for that channel. When the "On" button is depressed the studio is placed on the air and the "In Use" and "On Air" lights are lighted to indicate that the studio is feeding the channel.
- The system can be operated as a "roving" control if an operator is not stationed at the master control. The studio control switches for all studios and channels that will be used can be turned on and control can be handled at the studio controls without benefit of the master control operator.

All relays and main terminal blocks are located in the base of the master switching unit and readily accessible by raising the top and front portion of the case which are hinged at the rear. With the minimum of channel switching, the minimum power required for the operation of the complete system (master and studio consoles) exceeds 1 amp. The MI-11304



Studio Switching Console

Relay Power Supply (maximum output 5 amps.) is therefore recommended.

The master switching console is the common point for all control wire connections. 19 conductors are required from this console to each studio console if all three outgoing channels are used. No jumpers are required at any terminal blocks in case the maximum number of control boxes are not used. MI-61 shielded, 15-pair (twisted) cable is available for wiring between the Master Switching Console and the Studio Switching Consoles.

**Specifications**

Dimensions:

**Master Switching Console**

- Length \_\_\_\_\_ 24"
- Height \_\_\_\_\_ 10½"
- Depth \_\_\_\_\_ 17"
- Weight \_\_\_\_\_ (approx.) 80 lbs.

**Studio Switching Console**

- Length \_\_\_\_\_ 10½"
- Height \_\_\_\_\_ 10½"
- Depth \_\_\_\_\_ 17"
- Weight \_\_\_\_\_ (approx.) 30 lbs.

Stock Identification:

- BCS-1A Master Switching Console \_\_\_\_\_ MI-11625
- BCS-1A Studio Switching Console (each unit) \_\_\_\_\_ MI-11625-A

**Accessories**

- Relay Power Supply \_\_\_\_\_ MI-11304
- BA-3C Program Amplifier (Carbon Control) \_\_\_\_\_ MI-11224-E
- BA-3C Program Amplifier (Step-by step Control, Daven) \_\_\_\_\_ MI-11224-F
- BA-4C Monitoring Amplifier \_\_\_\_\_ MI-11223-B
- BR-2A Panel and Shelf \_\_\_\_\_ MI-11598 / 11599
- LC-1A Loudspeaker (Umbert Gray) \_\_\_\_\_ MI-11401 / 11411
- LC-1A Loudspeaker (Walnut) \_\_\_\_\_ MI-11401A / 11411
- Line Transformers, 250-600/250-600 ohms \_\_\_\_\_ MI-10253-A
- Pads, 6 db, 600/600 ohms \_\_\_\_\_ MI-4171-29
- 15 Pair Twisted Cable (per foot) \_\_\_\_\_ MI-61

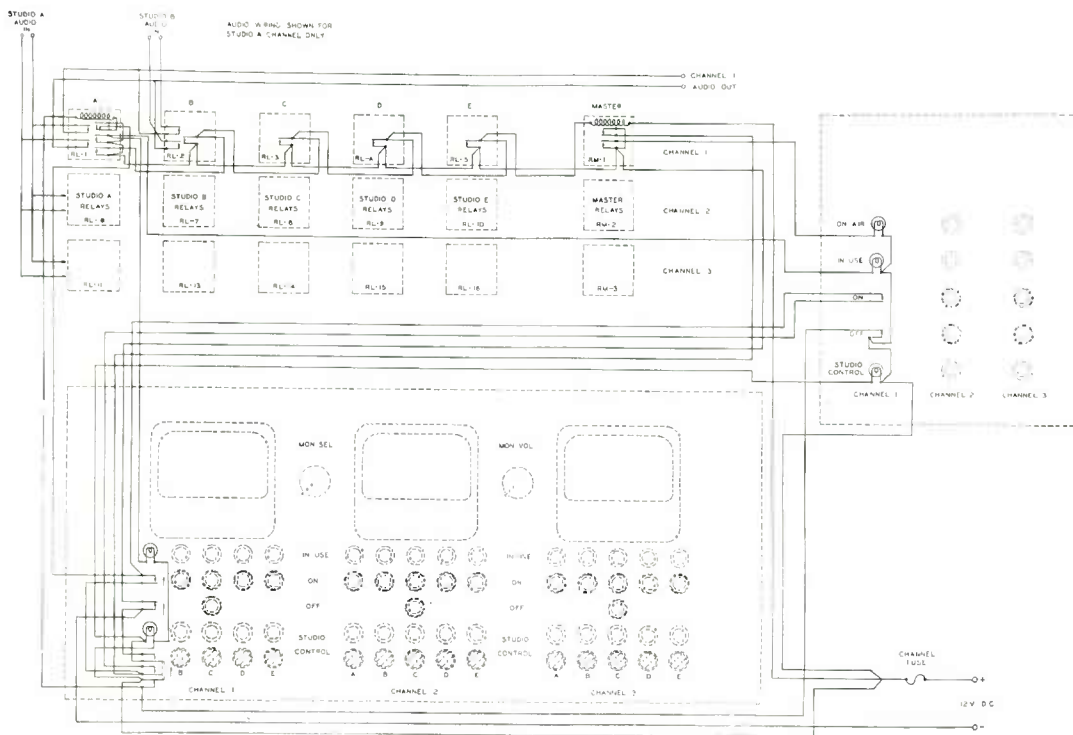
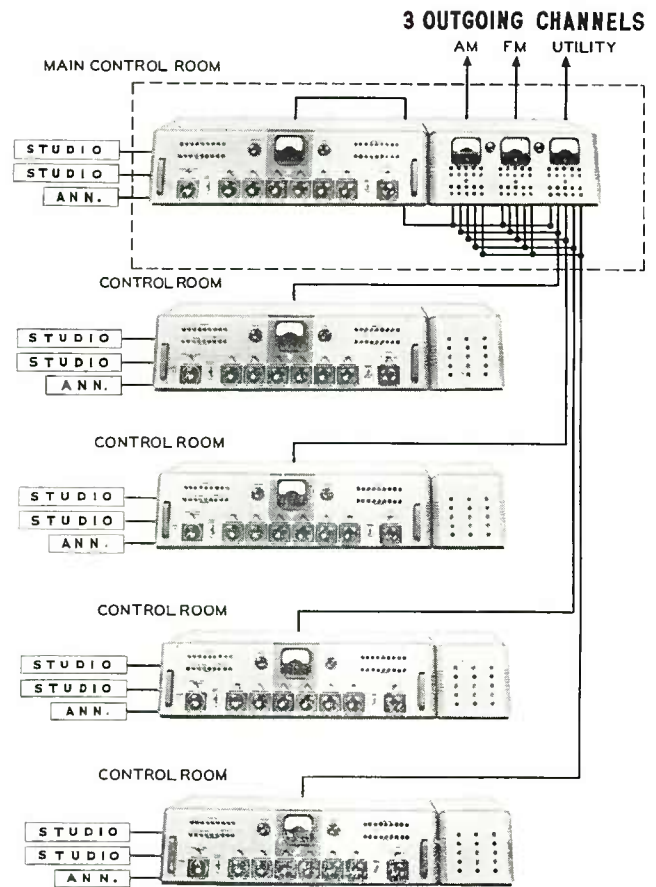

*Schematic diagram of BCS-1A Switching System*

# Studio Warning Lights, MI-11706 Series



**Features**

- Modern styling.
- Satin chrome finish.
- Available in five types.
- Uniform illumination.
- Easily mounted.

**Uses**

The MI-11706 series of warning lights is another new product to supplement the RCA line of modernistically designed studio equipment. These lights have been developed after many requests from broadcasters to furnish a studio warning light that has bold and uniformly illuminated lettering with an external design that would enhance the appearance of any studio.

**Description**

The lights are constructed of satin finish cast aluminum with trimmed etchings and tastefully styled for all studio furnishings. The sign is an opaque black glass with frosted translucent 2" letters, using a 40 watt 12" lumiline lamp for a light source.

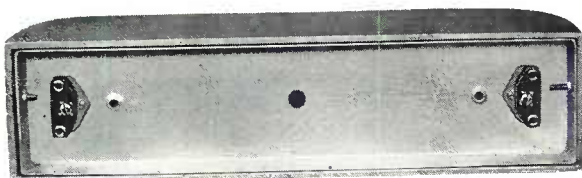

*Back view showing simplicity of construction and outer case mounting screws*

*Outer case removed showing Lumiline illuminating lamp*

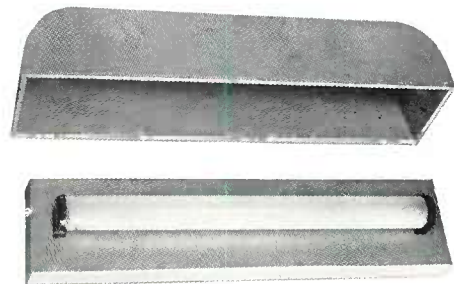

The interior or mounting base, containing the lamp, sockets and terminal strip for the a-c supply, is of separate metal construction and insures adequate protection from wires short-circuiting. The complete interior is a wall mounting fixture and allows a new lamp to be replaced quickly by simply removing the outer case by two screws. The warning light is available with five signs as indicated below.

**Specifications**

Dimensions: (overall of case)

Length	_____	14"
Width	_____	3 1/2"
Depth	_____	2 11/16"
(Glass Sign Aperture)		
Length	_____	9 3/4"
Width	_____	2 3/4"

Weight (unpacked) \_\_\_\_\_ 3 1/2 lbs.

Stock Identification:

"ON-AIR"	_____	MI-11706-1
"REHEARSAL"	_____	MI-11706-2
"AUDITION"	_____	MI-11706-3
"STANDBY"	_____	MI-11706-4
"SILENCE"	_____	MI-11706-5

# RCA Broadcast Amplifiers

The RCA line of high fidelity Speech Input Amplifiers has been designed to provide stations with studio, recording and portable remote amplifiers which will offer the maximum in fidelity, flexibility, convenience and reliability. All amplifiers are suitable for FM having a uniform response to 15,000 cycles. Distortion and noise levels have been reduced to a very low value through careful engineering design and construction.

While the apparatus is unexcelled in performance and appearance, it is very economical considering the many features which are offered. The amplifiers have been designed to give

unsurpassed service and nothing has been omitted which would contribute to their usefulness and reliability.

Attention is invited to gain and level references in this catalog. dbm—refers to gain.

dbm—sine wave power measurement referred to one milliwatt.

VU—refers to average program level as read on a standard VU meter. This value is subject to considerable variation from dbm but is generally considered 10 db below peaks.

Allowance must be made for program peaks to avoid amplifier overloading, for example, a pre-amplifier rated at +10 dbm should not be operated at more than 0 VU.

## Summary of RCA Broadcast Amplifier Characteristics

Type	Usage	Max. Gain db	Max. Input dbm <sup>o</sup>	Max. Output dbm*	Source Impedance Ohms	Load Impedance in Ohms	Type Mounting
BA-1A	Preamplifier	Matching 40	Matching -30	+10	30/250	250/600	Chassis or Rack
	Isolation Amp.	Bridging 7	Bridging +30	+10	10,000	250/600	Chassis or Rack
BA-2C	Mic. Preamp. or Turntable Preamplifier	50	-25	-2	30/250	250/600	Chassis or Rack
BA-3C	Program Amp. Line Amp. Isolation Amp. Monitor. Amp.	Matching 65 Bridging 27	Matching +11 Bridging +40	+33 2 Watts	600/250	600/250/150/15 7.5 and 5	Chassis or Rack
BA-4C	Monitoring or Recording Amplifier	105 70 with rem. v.c.	-25	+40.8 12 Watts	30/250 (10,000 ohms amp. input rem. v.c.)	600/250/15 7.5 and 5	Chassis or Rack
BA-5A	Recording Amplifier	Matching 80 Bridging 47	-15	+48 50 Watts	150/600	7.5/15/150	Chassis or Rack
MI-12236	Monitoring Amplifier	85	-25	+10	100,000 40,000 250	15	Chassis
86-A1	Limiting Amplifier	60	At verge of Limiting +10	+30	600/250	600/250	Chassis or Rack
76-B4	Studio Console	110	-30	+26	30/50/250 300/600	600 Pgm. 15 Monitor	Console
76-C	Studio Console	112	-30	+26	30/50/150 250/300/600	600 Pgm. 15 Monitor	Console
BN-2A	Portable Remote Amplifier	92.5	-30	+20	30/150/250	150/600	Portable Carrying Case
OP-7	Portable Pre-amp. Mixer	8	-27	-24	30/250	30/250	Portable Carrying Case
OP-6	Portable Amplifier	90	-24	+19	30/250	600/150	Portable Carrying Case

\* Reference level one milliwatt.

## Two Stage Preamplifier and Isolation Amplifier Type BA-1A

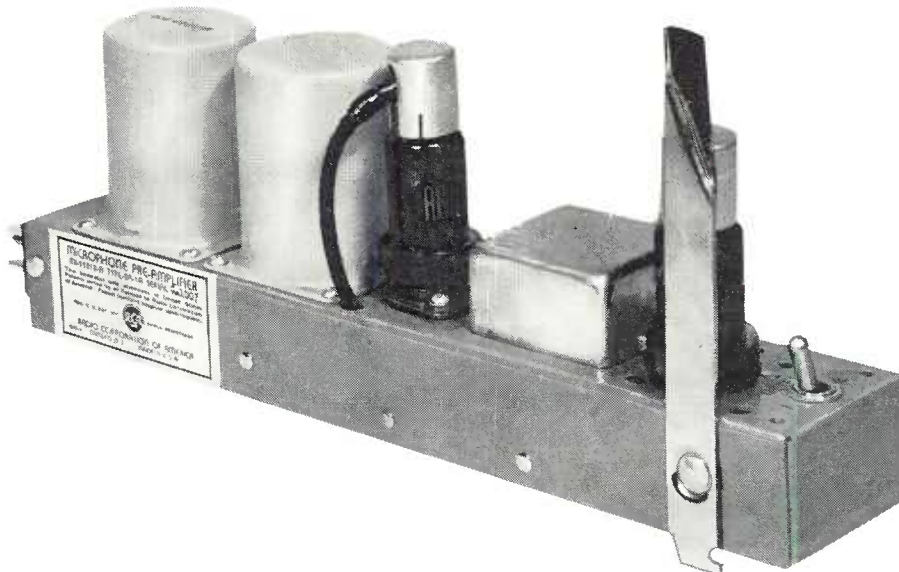

### Features

- Excellent frequency response  $\pm 1$  db 30 to 15,000 cycles.
- Two stages. Ample gain for any preamplifier application.
- May be used as an isolation amplifier providing 80 db isolation.
- Low distortion and hum level.
- Compact. Six units may be mounted in a single BR-2A Panel and Shelf Assembly.
- Hermetically sealed output transformer.

### Uses

The BA-1A is a compact, two stage high fidelity preamplifier. Its high gain (40 db), extremely low noise level and low distortion makes it an ideal unit for use as a microphone preamplifier, turntable preamplifier or booster amplifier. It may also be used as a low level isolation amplifier operating from a zero to +30 vu feeder bus by the simple addition of an MI-11274-B bridging volume control. The BA-1A has a plug-in type chassis using multi-conductor plugs. The small size of the BA-1A gives it a great deal of mounting flexibility. It may be placed directly in a control console, control desk or transcription turntable cabinet. Where cabinet rack mounting is desired, one to six of these units may be installed in a single BR-2A Panel and Shelf Assembly.

### Description

The BA-1A has been designed to obtain the maximum gain from two pentode-connected RCA 1620 low noise tubes. The tubes are mounted vertically and the first stage is shock mounted to prevent microphonics. The circuit is conventional with unloaded transformer input, resistance-capacitance coupling between stages and transformer output. The distortion and hum level has been reduced to a very low value through proper circuit design and through the use of stabilized feedback. Cross talk between units is  $-75$  dbm, 50 to 15,000 cycles when mounted side by side and operated from the BX-1C Power Supply.

As supplied the BA-1A has an essentially flat frequency response from 30 to 15,000 cycles. However, if desired to help compensate for deficient frequency response of other components of the system, or long input and output connections, a change can be made in one or both of two capacitors to provide either a 1 db boost at 30 cycles, a 1 db boost at 15,000 cycles or a 1 db boost at both 30 and 15,000 cycles. With the addition of the MI-11274-A or MI-11274-B volume control kit to provide a 10,000 ohm input, the BA-1A may also be used as an isolation amplifier. The MI-11274-B kit can be mounted on the BA-1A chassis. The MI-11274-A is intended for panel mounting remote from the amplifier. As an isolation amplifier, the BA-1A has a maximum of 7 db of gain with the volume control at minimum loss position. Approximately 80 db of isolation between output and input is obtained with the amplifier operating as an isolation amplifier. A switch is provided for metering a portion of the cathode voltage of each tube when connected to a high resistance voltmeter such as the Type BI-1A. The switch is "off" in the center position. The unit is designed to operate from the BX-1C Power Supply or its equivalent. The power requirements are 6.3 volts a-c or d-c at 0.6 amperes and 250 volts d-c at 3.4 ma.

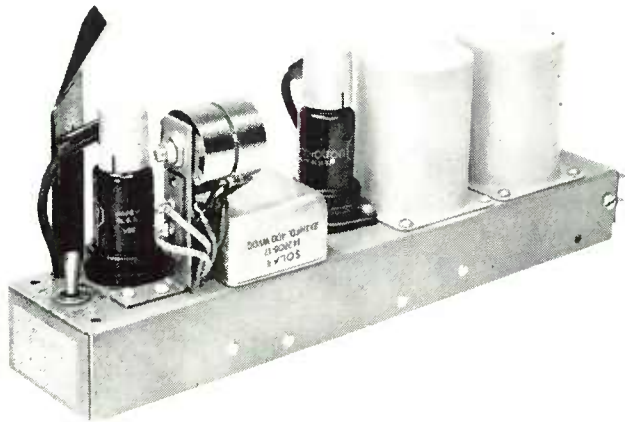

Side view of BA-1A used as an isolation amplifier showing MI-11274-B bridging input control mounted in place

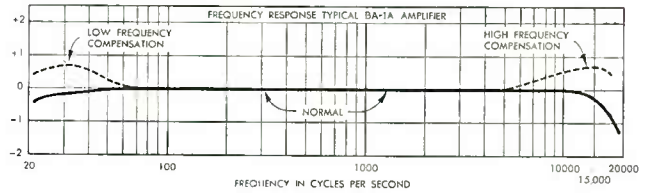

Noise Level  
 (+10 db\*, output full gain) below full output \_\_\_\_\_ -90 db  
 Equivalent Input Noise \_\_\_\_\_ -120 db  
 Plate Power Supply \_\_\_\_\_ 250 volts d-c at 3.4 ma  
 Filament Supply \_\_\_\_\_ 6.3 volts a-c or d-c at 0.6 amps  
 Dimensions, overall \_\_\_\_\_ Length 11 3/4", width 2 1/8", height 4 3/8"  
 Finish \_\_\_\_\_ Umber gray  
 Weight (unpacked) \_\_\_\_\_ 4 1/2 lbs.  
 Stock Identification (less tubes) \_\_\_\_\_ MI-11218-A

**Specifications**

BA-1A as Preamplifier:  
 Source Impedance \_\_\_\_\_ 30/250 ohms  
 Input Impedance (unloaded input transformer) \_\_\_\_\_  
 Substantially above source impedance  
 Load Impedance (balanced) \_\_\_\_\_ 250/600 ohms  
 Maximum Input Level (less than 0.5 rms dist. 50-7500 cps) \_\_\_\_\_  
 -30 dbm  
 Maximum Output Level \_\_\_\_\_ +10 dbm  
 Maximum Gain (250 ohm source to 250 ohm load) \_\_\_\_\_ 40 db

BA-1A as Isolation Amplifier (with MI-11274 Volume Control):  
 Source Impedance (Input Impedance 10,000 ohms) \_\_\_\_\_  
 30 to 600 ohms  
 Load Impedance (balanced) \_\_\_\_\_ 250/600 ohms  
 Maximum Input Level, Volume Control at:  
 Maximum \_\_\_\_\_ 0 dbm  
 Minimum \_\_\_\_\_ +40 dbm  
 Maximum Output Level \_\_\_\_\_ +10 dbm  
 Maximum Gain \_\_\_\_\_ +7 db

BA-1A as either Preamplifier or Isolation Amplifier Frequency Response \_\_\_\_\_ ±1 db 30-15,000 cps

**Accessories**

Tube Kit #1 (complete tube complement)  
 Two RCA 1620 \_\_\_\_\_ MI-11288

Tube Kit #2 (emergency tube complement)  
 Two RCA 6J7 \_\_\_\_\_ MI-11288-A  
 NOTE: 6J7 may be used when maximum uniformity of characteristics and minimum of microphonics, hum and distortion are not required.

Volume Control Kit (Chassis Mounting) \_\_\_\_\_ MI-11274-B  
 Volume Control Kit (Remote Panel Mounting) \_\_\_\_\_ MI-11274-A  
 Filament Transformer \_\_\_\_\_ MI-11606  
 BX-1C Preamplifier Power Supply (furnishes filament and plate power for 1 to 6 BA-1A Preamplifiers) \_\_\_\_\_ MI-11305-B  
 Type BI-1A Meter Panel (Black MI-4388B-U/G \_\_\_\_\_ MI-4388-C  
 BR-2A Panel and Shelf Assembly  
 (required when cabinet rack mounting is desired)  
 Umber Gray \_\_\_\_\_ MI-11598/11599  
 Black \_\_\_\_\_ MI-11598-A/11599-A

**Remote Volume Control MI-11274-A, MI-11274-B**

**Description**

The MI-11274-A and MI-11274-B Volume Controls are designed to provide a high resistance bridging input circuit for connections between any low impedance source and the 250 ohm input terminals of an amplifier. The use of one of these units makes it possible to pick up program material conveniently from a program buss or any low impedance terminated line without disturbing the operation characteristics of the buss or the line. Any line of +40 dbm or below may be bridged. The MI-11274-B Volume Control is designed to be mounted on the chassis of an amplifier (i.e., BA-1A pre-amplifier). The MI-11274-A Volume Control is designed for rear panel mounting with the shaft extending through the panel.



MI-11274-B

**Specifications**

Input Impedance \_\_\_\_\_ 10,000 ohms (approx.)  
 Output Impedance \_\_\_\_\_ 250 ohms  
 Insertion Loss (bridging a 600 ohm line and operating into a 250 ohm amplifier input) \_\_\_\_\_ 32 db  
 Control at maximum position  
 Maximum Input Level \_\_\_\_\_ +40 dbm  
 Overall Dimension (including shaft):  
 Height \_\_\_\_\_ 2 5/8"  
 Width \_\_\_\_\_ 1 1/2"  
 Depth \_\_\_\_\_ 1 1/2"  
 Weight \_\_\_\_\_ 4 1/2 ozs.

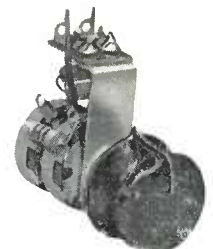

MI-11274-A

# Booster Amplifier Type BA-2C



BA-2C Amplifier—Front View

### Features

- High gain — Two stages — Self contained power supply.
- Excellent frequency response — Low distortion.
- Low noise level. Specially shielded transformers.
- Plug-in chassis—Simplified servicing.
- Compact—two BA-2C's may be mounted on one BR-2A Shelf.
- May be mounted inside turntable cabinet.
- Provision for tube plate current check.
- Economically priced.

### Uses

The RCA BA-2C Amplifier is a high fidelity two stage unit for use as a microphone preamplifier, a booster amplifier for transcription turntables or as an isolation amplifier when used with suitable bridging resistors. It is also useful at transmitter installations where a high gain amplifier is required between the announce microphone and the limiting amplifier. When used as a transcription pickup amplifier, the BA-2C may be mounted inside the turntable cabinet. For rack mounting, two BA-2C Amplifiers may be mounted on one BR-2A Panel and Shelf Assembly.

### Description

The BA-2C circuit is conventional and utilizes two RCA 1620 tubes operated as triodes. The first stage tube is shock mounted to reduce microphonic noises. An interstage gain control, which is a continuously variable potentiometer with a logarithmic taper, is provided for adjusting the output level. The amplifier is designed to work into a balanced load of 600/250 ohms.

The amplifier is complete with built in a-c power supply which eliminates the need for external rectifiers. The hum and noise level has been kept to a very low value through the use of

specially shielded power and audio transformers. Connections are provided from each cathode circuit to terminals on the male plug at the rear of the chassis. Corresponding terminals on the receptacle permit metering of tube condition when connected to a high resistance voltmeter such as the Type BI-1A. Input, output and a-c connections are also brought out to the male plug. The unit is equipped with a power switch and fuse and is provided with a base cover plate for shielding when used in turntable installations. A mating receptacle is supplied for the male chassis plug.

### Specifications

Source Impedance	30 / 250 ohms
Load Impedance (tapped transformer)	250 / 600 ohms
Input Impedance	Substantially above source impedance
Distortion (at normal output level of -15 dbm measured at any frequency between 40 and 15,000 cycles)	less than 0.75% rms
Maximum Input Level (less than 1% distortion cycles)	40-15,000 -25 dbm
Maximum Output Level (less than 1% distortion cycles)	40-15,000 -2 dbm
Frequency Response (see curve)	±1.5 db 30 to 15,000 cycles
Gain (250 or 30 ohm source to 600 or 250 ohm load)	50 db
Noise Level (below -2 db* output, maximum gain)	-70 db
A-c Power Input 105/125 volts, 50/60 cycles	13 watts
Dimension	Overall Chassis
Height	6 1/2" 2 1/2"
Width	8" 8"
Length	14" 11 3/4"
Weight (unpacked)	11 lbs.
Finish	Umber gray
Stock Identification (less tubes)	MI-11226-B

### Accessories

- Tube Kit (complete tube complement)  
2 RCA 1620, 1 RCA 6X5GT/G MI-11287
- Emergency Tube Kit (complete tube complement)  
2 RCA 6J7, 1 RCA 6X5GT/G MI-11287-A
- Note: 6J7's may be used when maximum uniformity of characteristics and minimum of microphonics, hum and distortion are not required.
- BR-2A Shelf and Panel MI-11598 / 11599

\* Reference level one milliwatt.

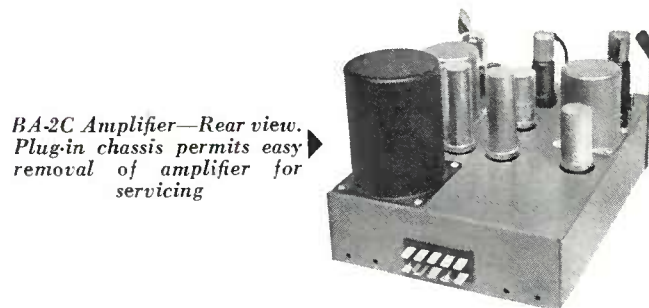

BA-2C Amplifier—Rear view. Plug-in chassis permits easy removal of amplifier for servicing

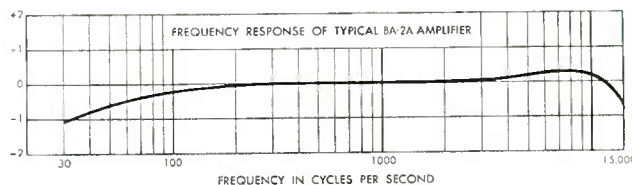

Frequency Response of a Typical BA-2C Amplifier

# Program Amplifier Type BA-3C

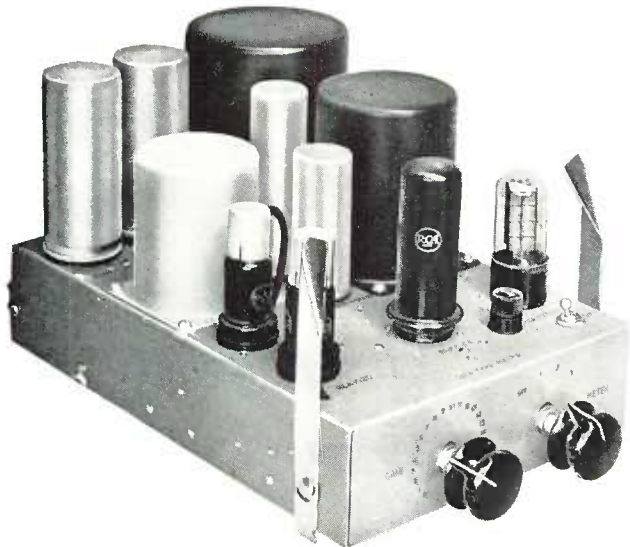

## Features

- Excellent frequency response—for FM and television.
- High gain—low distortion—low noise level.
- Provision for cathode metering.
- May be mounted in cabinet or panel and shelf.
- Economical in price.

## Uses

The BA-3C is one of the most versatile high fidelity broadcast amplifiers available. Its high gain and low distortion makes it ideal for use as:

1. Program or Line Amplifier.
2. Bridging Amplifier.
3. Isolation Amplifier.
4. Cueing Amplifier or Monitoring Amplifier with approximately 2 watts output.

The BA-3C is a plug-in type amplifier which has been designed for use with the BR-2A Panel and Shelf. This shelf permits quick and easy removal for servicing or interchanging units. An adaptor kit, furnished with each unit, permits mounting the amplifier in the Type 36-B Panel and Shelf. The Type BR-2A or the Type 36-B Shelf assemblies provide mounting space for the two Type BA-3C Amplifiers.

## Description

The BA-3C is a three stage amplifier employing one RCA 1620 pentode first stage, one RCA 1620 pentode second stage and one RCA 1622 beam power output tube. Excellent frequency response, high gain and low distortion have been provided in the design of this amplifier by use of resistance-capacitance interstage coupling and stabilized feedback. The noise level has been kept extremely low by the use of a dual volume control which simultaneously controls the gain of the first and second stages. When a step type control is required an MI-11224-F amplifier should be ordered.

A special design feature of the BA-3C permits a boost of the low, the high or the low and high frequencies as shown in the accompanying frequency response curve. This feature aids in obtaining an overall system flat response since compensation may be added to overcome high frequency losses in the interconnecting lines or inadequate low frequency response of associated equipment. High frequency compensation is easily made

by changing one resistor and one capacitor. Low frequency compensation is effected by changing two resistors and adding two capacitors.

All external connections to the BA-3C are made through the ten-prong male plugs which engage with two mating sockets supplied with the amplifier. Connections are provided from each cathode circuit through a selector switch to terminals on the plug in the back of the amplifier. These connections permit metering of tube conditions by means of a high resistance voltmeter such as the RCA Type BI-1A and Type BI-2A.

The amplifier is complete with built-in a-c power supply. The rectifier used is 1 RCA-5Y3GT/G.

## Specifications

Source Impedance \_\_\_\_\_ 250/600 ohms  
 Input Impedance (balanced—center tap grounded)  
 a. Matching (50-15,000 cps) \_\_\_\_\_ 250/600 ohms  
 b. Bridging (50-15,000 cps) \_\_\_\_\_ 20,000 ohms (approx.)

### Maximum Input Level

- (a) Bridging (less than 1.0% rms distortion 30 to 15,000 cycles) \_\_\_\_\_ +40 dbm\*  
 (b) Matching (with less than 1.0% rms distortion 30 to 15,000 cycles) \_\_\_\_\_ +11 dbm

### Load Impedance (tapped transformer)

5/7.5/18/150/600 ohms

### Output Level

- Less than 0.5% rms distortion 30-15,000 cycles \_\_\_\_\_ +25 dbm  
 Less than 1% rms distortion 30-15,000 cycles \_\_\_\_\_ +30 dbm  
 Less than 1% rms distortion 50-15,000 cycles (2 watts) \_\_\_\_\_ +33 dbm

### Gain Maximum

- (a) Matching Input (600 ohm line to 600 ohm load) \_\_\_\_\_ 65 db  
 (b) Bridging Input (600 ohm terminated line to 600 ohm load) \_\_\_\_\_ 27 db

Frequency Response (30 to 15,000 cps) \_\_\_\_\_ ±1 db

Noise Level (for +30 dbm output, max. gain) \_\_\_\_\_ -82 db

A-c Power Input, 100 to 130 volts, 50/60 cycles \_\_\_\_\_ 55 watts

Dimensions, overall \_\_\_\_\_ Length, 13 3/4"; width 8"; height 7 1/8"

Finish \_\_\_\_\_ Light amber gray

Weight (unpacked) \_\_\_\_\_ 17 1/2 lbs.

Stock Identification (with carbon volume control) \_\_\_\_\_ MI-11224-E

(with step-by-step control) \_\_\_\_\_ MI-11224-F

## Accessories

- Tube Kit (complete tube complement)  
 2 RCA-1620, 1 RCA-1622, 1 RCA-5Y3GT/G \_\_\_\_\_ MI-11266  
 Alternate Tube Kit  
 2 RCA-6J7, 1 RCA-6L6/G, 1 RCA-5Y3GT/G \_\_\_\_\_ MI-11266-A  
 BR-2A Panel and Shelf Assembly  
 (Black MI-11598A/11599A) U/G \_\_\_\_\_ MI-11598/11599  
 Type BI-1A Meter Panel (Black MI-4388-B) U/G \_\_\_\_\_ MI-4388-C

\* dbm = db referred to one milliwatt when single frequency tone modulation is used.

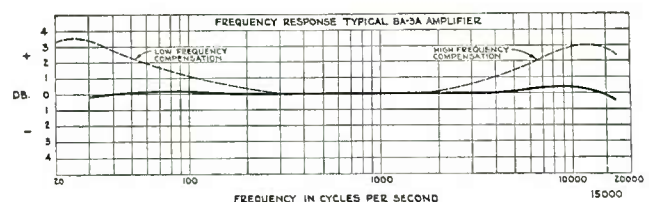

Frequency response of a typical BA-3C amplifier



# Monitoring Amplifier Type BA-4C

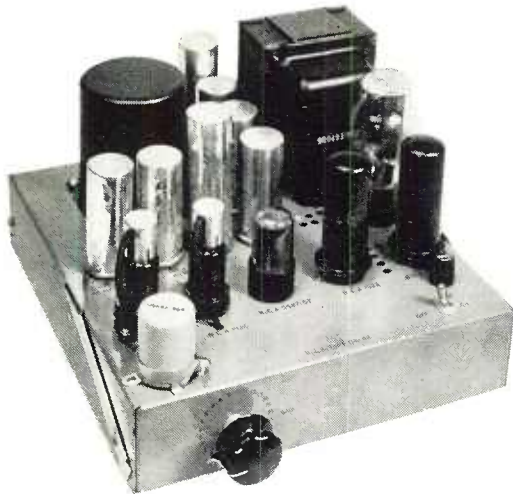

## Features

- Excellent frequency response to 15,000 cycles.
- 12 watts output with low distortion—uses feedback.
- Suitable for emergency use as program amplifier.
- Ideal for recording and playback applications.
- Sufficient gain for direct operation of a speaker from turntable output.
- High gain—Used directly in talk back circuits, without preamplifier.
- Heavy-duty components. Will operate continuous duty with ambients up to 120°F.
- Suitable for cabinet or panel mounting.
- Compensator Kit supplied for boosting response at 60 and 15,000 cycles.
- Economical in price.

## Uses

The BA-4C is a high fidelity, high gain flexible 12 watt amplifier suitable for monitoring, audition, recording, and talk back applications or it may be used in emergencies as a program or line amplifier. It is ideal for transcription playback booths since its 105 db gain is sufficient to operate an LC-1A or 64-B Speaker directly from the output of a 70-C2 or 70-D Turntable. The high gain feature also allows its use directly in studio talk back circuits without an intervening preamplifier. The BA-4C is an excellent recording amplifier being suitable for both high quality recording and playback applications. It may be mounted in a type BR-2A or 36-B Panel and Shelf Assembly. The BA-4C has a plug-in type chassis using multi-conductor plugs.

## Description

Employing metal tubes in the audio circuits, this amplifier has four stages consisting of: (1) RCA-1620 single stage, (2) RCA-1620 single stage, (3) single stage with RCA-6SN7-GT phase inverter, and (4) 2 RCA-1622's in push-pull. Feedback is used around the phase inverter and output tubes to reduce noise and distortion. Gain adjustment is provided through the use of an interstage control in the grid circuit of the second RCA-1620 tube and through an additional remote volume control. The remote volume control is a potentiometer and resistance network which is used when the BA-4C input is to be bridged across a 600/250 ohm line. This control provides for a bridg-

ing input impedance of 10,000 ohms and may be placed on the side of a speaker cabinet, on a console panel, or at any other point within two or three hundred feet of the amplifier. Where the normal flat frequency response is not desired by the customer, a boost of the low and high frequencies may be made by connecting additional resistors and capacitors which are supplied with the amplifier. A +5.0 db boost at 60 cycles is accomplished by adding a resistance capacity network into the plate circuit of the second stage. A +6.0 db boost at 15,000 cycles is accomplished by adding a resistance capacity network into the cathode circuit of the third stage.

The amplifier is complete with a heavy-duty built-in power supply. The hum level has been kept to a low value through the use of a multiple-case shielded input transformer. The amplifier is designed to supply a nominal low-distortion output of 12 watts.

## Specifications

Source Impedance (unloaded transformer input) 250/30 ohms  
 Bridging Impedance (when used with remote volume control) 10,000 ohms  
 Load Impedance 600/250/15/7.5/5 ohms  
 Audio Power Output (rated output with less than 3% total rms distortion 50-7500 cycles) 12 watts  
 +40.8 dbm\*

### Maximum Input Level

- (a) Matching (less than 1% rms distortion) -27 dbm
- (b) Bridging (less than 1% rms distortion) +40 dbm

### Maximum Gain

- (a) Overall from 250 ohm source to a 15 ohm load 105 ±2 db
- (b) With bridging volume control 600 ohm terminated line to 15 ohm or 600 ohm load 73 db

Frequency Response (see curve) 250 ohm source to 15 ohm load ±2 db, 30-15,000 cycles  
 Noise Level (for +40.8 dbm output, max. gain) -60.8 db  
 A-c Power Input (105-125 volts, 50-60 cycles) 105 watts

### Dimensions, overall

Width 10 3/4"  
 Depth 11 3/4"  
 Height 7 1/2"

Finish Light umber gray

Weight (unpacked) 21 1/4 lbs.

Stock Identification MI-11223-B

## Accessories

### Stock Identification

BR-2A Panel and Shelf, U/G MI-11598/MI-11599  
 Black MI-11598A/11599A  
 Tube Kit (complete tube complement) 2 RCA-1620,  
 1 RCA-6SN7-GT, 2 RCA-1622, 1 RCA-5U4G MI-11267  
 Alternate Tube Kit (complete tube complement) 2 RCA-6J7,  
 1 RCA-6SN7-GT, 2 RCA-6L6/G, 1 RCA-5U4G MI-11267-A

Note: 6J7's may be substituted for RCA-1620's and 6L6's for RCA-1622's when maximum uniformity of characteristics and minimum of microphonics, hum and distortion are not required.

\* Reference level one milliwatt.

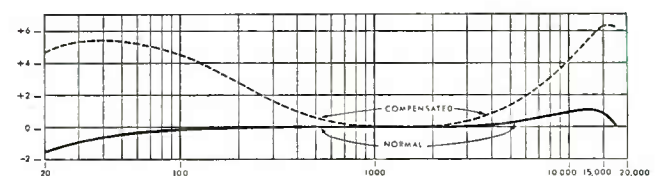

Frequency in Cycles per Second

# Recording Amplifier Type BA-5A

## Features

- Output of 50 watts with 1.5% distortion 50 to 15,000 cycles.
- Adequate power to drive two recorder heads.
- Response  $\pm 1$  db 30 to 15,000 cycles (without equalization).
- Provides switchable equalization for four recording characteristics.
- Plug-in capacitors—reduction in servicing time.
- Completely self-contained with power supply.
- Bridging facilities for all monitoring applications.

## Uses

The BA-5A 50 Watt Recording Amplifier is another development by RCA in high fidelity amplifier design. This amplifier has been primarily designed as a high quality, high power unit, with a variable equalizer incorporated in the circuit to provide compensation for the various Standard recording characteristics. The BA-5A with its large power handling capacity provides adequate power to drive two recorders with negligible distortion. A four-position rotary switch introduces the necessary equalization to produce recording characteristics as illustrated. In addition to recording facilities, this amplifier may also be used for any application where high power is required. Sufficient power to drive eight to twelve house monitoring speakers or several RCA LC-1A speakers is available. A bridging resistor network and an unloaded input transformer allows the BA-5A to bridge any high impedance line or any normal 0 to +8 VU bus monitoring purpose.

This unit is constructed as a self-contained amplifier complete with power supply for mounting in the BR-81 series cabinet, 9-AX or any 19" standard rack.

## Description

The BA-5A is a four-stage, all push-pull amplifier, using the highest grade input and output transformers. The circuit is a new four-stage design, employing resistance-capacitance inter-stage coupling with a stabilized feedback circuit over two stages. The first stage consists of (2) RCA 1620's triode connected in push-pull, with the interstage containing a variable compensating network for the response curves (see curves). The second stage with (2) RCA 1620's pentode connected work into (1) RCA 6SN7GT, operating as a dual triode. The last stage utilizes (4) RCA 807's connected in push-pull parallel to deliver 50 watts of power. Feedback is taken from the primary of the output transformer to the cathode of the second stage, maintaining an excellent frequency response with a negligible distortion. A four-position rotary switch introduces various equalization curves. Position (1)—a desirable flat curve with a response of  $\pm 1$  db, 30 to 15,000 cps., (2)—conforming to NAB Standards (Orthacoustic), (3)—75 microsecond tip-up, and Position (4)—a 50 microsecond tip-up.

Plug-in capacitors are used to simplify servicing and to reduce the time loss involved in capacitor failures. A small pilot lamp located in the center of the control panel gives a visual indication that the amplifier is in operation. Metering facilities are provided by a twelve-position rotary switch located on the front panel. This allows all tubes to be metered in the cathode circuit for a normal reading of 1 volt from an external volt-

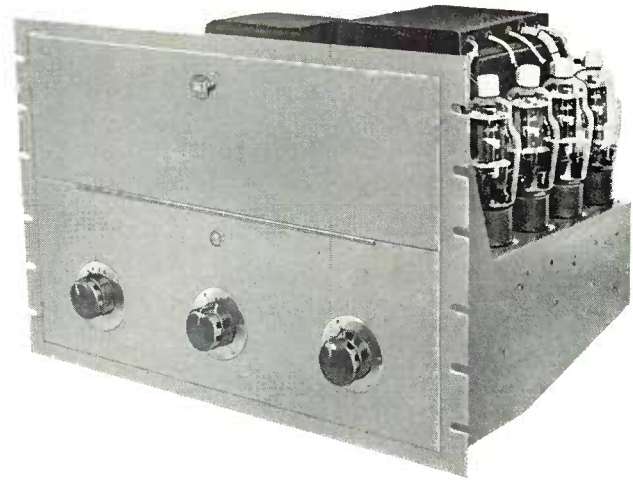

meter, such as the BI-1A or BI-2A. The hinged front panel permits ready accessibility for tube and capacitor replacement. The BA-5A is complete with a heavy-duty power supply employing (2) RCA 5R4GY tubes connected in parallel with the power switchable from the inside of the panel. All audio and power connections are terminated at the rear of the chassis.

## Specifications

Source Impedance (unloaded transformer input)	150/600 ohms
Bridging Impedance	(Approx.) 20,000 ohms
Load Impedance	7.5/15/150 ohms
Audio Power Output (rated output with less than 1.75% distortion)	50-15,000 cycles, 50 watts (+48 dbm)
Maximum Gain (overall from 150 or 600 ohm source to 150 or 15 ohms level)	Matching 80 db
Bridging (to 15/150 ohm load)	47 db
Frequency Response (see curves):	
1.	$\pm 1$ db, 30 to 15,000 cycles
2.	+6 db at 30 cycles, +16 db at 15,000 cycles for Standard NAB Orthacoustic response
3.	+6 db at 30 cycles, +15 db at 15,000 cycles
4.	+6 db at 30 cycles, +13 db at 15,000 cycles
Noise Level (for +48 dbm output max. gain)	-80 db
A-c Power Input	105-125 volts, 50-60 cycles, 225 watts
Dimensions (overall):	
Height	12 1/4"
Width (for rack mounting)	19"
Depth Behind Panel (overall)	13 1/8"
Weight (unpacked)	42 lbs.
Finish	Lightumber gray
Stock Identification (less tubes)	MI-11227

## Accessories

Tube Kit for BA-5A MI-11290  
 4 RCA-1620, 1 RCA-6SN7-GT, 4 RCA-807

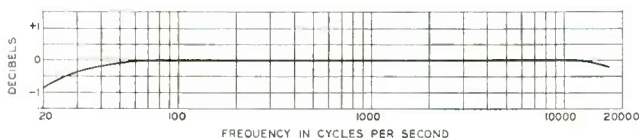

FREQUENCY RESPONSE OF A TYPICAL BA-5A AMPLIFIER WITHOUT COMPENSATION

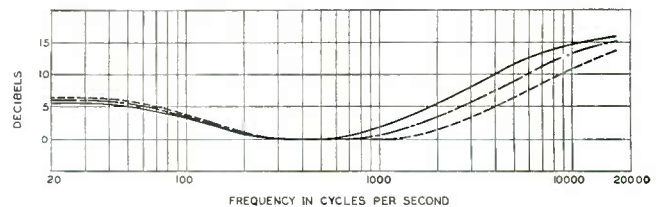

FREQUENCY RESPONSE CURVES OF A TYPICAL BA-5A AMPLIFIER WITH COMPENSATION

## Limiting Amplifier Type 86-A1

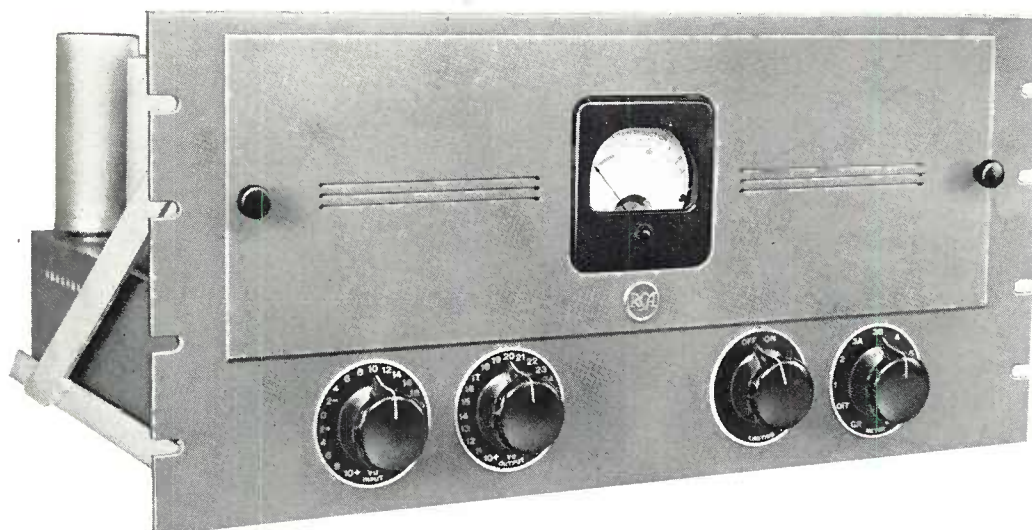

86-A1 Mounted on 36-B Shelf

### Features

- Excellent frequency response—suitable for FM.
- High compression with low distortion.
- Low noise level.
- Prevents distortion and adjacent channel interference caused by overmodulation of transmitters.
- Provides for a more effective use of transmitter power by raising the average modulation percentage.
- Meter with rotary selector switch shows gain reduction, checks plate current of all tubes, and checks overall voltage supply.
- Economical in price.

### Uses

The 86-A1 Limiting Amplifier has been designed for use in the speech input channels of FM and AM broadcast transmitters. It serves to limit the audio signal peaks to a certain pre-determined level thereby preventing over modulation with its consequent distortion and adjacent channel interference. This amplifier also provides for a more effective use of transmitter power by raising the average percentage modulation level several db without appreciably increasing the harmonic distortion. The limiting characteristics of the 86-A1 also readily adapt it for use in recording applications. For this use, it prevents overcutting of the recording disc on heavy passages of music or speech and permits a marked improvement in the signal to noise ratio.

### Description

The 86-A1 Limiting Amplifier uses push-pull vacuum tubes (RCA 6K7) in the variable-gain stage. The design is such that a uniform frequency response and a remarkably low distortion is maintained with large compression ratios as much as 18 db. Moreover, low distortion is maintained at all modulating frequencies in the normal audio band.

There are no audible "thumps" even though a large compression is suddenly applied. Compression timing constants have been chosen which have proved most desirable in actual broadcast service. The fast pick-up time of one millisecond restricts over-modulation surges which might cause transmitter outages. The return time is slow enough to prevent distorting low frequency tones, but fast enough to prevent noticeable level reduction after loud volume peaks.

The circuit of the 86-A1 is straight forward and push-pull stages are used throughout. The a-c power supply is self contained and utilizes one RCA 5T4 rectifier tube. New plug-in type electrolytic capacitors are used to simplify servicing the equipment. The hum and noise level is maintained to a low value through special transformer shielding. When used in conjunction with a two stage pre-amplifier, the 86-A1 has sufficient maximum gain (60 db) for making local announcements. The push-pull output stage and efficient circuit design provide a maximum power output of 1 watt (+30 VU) with less than 0.75% total rms distortion measured at 400 cycles with a compression of 18 db. The distortion is less than 1.8% rms when measured at any frequency between 50 and 7500 cycles.

All the components are mounted on a single metal chassis. A meter is provided for (1) indicating gain reduction directly in db, (2) dynamic match indicator for input tubes, (3) measurement of all tube plate currents, and (4) measurement of plate voltage. A switch on the front of the chassis selects the desired meter function.

Step-by-step input and output volume controls are provided. These controls are equipped with "vu" scales to indicate input and output levels at the verge of compression. Auxiliary adjustable controls are (1) hum balance, (2) zero adjustment of gain reduction meter scale, (3) vernier control for close adjustment of level at which limiting action takes place, and (4) switch (on front) which makes limiter function inoperative. A power switch and fuse are provided. For rack mounting the Type 36-B Shelf should be used. A special umber-grey 36-B door panel with meter cut-out is supplied with the 86-A1 Amplifier.

## Specifications

Input Source Impedance.....600 or 250 ohms

Output Load Impedance.....600 or 250 ohms

Frequency Response..... $\pm 2$ db 30-15,000 cycles  
(At any setting of gain controls—with or without compression)

### Input Level

Maximum (at limiting verge).....+10 dbm

Maximum (with 18 db gain reduction).....+30 dbm

Minimum (at limiting verge).....-30 dbm

### Output Level:

Less than 1.8% rms distortion with 18 db compression at any frequency between 50 and 7500 cycles.....+30 dbm

Less than 0.75% rms distortion at 400 cycles with 18 db gain reduction.....+30 dbm

Less than 0.4% rms distortion at 400 cycles with no gain reduction.....+10 dbm

Gain (with maximum volume control setting and signal below limiting level).....60 db

Noise Level: below +30 dbm output.....-85 db

below +10 dbm output.....-77 db

Output Range (at verge of limiting) — +10 dbm to +30 dbm

### Time Constants

Seconds for complete action of gain reduction.....0.001

Seconds for 90% recovery of gain after signal drops below limiting level (when connected as furnished).....2.0

Note: may be varied from .26 sec. to 5.2 sec. by changing one resistor.

Power Input (105-125 volts, 50-60 cycles).....70 watts

Dimensions.....Width 16", depth 13", height 7½"

Weight (mpacked).....30 lbs.

Stock Identification: Umber grey.....M1-11216-C

Black.....M1-11216-B

Complete with one set of tubes and special 36-B door panel but less 36-B shelf.

## Accessories

Tube Kit (complete tube complement).....M1-11286

2 RCA-6K7, 1 RCA-6N7, 2 RCA-1621, 1 RCA-6R7,

1 RCA-5T4

Tube Kit (set of two matched 6K7 tubes only).....M1-11250

Voltage Regulating Transformer.....60 cycles M1-11280

50 cycles M1-11280-A

(Not required unless line voltage variation exceeds 5%)

36-B Panel and Shelf Assembly: Umber gray.....M1-1682-B

Black.....M1-1682

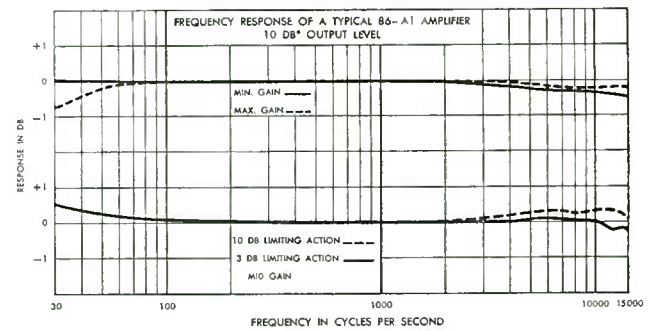
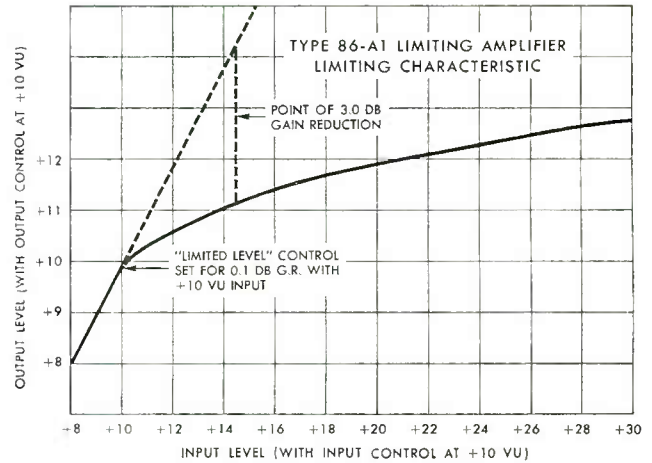

\* Reference level one milliwatt.

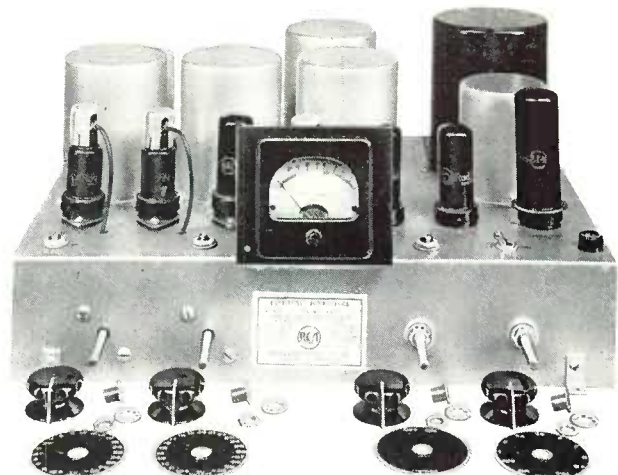
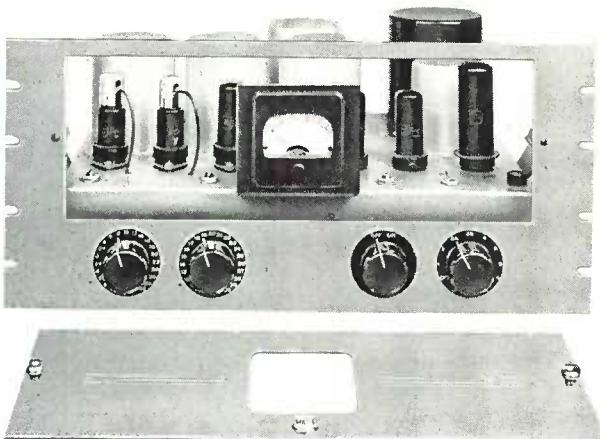

The 86-A1, as shipped, includes the Amplifier and small accessories as shown at right plus the special door panel shown in photograph at left

# 6 Watt Monitoring Amplifier MI-12236



**Features**

- Excellent frequency response.
- Provision for mixing microphone and turntable inputs.
- Microphone volume control, master control and tone control.
- Variable load impedance—4 to 30 ohms.
- Both high and low impedance input.

**Uses**

The MI-12236 amplifier is an ideal medium output unit, admirably suited for use as a cueing amplifier with transcription turntables. The unbalanced input enables it to be used for bridging an unbalanced line for monitoring applications, or listening circuits such as offices, laboratories, etc.



MI-12237 showing cover in place

**Description**

The amplifier is supplied with or without a cover and may be fitted within a 70-C or 70-D series turntable. The circuit employs two RCA 6J7's and one RCA 6L6 beam power tube in the output stage. The potentiometer is connected in the input with a master gain control in the second stage. 14 db of inverse feedback insures a flat response with a low distortion factor. The low impedance input allows a high impedance microphone or pick up to be used with excellent results.

**Specifications**

Frequency Response	_____	±3 db 40-10,000 cps
Inputs:		
(General Microphones)	_____	High Impedance Microphone
(Turntables)	_____	Low Impedance Turntable
(Crystal Pickups)	_____	High Impedance Pickup
Gain—High Impedance:		
100,000 ohm Source to 15 ohm load	_____	68 db
40,000 ohm Source to 15 ohm load	_____	68 db
Gain—Low Impedance:		
250 ohm Source to 15 ohm load	_____	85 db
Power Output (with 7½% distortion)	_____	6 watts
Output Impedance	_____	4, 7½ and 15 ohms
Dimensions:		
Length	_____	11½"
Width	_____	7"
Height	_____	7½"
Weight (unpacked)	_____	11½ lbs.
Power Supply	_____	115 volts, 50 to 60 cycles, 75 watts
Stock Identification:		
(Without Cover)	_____	MI-12236
(With Cover)	_____	MI-12237

# Remote Amplifier Type BN-2A

## Features

- High level mixing—15 to 20 db reduction in noise level.
- Portable, compact and completely self-contained for a-c operation.
- Excellent frequency response  $\pm 1$  db 30 to 15,000 cycles.
- Low distortion—less than 1% for complete range.
- Complete range facilities for feeding PA amplifier and program channel simultaneously.
- Suitable for battery operation with the MI-11214 battery box.

## Uses

The BN-2A is a light weight, three channel amplifier completely self-contained for a-c operation, requiring no additional equipment whatsoever. Battery operation may be used by simply removing the power connection and plugging in the cord of the MI-11214 battery box used with the OP-6 and OP-7 amplifiers. The three amplifier channels use RCA 1620 indirectly-heated tubes, shock mounted to insure low microphonics and maximum protection from vibration often experienced during remote broadcasts. Each channel offers an overall gain of 92.5 db, more than adequate for any application. High level mixing is used throughout, reducing microphonics and general noise level by at least 15 to 20 db. It has capacity for four microphone inputs, the third and fourth switchable to channel 3, making possible a total of six microphones. Program may be fed to the output channel and the PA amplifier simultaneously. Also, the cue circuit may be switched to isolate the remote amplifier and feed PA direct. Monitoring facilities in both circuits are provided.

## Description

The BN-2A consists of a three stage, resistance-capacitance coupled amplifier combined with three individual input channels for each mixing stage. Each input channel uses a high quality balanced transformer with electrostatic shielding, operating into a non-microphonic RCA 1620 tube. These tubes are connected with each mixer in parallel to feed the first stage of the main amplifier. This stage employs another RCA 1620 pentode connected with feedback from the master gain control, which is a high grade step-by-step potentiometer. The unique design of this arrangement produces maximum feedback with minimum gain, a feature which reduces any inadvertent overloading of the first stage by announcers "blasting" the microphone or by excessive background noise. The second and third stages each utilize a 6J7 pentode connected to the output transformer. Further feedback is taken from the plate of the last stage to the second stage cathode, resulting in an excellent frequency response with exceptionally low distortion. A three-position rotary switch selects either "Cue" when the PA amplifier is feeding the cueing circuit, "Off" with the PA and cueing circuit isolated from the program line, and the "Amp" position when the output channel is feeding the program line and the PA amplifier simultaneously.

The front panel is attractively styled and arranged to give centralized control of all circuits. The standard size VU meter is provided for measuring tube voltages in the cathode circuit and output level. A switch position for feeding +8 VU to line when the meter is reading 0 is also provided.

The steel case is ruggedly constructed with the front cover easily removed for quick operation. Accommodation for carrying spare tubes and fuses is provided within the case.

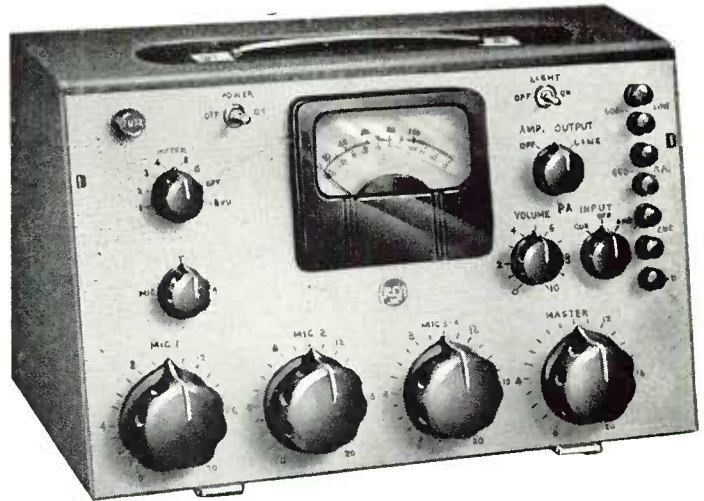

External connections located in the rear of the chassis include four, Camcon 3-connector microphone receptacles and the 12-connector plug for either a-c or battery operation. The power supply is built into the amplifier and employs one RCA 6X5GT full-wave rectifier tube.

## Specifications

Source Impedance	30/150/250 ohms
Load Impedance	150/600 ohms
Normal Output Level	+8 VU
Distortion (+18 db output 50 to 15,000 cycles)	Less than 1% rms
Maximum Output Level (less than 1% rms distortion)	+18 dbm
Maximum Gain (150 ohm source to 600 ohm load)	92.5 db
Frequency Response	$\pm 1$ db 30 to 15,000 cycles
Noise Level (for +18 dbm output max. gain)	-70 db
A-c Power Input	105-125 volts, 50/60 cycles, 25 watts
Battery Operation:	
"A" Supply	6.3 volts (nominal) 2.1 amps. (incl. VU lamp)
"B" Supply	270 volts (nominal) 10 MA
Dimensions:	
Length	19"
Depth (with cover)	9 1/2"
Height	10"
Weight	29 lbs. (complete with a-c cable and spare tubes)
Finish	Umber gray wrinkle
Stock Identification (less tubes)	MI-11230

## Accessories

Tube Kit (complete tube complement)	MI-11269
4 RCA-1620, 2 RCA-6J7, 1 RCA-6X5GT	
Receiver Type Tube Kit (complete tube complement)	MI-11269-A
6 RCA-6J7, 1 RCA-6X5GT	
Battery Box complete with cord connector	MI-11214
Kit of Batteries	MI-11255
Waterproof Cover for BN-2A	MI-11277

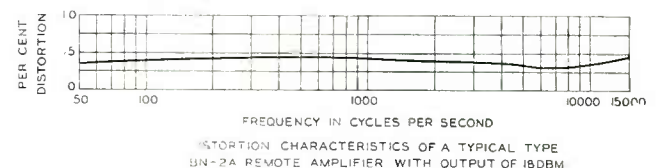
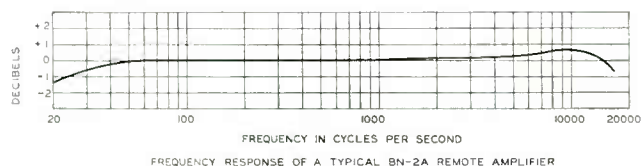

# Remote Pickup Amplifier Type OP-6

## Features

- Excellent frequency response.
- High maximum output level with low distortion.
- Low noise and hum level.
- High overall gain permits use with high quality microphones under adverse conditions.
- Small size and light weight.
- A-c power supply built in. No external supply required.
- Two input positions and transfer key.
- Tapped input transformer accommodates any type of microphone.
- Ruggedly built with high quality components.

## Description

The OP-6 is a three stage resistance coupled amplifier using RCA 1620 low noise, non microphonic tubes. The three stages afford a gain of 88 db which is more than ample for any required application. One RCA 6X5GT/G is used in the rectifier. Since only two tube types are used, the stocking of spares is simplified. The amplifier circuit is unique in that it utilizes two feedback loops. One loop is around the first stage and is varied with the main gain control thus maintaining a maximum feedback consistent with required gain. This arrangement prevents overloading the first tube by high output microphones. The gain control is located between the first and second stage and is a high quality step by step device equipped with a large knob. The second feedback loop is fixed and is connected around the second and third stages. Two inputs are provided and either may be selected by means of a turn key switch. One input is brought to shielded screw terminals and the other to a standard Cannon microphone receptacle. The output terminates on insulated binding posts which are located on the front panel for greater accessibility. The power input receptacle has a number of contacts which are used for altering the circuit for a-c or battery operation. An a-c power cord is furnished with the amplifier and the d-c battery cord is supplied with the MI-11214 Battery Box. Located on the front panel are the power switch, fuse and monitoring headset jack.

The complete amplifier and power supply is enclosed in a steel case which has removable cover, rubber feet, and steel reinforced handle. The handle lies flat when not in use. A leather shoulder strap facilitates transporting the unit and leaves the hands free to carry microphones, etc. The chassis and front panel may be easily slipped from the case by removing four thumb-screws. The unit is furnished less meter, thereby avoiding additional expense for those applications where a meter is unnecessary.

## Specifications

Source Impedance.....	30/250 ohms
Load Impedance.....	150/600 ohms
Normal Output Level.....	+8 dbm
Distortion (+8 db* output, 50-7500 cycles).....	Less than 0.5% rms
Maximum Output Level (less than 1% rms distortion between 50 and 7500 cycles).....	+18 db
Frequency Response.....	±2 db 30 to 15,000 cycles
	±1 db 40 to 10,000 cycles
Overall Gain.....	88 db
Noise Level (for +18 dbm output, 68 db gain).....	-70 db
Dimensions, overall	
Height.....	9 1/2"
Width.....	12 3/8"
Depth.....	7 1/4"
Finish.....	Grey wrinkle
Weight (unpacked but including 8' power cord).....	20 1/2 lbs.
A-c Power Input, 105-125 volts, 50 to 60 cycles.....	18 watts
Stock Identification (shipped less tubes).....	MI-11202-A

## Accessories

Tube Kit (complete tube complement)	
Three RCA 1620 and one RCA 6X5GT/G.....	MI-11253
Emergency Tube Kit (complete tube complement)	
Three RCA 6J7 and one RCA 6X5GT/G.....	MI-11253-A

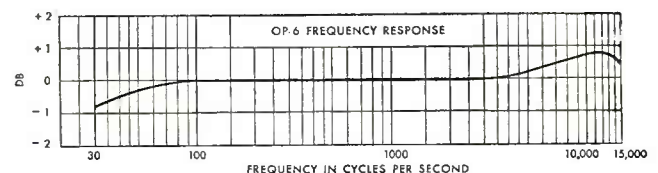
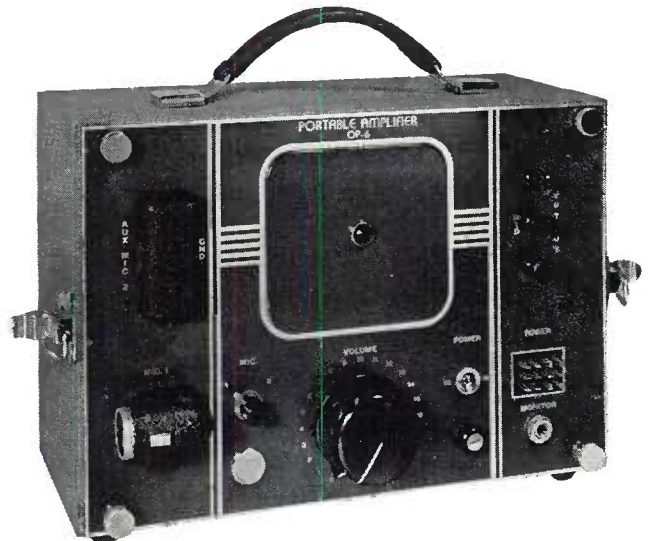

VU Meter and Attenuator Kit.....	MI-11251
Weatherproof Fabric Cover.....	MI-11256
Battery Box.....	MI-11214
Kit of Batteries.....	MI-11255
Cannon Microphone Plug.....	MI-4630-B
Mixer Amplifier, Type OP-7.....	MI-11213

# Mixer Preamplifier Type OP-7

## Features

- Excellent frequency response to 15,000 cycles.
- High level mixing reduces noise to a minimum.
- Provides unloaded transformer input and high level mixing for one to four microphones.
- Self contained a-c power supply or may be battery operated.
- May be used with any program amplifier having a gain of 80 db.

## Description

The OP-7 is a high fidelity, compact and lightweight portable unit. It provides unloaded transformer input and high level mixing for as many as four microphones. It may be used with the OP-6 Portable Amplifier or with any other program amplifier which has a gain of at least 80 db.

The front panel contains the power receptacle, "on-off" power switch, a-c fuse, four mixer knobs and shielded output terminals. A front panel cover held by two snap type clasps protects the equipment and provides space for carrying cables. Four Cannon Type "P" Microphone Receptacles are assembled on the rear of the amplifier chassis. A fifth receptacle, with male contacts, provides a cable output connection. This type of receptacle safeguards the battery from short-circuits that might occur using a male plug.

The OP-7 is equipped with long life carbon type mixing controls. In addition, the MI-11276 Modification Kit containing four Daven step-by-step attenuators with the necessary accessory equipment for modification, is available for modifying the MI-11213. The OP-7 is complete with built-in power supply or it may be operated from the MI-11214 Battery Box without circuit changes. A suitable OP-6 interconnection cable, equipped with Cannon Plugs, is furnished with the OP-7.

## Specifications

Source Impedance	30/250 ohms
Load Impedance	30/250 ohms
Normal Output Level	-55 dbm
Distortion (-55 dbm output, 50-7500 cycles)	less than 0.5% rms
Maximum Output Level (less than 1% rms distortion measured at any frequency between 50 and 7500 cycles)	-24 dbm
Gain (maximum, 250 ohm source to 250 ohm load)	8 db
Frequency Response	$\pm 2$ db 30 to 15,000 cycles $\pm 1$ db 40 to 10,000 cycles
Noise Level (-24 dbm output for 8 db gain)	-88 db
Dimensions	
Height	9 1/2"
Width	12 3/4"
Depth	9"
Finish	Gray wrinkle
Weight (unpacked but with cables)	23 lbs.
A-c Power Input, 105-125 volts, 50 to 60 cycles	20 watts
Stock Identification	MI-11213

## Accessories

Tube Kit (complete tube complement)	
4 RCA 1620, 1 RCA 6X5GT/G	MI-11254
Alternate Tube Kit (complete complement)	
4 RCA 6J7, 1 RCA 6X5GT/G	MI-11254-A
Weatherproof Fabric Cover	MI-11257
Battery Box	MI-11214
Kit of Batteries	MI-11255
Cannon Microphone Plugs	MI-4630-B
OP-6 Amplifier (shipped less tubes)	MI-11202-A

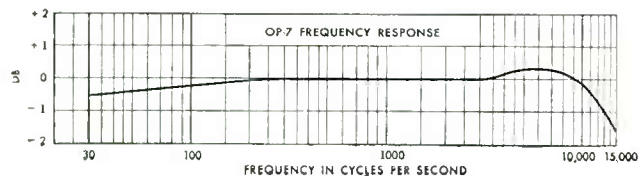

OP-7 with front panel cover removed. Covers of OP-7 and OP-6 provide space for carrying interconnecting cables.

MI-11257 Fabric Cover for OP-7. Similar covers, listed as accessories, are available for OP-6 and for the MI-11214 Battery Box.



OP-7 chassis, rear view. Four microphone receptacles and output receptacle are provided.

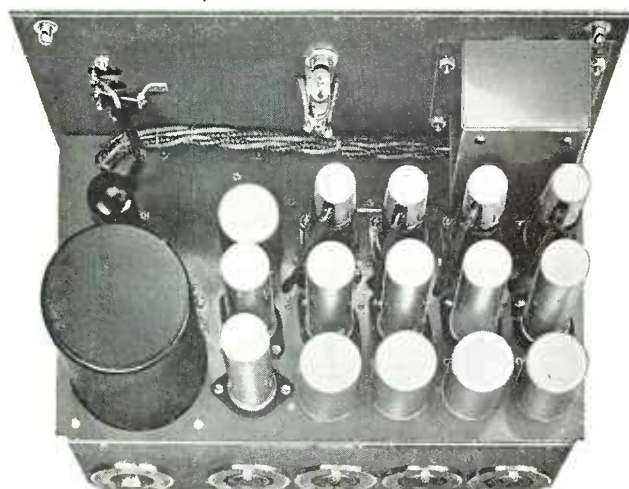



# Remote Pickup Equipment OP-6/OP-7

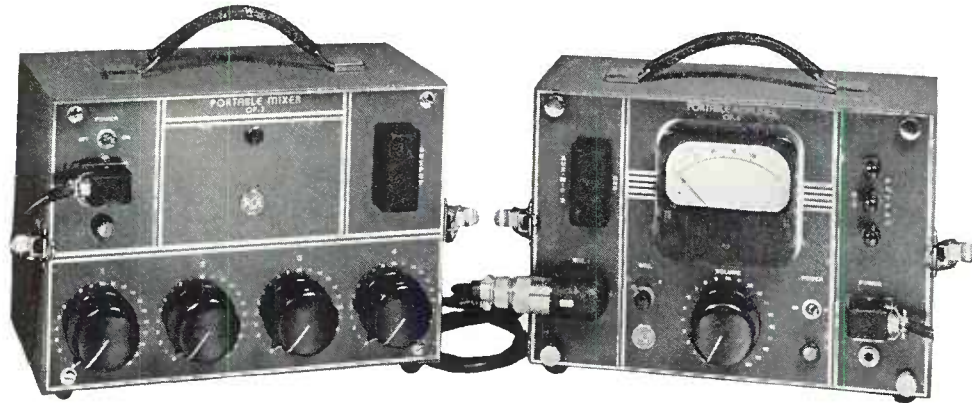

### Uses

The OP-6/OP-7 is a high quality, light weight portable pickup equipment providing four microphone inputs with high level mixing and separate preamplifiers, built in a-c power supply and full sized vu meter. Small sized cases furnished with shoulder straps provide a maximum of convenience in carrying these units. Battery operation may be used at any time by plugging in the cord of the MI-11214 Battery Box. No circuit changes are required. The mixer and amplifier units may be used side by side or the amplifier may be mounted on top of the mixer. An outstanding value at an economical price, the OP-6/OP-7 combination provides the broadcaster with a field pickup equipment having studio quality performance.

### Description

The OP-7 Mixer Preamplifier comprises four unloaded transformer input circuits each working into an RCA-1620 triode connected tube. Its source impedance is for 30 or 250 ohm microphones and the load impedance is 250 ohms. While primarily designed for use with the OP-6 Amplifier, the OP-7 may be operated with any amplifier having a 250 ohm source impedance and a gain of 80 db or more. A more complete de-

scription as well as features and specifications will be found on the OP-7 Mixer Preamplifier catalogue sheet.

The OP-6, companion unit to the OP-7, is a high quality, high gain, three stage resistance coupled amplifier using three RCA 1620 Pentode-Connected tubes. A more complete description as well as features and specifications will be found on the catalogue sheet for the OP-6 Amplifier.

Stock Identification OP-6 and OP-7 \_\_\_\_\_ MI-11202-A/11213

Complete as shown in photograph but less tubes, vu meter and microphone plug. Complete listing for accessories will be found under the catalogue listing for the individual OP-6/OP-7 units.

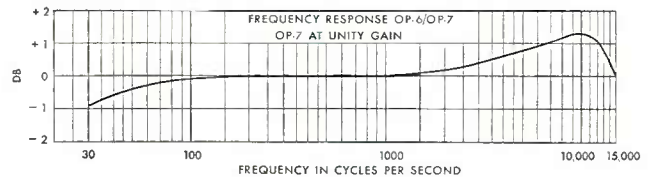

## Battery Box MI-11214

The MI-11214 Battery Box has been designed especially for use with the OP-6 and OP-7 Remote Amplifiers. It is equipped with two interconnection cords so that it may be used with both amplifiers simultaneously. The box is constructed of steel with durable gray wrinkle finish and is equipped with a large steel reinforced handle and rubber feet. The cables are stored in the cover when not in use.

Approximate Battery Life in hours for average amplifier operation of six hours per day.

RCA Type No.	Quantity	Burgess Type No.	OP-6		OP-7 and OP-7	
			3 RCA 1620	1 RCA 1620 2 RCA 6W7G	OP-6	OP-7
VS 004	(15)	4F "A"	34	50	26	7.5
VS 004	(10)	4F "A"	16	24	12	3.5
VS 012	(6)	B-30 "B"	270	270	240	95

### Specifications

Finish (matches OP-6/OP-7) \_\_\_\_\_ Grey wrinkle

Dimensions  
 Height \_\_\_\_\_ 12½"  
 Width \_\_\_\_\_ 13½"  
 Depth \_\_\_\_\_ 8¾"  
 Weight (unpacked) \_\_\_\_\_ 15½ lbs.  
 Weight (including batteries) \_\_\_\_\_ 44 lbs.

Stock Identification \_\_\_\_\_ MI-11214

### Accessories

Weather Proof Cover, MI-11258  
 RCA Battery Kit \_\_\_\_\_ MI-11255



# Radio-Microphone Type BTP-1A

## Features

- Light, compact and completely self contained.
- Excellent frequency response—low distortion.
- Crystal controlled transmitter for stability.
- Automatic gain control to prevent overload and distortion.
- Permits broadcasting from otherwise inaccessible places.

## Uses

The BTP-1A Radio-Microphone is a crystal controlled portable UHF transmitter and microphone. It is especially adapted to broadcasts by announcers mingling with crowds on the street, at conventions, large stores, golf matches or other locations, where wire connections are difficult or impractical.

The maximum satisfactory range of the BTP-1A is determined largely by the interference level at the receiver location. Under ideal conditions, several miles may be covered; however, building structures or other media which produce signal attenuation will limit the working range. Overall transmitted quality is comparable to the direct output of a good microphone.

## Description

The BTP-1A Radio-Microphone with its battery power pack is housed in an attractively styled aluminum case measuring 10 x 4½ x 3½ inches. Total weight of the unit with batteries is 6 pounds, 5 ounces. A 20 inch removable whip antenna projects from the top of the case during operation.

The transmitter portion of the Radio-Microphone is crystal controlled and is designed to operate at any specified frequency between 25 and 28 mc. Maximum power output from the r-f amplifier is approximately 0.25 watt. This carrier is amplitude modulated by a Class A audio stage to assure low distortion.

Automatic gain control is incorporated in the audio amplifier in order to insure proper modulation and prevent overloading over a wide range of sound intensity.

The microphone consists of three crystal units operated in series to give high output with excellent quality. Shock and wind noise from the microphone is very low.

Power for operating the transmitter is supplied by a battery pack which will give up to 10 hours service under normal operating conditions. A "high-low" battery switch is provided to insure uniform quality and power output throughout the life of the battery.

The BTP-1A is shipped complete with antenna, battery, crystal and one set of tubes.

## Specifications

Frequency Range \_\_\_\_\_ 25 to 28 mc.  
 Power Output \_\_\_\_\_ Approx. 0.25 watt  
 Carrier Frequency Stability \_\_\_\_\_ ±.02% deviation  
 Modulation Capability \_\_\_\_\_ 100%  
 Audio Frequency Response (including microphone)  
 \_\_\_\_\_ ±4 db 80 to 6000 cycles  
 Audio Distortion (90% modulation) \_\_\_\_\_ Less than 5%  
 Crystal Frequency (specify operating frequency  
 when ordering) \_\_\_\_\_ 1/3 transmitter output frequency

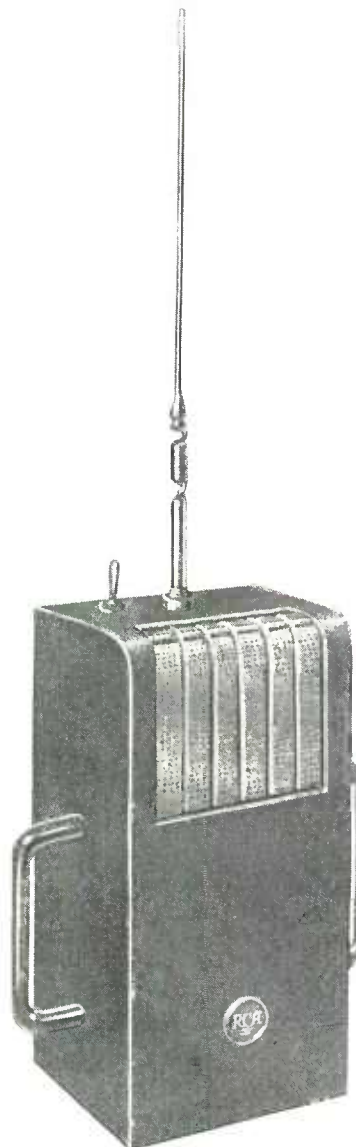

Battery life (approx.):  
 Continuous Service \_\_\_\_\_ 5 hours  
 Intermittent Service \_\_\_\_\_ 10 hours  
 Dimensions \_\_\_\_\_ Height 10"; Width 4½"; Depth 3½"  
 (Not including handles or antenna)

Tube Complement:  
 AF \_\_\_\_\_ 1 RCA-1L4 Voltage Amplifier  
 AF \_\_\_\_\_ 1 RCA-3A4 Modulator  
 RF \_\_\_\_\_ 1 RCA-3A5 Oscillator and Tripler  
 RF \_\_\_\_\_ 1 RCA-3A4 RF Amplifier  
 Weight (total) \_\_\_\_\_ 6 lbs. 5 oz.  
 Stock Identification \_\_\_\_\_ MI-28923

## Accessories

Spare Crystals Type RC-2A (specify operating  
 frequency desired) \_\_\_\_\_ MI-7681  
 Replacement Battery \_\_\_\_\_ MI-28291

# Standard Cabinet Racks BR-84 Series



BR-84A

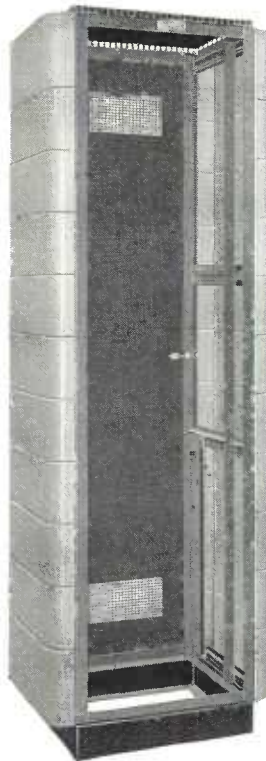

BR-84B

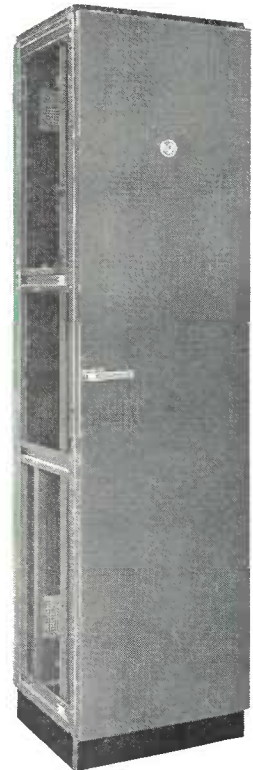

BR-84C

## Features

- Cabinets with same styling and height as RCA FM transmitters.
- Total panel space 77".
- Available in many combinations to suit all studio applications.
- Drilled and tapped for standard 19" panels.
- Attractively styled to blend with all control room installations.
- Suitable for fitting in a flush position to a side or rear wall.
- Accommodates the heaviest equipment encountered in studio use.
- Provides flexibility for future expansion.

## Uses

The BR-84 series cabinet rack program is another of the new feature lines of RCA. The cabinet program is presented after years of practical experience in finally developing a flexible scheme for accommodating broadcast equipment.

## Description

The five combinations of cabinets and accessories offer a versatile system for accommodating the user's immediate requirements with maximum accessibility for any future growth of the installation. Each rack may be mounted singly or, where desired, tandem together to facilitate the grouping of any number of cabinets. The cabinet is of sturdy metal construction, welded and bolted in one standard height and width. The ventilated top with slotted edges provides complete ventilation but protects the equipment from falling articles and dust. Vertical panel mounting angles have tapped holes at RMA standard locations to provide 77" of standard 19" panel mounting space. These angles may be installed to mount equipment within the cabinet, where doors are used, or flush with the front. When the latter method is desired, trim strips of neat design for panel mounting and clip fitting provide the finished appearance. The front and rear doors are of the universal type and may be hinged on the right or left side, to rotate in an arc of 180°. Electrical side shields are available in two sizes—21" for the center section, and 28" for the top and bottom sections. If found necessary after assembly, they may be fitted between racks of equipment. Terminal board mounting angles facilitate the mounting of power and audio blocks in a vertical or horizontal position. Additional terminal board mounting angles (MI-30527-G29) are available as accessories.

Units placed adjacently may be rigidly bolted together to produce a secure assembly. Locks may be fitted later by virtue of the "knock outs" provided. The cabinets are finished in a two-tone umber gray, with dimensional characteristics artistically blending with all RCA FM transmitters.

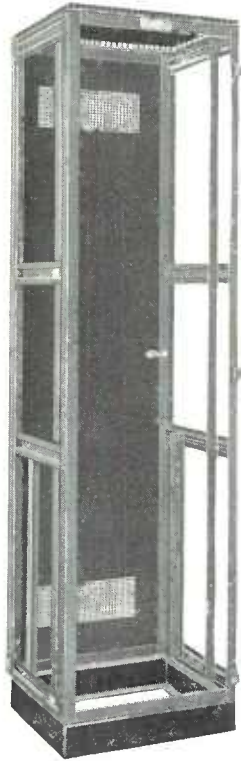

**BR-84D**

**Specifications**

Panel Width	19"
Panel Mounting Space (height)	77"
Clearance for Door Swing	23"
Weight (BR-84A)	225 lbs.
Finish	Two-tone umber gray enamel except for the base which is black

**Dimensions:**

Height	84"
Width - BR-84A, -B (with side panels)	28"
BR-84C, -D, -E	22"
Width of Frame	22"
Depth of Frame	18"
Depth (including doors and handles)	24 1/4"

**Stock Identification**

- Type BR-84A consisting of one frame, one base, one top cover, one front door (non-ventilated), one rear door (ventilated), one pair of side panels, one set of terminal board mounting angles and one set of panel mounting angles and instruction book \_\_\_\_\_ MI-30951-A84
- Type BR-84B, same as BR-84A, less front door only \_\_\_\_\_ MI-30951-B84
- Type BR-84C, same as BR-84A, less side panels only \_\_\_\_\_ MI-30951-C84
- Type BR-84D, same as BR-84A, less side panels and front door \_\_\_\_\_ MI-30951-D84
- Type BR-84E, same as BR-84A, less side panels, front and rear doors \_\_\_\_\_ MI-30951-E84

**Accessories**

- One front door (non-ventilated) \_\_\_\_\_ MI-30531-G84
- One side panel \_\_\_\_\_ MI-30541-G84
- One electrical shield (for top and bottom sections) two per side \_\_\_\_\_ MI-30546-G28

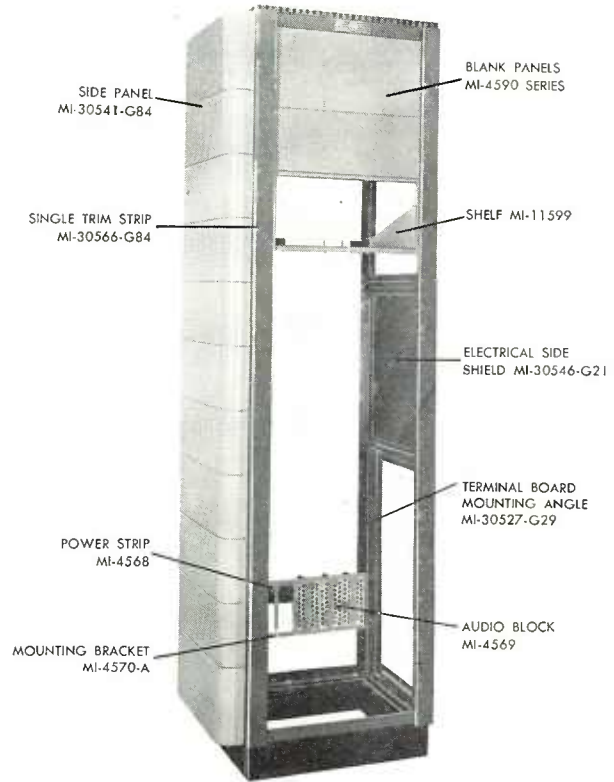

**BR-84E with Accessories**

- One electrical shield (for mid-section of rack) one per side \_\_\_\_\_ MI-30546-G21
- One only single trim strip for one cabinet where panels are fitted without door \_\_\_\_\_ MI-30566-G84
- One only double trim strip used where two or more cabinets are placed together \_\_\_\_\_ MI-30568-G84
- One lock \_\_\_\_\_ MI-30591
- One terminal board mounting bracket \_\_\_\_\_ MI-4570-A
- Blank panels \_\_\_\_\_ MI-4590 Series
- One audio terminal block \_\_\_\_\_ MI-4569
- One power terminal strip \_\_\_\_\_ MI-4568
- One panel and shelf assembly \_\_\_\_\_ MI-11598/11599\*

\* When ordering for cabinet with door, order MI-11599 shelf only.

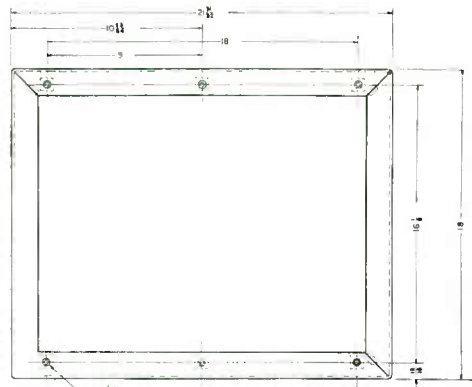

*Layout and dimensions of cabinet base.*

# Cabinet Rack Type 9-AX

## Uses

The Type 9-AX is a heavy-duty Broadcast Audio Cabinet Rack which is widely used in control room and transmitter installations. It provides 77" of panel space for mounting amplifiers, jack panels, switch panels, oscillators, measuring equipment or other panel-mounted equipment of standard 19" width. The 9-AX completely shields and protects all the equipment on the rack, while at the same time, largely dispensing with individual shield covers.

## Description

This rack is of sheet metal construction with an open front and a hinged ventilated door on the rear. A metal plate placed approximately one inch below a rectangular opening in the cabinet top provides complete ventilation, but protects equipment from falling articles and dust. The plate may be removed completely, if desired. The rack is drilled and tapped, as shown on the Dimension Drawing, for standard 19" panels and has an overall height of 6' 10 $\frac{3}{8}$ ". It is shipped with supporting rods to insure accurate alignment.

Accessories for the Type 9-AX Rack include "J" Strips, "U" Strips, Terminal Block Mounting Brackets, A-C Terminal Blocks, Audio Terminal Blocks and Cable Supports. "J" Strips

are used with the 9-AX Cabinet Racks to give them a finished appearance when the equipment is assembled on the racks. These strips, which mount along the side of the cabinet and cover the panel slots and mounting screws, are easily installed by means of clips and screws which are supplied with the strips. "U" Strips are used to dress up an assembly of cabinet racks when they are mounted side by side. Angle strips 8" long are mounted inside cabinet (see dimension drawing) as a support for the terminal block mounting bracket.

The bracket will accommodate as many as three W.E. 100-B (RCA Stock Identification, MI-4569) Audio Terminal Blocks and two General Electric 16EB1B3 (RCA Stock Identification, MI-4568) A-C Terminal Strips. The cable supports provide a convenient means for holding the cabling in place. They are mounted by means of the same screws which hold the front panels.

Included with each 9-AX Cabinet Rack is a quantity of 90 12-24 x 1/2" round head machine screws for mounting the panels.

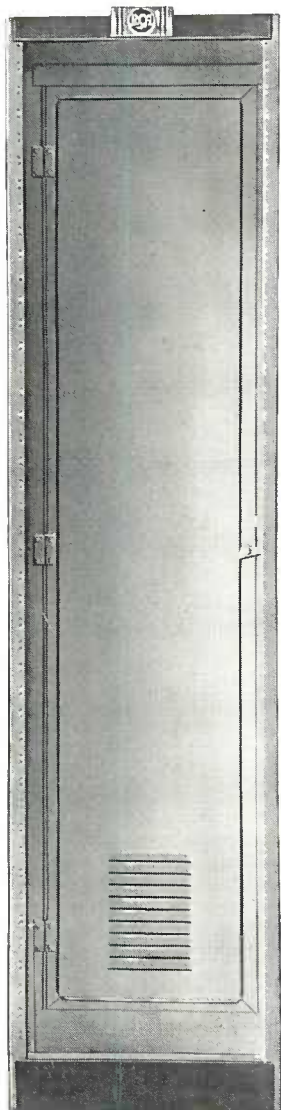

Front View Type 9-AX Cabinet Rack

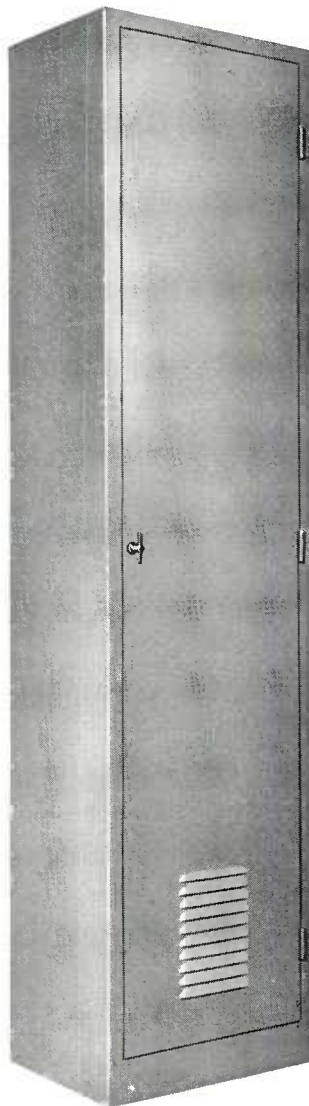

Rear View Type 9-AX Cabinet Rack

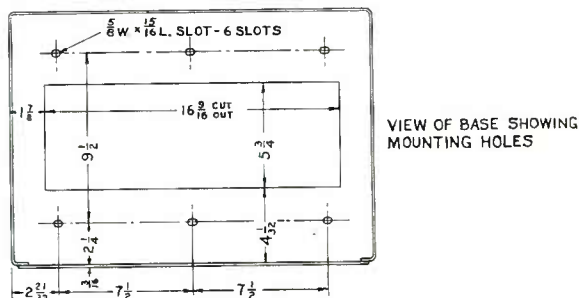
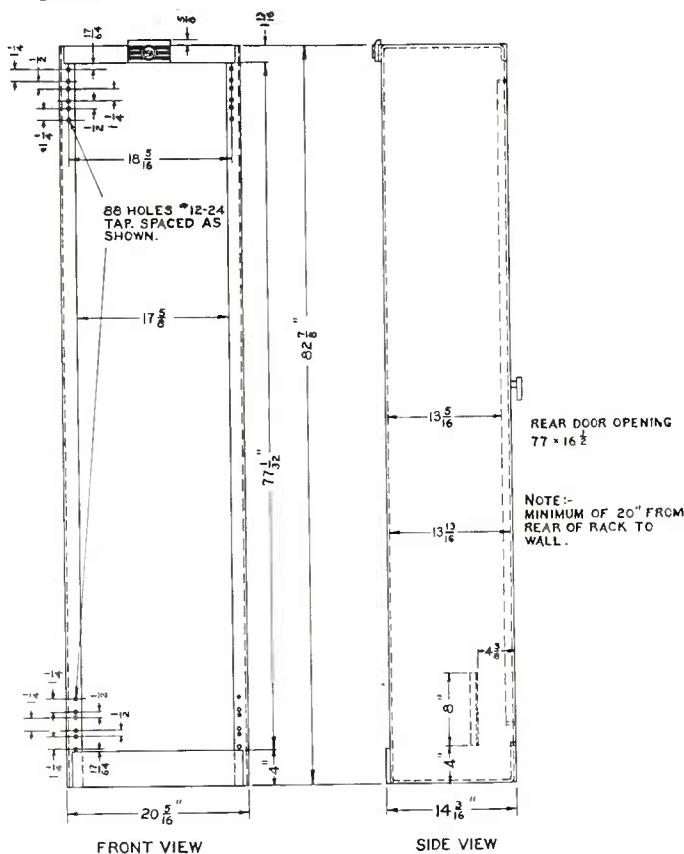

Outline Dimensions of 9-AX Cabinet Rack

**Specifications**

Dimensions, overall	
Height	82 $\frac{7}{8}$ "
Width	20 $\frac{5}{16}$ "
Depth	14 $\frac{3}{8}$ "
Panel Size	19"
Mounting Space	77"
Weight (unpacked)	190 lbs.
Stock Identification	
Black	MI-4519-C
Light Umber Grey	MI-4519-E

**Accessories**

"J" Strip	
Black	MI-4537-A
Dark Umber Grey	MI-4537-D
"U" Strip	
Black	MI-4524-A
Dark Umber Grey	MI-4524-D
Terminal Block Mounting Bracket	MI-4570
W.E. 100-B, 80 Terminal (4 rows of 20 each) Block	MI-4569
G.E. A-C Terminal Strip (12 terminals)	MI-4568
Cable Support	MI-4571

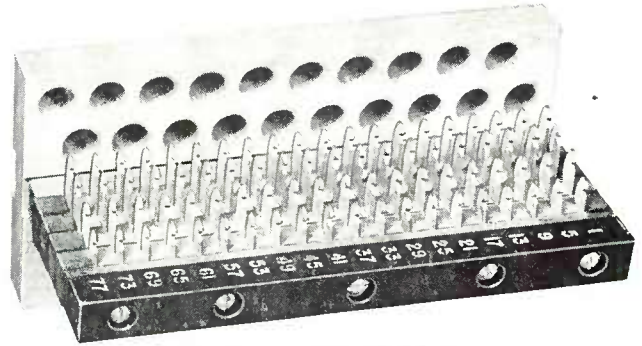

*Audio Terminal Block MI-4569*



*Cable Support MI-4571*

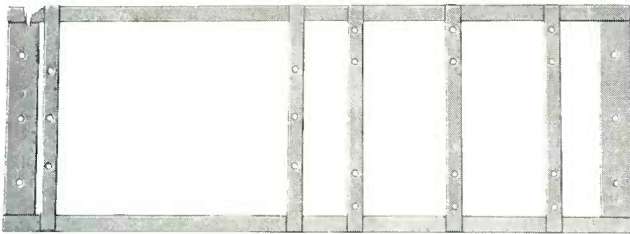

*Terminal Block Mounting Bracket MI-4570*

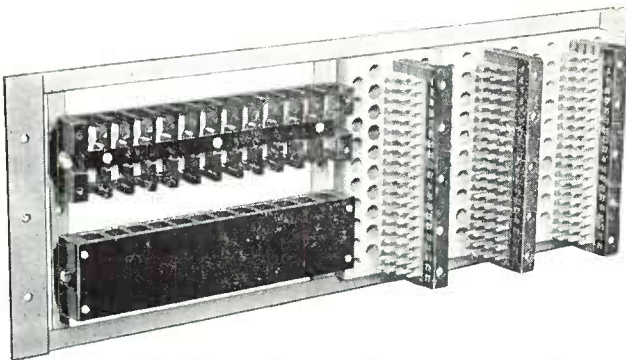

*Terminal Block Mounting Bracket with Terminal Blocks in Position*

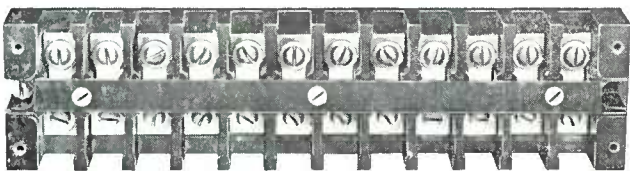

*Power Terminal Block MI-4568*

**Blank Panels**

A complete line of 19" blank panels are carried in stock for filling spaces on racks and cabinets not occupied by equipment panels. These blanks are also suitable for applications where equalizers, transformers, switches or other items must be panel mounted by the user. The stock of panels includes all standard widths from 1 $\frac{3}{4}$ " to 13  $\frac{31}{32}$ ". They are  $\frac{3}{16}$ " sheet steel and are finished and drilled to match the standard equipment panels. The 33-A and 33-B Jack Panel heights are not standard multiples of 1 $\frac{3}{4}$ ". Therefore when these jack panels are mounted in the Type BR-84 series Cabinet Racks or the Type 9-AX Rack it is often necessary to use either a 2 $\frac{1}{8}$ " or 2 $\frac{3}{8}$ " blank panel so that the summation of all panel heights will equal 77".

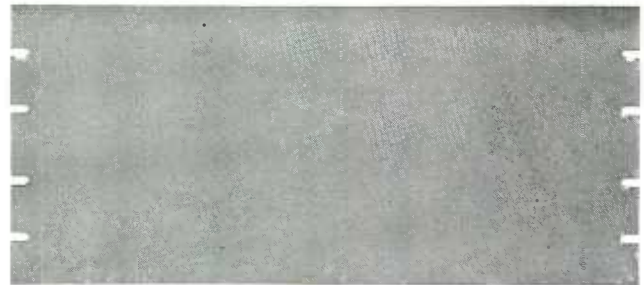

**Panel Width**

1 $\frac{23}{32}$ "	Blank Panel, Black	MI-4590
2 $\frac{1}{8}$ "	" " Umber Grey	MI-4590-A
	" " Black	MI-4598
2 $\frac{3}{8}$ "	" " Umber Grey	MI-4598-A
	" " Black	MI-4599
3 $\frac{3}{32}$ "	" " Umber Grey	MI-4599-A
	" " Black	MI-4589
3 $\frac{15}{32}$ "	" " Umber Grey	MI-4589-A
	" " Black	MI-4591
5 $\frac{7}{32}$ "	" " Umber Grey	MI-4591-B
	" " Black	MI-4592
6 $\frac{31}{32}$ "	" " Umber Grey	MI-4592-B
	" " Black	MI-4593
8 $\frac{23}{32}$ "	" " Umber Grey	MI-4593-A
	" " Black	MI-4594
10 $\frac{15}{32}$ "	" " Umber Grey	MI-4594-B
	" " Black	MI-4595
12 $\frac{7}{32}$ "	" " Umber Grey	MI-4595-B
	" " Black	MI-4596
13 $\frac{31}{32}$ "	" " Umber Grey	MI-4596-A
	" " Black	MI-4597
	" " Umber Grey	MI-4597-A

# Wall Mounting Cabinet MI-11500

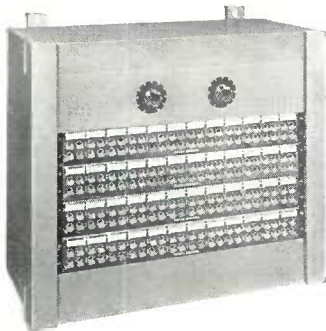
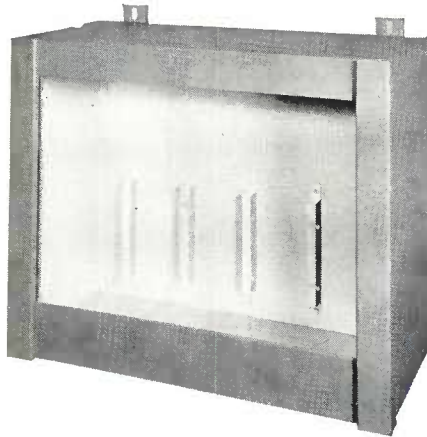

## Features

- Provides mounting space for equalizer and jack panels.
- May be mounted at any convenient wall location.
- Sturdy steel construction.
- Hinged door permits easy access for servicing.
- Drilled and tapped for standard 19" panels.
- Attractive appearance.

## Uses

The MI-11500 Cabinet has been designed especially to mount a combination of line equalizers (Type 56-D or 56-E) and jack panels (Type 33-A or 33-B). It will be found particularly useful for terminating remote lines in installations using the 76 Series Consolettes. Sample combinations for this cabinet are given below:

- 1—56-E Equalizer and 4—33-A Jack Strips.
- 1—56-E Equalizer, 3—33-A Jack Strips, 1—MI-4590 (1 $\frac{3}{4}$ " blank panel and 1—MI-11503 (7" Jack Mat.
- 1—56-E Equalizer, 2—33-A Jack Strips, 1—MI-4591 (3 $\frac{1}{2}$ " blank panel and 1 MI-11502 (5 $\frac{1}{4}$ " Jack Mat.
- 1—56-E Equalizer, 1—33-A Jack Strips, 2—MI-4598 (2 $\frac{1}{8}$ " blank panels and 1—MI-4599 (2 $\frac{3}{8}$ " blank panel.
- 1—56-E Equalizer, 1—33-A Jack Strip, 1—MI-11501 (3 $\frac{1}{2}$ " Jack Mat and 1—MI-4592 (5 $\frac{1}{4}$ " blank panel.
- 2—56-E Equalizers, 2—33-A Jack Strips and 1—MI-11502 (5 $\frac{1}{4}$ " Jack Mat.
- 1—56-D Equalizer, 1—33-A Jack Strip and 1—MI-11501 (3 $\frac{1}{2}$ " Jack Mat.

## Description

The cabinet is constructed of steel and is equipped with a hinged door on which the panels may be mounted. Drilling and tapping has been provided for standard 19" panels which are attached by means of the machine screws supplied. A left-hand and a right-hand "J" strip are furnished to cover the mounting screws. Five knockouts are provided in the bottom of the cabinet, and five in the top, for conduit connections. Five terminal blocks may be mounted inside the cabinet on the brackets provided. Mats are available for improving the appearance of the jack strips.

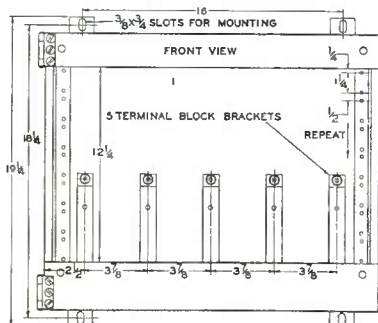
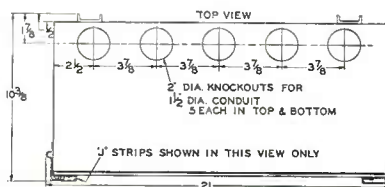

## Specifications

Dimensions Overall \_\_\_\_\_ 21" wide, 19 $\frac{1}{4}$ " high, 10 $\frac{3}{8}$ " deep  
 Weight (unpacked, less panels) \_\_\_\_\_ 36 lbs.  
 Finish \_\_\_\_\_ Dark Umber-Grey  
 Panel Mounting Space \_\_\_\_\_ 19" wide, 12 $\frac{1}{4}$ " high  
 Terminal Mounting Space \_\_\_\_\_ Maximum-five Standard W.F.  
 Cat. No. 100-B, 80 terminal (4 rows of 20 each)  
 blocks which are 2 $\frac{1}{8}$ " wide by 6 $\frac{1}{16}$ " long  
 Stock Identification \_\_\_\_\_ MI-11500

# Panel and Shelf Type BR-2A

## Features

- High quality panel mounting for chassis type units.
- Quick access to tubes.
- Easy insertion and removal of units.
- Provision for control shafts on front panel.
- Units installed from front of rack.

## Uses

The BR-2A Panel and Shelf was designed for use in a broadcasting station audio system primarily to hold the new RCA plug-in units. It may also be used, however, for amplifiers with terminal board connections. The shelf is capable of mounting the following quantities of specific equipments.

- 6—BA-1 Series Pre-amplifiers.
- 2—BA-3 Series Program amplifiers.
- 2—BA-2 Series Booster amplifiers.
- 2—BX-1 Series Power supplies.
- 1—BA-4 Series Monitor amplifier plus 2—BA-1A Pre-amplifiers.

## Description

This shelf will mount in either the 9AX or the BR-84 series of racks, or in any other standard nineteen-inch rack. It occupies eight and three-quarters inches of panel space. Since the RCA plug-in amplifiers have a standard dimension in depth, they all fit perfectly in this shelf. They are slid into the shelf from the front and the connection plugs pushed into the receptacles at the rear. Guide bars fitting between the amplifiers assist in guiding them into position. All the plug-in amplifiers are equipped with levers which serve either to force them into position or to eject the plugs when dismounting them. The receptacles are mounted on individual U-shaped brackets, secured to the chassis of the shelf. They fit in such a manner that a small amount of free movement is permitted in all directions. This eases the alignment of the plugs and receptacles when the amplifiers are pushed into position. The brackets are constructed with a small protruding stop on the lower, front edge, preventing the amplifier from being forced to the point where it would exert undue pressure on the receptacle. Provision is made for holding six of these receptacles. The holes in the chassis which are provided for fastening the brackets are slightly oversize to permit perfect alignment during initial installation. The wiring in back of the receptacles is protected by a steel cover which is fastened in place by two machine screws.

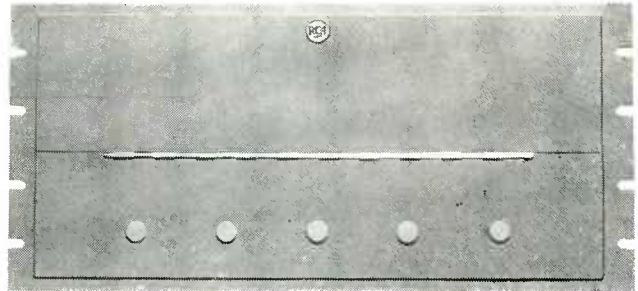

The opening in the front of the shelf is covered by a matching panel. This panel is hinged across the center so that the top half may be opened to gain access to the vacuum tubes of the amplifiers. The bottom half has five shaft holes to provide for any controls which the amplifiers may have. When not in use, these holes are covered by small removable buttons. The bottom of the shelf has several round holes for ventilation, and also a number of square holes into which fit the amplifier insertion levers.

The shelf may be obtained separately, if desired, or the shelf and panel together, as appropriate. It is supplied complete with mounting brackets, guide bars, and receptacle cover. The receptacles themselves are supplied with the amplifiers, and therefore need not accompany the shelf.

## Specifications

Dimensions, overall:	
Width	19"
Height	8 <sup>3</sup> / <sub>4</sub> "
Depth	12 <sup>3</sup> / <sub>4</sub> "
Inside Width	16 <sup>3</sup> / <sub>8</sub> "
Weight, unpacked:	
Shelf	12 lbs.
Panel	3 lbs.
Stock Identification:	
Shelf:	
Umber Gray	MI-11599
Black	MI-11599A
Panel:	
Umber Gray	MI-11598
Black	MI-11598A

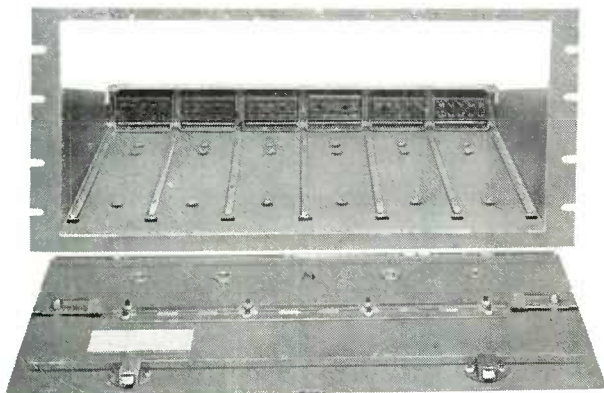

*Panel removed showing guide bars and receptacles*

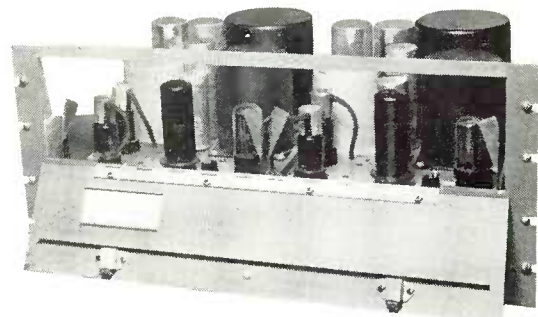

*Panel open showing two BA-3A amplifiers*



# Jack Panels Types 33-A and 33-B

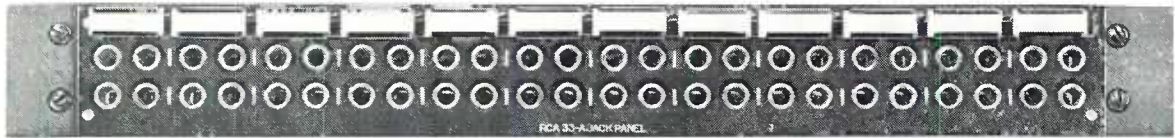

33-A Jack Panel

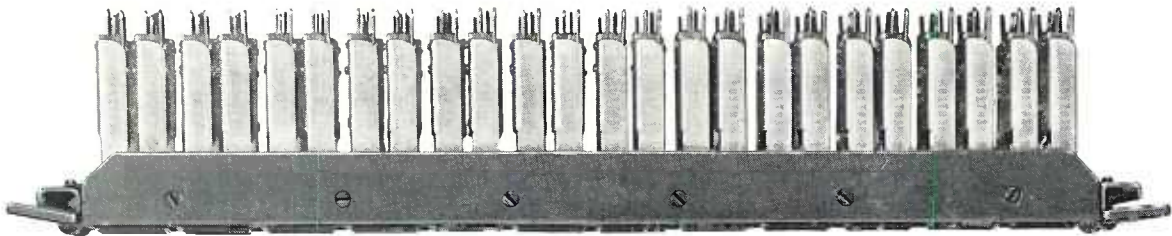

A Rear View of the 33-A Jack Panel

Jack Panels, with their associated patch cords, are used with broadcast speech input systems to improve the overall operating flexibility. In addition to providing a convenient termination for program and order wire telephone circuits, closed-circuit jacks may be connected to provide "patch cord" access to the input and output circuits of individual units of the speech assembly. When connected for this purpose, the regular circuits are continuous through the jacks until a patch cord is inserted to make an external connection. With properly connected jacks, patch cords may be freely used in emergencies or for test purposes to interchange or transfer telephone lines, amplifiers, mixers, microphones, or other equipment items.

The 33-A consists of two rows of twelve double jacks mounted on thick black bakelite and furnished with designation card holders. The 33-B is similar to the 33-A but has only one row of twelve double jacks. The jack sleeves of the 33-A and 33-B are chromium plated; the sleeves of the 33-AW and 33-BW are brass.

## Specifications

Number of Jack Pairs		
33-A	_____	24
33-B	_____	12
Type of Jacks	Double jacks of standard closed circuit type	
Dimensions		
33-A	2 1/8" x 19"	33-B 1 1/4" x 19"
Weight (unpacked)		
33-A	5 1/2 lbs.	33-B 3 lbs.
Stock Identification		
33-A (RCA Standard)	_____	MI-4645-A
33-AW (W. E. Jacks)	_____	MI-4536-B
33-B (RCA Standard)	_____	MI-1646-A
33-BW (W. E. Jacks)	_____	MI-1534-C



33-B Jack Panel

## Jack Mats

Jack Mats are available for covering 1, 2, 3, or 4 type 33-A Double Jack Strips. When ordering specify finish desired.

### Specifications

Single 33-A Jack Strip Mat, overall size	19" x 3 15/32"	
U/G	_____	MI-11501-A
Black	_____	MI-11501-B
Double 33-A Jack Strip Mat, overall size	19" x 5 7/32"	
U/G	_____	MI-11502-A
Black	_____	MI-11502-B
Triple 33-A Jack Strip Mat, overall size	19" x 6 31/32"	
U/G	_____	MI-11503
Black	_____	MI-11503-A
Quadruple 33-A Jack Strip Mat, overall size	19" x 10 15/32"	
U/G	_____	MI-11504
Black	_____	MI-11504-A

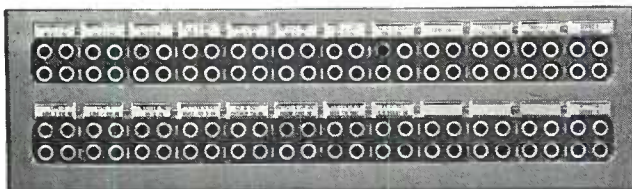

## Patch Cords

RCA maintains a stock of patch cords for the convenience of broadcasting stations. The W.E. Cord is the standard telephone type using two W.E. 241-A Double Plugs. The Audio Development Co. Cord is shielded and uses two of their Type PJ-1 Plugs which are interchangeable with the W.E. Type 241-A Plug. Three sizes of patch cords are available as listed below:

	Western Electric Co.	Audio Development Co.
Two Foot Cord Length	MI-4652-2A	MI-4652-2B
Four Foot Cord Length	MI-4652-4A	MI-4652-4B
Six Foot Cord Length	MI-4652-6A	MI-4652-6B

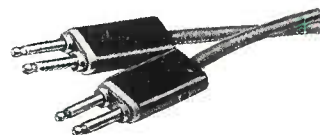

Western Electric Telephone Type Patch Cord



Audio Development Co. Shielded Type Patch Cord

# Switch and Fuse Panel Type 57-C

## Features

- Provides master switch and fuses for rack-mounted equipment.
- Subpanel drilled and tapped for mounting 6 MI-11606 Filament Transformers.
- Pilot lamp glows when equipment is on.
- Removable door permits front panel access to fuses and pilot lamp.

## Uses

The Type 57-C Switch and Fuse Panel is designed for use as a master input control of the a-c power supply. Ordinarily one such panel is used with each rack or channel of speech input units. The mounting is for a BR84 Series Standard cabinet rack or a 9AX Rack.

## Description

On this panel are mounted and wired an indicator lamp with red cap, two single fuse blocks of the screw-plug type and a double-pole single-throw power switch. In addition there is a subpanel which is drilled to provide a mounting for six of the standard MI-11606 Filament Transformers. This panel is ordinarily located near the bottom of the rack to keep the transformers well away from low-level amplifier circuits. A removable door permits front panel access to fuses and pilot lamp.

## Specifications

Switch \_\_\_\_\_ D.P.S.T., 250 volts, 30 amperes  
 Fuses \_\_\_\_\_ Screw-plug type (rating depends upon equipment to be protected)

Dimensions, overall (panel thickness  $\frac{3}{16}$ " )

Height \_\_\_\_\_ 5 7/32"  
 Width \_\_\_\_\_ 19"  
 Depth \_\_\_\_\_ 3 1/2"

Weight (unpacked) \_\_\_\_\_ 8 1/2 lbs.

Stock Identification \_\_\_\_\_

Black \_\_\_\_\_ MI-4395-A  
 Light Umber Grey \_\_\_\_\_ MI-4395-B

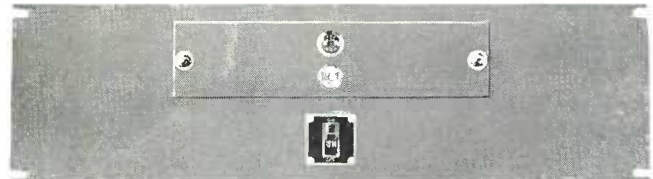

Front View

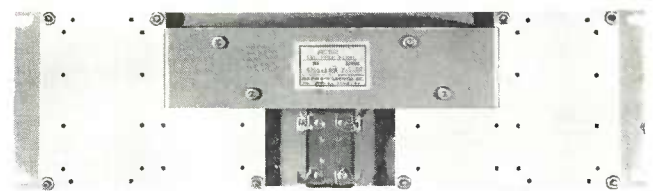

Rear View

# Ringdown Panel MI-11710

## Uses

The MI-11710 Ringdown Panel is a twelve position telephone panel designed for use in control rooms and transmitter installations. The panel provides complete facilities for receiving incoming calls, listening, talking and ringing on any of the twelve telephone lines. A two position turn-key introduces emergency ringing power should the normal supply fail. An additional feature of feeding cue signal to anyone, or all the lines simultaneously is provided.

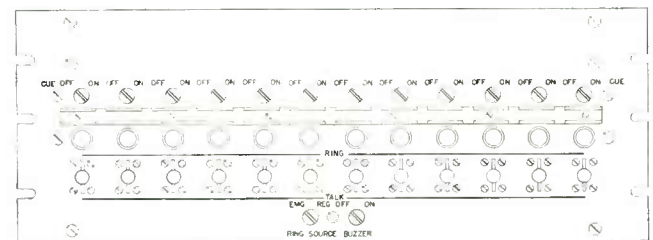
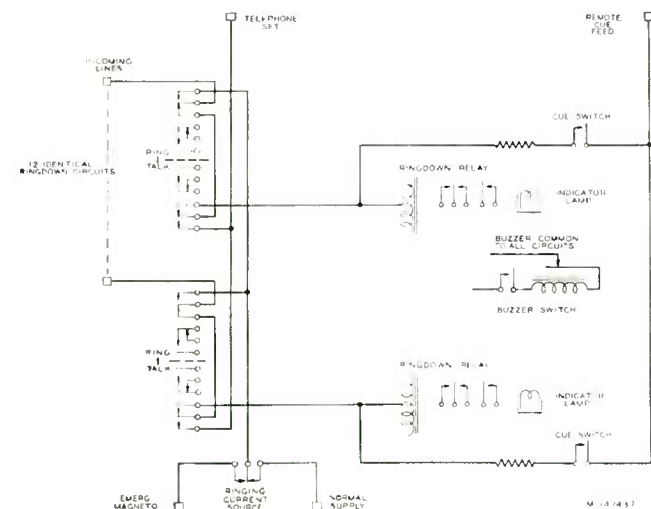

## Description

The panel contains twelve "ring-talk" keys with an associated "cue and off" turn-key for each circuit. For normal incoming calls, ringing current from line operates a ringdown relay and gives visual and audible indication of the appropriate calling circuit. A call buzzer is common to all circuits and may be rendered inoperative by a turn-key. This allows the circuit to be used in any location where an audible call is undesirable. Cue signal may be fed from any external bridging transformer to the cue input, thereby providing cue signal switchable to any one or all twelve lines. All connections are terminated on the two terminal boards mounted on the rear of the panel assembly.

## Specifications

Dimensions:

Height \_\_\_\_\_ 7"  
 Width \_\_\_\_\_ 19"  
 Depth \_\_\_\_\_ 10 5/8"

Weight \_\_\_\_\_ 15 lbs.

Stock Identification \_\_\_\_\_ MI-11710

## Meter Panel Type BI-1A

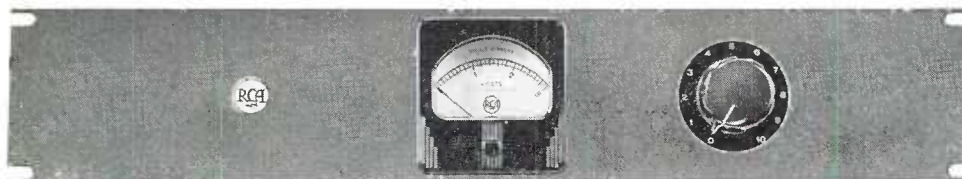

### Features

- Provides meter and switch for measuring cathode voltage of amplifier tubes.
- Gives plate current indication of operating condition of tubes and circuits.
- Up to 10 circuits may be metered by rotary selector switch.
- Designed for cabinet rack mounting.

### Uses

The BI-1A Meter Panel provides a convenient means for checking the cathode bias voltages of amplifier tubes and thereby furnishes an indication of the operating conditions of amplifier tubes and circuits. Metering terminals are provided on the BA-1, BA-2 and BA-3 Series Amplifiers for use with this panel. The mounting is for a BR84 Series Standard cabinet rack or a 9AX Rack.

### Description

The BI-1A consists essentially of a meter and switch mounted on a standard 3½",  $\frac{3}{16}$ " thick steel panel. The meter is a 3.0 volt d-c voltmeter having a resistance of 20,000 ohms per volt. The double section switch has eleven positions including the "off" position with the switch arms connected to the meter terminals. All connections to the panel are made to the switch contacts.

### Specifications

D-c Voltmeter	0-3.0 volts, 20,000 ohm per volt
Metering Switch	10 position and "off," double pole
Dimensions (overall)	
Height	3 15/32"
Width	19"
Depth	2 1/4"
Weight (unpacked)	4 1/2 lbs.
Stock Identification	
Light Umber Grey	MI-4388-C
Black	MI-4388-B

## Meter Panel Type BI-2A

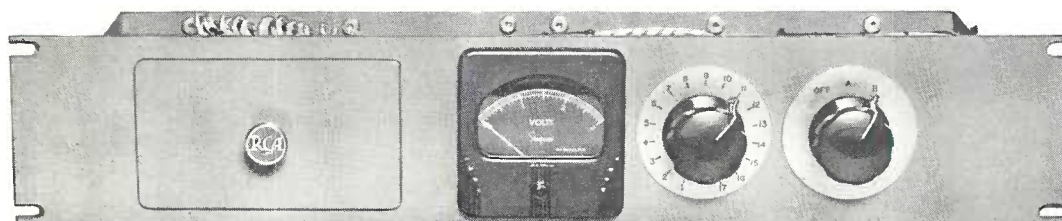

### Features

- Provides metering for 34 circuits by operation of rotary switches.
- Precision 0-3 volt voltmeter—20,000 ohms per volt.
- May be mounted in any standard 19" rack.
- Card index to log maintenance routine checks.
- High grade rotary switches.

### Uses

The BI-2A Meter Panel has been developed after numerous requests from broadcasters to supply a larger version of the BI-1A Meter Panel. The switching system provides for an instantaneous check of tubes and circuit conditions for 34 circuits and is ideal for use where a large number of circuits are required to be metered from a central point. The meter is suitable for use with all RCA standard equipment.

### Description

A high grade rotary switch with 17 positions and four banks of contacts is used in conjunction with a three position switch to effect the metering of 34 circuits. The precision built 0 to 3 volt meter possessing an internal resistance of 20,000 ohms per volt is mounted on a 3½" steel panel of standard 19" width. The hinged portion of the meter panel encloses a card index providing a convenient means of logging maintenance routine tests. The mounting is for a BR-84 Series Standard Cabinet Rack or a 9-AX Rack.

### Specifications

D-C Voltmeter	0-3 volts, 20,000 ohms per volt
Metering Switches	One 17 position, one 3 position, giving a total of 34 positions
Dimensions (overall):	
Height	3 1/2"
Width	19"
Depth (behind panel)	3 5/8"
Weight (unpacked)	6 lbs.
Stock Identification:	
Umber Gray	MI-11275
Black	MI-11275-A

# V. U. Meter Panel MI-11265

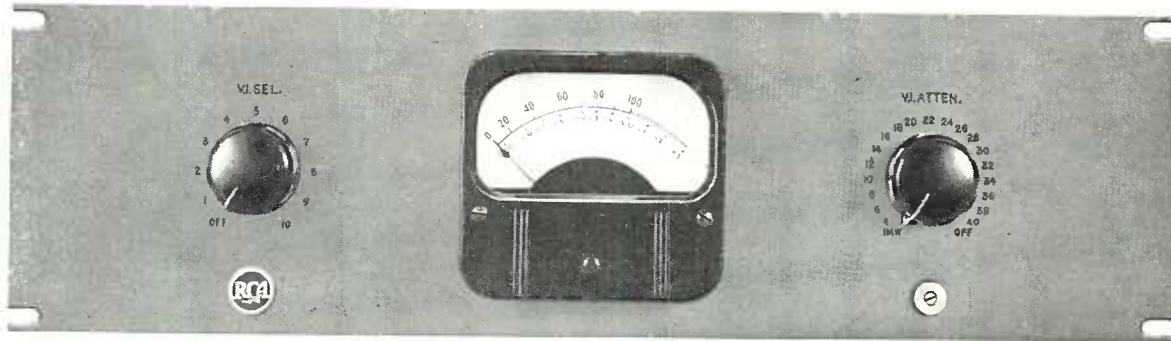

### Features

- Measures audio volume levels from +4 to +40 db.
- Ten point selector switch permits rapid connection to any number of circuits up to ten.
- Calibration curve supplied for loads other than 600 ohms.
- Large vu meter lessens eye strain and fatigue.

### Uses

The MI-11265 employs the industry standardized Weston Type 30 VU Meter which embodies closely controlled electrical and dynamic characteristics combined with deliberate pointer action, moderate pointer speed, and small pointer overswing. It is intended as an audio level indicator for broadcasting, recording or wherever it is desired to read the level of one or more audio circuits with a rack mounting type of instrument.

### Description

The volume indicator panel assembly includes the vu meter, a two circuit ten point selector switch, a variable step-by-step attenuator (4 to 40 db attenuation), and a vernier control for making a fine adjustment of the level reading over a range of  $\pm 0.5$  db. The attenuator has a 1 milliwatt reference position which enables a level reading of zero vu.

The vu meter scale is arranged with percent volts in black figures from "0" to "100" as the principal scale above the arc, and "vu" levels from "-20" to "0" to "+3" as supplementary figures in red below the arc.

The meter and attenuator are calibrated for use with a 600 ohm line, however, a calibration correction curve furnished with the instrument permits its use with loads other than 600 ohms. The ten point selector switch may be connected to any ten lines (or circuits). If one or more switch positions are connected to a jack strip, the number of circuits that may be monitored is unlimited. The meter is provided with the 6.3 volt lamp for illuminating the meter scale. If the 6.3 volt source is not available, MI-11606 filament transformer will be necessary.

### Specifications

Input Impedance (except on 1 milliwatt step)	7500 ohms
Attenuator steps	1 milliwatt position, +4 to +40 db in 2db steps and off position
No. of lines that may be measured	1 to 10 inclusive
Mounting	Standard Cabinet Rack
<b>Dimensions</b>	
Height	5 1/4"
Width	19"
Depth	3 3/4"
Finish	Light Umber Grey
Weight (unpacked)	7 1/2 lbs.
<b>Stock Identification</b>	
Umber Grey	MI-11265
Black	MI-11265-D

# VU Meter and Attenuator Kit MI-11251

The MI-11251 Meter and Attenuator Kit is used for indicating audio volume levels when installed in the OP-6 Portable Amplifier or the OR-1A Portable Recorder. It uses a Weston Type 30 VU Meter whose scale reads in percent voltage and in vu's. The meter has an impedance of 3900 ohms and is designed to be used in series with the furnished resistance of approximately 3600 ohms to effect the required ballistic characteristics. The circuit of the MI-11251 Kit employs the Type 30 Meter connected first to a 3900/3900 ohm constant impedance pad and then in series with 3200 ohm and tapped 800 ohm resistors across the amplifier's output. The 3900/3900 ohm pad has solder type terminals which permit attenuation adjustments for any value between 1 and 27 db in one db steps, while vernier adjustments in steps of 0.1 db, if required, are provided by the tapped 800 ohm resistor which is normally connected for 400 ohms. By changing the pad or resistor tap connections the "0" vu setting of the meter may be made to indicate any value from +4 to +31 db in steps of 1 db or 0.1 db.

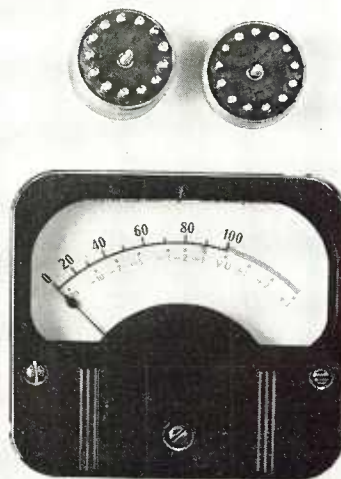

# Variable Line Equalizer Type BE-1B

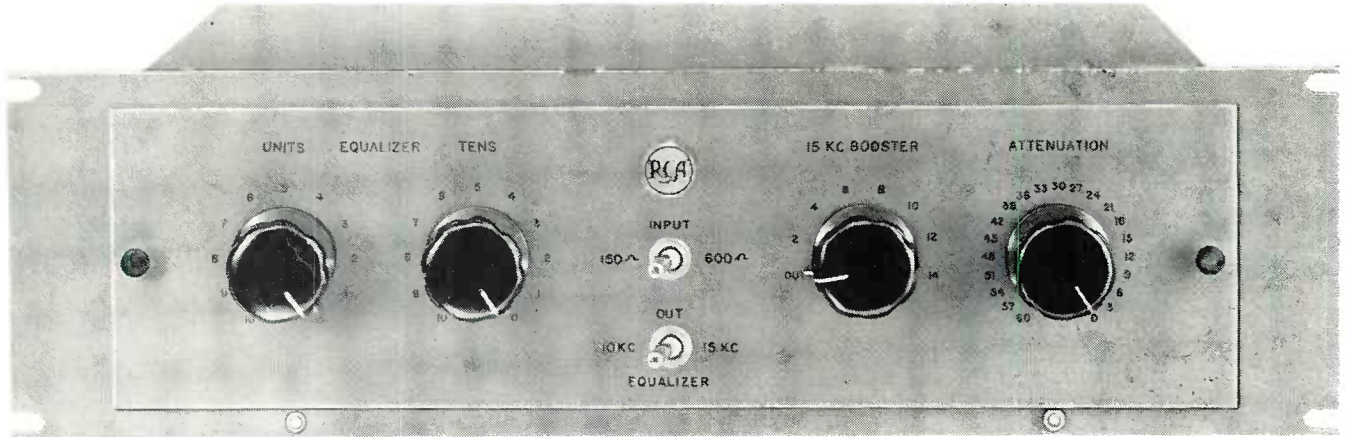

**Features**

- Provides a line response  $\pm 1$  db 30 to 15,000 cycles for FM.
- Frequency boost circuit permits up to 14 db boost at 15,000 cycles.
- Toggle switch permits 10 kc or 15 kc cut-off.
- 20 step attenuator affords variable output control.
- Line and Isolation transformers built in.
- Rack mounting panel—easy installation.

**Uses**

The BE-1B is an ideal unit for equalizing unloaded telephone lines up to ten miles in length to a frequency response within  $\pm 1$  db, 30 to 15,000 cycles. In addition to the conventional parallel resonant circuits this equalizer has additional tuned networks providing a variable frequency boost of 2 to 14 decibels (2 db steps) at 15,000 cycles. This feature aids materially in obtaining an overall flat frequency response to 15,000 cycles. More than 1,000 different attenuation vs frequency curves are available through adjustment of the front panel controls.

**Description**

The BE-1B consists of a tuned equalizing circuit, isolating transformer, attenuating pad, 15,000 cycle booster circuit and another isolating transformer in the output. A two-position input switch selects an impedance of 150 or 600 ohms for terminating lines offering 150 or 600 ohms impedance. A three-position switch prepares the circuit for equalization up to 10,000 cycles or 15,000 cycles. The center position of the toggle switch removes the attenuator from the circuit, leaving lines connected with a loss of 1.5 db at 1,000 cycles. A 20 step (3 db per step, last step infinity) attenuator is inserted in the circuit to permit control of the output level. The 15,000 cycle booster circuit is controlled by an 8 position switch which will vary the boost from 0 to 14 db in 2 db steps. Attenuation vs Frequency curves are shown for extreme boost control settings of "Boost out" and "14 db boost." Intermediate attenuation values will be obtained for intermediate settings of the boost control. The output transformer has variable taps for a load impedance of 150, 250 and 600 ohms. The BE-1B is built on a standard 19" panel and is supplied with a dust cover. A hinged door on the front panel permits easy access for cleaning or servicing the equipment. A terminal strip, mounted on the rear of the unit, has five screw-type terminals for input, output and ground connections.

**Specifications**

Source Impedance (balanced or unbalanced) \_\_\_\_\_ 150/600 ohms  
 Load Impedance \_\_\_\_\_ 150/250/600 ohms  
 Equalization Frequency Limit \_\_\_\_\_ 15,000 cycles  
 Insertion Loss (attenuator at zero)  
 For 15 kc equalization \_\_\_\_\_ Min. 6.5 db; Max. 59 db  
 For 10 kc equalization \_\_\_\_\_ Min. 3.5 db; Max. 42.5 db  
 Note: With equalization and boost out the minimum loss at 1000 cycles is 1.5 db.

Equalization Range \_\_\_\_\_ (See attenuation characteristic curves)  
 Mounting \_\_\_\_\_ BR-84 series and 9AX racks  
 Dimensions  
 Height \_\_\_\_\_ 5 <sup>3</sup>/<sub>16</sub>"  
 Width \_\_\_\_\_ 19"  
 Depth behind panel \_\_\_\_\_ 8"  
 Overall including knobs \_\_\_\_\_ 9 <sup>1</sup>/<sub>4</sub>"  
 Weight (unpacked) \_\_\_\_\_ 7 lbs.  
 Stock Identification  
 Light Umber Grey \_\_\_\_\_ MI-4196-B  
 Black \_\_\_\_\_ MI-4196-C

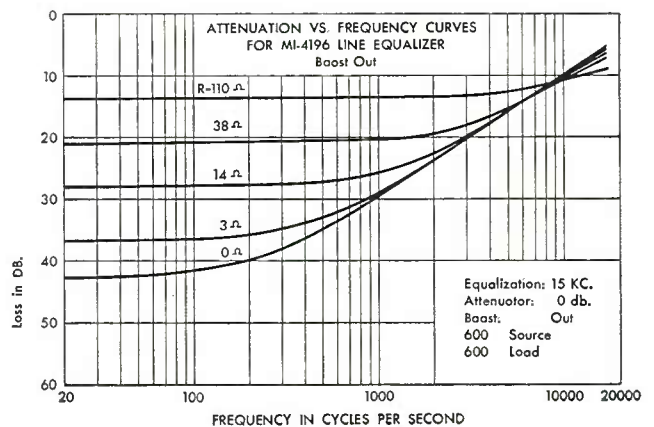
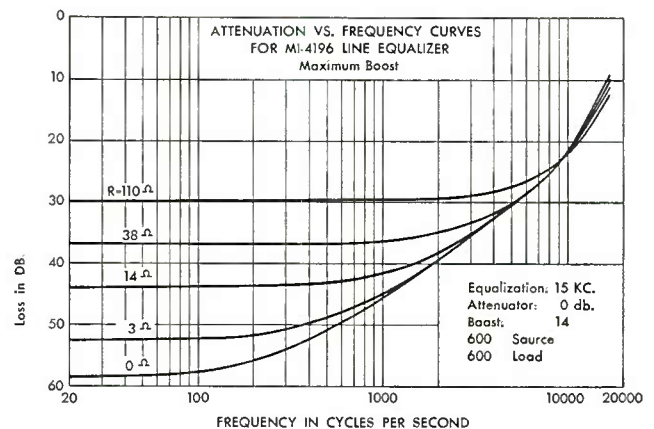

## Dual Line Equalizer Type 56-E

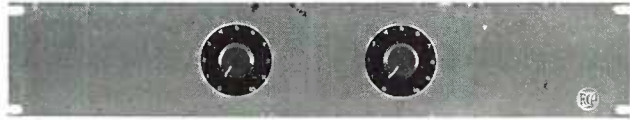

### Features

- Provides line equalization to 10,000 cycles or to 15,000 cycles when used with MI-4925-A Compensator.
- Equalization variable in steps of 3 db.
- Facilities for equalizing two lines.
- Rack mounting panel—easy installation.

### Uses

The 56-E has been designed to equalize the non-linear frequency characteristics of either one or two non-loaded telephone lines up to ten miles in length. It consists of two separate and complete variable equalizers mounted on a single panel. The 56-E is suitable for 15,000 cycle FM applications when used with the RCA MI-4925-A High Frequency Compensator. Without this compensator the cut-off frequency is 10,000 cycles.

### Description

Parallel resonant circuits are used in the two equalizers. Each unit consists of a capacitor, a reactor, a series of resistors and a rotary selector switch for selecting different resistance values. Varying amounts of equalization may be obtained in steps of 3 db by rotation of the selector switch to the proper position. The 56-E does not include line transformers or master attenuators.

### Specifications

Source Impedance \_\_\_\_\_ 600 ohms  
 Equalization Frequency Limit \_\_\_\_\_ 10,000 cycles  
 with MI-4925-A Compensator \_\_\_\_\_ 15,000 cycles  
 Insertion Loss (minimum at 1000 cycles) \_\_\_\_\_ 7 db  
 Equalization Range (see attenuation characteristic curve) \_\_\_\_\_ 1.5 to 40 db

Mounting \_\_\_\_\_ Standard 19" panel

#### Dimensions

Width \_\_\_\_\_ 19"  
 Height \_\_\_\_\_ 3 1/2"  
 Depth \_\_\_\_\_ 4 3/4"

Weight (unpacked) \_\_\_\_\_ 7 lbs.

#### Stock Identification

Black \_\_\_\_\_ MI-4162  
 Umber Grey \_\_\_\_\_ MI-4162-A

#### Accessory

### Accessories

High Frequency Compensator (2 units required if 56-E is to be converted for 15,000 cycle use) \_\_\_\_\_ MI-4925-A  
 Line Transformer \_\_\_\_\_ MI-10253

## Equalizer Type 56-C

The 56-C Equalizer is a semi-fixed unit which is particularly useful in connection with permanent lines. Its applications are similar to those of the Type 56-E described elsewhere on this page. It is a single unit with reactor, capacitor and all necessary resistors mounted in a metal case to reduce space requirements. The resistance terminals are brought out to soldering lugs on the top of the case where connections may be made for obtaining any resistance value between 1 and 111 ohms in 1 ohm steps.

### Specifications

Source Impedance \_\_\_\_\_ 600 ohms  
 Equalization Frequency Limit \_\_\_\_\_ 10,000 cycles  
 with MI-4925-A Compensator \_\_\_\_\_ 15,000 cycles  
 Insertion Loss (minimum at 1000 cycles) \_\_\_\_\_ 11.5 db

### Equalization

Range (see attenuation characteristic curves)  
 1.5 to 40 db

### Dimensions

Width \_\_\_\_\_ 3 5/8"  
 Height \_\_\_\_\_ 3 3/4"  
 Depth \_\_\_\_\_ 2 1/2"

Weight (unpacked) 7 lbs.

Stock Identification \_\_\_\_\_ MI-4168

### Accessory

High Frequency Compensator  
 (one only required if 56-C is to be converted for 15,000 cycle use) \_\_\_\_\_ MI-4925-A

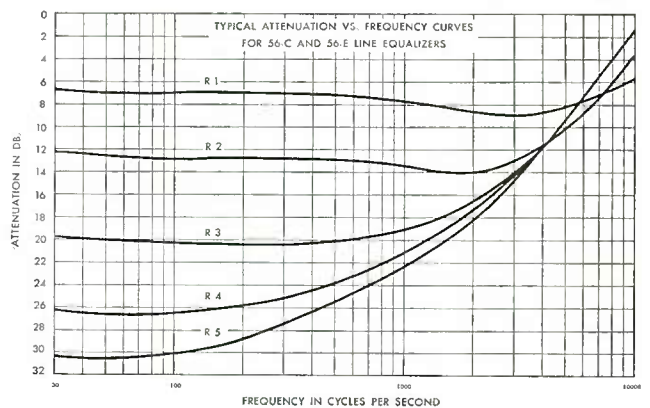

## High Frequency Compensator MI-4925-A

The MI-4925-A is a constant impedance bridged "T" type compensator network to extend the range of the 56-C or 56-E Equalizers to 15,000 cycles. The necessary reactors and condensers are mounted inside a round metal can, on the side of which is mounted a terminal board and two groups of resistors. Compensation can be varied by shifting the resistor connections which are connected by means of solder type terminals.

### Specifications

Source Impedance \_\_\_\_\_ 600 ohms  
 Equalization Frequency Limit \_\_\_\_\_ 15,000 cycles  
 Insertion Loss (minimum at 1000 cycles) \_\_\_\_\_ 4.8 db  
 Equalization Range (see curves) \_\_\_\_\_ 1.7 to 17.4 db  
 Mounting \_\_\_\_\_ Four-hole flange mounting

#### Dimensions

Width \_\_\_\_\_ 4 3/8"  
 Height \_\_\_\_\_ 4 3/4"  
 Depth \_\_\_\_\_ 3 3/4"

Weight (unpacked) \_\_\_\_\_ 2 3/4 lbs.

Stock Identification \_\_\_\_\_ MI-4925-A

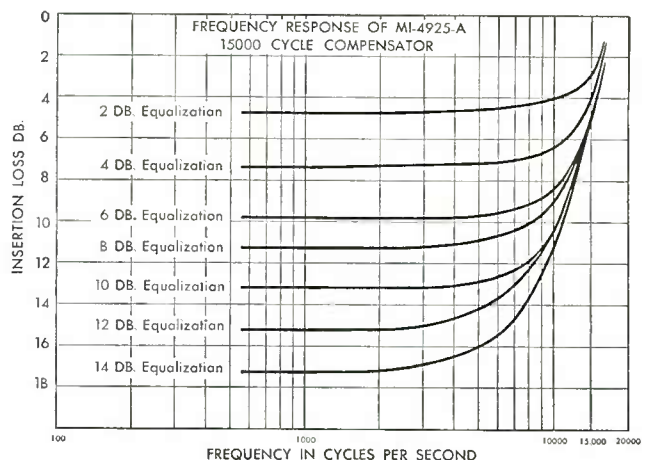

# Variable Sound Effects Filter MI-4917-A



**Features**

- Permits control of audio bandwidth to permit a variety of sound effects.
- Two front panel selector switches permit easy and quick change to desired sound effect.

**Uses**

The MI-4917-A furnishes a desirable means for producing a variety of special or unusual sound effects through control of the audio bandwidth of the transmitted program. It is especially useful in the production of dramatic plays for making programs sound "bassy" or "tinny" or for simulating the sound of telephone conversations, short wave radio communications or midget radios.

**Description**

The MI-4917-A consists of high and low pass filters assembled on a panel with two selector panel switches. The switches have nine positions each and are calibrated for high and low cut-off frequencies of 100, 250, 500, 1,000, 2,000, 3,000, 4,000, and 5,000 cycles. There is also an "off" position on each switch. A key switch is provided for removing the filter from the circuit thus making it possible to preset the filter for the desired

characteristics and insert it in the circuit instantly when required.

The 600 ohm input and output impedances of the filter enables it to be connected in any 600 ohm circuit or it may be used in a 250 ohm circuit with only a slight change in response characteristics.

**Specifications**

Source Impedance (unbalanced)	600 ohms
Load Impedance	600 ohms
Input Level	-60 to +23 db*
Output Level (maximum)	+23 db*
Frequency Response	see curves
Insertion Loss	1 db or less at frequencies remote from cut-off
Dimensions, overall	
Height	5 1/4"
Width	19"
Depth	5"
Weight (unpacked)	15 lbs.
Stock Identification—Black	MI-4917
Light Umber Grey	MI-4917-A

\* Reference level one milliwatt.

**MI-4917 VARIABLE SOUND EFFECTS FILTER (600Ω)**

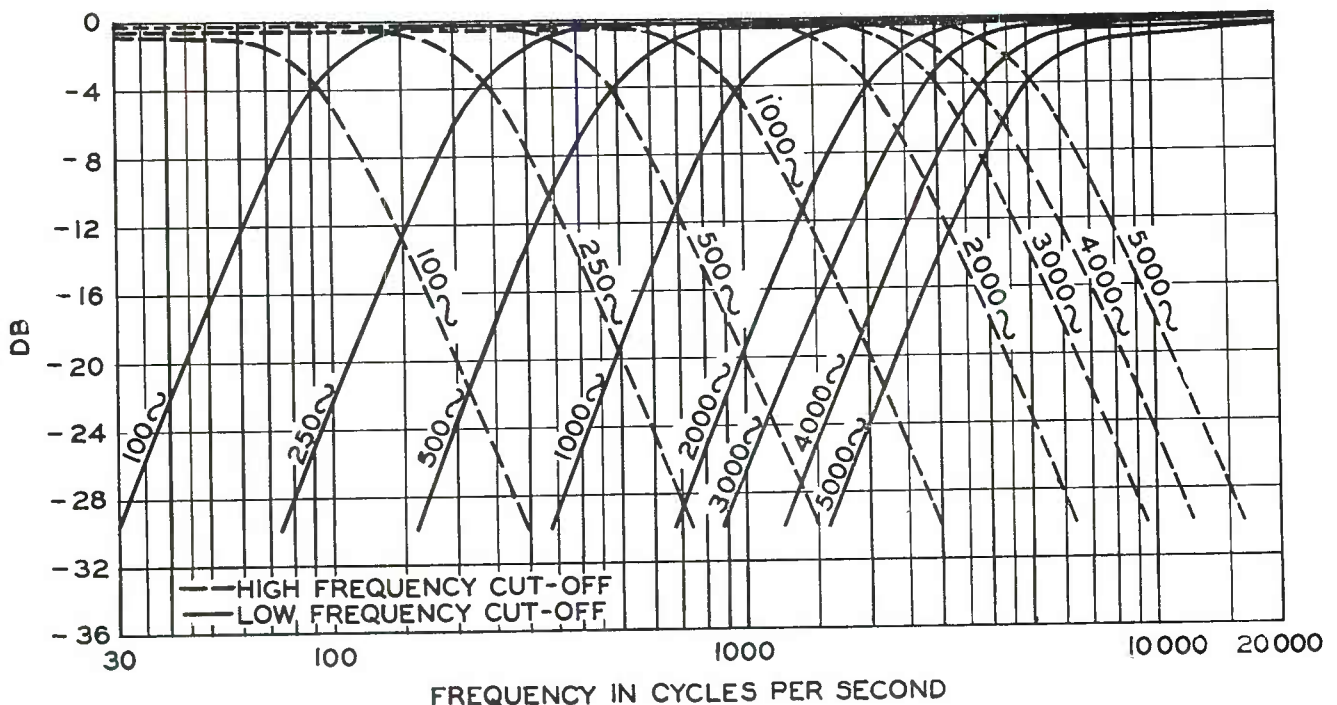

# Line, Mixing and Bridging Transformers

The following standard RCA transformers are stocked as a convenience to broadcasting stations. These transformers are of the highest quality design having a frequency response which is within  $\pm 1$  db. from 30 to 15,000 cycles. They are provided with electrostatic shields between primary and secondary and are furnished with heavily shielded cases. Cores are of special high permeability steel. Terminals are at the top and diagrams of the connections are stenciled on the side of the case. Broadcasting stations may employ the RCA terminal transformers between units with assurance that the overall fidelity of the system will be maintained.



## Line Transformer MI-10253

The core structure, frequency characteristics and shielding of this transformer makes it an ideal unit for isolating line circuits. Its large number of taps provide several combinations of available impedances. One to two of these transformers are very useful items to have around any broadcast station. The impedance combinations are:

Primary Impedances	Secondary Impedances
<i>ohms</i>	<i>ohms</i>
125	125
250	250
300	300
600	600
Stock Identification _____	MI-10253

## Bridging Transformer MI-4901-A

The MI-4901-A transformer may be used as an input transformer for a bridging line amplifier or a monitoring amplifier. It may also be satisfactorily used where it is desired to bridge a program line to feed programs to other mixing or outgoing circuits such as normally employed in a master control room line distribution system. The impedance combinations are:

Primary Impedances	Secondary Impedances
<i>ohms</i>	<i>ohms</i>
20,000	250
	600
Stock Identification _____	MI-4901-A

## Mixing Transformer MI-4902

Those contemplating the design of their own, or special microphone mixing circuits, will find this transformer ideal for a large number of mixer combinations. The impedance combinations are:

Primary Impedances	Secondary Impedances
<i>ohms</i>	<i>ohms</i>
76.5      153	250
90        187	600
109       237	
134       320	
Stock Identification _____	MI-4902

## General Specifications for MI-10253, MI-4901-A and MI-4902

Frequency Response \_\_\_\_\_  $\pm 1$  db. 30 to 15,000 cycles  
 Dimensions, overall for cases:  
 Height \_\_\_\_\_  $4\frac{3}{8}$ "  
 Diameter \_\_\_\_\_ 3"  
 Baseplate \_\_\_\_\_  $3\frac{1}{4}$ " x  $3\frac{1}{4}$ "

Mounting \_\_\_\_\_ Four holes with center lines  $2\frac{3}{4}$ " x  $2\frac{3}{4}$ "  
 Weight \_\_\_\_\_ 2 lbs. 14 ozs.  
 Finish \_\_\_\_\_ Aluminium gray



# Pads - Fixed, Bridging, Network

RCA offers a comprehensive selection of attenuator pads, bridging pads and dividing networks. The pads and networks are well constructed and insulated with precision wound resistors, assuring no internal reflection. The terminals are accessible and securely mounted with the connections stenciled in an appropriate place. The fixed balanced "H" type is available in two types, one introducing a loss of 6 db, the other 10 db. The dividing networks are also available in two types, unbalanced and balanced "H" type, as tabulated below.

**FIXED PADS—BALANCED "H" TYPE**

Input Impedance.....	600 ohms
Output Impedance.....	600 ohms
Insertion Loss.....	6 db
Stock Identification .....	MI-4171-29

**FIXED PADS—BALANCED "H" TYPE**

Input Impedance.....	600 ohms
Output Impedance.....	600 ohms
Insertion Loss.....	10 db
Stock Identification .....	MI-4171-30

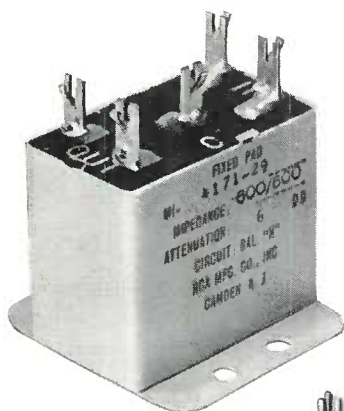

◀ MI-4171-29

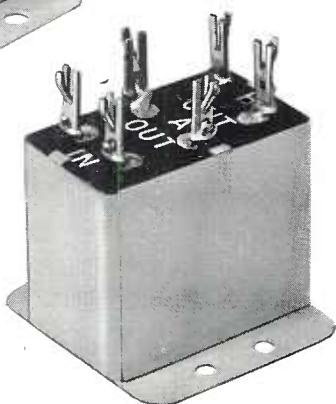

MI-4171-30 ▶



MI-11704-A

**DIVIDING NETWORKS**

Balanced Two-way, 600 ohms	Insertion Loss.....	6 db
	Stock Identification .....	MI-11704
Balanced Three-way, 600 ohms	Insertion Loss.....	9.5 db
	Stock Identification .....	MI-11704-A
Balanced Four-way, 600 ohms	Insertion Loss.....	12 db
	Stock Identification .....	MI-11704-B
Balanced Six-way, 600 ohms	Insertion Loss.....	15.6 db
	Stock Identification .....	MI-11704-D
Balanced Eight-way, 600 ohms	Insertion Loss.....	18.1 db
	Stock Identification .....	MI-11704-E
Unbalanced Two-way, 600 ohms	Insertion Loss.....	12 db
	Stock Identification .....	MI-11704-J
Unbalanced Three-way, 600 ohms	Insertion Loss.....	15.6 db
	Stock Identification .....	MI-11704-L
Unbalanced Four-way, 600 ohms	Insertion Loss.....	18.1 db
	Stock Identification .....	MI-11704-M

**BRIDGING PAD**

Input Impedance.....	600 ohms to two 600 ohm lines—	isolation between lines about 45 db
Insertion Loss.....		10 db
Stock Identification .....		MI-11705

## Filament Transformer MI-11606

The MI-11606 Filament Transformer furnishes filament voltage to a maximum of three BA-1A Pre-amplifiers. It has primary taps for 110 and 120 volts a-c 50/60 cycles. A variable potentiometer is connected across the secondary and is screw driver operated for obtaining minimum hum. This transformer is also used to provide voltage for the MI-11265 VU Meter Panel.

**Specifications**

Output.....	6.3 volts, a-c, 1.8 amperes max.
Dimensions, overall	
Height .....	4"
Base.....	2 <sup>1</sup> / <sub>16</sub> " x 2 <sup>3</sup> / <sub>8</sub> "



Mounting.....	Four .199" mounting holes are located on 2 <sup>5</sup> / <sub>16</sub> " x 1 <sup>1</sup> / <sub>4</sub> " center line
Weight (unpacked).....	2 lbs.
Stock Identification .....	MI-11606

# AM-FM Radio Tuner MI-6784, MI-6785

## Features

- Broadcast, shortwave and frequency modulation reception.
- Bass, treble tone controls.
- Good selectivity.
- Incorporates new ratio detector for FM.
- Compact and light in weight.
- Excellent sensitivity.

## Description

The AM-FM radio tuner is presented for broadcasters who desire a first-class tuner unit for monitoring and listening purposes. This unit may be mounted in a standard 19" cabinet or any desired location. The MI-6784 tuner is essentially the radio unit of the RCA "Crestwood" receiver. It is an eight tube mechanism on a single chassis, equipped to cover the standard broadcast, shortwave and FM bands.

The receiver is designed to operate from an external power pack and will supply low level, high impedance audio current to any amplifier with a 250,000 ohm or more source impedance. The AM portion of the receiver is a superheterodyne circuit incorporating one stage of RF pre-selection on both standard and shortwave broadcast bands. It is equipped with automatic volume control to hold the audio voltage constant over the wide range of input signal voltage.

The FM portion of the receiver is also a superheterodyne circuit, consisting of many outstanding features, including a stage of RF pre-selection, a high intermediate frequency for good signal reflection and the new RCA ratio-detector. This new detector is only sensitive to a frequency modulated signal, thus eliminating costly dual and triple limiter circuits. This also guarantees satisfactory reception of FM signals that may be weak in signal strength or variable due to fading. The MI-6784 tuner utilizes an open-front, slide-rule type of dial with uniform illumination for the appropriate scale in use. The front panel with escutcheon, press buttons, knobs, etc., is not included in the MI-6784. This allows the user to construct his own panel, if desired. The MI-6785, however, employs a front panel with a slope of 17° and is complete with press buttons and knobs. Both units may be accommodated by the MI-12380 panel and shelf, which may be mounted in any standard 19" rack. The panel controls consist of tuning, volume, low frequency tone control, high frequency tone control and range switch. The range switch provides connections for future accommodation of a television audio channel output and the receiver's audio output jack. The MI-12502 power supply available for this tuner is an a-c operated full-wave rectifier and filter unit associated with a suitable transformer to supply filament plate and bias voltages for receivers using 6.3 volt filament supply. The power supply connections are made by nine-prong male receptacles on the rear of the chassis. Coaxial connectors are provided for television audio and audio transcription inputs, in addition to the receiver's audio output.

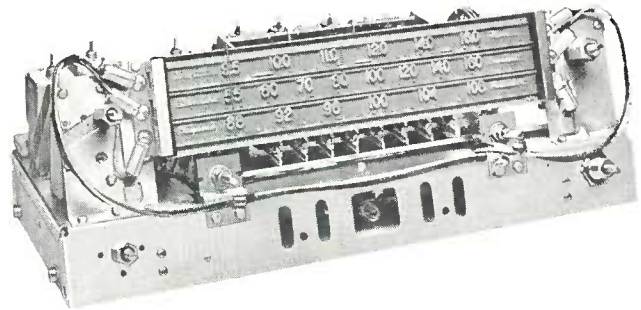

MI-6784

## Specifications

Frequency Coverage	535-1620 kc (Standard Broadcast Band)
	9.2-16.25 mc (Shortwave Band)
	84.5-108.5 mc (Frequency Mod.)
Sensitivity (Absolute)	3.5 microvolts at 1000 kc
	2.7 microvolts at 11.7 mc
	4.6 microvolts at 100 mc
Image Attenuation	7500 at 1000 kc
	165X at 11.7 mc
	500X at FM Frequencies
Bandwidth at 2 db down	7.5 kc at 1000 kc
Intermediate Frequencies	455 kc on Standard Broadcast and Shortwave Bands
	10.7 mc on FM Bands
Load Impedance	250,000 ohms or more
Control	Tuning, Volume, Range Switch Bass, Treble Tone Controls
Tube Complement	6BA6 RF Preslector
	6BA6 Mixer
	6BE6 High Frequency Oscillator
	6BA6 First IF Amplifier
	6AU6 Second IF and Phono Amplifier
	6AT6 Detector—AVC—Audio Amplifier
	6AL5 Ratio Detector

## Dimensions:

Length	17 1/2"
Depth	9 1/8"
Height	6"

Weight (unpacked) 9 lbs.

## Stock Identification:

AM/FM Radio Tuner (Less Escutcheon, Press Buttons, Knobs)	MI-6784
AM/FM Radio Tuner (Complete)	MI-6785

Power Supply Required 250 volts d-c at 50 ma  
100 volts d-c at 15 ma  
—24 volts d-c bias  
6.3 volts a-c at 2.5 amperes

Power Required 117 V.A.C. (full load) 64 watts

Fuse Type 3 AG 3 amperes

## Dimensions:

Length	9"
Width	5 1/4"
Height	6 3/4"

Tube (complement) One RCA 5Y3GT

Weight (unpacked) 6 lbs.

## Stock Identification:

Power Supply 105/125 v. 50/60 cycles	MI-12502
105/250 v. 25/60 cycles	MI-12505

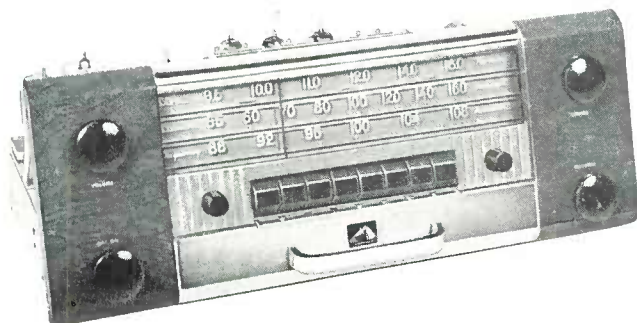

MI-6785

# Preamplifier Power Supply Type BX-1C

## Features

- Exceptionally low hum level.
- Compactly designed.
- Plugs into BR-2A Shelf Assembly.
- Simple design—minimum of parts.
- High capacity filter.
- Filament supply hum balancing potentiometer.
- Voltage variable 180 to 250 volts.

## Uses

The Type BX-1C Preamplifier Power Supply is designed to provide d-c plate and a-c heater power for preamplifiers in which the hum level must be kept to a minimum. It is intended especially for use as a power supply for preamplifiers and isolation amplifiers such as the BA-1A.

## Description

The BX-1C is a plug-in unit designed primarily for mounting in the RCA Shelf Assembly Type BR-2A. This type of mounting is the most convenient for the operator, since the unit may be easily slid into the shelf for installation or easily removed for maintenance. If desired, it may also be mounted in the Type 36-B Shelf Assembly. Two of these power supplies can be installed in either the BR-2A or the 36-B. If neither of these shelves is available, the BX-1C may be mounted in any convenient location. Connection to the terminals is made through a quickly removable, multi-contact connector which fastens to the plug at the rear of the chassis.

The power supply circuit is a full-wave, high-vacuum tube rectifier with a choke-input filter. With a total of 260 microfarads

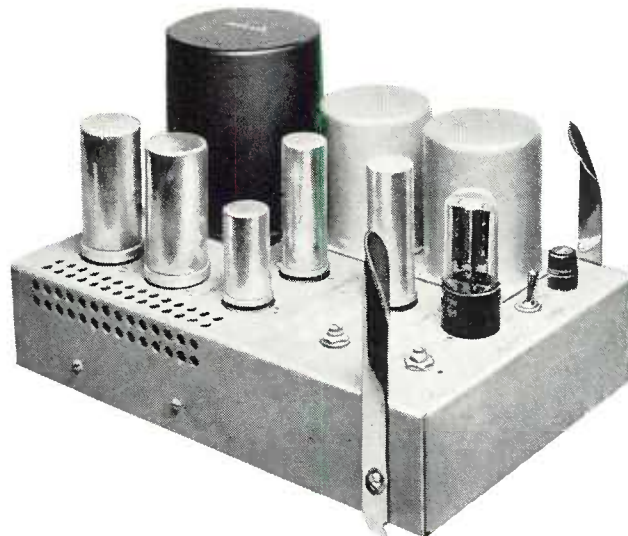

of filter capacitance, the d-c output is exceptionally free from hum. The voltage is variable, by means of a screw driver adjustment, between 180 and 250 volts. The voltage output is very stable with any load up to fifty milliamperes. A hum balancing potentiometer, likewise a screw driver adjustment, is connected across the filament supply circuit.

The BX-1C is designed for operation on any a-c line voltage between 100 and 130 volts, 50 to 60 cycles. A one ampere, glass-enclosed, time-delay fuse is mounted on the front of the chassis. This fuse is unaffected by high transient currents.

## Specifications

Power Supply Required	_____	100 to 130 volts, 50 to 60 cycles, 65 watts
Fuse	_____	1 ampere, Type MDL
Power Output		
D-c	_____	180 to 250 volts, up to 50 ma
A-c	_____	6.3 volts, up to 3.6 amperes
Output Hum Level	_____	Approximately -134 db (below 50 ma d-c load at 250 volts d-c)
Connections	_____	One 10-prong plug-in connection at the rear of the chassis
Dimensions and Weight:		
Length	_____	12 $\frac{5}{8}$ "
Width	_____	8 $\frac{1}{16}$ "
Height	_____	7"
Weight	_____	15 $\frac{1}{2}$ lbs.
Mounting	_____	Shelf mounting in the Type BR-2A or Type 36-B Shelf Assemblies
Stock Identification (less tube)	_____	MI-11305-B

## Accessories

Tube Complement, 1 RCA-5Y3GT/G	_____	MI-11262
Panel and Shelf Type BR-2A:		
Umber Gray	_____	MI-11598/11599
Black	_____	MI-11598-A/11599-A

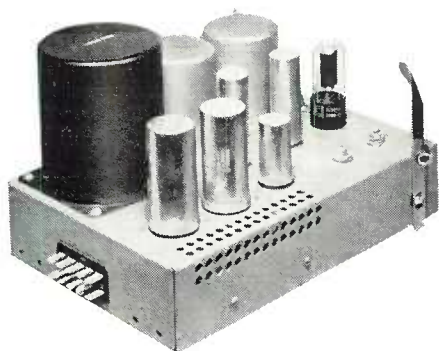

*Back view showing multi-contact connection plug*

# Relay Power Supply MI-11303

## Features

- Supplies 12 volts filtered d-c at 1 ampere.
- Rotary switch permits varying output voltage in 1/2 volt steps.
- Long life full wave copper sulphide magnesium rectifier.
- Housed in an attractive wall mounting cabinet with hinged door

## Uses

The MI-11303 Relay Power Supply is a complete unit capable of supplying filtered d-c power to a number of relays and pilot lights if the total load current at 12 volts does not exceed one ampere.

## Description

The power supply is built in an attractive wall-mounting box. The electrical circuit consists of a power transformer, copper-sulfide magnesium full wave rectifier, and a resistance-capacity filter system with three 1000 mfd. electrolytic plug-in capacitors. The power transformer primary is tapped at 105, 115, and 125 volts to provide line voltage adjustment. The secondary of the power transformer is tapped and connected to a six position rotary switch which permits a variation in output voltage of approximately 1/2 volt per step.

The chassis is bolted in the enclosure with a snap-off cover. The chassis, inside of the mounting box and the terminal board cover are finished in silver grey. The outside of the box is finished in light umber grey with a 4 inch dark umber grey stripe through the middle of the cover.

## Specifications

Output (adjustable for loads from 0.2 to 1.0 ampere) maximum 12 volts 1 amp.  
 Ripple Voltage (at maximum output of 1 amp.) 0.4 volts rms  
 Ac Power Input, 105 to 125 volts, 60 cycles (maximum at rated output) 34 watts  
 Rectifier \_\_\_\_\_ Copper-Sulphide magnesium full wave type

Dimensions  
 Height \_\_\_\_\_ 9"  
 Width \_\_\_\_\_ 9 5/16"  
 Depth \_\_\_\_\_ 6"

Mounting \_\_\_\_\_ Wall mounted by four mounting slots  
 Finish \_\_\_\_\_ Two tone umber grey  
 Weight (unpacked) \_\_\_\_\_ 14.5 lbs.  
 Stock Identification \_\_\_\_\_ MI-11303

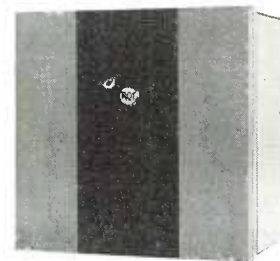

# Heavy Duty Relay Power Supply MI-11304

## Features

- Supplies 12 volts filtered d-c at 5 amperes.
- Output voltage substantially constant from no-load to full-load output.
- Full wave Selenium Type Rectifier.
- Housed in an attractive wall-mounting box.

## Uses

The MI-11304 Relay Power Supply is a complete unit capable of supplying filtered d-c power to a number of relays and pilot lights if the total load current at 12 volts does not exceed 5 amperes.

## Description

The power supply is built into an attractive cabinet for wall mounting. The electrical circuit consists of a power transformer, line and load voltage regulating and shunt reactors, full wave selenium rectifier, filter reactors and capacitors, variable resistors, and terminal board and fuses. Regulation of the d-c output voltage is accomplished by use of a saturable reactor which maintains the output voltage substantially constant from no-load to full-load output.

## Specifications

Output (substantially constant from no-load to full-load output) \_\_\_\_\_ maximum, 12 volts 5 amps.  
 Ripple Voltage (at full load) \_\_\_\_\_ 0.1 volt rms  
 Ac Power Input, 105 to 125 volts, 60 cycles (maximum at rated output) 165 watts  
 Rectifier \_\_\_\_\_ full wave Selenium type

Dimensions  
 Height \_\_\_\_\_ 16 3/8"  
 Width \_\_\_\_\_ 15 1/4"  
 Depth \_\_\_\_\_ 8 1/2"

Mounting \_\_\_\_\_ Wall mounted by four mounting slots  
 Finish \_\_\_\_\_ light umber grey  
 Weight (unpacked) \_\_\_\_\_ 80 lbs.  
 Stock Identification \_\_\_\_\_ MI-11304

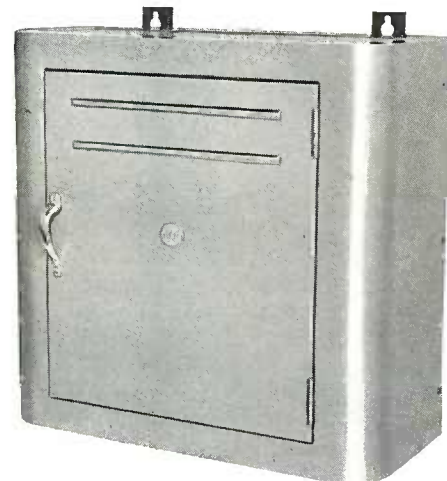

# Transcription Turntable Type 70-D



## Features

- High fidelity reproduction of vertical and lateral recordings.
- Universal lightweight pickup with long wear diamond point stylus.
- Heavy duty constant speed synchronous motor with ample driving power for recording or reproducing.
- Provision for RCA Recording Attachment.
- Quiet operation. Cushion-mounted motor with silent on-off switch.
- Speed change lever in rim of turntable permits change without removing record.
- Ruggedly built to give years of satisfactory service.

## Uses

The Type 70-D Transcription Turntable has been developed to meet the continued demand for higher and higher quality in the reproduction of broadcast transcriptions. It is the latest edition to the popular 70 SERIES of transcription equipments, of which more than 3000 are now in use. It has all the exclusive features of the former models, plus the newly designed universal pickup head and adjustable filter unit. The 70-D provides high fidelity reproduction of *all* vertical or lateral cut records.

## Description

The complete equipment is housed in a metal cabinet of modern design. The cabinet is finished in two tones of umber grey and trimmed in chromium. A large hinged door is located on the front of the cabinet so as to permit ready access to the motor and filter circuits. A heat resistant, "Micarta" top is used. All filters are securely mounted within the cabinet and arranged for minimum hum pickup. There is also sufficient space within the cabinet for a booster amplifier (such as the RCA BA-2 Series) where additional output level is required. If the user desires to raise the height of the cabinet from 28 to 30 inches, the MI-11803 mounting base complete with hardware is available for the purpose.

Terminal boards are provided for a-c and the audio connections and are accessible from the front of the cabinet. Mounted on top of the 70-D cabinet are the tone arm, tone arm rest and filter selector switch. The tone arm is of the counter weight balance type and provisions are made for accurately setting the stylus for one ounce weight on a record. The pickup head is unexcelled and designed to impart high fidelity characteristics for both vertical and lateral recordings. It is of a moving conductor type in which two ribbons are free to move in a vertical or lateral magnetic field. Possible damage to the pickup stylus is prevented by adjustable horizontal and vertical tone arm stops. The horizontal stop prevents the pickup stylus from reaching the small diameter on which the record driving holes are placed. The vertical stop can be adjusted so that the stylus just touches the top of the record platter. The pickup and filter reproduce the various types of records, Orthacoustic, RCA-Victor, Columbia, World and others, with a response characteristic that produces an ideal playback response. The filter unit is designed so that this may be accomplished by merely turning a switch to one of the following six positions:

### LATERAL

1. Transcriptions—NAB Lateral.
2. Home records with 500 cycle crossover frequency (Victor).
3. Home records with 300 cycle crossover frequency.
4. Test records and special recordings (wide open at high frequencies).

### VERTICAL

1. Transcriptions—NAB Standard Vertical.
2. Transcriptions (worn).

Two vacant positions are available on the switch to permit additional filters or compensators to be added if required.

The motor is a high torque synchronous type, cushion-mounted on the bottom shelf of the equipment, thus isolating motor noise from the cabinet. In order to insure the faithful reproduction of high fidelity records, the turntable platter has associated with it a separate specially designed flywheel. This flywheel is approximately 12" in diameter and is located within the cabinet itself. The turntable platter and flywheel assembly is completely isolated from the motor through a series of mechanical filters and a spring clutch arrangement. The combination insures excellent speed regulation and, with the cushion mounting of the motor, prevents noise and vibration

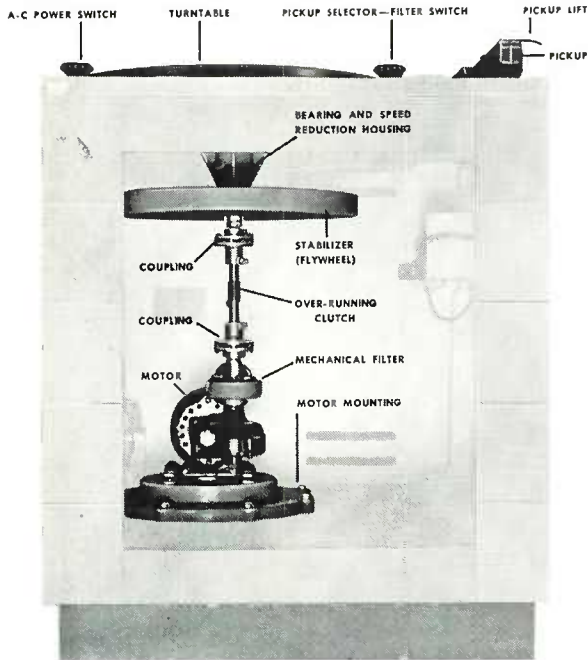

Outline photo of the Type 70-D showing its outstanding mechanical features, simplicity of design and ruggedness.

from being transmitted to the tone arm, a feature which is highly important when attempting to reproduce high fidelity records satisfactorily.

A silent type of power switch, located on top of the machine, permits the turntable to be operated near a microphone.

The RCA Type 72D/72DX Recording Attachments are available for use with the 70-D Turntable. Mounting holes are provided for easy and quick installation.

**Specifications**

Pickup Impedance \_\_\_\_\_ 250 ohms  
 Load Impedance \_\_\_\_\_ Output of compensator should be connected to the unloaded input transformer of an amplifier designed to operate from a 250 ohm source such as BA-1A or BA-2 series.

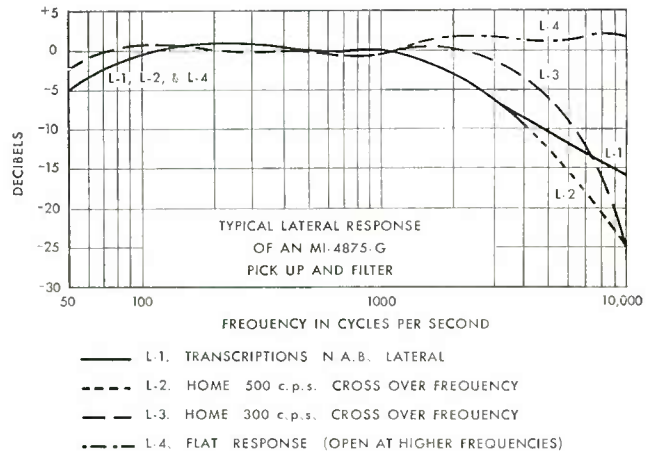
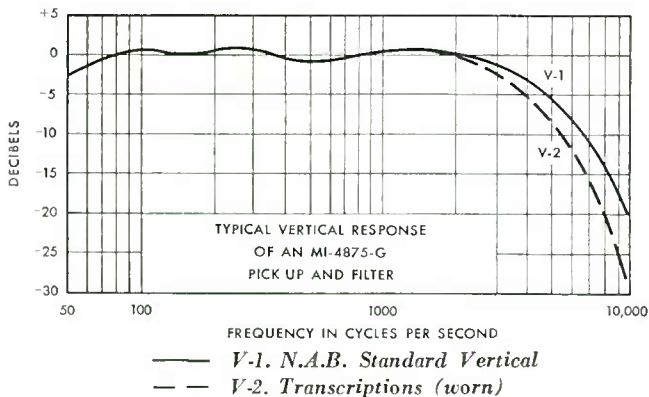

- Output Level \_\_\_\_\_ -63 dbm L1 position at 1,000 cycles T-2485 test record  
 \_\_\_\_\_ -68 dbm (.001 watt reference) V1 position at 1,000 cycles—TRV-104 test record  
 Noise Level (below 1 milliwatt reference level) \_\_\_\_\_ -120 dbm  
 Frequency Response (see curves) \_\_\_\_\_ 50-10,000 cycles  
 Transmission Loss of Filter \_\_\_\_\_ 24 db at 1,000 cycles at each of the 6 switch positions  
 Stylus \_\_\_\_\_ Polished diamond  
 Turntable Diameter \_\_\_\_\_ .16"  
 (Will handle records up to 18" in diameter)  
 Turntable Speed \_\_\_\_\_ 33 1/3-78 rpm  
 Speed Regulation (wows) \_\_\_\_\_ 0.2% rms at 33 1/3 rpm  
 \_\_\_\_\_ 0.09% rms at 78 rpm  
 Dimensions, overall  
 Height (overall) \_\_\_\_\_ 28 3/8"  
 Height (overall with MI-11803) \_\_\_\_\_ 30 3/8"  
 Width \_\_\_\_\_ 25 1/4"  
 Depth \_\_\_\_\_ 24 1/4"  
 Finish \_\_\_\_\_ Two tone umber grey with chromium trim  
 Weight (unpacked) \_\_\_\_\_ 155 lbs.  
 Power Supply \_\_\_\_\_ 105-125 volts, 50 or 60 cycles  
 Power Consumption \_\_\_\_\_ 35 watts  
 Stock Identification  
 UMBER GREY, 60 CYCLES \_\_\_\_\_ MI-11801  
 UMBER GREY, 50 CYCLES \_\_\_\_\_ MI-11802  
 BLACK, 60 CYCLES \_\_\_\_\_ MI-11802-A  
**Accessories**  
 BA-2C Booster Amplifier \_\_\_\_\_ MI-11226-B  
 72-D/72-DX Recording Attachment \_\_\_\_\_ MI-11901 or MI-11900  
 Mounting Base \_\_\_\_\_ MI-11803

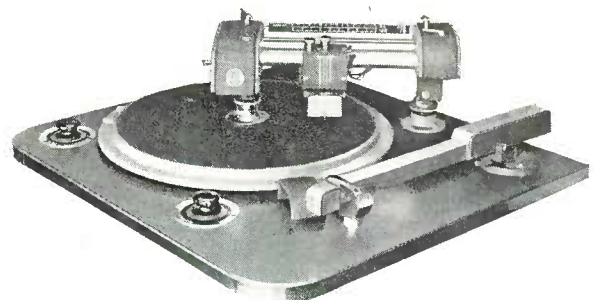

70-D Turntable with 72-D Recording Attachment in position

# Universal Pickup Kit MI-4875-G

**Features**

- High fidelity reproduction of vertical and lateral recordings.
- Adjustable weight pickup head.
- Low moving mass.
- Adjustable vertical and lateral stops.
- No stylus breakages.

**Uses**

The Universal Pickup Kit has been designed to give an ideal playback response for all vertical and lateral recordings. This unit has a versatile mounting attachment and may be fitted to most turntables.

**Description**

The pickup head is a high quality moving conductor type, in which two ribbons are free to move in a vertical and lateral field. The head used in conjunction with a carefully designed compensator, produces ideal curves for all the various types of records. The compensator uses a series resonant circuit, variably tuned and shunted by merely turning a switch to one of six positions. Each kit consists of a Universal Pickup Head with an attractively styled tone-arm complete with finger lift, tone-arm rest position, six position compensator switch with

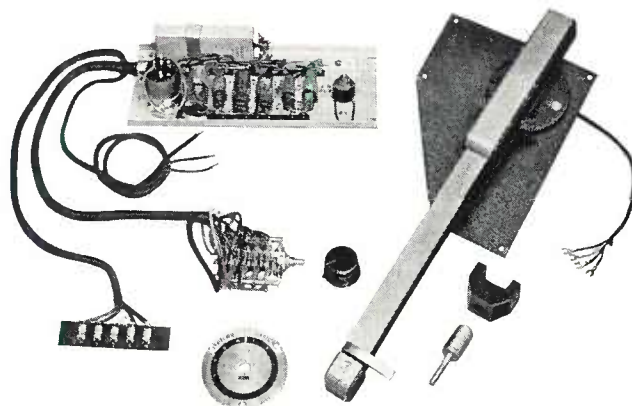

dial plate and filter kit with cable and terminal board. All the necessary accessories are provided for use on the 70-C series transcription turntables. For a more complete description and response curves, refer to the catalog page which features the 70-D turntable. The pickup compensator will operate satisfactorily into a BA-1A pre-amplifier, BA-3C program amplifier or any amplifier designed with an unloading input transformer for operation from a 250 ohm source impedance.

Weight (unpacked) \_\_\_\_\_ 12 lbs.  
 Stock Identification \_\_\_\_\_ MI-4875-G

# Reproducing Filter MI-4975

The MI-4975 Filter is a newly designed unit and is an integral part of the 70-C2 and 70-D Turntables and the MI-4875-G Universal Pickup Kit. This kit is made available for the user who wishes to convert the superseded 70-C and 70-C1 Turntables and the MI-4875-C Pickup and take advantage of the considerable improvement in this filter design. The high frequency response for the Associated records is very much improved and the overall response characteristics for lateral records now conform to an ideal curve. The kit consists of compensator complete with cable, terminal board and a six-position compensator switch.

The changes are effected by merely transferring five wires on the terminal board. For the new response characteristics produced, reference is made to the 70-D Turntable catalog page, where these curves are shown.

Weight \_\_\_\_\_ 5 lbs.  
 Stock Identification \_\_\_\_\_ MI-4975

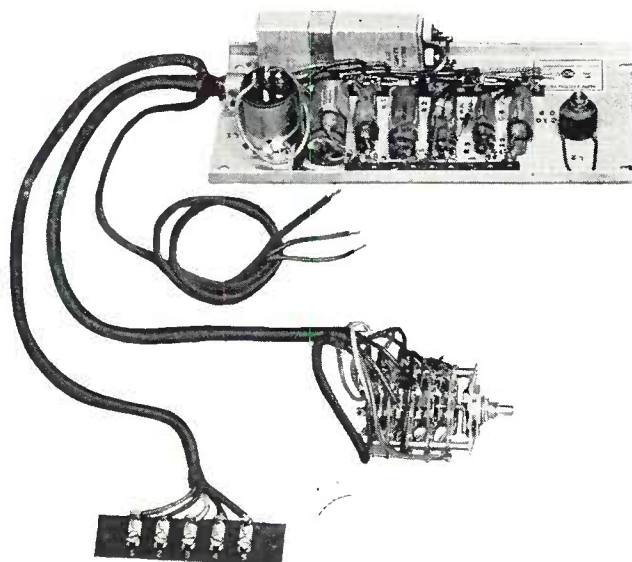

# RECORDING INSTALLATIONS



◀  
*Studio recording installation at KUTA, Salt Lake City, Utah, showing two bench-mounted RCA 73-B Professional Recorders.*

*An ideal recording installation at KECA, Los Angeles, Calif., showing two of the four RCA 73-B Professional Recorders. Note the conveniently located overhead lighting, the large size suction duct, and relatively short length of hose for chip removal.*

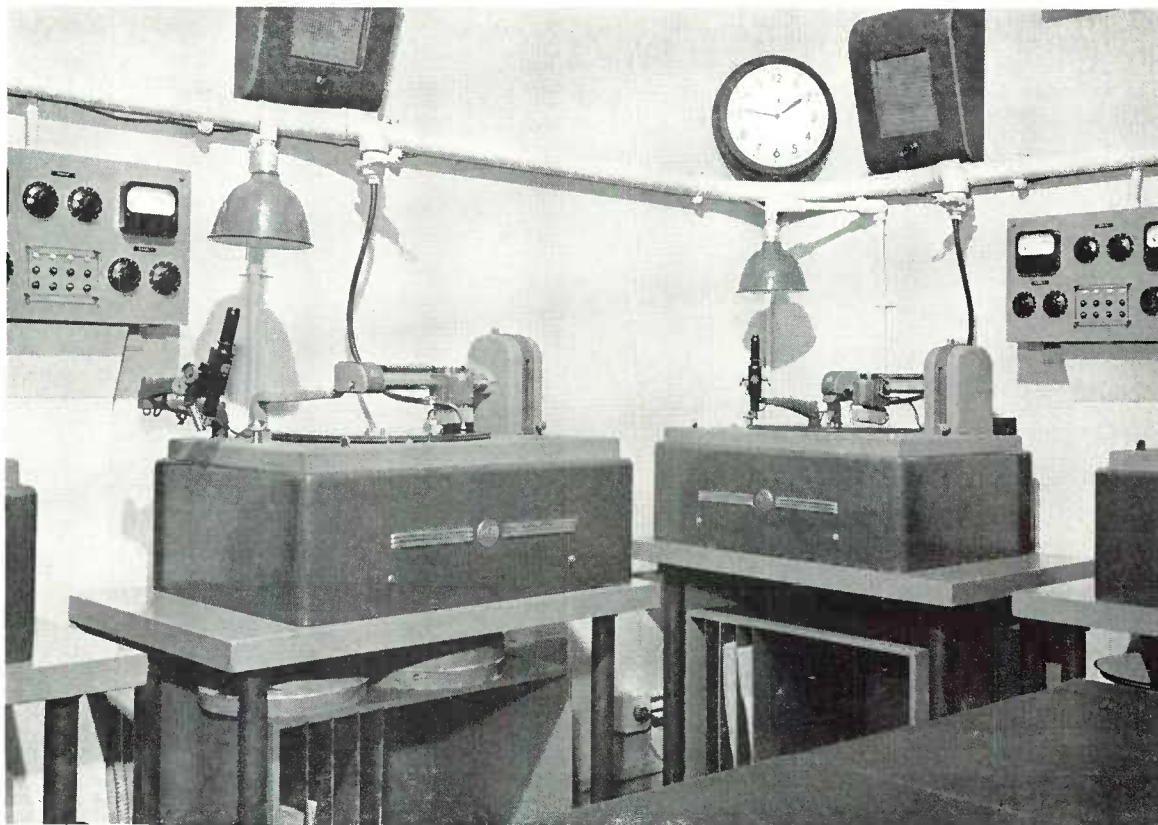



# Recording Equipment

RCA offers a complete line of high fidelity recording equipment featuring outstanding performance characteristics, simplicity of operation and many other exclusive features which are described on the following pages. For professional recording studios, broadcasting stations, educational institutions or wherever high quality discs are to be cut, these recorders are unexcelled.

Type	Usage	Recording Speed rpm	Recording Pitch Lines per Inch— Inside out or Outside in	Max. Dia. Blank	Frequency Response cps	Required Audio Power
73-B	Professional AM-FM Broadcast Studios Educational	33 $\frac{1}{3}$ or 78	Con. Var. 96 to 152	18 $\frac{1}{4}$ "	$\pm 2$ db 50-10,000	Approx. 1 Watt*
72-DX	AM-FM Broadcast Studios Educational	With 70 Ser. Turntables 33 $\frac{1}{3}$ or 78	96,112,136	18 $\frac{1}{4}$ "	$\pm 2$ db 50-10,000	Approx. 1 Watt*
72-D	AM-FM Broadcast Studios Educational	With 70 Ser. Turntables 33 $\frac{1}{3}$ or 78	96,112,136	18 $\frac{1}{4}$ "	$\pm 3$ db 50-7,500	Approx. 1 Watt**

\* For 6.3 cm/sec stylus velocity at 1000 cps.  
\*\* For 6.1 cm/sec stylus velocity at 1000 cps.

The following diagrams have been designed to assist the user in determining the equipment required for a recording channel. Since there is considerable difference in recording technique, these illustrations must only be regarded as suggested installa-

tions. For example, some engineers prefer to introduce compensation prior to the limiting amplifier, while others prefer to record "flat" with automatic equalization to compensate for the changes in cutting diameter.

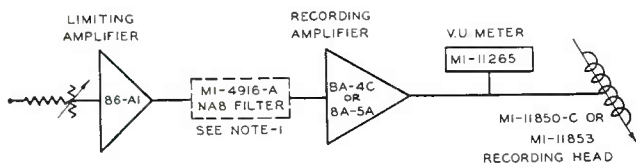

Fig. 1. This diagram illustrates a recording technique using the orthacoustic filter only.

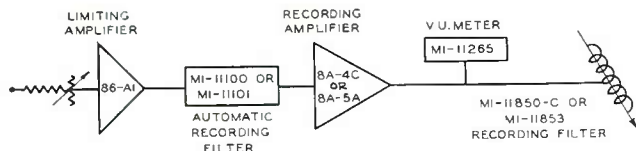

Fig. 2. This diagram illustrates a recording technique using the automatic recording filter only (or "flat").

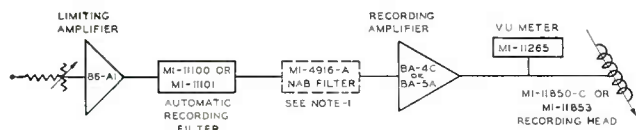
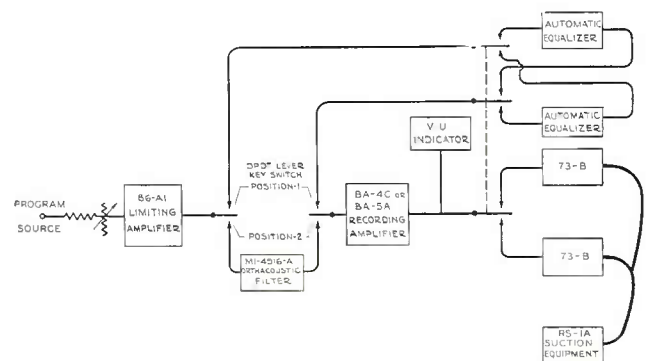

Fig. 3. This arrangement is included for recordists who choose to use both "automatic" and NAB orthacoustic compensation.



This diagram illustrates a recording installation which will handle recording techniques shown in Figures 1 and 2.

Note 1. The MI-4916-A recording filter is not required when the BA-5A recording amplifier is used. The compensating network is incorporated within this amplifier.

# Recording Attachment Type 72-D/72-DX

## Features

- Produces high quality recordings on any 70-Series Turntable.
- Records at 33 $\frac{1}{3}$  or 78 rpm at 96, 112 and 136 lines per inch. *Outside-in or inside-out* recording is accomplished without changing feedscrews or gears.
- Timing scales indicate remaining recording time.
- Improved lowering device avoids stylus or record damage.
- Convenient adjustment of stylus angle and depth of cut.
- Hand crank for spiralling grooves.
- Convenient adjustment for horizontal alignment.
- Lead screw protected by cylindrical tube housing.
- Provision made for installing automatic equalizer.

## Uses

The 72-D Recording Attachment may be easily and quickly installed on any of the RCA 70-Series Turntables to provide an unusually high quality instantaneous recording equipment at an economical price. It is a newly designed and much improved version of the widely used Type 72-C. Broadcast stations will find many uses for this item such as recording rehearsals and controversial broadcasts, making records for use by the time salesmen and recording programs for delayed broadcasts. It may also be satisfactorily used for making masters for processing.

## Description

The 72-D is equipped with a sturdy frame containing a screw mechanism for driving the cutter carriage across a record blank. Power coupling is made to the center of the turntable by means of a vertical shaft spiral gear and loosely coupled three pin driving flange which eliminates slippage and "knocks." Precision leveling adjustments are made by a swivel support with an accurate vertical adjustment. The mechanism is made so that it will swing clear when not in use or it may be easily removed from the transcription turntable if desired.

An improved lowering device permits the operator to gently lower the cutter on to the record, thus avoiding stylus breakage or deep cuts from sudden dropping. The angle of the stylus and the depth of cut may be conveniently adjusted even during operation. A spiralling hand crank permits spacing between musical selections without breaking the continuity of the groove. It is useful also for cutting starting and finishing spirals. The 72-D will record at either 33 $\frac{1}{3}$  or 78 rpm outside-in or inside-out at 96, 112 and 136 lines per inch. Selection of direction and pitch is made easily and quickly without changing lead screws or gears. Two interchangeable spring released hexagon timing scales are provided for giving an accurate indication of the remaining recording time. The scales are calibrated to cover all combinations of turntable speed and groove spacing. The cutter carriage does not ride on the feedscrew, but is supported on a metal tube in which the feedscrew is enclosed and is guided on another tube which is designed to house an automatic equalizer. This feature eliminates "grouping" of grooves, increases the life of the feedscrew and protects the feedscrew from dust. A lip has been turned on the driving spindle to catch the threads and prevent their climbing into the gears or bearings.

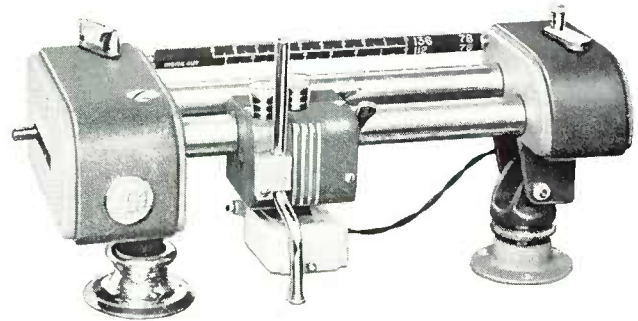

Type 72-D Recording Attachment

The 72-D is furnished complete with Standard recorder head, MI-11853-A mounting base and rest post. However, if a high fidelity response is required, the type 72-DX with the MI-11850-C recorder head is available. This high quality head is maintained at a constant temperature while operating by self-contained heater and thermostat. The power for the heater operation is obtained from an MI-11855-A heater and compensator kit as an accessory item. The MI-11854 base attachment is available for mounting the 72-D/72-DX on all 70 series turntables. Additional base attachment kits are available if the recorder is to be used on more than one turntable.

An MI-4910-A conversion kit, which consists of a replacement turntable felt, cement, support assembly and template, may be ordered when the 72-D attachment is to be used with a 70-A or 70-B turntable.

A suction nozzle is provided to facilitate the use of RCA suction equipment, MI-11857/MI-11858.

## Specifications

Input Impedance to Cutter	_____	15 ohms nominal
Frequency Response:		
Type 72-D	_____	±3 db, 50-7500 cps
Type 72-DX	_____	±2 db, 30-10,000 cps
Sensitivity:		
Type 72-D [groove velocity 6.1 cm/sec., .00079" (peak to peak) at 1000 cps]	_____	+28 dbm
Type 72-DX [groove velocity 6.3 cm/sec., .00079" (peak to peak) at 1000 cps]	_____	+30 dbm
Recording Direction (adjustable)	_____	Inside-out and outside-in
Recording Pitch (adjustable)	_____	96, 112, and 136 lines per inch
Drive	_____	Platter of an RCA 70-C series or OR-1A Turntable
Dimensions, overall		
Height	_____	5 $\frac{3}{4}$ "
Length	_____	15 $\frac{1}{2}$ "
Depth	_____	6 $\frac{1}{2}$ "
Weight (unpacked)	_____	8 $\frac{1}{2}$ lbs.
Finish	_____	Two tone umber-grey, wrinkle
Stock Identification (as normally shipped)	_____	MI-11901
		(Includes MI-11852 Attachment, MI-11853 Recorder Head, and MI-11854 Mounting Base)
Stock Identification (Type 72-DX)	_____	MI-11900
		(Includes MI-11852 Attachment, MI-11850-C High Fidelity Recorder Head, MI-11854 Mounting Base, and MI-11855-A Heater and Compensator Kit)

## Accessories

Automatic Equalizer	_____	MI-11101
Fixed Orthacoustic Equalizer	_____	MI-4916-A
Heater and Compensator Accessory Kit	_____	MI-11855-A
Recording Suction Equipment (less hose)	_____	MI-11857
Chip Remover and Hose Assembly	_____	
(for suction equipment)	_____	MI-11858
BA-4C Recording Amplifier	_____	MI-11223-B
Sapphire Stylus	_____	90° MI-4878-D
	_____	70° MI-4842
Steel Stylus, package of 6	_____	MI-4879-A
Additional Mounting Base Kit	_____	MI-11854



Type 72-D Recorder Mounted on a Type 70-C1 Turntable

## Professional Recorder Type 73-B

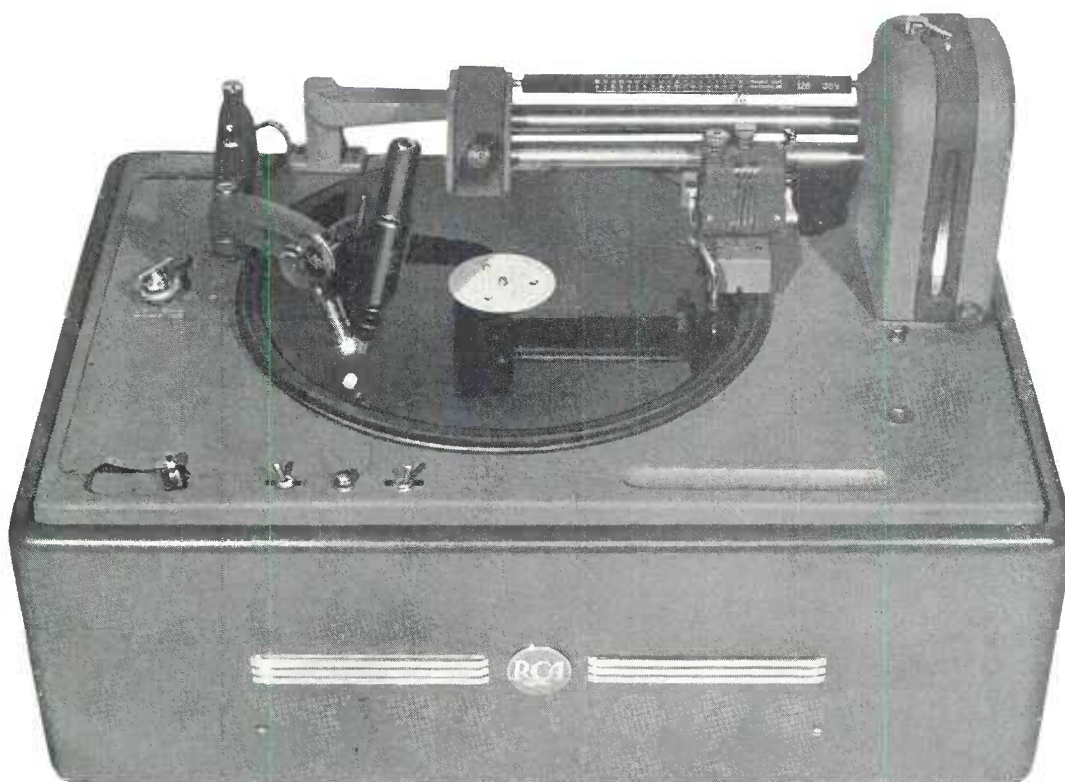

### Features

- Complete shock mounting and special motors reduce vibration and rumble to a minimum.
- High fidelity recording head handles full power with low distortion.
- Two motor drive. Each motor has its own rubber idler wheel providing high torque and excellent regulation.
- Can be adjusted, while recording, for 96 to 152 lines per inch *inside-out* or *outside-in* cut without changing lead screw or gears.
- Large platter with rubber mat takes blanks up to 18¼ inches.
- One driving pin enables any type blank to be used. Pin is held up by spring and sinks into platter if record without driving holes is used.
- Cutter angle and depth of cut can be easily adjusted while recording.
- Dropping mechanism can be operated with one hand; lowers cutter on record slowly to prevent stylus damage.
- Lathe type construction ensures accurate alignment and permits rapid record changing.
- Equipped with high grade microscope and illuminating lamp for accurately checking grooves on any portion of record.

### Uses

The 73-B Recorder is an outstanding professional type unit which has been designed to include almost every known device for making high quality recordings. Recording studios will acclaim the 73-B as the ideal recorder for making masters from which any number of pressings may be made. Broadcasting stations will find it unsurpassed for recording programs for use on delayed broadcasts, commercial accounts, rehearsals, auditions or the reference file.

### Description

The 73-B Recording Equipment consists of a high fidelity MI-11850-C Recording Head with its associated carriage and lead screw mechanism, a turntable assembly which includes a dual motor with rim drive mechanism, a turntable platter with rubber mat, a microscope and microscope lamp and a suction nozzle (less the suction generating and hose connecting equipment) for removing acetate shavings from the record.

The MI-11850-C Recording Head is a high quality, precision built, magnetic type unit with a frequency response which does not depart from an ideal response curve by more than two decibels between 30 and 10,000 cycles per second. Any discrepancies created by temperature variation are eliminated by the self-contained heater and thermostat. A visual indicator controlled by a switch on the base indicates when the heater is in circuit. Its flat type mechanical construction eliminates flutter without the use of special damping mechanisms. The recorder head rides on a smooth metal tube which encloses the feed screw and is guided on another tube which is designed to house an MI-11100 automatic equalizer. This arrangement eliminates "grouping" of grooves, increases the life of the feed screw and protects the feed screw from dust and dirt particles.

An improved cam-operated lowering device permits the head to be lowered gently with decreasing acceleration as the head approaches the record. This feature prevents stylus breakage or deep cuts from sudden dropping of the recorder head. The angle of the stylus, the depth of the cut and the number of lines per inch may be conveniently adjusted even while recording.

The turntable is rim driven through rubber idler rollers from two hysteresis type synchronous motors. These motors were chosen because of their quiet operation and accurate speed. The two motors and turntable drive wheels are both controlled by one "on-off" switch and both mechanisms are controlled by one "speed-change" switch. When the motor switch



# Portable Recording Equipment OR-1A

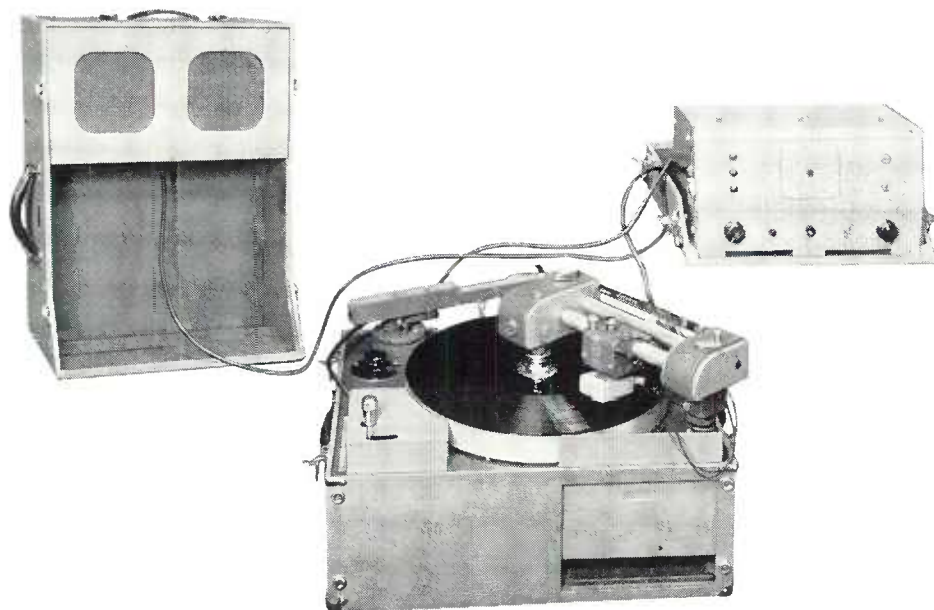

## Features

- Complete high quality portable recording and reproducing system.
- Records at 33½ or 78 rpm at 96, 112 and 136 lines per inch outside-in or inside-out.
- All exclusive features of the 72-D Recorder such as three pin drive, inside-out or outside-in recording without changing feed screws or gears, spiralling hand crank and timing scales.
- High quality shock-mounted hysteresis type motor and two rubber-tired driver wheels provides minimum slippage and eliminates wows.
- High fidelity universal pickup with long wear diamond point reproduces all lateral or vertical cut records.
- High fidelity amplifier ( $\pm 2$  db 30 to 15,000 cycles) with bridging and matching inputs provides 110 db gain and 12 watts rated output ample for any recording or reproducing requirement.
- Amplifier includes "playback-record" switch, two external input terminations, monitoring headphone jack, power switch and fuse.
- Low control panel includes necessary switches and controls while permitting good visibility of subject being recorded. Sloping mounting panel for installation of large volume meter.
- Two "accordion cone" speaker units mounted in carrying case with removable lid provide a total output of 6 watts.

## Uses

The OR-1A Portable Recording Equipment is a high quality reasonably priced assembly which includes all the equipment necessary for cutting high quality instantaneous recordings in the studio or at remote locations. It is a complete recording channel, less microphone, and will record at either 78 or 33½ rpm at 96, 112 or 136 lines per inch. The turntable will

accommodate any sized record up to 16 inches and the playback apparatus will reproduce all types of lateral and vertical records with a uniform frequency response between 30 and 10,000 cycles.

When required the turntable, amplifier and speaker units may be used, less the recording attachment, as a high fidelity record player for demonstration and sales purposes or, with a microphone, as a 12 watt P. A. system. The amplifier, turntable and speaker units may be ordered separately for this purpose. If desired, for a permanent installation, the turntable motor hoard may be removed from the carrying case and mounted in a desk or console.

## Description

The OR-1A consists of a 16" MI-11212-B Turntable, a Type 72-D Recording Attachment, Universal Pickup and Arm Assembly, a 12 watt amplifier MI-11212 with dual loudspeaker unit.

The recording mechanism (Type 72-D attachment) supplied with an MI-11853 recording head meets all requirements for producing high quality recordings. If, however, a higher fidelity characteristic is desired, the MI-11850-C recording head is supplied with the complete recorder, or may be obtained as an accessory item. High fidelity reproduction of both lateral and vertical cut records is accomplished by use of the newly designed MI-4875-G universal pickup which is essentially the same as that used on the 70-D Turntables.

The MI-11212 Amplifier has an overall gain of approximately 110 db. This gain remains approximately the same when the MI-11212 is used with the Orthoacoustic Recording Filter or with the Automatic Recording Equalizer since a compensating pad is removed when either of these units is connected to

the amplifier. The amplifier includes a built-in a-c rectifier, has a frequency response of  $\pm 2$  db from 30 to 15,000 cycles, a low noise level, and a distortion content of less than 3% rms at full output when measured at any frequency between 50 and 7500 cycles. A complete single stage preamplifier with input and output transformers is included as a part of the amplifier. This provides a 250 ohm circuit following the pre-amplifier for the insertion of equalizers, if desired.

A "playback-record" switch is mounted on the front panel and transfers both the input and output circuits of the amplifier. When thrown to the "playback" position, the input of the amplifier is connected to the pickup and the output to the loudspeakers. When the switch is in the "record" position, the input of the amplifier is connected to the input selector switch and the output to the recorder head. Two external input terminals are provided; one is a Cannon microphone receptacle for a 30 to 250 ohm microphone and the other is on insulated binding posts for bridging a 600 ohm line. The gain control is a high quality step-by-step potentiometer. A cut-out is provided in the front panel for the installation of an MI-11251 VU Meter Kit for monitoring the recording level, if desired. A monitoring headphone jack, a power switch and a fuse are also located on the front panel for ready accessibility. Mounted in the removable lid of the amplifier are two RCA "Accordion Cone" Speaker Units which are enclosed in a sealed compartment for proper cone loading and low frequency response. The unit is furnished with an a-c power cord and with a turntable interconnecting cable which is equipped with a Cannon plug to fit the receptacle in the MI-11211B Turntable.

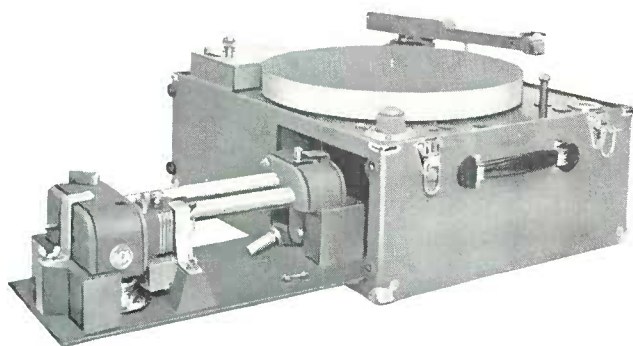

Showing method of Mounting Recording Attachment while transporting unit.

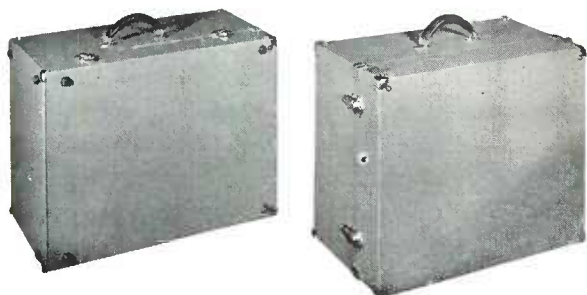

The complete OR-1A Equipment ready for transporting.

**Specifications**

**RECORDING MECHANISM TYPE 72-D**

Recorder Head \_\_\_\_\_ MI-11850-C or MI-11853  
 Frequency Response \_\_\_\_\_  $\pm 4$ db 50 to 7500 cycles  
 Recording Direction (adjustable) \_\_\_\_\_ Inside-out or outside-in  
 Recording Pitch \_\_\_\_\_ Adjustable, 96, 112, or 136 lines per inch  
 Finish \_\_\_\_\_ Two tone unher grey wrinkle

**PORTABLE TURNTABLE (60 cycles) \_\_\_\_\_ MI-11211-B**

Turntable Diameter (for 12", 14" or 16" records) \_\_\_\_\_ 16"  
 Turntable Speeds \_\_\_\_\_ 33 $\frac{1}{3}$  — 78 rpm  
 Turntable Drive \_\_\_\_\_ Rim driven through rubber idler rollers  
 by heavy duty synchronous motor  
 Speed Regulation (wows) \_\_\_\_\_ 0.15% rms max. at 33 $\frac{1}{3}$  rpm  
 0.1% rms max. at 78 rpm  
 Power Supply (105-125 volts, 50-60 cycles) \_\_\_\_\_ 120 watts

Dimensions Overall for Turntable Carrying Case  
 Height \_\_\_\_\_ 12 $\frac{3}{8}$ "  
 Width \_\_\_\_\_ 24"  
 Depth \_\_\_\_\_ 21"  
 Weight (unpacked, but including 72-D Attachment) \_\_\_\_\_ 56 lbs.

**AMPLIFIER AND SPEAKER ASSEMBLY \_\_\_\_\_ MI-11212**

Source Impedance (unloaded transformer input) \_\_\_\_\_ 250 ohms  
 Source (Bridging) Impedance \_\_\_\_\_ 600 ohms  
 Input Bridging Impedance \_\_\_\_\_ 20,000 ohms  
 Load Impedance  
 Cutter Head Terminals \_\_\_\_\_ 15 ohms  
 Speaker Terminals \_\_\_\_\_ 7.5 ohms  
 Preamplifier Output (to external filters) \_\_\_\_\_ 250 ohms  
 Audio Power Output (less than 3% rms distortion 50 to 7500 cycles) \_\_\_\_\_ (40.8 db\*) 12 watts

Frequency Response (250 ohm source to 15 ohm load)  
 \_\_\_\_\_  $\pm 2$  db 30 to 15,000 cycles

Maximum Gain  
 Overall from 250 ohm Microphone to 15 ohm cutter  
 \_\_\_\_\_ 110 db  $\pm 2.0$  db  
 Overall from 250 ohm Pickup to 7.5 ohm Speakers  
 \_\_\_\_\_ 110 db  $\pm 2.0$  db  
 Bridging 20,000 ohms Input \_\_\_\_\_ 500 ohm line to 7.5  
 or 15 ohm load approximately 30 db  
 Noise Level (40.8 db\* output, maximum gain) \_\_\_\_\_ 52 db\*  
 A-c Power Supply (105-125 volts, 50-60 cycles) \_\_\_\_\_ 120 watts

Dimensions, Overall for Amplifier-Speaker Carrying Case  
 Height \_\_\_\_\_ 14"  
 Width \_\_\_\_\_ 18 $\frac{1}{2}$ "  
 Depth \_\_\_\_\_ 23 $\frac{1}{2}$ "

Weight (unpacked—for Amplifier and Speakers) \_\_\_\_\_ 63 lbs.  
 Finish \_\_\_\_\_ Two tone unher grey

**Stock Identification**

Complete Recorder, less tubes with MI-11853 Recorder Head \_\_\_\_\_ MI-11210-E  
 Complete Recorder, less tubes with High Fidelity Recorder Head Type MI-11850-C and MI-11855-A Heater and Compensator Kit \_\_\_\_\_ MI-11210-D

**Accessories**

Tube Kit (complete tube complement)  
 5 RCA 1620, 2 RCA 1622, 1 RCA 5R4GT \_\_\_\_\_ MI-11259  
 Emergency Tube Kit (complete tube complement)  
 5 RCA 6J7's, 2 RCA 6L6's, 1 RCA 5R4GT \_\_\_\_\_ MI-11259-A  
 High Fidelity Recorder Head \_\_\_\_\_ MI-11850-C  
 VU Meter and Attenuator Kit \_\_\_\_\_ MI-11251  
 Orthacoustic Recording Filter \_\_\_\_\_ MI-4916-A  
 Automatic Recording Equalizer \_\_\_\_\_ MI-11101  
 Microphones \_\_\_\_\_ RCA 44-BX, 77-D, 74-B, or 88-A  
 Sapphire Stylus \_\_\_\_\_ 90° MI-4878-D  
 70° MI-4842  
 Steel Styli, Package of 6 \_\_\_\_\_ MI-4879-A

\* Reference level one milliwatt.

# High Fidelity Recording Head MI-11850-C

## Features

- Meets all high fidelity requirements.
- Does not depart from an "ideal response" by more than  $\pm 2$  db 50-10,000 cps.
- Response independent of ambient temperatures.
- Precision built.
- Self-contained heater.

## Uses

The MI-11850-C High Fidelity Recording Head has been specially designed for the user who demands high fidelity recordings. It was primarily produced for use with the 72-DX Recording Attachment, 73-B Professional Recorder and the OR-1A Portable Recorder.

## Description

The High Fidelity Head is a high quality professionally built and accurately adjusted unit of the magnetic type. Physically, the head consists of a cobalt-alloy permanent magnetic, laminated pole pieces, a driving coil, an armature, and dampening material assembled in an attractive case. The armature is supported on knife-edge bearings and held in position by a steel centering spring. Its flat type construction allows the head to

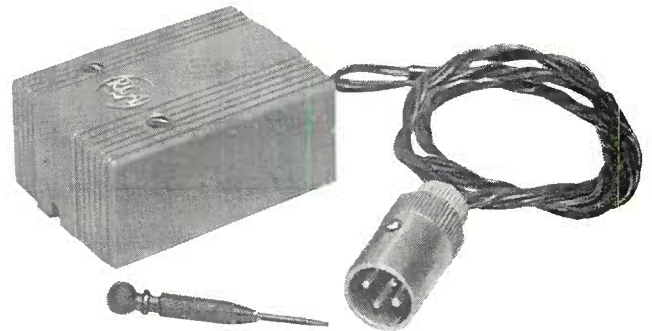

lie in a lateral plane, thus eliminating flutter without the need for special dampening mechanism. Connections are made through a four-pin plug. Any discrepancies that might be created by temperature variations are eliminated by a self-contained heater and thermostat. The power for the heater operation is obtained from an MI-11855-A Heater and Compensator Kit. A small screwdriver is provided to fit the stylus setscrew.

## Specifications

Input Impedance (with compensator)	15 ohms
Frequency Response	$\pm 2$ db 50 to 10,000 cps
Sensitivity [groove velocity 6.3 cm/sec., .00079" (peak to peak) at 1000 cps]	+30 dbm (1.0 watt)
Stylus	Sapphire or steel
Dimensions:	
Height	1 3/8"
Width	2"
Length	3 3/4"
Weight	10 1/2 oz.
Finish	Light umber gray
Stock Identification	MI-11850-C

## Accessories

Heater and Compensator Kit	MI-11855-A
Stylus Sapphire 90°	MI-4878-D
Sapphire 70°	MI-4842
Steel (packet of 6)	MI-4879

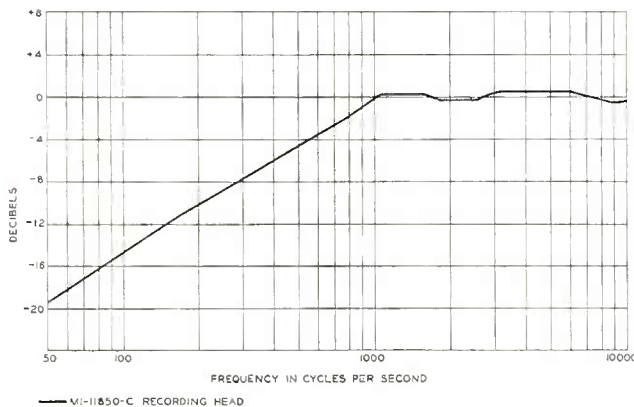

# Heater and Compensator Kit MI-11855-A

This kit was specifically design for use with an MI-11850-C High Fidelity Recording Head. This maintains the operating temperature at a constant value, rendering the response of the recorder head independent of ambient temperature. The temperature is held at approximately 95° F. by means of a thermostatically controlled heater mounted in the recorder head. The kit consists of the following components: heater transformer, pilot light assembly complete with bulb, 3 position switch, a 7 ohm 5 watt resistor, a dial plate reading "High", "Low" and "Off", and a Cannon X-4-13 Receptacle. Connections are made through this receptacle.

Mounting facilities are provided for 70-C and 70-D series of turntables and OR-1A portable recording equipment.

This kit is an integral part of the MI-11850-C Recording Head and should be ordered as an accessory except when used with Type 73-B Recorders, where this kit is self-contained.

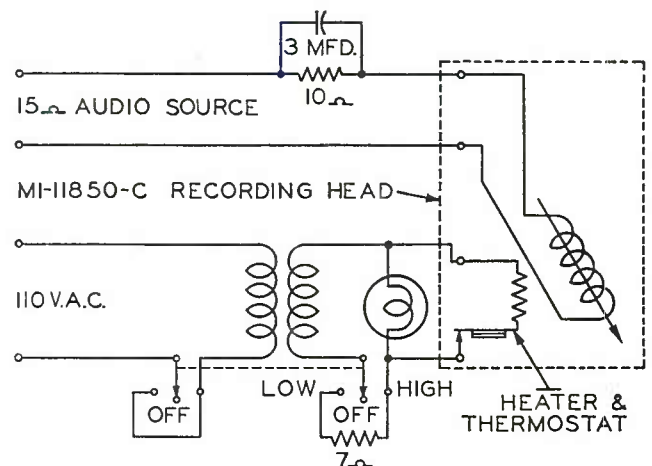

MI-11855-A HEATER & COMPENSATOR

# Standard Recording Head MI-11853-A

The MI-11853-A Recording Head is available to broadcasters who demand a good quality, low priced recording head for applications where the high fidelity response of the MI-11850-C is not required.

The physical construction of this head is similar to the MI-11850-C, possessing the feature of eliminating flutter without using special dampening material. The MI-11853-A is standard equipment with the 72-D Recording Attachment, the OR-1A Portable Recorder and may also be used with the 73-B professional recorder. The case is composed of durable, molded "Ureca" with screws for mounting on all RCA type recording attachments. A 28" two wire, "Vinylite" insulated cable is provided for external connections.

### Specifications

Frequency Response \_\_\_\_\_  $\pm 3$  db, 50 to 7500 cycles  
 Input Impedance (recording head and compensating resistor) \_\_\_\_\_ 15 ohms nominal  
 Sensitivity [Groove velocity of 6.1 cm/sec, for a stylus excursion of .00077" (peak to peak) at 1000 cps] \_\_\_\_\_  $+28$  dbm

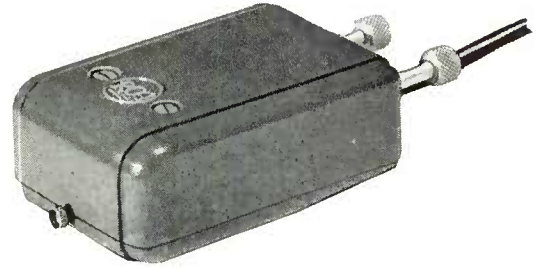

Stylus \_\_\_\_\_ Sapphire or steel  
 Method of External Connection \_\_\_\_\_ Two-wire "Vinylite" insulated 28" long  
 Dimensions  
 Height \_\_\_\_\_  $1\frac{1}{8}$ "  
 Width \_\_\_\_\_ 2"  
 Length \_\_\_\_\_  $2\frac{7}{8}$ "  
 Finish \_\_\_\_\_ Dark umber gray  
 Weight \_\_\_\_\_  $7\frac{3}{4}$  ozs.  
 Stock Identification \_\_\_\_\_ MI-11853-A

# Advance Ball Kit MI-11851

The MI-11851 Advance Ball Kit has been designed for use in conjunction with the MI-11850-C Recorder Head. It serves to control accurately the depth of groove when the cutter head is used with soft recording materials. The Advance Ball Kit is essential when recording on wax and some operators find it convenient for use with lacquer recordings when mechanical vibration is present.

The Advance Ball is a sapphire cylinder with a tip that has been highly polished to a spherical shape and mounted in a Duralumin shank. The Ball rests on the unrecorded portion of the record surface, supporting the head at a constant height above the record, so that the depth and width of the groove will remain constant. An adjusting knob on top of the head adjusts the vertical position of the Advance Ball to regulate the depth of cut. Provision is made for moving the Advance Ball to either side of the stylus to accommodate outside-in or inside-out cuts as desired.

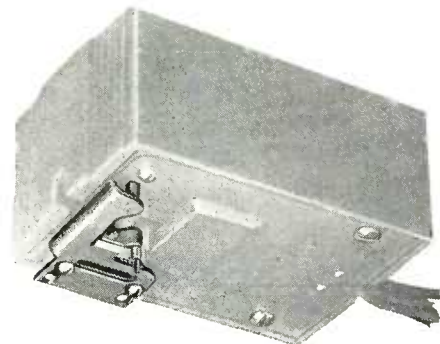

### Specifications

Dimensions, overall, approximate  
 Height \_\_\_\_\_  $\frac{1}{4}$ "  
 Width \_\_\_\_\_  $1\frac{1}{2}$ "  
 Depth \_\_\_\_\_ 1"  
 Weight, approximate \_\_\_\_\_ 10 grams  
 Finish \_\_\_\_\_ White nickel  
 Stock Identification \_\_\_\_\_ MI-11851

# Cutting Styli

The MI-4842 Sapphire Stylus with 70° angle and short shank is recommended for use with RCA recorders when cutting lacquer blanks for immediate playback and cutting masters for processing. The 90° stylus is recommended only for use in cutting masters from which 10" and 12" commercial pressings are to be made. Long shank styli are no longer stocked by RCA since their use impairs the recorder frequency response beyond 8000 c.p.s. and a rather severe peak may develop in this region.

The use of a sapphire stylus is recommended for all recordings except unimportant tests. Initial cost is reasonable and the moderate charge for sharpening brings the cost per minute

of recording equal to or below that for steel cutting points. Steel cutting points may be used with RCA recorders for unimportant tests or for cuttings being made by inexperienced personnel. In general, steel cutters are not recommended for high fidelity work because they may produce a higher noise level, a reduced frequency range and their life is relatively short. Both sapphire and steel cutting needles are carried in stock by RCA.

### Stock Identification

70° Sapphire Stylus (short shank) \_\_\_\_\_ MI-4842  
 90° Sapphire Stylus (short shank) \_\_\_\_\_ MI-4878-D  
 Steel Styli (package of 6) \_\_\_\_\_ MI-4879-A



# Recording Filter MI-4916-A

(Orthacoustic)

The MI-4916-A recording filter was designed to provide the most desirable reproduction characteristic for turntables as set forth by NAB standards for lateral transcriptions. This filter was primarily designed for use with an MI-11850-C and MI-4887 high fidelity recording head to give this orthacoustic response characteristic.

The filter may also be employed with the MI-11853 standard recording beads with an excellent frequency response. However, with the MI-11853 recording bead, the frequency response about 7500 cps will be slightly lower due to the lower frequency response of this bead. This unit may be mounted on a BR-2A or 36-B panel and shelf assembly.

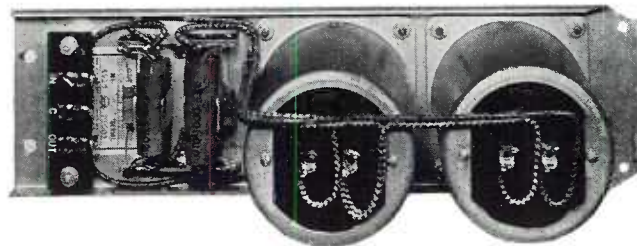
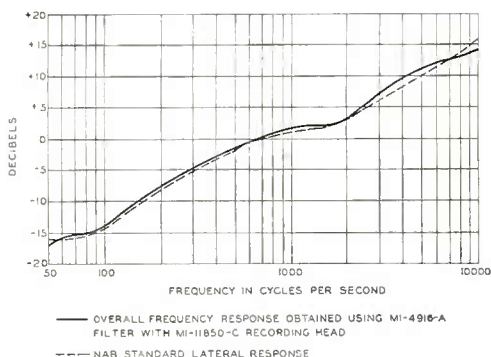

### Specifications

Input Impedance (unbalanced)	_____	250/600 ohms
Output Impedance (unbalanced)	_____	250/600 ohms
Insertion Loss		
(Operating from a 600 ohm source into a 250 ohm load at 400 cps)	_____	16 db
(Operating from a 600 ohm source into a 600 ohm load at 400 cps)	_____	10.5 db
Maximum Input Level	_____	+ 20 dbm
Hum Pickup Level (when placed 6" or more from a power transformer)	_____	Less than -120 dbm
Dimensions:		
Height	_____	4 <sup>3</sup> / <sub>4</sub> "
Width	_____	3 <sup>9</sup> / <sub>16</sub> "
Length	_____	12 <sup>5</sup> / <sub>8</sub> "
Weight (nnpacked)	_____	6 <sup>1</sup> / <sub>2</sub> lbs.
Stock Identification	_____	MI-4916-A

# Automatic Recording Equalizer MI-11100, MI-11101

### Description

The automatic recording equalizer is another addition to RCA equipment developed to contribute toward raising the standards of producing records and transcriptions. The equalizer is designed to compensate for the variation in recording level due to changes in surface speed of the recorder blank relative to the stylus. Without this compensation, the recording level due to the speed change would be of a lower level at the higher frequencies near the center of the record than they would near the periphery. The MI-11100 is for use with type 73-B professional recorders and the MI-11101 is for use with the 72D/72DX recording attachments. Fundamentally the two equalizers have the same equalization characteristics and differ only in the mounting facilities and the external connections. The equalizer consists of fixed capacitors, introduced by a switch, and a series of ten resistors, varied by a spring-tipped contact pin, riding with the recorder head carriage. The equalizers both contain a five-position switch to select the desired degree of equalization. Suitable hardware is included.

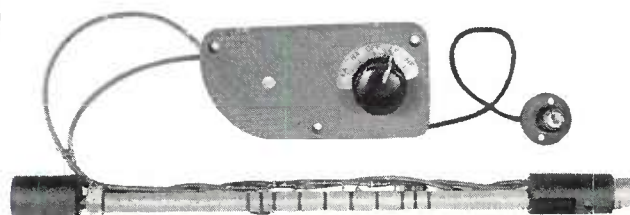

### Specifications

Impedances:		
Source	_____	600 ohms
Input	_____	Approx. 600 ohms
	(depending on compensation and frequency)	
Load	_____	Unloaded transformer
Output	_____	Approx. 600 ohms
	(depending on compensation and frequency)	
Insertion Loss (at low frequencies)	_____	22 db
Operating Level	_____	-40 db to + 20 db
Weight (unpacked, less cords and plngs)	_____	12 ozs.

# Wire Recorder MI-12775

## Features

- Good frequency range—80 to 4500 cycles.
- Portable—light weight and compact.
- Recording time 15 or 30 minutes.
- Plug-in type cartridge—no wire threading.
- Will playback from a self-contained speaker.
- Audio level indicator.
- Extremely low noise level.

## Uses

The wire recorder is offered to broadcasters as a recording unit that is portable and completely self-contained with playback facilities for direct programming or listening purposes. The wire recorder is ideal for field events, excerpts from speeches, spot announcements, audition, etc., with a playback response for musical programming comparable to network quality. Due to its compactness and portability, it is highly suitable for remotes, merely requiring an a-c supply. Recording is accomplished by simply inserting a cartridge and switching to "record". This method eliminates any wire threading or any inadvertent breakage of wire. Each cartridge offers 15 to 30 minutes of recording time. When recording for a 30 minute period, a slight interruption of one or two seconds is introduced after 15 minutes. The unit is modernistically styled and embraces all the latest electrical and mechanical achievements in wire recording design.

## Description

The magnetic wire recorder is a device for recording and reproducing sound using wire of high magnetic retentivity as a recording medium. The wire will retain its impressed magnetic influence for an indefinite period and the signal may subsequently be reproduced an infinite number of times without losing its original characteristics. The complete recording equipment includes the recorder-amplifier unit, wire cartridge and a low impedance dynamic microphone complete with desk stand. The recorder-amplifier contains two sets of recording, playback and erase head assemblies, a motor for driving and rewinding the spools, a 25 kc oscillator and a 3 stage audio amplifier. The 25 kc oscillator has two functions—to insure complete erasure of signal from the wire prior to recording and as a supersonic bias when recording. The audio section is a conventional resistance-capacitance coupled amplifier with a low impedance input operating into an RCA 6J7 voltage amplifier with a 500,000 ohm interstage potentiometer controlling the input to the following RCA 6SJ7 voltage amplifier.

The output utilizes an RCA 6V6GT power amplifier with (approximately) 14 db of feedback taken from the plate to the cathode of the 6SJ7 to effect a smooth response with minimum distortion and noise. The output is switchable for either driving the recorder head to impress signal upon the traversing wire or for amplifying the signal induced to the playback head. When the switch is in the playback position, the output feeds a 5" permanent magnet speaker with terminals for an additional speaker or high impedance headphones for monitoring purposes. For broadcasting applications, the output may be slightly modified for matching the input



channel of a consolette. A revolutionary feature of the RCA wire recorder is the plug-in cartridge. This cartridge automatically assumes the correct alignment with the head assembly when inserted, thereby eliminating any wire threading or breakages. Each cartridge contains two lengths of wire and two reels for each wire length. The two sets of wire and reels are arranged to function in opposite directions so that when one is being wound on the take-up reel, the other is being rewound on the supply reel. This method offers 15 or 30 minutes of recording time. A calibrated dial on the front of each cartridge readily indicates the number of recording or playback minutes elapsed.

All operating controls are located on the front panel. The tone control, which operates only when the selector switch is in the playback position, has ten positions for progressively attenuating the high frequencies. The center switch selects the play-record and rewind position with the last switch controlling the volume of the amplifier. A green pilot lamp in the upper left corner of the speaker grill is in circuit with the power supply, and a neon lamp in the opposite corner serves as a volume indicator. The power supply is orthodox and employs a 5Y3GT full-wave rectifier, supplying power for the amplifier and oscillator.

## Specifications

Frequency Range	80-4500 cycles
Amplifier Output	3 watts
Source Impedance	250 ohms
Load Impedance	6 ohms
Tubes	1 RCA-6J7, 2 RCA-6SJ7, 1 RCA-6V6GT, 1 RCA-5Y3GT
Power Requirements	115 volts, 60 cycles, 100 watts
Wire Speed	Constant, 2 ft./sec.
Wire Diameter	0.0046 in.
Dimensions:	
Width	10"
Height	10 <sup>3</sup> / <sub>4</sub> "
Depth	12 <sup>1</sup> / <sub>4</sub> "
Net Weight Complete	Approx. 25 lbs.
Stock Identification	MI-12775

## Accessories

Spare Cartridge	MI-12877
-----------------	----------

# Recording Suction Equipment Type RS-1A

**Features**

- ¼ h.p. motor—insuring adequate suction for two recorders.
- Reduces fire risk to a minimum.
- Motor maintains constant temperature.
- Chip collector eliminating pump failure.
- Motor may be isolated from recording room.

**Description**

This equipment is a new development by RCA and has been designed to use the most efficient method of removing acetate shavings from the record surface during the cutting of recordings. The suction apparatus is a high grade, rotary vane type pump, driven by a ¼ HP. Repulsion Start, Single Phase Motor. The unit is ruggedly constructed and mounted on shock dampening rubber cushions. A 10 foot length of tubing with a "Y" connector provides the suction outlet for one or two recorders. The chip filter and water jar insure that all chips removed are absorbed in the water and cannot foul the suction pump. This equipment is a combination of the following:

**MI-11857**

- One Suction Equipment
- One 10' Length of Black Rubber Tubing 1" ID
- One "Y" Branch Connector
- Two Couplings and Caps
- One Reducer Bushing

**MI-11858**

- One Chip Collector and Hose Assembly
- Two 6' Lengths of Black Rubber Tubing ¾" ID

If the user desires to place the suction apparatus remote from the recorder, 1' tubing which introduces a negligible loss of suction is recommended. As the majority of loss occurs in the ¾" diameter house, the length of this link should be kept to a minimum. When the apparatus is used with two recorders, an additional MI-11858 chip collector and hose assembly is necessary.

**Specifications**

Power Supply \_\_\_\_\_ 115 volts, 50/60 cycles, approx. 450 watts  
 Dimensions (overall of suction equipment):  
 Length \_\_\_\_\_ 15"  
 Width \_\_\_\_\_ 16"  
 Height \_\_\_\_\_ 10 ¾"  
 Weight \_\_\_\_\_ 75 lbs.

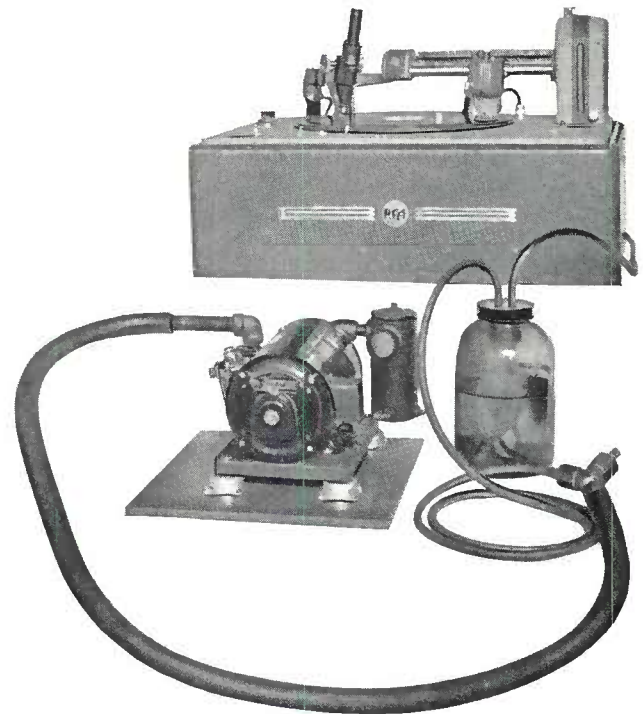

Normal operating temperature \_\_\_\_\_ 130-160°F.  
 Maximum vacuum for continuous operation \_\_\_\_\_ 8" mercury  
 Stock Identification:  
 RS-1A Equipment (complete for use with one recorder) MI-11857/11858

**Accessory**

Extra Chip Collector and Hose Assembly \_\_\_\_\_ MI-11858  
 (For use with two recorders)

# Microscope MI-4928

The MI-4928 is a high quality, 36 power Spencer Microscope and Arm Attachment for recorders. It permits close examination of the cutting needle to determine its condition and allows inspection of individual recording grooves for determining the noise level, quality and depth of cut.

The microscope has a calibrated eyepiece having 50 divisions of .001 inch and is mounted on an adjustable arm which permits it to be moved to any part of the record. On the same arm is mounted a small shielded lamp which is independently adjustable so as to illuminate the grooves under observation. The microscope is shipped complete with lens tube assembly, transformer for the microscope lamp, necessary mounting screws and installation instructions.

**Specifications**

Dimensions:	Microscope Unmounted	Overall with Microscope Mounted on Arm	Microscope Light Transformer
Height _____	7 ¾"	9"	2 7/16"
Width _____	3"	3"	2 5/16"
Depth _____	2 5/8"	2 5/8"	2 7/32"

Finish:  
 Microscope \_\_\_\_\_ Finished instrument black  
 Arm \_\_\_\_\_ Light number gray  
 Weight (unpacked less transformer) \_\_\_\_\_ 7 ½ lbs.  
 Transformer \_\_\_\_\_ 1 lb.  
 Stock Identification MI-4928

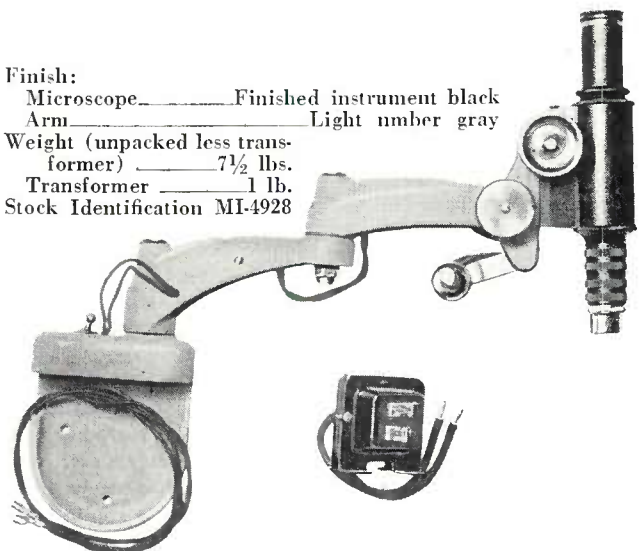

# RCA LOUDSPEAKERS

RCA offers to broadcasters a complete line of studio and station monitoring loudspeakers for use in monitoring and auditioning booths, hallway installations, talk-back applications, elevators and executives' offices. All RCA loudspeakers are designed to handle adequate power for the particular application for which they are designed. The LC-1A, representing the greatest advance in loudspeaker fidelity, is obtainable in a choice of cabinet styles and finishes, thereby making it possible to conform to any of several interior decorating schemes. In addition, the LC-1A speaker mechanism may be obtained by itself for those applications where it is desirable to use a special type, or custom-made, mounting.

For those applications requiring a high fidelity loudspeaker not necessarily having quite the same wide frequency range as the LC-1A, RCA offers the MI-12149.

In order to serve the vast multitude of miscellaneous needs for loudspeakers around broadcasting stations, there is also included in this line a choice of three permanent-magnet loudspeaker mechanisms. These mechanisms are intended to be mounted in one of the wall-mounting speaker housings, MI-13225, MI-6381, or MI-6382. The three loudspeaker impedance matching transformers, MI-12370, MI-12371, and MI-12373 are designed for use in conjunction with these loudspeaker mechanisms, or for coupling any of a wide variety of outputs to these and many other types of loudspeakers. The quick-selection chart given below provides for design engineers a quick, convenient reference by means of which they can select the RCA loudspeakers best suited to their particular requirement.

## LOUDSPEAKER DATA

<i>Identification</i>	<i>Voice Coil Impedance (ohms)</i>	<i>Power Handling Capacity (watts)</i>	<i>Weight (lbs.)</i>	<i>Cone Dia. (inches)</i>	<i>Bolt Circle Dia. (inches)</i>	<i>Freq. Range (CPS)</i>
LC-1A	15	20	21 (mechanism only)	15 $\frac{1}{4}$	16 $\frac{1}{4}$	50-15000
MI-12149	15	20	80 (in cabinet)	—	—	50-13000
MI-12122	15	10	3 $\frac{3}{8}$	12	11 $\frac{7}{8}$	50-6500
MI-12135	6	5	2 $\frac{1}{4}$	5 $\frac{3}{4}$	6 $\frac{1}{8}$	70-7000
MI-6333-C	6	25	6 $\frac{3}{4}$	10 $\frac{3}{32}$	9 $\frac{5}{8}$	60-7000

# Monitoring Speaker Type LC-1A

## Features

- Excellent frequency response, uniform 50-15,000 cps.
- Wide angle sound radiation of all frequencies.
- Tastefully styled cabinet.
- Low non-linear distortion.
- Ideal for monitoring AM-FM television programs.
- High grade Alnico V magnets.

## Uses

The LC-1A is a high fidelity loudspeaker with a low distortion, wide angle distribution, of extended frequency range, and specifically designed for the broadcaster and recording studios.

The fundamental principles are based upon extensive loudspeaker research and development performed by Dr. Olson at RCA Laboratories (Princeton).

For applications where it is desired to mount the mechanism on a wall baffle, ceiling, etc., the speaker may be used with assurance that the entire frequency range will be realized. The speaker's outstanding performance makes it ideal for the full frequency range of FM. The LC-1A is also being used with RCA's new "Festival" series of high quality custom-built home receivers.

## Description

The LC-1A is a duo-cone speaker mechanism of the direct radiated type, consisting of high and low frequency units mounted co-axially together. The 2" high frequency cone and the aluminum wound voice coil has a low mass utilizing the wide angle of the shallow, low frequency cone, to effect its remarkable directional pattern (see curve). An equilibrium has been reached between the electrical and mechanical design to impart a high frequency radiation of 120° arc with a loss of approximately 6 db at 15,000 cps. This eliminates the conventional "beam effect" usually experienced at this frequency.

The low frequency cone employs a 15" diaphragm with a high mass voice coil and produces the most desirable directional pattern with a handling capacity of 20 watts. Low distortion has been accomplished by a carefully designed compromise of many contributing factors. Distortion usually experienced when handling large power in the 100-1,000 cycles range is eliminated by using a high mass coil and a massive rigid cone, coupled with a low fundamental frequency peak of 35 cycles. Above this frequency, the reluctance due to the suspension system of the cone does not appreciably affect the velocity and, therefore, minimizes distortion.

The cross-over network utilizes the physical disposition of the cones to mutually vibrate in unison over the cross-over frequency region and merely employs one capacitor in the high

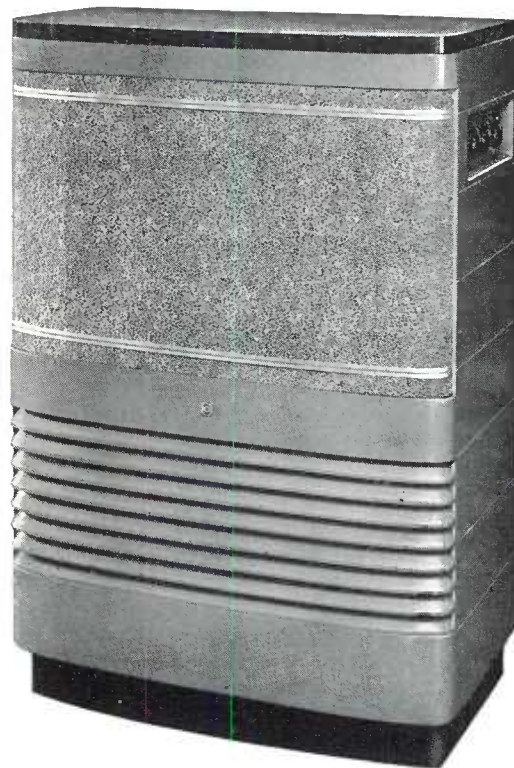

frequency unit to limit the current flowing at the low frequencies. When program material containing a large distortion factor is prevalent, such as worn records, etc., an MI-11707 high frequency compensator producing curves with a "roll-off" at 5, 10 and 15 kc, is available to restrict the high frequency range. The LC-1A is supplied with or without cabinet and is ideally suited for mounting in the wall or ceiling of the control room, giving a uniform response of 50 to 15,000 cycles.

The cabinet was specifically designed for this speaker and is attractively styled in two finishes—two-tone umber gray with a satin chrome trim to blend with all RCA studio equipment, and a rich walnut veneer for use in finely finished listening booths. This cabinet is particularly designed for high fidelity loudspeakers and is constructed with a fixed port to give maximum response in the low frequencies. Accommodation for the BA-4 series of monitoring amplifiers is provided. A brushed-chrome panel on the side of the cabinet will accommodate a volume control, 5/10/15 kc high frequency compensator, 10 channel selector switch, an "off-on" amplifier switch with a visual indicator.

With an MI-11708, 15 ohm attenuator, the speaker will operate from a speaker huss, or with an internal amplifier and selector switch, will function as an independent unit and will bridge any of ten speaker channels. The desired ordering arrangement is obtained by consulting the stock identification accessories.



LC-1A Speaker Mechanism

**Specifications**

**LC-1A SPEAKER MECHANISM**

Impedance (nominal)	15 ohms
Frequency Response (see curve)	50-15,000 cps
Directional Characteristic	See curve
Power Handling Capacity	20 watts
Non-linear Distortion (for 10 watt output, 50-15,000 cycles)	Less than 4% at 60 cycles
Weight (unpacked)	21 lbs.
Dimensions:	
Diameter (cone)	15 <sup>5</sup> / <sub>16</sub> "
Diameter (bolt fixing circle)	16 <sup>1</sup> / <sub>4</sub> "
Diameter (overall frame)	17"

**LC-1A CABINET**

Dimensions:	
Height	40 <sup>5</sup> / <sub>8</sub> "
Width	27 <sup>1</sup> / <sub>8</sub> "
Depth	15"
Weight	Approx. 50 lbs.

**Stock Identification**

- LC-1A Speaker, cabinet complete with BA-4C monitor amplifier, volume control, high frequency filter unit 5 kc, 10 kc, and 15 kc, 10-position channel selector switch, and an on-off switch with a visual indicator (less tubes for amplifier) **MI-11411 /11401 / MI-11711 /11223-B**
- LC-1A Speaker and Cabinet **MI-11411 /11401**
- LC-1A Duo-cone Loudspeaker Mechanism only **MI-11411**
- LC-1A Speaker Console Cabinet Only (Umber Gray) **MI-11401**
- LC-1A Speaker Console Cabinet Only (Walnut) **MI-11401-A**

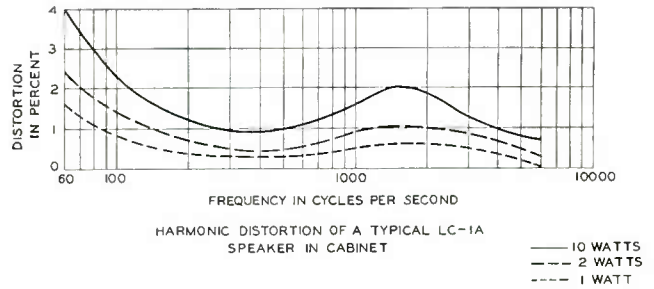
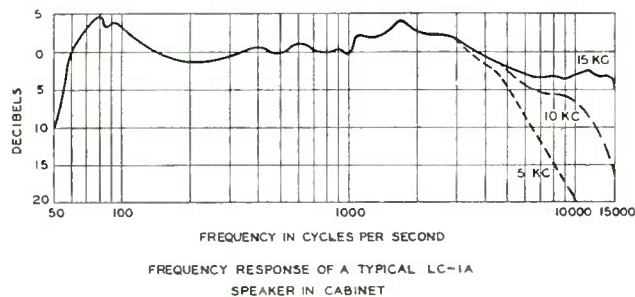

**Accessories**

- Speaker Filter Unit **MI-11707**  
 (This item is included in both cabinets, MI-11401 and MI-11401-A, but is necessary if a high frequency filter is desired when the speaker only is ordered. This unit includes a filter switch and an escutcheon plate reading 5 kc, 10 kc, and 15 kc.)
- Speaker Power Attenuator, 15 ohms **MI-11708**  
 (This is necessary when the audio source is fed externally through a buss bar, etc. This is mounted on the speaker cabinet escutcheon.)
- Speaker Accessory Kit **MI-11711**  
 (This kit contains a 10 position channel selector switch, "on-off" switch with visual indicator and necessary hardware for mounting BA-4C amplifier.)

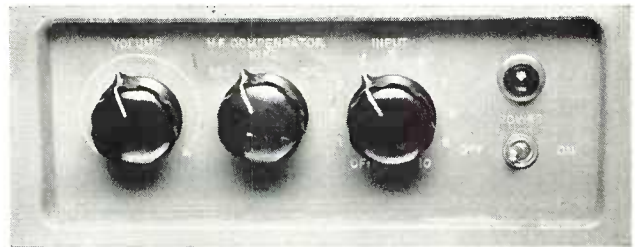

Close-up of control panel of LC-1A showing controls for MI-11707, MI-11708, and MI-11711

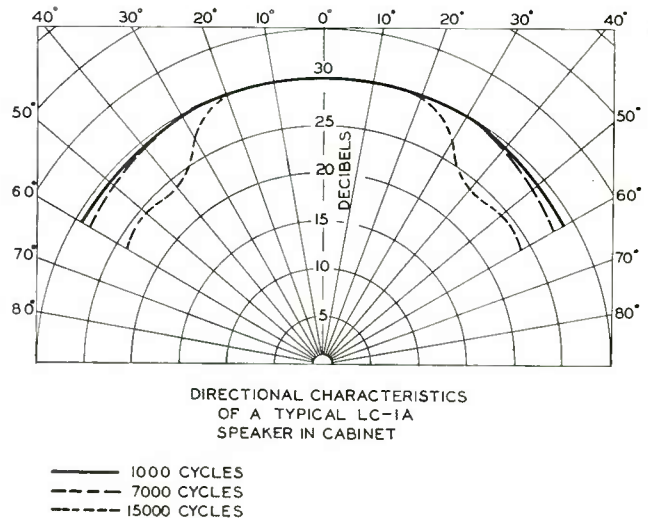

## Monitoring Loudspeaker MI-12449

The MI-12449 loudspeaker is another new high fidelity speaker recently designed by RCA. This speaker has an excellent frequency response and is admirably suited for use in listening booths where faithful reproduction is desired. The MI-12449 consists of a distinctively styled wooden cabinet finished in two tone umber gray, containing a low frequency speaker, high frequency horn driver with the high frequency horn an integral part of the cabinet. This assembly produces an unusually wide frequency range and directional pattern, with a low distortion power handling capacity of 20 watts.

### Specifications

Frequency Range \_\_\_\_\_ 50-13,000 cycles  
 Power Handling Capacity \_\_\_\_\_ 20 watts  
 Voice Coil Impedance \_\_\_\_\_ 15 ohms nominal  
 Axial Sensitivity \_\_\_\_\_ 95 db at 4 feet with 1 watt input  
 Distribution (coverage angle) \_\_\_\_\_ 100° at 1000 cycles  
 Cabinet Dimension (overall):  
     Height \_\_\_\_\_ 37 $\frac{1}{8}$ "  
     Width \_\_\_\_\_ 24 $\frac{1}{2}$ "  
     Depth \_\_\_\_\_ 20 $\frac{1}{2}$ "  
 Finish \_\_\_\_\_ Two tone umber gray  
 Weight (unpacked) \_\_\_\_\_ 80 lbs. (approx.)  
 Stock Identification \_\_\_\_\_ MI-12449



## Wall Speaker Housing MI-13225

The MI-13225 wall speaker housing is constructed of special molded material, with excellent acoustical properties. The exterior has an attractive appearance of rich brown Morocco-grain leather. The sloping front provides for maximum radiation in all directions. Mounting bolts in the housing facilitate a secure and easy speaker installation. This speaker housing was specifically designed to accommodate the MI-6234-B accordion speaker with adequate space for the MI-12371 or MI-12373 transformer. Mounting hardware and terminal strip for the speaker leads are provided.



### Specifications

Dimensions (exterior):  
     Height \_\_\_\_\_ 17"  
     Width \_\_\_\_\_ 13"  
     Depth \_\_\_\_\_ 6 $\frac{1}{2}$ " maximum  
 Stock Identification \_\_\_\_\_ MI-13225

## Molded Speaker Housings MI-6381 and MI-6382

These speaker housings are available for use with the MI-6333-C and MI-12422 speakers respectively. These molded fiber wall baffles are particularly suitable for all internal installations and are handsomely finished in dark umber gray hammeroid with a gray and silver grill cloth. The front of the housing has a 10° slope, giving good sound radiation characteristics. The baffle board attached to the housing permits the speaker to be securely installed and eliminates vibration. Speaker mounting bolts for either speaker render speaker installation an easy operation. Wall mounting brackets and associated hardware complement each housing.

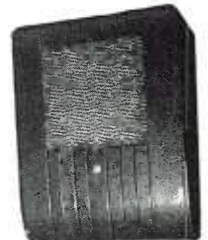

### Specifications

MI-6381 \_\_\_\_\_ for 10" PM Speaker MI-6333-C  
 MI-6382 \_\_\_\_\_ for 12" PM Speaker MI-12422  
 Dimensions:  
     Length \_\_\_\_\_ 23"  
     Width \_\_\_\_\_ 17 $\frac{3}{4}$ "  
     Depth \_\_\_\_\_ 8" (top)

# Permanent Magnet Loudspeaker Mechanisms

## Speaker Mechanism MI-12422

### Description

The MI-12422 is a 12" permanent magnet type speaker using an Alnico magnet and suitable for all general purpose applications. The cone is constructed in one piece, effecting a superior response to the lapped type of cone. The voice coil assembly is supported by an adjustable centering device. The speaker gives a good frequency response and has a power handling capacity of 10 watts. The MI-6382 speaker housing is recommended for use with this speaker. MI-12370 and MI-12373 transformers are available as matching transformers.

### Specifications

Frequency Range \_\_\_\_\_ 50-6500 cycles  
 Power Handling Capacity \_\_\_\_\_ 10 watts  
 Voice Coil Impedance \_\_\_\_\_ 15 ohms nominal



Finish \_\_\_\_\_ Umber gray  
 Weight (unpacked) \_\_\_\_\_ 3<sup>3</sup>/<sub>8</sub> lbs.  
 Stock Identification \_\_\_\_\_ MI-12422

## Accordion Edge Speaker Mechanism MI-12435

The MI-12435 is a 7" permanent magnet type loudspeaker with folded edge (accordion) cone. This type of cone is particularly suited for applications where an undistorted low frequency response is demanded. The cone is virtually freely suspended and allows the low frequencies to vibrate the maximum length and are not impeded by the reluctance of the conventional type suspension system. The permanent field is produced by Alnico magnet insuring a maximum and stable field. To derive maximum benefit from this type of speaker, an enclosed type of housing, such as the MI-13225 which was specifically designed for this speaker, is recommended.

### Specifications

Frequency Range \_\_\_\_\_ 70-7000 cycles  
 Power Handling Capacity \_\_\_\_\_ 5 watts



Voice Coil Impedance \_\_\_\_\_ 6 ohms nominal  
 Finish \_\_\_\_\_ Umber gray  
 Weight \_\_\_\_\_ 2<sup>1</sup>/<sub>4</sub> lbs.  
 Stock Identification \_\_\_\_\_ MI-12435

## Speaker Mechanism MI-6333-C

The MI-6333-C is a high quality 10" general purpose, permanent magnet speaker suitable for wall baffle or ceiling mounting. The cone is of single piece construction and moisture resistant, giving it great ruggedness and a handling capacity of 25 watts of power.

The speaker uses Alnico II metal for the permanent magnets, insuring high efficiency and sensitivity with an unusually good frequency response. The MI-6381 molded speaker housing was designed and is recommended for use with this speaker. MI-12370 and MI-12371 transformers are recommended.

### Specifications

Frequency Range \_\_\_\_\_ 60-7000 cycles  
 Power Handling Capacity (maximum) \_\_\_\_\_ 25 watts  
 Voice Coil Impedance \_\_\_\_\_ 6 ohms nominal



Cone Diameter \_\_\_\_\_ 10<sup>1</sup>/<sub>4</sub>"  
 Depth of Speaker \_\_\_\_\_ 6<sup>3</sup>/<sub>8</sub>"  
 Weight (unpacked) \_\_\_\_\_ 6<sup>3</sup>/<sub>4</sub>"  
 Stock Identification \_\_\_\_\_ MI-6333-C



## Speaker Transformer MI-12370

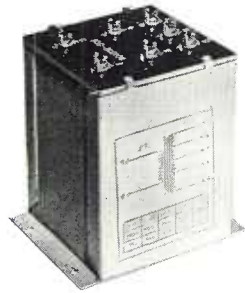
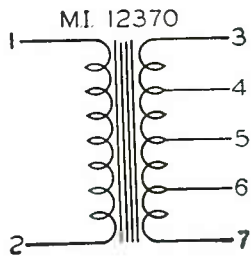

The MI-12370 is an ideal speaker matching transformer for use where a large power handling capacity is required. The secondary has three taps which, for a given source impedance provide ten different output impedances for matching to the load. All taps are connected to lugs on a bakelite terminal cover to which the load may be attached by either a screw or solder connection. The transformer is enclosed in a metal case which is finished in aluminum gray. The terminal arrangement, voltage ratios, and a schematic diagram of the windings are stenciled on the side of the case. Four holes through the two bottom flanges provide for mounting the unit.

### Specifications

Impedance: (primary connected to 500/600 ohm source)

Terminals	Impedance
1-2 (Primary)	500/600 ohms
3-4	33 "
3-5	66 "
3-6	132 "
3-7	264 "
4-5	6 "
4-6	32 "
4-7	106 "
5-6	10.6 "
5-7	63 "
6-7	22 "

Frequency Response \_\_\_\_\_  $\pm 1$  db, 30 to 10,000 cycles  
 Power Handling Capacity \_\_\_\_\_ 40 watts  
 Distortion \_\_\_\_\_ Less than 1% 100-8000 cycles  
 Maximum Primary Voltage \_\_\_\_\_ 125 volts rms  
 Dimensions \_\_\_\_\_  $4\frac{3}{8}'' \times 4\frac{1}{4}'' \times 5''$   
 Finish \_\_\_\_\_ Aluminum gray  
 Weight (unpacked) \_\_\_\_\_ 7 lbs.  
 Stock Identification \_\_\_\_\_ MI-12370

## Speaker Transformer MI-12371

The MI-12371 speaker transformer is a good quality unit with several taps on the primary winding, giving a wide impedance range of 1000 to 16,000 ohms. The secondary winding has a variable tap for three speaker voice coil impedances. It is designed for bracket mounting with 8" connection leads. This transformer is suitable for use with the MI-6234-B, MI-6333-C and the MI-12422 RCA speakers.

The MI-12372 is identical to the MI-12371 except that it is hermetically sealed.

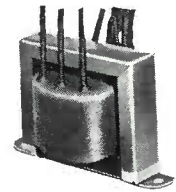
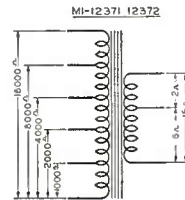

### Specifications

Frequency Response \_\_\_\_\_  $\pm 2$  db 100-6500 cycles  
 Distortion \_\_\_\_\_ Less than 1% 100-6500 cycles on 2000 ohm tap  
 Power Handling Capacity \_\_\_\_\_ 10 watts

Length \_\_\_\_\_  $2\frac{3}{8}''$   
 Width \_\_\_\_\_ 2"  
 Height \_\_\_\_\_  $2\frac{5}{8}''$   
 Weight \_\_\_\_\_  $1\frac{1}{4}$  lbs.

## Speaker Transformer MI-12373

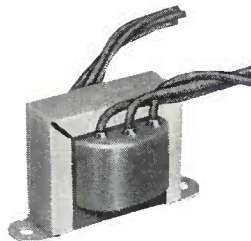
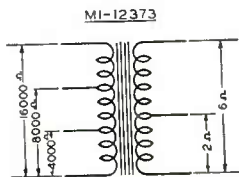

This transformer is ideal for operating a number of medium power speakers with a voice coil having 6 or 2 ohms impedance. The primary winding has three taps for 4000, 8000 and 16,000 ohms. It is designed for bracket mounting and has 10"

connection leads. The same transformer, hermetically sealed for tropical use, is available as MI-12374.

### Specifications

Frequency Response \_\_\_\_\_  $\pm 1$  db 100-12,000 cycles  
 Distortion \_\_\_\_\_ Less than 2% between 100 and 8000 cycles  
 Power Handling Capacity \_\_\_\_\_ 5 watts  
 Maximum Primary Voltage \_\_\_\_\_ 125 volts  
 Height \_\_\_\_\_ 2"  
 Length \_\_\_\_\_  $2\frac{1}{8}''$   
 Width \_\_\_\_\_  $1\frac{1}{2}''$   
 Mounting Centers \_\_\_\_\_  $1\frac{5}{8}''$   
 Connections \_\_\_\_\_ 10" leads  
 Net Weight \_\_\_\_\_  $\frac{3}{4}$  lbs.

# **AM TRANSMITTING EQUIPMENT**

	<b>Page</b>
<b>AM TRANSMITTERS</b>	<b>92</b>
<b>PHASING EQUIPMENT</b>	<b>106</b>
<b>TUNERS &amp; ANTENNA ACCESSORIES</b>	<b>112</b>

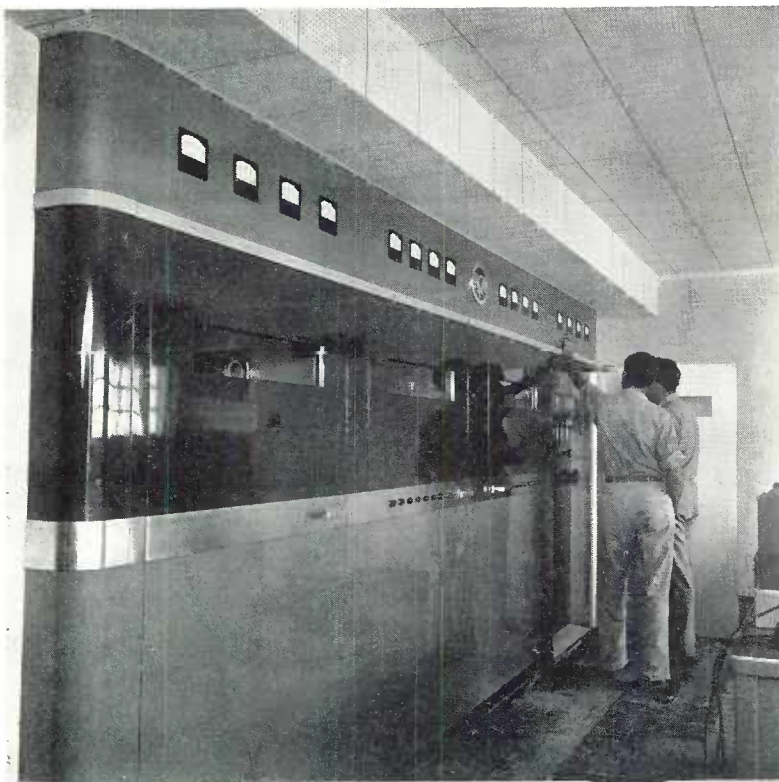

◀ At the power control section of the five kilowatt transmitter, Type BTA-5F, at KOOL, Phoenix, Ariz.



▲ Fifty kilowatt transmitter, Type BTA-50F, with control console and extension cabinets containing phasing equipment, at KMPC, Hollywood, Cal.

◀ At the controls of the one kilowatt transmitter, Type BTA-1L, at WBSA, York, Pa.

Installation of five kilowatt transmitter, Type BTA-5F, at KGKL, San Angelo, Texas. View shows left and right wing extension cabinets which contain broadcast audio and antenna phasing equipment.

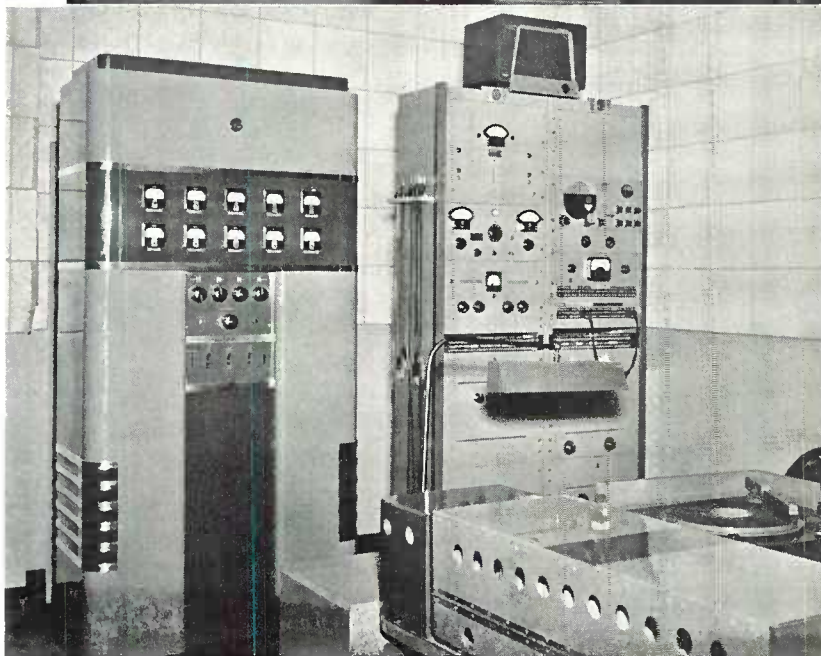

Control room at WMRN, Marion, Ohio, showing 250 watt transmitter, turntables, control console, and associated audio and test equipment.

Transmitter room at KRDO, Colorado Springs, Col., showing 250 watt transmitter, Type BTA-250L, and associated audio and test equipment.

# Broadcast Transmitter Type BTA-250L

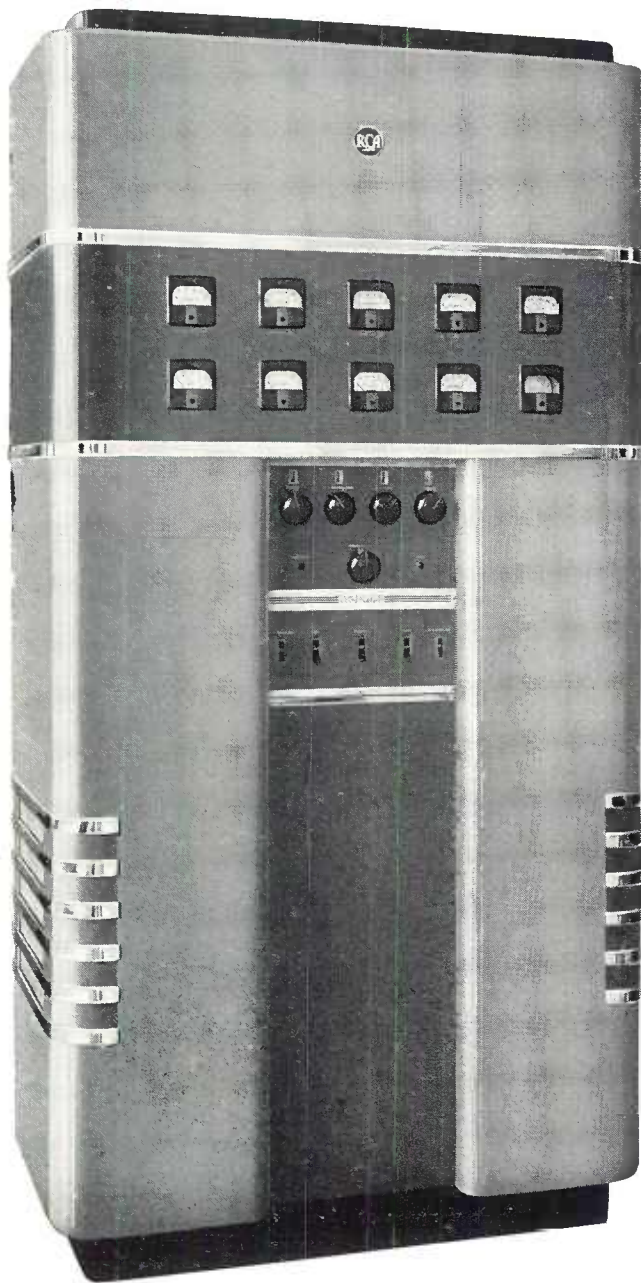

## Features

- Low installation cost.
- Low maintenance cost—only eleven tubes, six types.
- Completely self-contained.
- Simple and efficient in operation.
- Vertical chassis construction for accessibility and ventilation.

## Description

The Type BTA-250L Broadcast Transmitter is a complete self-contained unit that will provide reliable, high fidelity operation at any frequency within the range of 540 to 1600 kc. Encompassing the latest developments in broadcast transmitters, the RCA BTA-250L has been designed to fill every need of the 250 watt broadcasting station.

The BTA-250L is housed in a modern, attractive, steel cabinet finished in two tone umber gray and trimmed with strips of satin chrome. There are ten instruments conveniently located at eye level on the front panel. All controls are grouped together on a central control panel which is photo-etched and indirectly illuminated. The tuning controls are provided with indicators so that their positions may be accurately logged. The BTA-250L uses the RCA vertical chassis type of construction, whereby the equipment is mounted in such a manner that each item may be easily removed by one man in the shortest possible time. The variable elements are placed where they are functionally needed and where connection leads to other circuit components may be kept relatively short. This vertical type of construction provides a high degree of mechanical rigidity, adds considerably to the accessibility of the components, and greatly increases the normal circulation of air within the cabinet.

The BTA-250L employs a very simple basic circuit arrangement consisting of a crystal oscillator followed by a buffer amplifier and class "C" power amplifier.

Two RCA low temperature coefficient quartz crystals mounted in RCA Type TMV-129-B temperature controlled holders are provided. The oscillator stage has an extra crystal socket in which the spare crystal may be continuously maintained at the correct operating temperature. These crystals provide excellent frequency stability with no greater deviation than  $\pm 10$  cycles from the assigned frequency.

The BTA-250L uses no variable capacitors. Continuously variable inductors are employed as tuning elements throughout, thus eliminating the possibility of flashovers sometimes occurring in variable capacitors.

The modulation system is high-level with a class "B" modulator. High fidelity is materially aided by the use of approximately 20 decibels of audio feedback over the audio system.

In order to insure low maintenance cost, the BTA-250L uses a minimum number of tubes, all inexpensive. There are only eleven tubes, altogether, and only six tube types. A single high voltage power supply provides plate voltage for all tubes. This power supply makes use of two RCA 8008 mercury vapor rectifier tubes, which are known for their long life and unexcelled performance. Bias voltage for the modulators is provided by a separate power supply using a single RCA 5Y3-GT. The power control circuits of the BTA-250L were designed with an eye to simplicity while also providing adequate protection to the equipment and operating personnel. This transmitter features a relay which eliminates any necessity for re-

cycling of the time delay relay when momentary power failures or interruptions occur. Overall protection is provided by the use of magnetic circuit breakers, serving also as switches, and completely eliminating fuses from any power circuits.

A matching network is provided between the output tank circuit and the output terminals of the transmitter, which includes series inductive elements and shunt capacitances resulting in very complete radio frequency harmonic attenuation. Output terminals are provided at the top of the cabinet for connecting to an unbalanced open wire transmission line or an antenna lead-in. A concentric transmission line may be connected through either the base or the top of the transmitter.

## Specifications

Carrier Frequency Range \_\_\_\_\_ 540 to 1600 kcs  
 Carrier Frequency Stability \_\_\_\_\_  $\pm 10$  cycles  
 Carrier Power Output \_\_\_\_\_ 250 watts  
 Carrier Frequency Harmonics \_\_\_\_\_ Below .05%  
 A-c Power Input (105 to 115 volts, 50/60 cycles, single phase)  
 Average Program at 250 Watts Output \_\_\_\_\_ 1625 watts  
 Carrier Shift (zero to 100% modulation) \_\_\_\_\_ Less than 5%

## Carrier Noise and Hum Level

(unweighted below 100% modulation) \_\_\_\_\_ 60 db  
 Audio Frequency Response (30 to 10,000 cycles) \_\_\_\_\_  $\pm 1.5$  db  
 Audio Input Level for 100% Modulation \_\_\_\_\_ +16 dbm\*  
 Audio Frequency Harmonic Distortion (50 to 7500 cycles, 0 to 95% modulation) \_\_\_\_\_ Not to exceed 3% rms  
 R-f Load Impedance (unbalanced transmission line or antenna) \_\_\_\_\_ 20 to 250 ohms  
 Tube Complement \_\_\_\_\_ 1-807, 2-810, 2-6J7, 3-828, 2-8008, 1-5Y3GT

## Dimensions, overall

Width \_\_\_\_\_ 40 1/2"  
 Depth \_\_\_\_\_ 20 1/4"  
 Height \_\_\_\_\_ 84 7/8"  
 Weight (unpacked) \_\_\_\_\_ 1360 lbs.  
 (packed) \_\_\_\_\_ 1635 lbs.  
 Stock Identification \_\_\_\_\_ MI-7242-C

## Accessories

Type BPA-1 Antenna Tuning Unit \_\_\_\_\_ MI-28901-A  
 Remote Metering Kit for Antenna Current \_\_\_\_\_ MI-19404-B  
 Tube Kit (one complete tube complement) \_\_\_\_\_ MI-7245-B

\* dbm = no. of db above one milliwatt when single frequency tone modulation is used.

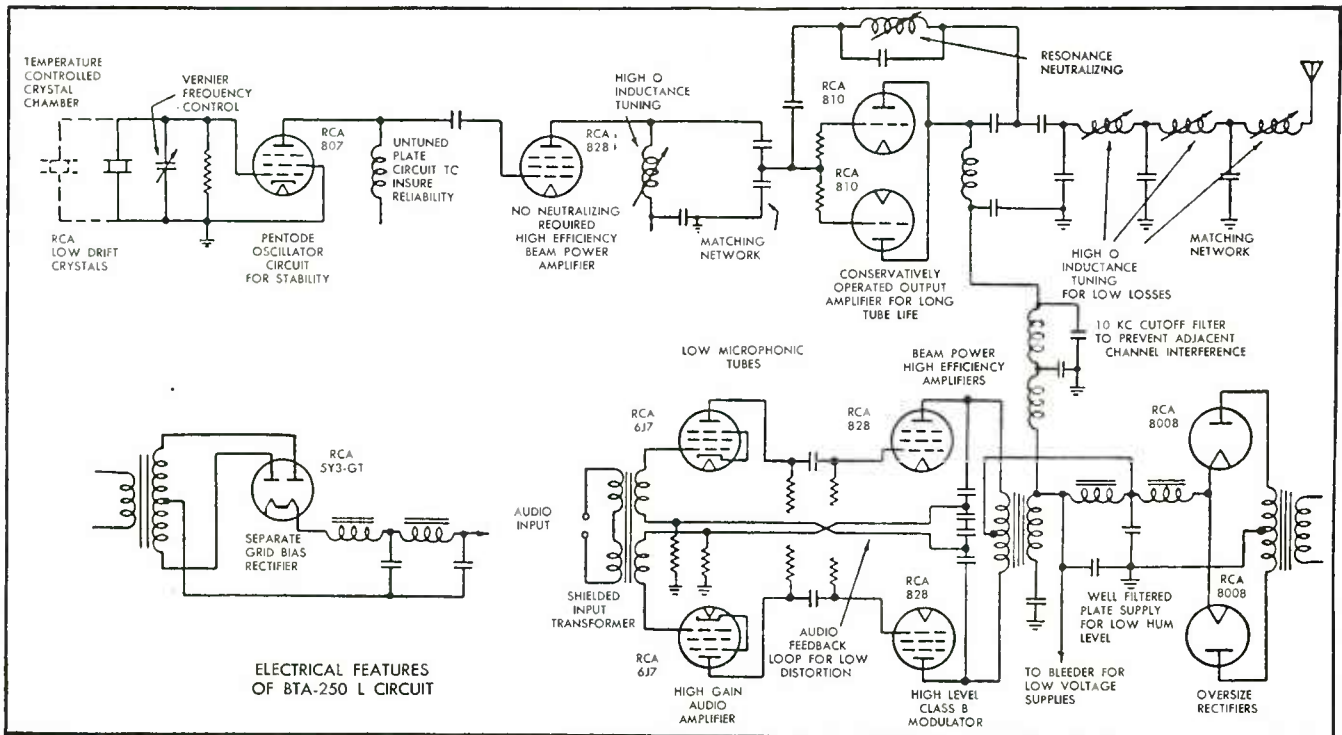

## Broadcast Transmitter Type BTA-1L



### Features

- Low installation and maintenance costs.
- Completely self-contained.
- Simple and efficient operation.
- Vertical chassis construction for accessibility and ventilation.
- 1000 watt, 500 watt, 500/1000 watt, 250/1000 watt and 250/500 watt operation.
- Adaptable to 500 or 250 watt operation.
- Low tube cost.

### Description

The BTA-1L is a one kilowatt transmitter designed to meet the most exacting demands of the modern broadcasting station. Essentially, the BTA-1L is composed of an RCA BTA-250L transmitter, serving as an exciter section, with the addition of an amplifier section. The complete transmitter is housed in an attractive cabinet assembly consisting of the BTA-250L cabinet, a matching amplifier cabinet, and a center section which contains the heavy power equipment. The completely accessible RCA open vertical chassis construction, which is used throughout, insures mechanical rigidity and good ventilation. The equipment is mounted in such a manner that every item can be easily removed by one man. Controls for each of the two units are grouped on indirectly illuminated panels conveniently placed on each of the two cabinets. There are no variable capacitors used in this transmitter. The tuning elements are continuously variable inductors which are connected to the control knobs by means of beveled gears and extension shafts. The tuning controls are provided with indicators so that their positions may be accurately logged. The cabinets and center section are finished in two-tone umber gray with trim strips of satin chrome.

The BTA-1L provides reliable, high-fidelity operation at any frequency between 540 and 1600 kc. Efficient high level modulation is employed. Only inexpensive tubes are used throughout and the number of tube types is kept to a minimum.

Two RCA low temperature coefficient quartz crystals mounted in RCA Type TMV-129-B temperature controlled holders are provided. The oscillator stage has an extra crystal socket in which the spare crystal may be continuously maintained at the correct temperature. These crystals provide excellent frequency stability with no greater deviation than  $\pm 10$  cycles from the assigned frequency. A control is provided in the oscillator circuit for precise adjustment of the crystal frequency.

The Type BTA-1L will deliver rated power into a 20 to 250 ohm transmission line or into any type of antenna normally used by broadcast stations. A matching network is provided between the output tank circuit and the output terminals of the transmitter which includes series inductors and shunt capacitors, resulting in excellent radio frequency harmonic attenuation. Output terminals are provided at the top of the cabinet for connections to an unbalanced open wire transmission line or antenna lead-in. A concentric transmission line may be connected through either the top or the base of the transmitter. Should the BTA-1L be coupled into either a concentric line or to a single ended line, the RCA Type BPA-1 (MI-28901) Antenna Tuner may be used. In such cases, a remote metering kit MI-19404-B is available to replace the r-f ammeter in the transmitter.

Terminals are provided on the BTA-1L for modulation indication by means of a pickup coil coupled to the tank coil of the output stage. Excitation for r-f frequency monitoring is

taken off an r-f voltage divider across a capacitor in the ground side of the buffer stage. A-f monitoring is accomplished by means of a voltage developed across a resistor connected in series with the secondary of the modulation transformer, at which point a level of approximately +10 dbm is available at 100% modulation.

Control circuits are simplified and offer maximum protection to the transmitter and operating personnel. A distinctive feature is a relay which eliminates the necessity of recycling of the time delay when momentary power failures or interruptions occur. Overload protection is provided by using magnetic circuit breakers that also serve as switches.

The BTA-1L is normally supplied for operation at 1000 watts output. Where power change is required, a kit of power change equipment (MI-7183-A) is necessary and is easily installed on the chassis in the center section of the equipment. This equipment will reduce the power output from 1000 to 500 or 250 watts or from 500 to 250 watts as required. A variable transformer adjustable from the control panel provides a means of maintaining the proper voltages as required. A separate 110 volts, 50 to 60 cycle supply is required for the crystal heaters.

The BTA-1L is furnished with two sets of tubes and two crystals.

## Specifications

Carrier Frequency Range \_\_\_\_\_ 540 to 1600 kes

Carrier Frequency Stability \_\_\_\_\_ ±10 cycles

Carrier Power Output

- |                    |                      |
|--------------------|----------------------|
| (a) 1,000 watts    | (c) 500/1,000 watts* |
| (b) 500 watts      | (d) 250/1,000 watts* |
| (e) 250/500 watts* |                      |

Carrier Frequency Harmonics \_\_\_\_\_ below .05%

A-c Power Input (220 to 240 volt, 50/60 cycles, single phase  
(Line voltage regulation and variation not to exceed 5%))

Average Program Level at 1,000 watts \_\_\_\_\_ 4,500 watts  
 500 watts \_\_\_\_\_ 3,700 watts  
 250 watts \_\_\_\_\_ 3,350 watts

100% Modulation 1,000 watts \_\_\_\_\_ 5,700 watts  
 500 watts \_\_\_\_\_ 4,900 watts  
 250 watts \_\_\_\_\_ 4,450 watts

A-c Power Input (crystal heaters) \_\_\_\_\_ 110 volts, 28 watts

Carrier Shift—from zero to 100% modulation \_\_\_\_\_ less than 5%

Carrier Noise and Hum Level  
(unweighted below 100% modulation) \_\_\_\_\_ —60 db

Audio Frequency Response (30 to 10,000 cycles) \_\_\_\_\_ ±1.5 db

Audio Input for 100% Modulation \_\_\_\_\_ +11 dbm\*\*

Audio Frequency Harmonic Distortion (50 to 7,500 cycles,  
0 to 95% modulation) \_\_\_\_\_ not to exceed 3% rms

R-f Load Impedance  
(unbalanced transmission line or antenna) \_\_\_\_\_ 20 to 250 ohms

Dimensions, overall

Width \_\_\_\_\_ 108<sup>3</sup>/<sub>4</sub>"  
 Depth (door swing 18<sup>3</sup>/<sub>4</sub>" ) \_\_\_\_\_ 20<sup>1</sup>/<sub>4</sub>"  
 Height \_\_\_\_\_ 84<sup>7</sup>/<sub>8</sub>"

Weight (unpacked) \_\_\_\_\_ 3,410 lbs.

Stock Identification

BTA-1L Transmitter \_\_\_\_\_ MI-7186-B  
 BTA-1L Amplifier (for 250R and BTA-250-L)  
 (complete with conversion accessories) \_\_\_\_\_ MI-7187-A

## Accessories

Power Change Equipment Kit \_\_\_\_\_ MI-7183-A

Type BPA-1 Antenna Tuning Equipment \_\_\_\_\_ MI-28901-A

Remote Metering Kit for Antenna Current \_\_\_\_\_ MI-19404-B

Tube Kit

For BTA-1L Transmitter Exciter Only \_\_\_\_\_ MI-7320

1 RCA-807	1 RCA-810	2 RCA-6J7
3 828	2 RCA-8008	1 RCA-5Y3GT

For Type BTA-1L Amplifier Only \_\_\_\_\_ MI-7318

4 RCA-833-A	4 RCA-8008	2 RCA-866/866A
-------------	------------	----------------

\* MI-7183-A Power Change equipment is required.

\*\* dbm = no. of db above one milliwatt when single frequency tone modulation is used.

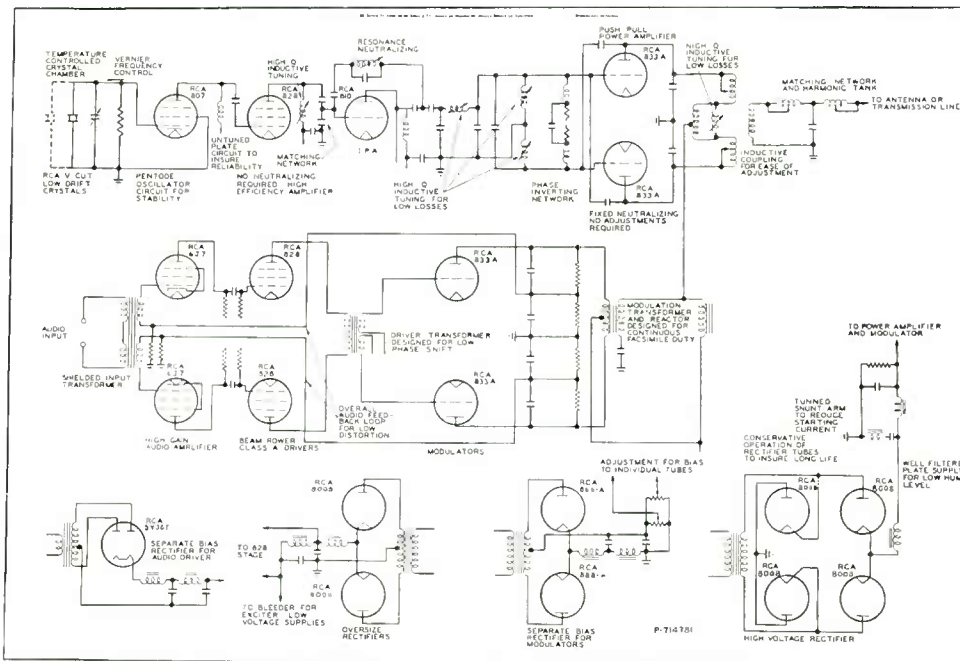

Simplified Schematic Diagram of BTA-1L



# Broadcast Transmitter Type BTA-5F

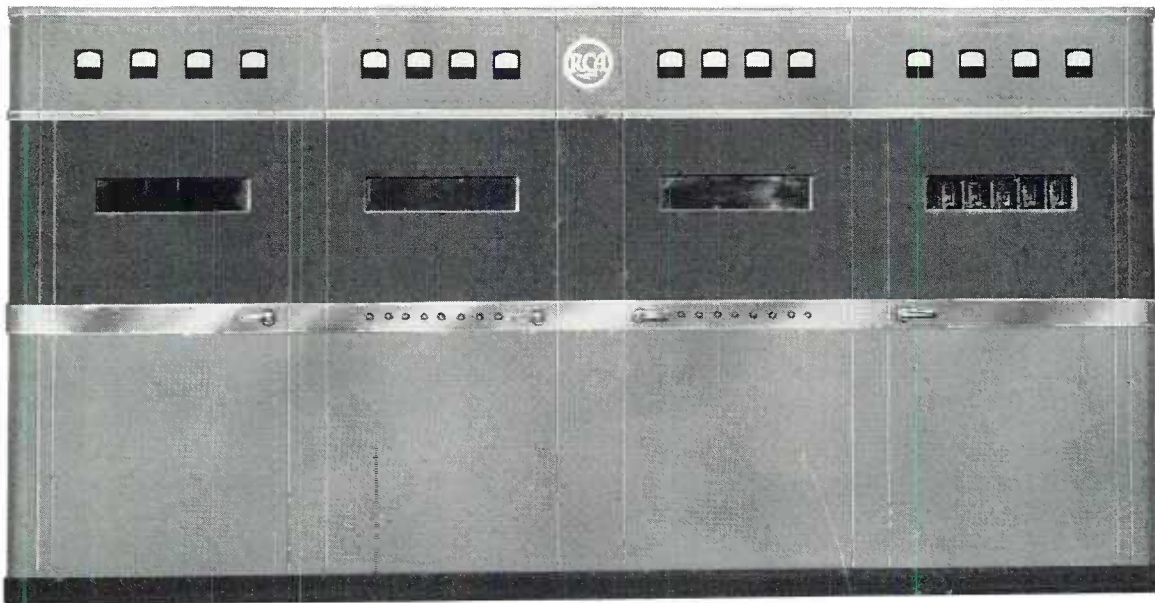

## Features

- Low operating cost—long life tubes—high efficiency circuits.
- Low installation cost—built-in wire channel—efficient layout.
- Vertical chassis construction—utmost accessibility.
- Push button electric tuning—complete circuit metering—panel viewing windows.
- Equipped with control console—centralized control system.
- Entirely air cooled—all cooling air filtered.
- Can be operated at 1 kw by the flick of a switch.
- Quickly and inexpensively converted for 10 kw operation.
- Extension wing cabinets available for housing phasing, monitoring, testing and audio equipments.

## Description

The BTA-5F 5 kw Broadcast Transmitter is considered one of the finest, most efficient equipments ever offered to broadcasters. Its excellent design includes refinements in circuits, carefully planned mechanical layout, long life components, and complete protection for personnel and equipment. The design of this transmitter is so conservative that it may be operated on 10 kw with only minor modifications. The BTA-5F has all of the exclusive features of the 5-F which it supersedes—the principal difference being front panel appearance and construction. The front panel view of the new BTA-5F shows the attractive unified panel with two-tone umber gray finish and light trim.

The BTA-5F offers a new concept of accessibility. When the front doors are opened, components and tubes are immediately accessible. This feature provides ready access for servicing, and allows a quick change of tubes when failures occur. In addition it is possible to erect a smaller and less costly structure to house the transmitter.

Vertical chassis construction is employed throughout. This type of construction facilitates the removal or testing of components and insures better ventilation of the cabinet with resultant longer life for individual units.

No trick circuits are used in the BTA-5F. Basic circuits have been time-tested and proved in at least one hundred 5-D, 5-DX, 5-E and 5-F installations throughout the world. The use of straight-forward circuits which are easily adjusted and maintained, prevents loss of time, eliminates the necessity for buying extra test equipment and simplifies tuning and maintenance. Some of the time proven circuit design features are:

Automatic reclosure without recycling on instantaneous power drop-outs.

Class C r-f Stages—easy tuning—no critical adjustments.

Class B Modulators—simple circuit design—high efficiency.

Equalized Feedback—low distortion operation—no adjustments.

Fixed Neutralization—stable performance.

The BTA-5F represents a distinct advance in tube economy. Fewer tubes are employed which reduces the number of spares required. Only 6 tube types are used as compared to 11 tube types in a previous design. Greater use is made of beam power tubes with consequently lower drive requirements and increased efficiencies. All tubes are air-cooled and each high power tube has its own blower, insuring an adequate supply of air and eliminating any possibility of overheating.

The control console for the BTA-5F has been designed to provide a maximum of ease and efficiency in station operation. Each major control function of the transmitter is at the engineer's fingertips, and important meters are placed within easy viewing distance.

For the purpose of housing phasing components and monitoring, test, and audio equipments, extension cabinets may be added to either or both ends of the BTA-5F.

## Increasing Power to 10 KW

The BTA-5F may be easily and inexpensively changed over to a standard RCA Type BTA-10F, 10 kw Transmitter by the installation of a 10 kw kit (MI-7267-A). The spare tube position of the BTA-5F provides a socket for the additional required Type 892-R Tube. Sockets, completely wired, are provided for two additional 828 modulator driver tubes. The MI-7267-A conversion kit includes a blower, filament transformers, 10 kw Modulation Transformer and Reactor, and all necessary accessories. Mounting facilities have been provided for new components so that conversion is rapid and easily made.

The BTA-5F is shipped with control console, 2 type TMV-129-B crystal units, 2 complete sets of tubes, 1 installation material kit, 1 touch-up kit and 2 instruction manuals.

## Electrical Specifications

Carrier Frequency Range \_\_\_\_\_ 540 to 1600 kc  
 Carrier Frequency Stability \_\_\_\_\_  $\pm 10$  cps  
 Carrier Frequency Harmonics \_\_\_\_\_ below .05%  
 Carrier Power Output  
 (40 to 350 ohms unbalanced load) \_\_\_\_\_ 5000/1000 watts  
 Carrier Shift  
 (50 to 7500 cps up to 100% mod.) \_\_\_\_\_ does not exceed 5%  
 Carrier Noise and Hum Level  
 (unweighted below 100% mod.) \_\_\_\_\_ 60 db  
 Power Supply Requirements \_\_\_\_\_ 208/230 volts, 6 cycles, 3 phase  
 capable of supplying loads up to 18 kw at 85% power  
 factor and peak loads up to 25 kw at 88% power factor  
 with an instantaneous regulation not exceeding 3% and  
 average regulation not exceeding 5%. Also approximately  
 30 watts at 115 volts, 60 cycle, single phase is required

### A-c Power Input

30% Modulation  
 5000 watts \_\_\_\_\_ 17.5 kw  
 1000 watts \_\_\_\_\_ 10.8 kw

100% Tone Modulation  
 5000 watts \_\_\_\_\_ 21.5 kw  
 1000 watts \_\_\_\_\_ 11.5 kw

Carrier Only  
 5000 watts \_\_\_\_\_ 16.5 kw  
 1000 watts \_\_\_\_\_ 10.25 kw

Audio Frequency Response \_\_\_\_\_  $\pm 1.5$  db, 30 to 10,000 cps

### Audio Input Level

5000 watts, 100% mod. \_\_\_\_\_ +12.5 dbm\*  
 1000 watts, 100% mod. \_\_\_\_\_ +5.5 dbm\*

### Audio Frequency Distortion

(0 to 95% mod. 50-7000 cps) \_\_\_\_\_ not to exceed 3% rms

Tube Complement (1 set) \_\_\_\_\_ MI-7083-A

2 RCA-807	3 RCA-892-R
5 RCA-828	2 RCA-1620
2 RCA-810	10 RCA-8008

## Mechanical Specifications

### Dimensions

Overall Length \_\_\_\_\_ 171½"  
 Overall Height \_\_\_\_\_ 85½"  
 Enclosure Depth \_\_\_\_\_ 38½"  
 Plate Transformer \_\_\_\_\_ Base 34" x 21", height 26"  
 Modulation Transformer \_\_\_\_\_ Base 26" x 19½", height 23½"  
 Console \_\_\_\_\_ Base 60" x 34½", height 41½"  
 Building Entrance (minimum) \_\_\_\_\_ 38½" wide 87" high  
 Maximum Length of Single Unit \_\_\_\_\_ 89½"

### Weight

Transmitter Weight (net approx.) \_\_\_\_\_ 6000 lbs.  
 Modulation Transformer \_\_\_\_\_ 992 lbs.  
 Plate Transformer \_\_\_\_\_ 735 lbs.  
 Console \_\_\_\_\_ 393 lbs.

### Stock Identification for Transmitter

60 cycles \_\_\_\_\_ MI-7260-C  
 50 cycles \_\_\_\_\_ MI-7260-D

## Accessories

Transmitter Monitor and Amplifier Rack \_\_\_\_\_ MI-11623  
 Left Wing (Phasing Cabinet) \_\_\_\_\_ MI-7485-F  
 Right Wing (Audio Cabinet) \_\_\_\_\_ MI-7485-E  
 Set of Tubes for BTA-5F \_\_\_\_\_ MI-7083-A  
 10 kw Modification Kit (60 cycle) \_\_\_\_\_ MI-7267-A  
 10 kw Modification Kit (50 cycle) \_\_\_\_\_ MI-7267-B  
 Set of Tubes for MI-7267 A/B Modification Kit \_\_\_\_\_ MI-19654  
 50 Cycle Conversion Kit \_\_\_\_\_ MI-7085-A

### BPA-10 Antenna Tuning Equipment

(less Monitor) \_\_\_\_\_ MI-28902-A  
 (with Monitor) \_\_\_\_\_ MI-28902-B

\* dbm = no. of db above one milliwatt when single frequency tone modulation is used.

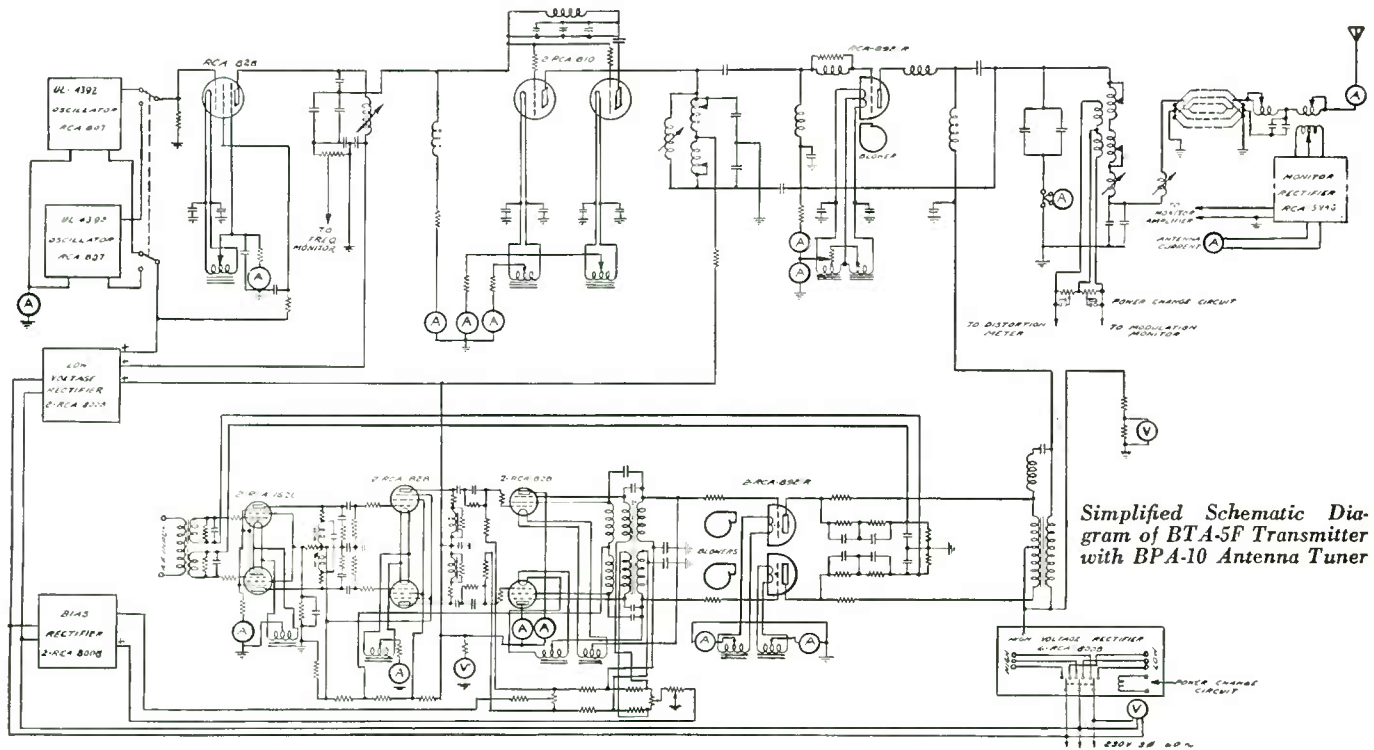

# Broadcast Transmitter Type BTA-10-F

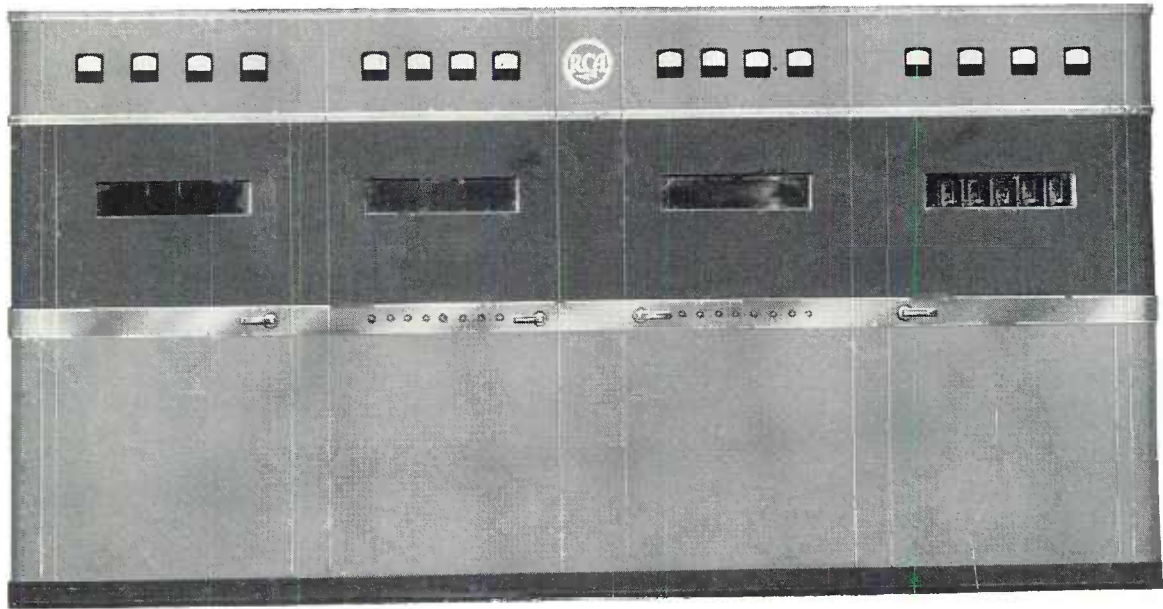

## Features

- Low operating cost—long life tubes—high efficiency circuit.
- Low installation cost—efficient layout—built-in wire channel.
- Vertical chassis construction—utmost accessibility—tubes easily removed.
- Entirely air-cooled. Push button electric tuning.
- Automatic reclosure without recycling on instantaneous power drop-out.
- Equipped with control console—centralized control system.
- Power output may be reduced to 2 kw in emergencies by operation of one switch.
- Extension wing cabinets available for housing phasing, monitoring, testing and audio equipments.
- Tube hour meter.
- Dry or oil filled transformer.

## Description

The Type BTA-10F provides a 10 kw transmitter which is outstanding in appearance, performance, and reliability. Fidelity, distortion, and noise level are held to standards meeting the highest requirements. Economy is assured by the use of extremely long life tubes, and the highly efficient high level system of modulation. The cost of operation per hour of this 10 kw equipment has been shown to be considerably less than that of many 5 kw installations. Except for front panel appearance and construction the BTA-10F is similar to the type 10-E Transmitter which it supercedes.

Basically this 10 kw Transmitter is similar to the Type BTA-5F 5 kw Transmitter. It differs in that it includes an additional 892-R tube with its associated filament transformers and blower motor, a larger modulation transformer, a reactor and two additional 828 modulator driver tubes. The conditions of operation of the tubes are the same, permitting similar performance and the same long tube life which experience has proved to be attained in the BTA-5F Transmitter. The fidelity of transmission and operating efficiency of the Type BTA-10F Transmitter is exceptional. Its high level modulation system is identical to that incorporated in the BTA-5F. The audio feedback circuit is extremely stable and unaffected by adjustments of the radio frequency circuits. Other exclusive circuit design features of the BTA-10F will be found under the description of the type BTA-5F Transmitter.

The BTA-10F Transmitter is equipped with an attractive, unified front panel finished in two-tone umber gray and light trim. Extension cabinets are available for both ends for phasing components and monitoring, test and audio equipment. This compact design not only represents the ideal installation but also permits transmitter houses to be planned for a complete installation with minimum space requirements.

The BTA-10F is shipped with control console, 2 type TMV-129-B Crystal Units, 2 complete sets of tubes (except only seven 892-R tubes are supplied), interconnecting wire kit, 1 touch-up paint kit and 2 instruction manuals.

## Specifications

Carrier Frequency Range	540 to 1600 kc
Carrier Frequency Stability	$\pm 10$ cps
Carrier Frequency Harmonics	below .05%
Carrier Power Output	10,000 watts
(40 to 250 ohms unbalanced load)	
Carrier Shift	does not exceed 5%
(50 to 7500 cps up to 100% mod.)	
Carrier Noise and Hum Level	60 db
(unweighted below 100% mod.)	
Power Supply Requirement	208/230 volts, 60 cycles, 3 phase
capable of supplying normal loads up to 26 kw at 89% power factor and peak loads up to 40 kw at 91% power factor with an instantaneous regulation not exceeding 3% and average regulation not exceeding 5%. Also approximately 30 watts at 115 volts, 60 cycle, single phase is required for the crystal heaters.	
A-c Power Input	
Average Program	26 kw
(equivalent to 30% sine wave modulation)	
100% Tone Modulation	33.5 kw
Carrier Only	24 kw
Audio Frequency Response	$\pm 1.5$ db 30 to 10,000 cycles
Audio Input Level (for 100% mod.)	approx. 12.5 dbm*
Audio Frequency Distortion	
(0 to 95% mod., 50-7500 cps) not to exceed 3% rms	
Tube Complement (one set)	MI-7084-A
2 RCA-307	4 RCA-892-R
7 RCA-828	2 RCA-1620
2 RCA-810	10 RCA-8008

\* dbm = no. of db above one milliwatt when single frequency tone modulation is used.

**Mechanical Specifications**

**Dimensions**

Overall Length	171½"
Overall Height	85½"
Enclosure Depth	38½"
Plate Transformer	Base 34" x 21", height 26"
Modulation Reactor	Base 29½" x 24½", height 21"
Modulation Transformer	Base 26" x 20", height 24½"
Console	Base 60" x 34½", height 41½"
Building Entrance (minimum)	38½" wide 50½" high
Maximum Length of Single Unit	89½"

**Weight**

Transmitter (net approx.)	6500 lbs.
Modulation Transformer	1138 lbs.
Modulation Reactor	1382 lbs.

Plate Transformer	735 lbs.
Console	393 lbs.

**Stock Identification for Transmitter**

60 cycles	MI-7266-C
50 cycles	MI-7266-D

**Accessories**

Transmitter Monitor and Amplifier Rack	MI-11623
Left Wing (Phasing Cabinet)	MI-7485-F
Right Wing (Audio Cabinet)	MI-7485-E
Set of Tubes for 10-F	MI-7084-A
50 Cycle Conversion Kit	MI-7085-C
60 Cycle Conversion Kit	MI-7085-D

**BPA-10 Antenna Tuning Equipment**

(Less Monitor)	MI-28902-A
(With Monitor)	MI-28902-B

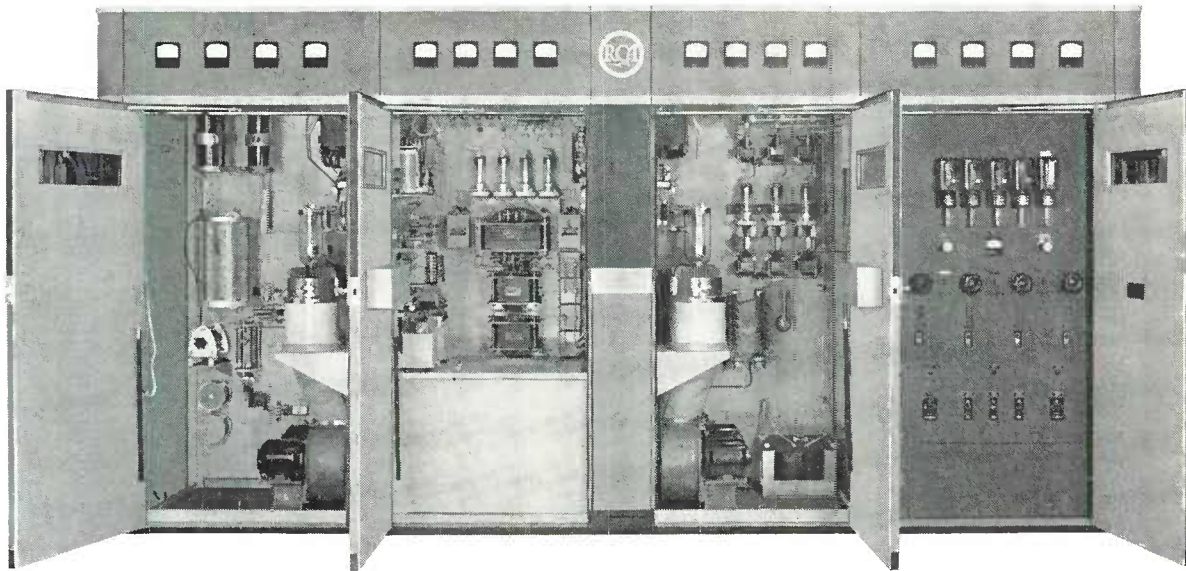

*Front view with doors open showing interior construction.*

*BTA-10F Transmitter with left and right wing extension cabinets.*

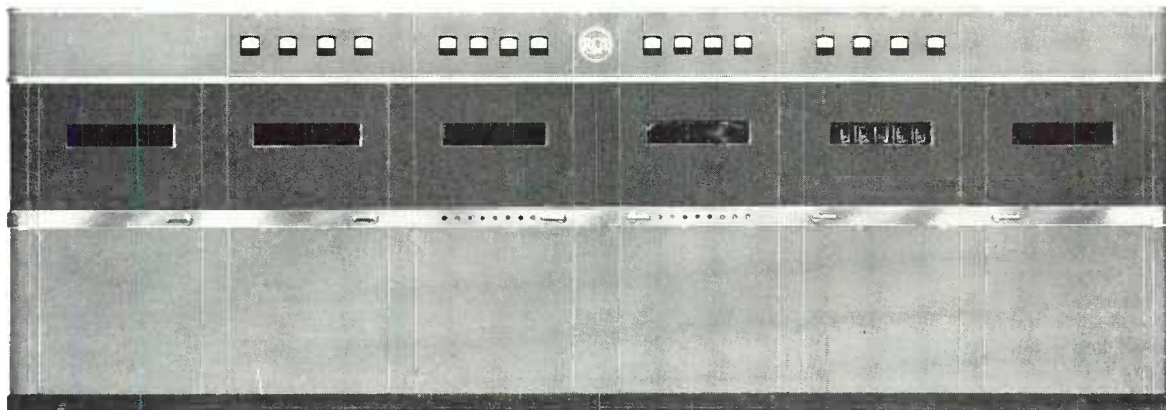

# Transmitter Control Console MI-11616



## Features

- Simplifies transmitter installation.
- Major control functions are at engineer's fingertips and important meters are within easy viewing distance.
- Contains all required mixing and switching facilities.
- Standardized vu meter plus extension modulation monitor and antenna current indication.
- All necessary controls for transmitter operations plus visual indicating lamps.

## Uses

The MI-11616 Transmitter Control Console is an attractive desk type console containing all the mixing and switching facilities required at the transmitter plant. It is equipped with a standardized vu meter, extension modulation monitor meter and antenna current meters. Designed primarily for use with the RCA BTA-5F and BTA-10F Broadcast Transmitter, it may be combined with the MI-11623 Transmitter Monitor and Amplifier Rack to provide a most flexible and complete system of control and monitors.

## Description

All controls, switches and meters are mounted on three panels which are assembled in the turret mounted on a metal desk. Each panel is hinged at the bottom so that it may be opened for easy servicing and the entire rear cover of the turret may be removed to facilitate installation or basic changes. Desk and turret are of metal construction throughout. The left hand pedestal contains a typewriter shelf and the right pedestal contains two convenient drawers. A third drawer is located in the center between the pedestals. A cylinder lock on this drawer also locks the drawers in the pedestal. Skirts have been provided below the pedestals to conceal the wiring conduits and all wiring is carried inside the desk. The desk top is covered with black linoleum with rounded corners and metal trim.

Mechanically interlocked push-keys permit instant selection of the circuit to be monitored by the vu meter or by the monitoring amplifier. By means of these keys, the monitoring speaker may be used to check (1) transmitter audio input, (2) transmitter audio output, (3 and 4) two incoming lines and (5) turntable output.

Balanced, high quality, step-by-step mixers are provided for the (1) incoming line, (2) announce microphone and (3) turntable. A master or transmitter input control and a monitor amplifier volume control are also furnished. Key switches in the outputs of the microphone and turntable mixers are equipped with indicating lamps. The microphone key is interlocked with the monitoring speaker through a relay and disconnects the speaker whenever the microphone is on. A line transfer key permits ready selection of two incoming lines and transfers the telephone set to the line not being used for the program. A three position key switch selects the studio line or the local microphone and turntable. Chromium plated guards prevent accidental operation of the important keys. A spare

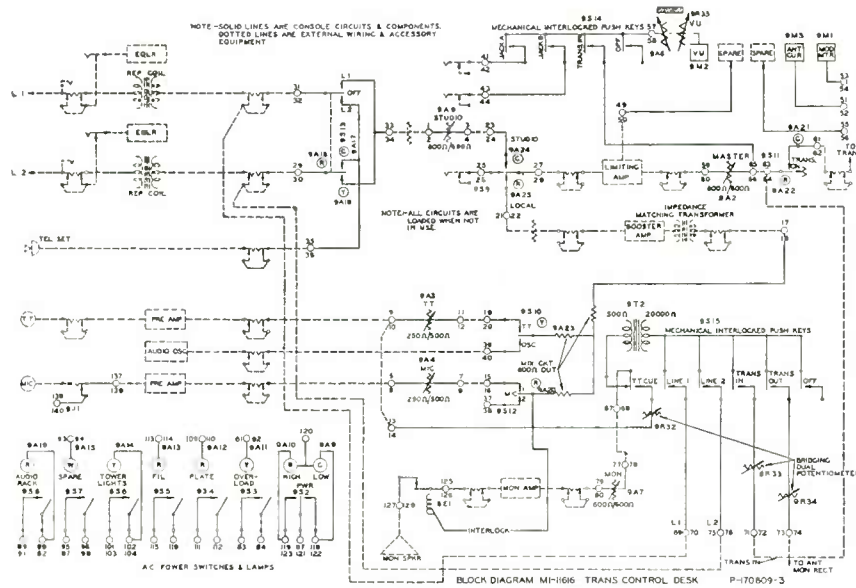

*Block Diagram MI-II616 Transmitter Control Desk*

D. P. D. T. lever key is furnished for the convenience of station personnel. The center panel contains a standardized vu meter, with a step-by-step control making it possible to read levels of +4 vu to +40 vu; a modulation meter intended to operate as an extension for a type 66A modulation monitor and an antenna current indicator consisting of a 0.50 ma, d-c movement with a scale of 50 divisions calibrated linearly from 0 to 10 amperes rf (other scales are available) and intended to be connected into the rectified carrier circuit. Cutouts are provided for two additional meters such as an extension db compression meter for the limiting amplifier; an extension meter from a frequency monitor or additional antenna current indicators where required. The attenuator controls are located below the meters on the center panel.

A 12 volt, 1 ampere, d-c power supply furnishes power to the speaker interlocking relay and to the audio circuit indicating lamps. The power supply utilizes a copper sulphide dry rectifier and capacity filter.

The power control switches are mounted on the left hand panel and are designed for 230 volt operation. Associated lamps are furnished and may be arranged for operation on 115 volt for audio power and 230 volt for transmitter power. Switches and lamps are provided for (1) transmitter filaments, (2) transmitter plate, (3) overload reset, (4) transmitter high-low power transfer, (5) tower lights, (6) audio equipment and (7) spare.

**Specifications**

**Input Impedances**

- Lines 1 and 2, Studio, Master and Monitor Controls \_\_\_\_\_ 600 ohms
- Telephone Set \_\_\_\_\_ 600 ohms
- Microphone and Turntables \_\_\_\_\_ 250 ohms
- Monitor—Transmitter in and out (Bridging) \_\_\_\_\_ 20,000 ohms
- Monitor—Lines 1 and 2 \_\_\_\_\_ 20,000 ohms

**Output Impedances**

- Lines 1 and 2, Lever Key; Microphone and Turntable Mixer; Studio, Master and Monitor Control \_\_\_\_\_ 600 ohms
- Microphone and Turntable Controls \_\_\_\_\_ 250 ohms
- Frequency Response (30 to 15,000 cycles) \_\_\_\_\_ ±0.1 db

**Insertion Losses**

- (microphone and turntable mixer circuit) \_\_\_\_\_ 7 db
- Noise Level: Circuits are isolated so that residual noise level will not exceed the aggregate noise level of the associated amplifiers.

**A-c Power Input for Lamps and Relays**

- (105-125 volts, 50-60 cycles) \_\_\_\_\_ 25 watts
- Dimensions, overall \_\_\_\_\_ Width 60", depth 34½", height 41½"
- Note—Turret extends approximately 11" above desk top
- Weight (unpacked) \_\_\_\_\_ 393 lbs.
- Stock Identification \_\_\_\_\_ MI-11616

**Accessories**

- Transmitter Monitor and Amplifier Rack \_\_\_\_\_ MI-11623
- Extension Meter for 86-A1 Amplifier \_\_\_\_\_ Stock No. 43504

**5/10 KW Conversion Kits For RCA AM Transmitters**

Any RCA 5 KW broadcast transmitter from type 5D to type BTA-5F may be easily and inexpensively modified to a standard 10 KW RCA transmitter by installing a 5/10 KW conversion kit. The conversion kit includes a blower, filament transformers, modulation transformer, reactor and all other necessary accessories and instructions.

Conversion can be easily and rapidly accomplished without loss of air time since only minor changes in the existing installation are required. The converted transmitter is efficient and reliable and has quality equal to that of the original.

Moreover, this does not make the installation an orphan, for with this change the former 5 KW transmitter becomes a standard RCA 10 KW unit which is registered with the FCC as such, and for which replacement parts can be readily obtained.

- 5D to 10D Conversion Kit \_\_\_\_\_ MI-7303
- 5DX to 10DX Conversion Kit \_\_\_\_\_ MI-7303-A
- 5F to BTA-10F \_\_\_\_\_ MI-7267-A
- or
- BTA-5F to BTA-10F \_\_\_\_\_ MI-7267-A

# Broadcast Transmitter Type BTA-50F

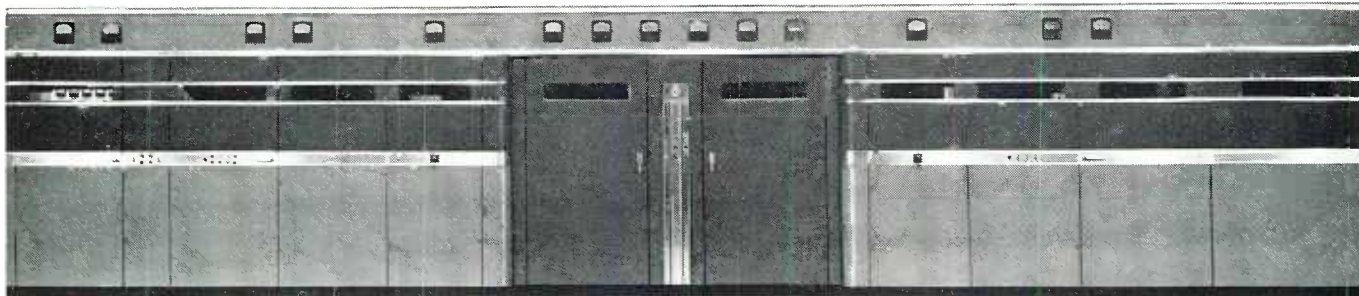

## Features

- Economical operation—lower power input.
- Reliable performance—conservative employment of parts and tubes.
- Reduced floor space requirements—compact design.
- Lower cost installation—built in wiring ducts.
- Air cooled entirely—no water connections of any kind.
- Simplified tuning and maintenance—single ended r-f circuits from crystal to output.
- Simplified power supply circuits—only 3 tube rectifiers.
- Single phase filaments throughout.
- Simplified, effective control circuit—high speed air circuit breakers—console fault indication.
- Push button motor tuning.
- Low distortion—non-critical feedback with cathode follower driver for modulator.
- High efficiency—Class “B” modulator—high level modulation.
- Convenient console with audio and power controls.
- Spare tube positions in power amplifier, modulator and main rectifier.
- Minimum number of tube types.
- Adaptable to single or dual floor layout.

## Description

The RCA Type BTA-50F is a 50 kw amplitude modulated, high fidelity broadcast transmitter for operation in the band of 540 to 1600 kilocycles. In its design, every consideration has been given to the simplification of mechanical and circuit design for ease in operation and maintenance and reduction of installation and operating costs to a minimum. Attractive panel appearance has been achieved through the application of functional design principles.

Low installation costs have been made possible by a single-floor layout, built-in wiring ducts and the RCA “unified” front. Low operating costs result from the use of high efficiency circuits, long-life, all air-cooled tubes and conservative

operation of components. Power input costs are kept to a minimum by the use of high efficiency Class “C” r-f amplifier and Class “B” modulator circuits.

The new type 9C22 tubes using single phase filaments are utilized in the power amplifier and modulator positions. The design of this tube permits more precise alignment of elements, smaller overall size, short filament and grid leads and uniform heat dissipation. The well known RCA-857-B rectifier tubes have been chosen for the BTA-50F because of their exceptionally long life which has been proved by years of actual operation in previous RCA transmitters. An automatic regulator maintains constant filament voltages on all tubes and high reactance type filament supply limits the starting current, thus reducing filament stress.

A simplified and straightforward control circuit provides complete protection to equipment and station personnel. Because of their higher operating speed and ease of maintenance, air circuit breakers of 600 volt rating are used in the power input circuits. A reliable power station type reclosing relay will reapply plate voltages immediately after an overload occurs, but if the overload persists, the relay will reclose two additional times and will then lock out the plate voltage until the reset is operated by hand. However, if a second overload does not recur within 90 seconds, the reset function is automatic. No fuses are used in the power feed circuits of the BTA-50F Transmitter.

Spare tubes are provided in the modulator, r-f power amplifier and high voltage rectifier units. Should a failure occur, the wiring is arranged to permit a quick change of connections to the spare tube. A hydraulically operated tube jack is furnished with the BTA-50F to facilitate the handling of the large power tubes.

Three single-phase, high-voltage plate transformers are used. These transformers are connected delta-delta for normal operation but remotely operated circuit breakers are provided to permit operation with a wye-delta connection giving low voltage (16 kw output) for tuning and test purposes.

50/10 kw operation may be automatically accomplished by installation of an MI-28905 power reduction kit.

A slow speed blower is utilized having a rated capacity of 10,500 c.f.m. at a static pressure of 2 inches at sea level. A spare is provided and each blower is equipped with its own three-phase motor and starter. An intake air filter is supplied and consists of 12 permanent, non-corrosive filter units which are easily cleaned.

The BTA-50F control console is similar to the MI-11616 Desk described elsewhere in this catalog. It differs from the MI-11616 in that it contains switching circuits adapted to the BTA-50F plus fault indicating lamps which are operated by the transmitter overload relays. All the audio mixing and switching facilities required at the transmitter are provided in this console. It is equipped with a VU meter, an extension modulation percentage meter, a "Time of Outage" clock and a "Duration of Outage" clock.

Because the design requirements of such equipment usually vary with each installation, transmission lines, antennas, transmission line terminating, antenna phasing or antenna tuning equipment are not made a standard part of the BTA-50F Transmitter. RCA will be pleased to submit proposals covering such equipment complete with tower lighting chokes, monitoring equipment and other associated apparatus.

The BTA-50F is supplied complete with two crystals, two complete sets of tubes (less one RCA-9C22), antenna monitor and remote meter, MI-11621 supervisory control desk, and 15 days tune-up service.

**Specifications**

- Radio Frequency Range—Any specific frequency in the band from 540 kc to 1600 kc
- Radio Frequency Power Output—53 kw at transmitter output terminals
- Output Load Impedance—40 to 250 ohms, non-inductive, unbalanced
- Radio Frequency Stability—±10 cycles
- Audio Frequency Response—Within 1 db of the arithmetic mean value of the two extremes of response between 30 and 10,000 cycles
- Audio Distortion—Less than 3% rms from 50 to 7500 cycles at 90% modulation

- Audio Input Level for 100% Sine Wave—+10 dbm ±2 db (0 dbm = .001 watts in 600 ohm line)
- Audio Input Impedance—150/600 ohms
- Noise Level—rms—60 db below 100% modulation
- Carrier Shift—Does not exceed 5%
- R. F. Harmonics—70 db below carrier fundamental measured at one mile

**Tube Complement (one set)**

2 RCA-807	4 RCA-9C22	1 RCA-5X5GT/G
7 RCA 828	1 RCA-89	1 RCA-5V4G
2 RCA-810	3 RCA-6C6	4 RCA-8008
1 RCA-892-R	2 RCA-5R4GY	6 RCA-857-B
	1 RCA-5Y3GT/G	

Power Consumption—110 kw at 87% P.F. without modulation  
 120 kw at 88% P.F. for 25% modulation  
 156 kw at 90% P.F. for 100% modulation

Power Supply Requirements—460 volts, 60 cycles, 3 phase, 3 wire, with 5% maximum combined regulation and variation. The equipment can be adapted for 50 cycle operation by minor modification (MI-7037 Kit). A separate power source of 115 volts, single phase, 30 watts, is required for the crystal heaters.

**Dimensions, overall**

- Transmitter Panel and Equipment Enclosures—33' long x 84<sup>1</sup>/<sub>8</sub>" high (allow depth of 9' to rear wall)
- Plate Transformer (each)—27<sup>3</sup>/<sub>4</sub>" dia. x 56<sup>3</sup>/<sub>4</sub>" high
- Modulation Transformer (incl. drain)—48<sup>1</sup>/<sub>8</sub>" x 56<sup>3</sup>/<sub>8</sub>" x 88<sup>3</sup>/<sub>8</sub>" high
- Modulation Reactor—39<sup>1</sup>/<sub>2</sub>" x 43" x 90<sup>1</sup>/<sub>2</sub>" high
- Filter Reactor—29<sup>3</sup>/<sub>8</sub>" x 37<sup>7</sup>/<sub>8</sub>" x 56<sup>1</sup>/<sub>8</sub>" high
- Switchgear Unit—44" x 48" x 90" high
- Console—60" long x 34<sup>1</sup>/<sub>2</sub>" deep x 41<sup>1</sup>/<sub>2</sub>" high
- Weight, total unpacked—43,000 lbs., approx.
- Finish—Two tone umber grey
- Stock Identification for Transmitter—MI-7050

**Accessories**

- Modification Kit for 50 Cycle BTA-50F—MI-7037
- Antenna Tuner—MI-28903-A/B
- Power Reduction Kit—MI-28905

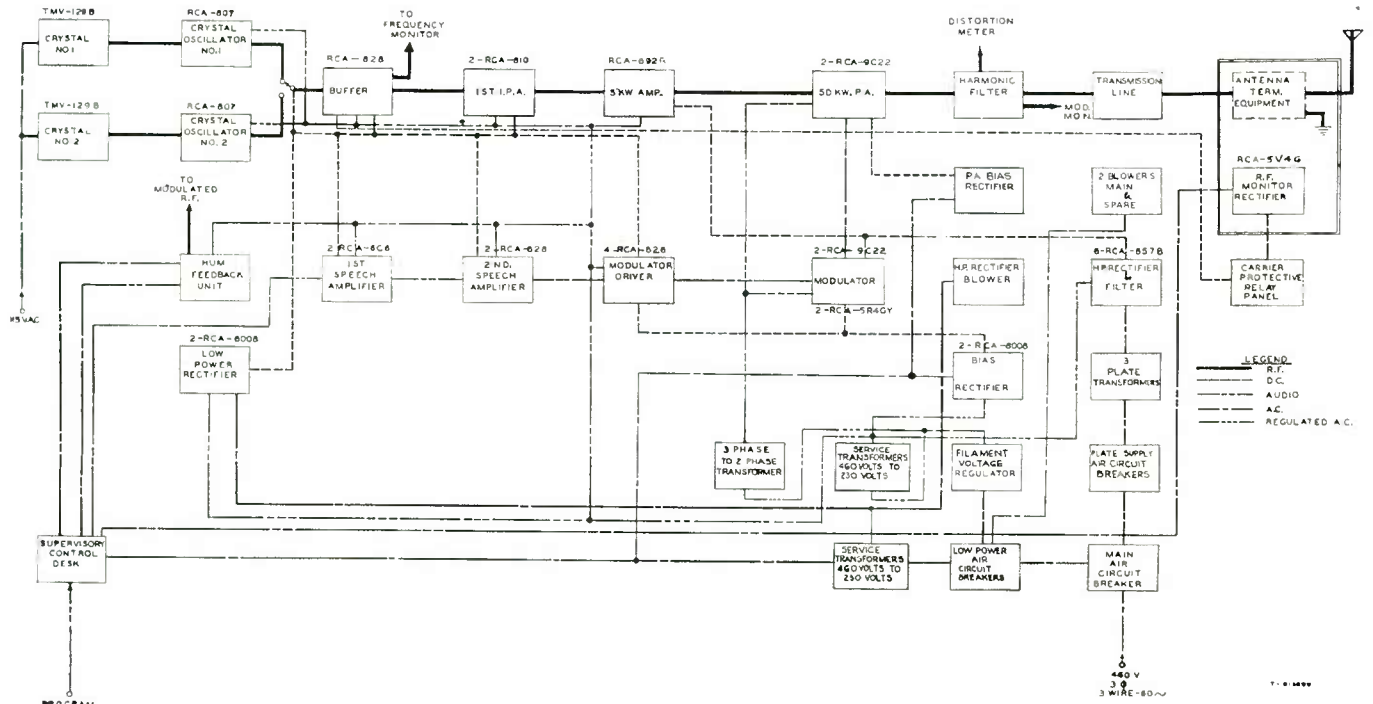



# RCA Custom Built Antenna Phasing Equipment

## Features

- Individual custom design provides an optimum circuit for any array.
- Lower cost—no excess equipment included.
- Quick delivery—components carried in stock.
- Economical installation—completely wired—supplied with tuning instructions.
- Monitoring rectifiers, lighting circuits, automatic switching and electric tuning furnished, if desired.
- Metering facilities may be expanded or minimized as required.
- Enclosure cabinets available in several types to match appearance of transmitters.

## Uses

Antenna Phasing Equipment is used to obtain and maintain proper magnitude and phase relationship of currents fed to the individual towers in a directional antenna array. To obtain a directional pattern each tower is supplied a certain prescribed portion of the total power output from the transmitter. The power fed to each tower must be accurately controlled as to magnitude and must radiate from each tower at the correct instant of time relative to the power from each other tower.

Directional arrays have become of considerable importance in the broadcast band of frequencies. The purpose has been twofold. In some cases, the energy is directed into a desirable or densely populated territory with a resulting decrease in the energy sent out into thinly populated territory, waste land or large bodies of water. The greatest use of the directive array has been to prevent energy from going out in directions which point toward the service areas of other stations on the same or adjacent channels. The use of such arrays allows stations to increase their power without increasing the amount of interference they cause to other stations.

## Description

RCA has adopted the policy of custom-building antenna phasing equipment in accordance with individual design to meet the particular requirements of the user. Experience has shown this policy to be more economical and satisfactory than to attempt to standardize on one elaborate design with sufficient components to meet the requirements of a wide range of powers, various numbers of towers and an almost infinite combination of networks. Such designs will inevitably have excess equipment and must, therefore, be a compromise rather than the optimum design. Several types of enclosures and all circuit components are manufactured in quantities and are available from stock, thus making possible a quick delivery of an individual and economical design.

It will be noted from the simplified schematic of a typical directional array installation that, where possible, "T-Networks", having a lagging phase shift, are used in order to take full advantage of their well known harmonic suppressing qualities and relative ease of adjustment with a minimum number of components and maximum efficiency.

The dividing network consists of a parallel-resonant tank circuit having a KVA to KW ratio of approximately two. The inductor is an adjustable unit shunted at various points, depending upon the power division, by front-panel controlled

rotary coils, one for each radiator. This gives independent amplitude control for each antenna and allows for a maximum of flexibility in power division. When the network is adjusted to parallel resonance, the input line from the transmitter may be tapped in at the point of proper resistance.

Each phasing network consists of a "T-Network" with a 1:1 impedance transformation. The two series legs consist of rotary coils, ganged, with a single front-of-panel control. For a fixed shunt element, this allows phase variations from approximately  $60^\circ$  to  $120^\circ$  with no appreciable change of impedance transformation.

The line terminating unit consists of a "T-Network" designed with a phase angle as near  $90^\circ$  as possible consistent with system phase and transmission line lengths, and with impedance-transformation ratio as required based upon the characteristic impedance of the transmission line and the calculated radiator operating impedances. Account is taken of negative operating resistances by suitable system phasing. In the event of operating resistance of very low values, approaching zero, special recommendations may be made.

Faradon, polystyrene treated, mica capacitors are generally supplied and are operated at approximately 50% of the nameplate rating. Polystyrene treated capacitors provide lower losses than the wax treated type and are also more stable under high temperatures sometimes encountered in unventilated antenna tuner houses. Gas-filled capacitors, operated well within their nameplate rating, are used where they become an economical choice or when requested by the customer. In general, RCA does not recommend the use of open, air-dielectric capacitors due to their vulnerability to the accumulation of dust and foreign matter, but in those cases where air capacitors are specifically desired, they will be supplied.

Inductors consist of high-Q copper coils supported by low loss ceramic insulation. In high current circuits, large coils wound with copper tubing supported by mycalex and ceramic insulation are used. All inductors are adjustable and normally include ample inductance to allow for variations in the adjustment of an array not predicted by the design. Remotely-controlled, motor-driven variable inductors are supplied where requested or required. All inductors are carefully chosen and are operated well within their current rating and in no case is excessive temperature rise permitted.

The r-f meters supplied employ expanded scales and have a full scale range between 1.3 and 2 times the RMS carrier value of the current being metered.

Facilities for remote control switching from directional to non-directional operation, or from night-time to day-time patterns, are supplied if required. Other optional items are: (1) Antenna monitoring rectifiers, (2) Circuit components for isolating the tower lighting system, (3) Current sampling coils, (4) Electric tuning, (5) Remote metering.

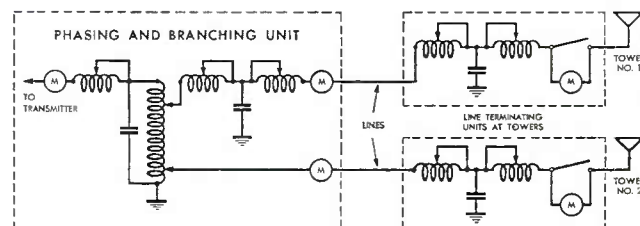

Schematic of a basic 2 element array.

**Specifications**

RCA antenna phasing equipment is custom built to the purchaser's specifications. RCA will assemble standard circuit components and, where necessary, will specially build components to meet these specifications. The purchaser's specifications may be completely detailed or, if desired, RCA engineers will submit overall and detailed layouts to meet the purchaser's requirements of power division and current phasing.

Unless otherwise specified, quotations for RCA phasing equipment include a dividing network, one line terminating unit for each radiator, phasing networks in the quantity one less than the total number of radiators, and all necessary meters.

Enclosures are available to match or install as an extension wing of 5/10 and 50 KW transmitters. Lower power branching equipment may be mounted in cabinets styled the same as RCA's new audio cabinet rack and FM transmitters. Economical out-door and/or wall mounted enclosures are also available.

All RCA Custom Built Phasing Equipment is factory-assembled and wired, and shipped in such state of assembly deemed suitable for domestic shipment. All components are clearly marked and bus leads clearly tagged. Photographs of the equipment prior to disassembly are supplied. Also supplied is a schematic diagram and parts list together with recommended initial network adjustments based upon design calculations.



*Exterior view of a 1 KW phasing and branching equipment in standard 84" cabinet*

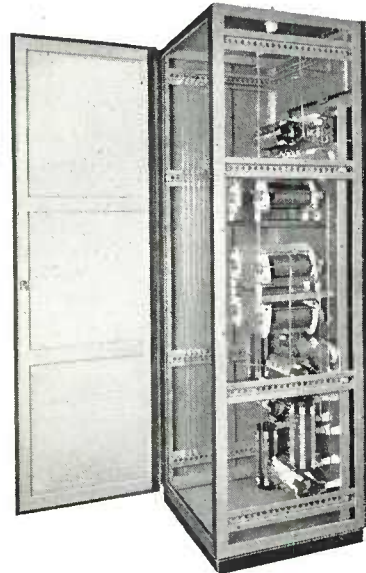

*Interior view of a 1 KW phasing and branching equipment*

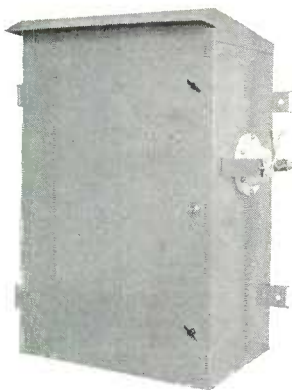

*Exterior view of a 1 KW line terminating unit in weatherproof cabinet*

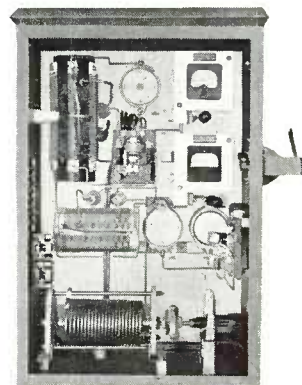

*Interior view of a 1 KW line terminating unit with relay switching and motor tuning*

**1 KW**

One kilowatt phasing and branching equipment is usually supplied in an MI-7485-G cabinet. This cabinet has both front and rear doors. The components are mounted on a sub-panel behind the front door and controls of rotary coils are brought out through the sub-panel. All controls are available behind the front door. The rear door gives access to all components and wiring. The MI-7485-G cabinet is 84" high, 31" wide and 31" deep overall.

The line terminating units are supplied in a weatherproof metal box. The interior view shows a typical arrangement of components for an installation having motor-driven rotary coils and switching for day-night pattern changes. During the manufacturing of the equipment, provision will be made for entrance of coaxial transmission line or open wire type line, depending upon the customer's preference. The line terminating unit cabinet is 30" high, 22" wide and 16" deep.

## PHASING

### 5 / 10 KW

The 5/10 KW phasing and branching equipment is available in two cabinet styles, the MI-7485-F or the MI-28935-B. When supplied in the MI-7485-F, the equipment is intended to form a left-wing extension for the RCA BTA-5F or BTA-10F transmitter. This cabinet matches the transmitters both in appearance and quality of material and workmanship. The decorative front panel is finished with a two-tone umber gray, rubbed and waxed, with stainless steel trim and handles. An interlocked door in the left side of the cabinet allows operating personnel to walk inside the cabinet for inspection of phasing components. Meters for measuring branch line and main line currents are mounted on a sub-panel behind the front door and may be read through the glass panel in the door. Controls for the phase and amplitude of the current in each tower are mounted on the same sub-panel. Switches for controlling remote motor tuning of the line terminating units (where such control is desired) may also be mounted on this panel. Rotary coils used in the phase shift networks are so arranged that one control operates the two coils in each network. The values chosen provide a wide range of phase shift without affecting impedance transformation. Rotary coils are also provided in the power dividing network to assure flexible control of the current amplitude in each tower. In the phase shift networks, tapped inductors, to provide a wide range of adjustment, are included in series with the capacitors in the shunt leg network. The input circuit of the phasing and branching equipment may be adjusted to match the impedance of the transmission line between the transmitter and phasing equipment.

The components used in this phasing and branching equipment are of the same high quality supplied in all RCA broadcast equipment. Components are conservatively rated and are normally operated at approximately half their nameplate rating.

The MI-28935-B standard rack type cabinet installation is designed for those stations where it is desired or necessitated by space requirements that the phasing and branching equipment be set apart from the transmitter. The two typical floor plans illustrated below show, in one case, a typical transmitter room where the phasing equipment is housed in the left wing extension cabinet, and in the other case, an application of the self-contained, standard rack type phasing cabinet. This cabinet is finished in two-tone umber gray lacquer



*Typical, double section, standard, rack type cabinet, MI-28935-B*

with stainless steel handles and trim. Necessary meters are mounted on the meter panel over the front doors. All controls are brought out through a sub-panel behind the front doors as described for the wing type cabinet. Interlocked, double doors in the rear of the cabinet provide access to all components for inspection. With installations involving unusual complexity, or those employing more than five towers, it may be necessary to supply phasing and branching equipment in a three section cabinet of the same design as the one illustrated.

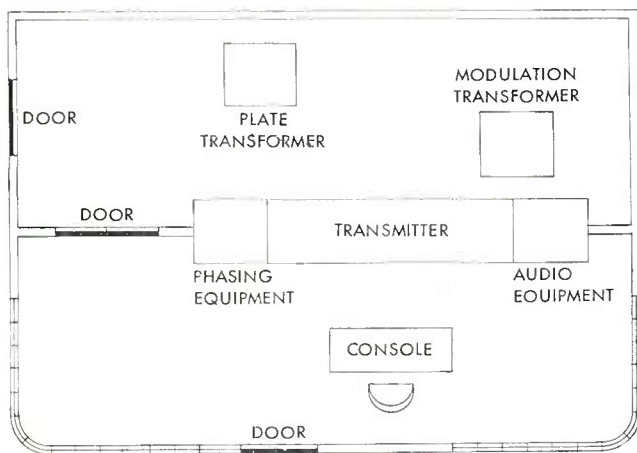

*Typical floor plan using left and right wing extension cabinets*

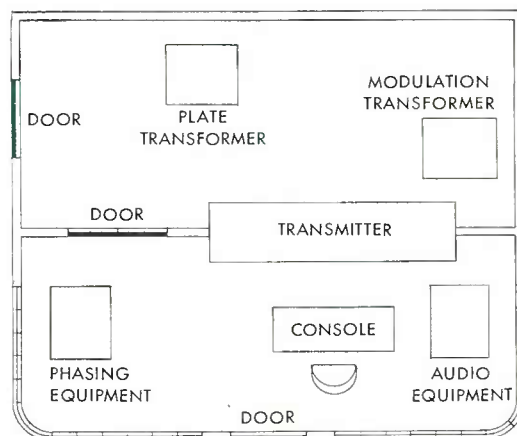

*Typical floor plan where audio and phasing equipment is housed in the separate standard rack type cabinets*

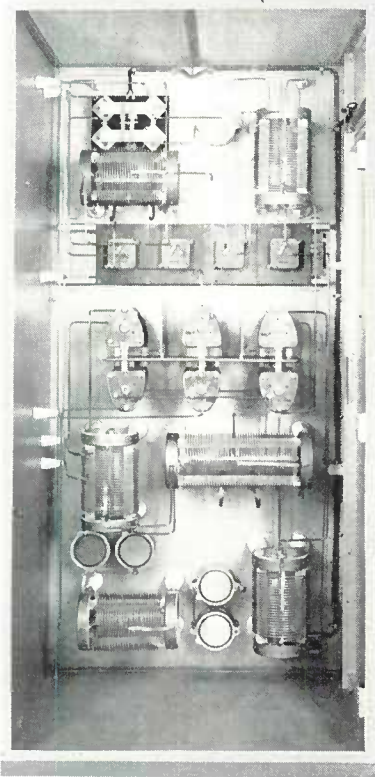

*Interior rear view of a 5 KW phasing and branching equipment housed in MI-7485-F left wing extension cabinet*

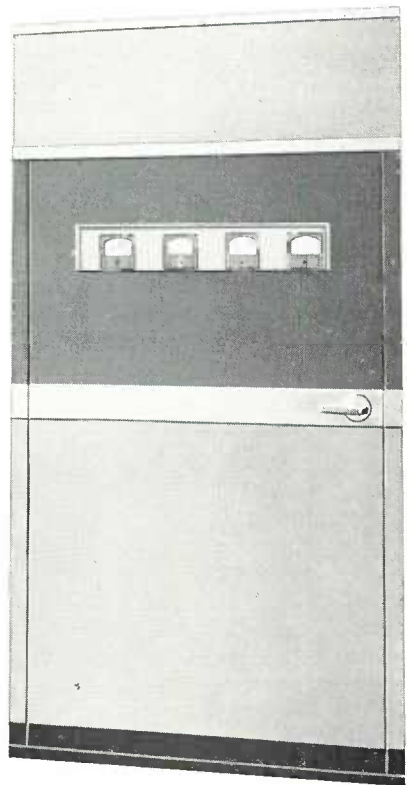

*Exterior front view of a 5 KW phasing and branching equipment housed in MI-7485-F left wing extension cabinet*

The five kilowatt line terminating unit is supplied in a weatherproof metal cabinet. The unit is designed for mounting on a wooden platform or steel angle cradle by means of side flanges at the bottom of the housing. Rear mounting strips are also provided to permit wall mounting. The antenna

ammeter may be read through a circular window in the door and is protected from lightning surges by a short circuiting switch, which is operated by means of a knob extending through the side of the house. The line terminating unit cabinet is 45" high, 35" wide and 24" deep.

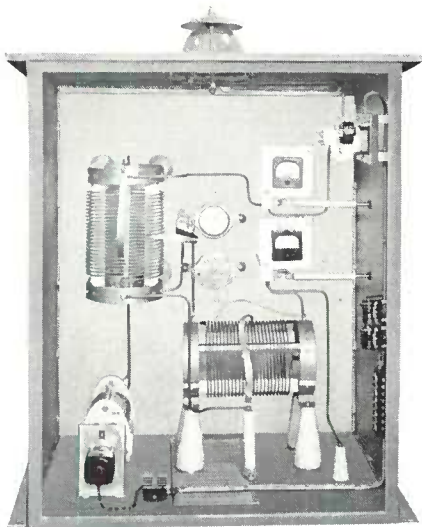

*Interior view of a 5 KW line terminating unit with relay switching and motor tuning in wall mounting cabinet*

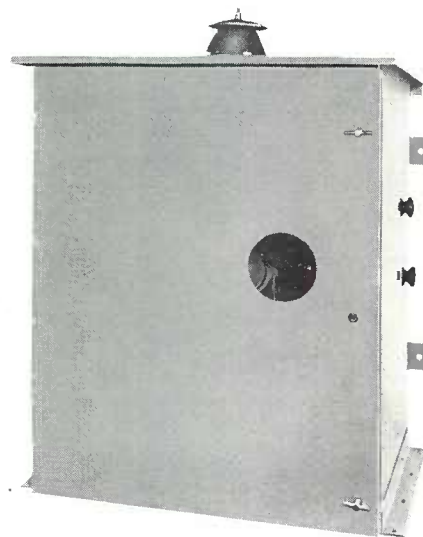

*Exterior view of a 5 KW line terminating unit in wall mounting cabinet*

## PHASING

### 50 KW

The fifty KW phasing and branching equipment is supplied in an MI-7485-J cabinet which may be used to provide a unified front left wing extension for an RCA BTA-50F transmitter. The MI-7485-J cabinet is 84" high, 103" wide and 79" deep.

The line terminating unit for 50 KW equipment is designed to be mounted in a tuner house at the base of the tower. RCA does not supply the tuner house but does supply all inductors, capacitors (gas or Faradon as required), meters, meter panels, static drain choke, bowl insulators, lightning gap, surge suppressor, wiring material, brackets and hardware. Not included are the protective grill, interlocks, ground strap, and light and telephone auxiliaries. The line terminating unit will require approximately 70 square feet of floor space and an 8 foot ceiling.

### How to Order

RCA will be pleased to furnish a proposal on custom built phasing equipment upon receipt of general requirements such as (1) number, height, type, self and mutual impedances, and spacing of towers, (2) phase and amplitude of current in each tower, (3) type of enclosures to be used, (4) data on transmission lines, (5) relative location of transmitter house and tower (a simple sketch with approximate dimensions), (6) special requirements such as (a) automatic switching, (b) front of panel phase control, (c) metering facilities and (d) monitoring facilities. To facilitate the transmission of this information, copies of an "Engineering Specification for Broadcast Antenna Phasing Equipment Form" are available at all RCA Broadcast Sales Offices. Those interested in phasing equipment are invited to communicate with their nearest RCA Sales Office for additional information.

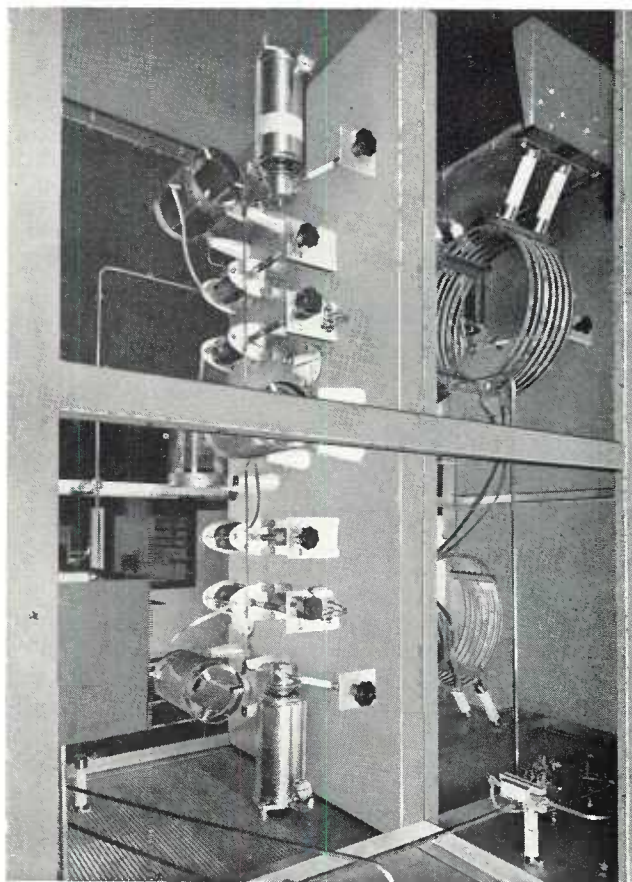

*Interior view of a 50 KW phasing and branching equipment*



*Exterior view of a 50 KW phasing and branching equipment*

# Antenna Current Sampling Equipment

## Pickup Loop MI-8217-C, Isolating Coil MI-7327-4, Sampling Coil MI-8217

Two general methods of obtaining samples of antenna current for phase and amplitude monitoring are commonly used.

The first method employs an electrostatically shielded, resonant, pickup coil mounted adjacent to the antenna feed line in the line terminating unit or tuner house. The tuned sampling coil can be coupled at virtually any point along the radiator or lead line in many installations and still pick up enough voltage to operate the current and phase indicators. Since the tuned circuit is more sensitive than a non-resonant loop, care must be taken to avoid pickup from adjacent towers or voltages induced by other inductors in the installation. Pickup from an extraneous field will cause error in phase indication and may also produce non-linearity in current indicators. Mounting the pickup coil inside a metal shield through which the feed line is run will generally produce satisfactory results.

The RCA MI-8217 remote metering and sampling coil kit supplies the pickup coil and also the thermo-milliammeter to be mounted on the panel of the WM-30A phase monitor.

The second method of sampling antenna currents employs a non-resonant loop mounted on the tower. This type installation has the advantage that indicators are not usually influenced by base currents if the loop is located up from the base of the tower. In the tower mounting loop type of installation, the sampling line, which may be clamped to the tower, must be brought across the tower base insulators. This may be accomplished by using the RCA MI-7327-4 isolation coil, which is a  $\frac{3}{8}$ " concentric line formed into a high impedance coil at broadcast frequencies. This coil, supplied with the necessary insulators for mounting, is usually located within the tuner house at the base of the tower. In some cases the sampling lines can be spaced from the tower by high voltage insulators, and brought across the base without an isolating network.

The RCA MI-8217-B remote metering and sampling loop kit supplies the pickup loop, mounting insulators, and also the necessary thermo-milliammeter to be mounted on the panel of the WM-30A phase monitor.

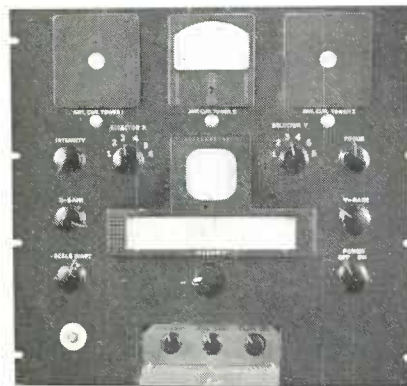

*WM-30A Phase Monitor. Blanks in top of panel are to provide for additional meters*

### Type WM-30A Phase Monitor

The RCA Type WM-30A phase monitor provides a simple means of accurately measuring phase differences between currents in the various towers of an antenna array. It is particularly useful in checking the directional arrays to insure proper phasing and hence proper field pattern. All phase angles up to  $360^\circ$  at any frequency between 225 and 1800 KC can be measured. The Type WM-30A can be used to adjust the phase shifting networks, to measure impedances of arrays, and to facilitate calculation of mutual impedances of antennas. The RCA phase monitor can be used for remote indication of both relative amplitude and phase of antenna currents in arrays employing up to three elements. Used in conjunction with the MI-8216-C remote meter panel, correct relationships can be maintained between phase and magnitude of currents in directional arrays having as many as six elements.

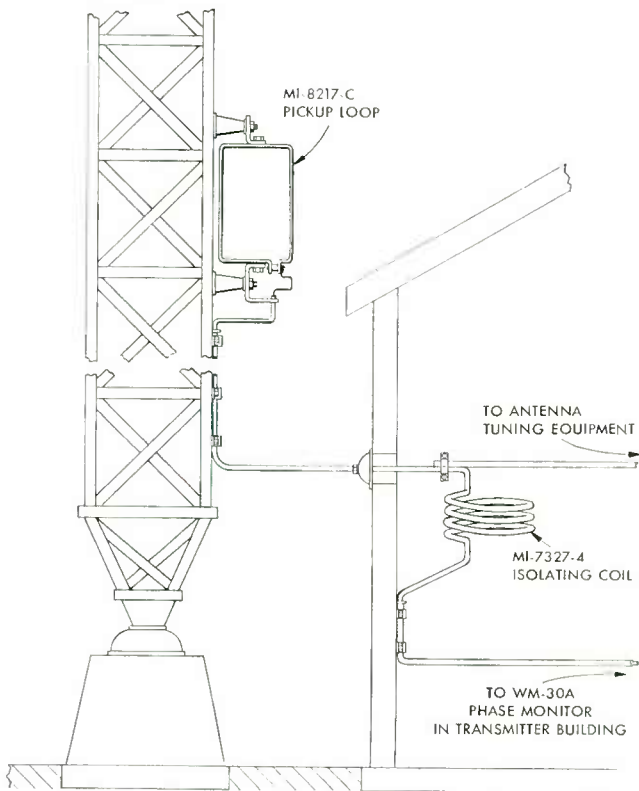

*Typical installation of MI-8217-C Pickup Loop and MI-7327-4 Isolating Coil*

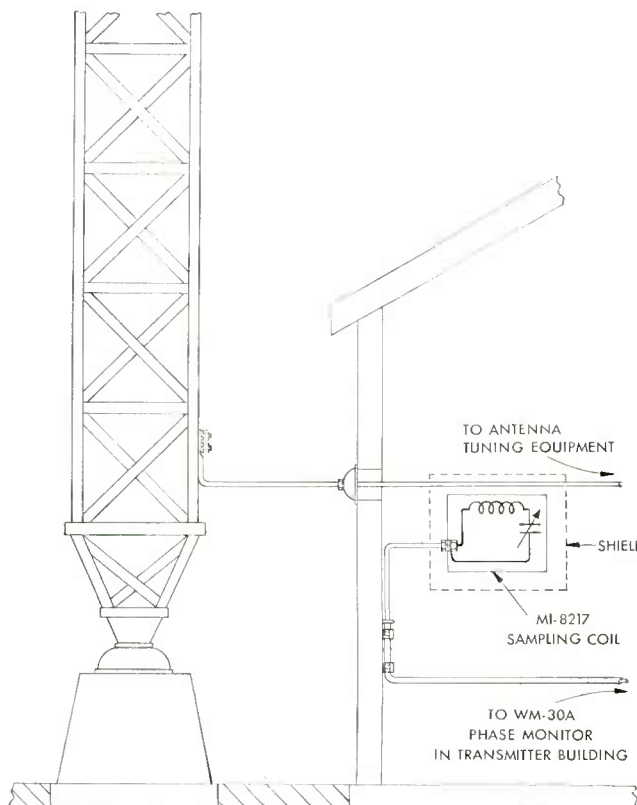

*Typical installation of MI-8217 Sampling Coil*

## Radio Frequency Transmission Lines Six Wire Open Line Accessories

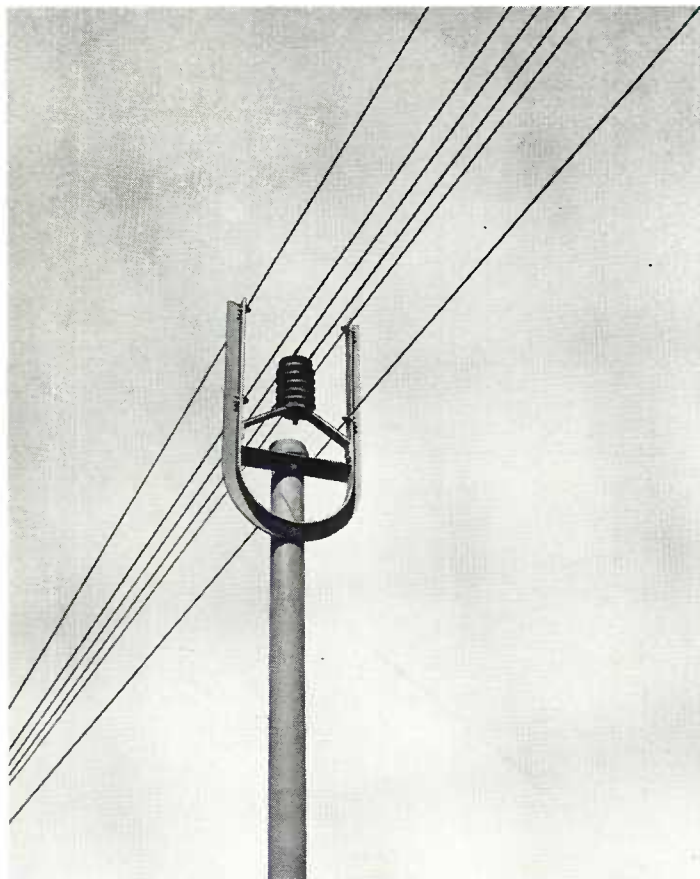

### Features

- Simplicity.
- Low maintenance cost.
- Open for constant inspection.
- Requires no auxiliary apparatus (dehydrators, gas, etc.).
- High power handling capacity at low cost.

### Uses

The six wire open line is intended for transmission of RF power from the transmitter to the antenna. The six wire line may be used for either phased arrays or non-directional antennas. It is suitable for use at any standard broadcast frequency and is designed for use in all weather conditions.

### Description

Open wire transmission lines when properly designed and constructed, provide high power handling capabilities at low cost. The open wire line is reliable and may be serviced easily. The various RCA transmission line kits simplify the installation of an efficient line suitable for RF powers up to 50 KW. Radiation is made negligible by using a six wire line consisting of two central power conductors surrounded by four grounded conductors. By use of this line configuration, with

appropriate spacing between conductors, a characteristic impedance of 230 ohms is obtained which results in an economy of phasing and terminating equipment.

### Specifications

#### MI-1942I TRANSMISSION LINE BAYONET INSULATOR

This kit consists of a bracket designed for mounting station post insulator and also supporting the four ground wires of the 6 wire transmission line. It is designed to be mounted on an MI-28013 or other suitable pole. Included are 1 bayonet bracket, 1 insulator, 4 ground wire connectors.

#### MI-28010 TRANSMISSION LINE WIRE

Transmission line wire consisting of hard-drawn, stranded, number 6 AWG copper wire may be ordered by the foot in any convenient length.

#### MI-280II-A TRANSMISSION LINE LEAD-IN KIT

This kit provides lightning protection to transmitter or tuner at the point where the transmission line enters the transmitter or tuner house. Included are horn gap, station post insulator, bracket for mounting insulator, anti-surge inductor, necessary copper tubing for ground and lead-in connections, all necessary hardware.

**MI-28012-A TRANSMISSION LINE DEAD-END KIT (USING POLE)**

This kit includes all parts necessary to terminate a 6 wire open line on a 4" steel pole. Wing type ground anchor and guy wire for supporting the pole are also supplied. The pole is not part of this MI. Included are two cross channels, 1 conductor plate, 4 turnbuckles for ground wires, 1 turnbuckle for center conductors, 1 Clevis for eye bolts, 1 insulator, 1 guy wire, 1 wing anchor, necessary clamps, hardware, etc.

**MI-28012-B TRANSMISSION LINE DEAD-END KIT (USING BUILDING)**

This kit consists of all parts required to terminating open wire line on the wall of the transmitter or tuner house. Included are one connector plate, 4 turnbuckles for ground wires, 1 turnbuckle for center conductors, 1 Clevis, 1 line connector, 6 dead-end clamps, 1 line insulator, 4 servisleaves  $\frac{3}{16}$ " x  $1\frac{1}{4}$ ", 5 shoulder eye bolts.

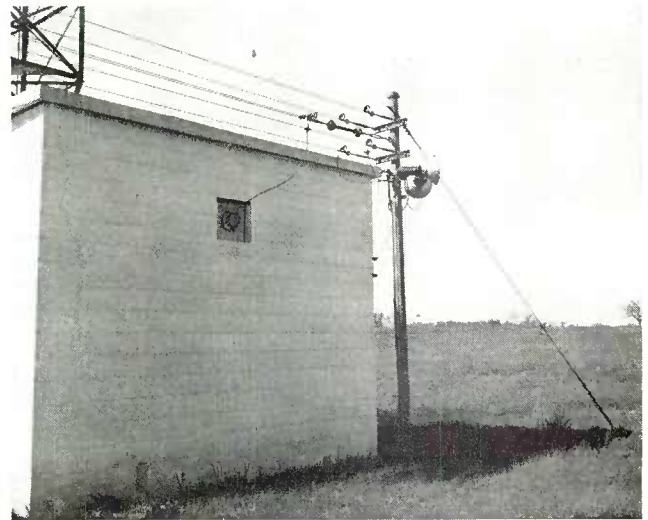

*Typical installation of MI-28012-A Dead-end Kit (using pole)*

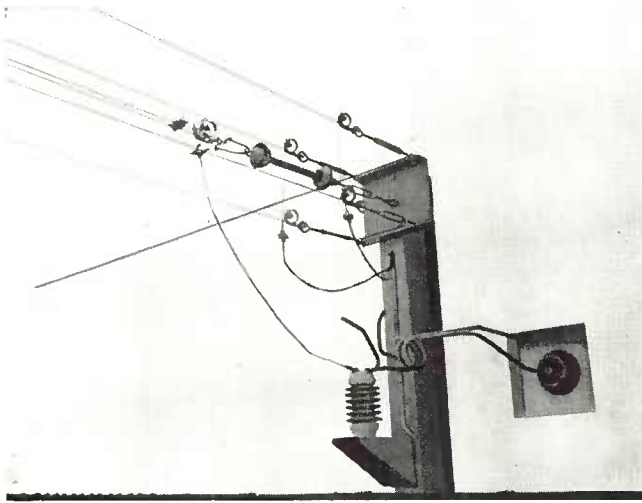

*Building dead-end installation using MI-28011-A, MI-28012-B and MI-28015*

**MI-28013 TRANSMISSION LINE POLE AND CAP**

The transmission line pole is a 4 inch diameter steel pole 20 feet long. It is supplied complete with cap to close the upper end and is suitably treated to render it corrosion resistant. It may be drilled at installation for use with either the MI-28012-A pole dead-end kit or MI-19421 bayonet and insulator.

**MI-28014 TRANSMISSION LINE BAYONET ACCESSORIES**

This kit consists of rack saddles and bolts necessary to mounting an MI-19421 bayonet and insulator on an MI-28013 pole. Five feet of 080 diameter copper wire for use in wiring transmission line center conductors to the station post insulator is also supplied.

**MI-28015 LEAD-IN AND GROUND ACCESSORY KIT**

This kit includes 1 plate drilled for mounting an MI-19413-1 entering insulator, 4 line termination clamps, 1 ground strap, 2 terminal lugs  $\frac{1}{2}$ " x  $2\frac{9}{16}$ ".

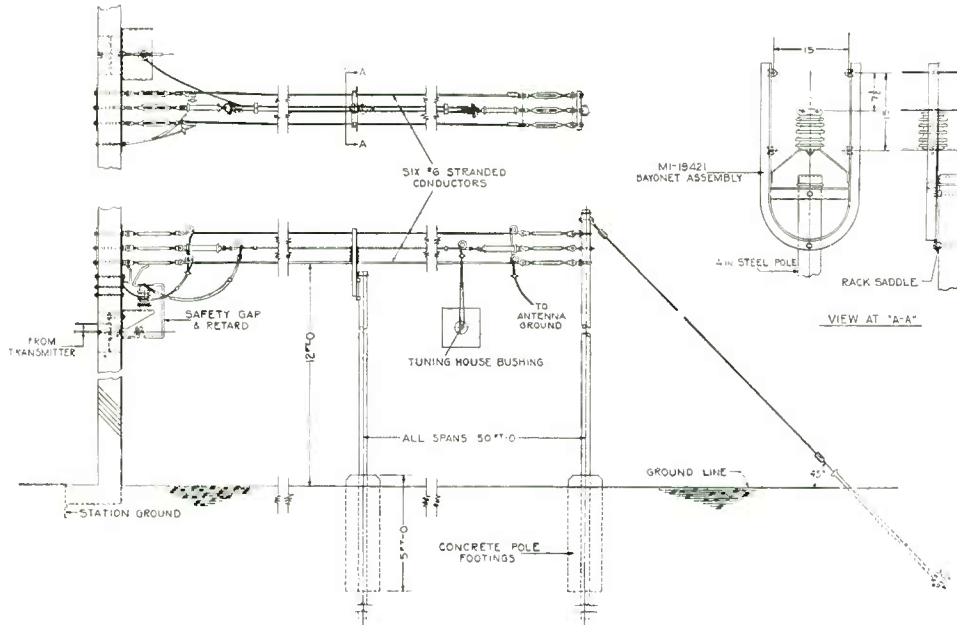



# 1 KW Antenna Tuning Unit Type BPA-1A

**Features**

- Designed for carrier powers up to 1 kw.
- Protective switch reduces damage to antenna ammeter from static discharges.
- Self extinguishing horn type gap protects equipment from lightning.
- Reliable operation—oversize capacitors and inductors.
- Equipment housed in weatherproof metal box with hinged door and lock.
- Designed for quick installation of remote metering kit.



**Uses**

The Type BPA-1 Antenna Tuning Unit serves to match broadcast antennas to either concentric or open wire transmission lines and also aids in suppressing carrier harmonics.

**Description**

The BPA-1 consists essentially of line terminating and antenna-tuning elements housed in a weatherproof metal box. Access to the interior and component parts of the tuning unit may be had through the front door which is provided with a lock, keys and two pivoting clamps. An opening is provided in the bottom of the housing for entrance

of a concentric tube transmission line, but the unit may also be used with an open wire type of line by addition of an entering insulator, MI-19406. Provision has been made for ready installation of Remote Metering Kit (MI-19404-B) which will provide for remote indication of antenna current. Electrically, the unit consists of a low-pass impedance-matching filter using a "T" type network.

**Specifications**

Input Impedance (unbalanced open wire or concentric line) 20-350 ohms  
 Output Matching—Will match any antenna having a reactance of +j500 to -j500 and a resistance of from 25 to 1000 ohms  
 Lightning Protection—Horn type gap and meter protective switch  
 Dimensions 30" x 22" x 16"  
 Weight (unpacked) 67 lbs.  
 Finish Durable grey  
 Stock Identification MI-28901-A

**Accessories**

Open Wire Line Entrance Insulator MI-19406  
 Remote Metering Kit MI-19404-B

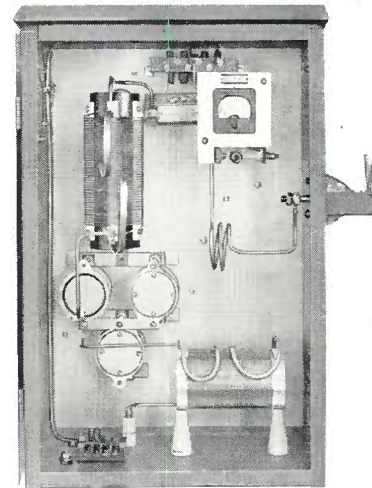

## Remote Metering Kit MI-19404-B and Remote Ammeter MI-7157-D

The MI-19404-B Remote Metering Kit permits metering at the transmitter of the current in a remotely located antenna. It has been designed for use with the BPA-1A Antenna Tuning Unit but it may be installed in similar tuners employed with transmitters of 1000 watts or less; provided the rms voltage between the external thermocouple and ground does not exceed 2000 volts.

The MI-19404-B kit contains an adjustable resistor, terminal block, two by-pass capacitors, ground straps, miscellaneous hardware and installation instruction sheet.

This kit is intended to be used with MI-7157-D Remote Ammeter which includes the necessary thermocouple.

The R.F. Ammeter and the variable resistor are to be mounted in the transmitter house while the balance of the parts are to be mounted in the antenna tuner housing.

The remote meter has a 150 ma. movement and is calibrated for a resistance of 10 ohms between meter and thermocouple. A coupling line of less than 10 ohms should be used and the final calibration made with the adjustable 10 ohm resistor. The remote meter is available in various ranges to match the scale at the antenna ammeter. When ordering specify meter scale and material of panel (steel, bakelite, etc.) on which the remote meter is to be used.



Remote Ammeter MI-7157-D

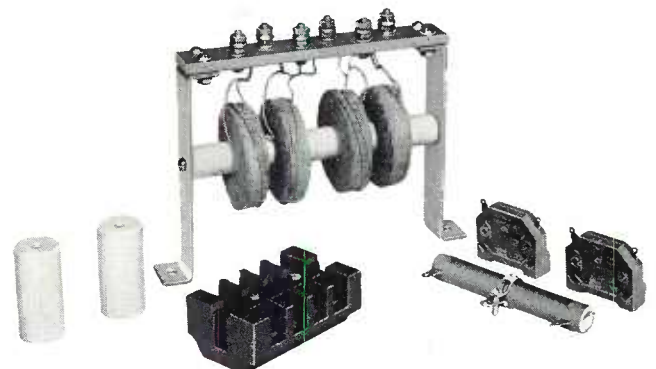

Remote Metering Kit MI-19404-B

## 5-10 KW Antenna Tuning Unit Type BPA-10

### Features

- Designed for carrier powers of 5 and 10 kw.
- Matches open wire or concentric transmission lines to antennas of widely divergent characteristics.
- Built-in monitoring rectifier supplies rectified current for remote antenna meter and furnishes audio voltage for program monitoring.



### Uses

The Type BPA-10 Antenna Tuning Unit serves the double purpose of matching broadcast antennas of widely divergent characteristics to either concentric or open-wire transmission lines and of suppressing carrier harmonics.

### Description

All parts of this equipment are enclosed in a weatherproof metal housing equipped at the front with a door affording ready access to the interior. This door is provided with a lock. The unit is designed for mounting on a wooden platform or a steel angle cradle by means of side flanges at the bottom of the housing. Rear mounting strips also are provided to permit mounting the unit on two upright posts. The Antenna ammeter may be read through a circular window in the door. This meter is protected from lightning surges by a double-throw switch, which is operated by means of a knob extending through the side of the housing.

The circuit of the BPA-10 essentially consists of a single "T" section low pass filter which reduces the number of elements to a minimum. The two series inductors of the "T" network are employed to adjust independently the respective terminating impedances of the transmission line and the antenna circuit. The capacitive shunt leg, which is common to the two branches, is fixed at a value determined by the operating frequency of the station. Faradon capacitors are used and the values of these capacitors are determined at the time of installation.

A monitoring rectifier unit (MI-7488-A) is contained within the housing to furnish, if desired, audio frequency voltage for program monitoring and rectified carrier current for remote antenna current indication and protective relay operation. Signal energy for operation of this rectifier is obtained from a tuned pickup coil which is coupled to the antenna loading inductor. This energy is rectified in a full wave circuit using an RCA 5V4G tube and the output is balanced to ground for excitation of a monitoring amplifier. For applications where the MI-7488-A Monitoring Rectifier unit is not required the Type BPA-10 Antenna Tuner may be purchased less the rectifier by specifying MI-28902-A. Terminals are also provided for connection to a remote antenna ammeter and interlock relay located in the transmitter house.

The antenna lead-in insulator is located on the top of the unit, and provision is made for mounting a similar insulator (MI-19413-1 bowl insulator) on the left hand side of the housing in case an open-wire line is used. A hole is provided in the bottom of the cabinet for bringing in a concentric line. When ordering specify:

1. Transmitter carrier power
2. Frequency
3. Antenna resistance and reactance
4. Transmission line impedance

### Specifications

#### Operating Limits

Carrier Frequency \_\_\_\_\_ 540 to 1700 kc  
Transmitting Power (maximum) \_\_\_\_\_ 10 kw

#### Input Impedance

(unbalanced open wire or concentric line) \_\_\_\_\_ 40-350 ohms  
Antenna Resistance (approximately) \_\_\_\_\_ 20 to 1100 ohms  
Antenna Reactance \_\_\_\_\_ +J500 to -J500  
(can be extended in a positive direction by the addition of a series capacitor; and in a negative direction if operating from a line of lower impedance than the antenna resistance.)

#### Monitoring Rectifier

##### Output Impedance

(Balanced) \_\_\_\_\_ designed to operate into a 500 ohm line  
Note: Load should be bridging with not less than 20,000 ohms d-c resistance.

##### Output Level to 500 ohm line

At 5-10 kw Output \_\_\_\_\_ +17 dbm\*

At 1 kw Output \_\_\_\_\_ +11 dbm\*

##### Rectified Current

75 ma d-c maximum into a maximum of 1000 ohms

Audio Frequency Characteristic (50 to 10,000 cycles) \_\_\_\_\_  $\pm 2$  db

Power Supply (230 volts, 60 cycles) \_\_\_\_\_ approx. 12 watts

Tube Complement (monitoring rectifier) \_\_\_\_\_ 1 RCA 5V4G

Type Antenna Meter (scale range determined at time of installation) \_\_\_\_\_ Weston Model 425

#### Dimensions

Height \_\_\_\_\_ 44"

Width \_\_\_\_\_ 34"

Depth \_\_\_\_\_ 23"

Weight (unpacked) \_\_\_\_\_ 330 lbs.

Finish \_\_\_\_\_ Durable grey

#### Stock Identification

(with MI-7488-A monitoring rectifier) \_\_\_\_\_ MI-28902-B

(less MI-7488-A monitoring rectifier) \_\_\_\_\_ MI-28902-A

### Accessories

Tube Kit (1 Type 5V4G) \_\_\_\_\_ MI-7321

1 Bowl Insulator (required for open wire lines) MI-19413-1

\* dbm = db level above one milliwatt reference when single frequency tone modulation is used.

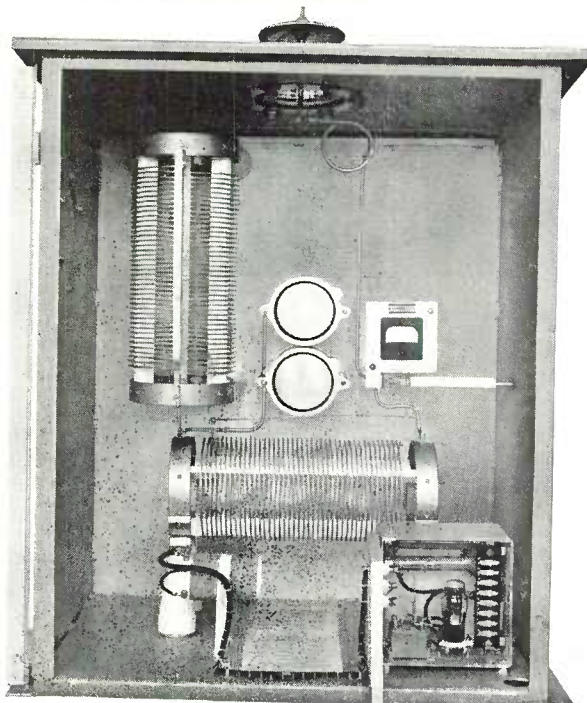

Interior view of BPA-10 with MI-7488A Monitor Rectifier

# 50 KW Antenna Tuning Equipment Type BPA-50

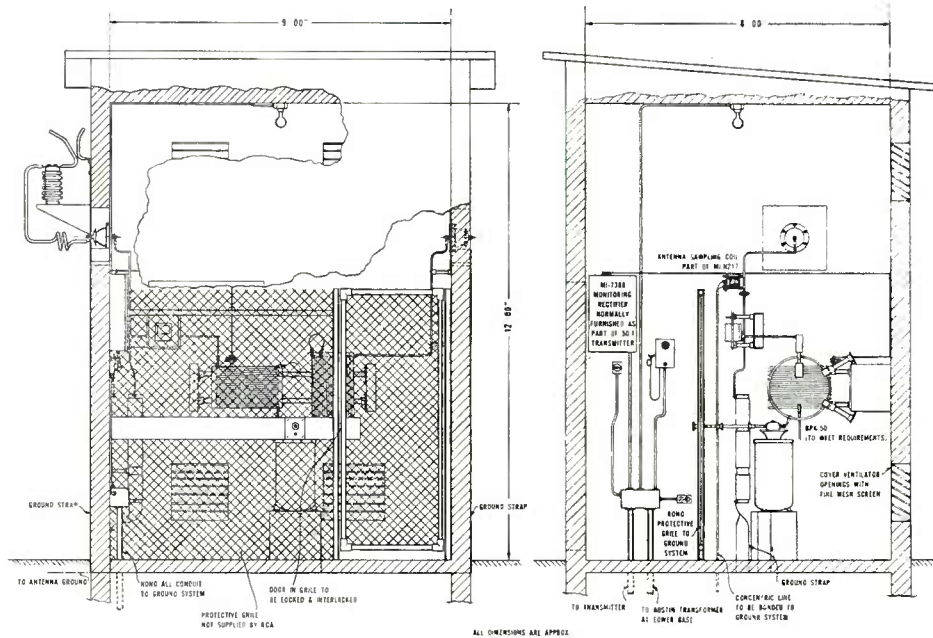

**Features**

- Matches open wire or concentric transmission lines to antennas of widely divergent characteristics.
- Self extinguishing horn gap helps protect equipment from lightning surges.
- Oversize capacitors and inductors for reliable operation.
- Static drain choke.

**Uses**

The type BPA-50 antenna tuning equipment serves to match broadcast antennas of widely divergent characteristics to either concentric or open-wire transmission lines at powers up to 50 kw.

**Description**

The type BPA-50 antenna tuning equipment is designed to be mounted in a tuner house at the base of the antenna tower. The tuning equipment does not include the tuner house, but all the necessary electrical components, brackets, wiring material and hardware are supplied. Complete blueprints, diagrams and instructions for assembly of the tuner are also included.

Essentially, the circuit of the BPA-50 consists of a single "T" section low pass filter which reduces the number of elements to a minimum and provides maximum harmonic suppression. The two series inductors of the "T" network are employed to adjust independently the respective terminating impedances of the transmission line and the antenna. The capacitive shunt leg, which is made up of Lapp variable gas capacitors, is set to a value determined by the operating frequency of the station. Faradon capacitors are used when very large values of capacitance are required.

A monitoring rectifier unit, MI-7488-A, may be purchased separately to furnish audio frequency voltage for program monitoring and rectified carrier current for remote antenna current indication and protective relay operation. A similar monitoring rectifier, MI-7389, is supplied as standard equipment with the RCA type BTA-50F transmitter.

The antenna ammeter is protected from lightning surges by a double-throw switch which cuts the meter out of the circuit.

**Specifications**

**TUNER**

**Operating Limits:**

- Carrier Frequency.....550-1700 kc
- Transmitter Power (maximum).....50 kw
- Input Impedance (unbalanced open wire or concentric line) 40 to 350 ohms
- Antenna Resistance (approximately).....20 to 1100 ohms
- Antenna Reactance.....+j500 to -j500  
(Can be extended in a positive direction by the addition of a series capacitor; and in a negative direction if operating from a line of lower impedance than the antenna resistance.)

**MONITORING RECTIFIER**

**Output Impedance:**

(Balanced).....Designed to work into a 500 ohm line  
Note: Load should be bridging with not less than 20,000 ohms resistance.

**Rectified Current:**

- 75 ma d-c Maximum into a maximum of 1000 ohms
- Audio Frequency Characteristics (50-10,000 cycles).....±2 db
- Power Supply (230 volts, 60 cycles).....Approx. 12 watts
- Tube Complement (monitoring rectifier).....1 RCA 5V4G
- Space Requirements.....Approximately 70 sq. ft. floor area with 10 ft. ceiling
- Net Weight (approx.).....500 lbs.

**Stock Identification:**

- For 230 Ohm Line.....MI-28903-A
- For 70/51.5 Ohm Line.....MI-28903-B

**Accessories**

- Extra Bowl Insulator.....MI-19413-1
- Monitoring Rectifier.....MI-7488-A
- Tube Kit (1 RCA 5V4G).....MI-7321

# Austin Tower Lighting Transformers

## Features

- Independent of frequency. No tuning adjustments.
- No housing required—eliminates leakage losses.
- Trouble-free operation under all conditions.
- Excellent regulation and efficiency.
- Cost is comparable to other types of tower lighting units.

## Uses

The Austin insulating transformer is a device for supplying a-c power to the lighting circuits of an insulated or section-alized radio tower. Being independent of frequency, the same transformer may be used for any radio frequency and for a wide range of transmitting power.

## Description

The Austin insulating transformer provides the radio engineer with a means of supplying current to tower lighting circuits which is more efficient, reliable and easier to install than other types of tower lighting filters. The transformer consists of ring type windings with a clear air gap between primary and secondary rings. This type of construction makes the Austin transformer independent of radio frequency and therefore it requires no tuning or adjustment. Since the windings are fully enclosed, no transformer housing is required, and the air gap between primary and secondary rings eliminates the possibility of surface leakage which may be appreciable in the housing covering other types of tower lighting filters. The total capacity added at the tower insulating zone is of the order of a very few micro-microfarads which produces only a slight effect upon the radio frequency circuit, and is constant under all weather conditions.

Installation is simplified since the Austin transformer requires no housing, chokes or filters. The primary of the transformer is usually attached to the base of the tower insulator or pier supporting the insulator. The secondary is supported by a conduit attached to the top of the insulator or to the tower above the insulator. Protection from lightning surges may be accomplished by installing an arc gap to by-pass static charges.

Austin tower lighting transformers are available in sizes ranging from 700 watts to 7 kw. The larger sizes may be used to furnish extra energy for lighting neon or other signs on the tower, or for de-icing.

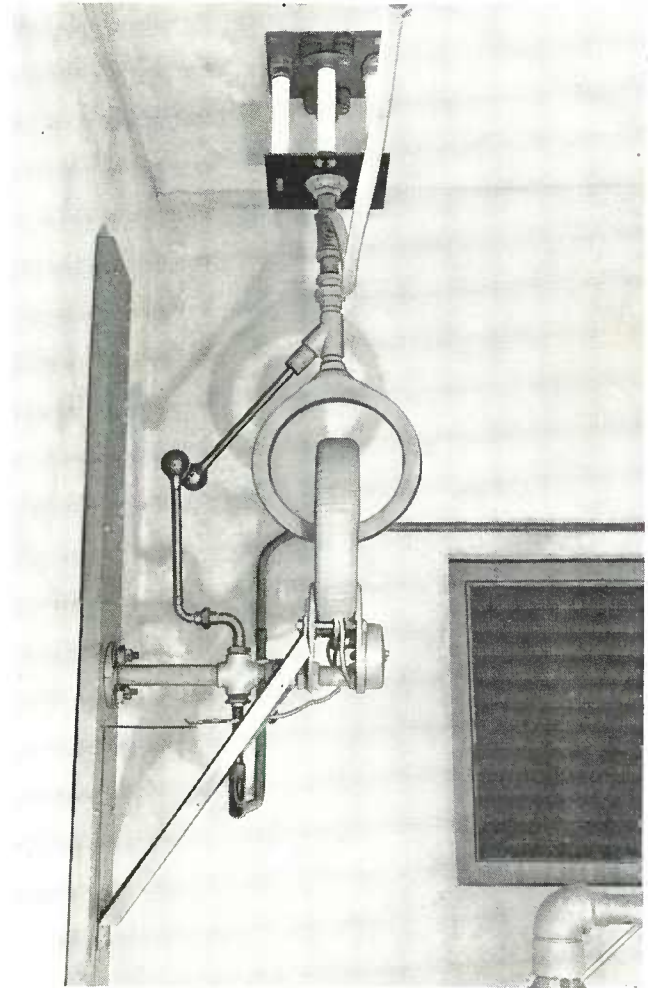

*Typical Installation of an Austin Tower Lighting Transformer*

## Specifications

Primary Voltage	_____	115 / 230
Secondary Voltage	_____	115
Capacity:		
Type A—2101	_____	1 to 1.75 K.V.A.
Type A—1971	_____	2 to 3 K.V.A.
Primary Taps	_____	2
Secondary Taps:		
Type A—2101	_____	None
Type A—1971	_____	10% over-voltage
Net Weight:		
Type A—2101	_____	85 lbs.
Type A—1971	_____	201 lbs.

Other sizes available up to 7 kw.

Detailed information will be furnished on request.

## Pyrex Entering Insulator MI-19413-1

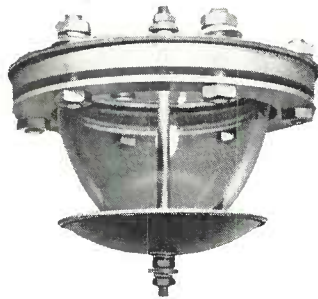

For transmitter carrier powers up to and including 50 kw, this insulator assembly is ideal for taking r-f leads into or out of antenna tuner or phasing equipment.

The insulator has an 8 $\frac{3}{4}$ " diameter flange with six  $\frac{1}{2}$ " mounting studs spaced equidistant on a 7 $\frac{3}{4}$ " bolt circle. The insulator is approximately 6" high from the bottom of the lower flange to the top of the center lead-in stud. The assembly is shipped complete as shown with corona shield and a lead-in stud which is  $\frac{3}{8}$ " in diameter and 8 $\frac{1}{2}$ " long. The unpacked weight of the bowl assembly is 11 $\frac{3}{4}$  lbs.

## Steatite Entering Insulator MI-19406

This insulator is recommended for antenna tuner or phasing equipment r-f lead-ins for carrier powers up to and including 1 kw.

The insulator flange is 5 $\frac{1}{4}$ " in diameter and has a bolt circle diameter of 4 $\frac{5}{8}$ ". The six equally spaced mounting bolt holes are each 17/64" in diameter and the insulator is designed for mounting in a 3 $\frac{3}{4}$ " hole. The lead-in stud is  $\frac{1}{2}$ " in diameter and is 6" long. The unpacked weight of the bowl assembly is 2 lbs. 2 ozs.

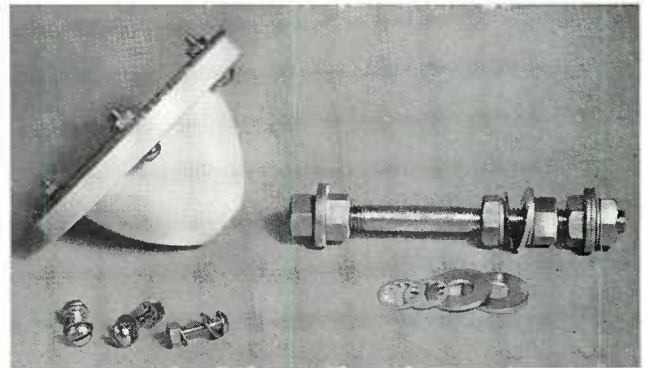

## Antenna Lighting Choke Coil Type 92-A

### Uses

In broadcast transmitter installations where the tower itself forms the antenna, special transformers or radio frequency choke coils must be employed to feed power to the lighting circuits on the tower. Type 92-A antenna lighting choke coil has been designed for this purpose. Its electrical characteristics are such that it presents a low impedance to commercial lighting frequency and a high impedance to the radio frequency in the broadcast range. It, therefore, provides a means for supplying energy to the tower lighting circuits and at the same time prevents any appreciable loss of r-f energy supplied to the tower by the radio transmitter.

### Description

The coil consists of a double winding on a bakelite form. The windings are coated with an insulating varnish which binds the turns together and prevents moisture absorption. This coil, however, must be protected from the weather by installing it within some weatherproof enclosure. Such an enclosure or housing is not provided with the unit. The natural resonant frequency of the coil is well removed from any frequency within the broadcast band. Its characteristics, therefore, are such that it presents a relatively high impedance in the order of several hundred ohms to all broadcast frequencies. All windings that are not directly connected to the tower or ground should be properly bypassed by suitable capacitors as illustrated.

### Specifications

Maximum Continuous Current (50/60 cycles) \_\_\_\_\_ 18 amperes  
 D-c Resistance (total both windings) \_\_\_\_\_ Approx. 1.1 ohms  
 Inductance—60 Cycles \_\_\_\_\_ 520 microhenries  
 1000 KC \_\_\_\_\_ 800 microhenries

Length \_\_\_\_\_ 33 $\frac{1}{2}$ "  
 Diameter \_\_\_\_\_ 4"  
 Weight Unpacked \_\_\_\_\_ 9 $\frac{1}{4}$  lbs.  
 Stock Identification \_\_\_\_\_ MI-7112

### Accessories:

1.5 KVA Isolation Transformer \_\_\_\_\_ MI-7012  
 Capacitors .01 MFD \_\_\_\_\_ UC3006

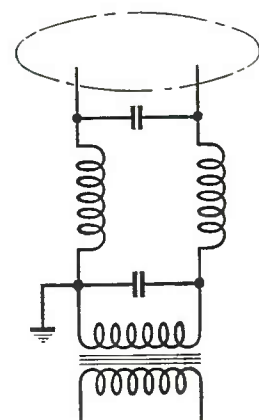

Isolation Circuit  
 (Single Choke)  
 with MI-7014 Isolation  
 Transformer

# **FM TRANSMITTING EQUIPMENT**

**FM TRANSMITTERS**

**Page**

**120**

**FM ANTENNAS**

**138**



◆ Making adjustments on the three kilowatt FM transmitter, Type BTF-3B, at KSCJ-FM, Sioux City, Iowa.

Three kilowatt FM transmitter, Type BTF-3B, as viewed from studio B, at WATG-FM, Ashland, Ohio.



Adjusting line voltage on the three kilowatt FM transmitter, Type BTF-3B, at WGP4-FM, Bethlehem, Pa.



One kilowatt FM transmitter, Type BTF-1C, as installed at radio station WBRE-FM, Wilkes-Barre, Pa.



# FM Broadcast Transmitter Type BTF-250A

## Features

- Incorporates RCA's new "Direct FM" system which requires fewer and less expensive tubes and parts, assures low distortion and less adjustment.
- Uniquely designed frequency control circuit provides crystal control precision.
- Excellent frequency response  $\pm 1$  db 30 to 15,000 cps.
- Low distortion—less than 1.5%, 30 to 15,000 cps.
- Single ended r-f circuits throughout—easy to tune.
- Simplified controls with complete circuit protection.
- Equipment protected against transmission line or antenna failures.
- Multi-unit construction permits easy addition of higher powered units.
- Vertical chassis construction—front and rear door accessibility.
- Inexpensive tube complement.
- Cabinets with similar styling available for housing audio, monitoring, and test equipment.
- Completely self-contained.

## Description

The new BTF-250A FM Transmitter incorporates all the latest engineering advances and many desirable basic features. Attractively housed in a single standardized cabinet, this compact unit will provide a maximum of 250 watts output at any specified frequency between 88 and 108 mc. Installation is simple and economical. Future power increases are easily made by adding one or more power amplifiers and power control units housed in matching cabinets. Accessibility is assured by vertical chassis construction plus surface mounting of components and exposed wiring for easy and speedy circuit tracing and servicing.

The exciter unit of the BTF-250A contains RCA's newly developed "Direct FM" modulator circuits plus a new frequency control circuit of unique design. Fewer circuits and fewer components are used in this new exciter than in previous designs. Only 16 inexpensive tubes are used (about half as many as in some exciters) with only six tubes in the r-f chain. All components are mounted on a single vertical panel and are easily accessible. The exciter power supply is on a separate chassis.

Frequency modulation is accomplished directly by push-pull reactance tubes connected across the frequency-determining circuit of the modulated oscillator. This "direct modulation" process eliminates numerous multiplier and converter stages with a resulting lower noise and distortion level.

Simplified single-ended amplifiers operating Class "C" and comprising a minimum of variable elements form the r-f section of the BTF-250A.

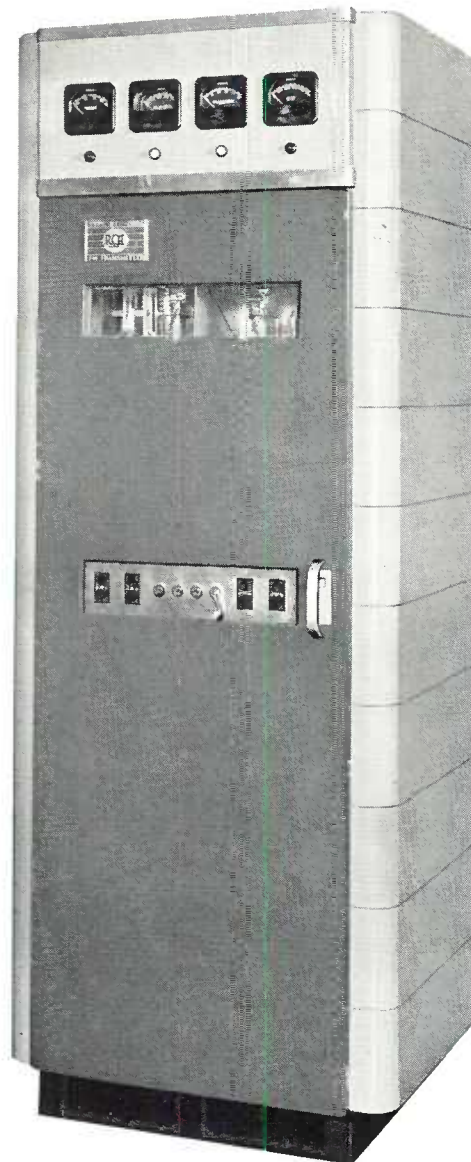

Tube costs have been kept low by using sturdy receiver type tubes in the FM exciter and high efficiency circuits plus inexpensive low power transmitting tubes in the r-f amplifiers. The same tube type is employed in several stages thus reducing spare tube requirements.

All power circuits are protected by magnetically-tripped circuit-breaker type switches. A transmission line monitor which acts as watchman over the antenna and transmission line system is provided. Any unwarranted change in the signal intensity such as might result from an arc in the transmission line, or a fault in the antenna itself, actuates this monitor and shuts down the transmitter. An interlocking control circuit prevents the application of plate power until the rectifier filaments have reached operating temperature. Filament voltage is con-

trolled by tapped transformers and a common filament rheostat. Door interlocks are provided, where required, for the safety of operating personnel. In addition, high voltage compartments are equipped with mechanically operated grounding bars which are automatically released when the doors are opened.

The entire transmitter is housed in a single fabricated steel cabinet which is bolted to a base frame. This cabinet is equipped with both front and rear doors which are provided with observation windows. End shields and a meter panel complete the cabinet-type enclosure which has been styled functionally and presents a pleasing appearance. A filtered air supply for the cabinet is supplied through the air inlet opening, and a removable filter is provided in the base frame. An exhaust fan in the roof expells the warm air.

The BTF-250A is shipped complete with two crystals, two sets of tubes and transmission line monitor.

### Specifications

- Frequency Range \_\_\_\_\_ Any specified frequency between 88 and 108 mc.
- Power Output (into transmission line) \_\_\_\_\_ 50 to 250 watts
- R-f Output Impedance (SWR 1.75 or less) \_\_\_\_\_ 35 to 90 ohms
- Carrier Frequency Stability, deviation less than \_\_\_\_\_  $\pm 1000$  cycles
- Modulation Capability \_\_\_\_\_  $\pm 100$  kc.
- Method of Modulation \_\_\_\_\_ Reactance-tubes
- Audio Input-Impedance \_\_\_\_\_ 150/600 ohms
- 100% Modulation Level \_\_\_\_\_  $+10 \pm 2$  dbm
- Audio Frequency Response<sup>1</sup>  
30 to 15,000 Cycles, 1000 Cycle Reference, within \_\_\_\_\_  $\pm 1$  db
- Audio Frequency Distortion<sup>2</sup>  
30-15,000 cycles \_\_\_\_\_ Less than 1% rms  
Including all harmonics up to 30 kc/s at 75 kc swing
- FM Noise Level, below 75 kc. swing \_\_\_\_\_ -65 db.
- AM Noise Level, below 100% amplitude modulation<sup>2</sup> \_\_\_\_\_ -50 db.

Power Supply Requirements \_\_\_\_\_ 208/230 volts, 50 or 60 cycles single phase, capable of supplying approximately 1200 watts at 85% power factor, and 5% maximum regulation and variation. Also approximately 30 watts at 115 volts, 50/60 cycles single phase, is required for the crystal heaters.

### TUBE COMPLEMENT

4 RCA 6V6	2 RCA 2E26
4 RCA 1614	5 RCA 6AC7
1 RCA 6SH7	1 RCA 2BP1
4 RCA 5U4G	3 RCA 4-125A/4D21
2 RCA 0D3/VR150	2 RCA 866A/866
1 RCA 0C3/VR105	1 RCA 2D21
1 RCA 6AL5	

### Dimensions in Inches

Overall Width _____	31"
Overall Height _____	84"
Overall Depth _____	31 $\frac{1}{8}$ "
Maximum Crate Size _____	28" x 30" x 84"

Weight in Pounds (unpacked—sembled) \_\_\_\_\_ 1025 (approx.)

Maximum Ambient Temperature \_\_\_\_\_ 45° C.

Finish \_\_\_\_\_ Two-tone umber gray with brushed chrome trim and fitting

Stock Identification \_\_\_\_\_ MI-28911

### Accessories

- Set of Tubes for BTF-250A \_\_\_\_\_ MI-28156
- 250 watt to 1 kw Conversion Kit \_\_\_\_\_ MI-28919
- Set of Tubes for above Conversion Kit \_\_\_\_\_ MI-28160

<sup>1</sup> For pre-emphasized response the pre-emphasis filter (MI-4926A) is provided to be inserted in the 600 ohm audio input line.  
<sup>2</sup> Distortion and noise are measured following a standard de-emphasis network.

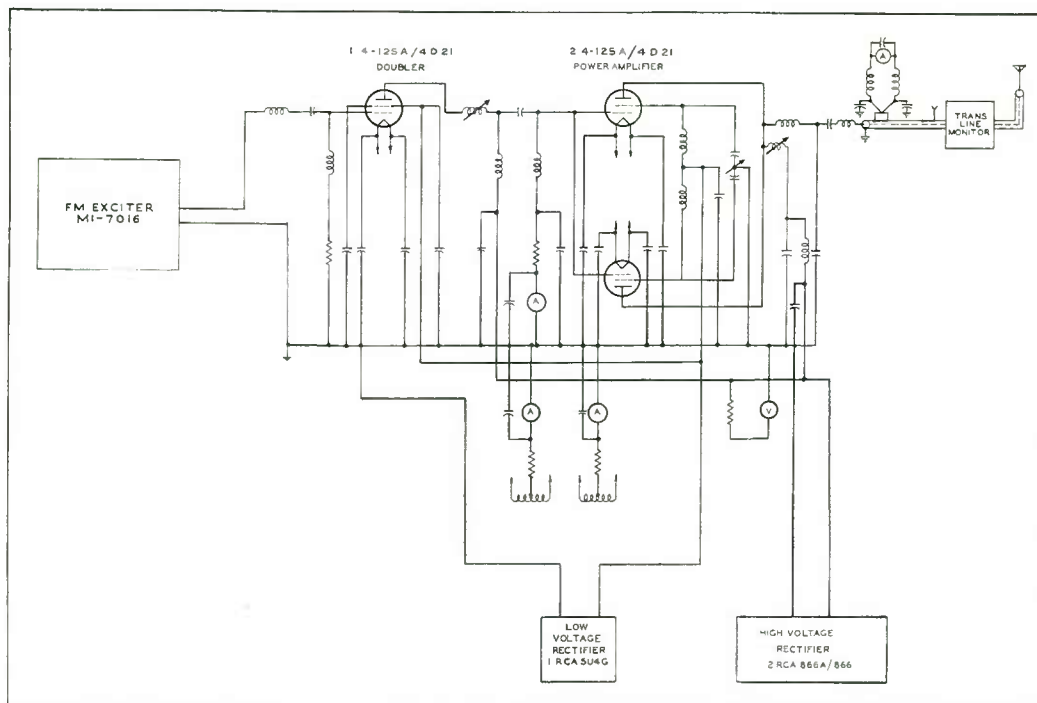

Simplified Schematic of BTF-250A

# FM Broadcast Transmitter Type BTF-1C

## Features

- Incorporates RCA's new "Direct FM" system which requires fewer and less expensive tubes and parts, assures low distortion and less adjustment.
- Uniquely designed frequency control circuit provides crystal control precision.
- Excellent frequency response  $\pm 1$  db 30 to 15,000 cps.
- Grounded grid amplifiers reduce overall transmitter and tube costs, reduce installation and maintenance costs and insure stable operation.
- Single-ended r-f circuits throughout.
- Simplified controls with complete circuit protection.
- Minimum of different tube types.
- Equipment protected against transmission line or antenna failures.
- Multi-unit construction permits easy addition of higher powered units.
- Vertical chassis construction—front and rear door accessibility.
- Cabinets with similar styling available for housing audio, monitoring and test equipment or spare exciter.
- Completely self-contained—no external units.

## Description

Attractively housed in two compact standardized cabinets, the new BTF-1C FM transmitter will provide 1000 watts output at any specified frequency between 88 and 108 mc. Initial installation is simple and economical. Conversion to 3 kw or 10 kw operation is quickly and inexpensively made by the addition of one grounded-grid amplifier unit and a power and control unit housed in matching cabinets.

The exciter unit of the BTF-1C contains RCA's newly developed "Direct FM" modulator circuits plus a new frequency control circuit of unique design. Fewer circuits and fewer components are used in this new exciter than in previous designs. Only 16 inexpensive tubes are used (about half as many as in some exciters) with only six tubes in the r-f chain. All components are mounted on a single vertical panel and are easily accessible. The exciter power supply is on a separate chassis.

Frequency modulation is accomplished directly by push pull reactance tubes connected across the frequency-determining circuit of the modulated oscillator. This "direct modulation" process eliminates numerous multiplier and converter stages with a resulting lower noise and distortion level.

Simplified single ended amplifiers, operating class "C" and comprising a minimum number of variable elements, form the r-f section of the BTF-1C. The same type tube is employed in several stages—an important item when considering spare tube needs. The final stage using a 7C24 tube is operated grounded-grid thus reducing tube, installation and maintenance costs and insuring stable operation. All tubes are air cooled.

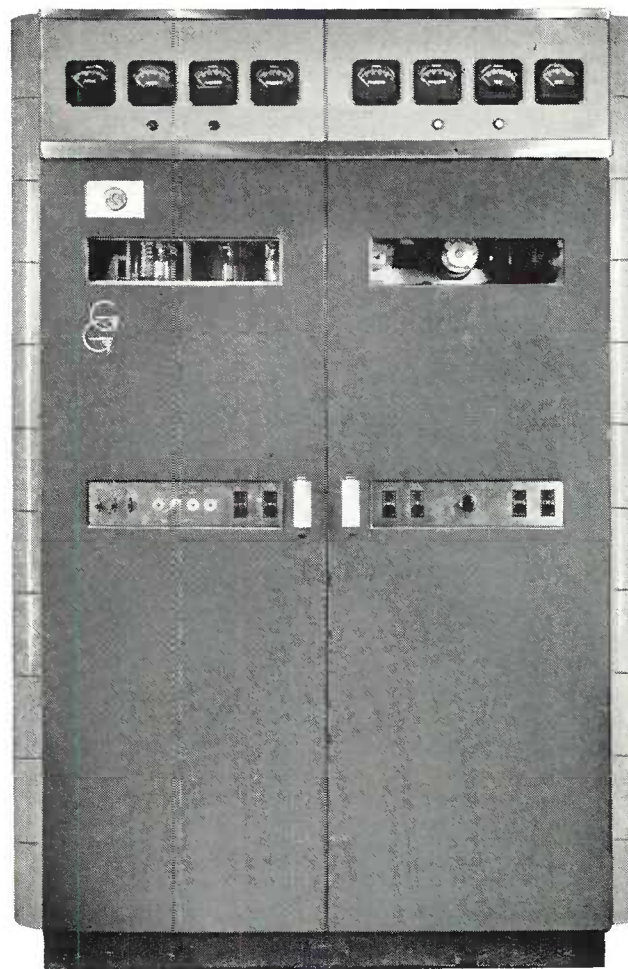

Variable output coupling, provided by front panel control, varies the output into the antenna transmission line from 250 to 1000 watts. Power circuits are protected by magnetically-tripped circuit-breaker type switches and overload relays. A transmission line monitor which acts as a watchman over the antenna and transmission line system is provided. Any change in transmission line characteristic which might result from an arc in the transmission line, or a fault in the antenna itself, actuates this monitor and shuts down the transmitter. An interlocking control circuit prevents the application of plate power until the rectifier filaments have reached operating temperature. Filament voltage is controlled by tapped transformers and a common filament rheostat. The 7C24 tube has a separate filament rheostat control. Means are provided for reducing the plate voltage for tuning purposes. Door interlocks are provided, where required, for the safety of operating personnel. High voltage compartments are equipped with mechanically operated grounding bars which are automatically released when a compartment door is opened.

Multi-unit construction is employed in the BTF-1C and the entire transmitter is housed in two fabricated steel frames which are bolted to a base frame. Each compartment is equipped with both a front and rear door. These doors are

provided with windows for observation of the interior of the transmitter while in operation. End shields and meter panels complete the cabinet-type enclosure which has been styled functionally, and presents a pleasing and dignified appearance. A filtered air supply for each compartment is supplied through individual air inlet openings and removable filter sections provided in the base frame. The warm air is exhausted through the roof. For ease in shipment and installation the equipment is partially disassembled. The transmitter is furnished with one FM exciter. A second exciter unit plus a transfer panel mounted in a separate cabinet are available as optional equipment. With dual exciters, instantaneous transfer of operation from one unit to the other is accomplished by the flick of a switch.

The BTF-1C is furnished with two crystals, two sets of tubes, interconnection wire kit, harmonic filter, and transmission line monitor.

**Specifications**

- Frequency Range \_\_\_\_\_ Any specified frequency between 88 and 108 mc
- Power Output (into transmission line) \_\_\_\_\_ 250 to 1000 watts
- R-f Output Impedance \_\_\_\_\_ 35 to 90 ohms
- Carrier Frequency Stability, deviation less than \_\_\_\_\_  $\pm 1000$  cycles
- Modulation Capability \_\_\_\_\_  $\pm 100$  kc
- Method of Modulation \_\_\_\_\_ Reactance-tubes
- Audio Input-Impedance \_\_\_\_\_ 150/600 ohms
- 100% Modulation Level \_\_\_\_\_  $+10 \pm 2$  dbm  
(0 dbm = 1 milliwatt)
- Audio Frequency Response<sup>1</sup>  
30 to 15,000 Cycles, 1,000 Cycle Reference, within  $\pm 1$  db
- Audio Frequency Distortion<sup>2</sup>  
30-15,000 Cycles \_\_\_\_\_ Less than 1% rms  
(Including all harmonics up to 30 kc/s at  $\pm 75$  ke swing.)
- FM Noise Level, below  $\pm 75$  ke swing<sup>2</sup> \_\_\_\_\_ -65 db
- AM Noise Level, below 100% amplitude modulation<sup>2</sup> \_\_\_\_\_ -50 db

Power Supply Requirements—208/230 volts, 50 or 60 cycles single phase, capable of supplying approximately 3700 watts at 89% power factor, and 5% maximum regulation and variation. Also approximately 30 watts at 115 volts, 50 or 60 cycles single phase is required for the crystal heaters.

**Tube Complement**

4 RCA 6V6	2 RCA 2E26
4 RCA 1614	5 RCA 6AC7
1 RCA 6SH7	1 RCA 2BP1
4 RCA 5U4G	3 RCA 4-125A/4D21
2 RCA 0D3/VR150	4 RCA 8008
1 RCA 0C3/VR105	1 RCA 7C24
1 RCA 6AL5	1 RCA 2D21

**Dimensions in Inches**

Overall Width _____	56 3/32"
Overall Depth (including door handles) _____	31 1/8"
Overall Height _____	84"
Maximum Crate Size _____	28" x 30" x 84"

Weight in Pounds (unpacked—assembled) \_\_\_\_\_ 1900 (approx.)  
 Maximum Ambient Temperature \_\_\_\_\_ 45° C.  
 Finish \_\_\_\_\_ Two-tone umber gray with brushed chrome trim  
 Stock Identification \_\_\_\_\_ MI-28912

**Accessories**

Set of Tubes for BTF-1C _____	MI-28157
1 kw to 3 kw Conversion Kit _____	MI-28920
Set of Tubes for Above Kit _____	MI-28161
1 kw to 10 kw Conversion Kit _____	MI-28921
Set of Tubes for Above Kit _____	MI-28162

<sup>1</sup> For pre-emphasized response the pre-emphasis filter (MI-4926A) is provided to be inserted in the 600 ohm audio input line.  
<sup>2</sup> Distortion and noise is measured following a standard de-emphasis network.

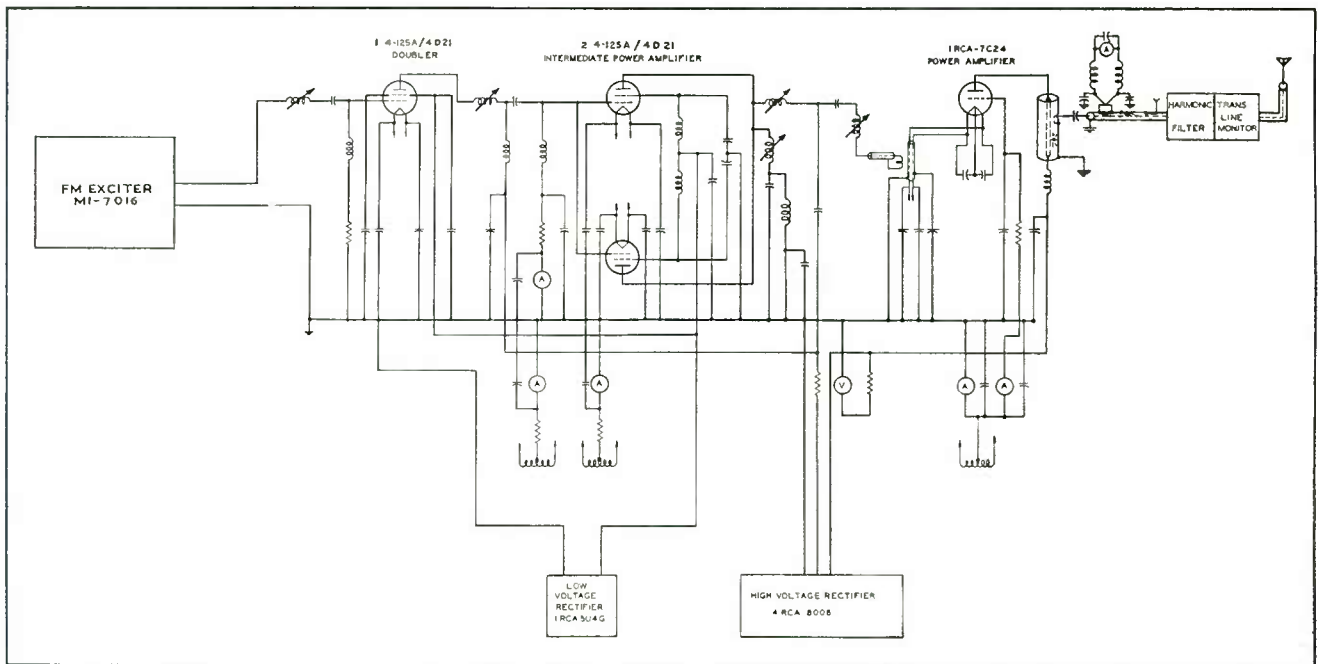

*Simplified Schematic of BTF-1C*

# FM Broadcast Transmitter Type BTF-3B

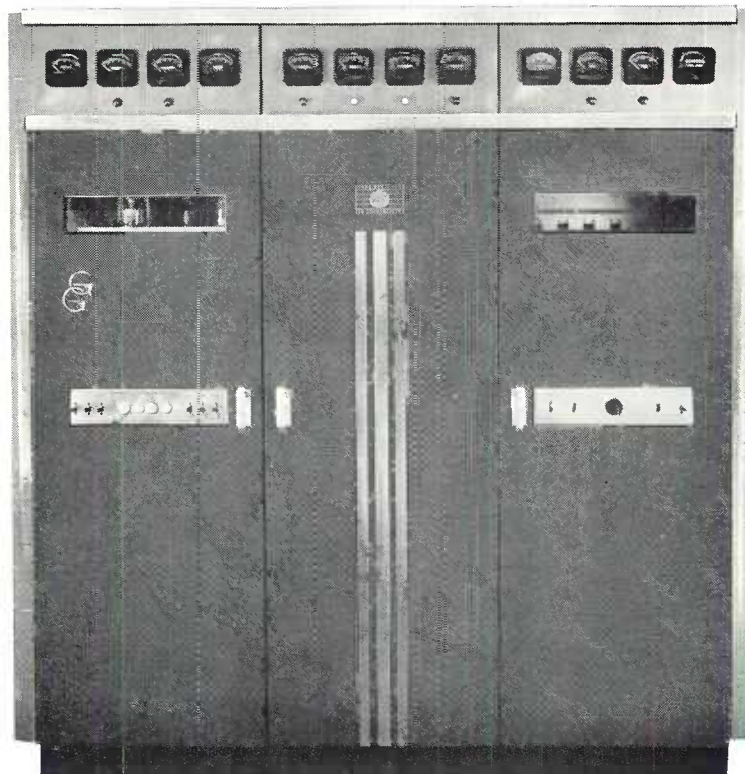

## Features

- Incorporates RCA's new "Direct FM" system which requires fewer tubes and parts, assures low distortion and needs less adjusting.
- Uniquely designed frequency control circuit provides crystal control precision.
- Excellent frequency response  $\pm 1$  db 30 to 15,000 cycles.
- Grounded grid amplifiers reduce overall transmitter and tube costs, reduce installation and maintenance costs and insure stable operation.
- Single-ended r-f circuits throughout.
- Simplified controls with complete circuit protection.
- Minimum of different tube types.
- Equipment protected against transmission line or antenna failures.
- Automatic recycling in case of momentary overload.
- Fixed-tuned harmonic attenuator.
- Multi-unit construction permits easy addition of higher powered units.
- Vertical chassis construction—front and rear door accessibility.
- Space provided for spare exciter.
- Cabinets with similar styling available for housing audio, monitoring, and test equipment.
- Completely self contained—no external units.

## Description

The BTF-3B FM transmitter will provide a maximum of 3000 watts output at any specified frequency between 88 and 108 mc. Attractively housed in three standardized cabinets, this compact unit is easily and economically installed. Power increases can be made by the addition of a grounded grid r-f amplifier, a power unit and a control unit housed in matching cabinets.

Accessibility is assured by vertical chassis construction plus surface mounting of components and exposed wiring for easy and speedy circuit tracing and servicing.

The exciter unit of the BTF-3B contains RCA's newly developed "Direct FM" modulator circuits plus a new frequency control circuit of unique design. Fewer circuits and fewer components are used in this new exciter than in previous designs. All components are mounted on a single vertical panel and are easily accessible.

Frequency modulation is accomplished directly by push-pull reactance tubes connected across the frequency determining circuit of the modulated oscillator. This "direct-modulation" process eliminates numerous multiplier and converter stages with a resulting lower noise and distortion level.

Simplified single-ended amplifiers operating class "C" and comprising a minimum number of variable elements form the r-f section of the BTF-3B. The number of tubes has been reduced to a minimum. The same type tube is used in several stages thus greatly reducing spare tube requirements. High stability grounded grid circuits using RCA type 7C24 tubes are employed in the last two stages.

A variable output coupling provided by front panel control permits adjusting the power output to the antenna transmission line over a range from 1000 to 3000 watts. A fixed-tuned harmonic attenuator (externally mounted) designed to reduce all harmonics 30 db or better is located in the output circuit and is provided as standard equipment. Filament voltage, except for the 7C24 tube, is controlled by tapped transformers and a common filament rheostat. The 7C24 tubes have separate filament rheostat controls.

The entire transmitter is housed in three fabricated steel frames which are bolted to a base frame. Each compartment has both front and rear doors which are provided with observation windows. End shields and meter panels complete the

cabinet type enclosure which has been styled functionally to present a pleasing and dignified appearance. Filtered air, supplied through individual air inlet openings and removable filters are provided in the base frame. Warm air is expelled through the roof.

A transmission line monitor externally mounted which acts as watchman over the antenna and transmission line system is provided. Any unwarranted change in the signal intensity such as might result from an arc in the transmission line or a fault in the antenna itself, actuates this monitor which shuts down the transmitter. Both manual and automatic sequence starting are provided. When in the automatic position, a three shot recycling sequence is provided by the control "brain center" which automatically returns the transmitter to the air up to three times in case of repeated overloads and then if such overload condition persists the transmitter is automatically shut down. All high power circuits are doubly protected by high-speed overload relays backed up by magnetic-trip circuit-breaker type switches. Door interlocks are provided, where required, for the safety of the operating personnel. High voltage components are equipped with mechanically operated grounding bars which are automatically released when a door is opened.

The transmitter is furnished with one FM exciter. A second exciter plus a transfer panel are available as optional equipment. Instantaneous transfer of operation from one exciter to the other is accomplished by the flick of a switch. The BTF-3B is furnished with one exciter, two sets of tubes, two crystals, interconnection wire kit, harmonic filter, and transmission line monitor. An interconnection wiring kit is furnished with each transmitter.

### Specifications

Frequency Range \_\_\_\_\_ Any specified frequency between 88 and 108 mc  
 Power Output (into transmission line) \_\_\_\_\_ 1000 to 3000 watts  
 R-f Output Impedance \_\_\_\_\_ 35 to 75 ohms  
 Carrier Frequency Stability \_\_\_\_\_ Deviation less than  $\pm 1000$  cycles  
 Modulation Capability \_\_\_\_\_  $\pm 100$  kc  
 Method of Modulation \_\_\_\_\_ Reactance-tubes  
 Audio Input Impedance \_\_\_\_\_ 150/600 ohms  
 100% Modulation Level \_\_\_\_\_  $+10 \pm 2$  dbm  
 Audio Frequency Response<sup>1</sup>  
 30 to 15,000 Cycles, 1000 Cycle Reference, within \_\_\_\_\_  $\pm 1$  db

### Audio Frequency Distortion<sup>2</sup>

30-15,000 Cycles \_\_\_\_\_ Less than 1% rms  
 (Including all harmonics up to 30 kc/s at 75 kc swing.)

FM Noise Level, below 75 kc swing<sup>2</sup> \_\_\_\_\_ -65 db

AM Noise Level, below 100% amplitude modulation<sup>2</sup> \_\_\_\_\_ -50 db

Power Supply Requirements \_\_\_\_\_ 208/230 volts, 50 or 60 cycles three phase, capable of supplying approximately 3600 watts at 88% power factor, and 5% maximum regulation and variation. Also approximately 30 watts at 115 volts, 50/60 cycles single phase is required for the crystal heaters.

### Tube Complement

4 RCA 6V6	2 RCA 2E26
4 RCA 1614	5 RCA 6AC7
1 RCA 6SH7	1 RCA 2BP1
4 RCA 5U4G	3 RCA 4-125A/4D21
2 RCA 0D3/VR150	2 RCA 7C24
1 RCA 0C3/VR105	6 RCA 8008
1 RCA 6AL5	1 RCA 2D21

### Dimensions in Inches

Overall Width \_\_\_\_\_  $81\frac{3}{16}$ "  
 Overall Height \_\_\_\_\_  $84$ "  
 Overall Depth (including door handles) \_\_\_\_\_  $31\frac{1}{16}$ "  
 Maximum Crat Size \_\_\_\_\_  $28" \times 30" \times 84"$

Weight in Pounds (unpacked—sembled) \_\_\_\_\_ 2900 (approx.)

Maximum Ambient Temperature \_\_\_\_\_  $45^\circ$  C.

Finish \_\_\_\_\_ Two-tone umber gray with brushed chrome trim

Stock Identification \_\_\_\_\_ MI-28913

### Accessories

Set of Tubes for BTF-3B \_\_\_\_\_ MI-28158  
 3 to 10 kw Conversion Kit \_\_\_\_\_ MI-28922  
 Set of Tubes for Above Kit \_\_\_\_\_ MI-28163  
 Spare FM Exciter Kit \_\_\_\_\_ MI-7015  
 Set of Tubes for Spare Exciter \_\_\_\_\_ MI-7020

<sup>1</sup> For pre-emphasized response the pre-emphasis filter (MI-4926A) is provided to be inserted in the 600 ohm audio input line.  
<sup>2</sup> Distortion and noise is measured following a standard de-emphasis network.

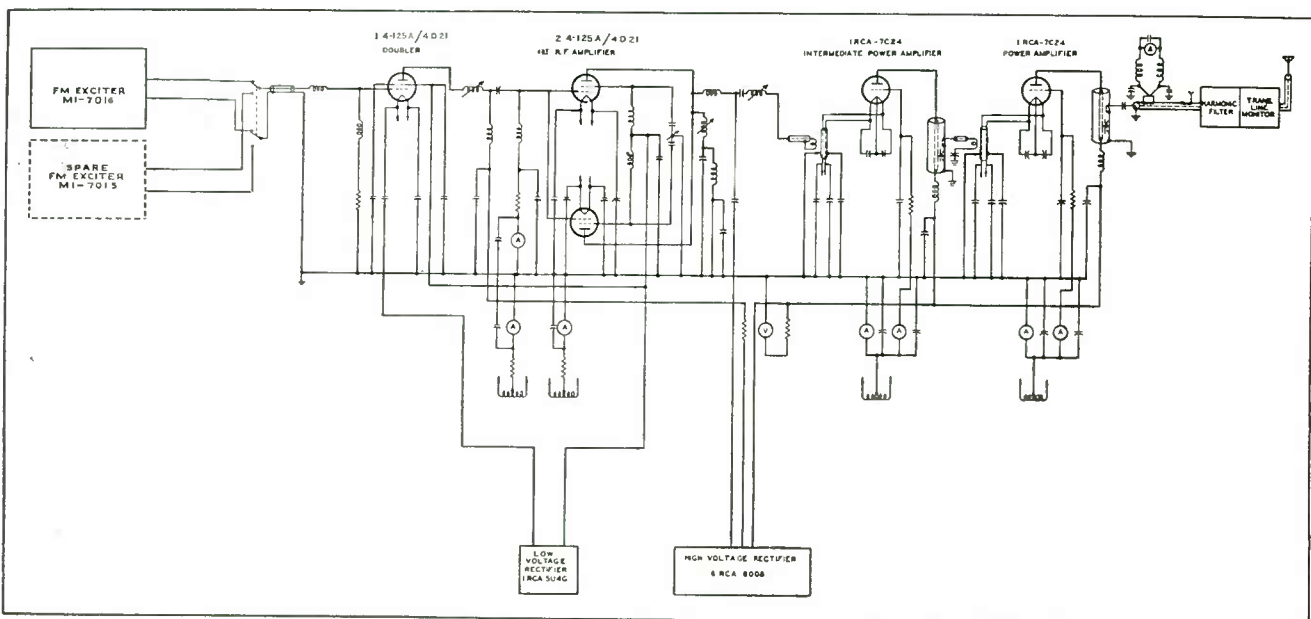

*Simplified Schematic of BTF-3B*

# FM Broadcast Transmitter Type BTF-10B

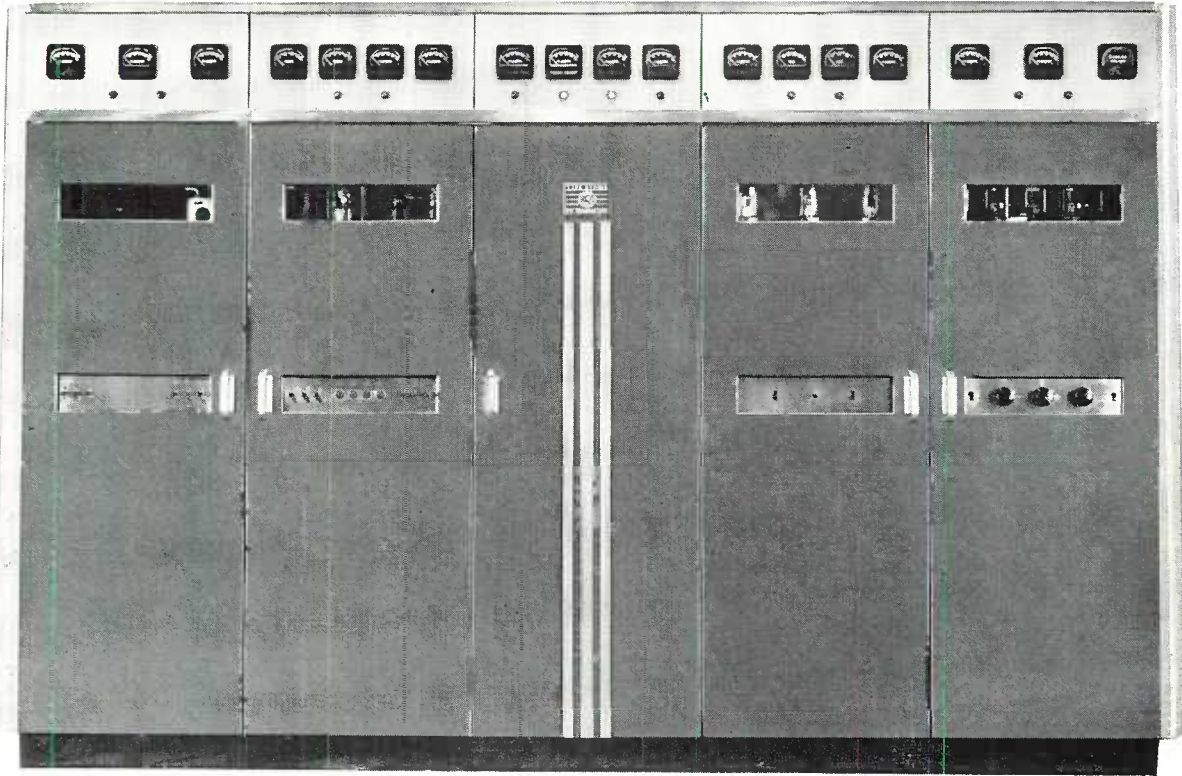

## Features

- Incorporates RCA's new "Direct FM" system.
- Uniquely designed frequency control circuit provides crystal control stability.
- Excellent frequency response  $\pm 1$  db, 30 to 15,000 cycles.
- Grounded-grid amplifiers reduce overall transmitter, tube and maintenance costs.
- Simplified controls with motor driven tuning for high-power stages.
- Equipment protected against transmission line or antenna failure.
- Instant carrier return after momentary power failure.
- Fixed-tuned harmonic attenuator.
- Compact multi-unit construction. Reduced floor space requirements.
- Space provided for spare exciter unit.
- Vertical chassis construction—front and rear door accessibility.
- Cabinets with similar styling available for housing audio, monitoring and test equipment.

## Description

The RCA BTF-10B is a new frequency modulated transmitter designed to supply up to 10,000 watts of power at any specified frequency in the 88 to 108 mc. band. Incorporating the latest developments in FM transmitter design, the BTF-10B is outstanding in performance and reliability. Compact and simplified mechanical construction plus attractive cabinet styling make for an economical installation with dignified appearance. The entire transmitter is housed in five fabricated steel frames which are bolted to a base frame. Each compartment has both front and rear doors with observation windows. Accessibility is assured by vertical chassis construction, surface mounting of components and exposed wiring for speedy circuit tracing.

The exciter unit of the BTF-10B contains RCA's newly developed "Direct FM" modulator circuits plus a new frequency control circuit of unique design. Frequency modulation is accomplished directly by push-pull reactance tubes connected across the frequency determining circuit of the modulated oscillator. This "direct modulation" process eliminates numerous multiplier and converter stages with resulting lower noise and distortion level.

Simplified single-ended amplifiers operating class "C" and using a minimum number of variable elements form the RF section of the BTF-10B. High stability grounded-grid circuits are employed in the last three stages using RCA type 7C24 tubes. This use of the same type tube in several stages results in greatly reduced spare tube requirements.

A variable output coupling with front panel control permits adjusting the power output into the transmission line over a range from 3,000 to 10,000 watts. Harmonic radiation is held to a minimum by a fixed-tuned harmonic attenuator which is located in the output circuit and is provided as standard equipment.

An externally mounted transmission line monitor acts as a watchman over the antenna and transmission line system. Any unwarranted change in standing wave ratio, such as might result from an arc in the transmission line, or a fault in the antenna itself, actuates this monitor which removes plate voltage from the transmitter to prevent damage. A three-shot recycling sequence is provided by the control "brain center" which automatically returns the transmitter to the air up to three times in the case of repeated overloads, and then, if such overload persists, shuts the transmitter down. A reset switch is provided which may be used to restore the transmitter to normal after one, two or three overloads. This switch can be set to lock out the recycling circuit.

All high power circuits are doubly protected by high speed overload relays backed up by magnetic-trip circuit-breaker type switches. Door interlocks are provided, where required, for the safety of operating personnel. High voltage components are equipped with mechanically operated grounding bars which are automatically released when a door is opened.

To minimize lost "air time", an antenna cut-back kit is available as optional equipment. When it is incorporated in the BTF-10B, the antenna can be instantly switched to the 3 kw intermediate power amplifier output. At the same time, the power amplifier plate voltage is removed and the plate circuit grounded. P. A. tube changes or necessary servicing in the power amplifier compartment can then be carried out in complete safety while program continuity is maintained through the driver.

Filtered air is supplied by an external blower for the 1, 3 and 10 kw stages. Individual, internal blowers for these stages are available as optional equipment where the single external blower is not desired. Space is provided in the exciter cabinet for a spare exciter which can be supplied as additional equipment. Instantaneous transfer of operation from one exciter to the other can then be accomplished by the flick of a switch.

The transmitter is furnished with one FM exciter, two sets of tubes, two crystals, interconnecting wire kit, harmonic filter and transmission line monitor.

### Specifications

Frequency Range \_\_\_\_\_ 88 to 108 mc  
 Power Output (into transmission line) \_\_\_\_\_ 3,000 to 10,000 watts  
 RF Output Impedance \_\_\_\_\_ 51.5 ohms (standing wave ratio 1.75 to 1 or less)  
 Carrier Frequency Stability \_\_\_\_\_ Deviation less than  $\pm 1,000$  cycles  
 Modulation Capability \_\_\_\_\_  $\pm 100$  kc  
 Method of Modulation \_\_\_\_\_ Reactance tubes  
 Audio Input Impedance \_\_\_\_\_ 600/150 ohms

100% Modulation Level\* \_\_\_\_\_  $\pm 10 \pm 2$  dbm  
 Audio Frequency Response\*\* 30 to 15,000 cycles \_\_\_\_\_  $\pm 1$  db  
 Audio Frequency Distortion\*\*\* 30 to 15,000 cycles (including all harmonics up to 30 kc/s at  $\pm 75$  kc swing) \_\_\_\_\_ Less than 1%

FM Noise Level, below 75 kc swing\*\*\* \_\_\_\_\_ Not more than -65 db  
 AM Noise Level, below 100% amplitude modulation\*\*\* \_\_\_\_\_ Not more than -50 db

Power Line Requirements—Transmitter:  
 Line Voltage \_\_\_\_\_ 208/230 volts  
 Phase \_\_\_\_\_ 3  
 Frequency \_\_\_\_\_ 60 cycles  
 (50 cycles equipment available at slightly higher cost)  
 Instantaneous Regulation and Variation \_\_\_\_\_ 5%  
 Power Consumption (approx.) \_\_\_\_\_ 22.5 kw  
 Power Factor (approx.) \_\_\_\_\_ 90%

### Tube Complement:

4 RCA 6V6	2 RCA 2E26
4 RCA 1614	5 RCA 6AC7
1 RCA 6SH7	1 RCA 2BP1
4 RCA 5U4G	3 RCA 4-125A/4D21
2 RCA OD3/VR150	4 RCA 7C24
1 RCA OC3/VR105	6 RCA 673
1 RCA 6AL5	1 RCA 2D21

### Dimensions:

Overall Length \_\_\_\_\_ 131  $\frac{3}{8}$ "  
 Overall Height \_\_\_\_\_ 84"  
 Overall Depth \_\_\_\_\_ 31  $\frac{1}{8}$ "  
 Building Entrance Requirements \_\_\_\_\_ 25" x 80"  
 Weight in Pounds (unpacked—assembled) \_\_\_\_\_ 5000 (approx.)  
 Maximum Ambient Temperature \_\_\_\_\_ 45° C.  
 Finish \_\_\_\_\_ Two tone umber gray with brushed chrome trim and fittings

\* Level at input of 600 ohm pre-emphasis network. Insertion loss of this network is approximately 24 db.

\*\* For pre-emphasized response, the pre-emphasis filter (MI-4926A) is provided to be inserted in the 600 ohm audio input line at the most effective point.

\*\*\* Distortion and noise is measured following a standard 75 microsecond de-emphasis network.

Stock Identification \_\_\_\_\_ MI-28914

### Accessories

Tube Kit for BTF-10B \_\_\_\_\_ MI-28159  
 Spare FM Exciter Kit \_\_\_\_\_ MI-7015  
 Set of Tubes for Spare Exciter \_\_\_\_\_ MI-7020  
 Power Cutback Equipment \_\_\_\_\_ MI-28154  
 Modification Kit for 50 Cycle Operation \_\_\_\_\_ MI-28178

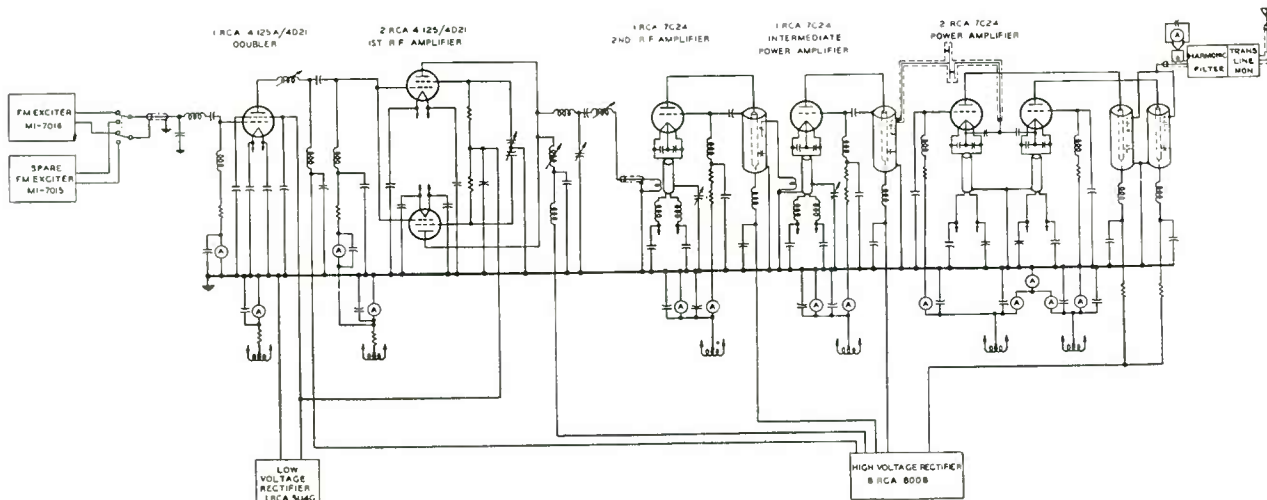

*Simplified Schematic Diagram of BTF-10B*



# FM Broadcast Transmitter Type BTF-50A

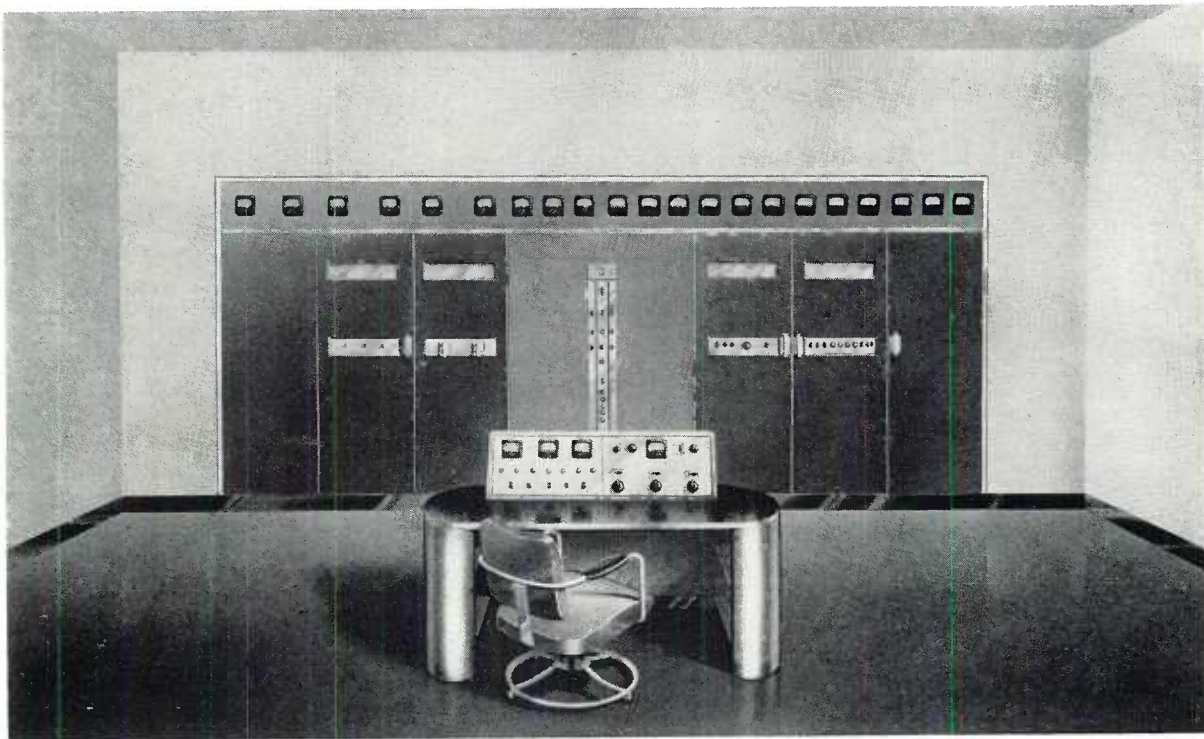

## Features

- Entirely air cooled—no water connections of any kind.
- Low cost installation—small space requirements—adaptable to single or dual floor layout.
- Vertical chassis construction for maximum accessibility and ventilation.
- Incorporates RCA's new "Direct FM" system.
- Grounded grid amplifiers.
- Simplified power supply—only one high-power rectifier.
- Single phase filament heating of all tubes. Voltage regulated filament supply.
- Reduced power operation feature assures uninterrupted program service.
- Motor driven tuning for high-power stages.
- Protection against transmission line or antenna failure.
- Sectional fault indicator lamps on front panel.
- New BTC-1A control console supplied as standard equipment.

## Description

The BTF-50A is an all-new 50 kw FM transmitter incorporating the latest developments in high power FM transmitter design. This RCA transmitter will supply 50,000 watts at any specified frequency in the 88 to 108 mc. band. Installation and operating costs have been held to a minimum through the use of compact mechanical construction and efficient, grounded-grid circuits using a minimum of different tube types. Relia-

bility is assured by conservative operation of all components and dependable forced air cooling.

The general arrangement of the transmitter consists of a series of vertical chassis supported by steel frames which are in line with an attractively styled, sectionalized front. All units employ "dead front" construction with doors in the front panel allowing free access to the low power RF cabinets and to the transmitter area. The entire radio frequency portion of the transmitter can easily be installed in a space only 16½ feet wide by 9 feet deep. External blower and power equipment may be installed either in a basement or on the same floor, depending on individual choice.

A new RCA transmitter control console (BTC-1A) is supplied as standard equipment with the BTF-50A. This control console contains audio mixing and monitor controls, primary power switching for the transmitter and tower lights. "Block type" construction permits the addition of control sections if other transmitters are to be operated in the same building.

The exciter unit of the BTF-50A contains RCA's new "Direct FM" system in which frequency modulation is accomplished directly by push-pull reactance tubes connected across the frequency determining circuit of the modulated oscillator.

Simplified single ended amplifiers operating class "C" and using a minimum of variable elements form the RF section of the BTF-50A. Only 26 of the 43 tubes used in this transmitter are required to maintain full 50 kw operation. The remaining tubes are used in frequency control, voltage regulator and monitoring circuits. High stability grounded-grid amplifiers using the new RCA 7C24 and 5592 tubes are employed in all stages above the 250 watt level. This use of the same type tube in several stages results in greatly reduced spare tube requirements. Inherent advantages of grounded-grid amplifiers at FM frequencies include greater stability, higher efficiency, simpler circuits and elimination of the need for neutralization.

Variable output coupling with a front panel control permits adjusting the power output into the transmission line over a wide range. Harmonic radiation is held to a minimum by a fixed-tuned attenuator, which is located in the output circuit. Full protection from antenna or transmission line failure is provided by a transmission line monitor which automatically shuts down the transmitter when any unwarranted change in standing wave ratio at the input of the transmission line is detected. An automatic "three shot" reclosing system will return full power up to three times when plate voltage is removed by operation of the transmission line monitor or other overload devices.

The power control system of the BTF-50A is carefully engineered to provide proper starting sequence. All high-powered circuits are doubly protected by high speed overload relays backed up by magnetic-trip circuit breaker type switches, and circuit indicator lamps provide a quick means for analyzing faults such as air failure, tube failure, etc. A single high-power rectifier supplies all anode voltages for the RF stages, and a heated spare tube is provided which may be quickly connected into the circuit, if necessary. Two small rectifiers are used for RF screen and exciter plate voltages. Door interlocks and high voltage grounding bars are provided, where required, for the safety of operating personnel.

To provide for continuous broadcast service with a minimum of interruption, the transmitter is equipped with an antenna cut-back arrangement. Operation of a single control switch transfers the antenna from the final amplifier to an intermediate amplifier which supplies approximately 7.5 kw. At the same time, the driver and power amplifier plate voltage is removed and the plate circuits grounded. Tube changes or necessary servicing in the driver, P.A. or high power blower compartments can then be carried out in complete safety, while program continuity is maintained through the intermediate power amplifier.

Air for all RF stages up to and including the intermediate power amplifier is supplied by a single blower. Air for the driver and final stages is supplied by a separate blower which draws filtered air from outside the transmitter area and may be exhausted into a manifold for outside delivery or for heating purposes, if desired.

The BTF-50A is furnished with a transmitter control console, two sets of tubes, two crystals, harmonic filter, transmission line monitor and one FM exciter. A spare exciter can be supplied as extra equipment for installation in the space provided in the exciter cabinet.

Carrier Frequency Stability—Deviation less than  $\pm 1000$  cycles  
 Modulation Capability— $\pm 100$  kc  
 Method of modulation—Reactance tubes  
 Audio Input Impedance—600/150 ohms  
 Audio Input Level for 100% Modulation\*— $+10 \pm 2$  dbm  
 Audio Frequency Response\*\* 30 to 15,000 cycles— $\pm 1$  db  
 Audio Frequency Distortion\*\*\* 30 to 15,000 cycles (including all harmonics up to 30 kc/s at  $\pm 75$  kc swing)  
 Less than 1.0%

FM Noise Level\*\*\* (below 75 kc swing)—Not more than -65 db  
 AM Noise Level (below 100% amplitude modulation)  
 Not more than -50 db

Power Line Requirements:  
 Line Voltage (normal open circuit)—440/480  
 Phase—3  
 Frequency—60 cycles  
 Total Variation from Normal Including Regulation—5%  
 Power Consumption (approximate)—125 kw  
 Power Factor (approximate)—87%

Tube Complement:  
 4 RCA 6V6                                   1 RCA 6AL5                                   1 RCA 2BP1  
 4 RCA 1614                                   2 RCA 2E26                                   3 RCA 4-125/4D21  
 1 RCA 6SH7                                   1 RCA 2D21                                   4 RCA 7C24  
 4 RCA 5U4G                                   1 RCA 6X5                                   3 RCA 5592  
 2 RCA OD3/VR150                           5 RCA 6AC7                                   6 RCA 857B  
 1 RCA OC3/VR105

Dimensions:  
 Transmitter Panel and Equipment Enclosure  
 198" long x 84½" high (allow depth of 9" to rear wall)  
 Plate Transformer—Base 25" x 49"; height 50"  
 Filter Reactor—Base 32" x 40"; height 50"  
 Rectifier—50" wide x 70" long x 84" high  
 Control and Distribution Unit—48" wide x 82" long x 80" high  
 High-power Blower Enclosure—8' x 8' x 6' (approx.)  
 Console—Base 46" x 36"; height (including turrets) 38½"  
 Minimum Entrance Requirements—30" x 84"  
 Weight, total unpacked—Approx. 24,000 lbs.  
 Finish—Two tone umber gray  
 Stock Identification—MI-28926

\* Level at input of 600 ohm pre-emphasis network. Insertion loss of this network is approximately 24 db.  
 \*\* For pre-emphasized response, the pre-emphasis filter (MI-4926A) is provided to be inserted in the 600 ohm audio line.  
 \*\*\* Distortion and noise is measured following a standard 75 microsecond de-emphasis network.

### Specifications

Frequency Range—88 to 108 mc  
 Power Output (into transmission line)—10 to 50 kw  
 RF Output Impedance—51.5 ohms

### Accessories

Spare FM Exciter—MI-7015  
 Set of Tubes for Spare Exciter—MI-7020  
 Modification Kit for 50 Cycle Operation—MI-28248

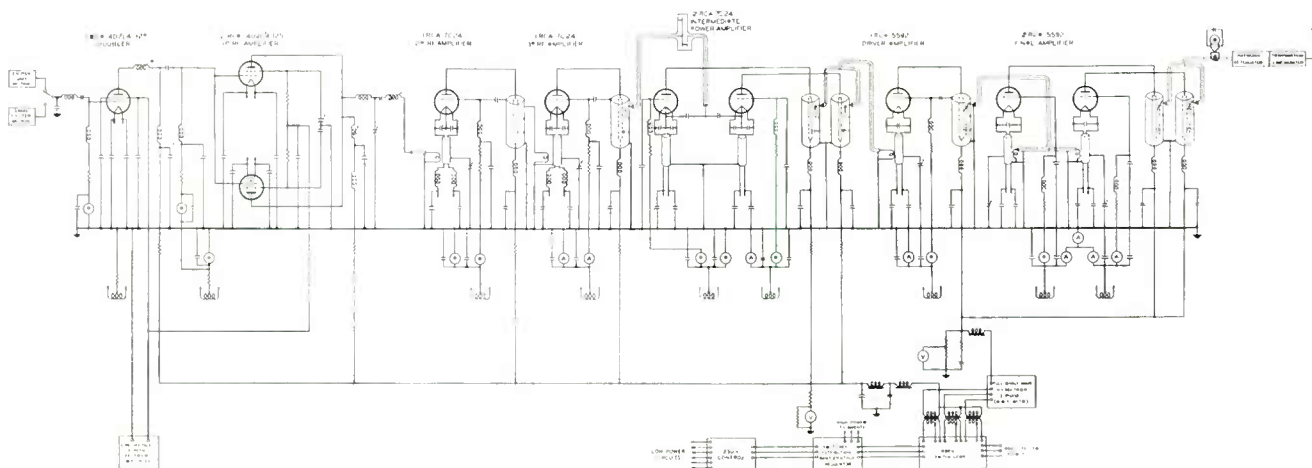

Simplified schematic diagram of BTF-50A

## Universal Transmitter Control Console Type BTC-1A

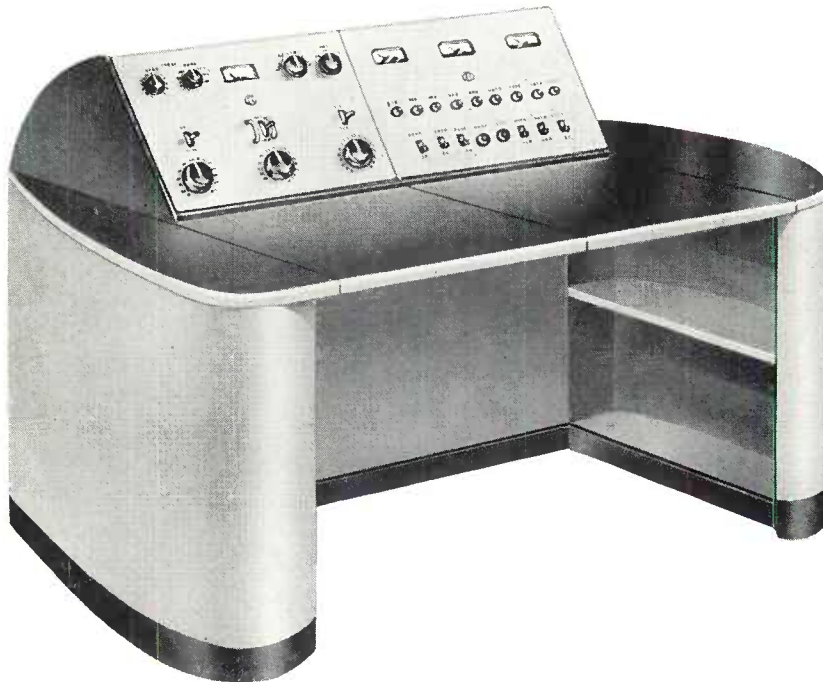

*BTC-1A Universal Transmitter Control Console*

### Features

- Contains all mixing and switching facilities required for supervisory transmitter control.
- "Block Type" construction allows the addition of control turrets and desk sections when other transmitters are installed.
- Provides a VU meter, and facilities for mounting three remote indicating meters.
- Seven position monitor selector switch and monitor gain control.
- Mixing and switching provided for six audio inputs.
- Transmitter power switches and indicating lamps on r-f turret for routine transmitter control.
- Attractively styled and finished to match RCA transmitters and auxiliary equipment.

### Uses

The RCA Type BTC-1A Universal Transmitter Control Console is meant to be used at transmitting plants to provide centralized control of all mixing and primary switching operations. Intended primarily for use with RCA 3 kw, 10 kw and 50 kw FM transmitters, this unit may be combined with the MI-11623 Transmitter Monitor and Amplifier Rack to provide audio amplification from program line to transmitter input, and a very flexible and complete system of controls and monitors.

The BTC-1A Universal Control Console is designed to satisfy the requirements of modern broadcast transmitting stations where it is often desirable to combine the operation of several transmitters. Because of the "block type" construction of this

console, additional control turrets and desk sections may be attached to the basic unit to form a console having facilities for control of AM, FM and/or television transmitters. The BTC-1A is flexible enough to permit a variety of possible combinations.

### Description

The Universal Control Console consists of an audio control turret and an r-f control turret mounted on an attractive two section desk having removable end sections. Control turret front panels have a satin chrome finish and the desk is two-tone umber gray with a durable black linoleum top. All meters are recessed behind the front panel and each panel is hinged at the bottom so that it may be opened for easy servicing. The rear turret covers may be removed to facilitate installation or basic changes.

The audio turret contains a standardized VU meter with a range switch to alter the maximum level indicated by the meter from +4 to +24 db in two db steps. Three high quality mixers and associated transfer keys provide for control of the six inputs, which are:

1. Microphone-Oscillator/Remote
2. Line 1, Line 2
3. Turntable 1, Turntable 2.

Operation of the microphone key cuts off the signal to the monitor amplifier to prevent feedback when the microphone is being used. The line transfer key removes equalization and connects the telephone set to the line not being used for pro-

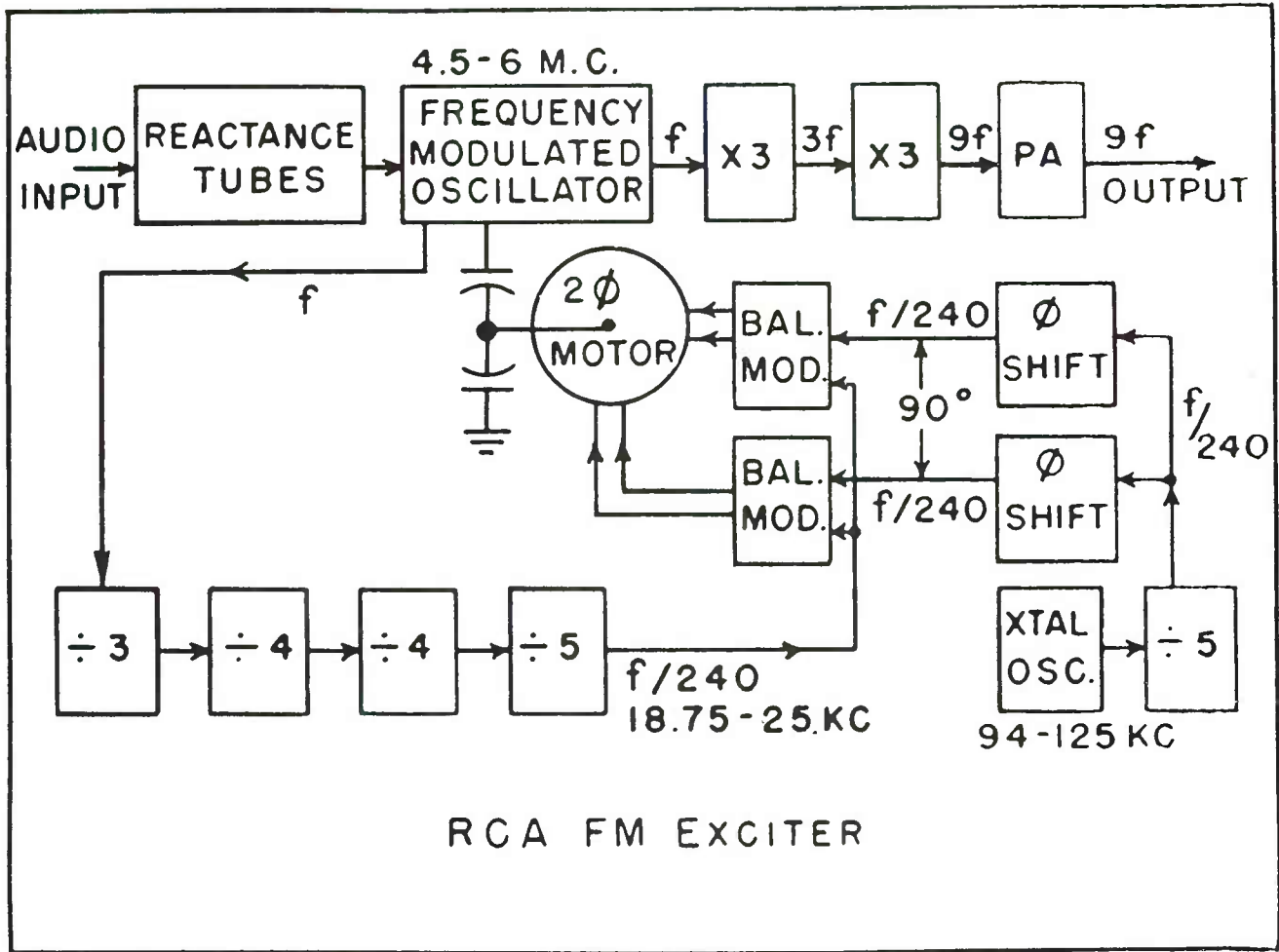

**RCA FM EXCITER**

Block diagram of the RCA FM Exciter. The frequency is doubled in the amplifier section.

**Specifications**

- Frequency Range \_\_\_\_\_ 44 to 54 mc  
     Frequency doubled in amp. section to 88-108 mc
- Carrier Frequency Stability, at FM output frequency  
     Deviation less than 1000 cycles
- Modulation Capability \_\_\_\_\_ ±100 kc
- Method of Modulation \_\_\_\_\_ Push-pull reactance-tubes
- Audio Input Impedance \_\_\_\_\_ 600/150 ohms
- Audio Frequency Response  
     30 to 15,000 cycles, 1000 cycle reference \_\_\_\_\_ ±1 db
- Audio Frequency Distortion  
     30 to 100 cycles \_\_\_\_\_ 1.0%  
     100 to 7,500 cycles \_\_\_\_\_ 0.5%  
     7,500 to 15,000 cycles \_\_\_\_\_ 1.0%  
     (including all harmonics up to 30 kc at 75 kc swing)
- FM Noise Level, below ±75 kc swing \_\_\_\_\_ 70 db
- AM Noise Level, below 100% amplitude modulation \_\_\_\_\_ 60 db

**Power Line Requirements**

- Line Voltage \_\_\_\_\_ 208/230 volts
- Phase \_\_\_\_\_ 1
- Frequency \_\_\_\_\_ 50/60 cycles
- Instantaneous Regulation (maximum) \_\_\_\_\_ 5%
- Power Consumption (approx.) \_\_\_\_\_ 370 watts
- Power Factor \_\_\_\_\_ 67%

**Power Line Requirements—(Crystal Heaters)**

- Line Voltage \_\_\_\_\_ 100 to 125 volts a-c or d-c
- Phase \_\_\_\_\_ 1
- Power Consumption \_\_\_\_\_ 28 watts

- Overall Height—(RF and Power Supply) \_\_\_\_\_ 29"
- Overall Width \_\_\_\_\_ 22 1/4"
- Weight (RF Unit) \_\_\_\_\_ 47 lbs.
- Weight (Power Supply) \_\_\_\_\_ 66 1/2 lbs.

**Stock Identification:**

- Exciter \_\_\_\_\_ MI-7016
- Power Supply \_\_\_\_\_ MI-7017

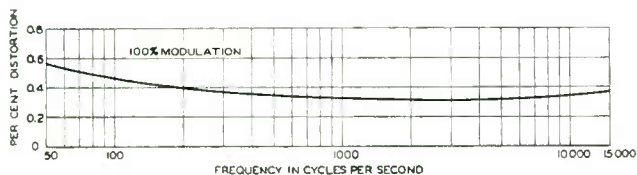

Percentage distortion at 100% modulation



Audio frequency response less pre-emphasis

# Transmitter Monitor and Amplifier Cabinet Rack MI-11623

## Features

- Simplifies transmitter installations.
- Provides complete monitor and amplifier facilities in one rack.
- Provides extreme flexibility through termination of all audio units in jack strips.
- Wiring and monitoring facilities furnished for addition of optional equipment.
- Attractive styling—matches all RCA transmitters and auxiliary equipment.

## Uses

The transmitter monitor and amplifier cabinet facilitates the grouping of all appropriate apparatus necessary to simplify the installation of any broadcast transmitter. This cabinet utilizes the new modernistically styled cabinet of the BR-84 series which blends with all RCA transmitters and equipment.

The cabinet is factory wired to accommodate all the required items for transmitter, speech input equipment, modulation and frequency monitors, and power change switch, etc. The MI-11623 has been designed to operate with the control desks supplied with the BTA-5F/BTA-10F, BTA-50F and BTF-50A Transmitters to provide a complete and flexible system of controls and monitors.

## Description

The transmitter control cabinet embraces all the functional equipment, amplifiers, jack panels, etc., required for the operation of an RCA broadcast transmitter in conjunction with the transmitter control console. The MI-11623 consists of one Standard Cabinet Rack complete with a ventilated rear door, one BA-4C\* monitoring amplifier, one type 86-A1 limiting amplifier, two type 33-A jack strips complete with mat, and one type 57-C switch and fuse panel. An additional BR-2A panel and shelf is supplied and wired to accommodate three type BA-1A pre-amplifiers, with one type BX-1B power supply for the pre-amplifiers. This arrangement allows microphones and transcription turntables to be used directly from the transmitter in the event of an emergency.

Mountings and all wiring are also provided for the following accessory equipment:

- Two type 56-C Fixed Line Equalizers
- Two MI-4925-A 15 KC High Frequency compensators
- One MI-4926-A FM pre-emphasis equalizer
- One MI-4309-B Power Reduction panel (BTA-5F/10F)
- One MI-7264-E Hum Equalizer (BTA-50F)

A blank panel is drilled and tapped for mounting three MI-10253 line transformers.

Measuring equipment space and wiring are available at the top of the rack for mounting the AM Frequency Monitor type WF-48A and the Modulation Monitor type WM-43A, or the combination FM Frequency and Modulation Monitor type WF-5A.

The two type 33-A jack panels provide flexibility for all the described audio circuits with spares for utility apparatus according to local requirements.

The photograph illustrates the MI-11623 complete with accessory side panels, MI-30541-G84 and MI-30566-G84 Trim Strips. These are not supplied, but are available for the user's individual requirements. Where fluctuating mains prevail, the Solar voltage regulator is available to regulate the a-c to the 86-A1 limiting amplifier.

\* Note: Limiting and monitoring amplifiers supplied with tubes.

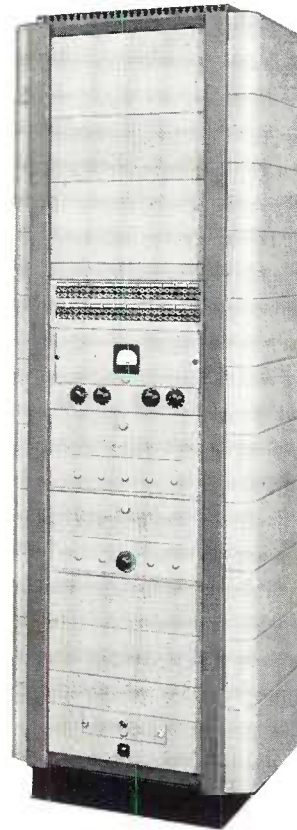

MI-11623 fitted with MI-30541-G84 Side Panels and MI-30566-G84 Trim Strips

## Specifications

Frequency Response (line in to transmitter in)	$\pm 2$ db 30-15,000 cycles
Noise Level (below +10 db output)	—75 db
Power Supply (115 to 125 volts, 50-60 cycles)	450 watts
Dimensions:	
Height	84"
Width (less side panels and 28" side panels)	22"
Overall Depth (including door handles)	19"
Panel Width	19"
Weight (unpacked)	400 lbs. (approx.)
Stock Identification (including tubes)	MI-11623

## Accessories

Side Panels (each)	MI-30541-G84
Single Trim Strip (each)	MI-30566-G84
AM Frequency Monitor	Type WF-48A
AM Modulation Monitor	Type WM-43A
FM Frequency and Modulation Monitor (RCA)	Type WF-5A
BA-1A Pre-Amplifier	MI-11218-A
Tube Kit for BA-1A	MI-11288
BX-1C Power Supply for Pre-Amplifier	MI-11305-B
Tube Kit for BX-1C Power Supply	MI-11262
Power Change Panel for BTA-5F and BTA-10F	
Transmitter	MI-4309-B
Line Transformer	MI-10253
56-C Fixed Equalizer	MI-4168
15 KC High Frequency Compensator	MI-4925-A
FM Pre-Emphasis Equalizer	MI-4926-A
Sola Voltage Regulator	
60 cycle	MI-11280
50 cycle	MI-11280-A

# Pre-emphasis Filter MI-4926-A



**Features**

- Accurate within 1.5 db from 30 to 15,000 cycles.
- Minimum insertion loss.
- Operation for levels up to +30 db.
- Compact design—completely shielded.

**Uses**

The MI-4926-A filter is designed for use in such equipment as disc recorders and frequency modulated transmitters to produce the FCC standard 75-microsecond audio pre-emphasis characteristic. The MI-4926-A is supplied as a part of all RCA FM and Television transmitters, as well as the studio-transmitter link equipment. It is also used in conjunction with disc recorders to obtain recordings having the 75 micro-second pre-emphasis characteristic. In FM transmitter installations, if a spare FM exciter is ordered, and it is desired to switch ahead of the filter rather than after, an additional pre-emphasis filter will be required. The MI-4926-A may also be used with composite transmitters.

**Description**

The MI-4926-A filter is of the constant impedance, balanced, "bridge T" type. The characteristic frequency curve of the filter follows a 75-microsecond curve in accordance with RMA and FCC recommendations.

Mechanically, the filter consists of two reactors, two capacitors and eight resistors sealed inside metal can. Connections are made to the filter by means of solder terminals on top of the can.

The filter may be inserted at any point in the audio system where the signal does not exceed +30 db, and may be mounted in any convenient place so long as the magnetic fields of transformers and similar equipment are avoided.

**Specifications**

Input:  
 Source Impedance \_\_\_\_\_ 600 ohms  $\pm 5\%$   
 Input Impedance \_\_\_\_\_ 600 ohms  $\pm 5\%$   
 Maximum Input Level \_\_\_\_\_ +30 db\*

Output:  
 Load Impedance \_\_\_\_\_ 600 ohms  $\pm 5\%$   
 Output Impedance \_\_\_\_\_ 600 ohms  $\pm 5\%$

Insertion Loss (from 600 ohm source to 600 ohm load):  
 Minimum Loss at 15,000 cps \_\_\_\_\_ Approx. 5 db.  
 Maximum Loss Below 500 cps \_\_\_\_\_ Approx. 22 db.

Frequency Response \_\_\_\_\_ Corresponds to FCC 75 microsecond pre-emphasis curve within  $\pm 1.5$  db from 30 to 15,000 cycles

Attenuation Characteristic \_\_\_\_\_ Fixed (See curve)

**Physical Specifications:**

Diameter \_\_\_\_\_ 3"  
 Height \_\_\_\_\_ 4 $\frac{3}{8}$ "  
 Weight (unpacked) \_\_\_\_\_ 2 $\frac{1}{4}$  lbs.  
 Base Plate \_\_\_\_\_ 3 $\frac{1}{4}$ " x 3 $\frac{1}{4}$ "  
 Mounting \_\_\_\_\_ Four holes with center lines 2 $\frac{3}{4}$ " x 2 $\frac{3}{4}$ "

\* 0 db = .001 watt.

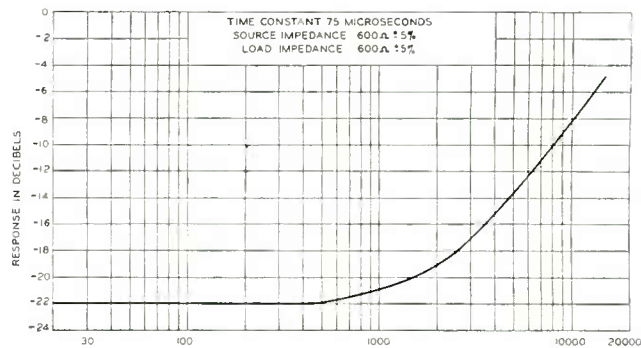

Frequency response of MI-4926-A

# The RCA Pylon Antenna For FM

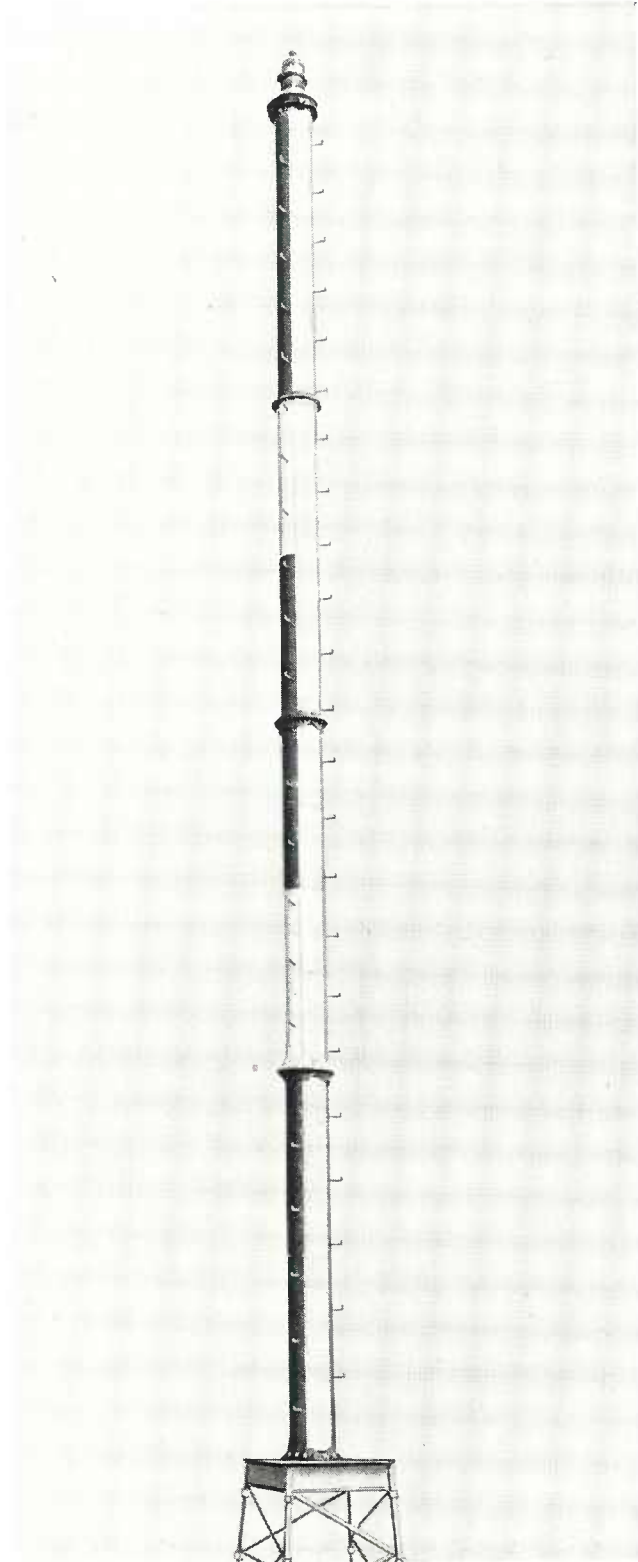

## Features

- Single element, self-supporting structure.
- Easy to install.
- High gain.
- High power handling capacity.
- Broad band—no tuning or adjusting.
- Low in weight.
- Mechanically strong and needs no guying.
- RCA Television Super Turnstile may be mounted on top.
- One feed point per section.
- Icing problem negligible.
- Easy to maintain.

## Description

The new RCA Pylon Antenna is a radically new design of antenna for the FM broadcast band. This antenna is simpler in design, poses fewer installation problems, and provides higher gain (height for height) than any other type of FM antenna.

The Pylon is essentially a cylinder of sheet metal, mounted in a vertical position, with a narrow slot running from top to bottom. This cylindrical structure itself is the radiator. The operation may be best understood by considering the edges of the slot as an open wire transmission line, and the cylinder as an infinite number of horizontal loops. The cylinder is approximately a wave length long and a half wave length in circumference. When properly excited, at the midpoint, there is a voltage distribution along the slot similar to that along any full wave transmission line shorted at both ends. This voltage excites the cylindrical portion, and results in horizontally polarized radiation. The Pylon has an essentially circular radiation pattern. Its gain depends upon the number of stacked sections. The basic cylindrical section is approximately thirteen feet high and twenty inches in diameter. The sections may be stacked, one on top of the other, with the gain increasing in a direct linear proportion. For example, at 98 megacycles, a single section will have a gain of one and a half, two sections will have a gain of three, and four sections

a gain of six. For a given number of sections, there is a model of the Pylon designed to operate in either the lower or upper half of the FM broadcast band.

The Pylon can be safely mounted almost anywhere. Its low weight places a minimum of load and stress on any building or tower on which it might be mounted, and it is entirely self-supporting in its mounting. There are no appendages or protruding elements which high winds would cause to loosen or fall, or which would require bracing against the possibility of ice loading. Icing is a negligible problem with the Pylon because the transmission lines are inside the cylinder where ice formation is unlikely. The formation of ice on the outside will add only a negligible amount to the total weight and loading. De-icing equipment is not considered necessary.

The Pylon presents extremely simple installation problems. One feed point per section is all that is required. For most installations, the interconnecting feed line may be mounted in place on the ground, and the whole assembly raised at once. Maintenance problems for this antenna are reduced by the extreme simplicity of the feed line arrangements, the small number of end seals, and the fact that the lines are enclosed within the cylinder. Provision is made for mounting a standard 300 mm. code beacon on the top of the antenna. The 300 mm. code beacon and associated equipment for the Pylon are contained in MI-28216-A tower lighting kit. Steps on the cylinder provide a means of servicing the lamp or inspecting the slot. The slot is normally covered with a strip of polyethylene for the purpose of excluding water, ice and other foreign matter. If it should ever become necessary to service the transmission line harness within the Pylon, the securing bolts, which are accessible at the slot, may be removed, and the harness lowered to the ground. Shackles are provided at the top of the Pylon, both inside and out, to permit the rigging of a boat-swain's chair and for the purpose of facilitating the lowering and raising of the harness.

## There Is A Pylon For Every Application

In order to meet the requirements of the many different sets of circumstances under which an FM antenna may be installed, the Pylon has been made available under three different classifications, each of which serves the needs of a particular application. These three types of Pylons are designated as: the Standard Pylon, the Heavy Duty Pylon, and the Low Power Pylon.

### Standard Pylon

The Standard Pylon is designed to meet the requirements of the majority of FM installations. It meets all of the RMA specifications, and will safely handle the output of any presently designed FM transmitter—up to 50 kw. This Pylon is constructed of light weight sheet metal and is designed to combine the maximum of strength and rigidity with the minimum of weight. It meets the RMA recommended wind loading capability equivalent to a wind velocity of 87 mph, assuming the structure to be covered with a half inch layer of ice.

### Heavy Duty Pylon

The Heavy Duty Pylon, when used alone, far exceeds the RMA specifications. Like the Standard Pylon, it is also capable of handling any power up to 50 kw. This Pylon, however, is fabricated from a much heavier gauge metal and will withstand a wind velocity in excess of 160 mph. The Heavy Duty

Pylon is designed for those special applications where high winds of hurricane intensity are normally to be expected. In addition, it is especially applicable to FM/TV installations wherein the RCA Television Super Turnstile is mounted on top of the Pylon. When used in this manner, the combination meets the RMA recommended wind loading capacity of at least 87 mph.

### Low Power Pylon

The Low Power Pylon is the ideal interim antenna. It will handle a power of 3 kw, and will withstand a wind velocity of 87 mph. The Low Power Pylon is also a low cost installation, and may be used as the final antenna for many low power FM stations not necessarily requiring exceptionally high gain. It does, however, have the same gain as the other single section Pylons. When purchased originally to serve an interim function, it may always be used thereafter as a standby antenna.



*Low Power Pylon*



# Engineering Data For Pylon Antennas

## STANDARD PYLONS

Type No.	Sections	Frequency Range (Mcs.)	Nominal Power Gain	R (lbs.)	h <sub>1</sub> (ft.)	h <sub>2</sub> (ft.)	D <sub>1</sub> (in.)	D <sub>2</sub> (in.)	W (lbs.)	Stock Identification
BF-11A	1	88-97.4	1.5	501	7.5	13.5	19.5	22 <sup>5</sup> / <sub>8</sub>	350	MI-28221-A
BF-11B	1	96.4-108	1.5	501	7.5	13.5	19.5	22 <sup>5</sup> / <sub>8</sub>	350	MI-28221-B
BF-12A	2	88-94.5	3.0	950	14	27	19.5	22 <sup>5</sup> / <sub>8</sub>	700	MI-28222-A
BF-12B	2	94.5-108	3.0	950	14	27	19.5	22 <sup>5</sup> / <sub>8</sub>	700	MI-28222-B
BF-14A	4	88-97.4	6.0	1868	27.5	54	19.5	22 <sup>5</sup> / <sub>8</sub>	2000	MI-28224-A
BF-14B	4	97.4-108	6.0	1868	27.5	54	19.5	22 <sup>5</sup> / <sub>8</sub>	2000	MI-28224-B
BF-18A	8	88-97	12.0	3887	54	108	20.0	27	12497	MI-28228-A
BF-18B	8	97-108	12.0	3887	54	108	20.0	27	12497	MI-28228-B

## HEAVY DUTY PYLONS

BF-12E	2	88-98.5	3.0	1058	14	27	20.0	25	4322	MI-28222-E
BF-12F	2	96-108	3.0	1058	14	27	20.0	25	4322	MI-28222-F
BF-14C	4	88-96	6.0	2074	28.5	54	20.0	27	10497	MI-28224-C
BF-14D	4	96-108	6.0	2074	28.5	54	20.0	27	10497	MI-28224-D

## LOW POWER PYLONS

BF-21A	1	88-96	1.5	515	7.5	13.9	19.8	22	376	MI-28231-A
BF-21B	1	96-108	1.5	419	7.0	12.2	17.8	20	312	MI-28231-B

### LEGEND—

- R Wind force. Equivalent to 87 mph wind, RMA Standard.
- h<sub>1</sub> Height of center of wind force.
- h<sub>2</sub> Height of antenna. Does not include beacon (3 feet).
- D<sub>1</sub> Diameter of cylinder.
- D<sub>2</sub> Diameter of flange bolt circle.
- W Total weight including beacon lamp.

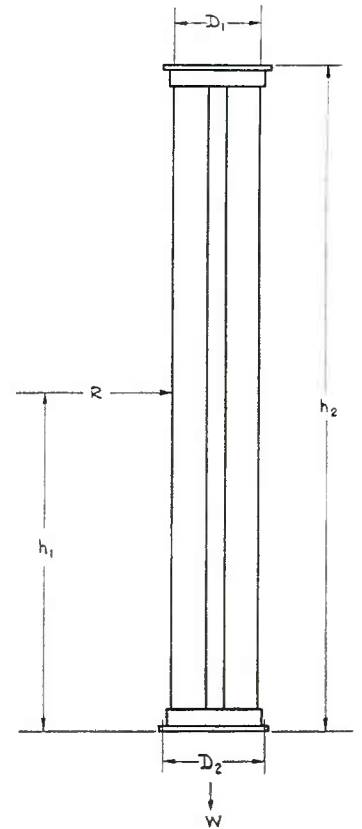

The Pylon is furnished complete with transmission line harness, fittings, mounting flanges, and all hardware. The harness of the Pylon terminates in a 51.5 ohm, 3<sup>1</sup>/<sub>8</sub>" flanged line at the base of the antenna. The standing wave ratio is, in all cases, less than 1.5. Connectors are available to couple the antenna to a 7/8", 1<sup>5</sup>/<sub>8</sub>", 3<sup>1</sup>/<sub>8</sub>", or 6<sup>1</sup>/<sub>8</sub>" plain or flanged transmission line. Where requested, RCA will also be glad to quote on tower and installation.



AM-FM Isolation Unit

### Accessory Equipment

300 mm Code Beacon Plus Cable:

- For Pylon of one or two sections.....MI-28216
- For Pylon of four or more sections.....MI-28216-A

Supporting Structures and Fittings.....On application

Coaxial Transmission Line for use from Antenna to Transmitter.....On application

FM-AM Isolation Unit Type BAF4A.....MI-28217

# Engineering Data For Pylon Super Turnstile Combination

The combined antenna structures are designed to withstand a maximum wind velocity of 85 mph when coated with 1/2" radial ice. Maximum unit stress = 20,000 lbs. per square inch. Reaction "R" shown is for estimating purposes only and is calculated on the basis of 20 lbs. per square foot of projected area without ice. All sections are rounds. "W" = total dead weight, including pole, 300 mm code beacon, pole steps, special connection between FM pylon and TV pole, transmission lines, Pylon, and miscellaneous hardware.

TABLE OF ORDERING INFORMATION

ITEM	TV CHANNELS	TV FREQ. BAND	TV SECTIONS	TV MI-SECTION	FM SECTIONS	FM FREQ. BAND	FM MI-SECTION	FM SALES TYPE NO.	TV SALES TYPE NO.
1	III	174-216 MC	6	19013-2	2	88-97 MC 97-108 MC	28222E 28222F	BF-12E BF-12F	TF-6B
2	III	174-216 MC	8	19013-2	4	88-99 MC 99-108 MC	28224C 282240	BF-14C BF-14D	TF-6B
3	VI	66-88 MC	3	19012-B2	2	88-97 MC 97-108 MC	28222-E 28222-F	BF-12E BF-12F	TF-3B
4	VI	66-88 MC	3	19012-B2	4	88-99 MC 99-108 MC	28224-C 28224-D	BF-14C BF-14D	TF-3B
5	III	54-66 MC	3	19012-A2	2	88-97 MC 97-108 MC	28222E 28222F	BF-12E BF-12F	TF-3B
6	III	54-66 MC	3	19012-A2	4	88-99 MC 99-108 MC	28224C 282240	BF-14C BF-14D	TF-3B

TABLE OF SPECIFICATIONS

ITEM	1	2	3	4	5	6
FREQ. MC.	174-216	174-216	66-88	66-88	54-66	54-66
TV NO. OF SECTIONS	6	6	3	3	3	3
APPROX. PWR. GAIN	7	7	4	4	3.8	3.8
FM NO. OF SECTIONS	2	4	2	4	2	4
APPROX. PWR. GAIN	3	6	3	6	3	6
A	13' 11"	27' 10"	13' 11"	27' 10"	13' 11"	27' 10"
B	27' 10"	55' 8"	27' 10"	55' 8"	27' 10"	55' 8"
C	32.0'	45.25'	33.5'	45.75'	42.6'	56.0'
D	54' 4 1/2"	82' 2 1/2"	56' 2 1/2"	84' 0 1/2"	60' 1"	87.11"
E	3' 2"	3' 2"	7' 3"	7' 3"	6' 11"	8' 11"
F FT	72' 5 1/2"	100' 3 1/2"	75' 11 1/2"	103' 9 1/2"	84' 1"	111' 11"
R LBS	2133	3119	2133	3149	2962	3978
W LBS	7092	13267	7442	13617	8988	15163
AREA SQ. FT. WITHOUT ICE	108.	161.	110	163	142.	195.
AREA SQ. FT. WITH 1/2" RADIAL ICE	145	205	140	200	190	250
MOMENT IN FOOT POUNDS NO ICE AT TOWER TOP	68,256	44,136	71,456	144,067	126,181	222,768
C' WITH 1/2" RADIAL ICE	34.75'	47.0'	33.9'	46.1'	43.0'	58.5'
R-LBS WITH 1/2" RADIAL ICE	2374	3482	2218	3306	3188	4256
MOMENT-FOOT POUNDS WITH 1/2" RADIAL ICE AT TOWER TOP	82,497	162,714	75,190	162,406	136,224	240,464

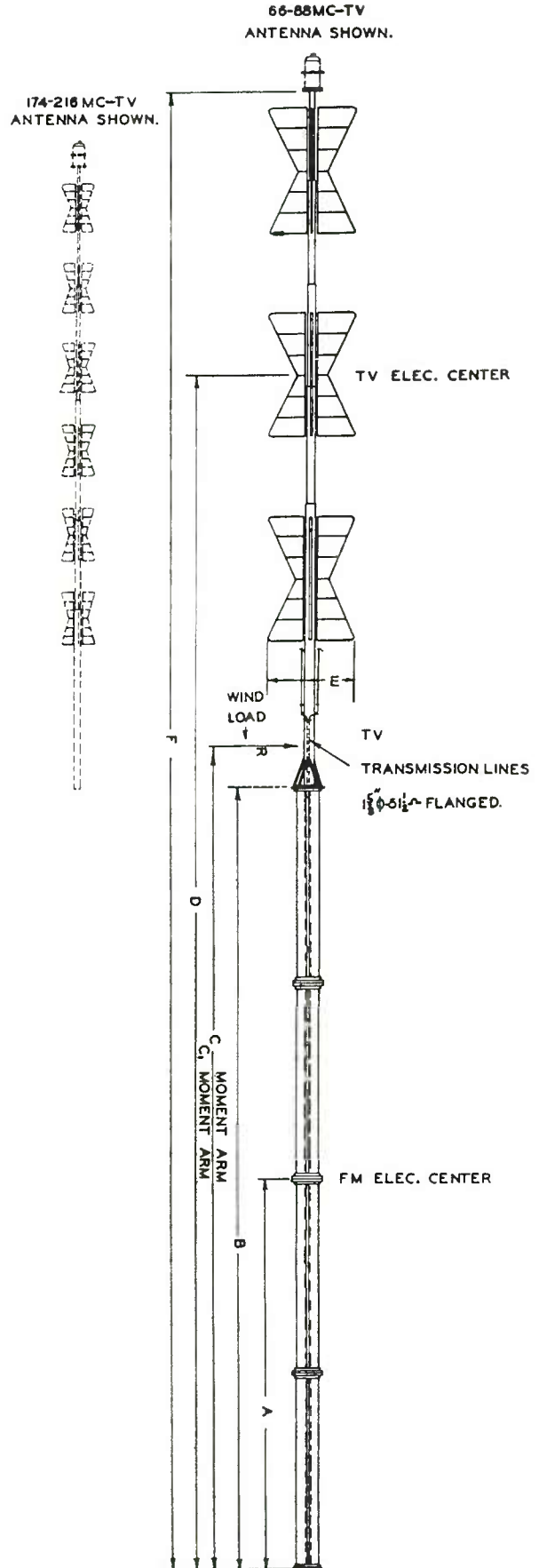

# AM-FM Isolation Unit Type BAF-4A

## Features

- No tuning adjustments required.
- Minimum effect on AM tower impedance.
- Efficient FM power transfer.
- Maintains low standing wave ratio on any FM channel.

## Uses

The RCA type BAF-4A FM-AM isolation unit is a device for transferring VHF power across the insulating zone of an AM antenna tower to feed an FM antenna mounted atop the tower. It is designed to provide complete isolation of FM and AM signals and efficient operation over the entire FM frequency range.

## Description

The circuit of the FM-AM Isolation Unit consists of two series-resonant circuits coupled together to such a degree as to provide good band-pass characteristics over a range of frequencies from 88 to 108 megacycles. The inductors consist of copper loops, and the capacitors consist of capacitor rings mounted concentric with the input and output transmission lines. The input assembly is insulated from the output assembly and there remains a stray capacitance of approximately 75mmfd. across the insulator. The effect of this capacitance in shunt with the input impedance will be negligible, except in the case of extremely high base impedance of the AM tower. In such cases, the stray capacitance may be parallel resonated by means of an auxiliary inductor.

The isolation unit is housed in a weatherproof metal box and includes provisions for mounting on a wooden pole or supporting platform either at the base of an insulated broadcast tower or in the immediate vicinity. A standard 1 $\frac{5}{8}$ " diameter 51.5-ohm transmission line extends six inches from the top and bottom of the unit for connection to the FM antenna line running up the tower and to the FM transmitter line running back to the transmitter house. Access to the interior of the housing for inspection or servicing is by means of a removable panel on one side. Provision is made for carrying the gas pressure across the unit by means of a composition high pressure hose.

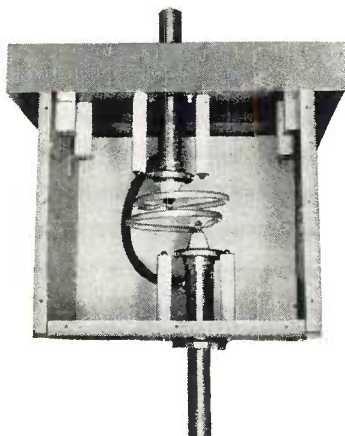

*Interior view of BAF-4A*



## Specifications

Frequency Range	88-108 mcs
Transmission Line Impedance	51.5 ohms
Input Impedance	51.5 ohms with 1.3 VSWR
Maximum FM Power	10 kw
Maximum AM Power	Base insulator voltage should not exceed 10,000 volts peak at 100% modulation

## Dimensions:

Height (housing)	17 $\frac{1}{2}$ "
Height (overall)	29 $\frac{1}{2}$ "
Width	19 $\frac{1}{2}$ "
Depth	19 $\frac{1}{2}$ "
Weight (net)	60 lbs.

## Accessories

- Adaptor for 3 $\frac{1}{8}$ " 51.5 ohm line  
Communication Products Catalog #84-506
- Adaptor for  $\frac{7}{8}$ " 51.5 ohm line (1 of each required)  
Communications Products Catalog #88-505  
#98-505

These adaptors are necessary only if an FM feed line other than 1 $\frac{5}{8}$ " diameter is used.

# Antenna Towers

RCA is a distributor of antenna towers for several prominent manufacturers. A wide selection of towers is available for all applications. These include standard self-supporting and guyed designs as well as custom made designs for special requirements, such as supporting structures for FM and TV antennas.

RCA can also furnish tower lighting equipment and tower erections, if desired. This may include erection and installation of FM or TV antennas and associated transmission lines.

Price and delivery quotations for towers and services may be obtained by forwarding essential information to RCA. The following questionnaire is provided as an aid to the station in determining specific requirements.

## Antenna Tower Questionnaire

### LOCATION

City \_\_\_\_\_ State \_\_\_\_\_

### QUOTATIONS TO BE FURNISHED

Tower: Guyed \_\_\_\_\_ ( )  
 Self-Supporting \_\_\_\_\_ ( )

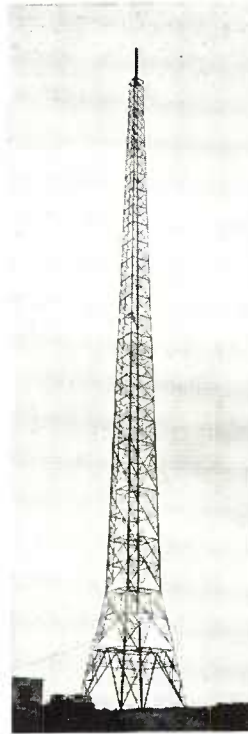

### Tower Erection:

Antenna and Harness Installation: FM \_\_\_\_\_ ( )  
 TV \_\_\_\_\_ ( )  
 Transmission Line Installation \_\_\_\_\_ ( )  
 Lighting Equipment \_\_\_\_\_ ( )

### SPECIFICATIONS

Tower Height: Ground to top of tower \_\_\_\_\_  
 Ground to top of base insulator \_\_\_\_\_

Tower Use: Antenna support \_\_\_\_\_  
 AM Radiator \_\_\_\_\_

AM Power \_\_\_\_\_ KW

Frequency \_\_\_\_\_ kcs.

FM Antenna: Type \_\_\_\_\_  
 Description \_\_\_\_\_

TV Antenna: Type \_\_\_\_\_  
 Description \_\_\_\_\_

Transmission Lines:                      Size                      Nr.

Design Load: B-1 Open Country \_\_\_\_\_  
 B-2 Congested Area \_\_\_\_\_

Remarks:  
 (Special requirements, site accessibility, etc.)

# Coaxial Line

RCA is prepared to furnish aid in determining the coaxial transmission line requirements of any FM, AM, or TV station. As a distributor for prominent coaxial line manufacturers, RCA is able to supply the necessary transmission line, associated fittings, and accessories for any type of complete antenna installation.

Interested stations are invited to submit detailed drawings or sketches of their proposed station and antenna layout plans for study and transmission line requirement recommendations by RCA.

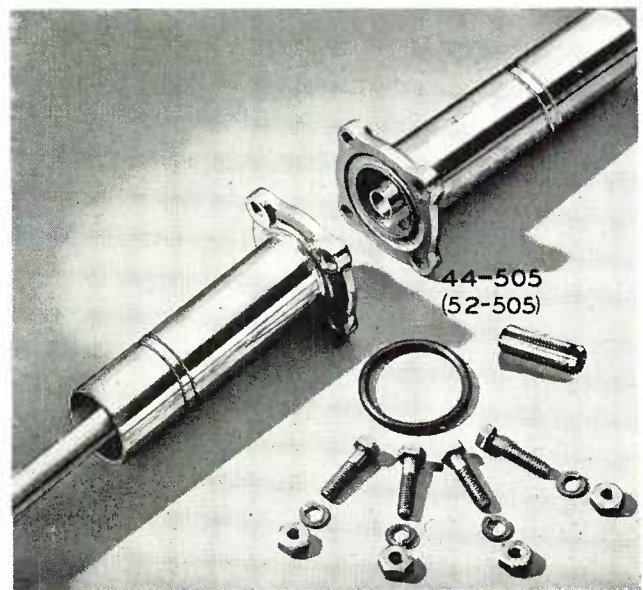
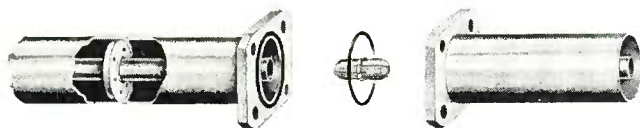

*Tower and two-section Pylon at WSBA-FM, York, Pa.*

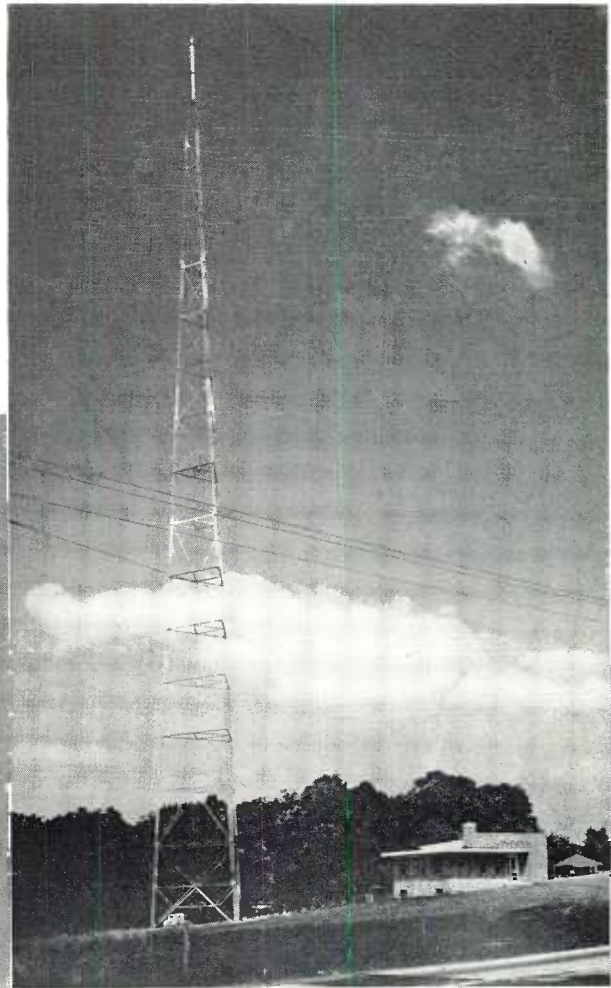

*Raising the four-section Pylon in one completely assembled unit at WJPG-FM, Green Bay, Wisc.*

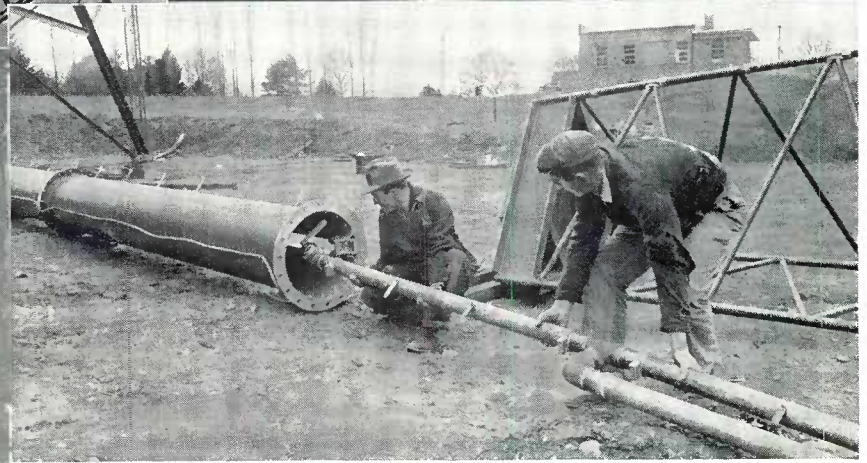
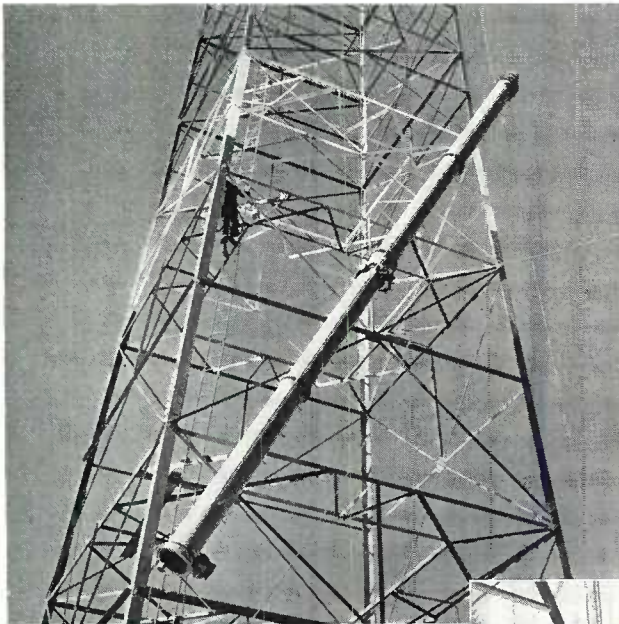

*Inserting the transmission line harness into the two-section Pylon at WSBA-FM, York, Pa.*

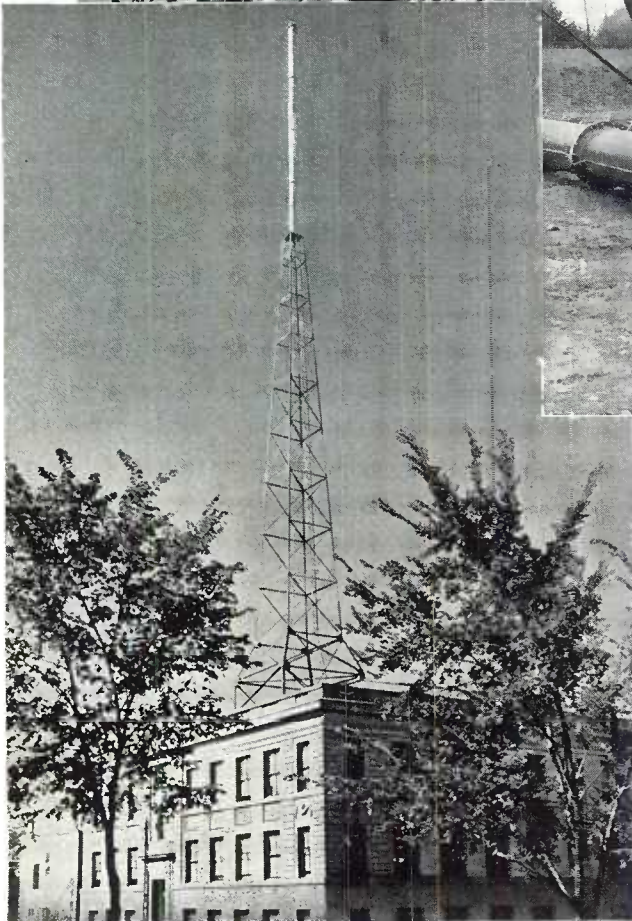

*Four-section Pylon installation with supporting tower atop building at WSUI, Iowa City, Iowa.*

# **TELEVISION STUDIO EQUIPMENT**

	<b>Page</b>
<b>CAMERAS</b>	<b>153</b>
<b>FILM PROJECTORS</b>	<b>157</b>
<b>SWITCHING EQUIPMENT</b>	<b>161</b>
<b>MONOSCOPE</b>	<b>162</b>
<b>SYNCHRONIZING GENERATOR</b>	<b>164</b>
<b>AMPLIFIERS</b>	<b>166</b>
<b>POWER SUPPLIES</b>	<b>169</b>

# How A Television Station Can Grow In Easy Stages

## STAGE ONE: A Minimum Layout Providing Facilities For Film and Network Programs Only

Many broadcasters, particularly in the smaller market areas, will want to start in television on a small scale. It will obviously be desirable for them to make their plans in such a way that investment and operating costs are relatively low during the initial period—increasing later as the scope of operations is broadened in accordance with the growth of the local television audience.

RCA television studio and transmitting equipment units have been designed to facilitate this normal expansion by making it easy and economical to add additional units as they are required. Two features are of outstanding importance. The first is that the basic units used in all RCA systems, large or small, are identical. The second is that the breakdown of the equipment into individual units has been carefully planned so that adding additional units does not make obsolete or useless any of the original units. The manner in which these features enable a television station to “grow” by easy stages is indicated by the illustrations on this and the following pages.

The diagram below shows the minimum equipment required for satisfactory operation of an independent (i.e., not a satellite) television station. Such a station would have all of the facilities necessary to transmit network programs or film programs originated locally. Live talent local programs would not be provided for during the initial period of station operation because of the relatively high cost of the additional facilities and staff required.

The studio and control equipment for a station of this type is relatively simple. Two 35 mm projectors are provided in order that continuous film programs (i.e., no break for re-winding) will be possible. A single film camera suffices, as it may be moved easily to face either projector port. The control console consists of a standard audio unit and a single video control unit. Auxiliary items include a transcription turntable, announce microphone and monitoring loudspeaker.

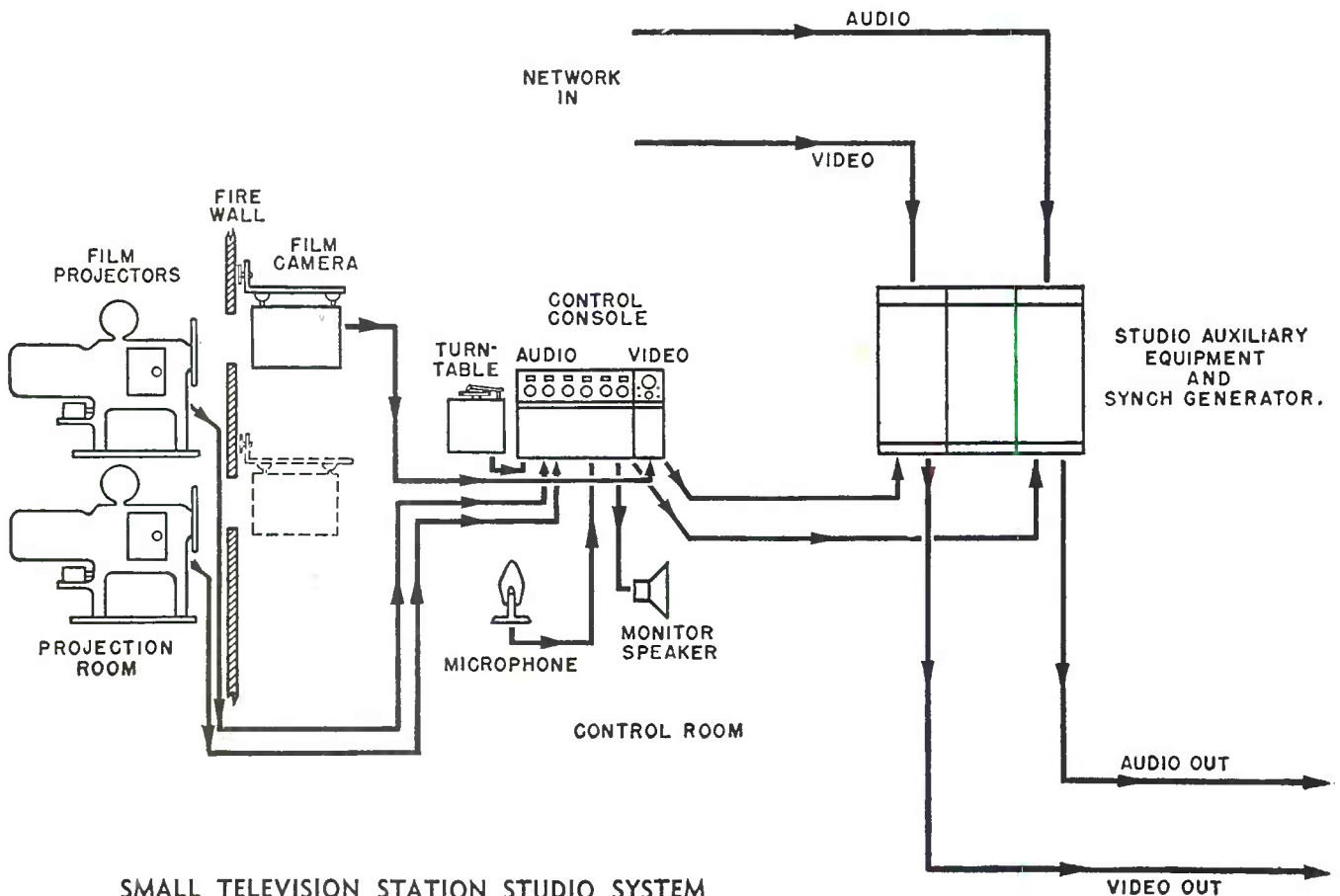

SMALL TELEVISION STATION STUDIO SYSTEM

## THE TRANSMITTER ROOM

By contrast, the equipment shown here in the transmitter room is fairly complete. It includes practically all of the units necessary for a television station. Since the transmitter room is much the same for all television stations, regardless of how elaborate or simple the studio facilities may be, only this one layout is shown. It is presumed that the station can grow completely through the four stages depicted here without necessitating any changes in the transmitter room equipment. This is necessarily so because even in the smallest station there can be no compromise in transmission quality or in compliance with FCC standards. The only marked difference in larger stations is that the transmitter and studio will nearly always be at different points, thereby requiring a coaxial or micro-wave link circuit.

The standard transmitter room installation includes the following basic pieces of equipment: five kilowatt television transmitter, vestigial side band filter and coupling network, transmitter console, audio and video amplifier and control

equipment, and auxiliary items such as record turntable, monitor speaker and microphone. Naturally, in addition to this equipment the station must also have an antenna and its associated tower.

The four stages in the development of a television station which are outlined in these pages can, of course, be varied in many ways. In most stations the additions indicated will probably be made in smaller steps than those shown. However, the arrangements shown here serve to illustrate the main stages and to indicate how the station may grow in accordance with its audience, starting in a small way with a minimum investment and operating staff, and adding facilities and personnel as the economics justify. The design of RCA Television equipment units makes it possible to do this without making original equipment obsolete, and with a minimum of interference to station operation during periods of equipment expansion.

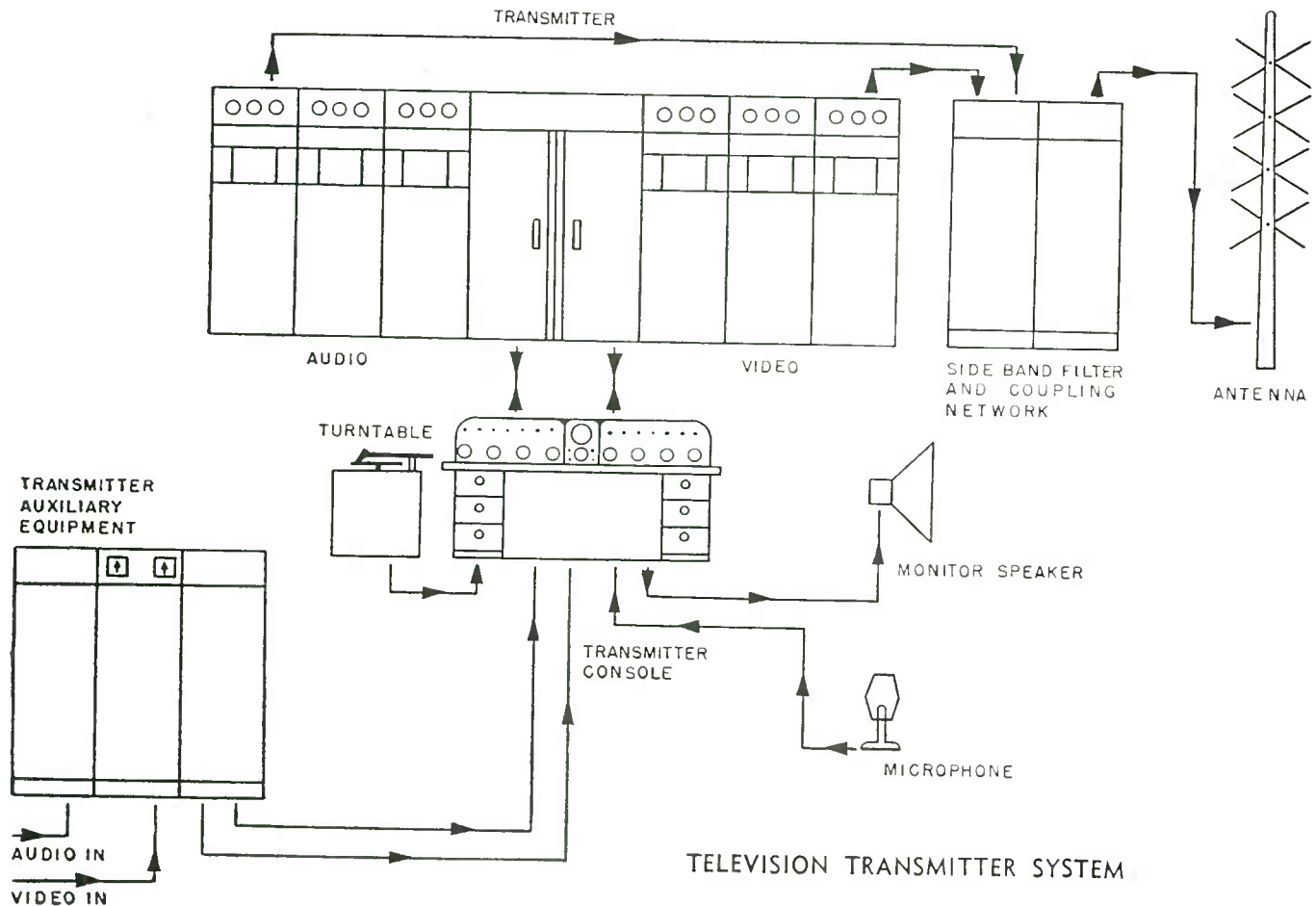



## STAGE TWO: Addition of Portable Equipment Provides For Field Pickups and Live Talent Studio Shows

When it is desired to increase the facilities included in Stage One this can be most easily and economically done by adding a set of RCA portable pickup equipment. This equipment consists of one or more cameras, an equal number of camera control units, a video master monitor unit, and audio and power supply units—all of which are designed and constructed in such manner as to be easily portable. While this equipment is intended primarily for field use its flexibility is such that it can easily be set up in the studio to produce the simple types of live talent shows. Thus, in Stage Two of the television plan outlined here, a set of this portable equipment will double as field and studio video equipment. This will make it possible for the station to put on a remote pickup—such as a football or basketball game—one night, and a local studio show the next night. Together with network and film programs this will make possible a reasonably varied program schedule. From one to four cameras may be used with this equipment. Since each camera “chain” (i.e., camera plus camera control unit) is independent of the others, it is entirely practical to start with one or two cameras and add others as required.

When the cameras are set up in the studios, the camera control units and the video master monitor unit are placed on a desk in the control room immediately adjacent to the con-

trol console. This desk is recessed so that the suitcase-type field units sit at an angle which brings their front panels flush with the panel of the control console. This gives the assembly the appearance of having been “built-in-one-piece,” and provides a compact and convenient operating unit. The portable synchronizing generator, and the power supply units may be placed beneath the desk or in any convenient nearby location.

For field use, the portable control equipment may be installed in a light truck, or it may be transported to the location and there set up wherever convenient. When it is to be operated in the truck it is handy to have a recessed desk similar to that used in the studio. Cabinets in the truck provide storage space for cameras, cables, microphones, etc. With a truck setup the cameras may be as much as 500 feet away with interphones providing communication between camera men and the control position. Where the truck cannot be brought within 500 feet of the camera positions it is necessary to set up the control units at some other convenient location.

In many cases it will be possible to send the video signal to the studio by means of specially-equalized telephone lines. When this is not feasible an RCA Microwave Relay Transmitter can be used.

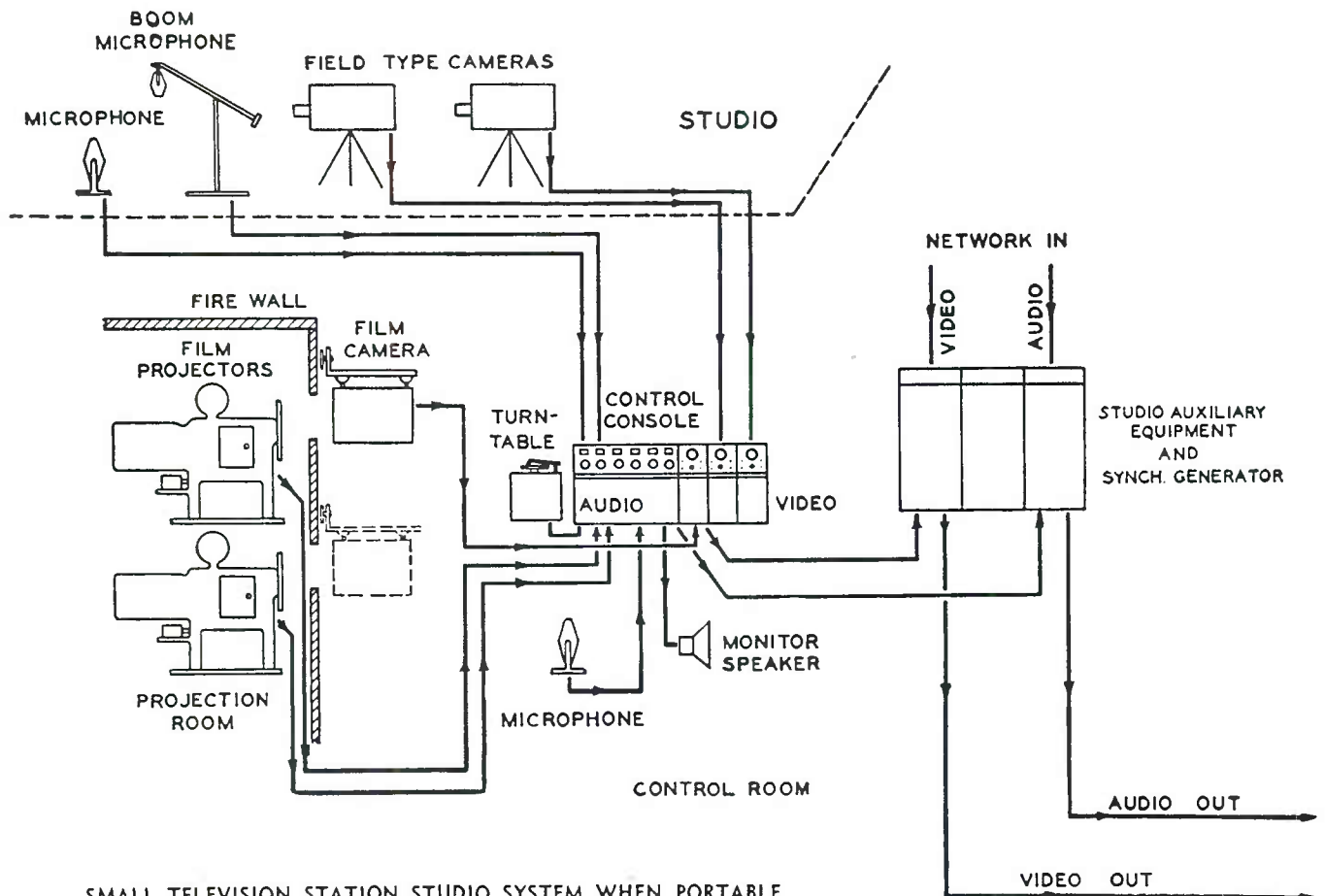

SMALL TELEVISION STATION STUDIO SYSTEM WHEN PORTABLE EQUIPMENT IS USED FOR LIVE TALENT STUDIO PRODUCTIONS

### STAGE THREE: Studio-Type Cameras and Video Equipment Added to Form a Permanent Video System

The equipment facilities included in Stage Two will provide for simple types of live talent studio programs in the early stages of station operation. However, as the station activities increase, several disadvantages will become evident. It will not, for instance, be possible to switch from a remote pickup to a studio show. Moreover, the equipment will not always be available for studio rehearsals and, in general, it will be less convenient to operate and maintain than would a permanent setup.

In going to Stage Three permanent equipment of fairly elaborate nature is installed in the live talent studio; the film equipment is greatly increased, and the control room facilities are expanded to include a large video console, a director's console and various additional auxiliary items.

The equipment in the studio (which, of course, can be varied to meet individual needs) includes three deluxe-type cameras. Two of these are usually mounted on small dollies while the third is mounted on a large crane-type dolly to provide for angle shots and shots from above. Two microphones are included (usually a number of additional microphone outlets are provided for). One of these is usually mounted on a large

boom-type stand while the other is suspended from overhead. In the film projection room a 16 mm projector and two slide projectors are added to the two 35 mm projectors previously installed, while in the control room a second film camera is installed. It will be noted that in thus enlarging the film facilities all of the original equipment is used—none is wasted.

In the control room proper the video and control equipment is, of course, greatly expanded. Here again, however, all of the original equipment is used without change. The audio console remains exactly as is, except that there are now more audio inputs brought into it. The video console now consists of five standard camera control units.

One entirely new item is the Director's Console. This desk-type unit contains three picture tubes which portray, respectively, the picture being transmitted, the picture on the second camera, and the "cue" picture on a program coming up.

In Stage Three the portable equipment is, of course, assigned entirely to field duty. The availability of special equipment for remote pickups, which is always ready (and preferably stored permanently in the field truck), is an advantage any broadcast engineer will appreciate.

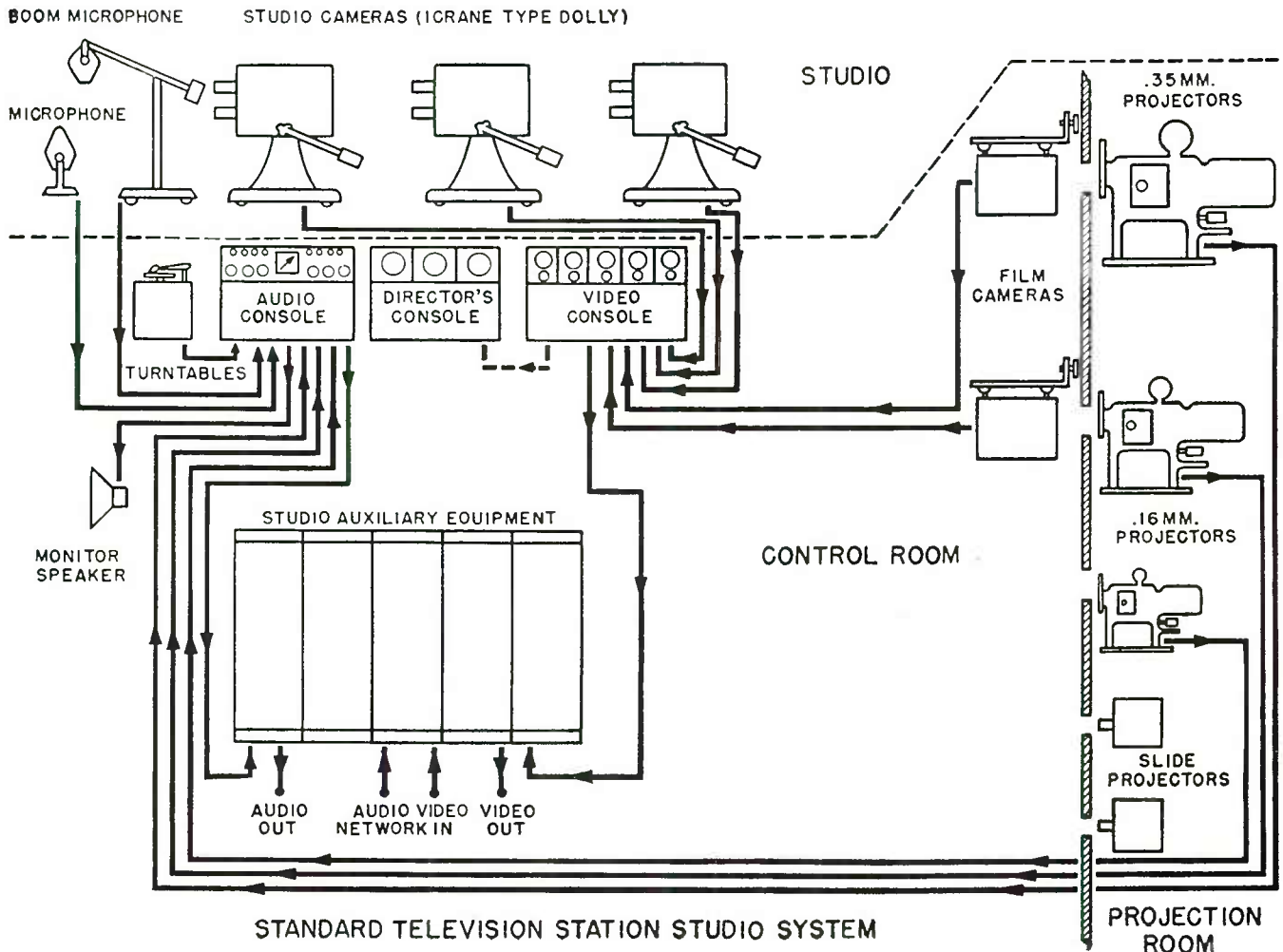

**STAGE FOUR: Additional Studio Provided and Master Control Room Added to Form a "Master Television Studio System"**

The equipment facilities included in Stage Three (preceding page) will provide for the requirements of most stations during at least the initial period of station development. Moreover, the unit plan on which RCA equipment is based makes it possible to add additional equipment, for example extra cameras, as these are required. It is even possible to add additional studios which can be handled from the original control room by the provision of additional camera control units. However, it is felt that major stations in large cities, and certainly all network stations that must originate many studio programs, will eventually require a master control setup, in which each studio has its own individual control booth and a separate master control room, is provided for centralizing all operations. Such an arrangement, which is similar in principle to that presently used in large broadcast stations and network studios, is the next stage in the television plan outlined here.

The arrangement depicted for Stage Four is a multi-studio installation in which each studio, whether film or live talent, is a complete operating unit in itself. Thus, while a program is being aired from one studio, rehearsals may be carried on

in others. Moreover, such rehearsals can be complete with the whole staff, including control room operators, in their final positions (which would not be possible if there were but one control room for all studios).

The number of live talent studios in an installation of this kind is not limited. A possible arrangement would be to provide space for as many as five or more, but to install equipment initially in only two or three. Each of these studios, with its associated control booths, would be equipped approximately as indicated for "Studio A" in the diagram below. It will be immediately noted that this equipment is the same as that provided in the studio and control room of Stage Three (except that film equipment has been moved to a new location). In fact, in progressing from Stage Three of this plan to Stage Four, it will often be possible to leave the original studio and control room intact. The transition can be made in easy steps by adding, one at a time, additional studios, each with its own control room.

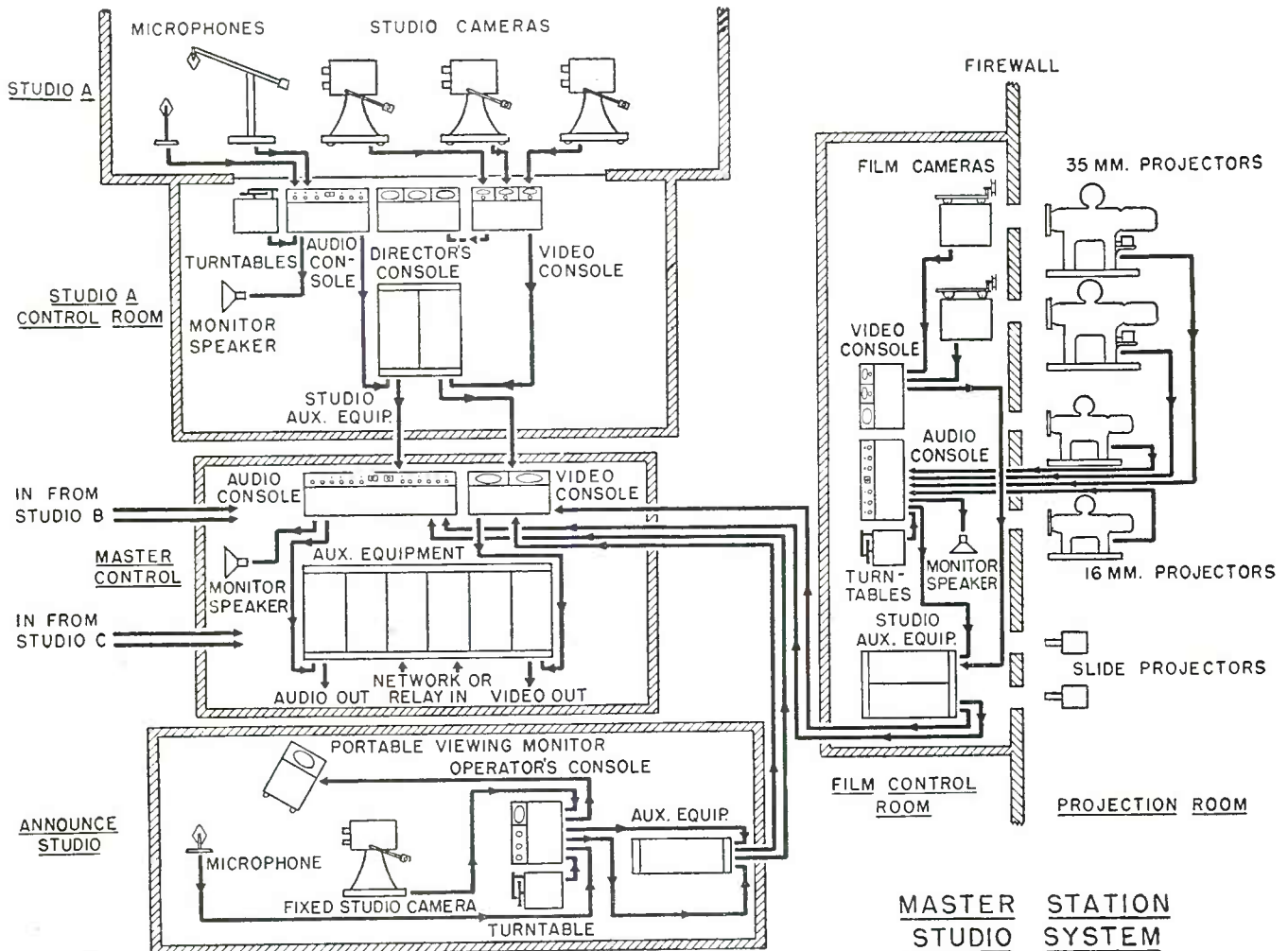

# RCA Television Studio Equipment

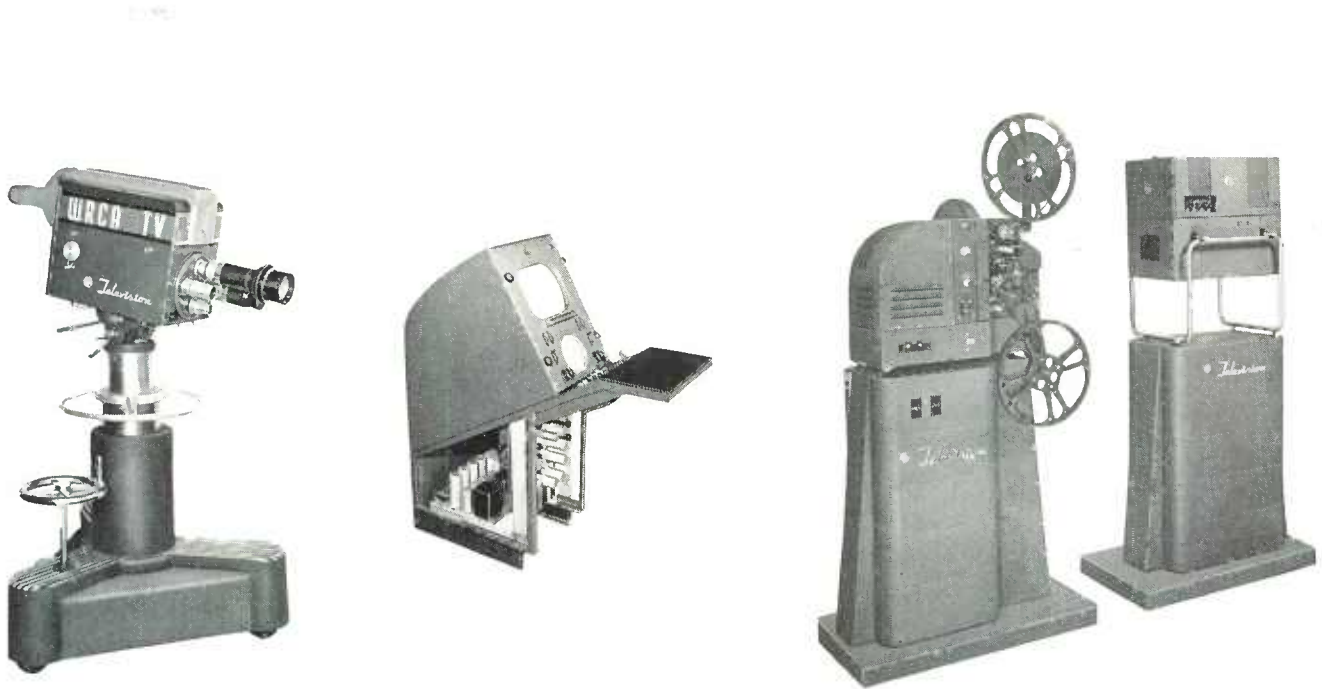

RCA Television Studio Equipment is designed for all television transmitting installations, large or small. It is economical for stations starting out in a small way, because a minimum number of equipment units will handle their early requirements. As these stations grow, and new sources of program material become available, additional equipment units can be added without discarding previously installed equipment. In this way the small broadcaster can expect to have eventually a station which duplicates in appearance and facilities those stations which start on a larger scale.

RCA add-a-unit designs are also economical for larger television stations; first, because they eliminate costly duplication of apparatus, and second, because their manufacture in relatively larger quantities makes it possible to offer better quality at lower prices.

For all television broadcasters who plan to provide studio and film telecasts, there are five basic types of equipment required. These are, namely: (1) Pickup equipment, i.e., studio cameras, film and slide projectors; (2) a switching system for the cameras (or for the studios); (3) sync generating equipment; (4) program monitoring equipment; and (5) camera dollies and pedestals, line amplifiers, power supplies, etc. These items can be obtained separately, so that in each case, the broadcaster

can buy to suit his particular needs. All units have matching appearance and number-gray finish. Moreover, they are electrically and mechanically designed to operate together. Additional units can be added at any time without fear of filling studios and control rooms with a number of dissimilar components.

A typical electrical arrangement of what we consider to be the basic equipment required for even the smallest station with studio facilities is shown in the block diagram above.

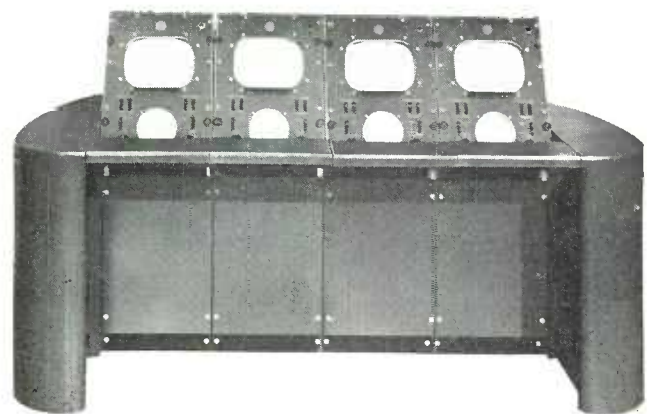

Use is made of two Type TK-10A Studio Camera equipments, two TK-20A Film Camera equipments, a TG-1A Studio Sync Generator, and a TS-10A Switching System. The switching system can handle six input lines. As shown in the diagram, two of these six inputs are used for remote lines such as network or field pickups, and the other four are divided between two studio cameras and two film cameras. Sync is fed from the Sync Generator through a pulse distribution box to the four camera equipments. Ordinarily, video signals fed to the remote inputs already contain sync which is supplied by the field equipment, or, in the case of the network input, is supplied at the station of origin. However, the switching system can also add sync automatically to remote input signals when necessary.

Program monitoring equipment required depends upon the number of studios employed by the broadcaster. For the smaller stations with perhaps one studio plus a projection

room, the video console formed by the camera control units and one switching unit will in most cases be adequate for satisfactory supervision and direction of programming. This video console is made up by bolting side by side one camera control section from each camera equipment plus a switching section. The addition of trim end-sections then forms an attractive desk-type console. Any number of these units can be fastened together.

Stations employing several studios and facilities for network programs will require a program director's console. This console is styled similarly to the video console, but the viewing monitors are built inside the housing and viewed through an opening in the top of the console. Thus, light cannot strike the screens. The director's console is provided with three monitors, two for preview and one for the program line. A switching panel allows the director to fade, lap-dissolve and switch the video signals.

## RCA TELEVISION STUDIO CAMERA EQUIPMENT

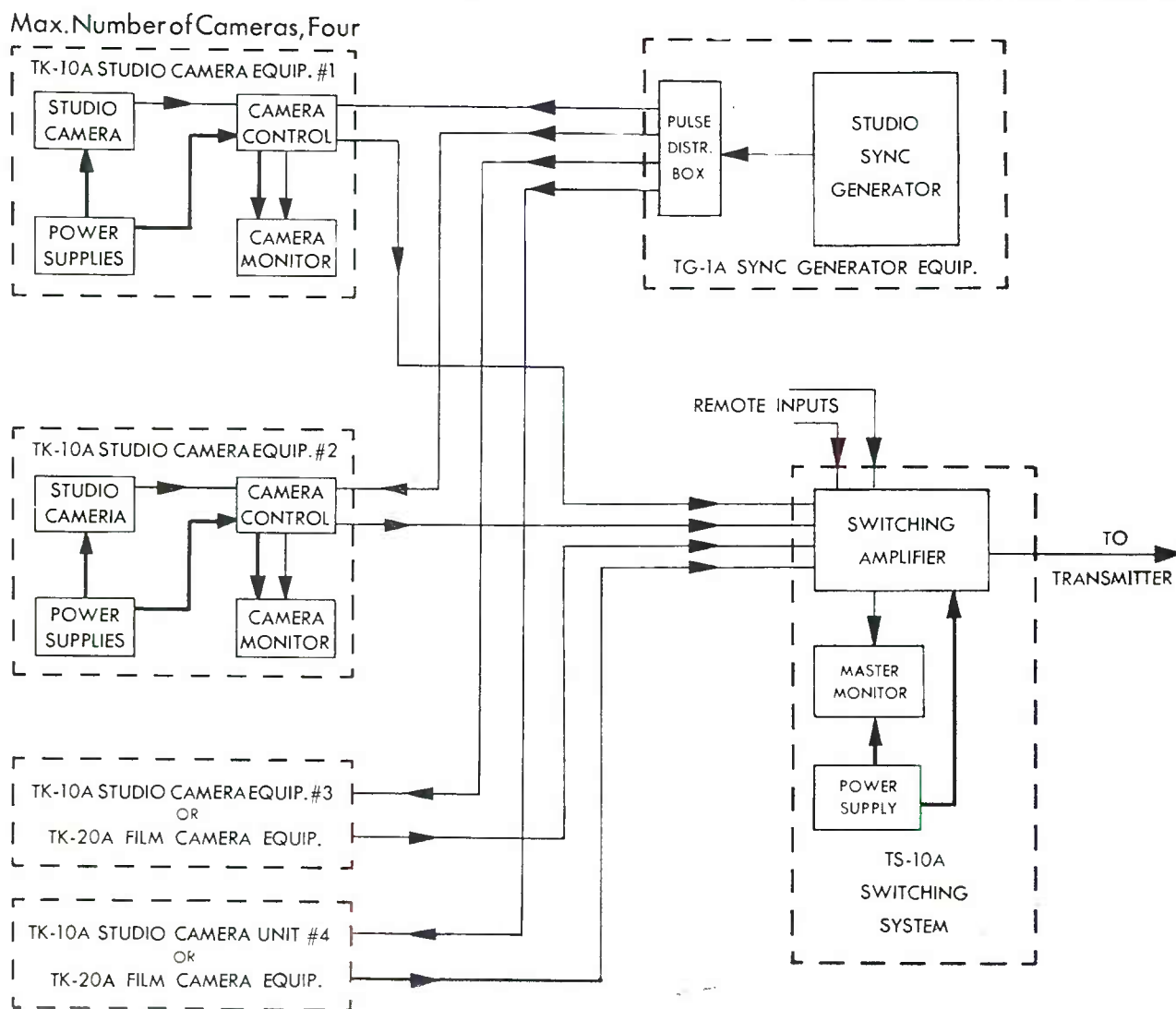

# Studio Camera Type TK-10A

## Features

- Camera does not require costly, uncomfortably-hot lights.
- Camera mounting designed for a standard tripod, a crane type dolly or studio pedestal.
- Four lens positions provided on a rotatable turret.
- Optical focusing easily accomplished by a knob on the side of the camera.
- Hinged doors and covers permit easy access to camera circuits and controls.
- Five tally lights, two on the front of the camera, one on rear of camera, one on the viewfinder and one along the viewfinder kinescope, indicate to the cameraman and performers when the camera is on-the-air.
- A combination microphone and headset for each operator produces program sound in one earphone and order wire conversation in the microphone and other earphone.
- Two jacks on camera—one for cameraman, one for production man.

## Uses

The TK-10A Studio Camera Equipment is designed to pick up scenes produced in television studios, and provide composite video signals that can be fed to a television transmitter.

The camera uses a studio type Image Orthicon pickup tube which requires much less light than former studio cameras employing the Iconoscope pickup tube. Under normal lighting conditions (100 to 200 foot-candles) an excellent picture is obtained. In fact, the quality of the picture compares favorably with that produced by the Iconoscope operating with light values of 1000 foot-candles.

## Description

The TK-10A Studio Camera Equipment consists of the Camera itself, which can be mounted on a crane type dolly or studio pedestal, a Camera Control mounted in a desk-type console section, and power supplies designed for rack mounting. The size and general appearance of the console section is identical to that of the Film Camera Equipment and the Studio Switching System. Therefore, the studio camera control unit can be used in conjunction with other studio and film units. Any number of these console sections (one for each camera) can be bolted together to form a convenient desk-type console.

### STUDIO CAMERA

The general arrangement of the controls and components of the Studio Camera resembles that of the RCA Field Camera. Like the field camera, the studio camera employs image orthicon deflection circuits, a picture preamplifier, and an electronic viewfinder which is mounted directly on the camera. The viewfinder, which enables the camera man to view the scene he is picking up, uses a small picture tube (RCA-5FP4A) which operates with an image brightness satisfactory for viewing scenes even in brightly lighted studios. Camera circuits are arranged on either side of the tube and coil assembly. On one side, the video preamplifier tubes are mounted on a shelf with the circuit components easily accessible on a terminal

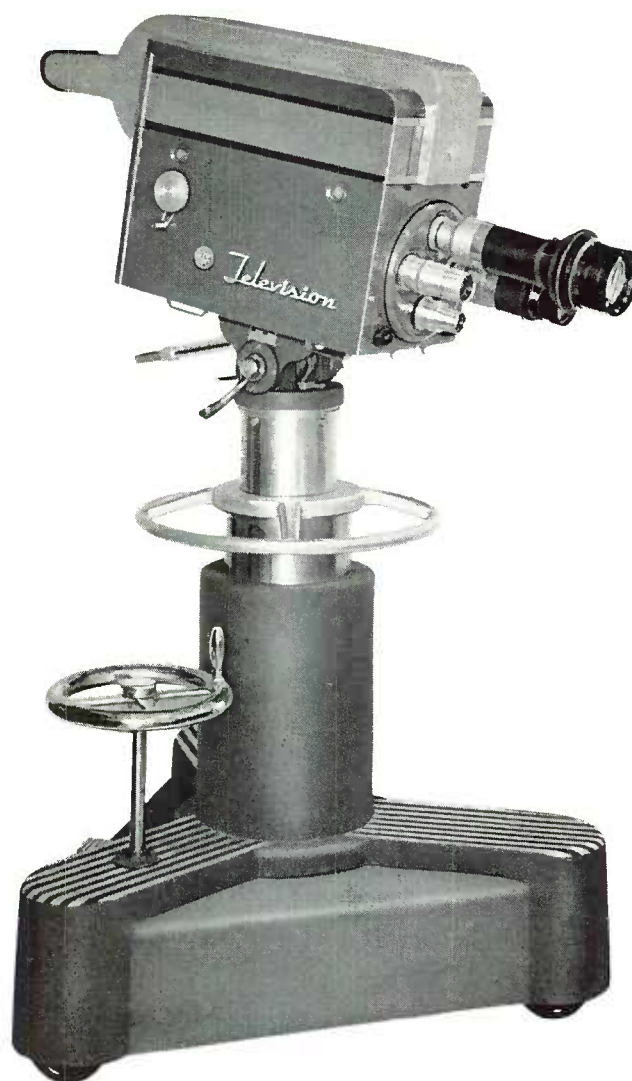

board below the shelf. The deflection and high voltage pulse supply circuits are mounted in a similar manner on the other side of the camera. Hinged doors on either side of the camera swing down to provide easy access to the camera circuits.

Four EKTAR type lenses are mounted on a lens turret which can be rotated by a handle at the rear of the camera. These lenses are relatively small due to the small size of the photocathode in the pickup tube. They are available in sizes from 35 mm f2.8 to 135 mm f3.8. Optical focusing is accomplished by adjustment of a knob on the side of the camera. This knob moves the pickup tube and its focus and deflection coil assembly with respect to the lens.

Controls for the studio camera circuits are located on the rear of the camera in two rows behind hinged covers. All these controls are normally preset and do not require adjustment during a program. Communication and tally light circuits are provided in the camera cable.

## CAMERAS

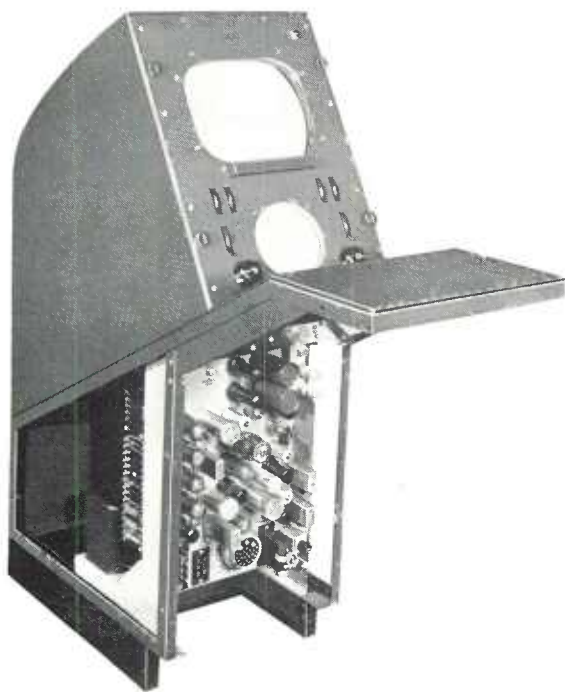

Studio Camera Control Unit

### STUDIO CAMERA CONTROL

The Studio Camera Control enables the video operator to monitor and control the quality of the picture signal produced by the studio camera. It is a desk-type console section with a TM-5A camera monitor mounted in the upper part, and the control chassis mounted in the compartment below. The camera monitor has a 10-inch picture tube for displaying the picture, and a 5-inch oscillograph tube which reproduces the picture signal waveform. Controls for gain and black level setting are brought out on the monitor front panel.

The control chassis contains the necessary circuits for amplifying the video signal, establishing black level, mixing in a sawtooth correcting signal, adding picture blanking to the picture signal, adding the synchronizing signal, and providing 3 separate outputs. It is a vertically mounted chassis with a bracket projecting from the top part of the chassis supporting the operating controls. Four commonly used controls project through the desk top surface. These are:

1. Orthicon Focus
2. Beam Current
3. Target
4. Image Focus

Three less frequently used controls are recessed under a small panel in the top surface.

The control unit complete with its controls can be removed easily from the console by removing the lower front panel and sliding the unit out. All electrical connections are made with plug-in connectors.

### POWER SUPPLIES

Four power supplies are required for each camera chain. These are as follows:

1. Type WP-33A to supply B+ to master monitor.
2. Type WP-33A to supply B+ to camera and viewfinder.
3. Type 580-C to supply B+ to camera control and to current regulator.
4. Current regulator to supply constant current to camera focus coil.

These four power supplies are designed for mounting in a standard rack in the studio control room.

### Specifications

Number of Lines	525
Odd Line Interlacing	2 to 1
Frame Rate	30 per sec.
Field Rate	60 per sec.
Picture Signal Level	1.5 volts, peak-to-peak max. (conforms to RMA standards)
Picture Polarity at Output	Black negative
Impedance of Coaxial Transmission Line	75 ohms
Maximum Length Camera Cable	1000 ft.
Total Included Angle of Lenses:	
(a) 35 mm f2.8 Ektar	50°
(b) 50 mm f1.9 Ektar	34°
(c) 90 mm f2.8 Ektar	20°
(d) 135 mm f1.5	13°
	(3 lenses furnished)
Incident Illumination (min.)	25 foot-candles
Incident Illumination for Best Results	100 to 200 foot-candles
Power Source	117 volts, 60 cycles
Power Consumption:	
(a) Heater Supply Camera Control	375 watts
(b) Two WP-33A Power Supplies	800 watts
(c) One 580-C Power Supply	370 watts
(d) Current Regulator	15 watts
Total for One Camera Chain	1560 watts

### MECHANICAL SPECIFICATIONS

Camera (including Viewfinder)	
Length	35"
Width	13"
Height	20"
Camera Control Console:	
Depth	36"
Width	13 $\frac{1}{4}$ "
Height (overall)	41"
Weights:	
Camera (including Viewfinder without lenses)	105 lbs.
Camera Control Console Assembly (including Master Monitor)	140 lbs.
Camera Cable	0.4 lbs. per foot

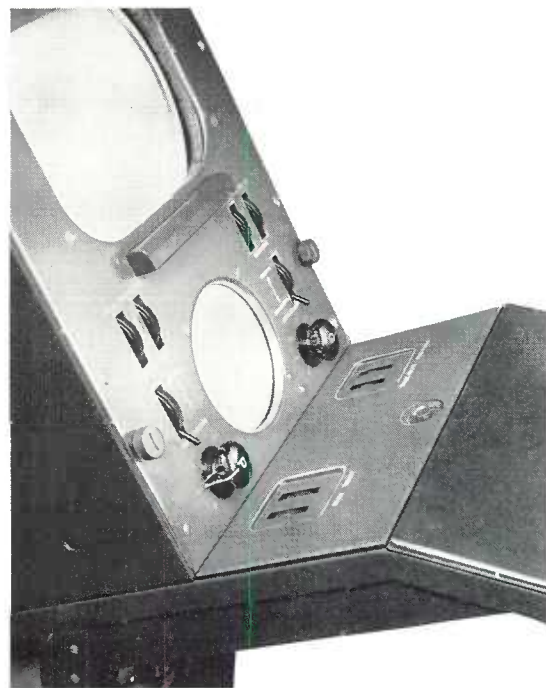

Close-up of Camera Control Unit controls (on sloping panel to right of TM-5A Monitor)

# Film Camera Type TK-20A



## Features

- Either positive or negative film can be used.
- Tubes and parts are easily accessible.
- Operation is simple—few controls are used.
- Camera can be operated 50 feet from control console.
- Oscilloscope in monitor can be used for measuring pulses.
- 10-inch aluminized tube for picture monitoring provides very bright picture.
- Clamp circuit eliminates low-frequency microphonics from video signal.

## Uses

The RCA Film Camera Equipment consists of a Film Camera, a Camera Control Unit, and associated power supplies and cables. This camera chain when properly set up with a motion picture film projector or a slide projector, and supplied with synchronizing signals, will produce standard video signals which can be fed to the television transmitter. By use of an RCA Multiplexer, which is a small, compact device having two mirrors mounted at the required angle, a single film camera can be arranged to serve two film projectors and a slide projector. The TK-20A can be used with either 16MM or 35MM projectors.

## Description

The Film Camera Equipment is designed to meet the requirements of any size television station. Ordinarily, the film camera is permanently mounted to the floor in the projection room, although it also can be mounted on a wall track so that it can be moved easily to any one of several film projectors installed in the room.

The Camera Control Unit consists of a chassis type unit containing circuits for control of the signal generated in the film camera, and a Type TM-5A Camera Monitor for analysis of the video signal and observation of its picture quality. These two units are mounted in a desk-type console section which is located in the transmitter room or studio control room. This console section can be grouped with other console housings (with end sections for trim) to form a neat convenient operating desk. The monitor unit contains a 10-inch picture tube and a 5-inch oscilloscope. D-c voltages for the TK-20A camera equipment are supplied by two Type WP-33A Heavy Duty regulated power supplies. These power supplies are rack-mounted in the control room or transmitter room. The TK-20A equipment is finished in umber gray to match other RCA television equipment.

## FILM CAMERA

In the illustration, the film camera is shown mounted on a pedestal, which provides for permanent mounting to the floor. If the camera is to be mounted on a wall track, the pedestal of course is not required. Contained in the film camera case



## CAMERAS

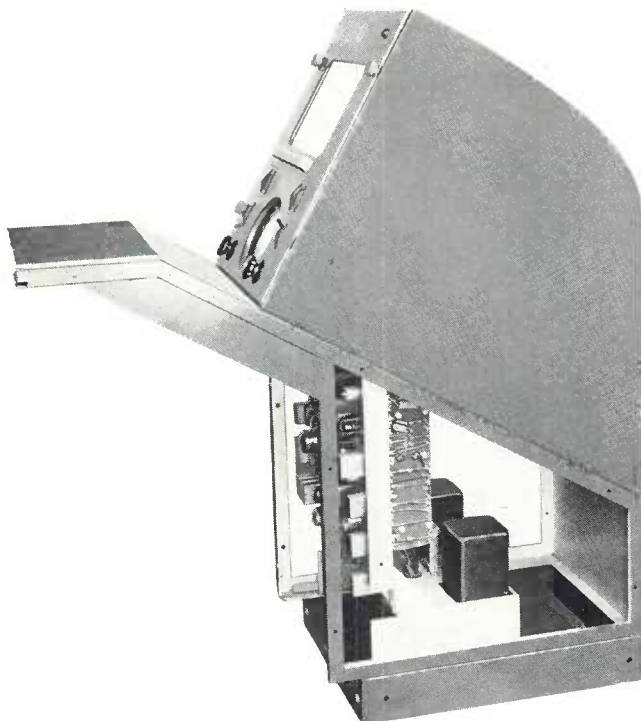

Camera Control Unit showing interior arrangement. This unit is normally housed in the master control console.

are the RCA 1850 Iconoscope pickup tube, blanking and deflection amplifiers and a 6-stage video preamplifier. Since the picture from the projector is focused directly on the mosaic of the Iconoscope, no focusing lenses are required for the film camera.

### CAMERA CONTROL

The Camera Control consists of the control unit proper and the Type TM-5A Camera Monitor. The control unit contains a picture signal amplifier fed by the preamplifier in the camera, pulse line amplifiers to feed driving signals from the studio sync generator to the camera, and several controls directly associated with the operation of circuits in the camera. All components of the control unit are mounted on a chassis installed in the console desk directly below the camera monitor, the controls projecting through a sloping panel on the top of the console.

Electrically, the Camera Monitor is identical to the TM-5A Master Monitor used with the field camera equipment. It contains a 10-inch aluminum-backed Kinescope for observation of the composite video signal fed to the transmitter, and a 5-inch oscilloscope for viewing the signal waveform and for quickly and accurately measuring signal levels. A calibration circuit in the monitor permits quick reference to a fixed voltage level. Circuits in the camera monitor include separate low-capacity inputs, video amplifiers and scanning generators for both the Kinescope and oscilloscope tubes. Transformers within the TM-5A provide filament voltages for all tubes in the monitor. Plate voltages are supplied by one of the WP-33A power supplies.

### POWER SUPPLIES

The Type WP-33A Heavy Duty power supplies each furnish extremely well-regulated d-c voltages at loads from 200 to 600 milliamperes. Output voltages are adjustable between 260 and 295 volts. The components are assembled on recessed type chassis for mounting in standard cabinets or open racks.

### Specifications

#### POWER REQUIREMENTS

Line Rating	105-125 volts, 60 cycle, single phase
Power	1000 watts
Current	10.1 amps.
Power Factor	0.94

#### INPUT SIGNALS

Horiz. Drive	4 volts, 15,750 cps, 10% pulse width
Vert. Drive	4 volts, 60 cps, 4% pulse width
CRO Drive (optional)	8 volts, mixed 30 cps and 7,875 cps
Mixed Sync (optional)	4 volts, RMA signal
Mixed Blanking	4 volts, RMA signal
Communication Circuits	

#### OUTPUT SIGNALS

Picture Output	1.5 v. peak-to-peak (picture signal)
Remote Monitor Output	1.5 v. peak-to-peak (picture signal)
Frequency Response	Flat within 1 db to 6 megacycles
Input Impedance for Pulses	High



Typical arrangement of TK-20A Film Camera and TP-16A Film Projector

# Film Projector Type TP-16A

## Features

- Simple, straightforward film path provides for quick and easy threading.
- Removable film gate makes aperture cleaning easy.
- Constant light source provides utmost simplicity in design.
- Film lengths up to 2000 feet can be used without replacing reels.
- Coated lenses minimize reflections and improve contrast.
- Resolving power of lens is 60 lines per millimeter at any point in the field.
- Projector can be operated on a current supply of 50 cycles as well as 60 cycles.

## Uses

The TP-16A Film Projector is used in television studios to provide regular program material using standard 16mm sound motion-picture film. To obtain the video signal, the projector is used in conjunction with the TK-20A Film Camera, and the two units are mounted in such a position that the TP-16A projects a picture directly onto the mosaic of the picture tube in the film camera.

The TK-20A Film Camera is similar to a studio camera except that it is not provided with any optical focusing system. Instead, the optical system of the projector is used to size and focus the picture which is projected on the pickup tube mosaic.

When more than one projector is used, it is not necessary to have a separate camera for each projector. If the film projectors are arranged in pairs, a mirror switching arrangement may be employed to make one camera serve both projectors. Since projectors are ordinarily used in pairs (for showing alternate reels) this is a very practical arrangement.

## Description

The TP-16A Projector is entirely self-contained and, with the exception of the film feed arrangement, is entirely enclosed. The projector housing is provided with an attractive umber-gray crackle finish matching that of other RCA television equipment. The projector proper is mounted on a heavy cast base frame. This frame in turn is mounted by means of leveling screws on a lightweight pedestal of matching design and finish. This pedestal greatly improves the appearance and provides a convenient place for mounting the controls and field-supply for the special three-phase motor which is a feature of the TP-16A.

The mechanism of the Type TP-16A Television Projector is an adaptation of that used in RCA's outstandingly successful PG-201 Deluxe 16mm Sound Projector. The film feed arrangement, optical system, and sound pickup unit of the TP-16A are identical to those of the PG-201. The cast-aluminum frame and the front part of the projector housing are also the same. Use of these precision-made components, whose satisfactoriness is attested by thousands of PG-201's in use, not only insures trouble-free operation, but also makes it possible to provide a deluxe-type projector at a price much lower than would be entailed if these machines were special-developed and manufactured from scratch in the relatively small quantities required for television use.

The optical projection system consists of a 1000-watt air blast cooled incandescent lamp, a silver-coated pyrex glass reflector, a large two-element aspheric condenser lens, and a 3 inch, F.2 "coated" projection lens. This system provides plenty of

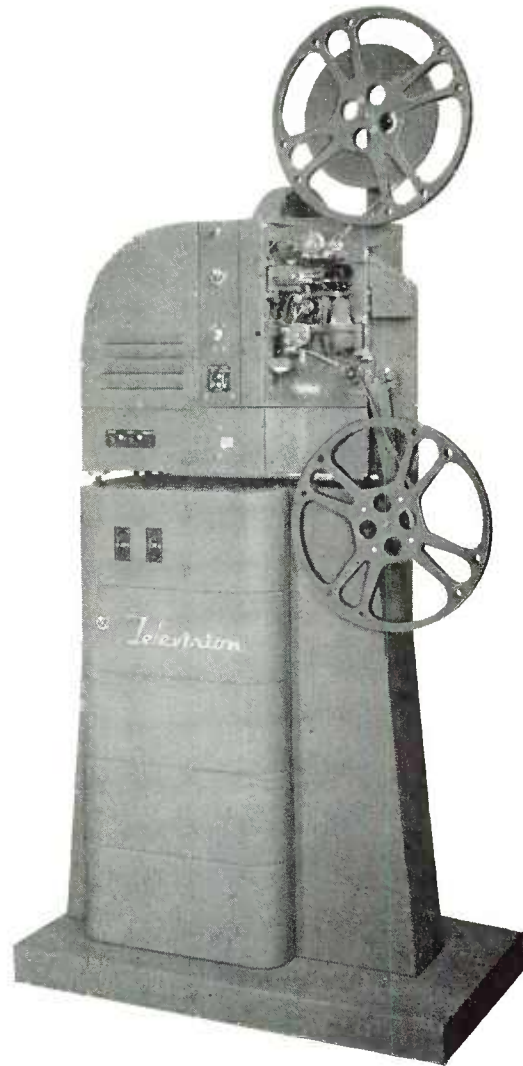

illumination on the mosaic of the camera iconoscope and is, of course, much simpler than systems using switched or pulsed light sources.

The film feed arrangement of the TP-16A is identical to that of the standard projector with the exception that the pull-down claw works at a greater speed. Film is fed from the upper reel under a large sixteen-tooth feed sprocket and through the precision made film gate. Light, controlled by a rotating shutter, is projected through the film at this point. The film is pulled down through the gate, a single frame at a time, by the pull-down claw just below the gate.

Since television standards (and proper synchronization) require transmission of 60 fields (30 frame, interlaced) per second, and motion picture film is made for projection at 24 frames per second, some means must be provided for conversion from the one rate to the other. In the TP-16A this is done by "scanning" the first frame twice, the second frame three times, the third twice, the fourth three times, and so on. The average rate, then is  $2\frac{1}{2}$  scanings per frame—which, multiplied by the 24 frames per second, provides 60 scanned fields per second.

If the "pull-down" could be accomplished during the vertical blanking interval—1/750th of a second, every 1/60th of a second—no further modifications of the standard projector would be necessary. Unfortunately this is not mechanically possible. Therefore, a further stratagem is employed. This consists in the use of short light flashes so timed that the film picture is projected on the pickup tube mosaic for only 1/1200th of a second, every 1/60th of a second. These flashes occur during the vertical retrace time and are provided by a rotary shutter which consists of an 18-inch metal disc with a slot cut in its periphery. This disc is driven at a speed of exactly 3600 rpm by a special 3-phase synchronous motor. This arrangement is possible because the mosaic of the pickup tube "stores" the picture during the interval between flashes of illumination.

Synchronization of the TP-16A Projector with the television system is assured by virtue of the fact that both the television synchronizing generator (which drives the beam in the camera pickup tube) and the motor which drives the projector shutter have a common source of power. To insure that the shutter will be in step at all times a large-size motor with a separately excited d-c field is used. The d-c field, being polarized, makes the motor always "lock" in proper phase relationship with the sync generator. The power supply for the motor field is mounted in the pedestal.

## Sound System

A number of unusual features are incorporated in this sound unit. One is the use of radio-frequency voltage (28 kc) on the exciter lamp filament. This prevents hum and noise from being introduced by the lamp itself. Another feature is the fact that the exciter lamp mounting and sound carriage are die-cast in one piece, thereby insuring permanent accurate alignment. Still another is the use of the famous RCA-developed rotary stabilizer on the sound drive. This maintains smoothly uniform film speed for sound take-off—a guarantee of sound reproduction at originally recorded pitch.

An audio preamplifier is built into the base of the projector. This amplifier, which is of conventional design, employs an RCA-1620 as a photo-cell amplifier, an RCA-6J7 as a voltage amplifier and RCA 6V6GT/G as an output tube. A tapped output transformer provides output impedances of 250 or 500 ohms. Output level is +4VU at 1000 cycles with less than 1% total r-m-s harmonic distortion.

The audio amplifier is assembled on a small chassis which can be easily removed from the base housing. Also mounted on this panel is the 28 kc oscillator which supplies voltage for the filament of the exciter lamp and a power supply using a 5Y3-GT/E which supplies plate voltage for the amplifier and oscillator.

A sound equalizer panel is available as an accessory for the projector sound channel and is identified as MI-26313. The unit is constructed to be mounted convenient to the audio control position so that the film sound may be easily adjusted for proper response. The compensation in frequency response is necessary because of the wide variation in recording of and printing of 16mm films. A single control is used in a tilt circuit with a straight through center position; with three high boost and three low boost positions of 2.5 db steps each.

## Provision for Remote Control

Controls mounted on the projector include "Standby," "Emergency Run," "Start," "Stop" and "Remote." When the remote switch is operated, "Start" and "Stop" controls at a remote location may be used to control operation. These circuits operate through relays and a master contactor mounted on the pedestal.

## Maintenance Features

Easy and quick maintenance is one of the features of the TP-16A projector. The field power supply, control circuits and all external connectors in the pedestal are easily reached by removing the pedestal side covers. The preamplifier and exciter filament supply unit are available when the cover plate, held by two thumbscrews, is removed. The projector lamp is reached through a hinged door. The film gate assembly is easily removed for cleaning. All parts of the film feed system are in the open where they may be constantly observed.

## Specifications

Film Type	Standard 16mm
Film Capacity	400' to 2000'
Film Speed	24 frames per second
Shutter Speed	60 frames per second
Projector Lens Line	48" above floor
Projection Distance (3" lens)	40"
Audio Output Power	+4 VU at 1000 cycles
Output Impedance	250/500 ohms
Frequency Response	+2 db from 80 to 3000 cycles ±3 db from 80 to 4000 cycles
Hum and Noise Level	50 db below output level
Dimensions	Height 68"; Length 32"; Width 16¾"
Weight	Projector 90 lbs.; Pedestal 135 lbs.; Total 225 lbs.
Tubes Required	1 RCA-927, 1 RCA-1620, 2 RCA-6V6GT/G, 4 RCA-5Y3GT/G, Projector Lamp T-12
Power Required	209-220 volts, three-phase 250 watts 105-125 volts, single-phase 1200 watts

# Film Projector Type TP-35A

## Features

- Highly efficient pulsed light source, no shutter mechanism required.
- Quiet operation.
- Excellent picture definition.
- Completely enclosed unit—even to film magazines.
- Very little heat on film—stills of any frame of the film can be projected.
- Spectral characteristics of light source comparable to natural light—advantageous for use of color film.
- RCA sound head used—response flat out to 6 kc.
- Light output of projector favorable for proper operation of film camera.

## Use

The TP-35A 35mm Television Projector is designed for use in television stations as a means for utilizing standard 35mm sound motion picture films as program material. The TP-35A can be used as the single source of program material for the television station, or it may be alternated with "live" programs and network shows to add variety to the station's program schedule.

The TP-35A Projector is designed for use with the TK-20A Film Camera. In the simplest arrangement, the projector is mounted in such a position that it projects motion pictures directly on the pickup tube in the TK-20A Film Camera. The video signal produced by the camera is then fed to the studio control room. A single TK-20A Film Camera can serve two motion picture projectors and a slide projector by using a Multiplexer. This device employs a slide projector and two mirrors mounted at the required angle to direct the pictures from either projector onto the pickup tube of the film camera.

## Description

The TP-35A Projector is entirely enclosed. The housing is finished in an attractive amber-gray crackle finish, matching that of other RCA equipment. Shatterproof glass windows permit viewing the operation of the mechanism without removing any door or cover.

Film is fed from the upper film magazine down through the film feed sprocket and through the film gate in the picture head. At this point, light produced by a pulsed-light lamp is projected through the film. The pulsed-light system eliminates the need for a shutter mechanism. It consists of an electrically operated gas-filled lamp which produces short pulses of light at the required rate of speed. The film then passes over the sound drum to the lower film magazine in the pedestal of the projector.

Also contained in the pedestal is a power supply which furnishes d-c voltage for the field of the driving motor, and a terminal board on which is mounted the relay for the pulsed-

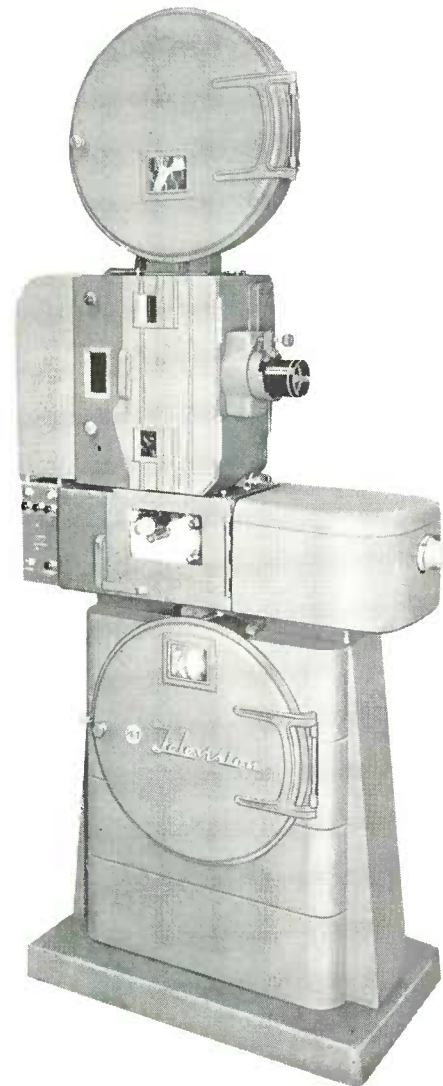

light lamp. Power for this lamp is furnished by a power supply which can be mounted in the studio control room rack containing the monitoring equipment and remote control panel. A control box on the rear of the projector contains the necessary switches for starting and stopping. For the use of two projectors, a changeover panel is provided. This panel, which is rack-mounted directly below the video monitor in the projection room, contains switches for starting and stopping either projector, and for changing over from one projector to the other. The changeover switches control relays which switch the optical systems (douse and undouse) as well as the sound circuits.

All moving parts of the projector are automatically and continuously lubricated. A pump inside the housing delivers a continuous flow of oil from the reservoir at the base of the main frame to the rotary lubricator which throws the oil over the gears and to every bearing. An oil sight gauge provides an indication of the amount of oil in the reservoir.

# Film Multiplexer Type TP-9A

## Features

- Permits use of a single film camera for two film projectors.
- Employs built-in slide projector.
- Employs long life front-surface type mirrors.
- Aids program continuity.
- Introduces negligible optical distortion.
- Permits use of a stand-by film projector.
- Designed for use with 16mm and 35mm projectors.
- Employs no moving parts.

## Uses

The Film Multiplexer is a device for use in the television projection room. It enables television station personnel to permanently arrange a single film camera and two film projectors so that either projector can be used with the film camera, without need for moving the units about the room.

The Multiplexer employs two mirrors mounted at the required angle to reflect the image from either projector onto the pickup tube in the film camera. In addition, a small slide projector mounted just above the two mirrors provides a means for station identification. The image from the slide projector is focused directly on the tube in the film camera.

Using the Film Multiplexer, it is also possible to have a standby film camera already set up for emergency use. The four units are then mounted opposite each other with the Multiplexer in the center. Since the mirror and slide projector assembly of the Multiplexer swivels on the pedestal mounting, the Multiplexer can be quickly swung around to serve either film camera.

## Description

The Film Multiplexer consists of a cast aluminum pedestal which mounts two front-surface mirrors and a slide projector. The pedestal is fitted with a flange at the bottom for bolting to the floor. The slide projector is an Eastman Type A-2 Kodaslide Projector with a 100-watt projection lamp. The Multiplexer is finished in umber gray to match other RCA television equipment.

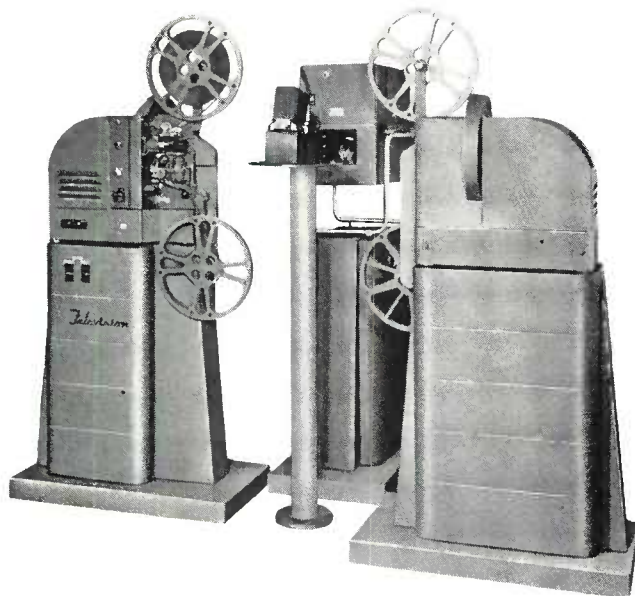

*Typical projection installation showing Multiplexer with two TP-16A Film Projectors and TK-20A Film Camera*

## Specifications

Power Requirement (for projector lamp)	110 volts a-c, 50/60 cycles
Dimensions (overall):	
Height	54"
Width	13"
Weight	40 lbs.
Stock Identification	MI-26318

# Studio Camera Switching Equipment Type TS-10A

## Features

- System will accommodate six signal inputs.
- Manual fading control allows choice of any fading speed.
- Remote signals can be previewed before being switched on-the-air.
- Full complement of tally lights.
- Tally lights at on-the-air cameras are activated by the switching system.
- Local sync automatically added when remote sync fails.
- Private or conference communication can be maintained between all stations.
- Intercommunication can be operated with other equipment off.
- All personnel have access to program sound.
- Stabilizing amplifier automatically corrects picture-sync ratio for transmitter.

## Uses

The TS-10A Studio Camera Switching System is designed for use by television stations obtaining video signals from more than one line. Briefly, the TS-10A will allow a single video operator to do these things: (1) Select any signal from six input lines; (2) switch the desired signal into the on-the-air line; (3) fade or dissolve two signals simultaneously at any speed; (4) fade in or fade out any one signal; (5) switch instantaneously from one signal to another; and (6) superimpose two signals with any desired degree of magnitude for each signal.

Intercommunication circuits in the TS-10A allow program personnel two-way conversation. In addition, volume-controlled program sound is supplied to all personnel through one earpiece of their headset.

## Description

The TS-10A Studio Camera Switching Equipment consists of the switching amplifier chassis-type unit, a TM-5A Master Monitor, two WP-33A Power Supplies and a TA-5B Stabilizing Amplifier. The switching amplifier is mounted in the lower compartment of an RCA desk-type console section, and the TM-5A Master Monitor is mounted above it. The TA-5B Stabilizing Amplifier and WP-33A Power Supplies are also chassis-type units designed for mounting in a standard equipment rack.

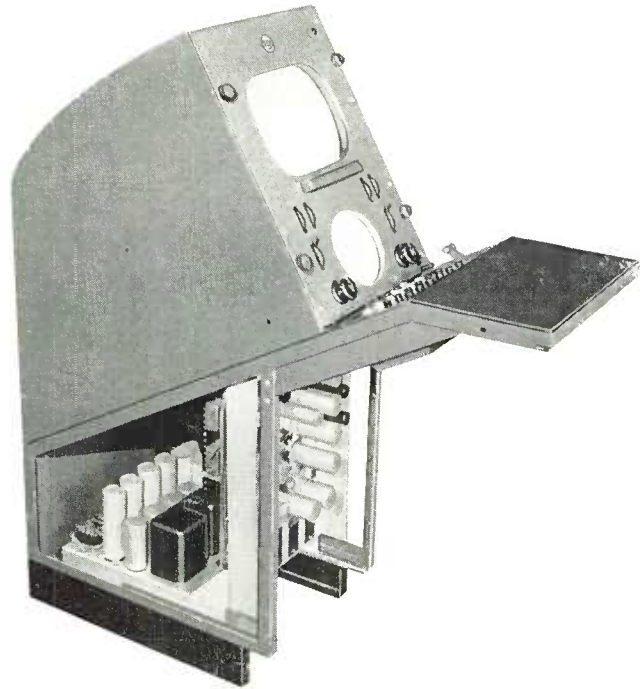

The controls for the switching amplifier project through the inclined top panel of the desk. These controls consist of two banks of pushbuttons from which the on-the-air signal is selected, two toggle switches for controlling local and remote sync, gain controls for two remote input lines, a three-position switch for selecting either the on-the-air signal or one of the two remote signals for preview display on the monitor, fading and dissolving controls, and tally lights showing which inputs are being used.

The switching amplifier consists of 3 two-stage picture amplifiers and 2 two-stage sync relay interlock amplifiers. Two of the picture amplifiers have their inputs connected to separate banks of camera selector switches. They have common outputs, however, so that they can serve one camera singly or two cameras together in a lap-dissolve or superimposition. The third picture amplifier feeds the monitor input. The two sync amplifiers automatically add local sync to the video signal when remote sync fails or when local sync is otherwise required.

## Specifications

### Power Line Requirements

100-120 volts, 50/60 cycles, 1060 (max.) watts

(includes power required by the two WP-33A Power Supplies)

### Input Signal:

#### Local Input

(video from camera control) \_\_\_\_\_ 1.5 v. peak-to-peak

Auxiliary Input (as remote) \_\_\_\_\_ 1.5 v. min. peak-to-peak  
video. 18-33% sync

### Input Impedance:

Local Input \_\_\_\_\_ 75 ohms

#### Auxiliary Input

(as remote) \_\_\_\_\_ 75 ohms, variable line termination

### Output Impedance

\_\_\_\_\_ 75 ohms

### Mechanical Specifications (Console Section):

Dimensions (overall) \_\_\_\_\_ 41" High, 13" Wide, 6" Deep

Weight \_\_\_\_\_ 46 lbs.

Finish \_\_\_\_\_ Dark umber gray

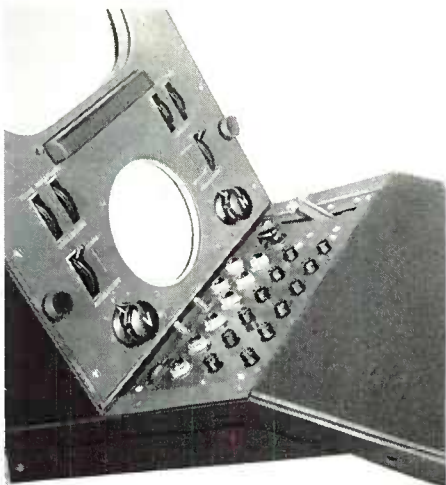

Close-up of TS-10A Control Panel

# Monoscope Camera Type TK-1A

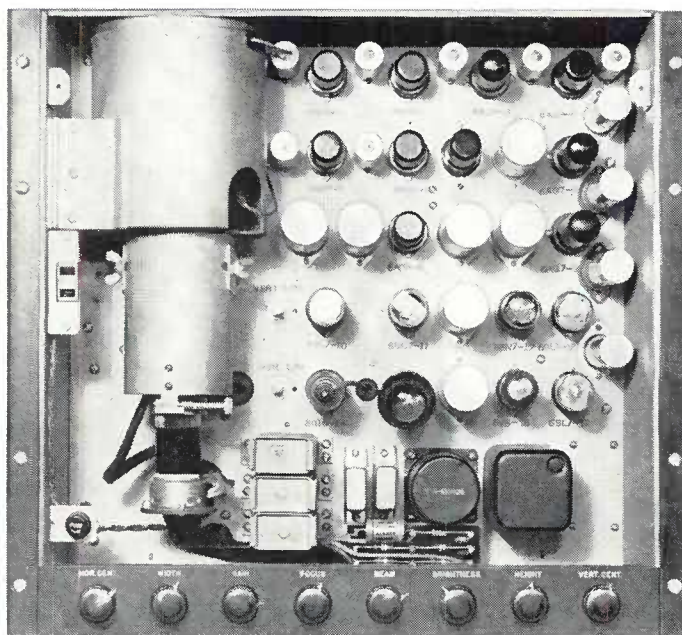

## Features

- Useful to television transmitting station, laboratory, factory, or service bench.
- Compact construction; bathtub chassis.
- Built-in high voltage power supply.
- Pattern shows scanning symmetry, vertical and horizontal resolution, shading, reproduction of isolated details, contrast and brightness.
- Accessible arrangement.

## Uses

The Type TK-1A Monoscope Camera may be used as a convenient means of obtaining an image for video testing of television transmitting equipment, or a "test pattern" to be transmitted during warm-up and stand-by periods. In the latter case, the station call letters may be made a part of the pattern, thereby providing station identification. It may, likewise, be used in the television transmitting station as a readily available source of video signal, of known quality, to be used in place of the studio camera when making tests or adjustments on other units of the system. In the laboratory, factory, or service bench, the equipment may be used as a source of video signal to test or adjust television receivers, video amplifiers, and picture tubes. With the addition of an IF sweep generator and an RF signal generator, it produces a complete television picture signal simulating that received off the air, and thus provides a means of testing receivers under conditions equivalent to actual use.

## Description

The TK-1A Monoscope Camera comprises the monoscope tube, the scanning generators, the video output amplifiers, and the high voltage power supply for the monoscope tube. This equipment is built on the familiar recessed bathtub type of chassis which fits into a standard nineteen-inch rack. All tubes and large components are located on the front of the chassis, while the wiring and smaller components are on the rear. The controls are grouped on a narrow control panel along the bottom of the chassis. When installed and in operation, the front is covered by a large cover plate which conceals everything but the control panel. This cover plate is interlocked to protect operating personnel from the high voltages present in the equipment.

The monoscope tube in the TK-1A is mounted in a vertical position at the left of the chassis. The upper part of the tube is enclosed in a mu-metal shield. The magnetic deflecting coils are mounted within the shield, and are attached to it. By disconnecting the tube socket, anode, and signal leads, the whole assembly—tube, coils, and shield—may be swung outward. This arrangement allows the tube to be changed very easily, and, at the same time, is very economical of rack space.

The monoscope tube ordinarily used in the TK-1A is an RCA-2F21. This tube provides a pattern which combines the features of several previously used tubes. It shows the following details of the quality of reproduction in a given television system: scanning symmetry, resolution in both vertical and horizontal directions, shading and reproduction of isolated details. In addition it provides a pattern to facilitate proper adjustment of contrast and brightness.

The Vertical Deflection Generator consists of four tubes and associated circuits. The first of these tubes amplifies the driving

signal received from the synchronizing generator and generates a sawtooth voltage wave which is amplified in the second, third, and fourth tubes. The output is applied to the magnetic deflecting coils of the monoscope tube. Negative feedback is employed to improve scanning linearity.

The Horizontal Deflection Generator includes three tubes and associated circuits. The first tube is the driving signal input amplifier and sawtooth voltage generator; the second and third tubes amplify the output wave and feed it to the horizontal deflecting coils of the monoscope tube.

The Blanking Amplifier is used to provide the proper level and polarity of the blanking pulses received from the synchronizing generator before these pulses are fed into the Video Amplifier for mixing with the video signal.

The Video Amplifier includes six stages of video amplification—together with a clipper stage which is inserted between the fifth and sixth stages. The monoscope output signal is fed directly into the first stage of this amplifier, and the blanking signal is introduced in the output of the fourth stage. The output of the fifth stage (which contains both video and blanking signals) is fed to a clipper stage which adjusts the height of the blanking "pedestals". The clipper feeds an output stage which consists of two tubes having their grids tied in parallel, but with the plate circuits separate. This provides

two separate outputs—one of which may be used to feed a monitor, while the other is usually connected to a distribution amplifier.

### Specifications

Output Voltage.....1.5 volts peak to peak  
 Power Supply Required:  
 110-120 volts a-c 60 cycles.....75 watts  
 280 volts d-c .....250 ma.

Dimensions.....17½" high, 19" wide, 11" deep  
 Weight .....55 lbs.

### Tube Complement:

6 RCA 6AC7	1 RCA 8016
1 RCA 6H6	1 RCA 6Y6
3 RCA 6AG7	1 RCA 6V6-GT
3 RCA 6SL7-GT	1 RCA 2F21

Stock Identification.....MI-26960

### Accessories

Tube Kit (complete tube complement).....MI-26679

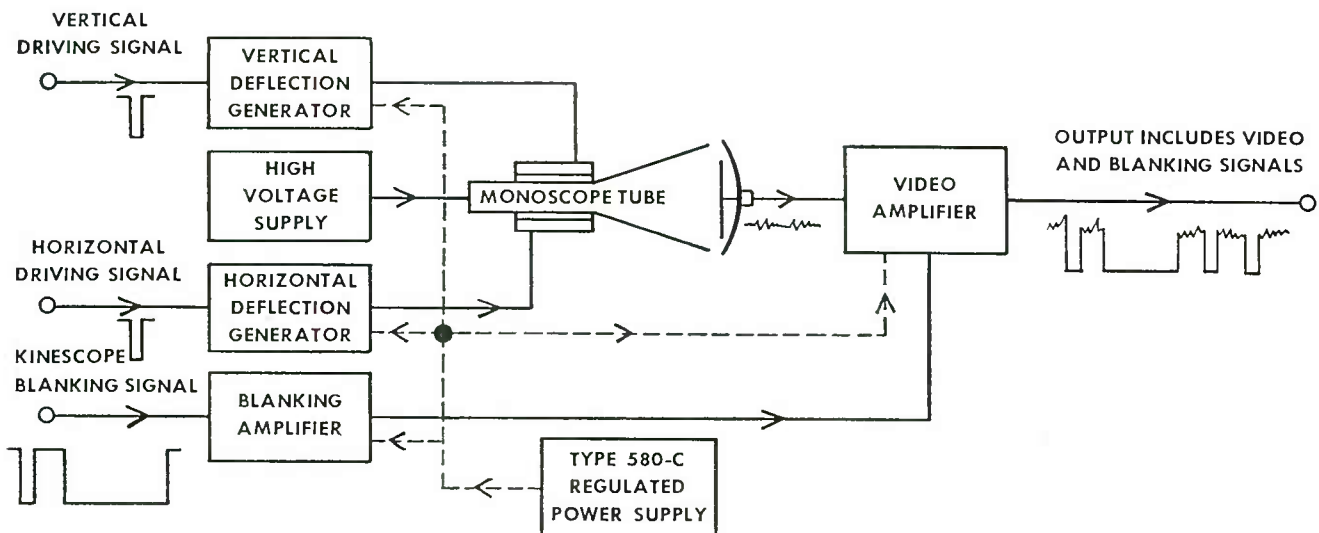

**BLOCK DIAGRAM OF THE TYPE TK-1A MONOSCOPE CAMERA**



# Synchronizing Generator Type TG-1A

## Features

- Special circuits which maintain the timing of the leading edges of the equalizing pulses, the horizontal synchronizing pulses and the vertical synchronizing pulses, with extreme accuracy.
- An improved locking circuit for synchronizing the generator with the 60-cycle power supply—or with a remotely generated synchronizing wave form.
- Use of circuits which are relatively insensitive to large changes in tube characteristics, so that ageing of tubes will not affect operation of the equipment.
- Operation of all tubes in extremely conservative manner, so that a very long, useful life may be expected.
- Wiring which has been greatly simplified by carefully grouping components so that all leads are very short.
- A built-in oscilloscope which, by means of a selector switch, can be used to check the step-down ratio of any of the frequency-dividing counter circuits.
- A regulated plate voltage power supply unit which, with the other panels, is mounted in place and wired at the factory. The unit is ready for operation immediately on installation.

## Uses

The TG-1A Synchronizing Generator is designed for use in television transmitting stations as a source of synchronizing pulses for the studio and film cameras, the monoscope camera, the monitoring oscilloscopes, and the mixing amplifier (which adds the synchronizing pulses to the transmitted video signal). In laboratories and factories it is used in conjunction with a monoscope camera to furnish a complete RMA standard video signal voltage which can be used in the development and production testing of television receivers.

## Description

The Type TG-1A Synchronizing Generator is an integral unit complete with power supply. It is assembled in a standard cabinet-type rack which is 84 inches high, 22 inches wide and 18 inches deep. The rack has front and rear doors which open the full length and width of the unit. This type of rack has been standardized for all RCA television, broadcast, and communications terminal equipment. Moreover, all RCA Television and FM transmitters are made up of racks which are similar in appearance, construction and height (although of greater width). Therefore, the TG-1A Generator, and other units mounted in similar racks, may be installed as needed, with assurance that they will match in appearance, other terminal and transmitting units which may be added later.

The 60 tubes and other components which make up the circuits of the TG-1A Generator are mounted on bath-tub type chassis which are placed in the cabinet vertically, as shown in the illustration. A 29 $\frac{3}{4}$  inch chassis at the top of the cabinet contains the "pulse forming" circuits. Immediately below is a similar chassis containing the "pulse shaping" circuits. The 10 $\frac{1}{2}$  inch chassis near the bottom is a standard Type 580-C Power Supply Unit, and just below is a 1 $\frac{3}{4}$  inch chassis containing electrolytic filter capacitors.

All of the controls, tubes and major components are mounted on the front of the vertical chassis. Thus, all ordinary adjustments, as well as routine checks, can be made by opening the front door. Since no high voltages are exposed on the front of the chassis, this door is not interlocked. Wiring and minor components, such as small capacitors and resistors, are on

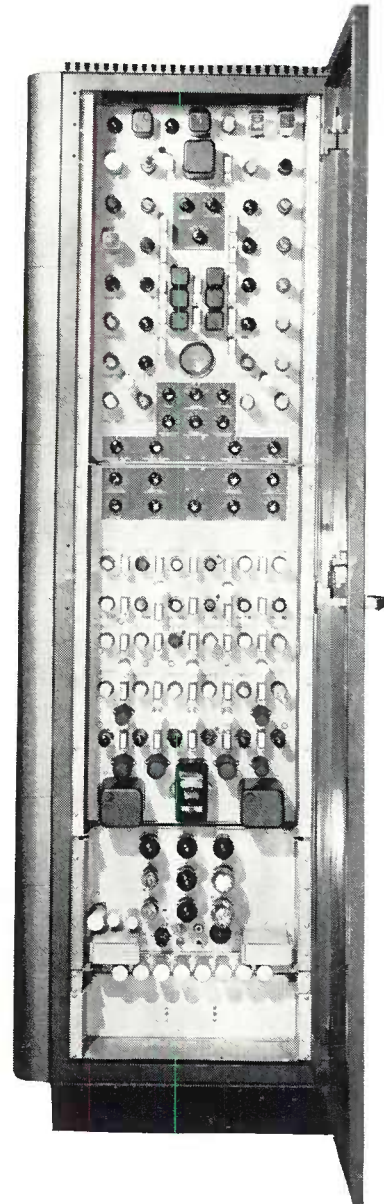

the back of the panels, and are accessible through the rear door. All terminals are in the clear, and components are identified so that circuit testing, when required, is relatively easy.

Electrically, as well as mechanically, the TG-1A Generator is divided into two main sections. The first section comprises the "pulse-forming" circuits while the second section comprises the "pulse-shaping" circuits. The "pulse-forming" unit generates all of the different timing frequencies which are required by the system. It also provides a means whereby these frequencies (which are all derived from a single master oscillator) may be "locked in", either with the local 60-cycle power line frequency, with a crystal oscillator, or with some other external source, such as a remotely generated synchronizing wave form. The "pulse-shaping" unit forms the pulses into the proper wave shapes and combines them as required to

provide the five different signals listed below. These signals are fed to ten output connectors located on a subpanel at the base of the "pulse-shaping" unit.

It is intended that RG11/U or RG59/U concentric lines be used between these points and the studio cameras, mixing amplifiers, etc. Two coaxial output connections are provided for each signal so that output of either negative or positive polarity is available. When more than one equipment is fed from a single output, a distribution amplifier, such as the Type TA-1A, should be employed in order to isolate the circuits.

Regulated plate voltages for the "pulse-forming" and "pulse-shaping" units are furnished by the Type 580-C Power Supply. Filament voltages are provided by transformers mounted on the units themselves. All a-c power input to the cabinet is controlled by the circuit-breaker switch at the bottom of the "pulse-shaping" unit.

The Type TG-1A Synchronizing Generator furnishes all of the timing pulses required in a complete television system. These pulses are accurately timed with relation to each other, and are carefully controlled as to wave form in accordance with the standards adopted by the RMA. The five different output signals which are generated will provide all of the timing and synchronizing requirements of a standard 525-line, 30-frame, interlaced television system. These five output signals are:

**(1) HORIZONTAL DRIVING SIGNAL**

This consists of short-duration, square-wave pulses at horizontal scanning frequency (15,750 cycles). These pulses are used to "trigger" the saw-tooth wave generator (in the camera) which supplies the horizontal scanning voltage for the pickup tube.

**(2) VERTICAL DRIVING SIGNAL**

This consists of square-wave pulses of somewhat longer duration which occur at vertical scanning frequency (60 cycles). These pulses are used to "trigger" the saw-tooth wave generator (in the camera) which supplies the vertical scanning voltage for the pickup tube. The width of these pulses is sufficient to blank out the vertical return trace of the camera tube.

**(3) SYNCHRONIZING SIGNAL**

This is the signal which must be added to the camera picture signal before it is transmitted in order to synchronize the scanning action in the receiver. It is a composite signal consisting of (a) short-duration, horizontal synchronizing pulses at 15,750 cycles, (b) longer duration, vertical synchronizing pulses of the "serrated" type at 60 cycles, and (c) a series of six short-duration, equalizing pulses just preceding each

vertical pulse interval and six more following it. All of these have the timing and wave shape prescribed by the RMA Standards.

**(4) KINESCOPE BLANKING SIGNAL**

This signal is added to the transmitted video signal in order to blank out the return trace in the receiver picture tube (kinescope). It consists of square-wave pulses at horizontal scanning frequency (15,750 cycles) and vertical scanning frequency (60 cycles). These pulses are of longer duration than the synchronizing pulses and are transmitted at approximately "black" level. They form the "pedestals" on which the synchronizing signals are placed.

**(5) OSCILLOSCOPE DRIVING SIGNAL**

This signal consists of pulses at half horizontal (7,875 cycles) and half vertical (30 cycles) frequencies. They are used to trigger the saw-tooth generator in the monitoring oscilloscope, thus providing (for "wave form" monitoring) oscilloscope patterns which are two lines or two fields in length.

**Specifications**

**Output Voltages**

- Synchronizing Signals (pulses as shown above black level in the FCC drawing below)
  - 4 volts, peak-to-peak across 75 ohms
- Kinescope Blanking Signal (pulses as shown below black level on FCC drawing below)
  - 4 volts, peak-to-peak across 75 ohms
- Horizontal Driving Signal (for actuating camera horizontal scanning circuits)
  - 4 volts, peak-to-peak across 75 ohms
- Vertical Driving Signal (for actuating camera vertical scanning circuits)
  - 4 volts, peak-to-peak across 75 ohms
- Oscilloscope Driving Signal
  - (for actuating oscilloscope for wave form monitoring)
    - 8 volts, peak-to-peak across 75 ohms

**Power Supply Required**

From 120 volt, 60 cycle, single phase line \_\_\_\_\_ 450 watts

**Dimensions**

Mounted in Cabinet \_\_\_\_\_ 84" High, 22" Wide, 18" Deep  
 Unmounted Rack Units \_\_\_\_\_ 77" High, 19" Wide, 12 1/2" Deep  
 Weight (in cabinet) \_\_\_\_\_ 375 lbs.  
 (unmounted) \_\_\_\_\_ 160 lbs.

Stock Identification \_\_\_\_\_ MI-26915

**Accessories**

Front Door \_\_\_\_\_ MI-30536-G84  
 Side Panel (single) \_\_\_\_\_ MI-30541-G84  
 Monogram \_\_\_\_\_ MI-30596

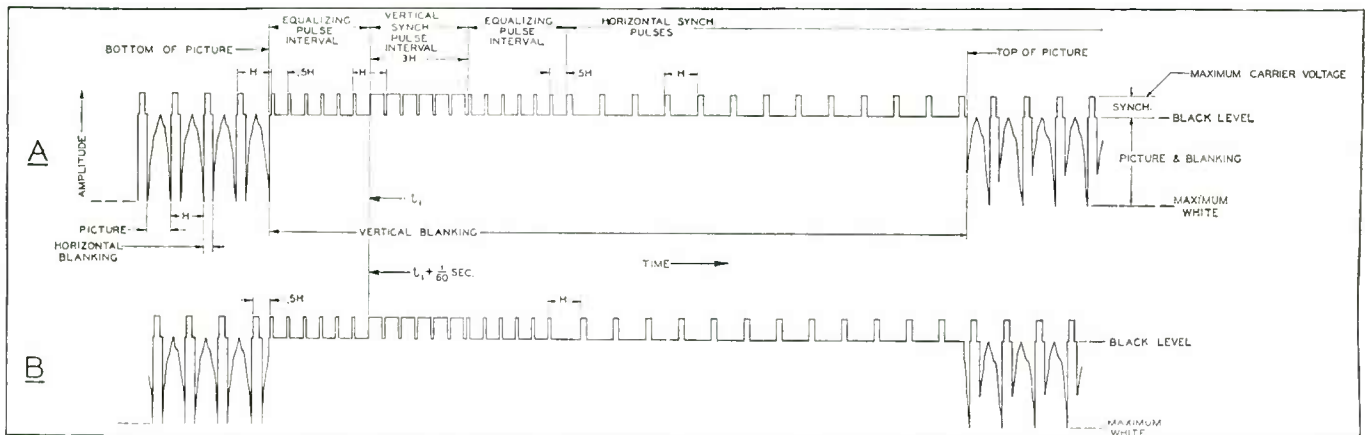

*Comparison of odd-line and even-line synchronizing pulses*

# Distribution Amplifier Type TA-1A

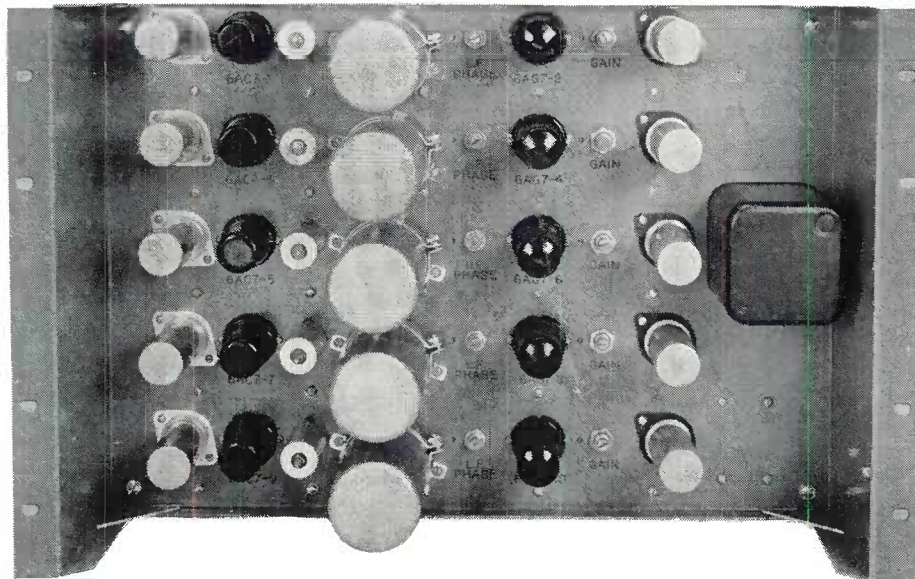

## Features

- Equally useful as distribution, mixing or isolation amplifier.
- Five amplifiers on one chassis.
- Bridging inputs.
- Excellent isolation between units.
- Positive or negative polarity.
- Standard "bath tub" type chassis.
- Accessible mounting arrangement.

## Uses

The Type TA-1A Distribution Amplifier may be used in any one of the three following applications: (a) to feed video or synchronizing signals from a single source to several separate outlets; (b) to mix video signals from several sources in order that they may be fed to a single output line; (c) as a straight-forward isolation amplifier requiring voltage gain of not over 15 db. The wide variety of possible uses of this equipment makes it equally adaptable to test bench, laboratory, or television transmitting installations.

## Description

The equipment consists of five separate video isolation amplifiers mounted on a single chassis. These amplifiers are of the bridging type, and have relatively high input impedance, permitting any number of them to be paralleled across a video line with a minimum disturbance to the driving source. Each amplifier delivers, to a 75 ohm output line, a signal of the same level and polarity as it receives.

When the amplifiers are used to feed several output lines, the inputs being paralleled, there is a high degree of isolation between lines and between any individual line and the source. Thus, disturbances, short circuits, equipment failures, or the like on one line will not be reflected onto the other lines. This is of considerable value to good overall operation in any television installation.

The components of the TA-1A are assembled on a chassis of the recessed, or "bath tube", type. All tubes and other large components are mounted on the front of the chassis, with the resistors and other small components on the rear. This type of construction provides neat appearance, convenient operation and maximum accessibility. The chassis is standard rack width and is designed to mount in either an enclosed cabinet type

rack or a standard open type rack. In the latter case a cover panel may be used, if desired.

Each of the five amplifiers consists of two stages. The two tubes and other components which make up each amplifier are arranged in a row across the chassis. Each amplifier is provided with a gain control so that the gain may be varied from approximately .9 to 1.1. This feature is especially convenient when it is desired to equalize accurately the levels on the several output lines.

The input and output connections on the rear of the amplifier are designed to accommodate standard fittings for either RG 11/U or RG 59/U coaxial lines. Two connectors are provided for each input and each output to facilitate interconnecting the sections. This amplifier may be used at any point in a television system regardless of whether the polarity at that point is positive or negative. An adjustment is provided for reducing the low frequency phase distortion to a negligible value.

A built in filament transformer provides filament voltages for all tubes. Plate voltages are obtained externally, preferably from a well regulated power supply such as the Type 580-C. Power connections are made by means of a standard cable receptacle at the lower left of the chassis.

## Specifications

Number of Amplifiers	Five
Voltage Gain, Each Amplifier	Adjustable .9 to 1.1
Input Signal Level (max.)	2 volts, peak-to-peak
Output Signal Level (per section)	2 volts, peak-to-peak
Input Impedance	Bridging
Input Polarity	Positive or negative
Output Impedance	75 ohms
Output Polarity	Positive or negative
Power Supply Required	
a-c 110-120 volts, 60 cycles	50 watts
d-c 280 volts	260 ma.
Tube Complement	5 RCA 6AC7, 5 RCA 6AG7
Dimensions	12 1/4" high, 19" wide, 3" deep
Weight	28 lbs.
Stock Identification	MI-26155

## Accessories

Tube Kit (complete tube complement)	MI-26676
-------------------------------------	----------

# Stabilizing Amplifier Type TA-5B

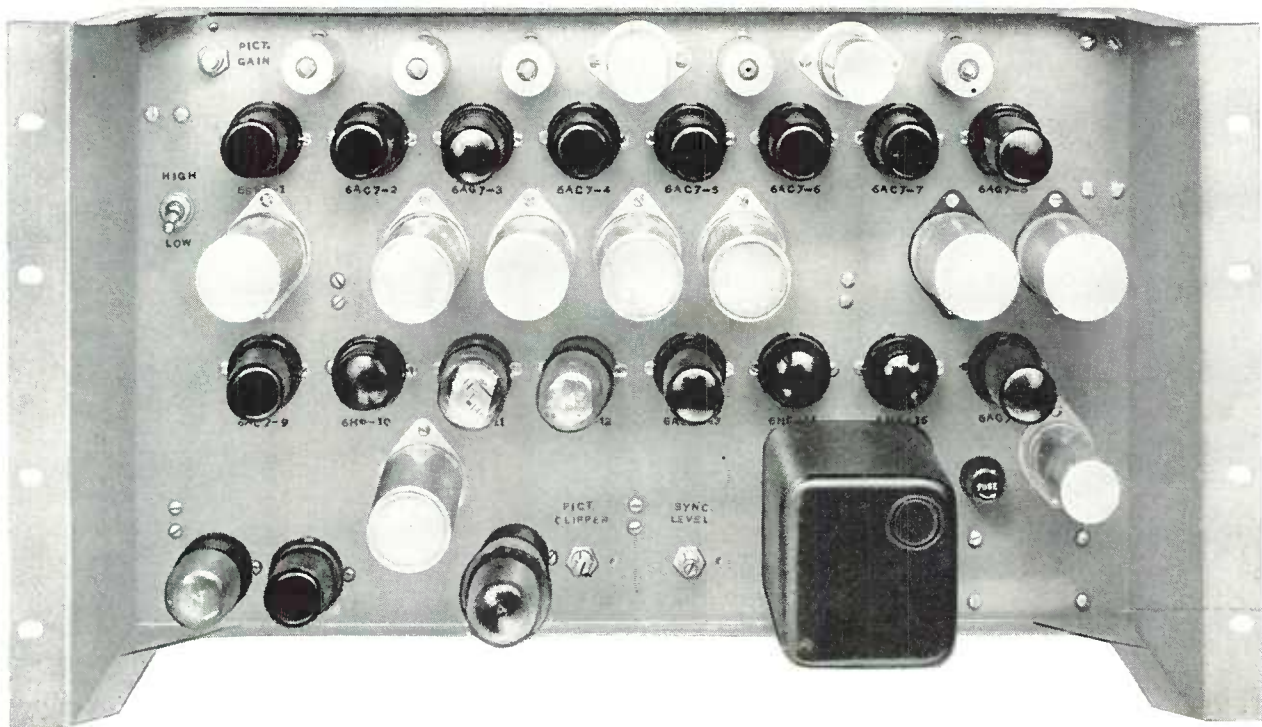

## Features

- Combines sync with video signals; separates sync from video signals.
- Corrects defective video signals, eliminates hum and low-frequency distortion.
- Improves the signal-to-noise ratio of the sync signal.
- Operates on signal levels as low as 0.25 volts peak-to-peak.
- Restores sync to standard 25% levels in signals where sync is less than 18%.
- Has two identical 75-ohm outputs.
- Power requirements are low.
- Bath tub type chassis mounts on standard rack.

## Uses

The TA-5B Stabilizing Amplifier is a unit designed to correct, automatically, faulty video television signals which may have become defective in their transmission from the pickup device to the input of the transmitter. It is also used with the RCA Studio Switching Equipment to combine the sync signal with the video signals from the cameras.

The common sources of disturbance in any television system may be classified as follows:

1. Hum or surges originating in power supplies and other random disturbances created by high-impedance grounding circuits, long cable sheaths, etc.
2. Circuit saturation, with resultant destruction of the proper sync-picture ratio.
3. Switching surges, including the shifting of patch cords.
4. Low-frequency distortion introduced by coupling circuits with inadequate time constants.

Elimination of these spurious disturbances at their source is often difficult and sometimes impossible. They must be eliminated, however, because in many cases not only is receiver operation impaired, but proper modulation of the transmitter will be affected. The Stabilizing Amplifier is capable of correcting any one or all of these faults simultaneously, thus producing a signal which is suitable for modulating the transmitter.

## Description

The TA-5B Stabilizing Amplifier employs 19 tubes. Nine of these are used in a 6-stage picture amplifier which has two identical output stages for supplying signal to the transmitter and to a picture monitor. The remaining tubes are employed as sync separators, keyers, shapers, clampers, and tubes for adding sync.

A two-position attenuator at the input accommodates a range of input signals from 0.25 volt to 2 volts, peak-to-peak. The output of the amplifier is designed to deliver the standard level of picture and blanking signal (1.5 volts peak-to-peak) with a maximum sync of 1.5 volts peak-to-peak. The amount of sync can be adjusted independently to any value between 0.2 and 1.5 volts, peak-to-peak.

The first three stages provide linear amplification of the incoming signal; while the fourth stage amplifies the sync pulses by a larger factor than it amplifies other parts of the signal. Three tubes are employed in this fourth stage. One operates as a normal amplifier and contributes signal throughout the useful portion of its characteristic curve. The second tube of the trio clamps the black level at a fixed point on the characteristic curve of the third tube, however, so that it operates only at grid levels above the blanking signal, amplifying only the sync signals. Since clamping action is independent of the signal, spurious additive components (at low frequencies) are eliminated from the sync amplifier.

## AMPLIFIERS

Amplified sync thus passes on to the fifth (clipper) stage of the amplifier which clips off the sync in accordance with its grid bias adjustment, yielding the desired sync-picture ratio at the output of the fifth stage. As is the case in the non-linear amplifier just described, the grid of the clipper is also clamped at black level so that the absolute amplitude of the sync pulses is fixed and independent of variations in the average amplitude of the picture signal. In this stage also, spurious components are eliminated from the picture and blanking portions of the signal.

The sixth and last stage comprises the two output amplifier tubes, one for the transmitter and one for the monitor. The grids of these tubes are in parallel and their plates are coupled separately to two output connectors for 75-ohm coaxial lines. When output higher than the 1.5 volt peak-to-peak is desired, the two outputs can be paralleled to give almost double the signal obtainable from either one alone.

Filament power for all tubes is provided by a transformer mounted on the chassis. Plate voltage must be obtained from an external regulated power supply such as the RCA Type 580-C. All external power connections are made through a 6-pin plug and receptacle. One side of the primary line to the filament transformer is fused.

The TA-5B Stabilizing Amplifier is mounted on a recessed chassis for standard rack-mounting. Therefore, it can be mounted in the transmitter room or studio control room with other rack-mounted equipment

### Specifications

Input Signal Voltage	
Min.	0.25 volts, peak-to-peak
Max.	2.5 volts, peak-to-peak
Permissible Input Signal-to-Noise Ratio	
(a) High-Frequency Noise	2
(b) Low-Frequency Noise (hum)	1.3
Output Signal Voltage	
(a) Picture and Blanking	1.5 volts, peak-to-peak
(b) Sync (Max.)	1.5 volts, peak-to-peak
Output Impedance	75 ohms
Power Requirements	
(a) A-c	100-120 volts, 50/60 cycles, 5 watts, fuse rating, 1 amp.
(b) D-c	280 volts, 235 ma., regulated (RCA Type 580-C or equivalent)
Dimensions	
Height	10 1/2"
Width	19"
Depth	8 5/8"
Weight	17 lbs.
Finish (front of chassis)	Light umber gray
Tube Complement	
1st Picture Amplifier	1-RCA 6SK7
2nd " "	1-RCA 6AC7
3rd " "	1-RCA 6AG7
4th " "	1-RCA 6AC7
5th Picture Amplifier (Sync Clipper)	1-RCA 6AC7
Sync Amplifier (Picture Clipper)	1-RCA 6AC7
Main Output	1-RCA 6AG7
Monitor Output	1-RCA 6AG7
1st Amplifier—Sync Channel	1-RCA 6AC7
Sync Separator	1-RCA 6SL7-GT
Pulse Former	1-RCA 6SN7-GT
Keying Pulse Driver	1-RCA 6AG7
Clamp Diodes	3-RCA 6H6
Sync Inserters	1-RCA 6SN7 and 1-RCA 6AC7
Voltage Regulator	1-RCA OD3/VR-150

# Regulated Power Supply Type 580-C

## (General Purpose)



### Features

- Extremely well-regulated output.
- Unusually low output ripple.
- Low internal d-c resistance.
- Components and connections easily accessible.
- Compact and neat in arrangement.

### Uses

The RCA Type 580-C Regulated Power Supply fills the need for a well-regulated source of d-c at loads of 50 to 400 milliamperes. The output is adjustable between 260 and 295 volts, with variations of less than 0.25 volts from minimum to maximum load. Thus it is suitable for laboratory, industrial, and communications applications in which an unusually well-regulated source of d-c is required. As a-c ripple in the output is less than 0.005 per cent, the output voltage may be used for most purposes without additional filtering.

The Type 580-C is especially suited for use with RCA television equipment, which it matches in appearance and construction.

### Description

The regulating circuit employed in the 580-C is of the series type. The d-c internal resistance is less than 0.7 ohms.

This Power Supply is assembled on a recessed chassis of the "bath-tub" type. Tubes and filter condensers project from the front of the chassis, while transformers, resistors, and wiring are at the rear. The chassis is standard rack width and may be mounted either in one of the new enclosed-type RCA cabinet racks, or on a standard "open-face" rack. In the latter event a blank panel may be mounted over the Power Supply if desired. Controls are centralized on a small, plainly-marked panel at the bottom of the unit. In addition to the power "on-off" switch there is provision for switching from a load range of 50-80 ma. to 80-400 ma., as well as a potentiometer for adjusting output voltage. A meter selector switch and a meter jack provide for plugging in a meter to read individual tube plate currents, output current, and output voltage. A special meter (MI-21200-C) is available for this purpose.

### Specifications

Output Voltage \_\_\_\_\_ Adjustable 260 to 295 volts  
 Output Current \_\_\_\_\_ 50 to 400 ma.  
 D-C Regulation \_\_\_\_\_ Less than 0.25 volts, minimum  
 to maximum load  
 A-C Ripple \_\_\_\_\_ Less than 0.005 per cent  
 Power Supply \_\_\_\_\_ 110-120 volts, 50-60 cycles  
 Power Input \_\_\_\_\_ 370 watts (maximum)

### Tube Complement:

2 RCA 0D3/VR150	1 RCA 6SL7GT
2 RCA 6U4G	6 RCA 6Y6G
1 NE 32	

Dimensions \_\_\_\_\_ 10½" high, 19" wide, 12" deep  
 Weight \_\_\_\_\_ 58 lbs.



# Current Regulator MI-26090

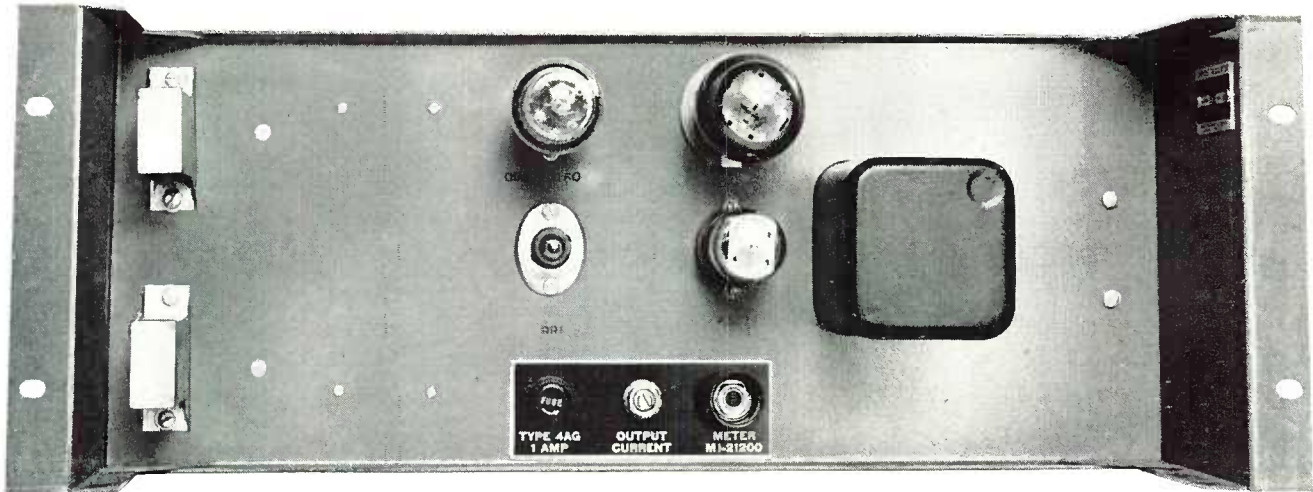

## Features

- Counteracts current variations in camera focus coil circuit.
- Current can be manually adjusted over a range from 65 to 85 milliamperes.
- Common tube types are employed.
- All tubes easily replaced from front of unit.
- Designed for standard racks and cabinets.

## Use

The Current Regulator is an electronic device which maintains constant current in the focus coil of the TK-10A Studio Camera. Variations in the magnitude of current flowing through the coil are brought about by temperature changes, which would ordinarily impair the focus of the camera. The Current Regulator counteracts these variations and also provides a means for adjusting the focus coil current to the proper value.

## Description

All components of the Current Regulator are mounted on a recessed chassis designed for rack mounting. The unit employs an RCA 6SL7-GT twin triode as a d-c amplifier, and an RCA 6Y6-G current regulator tube. The cathodes of the d-c amplifier are kept at fixed levels by voltage regulator tubes.

The 6Y6-G current regulator tube is effectively in series with the camera focus coil and its 400-volt source of d-c so that the internal resistance of the 6Y6-G, which is controlled by the d-c amplifier, determines the magnitude of current flowing in the coil circuit. The input of the d-c amplifier is connected across a small resistor also connected in series with the focus coil. Thus variations in the voltage developed across the small resistor (as a result of current changes in the focus coil circuit) are fed to the d-c amplifier which in turn raises or lowers the conductance of the 6Y6-G to counteract the current change taking place. Regulation is, of course, instantaneous and the result is a constant flow of current through the focus coil of the camera. The Current Regulator will maintain constant current at a preset value over wide ranges of resistance change in the load and over wide ranges of input voltage.

## Specifications

### Power Requirements:

A-c \_\_\_\_\_ Single phase 117 volts, 60 cycles, 15 watts  
(for fil. transformer)

D-c \_\_\_\_\_ 400 volts from Type 580-C Power Supply

### Chassis Dimensions:

Depth \_\_\_\_\_ 5½"

Width \_\_\_\_\_ 19"

Height \_\_\_\_\_ 8"

Weight \_\_\_\_\_ 9 lbs.

### Tube Complement:

1—RCA 0D3/VR150 Voltage Regulator  
1—RCA 991 Voltage Regulator  
1—RCA 6SL7-GT D-C Amplifier  
1—RCA 6Y6-G Current Regulator





# **TELEVISION FIELD and RELAY EQUIPMENT**

	<b>Page</b>
<b>FIELD EQUIPMENT</b>	<b>174</b>
<b>RELAY EQUIPMENT</b>	<b>185</b>
<b>MOBILE UNIT</b>	<b>188</b>

# RCA Television Field Pick-up Equipment

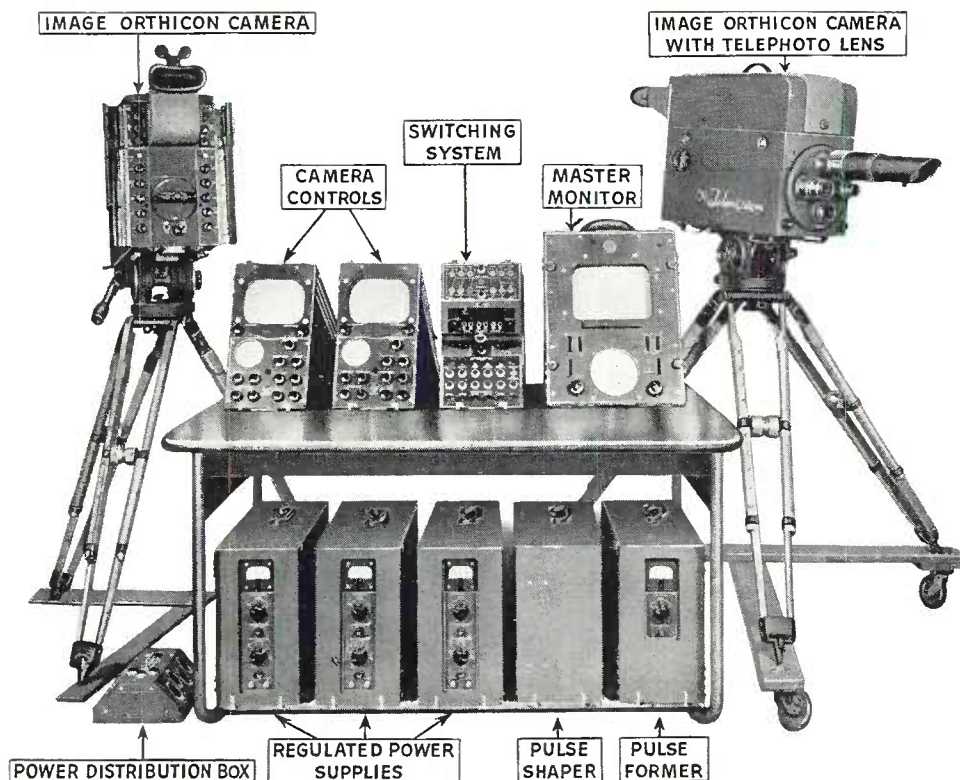

The RCA Television Field Pickup Equipment is designed for portable or field use in picking up television programs such as sporting events, parades, outdoor or indoor shows, and other special events in places where permanent television installations are not available. The design of the equipment is centered around the RCA Image Orthicon camera tube which is so sensitive that it may be used with incident illumination on the scene as low as approximately one foot candle, and which is entirely free of any blocking or "charging-up" effect from flashes of excess light which paralyze other types of pick-up tubes.

The Field Equipment includes such important features as a four-position lens turret on each camera, an electronic view finder in each camera, a complete telephone intercommunication system, accessibility of tubes, components, and circuits for easy servicing, and many other features.

To facilitate portability, the equipment has been divided into relatively small units with emphasis placed on keeping the number of major pieces to a minimum, and at the same time maintaining high standards of reliability and flexibility in operation. Wherever possible the major units have the shape and approximate size of a medium sized suitcase. The camera and view finder, master monitor, and power distribution box are the only exceptions. Each unit is provided with one or more carrying handles, and covers and shock mounts to protect fragile parts during transportation. All interconnections

are made with cables and plugs which may be connected or disconnected in a few minutes.

A general practice of making all electrical connections through receptacles mounted on the rear panels of the suitcase units has been followed. An exception exists in the case of intercommunication head-sets which are plugged into jacks on the front of the Field Switching System. Whenever possible, multiple conductor cables are used so that the number of cable connections is kept to a minimum consistent with flexibility of the equipment. With few exceptions, the connectors used have single-turn locking rings which prevent accidental disconnecting of the cables.

Careful consideration has been given to conservative design in the selection of high quality components and in allowing ample reserve in ratings. Also attention has been given to providing rugged construction and secure mountings so that the equipment will stand the wear and tear of daily use over long periods of time.

The Field Equipment is so designed that it may be set up for temporary operation on a table or desk. A special Field Control Desk (MI-26960) is available if it is desired to make a semi-permanent installation of this equipment for studio use. In such a case, the desk and control units comprise a simple operating console. The equipment may also be used in conjunction with a mobile television unit in which the suitcases may be installed to form a mobile television studio.

The units included with the standard Two-Camera Chain, Field Pick-Up Equipment are as follows:

- 2—Type TK-30A Field Camera Equipments
- 1—Type TG-10A Field Synchronizing Generator
- 1—Type TS 30A Field Switching Equipment

(All equipments are supplied with tubes)

The Type TK-30A Field Camera Equipment includes:

- 1—High Sensitivity Image Orthicon Camera with newsreel-type tripod, plug-in electronic view finder employing a 5" Kinescope and three turret-mounted lenses (50 mm and 90 mm and 135 mm focal lengths).
- 1—Field Camera Control Unit. This unit provides the required control and operating voltages for the Field Camera and provides picture (on a 7" Kinescope) and wave form (on a 3" Cathode Ray Oscilloscope tube) monitoring of the camera signal.
- 1—Field type Power Supply. This unit contains the heater and plate supply transformer, rectifiers and plate-voltage regulating circuits.
- 1—Set of Camera-Camera Control Unit Cables; one 50' length, one 100' length and one 200' length.

The Type TG-10A Field Synchronizing Generator includes:

- 1—Field Pulse Former
- 1—Field Pulse Shaper
- 1—Power Distribution Box. This unit provides for power supply connections to a-c power systems of three types: 3 phase—4 wire; Single phase—3 wire; Single phase—2 wire. 9 Twist Lok power outlets and 4 convenience outlets are provided.

The Type TS-30A Field Switching Equipment includes:

- 1—Switching System. This unit provides all the video program, monitor and intercommunication switching required for field pick-up equipment using up to four cameras, plus two auxiliary video program lines. Camera, view finder, camera control and switching equipment tally lights indicate to performers, cameraman, control operators and program director which camera is supplying program.

The Field Type Master Monitor (listed below) can be switched to:

- a. The outgoing video signal.
- b. Relay equipment monitoring signal.
- c. Either of the two auxiliary video program lines.
- d. A separate Monitor input.

The audio intercommunication facilities provide a flexible set-up so that the program director can talk to any or all of the operating personnel and the home station, or various special and separate intercommunication circuits may be set up. All operating personnel normally hear program sound on one headphone, and intercommunication sound on the other.

- 1—Field Type Power Supply. This furnishes power to the switching system and Master Monitor.

**OPTIONAL**

- 1—Field Type Master Monitor. This unit provides for picture (on a 10" Kinescope) and wave form (on a 5" CRO Tube) monitoring of the Signal selected by the field switching system.

**RCA TELEVISION FIELD PICKUP EQUIPMENT**

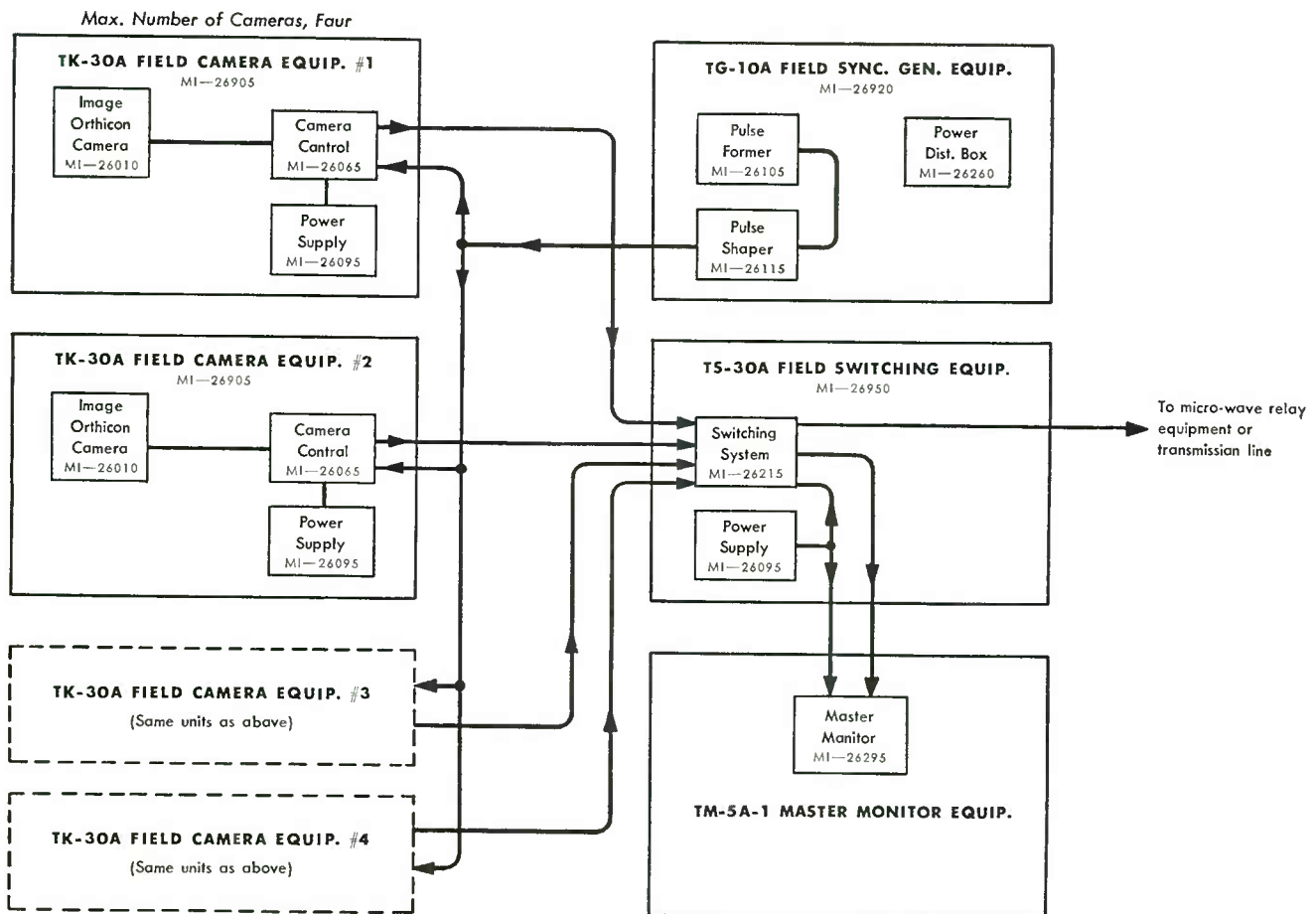

# Field Television Camera Type TK-30A

## Features

- Highly sensitive at extremely low light levels.
- Able to handle enormous light ranges.
- No loss of picture after intense flashes of light.
- Simplified interconnections providing quick assembly on location.
- Electronic view finder.
- Rugged mechanical construction.
- A four position lens turret controlled from rear.
- Provision for two intercom telephone sets.
- Suitable for studio use.
- Easy access to all parts.

## Uses

The TK-30 television camera is intended to be used in field television pick-ups of all kinds. It is especially suitable for use where the lighting conditions are poor, as is frequently the case at sporting events, in night clubs, and at other remote pick-up points. While designed especially for field use, it is also satisfactory for most types of studio programs; and for many applications the TK-30A has special advantages.

## Description

The TK-30A is a portable, field television camera equipment consisting of camera, tripod, camera control, field power supply, and miscellaneous accessory items; such as: cables, etc. The camera makes use of the RCA-developed Image Orthicon. The remarkable sensitivity of the Image Orthicon is so great that operation is possible with light levels as low as one foot-candle with an f3.5 lens. This is a considerable improvement over other types of picture tubes, and makes possible field television pick-ups without elaborate, special lighting installations, and under conditions which hitherto would have been impossible. In addition, the Image Orthicon is able to adapt itself automatically to enormous changes in scene brilliance without serious loss of contrast anywhere in the range. This characteristic makes it possible to shift instantly from a dark scene in heavy shadows to another in bright sunlight with only very slight readjustment. The Image Orthicon is able to withstand extreme peaks of intense illumination, such as photo flash lamps aimed directly at the lens, without any after effects requiring the resetting of controls.

The Field Camera Control is contained in a small easily carried case. On the front, there are located two cathode ray tubes which serve as indicators of the picture quality. A seven inch kinescope is used as a picture monitor, and a three inch oscilloscope is used as a wave form monitor.

The picture signal amplifier performs the following several important functions:

1. It provides a gain control for the picture signal.
2. It mixes the Picture Blanking signal with the signal from the Camera.
3. It establishes black level at the beginning of each scanning line by means of a "clamp" circuit.
4. It provides for the addition of the Synchronizing signal whenever only a single camera chain is used.
5. Its output stage is a line amplifier capable of delivering two volts peak to peak composite picture and synchronizing signal to a 75 ohm coaxial transmission line (or 1.5 volts of picture only).
6. It includes a stage for introducing a fixed amount of gamma correction.
7. It includes high level driver stages for feeding the two monitor tubes.

The Field Power Supply is a portable unit designed to provide all the d-c required by the circuits in the Field Camera, Field View Finder, and Field Camera Control in one camera chain. It may, of course, be used for any other application where its voltage and current ratings meet the requirements.



The output voltage of this power supply is electronically regulated within very close limits. It is capable of delivering 1 ampere at a maximum of 285 volts. The internal impedance of the power supply is less than 0.25 ohm. This low impedance makes it an excellent power supply for amplifiers having variable current requirements and critical low frequency response such as television amplifiers.

A separate electronic regulator circuit is provided to hold a constant current flow regardless of resistance changes, through the focusing field coil in the Field Camera.

On the rear panel are two receptacles for a-c input and power output respectively. In addition there is included a single convenience outlet with fuse.

The complete camera may be disassembled into several parts for easy carrying. The camera is built into an exceedingly compact case which mounts on top of the tripod. All controls are conveniently located on the back. The camera assembly includes a picture signal preamplifier and the deflection and camera blanking circuits. A feature of this camera is the provision of a lens turret in which four lenses of different focal lengths may be mounted. On the rear of the case is located a large handle which rotates the lens turret. A trigger switch incorporated in the handle cuts off the picture during the interval while the handle is turning. Changing from one lens to another requires only one and a half seconds. This compares to two or three minutes with prior types of cameras. Because the plate of the Image Orthicon is much smaller than that of previously designed pickup tubes, the focal lengths of the lenses required is only about half as great. This makes it possible to use relatively inexpensive standard lenses for all types of pick-up.

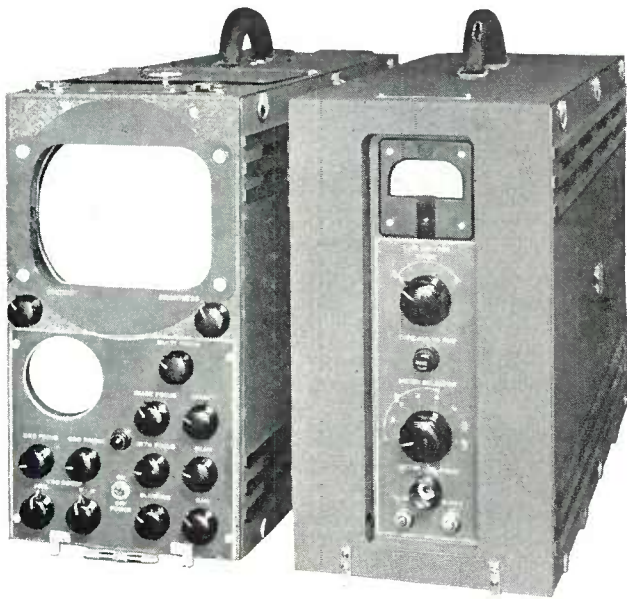

*Field Camera Control Unit and Field Power Supply*

The operator focuses the picture by observing the image in the electronic view finder, constituting the upper section of the camera assembly, and adjusting a knob on the right side of the cabinet. This knob slides the Orthicon back and forth inside the case. This saves having to adjust the lenses themselves for focusing. The use of the electronic view finder with this camera is a necessity; since at low light levels an optical view finder would not be satisfactory. It also has the advantage of eliminating the need for additional lenses which would be required for an optical system. The view finder employs a five inch kinescope with sufficient brilliance to produce a satisfactory picture under normal outdoor light conditions. Since the operator sees on the face of this kinescope the picture which is being transmitted, he is able to focus the picture, and also to monitor the quality and general operation. Two different viewing hoods are provided: one straight-on type, and the other a periscope type, which may be mounted in either of two positions. This gives the operator a choice of three different viewing heights. For ease in transporting and maintenance, the view finder and camera are separate units, each of which is an integral unit in itself. A streamlined cover with a carrying handle is placed on the camera unit when the view finder is removed. It is also possible to operate the camera without the view finder; as for instance where the camera is set up in a fixed position and operates unattended.



*TK-30A Electronic View Finder and Camera disassembled for easy carrying*

**Specifications**

**FIELD CAMERA CONTROL**

Number of Scanning Lines	525
Interlacing	2 to 1
Field Repetition Rate	60 per sec.
Frame Repetition Rate	30 per sec.
Line Repetition Rate	15750 per sec.
Picture Signal Level	2.0 volts, peak-to-peak, max. of which 75% is picture and blank, and 25% is sync. (See RMA Standards).
Picture Signal Polarity at Output	Black negative
Type of Transmission Line for Picture Signal	Coaxial
Impedance of Transmission Line	75 ohms
Maximum Length of Camera Cable	1000 ft.
Total Included Angle of Lenses (in horizontal plane):	
a. 50 mm f1.9 Extar	34°
b. 90 mm f3.5 Ektar	20°
c. 135 mm f3.8 Ektar	13°
***d. 220 mm f4.5 Ektar	8°
***e. 15 inch	4.5°
***f. 25 inch	2.75°

**Incident Illumination on Scene:**

- (a) Minimum (approx.) 0.5 ft. candle
- (b) Required for First Grade Results 10 to 20 ft. candles
- (c) Maximum Bright sunlight

Note: Figure for (a) above is based on the use of an f3.5 lens or faster.

Primary Volts 98-129 volts, a-c. 50-60 cycles  
 Primary Voltage Taps:

	Nominal	Range
Tap No. 1	125 v.	121-129 v.
Tap No. 2	117 v.	113-121 v.
Tap No. 3	109 v.	105-113 v.
Tap No. 4	102 v.	98-106 v.

**Power Outputs:**

Regulated d-c Supply 270-285 volts 1 amp.  
 Constant Current Supply intended to operate into 2000 ohm load (focusing coil) 50-80 ma.

**Dimensions (in inches):**

**FIELD CAMERA**

CASE ONLY			OVERALL		
Length	Width	Height	Length	Width	Height
20 $\frac{1}{8}$	10 $\frac{3}{8}$	11 $\frac{3}{16}$	25 $\frac{3}{4}$ *	11 $\frac{3}{4}$	13 $\frac{5}{8}$ **

**VIEW FINDER**

CASE ONLY			OVERALL		
Length	Width	Height	Length	Width	Height
21 $\frac{3}{4}$	10 $\frac{3}{8}$	7	21 $\frac{3}{4}$ ‡	10 $\frac{3}{8}$	7

**FIELD CAMERA CONTROL**

CASE ONLY			OVERALL		
Length	Width	Height	Length	Width	Height
24 $\frac{1}{2}$	8 $\frac{1}{8}$	15 $\frac{1}{8}$	27 $\frac{1}{4}$	8 $\frac{1}{2}$	18 $\frac{1}{2}$

**FIELD POWER SUPPLY**

CASE ONLY			OVERALL		
Length	Width	Height	Length	Width	Height
24 $\frac{1}{2}$	8 $\frac{1}{8}$	15 $\frac{1}{8}$	24 $\frac{1}{2}$	8 $\frac{1}{2}$	15 $\frac{1}{8}$

**Camera Cable Dimensions:**

Diameter 0.840 in.  
 Standard Lengths 50 ft., 100 ft., 200 ft.

**Weights:**

Field Camera (less Lenses)	65 lbs.
View Finder (less Hood)	34 lbs.
Field Camera Control	65 lbs.
Field Power Supply	58 lbs.
Turret with 3 Ektar Lenses	4 $\frac{3}{4}$ lbs.
Camera Cable (200 ft. with plugs)	80 lbs.

Finish Two tone umber gray wrinkle with chrome trim

**Stock Identification:**

Field Camera	MI-26010
View Finder	MI-26015
Field Camera Tripod	MI-26045
Field Camera Control	MI-26065
Field Power Supply	MI-26095

‡ Less viewing hood.

\* Less lenses.

\*\* Including cover.

\*\*\* Not standard equipment. Available as accessory items.

# Field Synchronizing Generator Type TG-10A

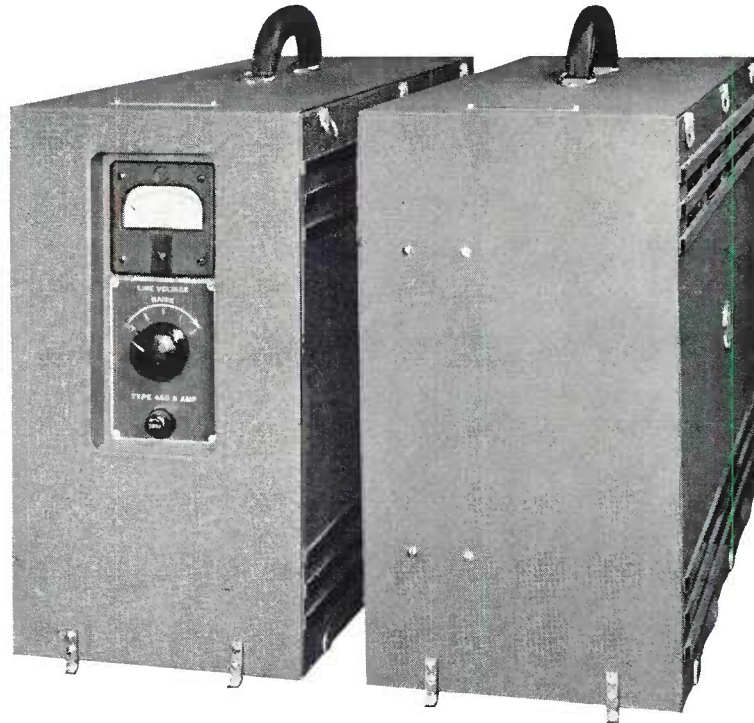

## Features

- Delivers standard RMA synchronizing and blanking.
- Also delivers separate horizontal and vertical driving signals.
- Complete in two suitcases, Pulse Former and Pulse Shaper.
- Frequency stabilization either by 60 cycle power line or by quartz crystal.
- Built-in cathode ray tube indicator for counter circuits.
- Built-in regulated power supply.
- Single cable connection between the two suitcases.
- All output signals, except synchronizing, on single cable.
- Synchronizing on separate cable to provide for single or multiple camera operation.
- Operation over wide range of line voltage.
- Built-in line voltage meter and tap switch.
- Convenience outlet with fuse.

## Uses

The field synchronizing generator is the heart of the field television pickup equipment. Its function is to provide all the timing information, in the form of electrical pulse signals, required for controlling and synchronizing the scanning processes in both the field pickup equipment and the home receivers.

## Description

In order to keep the weight and size of the TG-10A within reasonable limits, the equipment has been divided into two parts, each contained in a separate case, and called the Field

Pulse Former and the Field Pulse Shaper. Also included with the TG-10A is a Power Distribution Box which is intended to be used for connecting the 117 volt power source to the various units of the RCA Field Television Equipment.

The equipment generates four separate signals which are used in various ways to produce the RMA standard television signal. These four signals are those required for a 525 line interlaced system as recommended by the RMA. The signals are usually designated as follows:

1. Synchronizing
2. Picture blanking
3. Vertical driving (at field frequency, 60 cycles)
4. Horizontal driving (at line frequency, 15,750 cycles)

The first two of these signals, Synchronizing and Picture Blanking, are used directly in composing the final picture signal fed to the output of the system. In other words, they appear as parts of the composite picture signal. The last two signals, Horizontal and Vertical Driving, are used in the pickup equipment only. Their principal function is to trigger deflection generators in cameras and monitors. They are also used for keying signals in "clamp" circuits and for blanking signals in the camera.

## FIELD PULSE FORMER

The Field Pulse Former contains the timing circuits required in the system. Specifically, they include the master oscillator which operates at twice line frequency (31,500 cycles), a series of counters for stepping this master frequency down to line frequency (15,750 cycles) and to field frequency (60 cycles), and an automatic frequency control circuit for locking the synchronizing generator to the power supply frequency. A crystal oscillator operating at 94.5 kc. is provided as an alternative means of stabilizing the generator where the power supply system is not stable enough to serve as a reference.

Controls for the counter circuits, AFC circuit, and crystal oscillator are made accessible by removing the side cover on

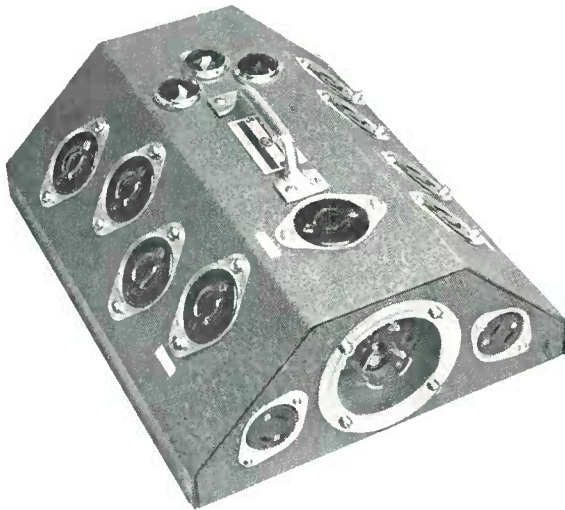

*Power Distribution Box*

the tube side of the unit. A cathode ray tube indicator (RCA 2BP1) for the counter circuits is mounted within the case and is visible when the cover is removed to make adjustments of the controls.

A single cable containing 4 coaxial lines and several other conductors carries signals and power between the Field Pulse Former and the Field Pulse Shaper. The a-c power enters the Pulse Former through a special connector. A convenience outlet, separately fused for 10 amperes, is provided on the rear panel. No other connections to this unit are required.

The Field Pulse Former also includes a regulated power supply which provides all the plate current required by both the Former and the Shaper. The Transformer primary is tapped at several points to accommodate a wide range of line voltage (98 to 129 volts). A selector switch for these taps is mounted on the front panel directly under a line voltmeter which indicates when the proper tap has been selected.

**FIELD PULSE SHAPER**

The Field Pulse Shaper contains all circuits necessary for shaping, mixing, and pulse width control to produce the four output signals. Pulse widths are adjustable by means of screw-driver-type controls which may be locked in position.

The outputs are fed to 75 ohm coaxial lines from the plate circuits of the final amplifier tubes (RCA 6AG7). These outputs are coupled through blocking capacitors to prevent d-c from flowing in the transmission lines. The normal signal level on these lines is 4 volts, peak to peak. All four signals are negative in polarity.

Two separate cables carry the signals to other units in the system. One multiple cable, consisting of several coaxials, carries the Picture Blanking and the Horizontal and Vertical Driving signals to the Field Camera Controls. The second cable is a single coaxial line which carries the Synchronizing signal.

Two filament transformers are mounted in this unit to supply the tube heaters. Plate current for the tubes is provided by the regulated power supply in the Field Pulse Former.

**POWER DISTRIBUTION BOX**

This distribution box has nine 2-prong twistlock receptacles which fit the power cables supplied with the equipment. This number of outlets is more than sufficient for a four camera setup, and thus allows extra outlets for operation of associated audio equipment. Two standard convenience outlets are also provided for soldering irons, trouble lights, etc.

The power feed line to the box is a four conductor water proof cable (each conductor #10 gauge, stranded) connected through 4-prong twistlock connectors. A total of 200 feet of this cable is supplied with each equipment.

Provision is made for connecting this box to any one of three types of power distribution lines which are normally encountered in the United States. These are:

1. Single phase, 2 wire (117 volts).
2. Single phase, 3 wire (117 volts from each outer line to neutral).
3. Three phase, 4 wire (117 volts from each outer line to neutral).

A link board under a trap door at one end of the box provides easy means for rearranging the circuits to fit any of these three systems. Outlets are color-coded to indicate phasing on the three phase system, and correspondingly colored pilot lamps indicate which phases are "hot" in case a main fuse burns out.

Provision is thus made to utilize all elements of any available power distribution system so as to minimize voltage drop.

**Specifications**

Field Repetition Rate \_\_\_\_\_ 60 per sec.  
 Frame Repetition Rate \_\_\_\_\_ 30 per sec.  
 Line Repetition Rate \_\_\_\_\_ 15,750 per sec.  
 Synchronizing Generator Master Oscillator Frequency  
 31,500 cycles/sec.

Synchronizing Generator Counter Ratios:  
 First \_\_\_\_\_ 7 : 1  
 Second \_\_\_\_\_ 5 : 1  
 Third \_\_\_\_\_ 5 : 1  
 Fourth \_\_\_\_\_ 3 : 1

Frequency Stability of Horizontal Sync.  
 (when stabilized by power supply) — ±0.15%/sec. max.

Frequency of Quartz Crystal \_\_\_\_\_ 94,500 cycles/sec. ±50 cycles

Synchronizing Generator Output Signals:  
 (a) Signal Level (all signals) \_\_\_\_\_ 4.0 (−0.5, +1.0 volts, peak-to-peak)  
 (b) Signal Polarity (all signals) \_\_\_\_\_ Negative  
 (c) Waveform-Sync. \_\_\_\_\_ Defined by "Recommended Sync. Generator Waveforms", a drawing submitted January 22, 1946 (Revised October 9, 1946) by the RMA Sub-committee on Studio Facilities.  
 (d) Waveform-Picture Blanking \_\_\_\_\_ Defined by "Recommended Sync. Generator Waveforms", a drawing submitted January 22, 1946 (Revised October 9, 1946) by the RMA Sub-committee on Studio Facilities.  
 (e) Waveform-Horizontal Driving \_\_\_\_\_ Rectangular pulse, 15,750/sec. Width 6.3 microsec. (approx.)  
 (f) Waveform-Vertical Driving \_\_\_\_\_ Rectangular pulse, 60/sec. Width 4% or .00067 sec.

**Dimensions (in inches):**

CASE ONLY			OVERALL		
Length	Width	Height	Length	Width	Height
<b>FIELD PULSE FORMER</b>					
24½	8½	15⅝	25¾	8½	18½
<b>FIELD PULSE SHAPER</b>					
24½	8½	15⅝	25¾	8½	18½
11⅜	8⅞	3¾	11⅜	8⅞	5

**Weights:**

Field Pulse Former \_\_\_\_\_ 67½ lbs.  
 Field Pulse Shaper \_\_\_\_\_ 52 lbs.  
 Power Distribution Box \_\_\_\_\_ 10 lbs.

Finish \_\_\_\_\_ Two tone mumber gray wrinkle with chrome trim

**Stock Identification:**

Field Pulse Former \_\_\_\_\_ MI-26105  
 Field Pulse Shaper \_\_\_\_\_ MI-26115  
 Power Distribution Box \_\_\_\_\_ MI-26260



# Field Switching System Type TS-30A

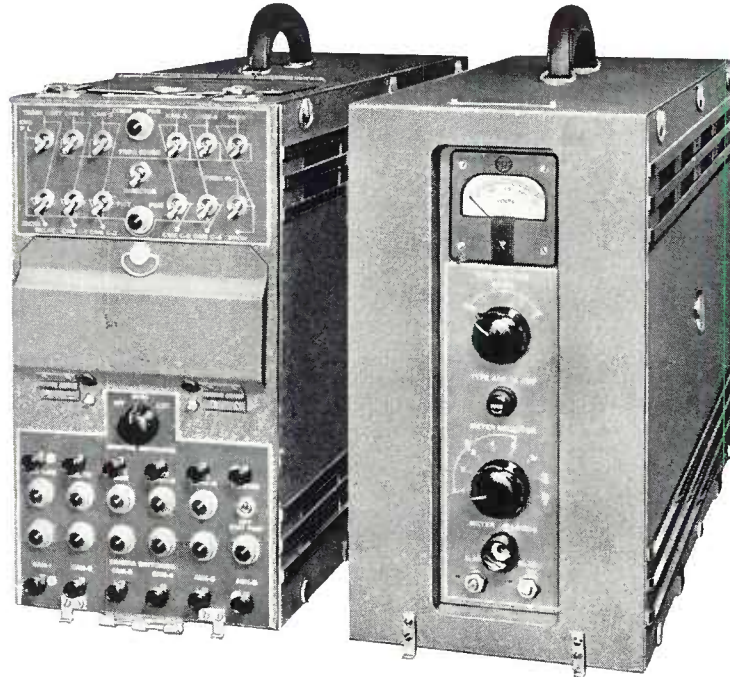

## Features

- Surgeless camera switching (clamp circuit) for four cameras and two auxiliary signals.
- Individual level control on each auxiliary picture input.
- Switching of Master Monitor for checking the outgoing picture line, auxiliary lines, relay transmitter, etc.
- Push button switches for picture signals.
- Tally system to indicate "on-the-air" to the camera control operator, camera man, and performers.
- Clamp circuit holds black level constant.
- Sync. level adjustable over wide range.
- Incoming signal may be with or without sync.
- Operation in conjunction with a Master Monitor from a single external power supply.
- Built-in power supply with separate control switch for the intercom. system.
- Complete miniature "central office" for an inter-communication system between all operators in a four camera setup and the program director, technical director, and main studio.

## Uses

The Field Switching System, when used in combination with the Field Master Monitor, is the equivalent, in the Field Equipment, of the director's console in a studio. It provides two major services in a setup involving more than one camera. The first is, of course, a means of switching between cameras and of monitoring the outgoing signal. The second is the

provision of an intercommunication center for the telephone system which enables all operating personnel to talk with each other.

## Description

The complete equipment consists of the Field Switching unit, contained in a compact, easily carried case; and the associated Field Power Supply, likewise contained in a portable case.

The picture signal circuits provide for switching between four cameras and two incoming auxiliary lines, or in unusual cases, between six cameras. Communication circuits are limited to a maximum of four cameras.

Two sets of push button switches are provided for picture switching. One set, located at the bottom of the front panel, and marked "CAMERA SWITCHING," switches signal from any of four cameras or two auxiliary inputs to the outgoing line. The second set marked "MONITOR SWITCHING" provides for switching the Field Master Monitor to any of the following five positions:

1. Outgoing picture line.
2. Monitor output of relay transmitter.
3. Incoming auxiliary line 5.
4. Incoming auxiliary line 6.
5. Spare input to monitor.

Each push button has an associated tally. Camera switching tallies operate in conjunction with tallies in the Cameras and Camera Controls.

The picture amplifier includes a "clamp" circuit to eliminate switching transients and other low frequency disturbances which may have been added to the signal earlier in the system, and thus provides that smooth switching which adds much to program technique.

The three 75-ohm coaxial outputs from the outgoing line amplifier are as follows:

1. Picture Output (for feeding a relay transmitter or studio line).
2. Master Monitor Output.
3. Auxiliary Monitor Output.

At output 1 appears the signal from the particular camera selected by the CAMERA SWITCHING push button. The second output is effectively in parallel with the first output.

The third output is provided to supply signal to any auxiliary equipment which it may be desired to operate such as an additional monitor, a standby link transmitter, or the switching system of an additional set of field equipment.

All three of these outputs deliver the same signal level and polarity, i.e., 2 volts, peak to peak, of picture and sync. with sync. negative. It is assumed that this level is based on the standard ratio of 75% picture and 25% sync. However, for signals from local cameras, where sync. is mixed with the camera signal in the Field Switching System, the amount of synchronizing voltage may be increased above the 25% value by adjusting the Synchronizing Gain Control.

Pulse signals for operation of the clamp circuit are derived from the synchronizing signal. The clamp operates at black level so that the output stage always operates over the same portion of its characteristic.

Filament power for the picture and pulse amplifier tubes is supplied by a transformer in the Field Switching System. D-c for plate supply is obtained from an M1-26095 Field Power

Supply which is also capable of providing plate current to a Field Master Monitor at the same time. The power control switch for the Field Power Supply with an associated tally, is located on the front panel of the Field Switching System.

The intercommunication system provides talking circuits between the camera men, the camera control operator, the technical director, the program director, and any assistant production personnel who may be stationed near the cameras. It provides also a circuit for distribution of the program sound to all the operators of the system. Each operator may be provided with a telephone set consisting of a double ear phone head band and a microphone. One ear phone in each set reproduces the program sound, and the other reproduces the operators' conversation.

Recessed under the front panel of the Field Switching System is a jack board with accommodations for six telephone sets; one for each camera, one for the program director and one without program sound for the relay transmitter operator.

A group of toggle switches on the upper part of the front panel provides means for making several circuit combinations in the intercommunication system. The following combinations are available:

1. Separate circuit to each camera and the relay transmitter.
2. A common circuit to all cameras or any grouping of them.
3. Optional tie-in between operators and program director.
4. Optional tie-in between operators and the engineering PL. (Private Line).
5. Optional tie-in between engineering PL. and production PL.
6. Optional circuit for the program director over the program line.

The circuit used for the intercommunication system is the common battery type. The power supply operates from the a-c line and is contained in the Field Switching System. A separate power switch, fuse, and tally are provided so that the intercommunication system may be operated while the rest of the equipment is turned off.

Four separate cables carry the intercommunication and tally circuits between the Field Switching System and the four Field Camera Controls. A jack provides means for a 2 wire circuit to the relay transmitter. Receptacles are provided for connecting the program sound, and the engineering and program phone lines, or PL's, from the main studio or transmitter.

Controls normally used during show time are located on the front panel. Others, used rather infrequently, are located under a small trap door on top of the suitcase. Controls normally preset are located on the chassis and are made accessible by removing the cover on the tube side of the unit.

Individual coaxial connectors are provided for all incoming and outgoing picture and synchronizing lines. All other connections are made with multiple conductor cables to keep the number of connections to a minimum.

A removable front cover is provided to protect the switches and other controls from damage during transportation. Removable side covers are also provided. The wiring side is interlocked and an auxiliary link is supplied to restore power for servicing.

**Specifications**

**Dimensions:**

**Field Switching Unit**

Case Only \_\_\_\_\_ 24½" long, 8⅛" wide, 15⅛" high  
 Overall \_\_\_\_\_ 26½" long, 8½" wide, 18½" high

**Field Power Supply**

Case Only \_\_\_\_\_ 24½" long, 8⅛" wide, 15⅛" high  
 Overall \_\_\_\_\_ 24½" long, 8½" wide, 15⅛" high

**Weight:**

Field Switching Unit \_\_\_\_\_ 71.5 lbs.  
 Field Power Unit \_\_\_\_\_ 58 lbs.

**Stock Identification:**

Field Switching Unit \_\_\_\_\_ MI-26215  
 Field Power Supply \_\_\_\_\_ MI-26095

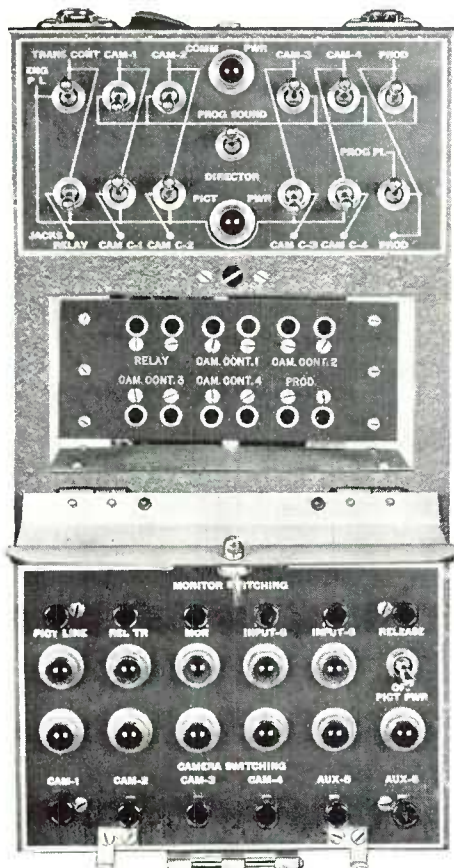

*Front view of Switching Unit showing panel detail*

# Master Monitor Type TM-5A

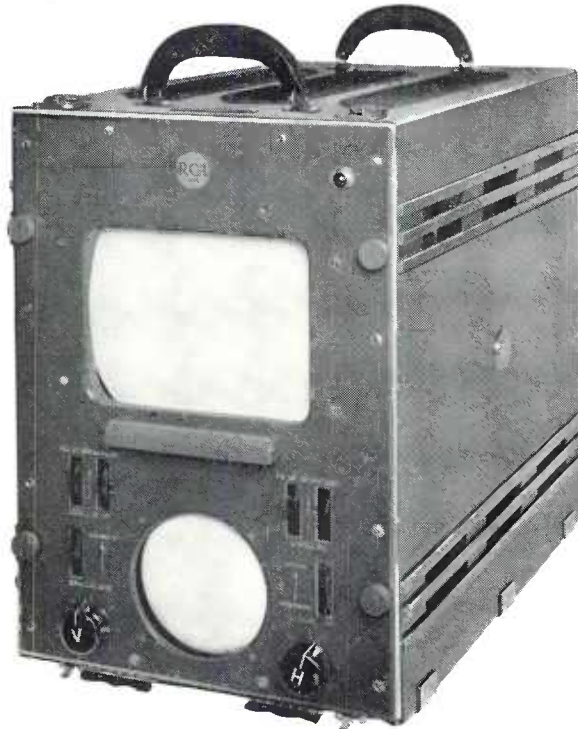

## Features

- Operates with composite picture signal input (synchronized operation) or with separate picture signal and pulse signal input voltages (driven operation).
- Special 10 inch diameter, kinescope with aluminum backing makes possible a very brilliant picture.
- Special low capacity input connection.
- Compact design permits location in operating consoles with minimum space requirements. Operator can easily look over the top of the console and can observe at least three adjacent monitors without difficulty.
- Synchronization of the oscilloscope sweep with the kinescope sweep at half line or half field frequency is completely automatic.
- Operating controls are extremely simple.
- Pulse high voltage supply reduces shock hazard considerably.
- Tubes and circuits are readily accessible.
- Adapter is available for rack mounting and a suitcase type enclosure available for portable or field use.
- Calibration circuit permits quick reference to a fixed voltage level.
- Grid circuit of oscilloscope is available for pulse measuring techniques.

## Uses

The Type TM-5A Master Monitor provides in a compact chassis a complete monitoring unit adaptable to the supervision of composite picture signals at any stage of transmission, from camera pickup to radio transmitter input. It may be used for both picture and waveform monitoring of signals from the relay receiver, the output signal at the master control room, or any other picture signals it may be desirable to monitor at the radio transmitter location.

## Description

The Master Monitor is furnished in chassis form. It may, therefore, be placed in a housing and grouped with other master monitors or camera controls to form an operating console. A case for table top mounting is available so it can be used conveniently with field equipment for monitoring purposes, and in conjunction with the adaptor, MI-26526, it can be used as a rack mounted monitor.

The unit employs a 10 inch kinescope for direct picture monitoring and a 5 inch oscilloscope for signal component analysis. Input circuits are arranged to permit the same or different picture signals to appear on the kinescope and oscilloscope screens at the same time.

A calibration circuit is included to establish a definite voltage level on the oscilloscope screen for measuring purposes. The horizontal scanning frequency of the oscilloscope tube is automatically half that of the kinescope and results in two cycles of either horizontal or vertical pulses, as may be selected by the operator, appearing on the oscilloscope screen.

The vertical front panel of the monitor, finished in dark amber gray is arranged with an opening at the top center, fitted with a rectangular mask, for the 10 inch kinescope to present the picture screen. The screen of the 5 inch oscilloscope is arranged immediately below the kinescope screen in a 5 inch circular opening. The lower section of the panel carries the switches and controls, conveniently grouped.

With the ends of the kinescope and oscilloscope presented to the panel, the other components of the circuits are mounted on vertical chassis on both sides of the cathode-ray tubes with tube sockets and circuit components arranged on narrow shelf members so that all parts are readily accessible for servicing.

A twelve contact plug at the rear of the assembly provides for the connection of necessary input power and external synchronizing pulse wiring. A safety feature is included in the form of an interlock which is attached to the monitor, so that withdrawal of the chassis from the case opens the high voltage circuits in the unit to prevent accidental contact with dangerous potentials.

The Master Monitor may be operated as either a "synchronized" or as a "driven" monitor. In the synchronized case, the scanning circuits are operated by blocking oscillators which in turn are triggered by the sync. pulses contained in the incoming composite picture signal. In the driven case, the incoming signal will normally come from a camera chain without sync. pulses. The scanning circuits are therefore "driven" directly by separate signals from the synchronizing generator. Connections to the sync. generator are made through the multi-contact plug. The switching arrangement employed for selecting the type of operation cuts off the blocking oscillators by opening the cathode circuits when the unit is operated as a driven monitor. The unit includes three step down transformers to furnish current for the tube heaters and filaments but d-c currents for the tube plate circuits and centering circuits must be obtained from an external regulated power supply.

**Specifications**

**INPUT POWER WHEN USED AS LINE OR RELAY RECEIVER MONITOR**

From Line for Tube Heaters:  
 Line Voltage \_\_\_\_\_ 105-125 volts  
 Line Frequency \_\_\_\_\_ 50-60 cycles, single phase

From Power Supply:  
 Plate Voltage \_\_\_\_\_ 285 volts d-c  
 Plate Current \_\_\_\_\_ 510 ma.  
 Centering Voltage \_\_\_\_\_ -7 volts d-c

**INPUT FROM CAMERA CHAIN WHEN USED AS CAMERA OR PROGRAM MONITOR**

	<i>Peak to Peak Voltage</i>	<i>Frequency in Cycles</i>	<i>Pulse Width</i>
Vertical Drive _____	2 min.	60	4%
Horizontal Drive _____	2 min.	15,750	10%
*Oscillator Drive _____	8	Mixed 30 and 7875	
** Bias _____	-18	d-c	
*** Tally Light _____	6.3 v.		

**Frequency Response:**

Kinescope Amplifier \_\_\_\_\_ Flat  $\pm 1$  db to 8 mc.  
 Oscilloscope Amplifier  
 (Vertical Deflection) \_\_\_\_\_ Flat  $\pm 1.5$  db to 4 mc.

**Input Impedance:**

CRO Input \_\_\_\_\_ High  
 Kinescope Input \_\_\_\_\_ High  
 CRO Drive Signal \_\_\_\_\_ High

**Signal Input Range:**

CRO Input \_\_\_\_\_ 0.5 to 3 volts  
 Kinescope Input \_\_\_\_\_ 0.5 to 3 volts

Chassis Dimensions \_\_\_\_\_ 17 $\frac{3}{4}$ " high; 13" wide; 20 $\frac{1}{4}$ " deep

Weight \_\_\_\_\_ 68 lbs.

Stock Identification (chassis only) \_\_\_\_\_ MI-26I35

- \* Use of this signal is optional.
- \*\* Used only with camera chain, under which condition following output voltages are available from monitor:  
 Pedestal Control \_\_\_\_\_ 0 to -18 volts d-c  
 Video Gain Control \_\_\_\_\_ 0 to -18 volts d-c
- \*\*\* Connected to switching or monitor heater circuit.

# Television Field Desk MI-26560

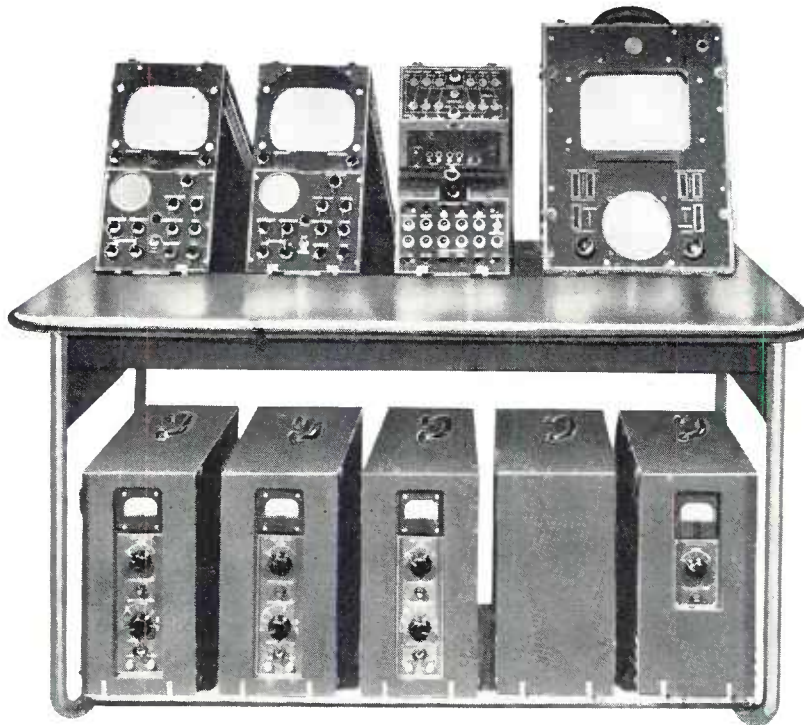

*Television field desk with field camera control and monitoring equipment in place*

## Features

- Desk is convenient height.
- Inclined desk top supports field units at eye level.
- Adequate space for all control units.
- Stainless steel strips protect mounting surfaces.
- Sturdy all-metal construction and durable finish assures long service and pleasing appearance.
- Ample desk space in front of control and monitoring units.



*Rear view of television field desk*

## Uses

The Television Field Equipment Desk was designed expressly for RCA field camera equipment. It is sturdy and easily transported, and when used where telecasts are being made, provides a convenient operating desk on which the units required for controlling and monitoring the television cameras can be mounted.

As shown in the illustration, the field desk will accommodate the nine units required for operation of two field cameras. The camera control, switching and master monitor units which require observation or adjustment can be placed in a convenient position on the inclined portion of the desk top, with the power supply and sync generator units on a shelf below.

## Description

The all-metal desk is sturdily constructed and attractively finished. Painted surfaces are finished in umber gray color; the table top is stainless steel. Stainless steel strips prevent the finished surfaces from being marred by the television units.

## Specifications

Dimensions:

Height	_____	28"
Width	_____	50"
Depth	_____	44"
Weight	_____	117 lbs.
Finish	_____	Uंबर gray

# Television Relay Transmitter Type TTR-1A



## Features

- Complete transmitting system.
- Suitable for permanent installation.
- Completely portable for field pickups.
- Superfrequency operation permits simplified circuits and small physical size.
- Flexibility of operation.
- Lightweight.
- Optional console operation.
- Highly directional antenna.

## Uses

The Type TTR-1A Relay Transmitter, when used with a Type TRR-1A Relay Receiver, constitutes a highly directional wide-band relay link especially suited to the transmission of television video signals. Such a link circuit has two important applications which are:

(a) FOR STUDIO-TO-TRANSMITTER CIRCUITS where conditions of terrain, distance, or right-of-way make it more convenient or economical than a coaxial line. For such use the transmitter and parabolic antenna units will be permanently mounted on the roof or other high location near the studio and the transmitter control unit will be mounted, ordinarily, on the equipment racks in the studio control room. The receiving equipment will be permanently located at the transmitter site.

(b) FOR FIELD PICKUPS as a means of transmitting the video signal back to the studio when no coaxial line or satisfactory wire line is available for the purpose. In this case, the rotatable tripod mounting illustrated will ordinarily be used. The antenna will be located on some high point, such as the top of a stadium where there is a line-of-sight path to the receiving antenna at the studio. The transmitter control unit will be located with the camera control equipment as, for instance, in the radio booth or in the field truck or mobile unit.

## Description

The TTR-1A Relay Transmitter is a complete, transportable transmitting system consisting of (1) a transmitter, (2) a highly directional antenna, (3) a rotatable antenna mounting unit, and (4) a transmitter control unit. These units are designed to work together, and may easily be set up and connected by means of plug-in cables.

## RELAY EQUIP.

The transmitter is contained in a cylindrical weatherproof housing attached to the rear of a parabolic reflector. It utilizes a klystron oscillator which is frequency-modulated by variations of the negative voltage on the repeller plate. It has a power output of approximately 100 milliwatts, operating at any selected frequency between 6500 and 7050 megacycles. The normal frequency deviation is 12 mc. with polarity such that a video signal in the white direction produces an increase in frequency. The output is fed to the parabolic reflector by means of a wave guide. Coupled into this wave guide system are an absorption type wavemeter, and a crystal detector monitor. The wavemeter is preset to any desired frequency. The d-c from the crystal detector may be measured either at the transmitter or at the transmitter control unit as a rough indication of relative power output. The a-c component of the crystal detector output is amplified and fed over a coaxial line to the transmitter control unit where it serves during preliminary adjustment to indicate the correct frequency, and during operation, to indicate proper centering of the signal around the resonant frequency of the klystron cavity. Filament power for the tubes in the transmitter is supplied from a small filament transformer on the same chassis. All other voltage supplies are received on the transmitter chassis which are accessible by removing the protective cover over the cable input connection. By plugging in a suitable meter in the proper jack, it is possible to measure the current through modulator tube, and the oscillator tube. Another jack is provided so that a telephone handset can be plugged into the unit for communication with the transmitter control unit location.

The parabolic antenna provides a very high gain in the direction of transmission. The four foot size (illustrated) has a gain of approximately 5000, thereby giving an equivalent power output of 500 watts. The parabola is also available in the six foot size, with approximately twice the gain, for use in communicating over greater distances. Transmission is limited to a line-of-sight path, and under normal conditions, a range of 10 to 15 miles may be expected with a satisfactory signal to noise ratio.

The antenna and transmitter are mounted on a standard rotatable camera tripod mounting unit. This mounting unit may be accurately adjusted over wide vertical and horizontal angles. For fixed installations, a different type of mounting, providing only small adjustments of angle, is available.

The transmitter control unit is housed in a small, easily-carried, portable cabinet with a convenient handle on the top. The controls are accessibly located on a control panel on the side of the cabinet. This control unit may be located up

to 400 feet away from the transmitter. It contains all the necessary operating and monitoring controls, and after initial adjustments of the transmitter and antenna have been made, all operations may be carried on from this unit. It also contains a regulated B+ supply for operation of the transmitter tubes, and a regulated negative supply for the klystron repeller plate. For greater operating convenience, provision is made for extending the operation of the controls necessary for routine adjustments of the transmitter to a monitoring console.

### Specifications

Frequency Range	6800-7050 mc.
Power Output	100 milliwatts
Antenna Gain	
4 ft. reflector	4,500
6 ft. reflector	10,000
Frequency Deviation for 100% Modulation	10 mc.
Video Input Impedance	75 ohms
Video Frequency Range	60 cycles to 6 mc.
FM Noise Level Below $\pm 10$ mc Swing	32 db
AM Noise Level Below (Maximum) Modulation	40 db
Power Supply Requirements:	
110 volt, 60 cycles a-c	150 watts

### Tube Complement:

#### Transmitter

1-6AG7	1-6H6
2-6SL7GT	1-2K26

#### Transmitter Control Unit

1-6AG7	1-5V4G
2-6X5GT	1-6AS7G
4-VR150	1-6SL7GT

Reflector Dimensions:	Diameter	Focal Length	Depth
	4'	14.5"	10"
	6'	21"	14"

Transmitter.....13" Diameter, 17" Long

#### Transmitter Control Unit:

Carrying Case	20" Long, 19" High, 13" Wide
Standard Rack Space	10 $\frac{1}{2}$ "

Finish.....Two-tone umber grey

#### Weights:

Transmitter and Housing	26 lbs.
Transmitter Control Unit	38 lbs.

Stock Identification.....MI-26935

# Television Relay Receiver Type TRR-1A

## Features

- Complete receiving system.
- Suitable for permanent installation.
- Completely portable for field use.
- Lightweight.
- Optional console operation.
- Effective automatic frequency control.

## Uses

The Type TRR-1A Relay Receiver, when used with a Type TTR-1A Relay Transmitter, constitutes a highly-directional wide-band radio link especially suited to the transmission and reception of television video signals. Such a link circuit has two important applications which are:

(a) FOR STUDIO-TO-TRANSMITTER CIRCUITS where conditions of terrain, distance, or right-of-way make such a system more convenient or economical than a coaxial line. For such use the antenna of the TRR-1A is located on a tower or other high point near the transmitter building in a fixed position directed toward the TTR-1A Transmitter located at the studio. The receiver control unit and power supply unit are ordinarily mounted on equipment racks in the transmitter control room.

(b) FOR FIELD PICKUPS where a TTR-1A Transmitter, arranged for portable use, is employed to send the video signal back to the studio (instead of wire or coaxial lines). In this case a rotatable mounting such as that illustrated will ordinarily be used (since there will be pickups from various directions). For temporary use, the tripod mounting may be used. When the equipment is used frequently, a more permanent mounting is desirable. In any event it must be high enough to provide a line-of-sight path to the transmitting antenna location.

## Description

The TRR-1A Relay Receiver is a complete (transportable, if desired) FM receiving system covering of frequency range of 6500-7050 megacycles. It consists of (1) a receiver, (2) a highly directional antenna, (3) an antenna mounting unit which may be either fixed or rotatable, (4) a receiver control unit, and (5) a regulated power supply unit. These units are easily set up and connected by means of convenient plug-in cables.

The signal is picked up on the highly directional, high gain (4500) parabolic antenna and fed into the receiver. The receiver is contained in a cylindrical, weatherproof housing attached to the back of the parabolic reflector. This housing contains a klystron tube heterodyne oscillator, a crystal mixer circuit, and five stages of the receiver i-f amplifier. This provides an output signal of about 50 millivolts at an i-f center frequency of 120 mc. This signal is fed to a coaxial line leading to the receiver control unit. The receiver has a built-in transformer which supplies filament power to all tubes. All other voltages are obtained from the power supply by way of the receiver control unit. The equipment is provided with an intercommunication system so that handsets may be plugged in and operators may communicate between the receiver and the receiver control unit.

The receiver control unit contains seven additional i-f stages, the limiter and discriminator stages, and the AFC system. There are two separate discriminator channels fed from the output of the i-f amplifier. One supplies signal to the main transmitter and monitoring circuits. The other is used to generate a control voltage for the AFC amplifier. The purpose of the AFC is to control the frequency of the heterodyne oscillator and keep it in proper adjustment for variations in transmitter frequency. The receiver control unit is connected to the receiver by means of a single cable with plug connectors at each end. In operation this cable may be as long as 200 feet. For special cases, however, it may be made as long



as 1000 feet by employing a separate coaxial line carrying the i-f signal. In addition, a cable connector at the rear of the receiver control unit permits the connection of an extension cable so that routine operation may be conducted from a nearby monitoring console. Both this unit and the power supply are intended to be mounted in a standard equipment rack, as illustrated. A small control panel is located on the front from which all adjustments can be made. They may also be mounted in convenient carrying cases for portable operation, if desired. This unit has its own filament transformer, but the other voltages are received from the power supply. All tubes are accessible from the front of the unit, and all cable connections are made at the rear.

## Specifications

Frequency Range	6800-7050 mc.		
Type of Reception	Frequency modulation		
Video Frequency Range	60 cycles to 6 mc.		
Band Width	15 mc.		
Tube Complement:			
Receiver	1-2K26	1-6J6	4-6AK5
Receiver Control Unit			
	11-6AK5	2-6AG7	
	3-6J6	2-6SL7-GT	
	2-6AL5	1-6SN7-GT	
	1-6AC7		

Total Power Consumption	110 volts, 60 cycles a-c, 250 watts
Weights:	
Receiver and Housing	35 lbs.
Receiver Control	36 lbs.
Power Supply	58 lbs.
Stock Identification	MI-26940



## Television Mobile Unit Type TJ-50A



### Features

- Economical and convenient to maintain—standard Chevrolet school bus chassis.
- Modern styling conforms with that of RCA Television Equipment.
- Six feet of head room in interior.
- Large windows in driving compartment.
- All glass is shatterproof.
- Complete and convenient stowage facilities.
- Cables contained on six convenient reels.
- Inside ladder and hatch provides access to roof.
- Roof covered with special non-skid tread material.
- Adequate heating facilities.
- Complete control room in rear of truck.

### Uses

The RCA Television Mobile Unit is a custom-built vehicle designed to carry the television equipment needed to pick up outdoor scenes and relay the pictures to a studio or transmitter room for broadcasting.

The interior arrangement provides adequate storage space for three cameras, their tripods and the relay transmitting parabola—units which must be set up outside the vehicle for telecasting. Equipment which need not be removed from the vehicle, such as the relay transmitter control unit, audio amplifier and mixer, monitors and the camera control units, are shockmounted on an attractively finished, linoleum covered operating table inside.

Use of the Mobile Unit greatly simplifies the work of transporting the television equipment required for field pickups. It also saves considerable wear and tear on the television units as well as time in setting them up for operation.

**Description**

The body of the vehicle, built on a standard 1½-ton Chevrolet chassis, is custom-built to provide an attractive, practical and compact unit. Finished in two-tone umber gray, it is both attractive and durable. The roof is reinforced to support the weight of the field cameras as well as the relay antenna and the operators. Access to the roof is made easy through use of an inside ladder and a 24" x 36" rain-tight hatch.

A short wheelbase gets the vehicle around sharp turns in narrow streets; large, full-view shatterproof windows facilitate safe driving in heavy traffic; and a 90-horsepower engine provides speed on open roads as well as pulling power on the hills.

Four cable reels mounted on swinging arms are housed in a rear compartment accessible through two doors in the back of the unit. When the rear doors are opened, the reels can be swung out into the clear to facilitate unreeling the cable. Each reel can accommodate 200 feet of cable. If additional cable is required, there is space in the compartment for the addition of two cable reels.

Inside, the vehicle has adequate heating facilities for cold weather. In warm weather, the heater fan can be used for ventilation. The linoleum covered operating table at the rear runs the full width of the Mobile Unit, and provides convenient operating space for three operators seated side by side. Swivel chairs for the operators are permanently mounted to the floor. The storage lockers for the cameras, tripods and accessories are built along the inside walls of the vehicle.



*Interior view, looking aft, showing ladder to roof, and operators' positions*

**Specifications**

Outside Dimensions (overall):

Length (bumper to bumper)	269"
Width	89"
Height	110"

Inside Dimensions:

Width	34"
Height	72"
Height (at operators' table)	67"
Gross Weight	13,500 lbs.
Tire Size	7.50 x 20
Chassis	Standard 1½-ton 160" wheelbase Chevrolet
Finish	Two-tone umber gray (light umber gray inside)

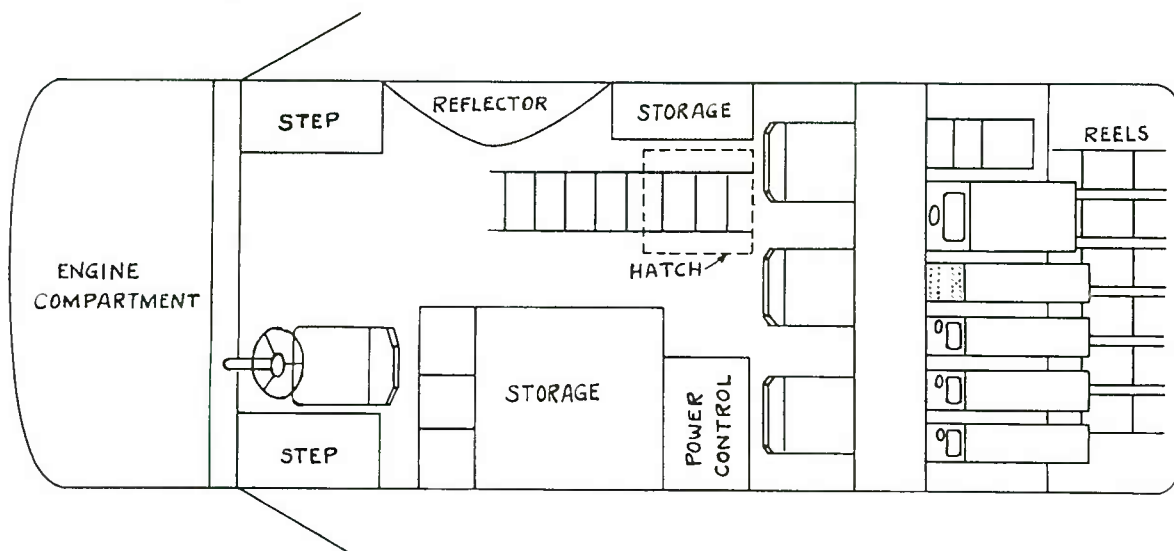

*Interior layout plan of TJ-50A*

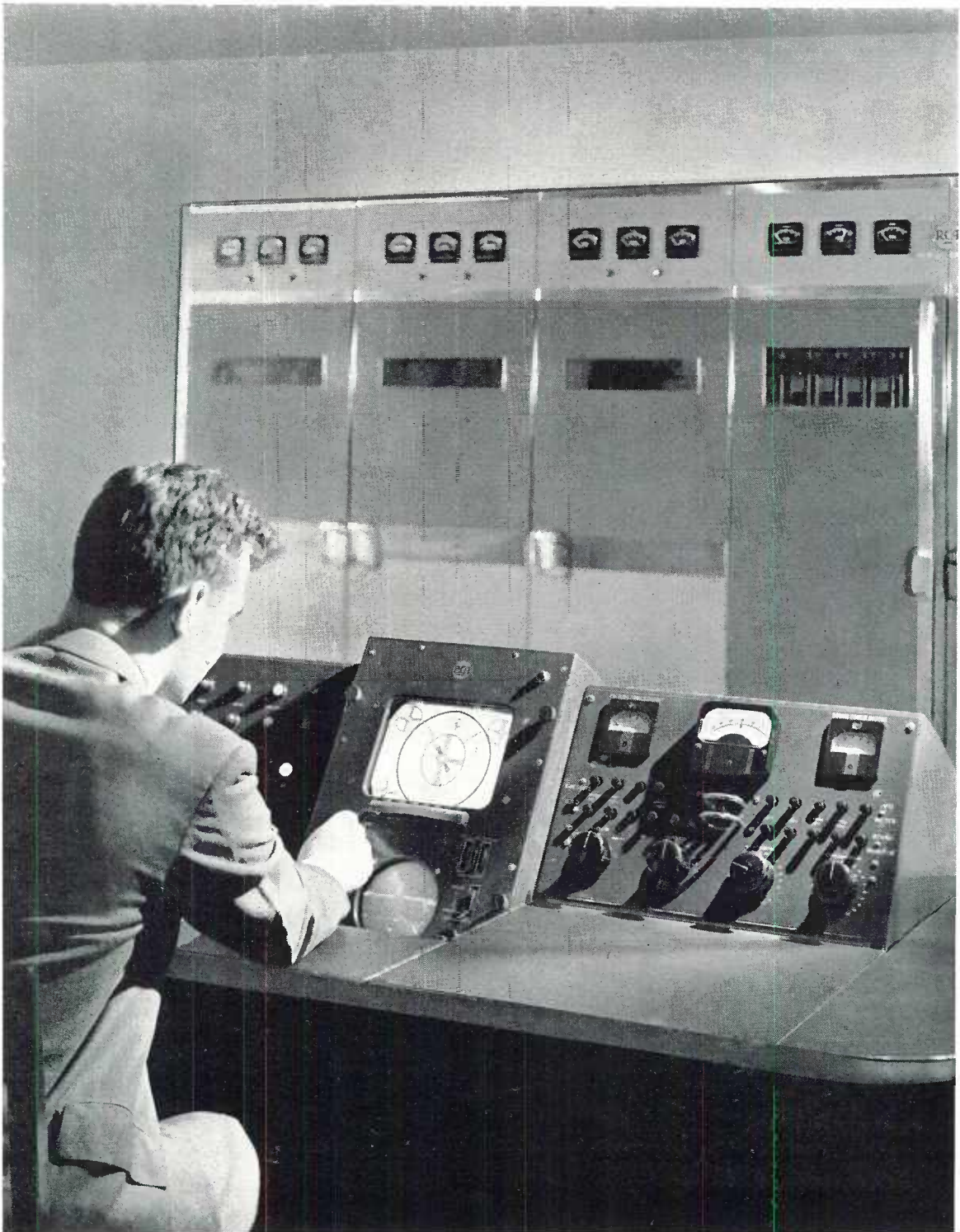

# **TELEVISION TRANSMITTING EQUIPMENT**

	<b>Page</b>
<b>TRANSMITTERS</b>	<b>192</b>
<b>SIDE BAND FILTER</b>	<b>194</b>
<b>DIPLEXER</b>	<b>195</b>
<b>TRIPLEXER</b>	<b>197</b>
<b>SUPER TURNSTILE ANTENNA</b>	<b>198</b>

# Television Transmitter Type TT-5A

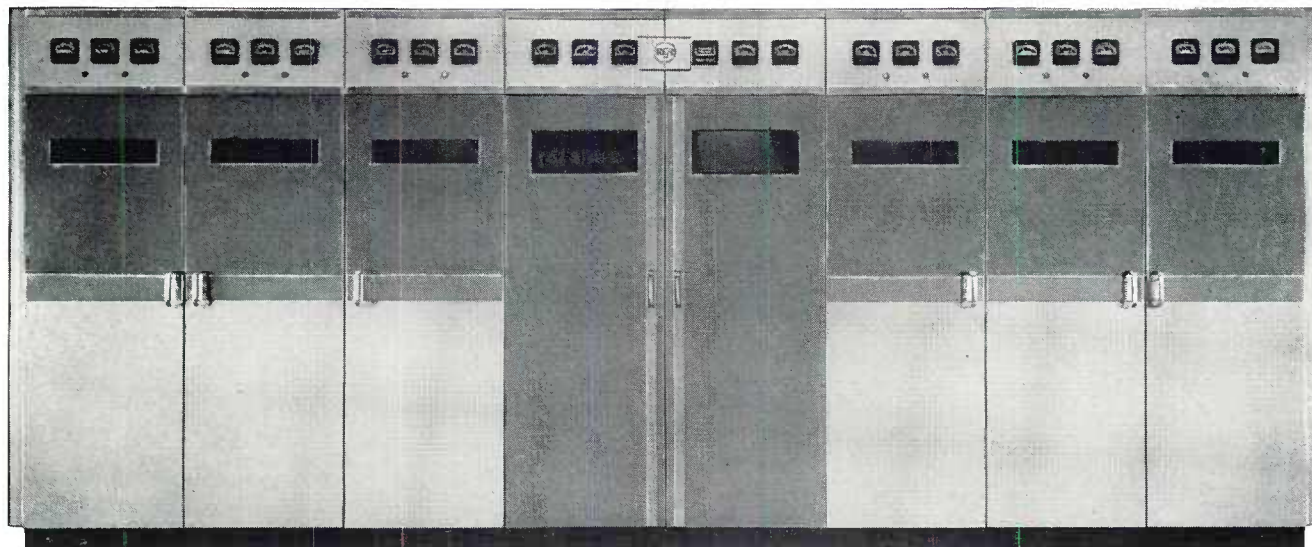

## Features

- Low installation costs—flexible cabinet arrangement.
- Low operating cost.
- Uses highly efficient RCA 8D21 dual tetrode as power amplifier.
- Power amplifiers require no neutralization.
- Quick changing of power amplifier tubes.
- High level modulation in visual section.
- Straight-forward “meter tuning” of all r-f driver stages.
- Uses highly efficient RCA FM exciter in aural section.
- Packaged for convenience in shipping and installation.
- All components readily accessible through front and rear doors.

## Description

The TT-5A is RCA's first post-war television transmitter. It represents the culmination of the many years of RCA Television research and development. Many new features found in this transmitter are the first applications of the latest RCA developments.

The transmitter has a nominal power output of five kilowatts peak visual power, and two and one-half kilowatts peak aural power. This ratio is in conformance with the RMA standard. The frequency range is from 54 to 216 mc., which covers the twelve presently assigned television channels for metropolitan operation.

The entire transmitter is housed in eight steel cabinets which are fastened to a base frame. This frame is divided in such a manner that the eight cabinets may be placed either in a straight line (overall width—208") or in a “U”-shaped arrangement (smallest possible overall width—150"). Each cabinet has both a front and rear door. The front doors are provided with windows for observing the transmitter while in operation. The components and wiring are arranged to permit

maximum accessibility, for testing and servicing. End trim and meter panels complete the cabinet enclosure, so that it presents a pleasing and dignified appearance. A filtered air supply for each cabinet is provided through individual removable filters in the bottom. Warm air is expelled through the top. The visual section of the transmitter is located on the right side and the aural section is on the left, with the power supplies and control panel for both sections in the center. This central location of power controls provides a high degree of convenience and flexibility in the operation of the transmitter.

The transmitter control circuits employ the newest and most modern techniques. Provision is made for both manual and automatic-sequence starting. The automatic system provides a three shot recycling sequence, which automatically returns the transmitter to the air up to three times in case of momentary overload. If the overload persists, the transmitter is automatically shut down. A special hold-in circuit permits the transmitter to return instantly to the air in the case of momentary power line failure, thus avoiding the thirty second delay required for the plate time-delay relay to close. A switch is provided for each main rectifier to provide a reduced power position for tune-up and emergency operation. All critical power supplies are electronically regulated, making possible stable, high-quality operation under all conditions of signal or line voltage variation.

The visual section of the transmitter is essentially a crystal oscillator followed by several r-f amplifier stages, and a grid-modulated, power amplifier. The use of final-amplifier, grid-modulation makes possible the operation of all driver stages as high-efficiency, narrow-band, class “C” amplifiers, which can be tuned quickly and easily from front panel meter observations.

The final power stage uses the new RCA 8D21 water-cooled dual tetrode operated as a push pull amplifier. The use of this tube is one of the outstanding features of this transmitter. Its highly efficient water cooling system introduces a new principle in tube construction which permits roughly ten times the power handling capacity of other tubes of comparable size. It results in exceptionally low output capacitance. This, together with the dual tetrode construction does away with the

necessity of neutralization. Since small physical size and low output capacitance are necessary requirements for broad band operation at television frequencies, this tube is an important development in the progress of television.

The aural section of the transmitter utilizes the highly efficient RCA FM exciter, MI-7015, followed by several amplifier stages, and a power amplifier likewise employing the RCA 8D21 dual tetrode.

Coupled into the outputs of both the visual and aural sections of the transmitter are "Reflectometer" units, which perform the following important functions:

1. Measure the standing wave ratio on the main transmission line.
2. Measure the "Peak of Sync" power output (when calibrated against the dummy load).
3. Operate as an r-f overvoltage output, thus protecting the transmission line against rupture due to lightning, bad instrumentation or any trouble which causes excessive standing waves to occur.

The power circuits are so arranged that the operator may do emergency maintenance or servicing work on the aural or visual section of the transmitter while the other is on the air. This includes changing the 8D21 tubes without shutting down the water circulator. The operator is fully protected by proper interlocking and safety devices. During test periods, either section of the transmitter may be operated independent of the other with a resultant saving in overall power consumption.

All high power circuits are doubly protected by highspeed overload relays backed up by thermal type circuit breaker switches. Similar circuit breaker type switches are used to connect water cooler, blowers, filaments, and low power circuits to the power line. All fuses are of the visual indicating type, and are mounted in a group on the front panel for easy accessibility and identification.

In order to provide greater convenience in shipping and installation, the transmitter is partially disassembled when it leaves the factory. The largest unit, uncrated, is 25 x 38 x 80 inches, and no single unit weighs over 1000 pounds. This facilitates handling in confined spaces and elevators. All connections between units are made from conveniently located terminal boards on each unit.

**Specifications**

	<i>Aural</i>	<i>Visual</i>
Type of emission	A3	A5
Frequency range	Chan. 2 to 13	Chan. 2 to 13
Power output (into transmission line)	2 to 4 kw.	2.5 to 5 kw peak
RF output impedance	72 ohms	72 ohms
Carrier frequency stability	±0.002%	±0.002%
Modulation capability	±50 kc.	90%
Method of modulation	Frequency mod.	Amplitude mod.
Input impedance	600 ohms	75 ohms
Input level	+12, ±2 db	1 volt peak to peak
Frequency response**	Uniform within ±1 db from 30 to 15,000 cycles	*0 db at 0.1 mc. 2 db at 0.5 mc. 2 db at 1.25 mc. 2 db at 2 mc. 2 db at 3 mc. 3 db at 4 mc.

	<i>Aural</i>	<i>Visual</i>
Audio frequency distortion:***		
50 to 100 cycles	1.5%	
100 to 7,500 cycles	1.0%	
7,500 to 15,000 cycles	1.5%	
Noise level:		
FM noise, below ±25 kc swing	60 db	
Amplitude noise, rms below carrier	50 db	
Amplitude variation over one frame.		Less than 5% of peak to peak signal amplitude

**Power Line Requirement:**

**Transmitter**

Line voltage	208/230 volts
Phase	3
Frequency	50 or 60 cycles
instantaneous regulation	5% maximum
Power consumption (approx.)	32 kw
Power factor	85%

**Console, crystal heaters, etc.**

Line voltage	115 volts
Phase	1
Frequency	50 or 60 cycles
Power consumption (approx.)	600 watts

**Dimensions:**

Overall length****	208"
Overall height	84"
Overall depth (inc. door handles)	38"
Building entrance and elevator clearance requirements	25" x 80"

**Weight:**

Transmitter**** (8 cabinets plus 2 PA cabinets)	8000 lbs. (approx.)
Console	600 lbs. (approx.)
Water circulating system	1300 lbs. (approx.)

Finish \_\_\_\_\_ Two-tone number gray with satin chrome trim and fittings

Stock Identification \_\_\_\_\_ MI-19205-A, B

\* Maximum attenuation with respect to idealized rectified vestigial sideband response.

\*\* For pre-emphasized response the pre-emphasis filter (MI-4926A) is provided to be inserted in the 600 ohm audio input line at the most effective point.

\*\*\* Distortion and noise are measured following a standard de-emphasis network.

\*\*\*\* To facilitate packaging and handling, the equipment breaks down into its component cabinets (8 plus 2 PA cabinets) and is shipped accordingly. The larger power supply components are also removed and packed separately. Thus, the dimensions of the largest unit (unpacked) is 25 x 80 x 38 inches, and the weight approximately 600 lbs.

# Vestigial Side Band Filter MI-19104

## Features

- Small size—small floor space.
- No adjustments.
- Low insertion loss.
- Constant impedance input over entire double sideband.
- Completely enclosed to prevent tampering and admission of dust.

## Description

The sideband filter is a device which is connected directly to the output of the television visual transmitter to absorb the relatively small amount of lower sideband energy falling outside of the assigned television channel. Use of a sideband filter has several advantages: first, the tedious adjustment of tuned radio frequency amplifiers needed for the rejection of the sideband when low level modulation is employed is eliminated; second, the sideband filter has a constant impedance input so that the process of sideband elimination is accomplished without a detrimental effect on the picture quality; and third, the high level modulation system used in the transmitter gives the visual transmitter a better overall linearity.

Electrically, the sideband filter is a combination of two M-derived filters. Since filter components of the common coil and condenser construction would be difficult to manufacture and uneconomical to use because of the currents, voltages and reactances involved, the sideband filter has been designed, using low loss coaxial transmission line elements. The undesired sidebands are passed through one of the filter units into a properly terminated transmission line that effectively eliminates reflections of the lower sidebands. The desired signals are passed through the other filter unit and a notch filter. The notch filter is incorporated in the design to give positive insurance against interference with the sound channel of the next lower television channel. This notch filter is a system of resonant coaxial transmission line elements that allows the absorption of a single frequency in a second terminated coaxial transmission line while the desired television signals are not effected.

Since the filter is completely assembled at the factory, all tuning adjustments are factory made. It is contained in a completely enclosed metal cabinet finished in umber-gray and styled to match the associated television transmitter. The sideband filter is designed to stand in a vertical position near the visual transmitter, with a connecting transmission line preferably not more than 10 feet in length. The transmission line connecting the filter to the visual transmitter may leave the filter through the top or bottom or on one side. The output line passes through the top of the unit. The only other connections are with the station water-cooling supply and the visual transmitter interlock circuit.

Vestigial sideband filter, MI-19104-A, covers channels 1 to 6 inclusive; and vestigial sideband filter, MI-19104-B covers channels 7 to 13 inclusive. Each unit is tuned for the desired specific channel at the factory.

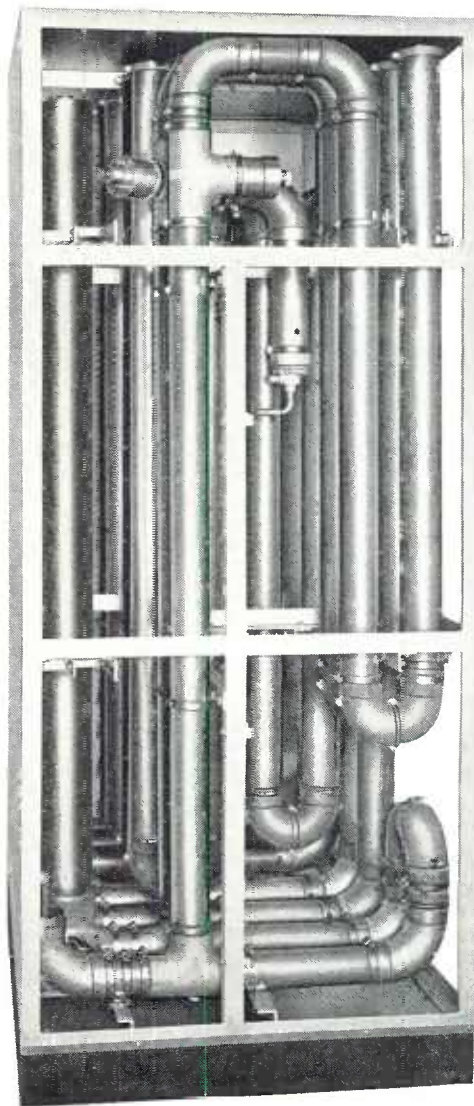

## Specifications

### Dimensions

Height\* \_\_\_\_\_ 84"  
 Width \_\_\_\_\_ 36"  
 Depth \_\_\_\_\_ 42"

Weight \_\_\_\_\_ 1400 lbs.

Finish \_\_\_\_\_ Two-tone umber gray

Water connections (connected to transmitter water cooling system)

“In” union for 1/2 nominal dia. copper water tubing

“Out” union for 1/2 nominal dia. copper water tubing

Electrical Connections \_\_\_\_\_ Transmitter interlock of circuit

### Radio Frequency Connections

Input Impedance \_\_\_\_\_ 72 ohms, 3/8" coaxial line

Output Impedance \_\_\_\_\_ 72 ohms, 3/8" coaxial line

\* Height of sideband filter with base taken off for shipment is 80".

## Television Diplexer Unit MI-19021, MI-19022

### Features

- Permits use of one antenna for both visual and aural television signals.
- Enclosed cabinet prevents tampering and admission of dust.
- Cabinet sides easily removed for inspection.
- Dependable. Electrical networks are composed of conservatively rated coaxial sections.
- No adjustment required at installation.
- Occupies little floor space.

### Description

The Television Diplexer is a device to permit the feeding of both the television visual signal and the television aural signal to the same turnstile antenna without detrimental cross talk. This eliminates one of the two transmitting antennas that would otherwise be required and thereby saves the expense of an additional antenna with its associated supporting tower.

There are two types of Television Diplexers: one for low frequencies and one for high frequencies. MI-19021 covers the television channels 1 through 6, and MI-19022 covers channels 7 through 13. The low frequency diplexer is larger than the high frequency unit because of the greater physical size of the components.

The diplexers are completely enclosed in steel cabinets finished in umber-gray, and styled to match the apparatus with which they are associated. The cabinet sides are easily removed for routine inspection. The unit is shipped complete, and no adjustment is required during installation.

In a simplified form, the diplexer may be considered to be a balanced bridge circuit in which there are four legs, as illustrated in the accompanying diagram. The visual and the aural

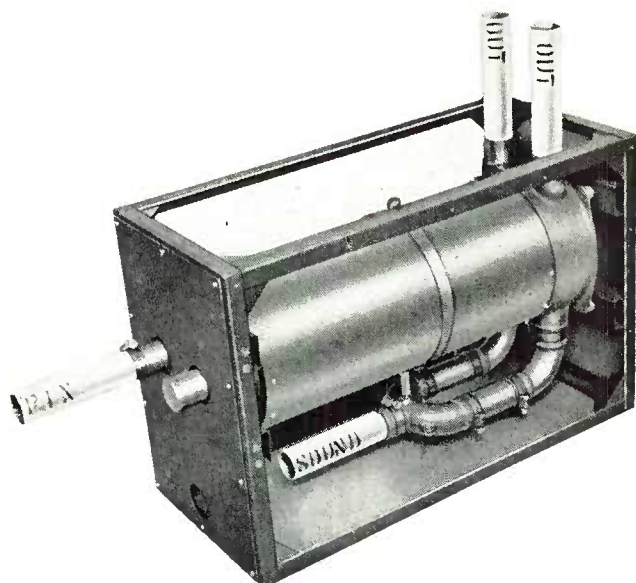

*High-frequency Diplexer, MI-19022*

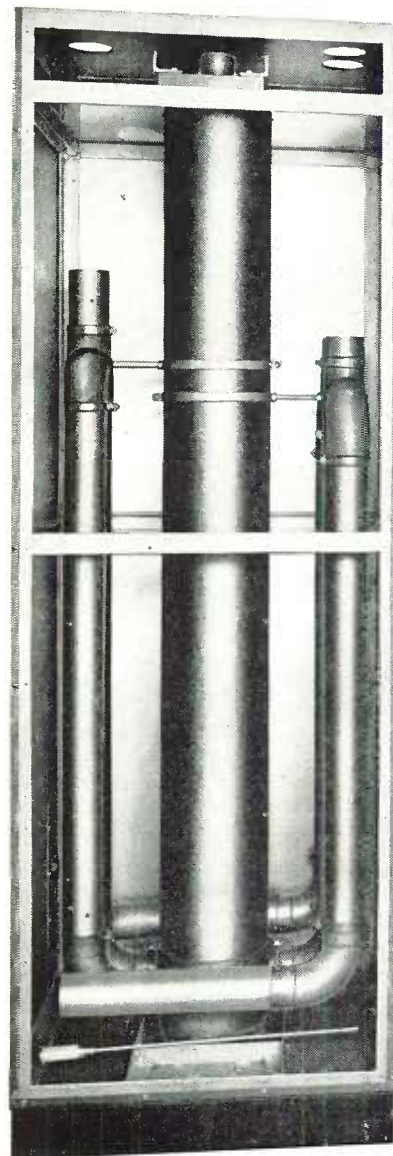

*Low-frequency Diplexer, MI-19021*

signals are fed to alternate diagonals of the bridge. Since the aural signal is fed into the circuit across the mid-points of the antenna and the reactors, no visual signal can go into the aural transmitter. In like manner, the visual signal is fed to the circuit between two points of equal potential with respect to the aural transmitter so that no aural signal can get back to the visual transmitter.

The Television Diplexer is installed in the station room, as near as possible to the vestigial sideband filter. In this way, it is convenient for inspection and maintenance, and no wind or weight load is added to the tower. Because of the upright cabinet type of construction, it occupies very little station floor space.



# DIPLEXER

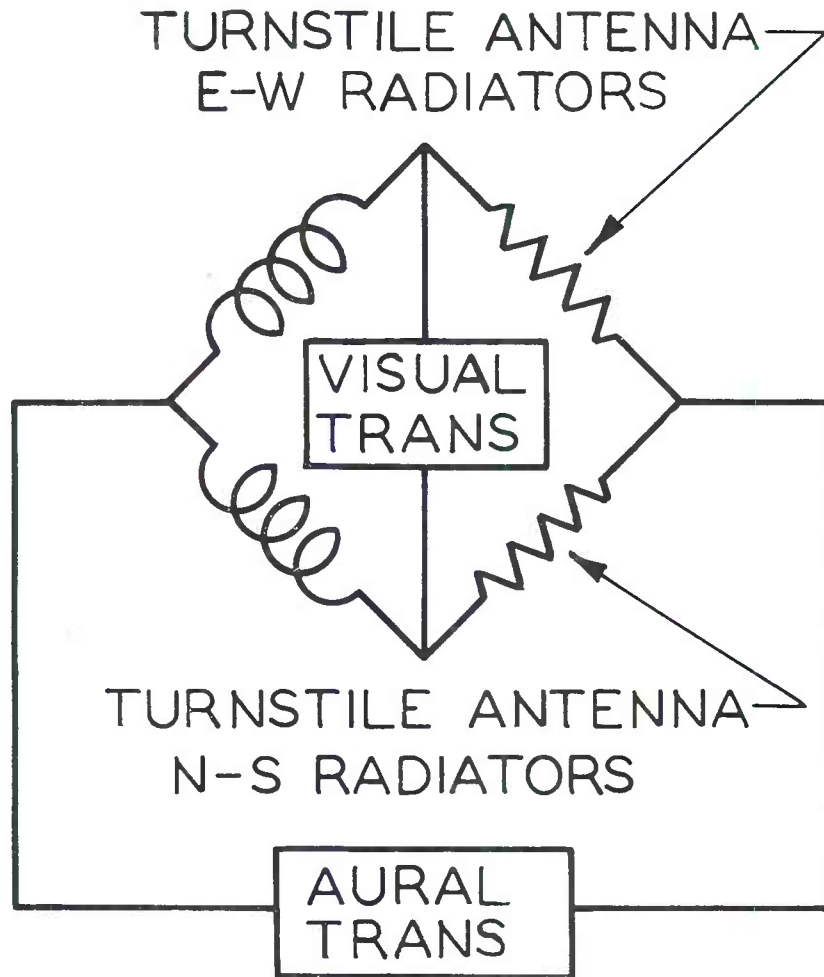

*Simplified Schematic Diagram of Television Diplexer Unit*

## Specifications

### LOW FREQUENCY DIPLEXER MI-19021

#### Dimensions

Height	84"
Width	28 $\frac{1}{8}$ "
Depth	22 $\frac{5}{8}$ "
Weight	450 lbs.

Finish \_\_\_\_\_ Umher gray

#### Radio Frequency Connections:

##### Input

Visual	72 ohms, 3 $\frac{1}{8}$ " coaxial line
Aural	72 ohms, 3 $\frac{1}{8}$ " coaxial line

##### Output

Two	51.5 ohms, 3 $\frac{1}{8}$ " coaxial line
Cross Talk	Below 40 db.

### HIGH FREQUENCY DIPLEXER MI-19022

#### Dimensions

Height	17"
Width	11"
Depth	26 $\frac{3}{8}$ "
Weight	110 lbs.

Finish \_\_\_\_\_ Umber gray

#### Radio Frequency Connections:

##### Input

Visual	72 ohms, 1 $\frac{5}{8}$ " coaxial line
Aural	72 ohms, 1 $\frac{5}{8}$ " coaxial line

##### Output

Two	51.5 ohms, 1 $\frac{5}{8}$ " coaxial line
Cross Talk	Below 40 db.

# Television Triplexer MI-19023

## Features

- Permits use of one Super Turnstile antenna for both FM and TV services.
- Styled to match other transmitting equipment.
- Simple, compact design.
- Requires no elaborate accessory items.
- Small floor space requirement.

## Uses

The RCA Triplexer is designed to permit feeding three independent signals to the Super Turnstile Antenna from where they can be radiated with good efficiency. The need for such a system might be found by the broadcaster planning television plus FM service. In this case all three, FM signals in the 88-108 mc band, the TV picture signal and the TV sound signal can be fed through the Triplexer to one Super Turnstile Antenna, saving the broadcaster the expense of separate antennas. The broadband characteristics of the Super Turnstile make such a system very practicable.

## Description

The Triplexer consists of a number of rigid coaxial line segments tuned to the frequencies of the three signals fed into it. These tuned segments act as wave traps to prevent any one of the three signals from feeding back into the feed lines of the other two.

The usual arrangement is to have the TV picture and sound transmitters feed through a Diplexer to the Triplexer. The FM signal is fed directly to the Triplexer as shown in the diagram.

The FM power that can be handled by this system is limited by the standing wave ratios appearing on the lines. This is, of course, determined by the operating frequencies used. In general, the following combinations apply: TV channels II and III with an FM input up to 3 kw; channels IV-VI with an FM input up to 10 kw; and channels VII-XIII with an FM input up to 3 kw.

The coaxial line assembly of the Triplexer is contained in a completely enclosed steel cabinet the same size as the standard low-frequency Diplexer unit. The Triplexer, which is installed adjacent to the Diplexer, is finished in number-gray to match the other television units.

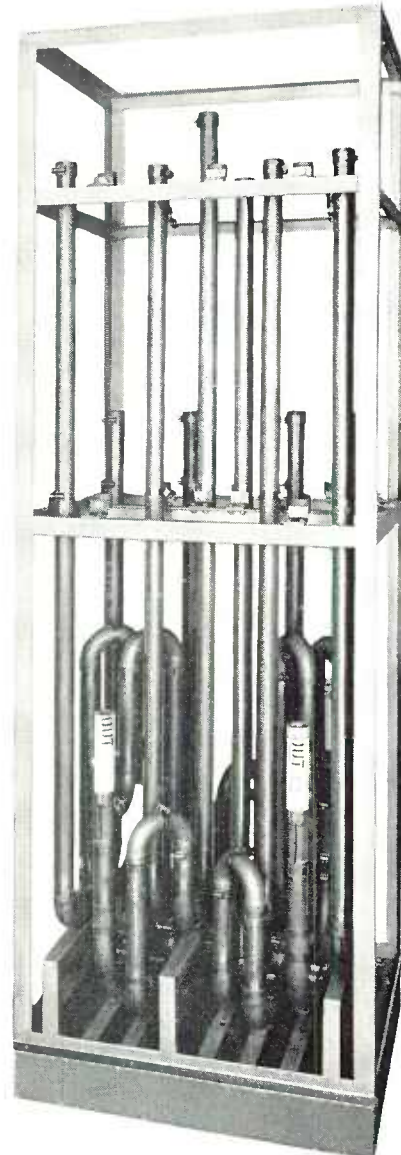

*Triplexer with all covers removed to show system of tunable coaxial lines. Two output connectors are made near the bottom, as shown. The two input lines are at the rear and are not visible.*

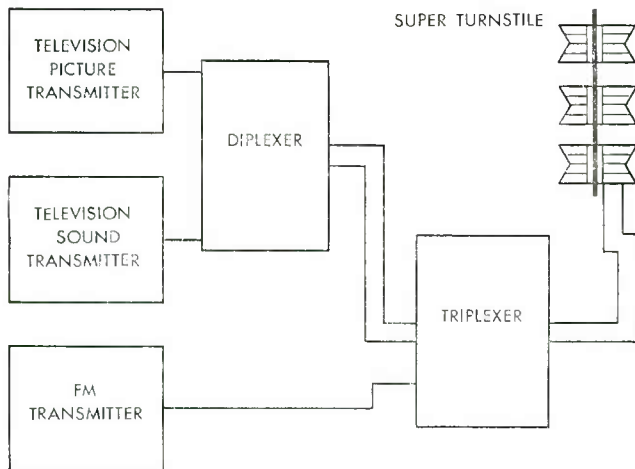

## Specifications

Input and Output Impedances	51½ ohms
Height	84"
Width	22⅝"
Depth	28⅛"
Weight	475 lbs.

# Super Turnstile Antenna For Television

Types TF-3A, TF-3B, TF-6A and TF-6B

## Features

- Extremely broad frequency characteristic
- High gain for given height.
- Permits diplexing of visual and aural signals into same antenna.
- No critical field adjustments—no coupling networks at tower top.
- Furnished complete with all fittings and hardware.
- Grounded for lightning protection.
- No weight supported by insulators.
- Attractive appearance—adds to appearance of tower structures.

## Description

The new RCA Super Turnstile for television broadcasting is a multi-element antenna system radiating horizontally polarized waves with a circular radiation pattern. An increased gain is accomplished by concentrating the radiation in the horizontal direction at the expense of radiation in the vertical direction. This gain increases with the number of sections, or layers, used in the antenna; however, practical considerations establish a maximum limit.

Each section of the antenna consists of four radiators mounted at intervals of ninety degrees around a steel pole. The individual sections are mounted approximately a wavelength apart, center to center. These radiators are attached to the steel pole at both the top and bottom so that the complete structure is grounded for lightning, and no weight is carried by endseals or insulators.

The radiators are fed by means of coaxial transmission lines. Each set of opposing radiators may be considered as comprising a horizontal dipole antenna. The outer conductor of the transmission line is connected to one radiator, and the inner conductor is connected to the opposite radiator. Connection is made at the center of the inner member of each radiator. In the event of icing, therefore, only the central part of each section is subject to impedance change. Ice formations can be prevented, however, by the use of sleet melting resistors, which will be provided, if specified. The sleet melting elements are inserted into the vertical tubing of the radiating elements which are adjacent to the pole. This will prevent ice formation between the radiator and the pole—this being the only place where ice formation will have a detrimental effect.

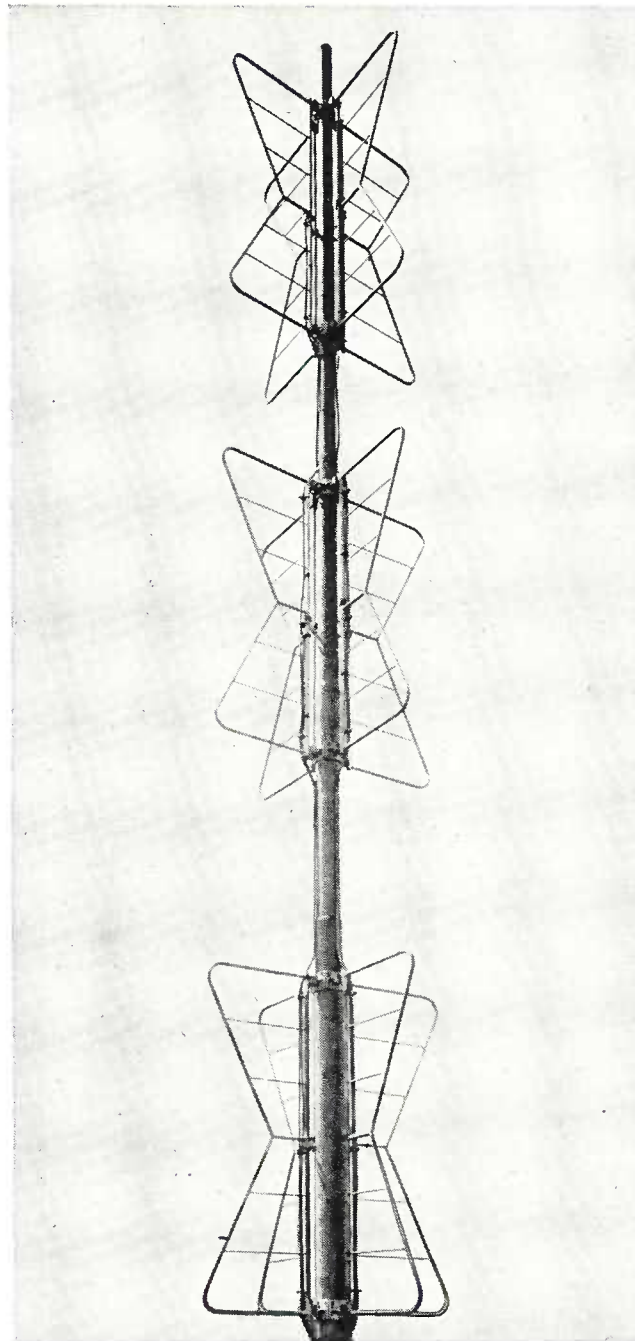

*Three Section Super Turnstile. The center pole is self-supporting and may be mounted on top of a suitable building, mountain or a supporting tower similar to that used for standard band broadcasting antennas.*

The individual radiators consist of frameworks of narrow diameter seamless steel tubing with cross members of cold rolled steel rods. This open construction results in an antenna with a rather low value of wind resistance, and the somewhat triangular shape of the radiator forms a structure which is

inherently rigid and well able to stand mechanical loads, vibration, wind force, etc.

The outstanding feature of this antenna is its broad frequency characteristic, which makes it ideal for use in television broadcasting. This important feature has eliminated the need for critical field adjustments, so common with antennas operating in the higher frequencies. It has further made possible a degree of standardization heretofore out of the question. Only three antenna designs are required to cover television channels two through thirteen. Finally, it permits efficient duplexing of the visual and aural signals into the same antenna.

The complete antenna installation consists of a tubular steel pole, the radiating elements, the transmission line assemblies

and all associated fittings and hardware. The pole is painted one coat of red metal primer and one exterior coat of CAA international orange paint. It is shop drilled and tapped for accommodating standard steel steps at required points on the pole. A circular plate, properly drilled, is welded to the top of the pole for the mounting of a 300mm. code beacon. The radiating elements, steel brackets, transmission line support assemblies and all required bolts and lock washers are either electro-galvanized or cadmium plated. The radiating elements with attached steel fittings are packed for domestic shipment in crates. The cross feeds, the brackets, clamps, pole steps and transmission line assemblies are packed in separate containers.

## Engineering Data For Super Turnstile Television Antenna

The antennae are designed to withstand a maximum wind velocity of 85 miles per hour when coated with 1/2" radial ice and a maximum wind velocity of 95 miles per hour when there is no ice. The antennae are designed for total transmitter power of 20 KW.

Maximum Unit Stress, 20,000 lbs./in.<sup>2</sup>

Type No.	TF-3A	TF-3A	TF-6A
No. Sections	3	3	6
Power Gain	3.45-4.1	3.6-4.5	7.2-8.6
Channels	II, III	IV, V & VI	VII to XIII
Frequency Band	54-66 Mc.	66-88 Mc.	174 to 216
W** Lbs.	3,800	2,650	2,300
A Ft.	8' 10"	7' 2 3/4"	3' 2 1/4"
B Ft.	44' 0"	36' 4"	32' 2 3/8"
C Ft.	3' 0"	2' 2"	2' 6 5/8"
D <sub>1</sub> Ft.	24' 5"	18' 0"	18' 0"
D <sub>2</sub> Ft.	12' 0"	10' 0"	10' 0"
R <sub>1</sub> * Lbs.	1,144	980	925
R <sub>2</sub> * Lbs.	2,330	1,746	1,711
R <sub>3</sub> * Lbs.	3,474	2,744	2,636
H <sub>1</sub> Ft.	61' 0"	50' 0"	46' 3"
H <sub>2</sub> Ft.	49' 0"	40' 0"	36' 3"
Dia. of Pole at Guide Flange	10 3/4"	8 5/8"	8 5/8"
Projected Areas			
With 1/2" Ice	94.6	71.8	75.34
Without Ice	62.8	44.4	48.1
Max. Dim. of Tower Top***	6' 0" x 6' 0"	5' 5" x 5' 5"	5' 5" sq.
Stock Identification	MI-19012-A	MI-19012-B	MI-19013

\* Reactions R<sub>1</sub>, R<sub>2</sub> and R<sub>3</sub> as shown in table are for estimating purposes only and are figured on the basis of 20 lbs./Ft.<sup>2</sup> of projected area without ice. All sections are rounds.

\*\* W—Total weight, including pole, guide flange, pole socket, 30 mm Beacon, pole steps and miscellaneous hardware.

\*\*\* Figures are for installation without railing on tower top. If railing is to be used, pole is extended as required. Super Turnstiles designed for mounting atop FM Pylon antennas are designated Types TF-3B and TF-6B.

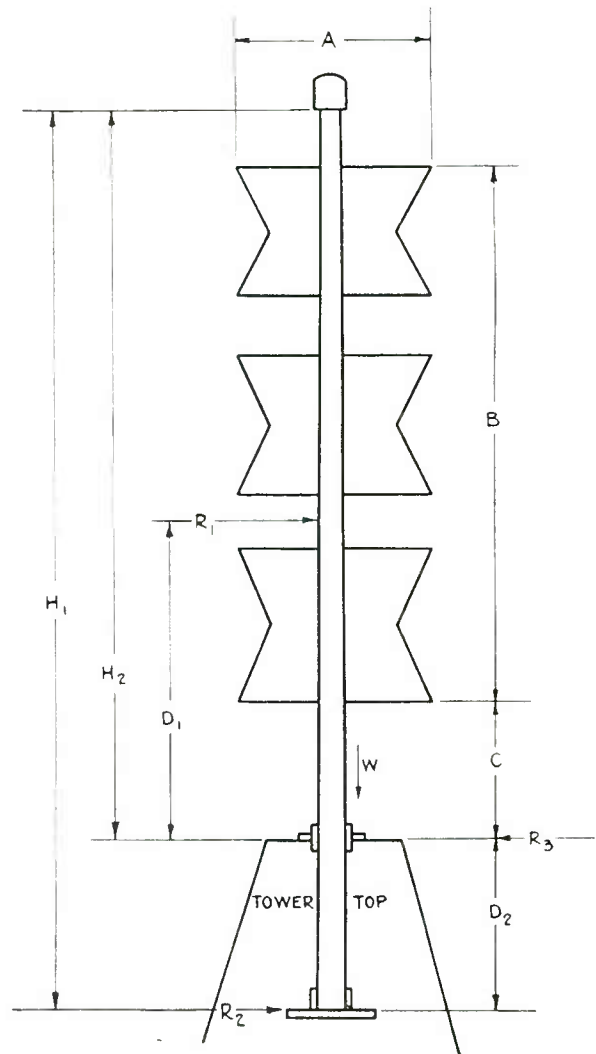



# **TEST AND MEASURING EQUIPMENT**

	<b>Page</b>
<b>MONITORS</b>	<b>202</b>
<b>AUDIO &amp; VIDEO MEASURING EQUIP.</b>	<b>211</b>
<b>OSCILLOSCOPES</b>	<b>217</b>
<b>SERVICE TEST EQUIPMENT</b>	<b>224</b>

# AM Modulation Monitor Type WM-43A

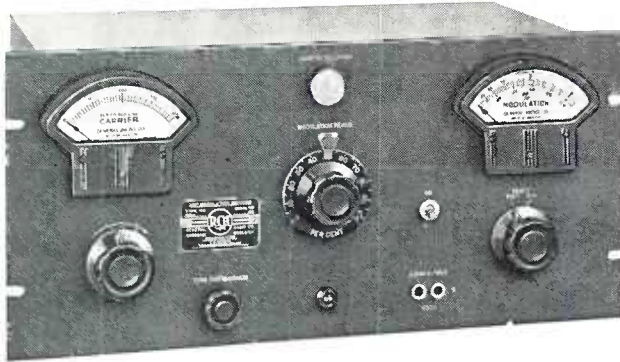

## Features

- Wide frequency range (0.5 to 60 mc).
- Operates at low r-f input power (0.5 watt in 75 ohms).
- Indicates either positive or negative peaks in percentage modulation and in decibels.
- Meets all FCC specifications for modulation monitors.
- Carrier amplitude shift with modulation can be measured.
- High impedance, low distortion output circuit permits use of RCA WM-71A Distortion and Noise Meter.
- Low impedance, low distortion output circuit for aural monitoring.
- Terminals for connecting remote percentage-modulation indicator.

## Uses

The RCA Type WM-43A Modulation Monitor is designed to give continuous direct reading indications of percentage modulation in the carriers of broadcast or other transmitters operating in the range of 0.5 to 60 mc. This modulation monitor performs the following specific functions:

1. Measurement of percentage of modulation on either positive or negative peaks.
2. Overmodulation indication.
3. Program level monitoring.
4. Measurement of carrier shift when modulation is applied.
5. Measurement of transmitter audio-frequency response.

## Description

The RCA WM-43A Modulation Monitor consists of three essential elements: (1) A linear diode rectifier which gives an instantaneous output voltage proportional to the carrier envelope, (2) a peak voltmeter which gives a continuous indi-

cation of the peak modulation, and (3) a trigger circuit which flashes a light whenever the modulation momentarily exceeds any previously set value.

The linear rectifier is designed for operation at a low power level, which greatly simplifies the coupling to the transmitter. In the output of the linear rectifier is a d-c meter, which indicates the carrier level at which the instrument is operating and also shows any carrier shift during modulation.

In addition, two auxiliary audio output circuits operating from a separate diode rectifier are provided. One of these at 600 ohms, is intended for audible monitoring; the other, a high-impedance circuit, gives a faithful reproduction of the carrier envelope with less than 0.1% distortion. The high impedance output circuit can be connected directly to the RCA WM-71A Distortion and Noise Meter, enabling overall fidelity and noise measurements to be made on the transmitter.

## Specifications

Carrier Frequency Range \_\_\_\_\_ 0.5 to 60 mc\*

### MODULATION PERCENTAGE RANGE

Negative Peaks \_\_\_\_\_ 0 to 100%  
Positive Peaks \_\_\_\_\_ 0 to 110%

ACCURACY, of full scale at 0 and 100% \_\_\_\_\_ ±2%  
of full scale at any other percentage \_\_\_\_\_ ±4%

### AUDIO FREQUENCY RESPONSE

Meter Indication, 30 to 15,000 cps. \_\_\_\_\_ ±0.25 db  
Meter Circuit, 50 to 15,000 cps. \_\_\_\_\_ ±0.1 db  
Audio Monitoring Output, 30 to 45,000 cps. \_\_\_\_\_ ±1.0 db  
Measuring Output, when used with RCA Type WM-71A Distortion-Noise Meter and Coupling Cable, 30 to 15,000 cps \_\_\_\_\_ ±1.0 db

R-f Input Power (over entire frequency range) approximately \_\_\_\_\_ 0.5 watts

R-f Input Impedance, broadcast band, approximately \_\_\_\_\_ 75 ohms

NOTE: Input impedance increases at higher frequencies. Actual impedance varies with coil position and input tuning.

### WARNING LAMP CIRCUIT

The overmodulation lamp will flash whenever the negative modulation peaks exceed the setting of the MODULATION PEAKS dial by approximately 2% modulation, for audio frequencies between 30 and 7500 cps. For higher audio frequencies, the percentage overmodulation required to flash the lamp increases slightly.

### AUXILIARY OUTPUT

A multipoint connector at the rear of the instrument provides a means of connecting:

1. A remote percentage modulation meter.
2. Line for 600 ohm monitoring.
3. The RCA WM-71A Distortion and Noise Meter.

### TUBE COMPLEMENT (shipped with instrument)

2 Type 6SN7-GT	1 Type 2050
2 Type 6SJ7	2 VR-150-30
1 Type 6H6	1 Type 6X5

Dimensions \_\_\_\_\_ width 19", height 8 3/4", depth 10"

Weight (unpacked) \_\_\_\_\_ 31 lbs.

Finish \_\_\_\_\_ Umher gray

FCC Approval Number \_\_\_\_\_ 1557

Stock Identification \_\_\_\_\_ MI-30043A

\* A single set of coils (either 0.5 to 8 megacycles or 3 to 60 megacycles) is supplied with each instrument, unless both sets are specifically ordered.

# AM Frequency Monitor Type WF-48A

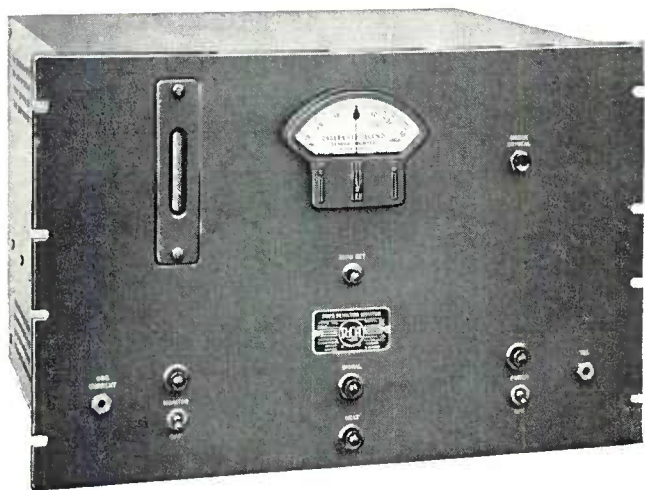

## Features

- Continuous Reading Deviation Meter.
- Modulation of transmitter does not affect frequency indication.
- Direct connection to transmitter not required.
- Simple pickup antenna supplies r-f excitation.
- Warning Lamp System indicates failure of either transmitter carrier or monitor crystal oscillator.
- Reliable—minimum of attention required from operating staff.

## Uses

The RCA Type WF-48A Frequency Deviation Monitor is FCC approved for use in standard broadcast stations. It indicates continuously, and directly in cycles-per-second, the magnitude and direction of any departure of the carrier from its assigned channel frequency.

## Description

The elements of the monitor are shown in the accompanying schematic block diagram. Voltages from a temperature controlled piezo-electric oscillator (frequency  $f \pm 1000$  cycles) and the transmitter to be monitored (frequency  $f \pm \Delta f$ ) are amplified and fed to a mixer from which their difference frequency ( $1000 \pm \Delta f$ ) is obtained. This audio frequency is

amplified, its peaks are clipped to produce an essentially square waveform, and the square waves are applied to an audio frequency meter.

The indicating element of the frequency meter is calibrated to read zero when the audio beat is exactly 1000 cycles per second. Deviations from 1000 cycles ( $\Delta f$ ) are indicated directly as frequency deviation of the transmitter in cycles per second.

The monitor is a-c operated and is mounted on a single relay rack panel. Coupling to the transmitter is obtained from a short length of wire attached to the input terminals to act as an antenna.

## Specifications

Frequency Deviation Range (readable to 1 cycle)  $\pm 30$  cycles  
 Carrier Frequency Range \_\_\_\_\_ 500 to 2000 kc  
 Accuracy \_\_\_\_\_  $\pm 10$  parts per million  
 Stability (under normal operating conditions)

Better than one part per million  
 R-f Input Voltage \_\_\_\_\_ Approx. 100 millivolts to 1 volt  
 Power Requirements \_\_\_\_\_ 60 cycles, 105-120 volts or 210-240 volts  
 Power Input \_\_\_\_\_ Heater 25 watts; monitor circuits 100 watts  
 Coupling to Transmitter \_\_\_\_\_ Short antenna

Tube Complement (supplied with instrument):

3 Type 6SJ7	1 Type 5V4-G
2 Type 6AC7	1 Type 6B4-G
2 Type 6H6	1 Type VR-105 (0C3)
2 Type 6SQ7	1 Type 2051
1 Type 6V6-GT	

Dimensions \_\_\_\_\_ 19" wide x 15 $\frac{3}{4}$ " high x 12 $\frac{1}{2}$ " deep

Finish \_\_\_\_\_ Umber gray

FCC Approval Number \_\_\_\_\_ 1468

Stock Identification \_\_\_\_\_ MI-30048-A

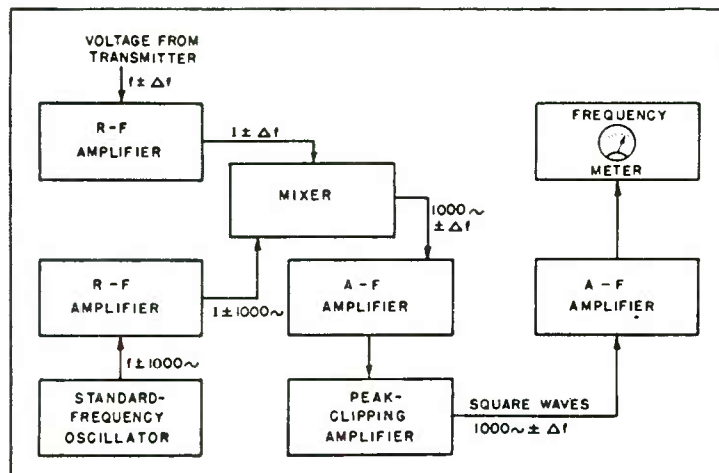

Schematic Block Diagram of Type WF-48A  
 Frequency Deviation Monitor



**Frequency Monitor  
Type WF-50A**

**Frequency Meter  
Type WF-49A**

Frequency Monitor  
Type WF-50A can  
be purchased and  
used separately.

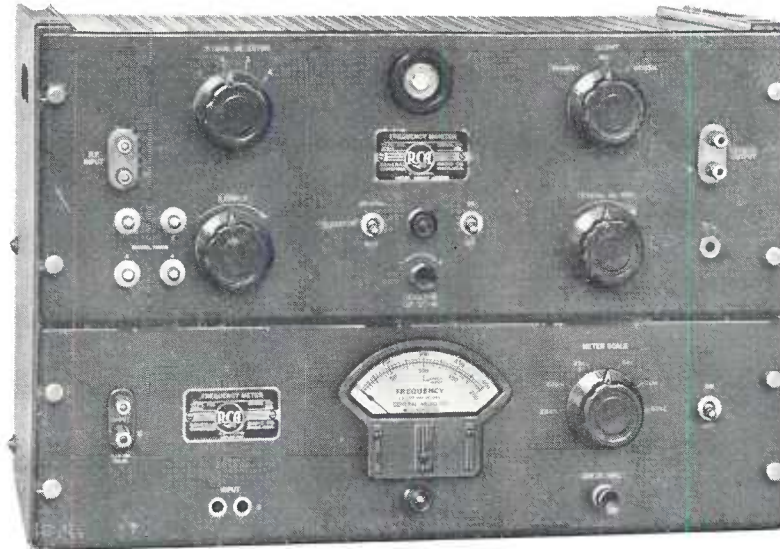

Frequency Meter  
Type WF-49A can  
be purchased and  
used separately.

**Features**

- High sensitivity.
- Two buffer stages.
- Deviation direction test.
- Stand-by operation.
- Jack for audio output.
- Panel terminals for crystal output.

**Uses**

The RCA Type WF-50A Frequency Monitor is designed to monitor the carrier frequency of AM radio transmitters in the HF range, and is particularly suitable for police, fire and other municipal departments. Because it is a high-sensitivity monitor it can be used to monitor the frequencies of mobile transmitters from a distance as well as for monitoring the main transmitter.

Airlines and airports will find that the WF-50A Frequency Monitor, used either singly or in groups, provides an excellent means of monitoring their frequencies.

Where a continuous indication of frequency deviation is desired, the WF-50A should be used in conjunction with the Type WF-49A Frequency Meter.

**Description**

The monitor consists of a temperature-controlled piezo-electric oscillator with mounting facilities for four crystals; two buffer amplifiers, one for the crystal and one for the transmitter frequency; a mixer; and an AF amplifier.

The audio output is available at a telephone jack on the panel, and the output of the crystal buffer stage is available at panel terminals for calibrating or adjusting other equipment, such as receivers and mobile transmitters. By means of a switch the monitor can be kept in a stand-by condition in which the vacuum-tube circuits are not operating but temperature control is maintained.

**Specifications**

Carrier Frequency Range.....1500 kc to 150 mc  
 Power Supply.....105/125 or 215/250 volts, 50/60 cycles  
 Power Input.....75 watts (including temperature control)  
 Mounting.....Standard 19-inch relay-rack panel  
 Finish.....RCA umher gray  
 Accuracy.....(With Type 376-M Quartz Plate) 0.002%  
 (Crystals are supplied separately)  
 Dimensions.....Length 19"; depth 11¼"; height 7"  
 Net Weight.....22 lbs.

**Features**

- Direct reading scales.
- Single range selector switch.
- Individual scale calibration for each range.
- Provision for connection of an external meter.
- Reading independent of input voltage over wide range.
- Accuracy unaffected by input wave shape.
- Regulated power supply.

**Uses**

The RCA Type WF-49A Audio Frequency Meter is a general purpose instrument which may be used in determining the frequency of an unknown source or for continuously monitoring the frequency of a system.

The electronics laboratory will find it a convenient means of measuring audio and supersonic frequencies up to 60 kc, regardless of waveform. For monitoring radio transmitters, it can be used in conjunction with an RCA Type WF-50A Frequency Monitor to indicate continuously the deviation from assigned channel frequency.

**Description**

The circuit consists of an input amplifier, followed by a series of clipping and limiting amplifiers, and a frequency indicating circuit composed of a capacitor, a diode and a d-c microammeter. The clippers and limiters convert the input signal to a square waveform so that the indication is not affected by changes in amplitude or waveform. A well regulated power supply eliminates effects of line voltage changes. Two sets of input terminals are provided on the panel, while at the rear of the instrument a multi-point connector provides a means of making connections that are more permanent. Plugging into the panel jacks automatically disconnects the rear terminals.

**Specifications**

Range.....25 to 60,000 cycles per second in 6 ranges  
 Accuracy.....±2 cycles, ±2% of full scale, for all ranges  
 (±3% of full scale for 60,000 cycles when  
 input becomes less than 0.5 volts)  
 Input Voltages.....0.25 to 150 volts  
 Power Supply.....105/125 or 215/250 volts, 50/60 cycles  
 Power Input.....Approximately 50 watts  
 Mounting.....Standard 19-inch relay-rack panel  
 Finish.....RCA umher gray  
 Dimensions.....Length 19"; depth 11¼"; height 5¼"  
 Net Weight.....19½ lbs.

# Phase Monitor Type WM-30A

## Features

- Phase angles can be read to better than  $\pm 0.5$  degree.
- No complicated preliminary adjustments.
- Oversize components insure long life.
- Accurate and quick field pattern checking.
- Direct reading phase angle scale.
- Plug-in resistors to match sampling line impedance.
- Instantaneous quadrant indicator.

## Uses

The RCA Type WM-30A Phase Monitor provides a simple means of accurately measuring phase differences between currents in the various towers of an antenna array. It is particularly useful in checking directional arrays to insure proper phasing and hence proper field pattern. All phase angles up to 360 degrees at any frequency between 225 and 1800 kc can be measured.

The WM-30A can be used to adjust phase-shifting networks, to measure impedances of arrays, and to facilitate calculation of mutual impedances of antennas. Another important application is the measuring of phase characteristics of television i-f circuits (this requires the use of an i-f signal generator, two mixer stages and a variable frequency oscillator).

The RCA Phase Monitor can be used for remote indication of both relative amplitude and phase of antenna currents in arrays employing up to three elements. Used in conjunction with the MI-8216-C Remote Meter Panel correct relationships can be maintained between phase and magnitude of currents in directive arrays having as many as six elements.

## Description

Two identical amplifiers are used to drive the two pairs of plates of the 3-inch Cathode ray tube. One of the amplifiers incorporates a network which permits a manual phase shift of 90 degrees by means of a potentiometer. Thus, if two out-of-phase voltages are impressed on the two amplifier units, it is only necessary to adjust the potentiometer until the ellipse on the tube screen becomes a straight line. Then the two voltages are in phase and their original angular differences can be read directly on the scale.

A unique circuit is incorporated for producing a keying impulse for correct quadrant indication. By means of a push button the proper impulse is selected and modulates the Cathode ray tube so that a spot appears in that quadrant on the screen in which phase balance occurs.

The RCA Phase Monitor can accommodate three self-contained meters for remote indication of antenna currents. The unit is complete with power cord and tubes but does not include sampling coils or meters. It is designed for rack mounting and is finished in RCA number gray.

The WM 30-A is supplied with three 79-ohm plug-in resistors for each of the three input circuits, to provide termination impedance for the commonly used type of sampling line which has a characteristic impedance of between 75 and 80 ohms. Resistors of other values may be substituted to match sampling lines of 50 to 100 ohms impedance.

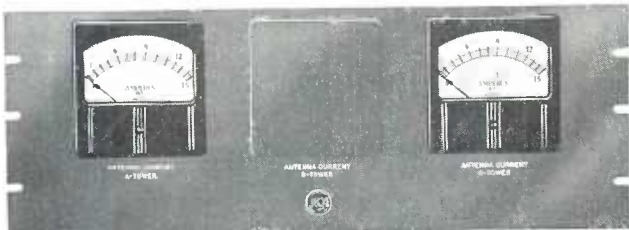

Remote Meter Panel MI-8216-C



Remote Meter Panel

## REMOTE ANTENNA METER PANEL

This unit is designed to give relative indications of the currents in antenna arrays employing up to three elements, thus insuring correct current relationships and proper field patterns. The unit is complete with power cord and tubes but does not include sampling coils or meters. It is furnished with a standard rack mounting panel. (This is the same unit that forms an integral part of the WM-30A Phase Monitor.) Dimensions: 7" high, 19" wide, 5½" deep.

## ANTENNA SAMPLING KITS

A single element Sampling Kit is recommended for each tower to be monitored. Two Kits are available, one of which employs a tuned sampling coil, while the other employs an untuned sampling loop. The Antenna Sampling Kit, MI-8217, comprises one Antenna Sampling Coil (MI-8217-A) and one Antenna Current Meter (MI-7184-A-150). The Antenna Sampling Kit, MI-8217-B, comprises one Antenna Sampling Loop (MI-8217-C) and one Antenna Current Meter (MI-7184-A-150).

## Specifications

Frequency Range\_\_\_\_\_ 225 to 1800 kc  
 Phase Angle Range\_\_\_\_\_ 0 to 360 degrees  
 Monitoring Accuracy—  
   For small angles (up to 30 degrees)\_\_\_\_\_  $\pm 1$  degree  
   All other angles\_\_\_\_\_  $\pm 2$  degrees  
 R-F Input Impedance\_\_\_\_\_ 79 ohms (other impedances obtainable)  
 R-F Input Voltage Range\_\_\_\_\_ 3.3 to 12 volts  
 Power Supply\_\_\_\_\_ 105/125 volts, 50/60 cycles  
 Power Consumption\_\_\_\_\_ 115 watts  
 Tube Complement:  
   4 RCA-6AC7                    2 RCA-6AG7                    1 RCA-6AB7  
   1 RCA-2Y2A                    1 RCA-5R4GY                    1 RCA-3AP1A  
 Dimensions\_\_\_\_\_ 17½" high, 19" wide, 15" deep\*  
 Weight \_\_\_\_\_ 80 lbs.

\* Will not fit 9AX6 rack but can be used in Type BR-1A rack.

# Accessories for Phase Monitor WM-30A

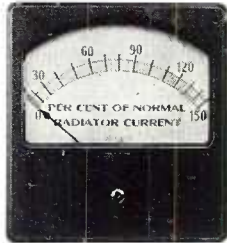

ANTENNA CURRENT METER, MI-7184-A-150

The Antenna Current Meter is a special high-frequency thermocouple, expanded scale unit calibrated 0-150 per cent of antenna current. This meter has been designed for use with the WM-30A Phase Monitor for remote antenna current monitoring.



SAMPLING COIL, MI-8217-A

The antenna current Sampling Coil comprises a tuned circuit constructed with an internal double electrostatic shield, so that the user need provide magnetic shielding only. It is normally mounted in a weatherproof housing between the tuning cabinet and the antenna. It feeds a sampling current to the WM-30A Phase Monitor.

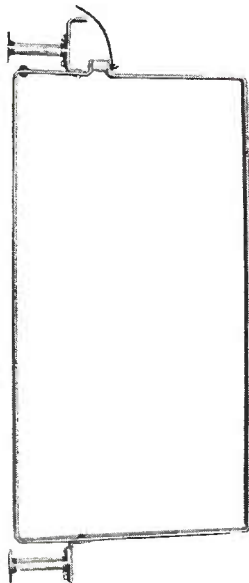

SAMPLING LOOP, MI-8217-C

The antenna current Sampling Loop comprises a rectangular metal loop approximately two by four feet, together with associated mounting hardware. The loop is designed for mounting directly to the tower. It feeds a sampling current to the WM-30A Phase Monitor.

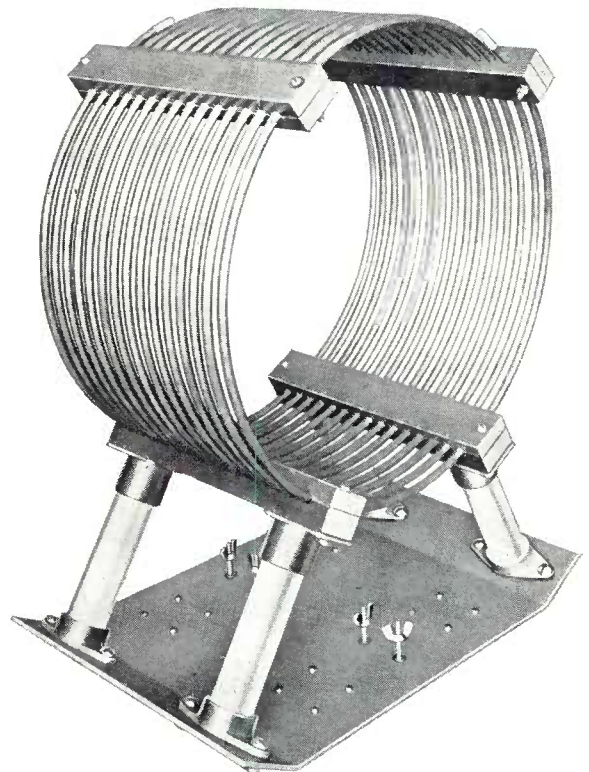

ISOLATION COIL, MI-7327-4

The Isolation Coil is an inductor consisting of a 110 microhenry coil wound with  $\frac{3}{8}$ " copper concentric line. It has an impedance of 70 ohms. It is recommended for carrying the sampling line across the base insulator of the tower, when employing the MI-8217-C Antenna Sampling Loop. The diameter of the coil is  $19\frac{1}{2}$ ". Approximate dimensions are: height, 30"; depth, 16"; width, 21".

# Field Intensity Meter Type 301-B

## (High Frequency)



### Features

- Measures AM and FM carrier strength.
- Range — 18-125 Mc.
- Sensitivity — 10 microvolts per meter at 18 Mc.
- Complete with power supply and antenna.

### Uses

The Type 301-B Field Intensity Meter has been designed for measuring field intensities of FM or AM stations operating in the frequency band of 18 to 125 megacycles. It is ideal for checking antenna efficiency, directivity and service range and for research and propagation studies. It provides either linear or logarithmic output and may be used in conjunction with a standard recording meter for making records of variation in signal intensity. It is intended particularly for field use and is arranged for convenient operation and for carrying from one location to another.

### Description

The RCA High-frequency Field Intensity Meter consists of three units—the field intensity meter unit—the power supply—and an accessory case.

It contains a local oscillator providing a source of calibrating voltage. Calibration curves on the line and doublet antenna are supplied so that readings may be converted into field intensity values. The frequency range of 18 to 125 megacycles is covered in three bands. The minimum readable field strength varies from 10 microvolts per meter at 18 megacycles to 50 microvolts per meter at 125 megacycles. The output indicating meter is a four-inch instrument and will provide indications which are either linear or logarithmic.

A separate FM detector is provided for identification of FM stations without detuning the instrument.

A recording milliammeter having a sensitivity of 5 milliamperes and a resistance up to 560 ohms maximum may be operated directly from the instrument. A jack is provided for head-

phones. Noise meter readings may be taken of the noise level to indicate interference which may be encountered from various industrial sources.

The power supply unit contains a storage battery and regulated vibrator system designed to operate continuously for 8 hours.

The accessory case contains an insulated tripod on the top of which is mounted a dipole adjustable in length for the frequency being measured.

### Specifications

Field Intensity Meter—Height 13"; width 20 $\frac{3}{8}$ "; depth 9 $\frac{1}{4}$ "; weight 38 lbs.

Accessory Case—Length 39"; height 12"; depth 7 $\frac{3}{8}$ "; weight 24 lbs.

Battery Unit—Height 14 $\frac{3}{4}$ "; width 13 $\frac{1}{4}$ "; depth 7 $\frac{1}{4}$ "; total weight 36 lbs.

Frequency Range—18 to 125 megacycles

Field Intensity Range at 18 Mc—10 to 500,000 u.v. per meter

Field Intensity Range at 125 Mc—50 to 2,500,000 u.v. per meter

#### Output Scales

Linear—10 to 1 or 20 db

Logarithmic—100 to 1 or 40 db

#### Output

Audio—Phones or noise meter

Recorder—Operates any recorder of 5 ma and 560 ohm maximum resistance

Antenna—Doublet in 6 sections

R-f Transmission Line—Length 30'

Vibrator Power Supply—6 volts at 4 ampere load

# Field Intensity Meter Type 308-B

## Features

- Direct readings in microvolts-per-meter.
- An accuracy independent of non-linear detectors and panel-meter scales.
- Wide frequency and amplitude ranges.
- Shielded loops for magnetic pickup.
- Simplified tuning by ganged controls.

## Uses

The 308-B, an entirely portable instrument, measures field strengths from 20 microvolts-per-meter up to 20 volts-per-meter. This wide range enables field surveys to be made practically anywhere, from the very shadow of the transmitting antenna to the most "down-in-the-noise" location—a welcome advantage in adjusting directive arrays and exploring radiation patterns.

## Description

The 308-B is a sensitive superheterodyne receiver with a built-in calibrating oscillator for standardizing the receiver sensitivity. A shielded, unbalanced loop picks up the signal to be measured.

Due to the design of critical components such as the r-f and i-f attenuators and the mutual-inductance coupler, which couples the calibrating signal to the input circuit of the receiver, measurements can be obtained with an accuracy that is considerably better than has been obtained in the past. For example, it is not necessary to know the exact frequency of the incoming signal in order to measure it accurately; moreover, the instrument can be calibrated on a frequency somewhat removed from that of a very strong, incoming signal, to prevent the strong signal from interfering with the low-level calibrating signal.

A series of readings can be obtained conveniently, with field strength indicated in microvolts-per-meter on the scales of the built-in attenuators; no involved calculations are necessary.

Special precautions have been taken in the RCA 308-B to obtain maximum oscillator stability and effective shielding. In addition, the i-f stages are selective enough to prevent interference from signals on adjacent channels.

The wide frequency range of this instrument is covered in six bands; no plug-in coils are used. Three loop antennas cover the entire frequency range.

Shielded loops are used to minimize distributed capacitance and eliminate "antenna effect", thus further reducing error. The loops require no balancing adjustments.

## Specifications

- Frequency Range  
(3 loops) \_\_\_\_\_ 120 kc.-18,000 kc.
- Field Intensity Range \_\_\_\_\_ 20 microvolts to  
20 volts per meter
- Accuracy \_\_\_\_\_  $\pm 5\%$  at 180 kc.-7,000 kc.  
 $\pm 10\%$  at any frequency
- Loop Antennas  
Loop #1 (Accessory) \_\_\_\_\_ 120 kc.-550 kc.  
Loop #2 (Furnished) \_\_\_\_\_ 550 kc.-3,000 kc.  
Loop #3 (Accessory) \_\_\_\_\_  
3,000 kc.-18,000 kc.
- Output Indication  
Linear and logarithmic scales  
(Provision made for standard 5 ma.  
recording meter and headphones.)

## POWER REQUIREMENTS

- "A" Battery Circuit \_\_\_\_\_ 6 volts, 1.5 amperes  
"B" Battery Circuit \_\_\_\_\_ 135 volts, 45 ma.  
"C" Battery Circuits (two) \_\_\_\_\_ 7.5 volts each

## TUBE COMPLEMENT

- 1 RCA 6L5-G      1 RCA 6J5      1 RCA 6R7  
1 RCA 6L7      3 RCA 6S7

- Dimensions (loop unmounted) \_\_\_\_\_ 13½" x 13¼" x 20¼"  
Weight (unpacked) \_\_\_\_\_ 48 lbs.  
Finish \_\_\_\_\_ Gray wrinkle  
Stock Identification \_\_\_\_\_ MI-7505-E  
(Includes Field Meter and #2 Loop less 93-A Power  
Supply and storage batteries.)

## ACCESSORIES

- Type 93-A Power Supply \_\_\_\_\_ MI-7519-A  
(Mounted in case but less storage battery.)  
Note: 93-A Power Supply Dimensions are 13½" x 13½" x 8"  
and its weight with storage battery is 29 lbs.
- Storage Battery for 93-A \_\_\_\_\_ MI-8204-A  
Loop #1 (120-550 kcs.) \_\_\_\_\_ MI-8223-A2  
Loop #3 (3 mc. to 18 mc.) \_\_\_\_\_ MI-8223-A3  
High Impedance Headset \_\_\_\_\_ MI-6214



# Visual Monitor Converter Type WM-12A



## Features

- Continuous check on quality of picture transmission.
- Picture information is comparable to ideal receiver.
- Compact, well-shielded instrument.
- Comes complete with r-f pickup device and r-f cable.
- Operates on all of the 13 RMA channels.

## Uses

The Visual Monitor Converter, Type WM-12A, is designed for use with Television Master Monitor to permit visual observation of the quality of the signal delivered to the antenna of a television transmitter operating in any of the 13 standard television-broadcast channels. The picture information supplied by the instrument is equivalent to that which would be obtained from an ideal television receiver located remotely from the station. This signal is free from interference by the accompanying aural transmitter.

Enclosed in an attractive aluminum case, the instrument is well-shielded, compact, and sturdy. It can be clamped to the ungasged transmission line to which it is electrically connected, or it may be mounted on some other equipment or on a shelf near the line.

## Description

Essentially a superheterodyne receiver designed for vestigial-sideband reception, the WM-12A samples a portion of the television transmitter r-f output and delivers to the Master Monitor a video signal which is applied to the monitor kinescope.

A simple attenuator is used for setting the r-f input of the instrument to the proper level. The r-f section of the instrument is similar to that used in RCA television receivers. The response of the video section extends from 30 cycles to 4.5 megacycles. The cathode follower stage which is used for video output supplies approximately 2 volts peak across 75 ohms to the Master Monitor input circuit. A standard output polarity with sync "down" is furnished to the Master Monitor.

The r-f pickup circuit is coupled to the transmission line at the output of the VSB filter. A variable attenuator is provided for adjusting the voltage level to the double-ended circuit

which forms the input to the control grids of the push-pull triode r-f amplifier. The plate circuit of the r-f amplifier is connected to a thirteen channel tapped transmission line type circuit which is coupled to a similar circuit at the grids of the r-f converter tube. The mixer is a dual triode with push-pull input to the control grids; the plates are connected in parallel and form the input to the i-f amplifier. The oscillator employs a dual triode in a thirteen channel circuit coupled to the mixer input.

A two stage stagger-tuned i-f amplifier employing pentodes is used in the instrument. Sound interference rejection of 20 db is accomplished by means of trap circuits coupled to the i-f stages. A crystal rectifier is used as a second detector. This is followed by a pentode video amplifier. The output video stage is connected as a cathode follower operating into a 75 ohm load.

The picture information provided by means of the WM-12A approaches in quality the best which can be obtained by the use of the present picture transmission standards. The output of the WM-12A is connected through a 75 ohm transmission line to the Master Monitor. The signal supplied to the Master Monitor includes both synchronizing pulses and video. The pulses so provided are used to synchronize the scanning system of the monitor kinescope.

## Specifications

Radio Frequency Ranges.....13 RMA channels  
Fine Tuning Range (approx.)—From  $\pm 300$  kc on channel 1  
to  $\pm 750$  kc on channel 13

### Intermediate Frequencies:

Picture Carrier Frequency.....25.75 mc  
Trap Frequencies.....21.25 mc, 26.5 mc, 26.75 mc  
Video Response.....30 cps to 4.5 mc  
Sound Rejection.....At least 20 db  
Output Voltage.....1.5 volts peak-to-peak (max)  
Output Polarity.....Sync negative  
Output Impedance.....75 ohms unbalanced  
Input Impedance.....50 ohms unbalanced  
Input Voltage.....0.1 volt (max)

### Power Requirements (Note: Use RCA MI-8262 Regulated Power Supply):

Plate.....200 volts d-c at 80 ma  
Filament.....6.3 volts a-c at 3 amp

### Tube Complement:

3 RCA-6J6  
2 RCA-6BA6  
1 IN34 (crystal rectifier)  
1 RCA-6AU6  
1 RCA-6V6-GT

Dimensions.....8" High, 8" Wide, 9 $\frac{1}{4}$ " Deep

Weight.....12 lb.

Finish.....Two toneumber gray

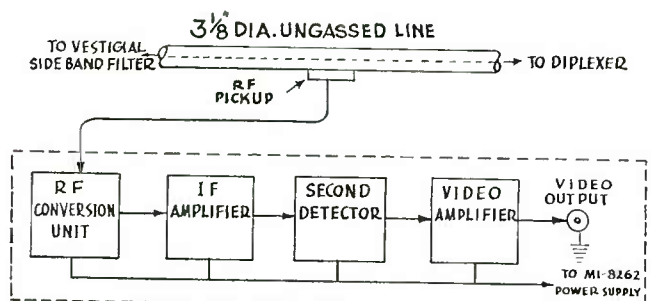

WM-12A VISUAL MONITOR CONVERTER

# Visual Modulation Converter Type WM-13A

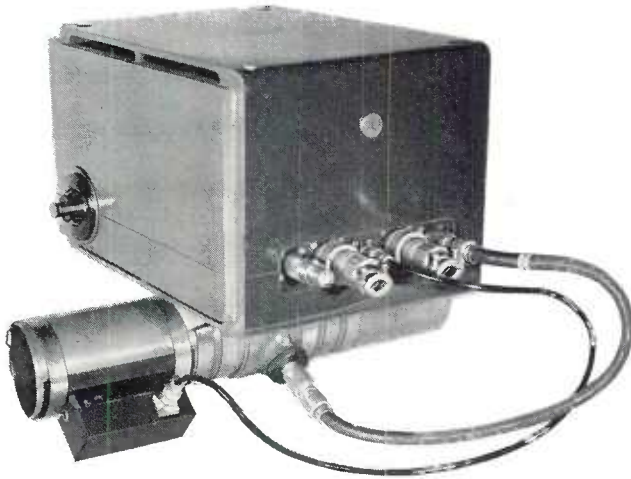

### Features

- Continuous check on waveform of transmitted television signal.
- Provides check on frequency response of transmitter.
- Operates on all of the 13 RMA channels.
- Comes complete with r-f pickup device, crystal pickup, and r-f cable.
- Compact and well shielded.

### Uses

The Visual Modulation Converter, Type WM-13A, provides the Television Master Monitor or equivalent unit with a video signal which is a replica of the modulation envelope of the television transmitter r-f output. In addition to the video information, the instrument supplies a signal corresponding to 100% modulation in the white direction (zero carrier level) during the decay time of the monitor-oscilloscope sweep. The picture signal is observed on the monitor oscilloscope as a composite video and sync waveform, plus a reference line representing zero transmitter output. Information for composite signal-component analysis is thus made available to the transmitter operating engineer.

A separate broad-band detector is included to allow measurement of the frequency response of the transmitter and its auxiliary equipment.

This instrument, although larger than the WM-12A, is similar in appearance and construction. It may be mounted near the WM-12A on the transmitter transmission line or on a shelf nearby.

### Description

The WM-13A employs r-f, i-f, second detector, and video circuits similar to those in the WM-12A. Two stages of sync separation and four stages of keying control are included in the unit. A germanium crystal rectifier with its input connected to the r-f pickup and its output circuit connected through a low-pass filter to the video amplifier input is provided for observation of transmitter frequency response characteristics. A simple switching system employing a remotely controlled relay allows selection of either the superheterodyne or the crystal outputs.

The sync separator circuits are provided with a sample of the composite-video signal and provides vertical sync pulses which are used to synchronize the keyer circuits. The first keyer control circuit consists of a blocking oscillator operating at one-half the vertical frequency. This is followed by a

flip-flop multivibrator the symmetry of whose output may be controlled. The rectangular wave output from this stage may be adjusted to appear as a rectangular pulse of duration equal to the flyback time of the monitor-oscilloscope sweep. This pulse is used to key the local oscillator plate voltage, and succeeds in stopping this oscillator during the time of its application. Since the monitor-oscilloscope sweep circuit is set to half the picture frame frequency, the result of the keying pulse will be a horizontal line on the screen of displacement equivalent to zero power output from the transmitter.

The germanium crystal detector is used to determine the frequency vs. amplitude response of the transmitter and its associated circuits. This test is accomplished by connecting a video sweep generator into the video modulation input and receiving the response in a suitable oscilloscope employing a 60 cycle properly phased sinusoidal sweep.

The WM-13A output is connected through a 75 ohm transmission line to the input of oscilloscope in the Master Monitor. Synchronism for the horizontal sweep circuit in the oscilloscope is derived from the signal which appears on the monitor kinescope.

### Specifications

Radio Frequency Ranges.....13 RMA channels  
 Fine Tuning Range (approx.)—From  $\pm 300$  kc on channel 1  
 to  $\pm 750$  kc on channel 13

Intermediate Frequencies:  
 Picture Carrier Frequency.....25.75 mc  
 Trap Frequencies.....21.25 mc, 26.5 mc  
 Video Response.....10 cps to 3 mc  
 Sound Rejection.....At least 20 db  
 Output Voltage.....1.5 volts peak-to-peak (max)  
 Output Polarity.....Sync negative  
 Output Impedance.....75 ohms unbalanced  
 Input Impedance.....50 ohms unbalanced  
 Maximum Nonlinearity.....Less than 2% of peak-to-peak  
 output voltage

Input voltage.....0.1 volt (max)  
 Power Requirements (Note: Use RCA MI-8262 Regulated  
 Power Supply):  
 Plate.....200 volts d-c at 230 ma  
 Filament.....6.3 volts a-c at 5.3 amp

### Tube Complement:

- |                            |               |
|----------------------------|---------------|
| 5 RCA-6J6                  | 1 RCA-6V6-GT  |
| 2 RCA-6BA6                 | 2 RCA-6SN7-GT |
| 2 IN34 (crystal rectifier) | 1 RCA-6C4     |
| 2 RCA-6AU6                 |               |

Dimensions.....8" High, 12½" Wide, 9¼" Deep  
 Weight.....18 lb.  
 Finish.....Two tone umher gray

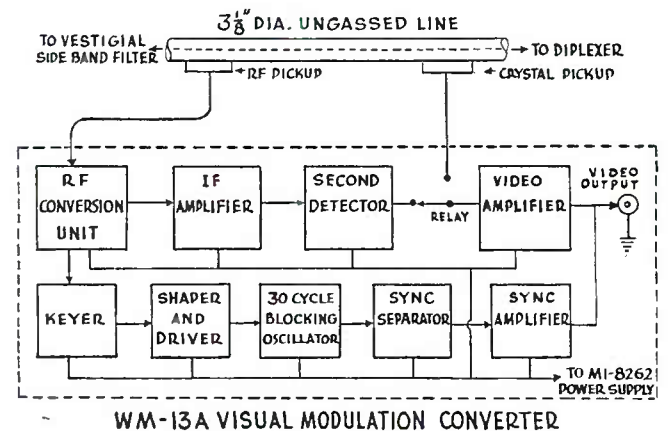

# Beat Frequency Oscillator Type 68-B

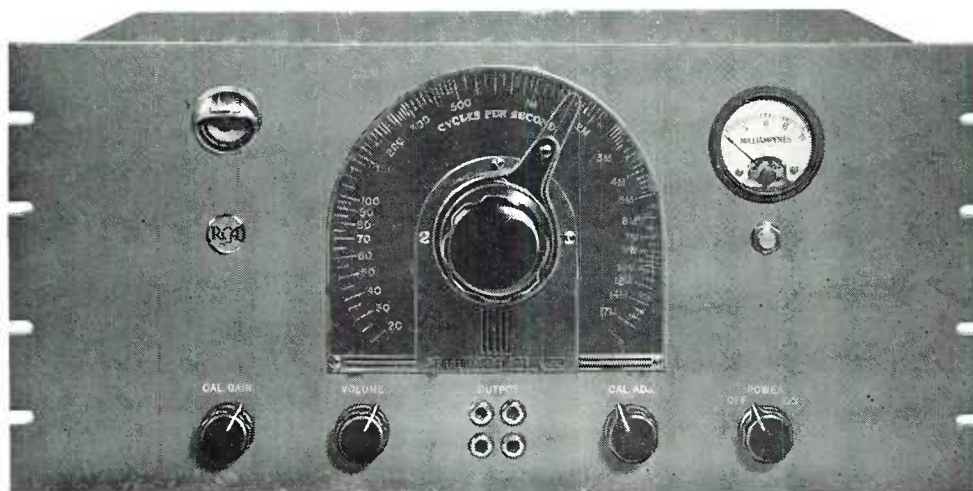

## Features

- Very low distortion—0.2 to 0.3 per cent total arithmetic sum.
- Low background level—70 db below maximum output.
- Wide frequency range.
- Electron-coupled oscillators.
- Push-pull detector and amplifier stages.
- Large direct-reading hand-calibrated frequency scale.
- Balanced outputs of 250, 500, 5000 ohms.
- Magic-eye tube for checking calibration.
- Standard double-jack output connections.
- High output level—125 milliwatts (max.).
- Frequency stability.

## Uses

The Type 68-B Beat Frequency Oscillator is designed for easy and fast fidelity measurements with laboratory accuracy. This instrument is required for frequency response, audio distortion, noise level, and other measurements which must constantly be made on broadcast station equipment in order to maintain high fidelity transmission.

The Type 68-B plus the 69-C Distortion Meter forms the combination necessary for making all types of fidelity observations. This equipment can be used to advantage by broadcasting stations and laboratories, and serves well in experimental work. Additional applications of these two units are: equalization of lines, receiver measurements, a source of sine waves for oscilloscope work or modulated oscillators.

## Description

The Type 68-B BFO employs the usual two r-f oscillators, one fixed and the other adjustable to produce a beat note of the desired frequency. In the 68-B, however, the oscillators are

electronically coupled to obtain the maximum of stability. Push-pull detector and amplifier stages are employed, thereby eliminating the second harmonic distortion frequently found in these stages, and providing linearity.

The instrument has sufficiently good waveshape to supply tone for distortion measurements at all frequencies. It has a range of 20 to 17,000 cycles throughout which optimum performance is obtained, and has useable output of good waveshape down to 5 cycles. The output is flat over the whole audio range, while the distortion content in the output is of the order of 0.2 to 0.3 per cent, total arithmetic sum. Precautions taken in design insure the low background level of -50 vu or 70 db below maximum output.

Output impedances of 250, 500, and 5000 ohms are obtainable from taps on the output transformer, which has a center tap to provide for balanced outputs at all impedances.

## Specifications

Frequency Range \_\_\_\_\_ 20 to 17,000 cycles  
(good waveform down to 5 cps)  
Output Power \_\_\_\_\_ 125 mw. (max.)  
Output Impedances \_\_\_\_\_ 250, 500, 5000 ohms

### Frequency Characteristics:

5000 ohm tap \_\_\_\_\_ ±0.5 db  
500 ohm tap \_\_\_\_\_ ±1 db  
250 ohm tap \_\_\_\_\_ ±1 db

### Distortion (total arithmetic sum):

Below 100 cycles \_\_\_\_\_ 0.3%  
Above 100 cycles \_\_\_\_\_ 0.2%  
Hum (max. output) \_\_\_\_\_ -70 db  
Power Input \_\_\_\_\_ 110/120 volts, 25/60 cycles, 70 watts

### Tube Complement:

6 RCA-6C5G	3 RCA-6J7
1 RCA-45	1 RCA-874
1 RCA-5Z4	1 RCA-6E5

Dimensions \_\_\_\_\_ 8¾" high, 19" wide, 10" deep  
Weight \_\_\_\_\_ 50 lbs.



# Distortion and Noise Meter Type 69-C

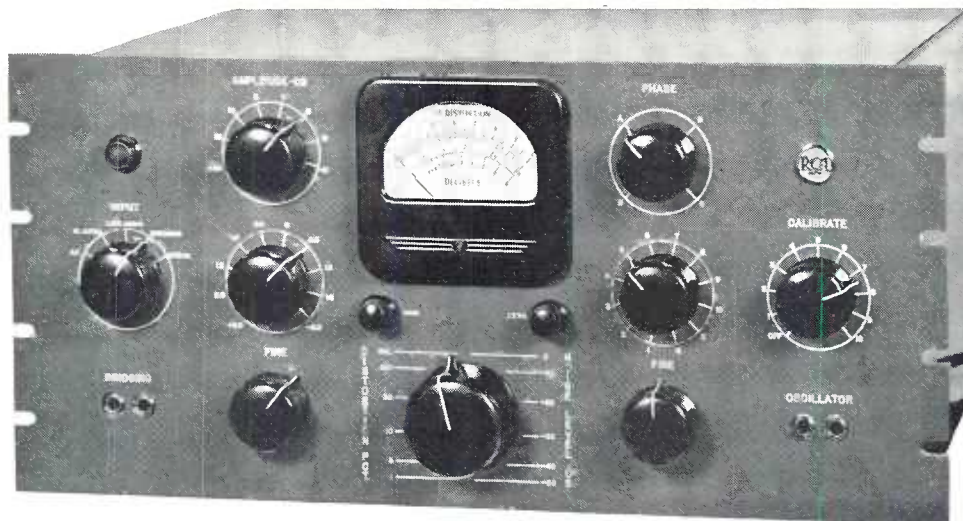

## Features

- Wide frequency range for f-m applications.
- Electronic output meter improves stability.
- Wide range distortion measurements.
- New bridging transformer for wider frequency band.
- Noise level measurements from -75 db.
- Direct reading, large-size meter.
- Gain standardized on 1 milliwatt, 600-ohm level.
- Self-contained power supply.

## Uses

The Type 69-C Distortion and Noise Meter has wide application in the broadcast field for measuring harmonic distortion, obtaining frequency response characteristics, and measuring background noise levels. It is designed for the accurate measurement of distortion over the entire audio range of 30 to 15,000 cycles, thus enabling the broadcaster to obtain a true picture of the fidelity of his station.

The RCA 69-C is capable of accurately measuring very low level distortions. It gives a precise indication of distortion from 0.3 to 100 per cent, rms.

Modern transmitters have noise levels 60 db below 100 per cent modulation. The Type 69-C can accurately indicate noise levels as low as 85 db below 100 per cent modulation. In addition, background noise levels down to -75 vu can be measured.

## Description

The Type 69-C employs a simplified switching arrangement for making distortion measurements over the entire audio range. The input and output fundamental signals from the equipment under test are balanced against one another by means of the amplitude and phase controls on the front panel, leaving the harmonics to be measured by a vacuum tube voltmeter. Noise voltages are measured directly by the voltmeter.

The Type 69-C has three alternative inputs so that measurements can conveniently be made at either the output of the transmitter, any 500 ohm termination in the speech input system, or at any point where no appreciable load may be drawn.

The meter can be connected by means of a patch cord to any point in the speech input system. A linear r-f rectifier stage in the 69-C provides for measurements of overall transmitter distortion. The r-f input terminals may be connected through a twisted pair from a pick-up coil in the transmitter.

Noise levels and distortion percentages can be read directly from the large-size meter.

## Specifications

R-F Range \_\_\_\_\_ 500 to 2000 kc

Frequency Range for  
Distortion Measurements \_\_\_\_\_ 30 to 15,000 cycles  
(harmonics to 30,000 cycles using bridging input)  
(harmonics to 45,000 cycles using unbalanced high impedance input)

Frequency Response:  
30 to 45,000 cycles  $\pm 1$  db unbalanced input  
30 to 30,000 cycles  $\pm 1$  db bridging input

Distortion Measurement Range \_\_\_\_\_ 0.3 to 100%

Noise Level Measurement Range:  
Any level down to 85 db below 100% modulation  
Any level down to -75 vu

Input Levels:  
Modulated r-f \_\_\_\_\_ 10 to 80 volts  
A-F Level from Oscillator \_\_\_\_\_ 2 to 4 volts  
A-F from System under Test  
Bridging Input \_\_\_\_\_ -15 to +22 vu  
Unbalanced Input \_\_\_\_\_ 0.12 to 8 volts and 1.2 to 80 volts  
by means of high-low taps

Audio Input Impedance:  
Bridging Input \_\_\_\_\_ 20,000 ohms  
Unbalanced Input \_\_\_\_\_ 200,000 and 20,000 ohms  
Power Input \_\_\_\_\_ 50 watts, 105/125 volts, 50/60 cycles

Tube Complement:  
2 RCA-6C5G 1 RCA-6F8G 1 Amperite  
2 RCA-6SJ7 1 RCA-VR150 Ballast Tube 6-8  
2 RCA-6X5G 1 RCA-VR105

Dimensions \_\_\_\_\_ 8 $\frac{3}{4}$ " high, 19" wide, 10" deep  
Weight \_\_\_\_\_ 44 lbs. (net)

# Distortion and Noise Meter Type WM-71A

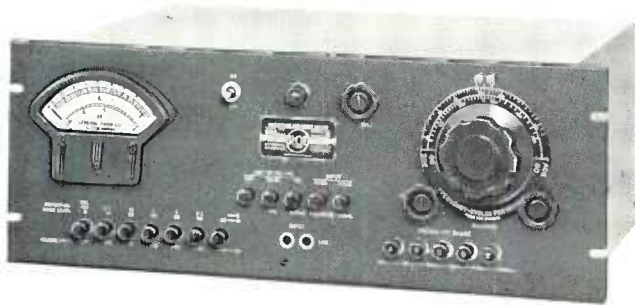

## Features

- Continuous coverage of audio range for distortion, noise and hum measurements.
- Distortion measurements, as low as .1%, quickly and easily made by one tuning adjustment.
- Distortion measurements independent of phase shift.
- Requires no direct connection to audio oscillator.
- Audio oscillator distortion can be measured.
- Can be used as a wide range highly sensitive voltmeter or VU meter.
- Tapped power transformer permits operation on either 105-125 volts or 210-250 volts.

## Uses

Distortion and Noise Meter RCA Type WM-71A is a compact precision instrument of new design. It permits continuous coverage of the audio frequency range, indicating directly the percentage of a-f distortion in modulators, speech amplifiers, a-f generators, receivers and other equipment employing audio frequencies. The instrument will give full-scale readings for distortion percentages as low as 0.3%, and is capable of measuring noise components at frequencies from 50 to 45,000 cycles.

Innovations in circuit design permit distortion measurements to be made easily and rapidly. Direct connection to the audio oscillator is not required, making it easy to measure at places remote from the oscillator. Moreover, the flat response and wide frequency range of the internal amplifier make the instrument useful for accurately measuring noise and VU levels.

## Description

Essentially, the WM-71A consists of a high-gain amplifier, an r-e interstage coupling unit, a calibrated attenuator for adjusting the sensitivity, and a panel meter to indicate amplifier output.

The r-e interstage coupling unit balances to a sharp null at the frequency to which it is tuned, the null frequency being controlled from the panel. Degeneration is employed to maintain high stability in the amplifier and to provide flat transmission characteristics (except within an octave of the null point).

In measuring distortion, the a-f signal is applied to the instrument and the null point is obtained to balance out its fundamental frequency, leaving only its harmonics and other distortion components which are indicated in percentage directly on the panel meter. When the modulated output of a radio transmitter is to be measured, a linear rectifier is required to produce the audio envelope. Any linear detector system having an undistorted output of 1.5 volts can be used.

A switch on the front panel provides for switching out the null circuit so that the instrument can be used as an extremely sensitive voltmeter for measuring noise and hum levels.

Since the WM-71A has only one tuning control plus a small trimmer, it can be quickly set to any frequency over its range. This is a time-saving feature in making a series of measurements.

## Specifications

Audio Frequency Range—50-15,000 cycles (fundamental) for distortion measurements; 50-45,000 cycles for VU and noise measurements.

Distortion Range—100% to 0.1% in six ranges.  
Full-scale meter deflection for values of 100%, 30%, 10%, 3%, 1%, and 0.3%.

Noise Range—Extends from 0 to -80 db below a reference level of one milliwatt in 600 ohms, in seven ranges; and to -80 db below 100% modulation when at least one volt is available from the modulation monitor at 100% modulation level.

Accuracy—For distortion measurements, accurate to within  $\pm 5\%$  of full-scale  $\pm$  residual distortion level which will not exceed .05% to .1%. Noise measurements accurate to within  $\pm 5\%$  of full-scale (residual noise level is less than -80 db). Effect of line-voltage variations from 105 to 125 volts, negligible.

Input Voltage Range—For distortion and noise, 1.2-30 volts at 100,000 ohms input; 0.8-30 volts at 10,000 ohms (bridging) input.

Input Impedance—100,000 ohms unbalanced; 600 ohms bridging input (10,000 ohms) balanced or unbalanced to ground

Audio Frequency Response—Flat within 1 db from 30-45,000 cycles

Tube Complement—5 Type 6J5, 1 Type 6H6, 1 Type 6X5, 1 Type 6SN7-GT, 1 Type 6K6-GT, 2 Type VR-150-30

Power Requirements—A tapped primary provides for operation on a-c line voltages of 105-125 volts 50/60 cycles, or 210-250 volts 50/60 cycles. Approximately 60 watts is required.

Dimensions—Rack mounting type—  
height 7", width 19", and depth 12" (approx.)

Weight \_\_\_\_\_ 35½ lbs.

Finish \_\_\_\_\_ Umber gray lacquer

Stock Identification \_\_\_\_\_ MI-30071-A

# Attenuator and Measuring Panel Type 89-C



## Features

- Simplifies fidelity measurements.
- Wide range.
- Levels can be read directly in db.
- Useful for taking frequency response curves.
- Output impedance switch for matching.
- Input switch for high or low level.

## Uses

The Type 89-C Attenuator and Measuring Panel has been designed for facilitating measurements with the Type 68-B Beat Frequency Oscillator and the Type 69-C Distortion and Noise Meter. It will serve equally as well for general measuring work.

By use of the 89-C suitable attenuation can be introduced to feed the equipment being measured from the 68-B Oscillator. Also, the voltage fed from the Oscillator to the Distortion Meter can be conveniently controlled.

The volume indicator is useful for measuring levels as well as for taking frequency response curves when the 68-B Oscillator is employed alone.

The 89-C Panel saves considerable time in setting up apparatus for measurement and provides for a wide range of conditions. It is particularly useful for laboratories and for broadcasting stations in the master control room or at the transmitter.

## Description

The Type 89-C Panel consists of a volume indicator meter, an input and output attenuator, an impedance matching system, and jacks for convenient connections.

Convenient switches allow the volume indicator to be connected to the input of the attenuator system or to a pair of jacks for external connection. Other switches control four balanced "H" pads having 5, 10, 20, and 40 db. attenuation, respectively. These pads may be inserted between the input and output jacks in steps of 5 db. from zero to 75 db. An output impedance switch allows matching to 600, 250, or 30-ohm circuits. An input switch for the Distortion Meter permits a choice of high or low signal level.

## Specifications

### Impedance Values:

Input \_\_\_\_\_ 600 ohms  
 Output \_\_\_\_\_ 600, 250, or 30 ohms  
 Volume Indicator \_\_\_\_\_ 20,000 ohms

### Volume Indicator Range

(1 mw. below zero level) \_\_\_\_\_ 0 to +22 v.u.  
 Attenuation \_\_\_\_\_ 0 to 75 db. in steps of 5 db.

### Operating Limits:

Input Level \_\_\_\_\_ 0 to +22 v.u.  
 Output:  
 600 ohms \_\_\_\_\_ -75 to +22 v.u.  
 250 ohms \_\_\_\_\_ -85 to +12 v.u.  
 30 ohms \_\_\_\_\_ -95 to + 2 v.u.

Dimensions \_\_\_\_\_ 5¼" High, 19" Wide, 7" Deep  
 Weight \_\_\_\_\_ 16 lbs. (approx.)

# Audio Voltmeter Type WV-73A

## Features

- Unusual sensitivity (0.001 volt a-c).
- Wide range (0.001 to 1000 volts a-c).
- Can be connected across high d-c potentials (1000 volts).
- May be used as an a-f amplifier with high gain and good fidelity.
- Unvarying meter readings despite line voltage changes or tube replacements.
- Logarithmic scale and overlapping attenuator provide accuracy even when pointer is at either end of scale.
- Excellent frequency response over the audio range (20 cycles to 20 kc.).

## Uses

The RCA Type WV-73A Audio Voltmeter is a sensitive electronic instrument designed to measure a-c voltages over wide ranges of frequency and amplitude. An input circuit with low capacity and high resistance makes the instrument particularly suitable for measuring voltages in high-impedance circuits. It may be used to measure the response of a-f power amplifiers and loudspeakers without disturbing their frequency characteristics.

For testing radio receivers and sound systems, the WV-73A may be used to measure gain and noise level in power amplifiers, and ripple voltage in power supplies. It can be used to locate sources of frequency distortion and faulty amplifier components in receivers, phonographs, and public address systems. Because of its unusual sensitivity, the instrument can well serve to measure the electrical conductivity of switches, circuit breakers, relays, buses, grounds, etc. In addition transmission losses on lines and circuits, as well as the response of special filters, compensators, and other apparatus, can be measured.

If desired, the WV-73A can be used as an a-f voltage amplifier. It will give high gain with essentially perfect fidelity, and its sensitivity readily adapts it for use with microphones having low output.

For making bridge measurements the Audio Voltmeter is ideal, readily indicating the null point at either high or low audio frequencies. By connecting the WV-73A to the output of a phototube, it will indicate extremely slight variations in light intensity to which the tube is exposed.

## Description

The WV-73A Audio Voltmeter was developed to fill the need in industry and in the laboratory for a high-impedance vacuum-tube voltmeter of good sensitivity and stability. It is also well suited for use in broadcast studios and for servicing public address systems.

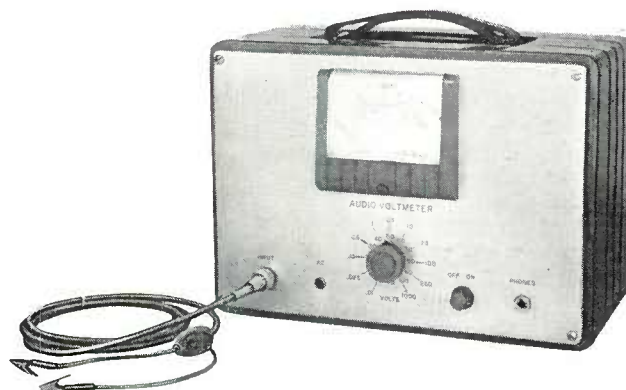

The main components consist of a precision attenuator, a 3-stage high-gain stabilized amplifier, a balanced diode rectifier, a special d-c microammeter, and a well-regulated power supply.

The voltage to be measured is fed to the attenuator through a shielded cable attached to a jack on the front panel. The attenuator consists of an 11-position switch and high-quality noninductive resistors designed so that consecutive ranges overlap by 10 db.

From the attenuator the voltage is fed to the high-gain amplifier, which employs a conventional feedback circuit to obtain stabilization. The feedback circuit also greatly reduces input capacity of the first tube. Output voltage from this amplifier is fed to a balanced diode rectifier to produce d-c for energizing the meter.

The high-level rectifier is designed to produce an output that is proportional to the average value of the full wave, thereby giving a meter reading that agrees very closely with an rms meter for all usual distorted waveforms. Because a balanced diode rectifier is used, the meter indicates the true value of both halves of the wave, avoiding the polarity or "turnover" error of half-wave circuits.

## Specifications

Voltage Range	0.001 to 1000 volts a-c
Frequency Range	20 to 20,000 cycles
Input Impedance	1 megohm and 25 mmf
Power Supply	105/125 volts, 50/60 cycles
Dimensions	13½" Wide, 9¾" High, 7¼" Deep
Weight	Approximately 15 lbs.
Finish:	
Cabinet	Dark cobalt gray Metalustre
Panel	Scratch brushed aluminum

# Video Sweep Generator Type WA-21A

## Features

- Sweep or CW signals up to 10 mc.
- Uniform sweep rate—no crowding at either end.
- Entire CW and Marker signal range covered in one continuous band.
- Unusually flat response.
- Built-in output metering circuit.
- Continuous control of output.
- Built-in mixer system eliminates spurious marker signals.

## Uses

The RCA Video Sweep Generator, Type WA-21A, is designed to facilitate rapid testing of video frequency networks by permitting visual observation of the frequency response characteristic. It permits direct viewing of the envelope of the output wave of a video circuit while the input signal sweeps through a range from 100 kc to 10 mc, at the rate of 60 complete sweeps per second. It is generally used in conjunction with a suitable detector and oscilloscope to observe the output voltage vs frequency curve. In this use the deflection voltage source provided in the instrument furnishes a convenient system for synchronizing the horizontal deflection of the oscilloscope with the frequency excursion of the video input signal.

The WA-21A also embodies a CW generating section that produces sine wave signals tunable from 100 kc to 10 mc for point-by-point or steady-state tests. The beat-frequency principle is employed, and the entire range is covered in one continuous band. The CW section is also valuable for detailed analysis of a narrow portion of the video frequency spectrum, for example, in adjusting infinite rejection traps in television circuits.

The section of the circuit which produces the CW signal is separate from that which generates the sweep signal, thereby allowing the CW signal to serve as a calibrating marker on the sweep trace. When the marker is employed, a clearly visible "pip" appears on the trace and the frequency at which this pip occurs may be read directly from the dial.

In testing video amplifiers this instrument is useful for adjusting peaking circuits and for checking overall performance. In setting up transmitters, it can be used for adjusting the r-f networks to insure proper frequency response, and can also be used in conjunction with a field intensity meter for checking sideband energy distribution. For special applications, the sweep width may be reduced and the center frequency adjusted (by means of screw-driver adjustments) to permit detailed observation of the response of narrow band-width circuits within the range of 100 kc to 10 mc.

## Description

The output of an FM sweep oscillator and a heterodyne oscillator are combined in a mixer to produce a sweep signal covering the range from 100 kc to 10 mc at a rate of 60 complete sweeps per second—when using a 60 cycle power supply. Output is uniform within 1 db of the midrange response over this range. A blanking circuit is provided to eliminate the signal during the return portion of the trace (from 10 mc to 100 kc) if desired, and this feature also furnishes a zero-output base line on an oscilloscope screen.

The CW circuit utilizes two oscillators, the outputs of which are combined in a mixer tube to produce a beat output that can be continuously adjusted from zero to 10 mc.

The CW generator and the sweep generator may be operated simultaneously to produce a fluctuation or pip on the output of the sweep, where it crosses the frequency at which the CW generator is set. In order to produce this marker without any spurious by-products, a special built-in mixer system has been



incorporated. The marker is visible on an oscilloscope screen either when using a video detector or when viewing the video waves directly. The pip is uniform in size over the entire range of adjustment, and the full range from 100 kc to 10 mc is covered by a single dial scale.

The CW output is supplied through the same coaxial line as the sweep signal, while a panel switch permits selection of sweep, sweep plus marker, or CW. The output feeds into a 75-ohm terminated coaxial cable. An output metering circuit is provided to indicate the RMS value of the signal voltage. This circuit consists of a diode VTVM with a step attenuator. Continuous control of the output from 1 millivolt to 1 volt is achieved through the use of a fine control in connection with the step attenuator. Distortion and spurious outputs are less than 5% of the fundamental signal voltages.

A built-in source of supply-frequency voltage is provided for connection to the horizontal deflection circuit of an oscilloscope. This voltage is adjustable in phase. It is useful for synchronizing the oscilloscope sweep rate and phase with the frequency sweep rate of the WA-21A. Stability of the WA-21A sweep signal is insured by use of an electro-mechanical sweeping capacitor.

The instrument is designed for either table top or rack mounting. It is normally furnished in a table model cabinet. For rack mounting, suitable protective enclosures are provided, the panel space required is 8¾ by 19 inches, and standard relay-rack mounting slots are provided in the panel.

## Specifications

Sweep Frequency Range	100 kc to 10 mc	
CW Range	100 kc to 10 mc	
Calibration Accuracy	2%	
Sweep Frequency Rate	Line frequency	
Marker Accuracy	2%	
Output Voltage	1 millivolt to 1 volt	
Output Impedance	75-ohm terminated coaxial line	
Output Characteristic	Flat within 1 db of mid-range response from 100 kc to 10 mc	
Power Supply	105/120 volts, 50/60 cycles, 180 watts	
Tube Complement:		
	5—6AG5	2—6Y6G
	2—955	1—6BA6
	1—6SQ7	1—6AS6
	1—VR150	1—5U4-G
1—6C4		
1—6BE6		
1—6SJ7		

## Dimensions:

Cabinet	22" wide, 10½" high, 15" deep
Relay Rack	8¾" high, 19" wide, 13½" deep
Finish	Umber gray
Weight	80 lbs.

# Cathode Ray Oscilloscope Type 155-C



## Features

- Light-shield with removable graph screen facilitates critical observations.
- High-fidelity amplifiers and improved wide-range timing oscillator insure accuracy and dependability of results.
- Three-inch cathode-ray tube provides a large, easily read image with sufficient detail for practically every application.
- Direct deflector connections accessible through door in side of case.

## Uses

The RCA Type No. 155-C Oscilloscope has been designed to meet the requirements of field service, industrial testing, commercial and university laboratories. Although practically unlimited in application, some of its more common uses include the study of wave shapes, measurement of modulation of transmitters, adjustment of radio receivers and transmitters, and determination of peak voltages.

## Description

This instrument was the first to have a built-in, deep, light-shield which permits general observations at lower intensity and makes many high speed transients visible in lighted rooms. A removable graph screen makes the Type 155-C still more

versatile, since critical observations can be made unobscured and various filter and limit screens can quickly be substituted by hand.

The timing axis oscillator is of an improved design allowing synchronization with low voltages in the audio, supersonic and low r-f ranges. Linearity is practically uniform through the range of 10 c.p.s. to 60 kc.

The 155-C has provisions for direct deflector-plate connection through a side opening in the case. It is housed in an attractive grey-wrinkle lacquered metal cabinet which provides adequate protection. A snap handle makes it conveniently portable.

## Specifications

Deflection Sensitivity with Amplifiers.....1 volt rms per inch  
 Sine Wave Response.....Flat 10 cycles to 40 kc; useful to 200 kc  
 Timing Oscillator Range.....10 cycles to 60 kc  
 Input Impedance......5 megohms in parallel with 22 mmfd.  
 Power Rating.....110-120 volts; 50-60 cycles; 50 watts  
 Dimensions.....14 $\frac{3}{8}$ " High, 8" Wide, 14 $\frac{1}{4}$ " Deep  
 Weight.....21 lbs.

# Cathode Ray Oscilloscope Type WO-79A

(Wide-Range Portable)

## Features

- Small size and light weight.
- Wide frequency range—10 cycles to 5 mc.
- Wide horizontal deflection—2 X screen diameter.
- Triggered sweep for examination of pulses and transients.
- Calibrated meter for voltage measurements.
- High voltage for photography.
- Wide range centering controls.
- Simplicity—multiple functions assigned each control.
- Direct and easy connections to deflecting plates.
- Time base voltages and 6 volts a-c available for external use.

## Uses

The RCA Type WO-79A Wide-Range 3-Inch Oscilloscope is designed to fill the need for an inexpensive and portable instrument which will permit close examination of extremely short, sharp-fronted pulses. It is ideal for detailed observation and accurate measurement of voltages produced by television synchronizing and deflection circuits, ignition systems, pulse generators, radar equipment, and other electronic devices. Centering controls permit expansion of the waveform over a distance twice the diameter of the screen without visible distortion, thus any portion of a complex waveform can be centered for study. Television servicemen, for example, will find this innovation in a small instrument to be very helpful. Voltage amplitude of a signal can be determined by means of a calibrated voltmeter on the instrument.

The triggered sweep feature makes the WO-79A particularly suitable for photographic study of transients, for television signal expansion, for checking square wave rise time, and for checking irregularly timed pulses. Signal triggered deflection, 60-cycle deflection, and blanking are some more of the unusual features of this instrument.

## Description

The Type WO-79A Wide Range 3-inch Oscilloscope is a general purpose portable precision instrument incorporating features for the study of electrical phenomena which have heretofore been available only in more elaborate and expensive laboratory-type equipment. Wide frequency range and high gain characteristics permit high speed transient and pulsed voltages in the order of 1 microsecond with frequency components up to 10 mc. to be displayed and accurately measured. Leading edges of short pulsed voltages are clearly and sharply reproduced so that all details stand out distinctly for either minute examination or photography. A retractable light shield provides easy viewing of faint traces.

Major electrical components include calibrated horizontal and vertical input attenuators, high gain horizontal and vertical amplifiers, a sync. amplifier, a time base oscillator and sweep generator, an intensifying amplifier, low voltage and high voltage power supplies, and a 3-inch high-contrast cathode-ray tube.

There are three types of internal voltages: (1) a sawtooth time base voltage, (2) a triggered linear time base voltage, and (3) a 60-cycle sinusoidal voltage supplied through a phase shifter circuit.

The intensifying amplifier increases the brilliancy of the spot after the time base generator is triggered, to permit examination and photography of small, faint and extremely short signals. The circuit also extinguishes the stationary spot.

The instrument comes complete with both direct and attenuating cables, probe and alligator clips, as well as power supply cord.



## Specifications

### Vertical Amplifier:

Frequency Range—Flat within  $\pm 2$  db. from 10 cycles to 5 mc.

### Deflection Sensitivity:

With 1000 volts on Second Anode  
0.5 peak to peak volts/in.  
With 1500 volts on Second Anode  
0.75 peak to peak volts/in.

### Horizontal Amplifier:

#### Frequency Range

Flat within  $\pm 2$  db. from 10 cycles to 500 kc.

#### Deflection Sensitivity:

With 1000 volts on Second Anode  
1.3 peak to peak volts/in.  
With 1500 volts on Second Anode  
2 peak to peak volts/in.

### Input Impedance:

#### Vertical Amplifier:

With Attenuating Cable—1 meg. in parallel with 15 mmf.  
With Direct Cable—1 meg. in parallel with 70 mmf.  
Direct (No Cable)—1 meg. in parallel with 30 mmf.  
Horizontal Amplifier—1 meg. in parallel with 50 mmf.  
Sync. Amplifier—1 meg. in parallel with 50 mmf.  
Sawtooth Time Base—20 cycles to 250 kc./sec.

### Triggered Time Base:

Max. Speed—1 microsecond per in.  
Repetition Rate—From single sweep to 50 kc./sec.  
Blanking—Return trace blanked on triggered deflection  
Power Supply—105/125 volts, 50/60 cycles  
Power Consumption—200 watts

### Tube Complement:

4 RCA-6AC7	1 RCA 6SH7
2 RCA-6SN7	1 RCA-5U4G
1 RCA-2X2/879	1 RCA-6H6
4 RCA-6AG7	1 RCA-0D3/VR150
	1 RCA-3KP1 (C-R tube)

Dimensions—14½" High, 8¼" Wide, 16¼" Deep  
Finish—Light blue-gray wrinkle  
Weight—42 lbs. (including cables)

# Cathode Ray Oscilloscope WO-60C



## Features

- Combines ruggedness and accuracy for heavy-duty continuous service.
- Linear sawtooth sweep with uniform rise.
- Useful range of 0.5 to 300,000 cycles.
- Especially suitable for measuring phase relations.
- New 5-inch C-R tube gives clearer trace.
- Faster changing of C-R tube gives unusual flexibility.
- Special circuits for steady signal.

## Uses

The RCA Cathode Ray Oscilloscope, Type WO-60C, is a general purpose, completely portable instrument, especially suitable for industrial applications. It will measure mechanical movements as low as 60 rpm., assist in the testing of servo mechanisms, aid in design of sonar and other supersonic equipment. Instantaneous pressure indications, vibration studies, and strain gage measurements can be made. Also it can be profitably employed to trace distortion in audio systems, to develop sound systems, to measure modulation characteristics. Industrially it is further applicable to testing and adjusting thyatron, ignitron and similar electronic control circuits used in modern machines. It also serves as a sensitive voltmeter for a-c or d-c measurements. In some of these applications the WO-60C is used directly, while in others a suitable pick-up device is also employed.

Industry can make widespread use of the WO-60C because of the inherent advantages of this electronic measuring instrument. It operates from almost zero input, has zero inertia, and practically unlimited speed of response. It has wide range, smooth and stepless control, and no moving parts. It is suitable for measuring very small quantities, for very rapidly changing quantities, and for very short time intervals,—those beyond the range of conventional measuring instruments.

For testing of electrical components and for A-M, F-M, and television receiver production the WO-60C is economically quite efficient. On the production line, this general purpose instrument, will usually show a savings because of a decrease in cost per test.

## Description

The RCA Type WO-60C Oscilloscope is designed for applications that require accuracy and long life despite rugged use. This instrument will maintain high sensitivity and precision under conditions of prolonged service, violent shock and vibration, in the presence of damp atmospheres and fumes, and over wide ranges of temperature. Results are reliable even when operating with the widely fluctuating line voltages often encountered in industry.

Controls are simplified and grouped for ease of operation. Connections are few and convenient to make. The WO-60C is quickly set up. There is no complicated terminal board, no difficult diagram of connections.

The instrument is entirely self-contained, comprising high-gain amplifiers, calibrated attenuators, sweep oscillator, and internal high and low-voltage power supply. An improved c-r tube of the zero-first-anode-current type gives better-than-usual sensitivity, sharp focus from one end of the 5-inch screen to the other, and less trapezoidal effect.





## D. C. Oscilloscope Type WO-27A



### Features

- Range—0 to 100,000 cycles.
- Response—flat down to zero cycles.
- Internal direct-coupled balanced amplifiers.
- Timing range from 1 to 30,000 cycles.
- Single sweep and blanking—excellent for photographic recording.
- Faster changing of c-r tube gives unusual flexibility.

### Uses

The RCA Direct Current Oscilloscope, Type WO-27A, is especially designed for observation of low-frequency a-c and d-c phenomena and, in addition, permits simultaneous observation of both a-c and d-c components.

Since the internal amplifiers of the WO-27A have flat frequency response down to zero cycles, it is useful in the study and servicing of extremely low-frequency actions such as occur in many mechanical, hydraulic, or electrical systems. This instrument may be employed for rapid adjustment of rotating machinery, for precise setting of relay contacts, and for measuring instantaneous air and water pressures that ordinary gages do not detect. Used in conjunction with a piezo-electric transducer, the WO-27A may be used to analyze and to correct vibration conditions in machinery or any other device or equipment. The d-c oscilloscope has proved to be very helpful in the development of internal combustion engines because, when used with suitable auxiliary apparatus, the pressure developed in a cylinder can be visually displayed on the screen. The instrument has also proved expedient in velocity measurement of projectiles, employing light screens to trigger the sweep and to apply vertical deflection, which allows the traverse time to be portrayed on the screen. The problem of arc-back in

power rectifier systems can be conveniently investigated with the WO-27A, because the nature of the arc and its time relation to other events in the system may be studied. In this connection, it is also of interest to circuit breaker designers and users.

There is a veritable host of applications in which the WO-27A can be employed as a time- and labor-saving device. Strain measurements can be quickly and easily made by employing standard test specimens and conventional auxiliary equipment. Lightning actions and vacuum tube characteristics may be studied. The instrument is not less than ideal for picturing a-c components of rectifier currents and their relation to the d-c value, in the study of grid current effects and other endless inter-related reactions. It will be found useful for locating discontinuities in transmission lines by recording the time interval between the application of an impulse to the line and the arrival of the reflected signal. It is widely employed in the design and servicing of servo mechanisms, sonar and other supersonic equipment.

The single sweep feature can be employed in the investigation of transients and other actions which occur at one time only. For example, flash-backs of any sort in electrical systems, one-time vibrations in mechanical systems, and pressure surges in hydraulic systems can be readily portrayed. By means of photography these transients can be permanently recorded for detailed study and for filing. A camera is set up and focused on the cathode ray tube. Since the return trace is blanked off, the shutter of the camera may be left open. When the transient occurs, it triggers the sweep and the trace is permanently recorded.

The WO-27A is highly suitable for studies in the field of medical science. Its low-frequency response, to cite but one example, enables it to be employed in the analysis of heart action as a visual stethoscope.

# OSCILLOSCOPES

## Description

The oscilloscope is probably the most useful of measuring instruments because of inherent versatility and unique freedom from limitations. It operates from almost zero input, has zero inertia, and practically unlimited speed of response. It has wide range, smooth and stepless control, and no moving parts. It is suitable for measuring very small quantities, for very rapidly changing quantities, and for very short time intervals—those beyond the range of conventional measuring instruments. The Type WO-27A Oscilloscope is an RCA development using direct-coupled amplifiers having a low-frequency response characteristic good to zero cycles per second, or direct current. This makes it useful in portraying the slowest changes and movements and also serves to eliminate low-frequency phase distortion.

The horizontal and vertical amplifiers are identical and have an essentially flat frequency response characteristic. Connection may be made to the output of either amplifier, or directly to either pair of deflecting plates.

The timing axis oscillator is of the Potter type, employing nongaseous tubes and operating down to 1 cycle per second. Provisions are made for converting the normal timing axis to a single sweep circuit for the study of transient phenomena. Triggering may be either externally or internally controlled.

The circuits used are ideal for high-speed photographic work in that a combined blanking circuit provides an increased intensity and illumination only during the sweep. Push-button switches are provided for all ranges, allowing rapid manipulation. Meter-calibrated comparison input is provided for both amplifiers. An improved c-r tube of the zero-first-anode-current type gives better-than-usual sensitivity, sharp focus from one end of the 5-inch screen to the other, and less trapezoidal effect.

The WO-27A is designed for fast changeover from one type of c-r tube to another. Tubes can be changed in 10 seconds or less. This is helpful for those applications requiring long or short persistence screens. The c-r tube supplied is of medium persistence which is most suitable for general applications. For the lowest frequencies, a long persistence screen is often held desirable. For the very best in photographic recording, the short persistence screen with its highly actinic radiation is more desirable.

This instrument combines in one compact unit the features that are usually associated only with larger, multiple unit and more expensive equipment. Extraordinary features of the WO-27A include a frequency range from zero cycles (or dc) to 100,000 cycles and a timing range from 1 to 30,000 cycles. Heavy duty components that give long life despite rugged service and high voltage input, together with convenience of connection and push-button control make the WO-27A what is probably the best buy in a d-c oscilloscope.

## Specifications

### Frequency Range:

Vertical and Horizontal Amplifiers.....0 to 100,000 cycles  
 Timing Axis Oscillator.....1 to 30,000 cycles  
 Blanking Amplifier.....30 to 100,000 cycles

### Deflection Sensitivity:

Vertical Amplifier .....0.084 d-c volts/in  
 Horizontal Amplifier .....0.105 d-c volts/in

### Direct to Deflection Plate:

Vertical.....54 peak-to-peak volts/in  
 Horizontal.....67.5 peak-to-peak volts/in

### Amplifier Characteristics (vertical and horizontal amplifiers are identical):

Input Resistance (approx.).....500,000 ohms  
 Input Attenuator.....4 steps, each 10 to 1  
 Coupling Capacitor.....1.0 mfd  
 A-C Input (max.).....500 volts  
 D-C Input (max.).....250 volts  
 Calibration Voltage.....Metered d-c voltage

### Synchronization:

Method.....Internal, external, or line frequency  
 Polarity.....Positive or negative

Power Supply.....105/125 volts, 50/60 cycles, 130 watts

### Tube Complement:

1 RCA-5UP1	1 RCA-2X2-A
12 RCA-6SF5	1 RCA-5V4-G
4 RCA-6SN7-GT	2 RCA-6X5-GT
1 RCA-6N7	2 RCA-0D3/VR150

Dimensions.....20" high, 13" wide, 25" deep

Weight.....80 lb

Finish.....Two tone umber gray

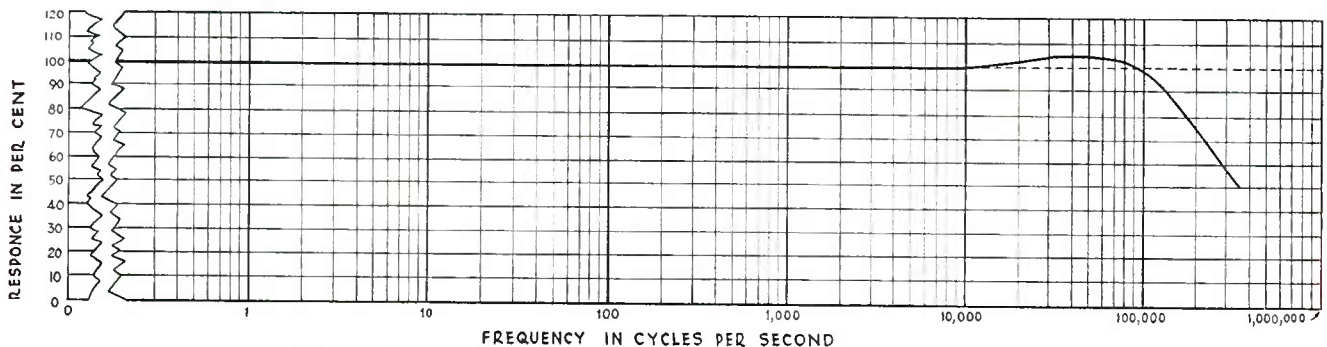

TYPICAL FREQUENCY RESPONSE OF WO-27A OSCILLOSCOPE

# Cathode Ray Oscilloscope Type 715-B

## (Laboratory Type)

### Features

- Extended frequency range—flat to 11 mc.
- High vertical deflection sensitivity.
- Low input capacity and high input resistance.
- Precisely compensated attenuator for vertical amplifier.
- Calibration meter.
- Triggered sweep.
- Adjustable phase.
- Time base marker.

### Uses

The RCA Cathode Ray Oscilloscope Type 715-B fills the need for a laboratory instrument that will permit detailed study of extremely short, sharp-fronted pulses, and other unusual waveforms. Recurring and transient phenomena can both be observed and measured with the Type 715-B; the waveform need not be repeated at regular intervals because even a random recurrence produces a clear, steady trace.

The wide-band amplifier, triggered sweep, blanking, and high accelerating voltage features make this instrument particularly well-suited to the photographic study of transients. Heavy-duty, ball-bearing swivel casters, and a conveniently located front handle make it easy to move the unit.

### Description

The 715-B Oscilloscope is a console type instrument especially designed for close examination of high-speed transients as well as regularly occurring phenomena. The cathode ray tube is operated with a high accelerating voltage in order to produce the intense spot necessary for many applications. A removable metal shield prevents direct external light from striking the surface of the cathode ray tube. A peak-to-peak a-c voltmeter is included. It may be used to check signal amplitude by pressing a convenient switch at the probe end of the input cable. The sweep can be triggered either from the signal causing vertical deflection or from an external signal. The speed with which the spot moves is completely independent of the repetition rate, being continuously adjustable by panel controls to give time calibrations from less than 2 microseconds per inch to over 100,000. Thus, pulses almost invisible on a standard oscilloscope can be expanded to reveal their true waveform on the 715-B. The aperiodic circuit will work satisfactorily when triggered by a single isolated impulse, or by pulses having any repetition rate up to 10,000 cps. When desired, a special built-in oscillator will superimpose clear, steady, microsecond peaks on the curve to facilitate the determination of time intervals.

With the control in the PERIODIC position a sawtooth deflection is produced, having the exceptional frequency range of 5 cps. to 100 kc. This can be synchronized with very high frequency signals or with pulses of extremely short duration.

### Specifications

#### VERTICAL AMPLIFIER

Frequency Range—Flat within  $\pm 1$  db from 5 cycles to 11 mc  
 Deflection Sensitivity:  
 With 2600 volts on Second Anode—0.17 rms volts per inch  
 With 1500 volts on Second Anode—0.10 rms volts per inch

#### INPUT IMPEDANCE

Vertical Amplifier:  
 With Attenuating Cable—1.1 megohm + 15 mmf  
 With Direct Cable—1.0 megohm + 150 mmf  
 Horizontal Amplifier—1.0 megohm + 50 mmf  
 Sawtooth Frequency Range—5 cps to 100 kc

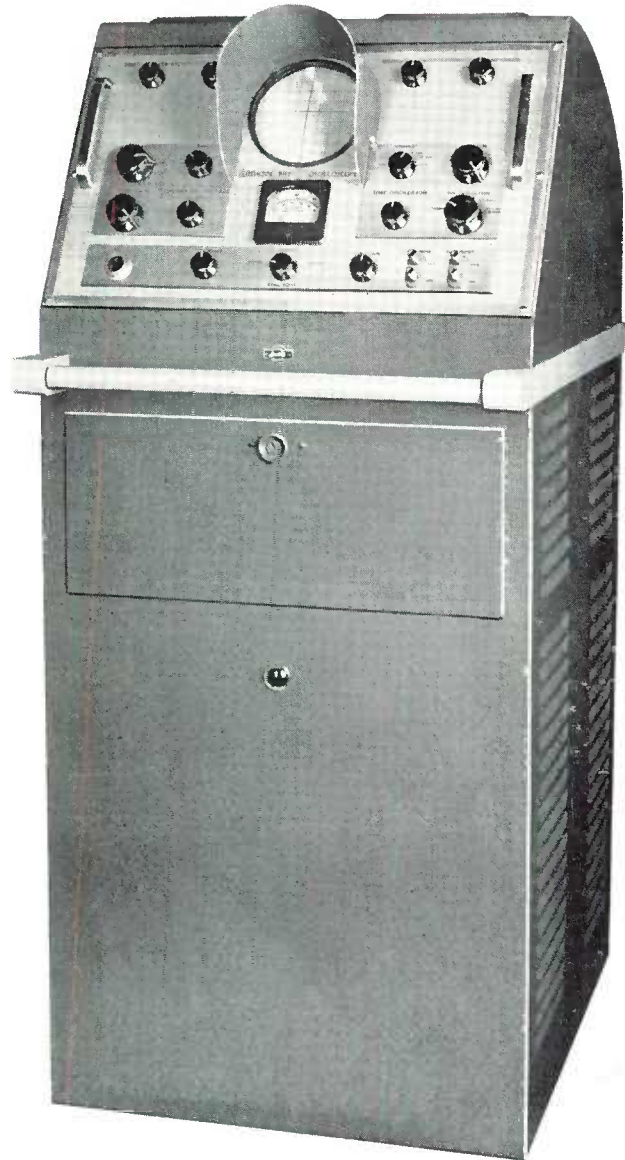

Triggered Sweep Speed—2 to 100,000 microseconds per inch  
 (continuously adjustable)  
 Time Interval Markers—1.0 microsecond  
 Blanking—Return line blanked on aperiodic deflection only  
 Power Requirements—105/125 or 210/250 volts,  
 50/60 cycles, 500 watts  
 Dimensions—50" High, 21" Wide, 27" Deep  
 Finish:  
 Cabinet—Two-tone gray enamel  
 Panel—Brush chrome  
 Tube Complement:  
 9—6AC7  
 2—6H6  
 1—6SH7  
 2—VR150-30  
 1—5VP1  
 Weight—350 lbs.

4—6AG7	2—6U6
1—6SJ7	2—6SL7-GT
1—2X2/879	4—6L6-G
2—807	2—866/866A

# VoltOhmyst Type 195-A

## Features

- Electronic—nonburnout meter.
- Measures a-c and d-c to 1000 volts, resistance to 1000 meg.
- 10 meg d-c input insures greater accuracy.
- 1 meg d-c probe for dynamic testing.
- Flat a-f response from 30 cycles to 10 kc.
- Zero center scale for FM discriminator alignment.

## Uses

The VoltOhmyst is an unusually accurate vacuum tube volt-meter designed for measuring both a-c and d-c voltages up to 1000 volts, and resistance up to 1000 megohms. A-F and supersonic voltages can be measured up to 100 volts within a range of 30 to 100,000 cycles and with linear reading at any frequency. The 195-A serves as an output meter for direct reading in decibels, or in volume units across 600-ohm audio circuits with standard zero level of 1 milliwatt. The VoltOhmyst is also designed to serve as an FM alignment indicator and indicates positive or negative deviation from balance.

The 195-A is used for maintenance of modern machinery embodying electronic control circuits, because it is ideal for oscillator grid voltage testing and trigger control voltage measurements. For servicing of sound systems, it is useful for level checking—and is a handy, all-purpose meter. For radio-servicing, the VoltOhmyst is the one indispensable instrument for AVC, AFC, FM discriminator and bias voltage readings—plus audio fidelity indication, supersonic and low r-f testing.

## Description

The extreme versatility and usefulness of the VoltOhmyst stems from the use of electronic measuring circuits. Additional advantages of the d-c VTVM circuit include high input resistance (which makes it possible to test radio receivers with the signal present), ability to measure high values of resistance, and protection against meter burnout. The 195-A also features a self-balancing diode for a-c measurements, a plastic meter case with one-piece unbreakable front, and a shielded a-c cable and probe.

For d-c measurements the 195-A has high resistance input of 10 megohms constant on all ranges, 1-megohm isolation resistor in d-c probe for dynamic socket voltage readings, a polarity reversing switch which eliminates time and trouble of reversing leads, and individual calibrations for positive and negative indications.

For measuring resistance up to 1000 megohms with absolute safety the 195-A applies only 3 volts to any circuit; one scale is used for all ranges from 0.1 ohm; and no zero resetting is necessary.

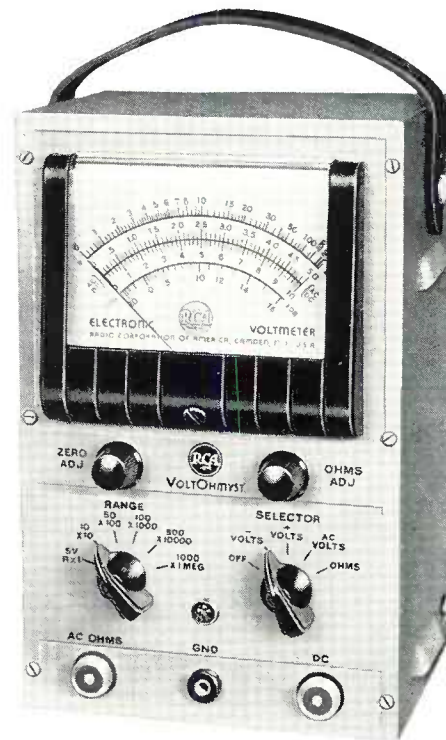

## Specifications

- D-C Voltmeter:**  
 Six Ranges \_\_\_\_\_ 0.5, 0-10, 0-50, 0-100, 0-500, 0-1000 volts  
 Input Impedance \_\_\_\_\_ 10 megobms (constant)
- A-C Voltmeter:**  
 Six Ranges \_\_\_\_\_ 0.5, 0-10, 0-50, 0-100, 0-500, 0-1000 volts
- Ohmmeter:**  
 Six Ranges \_\_\_\_\_ 0-1000, 0-10,000, 0-100,000 ohms;  
 0-1, 0-10, 0-1000 megobms
- A-F Voltmeter:**  
 Four Ranges \_\_\_\_\_ 0.5, 0-10, 0-50, 0-100 volts  
 Frequency Response \_\_\_\_\_ Flat from 30 cycles to 100 kc  
 Input Impedance \_\_\_\_\_ 200,000 ohms, 170 mmfd
- Output Meter:**  
 Six Ranges \_\_\_\_\_ -20 to +16, -14 to +22, 0 to +36,  
 +6 to +42, +20 to +56, +26 to +62 db  
 (When used for measurements across 600-ohm audio circuits, the readings are equivalent to Volume Units for a reference level of 1 milliwatt)
- FM Alignment Indicator:**  
 Provision for zero center adjustment meter reads plus or minus for alignment of FM discriminator circuit
- Power Supply:**  
 A-C Power \_\_\_\_\_ 105/125 volts, 50/60 cycles, 14 watts  
 Battery \_\_\_\_\_ 2—1½ volt flashlight cells
- Tube Complement** \_\_\_\_\_ 2 RCA-6K6-GT, 1 RCA-6H6, 1 RCA-6X5-GT
- Dimensions** \_\_\_\_\_ 9¾" High, 6½" Wide, 6¾" Deep
- Weight** \_\_\_\_\_ 14 lb.
- Finish:**  
 Case \_\_\_\_\_ Gray wrinkle  
 Panel \_\_\_\_\_ Brush chrome

# Voltomyst Type WV-75A

## (High Frequency)

### Features

- Measures a-c voltages up to 250 mc.
- Reads positive and negative peaks.
- One megohm isolating resistor in d-c probe for dynamic voltage checking.
- 11 megohms constant input resistance provides low drain and greater accuracy for all d-c ranges.
- Polarity reversing selector switch eliminates need of switching leads.
- Zero center selector switch for FM and AVM applications.

### Uses

The RCA WV-75A Advanced Voltomyst is designed for the convenience of radio and electronic service men, being especially helpful in making FM and television measurements as well as routine measurements. A newly developed diode probe makes it possible to read peak-to-peak voltage at frequencies up to 250 mc. Circuit innovations provide for readings of both positive and negative peaks. The WV-75A possesses all the outstanding characteristics of its well-known predecessor, the Type 195-A. It will measure d-c resistances up to 1000 megohms, a-c voltages up to 1000 volts, and d-c voltages up to 1000 volts.

In radio service work the WV-75A is very convenient because practically all a-c and d-c voltages can be measured. The high input resistance makes it possible to accurately measure d-c voltages directly at the grid, plate, screen or cathode terminal. A-C measurements in the average radio receiver include all a-c and audio voltages between the power transformer primary and the output transformer or voice coil of the speaker.

Other uses of this versatile voltomyst include the measurement of d-c value of AVC voltages; bias-cell voltages; AFC and FM discriminator voltages; d-c resistance and insulation leakage in oscillator and amplifier coils, audio and power transformers; leakage through the dielectric and insulation of condensers; and checking for gassy tubes.

### Description

The WV-75A employs a push-pull d-c VTVM circuit characterized by excellent linearity and stability.

An outstanding feature of the Advanced Voltomyst is the full wave diode rectifier which is built into the a-c probe. With this probe, the instrument is capable of measuring voltages at frequencies up to 250 mc. Accurate mechanical construction to close tolerances makes this probe a durable, dependable device. Measurements at high frequencies are made by direct contact with the central pin and the ground ring at the end of the probe, while an alligator clip for the central pin and a short ground lead serve as adaptors for voltage measurements at lower frequencies. An external multiplier can be screwed into the probe for measurements in the highest a-c voltage range at the lower frequencies.

### Specifications

D-C, 6 Ranges \_\_\_\_\_ 0 to 3, 0 to 10, 0 to 30, 0 to 100, 0 to 300, 0 to 1000 volts

A-C, 6 ranges:

Using diode probe directly or with adapters  
0 to 3, 0 to 10, 0 to 30, 0 to 100 volts

(Measures r-f voltages to 100 volts rms. up to 17 mc. Above that the maximum allowable input tapers to 10 volts at 250 mc.)

Using diode probe and multipliers \_\_\_\_\_ 0 to 300, 0 to 1000 volts



### Frequency Response:

Using diode probe directly \_\_\_\_\_ 30 cycles to 250 mc  
Using diode probe with supplied leads \_\_\_\_\_ 30 cycles to 30 mc  
Using diode probe and multiplier \_\_\_\_\_ 30 cycles to 15 kc

### Input Impedance:

	Equivalent Shunt Resistance, ohms	Equivalent Shunt Capacity, mmf.
Using Diode Probe Directly:		
At 1 mc. _____	625,000	15.6
At 10 mc. _____	32,000	14.5
At 250 mc. _____	100	13
Using Diode Probe with A-C Multiplier:		
At 1 kc. _____	1,650,000	2
At 10 kc. _____	1,650,000	2

Resistance, 6 Ranges \_\_\_\_\_ 0 to 1000, 0 to 10,000, 0 to 100,000 ohms; 0 to 1, 0 to 10, 0 to 1000 megohms

### Power Supply:

A-C Power \_\_\_\_\_ 105/125 volts, 50/60 cycles, 15 watts  
Battery \_\_\_\_\_ 2-1½ volt flashlight cells

Tube Complement \_\_\_\_\_ 2 RCA-6K6-GT, 2 RCA-6AL5, 1 RCA-6X5GT

Dimensions \_\_\_\_\_ 9 5/8" High; 6 5/16" Wide, 6 3/4" Deep

Weight \_\_\_\_\_ 9 lbs.

### Finish:

Steel Case \_\_\_\_\_ Gray wrinkle lacquer  
Panel \_\_\_\_\_ Etched brush chrome

# Battery VoltOhmyst, Type WV-65A

## Features

- Power supply completely self-contained.
- Measures voltage, current, and resistance.
- 11-megohm input resistance for all d-c ranges.
- 1-megohm isolating resistor in d-c dynamic probe.
- Electronic circuit—meter protected against burnout.
- Polarity reversing selector switch.

## Uses

The RCA Battery VoltOhmyst is a combined voltmeter-ammeter-ohmmeter of the electronic type for use in places when the conventional a-c outlet is not available. Internal battery operation of this VoltOhmyst makes it entirely independent of external power sources. It can be used in automobiles, boats, airplanes, rural areas and any other place when the regular a-c power supply is either difficult or impossible to obtain.

The Battery VoltOhmyst may be used for accurate measurements of a-c and d-c voltage, for d-c current and for resistance. In radio and audio applications it may be used for measuring AVC, AFC and FM discriminator voltages; d-c supply and bias cell voltages; oscillator strength; and resistance of coils, resistors, and insulation. This VoltOhmyst is quite helpful for measuring the d-c voltage developed across the picture channel of a television receiver when making antenna adjustments. It also is applied to determining when gassy tubes are present. D-C measurements may be made when a-c is present. In addition, this Battery VoltOhmyst is a useful tool for the servicing of all types of modern industrial electronic equipment.

When used with the inexpensive RCA Crystal Probe, the Battery VoltOhmyst may be employed to measure a-f and r-f voltages, thereby extending its usefulness to include applications that ordinarily would require the use of more elaborate and expensive equipment.

## Description

The Battery VoltOhmyst is a push-pull VTVM with 2-tube bridge circuit, possessing excellent linearity and stability characteristics. Circuit innovations that include zero grid current and controlled inverse feedback produce accurate readings over all ranges.

A high degree of self regulation is obtained without sacrifice of sensitivity. D-C input resistance has the unusually high value of 11 megohms

A 1-meg. shielded signal-tracing probe makes possible dynamic voltage measurements in signal-carrying circuits. The WV-65A is exceedingly stable in operation, requires no adjustment of zero controls when changing ranges and is essentially independent of changes in both tube characteristics and battery voltages during normal life.

A neon lamp mounted on the panel flashes whenever the battery is on. This serves two purposes. It indicates the condition of the battery, telling when replacement is necessary. It reminds the forgetful one that the instrument is on and that the battery is being drained.

The a-c circuit using a copper oxide rectifier is isolated from the case. The d-c circuit for current measurements is also isolated from the case.



## Specifications

### D-C Voltmeter:

Six Ranges \_\_\_\_\_ 0-3, 0-10, 0-30, 0-100, 0-300, 0-1000 volts  
 Input Resistance \_\_\_\_\_ 11 megohms constant for all ranges  
 Sensitivity (max.) \_\_\_\_\_ 3.7 megohms per volt on 3-volt range

### A-C Voltmeter:

Five Ranges \_\_\_\_\_ 0-10, 0-30, 0-100, 0-300, 0-1000 volts  
 Sensitivity \_\_\_\_\_ 1000 ohms per volt

### Ohmmeter:

Six Ranges \_\_\_\_\_ 0-1000, 0-10,000, 0-100,000 ohms,  
 0-1, 0-10, 0-1000 megohms

### D-C Ammeter:

Six Ranges \_\_\_\_\_ 0-3, 0-10, 0-30, 0-100, 0-300 millianp.  
 and 0-10 amp.  
 Voltage Drop \_\_\_\_\_ 450 mv. for full scale deflection

### Power Supply:

Batteries \_\_\_\_\_ Four 1½ volt RCA-VS036  
 Two 45 volt RCA-VS055

Tube Complement \_\_\_\_\_ 2 RCA-1C5GT, 1 GE-NE51

### Finish:

Panel \_\_\_\_\_ Etched brush chrome  
 Case \_\_\_\_\_ Gray wrinkle

Dimensions \_\_\_\_\_ 9½" high, 6¼" wide, 5½" deep

Weight \_\_\_\_\_ 9 lbs. (incl. batteries)

# Crystal Probe, MI-8263

Makes Any VoltOhmyst a V-H-F Voltmeter

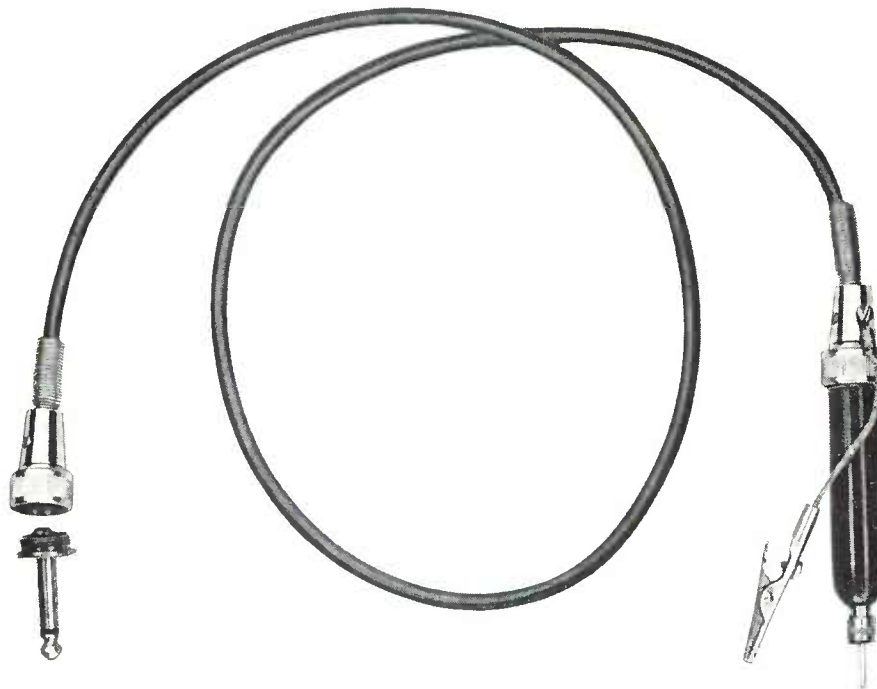

## Features

- Reads rf flat to 100 mc.
- For fm, television, and other h-f applications.
- Low-capacity input and high impedance.
- Good frequency characteristics.
- Excellent linearity over entire range.
- Withstands d-c loads of 250 volts.
- Highly accurate, even with low-resistance loads.
- Rugged but simple construction.
- Fits any RCA VoltOhmyst.

## Uses

The RCA Crystal Probe is designed for converting the d-c circuit of the VoltOhmyst to read a-c so that voltages up to a frequency of 100 megacycles or more can be indicated directly on the d-c scale. The Probe may be used with any model VoltOhmyst, including the original Senior and the Junior, and it may also be used on the Voltmeter channel of the RCA Chanalyst.

The Crystal Probe adapts the VoltOhmyst for fm, television, and other h-f testing requirements, within the sensitivity range of the instrument. It gives excellent linearity even at both ends of the scale. Because of its low input capacitance and high impedance, this Probe is especially suited for accurate reading without regard to load resistance.

## Description

The RCA Crystal Probe is an accessory for all models of the VoltOhmyst and connects to the d-c input for measurement of a-f and rf voltages. The Probe employs a Germanium crys-

tal which rectifies the applied a-c voltage so that it can be measured by the d-c circuit of the VoltOhmyst. The reading is proportional to the positive peak of the applied a-c voltage. Since this half-wave crystal rectifier involves no heater, it eliminates a possible source of hum and provides a rectifier which is operated far above ground potential. Use of a crystal rectifier means simplicity, compactness, and durability. The Probe is lightweight and rugged, it will withstand abuse from shock and vibration.

A detachable phone plug is used at one end of the cable for connection to the older models of the VoltOhmyst and Chanalyst. The phone plug may be unscrewed and the cable can then be attached to the single wire microphone connector used on the later models.

The probe point is long and narrow for easy testing in crowded places. The front part of the probe body is made of insulating material while the back part is made of metal for shielding hand capacity effects. A detachable ground lead with an alligator clip is provided for use at high frequencies where the lead length becomes an important factor in the overall accuracy. The regular VoltOhmyst ground lead can be used with the Crystal Probe for low frequency measurements. A shielded cable with durable plastic coating is provided with this probe.

## Specifications

Input Voltage	_____ 20 rms volts (max.)
Frequency Range	_____ 1000 cycles to 100 mc (gives useful readings up to 175 mc)
Overall Accuracy	_____ $\pm 7.5\%$ at full scale
Input Capacitance	_____ 3.5 mmf
Frequency Characteristics	_____ Flat within $\pm 10\%$ from 1 kc to 100 mc



# Audio Oscillator Type WA-54A



## Features

- Continuous coverage—20 to 17,000 cycles per second.
- Electronic eye calibrator and output indicator.
- Load-matching output transformer.
- Low distortion.
- Low hum level.
- Uniformly high- or low-power output.
- Temperature-compensated oscillators.
- Built-in voltage regulator.
- Large, easy-to-read drum dial.

## Uses

The RCA Type WA-54A Audio Oscillator is a portable, completely self-contained a-c operated instrument for generating audio frequencies within the range of 20 to 17,000 cycles per second—more than the range of most fine radio receivers. Because of its continuous coverage of the audio spectrum, it is excellent for rapidly testing loud speakers and audio amplifiers, locating cabinet rattles, and running fidelity curves on radio receivers. It is also a reliable low distortion signal source for oscilloscope studies, transmitter adjustments, and industrial electronic testing. The WA-54A output may be applied to balanced or unbalanced lines.

The pure fundamental tones of the WA-54A can be used to determine the frequency of any constant audible sound. Extreme accuracy can be obtained when used with tuning forks and a cathode ray oscilloscope, therefore, it is excellent for studies of the physical science of music. It may also be used to advantage in determining mechanical speeds by stroboscopic methods.

## Description

The RCA Audio Oscillator is a temperature-compensated beat frequency oscillator incorporating two r-f oscillators—one fixed, the other variable. The outputs are combined in a heterodyne detector to produce the desired audio frequency. This signal is amplified and then fed to a load matching output transformer.

The instrument can be conveniently calibrated at line frequency using the electronic eye to indicate zero beat exactly. This method of calibration affords exceptional accuracy as well as the utmost in convenience. The eye also functions as an output voltmeter for approximation of response measurements. In addition, it serves as a pilot light to indicate whether power is being supplied to the unit.

The tapped output transformer makes it possible to obtain load matching between the oscillator output and the most frequently encountered impedances, namely, 250, 500, and 5000 ohms. The transformer is center-tapped for proper operation on balanced-to-ground lines. For unbalanced measurements, additional impedances of 62.5, 125, and 1250 ohms are obtainable from the center tap to either side of each winding.

## Specifications

Frequency Range.....20 to 17,000 cycles  
 Distortion.....Under 5% (rms) over entire range  
 Hum Level.....60 db below max. output (approx.)  
 Power Output.....125 milliwatts  
 Power Supply.....105/125 volts, 50/60 cycles

### Tube Complement:

2—6AG5, 1—6BE6, 1—6J6, 1—6E5, 1—0A2, 1—6X4

Finish.....Case: Blue-gray Metalustre  
 Panel: Satin Alumilite

Dimensions.....9½" high, 13½" wide, 7½" deep  
 Weight.....Approx. 22 lbs.



# Audio Chanalyst Type 170-A

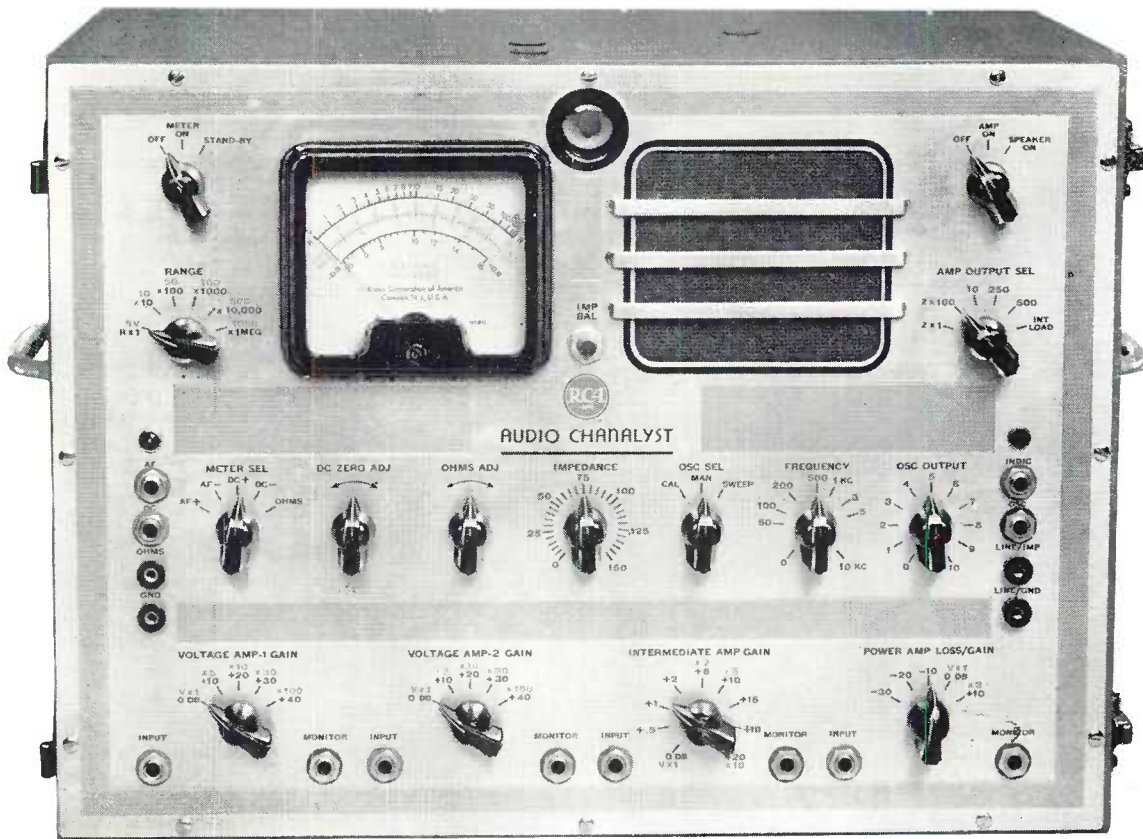

## Features

- Portable test bench with facilities for checking all makes of sound equipment.
- Self-contained audio signal source.
- Electronic vacuum tube voltmeter for a-c (a-f), d-c, ohms,
- Calibrated signal tracing amplifier.
- High speed electronic indicator and impedance tester.
- Channel monitoring facilities.

## Uses

The RCA Audio Chanalyst, type 170-A, is in itself a complete sound system testing laboratory. It can be set up in any convenient location to do a conclusive job of diagnosing trouble in audio amplifier, loud speaker systems, and pick-up devices.

## Description

The instrument is portable, weighing approximately 45 pounds and it is furnished complete with a cover which contains all of the necessary cables and test leads, packed in neat carrying order.

The Audio Chanalyst itself consists of three principal sections or channels; namely, a complete volt-ohmmeter, a complete signal source, and a calibrated audio amplifier. Beside its basic use as a testing unit, the audio amplifier section can be used as an emergency replacement unit or as an auxiliary amplifier for communications and entertainment.

There are several other units included which operate in collaboration with the above mentioned principal channels to extend the facilities of this instrument. They are: An impedance measuring device, a distortion indicating device, a loud speaker for audible testing, and a monitoring electronic indicator which also serves as a trouble-shooting device.

## Specifications

Height 14"; width 21"; depth 10<sup>3</sup>/<sub>8</sub>"; weight 47 lbs.

### Voltmeter Channel

A-c Diode and d-c Vacuum Tube V.M.—0-1000 v. in 6 ranges  
Ohmmeter—0-1000 megohms in 6 ranges

### Oscillator Channel

20 to 10,000 cycle beat frequency oscillator with direct low level output or high level when used with amplifier channel.  
Automatic 10 second audio sweep for multiple speaker testing.

### Amplifier Channel

4 stage high gain with power output of 1 watt at 10, 250, 500 or high output impedance. Calibrated in db and voltage ratios. Each stage can be used separately or in cascade.

### General

Also has speaker channel, electronic indicator, impedance tester and polarizing voltage supply.

# **DATA SECTION**

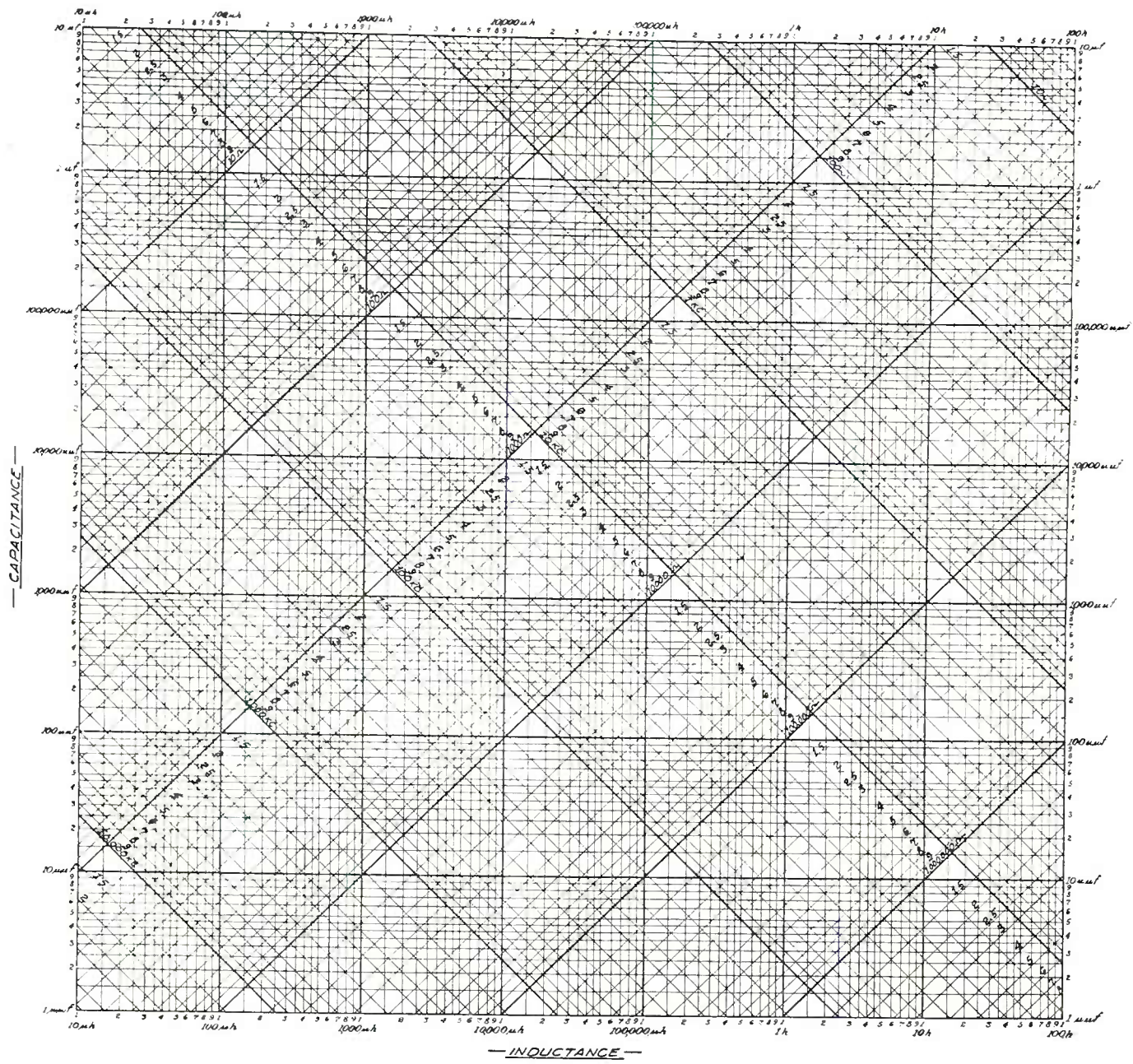

~ CHART OF FREQUENCY OR IMPEDANCE ~  
 ~ VS ~  
 ~ INDUCTANCE AND CAPACITANCE ~

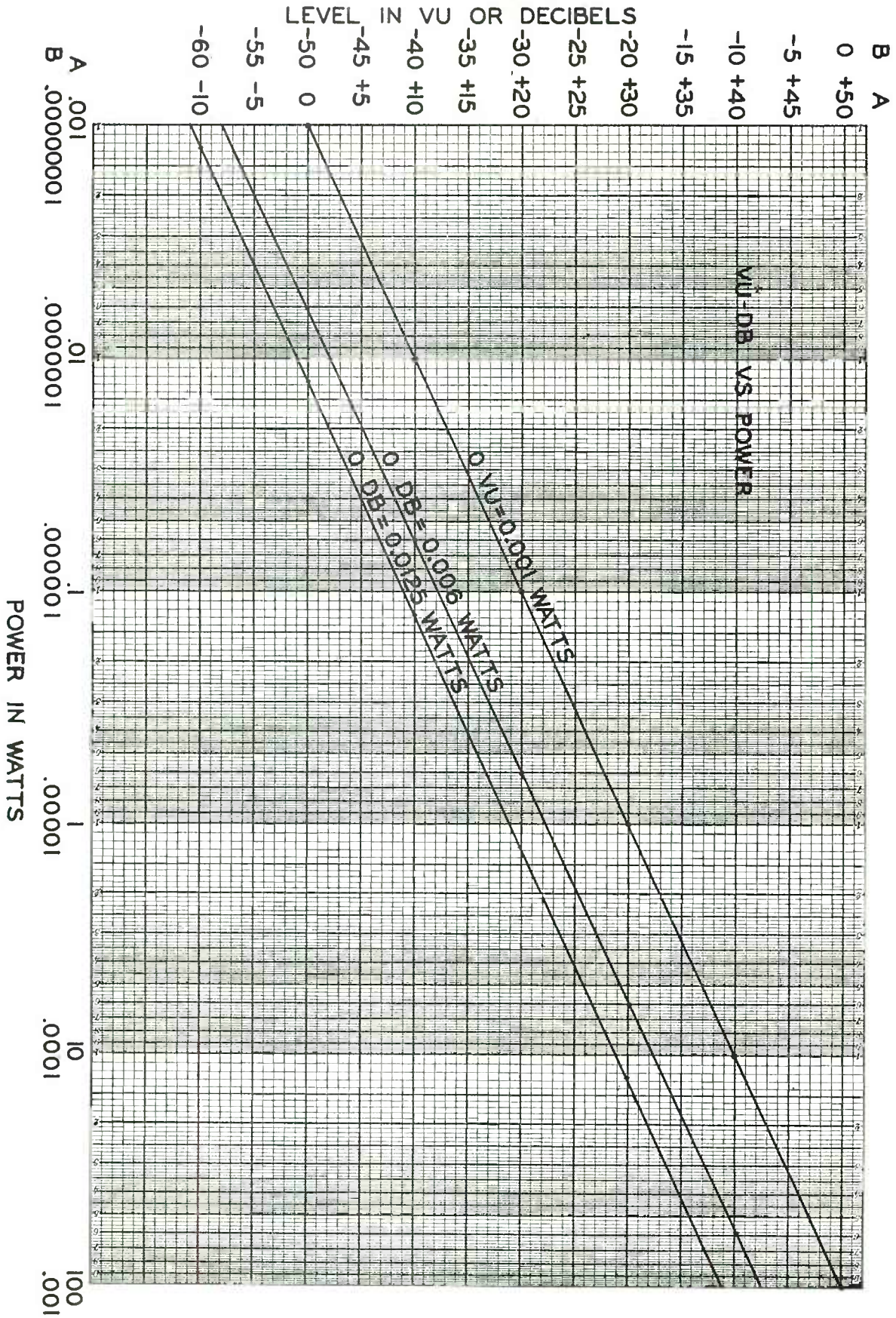

Impedance Loss, dB	600 Ohms		600 Ohms		600 Ohms		600 Ohms		600 Ohms		600 Ohms		600 Ohms	
	R <sub>1</sub> Ohms	R <sub>2</sub> Ohms	R <sub>1</sub> Ohms	R <sub>2</sub> Ohms	R <sub>1</sub> Ohms	R <sub>2</sub> Ohms	R <sub>1</sub> Ohms	R <sub>2</sub> Ohms	R <sub>1</sub> Ohms	R <sub>2</sub> Ohms	R <sub>1</sub> Ohms	R <sub>2</sub> Ohms	R <sub>1</sub> Ohms	R <sub>2</sub> Ohms
0	∞	∞	∞	∞	∞	∞	∞	∞	∞	∞	∞	∞	∞	∞
0.1	3.58	50204	0	7.20	100500	0	3.60	100500	0	3.58	100500	0	3.60	100500
0.2	3.41	26280	13.70	13.70	57380	6.85	57380	57380	6.82	57380	6.85	57380	6.82	57380
0.3	10.32	17460	20.55	34900	34900	10.28	34900	34900	10.32	34900	10.28	34900	10.32	34900
0.4	13.79	13068	27.50	26100	26100	13.80	26100	26100	13.79	26100	13.80	26100	13.79	26100
0.5	17.20	10464	34.40	20920	20920	17.20	20920	20920	17.20	20920	17.20	20920	17.20	20920
0.6	20.9	8640	41.7	17230	17230	20.85	17230	17230	20.9	17230	20.85	17230	20.9	17230
0.7	24.2	7428	48.5	14880	14880	24.25	14880	14880	24.2	14880	24.25	14880	24.2	14880
0.8	27.5	6540	55.05	13100	13100	27.53	13100	13100	27.5	13100	27.53	13100	27.5	13100
0.9	31.02	5787	62.3	11600	11600	31.2	11600	11600	31.02	11600	31.2	11600	31.02	11600
1.0	34.5	5208	68.6	10440	10440	34.3	10440	10440	34.5	10440	34.3	10440	34.5	10440
1.5	51.8	3452	104.3	6950	6950	52.1	6950	6950	51.8	6950	52.1	6950	51.8	6950
2.0	68.8	2652	130.4	5232	5232	87.7	5232	5232	68.8	5232	87.7	5232	68.8	5232
2.5	85.9	2053	175.4	4195	4195	106.2	4195	4195	85.9	4195	106.2	4195	85.9	4195
3.0	102.7	1703	212.5	3505	3505	129.0	3505	3505	102.7	3505	129.0	3505	102.7	3505
3.5	119.2	1448	258.0	3021	3021	143.8	3021	3021	119.2	3021	143.8	3021	119.2	3021
4.0	135.8	1249	297.5	2651	2651	162.3	2651	2651	135.8	2651	162.3	2651	135.8	2651
4.5	152.2	1109	324.6	2365	2365	182.3	2365	2365	152.2	2365	182.3	2365	152.2	2365
5.0	168.1	987.6	361.5	2141	2141	203.0	2141	2141	168.1	2141	203.0	2141	168.1	2141
5.5	184.0	886.8	405.9	1956	1956	223.8	1956	1956	184.0	1956	223.8	1956	184.0	1956
6.0	199.3	803.4	447.5	1807	1807	246.3	1807	1807	199.3	1807	246.3	1807	199.3	1807
6.5	214.6	730.8	492.6	1679	1679	268.5	1679	1679	214.6	1679	268.5	1679	214.6	1679
7.0	229.7	685.2	537.0	1569	1569	292.4	1569	1569	229.7	1569	292.4	1569	229.7	1569
7.5	244.2	645.6	584.2	1475	1475	317.1	1475	1475	244.2	1475	317.1	1475	244.2	1475
8.0	258.4	607.6	629.2	1393	1393	342.8	1393	1393	258.4	1393	342.8	1393	258.4	1393
8.5	272.3	575.0	673.9	1322	1322	369.4	1322	1322	272.3	1322	369.4	1322	272.3	1322
9.0	285.8	545.0	718.2	1260	1260	397.2	1260	1260	285.8	1260	397.2	1260	285.8	1260
9.5	298.9	517.0	764.4	1204	1204	427.0	1204	1204	298.9	1204	427.0	1204	298.9	1204
10.0	312.0	491.0	811.4	1154	1154	459.9	1154	1154	312.0	1154	459.9	1154	312.0	1154
11.0	336.1	467.4	868.1	1109	1109	495.5	1109	1109	336.1	1109	495.5	1109	336.1	1109
12.0	359.1	445.2	925.0	1066	1066	533.3	1066	1066	359.1	1066	533.3	1066	359.1	1066
13.0	380.5	424.4	983.0	1026	1026	573.0	1026	1026	380.5	1026	573.0	1026	380.5	1026
14.0	400.4	404.4	1041.0	988.0	988.0	614.3	988.0	988.0	400.4	988.0	614.3	988.0	400.4	988.0
15.0	418.8	385.0	1101.0	951.0	951.0	657.0	951.0	951.0	418.8	951.0	657.0	951.0	418.8	951.0
16.0	435.8	366.0	1162.0	916.0	916.0	701.0	916.0	916.0	435.8	916.0	701.0	916.0	435.8	916.0
17.0	451.5	347.0	1225.0	883.0	883.0	746.0	883.0	883.0	451.5	883.0	746.0	883.0	451.5	883.0
18.0	465.8	328.0	1290.0	852.0	852.0	792.0	852.0	852.0	465.8	852.0	792.0	852.0	465.8	852.0
19.0	479.0	309.0	1357.0	822.0	822.0	839.0	822.0	822.0	479.0	822.0	839.0	822.0	479.0	822.0
20.0	490.4	290.0	1426.0	796.0	796.0	887.0	796.0	796.0	490.4	796.0	887.0	796.0	490.4	796.0
22.0	511.7	255.0	1568.0	733.0	733.0	959.0	733.0	733.0	511.7	733.0	959.0	733.0	511.7	733.0
24.0	528.8	221.0	1714.0	680.0	680.0	1036.0	680.0	680.0	528.8	680.0	1036.0	680.0	528.8	680.0
26.0	542.1	187.0	1864.0	636.0	636.0	1118.0	636.0	636.0	542.1	636.0	1118.0	636.0	542.1	636.0
28.0	554.7	153.0	2018.0	600.0	600.0	1204.0	600.0	600.0	554.7	600.0	1204.0	600.0	554.7	600.0
30.0	563.0	119.0	2176.0	569.0	569.0	1294.0	569.0	569.0	563.0	569.0	1294.0	569.0	563.0	569.0
32.0	570.6	85.0	2338.0	542.0	542.0	1387.0	542.0	542.0	570.6	542.0	1387.0	542.0	570.6	542.0
34.0	576.5	50.0	2504.0	518.0	518.0	1484.0	518.0	518.0	576.5	518.0	1484.0	518.0	576.5	518.0
36.0	581.1	15.0	2674.0	496.0	496.0	1584.0	496.0	496.0	581.1	496.0	1584.0	496.0	581.1	496.0
38.0	585.1	0.0	2848.0	475.0	475.0	1687.0	475.0	475.0	585.1	475.0	1687.0	475.0	585.1	475.0
40.0	588.1	0.0	3000.0	455.0	455.0	1794.0	455.0	455.0	588.1	455.0	1794.0	455.0	588.1	455.0

Attenuator Networks.

TO EXTEND RANGE MULTIPLY 'VOLTAGE RATIO'  
BY 1000 AND ADD 60 TO DB

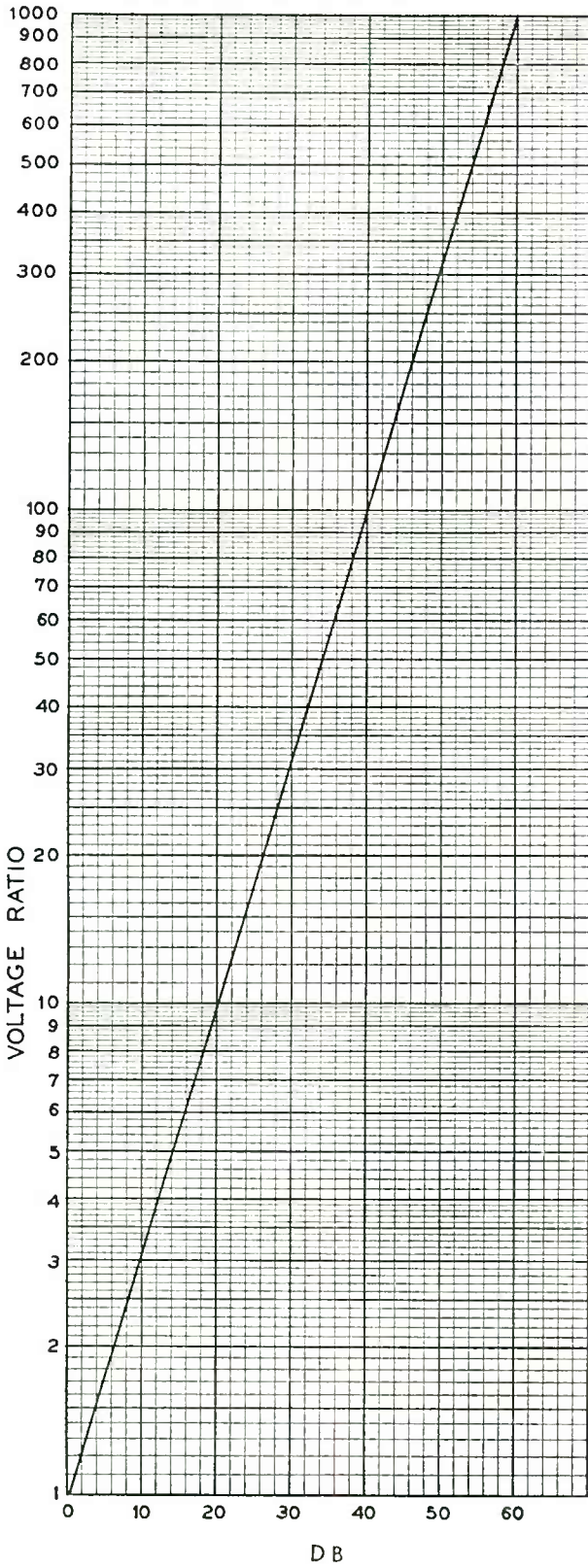

TO EXTEND RANGE MULTIPLY 'IMPEDANCE RATIO'  
BY 1000 AND ADD 30 TO DB

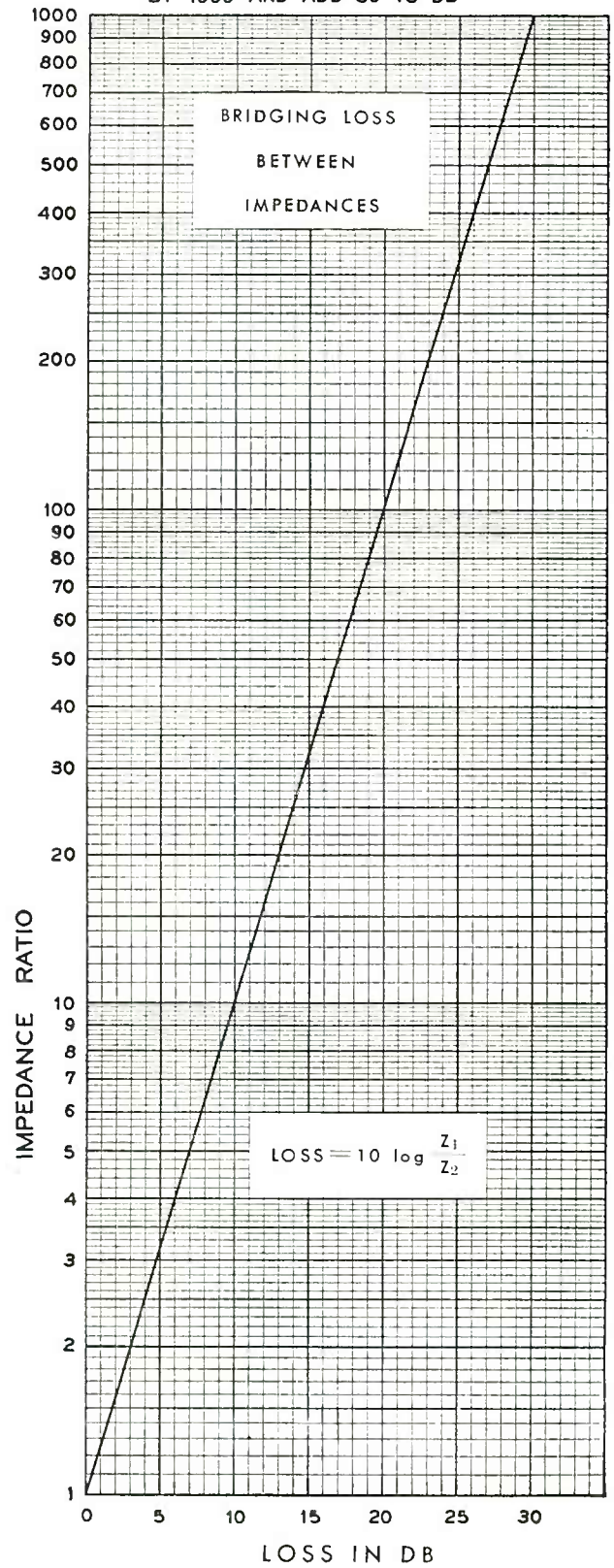



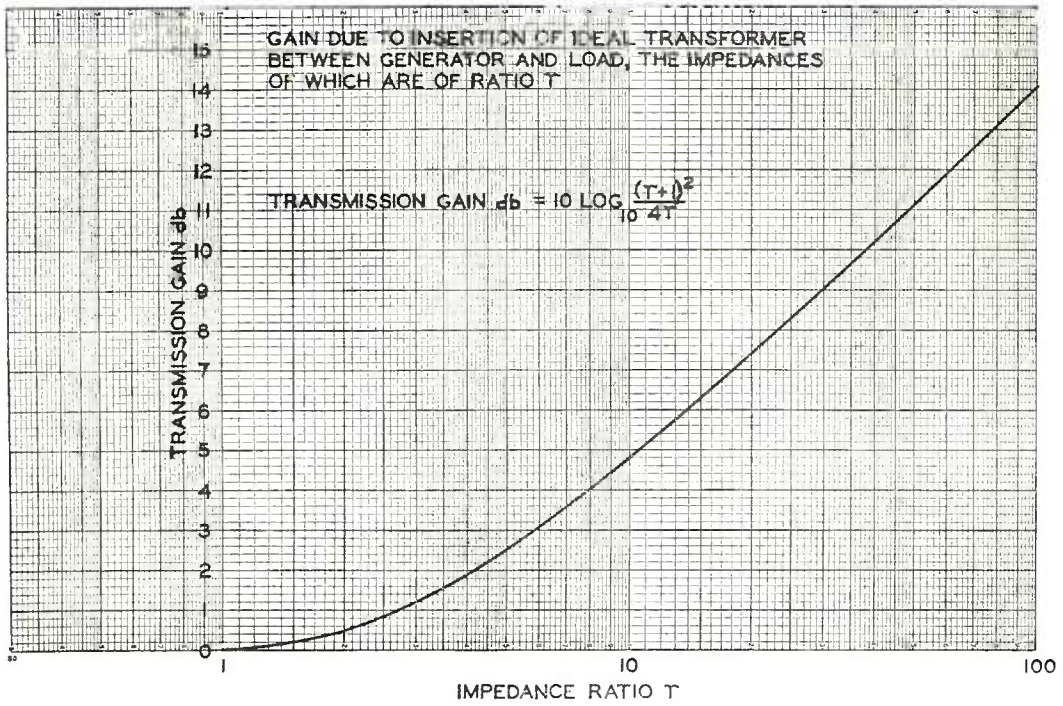

### CONTOURS OF EQUAL LOUDNESS TO THE EAR

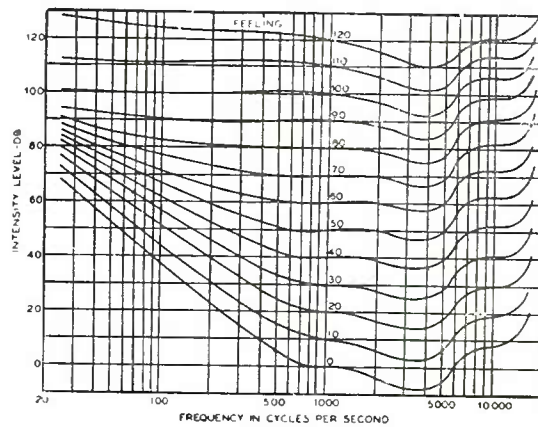

Loudness level contours.

Courtesy of the Acoustical Society of America

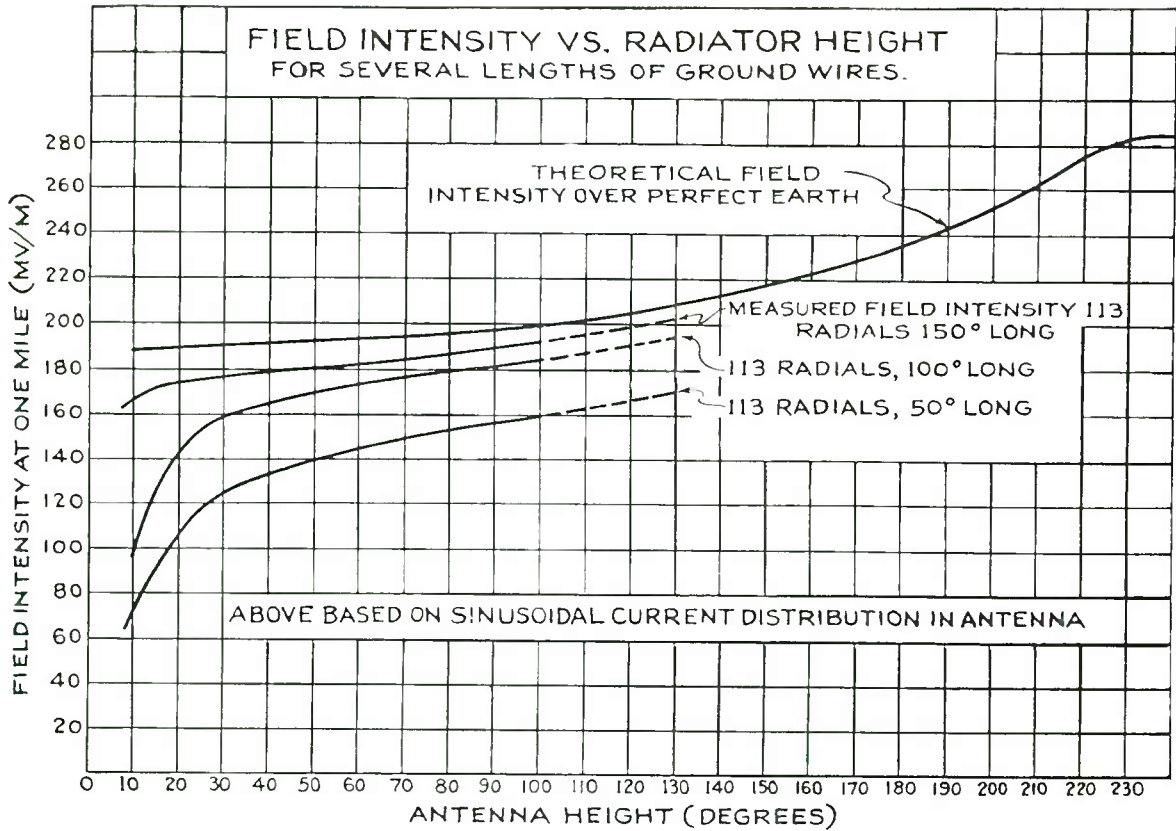

EFFECT OF GROUND WIRES ON FIELD STRENGTH

**RANGE FOR PROPAGATION OVER OPTICAL PATH**  
**HORIZON CALCULATIONS**

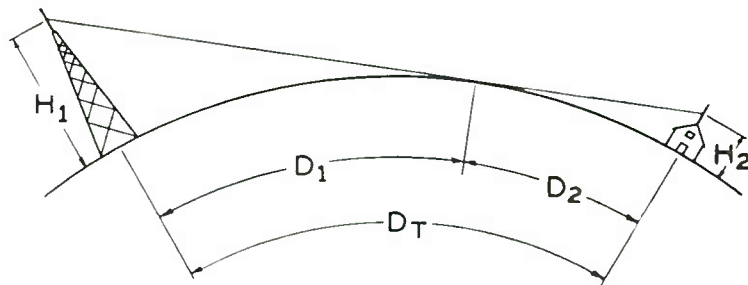

$$D_1 = K\sqrt{H_1}$$

$$D_2 = K\sqrt{H_2}$$

$$D_T = D_1 + D_2 = K [\sqrt{H_1} + \sqrt{H_2}]$$

K = 1.22 WHERE "D" IS IN MILES AND "H" IS IN FEET

K = 3.57 WHERE "D" IS IN KILOMETERS AND "H" IS IN METERS

THE ABOVE FORMULAE NEGLECT REFRACTION AND DIFFRACTION

# FM RANGE CHART

The ground wave signal range chart, shown on the opposite page, is intended to be used for determining approximate coverage of FM broadcast stations operating in the 88-108 mc band. The effect of transmitting antenna height and radiated power on field strength is indicated, and field strength vs. distance from the transmitting antenna is also shown.

To find the approximate radius of an area within a given field strength contour, proceed as follows:

1. Determine field strength in  $\mu\text{v}/\text{m}$  required and find this figure along extreme right-hand vertical column.
2. Follow the diagonal line corresponding to required field strength until it intersects with the vertical line representing radiated power.
3. From this point, lay a ruler or straight edge across the chart and along the vertical line corresponding to antenna height, read distance in miles to the  $\mu\text{v}/\text{m}$  contour selected.

The chart may also be used to find the value of radiated power required to cover a given area.

*For example:*

Find radiated power required to produce 1000  $\mu\text{v}/\text{m}$  signal at a distance of 30 miles with an antenna 500 feet high.

1. From the 500 foot mark on the "antenna height" scale, follow the vertical line upwards and locate the 30 mile point.
2. Lay a ruler or straight-edge across the chart from this point, taking care that the ruler is parallel with the bottom edge of the chart.
3. Mark the point where the ruler intersects with the diagonal line representing 1000  $\mu\text{v}/\text{m}$  and then from this point, place the ruler vertically on the chart and read approximately 18 KW radiated power on the scale at the upper right of the chart.

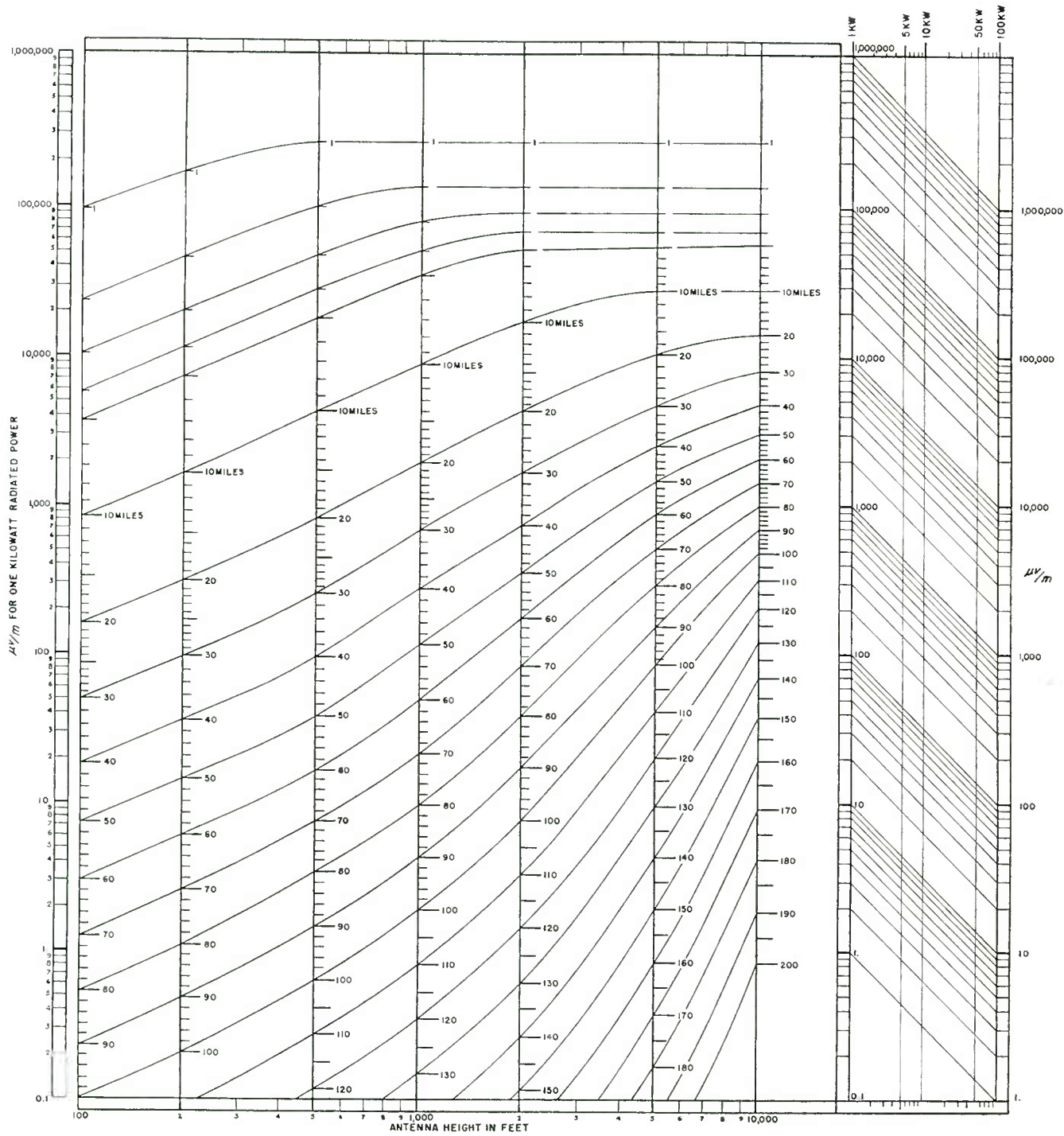
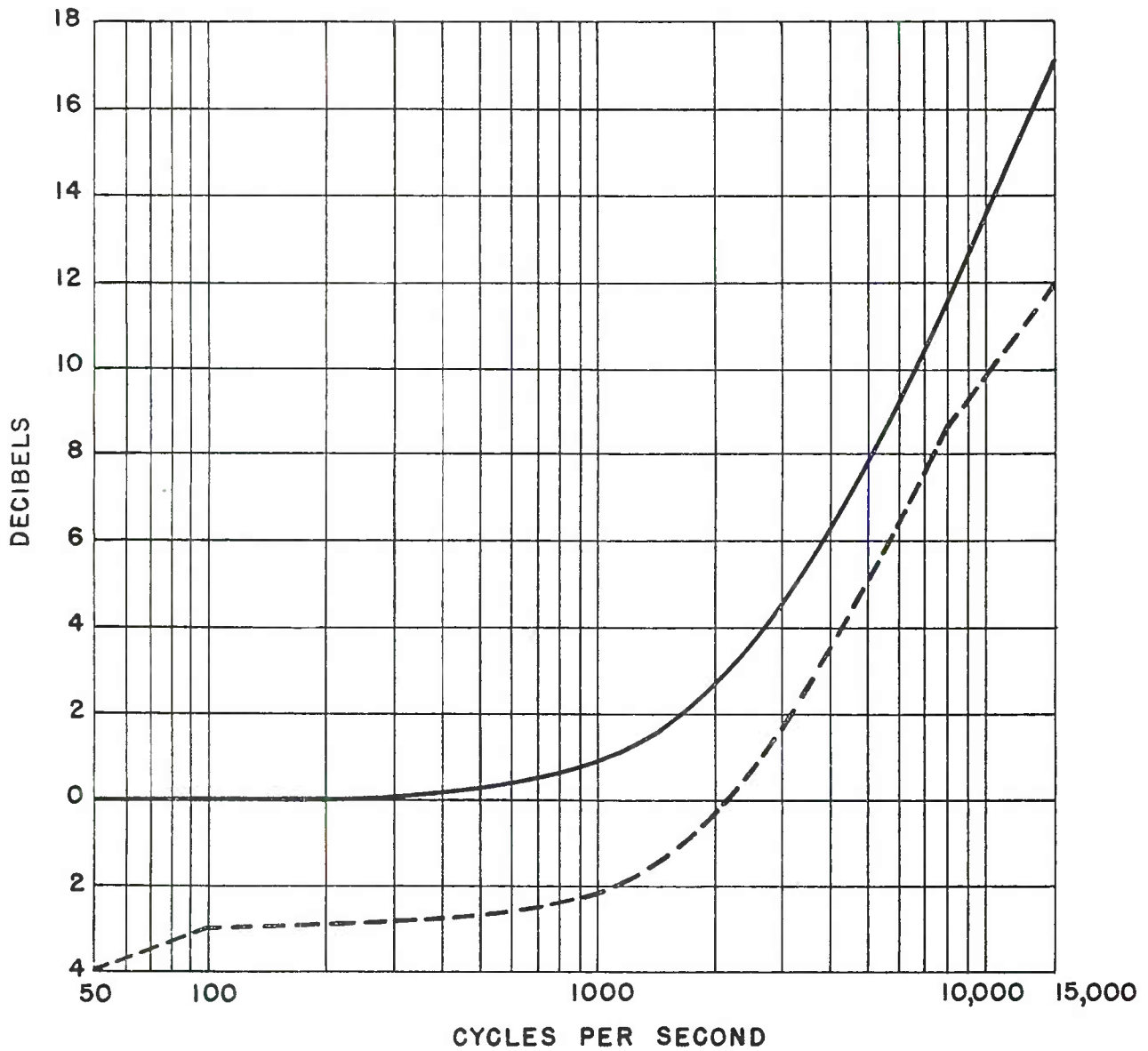

FIGURE 1

GROUND WAVE SIGNAL RANGE FOR FM BROADCASTING

98 mc,  $\sigma = 5 \times 10^{-16}$  e.m.u.,  $\epsilon = 15$ , RECEIVING ANTENNA HEIGHT 30 FEET  
 FOR HORIZONTAL (AND APPROX FOR VERTICAL) POLARIZATION

83911



— STANDARD PRE-EMPHASIS CURVE TIME CONSTANT 75 MICROSECONDS

..... FREQUENCY RESPONSE LIMITS

### COAXIAL LINE EFFICIENCY

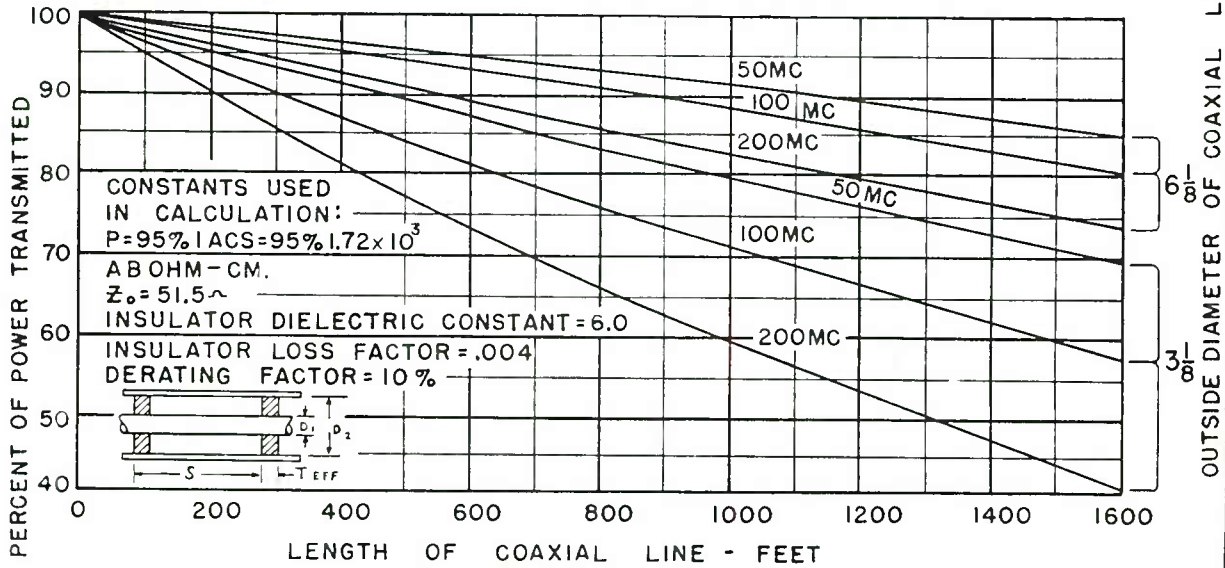
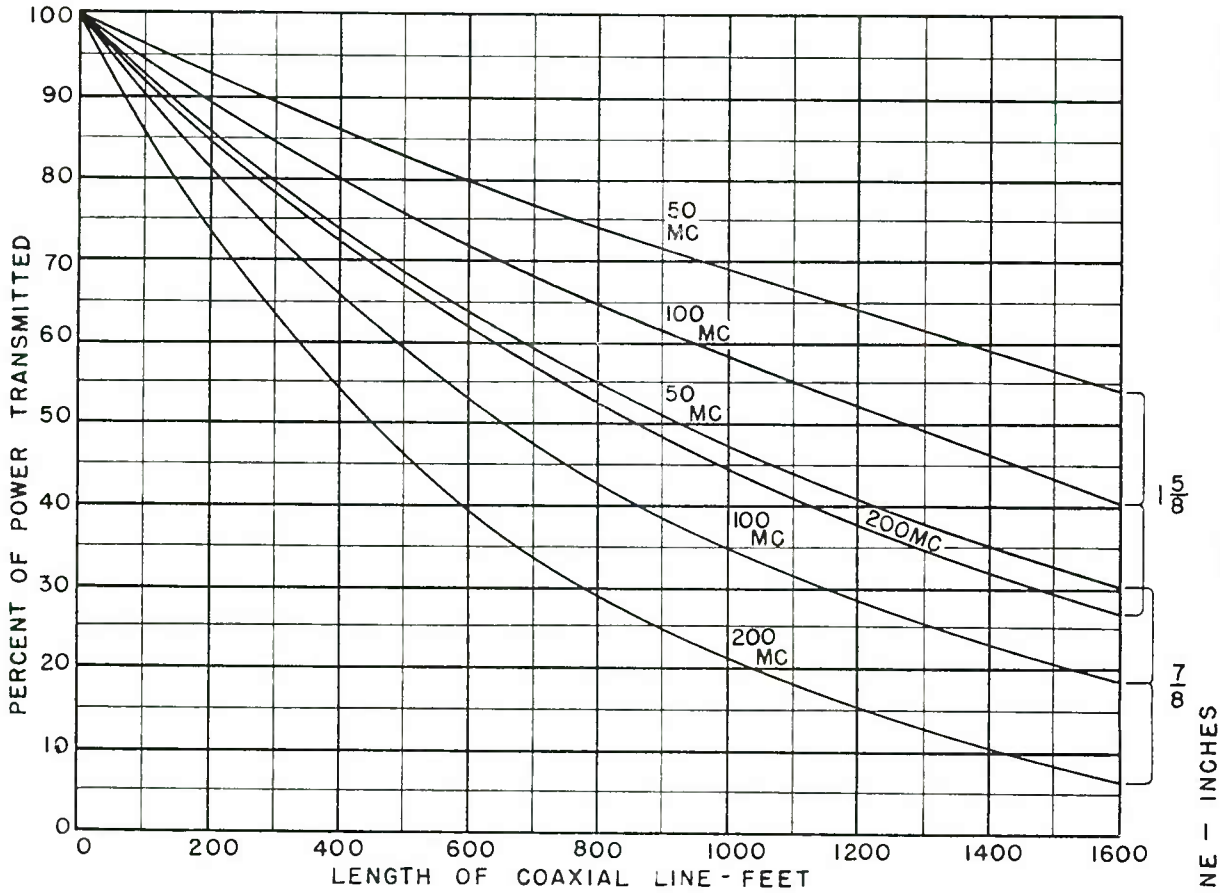

CONSTANTS USED  
IN CALCULATION:  
 $P=95\%$   $\text{ACS}=95\%$   $1.72 \times 10^3$   
 $Z_0 = 51.5 \sim$   
 INSULATOR DIELECTRIC CONSTANT = 6.0  
 INSULATOR LOSS FACTOR = .004  
 DERATING FACTOR = 10 %



SIZE	$D_1$	$D_2$	S	$T_{EFF}$	DB PER 100 FEET		
					50MC	100MC	200MC
7/8	.3125	.785	6	.187	.318	.460	.673
1 1/8	.625	1.527	12	.193	.161	.234	.346
3/8	1.200	3.027	12	.375	.096	.145	.230
6 1/8	2.500	5.981			.039	.056	.081
IN.	IN.	IN.	IN.	IN.			

P - 728591

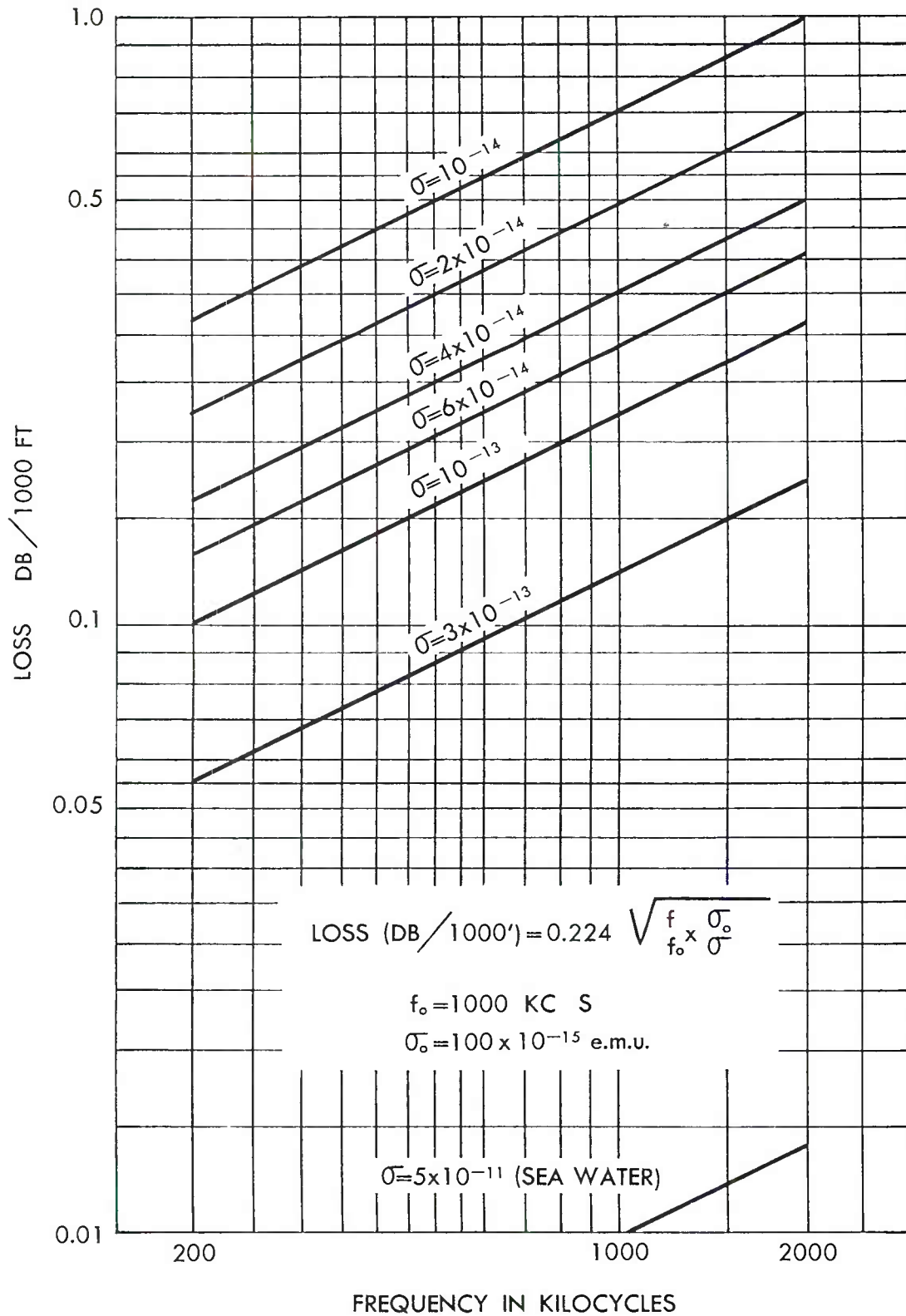

LOSS (DB PER 1000 FT.) OF RCA 6 WIRE TRANSMISSION LINE  
 LINE HEIGHT 12', WIRE SPACING 15", WIRE SIZE #8,  $Z_o = 230 \Omega$

# INDEX





# INDEX BY TYPE NUMBER

<i>Type</i>	<i>Description</i>	<i>Page</i>	<i>Type</i>	<i>Description</i>	<i>Page</i>
BA-1A	Preamplifier .....	38	TRR-1A	Relay Receiver .....	187
BA-2C	Booster Amplifier .....	40	TS-10A	Switching System .....	161
BA-3C	Program Amplifier .....	41	TS-30A	Field Switching System.....	180
BA-4C	Monitoring Amplifier .....	42	TT-5A	TV Transmitter .....	192
BA-5A	Recording Amplifier .....	43	TTR-1A	Relay Transmitter .....	185
BAF-4A	AM-FM Isolation Unit .....	142	WA-21A	Video Sweep Generator .....	216
BCS-1A	Switching System .....	34	WA-54A	Audio Oscillator .....	228
BCS-2A	Switching System .....	33	WF-48A	Frequency Monitor .....	203
BE-1B	Line Equalizer .....	62	WF-49A	Frequency Meter .....	204
BF-Series	Pylon Antenna .....	130	WF-40A	Frequency Monitor .....	204
BI-1A	Meter Panel .....	60	WM-12A	Visual Monitor Converter.....	209
BI-2A	Meter Panel .....	60	WM-13A	Visual Modulation Converter.....	210
BN-2A	Remote Amplifier .....	47	WM-30A	Phase Monitor .....	205
BPA-1A	1 KW Antenna Tuner.....	114	WM-43A	Modulation Monitor .....	202
BPA-10	5-10 KW Antenna Tuner.....	115	WM-71A	Distortion and Noise Meter.....	213
BPA-50	50 KW Antenna Tuner.....	116	WO-27A	D.C. Oscilloscope .....	221
BR-2A	Panel and Shelf.....	57	WO-60C	Cathode Ray Oscilloscope.....	219
BR-84	Standard Cabinet Racks.....	52	WO-79A	Cathode Ray Oscilloscope.....	218
BTA-1L	1 KW AM Transmitter.....	96	WP-33A	Power Supply .....	170
BTA-5F	5 KW AM Transmitter.....	98	WR-55A	Sweep Generator .....	229
BTA-10F	10 KW AM Transmitter.....	100	WV-65A	Battery VoltOhmyst .....	226
BTA-50F	50 KW AM Transmitter.....	104	WV-73A	Audio Voltmeter .....	215
BTA-250L	250 W AM Transmitter.....	94	WV-75A	VoltOhmyst .....	225
BTC-1A	Transmitter Console .....	132	9-AX	Cabinet Rack .....	54
BTF-1C	1 KW FM Transmitter.....	124	33-A/D	Jack Panels .....	58
BTF-3B	3 KW FM Transmitter.....	126	33-AW/BW	Jack Panels .....	58
BTF-10B	10 KW FM Transmitter.....	128	44-BX	Microphone .....	14
BTF-50A	50 KW FM Transmitter.....	130	56-C	Line Equalizer .....	63
BTF-250A	250 W FM Transmitter.....	122	56-E	Line Equalizer .....	63
BTP-1A	Radio Microphone .....	51	57-C	Switch and Fuse Panel.....	59
BX-1C	Power Supply .....	68	59-B	Microphone Stand .....	23
KB-2C	Microphone .....	16	68-B	B.F. Oscillator .....	211
KN-1A	Microphone .....	18	69-C	Distortion and Noise Meter.....	212
KS-1A	Microphone Stand .....	22	70-D	Turntable .....	70
KS-3A	Microphone Stand .....	23	72-D/72-DX	Recording Attachment .....	75
KS-4A	Microphone Stand .....	24	73-B	Recorder .....	76
KS-5A	Microphone Stand .....	20	74-B	Microphone .....	17
LC-1A	Monitoring Speaker .....	86	76-B4	Consolette .....	30
OP-6	Remote Amplifier .....	48	76-C	Consolette .....	32
OP-7	Remote Mixer .....	49	77-D	Microphone .....	12
OR-1A	Recorder .....	78	86-A1	Limiting Amplifier .....	44
RS-1A	Recording Suction Equipment.....	84	88-A	Microphone .....	15
TA-1A	Distribution Amplifier .....	166	89-C	Attenuator Panel .....	214
TA-5A	Stabilizing Amplifier .....	167	90-A	Microphone Stand .....	22
TF-3A/B-6A	Super Turnstile Antenna.....	198	91-A	Microphone Stand .....	20
TG-1A	Synchronizing Generator .....	164	91-B	Microphone Stand .....	20
TG-10A	Field Sync Generator.....	178	92-A	Antenna Lighting Choke.....	118
TJ-50A	Mobile Unit .....	188	115-C	Cathode Ray Oscilloscope .....	217
TK-1A	Monoscope .....	162	170-A	Audio Chanalyst .....	230
TK-10A	Studio Camera .....	153	195-A	VoltOhmyst .....	224
TK-20A	Film Camera .....	155	301-B	Field Intensity Meter.....	207
TK-30A	Field Camera .....	176	308-B	Field Intensity Meter.....	208
TM-5A	Master Monitor .....	182	580-C	Power Supply .....	169
TP-9A	Multiplexer .....	160	715-B	Oscilloscope .....	223
TP-16A	Film Projector .....	157	A-1971	Austin Tower Lighting Transf. ....	117
TP-35A	Film Projector .....	159	A-2101	Austin Tower Lighting Transf. ....	117

# INDEX BY MASTER ITEM NUMBER

<i>MI Number</i>	<i>Description</i>	<i>Page</i>	<i>MI Number</i>	<i>Description</i>	<i>Page</i>
41	Cable .....	26	6229	Microphone Adaptor .....	21
42	Cable .....	26	6333-C	Speaker Mechanism .....	89
43	Cable .....	26	6381/2	Wall Speaker Housing.....	88
49	Cable .....	26	6425	Microphone Stand .....	21
62	Cable .....	26	6427	Microphone Stand .....	21
63	Cable .....	26	6784/5	AM-FM Tuner .....	67
63-A	Cable .....	26	7014	Tower Lighting Isolation Transformer.....	118
64	Cable .....	26	7015	✓Spare FM Exciter Equipment.....	134
65	Cable .....	26	7016	FM Exciter Unit.....	134
4027-D	Microphone .....	14	7017	Power Supply .....	134
4036-AA	Microphone .....	17	7020	Tube Kit for MI-7016/7017.....	127
4045-A	Microphone .....	12	7037	60/50 Cycle Conversion Kit for BTA-50F..	105
4048-D	Microphone .....	15	7050	50 KW AM Transmitter.....	104
4058-C	Microphone Stand .....	20	7083-E	Tube Kit for BTA-5F.....	99
4068-D	Microphone Stand .....	23	7084-A	Tube Kit for BTA-10F.....	101
4092-C	Microphone Stand .....	20	7085-A	60/50 Cycle Conversion Kit for BTA-5F....	99
4093-B	Microphone Stand .....	23	7085-C	60/50 Cycle Conversion Kit for BTA-10F..	101
4094-B	Microphone Stand .....	23	7112	Lighting Choke .....	118
4095-A	Microphone Stand .....	20	7157-D	Remote Ammeter .....	114
4096	Microphone Stand .....	21	7184-A-150	Remote Antenna Current Meter.....	206
4162	Equalizer .....	63	7186-B	1 KW AM Transmitter.....	96
4168	Equalizer .....	63	7187-A	1 KW AM Amplifier.....	96
4171	Pads .....	66	7188-A	Power Change Kit, 1 KW Transmitter.....	97
4196	Equalizer .....	62	7242-C	250 W AM Transmitter.....	94
4309-B	Audio Power Change Panel.....	136	7245-B	Tube Kit for BTA-250L Transmitter.....	95
4388-C/D	Meter Panel .....	60	7260-C/D	5 KW AM Transmitter .....	98
4395-A/B	Switch Panel .....	59	7266-C/D	10 KW AM Transmitter.....	100
4519-C/E	Cabinet Rack .....	54	7267-A/B	5/10 KW Conversion Kit.....	103
4534-C	Jack Panel .....	58	7303	5/10 KW Conversion Kit.....	103
4536-B	Jack Panel .....	58	7318	Tube Kit for BTA-1L Amplifier.....	97
4568	Power Block .....	55	7320	Tube Kit for BTA-1L Exciter.....	97
4569	Audio Block .....	55	7327-4	Isolating Coil .....	206
4570	Terminal Bracket .....	55	7485-E	Right Wing Audio Cabinet for BTA-5F/10F.....	99
4571	Cable Support .....	55	7485-F	Left Wing Phasing Cabinet for BTA-5F/10F.....	99
4589/99	Blank Panels .....	55	7488-A	Monitor Rectifier .....	115
4620-B	Ext. Cord .....	19	8217	Sampling Coil .....	206
4624-A	Receptacle .....	19	8217-C	Pickup Loop .....	206
4630-B	Plug .....	19	10253	Transformer .....	65
4645-A	Jack Panel .....	58	11001	Microphone .....	16
4646-A	Jack Panel .....	58	11050	Microphone Stand .....	22
4652	Patch Cords .....	58	11052	Microphone Stand .....	24
4842	Stylus .....	81	11088	Receptacle .....	19
4875-G	Pickup Kit .....	72	11089	Plug .....	19
4878-D	Stylus .....	81	11090	Connector .....	19
4879-A	Stylus .....	81	11096	Receptacle .....	19
4901-A	Transformer .....	65	11099	Cable Hook .....	22
4902	Transformer .....	65	11100/1	Automatic Recording Equalizer.....	82
4916-A	Recording Filter .....	82	11202-A	Remote Amplifier .....	48
4917-A	Sound Effects Filter.....	64	11210-D/E	Recorder .....	78
4925-A	H.F. Compensator .....	63	11213	Remote Amplifier .....	49
4926-A	Pre-emphasis Filter .....	137	11214	Battery Box .....	50
4928	Microscope .....	84	11216-B/C	Limiting Amplifier .....	44
4975	Filter .....	72	11218-A	Preamplifier .....	38
6203-C	Microphone .....	18	11223-B	Monitoring Amplifier .....	42
6206-G	Microphone .....	18			
6208	Microphone Stand .....	23			

<i>Type</i>	<i>Description</i>	<i>Page</i>	<i>Type</i>	<i>Description</i>	<i>Page</i>
11224-E/F	Program Amplifier .....	41	19413-1	Entering Insulator .....	118
11226-B	Booster Amplifier .....	40	19421	Trans. Line Insulator.....	112
11227	Recording Amplifier .....	43	19654	Tube Kit for MI-7085-A.....	99
11230	Remote Amplifier .....	47	26010	Field Camera .....	176
11251	V. U. Meter and Kit.....	61	26015	View Finder .....	176
11256	Fabric Cover .....	48	26045	Tripod .....	176
11257/8	Fabric Cover .....	49	26065	Camera Control .....	176
11265	V. U. Meter Panel.....	61	26090	Current Regulator .....	170
11274-A/B	Remote Volume Control.....	39	26095	Power Supply .....	176
11275	Meter Panel .....	60	26105	Pulse Former .....	178
11280	Voltage Regulator Transf. ....	136	26115	Pulse Shaper .....	178
11301-B	Power Supply .....	30	26135	Master Monitor .....	182
11301-B	Power Supply .....	32	30951	Standard Racks .....	52
11303	Power Supply .....	69	26155	Distribution Amplifier .....	166
11304	Power Supply .....	69	26215	Switching Unit .....	180
11305-B	Power Supply .....	68	26260	Power Distribution Box.....	178
11401	Monitoring Loudspeaker .....	86	26256-1/2	Desk End Sections.....	133
11411	Monitoring Loudspeaker .....	86	26560	Field Desk .....	184
11500	Cabinet .....	56	26574	Boom Stand and Perambulator.....	25
11501-4	Jack Mats .....	58	26915	Syne Generator .....	164
11598-9	Panel and Shelf.....	57	26935	Relay Transmitter .....	185
11606	Filament Transformer .....	66	26940	Relay Receiver .....	187
11613-C	Consolette .....	30	26960	Monoscope Camera .....	162
11616	Transmitter Control Console.....	102	28010	Trans. Line Wire.....	112
11622	Switching System .....	33	28011-A	Trans. Line Lead-in Kit.....	112
11623	Monitor and Amplifier Rack.....	136	28012-A	Trans. Line Dead-end Kit.....	113
11624	Consolette .....	32	28012-B	Trans. Line Dead-end Kit.....	113
11625	Master Switching Console.....	34	28013	Trans. Line Pole and Cap.....	113
11625-A	Studio Switching Console.....	34	28014	Trans. Line Bayonet Ace. ....	113
11704	Dividing Networks .....	66	28015	Lead-in and Ground Ace. Kit.....	113
11705	Bridging Pad .....	66	28154	BTF-10B Power Cut Back Eq. ....	129
11706	Studio Warning Lights.....	36	28156	Tube Kit for BTF-250A Trans. ....	123
11707	Speaker Filter .....	87	28157	Tube Kit for BTF-1C Trans. ....	125
11708	Speaker Attenuator .....	87	28158	Tube Kit for BTF-3B Trans. ....	127
11710	Ringdown Panel .....	59	28161	Tube Kit for MI-28920 .....	125
11711	Speaker Accessory Kit.....	87	28162	Tube Kit for MI-28921 .....	125
11801-2	Turntable .....	70	28163	Tube Kit for MI-28922 .....	127
11825-6	Recorder .....	76	28217	AM-FM Isolator .....	142
11827	Recorder Base Cabinet.....	77	28221/8	Pylon Antenna .....	138
11850-C	Recording Head .....	80	28231	Pylon Antenna .....	138
11851	Advance Ball Kit.....	81	28316-A	Code Beacon Kit.....	140
11853-A	Recording Head .....	81	28401-1	Basic Desk Section.....	133
11855-A	Heater and Compensator Kit.....	80	28401-2	90° Desk Section.....	133
11857/8	Recording Suction Equipment.....	84	28403-1	Blank Turret .....	133
11900/1	Recording Attachment .....	75	28404-1	Blank Turret for 90° Section.....	133
12051	Microphone Adaptor .....	21	28410	Audio Control Turret.....	133
12053	Microphone Adaptor .....	21	28420	Transmitter Control Turret.....	133
12057/A	Microphone Adaptor .....	21	28425	Limiting Amp. Ext. Meter 4".....	133
12063	Microphone Stand .....	21	28901-A	1 KW Antenna Tuner.....	114
12065	Microphone Stand .....	22	28902-A/B	5-10 KW Antenna Tuner.....	115
12066, A	Microphone Stand .....	20	28903-A/B	50 KW Antenna Tuner.....	116
12081-B, C	Microphone .....	18	28905	Power Change Kit for BTA-50F.....	105
12236	Monitoring Amplifier .....	46	28911	250 W FM Transmitter.....	122
12370	Speaker Transformer .....	90	28912	1 KW FM Transmitter.....	124
12371	Speaker Transformer .....	90	28913	3 KW FM Transmitter.....	126
12373	Speaker Transformer .....	90	28914	10 KW FM Transmitter.....	128
12422	Speaker Mechanism .....	89	28920	1 KW to 3 KW FM Conversion Equip. ....	125
12435	Speaker Mechanism .....	89	28921	1 KW to 10 KW FM Conversion Equip. ....	125
12449	Monitoring Loudspeaker .....	88	28922	3 KW to 10 KW FM Conversion Equip. ....	127
12775	Wire Recorder .....	83	28923	Radio-Microphone .....	51
13225	Wall Speaker Housing .....	88	28926	50 KW FM Transmitter.....	130
19012-3	Super-Turnstile Antenna .....	198	28950	Universal Transmitter Console.....	132
19021/2	Diplexer .....	195	30043-A	Modulation Monitor .....	202
19023	Triplexer .....	197	30048-A	Frequency Monitor .....	203
19104	Side-Band Filter .....	194	30071-A	Distortion and Noise Meter.....	213
19205-A, B	TV Transmitter .....	192	30566-G84	Cabinet Rack Trim Strip.....	53
19404-B	Remote Metering Kit.....	114	30568-C84	Cabinet Rack Trim Strip.....	53
19406	Entering Insulator .....	118			

