

Bauer

AM BROADCAST TRANSMITTER
MODEL 707

INSTRUCTION BOOK

Bauer Electronics Corporation
1663 Industrial Road
San Carlos, California

BAUER ELECTRONICS CORPORATION
INSTALLATION AND OPERATING INSTRUCTIONS
AM BROADCAST TRANSMITTER
MODEL 707

CONTENTS

	<u>Page</u>
Summary of Mechanical and Electrical Specifications	1
Functional Block Diagram	1
Description of Circuit Functions	2
Installation Instructions	5
Initial Adjustments and Tuning	6
Maintenance Instructions	8
Remote Control	8
Warranty	10

TABLES AND ILLUSTRATIONS

	<u>Figure</u>
Bauer Model 707 Transmitter	1
Normal Meter Readings and Performance Data	2
Parts List	3
Frequency-Determining Parts and Adjustments	4
Power-Determining Parts	5
Cable Table	6
Transmitter, front view	7
Transmitter, rear view	8
Outline Drawing	9
Schematic Diagram	10

June 1966

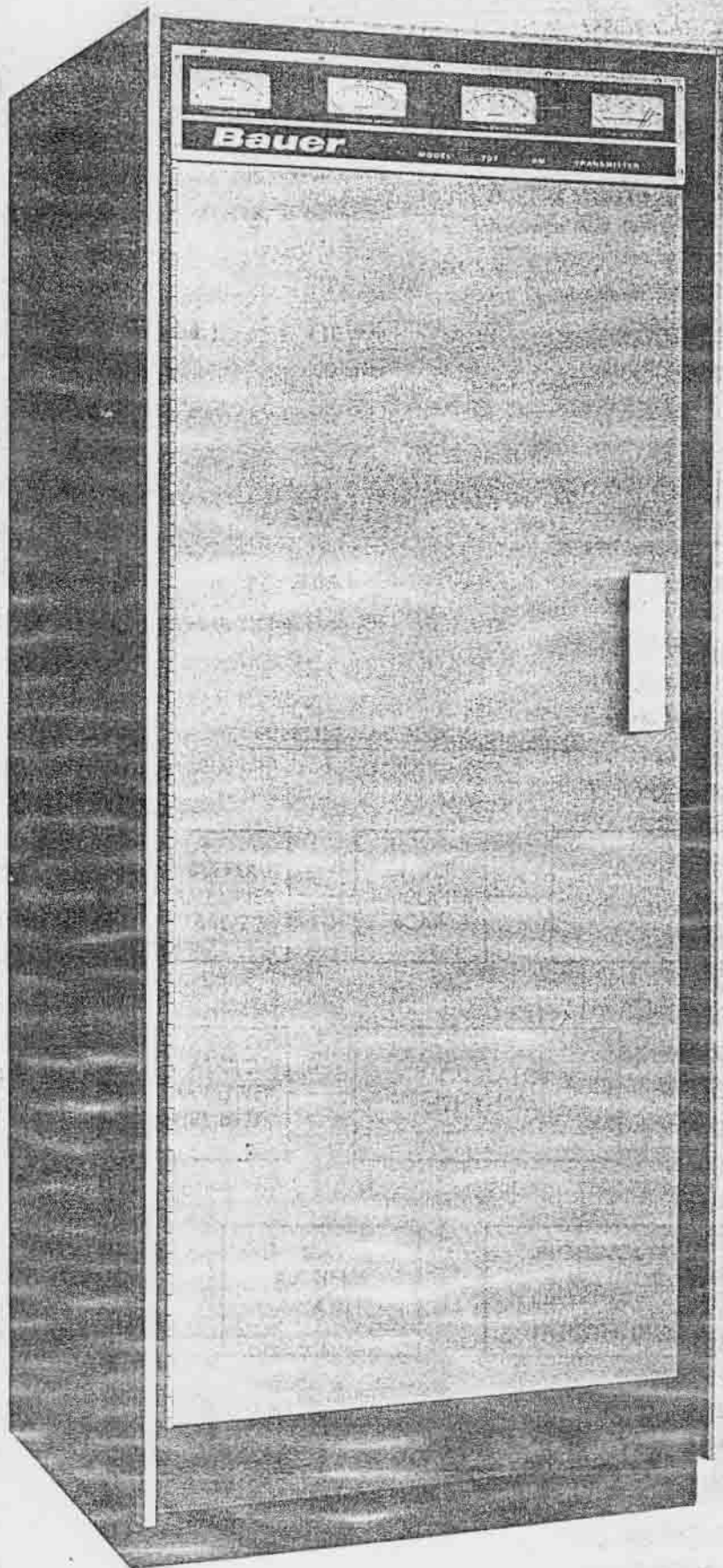
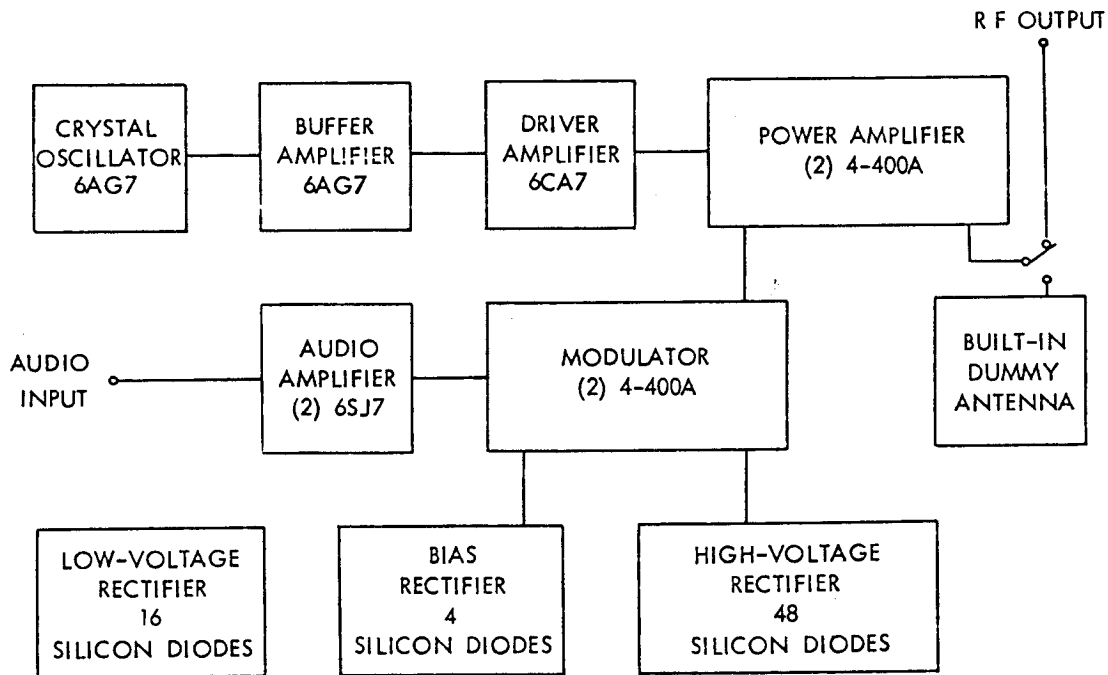

FIGURE 1

SUMMARY OF MECHANICAL AND ELECTRICAL SPECIFICATIONS

Type of Emission	A3	Noise Level (below 100% mod.)	-50 db
Rated Power Output	1000/500/250 watts	FCC Efficiency Factor (F)	0.70
Power Output Capability	1100 watts	Power Consumption (For one kilowatt carrier power)	
R. F. Output Impedance	50 ohms, unbalanced	Average modulation	3300 watts
Frequency Range	540-1600 kc	100% modulation	3950 watts
Frequency Stability	± 5 cps	Power Requirements	208-230 volts 60 cycles Single phase 90% power factor
Audio Input Level (100% mod.)	+10 dbm	Dimensions	Height 75 inches Width 30 inches Depth 25 inches
Audio Input Impedance	600 ohms	Net Weight	800 pounds
Frequency Response (0-95% mod.)		Ambient Temperature Range	-20° to +110°F
1000/500/250 watts		Altitude Range	0-8000 feet
50-10, 000 cps	± 0.5 db		
30-12, 000 cps	± 1.5 db		
Distortion (0-95% mod.)			
1000/500/250 watts			
50-10, 000 cps	2.0% max		
Carrier Shift 1000/500/250 watts	less than 3%		

FUNCTIONAL BLOCK DIAGRAM



DESCRIPTION OF CIRCUIT FUNCTIONS

The Bauer Model 707 AM Broadcast Transmitter employs high-level modulation and can operate on any carrier frequency in the range from 540 kc to 1600 kc. With modifications, operation can be extended to 30 mc. The transmitter is normally supplied pre-tuned to the desired channel. The frequency-determining components for the transmitter are detailed in Figure 4. Bi-level power operation is standard with this transmitter and it can be switched instantly between any two of the following three power levels: 250 watts, 500 watts, 1000 watts. Component values that establish the two operating power levels are shown in Figure 5.

Radio-Frequency Section

The radio-frequency portion of this transmitter begins with Type 6AG7 crystal oscillator V1. For emergency or Conelrad operation, a second crystal may be switched into the oscillator circuit by means of relay K6. The oscillator drives Type 6AG7 buffer amplifier V2. The cathode circuit of V2 supplies unmodulated RF at jack J1 to operate any standard frequency monitor. The entire oscillator/buffer assembly is constructed in a removable shielded chassis. The buffer output excites Type 6CA7 RF driver tube V3. Resistor R12 in the cathode circuit of V3 controls the gain of the driver stage and determines the amount of RF drive available at the grid of final power amplifiers V8 and V9. Plate and screen voltage on the final power amplifiers is varied by the modulator to produce amplitude modulated radio-frequency output. Plate choke L6 and capacitor C22 prevent RF power from feeding back into the modulator and power supply portions of the transmitter. The RF signal appearing across capacitor C25 and a small portion of tank L7 is coupled into a Tee matching network consisting of L8, C26, and L9. The location of the output tap on L7 is selected so that the combination of C25 and the lower portion of L7 form a low impedance circuit at the second harmonic of the carrier where necessary to provide additional suppression of second-harmonic radiation. The radio-frequency output from the Tee matching network can be switched to a built-in dummy load by means of switch S8. The load tap on coil L9 is automatically shifted slightly when the output is switched to the dummy to compensate for the small amount of residual inductance inherent in the dummy load. S8 is constructed to allow the insertion of an RF ammeter for use during the initial tune-up. M4 is an 0-1 ma DC meter with a 0-6 RF ampere scale intended to be used with a remote diode for metering antenna current. Should the transmitter be supplied with automatic power control, an optional accessory, M4 becomes an optical type metering relay. Its operation is described on Page II of this manual.

The transmitter is designed to feed a non-reactive 50 ohm unbalanced load. Non-standard load impedances can be accommodated with a matching network external to the pressurized transmitter cabinet.

Audio Section

The audio portion of the Model 707 Transmitter consists of push-pull Type 6SJ7 amplifier tubes V4 and V5, which drive push-pull Type 4-400A modulator tubes V6 and V7 operating class AB-1. The audio level supplied to input transformer T6 is controlled by the operation of relay K5 so that the degree of modulation remains unchanged when switching between the two power levels. Balance control R46 serves to balance the audio levels fed to the grids of V6 and V7 for

minimum distortion. Bias control R27 establishes the modulator plate current under conditions of no modulation. Inverse feedback around the two audio stages is provided by two voltage dividers. The combination of R55 and R43 returns a portion of the output voltage of V6 to the grid circuit of V5. Similarly, R58 and R44 return a portion of the output of V7 to the grid of V4. The resistance values establish the amount of audio feedback at 8 db. The audio output voltage appearing across the secondary of modulation transformer T7 produces amplitude modulation by alternately adding to and subtracting from the DC voltage applied to the final RF power amplifier.

Power Supply Systems

Three separate power supply systems provide the DC voltages necessary for operation of the transmitter. High-voltage plate transformer T1 drives a bridge rectifier consisting of two plug-in rectifier assemblies. The rectified high-voltage output is filtered and used to supply plate voltage to the four 4-400A tubes and screen voltage to the final RF stage. For 500 watt operation, series resistors are added to reduce the final plate and screen voltages. For 250 watt operation, increased efficiency is obtained by operating half of the high-voltage rectifier independently of the normal bridge circuit to produce half-voltage output for the final amplifier. A second section of filter (L10, C46) is added during 250 watt operation to maintain low hum level at the lower power. A plug-in bias rectifier consisting of a single silicon diode package D1 supplies negative bias voltage to the grids of modulator tubes V6 and V7. Another bridge rectifier consisting of silicon diodes D2 through D17 provides DC for audio amplifiers V4 and V5, RF driver V3, and the screens of modulators V6 and V7. Diodes D2 through D5 and D14 through D17 also function as a conventional full-wave rectifier to deliver a lower value of DC voltage at terminal 5 of transformer T5 which is filtered through L18 and C27 to provide power for V1, V2, and the screen of V3.

Power Control Circuits

Unlike tube-type rectifying systems, no time delay relays are required to prevent the premature application of high voltage to the rectifiers. This considerably simplifies the control and relay circuits. Power at 230 volts, single-phase, is supplied to the transmitter through main line fuses F6 and F7. Actuation of master-start switch S1 picks up relay K1 which in turn applies power to the primary of voltage regulating transformer T2 and to the blower. When door interlock S11 is closed, the operation of switch S2 applies power to the primary of low-voltage and bias rectifier transformer T5. With power supplied to T5, all of the low-level stages V1 through V5 will function and the RF drive supplied by V3 will produce sufficient grid current in the final amplifier to operate grid under-drive relay K2. When sufficient RF drive is present to operate relay K2 it is then possible to operate high-voltage supply contactor K7 (if high-voltage door interlocks S9 and S10 are closed) when the high-voltage switch S4 is closed. This also requires that the overload relay be in reset position. In normal operation, both the low and high voltage switches, S2 and S4, are left turned on and the entire transmitter is controlled by master-start switch S1.

Auxiliary contacts on relay K7 prevent the application of full screen voltage to the modulator tubes before the plate voltage has been applied. Overload relays K8, K9, and K10, will de-energize relay K7 and remove high voltage plate power in the event that there is excessive current in the cathode circuit of the final amplifier, in the cathode circuit of the modulators, or in the primary of plate transformer T1. Adjustable shunting resistors R16 and R59

control the sensitivity of overload relays K8 and K9. The improved "Silconetic" overload relays utilize a special silicone damping fluid. They provide instantaneous operation on large overloads and delayed operation on small but sustained overloads. As a result, superior overload protection is achieved while avoiding nuisance outages caused by short-term transients such as power line surges or isolated peaks of overmodulation which would not damage the transmitter. In case of an overload, flags are extended by the overload relays to indicate which circuit is involved. The operation of any one of the three overload relays removes primary power which, in turn, eliminates the overload current and restores the overload relay to the normally-closed position. Repetitive re-cycling of the overload relays and of contactor K7 is prevented (in the event of a sustained overload) by an "overload-lockout" circuit consisting of latching relay K3 and associated components. When any of the overload relays operate, the voltage across its normally-closed contacts is applied to diode rectifier D77 to charge capacitor C43. When sufficient voltage appears across C43, relay K3 will latch open its normally-closed contacts to prevent prolonged repetition of re-cycling. The time required to build a sufficient charge on C43 to actuate K3 is adjusted by rheostat R61. This is normally set so that the overload relays will re-cycle three times before K3 operates. When the cause of the overload has been cleared, momentary manual operation of overload reset switch S3 serves to energize the reset coil on K3 and restore it to the normally-closed condition.

The air flow switch S12, located in the tube compartment, is connected to prevent the application of filament power until sufficient air pressure has been built up within the cabinet.

Small adjustments in operating power are made with motor-driven rheostat R19 in the cathode circuit of the final amplifier. Power is raised or lowered through the momentary operation of switch S5 which determines the direction of rotation of the power control motor. The large change in power necessary when switching to the lower of the two power levels provided by the transmitter is accomplished through the operation of switch S6 which actuates power change relays K4 and K5. One set of contacts on relay K5 is used to reduce the audio input to the transmitter so that the same degree of modulation is maintained when going to lower power. A second set of contacts on relay K5 inserts an additional resistance R13 in the cathode circuit of RF driver V3 to reduce the RF drive to the final power amplifier stage. The operation of relay K4 serves to reduce the plate and screen voltage applied to the final power amplifier for lower power. Correction of modulation monitor feed when changing power is accomplished by relay K-11 and adjustable resistor R-75.

Terminals are provided to facilitate the connection of remote controls on all necessary operating switches.

Metering Circuits

Voltage or current meters are provided for all important circuits and remote metering facilities are built into the transmitter so that plate voltage and plate current for the final power amplifier can be metered by any conventional remote control system without adding accessory metering units within the transmitter. For added safety and to prevent the accumulation of dust, the final plate current meter M3, is kept at a low potential. This meter in the cathode circuit of the final amplifier reads combined plate and screen current. The value of net plate current can be obtained by subtracting the screen current indicated by meter M6. The references in the Federal Communications Commission Rules to final efficiency do not consider the screen power supplied to the final amplifier. The net plate current should accordingly be used in any calculations of efficiency in comparison to the FCC efficiency factor (F).

Environment

Install the transmitter in a well-ventilated room which is reasonably free from moisture and dust. Particular care should be given in remote control installations to obtain adequate room ventilation and to prevent the ambient temperature from rising to dangerously high levels.

External Connections

1. Connect a low-resistance ground to the transmitter frame using any of the base assembly bolts. Remove paint at all points of contact to obtain a good connection. On smooth wooden floors, an alternative method is to remove paint from the bottom of the base, set the front edge of the transmitter base on a length of copper strap, and anchor the transmitter with lag screws extending through the base and the copper strap.
2. Connect a 230 volt, 60 cycle, single-phase supply to the transmitter fuse block using number 10 wire. The safety disconnect switch or circuit-breaker supplying the transmitter should be rated at 30 amperes. The utility transformer feeding the transmitter should have a capacity of 5 kva or more to provide adequate regulation for minimum carrier shift.
3. A hole has been provided in the bottom of the cabinet near T-7 to accommodate an RF output transmission line such as RG-8/U or 1/2" Foamflex. The line can enter the transmitter cabinet at the top if desired. Any hole drilled to accommodate the transmission line should be no larger than necessary so as to maintain air pressure. It is important that the outer conductor be securely grounded at a point near the termination of the inner conductor.
4. Connect the frequency monitor to frequency monitor output jack J1. If unused, jack J1 should be shorted to prevent spurious oscillations.
5. Connect the modulation monitor to modulation monitor output jack J2.
6. Connect 600 ohm audio output to terminals 1 and 2 of TB1.

Internal Connections

To minimize transportation damage, the heavier components are normally removed from the transmitter prior to shipment. Reinstall these as follows:

1. Install modulation transformer T7 in the rear corner of the cabinet below L14. Terminals 1, 2, and 3 should be toward the rear of the cabinet.
 - a. Connect wire No. 164 to terminal No. 1.
 - b. Connect wire No. 155 to terminal No. 2.
 - c. Connect wire No. 165 to terminal No. 3.
 - d. Connect wire No. 154 to terminal No. 4.
 - e. Connect wire No. 156 to terminal No. 5.

2. Install high-voltage transformer T1 in the rear corner underneath the door interlock switches with the primary terminals toward the rear of the cabinet.
 - a. Connect wire No. 162 to high-voltage center tap (terminal 7).
 - b. Connect wire No. 158 to one side of high-voltage (terminal 6).
 - c. Connect wire No. 159 to other side of high-voltage (terminal 8).
 - d. Connect wire No. 129 to primary \pm tap (terminal 1).
 - e. Connect wire No. 130 to primary 230 volt tap (terminal 5).
3. Install modulation choke L12 in the remaining space on the transmitter floor with the terminals toward the front of the cabinet.
 - a. Connect wire No. 153 and No. 156 to left-hand terminal (as viewed from the rear of the transmitter).
 - b. Connect wire No. 163 to right-hand terminal.
4. Install Sola voltage regulating transformer T2 on the four shock mounts attached to the side of the cabinet adjacent to the door interlock switches. Add grommet to top knockout hole nearest the front panel if not already installed.
 - a. Connect wire No. 14 to terminal H1.
 - b. Connect jumper between terminals H2 and H3.
 - c. Connect wire No. 15 to terminal H4.
 - d. Connect wire No. 20 to terminal X1.
 - e. Connect wire No. 21 to terminal X2.
5. Install all tubes, making sure that the skirts of the 4-400A tubes clear the chassis holes and seat firmly on the ceramic sockets. Connect 4-400A plate caps.
6. Install main (No. 1) crystal in the right-hand socket (as is viewed from the rear) on the oscillator/buffer chassis.
7. Install auxiliary crystal used.

INITIAL ADJUSTMENTS AND TUNING

Remove high-voltage rectifiers, CB12 and CB13. Set front panel switches as follows: Low voltage - OFF; high voltage - OFF; high-low power control - LOW; crystal switch - No. 1.

With 230 volts supplied to the transmitter, operate the master-start switch S1. This should close relay K1 and start the blower. Close all doors to actuate the interlocks. As soon as sufficient pressure has been built up to activate the air-flow switch S12, the 4-400A filaments will light. Turn on low voltage switch S2. The low voltage supplies should now operate which will illuminate the red master-start switch. When the tubes have heated, there should be normal current indications on the four lower front panel meters. Compare these meter readings at both low and high power with those tabulated in Figure 2 and, if necessary, adjust the final grid current to the indicated value through adjustment of final drive control R12. The final grid tuning coil L5 (located in the tube compartment to the right of V9) does not normally require adjustment but should be checked if the correct value of grid drive and driver plate current cannot be obtained within the range of control R12. The optimum adjustment of L5 will result in maximum final grid current with minimum driver plate current.

To prepare for the next step, operate power control switch S5 to place the arm of power control rheostat R19 in the center of its range.

With the transmitter master-start switch turned off, place the antenna/dummy switch S8 in the DUMMY position. Set R61 on CB4 fully counter-clockwise. Install high-voltage diode rectifier boards CB12 and CB13. Adjust bias control R27 for maximum modulator bias by rotating fully counter-clockwise. With the high-voltage switch remaining off and the high/low power control switch in the low position, energize the master-start switch. When normal final grid current is obtained, turn on the high-voltage switch. The final plate voltage meter should now indicate approximately 1500 volts. Adjust the final plate tune control for minimum plate current and tune through both sides of the "dip" to make certain that the variable capacitor has not reached the limit of its range. If an RF output meter is used, it should now indicate. With no audio yet applied to the transmitter, adjust bias control R27 to set the modulator plate current at the value indicated for low-power operation in Figure 2. If all meter readings are now in substantial agreement with the typical values, the high/low switch can be changed to high and all meter readings compared with those tabulated in Figure 2 for high-power operation.

If the final plate voltage differs by more than 100 volts from the typical value, correct by means of the primary taps on high-voltage plate transformer T1. If the final plate current differs materially from the typical value, it may be necessary to change the final loading slightly to obtain maximum efficiency. Changes in loading are accomplished by moving the C23 and C24 taps on the final tank coil L7. The output tap on L7 should not be changed because this adjustment must remain fixed for maximum second-harmonic attenuation. Increasing the tank inductance results in lower tank current and looser coupling. Any change in tank inductance will require retuning the tank capacitor for minimum plate current. All loading and tuning changes should be made in small increments and at low power because larger departures from plate tank resonance will produce excessive final plate current and operate the overload relays. Care should be taken not to place a strain on the vacuum variable capacitor by turning the drive mechanism beyond minimum capacity (clockwise). Care should also be taken not to unscrew the drive mechanism past the point of maximum capacity (counter-clockwise). This condition is indicated by a slight reduction in torque and a sudden loosening of the dust cap inside the tube compartment. Normally the C23 and C24 taps connect to the same turn on the tank coil but finer loading adjustments may finally be made by moving them independently through a separation not exceeding two or three turns. Optimum loading exists when the rated RF output current can be obtained with the least plate current. To obtain best efficiency, the final tuning capacitor should then be turned slightly clockwise from the minimum plate current position to increase plate current by 20 ma. Refer to Figure 4 for normal tuning adjustments.

After optimum loading has been established and all meter indications are in substantial agreement with Figure 2, the transmitter audio performance should be checked by means of a modulation monitor and distortion meter. It is recommended that these measurements be made by using a suitable audio oscillator having negligible distortion fed directly into the transmitter input terminals without benefit of any other amplifying equipment. Any discrepancies in subsequent overall system measurements are then logically attributable to the equipment external to the transmitter or to the manner in which the external equipment is used.

Although any good 4-400A tube will operate satisfactorily in any of the four tube positions, the lowest carrier noise will be obtained by selecting the tubes for the final RF stage while making noise measurements. Adjust balance

control R46 for minimum distortion at 85% modulation with 3000 cycles. If minimum distortion occurs at the end of R46 rotation, select a different pairing of 6SJ7 audio amplifier tubes. If no distortion meter is available, set R46 at mid-range.

The overload circuits should now be checked. With the transmitter operating on high power, detune the final until the final plate and screen current is 600 ma. The plate overload should operate within one to two seconds. If necessary, readjust relay shunt R16 to get this condition. Restore tuning to normal.

Increase 7500 cycle audio input to obtain 500 ma of modulator plate current. The modulator overload relay should operate within one to two seconds. If necessary, readjust relay shunt R59 to get this condition.

The "overload lockout" circuit should now be adjusted. Set R61 on CB4 to mid-range and produce a large plate current overload by detuning the final amplifier. The overload relays should recycle several times before K3 latches open. Proceed to adjust R61 in small increments until overload relays recycle not more than three times before K3 latches open, remembering that CW rotation of R61 increases the number of recycles.

With transmitter on low power, set modulation monitor carrier level to 100. Then, switching to high power, adjust R-75 so that carrier level again reads 100.

The transmitter is now ready to be switched to a properly adjusted, non-reactive, 50-ohm load. Change the dummy/antenna switch S8 to the ANTENNA position. If the antenna load is near 50 ohms and is non-reactive, the loading and the point of C24 resonance will remain unchanged. The transmitter is now ready for routine operation.

MAINTENANCE INSTRUCTIONS

After the transmitter has been in operation for 30 days, all terminals should be tightened and again checked annually thereafter. No parts require periodic oiling. A soft dust brush augmented with a vacuum cleaner should be used as often as necessary to prevent any accumulation of dust within the cabinet. Wipe up any silicone fluid that may leak out of the modulation transformer. Slight seepage is not harmful. The permanent dust filter on the air intake should be cleaned as often as necessary. This will vary depending upon local conditions.

CB-8, the low voltage rectifier board and the bias rectifier, D1, should be removed and checked every three months. The forward resistance of each diode should be low (less than 20 ohms) and the reverse should be equal to the equalizing resistor across it when such resistors are used and several hundred thousand ohms when they are not.

Conditions that will lead to eventual component failures can often be localized before an outage occurs. The normal operating temperatures of coils, capacitors, chokes, transformers, relays, etc, can be established by feeling these components immediately after the transmitter is signed off. It is suggested that the major components, other than tubes and large resistors, be checked for excessive heating by feeling them at sign-off once each week.

REMOTE CONTROL

When operating the Bauer Model 707 by remote control the transmitter unit of the remote control system should be connected as follows:

Function	Model 707 Connections
Filament on	TB1 - 8 and 9
Plate on	TB1 - 12 and 13 *
Power control	TB1 - 14 (lower) TB1 - 15 (raise) TB1 - 16 (common)
High/Low power	TB1 - 16 and 17
Remote crystal (Conelrad)	TB1 - 16 and 18
Metering (plate voltage)	TB1 - 4 and 5 (common)
Metering (plate current)	TB1 - 6 and 5 (common)
Remote reset	TB1 - 11 and 12 *

*With some remote control systems outdoors latching relays may be required in these positions. For help in any remote control problems, contact the Bauer factory stating the make and model of remote control system to be used. Shown below is a Rust, Model 108-4A latching relay unit as it would be used with the Bauer Model 707 transmitter. When the "plate on" function is initiated a circuit is completed (through the operate relay contacts) between TB1-12 and 13, allowing plate voltage to come on. (Toggle switch S2 on the transmitter is always left on when the transmitter is to be run by remote control.) To turn off the plate voltage or to reset the overload relay K3, the "plate off/reset" function is initiated. This will break the connection between TB1-12 and 13 (removing plate voltage) and simultaneously apply 220 volts AC to reset K3. It is important in all remote control systems to duplicate the functions of S3 and S4 as closely as possible. When resetting the overload relay plate voltage must be automatically removed by the control system. The reset voltage applied to K3 can be continuous or momentary depending upon the type of latching relay used.

LATCHING RELAY UNIT - RUST MODEL 108-4A

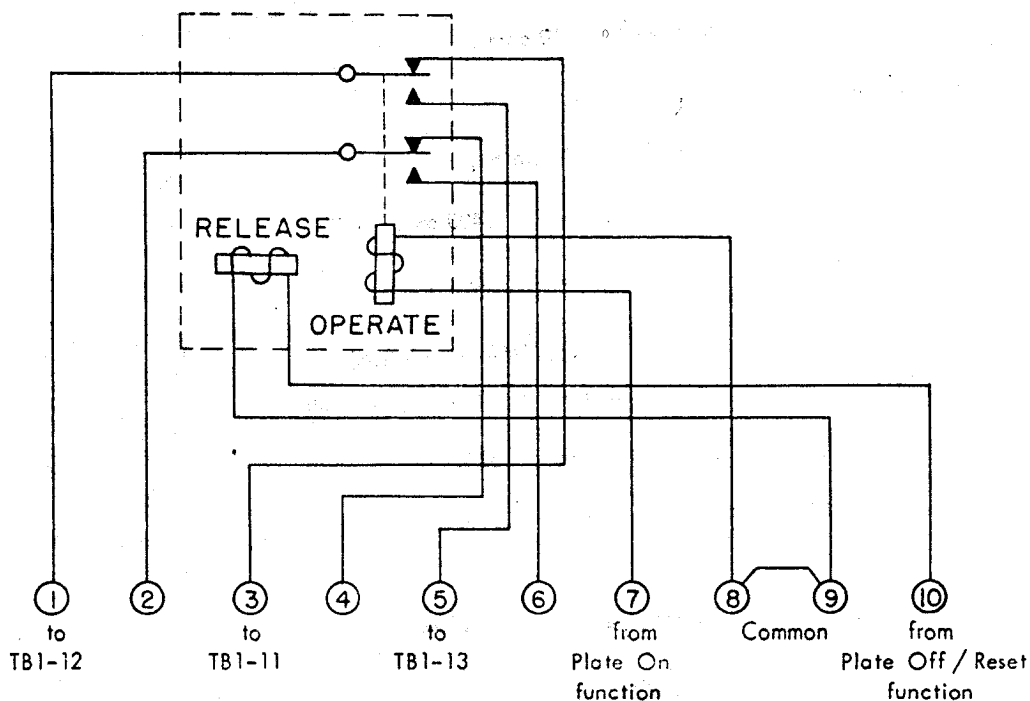

TYPICAL TRANSMITTER PERFORMANCE DATA

BAUER MODEL 707

Meter Readings

<u>Circuit</u>	<u>.250 Watts</u>		<u>1000 Watts</u>	
	<u>0% Mod.</u>	<u>100% Mod.</u>	<u>0% Mod.</u>	<u>100% Mod.</u>
Audio Plate	4-5 ma	4-5 ma	4-5 ma	4-5 ma
Oscillator Plate	10-12 ma	10-12 ma	10-12 ma	10-12 ma
Driver Plate	8-14 ma	8-14 ma	16-24 ma	16-24 ma
Final Grid	11-13 ma	11-13 ma	18-20 ma	18-20 ma
Final Screen	24-29 ma	24-29 ma	50-58 ma	50-58 ma
Modulator Plates	120 ma	190-210 ma	110 ma	380-420 ma
Final Plate Voltage	1450-1550 volts	1450-1550 volts	2900-3100 volts	2900-3100 volts
Final Plate and Screen	220-260 ma	220-260 ma	480-560 ma	480-560 ma
R.F. Output	2.28 amps	2.78 amps	4.56 amps	5.56 amps

Performance

Audio input level, 1000 cps, 100% mod., + 10 dbm

Noise, -58 db below 100% modulation

Distortion, measured at 95% modulation, 1000 watts

50 cps, 1.4% 100 cps, 0.9% 400 cps, 0.7%

1000 cps, 0.6% 5000 cps, 0.9% 7500 cps, 1.2%

Response at 1000 watts (variation from 1000 cps, 95% modulation)

30 cps, -1.0 db 50 cps, 0.0 db 100 cps, 0.0 db

400 cps, 0.0 db 1000 cps, 0.0 db 3000 cps, 0.0 db

5000 cps, +0.2 db 7500 cps, +0.3 db 10,000 cps, +0.1 db

Efficiency 70-75%

Dummy Resistance 48 ohms

WARRANTY

Bauer Electronics Corporation warrants new equipment of its manufacture and assembly for one (1) year against breakage or failure of parts due to imperfection of workmanship or material, its obligation being limited to repair or replacement of defective parts upon return thereof, prepaid to the Bauer plant. High-voltage transformers, modulation transformers and reactors and filter chokes carry an extended warranty with 50% of the replacement cost being allowed should failure occur during the second year. Warranty will be based on date of invoice. No return shipments will be accepted without prior authorization. Electron tubes and silicon rectifiers bear only the warranty of the manufacturer thereof in effect at the time of shipment to Purchaser.

PARTS LIST

<u>SYMBOL</u>	<u>BAUER PART NO.</u>	<u>DESCRIPTION</u>	<u>MANUFACTURER</u>
RESISTORS			
R1	10-100	Resistor, 56,000 ohms, 1/2 W, 10%	
R2	10-101	Resistor, 1,000 ohms, 1/2 W, 10%	
R3	10-102	Resistor, 56,000 ohms, 2 W, 10%	
R4	10-103	Resistor, 22,000 ohms, 2 W, 10%	
R5	10-104	Resistor, 4,700 ohms, 1/2 W, 10%	
R6	10-105	Resistor, 2,200 ohms, 2 W, 10%	
R7	10-106	Resistor, 51 ohms, 1/2 W, 5%	
R8, R9	10-107	Resistor, 10,000 ohms, 2 W, 10%	
R10	10-108	Resistor, 1,000 ohms, 2 W, 10%	
R11	10-109	Resistor, 3,000 ohms, 5 W, wire wound	Ohmite, "Axial"
R12	10-110	Potentiometer, 3,000 ohms, 4 W	Clarostat, A-10-3000
R13		Power determining part, see Figure 5	
R14	10-113	Resistor, 15,000 ohms, 5 W wire wound	Ohmite, "Axial"
R15	10-114	Resistor, 20,000 ohms, 20 W, wire wound	Ohmite, "Brown Devil"
R16	10-115	Resistor, 50 ohms, 25 W, wire wound, adjustable	Ohmite, 0366
R17, R18	10-116	Resistor, 100 ohms, 2 W, 10%	
R19	10-117	Rheostat, 300 ohms, 100 W, wire wound	Ohmite, 0453
R20	10-118	Resistor, 15 ohms, 20 W, wire wound	Ohmite, "Brown Devil"
R21		Not used	
R22	10-119	Resistor, 5,000 ohms, 10 W, wire wound	Ohmite, "Axial"
R23	10-120	Resistor, 25,000 ohms, 10 W, wire wound	Ohmite, "Axial"
R24	10-121	Resistor, 50,000 ohms, 10 W, wire wound	Ohmite, "Axial"
R25	10-122	Resistor, 1,000 ohms, 5 W, wire wound	Ohmite, "Axial"

PARTS LIST (CONTINUED)

<u>SYMBOL</u>	<u>BAUER PART NO.</u>	<u>DESCRIPTION</u>	<u>MANUFACTURER</u>
RESISTORS (CONTINUED)			
R26	10-111	Resistor, 5,000 ohms, 5 W wire wound	Ohmite, "Axial"
R27	10-124	Potentiometer, 2,500 ohms, 2 W	Ohmite, CLU 2521, locking
R28	10-125	Resistor, 6,000 ohms, 5 W wire wound	Ohmite, "Axial"
R29	10-126	Resistor, 10,000 ohms, 10 W wire wound	Ohmite, "Axial"
R30	10-127	Resistor, 5 megohms, 5 W, 1%	Dalohm, DC-5
R31	10-128	Resistor, 1,000 ohms, 25 W, wire wound	Ohmite, 0205
R33, R34		Power determining part, used in 1,000/500 watt only, See Figure 5	
R35	10-131	Resistor, 40,000 ohms, 200 W wire wound	Ohmite, 0921
R36	10-132	Resistor, 60,000 ohms, 25 W, wire wound	Ohmite, 0225
R37	10-133	Resistor, 4 megohms, 5 W 1%	Dalohm, DC-5
R38	10-134	Resistor, 10,000 ohms, 2 W, 10%	
R39, R40		Power determining part, see Figure 5	
R41, R42	10-138	Resistor, 33,000 ohms, 1/2 W, 5%	
R43, R44	10-139	Resistor, 6,800 ohms, 2 W, 5%	
R45		Same as R6	
R46	10-140	Potentiometer, 500 ohms, 2 W	Ohmite, CLU-5011, locking
R47, R48	10-141	Resistor, 82,000 ohms, 2 W, 10%	
R49, R50 R51, R52	10-142	Resistor, 68,000 ohms, 2 W, 10%	
R53, R54	10-143	Resistor, 220,000 ohms, 2 W, 10%	
R55		Same as R30	
R56, R57	10-144	Resistor, 3,300 ohms, 2 W, 10%	
R58		Same as R30	

PARTS LIST (CONTINUED)

<u>SYMBOL</u>	<u>BAUER PART NO.</u>	<u>DESCRIPTION</u>	<u>MANUFACTURER</u>
RESISTORS (CONTINUED)			
R59		Same as R16	
R60	10-147	Resistor, 4,700 ohms, 2 W, 10%	
R61	10-145	Potentiometer, 10,000 ohms, 2 W	Ohmite, CLU-1031 locking
R62, R63 R64, R65	10-146	Ohmspun resistance grids, 50 ohms	States, WR-31D
R66, R67		Power determining part, used in 1,000/250 watt only, see Figure 5	
R68	10-148	Resistor, 500 ohms, 50 W	Ohmite F518
R69, R70		Power determining part, used in 1,000/250 watt only, see Figure 5	
R71, R72		Power determining part, used in 1,000/500 watt only, see Figure 5	
R73, R74	10-156	Resistor, 470 ohms, 1/2 W, 10%	
R75	10-158	Resistor, 150 ohms, 25 W, WW adjustable	Ohmite 0369
R76-R91	10-157	Resistor, 100,000 ohms, 1 W, 10%	
R92-R93	10-159	Resistor, 25 ohms, 20W, WW	Ohmite 1805
R-94	Same as R76		
CAPACITORS			
C1, C2	20-100	Capacitor, variable, 2.6 - 25 mmfd	E. F. Johnson, 148-2
C3	20-101	Capacitor, 33 mmfd, 500 V	Elmenco, CM-20C-330J
C4	20-102	Capacitor, 500 mmfd, 500 V	Elmenco, CM-20D-501J
C5, C6	20-103	Capacitor, .01 mfd, 600 V	Centralab, D6-103
C7	20-104	Capacitor, 75 mmfd, 500 V	Elmenco CM-20C-750J
C8		Same as C5	
C9	20-105	Capacitor, 500 mmfd, 3 KV	Centralab, DD30-501
C10, C11 C12	20-106	Capacitor, .0022 mfd, 3 KV	Aerovox HVD-30
C13	20-107	Capacitor, .02 mfd, 150 V	Centralab, DDM-203
C14		Same as C9	
C15		Same as C10	
C16, C17 C18, C19	20-110	Capacitor, .02 mfd, 600 V	Centralab, DD-203

PARTS LIST (CONTINUED)

<u>SYMBOL</u>	<u>BAUER PART NO.</u>	<u>DESCRIPTION</u>	<u>MANUFACTURER</u>
CAPACITORS (CONTINUED)			
C20, C21	20-111	Capacitor, 150 mmfd, 3 KV	Centralab, DD-30-151
C22	20-112	Capacitor, 500 mmfd, 30 KV	Centralab, TV-8-503
C23A, B	20-113	Same as C-22 mfd, 12.5 KV	Sangamo, E-1221
C24		Frequency determining part, see Figure 4	
C25		Frequency determining part, see Figure 4	
C26		Frequency determining part, see Figure 4	
C27	20-119	Capacitor, 10 mfd, 600 V	Sprague, CP70E1EF106K
C28	20-120	Capacitor, .05 mfd, 1 KV	Sprague, CP53B1EG503K
C29	20-121	Capacitor, 12 mfd, 1 KV	Sprague, CP70E1EG126K
C30, C31	20-122	Capacitor, 2 mfd, 600 V	Sprague, CP53B1EF205K
C32	20-123	Capacitor, .1 mfd, 5 KV	CD, TJH 50001
C33, C34	20-124	Capacitor, 4 mfd, 4 KV	CD, TJH 40040AJ
C35	20-125	Capacitor, .05 mfd, 3 KV	PAS 503-3M
C36	20-126	Capacitor, 1 mfd, 4 KV	CD, TJH 20060
C37	20-127	Capacitor, .1 mfd, 600 V	Sprague, CP53B1EF104K
C38		Same as C30	
C39, C40	20-128	Capacitor, .1 mfd, 1 KV	Sangamo, SBBIE101004M
C41	20-129	Capacitor, 300 mfd, 150 V	CD, TVA-1425
C42	20-130	Capacitor, 2 mfd, 1 KV	CD, TJH 10020J
C43	20-131	Capacitor, 150 mfd, 150 V	Sprague, TVL-1429
C44		Not used	
C45		Power determining part, used in 1,000/250 watt only see Figure 5	
C46		Power determining part, used in 1,000/250 watt only see Figure 5	
C47	20-132	Capacitor, 0.47 mfd, 400 V	Hurst
C48-C56		Same as C10	

PARTS LIST (CONTINUED)

<u>SYMBOL</u>	<u>BAUER PART NO.</u>	<u>DESCRIPTION</u>	<u>MANUFACTURER</u>
INDUCTORS			
L1, L2	30-100	RFC, 1 mh	Miller, 4652
L3	30-101	RFC, 2.5 mh	National, R-50
L4	30-102	RFC, 2.4 mh	National, R-100
L5		Frequency determining part, see Figure 4	
L6	30-106	RFC, 1.5 mh	Bauer
L7		Frequency determining part, see Figure 4	
L8, L9	30-109	Inductor, 24 uh	Johnson, 232-633
L10		Power determining part, see Figure 5	
L11	30-111	Filter reactor 15 h, 85 ma	Chicago, RS-1585
L12	30-112	Modulation reactor, 65 h, 500 ma	Electro-Engineering, E9561B
L13	30-113	Filter reactor, 10 h, 800 ma	Electro-Engineering, E5933
L14		Deleted	
L15	30-115	Monitor pickup coil	Bauer
L16, L17		Not used	
L18		Same as L11	
RELAYS			
K1	40-100	Master start relay	Guardian, 2210-DPST-N0230
K2	40-101	Final grid underdrive relay	Potter-Brumfield, KCP5, 5000 ohm coil
K3	40-102	Overload reset relay	Automatic Electric, Series EIN
K4	40-103	Hi/Lo power change relay (high voltage)	Advance AT/2C/115VA
K5	40-104	Hi/Lo power change relay (audio pad and final drive)	Potter-Brunfield, KRP11A-115 V
K6	40-108	Crystal selector	Advance AM/2C/115VA
K7	40-105	H. V. transformer primary breaker	General Electric, CR105-K03

PARTS LIST (CONTINUED)

<u>SYMBOL</u>	<u>BAUER PART NO.</u>	<u>DESCRIPTION</u>	<u>MANUFACTURER</u>
RELAYS (CONTINUED)			
K8, K9	40-106	Mod. overload relay	Heinemann, CR1-617-XXA
K10	40-107	H. V. transformer primary overload relay	Heinemann, CT1-617-XXA
K11		Same as K6	
SWITCHES			
S1	50-100	Switch, master start	Molex MRC 8P1
S2	50-101	Switch, DPDT	JAN ST-52K
S3	50-102	Switch, DPST, momentary contact	JAN ST-52R
S4		Same as S2	
S5	50-103	Switch, DPDT, momentary contact, neutral center	JAN ST-52S
S6		Same as S2	
S7		Same as S2	
S8	50-104	Switch, dummy antenna	Bauer
S9, S10, S11	50-105	Switch, interlock	Acro, 3DO5-8P
S12	50-106	Air flow switch	Dietz 103A
METERS			
M1	60-100	Meter, mod. plate, 0-1A	
M2	60-101	Meter, final plate voltage, 0-5 KV	
M3	60-100	Meter, final plate, 0-1A	
M4	60-103	Meter, R. F. output, 0-1 ma, 0-6 a scale	
M5	60-104	Meter, final grid, 0-50 ma	
M6	60-105	Meter, final screen grid. 0-100 ma	
M7	60-104	Meter, driver plate, 0-50 ma	
M8	60-104	Meter, osc. plate, 0-50 ma	
M9	60-102	Meter, audio plate, 0-10 ma	

PARTS LIST (CONTINUED)

<u>SYMBOL</u>	<u>BAUER PART NO.</u>	<u>DESCRIPTION</u>	<u>MANUFACTURER</u>
TRANSFORMERS			
T1	70-100	High voltage transformer, 3560 V C. T., 0.78 A, 2.76 KVA	Electro-Engineering, E-11770
T2	70-101	Voltage regulator, 500 VA	Sola, 23-22-150 (60 cycle) 23-22-650 (50 cycle)
T3, T4	70-102	Filament transformer	Chicago, F-530
T5	70-103	L. V./bias transformer	UTC CG-422
T6	70-104	Audio input transformer	UTC LS-26
T7	70-105	Modulation transformer	Electro-Engineering, E-11591
TUBES			
V1, V2	80-100	Vacuum tube, Type 6AG7	
V3	80-101	Vacuum tube, Type EL34/6CA7	
V4, V5	80-102	Vacuum tube, Type 6SJ7	
V6-V9	80-103	Vacuum tube, Type 4-400A	
SILICON RECTIFIERS			
D1-D4	90-101	Bias assembly	GI-W06
D2-D17	90-100	Silicon rectifier, 600 V, 1A	Slater, SLA-17
D18-D19		HV rectifier assembly	Solitron PSPF-100-BE
D20		Same as D2	
FUSES			
F1-F4	100-100	Fuse, 1.6 A, 3 AG, Slo-Blo	Buss
F5, F9	100-102	Fuse, 1/2 A, 3 AG, Slo-Blo	Buss
F6, F7	100-101	Fuse, 30A-FRN-30	Buss
F8	100-103	Fuse, 1-1/2 A, 5 KV	Littlefuse

PARTS LIST (CONTINUED)

<u>SYMBOL</u>	<u>BAUER PART NO.</u>	<u>DESCRIPTION</u>	<u>MANUFACTURER</u>
CRYSTALS			
XL1, XL2	120-100	Crystal, vacuum	Northern Engineering Lab, T-12A
TERMINAL BOARDS			
TB1	130-100	Terminal strip, 20 position	Cinch-Jones, 20-141-Y
TB2	130-101	Terminal strip, 7 position	Cinch-Jones, 7-140-3/4 W
MOTORS			
B1	140-100	Blower motor, 115 V	Rotron, Saucer Fan
B2	140-101	Power control motor 115 v, 4 rpm	Hurst Type RSM
RECEPTACLES AND TUBE SOCKETS			
J1	150-100	Receptacle, freq. monitor	Amphenol, 31-102
J2	150-100	Receptacle, mod. monitor	Amphenol, 31-102
P1	150-101	Plug, freq. monitor	Amphenol, 31-002
P2	150-101	Plug, mod. monitor	Amphenol, 31-002
X1/X2	150-102	Osc./buffer dual turret socket	Vector, 10-00-18A3-2
X3, X4 X5	150-103	Socket, R.F. driver and audio amplifiers, bias rectifier	Amphenol, 77 MIP-8T
X6, X7 X8, X9	150-104	Socket, modulators and finals	Johnson, 122-275-100
X10, X11, X12	150-105	Socket, crystals	Pomona, XS-8
X13, X14	150-103	Socket, relays K2 and K5	Amphenol, 77 MIP-8T
X15		Same as X3	
MISCELLANEOUS			
SU1, SU2 SU3, SU4	160-100	Parasitic suppressor	Ohmite, P-300
	200-116	Osc./buffer chassis and cover	Bauer
	250-117	Fuse holders for F1-F5, F9	Bussman, HKL-X
	250-118	Fuse block for main line fuses, F6, F7	Bryant, B-1917

FREQUENCY DETERMINING PARTS

<u>Symbol</u>	<u>Bauer Part Number</u>	<u>Description</u>	<u>Manufacturer</u>
C24	20-114	Capacitor, final tank, variable vacuum, 25-500 MMF, 7.5V	Jennings, UCS
C24A	20-115	Capacitor, final tank padder _____	Jennings, JCS
C25	_____	Capacitor, loading _____	Sangamo, G1-B
C26	_____	Capacitor, loading _____	Sangamo, G1-B
L5	_____	Coil, Final Grid, adjustable _____	Miller, _____
L7	_____	Coil, Final Tank, _____	E. F. Johnson, _____

NOMINAL ADJUSTMENTS

Final Tank (L7)

Plate Tap (C23) _____ turns (From left end of L7) *

Tuning Capacitor Tap (C24) _____ turns (From left end of L7) *

Load Tap (To L8) _____ turns (From right end of L7)*

L8

Input Tap (From L7) end turn nearest panel *

Output Tap (To C26) _____ turns from input tap

L9

Input Tap (From C26) end turn at top of coil *

Dummy load tap _____ turns

Load Tap _____ turns

* Count end turn as No. 1

POWER DETERMINING PARTS

<u>Symbol</u>	<u>Bauer Part Number</u>	<u>Description</u>	<u>Manufacturer</u>
*R13	10-111	Resistor, driver cathode, 5000 ohms, 5 w, wire wound	Ohmite "Axial"
R39	10-135	Resistor, audio input pad, 330 ohms, 2 w, 10%	
R40	10-151	Resistor, audio input pad, 270 ohms, 2 w, 10%	
R66, R67	10-150	Resistor, K4 transient suppressor, 250,000 ohms, 50 w, wire wound	Ohmite 0428
R69, R70	10-149	Resistor, current limiting, 50 ohms, 5 w, wire wound	Ohmite "Axial"
C45	20-125	Same as C-35	
C46	20-133	Capacitor, 1500 volt power supply filter, 6 mfd, 2 kv	CD, TJL-20060
L10	30-110	Reactor, 1500 volt power supply filter, 8 h, 400 ma	UTC S-35

* R13 may also be a 4000 or 3000 ohm resistor -- depends on frequency and final grid coil efficiency.

CABLE TABLE

All are #18 wires in main harness except as noted.

Wire No.	From	To	Remarks	Wire No.	From	To	Remarks
1	F6	K1	#16 wire	24	T3-4	F4	
2	F7	K1	#16 wire	25	T3-3	S2	
3	F6	K7	#10 wire Heavy Insulation	26	S2	S11	
4	F7	K7	#10 wire Heavy Insulation	27	S11	T5-1	
5	K1	F1		28	F4	T5-2	
6		Not used		29	F4	TB1-16	
7	F1	TB1-8		30	F4	S6	
8	K1	TB1-9		31	S6	S5	
9	K1	S-1 (Red)		32	S5	S7	
10	CB10-9	S-1 (White)		33	T3-3	CB3-9	
11	T3-4	F-9		34	S6	CB3-10	
12	T5-11	V5-2	6.3 AC	35	S6	K4	
13	T5-18	V5-7	6.3 AC	36	T3-1	K4	
14	S12	T2-H1	#16 wire	37	T4-2	TB2-7	
15	K1	T2-H4	#16 wire	38	S7	TB2-6	
16	K1	F5		39	S7	TB1-18	
17	K1	Blower		40	S6	TB1-17	
18	K1	F3		41	T4-2	Power control motor-common (Term. 2)	
19	K1	F2		42	S5	Power control motor-lower (Term. 1)	
20	T2-X1	T4-4	#16 wire	43	S5	TB1-14	
21	T2-X2	T4-1	#16 wire	44	S5	Power control motor-raise (Term. 3)	
22	T4-3	T3-4	#16 wire	45	S5	TB1-15	
23	T4-4	T3-3	#16 wire	46	F2	CB4-5	
				47	F2	K8	

CABLE TABLE (CONTINUED)

Wire No.	From	To	Remarks	Wire No.	From	To	Remarks
48	K8	K9		73	C27	CB9-6	
49	K9	K10		74	C27	TB2-5	Buffer plate
50	K10	CB4-1		75	CB8-3	L11	
51	K10	K7		76	CB8-3	CB-7	Connects to C28
52	S10	CB10-5		77	L11	C29	
53	S9	S10		78	C29	M7 (Positive)	
54	CB4-3	S9		79	M7 (Negative)	CB9-2	Driver plate
55	CB10-6	K7		80	C29	CB7-3	
56	TB1-12	S3		81	CB7-6	CB1-12	Audio plate and screen
57	TB1-13	S4		82	CB7-4	K7	
58	S4	CB4-2		83	CB7-8	K7	
59	S3	F3		84	CB7-9	V6 screen	
60	TB1-5	Ground	Ground at F6/F7 Mounting bolt	85	T5-8	CB5-1	
61	TB1-11	S3		86	T5-10	CB5-6	
62	S3	CB4-4		87	CB5-10	R27	
63	T5-15	V3-Pin 7		88	R27	C31	
64	T5-17	V3-Pin 2		89	CB5-9	R27	
65	T3-1	TB1-20		90	TB2-4	J1	RG-174/U Coax
66		Not used		91	TB2-3	T5-15	
67	T5-3	CB8-2		92	TB2-2	T5-17	
68	T5-7	CB8-4		93	Buffer out	V3 Pin 5	Buffer output to driver grid
69	T5-5	L18		94	R12	CB9-4	
70	C27	L18		95	R12	CB3-12	
71	C27	M8 (Positive)					
72	M8 (Negative)	TB2-1	Osc. plate				

CABLE TABLE (CONTINUED)

<u>Wire No.</u>	<u>From</u>	<u>To</u>	<u>Remarks</u>	<u>Wire No.</u>	<u>From</u>	<u>To</u>	<u>Remarks</u>
96	L5	M5 (Negative)		117	T3-7	V7 (Fil)	#12 thin wall
97	M5 (Positive)	CB10-7		118	T3-5	V7 (Fil)	#12 thin wall
98	CB10-8	T4-6		119	T3-6	M1 (Positive)	
99	T4-6	M2 (Negative)		120	M1 (Negative)	K9	
100	M2 (Positive)	CB6-2		121	CB2-3	C38	
101	T4-6	K8		122	CB2-7	C37	
102	K8	M3 (Positive)		123	V4 Pin 5/3	R46	
103	M3 (Negative)	R19		124	V5 Pin 5/3	R46	
104	R19	TB1-6		125	R46	CB2-4	
105	CB6-1	TB1-4		126	CB2-9	M9 (Positive)	
106	R17/R18	M6 (Negative)	Final screens	127	M9 (Negative)	Ground at C37	
107	M6 (Positive)	R35/R36		128	K7	K10	#10 HW
108			not used	129	K7	T1	#10 HW
109			not used	130	K10	T1	#10 HW
110	Mod. Mon. Pickup coil	J2	R6-174/U Coax	131	Not used		
111	T4-7	V8 (Fil)	#12 thin wall	132	Not used		
112	T4-5	V9 (Fil)	#12 thin wall	133	TB1-1	CB3-4	
113	T4-5	V8 (Fil)	#12 thin wall	134	TB1-2	CB3-7	
114	T4-7	V9 (Fil)	#12 thin wall	135	CB3-8	T6-1	
115	T3-7	V6 (Fil)	#12 thin wall				
116	T3-5	V6 (Fil)	#12 thin wall				

CABLE TABLE (CONTINUED)

Wire No.	From	To	Remarks	Non-Numbered Jumper Wires Not In Harness		
				From	To	Remarks
136	CB3-5	T6-2		C37	Ground	
137	CB1-10	C31		C31	Ground	
138	CB1-13	CB2-3		C38	Ground	
139	CB2-1	T6-8		K9	Ground	
140	CB2-5	T6-9		R59	Ground	
141	V5-Pin 4	T6-7		R59	K9	
142	V4-Pin 4	T6-10		R59	R59	Grounded terminal to tap
143	V4-Pin 6	V5-Pin 6		T3-2	T3-4	#16 wire
144	CB2-8	V5-Pin 6		T3-1	T3-3	
145	V4-Pin 7	V5-Pin 7		C30	Ground	
146	V4-Pin 2	V5-Pin 2		CB6-7	C36	
147		Not used		C36	Ground	
148	R19	R20		C33	Ground	
149	CB5-4	C30		L13	Ground	
150	K1	S12 (#16 wire)		T4-2	T4-4	
151		Not used		T4-1	T4-3	
152		Not used		C29	Ground	
153	F5	R68		C27	Ground	
154	C42	Blower		R20	Ground	
155	R68	Blower		R16	K8	2 wires from each end of R16
				R16	R16	Terminal closest to panel to tap
				K1	K1	Start contact to coil
				Power control motor		Connect common poles
				S3	S4	
				CB10-9	K1 coil	

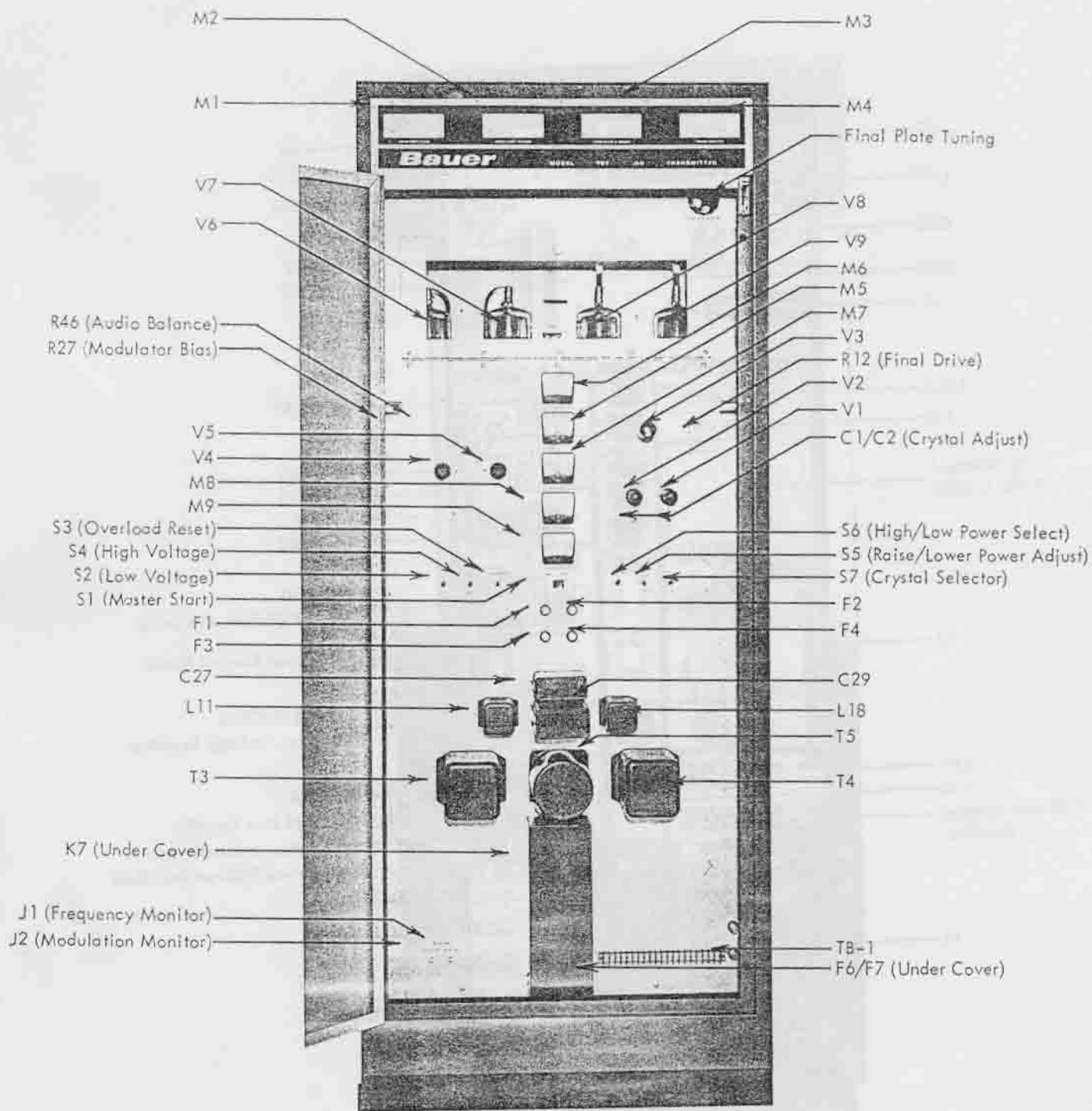

FRONT VIEW OF BAUER MODEL 707 BROADCAST TRANSMITTER

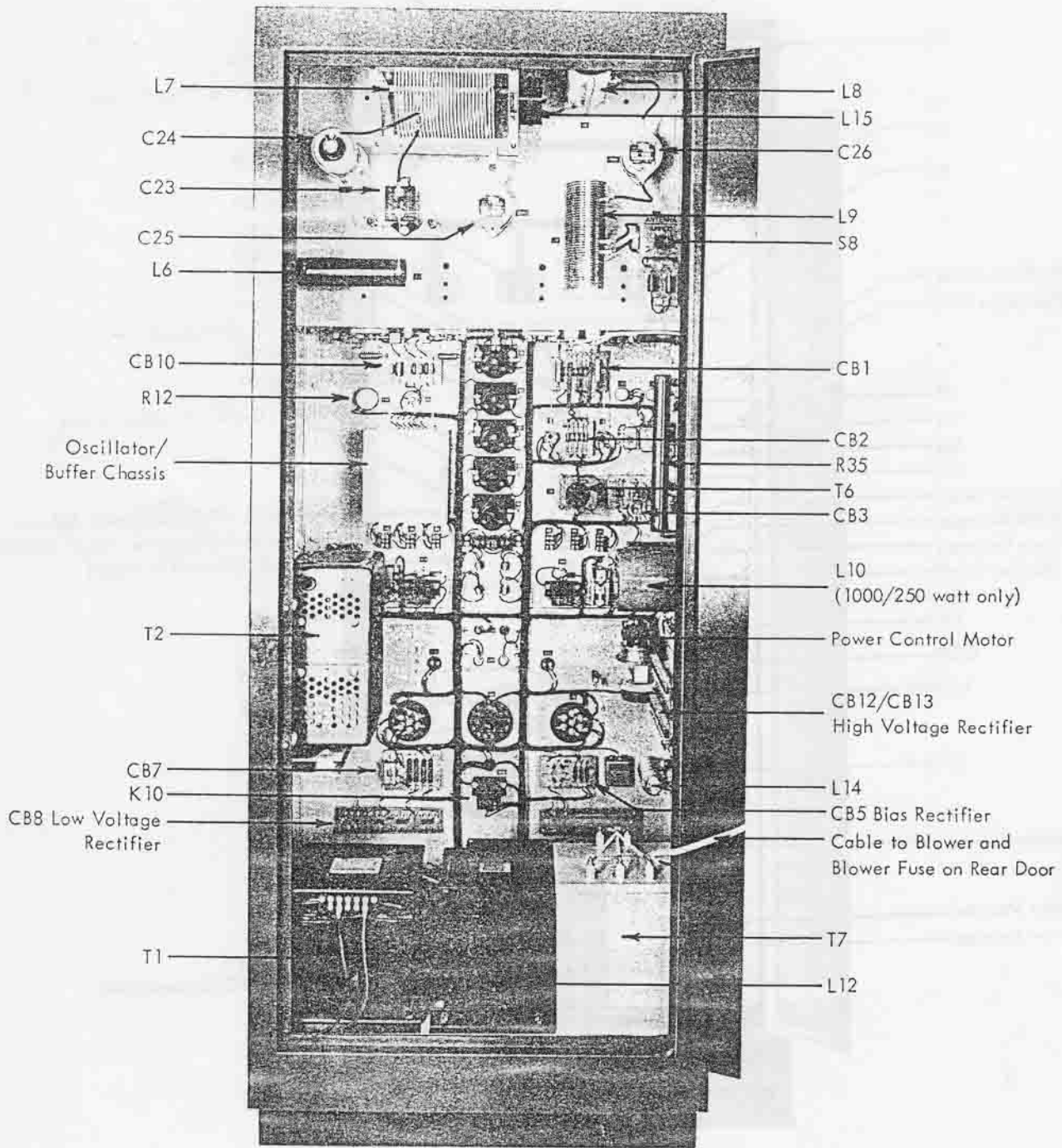

REAR VIEW OF BAUER MODEL 707 BROADCAST TRANSMITTER

600501

BASE OUTLINE

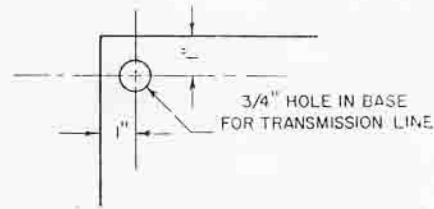
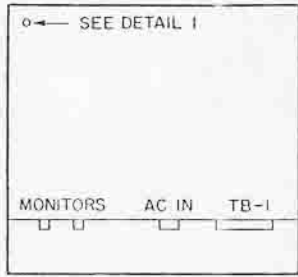

DETAIL I

CONNECTIONS TO LOWER PORTION OF FRONT PANEL

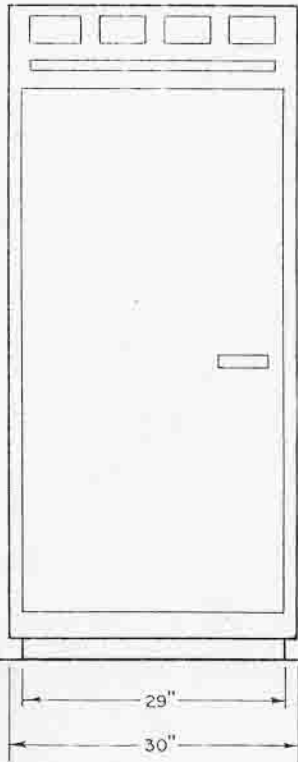
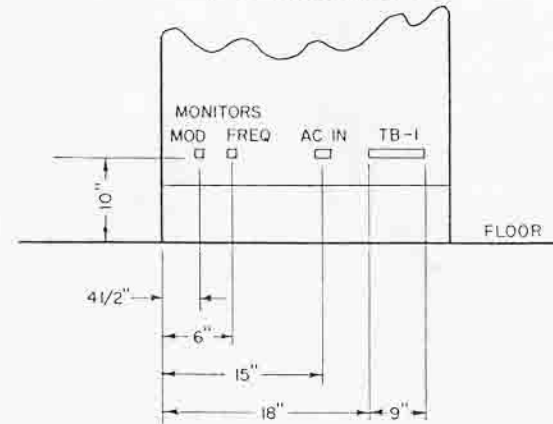

FRONT VIEW

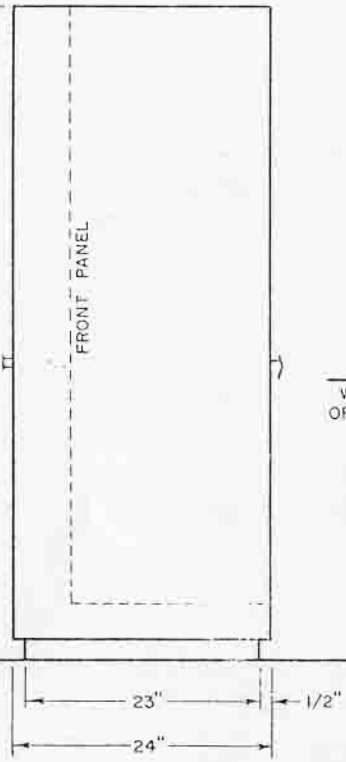

SIDE VIEW

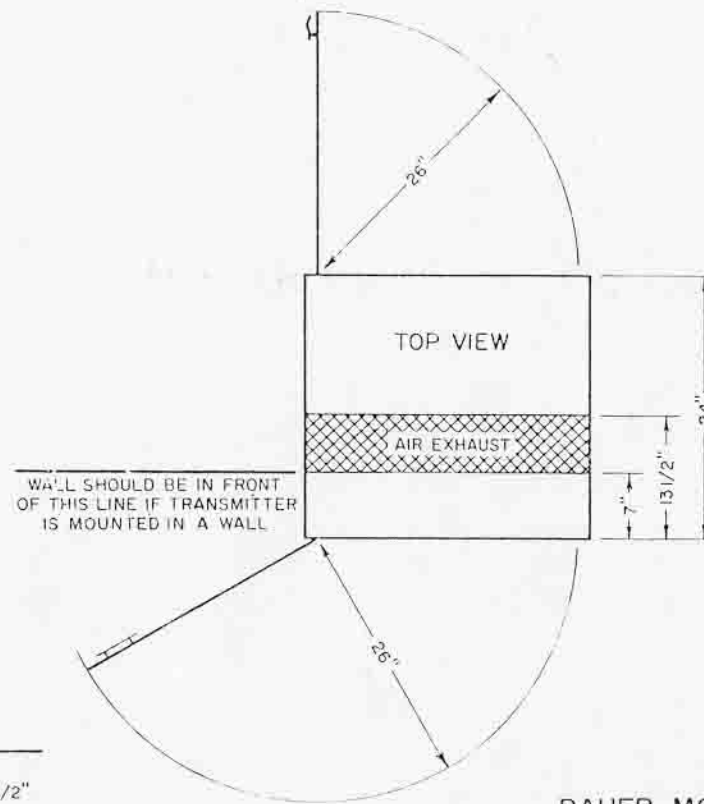

BAUER MODEL 707
AM BROADCAST TRANSMITTER

FIGURE 9

Table 4. Tuning Chart, Model 707 (Continued).

L5

- (1) P/N 187-1148 Miller 43A103CB/
- (2) P/N 187/1147 Miller 43A474CB1
- (3) P/N 187/1146 Miller 43A224CB1
- (4) P/N 186-0068 Delevan 2500-28
Used in series (1000 μ h)

L7

- (1) P/N 186-1409 EFJ 200-105 (120 μ h).
- (2) P/N 186-1410 EFJ 200-206 (50 μ h)

C24A

- (1) P/N 115-0107 Jennings JCS 500 (500PF/7.5 kv)

C25/C26

- (1) P/N 101-1206 Sangamo (.003 μ f/6kv)
- (2) P/N 101-1204 Sangamo (.002 μ f/6kv)
- (3) P/N 101-1207 Sangamo (.001 μ f/6kv)
- (4) P/N 101-1214 Sangamo (.005 μ f/6kv)

NOTES

- a. End turn is counted as No. 1
- b. Position will depend on loading required - move right (decrease turns) to tighten coupling. Move left (increase turns) to loosen coupling. C23/C24 taps usually 1 turn apart--set C23 tap for best efficiency.
- c. End turn on right side of L-7 counted as No. 1.
- d. Turn nearest front panel counted as No. 1
- e. Top turn counted as No. 1
- f. L8/L9/C26 combination selected to give loading of 65-75 ohms Zero reactance measured at input to L-8 with 50 ohm load.

Table 4. Tuning Chart, Model 707.

Components Used						Taps Used					
Freq (kHz)	L5	L7	C24A	C25	C26	L-7/C23 Tap (a)	L-7/C24 Tap (b)	L-7/L8 Tap (c)	L-8/C26 Tap (d)	L-9/ Dummy (e)	L-9/Load(f)
540	1/4	1	1	4	4	8	8	3	18	13	19
600	1	1	1	4	4	10	10	3	22	16	23
650	1	1	1	1	1	10	10	2	8	6	16
700	1	1	1	1	1	11	12	2	10	6	15
750	1	1	1	1	1	12	13	2	12	6	15
800	1	1		2	2	8	9	2	5	6	13
850	2	1		2	2	12	13	2	6	6	12
900	2	1		2	2	13	14	2	6	6	12
950	2	1		2	2	15	16	2	6	6	12
1000	2	1		2	2	18	19	2	8	6	11
1050	2	1		2	2	20	21	2	7	6	11
1100	2	1		2	2	21	22	2	8	6	11
1150	2	1		2	2	22	23	2	8	6	11
1200	2	2		2	2	2	2	2	9	6	11
1250	2	2		2	2	2	3	2	9	6	11
1300	3	2		2	2	2	3	2	11	6	12
1350	3	2		2	2	3	4	2	15	6	14
1400	3	2		2	2	4	5	2	15	6	14
1450	3	2		2	2	5	6	1 1/2	14	8	14
1500	3	2		2	2	6	7	1 1/2	14	8	14
1550	3	2		2	2	8	9	1 1/2	12	6	12
1600	3	2		2	2	10	11	1 1/2	11	6	11

Table 2. Typical Transmitter Performance Data, Bauer Model 707.

Circuit	Meter Readings					
	250 Watts		500 Watts		1000 Watts	
	0% Mod.	100% Mod.	0% Mod.	100% Mod.	0% Mod.	100% Mod.
Audio Plate	4-5 ma	4-5 ma	4-5 ma	4-5 ma	4-5 ma	4-5 ma
Oscillator Plate	10-12 ma	10-12 ma	10-12 ma	10-12 ma	10-12 ma	10-12 ma
Driver Plate	8-14 ma	8-14 ma	14-18 ma	14-18 ma	16-24 ma	16-24 ma
Final Grid	11-13 ma	11-13 ma	14-16 ma	14-16 ma	18-20 ma	18-20 ma
Final Screen	24-29 ma	24-29 ma	34-38 ma	34-38 ma	50-58 ma	50-58 ma
Modulator Plates	120 ma	190-210 ma	115 ma	290-315 ma	110 ma	380-420 ma
Final Plate Voltage	1450-1550 v	1450-1550 v	2050-2150 v	2050-2150 v	2900-3100 v	2900-3100 v
Final Plate and Screen	220-260 ma	220-260 ma	320-360 ma	320-360 ma	480-560 ma	480-560 ma
R. F. Output	2.28 amps	2.78 amps	3.18 amps	3.25 amps	4.56 amps	5.56 amps

Typical Performance

Audio input level, 1000 cps, 100% mod., +10 dbm

Noise, -58 db below 100% modulation

Distortion, measured at 95% modulation, 1000 watts

50 cps, 1.4% 100 cps, 0.9% 400 cps, 0.7%
 1000 cps, 0.6% 5000 cps, 0.9% 7500 cps, 1.2%

Response at 1000 watts (variation from 1000 cps, 95% modulation)

30 cps, -1.0 db 50 cps, 0.0 db 100 cps, 0.0 db
 400 cps, 0.0 db 1000 cps, 0.0 db 3000 cps, 0.0 db
 5000 cps, +0.2 db 7500 cps, +0.3 db 10,000 cps, +0.1 db

Efficiency 70-75% Dummy Resistance 48 ohms

2.0-25
volts

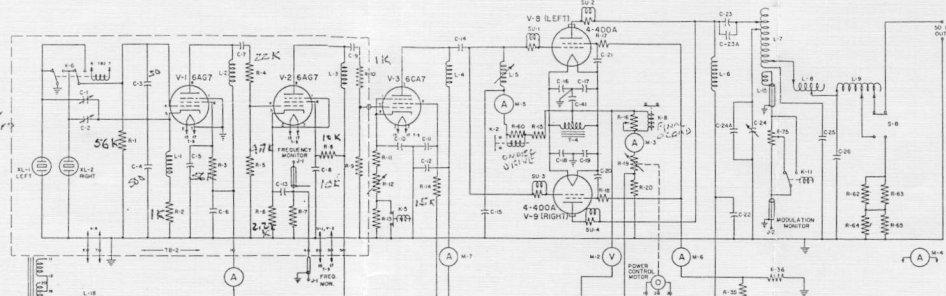

Audio Input

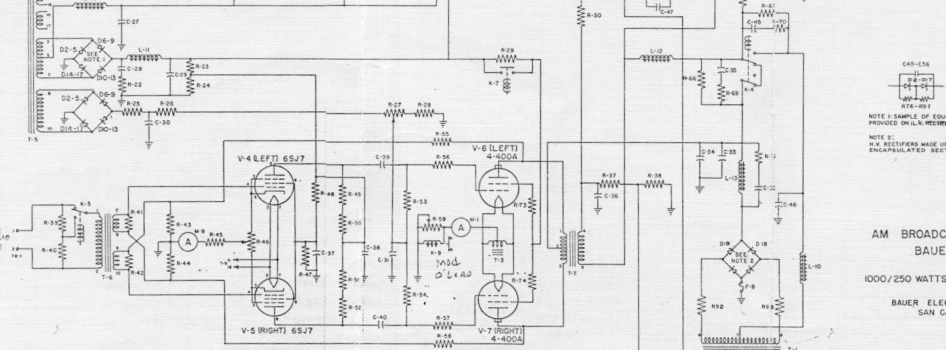

NOTE: SAMPLE OF EQUALIZATION PROVIDED ON ALL V. RECTIFIERS.
 NOTE 2: V. RECTIFIERS MADE UP OF TWO ENCAPSULATED SECTIONS.

AM BROADCAST TRANSMITTER
 BAUER TYPE 707
 1000/250 WATTS 540-1600 KC
 BAUER ELECTRONICS CORPORATION
 SAN CARLOS, CALIFORNIA

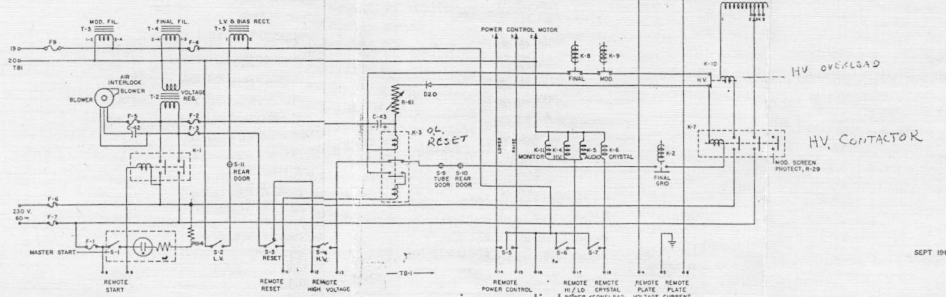

SEPT 1964