

Lafayette Space Age Electronics



Catalog 700
1970 Our 49th Year



LAFAYETTE

RADIO ELECTRONICS

Mail Order and Sales Center

111 Jericho Turnpike, Syosset, L.I., New York 11791 Phone: 516-921-7700

- Index—Pages 431-434
- Store Addresses—Page 14
- "Easy Pay" Budget Plan—Page 11
- International & Industrial Divisions—Page 13
- "Associate Stores" Coast-to-Coast



Play your favorite pre-recorded stereo or monaural cassette tapes on the cassette recorder. Make your own tapes by recording directly from the AM / FM, or stereo FM section of your receiver. Record famous speeches, great symphonies, operas, and sporting events.

NEW Lafayette LRK-1600 100 Watt Solid-State AM/FM STEREO CASSETTE/RECEIVER

IT'S A Deluxe Lafayette 100 Watt AM/FM Stereo Receiver

IT'S A Deluxe Performing Lafayette Stereo Cassette Recorder

PRINTED IN U.S.A. • ENTIRE CONTENTS COPYRIGHTED 1968 BY LAFAYETTE RADIO ELECTRONICS CORPORATION • MODEL L.R.K. 1190



RECEIVER SECTION

- 100 Watts ± 1 db of Exemplary Stereo Power
- 4 Gang FM Tuning Condenser
- Automatic FM Stereo Switching and Stereo Indicator Light
- Special Fused Circuitry Protects Output Transistors
- Front Panel Stereo Headphone Jack
- Push-button Switches for Loudness, Stereo-Mono, Tape Monitor, High Filters
- Illuminated AM and FM Tuning Meter
- Speaker Mode Switch: Main, Remote, Main and Remote
- Complete Tuning Panel is Illuminated when Power is Turned On

OUTSTANDING FEATURES Plus New PROFESSIONAL STYLING OF DISTINCTION

4  **4-IC's, 4-FET's, 24-Transistors, 25-Diodes expertly Crafted For Years Of Concert Quality Performance**

CASSETTE SECTION

- 7 Pushbutton Tape Functions Including Pause for Instant Editing and Cueing
- 4 Pole Hysteresis Synchronous AC Motor
- Large Dual Channel VU Level Recording Meter
- Semi-Slot Tape Loading for Complete Ease of Operation
- Cassette Ejector Button • Visual Record Indicator Light
- 2 Mike Inputs for Left and Right Channel on Front Panel
- 3 Digit-Tape Counter with Reset Button
- Records 4 Track Stereo and 2 Track Monaural; Playback 4 and 2 Track Stereo or Monaural

only **279⁹⁵** No Money Down*

Lafayette's most exciting new concept in stereo high fidelity component convenience, versatility, and performance. The LRK-1600 adds the complete recording and playback facilities of a professional stereo cassette recorder onto a superb 100 watt AM/FM Stereo Receiver at a surprisingly modest cost. And, it's all engineered into one beautiful, low profile enclosure. Listen to AM, FM or brilliant FM stereo broadcasts. Listen to prerecorded cassette tapes. Record live onto cassette tapes voice or instruments (2 mike input jacks are located on the front panel for your convenience). Record onto cassette tapes from records (just connect a record changer thru the magnetic or ceramic phono input) or just listen to your collection of records. Record directly from the Receiver's superb FM stereo tuner as well as the AM tuner. And, most important, make sound with sound recordings (record live with a mike simultaneously while recording an external source). The LRK-1600's exceptional quality and performance are assured by the use of 4 integrated circuits (IC's), 4 Field Effect Transistors (FET's), 24 Transistors, and 25 diodes. You'll hear more stations, as well as brilliant FM stereo reception with amazing noise free clarity.

Receiver Section utilizes a complete set of controls: Selector Switch for Aux., Phono, FM, FM Stereo, AM; Speaker mode switch: Power off, main, remote, main and remote, Phones (only). Pushbutton Switch: Loudness, Stereo/Mono, Tape Monitor, and High Filter; Stereo Head phono jacks, Separate bass, treble, volume/balance, tuning controls. Inputs on rear chassis for magnetic and ceramic phono, Auxiliary, and Tape Recorder Output; 2 AC convenience outlets. 1 Switched, 1 Unswitched. Flexible mount ferrite loopstick AM antenna. Special fused circuitry protects against burnout of output transistors.

Cassette Recorder Section features 2 front panel mike input jacks, Individual concentric Left and Right channel record level controls—for mike (live), and input source (Tuner, Phono, Tape); 7 pushbutton controls for all tape functions: record, play, stop, rewind, fast forward, pause, and cassette eject. The record button incorporates a safety-Interlock to prevent accidental erasures. Beautiful low profile enclosure with walnut side panels, and brushed aluminum gold anodized extruded front panel. Black-face tuning panel — Turn the power on and the Receiver's Tuning dial and Tuning meter come to life with the panel lit up. Size: 21½" L x 5¾" H x 14" D. Shpg. wt., 28 lbs. Imported. For 105-120 volts 50/60 Hz AC.

99 E 02172WX Net 279.95
99 E 46302 Dynamic Mike. Imported, Shpg. wt., 8 ozs. Net ea. 5.95

SPECIFICATIONS

Tuner, FM: 4-Gang Condenser; 88-108 MHz; IHF Sensitivity: 1.7µV; S/N Ratio: 75db (100% Mod.); Distortion: 0.25% (at 400 Hz 100% Mod.); Spurious Response Rejection: 100db; Capture Ratio: 1.5db; Stereo MPX Separation: 40db (400 Hz); Cross Modulation Index: 90db. Built-in Line Cord antenna plus 300-ohm balance input for external antenna. Tuner, AM: 3-Gang Condenser; 535-1650 kHz; Sensitivity: 20µV; Image Rejection: 55db; Built-in ferrite loopstick with power for external antenna. Amplifier: Power Output: 100 watts ±1db; 80 watts IHF; Frequency Response: 20-20,000 Hz ±1db; Power Bandwidth: 15-30,000 Hz; Harmonic Distortion: Less than 1% at rated output, 0.07% at 1 watt; Hum and Noise: Aux. —75db, Phono Mag. —63db; Input Sensitivity: Phono-Mag. 2-3mV, Phono-Cer. 80mV, Aux. 250mV, Output Impedance: 4-16 ohm speaker (main and remote) Headphone jack Impedance 8 ohms; Cassette Recorder: 4-Pole Synchronous hysteresis AC Motor; Tape Speed, Constant 1½ ips; Wow-Flutter, Less than 0.3% RMS; Fast-Forward Time, Within 3 minutes (C-60 tape); Rewind Time, Within 2.5 minutes (C-60 tape); 2 Heads, Record/Playback, Erase, Mic. Input Sens., 1mv for 0 VU at 10K ohm; High Level Input, 80mv for 0 VU @ 100K ohm; Frequency Response, 45 to 10,000 Hz; S/N Ratio, Better than 35db; Overall Distortion, Less than 3% at 0 VU recording; Channel Separation, 30db; Bias & Erase Frequency, 95 kHz.

For LRK 1600 AAM Guarantee see page 435

* See Page 11 for Full Credit Details on Easy Pay Plan



EXCITING SOUND with SOUND RECORDINGS—on the Cassette Recorder. Superimpose your voice or a musical instrument on a cassette tape using a mike while simultaneously recording an external program source such as an AM or FM broadcast, or a record.



Deluxe 100 Watt Component Hi-Fi System Featuring LRK-1600

ONLY 319⁸⁵

SAVE \$20.00

From Individual Catalog Prices

Magnificent 100 watt Component Hi-Fi System featuring the LRK-1600 Cassette/Receiver and 2 Lafayette Criterion 50 Bookshelf Speaker Systems (See Page 43 for complete description of the Criterion 50). 99 E 26130WXM Shpg. wt., 84 lbs. Net 319.85

Lafayette Cat. No. 700 3

Make live recordings on the cassette recorder. Front panel left and right channel mike input jacks for easy, convenient access to the recorder. Practice foreign languages, rehearse speeches, record voices of your family, or record the playing of musical instruments, solo or combo.

Play your most popular records through the receiver section, or record your favorite records on tape. Just connect a record changer and build a magnificent cassette tape library. No more problems about wearing out your records.

Lafayette AWARD-WINNING LR-1500T

220 Watt Deluxe Solid State AM/FM Stereo Receiver

Our Finest... Imitated But Never Duplicated!



**AWARD
WINNER**

**"High performance and an abundance of
features... an excellent buy on today's market."
"HIGH FIDELITY"**

COMPUTOR-MATIC™

PAT. PENDING

ONLY 299⁹⁵

With Walnut Grain Case

No Money Down*



FULL 2 YR GUARANTEE†

Protective Circuitry For Audio Driver And Power Stages

**4 IC's + 2 FET's
40 Transistors
35 Diodes
2 Thermistors**

- 220 Watts ± 1 db.† Output Power
- IHF FM Sensitivity 1.5 μ v
- Automatic Stereo FM Switching
- Adjustable Automatic Interstation Muting
- Center Channel Monaural Output

Lafayette's finest deluxe solid state AM/FM stereo receiver! The LR-1500T 220-watt stereo receiver is expressly engineered to blend the ultimate in high fidelity sound with superb performance, long life, and space-age reliability. In addition to its complement of fine quality transistors the LR-1500T includes 4 revolutionary new Integrated Circuits (IC's) and 2 high-performance Field Effect Transistors to provide truly sterling FM stereo reception. You'll hear more stations — the weak as well as the strong, with amazing, noise-free clarity! Features new patent pending computer designed protective circuitry for virtually foolproof protection against burnout or failure of audio driver and power output transistors. Utilizes a complete set of automatic and manual controls such as: Automatic FM stereo/mono switching; sharp, adjustable Muting circuit to silence the receiver when tuning between stations; dual system speaker switch permits enjoyment of stereo in one or two rooms separately or simultaneously; direct tape monitor switch for tape monitoring without changing cable connections; a front panel

stereo headphone jack for enjoyable private stereo listening; and a center channel low level output for monaural amplifier and speaker. Separate input jacks provide for two magnetic phono and for ceramic/crystal cartridges. AM rf section has a separate 3-gang tuning condenser and rf stage to accommodate the full sound potential of standard AM broadcasting. Incorporates built-in FM and AM antennas plus connections for external local and distant FM and AM antennas. Distinctively styled to enhance any decor. Features a handsome gold anodized extruded aluminum front panel with matching knobs and includes an attractive vinyl-clad metal enclosure finished with the simulated look of rich walnut wood-grain. For 117V., 50/60 Hz Ac. Imported. Size: 16 $\frac{3}{4}$ x 4 $\frac{1}{2}$ x 14 $\frac{1}{4}$ "D. Shpg. wt., 37 lbs.

99 E 01901WX Net **299.95**

Attractive Oiled Walnut Wood Cabinet for LR-1500T.
21 E 01582WX Shpg. wt., 6 lbs. Net **19.95**

†New Rating Standard Used By Major Audio Mfrs.

SPECIFICATIONS

AMPLIFIER SECTION: Power: 220 watts ± 1 db., 175 Watts (IHF). Total Harmonic Distortion @ rated output: under 1%; @ 1 watt 15%. Frequency Response: 20-20,000 Hz ± 75 db. Power Bandwidth: 12-40,000 Hz. Hum and Noise: Tape Hd., —57 db., Phono, —57 db; Aux., —75 db. Input Sensitivity: Tape Hd., 2.5 mv; Phono, (high) 1.8 mv, (medium) 4.5 mv, (low) 12 mv; Aux., 270 mv. Output Impedance: 4, 8, and 16 ohms:

FM SECTION: 4 Gang Tuning condenser. Tuning Range: 88-108 MHz. IHF FM Sensitivity 1.5 μ v. Capture Ratio: 1.25 db. Selectivity: 40 db. Total Har. Dist. @ 400 Hz: 0.3%. Stereo Separation: 40 db @ 400 Hz. S/N Ratio (100% Modulation): 68 db. Spurious Response Rejection: 95 db. Crossmodulation Index: 90 db. Antenna Impedance: 300 ohms balanced.
AM SECTION: 3 Gang Tuning Condenser. Tuning Range: 535-1605 kHz. External Antenna Sensitivity: 15 μ v.



Softly Illuminated Dial Illuminated Signal Strength Meter Permits Fast, Accurate Tuning On FM & AM

A fool-proof switching circuit with stereo indicating signal light automatically switches the receiver to either mono or stereo.

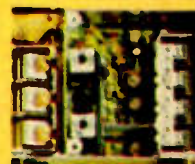

Sensitive FM "Front End" With Field Effect Transistors Completely Shielded FM "Front End" with F.E.T. RF

amplifier and F.E.T. mixer plus a 4-gang variable capacitor and four tuned circuits assure top reception of mono or stereo FM stations.



New Revolutionary Integrated Circuits Four revolutionary Integrated Circuits (IC's) in the FM IF stages provide superior, noise-free FM stereo reception and assure you of top performance for years to come.



"Computer-Matic" ... New, Fuseless Automatic Overload Protection for Driver & Output Transistors

Hundreds of times faster than a fuse, this special circuitry cuts off operation of the amplifier before damage can result. Permits resumption of normal operation when cause of overload is removed.

See Page 435 For Complete AAA Guarantee Details
See Page 11 for Full Credit Details on Easy Pay Plan

Lafayette Cat. No. 700 5

FULL 2 YR.

GUARANTEE†



Lafayette Deluxe 150-Watt Solid State AM/FM Stereo Receiver

LR-1000TA
239⁹⁵
WITH CASE



4 IC's + 36 Transistors
+ 2 FET's + 31 Diodes

**ACCLAIMED
by the
CRITICS**

"... It offers most of the refinements (and performance) typical of receivers selling for twice its price... clearly one of the best buys in audio."

"STEREO REVIEW"

COMPUTOR-MATIC™ (Pat. Pend.) Protective Circuitry For Audio Power Stages

- 150 Watts ± 1 db † Output Power
- Automatic FM Stereo Switching
- Interstation Muting Control
- Center Channel Output

Every performance feature that you'd expect to find along with many extras to obtain the superb character of brilliant sound. The LR-1000TA features the new space age miracle, Integrated Circuits (IC's) plus FET's in the tuner front end to assure outstanding selectivity, stability, and superior capture ratio. Ingenious COMPUTOR-MATIC™ circuitry (patent pending) provides protection of audio driver and power output transistors. Advanced circuitry is complemented by all the controls you need to adjust the sound to your particular taste. Fine features include special high and low frequency switchable noise filters, front panel headphone output jack, tape output jack for direct tape recording, tape monitor plus tape monitor illuminated jewel indicator, loudness switch, signal strength tuning meter for normal or center scale tuning, colored function

- Built-in FM Antenna Plus Flexible, Swivel-Mount AM Antenna
- High/Low Phono Sensitivity Switch
- Exclusive Front and Rear Tape Output Jacks

lights, and automatic FM stereo indicator light. Complete input and output facilities designed for easy installation and connection to any program source or external component. With 1 switched and 1 unswitched AC receptacle. The LR-1000TA's professional styling is enhanced by a brushed gold anodized extruded aluminum front panel and a simulated walnut grain metal case. For 105-120 VAC, 50/60 Hz. Size: 15 7/8 x 5 1/2 x 13 1/2" (incl. rear projections). Imported.

†New rating standard used by major audio mfrs.
99 E 02081WX No Money Down* Shpg. wt., 27 lbs. Net **239.95**
Attractive Oiled Walnut Wood Cabinet for LR-1000TA
21 E 01574WX Shpg. wt., 6 lbs. Net **19.95**

SPECIFICATIONS

TUNER SECTION — 4 Gang Tuning Condenser. Usable FM Sensitivity IHF: 1.65µV. FM Stereo Separation: 38db @ 400 Hz. Signal-to-Noise Ratio: 68db. Spurious Response Rejection: 95db. Harmonic Distortion: @ 100% modulation, 0.4%. Capture Ratio: 1.5db. Cross Modulation Index: 90db. FM Antenna Impedance: 300 ohms balanced. AM Section: 3 gang tuning condenser. IHF External antenna sensitivity: 18µV.

AMPLIFIER SECTION — Power: 150 watts ±1db†, 120 watts IHF. Response: 22-20,000 Hz ±1db. Harmonic Distortion: less than 1% at rated output. IM Distortion: 0.4% at rated output. Hum and Noise: Phono (low) —57db; Auxiliary —75db. Power Bandwidth: 20-40,000 Hz. Input Sensitivity: Phono (high) mag. 2.2mv., cer. 75 mv., Phono (low) mag. 7 mv., cer. 190 mv., Tape-In 500 mv.; Aux. 270 mv. Output Imped.: 4-16 ohms; 8 ohm stereo headphones.

* See Page 11 for Full Credit Details on Easy Pay Plan

† See page 435 for AAA guarantee details.



Colored Lights Indicate Phono, Auxiliary, or Tape Monitor Settings of Selector & Mode Switch.



Interstation Muting Control... Eliminates Tuning Noise Between Stations



Stereo Indicator Light, Automatically Switches "On" When FM Stereo Program is Being Received.



Illuminated Signal Strength Meter Permits Accurate Normal or Central Scale Tuning on FM & AM.



Selector Switch Determines the Mode of Operation For The Receiver—AM, FM, Filter, FM, Phono, and Auxiliary.



LR-775

NEW

Lafayette 100-Watt Solid State AM/FM Stereo Receiver

ONLY
199⁹⁵
WITH CASE

- 100-Watts ± 1 db \dagger of Exemplary Stereo Power
- 4-Gang FM Tuning Condenser
- Fused Output Transistors

- Automatic FM Stereo Switching and Stereo Indicator Light
- Front and Rear Panel Tape Output Jacks

This new 100-watt stereo receiver is one of Lafayette's finest with its distinctive styling and advanced solid state circuitry, truly a thing of beauty with top-notch stereo performance. The large tuning panel is black when the power is off, thus blending harmoniously even with the most luxurious decors. When the power is turned on, the tuning meter, FM Stereo Indicator and AM and FM dials light up and are revealed with the utmost clarity, thus enhancing the attractive appearance of the LR-775 and that of the room in which it performs. Another styling innovation is the aluminum and black knobs which contrast nicely with the gold anodized brushed aluminum panel trim. The LR-775's sensitive FM Stereo circuitry will receive even the weakest signals while maintaining excellent fidelity and freedom from distortion. The AM tuner section offers very good selectivity plus a built-in, flexible-mount ferrite loopstick

antenna for optimum sensitivity. A meticulously designed amplifier section gives faithful reproduction with more than adequate volume from any program source. Output transistors are fused for full overload protection. In addition to the illustrated selected features the LR-775 also has a selector switch for Aux, Phono, FM, MPX Filter, and AM; Front and Rear panel jacks for tape outputs; Rear panel stereo inputs for magnetic and ceramic phono, Aux, Tape Record, and Tape Play; and one switched plus one unswitched AC convenience outlets. Complete with built-in FM antenna and provision for external AM and FM antennas. Power requirements: 105-120 VAC, 50/60 Hz. Size: 14 $\frac{1}{2}$ Wx4Hx10 $\frac{1}{4}$ "D. Imported. Shpg. wt., 16 $\frac{1}{2}$ lbs. \dagger New rating used by major audio mfrs.

99 E 02156WX No Money Down* Net 199.95

SPECIFICATIONS

TUNER, FM: 4-Gang Tuning Condenser; 88-108 MHz; IHF Sensitivity: 1.7 μ V; S/N Ratio: 75db (100% Mod); Distortion: 0.25% (at 400 Hz 100% Mod.); Capture Ratio: 1.5db; Stereo MPX Separation: 40db (400 Hz); Cross Modulation Index: 90db. Image Rejection: 80db. **TUNER, AM:** 3-Gang Condenser; 535-1650 kHz; IHF External Antenna Sensitivity: 20 μ V; Image Rejection: 55db.

AMPLIFIER: Power Output: 100 watts ± 1 db \dagger , 80 watts IHF; Frequency Response: 20-20,000 Hz ± 1 db; Power Bandwidth: 15-30,000 Hz; Harmonic Distortion: Less than 1% at rated output, 0.07% at 1 watt; Hum and Noise: Aux. -75db, Phono (mag) -63db; Input Sensitivity: Phono (mag) 2.3 mv, (ceramic) 80 mv, Aux. 250 mv, Tape Monitor 500 mv; Output Impedance: 4-16 ohm speaker (main and remote), Headphone jack impedance: 8 ohms.

Amazing Performance plus Space-Age Styling of Distinction!

FULL 2 YR. GUARANTEE \ddagger

4



- + 4 FET's
- + 25 Diodes
- + 24 Transistors
- + 2 Thermistors



Illuminated Tuning Meter for accurate tuning of FM and AM stations.

Automatic FM Stereo Automatically switches to stereo mode and lights indicator when you tune to a stereo station.



SPEAKER MODE Switches sound to main or remote speakers separately or to both sets simultaneously, plus a headphone only position for private listening.

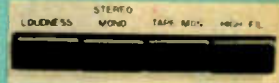

Pushbutton Function Switches for activation of Loudness, Stereo or Monaural, Tape Monitor, or High Filter functions.



FULL 2 YR.
GUARANTEE †



Field Effect Transistors
High Performance FET RF Amplifier and Mixer in FM "front end" provide high overload capability, excellent cross-modulation index and image rejection.



Illuminated Tuning Meter for accurate tuning of FM and AM stations.



Speaker Mode Switch
Switches sound to main or remote speakers separately, or to both sets simultaneously, plus a head phone only position for private listening.



Automatic FM Stereo Switching... receiver automatically switches to stereo mode and lights indicator when you tune to a stereo station.

Lafayette 75-Watt Solid State AM/FM Stereo Receiver

LR-500TA
179⁹⁵
with Case
No Money Down*

INTEGRATED CIRCUIT
4 IC's +29 Transistors
+2 FET's +17 Diodes

ACCLAIMED
By The
CRITICS

"...A unit with excellent tuner characteristics... I suspect that Lafayette will have a great many satisfied customers."

"MODERN HI-FI & STEREO GUIDE"

- With New Revolutionary IC's for Outstanding Performance
- 75-Watts± Of Flawless Stereo Output Power
- Automatic FM Stereo Switching and Indicator Light
- Illuminated Tuning Meter for Accurate FM/AM Tuning

- Fused Output Transistors—Protects Transistors Against Shorts or Overloads
- Exclusive Front and Rear Panel Tape Output Jacks
- Speaker Mode Switch Activates Main and/or Remote Speakers
- Front Panel Stereo Phone Jack

The LR-500TA incorporates 4 revolutionary Integrated Circuits and 2 high-performance Field-Effect Transistors to provide magnificent FM Stereo reception. Advanced solid-state engineering of its AM broadcast stages lets you hear your favorite AM stations with maximum possible fidelity. There are built-in AM and FM antennas for local stations, plus provision for an external antenna for those distant, hard-to-get stations. AM antenna has flexible swivel mounting for optimum reception. 4 rugged, silicon output transistors delivering 75 watts of stereo music power with full-fidelity assure you of stunning audio realism. Unit incorporates every needed control for complete flexibility of operation, plus a full range of stereo inputs including ceramic and magnetic phono to accommodate virtually any

external program source. You get outputs for stereo tape recording (both front and rear of unit for convenience), provision for 4, 8, and 16 ohm main and remote speakers, plus a Stereo headphone receptacle. There's a handsome, brushed gold anodized extruded aluminum front panel with matching knobs and, at no extra cost, you get a vinyl clad, heavy gauge metal enclosure with the simulated look of rich walnut wood-grain. Imported. 15W x 12D x 5"H. For 117 VAC, 50/60 Hz. Shpg. wt., 27 lbs.
†Rating standard used by major audio hi-fidelity manufacturers.
99 E 01943WX Net **179.95**
Optional Attractive Oiled Walnut Cabinet for LR-500TA
21 E 01566WX Shpg. wt., 6 lbs. Net **19.95**

SPECIFICATIONS

TUNER SECTION: 4 Gang Tuning Condenser. Tuning Range: FM 88-108 MHz, AM 535-1605 kHz. FM-IHF Sensitivity: 1.8 µv. S/N Ratio 67 db. Distortion: 0.5% at 100% Mod. Spurious Response Rejection: 95 db. Capture Ratio: 1.5 db. Stereo MPX. Separation: 35 db at 400 Hz. Cross Modulation Index: 90 db. AM SECTION: 3 Gang Tuning Condenser. IHF External Antenna Sensitivity: 20 µv.

AMPLIFIER SECTION: Power Output: † 75 watts ±1db: 60 watts IHF. Frequency Response: 22-20,000 Hz ±1 db. Power Bandwidth: 22-40,000 Hz. Harmonic Distortion: Less than 1% at full output: 0.3% at 1 watt. Hum and Noise: Auxiliary —72 db; Phono 55 db. Output Impedance: 4-16 ohm speaker (main and remote) 8 ohm headphone.

* See Page 11 for Full Credit Details on Easy Pay Plan

† See Page 435 For AAA Guarantee Details

NEW! A SUPERB AM/FM HI-FI STEREO TUNER ... plus Space-Age Styling of Distinction!

FULL 2 YR.
GUARANTEE †

Only
99⁹⁵
No Money Down*

- 1.7 μ v IHF Sensitivity • Front Panel Tape Output Jack
- Illuminated Signal-Strength Tuning Meter For Normal and Center Scale Tuning
- Automatic Stereo Switching and Stereo Indicator Light
- Internal FM Antenna plus Flexible Mount AM Loopstick Antenna
- Beautifully Styled Dial That Illuminates with "Power-On"
- 40db Stereo Separation

Lafayette SOLID-STATE AM/FM STEREO TUNER



4 IC's, 2 FET's, 18 Transistors, 21 Diodes



LT-725

The new Lafayette LT-725 establishes pace-setting standards for excellent performance, flexibility of controls, ease of operation, and distinctive styling will compliment any home decor. Yet with all this, it is priced within the budget of the music lover who seeks superior performance at a moderate cost. In addition to high performance design, the LT-725 boasts an ultra-modern exterior with space-age styling. Striking of these is the elegant ebony face-plate with gold accents. Equally impressive when the unit is "On", the logging scale, tuning meter and stereo indicator are illuminated into a soft, rich blend from behind the face-plate. The front panel also features a row of push-buttons for the functions of Stereo/Mono mode, MPX Filter, FM/AM reception, and tuning meter for center channel tuning and signal strength indication. There are tape output jacks at the rear and front panels; and rear inputs for external FM and AM antennas. Complete with built-in FM and AM antennas, AC fuse holder and grounding post. Output suitable for any quality stereo amplifier. Size: 12W x 3 3/4" H x 9 1/4" D. Imported. Shpg. wt., 10 lbs. 99 E 02184WX Net 99.95

SPECIFICATIONS

FM SECTION: 4 Gang Tuning Condenser. Range: 88-108MHz. Sensitivity: 1.7 μ v. Harmonic Distortion: @ 400 Hz, 100% modulation: 0.25%. Selectivity: 50db. Capture Ratio: 1.5db. Stereo Separation: 40db @ 400Hz. Cross Modulation Index: 90db. Signal-to-Noise Ratio: 75db (100% Mod.) Image Rejection: 80db. External Antenna Impedance: 300 ohms balanced. AM SECTION: 3 Gang Tuning Condenser; Range: 535-1650 kHz. Sensitivity (Antenna Terminal): 20 μ v.

LAFAYETTE deluxe Solid State AM/FM Stereo Tuner

FULL 2 YR. GUARANTEE †

Tune more stations than you ever thought possible before! Unprecedented clear reproduction of weak as well as strong stations with least outside noise interference! 2 FET's used in the separately shielded front and section provide a high degree of overload capability, minimum cross-modulation, and stronger image rejection. 4 IC's are used in the IF amplifier section for hard limiting, excellent temperature stability, and increased reliability. Front panel controls include: Tape output jack; AM/FM selector switch; meter function selector switch; Muting control; Filter In/Out; Mono/Stereo Mode switch; Power Off/On; and Tuning control. The LT-426T, with its handsome brushed aluminum gold anodized extruded front panel, and simulated walnut wood grain case, enhances any room decor. Size: 13 x 3 3/4" x 9 1/2". For 110V., 50/60 Hz AC. Imported. Shpg. wt., 16 lbs. 99 E 01844WX

Net 119.95

4 IC'S
PLUS 2 FET'S,
17 TRANSISTORS,
16 DIODES

119⁹⁵
with
Case
No Money Down*

SPECIFICATIONS. FM SECTION: 4 Gang Tuning Condenser. FM Sensitivity, IHF: 1.6 μ v. Harmonic Distortion @ 100% Modulation: 0.4%. Image Response: 85db. Selectivity: 40db; Capture Ratio: 1.5db; MPX Channel Separation: 38db at 400 Hz. Cross Modulation Index: 90 db. External Antenna Impedance: 300 ohms (balanced). AM SECTION: 3 Gang Tuning Condenser.

9 Lafayette Cat. No. 700

* See Page 11 for Full Credit Details on Easy Pay Plan



LT-425T

- Front Panel Zero Center Meter For Accurate Tuning of Stations
- Fully Automatic Stereo Indication
- Muting Control For Quiet Tuning Between Stations
- Static Noise Filter • Built-In AM/FM Antennas
- Front and Rear Tape Output Jacks

† See Page 435 For AAA Guarantee Details



LA-750

NEW

Engineered for
Years of
**DEPENDABLE
PERFORMANCE**

Lafayette

**80-WATT
SOLID STATE
STEREO
AMPLIFIER**

SPACE-AGE STYLING OF DISTINCTION!

- IHF Music Power: 80 Watts
- Fused Output Transistors
- Front and Rear Tape Output Jacks
- Front Panel Stereo Headphone Jack
- High Filter for Elimination of High Frequency Noises
- One Switched Plus One Unswitched AC Convenience Outlets

**2 FET'S — 6 DIODES —
16 TRANSISTORS —
2 THERMISTORS**

New, distinctive styling and performance is the accent with the Lafayette LA-750 stereo amplifier. Black front panel contrasting with gold lettering, aluminum and black knobs surrounded by a brushed gold anodized aluminum trim make this unit stand out and complement most any decor. Features outstanding versatility for even the largest of living rooms as well as for a den or bedroom with maximum fidelity and true stereo reproduction. All solid state for the utmost in dependable service with such advanced features as push on/push off switches for main power, loudness, stereo/mono, tape monitor, and high filter . . . plus all the additional controls found on much more expensive units: separate bass, treble, and volume/balance controls for adjusting the amplifier to suit individual tastes. Speaker Mode switch selects main, main plus remote, remote speakers, or

stereo headphones. Permits maximum enjoyment of selected HI-Fi programs in any predetermined location in your home. The headphone jack on the front panel has audio power at all times but with the Speaker Mode switch in the "Phones" position, only the headphones receive power offering truly private listening. Convenient tape output jacks on front and rear panels. Rear panel includes stereo inputs for Aux, Tuner, Phono, Tape Play, and Tape Record; Fused right and left channels for protection against shorts and overloads; Remote and main speaker outputs for stereo sound anywhere in your home without extra amplifiers or switches; 1 switched and 1 unswitched AC outlet; AC power fuse. Power requirements: 105-120 VAC, 50/60 Hz. Dimensions: 12Wx9 1/4Dx3 3/4"H. Imported.
99 E 02149WX Shpg. wt., 12 lbs. Net 79.95

SPECIFICATIONS

Power Output: 80 Watts IHF Music Power; **Frequency Response:** 20-20,000 Hz ±1 db; **Power Bandwidth:** 15-30,000 Hz; **Harmonic Distortion:** less than 1% at rated output, 0.07% at 1 Watt; **Channel Separation:** 65 db at 1 kHz; **Hum and**

Noise: Aux and Tuner —75 db, Phono(Mag) —63 db; **Input Sensitivity:** Aux 250 mv, Phono(Mag) 2.3 mv, Phono(Cer) 80 mv, Tuner and Tape Monitor 500 mv; **Output Impedance:** 4 Ω, or 16 ohm speakers, 8 ohm headphones.

only **79⁹⁵** **2 FULL YRS.**
No Money Down* **GUARANTEE†**

* See Page 11 for Full Credit Details on Easy Pay Plan

† See Page 435 for AAA Guarantee Detail

OPEN AN EASY-PAY CREDIT ACCOUNT TODAY

EXTENDED PLAN

**TAKE UP TO
2 Years
To Pay**

2 EASY PAY CREDIT PLANS

TO SUIT YOUR INDIVIDUAL NEEDS

STANDARD PLAN

**TAKE UP TO
16 Months
To Pay**

Pay balance in 30 days and save the entire FINANCE CHARGE.

NO MONEY DOWN

- It's easy to open a credit account. Simply fill in application on back of order blank when you send your order.
- Add-on any time you like. No money down and usually at no increase in monthly payment.

EASY PAY PAYMENT SCHEDULE

\$250.01 to \$500.00		STANDARD PLAN		EXTENDED PLAN	
If Unpaid Balance (Amount Financed) Is From	To	Add for FINANCE CHARGE	Monthly Payment Is	Add for FINANCE CHARGE	Monthly Payment Is
\$490.01	\$500.00	\$64.75	\$35.00	\$98.00	\$25.00
480.01	490.00	63.50	34.50	96.00	24.50
470.01	480.00	62.25	33.50	94.00	24.00
460.01	470.00	61.00	33.00	92.00	23.50
450.01	460.00	59.50	32.50	90.00	23.00
440.01	450.00	58.25	31.50	88.00	22.50
430.01	440.00	57.00	31.00	86.00	22.00
420.01	430.00	55.75	30.00	84.00	21.50
410.01	420.00	54.25	29.50	82.00	21.00
400.01	410.00	53.00	29.00	80.00	20.50
390.01	400.00	51.75	28.00	78.00	20.00
380.01	390.00	50.50	27.50	76.00	19.50
370.01	380.00	49.00	26.50	74.00	19.00
360.01	370.00	47.75	26.00	72.00	18.50
350.01	360.00	46.50	25.00	70.00	18.00
340.01	350.00	45.25	24.50	68.00	17.50
330.01	340.00	43.75	24.00	66.00	17.00
320.01	330.00	42.50	23.00	64.00	16.50
310.01	320.00	41.25	22.50	62.00	16.00
300.01	310.00	40.00	22.00	60.00	15.50
290.01	300.00	38.50	21.00	58.00	14.50
280.01	290.00	37.25	20.00	56.00	14.00
270.01	280.00	36.00	19.50	54.00	13.50
260.01	270.00	34.50	19.00	52.00	13.00
250.01	260.00	33.25	18.00	50.00	12.50

\$100.01 to \$250.00		STANDARD PLAN		EXTENDED PLAN	
If Unpaid Balance (Amount Financed) Is From	To	Add for FINANCE CHARGE	Monthly Payment Is	Add for FINANCE CHARGE	Monthly Payment Is
\$240.01	\$250.00	\$32.00	\$17.50	\$48.00	\$12.00
230.01	240.00	30.50	17.00	46.00	11.50
220.01	230.00	29.25	16.00	44.00	11.00
210.01	220.00	28.00	15.50	42.00	10.50
200.01	210.00	26.50	15.00	40.00	10.00
195.01	200.00	25.75	14.50	39.00	9.75
190.01	195.00	25.25	14.00	38.00	9.50
185.01	190.00	24.50	13.75	37.00	9.25
180.01	185.00	23.75	13.50	36.00	9.00
175.01	180.00	23.25	13.00	35.00	8.75
170.01	175.00	22.50	12.50	34.00	8.50
165.01	170.00	22.00	12.00	33.00	8.25
160.01	165.00	21.25	11.50	32.00	8.00
155.01	160.00	20.50	11.00	31.00	7.75
150.01	155.00	20.00	10.75	30.00	7.50
145.01	150.00	19.25	10.50	29.00	7.25
140.01	145.00	18.50	10.50	28.00	7.00
135.01	140.00	16.75	10.50	27.00	6.75
130.01	135.00	16.25	10.25	26.00	6.50
125.01	130.00	14.50	10.25	24.00	6.50
120.01	125.00	14.00	10.00	23.00	6.25
115.01	120.00	12.50	10.00	21.00	6.25
110.01	115.00	12.00	10.00	20.00	6.00
105.01	110.00	10.50	10.00	18.35	6.00
100.01	105.00	9.25	10.00	17.50	5.75

The ANNUAL PERCENTAGE RATE of each FINANCE CHARGE set forth in the above tables is 17.75%. The number of payments will be the Total of Payments (Amount Financed plus the FINANCE CHARGE) divided by the amount of one monthly payment.

\$50.01 to \$100.00		STANDARD PLAN			EXTENDED PLAN		
If Unpaid Balance (Amount Financed) Is From	To	Add for FINANCE CHARGE	Monthly Payment Is	ANNUAL PERCENTAGE RATE	Add for FINANCE CHARGE	Monthly Payment Is	ANNUAL PERCENTAGE RATE
\$95.01	\$100.00	\$9.25	\$10.00	18.50%	\$15.65	\$5.50	17.50%
90.01	95.00	9.25	9.75	19.50	14.85	5.50	17.50
85.01	90.00	9.25	9.50	22.50	13.45	5.25	17.75
80.01	85.00	9.25	9.25	23.75	12.00	5.25	17.75
75.01	80.00	9.00	9.00	24.50	10.70	5.00	17.75
70.01	75.00	8.40	8.00	24.50	10.00	5.00	18.75
65.01	70.00	7.80	7.50	24.50	10.00	5.00	21.25
60.01	65.00	7.20	7.00	24.50	10.00	5.00	24.50
55.01	60.00	6.65	6.50	24.50	8.55	5.00	24.50
50.01	55.00	6.10	6.00	24.50	7.25	5.00	24.50

Up to \$50.00		STANDARD PLAN	
If Unpaid Balance (Amount Financed) Is From	To	Add for FINANCE CHARGE	Monthly Payment Is
\$40.01	\$50.00	\$5.00	\$5.00
30.01	40.00	4.00	5.00
20.01	30.00	3.00	5.00
10.00	20.00	2.00	5.00

OVER \$500.00. Please write for terms for amounts to be financed over \$500.00.

Number of payments will be Total of Payments (Amount Financed plus the FINANCE CHARGE) divided by the amount of one monthly payment.

MAIL ORDER and Sales Center

All Departments 516 921-7700
Open Mon., Thurs., Fri. 'til 9:30 P.M.

111 Jericho Turnpike
(west of So. Oyster Bay Rd.)
Syosset, L. I., N. Y. 11791

C.O.D. Orders Only 516 921-7500
Open Mon., Thurs., Fri. 'til 9:30 P.M.

Our modern Mail Order Headquarters, located on over 8 acres of land, includes expanded warehouse facilities plus the most modern handling equipment to give you quicker service. Within 24 hours after receipt, most orders are processed, picked, wrapped and shipped.

30 Convenient Locations

Visit the Lafayette Store nearest you for fast personalized service. See the catalog "come to life" and many other exciting displays of the latest products just released. Associate Stores From Coast To Coast. Watch for New Grand Openings.

NEW YORK

BROOKLYN 11226
2265 Bedford Ave.
(cor. Snyder Ave.)
Phone: 212 469-8900
Open Mon., Thurs., Fri. 'til 9:30 PM

BUFFALO (Amherst) 14226
Sheridan Shopping Center
(3600 Sheridan Dr.)
Open Mon., Thurs., Fri. 'til 9:00 PM

JAMAICA 11433
165-08 Liberty Ave.
(Off Merrick Rd.)
Phone: 212 291-7000
Open Mon., Thurs., Fri. 'til 8:45 PM

LAKE GROVE 11755
2848 Middle Country Rd.
(Rt. 25—1/4 mile E. of Smithhaven Mall)
Phone: 516 585-3600
Open Mon.-Fri. 'til 9:30 PM

LYNBROOK, L. I., N. Y. 11563
381 Sunrise Highway
(2 miles East of Green Acres)
Phone: 516 887-9800
Open Mon., Thurs., Fri. 'til 9:30 PM

NEW ROCHELLE 10801
218 North Ave.
(opp. Macy's Mall)
Phone: 914 235-5101
Open Mon., Thurs., Fri. 'til 9:00 PM

N.Y.C. - 45th STREET 10036
71 West 45 St.
(between 5th-6th Aves.)
Phone: 212 757-3121
Open Thurs. 'til 9:00 PM

N.Y.C. - UNION SQUARE 10003
17 Union Square West
(corner 15th St.)
Phone: 212 924-4433
Open Thurs., Fri. 'til 7:00 PM

N.Y.C. - WARREN ST. 10007
45 Warren Street
(between Church and W. Broadway)
Phone: 212 964-0334
Open Daily 9 AM - 6 PM
Sat. 9 AM to 5 PM

ROCHESTER-IRONDEQUOI 14621
999 Ridge Road East
(Adjoining Arlan's)
Phone: (716) 467-1310
Open Mon.-Fri. 10 AM to 9 PM
Sat. 9:30 AM to 6 PM

ROCHESTER - PITTSFORD 14618
3330 Monroe Ave.
(Adjoining Arlan's)
Phone: (716) 586-6331
Open Mon.-Fri. 10 AM to 9 PM
Sat. 9:30 AM to 6 PM

SCARSDALE 10583
691 Central Ave.
(1/2 mile north of Ardsley Rd.)
Phone: 914 472-2700
Open Daily 9:30 AM - 9:30 PM
Sat. 9 AM to 5:30 PM

MASSACHUSETTS

BOSTON 02215
584 Commonwealth Ave.
(1/2 block above Kenmore Sq.)
Phone: 617 267-8900
Open Daily 9:30 AM - 9:00 PM
Sat. 9 AM to 6 PM

NATICK 01760
1400 Worcester St.
(Rt. 9 opp. Shopper's World)
Phone: 617 875-6146
Open Mon., Wed., Thurs.,
Fri. 'til 9:30 PM

SAUGUS 01906
Saugus Plaza Shopping Center
(Rt. 1 & Walnut St.)
Phone: 617 233-6710
Open Daily 9:30 AM - 9:00 PM
Sat. 9 AM to 6 PM

CONNECTICUT

HAMDEN 06514
Hamden Plaza
(2100 Dixwell Ave., adjoining Pegnatoro's)
Phone: 203 248-2182
Open Daily 10 AM - 9 PM
Sat. 9 AM to 6 PM

WEST HARTFORD 06117
Bishop's Corner Shopping Center
(357 North Main St. cor. Albany Ave.)
Phone: 203 236-0693
Open Mon., Thurs., Fri. 'til 9:30 PM

MARYLAND

TOWSON
815 Taylor Avenue
(Loch Raven Plaza)
Phone: 301 825-7750
Open Mon., Thurs., Fri. 'til 9:00 PM

PENNSYLVANIA

KING OF PRUSSIA 19406
King of Prussia Shopping Center
(Routes 202 and 23)
Phone: 215 265-3300
Open Mon. through Sat. 10 AM - 10 PM

LANCASTER 17603
2152 Lincoln Plaza
Phone: 717 397-3681
(Adjoining Two Guys)
Open Daily 10 AM - 9 PM
Sat. 10 AM - 6 PM

MONROEVILLE 15146
Monroe Plaza Shopping Center
4045 William Penn Highway
Phone: 412 373-0060
Open Mon. through Sat. 10 AM - 9 PM

PHILADELPHIA 19095
Wyncote (Cheltenham Township)
8156 Ogontz Ave.
Phone: 215 885-2140
Open Daily 10 AM - 9:30 PM
Sat. 9 AM to 6 PM

PITTSBURGH 15237
North Hills Village Shopping Ctr.
4801 McKnight Road
Phone: 412 366-0810
Open Daily 10 AM - 9 PM
Sat. 9 AM to 9 PM

NEW JERSEY

NEWARK 07102
24 Central Ave.
(west of Broad St.)
Phone: 201 622-1661
Open Wed. 'til 8:45 PM

PARAMUS 07652
182 Route 17
(1 mile north of Garden State Plaza)
Phone: 201 261-8800
Open Daily 9:30 AM - 9:30 PM
Sat. 9 AM to 5:30 PM

PLAINFIELD 07060
139 W. 2nd St.
(1 block east of Front St.)
Phone: 201 756-5100
Open Mon., Thurs. 'til 8:45 PM

TOTOWA

Opening Fall 1969

VIRGINIA

FALLS CHURCH 22044
Plaza 7 Shopping Center
(cor. Wilson & Roosevelt Blvd.)
(across from 7 corners)
Phone: 703 534-5772
Open Mon., Thurs., Fri. 'til 9:30 PM

MT. RAINIER/HYATTSVILLE 20822
3191 Queens Chapel Rd. (Rt. 500)
(Queenstown Shopping Center)
Phone: 301 779-7020
Open Mon., Thurs., Fri. 'til 9:30 PM

YOU CAN DEPEND ON

Lafayette[®]

TO MAKE YOUR SHOPPING EASIER THAN EVER

3 CONVENIENT WAYS TO SHOP

by mail

Shop in the comfort of your home at any time no matter where you live. Simply fill in order blank and mail. See page 436 for helpful ordering information.

by phone

Enjoy the extra convenience of shopping by phone. Simply dial 516-921-7500. Just give your C.O.D. order to our personal service shopper and your shopping is done, quickly and easily.

in person

Visit any of our large, modern, conveniently located stores listed on page 12. Select from a wide assortment of catalog and special merchandise.

Widest selection of the finest hi-fi, stereo, components, systems, C.B., and radio electronic equipment is at your fingertips in this catalog, along with tape-recorders, musical instruments, accessories, and useful items of all kinds.

Outstanding quality is the hallmark of all Lafayette products. Exact-ing specifications, through inspection and double checking are your assurances of the best merchandise for the price.

To serve you better, automated order filling system with the latest in mail order processing means most orders are shipped within 24 hours.

Guarantees: See page 435 for Lafayette's liberal guarantees.

Low prices are assured by Lafayette's huge buying power combined with minimum overhead and operating costs. We try to price every item in this catalog to be as low or lower than the same merchandise in any other mail order catalog. We will meet any price you find lower than ours.

QUICK INDEX (Complete Index p. 431-434)

Amateur Gear	454-465	Marine Equipment	450, 451
Amplifiers, HI-FI	10, 15-18	Microphones and Accessories	150-160
Amplifiers, Musical	200, 201	Microscopes and Accessories	437-442
Amplifiers, PA	140-145, 199	Musical Instruments	192-205
Antennas		Phonographs	78-91
Amateur, CB	464, 465, 470-475	Picture Tubes	266, 267
FM TV	376-383, 385, 386	Police/Fire Receivers	444-449, 495
Auto Accessories	364-375	Radios	179-191
Auto Radios	174-178	Radio Control Equipment	209-211
Batteries, Chargers	268-270, 364	Receivers, HI-FI	2-8, 30, 31, 33, 34, 496
Books	399-407	Receivers, Short-Wave	452, 453, 457
Cabinetry	66, 67	Resistors	275, 276, 285
Cameras & Accessories	416-426	Semiconductors	271-274
Capacitors	294-299	Soldering Equipment	331-335
Cartridges and Hi-Fi phono Accessories	126-135	Speakers & Speaker Systems	42-65
CB Equipment	468-495	Tape Recorders & Accessories	83-105
Connectors, Sockets, etc.	278-284	Telephones	164-167
Controls, Switches	290-293	Telescopes, Binoculars	337, 341, 342
Drafting Supplies	408-410	Television Receivers	168-170
Electrical Accessories	329	TV Accessories	376-398
Experimenters Specialties	216-223	Test Equipment	224-246
Headphones	123-125	Tools and Accessories	331-362
High Fidelity Systems	19-29	Transformers, Coils	286-289, 300-302
HOW TO ORDER	436	Tubes	260-267
Intercoms	161-166	Tuners, HI-FI	9, 40
Lamps, Lighting	324, 325	Walkie-Talkies	479-485
		Watches and Clocks	412-414
		Wire, Cable	308-312

**WOULD YOU LIKE TO OWN A
LAFAYETTE ASSOCIATE STORE?**

(See Insert Card next to Page 78)

MAKE LAFAYETTE YOUR ONE DEPENDABLE SOURCE FOR EVERYTHING IN ELECTRONICS

COMMERCIAL SALES DEPT.

The Commercial Sales Dept. services state, county and municipal purchasing offices; educational and medical facilities; Police, Fire and Civil Defense departments; churches, civic and social organizations; as well as commercial organizations whose activities are primarily outside the electronics industry. A special staff is prepared to give advice, quotations and prompt service.

For Personalized Service, Phone or Write:

Lafayette Commercial Sales Dept.
P.O. Box 260 Syosset, L.I., N. Y. 11791
(516) 921-7700

INDUSTRIAL ELECTRONICS DIVISIONS

Lafayette's Industrial Electronics Divisions, your "One Stop Electronics Source," will service all your industrial needs. Choose from a complete inventory at lowest factory prices. OEM quantity discount prices on request. In addition to the material in this catalog, Lafayette's Industrial Divisions carry a wide inventory of the following lines and brands.

IC's and Semiconductors

- Texas Instrument • RCA
 - Dickson • Amelco • G.I.
 - Continental Devices • TRN/IRC
 - Silicon Trans • Many others
- Special to Semiconductor Buyers—
Lafayette supplies from stock JAN-TX, SIN, JAN, USN, USAF and USA type transistors and diodes.

HEAT SINKS

- Thermalloy

Rheostats, Pots, Controls

- Ohmite • Dale

Tubes

- RCA • G.E.

Tantalum Capacitors

- Dickson • Sprague • Mallory

Voltage Regulators

- General Radio Variacs®

Relays

- Potter And Brumfield

Transformers

- UTC • Chicago-Stancor

Switches

- Mallory

Sensing Resistors

- Texas Instruments

Industrial, Institutional and Federal Agency Buyers
Write or Phone for complete Personalized Service

NEW YORK AREA

165-08 Liberty Avenue
Jamaica, N.Y. 11433
N.Y. Phone: (212) 658-5050
N.J. Phone: (201) 643-6868

NEW ENGLAND

1400 Worcester Street
Natick, Mass. 01760
Phone: (617) 875-1358

Consult phone book in major cities for Enterprise Phone No.

INTERNATIONAL SALES DIVISION

Specializes in export shipment for quantity industrial and dealer orders as well as single item purchases throughout the world. An expert knowledge of shipping and routing gives you the fastest and most dependable service.

WRITE TO: Lafayette Radio Electronics Corporation
International Sales Division
P.O. Box P
Syosset, L.I., N.Y., U.S.A.

Export Terms

Full payment must accompany your order. Enclose check or draft; or remit international Postal Money Order or confirmed, irrevocable Letter of Credit. All payments should be in U.S. Dollars payable at U.S. Bank. Foreign currencies will be accepted at prevailing exchange rate when converted. Include 20% above merchandise value to cover international postage, insurance, consular fees and other export shipping and handling costs. Slightly more should be allowed for heavy items and ocean or air freight shipments. These charges cannot be accurately predetermined—overpayments are promptly refunded.

We reserve the right to route order by the best method where order does not indicate routing or when method suggested is impractical or not possible. All prices F.O.B. our warehouses and subject to change without notice. Enclose Import License and/or Consular Declaration where so required by your government.



Model LA-125TA

NEW

160 Watt Solid State Stereo Amplifier

Enjoy the Richness of Superb Stereophonic Sound!

COMPUTOR-MATIC™ (Pat. Pend.)
 Protective Circuitry For Audio Power Stages

- 160 Watts (± 1 db) of Stereo Music Power
- High Gain Plus Low Gain Magnetic Phono Inputs
- High Gain Plus Low Gain Tuner Inputs
- Low and High Frequency Filters
- Simulated Walnut Wood Grain Case
- Brushed Aluminum, Gold Anodized Extruded Front Panel
- Tape Output Jacks, Front and Rear

20 Transistors, 4 Diodes

Only **129⁹⁵** with case
 No Money Down*

Full 2-Yr.

Guarantee:

Deluxe Lafayette solid state 160 watt single chassis pre-amplifier and amplifier. Its desirable 13" x 3 3/8" x 9 1/4" size and cool transistorized circuitry make it ideal for any location in your home. Produces a full 160 watts of audio power from 20-20,000 Hz with virtually no faltering at either end of the response range. The circuitry incorporated within the LA-125TA provide years of trouble free operation. Concentric Balance/Volume, Treble, and Bass Controls provide easy adjustment on both channels. Four "rocker" type switches are provided for Low Filter, High Filter, Loudness for tonal balance at low volume levels, and Tape Monitor for monitoring tape while recording and playing tape back through amplifier. Important front panel features are: quality multi-position rotary switches for Speaker Mode, Amplifier Mode, and Program Source Selector. Front panel also

has provisions for Stereo Headphones, Tape Output, and Microphone or Musical input. The rear panel provides you with 12 inputs (6 inputs per channel), and stereo output for tape recording through amplifier. The stereo inputs include: Magnetic (High, Low); Ceramic phono cartridge; Tuner (High, Low); Auxiliary; and Tape Input for connection of a tape deck that has its own preamplifier. Left and Right speaker connections permit the use of 4, 8, or 16 ohm speakers. Special remote speaker terminals are provided for remote placement of speakers anywhere in your home. Includes Computer-Matic protective circuitry for protection against burnout of audio driver transistor and audio output transistors. 2 AC convenience outlets (1 switched) on rear panel. For 117 volts AC, 50/60 Hz. Shpg. wt., 19 lbs. 99 E 02073WX Net 129.95

*See page 435 for AAA guarantee details.

Monitor switch for tape playback and recording

Speaker mode switch switches sound to main or remote speakers separately, or to both sets of speakers simultaneously; plus headphone only position for private listening.

Front panel stereo headphone jack.

Microphone/Musical Jack conveniently located on front panel



SPECIFICATIONS

Power Output: 160 Watts ± 1 db., 125 Watts IHF.
 Frequency Response: 22-20,000 Hz ± 1 db. at 1 watt.
 Power Bandwidth: 20-40,000 Hz.
 Harmonic Distortion: at 1 kHz., less than 1% at rated power; .2% at 1 watt.
 Channel Separation: 65 db. at 1 kHz.
 Hum and Noise: Aux. and tuner —75 db, phono, and microphone —56 db.
 Input Sensitivity: aux. and tuner, 270 mv; phono (cer), 80 mv; phono (mag), H, 2.2 mv; L, 7 mv; Mic/Guitar, 6 mv.
 Low Frequency Filter: —17 db at 20 Hz.
 High Frequency Filter: —10 db. at 10 kHz.
 Loudness Switch: +11 db at 50 Hz; +3.5 db at 10 kHz.
 Tone Controls: 25 db at 50 Hz., 23 db. at 10 kHz.

*See Page 11 for Full Credit Details on Easy Pay Plan

Lafayette Cat. No. 700 15



110-Watt Solid State Stereo Amplifier

Model LA-85TA

For Rich Room-Filling Hi-Fidelity Performance

Only **99⁹⁵** With Case
No Money Down*

20 Transistors + 4 Diodes

FULL 2-YEAR GUARANTEE†

- 110 Watts (± 1 db) of Stereo Power†
- Front and Rear Panel Tape Output Jacks
- High and Low Gain Phono Sensitivity Switch
- High and Low Gain Tuner Input Jacks
- Fused Output Transistors
- Simulated Walnut Wood Grain Case

Quality solid state stereo preamplifier and dual channel 110 watt amplifier on one integrated chassis. Compact 13" x 3 7/8" x 9 1/4" size and minimum of heat make for easy installation anywhere. Instant play, no waiting for warmup, and lasting trouble-free operation with an exceptionally low degree of hum and noise are characteristic of this quality transistorized amplifier. The LA-85TA also features: Selector for Ceramic and Magnetic Phono, Tuner and Auxiliary inputs; Mode switch for Right and Left Channel, Mono, Stereo, Reverse and Tape monitor; Bass and Treble Tone controls; dual concentric Volume/Balance control; rocker switches for Main and Remote speakers, Loudness, High Filter, and Power. Convenient front panel jacks for Stereo Headphone and Tape Output completes these sterling front panel features. In addition to 2-AC convenience outlets (1 switched), the rear panel of the LA-85TA also has jacks for High and Low Tuner inputs, for Magnetic and Ceramic Phono inputs, for Auxiliary Inputs, for Tape Record and Play, and a high gain and low gain Phono switch. Terminals for 4, 8 and 16 ohm Main and Remote speakers are also provided. This outstanding amplifier is attractively styled with a gold anodized extruded aluminum front panel with simulated walnut wood grained case. For 117VAC, 50/60 Hz, imported. Shpg. wt., 17 lbs. †New rating standard used by major audio manufacturers.

99 E 02065WX Net 99.95

SPECIFICATIONS
Power Output: 110 Watts ± 1 db; 85 Watts IHF
Frequency Response: 22-20,000 Hz ± 1 db.
Harmonic Distortion: less than 1% at rated output; .2% at 1 watt at 1 kHz.
Channel Separation: 65 db at 1 kHz.
Hum and Noise: Phono —57 db; Aux and Tuner —75 db.
Input Sensitivity: Aux and Tuner 270 mV; Phono less than 2.5 mV.
High Frequency Filter: —10 db at 10 kHz.
Tone Controls: 25 db range at 50 Hz; 24 db at 10 kHz.
Loudness Control: +11 db at 50 Hz; +3.5 db at 10 kHz.

* See Page 11 for Full Credit Details on Easy Pay Plan



Front Panel stereo headphone jack.

Separate Main and Remote Speaker Switches

High Filter for elimination of high frequency noises.

Front and Rear Tape Output Jacks.

Selector for Ceramic and Magnetic Phono, Tuner or Auxiliary Input

†See Page 435 for AAA Guarantee Details.

NEW

Successor to the Popular LA-224T
with **MORE POWER.....** *styled for distinction*



LAFAYETTE 50-Watt Solid State Stereo Amplifier

18 Transistors, 4 Diodes, 2 Thermistors

Only

59⁹⁵ Full 2 Yr.

Guarantee†

No Money Down*

† See page 435 for AAA Guarantee.

- 50 Watts ± 1 db, 40 Watts IHF Stereo Music Power
- Frequency Response: 20-20,000 Hz ± 1.5 db
- Front Panel Stereo Headphone Jack
- 2 AC Convenience Outlets, 1 switched
- Beautifully Styled Front Panel
- Attractive Simulated Walnut Vinyl-Clad Metal Case

SPECIFICATIONS

Power Output: 50-Watts ± 1 db, 40-Watts IHF
Frequency Response: 20-20,000 Hz ± 1.5 db
Harmonic Distortion: 0.7% at 1 kHz at 1-Watt
Channel Separation: 60 db at 1 kHz
Input Sensitivity: Aux. 250 mv, Tuner 500 mv, Phono Mag
 2.3 mv, Phono Ceramic 80 mv
Hum and Noise: Tuner —75 db, Aux —75 db, Phono Mag
 —60 db, Phono Ceramic —55 db
Power Bandwidth: 35-30,000 Hz
Speaker Impedance: 4, 8, 16-ohms
Stereo Headphones: 8-ohms

A fine Hi-Fi amplifier at an extremely low price. New distinctive styling features interesting black and aluminum knobs and switches that contrast neatly with an attractive black and brushed anodized aluminum front panel. With more than adequate power for any room in the home, the LA-324 will drive most speaker systems to maximum volume while maintaining very good frequency response and low distortion. The pleasing sound of the LA-324 will afford hours of tireless enjoyment to even the most critical listener. 18 transistors, 4 diodes and 2 thermistors are incorporated into the advanced circuitry of the LA-324 for an output of 50 watts of stereo power. The LA-324 features a front panel stereo headphone jack; fused right and left channel output transistors for protection against overloads, and full complement of front panel controls which include concentric Volume/Balance control, Treble and Bass controls, Input Selector for Aux., Tuner, Mag Phono, and Ceramic Phono. Also included are rocker switches for Mono/Stereo Mode, Remote/Main Speakers, and Power On/Off. Rear panel features stereo inputs for Aux., Tuner and Phono; 2 AC convenience outlets (1 switched, 1 unswitched); Tape Output jack; and Main and Remote Speaker terminals for 4, 8, and 16 ohm speakers. Its attractive design, only 10 $\frac{1}{2}$ "x3 $\frac{1}{2}$ "x8 $\frac{3}{4}$ "D will complement any home decor. Complete with simulated walnut vinyl-clad metal case. For 105-120 VAC, 50/60 Hz with AC power fuse. Imported. Shpg. wt., 9 lbs.

99 E 02206WX

Net 59.95

* See Page 11 for Full Credit Details on Easy Pay Plan

Functionally designed input control for switching to Auxiliary, Tuner, Magnetic or Ceramic cartridge input sources.



Speaker rocker switch permits amplifier output switching to main system speakers or to remote speakers in any desired room in your home.



2 AC convenience outlets (1 switched, 1 unswitched) in rear provide power to associated equipment.



Front panel headphone jack permits private listening to your favorite stereo programs.





LAFAYETTE

Stereo High Fidelity



Complete
Stereo
Phono System
Only
69⁹⁵
No Money Down*

Popular Budget-Priced Hi-Fi Stereo Phono System

featuring

- Lafayette Stereo/10 Solid State Stereo Amplifier
- Lafayette Model 200 4-Speed Automatic Stereo Record Changer with Balanced Feather-weight Tone Arm and Stereo Turnover Cartridge
- Oiled Walnut Base for Record Changer
- Two Lafayette Minuette® II Speaker Systems

An ideal music system for the Hi-Fi beginner or as a second system in the den, bedroom, or office. You get the following fine components: A Lafayette Stereo/10 solid state stereo amplifier designed to provide clean, smooth response. Features include separate volume controls for left/right channels and a tone control. The Lafayette Model 200 4-speed automatic record changer plays 16 $\frac{2}{3}$, 33 $\frac{1}{3}$, 45, and 78 RPM records; includes a 7", 10", or 12" record selector knob, automatic shut-off, intermix of 7, 10, and 12" records, and balanced feather-weight tone arm with stereo turnover cartridge. Deluxe oiled walnut base for record changer. Two rich sounding Lafayette Minuette/II 2-way speaker systems each containing a 5x7" woofer and 2 $\frac{1}{2}$ " tweeter mounted in a beautiful compact genuine oiled walnut wood base-reflex bookshelf enclosure. Size: 6"Wx15 $\frac{7}{8}$ "Hx9 $\frac{1}{4}$ "D. With speaker connecting cable. Imported. Shpg. wt., 33 lbs.

21 E 94405WXM Net 69.95
Plastic Dust Cover for Changer. Shpg. wt., 1 lb.
24 E 09043W Net 3.95

LAFAYETTE STEREO/10 SOLID STATE AMPLIFIER

- Left/Right Channel Volume Controls
- Front Panel Phono/Tuner Switch For Selection of Phono or Tuner Input

- Variable Tone Control (Bass/Treble)
- Selector Switch for Monaural or Stereo Operation

COMPACT SIZE, BIG PERFORMANCE! Ideal amplifier for Hi-Fi beginners, or use it in a second system for the living room, den, bedroom or business. Perfect for limited-space installation; bookshelf or end table. For use with record players, AM, FM and FM MPX tuners. Completely transistorized to provide clean, cool operation. Output stages couple directly to the speakers for smooth frequency response and low distortion. Input stages are designed to present a high impedance, resulting in an excellent low frequency response when used with high impedance crystal or ceramic phono

cartridges. Front panel features: Separate volume controls for Left/Right channels; tone control for Bass and Treble; individual slide switches for mode input (1-Stereo/Mono operation), (1-Phono/Tuner input); power On/Off slide switch. Rear panel features: Right/Left channel inputs for phono and tuner; Right/Left channel taps for 8-ohm speakers. Beautifully finished in neutral gray and aluminum. Size 7 $\frac{1}{2}$ "Wx2 $\frac{1}{4}$ "Hx5 $\frac{3}{8}$ "D. For 105-125V 50/60 Hz AC. Imported. Shpg. wt., 4 lbs.
99 E 01E12 Net 22.95

Lafayette®

"Stereo 25" 20-Watt Solid-State Stereo Amplifier



NEW!

Only

39⁹⁵
With Case

No Money Down*

• 20 Watts ± 1 db of Stereo Power †

• 20-20,000 Hz ± 2 db Frequency Response.

The new Stereo 25 offers a full 20 watts of stereo music power. Faithfully reproduces the full spectrum of audio sound with adequate volume and very low distortion. Solid state design assures minimum heat for safe placement anywhere and years of top-notch performance. Convenient operating features include front panel rocker switches for activation of source tuner, phono or auxiliary, selection of stereo or mono output at speakers, selection of remote or main speakers, and power on/off. A full complement of controls is supplied for best stereo effects and permits you to "tailor" the sound to suit your taste! Front panel controls include separate bass, treble,

concentric volume/balance and an always "on" stereo headphone jack for private listening. Stereo outputs are available for 4-16 ohm main and remote speakers. Permits placement of speakers in main listening area plus in the den, dining room or patio area. Attractive, modern styling with a matte black and satin gold front panel is complimented by a handsome walnut grained vinyl clad metal enclosure. Fused AC line and separately fused speaker outputs prevent damage to output transistors. Operates on 105-120 VAC, 50/60 Hz. Size: 10 $\frac{1}{4}$ "Wx3 $\frac{1}{2}$ "Hx6 $\frac{1}{2}$ "D. Imported.

99 E 02271WX Shpg. wt., 10 lbs. Net 39.95

"STEREO 25" SPECIFICATIONS

Power Output: 20 watts ± 1 db (10 watts per channel) at 4 or 8 ohms. Frequency Response: 20,20,000 Hz ± 1 db. Power Bandwidth: 40-25,000 Hz. Harmonic Distortion: 0.1% at 1 watt. Hum and Noise: -70 db. Channel Separation: 60 db. Input Sensitivity: Aux., 250 mv; Tuner, 500mv; Phono, 250 mv. Stereo Outputs: main speakers, re-

mote speakers, stereo headphones. Controls: concentric Volume/Balance; master Bass; master Treble; Rocker switches for: Aux., Phono, Tuner, Stereo/Mono Mode, Remote/Main Speakers, and On/Off Power. With front panel pilot light and rear panel AC convenience outlet. †Rating standard used by major hi-fi audio manufacturers.

Specially Matched 20-Watt Stereo Phono Systems

Superior 20-Watt Stereo System Special 20-Watt Stereo System



Minuette
Mark II

99⁹⁵
with case
No Money Down*

Model 30

Stereo 25



Criterion 50

128⁹⁵
with case
No Money Down*

Model 30

Stereo 25

This specially matched value-packed stereo system includes the new Lafayette "Stereo 25" 20-Watt Solid State Stereo Amplifier; Garrard Model 30 4-Speed Automatic Turntable with oversized turntable, ceramic stereo cartridge and long-life diamond stylus; Matching turntable wood base; and 2 decoratively designed Lafayette Minuette Mark II oiled-walnut 2-way bookshelf speaker systems with 5x7" woofer, 2 $\frac{1}{2}$ " tweeter and brilliance control. With speaker cable. Shpg. wt., 38 lbs.

21 E 92573WXM Net 99.95

An outstanding value for performance and price this stereo system consists of: the new Lafayette "Stereo 25" 20-Watt Solid State Stereo Amplifier; Garrard Model 30 4-Speed Automatic Turntable with ceramic stereo cartridge and diamond stylus; Matching turntable wood base; and 2 famous Lafayette Criterion 50 30-Watt 2-way speaker systems with 8" woofer, 4" tweeter and tuned ducted port in an attractive oiled walnut enclosure for bookshelf and wall placement. Complete with speaker cable. Shpg. wt., 78 lbs.

21 E 92581WXM Net 128.95
21 E 40267W Dust cover for Model 30: Shpg. wt., 1 $\frac{1}{2}$ lbs. Net 5.50

* See Page 11 for Full Credit Details on Easy Pay Plan

Lafayette Cat. No. 700 19



50-Watt AM-FM Stereo Systems with LR-100 Receiver

SAVE 44.15

From Individual
Catalog Prices.

199⁹⁵
with
Case
No Money Down*

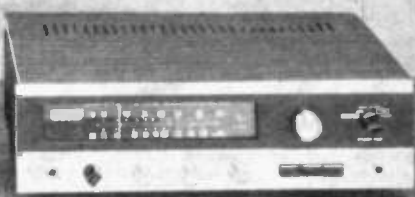
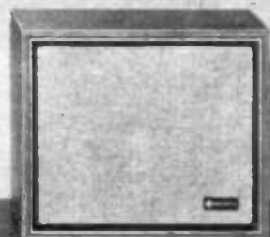

Super-Value 50-Watt AM-FM Stereo Systems

Extraordinary value in a complete 50-watt stereo system! Features the new Lafayette LR-100 50-Watt Solid State AM-FM Stereo Receiver which offers full-feature stereo versatility with controls and inputs from every source, handsomely styled in black and gold anodized front panel and with simulated walnut vinyl clad metal case; Garrard Model 40B 4-Speed Automatic Turntable with viscous damped, single lever cueing, complete with attractive wood base; Pickering PAT-E Elliptical Stereo Cartridge with high compliance diamond stylus; 2 Lafayette Criterion 25A 25-Watt 2-Way speaker systems, each featuring an extra-efficient 8" woofer and 2½" tweeter. Speakers are housed in attractive enclosures with hand-

rubbed oiled walnut finish. Complete with speaker cable. Shpg. wt., 53 lbs. ± 1 db rating standard used by major audio hi-fidelity mfrs.

21 E 94769WXM Net 199.95

Same system as above except with Shure M44E elliptical stereo cartridge. Shpg. wt., 53 lbs.

21 E 94777WXM Net 199.95

Same system as 21 E 94769WXM except with ADC 220E elliptical stereo cartridge. Shpg. wt., 53 lbs.

21 E 94785WXM Net 199.95

Specially Matched 50-Watt AM-FM Stereo Phono Systems

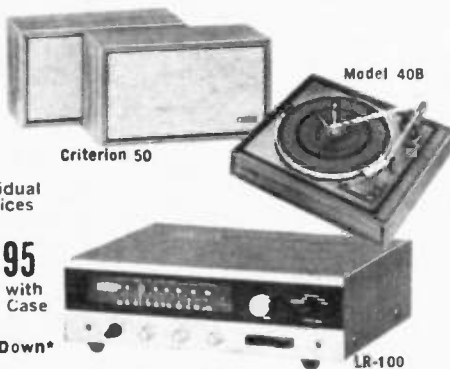

**SAVE
45.55**

From Individual
Catalog Prices

219⁹⁵
with
Case

No Money Down*

This specially selected 50-Watt AM-FM stereo phono system features the new Lafayette LR-100 50-Watt Solid State AM-FM Stereo Receiver with full stereo capability; the Garrard Model 40B 4-Speed Automatic Turntable with attractive wood base; Pickering PAT-E Elliptical Stereo Cartridge with high compliance diamond stylus; 2 famous Lafayette Criterion 50 30-Watt 2-way ducted port speaker systems with 8" woofer and 4" tweeter in attractive hand-rubbed oiled walnut finished enclosures. With cable. ± 1 db rating standard used by major audio hi-fidelity mfrs.

21 E 94793WXM Shpg. wt., 91 lbs. Net 219.95

Above system but with Shure M44E elliptical stereo cartridge.

21 E 94801WXM Shpg. wt., 91 lbs. Net 219.95

Above system but with ADC 220E elliptical stereo cartridge.

21 E 94819WXM Shpg. wt., 91 lbs. Net 219.95

21 E 40267W Plastic Dust Cover For Garrard Model 40B Turntable. Shpg. Wt., 1½ lbs. Net 5.50

See Pages 4-10, 15-17, 42-50 & 70-73 for Complete Description of Components on this Page.

50-Watt Omnidirectional AM-FM Stereo Systems

**SAVE
47.55**

From Individual
Catalog Prices

237⁹⁵
with
case

No Money Down*



This deluxe LR-100 stereo system consists of: Lafayette LR-100 50-Watt Solid State AM-FM Stereo Receiver; Garrard Model 40B 4-Speed Automatic Turntable with base; Pickering PAT-E Elliptical Stereo Cartridge with diamond stylus; and 2 new Lafayette Criterion "OMNI-1" 30-watt decorator styled thin-line 5-speaker systems with 360° omnidirectional acoustic deflector for excellent room-filling audio distribution. Includes 8" woofer and four 3½" tweeters. Complete with speaker cable.

21 E 94827WXM Shpg. wt., 95 lbs. Net 237.95

Above system but with Shure M44E elliptical stereo cartridge.

21 E 94835WXM Shpg. wt., 95 lbs. Net 237.95

Above system but with ADC 220E elliptical stereo cartridge.

21 E 94843WXM Shpg. wt., 95 lbs. Net 237.95

Lafayette

75-Watt AM-FM Stereo Systems with LR-500TA Receiver

SAVE 49.10

From Individual Catalog Prices

265⁹⁵ with Case

No Money Down*

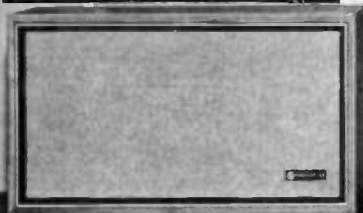

Value-Priced 75-Watt AM-FM Stereo Systems

Carefully matched for outstanding performance as well as for value for your dollar this 75-watt stereo system features the Lafayette LR-500TA 75-Watt† Solid State AM-FM Stereo Receiver, acclaimed by the critics for its performance and versatility; Garrard Model 40B 4-Speed Automatic Turntable with attractive wood base; Pickering PAT-E Elliptical Stereo Cartridge with high compliance diamond stylus; 2 popular Lafayette Criterion 50 2-way ducted port speaker systems with 8" woofer and 4" tweeter in neatly styled oiled walnut finished enclosure. Complete with speaker cable. ±1db rating

standard used by major audio hi-fidelity mfrs.
 21 E 94850WXM Shpg. wt., 97 lbs. Net 265.95
 Same system as above except with Shure M44E Elliptical Stereo Cartridge. Shpg. wt., 97 lbs. Net 265.95
 21 E 94868WXM Net 265.95
 Same as 21 E 94850WXM except with ADC 220E elliptical stereo cartridge. Shpg. wt. 97 lbs. Net 265.95
 21 E 94884WXM Net 265.95

Special 75-Watt AM-FM Stereo Systems

SAVE 52.55

From Individual Catalog Prices



292⁹⁵ with Case

No Money Down*

Feature-Packed 75-Watt AM-FM Stereo Systems

SAVE 57.55

From Individual Catalog Prices



337⁹⁵ with Case

No Money Down*

This specially selected stereo system features the acclaimed Lafayette LR-500TA, 75-Watt† Solid State AM-FM Stereo Receiver; Garrard Model 40B 4-Speed Automatic Turntable; Matching wood base for turntable; Pickering PAT-E Elliptical Stereo Cartridge with high compliance diamond stylus; and 2 Lafayette Criterion 100A 40-Watt 2-way ducted port systems with 10" woofer and 4" tweeter, in neatly styled oiled-walnut finished enclosures with brilliance control. Includes speaker cable. †±1db rating standard used by major audio hi-fidelity mfrs.

21 E 94892WXM Shpg. wt., 101 lbs. Net 292.95
 Above system but with Shure M44E elliptical stereo cartridge. Net 292.95
 21 E 94900WXM Shpg. wt., 101 lbs. Net 292.95
 Above system but with ADC 220E elliptical stereo cartridge. Net 292.95
 21 E 94918WXM Shpg. wt., 101 lbs. Net 292.95

This feature-packed stereo system consists of the renowned Lafayette LR-500TA 75-Watt† Solid State AM-FM Stereo Receiver; Garrard Model 40B 4-Speed Automatic Turntable; Wood base for turntable; Pickering PAT-E Elliptical Stereo Cartridge; and 2 Lafayette Criterion 200A 50-Watt deluxe 3-speaker systems with 12" woofer, 8" mid-range, and 3" tweeter, brilliance and presence controls, and handsome oiled walnut finished enclosure. With cable. †±1db rating standard used by major audio hi-fidelity mfrs.

21 E 94926WXM Shpg. wt., 111 lbs. Net 337.95
 Above system but with Shure M44E elliptical stereo cartridge. Net 337.95
 21 E 94934WXM Shpg. wt., 111 lbs. Net 337.95
 Above system but with ADC 220E elliptical stereo cartridge. Net 337.95
 21 E 94942WXM Shpg/ wt., 111 lbs. Net 337.95
 Plastic Dust Cover for 40B Turntable. Shpg. wt., 1½ lbs. Net 5.50
 21 E 40267W

See Pages 4-10, 15-17, 42-50 & 70-73 for complete description of components on this page.

* See Page 11 for Full Credit Details on Easy Pay Plan

Lafayette Cat. No. 700 21



100-Watt AM-FM Stereo Systems with LR-775 Receiver



SAVE 50.55
From Individual Catalog Prices

284⁹⁵ with Case
No Money Down*

A



A Choice 100-Watt AM-FM Stereo Systems

This complete versatile stereo system consists of new Lafayette LR-775 100-Watt† Solid State AM-FM Stereo Receiver with advanced solid state stereo circuitry; Garrard Model 40B 4-Speed Automatic Turntable; Matching base for turntable; Pickering PAT-E Elliptical Stereo Cartridge with high-compliance diamond stylus; and 2 famous Lafayette Criterion 50 2-way ducted port speaker systems with 8" woofer and 4" tweeter in oiled walnut finish enclosure. With cable. Shpg. wt., 86 lbs.

21 E 92102WXM Net 284.95

Same as above but with Shure M44E elliptical stereo cartridge. Shpg. wt., 86 lbs. Net 284.95

Same as above but with ADC 220E elliptical stereo cartridge. Shpg. wt., 86 lbs. Net 284.95

B Specially Selected 100-Watt Omnidirectional AM-FM Stereo Systems

This specially matched stereo system features the new Lafayette LR-775 100-Watt† Solid State AM-FM Stereo Receiver; Garrard Model 40B 4-Speed Automatic Turntable; Pickering PAT-E Elliptical Stereo Cartridge; and 2 new Lafayette Criterion "OMNI-1" omnidirectional 5-speaker thin-line speaker system. "OMNI-1" includes 8" woofer plus four 3½" close-back tweeters with 360° acoustic deflector in decorator styled oiled walnut enclosure for delightful room-filling audio. With cable.

21 E 92078WXM Shpg. wt., 90 lbs. Net 302.95

Same as above except with Shure M44E elliptical stereo cartridge. Shpg. wt., 90 lbs. Net 302.95

Same as 21 E 92078WXM except with ADC 220E elliptical stereo cartridge. Shpg. wt., 90 lbs. Net 302.95

C Deluxe 100-Watt AM-FM Stereo Systems

A truly deluxe stereo system that consists of the new Lafayette LR-775 100-Watt† Solid State AM-FM Stereo Receiver; Garrard Synchrolab Model SL-55B Automatic Turntable with synchronous motor, adjustable anti-skating control and viscous damped cueing; Matching wood base for turntable; Pickering V-15/ACE-3 Elliptical Stereo Cartridge with high compliance diamond stylus; and 2 Lafayette Criterion 200A 50-Watt deluxe 3-way speaker systems with 12" woofer, 8" mid-range, and 3" tweeter with Brilliance and Presence controls, and housed in handsome oiled-walnut finished enclosure. With cable.

21 E 92045WXM Shpg. wt., 100 lbs. Net 371.95

Same system as above except with Shure M55E elliptical stereo cartridge. Shpg. wt., 100 lbs. Net 371.95

21 E 40267W Shpg. wt., 1½ lbs. Plastic Dust Cover For Turntables. Net 5.50

†±1db rating standard used by major audio hi-fidelity mfrs. Shpg. wt., 100 lbs.

See Pages 4-10, 15-17, 42-50 & 70-73 for complete description of components on this page.

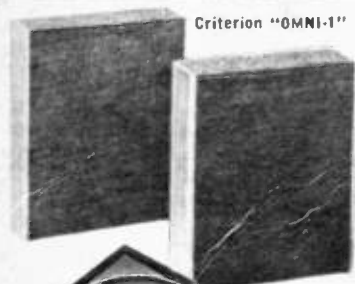

Criterion "OMNI-1"



Model 40B

B

302⁹⁵ with Case
No Money Down*

SAVE 51.75
From Individual Catalog Prices

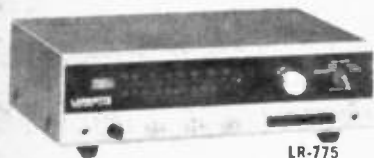

LR-775

C Deluxe 100-Watt AM-FM Stereo Systems



SL-55B

SAVE 62.75

From Individual Catalog Prices

371⁹⁵ with Case

C



LR-775

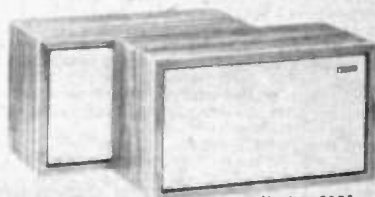

Criterion 200A

Lafayette®

150-Watt AM-FM Stereo Systems with LR-1000TA Receiver

SAVE 57.55

From Individual Catalog Prices

347⁹⁵ with case

No Money Down*



A

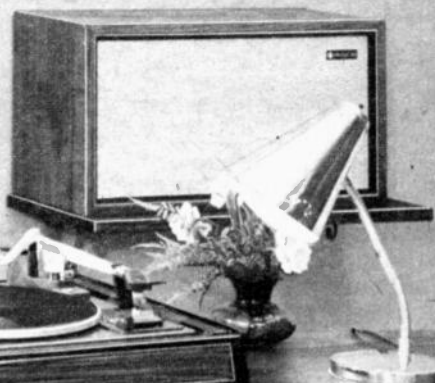

A Selected 150-Watt AM-FM Stereo Systems

This fine 150-watt stereo system features the Lafayette LR-1000TA 150-Watt† Solid State AM-FM Stereo Receiver cited by audio critics for its outstanding performance characteristics and fine circuitry innovations; the Garrard Model 40B 4-Speed Automatic Turntable; matching wood base for turntable; Pickering PAT-E Elliptical Stereo Cartridge with high compliance diamond stylus; and 2 Lafayette Criterion 100A 2-way ducted port systems with 10" woofer, 4" tweeter and brilliance control in an attractively styled oiled walnut finished enclosure. Includes speaker cable. Shpg. wt., 109 lbs. **21 E 92029WXM** Net 347.95

Same system as above except with Shure M44E elliptical stereo cartridge. **21 E 92011WXM** Shpg. wt., 109 lbs. Net 347.95

Same as 21 E 92029WXM except with ADC 220E elliptical stereo cartridge. **21 E 92003WXM** Shpg. wt., 109 lbs. Net 347.95

B Special 150-Watt AM-FM Stereo Systems

This specially matched stereo system features the citation-winning Lafayette LR-1000TA 150-Watt† Solid State AM-FM Stereo Receiver; Garrard Model 40B 4-Speed Automatic Turntable; matching wood base for turntable; Pickering PAT-E Elliptical Stereo Cartridge; and 2 Lafayette Criterion 200A deluxe 3-way speaker system with 12" woofer, 8" midrange, 3" tweeter and brilliance and presence controls in oiled walnut finished enclosure. With cable. **21 E 94991WXM** Shpg. wt., 119 lbs. Net 392.95

Same as above except with Shure M44E elliptical stereo cartridge. **21 E 94983WXM** Shpg. wt., 119 lbs. Net 392.95

Same as 21 E 94991WXM except with ADC 220E elliptical stereo cartridge. **21 E 94975WXM** Shpg. wt., 119 lbs. Net 392.95

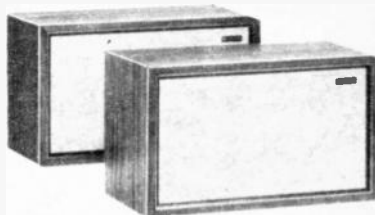

Criterion 200A



Model 40B

B

C Deluxe 150-Watt AM-FM Stereo Systems

Includes acclaimed Lafayette LR-1000TA 150-Watt† Solid State AM/FM Stereo Receiver; Garrard Synchronlab, Model SL55B 4-Speed Automatic Turntable with synchronous motor and viscous damped cueing; Base for turntable; Pickering V-15/ACE-3 Elliptical Stereo Cartridge with high-compliance diamond stylus; and 2 Lafayette Deluxe Criterion 3X 3-way acoustic suspension speaker system with 12" woofer, 6½" midrange and 3" tweeter in oiled walnut finished enclosure. With Cable. Shpg. wt., 113 lbs. **21 E 94967WXM** Net 443.95

Same as above except with Shure M55E elliptical stereo cartridge. **21 E 94959WXM** Shpg. wt., 113 lbs. Net 443.95

21 E 40267W Plastic Dust Cover for Turntables. Shpg. wt., 1½ lbs. Net 5.50

† ±1db rating standard used by major audio hi-fidelity mfrs.

SAVE 62.55

From Individual Catalog Prices

443⁹⁵ with case

No Money Down*

SAVE 62.55

From Individual Catalog Prices

392⁹⁵ with case

No Money Down*

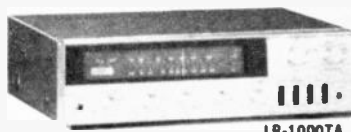

LR-1000TA



Model SL55B

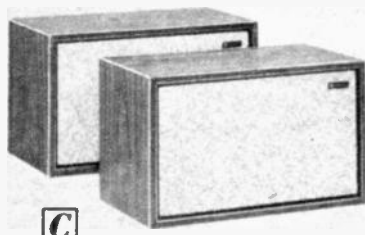

Criterion 3X

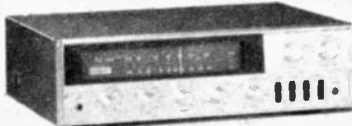

LR-1000TA

See Pages 4-10, 15-17, 42-50 & 70-73 for full description of above components.

* See Page 11 for Full Credit Details on Easy Pay Plan



220-Watt AM-FM Stereo Systems

SAVE 68.55

From Individual Catalog Prices

416⁹⁵ With Case

No Money Down*



A Selected 220-Watt AM-FM Stereo Systems

This expertly matched stereo system includes our finest receiver, the award-winning Lafayette LR-1500T 220-Watt† Solid State AM-FM Stereo Receiver which features advanced solid state circuitry with 4 Integrated Circuits, 2 F.E.T.'s, 40 discrete transistors and Computer-Matic® protective circuitry for extraordinary performance; Garrard Synchro-Lab Model SL55B 4-Speed Automatic Turntable with attractive matching wood base, Pickering V-15/ACE-3 Elliptical Stereo Cartridge with high compliance diamond stylus; and 2 Lafayette Criterion 100A 2-way speaker systems with 10" woofer, 4" tweeter, tuned ducted port and high frequency brilliance control in attractive oiled-walnut finished enclosures. Complete with speaker cable. †±1db rating standard used by major audio hi-fidelity mfrs. Shpg. wt., 117 lbs.
21 E 92110WXM Net 416.95

Same system as above except with Shure M55E elliptical stereo cartridge.
21 E 92126WXM Shpg. wt., 117 lbs. Net 416.95

B Feature-Packed 220-Watt AM-FM Stereo Systems

This excellent feature-packed stereo system consists of the acclaimed Lafayette LR-1500T 220-Watt† Solid State AM-FM Stereo Receiver with advanced solid state design and Computer-Matic® protective circuitry; the Garrard Synchro-Lab Model SL55B 4-Speed Automatic Turntable with neatly styled matching base; Pickering V-15/ACE-3 Elliptical Stereo Cartridge with high compliance diamond stylus; and 2 Lafayette Criterion 200A deluxe 3-way speaker systems with 12" woofer, 8" midrange, 3" tweeter, and Brilliance and Presence controls in attractively styled oiled walnut finished enclosures. Complete with speaker cable. †±1db rating standard used by major audio hi-fidelity mfrs.

21 E 92136WXM Shpg. wt., 127 lbs. Net 461.95

Same system as above except with Shure M55E elliptical stereo cartridge.
21 E 92144WXM Shpg. wt., 127 lbs. Net 461.95

Plastic Dust Cover for SL55B Turntable.
21 E 40267W Shpg. wt., 1½ lbs. Net 5.50

See Pages 4-10, 15-17, 42-50 & 70-73 for full description of components on this page.

SAVE 73.55

From Individual Catalog Prices

461⁹⁵ With Case

No Money Down*



with Award-Winning LR-1500T Receiver

SAVE 77.55

From Individual Catalog Prices

517⁹⁵

With Case

No Money Down*

A



A Deluxe 220-Watt AM-FM Stereo Systems

A truly deluxe stereo system consisting of the critics' acclaimed Lafayette LR-1500T 220-Watt Solid State AM-FM Stereo Receiver; Garrard Synchro-Lab Model SL65B 4-Speed Automatic Turntable with adjustable anti-skating control, viscous-damped cueing, etc.; Matching base for turntable; Pickering V-15/ACE-3 Elliptical Stereo Cartridge; and 2 Deluxe Lafayette Criterion 3X 3-way acoustic suspension speaker systems with 12" woofer, 6½" midrange, and 3" tweeter in attractive oiled-walnut finished enclosure. With speaker cable. Shpg. wt., 121 lbs.

21 E 92151WXM

Net 517.95

Same system as above except with Shure M55E elliptical stereo cartridge.

21 E 92169WXM Shpg. wt., 121 lbs.

Net 517.95

B Super-Deluxe 220-Watt AM-FM Stereo Systems

A super-deluxe stereo system that features the renowned Lafayette LR-1500T 220-Watt Solid State AM-FM Stereo Receiver; the Garrard Model SL65B Synchro-Lab 4-Speed Automatic Turntable; Matching wood base for turntable; Pickering V-15/ACE-3 Elliptical Stereo Cartridge with high compliance diamond stylus; and 2 new Lafayette Criterion 5XA 3-Way Acoustic Suspension shelf or floor speaker systems. Speakers are housed in a handsome oiled walnut finished enclosure and include a 12" woofer with over 6 lb. magnet structure, 6½" midrange and 4" super tweeter with aluminum cone. With cable. Shpg. wt., 154 lbs.

21 E 92177WXM

Net 589.95

Same system as above except with Shure M55E elliptical stereo cartridge.

21 E 92185WXM Shpg. wt., 154 lbs.

Net 589.95

C Ultra Deluxe 220-Watt AM-FM Stereo Systems

OUR finest, superbly performing stereo system features the acclaimed Lafayette LR-1500T 220-Watt AM-FM Stereo Receiver; the new Garrard Model SL72B Synchro-Lab Automatic Transcription Turntable with sliding weight anti-skating control, record safety platform, etc.; Wood base for turntable; Pickering V-15/ATE-3 Elliptical Stereo Cartridge for transcription turntables; and 2 new superb Lafayette Criterion 80 6-Speaker, 4-Way Acoustic Suspension Speaker Systems with a 12" woofer, 6½" midrange, 2-3" tweeters, 2-1½" super tweeters, separate level controls, housed in rich, hand-rubbed oiled-walnut finished enclosure. With speaker cable. Shpg. wt., 189 lbs.

21 E 92193WXM

Net 653.95

Same System as above with Empire 888E elliptical stereo cartridge.

21 E 92201WXM Shpg. wt., 189 lbs.

Net 653.95

Dust Covers. Shpg. wt., 1½ lbs.

21 E 40267W For SL55B and SL65B

Net 5.50

21 E 40275W For SL72B

Net 5.50

† = ±1db rating standard used by major audio hi-fidelity mtrs.

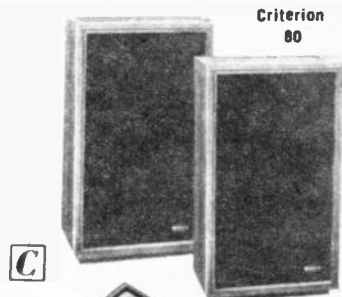

Criterion 80

C



Model SL72B

SAVE 102.55

From Individual Catalog Prices

653⁹⁵

With Case

No Money Down*

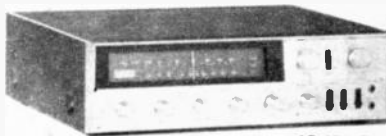

LR-1500T

SAVE 85.55

From Individual Catalog Prices

589⁹⁵

With Case

No Money Down*

B

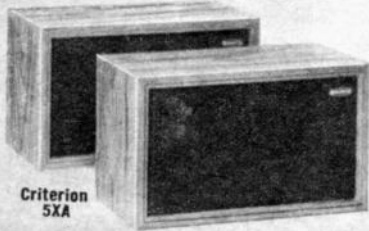

Criterion 5XA



LR-1500T



Model SL65B

See Pages 4-10, 15-17, 42-50 & 70-73 for Description of Components on This Page.

* See Page 11 for Full Credit Details on Easy Pay Plan

Lafayette Cat. No. 700 25

Lafayette

50-Watt Stereo Phono Systems with LA-324

SAVE 34.15

From Individual Catalog Prices

139⁹⁵
with case

No Money Down*



A



A Budget-Priced 50-Watt Stereo Phono Systems

A budget-priced system with high performance, this Lafayette matched stereo system consists of the new Lafayette LA-324 50-Watt† Solid State Stereo Amplifier; Garrard Model 40B 4-Speed Automatic Turntable with neatly designed matching wood base; Pickering PAT-E Elliptical Stereo Cartridge with high compliance diamond stylus; and 2 Lafayette Criterion 25A efficient 25-Watt 2-Way air-suspension speaker systems with 8" woofer, and 2½" tweeter in decorative hand-rubbed oiled walnut finished enclosure. With cable. Shpg. wt., 41 lbs.

21 E 92219WXM Net 139.95

Same as above except with Shure M44E elliptical stereo cartridge. Net 139.95

21 E 92235WXM Shpg. wt., 41 lbs. Net 139.95

Same as 21 E 92219WXM except with ADC 220E elliptical cartridge. Net 139.95

21 E 92243WXM Shpg. wt., 41 lbs. Net 139.95

B Special 50-Watt Stereo Phono Systems

Specially matched for impressive performance this stereo system features the Lafayette LA-324 50-Watt† Solid State Stereo Amplifier; the Garrard Model 40B 4-Speed Automatic Turntable with matching wood base; Pickering PAT-E Elliptical Stereo Cartridge; and 2 famous Lafayette Criterion 50 30-Watt 2-way speaker systems with 8" woofer and 4" tweeter in a handsome duc-ed port tuned, hand-rubbed oiled-walnut enclosure. Complete with speaker cable. Shpg. wt., 79 lbs.

21 E 92250WXM Net 159.95

Same as above but with Shure M44E elliptical stereo cartridge. Net 159.95

21 E 92268WXM Shpg. wt., 79 lbs. Net 159.95

Same as 21 E 92250WXM but with ADC 220E elliptical stereo cartridge. Net 159.95

21 E 92276WXM Shpg. wt., 79 lbs. Net 159.95

C Deluxe 50-Watt Stereo Phono Systems

Our deluxe 50-Watt stereo phono system consists of the Lafayette LA-324 50-Watt† Solid State Stereo Amplifier; the Garrard Model 40B 4-Speed Automatic Turntable with matching wood base; Pickering PAT-E Elliptical Stereo Cartridge with diamond stylus; and features 2 new Lafayette "OMNI-1" 30-Watt 5-speaker decorator-styled thin-line omni-directional speaker systems with 8" woofer, 4-3½" closed back tweeters and unique 360° acoustic deflector housed in handsome oiled-walnut enclosure. With speaker cable. Shpg. wt., 83 lbs.

21 E 92284WXM Net 177.95

Same as above but with Shure M44E elliptical stereo cartridge. Net 177.95

21 E 92292WXM Shpg. wt., 83 lbs. Net 177.95

Same as 21 E 92284WXM but with ADC 220E elliptical stereo cartridge. Net 177.95

21 E 92300WXM Shpg. wt., 83 lbs. Net 177.95

21 E 40267W Dust Cover for Model 40B Shpg. wt., 1½ lbs. Net 5.50

† = ± 1db rating standard used by major audio hi-fidelity mfrs.

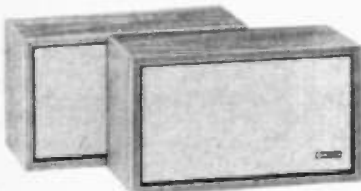

Criterion 50

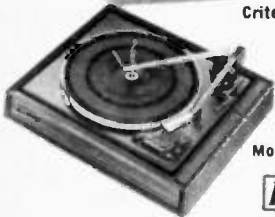

Model 40B

B

SAVE 35.55
From Individual Catalog Prices

159⁹⁵
with case
No Money Down*

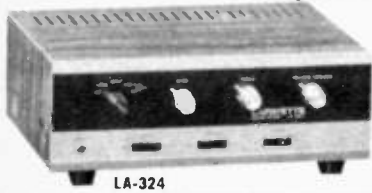

LA-324

SAVE 37.55
From Individual Catalog Prices

177⁹⁵
with case

No Money Down*

C

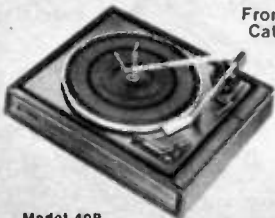

Model 40B

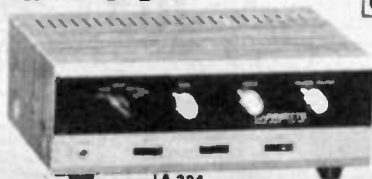

LA-324

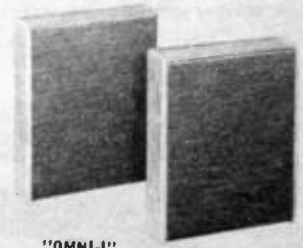

"OMNI-1"

Lafayette®

80-Watt Stereo Phono Systems with LA-750

SAVE 36.15

From Individual Catalog Prices

15/ with case

No Money Down*

A

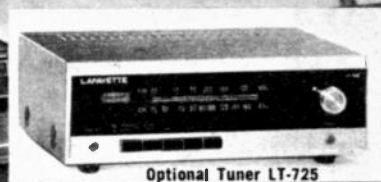
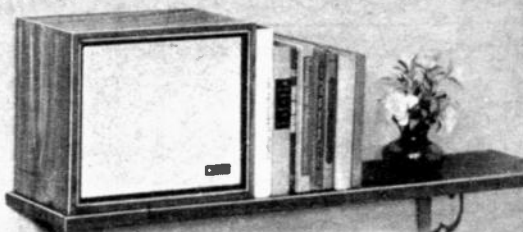

Optional Tuner LT-725

A Feature-Packed 80-Watt Stereo Phono Systems

An 80-watt stereo phono system that features the new Lafayette LA-750 80-watt† Solid State Stereo Amplifier; Garrard Model 40B 4-Speed Automatic Turntable with matching attractive wood base. Pickering PAT-E Elliptical Stereo Cartridge with high compliance diamond stylus; plus 2 Lafayette Criterion 25A 2 way air-suspension speaker systems with 8" woofer and 2½" tweeter in decorative oiled-walnut finished enclosure. Complete with speaker cable. Shpg. wt., 44 lbs.

21 E 92318WXM

Net 157.95

Same as above but with Shure M44E elliptical stereo cartridge.

21 E 92326WXM Shpg. wt., 44 lbs.

Net 157.95

Same as 21 E 92318WXM but with ADC 220E elliptical stereo cartridge.

21 E 92334WXM Shpg. wt., 44 lbs.

Net 157.95

B Selected 80-Watt Stereo Phono Systems

This specially matched system includes the Lafayette LA-750 80-Watt† Solid State Stereo Amplifier; Garrard Model 40B 4-Speed Automatic Turntable with matching wood base; Pickering PAT-E Elliptical Stereo Cartridge; and features 2 new Lafayette Criterion "Omni-1" 5-speaker decorator-styled thin-line omnidirectional speaker systems with 8" woofer, 4-3½" closed back tweeters and a unique 360° acoustic deflector housed in a handsome oiled-walnut enclosure. With speaker cable.

21 E 92359WXM Shpg. wt., 86 lbs.

Net 195.95

Same as above but with Shure M44E elliptical stereo cartridge.

21 E 92367WXM Shpg. wt., 86 lbs.

Net 195.95

Same as 21 E 92359WXM but with ADC 220E elliptical stereo cartridge.

21 E 92375WXM Shpg. wt., 86 lbs.

Net 195.95

C Deluxe 80-Watt Stereo Phono Systems

An exceptionally fine performing deluxe stereo system that includes the Lafayette LA-750 80-Watt† Solid State Stereo Amplifier; Garrard Model 40B 4-Speed Automatic Turntable with matching wood base; Pickering PAT-E Elliptical Stereo Cartridge; and 2 Lafayette Criterion 100A 40-watt 2-way speaker systems, each with 10" woofer, 4" tweeter, and ducted port in tuned hand-rubbed oiled-walnut decorative enclosure with brilliance control. Complete with speaker cable.

21 E 92383WXM Shpg. wt., 86 lbs.

Net 204.95

Same as above but with Shure M44E elliptical stereo cartridge.

21 E 92391WXM Shpg. wt., 86 lbs.

Net 204.95

Same as 21 E 92383WXM but with ADC 220E elliptical stereo cartridge.

21 E 92409WXM Shpg. wt., 86 lbs.

Net 204.95

Lafayette Matching Solid State AM/FM Stereo Tuner Model LT-725 For Any of Above Systems. Shpg. wt., 10 lbs.

99 E 02164WX

Net 99.95

21 E 40267W Dust Cover for Model 40B Turntable. Shpg. wt., 1½ lbs.

Net 5.50

† ±1db rating standard used by major audio hi-fidelity mfrs.

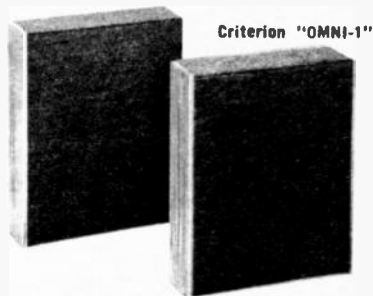

Criterion "OMNI-1"



Model 40B

B

SAVE 39.55
From Individual Catalog Prices

195.95 with case
No Money Down*



LA-750

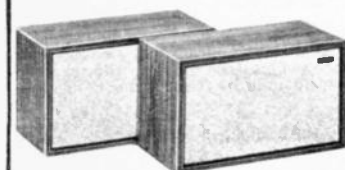

Criterion 100A

SAVE 40.55

From Individual Catalog Prices No Money Down*

204.95 with case

C



LA-750



Model 40B

See Pages 4-10, 15-17, 42-50 & 70-73 for complete description of above components.

* See Page 11 for Full Credit Details on Easy Pay Plan

Lafayette Cat. No. 700 27



110-Watt Stereo Systems with LA-85TA

SAVE 40.55

From Individual Catalog Prices

194⁹⁵ with case
No Money Down*

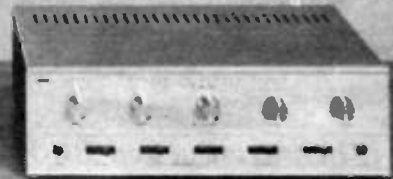
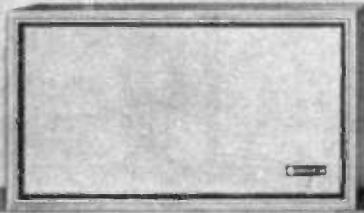

Value-Priced 110-Watt Stereo Phono Systems

An extra fine stereo system for an unbelievably low price! Consists of Lafayette LA-85TA 110 Watt† Solid State Stereo Amplifier featuring advanced solid state circuitry and fused output transistors; Garrard Model 40B 4-Speed Automatic Turntable; Matching wood base for turntable; Pickering PAT-E Elliptical Stereo Cartridge with high compliance diamond stylus; and 2 famous Lafayette Criterion-50 2-way speaker systems with 8" woofer, 4" tweeter and ducted port in a handsome oiled-walnut finished enclosure. With speaker cable.

†±1db rating standard used by major audio hi-fidelity mfrs. Shpg. wt., 87 lbs.

21 E 92482WXM Net 194.95

Same as above but with Shure M44E elliptical cartridge.

21 E 92490WXM Shpg. wt., 87 lbs. Net 194.95

Same as 21 E 92482WXM but with ADC 220E elliptical cartridge.

21 E 92516WXM Shpg. wt., 87 lbs. Net 194.95

Special 110-Watt Stereo Phono Systems

Criterion 100A

SAVE 43.55

From Individual Catalog Prices



221⁹⁵ with case
No Money Down*

Deluxe 110-Watt Stereo Phono Systems

SAVE 53.55

From Individual Catalog Prices



281⁹⁵ with case
No Money Down*

Specially matched stereo system featuring Lafayette LA-85TA 110-Watt† Solid State Stereo Amplifier; Garrard Model 40B 4-Speed Automatic Turntable; Matching wood base for turntable; Pickering PAT-E Elliptical Stereo Cartridge; and 2 fine Lafayette Criterion 100A 2-way speaker systems each with 10" woofer, 4" tweeter, ducted port and brilliance control in a handsome oiled-walnut finished enclosure. Complete with speaker cable. †±1db rating standard used by major audio hi-fidelity mfrs. Shpg. wt., 91 lbs.

21 E 92524WXM Net 221.95

Same as above but with Shure M44E elliptical Cartridge.

21 E 92532WXM Shpg. wt., 91 lbs. Net 221.95

Same as 21 E 92524WXM but with ADC 220E elliptical cartridge.

21 E 92540WXM Shpg. wt., 91 lbs. Net 221.95

Our deluxe 110-Watt Stereo system features the Lafayette LA-85TA Solid State Stereo Amplifier; Garrard Model SL-55B Synchro-Lab 4-Speed Automatic Turntable with advanced turntable characteristics; Matching wood base for turntable; Pickering V-15/ACE-3 Elliptical Stereo Cartridge with high compliance diamond stylus; and 2 Lafayette Criterion 200A deluxe 3-way speaker systems with 12" woofer, 8" midrange and 3" tweeter in attractive oiled-walnut finished enclosure, complete with brilliance and presence controls. With speaker cables. †±1 db rating standard used by major audio hi-fidelity mfrs. Shpg. wt., 101 lbs.

21 E 92557WXM Net 281.95

Same as above but with Shure M55E elliptical cartridge.

21 E 92565WXM Shpg. wt., 101 lbs. Net 281.95

Dust Cover for 40B and SL-55B turntables. Shpg. wt., 1½ lbs.

21 E 40867W Net 5.50

See Pages 4-10, 15-17, 42-50 & 72-73 for complete description of components on this page.



160-Watt Stereo Systems with LA-125TA

SAVE 46.55

From Individual
Catalog Prices

248⁹⁵
with
case

No Money Down*

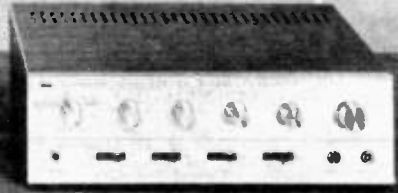
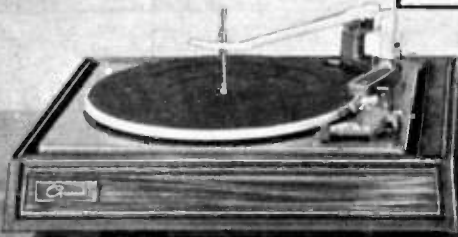
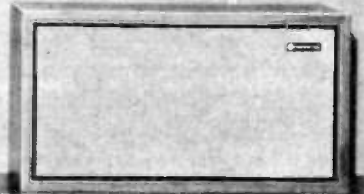

Feature-Packed 160-Watt Stereo Phono Systems.

Packed with satisfaction-giving audio features this stereo system consists of the Lafayette LA-125TA 160-Watt† Solid State Stereo Amplifier with COMPUTOR-MATIC™ protective circuitry for its audio power stages for unexcelled stereophonic sound reproduction; the new Garrard Model 40B 4-Speed Automatic Turntable with improved turntable features; Matching decorative wood base for turntable; Pickering PAT-E Elliptical Stereo Cartridge with high compliance diamond stylus; and 2 fine Lafayette Criterion 100A 2-way speaker systems with 10" woofer, 4" tweeter, tube-type port, and brilliance

control in a handsomely styled oiled-walnut finished enclosure. With speaker cable. †±1db rating standard used by major audio hi-fidelity mfrs. Shpg. wt., 93 lbs.

21 E 92417WXM Net 248.95

Same as above but with Shure M44E elliptical cartridge.
21 E 92425WXM Shpg. wt., 93 lbs. Net 248.95

Same as 21 E 92417WXM but with ADC 220E elliptical cartridge.
21 E 92433WXM Shpg. wt., 93 lbs. Net 248.95

Specially Matched 160-Watt Stereo Phono Systems

SAVE 56.55

From Individual
Catalog Prices

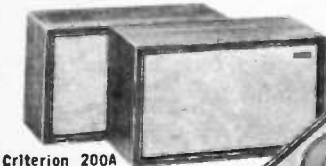

Criterion 200A

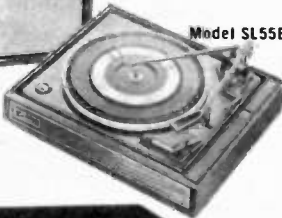

Model SL55B

308⁹⁵
with
case
No Money Down*

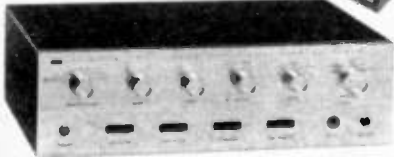

LA-125TA

This superbly matched stereo system includes the Lafayette LA-125TA 160-Watt† Solid State Stereo Amplifier; Garrard Model SL55B Synchro-Lab 4-Speed Automatic Turntable with synchronous motor, viscous damped cueing, etc.; Matching wood base for turntable; Pickering V-15/ACE-3 Elliptical Stereo Cartridge with high compliance diamond stylus; and 2 outstanding Lafayette Criterion 200A 3-way systems with 12" woofer, 8" midrange, 3" tweeter, and brilliance and presence controls in oiled-walnut finished enclosure. With cable. †±1db rating standard used by major audio hi-fidelity mfrs.

21 E 92441WXM Shpg. wt., 103 lbs. Net 308.95

Same as above but with Shure M55E elliptical cartridge.

21 E 92458WXM Shpg. wt., 103 lbs. Net 308.95

Deluxe 160-Watt Stereo Phono Systems

364⁹⁵
with
case

No Money Down*

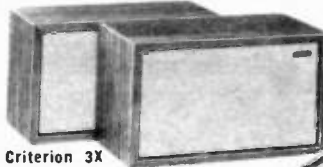

Criterion 3X

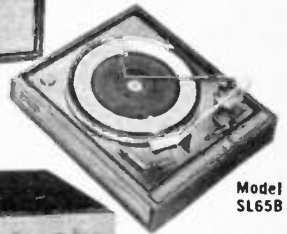

Model
SL65B

SAVE 60.55

From Individual
Catalog Prices



LA-125TA

This exceptionally fine stereo phono system features the Lafayette LA-125TA 160-Watt† Solid State Stereo Amplifier; Garrard Model SL65B Synchro-Lab 4-Speed Automatic Turntable with synchronous motor and advanced turntable features; Matching wood base for turntable; Pickering V-15/ACE-3 Elliptical Stereo Cartridge; and 2 deluxe Lafayette Criterion 3X 3-way acoustic suspension speaker systems with 12" woofer, 6½" midrange and 3" tweeter in a decorative oiled walnut finished enclosure. With speaker cable. †±1db rating standard used by major audio hi-fidelity mfrs.

21 E 92466WXM Shpg. wt., 100 lbs. Net 364.95

Same as above but with Shure M55E elliptical cartridge.

21 E 92474WXM Shpg. wt., 100 lbs. Net 364.95

21 E 40267W Dust cover for turntables. Shpg. wt., 1½ lbs. Net 5.50

See Pages 4-10, 15-17, 42-50 & 72-73 for complete description of components on this page.

* See Page 11 for Full Credit Details on Easy Pay Plan

Lafayette Cat. No. 700 29



Fisher Solid State Stereophonic Hi Fi Receivers

MODEL 175-T 65 WATT AM/FM STEREO RECEIVER

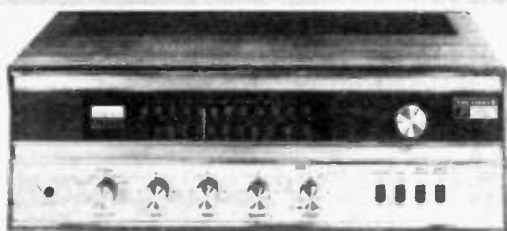

MODEL 250-T 100 WATT AM/FM STEREO RECEIVER



Only
249⁹⁵
Less Enclosure
No Money Down*

- Integrated Circuits and FET's
- 4-Way Main-Remote Speaker Switch
- Stereo Beacon Automatic Mono/Stereo Switching

Only
299⁹⁵
with Enclosure
No Money Down*

- Integrated Circuits and FET's
- Automatic FM Stereo Switching
- 4-Way Speaker Selector
- Convenient Tune-O-Matic® Tuning

A fine performing solid state AM/FM Stereo Receiver featuring an all silicon power amplifier, FM tuner section with FET's and 2 IC's, and a highly selective AM front end with AGC to minimize fading. Includes AFC control to minimize drift on FM. Stereo Beacon provides automatic mono/stereo switching. Useable tuner sensitivity is 2 μ v with a signal-to-noise ratio of 65 db and 0.6% harmonic distortion. Other features include: Transmit-O-Guard overload protection circuit; 4-way main/remote speaker switch; 5-position program selector with full phono and tape facilities; loudness contour control, bass, treble and balance controls, stereo/mono mode switch and front panel stereo head phone jack. 65 watts \pm 1 db @ 8 ohms! 28/28 watts IHF dynamic music power; 20/20 watts RMS power. Power bandwidth is 25-25,000 Hz. Hum and noise (phono low) 55 db. Frequency response: phono low, 30-15,000 Hz; auxiliary, 20-20,000 Hz. Dimensions: 15 $\frac{1}{2}$ "W x 5 $\frac{1}{4}$ "H x 12 $\frac{3}{4}$ "D. Shpg. wt., 20 lbs.

21 E 33437WX Net 249.95
21 E 33452W Oiled Walnut Cabinet for 175-T. Net 19.95
21 E 33452W Shpg. wt., 6 lbs.

Powerful Model 250-T AM/FM stereo receiver features automatic FM push button tuning convenience. Five adjustable push buttons provides instant selection of your favorite FM stations, also tune stations manually if desired. Features an all silicon power amplifier FM tuner front end with 2 FET's and 2 IC's; a highly selective wide band AM front end with AGC to minimize fading; diode tuned AFC control to eliminate FM drift; stereo Beacon to automatically switch between mono/stereo, and Transist-D-Guard overload protection circuit. Tuner sensitivity is 2 μ v; harmonic distortion is 0.5%, and signal-noise-ratio is 65 db. Styled control panel includes: 5 position program selector; loudness contour, treble and balance controls; mono mode, muting and tape monitor switch; 4 way speaker selector (Main, on/off; Remote, on/off) and convenient front panel head phone jack, 100 watts \pm 1 db @ 8 ohms; 40/40 watts IHF dynamic music power; 30/30 RMS power. 0.5% harmonic distortion. Power bandwidth is 25-25,000 Hz. Dimensions: 15 $\frac{1}{2}$ "W x 5 $\frac{1}{4}$ "H x 12 $\frac{3}{4}$ "D. Wt., 18 lbs.

21 E 33445WX Net 299.95
21 E 33452W Oiled Walnut Cabinet for 250-T Net 19.95

65-WATT FISHER-LAFAYETTE-GARRARD AM/FM STEREO MUSIC SYSTEM featuring MODEL 175T RECEIVER

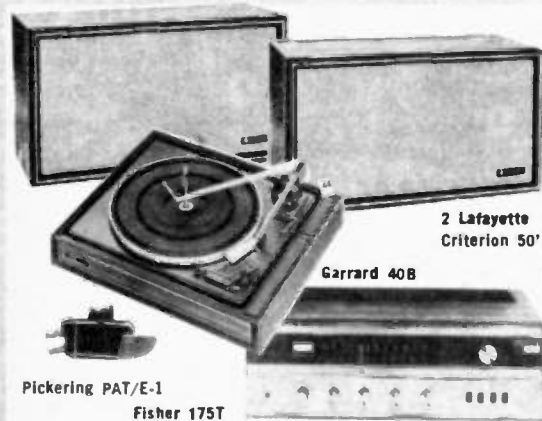

2 Lafayette
Criterion 50"

Garrard 40B

Pickering PAT/E-1

Fisher 175T

100-WATT FISHER-LAFAYETTE-GARRARD AM/FM STEREO MUSIC SYSTEM featuring MODEL 250T RECEIVER



2 Lafayette Criterion "OMNI-1"

Garrard SL55B

Shure M55E

Fisher 250T

Complete
System

329⁹⁵
No Money Down*

YOU SAVE 54.85
from individual
catalog prices

Enjoy beautiful stereo music reproduction from this quality stereo music system featuring: Fisher 175T 65-Watt AM/FM stereo receiver (less cabinet), Garrard 40B 4-speed automatic record changer with base, Pickering PAT/E-1 stereo elliptical cartridge, and 2 Lafayette "Criterion 50" true 2-way bookshelf type speaker systems in handsome hand rubbed oiled walnut. Nothing else to buy. System is complete with all necessary hook-up cable and instruction booklets. Shpg. wt., 87 lbs.

21 E 33635WX Net 329.95

Complete
System

399⁹⁵
No Money Down*

YOU SAVE 74.85
from individual
catalog prices

SAVE 74.85 on this magnificent 100-watt AM/FM stereo system featuring the following components: Fisher 250T 100-watt AM/FM stereo receiver (less cabinet), Garrard SL55B 4-speed Synchro-lab automatic turntable with base, Shure M55E stereo elliptical cartridge, and 2 Lafayette Criterion "OMNI-1" 5-speaker thin line systems with acoustic deflector for 360° sound radiation. Nothing else to buy. System is complete with all necessary hook-up cable and instruction booklets. Shpg. wt., 90 lbs.

21 E 33621WX Net 399.95

NEW**Fisher****Solid State Stereo Hi Fi Receivers****MODEL 400T 150-WATT AM/FM STEREO RECEIVER****MODEL 500TX 190-WATT AM/FM STEREO RECEIVER**

Only
349⁹⁵
Less Enclosure
No Money Down*

- Separate Main and Remote Speaker Switch
- Pushbutton Memory Tuning
- FM Stereo Indicator Light
- Tape Monitor

Only
449⁹⁵
Less Enclosure
No Money Down*

- Pushbutton Memory Tuning
- AutoScan Touch Tuning
- AutoScan Remote Tuning with Optional Adapter
- 5-Way Speaker Selector

Versatile, 150-watt solid state AM/FM stereo receiver featuring both Tune-O-Matic Pushbutton Memory Tuning and conventional flywheel tuning. Tune-O-Matic pushbutton Tuning permits you to preset five separate FM dials to your favorite FM stations and thereafter instantly select them at the press of a button. Automatic frequency control electronically locks-in the desired stations. Model 400T also features Stereo Beacon automatic mono/stereo switching and a D'Arsonval tuning meter. Bass and treble controls with Baxandall feedback circuits provide bass without boom. Tape monitor and separate main and remote speaker switches. Specifications: FM Tuner—Sensitivity, 2.0 μ v; Signal/Noise, 65 db; Separation, 38 db; Capture Ratio, 2.5 db. Power output 150 watts \pm 1 db @ 8 ohms; 60/60 watts IHF dynamic music power; 50/50 watts RMS; Harmonic Distortion, 0.5% at rated output; Overall Frequency Response, 20-25,000 Hz \pm 2 db; Power Bandwidth, 10-30,000 Hz; Hum and Noise, 90 db below rated output. Sensitivity: Phono Low, 2.5 mv; Phono High, 7.5 mv; Aux., 250 mv. Size: 15 $\frac{1}{2}$ "W x 4 $\frac{3}{8}$ "H x 14 $\frac{1}{4}$ "D. 21 E 33526WX Shpg. wt., 28 lbs. Net 349.95
21 E 01608W Walnut Vinyl Cabinet. Shpg. wt., 7 lbs. Net 22.95

Fisher's finest solid state AM/FM receiver. Features 3 methods of tuning: AutoScan touch tuning which electronically scans the tuning dial, converting the signal strength meter to a frequency indicator whenever you press the AutoScan buttons; Tune-O-Matic Pushbutton tuning which permits you to preset 4 separate FM dials to your favorite FM stations; and conventional flywheel tuning. Improved sensitivity and selectivity are provided by the use of a crystal IF filter and a ceramic ladder filter. Specifications: FM Tuner—Sensitivity, 1.7 μ v; Signal/Noise, 65 db; Stereo Separation, 38 db; Capture Ratio, 1.5 db. AM Tuner Selectivity: 80 db. Power Output: 190 watts \pm 1 db @ 8 ohms; 75/75 watts IHF dynamic music power; 65/65 watts RMS power. Overall Frequency Response: 20-25,000 Hz \pm 1.5 db; Power Bandwidth: 8-35,000 Hz. Sensitivity: Phono. low, 2.5 mv; Phono high, 10 mv; Aux., 250 mv. Size: 4 $\frac{1}{4}$ "H x 16 $\frac{3}{4}$ "W x 14 $\frac{1}{2}$ "D. Shpg. wt., 33 lbs. 21 E 33536WX Net 449.95
21 E 01616W Walnut Vinyl Cabinet. Shpg. wt., 7 lbs. Net 22.95
RK 30 AutoScan Remote Control for 500TX. Shpg. wt., 2 lbs. Net 9.95
21 E 33619

**150 WATT FISHER-LAFAYETTE-GARRARD
AM/FM STEREO MUSIC SYSTEM
featuring MODEL 400T RECEIVER**

Garrard SL 65B

2 Lafayette
Criterion 100

Pickering V15/ACE-3

Fisher 400T

Complete System **459⁹⁵**
No Money Down*

YOU SAVE 94.85
from individual
catalog prices

Superb stereo reproduction plus a big savings of **94.85** on this dazzling component system featuring: Fisher 400T 150-watt AM/FM stereo receiver (less cabinet), Garrard SL 65B Synchro-lab 4-speed automatic turntable with base, Pickering V15/ACE-3 elliptical cartridge, and 2 Lafayette Criterion 100 10" 2-way bookshelf-type speaker systems in beautiful hand rubbed oiled walnut. Nothing else to buy. System is complete with all necessary hook-up cable and instruction booklets. Shpg. wt., 97 lbs. 21 E 33650WXM Net 459.95

**190-WATT FISHER-LAFAYETTE-GARRARD
AM/FM STEREO MUSIC SYSTEM
featuring MODEL 500TX RECEIVER**

Garrard SL 72B

2 Lafayette Criterion 80

Pickering V15/ATE-3

Fisher 500TX

Complete System **749⁵⁰**
No Money Down*

YOU SAVE 156.30
from individual
catalog prices

Selected for the audio connoisseur—Spectacular performance from this outstanding stereo system featuring: Fisher 500TX 190-watt AM/FM stereo receiver (less cabinet), Garrard SL 72B Synchro-lab 4-speed automatic turntable with base, Pickering V15/ATE-3 elliptical cartridge, and 2 magnificent Lafayette Criterion 80 6-speaker 4-way acoustic suspension console-type speaker systems. Nothing else to buy. System is complete with all necessary hook-up cable and instruction booklets. Shpg. wt., 170 lbs. 21 E 33643WXM Net 749.50

* See Page 11 for Full Credit Details on Easy Pay Plan

Lafayette Cat. No. 700 31



Fisher
HI-FI COMPONENTS

Hi-Fi Amplifiers, FM Radio, & Accessories

NEW! Model TX-50 65-WATT STEREO CONTROL AMPLIFIER

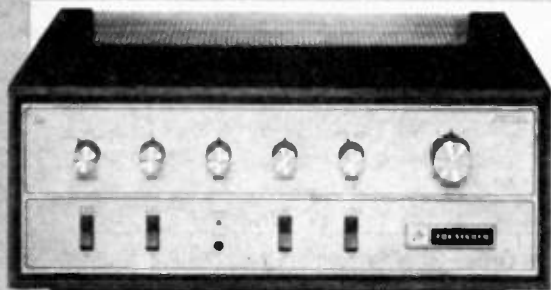

149⁹⁵
Less Case

- 4-Way Speaker Selector: Main, On/Off; Remote, On/Off
- Front Panel Headphone Jack

Incorporates all silicon Solid-State circuitry. Features Transist-o-Gard overload protection circuit. Provides a full complement of controls plus full tape and phono facilities. Loudness contour switch restores natural tonal balance at low and high volume levels. High frequency filter switch eliminates annoying high frequency noise. Transis-O-Gard® overload protective circuitry. Has front panel headphone jack with complementary speaker silencing switch for easy private or room listening. 4-way speaker switch selects main, on/off and remote, on/off. Gold plated die-cast front panel. Power Output: 65 watts ± 1 db at 8 ohms, Harmonic Distortion: 0.5% at 1 kHz. Power Bandwidth: 25-25,000 Hz. at 8 ohms. Stereo Separation: better than 45db. Hum and Noise: —85 db. For 117 Volts AC 60 Hz. Size: 15 1/8" W x 4 1/8" H x 9" D. Shpg. wt., 15 lbs.

21 E 33585WX No Money Down* Net 149.95
21 E 36414W Oiled Walnut Cabinet. Wt., 6 lbs. Net 22.95

Model TX-1000 120 WATT LABORATORY STANDARD STEREO CONTROL AMPLIFIER

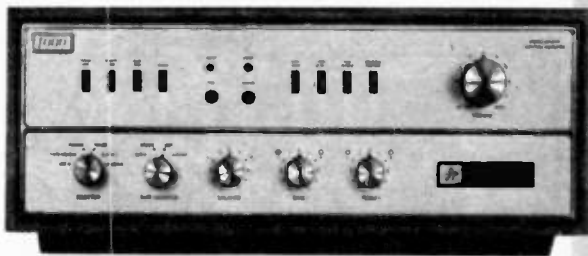

329⁹⁵
Less Case

- 4-Position Tape Monitor Selector
- Switchable Center Channel Power Output

TX-1000 stereo master control amplifier provides 120 watts at 8 ohms ± 1 db. undistorted power—enough reserve to drive sound systems in the largest auditoriums and theaters. The TX-1000 features pushbutton controls for selection of remote, main or center channel speakers; low filter, high filters 1 and 2; and loudness contour. Six position program selector permits choice of microphone, tape, phono, tuner plus Aux., 1 and 2 for input of other program sources. Tape monitoring facilities. Added conveniences include front panel jacks for tape and phones, plus a center channel power output to drive a "Third" or remote speaker system. Specifications—Power output: 120 watts ± 1 db @ 1 kHz; HD @ 1 kHz: 0.5%; IM Distortion: 60/7000 Hz, each channel @ rated power: 0.8%; Power Bandwidth: (IHF) 22-24,000 Hz; Sensitivity @ 4 ohms: Phono low 2 mv Phono high 7.5 mv; Tuner 200 mv; Tape HD 1.8 mv size 15 1/8" W x 4 1/8" H x 12 3/4" D. Shpg. wt., 30 lbs.

21 E 33205WX No Money Down* Net 329.95
21 E 36414W Oiled Walnut Cabinet. Wt., 6 lbs. Net 22.95

FISHER 100™ PUSHBUTTON SOLID STATE FM TABLE RADIO

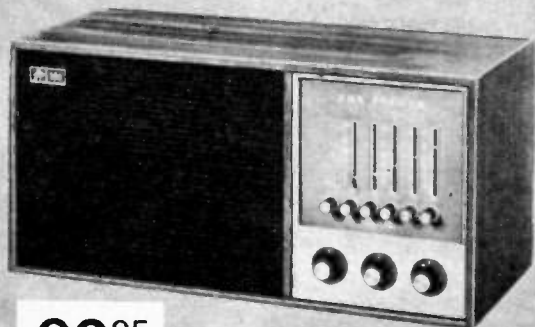

99⁹⁵

Featuring Tune-O-Matic® Pushbutton Tuning

- Select Any 5 Of Your Favorite FM Stations Instantly
- Built-In 5 1/4" Wide-Range Speaker

Powerful, compact FM table radio featuring Fisher's exclusive Tune-O-Matic electronic tuning circuit. Enables you to set each of five vertical FM dials to your favorite FM station and thereafter select it instantly at the touch of a button—or tune any one of these dials manually. Tuning section contains three IF stages, three limiters, and a wide-band ratio detector. 5 watt (IHF) amplifier section utilizes Baxandall feed back tone controls for adjusting the bass and treble tonal balance to your personal taste and listening conditions. Built-in 5 1/4" speaker reproduces the entire audio spectrum. SPECIFICATIONS—Music Power output: 5 Watts (IHF). HD @ full rated output: Less than 1.0%. Hum and Noise (below rated output): —90db, FM Usable Sensitivity (IHF) 2.5 μ v. Speaker impedance: 8 ohms. Comes with built-in cord antenna. For 110-120V., 50/60 cycle AC. Size: 13 3/8" x 6 1/2" x 6 3/4" D. Shpg. wt., 15 lbs.

21 E 33353WX No Money Down* Net 99.95
Model S30 External Matching Speaker System. Size: 13 3/8" x 6 1/2" x 6 3/4" D. Shpg. wt., 11 lbs.
21 E 33361WX Net 29.95

FAMOUS K-10 "SPACEXPANDER" ELECTRONIC REVERBERATION SYSTEM

Recreate Concert Hall Listening In Your Home

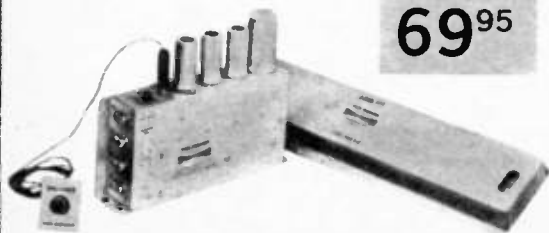

69⁹⁵

add a new dramatic sound to your listening pleasure with one simple control.

Add concert hall realism to your listening area. Supplies the reverberation normally heard in an acoustically perfect concert hall. Samples sound output from amplifier, and reinjects the same sound after a short time delay thus adding the reverberation effect. May be used with any mono or stereo home music system using separate pre-amplifiers or tape monitoring facilities. Connects to any signal from 0.2 to 5.0 volts. Simple to operate and easy to install. Tubes: 2-12AX7, 1-7247 plus a selenium rectifier. Size 9 1/2" L x 1 1/2" W x 6 7/8" H. Shpg. wt., 8 lbs.

21 E 36505 No Money Down* Net 69.95

Superb Quality Hi-Fi Components by **marantz**

NEW MODEL 22 40-WATT SOLID-STATE AM/FM STEREO RECEIVER

- Gyro-Touch Tuning
- Antenna Tuning and Multipath Meter

Combines a superb Stereo FM/AM Tuner, Stereo Preamplifier, and a powerful 40 watt Stereo Amplifier on one handsome chassis. Features center-of-channel and Signal-Strength/Multipath Meters. Delivers 40-watts RMS (20-watts per channel) with less than 0.3% HD over a wide 20-20,000 Hz range. Features exclusive variable overload drive, Multipath tuning Meter and Gyro-Touch Tuning. Interstation muting circuit suppresses noise between stations. Front and rear panel tape recorder jacks permit tape dubbing. SPECIFICATIONS: FM Tuner; Sensitivity: 2.4 μ V IHF; Selectivity: -80db; Capture Ratio: 2.5db; Separation: 40db; S/N ratio: -65db; Multiplex Suppression: -60 db; Required Power: 117 VAC 50/60 Hz or 240VAC conversion. Size: 17x5 $\frac{1}{2}$ x14"D. With simulated walnut metal case. Shpg. wt., 37 lbs.
 21 E 50183WX No Money Down* Net 425.00
 Oiled Walnut Wood Cabinet for Model 22. Net 25.50
 21 E 50191W Shpg. wt., 9 lbs. Net 25.50



425⁰⁰
with
Metal Case

- Power Output at 4 or 8 Ohms 40 Watts RMS Per Channel from 20 Hz to 20 kHz (Both Channels Operating Simultaneously)

MODEL 18 70-WATT SOLID STATE FM STEREO RECEIVER

Deluxe stereo receiver complete with dual 35 watt RMS solid state direct coupled amplifiers, solid state stereo preamplifier and solid state FM stereo tuner. FM tuner section features gyro-touch tuning which provides silky smooth tuning over the entire dial. Very low FM stereo distortion is made possible through the use of constant phase IF filters. Built-in oscilloscope shows exactly when station is tuned in for highest quality FM stereo reception. Direct coupled power amplifiers are designed so that overload recovery is virtually instantaneous. At and below rated power from 20-20kHz, distortion is less than .2%. Front panel dubbing input and output are provided, as is a stereophone output jack. Also features speaker selector switch for stereophone, remote, or main speakers. Specifications: signal-to-noise ratio 70 db; harmonic distortion 0.15%; stereo separation at 1 KHz 45 db. Size: 18 $\frac{1}{4}$ " x 16" x 6". Less Cabinet. For 105-130/220-240 V AC 50/60 Hz. Shpg. wt., 40 lbs.
 21 E 50134WX No Money Down* Net 695.00
 Oiled Walnut Wood cabinet for Model 18. Net 39.50
 21 E 50142W Shpg. wt., 11 lbs. Net 39.50

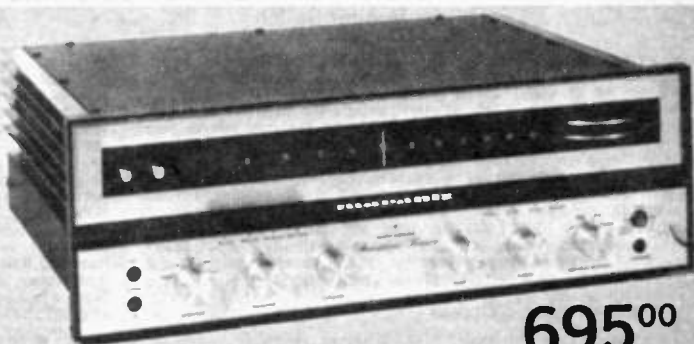

695⁰⁰
Less Cabinet

- Power Output at 4 or 8 Ohms 35 Watts RMS Per Channel from 20 Hz to 20 kHz (Both Channels Operating Simultaneously)

MODEL 7T SOLID STATE STEREO PREAMPLIFIER CONSOLE

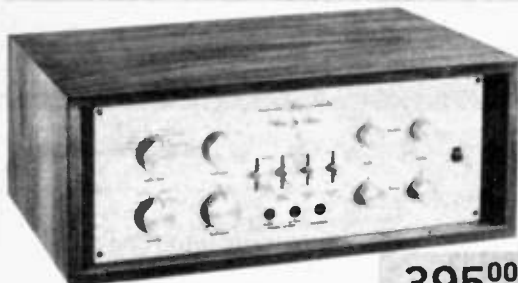

- Tape Play/Tape Copy Switch
- Center Channel Output

395⁰⁰
Less Cabinet

Deluxe self-powered solid state stereo preamplifier features: 2 front panel jacks for recording, copying, or playback with an external Tape Recorder, 8 pos. selector switch with automatic equalization insertion, Precision tracking volume control, selectable-curve feedback Tone control, 5 Pos. mode control, output level adjustments for high and low efficiency speakers, Tape head equalizer adjustments. Complete input facilities for every type of music source, 6 AC/Convenience outlets. Frequency Response: 20-20,000 Hz \pm 0.1 db, IM Distortion: 0.15% at 10 volts RMS output. Size: 15 $\frac{3}{4}$ x5 $\frac{3}{4}$ x8 $\frac{1}{2}$ "D. 105-130/220-240 volt. 50/60 Hz, AC. Shpg. wt., 12 lbs.

21 E 50092WX Less cabinet. No Money Down* Net 395.00
 21 E 50027W Oiled Walnut cabinet for 7T. Wt., 4 lbs. Net 24.50

NEW! Model 16 SOLID-STATE STEREO POWER AMPLIFIER — 80 watts continuous Power RMS per channel. Integrated Circuits virtually eliminate harmonic and IM distortion. Separate isolated power supplies for each channel. Freq. Response: 10 to 60,000 Hz within 1 db. Dim: 15x5 $\frac{3}{4}$ x8"D. Shpg. wt., 36 lbs.
 21 E 50159WX No Money Down* Net 395.00

NEW! Model 20 SOLID-STATE FM STEREO TUNER



- Built-in Oscilloscope
- Gyro-Touch Tuning

495⁰⁰
Less Cabinet

Highly sophisticated solid-state FM stereo tuner. Features built-in oscilloscope to display incoming signal strength for precise center-of-channel tuning. Exclusive Gyro-Touch tuning for virtually effortless tuning. Unique IF circuit utilizes Butterworth filters for better selectivity, lower distortion and superior separation. Automatic stereo switching and interstation muting by means of an electronically triggered, photoelectric circuit. Four limiters for ultimate quieting in excess of 70 db. Also has stereo indicator light, threshold adjustment and front panel defeat switch. 1% resistors are used in all vital circuits for low noise. IHF Sensitivity 2.8 μ V or better; THD 0.2% Max. 400 Hz, 100% mod.; Multiplexing 40 db @ 20 Hz, 30 db @ 15,000 Hz and 45 db at mid-frequencies; IF Bandwidth 3 db @ 230 kHz, 80 db @ 800 kHz; Spurious Rejection better than 90 db. For 105-125V., 50/60 Hz AC. Size: 15 $\frac{3}{4}$ x5 $\frac{3}{4}$ x14 $\frac{1}{8}$ "D. Shpg. wt., 25 lbs.

21 E 50167WX No Money Down* Net 495.00
 Oiled Walnut Wood Cabinet for Model 20. Net 29.50
 21 E 50175W Shpg. wt., 8 lbs. Net 29.50

* See Page 11 for Full Credit Details on Easy Pay Plan

NEW! **SCOTT** Solid-State Hi-Fi Receivers

Model 341X 70-WATT FM STEREO RECEIVER

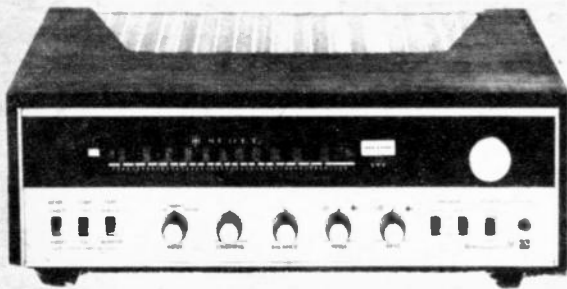

199⁹⁵

Less Case

- 70-Watts ± 1 db @ 4-Ohms
- Front Panel Headphone Jack
- FET Tone Control Circuit
- Separate Main and Remote On/Off Speaker Switches
- Tape Monitor Switch

Moderately priced, quality FM stereo receiver! Features silver-plated front-end for maximum sensitivity; all silicon circuitry; IC preamp; IC IF strip; Tuning meter for accurate FM tuning; FET Tone control circuit; 3-pair of stereo inputs for magnetic cartridge, Aux., and Tape Monitoring. Adequate control features add to your enjoyment: Stereo Balance control; Front-panel Headphone jack; Mono/Stereo switch; Loudness Volume compensation switch; separate Tone controls for each channel; Speaker Main/Remote, or both. **SPECIFICATIONS:** Power 70 watts ± 1 db @ 4 ohms, IHF 55 watts @ 4 ohms; Power bandwidth 25-20,000 Hz; Frequency response ± 1 db, 20-20,000 Hz. Hum and Noise, phono —55db; Cross Modulation Rejection, 80db; Usable Sensitivity, 2.5 μ V; Selectivity, 56 db; Tuner Stereo Separation, 30 db; Capture Ratio, 2.5 db; Signal-to-Noise Ratio, 60 db; Phono Sensitivity, 4mV. Size: 14 $\frac{3}{4}$ x12 $\frac{1}{2}$ x4 $\frac{1}{8}$ " Shpg. wt., 17 lbs. Less Enclosure.

21 E 54540WX No Money Down* Net 199.95
Walnut Wood Case for Model 341X. Shpg. wt., 6 lbs. Net 22.50
21 E 60240W

Model 342C 110-WATT FM STEREO RECEIVER

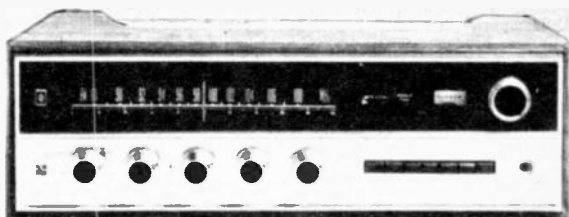

269⁹⁵

Less Case

- 110-Watts ± 1 db @ 4-Ohms
- Automatic FM Tuning Indicator
- Tape Monitor Switch
- Separate Main and Remote On/Off Speaker Switches
- FM IF Quartz Crystal Filter

Features superb FM stereo and FM reception. Incorporates many new features such as "Perfectune[®]" automatic tuning indicator—visually tells when tuned for best reception; new IC multiplex section with 40 transistors and 27 resistors; muting circuit; IC IF strip; IC preamplifier; FET tone control; plus a quartz filter IF section that never needs realignment. Professional controls let you vary the music to your own tastes and room acoustics: Stereo Balance, Loudness, Bass, Treble and Input Selector; Computer type pushbutton switches for Filter, Loudness comp., Tape monitor, Mono/Stereo mode, Muting, Speaker #1 and #2 selector. Stereo indicator light. **SPECIFICATIONS:** Power 110 watts ± 1 db @ 4 ohms, IHF 90 watts @ 4 ohms. Response ± 1 db, 20-20,000 Hz; Hum and Noise, phono —55 db; Usable Sensitivity, 1.9 μ V; Separation; Tuner, 40 db; Phono Sensitivity, 4mV. Size: 15 $\frac{3}{4}$ x5x11 $\frac{1}{2}$ " D. Shpg. wt., 18 lbs. Less Enclosure.

21 E 54532WX No Money Down* Net 269.95
Walnut Wood Case for 342C. Shpg. wt., 6 lbs. Net 22.50
21 E 54573W

Model 382C 110-WATT AM/FM STEREO RECEIVER



299⁹⁵

Less Case

- 110-Watts ± 1 db @ 4-Ohms
- Automatic FM Tuning Indicator
- IC Multiplex Circuitry
- Tape Monitor Switch
- FM IF Quartz Crystal Filter

Features improved AM reception by incorporating a new 4-pole LC filter AM front-end plus an IC AM IF strip. FM section includes Scott's new Perfectune[®] automatic tuning circuitry; quartz crystal lattice filter IF section; new IC multiplex section; muting circuit; and a 3-dimensional backlit dial. Plug-in speaker connectors eliminate phasing problems. Includes a patented Field-Effect-Transistor tone control. Line cord antenna eliminates the need for outside antenna except in areas of unusually poor reception. Computer-type push button switches. Control features: Tape monitor; Speaker #1 On/Off, Speaker #2 On/Off; front panel stereo headphone output jack. **SPECIFICATIONS:** Power 110 watts ± 1 db @ 4 ohms, IHF 90 watts @ 4 ohms; Frequency Response ± 1 db, 20-20,000 Hz; Hum and Noise, phono —55 db; Usable Sensitivity, 1.9 μ V; Tuner Separation, 40 db; Signal-to-Noise, 65 db; Phono Sensitivity, 3mV. Size: 15 $\frac{3}{4}$ x5x11 $\frac{1}{2}$ " D. Shpg. wt., 19 lbs.

21 E 54565WX No Money Down* Net 299.95
Walnut Wood Case for 382C. Shpg. wt., 6 lbs. Net 22.50
21 E 54573W

Model 386 170-WATT AM/FM STEREO RECEIVER



349⁹⁵

Less Case

- 170-Watts ± 1 db @ 4-Ohms
- Automatic FM Tuning Indicator
- FM IF Quartz Crystal Filter
- IC Multiplex Circuitry
- AM 4-Pole LC Filter

One of Scott's finest stereo FM/AM receivers; Enjoy fullrange AM as well as FM programming. AM section features: new FET RF mixer in the front-end, FET's and IC's in the AM IF amplifier for better S/N ratio and improved signal handling, and 4-pole LC filter. FM section features: new Perfectune[®] automatic FM tuning circuit; quartz crystal lattice FM IF filter; IC multiplex circuitry; patented FET tone control circuit. Also has computer-type push button switches, Loudness-Volume compensation switch, interstation muting, built-in line cord antenna for FM, front panel stereo microphone plus stereo headphone jacks. **SPECIFICATIONS:** Power 170 watts ± 1 db @ 4 ohms; IHF 135 watts @ 4 ohms; Power bandwidth 10-25,000 Hz; Frequency response ± 1 db, 20-22,000 Hz; Hum and Noise, phono —65 db; Cross modulation rejection, 80 db; Usable sensitivity, 1.9 μ V; Signal-to-Noise Ratio, 65 db; phono sensitivity, 3 mV and 6 mV. 17 $\frac{1}{2}$ x5 $\frac{1}{2}$ x15 $\frac{3}{4}$ ". Shpg. wt., 20 lbs.

21 E 54557WX No Money Down* Net 349.95
Walnut Wood Case for 386. Shpg. wt., 8 lbs. Net 22.50
21 E 60638W

Deluxe **SCOTT** Hi-Fi Components & Systems

NEW Model 3610 82-WATT SOLID-STATE AM/FM STEREO CASSEIVER

WHAT IS A CASSEIVER?
It's An AM/FM Stereo Receiver!
It's A Stereo Cassette Recorder!

For Only **399⁹⁵**

Including Cabinet

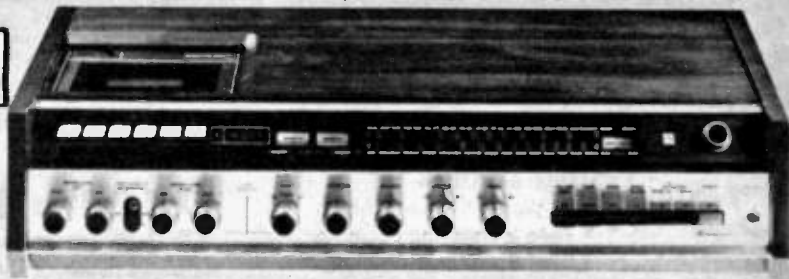

- Listen to AM, FM, or FM Stereo Broadcasts
- Record Your Own Music Live
- Record From An External Record Changer

- Record From AM, FM, or FM Stereo
- Make Sound-with-Sound Recordings
- Front Panel Stereo Headphone Jack

Features an ultra-sensitive 82-watt AM/FM stereo receiver with a built-in cassette recorder... all you have to do is add a pair of speakers and you have a complete, versatile, ready-to-play home music system. Build a great cassette library: just connect a turntable and put your favorite records on tape; record AM, FM or FM stereo from the Casseiver's tuner; connect a reel-to-reel tape recorder, convert ordinary tapes into compact cassettes; connect stereo microphones and record your own music live, or make sound-with-sound recordings by singing or playing along with broadcasts, records, or tape and record it all in stereo. Solid-

state circuitry features Scott's Silver-plated FET front-end plus Integrated Circuits in the IF strip and preamplifier. Controls feature switching for Main, Remote, or both sets of speakers; Tape Monitor control; Digital Tape Counter with reset button, separate left and right channel inputs for mike and external source, dual record level meters. "SPECIFICATIONS" Power ± 1 db @ 4 ohms. 82 watts; Frequency Response ± 1 db, 20-20,000 Hz; Usable Sensitivity, 2.5 μ V; Tuner Stereo Separation 30 db. Size: 22-3/4xx5x12-3/8". Shpg. wt., 30 lbs.

21 E 54581WX No Money Down* Net 399.95

82-WATT AM/FM STEREO MUSIC SYSTEM Featuring Model 3610

Complete System **499⁹⁵** YOU SAVE **79⁹⁰**
No Money Down* From Individual Catalog Prices

By just adding a deluxe pair of Lafayette Criterion 3X 12" 3-Way Acoustic Suspension Speaker Systems to the Model 3610—you have a spectacular money saving 82 Watt AM/FM Stereo Music System with record facilities. Speaker hook-up cable is included.
21 E 4920WXM Shpg. wt., 94 lbs. Net 499.95

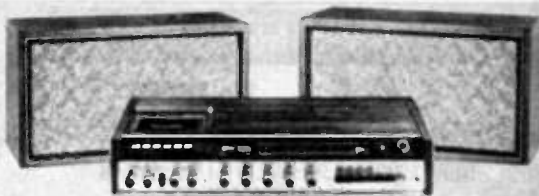

QUALITY HI-FI PHONO SYSTEMS FEATURING SCOTT-LAFAYETTE—GARRARO COMPONENTS

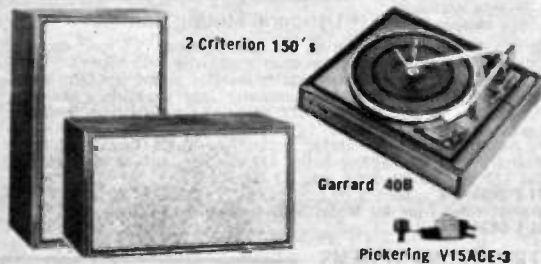

110-WATT FM STEREO PHONO SYSTEM Featuring The SCOTT 342 RECEIVER

Complete System **364⁹⁵** YOU SAVE **74⁹⁵**
No Money Down* From Individual Catalog Prices

A superb selection of stereo components make up this outstanding money saving system—Scott 342C 110-Watt FM Stereo Receiver (less case), Garrard 40B 4-Speed Automatic Stereo Record Changer (with base), Pickering V15ACE-3 Elliptical cartridge, and 2-Criterion 150 Acoustic Suspension 2-Way Bookshelf Speaker Systems. All connecting cable included. Shpg. wt., 70 lbs.
21 E 54938WXM No Money Down* Net 364.95

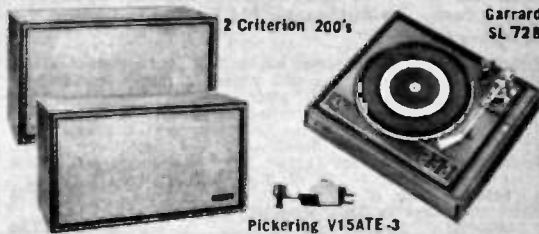

110-WATT AM/FM STEREO PHONO SYSTEM Featuring SCOTT 382C RECEIVER

Complete System **479⁹⁵** YOU SAVE **96⁸⁵**
No Money Down* From Individual Catalog Prices

An outstanding system featuring magnificent components: Scott 382C 110-watt AM/FM Stereo Receiver (less case), Garrard SL72 4-speed Synchro Lab Automatic Turntable (with base), Deluxe Pickering V15ATE-3 Elliptical Cartridge, and 2-Lafayette Criterion 200 3-Speaker 3-Way Systems in hand, rubbed oiled walnut cabinets. All connecting cables included. Shpg. wt., 96 lbs.
21 E 54946WXM No Money Down* Net 479.95

* See Page 11 for Full Credit Details on Easy Pay Plan

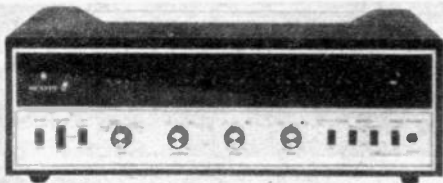

Model 299F 82 WATT SOLID STATE STEREO AMPLIFIER

179⁹⁵

less enclosure
No Money Down*

- 82-Watts ± 1 db at 4 ohms
- Tape Monitoring Facilities
- Dual Speaker Switching

Powerful 65 watt solid state amplifier features rugged direct coupled all silicon circuits, and modular type printed circuit boards for maximum reliability, low distortion. Has complete facilities for tape monitoring, dual speaker switching for remote-main or both operation, and a headphone jack. Full range of control functions including separate bass and treble for each channel, and a scratch filter. Frequency response: 10-30,000 Hz. Harmonic Distortion: 0.8% Hum and Noise: -55 db. 14 $\frac{3}{4}$ x 12 $\frac{3}{4}$ x 4 $\frac{1}{2}$ "D. For 117 VAC 60 Hz. Shpg. wt., 14 $\frac{1}{2}$ lbs.

21 E 54292WX Net 179.95
Walnut Wood Case for Model 299F. Shpg. wt., 6 lbs. Net 22.50
21 E 60240WX Net 22.50

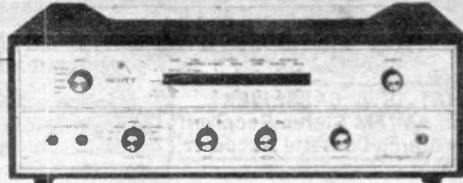

DELUXE MODEL 260B 160 WATT SOLID STATE STEREO AMPLIFIER

249⁹⁵

less enclosure
No Money Down*

- 160-Watts ± 1 db at 4 ohms
- Tape Monitoring Facilities
- Dual Speaker Switching

Superbly engineered and constructed solid state stereo amplifier. Features a multitude of modern conveniences—computer type push-button switches, complete tape monitoring facilities, dual front panel microphone inputs, and dual speaker selector switch for main and/or remote operation. Wide range of control functions including tone control by-pass switch for absolutely flat response. Direct Coupled Silicon outputs. Response: 15-30K Hz. Harmonic Distortion: .8%. Hum and noise: -55 db. Size: 14 $\frac{3}{4}$ x 12 x 4 $\frac{1}{2}$ ". For 117 VAC 60 Hz. Shpg. wt., 25 lbs.

21 E 54300WX Net 249.95
Walnut Wood Case for Model 260B. Shpg. wt., 6 lbs. Net 22.50
21 E 60240WX Net 22.50

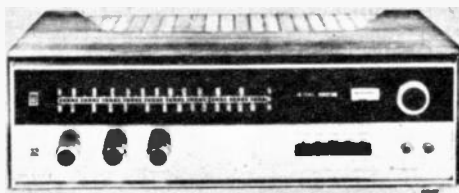

NEW! MODEL 330T SOLID STATE AM-FM STEREO MONITOR TUNER

199⁹⁵

less case
No Money Down*

- Built-in Monitor Amplifier for Headphones or Monitor Speaker
- Automatic FM Tuning Indicator

Versatile AM/FM stereo tuner has built-in self-contained stereo monitoring amplifier for use with phones or speakers. Computer type push buttons, select crystal filter, loudness, mode, inter-station muting, and speaker control circuitry. Other features: silver plated FET FM and IC AM front ends, two headphone jacks, balance control, and FM tuning meter. FM Sensitivity: 1.9 μ v. Selectivity: 40 db. Stereo Separation: 40 db. Capture Ratio: 2.5 db. Signal-to-Noise Ratio: 60 db. For 117 VAC 60 Hz. Size: 15 $\frac{3}{4}$ x 5H x 11 $\frac{1}{2}$ "D.

21 E 54607WX Shpg. wt., 17 lbs. Net 199.95
Walnut Wood Case for 330T. Shpg. wt., 6 lbs. Net 22.50
21 E 60240WX

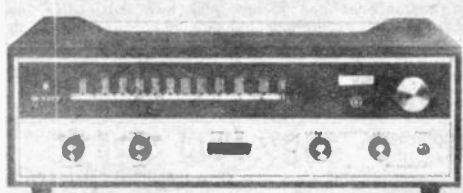

NEW! DELUXE MODEL 312D-1 SOLID STATE FM STEREOPHONIC TUNER

249⁹⁵

less enclosure
No Money Down*

- Three FET Front End
- Crystal Filter IF Strip
- Three-Way Tuning Meter
- Dynaural Muting Control

Scott's finest tuner featuring the silver plated, FET front end and crystal filter IF strip for maximum sensitivity with minimum interference. 3-way meter allows you to monitor signal strength, multi-path and center tuning. Has computer type pushbutton switches, interstation FM muting, AC outlet, patented time switching multiplex circuit, and stereo indicator light. Usable Sensitivity: 1.7 μ v. Signal to Noise Ratio: 65 db. Stereo Separation: 40 db. Cross Modulation Rejection: 90 db. Capture Ratio: 1.9 db. Size: 14 $\frac{3}{4}$ x 12 $\frac{3}{4}$ x 4 $\frac{1}{2}$ ". For 117 VAC 60 Hz. Shpg. wt., 13 lbs.

21 E 54599WX Net 249.95
Walnut Wood Case for Model 312D-1. Shpg. wt., 6 lbs. Net 22.50
21 E 60240WX

MONEY SAVING 82 WATT STEREO PHONO SYSTEMS
featuring Scott, Garrard, and Lafayette Hi-Fi Components

Complete System As low as **279⁹⁵**
No Money Down*

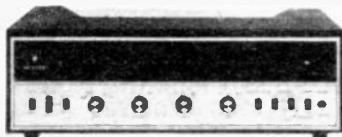

Scott Model 330T



Garrard 40B on Base



Shure M44E Elliptical Cartridge

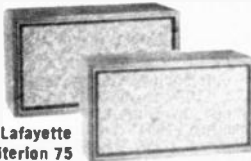

2 Lafayette Criterion 75

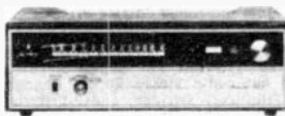

Save 72.80 from individual catalog prices. Deluxe system as above with addition of the Scott Model 330T solid state FM stereo tuner. Shpg. wt., 76 lbs. 21 E 54912WXM Net 459.95

SAVE up to 72.80 From Individual Catalog Prices

Save 54.95 from individual catalog prices on this top quality 82 watt stereo phono system consisting of:

- SCOTT MODEL 299F 82-watt solid state stereo amplifier (less case).
- GARRARD MODEL 40B 4-speed automatic stereo record changer with Garrard base.
- SHURE M44E Elliptical stereo cartridge.
- 2 LAFAYETTE CRITERION 75 ACOUSTIC SUSPENSION SPEAKER SYSTEMS. (See page 43 for complete description of Criterion 75's). Above system complete with all necessary cables. Shpg. wt., 64 lbs. 21 E 54904WM Net 279.95

Deluxe **SCOTT** Hi-Fi Kits

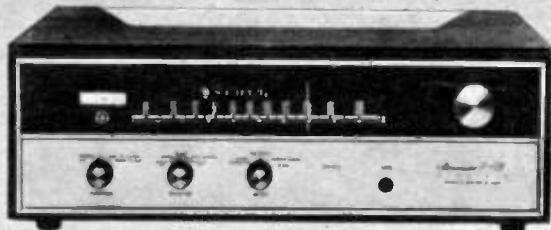

**Model LT-112B-1 SOLID STATE
FM STEREOPHONIC TUNER KIT**

149⁹⁵ SALE! SAVE 30.00

Less Case

- FET Front End
- Dynaural Muting Control
- Stereo Indicator Light

Was 179.95

1969 Catalog 690

A superb tuner in easy to build kit form. Learn as you build manual contains full color wiring diagrams, mistake proof double check instructions, and theory of operation. Finished product is a fine performer featuring the famous Scott silver plated FET front end for maximum sensitivity and low distortion. Has four position meter selector switch for signal strength, multipath center frequency tuning and alignment, and stereo indicator light for positive identification of stereo broadcasts. Dynaural® muting control virtually eliminates interstation static. Usable sensitivity: 1.8 μ V. Signal-to-noise ratio: 65 db. Cross modulation rejection: 90 db, Dtm. 14 $\frac{3}{4}$ x 12 $\frac{1}{2}$ x 4 $\frac{1}{8}$ ". For 110 VAC 60 Hz. Shpg. wt., 17 lbs.

21 E 54342WX No Money Down* Net 149.95

Walnut wood case for Model LT-112B-1 Shpg. wt., 6 lbs. Net 22.50

21 E 60240W

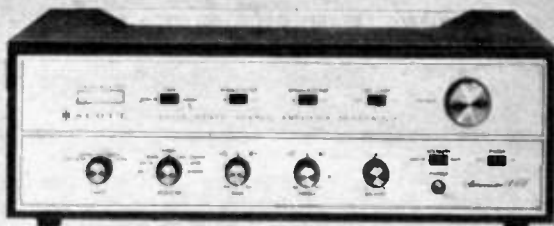

**MODEL LK60B 160 WATT SOLID STATE
STEREO AMPLIFIER KIT**

149⁹⁵ SALE! SAVE 30.00

Less Case

- 160 Watts \pm 1 db Output at 4 Ohms
- Tape Monitoring Facilities
- Front Panel Headphone Jack

Was 179.95

1969 Catalog 690

Enjoy the advantages of famous Scott quality in economical kit form. The LK-60B 160 Watt stereo amplifier features direct coupled silicon outputs for maximum power and low distortion. Step by step instructions with mistake proof cross checks assure optimum performance. Has complete tape monitoring facilities, built-in meter for power monitoring and construction testing, and a full range of control functions including a 7 position stereo selector, rumble and scratch filters, and separate bass and treble for each channel. Specifications: Frequency response: 15-30,000 Hz. Harmonic distortion: .8%. Hum and noise: -55 db. Dimensions: 14 $\frac{3}{4}$ x 13 $\frac{3}{4}$ x 4 $\frac{1}{8}$ ". For 110 VAC 60 Hz. Shpg. wt., 22 lbs.

21 E 54334WX No Money Down* Net 149.95

Walnut Wood Case for Model LK-60B. Shpg. wt., 6 lbs. Net 22.50

21 E 60240W

Model LR-88 SOLID STATE 130 WATT AM/FM STEREO RECEIVER KIT



Only **299⁹⁵**

less enclosure
No Money Down*

- 130 Watts \pm 1 db @ 4 Ohms
- FET Front End
- Integrated Circuit IF Strip
- Tape Monitoring Facilities
- Dynaural Muting Control

Superbly performing 130 watt AM/FM stereo receiver kit incorporating the latest advances in audio and FM stereo engineering. Full color easy to follow instruction manual has virtually mistake proof instructions for the audio connoisseur who wants to build his own quality receiver. Features IC IF strip and FET front end for maximum sensitivity and minimum interference. Has wideband AM with automatic variable bandwidth, dual speaker switch, com-

puter type pushbutton selector switches, 2 meters for signal strength dual front panel mike inputs. Response: 15-30 KHz. FM sensitivity: 2.0 μ V. Signal-to-noise ratio: 65 db. 17 $\frac{1}{8}$ x 15 x 5 $\frac{1}{4}$ ". For 110 VAC 60 Hz. Shpg. wt., 22 lbs.

21 E 54359WX Net 229.95

Oiled Walnut cabinet for LR-88. Shpg. wt., 8 lbs. Net 26.95

21 E 60638W

NEW! **SCOTT** Model 2560 SOLID STATE COMPACT AM/FM STEREO CASSEIVER SYSTEM

339⁹⁵

No Money Down*

- Versatile Home Music System consists of:
AM/FM Stereo Receiver, Stereo Cassette Recorder, and a Matched Pair of Air-Suspension Speakers

Handsome 3 piece modular AM/FM stereo cassette music system in beautiful walnut wood cabinetry. Plays back pre-recorded stereo cassettes, records onto cassettes from voice or instruments (2 mike input jacks are located on the front panel), directly from its own AM/FM stereo tuner, or from records (just connect a turntable). Tuner section features FET front end plus integrated circuits both in the IF and the preamplifier. FM stereo light visually indicates when an FM stereo broadcast is being received. Full compliment of controls. Tape monitor. Right and left channel record inputs. 6 pushbutton cassette functions: record, stop, play, rewind, fast forward and eject. 3 digit counter with reset button. Also features stereo headphone jack and left and right channel record level meter. Specifications: Amplifier frequency response: 20-20,000 Hz; Tuner sensitivity: 2.5 μ V; Recorder frequency response: 50-12,000 Hz. Size: Casseiver section: 13 $\frac{3}{4}$ W x 12 $\frac{1}{8}$ D x 6 $\frac{3}{4}$ H. Each speaker: 13 $\frac{3}{8}$ x 6 $\frac{3}{4}$ x 7 $\frac{1}{2}$. 21 E 54615WX Shpg. wt., 36 lbs. Net 339.95



* See Page 11 for Full Credit Details on Easy Pay Plan

Professional Solid State Components by **DYNACO**

PAT-4 STEREO PRE-AMPLIFIER KIT



PAT-4 KIT	PAT-4 WIRED
89⁹⁵	129⁹⁵
No Money Down*	No Money Down*

- Exclusive Tone Control Circuit (Patent Pending)
- 8 Silicon Transistors, 2 Diodes

Deluxe solid state stereo pre-amplifier offering complete control facilities for any conceivable stereo or music system source. Features exclusive "Dyna Tone Control Circuit" to assure truly flat response (Patent Pending). Also features a switch selected high frequency filter @ 7, 10, and 15 kHz. Plus flat position. SPECIFICATIONS: Freq. Response: ± 0.5 db from 10 to 100,000 Hz. Harmonic Distortion less than 0.05% at 2 volts output between 20 Hz and 20,000 Hz. IM: less than 0.5% at 2 volts output; Tone Control Range ± 12 db at 50 Hz and 10,000 Hz. Noise: less than 2 mv. 8 silicon Transistors, 2 diodes. For 120 or 240 volts 50 or 60 Hz. Shpg. wt., 10 lbs. Size: 13 $\frac{1}{2}$ x4 $\frac{1}{4}$ x8"

21 E 23255WX PAT-4 Kit Net 89.95
21 E 23263WX PAT-4A Factory Wired Net 129.95

"STEREO 120" POWER AMPLIFIER KIT

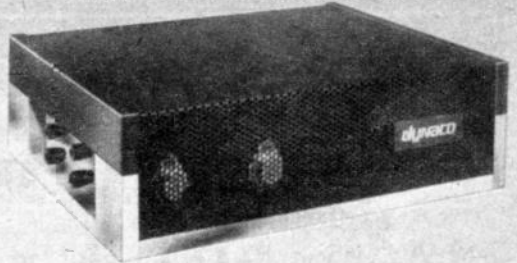

120 KIT	120 WIRED
159⁹⁵	199⁹⁵
No Money Down*	No Money Down*

- 60 Watts RMS Power Output Per Channel
- 15 Transistors, 15 Diodes

A solid state stereo power amplifier which offers superb performance. Perfect companion to the PAT-4. No interstage or output transformers are used. Power output per channel: 60 watts RMS @ 8 ohms. Features: Electronic protection against open circuits or shorts; by means of a current limiting biasing circuit. No fuses or circuit breakers are needed. SPECIFICATIONS: Frequency Response: 10 Hz to ∞ kHz; ± 0.5 db. Harmonic Distortion: less than 0.5% at any power level up to 60 watts. IM Distortion: less than 0.5% up to 60 watts. Noise: 95 db below rated output. 15 Transistors, 15 diodes. Size: 13x10 $\frac{1}{2}$ x4". For 120/240 VAC 50/60 Hz. Shpg. wt. 20 lbs.

21 E 23230WX Kit Net 159.95
21 E 23248WX Factory Wired Net 199.95

NEW SCA-80 INTEGRATED AMPLIFIER KIT



SCA-80 KIT	SCA-80 WIRED
169⁹⁵	249⁹⁵
No Money Down*	No Money Down*

- 40-Watts RMS Power Output Each Channel
- Tape Monitor Switch • Stereo Headphone Jack

Solid state, integrated stereo control amplifier combining the power amplifier of the Stereo-80 and a preamplifier incorporating most of the features of the PAT-4. SCA-80 also features automatic current limiting protection of audio output stages. Front panel controls: Volume, Bass, Treble, Balance and Selector for Special Low Level, Phono, Tuner, Tape and Spare. Rocker switches for: Illuminated Power, Tape Monitor, Loudness, Frequency Filter, Speaker Mode Selector. Front panel stereo headphone jack. 40-watts RMS per channel @ less than 0.5% H.D. from 20-20,000 Hz at full power. Power Bandwidth: 6 Hz to 50 kHz. Input Sensitivity: Phono, 3 mv; High Level, 0.13 v. Hum and Noise: Phono, better than -60 db; High level, better than -80 db. Size: 13 $\frac{1}{2}$ x4 $\frac{1}{4}$ x10"D. For 120/240 VAC 50/60 Hz. Shpg. wt., 16 lbs.

21 E 23271WX SCA-80 Kit Net 169.95
21 E 23305WX SCA-80 Factory Wired Net 249.95

NEW "STEREO-80" POWER AMPLIFIER KIT

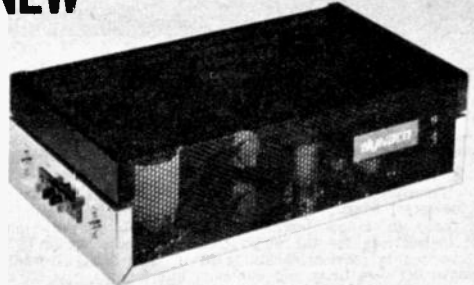

STEREO-80 KIT	STEREO-80 WIRED
119⁹⁵	159⁹⁵
No Money Down*	No Money Down*

- 40-Watts RMS Power Output Per Channel
- Current Limiting Protection Circuitry

The Stereo-80 is a conservatively designed stereo amplifier rated at 40-watts RMS per channel with both channels operating simultaneously. The Stereo 80 has excellent frequency response with low distortion levels, incorporates current limiting protection which eliminates the inconvenience of replacing fuses or resetting circuit breakers whenever the amplifier is overdriven. Illuminated rocker power switch. Color-coded speaker terminals to facilitate speaker hook-up. Frequency response: 15 Hz to 50 kHz $\pm .5$ db. Harmonic distortion: less than 0.5% up to 40 watts per channel; IM distortion: less than 0.5% up to 40 watts per channel. Power bandwidth: 6 Hz to 50 kHz. Input sensitivity: 1.3 volts, Hum and Noise: 95 db below rated output. For 120/240 VAC 50/60 Hz. Size: 13 $\frac{1}{2}$ x4 $\frac{1}{4}$ x9"D. Shpg. wt., 13 lbs.

21 E 23289WX Stereo-80 Kit Net 119.95
21 E 23297WX Stereo-80 Factory Wired Net 159.95

* See Page 11 for Full Credit Details on Easy Pay Plan

Quality **DYNACO** High Fidelity Components

PAS-3X STEREO PREAMPLIFIER KIT

"STEREO 70" 70-WATT STEREO BASIC AMPLIFIER KIT

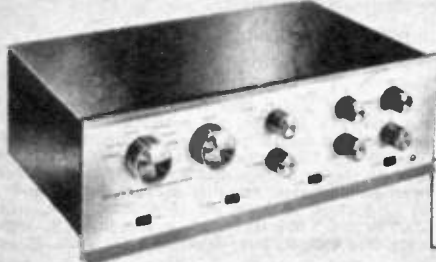

KIT
69⁹⁵

WIRED
109⁹⁵

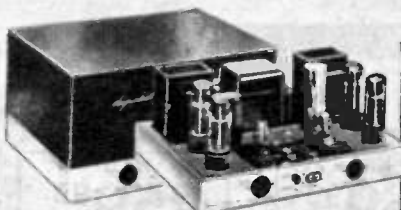

KIT
99⁹⁵

WIRED
129⁹⁵

Top-performing stereo preamp for use with high quality basic amplifiers. Includes two independent high gain, low noise preamplifier-control channels. All critical circuitry is pre-assembled on 2 printed circuit boards. Features "Dyna-Blend" for variable channel separation, DC heated tube filaments. Inputs: 3 stereo low level and 4 stereo high level. Frequency response: ± 0.5 db 10-40,000 Hz. Distortion: less than .05%. Noise less than 2 μ v. Gain, 60 db at 1000 Hz on RIAA, 20 db on high level. For 110-120V., 50/60 Hz. Deluxe gold panel. Size: 13 $\frac{1}{2}$ x4 $\frac{1}{2}$ x8". Shpg. wt., 11 lbs.

21 E 23016WX PAS-3X Kit, No Money Down* Net 69.95
21 E 23024WX PAS-3XA Wired, No Money Down* Net 109.95

The stereo 70 provides outstanding reproduction, firm bass, and smooth natural highs. Delivers 35-watts per channel. Frequency response: ± 0.5 db from 10 Hz to 40,000 Hz. IM distortion: less than 1% at 35 watts. Sensitivity 1.3 volts rms input for 35 watts output. Hum and Noise: better than 90 db below rated output. Output impedance: 4, 8 and 16 ohms. Nickel-finished chassis; vinyl coated charcoal brown cover. For 110-120V 50/60 Hz AC. Size 13Wx6 $\frac{1}{2}$ Hx9"D. Shpg. wt., 32 lbs.

21 E 23032WX Stereo 70 Kit, No Money Down* Net 99.95
21 E 23040WX Stereo 70/A Wired, No Money Down* Net 129.95

"SCA-35" 35-WATT STEREO INTEGRATED AMPLIFIER KIT

FM-3 FM STEREO TUNER KIT

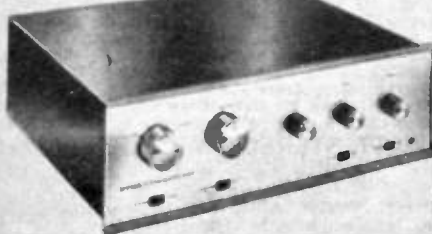

KIT
99⁹⁵

WIRED
139⁹⁵

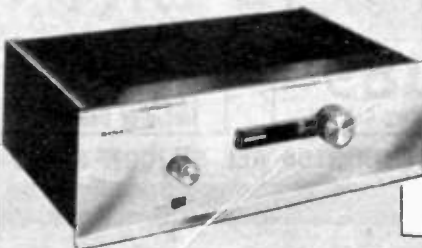

KIT
99⁹⁵

WIRED
154⁹⁵

Combines a quality stereo preamplifier with a 35-watt stereo power amplifier. Inputs 7 pairs; outputs; tape, 8 and 16 ohm speaker outputs, and provision for headphone connection. Frequency Response: 20-20,000 Hz ± 0.25 db. IM Distortion: less than 1%. Hum and noise, 70 db below rated output. Controls: Input Selector, Volume, Bass, Treble, Stereo-Mono Switch, Loudness compensation switch, Filter switch, Power switch. For 110-120 VAC. Complete with case, deluxe gold panel. Size: 13 $\frac{1}{2}$ x4 $\frac{1}{2}$ x10". Shpg. wt., 20 lbs.

21 E 23172WX SCA-35 Kit, No Money Down* Net 99.95
21 E 23180WX SCA-35 Wired, No Money Down* Net 139.95

Deluxe FM stereo tuner for flawless stereo on mono reception. High sensitivity, selectivity and separation. Uses 4 IF limiters, wideband balance bridge discriminator and time-switching multiplex system. "Stereomatic" tuning system automatically switches to stereo and signals when stereo is being received. Sensitivity: 4 μ v. Frequency response: 10-47,000 Hz ± 0.5 db (before de-emphasis). Separation: 30 db. For 110-120 VAC 50/60 Hz. With deluxe gold panel and brown vinyl covered cover. Size: 13 $\frac{1}{2}$ x4 $\frac{1}{2}$ x8"D. Shpg. wt., 13 lbs.

21 E 23222WX FM-3 Kit, No Money Down* Net 99.95
21 E 23081WX FM-3 Wired, No Money Down* Net 154.95

ACOUSTIC RESEARCH MODEL "AR" 120 WATT STEREO INTEGRATED AMPLIFIER

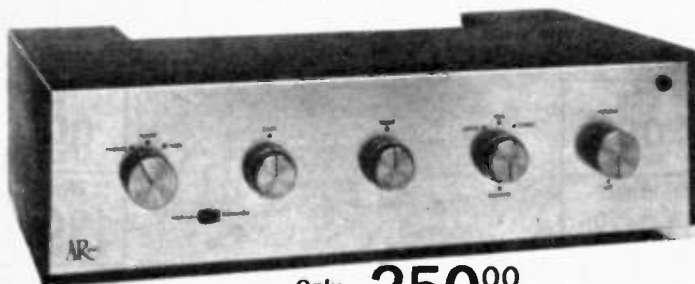

Only **250⁰⁰** With Black Anodized Aluminum Cover

- Power Output 60 Watts RMS Per Channel

Deluxe stereo control preamplifier and power amplifier. All silicon solid state circuitry. Special DC driver clamping circuit to provide very clean clipping and rapid recovery from overloads. This feature increases the usable dynamic range by keeping sound clean at very high power levels. Response: 20-20,000 Hz ± 1 db at full power or below. Distortion is less than 0.5% from 20-20,000 Hz up to full power. Input sensitivity: phono circuit—2 mv. to 5 mv. (adjustable); tape playback and tuner inputs—200 mv. for full power output. Self-resetting, thermostatic circuit breakers for both channels plus speaker fuses. For 110-120 volts AC, 60 Hz. 15 $\frac{1}{2}$ x4 $\frac{1}{2}$ x10". Shpg. wt., 21 lbs.

21 E 72666WX Walnut cover for AR amplifier. Shpg. wt., 4 lbs. Net 250.00
21 E 72674WX Net 15.00

OTHER DYNACIT COMPONENTS

MODEL "STEREO 35" BASIC STEREO AMPLIFIER KIT. High performance at low cost, 17.5 watts RMS each channel. Response: 10-40,000 Hz ± 1 db. For 110-120 VAC 60 Hz. Size: 13x4x8". Wt., 12 lbs.
21 E 23156WX Kit Net 59.95

MODEL FM-1 FM TUNER KIT. Tuner RF input provides 4 μ v. sensitivity and excellent rejection of spurious signals. For 110-120 VAC 60 Hz. Size: 13x4x8". Wt., 12 lbs.
21 E 23057WX Kit Net 74.95
21 E 23065WX Wired Net 109.95

MODEL FMX-3 MULTIPLEX INTEGRATOR KIT. Fits into chassis cutout of FM-1 and converts it to fully automatic stereo reception when multiplex is broadcast.
21 E 23511 Shpg. wt., 3 lbs. Net 29.95

MARK IV 40-WATT MONO BASIC AMPLIFIER KIT. Ideal match for PAM-1 or PAS-3 Preamps. Response: ± 0.5 db from 10-40,000 Hz. IM distortion: Less than 1%. Hum and Noise: 90 db down, 4, 8, 16 ohms output. With cover 14x5x7"H. Shpg. wt., 20 lbs.
21 E 23131WX Kit Net 59.95
21 E 23149WX Wired Net 79.95

PAM-1 MONO PREAMPLIFIER KIT. Full flexibility for all input sources. Response: ± 0.5 db. 10 Hz to 40 kHz. IM dist.: less than 0.05% at 2V output, 200 to 400 VDC at 4 ma and 6 Vac at .75 amps. With baked vinyl coated cover. 12x6x3. Shpg. wt., 7 lbs.
21 E 23529 Kit Net 34.95
21 E 23537 Wired Net 59.95

EICO Cortina Hi-Fi Components—Kit or Factory Wired

CORTINA 3570 SOLID-STATE 80-WATT FM STEREO RECEIVER

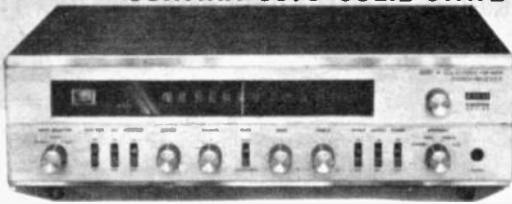

Kit
169⁹⁵
Including Cabinet

Wired
259⁹⁵
Including Cabinet

- Automatic Electronic Switching
- Baxandall Tone Control Circuit
- Full Complement of Controls for Every Music Source

Deluxe "Easy-To-Build" FM Stereo Receiver Kit. FM Tuner Section has RF, IF, and Multiplex sections, all pre-assembled and pre-aligned. Features complete control facilities: Tape monitor; Loudness control; Low and high filters; Balance control. SPECIFICATIONS—Tuner Section: 2-RF stages, 4-stage double-tuned IF, and 5 tuned circuits; D'Arsonval tuning meter. Amplifier Section: Output Power: 80 watts ± 1 db @ 4 ohms, 70 watts IHF @ 4 ohms. Frequency Response: 8-60,000 Hz ± 0.5 db.; 1M Distortion: less than 1%. With Danish walnut vinyl-clad cabinet. Size: 4 $\frac{1}{2}$ x16x9". For 117V. 60 Hz AC. Wt., 19 lbs.

21 E 25664WX 3570 Kit. No Money Down* Net 169.95
21 E 25672WX 3570 Wired. No Money Down* Net 259.95

CORTINA 3770 SOLID-STATE 80-WATT AM/FM STEREO RECEIVER

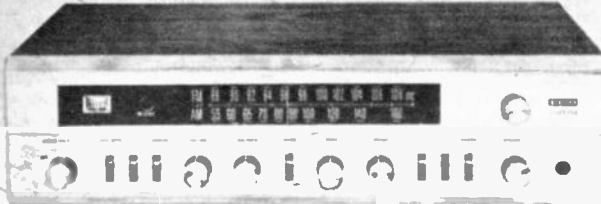

Kit
189⁹⁵
Including Cabinet

Wired
279⁹⁵
Including Cabinet

- All Silicon Audio Amplifier Section Delivers 80 watts ± 1 db @ 4 ohms
- 5 Tuned RF Circuits, 4-Stage Double Tuned IF Circuits
- Full Complement of Controls for Every Music Source
- Automatic Switching Between FM Mono and FM Stereo

Deluxe receiver delivers fine stereo performance as well as excellent noise-free FM and AM reception. Features precision D'Arsonval tuning meter and switchable AFC. FM channel separation more than 40 db. FM sensitivity is 5 μ v for 30 db quieting. Amplifier frequency response: 8-60,000 Hz, $\pm .5$ db. Hum and noise: 72 db below rated output. FM tuning section is pre-aligned and pre-assembled. Power output: 80 watts ± 1 db @ 4 ohms, 70 watts IHF @ 4 ohms. Danish walnut vinyl-clad cabinet. For 105-130 VAC, 50/60 Hz. Size: 16x9x4". Shpg. wt., 20 lbs.

21 E 25680WX Model 3770 Kit. No Money Down* Net 189.95
21 E 25698WX Model 3770 wired. No Money Down* Net 279.95

CORTINA 3150 ALL SILICON SOLID-STATE 190-WATT STEREO AMPLIFIER



Kit
149⁹⁵
Including Cabinet

Wired
225⁰⁰
Including Cabinet

- 190-Watt ± 1 db at 4 ohms
- 4-Way Speaker Selector Switch: Main — Remote—Main and Remote—Phone
- Tape Monitor Facilities
- Distortion Less than 0.15% at Rated Output

Quality solid-state stereo amplifier offers superb performance. Frequency Response: 10-50,000 Hz, ± 1.5 db. Hum and Noise: 75 db below rated output. Power Bandwidth: 20-20,000 Hz at .5% distortion. Harmonic Distortion: 0.15%. Power output: 190 watts ± 1 db @ 4 ohms, 150 watts IHF @ 4 ohms. Inputs: mag. phono, tuner, tape and auxiliary. Outputs: 4-16 ohm speakers, tape recorder, and stereo headphone (front panel). Danish walnut, vinyl-clad cabinet. For 105-130 VAC, 50-60 Hz. Size: 14 $\frac{1}{2}$ x9x3".

21 E 25706WX 3150 Kit. Shpg. wt., 19 lbs. Net 149.95
21 E 25714WX 3150 wired. Shp. wt., 19 lbs. Net 225.00

CORTINA 3070 SILICON SOLID-STATE 80-WATT STEREO AMPLIFIER

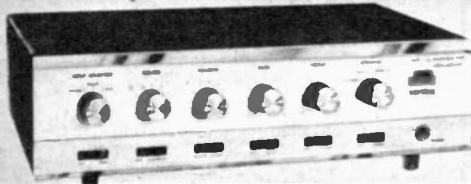

Kit
99⁹⁵
Wired
139⁹⁵

- 80 Watts ± 1 db @ 4 ohms
- Complete Control Facilities: Tape Monitor, Loudness Contour, Low and High Cut Filters, Balance Control and Speaker Systems Switch

"All Silicon Solid State Design" offers powerful performance and true-to-life sound. Delivers 40 watts of continuous power per channel ± 1 db at 4 ohms, 35 watts IHF @ 4 ohms. Freq. Response: 5-100,000 Hz ± 1.5 db.; 8-60,000 Hz ± 0.5 db. Hum and Noise: 72 db below rated output. Input Sensitivity: 4.2 mv on magnetic phono; 270 mv on auxiliary, tuner and tape. Input Impedance: 47k ohm on magnetic phono; 110k minimum on other inputs. Danish walnut vinyl clad case. For 105-130V 50/60 Hz AC. Size: 3 $\frac{3}{4}$ x12x8"D. Shpg. wt., 14 lbs.

21 E 25375WX Model 3070 Kit. No Money Down* Net 99.95
Model 3070W—same as above but wired and tested
21 E 25383WX No Money Down* Net 139.95

EICO "CORTINA 3200" SOLID STATE FM/MPX AUTOMATIC STEREO TUNER

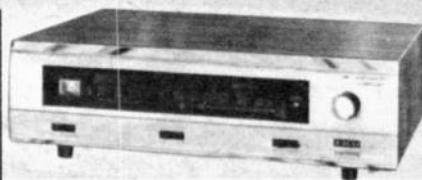

Kit
99⁹⁵
Wired
139⁹⁵

- 13 Transistors, 8 Diodes, 2 Rectifiers
- Contains 2 RF stages and 5 Tuned Circuits, plus a 4-Stage Double-Tuned IF Circuit

Quality solid state, RF, IF and multiplex circuitry, provides excellent channel separation and eliminates interference. Noiseless, electronic automatic switching automatically indicates stereo (with light), and switches to stereo mode. D'Arsonval tuning meter and AFC function. Sensitivity: 2.4 μ v for 30 db quieting. M.O.: less than 0.75%. Frequency Response: 20-15,000 Hz ± 1 db. Output Impedance: 5000 ohms. Antenna Input: 300 ohms balanced. Danish walnut vinyl case. For 105-130V 50/60 Hz AC. Size: 3 $\frac{3}{4}$ x12x8"D. Shpg. wt., 11 lbs.

21 E 25409WX Model 3200 Kit. No Money Down* Net 99.95
Model 3200W—same as above but wired and tested
21 E 25417WX No Money Down* Net 139.95



Color Organs, Translators & Strobe Lights

EICO SOUND N' COLOR AUDIO COLOR ORGANS KIT OR FACTORY WIRED

AS LOW AS
49⁹⁵
No Money Down*

- Easily Connects to Speaker Leads
- A New Dimension to Hi-Fi Sound
- Watch the Music You Love Spring to Life As a Vibrant Interplay of Colors
- Individual External Color-Crossover Controls for Precise Color Mixing

"SOUND N' COLOR" Audio/Color Organs—All-electronic solid state systems which provide true frequency synchronization of sound with color. See every tone, every note, every combination of instruments create its own vivid pattern. These devices electronically convert music into colored light. The color (hue) is controlled by the pitch (frequency) of the music, and the brightness by the loudness of each frequency band. EICO Audio/Color Organs are available in both 3 and 4 color frequency models and in various sizes. Attractive walnut grain cabinet with shatterproof plastic front. Comes in kit or factory wired.



Model 3440



Model 3445



Model 3450

Model 3340—3-Color Frequency (red, blue, and green) Electronic Audio Color Organ. Size: 15x10x6". Shpg. wt., 15 lbs.
 21 E 25722WX Model 3440 Kit Net 49.95
 21 E 25730WX Model 3440 Wired Net 79.95

Model 3445—4-Color Frequency (red, blue, green, and yellow) Electronic Audio Color Organ. Size: 24x12x10".
 21 E 25862WX Model 3445 Kit Shpg. wt., 23 lbs. Net 64.95
 21 E 25870WX Model 3445 Wired Net 99.95

Deluxe Model 3450—4-Color Frequency (red, blue, green, and yellow) Electronic Audio Color Organ. Size: 30x15x11".
 21 E 25888WX Model 3450 Kit Shpg. wt., 20 lbs. Net 79.95
 21 E 25896WX Model 3450 Wired Net 109.95

EICO SOUND/LITE TRANSLATORS KIT OR FACTORY WIRED

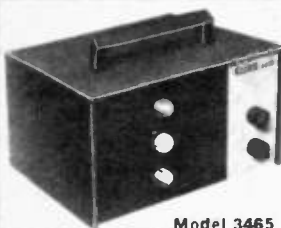

Model 3465



Model 3460

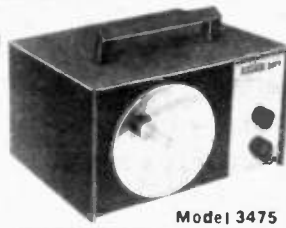

Model 3475



Model 3470

AS LOW AS
24⁹⁵
No Money Down*

- Transforms Sound Waves to Light Waves
- May be Used With Any Music System—Radio, Phonograph, Hi-Fi System—and Up to 3 400-Watt Lite Sources

Model 3465 Solid State 3 Channel Sound Lite Translator. Varies intensity of light by means of a change in frequency (high, low, or mid-range) from the output of a sound source (P.A., Hi-Fi system, phono). 3 separate 400-watt light sources can be hooked up to output receptacles on the translator. Using an arrangement of color bulbs you can project on a wall or screen a spectacular lighting effect in rhythm with the music played. Vinyl-clad metal cabinet. Size: 6 1/8" x 9 1/8" x 5 1/4". Shpg. wt., 3 lbs.

21 E 25771 Model 3465 Kit Net 49.95
 21 E 25789 Model 3465 Wired Net 69.95

Model 3460 Solid State Single Channel Sound Lite Translator. Varies intensity of light by means of a change in volume (amplitude) of a sound source. Handles only 1 400 watt light source to translator. Ideal for varying patio lights, xmas tree bulbs, or EICO 3455 color lite display (see below). Size: 2 1/2" x 6 1/8" x 3 3/4". Shpg. wt., 1 1/2 lbs.

21 E 25797 Model 3460 Kit Net 24.95
 21 E 25805 Model 3460 Wired Net 39.95

AS LOW AS
24⁹⁵
No Money Down*

- Strobe Light Flashes in Cadence with the Rhythm of Your Music System

EICO 3475 Solid State Sound Actuated Strobe Lite. New sensation in audio lighting effects. Strobe Lite flashes in cadence with the rhythm of your music system. Each music beat creates "different flash rate" automatically. Sensitivity control permits use with wide range of music sources (radio, Hi-Fi phonograph, P.A.) at minimum volume levels. Simple hook-up to speaker outputs. Housed in an attractive vinyl-clad metal case. Supplied complete with a spun aluminum reflector and plug-in xenon bulb. Size: 6 1/8" x 9 1/8" x 5 1/4". Shpg. wt., 2 lbs.

21 E 25813 Model 3475 Kit Net 39.95
 21 E 25821 Model 3475 Wired Net 59.95

EICO 3470 Solid State Electronic Strobe Lite. Solid state single head strobe lite with speed control that can be adjusted to the music beat. Ideal for the preferred lighting effects now in use by combo groups, discoteques, etc. Size: 6 1/8" x 9 1/8" x 5 1/4". Shpg. wt., 1 1/2 lbs.

21 E 25839 Model 3470 Kit Net 24.95
 21 E 25847 Model 3470 Wired Net 39.95

EICO 3455 COLOR LIGHTS

3 Color light display box (no electronics). Ideal for use with EICO Model 3460 Translator. Provides random, flashing red, blue, and green lights varying to the amplitude of the sound source. When used, separately color lights flash on and off. Attractive walnut grain cabinet. Size: 12" x 24" x 9 1/2". Shpg. wt., 4 lbs.

21 E 25854WX Net 29.95

29⁹⁵
Wired Only



* See Page 11 for Full Credit Details on Easy Pay Plan



Ultra-Compact Criterion Systems

5 YEAR AAA GUARANTEE FOR CRITERION® 20A AND 25A

A Lafayette quality product that is guaranteed against defects in material and workmanship for 5 years. If this unit fails to operate due to such defects, simply return it prepaid

with your original sales slip or order. Lafayette will repair it without charge including return transportation.

NEW! CRITERION® "25A" 2-Speaker 2-Way Air Suspension 8" System

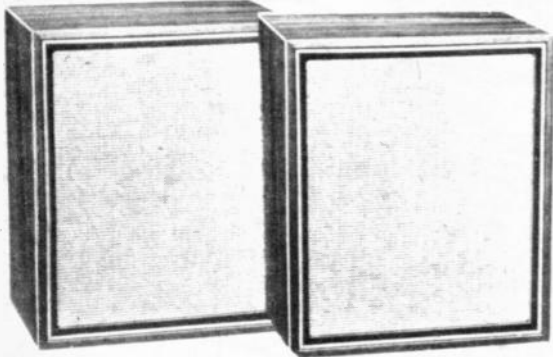

Only
19⁹⁵ **2 for 38⁵⁰**
No Money Down*

POWER HANDLING CAPACITY 25 WATTS

- 8" Woofer, 2½" Tweeter
- Frequency Response: 55-19,500 Hz.
- Rich, Hand Rubbed Oiled Walnut Finish

PERFECTLY MATCHED COMPONENTS

12¾W x 7D x 10¼"H

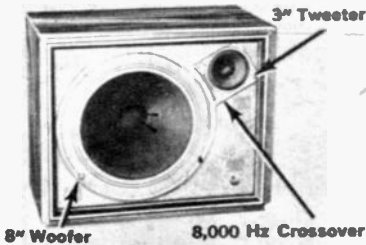

FULL SIZE PERFORMANCE . . . this outstanding ultra-compact Lafayette 2 speaker 2-way system achieves a purity of sound and music quality that is astounding for a speaker system measuring only 12¾W x 7D x 10¼"H. Perfect for use anywhere in your home or office. You get rich styling plus true high fidelity music reproduction at a low, low price. System consists of a powerful 8" woofer which provides smooth bass sound reproduction down to 55 Hz, and a 2½" cone tweeter that gives you sparkling clean high frequency response. Also includes a built-in 8,000 Hz. electrical crossover network. Power handling capacity of 25 watts makes it compatible for use with most amplifiers and receivers. Interior of cabinet is designed to damp out standing waves and other spurious vibrations. Specifications: Frequency Response: 55-19,500 Hz. Voice Coil Impedance: 8 ohms. Woofer 8" high compliance with 32.6 oz. magnet structure; rolled edge suspension. Tweeter: 2½" cone type with 2.4 oz. magnet structure. Electrical Crossover: 8,000 Hz. Imported. Wt., 9 lbs.

99 E 02255WX Net 19.95
Set of 2 for Stereo SAVE 1.40 Net 38.50

CRITERION® "20A" "The Miniaturized" 2-Speaker 2-Way System

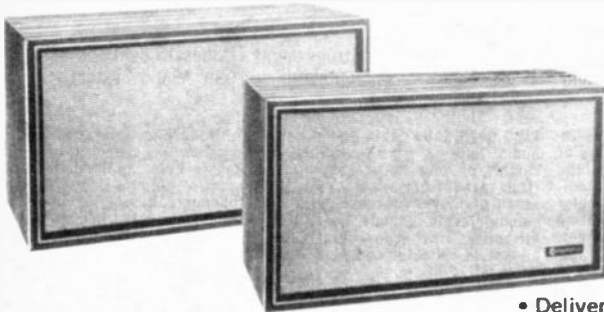

22⁹⁵ **2 for 44⁵⁰**
No Money Down*

POWER HANDLING CAPACITY 25 WATTS

- Rich, Hand-Rubbed Oiled Walnut Finish
- Equipped With Electrical Crossover Network and 4" Back-loaded Mid/High Frequency Unit
- Delivers True High Fidelity Sound With Outstanding Bass
- Uses a Specially Designed Large-Excursion Powerful 5" Woofer

A unique achievement in acoustic design, the Criterion 20A is hardly bigger than a table radio, yet offers astonishing high fidelity reproduction. The rich, deep-down bass delivered by this miniature-sized system must be heard to be believed—compares with systems many times its size! Music reproduced through the Criterion 20A comes through with complete naturalness...gives you sound that is excitingly real—you get full, wide-range response, from the lowest frequencies all the way up to the limits of the audio range. Yet this remarkable speaker system measures only 5¾ x 11¾ x 7¾" deep and fits anywhere...on a bookshelf...table...even on a wall! And, it has the look of fine furniture—comes finished on all four sides in a rich, hand-rubbed oiled walnut veneer, tastefully framed in an ebony and gold picture-frame molding with white gold acoustic grille material. The 20A is not an extension speaker but a miniaturized system specially developed to provide high quality reproduction with any fine mono or stereo component amplifier. Its amazing perform-

ance is made possible by the use of specially designed speakers. A powerful 5-inch woofer equipped with a large 28.7 oz. alnico V mag and voice coil, provides high efficiency and power capability. Special cone suspension results in extremely high compliance and permits large cone excursions to provide efficient, solid bass all the way down to 45 cycles. A 6 db per octave L-C crossover network transfers power at 2800 cycles to a back loaded mid-range/ high frequency unit which provides realistic "presence" and brilliant highs. Enclosure is rigidly constructed and filled (not just lined) with acoustic dampening material to assure freedom from resonances and provide smooth, uniform response. Power Rating: 25 watts program material. Frequency Response: 45 to 20,000 Hz. Crossover Frequency: 2800 Hz. Nominal Impedance: 8 ohms. Imported. Shpg. wt., 8 lbs.

99 E 01687W Net 22.95
Set of 2 for Stereo—SAVE 1.40 Net 44.50

Designed Especially for Bookshelf Use

5 YEAR AAA GUARANTEE FOR CRITERION® 50 AND 75

A Lafayette quality product that is guaranteed against defects in material and workmanship for 5 years. If this unit fails to operate due to such defects,

simply return it prepaid with your original sales slip or order. Lafayette will repair it without charge including return transportation.

CRITERION® "50" True 2-Way Bookshelf Speaker System

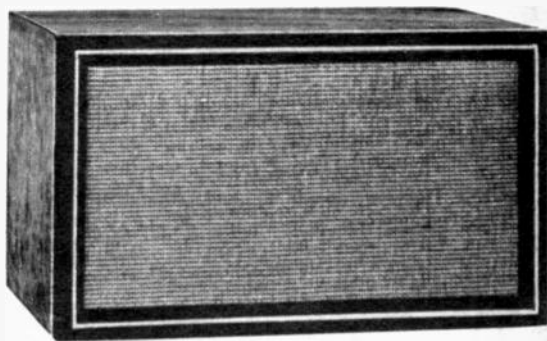
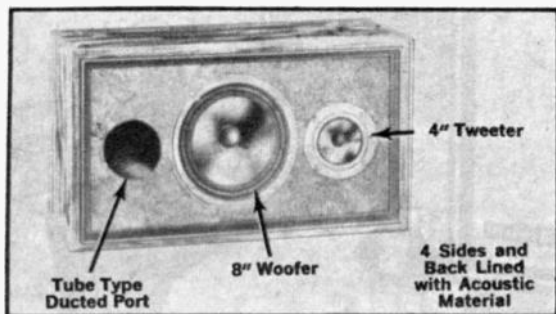

POWER HANDLING CAPACITY 30 WATTS

FAMOUS LAFAYETTE QUALITY AND PERFORMANCE FOR ONLY

29⁹⁵

- 8" Woofer Plus 4" Tweeter
- "Tuned" Enclosure with Tube-Type Ducted Port
- Overall Response 35-18,000 Hz
- 3000 Hz Electrical Crossover
- Handsome "Criterion" Styling

A true 2-way bookshelf-type speaker system that offers impressive hi-fi sound, yet measures only 19W x 8 $\frac{1}{2}$ D x 10 $\frac{3}{4}$ "H. Contains two separate speakers. A heavy-duty 8-inch woofer with a 32.6 oz. magnet structure and a ribbon-type voice coil edge wound on an aluminum form provides reproduction of the low and mid-range frequencies. A 4-inch cone-type tweeter with a 3.7 oz. magnet structure provides reproduction of the high frequencies (to beyond audibility). Electrical crossover at 3000 Hz. The enclosure is a bass-reflex design using a ducted port of the tube type to provide proper acoustic "tuning" of the enclosure with the speakers used. The tube provides a special path for the low frequency sound waves radiated from the rear of the woofer so that they emerge "in-step" with those radiated from the front of the speaker. This provides substantially greater bass sound power from the system. Finished on all four sides in a rich, hand-rubbed oiled walnut veneer and tastefully framed in an ebony and gold picture frame molding with white and gold acoustic grill material. Rated at 30 watts. Designed for vertical or horizontal placement. Overall response: 35-18,000 Hz. Nominal impedance: 8 ohms. Imported. Shpg. wt., 28 lbs.

99 E 01281WX Criterion 50

Net 29.95

CRITERION® "75" 2-Way Acoustic Suspension Speaker System

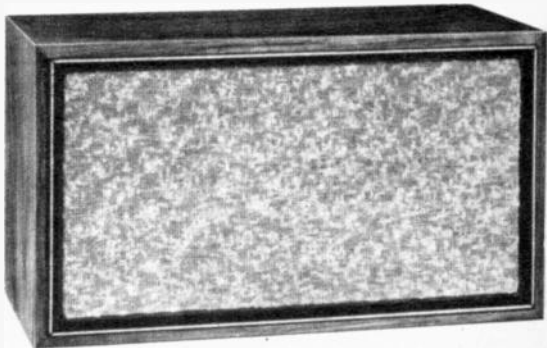
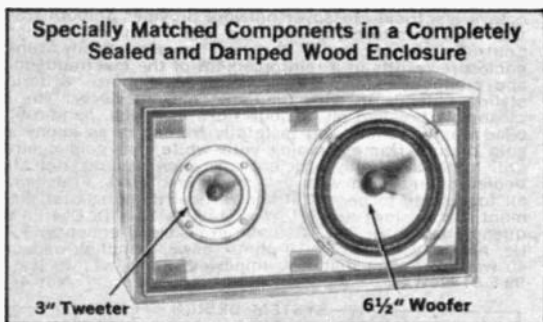

POWER HANDLING CAPACITY 30 WATTS

Only **39⁹⁵** No Money Down*

- 6 $\frac{1}{2}$ " High Compliance Woofer
- 3" Cone-Type Tweeter
- High Frequency Brilliance Control
- Crossover—Electrical 2,500 Hz.

Outstanding, compact, 2-way bookshelf speaker system mounted in a completely sealed and damped enclosure. Uses the acoustic suspension principle to extend low frequency response down to 30 Hz for deep rich bass. Powerful 6 $\frac{1}{2}$ " woofer features a 1 lb. 4 oz. magnet structure, ribbon shaped copper wire voice coil edge-wound on an aluminum form, and a mass loaded cone especially matched to the enclosure. Closed back, 3" cone type tweeter prevents speaker interaction and provides high frequency coverage to 20,000 Hz. A 2,500 Hz crossover network is built-in with an external brilliance control to adjust the output level of the tweeter for proper balance of volume between the high and low frequencies. Can be connected to amplifiers with a power output as low as 30 watts, or as 30 watts per channel. Impedance: 8 ohms. Styled in hand rubbed, oiled walnut finish on four sides. Acoustic grill is set off with contrasting ebony and gold picture frame molding. For vertical or horizontal placement. Size: 15 x 8 $\frac{1}{4}$ x 7 $\frac{1}{4}$ ". Imported. Shpg. wt., 7 $\frac{1}{2}$ lbs.

99 E 01927WX

Net 39.95

*See Page 11 for Full Credit Details on Easy Pay Plan

Lafayette CRITERION® "100A"

10" 2 Speaker 2 Way System

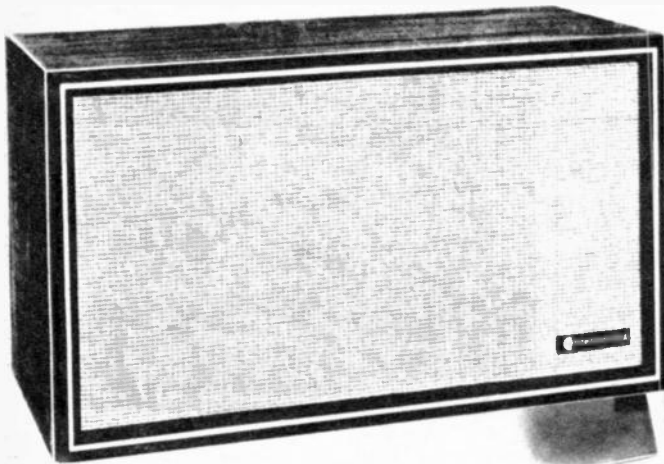

POWER HANDLING CAPACITY 40 WATTS

44⁹⁵ No Money Down*

Magnificent Full Range Sound Reproduction from a 10-inch System

5 Year A.A.A. Guarantee

A Lafayette quality product that is guaranteed against defects in material and workmanship for 5 years. If this unit fails to operate due to such defects, simply return it prepaid with your original sales slip or order. Lafayette will repair it without charge including return transportation.

- Two Separate Speakers — Powerful 10" Woofer with 4 lb. 6 oz. Magnet structure plus 4" Tweeter
- 10" Woofer has Ribbon-type Copper Voice Coil Edge-Wound on an Aluminum Form
- "Tuned" Enclosure with Tube-Type Ducted Port
- Full 12 db/Octave Crossover Network For 2800 Hz
- Overall Response 20-19,000 Hz
- High Frequency Brilliance Control

An unusually compact speaker system that delivers really "big" sound. Equipped with two separate speakers for wide-range response — a powerful 10-inch woofer with a 4 lb. 6 oz. magnet structure and a 4-inch closed-back cone-type tweeter with a 9.4 oz. magnet structure. A full 12 db per octave electrical crossover network provides smooth transition from lows to highs. Features High Frequency Brilliance Control at rear of cabinet. The use of an acoustically "tuned" enclosure results in a reinforcement of the low frequencies, and produces extended bass response. Superb "Criterion" styling blends in with the most elegant decor. The enclosure is finished on all four sides in a rich, hand-rubbed oiled walnut veneer and tastefully framed in an ebony and gold picture frame molding with white and gold acoustic grill material. Highly efficient operation assures rich, full-bodied sound even with low-power amplifiers. Finished on all four sides to permit either vertical or horizontal placement. Dimensions are 21½" W x 11¾" H x 10½" D. Overall frequency response: 20-19,000 Hz; crossover frequency: 2,800 Hz; nominal impedance: 8 ohms; power handling capacity: 40 watts program material. Imported. Shpg. wt., 30 lbs. 99 E 01489WX Net 44.95

PERFECTLY MATCHED COMPONENTS

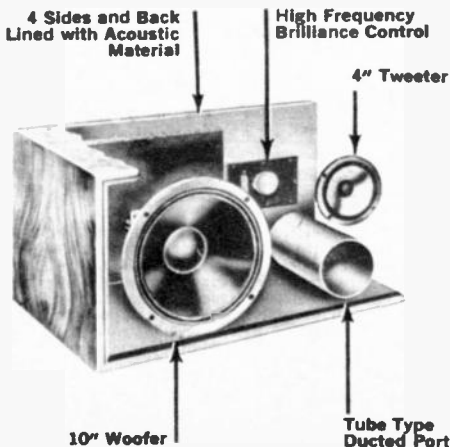

SYSTEM DESIGN

The enclosure is a bass-reflex design using a ducted port of the tube type to provide proper acoustic "tuning" of the enclosure. The tube provides a special path for the low frequency sound waves radiated from the rear of the woofer so that they emerge "in-step" with those radiated from the front and thus provides substantially greater bass sound power from the system. Solid wood construction, plus the use of sound absorbent material ensures an extremely rigid enclosure, free of undesirable resonances. A powerful 10-inch speaker with a 4 lb. 6 oz. magnet structure provides reproduction of the low frequencies. A 4-inch cone-type tweeter provides reproduction of the mid-range and high frequencies (to beyond audibility) and is of the closed back type to prevent interaction with the 10-inch speaker. Smooth transition is achieved by means of electrical crossover at 2800 Hz.

Lafayette CRITERION® "150"

2-Way Acoustic Suspension Speaker System

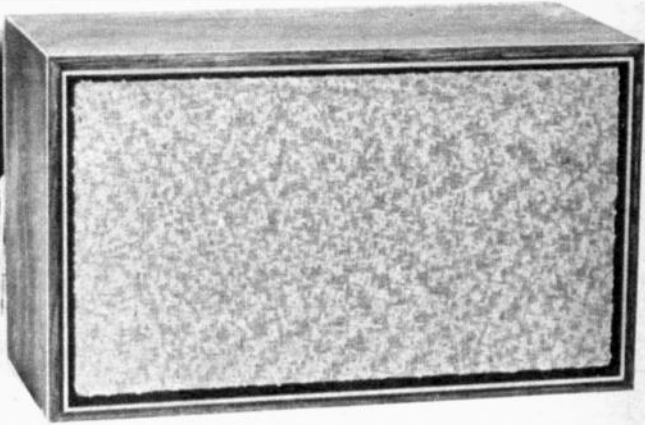

49⁹⁵
No Money Down*

POWER HANDLING CAPACITY 40 WATTS

Popular Priced Acoustic Suspension System - Contemporary Styling

- Overall Response—20-20,000 Hz
- 10" Woofer has Ribbon-type Copper Voice Coil Edge-Wound on an Aluminum Form
- Electrical Crossover—2000 Hz
- High Frequency Brilliance Control
- Fine Furniture Oiled Walnut Finish
- Completely Sealed and Damped Enclosure

High quality, excellent performance, and handsome decorator styling keynote the exciting Lafayette "Criterion 150" Speaker System. It utilizes the famous acoustic suspension design principle to develop extended bass with velvet smooth high frequency response in a cabinet of compact proportions. The system's main working element is a special 10 inch highly compliant woofer with a 2 lb. 10 oz. magnet structure and a ribbon-type copper voice coil, edge-wound on an aluminum form. This woofer is acoustically suspended and is free from the usual mechanical limiting suspension. Instead the woofer actually rides on the air within the sealed enclosure. This air is used as a spring suspension element. The extremely long cone excursion combines with this type of suspension to give bass reproduction that is outstanding in its depth and power. A 3½ inch tweeter extends the high frequency response of this system to beyond audibility. Thrilling clarity is achieved with the added extra of wide angle sound dispersion. The Criterion 150 also features a high frequency "brilliance" control on the rear of the cabinet. This enables balance of high frequency tones to suit individual tastes and match various room conditions. A built-in inductor and capacitor (LC) electrical crossover network is adjusted for 2000 Hz. to assure independent peak-free highs. The enclosure is of solid construction with fiberglass packing to virtually eliminate undamped resonance. All four sides are finished in luxuriant hand-rubbed oiled walnut veneer with gold frame molding and contemporary beige grille. Imported. Shelf size: 19W x 11H x 9"D. Shpg. wt., 17 lbs.

99 E 01810WX 49.95

SPECIFICATIONS

System Response: 20-20,000 Hz., Woofer: 10" acoustic suspension high compliance with long excursion cone and a 2 lb. 10 oz. magnet structure. Response, 20-2,000 Hz. Tweeter: 3½" high frequency wide dispersion. Response, 2,000-25,000 Hz. Crossover Network: Electrical (L-C) energy transfer circuit. Crossover Frequency: 2000 Hz. Power Capacity: 40 Watts. Impedance: 8 ohms.

5 Year A.A.A. Guarantee

A Lafayette quality product that is guaranteed against defects in material and workmanship for 5 years. If this unit fails to operate due to such defects, simply return it prepaid with your original sales slip or order. Lafayette will repair it without charge including return transportation.

SUPERB 2-WAY SYSTEM MOUNTED IN A COMPLETELY SEALED AND DAMPED ENCLOSURE

Solid 5/8" Air Tight Construction

Luxuriant Hand Rubbed Oiled Walnut Finish on Four Sides

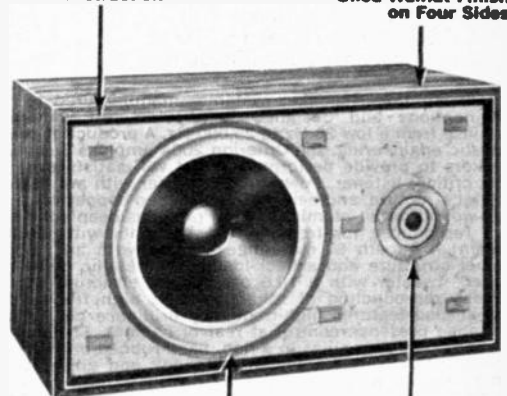

10" High Compliance Woofer with Acoustic Suspension

3½" Super Tweeter

Lafayette CRITERION® "200A"

Deluxe 3 Speaker 3-Way System

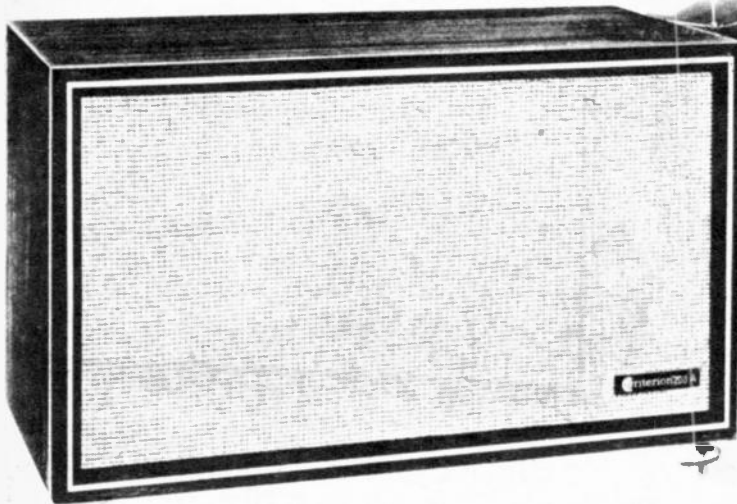

POWER HANDLING CAPACITY 50 WATTS

69⁹⁵ No Money Down*

5 Year AAA Guarantee

A Lafayette quality product that is guaranteed against defects in material and workmanship for 5 years. If this unit fails to operate due to such defects, simply return it prepaid with your original sales slip or order. Lafayette will repair it without charge including return transportation.

- Powerful 12" Woofer Features 4 lb. 6 oz. Magnet Structure and Heavy Ribbon Shaped Copper Voice Coil Edge-Wound on an Aluminum Form
- 3" Dome-Type "Super" Tweeter
- 2-Controls: Brilliance & Presence
- 8" Closed-Back Mid-Range Unit
- L-C Crossover At 700 and 5,000 Hz
- Overall Response 20 to 25,000 Hz

One of our finest speaker systems—manufactured to rigid specifications and designed to provide full wide-range response from a low 20 Hz to 25,000 Hz. A product of careful acoustic engineering, the Criterion 200A employs 3 separate speakers to provide performance that will satisfy even the most critical listener. Powerful 12" woofer with a 4 lb. 6 oz. magnet structure, and heavy ribbon shaped copper voice coil edge-wound on an aluminum form provides deep solid bass . . . reproduces low-frequency instruments with thrilling realism! A superb 8" mid-range speaker with an 11.5 oz. magnet structure and a back-loaded 3" metallic dome-type "super" tweeter with a 10.6 oz. magnet structure provide flawless reproduction of mid-range and high frequencies. System also features high-frequency brilliance control and mid-range presence control at rear of cabinet. Enclosure is finished on all four sides in a rich, hand-rubbed oiled walnut veneer, attractively framed in the ebony and gold picture-frame molding with white and gold acoustic grill material. For vertical or horizontal placement. Dimensions: 24W x 14H x 12"D. Overall Frequency Response: 20 to 25,000 Hz. Crossover Frequencies: 700 and 5000 Hz. Impedance: 8 ohms. Power Handling: 50 watts program material. Imported. Shpg. wt.. 35 lbs.

99 E 01497WX

Net 69.95

PERFECTLY MATCHED COMPONENTS

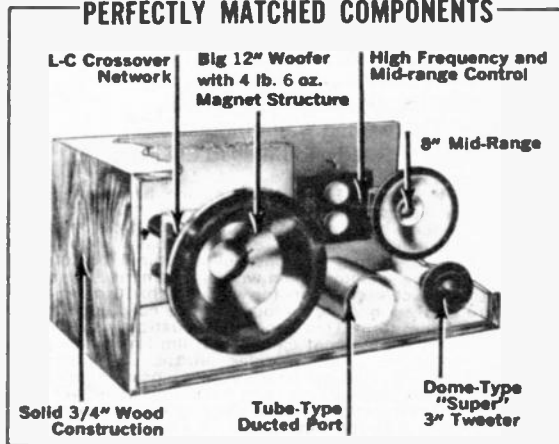

SYSTEM DESIGN

The enclosure is a bass reflex design using a ducted port of the tube type which is proportioned to provide correct acoustic "tuning" of the enclosure. This arrangement provides a special path for the sound waves radiated from the rear of the woofer so that they emerge "in-step" with those radiated from the front of the woofer. This provides a substantially greater bass sound power from the system. Solid 3/4" wood construction, internally braced, plus the liberal use of sound absorbent material, ensures an extremely rigid enclosure, free of undesirable resonances. Powerful 12" woofer with 4 lb. 6 oz. magnet structure, and a heavy ribbon shaped copper voice coil edge-wound on an aluminum form covers the range from 20 to 700 Hz and employs a foam-treated cone for efficient, distortion-free bass reproduction. An 8" midrange speaker covers the 700 to 5000 Hz range and is of the closed back type to prevent interaction with the woofer. A 3" dome-type "Super" tweeter, also with closed back, provides coverage from 5000 Hz to 25,000 Hz. All three speakers are acoustically matched and employ an L-C crossover network for crossover at 700 and 5000 Hz. System includes brilliance and presence controls.

Lafayette CRITERION® "3X"

Deluxe 12" 3-Way Acoustic Suspension Speaker System

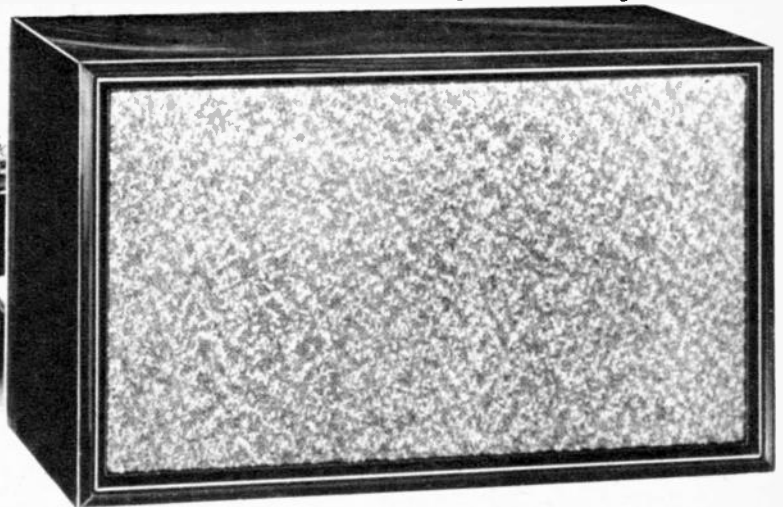

89⁹⁵

No Money Down*

POWER HANDLING CAPACITY 60 WATTS

- Designed For Use With The Highest Quality Component Amplifier and Receivers
- 12" Woofer With 6 lb. 2 oz. Magnet Structure, Heavy Ribbon Shaped Copper Wire Edge-Wound Voice Coil on an Aluminum Form
- Overall Response 20-25,000 Hz
- Separate Mid-Range and High-Frequency Controls
- Fine Furniture Oiled Walnut Finish

This brilliant performing 3-way speaker system uses the acoustic suspension principle to extend low frequency response down to a low 20 cycles . . . gives you the deep, powerful bass that is so necessary to proper musical enjoyment. Heart of the system is a special 12" high compliance woofer. Free of the usual mechanical suspension, this woofer actually uses the air within the sealed enclosure as a spring suspension element. This arrangement, used with a speaker capable of extremely long cone excursions, gives bass reproduction that is outstanding in its depth and power. Midrange frequencies are flawlessly reproduced by a 6½" cone driver with a 12 oz. magnet structure which employs a sealed back to avoid interaction with the woofer and to prevent air leakage from the enclosure. A 3" metallic, dome-type super tweeter with a 10.6 oz. magnet structure extends high frequency response to beyond audibility to provide brilliant, peak-free reproduction of the highs. Electrical L-C network ensures smooth crossover between all speaker units. Separate midrange and high frequency level controls let you "tailor" sound to suit your listening requirements. Fully air tight enclosure is solid ¾" construction with internal bracing and filled with fiber glass to prevent resonance. Finished on all four sides in rich, hand-rubbed oiled walnut veneer. Has attractive frame of ebony and gold with new snap-off nubby grille cloth panel. For vertical or horizontal placement; polarized input terminals. Size: 23 x 13½ x 11¾" deep. Imported. Shpr. wt., 32 lbs.
99 E 01760WX Net 89.95

5 Year A.A.A. Guarantee

A Lafayette quality product that is guaranteed against defects in material and workmanship for 5 years. If this unit fails to operate due to such defects, simply return it prepaid with your original sales slip or order. Lafayette will repair it without charge including return transportation.

SUPERB 3-WAY SYSTEM MOUNTED IN A COMPLETELY SEALED AND DAMPED ENCLOSURE

Solid ¾" Hardwood Enclosure Fully Airtight and Fiber-Glass Filled

6½" Midrange Cone-Type Driver with Sealed Back

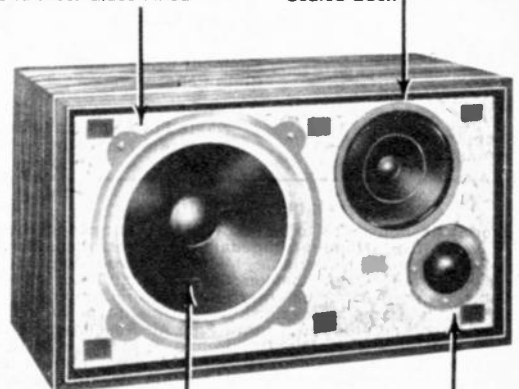

12" Acoustic Suspension Woofer with Heavy Ribbon Shaped Copper Edge-Wound Voice Coil

3" Dome-Type Super Tweeter

SPECIFICATIONS

System Response: 20 to 25,000 Hz. **Woofer:** 12" acoustic suspension, high-compliance type with 12" woofer with 6 lb. 2 oz. magnet structure, heavy ribbon shaped copper wire edge-wound voice coil on an aluminum form. **Response:** 20-1200 Hz. **Midrange:** 6½" cone driver with sealed back and 12 oz. magnet structure. **Response:** 1200-6000 Hz. **Tweeter:** 3" high frequency metallic dome-type with a 10.6 oz. magnet structure. **Response:** 6000-25,000 Hz. **Crossover:** Electrical (L-C) network at 1200 and 6000 Hz. **Power Capacity:** 60 watts **Impedance:** 8 ohms.

* See Page 11 for Full Credit Details on Easy Pay Plan

New! Deluxe LAFAYETTE CRITERION® "5XA"

75 Watt 12-Inch 3-Way Acoustic Suspension Shelf or Floor Standing Speaker System

Lets You Hear Music Like It Is!

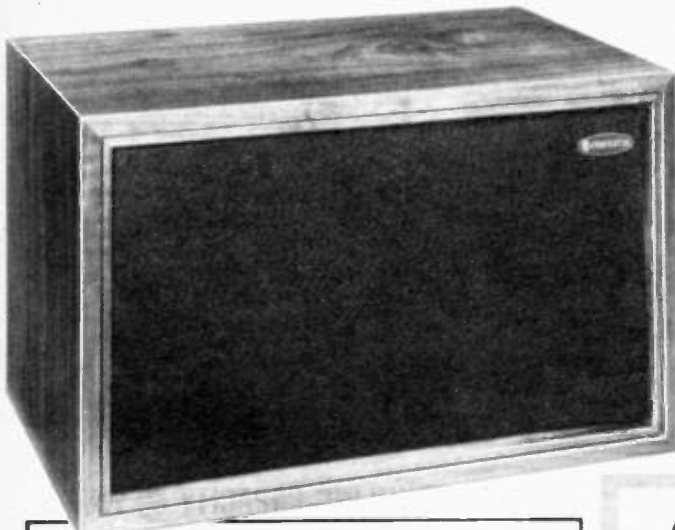

129⁹⁵ No Money Down*

5 Year A.A. Guarantee

A Lafayette quality product that is guaranteed against defects in material and workmanship for 5 years. If this unit fails to operate due to such defects, simply return it prepaid with your original sales slip or order. Lafayette will repair it without charge including return transportation.

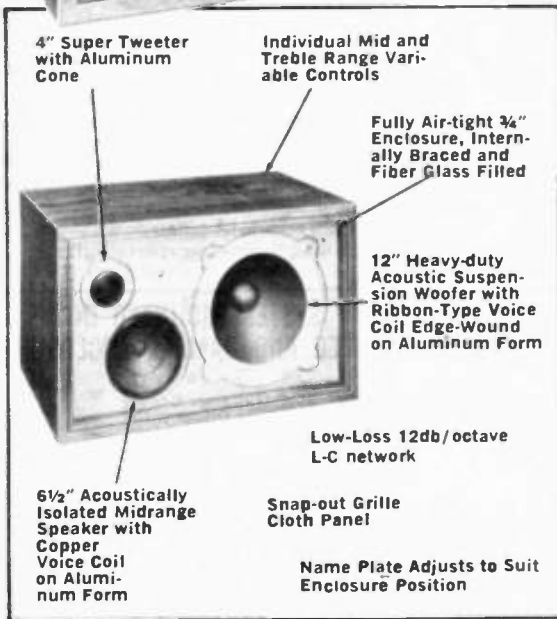

- Lafayette's Finest Bookshelf Speaker System
- 12" Woofer Features Special Ribbon Type Copper Voice Coil Edgewound on Aluminum Form
- 12" Woofer has 6 lb. 2 oz. Magnet Structure
- Individual Level Controls for Precise Midrange and Tweeter Adjustments
- Deco-ator Styled for Vertical or Horizontal Placement: Oiled Walnut Finish on All 4 Sides

Now, Lafayette brings you our all new Criterion 5XA . . . a 3-way bookshelf speaker system that provides a higher level of musical performance than any bookshelf system we have produced before. It provides astonishing range and clarity, with a deep, solid bass response that makes a stunning impact on the listener. Employing the acoustic suspension principle, the 5XA uses three outstanding speakers to cover the full spectrum of sound. Each was carefully designed for optimum response over a restricted frequency range. In conjunction with the full 12 db/octave crossover network, the system thus yields a carefully tailored, ultra-linear response. The 12-inch acoustic suspension woofer with 6 lb. 2 oz. magnet structure has an exceptionally compliant, long-throw suspension. Its uniquely constructed voice coil consists of heavy ribbon-shaped copper wire edgewound on an aluminum form. This arrangement offers extreme rigidity so that the coil cannot be deformed in any way and also assures rapid heat dissipation: Results; Remarkably low bass response —undistorted even at high power levels. An acoustically isolated 6 1/2-inch midrange speaker with 12 oz. magnet structure provides flawless reproduction—free of annoying peaks, yet adding true "presence" to the system. Extending response to beyond audibility is a 4-inch super tweeter with a specially designed aluminum cone for brilliant reproduction of the high frequencies—honey-smooth up to 25,000 Hz and without any shrillness to mar listening enjoyment. Separate continuously variable mid and treble range level controls provide full adjustment of the system to suit the acoustics of your listening area. The enclosure has a fine furniture finish in oiled walnut on all four sides and is designed for vertical or horizontal placement; either shelf or floor standing. Size: 23 3/8 x 14 3/8 x 11 1/2" D. Imported. Shpg. wt., 47 lbs. 99 E 0218CWX Net 129.95

SPECIFICATIONS

Overall Response: 18 to 25,000 Hz. Maximum Input Power: 75 watts (IHF). Nominal Impedance: 8 ohms. Acoustic Controls: Continuously variable Midrange level; continuously variable treble level. Speaker Components: 12" heavy-duty woofer with 6 lb. 2 oz. magnet structure employing the acoustic suspension design using ribbon-type voice coil edge-wound on aluminum form; Free Air Resonance, 18 Hz; 6 1/2" acoustically isolated midrange speaker with 12 oz. magnet structure and copper voice coil on aluminum form; 4" super tweeter with a 10.6 oz. magnet structure in a die-cast housing, utilizing an aluminum cone and protective acoustic screen. Crossover Frequencies: Low-loss 12 db/octave L-C network; Midrange crossover at 800 Hz, treble crossover at 4,500 Hz. Enclosure: Airtight acoustic suspension cabinet of 3/4" construction, internally braced and filled with glass fiber insulation for acoustic damping.

New! LAFAYETTE CRITERION® "80" 100 Watt 6-Speaker 4-way Acoustic Suspension Console Speaker System

*The Finest Reproducer of Sound
Offered by LAFAYETTE
for the Home....*

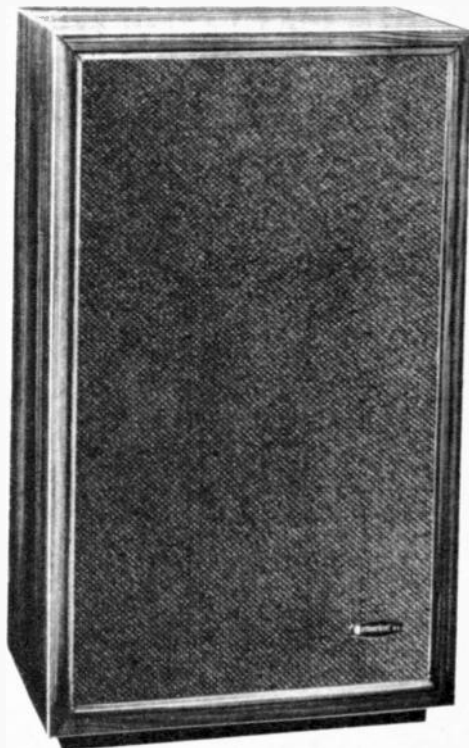

- Overall Response 18-25,000 Hz.
- 12" Acoustic Suspension Woofer with over 6-lb. magnet structure and edge-wound ribbon-type copper voice coil on an aluminum form.
- 6½" Acoustically Isolated Midrange Speaker with 12-oz. Magnet Structure.
- Four Tweeters—Two 3" Tweeters and Two 1½" Super Tweeters.
- Separate Midrange and High Frequency Level Controls.
- Enclosure in Rich, Hand-rubbed Oiled Walnut Finish.

Here is a no-compromise 6-speaker system created for just one purpose—the authentic reproduction of a massive symphony orchestra in spacious listening areas. Two of these superb floor-standing systems will spread the sound over the full width and depth of even the largest room, bringing the spectacular realism of a living performance right into your home. This major accomplishment was achieved by careful selection and design of speaker units and enclosure. A 12" acoustic suspension woofer in a large air-tight enclosure over 3½ cubic feet in overall size results in remarkably powerful, solid bass. Added to this is an acoustically isolated 6½" midrange speaker that offers natural "presence" without exaggerated midrange peaks. Four tweeters spread across the front in a calculated-configuration ensure a wide dispersion of the highs and reduce high frequency "beaming." Two of these are 3" units covering the 4,500 to 12,000 Hz range, and two are ultra-high frequency 1½" aluminum cone units that extend response to well beyond audibility. All this is housed in a handsome enclosure designed to blend unobtrusively into any decor—clean-lined and quietly tasteful in a rich, hand-rubbed oiled walnut finish and subdued dark brown tweed grille cloth. Dimensions: 30"H x 18"W x 12"D. Imported. Shpg. wt., 66 lbs. 99 E 02248WX Net 159.95

159⁹⁵ No Money Down*

Over 3½ Cubic Feet Enclosure
of ¾" Wood Construction,
Fully Air-Tight
and Fiberglass Filled

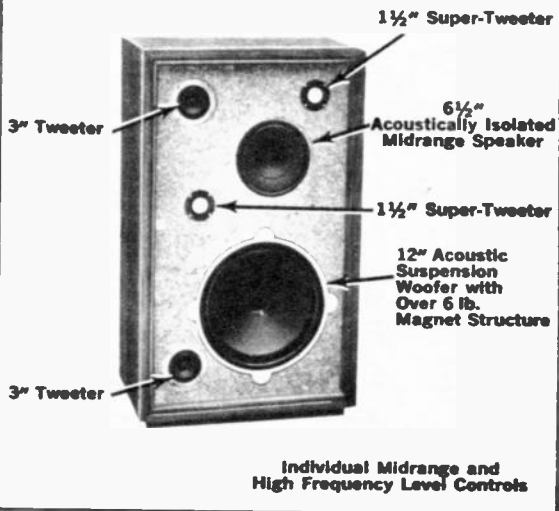

SPECIFICATIONS

Overall Response: 18 to 25,000 Hz. Power Handling Capacity: up to 100 watts (IHF). Impedance: 8 ohms. Speakers: 12" Acoustic suspension woofer, 6½" midrange, two 3" tweeters, two 1½" aluminum cone super-tweeters. Crossover frequencies: electrical at 800 and 4,500, mechanical at 12,000 Hz. Controls: Midrange and high frequency level.

5 Year A.A.A. Guarantee

A Lafayette quality product that is guaranteed against defects in material and workmanship for 5 years. If this unit fails to operate due to such defects, simply return it prepaid with your original sales slip or order. Lafayette will repair it without charge including return transportation.

* See Page 11 for Full Credit Details on Easy Pay Plan

Popular Price Floor and Shelf-Type Speaker Systems

5 YEAR AAA GUARANTEE FOR LAFAYETTE SPEAKER SYSTEMS

A Lafayette quality product that is guaranteed against defects in material and workmanship for 5 years. If this unit fails to operate due to such defects,

simply return it prepaid with your original sales slip or order. Lafayette will repair it without charge including return transportation.

NEW! LAFAYETTE CRITERION[®] "OMNI-1" 5-Speaker Thin Line System with Acoustic Deflector for 360° Radiation

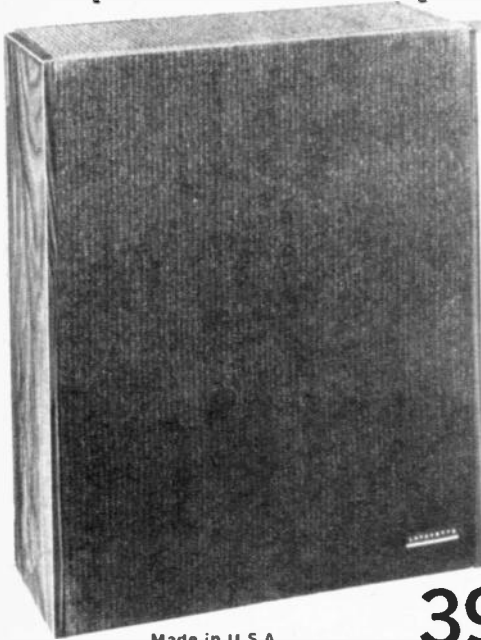

Made in U.S.A.

39⁹⁵

No Money Down*

POWER HANDLING CAPACITY 30 WATTS

- 8" High-Compliance Woofer with Long Throw, 4-Layer Voice Coil
- Four 3½" Close Back Tweeters Mounted In a Horizontal Line Source, with Acoustic Deflector for 360° Radiation

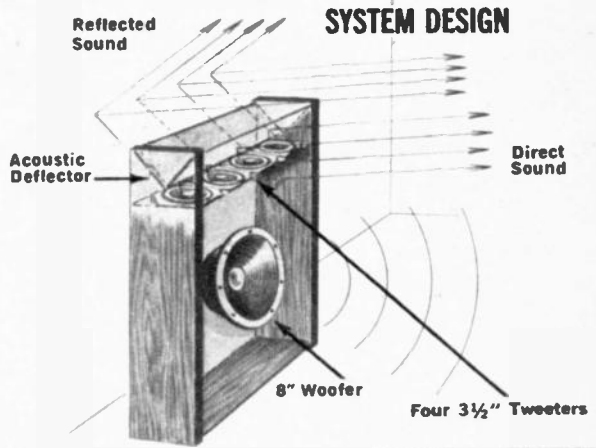

Deluxe omni-directional 5-speaker system in a convenient thin-line configuration. A new concept featuring a horizontal line source of four 3½" diameter tweeters mounted with a textured acoustic deflector to give 360° radiation and a listening illusion that is free, open, expansive, and non-boxed in. This most space saving form, permits the Criterion Omni-1 to be either floor mounted, top bookshelf mounted, or wall mounted. As sound is radiated from both, front and back, the Omni-1 is perfect for use as part of a room divider—or it may be situated close to a wall. The ultra-slim enclosure is only 5½" deep, and is finished in a rich, hand rubbed oiled walnut veneer. A luxurious brown/black decorator grille cloth covers the front, back and top surfaces. The extended bass is produced by a high compliance 8" diameter woofer with a four layer voice coil and ultra low free air resonance. In order to minimize bass distortion the woofer is asymmetrically mounted in a completely sealed enclosure, a true infinite baffle loading. Dimensions: 22" high x 17¾" wide x 5½" deep. Frequency Response: 40 Hz to 18,000 Hz Power Handling Capacity: 30 watts program material. Nominal Impedance: 8 ohms. Shpg. wt., 30 lbs. **Net 39.95**
21 E 01624WX

LAFAYETTE MINUETTE[™] "11" 2-WAY HI-FI SPEAKER SYSTEM

Room Filling Music Everywhere In Your Home **5 YEAR GUARANTEE - See Top Of Page**

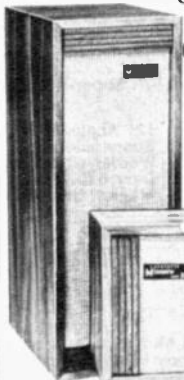

Only **14⁹⁵** 2 for **28⁵⁰**

**BUY 2 FOR STEREO
SAVE 1.40**

- 2 Speakers 5" x 7" Woofer, 2½" Tweeter
- Shelf Size 6"W x 15½"H x 9½"D.
- Genuine Oiled Walnut Finish On 4-Sides
- Brilliance Control

Lafayette Minuette "11" Hi-Fi Speaker System will bring music to any room in your home—and for a remarkably low cost. Designed for use where space is at a premium—ideal for the small apartment or listening area. Expands your stereo system to other areas of your home... easily used in the den, kitchen, patio or bedroom. Employs a specially designed 5 x 7" woofer, electrical crossover at 8,000 Hz, plus a 2½" tweeter in a ducted-port brass reflex type enclosure. Provides exceptionally fine musical quality yet measures only 6W x 15½"H x 9½"D. Small enough to fit anywhere. Superb oiled walnut finish on 4 sides allows placing speaker horizontally or vertically. Frequency response: 80 to 19,500 Hz. Features adjustable level control for brilliance. Impedance 8 ohms. Rated at 10 watts. Imported. Shpg. wt., 8 lbs. **Net 14.95**
99 E 01711W

Set of Two For Stereo—
SAVE 1.40

Net 28.50

Our Most Popular 8" Hi-Fi Speakers



DELUXE SK-128 8" BIAIXIAL SPEAKER



Only

16⁹⁵

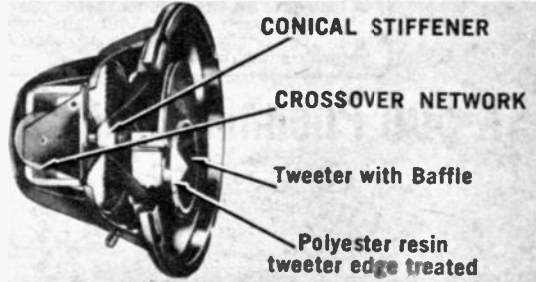

CONICAL STIFFENER

CROSSOVER NETWORK

Tweeter with Baffle

Polyester resin
tweeter edge treated

- Ultra-Linear Full Range Speaker with Acoustic Tweeter
- Eccentric Tweeter Mounting and Unique Elliptical Baffle Completely Eliminates Interaction Between Woofer and Tweeter

SPECIFICATIONS:

- Overall Response: 20-20,000 Hz (40-16,000 Hz ± 3 db).
- Free air Resonance: 45-65 Hz
- Impedance: 8 ohms.
- Power Rating: 20 watts
- Crossover: 2,500 Hz
- Rugged, vibration-free speaker frame with color-coded screw-type terminals for quick easy connection of amplifier leads.

The Lafayette SK-128 8" Biaxial Speaker offers full, even coverage of the entire audio range, with no distortion or coloration to mar your listening pleasure. The specially treated woofer cone has a unique "Conical Stiffener" at the apex which, coupled with its high compliance, enables the cone to operate in a piston-like manner—delivering a clean, powerful bass response. The 2-inch tweeter has its own voice coil and magnetic field. Special treatment of cone and cone edge provides even distribution of the high frequencies, with no peaks or resonance. The unusual off-center mounting of the tweeter and its elliptical baffle minimizes interaction between tweeter and woofer and insures an overall response free of intermodulation distortion. Electrical crossover from the woofer cone to the tweeter unit is provided by a built-in network. An adjustable brilliance control permits matching of sound to room acoustics. Efficiency of the speaker is such that it will operate from any amplifier with an output of 1 watt or more. Installed in a base-reflex type of enclosure, it performs outstandingly, and is recommended for all high-quality music systems—whether monaural or stereophonic. Overall depth, 5 $\frac{1}{2}$ ". Imported. Shpg. wt., 5 lbs. 99 E 00325

Net 16.95

SK-98® 8" DUO-CONE HI-FI SPEAKER

ONLY

9⁹⁵

2 for 18.95

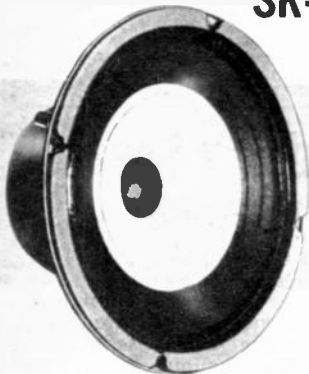

- Mechanical 2-Way Design
- Overall Response 40-16,000 Hz
- Large Magnet Structure
- Patented Cone Construction and Material High Excursion Woofer

The dual-cone construction used in this high quality 8" speaker provides the same type of wide-range response normally found in true coaxial speakers or multiple speaker systems. The woofer and tweeter cones "float" on flexible corrugated edges. This mounting results in true mechanical crossover, so that both cones operate at low frequencies, but only the tweeter cone operates at high frequencies. Patented cone materials provide extremely smooth response over the range of 40-16,000 Hz. Magnets are large and heavy, with a flux density of 10,500 gauss and total flux of 56,000 maxwells. Free air resonance is 55-70 Hz; impedance is 8 ohms, 4 $\frac{1}{2}$ " deep. Shpg. wt., 5 $\frac{1}{2}$ lbs. Imported.

99 E 00275 8" 2-WAY SPEAKER Net 9.95
2 FOR STEREO Net 18.95

LAFAYETTE 8" SPEAKER BOOKSHELF ENCLOSURE

- Ideal For Use With Lafayette SK-128 and SK-98 As Well As All 8" Wide Range Hi-Fi Speakers
- Solid 3/4" Wood Construction

Only

19⁹⁵

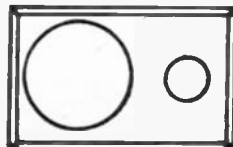
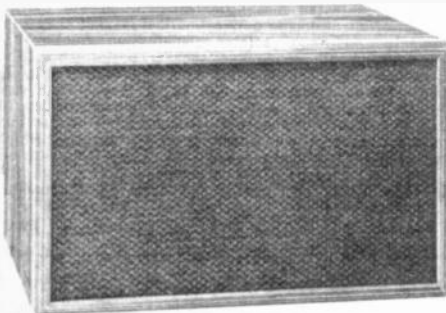

Handsome, decorator styled bookshelf speaker enclosure. Finished in oiled walnut veneer with picture frame moulding to lend a note of elegance to any decor. Features vented port design for improved bass response. Has fiberglass acoustic lining, solid 3/4" wood construction, plus factory mounted luxurious brown tweed grill cloth. Back has two lug terminal strip. 18x11x9" deep. Shpg. wt., 11 lbs. 20 E 01519WA

Net 19.95

Lafayette's FINEST 12" HI-FIDELITY SPEAKERS

Custom-Built in England to LAFAYETTE'S Rigid Specifications

5 YEAR AAA GUARANTEE

A Lafayette quality product that is guaranteed against defects in material and workmanship for 5 years. If this unit fails to operate due to defects, simply return it prepaid with your original sales slip or order. Lafayette will repair it without charge including return transportation.

SK-500 Pneumatic Air Suspension 12" 3-Way Speaker

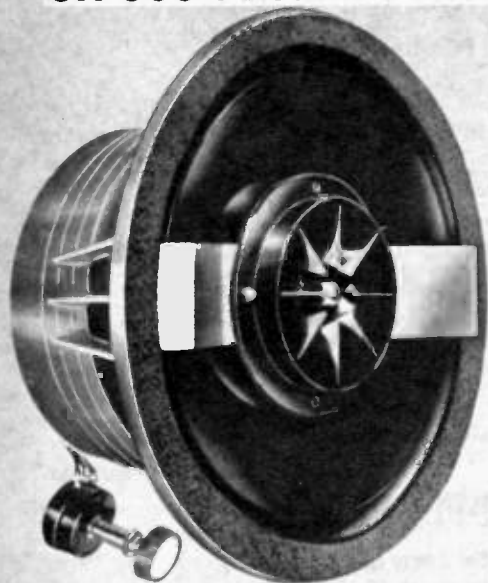

Only
37⁹⁵

- 3-Way Axial Design
- Pneumatic Air Suspension Woofer
- Powerful Dome Lens Compression Type Multicellular Radial Treble Horn
- Precisely Balanced Midrange Radiator
- Pneumatic Cone Suspension With Rigidflex Free Edged Surround

No Money Down*

Exciting pneumatic air suspension 12" 3-way Hi-Fi speaker which makes possible bass response with an almost unbelievable low distortion or less than 1% at power levels from 1 watt to 30 watts. Custom designed in England to Lafayette's rigid specifications. Pneumatic air suspension woofer, precisely balanced mid-range radiator and a powerful "dome lens" compression-type multicellular radial treble horn, axially mounted with a single rigid uniltized die cast frame to provide an outstanding integrated wide-range speaker. Construction features include a rugged, heavy-duty, extra long throw voice coil with a pneumatic air cone suspension. Has "Rigidflex" free-edged surround to eliminate standing waves and surround resonances. Frequency response is 25-20,000 Hz. Pneumatic air suspension woofer offers bass response which is tight and solid without boom or hangover to achieve a phenomenal sound realism. At 2,000 Hz frequencies are channeled into a balanced mid-range radiator by means of a smooth mechanical crossover. Superb "dome lens" treble horn reproduces high frequencies with silkiness and naturalness. A built in crossover allows the treble horn to take over at 5000 Hz. High frequency L-Pad control is provided with attractive escutcheon and knob. Impedance 8-16 ohms. Overall depth 6 1/2". Shpg. wt., 18 lbs.

21 E 01400WX

Net 37.95

SPECIFICATIONS

Magnetic Structure: 7 lbs. Frequency response: 25 to 20,000 Hz. Free air cone resonance: 22 to 27 Hz. Power handling capacity: 30 watts. Voice coil diameter: woofer 1 3/4", tweeter 1". Crossover network: built-in at 2,000 and 5,000 Hz. L-pad control: high frequency. Rated Impedance: 8-16 ohms.

Large 7 lb. Magnet Structure

Deluxe MODEL SK-216 3-Way 12" Hi-Fidelity Speaker



Only

59⁹⁵

Our Best 12" Speaker!

No Money Down*

- Free-Edged Cone Suspension
- 3-inch Dia. Main Voice Coil
- 12 DB/Octave Crossover Network with High Frequency Level Control
- Precision Pressure-Driven Horn-Loaded Tweeter with Aluminum Diaphragm & Coil
- Power Handling Capacity—50 Watts

Pride of British craftsmanship, coupled with Lafayette's rigid engineering specifications brings you a truly outstanding High Fidelity loudspeaker. The SK-216 features an exclusive patented concentric twin-gap magnetic system with a massive 9 lb. super efficient double duty cylindrical magnet structure. The three elements—woofer, mid-range radiator, compression tweeter—are axially mounted to achieve smooth wide-range speaker performance. The woofer section has a cone resonance of 35 Hz, is vacuum constructed by an exclusive process, and features a plastic terminated, free-edge cone suspension completely eliminating standing waves and surround resonances. At 5000 Hz, a 12 db per octave LC crossover network provides smooth transition from mid-range to a precision pressure-driven horn-loaded tweeter which employs an aluminum coil and diaphragm in a self-aligning assembly with air chamber and phase equalizer. This crossover is provided with a high frequency constant impedance L-pad level control for matching of sound to room acoustics and individual listening tastes. Shpg. wt., 25 lbs.

21 E 01293WX

Net 59.95

SPECIFICATIONS

Cone Resonance, 35 Hz; Overall Frequency Response, 20-20,000 Hz; Magnetic Flux Density, over 250,000 Maxwells; Crossover, automatic mechanical at 2000 Hz—12 db/octave LC at 5000 Hz; Power Capacity, 50 watts; Woofer Voice Coil Diameter, 3 inches; Tweeter Voice Coil Diameter, 1 inch; Impedance, 16 ohms. Dimensions: 5 1/2" overall depth; 12 1/4" diameter.

Features Massive 9 lb. Magnet Structure

52 Lafayette Cat. No. 700

* See Page 11 for Full Credit Details on Easy Pay Plan

OUR BEST SOUNDING 15" HI-FIDELITY SPEAKER

Deluxe LAFAYETTE Model SK-215 15" 3-Way Hi-Fi Speaker

Custom-Built in England to LAFAYETTE'S Rigid Specifications

- Free-Edged Cone Suspension
- 12 DB/Octave Cross-over Network with High Frequency Level Control
- Precision Pressure-Driven Horn-Loaded Tweeter with Aluminum Diaphragm & Coil
- 3-inch Main Voice Coil
- Overall Frequency Response: 20- 20,000 Hz
- Cone Resonance Frequency: 25 Hz
- Power Handling Capacity — 50 Watts

74⁹⁵

No Money Down*



3" Main Voice Coil

5 Yr. GUARANTEE
See Page 52

Features Massive 9 lb. Magnet Structure

LAFAYETTE 12" Bookshelf Speaker Enclosure

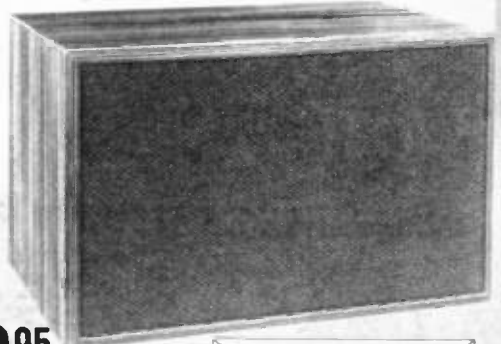

29⁹⁵

- Ideal For Use With Lafayette SK-216, SK-500, or any 12" Hi-Fi Speaker
- Solid 3/4" Wood Construction

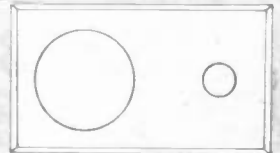

Beautiful, oiled walnut veneer 12" bookshelf speaker enclosure with picture frame moulding. Features quality construction plus contemporary styling. Custom designed to accept Lafayette 12" speakers, including 2 and 3 way types. Solid 3/4" wood construction. Dual vented port design plus fiberglass lining gives improved bass response. Acoustically transparent brown tweed grill cloth lets the sound come through without attenuating the highs. All four sides finished in oiled walnut veneer to match the decor of any room. For vertical or horizontal placement. Size: 14 3/4 x 23 3/4 x 12 1/4" deep. Shpg. wt., 26 lbs.
20 E 01501WX Net 29.95

Lafayette combined the finest British craftsmanship and advanced acoustic design to bring you this outstanding 3-way 15" speaker. The SK-215 utilizes a patented concentric twin-gap magnetic system with a massive 9 lb. super efficient double duty cylindrical magnet structure. Woofer, mid-range radiator and compression tweeter are axially mounted to achieve outstanding, efficient wide-range speaker performance. With a cone resonance of 25 Hz the woofer section is vacuum constructed by an exclusive process and features a virtually free-edged cone suspension that eliminates standing waves and surround resonances. An automatic mechanical crossover separates bass and mid-range frequencies at 2000 Hz to a highly stable mid-range radiator. A 12 db per octave LC crossover network provides smooth transition at 5000 Hz from mid-range to a precision pressure-driven horn-loaded tweeter employing an aluminum diaphragm and coil in a self-aligning assembly with air chamber and phase equalizer. This crossover has a high frequency constant impedance L-pad level control for matching of sound to room acoustics and individual listening tastes. Shpg. wt., 30 lbs.

21 E 01301WX

Net 74.95

SPECIFICATIONS

CONE Resonance, 25 Hz; Overall Frequency Response, 20-20,000 Hz; Magnetic Flux Density, over 250,000 Maxwells; Crossover Frequencies, 2000 and 5000 Hz; Power Capacity, 50 watts; Woofer Voice Coil Diameter, 3 inches; Tweeter Voice Coil Diameter, 1 inch; Impedance, 16 Ohms, Dimensions: 6 1/2" overall depth: 15 1/4" diameter.

Deluxe Universal Floor-Standing Speaker Enclosure



59⁹⁵

No Money Down*

Ideal For Use
With Lafayette SK-215

- Acoustically Engineered To Handle A Separate 15" or 12" Speaker — As Well As Deluxe 2-Way or 3-Way Speaker Systems
- Solidly Constructed of 3/4" wood — Acoustically lined

A low price for a deluxe speaker enclosure of this quality and flexibility. Provides rich, robust bass. Solidly constructed of 3/4" genuine veneer and acoustically correct flakeboard. Designed to achieve optimum performance from a separate 12" or 15" full range 3-way speaker or a 2-way or 3-way system. Cutouts are provided for a 15" bass speaker and an 8" mid-range with adapters to convert to a 12" bass and a 6" mid-range. Tweeter cut-out accommodates both round and rectangular units. Size: 29x22x16"D. Shpg. wt., 52 lbs.

20 E 01451WX Oiled Walnut finish

Net 59.95

* See Page 11 for Full Credit Details on Easy Pay Plan

Lafayette Cat. No. 700 53



HEAVY DUTY, 3-WAY CO-AX SPEAKERS



A 12", 3-WAY

15⁹⁵
NEW!

- 4 lb. Magnet structures in heavy steel return circuits.
- 4" TWEETERS are protected by beautiful, anodized screen which is trimmed in polished chrome . . . attractive durable finishes.
- DELUXE phase-coded, spring-loaded terminals with Teflon insulation. No tools needed.
- Magnet covers and chassis feature baked-on enamel to corrosion-proof the vital, critically dimensioned steel elements for years.

A 12" 3-WAY SPEAKER HANDLES 45 WATT PEAKS

Large voice coil (1½" Dia.) and large 4 lb. magnet structure for efficient, smooth handling of bass frequencies. 4" tweeter, with an Alnico V magnet, is coaxially mounted; has electrical crossover at 4,500 Hz. The midrange cone is mechanically coupled to the woofer voice coil. Handles 23 watts program material, 45 watts peak. Res., 45 Hz. Response, 35-20,000 Hz. Imp., 8 ohms. 21 E 47262 Shpg. wt., 7¼ lbs. Net 15.95

B 15", 3-WAY

19⁹⁵
NEW!

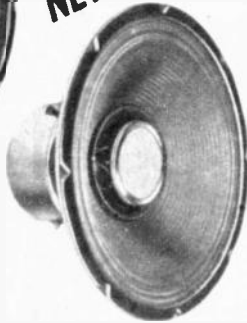

B 15" 3-WAY SPEAKER HANDLES 50 WATT PEAKS

Same heavy-duty combination of voice coil and magnet as the 12" version, above, plus the benefit of the extra cone area of a 15" speaker. Tweeter and midrange cone are also identical to above 12" speaker. Handles 25 watts of program material, 50 watts peak. Resonance, 40 Hz. Response, 30-20,000 Hz. Impedance, 8 ohms. 21 E 47254 Shpg. wt., 10½ lbs. Net 19.95

12" WIDE RANGE CO-AX SPEAKERS



C 12" HI-POWER

15⁹⁵

C 12" WIDE-RANGE HI-POWER HI-FI SPEAKER

- 4 Pound magnet structure, 1½" voice coil
- Deluxe, finger-tip operated, phase-coded terminals
- Magnet cover and chassis have baked-on lacquer finish
- Co-axially mounted high frequency cone extends range

An excellent, general purpose 12" speaker built to take power peaks up to 45 watts. 20 ounce ceramic magnet, 1½" voice coil. Impedance, 8 ohms; response, 35-17,000 Hz.; resonance, 45 Hz. Co-axially mounted high frequency cone extends range. 21 E 47122 Shpg. wt., 7½ lbs. Net 15.95

D 12" CO-AXIAL HI-FI SPEAKER

- 4" Co-axially mounted tweeter with built-in crossover
- Magnet cover and chassis have baked-on lacquer finish

A wide range, efficient speaker for medium power amplifiers. Will handle 12 watt program material, 25 watt peaks. Excellent for the hi-fi enthusiast with a limited budget. Response, 40-18,500 Hz.; impedance, 8 ohms; response, 35-17,000 Hz.; resonance, 45 Hz. Co-axially mounted high frequency cone extends range. 21 E 47155 Shpg. wt., 4½ lbs. Net 10.50

12" CO-AX
D **10⁵⁰**



8" SPEAKERS, EXTENDED RANGE & CO-AX



E **7⁹⁵**

E 8" CO-AX WITH 3" TWEETER

Wide range response at moderate power; 8 watts program, 15 watts peak. 3 ounce ceramic magnet; impedance, 8 ohms; resonance, 75 Hz.; resp., 60-17,500 Hz.; solder lugs; baked-on lacquer finish. 21 E 47171 Shpg. wt., 2 lbs. Net 7.95

F **8⁹⁵**

F 8" HI-POWER SPEAKER WITH HORN

TYPE CONE Deluxe, high efficiency speaker with special cone, 10 oz. ceramic magnet. Baked-on lacquer on magnet cover and chassis. 15 watts program, 30 watts peak. Impedance, 8 ohms; res., 75 Hz.; resp., 45-14,000 Hz.; phase-coded, fingertip terminals. 21 E 47221 Shpg. wt., 3¼ lbs. Net 8.95

G **5⁹⁵**

G 8" EXTENDED RANGE SPEAKER

Separate high frequency cone extends response. 5.5 ounce ceramic magnet. Baked-on lacquer finish. Handles 11 watts program material, 22 watts peak. Impedance, 8 ohms; resonance, 70 Hz.; resp., 45-16,000 Hz.; solder lugs. Voice coil diameter, 1". 21 E 47080 Shpg. wt., 2¼ lbs. Net 5.95

6½" CO-AXIAL SPEAKER



6⁹⁵

6½" woofer with heavy magnet for maximum efficiency and low distortion. 2" tweeter is co-axially mounted in a protective sealed housing; a mesh dispersion screen provides smooth wide angle high frequency propagation. Ideal for use in pairs for stereo music systems of up to 8-10 watts. Frequency range, 50-16,000 Hz. Resonant freq., 70 Hz.; Impedance, 8 ohms; built-in electrical crossover network. Requires 5½" dia. cutout. 6½" dia., 3¾" deep. Imported. Shpg. wt., 3¼ lbs. 99 E 00283 Net 6.95

DELUXE WOOFERS, TWEETERS and MID-RANGE SPEAKERS FOR DO-IT-YOURSELF SYSTEMS



WOOFERS FOR ALL POPULAR CABINET SIZES

A 15" WOOFER HANDLES 55 WATT PEAKS

A powerful, woofer capable of reproducing bass frequencies, at power levels you can feel. A mammoth 40 ounce ceramic magnet in a magnetic structure weighing 7¾ pounds. The oversize, 2" diameter voice coil easily handles 28 watts continuously and absorbs 55 watt peaks. The baked-on lacquer finish on the magnet cover and chassis protects against corrosion of the critically dimensioned steel elements. Deluxe, phase-coded, fingertip terminals with Teflon insulation. Res. freq., 50 Hz.; resp., 20-5,000 Hz.; imp., 8 ohms; Shpg. wt., 14½ pounds.

21 E 47197W

Net 24.95

B 12" WOOFER HANDLES 50 WATT PEAKS

This 12" woofer uses the same enormous magnet assembly and the same 2" voice coil we feature in our 15" woofer. Even though the cone is smaller, the resonance is held to a mere 30 Hz. by using a highly compliant cloth cone edge. Power handling is 25 watts continuous and 50 watts peak. Includes all the deluxe features you've come to expect from Lafayette: baked-on-lacquer finish on magnet cover and chassis, and fingertip terminals with Teflon insulation. Response, 20-4,500 Hz.; impedance, 8 ohms.

21 E 47205 Shpg. wt., 11 pounds

Net 22.95

C 8" WOOFER HANDLES 40 WATT PEAKS

A space-saving 8" diameter woofer that makes every effort to rival it's larger counterparts in frequency response and power handling ability. Features a 20 ounce magnet (4 pounds total structure), a 1½" voice coil and highly compliant cloth-roll cone suspension. Handles 20 watts of program material, 40 watts peak. Free air resonance is 55 Hz. Deluxe features include phase-coded, finger-tip terminals with Teflon insulation, baked-on lacquer on magnet cover and chassis. Response, 35-7,500 Hz.; impedance, 8 ohms; Shpg. wt., 5¾ pounds.

21 E 47213

Net 11.95

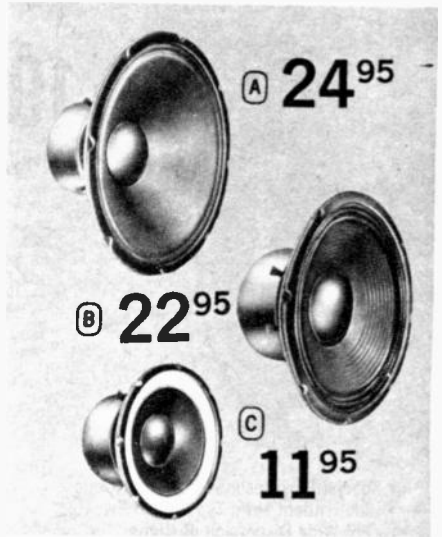

MIDRANGE COMPONENTS—HORN & DIRECT RADIATOR

D 8" HI-FI MIDRANGE HAS SEALED BASKET

The closed basket, (chassis) of this midrange speaker prevents inter-modulation from the back pressure of a woofer used in the same cabinet. A 10 ounce ceramic magnet and 1" voice coil are used for high sensitivity. When used with the proper crossover, this speaker will handle the midrange and high frequency power of a 30 watt program. Ideal for use with a 700 Hz. crossover. Baked-on lacquer finish, magnet cover and chassis; deluxe phase-coded, finger-tip terminals; resp., 350-14,000 Hz.; impedance, 8 ohms. Shpg. wt., 3¾ pounds.

21 E 47189

Net 7.95

E MIDRANGE HORN OFFERS HIGH EFFICIENCY

High efficiency means more sound output per watt input. Now hear cymbals and brass with outstanding brilliance. Enjoy, too, the wide dispersion angle of this die-cast horn. Rewired crossover operates at 1,000 Hz., attach to your woofer with two simple solder connections. Will handle the mid-range and high frequency power of a 30 watt program. Response, 600-12,000 Hz.; impedance, 8 ohms; voice coil diameter, ¾"; magnet, 1.4 ounce Alnico V; 10½x3¼x11" deep. Baked-on lacquer finish. Shpg. wt., 3 pounds.

21 E 47247

Net 8.95

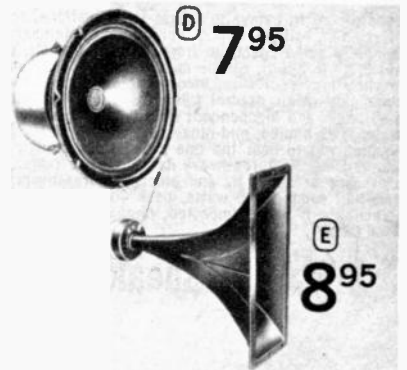

TWEETERS-COMPRESSION AND DIRECT RADIATOR

F ECONOMY HI-FI TWEETER

Economy Hi-Fi tweeter designed for mounting in most existing baffles and cabinets. Reproduces high frequencies without losing clarity and volume. Even sound dispersion insured by use of round cone. Completely sealed rear housing. Resp., 3,000-16,000 Hz. 2¾" dia. x 1¾"; imp., 8 ohms. Imported. Shpg. wt., 1 lb.

99 E 01174

Net 2.25

G HIGH EFFICIENCY TWEETER HORN

Die-cast, compression type tweeter horn featuring wide dispersion angle and rewired crossover operating at 4,500 Hz. handles highs of 30 watts. Response, 2,000-18,000 Hz.; imp., 8 ohms; 1.4 ounce magnet; ¾" voice coil; baked-on lacquer finish; 7¼" x 3 x 6¼"; Shpg. wt., 1¾ lbs.

21 E 47239

Net 7.95

H DOME LENS COMPRESSION TWEETER

Offers amazing clarity and brilliance. Phasing plug insures uniform output. Response, 1,500-20,000 Hz. Handles up to 20 watts. Recommended crossover frequency 2500 Hz. or higher. Dimensions: 5¼" long, mounts in 3¼" dia. hole. Impedance 16 ohms. Imported. Shpg. wt., 2 lbs.

99 E 62507

Net 9.95

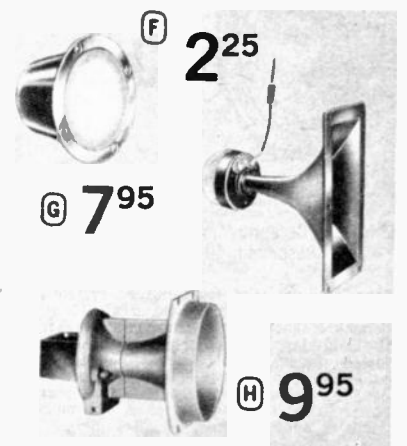

Depend on Lafayette For Complete Stocks, Lowest Prices, Fastest Service

LAFAYETTE "Thinline" 12", 8", 6x9", 6½" Hi-Fi Speakers

SPECIAL shallow frame Hi-Fi speakers for APPLICATIONS WHERE SPACE IS LIMITED. Can be mounted in virtually any "thin-type" cabinet, ready-made console or music systems with custom wall or ceiling installations.

SK-260 3-Way 12" Thinline Speaker

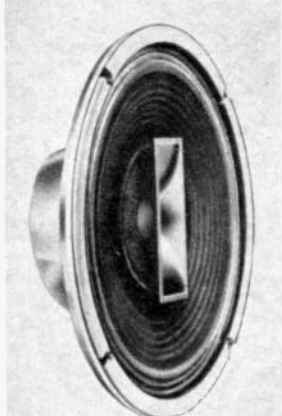

19⁹⁵

2 for 38.95



- Special Low-Resonance Woofer Cone
- Independent Horn Type Super Tweeter For Wide Dispersion of Highs
- Frequency Response 30-18,000 Hz
- Handles 40 Watts Peak Power
- Built-In Crossovers at 1,800 and 5,000 Hz.

Constructed to Lafayette's rigid specifications, the Lafayette SK-260 offers rich, brilliant sound reproduction. Engineered to reproduce the complete audio spectrum from 30 to 18,000 Hz, this fine speaker is but 3½" in depth, can be mounted in virtually any thin-type cabinet or shelf type enclosure. Incorporates a special low-resonance woofer cone, for clean natural bass response without boom, mechanical mid-range, and independent horn-type tweeter for wide dispersion of highs. Full-bodied mid-range and quality high frequency response enables you to hear the fine transients and high notes of the higher frequencies. Features heavy duty die-cast frame. Built-in mechanical crossover at 1,800 Hz and electrical crossover at 5,000 Hz. Power handling capacity 20 watts, peak 40 watts. Brilliance level control. Impedance 8 ohms. Imported. Shpg. wt., 10 lbs.

99 E 00291

Net 19.95; 2 for 38.95

2-Way 12" Thinline Speaker

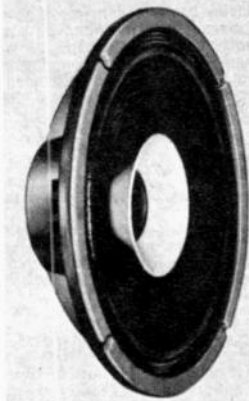

13⁹⁵

2 For 26.95

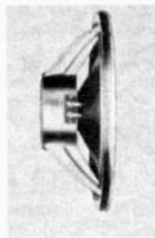

- Response: 40-13,000 Hz.
- Power Handling: 40 Watts Peak
- Built-in Crossover at 1,800 Hz.
- Dual Cone Construction
- Heavy Duty Magnet
- 2" Edge-wound "Voice Coil"

A dual-cone speaker featuring outstanding sound and heavy-duty die-cast frame to permanently center the sound reproduction elements. The shallow frame design permits custom installation in walls, "thin-type" enclosures, ready-made consoles or wall baffle extension speaker use. 12" high compliance woofer delivers plenty of solid bass while separate high frequency whizzer cone handles the middle and high frequencies clearly to the upper audio spectrum. Features 2" edgewound voice coil assembly; built-in mechanical crossover at 1800 Hz. Convenient binding post terminals for easy connections to any amplifier. Freq. Resp. 40-13,000 Hz. Power Handling Capacity: 20 watts, 40 watts peak. Voice Coil Impedance: 8 ohms. Cone resonance: 45 Hz ±10 Hz, Voice Coil Diameter: 2". Size: 12¼" dia. x 3½" D. Imported. Shpg. wt., 7 lbs.

99 E 00309

Net 13.95; 2 for 26.95

2-Way 8" Speaker

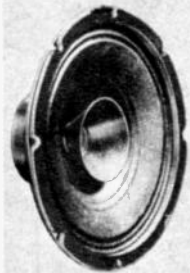

5⁹⁵

- 10 Oz. Ceramic Magnet
- Freq. Response: 40-17,000 Hz.

Especially designed for thin-type systems, this 8" dual cone speaker features a 10 oz. ceramic magnet. Shallow construction makes it ideal for in-wall mounting. Baked-on lacquer finish. Screw terminals, no need to solder. Response: 40-17,000 Hz. Capable of handling 15 watts normal and 30 watts on power peaks. Impedance: 8 ohms. Maximum depth is only 3". Shpg. wt., 2¾ lbs.

21 E 47108

Net 5.95

6 x 9" Wide Range Speaker



5⁹⁵

Ideal For Add-On Remote Stereo Speakers

- Freq. Response: 45-17,000 Hz.
- 1" Voice Coil

Hi-Fi, wide-range oval speaker with 10 ounce ceramic magnet and 1" voice coil for high sensitivity and power handling ability. Handles musical peaks up to 30 watts. Baked-on protective lacquer finish. Wide-range response, 45-17,000 Hz. Will fit in walls, total depth is only 3". Screw terminals, no need to solder. Impedance: 8 ohms. Outside dimensions are only 6¾ x 9¾". Shpg. wt., 2½ lbs.

21 E 47270

Net 5.95

6½" Thinline Hi-Fi Speaker



4⁹⁵

2 For 9.50

- Frequency Response: 75-12,000 Hz
- Ideal for Wall or Ceiling Installation

Low-cost, 3-way, full-range speaker with 3 diaphragms performing as woofer, mid-range and tweeter. Its small size, only 2" deep, makes it excellent for use in a wide variety of space-saving applications, including background music systems with wall or ceiling installation. Frequency response 75-12,000 Hz. Power handling capacity, 3 watts (6 watts peak) of program material. Impedance, 8 ohms. Binding post terminals. Imported. Shpg. wt., 2½ lbs.

99 E 00317

Net 4.95 each; 2 for 9.50

Specially Designed Miniature LAFAYETTE Hi-Fi Speakers

Powerful, high compliance miniature hi-fidelity speakers with heavy magnets.
 For the hi-fi enthusiast who requires quality performance in a compact area.

(A) LAFAYETTE 2½" TWEETER Remarkable compact tweeter handles 3 watts input music power. Frequency response of 3,000 to 15,000 Hz. Magnet weighs 1.3 oz. Depth 1¾". Impedance: 8 ohms. Imported. Shpg. wt., 1¼ lbs.
 99 E 01455

Net 1.49

(B) LAFAYETTE 3" TWEETER Fresh sounding foam-mounted cone tweeter delivers 1,200 to 20,000 Hz frequency response. Power handling capacity 8 watts peak. Depth 1¾". Impedance: 8 ohms. Imported. Shpg. wt., 1 lb.
 99 E 01562

Net 2.95

(C) LAFAYETTE 4" FULL RANGE HI FI SPEAKER. Fine performance from a speaker only 2" in depth. Frequency response 50 to 16,000 Hz. Power handling capacity 8 watts. Rugged steel frame construction. Heavy 8.11 oz. magnet. Impedance: 8 ohms. Imported. Shpg. wt., 3 lbs.
 99 E 01729

Net 4.95

(D) DELUXE LAFAYETTE 5" WOOFER Superb bass response is achieved through careful matching of large 1½ pound magnet, 1" voice coil, and specially treated cloth surrounded cone. Frequency response: 40 to 12,000 Hz. Will handle 15 watt peak power. Depth 4¾". Imported. Shpg. wt., 5 lbs.
 99 E 01554

Net 8.95

(E) LAFAYETTE 5" FULL RANGE HI-FI SPEAKER Outstanding 50 to 18,000 Hz audio reproduction. Magnet weighs 3.6 oz. Power capacity 8 watts (16 peak). Impedance: 8 ohms. Dia. 5¼", Depth 3¼". Imported. Shpg. wt., 3½ lbs.
 99 E 01513

Net 4.95

(F) LAFAYETTE 5" COAXIAL HI FI SPEAKER Super miniature speaker handles up to 25 watt power. Frequency range 38 to 19,000 Hz. Magnificent sound reproduction. Heavy magnet weight 1.1 lb. Rugged steel frame construction. Impedance: 8 ohms. Only 2¾" in depth. Imported. Shpg. wt., 5 lbs.
 99 E 01703

Net 11.95

(G) LAFAYETTE 6½" DUAL-CONE HI FI SPEAKER Powerful 6½" speaker only 2½" in depth. Large 1 lb. magnet. Frequency response 50-16,000 Hz. Power handling capacity—15 watts. Rugged steel frame construction. Impedance: 8 ohms. Imported. Shpg. wt., 6 lbs.
 99 E 01737

Net 6.95



As Low As

1⁴⁹

LAFAYETTE CROSSOVER NETWORKS

(H) ECONOMY 3000 Hz NETWORK

Crossover network designed for 8 ohm woofers and tweeters. Easy to install, has a low insertion loss of only 3 db. Crossover frequency, 3,000 Hz. Easily accessible lug terminals. Rugged metallic case 3½ x 1¾ x 1¼". Fibre mounting reducing extraneous pickup. Mount on inside of speaker cabinet. Complete with simplified instructions. Imported. Shpg. wt., 1/4 lbs.
 99 E 01406

Net 1.49

(J) 2-WAY CROSSOVER NETWORK

A carefully designed capacitive-inductive 2-way crossover network with crossover frequency easily set to either 2500 or 5000 Hz. Has a built-in continuously variable high-frequency "Brilliance" level control to match room acoustics perfectly. Control has a 2½ ft. cable to mount on rear or side of speaker cabinet, and a long shaft for thick wood panels. Has an attractive brushed-gold finish escutcheon plate. For use with 8-16 ohm speakers. Easily accessible screw terminals. Metal case 5¾L x 2½H x 2¾"D. Complete with simplified instructions. Imported. Shpg. wt., 5 lbs.
 99 E 00218

Net 7.95

(K) DELUXE 2 and 3-WAY L/C NETWORK

Can be used either as a 2-way or 3-way 6 db per octave network. Six crossover combinations are available—2-way crossover with 2000-3000 Hz or 5000 Hz crossover, and 3-way with crossover frequencies of 350 and 5000, 350 and 2000-3000, 700 and 2000-3000 or 700 and 5000 Hz for 8-16 ohm speakers. Brilliance and Presence controls—are mounted on the front panel. Level controls may be removed. Escutcheon plate, for external mounting; 3 ft. leads.
 99 E 00226 Imported. Shpg. wt., 6 lbs.

Net 14.95

(H) ECONOMY 3000 Hz CROSSOVER NETWORK

1⁴⁹

(J) 2-WAY CROSSOVER NETWORK

- For 8-Ohm Woofers And Tweeters
- Low Insertion Loss
- Easy To Mount

7⁹⁵

(K) 2- AND 3-WAY L/C CROSSOVER

- 4 Crossover Frequencies—6 Combinations
- With Brilliance And Presence Controls

14⁹⁵

DELUXE LAFAYETTE CONE TYPE METAL-CASE HI-FI TWEETER



Only
 5⁹⁵

- Handles 20 Watts
- Frequency Response 2000-20,000 Hz

Cone type tweeter particularly efficient in the high end of the audio spectrum where ordinary cone tweeters tend to lose clarity and volume. Entirely enclosed in metal case with stand and cabinet mounting bracket. Requires crossover network such as Lafayette networks listed above. Diameter 3". Depth 2¼". Voice coil impedance: 8-16 ohms. Imported. Shpg. wt., 4 lbs.
 99 E 00499

Net 5.95

Revolutionary LAFAYETTE "Poly-Planar" Speakers

Totally New Concept in Wide Range Electrodynamic Speakers

Lafayette "Poly-Planar" wafer-type component loudspeakers employ a lightweight acoustic panel supported by a frame of polystyrene plastic material to reproduce a range of frequencies from 40 Hz to 20,000Hz. This material also permits the speakers to be made impervious to extremes of temperature, humidity, shock and vibration. There is also a minimum of piston motion resulting in low distortion and high electromagnet efficiency.

12" LAFAYETTE POLY-PLANAR WIDE RANGE SPEAKER—Unique physical and audio characteristics permit a wide range of uses: Hi-Fidelity speaker systems, TV or radio, automotive, public address, architectural application (Build Poly-Planars into walls, closet doors, ceilings), and marine application. Use it as it is or cover it, baffle it, enclose it. **Specifications:** Power Capacity 20 watts Peak; Frequency Range, 40-20,000 Hz; Voice Coil diameter, 1"; Magnet weight, 4.8 oz.; Imp., 8 ohms; Maximum operating temperature, +175°F. Size: 17¹/₆"D x 14¹/₄"H x 11³/₄"W. Shpg. wt., 2 lbs.

21 E 56016 Net 10.95

5" LAFAYETTE POLY-PLANAR WIDE RANGE SPEAKER—Same physical and audio characteristics as above 12" speaker. Especially designed for small space high performance applications such as automobile speakers, extension speakers. **Specifications:** Power capacity, 5 watts Peak; Imp., 8 ohms; Frequency range, 60 Hz to 20,000 Hz. Operating temperature range, -20°F to +175°F; Voice coil diameter, 3/4". Size: 3¹/₄"D x 8¹/₂"H x 4¹/₂"W. Shpg. wt., 1 lb.

21 E 56024 Net 5.95

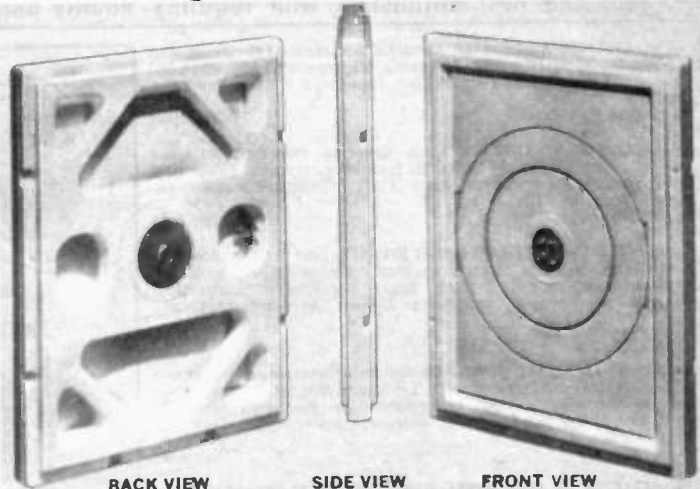

5 inch SPEAKER 5⁹⁵

12 inch SPEAKER 10⁹⁵



NEW! ALL-WEATHER OUTDOOR 12" POLY-PLANAR SPEAKER SYSTEM

- Mount It
- Stand It
- Hang It

ONLY **19⁹⁵**

Fully weatherproof! Use outdoors or indoors for hi-fi use or bi-directional PA paging. Uses 12" poly-planar speaker listed above. Handsome, high-impact white styrene enclosure with accessory walnut wood stand and 8 ft. hook-up wire. Also includes necessary hardware to simply let you stand, hang, or mount the system. Power: 20-watts peak. Frequency response: 40-20,000 Hz. Size: 13¹/₄ x 13¹/₄ x 16¹/₂". Impedance: 8 ohms. Shpg. wt., 4 lbs.

21 E 56032W Net 19.95

The Amazing Lafayette Sound Reproducer

Turns virtually any Surface into a Speaker

ONLY **7⁹⁵** **MADE IN U.S.A.**
Compact Enough To Be Used Anywhere

New, startling development for providing sound almost anywhere. Coneless reproducer attaches to wall, doors, ceilings, or most any object. Transforms the whole surface into a sounding board for beautiful "sound reproduction". Easily connects to speaker leads of any radio, phono, tape player, amplifier, receiver or other sound equipment. Perfect for use in background music or PA systems. For 4, 8, or 16 ohm solid-state or tube equipment. Can be used in a car. Built-in magnet for attaching to metal objects and screw for attaching to wood, plastic, etc. Size: 2" dia. x 1¹/₂"H. Shpg. wt., 1 lb.

21 E 01590 Net 7.95

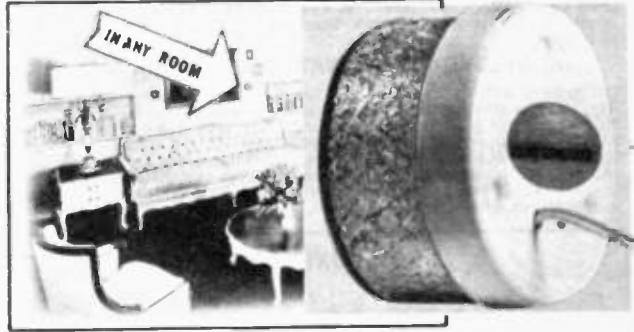

- For Stereo or As Extra Speaker Throughout Your Home or Office
- Turns Walls, Doors, Ceilings, Windows, Furniture, etc. Into a Speaker

DELUXE ELECTRO-VOICE & UNIVERSITY 8" & 12" HI-FI SPEAKERS

ELECTRO-VOICE SP8B RADAX SUPER EIGHT—8" speaker. Resonance 60 Hz. Power rating 20 watts. Response 35-15,000 Hz. 16 ohms impedance. Sens. Rtg. 47 db. Crossover 4500 Hz. 1 lb. 6 oz. ceramic magnet. 8 $\frac{3}{8}$ " diam. 7" baffle opening. 4 $\frac{3}{4}$ " depth behind panel. 21 E 30599 Shpg. wt., 9 lbs. Net 29.70

ELECTRO-VOICE SP12B RADAX TWELVE—12" speaker. Resonance: 50 Hz. Power rating 60 watts peak. Response: 35, 15,000 Hz. 16 ohms impedance. Sens Rtg., 49 db. Crossover: 4500. 1 lb. 6 oz. ceramic magnet. 12 $\frac{1}{4}$ " diameter, 11" baffle opening. 6 $\frac{3}{4}$ " depth behind panel. 21 E 30607 Shpg. wt., 12 lbs. Net 36.00

ELECTRO-VOICE 12TRXB—3-Way assembly completely wired with HF control. Overall diam. 12 $\frac{1}{4}$ ". Resonance: 50 Hz. Power rating 60 watts peak. Magnet weight, 1 lb. 6 oz. Frequency response: 35-20,000 Hz—Mech. crossover 2000 Hz elect. 3500 Hz. Depth behind panel 7". Imp., 16 ohms. Sens. Rtg. 52 db. Shpg. wt., 17 lbs. 21 E 30581WX No Money Down* Net 63.00

UNIVERSITY 312 12" 3-WAY DIFFAXIAL SPEAKER—Features an unusually rigid die-cast basket, heavy magnet, diffusiconic midrange and Sphericon super-tweeter. Woofer response down to 28 Hz. Multielement midrange operates over the frequency range of 1000—3000 Hz. Super-tweeter disperses high over 120°. Tweeter has reflector baffle to prevent interaction and intermodulation distortion. Cross-over network built-in, with brilliance control. Overall frequency response extends from 28 to 40,000 Hz. Power rating 35 watts. Impedance 8-16 ohms. 13" diam., 6 $\frac{3}{8}$ " deep. Shpg. wt., 10 $\frac{1}{4}$ lbs. 21 E 67518 No Money Down* Net 84.50

UNIVERSITY 1212—High compliance suspension with edge dampening and wide angle Sphericon dispersion tweeter. Frequency Range: 35-30,000 Hz. Crossover: 1000 Hz; mechanical, 300 Hz. electrical. Power Rating: 30 Watts. Impedance: 8 ohms. Size: 13" Dia. x 8 $\frac{3}{8}$ " D. 21 E 67773 No Money Down* Net 59.95

UNIVERSITY DIFFUSICONE-8 8" EXTENDED RANGE DIFFAXIAL—Speaker designed for quality performance in very small enclosures. Frequency response 30-15,000 Hz. Rated at 35 watts. Impedance 8-16 ohms. 9 $\frac{3}{8}$ " diam., 4 $\frac{1}{8}$ " deep. Shpg. wt., 5 lbs. 21 E 67534 Net 32.50

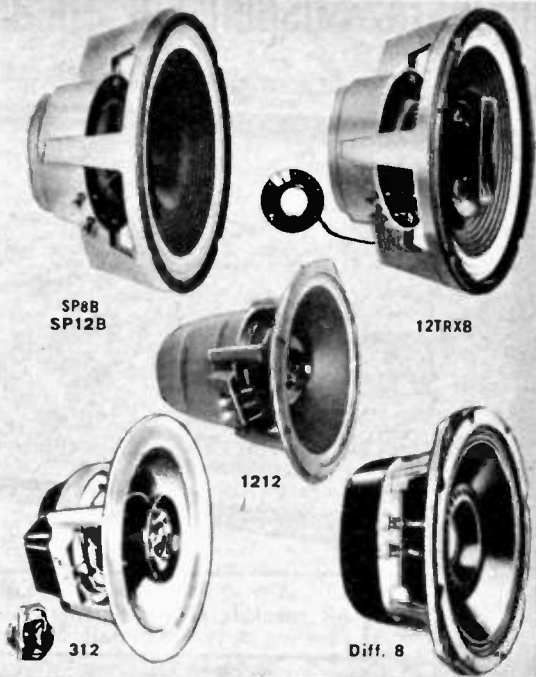

ELECTRO-VOICE WOLVERINE 8", 12", & 15" HI-FI SPEAKERS

MODEL LS8—Ideal for Hi-Fi in every room! A favorite 8" speaker built to high Wolverine standards. The LS8 features include: Heavy-duty die-cast frame; double-wound voice coil; Low silhouette design. 45-14,000 Hz. 40 watts peak. Resonance: 75 Hz. 8 ohms. Mech. cross-over 4500 Hz. Size 8 $\frac{3}{8}$ " diam. x 3 $\frac{1}{2}$ " D. Shpg. wt., 5 lbs. 21 E 30557 Net 18.00

MODEL LS12A—Famous 12" coaxial provides unusually clean frequency response (40 to 14,000 Hz.) Heavy-duty frame, precision-ground internal parts. 40 watts peak. Resonance: 60 Hz. 8 ohms. Mech. crossover: 4500 Hz. Size: 12 $\frac{1}{4}$ " dia. x 3 $\frac{3}{8}$ " D. Shpg. wt., 6 lbs. 21 E 30540 Net 20.70

MODEL LS15—Wolverine's popular 15" speaker features a heavy-duty die-cast frame, a treble cone plus double wound voice coil. Frequency response: 35-14,000 Hz. Power capacity: 40 watts peak. Resonance: 50 Hz. Impedance 8 ohms. Mechanical crossover at 4500 Hz. Size: 15 $\frac{1}{8}$ " diameter, 6 $\frac{1}{2}$ " depth. Shpg. wt., 13 lbs. 21 E 30532 Net 27.90

MODEL HF1 HIGH FREQUENCY STEP-UP KIT—Adds sparkling brilliance to LS8, LS12A or LS15. Extends response to 18,000 Hz., improves dispersion for stereo. Complete with driver, combined cross-over-level control, wiring, mounting hardware and instructions. Requires 1 $\frac{3}{4}$ x 4 $\frac{1}{4}$ " baffle opening. Shpg. wt., 3 lbs. 21 E 30565 Net 26.10

MODEL MF1 MID-RANGE STEP-UP KIT—Improves presence and dispersion from 1,000 to 3,500 Hz. Complete with horn, driver, cross-over-level control, wiring and instructions. Requires 9 $\frac{1}{2}$ x 3" baffle opening. Shpg. wt., 5 lbs. 21 E 30573 Net 27.90

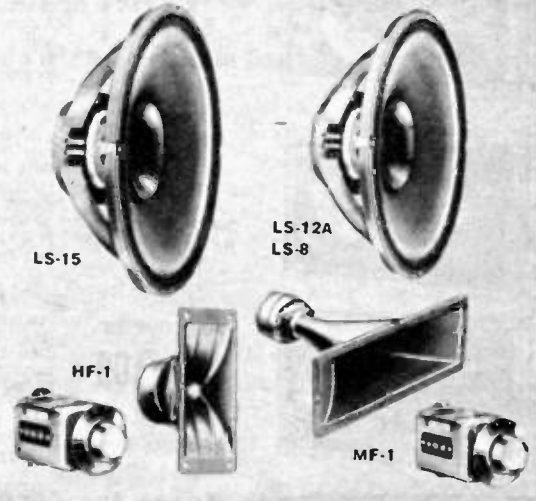

UNIVERSITY WOOFERS, MID-RANGE SPEAKERS, TWEETERS, DRIVERS & CROSSOVERS

C-12HC 12" HIGH COMPLIANCE WOOFER. Impedance, 4-20 ohms. Freq. response 20-30,000 Hz. Rated at 50 watts. Cone resonance 20 Hz. 6 $\frac{7}{8}$ " deep. Shpg. wt., 9 lbs. 21 E 67567 No Money Down* Net 57.00

MODEL C-15W 15" DVC WOOFER. 13 lb. magnet structure. Rated at 50 watts. Response from below 25 to 1500 Hz. Impedance, 4-20 ohms. 10 $\frac{1}{2}$ " deep. Shpg. wt., 27 lbs. 21 E 67724WX No Money Down* Net 109.50

MODEL C-8M 8" MID-RANGE SPEAKER. Frequency response, 700-5,000 Hz. Power rating, 50 watts. Impedance, 8 ohms. 4 $\frac{1}{2}$ " deep. 21 E 67674 Shpg. wt., 3 $\frac{1}{2}$ lbs. Net 18.20

AP-B BALANCE CONTROL. For use with N-2A and N-2B networks. Suits 8-16 ohm systems. 21 E 67658 Shpg. wt., 7 oz. Net 7.50

T-202 SPHERICON SUPER TWEETER. 3,000-40,000 Hz. (+2 db to 22,000 Hz.) Domed phenolic diaphragm with spherical diffractor. Built-in network and brilliance control. 8 ohms, 30 watts. Shpg. wt., 3 lbs. 21 E 67575 Net 27.00

HF-206 HYPERSONIC TWEETER. High frequency response to beyond audibility. N-2B network for 5,000 Hz. crossover recommended. 8 ohms. 25-50 watts. 6x3 $\frac{3}{4}$ x6 $\frac{3}{4}$ ". 21 E 67583 Shpg. wt., 3 $\frac{1}{2}$ lbs. Net 39.50

N-2A CROSSOVER. 350 or 700 Hz. @ 8 or 16 ohms; 700 Hz. @ 4 ohms. 3 $\frac{3}{8}$ x3 $\frac{1}{4}$ x3". 21 E 67633 Shpg. wt., 2 $\frac{1}{4}$ lbs. Net 22.95

N-2B CROSSOVER. 1250, 2500 or 5000 Hz. @ 8 ohms; 2500 or 5000 Hz. @ 16 ohms; 2500 Hz. @ 4 ohms. 3 $\frac{3}{8}$ x3 $\frac{1}{4}$ x3". 21 E 67641 Shpg. wt., 2 $\frac{1}{4}$ lbs. Net 17.95

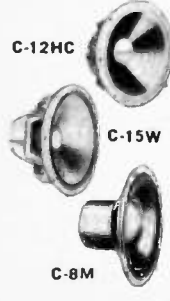

* See Page 11 for Full Credit Details on Easy Pay Plan

Acoustic Suspension Speaker Systems by

Our One Depth

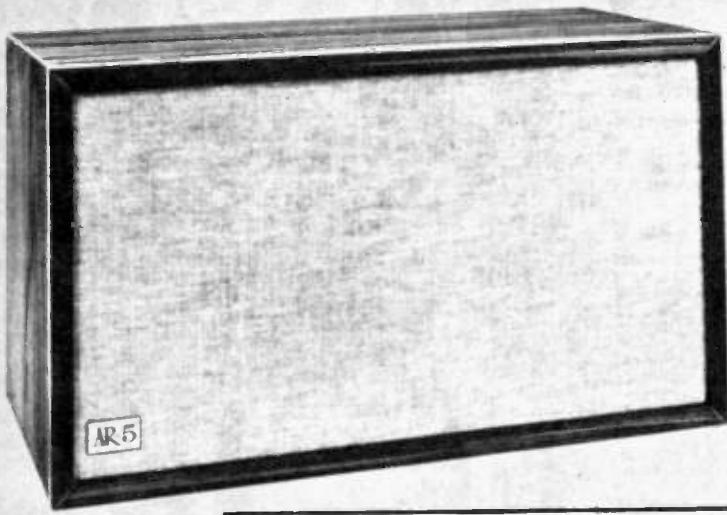

AR SPEAKER BASES

750 ea.

Size: 11x14½x13
Shipping Weight 5 lbs.

21 E 72419W Oiled Wal.	Net 5.50
21 E 72401W Unf. Birch	Net 7.50

AR's 5-YR. SPEAKER GUARANTEE
AR speakers are sold under the manufacturer's 5-year guarantee covering parts, labor, freight both ways, and packaging if necessary.



As Low As
51⁰⁰
No Money Down*

AR-4X 2-WAY ACOUSTIC SUSPENSION SYSTEM
Low cost acoustic suspension speaker system. Designed to give a superbly clean, realistic bass response and clear, crisp highs by utilizing the famous acoustic suspension principle. It incorporates an 8" woofer and a 2½" inch direct radiator tweeter with level control to compensate for different acoustic conditions of your listening room. Electrical crossover frequency is 1200 Hz. A compact (19Wx10Hx9"D) unit for floor or shelf-mounting. Suitable for use with amplifiers of 15 watts or more per chan. Imp: 8 ohms. Shpg. wt., 22 lbs.

21 E 72492WX Oiled Walnut	Net 57.00
21 E 72500WX Unfinished Pine	Net 57.00

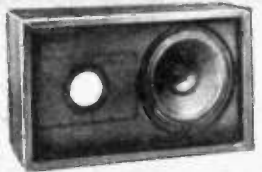

As Low As
89⁰⁰
No Money Down*

AR-2X 2-WAY ACOUSTIC SUSPENSION SYSTEM
Designed for use with any high quality amplifier supplying 20 watts or more over the entire audio range. Incorporates a 10" acoustic-suspension woofer (with crossover at 2,000 Hz.) plus a 3½" direct radiator tweeter assembly. Frequency response 42-15,000 Hz. ±2½ db; down 10 db. at 30 and 17,000 Hz. Harmonic Distortion, under 2% down to 60 Hz; under 3% down to 50 Hz. at 10 watts. Imp. 3 ohms. Finished on 4 sides. 24x11½x13½". Shpg. wt., 35 lbs.

21 E 72450WX Oiled Walnut	Net 102.00
21 E 72468WX Unfinished Pine	Net 109.00



As Low As
109⁰⁰
No Money Down*

AR-2AX 3-WAY ACOUSTIC SUSPENSION SYSTEM
Precision-made components plus the famous acoustic suspension design deliver truly magnificent sound. Includes 10" woofer for natural bass response; 3½" direct radiator mid-range for realism and a 1¾" dome type super tweeter providing highs out to the limits of audibility. Frequency response, 42-20,000 Hz. ±2½ db. Less than 2% harmonic distortion down to 50 Hz. Has 2 level controls. Designed for use with amplifiers rated at 20 watts or more. Finished on 4 sides. 24x11½x13½". Imp.: 8 ohms. Shpg. wt., 43 lbs.

21 E 72070WX Oiled Walnut	Net 128.00
21 E 72054WX Unfinished Pine	Net 109.00

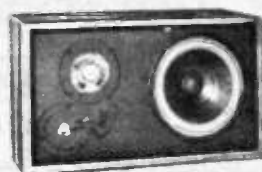

As Low As
156⁰⁰
No Money Down*

NEW! AR-5 3-WAY ACOUSTIC SUSPENSION SYSTEM
Newest AR book-shelf system! Provides superb full-range frequency response. System features a new 10" acoustic suspension woofer utilizing AR's most advanced cone design, 1½" mid-range and ¾" tweeter each have independent frequency driver controls with crossover at 650 and 5,000 Hz respectively. Frequency response: 38-20,000 Hz. Impedance: 8 ohms. Recommended amplifier power: 20 watts per channel. Size: 13½x24x11½"D. Shpg. wt., 46 lbs.

21 E 72716WX Oiled Walnut	Net 175.00
21 E 72724WX Unfinished Pine	Net 156.00

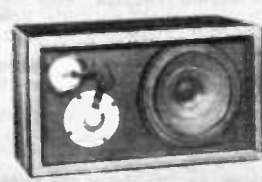

As Low As
225⁰⁰
No Money Down*

AR-3A DELUXE 3-WAY ACOUSTIC SUSPENSION SYSTEM
Acoustic Research's finest speaker system. Features a powerful 12" woofer with ¾ lb. magnet, hemispherical direct radiators for the mid-range and tweeter units with 1½" and ¾" domes, respectively. Frequency response from 38 Hz to 20,000 Hz (±2db). Woofer crossover frequency at 575 Hz; mid-range from 575 Hz to 5kHz; and the tweeter from 5 kHz up. Recommended power requirements: 25 watts (RMS) per channel. Impedance: 4 ohms. Cabinet finished on 4 sides. Size: 14Hx25Wx11¾"D. Shpg. wt., 69 lbs.

21 E 72658WX Oiled Walnut	Net 250.00
21 E 72708WX Unfinished Pine	Net 225.00



Acoustic Suspension Speaker Systems

Model Six 12" 2-Way Acoustic Suspension Speaker System

134⁰⁰

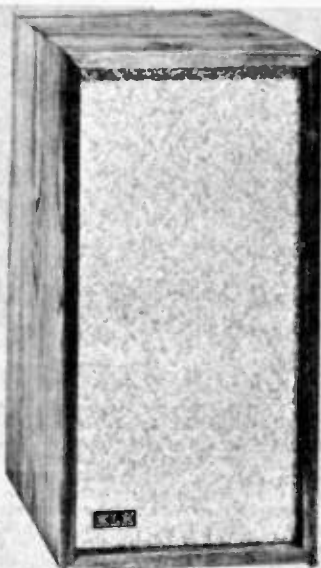

Designed to handle high power and deliver a full-range of rich sound. Has big 12" acoustic suspension woofer employing a heavy, oriented-ceramic magnet assembly and four-layer voice coil; 1 1/2" cone-type direct radiator tweeter, plus 3-position high frequency level control. Frequency Response: 32 to over 16,000 Hz. Crossover: 1500 Hz. Impedance: 8 ohms. Ideal for floor or shelf mounting. For amplifiers of 25 watts IHF or more. Oiled walnut finish on four sides. Size: 23 1/2 x 12 3/8 x 11 7/8" D. Shpg. wt., 40 lbs. 21 E 44061WX No Money Down* Net 134.00

Model Twelve 3-Way 4-Speaker Acoustic Suspension Speaker System

275⁰⁰

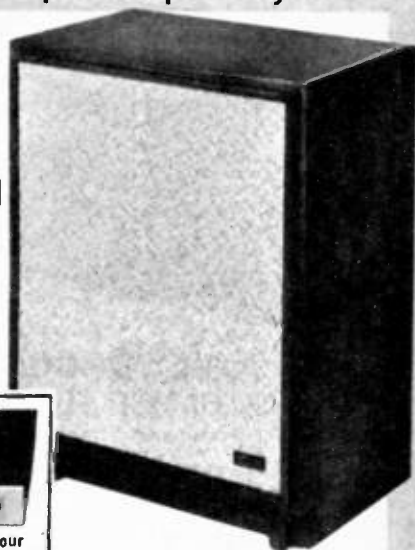

with Remote Control
Control Box

High-performance, wide frequency response, low distortion, and extended bass response are characteristic of the Model 12. Four-speaker arrangement includes: 12" long-excursion, acoustic-suspension woofer with heavy cone and magnet assemblies; two mid-range drivers individually mounted in a one-inch thick plywood, fiberglass-filled sub-enclosure; high-frequency, single-piece, direct radiator design tweeter. Outstanding feature is the contour control box with its four 3-position switches to permit adjustment of response over the frequency ranges that most affect the musical balance of each speaker; first switch operates 300-800 Hz, second 800-2500 Hz, third 2500-7000 Hz, and the fourth 7000-20,000 Hz. Response: 30-20,000 Hz. Crossover at 600 and 2500 Hz. Imped., 8 ohms. Oiled walnut cabinet. For amplifiers of 40 watts IHF or more. Size: 22 3/4 x 29 x 15" D. Shpg. wt., 114 lbs. 21 E 44236WX No Money Down* Net 275.00

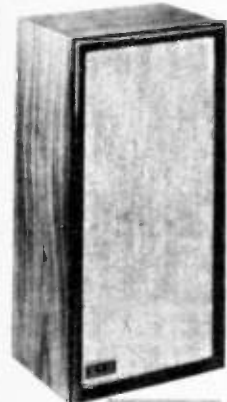

Model 17 69⁹⁵

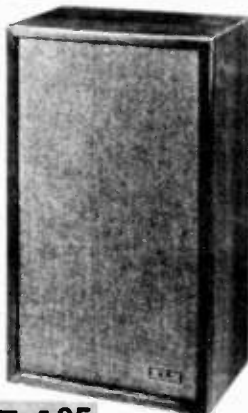

Model 22 54⁹⁵

Model Seventeen 10" 2-Way Acoustic Suspension System

Full-range two-way system offering a high level of musical enjoyment. 10" acoustic suspension woofer provides extended bass response; 1 3/4" direct radiator type tweeter provides smooth peak-free highs as well as exceptional performance at the mid-frequencies. 3-position high frequency control permits matching the system to any acoustic environment. Housed in a completely sealed, fiberglass filled, oiled walnut, 3/4" furniture grade cabinet. All four sides finished for vertical or horizontal placement. Impedance: 8 ohms. For use with amplifiers of 12 watts IHF or more. Size: 11 3/4 x 23 1/8 x 9" D. Shpg. wt., 29 lbs. 21 E 44210WX No Money Down* Net 69.95

Model Twenty-Two 8" 2-Way Acoustic Suspension System

Big enough to have all the requirements for excellent performance. Yet small enough to fit unobtrusively into any living room. Bass frequencies are reproduced through the use of an 8" acoustic suspension woofer; mid and high-frequency performance is provided by a 2" direct radiator tweeter. Tightly sealed cabinet is oiled walnut finished on all four sides for vertical or horizontal placement. Impedance: 8 ohms. For amplifiers with as little as 12 watts IHF per channel. Size: 18 x 10 1/4 x 7 3/8" D. Shpg. wt., 20 lbs. 21 E 44244WX No Money Down* Net 54.95

Model Five 4-Speaker 3-Way Acoustic Suspension Speaker System

179⁹⁵

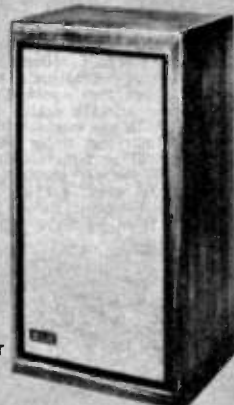

- 12" Acoustic Suspension Woofer
- Two 3" Mid-range Speakers
- 1 3/4" High-Frequency Speaker

Offers the best low-frequency and power handling capabilities of the KLH bookshelf-size speaker systems. Speaker compliment includes: big 12" acoustic suspension woofer with heavy magnet and cone assemblies; two 3" miniature heavy-magnet mid-range speakers; and a 1 3/4" high-frequency speaker mounted in a sub-enclosure. Two 3-position switches adjust the 2500-7000 Hz and 7000-20,000 Hz ranges. Cabinet of 3/4" plywood finished in oiled walnut veneer. 8-Ohms impedance. Minimum power: 40 watts IHF. Size: 26 x 13 3/4 x 11 1/2" D. Shpg. wt., 51 lbs. 21 E 44251WX No Money Down* Net 179.95



MODEL W60D 3-WAY SAND-FILLED SHELF/FLOOR SYSTEM

129⁹⁵

Exclusive sand-filled construction prevents cabinet sound coloration. Powerful 12½" woofer with massive 9½ lbs. magnet assembly provides deep rich bass and excellent transient response. 5" midrange speaker is acoustically isolated and has climatically impervious special cloth suspension. Omni-directional pressure dome tweeter gives extended and uniformly smooth treble response. Separate variable controls for mid and treble ranges. Handsome oiled walnut cabinet is 14¼" x 24" x 13" deep. Response: 30-20,000 Hz. Imp., 4-8 ohms. Power cap., 40 watts. Shpg. wt., 56 lbs. Imported. **21 E 75461WX No Money Down*** Net 129.95

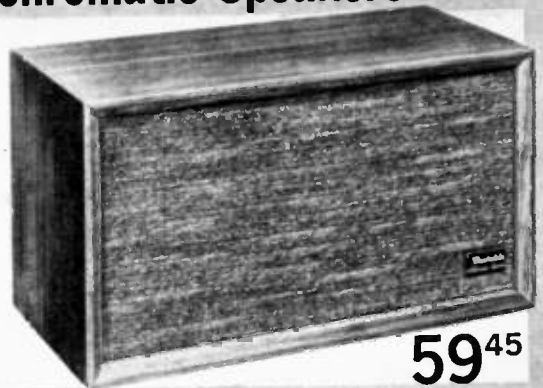

MODEL W30D 2-WAY COMPACT ACOUSTIC SUSPENSION SYSTEM

59⁴⁵

Uses big 8" woofer with exclusive long-throw "FLEXEPRENE" suspension and acoustically isolated, omni-directional mylar-domed pressure tweeter. Measures only 10" x 19" x 9¼" deep, yet superb as a main system, where space is at a premium. Professional LCR crossover network includes continuous acoustic control. Removable grille assembly. Imp. 4-8 ohms. Power cap. 35 watts. Scuff-resistant, oiled walnut type vinyl finish. Shpg. wt., 22 lbs. Imported. **21 E 75503WX No Money Down*** Net 59.45

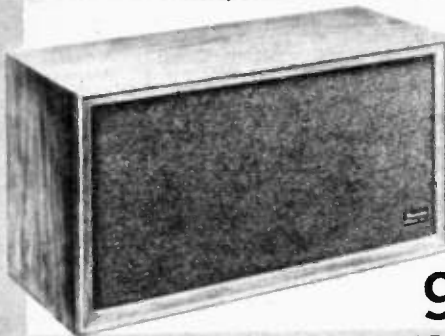

MODEL W40D 3-WAY BOOKSHELF SYSTEM WITH ACOUSTIC SUSPENSION

NEW!

94⁵⁰

Provides carefully tailored, ultra-linear response. Uses a heavy duty 10" high compliance, low resonance woofer; acoustically isolated 5" midrange speaker with climatically impervious cloth surround and advance design omni-directional pressure dome SUPER tweeter with low mass aluminum voice coil. Separate, continuously variable mid and treble range controls. Cabinet is hand-rubbed, oiled walnut air tight acoustic suspension type. Use either in horizontal or vertical position. Front grille assembly is removable. Dimensions: 12½" x 23½" x 10½" deep. Response: 35 to 20,000 Hz. Imp: 4-8 ohms. Power Cap: 35 watts. Imported. Wt., 37 lbs. **21 E 75511WX No Money Down*** Net 94.50



MODEL W90D 6-SPEAKER, 4-WAY SYSTEM IN SAND-FILLED ENCLOSURE

289⁰⁰

Truly faithful reproduction over the entire frequency range from 20 Hz. to inaudibility. Bass is divided between two 12½" woofers; each with massive 9½ lb. magnet assembly. One acts as a pressure radiator with 75 sq. in. polystyrene piston to couple low bass range into the room. The other reproduces the upper bass and lower mid-ranges. A pair of 5" heavy duty midrange speakers and a pair of omni-directional mylar-domed SUPER tweeters form a wide-angle array to insure correct musical timbre and definition of the rest of the spectrum—anywhere in the room. Fine furniture oiled walnut cabinet with removable grille assembly. Imp: 4-8 ohms. Power Cap: 50 watts. Dimensions: 23¾" x 30" x 13½" (includes table top). Imported. Shpg. wt., 100 lbs. **21 E 75487WX No Money Down*** Net 289.00



MODEL W70D 4-WAY SAND-FILLED HI/LO BOY SYSTEM

179⁹⁵

No Money Down*

- 12½" Woofer with 9½ lb. Magnet Assembly
- Power Handling Capacity: 40 Watts
- Handsome Oiled Walnut Wood Cabinetry

Life-like bass from a massive 12½" long-throw acoustic suspension woofer with 9½ lbs. magnet assembly. Heavy duty 8" unit serves as a "passive" radiator for upper bass and as energized driver for lower midrange. Acoustically isolated 5" speaker handles upper midrange, and advance design pressure dome tweeter contributes near distortion-free, wide-angle treble. Individual mid and treble range controls. Cabinet employs exclusive sand-filled construction. Response 24-20,000 Hz. Imp. 4-8 ohms. Power capacity 40 watts. Dimensions: 24" x 22¾" x 13½" deep (w/table top); Oiled walnut. Shpg. wt., 74 lbs. Imported. **21 E 75446WX** Net 179.95

Deluxe Floor Standing Speaker Systems

**NEW! HARMON KARDON HK-50
OMNI-DIRECTIONAL SPEAKER SYSTEM**

95⁰⁰

No Money Down*

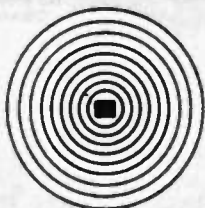

OMNI-DIRECTIONAL SOUND
Spreads sound through entire room. You sit anywhere you want and hear perfect stereo.



- Handles Up To 100-Watts
- Response: 22-18,500 Hz

Magnificent floor standing 4-way speaker system provides concert hall sound reproduction. Incorporates six drivers to achieve brilliant, smooth response from 22 to 18,500 Hz. (± 4 db). Woofer has 1" cone excursion capability and uses a 10 pound magnetic structure. Resonance in the enclosure is 20 Hz. Mid-range driver operates from 250 to 3000 Hz and is mounted in a fiber sub enclosure within the main cabinet. Two tweeters cover the 3,000 to 11,000 Hz range with two additional super tweeters carrying audio frequencies to in-audibility. Can be driven by any amplifier capable of 20 watt output (RMS). Impedance: 8-ohms. Beautiful hand-rubbed oiled walnut finish. Dim: 35H x 18W x 12 $\frac{1}{4}$ "D. Shpg. wt. 70 lbs.

Produces a natural blend of direct and reflected sound dispersed over 360° for full stereo effects anywhere in your room. Has 8" woofer and 2 $\frac{1}{4}$ " tweeter. Handsome hand rubbed oiled walnut enclosure will add to your room decor. Frequency response: 35-20,000 Hz. Power handling: 40 watts. Impedance: 8-ohms. Size: 10 $\frac{3}{4}$ " square x 18"H. Shpg. wt., 20 lbs.

21 E 42826WX

Net 95.00

21 E 86039WX

Net 279.00

Only
279⁰⁰

No Money Down*



**ALTEC LANSING 846A
CONSOLETTA SPEAKER SYSTEM**



Only **317⁵⁰**

No Money Down*

- 15" Low Frequency Driver
- Sectorial High Frequency Horn Driver
- High Frequency Driver
- 800 Hz Crossover Network

Altec has brought the sound of the famous A7 "Voice of the Theater" system into the home. Deluxe speaker components are mounted in a beautiful hand-finished walnut cabinet with fretwork wood grill. Features a 416A massive 15" low frequency driver with 10 lb. 8 oz. magnetic structure and 3" voice coil of edge-wound copper ribbon; 806A high frequency driver; 811B high frequency sectorial horn of heavy cast aluminum; plus N800G L/C crossover network. Frequency response; 35-22,000 Hz. Cap.: 50 watts. 8-16 Ohms. 29 $\frac{3}{4}$ H x 27 $\frac{1}{2}$ W x 19"D. Shpg. wt., 100 lbs.

21 E 76261WX

Net 317.50

EMPIRE DIVERGENT LENS SPEAKER SYSTEMS

Patented Acoustic Lenses allow you to enjoy phenomenal Stereo anywhere in the room... Speaker Placement is Non-Critical.



Only
209⁹⁵
No Money Down*

7000M 3-WAY "GRENADIER"

- 12" High Compliance Woofer With 8 Lb. Magnet Structure
- Direct Radiator Mid-Range
- Ultra-Sonic Dome Tweeter

Superb combination of cylindrical design and outstanding sound reproduction. 7000M features a direct radiator mid-range speaker and ultra-sonic tweeter both coupled to an acoustic lens for wide angle dispersion. 12" high compliance woofer provides smooth bass response down to 25 Hz. Speaker placement is not critical for wide frequency response and correct stereo separation. Response: 25-20,000 Hz. Music Power: peak 75 watts. 3 position treble control switch can also adjust bass to suit individual room acoustics. Beautifully styled in satin walnut with imported marble top. Impedance: 8 ohms. Size: 26 $\frac{1}{2}$ x19" Dia. Shpg. wt., 68 lbs.

21 E 34773WX

Net 209.95



Only
299⁹⁵
No Money Down*

9000M 3-WAY "ROYAL GRENADIER"

- 15" High Compliance Woofer with 4" Voice Coil and 18 Lb Magnet Structure
- Direct Radiator Mid-Range
- Ultra-sonic Domed Tweeter

Empire's finest speaker system. Larger diameter column houses a mass-loaded, high-compliance 15" woofer with a 4" voice coil and magnetic power of over one million lines of force. This enables the model 9000M to achieve a smooth frequency response of 20-20,000 Hz. High efficiency enables this deluxe system to be driven by any modern amplifier. Full presence direct radiator and domed tweeter coupled to die-cast acoustic lenses achieve broad dispersion. Handles up to 100 watts music power. Impedance, 8 ohms. 29 high x 22" dia. Satin walnut finish and durable marble top. Shpg. wt., 87 lbs.

21 E 34351WX

Net 299.95

* See Page 11 for Full Credit Details on Easy Pay Plan

Selected Utah and Dyna Hi-Fi Loudspeakers

DELUXE UTAH 12" 3-WAY HI-FI SPEAKER



MODEL BC12RXC-3

44⁹⁵

No Money Down*

- 6¾ lb. Magnet Structure
- 2" Voice Coil
- Handles 70-Watts Peak Power

MODEL BC12RXC-3: Outstanding 3-way 12" speaker provides clean, natural concert hall sound over a full frequency range of 20-19,500 Hz. Features a large 6¾ lb. magnet structure, and a 2" diameter voice coil. Rigid one piece pressure-die cast frame maintains precision alignment of critically spaced parts. High compliance woofer has cloth roll suspension for low, smooth bass, down to 20 Hz. Separate midrange cone for distortion-free middle frequencies. Cone-type super tweeter disperses clean, brilliant high frequencies up to 19,500 Hz. Calibrated tweeter level control. Solderless terminals are phase coded for easy stereo phasing, spring loaded for fast wiring and freedom from buzzing. Power handling: 35 watts (70 watts Peak). Impedance: 8 ohms.

21 E 47288WX Shpg. wt., 12 lbs. Net 44.95

MODEL BC8PC-8: 8" version of above speaker. Magnet structure 4 lbs. Voice coil diameter: 1½". Peak Power: 35 watts. Freq. Response: 28-19,000 Hz. 21 E 47296WX Shpg. wt., 7 lbs. Net 29.95

NEW DYNA A25 APERIODIC LOUDSPEAKER SYSTEM

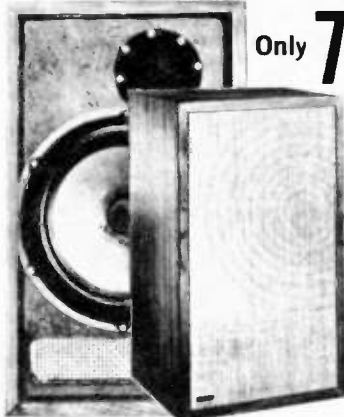

Only **79⁹⁵**

No Money Down*

- 10" Extended Range Woofer
 - Soft Dome Tweeter
 - Acoustic Impedance Enclosure Principle
- Non-resonant aperiodic design combines with acoustic impedance principle to assure uniform wide range response. Uses a 10" extended excursion woofer and new soft dome tweeter to achieve truly natural sound. 5-position tweeter control. Power handling: over 60 watts (RMS). Impedance: 8 ohms. Wall mounting brackets. Oiled walnut finish. Size: 20 x 11½ x 10"D. Shpg. wt., 22 lbs.
- 21 E 23545WX Net 79.95

HOME REVERBERATION AMPLIFIERS AND SPEAKERS

LAFAYETTE REVERBERATION AMPLIFIER AND SPEAKER SYSTEM



24⁹⁵

- Ideal for Stereo or Mono Systems
- Self-Contained with Built-in Power Supply

A compact space saving self-contained reverberation amplifier speaker system that works with your existing component HI-FI system, AM or FM radio, tape recorder to bring the realism of concert hall sound to your listening area. Thrill to this new dimension in sound. 3-tube amplifier delivers 2½ watts to a 6½" PM speaker. Inputs provided are stereo/mono high level and stereo/mono low level. For use with 110-117 volts AC, 50-60 Hz. per second. Unit is mounted in a deluxe, beautiful oiled walnut cabinet which measures 11¼"W x 7¾"H x 5¾"D. Imported. Shpg. wt., 7 lbs.

21 E 01463 W Net 24.95

DELUXE LAFAYETTE R-777 SOLID STATE HOME REVERBERATION AMPLIFIER

Recreates a 3rd Dimension in Sound

59⁹⁵

No Money Down*

Made in U.S.A.



Licensed by Hammond Organ

- Brings Forth True Concert Hall Or Opera House Realism In Your Home

- Ideal for Use with Lafayette LR-500TA, LR-1000TA, and LR-1500T Stereo Receivers, and all other Receivers and Amplifiers with 3-way Speaker Selector Switches

The Lafayette Solid State R-777 Home Reverb Amplifier will add a dramatic 3rd channel of listening pleasure to your present hi-fi system. This 3rd channel originates from the remote output speaker terminals of your receiver or amplifier—and is fed thru the REVERB AMPLIFIER with sound delay to a 3rd speaker*. The results created when listening to this 3rd speaker and the regular speakers of your hi-fi system simultaneously are truly 3-DIMENSIONAL. Reverb Amplifier features a "Percentage of Reverberation" control to allow for the best reverb mix for the acoustics of your room. Also includes tone control, volume control, and an on/off switch with pilot light. Specifications: Power Output: 10 watts RMS at 8 ohms, Output impedance: 8 ohms; 4 transistor, 4 Diodes. Handsome walnut wood enclosure with brushed aluminum front panel. Size: 19 x 8½ x 4¾"H. Shpg. wt., 9 lbs. *3rd speaker not included with Reverb Amplifier.

21 E 81006WX Net 59.95

Lafayette's R-777 reverberation amplifier is specially designed to operate with a stereo receiver or amplifier that has a 3-way speaker selector switch — main, remote, main and remote simultaneously. Easy to hook up with only 2 sets of wire to connect.

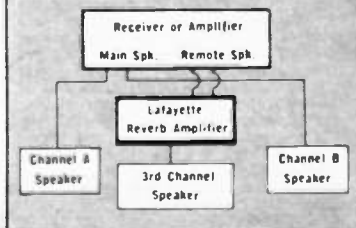

Easy-to-Assemble LAFAYETTE Speaker Enclosure Kits

The Famous ELIPTOFLEX® 12" Speaker Enclosure

In Ready-To-Finish, Easy-To-Assemble Kit Form

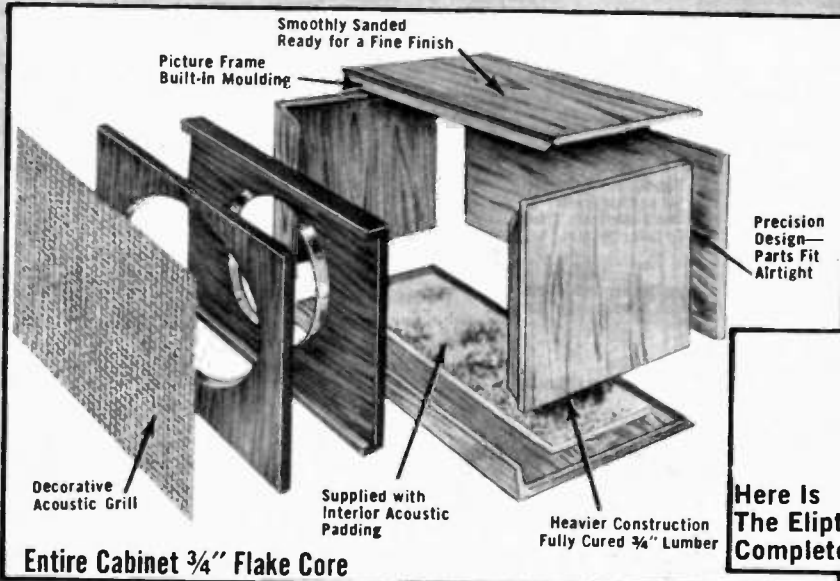

ASSEMBLE IT
FINISH IT

AS LOW AS

23⁹⁵



Here Is
The Eliptoflex
Completely Assembled

- 3 Sides Prepared for Finishing
- Designed for Horizontal Placement

- Provides Optimum Performance Without Use of Expensive High Power Amplifiers

This is the same Lafayette Eliptoflex Speaker Cabinet that has set a high standard of speaker enclosure excellence—available in ready-to-finish easy-to-assemble kit form. The easy-to-follow instruction sheet, with large pictures, guides you step-by-step for easy assembling. When completely assembled and highlighted with your favorite finish—you'll be amazed at the professional looking results.

You'll also appreciate the engineering excellence of this speaker cabinet. The Eliptoflex utilizes a unique elliptical port which broadens frequency response and provides better transient response. A specially engineered diffracting ring eliminates cancellation effects be-

tween front and rear radiation. The "Eliptoflex" achieves a degree of natural smoothness, low distortion and rich robust bass. Due to its highly efficient design characteristics, costly high wattage amplification is not required. The kit is available in either ready-to-finish birch or in ready-to-finish genuine walnut veneer. Assembled the "Eliptoflex" measures 14H x 23⁹/₁₆W x 13³/₁₆"D. Shpg. wt., 24 lbs.

20 E 01105WX Ready-to-Finish Kit in Birch Net 23.95

Ready-to-Finish Kit with Walnut Veneered Acoustically Correct Flake Core. Shpg. wt., 24 lbs.

20 E 01113WX Net 27.95

LAFAYETTE Bass Reflex Speaker Bookshelf Enclosure Kit

Not 1/2" But 3/4" Furniture Grade White Birch Plywood or Walnut Veneer on Flaked Core Plywood

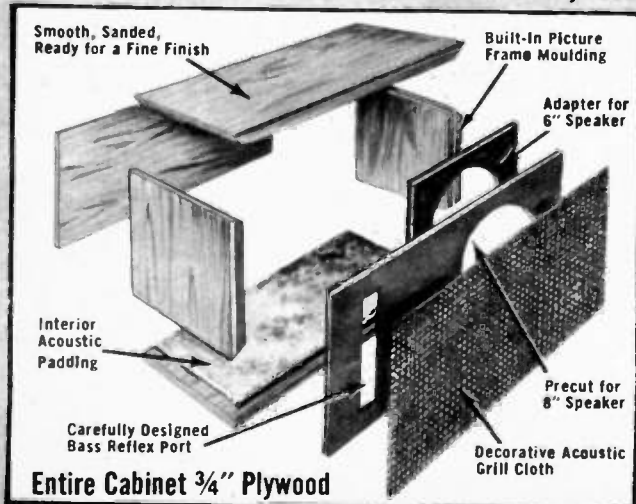

AS LOW AS **14⁹⁵**

For 8" or 6" Speakers

- Precision Cut—Fits Together Smoothly
- Adapts For 8" or 6" Speakers
- Easy To Follow Pictorial Instructions
- Versatile—Use As Floor or Bookshelf Enclosure

BUILD IT YOURSELF . . . Expensive woodworking equipment isn't needed—each cabinet component has been precision cut and fits together perfectly. There's nothing else to buy . . . acoustic padding, grill cloth and hardware are provided. Use any 8" or 6" speaker; the mounting board has been pre-cut for 8" speakers and an adapter is supplied for 6" speakers.

Designed for horizontal placement in a bookshelf, along a wall, etc. Constructed of veneer on 3 sides with handsome picture frame moulding. Dimensions: 23 x 9¹/₂ x 11". Available in either birch or walnut unfinished veneer.

20 E 01121WX Birch Kit. Shpg. wt., 15 lbs. . . Net 14.95

20 E 01139WX Walnut Kit . . . Net 16.95

Entire Cabinet 3/4" Plywood

Depend on Lafayette For Everything in Electronics

Lafayette Cat. No. 700 65

OUR FINEST HI-FI SPEAKER ENCLOSURE KIT

Deluxe Universal Floor-Standing Hi-Fi Enclosure Kits

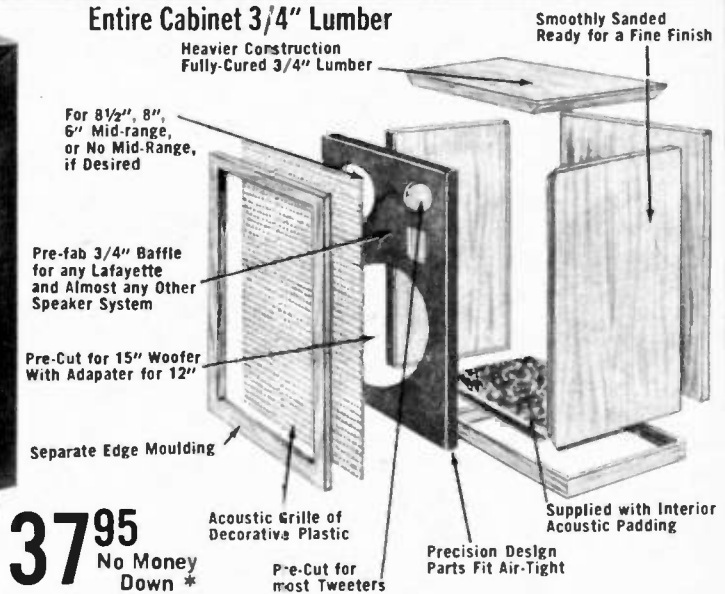
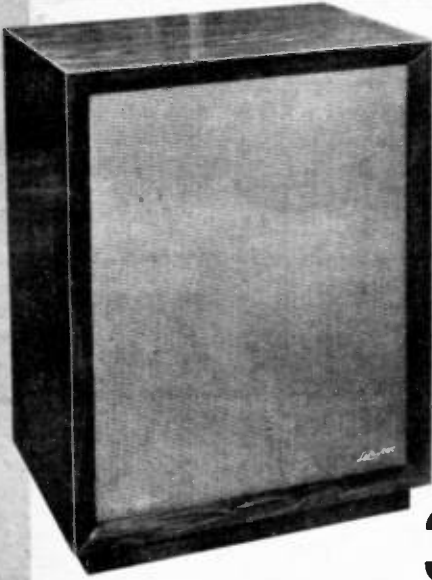

37⁹⁵
No Money Down *

- Easy To Assembly
- 3/4" Wood Construction
- Precision Cut—Fits Together Smoothly

All pieces of this carefully designed high fidelity speaker enclosure are accurately pre-cut of 3/4" lumber to fit snugly together and virtually eliminate all spurious resonances. White birch surface is finished on all 4 sides for either high or low boy styling. Front panels feature edge moulding and plastic acoustic grilles to blend with any finish and room decor. Lined with acoustic material that prevents reverberation and cabinet resonance. Flexible design includes cut-outs for 15" woofer (with 12" adapter), 8 1/2" or 8" mid-

- Ideal For Single Wide Range, 2- 3-Way Speaker Systems
- High or Low Boy Styling—Finished on All 4 Sides range (with 6" adapter), and adapters to accommodate either round or rectangular tweeters. Separate wood blanks are supplied if no midrange speaker or tweeter is used. Kit is supplied unfinished, smoothly sanded and ready for finishing. Dimensions (less base) 27 7/8"H x 23 1/2"W x 16 3/4"D. Island type base is 2 3/4" high. Complete with instructions, all parts, hardware, and grille. Shpg. wt., 54 lbs.

20 E 01493WX No Money Down* Net 37.95

LAFAYETTE Hi-Fi Component Shelf/Console

Oiled Walnut Finish

64⁹⁵

Unfinished

39⁹⁵

- Room For All Your Components
- Sturdy 3/4" Non-Wrap Wood Construction
- Holds Over 150 Records
- An Attractive Addition To Any Home—Place Along A Wall Or Use As A Room Divider

The ideal answer to your Hi-Fi Stereo component placement problems—measures 62 1/2" long, yet holds over 150 records with more than enough room for your amplifier, turntable or record changer, tape deck and stereo speakers. Veneered rear panel, finished on both sides, permits its use as a room divider. Speaker compartments spaced to achieve proper separation for stereo. Shipped knocked down—assembles in minutes. Shpg. wt., 65 lbs. Oiled Walnut Finish on Genuine Walnut Veneered Flake Core.

20 E 01147WX No Money Down* Net 64.95

Unfinished Flake Board
20 E 01154WX No Money Down* Net 39.95

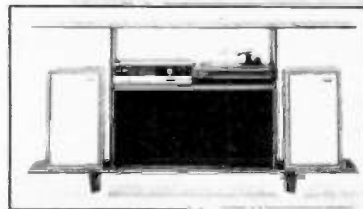
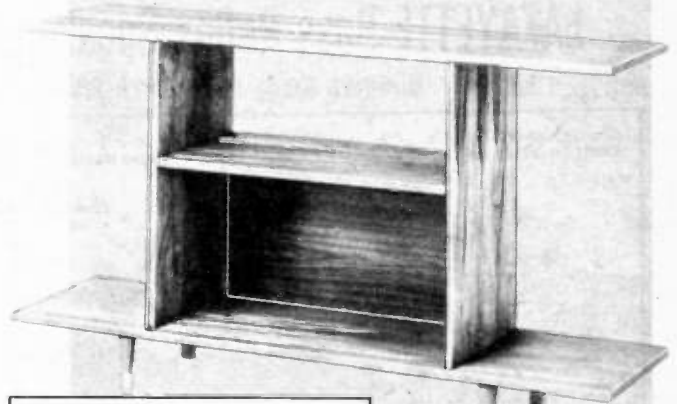

DIMENSIONS

Top Shelf	Speaker Compartments
11"Hx16"Dx31 1/2"W	27"Hx16"Dx14 3/4"W
Lower Shelf	Overall Dimensions
15 1/4"Hx15 1/2"Dx31 1/2"W	33 3/4"Hx16"Dx62 1/2"W
	(including 5" legs)

Attractive Cabinet Kits For Records and Components

(B) COMBINATION RECORD AND COMPONENT CABINET



27⁹⁵

(A) COMBINATION RECORD AND COMPONENT HUTCH

Handsomely styled hutch designed to accommodate your high fidelity components, records, and tapes. Can also be used to store books. 2 shelves are adjustable for placement of your tape recorder, phonograph, or even a television set. Oiled walnut finish on

hardboard. Comes knocked-down. Simple to assemble with easy-to-follow instructions. Includes all mounting hardware. Overall size: 63"Hx14¹/₄"Dx24"W. Lower compartment with sliding doors 16"Hx14¹/₄"Ox24"W.

20 E 23018WX Shpg. wt., 70 lbs. Net 59.95

(B) COMBINATION RECORD AND COMPONENT CABINET

Striking contemporary design in a cabinet made specially for installation of your high-fidelity components and records. Provides maximum capacity for areas where space is limited. Cabinet is shipped knocked-down in easy-to-assemble form complete with all

necessary instructions and hardware. Oiled walnut finish on hardboard. Overall measurements 36"Wx16"Dx30"H. Inside measurements: Record storage section 15"Hx15"D; Component shelf section 16"Dx9"H.

20 E 23026WX Shpg. wt., 33 lbs. Net 27.95



59⁹⁵

(A) COMBINATION RECORD AND COMPONENT HUTCH

ALL PURPOSE RECORD CABINET



Only
11⁹⁵

- Stores Up To 200 Records

Roomy storage section with sliding doors allows for dust-free storage of up to 200 records. Sturdy construction. Mar-proof, walnut Stylite finish. Size: 29¹/₂ x 15¹/₂ x 25". Easily assembled. Wt., 24 lbs. 20 E 58063W Net 11.95

CONTEMPORARY ALL-PURPOSE RECORD CABINET



Only
18⁹⁵

- Stores Over 200 Records
- Modern Styling With Walnut Finish

Versatile all-purpose cabinet, full 40" long with ample storage for over 200 records. Also has numerous other uses—holds hi-fi components, serves as liquor cabinet, bookcase or room divider. Expertly crafted and finished in rich walnut with plastic mar-proof top. Shipped knocked down. 40"L x 18"O x 28"H. Shpg. wt., 27 lbs. 20 E 58014W Net 18.95

CONTEMPORARY DOUBLE HUTCH ROOM DIVIDER



34⁹⁵

No Money Down*

- Sliding Doors On Both Sides of Cabinet

CREATE YOUR OWN ROOM SETTING TO SOLVE YOUR DECORATING AND SPACE PROBLEMS

Flush to the floor styling—with 2 shelves and sliding doors on both sides for complete flexibility. Sturdy construction. Attractive mar-resistant, walnut finish. Can store books, records, or your hi-fi components.

13" space between shelves. Overall size: 35¹/₂" x 14" x 48"H. Shipped knocked down. Easy to assemble. Shpg. wt., 58 lbs.

20 E 58089WX Net 34.95



LAFAYETTE'S Best Selling Automatic Record Changers

NEW

LAFAYETTE MC22 4-SPEED AUTOMATIC STEREO "MINI" CHANGER ENSEMBLE

ONLY
34⁹⁵

No Money Down*



Pre-Mounted on a Simulated Black Leather Base with Walnut Vinyl Trim, Heavy Gauge Tinted Plastic Dust Cover, and Diamond Needle Cartridge.

- Perfect Companion For Shelf Component Systems
- Automatic or Manual Play at 16, 33 $\frac{1}{3}$, 45, 78 RPM
- Intermixes 10" and 12" Records Of The Same Speed
- Automatic Shut-off After Last Record

A versatile, dependable 4-speed automatic stereo record changer pre-mounted on a simulated Black Leather base with walnut vinyl trim—completely ready to plug into your audio equipment. Especially suited for bookshelf width component systems and compact equipment installations. Features low-mass tone arm, high quality ceramic turnover stereo cartridge with diamond LP needle, detachable spindle, vibration-free dynamically balanced 2-pole motor. Handles stack of 6-records automatically or can be operated as a manual player. Also includes tinted plastic dust cover, UL listed AC cord, and all audio cables. Size (Includes Base): 14 $\frac{3}{8}$ x5x10". Shpg. wt., 7 lbs. For 110-130 volts AC, 60 Hz. Made in England.

21 E 01632W No Money Down* Net 34.95
24 E 02386 Replacement Diamond LP Needle. Wt., 1 oz. Net 1.89
24 E 02568 45 RPM Spindle Wt., 2 oz. Net 1.49

LAFAYETTE MODEL 200 4-SPEED AUTOMATIC STEREO TURNTABLE

- Plays 16 $\frac{2}{3}$, 33 $\frac{1}{3}$, 45, 78 Records
- Heavy 10" Turntable Platter
- Dial Your Own Intermix
- Heavy Duty Constant Speed Motor
- Automatic Shut-Off



Model 200 is a quality 4-speed automatic changer providing outstanding performance at a low, low price. Heavy duty 10" turntable platter delivers no noticeable hum, rumble, or wow. Plays 16 $\frac{2}{3}$, 33 $\frac{1}{3}$, 45, 78 RPM records automatically or manually. An extra added feature is a 7", 10" or 12" record selector knob. Can dial your own intermix of up to seven 7", 10", or 12" records of the same speed by manually adjusting this knob. Automatic shut-off after last record has been played. Balanced featherweight tone arm is equipped with a turnover stereo cartridge with dual synthetic sapphire stylus. Dimensions: 13 $\frac{1}{2}$ x12", 4 $\frac{7}{8}$ " above, 2 $\frac{1}{2}$ " below mounting surface. For 117VAC 60 cps. Brown with gold trim. Shpg. wt., 10 lbs.

21 E 01541W Net 19.95

ACCESSORIES FOR MODEL 200

Oiled Walnut Recessed Base. Wt., 2 lbs.
21 E 02010W Net 4.95
Tinted Plastic Dust Cover
21 E 09043W Shpg. wt., 1 lb. Net 3.95
45 RPM Spindle. Shpg. wt., 6 oz.
21 E 02028 Net 1.19
Replacement Cartridge. Shpg. wt., 4 oz.
24 E 29017 Net 2.50

Made in U.S.A.

19⁹⁵
Less Base

NEW PROFESSIONAL AUTOMATIC STEREO TURNTABLES BY

united audio Dual

YOUR CHOICE OF 1 OF 6 FAMOUS MAKE ELLIPTICAL STEREO CARTRIDGES WITH THE PURCHASE OF A NEW DUAL 1212, 1209, OR 1219 AUTOMATIC TURNTABLE

For Only

1^c More
OR
5⁰⁰ More

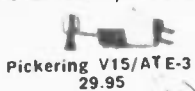

Pickering V15/ATE-3
29.95



Empire 888E
39.95

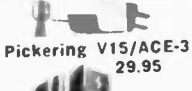

Pickering V15/ACE-3
29.95



Pickering XV15/400E
49.95



Empire 888TE
49.95



Shure M55E
29.95

SAVE UP TO 44⁹⁵
From Individual Catalog Prices

DUAL 1219 PROFESSIONAL AUTOMATIC TURNTABLE With Choice of Stereo Elliptical Cartridge

Dual's finest automatic stereo turntable combines unrestricted flexibility of operation with complete professional quality. Three speeds: 33½, 45, and 78 RPM. Fully automatic and manual operation. Two spindles: Multiple play—holds up to 6 records, and rotating single play. Mode selector lowers tone arm base to provide perfect 15° stylus tracking (zero degree vertical tracking error) when set for single play, and raises the tonearm base for multiple play. True four-point gyroscopic gimbal suspension for virtually friction-free tonearm movement. Separate antiskating for conical and elliptical styli. Adjustable stylus overhang. Full 12" diameter turntable with dynamically balanced 7 lb. platter. Synchronous/continuous pole motor combines high torque with absolute speed accuracy regardless of line voltage. Cue control system is damped to prevent bounce. Counter balance is elastically damped and has 0.01 gm. click stops for precision balancing. Pitch control for "tuning" records over a 6% range. 110/220 VAC 60 Hz. Size: 14½x12½x6", 6" above and 3" clearance below rotor board. Imported. Shpg. Wt., 24 lbs.

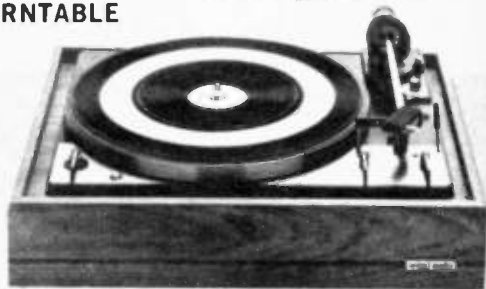

MODEL 1219
Less Cartridge

159⁵⁰
Less Base

MODEL 1219
With Choice Of
Deluxe Ellip. Cart.

159⁵¹
Less Base

MODEL 1219
With Choice Of
Super Ellip. Cart.

164⁵⁰
Less Base

- 21 E 65827WX 1219 Less Cartridge. Net 159.50
- 21 E 65959WXM 1219 Plus Pick. V15/ATE-3 Ellip. Cart. Net 159.51
- 21 E 65967WXM 1219 Plus Empire 888E Ellip. Cart. Net 159.51
- 21 E 65975WXM 1219 Plus Pick. XV15/400E Ellip. Cart. Net 164.50
- 21 E 65983WXM 1219 Plus Empire 888TE Ellip. Cart. Net 164.50

DUAL 1209 AUTO/PROFESSIONAL TURNTABLE With Choice of Elliptical Cartridge

Deluxe Auto/Professional Stereo turntable with a new synchronous Hi-Torque motor. Three speeds: 33½, 45, and 78 RPM. Automatic or manual operation. Multiple Play spindle holds up to 6 records. Dynamically balanced tonearm has damped counterbalance. Flawless ½ gram tracking. Tubular feather-touch cue control for auto and manual starts. Separately calibrated anti-skating scales for conical and elliptical styli. Rotating single-play spindle. Pitch control. Direct dial tracking force set around pivot. Size: 12¾x10½", 6" above and 3" clearance below mounting board. 110/220 VAC, 60 Hz. Imported. Shpg. wt., 21 lbs.



MODEL 1209
Less Cartridge

129⁵⁰
Less Base

MODEL 1209
With Choice Of
Deluxe Ellip. Cart.

129⁵¹
Less Base

MODEL 1209
With Choice Of
Super Ellip. Cart.

134⁵⁰
Less Base

- 21 E 65819WXM 1209 Less Cartridge. Net 129.50
- 21 E 65918WXM 1209 Plus Pick. V15/ATE-3 Ellip. Cart. Net 129.51
- 21 E 65926WXM 1209 Plus Empire 888E Ellip. Cart. Net 129.51
- 21 E 65934WXM 1209 Plus Pick. XV15/400E Ellip. Cart. Net 134.50
- 21 E 65942WXM 1209 Plus Empire 888TE Ellip. Cart. Net 134.50

DUAL 1212 AUTOMATIC TURNTABLE With Choice of Elliptical Cartridge

Quality 3-speed stereo turntable with low mass counterbalanced tonearm. Tracks flawlessly as low as 1 gm. Features direct dial tracking force, synchronized anti-skating, pitch control for all three speeds: 33½, 45, and 78 RPM, silicone damped cue control, and adjustable stylus overhang. Multiple play spindle holds up to 6 records. Size: 12¾x10½", 6" above and 3" clearance below mounting board. 110/220 VAC, 60 Hz. Shpg. wt., 21 lbs.



MODEL 1212
Less Cartridge

79⁵⁰
Less Base

MODEL 1212
With Choice Of
Ellip. Cart.

79⁵¹
Less Base

MODEL 1212
With Choice Of
Deluxe Ellip. Cart.

84⁵⁰
Less Base

- 21 E 65801WX 1212 Less Cartridge. Net 79.50
- 21 E 65876WXM 1212 Plus Pick. V15/ACE-3 Ellip. Cart. Net 79.51
- 21 E 65884WXM 1212 Plus Shure M55E Ellip. Cart. Net 79.51
- 21 E 65892WXM 1212 Plus Pick. V15/ATE-3 Ellip. Cart. Net 84.50
- 21 E 65900WXM 1212 Plus Empire 888E Ellip. Cart. Net 84.50

ACCESSORIES FOR DUAL TURNTABLES

Stock No.	MFG. No.	Description	For	Shpg. Wt.	Net
21 E 65835W	W12B	Walnut Base	1212, 1209	6 lbs.	10.95
21 E 66007W	W19B	Walnut Base	1219	7 lbs.	14.95
21 E 65843W	OC2	Dust Cover	WB12 Base	2 lbs.	10.95
21 E 66015W	DC9	Dust Cover	WB19 Base	2 lbs.	12.95
21 E 65868	CH12	Cart. Holder	1212, 1209, 1219	6 oz.	3.95
21 E 65850	AS12	45 Spindle	1212, 1209, 1219	6 oz.	5.95

NEW!

Garrard Synchro-Lab Automatic Turntables Featuring...



SL95B 3 SPEED ADVANCED AUTOMATIC TRANSCRIPTION TURNTABLE

with Choice of Elliptical Stereo Cartridge

Garrard's finest 3-speed Automatic Stereo Transcription turntable with synchronous motor for perfectly constant speed. Plays 33 1/2, 45, and 78 RPM Records. Advanced ultra-low mass tonearm of Afrosmosia wood set into aluminum, floats virtually friction free on jewel-like pivots in gyroscopically gimbaled mounting. Fully adjustable counterweight. Fully damped single-control cueing/pausing. Viscous damped slow descent of tonearm during manual and automatic play. Exclusive 2-point record support at center and edge during automatic play. Permanently accurate anti-skating control of patented sliding weight design. Calibrated stylus pressure gauge adjustable in 1/4 gram increments with window scale for easy reading. Slide-in cartridge clip. Full size, light-weight turntable. Two interchangeable spindles. All connecting cables. For 110-130V 60 Hz AC. Size: 15 3/4" W x 14 1/8" L, above motor board 4 3/8", below 2 1/8". Imported. Wt., 13 lbs. Less Base.

No Money Down*



Built-in calibrated stylus pressure gauge permits accurate audible/visible click settings in 1/4 gram increments. Viewing window in tonearm for easy reading.



Tonearm floats virtually friction-free within a gyroscopically gimbaled mounting on jewel-like needle pivots for lightest possible tracking.

129⁵⁰	129⁵¹	134⁵⁰
less cartridge, less base	choice of deluxe elliptical cartridge, less base	choice of super elliptical cartridge, less base

- | | |
|---|------------|
| 21 E 40440WX SL95B only. | Net 129.50 |
| 21 E 40762WXM SL95B plus Pick. V15ATE-3 Ellip. Cart. | Net 129.51 |
| 21 E 40770WXM SL95B plus Empire 888E Ellip. Cart. | Net 129.51 |
| 21 E 40788WXM SL95B plus Pick. XV15/400E Ellip. Cart. | Net 134.50 |
| 21 E 40796WXM SL95B plus Empire 888TE Ellip. Cart. | Net 134.50 |

SAVE UP TO 44⁹⁵

From Individual Catalog Prices

Your Choice of ELLIPTICAL STEREO CARTRIDGE

For Only **1^c** or **5⁰⁰** More

with Purchase of a Garrard Turntable listed on Page 70 or 71



Pickering XV15/400E
49.95



Pickering V15/ATE-3
39.95



Pickering V15/ACE-3
29.95



Empire 888TE
49.95



Empire 888E
39.95



Shure M55E
29.95

See Listing Under Each Turntable
See Page 126 For Cartridge Description



109⁵⁰
less cartridge and base

109⁵¹
choice of deluxe elliptical cartridge, less base

114⁵⁰
choice of super elliptical cartridge less base

No Money Down*

MODEL SL75B 3-SPEED AUTOMATIC TRANSCRIPTION TURNTABLE with Choice of Elliptical Stereo Cartridge

Plays 33 1/2, 45, and 78 RPM Records. Features Synchro-Lab Motor. Dynamically balanced, low mass aluminum tonearm; fully adjustable counterweight; patented, anti-skating control. Record safety platform. Viscous damped single control cueing/pausing. Automatic and rotating manual spindle. All connecting cables. For 110-130V 60 Hz AC. Size: 15 3/4" W x 14 1/8" L, above motor board 4 3/8", below 2 1/8". Imported. Wt., 13 lbs. less base.

- | | |
|---|------------|
| 21 E 40457WX SL75B only. | Net 109.50 |
| 21 E 40721WXM SL75B plus Pick. V15ATE-3 Ellip. Cart. | Net 109.51 |
| 21 E 40739WXM SL75B plus Empire 888E Ellip. Cart. | Net 109.51 |
| 21 E 40747WXM SL75B plus Pick. XV15/400E Ellip. Cart. | Net 114.50 |
| 21 E 40754WXM SL75B plus Empire 888TE Ellip. Cart. | Net 114.50 |

* See Page 11 for Full Credit Details on Easy Pay Plan



SYNCHRO-LAB MOTOR For flawless, silent synchronous speed.



VISCIOUS DAMPED setdown of tonearm in automatic play... an exclusive SL95B, SL75B, SL72B feature.

ADJUSTABLE ANTI-SKATING CONTROLS prevent record and stylus wear.



TWO-POINT RECORD SUPPORT on SL95B, SL75B, SL72B at both center and edge.



SLIDE-IN CARTRIDGE CLIP assures positive alignment.

SL72B 3-SPEED SYNCHRO-LAB AUTOMATIC TRANSCRIPTION TURNTABLE

with Choice of Elliptical Stereo Cartridge

Plays 33 $\frac{1}{3}$, 45, and 78 RPM Records. Synchro-Lab Motor for perfectly constant speed, unwavering musical pitch. Record platform for safe, two-point support during automatic play. Low-mass tubular aluminum tonearm of advanced design floats on needle pivots within a gyroscopically gimbaled mounting for flawless tracking. Fully adjustable counterweight. Slide-in cartridge clip. Patented, permanently accurate sliding weight anti-skating control. Calibrated stylus pressure gauge with visible scale. Damped set-down of tonearm in manual and automatic play. Single control viscous damped cueing. Simplified finger-tip tab operating controls. Full size turntable. Two interchangeable spindles. All connecting cables. For 110-130V 60 Hz. AC. Dimensions: 15 $\frac{1}{2}$ "x14 $\frac{1}{2}$ "L; above motorboard 4 $\frac{3}{4}$ ", below 2 $\frac{3}{4}$ ". Imported. Shpg. wt., 13 lbs. Less base.



No Money Down*

89⁵⁰ Less cartridge, and base	89⁵¹ choice of deluxe elliptical cartridge, less base	94⁵⁰ choice of super elliptical cartridge, less base
--	--	---

- 21 E 40465WX SL72B only. No Money Down* Net 89.50
- 21 E 40689WXM SL72B plus Pick. V15/ATE-3 Ellip. Cart. Net 89.51
- 21 E 40697WXM SL72B plus Empire 888E Ellip. Cart. Net 89.51
- 21 E 40705WXM SL72B plus Pick. XV15/400E Ellip. Cart. Net 94.50
- 21 E 40713WXM SL72B plus Empire 888TE Ellip. Cart. Net 94.50



Gyroscopically gimbaled tonearm mounting, plus needle-pivots assure friction-free tonearm movement... vertically and horizontally... and light tracking.



Ultra-low-mass, lightweight tonearm of advanced hexagon shaped design and adjustable counterweight provides perfect balance and flawless tracking.

79⁵⁰
less cartridge and base.

79⁵¹
choice of quality elliptical cartridge, less base

84⁵⁰
choice of deluxe elliptical cartridge, less base



No Money Down*

MODEL SL65B 4-SPEED SYNCHRO-LAB AUTOMATIC TURNTABLE

with Choice of Elliptical Stereo Cartridge

Plays 4 Speeds: 16 $\frac{2}{3}$, 33 $\frac{1}{3}$, 45, and 78 RPM. Features: Synchro-Lab Motor, and low-mass tubular aluminum tonearm dynamically balanced with adjustable counterweight, adjustable anti-skating control, viscous damped, single lever cueing. Precision stylus pressure gauge with optical scale. Automatic and manual spindles. Connecting cables. For 110-13V, 60 Hz. AC. Size: 15"x13 $\frac{1}{4}$ "L; above motorboard 4 $\frac{3}{4}$ ", below 3". Imported. Wt., 13 lbs. less base.

- 21 E 40473WX SL65B only. No Money Down* Net 79.50
- 21 E 40648WXM SL65B plus Pick. V15/ACE-3 Ellip. Cart. Net 79.51
- 21 E 40655WXM SL65B plus Shure M55E Ellip. Cart. Net 79.51
- 21 E 40663WXM SL65B plus Pick. V15/ATE-3 Ellip. Cart. Net 84.50
- 21 E 40671WXM SL65B plus Empire 888E Ellip. Cart. Net 84.50

59⁵⁰
less cartridge and base

59⁵¹
choice of quality elliptical cartridge, less base

64⁵⁰
choice of deluxe elliptical cartridge, less base



No Money Down*

MODEL SL55B 4-SPEED SYNCHRO-LAB AUTOMATIC TURNTABLE

with Choice of Elliptical Stereo Cartridge

Plays 16 $\frac{2}{3}$, 33 $\frac{1}{3}$, 45, and 78 RPM Records. Light weight, tubular aluminum tonearm with fixed-position damped counterweight and slide-in cartridge clip. Built in stylus force adjustment and optical scale. Viscous damped, single-lever cueing. Fully adjustable anti-skating. Oversized turntable with all connecting cables. For 110-130V 60 Hz. AC. Size: 14 $\frac{3}{8}$ "x12 $\frac{1}{2}$ "L; above motorboard 4 $\frac{3}{4}$ ", below 2 $\frac{7}{8}$ ". Imported. Wt., 10 lbs. less base.

- 21 E 40481WX SL55B only. No Money Down* Net 59.50
- 21 E 40606WXM SL55B and Pick. V15/ACE-3 Ellip. Cart. Net 59.51
- 21 E 40614WXM SL55B and Shure M55E Ellip. Cart. Net 59.51
- 21 E 40622WXM SL55B and Pick. V15/ATE-3 Ellip. Cart. Net 64.50
- 21 E 40630WXM SL55B and Empire 888E Ellip. Cart. Net 64.50

Garrard TURNTABLES, MODULE SERIES, AND ACCESSORIES

Model 40B 4-Speed Automatic Turntable

With Choice of Stereo Elliptical Cartridge

Plays 16 $\frac{2}{3}$, 33 $\frac{1}{3}$, 45, and 78 rpm records. Full viscous damped, single lever cueing. Low-mass, tubular aluminum tonearm with fixed isolated counterweight. Slide-in cartridge clip assures positive cartridge alignment. Easy to adjust stylus pressure control and visible scale. Swingaway overarm moves to the rear, out of the way for manual play. Two interchangeable spindles. Oversize turntable with handsome safety mat. Size: 14 $\frac{3}{8}$ "x12 $\frac{1}{2}$ "L. Requires 4 $\frac{5}{8}$ " above and 3" below motor board. With all connecting cables. Less base. For 110-130-VAC, 60 Hz. Imported. Shpg. Wt., 11 lbs. 21 E 40499W Model 40B only. Net 44.50

Model 40B and Pickering PAT/E-1 Elliptical Cartridge. No Money Down*
21 E 40556WM Net 44.51

Model 40B and Shure M44E Elliptical Cartridge. No Money Down*
21 E 40564WM Net 44.51

Model 40B and ADC 220E Elliptical Cartridge. No Money Down*
21 E 40572WM Net 44.51

Model 40B and Pickering V15/ACE-3 Elliptical Cartridge. No Money Down*
21 E 40580WM Net 49.50

Model 40B and Shure M55E Elliptical Cartridge. No Money Down*
21 E 40598WM Net 49.50



See Page 126 & 127 for Cartridge Description

SAVE UP TO **24⁹⁵**

From Individual Catalog Prices



Choice of Pickering, ADC or Shure Elliptical Stereo Cartridge

For Only **1[¢]** or **5⁰⁰** more

With Purchase of Garrard 40B

44⁵⁰
Less Cartridge and Base

44⁵¹
With Choice of Elliptical Stereo Cartridge, Less Base

49⁵⁰
With Choice of Quality Elliptical Stereo Cartridge, Less Base



Model 30 4-SPEED AUTOMATIC TURNTABLE

With Diamond Needle Ceramic Cartridge, Less Base

39⁵⁰

Garrard 4-speed automatic stereo turntable designed especially for use in low priced hi-fi systems, and perfect for replacement in consoles and phonographs. Features oversized, weighted turntable, one piece cast aluminum tone arm, ultra compact size. Plays 16 $\frac{2}{3}$, 33 $\frac{1}{3}$, 45 and 78 RPM records. Intermix automatic operation when desired. Two spindles-short for manual, center drop for automatic play. With ceramic cartridge, diamond stylus. All connecting cables. Dim: 14 $\frac{1}{4}$ "x12 $\frac{3}{4}$ " above motor board 4 $\frac{3}{4}$ " below 2 $\frac{1}{4}$ ". For 110-130 VAC, 60 Hz. Less base. Imported. Shpg. wt., 10 lbs. 21 E 37925W No Money Down* Net 39.50



Model SP20B 4-SPEED MANUAL RECORD PLAYER With Choice of Stereo Cartridge

37⁵⁰
Less Cartridge and Base

37⁵¹
With Pickering P/AC-1 Conical Stereo Cartridge, Less Base

42⁵⁰
With ADC 220E Elliptical Stereo Cartridge, Less Base

A compact, efficient manual player with high fidelity features. Low-mass tubular aluminum arm with fixed counterweight, isolated in a resilient housing to effectively damp out tonearm resonances. Fully adjustable stylus pressure control with optical scale. Slide-in cartridge clip accommodates all the latest cartridges and assures positive alignment. Automatic return of tonearm after record has played. Full-size turntable. Supersensitive trip. Size: 14 $\frac{3}{8}$ "x12 $\frac{1}{2}$ "x3 $\frac{1}{2}$ "H above and 2 $\frac{1}{8}$ " below motor board. Imported. Less base. For 110-130V 60 Hz AC. Shpg. wt., 10 lbs. 21 E 40507W SP20B only Net 37.50

SP20B plus Pickering PAC-1 Conical Cartridge
21 E 40812WM No Money Down* Net 37.51

SP20B plus ADC 220E Elliptical Cartridge
21 E 40804WM No Money Down* Net 42.50

Module XII Garrard 4-Speed Automatic "Demi" Changer with Pre-Installed Stereo Ceramic Diamond Needle Cartridge, Base & Dust Cover

39⁹⁵

Complete
No Money
Down*

Miniature automatic record changer. Small enough to fit on a bedside table or a small shelf. Can play up to 8 records in automatic play . . . 4 Speeds: 16 $\frac{2}{3}$, 33 $\frac{1}{3}$, 45, 78 rpm. Tubular aluminum tonearm precisely balanced for correct tracking. Automatic shut-off after last record has played. With all hook-up leads. Size: 13 $\frac{1}{4}$ "Lx10"Wx6 $\frac{3}{4}$ "H. Imported. For 110-130 VAC 60 Hz.

21 E 40523W Shpg. wt., 10 lbs. Net 39.95

Module X10 Precision Automatic Turntable with Pre-Installed Stereo Ceramic Diamond Needle Cartridge, Base & Dust Cover.

52⁵⁰

Complete
No Money
Down*

Features ultra-low-mass tubular aluminum tonearm. Large oversize turntable. Single lever control for convenient cueing and pausing. Simplified speed/size controls. Plays 7", 10", 12" records at 33 $\frac{1}{3}$, 45 or 78 rpm. For 110-130 VAC, 60 Hz. Size (on base): 15"Wx13 $\frac{1}{4}$ "Dx7 $\frac{3}{4}$ "H. Imported. With all connecting cables. Shpg. wt., 17 lbs.

21 E 40846WX Net 52.50

Module SLX-2 Synchronous 3-Speed Automatic Turntable with Pre-Installed Stereo Magnetic Diamond Needle Cartridge, Base & Dust Cover

69⁵⁰

Complete
No Money
Down*

Synchro-lab® motor for constant synchronous speed, dynamically balanced tone arm with ball bearing pivots, cueing and pause control, adjustable stylus pressure gauge built into tone arm—adjustable from 0 to 5 grams. Plays 33 $\frac{1}{3}$, 45, or 78 rpm records (12", 10", or 7"). For 110-130 VAC 60 Hz. Dim. (on base): 15"Wx13 $\frac{1}{4}$ "Dx7 $\frac{3}{4}$ "H. With all connecting cables. Imported. Shpg. wt., 14 lbs.

21 E 40432WX Net 69.50

Module SLX-3 Synchronously Powered 3-Speed Automatic Turntable with Pre-Installed Magnetic Elliptical Cartridge, Base & Dust Cover

99⁵⁰

Complete
No Money
Down*

Synchro-Lab® motor guarantees perfectly constant record speed . . . unwavering musical pitch. Exclusive two-point record support at center and edge during automatic play. Stylus force adjustment with window scale. Ultra-low-mass tubular aluminum tonearm. Permanently accurate sliding weight anti-skating control. Fully damped, single control cueing. Viscous damped tonearm. Finger-tip controls. Oversize turntable. With all audio cables. Size (includes base and cover): 15 $\frac{1}{2}$ "Wx14 $\frac{1}{2}$ "Dx8"H. For 110-130 V AC, 60 Hz. Imported.

21 E 40515WX Shpg. wt., 22 lbs. Net 99.50

ACCESSORIES FOR GARRARD AUTOMATIC TURNTABLES



STOCK NO.	FIG	MODEL NO.	DESCRIPTION	FOR	SHPG. WT.	NET EA.
21 E 40226W	A	B1	Ebony Pin-Seal Plastic Base	SL65B, SL55B, 40B, 30, SP20B	2 lbs.	5.50
21 E 40234W	A	B2	Ebony Pin-Seal Plastic Base	SL95B, SL75B, SL72B	2 lbs.	6.50
21 E 40242W	B	B1P	Power-Matic Base w/Auto Shut-off	SL65B, SL55B, 40B, 30, SP20B	3 lbs.	14.05
21 E 40259W	B	B2P	Power-Matic Base w/Auto Shut-off	SL95B, SL75B, SL72B	3 lbs.	15.95
21 E 40820W	C	WB1	Deluxe Walnut Wood Base	SL65B, SL55B, 40B, 30, SP20B	7 lbs.	19.95
21 E 40838W	C	WB2	Deluxe Walnut Wood Base	SL95B, SL75B, SL72B	7 lbs.	19.95
21 E 40267W	D	D1	Plastic Dust Cover†	SL65B, SL55B, 40B, 30, SP20B	3 lbs.	5.50
21 E 40275W	D	D2	Plastic Dust Cover†	SL95B, SL75B, SL72B	3 lbs.	6.50
24 E 12096W	E		Wood Mounting Board—Unfinished	SL65B, SL55B, 40B, 30, SP20B	1 $\frac{1}{2}$ lbs.	1.75
24 E 12161W	E		Wood Mounting Board—Unfinished	SL95B, SL75B, SL72B	1 $\frac{1}{2}$ lbs.	1.75
21 E 40531	F	FLRS35	45 rpm Spindle	65B, 55B, 40B, 30, SLX-2, X10	6 oz.	1.95
21 E 37974	F	LRS25	45 rpm Spindle	SL95B, SL75B, SL72B, SLX-3	6 oz.	3.80
21 E 40549	F	F40	45 rpm Spindle	X11	6 oz.	1.95
21 E 37982	G	C1	Cartridge Clip Holder	SL75B	2 oz.	1.05
21 E 37966	G	C2	Cartridge Clip Holder	SL95B, SL72B, SL65B, SL55B, 40B, 30, SP20B	2 oz.	1.05

†Can be used with only B1 or B1P Bases

‡Can be used with only B2 or B2P Bases

* See Page 11 for Full Credit Details on Easy Pay Plan

Famous Precision Made Stereo Turntables

MODEL XA 2-SPEED MANUAL STEREO TURNTABLE

With Choice of Elliptical Stereo Cartridge



Turntable Comes Complete With Tone Arm, Walnut Wood Base And Plastic Dust Cover

78⁰⁰

Less Cartridge
No Money Down*

78⁰¹

With Elliptical Cartridge
No Money Down*

Choice of Elliptical Stereo Cartridge For Only **1^c**
More With Purchase of XA Turntables



**PICKERING
PAT/E-1
24.95**



**ADC
220E
24.95**



**SHURE
M44E
24.95**

SAVE UP TO 24.94

From Individual Catalog Prices

Outstanding turntable featuring a rugged 3.3 lb. balanced aluminum platter belt driven from synchronous motors operating at 33 1/3 and 45 RPM. Turntable and arm are shock-mounted from the top plate eliminating vibration. Meets NAB specifications for broadcast equipment on wow, flutter and speed accuracy. Includes cables, overhang adjustment device and needle force gauge. Size with cover—12 3/4 x 16 3/4 x 5 1/4". Shpg. wt., 18 lbs.

- 21 E 72013WX XA less cartridge Net 78.00
- 21 E 72732WXM XA and Pickering PAT/E-1 Net 78.01
- 21 E 72740WXM XA and ADC 220E Net 78.01
- 21 E 72757WXM XA and M44E Net 78.01

Model XA/UNIVERSAL TURNTABLE—Same deluxe features as above but can be used anywhere in the world. For 110 or 220 volts, 50 or 60 Hz operation. Shpg. wt., 19 lbs.

- 21 E 7267WX XA/U less cartridge Net 87.00
- 21 E 72765WXM XA/U and Pickering PAT/E-1 Net 87.01
- 21 E 72713WXM XA/U and ADC 220E Net 87.01
- 21 E 72741WXM XA/U and Shure M44E Net 87.01

Extra cartridge shell for AR turntables. Wt., 1 oz.
21 E 72555 Net 1.99

NEW Benjamin/Miracord 750 4-Speed Automatic Stereo Turntable



139⁵⁰

Less Cartridge
And Base

139⁵¹

With Pickering
V15/ATE-3 Elliptical
Cartridge (Less Base)



**Pickering V15/ATE-3
39.95**

Pickering V15/ATE-3 Elliptical Cartridge Only **1^c**
With Purchase of Model 750

SAVE 39.94 From Individual Catalog Prices

Precision-machined and balanced 12" heavy die-cast, non-magnetic turntable. Features silicone-damped cueing mechanism; anti-skate and stylus force adjustments; 4-pole heavy-duty induction motor; automatic shut-off or continuous play; 78, 45, 33 1/3 and 16 2/3 rpm. Plays 7, 10 or 12" records. Minimum mounting clearance: 7 1/2" above, 3 3/4" below mounting board. Size: 14 1/2" W x 12 1/2" D. For 117VAC, 60 Hz. Shpg. wt., 18 lbs. Imported.

- 21 E 16499WX Model 750 less cartridge Net 139.50
- 21 E 16523WXM Model 750 plus Pick., V15/ATE-3 Net 139.51
- 21 E 16507W RB-2A Walnut Base for 750, Wt., 6 lbs Net 7.95
- 21 E 16515W DC-1 Dust Cover for 750, Wt., 2 lbs. Net 4.95

NEW Empire Troubador 990 Professional Stereo Turntable



199⁹⁵

Less Cartridge
And Base

199⁹⁶

With 888TE
Elliptical Stereo
Cartridge (Less Base)



**888TE Ellip. Cart.
49.95**

Empire 888TE Elliptical Cartridge Only **1^c**
With Purchase of Model 990

SAVE 49.94 From Individual Catalog Prices

Professional 3-speed (33 1/3, 45 and 78 rpm) turntable, designed exclusively for low-tracking force cartridges. Features Empire's new 990 tone arm. Tracks as low as 1/4 gram. Tone arm automatically lifts off record at end of music. Has professional-type hysteresis synchronous motor, flexible belt drive and massive drive wheel. Includes adjustable stylus force and anti-skating. Size: 17 W x 15 D x 1 1/4" H. Shpg. wt., 25 lbs.

- 21 E 34872WX Model 990 less cartridge Net 199.95
- 21 E 34891WXM Model 990 plus 888TE Ellip. Cart. Net 199.96
- Combination Satin Walnut Base plus Plexiglass Dust Cover.
- 21 E 34886W Shpg. wt., 9 lbs. Net 34.95

* See Page 11 for Full Credit Details on Easy Pay Plan

NEW Harmon-Kardon Solid-State Stereo Modular Music Systems

New!! Harmon-Kardon SC2350 80 Watt AM/FM Stereo Hi-Fi Music System

399⁵⁰

No Money Down*



- Two 360° Omni-directional Speaker Systems
- 4-Speed Garrard Automatic Record Changer

Deluxe AM/FM stereo music center engineered to complement the spacious and engulfing sound of the two HK50 omnidirectional speakers. Incorporates Integrated Micro-Circuits. Boasts automatic FM stereo switching, stereo indicator light, center-of-channel tuning meter, two-room stereo speaker switching, separate full-range Bass and Treble controls, inputs and outputs for tape recorder, plus front panel stereo headphone jack. Low-noise AM tuner delivers true high fidelity performance.

Garrard 4-speed record changer equipped with stereo magnetic cartridge provides automatic shut-off. Power: 80 watts ± 1 db. Usable FM Sensitivity: 2.9 μ v. FM Stereo Separation: 30 db. HK50 omnidirectional speakers each contain: 8" woofer, 2 1/4" tweeter, crossover network and tweeter control. Size: Speakers—18H x 10 3/4W x 10 3/4"D. Control Center—8 1/2H x 18 1/2W x 17 3/4"D. Shpg., 65 lbs. 24 E 69013WX Net 399.50

24 E 69005W Model DC44A Dust Cover. Wt., 2 lbs. Net 19.95

NEW Model SC1512 40-Watt Stereo Phono System

NEW Model SC1825 40-Watt FM Stereo Music Center



219⁵⁰

- Garrard 4/Speed Automatic Record Changer
- Two 360° Omni-directional Speaker Systems

Graceful, compact solid state stereo phono system with two separate full range 360° omni-directional speaker systems. Four speed Garrard record changer is equipped with a diamond stylus and features automatic shut off after last record has been played. Front panel stereo headphone jack for private listening. Separate full range bass and treble controls. Stereo/Mono speaker switch. Provisions for Aux. Tape and Tuner inputs. Power Output 40 watt ± 1 db. Frequency Response 18-30,000 Hz. Each speaker system has a 6" twin-cone long-throw extended range speaker, and a 360° reflector. Size: Control Unit, 15 1/4"W x 8"H x 17 3/4"D; Each Speaker System 13 3/4"H x 9 1/2"D. Handsome walnut cabinetry. Shpg. wt., 16 lbs. 24 E 69039WX No Money Down* Net 219.50

Model DC22 Plastic Dust Cover for SC 1512 Net 19.95
24 E 69054W Shpg. wt., 2 lbs.

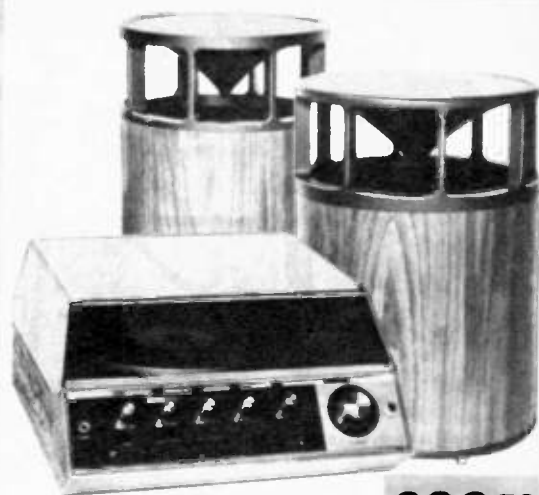

299⁵⁰

- Two 360° Omni-directional Speaker Systems
- 4-Speed Garrard Automatic Record Changer

Handsome, compact 3-piece modular FM stereo music system featuring two Model MK25 two-way omni-directional speaker systems. Each speaker system contains a 6" woofer and 2 1/4" tweeter and provides exciting wide range 360° sound dispersion. Control Center of the SC 1825 includes a powerful 40 watt FM stereo receiver and a Garrard 4 speed automatic stereo record changer with magnetic diamond needle stereo cartridge. Also features automatic mono/stereo FM switching. FM stereo indicator light, front panel headphone jack, and provision for tape input and tape output. Power output: 40 watts ± 1 db. FM sensitivity 2.9 μ v. Handsome walnut cabinet. Size: Control Unit 15 1/4"W x 8"H x 17 3/4"D. Each Speaker System 13 3/4"H x 9 1/2"D. Shpg. wt., 18 lbs. 24 E 69047WX No Money Down* Net 299.50

Model DC 22 Plastic Dust Cover for SC1825 Net 19.95
24 E 69054W

* See Page 11 for Full Credit Details on Easy Pay Plan

Famous KLH Compact Stereo Hi-Fi Music Systems



249⁹⁵
No Money Down*

NEW Model 26 Solid State Hi-Fi Phono System

Handsome 3-piece high performance stereo-phonographic system in attractive walnut cabinetry. Each separate speaker system incorporates an 8 inch acoustic suspension bass driver and a 2-inch direct radiator for mid and high frequencies. Control center includes a powerful solid state amplifier with Baxendall-type tone controls and a Garrard 4-speed automatic record changer with Pickering V15/AT-3 dustomatic stereo diamond needle cartridge. Inputs are provided for an auxiliary source as tuner or tape deck as well as tape outputs and a top panel headphone jack. Dim: Cont. Unit, 18x14½x8¾"; Each Speaker System, 10¼x18x7¾". For 110-120V, 60 Hz AC. Shpg. wt., 52 lbs.
24 E 44206WX Net 249.95



299⁹⁵
No Money Down*

Model 24 Solid State FM Stereo Music System

35 watt (IHF) system provides superb FM stereo listening plus quality phono sound reproduction. Control center has a sensitive FM stereo tuner with vernier tuning, zero tuning meter and stereo indicator. Garrard 4-speed automatic turntable uses a Pickering V15 cartridge with diamond stylus. Speakers have 8" acoustic suspension woofers and 2" wide dispersion tweeters. Other features include tape and headphone outputs, auxiliary inputs, and deluxe oiled walnut cabinetry. Dim: Control Center, 18Wx4Hx14"D.; Speakers, 18Wx10¼Hx7½"D.

24 E 44099WX Shpg. wt., 72 lbs. Net 299.95
Model 24 with AM: Same components as above but with high performance AM circuitry. For 110-120V, 60 Hz AC. Shpg. wt., 74 lbs.
24 E 41178WX Net 329.95



399⁹⁵
No Money Down*

Model 20 Solid State FM Stereo Music Center

Stylish 50 watt (IHF) music system integrates a FM stereo tuner, preamp., and power amplifier into one convenient control center. Includes Garrard 4-speed automatic turntable and two walnut finished speaker systems with 10" acoustic suspension woofers and 1¾" tweeters. Incorporates tape and headphone outputs, auxiliary inputs, zero tuning meter, and FM stereo indicator. Dim: Control Center, 18¼Wx8¾Hx14"D.; Speakers, 11¾Wx23¼Hx9"D. For 110-120V, 60 Hz AC. 24 E 44032WX Shpg. wt., 84 lbs. Net 399.95
KLH Model 20 With AM: Same components as above but with high performance AM circuitry. Shpg. wt., 86 lbs.
24 E 44172WX Net 429.95

Model 21 Professional FM Radio



89⁹⁵
Beautiful Walnut Cabinet

Other KLH Music Systems

Model 11 Portable Stereo Phonograph—with Garrard automatic 4-speed changer, and luggage type case. Dim: 24x14x7"H. Wt., 28 lbs.
24 E 44014WX No Money Down* Net 199.95
Model 11-W—Same as Model 11 but components are mounted in oiled walnut furniture styled cabinetry. Dim: 18x14½x4"H. Wt., 40 lbs.
24 E 44107WX No Money Down* Net 199.95
Model 20 PLUS—Deluxe FM stereo 3 piece music system. Components are mounted in oiled walnut wood cabinets on curved pedestals of white cast aluminum. Same specs. and features as Model 20. Dim: Control center 20½Wx23¾Hx15¼"D; Speaker, 19Wx23¾Hx15¼"D. Shpg. wt., 25 lbs.
24 E 44057WX No Money Down* Net 525.00

A complete high performance monaural FM receiving system. Sealed oiled walnut cabinet combines with an outstanding built-in acoustic suspension speaker to provide truly full range sound. Stable solid state circuitry utilizes vernier tuning, built-in antenna, bass, and treble controls. Powers external accessory speaker and supplies signals directly to tape recorder for quality reproduction of FM broadcasts. Dim: 12Wx6¼Hx6¾"D. For 110-120V, 60 Hz AC. Shpg. wt., 10 lbs.
24 E 44073WX No Money Down* Net 89.95

ACCESSORIES FOR KLH MUSIC SYSTEM AND RADIO

Stock No.	KLH No.	Type	For	Wt. Lbs.	Net Ea.
24 E 44112W	700	Dust Cover (Lift Type)	20, 24, 26, 20AM, 24AM, 11W	9	29.95
24 E 44123W	701	Dust Cover (with Hinges)	20, 24, 26, 20AM, 24AM, 11W	5	9.95
24 E 44131W	702	Dust Cover (Lift Type)	11, 11FM	1	5.95
24 E 44164W	703	External Speaker	11, 11W, 11FM, 15, 19, 21	8	24.95
24 E 44198	706	Speaker Selector Box	All Models Except 21	½	9.00

Memorable Stereophonic Long Play Record Albums

7 STEREO LP
RECORD ALBUM

Only
9⁹⁵

Including 24
page Illustrated
Booklet

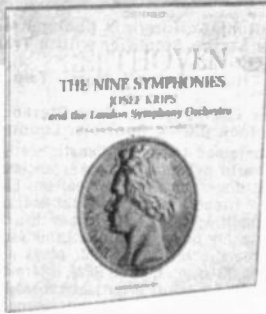

Beethoven — The Nine Symphonies
Josef Krips, Conductor
and the London Symphony Orchestra

A true collectors item. The complete set of nine Beethoven Symphonies in a handsome gift packaged box including a 24 page illustrated booklet — a pictorial History of Beethoven's Life and Times. Josef Krips conducts the London Symphony Orchestra in this memorable 7 stereo record album set. Shpg. wt., 4 lbs.
28 E 28515 Net **9.95**

7 STEREO LP
RECORD ALBUM

Only
9⁹⁵

Dean Martin
Jack Jones
Nat "King" Cole
Judy Garland,
Jackie Gleason,
Harry James, Nelson Riddle



Collectors Treasure of
Great Stars and Great Hits

Seven stereo LP records and seven of our greatest musical artists: Dean Martin, Harry James, Nat "King" Cole, Jack Jones, Jackie Gleason, Judy Garland and Nelson Riddle. Each artist performs on a separate LP record. Some of the great songs: Dean Martin—I Can't Give You Anything But Love; Harry James—You Made Me Love You; Nat "King" Cole—Love Is A Many Splendored Thing; Jackie Gleason—Stella By Starlight; Judy Garland—Over The Rainbow; Nelson Riddle—Witchcraft; Jack Jones—Suddenly. Shpg. wt., 5 lbs.
28 E 28523 Net **9.95**

Introduction to the World's Great Composers and Their Music...

10 STEREO LP RECORD ALBUM SET

from the Works of:

Brahms • Tchaikovsky • Chopin • Bach • Mendelssohn
Beethoven • Schubert • Haydn • Schumann • Mozart

Only
9⁹⁵

With 275 Selections and
an Informative Illustrated
Booklet

A superb 10 record stereo album relates to the lives and music of 10 of the world's major composers interspersed with 275 selections from their works performed by leading soloists and orchestras. Each of the 10 composers gets a full disc devoted to his works. You will get an insight into the greatness of these 10 famous men. The album serves as a valuable learning tool for both youngster and adult alike. Beautifully gift boxed. Shpg. wt., 7 lbs.
28 E 28531 Net **9.95**



2-SPEED SOLID-STATE BATTERY/ELECTRIC
AM/FM PORTABLE RADIO PHONO

Only
32⁹⁵

with batteries,
45 rpm adapter

No Money Down*

- Self-Storing AC Line Cord
- Plays 33 1/3 and 45 RPM Records



A look looking, good listening all transistor AC/Battery powered 2-speed AM/FM portable radio/phonograph. Play it at home, or take it with you to a picnic, on a boat, or wherever you go. Features advanced solid state circuitry. 4 stage of IF on FM, plus 3 stages of IF on AM. Pulls in AM and FM stations near and far. Built-in ferrite antenna for AM, telescoping antenna for FM. Operates on self-contained batteries or plugs into 117V-60 Hz AC with self storing AC line cord. Large 3 1/2" speaker for rich, resonant sound. Color: Brown & White. Imported. Size 9"x10 1/2"x3". Shpg. wt., 7 lbs.
24 E 57042W Net **32.95**

Extra "D" Batteries (4 required)
99 E 62564

Net ea. .15

PANASONIC SG-773 BATTERY/ELECTRIC
2-SPEED AM/FM PORTABLE PHONOGRAPH

49⁹⁵

with
batteries
and 45
RPM
adapter

- AFC for Drift-Free FM Reception
- 2-Speeds: 33 1/3 and 45 RPM



Truly portable 2-speed AC/battery phono with unique clock-style AM/AF tuning dial. Continuous tone control and built-in AM and FM antennas for superb reception. Large 6x3" wide range speaker provides fine tone. Phono plays 33 1/3 and 45 RPM records. Has ceramic cartridge. Operates on 6 "D" batteries (included) or on 117 VAC 60 Hz. Attractive dark gray and white color. With batteries. Size: 13 1/2"Wx4Hx13"D. Imported. Shpg. wt., 8 lbs.
24 E 41103W No Money Down* Net **49.95**

Model SG-553 AM Phonograph: Same as above but with AM radio only.
24 E 41095W Shpg. wt., 8 lbs. Net **29.95**

99 E 62564 Extra "D" batteries—(6 required) Net ea. .15

* See Page 11 for Full Credit Details on Easy Pay Plan

LAFAYETTE'S FINEST PORTABLE PHONOGRAPHS

A DELUXE MODEL T33C SOLID STATE 4-SPEED AUTOMATIC STEREO PHONOGRAPH



Made in U.S.A. Only **99⁹⁵**



Diamond Needle

No Money Down*

- Garrard 4-Speed Automatic Intermix Changer with Diamond LP Needle
- 10 Watt Solid State Stereo Amplifier with 8 Transistors, 2 Diodes, and 2 Silicon Rectifiers
- 4 Speakers: Two 8" Heavy Duty Woofers - Two 3½" Tweeters Provide Dazzling Tone
- Detachable Speaker Enclosure for True Stereo Separation
- Stereo Headphone Jack plus 4 Controls: Loudness, Balance, Bass, Treble

Deluxe, solid state self-contained 4-speed automatic stereo phonograph in stylish "Swing-Down" design. Equipped with detachable speaker enclosures with built-in, 6' extension cords for wall-to-wall full dimensional sound realism. Each enclosure contains a heavy-duty 8" woofer and a 3½" tweeter for magnificent hi-fi sound reproduction. Powerful 10 watt solid state stereo amplifier has 12 semiconductor devices; features a stereo headphone jack for private listening plus 4 controls: Loudness, Balance, Bass, Treble. Quality Garrard 1000 4-speed automatic record changer plays all record sizes and speeds—7", 10" and 12" records at 16⅓, 33⅓, 45 and 78 RPM. Intermixes all size records of the same speed. Changer automatically shuts off after last record has been played and is equipped with a stereo turnover cartridge with diamond LP needle. Decorator designed wood cabinet is covered with simulated walnut and black washable vinyl material. Size: 21¼x12½x14¾". For 110-120 VAC 60 Hz. Shpg. wt., 32 lbs.

24 E 02741WX

24 E 02543 Replacement Needle for T33C

24 E 02170 45 RPM Spindle for T33C

Net 99.95

Net 1.99

Net 3.80

B NEW DECORATOR STYLED MODEL T60 SOLID STATE 4-SPEED AUTOMATIC STEREO PHONOGRAPH

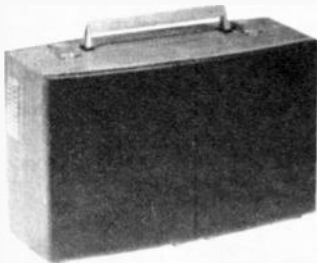

Made in U.S.A. Only **64⁹⁵**



Diamond Needle

No Money Down*

- BSR 4-Speed Automatic "Mini" Stereo Record Changer
- Each Detachable Enclosure Contains a Wide Range High Compliance 4" Air Suspension Speaker
- Built-in Stereo Headphone Jack with Private Listening Switch on Front Panel
- Solid State Stereo Amplifier with 6 Silicon Transistors and 3 Diodes
- Ultra Modern Cabinet Designed with Curved Top and Bottom

Take this handsome stereo phonograph with you as often as you like, anywhere you like. Superbly engineered, it will give you years of dependable stereo listening. Two detachable lid-type speaker enclosures each contain a 4" high-compliance, acoustically matched, wide-range hi-fidelity speaker, and a 6 ft. extension cord enabling you to separate the speakers up to 12 ft. for magnificent full dimensional sound. Quality BSR record changer plays all size records at 16⅓, 33⅓, 45, and 78 RPM. Intermixes 12" and 10" records of the same speed. Instant-on solid state stereo amplifier employs 6 silicon transistors plus 3 silicon diodes. 3 Controls: separate volume for each channel plus tone. Built-in stereo headphone jack with private listening switch on front panel. Equipped with stereo turnover cartridge with diamond LP needle. Bold modern styling—curved top and bottom cabinet is covered with simulated walnut and black vinyl material. Size: 19½x12x12x8½"H. For 110-120 VAC, 60 Hz. Shpg. wt., 18 lbs.

24 E 02923WX

24 E 02568 45 RPM Spindle for T60

24 E 02386 Replacement Dual Needle for T60

Net 64.95

Net 1.49

Net 1.99

C "MINI" MODEL MS24B 4-SPEED AUTOMATIC STEREO PHONOGRAPH

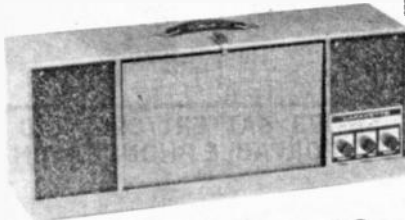

Made in U.S.A. Only **49⁹⁵**



Diamond Needle

No Money Down*

- Exciting BSR 4-Speed Automatic "Mini" Stereo Record Changer
- 4 Transistors and 2 IC's
- Two 4" Wide Range Speakers
- Diamond LP Needle

A truly outstanding performing stereo phono in a sleek cabinet of compact proportions. Beautifully styled with drop-down compartment which folds away for maximum space saving efficiency. Features BSR 4-speed stereo automatic "Mini changer", with automatic shut-off. Plays all size records at 16⅓, 33⅓, 45 and 78 RPM. Intermixes 12" and 10" records of the same speed. Two separate 4" wide range speakers are acoustically balanced and spaced for true stereophonic full-dimensional sound. Powerful solid-state stereo amplifier with 4 transistors and 2 IC's provides instant-on operation—no warm up. 3 controls: volume left, volume right, and tone. Equipped with stereo turnover cartridge with diamond LP needle. Attractive, washable bright textured blue covering. For 110-120 VAC, 60 Hz. Measures 27¼x10¼x6¼"D. Shpg. wt., 18 lbs.

24 E 02717WX

24 E 02568 45 RPM Spindle for MS24B

24 E 02386 Replacement Dual Needle for MS24B

Net 49.95

Net 1.49

Net 1.99

D MODEL M5B 4-SPEED MANUAL PHONO

14⁹⁵

Made in U.S.A.

- Instant-On Solid State Circuitry
- 4-Speeds: 16⅓, 33⅓, 45, 78 RPM
- Built-in 45 RPM Record Adapter

Ideal phono for the youngster in your family. Plays up to 12" monaural and stereo records at 16⅓, 33⅓, 45 or 78 RPM. A single lever selects any speed. "Feather-light" retractable tone arm is equipped with a single crystal cartridge. Volume control with on-off switch. Built-in 45 RPM record adapter. Fine quality 4" speaker. Attractive blue and white leatherette covered case. For 110-120 Volts, 60 Hz. Size: 12Wx9¾Dx5"H. Shpg. wt., 8 lbs.

24 E 02725W

Net 14.95

E DELUXE MODEL 10C 4-SPEED MANUAL PHONOGRAPH

19⁹⁵

Made in U.S.A.

- Speaker Front-Mounted for Full-Tone Sound Dispersion
- Front Mounted Controls for Convenience
- Built-in 45 RPM Adapter Disc
- Instantaneous ON
- 2 Transistors and IC

Plays stereo and monaural records of all speeds . . . 16⅓, 33⅓, 45, and 78 RPM . . . all sizes 12", 10", 7", 4" wide range speaker is set in front grill for full-tone sound dispersion. 2 front mounted controls—on/off volume and tone. Tone arm has dual turnover cartridge. Attractive blue washable pyroxin coated fabric with silver metal grill cloth. Size: 13½x6½x10¼"D. For 110-120 VAC, 60 Hz. Built-in 45 RPM record adapter.

24 E 02899W Shpg. wt., 8 lbs.

Net 19.95

A
Deluxe
Model T33C
4-Speed
Stereo
Phonograph

99⁹⁵

No
 Money
 Down*



B
Model T60
4-Speed
Decorator Styled
Stereo Phono

64⁹⁵

No Money Down*



C
Model MS24B
4-Speed Stereo
Mini Phono

49⁹⁵

No Money Down*



**INTEGRATED
 IC
 CIRCUIT**

2 IC's and
 4 Transistors

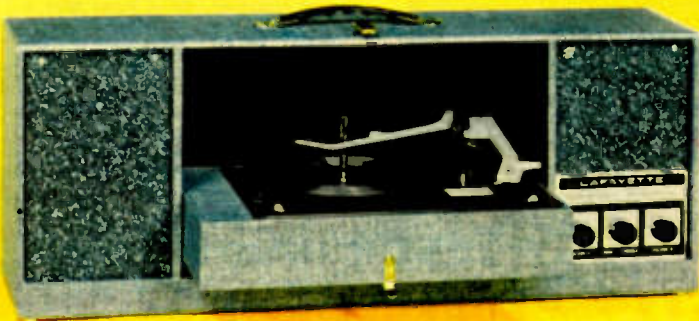

D
Model M5B
Manual Phono

14⁹⁵

Made in U.S.A.



1 IC and
 2 Transistors

E
Model 10C
Our Best
Manual
4-Speed
Phono

19⁹⁵

Made in U.S.A.



**INTEGRATED
 IC
 CIRCUIT**

Our Most Revolutionary STEREOPHONIC PHONOGRAPH

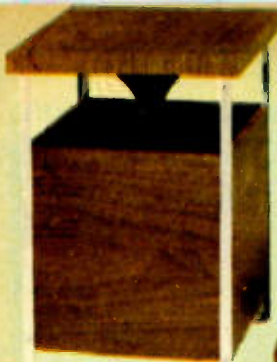

Diamond Needle
Made in U.S.A.

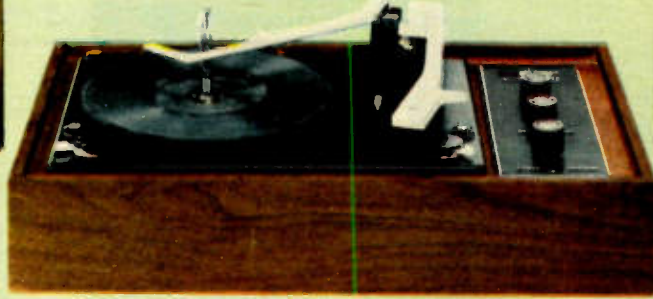

NEW Lafayette LSC-50 Solid State Modular Hi-Fi Phono System featuring TWO 360° Omni-directional 8" Speaker Systems

69⁹⁵ No Money Down*
With Plastic Dust-Cover



HEART OF THE SYSTEM OMNIDIRECTIONAL SOUND

Spreads sound throughout the entire room.
You sit anywhere you want and hear stereo.

- 2 IC's and 4 Transistors
- Stereo Headphone Jack for Private Listening

Presenting a new, imaginative and modernistic design in stereo phonos. Thrill to breathtaking hi-fi sound from our handsome 3-piece modular hi-fi phono system. Featuring 2 revolutionary, omni-directional speaker systems with 360° sound dispersion. Sound waves from a wide range 8" speaker are beamed off a uniquely designed cone reflector dispersing sounds in all directions. Solid state stereo amplifier has two integrated circuits (IC's) and 4 transistors. Delivers a big 10-watts of power. Has 3 controls: Volume Left, Volume Right, Continuous Tone (Bass/Treble), plus a stereo headphone jack for private listening. BSR 4-speed stereo automatic "Winl-Changer" features automatic shut-off after last

- BSR 4-Speed Automatic Stereo Record Changer
- 10 Watt Stereo Amplifier

record has been played. Plays all size records: 7", 10" and 12"; and all speeds; 16 $\frac{2}{3}$, 33 $\frac{1}{3}$, 45, and 78 RPM. Intermixes 12" and 10" records of the same speed. Tone arm is equipped with a stereo turnover cartridge with diamond LP needle. Attractive wood cabinetry is covered with simulated walnut vinyl. Includes plastic dust cover, and speaker hook-up cable. Size: Amplifier/Changer Control Section—17 $\frac{1}{2}$ Lx10 $\frac{1}{2}$ Dx7"H (with tinted plastic dust cover); Speaker Systems (each): 9Wx9Dx12 $\frac{1}{2}$ "H. For 117 VAC, 60 Hz. Shpg. wt., 25 lbs.
24 E 03160WX Net 69.95
24 E 02568 45 RPM Spindle 1.49
Replacement needle for LSC-50
24 E 02386 Net 1.99

NEW PSYCHEDELIC PHONOGRAPH

29⁹⁵

MADE IN THE U.S.A.

- Beautiful Color Lights Are Activated When Record Is Playing
- 3 x 5" Front Mount Speaker



Become the center of attraction, the hit of the party with your psychedelic phono. Beautiful array of color lights are activated when a record is playing. Large, 3x5" front mounted speaker provides fine tonal quality. Plays all size monaural and stereo records at 16 $\frac{2}{3}$, 33 $\frac{1}{3}$, 45 and 78 RPM. A single lever selects any speed. 2 controls: On-Off/Volume (light intensity) and tone. Built-in 45 RPM adapter disc. Dual turnover cartridge with 2 synthetic sapphire needles. Case colors: bottom section—psychedelic blue, white, and orange; top section—blue; white portable carrying strap. Size: 12 $\frac{1}{2}$ Wx7 $\frac{7}{8}$ Hx11"D. Sagg. wt., 10 lbs.
24 E 02915W Net 29.95



NEW Deluxe Lafayette LSC-100 AM/FM Stereo Modular Hi-Fi System

149⁹⁵

Including
Tinted Plastic Dust Cover,
Diamond LP Needle,
and 45 RPM Spindle



Magnificent Ultra-Modern Styling

- Garrard 4-Speed Automatic Record Changer with Cueing
- 40-Watt Solid State Stereo Amplifier
- Electromatic FM Stereo Indicator Light
- Two 8" 2-Way High Compliance Speaker Systems
- Guitar Microphone Input Jack
- Tape Input Jacks ● Stereo Headphone Jack

Our best stereo phonograph with built-in stereo FM/AM radio is fully solid state and features magnificent ultra-modern styling. The control center's stereo amplifier provides 40-watts peak music output—and has provisions for tape input, guitar mike input, and stereo headphone. Also includes AC convenience outlet on rear panel. Tunes in regular FM & AM radio and receives full-dimensioned stereo FM broadcasts. 6 controls for complete flexibility: selector, balance, bass, treble, loudness, and tuning. Built-in AM/FM antennas. Provision for attaching external FM antenna. Calibrated slide rule tuning. AFC for drift-free FM reception. Garrard 2025 4-speed automatic stereo record changer with cueing lever plays 7", 10" and 12" records at 16 $\frac{2}{3}$, 33 $\frac{1}{3}$, 45, and 78 rpm. Operates automatically or

manually. Shuts off both changer and amplifier automatically after last record. Features tubular tone arm with Vaco TN-4 stereo turnover cartridge with diamond LP needle. Each 2-way 8" speaker system provides brilliant concert hall realism from its acoustically balanced high compliance 8" woofer and 4" tweeter. You also get a handsome tinted plastic dust cover for the complete control unit, speaker hook-up cable and a 45 rpm spindle. The components are mounted in beautiful walnut vinyl covered wood cabinets. Size: Control unit 32 $\frac{1}{2}$ "Wx14Dx10 $\frac{3}{4}$ "H (with dust cover) Speaker Encl.: 15 $\frac{1}{2}$ "Hx10 $\frac{1}{2}$ "Wx 4 $\frac{1}{2}$ "D. For 110-120 VAC, 60 Hz. Shpg. wt., 45 lbs.

24 E 02907WX No Money Down* Net 149.95
24 E 02550 Replacement needle for LSC-100 Net 1.99

NEW Lafayette LSC-45 Stereo Modular Hi-Fi Phono System

Genuine Walnut Wood Veneer Cabinetry

- Garrard 4-Speed Automatic Record Changer with Cueing
- 20-Watt Solid State Stereo Amplifier
- Two 8" High Compliance Speaker
- Input For Tuner or Tape Recorders
- Stereo Headphone Jack

Handsome solid-state 3 piece stereo hi-fi modular phono system in genuine walnut wood veneer cabinetry. Two separate acoustically matched, rich sounding 8" high compliance speaker systems can be spaced apart for the utmost stereo effect. Has Aux. Input Jack so as AM or FM tuner or tape recorder can be played thru the powerful 20-watt solid state amplifier (Peak Music Power). Full compliment of controls: balance, bass, treble, volume, selector, automatic shut-off switch, front panel stereo headphone jack. Garrard 2025 4-speed automatic stereo changer with cueing control plays 7", 10", and 12" records at 16 $\frac{2}{3}$, 33 $\frac{1}{3}$, 45, and 78 RPM. Tubular tone arm has a Vaco TN-4 stereo turnover cartridge with diamond LP needle. System includes a beautiful plastic dust cover, 45 RPM spindle, and speaker cable. Size: control unit: 16x 16 $\frac{1}{2}$ x7 $\frac{1}{2}$ "H; speaker system: 13 $\frac{1}{2}$ x9 $\frac{3}{4}$ x5"D each. Shpg. wt., 40 lbs.

24 E 03180WX No Money Down* Net 99.95
24 E 02550 Replacement needle for LSC-45 Net 1.99



99⁹⁵

Including
Plastic Dust Cover,
Diamond LP Needle,
and 45 RPM Spindle

DELUXE LAFAYETTE LRC-60T SOLID-STATE COMPACT AM/FM/FM STEREO RECEIVER TURNTABLE CONTROL CENTER

Featuring The New Space Age Miracle IC's and FET's



See AAM Guarantee Page 435



Only **229⁹⁵** No Money Down*



High Performance Compact Music System featuring The LRC-60T

ONLY **269⁸⁵** SAVE **20.00**
From Individual Catalog Prices

Deluxe Hi Fi System featuring LRC-60T and 2 Lafayette Criterion 50 Speaker Systems. See page 43 for complete description of the Criterion 50 Speaker Systems.
99 E 98375WX Shpg. wt., 96 lbs. Net 288.85

NEW! Lafayette RK-760 SOLID-STATE STEREO CASSETTE TAPE DECK



● Ideal As Matching Recorder For LRC-60T

With The RK-760 Stereo Cassette Tape Deck You Now Have A Complete Home Entertainment Center—And You Can Make Sound with Sound Recordings. See Page 91 For Description of the RK-760. wt., 8 lbs. Imported.
99 E 18752WX Net 89.95

89⁹⁵

- Famous BSR McDonald 500 Stereo Automatic Turntable
- Pickering V15/AC-3 Dustomatic™ Stereo Cartridge with Diamond Needle

- Powerful 75 Watt AM/FM Stereo Receiver
- Superbly Crafted Oiled Walnut Wood Cabinetry

The LRC-60T is a compact, graceful hi-fi control center engineered to reproduce a maximum of sound from a minimum of visible equipment. The LRC-60T consists of a 75 watt AM/FM stereo receiver with FET front-end and 4 IC's, plus the famous BSR McDonald 500 4-speed automatic stereo turntable with a Pickering V15/AC-3 dustomatic stereo cartridge, all mounted in a superbly crafted and styled oiled walnut wood cabinet. You get a stunning blend of beauty and performance from a truly space saving compact control unit. With any of the superb Lafayette Speaker Systems listed you have a magnificent component HI-FI system. The receiver section uses an FET (Field effect transistor) FM tuner, and 4 Integrated Circuits (IC's): An IC is a complete circuit in miniature, in which all components: transistors, diodes, resistors, etc. are etched into a silicon wafer. The IC provides significantly better front-end performance and greater sensitivity enabling you to hear more stations with less noise and interference. Deluxe McDonald 500 turntable features a low mass tubular tone

arm, micrometer stylus pressure adjustment, dynamic anti-skate control, and a cueing and pause control. Plays 7, 10, or 12" records at 16 $\frac{1}{2}$, 33 $\frac{1}{3}$, 45, and 78 rpm. Amplifier delivers wide-range response of 20-20,000 Hz \pm 1 db, plus full 75 watts \pm 1 db, 60 watts IHF power. Impedance: 8-16 ohms. FM Sensitivity: 1.8 μ v IHF: 11-audio controls, plus precision D'Arsonval tuning meter, automatic FM stereo/mono switching, stereo FM indicator light, stereo headphone jack, tape recorder jacks, and precision vernier dial drive for accurate, effortless tuning. The rich oiled walnut cabinetry with slanted, brushed aluminum front panel and controls will harmonize with any home decor. Control Center: 16 $\frac{1}{2}$ "W x 7H x 15 $\frac{1}{2}$ "D. Imported. Shpg. wt., 42 lbs.
99 E 01893WX Net 229.95

Beautiful, Heavy Gauge, Tinted Plexiglas Dust Cover
Size: 15 $\frac{1}{2}$ " x 13 $\frac{1}{2}$ " x 4 $\frac{1}{2}$ ". Shpg. wt., 1 lb.
24 E 09050W

8.95

* See Page 11 for Full Credit Details on Easy Pay Plan

DELUXE Lafayette RK-580 COMPACT FM STEREO CASSETTE MUSIC CENTER



ONLY

329⁹⁵

No Money Down*

with the
New Space Age Miracle—
Integrated Circuits (IC)



See Page 435 For AAM Guarantee

THE ULTIMATE IN COMPACT SOLID-STATE CASSETTE HI-FIDELITY EQUIPMENT

The professional Lafayette RK-580 compact FM stereo cassette control center will reproduce more music in more ways than you ever thought possible. The magnificent integrated RK-580 includes: 65 watt, 40-silicon transistor FM Stereo Receiver; famous BSR McDonald 4-speed Automatic Stereo Turntable equipped with a Pickering V15/AC-3 Dustomatic stereo cartridge; and a deluxe Lafayette Cassette stereo tape recorder. All components are housed in a beautiful walnut wood case. The highly sensitive FM stereo receiver has "2-IC's" and an FET in the tuner front-end section for improved rejection of unwanted signals, and greater sensitivity. Stereo FM Tuner multiplex circuit automatically locks in and signals FM stereo broadcasts. BSR McDonald 500, 4-speed turntable features a low mass tubular tone arm; micrometer stylus pressure adjustment; variable, adjustable, dynamic anti-skate control; automatic or manual selection of 7", 10", or 12" records at 16 $\frac{2}{3}$, 33 $\frac{1}{3}$, 45, and 78 rpm; Deluxe Lafayette Cas-

sette Recorder requires no tape threading. Just insert a cassette cartridge and play or record up to 120 minutes of 4-track stereo or mono music; records "Live" with microphones, or direct from the FM receiver or turntable. Features a narrow gap head with 4 laminations per stack for wideband frequency response and virtually distortion-free performance. Tilted ebony front panel contains stereo headphone output jack; stereo indicator light; and D'Arsonval tuning meter. For 110-120v., 60 cycles AC. Size: 26 $\frac{1}{2}$ x 10 $\frac{1}{2}$ x 18 $\frac{1}{2}$ " D. Imported.
99 E 15554WX Wt., 50 lbs. Net 329.95

ACCESSORIES FOR RK-580

Dynamic Mike. Shpg. wt., 1 lb.
99 E 46307 Net 5.95
60 Minute Tape Cartridge. Shpg. wt., 3 oz.
28 E 01223 Net 1.19
Beautiful, heavy-gauge, tinted plexiglass Dust Cover. (For record changer section only)
Size: 15 $\frac{3}{8}$ x 13 $\frac{3}{8}$ x 4 $\frac{1}{8}$ ". Shpg. wt., 1 lb.
24 E 09050W Net 8.95

Featuring

- 1 65-Watt Solid State FM Stereo Receiver.
- 2 LAFAYETTE Cassette Stereo Tape Recorder.
- 3 BSR McDonald 500 4-Speed Automatic Stereo Turntable with Pickering Magnetic Cartridge.
- 4 Elegantly Styled Oiled Walnut Base Housing All Components.

RK-580 SPECIFICATIONS

Circuitry: 40-Transistors, 26-Diodes (Including 1-FET and 2-IC's). Tuner Section. Tuning Range: 88-108MHz. IHFM Sensitivity: 3 μ v. Capture Ratio: 3.5 db. HD: 0.5%. S/N Ratio: -60db at 100% mod. Amplifier Section. Power Output: 65-watts, \pm 1 db @ 4 ohms, 50 watts IHF. Frequency Response: 20-20,000 Hz. Power Bandwidth: 30-20,000 Hz. Output Impedance: 4-16 ohms. Cassette Section. Frequency Response: 50-12,000 Hz. S/N Ratio: Better than 45 db. Overall Distortion: Less than 1.5% at -4 VU. Wow & Flutter: Less than 0.25% rms.

Dazzling Stereo System Featuring RK-580 Music Center with 2-Lafayette "Criterion 50" Speaker Systems



369⁸⁵

SAVE 20.00

From Individual Catalog Prices

Deluxe system features the revolutionary Lafayette RK-580 stereo music center and 2-Lafayette Criterion 50 speaker systems (see page 43 for complete specifications of Criterion 50 speaker system.) Shpg. wt., 106 lbs.
99 E 99366WX Net 369.85

DELUXE Lafayette RK-570 SOLID STATE FM STEREO CASSETTE Hi-Fi Music System

Complete stereo music system consists of:

- 17 Watt! Lafayette FM Stereo Receiver
- Lafayette Cassette Stereo Tape Recorder
- 4-Speed Mini-Automatic Stereo Record Changer
- Handsomely 5"yled Oiled Walnut Wood Cabinet
- Two Detached Matching Oiled Walnut Wood Bookshelf-type Speaker Systems



249⁹⁵

No Money Down*
With 60 Minute
Cassette

Optional Tinted Plastic
Dust Cover for RK-570



**The Most Complete Integrated Hi-Fi Stereo Music System
We Have Ever Designed For Home Use**

See Page 435 for AAA Guarantee

Play monaural and stereo records. Listen to stereo and monaural FM radio broadcasts. Play and record stereo and monaural cassette tapes. Record live. Record your records while they play on the Mini-changer. Tape FM stereo and monaural broadcasts directly off the air—THERE IS NOTHING ELSE TO BUY (but optional microphones) because you also get two deluxe matching 2-way speaker systems each containing a high compliance 5" woofer and a wide dispersion 3" tweeter which provide the listener with superb full range hi-fidelity sound reproduction. 17-watt! solid state FM stereo receiver features powerful 2N-transistor, 1-FET, and 20-diode solid-state circuitry; FET front-end FM stereo tuner for superb sensitivity and selectivity; stereo indicator light, precision sliderule logging scale; stereo headphone jack; separate balance, volume, treble, and bass controls. Direct recording from FM stereo tuner or stereo record changer to cassette recorder. Two auxiliary input jacks and two external speaker output jacks. Cassette stereo recorder features narrow gap record/playback head with four laminations per stack to deliver wideband frequency response and virtually distortion-free

performance. Has six push-button controls (Record, Rewind, Stop, Play, Fast Forward, and Pause for editing), tape speed 1 1/2 ips, 2 microphone input jacks with stereo/mono input selector switch, record/playback VU meter, 4 speed stereo automatic minichanger plays all size records and intermixes 12" and 10" records of the same speed. Tone arm is equipped with a turnover stereo cartridge with diamond LP needle. Handsomely styled walnut decorator cabinet. Control center 20 1/2" x 14 1/2" x 3 1/2" H (overall height to top of spindle, 7"). Each speaker system 12 1/2" x 18". Includes two 5-ft. connecting speaker cables. Imported. For 117 VAC, 60 Hz. Shpg. wt. 44 lbs.

99 E 88312WXM Net 249.95

ACCESSORIES FOR RK-570

24 E 88362W Tinted Plastic Dust Cover, Wt. 1 lb.	Net 7.95
80 E 483a2 Dynamic Mics, Wt. 6 oz.	Net 9.95
28 E 81223 60 Minute Blank Cassette Tape wt. 2 oz.	Net 1.19
Cassette Storage Rack Shpg. Wt., 5 lbs.	Net 19.95
28 E 18834W	Net 19.95

SPECIFICATIONS

TUNER SECTION: FM Tuning Range: 88-108 MHz; Sensitivity: (IHF) 2.5 μ V; Signal-to-Noise Ratio: 60 db @ 100% Modulation; Antenna Input: 300-Ohm balanced line; Image Rejection: -50 db; Capture Ratio: 2.5 db; Harmonic Distortion: .8%; MPX (Stereo) Channel Separation: 30 db @ 400 Hz.

AMPLIFIER SECTION: Frequency Response: 20-30,000 Hz \pm 2 db; Power Output: \pm 17 Watts \pm 1 db at 4 ohms, 12 Watts at 8 ohms.

Channel Separation: -55 db; Total HO: (@ 5 Watts) .9%; Hum and Noise: -50 db; Power Bandwidth: 20-20,000 Hz. Speaker Output Impedance: 4-16 Ohms.

TAPE CASSETTE RECORDER SECTION: Frequency Response: 50-12,000 Hz; Channel Separation: 35 db; Signal-to-Noise Ratio: Better than 45 db; Bias Frequency: 96 KHz; Sensitivity: Microphone Input 0.2mV @ 200 Ohms; Wow and Flutter: (BMS) Less than 0.3%.

NEW

Lafayette RK-710A Professional 3-Speed Solid State 7-inch Tape Recorder

ONLY

69⁹⁵

No Money Down*



NEW IMPROVED FEATURES

- Tape Spill-Proof
- Reel Hub with Rubber Pads
- Tape Lifters
- 600 ohm Impedance Mike
- New, Wide Range 3 x 5" Speaker

New improved version of our best selling Model RK-710. Superb, self-contained, professionally styled, three speed, two-track monaural 7" tape recorder. The RK-710A now's tape spill-proof. Includes tape lifters, reel hub with rubber pads, 600 ohm impedance mike for better recording quality, and a powerful 3x5" speaker for magnificent voice and music reproduction. Solid state circuitry permits you to start recording the instant you turn it on. Records and plays back two-track monaural at three speeds: 7½, 3¾, and 1⅞ IPS. Easy-to-operate, offers the convenience of a single tape function control knob for five modes of operation: Rewind, Stop, Run, Pause for editing and cueing, and Fast Forward. Records directly from FM tuner, phono, TV, plus "live" performances using the dynamic mike. Deluxe features include: Vertical or horizontal operation; Illuminated VU meter for record/playback level. Record safety button to guard against accidental tape erasure; Individual volume and tone controls; 4-pole induction motor. Comes with low impedance dynamic microphone, 7" empty reel, and two rubber reel caps. Housed in a solid vinyl case with built-in accessory compartment and carrying handle. For 110 VAC, 60 Hz. Imparted. Shpg. wt., 16 lbs.

99 E 15648WX Net 69.95
 7" Reel of 1800' Lafayette Mylar Recording Tape. Shpg. wt., 1¼ lbs.
 28 E 01066 Net 2.14

TAKES REELS UP TO 7 INCHES

- 3 Speeds—7½, 3¾, 1⅞ ips
- 2 Track Monaural Record/Playback
- Vertical or Horizontal Operation
- Record Safety Button
- Single Tape Function Control: Rewind, Stop, Run, Pause for Editing, Fast Forward

SPECIFICATIONS

Response: 60-12,000 Hz at 7½ ips, 60-8,000 Hz at 3¾ ips; Wow and Flutter: Less than 0.25 rms at 7½ ips; Signal-to-Noise Ratio: Better than 42 db; Bias and Erase Frequency: 60 kHz; Power Output: 1.5 watts maximum, 2-Inputs: Microphone and Auxiliary. 1-Output: External speaker. Size: 11¾ x 12¼ x 6¾"D.



Individual Volume and Tone Controls
 Illuminated VU Meter For Record/Playback Level
 Large 3 x 5" Speaker

* See Page 11 for Full Credit Details on Easy Pay Plan

Top Performing LAFAYETTE RK-825 Solid-State 4-Track Stereo Recorder

SALE NOW **129⁹⁵**

SAVE 10.00
WAS 139.95
 1969 Catalog 694

COMPLETE WITH

2 dynamic microphones,
 4-connecting cables, 2-rubber reel caps, 7" empty take-up reel



Feature-Packed—"low-priced" stereo hi-fidelity portable tape recorder with professional features. Built for portability and ease of operation. Solid-state circuitry permits instant play or (pause). Features three speeds, 1½, 3¼ and 7½ ips plus aluminum die cast tape transport chassis with 4-pole induction motor, uses quality laminated 4-track record/play head with double gap erase head for thrilling stereo and mono. Records sound-with-sound, sound-on-sound, for voice language training and sound effects. Stereo headphone monitoring facilities. 2-microphone/auxiliary inputs and 2-extension speaker outputs. Easy-to-operate pushbutton control for VU meter, "Pause" for editing and cuing, safety-interlock to prevent accidental tape erasure and Mike/Aux Input selector. Takes 7" reels. Housed in a handsome sturdy wood cabinet with attractive black leatherette cover. Built-in accessory compartment and carrying handle. For 110-120V., 60 Hz AC. Imported. Shpg. wt., 22 lbs.

99 E 18687W1 Net 129.95
 7" reel of 1800' Master Base Recording Tape.
 Shpg. wt. 1¼ lbs. Net 2.14
 28 E 01088

- 4-Track Stereo and Monaural Record/Playback
- 3 Tape Speeds 1½, 3¼ and 7½ IPS
- Sound-with-Sound
- Stereo Headphone Monitoring
- Separate Tone and Volume Controls for Each Channel
- Tape Spill-Proof
- Tape Lifters
- Stereo Headphone Jack
- 3-Digit Tape Counter with Reset Button
- 2 Full Range 3 x 5" Speakers for Superb Voice and Music Reproduction



1/4-Track Lamination-Type Record/Playback Stereo Head



Illuminated VU Meter Indicates Record/Playback level for Top Stereo Sound Results



Spill-Proof, single Tape Function Selector knob for 5-modes of Tape Transport



2 Record Safety Buttons for Left and Right Channels—Prevent Accidental Erasures



1/4-Track Double-Gapped High Efficiency Erase Head

SPECIFICATIONS

Frequency Response: ±3 db, 40-15,000 Hz at 7½ ips; ±3 db, 40-10,000 Hz at 3¼ ips. Wow and Flutter: under 0.23% rms at 7½ ips; under 0.35% at 3¼ ips. Signal-to-Noise: Better than 46 db. Bias & Erase Frequency: 96 kHz. Cross Talk: Better than 55 db. Power Output: 5-watts maximum. Input Sensitivity: Mike, 0.5 mv. for 0 VU, 600 ohms; Aux., 100 mv. Monitor Output: 16-ohm speaker or low impedance stereo headphones. Solid-State Circuitry: 10 transistors, 4 diodes. Dimensions: 12W x 12H x 7¼"D.

*See page 11 for Full Details on Easy Pay Plan

Deluxe LAFAYETTE RK-835 4-Track Solid State Stereo Pushbutton Recorder

- Tape Spill-Proof
- Tape Lifters
- Solid State Silicon Modular Circuitry
- Independent Power Switch
- Reel Hub With Rubber-Pads
- Automatic Equalization For 3-Speeds
- 2-Mic., and 4-Aux. Inputs
- Two 600 Ohm Impedance Dynamic Mikes For Quality Recordings

Designed to satisfy even the most critical music listeners. Delivers magnificent stereo performance. Can be operated either vertically or horizontally. Records and plays back stereo and monophonic tapes at three tape speeds; 7½, 3¾ and 1½ ips, plus direct record/playback from a record changer or turntable with magnetic phono cartridge. Also features sound-on-sound, sound-with-sound; front panel jack for stereo headphone monitoring. Aluminum die-cast tape transport chassis with 4-pole induction motor for smooth tape operation. Automatic shut-off at end of tape; automatic equalization for three tape speeds; single tape selector for three speeds. Input selector button for mic., and aux./magnetic cartridge. Separate volume control for both channels; master tone control for both channels. Hi-fi sound is provided by 2-full-range built-in, 5" speakers. Takes up to 7" reels. In black leatherette covered wood case with silver metal trim. Size: 15¾" W x 14" H x 7¾" D. For 105-125V., 60 Hz AC. Imported. Shpg. wt., 27 lbs.

99 E 15695WX

Net 179.95

7" reel of 1800' Lafayette Mylar Base Recording Tape. Shpg. wt., 1¼ lbs.

Net 2.14

SPECIFICATIONS

Frequency Response: ±3 db, 30-18,000 Hz at 7½ ips; 4-12,000 Hz at 3¾ ips. Wow and Flutter: Less than 0.18% rms at 7½ ips. Signal-to-Noise: better than 50 db. Bias & Erase Frequency: 105 kHz. Crosstalk: better than 60 db. Equalization: NAB Standard. Power Output: 8 watts maximum. Input Sensitivity: Mike, 0.15 mV., for 0 VU, 600 Ohms; Magnetic Phono: 0.7 mV.; Aux., Inputs: (low) 100 mV., (high) 500 mV. Outputs: External Amp: 1V., to 2.5V variable. Headphone and Speaker Impedance: 8 Ohms. Solid-State Circuitry: 12-transistors, 4-Diodes.



OUTSTANDING FEATURES



¼-Track Lamination-type Record/Playback Stereo Head



¼-Track Double-Gapped High Efficiency Erase Head



2 Record Safety Buttons for Left and Right Channels Prevents Accidental Erasures



Spill-Proof, 5-Position Tape Function Selector knob for Record, Stop, Play, Fast Forward, and Pause for Instant Editing



Two Large Illuminated Studio-Type Record/Playback VU Level Meters



Individual Volume Controls for Each Channel

- 4-Track Stereo and Monaural Record/Playback
- 8-Watts Output Power
- Sound-with-Sound
- Sound-on-Sound
- Automatic Shut-off
- 3 Tape Speeds: 7½, 3¾ and 1½
- Stereo Headphone Monitoring Facilities
- Direct Record from Record Player with Magnetic Pickup
- 3 Digit Tape Counter with Pushbutton Reset
- 2 Full Range 5" Speakers

* See Page 11 for Full Credit Details on Easy Pay Plan

ONLY

179.95

No Money Down*

COMPLETE WITH



2-dynamic microphones, 4-connecting cables, 2-rubber reel caps, 7" empty take-up reel

LAFAYETTE Professional RK-960 "Computer-Matic"™ Solid State Stereo Tape Recorder

Featuring Automatic Reversing in Both Record and Playback Mode

RK-960 "COMPUTER-MATIC" Reversing System Works on 1-Manual and 3-Automatic Reversing Positions In Both Record and Playback Mode.

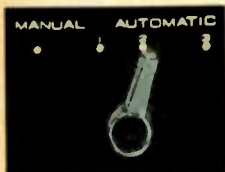

REVERSE POSITIONS

- 1) **MANUAL**—Same as any tape recorder, but permits manual reverse at any point by depressing a button. Sensing metallic foil is disregarded.
- 2) **AUTOMATIC 1**—Tape moves in one direction and stops at end of tape where sensing metallic foil is located.
- 3) **AUTOMATIC 2**—Single Reverse—Tape playing or recording from either left or right reel feeds to opposite take-up reel, reverses itself at the end of the tape where metallic sensing foil is located and then feeds back to starting reel and automatically stops.
- 4) **AUTOMATIC 3**—Continuous Reverse—Tape continues changing (reversing) its direction at each end of the tape where the metallic sensing foil is located.

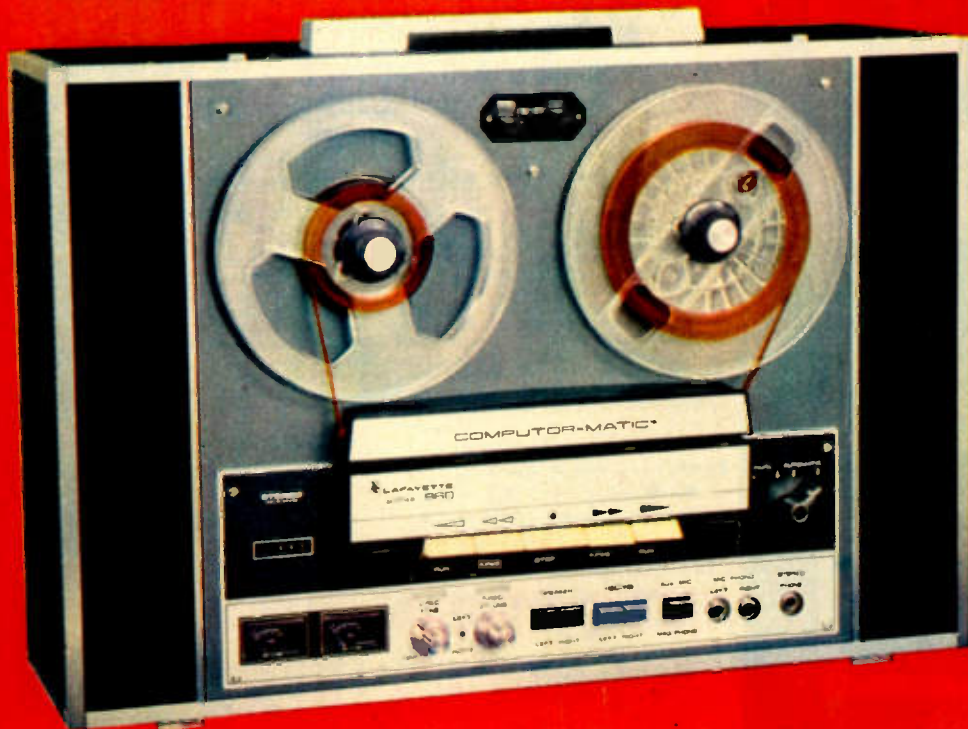

ONLY
299⁹⁵

NO MONEY DOWN*



Optional Dynamic
Mikes
14⁹⁵
ea

- Dual Capstan Drive with Dual Drive Motors
- Sound on Sound, Sound with Sound, and Sound Monitoring
- Bi-Directional Recording and Playback
- 4-Track Stereophonic or Monaural Record/Playback
- Solid State Amplifier Circuitry—12 Watts Music Power
- 4-Heads
- 3-Speeds 1½, 3¾, 7½ ips
- Two Sensory Switches for Automatic Tape Reversing System

Our most versatile precision engineered stereophonic tape recorder... designed to give the highest standards of performance and dependability. The Model 960 features "Full Automatic Reversing." Makes professional quality recordings from AM, FM, FM Stereo broadcasts, phonograph (direct from magnetic or ceramic phono cartridge). With microphones you can record "live" any program material you desire. Records and plays 4-track stereo or mono at 7½, 3¾ and 1½ ips. Two self-contained 5 x 7" wide-range hi-fi speakers provide optimum stereo separation. Two 4-pole induction capstan drive motors assure ultra-smooth, quiet drive. Feather-touch, pushbutton operated solenoids control all tape motion modes. Also has instant reset digital tape counter. 2-studio type VU meters, stereo headphone jack, 6-inputs: 2-microphone/Magnetic P.U., 2-auxiliary, microphone and Auxiliary/Magnetic P.U., selector button. 4-outputs: 2-extension speaker; 2-external outputs, RIAA phono curve equalization. Housed in a handsome black leatherette covered wood cabinet with silver metal trim. 22 x 15½ x 8¼" D. Imported. Shpg. wt., 44 lbs.

99 E 15488WX Net 299.95
99 E 45882 Optional Dynamic Mike Net ea 14.95
7" reel of 1800 ft. Mylar Recording Tape with reversing sensing foils.
28 E 01181 Net 2.89

SPECIFICATIONS

Solid-State Circuitry: 22 transistors, 32 diodes. Record/Play Frequency Response: 30-22,000 Hz ± 3 db at 7½ ips; 40-16,000 Hz ± 3 db at 3¾ ips. Wow and Flutter: Less than 0.25% rms at 3¾ ips. S/N Ratio: 50db or better. Harmonic Distortion: Less than 1.5%. Bias/Erase Freq.: 96 kHz. Cross-talk: Better than 60 db. Equalization: 7½ ips, NAB; 3¾ ips, RIAA. Input Imped.: Mic., 10K ohms; Mag., 45K ohms; Aux., 500K ohms. Output Imped.: Ext. spkr., 8-ohms; Headphones, 8-ohms. Heads: Two 1/4-track lamination type stereo record/playback; two 1/4-track double-gapped high efficiency erase heads. For 110-120V., 60 Hz, AC.

* See Page 11 for Full Credit Details on Easy Pay Plan

LAFAYETTE RK-870 SOLID-STATE 4-TRACK STEREO RECORD PLAYBACK TAPE DECK

119⁹⁵

No Money Down*

Complete with
4 connecting cables,
2 rubber reel caps,
7" take-up reel.



Optional
Dynamic
Mikes

5⁹⁵
ea.

OUR BEST SELLING TAPE DECK FEATURES:

- 4-Track Stereo and Mono Record/Playback
- Separate Record/Playback and Erase Heads
- 3-Speeds: 7½, 3¾, 1½ IPS
- Single Tape Speed Selector for 3-Speeds
- Built-in Advanced Silicon Solid-State Modular Record/Playback Stereo Preamplifiers
- Records 4-Track Stereo or Mono from FM, AM, FM Stereo Radio or Phono Sources; Live from Mikes
- Sound-with-Sound, Sound-on-Sound
- Aluminum Die-Cast Tape Transport Chassis with 4-Pole Induction Motor
- Deluxe Oiled Walnut Wood Veneer Case
- Tape Spill-Proof
- Tape Lifters
- Reel Hubs with Rubber Pads
- Automatic Equalization For 3-Speeds
- 2-Mic., and 4-Aux. Inputs
- 2-Variable Ext. Amp. Output Jacks
- Silicon Solid State Modular Circuitry
- Stereo Headphone Monitoring Facilities
- Pushbutton Power Switch

With this magnificent performing deck you can add the brilliance of 4-track stereophonic and monophonic tape recording and playback to your present hi-fi system at a remarkably low cost. Engineered and designed for vertical or horizontal operation. Features automatic equalization for 3-tape speeds—separate record volume controls, instant "on" solid state stereo record/play preamps, and 2-record/playback VU level meters with pilot lights and record mode indicator lights. Spill-proof, single tape function selector for 5 modes of tape transport: fast rewind, stop, run and fast-forward plus "pause" for precise editing. 3-digit tape counter with fast pushbutton zero reset in editing and indexing. Rear panel preamp outputs, auxiliary inputs and front panel mike input jacks are all readily accessible for easy hook-up. Takes up to 7" reels. Housed in oiled walnut wood veneer case. For 110V., 60 Hz AC. Imported. Shpg. wt., 18 lbs.

99 E 15861WX Net 119.95

7" Reel of 1800 Ft. Lafayette Mylar Base Recording Tape. Shpg. wt., 1 lb.

28 E 01066 Net 2.14

Dynamic Mike, with stand. Imported. Wt., 1½ lbs.

99 E 46302 Net 5.95

SPECIFICATIONS

Frequency Response: ±3 db 40-18,000 Hz at 7½ ips; 40-12,000 Hz at 3¾ ips. Wow and Flutter: Less than 0.2% rms at 7½ ips. Signal-to-Noise Ratio: 50 db or better. Bias & Erase Frequency: 105 kHz. Cross Talk: Better than 60 db. Equalization: NAB standard. Overall Distortion: Less than 1.5% at 0 VU. Sensitivity and Impedance: Inputs—microphone, 0.15 mV for 0 VU, 600 ohms; Auxiliary (low), 100 mV for 0 VU, 150K ohms; Auxiliary (high), 500 mV for 0 VU, 700K ohms. Outputs—External Amplifier, 1V to 2.5V variable, 5K ohms; Headphone, 10K ohms. Size: 12½Wx11¼Hx6"D (in wood case); 11¾Wx10Hx5¾"D. Uncased.



OUTSTANDING FEATURES

- 1) Heads: Separate 1/4-Track Record/Play & Erase
- 2) Tape Reels: Up to 7" Size
- 3) Spill-proof 5-position Tape Function Control with "Pause"
- 4) 3-Speed Selector Lever
- 5) Pushbutton Power Switch
- 6) Digital Tape Counter with Pushbutton Reset
- 7) 2-Record/Playback VU Level Meters with Pilot Light and Record Mode Indicator Lights
- 8) Separate Record Volume Controls
- 9) Individual Record Safety Buttons
- 10) Stereo Microphone Inputs
- 11) Stereo Headphone Jack
- 12) Oiled Walnut Wood Case

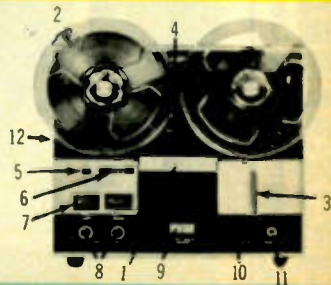

* See Page 11 for Full Credit Details on Easy Pay Plan



featuring "Automatic Reversing"
In both Record and Playback Modes

For The Individual Who Insists Upon Professional Performance



**LAFAYETTE RK-920
 COMPUTER-MATIC™
 REVERSING
 SOLID STATE
 STEREO TAPE DECK**

ONLY 199⁹⁵

No Money Down*
 with 4-connecting cables,
 2-rubber reel caps,
 7" empty reel

Optional Dynamic Mikes

14⁹⁵
 ea.



- Automatic and Continuous Reverse in Record or Playback
- Bi-directional Recording and Play-back in Connection with External Amplifier and Speaker System
- Built-in Solid State Stereo Record/Playback Preamplifier
- 4-Track Stereophonic or Monophonic Recording/Playback in connection with External Amplifier
- Two Sensory Switches for Automatic Tape Reversing System
- Automatic Shut Off Switch
- Sound-on-Sound, Sound-with-Sound
- 3-Digit Tape Counter with Push Button Reset
- Horizontal or Vertical Operation
- Two Large Illuminated VU Meters

Lafayette's RK-920 Computer-Matic Reversing System Works on 1-Manual and 3 Automatic Reversing Positions In both Record and Playback Mode.



Reversing Positions:

- 1) Manual—Same as any tape recorder, but permits manual reverse at any point by depressing a button. Sensing metallic foil is disregarded.
- 2) Automatic-1—Tape moves in one direction and stops at end of tape where sensing metallic foil is located.
- 3) Automatic-2—Single Reverse—Tape playing or recording from either left or right reel feeds to opposite take-up reel, reverses itself at the end of the tape where metallic sensing foil is located and then feeds back to starting reel and automatically stops.
- 4) Automatic-3—Continuous Reverse — Tape continues changing (reversing) its direction at each end of the tape where the metallic sensing foil is located.

Deluxe professional 4-track stereo tape transport system offering continuous automatic reverse with full record and playback provisions. In addition to automatic Computer-Matic reversing, the RK-920 features a top performing stereo preamp, perfectly matched for use with high quality basic amplifiers. You can record "live" from microphones, or from auxiliary sources such as receivers, tuners or phonographs, and playback at either 1½, 3¼ or 7½ ips. The tape transport is powered by two separate 4-pole induction capacitor drive motors to assure ultra-smooth, accurate speed. Feather-touch push-button controls allow you to

change operational modes instantly or preset the unit to automatically reverse itself. Instant pause control assures smooth, professional editing during recording sessions. Two professional VU meters are provided for visual monitoring of signal levels from either tape or auxiliary audio source. Housed in a beautiful brown leatherette covered wood case. 17x15½x14" D. Imported.
 © E 1984-TWX Int., 50 lbs. Net 199.95
 Optional Dynamic Mike Net ea. 14.95
 7" reel of 1800 ft. Mylar Base Recording Tape with reversing sensing foil. Net 2.99

SPECIFICATIONS

Solid-State Circuitry: 14 transistors, 27 diodes. **Frequency Response:** 30-22,000 Hz ±3db at 7½ ips; 40-18,000 Hz ±3db at 3¼ ips. **Wow and Flutter:** Less than 0.2% rms at 3¼ ips. **S/N Ratio:** 50db or better. **Harmonic Distortion:** Less than 1.5%. **Crosstalk:** Better than 58db. **Equalization:** 7½ ips, NAB; 3¼ ips, RIAA. **Input Imped.:** MIC., 10K ohms; Aux., 500K ohms. **Output Imped.:** Ext. amp., 3K ohms; **Heads:** Two ¼-track lamination type stereo record/playback; two ¼-track double-gapped high efficiency erase heads. For 110-120V., 60 Hz, AC.

Professionally Record Your Own Cassette Stereo Tape Library

NEW Lafayette RK-760 Solid-State Stereo Pushbutton Cassette Deck

only **89⁹⁵**
Less
Microphone

EXCLUSIVE FEATURES

• **4-POLE HYSTERESIS SYNCHRONOUS AC MOTOR**

• **PLAYBACK OUTPUT UP TO 2.5 VOLTS VARIABLE AT 0 VU RECORDING**

• **SOUND-WITH-SOUND**

Loaded With these Deluxe Features For Your Personal Convenience

- 3-Digit Tape Counter with Reset Button
- Large Dual Channel VU Level Record Meter
- 7-Pushbutton Tape Functions Including Pause For Cueing and Editing
- Visual Record Indicator Light
- 2-Mike Inputs On Front Panel
- Cassette Ejector Button • Semi-Slot Tape loading

The RK-760 is a solid-state cassette tape deck designed for use with an existing stereo system. Connects into any standard tape input and output. Features semi-slot tape loading for complete ease of operation plus a full set of pushbutton controls for all tape functions: Record, Play, Stop, Rewind, Fast-Forward, Pause, and Cassette Eject. The Record button incorporates a safety-interlock to prevent accidental erasures. Includes left and right channel dual concentric record level controls—enables you to make sound with sound recordings. Simultaneously record live with mikes and thru an external source such as record changer, Tuner, or another tape recorder. Tape speed is a constant 1 7/8 ips. Specifications: 4-pole hysteresis synchronous AC motor, AC biasing and erase frequency:



- **Records 4-Track Stereo and 2-Track Monaural**
- **Playback 4 and 2-Track Stereo and Monaural**

95kHz. Frequency Response: 45 to 12,000 Hz. S/N Ratio: Better than 35 db. Overall Distortion: less than 3% at 0 VU recording. Channel Separation: 30 db. Input: 2-mike, 2-high level tape. Mike Input Sensitivity: 1.0 mV for 0 VU at 10K ohms. Tape Input Sensitivity: 80 mV for 0 VU at 100K ohms. Wow and Flutter: Less than 0.3%. Outputs: 2-tape. Handsome walnut side panels, brushed aluminum gold anodized extruded front panel. For 117VAC, 60Hz. Imported. Size: 12 3/4 x 5 1/2 x 8 3/4" W. Shpg. wt., 8 lbs.

99 E 15752WX No Money Down* Net **89.95**
Dynamic Mike for RK-760. Imported. Shpg. wt., 8 oz.
99 E 46302 Net **5.95**
28 E 01223 60 Min. Cassette Recording Tape Net ea. **1.19**

Deluxe LAFAYETTE RK-550 Solid-State Stereo Pushbutton Cassette Deck

only **119⁹⁵**
Less
Microphone

- Automatic Shut-Off Switch
- Record Safety Button



- **Records: 4 Track Stereo and 2 Track Monaural**
- **Plays back 4 and 2 Track Stereo and Monaural**

- **2 Large Illuminated VU Meters**
- **3 Digit Tape Counter with Reset Button**

Professionally styled and engineered to provide superb stereo and monaural cassette recording facilities. Features a full set of pushbutton controls for all tape modes; record, play, fast-forward, rewind, pause, stop, cassette ejector; stereo/mono input selector switch, record safety button. Specifications: 1/4 Track Record/Play narrow gap head, with 4 laminations per stack to deliver wideband frequency response and virtually distortion-free performance; 1/2 Track double gapped high efficiency erase head. Response 40-12,000 Hz, S/N Ratio: better than 45 db. Wow and Flutter: Less than 0.25%, Overall Distortion: Less than 1.5% at 0 VU @ 600 ohms, Aux. Input

(Low) 100 mv for 0 VU @ 150 K ohms. Aux. Input (high) 500 mv for 0 VU @ 700 K ohms. Tape Speed 1 7/8 ips. Size: 15Wx5Hx9"D. Handsome brushed aluminum gold anodized extruded front panel. Attractive metal enclosure with the simulated look of rich walnut wood grain. Matches Lafayette Hi-Fi Line of Receivers, Tuners, and Amplifiers. For 117VAC, 60Hz. Imported. Wt., 12 lbs.

99 E 15711WX No Money Down* Net **119.95**
Dynamic Mike for RK-550. Imported. Shpg. wt., 8 oz.
99 E 46302 Net ea. **5.95**
28 E 01223 60 Min. Cassette Recording Tape Net ea. **1.19**

* See Page 11 for Full Credit Details on Easy Pay Plan

NEW! Deluxe Lafayette RK-510

SOLID STATE

Stereo Cassette Recorder



Only **149⁹⁵**
with mikes
LESS SPEAKERS



Only **179⁹⁵**
with mikes
and 2-Lafayette
Criterion 25A Speakers

SAVE 8.50

From Individual
Catalog Prices When
You Purchase RK-510
With Criterion Speakers



- Records 4-Track Stereo and 2-Track Monaural
- Playsback 4 and 2-Track Stereo and Monaural
- All Silicon Transistor Record/Playback Preamps
- 10 Watt Solid-State Stereo Amplifier
- 6-Pushbutton Tape Function Controls with Pause
- 2-Mic. and 4-Aux. Input Jacks

Superb hi-fidelity stereo cassette tape recorder with the added convenience of no tape threading. Magnificently plays stereo and monaural pre-recorded cassette tapes by just adding two external speaker systems. Features narrow-gap record/playback heads with four laminations per stack to deliver wideband frequency response, and virtually distortion-free performance. Records voice, musical instruments, and musical combos live through the two microphones (mike input jacks are located on the front panel for your convenience). Input jacks for plugging in a record changer or phono, and an FM stereo tuner are provided on the rear of the recorder. You can record brilliant FM stereo broadcasts directly off-the-air. All silicon transistor Record/Playback preamps. Powerful 10-watt-stereo power amplifier, 2 tape outputs, and 2 speaker terminals. Unique jam-proof tape drive system. Full set of 6 pushbutton controls for all tape modes including Pause for instant editing and cueing, 3 digit tape counter with reset button, large dual illuminated VU record level meters. Handsome

brushed aluminum gold anodized extruded front panel. Attractive metal enclosure with the simulated look of rich walnut grain. **SPECIFICATIONS** — Cassette Section: Frequency Response — ± 2 db 30-12,500 Hz; Wow and Flutter, less than 0.2% rms. Signal-to-Noise — better than 44 db @ 0 VU. Channel Separation — 36 db. Bias Frequency — 106 kHz. Input Sensitivity: Mic., 0.23 mV; Aux., 100 mV. Record Playback Amplifier: Output Power — 10 watts @ 8 ohms with less than 1% THD. Overall Frequency Response — ± 1 db 35-22,000 Hz. Power Bandwidth — ± 3 db 25-37,000 Hz. Channel Separation — 58 db. For 110-125 VAC., 50/60 Hz. Imported. Size: 14 $\frac{3}{4}$ Wx 4 $\frac{1}{2}$ Hx8 $\frac{1}{2}$ D. Shpg. wt., 12 lbs.

99 E 15776WX No Money Down* Net 149.95
Lafayette Model RK-510 Stereo Cassette Recorder. Plus 2 Lafayette Criterion 25A Speaker Systems. See Page 43 for complete description of Criterion 25A. Shpg. wt., 30 lbs.
99 E 99459WX No Money Down* Net 179.95

DELUXE FEATURES AND CONTROLS OF THE RK-510

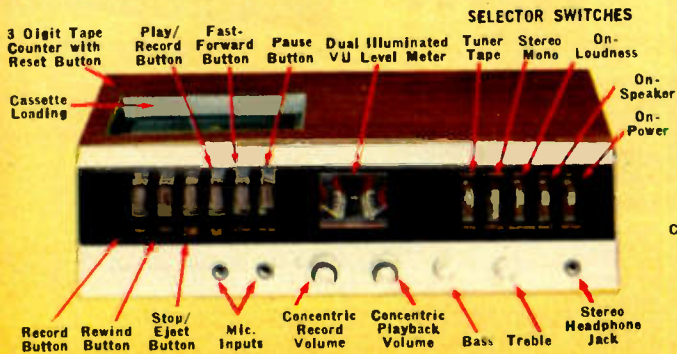

REAR VIEW OF RK-510 CHASSIS

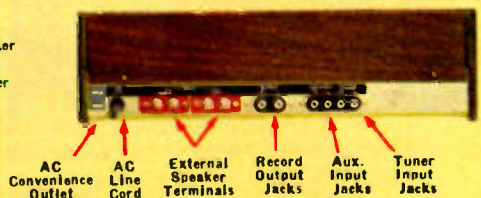

LAFAYETTE's Finest Solid-State Radio Cassette Recorders

Deluxe LAFAYETTE RK-160 AC/Battery AM/FM Radio Cassette Recorder

Check and Compare These Quality Features

- Includes Remote Control Mike with Stand, Earphone, Built-in AC Line Cord, Batteries, Blank 60-Minute Cassette, and Integrated Carrying Handle For Ease Of Portability.
- Direct Recording From AM or FM Radio
- 4" Acoustically Matched Hi-Fi Speaker
- 8 Pushbutton Tape Function Controls
- Battery Condition/Recording Level Meter
- Semi-Slot Tape Loading
- Individual Compartments In Rear for All Accessories

Magnificent Lafayette full-feature AM/FM Cassette Radio-Recorder is an entertainment center in itself. Easy to use—no tape threading. 8 Piano Key type pushbutton controls. Plays back or records on a cassette tape for up to two hours. Records AM or FM programs directly "Off the Air" while monitoring through the speaker. Versatile and handsome simulated plastic walnut grain case with metal trim. Operates on 4 "O" batteries or 117 VAC with built-in self-storing AC Line cord. Superb AM/FM radio section features a precision slide-rule tuning dial, bass/treble control. 4" acoustically matched Hi-Fi speaker provides rich, full-frequency sound reproduction. Telescopic FM antenna and ferrite core AM antennas. External speaker or earphone jack. Speaker on/off Switch, Aux. input for phono or another recorder for tape duplicating. 8 pushbutton Tape Functions: Eject, Record, Play, Rewind, Fast-Forward, Stop, Cassette/Radio, AM/FM radio. Record safety interlock prevents accidental erasures. Also includes self-storage compartment for microphone and accessories. SPECIFICATIONS: Professional AC bias recording system; Power output 1 watt. Size: 3 3/4 x 11 1/2 x 11 3/8" H. Shpg. wt., 9 lbs. Imported

99 E 15471WX No Money Down* Net 89.95
 99 E 62564 Extra "O" Batteries (4 req.) Net ea. .15
 28 E 01223 Lafayette 60 Minute Tape Cassette Net 1.19



89⁹⁵
 Delivery Oct. 1969

LAFAYETTE Portable Desk Top Radio Cassette Recorders

SALE	RK-95 AM-FM Radio Cassette Recorder	RK-90 AM Radio Cassette Recorder
	WAS 59.95	44⁹⁵
1969 Cat. 694	54⁹⁵	

- Complete with Remote Control Microphone with Stand, Blank 60 Minute Cassette, Earphone, Vinyl Accessory Pouch, Shoulder Strap and Batteries

Model RK-95 AM-FM RADIO-CASSETTE RECORDER. Sensational combination of a quality AM-FM RADIO and Cassette recorder lets you record broadcasts directly, or live with a microphone. You can permanently build your own tape library of fine music, world-wide news events as they happen, historic speeches by renowned statesmen, thrilling sports events like the World Series and the Super Bowl. Easy to use—no tape threading, pushbutton controls, record safety interlock button, AC bias and erase system, dynamic speaker for outstanding tonal quality, recording level and battery indicator. Can record up to 120 minutes (both tracks) on one Phillips type Cassette. External speaker output. Operates on 4 "C" batteries or 117VAC 60 Hz with optional adapter (see below). Includes Aux. input and remote control mike input. Tape speed 1 7/8 ips. Radio tunes: FM 88-108 MHz, AM 550-1600 kHz. Beautiful black case with chrome and walnut wood trim. Size: 7W x 9 1/2D x 2 1/4"H. Imported.

27 E 01126L Shpg. wt., 5 lbs. Net 54.95

Model RK-90 AM RADIO CASSETTE RECORDER—Same deluxe features and size as the RK-95 except with AM radio instead of AM/FM radio. Imported. Shpg. wt., 5 lbs.

27 E 01100L No Money Down* Net 44.95

ACCESSORIES FOR RK-90 AND RK-95

- 27 E 01118L AC Adapter. Shpg. wt., 1/2 lb. Net 3.95
- 28 E 01223 Lafayette 60 Minute Tape Cassette Net 1.19
- 99 E 62572 Extra "C" Batteries (4-required) Net ea. .14



LAFAYETTE Cassette Spectaculars

LAFAYETTE Professional RK-85 Solid-State Battery/AC Portable Cassette Transcoder*

SALE

Save 4.95
NOW
39⁹⁵
WAS 44.90
 1969 Cat. 694

With Remote Control Mike and Stand, AC Adapter, Earphone, Batteries, Accessory Case, Hand Strap, Blank Cassette Tape

- Simple To Operate
- No Tape Threading
- Pushbutton Controls
- Battery Record Level Indicator
- Record Safety Interlock Button
- Remote Control Start/Stop Mike



- Utilizes Professional AC Bias and Erase System

The RK-85 portable Cassette recorder is one of the easiest tape recorders in the world to operate—there are no reels, and therefore no tape threading. Just insert the tape cartridge, press a button and you are ready to playback or record. Tape stops automatically at the end. To record or playback on the other side, just turn the cartridge over. Beautifully styled and engineered. Capstan drive for constant 1 7/8 ips speed. Operates on 5 "C" batteries or 117VAC with AC adapter included. Perfect for "on-the-go" recordings. Records up to 120 minutes (both tracks). Separate pushbutton controls for: Fast Forward, Rewind, Stop, Play, plus safety record button. Permits perfect recordings with level meter that also checks batteries. 8-transistors, 1-diode. Includes: earphone jack, auxiliary input jack for recording from external sources such as phonograph, TV set, or Tuner, and remote control mike jack. Large 2 3/4" dynamic speaker. Size: 8 3/4 x 5 x 2 1/4 "H. Imported. Shpg. wt., 4 lbs. **99 E 15794L No Money Down*** Net **39.95**

ACCESSORIES FOR RK85

Stock No.	Description	Shpg. wt.	Net ea.
99 E 15620	Vinyl Case with Strap	1 lb.	2.95
99 E 62572	Extra "C" Batteries...5 req.	2 oz.	.14
99 E 15406	60 minute Lafayette Cassette Cartridge	6 oz.	1.35

Deluxe LAFAYETTE RK-99 Battery/AC Cassette Recorder

Featuring Built-In AC Line Cord

49⁹⁵

Including: Remote Control Mike, Leather Carrying Case, Earphone, Batteries, Patch Cord, Blank 60 Minute Cassette



Semi-Slot Loading

6 Pushbutton Controls!



- Professional AC Bias Recording System with ALC
- Reliable Instant Start Solid-State Circuitry
- Cassette "Semi-Slot" Loading For Ease of Operation

One of the finest portable cassette recorders offered by Lafayette. Operates on 4 "C" batteries, or, 117VAC with built-in AC line cord. Plays and records up to 2-hours using standard type cassettes. Cassette semi-slot loading and pop-up removal for complete ease of operation. Six piano-type keyboard pushbuttons: Play, Record, Fast-Forward, Rewind, Stop, and Cassette Eject. Automatic Level Control (ALC) to keep loud tones from distorting. Also features: dual purpose battery level and recording meter, record safety interlock, Individual Tone and Volume controls, Auxiliary input for radio, phono, or tape recorder for tape duplicating, external speaker/headphone jack. Speed 1 7/8 ips. Handsomely styled cabinet enhanced by simulated walnut wood grain panels. Sizes: 10 1/2 L x 5 1/4 W x 2 5/8 "H. Imported. Shpg. wt., 5 lbs.

27 E 01746L No Money Down*	Net	49.95
99 E 62572 Extra "C" Batteries (4-required)	Net ea.	.14
28 E 01223 60 Minute Blank Cassette Tape	Net	1.19

LAFAYETTE Cassette Recorder and Players for Every Occasion

Lafayette RK-70 SOLID-STATE PORTABLE CASSETTE RECORDER



Our Sensational
Low Price of **24⁹⁵**

GIFT PACKED
To Include Remote
Control Microphone,
Earphone, and
Carrying Strap

- No Tape Threading
- 5-Pushbutton Controls Including Cassette Pop-Up
- Automatic Record Level Control
- Ideal for Use in the Office for Dictation
- Ideal for Classroom Work for the Student

Handsome, low-cost quality portable cassette recorder. Use for dictation or classroom work; take along to a party, the beach, or a picnic. Simple to use—no tape threading. Advanced solid-state circuitry features 5-transistors, 1-thermistor, and 2-diodes. Constant 1 7/8 ips speed capstan drive. Pushbutton controls include Stop/Cassette Pop-Up, Fast-Forward, Tape Rewind, Play, Safety Record button. Automatic Level Control (ALC) to keep loud tones from distorting. Records up to 120 minutes (both tracks) on a cassette. Large 2 3/4" speaker for excellent sound reproduction. Operates on 4 "C" batteries or 110V., 60 Hz AC with optional adapter (see below). Remote control mike and earphone. Size: 9 3/4" x 5 1/4" x 2 1/2" H. Imported. Shpg. wt., 4 lbs.

27 E 01738L

Net 24.95

ACCESSORIES FOR RK-70

- 27 E 01142L AC Adapter. Shpg. wt., 1/2 lb. Net 3.95
 28 E 01723 Lafayette 60-Minute Tape Cassette Net 1.19
 99 E 62572 Extra "C" Batteries (4-req.) Net ea. .14

EXCITING Lafayette SOLID-STATE "CASSETTE-MATE" PORTABLE TAPE PLAYER

17⁹⁵

With Batteries
and Earphone



A great new way to listen to the vast selection of pre-recorded cassette tapes on the market today. The Lafayette "Cassette-Mate" gives you remarkably Full Range sound and unlimited convenience. Battery operated or can be played on 110 VAC house current with optional adapter. Integrated carrying handle for ease of portability. Earphone for private listening. Instant-on solid-state circuitry. Easy to use "Stop/Play Switch." Earphone/external speaker jack. Volume Control. With batteries and earphone. Size: 9 1/2" H x 5 3/4" W x 2 1/2" D. Shpg. wt., 4 lbs. Imported.

99 E 15786

Net 17.95

99 E 35685 AC Adapter For Cassette-Mate Net 3.95

99 E 62572 Extra "C" batteries (4 req.) Net ea. .14

Lafayette Stocks A Complete Line Of Tape Accessories



NEW

NEW

LAFAYETTE PUSHBUTTON CASSETTE PLAYER with BUILT-IN AM RADIO

29⁹⁵

With Batteries
and Earphone



- Instant "On" Solid-State Circuitry
- Handsome Blue and White Cabinet
- 3 Cassette Controls: Stop-Play-Rewind

Enjoy the pleasure of listening to wonderful pre-recorded cassette tapes with added convenience of being able to also hear music, news and sports events on the built-in AM radio. Compact, portable cassette player is pushbutton operated. Plays on 4 "C" batteries, or, 117VAC with optional adapter. Superheterodyne AM radio has a ferrite core antenna. You get excellent sound quality from a special dynamic speaker. Size: 11H x 6 3/8W x 2 3/4"D. Imported. Shpg., 5 lbs.

27 E 01134

Net 29.95

27 E 01142L AC Adapter for Above. Wt., 6 oz. Net 3.95

99 E 62572 Extra "C" Batteries (4 req.) Net ea. .14

Lafayette Cat. No. 700 95

Portable Solid State Cassette Tape Recorders

FAMOUS NORELCO 150 PORTABLE CASSETTE RECORDER

SALE! 49⁵⁰ Save 10.00
Was 59.50

with mike, deluxe carrying case,
mike pouch, tape cartridge & patch cord

1969 Catalog 690

Extremely lightweight — weighs less than 3 lbs. including batteries. Carry it everywhere... ideal for students, salesmen, busy executives. Records voice and music on 2 tracks at 1 7/8 ips with perfect fidelity. Fully transistorized for instant playback. No warmup. Easy to use. No tape threading. Single master control starts, stops, winds and rewinds tape. Microphone has remote switch for start-stop. Uses 5 "C" size flashlight cells. Has recording level battery life meter. Can be used with external amplifier, headphones. Complete with mike, patch cord, vinyl carrying case, 1-tape cartridge and separate microphone pouch. Size 7 3/4 x 4 1/2 x 2 1/4". Imported. Shpg. wt., 4 lbs.

27 E 48044L No Money Down* Net 49.50
99 E 62572 "C" Type Battery, 5 required Net ea. .14

ACCESSORIES FOR MODEL 150

Universal Car-Mount For Carry-Corder. Easy to hookup — Does not use car battery. Mounts under dash. Enables self-contained carry-corder to be played thru car radio. You can easily remove Carry-Corder and take it with you. 1 1/2 L x 3 D x 5 1/2 W. Imported. Shpg. wt., 3 lbs.

27 E 48150 Net 29.95
27 E 48085 117VAC Adapter, Wt., 6 oz. Net 9.95
27 E 48267 Rechargeable Nicad Battery Pack. Wt., 1 lb. Net 24.95
27 E 48127 Model FP86 Foot Pedal. Wt., 6 oz. Net 11.95
27 E 48143 Model TP86 Telephone Pickup Coil Wt., 2 oz. Net 7.65
28 E 01223 Lafayette 60 Minute Tape Cassette Net 1.19



NEW CRAIG 2603 BATTERY/AC PORTABLE CASSETTE RECORDER

44⁹⁵



with microphone,
earphone, accessory
pouch

"No threading" convenience of cassettes plus automatic volume adjustment make the Craig 2603 ideal for home, office and school. Detachable AC power cord lets you operate this battery-powered recorder from any standard AC outlet. Single "T" control lever for rewind, fast-forward, play/record and stop. AC bias (45kHz) record system, DC erase system. 60 minutes record time with C-60 cassette, more with extended play cassettes. Speed: 1 7/8 ips. Response: 100-7,000 Hz. Size: 5 1/4 x 2 3/4 x 9"D. Operates on 5 "C" batteries, or 117 VAC., 60 Hz. Imported. Shpg. wt., 4 lbs.

27 E 27097WX No Money Down* Net 44.95
99 E 62572 "C" batt., for Model 2603 (5-req.) Net ea. .14

NEW SONY/SUPERSCOPE MODEL 70 BATTERY/AC CASSETTE RECORDER

69⁵⁰



With Cardioid Dynamic Mike,
Earphone, and Leather
Carrying Case

Perfect for office use or carry 'round entertainment. Features, easy-matic pushbutton operation, start-stop microphone for easy dictation and back-space cueing—which makes it ideal for stenographic work. Also includes an end-of-tape alarm, built-in recharging circuit for optional ni-cad battery pack and a record level/battery level meter. Frequency response: 50-10,000 Hz. Complete with F-25S cardioid mike, personal earphone and leather carrying case. Size: 8 1/4 x 2 3/4 x 8 1/4". Imported.

27 E 60460W Shpg. wt., 6 1/2 lbs. No Money Down* Net 69.50
99 E 62572 "C" Batteries for Model 70 (4 req.) Net .14
27 E 60452 Shpg. wt., 1/2 lb. Net 14.95

NEW SONY/SUPERSCOPE MODEL 110 BATTERY/AC CASSETTE RECORDER with Built-in Condenser Microphone

99⁵⁰



with
Cardioid Remote
Start/Stop Mike,
Leather Carrying
Case, Earphone,
and 60 Min. Cassette

Features a revolutionary built-in electret condenser microphone. Also comes with remote control microphone. Complete pushbutton operation with pop-up cassette ejector. Recharger circuit for optional nicad pack. Aux. input jack, Battery/record meter. Tone control. Imported. Shpg. wt., 5 1/2 lbs.

27 E 60486WX No Money Down* Net 99.50
99 E 62572 "C" batteries for above (4 req.) Net ea. .14
27 E 60221 Shpg. wt., 1 lb. Net 14.95

NEW DELUXE SONY/SUPERSCOPE MODEL 120 BATTERY/AC PORTABLE CASSETTE RECORDER with built-in Condenser Microphone

129⁵⁰



with leather carrying case,
cardioid remote stop/start mike,
and remote stop/start control

Sony's finest monaural portable cassette recorder. Low silhouette design. Built-in electret condenser mike enables you to dictate from anywhere in the room. Battery condition indicator. Record-level meter. Digit tape counter, End-of-tape alarm. Built-in battery recharging circuit. For optional nicad pack. Imported. Size: 10 1/4 x 2 1/2 x 6".

27 E 60478WX No Money Down*. Shpg. wt., 6 lbs. Net 129.50
99 E 62572 "C" Batteries for Model 120 (4 req.) Net ea. .14
27 E 60221 Shpg. wt., 1 lb. Net 14.95

Deluxe Instant-On Solid-State Cassette Tape Recorders

NEW! DELUXE AMPEX MICRO-32 PORTABLE AM/FM CASSETTE TAPE RECORDER



129⁹⁵

with earphone, microphone, 60-minute cassette

- AC/Battery/Car Operation
- Automatic Built-in Battery Recharger
- Recording Level/Battery Condition Meter

Deluxe Portable cassette tape recorder, offers the convenience of direct recording from a powerful built-in quality AM/FM radio, and a full watt audio output. Plays wherever you go. Operates on 117VAC., 5 "D" batteries, or, 12VDC car battery with optional adapter. Built-in Ni-Cad battery recharger circuit. Has 3-digit reset counter, switchable automatic record level control, record level/battery condition meter, and FM/AM antennas. Housed in deluxe case with die cast trim. Size: 12½x7x3". Imported. Shpg. wt., 10 lbs.

27 E 25521WX No Money Down*	Net 129.95
27 E 25513 12VDC Car Adapter. Wt., 2 lbs.	Net 17.95
99 E 62564 Extra "D" batt., for MICRO-32	Net ea. .15
28 E 01223 Lafayette 60 minute tape cassette	Net 1.19

SONY/SUPERSCOPE Model 50 PORTABLE MINI-CASSETTE RECORDER



119⁵⁰

Complete with leather case, one Sony tape cassette and 4 "AA" batteries.

- Hand "Snap-in" Battery Pack
- Built-in Microphone
- Automatic Recording Level

Small enough to fit into a jacket pocket, the deluxe Sony TC-50 is a marvel of miniaturization and performance. Features: Sonymatic A.R.C. automatic recording control; built-in mike; and speaker. 2-track mono record and Playback. Speed 1½ ips. Push-button rewind; battery level and record meter. AC with optional adaptor. Handy "snap-in" battery pack containing 4 type "AA" batteries. With leather case and one 60-min. cassette. Imported. 3¼x1½x5¼"D. Shpg. wt., 3½ lbs.

27 E 60312L No Money Down*	Net 119.50
----------------------------	------------

ACCESSORIES FOR SONYMATIC 50

Model AK-1 Nickel Cadmium Battery Pack and AC Adapter charger.	
27 E 60411 Shpg. wt., 1 lb.	Net 27.50
27 E 60239 FS-5 Footswitch. Shpg. wt., 1 lb.	Net 6.95
28 E 01223 Lafayette 60 minute tape cassette, 2 oz.	Net 1.19
99 E 62580 Extra "AA" batteries (4 required)	Net ea. .10

NEW! DELUXE PANASONIC RQ-208S "SLIDE-IN" CASSETTE TAPE RECORDER



79⁹⁵

with remote control microphone and stand, 30 minute Cassette, radio cord and 6 "D" batteries

- AC/Battery/Car Operation
- "Easy-Matic" Recording Level Control
- Automatic Slide-In-Pop-up Cassette System

Perfect recorder for home, travel and automobile listening pleasure! Operates on 117VAC., 6 "D" batteries, or 12VDC with optional car mounting bracket. Has push-button fast-forward and rewind, 3-digit tape counter, continuous tone control, "Easy-Matic" recording level control and easy-see VU meter. Sound monitoring serves as a public address system. Has AC bias and Erase. Tape Speed: 1½ ips. Size: 11¼x8¾x3¾". Imported. Shpg. wt., 8 lbs.

17 E 31595W No Money Down*	Net 79.95
17 E 31603 RP-910 Car Mntg. Bracket. Wt., 2 lbs.	Net 24.95
99 E 62564 Extra "D" batteries (6-required)	Net ea. .15
28 E 01223 Lafayette 60 minute tape cassette	Net 1.19

Model RQ-210 "MINI-CASSETTE" PORTABLE TAPE RECORDER

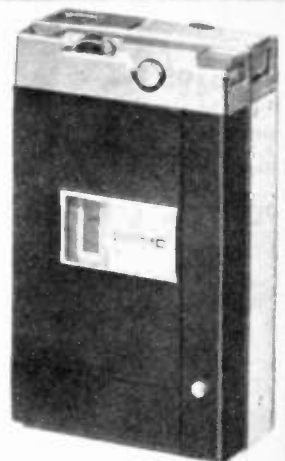

99⁹⁵

WITH:

- Remote Control Pencil Mike
- Earphone
- 60 Minute Cassette
- 4 "AA" Batteries
- Leather Carrying Case
- Wrist Strap

FEATURES:

- Five Integrated Circuits
- Built-In Speaker
- Automatic Record Level Control

Dual track miniature Cassette tape recorder, compact enough to be hand-held for on-the-spot recording anywhere! Simple to use—no tape threading; use standard Phillips Type Cassettes. Features: Cassette tapes, advanced solid-state circuitry utilizing 5-Integrated Circuits, 5-transistors and 3-diodes. Records and plays back music or voice up to an hour per cartridge at 1½ ips (both tracks). Single lever control knob determines all modes of tape operation; Record, Play, Stop, Rewind, Fast-Forward, Automatic Recording Level Control assures easy, perfect recordings everytime. Built-in 2½" dynamic speaker offers full fidelity mono sound. Remote control start/stop mike input, earphone output for private listening. Response: 50-10,000 Hz. Size: 3¼Wx6¼Hx1½"D. Imported. Shpg. wt., 3 lbs.

27 E 12172L No Money Down*	Net 99.95
27 E 12180 Accessory Tie Clip Mike. Shpg. wt., 2 oz.	Net 14.95
99 E 62580 Extra "AA" Batteries (4-required)	Net .10
28 E 01223 Lafayette 60 min. Tape Cassette, 2 oz.	Net 1.19

* See Page 11 for Full Credit Details on Easy Pay Plan

Deluxe Solid-State Stereo Cassette Tape Decks

SONY/SUPERSCOPE Model 125 SOLID-STATE STEREO CASSETTE DECK



109⁵⁰

- Built-in Stereo Record/ Playback Pre-Amplifier
- Handsomely Mounted In A Walnut Wood Base

Add this "Easy-Matic" stereo Cassette-Corder® deck to your present sound system and you're ready for up to two hours of 4-track stereo recording and playback on a single tape cassette. Standard features are pushbuttons for all tape modes: Fast-Forward, Rewind, Play, Stop, "Pop-Up" Cassette Eject, Record Interlock, and Pause. Extra convenience features include automatic recording level control plus a tape sentinel lamp that visually indicates when the end of a cassette has been reached. Has noise-suppressor switch, stereo headphone jack, 2-line outputs, 2-mike inputs, 2 auxiliary inputs. Response: 50-10,000 Hz. Wow/Flutter: 0.2% S/N ratio: 45 db. For 117 VAC., 60 Hz. Size: 13 x 3 3/4 x 7 3/4". Imported. 21 E 60422WX No Money Down* Shpg. wt., 8 lbs. Net 109.50

NORELCO Model 2502 SOLID STATE AUTOMATIC STEREO CASSETTE PLAYBACK CHANGER DECK

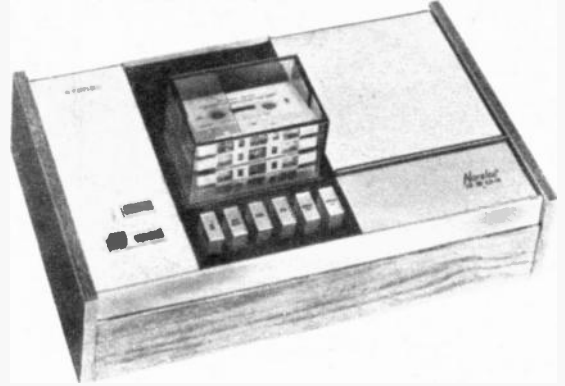

129⁹⁵

- Stacks & Plays Up To 6 Pre-Recorded Cassettes Automatically Non-Stop

Sit back and enjoy up to 6 hours of non-stop play of pre-recorded Cassette Tapes. Exciting Automatic Stereo Cassette changer stacks up to 6 pre-recorded tapes. Plugs into stereo or mono systems. Automatic operation moves played cassettes to built-in storage compartment. Features Solid State instant play, pushbutton controls for Forward, Rewind, Pause, Stop, Start/Reject, On-Off. Automatic stop after last cassette. Beautiful rich walnut case. Size: 15 1/2 L x 9 1/4 W x 4 3/4" H. Imported. Shpg. wt., 15 1/2 lbs. For 110-120 VAC 60 Hz. 27 E 48263WX No Money Down* Net 129.95
Model 2401A Automatic Stereo Cassette Changer/Recorder Deck — Same as above but with record facilities. Imported. Net 199.95
21 E 48302WX Shpg. wt., 17 lbs.

NEW! AMPEX MIRC0-52 SOLID-STATE STEREO CASSETTE DECK

- Built-in Stereo Record/ Playback Pre-Amplifier

Add stereo cassette recording and playback to your existing stereo system! Records in stereo with mikes, or external inputs (phono tuner) Sound mixing with sliding level controls; two lighted VU meters; hysteresis synchronous motor; easy cassette drop-in load door; post-touch pushbutton cassette function controls; pushbutton reset digital counter; switchable automatic record level control. Response: 40-12,000 Hz. S/N ratio: 45 db. Wow/Flutter: 0.15%. Handsomely styled in a deluxe walnut and smoked plexiglass cabinet. Size: 16 1/4 x 10 1/4 x 5 3/4". 21 E 25532WX Shpg. wt., 15 lbs. Net 149.95

Only
149⁹⁵

with 2-mikes,
Amplex/London
demo tape



PORTABLE SOLID-STATE BATTERY/AC STEREO CASSETTE TAPE RECORDERS



AIWA TP1004
99⁹⁵

Includes: 2-mikes,
2-earphones, blank cassette,
batteries AC line cord

AIWA TP1004 Stereo Cassette Recorder — Enjoy stereo pre-recorded cassette music or record wherever you go! Both speakers detach for fullest stereo sound enjoyment. Operates on self-contained batteries, or 117 VAC house current. Features pushbutton controls; separate Bass, Treble Volume controls; VU meters for each channel. Size: 12 3/4 H x 13 W x 3 1/2 D. Imported. 27 E 10242WX No Money Down* Shpg. wt., 9 1/2 lbs. Net 99.95



SONY 124CS

Only **175⁰⁰**

No Money Down*

Deluxe Sony/Superscope 124CS Stereo Cassette Recorder — Complete 4-track stereo cassette-corder® system with matched pair of extension speaker systems. Operates on 117 VAC, or batteries with recharging circuit. Other features: Sonymatic® recording level control; record level/battery indicator; separate Tone, Volume and stereo Balance controls; stereo headphone jack; mike and aux. inputs. With batteries, remote start/stop mike, earphone, patch cords, AC power cord, carrying case and 60 minute blank cassette. Size: 6 1/4 W x 2 1/4 H x 9 3/4 D. Imported. Shpg. wt., 7 1/2 lbs. 27 E 60437WX No Money Down* Net 175.00

Deluxe Solid-State Stereo Cassette Recorders

NEW SONY/SUPERSCOPE 130 STEREO CASSETTE-RECORDER CONSOLE SYSTEM

In Handsome

Walnut Wood Cabinetry

Deluxe, solid-state 4-track stereo cassette system with two matching full-range speakers. Delivers 15 watts IHF music power for big-console sound, yet is small enough to be placed on a bookshelf. Features easy-to-use pushbutton operation; automatic recording control; public address capabilities; noise suppressor switch; speaker monitor switch; tape sentinel lamp to indicate when end of tape has been reached. Has record interlock, headphone monitor jack, pause control, 3-digit tape counter, stereo balance/volume and tone controls plus mike and auxiliary inputs. Response: 50-10,000 Hz. Wow/Flutter: 0.2%. S/N ratio: 45 db or better. Play Time: 0p to 120 minutes. For 117VAC., 60 Hz. Size: 13 $\frac{1}{2}$ "x31 $\frac{1}{2}$ "x9 $\frac{1}{4}$ ". Imported. Shpg. wt., 13 lbs. 27 E 60497WX No Money Down* Net 169.50



169⁵⁰

with stereo mike, stereo patch cord, 60 minute cassette tape

NEW PANASONIC RS-280S STEREO CASSETTE TAPE RECORDER With AM/FM/FM STEREO RADIO

In Handsome

Walnut Wood Cabinetry

Complete professional cassette sound system! Features a high-quality 4-track stereo cassette recorder, built-in AM-FM/FM stereo tuner and two separate full-range 6" dynamic speaker systems. Offers classic simplicity with slide-in cassette operation, precision capstan drive, direct recording from auxiliary source, sound monitoring, stereo headphone jack, dual VU meters, digital tape counter, plus fast-forward/rewind controls. Tuner has FET circuitry and AFC for clear, drift-free reception. "Stereo Eye" indicates when FM stereo signal is received. Delivers 20 watts music power. Includes a "Black-Out" illuminated slide-rule dial. For 117VAC., 60 Hz. Main Unit—19 $\frac{1}{2}$ "x11 $\frac{1}{2}$ "x5 $\frac{1}{2}$ "D; Speakers—11 $\frac{1}{2}$ "x10 $\frac{1}{2}$ "x4". Imported.



229⁹⁵

with 2 dynamic mikes with stands, and 30 minute cassette tape

No Money Down*

NEW CRAIG 2705 AM/FM STEREO CASSETTE RECORDER SYSTEM

Only

199⁹⁵

No Money Down*
with 2 mikes
and 2 patch cords



In Handsome Walnut Wood Cabinetry

- Slide Controls for Volume, Balance and Tone

Compact, home sound system consisting of a fine quality stereo cassette tape recorder, sensitive AM/FM stereo receiver with automatic FM stereo switching and stereo indicator lamp, plus two matching walnut wood grain finish speakers. Features easy-to-operate slide controls for volume, balance and tone, plus digital tape counter and dual VU meters. Speed: 1 $\frac{1}{2}$ ips; Response: 50-10,000 Hz; Wow/Flutter: Less than 0.3%; S/N ratio: 40 db; Separation: 30 db; Output: 5 watts/channel; Speaker size: 4x6" oval. For 120VAC., 60 Hz. Main Unit: 15 $\frac{1}{2}$ "x4 $\frac{1}{2}$ "x10 $\frac{1}{4}$ "D; Speakers: 7x10x6"D. Imported. Shpg. wt., 25 lbs.

27 E 27154WX

Net 199.95

NEW NORELCO 2401 AUTOMATIC STEREO CASSETTE CHANGER RECORDER SYSTEM

249⁹⁵

with stereo
microphone



In Handsome Walnut Wood Cabinetry

- Plays Up To Six Cassette Tapes Automatically

Deluxe cassette recorder featuring 4-track stereo record/playback, 2-track mono record/playback with automatic tape changing system. Will play or record up to 6-hours non-stop at 1 $\frac{1}{2}$ ips tape speed. Two separate full-range speakers produce full, rich sound quality. Solid-state circuitry delivers ± 3 db 60-10,000 Hz frequency response. Has push-buttons for record, playback, stop, fast-forward, rewind, pause, start/reject. Separate balance, tone, volume controls; index counter with zero reset, illuminated record level indicator and program indicator. Output Power: 4-watts/channel. S/N ratio: 43 db. For 117VAC., 60 Hz. Size 15 $\frac{1}{2}$ "x8 $\frac{1}{2}$ "x4 $\frac{3}{8}$ ". Shpg. wt., 45 lbs. Imported.

27 E 48291WX No Money Down*

Net 249.95

* See Page 11 for Full Credit Details on Easy Pay Plan

Lafayette Cat. No. 700 99

Deluxe Solid-State Stereo Reel-To-Reel Tape Decks

SONY/SUPERSCOPE 155 PLAYBACK/DUBBING STEREO TAPE DECK

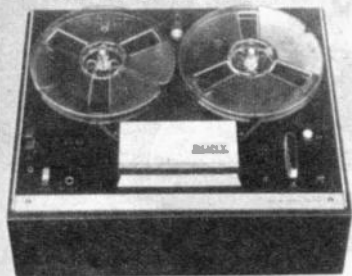

99⁵⁰

Complete stereo playback transport deck with solid state playback preamplifiers specifically designed for those who already own a stereo tape recorder and want their own complete 4-track stereo tape duplicating system. The model 155 can also be used for normal stereo tape playback through any receiver or amplifier system. Features include retractomatic instant tape threading rollers, vibration free motor, pause control, 4-digit counter, and stereo headphone jack. Frequency response: 30-18,000 Hz at 7½ ips. Speeds: 1½, 3¼, 7½ ips. Wow & Flutter: .09% at 7½ ips. Supplied with walnut base. Size: 15¾ x 6¼ x 13¾" D. For 117 VAC 60 Hz. Imported. Shpg. wt., 24 lbs. 27 E 60395WX No Money Down* Net 99.50 Model DP-15 Plastic Dust Cover for 155. 27 E 60445W Shpg. wt., 1 lb. Net 3.95

SONY/SUPERSCOPE STATE STEREOSONIC TAPE DECKS

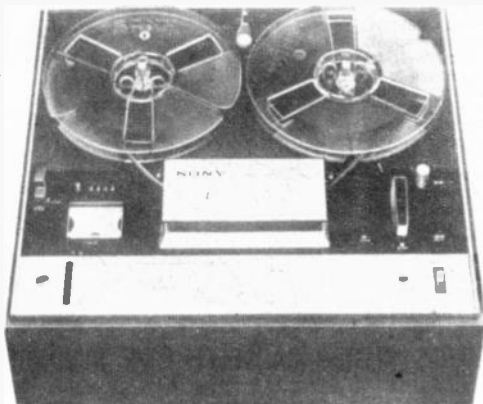

MODEL 255
159⁹⁵

MODEL 355
199⁵⁰

Model 255 professional two head, 4-track stereo tape deck with self-contained solid state preamplifiers for the recording and playback of four-track stereo and 4 track mono reel to reel tapes. Features two VU meters for accurate recording level indication, automatic tape lifters, automatic shut-off switch, Sony-accurate vibration-free motor, "scrape flutter filter" for eliminating tape modulation distortion, sound-with-sound recordings, individual channel recording buttons, and separate recording level controls. Operates at 7½, 3¼, 1½ ips. Includes 4-digit tape counter. Specifications: Frequency Response 30-18,000 Hz. Signal-to-noise: 52 db, Wow and Flutter: 7½ ips, 0.09%; 3¼ ips, 0.12%, 1½ ips, 0.17%. Takes reels up to 7". Inputs for 2 mikes. Comes mounted on a walnut wood base with protective dust cover. Size: 15¾ x 7¼ x 13¾" D. Imported. Shpg. wt., 24 lbs. 27 E 60353WX No Money Down* Net 159.95

Model 355 Deluxe version of the model 255 featuring 3 heads, 4-digit tape counter, source and tape monitoring switches, individual channel record button and record level controls with built in connection and switching for sound-on-sound. Instant stop. Supplied with walnut base with protective dust cover. Size: 15¾" W x 7¼" H x 14" D. Imported. Net 199.50 27 E 60361WX Shpg. wt., 26 lbs. No Money Down* Net 199.50 27 E 60379 F98 Mike for Models 255 and 355 Net 13.50

NEW AMPEX MODEL 755A 3-HEAD STEREOSONIC TAPE DECK



249⁹⁵ with Walnut Base plus 2-sets of Patch Cords for use with line Inputs and Outputs

Quality engineered 3-speed stereo tape deck. Features three deep-gap head assemblies—enables sound-on-sound, sound-with-sound, and echo effect. Exclusive rigid-block head suspension assures perfect head-to-tape alignment. Pause control stops tape movement instantly for precise editing and cueing. Other quality features: exclusive dual capstan drive, solid-state electronics throughout, automatic tape lifters, automatic shut-off, safety record lock, individual channel record level controls and record level VU meters, on/off-record pilot light and stereo inputs. Response: 7½ ips 50-15,000 Hz; 3¼ ips 50-7,500 Hz ± 4 db. S/N ratio: 7½ ips 46 db; 3¼ ips 43 db. For 117VAC., 60 Hz. Size: 13 x 15¼ x 6½". Shpg. wt., 30 lbs.

27 E 25505WX No Money Down* Net 249.95

NEW TEAC MODEL A1200 PROFESSIONAL 3-HEAD STEREO TAPE DECK

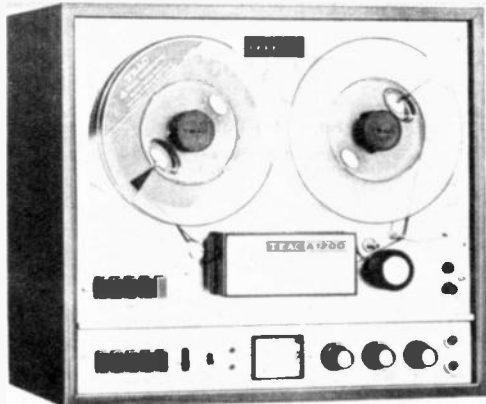

299⁵⁰ with Walnut Wood Base

Combines 1—hysteresis synchronous motor, 2—eddy current outer-rotor motors and 3-precision record/playback heads for 4-track 2-channel stereo, half-track stereo or monaural and full-track monaural. Has all pushbutton system; ADD Recording and Stereo Echo for special sound effects. Standard features: Dual VU meters, automatic shut-off and 4-digit reset index counter. Tape speed: 7½ and 3¼ ips (0.5%). Response ± 3 db: 7½ ips, 50-15,000 Hz; 3¼ ips, 50-10,000 Hz. S/N ratio: 50 db. Wow/Flutter: 7½ ips, 0.12%; 3¼ ips, 0.15%. For 100/115 VAC., 50/60 Hz. Size: 17 x 15½ x 9¾". Imported. Shpg. wt., 50 lbs.

27 E 15001WX No Money Down* Net 299.50 Model A1500 same specs and features as above but with Automatic Reverse and 4-Heads. Imported. Size: 16 x 16¼ x 9¾". Net 399.50 27 E 15010WX Shpg. wt., 45 lbs.

Solid-State Reel-to-Reel Stereo Tape Recorders

**ROBERTS 1720 STEREO RECORDER
WITH DETACHABLE MATCHING SPEAKERS**



199⁹⁵

With 2 Mikes

- 4 Track Stereo And Mono Record
- 4 Track Stereo And Mono Play
- Twin VU Meters
- 3 Digit Tape Counter

Breathtaking stereo realism and outstanding versatility are yours with the Roberts 1720 tape recorder. Provides a big 10 watts of stereo output per channel and a broad, flat response of 40-15,000 Hz. 2-speed operation, 3¾ and 7½ ips, with automatic shutoff. Has 3 digit counter, fast forward/rewind for rapid and precise position locating. Twin VU meters, headphone jack, monitor/pause edit lever, and equalized preamp outputs provide full taping flexibility. Takes up to 7" reel. With 2 mikes, twin detachable speakers, and empty 7" reel. 15½" x 17½" x 10½". For 110-120 VAC, 60 Hz. Imported. Shpg. wt., 26 lbs.

27 E 55155WX No Money Down* Net 199.95

**SONY SUPERSCOPE 230 "STEREO COMPACT"
PORTABLE TAPE SYSTEM**



229⁵⁰

With 2 Mikes

- Complete Input Facilities For Connection Of Magnetic Phono Cartridge or Tuner
- 4-Track Stereo/Mono Record and Playback

Portable 4-track stereophonic record and playback tape system featuring built-in solid state stereo control center with 20-watt stereo amplifier. Complete input and switching facilities for the connection of external stereo hi-fi components such as magnetic phono cartridge, tuner-radio, TV, PA and mike. Two lid-integrated full range speaker system that may be separated up to 15 feet; three speeds 7½, 3¾, and 1½ ips; left, right and stereo speaker modes; retractomatic pinch roller for unequalled threading ease; tone control; stereo headset jack; automatic sentinel end-of-reel shut off; sound with sound; digital tape counter; takes reels up to 7"; two VU meters. Output, external speakers (2), line output 2; stereo headphone. For 117 VAC 60 Hz. Includes 2 Sony F-26 cardioid dynamic mikes. 15¾" x 7½" x 13½" D. Imported. Shpg. wt., 41 lbs.

27 E 60288WX No Money Down* Net 229.50

**DELUXE ROBERTS 778X INTEGRATED
REEL-to-REEL and 8-TRACK CARTRIDGE RECORDER**

**NEW PANASONIC RS-790S 4-TRACK STEREO
RECORDER With AUTOMATIC REVERSE**



279⁹⁵

With 2-dynamic
Mikes and
Stands,
7" Reel of tape,
7" Empty Reel
and Sensing Tape

**Continuous Automatic Reverse or Manual Reverse
in Record or Playback Mode**

Handsome in appearance, excellent in performance, this 4-track 3-speed stereo tape recorder literally has everything: solid-state for sure reliability, dual capstan drive, continuous automatic or manual reverse for record and play in both directions, 2-large VU meters, 4-head precision operation, automatic shut-off, lever-type controls, safety-lock record button, and directional lights. Takes up to 7" reels. Includes sound monitor, sound-on-sound and sound-with-sound plus pause control. Speed: 7½, 3¾ and 1½ ips. Music Power: 20 watts. Frequency Response: 30-20,000 Hz. Detachable speakers each contain 7x5" oval dynamic speakers. Size: 17x16½x7½" D. Imported. For 117VAC 60 Hz.

27 E 12198WX Shpg. wt., 40 lbs. No Money Down* Net 279.95

399⁹⁵

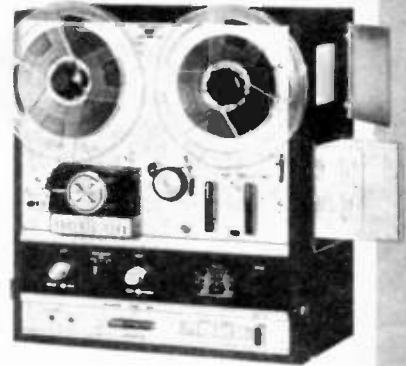

- Records "Stereo 8" Cartridge From Reels
- Built-In Cartridge Erase
- 4-Track Stereo Reel to Reel Plus "Stereo 8" Track Combination Record And Play

Deluxe home instrument that records "Stereo 8" cartridges for music in your car or home, plays stereo reel-to-reel tapes and records cartridges at the same time. Also features 4 track stereo/monaural record and playback at 3 speeds—1½, 3¾, 7½ ips with Cross Field heads; cartridge channel selector and illuminated track selector read-out indicators; 12 watt solid state stereo amplifier; two 4" acoustic suspension speakers. Signal-to-Noise ratio: reel -50 db. cartridge -45 db. Twin VU recording level meters. For 120 volt 50/60 Hz. Size: 15x13½x9½" D. Imported. Shpg. wt., 47 lbs.

27 E 55171WX No Money Down* Net 399.95

ROBERTS MODEL 1725-8L III. Compatible 8-Track Cartridge and Reel to Reel Recorder—Same as Model 778X but less built-in 8-Track Cartridge erase, and Cross Field heads. Size: 15Hx13½x9½" D. Imported. Shpg. wt., 34 lbs.

27 E 55163WX No Money Down* Net 299.95

* See Page 11 for Full Credit Details on Easy Pay Plan

Solid State Monaural Reel-To-Reel Tape Recorders

**TRUTEST® 150 BATTERY OPERATED
SOLID STATE RECORDER**



14⁹⁵

With Remote Control Mike, 3" Reel of Recording Tape, Take Up Reel, Earphone, Carrying Strap, and Batteries

Compact, dual track, recorder operates from batteries or 117 VAC with optional adapter. Dynamic microphone has its own remote control on/off switch for taping "letters". Jam-proof piano style pushbuttons simplify operation. Convenient earphone for monitoring recordings, or, for private listening. Uses 2—1.5V., and 1—9V battery. Reel size: 3¼". Size: 8¾ x 3¼ x 6½"D. Imported. Shpg. wt., 2¼ lbs. (with batteries).

99 E 15562L Net 14.95
ACCESSORIES FOR TRUTEST® 150
 99 E 35370 117V AC Adapter 6 oz. 3.95
 28 E 01090 3" Reel Rec. Tape 6 oz. .69
 99 E 60212 Extra 9V Bat. (1 req.) 2 oz. .21
 99 E 62572 Ex. "C" Cell (2 req.) 2 oz. .14

**SONY/SUPERSCOPE 104A
SOLID STATE PORTABLE RECORDER**



112⁵⁰

- 3 Speed — 7½, 3¾, 1½ ips
- Automatic Recording Control
- Takes Reels Up To 7"

Top quality 3-speed dual track mono recorder. Automatic recording control adjusts recording level to insure perfect recording every time. Tape lifter prevents head wear. Record safety interlock prevents erasure of tape. Automatic tape shut-off. Speeds of 7½, 3¾, and 1½. Takes 7" reel. Powerful 10-watts of solid state play-back power. Features adjustable tone and pause controls, easymatic tape threading, automatic tape lifter, and VU meter. Model 104A can also be used for public address. For 110 V. AC 60 Hz. With Dynamic microphone. Size: 6½H x 16W x 10¾"D. Imported. Shpg. wt., 21 lbs. 27 E 60387WX No Money Down* Net 112.50

**CRAIG MODEL 212 SOLID STATE
AC/DC PORTABLE TAPE RECORDER**



**SALE!
SAVE
9.95**

Was 44.90 Now **34⁹⁵**
1969 Cat. 690

With AC Adapter, mike, take-up reel, 3" reel of tape

Widely acclaimed, solid state, 2-speed monaural tape recorder. Operates on batteries (Not included), or, 117 VAC current with AC adapter. Features constant speed capstan drive; automatic level control; speeds 3¾ and 1½ ips—allows up to four hours recording time on 3¼ reels. Power output: 750 milliwatts. Has input for mike-remote foot-switch; outputs for earphone and external 8-ohm speaker. Supplied with AC adapter accessory pouch, mike, reel and tape. Size: 7¾W x 9¾D x 3¾"H. Imported. Shpg. wt., 5 lbs.

27 E 27048L No Money Down* Net 34.95
 "C" batteries for Craig 212 (6 req.)
 99 E 62572 Net ea. .14

**7" BATTERY/ELECTRIC PORTABLE
SOLID STATE TAPE RECORDER**



119⁹⁵

- Takes Up To 7" Reel
- 3 Speeds—7½, 3¾, 1½ ips

Two track, monaural Battery/Electric portable tape recorder takes reels up to 7 inches. Use it anywhere. Works on self-contained batteries, 117-volt household current or car battery with an adapter that is included. Capstan drive assures smooth, uniform speed at 7½, 3¾ and 1½ ips. Cover closes with 7 inch reels in place. With dynamic mike, tape counter, VU meter, push-button controls, with fast forward function. Beautifully textured polystyrene attache case, with de-cast frame and carrying handle. Imported. 16½W x 3¾H x 13"D. Shpg. wt., 19 lbs. 27 E 10176WX No Money Down* Net 119.95
 Extra "D" Batteries (8 req.)
 99 E 62564 Net ea. .15

**CONCORD F-20 BATTERY OPERATED
"SOUND CAMERA"**

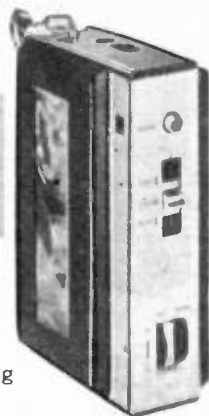

19⁷⁵
with Mike
Take Up Reel

- Up to 30 Minutes Recording Time

Really portable—the F-20 goes anywhere: to school, in a briefcase, on a trip. Features reliable solid state circuitry, "flux-field" head for wide frequency response and variable speed control. Records up to 30 minutes on standard 2¾" reel. Easy finger-tip control of transport functions. Includes dynamic microphone, built-in speaker, empty reel and earphone jack. Uses penlight cells (see below). Size: 6¾x 2½x4½". Imported. Shpg. wt., 4 lbs. 27 E 35108L Net 19.75

27 E 35058 195 ft. reel of tape Net .59
 Batteries for F-20 (4 required)
 99 E 62580 Net ea. .10

**Deluxe WOLLENSAK SOLID STATE
MODEL 1500SS TAPE RECORDER**



184⁹⁵

- 2 Track Mono Record/Play
- 10 Watt Push-Pull Output
- Keyboard Operation

Deluxe solid state, portable tape recorder. Records/playback at 7½ and 3¾ ips. Features VU meter; tape counter; automatic tape lifters; pause control; fast forward/rewind. Has provisions for monitoring and P.A. All metal construction. Includes mike, accessory cords, blank tape, self-threading take-up reel. Freq. Resp.: 40-15,000 Hz ±3db at 7½ ips, 40-8,000 Hz ±3db at 3¾ ips. Wow/Flutter; less than 0.3%. S/N greater than 48db. Inputs for mike, phonoradio; outputs for ext. speaker, preamp. 117V., 60 Hz, AC. Size: 6½H x 10¼D x 11¾"W. Shpg. wt., 22 lbs. 27 E 50222WX No Money Down* Net 184.95

ACCESSORIES FOR 1500SS
 Vinyl Carrying Case. Shpg. wt., 1 lb. 27 E 50214 Net 8.95
 TE401 Earphones. Shpg. wt., 8 oz. Net 9.95
 27 E 50081 Net
 TE404 Foot Control. Shpg. wt., 2 lbs. Net 16.95
 27 E 50099 Net

CASSETTE *Stereo Tape Listening and Recording in the Car*

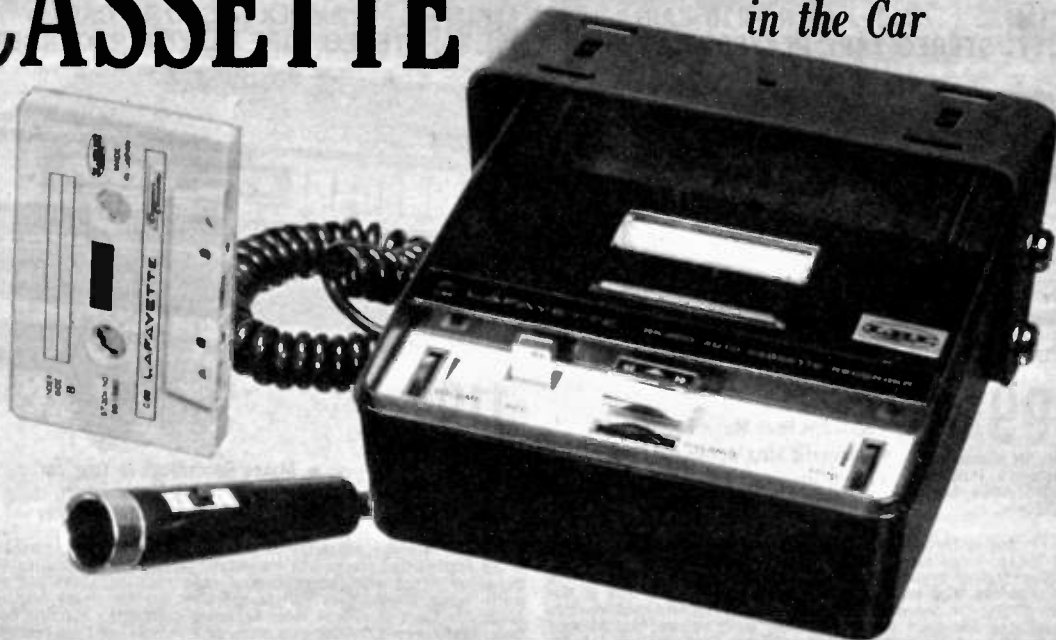

LAFAYETTE RK-200 CASSETTE STEREO TAPE SYSTEM

Stereophonic Playback
Monaural Record

ONLY **79⁹⁵**
less speakers
No Money Down*

- Reliable Space Age Solid-State Circuitry
- Compact Design For Easy Mounting in Dash or Console
- Fast-Forward and Rewind Lever Control
- Separate Balance, Volume, and Tone Controls
- Up To 120 Minutes Record Time
- No Tape Threading—Simple To Use



STEREO SOUND Wherever You Travel in Your Car!

Enjoy concert hall stereo sound reproduction in the comfort of your car. Lafayette's stereo cassette tape system provides 4-track stereo playback as well as 2-track monaural record. Fast-Forward and Rewind lever control allows you to choose the exact selections on a tape. Dependable solid-state circuitry provides outstanding, reliable performance. Convenient ONE-LEVER operation for Start, Stop, Fast-Forward, and Rewind. Stereo balance control adjusts stereo separation through left and right channels. Also features Record safety button, automatic stop at end of tape and plastic

slide door. Includes: Remote Control Start/Stop Mike with spiral retractable cord; adjustable gimble mounting bracket and hardware that permits unit to easily mount in any car dash or console, truck, or boat; and blank 60 minute-tape cassette. For 12VDC, negative ground systems. Uses AC bias erase. Tape speed 1 7/8 ips. Size: 7x8 1/4x4". Imported. Shpg. wt., 5 lbs. Net 79.95
99 E 15737
Deluxe Set of 2 Rear Deck Matching Speaker Systems. Net 9.95
99 E 62986 Imported. Shpg. wt., 4 lbs.

DELUXE Norelco "2602" AUTOMOBILE STEREO CASSETTE PLAYER

Only **119⁹⁵**
less speakers

- Fast Cassette Forward/Rewind
- Automatic Stop at End of Tape

Plays 4-track stereo, or 2-track mono at 1 7/8 ips... up to 1 hour playing time each side. Reliable solid-state circuitry. Controls for Fast Forward/Rewind, Balance, Cassette Eject, Bass/Treble, Volume. Response: 60 Hz to 10 kHz. 8-watts power. For 12VDC (neg. gnd. system). Simple under dashboard mount. Includes adjustable mounting bracket. Imported from Holland (less speakers).

27 E 48317 WX Shpg. wt., 4 lbs. No Money Down* Net 119.95
99 E 62986 Set of Two Rear Deck Speakers. Wt., 4 lbs. Net 9.95



* See Page 11 for Full Credit Details on Easy Pay Plan

Solid-State Stereo Cassette Player/Recorders for the Car

NEW! Lafayette RK-210 CAR
STEREO TAPE PLAYER/RECORDER



Push-In Front Loading of Cassette Tapes

99⁹⁵

With All Mounting Hardware, Remote Control Mike, Less Speakers.

- 20 Watts Peak Music Power
- Automatic Stop/Automatic Eject
- Pushbutton Fast Forward and Rewind

Full Feature instant-on solid state cassette car stereo tape player with built-in monaural recording system. Operates with any 12 volt negative ground system. Designed for convenience—front loading tape insertion with automatic stop and ejection when tape is finished playing or recording. Pushbutton fast forward and rewind. Manual stop and eject button. Separate tone, volume, and balance controls. Record safety button and indicator light. Built-in ALC for record. Professional AC record bias system. Plays-back 4 Track 2 channel stereo; Records 2 Track monaural. Channel Separation 30 db. Power Output—20 watts peak per channel. Includes mounting bracket, hardware, and remote control mike with suction cup stand. Size: 8 $\frac{1}{2}$ " x 8 $\frac{3}{4}$ " x 3". Shpg. wt., 7 lbs. Imported.

99 E 15802WX Net 99.95
Deluxe Set of 2 Lafayette Rear Deck Matched Speakers. Net 9.95
99 E 62986 Imported. Shpg. wt., 4 lbs. Net 9.95

NEW! AMPEX MICRO-42 CAR
STEREO TAPE PLAYER/RECORDER



119⁹⁵

with all mounting hardware Less Speakers

- Makes Recordings In Your car
- 20-Watts Peak Music Power
- Unique Slide-Out Storage Tray

Enjoy your favorite cassettes in your automobile. Instant playback of all pre-recorded stereo and monaural cassette tapes, plus instant monaural record with remote control mike supplied. Gives you 20-watts music power. Uses slot load system for fast, easy loading. Automatic eject at end of tape. Recessed pushbutton function controls: Fast-Forward, Rewind plus drum-style Volume and Tone controls. Has pilot light and separate record indicator light. Slim-line style blends with any car interior. Slide-out storage tray holds microphone and 4-cassette tapes. For 12VDC negative ground systems. Mounting bracket and all hardware supplied. Size: 9 $\frac{1}{2}$ "x4 $\frac{1}{2}$ "x9"^D. Shpg. wt., 7 lbs.

17 E 57004WX No Money Down* Net 119.95
Deluxe Set of 2-Rear Deck Matched Speaker Systems. Imported. Net 9.95
99 E 62986 Shpg. wt., 4 lbs. Net 9.95

Solid-State Stereo Cassette Players for the Car

NEW! AUTOMATIC CRS-9440
CAR STEREO CASSETTE PLAYER



79⁹⁵

with mounting hardware Less Speakers

- For 12V., Neg. Ground Systems
- Fast-Forward and Reverse
- Thumbwheel Type Safety Controls

Compact stereo cassette tape car player. Produces 8 watts stereo music power. Plays standard monaural or stereo pre-recorded cassette cartridges at 1 $\frac{7}{8}$ ips. Features ultra-modern, solid-state circuitry, plus thumbwheel type Volume, Balance, and Tone controls which conform to latest auto safety standards. Fast-Forward—Reverse controls permit rapid, manual choice of different selections. Operates on any 12-volt, negative ground electrical source. Beautiful chrome face panel with jet-black trim. Comes complete with mounting bracket. Size: 6 $\frac{1}{2}$ "x7 $\frac{1}{2}$ "x2 $\frac{3}{4}$ "H. Imported. Shpg. wt., 10 lbs.

17 E 26363WX No Money Down* Net 79.95
Set of 2-Lafayette 3x5" Matching Rear Deck Speakers. Net 6.95
99 E 62994 Shpg. wt., 3 lbs. Net 6.95

NEW! SONY/SUPERSCOPE TC-20
CAR STEREO CASSETTE PLAYER



119⁹⁵

with mounting hardware head cleaning pencil Less Speakers

- Automatic Cassette Eject
- Tone Control
- Pushbutton Operation

Deluxe stereo playback car cassette system. Features single action "Letter-Box loading." Provides instant playback at a power output of 6-watts per channel. Cassettes can be ejected either automatically or manually. Has push-button "Fast-Forward" and "Rewind"; Volume, Stereo Balance and Tone controls. SPECIFICATIONS: Frequency Response 50-10,000 Hz; Wow/Flutter 0.28%; Signal-to-Noise Ratio 45 db; Tape Speed 1 $\frac{7}{8}$ ips. Switchable for negative or positive ground 12VDC electrical systems. Complete with mounting bracket, hardware and head cleaning pencil. Size: 7 $\frac{1}{2}$ "x2 $\frac{1}{2}$ "x8 $\frac{1}{4}$ ". Imported. Shpg. wt., 8 lbs.

17 E 50017WX No Money Down* Net 119.95
Deluxe Set of 2-Rear Deck Matched Speaker Systems. Imported. Net 9.95
99 E 62986 Shpg. wt., 4 lbs. Net 9.95

LAFAYETTE Pre-Recorded Long-Play Stereo Cassette Tapes



YOUR CHOICE **295** each

Playable On Stereo or Monaural Equipment

*Includes Side A and B



STOCK NO.	DESCRIPTION	STOCK NO.	DESCRIPTION
CLASSICAL MUSIC		MOVIE and BROADWAY SHOW MUSIC	
28 E 41013L	1812 Overture/Russian Eastern Overture/Polovetsian Dances/A Night On Bald Mountain—Vienna Symphony Orchestra. Playing Time* 55:36.	28 E 41088L	Gershwin's Rhapsody in Blue—American In Paris—London Pops Orchestra. Playing Time* 30:79.
28 E 41021L	Bolero/Espana Rapsodie/The Sorcerer's Apprentice/Afternoon of a Faun—Vienna Symphony Orchestra. Playing Time* 44:28.	28 E 41096L	Hits from: My Fair Lady—Camelot—GIGI—Sound of Music—Hollywood Radio City Orchestra and Chorus. Playing Time* 26:35.
28 E 41039L	Beethoven:—Piano Concerto #5 (Emperor) Alfred Brendel Soloist, Pro Musica Orchestra, Vienna. Playing Time* 38:43.	28 E 41104L	Hits from Oklahoma—South Pacific—King & I—Flower Drum Song—Hollywood Radio City Orchestra and Chorus. Playing Time* 26:06.
28 E 41435L	Beethoven: Symphony No. 5. Cento Soli Orchestra of Paris. Playing Time* 26:36.	28 E 41112L	Hits from Music Man—Can Can—Porgy & Bess—Showboat—Hollywood Radio City Orchestra and Chorus. Playing Time* 26:36.
28 E 41450L	Beethoven: Symphony No. 6. "Pastoral", Vienna Symphony Orchestra, Klemperer, Cond. Playing Time* 42:31.	28 E 41120L	Around the World in 80 Days—Robert Fielding Orchestra. Playing Time* 27:22.
28 E 41443L	Beethoven: Symphony No. 7. London Symphony, Van Remoortel, Cond. Playing Time* 33:44.	28 E 41138L	Hollywood Strings Play Rogers & Hammerstein. Playing Time* 28:46.
28 E 41047L	Tchaikovsky: Nutcracker Suite: Weber: Invitation to the Dance—Bamberg Symphony Orchestra. Playing Time* 31:06.	28 E 41146L	Hollywood Strings Play Irving Berlin. Playing Time* 28:19.
28 E 41062L	Tchaikovsky: Symphony No. 6 "Pathetique" Hollreiser, Conductor—Filarmonica Triestina. Playing Time* 44:00.	28 E 41229L	Great Movie Themes—London Pops Orchestra—Exodus, Around the World in 80 Days, Picnic, Moulin Rouge, Merry Widow. Playing Time* 28:51.
28 E 41377L	Tchaikovsky: Sleeping Beauty—Swan Lake Ballet Suites, Vienna Symphony Orchestra. Playing Time* 39:02.	28 E 41260L	Hits from Fiddler On The Roof, West Side Story, Pal Joey—Hollywood Radio City Orchestra and Chorus and London Pops Orchestra. Playing Time* 27:53.
28 E 41054L	Rachmaninoff: Piano Concerto #2—Tchaikovsky: Piano Concerto #1—Felicia Blumental Soloist, Orchester Der Wiener Musikgesellschaft. Playing Time* 61:35.	POPULAR, FOLK, JAZZ, ROCK	
28 E 41070L	Grieg: Peer Gynt Suites—Bizet: L'Arlesienne Suites, Bamberg Symphony Orchestra. Playing Time* 49:20.	28 E 41153L	Mardi Gras Time with the Dukes of Dixieland. Playing Time* 36:51.
28 E 41344L	DeFalla: The Three Corned Hat: Vienna Symphony Orchestra. Playing Time* 38:35.	28 E 41161L	Percussion Espanol—Charlie Fox and Orchestra—Hoot Blues; Guajira, Holiday, Hollywood Cha-Cha, Minor Mambo, plus other selections. Playing Time* 28:18.
28 E 41351L	Liszt: Piano Concerto No. 1 & No. 2. Alfred Brendel, Soloist—Pro Musica Orchestra, Vienna. Playing Time* 37:18.	28 E 41179L	Big Band Percussion—Francis Bay and Orchestra—When Your Lover Has Gone, The Song Is You, As Time Goes By, Bye-Bye Blackbird plus other selections. Playing Time* 27:14.
28 E 41369L	Mendelssohn: Symphony No. 4 "Italian"—Tchaikovsky: Capriccio Italien—Orch. Der Wiener Musikgesellschaft. Playing Time* 41:29.	28 E 41187L	Andre Previn Plays: I've Got A Feeling I'm Falling, Black and Blue, Gypsy Dance, Honey Suckle Rose plus other selections. Playing Time* 25:54.
28 E 41385L	Brahms—Dvorak: Hungarian and Slavonic Dances, Bamberg Symphony Orchestra; Perlea, Cond. Playing Time* 39:12.	28 E 41195L	Herbie Mann—Hi Flutin—Herbie's Buddie; Perldo, Baubles, Bangles & Beads, Give A Little Whistle, plus other selections. Playing Time* 32:17.
28 E 41468L	Rossini "William Tell" and other Famous Overtures, Bamberg Symphony Orchestra, Perlea, Cond. Playing Time* 50:22.	28 E 41203L	John Gary—New Singing Sensation—How Many Tears Must I Shed, One Last Night Together, How Can My Heart Forget You, Little People, plus other selections. Playing Time* 26:08.
28 E 41476L	Berlioz: Symphonie Fantastique, Bamberg Symphony Orchestra, Perlea Cond. Playing Time* 54:28.	28 E 41211L	Go Go Discotheque—The Kites—Stomp (Frog), No More (Jerk), Watusi Ball (Watusi), Monkey Mash (Monkey), Baby Love Me More (Hully Gully), plus other selections. Playing Time* 24:38.
OPERA		28 E 41237L	Rock & Roll Guitar—Rhythm Rockers—Guitar Boogie, Moon Rock, 120 MPH, String Blues, Chick's Song, Picking and Rooking, plus other selections. Playing Time* 26:50.
28 E 41393L	Vocal Highlights from Aida, Soloists and Orchestra from the Milan Opera. Playing Time* 47:07.	28 E 41245L	Dancetime—Tribute To Glen Miller—Sleepy Town Train, In the Mood, American Patrol, Tuxedo Junction, Greensleeves, plus other selections. Playing Time* 26:40.
28 E 41401L	Vocal Highlights from Madam Butterfly, Soloists and Orchestra from the Milan Opera. Playing Time* 41:24.	28 E 41266L	Pradomania — Francis Bay Orchestra — Pradomania Mambo No. 5, April In Portugal, Guaglione, Mangas plus other selections. Playing Time 27:00.
ORCHESTRATION—BACKGROUND MUSIC		28 E 41294L	Salute to Benny Goodman by the members of the Benny Goodman Band—Jersey Bounce, and the Angels Sing, Let's Dance, Benny Rides Again plus other selections. Playing Time* 25:50.
28 E 41252L	Under Paris Skies—Roger Lecussand and His Club Lido Orchestra. Playing Time* 25:47.	28 E 41310L	Guadalajara Brass—Zorba the Greek, Whipped Cream, A Taste of Honey, plus other selections. Playing Time 22:16.
28 E 41278L	The Brave Bulls—La Orchestra de la Plaza De Toros. Playing Time* 25:01.	28 E 41328L	Psychedellic Rhythm—The Cross Fires, Anna, Highland Guitlar, Third Man Cha, Cha, Cha, Taboo plus other selections. Playing Time 28:20.
28 E 41302L	Tribute to Mantovani by the Hollywood String—Lovers of Paris, Lover's Waltz, The Golden Touch, Plus other selections. Playing Time* 24:50.	28 E 41336L	Folk Festival on Campus—The Minute Man, Song of Hope, California, Green Grow the Laurels, Scotch and Soda, I'm Comin Home. Playing Time* 34:10.
28 E 41419L	Great Million Sellers: Never on Sunday—Los Espanoles, Vanity—Don Cherry, Peter Gunn—Embers & Candido, You Made Me Love You—Karin Chandier, Greensleeves—Joe Zawinul, plus 5 more hits. Playing Time* 24:03.	* Includes Side A & B	
28 E 41427L	Elegant Violins—The Philharmonic Strings, C'est Ci Bon, C'est Magnifique, Isle of Capri, If I Love Again, Lovers Theme, Brahms Waltz plus 5 more selections. Playing Time* 27:24.		

To Speed Your Mail Order—Please Give Your Zip Code Number

Lafayette Cat. No. 700 105

Accessories For Cassette Players and Recorders

NEW DELUXE CASSETTE TAPE CARRYING CASE

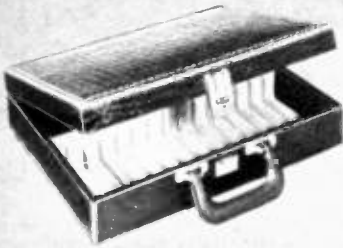

Only **7⁹⁵**

- Holds up to 30 Cassettes

Solid wood construction. Durable black alligator vinyl covering with attractive red plush interior. Horizontal storing of cassettes permits immediate visibility of all titles. Equipped with lock and key and handle. Shpg. wt., 3½ lbs.
28 E 78072 Net 7.95

CASSETTE TAPE CARTRIDGE STORAGE RACK

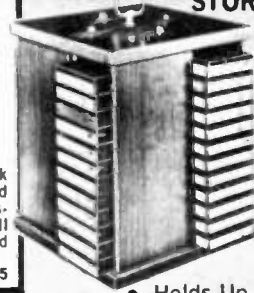

10⁹⁵

- Holds Up To 48 Tapes
- Lazy Susan Type Base

Attractively styled wood and masonite cassette cartridge storage rack with simulated walnut vinyl finish. Has "Lazy Susan" type base for easy access to your cassettes. Size: 7½x7½x10"H. Shpg. wt., 5 lbs.
28 E 78056W Net 10.95

SOLID STATE CASSETTE AM & FM RADIO TUNERS

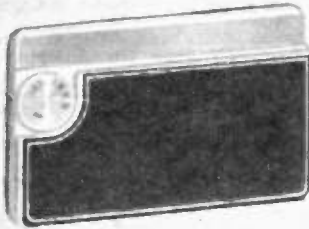

AM RADIO TUNER
6⁹⁵

FM RADIO TUNER
12⁹⁵

- Converts Most Cassette Tape Recorders and Players into a Sensitive Radio

Miniaturized, solid-state radio tuner circuit with self-contained battery (included). Same size as any standard impact break resistant case. Size: 4x2½x¾". Imported. Shpg. wt., ½ lb.

28 E 43019L AM Radio Tuner
28 E 43027L FM Radio Tuner

Net 6.95
Net 12.95

CASSETTE CARRYING CASE

- Holds 12 Cassettes



1⁹⁵

Black vinyl with chrome trim, shoulder strap, and spring snap lock. Dim.: 6½L x 5½H x 3"D. Shpg. wt., 1 lb.
28 E 27012 Net 1.95

CASSETTE TAPE HEAD CLEANER



1²⁹

Removes coating deposits from tape heads and restores both volume and high frequency response. For use in any player accepting cassettes. Simply run tape, impregnated with special formula, like regular tape cassette. Cleans in a couple of minutes. Can be reused many times. Shpg. wt., 6 oz.

28 E 16015 Net 1.29

CASSETTE TAPE SPLICER

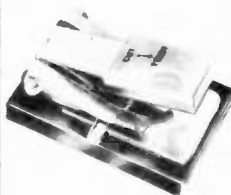

1⁹⁵

Sturdy precision instrument for use in all splicing and editing of cassette tapes. Shpg. wt., 8 oz.

28 E 78080 Net 1.95

UNIVERSAL CARRYING CASE for PORTABLE CASSETTE RECORDERS



2⁹⁵

• Measures 9½"Dx5¾"Wx2½"H
Durable black texon carrying case for most portable cassette recorders. Double adjustable strap. Shpg. wt., 1 lb.
† Inside Dimensions of Case.

28 E 27020 Net 2.95

PANASONIC 7270 PORTABLE CAR AM-FM RADIO/CASSETTE RECORDER



99⁹⁵

- Records And Plays Up To 120 Minutes on Cassette Tapes

With Remote Control Mike and Batteries

As a fine performing tape player/recorder

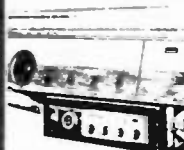

As a superb FM-AM radio

A complete portable entertainment center for portable or car use. Listen to superb standard FM and AM broadcasts—or enjoy hour after hour of fine music by simply inserting a pre-recorded cassette tape. You can also record your own music from the radio itself, or from an optional remote control mike. Recorder is easy to use—No tape threading. Features capstan drive—1½ ips. constant speed. Operates from any 6 or 12 volt car battery with accessory mounting bracket, or as a portable with 5 "D" batteries (included). Features 6" dynamic speaker for rich hi-fi sound, Ferrite core and built-in telescopic whip antenna, continuous tone control, AFC on FM, 2 watt output, dial light and vernier tuning. 17 transistors and 10 diodes. Dim. 11"Wx3½"Hx11"D. Shpg. wt., 10 lbs. Imported. With batteries. 17 E 30688WX No Money Down* Net 99.95

ACCESSORIES FOR 7270

Stock No.	Description	Shpg. Wt.	Net Ea.
17 E 3069W	Car Mounting Bracket with Lock	4 lbs.	19.95
17 E 31850	117 VAC Adapter, 6 oz.		Net 9.95
99 E 62564	Extra "D" Batteries—5 req.	2 oz.	15

Accessories For Car 8-Track and Cassette Tape Players

LAFAYETTE Speakers for 8-Track and Cassette Car Stereo Tape Players

"VARY-MOUNT" SPEAKER



Only
3⁹⁵

Deluxe flush-mounting speaker, with beautiful chrome grill. Ideal for use as an auto speaker or anywhere shallow depth is required. Full range speaker has heavy magnet and offers outstanding sound quality. Can also be used as a ceiling or wall mount speaker in your home. Imp., 8 ohms. Overall dia.: 6 1/4". Imported. Wt., 3 lbs. Net 3.95 99 E 01794

3x5" SET OF TWO UNDER-DASH MATCHING SPEAKER SYSTEMS

6⁹⁵

Two—3 x 5" wide-range ceramic speakers mounted in plastic housing will mount under dash, under seats, on kick panels, doors, or rear package shelf. Includes all necessary cables and mounting hardware. Imported. Shpg. wt., 3 lbs. Net 6.95 99 E 62994

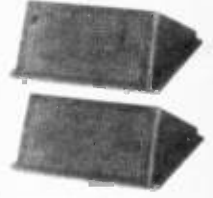

CUSTOM IN-DOOR SET OF 4 SPEAKERS AND MATCHING GRILLES



8⁹⁵

Ready for quick installation. Improves the sound and performance of any car tape player. Kit includes: Four 4 3/4" extended range 8-ohm PM speakers; four round custom mount plastic speaker grilles; all necessary hook-up wire with solderless connectors; mounting hardware and easy-to-follow instructions. Imported. Shpg. wt., 3 lbs. Net 8.95 99 E 62861

DELUXE SET OF TWO REAR DECK MATCHING SPEAKER SYSTEMS

- 5 Watts Peak Handling Power

Set of two powerful 4" speakers mounted in handsome ebony plastic cabinets with silver trim! Specially designed to mount on car's rear deck. Can also be surface mounted anywhere. Provides outstanding sound reproduction. Includes all necessary cables and mounting hardware. Imported. Shpg. wt., 4 lbs. Net 9.95 99 E 62986



9⁹⁵

UNIVERSAL LAFAYETTE HOME POWER SUPPLY FOR CAR TAPE PLAYERS

NEW
16⁹⁵

- Converts 117 VAC to 12 VDC

Play your 8-Track car stereo tape player in your home or office on household current. Converts 117VAC to 12VDC. 4.5 amp output. Very low ripple. Grey hammertone metal cabinet. On/off switch. For 117VAC 60 Hz. 17 E 01853 Net 16.95



AUTOMATIC FMX-8401 UNIVERSAL FM STEREO TUNER CARTRIDGE

NEW
54⁹⁵

No Money Down*

- Converts 8-Track and Compatible 4 and 8-Track Car Tape Players into an FM Stereo Radio

Listen to rich stereo FM radio broadcasts in your car. Will operate without modifications to your present car tape player. Stereo Beacon light indicates when an FM stereo program is being broadcast. Features roll tuner for smooth, accurate station selection. Solid state circuitry with 14 transistors and 14 diodes for optimum sensitivity and selectivity. Also provides excellent reception of monaural FM broadcasts. AFC provides drift-free performance. Operates on 12 VDC negative ground car battery electrical source. With antenna lead. Size 4L x 7D x 1 1/2"H. Imported. Shpg. wt., 1 lbs. Net 54.95 17 E 26348L



MOBILE BURGLAR ALARM FOR CAR TAPE PLAYERS AND RECORDERS

Only **4⁹⁵**

- Prevents Theft of Your Player
- Solid State Integrated Circuit
- For 12 V. Negative or Positive Ground

Protect your car tape player. Burglar alarm connects to your horn and tape player. Horn automatically blows when someone tries to steal your player. Two-way switch permits you to remove your player without sounding alarm. Features reliable, solid-state IC circuitry. Complete with instructions, wire and mounting hardware. Shpg. wt., 3 oz. Net 4.95 42 E 71011



AUTOMATIC "UNIVERSAL" AM/FM TUNER CARTRIDGE

43⁹⁵

No Money Down*

- Converts 8-Track and Compatible 4 & 8-Track Tape Players Into High-Fidelity AM / FM Receivers

Now listen to all your favorite radio news, music, and information programs on your cartridge tape player. True, high-fidelity reception through your car or home system with this quality AM/FM tuner cartridge. No modification of your tape player is required. Solid-state tuner features AFC and 4 FM IF stages, AVC on AM, and a precision slide-rule dial. Power for the tuner cartridge is provided by the player itself. With antenna lead. Size: 6 1/2L x 4W x 1 1/2"H. Imported. Shpg. wt., 1 lb. Net 43.95 17 E 26256L



"STEREO 8" TAPE CARTRIDGE PLAYER HEAD DEMAGNETIZERS

As Low As **3⁵⁰**



Maintain the sound quality of your tape player. Prevents background noise and sound distortion. For car tape players—helps prevent strong magnetic fields from (generator, starter, etc.) distorting part of your tapes. Imported. Shpg. wt., 1 lb. Net 4.25 28 E 78023 For Car Players—Plugs into Lighter Net 4.25 28 E 78031 For Home Players—For 115 volts 60 Hz. Net 3.50 17 E 26173L

* See Page 11 for Full Credit Details on Easy Pay Plan

Our Best Selling 8 Track Car Stereo Tape Players

RANGER 4 AND 8-TRACK SOLID STATE CAR STEREO TAPE PLAYER

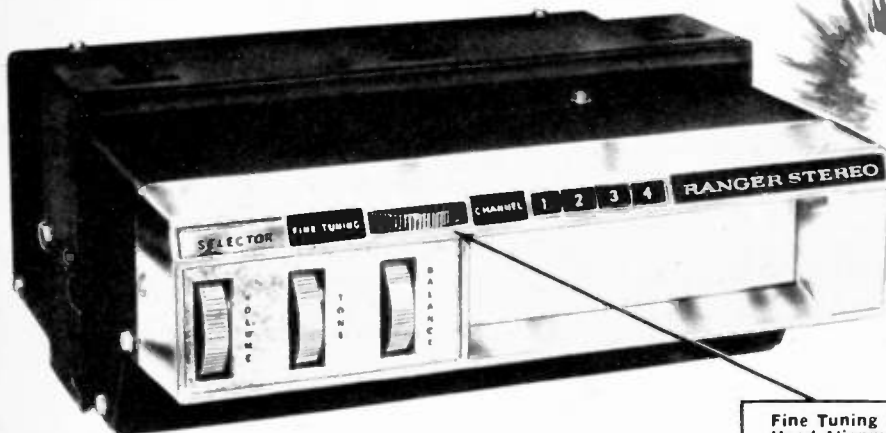

with Built-In
**BURGLAR
ALARM**

79⁹⁵

Less Speakers
No Money Down*

Fine Tuning Control For Precision
Head Alignment with the Tape

- For All 12 Volt Neg./Pos. Ground Car Systems
- Thumbwheel Type Control Knobs Conform With Federal Safety Regulations

- Fully Automatic—Instant Operation
- Illuminated Channel Indicator Light

A fully automatic 4 and 8-track stereo tape player with exclusive fine tuning control and built-in Burglar Alarm. Any attempt by unknown persons to remove a properly installed player will result in setting off the built-in alarm system—continuous horn blowing to scare the would-be thief away. Handsomely styled in black and chrome, this compact unit measures only 2 7/8 x 7 7/8 x 8" and can be easily mounted under the dash of your car with attached universal bracket. Fully automatic—no switches or lever to select choice of cartridge. Either 4 or 8-track cartridge slips in easily and plays instantly. Provides superb tape reproduction. Removal of cartridge automatically switches player off. Fine tuning control tunes out undesirable crosstalk in worn or defective 8-track cartridges by ad-

justing the playback head to precision alignment with the recorded tracks. Illuminated channel indicator shows channel that is playing. Channel changes automatically after each program by instantly operating the selector bar. Specifications: Peak Audio Output: 20 watts; Impedance: 4 ohms each channel; Transistors: 12; Thermistors: 4; Battery drain: .75 amp; Dual Tone Control. For 12 volt neg./pos. ground. Imported.

17 E 74496WX Shpg. wt., 12 lbs.	Net 79.95
Alternator Noise Filter for above Ranger Tape Player	
17 E 74223 Shpg. wt., 4 oz.	Net 1.25
Set of 2 Matched Lafayette Car Speaker Systems	
99 E 62994 Shpg. wt., 2 lbs.	Net 6.95

AUTOMATIC 8-TRACK CAR STEREO TAPE CARTRIDGE PLAYER WITH BUILT-IN FM STEREO RADIO



119⁹⁵

Less Speakers
No Money Down*

FM STEREO CAR RADIO

STEREO 8-TRACK CAR PLAYER

- Instant on Solid State Circuitry

- For all 12 Volt Neg. Ground Car Systems

Wherever you travel in your car, enjoy the full dimension and "live" reality of either 8-track STEREO TAPE or FM STEREO MULTIPLEX RADIO as well as FM monaural broadcasts. Plays all 8-track stereo tape cartridge and any 4-track tape cartridge with an adapter. You can also listen to standard AM broadcasts with an optional AM tuner pack. For instant music—just slip in a cartridge . . . automatically your car is filled with any kind of tape entertainment you select . . . jazz, pop, classical. Modern, solid-state circuitry insures reliable, outstanding performance. Features a tape channel indicator, channel selector button, plus an FM stereo indicator and separate balance and tone controls. Tape speed: 3 3/4 IPS. Operates on 12 VDC

neg. ground. Power output: 8-watts, Frequency range: 60-12,000 Hz. FM section features 4 tuned IF stages. Size: 2 1/2 x 7 1/2 x 7" D. Complete with adjustable mounting bracket and all mounting hardware. Imported. Shpg. wt., 13 lbs.

17 E 26231WX	Net 119.95
Set of 2 Matched Lafayette Car Speaker Systems.	
99 E 62994 Shpg. wt., 21 lbs.	Net 6.95
AM RADIO TUNER CARTRIDGE 5 Semiconductors. Slide-rule Illuminated Dial. Imported. Shpg. wt., 1 lb.	
17 E 26050L	Net 24.95

NEW 8-Track Stereophonic Tape Players for 1970

Automatic 8-Track Solid-State Stereo Car Tape Player

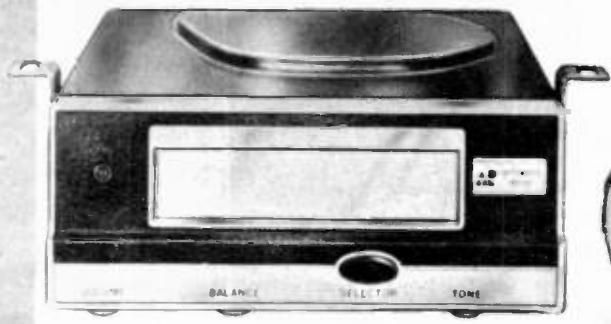

Compact, Ultra-Modern 8-Track Solid-State Stereo Car Tape Player



49⁹⁵
Less Speakers

- Simple Installation
- Automatic and Manual Channel Selection
- Reliable Solid-State Circuitry

Compact car stereo tape player with attached mounting bracket for quick and easy installation under the dash. Plays 8-track stereo tape cartridges as well as 4-track tape cartridges with optional adapter listed below. Solid-state circuitry for instant on operation. Operates reliably on any 12-volt negative ground electrical source. Thumb-dial Volume, Tone, and Balance controls. Manual or automatic channel selection. Complete with all mounting hardware. Size: 10x10x7". Imported. Shpg. wt., 10 lbs. Less Speakers.

17 E 26355W No Money Down*	Net 49.95
99 E 15745 4-Track Tape Cartridge. Wt., 6 oz.	Net 2.95
Set of 2-Lafayette Matching Car Speaker Systems.	
99 E 62994 Shpg. wt., 3 lbs.	Net 6.95

54⁹⁵
Less Speakers

- Ideal For Sports Car Installations
- For 12-Volt Negative Ground Systems
- Beautiful Black Molded Case

Fully automatic—simply insert an 8-track cartridge for instant stereo sound. Compact ultra-modern styling allows easy installation in the smallest areas, even glove compartments. Precision engineered solid-state stereo circuitry. Separate Volume, Balance, and Tone controls. Automatic channel selector button. Heavy-duty black and chrome custom molded case. Powerful 12-transistor, 10-watt stereo amplifier. For 12-volt negative ground systems. With mounting bracket and hardware. Size: 6½x6¾x2½"D. Imported. Shpg. wt., 6½ lbs. Less Speakers.

17 E 49027W No Money Down*	Net 54.95
Set of 2-Lafayette Matching Car Speaker Systems.	
99 E 62994 Shpg. wt., 3 lbs.	Net 6.95

MINI Ranger 4 and 8-Track Solid-State Stereo Car Tape Player



Theft-Proof

69⁹⁵
Less Speakers

- Built-in Burglar Alarm System
- Fine Tuning Control
- For 12-Volt Negative Ground Systems

Fully automatic—instantly plays 4 or 8-track tape cartridges. Ideal for cars where space is at a premium. Theft-proof with built-in burglar alarm system. Fine Tuning control tunes out undesirable crosstalk in worn or defective cartridges by adjusting the playback head to align with the recorded tracks. Thumbwheel control knobs. Channel selector button with universal mounting bracket and hardware. For 12V., negative ground systems. Size: 5¾x5x8". Imported. Shpg. wt., 8 lbs. Less speakers.

17 E 74520W No Money Down*	Net 69.95
Set of 2-Lafayette Matching Car Speaker Systems.	
99 E 62994 Shpg. wt., 3 lbs.	Net 6.95

Deluxe Lear-Jet 8-Track Solid-State Stereo Car Tape Player

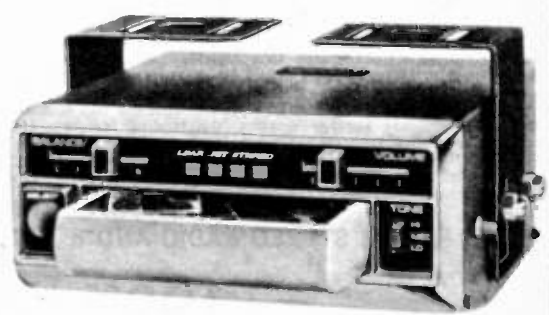

79⁹⁵
Less Speakers

- Unique Visible Indicating Slide Switches for Balance and Volume
- Lighted Channel Indicators
- Pushbutton Channel Selector

Surround yourself with rich, full-dimensional, 8-track stereo tape cartridge entertainment wherever you drive. Truly reliable solid-state circuitry. Deluxe sliding control switches for precise visible stereo separation (Balance), and visible sound level indication. Separate variable Tone control. Pushbutton program selector. Lighted program indicators. 12-transistors, 1-diode, 4-thermistors. Peak Power Output: 16-watts. For 12V., negative ground electrical systems. Size: 6¼x7Dx3"H. Imported. Shpg. wt., 7½ lbs. Less Speakers.

17 E 16034WX No Money Down*	Net 79.95
Set of 2-Lafayette Matching Car Speaker Systems.	
99 E 62994 Shpg. wt., 3 lbs.	Net 6.95

* See Page 11 for Full Credit Details on Easy Pay Plan

NEW LAFAYETTE LR-808

3-Band Stereo FM/AM/SW Modular Hi-Fi Receiver

with Built-In 8-Track Stereo Cartridge Tape Player

ONLY **169⁹⁵**
In Handsome 3 Piece
Walnut Wood Cabinetry

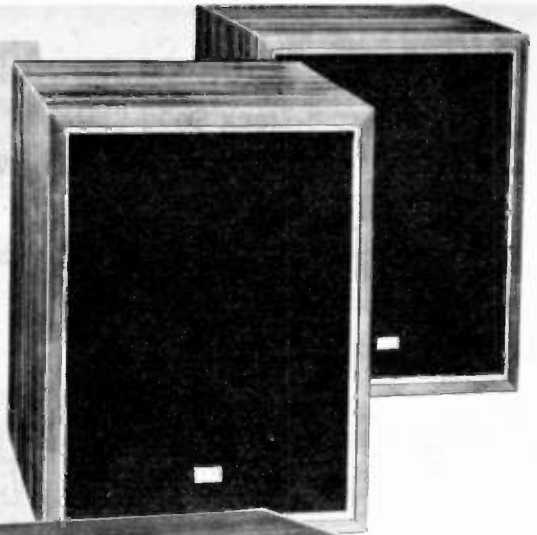

- Instant-on Space Age Solid-State Circuitry
- Power Output: 36-Watts
- Illuminated Tuning Dial
- Front Panel Stereo Headphone Jack
- Built-in AM, FM, SW Antennas

- 8-Track Channel Selector Button
- Channel Indicator Light
- FM Stereo Indicator Light
- Each Speaker Enclosure Contains a 6" Woofer and 3½" Tweeter

Magnificent solid state 8 track hi-fidelity home entertainment center. Play prerecorded 8-track stereo tape cartridges through the tape player. Listen to standard AM/FM and FM stereo radio broadcasts. Tune-in on exciting international shortwave broadcasts on the 4-12 MHz SW band. Thrill to "concert hall" sound from the two acoustically balanced 2-way speaker systems. Outstanding features: FM stereo indicator light, separate volume, balance, bass, and treble controls, On/Off loudness switch, 6 position selector knob, tuning meter, lighted tape cartridge channel indicator; front panel stereo

headphone jack, stereo output jacks for external tape recorder, phono input jacks for record changer with ceramic cartridge, built-in AM and FM/SW antennas with provisions for external SW and FM antennas. Power Output — 36 watts. FM sensitivity — 4 μ v. Stereo separation — 26 db. Frequency response — 30-20,000 Hz. UL listed. Oiled walnut wood cabinetry. Size: Control Unit — 19¾ x 10½ x 4¼"; each speaker enclosure 13½ x 10 x 7½". Imported. Shpg. wt., 20 lbs.

17 E 01846WX No Money Down* Net 169.95

PANASONIC RE-7070 "THE SYMPHONY 8" SOLID STATE FM/AM STEREO RADIO AND 8 TRACK STEREO TAPE CARTRIDGE PLAYER

199⁹⁵ No Money
Down*



- Matched Twin Speaker Systems
- FM Stereo Indicator Light
- Black-out Dial
- Pushbutton Channel Selector

Quality performing home entertainment center! Plays 8-track stereo tape cartridges as well as your favorite FM stereo, FM, and AM broadcasts. Glorious wide-range sound reproduction from 4 perfectly balanced speakers in separate enclosures. Radio section features: Black-out dial . . . illuminating when it's on; separate Bass and Treble tone controls, stereo balance control, illuminated band selector, stereo indicator, AFC on FM, tuned RF stage for FM, phono input jack,

plus built-in FM and AM antennas. 8-track cartridge player features pushbutton channel selector, headphone jack . . . requires no tape threading or rewinding. Speaker and control center in handcrafted rich walnut. 18W music power, 41 solid state devices. Size: Amp: 18½W x 6¾ x 11½" D; Speaker: 9¾W x 8¾H x 3¾"D. Imported. Shpg. wt., 31 lbs.

17 E 30746WX Net 199.95

Solid State Home 8-Track Stereo Playback Decks & Systems

NEW CRAIG 3204 8-TRACK STEREO CARTRIDGE PLAYBACK SYSTEM

- Walnut Finish Cabinet with Matching Speaker Enclosures

Deluxe Solid State Stereo 8-track tape cartridge system that operates independently of other equipment. Features fully automatic cartridge and track selection and "E-Z-Ject" cartridge release button for convenient tape changing. Pushbutton program selector for tracks 1 thru 4. Illuminated program indicators visually shows which channel is playing. Separate tone, volume, and balance controls for maximum versatility. SPECIFICATIONS: Power output: 12 watts peak, 6 watts each channel. Freq. response: 70-10,000 Hz, channel separation: 35db. 2 acoustically matched high compliance speaker systems. Playing time up to 80 minutes. 13 transistor and 4 diode circuitry. Size: control unit: 9½Wx4Hx11½"D. each speaker system: 9½wx11½Hx4½"D. Imported. Shpg. wt., 23 lbs. 27 E 27121WX Net 99.95



Only
99⁹⁵
No Money Down*

PANASONIC RS-802US 8-TRACK STEREO TAPE CARTRIDGE PLAYBACK DECK

- Plays 8-Track Pre-Recorded Tape Cartridges Thru the Stereo Amplifier of Your Hi-Fi System

Solid state 8-track home cartridge deck with advanced IC circuitry. Built-in dual pre-amplifier permits use with any stereo amplifier or receiver having an "Auxiliary" input jack. Simple push-button channel program selector. 4 easy-to-read illuminated channel indicators that individually light-up to quickly show you the exact channel you are listening to. Decorator styled in tasteful walnut grain finish metal cabinet with silver control panel. For 117 VAC, 60 Hz. Size: 8¼W x 4¼H x 9¾"D. Imported. Wt., 7 lbs. 17 E 31504 W Net 49.95

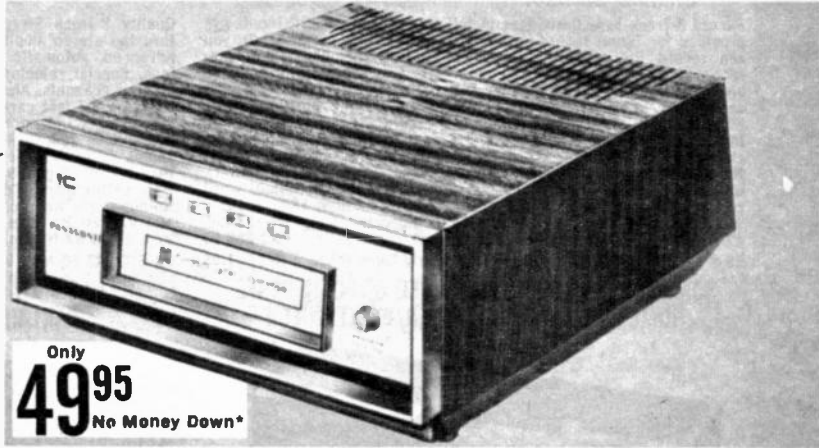

Only
49⁹⁵
No Money Down*

NEW LEAR JET H-310 8-TRACK STEREO TAPE CARTRIDGE PLAYBACK DECK



Oiled Walnut Wood Cabinet

only **59⁹⁵** Plays Thru Your Existing Home Stereo System

Enjoy the magic of long playing stereo 8-track tape cartridges brilliantly reproduced through the speakers and amplifier of your home stereo system. Automatically changes channels at end of each program, or you can manually select any channel at any time. Channel indicator lights show which channel is playing. All solid state circuitry. Handsome walnut wood cabinet. Size: 7¼Wx9¾Dx 3¼"H. For 115 VAC, 60 Hz. Imported. Shpg. wt., 8 lbs. 17 E 18067W Net 59.95

Lear Jet H-330 Home 8-Track Stereo Tape Cartridge Playback System. Same as above but with built-in power amplifier and matching twin speakers. Size: 6½Hx10½Dx24"L. Imported. Shpg. wt., 23 lbs. 17 E 18075WX No Money Down* Net 99.95

PANASONIC Model RS800US SOLID STATE 8-TRACK STEREO CARTRIDGE PLAYBACK DECK



Only **69⁹⁵** Oiled Walnut Wood Cabinet
No Money Down*

Handsomely styled, low profile solid state 8-track home stereo tape deck. Play all prerecorded 8-track tape cartridges through your existing hi-fi amplifier or receiver. Features pushbutton channel selector; lighted channel indicators; automatic or manual switching of channels. Oiled walnut wood cabinetry. 12-solid state devices. Dimensions: 16¼x4¼x8½". Imported. Shpg. wt., 9 lbs. 17 E 30530WX Net 69.95

Panasonic "Music Master 8" Solid State 8-Track Stereo Cartridge Playback System. Includes 2 separate decorator styled walnut speaker systems. Each contain a full range 6½" speaker. Features pushbutton channel selector with illuminated channel indicators, precision balance control, bass and treble control, and a stereo headphone jack. 16-watts peak music power. Dimensions, control unit — 16¼x4Hx9"D. Speakers — 8½Wx8¼Hx8½"D. Imported. Shpg. wt., 22 lbs. 17 E 30548WX No Money Down* Net 129.95

8-Track Stereo Tape Recorders and Tape Decks

NEW LEAR JET H-360 SOLID STATE 3-PIECE
8 TRACK RECORD/PLAYBACK SYSTEM



- Records in Stereo or Monaural on all 8 Tracks
- Dual VU Recording Meters
- Automatic and Manual Channel Selector

289⁹⁵
with 2 mikes

Record 8-Track Tape Cartridges in full stereo or monaural. Inputs are provided for Tuner, record changer, or another tape recorder. Or, you can record live with the 2 dynamic mikes included. Plays pre-recorded 8-track tape cartridges thru its two acoustically matched air-suspension speaker systems. Automatic and/or manual program selector. Fast forward for rapid selection of any portion of the tape. Stereo/Mono switch; Illuminated record light; Lighted channel indicators; Twin VU record meters; Stereo Balance, Bass and treble controls. Records 4 stereo or 8 individual monaural programs. Powerful 13-watts music power per channel. (52 watts Peak Music Power), inputs for phono, mic, aux. and tuner. Handsome walnut wood cabinetry. For 115 VAC, 60 Hz. Size: control section, 18½ x 5½ x 9½" D; each speaker, 8W x 8¾ D x 11" H. Imported. Shpg. wt., 23 lbs. 17 E 16042WX No Money Down* Net 289.95

28 E 17047 60 Min. 8-Track Cart. Recording Tape, 6 oz. Net 1.95

SONY/SUPERSCOPE TC-8 "STEREO 8" SOLID STATE HOME CARTRIDGE RECORDER/PLAYER DECK

NEW CRAIG 3302 SOLID STATE 8 TRACK
RECORDER/PLAYER DECK



Make Your Own Tapes
for the Car and the Home

119⁹⁵

Quality 8-Track Stereo Tape cartridge record/playback deck plays thru the stereo amplifier or receiver of your present home system. Advanced, automatic record level control for superb music recordings. Special selector provides automatic stop after one channel or all four channels. Also has provisions for automatic continuous play. Features E-Z-Ject cartridge release button, Record level meter, individual track indicator lights, and a pushbutton selector. Inputs for microphone and auxiliary high (1 Meg. ohms) and auxiliary low (20K ohms)...Frequency response: 50-10,000 Hz. Wow and flutter: less than 0.25%. Signal-to-noise ratio: better than 40 db. Stereo separation: better than 30 db. AC Bias record system, AC Erase. Handsome walnut finish wood cabinet. With all connecting cables. Operates on 120 VAC 60 Hz. Size: 9½W x 11½D x 4" H. Imported. Wt., 14 lbs. 27 E 27162WX No Money Down* Net 119.95

28 E 17047 60 Min. 8-Track Cart. Recording Tape, 6 oz. Net 1.95

DELUXE VIKING 811R 8-TRACK SOLID STATE HOME CARTRIDGE RECORDER/PLAYER DECK



129⁵⁰

Records and plays back
8-track cartridges
through your existing
stereo Hi-Fi System.

- Sony-Matic Recording Control
- Cartridge Alignment Indicator
- Automatic Shut-Off

Now, with the exciting Sony TC-8, you can select and record your own library of stereo 8-track cartridges for automobile and home use. Instantly connects to your home system for recording or playback. Features "Sonymatic" recording control which automatically adjusts recording level and indicates which tracks are being recorded. Perfect track alignment is assured by alignment indicator light, and automatic power mechanism which turns unit on only when cartridge is properly inserted and shuts it off at the end of the tape. Also has record interlock to prevent accidental erasure. Frequency Response: 40-12,000 Hz. Tape speed: 3¾ ips. Wow and Flutter: 0.32%. Dimensions: 12W x 8½H x 4½D. Imported. Wt., 11 lbs. 27 E 60346WX No Money Down* Net 129.50

28 E 17047 60 Min. 8 Track Cart. Recording Tape, 6 oz. Net 1.95

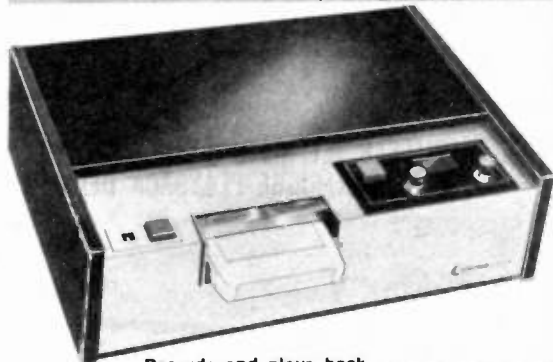

Records and plays back
8-track cartridges
through your existing
stereo Hi-Fi System.

169⁹⁵

- Individual Record Gain Control For Left And Right Channels
- Automatic Stop At End Of Any Single Track or Completion Of All 4-Tracks On Record Mode

High quality 8-track stereo tape cartridge RECORD/PLAYER deck in a handsome walnut cabinet with built-in record/playback pre-amp for use with existing stereo equipment in the home. Features a special Logic Circuit that permits choice of continuous play or auto-stop at end of tape in PLAY mode, and, allows choice of auto-stop at end of single track or completion of all 4-tracks in RECORD mode. Unit automatically plays when cartridge is inserted; has automatic pushbutton track selection; 40-15,000Hz response; 0.3% rms wow and flutter; numerical track indicator; VU meter; record button interlock, and pilot light. For 117VAC, 60 Hz. Size: 15¼ x 11 x 4". Shpg. wt., 26 lbs. 27 E 68091WX No Money Down* Net 169.95

28 E 17047 60 Min. 8 Track Cart. Recording Tape, 6 oz. Net 1.95

Model 811P—Portable, Self-contained, 8-Track, Stereo Tape Player only. With built-in power amplifier and two detachable speakers. Size: Player 15¼L x 11D x 4½" H. Speakers 10¾H x 7¾W x 3¾" D. Shpg. wt., 30 lbs. 27 E 68109WX No Money Down* Net 139.95

27 E 68109WX No Money Down* Net 139.95

8-Track Recording and Pre-Recording Tape Cartridges

8-Track Cartridge
Mylar Recording Tape

8-Track Test and Head Cleaning
Tape Cartridge

Deluxe 4 and 8 Track Tape
Cartridge Storage Rack

As Low As
1.75



1.49



10.95

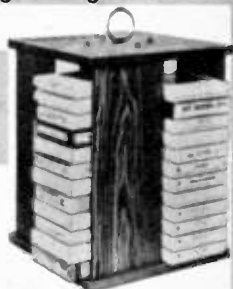

Continuous loop 8-track cartridges well lubricated to preserve tape life. Fits all standard 8-track recorders and players. With UNI-tension pressure pads, precision molded tape guide.

Stock No.	Recording Time	Wt.	Net
28 E 10315	30 Minute	6 oz.	1.75
28 E 17047	60 Minute	6 oz.	1.95
28 E 17039	80 Minute	6 oz.	2.25

3-In-1 Cartridge

- 1) Tests For Proper Head Alignment
- 2) Tests For Stereo Balance
- 3) Cleans Tape Head

Keep your stereo 8-track tape player sounding new with this professionally calibrated test tape. Cleans tape and restores full richness of tone. Checks for proper alignment of heads to eliminate crosstalk. Checks for proper equalization of channels. Shpg. wt., 6 oz.
28 E 92016 Net 1.49

- Holds Up To 48 Tapes
- Lazy Susan Type Base

Easy access to your 4 and 8-track tape cartridges. No more misplaced tapes. Attractively styled wood and masonite storage rack with simulated walnut vinyl finish. Has "Lazy Susan" type base. Holds up to 48 tapes. Size: 9½" W x 9½" D x 12½" H.
28 E 78049 Shpg. wt., 8 lbs. Net 10.95

LAFAYETTE 4-Track Tape Cartridge Adapter

- Permits 4-Track Tape Cartridges To Be Placed on 8 Track Tape Player

2.95

Universal adapter that turns any 4-track cartridge into an 8-track cartridge. Simply insert adapter into your 4-track cartridge—can easily be moved from cartridge to cartridge. Shpg. wt., 6 oz.
99 E 15745 Net 2.95



8-Track Tape Head Cleaning Cartridge

- Automatically Cleans Tape Head

99c

A must for removing coating deposits from tape heads to restore high frequency response and volume. For use in any 8-track player accepting 8-track cartridges. Easy to use and reuse. Simply run the cartridge for a short period.
28 E 12923 Shpg. wt., 8 oz. Net .99



LAFAYETTE PRE-RECORDED 8-TRACK STEREO TAPE CARTRIDGES

As Low As
2.95
ea.
*Twin Pack



- Beethoven Sym. No. 5 Cento Soil Orch. of Paris
28 E 40502L Shpg. wt., 8 oz. Net 2.95
- Beethoven Sym. No. 6 "Pastoral" Vienna Symphony, Orch. Klemperer Cond.
28 E 40510L Shpg. wt., 8 oz. Net 2.95
- Beethoven Sym. No. 7 London Sym., Orch. Van ReMoortel Cond.
28 E 40528L Shpg. wt., 8 oz. Net 2.95
- Berlioz Sym. "Fantastique" Bamberg Symphony, Orch. Perlea Cond.
28 E 40551L Shpg. wt., 1 lb. Net 3.29
- *1812 Overture, Russian Easter Overture, Polovetsian Dances, A Night on Bald Mountain. Vienna Symphony Orchestra.
28 E 40569L Shpg. wt., 1 lb. Net 3.29
- *Rachmaninoff Piano Concerto No. 2; Tchaikovsky Piano Concerto No. 1. Felicja Blumental solist. Orchestra Der Wiener Musikgesellschaft.
28 E 40577L Shpg. wt., 1 lb. Net 3.29
- *Offenbach—Galte Parisienne; Bizet—Carmen Suite; Ravel—Bolero, Cento Soil Orchestra of Paris. Shpg. wt., 8 oz.
28 E 40536L Shpg. wt., 8 oz. Net 3.29
- Brahms—Dvorak, Hungarian and Slavonic Dances. Perlea conductor. Bamberg Symphony Orchestra. Shpg. wt., 8 oz.
28 E 40544L Net 3.29
- Great Movie Themes—Exodus, Around the World in 80 Days, Picnic, Moulou Rouge, Merry Widow. London Pops Orchestra. Shpg. wt., 8 oz.
28 E 40585L Net 2.95
- Hits from Broadway Shows—My Fair Lady, Camelot, Gigi, Sound of Music, Hollywood Radio City Orchestra. Shpg. wt., 8 oz.
28 E 40593L Net 2.95

Popular Pre-Recorded Long Play 8-Track Stereo Tape Cartridges

Only **3.95**
ea.



- Pops, Country and Western**
- 28 E 44009 Today's Pops—Hey Jude; Those Were the Days; Abraham. Martin and John, plus 7 more.
28 E 44017 Nitty-Gritty Guitar of Mason Williams, Glen Campbell, Bill Strange, 12 String Guitar Band.
28 E 44025 Frank Sinatra—Nevertheless I'm in Love with You.
28 E 44033 Sergio Mendes Trio—So Nice.
28 E 44041 Nat King Cole—Love is a Many Splendored Thing.
28 E 44050 Nat King Cole—Stay as Sweet as You Are.
28 E 44066 Dean Martin—Young & Foolish.
28 E 44074 Dean Martin—I Can't Give You Anything But Love.
28 E 44082 Jackie Gleason—The More I See You.
28 E 44090 Pete Fountain—New Orleans Style.
28 E 44108 Harry James—You Made Me Love You.
28 E 44116 Glen Campbell—A Satisfied Mind.
28 E 44124 Jimmy Dorsey—Plays Bacharach/David.
28 E 44132 You're a Good Man Charlie Brown—"Bugs" Bower Orchestra & Ron Marshall Singers
28 E 44140 Finian's Rainbow—"Bugs Bower" Orchestra & Ron Marshall Singers.
28 E 44157 Parris Mitchell Voices—Mame, Fiddler on the Roof, Sweet Charity, Man of La Mancha.
28 E 44165 Hank Thompson—Simple Simon, Simple Heart.
28 E 44173 Hank Larklin—Queen of Hearts.
28 E 44181 Patsy Cline—I Can't Forget You.
28 E 44199 Tennessee Ernie Ford—I Can't Help It If I'm Still in Love with You.

Classicals

- 28 E 44207 Mozart—"Eine Kleine Nachtmusik," Handel—Water Music—Steinberg and Pitts. Symp. Orch.
28 E 44215 Rimsky-Korsakov—"Le Coq D'or," Prokofiev—"Love of Three Oranges"—Steinberg and Pitts. Symp. Orch.
28 E 44223 Beethoven Piano Concerto No. 5 "Emperor"—Firkusny Solist, Steinberg Cond.—Pitts. Symp. Orch.

Portable 8 Track Tape Players & Accessories

NEW "AUTOMATIC" PORTABLE AC/DC SOLID STATE STEREO 8 TRACK PLAYER

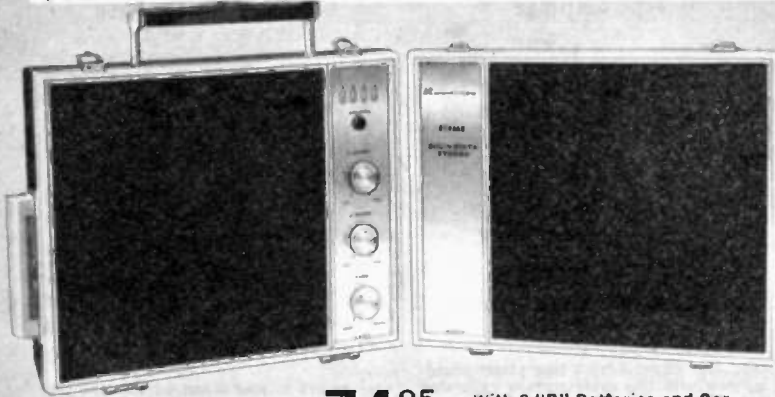

74⁹⁵ With 8 "D" Batteries and Car Cigarette Lighter Adapter

NEW "AUTOMATIC" PORTABLE 8-TRACK TAPE PLAYER



34⁹⁵ With 6 "D" Batteries and Car Cigarette Adapter

- 2 Quality Hi-Fi Speakers May Be Placed As Far as 5 Feet Apart From Each Other
- Enjoy 8 track stereo tape cartridges wherever you are. Attractive portable instant-on player operates on 117VAC home current or 8 "D" batteries. Cigarette lighter adapter cord permits use in cars and boats with 12V pos. or neg. ground electrical source. Separate left and right channel volume controls. Continuous tone control. 10 transistors, 4 diodes. 9"Hx11"Wx 6 1/4"D. Imported. Shpg. wt., 16 lbs.
 17 E 26322W No Money Down Net 74.95
 99 E 62564 Extra "D" Batteries, 8 required Net ea. .15

- Listen to 8 Track Tape Cartridges wherever you go

An exciting way to listen to 8-track stereo tape cartridges. Portable instant-on solid state tape player operates on 6 "D" batteries or may be plugged into the cigarette lighter of any car or boat with a 12V neg. ground electrical source. Continuous tone control and dynamic speaker for quality sound reproduction. Earphone jack for private listening. Channel indicator. Integrated carrying handle. Includes 6 transistors and 1 thermistor. 8"Hx 7"W x 3 1/4"D. Imported Shpg. wt., 7 lbs.
 17 E 26330 Net 34.95
 99 E 62564 Extra "D" batt. 6 req. Net ea. .15

NEW LEAR JET P-650 8 TRACK SOLID STATE STEREO TAPE PLAYER WITH BUILT IN AM/FM RADIO



99⁹⁵

Completely portable 8 Track Stereo Tape Player and AM/FM radio combination with matching high performance stereo speakers. Use it anywhere as a portable with batteries; in home or office with AC power cord; in boat or car with 12 V DC input. Detachable second speaker can be separated up to 6' for true wide range stereo sound. Automatic tape cartridges program selector and lighted program indicators. Full variable tone control and stereo balance control. AM radio section features 4 tuned circuits and AGC (Automatic Gain Control); FM radio section features 7 tuned circuits and AFC to eliminate drift. Telescoping FM antenna, built in AM antenna. 10Wx 5 3/8"D x 7 3/8"H. Uses 8 "C" batteries (not incl.) Imported. Shpg. wt., 10 lbs.
 17 E 16059W No Money Down Net 99.95
 99 E 62572 Net ea. .14

- Detachable Second Speaker for Wide Angle Stereo Sound

NEW! LAFAYETTE 8-TRACK TAPE HEAD DEMAGNETIZERS



3⁹⁵

A must for all owners of 8 track tape cartridge recorders and players. Removes excessive magnetic build-up on heads. Use after every 15 hours of player use. Shpg. wt., 1 lb. Imported
 For 117VAC Home Players Net 3.95
 99 E 15091
 For 12 VDC Car Players Net 5.95
 99 E 15422

DELUXE CARRYING CASE FOR 8-TRACK TAPE CARTRIDGES

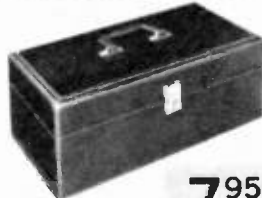

7⁹⁵

- Holds Up To 24 Cartridges

Deluxe Lafayette all wood carrying case. Measures 17 1/2 Wx 6 1/2 H x 7 1/2 "D. Black simulated alligator vinyl covering. Felt inserts, brass fasteners, and handle.
 28 E 78064W Shpg. wt., 4 lbs. Net 7.95

CARRYING CASE FOR 8-TRACK TAPE CARTRIDGES



2⁶⁵

- Holds up to 10 Cartridges

Keep tape cartridges for your car neat, orderly, dust free. Compact, 9x6x6" case stores 10 tapes of any standard brand. 2 lbs. 28 E 20124 Net 2.65

8-TRACK TAPE CARTRIDGE SYSTEM MAINTENANCE KIT



1⁹⁵

An all-in-one maintenance kit for your 8-track cartridge tape system... keeps heads in top operating condition. Contains cleaner, lubricant, applicators, brush and convenient storage case. Simple operation with descriptive instructions. Brushes fit together to reach depths of player system. Ideal for all 4 and 8 track systems. Shpg. wt., 1/2 lb. 28 E 78015 Net 1.95

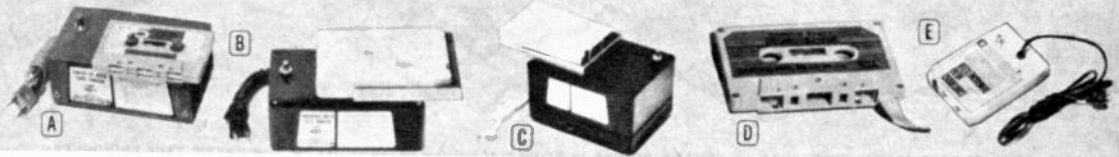

CASSETTE AND CARTRIDGE BULK TAPE ERASERS. Removes recorded sound from the entire tape. In seconds, restoring tapes to "like-new" blank condition to a lower level than that of your recorder. Now erase permanently recorded cassettes when desired. Operation: 110V., 50/60 Hz AC.

(A) TMC-1 for Cassettes. Shpg. wt., 3 lbs. 28 E 72265 Net 11.99

(B) TMC-2 for Cartridges. 28 E 72273 Shpg. wt., 5½ lbs. Net 17.99

(C) TMC-3 UL listed Professional Bulk Eraser for Cartridges. Shpg. wt., 9 lbs. 28 E 72281 Net 32.95

CASSETTE RECORDER AND CARTRIDGE PLAYER HEAD DEMAGNETIZERS. Recommended by equipment manufacturers to remove excessive magnetic build-up on heads. Use every 15-20 hours of player use. Built-into Cassette and Cartridge.

(D) TD-10 for Cassette Players. Built-in Pilot light. 110V., 50/60 Hz AC. Wt., 8 oz. 28 E 72289 Net 4.99

(E) TD-12 for Home Cartridge Players. 110V., 50/60 Hz AC. Shpg. wt., 14 oz. 28 E 72307 Net 7.99

TD-15 for Auto Cartridge Players. (Not illus.). 12 Volt DC model. Wt., 1 Lb. 28 E 72315 Net 9.95

3-WAY COMBINATION TEST-N-CLEAN CASSETTE AND CARTRIDGE. Cleans player/recorder heads of accumulated oxide and dust particles. Tests head for correct alignment to assure optimum playback without annoying cross-talk. Tests stereo balance equalization between channels. (Not illus.).

THC-6 Cassette. Shpg. wt., 2 oz. 28 E 72323 Net 1.69
THC-8 Cartridge. Shpg. wt., 5 oz. 28 E 72331 Net 1.69

THC-7 CASSETTE HEAD-KLEEN TAPE. (Not illus.). Safely cleans and polishes player heads. Removes accumulated oxides and other particles to maintain top sound performance. Shpg. wt., 2 oz. 28 E 72349 Net 1.49

TCW-2 CASSETTE TAPE TENSIONING WINDERS. (Not illus.) Set of two winders. Insert in holes of Cassette. Winds in either direction to take-up slack and unravel tape. 28 E 72398 Shpg. wt., 1 oz. Net .89

(I) TK-3 CASSETTE AND CARTRIDGE PLAYER/RECORDER HEAD-KLEEN KIT. 2-oz. bottles of Head Cleaner, Head and Guide Lubricant, and 25 extra-long Cleaning Swabs for cleaning and lubricating hard to reach parts of equipment. Wt. 8 oz. 28 E 72406 Net 1.35

THS-1 HEAD-KLEEN SPRAY. (Not illus.) For Cassette and Cartridge Tape Players/Recorders. 4 oz. Aerosol formula Cleaner removes all oxide and other particles from heads to improve sound performance. Has extension nozzle for hard to reach heads. 28 E 71945 Shpg. wt., 6 oz. Net 1.25



CASSETTE TAPE SPLICERS. Professional editing and repairing of Cassette. 150 tapes are now possible. Strip in sound effects and passages into existing tapes, repair broken tapes, etc.

(F) TS-115 Economy model "Cut-N-Splice." Cuts at 45° angle. 25 pre-cut, self-stick splicing patches included. Shpg. wt., 5 oz. 28 E 72356 Net 2.99

(G) TS-215 Precision pocket size splicing block with choice of either 45° or 90° angle cut. Block comes in self-contained plastic carrying case with cutting blade and 25 pre-cut splicing patches. Wt., 5 oz. 28 E 72364 Net 5.99

CASSETTE AND CARTRIDGE TEST STROBES. With Strobe Tape and Light built-in. Check your player/recorder for proper speed. Too fast produces flutter. Too slow, creates tape drag or wow. 110 V. 50-60 Hz. A.C.

(J) TSC-9 Cassette. Shpg. wt., 5 oz. 28 E 72414 Net 3.69

(K) TSC-8 8-Track Cartridge. Wt. 7 oz. 28 E 72422 Net 4.49

(H) TS-315 Professional studio type heavy-duty .150 splicing block. Precision made, 45° or 90° cut. Mounted on heavy base. Supply of 100 pre-cut splicing patches and burnishing roller included. Wt., 3 lbs. 28 E 72372 Net 14.99

TT-15 Splicing patches for splicers. Pre-cut, self-stick. Pkg. of 100. Wt., 2 oz. 28 E 72380 Net .99

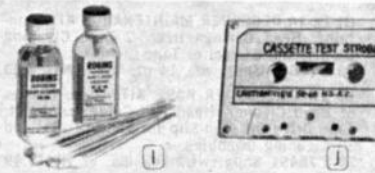

(L) PHONE PICK-UP TRP-4. Record phone conversations with friends and relatives. Attaches by suction cup to receiver of phone. Plug attached. Simple, easy to use. 28 E 72430 Shpg. wt. 3 oz. Net 2.69

CASSETTE CARRYING AND STORAGE CASE. For home or auto. Each case holds 12 tapes. FREE Log Book included.

(M) TCC-6 for Cassettes. Shpg. wt., 12 oz. 28 E 72448 Net 2.79

CASSETTE AND CARTRIDGE MODULAR STORAGE UNITS. Decorator Walnut Grain Vinyl covered. Each holds 12 tapes. Mount on wall or for book shelf use. Stand on end or stack.

(N) TCS-6 for 12 Cassettes, Shpg. wt., 14 oz. 28 E 72455 Net 1.99

TCS-8 for 12 Cartridges. Shpg. wt., 1 lb. 2 oz. 28 E 72463 Net 2.49

TCM-1 CASSETTE MAINTENANCE AND STORAGE CASE. Hold 10 Cassettes, Head Demagnetizer, "3-in-One" Head Clean and Test Tape, 240 Color-Coded Index Spots and Log Book. Shpg. wt. 1¼ lbs. 28 E 72471 (Not illus.) Net 9.99



(O) TSA-12 BOOK TYPE CASSETTE STORAGE ALBUM. Holds 12 Cassettes neatly in recessed compartments. Shpg. wt., 8 oz. 28 E 72489 Net 1.99

PLASTIC CASSETTE AND CARTRIDGE END DUST-CAPS. (Not illus.) Protects delicate tape at openings from dust, grime, and accidental damage. Package of 10. 28 E 72497 TJ-12 for Cassettes. Wt. 4 oz. .79 28 E 72505 TJ-10 for Cartridges. Wt. 5 oz. .79

CASSETTE AND CARTRIDGE PLASTIC DUST PROTECTORS. (Not illus.) For that extra ounce of protection from dust, grease, and grime. Package of 10 clear Vinyl bags. TCI-18 for Cassettes. 28 E 72513 Wt. 2 oz. Net .69

TCI-20 for Cartridges. 28 E 72521 Wt. 3 oz. Net .89



(P) CASSETTE AND CARTRIDGE COLOR-CODE LOG KIT. TK-35. Catalog and index your tapes by category: Red-Jazz, Yellow-Shows, etc. Kit contains: 120 page log book, 240 numbered index spots in 2 sets, 120 title labels, all self-stick, in 5 basic Colors. 28 E 72539 Shpg. wt., 1¼ lbs. Net 2.99

(Q) CASSETTE COLOR-CODE REPLACEMENT TITLE LABELS. TCI-20. Self-stick, die-cut to fit Cassettes. Pkg. of 20 in 5 Colors. 28 E 72547 Shpg. wt., 4 oz. Net .89

(R) CASSETTE OWNER IDENTIFICATION END LABELS. TCI-30. Printed "Property Of—." Apply to Cassette end for identification of ownership. Package of 30, self-stick. 28 E 72554 Shpg. wt., 4 oz. Net .89

TL-80 CASSETTE, CARTRIDGE, AND CANISTER INDEX SPOTS. (Not illus.) 240 self-stick Spots, 2 sets, numbered 1 to 24 in 5 Colors. Index tapes and their matching canisters. 28 E 72075 Shpg. wt., 2 oz. Net .89

ROBINS® TAPE SPLICERS AND EDITING ACCESSORIES



(A) TK-9 COMPLETE TAPE EDITING WORKSHOP. Tape Winders for reels to 7". Deluxe Tape Splicer with Splicing Tape. Sturdy walnut grained base has Calibrated Tape Timing and Editing Scale. Editing Pencil and Editing Guide Book included.
28 E 71069 Shpg. wt., 2 lbs. Net 14.99

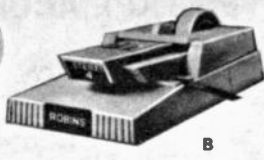

(B) TS-80 DELUXE STEREO SPLICER. Precision diagonal cut and "Gibson Girl" trim. "See-thru" windows show "Cut" and "Trim." Tape guide and fingers secure tape. Tape dispenser has 1/2" x 100' roll Splicing Tape. Replaceable cutter pad and blades. Blade centering adjustment for accuracy. Of super-strong Cycloc. Instructions.
28 E 60096 Shpg. wt., 1 lb. Net 7.99

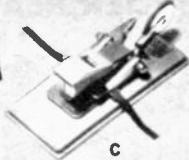

(C) TS-7S STANDARD STEREO SPLICER. Same features as TS-80. Made of plated steel and plastic. Dispenser has 3/8" x 100' roll Splicing Tape. Instructions.
28 E 71416 Shpg. wt., 12 oz. Net 5.99

TS-7J JUNIOR "STEREO" SPLICER. (Not illus.) Same as TS-7S, less dispenser and tape. Uses 3/8" wide splicing tape.
28 E 71424 Shpg. wt., 8 oz. Net 4.99



(F) TM-2 MAGNETIC TAPE EDITING PEN. Erase single sounds, noise, etc. from recordings. Fade in and out for special sound effects.
28 E 71549 Shpg. wt., 3 oz. Net 1.49

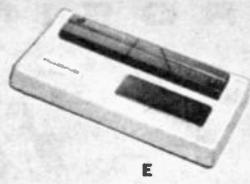

TT-240 COLOR-CODE SPLICING PATCHES. (Not illus.) 12 each of 6 colors, Orange, Yellow, Red, Blue, Green and White. Splice color patches between subjects on reel for indexing.
28 E 71135 Shpg. wt., 3 oz. Net .99

TSP-50 SENSING AND CUEING PATCHES. (not illus.) Aluminum foil. 1/4" wide x 3/4" lengths. For recorder with automatic stop and reverse control.
28 E 71150 Pkg. of 50, Wt., 3 oz. Net 1.05

(D) TS-6 DELUXE "CUT-N-SPLICE." Cuts tape at 30°, 45°, or 90° angle. 25 self-stick Splicing Patches included in built-in tray of splicer.
28 E 70863 Shpg. wt., 5 oz. Net 2.99

TS-5 "CUT-N-SPLICE" METAL SPLICING BLOCK. (not illus.) With 25 self-stick Splicing Patches.
28 E 70871 Shpg. wt., 5 oz. Net 1.99

(E) TS-14 PROFESSIONAL STUDIO PRECISION TAPE SPLICING BLOCK. Has 90° and 45° cutting guide. Burnishing plate and roller provided. Sturdy cast base has rubber bumpers. Includes cutting blade and supply of 100 Splicing Patches. Wt. 3 lbs.
28 E 72059 For 1/4" tape 14.98

SPICING TAPE. Mylar. Wt. ea. 2 oz. (Not illus.)

Stock No.	Type	Width	Length	Net
28 E 70889	TST-235	1/4"	x 300"	.69
28 E 70897	TST-376	3/8"	x 275"	.69
28 E 70905	TST-501	1/2"	x 250"	.69
28 E 70913	TST-751	3/4"	x 150"	.85

TST-233 Pkg. of 75 Self-Stick Splicing Patches for TS-14, TS-6, TS-5 Splicers.
28 E 70921 (not illus.) Net .79



(K) TK-1 COLOR-CODING TAPE LOG KIT. Color-code indexing by title, artist, category. 120 page color-indexed Log Book, 240 Title Labels, 72 Tape End Tabs, 48 Numbered Cueing Spots, 30 Box Ends, in 6 Colors, and Pen.
28 E 71457 Shpg. wt., 1 1/4 lbs. Net 5.29

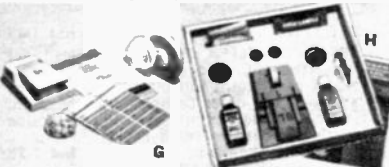

(G) TK-30 TAPE EDITING KIT. Contains: TS-6 "Cut-N-Splice" Splicer, 25 self-stick Patches, White Leader Tape - 1/4" x 100" on a 2 1/2" reel, 12 Tape Clips, Tape Cleaning Cloth, 3" reel of Tape-Clean, and 120 Color Title Labels.
28 E 72067 Shpg. wt., 8 oz. Net 5.98



(H) TK-14 RECORDER MAINTENANCE KIT. Contains: Head Demagnetizer, 2 Tape Cleaning Cloths, and 3" reel of Tape-Clean.
28 E 71598 Shpg. wt., 14 oz. Net 4.39

(H) TK-80LX DELUXE KIT. Contains: TS-8D Splicer, Splicing Tape, Threader, Head Clean and Lube 2 oz. bottles, Clips, Reel Title Labels, Reel Holders, and Editing Guide Book.
28 E 70442 Shpg. wt., 1 1/2 lbs. Net 12.49

(J) TK-7 RECORDER CARE KIT. 2 oz. bottles of Head Cleaner, Head and Guide Lubricant, Tape Drive Oil, Non-Slip for Tape Drives, and 50 Cleaning Swabbies.
28 E 70491 Shpg. wt., 1 1/2 lbs. Net 2.49

TK-6 HEAD-CLEAN AND LUBE KIT. (Not illus.) 2 oz. bottles - Head Cleaner and Head and Guide Lubricant.
28 E 70855 Shpg. wt. 6 oz. Net 1.29

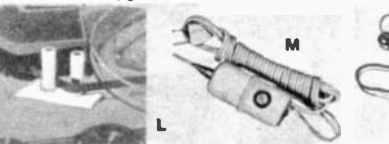

(L) TLA-1 TAPE-CLEAN-LUBE SYSTEM. Self-stick base mounts to deck of any recorder. Applies liquid Silicone Lubricant and Cleaner to both sides of tape while playing. Reduces recorder head and guide wear. Stops tape squeal. Reduces drag. Includes extra Lube-Cleaner.
28 E 71911 Shpg. wt., 5 oz. Net 2.99

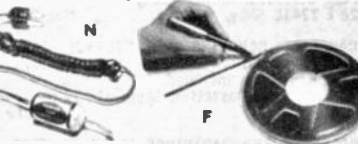

HEAD DEMAGNETIZERS. In normal use, heads build-up magnetism resulting in loss of fidelity. Demagnetizers safely remove magnetism from heads to improve recorder sound performance.

(M) TO-6 PROFESSIONAL UL LISTED HEAD DEMAGNETIZER.
28 E 60260 110 V. A.C., Wt. 1 lb. Net 7.29

(N) TO-3 DELUXE HEAD DEMAGNETIZER. Fully encapsulated components.
28 E 60278 110 V. A.C., Wt. 8 oz. Net 3.99

TLA-2 TAPE LUBE-STICK. (Not illus.) Lubricates both sides of tape at same time while in use. Stops squeal, reduces drag. Self-stick base mounts to recorder deck.
28 E 71929 Shpg. wt., 3 oz. Net 1.99

(O) SKA-2 DELUXE TAPE EDITING AND CARE KIT. Contains: TS-7J Stereo Splicer, Splicing Tape, Head Demagnetizer, 75 Clips, 2 Oz. bottles of Head Cleaner and Lubricant, 240 self-stick Title Labels in 5 Colors, three 7" reels of Brand Five Recording Tape, each 1200 ft. 1.5 mil acetate, 7" take-up Reel, four 7" Tape Storage Boxes, and Tape Editing Book. All in a vinyl attache case - 3 1/4" x 16" x 11". Shpg. Wt. 7 1/2 lbs.
28 E 71903 Net 19.98



TL-16 COLOR-CODING LEADER TAPES. (Not illus.) Color-Code subjects, 100 ft. each Red, Blue, Yellow, Green, White on 2 1/2" reels.
28 E 71499 Shpg. wt., 14 oz. Net 2.69

TT-100C CLEAR LEADER TAPE. (Not illus.) 100 ft. x 1/4" wide on a 2 1/2" reel.
28 E 71887 Wt. 3 oz. Net .75

TC-75 TAPE CLIPS. (Not illus.) Plastic. Reusable. Keeps tape from unwinding. Fits all reels. 72 clips in handy plastic container.
28 E 71093 Shpg. wt., 8 oz. Net .89

TL-80 TAPE AND BOX INDEX SPOTS. (Not illus.) Pkg. of 240. Numbered 1 to 24, 2 sets in 5 basic Colors. Self-stick, index tapes and their matching boxes or canisters. Wt. 3 oz.
28 E 72075 Net .79

TL-240 COLOR-CODE TITLE LABELS. (Not illus.) 2" x 1/2" self-stick, 40 each of 5 Colors. Write or type. Label reels, boxes, canisters, etc.
28 E 71507 Package of 240, Wt. 4 oz. Net 1.09

TK-2 TAPE CARE KIT. (Not illus.) 2 oz. bottle of Head Cleaner and Tape Cleaning Cloth.
28 E 70483 Shpg. wt., 4 oz. Net 1.29

TX-20 TAPE HEAD CLEANER. (Not illus.) 2 oz. bottle with applicator.
28 E 60310 Shpg. Wt. 4 oz. Net .69

TX-33 TAPE DRIVE OIL. (Not illus.) 2 oz. bottle with applicator. Inhibits rust and oxidation.
28 E 72083 Shpg. Wt. 4 oz. Net .49

TX-22 HEAD AND GUIDE LUBRICANT. (Not illus.) 2 oz. bottle with applicator. Silicone base liquid. Provides friction-free tape path.
28 E 71937 Shpg. Wt. 4 oz. Net .69

SKA-1 ECONOMY TAPE EDITING AND CARE KIT. (Not illus.) Contains: Tape Splicer, Splicing Tape, 75 Clips, 7" Reel of 1200 ft. 1.5 mil acetate Brand Five Recording Tape, 7" take-up Reel, six 7" Tape Storage Boxes, 2 oz. bottles of Head Cleaner and Lubricant. All in a Vinyl Attache Case - 3 1/4" x 16" x 11". Shpg. wt., 5 1/2 lbs.
28 E 71895 Net 9.98

BULK TAPE ERASERS



MAGNETIC BULK TAPE ERASERS. Erase tapes in seconds to below normal recorder erase head level. Restores tapes to "blank" condition. For magnetic stripped film also. All units 110-120 V. 50-60 Mz. A. C.

(P) **TM-88 HAND HELD ERASER.** For 1/4" tape, any size reels. Erases by moving unit over each side of reel. Demagnetizes guide posts, capstans, flywheels. 4" x 2 1/2" x 4 1/4".
28 E 71523 Shpg. Wt. 4 lbs. Net 10.99

(R) **TM-77 DELUXE BULK ERASER.** For 1/4" tape, reels to 7". Erasure 2 to 4 db below normal erase head level. Size: 2 3/4" x 3 3/4" x 6 1/4".
28 E 60252 Shpg. Wt. 5 lbs. Net 16.75

(S) **TM-99 PROFESSIONAL UL LISTED BULK ERASER.** For tape to 1/2" wide, reels to 10 1/2". Erasure 3 to 6 db below erase head level. Size: 5 1/4" x 6 3/4" x 3 3/4". Wt. 8 1/2 lbs.
28 E 60245 Net 29.95

(Y) **TK-12 AUDIO/VISUAL ACCESSORY KIT.** For language labs, recording studios, audio/visual depts. and serious home recordists. Contains: TS-8D Splicer, 6 rolls 1/2" Splicing Tape, Tape Threader, Tape Cleaning Cloths, Head Cleaner, Lubricant, 24 Tape Clips, 180 Title Labels, Tape Strobe and Light Kit, U.L. Listed TM-99 Bulk Tape Eraser and T-6 Demagnetizer.
28 E 70517 Shpg. Wt. 14 lbs. Net 52.50

RECORDER AND TAPE CARE ACCESSORIES

TK-21 LOW COST TAPE EDITING KIT. (Not illus.) Contains TS-3 Splicer consisting of self-stick tape guide, hand-held cutter with protective cover, Splicing Tape, and Tape Editing Pencil.
28 E 71440 Shpg. Wt. 5 oz. Net 1.75

TAPE-CLEAN. (Not illus.) Chemically treated cloth tape cleans and lubricates heads and guides of recorder when played. Deposits film of Silicone for friction-free tape path.
28 E 71168 THC-3, 3" reel. Wt. 3 oz. Net 1.19
28 E 60351 THC-5, 5" reel. Wt. 5 oz. Net 2.19

(U) **THC-12 QUICK-CLEAN FELT PEN.** With pocket clip. Applies efficient fast drying solvent to remove dirt, accumulated oxide from recorder heads to improve sound fidelity. Includes fluid supply. Imported.
28 E 72091 Shpg. wt. 3 oz. Net .99

THC-1 HEAD-KLEEN POLISHING TAPE. (Not illus.) 3" reel, 225 ft. Removes oxide and all particles from heads when played.
28 E 71606 Shpg. Wt. 3 oz. Net 1.29

THS-1 HEAD-KLEEN SPRAY. (Not illus.) 4 oz. Aerosol formula Head Cleaner removes accumulated oxide, grime, and other particles from recorder heads. Extension nozzle included for easy access to hard to reach heads.
28 E 71945 Shpg. Wt. 6 oz. Net 1.25

TGG-5 FRISCH TONE GENERATOR-CUEING DEVICE. Mechanically prints a continuous tone of any desired length on tapes. (Pat.)
28 E 72174 Shpg. Wt. 6 oz. Net 19.95

TG-18 DISPOSABLE TAPE CLEAN-LUBE CLOTHS. (Not illus.) 18 individual Packages. Silicone treated Cloths for recording tape. Deposits film of Silicone for friction-free performance. Eliminates tape squeal improves fidelity.
28 E 72104 Shpg. Wt. 6 oz. .99

(T) **MSW-150 "SWABBIES".** Soft cotton tips wound on 6" applicators for cleaning and oiling hard to reach parts of equipment. Package of 125.
28 E 72117 Shpg. Wt. 6 oz. Net .79

(V) **TW-1 PRECISION TAPE STROBE.** Metal, chrome plated. Needle bearings. Tests speed accuracy, wow, and flutter of 7 1/2 and 3 3/4 ips recorders. Instructions.
28 E 71176 Shpg. Wt. 1 lb. Net 6.99

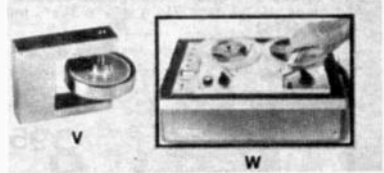

(W) **TK-5 TAPE STROBE AND LIGHT KIT.** Tests speed accuracy of recorder at 15, 7 1/2, and 3 3/4 ips. Strobe tape, neon lamp. 110 V. A.C.
28 E 72125 Shpg. Wt. 6 oz. Net 1.79

(X) **BLOWER BRUSH #TBB-1.** Squeeze blower and soft camel's hair brush. Blows away dust and other particles from delicate recorder heads, guides, and other parts. Ideal for phono, records, delicate parts, fine optical lenses, etc.
28 E 72133 Shpg. Wt. 4 oz. Net 1.29

EMPTY TAPE REELS FOR ALL RECORDERS. Colors available: Red-R; Blue-B; Yellow-Y; Green-G. indicates Low Torque. Av. wt. per pkg. 6 oz. *Assorted colors.

Stock No.	Mfr's Type	Size	Pkg.	Qty.	Net
28 E 70954	TR20-6	2"	6		.69
28 E 70962	TR25-6	2 1/2"	6		.69
28 E 70970	TR30-6	3"	6		.69
28 E 70988	TR32-4	3 1/4"	4		.69
28 E 71259	TR36-6*	3"	6		.79
28 E 70996	TR40-4	4"	4		.79
28 E 71002	TR50-2	5"	2		.69
28 E 71960	TR51-2R	5" R	2		.79
28 E 71978	TR51-2B	5" B	2		.79
28 E 71986	TR51-2Y	5" Y	2		.79
28 E 71994	TR51-2G	5" G	2		.79
28 E 71317	TR53-2	5"	2		1.05
28 E 71010	TR70-2	7"	2		.75
28 E 72018	TR71-2R	7" R	2		.99
28 E 72026	TR71-2B	7" B	2		.99
28 E 72034	TR71-2Y	7" Y	2		.99
28 E 72042	TR71-2G	7" G	2		.99
28 E 71028	TR74-2	7"	2		1.29

TL-9 LONG TITLE LABELS. (Not illus.) 3/8" x 9 1/2". Self-stick. Label canisters, boxes, etc.
28 E 72166 Pkg. of 50. Wt. 4 oz. Net .75

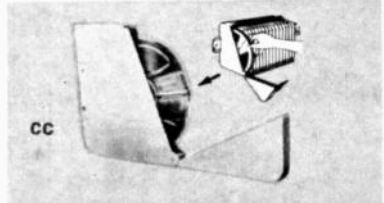

(Z) **TRP-2 PHONE PICK-UP.** Fastens to phone by suction cup. Provides clear recording of phone conversations. Has 5 ft. cable with stripped ends to attach connector to fit recorder.
28 E 70947 Shpg. Wt. 6 oz. Net 2.29

(BB) **TSO-1 AUTOMATIC TAPE SHUT-OFF.** Attaches to side of recorder. Recorder plugs into side of unit. 110 VAC. 3 amp. rating. Arm gently contacts recording tape. When tape plays through and ends, automatically shuts off recorder or other devices.
28 E 72150 Shpg. Wt. 1 lb. Net 4.95

(AA) **TB-3 SOLIO-STATE BEEPER AND PHONE PICK-UP.** Integrated Circuit (I.C) signal generator-timer and high-efficiency ferrite core induction coil. Injects 1 kc "Beeps" into phone lines and recorder at 15 second intervals. Has on-off switch and 6 ft. cable to phone, 6 ft. cable to recorder. Fastens to phone by spring. 110 V. 50-60 Mz A.C.
28 E 72141 Shpg. Wt. 6. 18 oz. Net 19.95

RM-6 PLASTIC TAPE MAILING CANISTERS. (Not illus.) Impact resistant. Reusable. For up to 3 1/4" reels. With 2-sided address cards.
28 E 71564 Pkg. of 6. Wt. 5 oz. Net 1.09

TMC-3 DOUBLE-SIDED ADDRESS CARDS. (Not illus.) Pkg. of 30 for RM-6 Tape Mailers.
28 E 71572 Shpg. Wt. 3 oz. Net .79

TB-15 CARDBOARD TAPE MAILING BOXES. (Not illus.) Package of 15. For up to 3 1/4" reels.
28 E 71580 Shpg. Wt. 6 oz. Net .89



(CC) **TCP-12 SET OF 12 DELUXE INDIVIDUAL MOLOD TAPES.** Protects 7" tapes from dust, dirt, ageing. Hinge covers. Bottoms have dovetail grooves to fit metal wall mount bracket included. (less tape and reels).
28 E 71226 Shpg. Wt. 8 lbs. Net 11.89

TCB-18 CAROBOARD CASSETTE MAILERS. (Not illus.) Package of 18. Features "built-in stops" to prevent tape unwinding or becoming slack.
28 E 71952 Shpg. Wt. 6 oz. Net .99

TL-5 COLOR-CODE TAPE BOX ENDS. (Not illus.) 30 self-stick, textured book binding strips in 6 colors. Reinforce and hinge lids.
28 E 71481 Shpg. Wt. 5 oz. Net 1.79

LAFAYETTE Recording Accessories

LAFAYETTE BULK TAPE ERASERS



11⁹⁵
Deluxe Model

26⁹⁵
Professional Model

PROFESSIONAL MODEL

- Completely Erases Tape
- Two Erasing Coils
- Erases up to 1" Tapes
- Erases 1/4" Tapes in One Operation—No Reversing
- For 3", 5", 7" or 10 1/2" Reels

A carefully designed and precisely manufactured tape "degausser" for complete erasing of tapes. Just place the tape reel on spindle of demagnetizer, slowly rotate 2 or 3 turns, take off, and that's all. Reduce tape hiss to the level of new "virgin" tape. Two completely separate coils are used for doubly-effective erasures, even of large, 10 1/2" reels. Will erase 1" wide tape. An extra powerful unit for heavy-duty use—draws over 9 amperes. Can be used to demagnetize tape, magnetically stripped film, plus tools and watches. Has a heavy, custom finished case, a rugged non-magnetic top, heavy duty on-off switch and power cord. Has built-in fuse. Pilot light prevents accidentally leaving it turned on. Size 6 1/4 x 7 7/8 x 3 1/2". 105-125V, 60 Hz Imported. Shpg. wt., 14 lbs.

99 E 15186 Professional Model Net 26.95

DELUXE MODEL

Similar to professional model for all size reels but handles only standard size 1/4" tapes or smaller and reel must be turned over once. Has separate spindle positions for 10 1/2" and 3, 5, and 7" reels; non-magnetic bakelite plate for reel rest. One powerful coil consumes 5 amps Metal case 7 1/4 x 4 1/4 x 3 1/2". Imported. Shpg. wt., 9 lbs.

99 E 15182 Net 11.95

HAND HELD BULK ERASER

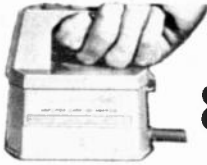

8⁹⁵

Easily erases tapes or sound films regardless of reel size. Convenient, comfortable hand held design. Also demagnetizes capstans, tape guides, etc. Lowers background noise better than new tape. Safe, durable plastic case and control switch. High intensity field with low power consumption.

28 E 30016 Shpg. wt., 4 lbs. Net 8.95

LAFAYETTE TAPE HEAD DEMAGNETIZER

DELUXE MODEL WITH SWITCH



2⁹⁵

Pencil shaped head demagnetizer with one extending probe. Styling allows you to reach all heads in all positions. Features switch control...no need to leave unit on constantly. Turn on when needed and off to conserve unit's life. Operates on standard 110-120 VAC 60 Hz Imported. Shpg. wt., 1 lb.

99 E 15331 Net 2.95

RECORDER TEST TAPE

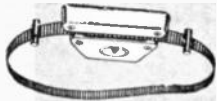

98¢

Checks speed, timing, wow and flutter. For 7 1/2 IPS. Accurate within 1/10 of one percent. Shpg. wt., 6 oz.

28 E 50014 Net .98

TAPE CLEANER



1⁸⁸

Tape is impregnated with special formula cleaner. Simply run through like regular roll of tape. Entire job done in 2 minutes. Can be reused many times. 100' roll on 5" reel. Shpg. wt., 8 oz.

28 E 20017 Net 1.88

28 E 20025 3" Reel Net .99

1200 FT. LEADER TAPE ON 7 INCH REEL



• For Indexing and Cueing

Lafayette brings you this jumbo reel of leader tape at a tremendous savings over the cost of leader tape customarily available in 100 ft. quantities. 1 1/2 mil mylar tape. 1200 ft. x 1/4" wide on 7" clear plastic reusable reel. Individually boxed. Shpg. wt., 1 lb.

28 E 77017 Net 2.00

TELEPHONE PICKUP COIL



Designed to feed into the microphone input of a tape recorder or any high gain amplifier. Easily attached to the telephone by rubber suction-type attachment. Imported. Shpg. wt., 6 oz.

99 E 61970 Net 1.39

LAFAYETTE TAPE SLICER



2³⁹

- Two Operations—Cuts & Trims
- Clean Splices in Seconds
- For Monaural or 2 and 4-Track Stereo
- Splicing Tape Supplied

A sturdy precision instrument for professional use in all splicing and editing applications. Gives clean, quick cuts on all tapes without losing a significant portion of the sound track. Splicing tape fed from below will not foul and waste tape. Sharp long lasting blades provide trouble-free operation. A must for professionals and demanding audio hobbyists. Imported. Shpg. wt., 3/4 lb.

28 E 09051 Net 2.39

Replacement splicing tape for above. Net .30
28 E 09069 Shpg. wt., 2 oz.

TELEPHONE PICKUP FOR CRADLE OR UPRIGHT PHONES



1⁴⁹

Induction telephone pick-up for cradle or upright phones. Simply place phone base on pickup and connect leads to high impedance input of an audio amplifier or directly to a tape recorder. Imported. Shpg. wt., 8 oz.

99 E 10340 Net 1.49

HUM-BUCKING TELEPHONE PICKUP COIL



Designed with symmetrical hum cancelling pick-up coils to eliminate high stray hum pickup usually encountered with conventional coils. For use with high impedance tape recorders, amplifiers and dictating machines. Double suction cup for easy mounting. 5' cable with stripped leads. Shpg. wt., 3 oz.

28 E 32012 Net 4.95

LAFAYETTE DYNAMIC 1kHz & 10kHz GENERATOR SALE!



9⁹⁵
SAVE 5.00

- For Bias Adjustments And Azimuth Alignment

An essential transistorized instrument for the serious minded tape recordist who demands peak performance of his tape deck or recorder. The 1000 Hz signal adjusts the bias in recorders having such adjustments to provide improved performance, particularly with reference to the brand and type of tape used. The 10 kHz signal aligns the azimuth of the recording head. Puts out at least 1 volt with frequency tolerance of ± 1%, 5% distortion, and 50 ohm output impedance. 4 ft. cables with phono plug terminations. Self-power by 9V. battery. (Not supplied). 3 1/2 x 1 1/2 x 1 3/4".

99 E 15497 Shpg. wt., 1 lb. Net 9.95

99 E 60212 9V. battery for above Net .21

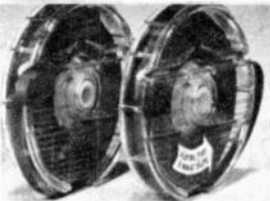

Tape Recording Accessories

COUSINO AUDIO VENDOR

- Continuous Repeating Magnetic Magazine Tape

Endless tape loop magazines provide continuous play. Ideal for sales messages, language study, sleep learning, exhibits, etc. Fits most standard recorders. Running time in minutes at 3 3/4 ips. Counter-clockwise. 1510 Series 2 3/4" dia., 1310 Series 3 3/4" dia., 1210 Series 5 3/4" dia. Shpg. wt., 12 oz.

STOCK NO.	TYPE	RUNNING TIME	NET EACH
28 E 35031	151003	3 Min.	3.95
28 E 35049	151005	5 Min.	4.75
28 E 35058	131008	8 Min.	7.15
28 E 35064	131012	12 Min.	8.00
28 E 35072	131015	15 Min.	8.95
28 E 35080	131018	18 Min.	9.75
28 E 35098	121024	24 Min.	10.95
28 E 35106	121030	30 Min.	12.95

TWIST-LOCK STYRENE CANS



- Buy the set — save and GET THE CHEST FREE!

12 dust-free, moisture-proof unbreakable styrene tape cans in storage chest. Can has foolproof twist lock feature and is ribbed for convenient stacking. Center locking stud prevents reel movement on all 7" reels and most 3" and 5" reels. Shpg. wt., 6 lbs.

28 E 65103W	TWIST LOCK CANS ONLY	Net 4.75
28 E 65111	Lots of 6 ea. .40	Single ea. .45

LAFAYETTE RECORDER



79^c

IDEAL FOR Making Connections From Radio, Phono or TV To Tape Recorder

Handy 6 ft. lead has insulated alligator clips at one end and RCA phono plug at the other. Supplied with shielded phono plug adapter to adapt the RCA phono plug to standard phono plug if necessary. Attach alligator clips to speaker terminals and simply plug other end into tape recorder. Ideal for recording from Radio, Phono or TV. Imported. Shpg. wt., 8 oz.

95 E 15174 Net .79

LAFAYETTE STEREO RECORDER PATCH CORD



1 19

Ideal for making tape recorder connections from stereo receivers, tuners and amplifiers having front panel tape output jacks. A convenient 6 foot cable has stereo 3 conductor phono plug at one end and two standard color coded RCA type phono plugs at the other. Insert phono plug into front panel tape output jack of receiver, tuner or amplifier and connect phono plugs to inputs of tape recorder for convenient connection. Imported. Shpg. wt., 8 oz.

99 E 63364 Net 1.19

HEAD AZIMUTH ALIGNMENT TAPE



For accurate alignment of recorder heads for maximum sound output. 100 ft.

on 2 1/2" reel. Tape has 6 kHz steady tone in either direction. Instructions included. Shpg. wt., 4 oz.

28 E 71184 Net 1.19

TAPE THREADER 79^c



Eliminates awkward fumbling. Place tape against reel, slip threader on — turn crank — tape is threaded. Use with all 5" and 7" reels. Shpg. wt., 3 oz.

28 E 60211 Net .79

CLEAR PLASTIC REELS



As Low As **9^c**
IN LOTS OF 4

Sturdy, non-warp plastic reels for recording tape. All clear except "high impact milky plastic. Avg. Shpg. wt., 4 oz., singly.

28 E 23052 3" reel	lots of 4, Ea. .09
28 E 23011 3 1/4" reel	Singly, Ea. .10
28 E 23011 3 1/4" reel	lots of 4, Ea. .14
28 E 23029 5" reel	Singly, Ea. .17
28 E 23029 5" reel	lots of 4, Ea. .22
28 E 23037 7" reel	Singly, Ea. .24
28 E 23037 7" reel	lots of 4, Ea. .27
	Singly, Ea. .29

COLORLED PLASTIC REELS

Catalog your tape library by color-coding the different categories of recordings. Available in red, blue, yellow and green in both 5" and 7" reels. Shpg. wt., 4 qz.

5" COLOREO REELS

Stock No.	Color	1-3 ea.	4 up
28 E 72182	Red	.29	.27
28 E 72190	Blue	.29	.27
28 E 72208	Yellow	.29	.27
28 E 72216	Green	.29	.27

7" COLORED REELS

28 E 72224	Red	.39	.36
28 E 72232	Blue	.39	.36
28 E 72240	Yellow	.39	.36
28 E 72257	Green	.39	.36

LOW TORQUE REELS

Professional type clear plastic reels with large hubs for smooth tape feed and reduced flutter. Shpg. wt., 5 oz. ea.

5" Low Torque Reel—Holds 400 ft. 1 1/2 mil, 600 ft. 1 mil, 800 ft. 1/2 mil or 1200 ft. 1/2 mil triple play tape.

28 E 23060 lots of 4, Ea. .36
Singly, Ea. .39

7" Low Torque Reel—Holds 960 ft. 1 1/2 mil, 1440 ft. 1 mil, 1920 ft. 1/2 mil or 2880 ft. 1/2 mil triple play tape.

28 E 23045 lots of 4, Ea. .45
Singly, Ea. .49

REEL LOCKS



45^c
Set of Two

Holds tape recorder reel in place by locking spindle to reel. Especially useful if recorder is in vertical position. Will not interfere with normal operation of reels. Easily removable. Imported. Shpg. wt., 6 oz.

99 E 15190 Set of two Net .45

METAL STORAGE CANS



18^c Lots of 6

Cans are ribbed for easy storage. Precision fit. Baked enamel finish. Av. wt., 8 ozs.

28 E 63058 3" Can	lots of 6, Ea. .18
	Singly, Ea. .20
28 E 63066 5" Can	lots of 6, Ea. .27
	Singly, Ea. .30
28 E 63074 7" Can	lots of 6, Ea. .38
	Singly, Ea. .39

METAL TAPE STORAGE CHEST

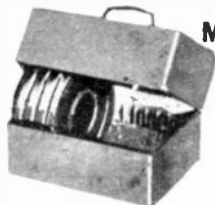

3 29

STANDARD CASE: Sturdy all steel carrying case. Holds 12 7" reels and cans. Twin snap locks. Platinum gray hammeroid finish. Metal separators. Index cards.

28 E 15017 Wt., 5 lbs. Net 3.29

DELUXE CASE: Holds 12 7", 5" or 3" intermixed reels and cans. Finger touch roll-out action, drop-front with spring lock. Exterior and interior index.

28 E 15025 Shpg. wt., 9 lbs. Net 5.95



PROFESSIONAL EDITALL TAPE EDITING KIT

All you need for a complete professional editing job. The cutting block is made of duraluminum precisely machined and polished (makes straight or diagonal cut). All accessories such as grease pencil, blades, splicing tape (66 ft. roll of 3/4") supplied. Comes with instruction booklet—in a smart plastic case. Shpg. wt., 1 lb.

28 E 38050 Net 9.00



EDITALL KP-2 TAPE EDITING And SPLICING KIT

Easy to use, makes perfect splices without trimming or damage. Complete kit consists of editall plastic block, 30 pre-cut editall splices, cutting blade, grease pencil, instruction booklet and tape guide. Shpg. wt., 5 oz.

28 E 38068 Net 3.50
Package of 50 pre-cut Editab splices.
28 E 38076 Net 1.50



Scotch® RECORDING TAPE AND ACCESSORIES



TYPE 111 STANDARD TAPE—1½ Mil Acetate Coated with red oxide. Popularly used for high fidelity all purpose recordings. On plastic reels except *NARTB metal reels. Avg. shpg. wt., 8 oz. ea.

Stock No.	Type No.	Reel	Length Feet	Net Each	
				1-11	12 Up
28 E 33044	111-1.5	3"	150	.52	.47
28 E 33051	111-3	4"	300	1.35	1.21
28 E 33069	111-6	5"	600	1.69	1.52
28 E 33077	111-12	7"	1200	2.59	2.33
28 E 33085	111-25H	Hub	2500	5.23	4.71
28 E 33093	111-25R*	10½"	2500	7.20	6.48

TYPE 190 EXTRA-PLAY TAPE—50% more playing time on standard size reels. 1 mil acetate base. All on plastic reel except *NARTB aluminum reel. Avg. shpg. wt., 12 oz.

Stock No.	Type No.	Reel	Length Feet	Net Each	
				1-11	12 Up
28 E 33101	190-9	5"	900	2.29	2.06
28 E 33119	190-18	7"	1800	3.99	3.59
28 E 33127	190-36R	10½"	3600	8.53	7.68

TYPE 282 SANDWICH TAPE—1½ Mil polyester. Features micro thin protective layer over oxide coating lasts up to 30 times as long as standard tapes. Reduces head wear and tape recorder maintenance. Avg. shpg. wt., 10 oz.

Stock No.	Type No.	Reel	Length Feet	Net Each	
				1-11	12 Up
28 E 33135	282-6	5"	600	2.07	1.86
28 E 33143	282-12	7"	1200	3.30	2.97

TYPE 201, 202, 203 "OYNARANGE" SERIES—Designed primarily for professionals, but now available for home recording. Permits slower speeds without loss of fidelity. Low noise level, long wear. Ideal for transcribing. Shpg. wt., 1 lb.

Stock No.	Type No.	Base	Reel	Lgth. Ft.	Net Each	
					1-11	12 Up
28 E 33374	201-6	1.5 Mil Acet.	5"	600	1.95	1.75
28 E 33350	201-12	1.5 Mil Acet.	7"	1200	2.99	2.69
28 E 33382	202-6	1.5 Mil Poly.	5"	600	1.99	1.79
28 E 33390	202-12	1.5 Mil Poly.	7"	1200	3.40	3.06
28 E 33408	203-9	1 Mil Poly.	5"	900	2.83	2.55
28 E 33366	203-18	1 Mil Poly.	7"	1800	4.90	4.41

TYPE 150 EXTRA-PLAY TAPE—1 Mil extra strong Polyester base high fidelity tapes. Withstands high tension and break resistant. All plastic reels except *NARTB aluminum reel. Avg. shpg. wt., 12 oz.

Stock No.	Type No.	Reel	Length Feet	Net Each	
				1-11	12 Up
28 E 33168	150-9	5"	900	2.29	2.06
28 E 33176	150-18	7"	1800	3.99	3.59
28 E 33184	150-36R*	10½"	3600	9.57	8.61

TYPE 120 HIGH OUTPUT TAPE—Acetate base recording tapes of 1½ mil thickness. Provides 8 to 12 db higher output than standard types. On plastic reel. Avg. shpg. wt., 14 oz.

Stock No.	Type No.	Reel	Length Feet	Net Each	
				1-11	12 Up
28 E 33192	120-6	5"	600	1.69	1.52
28 E 33200	120-12	7"	1200	2.59	2.33

TYPE 200 TENSILIZED—Tensitized Polyester .50 mil tapes. Provides as much playing time as the 1.5 mil standard tape. Stronger and more durable than usual long-play tapes. On plastic reel. Avg. shpg. wt., 12 oz.

Stock No.	Type No.	Reel	Length Feet	Net Each	
				1-11	12 Up
28 E 33234	200-12	5"	1200	3.69	3.32
28 E 33218	200-24	7"	2400	6.49	5.84
28 E 33226	200-48RPS	10½"	4800	14.67	13.20

TYPE 290—½ Mil polyester tensitized tape super strong 50% extra playing time has silicon lubricant to give minimum of friction wear.

Stock No.	Type No.	Reel	Length Feet	Net Each	
				1-11	12 Up
28 E 33242	290-18	5"	1800	4.69	4.22
28 E 33267	290-36	7"	3600	7.99	7.19

TYPE 175 TENZAR—1½ Mil tenzar coated with a high potency oxide, offers 16 times greater tear resistance than acetate backing. For continuous play, fast stops and starts non-drying silicone lubricated to protect recorder heads. Avg. shpg. wt., 10 oz.

Stock No.	Type No.	Reel	Length Feet	Net Each	
				1-11	12 Up
28 E 33275	175-6	5"	600	1.60	1.44
28 E 33283	175-12	7"	1200	2.50	2.25

SCOTCH TAPE CASSETTES



For all Lafayette, Norelco, Wollensak, Ampex, Concord and other recorders using Phillips-type cassettes. In reusable hinged plastic mailer; except C-120 in hinged plastic album box. Shpg. wt., 6 oz.

Stock No.	Type	Minutes	Net Each	
			1-11	12 Up
28 E 33473	271 C-30	30	1.75	1.50
28 E 33416	271 C-60	60	2.05	1.85
28 E 33457	272 C-90	90	3.05	2.75
28 E 33465	273 C-120	120	3.95	3.56



"LIVING LETTERS" TAPE IN PLASTIC MAILERS

3" reels providing ¼, ½ or 1 hour recording. 150' of 1½ mil acetate tape per reel. Others are ½ mil tensitized polyester. All tape sizes are furnished in convenient hinged plastic mailers designed for postal treatment and meeting all post office standards. Shpg. wt., 5 oz.

Stock No.	Type	Lgth. Ft.	Net Each	
			1-11	12 Up
28 E 33424	111-1.5LL	150	.69	.62
28 E 33432	200-3LL	300	1.39	1.25
28 E 33299	290-6LL	600	1.99	1.79

#11 ADDRESS LABELS FOR LL MAILING CONTAINERS. Package of 10 additional pressure-sensitive adhesive address labels for "Living Letters" plastic mailing boxes. Shpg. wt., 3 oz.
28 E 33440 Lots of 12, Ea. .20 Singly, Ea. .33

TAPE CARTRIDGES



TYPE 270 (M-2)—For Reverse self-changing recorders. 560', plays 45 minutes stereo, 90 minutes mono. **TYPE 8000**—Quick-load cartridge for other cartridge recorders. 560', plays 1 hour stereo, 2 hours mono. Avg. shpg. wt., 12 oz.

Stock No.	Type	Lgth. Ft.	Net Each	
			1-11	over 12
28 E 33333	270	560	4.26	3.90
28 E 33341	8000	560	3.00	2.70

SCOTCH RECORDING ACCESSORIES

SPlicing TAPE

Pressure-sensitive tape made especially for splicing and editing magnetic tape. Avg. shpg. wt., 3 oz.

SCOTCH 41-½S	½x50"	On dispenser.		
28 E 33291		Lots of 12, Ea.	.35	Singly, Ea. .39
SCOTCH 41-½L	½x66"	Less dispenser.		
28 E 33309		Lots of 12, Ea.	.51	Singly, Ea. .57

SENSING TAPE

Type S1 7/32S—To actuate automatic stop and reverse on recorders so equipped. 150' long x ¾" wide. One side foil, other adhesive. Shpg. wt., 4 oz.
28 E 33150 Lots of 12, Ea. 1.70 Singly, Ea. 1.89

LEADER-TIMER TAPE

TYPE 24-1W—Has 1 second interval markings for 7½" and 15" per second speeds. 100 ft. ¼" wide roll. Individually boxed. 5 oz.
28 E 33325 Lots of 12, Ea. .54 Singly, Ea. .60

7" SELF-THREADING REEL

TYPE PRST-7—Just lay recording tape inside and start recorder. Threads automatically. Snap-tight collar seals edges against dust. Shpg. wt., 8 oz.
28 E 33317 Lots of 12, Ea. .90 Singly, Ea. 1.00

LAFAYETTE RECORDING TAPES

LAFAYETTE'S FAMOUS MONEY-BACK GUARANTEE YOU BE THE JUDGE!

Lafayette's tape is made by outstanding nationally known manufacturers. It is first quality, splice free, red oxide coated, with full frequency response, uniform output and no "drop-outs." Resistant to moisture, heat, cold and abrasion.

We guarantee absolute satisfaction or your money back. If for any reason you are dissatisfied, return the tape within 30 days and we will refund your money less only transportation charges. You are the sole judge.



LAFAYETTE ACETATE BASE RECORDING TAPE

Acetate base magnetic recording tape with uniform stand and red oxide coating provides wide range high fidelity response over the audio spectrum. Features noise free reproduction, low abrasion and uniform output. In 1 mil and 1/2 mil thickness. Average shpg. wt., 1 lb.

Stock No.	Feet	Reel	Mils	Wt. lbs.	Net Per Reel		
					1-4	5-24	25 Up
28 E 01025	600	5"	1 1/2	1/2	.99	.90	.85
28 E 01033	900	5"	1	3/4	1.20	1.10	.99
28 E 01017	1200	7"	1 1/2	1	1.59	1.49	1.35
28 E 01041	1800	7"	1	1 1/4	1.98	1.88	1.79

LAFAYETTE MYLAR®* BASE RECORDING TAPE

Mylar base is especially strong, durable and break resistant, and is virtually impervious to heat, cold or humidity. All in clear plastic reels, individually boxed. Average shpg. wt., 1 lb.

Stock No.	Feet	Reel	Mils	Wt. lbs.	Net Per Reel		
					1-4	5-24	25 Up
28 E 01058	1200	5"	1/2	3/4	1.75	1.58	1.42
28 E 01066	1800	7"	1	1 1/4	2.14	1.93	1.75
28 E 01074	2400	7"	1/2	1 1/4	3.10	2.79	2.51

LAFAYETTE TENSILIZED MYLAR®* TAPES

These tapes are of the same high quality as the standard acetate and mylar Lafayette tapes with the added advantages of the tensilized mylar base. Super-strong mylar is prestretched and is highly resistant to breakage, moisture, heat, cold and humidity. Highly polished, splice-free, quiet, non-abrasive finish. Smooth output throughout the entire audio spectrum. Tensilized mylar gives you the most permanent type of base and is therefore ideal for your most treasured recordings. All are 1/2 mil, thus permitting the maximum amount of footage per reel. Individually boxed.

Stock No.	Feet	Reel	Mils	Wt. lbs.	Net Per Reel		
					1-4	5-24	25 Up
28 E 01090	300	3"	1/2	1/4	.69	.63	.59
28 E 01108	600	3 1/4"	1/2	1/2	.99	.90	.81
28 E 01116	1200	5"	1/2	1	2.25	2.03	1.83
28 E 01082	2400	7"	1/2	1 1/4	3.49	3.14	2.86
28 E 01231	3600	7"	1/2	1 3/4	4.98	4.49	3.99

*Mylar is the registered DuPont trademark for its polyester film.

LAFAYETTE RECORDING TAPE FOR AUTOMATIC REVERSING TAPE RECORDERS

• Ideal for the Lafayette RK-920 and RK-960 Recorders

These tapes are specifically intended for tape recorders providing automatic reversing of tape. Each tape has a green color coded leader, a red color coded trailer, and a metal sensing strip at each end to activate the automatic reversing mechanism in tape machines having this feature. This tape may also be used on machines which do not reverse tapes. This superb tape is of the same excellent quality, provides all of the features, and carries the same money-back guarantee as the other Lafayette recording tapes on this page. Average Shpg. Wt., 1 lb.

Stock No	Feet	Reel	Description	Net Per Reel		
				1-4	5-24	25 up
28 E 01165	1200	5"	1/2 mil mylar	1.99	1.84	1.67
28 E 01173	1200	7"	1 1/2 mil acetate	1.84	1.73	1.62
28 E 01181	1800	7"	1 mil mylar	2.89	2.69	2.43
28 E 01199	2400	7"	1/2 mil tens mylar	3.99	3.74	3.52

LAFAYETTE CASSETTE RECORDING TAPE



As Low As **69¢**

High quality tape assures full fidelity recording. Records and plays 2-tracks at 1 1/2 ips. Super strong polyester base. Proper lubrication for longer tape life. Protects heads. Imported. Shpg. wt., 4 oz.

Stock No.	Model No.	Playing Time	NET EACH		
			1-2	3-9	10 Up
28 E 01280	C-30	30 Minutes	.89	.79	.69
28 E 01223	C-60	60 Minutes	1.19	.99	.89
28 E 01207	C-90	90 Minutes	1.99	1.79	1.59
28 E 01215	C-120	120 Minutes	2.49	2.19	1.99

TDK C-60SD HIGH FIDELITY

- Low Noise Level. CASSETTE
- Frequency Response 30-20,000 Hz.

This 60 minute hi-fi tape uses a new gamma ferric oxide developed for high-density recording. The wide dynamic recording range 32-20,000 Hz. Makes available low noise, distortion-free output for the highest performance that can be expected of a cassette tape. Imported. Shpg. wt., 4 oz.

28 E 01240 Net 2.99

PLASTIC CASSETTE STORAGE BOX

Snap-open plastic box for individual cassettes. Clear hinged cover for instant identification. Built-in stops prevent tape slack and unwinding. Shpg. wt., 3 oz.

28 E 17054 Net ea. .25 Lot of 5 .99

CARDBOARD CASSETTE MAILERS

Ready to address. Features stops to prevent tape slack and unwinding for safe mailing. Package of 18. Shpg. wt., 8 oz.

28 E 71952 Net .99

LAFAYETTE QUADRUPLE-PLAY 1/4 MIL. RECORDING TAPE



- Four Times More Recording Time Than Standard Tapes
- Up To 32 Hours Recording

Greatly extends the playing time of all recorders, particularly 3 1/4" reel machines. An ultra-thin 1/4 mil tensilized mylar recording tape with high-density magnetic coating. Offers excellent frequency response for sharper, brighter recordings. Outstanding performance with capstan-drive recorders.

1100 Ft. on 3 1/4" Reel. Records 7 hours 20 minutes (all four tracks) at 1 1/2 ips; 3 hours 40 minutes at 3 3/4 ips. Shpg. wt., 12 oz.

28 E 01258 Net 2.10

2400 Ft. on 5" Reel. Records 16 hours (all four tracks) at 1 1/2 ips; 8-hours at 3 3/4 ips. Stereo 2-track records 8-hours at 1 1/2 ips, 4-hours at 3 3/4 ips. Shpg. wt., 1 1/2 lbs.

28 E 01264 Net 4.50

4800 Ft. on 7" Reel. Records 32 hours (all four tracks) at 1 1/2 ips; 16-hours at 3 3/4 ips; 8-hours at 7 1/2 ips. Stereo 2-track records 16 hours at 1 1/2 ips, 8-hours at 3 3/4 ips, 4-hours at 7 1/2 ips. Shpg. wt., 2 lbs.

28 E 01272 Net 8.95



Premium quality no-mount heads for replacement and conversion purposes. Use with mounting kits, below, for easy installation.

Response 40-20,000 Hz at 7 1/2 ips. Crosstalk rejection 55 db. For frequencies to 100 kHz. Av. Shpg. wt., 6 oz.

Stock No.	Mfr. No.	Type	Imp.	Net Ea.
20 E 57019	1000	4SRP	Hi	21.00
20 E 57150	1001	4SRP	Med.	21.00
20 E 57977	3000	2MRP	Hi	8.40
20 E 57965	3001	2MRP	Med.	8.40
20 E 57092	1400	4SE	Hi	12.00
20 E 57100	1401	4SE	Med.	12.00
20 E 57134	3600	2ME	Hi	8.00
20 E 57142	3601	2ME	Med.	8.00

QUICK-KIT MOUNTING HARDWARE				
Stock No.	QK No.	Description	Net Ea.	
20 E 57357	18	SIDE-MOUNT All erase	1.00	
20 E 57340	20	3000 RP series	1.00	
20 E 57332	38	Other RP	1.00	
BASE-MOUNT				
20 E 57381	19	All erase	1.00	
20 E 57373	21	3000 RP	1.00	
20 E 57385	66	Other RP	1.00	
SPECIALS				
20 E 57928	102	Sony RP	1.75	
20 E 57993	119	Sony RP	1.00	
20 E 57951	305	Sony erase	3.00	
20 E 58258	306	Sony erase	1.50	

ADJUSTABLE MOUNT ASSEMBLIES.

Complete Range of adjustment for height, face and azimuth. Can use with TG-7 guide posts. Base size 1 1/4" x 1 1/2" L w/tabs 1 1/2" x 1/2" L w/o tabs. Shpg. wt., 4 oz.

Stock No.	QK No.	Description	Net Ea.
20 E 57399	74	For all RP heads except 3000, 3100 Ser.	2.25
20 E 57407	77	For 3000, 3100 Ser. RP heads	2.25
20 E 57415	78	For all erase heads	2.25

OSCILLATOR TRANSFORMERS: To provide high frequency AC bias to record heads and erase heads. Shpg. wt., 6 oz.

20 E 57597 T-60F	For tube circuits; 60 RMS @ 60-100kHz	Net 4.50
20 E 57605 T-60T2	For transistor circuits; 40-120 RMS @ 60-100kHz	Net 4.50
20 E 58116 T-70T2	For PC transistor circuits; 40-120 RMS @ 60-100kHz	Net 4.50

RECORDING ACCESSORIES

AT-100 Alignment tape. Full-track 7 1/2 ips. For head azimuth alignment & NAB testing frequency response of any recorder or tape head. Shpg. wt., 4 oz.

TG-7 Tape Guide Post. Adjustable height chrome-plated brass with hardware and instructions. Shpg. wt., 3 oz.

L-7 Mounting Bracket. Left angle universal for side mount heads, narrow base. Includes azimuth plate. Shpg. wt., 3 oz.

Frequency AC bias to record heads and erase heads.

FREE TAPE HEAD REPLACEMENT GUIDE

This is a partial tape head replacement listing. A complete replacement guide is available including over 1800 recorder models with the Nortronics replacement type and other pertinent information.

20 E 58280

FREE

DIRECT REPLACEMENTS FOR POPULAR TAPE RECORDERS

R-Record; P-Play; E-Erase. *Mounting hardware where required. (See below). With instructions. Average wt. 1 lb.

Stock No.	Mfrs. Type	Function	For WEBCOR Models—Some Prefixed CP, EP, LT, PB, TP	*Quik Kit	Net Ea.
20 E 57052	7403	RP	2001(-1), 1A, 1B, 1C, 2002, 2009, 2203, 2206-1, 2800 & 2900 series	—	10.50
20 E 57076	3100	RP	2101-1, 2200(-1), 2202(1), 2205(-1), 2300(-1), 2302(-1), 2303(-1), 2400-1, 2402(-1), 2500(-1, 10, 22), 2502(-1, 10), 5400	—	8.40
20 E 57019	1000	RP	2008, 2208, 2323(-1, 1A)	—	21.00
20 E 57860	7500	E	For all models above	—	8.00
20 E 57019	1000	RP	2007, 2107(-1), 2150, 2007(-1), 2208-1, 2250 (-1), 2328(-1), 2356(-1, 1A, 1B), 2357(-1), 2360(-1), 2366-1B, 2391, 3392, 3393, 4007-1, MUSIC MAN	—	21.00
20 E 57225	1402	E	For all models above	18	12.00
20 E 57078	6003	RPE	2520-1, 2522-1, 2456(-1), 2457(-1), REGENT	—	33.00
20 E 58284	7400	RP	For all models utilizing replaceable pole piece.	—	8.00
For CONCORD					
20 E 57084	3101	RP	320, 330	—	8.40
20 E 57134	3600	E	All above	19	8.00
20 E 57019	1000	RP	400D, 401, 400RP	66	21.00
20 E 57092	1400	E	400D, 401, 400RP	19	12.00
20 E 57027	1002	RP	440	66	21.00
20 E 57100	1401	E	440	19	12.00
20 E 57100	1401	R	880	66	21.00
20 E 58090	1007	P	884	66	21.00
20 E 57159	1001	RP	990, 994	66	21.00
20 E 58090	1007	RP	990, 994	66	21.00
20 E 57100	1401	E	All above	19	12.00

For PANASONIC					
20 E 57084	3101	RP	101S, 102S, 152S	21	8.40
20 E 57134	3600	E	101S, 102S, 152S	18	8.00
20 E 57084	3101	RP	115, 500, 555	—	8.40
20 E 57076	3100	RP	705	21	8.40
20 E 57134	3600	E	All above	19	8.00
20 E 58165	1008	RP	755, 755S	66	21.00
20 E 57100	1401	E	755, 755S	19	12.00

FOR ROBINS/MICHIGAN MAGNETICS					
20 E 57885	3001	RP	3L20-101, 3L205	20	8.40
20 E 57803	6005	RPE	2N92Q10B-1	38	33.00
20 E 57027	1002	RP	1NPR-300	—	21.00
20 E 57522	5800	RP	4NE-100, 4NH2L (S-O, X-O)	—	15.00
20 E 57282	6002	RPE	4NPPV-300	—	33.00
20 E 58066	1009	RP	69NR2QB-1, 300, 5Q08, 5Q8, 5Q117 (105, 300), 5P17-300	—	21.00
20 E 57142	3601	E	5S1 (-103, 321), 7EM12, 551-115	18	8.00
20 E 57977	3000	RP	7H17, 7H40, 7L17 (-108), 10L17-104	20	8.40
20 E 57100	1401	E	9QE3, 9QTE3, 12ER2Q-1, 12EQ, 18HE6, 9EQ3	18	12.00
20 E 57134	3600	E	40EM12A, 50HE6	18	8.00
20 E 58074	6009	RPE	5AV17, 6AV17-200, 4UW2Q10B-1	38	33.00

Heads with -100 same as -300 series

AUTO AND HOME 8-TRACK CARTRIDGE REPLACEMENT HEAD
Record/Playback replacement head for practically all auto and home 8-track cartridge tape players. Shpg. wt., 6 oz.
20 E 58272 Nortronics 5800 Net 9.60

Stock No.	Mfrs. Type	Function	For SONY SUPERSCOPE Some Prefixed TC, SSA	*Quik Kit	Net Ea.
20 E 57019	1000	RP	262(D, SL), 464(C, S, D, SL)	102	21.00
20 E 57019	1000	RP	300, 500, 501, 521	119	21.00
20 E 58090	1007	RP	200, 250, 260, 350, 530, 600	102	21.00
20 E 57837	1210	R	263-263E, 350, 600	102	28.20
20 E 57100	1401	E	260, 350, 530	306	12.00
20 E 57225	1402	E	200, 250, 262(CS, D, SL), 464(CS, D, SL)	305	12.00
20 E 57225	1402	E	263-263E, 300, 500, 501, 521, 600	306	12.00
20 E 57191	2601	RP	101, 102	102	15.90
20 E 57134	3600	E	102	19	8.00
20 E 57977	3000	RP	135-111	—	8.40
20 E 57985	3001	RP	905A-801A	—	8.40

For REVERE WOLLENSAK, 3M

20 E 58033	**RPE-20 or RPE-23 (See Note)	RPE	10, 11, 15-27, 200, 202, 700, 700D, 750, 752, 762, 800, 800D, 826, 850, 852, 900, 905, 925, 926, 1000, 1005, 1025, 1026, 1100, 1105, 1125, 1126, 1200, 1205, 1225, 1226, 1400 (B, C, D, E), 1405, 1425, 1426, 1500, 1520, 1570, 1600, 1700, 1800, 2000, 2005, 2025, 7805, 70000 series	—	18.80
20 E 57423	**RPE-23 (See Note)	RPE	100, 300, 301, older 2TR mono	—	15.60
20 E 58041	RPE-21	RPE	1500 (SS, AV, D)	—	22.80
20 E 57761	7601	RP	11-4, 204-4, 1440 (B, C, D, E), 1515-4, 1616-4, 1818	—	28.50
20 E 57779	7720	E	All above	—	11.00
20 E 57282	6002	RPE	1280, 1281	—	33.00
20 E 57761	7601	RP	1580, 1780 (B, C, D, E), 1980 (B, C, D, E), 1981 (B, C, D, E), 2200, 2205, 2225	—	28.50

For VM Models

20 E 57084	3101	RP	710(A), 711(A), 714, 730, 750(A), 1000	20	8.40
20 E 57977	3000	RP	700, 701	20	8.40
20 E 57142	3601	E	Models above except 700	18	8.00
20 E 57134	3600	E	700	18	8.00
20 E 58066	1009	RP	710Q, 720, 722, 735 (add A track) 740(1), 741, 755, 1001(-1, 2), 1002(-1, 2)	38	21.00
20 E 57035	1800	P	1001(-1, 2), 1002(-1, 2)	38	23.30
20 E 57100	1401	E	710Q, 720, 722, 755, 1001(-1, 2), 1002(-1, 2)	18	12.00
20 E 57282	6002	RPE	740, 740-1, 741	38	33.00

For VIKING

20 E 57084	3101	P mono	75, 76, 77, 78, 770	21	8.40
20 E 57134	3600	E mono	Above	19	8.00
20 E 58173	1201	RP-4tr.	Above	66	28.20
20 E 57092	1400	E-4tr.	Above	19	12.00
20 E 58181	1200	RP-4tr.	85, 86, 87, 88, 880, 95	—	28.20
20 E 58090	1007	RP	423	—	21.00

**RPE-20 replaces original Nortronics. RPE-23 replaces original Shure.
*Quik-Kits purchased separately; see table above.

LAFAYETTE Stereo Headphones For Magnificent Private Listening

Lafayette MODEL SP55 STEREO PHONIC HEADPHONES

- Frequency Response 30-15,000 Hz
- Air-Cushioned Headband
- Soft Foam Rubber Ear Cushions for Maximum Comfort and Bass Response
- Two 2½" Wide Range Transducers

11⁹⁵

Improved version of our widely acclaimed F-767 series stereo headphone. Provides outstanding full-fidelity private stereo listening. Extremely comfortable headband is covered with an air-filled vinyl bag which serves as a gentle cushion. Soft foam rubber ear pads keep out external noise and provide maximum bass response. Sensitivity is very high—a signal power of 1 to 2mw will produce adequate listening volume. Two specially designed full range 2½" transducers are precisely matched to each ear cup. Complete with attached stereo phone plug, overload cylindrical junction box for connection of the headphones to equipment which does not have stereo phone jacks, 5 ft. cord, and instructions. Frequency Response: 30-15,000 Hz. Impedance: 8 ohms per phone. Imported. Shpg. wt., 2½ lbs.

99 E 01835

Net 11.95



Lafayette MODEL F-880 STEREO HEADPHONES

- Soft Rubber Air-Cushioned Ear Pads
- Actually Two 2½" Hi-Fi Speakers
- Frequency Response 25 to 15,000 Hz

17⁹⁵

Make stereo listening a personal experience with these quality stereo headphones. Provides dazzling wide range sound reproduction. Comfort-oriented design makes music listening a real pleasure. The F-880 stereo headphones are actually two 2½" high fidelity dynamic speakers with a frequency response range of 25 to 15,000 Hz and are rated at 1/2 watt maximum input; impedance, 8 ohms per phone. The soft rubber air-cushioned ear pads provide extremely comfortable listening, help to keep out noise and maintain an excellent bass response. With 5 ft. cord and standard 1/4" phone plug. Imported. Shpg. wt., 2 lbs.

99 E 02040

Net 17.95



Lafayette MODEL 8X STEREO HEADPHONES

- Soft Rubber Cushion Earcups
- With 5 ft. Coiled Cord
- Frequency Response: 35-15,000 Hz

7⁹⁵

The moment you put this headset on you will be enveloped in breathtaking full-dimensional stereo sound with the best "seat" in the house. Wonderfully comfortable too. Soft rubber cushion earcups block out most external noise. Lightweight vinyl covered headband adjusts to fit easily...lets you listen comfortably to your favorite programs hour after hour without fatigue. The big 2" transducers in each earcup bring to your ears smooth, full fidelity sound and complete stereo separation. The headset weighs only 11 oz. Frequency response: 35 to 15,000 Hz. Output: 100 mw. Matches 8 or 16-ohm impedance. Supplied complete with 5-ft. coiled cord and standard 1/4" phone plug. Imported. Shpg. wt., 1½ lbs.

99 E 01802

Net 7.95



Lafayette SP22 STEREO HEADPHONES

*Ideal For Use With Stereo Phonographs
And Low-Power Stereo Receivers and Amplifiers*

- Frequency Response: 35-12,000 Hz
- Lightweight, Only 10 oz.
- Adjustable Headband

**ONLY
5⁹⁵**

Quality, private listening stereo headphones at a price everyone can afford. Perfect for stereo or mono. Designed for use with low priced stereo receivers, amplifiers, and phonographs. Adjustable headband and comfortable foam-filled vinyl ear pads. Large, 2¼" diameter transducers for full-range response. Impedance: 8-ohms. With 6-feet of cable and standard stereo phone plug. Imported. Wt., 1½ lbs.

99 E 02123

Net 5.95



LAFAYETTE Stereo Headphones and Accessories

Deluxe LAFAYETTE F-990 Professional Stereo Headphones



Lafayette's Finest Quality Headphones

ONLY
29⁹⁵
With 6½' Cable

- Two large 3½" Wide Range Transducers
- Frequency Response 20-20,000 Hz
- Air-tight Earphone Cushions

Now the listener, in his home, can own a pair of professional stereo headphones similar to the one used in laboratories, recording studios and broadcast stations. Superbly engineered to provide brilliant, full-dimensional stereo sound. Two large 3½" transducers provide complete full-range coverage from 20-20,000 Hz. A comfortably soft, but air-tight seal to the ear is provided by foam filled earphone cushions. Fully adjustable, cushioned vinyl headband will give you hours of listening comfort without any fatigue. Comes with 6½ ft. cable and standard stereo phone plug. Impedance: 8 ohms. Imported. Shpg. wt., 2½ lbs.

99 E 02099

Net 29.95

Accessories For LAFAYETTE Stereo Headphones



4⁹⁵

(A) Stereo Headphone Remote Control Box

Designed to connect 1 or 2 stereo headphones to an existing system without the need of continually disconnecting speakers. Separate volume controls are provided for each side of the headset. Speaker muting switch permits using stereo headphones and speakers together, or stereo phones only for private listening. Impedance: 4-16 ohms. 4¾W x 1¾H x 1¾"D. Imported. Shpg. wt., 1¼ lbs.

99 E 00366

Net 4.95



2²⁹

1⁴⁹

(B) 25 Ft. Universal Stereo Headphone Extension Cord

Listen to stereo through your favorite stereo headphone anywhere in the room. Ideal for use with Lafayette, Koss, Superex, Jensen, Sharpe and many other headsets. Flexible 3-conductor cable. With a 1/4" 3-circuit plug on one end, a 3-circuit jack on the other end. Imported. Shpg. wt., 1 lb.

99 E 01166

Net 2.29

(C) 10-Ft. Stereo Headphone Extension Cord

For stereo amplifiers and receivers, that do not have a stereo headphone jack. Terminates in 3 spade-lug terminals instead of phone plug. Imported. Shpg. wt., 1/2 lb.

99 E 01695

Net 1.49

NEW SENNHEISER HD-414 "Open Aire" Stereo Headphones

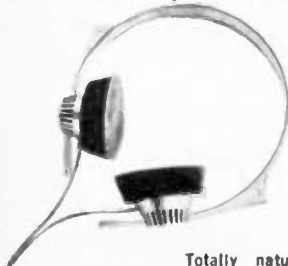

29⁹⁵

With 10' Cable
• Lightweight and Compact

Totally natural, full-fidelity reproduction with a minimum of distortion. Unique "open air" foam ear cushions drastically reduce weight and bulk of the headset (only 5 oz. without cord). Eliminates need for closed cavities on either side of earphone diaphragms. Features 1¾" wide range transducers. Frequency response: 20-20,000 Hz. 2000 ohm impedance. Connects directly to either high or low impedance outputs. With 10 ft. cable and stereo phone plug. Shpg. wt., 1½ lbs. Imported.

21 E 58004

Net 29.95

Koss ESP-6 Electrostatic Stereo Phone



95⁰⁰

with portable carrying case

Totally new concept in stereo headphones! Uses electrostatic principle...self-energized diaphragms will reproduce 3 octaves of sound beyond the limits of voice coil and cone type driven headphones. Frequency Response: 40-12,000 Hz ±2dB; Usable Response: 10 Hz to 20 kHz. Input Impedance: 4 to 100 ohms. Cushioned foam rubber headband for maximum comfort. Liquid-filled ear cushions minimize annoying external noise. Pilot lamps on each ear piece indicates when sound level exceeds 90 dB. With coiled cord extends to 10' and standard stereo phone plug. Shpg. wt., 2 lbs.

21 E 45167 No Money Down*

Net 95.00

* See Page 11 for Full Credit Details on Easy Pay Plan

SUPEREX and KOSS STEREO HEADPHONES

Superex Model ST-M

29³⁵



- Separate Woofer and Tweeter in Each Phone

For discriminating music lovers. A separate dynamic woofer, ceramic tweeter and crossover network with external tweeter controls built into each phone, give you concert hall sound. The reproducers are mounted in smartly styled hi-impact cyclocast plastic shells. A tight but soft seal to the ear is provided by removable and washable vinyl covered urethane foam cushions plus a fully adjustable vinyl covered spring steel headband. Impedance 4-16 ohms. Frequency response: 20-20,000 Hz, with less than 1% distortion. Complete with 7 foot four conductor cable terminated with a standard stereo plug. 21 E 80016 Shpg. wt., 3½ lbs. Net 29.35

Deluxe Superex Model ST-Pro-B

49⁰⁰



No Money Down*

- Co-Axially Mounted Woofer and Tweeter in Each Phone
- 18 to 22,000 Hz Frequency Response

Professional quality stereo headphones for listening to stereo FM, records, and tape. Frequency response: 18 to 22,000 Hz. Dynamic woofer for low frequency and ceramic tweeter for high frequency are mounted co-axially in a high impact case. Luxuriously soft vinyl urethane foam filled cushions make tight ear seal. Adjustable, spring steel headband. 4-16 ohm impedance. Nominal power 30 mw., maximum power, 2 watts. Comes with 7 ft., four conductor cord, standard stereo plug. Shpg. wt., 3½ lbs. 21 E 80057 Net 49.00

Koss Model KO-727 Wide-Band Phones

34²⁵

No Money Down*



- With New 10-ft. Coiled Cord

Enjoy full dimensional stereo music with maximum comfort. Highly sensitive stereophonic reproducers will accept up to 60 watts per channel from any normal program source and can be used in any system with a 4, 8 or 16 ohm output. Foam-filled ear cushions are removable for easy cleaning. New 10-ft. coiled cord for added convenience. Distortion—less than 1% at maximum output. Response: 10-15,000 Hz. Fully adjustable for comfortable private listening—even during long listening periods. Shpg. wt., 3½ lbs. 21 E 45076 Net 34.25

Koss Professional Model PRO-4A

49⁰⁰

No Money Down*

- Equipped For Boom Mike Attachment



Rugged construction makes it both shatterproof and shockproof. Adjustable, spring steel headband and fluid filled ear cushions are designed to fit head contour, thus forming a more efficient seal for almost complete attenuation of ambient noise. High quality drivers mounted in acoustically designed enclosures provide smooth frequency response from 30 to 20,000 Hz. Removable cushions can be cleaned up with soap and water. With 10 ft. coiled cord and plug, 4 ohms impedance. Shpg. wt., 3 lbs. 21 E 45142 Net 49.00

Koss Model SP-3XC



19⁵⁵

Low cost SP-3XC Stereophones are a specially constructed headset that provide a wide frequency range of 10-15,000 Hz. by means of unusual 3½" dynamic reproducers incorporated into each earphone. Foam cushioned earcups are extremely comfortable to wear, light and rugged. Ideal for Stereo, they can also be used for monaural sound. Impedance of 4-16 ohms. With 8 ft. cord and plug. Shpg. wt., 2 lbs. 21 E 45134 Net 19.55

Koss Model K-6



25⁹⁷

Combines famous Koss sound with comfortable efficient fit. Spring steel headband and foam-filled ear cushions form effective seal to achieve a freq. response of 10-15,000 Hz. Vinyl-covered cushions removable for easy cleaning with soap and water. Sponge foam headband for comfort during extended listening periods. Impedance: 4-16 ohms. 8-ft. cord with standard stereo phone plug for direct connection to most amplifier and receiver systems. 21 E 45175 Shpg. wt., 3 lbs. Net 25.97

ACCESSORIES FOR KOSS PHONES

(A) T-1 Monitoring Box



(B) T-5 Remote Control Box

(A) Model T-1 Monitoring Box

For use in monitoring tapes from high impedance sources such as tape recorders with preamp only. Contains matching transformers for 600 to 10,000 ohm outputs. Shpg. wt., 1½ lbs. 21 E 45035 Net 7.79

(B) Model T-5 Headset Control Box

Provides stereophonic and speaker control from remote location. Has jacks for 2-sets of stereophones. Left and right channel volume controls and speaker on-off switch. Impedance: 4-16 ohms. Metal cabinet. 21 E 45043 Shpg. wt., 1¼ lbs. Net 9.75

* See Page 11 for Full Credit Details on Easy Pay Plan

Pickering EMPIRE SHURE Stereo Cartridges

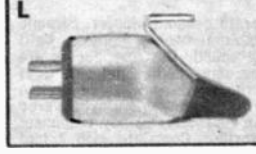
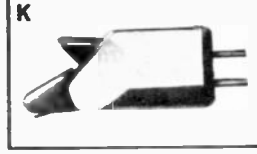
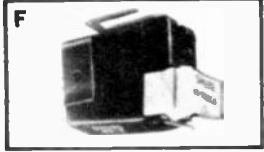
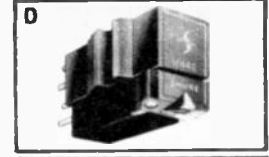
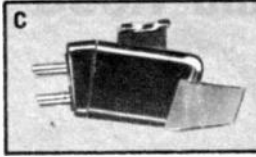
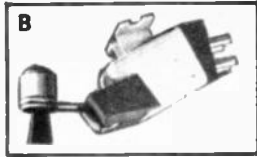

PICKERING MAGNETIC STEREO CARTRIDGES

To simplify cartridge mounting all Pickering cartridges will be supplied with a universal mounting platform which will snap into any standard tone arm head. The Pickering cartridge will then easily snap onto the platform.

A) DELUXE XV-15 D.C.F.† SERIES — Engineered so that each type cartridge in the series is specially indexed with a DCF† number for use with specific playback equipment. Provides maximum stylus performance. Includes "Dustamatic Brush" which automatically cleans the grooves in advance of the stylus. Specifications: Channel separation 35 db; Nominal output: XV-15/750E, XV-400E—5.5 mv, XV-15/200E, XV-15/100—8 mv. Frequency response: 10 to 25,000 Hz except XV-15/100—10 to 20,000 Hz. Stylus type: XV-15/750E—.0002 x .0009" elliptical; XV-15/400E—.0003 x .0009" elliptical; XV-15/200E—.0004 x .0009" elliptical; XV-15/100E—.0007 conical. Tracking force: XV-15/750E—½ to 1 gram; XV-15/400E—¾ to 1½ grams; XV-15/200E—1 to 4 grams; XV-15/100—2 to 5 grams. †Dynamic coupling factor. Shpg wt., 6 oz.

Stock No.	Model	DCF†	For	Net
21 E 53064L	XV-15/750E	750	Manual turntables	60.00
21 E 53757L	XV-15/400E	400	Manual turntables	49.95
21 E 53781L	XV-15/200E	200	Automatic turntables	44.95
21 E 53799L	XV-15/100	100	Automatic changers	29.95

B) DELUXE "MICRO-MAGNETIC" DUSTAMATIC (M) SERIES. Dustamatic stylus will protect your records from dust and preserve their natural sound. Integrated with the stylus assembly, the Dustamatic brush automatically cleans the grooves in advance of the stylus—without interfering with the tracking force. SPECIFICATIONS: Freq. Response: AME-3, 10 to 25,000 Hz, ATE-3, AM-3, ACE-3, AC-3, 10 to 20,000 Hz; Output: AME-3, 5.5 mv, AM-3, ATE-3, 6.5mv, ACE-3, AC-3, 7.5mv; Separation: All 32 db except ACE-3 and AC-3, 26 db; Tracking Force AME-3, ¾ to 1½ grams, AM-3, 1 to 3 grams, ATE-3, ACE-3, 3 to 5 grams, AC-3, 3 to 7 grams. Average shpg. wt., 5 oz.

21 E 53708L V15/AME-3 Elliptical No Money Down* Net 44.95
 21 E 53740L V15/ATE-3 Elliptical No Money Down* Net 39.95
 21 E 53773L V15/AM-3 Elliptical Net 29.95
 21 E 53724L V15/AC-3 Conical No Money Down* Net 34.95
 21 E 53765L V15/AC-3 Conical Net 24.95

C) P SERIES STEREO CARTRIDGES—Frequency response: 20 to 15,000 Hz. Nominal output: P/ATE-1, 8 mv.; P/AT-1, 8.5 mv.; P/AC-1, 9 mv. Channel separation: 20-25 db. Tracking force: P/ATE-1, P/AT-1, 2 to 5 grams; P/AC-1, 3 to 7 grams. P/AC-1, P/AT-1 with .7 mil conical diamond stylus; P/ATE-1 with .0005 x .0010 elliptical stylus. Shpg. wt., 4 oz.

21 E 53880L P/ATE-1 Elliptical Net 29.95
 21 E 53567L P/AT-1 Conical Net 19.95
 21 E 53575L P/AC-1 Conical Net 17.95

EMPIRE MAGNETIC STEREO CARTRIDGES

K) 888 SERIES. Deluxe stereo cartridge with patented "Magnetic Cone Stylus." Frequency response 888—12 to 25,000 Hz, 888E—10 to 30,000 Hz, 888TE, 8 to 32,000 Hz, 888VE, 6 to 32,000 Hz. Channel separation for each cartridge exceeds 30 db. Tracking force: 888—¾ to 4 grams, 888E—¾ to 3 grams, 888TE ½ to 1½ grams, 888VE ½ to 1½ grams. Tracking angle 15° on all cartridges. Stylus: 888—.7 mil conical diamond, 888E—.4 x .9 mil elliptical diamond, 888TE—.888VE .2 x .7 mil elliptical hand polished diamond. Shpg. wt., 7 oz.

21 E 34187L 888 Conical—for automatic turntable Net 24.95
 21 E 34575L 888E Elliptical—for automatic turntable Net 39.95
 21 E 34490L 888TE Elliptical—for manual turntable Net 49.95
 21 E 34799L 888VE For manual turntable Net 59.95

SHURE MAGNETIC STEREO CARTRIDGES

D) MODEL M44E ELLIPTICAL STEREO CARTRIDGE. Features an elliptical stylus (.0004"x.0007") designed for automatic turntables. Tracks from 1¼ to 4 grams. Specifications: Frequency response: 20-20,000 Hz, channel separation: 25 db, Output voltage: 9.3 mv. Compliance: 15.0x10⁻⁴ cm/dyne. Shpg. wt., 6 oz.

21 E 62360L Net 24.95

E) MODEL M-55E ELLIPTICAL STEREO CARTRIDGE. Features elliptical diamond stylus and 15° vertical tracking angle. For outstanding performance use with tone arm at a tracking force of 1 to 3 grams. Separation over 25 db. Output voltage: 9.3 mv. Compliance 25x10⁻⁴ cm/dyne. Shpg. wt., 6 oz. (Not illustrated).

21 E 62410L No Money Down* Net 35.50

F) MODEL M93E ELLIPTICAL STEREO CARTRIDGE. Hi-Track Elliptical cartridge with easy snap-in mount. Tracking force between 1½ to 3 grams. Provides outstanding results in automatic or manual turntables. With Bi-Radial .0004" x .0007" diamond stylus. Freq. Response 20 to 20,000 Hz. Separation 25 db at 1 kHz. Wt., 6 oz.

21 E 62436L No Money Down* Net 39.95

G) MODEL M91E DELUXE HI-TRACK ELLIPTICAL STEREO CARTRIDGE with optimized design parameters for trackability. For use in automatic and manual turntables. With Bi-Radial .0002" x .0007" diamond stylus. Freq. Response 20 to 20,000 Hz. Separation at 1 kHz 25 db. Tracking force: ¾ to 1½ grams. Shpg. wt., 6 oz.

21 E 62444L No Money Down* Net 49.95

H) V15 TYPE II SUPER TRACK 15° STEREO DYNETIC ELLIPTICAL CARTRIDGE. Shure's premiere cartridge featuring high frequency trackability. Recreates music with transcendent purity. Retractable elliptical .0007"x.0002"x.15° diamond stylus. Specifications: Frequency response: 20 to 25,000 Hz. Channel separation: 25 db at 1 kHz. Output voltage: 3.5 mv., Compliance: 25x10⁻⁴ cm/dyne. Tracking force: ¾ to 1½ grams. Shpg. wt., 6 oz.

21 E 62386L No Money Down* Net 67.50

I) MODEL M75-6 4-TRACK STEREO CARTRIDGE for manual or light tracking automatics. Bi-Radial .0002"x.0007" diamond stylus. Response 20 to 20,000 Hz. Separation 25 db at 1 kHz. Tracking force range 1½ to 3 grams. With .6 mil conical stylus. Shpg. wt., 6 oz.

21 E 62428L Net 24.50

J) MODEL M7/N21-0 STEREO CARTRIDGE. Frequency response: 20 to 20,000 Hz. Channel Separation: More than 20 db at 1000 Hz. Output voltage: 4 mv. per channel at 1000 Hz. Tracking force: 2 to 5 grams. Tracks perfectly in all record changer arms with .7 mil conical diamond stylus. Shpg. wt., 5 oz.

21 E 62063L Net 9.95

EMPIRE MAGNETIC STEREO CARTRIDGES

L) EMPIRE PROFESSIONAL 999VE QUALITY STEREO ELLIPTICAL CARTRIDGE—for high performance record playback systems only. Will track 30 cm/sec at less than 1 gram. Patented 4-pole, 4-coil, 3-magnet design. Response: 6 to 35,000 Hz. Output voltage: 5.0 mv. per channel. Channel separation: more than 30 db. Tracking force ½ to 1½ grams. Stylus: .2 x .7 mil elliptical hand polished diamond. Shpg. wt., 6 oz.

21 E 34716L No Money Down* Net 74.95

M) NEW! EMPIRE'S FINEST STEREO ELLIPTICAL CARTRIDGE—MODEL T000ZE. Frequency response: 6 to 40,000 Hz. Output voltage: 5 mv per channel. Separation: more than 30 db. Tracking force: .25 to 1.25 grams. Stylus: .2 x .7 mil elliptical hand polished diamond. Shpg. wt., 5 oz.

21 E 34856L No Money Down* Net 99.95

Tone Arms, Cartridges, Replacement Diamond Needles

SHURE AND EMPIRE STEREO TONE ARMS

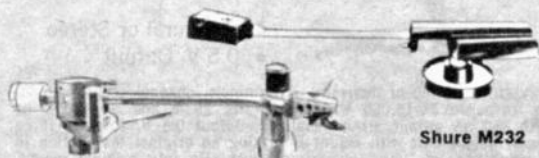

New Empire 990

Shure M232

SHURE MODEL M232 TONE ARM. A quality 12" tone arm that ACCEPTS PRACTICALLY ALL CARTRIDGES and permits them to operate at their maximum potential performance. Features precision ball bearings at all pivot joints, plug in head with positive alignment lock and variable height adjustment. Positive visual control over balance without altering overall arm length. Tracking force 1½ to 6 grams. Comes with arm rest, mounting template, mounting hardware. Shpg. wt., 2 lbs.

21 E 62519L Net 29.95

Model M236 Same as Model M232, but for 16" Records.

Shpg. wt., 2½ lbs.

21 E 62527L No Money Down* Net 31.95

Shure A23H Extra Plug In Head. Shpg. wt., 2 oz.

21 E 62535L Net 2.40

EMPIRE 990 DELUXE PROFESSIONAL STEREO TONE ARM. Dynamically balanced in all planes. Counterweight zero balance adjustment. Sealed micro-ball bearings makes vertical and lateral friction virtually unmeasurable. Features anti-skate and exclusive Dyna Lift. Fundamental resonance: 6 Hz. Calibrated knob dials stylus force from 0 to 4 grams. 5-wire circuit eliminates ground loops, 4-ft. shielded cable assembly. Satin gold finish. Overall length: 12¾". Height adjustable to 1½". Shpg. wt., 2 lbs.

21 E 34864L No Money Down* Net 74.95

ADC MAGNETIC STEREO CARTRIDGES

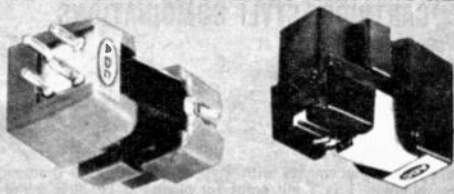

ADC 220E

ADC 10/E MKII

220 STEREO CARTRIDGE—Induced-magnet low mass design. Tracking force 2-5 grams. Separation 20 db. Response 10 to 18,000 Hz. Shpg. wt., 4 oz.

21 E 13231L Net 19.50

220E ELLIPTICAL STEREO CARTRIDGE. Completely compatible with all micro-groove records-mono or stereo. Induced magnetic design. Channel separation: 20 db. Frequency response: 10-18,000 Hz ±3 db. Tracking force; 1½ to 4 gm. Compliance: 18 x 10-6. Stylus: .3 x .7 mil. Elliptical Diamond. Output: 5 mv.

21 E 13272L Shpg. wt., 4 oz. Net 24.95

660/E ELLIPTICAL STEREO CARTRIDGE—Induced magnet low mass design. Frequency response 10-20,000 Hz ± 3 db. Channel Separation 30 db. Vertical Tracking angle 15°. Elliptical Diamond stylus-contact radius .0002". Lateral radius .0008". Tracking force 1 to 3 grams Wt 5 oz.

21 E 13140L No Money Down* Net 39.50

MODEL 10/E-MKII ELLIPTICAL STEREO CARTRIDGE. Deluxe induced magnet low mass design stereo cartridge with .0003" x .0007" Elliptical diamond stylus. Vertical tracking angle 15°, tracking force range—½ gram to 1½ grams, channel separation 30 db, frequency response 10 to 20,000 Hz. Sensitivity 4mv at 5.5 cms/sec. recorded velocity. Shpg. wt., 6 oz.

21 E 13199L No Money Down* Net 59.50

NEW GRADO F SERIES MAGNETIC STEREO CARTRIDGES



Model FTR
Spherical
9⁹⁵

Model FTE
Elliptical
19⁹⁵

NEW GRADO F SERIES STEREO CARTRIDGES. Frequency Response: 10 to 35,000 Hz. Channel separation: 25 db. Output: 5 mv @ 3.54 CMV. Shpg. Wt. 4 oz.

Stock No.	Model	Stylus	Net
21 E 41356L	FTR	.6 Spherical	9.95
21 E 41364L	FTE	.7 x .3 Elliptical	19.95

NEW MODEL 25 STEREO PICK-UP SYSTEM

100⁰⁰

• 3 Interchangeable Stylus Assemblies

Features three interchangeable stylus assemblies for optimum compatibility of the cartridge with the groove formation of the disc. Styli included are: .0009" x .0003" (elliptical); .0007" x .0003" elliptical; and .0006" spherical. Tracking force, ½ to 1¼ gms.; Response, 10-24,000 Hz ±2 db; Channel Separation, 30 db; Vertical Tracking angle, 15°; Impedance, 47k ohms.

21 E 13298L Shpg. wt., 6 oz. Net 100.00

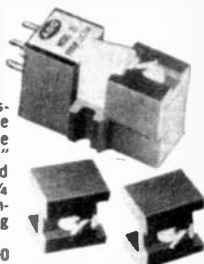

DIAMOND REPLACEMENT NEEDLES FOR FAMOUS HI-FI CARTRIDGES

Exact Styli Replacements for Pickering, Shure, Empire, GE, Grado and ADC

Stock No.	MFR.	Type	STYLUS	For	Net
21 E 53450L	Pick.	D1500AME-2	ELLIP.	V15/AME-1, AME-2	19.90
21 E 53468L	Pick.	D1507AM	.7 MIL	V15/AM-1, AM-2	12.25
21 E 53476L	Pick.	D1507AT	.7 MIL	V15/AT-1, V15/AT-2	10.95
21 E 53484L	Pick.	D1507AC	.7 MIL	V15/AC-1, V15/AC-2	9.95
21 E 53492L	Pick.	D1510	1 MIL	V15 Series	11.90
21 E 53500L	Pick.	D1527	2.7 MIL	V15 Series	9.90
21 E 53591L	Pick.	P/DO7-T	.7 MIL	P/AT-1	9.90
21 E 53609L	Pick.	P/DO7-C	.7 MIL	P/AC-1	9.15
21 E 53898L	Pick.	P/DO7-E	ELLIP.	P/ATE-1	14.95
21 E 53021L	Pick.	D3807AT	.7 MIL	U38AT	9.90
21 E 53070L	Pick.	D3807A	.7 MIL	380A	12.00
21 E 53062L	Pick.	D3807C	.7 MIL	380C	10.90
21 E 53534L	Pick.	D3810C	1 MIL	U38AT, 380C	9.90
21 E 53138L	Pick.	D3827C	2.7 MIL	U38AT, 380C	9.90
21 E 53112L	Pick.	D9007	.7 MIL	MARK/II	9.90
21 E 53633L	Pick.	D1500ATE-2	ELLIP.	V15/ATE-2	17.90
21 E 53641L	Pick.	D1500AME-3	ELLIP.	V15/AME-3	24.95
21 E 53658L	Pick.	D1507ATE-3	ELLIP.	V15/ATE-3	22.50
21 E 53674L	Pick.	D1507AT-3	.7 MIL	V15/AT-3	13.75
21 E 53815L	Pick.	4500AME	ELLIP.	XV-15AME	26.95
21 E 53823L	Pick.	4500ATE	ELLIP.	XV-15ATE	24.95
21 E 53807L	Pick.	4507AC	ELLIP.	XV-15AC	12.40
21 E 53682L	Pick.	D1510-3	1 MIL	V15-3 Series	14.40
21 E 53690L	Pick.	D1527-3	2.7 MIL	V15-3 Series	12.40
21 E 53631L	Pick.	D1507AC-3	.7 MIL	V15AC-3	10.90
21 E 53849L	Pick.	D1500ACE-3	ELLIP.	V15ACE-3	20.40
21 E 53872L	Pick.	D7500E	ELLIP.	XV-15/750	30.00
21 E 34047L	Empire	S880P-6RD	.6 MIL	880P	12.95
21 E 34401L	Empire	S888PE-ERD	ELLIP.	888PE	20.95
21 E 34419L	Empire	S888P-6RD	.6 MIL	888P	14.95

Stock No.	MFR.	Type	STYLUS	For	Net
21 E 34450L	Empire	S888-7RD	.7 MIL	888	12.95
21 E 34617L	Empire	S888E-ERD	ELLIP.	888E	16.95
21 E 34625L	Empire	S888SE-ERD	ELLIP.	888SE	22.95
21 E 34724L	Empire	S999VE-ERD	ELLIP.	999VE	36.95
21 E 34732L	Empire	S888TE-ERL	ELLIP.	888TE	24.95
21 E 34823L	Empire	S888VE-ERD	ELLIP.	888VE	29.95
21 E 62022L	Shure	N3D	.7 MIL	M3D, M7D	7.95
21 E 62071L	Shure	N21D	.7 MIL	M7D, M3D	9.95
21 E 62170L	Shure	N44-5	.5 MIL	M-44-5	11.00
21 E 62188L	Shure	N44-7	.7 MIL	M-44-7	9.75
21 E 62204L	Shure	VN2E	ELLIP.	V15	27.00
21 E 62246L	Shure	N55E	ELLIP.	M80, M55	14.95
21 E 62253L	Shure	N99	.7 MIL	M99	12.95
21 E 62378L	Shure	N44E	ELLIP.	M44E	12.50
21 E 62402L	Shure	N32E	ELLIP.	M32E	14.50
21 E 62477L	Shure	N91E	ELLIP.	M91E	24.50
21 E 62469L	Shure	N93E	ELLIP.	M93E	19.50
21 E 62451L	Shure	N75-6	.6 MIL	M75-6	11.35
21 E 13090L	ADC	R-4	.7 MIL	P/4/FOUR	12.00
21 E 13108L	ADC	R-4E	ELLIP.	P/4/E	18.00
21 E 13116L	ADC	R-660	.7 MIL	660	10.00
21 E 13124L	ADC	R-770	.7 MIL	770	9.00
21 E 13157L	ADC	R-660/E	ELLIP.	660/E	18.00
21 E 13207L	ADC	R-15-2	ELLIP.	10/-11, 10/E	22.50
21 E 13280L	ADC	R-220/E	ELLIP.	220E	12.00
21 E 38048L	GE	DR-7D	.7 MIL	V1000-7	6.93
21 E 38063L	GE	VR222	.7 MIL	VR-22	5.13
21 E 38501L	GE	DR3D	ELLIP.	VR-10003	13.20
21 E 41372L	Grado	FTR/S	.6 MIL	SPHERICAL	7.50
21 E 41380L	Grado	FTE/S	.7x.3 MIL	ELLIP.	12.50

Electro-Voice and Astatic Cartridges

EXACT DUPLICATE PLUG-IN CARTRIDGE-STYLI COMBINATIONS

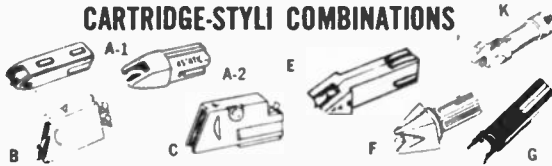

Exact duplicate replacements with styli. STYLI CODE: D Diamond, S Synthetic sapphire. 1 is 1 mil point for monoaural LP; 2 is 2 mil for mono LP & 78; 7 is .7 for stereo; 3 is 3 mil for 78 RPM. We will ship either Electrovoice, Astatic or cartridge of original manufacturer. Color given to assist identifying original part sometimes is a color dot. Avg. shpg. wt., 6 oz.

FOR RCA

Stock No.	Fig.	Mfr. No.	Ast. No.	E.V. No.	Styli	Net
24 E 50203	A-1	105836,37	83-1	83	S-1	2.10
24 E 50211	A-1	105836,37	83-1X	83D	D-1	3.90
24 E 50229	A-1	108555	89-1	—	S-1	2.55

FOR WEBCOR

24 E 50237	A-2	A1919	White	91T	76	S-1, S-3	2.37
24 E 50245	A-2	A1920	Pink	91TX	76D	D-1, S-3	4.17

FOR ZENITH

24 E 50252	B	S11473	Red	97-3	114	S3	2.10
24 E 50260	B	S15222	Green	97-1	113	S1	2.10
24 E 50278	B	S15780	Red & Green	97-2	112	S2	2.10
24 E 50286	B	S21458	Gold	97-1D	113D	D1	3.90
24 E 50294	C	142-71	Blue	99-1	109	S1	3.00
24 E 50302	C	142-72	Yellow	99-2	110	S2	3.00
24 E 50310	C	142-74	Black & White	99-1D	109D	D1	4.77
24 E 50328	C	142-76	Gray	101D	111D	D1, S3	6.30
24 E 50336	C	142-77	Brown	101	111	S1, S3	4.50
24 E 50054	A-2	142-80	Blue	93T	56	S1, S3	2.37
24 E 50062	A-2	142-83	Orange	93TX	56D	D1, S3	4.17
24 E 50369	A-2	142-87	Purple	95	116	S1, S3	2.37
24 E 50146	A-2	142-90	Red	93T-1	51	S1, S3	2.37
24 E 50393	E	142-103	Green	13AT	—	S7, S3	4.77
24 E 50195	E	142-106	Green	13ATX	—	D7, S3	6.57
24 E 50401	F	142-108	Blue	111	106	S7, S3	3.57
24 E 50419	F	142-109	Blue & Gold	111D	106D	D7, S3	5.37
24 E 50427	G	142-119	Dark Green	13T	13	S7, S3	3.57
24 E 50013	G	142-120	Dark Green	13TX	13D	D7, S3	5.37

OTHER STEREO-MONAUURAL TYPES

24 E 50070	E	Red-Silver	103	61	S7, S7	4.17
24 E 50096	E	Blue-Silver	105	66	S7, S3	4.17
24 E 30189	K	Black	—	104	S7, S3	5.82
24 E 51334	F	Brown-White	115	108	S7, S3	5.37
24 E 51342	F	Brown-White	115D	108D	D7, S3	5.37

EXACT REPLACEMENTS FOR PLUG-IN AND POWER POINT CARTRIDGES

Exact replacements for the popular Electro-voice power points. Astatic Sound-flow and Jensen combination cartridge-styli. Made in U.S.A. Shpg. wt., 6 oz. Replacement for Astatic 13TX, Electrovoice 13D, and Jensen A-44XSD. Has diamond .7 mil and synthetic sapphire 3 mil styli.

24 E 37036 Net 3.95
Replacement for Astatic 13T, Electrovoice 13, and Jensen A-44X. Same as above but both tips synthetic sapphire.

24 E 37028 Net 2.95
Replacement for Astatic 81T, Electrovoice 81, and Jensen A-41. Has 1 mil and 3 mil styli—both synthetic sapphire.

24 E 37010 Net 1.73



As Low As

173

BSR STEREO AND MONAUURAL TURNOVER CARTRIDGES

The BSR TC8S/SX1H stereo and TC8H/X1HE output monoaural cartridges are designed for quality performance. Both are turnover types. Complete with turnover mechanism. Imported. Shpg. wt., 3 oz.

MONAUURAL TYPE (Fig. A)
Replaces BSR TC8M, TC8H/1, and TC8H/2 and X1HE with 1 and 3 mil styli, mtg. bracket.
24 E 40014 Net 1.75

STEREO/MONAUURAL (Fig. B)
Replaces BSR, TC8S, TC8SM and SX1H. With .7 and 3 mil styli, mtg. bracket.
24 E 40022 Net 2.15



STEREO PLUG-IN COMBINATION CARTRIDGE AND STYLI



- Monoaural or Stereo
- 0.5 V. Output

Play either stereo or monoaural. 4 terminals, channel separation: 20 db, response 20-15,000 Hz except * is 25 db and 30-20,000 Hz with 350 mv output. RIAA equalized. Output 0.5 V, tracking force 6 gm. Select unit with mount if making an original installation in a standard arm; units less mount just slip into original mount. We will ship either Astatic or Electrovoice. Shpg. wt., 6 oz.

Stock No.	Ast. No.	E.V. No.	Styli	Mount	Net
24 E 50112	1177B	11B	S7, S7	With	4.17
24 E 50120	1177	11	S7, S7	Less	3.57
24 E 50138	13TB	13B	S7, S3	With	4.17
24 E 50427	13T	13	S7, S3	Less	3.57
24 E 50161	13TBX	13DB	D7, S3	With	5.97
24 E 50013	13TX	13D	D7, S3	Less	5.37
24 E 50393	13AT*	—	S7, S3	Less	4.77
24 E 50195	13ATX*	—	D7, S3	Less	6.57

24 E 50435 STEREO MOUNT for all above60

WIDE RANGE AND HI-FI PLUG-IN MONAUURAL CARTRIDGES



All are turnover type ceramic cartridges with dual 1 mil and 3 mil styli. Styli code same as all other cartridges on page. We will ship either Astatic or Electrovoice. Shpg. wt., 6 oz.

WIDE RANGE TYPES

Replaces Sonotone 2T, Shure PC-2, 4 series and many others.

Stock No.	Ast. No.	E.V. No.	Styli	Mount	Net
24 E 50443	81TB	81B	S1, S3	With	2.97
24 E 50021	81T	81	S1, S3	Less	2.37
24 E 50468	81TBX	81DB	D1, S3	With	4.77
24 E 50476	81TX	81D	D1, S3	Less	4.17

HIGH FIDELITY TYPES

Replaces Sonotone 3T series, Shure PC-6, etc.

Stock No.	Ast. No.	E.V. No.	Styli	Mount	Net
24 E 50484	89TB	89B	S1, S3	With	3.57
24 E 50492	89T	89	S1, S3	Less	2.97
24 E 50500	89TBX	89DB	D1, S3	With	5.37
24 E 50518	89TX	89D	D1, S3	Less	4.77

24 E 50526 MONAUURAL MOUNT for all above60

ASTATIC STEREO MONAUURAL CARTRIDGES

All crystal turnover cartridges except * which are ceramic turnover. All are equipped with .7 mil and 3 mil synthetic sapphire styli except † has 7 mil diamond and 3 mil synthetic sapphire styli to play stereo. LP and std. 78 RPM. Shpg. wt., 6 oz.

	Stock No.	Fig.	Mfr. No.	Output	Net
M	24 E 50534	M	70-TS	2.0V	4.35
	24 E 50542	M	74-TS	2.0V	4.35
	24 E 50559	N	76TSB	2.0V	4.77
	24 E 50567	M	80-TS	0.8V	4.50
N	24 E 50575*	P	17	0.4V	7.05
	24 E 50583*†	P	17D	0.4V	9.45
	24 E 50591†	N	86D	0.8V	8.10
	24 E 50609	N	86TSB	0.8V	5.10
	24 E 51359*	Q	133	0.5V	5.85
	24 E 51367*†	Q	133D	0.5V	8.25
	24 E 51318	R	140	1.0V	4.50
	24 E 51326†	R	140D	1.0V	7.50
	24 E 51375	R	142	2.0V	4.35
	24 E 51425†	R	142D	2.0V	7.35
	24 E 51433	R	142R	2.0V	5.55
	24 E 51441†	R	142RD	2.0V	7.35
	24 E 51383	R	146	3.0V	3.87

ASTATIC REPLACEMENTS FOR VACO CARTRIDGES

Crystal cartridges to replace Vaco cartridges used in many changers such as BSR, Glaser-Steers etc. Turnover type equipped with 2 needles. Tip Code: LS 1 mil and 3 mil; LT.7 mil and 3 mil. Shpg. wt., 6 oz.

Stock No.	Ast. No.	Tip	Fig.	Vaco equiv.	Output	Net
24 E 50617	470	LS	S	TO-45 X (G)	3.0	3.57
24 E 50625	472	LT	T	ST-2X, 100X, 20X, 20G	0.8	4.50
24 E 50633	474	LT	T	ST-200X, 40X, 4X, 40G	2.0	4.35

Astatic and Electro-Voice Cartridges

E-V SERIES 20 HI-FI STEREO-MONOPHONIC CARTRIDGES

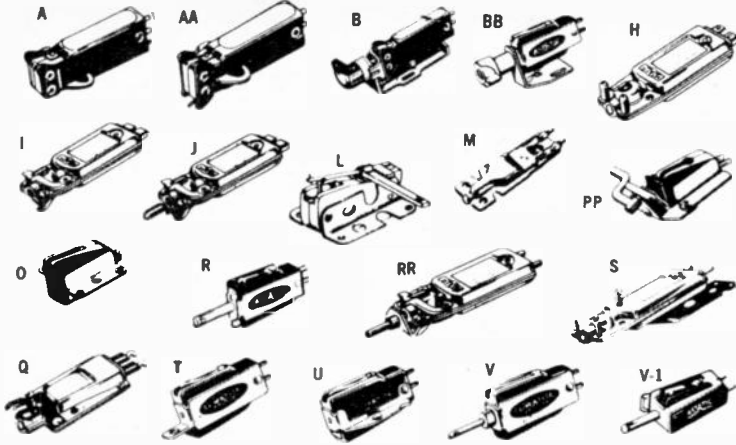

MONAURAL REPLACEMENT CARTRIDGES

Order by stock number. We will ship either Astatic or Electrovoice.

TURNOVER TYPES

All are equipped with dual synthetic sapphire styli; 1 mil (LP) and 3 mil (std 78). Average shpg. wt., 6 oz.

Stock No.	AST No.	E.V. No.	Fig.	NET	Stock No.	AST No.	E.V. No.	Fig.	NET
24 E 50658	40T	24	AA	4.17	24 E 50781	310T	62	U	3.27
24 E 50666	40TB	25	B	5.07	24 E 50799	310TS	63	V	3.27
24 E 50674	41T	28	AA	5.70	24 E 50815	312TS	67	V	3.87
24 E 50690	55T	38	PP	4.77	24 E 50823	314TS	68	R	3.27
24 E 50716	62TY	43	J	4.77	24 E 50831	405	49	J	4.77
24 E 50724	64TS	84	R	4.17	24 E 50849	406	134	RR	4.77
24 E 50732	66TS	84	RR	4.35	24 E 50864	420	80	BB	3.27
24 E 50740	66TY	49	J	3.90	24 E 50872	422	82	BB	3.57
24 E 50757	118	91	V-I	3.87	24 E 30205	445	38	L	3.39
24 E 50773	124	87	V-I	3.87	24 E 50765	120	—	V-I	3.87

MICRO-GROOVE TYPES

All with synthetic sapphire 1 mil styli for LP only. Except * has .7 mil. Shpg. wt., 6 oz

Stock No.	AST No.	E.V. No.	Fig.	NET	Stock No.	AST No.	E.V. No.	Fig.	NET
24 E 50971	40-1	20	A	3.90	24 E 51029	310-7	58	T	2.37
24 E 50997	51-1	30	O	4.44	24 E 51045	414-1	77	U	2.67
24 E 51011	62-1	41	Q	2.97					

ALL GROOVE TYPES

All equipped with single 2 mil synthetic sapphire styli for all speeds except * is osmium tip and † is less needle. Shpg. wt., 6 oz.

Stock No.	AST No.	E.V. No.	Fig.	NET	Stock No.	AST No.	E.V. No.	Fig.	NET
24 E 51052	16†	17	H	2.37	24 E 51102	66-2	45	H	2.97
24 E 51391	18	18	M	1.95	24 E 51110	106†	50	S	2.97
24 E 51086	40-2	23	A	3.90	24 E 51128	310-2	59	T	2.97
24 E 51094	51-2	—	O	4.44	24 E 51144	414-2	78	U	2.67

REPLACEMENT FOR MAGNAVOX

Complete with mounting hardware and dual synthetic sapphire styli except the LP needle in types ending in D are diamond. † indicates stereo cartridge. Shpg. wt., 6 oz.

Stock No.	Mrf. No. Fig.	Replaces Magnavox No.	NET
24 E 30213	188D	560151-4-9, 560158-2	12.00
24 E 30221	189D	560169-1, 560170-1	11.20
24 E 51169	463 1	560216-1-2, 560217-2, 560218-1-2	6.30
24 E 51177	463D 1	560219-2, 560228-1-2, 560229-2	8.70
24 E 51185	461† 2	560281-1-4, 560296-3-7	6.30
24 E 51193	461D† 2	560290-1-3*	6.30
24 E 51201	459† 3	56029-1-2, 560275-1-2	8.70
24 E 51219	459D† 3	560290-1-3*	8.70
24 E 51409	163D† 4	560350-1	8.70
24 E 51417	165D† 4	560355-1	7.50

* for Magnavox 560290-1 or -3 use Astatic 459 series for 2 hole mount, use Astatic 461 series for single hole mount.

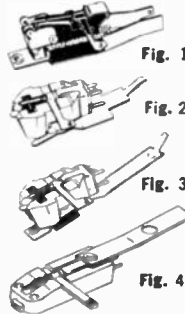

REPLACEMENT CARTRIDGE FOR RCA

• Replacement for cartridges in many thousands of RCA-45 and many LP record changers • 1 mil Synthetic Sapphire Stylus • 2.3 volt output • High Impedance Crystal • Takes 7-10 grams pressure • 5/8" Mounting Centers

Exact replacement for many standard 45 RPM and 33 1/3 RPM cartridges. For RCA: 74067, 74625, 75476, 75575, 76318; and Shure: W31AR, P73, P73A, P73AR, P73R. 24 E 60012 Imported. Net 1.25



125

Synthetic Sapphire replacement stylus for above. 24 E 02055 Net .69



Hi-Fi Ceramic cartridges. Exclusive design eliminates turntable rumble. 21 series are single needle types with .7 mil styli to play stereo and LP monaural. 26 series are turn-over types with .7 mil and 3 mil styli to play stereo and all monaural records. Types with * match magnetic phono input. TIP CODE S = SYNTHETIC SAPPHIRE, D = DIAMOND. Shpg. wt., 3 oz.

Stock No.	E.V. No.	Styli	NET
24 E 30056	21	S-7	6.30
24 E 30064	22*	S-7	7.50
24 E 30072	21D	D-7	9.00
24 E 30080	22D*	D-7	10.80
24 E 30098	26	S-7, S-3	6.90
24 E 30106	27*	S-7, S-3	8.10
24 E 30114	26D	D-7, S-3	9.90
24 E 30122	27D*	D-7, S-3	11.70

ELECTRO-VOICE FEATHERIDE WIDE-RANGE CERAMIC



- Absolutely Scratch Proof
- Plays Stereo or Monaural

Protect your records with these fine floating-action spring-suspension cartridges which makes it practically impossible to damage either record or stylus. Reduces distortion caused by warped records. Both are Hi-Fi quality and will fit all standard arms with 7/16" or 1/2" mtg. centers. Excellent separation and low distortion. Equipped with .7 mil diamond and 3 mil synthetic sapphire styli. Shpg. wt., 5 oz.

TYPE 149DF Tracking pressure	2-4 grams.
24 E 30163	Net 10.50
TYPE 1500F Tracking pressure	4-6 grams.
24 E 30171	Net 10.50

REPLACEMENTS FOR RCA STEREO

All equipped with dual .7 mil and 3 mil styli. Types with * have diamond .7 mil and synthetic sapphire 3 mil; others both tips synthetic sapphire. Series 475 in phase; series 477 out of phase. Series 487 feather action. We will ship either E.V. or Astatic. Shpg. wt., 6 oz. Type 320 is fig. B, others fig. A. Shpg. wt., 6 oz.

Stock No.	AST No.	E.V. No.	Replaces RCA	NET
24 E 51227	475	54	108213, A	6.00
			11021	
24 E 51235	*475D	54D	106960, A	11.40
			11023	
24 E 51243	477	133	106771, A, B	6.00
24 E 51250	*477D	133D	106770, A, B	11.40
24 E 51276	*487D	195D	111348	11.61
24 E 51284	320	—	973543-7	3.27

CARTRIDGES FOR VM EUPHONICS AND OTHERS

All with dual .7 mil and 3 mil synthetic sapphire styli except** have diamond .7 mil. Shpg. wt., 6 oz.

Stock No.	Astatic Fig. No.	Replaces	NET
24 E 51318	A 140	VM 31615A	4.50
24 E 51326*	A 140D	VM 31615B	7.50
24 E 51292*	B 153RD	VM 27493D	10.50
24 E 51458	B 710	Euphonics U1	5.97
24 E 51468*	B 710D	Euphonics U2	9.90
24 E 51300	B 153R	Euphonics UIOR	8.10
24 E 51292*	B 153RD	Euphonics-U11R	10.50

Popular Replacement Cartridges

ASTATIC - SONOTONE CERAMIC CARTRIDGES

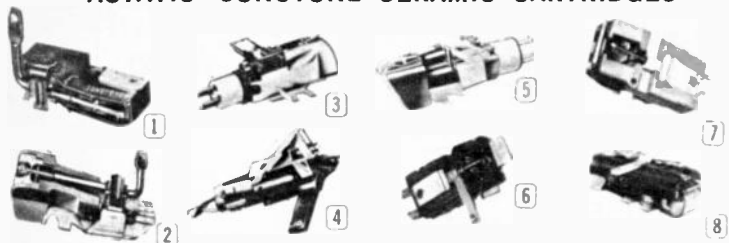

High performance ceramic cartridge now in use by many phono manufacturers and ideal for either general replacement or updating present equipment. All are stereo, stereo-monaural except series 3T which is for monaural use only. Series 21T, 24TA and 54T are designed for use with transistorized

equipment. Series 9TAF, 16TAF, 18T, 21T, and 24TA feature the accident-proof, drop-proof Sono-flex "F" stylus. All have standard mounting dimensions and have complete hardware and instructions. Styli code for all below: D-diamond, S-synthetic sapphire. Avg. shpg. wt., 6 oz.

Stock No.	Model	Fig.	Styli	Net	Stock No.	Model	Fig.	Styli	Net
24 E 79012	3T-S	1	S1-S3	5.84	24 E 79236	16TAF-SD	5	D,7-S3	6.98
24 E 79020	3T-SD	1	D1-S3	7.92	24 E 79244	18TA-S	5	S,7-S3	4.52
24 E 79079	8TA-4S	2	S,7-S3	6.60	24 E 79269	18TA-SD	5	D,7-S3	6.60
24 E 79087	8TA-4SD	2	D,7-S3	8.68	24 E 79509	21T-S	6	S,7-S3	4.90
24 E 79095	8TA-4S77	2	S,7-S,7	6.60	24 E 79525	21T-SD	6	D,7-S3	6.98
24 E 79178	9TAF S	3	S,7-S3	6.67	24 E 79533	24TA-S	7	S,7-S3	6.60
34 E 79194	9TAF-SD	3	D,7-S3	8.74	24 E 79541	24TA-S77	7	S,7-S,7	6.60
24 E 79202	9TAF-D77	3	D,7-D,7	9.50	24 E 79558	24TA-SD	7	D,7-S3	8.79
24 E 79343	10T2-S	4	S,7-S3	5.24	24 E 79566	51T-S	8	S,7-S3	4.90
24 E 79350	10T2-SD	4	D,7-S3	7.32	24 E 79582	51T-SD	8	D,7-S3	6.98
24 E 79376	10T2-SD77	4	D,7-S,7	7.32	24 E 79590	54T-S	8	S,7-S3	6.60
24 E 79210	16TAF-S	5	S,7-S,3	4.90	24 E 79616	54T-SD	8	D,7-S3	8.74

REPLACEMENT CARTRIDGES FOR VACO and RONETTE



Replacements for thousands of changers and players both imported and domestic. All types equipped with synthetic sapphire styli and turnover mechanism. Imported. Shpg. wt., 6 oz.

Stereo/monaural with .7 mil and 3 mil styli, mtg. bracket and knob. Output .7 volts. Replaces VACO ST-2, ST2X, ST-20, ST20X, ST-100, ST-100X; Ronette types 1, 2, 3, 4, 92 and 105 series, stereo OV series and stereo T series; Astatic 86TSB, 80TS, and EV 95 and 97. Imported.

Stereo/monaural with .7 mil and 3 mil styli with bracket and knob. For stereo records and LP monaural. Replaces VACO ST5, ST5X. Output 2.5 volts. Very high compliance.

REPLACEMENT STYLI
 99 E 10175 .7 mil for stereo Net .69
 99 E 10183 3 mil for 78 Net .69
 Diamond .7 mil for stereo
 24 E 01586 Net 1.99
 Stereo/monaural. Same as above but output is 2 volts. Replaces VACO ST4, ST4X, ST40, ST40X, ST200, ST200X and Ronette 106 series, 208 series, Astatic 76TSB, 70TS and E.V. 96 and 98.
 24 E 79103 Net 2.64

24 E 40030 Net 2.49
 Monaural with 1 mil and 3 mil styli, mtg. bracket and knob. Output: 2-3 volts. Replaces VACO types T45, T045, T045X. Ronette types 15, 18, 21, 24, 7825, DC395, DC395S, DC400, DC-400-222, DC-400-222S, DC500, TO-284 series, T0285T, T0287 series, TO-395 series, TO-400-200, TO-400-222; Astatic 420, 120 and E.V. 80, 88.
 99 E 10225 Net 1.20
 Monaural. Same as above but to replace Ronette cartridges with wider frequency response and lower output. Output: .7 volt.
 99 E 10217 Net 1.20

BSR SPINDLES

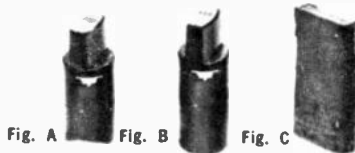

For automatic operation of a stack of 45 R.P.M. records on BSR Changers. Shpg. wt., 6 oz.

Fig. A, For use with BSR Model UA-15
 24 E 40055 Net 1.65
 Fig. B, For use with BSR Models UA-12, UA-14, UA-16, UA-24.
 24 E 40063 Net 1.65
 Fig. C, Flat spindle for use with UA-15SS, UA-25, UA-40.
 24 E 02204 Net 1.49
 Fig. C, For use with Mini-Changer UA-50.
 24 E 02568 Net 1.49
 Fig. C, For use with McDonald 400, 500, 500A, 600; BSR 1500, 2500, 15, 25, 65 and 75 series.
 24 E 40089 Net 1.95

SONOTONE 2TA-S CERAMIC CARTRIDGES



359

This high fidelity monaural turnover cartridge is equipped with dual styli to play all types of both monaural and stereo records. Has .7 mil and 3 mil synthetic styli. Replaces a host of cartridges including previous Sonotone models of 2T series, 9980 series which were used in thousands of record changers and players. Frequency response: 20-20,000 Hz—flat to 12,000 Hz; output 1-volt; compliance 2.0x10⁻⁴ cm/dyne; tracking force 6 grams. Ceramic element highly immune to heat and humidity.
 24 E 79111 Net 3.59

G.E. CARTRIDGES



VR-1000 STEREO CARTRIDGES

Variable reluctance stereo cartridges featuring extended frequency response and low tracking pressure. Supplied with diamond stylus.

VR-1000-3 ELLIPTICAL DIAMOND NEEDLE STEREO CARTRIDGE. For any quality changer or tone arm that tracks from 3-7 grams vertical force. Shpg. wt., 5 oz.

21 E 38493L Net 18.75
 VR-1000-5 FOR TURNTABLES. Complete with .5 mil. diamond stylus for use with automatic turntables or professional tone arms that track at 4 grams or less. Shpg. wt., 6 oz.
 21 E 38014L Net 13.59
 VR-1000-7 FOR CHANGERS. Essentially the same as VR-1000-5 but designed for the greater 3-7 gram tracking force required by most record changers. Shpg. wt., 6 oz.
 21 F 38030L Net 11.31

VR-II MONAURAL CARTRIDGES

Variable reluctance monaural cartridges featuring smooth frequency response and extremely high compliance. Utilizes clip-in tip styli assembly for simple installation. Cartridges supplied less stylus. Select stylus type(s) to suit your particular application from listing below.

VR-11S SINGLE-TYPE STYLUS. "Single-Play" cartridge accommodating one stylus. Supplied less stylus. Select stylus from listing below. Shpg. wt., 4 oz.
 21 E 38519 Cartridge less stylus Net 4.89
 VR-110 DUAL TYPE CARTRIDGE. Convenient dual stylus "Triple-Play" cartridge. A twist of the knob brings either microgroove (LP or 45 RPM) or standard 78 RPM stylus into position. Supplied less stylus. Select styli from listing below. Shpg. wt., 4 oz.
 21 E 38535 Cartridge less styli Net 5.97

G.E. STYLI

Individual stylus tips for VR-II series cartridges. D—diamond stylus, S—synthetic stylus. Shpg. wt., 2 oz.

Stock No.	GE Type	Stylus	Net
21 E 38188L	4G-07S	.7 mil S	1.28
21 E 38196L	4G-02S	2.5 mil S	1.28
21 E 38204L	4G-03S	3 mil S	1.28
21 E 38212L	4G-07D	.7 mil D	3.00
21 E 38220L	4G-02D	2.5 mil D	3.00
21 E 38238L	4G-03D	3 mil D	3.00

MODELS C100A and C200 STEREO CERAMIC CARTRIDGES



MODEL C100A—A quality stereo ceramic replacement cartridge for thousands of phonographs and changers in use today. Freq. response 20 thru 12,000 Hz, output 450 millivolts. With .0007 dia. and .003 synthetic sapphire stylus.
 21 E 38469L Shpg. wt., 6 oz. Net 8.07
 MODEL C200—Essentially same as Model C100A except frequency response 20 thru 17,000 Hz, output 300 millivolts.
 21 E 38477L Net 8.07
 TA-1 Replacement stylus for C100A and C200.
 21 E 38485L Net 4.17

Phono Preamps, Amplifiers & Accessories

LAFAYETTE PHONO PREAMPLIFIERS

NEW! LAFAYETTE SOLID STATE STEREO PHONO PREAMP

- 4 Silicon Transistor Circuitry • Compact Size Permits Concealed Mounting

A self-powered, compact solid-state stereo phono preamplifier especially designed for use with Hi-Fi stereo amplifiers not having magnetic cartridge inputs. The exceptional feature of this preamplifier is that its compact size permits mounting quickly and simply to the sides or back of the record changer/player base, without marring the appearance of your matched Hi-Fi system.

Frequency response: 30-20,000 Hz. RIAA Playback Curve. Gain: 6 mv. input for 0.5 volt output. Input Impedance: 50,000 ohms. S/N ratio over 60 db. Input: 2 RCA type phono jacks. Output: 2 RCA type phono jacks. Power Supply: 117 VAC 50/60 Hz. Power consumption: .1 watt. Size: 4x2½x1½". Imported.
99 E 02198 Shpg. wt., 1½ lbs. Net 7.95

7⁹⁵



MONAURAL PHONO PREAMP

A self powered monaural pre-amplifier for use with any Hi-Fi amplifier that does not have a low level input for magnetic cartridges, tape head, or microphone. Response: ±2 db 30-20,000 Hz. Gain (Phono): 40 db, 5 mv input for 1 volt output. Gain-Mike 60 db, 1 mv input for 1 volt output. Output impedance: 100,000 ohms. Phono-Tape Equalization

switch, 2 input jacks, 16 inch output lead with RCA phono plug. Power supply: 105-125 VAC, 50/60 Hz, 4 watts. Size: 3¾x3¾x3¼". Polished chrome chassis. Less 12AX7A tube. Imported. Shpg. wt., 2½ lbs.
99 E 01380 Net 5.95
12AX7A tube for above. Shpg. wt., 4 oz. Net 1.13
36 E 31900

5⁹⁵

- Ideal For Use With Amplifiers That Do Not Have Low Level Inputs For Magnetic Cartridges



STEREO PHONO PREAMP

Self-powered stereo preamplifier for use with any stereo amplifier that does not have low level inputs for magnetic cartridge, tape head, or microphone. Response: ±2 db 30-20,000 Hz. Gain (Phonograph): 40 db, 5 mv input for 1 volt output. Gain (Microphone): 60 db, 1 mv input for 1 volt output. Output impedance: 100,000 ohms. Preamp has Phono-

Tape Equalization Switch, 4 input jacks, 2 16-inch output leads with RCA phono plugs. Power supply: 105-125 VAC, 50/60 Hz, 8 watts. Size: 5¾x3¾x4¼". Polished chrome chassis. Less 2 12AX7A tubes. Imported.
99 E 01398 Shpg. wt., 3½ lbs. Net 9.95
12AX7A tube for above (2 required) Net 1.13
36 E 31900

9⁹⁵

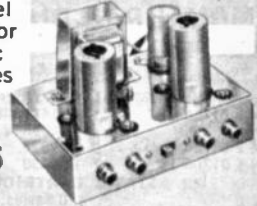

THREE TUBE AC-DC PHONO AMPLIFIER

4³⁹ (Less Tubes)

- Output Transformer
- Variable Tone Control

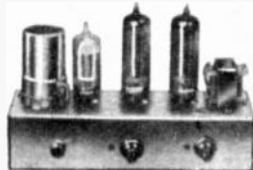

Equipped with a variable tone control and volume control with off position. Delivers up to 2 watts output to 3 ohm speaker. Uses 3 tubes: 35W4, 50C5, 12AV6. Input impedance: 150 K ohms. Features top mounted output transformer. Less tubes. Size: 5¾ x 2¾ x 4". Imported. Shpg. wt., 2 lbs.

99 E 01539

36 E 90013M Kit of 3 tubes

Net 4.39

Net 2.21

4 TUBE AC/DC STEREO PHONO AMPLIFIER

6⁹⁵ (Less Tubes)

- 2 Output Transformers
- 2 Separate Tone Controls

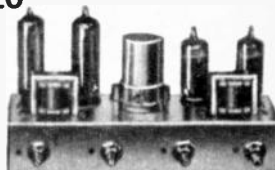

Powerful yet compact stereo amplifier produces up to 2 watts per channel. Uses 4 tubes: 2 12AV6 2 50C5. Selenium rectifier power supply. Output impedance: 3 ohms. Separate volume controls for each channel. Size: 6¼ x 2¾ x 4". Less tubes. Imported. Wt., 3 lbs.

99 E 01547

36 E 90021M Kit of 4 tubes

Net 6.95

Net 3.24

4-SPEED PHONO MOTOR

Quiet dependable AC operation assured by rubber shock-mounted friction drive motor. Speed change control through idler driving rim of 8" metal turntable having foam record cushion and retractable 45 RPM center adapter. Requires 2½" below base plate. Shpg. wt., 3½ lbs.

24 E 27029 Motor and turntable

Net 4.95

24 E 35014 Mounting boards. Wt., 1 lb.

Net 1.29



RADIO BROADCASTER/PHONO OSCILLATOR

4⁹⁵

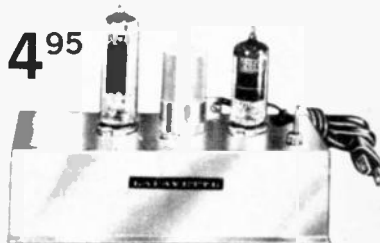

Have fun making announcements and broadcasting music through your own radio—with this broadcaster. Simply connect high impedance microphone or phono pickup to broadcaster and tune in broadcaster on radio. No wiring between the broadcaster and radio set. Pretuned to 1600 on radio dial but easily retuned. With 12BE6 and 35W4 tubes, phono jack, 2 feet of antenna, schematic and line cord. Completely wired. Chassis size: 4x2". For 110-125V AC/DC operation.

99 E 01778

Shpg. wt., 2 lbs.

Net 4.95

STEREO/MONAURAL PICKUP



1⁹⁵

High output crystal turnover cartridge for either stereo or monaural operation. Synthetic sapphire needles (1 mil and 3 mil) for LP and standard 78 RPM use. Replacement for most manual players. Mounts in ¼" dia. circular hole. Imported.

99 E 10241 Shpg. wt., 7 oz.

Net 1.95

Synthetic Sapphire LP replacement needle.

Net .49

99 E 10274

Synthetic Sapphire STD replacement needle.

Net .49

99 E 10282

AUTOMATIC HI-FI SHUTOFF



5²⁵

Shuts off Hi-Fi equipment at the end of the last record. A 3-position switch allows the use of this one unit for all record changers, domestic and imported. This switch also permits manual operation if the automatic shut-off feature is not desired. Housed in a rugged drawn-steel case with mounting ears, amplifier outlet, and 6 ft. AC cord. Size: 2¾ x 4¾ x 1¾". Shpg. wt., 1 lb.

24 E 28019

Net 5.25

LAFAYETTE Diamond and Sapphire Styli

MADE FOR LAFAYETTE BY THE FOREMOST AMERICAN MANUFACTURERS

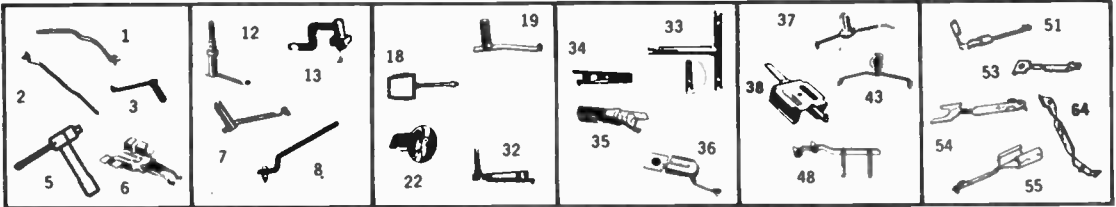

KEY TO POINT CODES HOW TO ORDER

The symbols in the column headed "PT SIZE" are explained in the table below.

LP = SINGLE 1 MIL DIAMOND MICROGROOVE FOR 33 $\frac{1}{2}$ AND 45 RPM

AG = SINGLE 2 MIL DIAMOND ALL GROOVE FOR ALL SPEEDS

COMB = DUAL 1 MIL DIAMOND AND 3 MIL SYNTHETIC SAPPHIRE

Identify your needle by cartridge number and illustration and order by stock no. Note that all needles listed here are for monaural cartridges.

ALL SINGLE
DIAMOND AND
DIAMOND SAPPHIRE
STYLI ON THIS PAGE



LAFAYETTE DIAMOND
STYLI ARE MADE FROM
WHOLE DIAMONDS,
PRECISION GROUND
AND POLISHED. SAPPHIRE STYLI
ARE FINEST SYNTHETIC.

199

MONAURAL DIAMOND and DIAMOND-SAPPHIRE

Stock No.	Size Pt.	Fig.	Cartridge
-----------	----------	------	-----------

FOR ADMIRAL CARTRIDGES
24 E 01156 LP 1 409A11, 409B11, 409B12, 409A12

24 E 01180 Comb. 6 409B20
24 E 01206 LP 7 409A30

FOR ASTATIC CARTRIDGES
(AC Series, 40T, 41T, 40-1, 41-1)

24 E 01214 LP 3 42-1, 90T Series
10L-3, 11L-3
24 E 01222 LP 12 406, 410L
24 E 01230 Comb. 13 57T, 57TJ, 57TM
24 E 01248 Comb. 13 6CD, 409, 55-T, 55TJ, 55TM

24 E 01206 LP 7 CAC, CQ, CQ-1, LQD, LQD-1, QT, QT-33, 44T, 46-1, 48-1, 186T series
6L3-0, 8L3-0, 64T, 66, 66-1, 68
24 E 01297 LP 19 94T series, 66-3L, 68-3L, 62-1, 68-1, 405, 406
(118, 120, 124 series 310T, 312T, 420, 422, 424T series, 310-1, 310-TB, TS, 312-TB, TS, 414-1)

FOR BSR CARTRIDGES
24 E 02758 Comb. 5 XIM, XIH, XIHE

FOR ELECTRO-VDICE CARTRIDGES
24 E 01164 LP 2 14, 20, 22, 34, 44, 46, 47, 74, 82, 82SM, 82DM, 84, 84SM, 84DM, 850, 85DM, 86S, 86M, 86DM, 96T

FOR GENERAL ELECTRIC CARTRIDGES
24 E 01347 LP 32 RPX-040, -041, -042, -046, -061, -063, RPX-040A, -047, -047A, -050, -050A, -051, -051A, -052A, -053A, -061A, -063A, -145, -146, -147
24 E 01362 LP 34 VR-II Series, 46-050, 46-052, 46-053, 46-040, 46-041, 46-061, 46-063
24 E 01370 LP 35

FOR GOLDRING CARTRIDGE
24 E 01388 LP 36 500SS, 500DD, 500SD

FDR MAGNAVOX CARTRIDGES
(560176, 560180)
24 E 01396 Comb. 37 560133, 560151, 560169-1, 560170
24 E 01792 LP 54 560176, 560180
24 E 01180 Comb. 6 560177, 560188-1 series
24 E 01461 Comb. 51 560161

Stock No.	Size Pt.	Fig.	Cartridge
-----------	----------	------	-----------

FOR PHILCO CARTRIDGES
24 E 01404 Comb. 43 45-9612, 76-4649, 425-0016
24 E 01404 Comb. 43 45-0009, 425-0011, 425-0014

FOR PERPETUUM EBNER CARTRIDGES
24 E 01420 Comb. 48 PE-8, PE-10
24 E 01438 LP 22 P7000 (MJ, MD) (LP only)

FOR R.C.A. CARTRIDGES
24 E 01222 LP 12 74067
24 E 01347 LP 32 74466
24 E 01156 LP 1 S5852, 76257, (988370-1), 75044
24 E 01214 LP 3 76257, (988370-2)
24 E 01461 Comb. 51 78748, 79807, 100653
24 E 01248 Comb. 13 100329

FDR RONETTE CARTRIDGES
24 E 01792* LP 53 TO-200, TO-222, or TO-284, TO-400 series, RA284, DT60 series
24 E 01453 LP 38 TX88, A
24 E 02469 LP 18 BF40, 105

FOR SHURE CARTRIDGES
24 E 01180 Comb. 6 WC10, WC100, PC2 series, PC3 series, PC4 series, PC5 series, ML44 series P-72, P-73, P-73R, P-75, P76, P-77
24 E 01156 LP 1 P-80, W-21, W-21AR, W-22A, WC-24, WC-25, series

FOR SONOTONE CARTRIDGES
24 E 01461 Comb. 51 1P-LB-1D, 2TD, 2TS, 2T-SD, 2T-LB-0, 2T-LB-S, 2T-LB-S0, 9980-S, 9980-SD, 99800, 5T, 5T-LB-S, 5T-LB-SD
24 E 01305 Comb. 51 3T, 3TS, 3TD

FOR TELEFUNKEN CARTRIDGES
24 E 01487 Comb. 64 TTSA

FOR VACO CARTRIDGES
24 E 01016 LP 55 T-45, S-45

* The open end type (Fig. 54) replaces both Fig. 53 & 54.

MONAURAL SAPPHIRE

Popular replacements made of finest synthetic sapphire.

FOR G.E. CARTRIDGES

(FIG. 35). Direct Replacements for Clip-in Styli in GE VR II Series, 4G-050, 4G-052, 4G-040, 4G-041, 4G-061, 4G-063.
24 E 01917 1 MIL Mono LP Net .69
24 E 01925 3 MIL 78 RPM Net .69

GE MODERNIZATION ASSEMBLIES

(Fig. 33 at top of page)

Modernize your old triple-play cartridge. These assemblies replace both the old and new series "A". Once installed, you can replace one point at a time.
DIAMOND SAPPHIRE. Replaces old RPJ-013 and new RPJ-013A. Avg. wt., 2 oz.
24 E 01354 Net 1.99
DUAL DIAMOND. Replaces old GE RPJ-012 and RPJ-012A.
24 E 01511 Net 3.90
DUAL SAPPHIRE. Replaces old GE RPJ-010 and new RPJ-010A.
24 E 01933 Net .99

FOR ASTATIC, PHILCO, MAGNAVOX AND RONETTE

(FIG. 54). For ASTATIC 310T, 310TB, 310TS, 310-2, 414-1, 420-TS, 422-TS, 424-TS; PHILCO 35-8014, 325-8021; MAGNAVOX 560176; RONETTE Series DT-60, RA-284, TO-284.
24 E 01982 3 Mil for 78 RPM Records Net .69
24 E 01990 AG for 78 & Mono LP Net .69
24 E 02014 1 Mil for Mono LP Net .69

DUAL DIAMOND STEREO STYLI

Styli listed below have 2 stereo points so that as one wears out you can use the other. Use to replace original styli with one stereo and one 78 RPM point if you are no longer using 78 RPM records. Figures shown at top of facing page. (FIG. N). Replaces Astatic N41SD styli in 17D cartridge.

24 E 01800 Net 2.99
(FIG. E). Replaces RCA styli 11020 and 110022 in cartridge series RPM, 106960-A, 108213A, 106770-A and 106771-A.
24 E 01818 Net 2
(FIG. D). Replaces Sonotone styli N-8TAS SD, DD in cartridge 8T, 8TA.
24 E 01826 Net 2.99
(FIG. L). Replaces Sonotone styli N-9TS, SD, DD in cartridge series 9T.
24 E 01834 Net 2.99
(FIG. L). Replaces Sonotone styli N16TS, SD, DD in cartridge series 16T.
24 E 01842 Net 2.99

Stereo Diamond And Diamond-Sapphire Styli

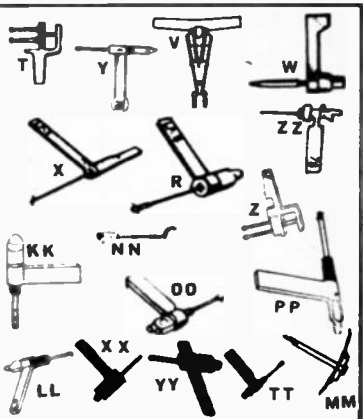
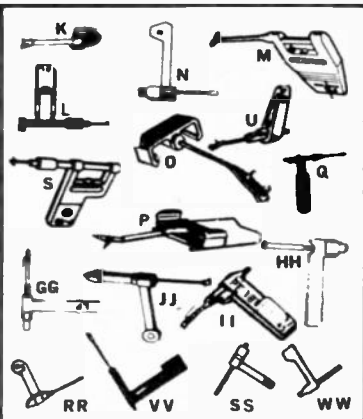
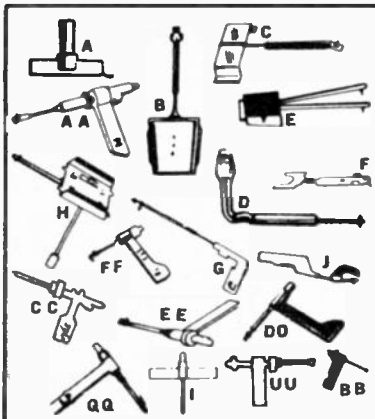

KEY TO STEREO POINT CODES HOW TO ORDER

Table below explains symbols in Column head "PT SIZE."
 S = .7 MIL DIAMOND
 SST = .7 MIL DIAMOND and 3 MIL SAPPHIRE*
 SLP = .7 MIL DIAMOND and 1 MIL SAPPHIRE*
 * Synthetic

Stock No.	Pt. Size	Fig.	Cartridge
FOR ACOS CARTRIDGES			
24 E 01602	SST	G	73-1
FOR ADMIRAL CARTRIDGES			
24 E 01529	S	C	409B33-1 (2-1)
24 E 01537	S	B	409C37-1
FOR ASTATIC CARTRIDGES			
24 E 01644	SST	M	17, 17D
24 E 01850	SST	W	133
24 E 02295	S	F	ST-100, 70, 74, 76, 78
24 E 02303	SST	W	153, 157, 461, 481
24 E 02311	SST	DD	138, 140, 142, 146
24 E 02329	SST	EE	181D
24 E 02766	S	I	346, 348
24 E 02774	SST	BB	165, 353, 355
24 E 02931	SST	TT	393
24 E 02949	SST	SS	271, 273, 349, 351
FOR BSR CARTRIDGES			
24 E 01506	S	F	TC8S, TC-8SH, TC8S
24 E 02386	SST	FF	C-1
FOR COLUMBIA CARTRIDGES			
24 E 01500	S	J	SC-1-2-7-8
FOR ELAC-MIROTWIN CARTRIDGES			
24 E 01693	SST	O	KST-100, PE-180
24 E 01701	SST	O	KST-104, PE-182
FOR ELECTRO VOICE CARTRIDGES			
24 E 01529	S	C	21 and 26 Series
24 E 01867	SST	X	117, 131, 131D
24 E 01875	SST	Y	132
24 E 01883	SST	Y	141, 149
24 E 02337	SST	GG	198, 199
24 E 02345	SST	HH	194
24 E 02782	SST	Q	5000, 5005
24 E 02956	SST	ZZ	5015
24 E 02964	SST	CC	5050, 5051
FOR EUPHONICS CARTRIDGES			
24 E 01651	S	K	E-1-3
24 E 01719	S	P	U-1-2-4-5
24 E 01784	SST	T	U-8
24 E 01891	SST	Z	U10, U11
24 E 02352	SST	T	U12, U13
FOR GENERAL ELECTRIC CARTRIDGES			
24 E 01594	S	A	GC7
24 E 01610	S	A	VR227
24 E 01776	SST	Y	C100
24 E 02360	SST	JJ	C200, C100A
24 E 02378	SST	KK	C500

199 ANY STEREO STYLI IN THIS LISTING

Stock No.	Pt. Size	Fig.	Cartridge
FOR MAGNAVOX CARTRIDGES			
24 E 01529	S	C	560233-3-4
24 E 01669	SST	D	560260-1
24 E 01875	SST	R	560305-1
24 E 02576	SST	QQ	560344-45
24 E 02774	SST	BB	560355
24 E 02782	SST	Q	560385
FOR MASTERCRAFT CARTRIDGES			
24 E 02584	SST	RR	RP100
FOR MOTOROLA CARTRIDGES			
24 E 01529	S	C	59K643335
24 E 01537	S	B	59B64395
FOR PERPETUUM-EBNER CARTRIDGES			
24 E 01537	S	B	PE90 (M, N)
24 E 02790	SST	U	PE-106
24 E 02808	SST	II	PE-188
FOR PHILCO CARTRIDGES			
24 E 01529	S	C	{ 35-2809-1, 35-2824-1, 325-8047, 35-2825-1, 325-8036
24 E 01537	S	B	{ 35-2820-1, 35-2826-1, 325-8048, 325-8049
24 E 01586	S	F	{ 35-2827-1, 35-2829-1, 325-8051, 325-8052
FOR PHILLIPS CARTRIDGES			
24 E 01909	SST	AA	AG3306, 3310
FOR RCA CARTRIDGES			
24 E 01537	S	B	T, T-1
24 E 01578	SST	E	RPM 200 Series— 106770, 106771, 106960A, 108213A
24 E 01768	SST	V	110021
24 E 02394	SST	V	11348, 200-A2
24 E 02402	S	NN	115059
24 E 02592	SST	SS	RMP-204, 115276
24 E 02600	SST	TT	117330
24 E 02816	S	YY	116931
FOR RONETTE CARTRIDGES			
24 E 01537	S	B	{ DV, OV1, T1 Single BF40, 105, 105-1 (2, 3, 4) 106-1 (2, 3, 4)
FOR SONOTONE CARTRIDGES			
24 E 01545	SST	D	8T and 8TA
24 E 01552	SLP	D	8T and 8TA
24 E 01677	SST	L	9T Series
24 E 01685	SST	M	12THS
24 E 01727	SST	L	16T Series
24 E 01735	SST	L	18T Series
24 E 01743	SST	S	12THSR
24 E 01750	SST	S	12TLAS
24 E 02410	SST	OO	21T, 22T, 23T, 24T
24 E 02428	SST	PP	26T, 27T
24 E 02436	SST	PP	25T, 28T
24 E 02824	SST	LL	32T, 39T

Stock No.	Pt. Size	Fig.	Cartridge
FOR TELEFUNKEN CARTRIDGES			
24 E 01628	SST	H	T20-2
24 E 02618	SST	VV	T-23
FOR TETRAD			
24 E 02626	SST	UU	11, 31
24 E 02634	SST	UU	21, 41
24 E 02842	SST	UU	32
24 E 02659	SST	UU	13, 33
24 E 02667	SST	UU	52, 62
24 E 02675	SST	UU	42
24 E 02832	S	UU	10, 40, 80
24 E 02840	SST	UU	23, 24
24 E 02972	SST	UU	51, 61
24 E 02980	SST	UU	53, 63
24 E 02998	SST	UU	54, 64
24 E 03004	S	UU	20, 40
24 E 03012	S	UU	10, 30
24 E 03020	S	UU	80
24 E 03038	SST	UU	71, 91
24 E 03046	SST	UU	73, 93
24 E 03053	SST	UU	14, 34
FOR VACO (VACO)			
24 E 02543	SST	WW	CN Series
24 E 02550	SST	XX	TN Series
FOR VM CARTRIDGES			
24 E 01529	S	C	16707-A
24 E 01545	SST	D	16708-F
FOR WEBCOR CARTRIDGES			
24 E 01529	S	C	21P573
24 E 01537	S	B	21P596, 21P598
24 E 01545	SST	D	21P700-1-2-3-4
FOR ZENITH CARTRIDGES			
24 E 01537	S	B	142-99B
24 E 02857	SST	MM	{ 142-126-7-8, 142-136-7-8
24 E 02865	SST	MM	142-150, 142-151

POPULAR REPLACEMENT DIAMOND STYLI FOR SHURE AND EMPIRE CARTRIDGES

(FIG. 1) .7 Mil Diamond Stylus For Shure M7D and M3D Stereo Cartridges. Net 7.50

(FIG. 2) 7 Mil Diamond Stylus For Shure M44 Stereo Cartridge. Net 8.75

(FIG. 3) .6 Mil Diamond Stylus For Empire 880P Stereo Cartridge. Net 7.95

(FIG. 4) 7 Mil Diamond Stylus For Empire 888 Stereo Cartridge. Net 7.95

CHUCK-TYPE NEEDLES

For screw-type chucks. Offset shank, 2 mil point for 33 $\frac{1}{2}$, 45 and 78 mono records.

24 E 70011 Osmium point. Singly ea. .29
lots of 10, ea. .26

24 E 70029 Synthetic ruby singly ea. .69
lots of 10, ea. .59

Hi-Fi And Phono Accessories

STEREO VU BALANCE METER

11⁹⁵



- Two Meters in One
- Balances Stereo Systems

Ends the problem of balancing your stereo system. Two precisely damped loudness meters provide a continuous comparison of speaker levels. Scales calibrated in "Volume Units" and percent. 1.2 volts input sensitivity for 0 VU or 100 percent indication. The special calibrating switch and 20 db attenuation controls permit exact matching of channels. Greater than 8,000 ohm impedance permits connecting to output circuits without loading. The entire unit is housed in an attractive plastic case 6"W x 3 1/4"H x 2 7/8"D. Imported.

99 E 50387 Shpg. wt., 3 lbs. Net 11.95

General Purpose Miniature Cooling Fan

- Motor Shunt Varies Both Volume of Air Moved and Noise level

A venturi fan for use with hi-fi, TV, Ham radio and other electronic installations, to ventilate equipment and give maximum life and best performance. With shunt delivers 75CFM at low noise level, shunt removal delivers 90CFM with slight increase in noise level. Front and back grilles. Permanently lubricated. Rated 115VAC, 60 Hz. Size: 5 1/2 x 6 x 2 3/4". Complete with grill bracket, mounting hardware and instruction sheet.

24 E 39016 Shpg. wt., 2 lbs.

8⁹⁵



Net 8.95

imc HI-FI BOXER FAN

- Ideal For Cooling TV And Hi-Fi Equipment
- Super Silent, Compact
- Sturdy Metal Construction

14⁸⁵

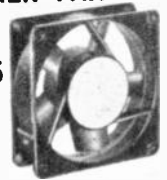

Exceptionally low-noise fan for cooling hi-fi equipment. Slow rotating 5-blade impeller delivers 50 cfm, enough air to exhaust the average enclosure 10 to 30 times per minute, to minimize thermal drift and increase equipment life. Airflow is reversible. Has heavy non-warp all metal frame and motor mounting acts as an efficient heat sink, adding life to motor and bearing. Pre-lubricated for years of maintenance-free operation. Only 4 1/4" square by 1 1/2" deep, fits any cabinet. Easy to install. Comes with complete mounting kit including special heavy duty brackets for mounting versatility, hardware, grommets, shock-absorbing spring mounting pad. A.C. power cord and clip on plug, template and instruction sheet. Rated 115 VAC, 60 Hz.

24 E 43018 Shpg. wt., 2 lbs. Net 14.85

STEREO RUMBLE FILTER

3⁹⁵



Filters out turntable vibration and rumble—makes every low-priced turntable and changer quiet and rumble-free. Designed for use with ceramic or magnetic cartridges. 3-position selector switch—ceramic, magnetic cartridge, off. Just plug it in between cartridge and amplifier inputs. Overall size: 5 x 2 5/8 x 5/8". Imported. Shpg. wt., 14 oz.

99 E 10191 Net 3.95



AUDIODISCS PROFESSIONAL RECORDING BLANKS

The highest quality recording discs on heavy aluminum base, smoothly coated on both sides. Use Yellow Label for general studio and school work; Blue Label is .027" base for home recording. All Yellow Labels are .050" base except * are .040.

Stock No.	Size Inches	Wt.	Net Each	
			1-24	25 up
YELLOW LABEL				
24 E 10086	8"	5 oz.	1.18	1.00
24 E 10074	10"	6 oz.	1.42	1.20
24 E 10082	12"	9 oz.	3.00	2.59
			1.49	50 up
BLUE LABEL				
24 E 10108	6 1/2"	3 oz.	.60	.51
24 E 10116	8"	4 oz.	.90	.76
24 E 10124	10"	5 oz.	1.20	1.01

AUDIO POINT CUTTING NEEDLES

All have .003" tip except microgroove types have .0005". All tips are finest synthetic sapphire except type 34S and 34L are steel. For professional as well as amateur use. All have 87° included angle. Wt. 2 oz.

Stock No.	Mfr. No.	Description	Net
24 E 10132	14-S	Short dural shank	5.34
24 E 10140	20-S	As above for microgroove	5.34
24 E 10157	14-L	Long dural shank	5.34
24 E 10165	20-L	As above for microgroove	5.34
24 E 10173	34-S	Short brass shank	1.74
24 E 10181	34-L	Long brass shank	1.74

RECORD CLEANER KIT



Deep clean your records the modern way. Specially prepared detergent anti-static record cleaning fluid protects your valuable records as it cleans. Just a few drops on new velvet-foam rubber applicator mitt will give your records a professional cleaning job. Supplied with anti-static fluid, velvet applicator mitt and polyurethane pad.

24 E 85027 Shpg. wt., 10 oz. Net 1.29

RECORD CARRYING CASES



DELUXE CASE FOR 12" RECORDS

(Fig. A) Handsome case holds 60 — 12" records without jackets, 36 with. Solid wood frame lock corner construction. Covered with Pyroxolin coated cloth, washable and long wearing. Two tone. Sure-hold lock. 13 1/4 x 7 x 1 1/2". Shpg. wt., 7 lbs.

24 E 82016 Net 5.75

DELUXE CASE FOR 7" RECORDS

(Fig. B) Same construction as above. Double sided. Holds 120 records. 15 1/2 x 7 x 8 3/4". With index and separators. Shpg wt, 7 lbs.

24 E 82024 Net 5.25

LAFAYETTE STYLUS INSPECTION MICROSCOPE

With this pocket-sized inspection microscope you can examine your stylus tip for signs of wear, imperfections, general condition. Its 50X magnification is enough to provide a good, clear image for observation. Size 3 3/4" long x 1/2" diam. Imported.

99 E 10126 Shpg. wt., 8 oz. Net .88

SNAP-ON RECORD AND BOOK HOLDERS

For 3/4" thick standard shelf

Hold records, tapes or books upright on shelves. Fits any standard shelf; completely adjustable and self-locking. 7" triangular shape, brass finished with plastic tips.

24 E 31013 Shpg. wt., 1 lb. Net .89



THE WATTS "DUST BUG"



Automatically removes dirt and dust on each playing. Light plastic arm mounts by suction cup. Can be permanently mounted by rubber cement. The bottle of antistatic cleaning fluid has a built-in wick for application to a brush and pad at the end of arm. Imported. Shpg. wt., 6 oz.

24 E 25015 Net 6.50

DISPENSER OF ACTIVATING FLUID. For Dust Bugs. Shpg. wt., 2 oz. Net 2.50

24 E 25049 Net 2.50

24 E 25031 Replacement Plush Pad and Nylon Brush. Shpg. wt., 4 oz. Net 3.00

RECORD DUST REMOVER



For a dust-free record collection. The "Preener" penetrates each groove, removing all dust and grit and deposits a non-toxic ionic compound. Leaves no trace of film or residue. Ideal for keeping new records new. Shpg. wt., 4 oz.

24 E 25056 Net 4.00

RECORD STATIC and DUST ELIMINATOR

Sprays a fine mist which keeps your records clear of surface noise created by static (common to all vinyl records) and clean of dust attracted by the static charge. Prevents groove and needle wear caused by static-dust and keeps records lustrous. Extends their life. Two applications a year are sufficient. Enough for hundreds of records. Shpg. wt., 8 oz.

24 T 70037 Net .88



ROBINS PHONO AND RECORD ACCESSORIES



(A) PK-11 COMPLETE DELUXE RECORD CARE KIT. Record Sweep mounts to any phono deck by suction cup. Cleans and lubricates records as they play. Includes Anti-Static Cleaner and Lubricant, Stylus Pressure Gauge, Stylus Microscope, and "Rob-O-Stat" Record Care Kit. 24 E 80648 Shpg. Wt. 1 1/4 lb. Net 7.15

(B) PK-3A DELUXE RECORD CARE KIT. Contains Stylus Pressure Gauge, Adjustable Stylus Brush, Record Brush to clip on to tone-arm, Turntable Level, Anti-Static Record Cleaning Cloth, and 18 Round Bottom Record Covers. 24 E 80655 Shpg. Wt. 1 lb. Net 4.49

(C) PB-10 PROFESSIONAL RECORD SWEEP. Sweeps dust and particles from delicate sound grooves of records. Deposits Anti-Static Silicone Cleaner and Lubricant. Improves sound fidelity. Mounts to phono by suction cup. Includes Cleaner and Lubricant. 24 E 80663 Shpg. Wt. 6 oz. Net 2.99

(D) PB-3 ADJUSTABLE STYLUS BRUSH FOR ALL U.S. AND IMPORTED PHONOS. Spring secured flexible brush adjust from 3/4" to 2 1/4" height. Removes dust blob accumulation on stylus when tone-arm is cycled. Self-stick base for easy mount to phono deck. 24 E 80549 Shpg. Wt. 4 oz. Net .85

(E) PB-88 "CLEAN-SWEEP". Large soft hair brush cleans entire tracking surface of records up to 12". Self-stick base mounts to any phono deck. Swings out of way when not in use. Wt. 8 oz. 24 E 80010 Net 4.49

PB-75 CLIP-ON RECORD BRUSH. (Not illus.) Clips to tone-arm. Sweeps dust from records. 24 E 80036 Shpg. Wt. 3 oz. Net .49

PB-2 COMBINATION TONE-ARM LIFT AND RECORD BRUSH. (Not illus.) Clips to tonearm. Sweeps dust and particles from records. Convenient finger lift prevents scratching records. 24 E 80028 Shpg. Wt. 3 oz. Net .69

MRB-1 POCKET RECORD AND STYLUS BRUSH. (Not illus.) Soft hair brush in Gold anodized case with pocket clip. 24 E 80416 Shpg. Wt. 4 oz. Net .99

(F) PK-5 PHONO STROBE AND LIGHT KIT. Tests turntable for correct speed at 33 1/2, 45, and 78 rpm. Strobe disc and neon lamp. 110V. 50-60 Hz A.C. Instructions. 24 E 80358 Shpg. Wt. 6 oz. Net 1.59

(G) PSG-3 STYLUS PRESSURE GAUGE. Accurately calibrated gauge and counter balance weight. Measures pressure to 1/2 gram. 24 E 80556 Shpg. Wt. 4 oz. Net .99

(H) PM-1 STYLUS MICROSCOPE. Inspect stylus tip for signs of wear, chips, etc., to prevent record damage. Precision ground lenses. 50X magnification. Knurled focusing adjustment. Pocket clip. Slot at end of scope holds stylus. Size: 3 3/4" x 1 1/2". Imported. 24 E 80168 Shpg. Wt. 4 oz. Net 1.89



PC-4 TWO RECORD CLOTHS AND A 45 RPM SPINDLE ADAPTOR. (Not illus.) 24 E 80523 Wt. 4 oz. Net .79

PC-2 TWO ANTI-STATIC RECORD CLEANING CLOTHS AND CLIP-ON RECORD BRUSH. (Not illus.) Shpg. wt. 4 oz. 24 E 80440 Net 1.19

(I) PX-8 ANTI-STATIC RECORD-KLEEN SPRAY. Silicone lubricant and cleaner prevents dust accumulation on records. Eliminates static pops and clicks to improve fidelity. 8 oz. 24 E 80689 Shpg. Wt. 11 oz. Net 1.19

(J) PC-6 AUTOMATIC RECORD DUST COVER AND END RECORD. Covers records stacked on automatic changer while playing. Automatically drops after last record plays to continue protection. Seals out dust and grime. Recorded sign-off tells when last record is played. 24 E 80697 Shpg. Wt. 9 oz. Net 1.99

PL-2 ROUND TURNTABLE LEVEL. Assures accurate leveling of turntable for correct tracking. Minimizes stylus and record wear. Self-stick base for mount to phono. (Not illus.) 24 E 80184 Shpg. Wt. 4 oz. Net 1.59

(K) PSD-4 METAL 5" DIA. 4-SPEED STROBE DISC. Checks 16, 33 1/2, 45, and 78 rpm speeds. Shpg. Wt. 2 oz. 24 E 80424 Net 1.09

(L) PB-9 DISC-WHISK RECORD CLEANER. Cleans and lubricates LP and 45 rpm records on both sides in one operation by rotating record. Deposits Anti-Static Silicone to improve fidelity. Record handling disc included. 24 E 80671 Shpg. Wt. 5 oz. Net 1.19

(M) PK-6 "ROB-O-STAT" RECORD CLEANING KIT. Super-soft foam applicator mitt, 1 1/2 oz. Anti-Static cleaner and lubricant, and poly-foam pad. Shpg. Wt. 8 oz. 24 E 80366 Net 1.49

(N) PHONO STYLUS TIMER. PNT-1. Records elapsed time phono is in operation. Calibrated 400 hour use gauge indicates stylus wear to prevent needless damage to precious records. Timer also indicates time for cleaning and general maintenance of equipment and records. Has self-stick back to mount to phono deck. Imported. Wt. 6 oz. 24 E 80770 Net 4.98

(O) PJ-18 ROUND BOTTOM PLASTIC RECORD COVERS. Protects 12" records. Pkg. of 18. 24 E 80564 Shpg. Wt. 7 oz. Net .75

(P) PJ-25 ALBUM COVERS. 12 heavy weight plastic window clear covers with thumb notch for easy insertion and removal of record albums. 24 E 80705 Shpg. Wt. 6 oz. Net .99

(Q) REPLACEMENT RECORD JACKETS/PJ-4 Four decorative Record Jackets to replace worn jackets. Protects 12" records. Titles, recording artists and other information can be written on backs. Packaged assorted in Popular, Classical, and Psychedelic art motifs. 24 E 80788 Shpg. Wt. 1 lb. Net 1.29

(R) PK-20 COLOR-CODE LOG KIT. Catalog and color-code your record collection. Kit contains 120 page color-indexed Log Book, 80 self-stick identification Labels for LP and 45 rpm records, 240 Album Index Spots in 2 sets, numbered 1 to 24, all in 5 Colors, and Writing Pen. 24 E 80739 Shpg. Wt. 14 oz. Net 2.75

TURNTABLE COVERS. (Not illus.) Soft, heavy-gauge durable plastic covers. Fits most changers.



PL-5 ALBUM AND RECORD INDEX SPOTS. (not illus.) 240 self-stick Spots. 2 sets numbered 1 to 24 in 5 Colors. Index records and their matching albums. 24 E 80747 Shpg. Wt. 2 oz. Net .79

(S) POLY-LINED RECORD SLEEVES, PRS-12. Paper protective sleeves for 12" records has clear poly windows to show labels of records. Seals out dust and grime to preserve records. Package of 12. 24 E 80796 Shpg. Wt. 8 oz. Net 1.29

PRA-50 RECORD SPIDERS. (Not illus.) 50 impact plastic, reusable 45 rpm adapters. Easy insertion in records. 24 E 80465 Shpg. Wt. 6 oz. Net .79

TX-56 NON-SLIP FOR PHONO DRIVES. Stops slippage of drive wheels, belts, etc. Fast drying, stable and penetrating material dries to tack-free, non-slip surface. 2 oz. bottle. 28 E 80804 Shpg. Wt. 4 oz. Net .89

TX-33 PHONO DRIVE OIL. Highly refined lubricant formulated especially for phono drives. Inhibits rust and oxidation. 2 oz. bottle with applicator. 24 E 72083 Shpg. Wt. 4 oz. Net .49

MSW-150 "SWABBIES". (Not illus.) Soft cotton tips wound on 6" applicators for cleaning and oiling hard to reach parts of equipment. Wt. 6 oz. 28 E 72117 Pkg. of 125. Net .79

DISPOSABLE DISC-KLEEN CLOTHS, PC-20. (Not illus.) Package of 18 Anti-Static, Silicone impregnated Cloths for cleaning and lubricating records. Prevents dust accumulation. Removes harmful grime and other particles. 28 E 80812 Shpg. Wt. 6 oz. Net .99

(T) RECORD CUEING CONTRL, #PCD-1. For manual turntables. Raise or lower tonearm without touching it. Floats to desired track of record with pin-point accuracy. 24 E 80820 Shpg. Wt. 12 oz. Net 6.98

Stock No.	Mfr's No.	Size	Wt.	Net
24 E 80275	PJ-1	13"x13 1/2"x8"	8 oz.	1.49
24 E 80267	PJ-2	12 1/2"x15"x8 3/4"	8 oz.	1.49
24 E 80838	PJ-3	22"x16 1/2"x9"	8 oz.	1.79
24 E 80291	PJ-4	17 1/4"x17 1/2"x9"	8 oz.	1.79
24 E 80846	PJ-5	17"x15"x18 3/4"	8 oz.	1.79



LAFAYETTE COMPLETE CABLE ASSEMBLIES FOR HI-FI AND P. A.

High quality extension cables "tailor made" for users of recorders, hi-fi equipment, etc. All plugs molded directly to various cable combinations. Shielded cable for high impedance (mike, etc.) connections; parallel wire for low impedance (speaker, etc.) connections. Imported. Avg. shpg. wt., 9 oz.

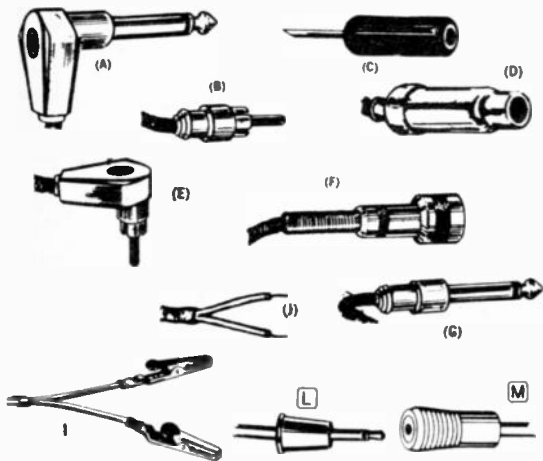

PIN TYPE PHONO PLUG (B) TO VARIOUS CONNECTIONS. All Cables shielded. Imported.

Stock No.	One Termination	Cable Length	Other Termination	Net
99 E 00648	pin plug (B)	36 in.	pin plug (B)	.49
99 E 00580	pin plug (B)	60 in.	pin plug (B)	.59
99 E 00598	pin plug (B)	72 in.	Straight phone plug (G)	.69
99 E 00655	pin plug (B)	48 in.	Phono Jack (D)	.67
99 E 00614	pin plug (B)	60 in.	Phono Jack (D)	.74
99 E 00846	pin plug (B)	36 in.	Stripped & tinned ends (J)	.39
99 E 00853	pin plug (B)	48 in.	Stripped & tinned ends (J)	.48
99 E 00861	pin plug (B)	60 in.	Stripped & tinned ends (J)	.59
99 E 00879	pin plug (B)	72 in.	Stripped & tinned ends (J)	.65
99 E 00887	pin plug (B)	144 in.	Stripped & tinned ends (J)	.90
99 E 01125	pin plug (B)	120 in.	90° pin plug (E)	.90

90° PHONE PLUG (A) TO VARIOUS CONNECTIONS. Std. 1/4" sleeve; completely shielded. All cables shielded. Imported.

99 E 00671	90° phone plug (A)	72 in.	Pin plug (B)	.72
99 E 00721	90° phone plug (A)	72 in.	90° pin plug (E)	.72

90° PIN PLUG (E) TO VARIOUS CONNECTIONS. All cables shielded Imported.

99 E 01026	90° pin plug (E)	18 in.	90° pin plug (E)	.43
99 E 01067	90° pin plug (E)	120 in.	90° pin plug (E)	.84
99 E 01109	90° pin plug (E)	120 in.	Phono Jack (D)	.84

PHONE PLUG (G) TO VARIOUS CONNECTIONS. Std. 1/4" diam. sleeve; completely shielded. All cables shielded. Imported.

99 E 00630	Phone plug (G)	72 in.	Phone jack (C)	.94
99 E 00752	Phone plug (G)	72 in.	Mike connector (F)	1.29

MINIATURE PHONE PLUG (L) TO VARIOUS TERMINATIONS

Shielded audio cables with molded miniature phone plug (1/8" diameter finger). For use with Sony, Concord, and most Japanese tape recorders and radios. Cables are 69" long. Imported. Shpg. wt., 6 oz.

99 E 10365	mini phone plug (L)	69 in.	stripped & tinned ends (J)	.59
99 E 10373	mini phone plug (L)	69 in.	alligator clips (I)	.65
99 E 10381	mini phone plug (L)	69 in.	pin plug (B)	.72
99 E 10399	mini phone plug (L)	69 in.	phone jack (D)	.74
99 E 10407	mini phone plug (L)	69 in.	phone plug (G)	.85
99 E 10415	mini phone plug (L)	69 in.	phone jack (C)	.85
99 E 10423	mini phone plug (L)	69 in.	mini phone plug (L)	.72
99 E 10431	mini phone plug (L)	69 in.	mini phone jack (M)	.77

SET OF 36" AUDIO CABLES



SET OF FOUR **1.59**

A set of four individual 36-inch insulated and shielded cables. Color coded for ease of installation and instant identification. Cables are terminated at each end with phono plugs. Ideal for interconnections between tuners and amplifiers. Quality construction assures trouble free service. Plugs molded directly to cable for positive "no-slip" contact. Imported. Shpg. wt., 6 oz. 99 E 01372 Net 1.59

SWITCHCRAFT RETRACTABLE CABLE ASSEMBLY

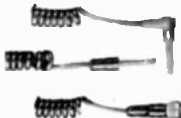

Supplied with 4 feet of cable, stripped and tinned at one end. Shpg. wt., 5 oz. With straight 2-cond. phone plug. 24 E 88526 Net 1.89 With Rt. angle 2-cond. phone plug. 24 E 88534 Net 1.89 With single microphone connector. 24 E 88542 Net 1.95

AUDIO ADAPTERS



- (P) Phono plug coupler, accepts phono plug at each end. 32 E 52012 Net .39
- (S) 2-conductor phone jack input to phono plug output. 99 E 62309 Net .52
- (T) Phono jack input to standard 2-conductor phone plug output. 99 E 62168 Net .39 ea.; 10 for 3.25
- (U) Phono jack input to a mini-plug (1/8" dia. finger) output. 99 E 63448 Net .52
- (V) 2-conductor mini-jack (1/8" dia. sleeve) input to phono plug output. 99 E 63455 Net .59
- (W) 2-conductor mini-jack (1/8" dia. sleeve) input to standard 2-conductor phone plug output. 99 E 63463 Net .59
- (X) 2-conductor subminiature jack (3/32" dia. sleeve) input to mini-plug (1/8" dia. finger) output. 99 E 63471 Net .59
- (Y) 2-conductor standard phone jack input to 2-conductor subminiature plug (3/32" dia. finger) output. 99 E 63489 Net .69

D.I.N. ADAPTER CABLES FOR EUROPEAN RECORDERS

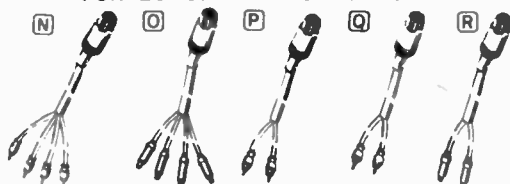

Adapts European 3 contact (180°) and 5 contact (180°) DIN connectors to mate with standard domestic RCA type phono jacks and plugs. For use with Ampex, Morelco, Grundig, Korting, Uher, SONY, and other cassette or tape recorders, radios, phonos, amplifiers etc. All phono plugs and jacks are color coded, 69" shielded cables. Imported. Shpg. wt., 6 oz.

- (M) 5-pin adapter connects to 4 RCA-type color coded phono plugs 99 E 63539 Net 1.69
- (O) 5-pin adapter connects to 4 RCA-type color coded phono jacks 99 E 63547 Net 1.89
- (P) 5-pin adapter connects to 2 RCA-type color coded phono plugs 99 E 63554 Net 1.59
- (Q) 3-pin adapter connects to 2 RCA-type color coded phono plugs 99 E 63562 Net 1.49
- (R) 3-pin adapter connects to 2 RCA-type color coded phono jacks 99 E 63570 Net 1.50

UNIVERSAL CABLE KIT



Kit contains: 2 phono plugs with 69" connecting cable; phono plug connected to 2 alligator clips by 4" cable, coupler with phono jack and phone jack; phone plug output with phono jack input. All connecting cables are shielded and insulated. Ideal for connecting tape recorder to phonograph, radio or T.V., or tuner to amplifier. Imported. 99 E 01356 Shpg. wt., 6 oz. Net 1.79

STEREO AUDIO CABLES



Two shielded insulated cables, (of different color tones, for easy identification of channels) inside a common chrome grey plastic jacket, providing two completely isolated channels. Avg. shpg. wt., 6 oz. Imported.

Type	Length	Net
99 E 01133	36"	Phono pin 1.17
99 E 01141	6'	plugs at 1.35
99 E 01158	10'	all ends. 1.62

SWITCHCRAFT COMPLETE CABLE ASSEMBLIES FOR HI-FI AND P. A.

High quality extension cables "tailor made" for users of recorders, hi-fi equipment, etc. All plugs molded directly to various cable combinations with grey plastic handle; built-in

electrical shield and cable clamp. Chrome grey shielded cable for high impedance (mike, etc.) connections; chrome grey parallel wire for low impedance (speaker, etc.) connections.

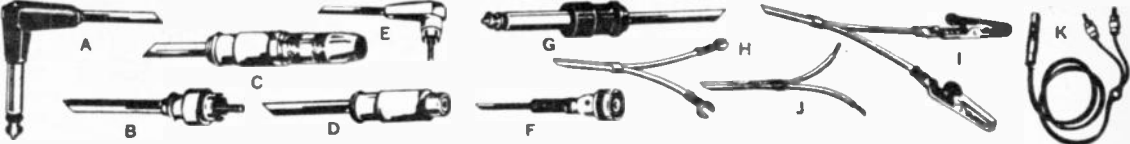

PHONE PLUG (A) TO VARIOUS CONNECTIONS. Std. 1/4" dia. sleeve; completely shielded. All cables shielded except* unshielded parallel cable. Avg. shpg. wt., 5 oz.

RCA TYPE PHONO PLUG TO VARIOUS CONNECTIONS All Cables shielded except* unshielded parallel cable. Wt. 5 oz.

Stock No.	One Termination	Cable Length	Other Termination	Net
24 E 88013	90° phone plug (A)	72 in.	90° phone plug (A)	1.89
24 E 88021	90° phone plug (A)	120 in.	90° phone plug (A)	2.55
24 E 88039	90° phone plug (A)	25 ft.	90° phone plug (A)	3.36
24 E 88047	90° phone plug (A)	120 in.	Pin plug (B)	1.98
24 E 88023	90° phone plug (A)	72 in.	Phono jack (D)	1.59
24 E 88031	90° phone plug (A)	72 in.	Phone jack (C)	1.89
24 E 88062	90° phone plug (A)	120 in.	Phone jack (C)	2.55
24 E 88070	90° phone plug (A)	25 ft.	Phone jack (C)	3.36
24 E 88068	90° phone plug (A)	120 in.	90° Pin plug (E)	1.98
24 E 88096*	90° phone plug (A)	120 in.	Strip, tin, ends (J)	1.38
24 E 88104*	90° phone plug (A)	72 in.	Spade lugs (H)	1.08
24 E 88112*	90° phone plug (A)	120 in.	Spade lugs (H)	1.44
24 E 88708*	90° phone plug (A)	72 in.	Alligator Clips (I)	1.38

Stock No.	One Termination	Cable Length	Other Termination	Net
24 E 88724	90° Pin plug (E)	36 in.	90° Pin plug (E)	.87
24 E 88732	90° Pin plug (E)	48 in.	90° Pin plug (E)	.99
24 E 88740	90° Pin plug (E)	72 in.	90° Pin plug (E)	1.08
24 E 88773	90° Pin plug (E)	18 in.	Phono jack (D)	.93
24 E 88781	90° Pin plug (E)	72 in.	Phono jack (D)	1.29
24 E 88804	90° Pin plug (E)	72 in.	Phone exten. jack (C)	1.44
24 E 88351	90° Pin plug (E)	120 in.	Phone exten. jack (C)	1.98
24 E 88369*	90° Pin plug (E)	72 in.	Stripped, tin ends (J)	.66
24 E 88377*	90° Pin plug (E)	120 in.	Spade lugs (H)	1.08
24 E 88716*	90° Pin plug (E)	72 in.	Alligator clips (I)	1.29
24 E 88385*	90° Pin plug (E)	120 in.	Alligator clips (I)	1.65
24 E 88807	Pin plug (B)	72 in.	Phone jack (C)	1.44
24 E 88815	Pin plug (B)	72 in.	90° Pin plug (E)	1.08
24 E 88393	Pin plug (B)	120 in.	Mike Connector (F)	1.31
24 E 88401	Pin plug (B)	25 ft.	Mike Connector (F)	1.79
24 E 88419*	Pin plug (B)	72 in.	Spade lugs (H)	.72
24 E 88427*	Pin plug (B)	120 in.	Spade lugs (H)	1.08
24 E 88435*	Pin plug (B)	72 in.	Alligator clips (I)	1.29

PHONE PLUG (G) TO VARIOUS CONNECTIONS

24 E 88849	Phone plug (G)	72 in.	Phono jack (D)	1.59
24 E 88237	Phone plug (G)	72 in.	Phone plug (G)	1.89
24 E 88245	Phone plug (G)	120 in.	Phone plug (G)	2.55
24 E 88856	Phone plug (G)	120 in.	Mike Connector (F)	2.55
24 E 88260	Phone plug (G)	25 ft.	Mike Connector (F)	3.36
24 E 88278	Phone plug (G)	72 in.	90° Phone plug (A)	1.89
24 E 88286	Phone plug (G)	120 in.	90° Phone plug (A)	2.55
24 E 88294	Phone plug (G)	72 in.	90° Pin plug (E)	1.44
24 E 88302	Phone plug (G)	120 in.	90° Pin plug (E)	1.98
24 E 88310*	Phone plug (G)	72 in.	Spade lugs (H)	1.08
24 E 88328*	Phone plug (G)	120 in.	Spade lugs (H)	1.44
24 E 88336*	Phone plug (G)	72 in.	Alligator clips (I)	1.38
24 E 88344*	Phone plug (G)	120 in.	Alligator clips (I)	1.74

MISCELLANEOUS CABLES

24 E 88138*	Spade lugs (H)	120 in.	Spade lugs (H)	.86
24 E 88146*	Spade lugs (H)	25 ft.	Spade lugs (H)	1.32
24 E 88153*	Alligator clips (I)	120 in.	Alligator clips (I)	1.29
24 E 88229	Phono Jack (D)	72 in.	Phono jack (D)	1.41

STEREO ADAPTER CABLE Fig. K

Two standard, color coded, molded phono plugs wired to a 3-conductor molded extension phone jack. Ideal for adapting 3-circuit stereo phone plugs, as used on microphones and headsets, to 2-separate phono jack inputs. Completely shielded 4' grey stereo cable. 24 E 88898 Shpg. wt., 6 oz. Net 2.58



SWITCHCRAFT ADAPTERS — Shielded plug adapters for mikes & Hi-Fi cables. Avg. Shpg. wt., 5 oz.

332A—2 cond. phone jack input to female mike output. Coupling ring back converts mike conn. to male type. 24 E 88559 Net 1.20	345A—2 cond. phone plug output with phono jack input. 24 E 88625 Net .87	374—2-Conductor phone jack input to a 2 conductor tini-plug (1/4" dia. finger) output. 24 E 88930 Net 1.20
334A—Phono jack input to female mike connector output. 24 E 88567 Net .99	349A—Phono plug coupler—with phono jack at each end. 24 E 88641 Net .72	383—3 contact female mike input to a 2-cond. phono jack output. 24 E 88948 Net 2.76
336A—2 cond. phone jack input to phono plug output. 24 E 88583 Net 1.20	364A—2-Conductor tini-jack 1/4" dia. sleeve to 2-conductor standard 1/4" plug. 24 E 88906 Net 1.05	384—3 pin male mike input to a 2-cond. phone jack output. 24 E 88955 Net 2.46
338A—Phono plug at one end with male mike connector at other end. 24 E 88591 Net .75	365—2-Conductor tini-jack 1/4" dia. sleeve to phono plug output. 24 E 88914 Net 1.05	386—3 contact female mike input to a standard 2-cond. phone plug output. 24 E 88963 Net 2.70
	370—Phono jack input to a 2-conductor tini-plug (1/4" dia. finger) output. 24 E 88922 Net .81	387—3 pin male mike input to a standard 2-cond. phone plug output. 24 E 88971 Net 2.40

COILED CORD AUDIO CABLE ASSEMBLIES

FLEXIBLE Y CONNECTORS AND SHIELDED Y ADAPTERS

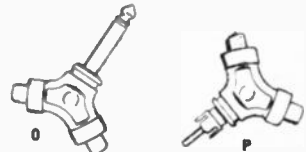
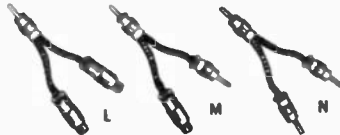
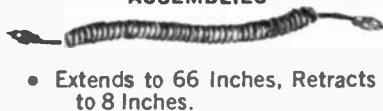

- Extends to 66 Inches, Retracts to 8 Inches.

Stretch cable permits neat interconnections without tangle, drape or droop. Durable, shielded coiled cord. Available with RCA type phono plug, alligator clips and stripped and tinned terminations. Shpg. wt., 9 oz. RCA type phono plug at each end. 24 E 34025 Net .99
 RCA type phono plug at one end, alligator clips color coded red and black at other end. 24 E 34033 Net .99
 RCA type phono plug at one end, stripped and tinned leads at other end. 24 E 34017 Net .99

For converting Stereo Player to Monaural. Can be used for a Tap-in-Meter Monitor connection. Also required on some Tape Recorders. Imported. Shpg. wt., 4 oz.
 (L) Phono Plug connected to 2 Phono Jacks by 4" shielded cable. 99 E 00937 Net .59
 (M) Phono Jack connected to 2 Phono Plugs. 99 E 00945 Net .59
 (N) 3 Phono Plugs connected together by 4" shielded cable. 99 E 00952 Net .59

Completely shielded Y-Adapters with choice of connectors and terminations. Imported. Avg. shpg. wt., 7 oz.
 (O) Two phono jacks connectors in parallel to a standard 2-conductor phone plug. 99 E 00895 Net .69
 (P) Two phono jacks connectors in parallel to a standard phono plug. 99 E 00903 Net .69

LAFAYETTE T & L Pads - Faders - Switches

STEREO LEVEL BALANCE CONTROL

- Dual Concentric 8 ohm L Pads
- Logarithmic Curve



Provides individual level control for stereo speakers. Varies "brilliance" or "presence" Controls stereo extensions without mismatching. Dual control mounted on concentric shaft. Gold-finished brass plate and attractive black knobs with gold trimming. L pad for 8 ohm circuits. Plate is 2 1/4" across; overall depth 3/4". Imported. Shpg wt., 10 oz.

99 E 61400 Level Control ... Net 2.69

DELUXE STEREO LEVEL BALANCE CONTROL

- Dual Concentric 8 ohm L Pads
- Logarithmic Curve



Two phono jacks enable you to plug in extension or monitoring speakers from the front. Screw terminals in the rear provide for a simple, permanent hookup. Control mounted on concentric shaft. Brushed brass plate with attractive black with gold-trim knobs. Concentric 8 ohm L pads. Use it to control volume on a second set of speakers. Plate is 4 1/2 x 2 3/4"; from front of knob to plate 1"; Overall depths 3 3/4". Imported. Shpg. wt., 1 lb.

99 E 61418 Deluxe Level Control ... Net 3.95

LAFAYETTE L PADS

L pads for use as "brilliance" controls to vary tweeter level, or as "presence" controls to vary midrange speaker level. Both wire-wound elements are concentrically mounted within one plastic housing. With gold-finished metal escutcheon plate, mtg. screws, and attractive black knob. Size: 1 1/4" dia., 7/8" deep (less shaft), 2 1/2" deep overall. Imported. Shpg. wt., 6 oz.



L pad for 8 ohm circuits ... Net 1.69

L pad for 16 ohm circuits ... Net 1.69

LAFAYETTE T PADS

Constant impedance control to adjust speaker volume. With brass satin plate for wall mounting. Impedance, 8 ohms. With all parts and instructions. Imported. Shpg. wt., 10 oz.



99 E 61368 ... Net 4.49

LAFAYETTE REMOTE SPEAKER FADERS

As Low
As

79^c



Remote Speaker Fader Provides adjustable volume level for Radio, TV, Hi-Fi and remote speaker. Gradually increases volume on one speaker while diminishing volume on the other. May also be used to adjust volume for 1 speaker. Gold plate for front panel mounting. With instructions. Imported. Shpg. wt., 6 oz.

99 E 61384 ... Net .79

Remote Speaker Fader. Same as above except for wall mounting. Imported. Shpg. wt., 6 oz.

99 E 61392 ... Net .89

MULTI-INPUT SELECTOR CONTROL

176



An all purpose selector control ... connects any one of 5 inputs to one output. For AM, FM radio, phono, tape recorder or other auxiliary. Unit is completely shielded to prevent hum. Comes complete with all necessary mounting hardware and 5 input phono jacks and one output phone jack. An inexpensive addition to any multi-component system. Imported. Shpg. wt., 1 lb.

99 E 10290 ... Net 1.76

LAFAYETTE VC-64 STEREO LEVEL CONTROL

398



- Logarithmic Curve

Two precision 8-ohm level controls concentrically mounted for stereo. Ideal for controlling individual volume control of stereo extension speakers without fear of mismatch or affecting volume of main speakers. Also may be used to vary "brilliance" or "presence." Screw terminals. Handsome cream finish with gold panel plate. Overall size 3 3/4" H x 4 1/2" W x 2 3/4" D. Imported. Shpg. wt., 1 1/2 lbs.

99 E 61475 ... Net 3.98

STEREO SELECTOR SWITCHES



(Fig. A)



(Fig. B)

- Permits remote Selection of any 3 Pairs of Speakers

Recommended only for Hi-Fi Systems Using Vacuum Tube Circuitry

(Fig. A) A constant impedance speaker selector switch for multiple-speaker Stereo Hi-Fi. Selects 3 sets of speakers in any combination, with up to 60 watts of audio power. Mounted on an attractive, gold-finished, steel, electric outlet plate. 2 3/4 x 4 1/2". Imported. Shpg. wt., 1 lb.

Stereo Speaker Selector Switch ... Net 1.59

(Fig. B) As above in enclosed case 2Hx4Wx3"D. ... Net 2.95

VOLUME CONTROL ADAPTER



Built in volume control permits high volume signals to be fed into the high gain input of tape recorders without overloading. Phono jack input to a 2-conductor standard phone plug output. Completely shielded. Designed for use in unbalanced stereo channels; use in pairs for dual stereo channel control. Imported. Shpg. wt., 6 oz.

99 E 00994 ... Net 1.39

STEREO SELECTOR SWITCHES FOR SOLID STATE HI-FI SYSTEMS



Speaker selector switch for solid state stereo systems. Allows choice of one of three pairs of speakers. High quality, non-shorting contacts capable of handling up to 60 watts audio. Imported. Shpg. wt., 1 lb.

Wall Box Selector. ... Net 1.99

Enclosed Case Selector. ... Net 2.95

LAFAYETTE MULTIPLE 6 SPEAKER SWITCHES

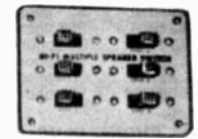

(A)

(B)

- Recommended only for Hi-Fi Systems Using Vacuum Tube Circuitry

Multiple Speaker Switch Constant impedance device for controlling any 6 remote speakers; up to 63 different combinations. Wall mounting with brass plate. With instructions and hardware. Shpg. wt., 10 oz.

99 E 00549 Imported. Fig. A ... Net 2.10

Multiple Speaker Switch Identical to above but mounted on flat, gold-embossed plate for mounting on flat panel. 3 1/2 x 2 3/4". Imported. Shpg. wt., 10 oz.

99 E 00663 Fig. B ... Net 1.49

LAFAYETTE REMOTE SPEAKER SWITCHES



(Fig. A)



(Fig. B)

- Recommended only for Hi-Fi Systems Using Vacuum Tube Circuitry

(Fig. A) Selects any one of 3, or any combination of 2 or 3 speakers with up to 60 watts of audio power. A constant impedance device. On gold finished steel electric outlet plate with black and ivory knob. 2 3/4 x 4 1/2". Imported. Shpg. wt., 1 lb.

99 E 00531 ... Net 1.39

(Fig. B) Same as above in enclosed case 3 1/4 x 4 1/2 x 2 1/8". Imported.

99 E 00838 ... Net 1.69

STEREO SPEAKER WALL JACK KIT

129



A handsome Ivory-finish wall stereo jack kit designed to be mounted in a standard outlet box. Ideal for remote amplifiers or for added stereo pleasure in the den, play room, etc. Contains two standard 1/4" phone plugs and two standard 1/4" phone jacks. Size: 4 1/4 x 2 1/4". 1" back clearance required. Imported. Shpg. wt., 1/2 lb.

99 E 01364 ... Net 1.29

Hi-Fi Installation Accessories

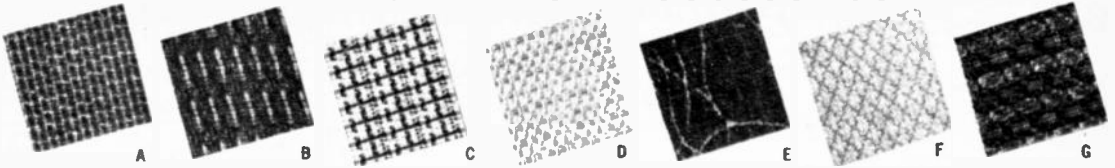

ACOUSTONE GRILLE CLOTH

Choice selection of latest patterns and beautiful decorator colors. Made of finest quality vinyl plastic, woven with proper mesh for passage of high frequencies as well as low. Shpg. wt., (36" x 36") 8 oz. (18" x 24") 5 oz.

- Description**
- Random silver metallic
 - Mahogany background with ivory threads
 - Medium beige background with walnut threads
 - Fine gold mesh
 - Black background with metallic gold scroll
 - Black and metallic gold sparkle threads
 - Blended walnut diamond with random rust threads
 - Blended white background with gold metallic threads
 - Black with raised walnut check
 - Black, white with interwoven silver threads

- DELUXE CANE CLOTHS**
- Brown background with natural cane crisscross lattice
 - Black with interwoven wicker cane
 - Rattan cane with walnut and gold threads
 - Blended walnut cane on dark brown base

LEVEL AND LEVELING SCREWS

2⁶⁹



For stereo and mono Hi-Fi systems. Prevents unnecessary needle and record groove wear. Precision, circular bubble type level indicator for accurate turntable leveling. Circular 4-way spirit level mounts to top deck of turntable. Four adjustable leveling screws and T nuts. Provides quick, easy adjustment. 24 E 80341 Shpg. wt., 6 oz. Net 2.69



As Low **1.49**
As

FIBERGLASS INSULATION

Excellent sound absorbing material. For lining interiors of speaker cabinets, consoles, phonos, TV's, etc. Damps medium and high frequency reverberation and distortion. Suitable for many other installation purposes. 9 sq. ft. 1" thick with glue and applicator. Shpg. wt., 1 lb. Net 1.49

DELUXE BASS REFLEX KIT: Same as above but contains 20 square ft. 16" x 16" x 1" thickness fibreglass. Shpg. wt., 2 lbs. Net 2.79

20 E 19014
20 E 19022

BALL BEARING HEAVY DUTY SLIDES

Drawer slides made of 16 gauge steel. Supports 50 lbs. Ball bearing, double-extension type, drawer slides. Length 15", travel length 11", extended 22". Shpg. wt., 5 lbs.



20 E 52017 per pair Net 1.75
SHORT TYPE. Same construction as above but 13" long; travels 9"; extends to 18".
20 E 52025 per pair Net 1.55

DANISH WALNUT FINISHING KIT

A professional wood finishing kit. Ideal for the unfinished speaker enclosure kits listed in this catalog. Consists of 1/2 pint stain, 1/4 pint finish, cloth, steel wool, 2 pipe cleaners, and sandpaper. Will stain and finish (2 coats) approximately 50 sq. ft. Shpg. wt., 2 lbs. Net 3.40



16 INCH HI-FI SHELF

- Ideal for Large Components or TV



Handsome oiled walnut veneer shelf. 16" wide x 36" long, designed to hold turntables, TV or other large units. Optional 15" walnut finished hardwood brackets permit a floating shelf arrangement. May also be mounted with heavy duty 16" brackets and standards. Shelf 16"x36". Shpg. wt., 12 lbs. Net 9.50

15" Wood Brackets with mounting screws. Shpg. wt., 1 1/2 lbs. Net per pair 4.75
20 E 24018

FREE SAMPLE SWATCHES

Supplied free. Just specify stock number below for assortment

36 x 36		18 x 24	
Fig. Stock No.	Net	Stock No.	Net
A 20 E 12417	2.59	20 E 12425	1.40
B 20 E 12029	3.35	20 E 12037	1.40
C 20 E 12391	3.35	20 E 12409	1.40
D 20 E 12128	3.35	20 E 12201	1.40
E 20 E 12136	3.75	20 E 12210	1.85
A 20 E 12276	3.75	20 E 12284	1.85
F 20 E 12433	3.75	20 E 12441	1.85
D 20 E 12318	3.75	20 E 12326	1.85
G 20 E 12458	3.75	20 E 12466	1.85
C 20 E 12474	3.75	20 E 12482	1.85
NO CHARGE			
20 E 12011			
DELUXE CANE CLOTHS			
G 20 E 12169	2.99	20 E 12243	1.85
G 20 E 12490	3.75	20 E 12508	1.85
A 20 E 12151	3.75	20 E 12235	1.85
C 20 E 12516	3.75	20 E 12524	1.85

LAFAYETTE HI-FI TEST RECORD

- For Both Stereo And Monaural
- Tests Level And Rumble Each Channel
- Tests Balance, Equalization, Resonance
- Checks Speaker Phase And Stylus Wear

This two sided 12" LP record uses easy to make tests to check the performance of stereo and monaural high fidelity equipment. Simple narrative and complete instructions enable you to check frequency response, level balance, channel identification and separation, hum, rumble, and other characteristics of your hi-fi system. 24 E 45070 Shpg. wt., 1 lb. Net 2.95

SLIDE-OUT DRAWER FOR RECORD CHANGERS

Designed for custom installations of record changers in bookcases, cabinets, tables, etc. Made of durable plywood and equipped with heavy duty steel slides which operate smoothly and quietly on ball-bearings. Slides extend drawer up to 10 3/4" beyond edge of cabinet. Supplied with uncut blank top. Unfinished wood permits your painting to suit your own decor. Size: 15 1/4 x 15 1/4 x 3 1/2". 20 E 41010W Shpg. wt., 7 lbs. Net 5.95



BOOKSHELF-ROOM DIVIDERS

- Superbly Styled Decorator Shelving in Sturdy All Steel Construction
- Ideal For Hi-Fi, Knick-Knacks, and Book Storage



Incomparable styling and color harmony to blend with any decor provided by luxurious wood grain shelves and polished pewter posts. Units have utmost rigidity and strength and are accessible from either side. All hardware completely hidden, no screw holes in view. Shelves adjustable at 1 1/2" intervals. Security shelf edges keep items from falling off. A screwdriver is the only tool needed for simple and speedy assembly. 4-shelf unit, 36Wx12Dx36" High. Shpg. wt., 20 lbs. Net 9.95

20 E 19016WX
6 shelf unit same as above, 36Wx12Dx60" High. Shpg. wt., 28 lbs. Net 14.75
20 E 19024WX
12 shelf double unit same as above, 72Wx12Dx60" High. Shpg. wt., 52 lbs. Net 26.95
20 E 19032WX



LAFAYETTE

P. A. Systems

LAFAYETTE P.A. AMPLIFIER GUARANTEE

ONE Year Guarantee: All parts guaranteed against defects in material and workmanship for one year. Ship defective part to us prepaid for replacement or ship amplifier prepaid for repair



PA-612A

12-Watt P.A. Amplifier

- For Small Areas and Halls
- Offers 1 Mike and 2 Auxiliary Inputs
- 12-Watt Push-Pull Output

41⁹⁵

No Money Down*

A low priced high quality P.A. Amplifier—especially suitable for paging applications in small size areas of up to 5500 sq. ft. Controls are provided for 1 mike and 2 auxiliary inputs (phono, tuner, or recorder); master tone control; inverse feedback circuit delivers 40-20,000 Hz response, effectively reduces hum and distortion. Output for 4, 8, 16 ohms, 25 and 70.7 volts. Rear chassis terminations for optional economical B+ on-off switching. Tubes: 2—6BM8/ECL-82, 12AX7, 6CA4/EZ-81 rectifier. Attractive brushed aluminum front panel with black vinyl-clad metal case. Size: 12³/₄x8³/₄x5¹/₄". For 110-120 volts 50/60 Hz. AC. Shpg. wt., 12 lbs.

44 E 01279WX

Net 41.95

4-Speed Phono Top for Amplifier Above.

44 E 01584 Shpg. wt., 8 lbs.

Net 18.95

COMPLETE PERMANENT SYSTEM



99 - 45874



Only
56⁹⁵

Wall Baffle

High quality, low cost system engineered for smaller permanent installations. For areas up to 5500 sq. ft. **THE COMPLETE SYSTEM INCLUDES:** The Lafayette Model PA-612A, 12 watt amplifier; the Lafayette 99-45874 crystal microphone with on-off switch, desk stand, lavaliere cord, cable, and detachable swivel-type floor and desk stand adapter, easily hand-held without adapter-holder; 12" heavy duty PM speaker; 35' speaker cable and plug; and attractive polished walnut finish speaker wall baffle. For 110-120 volts, 50-60 Hz AC operation. Shpg. wt., 27 lbs. Complete 12-watt Permanent System as described above.

44 E 91478WXM Net 56.95

12-WATT PORTABLE SYSTEM



Only **73⁵⁰**

Includes Lafayette Model PA-612A 12-Watt amplifier, sturdy amplifier and speaker carrying case, heavy duty 12" P.A. speaker. Lafayette 99-45874 crystal microphone and connector. Entire system can be carried in baffle case. Shpg. wt., 45 lbs.

44 E 91486WXM Net 73.50

PHONO TOP FOR AMPLIFIERS



18⁹⁵

4-speed (16, 33¹/₃, 45, and 78 RPM) phono-graph turntable is designed to fit on top of the amplifier and is easily mounted with two screws. Fits snugly over amplifier. Takes records up to 12". High quality ceramic pickup—turnover type with dual synthetic sapphire stylus. Power requirements: 15 watts. 117 volts 60 Hz AC. Durable finish matches amplifier. Sizes: 12³/₄x8³/₄x4". Shpg. wt., 8 lbs.

For PA-612A, PA-622A, PA-645A and PA-675A. 44 E 01584 Net 18.95

LAFAYETTE PORTABLE PA CASE



20⁹⁵

- 2 Baffles In One Case
- Room For Two 12" Speakers

A sturdily constructed case for amplifier and two 12" speakers. Made of heavy plywood with reinforced metal corners. Case splits into 2 baffles, each with heavy duty plastic carrying handle. Covered with attractive grill cloth. Has 2 hooks in each half for carrying speaker cables and provision for mike and mike base. 4 snap locks. In addition to room for two 12" speakers, there is ample space for any amplifier and phono top measuring up to 16³/₄W x 11³/₄D x 10"H. 17³/₄ x 12³/₄ x 22"O.D. Shpg. wt., 25 lbs.

44 E 01261WX

Net 20.95

DELUXE LAFAYETTE PISTOL-GRIP POWER MEGAPHONE



29⁹⁵

- Weighs only 4¹/₄ lbs. complete with batteries

A lightweight megaphone notable for its extreme economy in battery power despite its high sound volume output. Uses 4 size D flashlight batteries and has a patented non-linear current-limiting device to give maximum possible battery life. The reflexed air column in the horn plus its special shape serve to concentrate and direct the amplified sound and throw it for a considerable distance! The rubber-rimmed horn is of lightweight spun aluminum and construction is extremely sturdy throughout. Microphone is built into the base of the horn. Unit measures 12¹/₂" long; mouth diameter is 8³/₄". Imported. Shpg. wt., 6 lbs.

99 E 45049W (Less Batteries) Net 29.95
"D" Battery for above (4 required).
99 E 62564 Net ea. .15

LAFAYETTE P.A. AMPLIFIER GUARANTEE

ONE Year Guarantee: All parts guaranteed against defects in material and workmanship for one year. Ship defective part to us prepaid for replacement or ship amplifier prepaid for repair



22-WATT PERMANENT INDOOR SYSTEM with HEAVY DUTY 12" SPEAKER

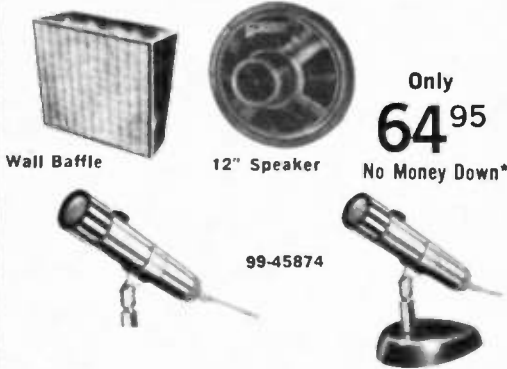

Wall Baffle

12" Speaker

99-45874

Only **64⁹⁵**
No Money Down*

Includes PA-622A 22-watt P.A. amplifier; Rugged, specially designed hi-power 12" P.A. speaker; Polished walnut wooden wall baffle; Lafayette 99-45874 slim crystal microphone with on-off locking switch, desk stand, lavalier cord, cable and removable type floor stand and desk stand adapter; mike connector, 35 ft. speaker cable. For 110-130 volts 50/60 Hz. AC. Shpg. wt., 28 lbs. 44 E 91494WXM Net 64.95

Additional 12" 15 watt P.A. speaker and walnut wood baffle. Shpg. wt., 10 lbs. 44 E 90504WXM Net 10.95

with COLUMN SPEAKERS

As Low As **76⁹⁵**
No Money Down*

Complete Lafayette 22-watt public address system includes the PA-622A 22-watt amplifier, Lafayette 99 E 45874 Slim Crystal Microphone, and efficient "long throw" column speaker. Attains extra efficient sound reproduction with six internal speakers. Measures 30 3/4" x 7" x 3 1/2". Comes with 35' length of speaker cable. Shpg. wt., 32 lbs.

44 E 91502WXM Net 76.95
Same system as above plus additional 6-speaker matching column speaker and additional 35 ft. cable. Shpg. wt., 47 lbs. 44 E 91510WXM Net 99.95

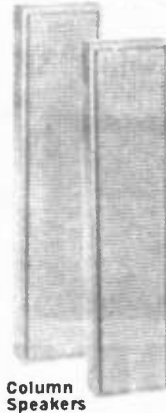

Column Speakers



PA-622A

22-Watt P.A. Amplifier

- For Medium Halls
- Inverse Feedback For Low Distortion
- Outputs For 4, 8, and 16 Ohms, 25 and 70.7 Volts
- Handsomely Designed, Rugged Cabinet

49⁹⁵

No Money Down*

An outstanding 22-watt P.A. amplifier. Perfect for applications in a medium sized area—indoors or outdoors—up to 6000 sq. ft. Inverse feedback circuitry assures low hum and distortion for exceptionally clean, pure sound. Extremely good frequency response—30-20,000 Hz \pm 2 db—make this an ideal unit not only for paging, but for background music, etc. Functionally designed front panel controls: mike, and two auxiliary inputs (phono, tuner, recorder); master tone control, and on-off switch. Handy Indicator light automatically signals when unit is energized. Outputs are provided for 4, 8, and 16 ohms, 25 and 70.7 volts, to match a wide variety of speaker impedances. Microphone gain is +126db while aux. is +83db. Comes complete with Amphenol 75MCF mike connector and phono plug for auxiliary input. Handsomely designed appearance with brushed aluminum front panel and contrasting black vinyl-clad metal case. Rear chassis terminations for optional economical B+ on-off switching. Tube complement, 2-7189 in push-pull output, 12AX7, 6AU6, 6CA4/EZ-81 rectifier. For 110-120 volts, 50-60 Hz AC. Size: 12 3/4" x 8 1/2" x 5 1/2". Shpg. wt., 14 lbs. 44 E 01370WXM Net 49.95

4-Speed Phono Top For Amplifier Above, 44 E 01584 Net 18.95

22-WATT PORTABLE P.A. SYSTEMS

As Low As **77⁹⁵** No Money Down*

A complete 22-watt P.A. portable system that in addition to Lafayette's fine 22-watt P.A. amplifier, includes a heavy duty 12" P.A. speaker; a rugged excellently constructed carrying case that serves as an efficient speaker baffle and housing for the amplifier, optional phonotop, microphone, cables and up to 2-12" speakers; Lafayette 99 E 45874 high impedance slim crystal microphone with on-off locking switch, with cable, desk stand, removable swivel type floor stand adapter, and lavalier cord; and 35 ft. speaker cable. For 110-130 volts 50/60 Hz. AC. Shpg. wt., 47 lbs. 44 E 91528WXM Net 77.95

Same as 44 E 91528WXM except with 2-12" heavy duty 15 watt PA speakers plus 35' speaker cable. Shpg. wt., 52 lbs. 44 E 91536WXM Net 85.95
See page 140 for phonotops for above systems.

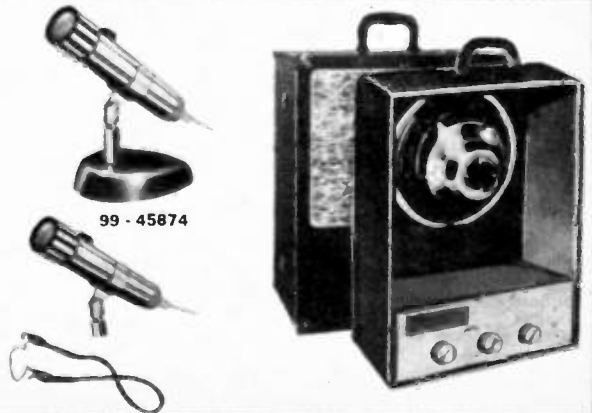

99 - 45874



45-Watt P.A. Amplifier

An outstanding P.A. amplifier for indoor and outdoor coverage. Combines power with versatility for superb performance in any application. Features a low frequency filter which acts as an anti-feedback network and trumpet protector. Two handy outputs are provided for constant output into speakers; one at 25 volts and the other at 70.7 volts. Separate bass and treble controls for flawless performance and extreme ease of operation. Power output is a full 45 watts RMS (90 watts peak), more than enough to drive even low-efficiency speakers to full output capabilities. Master gain control eliminates chance errors when making volume adjustments. Outputs: 4, 8, and 16 ohms to match a wide range of speaker impedances for maximum power transfer. Terminations on rear of chassis make possible optional B+ on-off switching with resultant tube and component saving. Comes complete with Amphenol 75MC1F connector and phono plug. Handsomely styled black vinyl-clad metal case with attractive brushed aluminum front panel. For 115V, 50/60 Hz AC. Size: 15 1/4 x 10 1/4 x 5 1/4". Shpg. wt., 21 lbs.
44 E 01451WX Net 73.95
4-speed Phono Top for Amplifier Above. Shpg. wt., 8 lbs.
44 E 01584 Net 18.95

Only **73⁹⁵** No Money Down*



PA-645A SPECIFICATIONS

POWER OUTPUT: 45 watts RMS (90 watts peak)
FREQUENCY RESPONSE: ±2 db, 30 to 20,000 Hz.
INPUTS: 2—Microphone; 2—Auxiliary (high gain phono, tuner, or tape recorder)
CONTROLS: 2—Microphone; 1—Auxiliary fader; 1—Bass, 1—Treble; 1—Master gain, 1—Anti-Feedback; 1—On-Off
OUTPUTS: 4, 8, 16 ohms; 25 and 70.7 volts
TUBES: 2—12AX7A/ECC83; 1—6AV6; 2—6L6GC; 1—5AR4/GZ-34
POWER CONSUMPTION: 110 watts at 120 VAC

45-WATT INDOOR SYSTEMS

Excellent for Large Halls, Department Store Paging Systems, Auditoriums, Supermarkets, etc.

WITH 12" HEAVY DUTY SPEAKERS

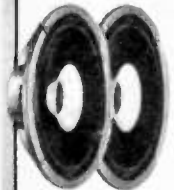

As Low As **119⁹⁵** No Money Down*

- Consists of:
- Lafayette PA-645A 45-Watt PA Amplifier.
 - 2-12" Dual Cone Heavy Duty Speakers. Each with 2" Edge-Wound Voice Coil and 40-13,000 Hz Range
 - 2 Sturdy Attractive Walnut Wall Baffles for Speakers
 - Choice of Deluxe Dynamic Mikes
 - 2-35' Lengths of Speaker Cable

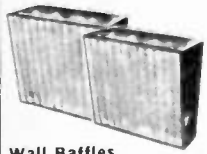

Above system with Lafayette 99-46039 dual impedance dynamic microphone and 99-45999 desk stand. Can also be hand held or used with standard floor stand 110-130 VAC 50/60 Hz. Shpg. wt., 51 lbs.
44 E 91544WXM Net 119.95
Same as above with Shure Unisphere A dynamic "pop-proof" cardioid mike instead of Lafayette microphone. Shpg. wt., 51 lbs.
44 E 91551WXM Net 144.95

WITH 8" SPEAKER-BAFFLE COMBINATIONS

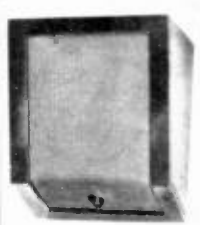

As Low As **153⁹⁵** No Money Down*



- Consists of:
- Lafayette PA-645A 45-Watt PA Amplifier.
 - 4-8" Speaker-Baffle Combinations; each with Matching Transformer for 25 and 70.7 Volt Constant Voltage Outputs, plus Volume Control.
 - Choice of Deluxe Dynamic Microphones.
 - 4-35' Lengths of Speaker Cable.



Complete PA system as above with Lafayette 99-46039 dual impedance dynamic microphone and 99-45999 desk stand. Mike can also be hand-held or can be used with standard floor stand. Shpg. wt., 57 lbs.
44 E 91569WXM Net 153.95
Same as 44 E 91569WXM except with Shure Unisphere A dynamic cardioid "pop-proof" microphone instead of Lafayette microphone. Shpg. wt., 56 lbs.
44 E 91577WXM Net 178.95

LAFAYETTE P.A. AMPLIFIER GUARANTEE

ONE Year Guarantee: All parts guaranteed against defects in material and workmanship for one year. Ship defective part to us prepaid for replacement or ship amplifier prepaid for repair



45-WATT OUTDOOR PA SYSTEMS

For Airports, Loading Platforms, Railroad Stations, Country Clubs, Camps, etc. For up to 100,000 Square Ft. of Outdoor Area

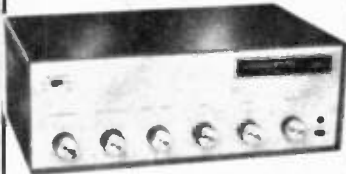

Lafayette PA-645A

E-V PA-30A Projectors



Lafayette 99-46039 Dynamic Mike with 99-45999 Desk Stand



Shure Unisphere A Dynamic Mike

As Low As **139⁹⁵**

No Money Down*

Consists of:

- Lafayette PA-645A Versatile 45-Watt PA Amplifier
- Choice of Deluxe Dynamic Microphones
- Three E-V PA-30A 30-Watt Weatherproof Speakers

Above system with Lafayette 99-46039 deluxe dual impedance dynamic microphone with 99-45999 desk stand. Microphone can be hand held or used with standard floor stand. Includes 20 ft. of detachable mike cable and connector. Shpg. wt., 48 lbs.
44 E 91585WXM Net 139.95

Same system as above except with Shure Unisphere A dynamic cardioid mike instead of Lafayette microphone. Shpg. wt., 46 lbs.
44 E 91593WXM Net 164.95

45-WATT PORTABLE PA SYSTEMS

With Dual Speakers

For the Majority of Sound System Applications . . . School Auditoriums, Churches, Theaters, Dance Halls, Studios, Lecture Halls, etc.

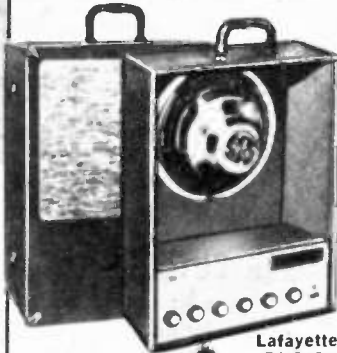

Lafayette PA-645A



Lafayette 99-46039 Dynamic Mike with 99-45999 Desk Stand



Shure Unisphere A Dynamic Mike

As Low As **135⁹⁵**

No Money Down*

Consists of:

- Lafayette PA-645A 45-Watt P.A. Amplifier
- Two 30-Watt Heavy Duty 12" P.A. Speakers
- Lafayette 99-46039 Dual Impedance Dynamic Microphone & Desk Stand
- Attractive, Sturdy Carrying Case for Amplifiers, Speakers, & Accessories. Serves As Efficient Baffle
- Two 35' Speaker Cables

Complete System as above. Shpg. wt., 68 lbs.
44 E 91601WXM Net 135.95

Same as above system except with Shure Unisphere A Cardioid Dynamic Microphone Instead of Lafayette microphone. Shpg. wt., 67 lbs.
44 E 91619WXM Net 160.95

Phototop for above. Shpg. wt., 8 lbs.
44 E 01584 Net 18.95

45-WATT INDOOR P.A. SYSTEMS

with LAFAYETTE 6-Speaker Column Speakers

Excellent for: Auditoriums, Churches, Theatres, Studios, and Special Events.



Lafayette PA-645A



Lafayette 99-46039 Dynamic Mike with 99-45999 Desk Stand



Shure Unisphere A Dynamic Mike

Column Speakers

As Low As **129⁹⁵**

No Money Down*

- Lafayette PA-645A 45-Watt PA Amplifier
- Two 30-Watt 6-Speaker Column Speakers
- Choice of Deluxe Dynamic Microphones
- 2-35 Ft. Cables

Above system with Lafayette 99-46039 dual impedance dynamic microphone and 99-45999 desk stand. Can also be hand-held or used with standard floor stand. Column speaker is 30 1/4"x7"x3 1/8" utilizing 6 speakers for efficient reproduction of program material. Shpg. wt., 57 lbs.
44 E 91627WXM Net 129.95

Same as above system except with Shure Unisphere A Cardioid Dynamic Microphone instead of Lafayette microphone. Shpg. wt., 55 lbs.
44 E 91635WXM Net 154.95

Same system as 44-91627WXM except with 2 Deluxe 60 watt, 6-speaker sound column speakers instead of 30 watt speakers. Shpg. wt., 77 lbs.
44 E 91643WXM Net 169.95

Same as 44 E 91643WXM except with Shure Unisphere A Cardioid Dynamic Microphone instead of Lafayette microphone. Shpg. wt., 75 lbs.
44 E 91650WXM Net 194.95

* See Page 11 for Full Credit Details on Easy Pay Plan



75-Watt P.A. Amplifier



PA-675A

Only

89⁹⁵

No Money Down*

- High Power • Wide Range
- Anti-Feedback Network
- 25 Volt and 70.7 Volt Constant Voltage Outputs

LAFAYETTE P.A. AMPLIFIER GUARANTEE

One Year Guarantee: All parts guaranteed against defects in material and workmanship for one year. Ship defective part to us prepaid for replacement or ship amplifier prepaid for repair

A high quality 75-watt P.A. amplifier ideal for large meeting areas, factories, department stores, outdoor areas, etc. where maximum coverage is essential. Features include separate bass and treble controls, efficient master gain control, separate mixer controls, inputs for two microphones, and common mixer control for both auxiliary inputs (phono, tuner, or recorder). Switchable anti-feedback network attenuates the lower frequencies to minimize feedback and to protect the speakers against burnout. Also features 25 volt and 70.7 volt constant voltage outputs for a constant level sound system. Complete with microphone connector and one phono plug. Attractively styled black vinyl-clad metal case with brushed aluminum front panel. For 105-120 volts, 50/60 Hz AC. 1 AC accessory outlet provided. Size: 15 1/4 x 10 1/4 x 5 1/4" H.
 44 E 01477WX Shpg. wt., 39 lbs. Net 89.95
 Phototop for above. Shpg. wt., 8 lbs.
 44 E 01584 Net 18.95

SPECIFICATIONS

POWER OUTPUT: 75-watts RMS (150-watts peak).
 FREQUENCY RESPONSE: 30-20,000 Hz ±2 db.
 INPUTS: 2-Microphone, 2-Auxiliary (high gain phono, tuner, or tape recorder).
 CONTROLS: 2-Microphone, 1-Auxiliary Fader, 1-Master Gain, 1-Bass, 1-Treble, 1-Anti-Feedback, 1-Power On/Off.
 OUTPUTS: 8, 16 ohms; 25 volts and 70.7 volts.
 Tubes: 2-12AX7A, ECC83, 1-6AV6, 2-6CA7, EL34, 1-GZ34, 1-5Y3GT.

75-WATT HI-POWER OUTDOOR P.A. SYSTEMS

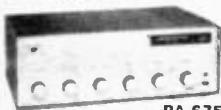

PA-675A

As Low As **154⁹⁵**

A high power outdoor Public Address system for up to 200,000 square feet of coverage.

Consists of:

- Lafayette PA-675A 75-Watt PA Amplifier
- 3 Electro-Voice PA30A 30-Watt Projector Speakers
- Choice of Deluxe Dynamic Microphones

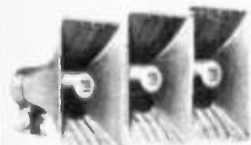

E-V PA-30A Projectors

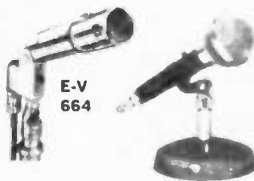

E-V 664

Lafayette 99-45981

Above P.A. system with Lafayette 99-45981 deluxe dual impedance, dynamic "pop-proof" microphone with on-off switch, desk stand and 6 ft. detachable cable. Microphone can also be hand-held or mounts on any standard floor stand.

44 E 91668WXM Shpg. wt., 64 lbs. Net 154.95
 Same P.A. system as above except with famous Electro-Voice Model 664 dynamic cardioid microphone instead of Lafayette microphone.
 44 E 91676WXM Shpg. wt., 64 lbs. Net 190.95

75 WATT INDOOR P.A. SYSTEMS

Excellent for: Department Stores, Auditoriums, Airports, Large Meeting Halls, Churches, Temples, etc.

with WALL-MOUNT SPEAKERS



Wall-Mount Speaker Baffle Combination



Lafayette 99-45981



PA-675A

As Low As **139⁹⁵**



E-V 664

with COLUMN SPEAKERS



Column Speakers

- Lafayette PA-675A 75-Watt PA Amplifier
- 6 Lafayette Pre-Wired Speaker Baffle Combinations with 8" Speakers, Volume Controls and 25 Volt/70.7 Volt Constant Voltage Matching Transformers.
- Choice of Deluxe Dynamic Microphones
- Six 35 ft. Speaker Cables

Complete 75-watt indoor PA system as above with Lafayette 99-45981 deluxe dual-impedance dynamic "pop-proof" microphone with on-off switch, desk stand and 6 ft. detachable cable. Mike can also be hand held or mounts on any standard floor stand. Includes microphone and phono plugs.
 44 E 91684WXM Wt., 86 lbs. Net 199.95
 Same as above system except with Electro-Voice 664 dynamic cardioid microphone with 15 ft. of cable instead of Lafayette microphone.
 44 E 91692WXM Wt., 86 lbs. Net 235.95

- Lafayette PA-675A 75-Watt PA Amplifier
 - Two 30-Watt 6-Speaker Sound Column Speakers. 30 1/4 H x 7 W x 3 1/2" D Each. For Optimum Voice and Music Reproduction
 - Choice of Deluxe Dynamic Microphones
- Above PA system with Lafayette 99-45981 deluxe dynamic "pop-proof" microphone with on-off switch and desk stand. Includes two 35 ft. speaker cables.
 44 E 91700WXM Shpg. wt., 72 lbs. Net 139.95
 Same as 44-91700WXM except with Electro-Voice 664 dynamic cardioid microphone instead of Lafayette 99-45981 microphone.
 44 E 91710WXM Wt., 72 lbs. Net 175.95
 Same as 44-91700WXM except with 2 Lafayette deluxe 6-speaker 60-watt 41 1/2 H x 7 3/4 W x 5" D sound column speakers instead of 30-watt sound column speakers.
 44 E 91726WXM Shpg. wt., 92 lbs. Net 184.95
 Same as 44-91726WXM except with Electro-Voice 664 dynamic cardioid microphone instead of 99-45981 microphone.
 44 E 91734WXM Shpg. wt., 92 lbs. Net 220.95

40 WATT SOLID STATE MOBILE PA AMPLIFIER

IDEAL FOR:

- Outdoor Campaigns
- Police
- Fire
- Civil Defense
- Boats



PA-640

ONLY **69⁹⁵** No Money Down*

40-WATT MOBILE P.A. SYSTEMS



Excellent 40-watt mobile P.A. amplifier for civil, military and general commercial use. 55-watt peak power solid state circuitry employs 5-transistors and 1-diode for economical and instant "On" operation. Three separate easy to see fiber-optic illuminated controls have individual On/Off and gain functions to permit separate or simultaneous playing of external equipment and paging system. Three inputs are provided: 1—low impedance microphone input (50-500 ohms); 1—high level crystal or ceramic phono input; 1—auxiliary input for tuner, tape recorder, etc. Has 12-14VDC power and audio output socket for siren, fog horn, etc. Response: 150-15,000 Hz Output Impedance: 4, 8, 16 ohms. Operates from any 12-15VDC source. Includes mobile mtg. bracket and DC cable. Size: 9 $\frac{1}{4}$ x 2 $\frac{1}{4}$ x 9" D. Shpg. wt., 9 lbs.
44 E 01402WX PA-640 Net **69.95**
 Dynamic Push-to-Talk Public Address Microphone.
99 E 45775 Net **3.95**



Atlas MO-1 99-45775 Microphone Atlas MO-2

Complete 40-watt mobile PA system featuring the Lafayette PA-640 40-watt solid state mobile public address amplifier with DC battery cable, 2 each Atlas MO-1 mobile weatherproof speakers with special fail-safe mobile bracket, Lafayette 99-45775 push-to-talk dynamic microphone with plug, and two 35 ft. speaker cables.
44 E 91015WXM Shpg. wt., 20 lbs. Net **114.95**
 Same system as above except with one Atlas MO-1 mobile communications speaker, instead of two MO-1 speakers, for mounting under the hood and/or concealed limited spaces. MO-2 speaker size: 6 $\frac{1}{2}$ "W x 8"H x 4 $\frac{1}{2}$ "D. System shpg. wt., 15 lbs.
44 E 91023WXM Net **89.95**

"TINY MITE" SOLID-STATE 16 WATT MOBILE PA AMPLIFIER

- Real Tiny—Only 1 $\frac{3}{8}$ "Hx3 $\frac{3}{8}$ "Dx $\frac{7}{8}$ "W
- All Solid State — No Warmup!
- For 12 Volts DC, Negative or Positive Ground

Ideal for mobile PA applications, the "Tiny Mite" fits into practically all cars and trucks, and features two inputs (100K and 600 ohms) for use with dynamic, crystal, or magnetic microphones; phono pickup; tape recorder or AM radio. Output impedance: 8 or 16 ohms. Low current consumption: draws maximum of 1.6 ampere from vehicle's battery. Fused for overload protection. Complete with microphone plug, battery and speaker cables, and under-dash mobile mounting bracket. Imported. Shpg. wt., 2 lbs.
99 E 45890 Net **29.95**

LAFAYETTE Solid State 16 Watt Mobile PA System

Lafayette Solid State 16 Watt Mobile PA Amplifier	Net 29.95
2 Lafayette Horn PA Speakers	Net 15.90
Lafayette Push-to-Talk Dynamic PA Microphone	Net 3.85
TOTAL	49.80

Above Lafayette mobile PA system consists of Lafayette's 16 watt solid state miniature mobile PA amplifier, 2 weather-proof 8 watt P.A. trumpet speakers with 90° dispersion and low impedance matching dynamic push-to-talk microphone. Shpg. wt., 7 lbs.
44 E 90694WXM Net **43.95**

Same system as above except with Atlas MO-1 25 watt weatherproof speaker with fail safe mobile bracket instead of two horn speakers.
44 E 91031WXM Shpg. wt., 7 $\frac{1}{2}$ lbs. Net **52.50**



Only **29⁹⁵**

Complete System

43⁹⁵

No Money Down*

SAVE 5.85

From Individual Catalog Prices

OPTIONAL
Atlas MO-1

* See Page 11 for Full Credit Details on Easy Pay Plan

PA Sound Columns, Indoor and Outdoor Speakers

LAFAYETTE 6 SPEAKER DIRECTIONAL SOUND COLUMNS

As Low As

24⁹⁵

Ideal For Installation In:
Auditoriums,
Schools,
Churches,
Meeting Rooms

- Reduces Reverberation and Feedback Problems
- Concentrates or "Focuses" Sound Where Needed

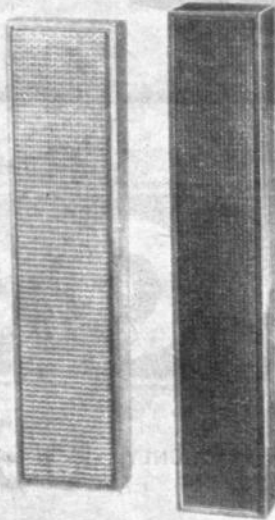

Sound columns contain specially designed, matched and balanced speakers stacked in a vertical array. Sound columns are most desired where difficult acoustics exist. This is accomplished by widely directing sound in a horizontal plane so as to cover a large audience, and by narrowing the vertical plane in order to reduce normal acoustic feedback and reverberation from floor and ceiling reflections, resulting in crystal-clear voice and music reproduction.

A Lafayette 30 Watt Sound Column—Handles up to 30 watts power. Frequency response 200-10,000 Hz. Dispersion 120° horizontal, 30° vertical. Impedance 16 ohms. Attractive vinyl covered wood cabinet. Dimensions 31"H x 7 1/4"W x 3 1/4"D. Imported. Shpg. wt., 15 lbs. **99 E 46146WX** Net 24.95

B Deluxe Lafayette 60 Watt Sound Column—Handles up to 60 watts power. Size: 41 1/2"H x 7 3/4"W x 5"D. Frequency response 70-10,000 Hz. Dispersion 120° horizontal, 30° vertical. Handsome vinyl covered wood cabinet. Impedance 8 ohms. Shpg. wt., 25 lbs. **99 E 46252WX** No Money Down* Net 48.95

Electrovoice AND *utah*

PA SOUND COLUMN SPEAKERS

ELECTRO-VOICE MODEL LR4A CURVED LINE RADIATOR. Curved design overcomes unwanted high-frequency lobes at ends, eliminating echo and feedback distortion components. Features nine 3" x 5" and three 3 1/2" cone speakers. Dispersion: 160° horizontal, 60° vertical. Response: 200-15,000 Hz. 25 watts program, 50 watts peak. Impedance 8 ohms. Beautifully finished in mesa tan. Size: 49 x 7 x 13". Shpg. wt., 30 lbs. **44 E 23021WX** Net 94.80

NEW UTAH Model SND-3. Six powerful 8" speakers excellent for both voice and music. Impedance: 16 ohms. Power handling capacity: 72 watts peak. Response: 110-12,500 Hz. Fiberglass lined. Separate compartment for installing constant voltage line transformers. Walnut grained, plastic impregnated covering. Size: 51 x 11 x 7 3/4". Shpg. wt., 36 lbs. **44 E 20006WX** Net 79.95

LR4A No Money Down* SND-3

94⁸⁰ **79⁹⁵**

NEW LAFAYETTE 8" 10-WATT MULTI-TAP PA SPEAKER SYSTEM

17⁹⁵

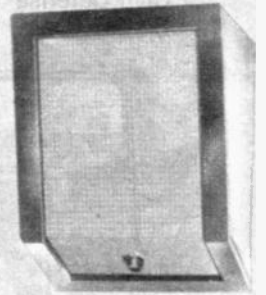

- 70 Volt and 25 Volt Line Matching Transformer with Taps for 10, 5, 2.5, 1.25, and .625 Watts
- Built-in Volume Control

An 8" multi-tap PA speaker completely prewired in a finished wood baffle. Ideal for any type of indoor sound system. Heavy duty speaker has 4.64 oz. Alnico magnet. Power rating: 10-watts. Transformer is mounted directly on speaker frame. Taps are 10, 5, 2 1/2, 1 1/4, and 5/8 watts for connection to 70 volt and 25 volt amplifier output. Terminal board with screw terminals is provided at the rear of baffle for easy connections. Speaker has its own volume control for setting volume levels as desired at speaker location. Size: 11W x 9 3/4"H x 6 1/4"D. Imported. Shpg. wt., 7 lbs.

99 E 4631EW

Net 17.95

WEATHERPROOF OUTDOOR P.A. AND HI-FI SPEAKERS

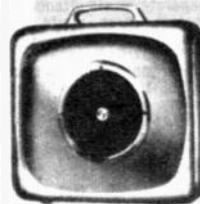

SONOCASTER

As Low As

22⁵⁰

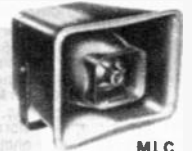

MLC

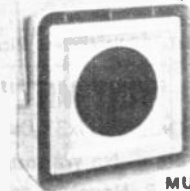

MUSICASTER 1A

ELECTROVOICE SONOCASTER Lightweight, rugged and weatherproof for extension or portable use anywhere. Special radax coaxial 8" speaker provides amazingly wide range response, 70-13,000 Hz. Ideal for use with existing stereo system. Improves performance of any portable radio, record player, recorder, etc. Black molded housing similar to fine air travel luggage; can't chip, fade or peel. Accessory hangup bracket included. Molded in handle. 8 ohms. 30 watts peak. 16 3/4"H x 17W x 5 1/2"D. Wt. 8 lbs. **21 E 30300W** Net 22.50

UNIVERSITY MLC Ideal for coverage of moderate size areas or crowds—or for sound reinforcement where smooth, clean, wide range musical reproduction and even distribution are important. Fiberglass reinforced polyester housing with moveable mounting bracket. Excellent reproduction from 150-15000 Hz with a power rating of 15 watts. System has a 2000 Hz crossover. 120° dispersion; 8 ohms impedance. Dimensions 12 3/4"W x 9 1/4"H x 15 1/2"D. Shpg. wt., 10 lbs. **44 E 80018** No Money Down* Net 40.95

NEW ELECTROVOICE MUSICASTER 1A. Designed for superior voice and music reproduction. Provides excellent bass response in a compact one-piece compression molded enclosure. Deluxe 12" Radax speaker has weather-proof cone. Ideal for schools, clubs, churches, and general auditorium use. Response: 80-10,000 Hz. EIA rating: 49 db. Power Output: 30 watts. Impedance: 8 ohms. Dimensions: 21 1/2 x 21 1/2 x 8 1/2". Universal "U" mounting bracket. Shpg. wt., 34 lbs. **44 E 25757WX** No Money Down* Net 69.90

PA Projectors, Trumpets, Paging Speakers and Drivers

LAFAYETTE MINIATURE HORN PAGING SPEAKER

7⁹⁵

- Mounts Easily
- 90° Dispersion
- Weatherproof



An excellent general purpose paging speaker of amazingly compact size. Ideal for portable PA systems, patios, etc. Long-throw projection of 90° dispersion offers maximum speech intelligibility in high noise areas. Compact size enables it to be mounted anywhere in almost any position. Frequency response 400-12,000 Hz. Impedance 8 ohms. Power handling capacity 5 watts, 8 watts maximum. Complete with mounting bracket, 2-conductor cable. Horn diameter 5 1/8", Depth 4 3/4". Imported, Shpg. wt., 1 1/2 lbs.

99 E 45080 Net 7.95

E-V PROJECTORS AND PAGING SPEAKERS

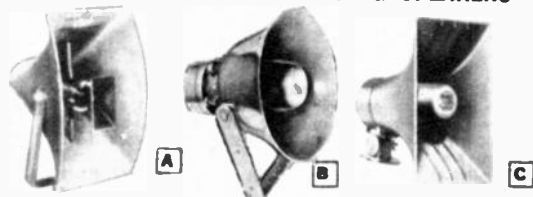

(A) Model 848A, COMPOUND DIFFRACTION PROJECTOR—a wide range horn and driver system using two way driver plus high and low frequency horns coupled to both sides of diaphragm. Delivers wide angle sound with extremely low distortion. Outer horn is fabricated of fiberglass and polyester resin for strength and resistance to corrosion. Rating: 52 db. Power handling capacity: 30 watts program. Response: 150-10,000 Hz. Impedance: 8 ohms. Dispersion: 120° Universal U Mounting bracket. Dimensions: 10 1/2 x 20 1/2 x 20". 44 E 25641WX Shpg. wt., 17 lbs. Net 54.60

(B) Model 844A, 30 WATT PAGING SPEAKER. Rugged diecast horn. Freq. response: 250 to 13,000 Hz. EIA sensitivity rating: 54 db. Power handling capacity—30 watts. Impedance 8 ohms; dispersion: 90°; for mounting: universal "U" bracket. Dimensions: 9 3/8 x 8 1/4" deep. Shpg. wt., 15 1/2 lbs. Net 24.00

(C) Model PA-30A, 30-WATT PAGING PROJECTOR. Rugged, high-impact horn. Rectangular horn design for maximum versatility, wide dispersion. Smooth response for both voice and music: 250-14,000 Hz. 30 watts, 8 ohms. Dispersion: 120° x 90° EIA sensitivity rating 59 db. 11H x 6 1/2 W x 8 1/2" D. Shpg. wt., 7 1/2 lbs. Net 22.80

UNIVERSITY PAGING/TALK BACK SPEAKERS

As Low As
19⁷⁷



Compact sized, weatherproof, highly efficient speakers for all PA fixed and mobile installations. With patented "Omni-Lok" swivel mount—quickly converts for fitting to 1/2" pipe.

Model MIL-AB—Response: 350-13,000 Hz. Impedance: 8 ohms. Ideal for low power systems requiring high efficiency. Handles 10 watts. Dispersion: 120°. Size: 7 1/8 x 6 7/8". Shpg. wt., 3 3/4 lbs. Net 19.77

Model IB-AB. Ideal for fill in applications in high power sound systems and as the main speaker in low to moderate power sound systems. Response: 250-13,000 Hz. Handles 30 watts. Impedance: 8 ohms. Dispersion: 90°. Size: 10 x 9 3/4". Shpg. wt., 4 lbs. Net 23.97

44 E 80034

LAFAYETTE PA DRIVER UNITS

30 Watt Driver 11⁹⁵
40 Watt Driver was 18.95
SALE! 16⁹⁵
1969 Cat. 690

FITS ALL TRUMPETS AND PROJECTORS

Hermetically sealed weatherproof driver units. Recommended for all type of PA work and industrial requirements. Wide-range response of these drivers assure excellent reproduction of voice and music. Will fit all trumpets and projectors. Impedance 16 ohms.



Stock No.	Response (Hz)	Size	Watts	Shpg. Wt.	Net
99 E 45072	120-7100	4 x 3 3/4	25	3 3/4 lb.	11.95
99 E 46260	80-12,000	4 1/2 x 4	40	6 lb.	16.95

UNIVERSITY WEATHERPROOF REFLEX TRUMPETS

As Low As

23³⁷

- Ideal for use with Lafayette PA Drivers



GH
LH
PH
SMH

Highly efficient air column directional reproducer to give maximum intelligibility in areas of high noise level. Design of units listed below provide optimum sound distribution pattern, increases sound intensity along speaker axis dependent upon diameter of horn. Made of heavy gauge spun aluminum, weather proof, gray finish. With universal "U" type mounting bracket, less driver unit. Type GH: 85 Hz cut off for music. Types LH and PH: 120 and 150 Hz cut off for general use. Type SMH: 200 Hz cut off for voice only.

Stock No.	Model	Diam.	Lng.	Air Col.	Shpg. Wt.	Net
44 E 80125WX	GH	30 7/8"	27 7/8"	6 1/2"	22 lbs.	58.50
44 E 80133WX	LH	25 3/8"	19"	4 1/2"	16 1/2 lbs.	37.50
44 E 80141WX	PH	20 1/4"	15 3/4"	3 1/2"	11 1/4 lbs.	25.57
44 E 80158WX	SMH	16 1/4"	12"	2 1/2"	8 lbs.	23.37

ATLAS MOBILE PA MARINE AND CB SPEAKERS



MO-1

Your Choice
27⁶⁰ ea.



MO-2

Model MO-1 Weatherproof speaker with special, rigid, one-piece cast bracket for fail-safe use on vehicles or boats. Concealed wiring and special one-piece horn discourage tampering. High efficiency for use with mobile radio transceivers. Ideal for shipboard cabin-top mounting. Power: 25 watts. Impedance: 8 ohms. Response: 300-13,000 Hz. Dispersion: 130°. Size: 7 1/4" bell diameter, 6 3/8" D. Shpg. wt., 4 1/2" lbs. Net 27.60

44 E 10346
Model MO-2 Compact, weatherproof mobile communications speaker with welded steel bracket for concealed, limited space use in vehicles or on boats for bulkhead or cabin-top mounting. Power: 25 watts. Impedance: 8 ohms. Response: 300-13,000 Hz. Dispersion: 130°. Size: 6 3/8 W x 8 3/4" D. Shpg. wt., 5 lbs. Net 27.60

44 E 10353

UNIVERSITY LINE MATCHING TRANSFORMERS

Model 5433—30 watt. Primary 45/165/200/250/1000/2000 ohms; secondary 4, 8 and 16 ohms; 70 volt line taps 30/25/20/10/5/2.5 watts. 1 1/4 x 2 1/8 x 1 1/8". 2 3/4" centers. Fits into CTR housing. 44 E 00186 Shpg. wt., 1 lb. Net 5.97

Model 5434—15-watt. Primary 45/325/500/1000/2000/4000/8000 ohms; secondary 4/8/16 ohms; power taps with 70 volt line 15/10/5/2.5/1.25/.65 watts. 1 1/8 x 1 1/8 x 1 3/8". 2" centers. 44 E 00174 Shpg. wt., 3/4 lb. Net 4.50

Extension, Outdoor and TV Remote Control Speakers

Deluxe LAFAYETTE "DECORATOR TYPE" EXTENSION SPEAKER SYSTEM

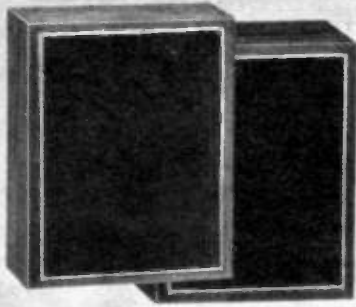

Only
9⁹⁵ ea.
Buy Two
And SAVE 2.00
2 For 17.90

- Powerful 6 1/2" Wide-Range Speaker
- Handles Up To 6-Watts Music Power
- Handsome Oiled Walnut Wood Enclosure

Our finest quality extension speaker system. Powerful 6 1/2" rich sounding wide-range speaker is housed in a handsomely styled oiled walnut wood enclosure with a decorative black grill cloth. You can enjoy fine hi-fi music everywhere in your home as well as enhance the decor of your home. Use 2 for stereo or place these systems in every room of your house. Also ideal for use in background music systems in offices and restaurants. Handles up to 6-watts. Impedance 8 ohms. Size: 7 1/2"W x 9 3/4"H x 5 3/4"D. Wt., 7 lbs. Imported. 99 E 02032W Net 9.95; 2 for 17.90

LAFAYETTE OUTDOOR 8" PATIO SPEAKERS



As Low As
9⁹⁵

- Weatherproof Waterproof
- Freq. Response: 40-15,000 Hz
- 5.5 oz. Ceramic Magnet
- Peak Power 20 Watts

Relax with music outdoors at patio, porch or poolside. Prewired with 25' cable for easy connection to radio, phono or hi-fi system. Unaffected by dampness or rain. Durable steel enclosure with baked-on finish. Convenient, step-saving volume control. 8 ohms; 20 watts peak; 40-15,000 Hz.; 10 7/8"x10 7/8"x5 3/4"D. Shpg. wt., 6 1/4 lbs. 44 E 33058 Net 9.95
DELUXE VERSION of above with heavy-duty speaker featuring 10 oz. ceramic magnet and co-axially mounted high-frequency cone for 35-19,000 Hz response. 15 watts normal, 30 watts peak. 44 E 33066 Shpg. wt., 6 1/4 lbs. Net 10.95

MISCO WEATHERPROOF SPEAKERS

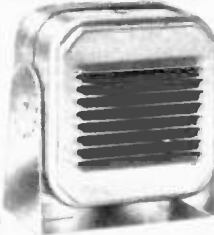

As Low As
6⁹⁵

- 3 1/2" and 8" Models
- Gimbal Type Mounting Bracket
- For Patio, Paging, or Mobile Applications

Model MS-3-3BB. Compact, weatherproof, dustproof. Ideal for use in mobile communications, for intercom paging, and as an extension speaker. Can be immersed in water. Power rating 3-watts. Resp: 100 to 10,000 Hz; 8 ohms imp. 4 1/2 x 4 1/8 x 2 5/8 with bracket. Wt., 2 lbs. 44 E 52017 Net 6.95
Model MMS-8F. Similar to above, but with 8" speaker. Power rating 8 watts. Resp: 70-13,000 Hz. 9 x 9 x 4 1/4". Shpg. wt., 5 lbs. 44 E 52025 Net 12.96

LAFAYETTE EXTENSION SHELF SPEAKER SYSTEM

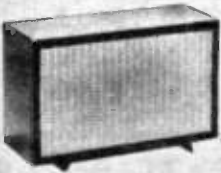

Only
6⁹⁵

- Attractive Mahogany Finished Wood Cabinet

Ideal as an extension speaker for your den, basement, kitchen or bedroom. Use two for stereo or with your TV and Radio. Housed in a beautiful mahogany finished wood cabinet. 5-watt 4 x 6" speaker is designed to work from either 4- or 8-ohm output. Supplied with 25-feet of cable. Size: 9 1/2 x 7 3/4 x 3 1/4"D. Imported. Shpg. wt., 5 lbs. 99 E 43502 Net 6.95

LAFAYETTE EXTENSION WALL SPEAKER SYSTEM



Only
7⁹⁵

- 6" Wide-Range Speaker
- Oiled Walnut Wood Finish

Fine sounding and handsome looking extension speaker system with brackets for hanging on any wall. Outstanding tonal quality from a wide-range 6" speaker makes it ideal for Hi-Fi extension speakers at home and for background music systems in the office, restaurant, etc. Excellent for P.A. and paging. 9 7/8"H x 9 7/8"W x 4"D. Imp: 8 ohms. Imported. 99 E 45494 Shpg. wt., 4 lbs. Net 7.95

LAFAYETTE DESK TYPE EXTENSION SPEAKER SYSTEM

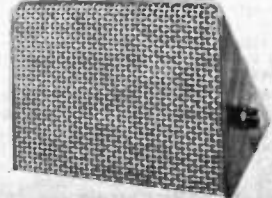

Only
5⁹⁵

- Walnut Decorator Baffle with Cane Grille

Versatile extension speaker suitable for desk or shelf use. Attractive tri-angular shaped, oiled walnut finished cabinet. Powerful 4 x 6" oval speaker provides fine tone. Complete with volume control and 22 ft. of wire. Impedance 8 ohms. Size: 7 3/4"W x 5 1/4"H x 5 1/2"D (at the base). Imported. Wt., 3 1/2 lbs. 99 E 01216 Net 5.95

LAFAYETTE 4" PAGING SPEAKER SYSTEM

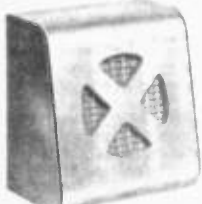

4⁵⁰

- Includes 25-Ft. Speaker Cable With Plug

For use in multi-speaker low power paging systems, intercom systems, auxiliary bench speaker, etc. 4" PM speaker with heavy magnet. Mounted in 2-tone walnut and black wood baffle. The baffle has sloping-front and enclosed-back acoustic construction and has a built-in jack for plug-in connection of the 25' cable and plug supplied. Speaker voice coil is 4 ohms. Size: 5W x 5 5/8"H x 3 1/4"D. Imported. Shpg. wt., 4 lbs. 99 E 45510 Net 4.50

MINIATURE 2-WAY REMOTE CONTROL TV SPEAKER

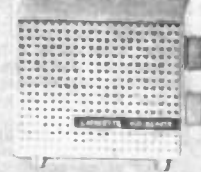

Only
3⁹⁵

- Control Both TV Set Speaker and Remote Speaker From Your Armchair

Fine quality built-in speaker makes it perfect for use as a remote TV speaker anywhere in your home or office. Dual controls for listening to TV speaker only, remote speaker only, or both speakers together. Attractive molded cabinet measures 4W x 2 7/8"H x 1 3/4"D. Complete with 20-ft. of conductor cable. Imported. Wt., 1 1/2 lbs. 99 E 45486 Net 3.95

DELUXE 2-WAY REMOTE CONTROL TV SPEAKER



Only
6⁹⁵

- Control Both TV Set Speaker and Remote Speaker From Your Armchair

A large 4 x 6" full-range speaker mounted in a larger cabinet for improved tonal quality. With 2 fader controls so that you may listen to either the TV speaker, this remote speaker, or both blended to the volume level you desire for each. You can turn off volume on both speakers without turning off the set. Attractive walnut finished cabinet which measures 9 3/4"L x 6 1/4"H x 3 3/4"D. Complete with 20' of cable. Imported. Shpg. wt., 4 lbs. 99 E 45965 Net 6.95

LOWELL, LAFAYETTE PA Baffles And Speakers

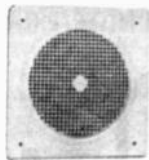

CR80-P

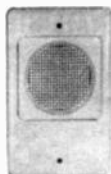

L35-P



ADS80-P

LOWELL FLUSH-MOUNTING PLASTIC SPEAKER BAFFLES

Decorative high impact Styrene plastic baffles. White finish. Lightweight and durable — will not fade, chip or mar — Model ADS80-P has full 360° dispersion. Self-tapping speaker mounting screws supplied.

Stock No.	Type	Description	Wt.	Net
44 E 50144	ADS80P	For 8" ceiling Spkr 10x10"	8 oz.	2.95
44 E 50151	CR80P	For 8" ceiling/wall Spkr 10x10"	8 oz.	2.75
44 E 50189	L35P	For 3½" intercom Spkr 4½x7"	3 oz.	1.03

LOWELL STEEL RECESSED BAFFLES



LK-8



CW-8

Popular steel style grills with enduring baked on white enamel finish. All grills have 4 studs on rear to mount speaker. For 8" speakers. All hardware is furnished.

Stock No.	Type	Description	Wt.	Net
44 E 50201	LK-8	For 8" Ceiling Speaker 13¼" dia.	2 lbs.	2.40
44 E 50219	CW-8	For 8" Ceiling Speaker 12" dia.	2 lbs.	3.71

LOWELL FLAT TILE TYPE PANEL BAFFLE

- Replace Standard 12 x 12½ Acoustic Types Tiles

Type M8—Square steel type. Designed to match and replace standard 12x12½ acoustic tile blocks. Permits a completely hidden speaker system — for 8" speakers — speaker mounting hardware is furnished — Baffle is zinc chromate undercoated and finished in flat white lacquer 12x12½". For proper enclosure see enclosure listing. Shpg. wt., 1½" lbs.

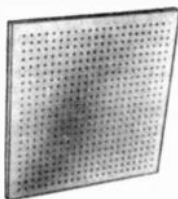

44 E 50183 Net 3.30



RS



AL

LOWELL RECESSED MOUNTING ALUMINUM BAFFLES

RS and AL ceiling baffles are ideal for installation in homes, offices, restaurants, etc. Spun aluminum material has lacquer protected satin finish. Model AL features diffuser cone for full 360° sound dispersion. Require protective speaker enclosures (Type CP and XCP listed below).

Stock No.	Type	Description	Lbs.	Net
44 E 50011	RS-6A	For 6" spkr 10¾x7½"	1	2.53
44 E 50029	RS-8A	For 8" spkr 12¾x½"	1	2.50
44 E 50037	RS-8A	Same as above but wh. enam.	1	2.50
44 E 50045	RS-12A	For 12" spkr 16½x½"	1¾	3.83
44 E 50052	AL6A	For 6" spkr 10½" Dia.	1½	3.78
44 E 50060	AL8A	For 8" spkr 12¾" Dia.	1¾	6.13
44 E 50078	AL12A	For 12" spkr 16¾" Dia.	3½	7.75

LOWELL PROTECTIVE ENCLOSURES FOR MOUNTING BAFFLES



XCP

These enclosures protect against damage from falling mortar, dust, rodents, etc. All 22 ga. steel welded construction. Exteriors are rust-proofed with zinc chromate; interiors are heavily undercoated to prevent resonance. Sufficient speaker back pressure on all

models assures sound quality. Note: CP series used for new construction, XCP for existing ones, P875X for either. Hardware for mounting enclosures and speakers supplied with baffle or grille used. Shpg. wt.: Types CP1012, XCP1012 — 7½ lbs.; Types CP84, XCP84, P875X, CW-8 — 4½ lbs.; Types CP-6, XCP-6 — 3½ lbs.; Type P22X — 1 lb.

Stock No.	Type	For	I.O.	O.O.	Depth	Net
44 E 50088	CP-6	AL6-A, RS6-A	7½"	11¼"	4¾"	3.77
44 E 50094	CP84	AL8-A, RS8-A, M8	8¾"	13¼"	4¾"	4.54
44 E 50102	CP1012	AL12-A, RS12-A	12½"	17½"	7¾"	6.22
44 E 50110	XCP6	AL6-A, RS6-A	7½"	10¼"	4¾"	3.25
44 E 50128	CP84	AL8-A, RS8-A, M8	8¾"	11¾"	4¾"	4.05
44 E 50138	XCP1012	AL12-A, RS12-A	12½"	16"	7¾"	5.49
44 E 50177	P875X*	AL8-A, RS8-A, M8, ADS80-P, CR80-P	—	—	3¾"	5.26
44 E 50185	P22X**	L35P	—	—	2"	2.13
44 E 50227	CP-200	CW-8	10"	13½"	5"	4.80

*Size 8¾x8¾" **Size 6¼x4"

BEST SELLING LAFAYETTE PA SPEAKERS

8" PA SPEAKER

- Handles 20 Watt Peaks

The 8" favorite of professional sound installers; with 5.5 oz. ceramic magnet and 3/4" voice coil. Magnet assembly bonded with RF-cured epoxy, can't shift. Internal magnet seal for added dependability. Handles 10-watts program, 20-watts peak. Impedance, 8-ohms. Only 2¾" deep, fits inside walls. A popular speaker at a popular price.

44 E 01030 Shpg. wt., 2 lbs. Net 4.50

4.50



LAFAYETTE HI-FI CEILING BAFFLE WITH SPEAKER

Only 5.95

- Measures Only 2¼" Deep

The perfect speaker to furnish music or paging throughout your home, office or factory, this unique ceiling and wall baffle speaker offers fine audio reproduction. Advanced design employs an inverted magnet, placing the 12 oz. magnet structure in front of the speaker rather than behind as in conventional speakers. Only 2¼" deep with its own metal baffle plate, it easily mounts in any wall, ceiling, closet or ordinary wood enclosure. Two are perfect for stereo. Voice coil is 1" Diam. Frequency Response: 90-9,000 Hz. Impedance: 8 ohms. Overall size including metal baffle is 9½". Requires 6¾" wall cutout. Imported. Shpg. wt., 3 lbs.

99 E 45056 Net 5.95

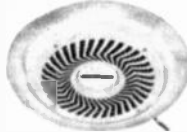

12" PA SPEAKER

- Handles 36 Watts Peaks

Highly efficient magnet and voice coil combination for maximum sound output per watt; 10 oz. ceramic magnet and 1" voice coil. Magnet assembly bonded with RF-cured epoxy, can't shift. Internal magnet seal for added dependability. Handles 8-watts program, 36-watts peak. Impedance, 8-ohms. 4¾" deep. Shpg. wt., 4 lbs.

44 E 01022 Net 6.95



SURFACE-MOUNTED CEILING SPEAKER

NEW!

Only 9.95

- Installs On Ceiling Surface—No Cutouts Needed
- 8" Speaker Has Powerful Barium Ferrite Magnet
- Natural Beige Finish May Be Repainted Any Color

Inconspicuous, thinner than most lighting fixtures. For home or office. 8" speaker (with new barium ferrite magnet) handles 5 watts. Imp., 8 ohms. 11 x 11 x 2¾" deep. Shpg. wt., 4¼ lbs.

44 E 20014 Net 9.95

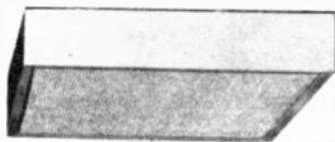

To Speed Your Mail Order—Please Give Your Zip Code Number

Lafayette Cat. No. 700 149

MIXERS—PREAMPS—EQUALIZERS

LAFAYETTE TRANSISTORIZED STEREO/MONAUROAL MIKE MIXER

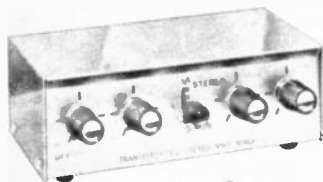

9⁹⁵

- Transistorized No Warm-up
- Compact and Durable
- Matches High Impedance Microphones
- Up to 4 Input Channels

A stereo version of the popular LAFAYETTE mono mixer. Combines up to four microphones professionally into one stereo output, or may be used as a monaural mixer. Each mike control independent of the other, permits fading of one input while increasing others. Controls high impedance microphones, recorders, phonographs or tuners. Output jack fits standard RCA type phono pin plugs. Inputs are standard 2-conductor phone plugs. Requires single 9 volt battery (not supplied). Size: 6Wx2½Hx3½"D. Imported. Shpg. wt., 1¼ lbs.

99 E 45635 Net 9.95
99 E 60212 Battery for above Net .21

LAFAYETTE TRANSISTORIZED MIKE MIXER

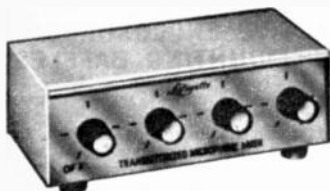

4⁸⁵

- Up to 4 Channels
- Matches High Impedance Microphones
- Modern Solid State Design

Mixer controls high impedance signals from mikes, phonos, recorders or tuners. Standard 2-conductor phone inputs, standard RCA type phono pin plug output, 9 volt battery. Imported. Shpg. wt., 1¼ lbs.

99 E 45353 Monaural Mixer Net 4.85
99 E 60212 Battery for above Net .21

BOGEN VERSATILE MIXER — PRE AMPLIFIER

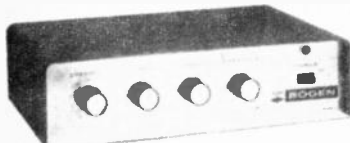

MODEL MX6A-T
48⁷⁵

No Money Down

- 4 Mic and 2 Phono Inputs
- All-Silicon Solid State
- Excellent For Electric Guitars

FEATURES: Any 4 channels may be used simultaneously, each individually controlled for mixing and fading. Connects to high impedance radio/phono input of any amplifier, tape recorder or microphone. SPECIFICATIONS — OUTPUT VOLTAGE: 2 Volts and .04 volts at 0.5% distortion; FREQUENCY RESPONSE: 50-20,000 Hz ± 2 db; GAIN: Mic —60 db, phono —20 db; HUM: —68 db below 5 volt; OUTPUT IMPEDANCE: 2200 ohms; CONTROLS: 2 Mic volume, 2 Mic or phono volume, on-off; SEMICONDUCTORS: 6 transistors, 2 diodes (all silicon); POWER CONSUMPTION 1.2W at 117 VAC, 50-60 Hz; DIMENSIONS: 9¼x6x2¾". Shpg. wt., 5 lbs.

44 E 12201 No money down* Net 48.75



SHURE LEVEL — LOC
57⁰⁰

Model M62 "Level-Loc" audio level controller. Automatically and instantly locks the volume level of a sound system, virtually eliminating annoying volume changes, blasting, fadeout, etc. Level is predetermined by setting a single switch. Ideal where varying volume is caused by different voices, bobbing and weaving speakers. Frequency response: 20-20,000 Hz ± 2 db. input impedances: 100K and 500 ohms; output approximately 500 and 10 ohms. Cannon-type connectors. Gain: low imped. input to low output is 0; to high output is +22; high imped. input to low output is 0; to high output is 0. Battery operated. 2½x11¾x5¼". Shpg. wt., 2¾ lb.

44 E 75638 Complete with battery. No money down* Net 57.00
99 E 60212 Extra 9 volt battery Net .21

LAFAYETTE SOLID STATE STEREO MIXER/PREAMP

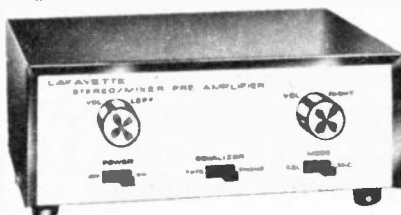

14⁹⁵

"All-Transistor" stereo-mixer/preamp! For use with any power amplifier not incorporating low-level inputs for magnetic cartridges, tape heads and low-impedance microphones. Raises the output of any low level source without affecting the signal-to-noise ratio. Features: 2-mike, 2-phono, 2-tape inputs, volume controls for left/right channel; equalization switch; power off/on switch; mode switch; built-in 9V DC power supply, or operates off 117V 50/60 Hz AC. Input impedance: 50K ohms. Output impedance 5K ohms at max. vol. Size: 2½Hx7Wx5¼"D. With battery. Imported. Shpg. wt., 1¾ lbs.

99 E 01786 Net 14.95
99 E 60212 Replacement Battery Net .21

SHURE MICROPHONE MIXERS

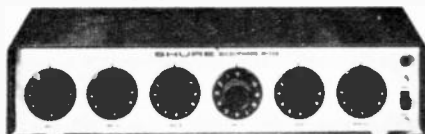

78⁶⁰

No Money Down*

The Shure M68 is a fully transistorized professional mixer providing for the utmost flexibility in use. It has four microphone channels plus an auxiliary channel. There are five gain controls (an individual one for each channel) plus a master gain control. There is instantaneous and independent selection of high or low impedance on each of the microphone inputs. Male Cannon-type input receptacles. Outputs to match high or low impedance microphone inputs or high imp., high level auxiliary input. Size: 2¾x11¾x5¼". Shpg. wt., 5 lbs.

44 E 75588 No money down* Net 78.60

MODEL M68FC. Same as above but with female Cannon-type input receptacles.

44 E 75851 No money down* Net 85.20

HIGH IMPEDANCE MIXER

MODEL M68P. Same as M68 above but with high impedance inputs only. Phone plug input receptacles.

44 E 75869 No money down* Net 63.00

REVERBERATION MIXER

MODEL M68RM. Similar to M68FC above, except has built-in adjustable intensity reverb for special effects. Master volume control. Four inputs, and can be combined with M68 or M68FC for more inputs. Jack for use with remote reverb. On-off switch. 28 VDC jack. Response: 40-20,000 Hz. Size: 2½ x 11¾ x 5¼". For 105 — 130 volt AC, 50/60 Hz.

44 E 75877 No money down* Net 108.00

SHURE AUDIO MASTER



MODEL M63. Designed to give maximum flexibility in the control of volume, bass response, treble response, and high and low frequency roll-off to any high level input source. Works ideally as a final audio controller in conjunction with the Shure M68 series of mixers. Provides the means to shape frequency response to equalize sound system for correction of room acoustics, to reduce feedback, to provide special sound effects, for recording, to reduce stand and stage noise, etc. Has VU meter to monitor audio level. Five types of outputs: 600 ohm balanced line, high impedance high level, high and low impedance microphone levels, and headphone jack for monitoring. Continuously variable high pass and low pass 6 db per octave filters. Bass and treble tone controls. Two 30 VDC jacks and an AC receptacle. Frequency Response: 20-20,000 Hz. Size: 2½ x 11¾ x 5¼". For 105-130 volts, 50/60 Hz. AC or 30 VDC. Shpg. wt., 5 lbs.

44 E 75844 No money down* Net 90.00

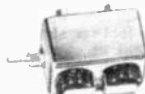

MINIATURE MIXERS

See Page 154 for Complete Listing of Miniature Audio Mixers.

Microphone Stands — Booms — Connectors

ATLAS MICROPHONE STANDS AND BOOMS



Model MS-10C Full Grip Mike Stand. Economical mike stand featuring "Full-Grip" clutch mechanism for fast quiet adjustments without slipping and wear. Functionally designed base assures maximum stability and includes self-leveling, shock-absorbing pads plus 3 "anti-tip" points. Full chrome plated tube assembly. Terminates in a 5/8"-27 thread. Base dia. 10", finished in gray shrivel. Height adj., 35 to 63". Shpg. wt., 10 lbs.

44 E 10031 Net 8.16

Model MS-12C. As above but heavier and tube extends to 62". Shpg. wt., 12 lbs.

44 E 10049 Net 8.67

Model MS-11C. As above but with full chrome finished base.

44 E 10056 Net 10.67

MS-14C. Same as above, but gold finish.

44 E 10304 Net 13.50

Model MS-12S "Sleeve Action" Mike Stand. New mike stand featuring a fully automatic means of height adjustment. To lower the stand, just press on the "Sleeve Action" control. To raise the stand, any point on the tube can be grasped. Quiet and smooth action. Ht. 39 to 62". 10" dia. gray base, chrome tube. 5/8"-27 thread. Shpg. wt., 12 lbs.

44 E 10064 Net 17.00

Model CS-32 Demountable Stand. Revolutionary in design, this mike stand is fully collapsible to fit in amplifier or speaker-carrying case. No tools needed. Self-leveling legs are skid-proof. Features "Full-Grip" and "Velvet Action." Adjustable from 36 to 64 in. Fully chrome plated. 5/8"-27 thread. Shpg. wt., 5 lbs.

44 E 10072 Net 9.84

Model CS-33. As above but with ht. adj. of 26-64". Collapses to 22 1/2". Shpg. wt., 4 lbs.

44 E 10800 Net 10.67

MS-25—Professional stand, featuring "Safety Air Lock Cushion." Prevents accidental slippage of telescoping section, smoothly lowers on cushion of air. Grey and chrome base. Ht. adj. From 38" to 67". Oversize chrome tubing with 5/8"-27 adapter. Shpg. wt., 22 lbs.

44 E 10288 Net 21.66

DS-14—Contemporary motif desk stand. Suits elongated, slim mikes. Gun metal, shrivel base with protective felt pads. 3" polished chrome upright tube with 5/8"-27 thread. Shpg. wt., 2 lbs.

44 E 10296 Net 3.33

Model DS-5. "Velvet Action" Desk Stand. Same quality as floor models. Base dia. 6". Gun metal shrivel finish. Fixed ht. 4".

44 E 10098 Net 2.67

Model DS-7. Like DS-5 but with ht. adj. 8 to 13". Shpg. wt., 3 lbs.

44 E 10106 Net 4.34

Model TS-8 Adjustable Stand. A decorative and fine appearing stand, suitable for use on a banquet table. Features quiet "Full Grip, Velvet Action" control. Adjustable from 14 1/2" to 26". Base diameter 8" Fully chrome-finished base and tube assembly. Shpg. wt., 5 lbs.

44 E 10114 Net 8.01

Model BS-36. Professional boom stand. Has removable 62" boom with gyromatic swivel joint to keep mike positioned. "Safety Air-Lock Cushion" eliminates slippage. Super-chromed tubes adjust 48" to 72". Chrome and gun metal base. Shpg. wt., 36 lbs.

44 E 10122WX Net 52.50

Model BS-36W. Same as above but with swivel casters. Wt., 40 lbs.

44 E 10338WX Net 59.16

Model BB-1 "Baby Boom" Attachment. Use with any mike stand. 32" long. 5/8"-27 thread. Chrome plated. All swivel parts are precision die castings. Shpg. wt., 3 1/2 lbs.

44 E 10130 Net 6.49

FLEXO MIKESTER

Model 1. Versatile mike stand with an extremely flexible arm, providing wide range of adjustment. Swings out 36" in any direction. Ideal for use in radio broadcast or recording studios, offices, airport, switchboard, theatres, night clubs, schools, hotels. Handles any mike up to 4 lbs. in weight. Clamps or screws to any horizontal or angular surface up to 3" thick. Shpg. wt., 4 3/4 lbs.

44 E 10148 Net 11.95

ATLAS 3-LEGGED STANDS

MODEL CS-52. Handsome, slim, low profile 15" gray base with chrome tube. Height adjusts from 34 to 62". Shpg. wt., 9 lbs.

44 E 10312 Net 9.33

MODEL CS-1A. Tripod base adjustable from 10 to 42" diameter. Collapses to 32" for storage. Useful for clustering microphones and supporting small speakers. Chromed tube, cadmium plated legs. Shpg. wt., 6 lbs.

44 E 10544 Net 16.34

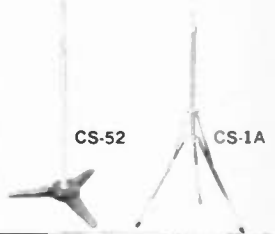

Mike Flanges And Extension Rods. For neat and permanent mounting. Fits 5/8"-27 mikes. Base dia., 1 1/4" .3 mounting holes with 7/8" mounting centers. Extension rods, male on both ends. Av. shpg. wt., 6 ozs.

44 E 10155 AD-12 Male Flange Net .80

44 E 10163 AD-11 Female Flange Net .80

44 E 10171 AD-8 6" Ext. Rod Net .74

Mike Adapters. For adapting special fittings. Wt., 2 oz.

AD-1 5/8"-27 female to 1/2" male thread (RCA) Net .75

44 E 10189

AD-2 1/8" female pipe to 5/8"-27 male Net .54

44 E 10197

AD-3 1/8" female pipe to 5/8"-27 female Net .59

44 E 10205

AD-4 3/4" long 5/8"-27 male running thread Net .44

44 E 10213

AD-5 5/8"-27 female to 5/8"-27 female coupling Net .59

44 E 10221

AD-10 5/8"-24 female to 5/8"-27 female (W.E. Adapter) Net 1.17

44 E 10239

Model SW-1 Gyromatic Swivel. Permits any mike to be locked at any angle. 5/8"-27 thread. 4 1/2" long.

44 E 10247 Net 4.01

Model SO-1 "Snap-On" Mike Attachment. Quick and safe. For all mikes and stands. Two "Snap-On" sections.

44 E 10254 Net 2.34

Model LO-2 "Lock-On" for quick disconnect of mike from stand. Positive lock when on stand, push button release. Shpg. wt., 4 oz.

44 E 10023 Net 2.84

ATLAS MICROPHONE ACCESSORIES

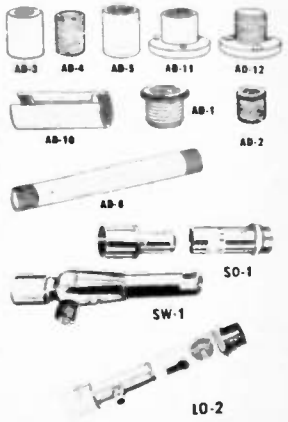

FLEXIBLE GOOSE NECKS



Model GN-13 Goose Neck. 13" long for complete adjustment of mike 5/8"-27 thread. Chrome finish. Shpg. wt., 1 lb.

44 E 10262 Net 2.09

Model GN-19. As GN-13 but 19" long. Shpg. wt., 1 1/2 lbs.

44 E 10270 Net 3.00

To Speed Your Mail Order—Please Give Your Zip Code Number

Dynamic Microphones

**New
Low
Price**

17⁹⁵

less stand



11⁹⁵

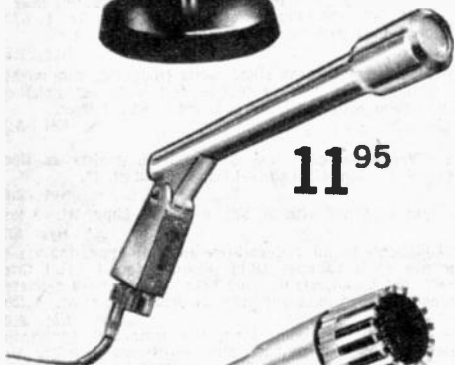

11⁹⁵

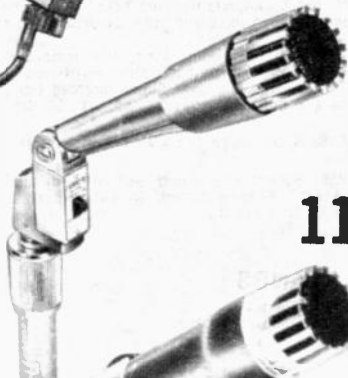

9⁹⁵

less stand

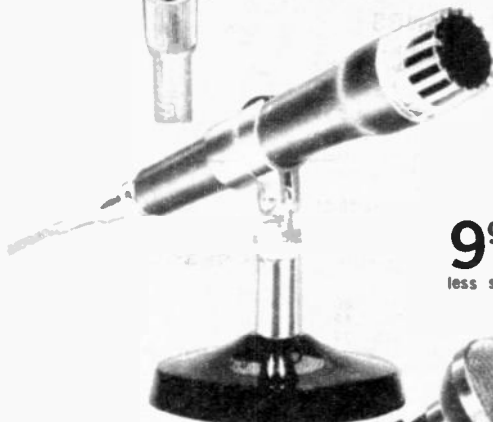

13⁹⁵



LAFAYETTE'S REVOLUTIONARY "DCD" DUAL CARTRIDGE HI-FI DYNAMIC

- Wide-range Frequency Coverage by 2 Independent Cartridges
- Quick Adaption for Floor Stand or Hand-Held Use

Lafayette's "DCD" high impedance (50K ohms) dynamic incorporates a new engineering concept designed to overcome the limitations on high quality wide frequency response imposed by ordinary single cartridge microphones. The "DCD" has 2 independent cartridges, one each for the high and low frequency ranges in a carefully engineered acoustic design. Response is 50 to 15,000 Hz. Output is —56 db. Pattern is omnidirectional. Has non-inductive transformer to eliminate effects of external alternating fields. On-Off slide switch. Die cast body is finished in satin-black and gleaming chrome. Black metal desk stand. Comes with adapter for mtg. on desk stand or floor stand and 54" detachable cable. Sizes: mike 6¼Lx1¼"O.D.; base 4½" diam. Imported. Shpg. wt., 4 lbs. 99 E 45973 Net 17.95

SLIM OMNIDIRECTIONAL DYNAMIC

- Dual Impedance
- Ruggedly Constructed
- Tilttable Head

An attractive dynamic microphone for use on any standard ¾"—27 stand. Has wide frequency response of 100-10,000 Hz. Output is —57 db. Dual impedance: (High 50K; Low 250 ohms) selectable at cable. Pattern is omnidirectional. This is an ideal general purpose mike for entertainment groups. Mike may be tilted at any angle thru a 90° vertical arc. Has on-off switch. Die cast case is finished in satin-silver. 18 ft. detachable cord with mike connects at one end. Length 9", diam. of head 1¾". Imported. Shpg. wt., 3 lbs. 99 E 45932 Net 11.95

LAFAYETTE DUAL IMPEDANCE DYNAMIC MIKE

- Designed Specifically for High Quality PA Applications
- Omni-directional Pattern at all Frequencies

A superb dual impedance, omni-directional dynamic microphone. Designed for high quality PA applications. Superior anti-feedback properties. Allows close talking without boom or bass accentuation. Features pop-proof wire mesh grille. Special filter minimizes wind effect. Attractive chrome plated frame of modern design. Equipped with on-off switch. Freq. response 100-10,000 Hz. Sensitivity: —58db at 30K. Mylar diaphragm for "pop" and "blast" proofing. Dual impedance: may be shifted from high impedance to 250 ohm low impedance by means of a cable connection. Mike tilttable thru 90° arc. For all standard ¾"—27 stands. Size: 7¼Lx1½ Dia. With 20 ft. detachable cable with mike plug at one end. Imported. 99 E 45460 Shpg. wt., 2 lbs. Net 11.95

LAFAYETTE MODERN DYNAMIC

- Dual Impedance
- Omni-directional

A lightweight non-directional dual impedance: (High 50K; Low 250 ohms) selectable at cable with a fine response of 100-10,000 hertz. Output —60 db. For use either as hand-held or on any standard ¾"—27 desk or floor stand. Adapter supplied. Has 20 ft. detachable cable with mike plug. On-off slide switch. Tapered metal case finished in satin-black and aluminum. Size: 7Lx1¾" diam. Wire mesh grille for protection against "pop" or wind blast. 99 E 46039 (less stand). Imported. Shpg. wt., 2 lbs. Net 9.95 Heavy metal desk stand for above. Diam. 3¾". Shpg. wt., 2 lbs. 99 E 45999 Net 14.95

LAFAYETTE DELUXE BALL DYNAMIC

- Dual Impedance
- For High Quality PA and Recording
- Complete with Stand

The most modern design features dual impedance: high (50K ohms) or low (250 ohms) selectable at cable end. Pattern is omnidirectional. Output at high impedance is —59 db. Frequency response is 100-10,000 Hz. Has on-off switch. Ball screen insures against "pop" and wind blast. Die cast case is 6¼" long. Max. diam. of ball 2¼". Finished in satin aluminum. 6 ft. detachable cable with mike plug at one end. With black metal desk stand and adapter for any standard ¾"—27 stand. An excellent general purpose mike. 99 E 45981 Imported. Shpg. wt., 2 lbs. Net 13.95

Dynamic Microphones

LAFAYETTE ENTERTAINERS MIKES



For Musical Instrument Amplifiers

A CARDIOID DYNAMIC MIKE

A superb dynamic microphone designed for applications where location of performer in relation to speakers causes feedback and reverberation. Highly directional cardioid pattern. Dual impedance: 50K or 600 ohms, selectable by switch. Response: 100-10,000 Hz. Mylar diaphragm. On/off switch. Modern design, satin chrome finished die-cast case. For hand-held or stand use. Size: 8¼x1½"D head. With swivel stand adapter and 20 ft. detachable cord with phone plug at other end. Imported. Shpg. wt., 3 lbs. 99 E 46294 Net 12.95

B DELUXE BALL DYNAMIC MIKE

• For Hand and Stand Use

Modern design features dual impedance—High 50K ohms, or low 250 ohms. Omni-directional, 100-10,000 Hz. Has on-off switch. Ball screen insures against "pop" and wind blast. Die-cast, finished in satin aluminum. Size: 6¼" long, max. diam. of ball 2¼". Complete with detachable 20 ft. cable and phone plug. Black metal desk stand and adapter for any ¾"-27 floor stand. Imported. Shpg. wt., 2 lbs. 99 E 46203 Net 15.95



LAFAYETTE PA DYNAMIC MICROPHONE

- Press-to-Talk
- Integral Desk Stand
- Dual Impedance

Ideal for public address work. Integral desk stand has press-to-talk switch with optional locking feature. Dual impedance: 50K ohms and 250 ohms. Dynamic with omni-directional pattern, output of -60 db and frequency response of 50-9,000 Hz. Metallic green finish. 7 ft. cable. Size: 7¾H; base 5½D x 3¾"W. Imported. Shpg. wt., 4½ lbs. 99 E 46096 Net 12.95

12⁹⁵



LAFAYETTE DUAL IMPEDANCE DYNAMIC

New Low Price 7⁹⁵

A fine quality general purpose dynamic microphone. Dual impedance selectable at cable end: high (50K ohms) or low (600 ohms). Frequency response 100-10,000 Hz with high impedance. Output of -58 db. Omnidirectional pickup pattern of 325°. Has on-off slide switch. Die cast, chrome plated case. Mike case measures 5"Lx2"Hx2". Complete with 20 ft. detachable cable with mike connector. For all standard ¾"-27 stands. Imported. Shpg. wt., 3 lbs. 99 E 45817 Net 7.95

LAFAYETTE PA DYNAMIC

An excellent general purpose dynamic microphone for PA and paging, etc. Designed for flexibility in use, it may be hand-held, mounted on any ¾"-27 stand or on lavalier cord. Frequency range 100-15,000 Hz. Output -56 db, high impedance (50K ohms). Omnidirectional pickup pattern. Has on-off slide switch. Gleaming black body with chrome head. Tapered body size 6¾" long, max. O.D. 1¼". Complete with 7 ft. 9" detachable cable with mike connector, adapter for stand mounting and lavalier cord. Imported. Shpg. wt., 3 lbs. 99 E 46336 Net 7.95

7⁹⁵



LAFAYETTE 3-WAY DYNAMIC

Uni-directional microphone has cardioid pattern. Excellent for general use wherever feedback or unwanted pickup is a factor. May be hand-held, slipped into its own desk stand or used on lavalier cord. Frequency response 200-10,000 Hz., output -61 db. High impedance (50K ohms). Case is high impact plastic finished in blue and gray. Chrome plated desk stand. Really "fly-weight" mike measures only 3¾"Lx1" max. diam. Complete with 5 ft. cord, stand and lavalier cord. Imported. Shpg. wt., 1½ lbs. 99 E 45866 Net 6.95

6⁹⁵



LAFAYETTE VERTICAL DYNAMIC MICROPHONE

6⁹⁵

- Ideal For Tape Recording and P.A.
- Smooth Omnidirectional Sound Pickup

A highly versatile studio-type dynamic microphone which is equally at home with the tape recordist and public address sound systems. Lightweight, it can be mounted on any standard ¾"-27 stand. Has omni-directional polar pattern. Frequency response: 100-10,000 hertz. High output, -54 db. Impedance. 50,000 ohms. Smart, durable chrome finish, with silver grey screen. Complete with self-adjusting swivel, standard ¾"-27 stand thread and non-detachable 5 ft. cable. Dimensions: 5"Hx1½"W. Imported. Shpg. wt., 1½ lbs. 99 E 45593 Net 6.95



LAFAYETTE HEAVY DUTY DYNAMIC

New Low Price 7⁹⁵

- 100-10,000 Hz
- High Output

An especially rugged dynamic microphone featuring a wide response of 100-10,000 Hz. and output of -55 db. High impedance (50K ohms). Omnidirectional pattern. On-off slide switch. Very heavy die cast case. Finished in satin chrome. Mounts on any standard 5/8"-27 stand. Size: 4"Hx1.1". With 18 ft. detachable cable with mike plug on one end. Imported. Shpg. wt., 3 lbs. 99 E 45908 Net 7.95



For Complete Index See Pages 431 - 434

Economy Mikes and Miniature Mixers

4-WAY SLIM CRYSTAL MICROPHONE

Only **3⁹⁵**



- Complete With Desk Stand, Lavalier Cord and Bracket and Floor Stand Adapter.

Designed for every possible type of mounting, this slim mike may be hand-held, mounted on the desk stand, used as a chest mike with the lavalier cord and bracket, or mounted on any standard $\frac{5}{8}$ "-27 floor or desk stand with adapter supplied. Good clean reproduction. Frequency response 50-9,000 Hz. Output, -65 db. Equipped with on-off switch which may be used as press-to-talk or locked into "on" position. Brushed aluminum body is 5" long with 54" cord. Black oval base is $3\frac{3}{8}$ "x $2\frac{1}{2}$ "W. Imported. 99 E 45874 Shpg. wt., 2 lbs. Net 3.95

LAFAYETTE DYNAMIC PA MICROPHONE W/SWITCH



- 300-2500 cps Frequency Response
- Push-to-talk Switch
- Ideal for Solid State PA Amplifiers

3⁹⁵

The perfect companion microphone to the "Tiny Mite" mobile PA amplifier. Features a high impact styrol case, hang-up clip and flexible single conductor shielded cable. Omnidirectional pattern mike has output impedance of 300 ohms and output level of -73 db at 1000 cps. Frequency Response: 300-2500 cps. Grey and black case, with push-to-talk switch. Imported. Shpg. wt., 1 lb. 99 E 45175 Net 3.95

HARMONICA CONTACT MICROPHONE

1⁴⁹



This is a fine quality, sensitive, crystal contact microphone with a high output that is especially designed to fit harmonicas. Installation is simple. It is sturdily built and measures only $1\frac{1}{4}$ "x $\frac{3}{4}$ "x $\frac{3}{8}$ "D. Complete with 7 ft. shielded cable. Imported. Shpg. wt., 12 oz. 99 E 45163 Net 1.49

LAFAYETTE QUALITY CRYSTAL MICROPHONE



3⁹⁵

- Die Cast Case

Excellent for PA systems, home recorders and general applications. Frequency response 50 to 10,000 Hertz. Output level -52 db provides ample output for use with low gain amplifiers. Uses quality moisture sealed crystal; Die cast case in rich green baked enamel finish, with chrome grill. Completely equipped with 5 feet of shielded cable. Mike may be used on any stand with $\frac{5}{8}$ "-27 thread. Grill diameter $2\frac{3}{4}$ ", depth $4\frac{1}{4}$ ", height $4\frac{1}{2}$ ". Imported. Shpg. wt., 3 $\frac{1}{2}$ lbs. 99 E 45122 Net 3.95

GENERAL PURPOSE MIKE

1⁹⁵



- May Be Hand-Held or Suspended By Lavalier Cord

A crystal microphone for use either as a hand-held or as a breast mike. Silver colored lavalier metal chain and holding bracket. Good frequency response with an output of -53 db. Aluminum alloy case with black baked finish and silver screen. 6' cord. $2\frac{1}{8}$ "L x $1\frac{1}{8}$ " max. diam.; convenient to hold. Shpg. wt., $1\frac{1}{2}$ lbs. Imported. 99 E 45957 Net 1.95

TINY CRYSTAL MIKE



1⁹⁵

- For Desk-Top, Hand-Held Use
- Full -55 DB Output Level
- Excellent Frequency Response

An attractive, specially engineered general purpose crystal mike for desk-top or hand-held use. Excellent frequency response. Output level -55db. Only $1\frac{1}{8}$ " in diameter. Includes 5-ft. of shielded cable for connection to tape recorders, public address amplifiers and radios. Chrome plated stand. Imported. Shpg. wt., $1\frac{1}{4}$ lbs. 99 E 45437 Net 1.95



LAPEL MICROPHONE

1⁹⁵

A sensitive general purpose crystal microphone designed to attach to your lapel for situations requiring both mobility and the full use of both hands. Only $1\frac{1}{8}$ " in diameter. Excellent frequency response. Output level -55 db. Chrome plated case and clip for attaching to lapel. Includes 5 ft. shielded cable. Imported. Shpg. wt., 1 lb. 99 E 45106 Net 1.95

LAFAYETTE MINIATURE AUDIO MIXERS



- (A) Performs any mixing operation where 2 high impedance input channels are connected to a single, mixed high impedance input channel. Each input has its own level control. Momentary switch protects speaker while inserting into system. Shielded, chrome plated housing. Has 2 RCA-type female input jacks and an RCA-type mate phone plug output. $2\frac{3}{8}$ "x $1\frac{3}{4}$ "x $\frac{7}{8}$ " overall. Imported. Shpg. wt., $\frac{1}{2}$ lb. 99 E 10134 Net 1.99
- (B) Same as above except output is standard phone plug. $3\frac{1}{4}$ "x $1\frac{3}{8}$ "x $1\frac{1}{4}$ " overall. Imported. Shpg. wt., $\frac{1}{2}$ lb. 99 E 10142 Net 1.79



SWITCHCRAFT AUDIO MIXERS

2-input hi-impedance mixers. Record sound-on-sound. Record music direct and dub your voice at the same time. Record from 2 mikes at once. Separate gain controls for each channel allow Fading. Shielded housing. Size: $2\frac{1}{4}$ "x $1\frac{1}{4}$ "x $1\frac{1}{4}$ ". Shpg. wt., $1\frac{1}{4}$ lbs.

- Type 310. Two 2-cond. phone jack inputs to 2-cond. phone plug output. 24 E 88666 Net 5.88
- Type 311. As above but has long output plug to fit recorders with recessed jacks. 24 E 88674 Net 5.88
- Type 313. As above but with short Revere plugs and jacks for std. or short phone plugs. For all Revere/Wollensak recorders. 24 E 88518 Net 5.88
- Type 320. Male mike connector inputs and female mike connector output. 24 E 88558 Net 5.88

MAGNETIC MICROPHONE HOLDER 79^c

- For CB, Ham and Commercial Mobile Radios



Either clip to microphone or attach to any steel surface and slip microphone in holder. Fits most microphones. Imported. wt., $\frac{1}{4}$ lb. 99 E 45585 Net .79



MICROPHONE MOUNTING CLIP

Standard microphone mounting clip. Accommodates most stud mounting CB and Ham microphones. Attaches to metal case or dash board with 2 screws. Shpg. wt., 4 oz. 99 E 31841 Net .50

LAFAYETTE Top Performing CB Microphones

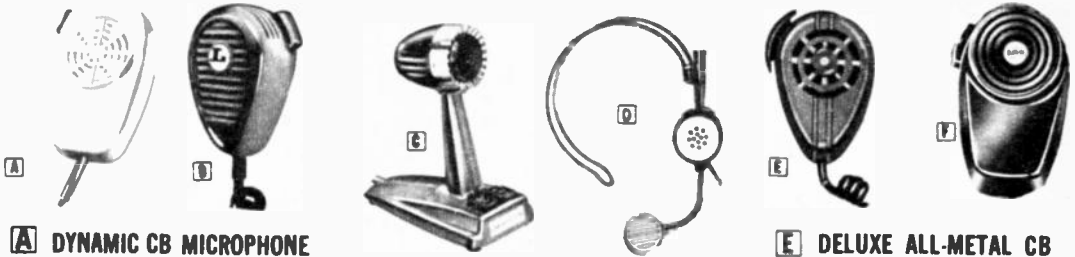

A DYNAMIC CB MICROPHONE

• For Use With Low Impedance Solid State Transceivers

Super efficient low impedance dynamic microphone. Housed in attractive, professionally styled, gray and black, high-impact plastic case. Fits snugly in palm of hand. Top-performing coiled cord consists of 3 conductors plus shield and terminates in 4 prong miniature plug. Wired for relay switching. Mates directly with microphone input chassis socket of Lafayette HB-500, HB-500A, HB-555, HB-525, HB-525A, HB-525B, HB-525C, HB-625, HB-23, HE-20T, HE-20D, HA-450T, HB-600, and Telsat 23. Size: 3½x2¾x1¼". Imported. 99 E 46187 Shpg. wt., 1 lb. Net 5.95

B NOISE CANCELLING CB MIKE

A high output (-48 db) low noise cardioid pattern PTT ceramic mike excellent for mobile and base applications. Minimizes noise pickup from rear to avoid interference with audio input. Rugged, high-impact Cyclocac dark grey case with 3 conductors (one conductor shielded) coiled cord. Fits comfortably in palm of your hand. Frequency response 300-3000 Hz. For use with tube-type CB equipment. With hang-up clip. Less plug. Shpg. wt., 1 lb. 44 E 45011 Net 5.50

Miniature Microphone Plug. For connection to Comstat 19, 23, 25, 25A, HB-444, A, B, and Comstat 23 Mark V. Imported. 99 E 62630 Net 1.29

CB CRADLE HAND SET

24⁹⁵



Modernize your present fixed or mobile CB station with these telephone style handsets. Attaches to dashboard, side of unit or wall of fixed station. Switch in the cradle automatically disconnects the speaker when the handset is lifted. The microphone is activated by means of a push-bar, push-to-talk switch. Ideal for use in heavy traffic, loud background noise area, at home or in the office for privacy. Shpg. wt., 2 lbs.

For Solid State Transceivers 42 E 65039 Net 24.95

For Tube-Type Transceivers 42 E 65047 Net 24.95

Accessories for direct connection of handset to LAFAYETTE Solid State Transceivers HB-23; HB-500A; HB-525, A, B, C; HB-555; HB-600; HB-625; HE-20T; Teistat 23. 99 E 62638 Microphone Plug Net .99

Speaker Plug for insertion into external phone/speaker jack. 99 E 62101 Net .22

Accessories for direct connection of handset to LAFAYETTE Tube-Type Transceivers LAFAYETTE Comstat 19; LAFAYETTE Comstat 23 MK V; LAFAYETTE Comstat 25, A. 99 E 62630 Microphone Plug Net 1.29

Speaker Plug for insertion into external phone/speaker jack. 99 E 62218 Net .25

C CB BASE STATION CERAMIC MICROPHONE

For tube-type CB transceivers. Efficient, attractive high impedance desk ceramic microphone. With convenient push-to-talk button plus lock-switch for prolonged transmission. 3-conductors plus shield for normal relay or electronic switching. 3¾x5¾x7¾". Imported. Shpg. wt., 1½ lbs. 99 E 46070 Less plug. Net 9.95

Miniature Microphone Plug. For connection to Comstat 19, 23, 25, 25A, HB-444, A, B, and Comstat 23 Mark V. Imported. 99 E 62630 Net 1.29

LAFAYETTE CB BASE STATION DYNAMIC MICROPHONE. Same as above but has dynamic element. Low impedance for use with transistorized CB. Imported. 99 E 46088 Less plug. Net 11.95

Microphone Plug. Permits use of microphone with HB-600, HB-500, A, HB-555, HB-525, A, B, C, HB-625, HB-23, and Teistat 23. 99 E 62638 Imported Net .99

D BOOM MIKE/HEADSET

Frees hands for safe driving. Perfect answer to your CB and Ham mobile needs. For use with VOX or foot switch for transmit-receive changeover. Lightweight and comfortable with 8-ohm earphone. Crystal mike for high output and full modulation. Boom and headband adjust to individual preference. Mike mounted on swivel. Finished in chrome and two tone plastic. With 5 ft., 4-conductor cable. Imported. Shpg. wt., 1 lb. 99 E 25652 For tube transceivers Net 3.98

E DELUXE ALL-METAL CB CERAMIC MICROPHONE

High output ceramic microphone with deluxe chrome plated metal case and 4 ft. coiled cord. Fits snugly in the palm of the hand; resists abuse of tough mobile operating conditions. The 3 conductor plus shield coiled cord is permanently attached for minimum wear. Hang-up button for mobile mounting. Wired for electronic switching, with instruction for conversion to relay switching. For tube-type CB equipment. Imported. Shpg. wt., 1 lb., less plug. 99 E 45627 Net 6.95

Miniature Microphone Plug. For connection to Comstat 19, 23, 25, 25A, HB-444, A, B, and Comstat 23 Mark V. Imported. 99 E 62630 Net 1.29

F "MITY-MITE" CB CERAMIC MICROPHONE

Ceramic microphone expertly designed and professionally styled for real performance. Fits snugly in palm of hand for effortless operation. Features a "Long Life" ceramic element. Three conductors plus shield connected for electronic switching. Includes instruction sheet for conversion to relay switching. For all high impedance input CB transceivers (tube type). High impact plastic case and 4 foot coiled cord. 1x1¼x3¼". 99 E 45791 Wt., 8 oz. imported Net 4.95

Miniature Microphone Plug. For connection to Comstat 19, 23, 25, 25A, HB-444, A, B, and Comstat 23 Mark V. Imported. 99 E 62630 Net 1.29

LAFAYETTE MINIATURE MIKES & CARTRIDGES

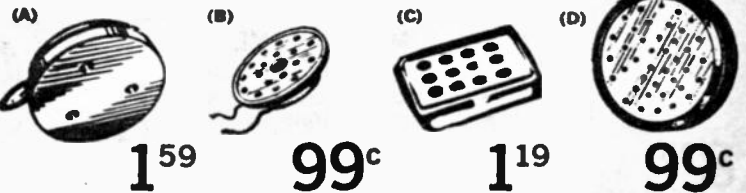

A. MINIATURE DYNAMIC MIKE

Rugged—metal encased—to resist mechanical shock and variations in heat and humidity. Measures only 1¼" dia. x 5/16" thick. High sensitivity in the voice range. Frequency response 300 to 5000 Hz. 600 ohm impedance. Output —73 db. Includes 4" flexible lead terminals. Imported. 4 ozs. 99 E 45270 Net 1.59

B. MINIATURE CRYSTAL

This extremely sensitive and small crystal microphone may be used as a replacement in hearing aids and other small apparatus. May be used as a lapel microphone. Size is 1¼D.x¾" deep. Imported. Shpg. wt., 6 oz. 99 E 45098 Net .99

C. SUBMINIATURE CRYSTAL MICROPHONE

An extremely sensitive and small crystal microphone similar to the round types but for replacement use in hearing aids where a rectangular shape is required. Measures: 1¾x1¼x¼" deep. Imported. Shpg. wt., 4 oz. 99 E 45189 Net 1.19

D. CRYSTAL CARTRIDGE

Crystal microphone cartridge with heavy flexible rubber cushioned rim designed for speedy, economical repair. Replaced for Astatic, Shure, and many other popular microphones. Overall diameter 2", depth 1/2". Output —52 db. Excellent frequency response. Imported. Shpg. wt., 8 ozs. 99 E 45130 Net .99

LAFAYETTE Deluxe Recording Microphones

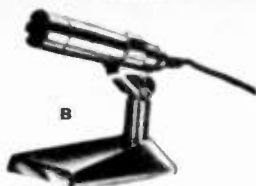

LAFAYETTE PROFESSIONAL DYNAMIC (A)

- Specially Designed for Transistorized Recorders

Recommended for all high quality recorders and particularly solid-state units. Has a wide frequency response of 80-15,000 Hz. High impedance (10K ohms) with an output of -65 db. Die cast satin-black body with aluminum trim. Slim tapering design. May be hand-held, used on desk stand supplied or mounted in any 5/8"-27 stand. Black stand with aluminum trim. Mike is 5 1/2" x 1" dia. with 8 ft. attached cord and plug. Stand is 4 1/4" x 2 1/2". Imported. Shpg. wt., 2 lbs. Net 14.95
99 E 45882

LAFAYETTE STANDARD DYNAMIC (C)

An outstanding value, this featherweight dynamic microphone is attractively styled in a tapering design, and finished in handsomely contrasting black with aluminum trim. It may be hand-held or used on the small desk stand supplied. The omni-directional pattern picks up sounds from all sides. Assures wide coverage. Impedance is 10,000 ohms. Frequency Response is 70 to 9000 Hz ± 7 db and the output is -67 db. Has a built-in on-off switch. Comes complete with 6 ft. cord with standard plug. Size: 6 1/4" x 7/8" diam. Imported. Net 5.95
99 E 46161 Shpg. wt., 2 lbs.

LAFAYETTE VOICE-ACTUATED MICROPHONE (D)

- Also Operates As Remote Control Dynamic Microphone

Allows a transistorized portable tape recorder to start automatically when sound is picked up by the microphone and stop a few seconds after the sound stops. Designed for recorders having a "Remote" jack for remote Start/Stop switch equipped microphone. Has electronically controlled relay, 3 position switch for voice Control-Off-Remote. Threshold sensitivity control adjustable for varying noise level locations. In "Remote" position, it operates as a dynamic microphone with remote control switch. Complete with cord, plugs, and instructions. With 9V battery. Imported. Shpg. wt., 1 lb. Net 14.95
99 E 46047

LAFAYETTE DELUXE DYNAMIC (B)

For fine recording and general use, this slim beauty may be hand-held, placed on its own desk stand, used as a lavallier mike or mounted on any standard 5/8"-27 stand. Omnidirectional pattern gives wide coverage. Wide range response from 100 to 10,000 Hz. Dual impedance: 50K and 250 Ohms. Output -64db. All metal. Die case base and mike finished in handsome satin-chrome. 5 ft. cable. Mike only 3 7/8" L x 3/4" diam. Stand 3 3/8" x 2 1/8" with stand, lavallier cord and bracket and stand adapter. Imported. Shpg. wt., 2 lbs. Net 7.95
99 E 45924

LAFAYETTE TINY DYNAMIC MIKE

Only 3 1/4" Long

- For Solid State Recorders

This is an excellent quality dynamic microphone which may be set on table or desk top or hand held. Impedance is 600 ohms and is designed for use with solid-state recorders requiring relatively low impedance dynamic microphones. Used with many Lafayette recorders. Size is 3 3/4" L x 3/4" D. Supplied with 5 ft. of cable terminating in standard phone plug. Imported. Shpg. wt., 8 oz. Net 5.95
99 E 46302



LAFAYETTE REMOTE CONTROL CASSETTE MIKE

Remote control dynamic microphone for table top or hand use. Impedance is 200 ohms for cassette recorders requiring low impedance mikes. Response: 100 to 9,000 Hz. Has on-off switch. Size: 4 1/2" x 7/8" dia. With 5 ft. cable terminating in dual miniature plugs for mike and remote control. Plugs fit most cassette recorders. Complete with prop stand. Imported. Shpg. wt., 8 oz. Net 3.95
99 E 46344



LAFAYETTE MUSICAL INSTRUMENT MICROPHONES

DELUXE GUITAR MICROPHONE

- Individual String Controls
- 2 Pickups Tone Control
- 2 Volume Controls

This unusual microphone gives the utmost in versatility of tonal effects. Each of the 2 sensitive magnetic pickups has 6 adjustable heads so you may vary the power of each individual string. Each pickup has its own separate volume control. Combining these with the overall tone control, makes available an almost infinite adjustment of sound for any requirement. Comes complete with 6 ft. removable cord with mike plug at one end and standard phone plug for amplifier at other. For F hole guitars. Size: 10 1/2" long. With bracket and mounting accessories. Imported. Shpg. wt., 3 lbs. Net 8.95
99 E 45833

8.95

ROUND HOLE GUITAR MICROPHONE

For use with Spanish guitar, ukuleles or other round hole instruments. Magnetic pickup with 6 adjustable heads so you may vary the power of each string. It has separate tone and volume controls. 7 ft. cable with standard phone plug for musical amplifier. Finished in black and gleaming nickel. Simple to mount, easily adjustable. Imported. Shpg. wt., 2 lbs. Net 5.95
99 E 46351

5.95

GUITAR MICROPHONE

- Volume and Tone Controls

High Impedance contact-type microphone specially designed for use with guitar. Easily mounted under strings without special attachments. Separate variable tone and volume controls permit wide adjustment to suit personal requirements. While in mounted position, microphone unit can be raised or lowered easily on rod, to create varying tonal effects. Supplied with 8 ft. cable and attached standard size phone plug for connection to amplifier. All metal; finished in bright nickel, for F hole guitars. Imported. Shpg. wt., 2 1/2 lbs. Net 6.95
99 E 45171

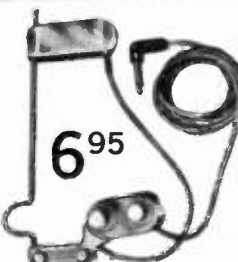

6.95

MUSICAL CONTACT MICROPHONES



Easily attached to all stringed instruments. Provides rich reproduction. Clamp slips under sounding board cutout. With 8 ft. cable. 1 3/4" long. Imported. Shpg. wt., 12 oz. Net 1.99
99 E 45767 With volume control

Turner Microphones



MODEL 254C
 Attractive ceramic microphone with DPDT push-to-talk switch plus lock switch for fixed station operation—either relay or electronic switching. 7 foot 3 conductor (one shielded) straight cable. Response 80-7000 Hz. Output level—54 db. Gray hammertone finish with chrome trim. 7 7/8x3 3/4x5 1/4" base. Shpg. wt., 3 lbs.
44 E 70035 Net 17.00

MODEL 294X
 Crystal version with output of —48 db.
44 E 70100 Net 17.00

MODEL 454C
 Single side band ceramic mike that is ideal for hams. Output level of —52 db. Frequency response 300-3000 Hz. Push-to-talk front bar plus locking switch gives choice of PTT or continuous VOX operation. For electronic or relay switching. Complete with coiled cord that extends to 5 ft. Size 7 3/4x5 1/4" deep. Shpg. wt., 3 lbs.
44 E 70019 Net 18.82

MODEL 454X
 Same as above but crystal with output of —48 db.
44 E 70043 Net 18.82

MODEL 350C
 Ideal for CB use. A rugged push-to-talk ceramic microphone wired for relay operation. Extra-tough polystyrene case; hanger button and standard dash bracket are included. Also neoprene coiled cord, 11 inch retracted. 5-ft. extended. Output, —54 db. Response, 80-7000 Hz. Dark grey finish. Shpg. wt., 1 lb.
44 E 70027 Net 8.82

MODEL 355C
 Mobile ceramic microphone with handy grip-to-talk switch. Comfortable to hold, comfortable to use. Features an output level of —50 db. Frequency response 80-7000 Hz. Tough plastic case. Complete with 5 ft. coiled cord. Shpg. wt., 1 lb.
44 E 70050 Net 8.82

MODEL 866 CARDIOID DYNAMIC
 Cardioid dynamic type; high impedance. An excellent sounding mike for music and home recording. Minimum feedback. Response 100-13,000 Hz. 12 ft. cable and plug. With carrying case. Shpg. wt., 3 1/2 lbs.
44 E 70290 Net 24.40

MODEL 2050 CARDIOID
 Directional, multi-purpose dynamic for tape recording, P.A., etc. Response 70-10,000 Hz. Rear sound pickup reduced 15 db over most of range. Output —64 db at hi impedance. Select high or 150-ohm low impedance at end of 12 ft. cable. On/off switch. Size 6Lx 1 1/2". With lavaller cord and stand adaptor.
44 E 70308 Net 23.52

MODEL 600 DYNAMIC
 Highly directional cardioid pattern rejects background noise—no feedback "howl." For hand-held or stand use. Response 50-15,000 Hz; output —55 db. High impedance. Die cast case. Size: 6x1 3/8" Diam. With on-off switch, stand adaptor and 12 ft. cable. Shpg. wt., 3 lbs.
44 E 70175 No Money Down* Net 34.99

REPLACEMENT CARTRIDGES
 Ceramic for "+2" and 360..... Net 4.70
44 E 70324 Net 4.70
 Ceramic for "M + 2/U" and "JM + 2U"
44 E 70332 Net 4.70
 Crystal for Model 254, 350X, etc.
44 E 70084 Net 3.81
 Ceramic for 254C, 350C, etc.
44 E 70092 Net 3.81

NEW!

Model "Plus-3" Base Station Microphone
 The "Plus-3" ceramic microphone has a new transistorized pre-amp with volume control plus a new compression amplifier circuit which allows user to talk close or far from the mike without varying the output signal. This prevents mike sput and sputter. Response: 300-3000Hz, 3 conductor (1 shielded) coiled cord. Touch-to-talk front bar switching with slide lock when desired. Wiring instructions for over 100 popular transceivers. Shpg. wt., 3 lbs.
44 E 70316 No Money Down* Net 44.10

MODEL "+2" BASE STATION MICROPHONE
 "M+2/U" MOBILE MIKE increases signal strength and range. Frequency 300-3000 Hz. Preamp has volume control on rear to adjust modulation for best performance. Complete with battery, dash bracket and 5 ft. coiled cord. For sets with relay switching.
44 E 70183 Net 23.23
 Same for electronic switching
44 E 70191 Net 23.23

MODEL "M + 2U" MOBILE MICROPHONE
 "+2" BASE STATION MIKE increase signal strength and range! Frequency response of 300-3500 Hz. Push-to-talk bar with locking switch permits normal PTT operation or VOX. Works with all sets—Relay or Electronic switching! 3 conductor, 1 shield blue coiled cord. Finished in blue and chrome. Output impedance 5000 ohms. Battery included.
44 E 70167 Shpg. wt., 4 lbs. Net 32.34

MODEL D-104 MICROPHONE
 Used extensively by radio amateurs for its high intelligibility and "punch." Responds with rising characteristics from 500-4,000 Hz. With high output sealed crystal element. Output level —46 db. Chrome finished mesh grille and body. With 5-ft. cable and adaptor to 3/8"—27 thread. Shpg. wt., 1 3/4 lbs.
44 E 14017 Less Stand Net 18.23
MODEL GO-104. Same as D-104 except with grip-to-talk stand. SPST switch.
44 E 14025 Shpg. wt., 4 lbs. Net 30.11

MODEL UG8-D104
 The D-104 microphone with the UG8 grip-to-talk stand. Described below. DPDT switch.
44 E 14033 Shpg. wt., 4 lbs. Net 33.05
MODEL UG8 STAND
 Die cast, all metal with bar activated DPDT leaf-switch for either momentary or "lock-on." Two switch sections. Noise free, silver contacts rated up to 3 amp DC, 8 terminals for connections. 6 ft., 4 conductor cable. Chrome and gray. 5 1/2" diam. x 8 1/4"H. Shpg. wt., 2 1/2 lbs.
44 E 14041 Net 17.61

MODEL 332 CRYSTAL MIKE
 For general purpose use. Response 30-15,000 Hz. Output —54 db, high impedance. Die-cast housing. Satin chrome finish, chrome cap and black grille. 8 ft. single conductor cable. Built-in ON-OFF switch with lock-on provision. With lavaller and stand adaptor for 3/8"—27 thread. 4 1/2" long, 1 1/4" dia. Shpg. wt., 1 lb.
44 E 14068 Net 10.53
A7 Stand for above. Shpg. wt., 1/4 lb.
44 E 14066 Net 1.44

MODEL 150 RECORDER MIKE
 Weighs only 3 ounces. Response 30-10,000 Hz. Output —44 db, high impedance. Grey impact-resistant case, aluminum anodized grille. 5 ft. single conductor cable. Size 2 3/4x2 3/4x1 1/4" D. Shpg. wt., 3/4 lb.
44 E 14082 Net 3.82
MODEL 151 CERAMIC MIKE
 Similar to Model 150 but ceramic type. Output —48 db. Response 30-8000 Hz. Shpg. wt., 3/4 lb.
44 E 14090 Net 3.82

SHURE

Microphones

Broadcasting—PA—and General Purpose



"UNISPHERE A"

MODEL 585SA. Rugged dynamic unidirectional "pop"-proof unit with wire-mesh spherical screen. Feedback free. Response 50-13,000 Hz. High impedance. Output—57 db. Chrome and black case. Has on-off switch, adjustable swivel stand adapter and 15 ft. single conductor shielded cable. Size: 6 $\frac{1}{2}$ x 1 $\frac{1}{4}$ " diam. 3 lbs.

44 E 75521 No Money Down* Net 39.98

MODEL 585SAC. Same as above but with prewired plug end assembly which can be used as MCIF, MCIM or phone plug.

44 E 75687 No Money-Down* Net 41.16

MODEL 585SB. Same as 585SA except low impedance, output—59 db and 2 conductor cable.

44 E 75539 No Money Down* Net 39.98

MODEL 585SAV. Similar to 585SA but instead of on-off switch has built-in volume control to change loudness without adjusting amplifier controls. Shpg. wt., 3 lbs.

44 E 75612 No Money Down* Net 44.69

MODEL 585SAVC. Same as above but with plug end assembly like 585SAC.

44 E 75895 No Money Down* Net 45.86

MODEL 585SBV. With volume control like 585SAV but low impedance like 585SB.

44 E 75703 No Money Down* Net 44.69

"UNISPHERE I"

MODEL 563. Deluxe ball-type pop-proof unidirectional dynamic microphone. Features dual impedance; low imp (50-250 ohms) output—57 db, high imp—55 db. Response 50-15,000 Hz. With swivel adapter and 15 ft. 3 cond. detachable cable. Size 6 $\frac{1}{2}$ x 2"D. No switch. Shpg. wt., 3 lbs.

44 E 75547 No Money Down* Net 58.80

MODEL 563S. Same as above but with on-off switch. Designed for mike stand use. Shpg. wt., 3 lbs.

44 E 75620 No Money Down* Net 61.74

"UNIDYNE B"

MODEL 515SA. Very low priced unidirectional dynamic microphone with a highly effective cardioid pickup pattern which solves feedback and boominess. Ideal for low budget sound systems. Frequency: 80—13,000 Hz. High impedance with output of—58 db. Has on-off switch and swivel adapter. 15 ft. single conductor non-detachable cable. Chrome and black case. Size: 1 $\frac{1}{2}$ D.x6 $\frac{1}{8}$ "L. Shpg. wt., 1 $\frac{1}{2}$ lbs.

44 E 75661 Net 24.78

MODEL 515SAC. Same but with prewired plug-end assembly for use as MCIF, MCIM, or phone plug.

44 E 75959 Net 25.84

555W "UNIDYNE II"

An unusually dependable rugged dynamic microphone for deluxe sound systems indoors or outdoors. 50 to 15,000 Hz response. Unidirectional pickup prevents feedback. Three-way impedance switch. Output levels: 35-50 ohms.—55 db; 150-250 ohms.—56 db; hi-Z.—55 db. Satin chrome. Complete with on-off switch, swivel mount. 15 ft. 2-conductor cable. 7 $\frac{1}{8}$ x 2 $\frac{1}{4}$ x 3 $\frac{1}{8}$ " L. Wt. 3 $\frac{1}{2}$ lbs.

44 E 75018 No Money Down* Net 52.33

MODEL 55S. Same as above, without on-off switch. Shpg. wt., 3 $\frac{1}{2}$ lbs.

44 E 75028 No Money Down* Net 51.16

MODEL 556S. Deluxe version of 555W. Closer tolerances: wider response (40 to 15,000 Hz). Shock mounted. 20 ft. 2-conductor cable. 3 $\frac{1}{2}$ lbs.

44 E 75034 No Money Down* Net 83.50

SHURE 5455 "UNIDYNE III"

Slender dynamic unit with completely symmetrical unidirectional pattern. Performs perfectly in difficult applications where other type mikes pick up feedback and sound boom. Widely acclaimed for its natural reproduction of human voice. 50 to 15,000 Hz. Dual Impedance. Outputs: 50-250 ohms.—57 db; hi-Z.—55 db. Chrome, black, On-off switch; swivel mount. 15-ft. 3-conductor cable 5 $\frac{1}{8}$ x 1 $\frac{1}{4}$ " dia. 3 lbs.

44 E 75042 No Money Down* Net 55.27

MODEL 545. As above. In probe design, ideal for hand held use. Without on-off switch. Swivel stand adapter included.

44 E 75059 No Money Down* 52.33

MODEL 545L. Multiple use Unidyne III dynamic. For lavalier, stand-to-hand, or goose-neck mounting. Freq.: 50-15,000 Hz. Low impedance. Output:—57.5 db. With lavalier cord and clip assembly. 20 ft. two-conductor cable. Black and chrome case. Size: 5 $\frac{1}{8}$ x 1 $\frac{1}{4}$ " diam. Shpg. wt., 2 lbs.

44 E 75562 No Money Down* Net 43.51

MODEL 546 BROADCAST UNIDYNE III. Similar but shock mounted; response, 40-15,000 Hz; impedance switch for 50-250 ohms. Swivel mount. 20 ft. 2-conductor cable. 3 $\frac{1}{2}$ lbs.

44 E 75067 No Money Down* Net 83.50

MODEL 580SA "UNIDYNE A"

Low cost cardioid dynamic. Ideal for controlling feedback in P.A. systems and improving home recording. Features rugged dynamic element with true cardioid unidirectional pickup pattern, built-in On-Off switch and 15-foot attached shielded cable. High impedance. Response: 50 to 13,000 Hz. Output,—56.5 db. Satin chrome case with "Armour-Dur" cap and stainless steel mesh grille. 6 $\frac{1}{2}$ x 1 $\frac{3}{8}$ ". Shpg. wt., 2 $\frac{1}{2}$ lbs.

44 E 75497 No Money Down* Net 36.46

"SPHER-O-DYNE"

MODEL 533SA. Omnidirectional dynamic probe type. Ideal for entertainers, lecturers. Spherical front with built-in wind, breath and "pop" filter 40-11,000 Hz. High impedance. Output—55 db. On-off switch, swivel stand adapter and 15 ft. single conductor cable. Chrome case. 6 $\frac{1}{2}$ " x 2 $\frac{1}{8}$ " dia. 2 $\frac{1}{2}$ lbs.

44 E 75554 No Money Down* Net 31.18

MODEL 533SAC. Same but with prewired plug assembly which can be used as MCIF, MCIM or phone plug.

44 E 75711 No Money Down* Net 32.34

MODEL 533SAV. Same as 533SA but with volume control to regulate amplifier output at microphone.

44 E 75835 No Money Down* Net 35.28

MODEL 533SAVC. Same as 533SAV above but with plug assembly like 533SAC.

44 E 75943 No Money Down* Net 36.75

540S "SONDDYNE II"

Modern design all-directional microphone. Fine for recording applications and sound systems. Has on-off switch. Adjustable response: 50-13,000 Hz for music. 400-6,000 Hz for speech. Dual impedance: 50-250 ohms and high impedance. Outputs: Hi-Z.—55 db; Low-Z.—56 db. Chrome and black. Swivel mount; 5/8"-27 thread. 15 ft. 2-cond. cable 3 $\frac{1}{8}$ x 1 $\frac{1}{4}$ ". Shpg. wt., 3 $\frac{1}{2}$ lbs.

44 E 75166 Net 38.58

**NEW!****NEW!**

NEW! "UNISPHERE B"

MODEL 588SA. A dynamic unidirectional microphone with popular ball-type styling. Features feedback-free cardioid pickup pattern, shock-mounted cartridge, wind, pop and blast filters; lockable "On-Off" switch and a broadcast-type cannon connector with 15' detachable cable. Includes swivel stand adapter. Response: 50-13,000 Hz. High impedance. Output:—58 db. Satin chrome housing. 6 $\frac{1}{2}$ x 2" dia. Shpg. wt., 1 $\frac{1}{2}$ lbs.

44 E 75993 Net 35.28

MODEL 588SAC. Same as above but with prewired plug end assembly for use as MCIF, MCIM, or phone plug.

44 E 75885 No Money Down* Net 36.46

MODEL 588SB. Same as 588SA above, but low impedance. Output:—59.5 db. 15' two-conductor cable.

44 E 75901 No Money Down* Net 35.28

NEW! "VOCAL SPHERE"

MODEL 579SB. Omnidirectional dynamic microphone with natural and intelligible voice reproduction. Ideal choice for public-address, entertaining, recording, etc. Extremely rugged. Has built-in wind and breath noise filters. Lockable "On-Off" switch and a broadcast-type Cannon connector with 20' two conductor detachable cable. Includes swivel stand adapter. 50-15,000 Hz frequency response. Low impedance. Output:—59 db. Satin chrome and gray housing. 6 $\frac{1}{2}$ x 1 $\frac{3}{8}$ " diameter.

44 E 75919 Wt., 2 lbs. Net 44.10

"UNIDYNE IV"

MODEL 548S. This member of the Unidyne family of feedback-free unidirectional dynamic microphones offers remarkable ruggedness and performance features such as improved shock mounting; wind, pop and blast filters; broadcast-type Cannon XLR-3-11c connector; high flexibility cable, etc. Frequency: 40—15,000 Hz. Dual (high and low) impedance with output of—55.5 db. On-off switch, swivel mount, chrome and black case, 15' 2 conductor detachable cable. Size: 1 $\frac{1}{2}$ D.x5 $\frac{1}{8}$ "L. Shpg. wt., 2 $\frac{1}{4}$ lbs.

44 E 75648 No Money Down* Net 64.68

MODEL 548. Same as above but less on-off switch and swivel mount, but including swivel adapter.

44 E 75653 No Money Down* Net 61.74

Microphones SHURE

Communications—CB—Ham—General Purpose



SHURE HAM AND DISPATCHING MICROPHONES

MODEL 520SL "DISPATCHER" MAGNETIC. The ideal mike for busy radio operators or for dispatching and paging. Consists of Model 520 mike mounted on special stand. Push bar to talk, slide down permanent connection. Easy to operate. Frequency response: 100 to 9000 Hz. Output level—52.5 db. Omni-directional polar pattern. High impedance. Recommended load 100,000 ohms or more. Chrome and green finish. 7 ft. cable. 9½" H x 5" W x 7" D. Shpg. wt., 5 lbs.
44 E 75396 Net 27.64

MODEL 444 HAM MIKE. Modern, 2-tone gray rugged "Armo-Duo" case. Adjustable stand height. Push-to-talk lockable mike-relay switch. High impedance. Output—52.5 db. Response: 300-3000 Hz. Separate switch for VOX operation. Shpg. wt., 3½ lbs.
44 E 75372 Net 27.66

MODEL 522 UNI-COM

A new unidirectional dynamic base station microphone. Suppresses unwanted background noise and feedback. Press-to-talk bar. Adjustable height. Response: 60-11,000 Hz. Dual impedance. Output: Hi-imped., —56.5 db, low imped., —57 db. Gray case. 7' 4-conductor cable. Size: 12¼ x 4 x 5¾". Shpg. wt., 2¼ lbs.
44 E 75927 No Money Down* Net 38.81

NOISE CANCELLING MICROPHONES

MODEL 202 CERAMIC—Effectively reduces background noise for use in Mobile, CB and Ham rigs. 200-4,000 Hz. Hi-Z, —50.5 db. Switch, hang-up bracket. 5-ft. 3-conductor, coiled cable. Shpg. wt., 2 lbs.

44 E 75257 Net 12.35
MODEL 401A, as above, but controlled magnetic. —49 db.
 44 E 75273 Net 13.52

THE COMMANDO SERIES

Rugged, controlled magnetic mikes for use indoors or outdoors. For general purpose applications. Frequency response: 60-10,000 Hz. Dual impedance. Output level: high, —52 db; low —52 db.

MODEL 430. For hand or stand push-to-talk switch. 15' two conductor shielded cable; cable connector, swivel adapter; Size: 6¼" long x 1¼" dia. Shpg. wt., 2¼ lbs.
44 E 75323 Net 23.52
MODEL 420. Lavaller type. With 20', two-conductor, nondetachable, shielded cable; lavaller cord and clip assembly. 3¼" x 1¼". Shp. wt., 3/4 lbs.
44 E 75331 Net 18.82
MODEL 425. Specially designed for goose-neck mounting. 5/8-27 thread. 7', two-conductor shielded cable attached. Less goose-neck.
44 E 75349 Net 18.82

MODEL 575S "VERSADYNE"

Smooth response from 40-15,000 Hz—rugged, omnidirectional dynamic cartridge. High or low impedance models. Complete with switch, stand adapter and lavaller cord. For use in hand, on stand, or used as lavaller. Single cond. 7 ft. shielded cable. Black high-impact body, satin anodized cap, stainless steel grille. Size: 4¾" lg. x 1¼" dia. Wt., 5 oz. High impedance model Output: —56 db. Shpg. wt., 17 oz.
44 E 75174 Less Base Net 14.70

MODEL 575SB "VERSADYNE." Similar to above, but impedance: 150-250 ohms. Output—56 db.
44 E 75182 Net 12.94

TRANSISTORIZED BASE STATION MICROPHONE



- Built-in 2 Transistor Preamp.
- Variable Output Level

Model 444T. Provides optimum performance for CB and other types of communications equipment including AM, FM, and single side-band. Built-in 2 transistor preamp increases signal strength. Controlled magnetic type with response of 200-6000 Hz. Semi-directional. Output level variable from 2 to 45 mv. Press-to-talk control bar for locking or non-locking operation. Height adjustable from 9¼" to 11¼". Base 5¼" x 4". Four ft. coiled cable. Battery Supplied.
44 E 75604 Wt., 2¼ lbs. Net 30.50

99 E 60212 Replacement battery Net 21

DESK STANDS



TYPE 530B DESK STAND. Round, black base for models 575S, 575SB, 275S, 415 and 430. Shpg. wt., 1¼ lbs.
44 E 75208 Net 2.94

TYPE 533B DESK STAND. Black finish. For models 515, 545, 546, 548, 556S, 565, 566, 580 and 585. Shpg. wt., 3 lbs.
44 E 75440 Net 9.41

TYPE 536A DESK STAND: Gray finish. Fits all Shure connector type mikes including 555W, 545S, 548S, 565S, etc.
44 E 75201 Net 5.29



R5



C15C



R7

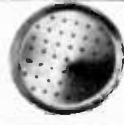

REPLACEMENT CARTRIDGES

Exact replacements. Shpg. wt., 8 oz.
TYPE R5: Magnetic for hi-imp. models 410, 410S, 440, 440SL, 505C, 505K, 510C, 510S, 520, 520SL.
44 E 75422 Net 7.06

TYPE R7: Crystals for models 707A, 708A.
44 E 75430 Net 5.29

TYPE R33: Dynamic for Spher-o-Dyne models 533SA and 533SB.
44 E 75729 Net 12.35

TYPE R45: Dynamic for Unidyne III models 544, 545, 545S and 546.
44 E 75737 Net 22.93

TYPE R55: Dynamic for Unidyne II models 555 and 555W.
44 E 75745 Net 18.82

TYPE R58: Dynamic for 580SA and 580SB.
44 E 75752 Net 14.11

TYPE R65: Dynamic for Unisphere I models 565 and 565S.
44 E 75760 Net 24.70

TYPE R85: Dynamic for Unisphere "A" models 585SA, 585SB, 585AV and 585SBV.
44 E 75778 Net 15.29

LINE TRANSFORMERS

For connecting low impedance mikes to high impedance amplifiers. Preserves high frequencies and cuts hum pickup in long lines. 20-20,000 Hz ± 1 db. 3/4" x 2½" L. Built-in MC1F and XLR-3-11C connectors. Shpg. wt., 9 oz.
44 E 75414 Type A95A Net 11.17
TYPE A95P. Same as above but with phone plug output.
44 E 75960 Net 12.35

CABLE-PLUG ASSEMBLIES

Exact replacements. Shpg. wt., 1 lb.
TYPE C55: For Unidyne models 55S, 55SW.
44 E 75786 Net 6.47

TYPE C56: For Unidyne models 545, 545S and Unisphere models 565, 565S.
44 E 75794 Net 7.64

TYPE C57: For Spher-o-Dyne model 533SB and Unisphere model 585SB.
44 E 75802 Net 5.29

TYPE C58: For Spher-o-Dyne model 533SA and Unisphere model 585SA.
44 E 75810 Net 3.53

TYPE C60: For Unidyne model 580SA.
44 E 75828 Net 6.47

TYPE C61: For Unidyne model 580SB.
44 E 75836 Net 6.47

* See Page 11 for Full Credit Details on Easy Pay Plan

Electro-Voice Popular Microphones

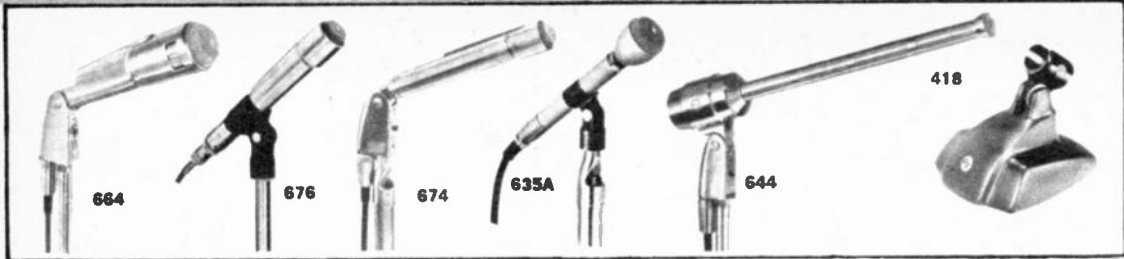

664 "VARIABLE D"® CARDIOID DYNAMIC

A cardioid "Variable D" (variable distance) microphone designed for top quality PA applications. Cardioid pattern provides a significant front-to-back signal ratio to suppress noise, reverberations and feedback. Allows close talking without booming bass, air blasts or distortion. Non-metallic diaphragm is shielded against dust and magnetic particles. Resistant to extreme conditions of humidity, temperature and vibration. Response 60-15,000 Hz. Output level—58db. High impedance easily lowered to 150 ohms without tools. Standard 5/8"-27 thread. Satin chrome finished die-cast case, with ON-OFF switch and 15 ft. 2 conductor shielded cable. 1 7/8" dia. 7 3/4" long. Shpg. wt., 2 lbs.

- 44 E 25328 No Money Down* Net \$3.40
- 664G—Same as above but gold finish.
- 44 E 25338 No Money Down* Net \$6.70
- 664A—Same as above but non-reflecting gray finish.
- 44 E 25351 No Money Down* Net \$3.40

676 CONTINUOUSLY "VARIABLE-D"® CARDIOID DYNAMIC

Radically new design brings professional quality to public address, recording, communications and other general purpose applications. Continuously "Variable-D" principle assures uniform, symmetrical cardioid pattern at all frequencies. Response 60 to 15,000 Hz. Highest discrimination against feedback and unwanted sound. Exclusive 3-position switch offers controlled low-frequency attenuation to overcome rumble and feedback when microphone is used at a distance. Slim design—full view of speaker. Use hand-held or with stand clamp supplied. Rugged die-cast case. Acoustalloy® diaphragm. 150 ohms or Hi-Z; impedance changed by new connector (no tools required). Output—57db. Satin chrome finish. 16' cable. Size: 7 3/8" long x 1 1/4" dia. Shpg. wt., 3 lbs.

- 44 E 25229 No Money Down* Net \$3.40

674 CONTINUOUSLY "VARIABLE D"® CARDIOID MICROPHONE

Professional quality for PA, recording and general purpose uses. Continuously Variable D" feature assures uniform symmetrical cardioid pattern at all frequencies. Response: 60-15,000 Hz. Highest discrimination against feedback and unwanted sound. 3-position switch for low frequency attenuation to overcome rumble and feedback. Slim design. On-off switch. Acoustalloy® diaphragm. Diecast construction. Dual impedance. New connector or allows easy change from hi-Z to low-Z without tools. Output: —57 db. Satin chrome finish. Fits 5/8"-27 stands. 15' cable. Size: 7 7/8" x 1 1/4" Diam. Shpg. wt., 2 lbs.

- 44 E 25724 No Money Down* Net \$3.40

635A BROADCAST DYNAMIC

- Top Quality, Professional Use Microphone

A popular design microphone now redesigned and improved. Omni-directional pick up pattern perfect for use by entertainers and vocalists. For desk or floor stand or hand held use. The rugged steel case is finished in matte satin chrome with magnetic shielding, light weight, slim and attractively styled. 4 stage pop and dust filter eliminates need for external wind screen. Response: 80-13,000 Hz (rising), output—55 db. low impedance. Features Acoustalloy® diaphragm. Supplied with 18' 2 cond. cable and Cannon XL-3 connector. Convenient microphone size: 6" long x 1 3/8" diameter at head. Shpg. wt., 1 1/2 lbs.

- 44 E 25591 No Money Down* Net \$9.20

TYPE 502B MATCHING TRANSFORMER

Matches 150 ohm to Hi Z amplifier. Input 30-20,000 Hz ±1 db. Size 3 3/4" x 1" dia. Shpg. wt., 1 lb.

- 44 E 25666 Net 9.90

DESK STAND

TYPE 418 Desk stand for use with microphones having small type stud, such as 611, 623, 630, 636, 641, 644, 664 and 674. Die-cast base. Gray finish. Shpg. wt., 4 lbs.

- 44 E 25150 Net 8.10

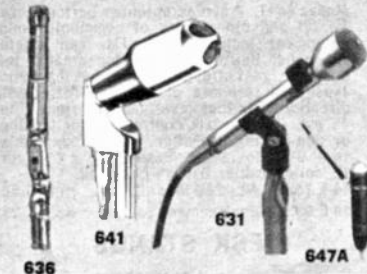

636 "SLIMAIR" DYNAMIC

Slim omni-directional mike for PA or recording. Acoustalloy diaphragm. Output level—58 db. Response 60-13,000 Hz. Selection of Hi Z or 150 ohm impedance made at plug. On-off switch; satin chrome finish. Swivels 90° on base, tapped for 5/8"-27 stand. 16 ft. cable. 1 1/8" dia., 10 1/4" long. Shpg. wt., 2 1/2 lbs.

- 44 E 25161 Net 45.60
- Model 636G—Same as above but gold finish.
- 44 E 25179 Net 48.90

641 DYNAMIC

High output level, high impedance. Ideal for paging, recording, P.A., etc. Integral on-off switch. Freq. 70-10,000 Hz. Output—57 db. With 15 ft. cable, standard 5/8"-27 stand connector. Case is die-cast chrome with gray hi-impact plastic. 4 1/2" x 1 3/4" dia. Shpg. wt., 1 lb.

- 44 E 25575 Net 24.90

631 HAND AND STAND DYNAMIC

High quality entertainers microphone. Omni-directional. Lightweight, rugged, shockproof. Effective 4-stage filter allows closeup use without blasting, pops, or distortion. Silent magnetic on-off switch with removable actuator button. Satin chrome case. Frequency Response: 80-13,000 Hz. Output: —55 db. 16 ft. cable. With stand clamp. Size: 6" L x 1 3/8" head dia., 3/4" shank dia. Shpg. wt., 1 lb.

- 44 E 25732 Hi Impedance Net 37.80
- 44 E 25740 Lo Impedance Net 37.80

647A LAVALIER DYNAMIC

Tiny size with big performance 70-10,000 Hz. Hi-Z or Balanced low-Z. Output level, —60 db. 18 ft. cable. Complete with neck cord. Size 3 1/8" x 3/4" Dia. Shpg. wt., 1 lb.

- 44 E 25195 Net 51.90

Electro-Voice GENERAL PURPOSE OMNIDIRECTIONAL MICROPHONES



719 "PRESS TO TALK" MICROPHONE

A ceramic omnidirectional mike for communications and paging. Integral stand and head of die cast gray and chrome plate. Switch in base for press to talk or in stand for grip control. Switch shorts mike in off position for relay or electronic switching. Hi-Z, output—58 db, 70-7000 Hz response. With 6 1/2' cable. Shpg. wt., 2 1/2 lbs.

- 44 E 25609 Net 17.40

7275R SLIM MICROPHONE

Ceramic element. Comes with desk stand and floor stand coupler. Response: 60-8,000 Hz. Output: —55 db. Hi-imped. Leaf switch to close relay circuit and 3-cond. (1-shielded) cable. 5' cable. Size: 7 3/4" x 1 3/8" x 1 1/4".

- 44 E 25278 Shpg. wt., 1 1/2 lbs. Net 14.70

LAFAYETTE'S Best-Selling Wired Intercom System

DELUXE LAFAYETTE XL-6 SOLID STATE 6 STATION INTERMIX INTERCOM SYSTEM

3 Super Selective Systems:

- Master to Master
- Master to Remote
- Intermixed Master and Remote

XL-6 MASTER

29⁹⁵
ea.

R-6 REMOTE

10⁹⁵
ea.

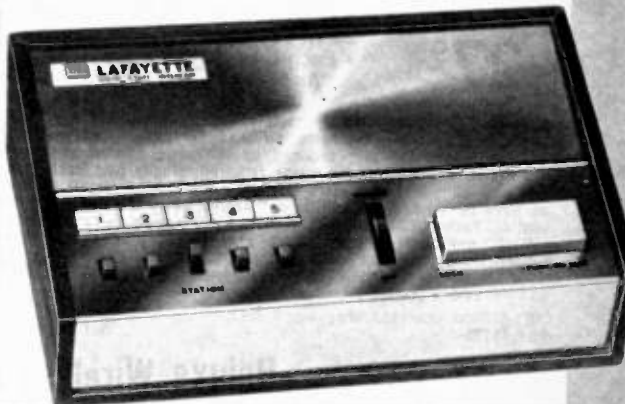
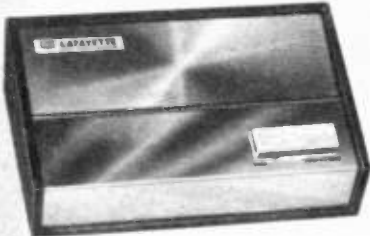

- Balanced Input and Output to Virtually Eliminate Annoying Noise Interference

Designed to fulfill virtually every office, industrial, commercial or home intercom need, Lafayette's deluxe new 6 station intermix system provides complete flexibility and versatility with 3 separate types of installations: (1) MASTER TO MASTER HOOKUP: All Master Intercom System incorporates up to 6 separate master stations enabling 3 private conversations or 6 station conferences to be held. Master can initiate calls to any other Master. (2) MASTER TO REMOTE HOOKUP: Enables 1 Master station to communicate with up to 5 remotes either separately or in a six station conference. Remote can be hooked-up private or non private. Remotes can initiate call back to Master, but cannot talk directly to other remotes. (3) INTERMIX SYSTEM USING UP TO 12 MASTERS AND REMOTES: The number of units in this system may be as high as 12 depending on how many masters are used. For example if 3 Masters are used, each Master has 3 of its selector switches available to call 3 remotes, thus giving a total of 3 Masters and 9 remotes or 12 units in the system. The maximum number of remotes associated with any 1 Master is 6 minus the number of Masters in the system. The Lafayette XL-6 Intercom utilizes powerful advanced solid state cir-

cuitry for "Instant on" operation. incorporates a balanced 40 ohm input and output circuit design. The advantages of this type of design is that the entire system when operating is virtually not susceptible to noise interference. Master unit has 5 individual station selector slide switches, 2 position press to talk—talk/Lock bar, and volume control. Remote unit has 2 position press to talk—talk/Lock bar. Handsome walnut wood cabinet with brushed aluminum finish. Includes junction box for wiring.

WIRING INSTRUCTIONS: In a balanced input and output system both Master to Master or Master to Remote hook-ups use separate 4 conductor unshielded pairs for each master or remote used in the system. Dim.: Master & Remote 7 $\frac{1}{8}$ "L x 2 $\frac{1}{4}$ "H x 4 $\frac{3}{4}$ "D. For 117VAC, 50 Hz. Imported.

99 E 46112 Model XL-6 Master. Shpg. wt., 3 lbs. Net 29.95

99 E 46120 Model R-6 Remote. Shpg. wt., 2 lbs. Net ea. 10.95

100 FT. SPOOL OF CABLE FOR ABOVE SYSTEM

Beldon 8741 — unshielded 4 conductor, vinyl insulated cables 32 E 15707 Net 4.30

LAFAYETTE SOLID STATE 2 STATION INTERCOM SYSTEM



8⁹⁵

- Inter-Unit Tone Calling
- Beautifully Styled
- Simple Plug-in Connecting Cord

Battery operated solid-state 2-station intercom system. Especially useful where AC outlets are not readily available. Complete system includes 1-Master unit, 1-Remote unit, and 70' of interconnecting cable with molded plugs for easy installation. Master unit features On/Off/Volume control plus a Listen/Talk switch. "Beep" tone signaling from either Master or remote operates even when Master is "Off". Has simple provision for stationary wall mounting, or, can be conveniently placed on desk top. 9-volt battery included. Size: 2Hx3 $\frac{1}{2}$ Wx5"D. Shpg. wt., 1 $\frac{1}{2}$ lbs. Imported.

99 E 46245 2-Station System Net 8.95

99 E 60212 Extra 9-Volt Battery Net .21

LAFAYETTE 4-STATION SOLID-STATE INTERCOM SYSTEM



Complete System

17⁹⁵

Includes

- 1 Master Control Unit
- 3 Remote units
- 3—60 Ft. lengths of hook-up wire
- 1—9 volt battery

- Instant Communications—No Warm up, Heat or Hum
- 4-Way Selector Switch—3 Remote Stations
- Remote Tone Call
- 2-Wire Distribution System
- Battery Powered

Deluxe solid state 4-station intercom system that combines smart styling, and portability with high quality performance. All interstation calling is accomplished with one 4-way selector switch. Push-button listen-call on all units. Call signal operates even when master switch is "off". Simple coded interruption of buzzer signal lets master operator know which remote is calling. Cool, efficient solid state master unit runs on a single, economical 9-volt battery. With selector switch in "wait" position battery life is further extended. Master unit has its own volume control with "on-off" switch. Easy hook-up is facilitated by inclusion of three 60 foot lengths of 2-conductor wire with jacks at each end. Just plug in and talk. Additional wire is available at extra cost. See below. Complete set consists of: master control unit, 3-remote units, 9-volt battery and wire. Size: Master: 4 $\frac{1}{2}$ Wx3 $\frac{1}{2}$ "D; Remotes: 2Wx4"D. Imported. Shpg. wt., 2 $\frac{1}{2}$ lbs.

99 E 45551 Complete 4-station System Net 17.95

99 E 60212 Replacement 9-volt Battery (1 Req.) Net .21

32 E 30521 Additional wire. 100 Ft. Coil Net 1.14

Depend on Lafayette For Everything in Electronics

Lafayette Cat. No. 700 161

LAFAYETTE Wireless Intercoms - Plug Into AC Outlets

Solid State Wireless Intercom System

2-Stations
Only

27⁹⁵

- 4 Transistors — No Warm-Up
- Plugs Into Any 117V AC Outlet In Your Home
- Each Unit Is A "Master" — Use As Many As You Need

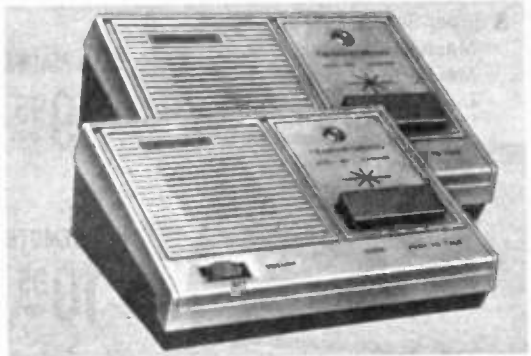

Solid-State 2-station intercom system at an amazingly low, low price. Ideal for use in the home, office, factory, etc. — will connect any two places that are serviced by the same electric company power line transformer. No wiring required, simply plug each unit into any AC outlet and start talking — 4-transistor circuit means no warm-up time. Each unit is a "Master" with a Volume/On-Off control. Push-to-Talk Bar with a "lock-bar" feature for continuous talking, and a pilot light. 2-tone gray-colored plastic case has rubber-tipped base that will not scratch furniture. Overall 6 1/2" x 5" x 2 1/2" H. For 110-120V 60 Hz. AC. Imported. Shpg. wt., 4 lbs. **99 E 45734M 2-Station Intercom System Net 27.95**
Extra Station. Imported. Shpg. wt., 2 lbs. **99 E 45726 Net ea. 14.95**

Deluxe Wireless Intercom System

2-Stations
Only

32⁹⁵

No Money Down*

- Operates from any 117V AC/DC Outlet
- No Wires to Connect
- Ideal for Home or Office
- Add as Many Extra Stations as Desired

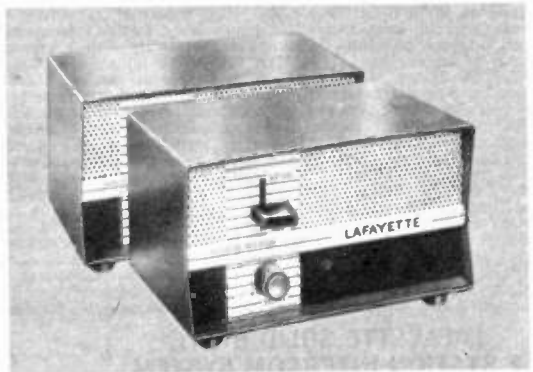

Handsomely styled, these units offer quality performance for home or business use. Each unit features a 3-position bar-control lever: Dictate (for use as "baby sitter," lengthy talking), Talk (has spring return to Listen position), and Listen. No wires to connect — simply plug into any 117V AC/DC outlet. Front panel volume control and pilot light; adjustable squelch control at rear reduces interference during quiet periods. Dependable 3" speaker. Add as many remotes as needed. Imported. Shpg. wt., 10 lbs. **99 E 45478M 2-Station Intercom System Net 32.95**
Extra Station. Imported. Shpg. wt., 5 lbs. **99 E 45445 Net 16.95**

Deluxe Multi-Channel Solid State Wireless Intercom Systems

YOUR CHOICE OF EITHER 2 OR 3 STATION SYSTEMS

- For Up to 3 Simultaneous But Independent Communications Using Separate Channels
- Each Station A "Master" — Use As Many As Needed

Our finest and most versatile wireless intercom systems. Your choice of either deluxe 2 or 3 station systems. No wiring to install, plug into AC outlets on the same electric line between offices, rooms, and even between buildings. 3 channel design permits using up to 3 simultaneous but independent communications using separate channels. Units operating on channel 1 will not interfere with units operating on channel 2 or 3. Since each unit is a master, any number of stations can be set up to form a super-deluxe wireless intercom system. Controls: Press-to-talk bar with "lock-talk" feature for continuous monitoring, channel 1-2-3 selector. Powerful solid-state circuit provides instant-on operation and includes squelch for noise free operation, transformer power supply and pilot light. Handsome high impact plastic case. 5 Transistors, 3 diodes, 1 silicon rectifier, 1 thermistor. Size each station: 5x6 1/4 x 3". For 117 VAC 60 Hz. Imported.

Stock No.	Type of System	Wt.	Net
99 E 46237M	2 Station System	8 lbs.	39.95
99 E 46153M	3 Station System	12 lbs.	57.95
ADDITIONAL SINGLE STATIONS. Wt., 4 lbs.			
99 E 46104			Net 22.95



Set of 2 Stations

39⁹⁵

No Money Down*

Set of 3 Stations

57⁹⁵

No Money Down*

No Wires to Attach —
Just Plug Into Any AC
Outlet and Talk

Bogen and Emerson—Rittenhouse Intercom Systems

NEW BOGEN IE SERIES SOLID-STATE 7 and 13 STATION INTERCOM SYSTEMS

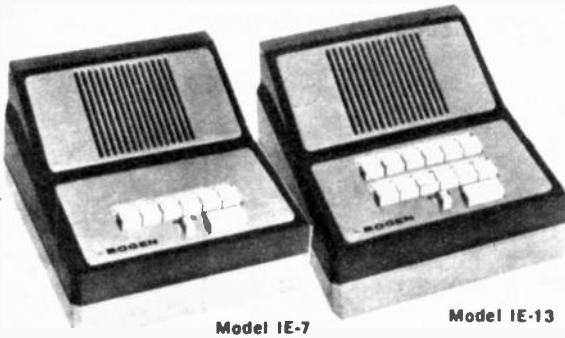

Model IE-7

Model IE-13

ALL MASTER SYSTEM: Consists of a Multiple-Conversation intercom system using up to 7 IE-7 masters or up to 13 IE-13 masters. Any master can call one or more stations. IE-7 and IE-13 masters have volume control, press-to-talk bar with dictate lock, rugged push-push selector switches with identification strips, and compact external power supply that operates from 120VAC 50-60Hz. Wiring Instructions—use unshielded cable with at least one more conductor than total number stations in system.

SINGLE MASTER-MULTIPLE REMOTE SYSTEM: Consists of: 1 IE-7 master and up to 6 RIE-1 remote stations, or 1 IE-13 master and up to 12 RIE-1 remote stations. Master can call one station—or several simultaneously. RIE-1 remote station can originate calls to master, privately or non-privately. RIE-1 remote has press-to-talk bar and privacy switch. Wiring requirements—use 3 conductor unshielded cable between master and each remote.

Size of IE-7, IE-13, RIE-1 are 7 $\frac{1}{2}$ x 6 $\frac{3}{4}$ Wx4 $\frac{3}{8}$ " H. Shpg. wt., (IE-7 and IE-13) 4 lbs., (RIE-1) 3 lbs.

Stock No.	Bogen No.	Item	Net
44 E 12318	Model IE-7	7 Station Master	37.45
44 E 12300	Model IE-13	13 Station Master	46.45
44 E 12292	Model RIE-1	Remote Station	11.99

Stock No.	WIRE FOR BOGEN "IE" INTERCOMS			Net
	Length	Conductor	Weight	
32 E 14525	100 ft.	3 cond. unshielded	— 2 lbs.	3.30
32 E 14566	100 ft.	7 cond. unshielded	— 4 $\frac{1}{4}$ lbs.	8.70
32 E 14582	100 ft.	10 cond. unshielded	— 5 $\frac{1}{4}$ lbs.	10.05
32 E 14947	100 ft.	15 cond. unshielded	— 8 lbs.	18.75

BOGEN HOME INTERCOM SYSTEM



HCM-9
33⁹⁰



HCA-1
32³⁵

HCR-1
10³⁰

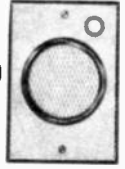

A deluxe home intercom system for built-in mounting in walls. Any combinations of master control stations and HCR remotes totaling up to 9 in a system may be used. Master control stations may call any other control station or remote. Control stations can enjoy complete privacy when desired. Fully transistorized HCA-1 amplifier powers complete system. Output of any AM or FM radio may be connected from its speaker voice coil into the music jack of the amplifier. Any HCM-9 control station can pick up broadcasts thru HCA-1 amplifier. Dimensions HCM-9, HCA-1: 11 $\frac{1}{2}$ x 4 $\frac{1}{2}$ ". HCR-1, HCR-2: 6 $\frac{3}{8}$ x 4 $\frac{1}{2}$ ".

Stock No.	Bogen No.	Item	Net
44 E 12102	HCM-9	Master control station. Shpg. wt., 2 lbs.	33.90
44 E 12110	HCA-1	Amp. for each system, 110-120v. Wt., 3 lbs.	32.35
44 E 12193	RBAF	Flush Mounting box for HCA-1, Wt., 3 lbs.	6.70
44 E 12136	HCR-1	Remote. Shpg. wt., 1 lb.	10.30
44 E 12144	RBM-F	Flush Mounting box for HCM-9, Wt., 2 lbs.	5.10
44 E 12151	HCR-2	Remote with doorbell button. Wt., 1 lb.	11.65
44 E 12169	RBR-F	Flush mounting box for HCR-1, HCR-2. Shpg. wt., 1 lb.	3.00

WIRING REQUIREMENTS

Run an unshield, cable in which the number of twisted pairs is 4 more than the total of control stations and remotes in the system. Between amp. and closest control station run a 3 pair twisted cable; between each remote station and the most convenient control station run an unshielded pair.

Stock No.	Belden No.	Cond. (pair)	wt./100' coil	Net
32 E 15761	8740	2 (1 pair)	1 $\frac{3}{4}$ lbs.	2.55
32 E 15787	8741	4 (2 pair)	2 $\frac{3}{4}$ lbs.	4.30
32 E 15803	8742	6 (3 pair)	3 $\frac{1}{2}$ lbs.	5.65
32 E 15829	8743	12 (6 pair)	5 $\frac{3}{4}$ lbs.	9.00
32 E 15860	8754	26 (13 pair)	10 lbs.	18.00

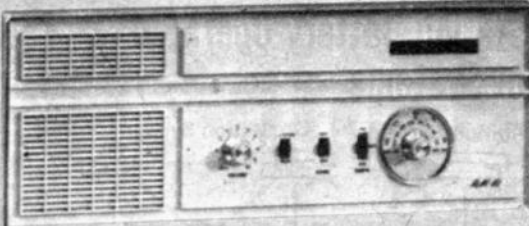

RM-16 Master



RI-17 Remote

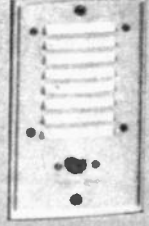

RO-14 Remote

EMERSON-RITTENHOUSE SOLID-STATE AM/FM HOME RADIO-INTERCOM SYSTEM

- AM-FM Master Unit Features Powerful 17 Semi-Conductor Solid State Circuitry with Tuned RF Stage For Improved FM Performance
- Radio Is Silenced Automatically When Intercom Calls Are Made From Any Station

Handsomely styled FM/AM home radio intercom system fills your home with the pleasant sounds of music, entertainment and news. Intercom permits instant room-to-room communication, monitoring and door answering. Radio is silenced automatically when intercom calls are made from any station. Twelve transistors and 5 diodes with tuned RF stage for improved FM performance. Up to 8 remote stations may be connected to master. All stations are designed for built-in installation in walls of 2" or more thickness. Color coded wiring simplifies connections. Powered by U.L. listed low voltage transformer (supplied). Complete system includes 1 RM-16 master

* See Page 11 for Full Credit Details on Easy Pay Plan

Complete System
Only

99⁹⁵

COMPLETE SYSTEM INCLUDES

- 1—AM/FM Master Unit
- 3—Indoor Remote Stations
- 1—Entrance Remote Station
- 1—Installation Kit with Plaster Frames For Above Equipment, AM/FM Antenna, Low Voltage Transformer and 165 ft. 3-Wire Cable

station with off-white finish and gold trim, 3 each RI-17 indoor stations, 1 RO-14 weatherproof door entrance station, AM and FM antenna, RT-28 low voltage transformer, plaster rings for above and 165 ft. coil of 3-wire intercom cable. Dimensions: Master Unit—14 $\frac{1}{2}$ x 5"; RI-17: 7 $\frac{3}{4}$ x 4 $\frac{1}{2}$ "; RO-14: 3 $\frac{3}{8}$ x 5 $\frac{3}{8}$ ". Shpg. wt., 14 lbs.

44 E 46019WX No Money Down* Net 99.95

ADDITIONAL STATIONS AND WIRE FOR ABOVE SYSTEM

44 E 46027W RI-17 Indoor Remote, Shpg. wt., 2 lbs. Net 7.50

44 E 46035W RO-14 Entrance Remote, Wt. 1 $\frac{1}{2}$ lb. Net 6.50

32 E 14525 100' 3-cond. Cable, Shpg. wt., 2 lbs. Net 3.30

Deluxe LAFAYETTE Private Telephone Intercom Systems

Selective Ring—Selective Talk 10-Station Telephone Intercom System

100% Privacy—Up to 5 Simultaneous Conversations

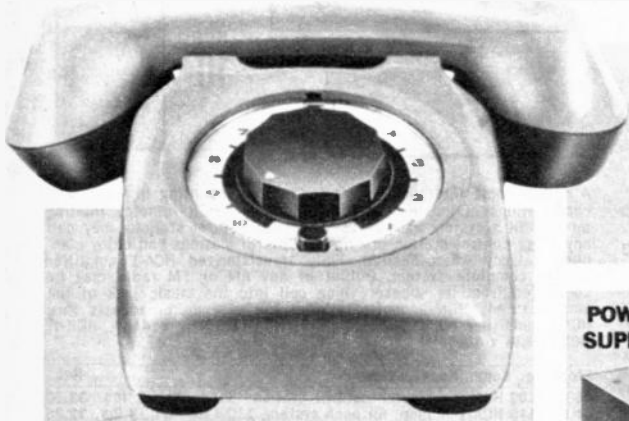

ONLY
24⁹⁵
PER PHONE

POWER SUPPLY **12⁹⁵**



- Immediate Operation—No Dialing
- Selective Ring—Selective Talk
- Battery or AC Operated



Completely private 10 station ultra-selective intercom system. Unit is styled like regular telephone, complete with coiled cord and junction box. Its functional design permits positioning on desk or hanging from the wall. No need to waste time dialing, simply set pointer to desired station, push ring button and speak. Interruptions or listening in by other stations is impossible. Handles up to 5 simultaneous conversations. Conference calls are available by one station calling another until all are on the line. Frees your regular telephone lines for outside calls. Power for all units in the system is obtained from a central location, either from a battery source or the AC power adapter listed below. Low power consumption on either AC or DC: 100 ma calling, 25 ma talking. Finished in beige plastic. Imported.

99 E 45601 10 Station Lafayette phone. Shpg. wt., 3 1/8 lbs. Net ea. 24.95
19 E 45617 AC Power Supply for system Net 12.95
32 E 48668 1 1/2 V Battery for DC operation—6 required Net ea. .91

In the above 10-station system, up to 5 private conversations can be held simultaneously—or any station may converse with any other station.

WIRING INSTRUCTIONS

The total number of unshielded conductors common to each phone is 2 more than the total number of phones in the system.

32 E 14988 100 ft. length. Belden 8456, 10 cond. unshielded Net 10.20
32 E 14970 100 ft. length. Belden 8457, 12 cond. unshielded Net 10.95

Solid-State All Master 2 and 4 Station Battery-Operated Telephone Intercom Systems

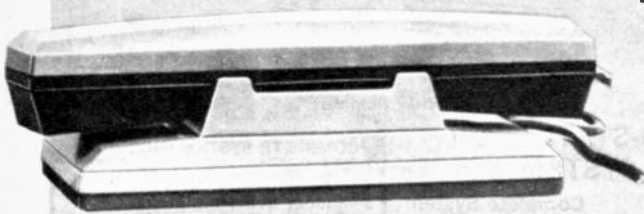

2 Station System



4 Station System

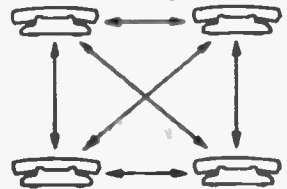

- Simple Call and Push to Talk Buttons
- Operates for Distances Up to 1000 Yards
- Each Phone has Its Own Junction Box for Wiring

ONLY
19⁹⁵

SALE! Now **34⁹⁵**
WAS 39.95
1969 Catalog 690

2 STATION TELEPHONE INTERCOMS SYSTEM: Simple to install, provides all the privacy of regular telephones. Solid state circuitry transmits your voice over amazingly long distances. Battery powered. Operates on 4 "D" batteries. A separate call button and a single push-to-talk button conveniently located on the phone-piece. Buzzer indicates when you are being called. Requires 2 conductor cable for hook-up. Complete with 4 "D" batteries, battery case, and 30 wire staples. Size: each phone 9L x 2 3/4H x 3 3/4"D. Imported. Wt., 2 lbs.

99 E 46211 Net 19.95

100' 2 conductor cable for 2 station system. Shpg. wt., 2 lbs.
32 E 30521 Net 1.14

DELUXE 4 STATION TELEPHONE INTERCOM SYSTEM: An extremely flexible system for inter-office communications—greatly relieves traffic on over-burdened office switchboards. Operates on 2 "D" batteries. Each phone-piece contains a separate call button and 3 station selector buttons. No need to waste time dialing. You can have private or conference calls. Buzzer signals when you are being called. Requires 6 conductor cable. With batteries and battery case and 90 wire staples. Size: each phone: 9"L x 2 3/4"H x 3 3/4"O. Imported.

99 E 46220 Shpg. wt., 8 lbs. No Money Down Net 34.95
99 E 62564 Extra "D" batteries for above Systems Net ea. .15
Belden 8742—100 ft. length 6 conductor cable for 4 station system.
32 E 150C3 Shpg. wt., 100 ft., 3 1/2 lbs. Net 5.65

LAFAYETTE Telephone Amplifiers and Bogen Telephone Intercoms

BOGEN TELEPHONE INTERCOMS



(A) TQ SERIES—
SELECTIVE RING—COMMON TALK

AS LOW AS
29⁰⁵



(B) TSL SERIES—
SELECTIVE RING—SELECTIVE TALK

AS LOW AS
40⁷⁵

No Money Down*

(A) TQ SERIES—SELECTIVE RING—COMMON TALK: allows only 1 conversation at a time. "Conference" feature lets you talk to as many stations at once as there are receivers in the system. Two models are available to handle up to 13 stations. All stations are housed in impact-resistant gray plastic. Rubber feet on the base prevent sliding. Each handset has a 4-ft. cord, self-coiling to prevent snarling. Each station is supplied with a 6-ft. master cable and a junction box for easy wiring and supplied ready for desk or wall mounting. An adhesive push-button-directory tape is supplied with each station, also includes provisions for paging with optional adapter. Each TQ system requires a PRS-1A Power Supply (117 VAC, 60 cycle). Shpg. wt., 5 lbs. per unit.

TQ6A 6-Button, 7-Station Handset Less wire
44 E 12045 Net each **29.05**

TQ-12A 12-Button, 13-Station Handset less wire
44 E 12052 Net each **32.65**

PRS-1A Power Supply (1 req. per system) Shpg. wt., 4 lbs.
44 E 12060 Net each **25.00**

(B) TSL SERIES—SELECTIVE RING—SELECTIVE TALK: Bogen TSL Phones will permit you to reach other individuals in their offices without depending upon an overburdened telephone switchboard. 100% trunkage permits as many as 8 conversations to take place at the same time, making these phones an ideal choice for busy applications. Select the station with which you wish to converse, press the ring button. When the called party lifts his handset, he is in direct communication with you. Phones may be desk or wall mounted. Each phone is furnished with snarl-proof handset cord, 6' master cable and junction box. Also includes provisions for paging with optional adapter. PRS-16 Power supply required to power each system.

44 E 12011 TSL-8 8-station phone, less wire Net **40.75**

44 E 12029 TSL-16 16-station phone, less wire Net **48.25**

44 E 12037 PRS-16 Power supply (1 required per system) Net **41.55**

WIRE REQUIREMENTS FOR BOGEN PHONES

Use 3 more unshielded conductors than the total number of phones in the system. Those listed below may be used between phones.

32 E 14525	3 conductor unshielded per 100'	3 lbs.	3.30
32 E 14502	9 conductor unshielded per 100'	5½ lbs.	10.05
32 E 14970	12 conductor unshielded per 100'	5½ lbs.	10.95
32 E 14954	25 conductor unshielded per 100'	11½ lbs.	28.50

Connect PRS-16 power supply to any junction box with a short 3 conductor cable.

"LISTEN-IN" DUAL TELEPHONE DEVICE

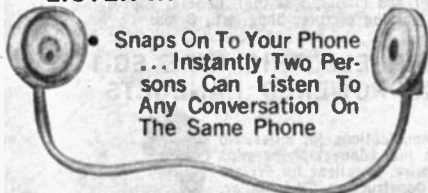

• Snaps On To Your Phone
... Instantly Two
Persons Can Listen To
Any Conversation On
The Same Phone

3⁵⁰



Share the pleasure of long distance calls. Use your regular phone as you would normally. Just snap "Listen-in" over earpiece, 2nd listener simply presses receiver of "Listen-in" next to his ear and he is ready to listen in on conversation. Other uses: For better listening in noisy areas! Hear thru both ears—shut out noise. Ideal for hard of hearing—Teenagers can use listen-in for extra "Party-Line" fun. Imported Shpg. wt., 1 lb.

44 E 27019 Net **3.50**

MINIATURE "SNAP-ON" LAFAYETTE SOLID STATE TELEPHONE AMPLIFIER AND TELEPHONE HEARING AID



- Ideal For Hard Of Hearing
- Portable — Carry It In Your Pocket
- 4 Transistor Circuitry

SALE
6⁹⁵

Was 7.95
1969 Cat. 690



Miniature, portable, snap-on telephone amplifier because of its compact size can be carried in a pocket or purse. Designed to fit any modern telephone. Just insert battery (supplied) into battery holder. Attach amplifier to the receiver of the telephone you are using—and turn up the volume control of the amplifier. IDEAL FOR HARD-OF-HEARING. Specifications: 4 transistors, 2" dynamic speaker. Size 2½" round, 1" depth. With battery and snaparound band. Imported.

99 E 92082 Shpg. wt., 1 lb. Net **6.95**
Eveready E90 Replacement Alkaline Batt.ry
32 E 48929 Net **.33**

LAFAYETTE SOLID STATE TELEPHONE AMPLIFIER



only
6⁹⁵

with private earphone, batteries

- Several People Can Listen in on Conversation Simultaneously
- 2½" PM Speaker
- Battery Operated

Efficient battery-operated telephone amplifier for use with any type of telephone. Amplifies incoming voice and projects it through a 2½" PM speaker. Suction cup on pickup coil attaches easily to telephone and makes permanent installation unnecessary. On-off switch and separate volume control permits adjustment of volume to desired level—several people may listen in on a conversation at the same time. Powered by 4 penlite batteries (supplied). Size: 2½x3x4¼". Imported. Shpg. wt., 2 lbs.

99 E 91308 Net **6.95**
99 E 62580 Replacement "AA" Type Batteries (4 req.) Net **.10**

Deluxe LAFAYETTE EASY-PHONE TELEPHONE AMPLIFIER

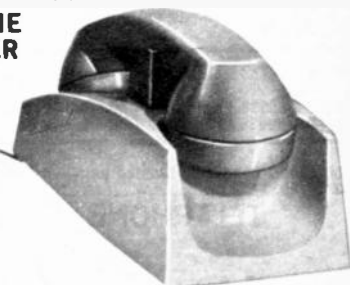

12⁹⁵
with
batteries

- 4-Transistors
- No Warm-up, Instant Operation
- No Pick-ups To Connect
- Amplifies Telephone To Room Volume

The Easy-Phone amplifier is ideal for group conversation with one telephone in the room. Easy to operate: simply place the telephone on the amplifier, adjust the volume and everyone can listen through the separate matching speaker system, leaving both hands free for writing or typing. The Easy-Phone utilizes a 4-transistor battery powered amplifier and inductive pick-up, in an attractive plastic case. Features separate 3" speaker, volume control, on/off switch. Imported. Dimensions — Amplifier Section: 8W x 3¾H x 3¾D. Speaker Section: 3½W x 2½H x 4¼D. Supplied with batteries. Shpg. wt., 3 lbs.

99 E 92066 Net **12.95**
99 E 62580 Replacement "AA" Type Batteries (4 req.) Net **.10**

* See Page 11 for Full Credit Details on Easy Pay Plan

Telephones and Accessories for Private Systems

*Authentic Lafayette Reproduction of
a French Cradle Phone*



For Only
39⁹⁵

An exquisite reproduction of the classic turn-of-the century French Cradle Phone. Adds a touch of continental charm to your home—your phone will become a conversation piece. Simple hook-up. Ideal for private phone systems, extension, or intercoms. Ready to use...equipped with bell ringer, induction coil, dial, horn, mouthpiece handset, 5-ft. cord and plug. Finished in beautiful Ivory with gold trim. Imported. Shpg. wt., 9 lbs.

99 E 46328 \$5 Monthly Net 39.95

30 FT. TELEPHONE EXTENSION CORD

• Ideal Extension Cord for Use
With Phones Listed
on this Page

2⁴⁹



Add flexibility to your telephone intercom. Now be able to move your telephone intercom from room to room. 30 feet of telephone extension cord with standard 4-pin plug and jack. Color coded cord to match screw terminals on plug and socket. Imported. Wt., 1½ lbs.

99 E 45395 Net 2.49

TELEPHONE PLUGS AND JACKS

44 E 60036 Phone Plug (Imported) 2 oz. Net .59
44 E 60028 Phone Jack (Imported) 2 oz. Net .59

100 Feet 2-Conductor Twisted pair—unshielded telephone wire.

32 E 13030 Net 2.45

TELEPHONE OUTLET KIT

Only **1⁴⁹**



Complete telephone outlet kit with telephone jack, mounting bracket, and wall plate for standard outlet box. Flush mounted.

44 E 86007 Shpg. wt., 6 oz. Net 1.49

3 AND 4-CONDUCTOR COILED CORDS

As low as **1²⁹**



4 conductor coiled cord extends to 5 feet, retracts to 18 inches. All four conductors are vinyl insulated and terminated with metal spade lugs at each end. Ideal for telephone, push-to-talk microphone, headphones and many other applications. Imported. Shpg. wt., 7 oz.

99 E 46005 Net 1.39

3 Conductor Coiled Cord. Same as above but only 3 conductors.

99 E 46013 Net 1.29

"PRINCESS-DUTCHESS" TYPE DIAL TELEPHONE



Only **29⁹⁵**

With 6 Ft. Coiled
Cord and Plug

• For Use As Intercoms Or Private Systems.

Add a touch of elegance to your decor with the "Princess-Dutchess" type dial phone. Can be used to make complete private systems or intercoms. Comes complete with built-in ringer, metropolitan dial (bells and numbers), ear piece, transmitter, and 6 ft. coiled cord with plug. Beautiful pearl white finish. Imported. Shpg. wt., 5 lbs.

44 E 17010 Net 29.95

DIAL PHONE

Have your own
Private Intercom

8⁹⁵

• For Intercoms,
Private Systems



Popular modern dial phone. Can be used to make complete private systems. Equipment taken from service, reconditioned and ready to work. Simple 3-wire hook-up. Complete with handset, dial bell, induction coil and connecting cable. General appearance may vary slightly from catalog illustration. Shpg. wt., 8 lbs.

44 E 18018 Net 8.95

CRADLE PHONE

5⁹⁵



Popular type Stromberg-Carlson cradle phone. Can be used as private telephone intercom. Reconditioned and ready to work.

Consists of handset and cradle, less dial. General appearance may vary slightly from catalog picture. Shpg. wt., 6 lbs.

44 E 65019 Net 5.95

WESTERN ELECTRIC TYPE SG-1 SOUND POWERED HANDSETS

Simple 2-way communications for miles. No batteries required. Just connect phone clips to two conductor wire. Excellent for Private Intercom System, Construction, TV Installer, Motels, or Camps, etc. Any number of handsets can be installed on one line. Complete with retractable cord and alligator clips. Shpg. wt., 4 lbs.

44 E 18034 Net ea. 7.95

Set of two Handsets with 100 ft. of 2 Conductor Inside-Outside Wire.

44 E 18042 Net 15.95



Telephone Answering, Recording, Automatic and Dialing Equipment

CROWN 4400 Solid-State Telephone Answering and Recording Machine

featuring Built-in Cassette
Tape Recorder

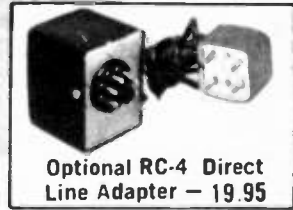

Optional RC-4 Direct
Line Adapter — 19.95

Deluxe, complete self-contained telephone answering and recording machine with built-in cassette recorder and phone cradle. Answers your phone with a 20 sec. prerecorded message and automatically receives a message from the caller. Model 4400 can take up to 50 messages on a 90 minute tape. Features simple push-button controls. When a message is finished communication is cut off and another message can be received. With an optional RC-4 line adapter (see below), the 4400 can be plugged directly into the phone line, bypassing the phone itself. The 4100 can also be used as a message repeater or as a separate Tape Recorder. Comes housed in a fine-grained walnut wood cabinet. Size: 12 $\frac{1}{2}$ " x 10 $\frac{1}{4}$ " x 3 $\frac{3}{4}$ ". Uses Standard Cassette cartridges. Comes with 60 min. cassette, microphone, and phone cradle. Imported. For 117VAC 60 Hz. 27 E 72135WX Shpg. wt., 11 lbs. Net 199.95

27 E 72150 Model RC-4 In-Line Adapter. Shpg. wt., 1 lb. Net 19.95
Accessory Cassette Recording Tapes for Model 4400
28 E 01123 Lafayette 60 Min. Cassette. Imported. Net 1.19
28 E 01207 Lafayette 90 Min. Cassette. Imported. Net 1.99

Only **199⁹⁵**
No Money Down*

With Dynamic Mike, Phone Cradle, 60 Min Tape Cassette

- Requires No External Recorder
- Records Up To 45 Second Individual Incoming Messages
- Can Take Up To 50 Messages On A 90 Minute Tape Cassette
- Can Also Be Used As Outgoing Message Repeater

NEW! CROWN 4100 Automatic Telephone Answering and Message Taking Machine



Only
119⁹⁵
No Money Down*

Records Incoming
Messages Up To
1 Minute In Duration
With Any
Tape Recorder†

Reliable low cost automatic telephone answering and message taking device for home as well as business. Simply put your phone on the cradle and then connect the 4100 to a tape recorder that operates with a remote control mike input.† No connections have to be made into the telephone line. Answers phone callers with up to 60 second pre-recorded message. Incoming phone calls are recorded for up to 1-minute in duration. Can be played back at a later time at your leisure. Can also be used as a message repeater. With AC/DC remote control terminal, recording switch, and built-in mike. For 110VAC 60 Hz. Imported. Shpg. wt., 6 lbs.

27 E 72143WX Net 119.95
Model RC-4 In-Line Adapter. Permits 4100 to be plugged directly into phone line, bypassing the phone itself. Shpg. wt., 1 lb.
27 E 72150 Net 19.95
Extra 1-Minute Message Tape Cartridge For 4100.
27 E 72101 Net 4.95

PRESTODIAL™ Automatic Telephone Dialer

No More Looking Up Phone Numbers

- Computerized Number Memory and Automatic Dialing
- Dials Local, Long Distance, Inter-Office Calls
- Fits All Telephones

At a press of a button talk to Police, Fire House, Doctor, Emergency Services, friends, relatives, business associates, or up to 36 pre-determined phone numbers. The PRESTODIAL uses no magnetic tapes, no cards. Numbers are stored in a "memory bank" consisting of 36 unbreakable cycolac® disks. The phone caller slides a pointer on the visual index of the memory bank to the name he wishes to call, picks up the receiver, and presses a single button. The PRESTODIAL then dials the call automatically—and correctly. Each PRESTODIAL disk will handle 14 digits—or more. This permits the automatic dialing of even the most complex long distance phone calls—also equally useful for frequently called inter-office numbers. Works with all phones. One simple connection. Comes complete with programmer, memory bank, and 42 memory disks. Programmer contains dial and cutter for cutting a permanent disk which will contain the required telephone number. Dim. of memory bank: 8 $\frac{1}{2}$ " x 4" x 3 $\frac{1}{4}$ ". For 110V., 60 Hz AC. Shpg. wt., 6 lbs.

44 E 54013 Net 99.95
Package of 12 extra disks. Shpg. wt., 1 lb.
44 E 54021 Net 3.95



99⁹⁵

No Money Down*
Includes Programmer,
Memory Bank,
42 Memory Discs

* See Page 11 for Full Credit Details on Easy Pay Plan

Lafayette Cat. No. 700 167

Personal Solid State Portable TV Sets

NEW

Panasonic AN-409T
Portable TV with Digital Clock



- 9 Inch Picture—Measured Diagonally
- 3½ Hour Shut-Off Timer
- Channel Coverage: VHF 2-13, UHF 14-83
- Detachable Black Front Glass

99⁹⁵

Tomorrow's look featuring built-in digital clock. Up to 3½ hour sleep timer with automatic shut-off. 38 square inch viewing area. 90° deflection aluminized picture tube plus 10-tube 8-solid-state component circuitry delivers sharp "black and white" pictures. Instant On with "one touch" On/Off power switch. Sliding vertical controls for contrast, brightness and pre-set volume. VHF-UHF antennas. 3" up-front speaker. With earphone and retractable handle. Charcoal grey, ivory trim. For 117 VAC., 60 Hz. 9¾ x 15 x 11"D. Shpg. wt., 14 lbs. Imported.

17 E 31561WX No Money Down* Net 99.95

NEW

Panasonic Model TR-415B Mini
Solid-State Battery/Electric TV



129⁹⁵

With Batteries,
AC Adapter/Charger,
Snap-On Cover

- Slide Rule UHF Tuning
- 5 Inch Picture—Measured Diagonally (16 Sq., Inches)
- Channel Coverage: VHF 2-13, UHF 14-83

The new look in Battery/Electric miniature portable TV viewing. Modern design and solid-state reliability make for superb performance and lasting reliability. Operates on 117VAC 60 Hz or on a set of Panaloid Rechargeable Batteries (supplied). Gives up to 100-hours of portable TV viewing. Features dark tinted glass to reduce annoying glare and reflections, slide rule VHF Tuning, telescoping antenna for VHF, Loop Antenna for UHF, big 2½ dynamic front mounted speaker, earphone jack. Handsome decorator Black accented cabinet with silver trim and fold down handle. Size: 9½ x 6¾ x 8½". For 110-120VAC 60 Hz. Imported. Shpg. wt., including batteries 15 lbs.

17 E 31553WX No Money Down* Net 129.95

Sony TV-720U
Portable TV

109⁹⁵

With Earphone,
Loop Antenna
for UHF
and Built-In
Battery Charger

- 7" Picture—Measured Diagonally
- Operates On Battery or AC
- Channel Coverage: VHF 2-13, UHF 14-83

Rich, contemporary styling in ebony and gleaming chrome. Operates on 117V., 60 Hz AC; optional rechargeable 12-volt battery, or 12VDC car/boat battery. Black 7-inch diagonal screen gives superb contrast. All solid-state circuitry that includes new passivated mesa transistors and a forward AGC system for sensitive reception. Built-in UHF telescoping antenna and front mounted speaker. With earphone, UHF loop antenna, built-in battery charger. Size: 9¾x9x9x11¼"D. For 117V., 60 Hz AC. Imported. Shpg. wt., 11 lbs.

17 E 32650WX No Money Down* Net 109.95

NEW **Sony TV-920U**
Portable TV

129⁹⁵

With Earphone,
Sun Visor, Front
Cover, and Built-
In Battery Charger

- 8" Picture—Measured Diagonally
- Operates On Battery or AC
- Channel Coverage: VHF 2-13, UHF 14-83

Weights only 10 lbs.! Features 8" sunglass picture tube (measured diagonally) for perfect outdoor and indoor viewing. 25 transistors plus 13 diodes assures sensitive reception even in fringe areas. Operates on all power sources: optional rechargeable 12 volt battery; 12VDC car/boat battery, or 117V., 60 Hz AC. Built-in VHF telescoping antenna, front mounted controls, push-pull on/off switch and front mounted speaker. With earphone, VHF telescoping antenna, built-in battery charger. Size: 10H x 9W x 8¾"D. Imported. Shpg. wt., 12 lbs.

17 E 32605WX No Money Down* Net 129.95

Sony TV-110V
Portable TV

139⁹⁵

With Earphone,
Loop Antenna for UHF,
Snap-In Sunglass Filter

- 11" Picture—Measured Diagonally
- Operates On Battery or AC
- Channel Coverage: VHF 2-13, UHF 14-83

Big 11" screen measured diagonally. Lightweight enough to be carried anywhere. Snap-in sunglass filter provides bright, glare-free reception in any light. Super sensitive solid-state circuitry. Built-in VHF adjustable telescoping antenna. UHF loop antenna. Front mounted oval speaker. 27-transistors, 15-diodes, 1-rectifier. Contemporary styling in black with silver trim. Size: 11½ x 11¼ x 11½"D. Imported. Shpg. wt., 17 lbs.

17 E 32791WX No Money Down* Net 139.95

ACCESSORIES for SONY PORTABLE TV'S

Model BP/7 564. Shoulder rechargeable battery pack. Net 22.95

17 E 32296 Shpg. wt., 3 lbs. Net 22.95

Model OCC-2AW. Car battery cord. For 12V/neg. ground systems. Net 14.95

17 E 32304 Shpg. wt., 1/2 lb. Net 14.95

Model YCA-14. Car window antenna. Shpg. wt., 1 lb. Net 22.95

17 E 32601 Net 22.95

Deluxe Personal Black & White, and Color TV Sets

NEW Personal Portable UHF/VHF TV Set



69⁹⁵ UL Listed
With Earphone for Private Listening

- 9 Inch Viewable Picture—Measured Diagonally
- 82 Channel UHF/VHF Reception

Perfect for portability. Styled in a modern mood—rich walnut grain with champagne gold trim. Transistorized (both tube and solid-state) circuitry. 44 square inch, 90° deflection, aluminized picture tube. Precision-engineering for top reception anywhere...even in fringe areas! Front-mounted 3" speaker for fine sound. Front-mounted controls for greater convenience. Separate UHF and VHF tuning knobs. With "Split-Second Start" for instant picture...instant sound. Telescopic VHF and loop UHF antenna. Earphone and jack for personal listening. Size: 9¼ x 13¾ x 9¾"D. For 117 VAC, 60 Hz. Imported. Wt. 18 lbs.

17 E 53128WX No Money Down* Net 69.95

NEW Personal Portable UHF/VHF TV Set



79⁹⁵ UL Listed
With Earphone for Private Listening

- 12 Inch Viewable Picture—Measured Diagonally
- 82 Channel UHF/VHF Reception

Handsome, lightweight, transistorized "personal" television for true portability! Big 75 sq. in. viewing area (12" diag. measurement). 82-channel reception lets you enjoy all stations, present and future. Split-second start—instant picture, instant sound. 110° aluminized picture tube produces rich blacks and white, and brilliant high-lights. Separate UHF and VHF tuning, plus VHF fine tuning control allows accurate station selection on all channels. Complete with built-in 3¼" dynamic oval speaker, VHF telescopic unipole antenna, and a rear mounted UHF loop antenna. Earphone for private listening. For 117VAC, 60 Hz. Imported. UL listed. 13¾ x 13¾ x 10¾"D. Shpg. wt., 19½ lbs.

17 E 53136WX No Money Down* Net 79.35

Personal Portable UHF/VHF TV Set



109⁹⁵ UL Listed
With Earphone for Private Listening

- 19 Inch Viewable Picture—Measured Diagonally
- 82 Channel UHF/VHF Reception

Quality portable TV with big 184 sq. in. viewing area. Attractive, slimline cabinet in off-white with black and chrome trim. Non-glare, 114° aluminized picture tube produces sharp, crisp black and white pictures. 82 channels for full UHF/VHF coverage. Powerful front mounted 6¼ x 2" dynamic speaker. Convenient, fold-away carrying handle for easy portability. AFC and keyed AGC circuits for maximum stability in reception. Includes: VHF dipole and UHF loop antennas and earphone for personal listening. Size: 17H x 21¾W x 13¾"D. For 117VAC, 60 Hz. U.L. Listed. Imported. Shpg. wt., 34 lbs.

17 E 53078WX No Money Down* Net 109.95

NEW Panasonic CT-64P Portable UHF/VHF Color TV Set



319⁹⁵

- 15 Inch Viewable Picture—Measured Diagonally
- Automatic Degaussing
- 82 Channel UHF/VHF Reception

Experience the thrill of viewing your favorite TV shows in their magnificent, "true-to-life" colors. Features: Exact-O-Vision, for effortless color fine tuning; Set and Forget tuning, for custom-tuning and automatic lock-in of picture on each channel; Speed-O-Vision, for instant picture and sound. Sensitive dipole VHF and bow tie UHF antennas. Pull in strong, steady signals even in fringe areas. Dynamic 5" oval speaker provides rich, full-bodied sound. Earphone for private listening. Size: 21¾ x 15¾ x 17¾"D. For 117 VAC, 60 Hz. Imported. Shpg. wt., 52 lbs.

17 E 31579WX No Money Down* Net 319.95

NEW Panasonic AN-46 UHF/VHF TV Set



99⁹⁵ • 15 Inch Viewable Picture—Measured Diagonally
• 110° Deflection Aluminized Picture Tube

Lightweight portable with a big 15" screen (measured diagonally). Advanced transistorized circuitry. Set and Forget tuning plus Speed-O-Vision controls. Dynamic Speaker is front-mounted. Sensitive VHF telescopic and UHF loop antenna. Retractable Handle. Molded grey and charcoal cabinet. Size: 14 x 20 x 11½"D. For 117 VAC, 60 Hz. Imported. Wt., 23 lbs.

17 E 31587WX No Money Down* Net 99.95

Deluxe TV Table Kits

For Color TV Sets: Contemporary styling. Designed for all color TV sets as well as B & W. Oiled walnut wood finish. Ball casters. Width 25½", depth 16", height 19". Easy-to-assemble. Shpg. wt., 15 lbs. 17 E 39010W Net 27.95

For Black and White Sets: In genuine oiled walnut. Rigid construction. Easy-to-assemble with full magazine shelf. Overall height 31", height to shelf 26½", width 25", depth 12". Includes extra wide coated casters for easy mobility. Shpg. wt., 9 lbs. 17 E 39028W Net 17.95

* See Page 11 for Full Credit Details on Easy Pay Plan

Closed Circuit TV Cameras and Detection Devices

Deluxe Solid State Closed Circuit Television Camera

**For Sales Promotion
For Security
For Surveillance**

High quality, moderately priced CCTV camera that has unlimited applications in industry, business, education, institutions, and the home. Easy to install—all cables supplied are terminated with connecting plugs and leads. Simple to operate—can be used with either a commercial video monitor or any standard television set. Solid state circuitry—power consumed is very low. Provides cool and dependable operation. Lightweight, compact size permits inconspicuous mounting. Once focused, the camera needs no further attention. Automatic Eye (through the lens light control). Provisions for hooking up an intercom for intercommunications between CCTV camera and television receiver location. Specifications: Composite video output: 1.4V P-P to 2.2v P-P; RF modulated: more than 50 mv at 75 ohms; Scanning frequencies: Horizontal-15.750 kHz Vertical-50-60 Hz synchronized to power line. †Horizontal resolution: more than 400 lines at center. †Vertical resolution: more than 280 lines at center. Camera comes complete with 25 mmf/1.8 lens with adjustable iris, C-mount, lens cap, vidicon cap, 32 ft. 75 ohm twin lead, 75:300 ohm line transformer and instruction manual. For 105-125 VAC, 50/60 Hz. Size: (less lens) 6¼H x 3¼W x 10½D. Imported. Shpg. wt., 7 lbs.



Now

199⁹⁵ No Money Down*

- Use With Any Home TV Set or Commercial Monitor
- Switchable Output Signals, Composite Video: up to 2.2v P-P at 75 ohms, RF Modulated: 50 mv
- Automatic Eye
- Provision For Intercom Permits Simultaneous Sound with RF Video Signal

44 E 08019WX Net 199.95

Heavy Duty Tripod for CCTV Camera. Shpg. wt., 2½ lbs. Net 11.95

15 E 87013 Net 11.95

†Based on standard television test chart with 300 lux illumination at center.

LAFAYETTE 7735A VIDICON TUBE FOR CLOSED CIRCUIT TV CAMERAS

A small 1" diameter camera tube for televising live scenes in many industrial closed circuit TV systems. Its high sensitivity produces high quality pictures under normal room or industrial area lighting conditions. Has 600 to 900 line resolution. Size: 6¼"l. x 1" dia. Imported. Shpg. wt., 1½ lbs.

- Widely Used in Concord, Panasonic, Unimetric and Other CCTV Cameras

Only **49⁹⁵** No Money Down *



99 E 38022L Net 49.95

FM TRANSMITTER DETECTOR

- All Range "Bug" Locator
- Detects, Locates and Tunes in on All Concealed Room or Telephone FM Transmitters



79⁵⁰

No Money Down *

Highly sensitive, all range FM transmitter locator. Will detect any FM/RF transmitter in operation up to 75 feet. Audible and visual signals alert the user and locate the "bug." Actually tunes and reproduces the transmission so user can hear what is being broadcast. Solid state reliability—designed for professional use. Protects any area against electronic eavesdropping. Size: 6¼x3¼x2"D. Shpg. wt., 2 lbs.

15 E 35020L Net 79.50

ONE WAY DOOR VIEWER

Only **99¢**

Permits thru-the-door identification without being observed. One way viewing only—you can look out, no one can see in. Provides wide-angle view—you can see anyone standing or crouching even at the side of the door. Installs quickly with a simple hand drill. 1/2" in diameter, length adjusts to fit any standard door thickness up to 1¾" thick. Cannot be removed from the outside. Rust-proof aluminum. Imported. Shpg. wt., 4 oz.



14 E 65620 Net .99

170 Lafayette Cat. No. 700

PROTECTO-COM SOLID STATE DOOR ANSWERING INTERCOM SYSTEM

Complete System

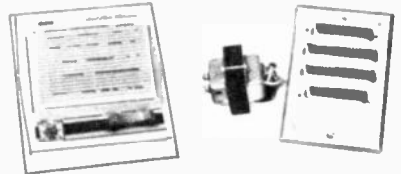

Only **24⁹⁵** Includes:
1 Master Amplifier Control Station
1 Door Station
1 16 Volt Transformer
50 ft. of 2 Conductor Cable
All Hardware Necessary For Installation

- Provides Protection—Identify Callers Without Opening Doors

A complete door answering intercom system designed for installation in new or existing homes. Easy-to-use "talk-listen" switch on master. Protects residents from unwanted callers. Inexpensive and easily installed. Comes complete with Master station, door station, transformer, 50 ft. of 2-conductor cable, and all hardware necessary for installation. Shpg. wt., 14¾ lbs.

44 E 37059 Net 24.95

32 E 30521 Extra 100 ft. coil of wire Net 1.14

PEN-SCOPE

- 8 Power Telescope
- 30 Power Microscope

1⁹⁸

8 power telescope with adjustable sliding focus barrel that extends to over 8 inches, collapses to 5½" and fits easily in pocket. Barrel slips off to convert to a 30 power microscope. Nickel-plated metal case with pocket clip. Dia. only 5/16". Imported.

99 E 71987 Shpg. wt.. 8 oz. Net 1.98

* See Page 11 for Full Credit Details on Easy Pay Plan

Replacement Speakers and Baffles

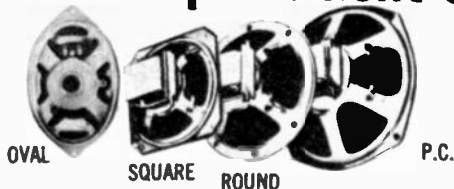

LAFAYETTE ECONOMY-LINE PM SPEAKER

Top quality replacement speakers. Selected for universal application rugged construction-standard configurations. All have 3.2 ohm voice coils except *, which is 8-ohm. Made in U.S.A. except 99 Series are imported.

Stock No.	Size	Shape	Mag. Wt.	Peak Watts	Shpg. Wt.	Net Ea.
99 E 62689	4"	Square	.60 oz.	3.0	1	1.29
99 E 62687	5"	P.C.	.68 oz.	4.0	1	1.49
32 E 01092	5x7"	Oval	1.0 oz.	5.0	1½	2.49
32 E 01076	6x9"	Oval	1.47 oz.	7.0	2	2.99
32 E 01043	6x9"	Oval	2.15 oz.	8.0	2½	3.49
32 E 01084*	12"	Round	3.16 oz.	12.0	5	5.99

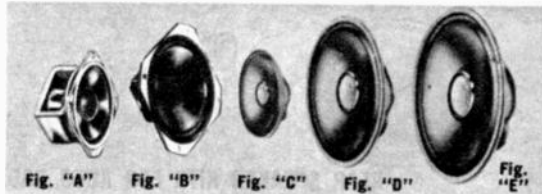

EXACT REPLACEMENT MINIATURE SPEAKERS

Quality Alnico PM speakers for replacement in transistor portable sets. Ideal for the experimenter. * have mtg. holes on 2" centers; † on 1½" centers; OHMS is Voice coil impedance. Dimensions given are overall. Imported.

Stock No.	Fig.	Diam.	Depth	Ohms	Wt.	Net
99 E 60352†	A	1½"	1¾"	10	6 oz.	.99
99 E 60360	C	2"	1½"	8	8 oz.	.99
99 E 60378	C	2¼"	1½"	8	8 oz.	.99
99 E 60386	C	2½"	1½"	8	8 oz.	.99
99 E 60394*	B	2½"	1¼"	3-4	8 oz.	.99
99 E 60972*	B	2½"	1¼"	10	8 oz.	.99
99 E 60329	E	3"	1¾"	8	10 oz.	.99

LAFAYETTE SPEAKERS FOR CAR RADIOS AND TAPE PLAYERS

SET OF 2 UNDER-DASH 3x5" MATCHING SPEAKER SYSTEMS

2—3x5" wide-range ceramic speakers mounted in plastic housings will mount under dash, on rear seats, on kick panels, doors, or rear package shelf. Includes all necessary cables and mounting hardware. Imported.

6.95

99 E 62994 Shpg. wt., 3 lbs. Net 6.95

CUSTOM IN-DOOR SET OF 4 SPEAKERS

Get that full, rich stereo sound from your car tape player. Ready for quick installation. Improves the sound and performance of any car tape player. Kit includes: Four 4¾" extended range 8-ohm PM speakers; four round custom mount plastic speaker grills; all necessary hookup wire with solderless connectors; mounting hardware and easy-to-follow instructions. Imported.

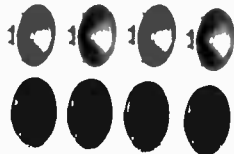

8.95

99 E 62061 Wt., 3 lbs. Net 8.95

SET OF 2 DELUXE REAR DECK MATCHING SPEAKER SYSTEMS

Set of two powerful 4" speakers mounted in handsome ebony plastic cabinets with silver trim. Specially designed to mount on car's rear deck. Can also be surface mounted anywhere. Provides outstanding sound reproduction. Includes all necessary cables and mounting hardware. Imported.



9.95

99 E 62986 Shpg. wt., 4 lbs. Net 9.95

utah MICROGAP PM SPEAKERS

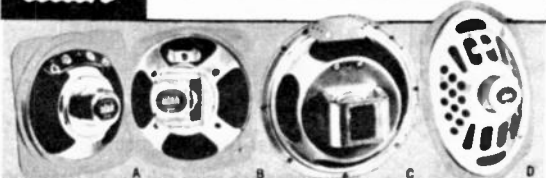

Features famous MICROGAP precision in centering of voice coil, giving increased and uniform sensitivity. All heavily cadmium plated rust proof construction. All with alnico V magnets. All voice coils 3-4 ohms except 12" is 8 ohms. † With provisions for mounting transformer.

Stock No.	Size-Shape	Program Power Watts	Mag. Oz.	Fig.	Shpg. Lbs.	Net Ea.
32 E 49141	5x3 OVAL	4	.55	D	½	2.25
32 E 49018	3½" SQUARE	3	.68	A	½	2.31
32 E 49029†	4" SQUARE	5	1.2	A	1	2.64
32 E 49034	4x6 OVAL	5	1.2	D	1	3.09
32 E 49042†	5" P. C.	5	1.2	B	1	2.79
32 E 49455	6" P. C.	6	.75	B	¾	2.50
32 E 49059†	6" P. C.	8	3.16	B	1½	4.23
32 E 49067	6x9 OVAL	10	3.16	D	2	5.01
32 E 49463	8" P. C.	8	1.47	B	1½	3.33
32 E 49075†	8" ROUND	10	3.16	C	2	5.40
32 E 49083†	12" ROUND	14	6.8	C	4¾	7.95

UTAH TAPE RECORDER SPEAKER

5x3" oval. Rated 4 watts Program 3.2 ohm voice coil.

32 E 49141 Shpg. wt., ½ lb. Net 2.25

UTAH INTERCOM SPEAKERS

High sensitivity, especially designed for "talk-back" circuits. Ideal for selective paging systems. Use as speaker and microphone. All 45 ohm voice coil impedance.

Stock No.	Size-Shape	Mag. Wt.	Peak Watts	Fig.	O.D.	Depth	Shpg. Wt.	Net
32 E 49125	3½" SQUARE	.68	4	A	3½"	1¾"	1	2.55
32 E 49133	4" SQUARE	.68	4	A	4¾"	1¾"	1	2.40



MODERN SPEAKER Baffles

AS LOW AS **2.61**

Well built plywood speaker baffles for indoor public address and paging systems, intercoms, extension speakers, etc. Frieze-design grille cloth, modern walnut finish.

Stock No.	Description	Wt. lbs.	Singly Each	Lots of 3 Each
20 E 13068	For 5" or 6"	3	2.85	2.61
20 E 13076	For 8"	4	3.49	3.19
20 E 13084	For 10" or 12"	5	4.65	4.45



Frames constructed of plywood, front panels of acoustically correct particle board. Locked corners for maximum strength. Attractive recessed front, beautiful walnut wood-grain fabric covering. Complete with speaker mounting hardware.

Stock No.	Utah No.	Fig	For Spkr.	Size HxWxD"	Shpg. Wt.	Net
20 E 48122	SS8-W	A	8"	14x15½x8¼	3	6.20
20 E 48148	CS8-W	B	8"	9½x9½x6¼	1½	5.16
20 E 48155	CS12-W	B	12"	13½x13½x8¾	2	6.90

Auto-Speaker Kits – Auto Speakers – Accessories

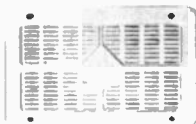

REAR SPEAKER KITS FOR AUTO RADIOS

Complete kits for adding second speaker in rear of your car. Switch-controlled kits include a P.M. speaker, 3-position selector switch for cutting in front, rear, or both speakers; dial plate with mounting bracket, knob and hardware; chrome grille, wire and wiring instructions. Fader controlled kits are identical except in place of switch a fader

is supplied which controls volume of both speakers simultaneously, gradually reducing volume on one while increasing volume on the other. Kits for transistorized auto radios have speakers with multi-impedance voice coils to match 40, 20, 8-10 ohms or less; work with all sets, transistorized or tube. Simple to install. Shpg. wt. 4 lbs.

STOCK NO.	SPEAKER	MAG. OZ.	CONTROL	RADIO TYPE	NET
32 E 22098	5x7	.68	Switch	Tube	3.95
32 E 22072	6x9	.68	Switch	Tube	4.39
32 E 22114	6x9	2.15	Fader	Tube	4.99
32 E 22023	6x9	1.47	Fader	Trans.	5.39
32 E 22031	6"†	1.47	Fader	Trans.	4.59

† This kit for installation in autos with recess between seats in rear No grille supplied.

REPLACEMENT AUTO PM SPEAKERS

LAFAYETTE TRANSISTOR AUTO PM SPEAKERS

All have multi-impedance voice coils to match all transistor sets. Will match 40, 20, 8 ohms or less. Slimline design.

STOCK NO.	SIZE-SHAPE	V.C. IMP.	PEAK WATTS	MAG. OZS.	SHPG. WT.	NET
32 E 22049	6x9" Oval	Multi-ohm	7	1.47	1½	3.89
32 E 22148	6x9" Oval	Multi-ohm	12	5.0	1½	5.29
32 E 22056	6" round	Multi-ohm	7	1.47	1	3.39
32 E 22155	4x10" Oval	Multi-ohm	7	2.15	1½	3.69

UTAH AUTO SPEAKERS

A complete line of speakers of replacement for all types of auto sets including the new transistorized sets. Voice coil impedances where shown as "10/20/40" are 40 ohm tapped useable for either impedance and are specially designed for transistor sets. # indicates shallow type, only 2½" deep.

STOCK NO.	SIZE-SHAPE	V.C. IMP.	MAG. OZ.	SHPG. WT.	NET
32 E 49186	5x7 Oval	10/20/40	1.47	1	4.11
32 E 49174	4x10 Oval	10/20/40	2.15	1¼	5.07
32 E 49182	6x9 Oval	10/20/40	1.47	1¼	4.35
32 E 49190 #	6x9 Oval	10/20/40	2.15	1¼	4.35

DELUXE SPEAKER GRILLES

Dress up original equipment or accessory speaker installations with a contemporary styled two-toned slotted speaker grille. Molded high impact black cyclac with raised chrome bead and luxurious black and chrome medallion, dress up speaker installations. With chrome bolts, nuts.

5 x 7" Deluxe Grille		
32 E 57029 Wt., 10 oz.		Net 1.69
6 x 9" Deluxe Grille		
32 E 57003 Wt., 12 oz.		Net 1.89

SPEAKER GRILLES

Handsome perforated metal grilles for rear-seat speaker use or other installations. Avg. Shpg. wt., 1 lb.



CHROME GRILLES

32 E 34010 5x7"	Net .98
32 E 34028 6x9"	Net .98

GRAY GRILLES (Non-Reflecting)

32 E 34069 5x7"	Net .88
32 E 34077 6x9"	Net .88

DELUXE REAR SEAT SPEAKER CONTROLS



The exclusive design of these selectors afford both smooth-positive electronic control of sound and attractive design die-cast body, knob and heavy chrome plating. Fader control will permit either front or rear speaker to work alone or blend any combination of both from a whisper at one and full sound at other to perfect balance of both. Three-way switch positively selects either speaker or directs equal power to both. Complete with hardware and instructions. Imported. Shpg. wt., 1½ lbs.

99 E 85219 Fader Control	Net 1.70
99 E 85227 3-Way Switch	Net 1.50

CUSTOM 2-WAY REAR SEAT SPEAKER KIT

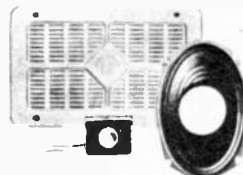

11⁹⁵

This two-way auto speaker was specially designed to satisfy the demand for the finer tone quality available from modern FM car radios and tape players. Now you can enjoy full quality reception in the rear seat of your car. It has a co-axially mounted 3" tweeter for high frequencies, and matches 8, 10, 20, or 40 ohm outputs for universal use. 6-oz. ceramic magnet with power handling capacity of 15 watts. Complete with chrome grille, fader control, hardware, wire, and illustrated instructions. Wt., 2½ lbs. 32 E 49448 Net 11.95

DUAL HI-FI REAR-SEAT SPEAKER KIT

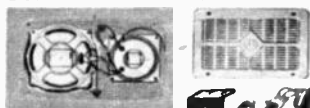

• Woofer-Tweeter-Crossover

Multi-impedance voice coil for all transistor and tube sets. "Universal" speaker kit includes two Alnico V units—a 5" woofer and 3" tweeter with electronic crossover network, fader control, chrome grille and baffle which fits regular 6x9" cut-out; plus pre-wired, pre-soldered, 3-position switch. 32 E 49331 Shpg. wt., 4 lbs. Net 7.98

LAFAYETTE REAR-SEAT SPEAKER KIT



OVAL



ROUND

REAR SEAT SPEAKER CONTROLS



Controls come completely mounted on black and silver metal plate with ivory pointer knob plus attached wiring for connections to both speakers. With mounting hardware and instructions. Imported. Shpg. wt., ½ lb.

FADER TYPE (Fig. A)

Controls the volume of both front and rear speakers. Gradually reduces the volume on one while increasing volume on the other. 99 E 85078 Net Ea. .64

SWITCH TYPE (Fig. A)

Gives choice of front speaker alone, rear speaker alone, or both together. 99 E 85086 Net Ea. .49

PUSH-BUTTON TYPE (Fig. B)

Just push a button to select front speaker alone, rear speaker alone, or both together. 99 E 85102 Net Ea. .89

- Fits Compacts, Station Wagons
- Fits Foreign Cars, Sports Cars
- Prewired—Self Contained
- 3-Position Switch

Easy to install, it will fit any auto radio in any domestic or foreign car. Finished in a gleaming chrome shock resistant case, it can be hung up or clipped almost anywhere. Includes all necessary wire, instructions and 3-position switch for front, rear or 2-speaker operation. Speaker enclosure 2¼" square. Imported. Shpg. wt., 12 oz. 32 E 22502 Net 2.75

LAFAYETTE "VARY-MOUNT" SPEAKER FOR CAR RADIOS AND TAPE PLAYERS



Only 3⁹⁵

Deluxe flush-mounting speaker with beautiful chrome grill. Ideal for use as an auto speaker or anywhere shallow depth is required. Full range speaker has heavy magnet and offers outstanding sound quality. Can also be used as a ceiling or wall mount speaker in your home. Imp., 8 ohms. Overall dia.: 6¼". Imported. Wt., 3 lbs. 99 E 01794 Net 3.95

Auto Antennas — Accessories — Vibrators

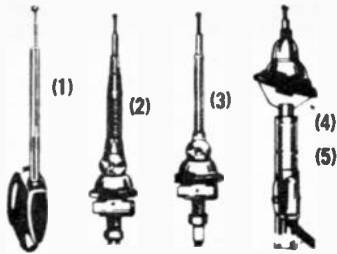

(1) **CONTINENTAL SINGLE SIDE MOUNT**
Continental single side mount. For trucks, Volkswagens and other foreign cars. Flexible adjustment with unique vertical locking. 3 section. Extends to 55" from 20". 32" lead cable.

11 E 80010 Shpg. wt., 1 lb. Net 2.49

(2) **"FLEX-O-MATIC" UNIVERSAL ANTENNA**
Heavy-duty, bounce-back, spring mount. Fully adjustable—mounts anywhere. 3 sections. 63" extended, 28" collapsed. 48" lead.

11 E 74077 Shpg. wt., 2 lbs. Net 3.29

(3) **UNIVERSAL MOUNT AERIAL**

Can be mounted anywhere on car. Adjusts to any angle, 3 section, measures 20" collapsed, extends to 59". Complete with 48" lead.

11 E 74119 Shpg. wt., 1 1/4 lbs. Net 2.19

(4) **DISAPPEARING ANTENNA**

For concealed installation. Extends to 52" from 6 1/2". Fully collapsible—only mounting protrudes. 54" lead.

11 E 74020 Shpg. wt., 2 lbs. Net 3.39

(5) **LO-BOY DISAPPEARING ANTENNA**

For shallow installations, foreign and sports cars. Takes only 9 1/2" below fender or deck. Extends to 25" collapses to 1 3/4". 48" permanent lead. Shpg. wt., 1 lb.

11 E 74036 Net 2.19

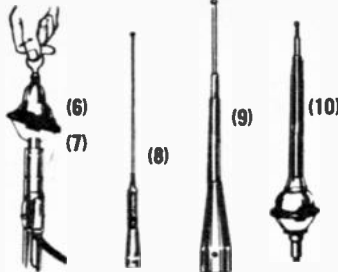

(6) **DISAPPEARING KEY-TENNA**

Slides completely into mounting base. Locks with key rendering the antenna theft proof. 16 1/2" below fender, ext. 43". With 48" leads; 2 keys. Shpg. wt., 1 lb.

11 E 74044 Net 2.75

(7) **DISAPPEARING FM-KEY-TENNA**

3-section disappearing safety-lok antenna. Extends to 31" for top FM performance. Complete with 48" leads, 2 keys. Shpg. wt., 1 lb.

11 E 74127 Net 2.99

(8) **SPRING BACK REPLACEMENT STAFF**

One piece, stainless steel, spring mounted replacement staff. 27 1/2" long overall. Mounts over stub of old antenna. Fits all cars. Simple set screw installation. Shpg. wt., 8 oz.

11 E 74069 Net 1.09

(9) **REPLACEMENT ANTENNA STAFF**

3 section 57" replacement staff. Telescoping staff replaces antenna lost through accident or vandalism. Mounts on stub of broken antenna. Simple lock on mount. Shpg. wt., 8 oz.

11 E 74051 Net 1.29

(10) **TOP COWL MOUNT**

3 section antenna measures 22" collapsed, and extends to 56". Mounts on polyethylene insulator. With 54" cable.

11 E 74010 Shpg. wt., 1 1/4 lbs. Net 1.99



UNIVERSAL 6 & 12 VOLT VIBRATORS

Direct replacements for most popularly-used types. All brand new factory-fresh stock. Made by leading national manufacturers. Fully guaranteed. All types may be assorted for quantity prices.

6-VOLT 4-PRONG

Replacement for Mallory 294, 859, 901M, Radiart 5300, 5301 and many others.

Lets of	1-4	5-9	10+
Net ea.	1.99	1.89	1.79

12-VOLT 3-PRONG

Replacement for Buick, Olds, Pontiac and GM part no. 122-0155; Mallory G874, CO 6330, Delco 8550; and Vekar 3129.

Lets of	1-4	5-9	10+
Net ea.	1.99	1.89	1.79

12-VOLT 4-PRONG

Replacement for Mallory G859, Motorola 45B22000, Philco and Mepar 83-0025-1. ATR 1840, Vekar 4124; and most later 12-volt car-radio vibrators.

Lets of	1-4	5-9	10+
Net ea.	1.99	1.89	1.79

MALLORY REPLACEMENT VIBRATORS

Replacement for most popular sets.

Stock No.	Type No.	Net ea.
33 E 11040	6 VOLTS	2.95
	1601	
33 E 11065	12 VOLTS	4.39
	G1501	
33 E 11073	G1601	2.95



REPLACEMENT LEADS

Replacement lead 54" Universal. Shpg. wt., 1 lb.

11 E 74085 Net .99

Universal extension lead, 24"

11 E 74093 Net .69

Universal extension lead, 36"

11 E 74101 Net .89

ADAPTERS/JACKS/PLUGS/CONNECTORS



(A) Adapter converts Motorola to Delco fitting

11 E 68016 Net .12

11 E 68024—(B) Motorola jack Net .19

11 E 68032—(C) Motorola plug Net .12

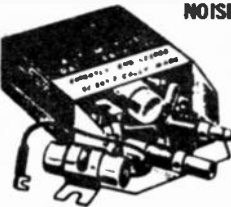

NOISE SUPPRESSOR KITS

As Low As

2.39

For all 6 and 8-cylinder cars to suppress wide band pulse noise created by the distributor, spark plugs and generator "hash". Includes spark plug suppressors, generator and light or ammeter by-pass capacitors. Complete with easy installation instructions. Shpg. wt., 6 oz.

11 E 71057 for 6-cylinder cars Net 2.39

11 E 71065 for 8-cylinder cars Net 2.79

POWER HOUSE AUTO ANTENNA

• Built-in Booster **375**

New! 3-section universal mount (for all cars) auto antenna designed to increase the range and signal strength of your auto radio. Built-in booster coil lets you tune twice as many stations, **TWICE AS STRONG!** Stainless steel spring mount withstands severe shock, eliminates constant replacement of broken antenna staffs. Swivel base permits mounting at any surface angle. Comes with 48" lead cable.

11 E 71073 Wt., 1 lb. Net 3.75

TOP-MOUNT ANTENNA FOR VOLKSWAGEN CARS

• For '67 Models & Up

Three section top-mount antenna fits the prepunched hole which Volkswagen has incorporated into its 1967 cars. Extends to 38", collapses to 15". Chrome plated. Complete with 42" cable. Shpg. wt., 1 lb.

11 E 74135 Net 2.59

"TENNAMATIC" ELECTRIC AUTO ANTENNA

- Electrically Raises and Lowers Automatically
- Eliminates Vandalism

As Low As **1750**

Operate the antenna at the flip of a switch. Designed to fit most 12 volt cars. Mast extends to 35" and retracts to 1 1/4". Antenna cable is copper shielded. External parts are plated with chrome. Positive 15 lbs. thrust insures "free action" even in sub zero temperatures. Complete with cable, clips, brackets, switch and plate, screws, wiring harness and instructions. Shpg. wt., 6 lbs. REAR MOUNT—18 feet of antenna lead and 20 feet electric harness.

11 E 71024 Net 18.95

FRONT MOUNT—54" of antenna lead and 72" electric harness.

11 E 71016 Net 17.50

DYNAMIC AUTO TENNA BOOSTER

- For New Transistor Auto Radios
- Increases Radio Range and Reception
- Electronically Equivalent to 110-ft. Antenna

Increases the signal strength and range of your auto radio with the new Dynamic Auto Antenna Booster. Brings in distant and weak stations... stops station-fade. Installs easily in 4 simple steps. Fits all except 4 sect. Antennas. Shpg. wt., 1/2 lb.

11 E 89026 Net 2.29

Custom Deluxe Solid State Radios For Volkswagen Cars

NEW!



Only
34⁹⁵

No Money
Down*

Designed To Fit All Standard
Models From 1957-1969

DELUXE PUSHBUTTON SOLID STATE AM RADIOS

- Easy Snap-In Mount
- 3-Watts Audio Power

Just a snap to install. Custom designed to snap into instrument panel on the dash board from the front. Mounts in a matter of minutes. Features all-transistor circuit of advanced design which gives a full 3-watts of superb audio power. Automatic volume control provides constant, even comfort-level listening. Continuously variable tone control. Five quick-set pushbuttons permit finger-tip station tuning. Seven tuned circuits, including RF stage, give maximum sensitivity.

- Complete with 5" Diameter External Speaker and All Mounting Hardware

Radios for 1958-67 VW cars are for 6-volt systems. Radios for 1967 & 1968 VW cars are for 12-volt systems. Imported. Shpg. wt., 6 lbs.

For 1958-67 1200-1300 series Volkswagen cars.

17 E 26280

Net 34.95

For 1968-69 1300 series Volkswagen cars.

17 E 26298

Net 34.95

DELUXE PUSHBUTTON SOLID STATE FM-AM CAR RADIOS



69⁹⁵

No Money Down*

- For 1967 Thru 1969 1300 Series Models
- 6-Inch External Speaker
- 11-Transistors, 2-Diodes
- Snap-in Front Mount for Easy Installation

Deluxe solid-state custom AM-FM radio for all standard Volkswagen 1967-1969 models. Matches decor of car's interior. All solid-state circuitry with hi-fi features. 11-transistors, 2-diodes, AFC on FM for drift-free performance. Push-pull output. High sensitivity for long distance reception on both AM and FM. 4-IF stages on FM. Continuous variable tone control. Snap-in front mount for easy installation. Large 6" external speaker. Imported. Shpg. wt., 6 lbs.

17 E 74405 For 1967-1969 Volkswagens

Net 69.95

MANUAL SOLID-STATE AM CAR RADIO



27⁹⁵

No Money Down*

Designed To Fit All Standard 6 or 12 Volt 1200 & 1300 Series Volkswagen Cars Up To And Including 1969

- 5" External Speaker and All Necessary Mounting Hardware

Custom manual radio for all standard Volkswagen cars thru 1969 Operates on 6/12 volt negative ground. Provides fine sound reproduction thru 5" round external speaker. Features tone control slide switch. 7-transistors, 2-diodes, RF stage. 2 watts output. AVC. Shpg. wt., 5 lbs.

17 E 74264

Net 27.95

CUSTOM TRIM KIT For 1967 and 1968 Volkswagen 1600

Special kit enables you to mount manual radios for VW cars listed above in the VW 1600. Shpg. wt., 6 oz.

17 E 55081

Net 2.95

PUSHBUTTON AM/FM CAR RADIOS FOR 12 VOLT SYSTEMS

SOLID STATE PUSHBUTTON AM/FM CAR RADIO



49⁹⁵

No Money Down*

- Includes Free Antenna
- Large 5x7" External Speaker
- For 12 Volt Neg./Positive Ground Systems

All solid state circuitry. 11 transistors, 8 diodes, 2 thermistors. Push-pull Hi-Fi output. AFC for FM drift-free performance. High sensitivity for long distance reception on both AM and FM. Four I.F. stages on F.M. for maximum noise limiting. Large 5 x 7" external speaker. Radio mounts neatly under dash. Overall size: 6 1/2" x 2 3/4" x 6 5/8" D. Imported. Shpg. wt., 6 lbs.

17 E 74124

Net 49.95

NEW SOLID STATE PUSHBUTTON STEREO FM/AM CAR RADIO



109⁹⁵

less speakers

No Money Down*

- For 12 Volt Neg./Positive Ground
- 5-Watts Audio Power Per Channel

Stereo FM/AM radio with pushbutton station selector and stereo/mono switch. Enjoy high quality stereo in your car wherever you go. Stereo light indicates when FM stereo broadcast is being received. Continuous dual tone control. Response: 50-10,000 Hz. FM and AM sensitivity: 5 μ v. 22 transistor circuitry. Mounts in or under dash. Size: 2 1/2 x 6 1/2 x 8 1/2". Imported. Shpg. wt., 6 1/2 lbs.

17 E 74512

Net 109.95

Set of 2 Rear Deck Matching Speaker Systems. Imported.

99 E 62994 Shpg. wt., 3 lbs.

Net 6.95

Slim Decorator Styled Underdash Car Radios

DELUXE SOLID STATE FM STEREOHONIC CAR RADIO



The Ultimate in FM Car Radio Entertainment

99⁹⁵

With 2 Instant-Mount Speakers

• For 12 Volt Negative Ground Systems

Enjoy rich, vibrant FM stereophonic programming in your car with this magnificent performing FM stereo radio. Simple to install under the dash with adjustable brackets—only 2 screws are required to mount the radio. Features powerful Hi-Fi audio circuit for true stereo sound reproduction on both channels. Stereo Indicator Lamp illuminates when station is receiving stereophonic sound. Dual channel tone and volume controls. Balance control permits adjust-

ment of channel separation for perfect sound balance. Illuminated slide rule dial Specifications: 23 Transistor, 11 Diodes, Output 7 watts per channel. Sensitivity: 5 μ v. For 12V negative ground systems. Includes 2 instant-mount speakers in plastic housings. Size: 9" W x 1 1/2" H x 6 3/4" D. Shpg. wt., 6 lbs. Imported. 17 E 74371 No Money Down* Net 99.95

DELUXE SOLID STATE AM CAR RADIO

• For 6 or 12 Volts Negative or Positive Ground

Superb quality in a completely self-contained universal AM radio. Features all-transistor circuitry for instant action, continuously variable tone control, built-in speaker, and slide rule dial for fast accurate tuning. AVC assures stable, fade-free reception of distant stations. Sensitivity: 10 mv, peak audio out: 2 watts; speaker: 3 1/2" round; 6 transistors, 2 diodes. Size: 17 1/8" x 4 1/2" x 9". For 6 or 12 Volt Negative or Positive ground. Imported. Shpg. wt., 5 lbs. 17 E 74173

Net 29.95



29⁹⁵

SOLID STATE FM CAR RADIO CONVERTER

• Converts Your Existing 12 Volt Negative Ground AM Radio to the FM Band

Complete auto radio entertainment at a minimum cost. All solid state circuit (6 transistors, 8 diodes) gives instant operation. Built in AFC permits drift-free reception of distant FM stations. AM/FM switch allows instant selection of AM or FM stations. Simplified installation. Sensitivity: 4 Mv. Size: 1 7/8 x 4 x 9". Imported. Shpg. wt., 4 lbs. 17 E 74207 No Money Down* Net 39.95

Net 39.95



39⁹⁵

DELUXE SOLID STATE AM/FM CAR RADIO

• For 12 Volt Negative Ground

Complete auto radio entertainment in one compact unit. All solid state circuitry gives superb sound quality on both AM and FM bands. This trim unit features a continuously variable tone control, FM Multi-plex plug for adaption to FM stereo, and an external 5 x 7" heavy duty speaker for crisp, clear tone. 11 transistors, 1 thermistor, 8 diodes, RF stage, AVC, and AFC. Dimensions: 1 7/8 x 4 x 9". For 12 Volt Negative Ground. Imported. Shpg. wt., 6 lbs. 17 E 74181 No Money Down* Net 59.95

Net 59.95



59⁹⁵

EXTERNAL 5" x 7" SPEAKER

FM STEREO MULTIPLEX ADAPTER for above radio. Dim. 17 1/8 x 4 1/2 x 9". Imported. Shpg. wt., 4 lbs. 17 E 74280 No Money Down* Net 69.95

Net 69.95

OUR LOWEST COST Solid State AM Car Radio



19⁹⁵

- For 12 Volt Negative Ground Systems
- Built-in Speaker
- Removable Face Plate
- Tone Control Switch

Universal Solid State AM radio that is easy to install under the dash. Offers fine sound reproduction. Features built-in speaker and tone control slide switch, 7 transistors, 2 diodes, RF stage, AVC. Removable face plate. For 12 volt negative ground system. Size: 2 x 4 3/4 x 6 1/2". Imported. Shpg. wt., 3 lbs. 17 E 74256

Net 19.95

A 3rd Dimension In Sound



SALE 19⁹⁵ Was 22.95 1969 Cat. 694
Complete with 6 x 9" speaker and chrome grill.

DELUXE LAFAYETTE SOLID STATE CAR REVERBERATION SOUND SYSTEM

For 12 Volt Negative Ground AM and FM Auto Radios—Convenient Under Dash Mounting

Deluxe solid state tuneable reverberation unit converts your present car radio into a magnificent sound system offering concert hall realism. Beautifully styled to enhance the decor of your car. Consists of the tuneable amplifier control unit which easily mounts under the dash panel of your car by means of adjustable brackets. 6 x 9" dynamic speaker and chrome grill for rear seat mounting, and all connecting cables. Includes simple instructions for connecting the reverb unit to your regular car radio system and for separate rear seat speaker. Reverberation is an entirely different approach to sound reproduction. Normal sound reproduction from

• Tuneable . . . Electronic Tuning Control. "Custom Fits" the Sound to your Car, to your Ear a single source has a flat, one dimensional effect; with proper sound delay thru "REVERBERATION," tones are created with a truly third dimension for concert hall originality. The LRE unit features complete sound control—simplified controls permit balance of sound between front and rear seat speaker. Verb-A-Tone control adjusts the amount of reverberation to your taste. Specifications for 12 volt negative ground cars, peak audio output—4 watts, 2 transistors. Size: 1 7/8" x 4" x 9". Shpg. wt., 5 lbs.

17 E 01093 Net 19.95

LAFAYETTE SOLID-STATE CAR REVERBERATION AMPLIFIER

Recreates Concert Hall Listening In Your Car

LAFAYETTE "STEREO VERB" SOLID STATE REVERBERATION SOUND SYSTEM

For Stereo Tape Players & FM Stereo Radios



Only **11⁹⁵**

Including Mounting Bracket
Less Speaker

- Can Be Used With Any 12-Volt Negative Ground Car Radio—AM or FM

NDW—listen to the most dramatic sound of music you have ever heard in a car with the Lafayette solid state Automobile Reverberation amplifier. When used with your present 12-volt negative ground AM or FM car radio, the Lafayette Reverb amplifier creates a second set of reflected sound waves reproduced through a rear seat speaker (not included). These reflected sound waves provide this exciting new dimension in sound reproduction. Features a pushpull Fader/Balance control. Balances regular car radio speaker and reverb speaker. Also controls amount of reverberation—from 0 to maximum. Separate isolation transformer for ultimate matching conditions. For underdash mounting. Dim.: 7 1/2" D x 3 1/2" W x 1 3/4" H. Includes mounting bracket. Imported. Shpg. wt., 4 lbs.

99 E 05103

Net 11.95

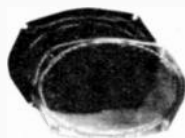

Only **29⁹⁵**

With 6"x9" Speaker, Grill
and All Connecting Cables

Made in U.S.A.

- Add 3-Dimensional Reverberation Sound to your Car Stereo Tape Player or Car FM Stereo Radio
- Compatible—can also be used on Monaural Car Radios
- Convenient Under Dash Mounting
- Tuneable—Controls Amount of Reverberation

Exciting concept in a reverberation sound system to greatly enhance car stereo tape and FM stereo radio performance. Add a third channel 3-Dimensional reverberation output to your car stereo system. The Lafayette Stereo Verb's dual input tuneable reverb amplifier creates this magnificent 3rd dimension in sound by adding a 3rd channel output. This 3rd channel is electronically delayed (echo effect) thru the reverb amplifier to a separate rear seat speaker—and combined with the regular stereo speaker output provides the ultimate in car sound reproduction. Multiple controls are provided for volume, balance, and amount of reverberation. Completely compatible—includes switch which permits use of reverb amplifier with car stereo equipment or car monaural AM and FM Radios. Complete system includes tuneable dual input reverberation amplifier, 6 x 9" dynamic speaker and chrome grill for rear seat mounting—and all connecting cables. Amplifier mounts easily under dash. For 12 volt negative ground systems. Size: 7 1/4" W x 1 3/8" H x 5 1/2" D. Wt., 5 1/2 lbs. 17 E 01705 Net 29.95

Exciting Selection of Accessories for Your Car Radio

VERBALITE SOLID-STATE CAR REVERBERATION SOUND SYSTEM with COLOR-LIGHTS

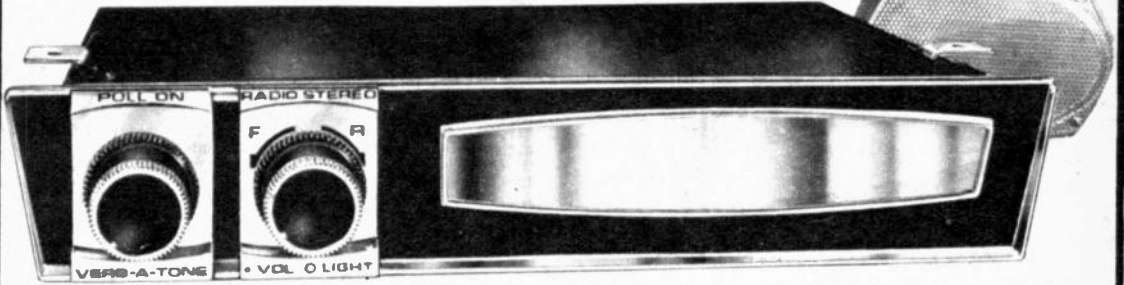

Only **34⁹⁵**
No Money Down*

With 6 x 9" Speaker,
Chrome Grill, and All
Connecting Cables.

- For Car AM, FM, FM Stereo Radios and Stereo Tape Players
- Tuneable . . . Custom Fits Sound To Your Car
- Can Be Used With Any 12-Volt Negative Ground System
- Control Panel Provides A Myriad of Colorful Patterns

Verbalite is a unique, tuneable reverberation system that blends and matches sight with sound. Features a deluxe, solid-state tuneable reverberation amplifier that converts your present car radio or tape player (stereo or mono) into a brilliant sound system providing truly 3-dimensional concert hall realism. The Verbalite's panel is illuminated with a myriad of colors. Everchanging, colorful patterns are activated by the beat and frequency range of the music you are

listening to. Features controls for adjusting the intensity of the light and the amount of reverberation. Easily mounts under dash of your car by means of adjustable bracket. Includes 6x9" dynamic speaker and chrome grill for rear deck mounting. Specifications: 9-transistors and 2-watts peak audio output. For 12-volt neg. ground systems. Size: 1 3/4"Hx8Wx5 3/4"D. Imported. Shpg. wt., 3 lbs. 17 E 74488 Net 34.95

SOLID STATE MOBILE FM-VHF LOW AND HIGH BAND POLICE TUNERS



Three Models To Choose From
Model PC-200: 30-38 MHz
Model PC-201: 37-50 MHz
Model PC-202: 150-174 MHz†

† Plus Continuous U.S. Weather
Bureau Broadcasts on 162.55 MHz

Your
Choice
39⁹⁵ ea.
No Money Down*

- Connects to Existing 12 volt
Neg. Ground AM Car Radio
- Listen to Police Calls, Fire Calls, Mobile Phones
- Tuneable—No crystals required

Hear police calls, fire calls, and mobile phones on your AM car radio. Deluxe solid-state FM-VHF High and Low Band Tuners mount under the dash. Tuneable—requires no crystals, no batteries, no special antenna. Connects in minutes to your existing AM auto radio and antenna. 3 models to choose from: Model PC-200 tunes 30-38 MHz, Model PC-201 tunes 37-50 MHz, Model PC-202 tunes 150-174 MHz, plus continuous U.S. Weather Bureau Broadcasts on 162.55 MHz. Automatic noise limiter provides exceptionally fine reception of all signals. Specifications: 8 transistors, 4 diodes. Sensitivity 2 μ v at 20db of quieting. Converts FM signals to 870 kHz AM. Smartly styled chrome and rich walnut grain front panel. Compact—only 6 1/2" x 3 1/2" x 1 1/2". For 12 volt Neg. ground systems. Shpg. wt., 3 lbs.
40 E 36018 Model PC-200—Tunes 30-38 MHz. Net 39.95
40 E 36026 Model PC-201—Tunes 37-50 MHz. Net 39.95
40 E 36034 Model PC-202—Tunes 150-174 MHz. Net 39.95

NEW SOLID STATE FM CAR CONVERTER for AM RADIOS

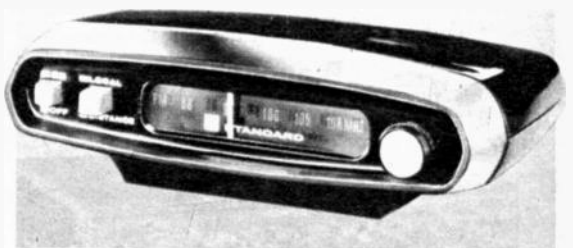

Only
29⁹⁵

Includes: Mounting Bracket for Under-Dash Installation, Fastener for Top of Dash or Console Installation, Antenna and Patch Cords.

- For 12 Volt Neg/Pos Ground Systems

Operates with no alterations to your present AM car radio by tuning to 1580 KHz and then turning on the FM converter. Tunes standard FM Broadcasts from 88-108 MHz. Volume and tone are controlled from the AM radio. Features 8 transistors, 7 diodes and a built-in noise filter for fine FM reception. Also includes vernier slide rule tuning dial with luminous scale and dial pointer, AFC for drift free reception and local/distance switch for optimum reception. Slim-line design allows converter to be placed on or beneath dashboard with equal convenience. With all mounting hardware. Size: 1 3/4"H x 4 1/4"D x 5 1/2"W. Imported. Shpg. wt., 3 lbs. 17 E 41008 Net 29.95

"VARY-MOUNT" SPEAKER

Deluxe flush-mounting speaker with beautiful chrome grill. Ideal for use as an auto speaker or anywhere shallow depth is required. Full range speaker has heavy magnet and offers outstanding sound quality. Can also be used as a ceiling or wall mount speaker in your home. Imp., 8 Ohms. Overall dia.: 6 1/4". Imported. Wt., 3 lbs. 99 E 01794 Net 3.95



3⁹⁵

* See Page 11 for Full Credit Details on Easy Pay Plan

Deluxe Selection of Solid-State Car/Portable Radios

NEW Sharp FX28 FM-AM Car/Portable Radio



Complete with Car Bracket,
Lock and Key, Batteries, AC Line Cord, Earphone

39⁹⁵

- Install In Any 6 or 12 Volt Car or Boat System
- Use As A Portable, or On 117VAC 60 Hz. With Built-In AC Line Cord

Versatile "multi-purpose" AM/FM 12 Transistor Radio designed to provide outstanding reception anywhere. Used as an AM/FM car radio, it locks into its specially designed under-the-dash bracket and operates thru the car's electrical system (6 or 12 volts pos./neg. ground). Slips easily out of bracket for use outdoors—and plays on 4 "C" Batteries (Included). For indoor use, it operates on regular 117VAC household current with the AC line cord provided. Push-button switches for tone, AFC, and Car antenna. 3-Controls: Tuning, On/Off-Volume, and Band Switching. AFC for drift free FM reception. Ferrite bar AM antenna, telescoping FM antenna. Wide range 4 x 2 1/4" oval speaker. Wood grain finish front panel. 2H x 7 3/4W x 5 1/2"D. Imported. Shpg. wt., 5 lbs.
 17 E 53110 No Money Down" Net 39.95
 99 E 62572 Extra "C" cells (4 required) Net ea. .14

Sharp FYP-30 3-Band AM/FM/FM VHF Car/Portable Police Radio



Complete with Car Bracket,
Lock and Key, Batteries, AC Line Cord, Earphone

49⁹⁵

Tunes:

- FM-VHF 150-176 MHz. High Band Police and 162.55 MHz, U.S. Weather Bureau Forecasts
- AM 550-1600 kHz.
- FM 88-108 MHz.

Deluxe, multi-purpose 3-way solid state radio specially designed for use in car, as a portable, or in the home. Features dramatic FM-VHF High Band (150-176 MHz) reception of police, fire, civil defense, and U.S. Weather Bureau forecasts. Also tunes the standard AM and FM broadcast bands. As a car radio, it locks into its specially designed, under-the-dash bracket (supplied) and operates thru the car's 6 or 12-volt electrical system. Outdoors it plays on 4 "C" size flashlight cells. Indoors it plays on 117 VAC with an AC line cord (supplied). Features: dynamic oval speaker and 2-watt output for excellent sound quality; precision vernier slide-rule tuning dial; dial light (when operated on car battery); pushbutton tone control; earphone jack and earphone for personal listening; telescoping FM and FM-VHF antenna; ferrite core AM antenna. Dimensions: 7 1/2 x 5 3/4 x 2"D. U.L. listed. Imported. Shpg. wt., 6 lbs.
 17 E 53060 No Money Down" Net 49.95
 99 E 62572 Extra "C" cells, 3 Required Net ea. .14

Blaupunkt "Derby" 6 Band Car/Portable Radio

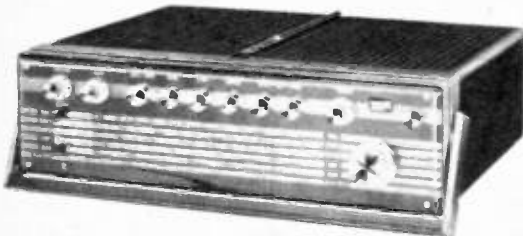

Less Mounting Bracket

79⁹⁵

Tunes:

- AM:550-1620 kHz
- FM:87.4- 108 MHz
- SW-1: 11.5-15.6 MHz
- SW-2: 5.9-9.8 MHz
- AM Bandsread : 1400-1600 kHz
- Long Wave: 148-285 kHz

Superb performing 6-band radio operates on 6 "D" batteries, 6 or 12 volt car electrical system with accessory car mounting bracket, or 117VAC 60 Hz with accessory adapter. Features battery and tuning indicator, dial illuminator, AFC on FM, separate base and treble control, push pull audio output stage, heavy duty wide range speaker. Size 9 3/4" x 7 3/4" x 3 3/4". Imported. Shpg. wt., 5 1/4 lbs.
 17 E 15218L No Money Down" Net 79.95
 Universal Car Mounting Bracket for autos (6 or 12 volt, positive or negative ground). Shpg. wt., 2 lbs. Net 18.25
 17 E 15209 117 VAC, 60 Hz AC adapter—6 oz. Net 7.95
 99 E 52565 "D" batteries (6 req.) for portable use Net ea. .15

Panasonic RF-880 3-Band Radar-Matic FM/AM/MB Car/Portable Radio



Less Mounting Bracket
With Batteries and Earphone

89⁹⁵

- Automatic Electronic Tuning
- 18 Transistors, 13 Diodes
- Full Size 5" Speaker

Amazing 3 band radio features Automatic Electronic Tuning. Just touch and it's tuned. Receives standard AM and FM broadcast bands as well as 1.6 to 4.5 MHz Marine band. 5" dynamic speaker provides outstanding sound reproduction. Powerful 2.5 watt audio output for auto use. Has telescoping FM swivel antenna, ferrite-core AM antenna, tone control, AFC for drift-free FM reception, illuminated slide rule tuning dial, DX-Local switch, and earphone jack. Optional car mounting bracket with lock and 2 keys (for 6 or 12 volt reverse polarity). Size: 10 1/4" x 7 1/4" x 3 3/4". Imported. Shpg. wt., 6 lbs.
 17 E 30454L No Money Down" Net 89.95
 Model AS-303 Universal Mounting Bracket with lock for auto use. (6 or 12 volts reverse polarity.) Net 14.95
 17 E 30472 Shpg. wt. 2 lbs. Net 7.95
 99 E 62564 Extra "D" batteries for above (4 req.) Net ea. .15

Quality Solid-State Multiband Portable Radios

NEW Nordmende 15-Band Globetraveler III AM/FM/SW Radio

159⁹⁵

15 Exciting Bands:

AM Broadcast	540-1600 kHz
FM Band	88-108 MHz
MB Marine	1.5-3.5 MHz
LW Weather	145-420 kHz
80 meter band	3.61 to 3.84 MHz
61 meter band	4.60 to 4.89 MHz
59 meter band	4.84 to 5.13 MHz
49 meter band	5.90 to 6.26 MHz
41 meter band	6.96 to 7.40 MHz
31 meter band	9.35 to 9.90 MHz
25 meter band	11.50 to 12.16 MHz
20 meter band	13.80 to 14.50 MHz
19 meter band	14.85 to 15.70 MHz
16 meter band	17.38 to 18.35 MHz
13 meter band	20.95 to 22.10 MHz



**For Use As A Portable,
Home Radio, Auto Radio, Boat Radio**

Deluxe 15-band Globetraveler III AM/FM/SW radio offers a wide variety of features making it adaptable for portable, home, auto, or marine operation. The entire world of radio listening pleasure and excitement is at your finger tips. Includes standard AM broadcast band, FM, Marine Band, LW Weather-Navigation Band and 11 shortwave bands. Outstanding features: Built in AC with compartment for AC cord, Drum dial for all 11 shortwave bands, and I. F. Bandwidth switch. 2-speakers: 5 x 7" woofer, 2½" tweeter. Separate jacks for earphone, external speaker, phonograph, tape recorder, and separate amplifier. A built-in ferrite antenna for AM, a telescopic antenna for FM, and an additional telescopic antenna for SW increases its sensitivity and selectivity. Also includes tuning meter and battery tester, AFC on FM, noise filter on AM and SW. Separate bass and treble control. 15 transistors and 12 diodes. Wood cabinet covered with scuff-proof black vinyl. 12¼ W x 8½ H x 4"D. Imported. Shpg. wt., 12 lbs.

17 E 72177WX **Net 159.95**
Globetraveler IV 16 Band AM/FM/SW/FM-VHF Police Radio. Same features and specifications as Globetraveler III, except cannot be used as a car or boat radio. Operates only on 5 "D" batteries, or, 117VAC with built-in AC line cord. Includes 147-174 MHz FM-VHF band enabling you to listen to police and fire calls, as well as 162.55 MHz U.S. Weather Bureau Forecasts. Shpg. wt., 14 lbs.

17 E 72183WX **Net 189.95**
Globetraveler PRD 15 Band AM/FM/SW Radio with BFD. All the features and specifications as Globetraveler III except tunes 10 meter and 11 meter bands instead of the 59 and 61 meter bands. And most important, has the added feature of BFO (Beat Frequency Oscillator) enabling the listener to tune in on amateur SSB broadcasts and receive code signals and messages clearly. Without BFO these signals are scrambled and unintelligible. Imported. 17 E 72183WX Shpg. wt., 12 lbs. **No Money Down*** **Net 209.95**

Accessories for Globetraveler Radios
 17 E 72094W Universal 6 or 12 volt car boat mounting Bracket with lock. 4 lbs. **Net 22.95**
 99 E 62564 "D" type Flashlight Batteries. 5 required. **Net 15**



Globetraveler IV

189⁹⁵

NEW Hitachi KH-1316W Battery/AC AM/FM Weather Portable Radio



44⁹⁵

• With Built-in 117VAC Line Cord

Deluxe in every detail for outstanding performance wherever you go. Highly sensitive and selective circuit tunes standard AM and FM broadcast bands plus U.S. Weather Bureau forecasts. Exceptional circuitry has 12-transistors and 1-diode with AFC to prevent FM station drift. 800 mW audio output power into a 3½" round speaker provides quality sound reproduction. Operates on 4 "C" batteries, or 117VAC with built-in AC line cord. Pushbutton band selector; Hi-Lo tone switch; Tuning and DN/OFF Volume controls. Built-in ferrite AM and telescopic FM antennas. Convenient handle for carrying. Size: 6¼ x 9½ x 2¾"D. Imported. Shpg. wt., 3½ lbs. 17 E 24178 No Money Down* **Net 44.95**
 99 E 62572 Extra "C" batteries (4-required) **Net ea. 14**

"Tom Thumb" Solid-State Car/Portable Radios

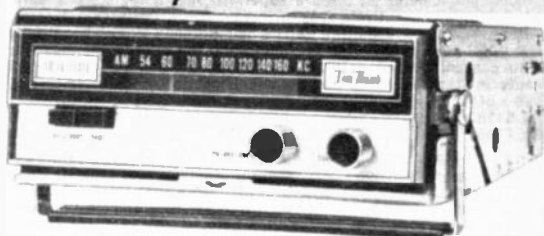

AM Car Portable

29⁹⁵ with Mounting Bracket

AM-FM Car Portable

49⁹⁵ with Mounting Bracket

• For Portable Use or Operation on 12 Volt Negative or Positive Ground Systems

TOM THUMB AM CAR PORTABLE—A superb dual-purpose AM radio. As a mobile unit, operates on 12-volt positive or negative ground. As a portable, operates on four "C" batteries. Features 6 tuned circuits, 8 high-gain transistors, and improved AVC and RF stage. Powerful built-in antenna assures good reception in virtually all locales and under almost all weather conditions. With lock-and-key theft-proof mounting bracket. Less batteries. Size: 7¼" L x 6¼" D x 2¼" H. Shpg. wt., 6 lbs. **17 E 26025 Net 29.95**

TOM THUMB FM-AM CAR PORTABLE—Same features as above but with FM and rear speaker. Shpg. wt., 8 lbs. **17 E 26074 No Money Down* Net 49.95**

99 E 62572 "C" type batteries for above radio (4 req.) **Net ea. 14**

* See Page 11 for Full Credit Details on Easy Pay Plan

Lafayette Cat. No. 700 179

Deluxe Selection of Solid State Portable and Table Radios

A NEW SHARP
BP 200 AM
WEATHER RADIO

14⁹⁵



D NEW
SHARP
FXC-39
AM/FM
DIGITAL
CLOCK
RADIO

49⁹⁵



E PANASONIC RF-738
BATTERY/ELECTRIC
AM/FM PORTABLE

39⁹⁵

With
Earphone
and
Batteries



79⁹⁵

B NEW 3-PIECE MODULAR
AM/FM STEREO TABLE RADIO

F 10-BAND
AM/FM/SW
MARINE
BATTERY/AC
PORTABLE

109⁹⁵

With
Batteries,
Earphone and
External Wire
Antenna



99⁹⁵

C NEW
5-BAND
GLOBETRAVELER
AM/FM/SW MARINE
PORTABLE RADIO

A NEW! Sharp BP200 AM Weather Radio. It's an AM radio... it's a room thermometer... it's a supergift! And it registers a warm welcome on an executive's desk or in your home. Features a dynamic speaker, AGC, and a built-in ferrite bar antenna. Plays beautifully on 2 "AA" penlite batteries (included) and the built-in thermometer is so convenient and accurate. Instant-on solid state circuitry. A beauty in its satin black and chrome impact-proof case. Imported. 2 1/2"H x 5 1/2"W x 3 1/2"D. Shpg. wt., 3 lbs.

17 E 53102 Net 14.95
99 E 62580 Extra "AA" Batteries (2 req.) Net ea. .10

B NEW! 3-Piece Modular AM/FM Stereo Table Radio. Features 2 matching air-suspension type speaker systems for superb high fidelity sound reproduction. Beautiful walnut finished wood cabinetry. Modern upright styling. AFC for drift-free FM reception. 5 Controls: Power/Volume, Tone, Tuning, Function Selector (AM, FM, FM Stereo, Aux.), Balance, AFC (on-off). Front panel stereo headphone jack. FM Stereo indicator light. Auxiliary input for record changer or tape recorder. Instant on solid state circuitry. Size 20 1/2"W x 11"H x 6 1/2"H. Imported. For 117VAC 60 Hz. Shpg. wt., 18 lbs. Imported. 17 E 78455WX No Money Down* 79.95

C NEW! Globetraveller Exec 5-Band AM/FM/SW Marine Portable Radio with Built-in AC. Five individual tuning dials for precise and accurate tuning. Tunes: AM: 550 to 1600 kHz, Marine: 1.5 to 3.5 MHz, International SW-1, 12 to 18 MHz; International SW-2, 6 to 12 MHz; FM: 88 to 108 MHz. Uses 6 "D" flashlight cells (not included) or A.C. house current. 2 1/2-watts of output insures excellent tone quality. No-drift AFC switch on FM. Visual tuning meter. Separate switch for phono and tape recorder outputs. Separate bass and treble controls; 3 separate antennas plus neon AC pilot light. Concealed jacks for earphone, headphones, phono, tape recorder input, and external antenna. 13 transistors and 12 diodes. Full range 5" x 7" speaker. Handsome wood cabinet with scuff proof black vinyl covering and chrome trim. For 110/220 VAC, 50/60 Hz. Dimensions: 14 1/4"W x 8 1/4"H x 4"D. Shpg. wt., 10 lbs. Imported. 17 E 72136WX No Money Down* Net 99.95

"D" Batteries for above (6 required). Net 99.95
99 E 62564 Net ea. .15

D NEW! Sharp FXC-39 AM/FM Digital Clock Radio tells time by the numbers instead of hands! Wakes you up to beautiful AM or FM music or by an alarm. Handsome radio is decorator styled. Handsome, walnut-grain cabinet is combined with smoked glass and rich chrome trim. Equally deluxe is its performance. Big 3 1/4" dynamic speaker. Automatic gain control and automatic frequency control (AFC) for drift-free FM reception. Earphone for private listening. Instant-on solid-state circuitry. Precision digital clock system includes up to 1 hour sleep switch alarm, and illuminated clock dial. UL listed. Size 3 1/4"H x 11 1/4"W x 4 3/4"D. Imported. For 117 VAC 60 Hz. 17 E 53094 Shpg. wt., 7 lbs. No Money Down* Net 49.95

E Panasonic RF738 Battery/Electric AM/FM Portable. Elegantly styled in luxurious black leatherette with silver trim. Provides superb FM and AM reception indoors or outdoors... a built-in AC adapter provides complete versatility. Built-in full-range dynamic speaker assures strong, full-bodied sound. AFC on FM provides drift-free reception. Slide-rule vernier tuning; 2-step tone control; volume control; telescopic whip antenna for FM and built-in Ferrite core antenna for AM. Earphone and external speaker output jacks. Includes earphone. Operates on 4 "AA" batteries (included) or 117VAC. Size: 8 3/8"W x 5 1/2"H x 2 3/4"D. Imported. Shpg. wt., 4 lbs. 17 E 30637L No Money Down* Net 39.95

99 E 62580 Extra "AA" Batteries (4-required) Net ea. .10

F Deluxe Solid State 10-Band AM/FM/SW Marine Battery/AC World-Wide Shortwave Portable Radio. Tunes: AM—540 to 1600 kHz; FM—88 to 108 MHz; Marine—1.6 to 4.7 MHz, and 7-Shortwave Bands. SW-1 5.95 to 6.2 MHz, SW-2 7.1 to 7.3 MHz, SW-3 9.5 to 9.77 MHz, SW-4 11.7 to 11.975 MHz, SW-5 15.1 to 15.45 MHz, SW-6 17.7 to 17.9 MHz, SW-7 21.45 to 21.75 MHz. Outstanding features; Electronic bandsread on shortwave, battery and tuning meter, band indicator, tone control, headphone jack, earphone jack. International Shortwave log and charts. 25 solid-state devices. Operates on 6 "D" batteries, or 117VAC 60 Hz with self-storing AC line cord. 2 telescoping antennas. Attractive simulated black leatherette case with chrome die-cast trim. Size: 12 3/4 x 4 7/8 x 10". With batteries, earphone. Imported. 17 E 69371WX Shpg. wt., 16 lbs. No Money Down* Net 109.95
99 E 62564 Extra "D" batteries (6-required) Net .15

Deluxe Performing Personal Solid State Portable Radios

Deluxe LAFAYETTE "Mini" AM/FM Pocket Portable Radio

14⁹⁵

With Carrying Strap, Earphone and Battery

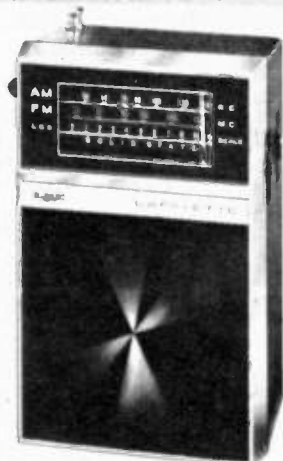

- Precision Slide Rule Tuning Dial

Supersensitive, power-packed beauty provides sparkling performance on both FM and AM and measures only 2 $\frac{7}{8}$ "W x 4 $\frac{3}{8}$ "H x 1 $\frac{1}{2}$ "D. Advanced solid state superheterodyne circuit gives you real pulling power of stations both near and far. Built-in AFC circuitry to prevent drift on FM. Features slide rule dial and logging scale for precise tuning. Large 2 $\frac{1}{4}$ " dynamic speaker reproduces voice and music with fine tonal balance. Ferrite rod antenna for AM, telescoping antenna for FM. Superbly styled and constructed die cast front. Powered by single 9-volt battery. Includes earphone for private listening, battery, and handy carrying strap. Imported. Wt., 3 lbs. 99 E 35248L Net 14.95

Extra 9 volt battery for above
99 E 60212

Net .21

NEW LAFAYETTE Personal "Mini" AM Pocket Radio

7⁹⁵

With Carrying Case, Earphone and Battery

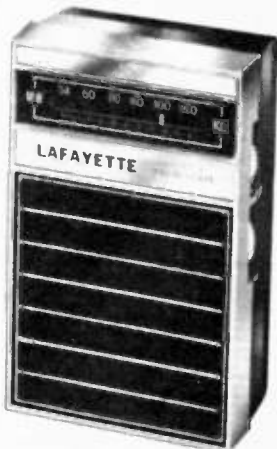
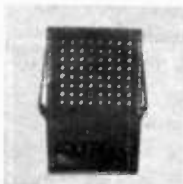

Beautifully styled instant play AM pocket radio. Engineered and constructed with the jewel-like precision of a fine watch. Powerful 2 $\frac{1}{4}$ " speaker provides clean, crisp tone. Features professional vernier slide rule tuning dial, and 3 IF transformers for superb sensitivity and selectivity—gives you real pulling power for stations both near and far. Superheterodyne circuit utilizes the latest space-age solid state devices. Built-in ferrite antenna. Operates on only one inexpensive 9-volt battery. Includes vinyl carrying case, batteries and earphone for private listening. Color: Black. Size: 4 $\frac{1}{2}$ "H x 2 $\frac{3}{4}$ "W x 1 $\frac{1}{4}$ "D. Imported. Shpg. wt., 2 lbs. 17 E 01762L Net 7.95

99 E 60212 Extra 9-Volt Battery

Net .21

Lafayette FM/AM Portable with Built-In Telephone Amplifier



22⁹⁵

With Earphone, and Batteries

Take advantage of this exciting concept in radio design...a superb performing FM-AM portable radio that can also be used as a telephone amplifier with any telephone pick-up. Operates on 4 "C" type batteries or use in the home with economical optional accessory AC adapter which connects to 110-120 volt house line. Features 1 RF and 3 IF stages for extremely high sensitivity and selectivity. AFC circuit makes drift on FM virtually non-existent. Built-in carrying handle is recessed to hold 33" telescoping antenna. Built-in ferrite antenna for AM. Luxurious break-resistant black plastic case with chrome trim. Complete with earphone for private listening, batteries, telephone amplifier jack. Imported. Shpg. wt., 3 $\frac{1}{2}$ lbs. 99 E 35511L Net 22.95

Telephone Pick-up with plug, Wt. 4 oz. Net .99

99 E 35321 Net .99

Plug-in 117 VAC Adapter. Shpg. wt., 6 oz. Net 3.95

99 E 35164 Net 3.95

Extra "C" Batteries (4 required) Net ea. .14

99 E 62572 Net ea. .14

NEW Miniature Pocket AM Radio

5⁹⁵

With Earphone, and Batteries

Makes an ideal gift for any occasion. Remarkable miniature radio is small enough for your pocket or pocket-book with room to spare. Specially designed high efficiency 2" dynamic speaker plays all of your favorite AM stations. Utilizes the latest solid state devices. Built-in ferrite bar antenna. Operates on inexpensive 9 volt battery. Includes handy carrying strap, earphone, and batteries. Shpg. wt., 1 lb. Imported. 17 E 69405L Net 5.95

99 E 60212 Extra 9 Volt Batt. Net .21

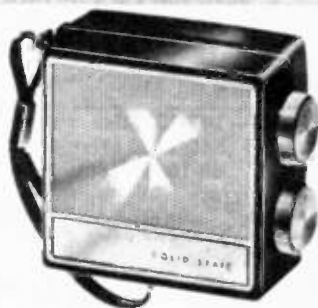

- Only 2 $\frac{3}{4}$ " x 2 $\frac{3}{4}$ " x 1 $\frac{1}{2}$ "
- Includes Handy Carrying Strap

Deluxe Solid-State Battery/Electric AM Radio

16⁹⁵

With Earphone, and Batteries

Supersensitive Battery/Electric AM Radio in attractive simulated brown leather case. Features tuned RF stage for improved sensitivity and selectivity. Advanced 10 transistor, 2 diode, and 1 thermistor circuitry. Built-in AC line cord for 110V operation. Also plays on 4 "C" batteries. Large 3 $\frac{1}{2}$ " speaker provides rich tone. Vernier tuning. Includes earphone for private listening and batteries. Size: 5 x 9 x 2 $\frac{1}{2}$ ". Imported. Wt., 6 lbs. 17 E 69363 Net 16.95

Extra "C" batteries (4 required) Net 16.95

99 E 62572 Net .14

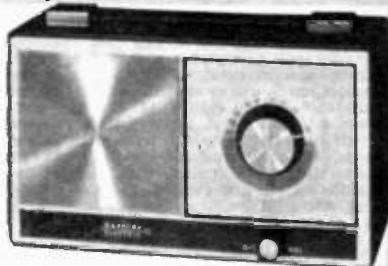

- Features Tuned RF Stage with 3 Gang Condenser
- Built-In AC Line Cord
- Large 3 $\frac{1}{2}$ " Speaker

Depend on Lafayette For Complete Stocks, Lowest Prices, Fastest Service

BECOME AN INFORMED CITIZEN IN YOUR COMMUNITY WITH LAFAYETTE FM-VHF PUBLIC SERVICE POLICE RADIOS

- Listen To Police and Fire Calls
- Monitor Civil Defense and Public Services
- Receive Regional U.S. Weather Bureau Forecasts*

ANOTHER LAFAYETTE EXCLUSIVE

† High-band Radio Receives Newly Established Regional Weather Bureau Forecasts On 162.55 MHz and 163.275 MHz

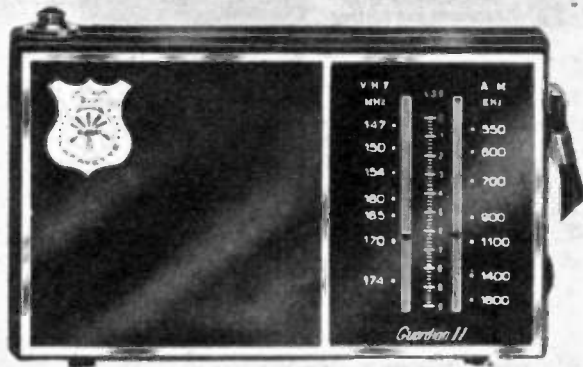

“GUARDIAN 300 SERIES”-3-BAND SOLID STATE BATTERY/AC HIGH or LOW FM-VHF POLICE AND AM-FM PORTABLE RADIOS

2 Models

“GUARDIAN II SERIES”-2-BAND SOLID STATE LOW OR HIGH FM-VHF POLICE AND AM RADIOS

2 Models

HIGH BAND	LOW BAND
FM VHF—147-174MHz AM— 540-1600 kHz FM— 88-108 MHz	FM VHF— 30-50 MHz AM— 540-1600 kHz FM— 88-108 MHz
34⁹⁵ with earphone and batteries	34⁹⁵ with earphone and batteries

HIGH BAND FM-VHF POLICE AND AM FM RADIO

- 12 Transistors, 6 Diodes
- Large 3½" Speaker For Excellent Tone
- Slide Rule Dial for Precise Tuning

HIGH BAND	LOW BAND
FM VHF—147-174MHz AM— 540-1600 kHz	FM VHF—30-50 MHz AM— 540-1600 kHz
21⁹⁵ with earphone and batteries	21⁹⁵ with earphone and batteries

HIGH BAND FM-VHF POLICE AND AM RADIO

- 147-174 MHz FM Police Band • 540-1600 kHz AM Band
- Slide Rule Logging Scale for Precise Tuning

Monitor the heart-beat of your city with the exclusive Guardian 300. Listen to Police and fire calls... ANYWHERE—ANYPLACE. Deluxe 3-band radio operates on 4 "C" batteries or 117 VAC 60 Hz by means of a self-storing AC line cord. Powerful space age solid-state circuitry with 12 transistors, 6 diodes, and 2 thermistors. Variable 6-gang capacitor tuning for extremely high sensitivity and selectivity enables you to pull in even the weakest stations. Complete coverage includes high-band FM-VHF 147-174 MHz and standard AM and FM broadcast bands. Also features slide rule dial for precise tuning, ferrite rod antenna for AM, telescoping antenna for FM-VHF and FM bands, and an external antenna input jack. Beautiful, padded black leatherette case with silver trim. Includes batteries, earphone, and self-storing AC line cord. Size 8¾W x 4½H x 2¾D. Imported. Shpg. wt., 6 lbs.

99 E 35461L Net 34.95

“LOW BAND” FM-VHF POLICE AND AM-FM RADIO

Same deluxe features and specifications as above but with 13 transistors and tunes Low Band FM-VHF 30-50 MHz instead of High Band. Imported. Shpg. wt., 6 lbs.

99 E 35479L Net 34.95
99 E 62572 Extra "C" bat. for above radios—4 req. Net ea. .14

Listen to the drama of everyday life with this exciting radio. Monitor local and state police, as well as fire departments, 162.55 MHz and 163.275 MHz, U.S. Weather Bureau stations, civil defense, and emergency public services. Includes standard AM band. Loaded with these outstanding features: 2 RF stages, 4 IF stages, slide rule logging scale for precise tuning, ferrite rod AM antenna, telescoping VHF antenna, large 3" speaker for superb fidelity. Handsome black case with silvertrim. Earphone jack for private listening. Operates on 4 "AA" type batteries (included) or 117 VAC with optional AC adapter, 11 transistors, 4 diodes, 1 thermistor, 7W x 4½H x 2¾D. 99 E 35222L Imported. Shpg. wt., 4 lbs. Net 21.95

† Consult your local weather bureau concerning reception in your area.

“LOW BAND” FM-VHF POLICE AND AM RADIO

- 30-50 MHz FM Police Band • 540-1600 kHz AM Band

Same deluxe features and specifications as above Police radio but tunes low band 30-50 MHz instead of High Band. Imported. 99 E 35347L Shpg. wt., 4 lbs. Net 21.95

ACCESSORIES for GUARDIAN POLICE RADIOS

Stock No.	Description	Shpg. Wt.	Net Ea.
99 E 35362	117 VAC Adapter	10 oz.	3.95
99 E 62580	Extra "AA" Batteries (4 required)	1 oz.	.10

LAFAYETTE Multiband TV, Police and Aircraft Radios

Lafayette 4-BAND TV-FM-FM/VHF PORTABLE RADIO

- Perfect For Remote Control of TV Sound.
- Monitor Exciting Police, Fire, and U.S. Weather Bureau Broadcasts.
- Listen To Beautiful FM Music.
- Instant-On Reliable Solid State Circuitry



A unique and truly different concept in the design of a radio allows you to tune TV channels 2 thru 13. Listen to the many outstanding sporting events, variety shows and specials normally transmitted only on TV. At night, use TV for picture but control sound from radio—earphone lets you listen without disturbing others. You can also monitor Police and Fire emergency calls. Listen to J.S. Weather Bureau forecasts on 162.55 or 163.275 MHz. Also receives standard FM broadcasts. Operates on 4 "D" batteries or 110 VAC with optional adapter. Powerful, super sensitive 14-transistor, solid-state circuitry. Precision, slide-rule tuning dial. Large speaker provides fine tonal quality. With built-in telescoping antenna, external antenna jack, leatherette carrying handle, earphones, and batteries. Handsome, black plastic cabinet with silver trim. Size: 9Lx 5 1/4 H x 2 1/2 "D. Imported. Shpg. wt., 2 lbs.

99 E 35636L Net 39.95
 99 E 62572 Extra "C" cells, 4 req. Net ea. .14
 117 VAC Adapter. Shpg. wt., 10 oz.
 99 E 35362 Net 3.95

Listen to TV Without Viewing!

TUNES:

- TV Low: Channels 2 thru 6
- TV High: Channels 7 thru 13
- FM-VHF High band Police: 146-175MHz
- Standard FM Broadcasts: 88-108MHz

39⁹⁵

With batteries and earphone for private listening.

No Money Down*

LAFAYETTE Solid State Battery/Electric 4-Band Twin Speaker AM/FM/Police/Aircraft Radio



- 147-174 MHz FM/VHF Police Band
- 108-136 MHz Aircraft Band
- 88-108 MHz FM Band
- 540-1600 KHz Standard AM Band

44⁹⁵

With Earphones and Batteries

Powerful 4-band, battery/electric portable radio with 18 transistors and 6 diodes. Listen to dramatic police-fire calls, U.S. Weather Bureau reports, on the FM-VHF high band (147-174 MHz). Tune in on aircraft in flight on the AM-VHF aircraft band (108-136MHz). Listen to the standard AM band (540-1600KHz). Two large 3" dynamic speakers with precision slide rule dial and continuous tone control. Self-storing AC line cord for 117 VAC operation. Also operates on 4 "C" batteries. Rotary, telescoping antenna for FM, Police, and Aircraft. Built-in ferrite bar antenna for AM. Vinyl padded black case with earphone and batteries. Size: 11 1/4 x 7 1/8 x 3 1/2". Imported. Shpg. wt., 6 lbs.

99 E 35503W No Money Down* Net 44.95
 99 E 62572 Extra "C" batteries (4 required) Net ea. .14

LAFAYETTE "Air Master" 10 Transistor AM and VHF Aircraft Portable Radio



- 108-136MHz VHF AM Aircraft Band
- 540-1600kHz AM Band
- Precision Slide Rule Logging Scale
- Large 3" Speaker

19⁹⁵

With Batteries, Earphone, and Carrying Strap

Listen to the exciting frequencies of aircraft communications in your home, car, or office on the 108-136MHz aircraft band. Monitor aviation control tower transmissions, listen to planes in flight, get their landing patterns and weather reports. You are actually with the pilot as he receives instructions for take-offs and landings. Also includes AM band. Features large 3" speaker, slide rule dial with logging scale, ferrite rod AM antenna, telescoping VHF antenna. Operates on 4 "AA" batteries (included) or on 117V AC with optional AC adapter. Earphone for private listening. 10 transistors, 2 diodes, 1 thermistor. Size: 7"W x 4 1/8"H x 2 1/8"D. Imported. Shpg. wt., 4 lbs.

99 E 35230L Net 19.95
 99 E 35362 AC Adapter for above. Wt. 6 oz. Net 3.95
 99 E 62580 Extra "AA" batteries (4 required) Net ea. .10

* See Page 11 for Full Credit Details on Easy Pay Plan

Super Deluxe LAFAYETTE "Guardian 5000" 5-Band Solid-State AC and Battery-Operated AM/FM/SW/FM-VHF Public Service Radio

Tunes 5 Exciting Bands!

<p>Low Band FM-VHF 30-50 MHz</p>  <p>Police and Fire</p>	<p>High Band FM-VHF 147-174 MHz</p>  <p>Police, Fire, U.S. Weather Bureau†</p>	<p>International Shortwave 4-12 MHz</p>  <p>Moscow BDC London Vatican Peking Voice of America And All The Languages of the World</p>	<p>Standard AM Broadcasts 540-1600 kHz</p>  <p>Sports and News</p>	<p>Standard FM Broadcasts 88-108 MHz</p>  <p>World Famous Symphonic Orchestras</p>
---	--	--	--	--



59⁹⁵

with batteries, earphone for private listening, and AC adapter

An Exciting Concept in Providing Dramatic Live Radio Coverage!

Outstanding Features:

- Two Separate Front End RF Tuning Sections For Both High And Low FM-VHF Bands
- Variable Squelch Control While Tuning FM-VHF Bands...Also Serves As Interstation Muting on Standard FM Band
- 17 Transistors, 9 Diodes, 2 Thermistors
- Battery Tester And Tuning Meter
- Modern, Convenient Upright Styling For Ease Of Portability

Endless hours of dramatic and informative radio listening. Monitor the airwaves of the world! Listen to Police, Fire, Civil Defense, 2-way Business and U.S. Weather Bureau forecasts‡ on BOTH THE HIGH (147-174MHz) and LOW (30-50 MHz) FM-VHF band. World Wide Radio listening pleasures and excitement is at your fingertips when you tune the 4-12 MHz International Shortwave Band. Enjoy outstanding music by world famous symphonic orchestras and soloists on the standard FM band (88-108MHz), as well as news, weather and sports on the standard AM band (55-1600kHz). Advanced space age solid-state circuitry permits instant operation—no loss of precious time due to warmup—permits immediate response to emergency situations. Two separate front end RF Tuning sections for both high and low FM-VHF Police bands for greater sensitivity and more dependable selectivity—weak stations can be heard clearly—while outside noise and interference are drastically reduced. Variable squelch control achieves truly quiet operation while tuning the high and low FM-VHF bands. Operates on 4 "C" batteries or 117 VAC household current with AC adapter (included). Excellent quality of tone from large 3½" speaker makes this a truly hi-fidelity portable radio. Telescoping antenna for FM, FM-VHF, and SW bands. Built-in ferrite core antenna for AM band. Accessory jack for use of separate external antenna. Slide rule logging scale for precise tuning. AFC circuitry prevents drift on FM. Beautiful walnut wood grain molded case with metal grill, gold trim, and handle. Includes 4 "C" batteries, earphone, and AC adapter. Dim.: 8¾"H x 6"W x 2¾"D. (Metal handle 3½"). Imported. Shpg. wt., 6 lbs.

99 E 354381. Net 59.95
 99 E 62572 Extra "C" batteries—4 required. Net ea. 14
 ‡162.55 MHz, or, consult your local weather bureau concerning reception in your area.

- The Guardian 5000 Keeps You Informed Of Emergency Situations—Where It Happens, While It's Happening
- Listen To Police, Fire, Civil Defense, 2-Way Business And U.S. Weather Bureau Forecasts‡
- You Become An Informed And Helpful Citizen In Your Community With The "Guardian 5000"

LAFAYETTE "Star-Fire® VI" AM/FM/SW/FM-VHF Radio

*Six Thrilling Bands
That Span The Globe!*

- AM- 535-1605kHz
- FM- 88-108MHz
- FM-VHF 147-174MHz (Police)
- SW-1 1.6-4.5MHz (Marine)
- SW-2 4-10MHz (International)
- SW-3 10-23MHz (International)

79⁹⁵

No Money Down*

TUNES:

- FM VHF Police and Fire Broadcasts
- Low Band Marine Weather
- World-Wide Shortwave
- Standard AM and FM
- New 162.55 MHz Regional Weather Bureau Forecasts†

†Consult your local weather bureau concerning reception in your area.

Deluxe Star-Fire VI speaks all the languages of the world. Powerful 18-transistor and 7-diode solid-state circuitry provides extremely high sensitivity. Cover has worldwide shortwave time zone chart. Monitor exciting police radio calls on the 147-176MHz VHF band. Also features: AFC to eliminate drift on FM, push-button controls, tone control, dial light, tuning/battery strength meter, built-in compass-point indicator, black leather cabinet with die-cast front, telescoping antenna for FM, SW and VHF reception. Supplied with earphones, 4 "D" type batteries and booklet of worldwide shortwave stations. 12x9½x4½"D. Imported. Shpg. wt., 18 lbs.

99 E 35263WX Net 79.95
 Extra "D" Batteries (4-required).
 99 E 62564 Net ea. .15
 AC Adapter for Star-Fire VI. Shpg. wt., ½ oz.
 99 E 35412 Net 4.95



- Instant-On Solid State Circuitry
- Electronic Bandspread Fine Tuning Control
- Operates on 4 "D" Type Batteries or 117VAC with Optional AC Adapter
- Two 4" Wide-Range Speakers for Magnificent Sound Reproduction

NEW Deluxe LAFAYETTE Solid-State 2-Band AM/FM Stereophonic Battery/AC Portable Radio

- Stereo Indicator Light
- AFC For Drift-Free FM Reception

54⁹⁵

with batteries



Each Detachable Swing-Out Speaker Extends to 18" For Magnificent True Stereo Separation

• With this handsome component type portable radio, you do not have to stay home to enjoy glorious FM stereo broadcasts as well as standard FM and AM broadcasts. Two detachable full-range 3½" high-compliance speakers separate for true stereo effect—and fold behind the cabinet for carrying. Five controls plus stereo indicator light: Volume, Tone, Balance, Selector, Tuning. AFC on FM to prevent drift. Precision slide-rule tuning dial with logging scale. Simulated black plastic leather with padded side panels, and chrome trim. Operates on 4 "D" batteries, or 117VAC with built-in line cord. 17-transistors, 12-diodes. Telescopic swivel antenna for FM; Ferrite core AM antenna. Size: Main cabinet—6¾" x 10¾" x 2½"; Speakers—6¾" x 5¾" x 2½". Imported. Shpg. wt., 7 lbs. 17 E 01812 Net 54.95
 Extra "D" Batteries (4-required).
 99 E 62564 Net ea. .15

* See Page 11 for Full Credit Details on Easy Pay Plan

Feature-Packed LAFAYETTE 2 and 3-Band Portables

NEW Lafayette 2-Band Solid-State Battery/Electric FM/AM Portable



• Self-Storing AC Line Cord



ONLY **17⁹⁵** with earphone and batteries

- Plugs Into Any AC Outlet or Plays Anywhere on 6 "A A" Batteries

Smartly styled, full-sized personal AM/FM portable. Handsome, olive leatherette cabinet with beige and chrome trim. Provides excellent FM as well as AM reception. Comes gift packed with earphone and batteries included. Features precision slide rule dial with logging scale, and wide range dynamic speaker for clear, crisp tonal quality. 9 transistors and 4 diodes. Telescopic FM antenna and ferrite core AM antenna. Size: 4 3/4 x 7 3/4 x 2 1/2" D. Imported. Shpg. wt., 3 lbs.

17 E 01770L _____ Net 17.95
99 E 62580 Extra "AA" bat. (6 req.) _____ Net ea. .10

NEW Deluxe Lafayette 2-Band Solid-State Battery/Electric FM/AM Portable



• Self-Storing AC Line Cord

ONLY **22⁹⁵** with earphone and batteries

- AFC for Drift-Free FM Reception
- Precision Slide Rule Tuning
- Superb Tone with Wide Range 3 1/2" Speaker

Supersensitive AM/FM portable radio in a deluxe cabinet with a big 3 1/2" wide range speaker for magnificent tone. Features one RF and three IF stages for extremely high sensitivity and selectivity, enabling the listener to hear more stations. Operates on 4 "C" batteries or 117 VAC with built-in line cord. Precision slide rule dial with logging scale. AFC on FM to prevent drift. Pushbutton control for FM or AM. Telescoping FM and ferrite core AM antennas. 10 transistors and 5 diodes. AC/DC switch. Attractive metal front panel with chrome trim. Rugged, black leatherette case. With earphone and 4 "C" batteries. Size: 5 5/8 x 9 x 2 1/2". Imported. Shpg. wt., 4 lbs.

17 E 01788L _____ Net 22.95
99 E 62572 Extra "C" bat. (4 req.) _____ Net ea. .14

Lafayette 3-Band Solid-State Battery/Electric AM/FM/SW Portable



Tunes 3 Bands:
SW: 4-12 MHz
FM: 88-108 MHz
AM: 540-1600 kHz

29⁹⁵ Includes Batteries, Carrying Strap, and Earphone

- Slide Rule Dial for Precision Tuning

Tunes the standard AM broadcast band (540-1600kHz), FM Band (88-108MHz) and the 4-12 MHz International Shortwave Band for exciting world-wide listening pleasure. Provides magnificent tone from large 3 1/2" speaker powered by 15 transistors and 5 diodes. Built-in AFC circuitry to prevent drift on FM. Slide rule dial for precision tuning. Built-in ferrite antenna for AM reception, telescopic antenna for FM and SW. Texon leatherette finished case in black, with chrome trim. With batteries and earphone for private listening. Operates on 117V AC 60 Hz with self storing AC line cord, or on 4 "C" batteries. Size: 11W x 7H x 3 3/4" D. Imported. Wt., 8 lbs.

99 E 35271 L _____ Net 29.95
99 E 62572 Extra C batteries (4 req.) _____ Net ea. .14

LAFAYETTE Battery/AC Multiband Portables

NEW Lafayette 6-Band Solid-State AM/FM/SW Portable

Put the World at Your Fingertips: London, Paris, Moscow, Rome

49⁹⁵

With Batteries
and Earphone

No Money Down*

- Precision Slide Rule Dial with Logging Scale
- AFC for Drift-Free FM Reception
- Large 3½" Speaker

Pinpoint tuning accuracy for the widest pick of international shortwave broadcasts and the Voice of America. Listen to these exciting and informative programs at the flick of a switch. For best all around reception, this radio has two antennas: a telescoping swivel antenna for the clearest possible shortwave and FM reception and a built-in ferrite bar antenna for greater AM range. High compliance, wide range 3½" speaker delivers extra clear and rich AM and FM broadcasts. Automatic frequency control (AFC) locks FM to strongest signal, thus preventing drift. Large slide rule tuning dial with logging scale. Continuous tone control. Rotary band selector. Chassis contains 12 transistors and 5 diodes. Handsome, high impact styrol leather grain cabinet with integrated carrying handle and chrome plated sides with leather insert. External antenna and earphone jacks. Comes complete with batteries and earphone. Operates on 4 "C" batteries or 117 VAC, 60 Hz with self storing AC line cord. Size: 6¾ x 10½ x 3½" D. Imported. Shpg. wt., 6½ lbs.

17 E 01804L Net 49.95

Extra "C" batteries for above. 4 required. 99 E 62572 Net ea. .14

International Shortwave Bandspread On
4 Bands for Pinpoint Tuning Accuracy

SW-1: 5.95—6.25 MHz SW-3: 11.65—12.0 MHz
SW-2: 9.45—9.7 MHz SW-4: 15.05—15.5 MHz

Also Tunes Standard AM and FM



• Self-Storing AC Line Cord

NEW Lafayette 4-Band Solid-State AM/FM/SW/Marine Portable

39⁹⁵

With Pillow Speaker,
Headphone, Earphone,
External Antenna Cord
and Battery.

Tunes 4 Bands:
AM: 540—1600 kHz
MB: 2.5—6.5 MHz
FM: 88—108 MHz
SW: 9—18 MHz

Superb performing 4-band portable radio for all around use. Listen to exciting foreign shortwave stations, marine reports, standard AM and FM broadcasts. Power loaded chassis has 6 diodes plus built-in automatic frequency control for drift-free FM performance. Easy-to-read slide rule dial with logging scale for precise tuning. Separate AC/DC switch permits you to play this fine portable on 117 VAC, 60 Hz or with 4 economical "C" batteries. AC line is self-storing. Large 3½" full range dynamic speaker for outstanding tonal quality. Built-in ferrite core antenna for AM and telescopic antenna for FM, Marine and SW bands. Handsome black padded, simulated leatherette cabinet with die-cast frame and chrome grill. Size: 9¾ x 6 x 3½". Imported. Shpg. wt., 7 lbs.

17 E 01796L No Money Down* Net 39.95

Extra "C" batteries for above. 4 req. 99 E 62572 Net ea. .14



• Self-Storing AC Line Cord

ONLY **99⁹⁵**
No Money Down*

Now With Provisions For Tape Recorder Input And Output



Deluxe LAFAYETTE LR-20 Solid State AM/FM Stereo System With Two Separate Matching Oiled Walnut Wood Speakers

- 26 Transistors, 18 Diodes, and 4 Thermistors
For 12 Watts of Music Power To Drive The
Two Full Range 6½" Speaker Systems

Brilliant and rewarding AM/FM stereo radio performance is the result of demanding stereo engineering. Proof of this superb engineering is Lafayette's LR-20. The characteristics of a fine hi-fi stereo component music system have been incorporated into this fine unit. You get rich hi-fi modular styling, exceptional quality, and flawless performance. The LR-20 employs the latest space age solid state devices, and because of the amazing reliability of these devices, you are assured of superior radio performance for years to come. The two separate 6½" rich sounding wide range matching oiled walnut wood speaker systems permit you to enjoy true stereo separation. A perfect optional addition to the LR-20 is the new Lafayette 4-speed automatic "mini" stereo record changer with diamond LP needle. With this changer you can have a complete AM/FM stereo phono system at an amazingly low cost. A deluxe feature of the LR-20 usually found only in more expensive hi-fi receivers is automatic FM stereo switching. This permits the LR-20 to automatically switch to stereo mode when you tune to an FM stereo station. A stereo indicator bulb lights up during reception of FM stereo broadcasts. Control Complement Includes: 6 position

- Automatic FM Stereo Switching
- Stereo Headphone Input Jack
- Tape Input and Output Jacks

Function Selector for AM, FM, FM AFC, FM Stereo, Phono, Aux (for tape recorder in); Volume/Balance; continuous Tone (Base/Treble); Mode switch (stereo-mono); Tuning; Main On/Off; and Loudness compensator switch; stereo headphone jack. The rear chassis also includes tape recorder output jacks. Quality components used include 26-transistors, 18-diodes and 4-thermistors. AM RF Section features a separate 3-gang tuning condenser, and incorporates a built-in AM ferrite rod antenna; Tuning Range: 540-1600 kHz. FM RF Section features a 3-gang air variable tuning capacitor and connection for external 300-ohm antenna; Tuning Range: 88-100 MHz. Overall Sensitivity: 7µv; Stereo Separation: 30 db @ 400 Hz. Amplifier section produces 12-watts power (6 watts per channel) with an output load of 8-ohms. Matching speakers are housed in beautiful oiled walnut wood enclosures. Control unit is housed in a handsome simulated walnut metal enclosure. For 117V., 50/60 Hz AC. Size: Control Unit—15W x 4¼H x 10¼"D.; Speakers—7½W x 9¼H x 5¼"D. Imported. Shpg. wt., 24 lbs.

99 E 35495WX

Net 99.95



"MINI" Changer
34.95

LR-20 with the Lafayette "Mini" 4 Speed Automatic Record Changer on Simulated Black Leather Base

DELUXE LAFAYETTE MODEL MC-22 4-SPEED "MINI" AUTOMATIC STEREO RECORD CHANGER mounted on simulated black leather base with walnut vinyl trim, tinted plastic dust cover and diamond LP needle (See page 68 for complete description). Dimensions: 14¾ x 5 x 10". Shpg. wt., 7 lbs. 21 E 14015W Net 34.95

* See Page 11 for Full Credit Details on Easy Pay Plan

Our Best Selection of Low-Priced Stereo FM/AM and FM Table Radios

NEW! LAFAYETTE Solid-State Stereo FM/AM Table Radio



49⁹⁵

No Money Down*

- Twin 4" Wide-Range Speaker
- Precision Slide-Rule Dial

NOW YOU CAN OWN A FULL 20 Inch Long Stereo FM/AM Table Radio with two self-contained 4" wide-range speakers. And it features Instant-on sound solid-state circuitry plus an FM stereo indicator light. Speakers are placed at each end of the cabinet for true stereo separation. 4-way selector knob enables you to listen to AM, FM or FM stereo broadcasts, or stereo records (when you plug in a record changer with ceramic

- Stereo Indicator Light
- Record Changer Input Jack

cartridge). AFC for drift-free FM reception. Separate Volume, Tone Balance, and Tuning controls. Ferrite core AM antenna, FM line cord antenna. Beautiful walnut plastic grain cabinet with black louvered speaker grill. For 117VAC 60 Hz. Size: 20W x 5H x 8"D. Imported.

17 E 01820WX Shpg. wt., 9 lbs. Net 49.95

LAFAYETTE Criterion "IV" Solid-State Professional FM Radio Featuring 5" Acoustic Suspension Speaker



- Tuned RF FM Stage
- Tape Input and Output Jacks

69⁹⁵

No Money Down*

Engineered to reproduce the full-range brilliance of FM broadcasting in your home. Measures only 14½" W x 9" D x 8¼" H, yet its sound quality is astonishing. Solid-state circuitry with 17-transistors and 5-diodes provides FM performance equal to that of expensive FM receivers. Tuned RF and 4 IF stages assure superb sensitivity and selectivity—bringing in the most distant stations, without distortion, noise or drift. Superb sound quality is provided by a powerful 5" full range, high-compliance speaker mounted in a completely sealed and damped enclosure, utilizing the acoustic suspension principle. Includes inputs for external program sources such as record changer (with ceramic/crystal cartridge) or tape recorder. Output jacks for tape, external 8-ohm speaker, and external antenna. SPECIFICATIONS: Output: 6-watts music power. Sensitivity: 2.5 µV. Controls: Tuning, Volume, Bass, Treble, FM-AUX Selector Switch, Main-Remote Speaker Selector. Protective output fuse. Built-in FM antenna. For 110-120 VAC 50/60 Hz. Imported. Shpg. wt., 12½ lbs. Net 69.95

Solid-State Stereo FM/AM Table Radio with Modular Speakers

Full FM Stereo Multiplex Reception Plus Standard AM



59⁹⁵

No Money Down*

- 19 Transistors, 11 Diodes

Unique 3-piece solid state design featuring high styling and quality electronics. Each separate speaker enclosure contains a 4 x 6" wide range Hi-Fi speaker. Convenient stereo eye assures pinpoint FM stereo reception. Large slide rule for precision tuning. Other fine features include AFC for drift free FM, accurate tuning meter, separate Bass,

- Accurate Tuning Meter

Treble, Balance and Loudness controls. Stereo phono input jack, tape input and output provisions, and front panel stereo headphone jack. Handsome plastic walnut wood grain cabinets. Size: Radio, 15½ x 8½ x 5". Speakers 9¼ x 7¼ x 4¾". For 117VAC 60 Hz. Imported. 17 E 69389WX Shpg. wt., 18 lbs. Net 59.95

- Stereo Headphone Jack

189 Lafayette Cat. No. 700

* See Page 11 for Full Credit Details on Easy Pay Plan

Superb Selection of Solid-State Table and Clock Radios

NEW Deluxe LAFAYETTE AM/FM Walnut Wood Hi-Fidelity Table Radio

37⁹⁵

No Money Down*

- Tuned RF FM and 4 IF Stages
- Tape Recorder Output Jack
- 12-Transistors and 14-Diodes
- External Speaker Output Jack

A deluxe high-fidelity AM/FM radio employing an advanced solid-state circuit with 12-transistors and 12-diodes. However, it is more than just an AM/FM radio. It combines a super-sensitive AM and FM receiving section with a tuned RF FM stage and 4 IF's, a high-fidelity amplifier, and a full-range acoustic suspension loudspeaker in one compact and handsomely designed 3/8" walnut wood enclosure. Equipped with a built-in AM and FM antenna system, this outstanding radio need only be connected to a standard 117 VAC outlet to place it in operation. Separate Band Selector, Continuous Tone control, and Volume control. AFC for drift-free FM. Jack at the rear of the radio marked REC may be used to plug in a tape recorder to record any programs heard on radio. Also includes provisions for hooking up an external 8-ohm speaker as well as external FM or AM antenna. Beautiful oiled walnut wood cabinet with woven tan grill. For 105-120V., 50/60 Hz AC. Size: 13L x 5 7/8" D x 8 3/4" H. Imported. Shpg. wt., 8 1/2 lbs. 99 E 35664W Net 37.95

Our Finest AM/FM Table Radio!
Featuring 5" Acoustic Suspension Speaker For Magnificent Full-Fidelity Sound Reproduction

3-Band AM/FM/SW Battery/AC Table Radio

39⁹⁵

No Money Down*

TUNES:
 SW—5.8 to 10.2MHz
 AM—550 to 1600kHz
 FM—88 to 108MHz

Magnificent performing 3-band table radio receives International Shortwave broadcasts on the 5.8 to 10.2 MHz SW band. Also assures perfect reception of the standard FM and AM bands. Slide-rule dial and pushbutton selection. Input jacks for phono or tape recorder. External speaker, headphone, and antenna jacks. For 110 VAC, 60Hz, or as a portable with 6 "C" batteries. 10 transistors plus 4 diodes. 4" speaker for superb tone. Imported. Dim.: 17 3/4 x 5 1/4 x 6 1/4". Shpg. wt., 6 lbs. 17 E 72151W

17 E 72169 Earphone for private listening. Wt., 2 oz. Net 3.95
 34 E 31020 Input plug for phono or tape. Wt., 2 oz. Net .70

Deluxe Panasonic Model RC-7469 AM/FM Digital Clock Radio



NEW

- Easy Time Reading
- Easy Time Setting—Preset Time Once

59⁹⁵

No Money Down*

Drift off to sleep and awaken either to music, morning weather, traffic and news reports, or awaken by alarm. Preset the time once and the RC-7469 turns on automatically everyday at the same time; turns off automatically after one hour of play. For ordinary use there's an Off/On button. Highly stylized clock and radio dials are illuminated for convenient night use. Has built-in FM and AM antennas, and earphone jack. For 110-120V., 50/60 Hz AC. Size: 5 1/4" H x 13 1/4 x 7 1/4" D. Imported. Shpg. wt., 4 lbs. 17 E 31546 Net 59.95

NEW "Mini" Twin Speaker AM/FM Table Radio

19⁹⁵

- Matched 3" and 2 1/4" Twin Speakers
- Walnut Wood Cabinet

The ideal size AM/FM table radio for persons who do not have the space to accommodate a large radio. Superheterodyne circuit features 10-transistors and 7-diodes, AFC for drift-free reception. Lighted slide-rule tuning dial. Bass-Treble tone control. Ferrite AM antenna, line cord FM antenna. Walnut wood cabinet with metallic silver speaker grills. For 117V., 50/60 Hz AC. UL Listed. Size: 11 1/2" W x 4 1/4 x 4 1/2". Imported. Net 19.95 17 E 70430 Shpg. wt., 4 lbs.

Instant Sound Solid State Clock Radios

LAFAYETTE Low-Profile Full-Feature AM/FM Clock Radio



Quality FM-AM clock radio for your home. Combines a fully automatic full feature Telechron clock and a superb FM/AM radio in a handsomely low profile styled walnut grained plastic cabinet with black and silver trim. Handy sleep-switch permits you to slowly drift-off to dreamland while the radio automatically shuts itself off (up to 60 minutes). Beautiful FM or AM music awakens you at a preset time pleasantly. Even includes a snooze button so that the set can again be turned off to permit you an extra 10 minutes of sleep. Clock face has luminous hand and dial markers. FM-AM radio features a slide rule dial for precise tuning, and a large 3 1/2" wide range speaker for luxurious tonal quality. All solid state circuitry with 10 transistors, 4 diodes and 1 thermistor provides high sensitivity and selectivity. Size: 9 1/2 x 5 1/4 x 3 1/4" D. For 117V AC, 60 Hz. Imported. Shpg. wt., 4 lbs.

17 E 01648W

Net 27.95

27⁹⁵

With Earphone
for Private Listening

- 60 Minute Sleep Switch
- Slide Rule Dial For Precise Tuning
- 10 Minute Snooze Button
- Large 3 1/2" Wide Range Speaker

NEW

Handsomely Styled LAFAYETTE Solid-State AM/FM Clock Radio

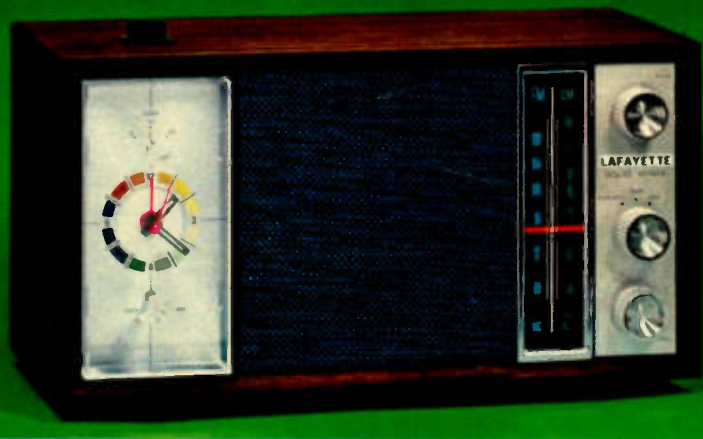

- Full Feature Telechron Clock with Lighted Dial And Snooze Button
- Large 4" Speaker
- AFC Lock Prevents Drift on FM

34⁹⁵

No Money
Down *

Rich Walnut Veneer
Wood Cabinet

Our finest AM/FM clock radio. Extra powerful solid-state circuitry, automatic frequency control (AFC) plus an FM signal boosting stage provides brilliant FM as well as AM reception. The full-feature Telechron clock with lighted dial lulls you to sleep, wakes you to music, lets you nap. Up to 60-minute automatic shut-off for late night listening. Also features precision slide rule dial, wake-up alarm, and a large 4" wide range speaker for superb tone. This clock radio is housed in a rich walnut veneer wood cabinet that will enhance the decor of your home. Size: 11 3/4" x 6 1/4" x 3 3/4". Imported. For 117 VAC 60 Hz. Shpg. wt., 6 lbs.

17 E 01638W

Net 34.95

* See Page 11 for Full Credit Details on Easy Pay Plan

NEW

Panasonic RC1089 AM Clock Radio



- Full Size Clock Face
- Slide Rule Tuning Dial

19⁹⁵

In Beautiful
Antique White

Compact and futuristic in design with full size clock face. Pre-set the clock and you can awaken to crisp clear sound from the sensitive AM radio. Easy-to-see slide rule dial. 2 1/4" dynamic speaker. Built-in ferrite core antenna. Beautiful antique white finish. Size: 6 1/4" H x 5 0" x 3 3/4" W. For 117 VAC, 60 Hz. Imported. Shpg. wt., 2 1/2 lbs.

17 E 31538

Net 19.95

SOLID

Electric Guitars

SAVE UP TO \$16.50

WHEN YOU BUY AN OUTFIT

BODY

(A) 2-Pick-Up

ONLY

29⁹⁵



(A) 2 PICK-UP CUTAWAY
SOLID BODY ELECTRIC GUITAR

- True Vibrato Tailpiece
- Steel Reinforced Adjustable Neck
- Volume and Tone Controls

Solid-body, double cutaway, electric guitar. Has friction free adjustable chrome bridge; compression tremolo; dual adjustable pickups with individual Off/On switches; and rugged chrome plated machines. Thin, fast action, steel reinforced neck is laminated and features a 21 fret rosewood fingerboard with 8 distinctive, white inlaid position markers. Beautiful lacquered body has inlaid highly polished chrome plate. Bevelled contour body is finished in a glittering red sunburst shade. Complete with cord. Size: 38½Hx12Wx1¼"D. Imported.

13 E 24516WX Shpg. wt., 10 lbs. Net 29.95
Sturdy Lined Case for Above Guitar. Wt., 3 lbs.
13 E 13261WX Net 8.95

(B) DELUXE 4 PICK-UP SOLID BODY
ELECTRIC GUITAR

- With Tremolo Tailpiece
- Modern, Double Cutaway Design
- Adjustable, Steel Reinforced Neck

Thin body, double cutaway design features a fast, slimline neck. An instrument with great flair that can be played with pride by all guitarists. Features a steel reinforced adjustable neck with variable string guides and an adjustable metal bridge. Includes tremolo with a large, flat bar for convenient use. Has attractive oval rosewood fingerboard and 20 new flat-type frets providing faster fingering. Separate on/off switch and volume control for each pick-up plus a master tone control. Richly designed, ebony pick guard with gold floral inlay. 9 mother-of-pearl inlaid position markers. Highly polished green sunburst finish. Imported. Shpg. wt., 14 lbs.

13 E 24599WX Net 44.95
Sturdy lined case for above. Shpg. wt., 3 lbs.
13 E 24607WX Net 8.95

4-Pick-Up
ONLY

(B) **44⁹⁵**

No Money
Down*



MONEY SAVING GUITAR OUTFITS

All outfits include a guitar, amplifier remote foot switch, plus neck strap, pickup cord, extra set of strings, pitch pipe, 6 picks, instruction book and record.

2 Pick-Up Solid Body Guitar Outfit

Includes: 13—24516WX Guitar, 99—92074WX 10 watt Reverb/Tremolo Amplifier (see page 199), plus all of above accessories. Shpg. wt., 27 lbs.
13 E 90798WXM No Money Down* Net 89.50

4 Pick-Up Solid Body Guitar Outfit

Includes: 13—24599WX Guitar, 99—92074WX 10 watt Reverb/Tremolo Amplifier (see page 199), plus all of above accessories. Shpg. wt., 28 lbs.
13 E 91168WXM No Money Down* Net 99.95

Deluxe 4 Pick-Up Solid Body Guitar Outfit

Includes: 13—24599WX Guitar, 13—01555WX 30 watt Reverb/Tremolo twin speaker amplifier (see page 200), plus all of above accessories. Shpg. wt., 40 lbs.

13 E 91176WXM No Money Down* Net 148.75



FOR BIG

DYNAMIC SOUND!

deluxe hollow body

ELECTRIC GUITARS

C
ONLY
49⁹⁵
No Money Down*

D
ONLY
79⁹⁵
No Money Down*

E
ONLY
89⁹⁵
No Money Down*



C "ULTRA-SLIM" 2 PICK-UP HOLLOW BODY ELECTRIC GUITAR

- "Hi-Response" True Vibrato Tailpiece
- Steel Reinforced, Adjustable Neck
- Adjustable Bridge—Adjustable Pick-Ups

Handsomely styled double cut-away electric guitar with dual pickups for solo or rhythm work. Narrow celluloid bound high speed adjustable neck is steel reinforced for extra strength and features a 21 fret rosewood fingerboard with white inlaid position markers. Also has sturdy tremolo tailpiece, laminated arched top and back, volume and tone controls plus 3-position selector switch for choice of pickup. Individual precision machine heads. Hand rubbed shaded red finish. 16Wx41¹/₄Hx1³/₄"D. Imported. Wt., 14 lbs. No Money Down*

13 E 66186WX Net 49.95
Sturdy Case For Above Guitar. Shpg. wt., 4 lbs.

13 E 66012WX Net 9.95

D DELUXE 2 PICK-UP "SLIMLINE" HOLLOW BODY ELECTRIC GUITAR

- "Laminated" — Steel Reinforced Adjustable Neck
- Individual Volume and Tone Controls
- Custom Designed Tremolo Tailpiece

Custom crafted, professional quality instrument! Features 21 fret, oval rosewood fingerboard with mother-of-pearl inlaid position markers and triple bound edges. Has two ultra-sensitive, hum-free pick-ups with individual pole adjustments, height adjustments, and individual volume and tone controls. 3-position lever switch selects bridge pickup for solo, and forward pickup for rhythm work; or, permits use of both pickups simultaneously. Large handsome celluloid bound body is shaped and contoured for optimum sound response. Beautifully flamed high-gloss polystyic finish. 16Wx44Hx2"D. Imported. Shpg. wt., 16 lbs.

13 E 66020WX Net 79.95
Sturdy Case With Plush Lining For Above. 13 E 66038WX Shpg. wt., 4 lbs. Net 11.95

E DELUXE 12-STRING 2 PICK-UP HOLLOW BODY ELECTRIC GUITAR

- Fully Adjustable Compensating Bridge
- Steel Reinforced Adjustable Neck
- 4-Controls plus Switch for Exciting Musical Sounds and Effects

Ultra sleek, double cutaway, thin-line instrument for the professional guitarist. Two ultra-sensitive hum-free pick-ups with individual pole and height adjustment. Separate volume and tone controls for individual pickups; 3-position selector switch for Solo/Rhythm and Super Bass sounds. The body is of selected flame grained woods and contoured both front and back for perfect body comfort. Slim fast-action neck is steel reinforced and features a 21 fret oval rosewood fingerboard with mother-of-pearl inlaid position blocks plus side position markers and triple bound edges. Also has Universally adjustable bridge; custom designed tailpiece. Beautifully flamed high-gloss polystyic finish. Imported. With cord. Shpg. wt., 18 lbs.

13 E 66046WX Net 89.95
Sturdy Case With Plush Lining For Above. 13 E 66053WX Shpg. wt., 4 lbs. Net 13.95

* See Page 11 for Full Credit Details on Easy Pay Plan

HOLLOW BODY Electric Guitar Outfit

with 5-WATT AMPLIFIER

55⁷⁵

No Money Down*

SAVE OVER 6.00

From Individual Catalog Prices



- Includes: Guitar, 5-Watt Amplifier, Carry Case, Extra Strings, Neck Strap with Shoulder Pad

Big sounding outfit! Features an ultra-slim semi-acoustic, hollow body guitar; 2-powerful magnetic pickups with individual switches for each pickup plus adjustable sensitivity controls for each string. Tremolo tailpiece, adjustable neck and compensating bridge, plus individual Volume/Tone controls. Rosewood fingerboard has inlaid pearl position markers; body is lustrous sunburst acrylic finish. 5-watt amplifier features built-in 6" heavy-duty speaker, 2 Instrument inputs, On/Off and Volume/Tone controls; in sturdy vinyl covered wood cabinet. Size: Guitar

40L x 13 $\frac{3}{4}$ W x 1 $\frac{3}{4}$ "D. Amp., 15 $\frac{1}{2}$ H x 13 $\frac{1}{2}$ W x 1 $\frac{1}{4}$ "D. Imported.
 13 E 01200WX Shpg. wt., 23 lbs. Net 55.75
 Guitar Outfit less amplifier.
 13 E 24031WX Shpg. wt., 11 lbs. Net 39.95



Complete Outfit

Only **19⁹⁵**

7 PIECE "BEGINNERS OUTFIT"

- Everything You Need Including Beginners Record Course and Book

Nicely finished with open headpiece and pinless bridge. Can be used either as nylon string classic or steel string Folk guitar. Steel reinforced neck. Guitar has hardwood body with Blonde top. Highly polished finish with design around sound hole. Comes complete with Nylon and extra set of steel strings, Vinyl zippered carrying bag, neck cord, pick, instruction book and record course. Size: 36 $\frac{1}{4}$ L x 13W x 3 $\frac{1}{2}$ "D. Imported. Shpg. wt., 9 lbs. Net 19.95
 13 E 60123WX



A
Only **19⁹⁵**

B
Only **29⁹⁵**

A CONCERT SIZE CLASSIC GUITAR

- Steel Reinforced Neck • Fan Braced Top

Magnificent sounding classic guitar! 19 fret fingerboard. Sound hole features a mosaic decoration. Has fixed Spanish style bridge, 6-precision tuning machines with plastic roller, slotted headpiece, and a steel reinforced neck. Mahogany sides and back, with a white spruce top. Size: 38 $\frac{3}{8}$ L x 14 $\frac{1}{8}$ W x 3 $\frac{3}{8}$ "D. Nylon Strings. Imported.

13 E 06137WX Shpg. wt., 10 lbs. Net 19.95
 Sturdy case for above. Shpg. wt., 4 lbs. Net 8.95
 13 E 66145WX

B GRAND CONCERT CLASSIC GUITAR

- White Spruce Top with Mahogany Sides & Back

Beautifully detailed concert classic guitar! Features a steel reinforced rosewood neck with 19 fret fingerboard, and a fan-braced finest quality spruce top. Both front and back of the large handsome body are individually shaped and contoured for ultimate performance. Also has rosewood pinless bridge, 6 side position markers, heavy-duty precision machine heads with rollers, open headpiece. Highly polished, grained, sides and back. Size: 39L x 14 $\frac{1}{4}$ W x 3 $\frac{3}{8}$ "D. Nylon Strings. Imported.

13 E 66152WX Shpg. wt., 10 lbs. Net 29.95
 Sturdy case for above. Wt., 4 lbs. Net 8.95
 13 E 66145WX

5-STRING BANJO With RESONATOR

Top quality 5-string banjo! Heavy cast nickel-plated rim with 20 adjustable brackets. Adjustable hard rock maple neck with celluloid bound rosewood fingerboard. Has 22 frets, and position markers. Individual tuning pegs, wood arm rest. Nickel plated tailpiece and strap attachment. Size: 39 $\frac{1}{2}$ "L. Resonator: 13" Dia. Shpg. wt., 12 lbs. Net 39.95
 13 E 52764WX

Same as above but 4-String Tenor Banjo.
 13 E 52772WX Net 39.95
 Sturdy Lined Case for above Banjo's.
 13 E 52780WX Shpg. wt., 3 lbs. Net 8.50



Only **39⁹⁵**

RICH TONE

ACOUSTIC GUITARS



(A)
Folk Guitar
Only
29⁹⁵

(B)
Deluxe Folk
Guitar
Only
49⁹⁵



(C)
Deluxe Classic
Guitar
Only
54⁹⁵

(D)
Jumbo Country
and Western
Guitar
Only
59⁹⁵

(A) POPULAR FOLK GUITAR

Grand concert size, attractively crafted in highly polished selected spruce top with mahogany back and sides. Bound edges, decorated sound hole with shell celluloid decorated pickguard. Has rosewood fingerboard with black pearl position markers; rosewood pin style bridge; steel strings, chrome plated tuning gears. Imported. Size: 15 $\frac{1}{4}$ "W x 40 $\frac{1}{4}$ "L x 3 $\frac{1}{2}$ "D. Shpg. wt., 10 lbs.

13 E 66434WX Net 29.95

Country & Western Model, Similar to above Western Style; Grand Concert size: 15 $\frac{3}{8}$ "W x 40 $\frac{1}{4}$ "L x 3 $\frac{1}{2}$ "D. Shpg. wt., 10 lbs.

13 E 66442WX Net 29.95

Sturdy Lined Case for above guitars. Shpg. wt., 4 lbs.

13 E 66456WX Net 9.95

(B) DELUXE FOLK GUITAR

• **Genuine Spruce Top—Rosewood Finished Sides & Back**

Grand Concert Size. Use of selected, close-grained spruce top and mahogany back and sides permits an exceptional degree of resonance and response. Adjustable celluloid bound hardwood neck, rosewood fingerboard with inlaid pearl position markers and nickel silver frets. Celluloid covered, decorated inlaid headpiece; adjustable rosewood bridge; sound hole inlaid with genuine wood Marquetry. Attractive celluloid pickguard to protect the top. Size: 15W x 40L x 3 $\frac{1}{2}$ "D. Imported. Steel strings. Shpg. wt., 11 lbs.

13 E 52794WX No Money Down* Net 49.95

13 E 52806WX Sturdy Lined Case. Shpg. wt., 3 lbs. Net 9.95

* See Page 11 for Full Credit Details on Easy Pay Plan

(C) DELUXE CLASSIC GUITAR

• **Concert Size—Beautiful Grained Rosewood Sides and Back**

Made of carefully selected hardwoods. Back and sides of matched rosewood with inlaid Marquetry trim; top from close grain spruce in a beautiful burnt orange finish. Custom design fan bracing adds vibrant tone, wider range. Bridge and sound hole inlaid with wood Marquetry of matching Spanish design. Marquetry inlaid headpiece; rosewood fingerboard with nickel silver frets and side position markers. Size: 39 $\frac{1}{4}$ "L x 14 $\frac{1}{4}$ "W. Nylon strings. Imported. Wt. 10 lbs.

13 E 66467WX No Money Down* Net 54.95

Sturdy case with Plush Lining for above. Shpg. wt., 4 lbs.

13 E 66475WX Net 14.95

(D) JUMBO COUNTRY AND WESTERN GUITAR

Rich deep bass and clear treble tones are built-in this jumbo size model. Made of carefully selected woods—resonant hand rubbed maple back and sides, and close grained, antique colored spruce top. Genuine "Nato" wood adjustable neck with celluloid bound rosewood fingerboard; inlaid pearl position markers; 20 nickel silver frets. Rosewood adjustable bridge, black pickguard with flowered design, individual tuning pegs. 40 $\frac{1}{4}$ "L x 16 $\frac{1}{2}$ "W x 4 $\frac{1}{4}$ "D. Steel Strings.

13 E 52814WX Imported. Shpg. wt., 13 lbs. Net 59.95

Jumbo Country & Western 12-String Guitar similar to above.

13 E 52822WX Shpg. wt., 13 lbs. Net 84.95

Sturdy Lined Case for above guitars. Shpg. wt., 4 lbs.

13 E 52830WX Net 11.95

SOLID & HOLLOW BODY Electric Bases



A
VIOLIN-SHAPED
2 PICK-UP BASS
49⁹⁵
No Money Down*

A VIOLIN SHAPED
2-PICK-UP ELECTRIC BASS

Classic violin shape with Italian styled head-piece, combines with two magnetic pick-ups for a pure, rich, bass sound. Three position switch accentuates the highs, lows and mid-range. Delicately arched hollow body bound in decorative celluloid trim, features: a 4-piece laminated, fully adjustable, steel reinforced neck; bound rosewood fingerboard with heavy nickel silver frets and inlaid position markers; chrome plated trapeze tailpiece; adjustable bridge; fully enclosed tuning machines; sparkling sunburst finish with a celluloid pick guard, and mahogany finger rest, cord. 44 1/2 x 13 x 2 1/4". Imported. 13 E 24532WX Shpg. wt., 12 lbs. Net 49.95 Sturdy case for above. Shpg. wt., 4 lbs. 13 E 24540WX Net 8.95

Save
UP TO
25⁰⁰
ON
COMPLETE
OUTFITS

B
2 PICK-UP
SOLID BODY
BASS
39⁹⁵
No Money Down*

C
DELUXE 2 PICK-UP
HOLLOW BODY
ELECTRIC BASS
89⁹⁵
No Money Down*

B 2 PICK-UP SOLID
BODY ELECTRIC BASS

Long neck, slimline electric bass guitar of selected woods for excellent speed and response and easy fingering. Hand rubbed, shaded sunburst body finished in durable acrylic lacquer. 46" steel reinforced adjustable neck has celuloid bound oval rosewood fingerboard, 20 frets, 8 pearl inlaid position markers, and large machines for fast accurate tuning. Sensitive pick-ups have adjustable pole pieces for precise balancing of individual strings. Two, feather-touch rocker standby switches for instant control of each pick-up. Includes separate volume and tone controls and compensation adjustable bridge. With cord. Imported. Size: 46Lx13 1/2 Wx1" D. 13 E 24615WX Shpg. wt., 15 lbs. Net 39.95 Sturdy Case for above. Shpg. wt., 4 lbs. 13 E 24623WX Net 9.95

C DELUXE 2 PICK-UP
HOLLOW BODY ELECTRIC BASS

Produces deep bass tones with brilliant cadence! Features adjustable muting control; 2 perfectly balanced adjustable pick-ups; individual tone and volume controls for each pick-up; 3 position toggle switch for solo/rhythm; fully adjustable compensating bridge; individual chrome covered precision machines; and custom designed tallpiece. Hard maple, steel reinforced adjustable neck with a 20 fret, oval rosewood fingerboard. 9 mother-of-pearl inlaid position blocks, side position markers and triple bound edges. The beautiful, flame grained thin-line, double cutaway hardwood body is celluloid bound and protected by a pick guard. With cord. Imported. Size: 46Hx16Wx 2"D. Shpg. wt., 18 lbs. 13 E 66087WX Net 89.95 Sturdy case with plush lining for above. 13 E 80095WX Shpg. wt., 4 lbs. Net 13.95



COMPLETE ELECTRIC BASS OUTFITS—SAVE UP TO \$25.00 from Individual Catalog Prices

Each Electric Bass Guitar Outfit consists of a Electric Bass, Amplifier, Case, Neck Strap, Pick-up Cord plus "Modern Electric Bass Guitar Method" book. See Pages 199 to 200 for Amplifiers

Outfit No.	Elect. Bass	Amplifier	Watts	Shpg. wt.	Net
13 E 91184WXM	13 E 24615WX	13 E 01480WX	80	75 lbs.	182.50
13 E 91192WXM	13 E 24615WX	13 E 01548WX	50	52 lbs.	137.50
13 E 91127WXM	13 E 24532WX	13 E 01480WX	80	75 lbs.	190.95
13 E 91135WXM	13 E 24532WX	13 E 01548WX	50	52 lbs.	145.95
13 E 90327WXM	13 E 66087WX	13 E 01480WX	80	79 lbs.	230.95
13 E 90749WXM	13 E 66087WX	13 E 01548WX	50	56 lbs.	185.95

*See Page 11 for Full Credit Details on Easy Pay Plan

BIG SOUND Drums



OPTIONAL
16"x16" Floor Tom Tom



ONLY
99⁹⁵

No Money
Down*



ONLY **199⁹⁵** No Money
Down*

9-PC. "COMBO" DRUM OUTFIT

- 9-Ply Construction Thru-Out
- Double Lug—Separate Tension
- With 14" Cymbal—Cow Bell—Toneblock—Sticks—Brushes

A quality 9 piece drum outfit for the beginner or advanced musician. Outfit contains an 8"x12" Tom Tom, a 14"x20" bass drum, both with double lug separate tension rods, and a 5½"x14" separate tension snare drum. Bass drum features a fully adjustable "fast" action pedal, die-cast chrome plated steel rims, streamlined hardware, and chrome plated cow bell. All drums have plastic heads, feature triple flanged rims and chrome plated hardware. Other items include a 14" cymbal with fully adjustable cymbal holder that will adjust to any height or angle, disappearing spurs, sticks, and stick holder, a flat base snare drum stand, and a universal adjustable roll mount console for "ride" of Tom Tom. Bright finish. Imported. Shpg. wt., 60 lbs.

13 E 24508WX Bright Blue Net 99.95
13 E 24565WX Bright Silver Net 99.95

16"x16" FLOOR TOM TOM FOR ABOVE
13 E 24573WX Bright Blue Net 34.95
13 E 24581WX Bright Silver Net 34.95

197 Lafayette Cat. No. 700

A DRUMMERS THRONE

Drummer's throne, chrome plated. Padded seat, 11" dia. Adjustable height from 20" to 27". Folds easily. Shpg. wt., 7 lbs.
13 E 66293W Net 12.50

B HIGH HAT OUTFIT

Two 14" Swiss brass cymbals on an adjustable, chrome plated flat base. Features a fast action foot pedal for added speed and comfort in playing. Base adjusts from 24" to 31". Shpg. wt., 8 lbs.
13 E 66285W Net 29.95

C SNARE DRUM SET

An exciting 14"x5½" separate tension, 6 ply snare drum with metal snares, tone modulator, speedy throw-off, flanged hoops, rolled chrome plated rims, plastic head, and nickel plated hardware. Attractive celluloid sparkle finish. Complete with deluxe flat base chrome stand, 10" cymbal, sticks, brushes, and instruction book. Imported. Shpg. wt., 9 lbs.
13 E 87059W Net 29.95



12⁵⁰

29⁹⁵



29⁹⁵

- Complete w/lt Stand, 10" Cymbal, Brushes, Sticks

PROFESSIONAL 15-PC. DRUM OUTFIT

- 9-Ply Construction Thru-Out
- Double Lug—Double Tension

Deluxe, professional quality drum outfit with all the most wanted accessories. Meets the demand for quality and sound in every way. Each drum has completely adjustable tension rods for quick and easy tuning. Set consists of 14"x20" Bass Drum with 8-separate beaver-tail tension lugs, spurs, cymbal holder, console tom tom mount, internal muffler and inlaid chromed hoops. 5½"x14" Snare Drum—8-tension, speedy throw-off, and internal muffler. 16"x16" Floor Tom Tom—8-tension with internal muffler. One 8"x12" and one 9"x13" Tom Tom—6-tension with muffler. Drums have coated plastic heads, celluloid covered for bright finish. Includes deluxe, flat-base snare stand, floor cymbal stand, and a super deluxe, direct-action Hi-Hat stand with fast action pedal. Set also contains a 16" Ride Cymbal, a pair of 14" Hi-Hat Cymbals, and deluxe bass drum pedal, drum sticks and brushes, cowbell, woodblock and holder. Imported. Shpg. wt., 85 lbs.
13 E 66281WX Bright Red Net 199.95
13 E 66269WX Bright Blue Net 199.95

5-Piece Vinyl Drum Cover Case
13 E 66277W Shpg. wt., 10. lbs. Net 34.95

* See Page 11 for Full Credit Details on Easy Pay Plan



PORTABLE TRANSISTORIZED
ELECTRONIC ORGAN
With Built-In Amplifier

299⁹⁵

- Fully Transistorized—With Two Speakers
- Easy to Carry—Packs Like a Suitcase
- Perfect for Combo or Home Use

Portable organ has a built-in fully transistorized 10-watt amplifier and two oval speakers. Ready to play anywhere... Suitable for any entertainer, at home or school. 49-key keyboard spans 4 full octaves and produces a wide range of tonal variations. Three 16" voice tabs — bass bourdon; bourdon; and strings. Four 8" voice tabs — flute; diapason; strings; and trumpet. Trumpet tab simulates 4 effects to give an even wider variety of sounds. On-Off tab vibrato with rotary speed and intensity controls. Volume/On-Off switch with pilot light and separate volume control for bass octave. Photo-cell type expression pedal. Can also be played through an external amplifier. Comes in red and black trim. Size: 31" keyboard; height 32"; 18" deep. Operate on 117 VAC. Imported from Italy. Shpg. wt., 68 lbs.
13 E 66343WX Net 299.95



Estey DUAL MANUAL &
CHORD ORGAN
ONLY **249⁹⁵**

- Lifetime Stainless Steel Reeds
- 37 Key Upper—32 Key Lower Keyboard with 40 Chord Buttons

Play music in 60 seconds. Features dual manual keyboard with full size waterfall keys in a 37 note upper and 32 note lower keyboard with 40 chord buttons. Includes major, minor, seventh, diminished, and bass. Magnificent console cabinet is finished in mar, burn, and stain resistant walnut tone. Hand tuned stainless steel reeds. Built-in tone chamber gives more mellow sound. Foot pedal volume control. On/Off switch with pilot light. With instructions/song book and chord chart. Operates on 117 VAC. Size: 36½Wx19Dx34¼"H.
12 E 58573WX No Money Down⁴ Shpg. wt., 110 lbs. Net 249.95

Storage Compartment Bench. Burnproof, mar-resistant walnut finish. Shpg. wt., 16 lbs.
12 E 58581WX Net 24.95



Estey 40 CHORD ORGAN

- 37 Keys—Foot Volume Control
- Permanently Tuned Stainless Steel Reeds

149⁹⁵

No Money Down⁴

40 chord electric organ features 37 ivory white keys; 40 chords — 8 bass, 8 major, 8 minor, 8 sevenths, and 8 diminished. Convenient on/off switch, foot pedal volume control for playing with expression. Grained walnut finish is burn, stain and scratch resistant. Matching music rack. With Instruction book. Size: 33Lx17Dx31"H. For 117 VAC. Less bench. Shpg. wt. 69 lbs.
12 E 58524WX Net 149.95

Storage compartment bench. Burnproof, mar-resistant walnut finish. Shpg. wt., 16 lbs.
12 E 58599WX Net 24.95

198 Lafayette Cat. No. 700



Estey 18 CHORD ORGAN

- 37 Keys—Hand Volume Control
- Stainless Steel Reeds

99⁹⁵

No Money Down⁴

With Bench and 5 Music Books

18 chord electric organ with 37 full size, white numbered keys. 18 chords include 6 major, 6 minor, and 6 sevenths. Features lifetime hand tuned stainless steel reeds. Modern style console cabinet with music rack has burn proof, mar-resistant walnut finish. Complete with vinyl covered bench and 5 music books. Convenient on/off switch and volume control. With easy-to-play A-B-C and 1-2-3 instruction book. Size: 30½Hx29½Wx15"D. For 117 VAC, 60 Hz.
Shpg. wt., 66 lbs.
12 E 58607WX Net 99.95



Magnus 12 CHORD ORGAN

- 37 Treble Keys
- Music Light

59⁹⁵

No Money Down⁴

Handsome contemporary styled 12 chord electric organ with matching music rack. Easily played in 30 seconds without lessons. 37 treble keys and 12 chord buttons. With hand volume control and on/off switch. Has convenient Magna-Lite music light. Cabinet has mar-resistant walnut grained finish. With music book. Size: 32Hx30Wx13"D. For 117 VAC, 60 Hz. Shpg. wt., 50 lbs.
12 E 58052WX Net 59.95

Non-lift Bench. Burn proof, mar-resistant walnut finish. Shpg. wt., 12 lbs.
12 E 58532W Net 14.95

* See Page 11 for Full Credit Details on Easy Pay Plan

LAFAYETTE SOLID-STATE 120-WATT PA and MUSICAL INSTRUMENT SOUND SYSTEM

A two piece portable sound system that is easy to handle and extremely versatile. Features a mono-stereo mixer control center and a separate solid-state amplifier-speaker system. Mixer can handle up to 4 amplifier-speaker (120 watts each) giving up to 480 watts of power and all the flexibility you will ever need. Amplifies voices as well as instruments.

Master Control Center Features

- 4 Channels—8 Inputs
- Each Channel Has 2 Inputs (High and Low) with Individual Volume, Bass and Treble Controls
- 2-Slider-Type Master Volume Controls for Mono or Stereo
- Two 3" Illuminated VU Meters to Monitor Preamp or Power Amp with Selector Switch
- Solid State—All Silicon Transistors
- Drive Capacity for 4 Amplifier-Speaker Systems
- Control Center is Built Into A Carrying Case with Detachable Lid

Only
299⁹⁵
No Money Down*

Amplifier Speaker System Features

- Solid State 120-Watt Power Amplifier with Four 10" Jensen Speakers

This unique portable sound system has exceptional performance for use with many instruments and voices. Control center features all of the above plus on-off switch, pilot light, fuse, 2 aux. AC receptacles and output connector with on-off switch for echo or reverb equipment. Amplifier-speaker systems and control center may be stacked. May be used for stereo with second amplifier-speaker system. Amplifier-speaker system size: 27Hx23W x11½"D. Control center size: 9Hx21Wx8"D. Sturdy black vinyl covered wood cabinets with handles. With cords and plugs. For 117VAC 60 Hz.

13 E 90756WXM Shpg. wt., 66 lbs. Net 299.95
"Add On" 120 Watt Amplifier-Speaker System. Shpg. wt., 50 lbs.
13 E 01597WX No Money Down* Net 139.95
Reverberation Unit: Studio type tone reverberation with Hammond unit. 30-40 millisecond delay with a total of 1.2 sec. tone decay. Reverb and Tone Color controls. Vinyl covered case with chrome handles and illuminated push-button switch. With Foot Switch. Size: 19"Wx6"Hx7"D. Shpg. wt., 12 lbs.
13 E 01613WX No Money Down* Net 69.95
Heavy Duty Aluminum Dolly for above system. Shpg. wt., 4 lbs.
13 E 01605WX Net 21.95



SOLID-STATE MUSICAL INSTRUMENT AMPLIFIERS



21⁹⁵

5-WATT STUDENT AMPLIFIER

- Two Instrument Inputs
- Volume And Tone Controls

Great for the student or beginner! Features rugged, solid state circuitry for cool, instantaneous amplification and trouble-free operation. Provides 5-watts peak music power into a heavy-duty specially designed 6" speaker with excellent clarity and tonal response. Smartly styled control panel has Tone and Volume control; two Instrument inputs; On/Off switch. Attractively designed lock plywood construction covered in water repellent, scuff-resistant black vinyl. With carrying handle. Size: 15¾"Hx13¼"Wx6"D. For 117V., 60 Hz AC operation. Shpg. wt., 13 lbs.
13 E 01639W Net 21.95



32⁹⁵

8 WATT "TREMOLLO" AMPLIFIER

- Tremolo Speed And Intensity Controls
- 3 Inputs—Foot Switch Jacks

Functional, attractive, all-transistor tremolo amplifier. Delivers 8-watts peak power to a specially designed 8" speaker for full instrument range. Front mounted control panel has controls for Tone, Volume, Tremolo speed, Tremolo intensity; three instrument inputs; tremolo foot switch input jack; and pilot light. Housed in a sturdy wood cabinet with jet black vinyl covering and harmonizing grill. Chrome carrying handle. Size: 17½"Hx14¾"Wx7"D. For 117 V., 60 Hz AC. Shpg. wt., 12 lbs.
13 E 01621W No Money Down* Net 32.95
Foot Switch For Remote Control of Tremolo
13 E 01514 Shpg. wt., 1/2 lb. Net 2.99



49⁹⁵

TREMOLLO/REVERB AMPLIFIER

- Tremolo Speed/Depth Reverb Controls
- Heavy-Duty 10" Speaker

Impressive, 10-watt solid state reverb and tremolo amplifier with self-contained 10" heavy-duty speaker. Slanted, front-mounted control panel features "easy-to-reach" controls for Volume, Tone, Reverb, Tremolo speed, Tremolo depth; two instrument inputs; reverb and tremolo foot switch input jack; bright-glow pilot light. Housed in an attractive sturdy vinyl covered wood cabinet with carry handle and grill cloth. Size: 19"Hx 15"Wx6½"D. For 117V., 60Hz AC. Imported. Shpg. wt., 16 lbs.
99 E 92074WX No Money Down* Net 49.95
Dual Foot Switch For Remote Control of Tremolo and Reverb. Shpg. wt., 1½ lbs.
13 E 01506 Net 4.95

* See Page 11 for Full Credit Details on Easy Pay Plan



LAFAYETTE

Amplifiers

Deluxe Powerful Musical Instrument Amplifiers



**50
WATT**

99⁹⁵

No Money Down*

50-Watt Solid State "Piggy Back" Bass Amplifier

- Heavy Duty 15" Special Design Speaker
- For Use With Electric Bass, Regular Guitar, Accordion and Combo-Organ • 2-Instrument Inputs

Gives full bass and vibrant sound with a minimum of distortion. Powerful 50 watt peak amplifier is ideal for use with electric bass or standard guitars, and combo organs. All solid state circuitry (5-transistors and 4-silicon rectifiers) provides excellent sound. Features a specially designed 15" speaker with a wide range response. High and low gain inputs plus separate volume and tone controls allow complete operating flexibility. Has On-Off switch plus pilot light and fuse. Two units; speaker and amplifier in matching black, vinyl covered wood enclosures with handles. Size: Amp., 4³/₄H x 14W x 8"D; Speaker, 22⁷/₈H x 18W x 11"D. For 117V 50/60 Hz AC. **13 E 01548WX** Shpg. wt., 35 lbs. Net **99.95**

200 Lafayette Cat. No. 700



**80
WATT**

149⁹⁵

No Money Down*

80-Watt "Piggy Back" Bass Amplifier

- Powerful 15" Special Design Jensen Speaker with 27 oz. Magnet
- Projects "Big Bass Sound"
- Excellent For Use With Electric Bass, Regular Guitar, Accordion and Combo-Organ
- "Easy Reach" Extruded Brushed Aluminum Control Panel will handle up to 3 instruments

Fabulous, full bass sound with a minimum of distortion. Specially designed durable 15" Jensen speaker has a wide range response. Has 3 Inputs: bass, high and low. Two slide switches for "deep" or "sharp" reproduction. Treble, bass, and volume controls: Neon pilot lamps. Fuse and 3-position switch for power off/standby/on. Super 80-watt peak power chassis uses 5 tubes, 2 dual purpose tubes for 7 tube performance, and all solid state rectifier circuit. Heavy duty transformers provide greater output. Two units; 3/4" wood amplifier /speaker cabinet, and "piggy back" amplifier which sits neatly on top of speaker cabinet. Cabinets have attractive gray and silver acoustical cloth. Ribbed vinyl carrying handle. Speaker cabinet size: 23¹/₂H x 22L x 11¹/₂"D. Amplifier: 7¹/₄H x 18¹/₂L x 10¹/₂"D. For 117V AC 50/60 Hz Shpg. wt., 58 lbs.

13 E 01480WX

Net 149.95

13 E 01498W Dolly for above amplifier

Net 11.95



NEW 100 WATT UNIT

199⁹⁵

No Money Down*

100 Watt Solid State "Piggy Back" Amplifier with Reverb-Tremolo, 3-Speakers, 2-Channels

- For Guitar, Organ and Vocal Use
- Hammond Reverberation Unit • Variable Tremolo
- 2-12" Special Design Heavy Duty Jensen Speakers plus High-Frequency Horn • Extruded Aluminum Panel

Piggy back amplifier with 14 silicon transistors plus silicon rectifier and heavy-duty power and driver transformers. Closed back speaker designed to project low end response. Two 12" Jensen speakers plus a high frequency horn results in tremendous reproduction of brilliant highs, deep lows and solid midrange. Excellent for lead or rhythm guitars. Two channels with high and low level inputs. Separate volume and tone controls for each channel. Depth control for reverb. Intensity control for tremolo circuit. Footswitch jacks for reverb and tremolo activation. Pilot light, fuse, and on-off switch. Sturdy wood cabinets covered in black textured scuff-resistant vinyl with metal corner protectors and heavy duty handles. Amplifier size: 7H x 22¹/₂L x 10³/₄"D. Speaker cabinet size: 27H x 23¹/₂ x 11¹/₂"D. For 117 VAC 50/60 Hz. Shpg. wt., 60 lbs.

13 E 01647WX

Net 199.95

Dual Foot Switch for Remote Control of Tremolo and Reverb.

13 E 01506 Shpg. wt., 1¹/₂ lbs.

Net 4.95

13 E 01498W Dolly for above Amplifier. Wt., 5 lbs.

Net 11.95

*See Page 11 for Full Credit Details on Easy Pay Plan



**50
WATT**

139⁹⁵

No Money Down*

**"Reverb""Tremolo" Twin-Speaker
2 Channel Amplifier**

- 2-12" Heavy Duty Special Design Jensen Speakers
- Pulsating "Tremolo" For "Go-Go" Effect
- Hammond "Reverb" Unit For Echo-Like Effect

Get faithful reproduction of every note. Excellent for guitar, organ and vocal use. Has special heavy-duty Jensen speakers. AC chassis utilizes 6 tubes, 4 dual purpose tubes provide 10 tube performance. 4 instrument inputs provide outstanding versatility. Two channel 50 watt peak amplifier. Has 2 volume and 2 tone controls. Features remote control foot switch jacks for colorful tremolo and reverb operation, plus 2 tremolo controls—speed and intensity; reverb "depth" control; on/off/standby switch; pilot light and carrying handle. Sturdy wood case covered in shimmering black vinyl. "T" nut provision for dolly. Size: 32H x 23L x 10"D. For 117V., 50/60 Hz AC. Shpg. wt., 45 lbs.

13 E 01563WX

Net 139.95

Dual Foot Switch for remote control of tremolo and reverb.

13 E 01506 Shpg. wt., 1½ lbs.

Net 4.95

13 E 01498W Dolly for above amplifier. Shpg. wt., 5 lbs.

Net 11.95

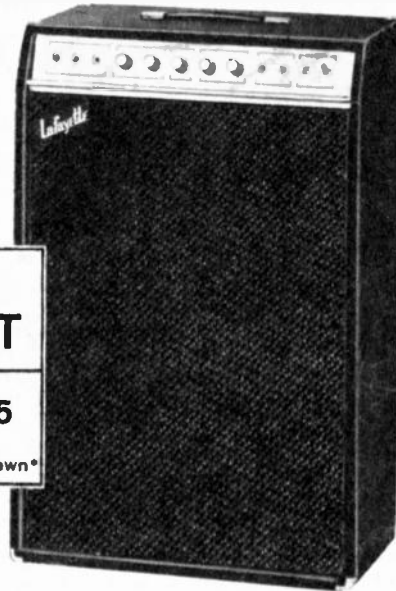

**30
WATT**

99⁹⁵

No Money Down*

"Reverb" "Tremolo" Twin-Speaker Amplifier

- "Reverb" For Echo-Like Effect
- Tremolo For Pulsating Sound
- 2-10" Special Design Jensen Speakers
- 3-Instrument Inputs
- Extruded Aluminum "Slanted" Front Panel

Features two built-in heavy duty 10" Jensen speakers for clean reproduction of every musical note. Excellent for guitar, microphone and accordion use. Three instrument inputs. Five controls: two for volume and tone; two for speed and intensity of tremolo and one for "reverb" depth control. Footswitch jacks for remote control of tremolo and reverb. 30 watt peak AC amplifier chassis utilizes 5 dual tubes equivalent to an 8 tube circuit, plus solid-state rectifiers for reliable operation. Also has pilot light, on/off switch and fuse. Sturdy wood cabinet covered in luxurious black vinyl. Has "T" nut provision for dolly. Size: 31½H x 20W x 10"D. For 117V., 50/60 Hz AC. Shpg. wt., 37 lbs.

13 E 01555WX

Net 99.95

Dual Foot Switch for remote control of tremolo and reverb.

13 E 01506 Shpg. wt., 1½ lbs.

Net 4.95

13 E 01498W Dolly for above amplifier. Wt., 5 lbs.

Net 11.95



**15
WATT**

"Tremolo" Amplifier

- Big 12" Jensen Speaker
- 3-Instrument Inputs
- Extruded Aluminum "Slanted" Control Panel

59⁹⁵

No Money Down*

An efficient 15-watt peak tremolo amplifier with big 12" specially designed speaker by Jensen. Provision for three instrument inputs. Jack provided for tremolo foot switch. Handy carrying handle. Controls: volume, tremolo speed, tone. AC chassis utilizing 4-tube circuitry. 4 dual purpose tubes used to provide 7 tube design. Handsome brushed aluminum slope mounted control panel for "easy reach." Sturdy wood cabinet covered in luxurious black vinyl. On-Off switch activates pilot light. Size: 17¾H x 16½L x 10"D. For 117 volts, 50/60 Hz AC. Shpg. wt., 29 lbs.

13 E 01472WX

Net 59.95

Foot Switch for remote control of Tremolo. Wt., 1½ lbs.

13 E 01514

Net 2.95

PROTECTIVE VINYL COVERS

Dustproof, water repellent, and stain resistant. Made of black, heavy gauge, leather grain embossed virgin vinyl bonded to heavy duty twill. Shpg. wt., 3 lbs.	Stock No.	For Amplifier	Net
	13 E 86194	13 E 01480WX	11.25
	13 E 86202	13 E 01548WX	8.50
	13 E 86210	13 E 01571WX	9.95
	13 E 86210	13 E 01563WX	9.95
	13 E 86228	13 E 01555WX	9.25
	13 E 86236	13 E 01472WX	5.95
	13 E 86426	13 E 01647WX	11.95

Only
124⁹⁵ No Money Down*

MUSICAL INSTRUMENT

AUTOMATIC RHYTHMER

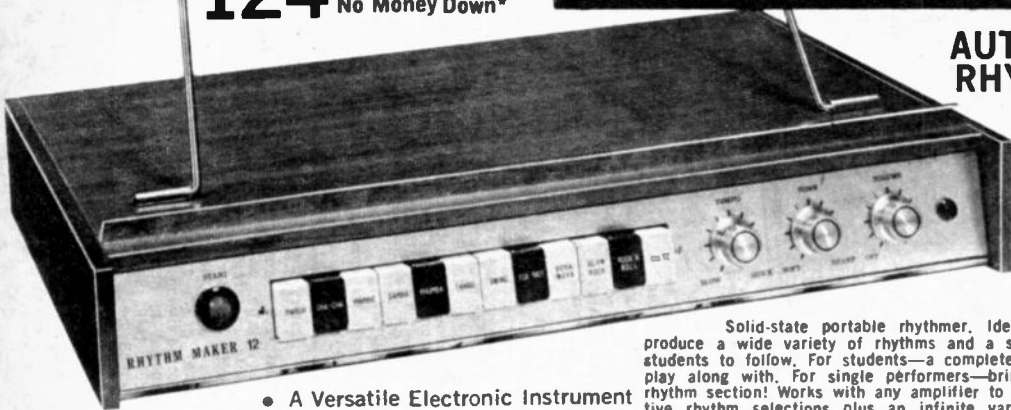

- A Versatile Electronic Instrument Producing a Wide Variety of Rhythms For Accompaniment

Solid-state portable rhythmmer. Ideal for teachers to produce a wide variety of rhythms and a steady beat for the students to follow. For students—a complete rhythm section to play along with. For single performers—bring along your own rhythm section! Works with any amplifier to produce 12 distinctive rhythm selections plus an infinite variety of accompaniments by mixing two or more rhythms. Variable tempo control can be set for accompaniment to a Waltz, Fox Trot, Rhumba, Samba, Mambo, Slow Rock, Fast Rock, Swing, Bossa Nova, Cha-Cha, Tango, or a March. Each rhythm is made up of a variety of percussion sounds: Bass Drum, Snare Drum, High Hat, Cow Bell, Bass Conga, Tenor Conga, and Cymbal. Additional features include: Master Volume and On/Off control, Tone control, On/Off rocker switch for instant control of rhythmmer plus On/Off Remote Control Foot switch, pilot light and 12 pushbutton rhythm selectors. Circuitry: 32 transistors, 95 diodes. For 100-117 VAC, 50/60 Hz. Handsomely styled walnut finish case with brushed aluminum panel. Size: 17 $\frac{3}{4}$ x4 $\frac{1}{4}$ x9 $\frac{1}{2}$ "D. Shpg. wt., 10 lbs.
13 E 24557W Net 124.95

NEW! Deluxe
Audio-Lites

- Ideal For Band Use
- Extra Large 48H x 14"W Front

Only **99⁹⁵** No Money Down*

Visually re-create the full effect of your favorite music! The all-transistor Audio-Lites' performance is a dazzling "vista" of music in motion; Four different colors of light are controlled by the frequency of the music. Designed to pulsate one set of colored lights from an audio signal of 3,000 Hz and lower and another from 3,000 Hz and over. Has four separate controls for On/Off; Master, Bass, and Treble sensitivity plus On indicator light. Can be easily connected to amplifier. Covered in heavy grade leather grain black vinyl trimmed with white plastic piping. Has protective chrome plated metal corners plus deluxe vinyl carrying handle with ends trimmed in chrome. Shpg. wt., 30 lbs.
13 E 75510WX Net 89.95

Audio-Lites

Panorama of Living Music
In Colored Lights

Only **49⁹⁵** No Money Down*

Add a new dimension to your musical enjoyment the modern way! Offers more than listening pleasure from your favorite music, you can actually visualize a brilliantly moving panorama of four different colors, dancing images with each note, tone, and pitch produced by the music. Will not affect amplifier operation. Easily connects to speaker leads. In attractive simulated walnut grained cabinet with shatter-proof plastic front. Size: 24x12x11 $\frac{3}{4}$ "D. Shpg. wt., 10 lbs.
13 E 75500WX Net 49.95

FREQ-LITE

29⁹⁵

- Fantastic Color Frequency of Light with Sound
- The Louder the Sound, the Brighter the Light!

Now, without complicated and costly stage production equipment, lighting can be as wild as voice or music! Connected to any amplifier, tape recorder, or record player, its brilliance changes from note-to-note, projecting fantastically fast and precise variations of lighting to match the intensity of sound. Use multiple units in a group with varied light colors in each unit to get sensational color blending with sound. Control unit can be placed virtually anywhere for remote operation of light sensitivity, or, to turn lights on and off. System can also be used as a constant light source. Uses 2-75W flood lamps. Operates on 110-125V., 60 Hz AC. Includes lamps, 10' AC line cord. Shpg. wt., 4 lbs.
13 E 17759 No Money Down* Net 29.95

LAFAYETTE SOLID-STATE "ECHO-VERB" REVERBERATION UNIT

Only
21⁹⁵

- "Add-on" Reverb Unit for any Musical Instrument Amplifier or P.A. System

Simulates the full sound top artists get! Compact, lightweight, transistorized reverberation unit creates a new dimension in audibility to overcome dull, flat ordinary sound. Can be used with any instrument amplifier, or P.A. system. Minutes to connect, the "Echo-Verb" may be used for sound effects. Has inputs for mike and/or instrument—plus a foot switch input to cut reverberation in or out from a remote location, pilot light and a reverb mix control that lets you select whatever intensity of reverberation you desire. With reverb mix control in the "Off" position, standard sound will be heard from the amplifier. With on/off switch. For 117v., 50/60 Hz. AC. Size: 3 $\frac{3}{4}$ H x 11 $\frac{1}{2}$ W x 6 $\frac{1}{2}$ "D. Imported.
99 E 92025W Shpg. wt., 5 lbs. Net 21.95
Foot Switch for Remote Control of "Echo-Verb"
13 E 01514 Shpg. wt., 1 $\frac{1}{2}$ lbs. Net 2.99

ACCESSORIES

ROTO VIBE

IN SOUND

A NEW DIMENSION

PRODUCE THE ROTATING SPEAKER EFFECT AND VIBRATO WITH YOUR OWN AMPLIFIER — ELECTRONICALLY!



ONLY **79⁹⁵**

No Money Down*

Finally an electronic instrument that can truly simulate the rotating speaker effect through any musical instrument amplifier! Not only produces the Fast or Slow rotating effect but, by the use of the remote speed control pedal, can vary the speed at any rate you desire. Enables the player to produce the various modern effects which are being used on the stage, in the studio, and with theater organs. Can be used with any of the following instruments: organ, bass guitar, rhythm and lead guitar, electric piano, accordion, and other electronic band instruments. Plus: Voice for vocal effects now being used by the top recording groups around the country. Easily connects

between instrument and amplifier. Foot pedal has cancel switch to instantly cancel effect being produced. Also features a rocker switch for selecting either the rotating speaker effect or a true vibrato effect. Other controls include Volume, Chorus/Vibrato, Intensity, On/Off power switch, fuse, pilot light, inputs for 2 Instruments, and an output for the amplifier. Unit is AC operated, fully transistorized, and has a rugged metal construction. Compact, only 10"Wx6½"Dx3"H. Can be placed in any conveniently reached location. Imported. Shpg. wt., 6 lbs.

13 E 66400

Net 79.95

LAFAYETTE "FUZZ SOUND"

Only **14⁹⁵**

- Make your guitar or bass produce the harmony of several wind instruments!



Add more instruments to your small combo with the "Fuzz" Sound! Create a wide variety of synthesized tones such as those produced by a baritone, or bass saxophone. Battery powered, it easily connects between your guitar, or bass and the amplifier and is operated by an On/Off foot switch. Has two variable control knobs; one for regulating the "fuzz" effect and one for volume and intensity. A supplementary On/Off switch is combined with the volume control to conserve battery life. Fully transistorized, the unit is built for heavy duty use and operates on a single penlight battery. A rugged metal case protects inside circuitry. Overall size: 5½L x 3½W x 2¼" over. H. Imported. Shpg. wt. 1¾ lbs.

99 E 91993

Net 14.95

99 E 62580 Battery for above:

Net .10

WAH WAH SOUND and VOLUME CONTROL

Only **29⁹⁵**

- Produce A Wide Variety of Special Sound Effects
- Use With Any Electric Guitar or Bass



Produce the Wah-Wah effect of a trumpet or trombone with your guitar or bass, electronically. Add extra instruments to your combo by creating the effect of synthesized tones identical to those of a trombone or trumpet when muted by hand or derby. No reaching down for controls. Large, 8½" footpedal gives you the full range of Wah-Wah sounds plus operates as a volume control by depressing a built-in switch under the heel of the footpedal. Input jack contains a switch to turn the unit on or off. Operates on 3 "C" cells. Fully transistorized, rugged construction. Imported. Size: 10x3¼x3".

13 E 66301 Shpg. wt., 3 lbs.

Net 29.95

99 E 62572 Battery for above 3 required. Net ea. .14

DELUXE AC SUPER FUZZ

- Remote Control Foot Switch for Ease of Operation
- Expanded Fuzz Produces A New Dimension in sound Effects
- Complete Controlled Range of Sustained Fuzz Effects



39⁹⁵ No Money Down*

AC operated super fuzz. No more bending to adjust controls; control unit is separate from foot switch. Can be placed on amplifier or speaker within easy reach of the performer. Controls include Balance, Expander, and Tone control for a complete, controlled range of sustained fuzz effects. Electronically creates an harmonic producing sustained sound, now being used by top recording artists. Connects easily between your guitar or bass and the amplifier. Includes remote control foot switch. Long-lasting, solid-state circuitry combined with rugged metal construction. Size: 7¾"Wx5"Dx2"H. For 117 VAC, 60 Hz. Imported. Shpg. wt., 3 lbs.

13 E 66418

Net 39.95

SUPER FUZZ Today's "In-Sound"

Only **24⁹⁵**

- Expanded Fuzz Can Produce a Sitar-Like Dimension in Sound
- Complete Controlled Range of Sustained Fuzz Effects



Solid-state Super Fuzz provides a complete range of controlled new harmonic sustained fuzz effects. Produces the wild new In-Sound widely used by the top recording groups. Balance control enables perfect blend of fuzz and normal tones. Expander control provides unlimited range of sustained fuzz effects. Two position tone compensator permits choice of standard fuzz or new harmonic sustained sitar-like dimensional sound. Master foot control switches instantly to normal guitar operation. Rugged metal construction. Size: 6½ x 3¾ x 1¾". With cord and battery. Imported. Shpg. wt., 1½ lbs.

13 E 66178

Net 24.95

99 E 60212 Battery for above Net .21

* See Page 11 for Full Credit Details on Easy Pay Plan

Lafayette Cat. No. 700 203

Famous Name Musical Instrument Speakers



SUPER POWER CADENCE MUSICAL INSTRUMENT SPEAKERS

As
Low
As

9⁷⁵

- Provides Natural Reproduction of Amplified Instruments
- Full Rich Tonal Quality
- Aluminum Dust Cone and Rubberized Cone Edges for Prolonged Life

Improved musical instrument speakers with heat-proofed voice coils and reinforced steel chassis for long life at higher power levels. Specially designed to meet the rigid requirements for

replacement in electric organs, guitars, bass guitars, and accordions. All speakers have 8-ohm voice coils. All speakers are round except * which is oval.



Stack No.	Utah Model	Type	Mag. Wt. (oz.)	V.C. Dia. (in.)	Peak Audio (watts)	For Use With	Depth (in.)	Shpg. Wt. (lbs.)	Net Ea.
32 E 49349	MH-8JC	8"	10	1	30	Organ, Guitar	3	2¾	9.95
32 E 49356	MH-10JC	10"	10	1	35	Organ, Guitar	3 1/4	3	10.95
32 E 49430	MH-10PC	10"	20	1½	50	Organ, Guitar, Bass Guitar, Accordion	3 7/8	6 1/4	15.95
32 E 49364	MH-12JC	12"	10	1	40	Organ, Guitar	4 1/8	3 3/4	11.95
32 E 49372	MH-12PC	12"	20	1½	60	Organ, Guitar, Bass Guitar	4 5/8	6	16.75
32 E 49380	MH-12PXC	12"	30	1½	70	Organ, Guitar, Bass Guitar	5 1/8	9	22.50
32 E 49398	MH-12RC	12"	40	2	85	Organ, Bass Guitar	5 1/8	10 1/2	39.00
32 E 49406W	MH-15PXC	15"	30	1½	75	Organ, Guitar, Bass Guitar	6 1/2	12	27.00
32 E 49414W	MH-15RC	15"	40	2	90	Organ, Bass Guitar	6 5/8	12 1/4	44.50
32 E 49422	MH-69JC*	6x9"	10	1	30	Guitar	3	2¾	9.75

ALTEC LANSING PROFESSIONAL INSTRUMENT SPEAKERS

417B

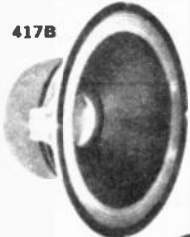

418B

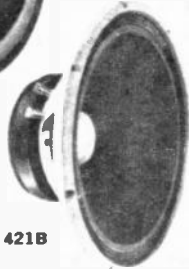
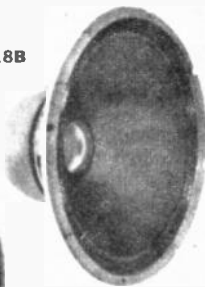

421B

As Low As

79⁰⁰

No Money Down*

- Upgrade Your Present Equipment
- Designed For String Bass Instruments, Electric Guitars, Electric Organs
- Reproduces Crisp Brilliant Highs, And Full Clean Lows
- Massive Magnet Structures Up To 17½ Lbs.
- Rugged Heavy Cast Aluminum Frames
- 3" Aluminum Edge-Wound Voice Coils

MODEL 417B—12" Professional Quality Instrument Speaker. Power: 75 watts, Impedance: 8-ohms, Voice Coil: 3", Magnet Structure: 10½ lbs., Diameter: 12½", Depth: 5½". Shpg. wt., 17 lbs.

32 E 38508WX Net 79.00

MODEL 418B—15" Professional Quality Instrument Speaker. Power: 100 watts, Impedance: 8-ohms, Voice Coil: 3", Magnet Structure: 10½ lbs., Diameter: 15¾", Depth: 7". Shpg. wt., 18½ lbs.

32 E 38516WX Net 89.00

MODEL 421A—15" Professional Quality Instrument Speaker. Specially designed for the BASS INSTRUMENTS... Bass Guitars and Organs. Power: 100 watts, Impedance: 8 ohms, Voice Coil: 3", Magnet Structure: 17½ lbs., Diameter: 15¾", Depth: 6½". Shpg. wt., 22 lbs.

32 E 38524WX Net 105.00

LAFAYETTE ENTERTAINER MICROPHONES & STANDS

A CARDIOID DYNAMIC MIKE

A superb dynamic microphone designed for applications where location of performer in relation to speakers causes feedback and reverberation. Highly directional cardioid pattern. Dual impedance: 50K or 600 ohms, selectable by switch. Response: 100-10,000 Hz. Mylar diaphragm. On/off switch. Modern design, satin chrome finished die-cast case. For hand-held or stand use. Size: 8¼x1½"D head. With swivel stand adapter and 20 ft. detachable cord with phone plug at other end. Imported. Shpg. wt., 3 lbs.

99 E 48294 Net 12.95

B DELUXE BALL DYNAMIC MIKE

Modern design features dual impedance—High 50K ohms, or low 250 ohms. Omni-directional, 100-10,000 Hz. Has on/off switch. Ball screen insures against "pop" and wind blast. Die-cast, finished in satin aluminum. Size: 6¼" long, max. diam. of ball 2¼". Complete with detachable 20 ft. cable and phone plug. Black metal desk stand and adapter for any 5/8"-27 floor stand. Imported.

99 E 48203 Shpg. wt., 2 lbs. Net 15.95

C ATLAS MIKE FLOOR STAND

Features "Full-Grip" clutch. Chrome plated tube. 10" base. Height adj. 35-63".

44 E 10031 Shpg. wt., 10 lbs. Net 8.16

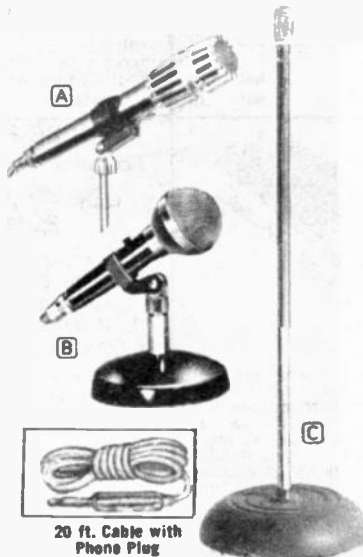

20 ft. Cable with Phone Plug

BANSHEE VOICE SPEAKERS

- Designed To Boost Vocals Above Instrument Levels



As Low As
37²⁰

Model CJ-40. Voice speaker. Attractive charcoal gray, molded fiberglass. Minimizes feedback, boom, and annoying harmonics to create performances that can be heard. 40 watts peak music power. Can be mounted on any mike stand (page 151) or with model SS-4 stand below. Quick connect-disconnect receptacle takes standard phone plug. Response: 150-14,000 Hz. Impedance 8 ohms. 6H x 14W x 12¾"D. Shpg. wt., 9 lbs.

44 E 10361W Net 37.20

Model CJ-125. Similar to above except 125 watts peak music power. Uses SS-4 Stand below. Response: 100-12,000 Hz. 13H x 23W x 19"D. Shpg. wt., 21½ lb.

44 E 10379WX Net 74.40

Model SS-4 weighted base speaker stand. Black wrinkle finish base, chrome steel tubing extends to over 6 ft. Shpg. wt., 20 lbs.

44 E 10387WX Net 17.51

Musical Instruments & Accessories

PROFESSIONAL TUNABLE BONGOS

13⁹⁵

- Fast, Unobstructed Hand-Playing



Pure white perfect calfskin heads for best rhythm effect and authentic tone. Sparkling color finish. Sturdy construction full flanged counter loops with heavy chrome plated hardware. Four tuning-lugs on each bongo. Head sizes: 7 3/4" and 6 1/2". Overall 7" deep. Complete with Tuning Key, Imported. Shpg. wt., 5 lbs.

13-E 87042W

Net 13.95

GUITAR SELF-INSTRUCTOR FOR THE BEGINNER

- Book And Record

Book and instruction record for the beginner. Chord sounds and pictures plus "strum" along favorites. Shpg. wt., 6 oz.

12 E 67079

Net 1.50



HOW TO PLAY THE GUITAR

- Famous "Music Minus One" Records

The easy way to learn all the chords and rhythms on your guitar. Has vocal accompaniment; ballad styles; folk, country and western; rhythm and blues; shuffle beats. Features guitar demonstration and text by George Barnes, spoken commentary by Bob Mersey

24 E 45062 Shpg. wt., 1 lb.

Net 3.50



THE MEL BAY MODERN GUITAR METHOD

The most popular and contemporary approach towards comprehensive mastery of the guitar written in a clear concise manner by a professional. The strings are learned in order of their difficulty with musical arrangements for study. Profusely illustrated.

13 E 52848 Grade 1 Book

Net 1.25

13 E 52855 Grade 2 Book

Net 1.25

13 E 52863 Grade 3 Book

Net 1.25



SMITH'S MODERN ELECTRIC BASS BOOK

Authoritative 4 string electric bass guitar method book

12 E 67095

Net 1.25

4 PIECE GUITAR ACCESSORY KIT

An ideal 4 piece set for the beginner — Consists of: 1 set of (6) Flatwound Guitar strings; guitar pitchpipe; adjustable foam padded guitar neck strap and 8 guitar picks — 6 flat and two thumb picks.

13 E 22577 Shpg. wt., 1 lb.

Net 4.95

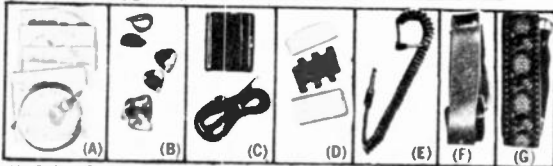

(A) Guitar Strings. Set of 6, plated copper wire wound.

13 E 22536

Net 1.49

(B) Nylon Classic Guitar Strings. Set of 6.

13 E 22544

Net 1.49

(A) Electric Guitar Strings. Flat wound, set of 6.

13 E 22528

Net 2.19

(A) Deluxe Electric Guitar Strings. Gibson, flat wound hi-fi strings. High quality. Set of 6.

13 E 52871

Net 3.95

(B) Guitar Picks—6 Flat, 2 Thumb

13 E 22569

Net .49

(C) Adjustable Foam Padded Guitar Neck Strap.

13 E 22502

Net 1.49

(D) Guitar Pitch Pipe

13 E 22510

Net 1.49

(E) Retractable Guitar Cords with Plugs

13 E 52889 10 Ft.

Net 1.49

99 E 91282 15 Ft.

Net 1.89

99 E 91290 20 Ft.

Net 2.19

(F) Deluxe Adjustable Bright Sparkle Vinyl Neck Strap for Guitar. Brass Plated Buckle.

13 E 22585

Net 2.95

(G) Deluxe Adjustable Embroidered Hootenanny Neck Strap, colorful fabric and leather, brass plated buckle.

13 E 88016

Net 2.39

Hohner Melodicas

As Low As

10⁹⁵

- With Case, Spare Mouthpiece—Instructions



Student Melodica—Ideal for the beginner. 20 chromatic keys from middle C to G, give it a range adequate for most music. 13 E 86319 Shpg. wt., 2 lbs. Net 10.95

Soprano Melodica—Similar to above, 25 keys from middle c. 13 E 86327 Net 12.50

Alto Melodica—Similar to above, 25 keys from low F. 13 E 86335 Net 14.50

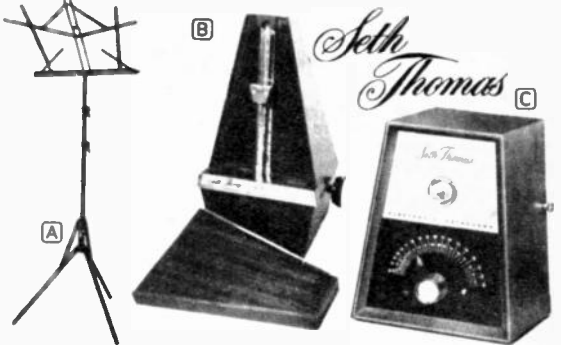

THREE SECTION MUSIC STAND

Chrome plated steel, rust proof. Fixed position desk with wide ribbed ledge and wires to hold music in place. Automatic locking base. Folds compactly to 17"—extends to 60".

13 E 52756 Shpg. wt., 2 lbs.

Net 3.95

SETH THOMAS KEYWORD METRONOME

Streamlined, keyword metronome gives both a visual and audible beat timing from 40 to 208 beats per minute. Invaluable aid while practicing or giving instruction. Brown case with wood grain cover and gold-colored trim. 8 3/8" H x 4 3/8" W x 3 3/8" D. Shpg. wt., 3 lbs.

13 E 44563

Net 9.95

SETH THOMAS ELECTRONIC METRONOME

Precision instrument, contains 2 complete electronically calibrated beat systems; audible and visual, 40 to 208 beats per minute. Single knob control, calibrated radial dial plus neon light. Wooden cabinet, operates on 115 V AC 60 Hz.

13 E 44530 Walnut. Shpg. wt., 3 lbs.

Net 19.95

13 E 44548 Mahogany. Shpg. wt., 3 lbs.

Net 19.95

POCKET SIZE ELECTRONIC METRONOME

- Features Speaker and Earphone

Unique electronic metronome gives 42-160 beats per minute, allows any member of band to keep perfect time with a personalized earphone. Even a bass drummer can't drown it out. Pocket size with neck strap and 9 volt battery. Special circuit allows instructor to hear beat thru speaker when student uses earphone. Walnut finish, brushed aluminum face. Comes in handy case. Shpg. wt., 1 lb. Size: 2 1/2" W x 1 1/4" D x 4 1/4" H.

13 E 88503

Net 14.95

99 E 80212 Extra 9 V Batt. Net .21



PLAY GUITAR IN MINUTES

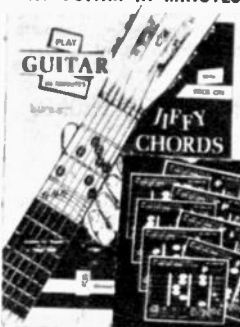

- With Stick-on Jiffy Chord Cards 5⁹⁵

Just stick Jiffy Chords under the strings of your guitar and learn to play in minutes, no knowledge of music required! Press a color for each chord, 3 chords per card. Helps develop an ear for harmonies and a sense of rhythm. With 8 reusable cards, illustrated instruction book with 27 songs. Wt., 1/2 lb. For "Regular" size neck guitars. With string span of 1 1/2" at top of neck.

13 E 63506

Net 5.95

For "Thin" size neck guitars. With string span of 1 3/4" at top of neck.

13 E 63514

Net 5.95

To Speed Your Mail Order—Please Give Your Zip Code Number

Lafayette Cat. No. 700 205

Hearing Aids And Ear Phones

SUB-MINIATURE HEARING AID

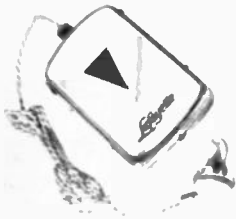

Lightweight!

24⁹⁵

- 2½" L x 1½" W x ½" D
Only 2 ounces!

A high quality, completely adjustable, hearing aid which weighs only 2 ounces. Features an advanced 4 transistor circuit, wide range volume control, crystal microphone, magnetic earphone, and a 4 position tone converter control. Three tiny ear plugs and a 3 ft. flexible cord are included. Supplied with leather carrying case, earphone, and battery. Shpg. wt., 1 lb. Imported.

99 E 90690L	Net 24.95
32 E 48754 Extra Battery, Burgess NE type	Net .10
99 E 90698 Extra Plug in cord	Net .55
99 E 90706 Extra Earphone	Net 1.59

BEHIND-THE-EAR HEARING AID



62⁹⁵



Battery charger

- Weighs Only 1/2 Oz.— No Cords
- Self-Contained Miniature Unit
- Complete with Battery Charger, 2 Rechargeable Nickel Cadmium Batteries and Case

A fine unit combining good performance and very small size. Designed as a light and compact "ear-lobe" hearing aid. All components are contained in the flesh-colored high impact case, which is worn behind the ear. Weighs only 1/2 of one ounce! Sound travels to the ear through a clear tube. Independent on-off switch and volume control. Operates 8-10 hours on a rechargeable nickel cadmium battery and 80-100 hours with a non-rechargeable mercury cell. Complete with a handy battery charger capable of charging cells overnight. Imported. Shpg. wt., 1 lb.

99 E 90722L No Money Down*	Net 62.95
32 E 47487 Rechargeable nickel cadmium cell for above	Net 1.05
32 E 46683 Pkg. of 6 Mercury cells for above	Net 1.92

PRIVATE RADIO-TV LISTENER

1⁸⁹

- Control Either Private Earphones or Remote Speakers



Simply installed unit allows normal use of TV or radio while adding controllable earphones or extension speakers. The hard of hearing may control their volume while others may listen at normal listening levels. May be operated up to 17 feet from set. Supplied complete with instructions, one earphone, and two earphone jacks. Imported. Shpg. wt., 1 lb.

99 E 91720	Net ea. 1.89
99 E 25488 Extra Earphone	Net ea. .59
99 E 25496 10 ft. extension cord	Net .49

"WHISPER" BONE-CONDUCTION PILLOW SPEAKER

- "Sonic Transducer" cannot be heard at a distance

2⁴⁹



Sound is actually conducted through your pillow and bone to the inner ear. No danger of disturbing others—even husband or wife asleep in the same bed! 2½" diameter round ivory plastic case is only 5/8" thick. With 6 ft. cord, ¼" plug and jack. Plugs into radio or TV. Imported. Shpg. wt., 8 oz.

99 E 90730	Net 2.49
99 E 25496 10 ft extension cord	Net .49

CRYSTAL HEADSET

- Under-the-Chin Design
- Lightweight
- Sensitive Crystal Element



1³⁹

This lightweight, under-the-chin crystal headset provides the utmost in listening comfort wherever a headset is used. This unit is characterized by a high sensitivity and is ideal for all applications where a very high impedance unit is required. This headset offers fine reproduction and comfortable listening in a lightweight design. Complete with 3ft. cord. Imported. Shpg. wt., 5 oz.

99 E 25504	Net 1.39
------------	----------

SUPEREX AMATEUR PHONES

24⁴⁵



These earphones are made specially for the Ham and short wave listener. Comfortable, removable and replaceable vinyl foam ear cushions make long hours at the rig a real pleasure. Dual impedance, 600 and 4-16 ohms, can be changed at plug. High sensitivity and a crisp clear reproduction for that hard to read station. Shpg. wt., 2½ lbs.

40 E 85015	Net 24.45
------------	-----------

REMOTE CONTROL FOR SILENT TV VIEWING

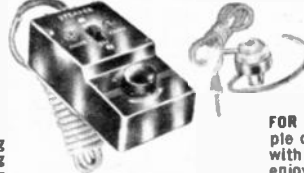

- Simple to Attach to any TV or Radio Set
- See and Hear—Noiselessly and Conveniently

FOR LATE LISTENERS. One or two people can both see and hear the program with the loudspeaker cut off. Tops for enjoying the late-late show without disturbing the rest of the household or the neighbors.

FOR HARD-OF-HEARING. Hear without turning the set volume so high that others can't stand the noise. It is possible to listen either with the loudspeaker cut off or, if the everyone wants to hear, with the speaker on.

FOR NOISY PROGRAMS view with the speaker off.

FOR NORMAL OPERATION it does not affect the regular use of the TV set. It does not have to be disconnected.

REMOTE CONTROL comes complete with 20 ft. of cable so it can be operated comfortably from a distance. Has its own volume control, speaker on-off switch, and two sets of jacks so either 1 or 2 earphones can be connected. Supplied with a miniature dynamic earphone. Highly sensitive and efficient. Complete with 1 earphone with 3 ft. of cord and plug and control box with 20 feet of cable. Only 3½"x2x1½". Instructions included. Shpg. wt., 3 lbs.

13 E 09012	Net 6.50
EXTRA EARPHONE. Shpg. wt., 8 oz.	
99 E 25488	Net .59
10' EXTENSION CORD for above.	
99 E 25496	Net .49

LAFAYETTE HEADSET

2²⁹

- 4000 ohm DC Resistance
- Double Permanent Magnet



A real bargain—the convenience and advantages of earphone listening at an especially low price. This is an extremely efficient, double headset with adjustable headband, for private listening or for greater intelligibility when there are distracting sounds and external noise. 4,000 ohms DC resistance. Has durable permanent magnets, removable earpiece and 3½ feet of extension cord terminated with standard headphone tips. Imported. Shpg. wt., 12 oz.

99 E 25041	Net 2.29
------------	----------

HIGH OUTPUT CRYSTAL EARPHONE

- Mouthpiece allows Use as a Crystal Mike

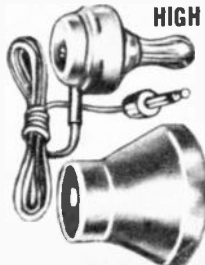

High output crystal earphone with a plastic ear-insert and 5½ feet of flexible cord with a ¼" diameter phone plug. Makes into a sensitive high impedance microphone by simply unscrewing the earpiece and attaching the included mouthpiece. Imported. Shpg. wt., 8 oz.

99 E 25157	Net 1.09
Crystal earphone only with phone-tips.	
99 E 25512	Net .89

Miniature Earphones & Headphones

Argonne

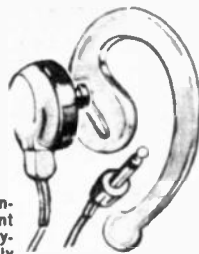

- Detachable Plug-in Cord
- Flexible Plastic Support
- Excellent Sound Reproduction

A sensitive dynamic earphone of exceptionally fine quality. Lightweight, convenient and comfortable to wear. A flexible polyethylene support holds the receiver securely in place for either ear. The practically invisible transparent cord is connected to the cased earpiece by means of a special plug. Provides clear reproduction with a pleasing tone quality. Complete with 3-ft. cord. Shpg. wt., 5 oz. Imported.

- 99 E 25439 6-Ohm Impedance with phone tip plug Net 1.09
 99 E 25421 3000-Ohm Impedance with phone tip plugs Net 1.19
 6-Ohm Impedance with 1/4" diameter phone plug and phone jack
 99 E 25413 Net 1.20
 3000-Ohm Impedance with 1/4" diameter plug and phone jack
 99 E 25405 Net 1.39

CLEVITE-BRUSH HEADPHONES

22⁰⁰



- Model BA-200-1. Rugged, sensitive, impedance, 45,000 ohms. Response, 100-8,000 Hz. With 5' cord and headband and phone plug termination.
 40 E 80016 Shpg. wt., 2 lbs. Net 22.00
 Model BA200-B. Same as above but wired for stereo use. Impedance, 90,000 ohms. With eyelet terminals. Net 22.00
 40 E 80024 Net 22.00
 262720 Ear Cushions. Custom foam cushions for above. Wt., 5 oz.
 40 E 80040 Per pair Net 1.50

C. F. CANNON HEADPHONES

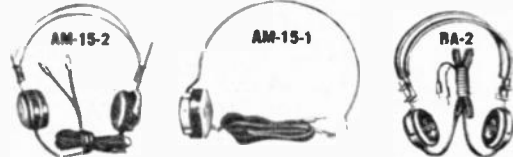

"CANNON-BALL" DOUBLE HEADSET

- Low-priced, lightweight, with powerful Alnico V magnets and double coils. Adjustable steel headband. 4 1/2 ft. cord. With pin tips.
 40 E 81014 AM-15-2—2000 ohms DC 2.88
 2000 ohm DC, with standard phone plug, vinyl headband
 40 E 81113 Net 3.35
 40 E 81030 AM-15-5—5000 ohms DC 3.54

"CANNON-BALL" SINGLE HEADSET

- Single efficient phone with spring steel headband and 4 1/2 ft. cord. Shpg. wt., 1 lb.
 40 E 81048 AM-15-1—1000 ohms DC 1.58

"CHIEF" HEADSET

- Similar to above but all—Bakelite phones, double coils, alnico magnets and vinyl headband. Diaphragm diameter 2 1/4".
 40 E 81063 CC11-11 ohms DC Net 3.18

BRANDES "ADMIRAL" HEADPHONES

- "Matched-tone" headset. Large diaphragms. Double coils, chrome steel magnets. Adjustable steel headband. 4 1/2 ft. cord. Shpg. wt., 2 lbs.
 40 E 81071 BA-2—2000 ohms 3.27
 40 E 81097 BA-5—5000 ohms 3.99

REPLACEMENT CUSHIONS

- Soft rubber cushion fits all above phones and most standard headphones.
 40 E 59325 Net per pair .64
 Deluxe, super comfortable foam cushion,
 40 E 59038 Net per pair 1.00



REPLACEMENT CORDS, & TIPS

- Sturdy copper conductor replacement cords with cotton insulation. 4 1/2 feet long, with terminations indicated. Double phone cord, except * is single cord.
 40 E 59291 Spade and pin tip Net .65
 40 E 59309 Pin tip both ends Net .65
 40 E 59317 *Pin tip both ends Net .47
 Heavy plated tips. Takes up to No. 18 wire, 1" long, 4 oz.
 32 E 85244 Pkg. of 10, Net .20

SOUND SHELL EARPHONE WITH DYNAMIC SPEAKER

NEW! 2⁹⁵

- Fits over the ear
- Less than 1 1/2 oz.

Unique, new listening device incorporates a wide range (30 to 14,000 Hz.) speaker in a specially designed plastic sound shield. Comfortably fits over either ear for maximum listening pleasure. Impedance 8 ohms. Complete with 4 1/2' cord and 1/4" dia. miniature plug. Imported. Shpg. wt., 1/4 lb.
 99 E 26148 Net ea. 2.95



SUPER POWER DYNAMIC EARPHONE FOR TRANSISTOR CIRCUITS

- Powerful Efficient Magnet

Extra efficient construction and a powerful magnet provides exceptional performance. Ideal solution to the problem of low output in transistor circuits. You'll be amazed at the difference in volume, as well as its quality of reproduction, when you use this dynamic earphone. AC impedance 6700 ohms. DC resistance 3000 ohms. Snap on ear-plug. Complete with 3 ft. detachable plug-in cord with miniature 1/4" diameter plug. Imported. Shpg. wt., 4 oz.
 40 E 78010 Net 2.95

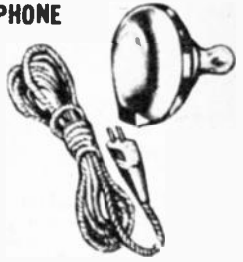

ECONOMY ALL-PURPOSE DYNAMIC EARPHONE

- For Transistor and Subminiature Receivers
- For Silent Radio and TV Listening

A sensitive all-purpose earphone which is ideal for use with TV and radio sets, amplifiers, and transistor receivers. Lightweight and equipped with a practically invisible support which is comfortable over either ear. Impedance 6 ohm, with a miniature 1/4" diameter phone plug and a 3 ft. cord. Shpg. wt., 5 oz. Imported.
 99 E 25488 1/4" dia. plug Net .59
 Same as above with 1/2" dia. plug Net .59
 40 E 79018 Net .59



STEREOPHONIC HEADPHONES

- True Binaural Reproduction
- Lightweight—Less Than 2 Oz.

Binaural magnetic units are equipped with two separate transducers and cord sets for true dual-channel reproduction. Extremely sensitive, sound is carried through plastic tubes to earpieces. Hinge permits adjustment to desired spacing. Complete with 1/4" dia. plugs. Imported. Shpg. wt., 6 oz.
 99 E 10019 6 ohms Impedance Net 2.35
 99 E 10027 5000 ohms Imped. Net 2.45



MONAURAL HEADPHONES

Single channel version of above FM Monaural Listening. Single transducer is removable and may be used as earphone with a snap-on earpiece which is included. Complete with 1/4" dia. plug and jack. Imported. Shpg. wt., 6 oz.
 99 E 25462 6 ohms Impedance Net 1.75
 99 E 25470 5000 ohms Impedance Net 1.95

EXTENSION WITH PLUG & ADAPTER

Perfect for extending earphone from transistor and portable radios. 10 ft. extension cord has 1/4" dia. miniature plug at one end and enclosed socket on the other which accepts 1/4" dia. plug. Cable comes in attractive light pink color. Imported. Shpg. wt., 2 oz.
 99 E 25496 Net .49



49^c

Telex Headphones and Microphones

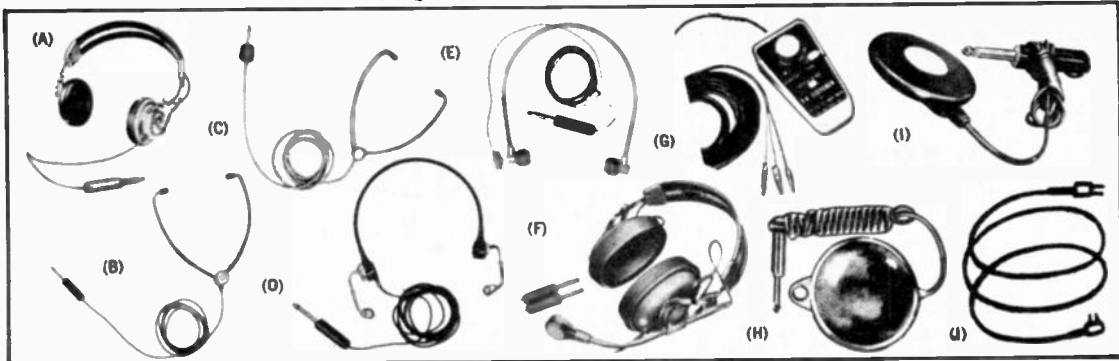

TELEX TELESET

(A) Lightweight (8 ounce) headsets tailored to the requirements of radio operators, and all general work. Fine stainless steel and plastic design delivers high sensitivity and faithful sound reproduction. Freq. Resp.; 50-10,000 Hz. 5-ft. durable vinyl-covered cord. Shpg. wt., 1 lb.
 40 E 59010 Imp. 2,000 ohms Net 14.50
 40 E 59028 Imp. 500-600 ohms Net 14.50
 Soft foam plastic cushions. Wt. 6 oz.
 40 E 59036 One air ACT-2 Net 1.00

TELEX MONOSET

(B) An under-chin headset ideal for secretarial office dictating machine use and private listening to radio, TV and recordings. Anodized aluminum tone arms are fully adjustable and weigh only 1.2 ounces. Frequency response: 50-5,000 Hz. Single detachable 5 ft. cord with standard phone plug eliminates tangling. Shpg. wt. 1 lb.
 40 E 59044 125 ohm model HMV-2 Net 7.95
 40 E 59051 2000 ohm model HMY-2 Net 7.95

TELEX DYNASET

(C) This lightweight headset is excellent for every kind of communication use, including office equipment, radio, TV and commercial applications. A magnetic driver element provides clear reproduction. Sound travels through 5 ft. tubing. With phone plug. Frequency Response: 50-5,000 Hz. Shpg. wt., 6 oz.
 40 E 59069 Model HUP-01 Net 8.95

TELEX TWINSET

(D) Banishes bothersome ear pressure. Tubular sound arms pipe signal to ears. Only 1.6 oz. Complete with 5 ft. cord and standard phone plug. Shpg. wt., 10 oz.
 40 E 59085 500 ohms HTW-2 Net 14.50
 40 E 59093 1000 ohms HTX-2 Net 14.50

TELEX 1200 FOR LANGUAGE LABS

30⁹⁵



● Meets All Language Institute & Governmental Specifications

Deluxe headset with boom mike designed for language laboratory use. Dynamic headphone response is 20-20,000 Hz. Dynamic boom noise-cancelling microphone response 100-8000 Hz. Headset impedance 600 ohms. With 1/4" phone plug. White with gray trim. Shpg. wt. 1 lb.
 40 E 59457 Telex 1200-42 Net 30.95
 Headset only, less boom mike.
 40 E 59465 Telex 1210-04 Net 21.95

TELEX TELE-FI

(E) Fidelity "in depth" with only one speaker. The 1/2 ounce continuous piece tone arm delays the sound to the ear opposite the speaker for one millisecond. This delay creates greater depth and clarity. Unlimited applications. A perfect leisure listening set for individuals with a hearing loss. 5 ft. flexible cord included. Shpg. wt. 6 oz.
 40 E 59101 15 ohm HFR-91 Net 5.95
 40 E 59119 125 ohm HFV-91 Net 5.95
 40 E 59127 500 ohm HFV-91 Net 5.95
 40 E 59135 1,000 ohm HFX-91 Net 5.95
 40 E 59143 2,000 ohm HFY-91 Net 5.95

TELEX MAGNA-TWIN

(F) Rugged magnetic headset ideal for general laboratory, and mobile communications use. Response: 50-10,000 Hz. Includes 5 ft. cord, standard phone plug and foam earphone cushions. Shpg. wt., 1 1/2 lbs.

WITHOUT MICROPHONE

MR-4 10,000 ohm impedance Net 18.95
 40 E 59150 Net 18.95
 MR-6 500-600 ohm impedance Net 18.95
 40 E 59168 Net 18.95

WITH BOOM MIKE

MRB-30 10,000 ohm headset. High impedance ceramic microphone, response 50-9000 Hz. With 5 ft. cord and 2 standard phone plugs.
 40 E 59178 Net 32.95
 MRB-45 500-600 ohm headset, 20-ohm carbon microphone, response, 50-6000 Hz. With 5 ft. cord and 2 standard phone plugs.
 40 E 59184 Net 30.95

TELEX 600 SERIES

MAGNETIC BOOM MIKE HEADSETS

As Low As

19⁹⁵



Dual magnetic headsets with removable ear cushions. Light in weight—yet very rugged. Choice of 600 or 2000 ohm headphone impedance. *With 250 ohm noise cancelling dynamic boom microphone. † With High Z ceramic boom microphone. Model 605 has single headphone only. All with 5 ft. cord and standard 1/4" phone plugs. Average shpg. wt., 1 lb.

Stock No.	Type	Impedance	Net
40 E 59374	*600-1	600 ohm	19.95
40 E 59382	*600-2	2000 ohm	19.95
40 E 59390	†600-3	600 ohm	21.95
40 E 59408	†600-4	2000 ohm	21.95

DUAL HEADPHONES ONLY - LESS MICROPHONE

40 E 59440	610-1	600 ohm	8.95
40 E 59418	610-2	2000 ohm	8.95

TELEX TV LISTENER

(G) Cord clips allow simple and safe attachment to any radio or TV. The control switches turn the radio or TV speaker on or off and control the volume through the earset. Listener complete with one earset, 15 ft. listener cord, and 4 ft. earset cord. Shpg. wt., 6 oz.
 40 E 59192 LCP-90 Net 9.95
 Extra earpiece ELV-98. Allows two to listen at once. Shpg. wt., 1/4 lb.
 40 E 59333 Net 2.95

TELEX DYNAMIC PILLOW SPEAKER

(H) New dynamic miniature pillow speaker gives the ultimate in tonal quality without distortion. For individual and institutional use. Safe and no complicated wiring necessary. Stainless steel, moisture proof housing. Size: 3 3/4" D, 1 1/4" max. thickness. Complete with a 5 ft. cord and standard phone plug. Shpg. wt., 8 oz.
 40 E 59200 3.2 ohms SDN-2A Net 6.95
 40 E 59218 10,000 ohms SDM-2A Net 9.95

TELEX MAGNETIC PILLOW SPEAKER

(I) Ideal for radio or TV. Enjoy private listening in bed or in a chair without disturbing others. Great for late listening. Only 2 1/4" diameter and 5/8" thick. Maroon waterproof plastic. Complete with 5 ft. cord and standard phone plug. Shpg. wt., 8 oz.
 40 E 59234 2000 ohms SMY-2A Net 6.95

ACCESSORIES CORDS AND CUSHIONS (J)

Stock No.	Description	Use With	Net
40 E 59242	ACV Foam Cush	(F) pr.	1.50
40 E 59259	CCM-2, 5' Coiled Cord	(D),(I)	2.95
40 E 59267	CMM-2, 5' Repl. Cord	(D),(I)	2.25
40 E 59275	CCT-2, 5' Coiled Cord	(B),(E)	2.95
40 E 59283	CMT-2, 5' Repl. Cord	(B),(E)	2.25

FULL FIDELITY MUSIC HEADPHONES



Designed For Music Appreciation Courses, Electronic Instrument Lessons & Libraries.

Telex 820 Series Headphones offer outstanding versatility and value. Frequency response of 50-18,000 Hz. Light-weight and attractively styled in brown with white trim and vinyl protected spring steel headband. Monaural version has 4-ohm impedance, six foot white cord and two-circuit phone plug. Stereo version has 8-ohm impedance, six foot brown cord and three circuit plug. Shpg. wt. 1 lb.
 40 E 59499 Monaural Net 9.95
 40 E 59481 Stereophonic Net 9.95

FLY THE BIG SKYHAWK BY REMOTE CONTROL

COMPLETE OUTFIT:
Plane, Receiver, Transmitter,
Batteries and Charger



TESTOR'S R/C SKYHAWK

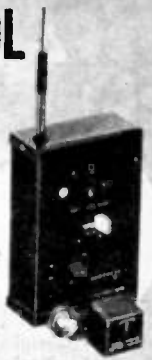

Only
79⁹⁵
No Money Down*

- Easy To Fly—Ideal For Beginners
- One Mile Range of Control
- Rechargeable Batteries with Charger
- Big 44" Wingspan—Length 27"
- Internal Combustion .049 Engine

Completely assembled ready to fly radio controlled plane which incorporates true (pulse) proportional control for smoother, more realistic flight control. This plane is so easy to fly that it is recommended for beginners—no electronic or mechanical skill is required. Aircraft fuselage constructed of virtually indestructible super-impact styrene. Wings and horizontal stabilizer are of super light styrofoam. Tricycle landing gear assures simple landings. High torque .049 cubic inch internal combustion engine has gas tank attached for 4 minutes of powered flight. Super sensitive 9 transistor superhet receiver combines with a powerful dual coil, twin magnet actuator

SKYHAWK SPECIFICATIONS

Length: Fuselage 27", Wing 44". Flying Weight: 23 ounces (approximately). Speed: 30 MPH True. Fuel Capacity: 4 Minutes powered

for superior reliability. 8 transistor 250 milliwatt transmitter provides up to one mile range control. Simple guidance controls include finger tip trim for basic in-flight stabilization. Heavy duty rechargeable batteries are easily charged with convenient charger (Included). Complete with R/C plane, transmitter, battery charger, and illustrated flying instruction book. Shpg. wt., 9 lbs.

42 E 73017WX for 27.145 MHz. Net 79.95

42 E 73058WX for 26.995 MHz. Net 79.95

42 E 73090WX for 27.195 MHz. Net 79.95

REMOTE CONTROL MUSTANG GT OUTFIT



COMPLETE OUTFIT:
MUSTANG, Receiver,
Transmitter, Batteries
and Charger

79⁹⁵
No Money Down*

- Completely Assembled—Ready To Use
- Twin High Torque Drive Motors
- Rechargeable Batteries with Charger
- Electronic "Relay-less" Drive Control

Authentic 1/11th scale model R/C Mustang GT. Fully-assembled. Car body of glossy polystyrene. Durable chassis is tempered aluminum. Twin high torque drive motors are coupled to rear wheels through an electronically controlled 4 transistor rear end... achieves true differential action! True (pulse) proportional circuitry permits feather-touch control. Guidance controls include steering (left-center-right), drive motor (start-stop) and speed (high-low). Super sensitive 9 transistor receiver combines with powerful dual coil, twin magnet actuator for superior reliability. 8 transistor 100 milliwatt transmitter provides convenient control board. Heavy duty rechargeable batteries are easily charged with convenient charger (Included). Complete with R/C model, transmitter, and battery charger. Shpg. wt., 7 lbs.

42 E 73033WX for 27.095 MHz. Net 79.95

42 E 73108WX for 26.995 MHz. Net 79.95

42 E 73124WX for 27.195 MHz. Net 79.95

MUSTANG GT SPECIFICATIONS

Length: 16 inches. Width: 6 inches. Height: 4 inches. Weight: 2 lbs., 8 ounces. Speed: 100 MPH Scale. Turning Radius: 3 feet. Transmitter: Single Tone AM Modulated Relayless Pulse. Receiver: Superheterodyne With Pulse Width Rate Decoders.

5-CHANNEL RESONANT REED HOBBY RELAY



Tuned to 266.0 Hz, 280.8 Hz
313.0 Hz, 349.0 Hz & 389.0 Hz

Frequency tolerance $\pm 1\%$. Especially adaptable to 5 channel remote control hobby tone receivers and Citizen Band tone signalling receivers. May also be used as high stability, resonant reed oscillator control. Features low tuning error, good temperature stability, low driving require-

ments. SPECIFICATIONS: (at 25° C): Frequency stability: $\pm .0025\%$ per degree C over the range of -40 to +85° C; Coil resistance: 600 Ohms DC $\pm 10\%$; Threshold Sensitivity: 1.0 V rms to 2.0 V rms at resonant frequency; Operating level: 6.0 vrms. Design frequencies: (Hz) $\pm 1.0\%$: REEDS: A=266.0, B=280.8, C=313.0, D=349.0, E=389.0 Constant rating 100 ma peak at 48 vdc (resistance load, contacts (+) in relation to reeds) Weight 2.5 oz. Mounts with 2-6/32" tapped holes on back. Size: 1 $\frac{1}{4}$ "x1 $\frac{1}{2}$ "x1 $\frac{1}{4}$ ". Shpg. wt., 8 oz.

42 E 61012

Net 8.95

LITTLE "JEWEL" REMOTE CONTROL RELAY

- The Mighty Mite of the R/C Field
- Size: $\frac{3}{4}$ "H, $\frac{1}{2}$ "W, $1\frac{1}{8}$ "L • Weighs less than $\frac{1}{2}$ oz.

A natural for remote control receivers, it is highly sensitive, and built to withstand severe crashes. The smallest commercial job available, it weighs less than 1/2 oz. Factory adjusted to pull in at 1.4 MA drop out at 1.2 MA D.C. Single pole, double throw. Used in outstanding R/C receivers. 5,000 ohm coil. Imported. Shpg. wt., 1 oz.

90 E 60915

Net 1.95



27.255 MHz CRYSTAL .005% TOLERANCE!

Designed for use in R/C model planes, boats, cars, etc., as well as on channel 23 of class "D" Citizens Band Equipment. Type HC-6/U holder; Pin spacing .493; Pin dia. .050".

46 E 18237

Net 2.25

42 E 09011 Crystal Socket for above Net .36



* See Page 11 for Full Credit Details on Easy Pay Plan



Citizen-Ship

RADIO CONTROL EQUIPMENT

SINGLE CHANNEL DIGITAL PROPORTIONAL SYSTEM Model DP-1

- Perfect Control Of Any Size Plane From .049 Models and Larger
- Powerful Feedback Actuator With 4 1/2 Pound Thrust

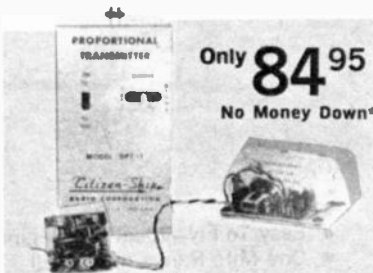

Only **84⁹⁵**
No Money Down*

- Rudder and Throttle from a Completely Proportional Simultaneous Digital System
- Temperature Stabilized from 0° to 140° F.



Only **169⁹⁵**
No Money Down*

Consists of:

- DPT-2 Transmitter: With ratchet for throttle control on left stick—easily changed to spring centering.
- DPR-2 Receiver: Featherweight and miniature size with harness and plugs to attach to servos and battery pack. Integrated circuits used for Decoder.
- 2 DMS Servos: High strength molded nylon case and gears. 4 pounds minimum thrust. With integrated circuit.
- Battery: 4 cell Nicad Pack for receiver and Servos.

Model DP-2 for 26.995, 27.045, 27.145, 27.195 or 27.255 MHz
Specify Frequency (3 to 4 wks. delivery) Net 169.95
42 E 19302Z† Shpg. wt., 4 lbs. Net 1.57
32 E 47053 9-volt battery for transmitter Net 1.57

Now you can fly a system that moves the rudder only when you move the stick, steers your plane, boat or car in direct response to the movement of the stick. Battery drain is kept to a minimum—Servos use current only when a command is signalled. Has the power to move any size control surface, yet is light enough for a 1/2A plane. Transmitter is high output digital type. Superheterodyne receiver works from servo battery. Servo is powerful feedback type. Decoder, Switch, Servo and connectors assembled on printed circuit mounting tray in a compact unit. Complete system. Shpg. wt., 3 lbs.
42 E 19242 For 27.145 MHz Only Net 84.95

OP-1 System for operation on 26.995, 27.045, 27.195 or 27.255 MHz
42 E 19218Z† Specify frequency (3-4 wks delivery) Net 84.95
250 Ma/H Nicad Battery for Receiver and Servo. Shpg. wt., 8 oz.
42 E 19226 Net 12.90
32 E 47525 Alternate Alkaline Batteries—4 req. Pkg. of 2 .79
32 E 47053 9-volt battery for Transmitter Net 1.57

3 CHANNEL R/C DIGITAL PROPORTIONAL SYSTEM MODEL DP-3

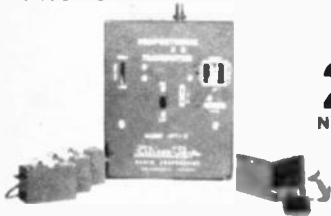

Only **233⁷⁵**
No Money Down*

- Includes Proportional Motor Control
- Completely Wired... Ready For Use

Consists of:
DPT-3 Transmitter: With built-in charger for airborne battery supply.
DPR-3 Receiver: Superheterodyne. Size: 2 1/2" x 1 1/8" x 1 3/4", 3 3/4 oz. wt. Includes batteries.
3-DMS SERVOS: Powerful 4 pounds thrust plus. High quality nylon gear train.

Wiring Board: Just plug individual units into wiring board. Complete with connectors.

Battery: 4 cell Nicad Pack for Receivers and Servos.
Model OP-3 for 27 MHz Frequencies: 26.995, 27.045, 27.145, 27.195 or 27.255 MHz. System Shpg. wt., 4 lbs.

42 E 19267Z† Specify frequency (3-4 wks delivery) Net 233.75
FCC Type Accepted 72 MHz Operation on 72.080, 72.240, 72.400, 75.640 MHz.
42 E 19234Z† Specify frequency (3-4 wks delivery) 254.95

Batteries Required
32 E 47053 9 volt battery for transmitter Net 1.57

6 CHANNEL DIGITAL PROPORTIONAL SYSTEM MODEL DV-6

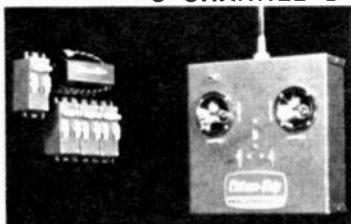

- Closed Sticks • Vinyl Case
- 27 MHz, 6 Meter, or 72 MHz.

Same as Model DV-4 but has 6 Channels. Includes:

DVT-6 Transmitter type AER for aileron and elevator on right stick or type AMR for aileron and motor on right stock; DPR Receiver; 4 DMS Servos. 4-Cell Nicad Battery Pack for receiver and servos. Complete with shorting harness. Shpg. wt., 6 lbs.
SPECIFY FREQUENCY — 3 to 4 wks. Delivery.

Model DV-6 for 26.995, 27.045, 27.145, 27.195 or 27.255 MHz
42 E 19457Z† Type AER Net 339.95
42 E 19465Z† Type AMR Net 339.95
Model DV-6 for 72.080, 72.240, 72.400, or 75.640 MHz
42 E 19473Z† Type AER Net 362.95
42 E 19481Z† Type AMR Net 362.95
Model DV-6 for 53.100, 53.300, or 53.500 MHz
42 E 19499Z† Type AER Net 362.95
42 E 19507Z† Type AMR Net 362.95

4 CHANNEL DIGITAL PROPORTIONAL SYSTEM MODEL DV-4

- Closed Sticks
 - Vinyl Case
 - 27 MHz., 6 meter or 72 MHz. Only
- Only **319⁹⁵**
No Money Down*

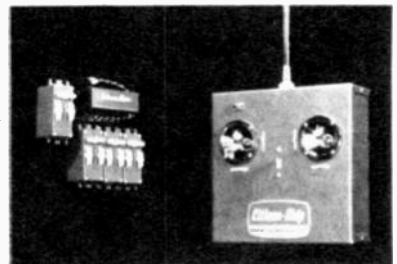

Consists of:

DVT-4 Transmitter: Slim line, in vinyl-clad aluminum case. Type AER-aileron and elevator on right stick or Type AMR-aileron and motor on right stick. With power output and charging rate meter. Size: 6 7/8" x 1 3/4".

DPR-4 Receiver: Featherweight and miniature size; with cables and plugs for servos and battery pack.

4-DMS Servos: 4 lbs. thrust: 5 pole Hi-torque motor.

Battery: 4-cell Nicad pack for receiver and servos.
SPECIFY FREQUENCY — 3 to 4 wks. delivery. Shpg. wt., 6 lbs.

Model DV-4 for 26.995, 27.045, 27.145, 27.195, or 27.255 MHz
42 E 19390Z† Type AER Net 319.95
42 E 19408Z† Type AMR Net 319.95

Model DV-4 for 72.080, 72.240, 72.400, or 75.640 MHz
42 E 19416Z† Type AER Net 339.95
42 E 19424Z† Type AMR Net 339.95

Model DV-4 for 53.100, 53.300, or 53.500 MHz
42 E 19432Z† Type AER Net 339.95
42 E 19440Z† Type AMR Net 339.95

†NOTE: Stock numbers terminating in "Z" are shipped F.O.B. Indianapolis, Indiana. No C.O.D. Send full remittance or use Lafayette's Easy Pay Plan. Shipping charges collected on delivery.



R/C Transmitters, Receivers and Accessories



CITIZEN-SHIP MODEL SL-6 SIX CHANNEL ALL-TRANSISTORIZED HIGH POWER TONE TRANSMITTER

59⁹⁵

No Money Down*



Operates RL-6 Reed Receiver, and all single channel receivers on these pages. Features F output from silicon transistor and center loaded antenna; "contest type" lever switches, 4-transistor temperature-compensated circuit for tone stability. Six adjustable tone frequencies from 350-650 Hz. Battery drain 50 MA. Anodized aluminum case with rubber feet. 6 7/8 x 5 3/8 x 2 3/4". Weight 2 3/4 lbs. with battery. Complete with antenna, less battery. For 27.145MHz
42 E 19010 27.145 MHz Net 59.95

Model SL-6 for operation on 26.995, 27.045, 27.095, 27.195 or 27.255 MHz.
42 E 19309Y Specify frequency (4 wks delivery) Net 59.95
32 E 47053 9-volt battery for above Net 1.57

CITIZEN-SHIP MODEL TTX TRANSISTORIZED TONE TRANSMITTER

24⁹⁵



This popular single channel tone transmitter measures 3 1/4 x 5 1/2 x 1 7/8" and weighs only 12 oz. with battery. 100% collector modulated (no reduction of RF signal with modulation). Operates on single 9V battery; requires no license. Operates R/C pack with SE-2 Escape-ment and with SSH-P receiver giving rudder, or rudder and motor control. High efficiency, externally loaded antenna. Printed circuit chassis. 99 milliwatt input. For 27.145 MHz. Shpg. wt., 2 lbs.
42 E 19135 27.145 MHz less battery Net 24.95

Model TTX for operation on 26.995, 27.045, 27.090, 27.195 or 27.255MHz
42 E 19325Y Specify frequency (4 wks delivery) Net 24.95
32 E 47048 9-Volt Battery (Burgess 2N6) Net 1.30

CITIZEN-SHIP MODEL RL-6 SIX-CHANNEL TRANSISTORIZED RELAYLESS SUPERHET REED RECEIVER

Only
43⁹⁵

No Money Down*



- Companion to SL-6
- Light weight
- Ideal For Class I, II, and Pylon Rac ng

Especially designed for use with the Citizen-Ship SL-6 transmitter, the combination is ideal for Rudder (class I), Intermediate (class II), and Pylon racing. Receiver operates 3 separate servos (rt., lft.; up, down; high and low motor). 6 transistors, crystal controlled. Change frequency by changing crystals. High selectivity permits flying up to 5 different models simultaneously without interference. Current drain: 5 MA signal off, 15 MA signal on. Weighs only 3 1/2 oz. Size 2 7/8 x 1 3/4 x 1". Less battery. 1, 2 or 3 TCB or TLB actuators required. For 27.145 MHz.
42 E 19051 27.145 MHz Net 43.95

Model RL-6 for operation on 26.995, 27.045, 27.095, 27.195 or 27.255 MHz.
42 E 19317Y specify frequency (4 wks delivery) Net 43.95
32 E 48077 9-volt battery for above Net .48

CITIZEN-SHIP SSH-P RECEIVER

27⁹⁵

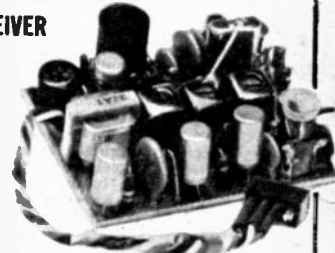

- For Pulse OR TTX Transmitter Operation
- Single Channel 7 Transistor Superhet Receiver
- 1 7/8" x 1 1/8" x 3/4", Weighs Only 1 oz.
- Permits Flying in Smallest R/C Planes

This extremely versatile 7 Transistor miniature R/C Receiver features excellent selectivity. Permits flying up to 6 models simultaneously with no interference. It is ultra sensitive and can be flown to limit of sight. Especially reliable superhet relayless circuit design and will not "swamp" at any distance. It is crystal controlled and you simply change crystals to change frequencies. Uses silicon transistors in critical temperature-sensitive circuits. Also has rugged crash proof epoxy glass printed circuit board. Operates on 2.4 to 4.5 volts DC with an idle current of 6 ma. No width drift with rate change. May be used with Model TTX (no license required) Transmitter. Shpg. wt., 8 oz. For 27.145 MHz.
42 E 19358 27.145 MHz Net 27.95

Model SSH-P for operation on 26.995, 27.045, 27.090, 27.195 or 27.255 MHz.
42 E 19374Y Specify frequency (4 wks delivery) Net 27.95
1 1/2-volt Penlight Batteries (2 Required)
99 E 92580 Net ea. .10

CITIZEN-SHIP MODEL TCB CAM ACTION SERVO



- Ideal For Contest Work
- Gives Variable Ratio

For use up to 140°F. Operates directly from any standard reed bank. Features a variable push and pull ratio for slow start, smooth flying, and fast finish for quick recovery. Perfect for alleron and elevator. Weighs 3 oz. Uses 6 volts (4 penlight cells). Wt., 1 lb.
42 E 19093 Less Batteries Net 20.75
1 1/2 Volt Batteries (4 required),
99 E 92580 Net ea. .10

MODEL TLB TRANSISTORIZED LINEAR ACTION SERVO. Same as Model TCB except true linear motion-rack and pinion gearing. Ideal for motor and trim. Shpg. wt., 1 lb.
42 E 19143 Less Batteries Net 21.75
1 1/2 Volt Batteries (4 required),
99 E 92580 Net .10

MULTI-PURPOSE ELECTRO SERVO MECHANISM

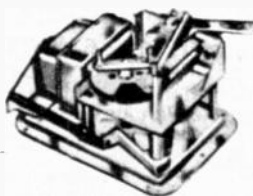

4⁹⁵

Operates with any single channel R/C receiver and transmitter. Requires 3 volts. Provides for steering and automatic return to neutral. Single pulse operation. Only 2 1/2 x 2 x 1 3/4" overall. Includes instructions and linkage to extend actuator arm. Imported. Shpg. wt., 8 oz.
99 E 90334 Net 4.95

R/C CENTER LOADING COIL ANTENNA



High efficiency, center loaded, 11-section telescoping antenna collapses to 8 1/2" and extends to 54". High Q chrome-plated brass antenna transfers maximum power for distant remote control. Imported. Shpg. wt., 1 lb.
99 E 90987 Net 2.99

SE-2 ESCAPEMENT



- For Relay or Relayless Operation

Select right or left rudder at will. Always starts from same neutral. One pulse gives Right; two pulses give Left rudder. Operates from receiver batteries or two pen-cells. Shpg. wt., 8 oz.
42 E 19077 Net 7.95
99 E 92580 1 1/2 Volt Batteries (2 req.) Net ea. .10

* See Page 11 for Full Credit Details on Easy Pay Plan

Exciting Kits for the Experimenter

LAFAYETTE "EXPLOR-AIR"™ 4-BAND RECEIVER KIT

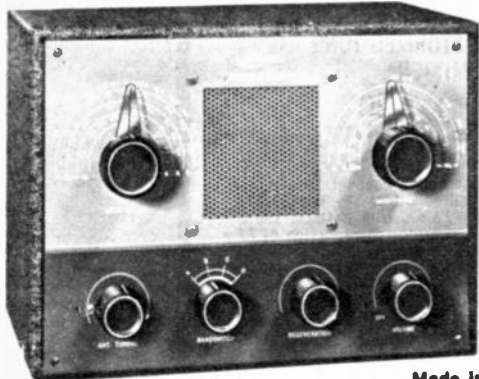

Made in U.S.A.

- Covers 10, 15, 20, 40, 80, 160 Meter Amateur Bands
- Tunes International Broadcast, Citizens Band, Maritime, Aeronautical and WWV Time Signals
- Covers Standard AM Broadcast Band
- Complete Band Switching from Front Panel
- Bandsread Tuning
- Built-in 4" Speaker

**TUNE IN
THE WORLD!**



22⁹⁵
Less Cabinet

Lafayette's sensational shortwave receiver kit is a complete shortwave and standard broadcast set which covers the entire region from 550 kHz to 30 MHz. Four whole bands of fascinating programming. Perfect for language students and shortwave listeners. Only a regenerative circuit can offer such amazing performance and yet be so simple to build. Building this fine kit is an absolute pleasure—it's so well designed you can't go wrong. Kit includes all the parts you need and the detailed step-by-step instruction book with its giant pictorial drawings shows you just how to put them together. One front panel knob does all the bandswitching, immediately taking you from band to band. All coils are prewound for greater accuracy. Complete 4 band coverage of broadcast stations, international broadcast bands, amateur, maritime, and WWV time

signals. Big 4" speaker and sensitive circuit with 50C5 output stage and 12A7 regenerative detector and amplifier stages give you all the volume you want. Phone jack for privacy automatically disconnects speaker. All controls are on the front panel: On-Off Volume, Main Tuning, Band Spread, Bandswitch, Antenna Tuning, and Regeneration. 110 volt 50-60 Hz AC-DC power supply. Size: 10x7x5".
19 E 09050 (Less Cabinet) wt., 5 lbs. Net 22.95

Shortwave antenna kit for above. Shpg. wt., 2 lbs.
32 E 30984 Net 1.99

Leatherette covered Wooden Cabinet for above. 1 lb.
19 E 09060 Net 3.49

20 WATT STEREO SOLID STATE AMPLIFIER MODULE

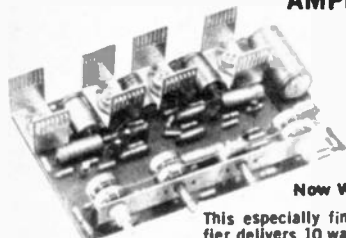

21⁹⁵

Now With Integrated Circuits

This especially fine transistor stereo amplifier delivers 10 watts per channel continuous power (RMS) into any 8 ohm speaker. Has

2-IC's and 8-transistors. The separate bass and treble controls allows 20 db adjustment at 100 Hz and 10 kHz. The dual volume control allows simultaneous increase in volume of both channels, while the balance control allows compensation for program variations. The low noise preamp stage provides a sensitivity of 0.5 volts for use with a ceramic phono cartridge or a AM/FM tuner. The direct coupled complementary symmetry circuit gives a Hi-Fi frequency response of 30 Hz to 40 kHz @-3 db. Includes the power supply components except a power transformer. Size: 7 $\frac{1}{2}$ " x 1 $\frac{1}{2}$ " x 4 $\frac{3}{4}$ ".
19 E 09159 Shpg. wt., 2 lbs. Net 21.95

Same model as above but on two separate printed circuit boards for compact mounting. Control strip size: 7 $\frac{1}{2}$ "x1 $\frac{1}{2}$ "x1 $\frac{1}{4}$ ". Power amplifier size: 7 $\frac{1}{2}$ "x1 $\frac{1}{2}$ "x2 $\frac{1}{4}$ "D. Shpg. wt., 2 lbs.
19 E 09167 Net 21.95

Power transformer for above amplifier modules. Shpg. wt., 1 lb.
19 E 09175 Net 2.95

8-WATT STEREO SOLID STATE AMPLIFIER MODULE

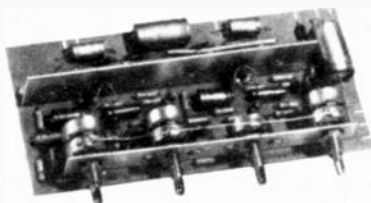

14⁹⁵

Now With Integrated Circuits

A complete 4-control stereo amplifier with 2-IC's and 6-transistors which provides 4 watts RMS per channel; 8 watts continuous power total output! The four controls allow separate volume, balance, bass and treble adjustments. The direct couple complementary symmetry circuit gives a true Hi-Fi response of 45 Hz to 20 kHz @-3 db. 1 Meg input impedance allows this amp to be used with a wide range stereo crystal cartridge, FM tuner or other 1.5 volt source. Use with 8 ohm speakers to give top performance. The amplifier includes power supply components (2 diodes, 1 filter capacitor) except the power transformer. Dimensions: 7 $\frac{1}{2}$ "L x 1 $\frac{1}{2}$ "W x 3 $\frac{1}{2}$ "D. Shpg. wt., 2 lbs.
19 E 09142 Net 14.95

Power transformer for above amplifier module. Shpg. wt., 1 lb.
19 E 09193 Net 2.95

LAFAYETTE KT-92 5-WATT PUSH-PULL AMPLIFIER KIT

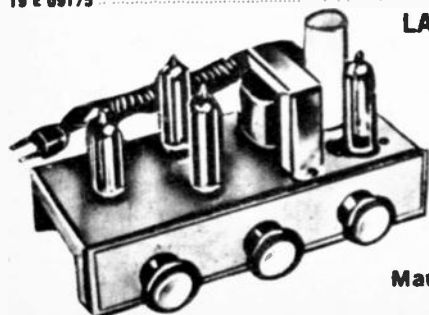

12⁹⁵

Made in U.S.A.

- Push-Pull Audio Output Stage—Inverse Feedback Circuit
- Separate Volume, Bass & Treble Controls
- AC or DC Operation

Here in kit form is an AC-DC hi-fi amplifier that presents deluxe features despite its amazingly low price. The separate bass and treble controls permit adjustment of both low and high frequency response and balance. Works equally well with both crystal or ceramic cartridges. Tube line-up consists of a 12AX7 amplifier and phase inverter, a pair of 35C5's in push-pull, having a power-packet low-distortion output plus a 35W4 rectifier. The circuit utilizes an inverse feedback loop to reduce the level of hum and distortion. Kit is complete containing all essential parts, tubes and detailed instruction manual showing pictorial and schematic diagrams. Shpg. wt., 4 lbs.
19 E 01016 Net 12.95

Easy To Build Educational Kits



Made in U.S.A.

LAFAYETTE WIRELESS BROADCAST/AMPLIFIER KIT

Use it either as a AM Wireless Broadcaster or Audio Amplifier!

ONLY **15⁹⁵**

- Clean, Modern Styling • Powerful Signal
- Works With All Crystal and Magnetic Mikes and Phono Cartridges
- Plays Through All AM Radios

Treat yourself and your family to hours of fun with this Lafayette Kit. Make your own radio programs, announcements, etc., through AM radios anywhere in the house, without wires or extra gadgets. Designed for easy construction by youngsters, it combines in one compact unit a powerful 3-tube wireless broadcaster and an audio amplifier. Clearly written instruction manual makes it a cinch to build. Operates on any frequency between 900 and 1600 kHz on your radio dial. It will accept any crystal or magnetic microphone. In addition, it may be used directly as a phono or microphone amplifier. No external preamp is required. Simple slide switch permits either form of operation. Just connect it to a PM speaker (4-16 ohms). Conforms to FCC regulations and is designed to provide voice or record broadcasts. No license or permit is necessary. Complete with crystal clear instruction manual, Less Mike. For 105-125V AC or DC. Attractively styled metal cabinet. Size 4Hx8Wx4 1/2"D. Shpg. wt., 3 lbs.

19 E 09035 Net 15.95

Crystal microphone for above, Desk or hand held. 5 ft. cable.

Shg. wt., 1 lb. Imported.

99 E 45437 Net 1.95

AM BROADCAST TRANSISTOR RADIO KIT



This solid state kit covers the regular broadcast band from 540-1500 kHz. Contains all parts necessary for construction including 1 transistor for amplifier, 1 diode detector, single headphone and 50 ft. of wire for required outdoor antenna. The attractive plastic case is 8"W x 4 3/4"H x 3 1/2"D. This kit is designed with easy to follow instructions so that the young student can put it together easily. Educational and enjoyable. Operates on a single "0" cell battery (not supplied). Shpg. wt., 3 lbs.

19 E 31047 Net 6.49

99 E 62564 "0" battery Net 1.15

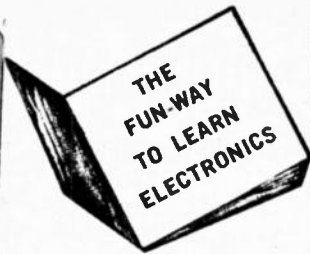

A



B

Made in U.S.A.

A LAFAYETTE SUPER-SENSITIVE PHOTOCCELL ELECTRONIC RELAY KIT

- Adjustable Super Sensitivity—Works with Just A Flashlight At 250 Feet!

Ideal for sustained operation required for burglar alarms, door buzzers and for instantaneous on-off operation required for counters, packaging, door opening, motor activation plus countless industrial applications. Switch converts unit from instantaneous "on-off" to sustained "on" operation. "RESET" switch opens the external circuit and turns off the alarm. The unit operates on 110 volts AC and incorporates the efficient 5823 cold cathode tube. A simple change in wiring (in instructions), as well as convenient input terminals, enables you to supply the external circuit with any desired voltage. Relay contacts rated at 3 amps permitting up to 300 watts external load on 110 Volts AC. Complete with all parts, photocell, tube chassis, silkscreened metal cabinet and easy-to-follow illustrated instructions. Size: 3x4x5". Shpg. wt., 3 lbs.

19 E 09043 Complete Kit Net 16.95

ACCESSORIES FOR ABOVE

Electric Bell, 110V AC Imported. Shpg. wt., 2 oz. Net 1.99

99 E 90235 Net 1.79

Electric Buzzer, 110V AC Imported. Shpg. wt., 10 oz. Net 1.79

99 E 90243 Net 1.79

6 Digit Electric Counter Imported. Shpg. wt., 1 1/2 lbs. Net 12.95

99 E 90110 Net 12.95

B LAFAYETTE LIGHT SOURCE KIT

Used to actuate electronic relay. Unlike units using sealed beam, this light source is carefully designed to throw a narrow beam of light so relatively small objects and people will "break" the beam. Unit includes adjustable focus and infra-red filter to make beam practically invisible. Range: white light—70', infra-red 45', with instructions. Size: 6Lx5Hx4"W. Shpg. wt., 5 lbs.

19 E 09118 Net 9.95

Replacement bulb for above. GE No. 1700. Net .84

32 E 66889 Net .84

PHILMORE DUAL BAND BROADCAST SHORTWAVE RADIO KIT



• 2 Bands
550-1650 kHz, 3-13 MHz

This radio covers the standard broadcast band from 550 to 1650 kHz and a shortwave band from 3 to 13 MHz. Modern circuitry with enough audio to drive a built-in 3 1/2 inch speaker. Be rewarded with the satisfaction of having built a radio which will actually pull in standard broadcast, amateur and other shortwave stations. Includes punched chassis, grey hammertone panel, 3 1/2" speaker, pictorial and schematic diagrams, and easy-to-follow instructions. Complete with all hardware: less solder, wire and tubes. Tubes required: 1—50C5, 1—12AU6 plus 1—35W4 rectifier. For 105-125 volts, AC or DC. Shpg. wt., 4 lbs.

19 E 58016 MODEL 7001CR. Net 14.50

Shortwave antenna kit for above

32 E 30884 Shpg. wt., 2 lbs. Net 1.50

SHORTWAVE AND SUPERHET BROADCAST RADIO KIT



17⁹⁵

2 bands cover both standard broadcast 540-1620 kHz and shortwave 5.8-18 MHz which includes international broadcast, 40 and 20-meter ham bands and some of the aeronautical and marine bands. Superheterodyne circuit has high gain IF's, built-in broadcast band loop antenna. Comes complete with ivory cabinet 4" PM speaker, tubes (12BE6, 12BA6, 12AV6, 50C5, plus 35W4 Rectifier) and all parts. Easy to follow step-by-step instructions. Shortwave band requires external antenna (not supplied). Size: 8 3/4"W x 5 3/4"H x 5 1/4"D. For 110V AC or DC.

19 E 40071 Shpg. wt., 5 lbs. Net 17.95

Shortwave antenna kit for above

32 E 30884 Shpg. wt., 2 lbs. Net 1.50

Make Lafayette Your One Dependable Source for Everything in Electronics

Lafayette Cat. No. 700 213

Educational Computer and Kits

GENIAC® COMPUTER KITS



DOUBLE GENIAC

The newest kit in famous Geniac series! The "Double" Geniac contains over 800 parts. Two of everything in the Standard model. Offers the advanced experimenter a far wider range of activities. Perfect for school demonstration. Multiple setup is ideal for Science Fair projects—submit one or more designs. Build "electric brains" that test intelligence—code and decode—add, subtract, multiply and divide—solve puzzles

—play games—forecast weather—reason in syllogisms—information and logic circuits. No soldering required. Easily assembled and operated. 64 page guide and reference book, beginners manual, wiring diagrams and many extra pamphlets outlining projects and methods. Complete with mounting rack and batteries. Shpg. wt., 12 lbs.

19 E 38034 Net 18.95

STANDARD GENIAC

You build up to 125 exciting "electric brain" machines. Has special circuits for forecasting weather. No soldering required. Comes complete with extra pamphlets including 64-page "Simple Electronic Brains and How To Make Them," "Symbolic Analysis of Relay

and Switching Circuits," "Beginner's Manual," "Machine to Compose Music," wiring diagrams, etc. Complete with battery. 16½x 11¾". Shpg. wt., 6 lbs.

19 E 38042 Net 11.95

Minidac 601 DIGITAL COMPUTER

165⁰⁰

No Money Down*

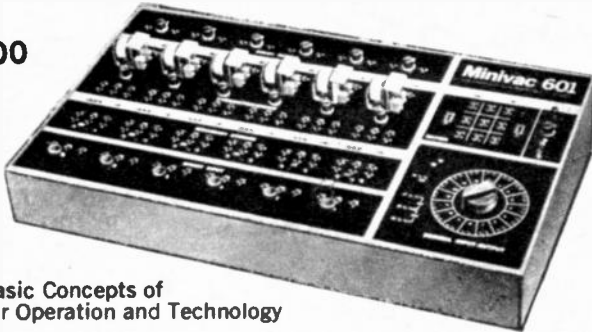

- Teaches Basic Concepts of Computer Operation and Technology

Your Rewarding Introduction to the Exciting Computer Field — Performs Functions of Full Size Computer — Solves Scientific & Business Problems

The 601 demonstrates how computers operate, what they can and cannot do by simulating computer applications in business, science and military. It can learn, remember, calculate, and make decisions. Indispensable to teachers, businessmen who need to keep up with modern technology, a first hand opportunity to explore space age techniques and experimentation. A set of six comprehensive manuals are provided with each Minidac 601. These provide step-by-step experiments demonstrating how computers do arithmetic, use logic, provide automatic control, and language translation... It even plays games as an opponent, partner or referee. The Minidac is ready to use the moment you unpack it. Operates on a low 12-volt system—it is safe to use as an electric train. Minidac consists of a 24" console with 12

Indicator lights. 1 circuit breaker; 6 DPDT memory storage relays; 6 secondary memory storage switches; 6 data input push buttons; 16-position switch (motor driven); game matrix; 194 dual terminals and 100 program wires. The console measures 24x13x5½"H. Shpg. wt., 17 lbs. Power input 110V AC.

19 E 61010WX No Money Down* Net 165.00

MINIDAC 6010. A deluxe version of the 601 which is capable of handling a larger variety of more advanced computer programs. Ideal for industrial use. A seventh capacitor/resistor manual will accompany the 6010. Now with the additional features of individual protective dust covers for relays, improved slide switches and push-buttons for tighter specs and greater reliability. wt., 20 lbs.

19 E 61028WX No Money Down* Net 298.00

GENIAC® PORTABLE MEMORY CARD FILE



How to file a card in 25 places simultaneously.

For the busy scientist, engineer, teacher, businessman or student who must keep basic information on file. NOW the Geniac Portable Memory Unit, (PMU), a low cost information retrieval system can conservatively sort 400 cards per minute—using no electrical parts or gadgets. Sorting is by rods. Information is coded into the cards by matching prepunched holes around the edge of the card. No previous knowledge is necessary. Once coded the card is filed at random and will automatically appear during sorts. Includes a single hand punch, sorting rods and 200 cards. Shpg. wt., 6 lbs.

19 E 38018 Net 14.95

Double Punch: For use when more extensive coding requires punching of double rows.

19 E 65011 Net 9.00

Additional Cards, Pkg. of 100

19 E 38026 Net 3.92

MASTER FILE

Includes same components as above plus filing cabinet and 1200 cards. Shpg. wt., 19 lbs.

19 E 38067 Net 49.95

Filing cabinet only. Shpg. wt., 7 lbs.

19 E 38075 Net 8.95

ANALOG COMPUTER KIT



14⁹⁵

- Ideal Introduction to Basic Elements of Analog Computers
- Work Over 50 Experiments
- Easy-to-Assemble with Screwdriver and Pliers
- Learn the Way to Sound Scientific Knowledge

Analog Computer Kit offering a basic introduction to computer theory—gives accurate answers to practical problems. Perform over 50 experiments—multiplication, division, powers, square roots, rocketry, interest, radio-active decay, light, kinetic energy, etc. Level of accuracy better than 5%. The computer consists of a masonite, solid instrument panel, kits, potentiometers, meter specially calibrated scales, guide and operating booklet. Easy-to-assemble.

19 E 38058 Shpg. wt., 6 lbs. Net 14.95

Science Kits

Norelco 23-In-1 Electronics Kit

21⁹⁵



- No Soldering — No Tools
- Quick Easy Peg Board Assembly
- Safe — Educational

Build any of 23 useful operating projects including 3 transistorized radio receivers, 5 amplifiers, 2 code trainers, burglar alarms, intercom, rain indicator, electronic organ, light meter and other interesting projects. No soldering, no tools required. Template for each model placed on peg board for quick easy guide. All parts mounted with pressure springs. Step-by-step details with pictorial charts in large 72-page instruction manual with section on general theory. All powered by a single 9 volt battery. Absolutely safe. Size: 14 $\frac{1}{2}$ x 10 $\frac{1}{4}$ x 2 $\frac{1}{2}$ ". Imported. Shpg. wt., 4 $\frac{1}{2}$ lbs.

19 E 63016 Less Batteries Net 21.95
32 E 47178 Battery for above (2 required) Net ea. 1.36

NORELCO MECHANICAL ENGINEER KIT

ONLY
29⁹⁵



- Over 600 Parts
- Over 30 Projects
- For Age 9 up

Consisting of over 600 components, this kit promotes understanding of fundamentals of sources of energy such as mechanical, water pressure, air pressure, gravity, and electro-mechanical. Builds any-one of 32 educational operating models including electric windmill, water turbine with dynamo, compressed air motor with pump, crane, electric pile driver, water pump, clocks, etc. Includes special electronic section for combined projects with electronic kit at left to build 13 more projects including electronic car which reduces speed in dark and turns on headlamps — all automatically. Size: 21 $\frac{1}{4}$ x 10 $\frac{1}{4}$ x 1 $\frac{3}{4}$ ". Imported. Shpg. wt., 6 lbs.

19 E 63024 Less Batteries Net 29.95
99 E 62580 Battery for above (6 required) Net ea. .10

ELECTROCRAFT MASTER ELECTRIC BUILD-IT SET



An advanced but completely safe educational kit in the field of electricity that enables the student to make any one of over 30 projects including motor driven hot rod, motor driven dune buggy, lamp, flashlight, electro-magnet, telegraph set, traffic signal, electric crane and many others. All projects are battery operated. Easy-to-read, illustrated 76-page instruction manual. Size: 21 $\frac{1}{4}$ x 13 $\frac{1}{4}$ x 2 $\frac{1}{4}$ ". Shpg. wt., 5 lbs.

19 E 64030 Less batteries Net 8.95
Batteries For Above
99 E 62564 "D" 2 required Net ea. .15
99 E 62580 "AA" 2 required Net ea. .10

RAYTHEON-ELECTRON EDUCATIONAL SETS

- Space-Age Magnetic Blocks Make Electronics Child's Play
- No wiring • No tools No Electronics Knowledge Needed
- Match magnetic blocks with a schematic diagram in guidebook
- Series 2 Set Builds 43 Projects
- Series 3 Set Builds 56 Fascinating Projects

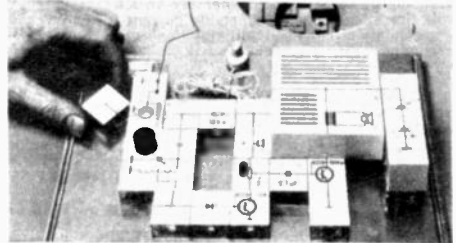

Set consists of domino-like see-thru magnetic connecting plastic blocks each self-contained with a transistor, capacitor, or other electronic component, etc., inside and the electronic symbol therefor engraved on the top; an 8" x 11" metal ground plate and an 80 page instruction manual. When a project is complete, circuit symbols on the blocks form a schematic diagram. Manual covers basic theory principles of the components and project diagrams and explanation. Easy! And Fun!

SERIES 2 LECTRON SET—make 43 working projects including transistor radio, electronic organ, rain moisture indicator, audio amplifiers, light modulated detector, morse code transmitter, metronome, burglar alarm and more, plus your own ingenuity. Shpg. wt., 4 lbs.
19 E 18031 Net 17.95

SERIES 3 LECTRON SET—make a solid state radio with speaker in 2 minutes and 55 more projects—all of Series 2 plus intercom, voice transmitter, public address and telephone amplifier, automatic night light, etc. Shpg. wt., 5 lbs.
19 E 18044 Net 24.95

MAGIC-GLO BLACK LIGHT



- Learn Invisible Detection
- Write Secret Messages
- Educational—Scientific
- Enjoyable—Interesting

The Black Light Kit enables you to see the invisible. Guaranteed completely safe and harmless. This kit allows children to study the phenomena of fluorescence and phosphorescence. Set contains black light, socket and cord, laboratory lamp stand, 4 jars of fluorescent paint, invisible ink, invisible crayon, tracer powder, 3 fluorescent mineral specimens, phosphorogram, optical bleach, brushes and pen, and a pkg. of fluorescent materials. Enables the student to perform endless numbers of fascinating experiments. The amply illustrated 48 page booklet "The Story of Black Light — The Unseen World Around Us." explains the use of black light in fields such as mineralogy, electronics, crime detection, medicine, stamp collecting, and many others. Shpg. wt., 4 lbs.

19 E 13011 Net 12.95
19 E 13029 Replacement U.V. Bulb for above Net 3.95

IC TRANSISTOR 12-in-1 EXPERIMENTAL ELECTRONIC KIT

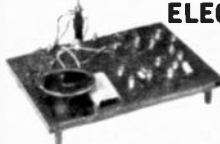

- 12 Exciting Experiments, Using Integrated Circuits

7⁹⁸

This kit is the last word for young experimenters wanting to learn about electronics. Employs integrated circuits, the electronic miracle of the space age, built and housed in a transistor case no larger than a pea. Contains enough parts and detailed instructions to build: BURGALAR ALARM-ELECTRONIC TIMER-RADIO RECEIVER-AUDIO AMPLIFIER-VOICE TRANSMITTER-AUDIO OSCILLATOR-CODE PRACTICE OSCILLATOR-LIGHT BLINKER-METRONOME-VOICE ACTIVATED SWITCH-RAIN ALARM. Safe to use, no soldering or high voltage. Spring clips simplify assembly of parts which are used over and over. Uses one inexpensive 9-volt transistor battery, not supplied. Detailed instruction booklet. Shpg. wt., 2 $\frac{1}{4}$ lbs.

19 E 31039 Kit, less battery Net 7.98
99 E 60212 9V battery for above Net .21



LAFAYETTE Solid State Modules

FOR HOBBYISTS, EXPERIMENTERS AND KIT BUILDERS



- All Solid State
- Completely Wired
- Approx. 1 3/4" L x 1 1/4" W

As Low As **1.98**

- Fully and Permanently Encapsulated
- Pre-Tested for Performance
- With Instructions and Parts List

Lafayette semiconductor modules are especially designed for many educational, enjoyable, and useful projects. Each permanent module encapsulates the complete solid state circuit required for each project, less accessories. With a few additional simple connections to

accessories below such as batteries, speaker, etc., you create an enjoyable and practical device. Every module is carefully checked for reliable performance. Supplied complete with instructions and parts list. Size: Approx. 1 3/4" L x 1 1/4" W. Shpg. wt., 8 oz.

ELECTRONIC SIREN MODULE

Complete solid state electronic circuitry ready for immediate use as a modern efficient high volume siren. It will drive any 8 ohm P.M. speaker to a very high level of attention-getting volume with an upward scream end downward wail. Use with: A, H, I, J. See accessory list below.

19 E 55053 Net 2.90

BURGLAR ALARM MODULE WITH SIREN ALARM

Protect your home, car, boat, garage, etc., with this efficient burglar alarm module. Complete electronic circuitry with a built-in electronic high volume upward screaming siren as the alarm sounds. Use with: A, H, I, K.

19 E 55061 Net 2.90

ELECTRONIC LATCHING RELAY MODULE

For Momentary Break Contact to Operate Tamper-Proof "Lock-On" Switch. Ideal for Burglar and Emergency Alarms. Ready for immediate use as an efficient latching relay for controlled switching of a 6 volt D.C. power source into any secondary circuit drawing up to 1/2 amp. Any momentary breaking of contact at "momentary switch" will fire module "on" (supplying current to a secondary circuit) and will stay "on" until manually reset. Use with: A, I, K.

19 E 55079 Net 2.90

FM WIRELESS MICROPHONE MODULE

Ready for immediate use as an efficient wireless means of transmitting your voice over moderate distances within a home, from a high impedance microphone into any standard FM radio. Use with B, C, O, or P.

19 E 55277 Net 2.90

TV WIRELESS MICROPHONE TRANSMITTER MODULE

Transmits from your high impedance microphone (crystal, ceramic, high impedance dynamic) over moderate distances into any TV set in your home on channels 2, 3 or 4. Built-in fine tuning control. Use with accessories D, E, P, and X below.

19 E 55343 Shpg. wt., 8 oz. Net 5.00

METRONOME MODULE

An excellent aid for keeping proper beat in music and dancing. Capable of reproducing beats at varying frequencies ranging from 40 cycles to over 300 cycles per minute. Use with: A, H, I, Z, DD.

19 E 55202 Net 1.90

PUBLIC ADDRESS AMPLIFIER MODULE

Complete solid state circuitry for immediate use as a public address amplifier and for use in portable high gain P.A. systems. Produces clear audio signal sufficient for large rooms. Ideal for small gatherings and business meeting. Use with: A, G, O or P, Y, DD.

19 E 55111 Net 2.90

CB MICROPHONE PREAMP MODULE

Effectively increases CB modulation for more dependable communications. More than doubles the sensitivity and output of your microphone when powered by a 1 1/2 volt battery.

Use with: B, C, W, AA on accessory list.

19 E 55152 Net 2.90

TELEPHONE AMPLIFIER MODULE

Compact module with complete solid state circuitry for use as a telephone amplifier. Permits group and conference listening to any phone conversation. Use with: A, H, Q, Y, DD.

19 E 55129 Net 2.90

FM WIRELESS PHONO TRANSMITTER MODULE

Transmits music for moderate distances within a home from the crystal or ceramic tone arm cartridge of a phonograph into any FM broadcast band radio. Meets FCC regulations. No license or registration required.

Use with B, C, W.

19 E 55327 Net 2.90

INTERCOM AMPLIFIER MODULE

A low cost highly efficient intercom module that facilitates conversations between two separate and remote points. Use with: A, L, U, CC and two H.

19 E 55137 Net 2.90

BABY NURSE AMPLIFIER MODULE

Will amplify not only a baby's whimper, but even report his normal movements and breathing in his crib. Use with: A, U, CC, and 2 ea. H.

19 E 55145 Net 2.90

BIRD CALL MODULE

Bird Call Simulator. Complete electronic circuitry ready for immediate use for electronically reproducing bird calls. Capable of simulating the songs of canaries, parakeets, and other exotic warbling birds. Use with: B, C, F, I.

19 E 55170 Net 2.90

STEREO PHONO AMPLIFIER MODULE

Compact module for use as a stereo phono amplifier for use with crystal or ceramic cartridges. Drives any 8-ohm speaker. Use with accessories A, two Y and two F below.

19 E 55335 Shpg. wt., 8 oz. Net 5.00

QUAL FLASHER MODULE

For Auto Road Warning Lights, Window and Counter Display, Attention Getters, Model Train Grade Crossings Flasher, Emergency Boat Flasher, Bicycle Rear Wheel Flasher, Alarm Indicator, etc.

A complete solid state astable multivibrator with a cycling rate of about 100 times per minute. Use with: A, 2 ea. S, 2 ea. T.

19 E 55194 Net 1.90

AM WIRELESS MICROPHONE MODULE

Transmit from your high impedance microphone (crystal, ceramic, high impedance dynamic) into any AM broadcast band radio in your home. Meets FCC regulations. No license or registration is required. Use with: D, E, O or P, BB. See accessory list.

19 E 55228 Net 2.90

WIRELESS CODE OSCILLATOR MODULE

Broadcast Code into Any AM Radio. When connected to a small 9 volt transistor battery and any telegraph key, this module will wireless transmit standard Morse Code signals over short distances into any AM broadcast band radio. Meets FCC regulations. No license or registration is required.

Use with: D, E, R, BB.

19 E 55236 Net 2.90

WIRELESS PHONO OSCILLATOR MODULE

Transmits music, etc., over moderate distances within a home, from the crystal or ceramic tone arm cartridge of a phonograph into any AM broadcast band radio. Meets FCC regulations. No license or registration reqd. Use with D, E, X, BB.

19 E 55251 Net 2.90

SIGNAL INJECTOR MODULE

For RF and AF Trouble Shooting. An efficient signal injector which generates a 2Kc audio frequency signal with modulated radio frequency harmonics up to 30 Mc. Enables isolation of defective electronic stages. Use with: D, E.

19 E 55269 Net 2.90

GUITAR TREMOLO MODULE

Add Guitar Tremolo To Any Guitar. Provides your guitar with a tremolo sound effect when connected between guitar pick-up microphone and guitar amplifier. Tremolo depth is preset to ideal level and tremolo frequency may be varied for about 4 to 15 cycles per second. Use with: D, E, V.

19 E 55160 Net 2.90

GUITAR AMPLIFIER MODULE

Electrify your guitar with this guitar amplifier module. Complete solid state circuitry ready for immediate use as a sensitive and efficient guitar amplifier. Use with: A, G, M, Y, DD.

19 E 55103 Net 2.90

FM WIRELESS GUITAR TRANSMITTER MODULE

Contains complete solid state electronic circuitry to transmit guitar music over moderate distances within a home from a guitar contact microphone into any FM radio. You can play your musical instrument in one part of the house while your family and friends listen to you on a FM radio in another room. Requires accessories B and M or N.

19 E 55319 Net 3.50

ACCESSORIES FOR SOLID STATE MODULES ABOVE

Stock No.	Price	Description	Stock No.	Price	Description
A. 32 E 48184	.99	Battery, 6 Volt Lantern	P. 99 E 45437	1.95	Microphone, Hand Held/Desk Crystal
B. 99 E 62564	.15	Battery, 1 1/2 Volt "D"	Q. 99 E 10340	1.49	Telephone Pickup Coil
C. 34 E 50137	.30	Holder for B	R. 99 E 25553	2.29	Telegraph Key
D. 99 E 60212	.21	Battery, 9 Volt	S. 32 E 66194	.15	≠47 Pilot Light Bulb
E. 99 E 62879	.29	Clips for D	T. 32 E 28053	.40	Socket for ≠47 Bulb
F. 99 E 60329	.99	Speaker, PM, 8 ohm, 3"	U. 32 E 22510	.67	Potentiometer, 5,000 Ohm/SPST Switch
G. 44 E 01030	4.50	Speaker, PM, 8 ohm, 8"	V. 33 E 11313	1.02	Potentiometer, 25,000 Ohm
H. 32 E 22056	3.39	Speaker, PM, 8 ohm, 6"	W. 32 E 22544	.67	Potentiometer, 1/2 Megohm with Switch
J. 99 E 61509	.28	Switch, SPST, On-Off	X. 32 E 22536	.67	Potentiometer, 100K with Switch
J. 99 E 62184	.19	Switch, SPST, Push-Button, Momentary, NO.	Y. 32 E 22551	.67	Potentiometer, 1 Megohm with Switch
K. 34 E 60029	.57	Switch, SPST, Momentary, NC	Z. 33 E 11552	1.02	Potentiometer, 2 Megohm
L. 30 E 41241	1.20	Switch, 4PDT	AA. 32 E 13071	1.02	Microphone Cable, Shielded (Cut to 3 ft.)
M. 99 E 45767	1.89	Microphone, Guitar Contact	BB. 32 E 31982	.40	Wire, Antenna (Cut to less than 10 ft.)
N. 99 E 45171	6.95	Microphone, Guitar Contact for Guitars with F Hole	CC. 32 E 24052	.12	Knob, Miniature
O. 99 E 45106	1.95	Microphone, Lapel Crystal	DD. 32 E 24185	.14	Knob

Mod-u-Kits Educational Useful And Fun to Build



A AUTO LIGHT REMINDER KIT

Eliminates dead batteries resulting from leaving car lights lit. Automatically sounds a siren when lights are left on and the ignition shut off. Fits any 6 or 12 volt car. Easily installed after assembly. Complete with all parts, including speaker. Size: 3 x 2 x 1 1/4".
19 E 70136 Shpg. wt., 1 lb. Net 6.95

B 5-WATT UNIV. AMPLIFIER KIT

Excellent as a portable amplifier, guitar amplifier, etc. Complete with all parts, case, volume control, and instructions. Works on a 6-volt battery or power supply. Will accept almost any type of pickup device, i.e., phono cartridge, tuner, etc.; will work with any 3-ohm to 15-ohm PM speakers. 3" x 2" x 1 1/4".
19 E 70011 Shpg. wt., 1 lb. Net 5.95

C PROXIMITY SWITCH KIT

An alarm at the touch of the hand! The Proximity Switch kit when properly built can be used as a special light alarm and night light. Can control devices using universal type motors up to 5 amps, and can trigger off an alarm when used with a special transformer and AC supply. Touching a door knob or other chosen part switches circuit on! 4 x 3 x 1 1/4".
19 E 70045 Shpg. wt., 1 lb. Net 6.95

D AM WIRELESS MIKE KIT

Transmits through any standard AM radio. Can be located up to 50-ft. away from set. Basic 2-transistor circuit. Frequency varied by tuneable coil. Complete with crystal mike and telescoping antenna. Size: 3x2x1 1/4". Shpg. wt., 1 lb.
19 E 70094 Less Battery Net 7.95
99 E 60212 9V Battery Net .21

E AM BROADCAST RADIO KIT

Learn as you build this fun-giving AM broadcast radio. Ingenious solid state circuitry uses a novel 2 transistor audio-reflex circuit with diode detection. Gives high gain at very low current drain. Complete with all parts, case, earphone and instructions. Supplied with matching transformer to permit use as an AM tuner. Powered by a single 9 volt battery. 3 x 2 x 1 1/4". Shpg. wt., 1 lb.
19 E 70029 less battery Net 4.95
99 E 60212 battery Net .21

F AIRCRAFT RECEIVER KIT

Permits reception of standard FM(88-108 MHz.), standard AM(550-1600 kHz.), and Citizens Band. Consists of a sensitive amplifier kit, e citizens band tuning head kit, FM tuning head kit and AM tuning head kit. Each tuning head works in conjunction with the amplifier by simply plugging into the amplifier input-jack. Requires 9-volt battery. Wt., 2 1/2 lbs.
19 E 70144 Less Battery Net 14.95
99 E 60212 9V Battery Net .21

G MULTI-BAND RECEIVER KIT

Listen to airplane to ground communications. Will pick up and amplify the strongest signals in its vicinity in the 100 to 200 MHz range. Has 3-stage high gain amplifier. Circuitry incorporates a passive detector that does not radiate signals. Does not interfere with aircraft navigational systems. Telescoping antenna. Supplied with earphone. Unplugging earphone disconnects power. Powered by a single 9 volt battery. DC Size: 3x2x1 1/4". Shpg. wt., 1 lb.
19 E 70088 Less Battery Net 5.95
99 E 60212 Battery Net .21

H FM WIRELESS MIKE KIT

Transmits your voice to be picked up by any standard FM radio. 2-transistor circuit with an audio modulator and R.F. oscillator. Frequency controlled by external trimmer condenser. Complete with mike and telescoping antenna. Size: 3x2x1 1/4". Shpg. wt., 1 lb.
19 E 70102 Less Battery Net 6.95
99 E 60212 9V Battery Net .21

I WIRELESS INTERCOM KIT

Just plug into AC outlet. This intercom feeds an AM modulated signal into the ground side of the A.C. line. Your voice may be picked up at any AC outlet in the house on any good AC operated table radio. Signal frequency is tuneable so you can find open spot on radio. Size: 3 1/2 x 3 3/4 x 1 3/4". Shpg. wt., 2 lbs.
19 E 70120 Net 7.95

J FIRE ALARM KIT

Has a special heat sensor that will activate the unit when temperature near it reaches a 130°. Includes test button for periodic checks to make sure unit is operative. When connected to any speaker will produce a siren effect. Requires 6-volt battery or a power supply. Size: 3x2x1 1/2". Shpg. wt., 1 lb.
19 E 70078 (Less Battery) Net 4.95

K TV-FM BOOSTER KIT

An interesting useful kit that will give a signal boost of up to 10 db when properly assembled. For color, black and white and FM. Will also help color reception on indoor antennas. Complete with matching coils, printed circuit board, all parts, plastic case, and instructions. 4x3x1 1/2".
19 E 70052 Shpg. wt., 1 lb. Net 9.95

LAFAYETTE CONVERTER MODULES



LISTEN TO POLICE, FIRE, AIRCRAFT, AND SHORFWAVE ON YOUR PRESENT AM SET

Now you can have the thrill of listening to the exciting police broadcasts, the fire department calls, communications between planes and ground stations as well as international shortwave bands. Simple to connect to your present AM broadcast radio. Size: 1 3/4 x 3/4 x 1". Control extends 1 1/2". Shpg. wt., 1 lb.

VHF POLICE AND FIRE CONVERTER MODULE
Permits reception of police and fire calls in the 30-50 MHz band on your standard broadcast band AM radio. Requires 9V transistor battery and wire.
19 E 59293 Net 5.00

FM VHF POLICE AND WEATHER CONVERTER MODULE
Permits reception of 150-164 MHz FM-VHF police, fire, emergency, marine and weather transmissions on a standard FM radio. Requires 9V transistor battery, 5K potentiometer and knob, and wire.
19 E 55368 Net 5.00

AIRCRAFT CONVERTER MODULE
Same as above but for reception of 118 to 128 MHz. Band. Requires 9 volt battery D.
19 E 55293 Net 5.00

SHORTWAVE CONVERTER MODULE
Same as above but tunes 25, 31, and 41 meter bands (7-12 MHz.). Requires 9 volt battery D and Wire EE.
19 E 55301 Net 5.00

ACCESSORIES FOR MODULES

99 E 60212	9V Battery	.21
99 E 62679	Battery clips for above	.29
32 E 31982	Wire	.40
32 E 22510	5K Potentiometer	.67
32 E 24052	Knob, miniature	.12

Solid State Audio Amplifiers, Tuner and

5-TRANSISTOR PUSH-PULL AUDIO AMPLIFIER

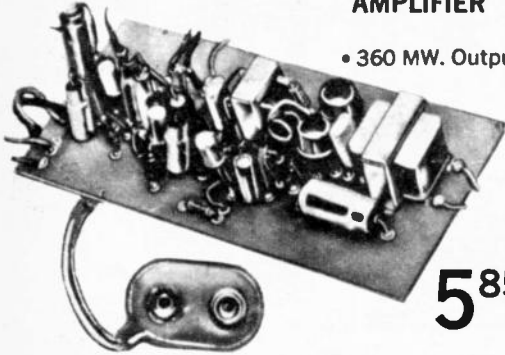

• 360 MW. Output

5⁸⁵

A more powerful and sensitive version of the 4-transistor amplifier on right, this amplifier employs 3 stages of audio driving a push-pull output stage. Power output is 360 mw, designed for speakers with a voice coil impedance of 8-11 ohms. Low impedance input has sensitivity of 300 microvolts. Input transformer for matching high impedance to the amplifier input available as an accessory (see below). Comes with leads for low impedance input, speaker, volume control/on-off switch. Battery clips and leads supplied for 9 volt miniature battery (one required). Imported. Shpg. wt., 5 oz.

99 E 90375 Use with access. below. A, D, H, or I, and J. . . . Net 5.85

1-WATT 4-TRANSISTOR PUSH-PULL AUDIO AMPLIFIER

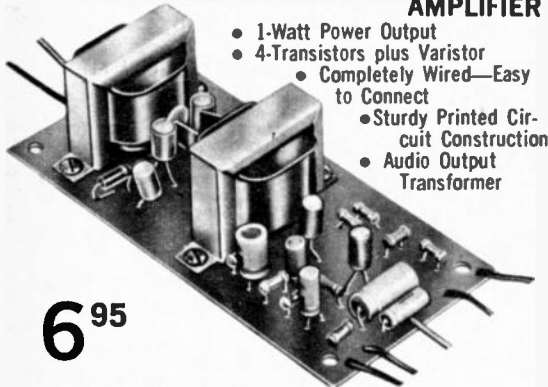

- 1-Watt Power Output
- 4-Transistors plus Varistor
- Completely Wired—Easy to Connect
- Sturdy Printed Circuit Construction
- Audio Output Transformer

6⁹⁵

One of our most powerful miniature amplifiers. It has many direct uses in audio frequency applications for tuners, test equipment, etc. Push-pull circuit is very sensitive and has an output of 1-watt! Using only 4 transistors, it requires a 12-volt source supplied by Standard 'D' cells in series. Outputs from record players with magnetic cartridge, tape heads, microphones, etc. (not exceeding 20 millivolts) can be connected directly. Higher output devices may be easily connected with a resistor in series. Components are neatly laid out on a printed circuit board with pre-drilled holes for mounting the entire unit in a vertical or horizontal position. Built-in leads are supplied for a volume control, on-off switch, battery and 8 ohm loudspeaker. Dimensions: 4 7/8" x 1 1/2" x 2 3/4" W. Imported. Shpg. wt., 12 ozs.

99 E 90383 Use with accessories B and C below. . . . Net 6.95

TRANSISTORIZED MINIATURE AMPLIFIER AND TUNER APPLICATIONS

Many original Applications Not Found Elsewhere!

By Rufus P. Turner

1⁵⁰ 96 Pages . . . 56 Circuits . . . 73 Illustrations

An inspiring new book written by a registered professional engineer and author. Deals primarily with 56 challenging and interesting applications of the Lafayette transistorized miniature amplifiers and tuner described on this and facing page. 6 chapters . . . Audio, Amplifier & Citizens Band, Controls, Test Instruments, Tuner, Hearing Aids, Intercoms, etc. 96 pages with 73 illustrations. 10 E 01049 Shpg. wt., 6 oz. . . . Net 1.50



4-TRANSISTOR SUBMINIATURE PUSH-PULL AUDIO AMPLIFIER



• 100 MW. Output

4⁹⁵

A tiny, transistorized push-pull audio amplifier with a multitude of applications. Only 3" x 1 1/4" x 1 1/4", it can be mounted inside other equipment to serve as a subminiature phono amplifier, tape recorder, amplifier, etc. Two stages of audio are followed by a push-pull output stage designed to deliver 100 mw to an 8-11 ohm impedance. Low impedances input, with a sensitivity of 0.9 mv. Input transformer for matching high impedances to the amplifier available as an accessory (see below). Includes leads for input, speaker, and volume control/on-off switch. Battery clips and leads supplied for 9-volt miniature battery (one required). Imported. Shpg. wt., 5 oz.

99 E 90425 Use with access. below. A, E, H, or I, and J. . . . Net 4.95

3-TRANSISTOR SUBMINIATURE AUDIO AMPLIFIER

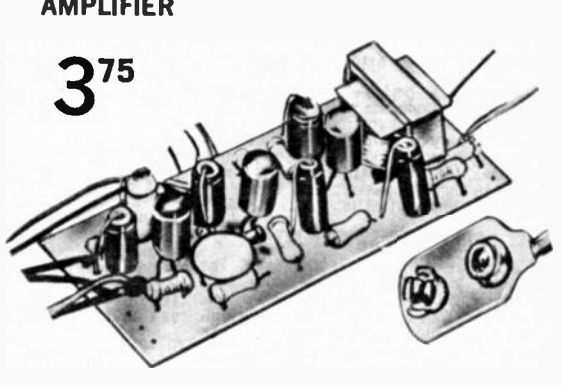

3⁷⁵

- Printed Circuit
- Complete with Transistors

Here is an amazing little audio amplifier with a multitude of challenging applications; i.e., subminiature phono amplifier, tape recorder amplifier, hand-held public address amplifier, telephone pick-up amplifier, etc. Output sufficient for average listening. Has leads for any one of the following inputs: Tape recorder record/playback heads, radio-tuner, crystal or ceramic phono cartridge, and crystal or ceramic microphone. Has lead terminations for ON-OFF switch, Volume Control, 4 to 10 ohm speaker, and leads terminating in clips for a 9-volt miniature battery. Size: 2 1/4" x 1 1/4" x 3/4". Can be readily mounted on chassis. Imported. Shpg. wt., 8 oz.

99 E 90391 Use with accessories A, C, F, and G below. . . . Net 3.75

ACCESSORIES FOR AMPLIFIERS AND TUNER ON THIS AND FACING PAGE

A.	99 E 60212* 9 Volt Battery	Net .21
B.	99 E 62564* "D" Cell Battery	Net ea. .15
C.	5,000 Ohm Volume Control/Switch/Knob. 2 oz.	
	99 E 60196*	Net .59
D.	32 E 22528* 10,000 Ohm Volume Control/Switch	Net .67
E.	100,000 Ohm Volume Control/Switch. 2 oz.	
	32 E 22536*	Net .67
F.	99 E 45098* Crystal Microphone. 6 oz.	Net .99
G.	99 E 60972* 2 1/2", 10 Ohm Speaker. 8 oz.	Net .99
H.	99 E 60329* 3", 8 Ohm Speaker. 10 oz.	Net .99
I.	99 E 60360* 2", 8 Ohm Speaker. 8 oz.	Net .99
J.	Matching transformer (high impedance to amp.)	
	99 E 60345* Wt., 4 oz.	Net .99

* Imported

Accessories For Experimenter and Hobbyist

1 WATT, 4 TRANSISTOR, DIRECT OUTPUT PUSH-PULL AUDIO AMPLIFIER

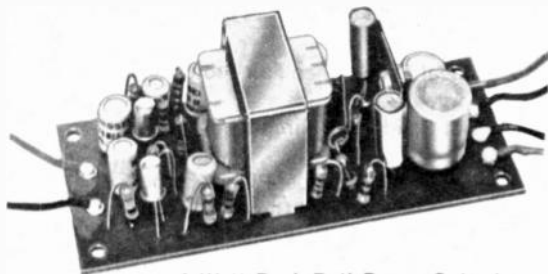

6⁹⁵

- 1 Watt Push-Pull Power Output
- 4 Transistors Plus Thermistor
- Completely Wired—Easy to Connect
- Direct Output—8 and 16 Ohms

Amazingly powerful miniature solid state audio amplifier with many direct uses in audio frequency applications for tuners, test equipment, as a phono amplifier, tape recorder amplifier, public address or telephone pick-up amplifier, etc. Push-pull circuit has an output of 1 watt. Using 4 transistors and a thermistor, it requires a single 9 volt battery. Direct output into 8 or 16 ohm speakers for minimum distortion. Can be readily mounted on chassis. Dimensions: 4 7/8" x 1 1/2" x 2 1/4" W. Shpg. wt., 12 oz. Imported.

99 E 90979 Use with accessories A, E, and H. (See p. 218.) Net 6.95

3 WATT 4 TRANSISTOR PUSH-PULL AUDIO AMPLIFIER

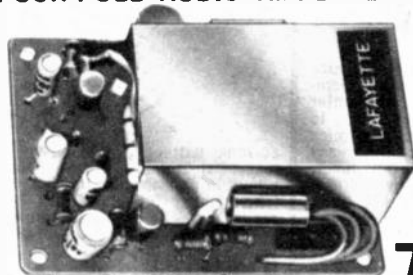

7⁹⁵

- 3 Watt Push-Pull Power Output
- 4 Transistors Plus Thermistor
- Completely Wired—Easy to Connect

A mighty amplifier with 3 watt push-pull output which fits in the palm of your hand and weighs less than 6 oz! This versatile general purpose amplifier suitable for phono amplifier, public address, intercom, monitor modulation, test equipment and a host of other uses. Sensitive 4 transistor push-pull circuitry has 3 watt output, requiring a 9 volt DC source. Frequency response 150-10,000 cps; input impedance 2,000 ohms; output impedance 8 and 16 ohm terminations. Components neatly laid out on printed circuit board with pre-drilled holes for horizontal or vertical mounting. Heat sink for power transistors. Dimensions: 3L x 2 1/4" W x 1 1/4" H. Imported. Shpg. wt., 9 oz.

99 E 91324 Use with accessories: D, and H. (See p. 218.) Net 7.95

3-TRANSISTOR SUBMINIATURE AM BROADCAST TUNER

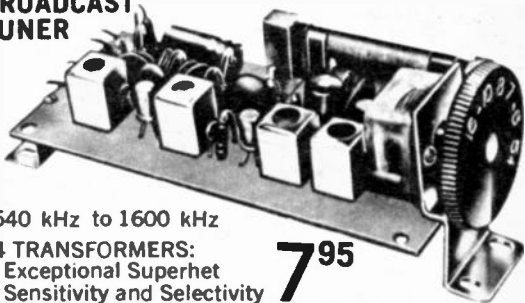

7⁹⁵

- 540 kHz to 1600 kHz
- 4 TRANSFORMERS: Exceptional Superhet Sensitivity and Selectivity

A deluxe 3-transistor subminiature AM broadcast tuner that features 3 dependable transistors, 3 IF plus 1 oscillator transformer, and ferrite antenna in an efficient, completely wired superheterodyne circuit on a sturdy printed-circuit board.

Now you can build your own highly efficient broadcast receiver by simply adding this exceptional tuner to any of the transistor audio amplifiers listed. The long tuner leads for connecting to external amplifier and/or to a separate 9-volt battery, makes this easy as pie. Also features a large clearly visible calibrated tuning dial. The printed circuit board layout permits either vertical or horizontal mounting. Supplied complete with mounting brackets and detailed instructions. Size: 4x1 3/4x2 1/2" with brackets. Imported. Shpg. wt., 8 oz.

99 E 90409

Net 7.95

ADJUSTABLE POWER SUPPLY KIT

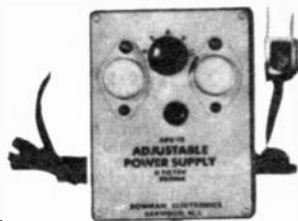

Only
12⁹⁵

- Simple To Build
- Variable 0-12V DC

- Ideal Power Supply For Modules On This and Facing Page

This simple-to-build power supply is ideal for any application requiring a low voltage DC source of power to be used as an alternative to batteries. Plugs into regular 110 volt AC current and delivers DC voltage which you can adjust from 0 to 12 volts at a current drain of up to 500 ma. A neon indicator light is supplied to indicate if the 110 AC power is on. Uses a special transformer that supplies approximately 16 VAC to a full wave bridge circuit. The DC produced is fed into a special dual transistor filter and regulating circuit. The base voltage of the first transistor is made variable by means of a control. Size: 4x4x1 1/2".

19 E 70110 Shpg. wt., 3 lbs.

Net 12.95

MOD-U KIT SOUND TO LIGHT CONVERTER KITS

SOUND TO LIGHT CONVERTER KIT

5⁹⁵

- Supplies 100 Watts Of Psychedelic Lighting!

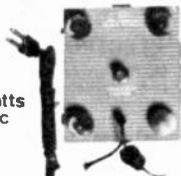

Accepts sound from any radio, hi-fi, phono, or any amplifier and changes these direct audio signals to light keying signals. In addition to 4 colored pilot light indicators plugged into the unit, an AC socket supplies 100 watts of external psychedelic lighting which varies with the sound. Shpg. wt., 1 lb. 19 E 70151 Net 5.95

3-CHANNEL PSYCHEDELIC CONTROL CENTER KIT

12⁹⁵

- Provides 500 Watts Per Channel



Converts audio signals to 1500 watts of available external psychedelic lighting. Output of the 3 transistor amplifier is applied to 3 separate SCR's providing 500 watts per color channel. Has a sensitivity control for low, middle, and high frequencies, and panel indicator light for each 500 watt color channel. Complete with outlets. 19 E 70169 Shpg. wt., 2 lbs. Net 12.95

ELECTRONIC STROBE KIT

9⁹⁵

- 100 Watt Incandescent Lamp Strobe

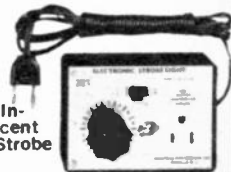

This electronic strobe converts a 100 watt incandescent bulb into a strobe type lighting unit which gives eerie stopmotion and light-burst effects for light shows. An adjustable frequency audio oscillator and SCR circuit controls the lamp. The pulsations can be varied from fast to a one pulse per second slow rate. Powered by a 9 volt internal battery (not supplied). 19 E 70177 Wt., 1 1/2 lbs. Net 9.95

99 E 60212 9V battery Net .21

EICOCRAFT Solid-State Kits

- ★ EASY
- ★ FAST
- ★ EDUCATIONAL
- ★ USEFUL

NO TECHNICAL KNOWLEDGE OR EXPERIENCE NECESSARY

- Ideal For Science Fair Projects
- All Solid-State Circuitry
- Pre-Drilled, Copper-Plated Etched Printed Circuit Boards
- Comprehensive Step-By-Step Instructions

AS LOW AS

2⁵⁰



TREASURE FINDER KIT

9⁹⁵

EC-1900 Battery operated beat-frequency metal locator can be used to locate both ferrous (iron, steel etc) and non-ferrous (gold, silver, copper) metals. Has two RF oscillators and search loop. Distinctive audio variations in tone indicate the presence of buried metal objects over a wide area. Use with A. Shpg. wt., 8 oz. **19 E 66100** Net 9.95

FM WIRELESS MIKE KIT

9⁹⁵



EC-1100 Pocket size wireless FM microphone transmitter permits you to broadcast your voice or music through any FM standard broadcast radio or tuner, without any interconnecting cables. Broadcasts on vacant frequency in FM band. 90-100 MHz. No license or age requirements. Complete with telescoping antenna. Use with A. Shpg. wt., 8 oz. **19 E 66019** Net 9.95

ELECTRONIC ORGAN KIT

9⁹⁵

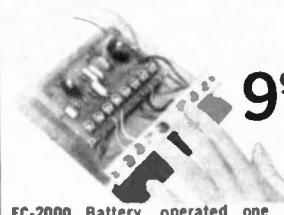

EC-2000 Battery operated one octave (8 tones) electronic organ. Supplied with a built-in preamplifier. Has outputs for melow, bright or flute-like tones. Two or more can be played in harmony to produce chords. An excellent multitone audio generator for testing. Use with A. Shpg. wt., 8 oz. **19 E 66118** Net 9.95

CODE OSCILLATOR KIT

EC-1000 Two transistor code practice oscillator produces strong, sharp tones. Can be used as monitor by paralleling an existing transmitter key. Other uses as bicycle horn, doorbell, entry signaller, etc. Use with B, D and E. Shpg. wt., 8 oz. **19 E 66050** Net 2.50

LOW BAND POLICE AND FIRE CONVERTER KIT

EC-2700. An RF converter operating in the 30-50 MHz VHF band which permits you to hear police, fire and emergency services on your standard AM radio. Inductively coupled without interconnecting wires. Use with A. Shpg. wt., 8 oz. **19 E 66126** Net 7.95

HI BAND POLICE AND FIRE CONVERTER KIT

EC-2900. Convert your standard (car or home) AM radio to receive police, fire, marine and weather broadcasts in the 152-174 MHz VHF band. Inductively coupled without interconnecting wires. Use with A. Shpg. wt., 8 oz. **19 E 66134** Net 7.95

ELECTRONIC SIREN KIT

EC-100. Powerful 3-transistor piercing signal ideal for attention-getting and signalling. Use as alarms for burglary, fire, automobile, boat, etc. and sound effects for model trains and cars. Use with B and E. Shpg. wt., 8 oz. **19 E 66142** Net 4.95

FM RADIO KIT

EC-1400. Receives the FM broadcast band from 88-100 MHz. May be used as a private listening personal radio with earphone supplied, or as an FM tuner when coupled with audio amplifier such as EC-300. Use with B. Shpg. wt., 8 oz. **19 E 66092** Net 9.95

AUDIO POWER AMPLIFIER KIT

EC-300. General purpose 2-watt audio amplifier. Accepts microphone, phono cartridge, radio, recorder and other high-level inputs. Two used for stereo. Handles one or more speakers for intercom. PA, or long distance hauling. Use with B and E. Shpg. wt., 8 oz. **19 E 66027** Net 5.95

ELECTRONIC BONGOS KIT

EC-1600. Electronically produces exciting percussive sounds of bongos, tomtoms, bass drum, marimba, gongs, etc. when used with amplifier and speaker. Ideal accessory for use with electronic guitars. Mounts on or near instrument. Use with B. Shpg. wt., 8 oz. **19 E 66084** Net 7.95

FUZZBOX KIT

EC-2500. Creates a wide variety of synthesized tones consisting of multiple harmonics and square waves to produce the fuzz sound. Mounts on guitar amplifier with ON-OFF slide switch which mounts on guitar. Use with A. Shpg. wt., 8 oz. **19 E 66159** Net 8.95

ELECTRONIC "MYSTIFIER" KIT

EC-700. A fascinating "do nothing" relaxation oscillator circuit of 6 blinking lights whose random geometric sequence of blinks you control. An ideal conversation piece for desk, den or mantle. Use with C. Shpg. wt., 8 oz. **19 E 66035** Net 4.95

VOICE-OPERATED SWITCH KIT

EC-1300. An audio-activated relay amplifier for audio remote control of such devices as tape recorder, radio, TV, etc. Activated by music as well as voice. Provides variable time delay (adjustable). Use with B. Shpg. wt., 8 oz. **19 E 66167** Net 8.95

AC POWER SUPPLY KIT

EC-900. Transformer operated full-wave bridge rectifier power supply converts house current (110-125V AC) to 6V DC. It can power all Eicocraft kits using 6V batteries, eliminating battery operation and converting to AC use. Shpg. wt., 8 oz. **19 E 66076** Net 8.95

EICOCRAFT KIT ACCESSORIES

A. 99 E 60212 Battery, 9 Volt	Net .21
B. 32 E 48184 6V. Lantern Batt.	Net .99
C. 32 E 48515 Battery, 90 Volt	Net 2.97
D. 99 E 25546 Telegraph Key	Net .79
E. 99 E 60384 3.2 Ω, 2½" spkr.	Net .99

For Suitable Enclosures See page 313

Make Lafayette Your One Dependable Source for Everything in Electronics

Educational Science Specialties

PORTER DELUXE MINERALOGY SENIOR LAB OUTFIT

9⁹⁵

- Alcohol Lamp With Blowtorch
- 24 Mineral Specimens
- Geologist's Hammer



The ideal mineralogy lab kit for the junior geologist to determine the various mineral types. In addition to 24 selected mineral specimens, the set includes the necessary scientific instruments. Contains a geologist's hammer for dislodging specimens, an alcohol lamp with blow torch attachment, magnifier for examining surface and crystalline structure of minerals, tweezers, chemicals and test papers, test tube rack, charcoal block, streak plate and detailed instruction manual. Wall size identification chart lists nearly 200 minerals. Three-panel metal cabinet. Shpg. wt., 6 lbs.

19 E 34017 Net 9.95

PORTER WEATHERCRAFT FORECASTING LAB

11⁸⁸

- Build and Use Barometer, Wind Vane, Psychrometer and Rain Gauge
- Forecast Weather Accurately



Be your own meteorologist and simply forecast the weather. This deluxe weather laboratory kit contains every instrument necessary for extremely accurate weather prediction. Includes: a wind vane to show wind direction and an anemometer to give its speed; a compensated aneroid barometer provides barometric pressure; a psychrometer determines relative humidity; a set of graphs for charting air pressure and temperature; a detailed weather map and cloud chart. A gauge measures rainfall to 1/100th inch, and a detailed manual shows how to make accurate forecasts. Three-panel metal cabinet. Requires 2 "C" batteries, not supplied. Shpg. wt., 6 lbs.

19 E 34009 Less batteries. Net 11.88
99 E 62572 1.5v C battery (2 required) Net ea. .14



8⁹⁵

WEATHER STATION KIT

Fun to erect and fascinating to use, this weather station kit operates with flashing neon lights to show wind speed and direction on indoor indicator board. Includes a sensitive air tank barometer with 4-ft. indicator column, a sling psychrometer to measure relative humidity, rain gauge with scale calibrated to measure 1/100th of an inch rainfall, cloud chart, weather map and forecasting manual. 150 ft. wire supplied, enough for a 2-story house. Safety power cord. All connections safe to touch. Shpg. wt., 3 lbs.

19 E 30023 Net 8.95

SKY ROVER CRYSTAL RADIO KIT

2⁷⁵



Easy to assemble, brings in loud, clear reception. Precision wound tuning coil, super-sensitive crystal, bakelite cabinet. No batteries or electricity required. Complete with earphone with plastic ear-holder, antenna lead-in wire, and hardware. Requires external antenna (not supplied). Shpg. wt., 3 lbs.

19 E 58024 Net 2.75
32 E 30984 Antenna kit Net 1.50

NOVATRON

A SCIENTIFIC INSTRUMENT FOR THE EXPERIMENTER

- Miniature Atom Smasher
- Produces 75,000 Volts
- Absolutely Safe

Completely Wired (Not A Kit)

A scientific instrument capable of producing 75,000 volts—makes sparks up to 2" long—yet it is absolutely safe because the current is infinitesimal. The science-teacher—science lover—or hobbyist can perform experiments to astound students—friends—family. Makes smoke disappear—defy gravity—turns propellers at a distance—transforms atomic energy into light—makes artificial lightning—smashes atoms—demonstrates ionic space ship drive—and many other experiments. Includes an experimental kit and illustrated experiment manual. A fine research tool that will give years of beneficial service. 110 VAC. Imported. Assembled.

99 E 90086 Shpg. wt., 4 lbs. Net 12.95

THE SCIENCE 6

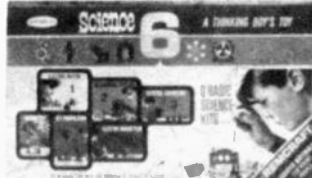

- Chemistry
- Jet Propulsion
- Electro-chemistry
- Electric Motor
- Magnetism
- Physics

A set of 6 kits for the young budding scientist, each of which contains material for conducting experiments that teach basic principles in a scientific field. Six subjects covered are electric motor, chemistry, electro-chemistry, jet propulsion, electro-magnetism and mechanical physics.

19 E 31013 Shpg. wt., 3 lbs. Net 4.98

ATOMIC ENERGY LAB

7⁹⁵

- Atomic cloud chamber with projector illuminator

Ingenious kit for studying some basic nuclear physics by experimentation. See the vapor trails of alpha and beta particles, and of cosmic rays. Shows exploding atoms. Instruction book covers such experiments as detecting radioactivity with a cloud chamber, with a spintharoscope, and with radioautographs; checking radioactivity with an electroscope, detecting ionization and others. Kit includes radioactive materials. Shpg. wt., 3 lbs.

19 E 30015 Net 7.95

MINERAL TEKNIKIT SET 1

2⁵⁰



Contains 48 specimens of ore, organics, fossils, elements, plutonics, oxides, volcanics, hypabyssals, effusive crystals, common and uncommon minerals. Each specimen is tagged with name and classification. An excellent introduction to rock and mineral identification. Imported. Shpg. wt., 1 lb.

99 E 71557 Net 2.50

SET II Includes additional specimens of some of above plus carbonates, tantaline, phosphates, and gemstones. 48 specimens. Imported. Shpg. wt., 1 lb.

95 E 71565 Net 2.50

Special Combination. Buy both sets and save. You get all 96 specimens. Shpg. wt., 2 lbs.

99 E 71573M Net 3.95

To Speed Your Mail Order—Please Give Your Zip Code Number

Lafayette Cat. No. 700 221

Rock Polishers & Specialty Items

GEM STONE TUMBLING AND JEWELRY MAKING KIT

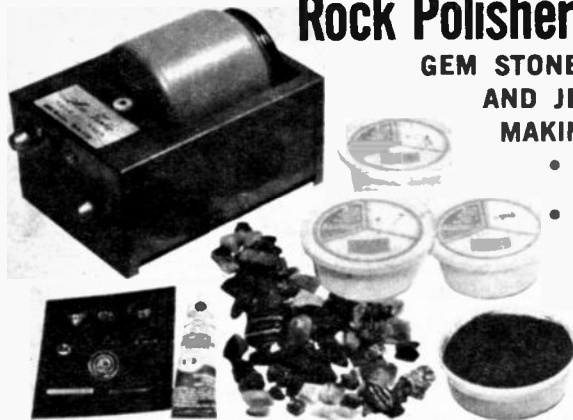

- Grinds and Polishes Rocks and Gem Stones
- Complete Outfit, Nothing Else to Buy

Only **23⁹⁵**

Here is your opportunity to enjoy the fascinating craft of gem polishing. Kit includes Mini-Tumbler, 2½ lb. load capacity drum and liner, 3 grades of abrasive grits plus polishing medium, assorted jewelry mountings (tie clasp, earrings, etc.), jewelry glue, and assortment of rough, exotic and aztec stones. Motor operates on 115 VAC, with built-in circuit protection, UL listed. Everything you need to go from "rocks" to "jewelry"

15 E 58006 Shpg. wt., 12 lbs. **Net 23.95**

ACCESSORIES FOR TUMBLERS

- Stones, 1 lb. pkg. of Oregon Beach Agate and Jasper. **Net 1.89**
- 15 E 44030 Deluxe Rough Stone Assortment, Approximately 200 agate and rose quartz, tiger eye, jasper, etc. Exotic colored rock is from all over the world; will polish to a jewelry like finish. **Net 5.95**
- 15 E 58014 Shpg. wt., 1 lb. **Net 2.50**
- Grit and Polish Assortment Kit. Provides everything needed to polish rocks. Packed in re-sealable plastic container. Each kit contains graded silicon carbide grit and fine polish compound for fast grinding and fine finishes. Each set will process 14 lbs. of rock. **Net 3.50**
- 15 E 58022 For Smooth Rocks, 3 step. Shpg. wt., 3 lbs. **Net 2.50**
- 15 E 58030 For Rough Rocks, 4 step. Shpg. wt., 5 lbs. **Net 2.50**
- Rock Polishers Jewelry Making Kit. Selected blanks for mounting those semi-precious stones that have been polished. Earrings, cuff links, chain bracelet, etc. Consists of: 2 sets of earring mounts, 1 set of cuff links, key ring, finger ring (adjustable), tie bar clip, chain pendant, wrist bracelet (takes 5 stones), one tube of on-off cement. **Net 2.50**
- 15 E 58040 Shpg. wt., ½ lb.

THUMLERS TUMBLER



Only **18⁹⁵**

- Grinds and Polishes Rocks, and Gem stones

A fascinating hobby-craft. You can polish all rocks to a sleek, gleaming gem-like finish. Use them for decoration, put in settings, etc. Tumbling machine has two side by side barrels with a total capacity of approx. 6 lbs. of stones. This is not a knock-down kit, but a completely assembled unit ready to run with powerful continuous duty motor that operates on standard 110 VAC current. Size: 7"x9"x11". Complete with cans, but less grit and can liner. See listing on left for additional accessories. Shpg. wt., 7 lbs.

15 E 44014 **Net 18.95**

Accessory pack, Asst. of coarse and fine grits, pre-polish and polish, and liners for above drums. Shpg. wt., 2 lbs. **Net 2.95**

Extra Cans For Above Tumbler. 15 E 44048 Shpg. wt., 4 oz. **Net ea. .30**

Extra Rubber Liners For Above. (Pkg. of 2). 15 E 44055 Shpg. wt., 4 oz. **Net .89**

LOUDSPEAKER TELEPHONE INTERCOMS



13⁹⁵

- Push A Button, It's A Telephone . . . Push Another Button, An Intercom . . .

This fascinating set consists of two standard telephone handsets and intercom "squawk boxes." Push a button and they operate as regular telephones; push another button and the voice at the other end of the wire comes through the intercom speaker so that anyone in the room can hear. Fun for everyone! Grownups use it too. Complete with connecting wires, the Loudspeaker Telephone Intercom may be operated from room to room, upstairs and down, house to house or patio to house. Uses 4 "D" batteries (not included). Each phone unit measures: 11¼x8¼x3¼". Shpg. wt., 5½ lbs.

19 E 31062 Less Batteries **Net 13.95**

99 E 62564 1½V "D" battery (4 required) **Net ea. .15**

SLIMLINE PUSHBUTTON TELEPHONE SET

- Authentic Replica Of Newest Western Electric Telephone **7⁹⁵**



Two complete battery operated phones that really work. Elegantly designed, the Slimline is the newest model pushbutton handset — the same size and style as its real-life counterpart. When one of the buttons is pushed, the bell rings at the other end of the line . . . Children are able to talk from room to room, upstairs and down or even from house to house. 25 feet of wire to complete the hookup is included. Requires 4 "C" size batteries (not included). When not in use, phones rest on beautifully matched cradle. Phone size: 7¼x3x2½". Shpg. wt., 4 lbs.

19 E 31070 Less batteries **Net 7.95**

99 E 62572 1½V "C" battery (4 required) **Net ea. .14**

ALL-TRANSISTOR BULL HORN

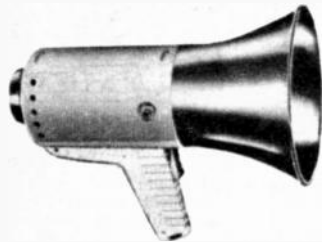

Made in U.S.A. Only **7⁹⁵**

NOT A KIT COMPLETELY PREASSEMBLED

- Range up to 400 feet • Weighs only 2½ lbs.
 - For Hunting, Camping, Boating, Sports
- A fully transistorized directional megaphone at Lafayette's low price. Lightweight, it carries your voice over 100 yards or above noise. Just press the trigger and talk. Features variable volume control and carrying strap. Uses 4-standard "D" cells (not supplied with unit). 11" long. Shpg. wt., 3 lbs.
- 44 E 15087 **Net 7.95**
- 1½-volt D batteries, 4 required, Imported. 99 E 62584 **Net ea. .15**

TELEPHONE AMPLIFIER KIT

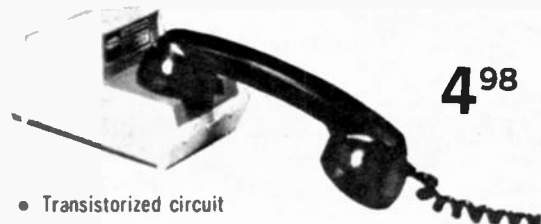

4⁹⁸

- Transistorized circuit
- Amplifies incoming voice and projects it through built-in speaker so many people can listen in on conversation and participate simultaneously. Speaker has loudness control. Fits any standard phone—just place receiver on the amplifier. Easy-to-assemble, requires no cementing or soldering. Modern high-impact plastic cabinet. Shpg. wt., 2 lbs.
- 19 E 31021 (less battery) **Net 4.98**
- 99 E 60212 Battery for above **Net .21**

Hobby Kits & Specialties

ELECTRIC WORLD TIME CLOCK KIT



- 24 Hour Clock Tells Time Anywhere In The World

This decorator-styled global timepiece tells time locally and anywhere in the world. The precision electric clock movement is pre-assembled and pre-wired. Simply mount it in the crystal-clear plastic case and add the 3-dimensional plated trim. Cover side panels with wall paper or fabric of your choice. Clock hangs on wall or stands on desk. UL listed. Clock stands 13 3/4" H x 11 1/4" W x 2 1/4" D. Shpg. wt., 4 lbs.

19 E 31054 Net 11.95

RENWAL VISIBLE V-8 ENGINE KIT

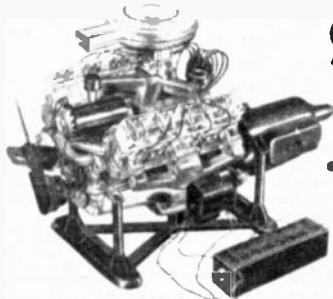

9⁹⁵

- Looks And Performs Like The Real Thing

The Visible V-8 is a superb guide to the study of the internal combustion engine. Precise 1/4 scale "see-thru" model engine that simulates the power plant of V-8 autos. Parts molded in 4 colors, including "clear", so that functioning pistons, connecting rods, rocker arms and properly timed spark plugs can be observed. Powerful permag motor activates over 100 moving parts. Powered by two "C" batteries (not supplied). Complete with polystyrene cement, hardware, screwdriver, and illustrated instruction manual which details how an auto engine works. Shpg. wt., 5 lbs.

19 E 69005 Complete Kit Less Batteries Net 9.95
99 E 62572 1.5V "C" battery, (2 required) Net ea. .14

PORTER COMMUNICRAFT LAB KIT

- Build 12 Projects In Sound Communications



All the necessary components to explore the wonders of sound. Includes control panel, electronic parts, transistor, speaker to build such projects as radio receivers, code oscillators, voice transmitter and more. Manual explains electronics in simple terms, includes easy to follow diagrams. Powered by 2 "D" cells (not supplied). Shpg. wt., 4 lbs.

19 E 34066 Kit less batteries, Net 11.95
99 E 62544 1.5 v "D" battery (2 Req.) Net ea. .15

PHOTOGRAPHY DARKROOM LAB WITH ENLARGER

- Complete Darkroom Outfit
- Photo Enlarger, Contact Printer, 35mm Projector — All In One Kit

12⁹⁵



Photography lab kit enables you to print and develop your own photos, enlarge 35mm shots up to 8 x 10", and project your 35mm negatives. Kit includes developing chemicals, printing and enlarging paper, 3 trays, thermometer, neon safelight, print frame taking negatives up to 3 1/2 x 4 1/4", twin condensing lenses and G.E. projection lamp. A complete photo lab in one kit. Shpg. wt., 4 lbs.

19 E 30031 Net 12.95

VALKYRIE-2 ROCKET KIT

13⁷⁵

- Looks And Performs Like The Real Thing
- Safe, Non-Flammable Non-Toxic Propellant
- Altitude Capability Over 1000 Feet
- Reusable With Parachute Recovery
- Launched Mechanically Or Electrically



Here is an authentic, educational and yet entirely safe rocket kit for modelers and hobbyists which demonstrates the principles of rocket propulsion. The propellant releases no heat, is non-flammable, non-toxic and non-explosive. The 16 inch long Valkyrie-2 which blasts off to 1000 feet, can be safely held in hand. Uses durable polished aluminum rocket, engine and parts, with real working valves, separator and parachute. At liftoff, the rocket starts slowly at 4 "G's", with acceleration at burnout about 10 "G's". A timer assures deployment of the parachute which returns the rocket for another launch. May be either mechanically or electrically launched with a battery (not supplied). Complete kit includes rocket, engine, timer, separator, parachute, balsa nose cone, fins, loading valve and hose, electric firing assembly, launch stand, one can of propellant, accessories and instructions. Size: 16" long x 1" dia.

19 E 75010 Complete rocket kit. Shpg. wt., 3 lbs. Net 13.75

Can of propellant sufficient for 4 launchings.

19 E 75028 Shpg. wt., 2 lbs. Net 2.00

6-Volt battery for electrical launching.

32 E 48184 Shpg. wt., 1 1/4 lbs. Net .99

Replacement ignitor wire for electrical launching.

19 E 75036 Shpg. wt., 3 oz. Net .35

GILBERT DELUXE GRADUATE CHEMISTRY MODULAB KIT

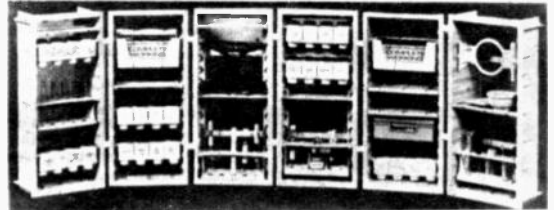

- Full Range of Chemicals and Supplies
- File Cards for Over 700 Experiments
- Six Modular Laboratory Storage Racks

14⁹⁵

Ideal deluxe chemistry lab kit for experimenters, hobbyists, students. Conduct over 700 experiments in chemical gardening, analytical testing, thermal chemistry, chromatography, chemical magic and many more. Six modular storage racks hold complete set of chemicals and supplies. Advanced equipment includes precision lab scale, mortar and pestle, hydroponics tray, alcohol lamp, test tubes, etc. Project file cards provide detailed instructions and operating procedures. Shpg. wt., 15 lbs.

19 E 34058 Net 14.95

GILBERT LIFE SCIENCE MICRO-BIOLOGY LAB KIT



- With Microscope

9⁹⁵

Features die-cast metal 75X microscope for proper magnification of specimens in home or field study. Materials supplied to grow and observe live protozoa and brine shrimp. Includes preserved specimens of frog, crayfish, earthworm, grasshopper and fish. 5 prepared specimen slides provided. Kit also includes dissecting instruments (scissors, scalpel, etc.), materials for slide preparation and study manual. Shpg. wt., 5 lbs.

19 E 34041 Net 9.95

High Quality Lafayette Multitesters

DELUXE 30,000 OHMS PER VOLT MULTITESTER WITH MIRROR SCALE



17⁹⁵

- 30,000 Ohms per Volt DC, 15,000 Ohms per Volt AC
- Low Voltage Scale for Transistor Tests
- 1% Precision Resistors for High Accuracy
- Unique "Buzzer" for Fast Short Tests
- 27 Meter Ranges on 2-Color Scale
- Built-in Overload Protective Circuitry

Deluxe portable Volt-Ohm-Milliammeter with a mirror scale. Provides wide voltage, current, resistance and db ranges clearly visible on a big 4" meter with 2 color calibrations. Built-in overload protective circuitry. Sensitivity is 30,000 ohms-per-volt DC and 15,000 ohms-per-volt AC. All multipliers used are 1% precision resistors for maximum accuracy and years of dependable service. Sensitive 33-micro-ampere meter provides full scale readings down to 1/4 volt on DC and .05 milliamps. Features a unique self-contained buzzer to give you fast in-circuit checks on opens, shorts. Audio output jack with DC blocking capacitor. Handsome, dust proof black plastic case. Complete with leads, batteries. Size: 4 1/4" W x 6 1/2" H x 2 3/4" D.

99 E 50718 Imported. Shpg. wt., 2 lbs. Net 17.95
38 E 01081 Pigskin Carrying Case for the above. Shpg. wt., 1/2 lb. Net 1.95

SPECIFICATIONS

Sensitivity: 30,000 ohms/volt DC, 15,000 ohms/volt AC. Ranges: DC volts: 0-.25, 1, 2.5, 10, 25, 100, 250, 500, 1000; AC volts: 0-2.5, 10, 25, 100, 250, 500, 1000. Direct Current: 0-0.05, 5, 50, 500 ma; 0-12 amps Ohmmeter: 0-60K, 6M, 60 Meg-ohms, Decibels: -20 to +56 db. Short Test: Internal Buzzer, Audio Output Jack. Controls: Range Switch, Ohms Adjust. Batteries: 1 type Z cell, 15-volt.

DELUXE 20,000 OHMS-PER-VOLT MULTITESTER WITH MIRROR SCALE



12⁹⁵

- 20,000 Ohms-Per-Volt DC, 10,000 Ohms-Per-Volt AC
- Low Voltage Scale for Transistor Tests
- 1% Precision Resistors for High Accuracy
- 40-Microamp 3 1/2" D'Arsonval Meter
- Built-in Overload Protective Circuitry

Handy pocket multi-tester with mirror scale. Has every needed range. Ideal for repair and service work, testing and troubleshooting electronic circuits and appliances in the labor shop. 40 micro-ampere meter movement permits a high input resistance on all ranges. Has a single range/function control for quick, simple operation, plus zero ohms adjust and built-in overload protective circuitry. With batteries, test leads 5 1/2" x 3 1/4" x 1 7/8" D. Imported. Shpg. wt., 1 1/2 lbs.

99 E 50734 Net 12.95
38 E 01073 Pigskin Carrying Case for above. Shpg. wt., 1/2 lb. Net 1.95

SPECIFICATIONS

Sensitivity: 20,000 ohms/volt DC; 10,000 ohms/volt AC. Ranges: DC volts, 0.6, 6, 30, 120, 600, 1200V; AC volts: 0-6, 30, 120, 600, 1200. Resistance: 0-10K, 100K, 1M, 10Megs. Current: 0-60 μA, 0-6, 60, 600 MA. Decibels: -20 to +63. Capacity: 200 mmf to 0.2 mfd.

20,000 OHMS-PER-VOLT MULTITESTER WITH MIRROR SCALE



9⁹⁵

- 20,000 Ohms/Volt DC, 10,000 Ohms/Volt AC
- 1% Precision Resistors
- Easy-to-Read 3" Meter
- Built-in Overload Protective Circuitry

Easy visibility is provided by the large 2-color 3" meter with mirror scale. The 40-Microampere D'Arsonval meter movement permits a high input resistance on all ranges. Built-in overload protective circuitry. Supplied with battery and test leads. Rugged, high impact plastic case. Size 3 1/4" x 4 1/4" x 1". Imported. Shpg. wt., 1 lb.

99 E 50726 Net 9.95
38 E 01073 Pigskin Carrying Case for above. Shpg. wt., 1/2 lb. Net 1.95

SPECIFICATIONS

Sensitivity: 20,000 ohm/volt DC, 10,000 ohms/volt AC. Range DC Volts: 0-3, 30, 60, 300, 600, 3,000V. AC Volts: 0-6, 60, 120, 1,200V. DC Current: 0-60 μA, 0-12, 0-300 ma. Resistance: 0-60K, 0-6, 60, Megohms. Decibels: -20 to +63db. Audio Output Jack. Type "Z" 1.5V cell for resistance measurements.



4⁹⁵

- "Super Mini" AC/DC VOM
- Compact Pocket Size: 3 1/2" H x 2 1/8" W x 1 3/8" D.
- Reads AC/DC Volts To 1200 Volts
- 8-Input Ranges • 4-Reading Scales
- Separate Red Scale For Low AC Reading

Highly accurate, low cost multitester: Handy to use anywhere by technicians, hobbyist or home owners for trouble shooting electronic circuits and testing appliances. Ranges: AC/DC voltage, 0-12, 0-120, and 0-1200; DC current, 0-1mA and 0-120mA. Reads resistance from 0 to 200,000 ohms. Easy to read red scale for low AC readings. 1% resistors offer precise readings. Sensitivity: 1000 ohms per volt. Zero ohms adjust. Operates on 1.5 volt "Z" cell. Complete with test leads and battery.

99 E 50791 Imported. Shpg. wt., 10 oz. Net 4.95
99 E 50668 Pigskin Carrying Case for above. Shpg. wt., 1/2 lb. Net 1.29

LAFAYETTE'S FINEST VOM TEST INSTRUMENTS

Super LAFAYETTE 50,000 Ohms Per Volt Multitester

- 50K Ohms Per Volt DC
- 5K Ohms Per Volt AC
- Giant 5¼" Meter
- Built-in Overload Protection
- Low Voltage Ranges For Transistor Circuitry

24⁹⁵

Super-sensitive, self-contained, portable Multi-Tester! Employs 1% precision resistors and high quality components for an accuracy of better than 2% on DC; 3% on AC. Useable at frequencies up to 100Hz. Meter movement is self-shielded with spring-backed jewels. Also has polarity switch and easy-to-read range indicator. Built-in meter overload protection. Size: 5¼x2¾x6½". With batteries and test leads. Imported. Shpg. wt., 4 lbs.

99 E 50767

Net 24.95

SPECIFICATIONS

Ranges: DC Volts: 0-0.25-2.5-10-50-250-1000 @ 25K ohm/V; 0-0.125-1.25-5.0-25-125-500 @ 50K ohm/V. AC Volts: 0-3-10-50-250-1000 @ 2.5K ohm/V; 0-1.5-5.0-25-125-500 @ 5K ohm/V. DC μ A: 0-25 @ 125 mV; 0-50 @ 250 mV. DC mA: 0-5-50-500 @ 250 mV; 0-2.5-25-250 @ 125 mV. DC amperes: 0-10-250 mA; 0-5 @ 125 mV Ohms: R/5, R, 10R, 100R, 1000R (13, 65, 650, 6.5K, 65K Ohms @ center). DB: -20 to +81.5 in 10 AC volt ranges.



SALE! Deluxe LAFAYETTE 100,000 Ohms Per Volt VOM

- 100,000 Ohms Per Volt DC
- Giant Easy-to-Read 6½" Scale
- 2% Accuracy on DC; 3% on AC
- Low Voltage Range for Transistor Testing
- Built-in Meter Protection on All Ranges

39⁹⁵

No Money Down*

Deluxe laboratory-type volt-ohm milliammeter with performance that satisfies virtually any lab or shop requirement. Unique yellow function selector visually indicates exact range being used—thus eliminating chance or error. Completely self-contained, advanced circuitry features ½% precision resistors and 100,000 ohms-per-volt input resistance on DC. Measures voltage in sensitive circuits with precise accuracy. Large, easy-to-read 6½" 2-color meter has a 90° arc for greater legibility and accuracy plus built-in protection against burnout and bent pointers. Provides full coverage with thirty-three ranges for optimum flexibility. Case has carrying strap. Size: 8W x 6½H x 3½D. With batteries and test leads. Imported. Shpg. wt., 4½ lbs.

99 E 50650

Net 39.95

38 E D1099 Carrying Case for above

Net 4.95

SPECIFICATIONS

Sensitivity: 100K ohms/volt DC, 5k ohms/volt AC. Ranges: DC 0-5-2.5-10-50-250-500-1000 v. AC 0-3-10-50-250-500 1000 v. DB: -10 to +49.4 in 4-ranges. DC Current: 0-10-100 μ A, 0-10-100-500 mA, 0-2.5-10 amps. Resistance: 0-1k-10k-100k-10m-100 meg-ohms \pm 2%. Meter Movement Sensitivity: 9 μ A for full scale deflection. Output: to 250 v with built-in series capacitor.



Save \$5.00 WAS 44.95
1969 Cat. 690

NEW! LAFAYETTE Solid-State FET Volt-Ohmmeter

Meter and Transistors Protected against Burnout

- 4 DC Voltage Ranges
- 4 Resistance Ranges
- 4 RMS AC Voltage Ranges
- Large 4½" 200 μ A Meter
- 4 Peak-to-Peak AC Ranges
- 11 Megohm Input on DC

FET volt-ohmmeter kit with the high impedance of a vacuum tube voltmeter plus complete portability and instant operation. 1 FET, 4 transistors and 2 diodes plus self-contained batteries allow this precision test instrument to be used both in the home and in the service shop. Minimum loading allows accurate measurement of grid voltages and other low power circuits. Simple, easy-to-follow instructions save time and eliminate confusion when assembling as a kit. Housed in a high impact bakelite case with handle. Complete with batteries, leads, and complete instructions. Size: 5¼"x7"x2¾". Shpg. wt., 4 lbs.

38 E D1156 Kit

Net 29.95

38 E D1164 Factory wired and tested

Net 39.95

SPECIFICATIONS

DC Voltage: 0-1.2-12-120-1200. 11 megohm input impedance. AC Voltage: 0-1.2-12-120-1200. 1 megohm input impedance. Peak-to-Peak AC Voltage: 0-3.3-33-330-1200. Resistance: 0-1K, 0-100K, 0-10 meg, 0-1000 meg. DB Ranges (4): -24 to +56.

KIT
29⁹⁵

Factory Wired
and Tested

39⁹⁵

No Money Down*



Lafayette Cat. No. 700 225

* See Page 11 for Full Credit Details on Easy Pay Plan

DELUXE LAFAYETTE VTVM WITH GIANT 6½" METER



Made In U.S.A.

Only
34⁹⁵
No Money Down*

- Wide Band RMS Measurements on any Waveform from 30 Hz. to Over 5MHz., Without Additional Probes or Accessories
- 11 Megohm Input Resistance—Negligible Loading Effects on DC Circuits
- Direct Reading DB Scale
- Balanced Push-Pull Amplifier—Isolates and Protects Meter
- Pilot Light Indicates When Unit is "On"
- Selected 1% Zero Temperature Coefficient Multiplier Resistors for Dependable, Accurate Readings
- Silicon Rectifier in Power Supply Reduces Effects of Heat on Component Values
- Accurately Measures AC Peak-To-Peak Voltage, AC RMS Voltage, DC Voltage and Resistance
- Giant 6½" Full-View Meter With Easy-To-Read Two-Color Scales

A high quality, accurate VTVM employing a giant 6½" easy reading 400µA meter. 11 megohm input resistance. AC RMS voltages may be read directly up to 1500 volts and resistance from 0 to 1,000 megohms in 5 overlapping ranges. Has zero-center scale for alignment of FM and TV detector circuits. Push-pull amplifier electrically isolates the meter movement—meter is virtually impossible to burn out. Precision 1% multiplier resistors. SPECIFICATIONS: DC VOLT-METER RANGES: 0 to 3, 30, 150, 300, 1500 volts. Input resistance: 11 megohms (1 megohm in probe) on all ranges. A.C. VOLT-METER RMS RANGES: 0 to 3, 30, 150, 300, 1500 volts. PEAK-TO-PEAK RANGES: 0 to 8, 80, 400, 800 volts. DECIBEL RANGES: -10 to +5, +6 to +25, +26 to +45 db. Response: 30Hz. to above 5 MHz. OHM-METER RANGES: 0 to 1000 megohms in 5 overlapping ranges. ZERO CENTER VOLT-METER RANGES: 0-1.5, 15, 75, 150, 750 volts. Complete with 1½ V battery, Instructions, and 3 probes: Common, AC volts/ohms and DC volts probe. Size 7½W x 6½H x 5"D. For 110-120 V 60 Hz. AC. Shpg. wt., 7 lbs.

38 E 01016W	Net 34.95
38 E 01032 Accessory RF Probe 1 lb.	Net 3.95
H.V. Probe. Extends range to 30,000 V. 1 lb.	
38 E 01065	Net 5.95
38 E 15016 Leather Case for VTVM, 1 lb.	Net 2.95
99 E 62572 Replacement Battery	Net .14

DELUXE PORTABLE TUBE AND CRT TESTER

Test All Modern Tubes Including Novars, Nuvistors, Compactrons, and Decals.
Test All Picture Tubes; Black and White—and Color



Housed in a Handsome, Sturdy, Portable Case Complete With All Adapters and Accessories Ready To Plug In and Use. No Extras To Buy!

Only
47⁵⁰
No Money Down*

- Tests Each Section of Multi-Section Tubes Individually For Shorts, Leakage and Cathode Emission
- Tests All Black and White Picture Tubes For Emission, Inter-Element Shorts and Leakage
- Red, Green, and Blue Color Guns Are Tested Individually For Cathode Emission, Leakage, and Shorts
- Large 4½" Dual Scale Meter

Versatile, reliable and highly accurate tube checker! Designed to meet the demands of servicemen, technicians, students and hobbyists. Checks more than 2,500 tubes—and will accept new tubes as they become available. Tests Nuvistors; 10 pin types; Magnavols; Compactrons; Decals; and black/white CRT's with deflection angles from 50° to 114° including 110° RCA plus color CRT's. Tests each section of multi-section tubes individually for shorts, leakage and cathode emission. Indicates leakage up to 5 Megohms. Checks color guns (Red, Blue and Green) individually for shorts and leakage between control grid, cathode and heater elements. Front panel has complete set of tube pin straighteners. 4½" dual scale meter features a sealed damping chamber to assure accurate, steady readings. Unit comes complete with all cables and accessories plus instruction book for current receiving and CRT tube listings. Size 14 x 3¾ x 9"D. Shpg. wt., 8 lbs. For 117VAC, 60 Hz.

38 E 01149W Net 47.50

Low Cost Tube and Transistor Checkers

LAFAYETTE TUBE AND TRANSISTOR CHECKER

- Easy To Build Step By Step Instructions
- Checks Latest Compactrons, Nuvistors, Novar And 10 Prong Tubes
- Checks Tubes For Shorts, Leakage, Intermittants, and Quality
- Checks Transistors For AC Current Amplification

Easy, step-by-step wiring and assembly instructions. Enjoy big dollar savings when you build this fine tube and transistor tester kit. Tube section features testing of compactrons, nuvistors, novars, and 10-pin tubes in addition to 7- and 9-pin miniatures, octals, and loctal types. Short, leakage, and intermittent tests available. Quality is indicated directly on an easily read, 3-color meter scale. Each section of multi-purpose tubes is checked separately. Hi-Fi, Magic-Eye, and voltage regulator tubes can also be tested. Obsolescent proof: Unique switching arrangement allows new tubes to be tested as they become available. In addition, this fine tester also checks transistors: PNP and NPN, high or low power, for AC amplification. Tells immediately whether or not transistor is operable. Portable, rugged tester is ideal for serviceman and hobbyist alike. Enclosed in a high impact bakelite case with carrying strap. Supplied with batteries, full instructions, and ring bound manual of tube charts. For 110 VAC 60 Hz. Size: 8½ x 7½ x 4". Wt. 5 lbs.

30 E 01123W Net 27.95

As above, wired and tested.

30 E 01131W Net 39.95

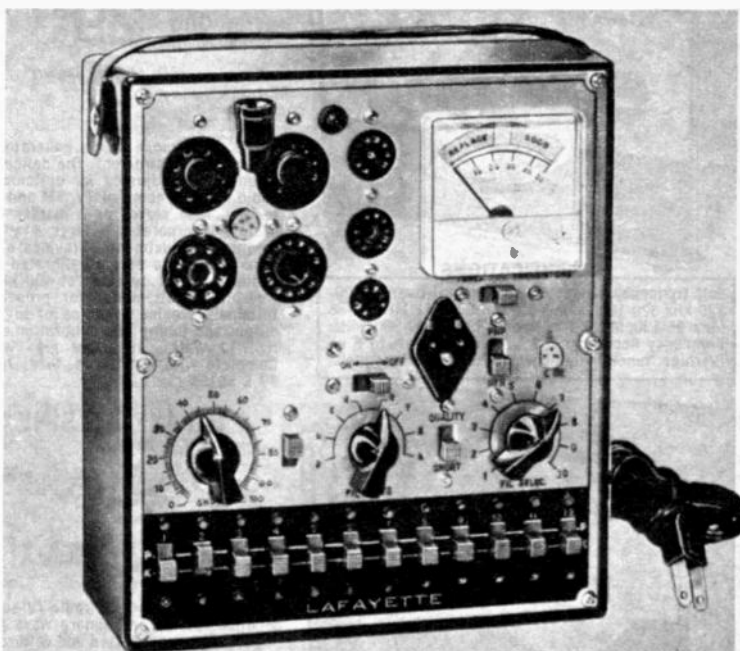

Kit
Only **27⁹⁵**

Factory Wired
SALE 39⁹⁵
Was 42.95 1969 Cat. 693

LAFAYETTE FILAMENT CONTINUITY TUBE CHECKER



2⁶⁹

- Compact, Ideal For Tube Caddy

Small and compact as a cigarette box. Quickly checks filament continuity in a matter of seconds. Ideal for the serviceman or the technician working in the field. Tests filaments of radio TV picture tubes. Also can be used to test many other electrical devices and line cords, fuses, lamps and bulbs. Has sockets for TV picture tube and loctal, octal, 9-pin, as well as 7-pin sockets. Provided with two test leads. Grey hammertone finish. Size: 4x3x1½". Shpg. wt., 12 oz. Imported.

90 E 50163 Net 2.69

VERSATILE TRANSISTOR And DIODE TESTER



19⁹⁵
less battery

- Checks Transistors For Opens, Shorts, High Leakage
- Checks Diodes and Rectifiers For Opens, Shorts, Relative Forward/Reverse Resistance

Provides all necessary servicing checks: checks transistors and diodes for shorts, leakage, open elements, forward and reverse current, and DC beta gain. Handles both low and high power transistors. Also serves as a continuity checker. Simple slide switch operation handles PNP or NPN type transistors. Test leads are provided for checking transistors which do not fit in the tester socket. Operates on standard 9 volt battery. Size: 2¾H x 4W x 1¼"D. Shpg. wt., 8 oz.

30 E 02014 Less Battery Net 19.95

99 E 60212 Battery for above Net ea. .21

KINECOLOR CIRCUIT ANALYZER



19⁹⁵

- Instant Hook-up for Analyzing, Testing and Adjusting Color CRT's and Associated Circuitry Under Actual Operating Conditions

Speed color-TV servicing by using this analyzer. Turning off electron guns is as easy as opening switches. Each color gun has its own switch and any combination of colors may be chosen. Voltage and current tests are easily performed using single pin jacks provided on the panel. Simplifies purity adjustments, convergence, gray-scale and tracking, voltage test, current measurement, and wave form observations. Sturdy compact unit is fully insulated and enclosed. Complete with detailed procedure booklet. 6¼x 3¾x 2". Shpg. wt., 6 lbs.

30 E 14019 Net 19.95

* See Page 11 for Full Credit Details on Easy Pay Plan

Lafayette Cat. No. 700 227

Signal Generators—Color Bar Generator



LAFAYETTE RF SIGNAL GENERATOR

Only **29⁹⁵**

No Money Down*

- Six Bands: 120 kHz—260 MHz
- Separate Variable Audio Output
- Etched 4 1/4" Circular Vernier Dial
- Factory Calibrated and Tested
- Dual Output RF Terminals
- Dial Calibration $\pm 2\%$

Stable, wide-range signal generator engineered to fill the need for an accurate low cost service instrument. The delicate oscillator coils and tuning assembly are factory mounted and adjusted for optimum performance. Can be used for IF-RF alignment, audio signal tracing of TV, FM and AM sets, TV linearity checks, and 400 cycle audio testing. Also serves as a marker generator when used with a suitable sweep generator. Incorporates a large 4 1/4" etched circular vernier dial for easy, accurate frequency adjustments. Provides a fundamental frequency output of 120 kHz to 130 MHz in 6 bands plus a calibrated harmonic output of 120 kHz to 260 MHz. Built-in audio oscillator operates at 400 kHz with adjustable output to 8 volts. Continuously variable RF attenuator for proper signal attenuation and two plug-in RF output terminals provide a choice of high and low outputs for maximum flexibility. High output and tuning dial calibration of $\pm 2\%$. Power Requirements: 105-125 VAC 50/60 Hz., 12 Watts. Attractive gray wrinkle steel case with leather carrying handle. Complete with test leads. Size: 7H x 10 1/2W x 5 3/8"D. Shpg. wt., 9 lbs. Imported. **99 E 50155** Net **29.95**

SPECIFICATIONS

Full frequency range: 6 Fundamental bands—120-320 kHz 320-1000 kHz 1-3.5 MHz. 3.2-11 MHz 11-38 MHz 36-130 MHz; 1 harmonic band 120-260 MHz. Frequency Accuracy: $\pm 2\%$, Audio Output: to 8 v., (Vernier tuned) High-Low RF out-put Terminals.



LAFAYETTE SINE/SQUARE WAVE GENERATOR

Only **39⁹⁵**

No Money Down*

- Frequency Range—Sine Wave: 20-200,000 Hz in 4 Bands, Square Wave: 60-30,000 Hz
- Etched Circular Vernier Dial

Especially designed for radio-TV servicemen, Hi-Fi fans and students who require a dependable sine and square wave generator at low cost. An outstanding instrument... factory wired, tested and calibrated. Among its many applications are square wave testing of audio amplifiers, determining the frequency and transient response of loudspeakers, TV audio circuit testing and many other uses. Quality features and specifications consists of a frequency range of 20 Hz to 200,000 cycles Hz in 4 bands. A large easy-to-read and set etched dial (vernier tuned) adds a professional quality touch. Variable attenuator adjusts amplitude of output signal. A full wave power supply is incorporated to provide low distortion and constant output. Factory wiring and calibration insure accuracy of $\pm 3\%$. Output voltage is 7 volts across a 1 megohm load. Rugged steel cabinet and shock-proof mountings protect components. Complete with instructions and test leads. For 117 V 50/60 Hz AC. Size: 10 1/2Wx7 1/2Hx5 3/8"D. Imported. Shpg. wt., 10 lbs. **99 E 50148** Net **39.95**

SPECIFICATIONS

Frequency range: Sine wave: 20-200,000 Hz in 4 bands. Square wave—60-30,000 Hz. Output Voltage: Sine: 7V RMS. Square 7V. P-P. Output Impedance—0-5000 Ohms. Frequency Accuracy: $\pm 3\%$. Distortion: Less than 2%.

PRECISION E-200C RF MULTI-BAND SIGNAL GENERATOR



ONLY

149⁹⁵

No Money Down*

- 88 kHz to 440 MHz Coverage
- 0-100% Variable Modulation

Frequency coverage: 88 kHz-440 MHz; 10 direct-reading 1% accurate bands, 400 Hz audio with up to 80 volts output. Dual shielded RF attenuators. Four types of signals: Unmodulated RF; 400 Hz modulated RF; externally-modulated RF; audio output. Size: 13 x 11 1/2 x 6 5/8". 117V 50/60 Hz AC. Shpg. wt., 16 lbs. **38 E 18002WX** Net **149.95**

DELUXE COLOR BAR PATTERN GENERATOR

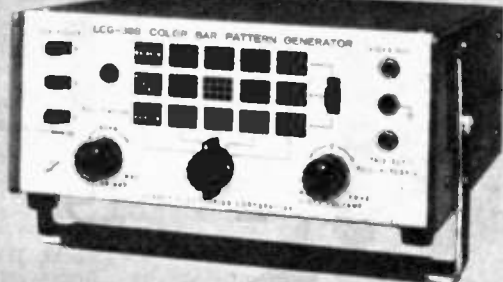

149⁹⁵

No Money Down*

- 15 Patterns Including Single Dot and Single Cross
- Scope Sync Pulse

Extremely versatile color generator produces 15 patterns including the all important single dot and single cross. Trigger pulses available to sync oscilloscope. Composite video signals for video circuit testing. Gun killers for purity and convergence adjustments. Outputs: RF Output, Channel 5 and 6; Patterns-Color Bars: Gated Rainbow, R-Y, B-Y, and (R-Y), Rainbow; Dots: Fine 15 vert. x 21 horiz., Coarse 7 vert. x 11 horiz., Single Dot centered on raster; Cross-hatch: Fine 21 vert. x 15 horiz., Coarse 11 vert. x 7 horiz., Single Cross centered on raster; Vertical: Fine 21 lines, Wide 11 lines, Single line; Horizontal: Fine 15 lines, Wide 7 lines and Single line. Chroma Level control: 0-200% continuously adjustable. For 105-125 V., 50/60 Hz AC. Size: 3 1/4H x 7 3/4W x 7 1/4"D. Shpg. wt., 7 lbs. Imported. **38 E 40006 WX** Net **148.95**

LAFAYETTE SOLID STATE 1000 Hz. AUDIO GENERATOR

SALE
5⁹⁵ QUANTITIES LIMITED

Was 7.95 1969 Cat. 690

Compact transistor audio oscillator with a sinusoidal output of 1,000 Hz. The stability is excellent, and the wave form has less than 2% distortion. Output amplitude adjustable up to 0.5 V. RMS or more. Used to adjust audio amplifiers for linearity or to make low frequency power measurements. The on-off switch and separate amplitude control are on front panel. With 9V battery. Imported. Wt., 1 1/2 lbs. **99 E 50304** Net **5.95**

99 E 60212 9V. Replacement Battery Net **.21**

228 Lafayette Cat. No. 700

* See Page 11 for Full Credit Details on Easy Pay Plan

In Circuit Checkers, Substitution Boxes, Test Leads

LAFAYETTE IN-CIRCUIT CAPACITOR CHECKER



Only **18⁹⁵**

- Checks Capacitors in Circuit
- Magic Eye Indicator
- Wide Range 10 Pf to 2000 MFD

Allows you to check most capacitors from 10 pf to 2000 mfd for open or shorted conditions without unsoldering. Just connect the test leads across the component you wish to test, press the switch and note the eye tube's face for an open or short condition. Checks coupling, by-pass, filter and blocking capacitors. Accurate readings are made in seconds—an important factor in today's complex electronic equipment. It also indicates capacitor leakage. Tests for opens on capacitors of 10 pf, or more; for shorts up to 2,000 mfd. Shunted by not less than 10 ohms. Complete with test leads and instructions. For 117 VAC. Size 7 3/4" W x 5 H x 4 1/4" D. Imported. Shpg. wt., 5 lbs.

99 E 50221 Net 18.95

CAPACITANCE SUBSTITUTION BOX

- 9 Ranges From .0001 to .22 MFD

A must for the serviceman, experimenter or student. Fast accurate selection of any one of 9 capacitor values from .0001 to .22 MFD. Condensers are porcelain cased tubular type impervious to moisture and are rated at 600 volts working capacity. 9 capacitance ranges are .0001, .001, .0022, .0047, .01, .022, .047, .1 plus .22 MFD. Complete with 36" red and black test leads and alligator clips. Size 4 3/4 x 2 5/8 x 1 3/8". Imported. Shpg. wt., 1 1/2 lbs. Net 1.95



1⁹⁵

RESISTANCE SUBSTITUTION BOX

- 24 Resistance Values
- Two Ranges—Low: 15-10K Ohms. High: 15K-10 Megohms

Substitute resistance values fast and accurately in trouble shooting circuits where values may have changed. Slide switch selects two ranges—Low: 15 ohm-10K ohms (1 watt resistors). High: 15K ohm-10 Megohms (1/2 watt resistors). Two rotary switches (12 steps each) selects 24 separate resistances. Size: 4 3/4 x 2 5/8 x 1 3/8". Imported. Shpg. wt., 1 1/2 lbs.

99 E 50213 Net 2.95

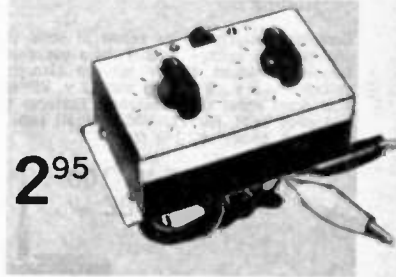

2⁹⁵

LAFAYETTE RESISTANCE-CAPACITY SUBSTITUTION BOX

- 24 Resistance Values
- 9 Capacitance Ranges

Versatile service instrument...enables rapid substitution of a wide range of resistor or capacitor values. Resistance values in two ranges (12 steps each)—Low: 15 ohms to 10K ohms; High: 15K ohms to 10 Megohms. ±10% accuracy. Capacitance ranges are: .0001; .0010; .0022; .0047; .010; .022; .047; .10; .22 MFD (rated at 400 volt working capacity). Size: 5 1/4 x 2 3/4 x 1 3/8". Imported. Shpg. wt., 1 lb.

99 E 50759 Net 4.95



4⁹⁵

TEST LEADS

NEON CIRCUIT TESTER

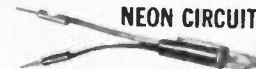

A simple, safe, electrical circuit tester voltages from 60 volts AC to 550 volts AC or DC. Imported. Shpg. wt., 2 oz. Net ea. .39

99 E 80715 Net ea. .39

STANDARD TEST LEADS



Standard test leads furnished with plastic prods and pin plugs which withstands chipping or breaking. Extra flexible kinkless vinyl covered 60" red and black leads. Prods are red and black. 4" long x 3/8" diameter. Supplied in pair of one red and one black. Available with either pin or banana plugs. Shpg. wt., 8 oz. Imported.

99 E 50015 With Banana Plugs Net .39

99 E 50023 With Pin Plugs Net .39

6 FT. COIL CORD TEST LEADS

99^c



Stretch-type color-coded coiled cord twin test leads. Furnished with 5/16" test prods on one end and pin plugs on the other end. Flexible vinyl clad wire cannot become entangled. 30" coiled leads extends to 6'.

Imported. 99 E 50783 Shpg. wt., 3 oz. Net .99

STRETCH-TYPE TEST LEADS



Cannot kink or become entangled. 16" coil extends to 9 feet. Includes red and black plastic handles on each end. Probe 6 1/2" long including tips. Shpg. wt., 4 oz. Imported. Net 1.95

99 E 50239 Net 1.95

HIGH VOLTAGE LEADS



For hi-volt testing in TV sets. Extra heavy duty. Special finger guards. High tension wire. 22,000 volts breakdown. 48" long. Shpg. wt., 6 ozs. With phone tips.

Stock No.	Type	Wt.	Per Pair
32 E 64017	Phone tips	6 Oz.	2.20
32 E 64025	Spade lugs	6 Oz.	2.20
32 E 64033	Allig. Clips	6 Oz.	2.40

KLIPZON ADAPTERS



Convert old test points to self holding prods. Fits over standard phone tips or needle type. 32 E 80153 Red, 2 oz. Net Ea. .38
32 E 80161 Black, 2 oz. Net Ea. .38

UNIVERSAL TEST LEAD KIT IN PLASTIC CASE



99^c

Consists of: pair of red and black coded 4 5/8" x 3/8" plastic handle pin prods with 37" heavy duty, 5000V rubber insulated leads terminating in coded 2" x 3/8" banana plugs; pair of spade lugs; pair of phono-tips; and pair of red and black insulated alligator clips. Handsome compartmented plastic case. Imported. Shpg. wt., 1 1/2 lbs.

99 E 50031 Net .99

KLIPS "SPRING LOADED" TEST PROBES

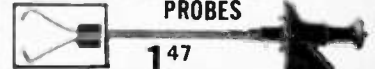

1⁴⁷

Completely flexible for difficult test situations. Plunger when pushed in enables steel forked tongue to grip wire or terminal you are testing. Accepts banana plug or bare wire. 6" long. Imported. Shpg. wt., 4 oz.
32 E 37005 Red Net 1.47
32 E 37013 Black Net 1.47

Make Lafayette Your One Dependable Source for Everything in Electronics

Reliable, Popular Priced Test Equipment

LAFAYETTE SOLID-STATE DC POWER SUPPLY/BATTERY ELIMINATOR



Only
7⁹⁵

- For Use As A Serviceman's DC Power Supply
- For Use As A Battery Eliminator For Transistor Radios

Essential instrument for repair of solid state equipment requiring constant low voltage. Doubles as a convenient battery eliminator for transistor radios. Highly filtered circuitry provides four output voltages: 4.5 v., 9 v., 6 v. and 12 v. Voltage selection is simplified with front panel slide switches. Features transformer power supply and pilot light. For 117 VAC. Overall size: 5 1/4" W x 2 3/4" H. Imported. Shpg. wt., 1 1/4 lbs.

99 E 50742

Net 7.95

LAFAYETTE TRANSISTORIZED DC POWER SUPPLY



Only
16⁹⁵

- AC Ripple Less Than .025%
- Transistorized Regulation Circuitry

Provides continuously variable voltage and current with low ripple. Excellent for operation of transistorized devices. Panel meter reads either current or voltage. SPECIFICATIONS—Output voltage: 0-20 volts DC (continuously variable). Output Current: 0-20 MA, 0-200 M⁻ (in two ranges). AC Ripple: less than .025%. Power Input: 110-120 volts, 50-60 Hz, AC. Fully fused. Size: 6 1/4 x 1 1/4 x 3 3/4". Imported. Shpg. wt., 4 lbs.

99 E 50684

Net 16.95

AMPROBE VT-100 VOLTPROBE

Only
9⁵⁰

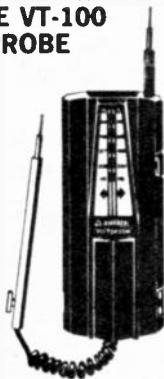

- Voltage Tester For Levels Up To 550 V AC, 750 V DC
- Indicates Grounded Side of Line
- Shows Grounded Side of Motors and Appliances

For easy voltage readings anywhere—anytime. Fits into shirt pocket. "Thermometer Style" illuminated window indicates voltage level, AC or DC. Operates over a wide 25-800 cycle range. Compact unit incorporates a sliding push-up probe and a retractable probe with expanding coil cord attached that permits measurements of points over 3 feet apart. Voltage Levels: AC 115-220-277-440-550 Volts, DC 115-220-400-600-750 Volts. Size: 6 x 2 1/4 x 3/4" with probes retracted.

38 E 13136 Shpg. wt., 1 1/2 lb. Net 9.50

CHEK-IT ELECTRICAL CIRCUIT TESTER

1⁶⁴



Here is a handy pocket size tester which is ideal for servicemen, schools, electricians and hobbyists. Completely portable and simple to use, checks electrical continuity of line cords, switches, coils, and fuses. Ideal for checking out buzzers, chimes, and various other electrical appliances. Uses 2 inexpensive penlight cells. Shpg. wt., 3 oz.

38 E 70067 Chek-It less batteries Net 1.64
Battery for "Chek-It." 2 required.
99 E 62560 Net ea. .10

CRT 30KV TEST PROBE

19⁹⁵ • With Built-In Meter



This small self-contained probe featuring a built-in voltmeter, can be used for any color or B&W TV set. Easy to operate! Made of high impact plastic, it requires no batteries or external power source—no warm-up time. 30,000 volts DC range; 20,000 ohms/volt sensitivity; accuracy of $\pm 3\%$; multiplier resistance is 600 Megohm $\pm 2\%$. Overall length is only 14 3/4". With ground wire and clip. Shpg. wt., 1 lb.

38 E 12013

Net 19.95

PROTECT YOUR METER with METERGARD

2⁹⁵



- Easily Installed
- No Overload Damage

Protect your meter, regardless of make, against overloads. No more bent pointers, damaged pivots, or burnt out coils. Installation of metergard will allow your meter to withstand as much as a 10,000% overload. Shpg. wt., 1 lb.

38 E 68015

Net 2.95

KINGSTON PROBEMASTER

4⁹⁵



- All Purpose Electronic And Electric Probe

A unique test instrument combining the features of a highly versatile probe with a neon checker. Its built-in capacitive network permits bypassing stages, checking open capacitors, isolating defective stages without external signal generator, and elimination of time consuming capacitor substitution. Shpg. wt., 1 lb.

38 E 41012

Net 4.95

EMICO PLUG-IN AC LINE VOLTAGE TESTER

Only
4⁹⁵



Low cost AC line voltage tester. Permits accurate instantaneous check of line voltage AT THE RECEPTACLE. Easy to read black-on-white scale has 5-volt graduations between 50 and 150 volts. 2" meter has a damped movement accurate to within 5% at full scale. Shpg. wt., 8 oz.

38 E 31039

Net 4.95

LECTROCELL DC POWER SUPPLY FOR VTVM's

3⁹⁵



Quickly replaces 1 1/2 volt battery used in VTVM's for resistance measurements. Regular battery must be replaced at regular intervals. If it is forgotten the instrument may be ruined by chemical corrosion. Eliminate trouble by installing this power supply. Install it and forget it. Shpg. wt., 2 lbs.

38 E 68023

Net 3.95

DON BOSCO "MOSQUITO" SIGNAL INJECTOR

9⁹⁵



A pocket-size, cordless pen-type instrument. Oscillates at 1 kHz with harmonics to 30 MHz. Can be coupled into magnetic circuits and pickups without leads. Ideal for tracing radios, TV, tape recorders, hearing aids and sound systems. Lightweight, transistorized. Output 50v p-p. Features a detachable attenuator probe. Output impedance, 10K. DC input voltage, 600 v max. Uses economical 1.5 volt penlight cell. Size: 5 3/8" long x 1/2" O.D. Shpg. wt., 2 oz.

38 E 22103

Net 9.95

Bench Power Supplies—Battery Eliminators & Chargers

Lafayette SOLID-STATE REGULATED DC BENCH POWER SUPPLY

ONLY
39⁹⁵
No Money
Down*



- Automatic Protection Against Overload
- Continuously Variable Output Voltage 5-13, 12-20 VDC at 0-2 Amp
- Output Voltage Regulation: $\pm 1\%$

Lab-type regulated DC bench power supply with dual range voltage selector. Ideal for all types of transistor servicing and testing. Provides well filtered, continuously adjustable DC output of 5-13 or 12-20 volts. Fully regulated with continuous output current of up to 2 amp, with less than 5 mV RMS ripple at full load. Self-restoring overload protection. Two O'Arsonval meters for constant monitoring of voltage and current output. Both input and output of power supply are fused for maximum protection. Input: 115 or 230 VAC $\pm 10\%$ 50/60 Hz. Housed in a rugged steel case. Size: 6 $\frac{1}{2}$ "H x 4 $\frac{1}{2}$ "W x 8 $\frac{3}{4}$ "D. Imported. Shpg. wt., 9 lbs.
99 E 88775

Net 39.95

EICO 1025 SOLID STATE PORTABLE DC POWER and BIAS SUPPLY KIT

KR
34⁹⁵

Wired
49⁹⁵

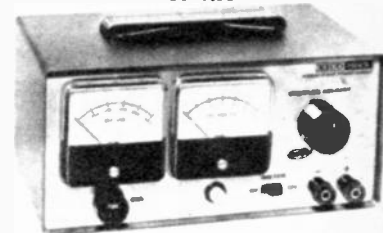

- Continuously Variable Output Monitored by A Dual Range Voltmeter: 0-6, 0-30 VDC
- 500 MA Milliammeter

Versatile, stable DC power and bias supply provides continuously variable output monitored by a dual range voltmeter (0-6, 0-30 VDC) and 500 ma meter. Applications include: a variable bias supply for transistors on vacuum tubes; to offset AVC and AGC voltages in the alignment of TV and radio receivers or to cut off the color burst amplifier in color TV adjustment; a DC filament supply or a filament bias source to recharge small storage batteries or to do light electroplating. Max. continuous output current: 150 ma from 0-12V, 200ma from 12-24V, 300 ma from 24-30V. Ripple .005% at full load. For 117 VAC at 60 Hz. 3 $\frac{3}{4}$ x 8 x 4 $\frac{3}{4}$ ". Shpg. wt., 6 lbs.
38 E 27328 Model 1025 Kit

Net 34.95

Model 1025W—As above but factory wired.

38 E 27334

Net 49.95

EICO 1020 TRANSISTOR DC POWER AND BIAS SUPPLY KIT

Kit
25⁹⁵

Wired
34⁹⁵



- 0-6, 0-30 VDC Variable Output Voltage

Continuously variable output voltage to 30 volts monitored by a dual range voltmeter (0-6, 0-30 VDC). Ideal for servicing both tube and transistor gear. Maximum continuous output: 150 ma from 0-12V; 200 ma from 12-24v.; 300 ma from 24-30v. Full-wave silicon-diode rectifier circuit with R-C input filter plus two power transistors in a cascaded filter circuit. Fuse protects unit against overload. Rugged steel case, 4W x 5H x 5 $\frac{1}{2}$ "D. For 105-125 v., 60 Hz AC.

38 E 26955 Model 1020 Kit Shpg. wt., 5 lbs.

Net 25.95

Model 1020W—As above but factory wired.

38 E 26963

Net 34.95

EICO 1030 REGULATED POWER SUPPLY

Regulated B+ power, 0-400 volts DC continuously variable. 6.3 and 12 volts AC filament supply. For 105-125 VAC 60/60 Hz. WT., 25 lbs.
38 E 27144W 1030 Kit

Net 69.95

38 E 27151W Factory Wired

Net 99.95

ELECTRO MODEL EC-2 0-16 VOLT DC POWER SUPPLY

49⁵⁰
No Money Down*

- Continuously Adjustable Output
- Very Low Ripple Current

Versatile, compact DC power supply. Provides well filtered, continuously adjustable DC output of 0-16 volts at 5 amps. Suitable for transistor servicing and lab or industrial development needs. Ripple is less than 0.5% at full output. Output changes only 1.8v for each amp of load current change. Meter reads both voltage and current through switch. Steel cabinet, 4 $\frac{1}{2}$ x 10 $\frac{1}{2}$ x 6 $\frac{1}{2}$ ". For 117 v, 50/60 Hz AC. Shpg. wt., 11 lbs.
38 E 33118

Net 49.50

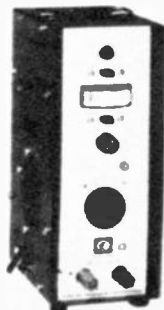

EICO BATTERY ELIMINATOR AND CHARGER KITS

As Low As
45⁹⁵

No
Money
Down*



A 1060S



B 1064S

A. MODEL 1060S KIT. SPECIALLY DESIGNED FOR SERVICING ALL TYPES OF TRANSISTOR EQUIPMENT. Selection of voltage range automatically provides appropriate current range. Fused transformer primary. Continuous voltage adjustment with Variac. 2 DC ranges and dual-range ammeter for accurate readings. Ranges: high = 0-16V. 1.5% ripple at 2 amps; 2% at 6 amps; 6 amps. continuous, 12 amps intermittent; low = 0-8v. 3.3% ripple at 2 amps. 1.5% at 10 amps. 10 amps continuous, 20 amps intermittent. Heavy-duty silicon rectifiers. For 105-125 volts 50/60 Hz A.C. All components and instructions included. 8 $\frac{3}{4}$ x 10 $\frac{1}{2}$ x 7 $\frac{3}{4}$ ". Shpg. wt., 19 lbs.
38 E 27284 KR

Net 45.95

Model 1060. As above, but factory wired and tested.

38 E 27292

Net 59.95

B. MODEL 1064S KIT. IDEAL FOR TRANSISTOR, TUBE, "HYBRID" AUTO RADIO REPAIR. Features 2 DC voltage ranges, 6 or 12 V. DC. Separate voltmeter and dual range ammeter—up to 10 amperes continuous. Heavy duty silicon rectifiers. AC ripple: 0.3% @ 2 amperes. For 105-125 volts, 50/60 Hz; Size: 8 $\frac{1}{2}$ "H x 5 $\frac{3}{4}$ "W x 7 $\frac{1}{2}$ "D. Shpg. wt., 14 lbs.
38 E 27300 Kit

Net 49.95

Model 1064. As above, but factory wired and tested.

38 E 27310

Net 64.95

* See Page 11 for Full Credit Details on Easy Pay Plan

EICO VTVM's and VOM's—Kit or Factory Wired

NEW SOLID-STATE FET-VOM'S



KIT
49⁹⁵

WIRED
69⁹⁵

Model 240 FET VOM Kit

Transistorized volt-ohmmeter especially suited for semiconductor circuit testing. Low 1 v. scale allows accurate readings as low as 0.05 v. Features DC/AC-Ohms Uni-Probe and 7 non-skip ranges in professional 10 db steps. 4½" 200µa meter movement. DC impedance: 11 megs. AC impedance: 1 meg. Peak-to-Peak AC volts: 0-2.8, 8.5, 28.85, 280, 850, 2800. AC RMS/DC volts: 0-1, 3, 10, 30, 100, 300, 1000. Frequency response: 25 Hz to 2 MHz (up to 250 MHz with optional PRF probe). Ohmmeter: 2-1000 Meg. Operates on 105-132 VAC or batteries. Size: 8½ x 8¾ x 5". Shpg. wt., 6 lbs.
38 E 27466 Model 240 Kit Net 49.95
38 E 27474 240 Factory Wired Net 69.95



KIT
59⁹⁵

WIRED
79⁹⁵

Deluxe Model 242 FET-VOM Kit

FET volt-ohmmeter with single Uni-Probe for DC/AC-ohms-ma measurements. Large 6½" meter. Designed to be used effectively on vacuum tube and semiconductor circuits. 1 v. scale for accurate readings as low as 0.05 v. P-P AC volts: 0-2.8, 8.5, 28, 85, 280, 850, 2800 and milliamperes. AC RMS/DC and current: 0-1, 3, 10, 30, 100, 300, 1000 v. and milliamperes. Input impedance: DC-11 Meg., AC-1 Meg. Frequency response: 25 Hz to 2 MHz. (up to 250 MHz with optional PRF probe). Ohmmeter: 0.2 ohms—1000 Megohms in 7 ranges. For 105-132 VAC or battery operation. Size: 7½ x 8½ x 5". Shpg. wt., 6 lbs.
38 E 27482 Model 242 Kit Net 59.95
38 E 27508 242 Factory wired Net 79.95

FAMOUS 500 SERIES VOM KITS



As Low As
16⁹⁵

MODEL 566K. Large 4½" meter features: AC/DC sensitivity of 1K ohm/v. totals 38 ranges: AC/DC volts: 0-1.5-10-500-5000AC/DC. Current: 0-1-10 m.a. 0-0-1-1 amps. Ohms: 0-5K-100K-1 meg. DB: -20 to +68 in 6 ranges. All components and instructions supplied. 6¾ x 5¾ x 3". Shpg. wt., 4 lbs.
38 E 26013 Model 566 Kit Net 19.95

Model 566. As above, but factory wired.
38 E 26021 Net 27.95

Model 556K. Same as 566K but with 1% resistors.
38 E 26039 Net 21.95

Model 556. As above, but factory wired.
38 E 26047 Net 29.95

MODEL 536K (Not Illustrated). Outstanding value. 3" meter features AC/DC sensitivity of 1K ohm/v. 31 ranges—AC/DC volts: 0-1-5-10-50-100-5000. AC/DC current: 0-1-10 ma., 0-0-1 amp. ohms: 0-5K; 100K-1 meg. DB -20 to +69 in 6 ranges. All components and instructions supplied. 6½ x 3¾ x 2¾". Shpg. wt., 2 lbs.

38 E 26054 Model 536 Kit Net 16.95

Model 536. As above, but factory wired.
38 E 26062 Net 22.95

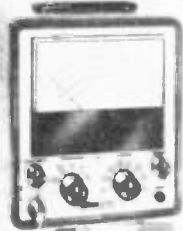

KIT
49⁹⁵

WIRED
69⁹⁵

MODEL 235K PROFESSIONAL VTVM KIT

Deluxe VTVM features 6" 200 micro-amp meter, 1/2-volt full scale DC range for transistor servicing. AC/DC "Uni-Probe", and 1% precision multiplier resistors. Ranges: AC/DC volts, 0-0.5, 1.5, 5, 15, 50, 150, 500, 1500; p-p volts, 0, 4, 14, 42, 140, 4200; resistance, 0.2 ohms to 1000 megs in 7 ranges. Response: 3 Hz to 3MHz. Accuracy: 3% AC and DC. Has 11 megohm DC input supplied with uniprobe. For 117 v., 50/60 Hz AC. Size: 8½H x 7½W x 5"D. Shpg. wt., 9 lbs.
38 E 27169 Net 49.95
Model 235. As above, but factory wired.
38 E 27177 Net 69.95



KIT
34⁹⁵

WIRED
49⁹⁵

MODEL 232K PEAK-TO-PEAK VACUUM TUBE VOLTMETER KIT

A precision-unit with advanced engineering features. 11 megs input impedance. 1% precision ceramic multiplier resistors used. Measures directly peak-to-peak voltage 0-4, 14, 42, 140, 420, 1400, 4200. DC/RMS sine volts: 0-1.5, 5, 15, 50, 150, 500, 1500 (up to 30,000 volts with HVP probe, and 250 MHz with PRF probe). Ohms: 0.2 ohms to 1000 megs in 7 ranges. Easy calibration. 4½" meter, can't-burn-out circuit. Zero center. With AC/DC Uni-Probe. Exceptional stability and accuracy. All components and instructions supplied. For 105-125 50/60 Hz AC. Size: 8½ x 5 x 5". Shpg. wt., 7 lbs.
38 E 26179 Model 232 Kit Net 34.95
Model 232. As above, but factory wired.
38 E 26187 Net 49.95



KIT
9⁹⁵

WIRED
12⁹⁵

MODEL 584K BATTERY TESTER KIT—

Tests all A and B portable radio batteries in or out of receiver. Tests lantern batteries and may be adapted to other types. Tests by checking battery terminal voltage, simulating conditions of actual operation. Test positions: volts—1.5, 4.5, 6.0, 7.5, 9.0, 27.5, 45, 67.5, 75, 90, plus spare position. Complete, easy to follow instructions. Test leads provided. 6¼ x 3¾ x 2". Not illustrated. Wt., 2 lbs.
38 E 26930 Net 9.95
Model 584. As above, but factory wired.
38 E 26948 Net 12.95

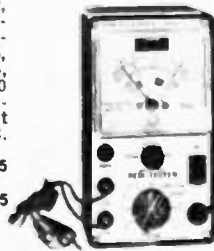

KIT
15⁹⁵

WIRED
19⁹⁵

MODEL 540K UTILITY TESTER KIT

An all-in-one Multi-Range AC/DC voltmeter, ammeter, ohmmeter, wattmeter and leakage checker. Indispensable in home repairs of electrical appliances, and in automotive trouble-shooting of batteries, generators, distributors, etc. 3¾" meter. Ranges: Volts AC/DC 0-7.5-15-150-300. AC/DC current: 0-15 amps. Ohms: 0-1000 ohms. Capacitor leakage test. All components and instructions supplied. 3¾ x 6¾ x 3¾". Shpg. wt., 3 lbs.
38 E 26245 Model 540 Kit Net 15.95

Model 540. As above, but factory wired.
38 E 26252 Net 19.95

OTHER EICO VOM'S & VTVM'S

38 E 26195 249 P-P VTVM Kit 9 lbs. 39.95
38 E 26369 249 Wired 9 lbs. Net 59.95
38 E 27185 567 VOM Kit 3 lbs. Net 34.95
38 E 27193 567 Wired 3 lbs. Net 44.95

PROBES FOR VTVM'S

HVP2 HV Probe-wired only. Extend range of VTVM to 30,000 v. Shpg. wt., 1/2 lb.
38 E 26344 Net 8.95
PRF-11K—11 meg RF probe kit.
38 E 26286 Shpg. wt., 1/2 lb. Net 4.50
PRF-11—As above, Factory wired.
38 E 26294 Shpg. wt., 1/2 lb. Net 5.95

EICO Tube and Transistor Checkers—Kit or Factory Wired

MODEL 680K TRANSISTOR & CIRCUIT TESTER KIT



KIT 34⁹⁵ **WIRED** 49⁹⁵

- Measures Transistor ICBO, ICEO, DC Beta

Accurately measures basic transistor and diode characteristics. Checks ICBO, ICEO, Beta; simulated AC Beta. 20,000 ohms/c meter includes 5 DC current ranges, m to 50 μ a full scale, DC voltage ranges 50) 3 resistance ranges: (0 to 2,000, 200,000, 0 to 20 megohm). $\pm 3\%$ acy. Self-powered. With leads, batteries. Lite case 6 $\frac{3}{4}$ "Hx5 $\frac{3}{4}$ "Wx3 $\frac{1}{2}$ "D. Shpg. wt.,

6956 Kit Net 34.95

680 Same as above, but factory wired. 26864 Net 49.95

MODEL 635K PORTABLE TUBE TESTER KIT



KIT 44⁹⁵ **WIRED** 69⁹⁵

- Extremely Portable Design

Tests new Decals, Magnovos, Novars, Nuvisors, Compactrons, 10 pin, foreign, hi-fi, industrial types, and all popular TV picture tubes. Rapid tests for dynamic cathode emission, shorts, grid leakage, and gas. Even where internal pins are tied or heater is tapped, shorts can be detected. 3 $\frac{1}{2}$ " D'Arsonval type meter protected against burnout. Other features include: meter bridge circuit for assured accuracy; pin straighteners; long life phosphor bronze sockets; short and grid leak indicator; power indicator; modern luggage design, scuff-proof case. Includes complete tube chart. 8 $\frac{1}{2}$ "Hx11 $\frac{3}{4}$ "x3 $\frac{1}{4}$ ". Shpg. wt., 5 lbs.

38 E 27383 Kit Net 44.95

Model 635—As above, but factory wired.

38 E 27391 Net 69.95

MODEL 443K SEMICONDUCTOR CURVE TRACER KIT

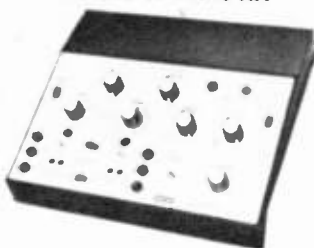

KIT 69⁹⁵ **WIRED** 99⁹⁵

Tests power and signal transistors, diodes and rectifiers. Adopts to any general purpose oscilloscope and displays the DC characteristics of semiconductor devices. Built in oscilloscope calibrator voltage switch. Contains a flashing indicator light to indicate when high voltage is present at the diode test terminals. Transistor tests: Beta — 6 volts at 10 ma, maximum collector current for signal transistors and 6 volts at 1 amp. max. collector current for power transistors. Diode tests include: Forward current (0-1,100 ma). Reverse Current (IR) — (1,10,100 μ a/div). Peak inverse voltage (PIV) — (1,10,50, 100 volts/div). 3x1 $\frac{1}{2}$ "x9 $\frac{1}{2}$ ". Shpg. wt., 12 lbs.

38 E 27409 Net 69.95

Model 443 as above but factory wired. 38 E 27417 Net 99.95

MODEL 628K CATHODE CONDUCTANCE TUBE TESTER KIT

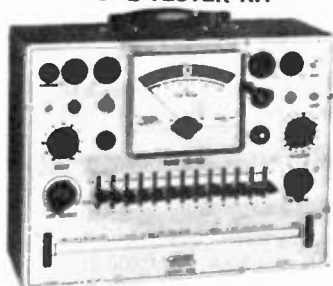

KIT 59⁹⁵ **WIRED** 79⁹⁵

- Test All New Tube Types

Cathode conductance type of tube tester features 13 individual lever switches for complete flexibility. Tests 7, 9 and 10 pin miniatures, octal, loctal, 5 and 7 pin nuvisors, novars and compactrons. Pilot light socket. Tests VR's and "eye" tubes. Tests for short and open elements. Also tests all color and black and white CRT's with optional adaptor. Protective overload lamp shows transformer overloads and acts as fuse. 3-column roll chart frequently revised for up-to-date data. 4 $\frac{1}{2}$ " meter. With all parts and instructions. For 105-125V 60 Hz AC. Size: 12 $\frac{1}{2}$ "Hx9 $\frac{1}{2}$ "Hx4 $\frac{1}{2}$ "D. Shpg. wt., 11 lbs.

38 E 26559 Kit Net 59.95

Model 628 as above, but factory wired.

38 E 26567 Net 79.95

MODEL 633K CRT TESTER AND REJUVENATOR KIT



KIT 69⁹⁵ **WIRED** 99⁹⁵

- Tests, Repairs, Rejuvenates Color or B&W CRT's

- Luggage Case Holds 5-Socket Cable and Line Cord

Universal multi-socket cable accommodates any black and white or color CRT. 3-range filament voltage selector. Grid cut-off voltage and filament voltage read on 4 $\frac{1}{2}$ " meter, also beam current on a 3-color BAD-7-GOOD scale. Neon-lamp circuit for short-open testing. 6 push-buttons enable instantaneous measurement without danger of CRT damage. Spring-return repair push-button is used to apply 1000 VDC for rejuvenate process. For 105-130 Volts AC. 60 Hz. Size: 12x x 9 $\frac{3}{4}$ "H x 5"D. Shpg. wt., 15 lbs.

38 E 27367 Kit Net 69.95

As above, but factory wired.

38 E 27375WX Net 99.95

MODEL 667K DYNAMIC CONDUCTANCE TUBE AND TRANSISTOR TESTER KIT



KIT 89⁹⁵ **WIRED** 139⁹⁵

- Separate Plate, Screen, and Grid Switches

- Test All New Tube Types

Combines a mutual conductance test with a peak emission test to give a single reading of tube quality. Also checks transistors for leakage and beta. Tests almost every domestic or foreign tube including nuvisors, novars, compactrons, miniatures, subminiatures, octals and loctals. Tests special purpose tubes, voltage regulators, electron ray, etc. Multi-circuit level switch; 15 tube-element pushbutton switches. 4 $\frac{1}{2}$ " 200 μ a D'Arsonval meter; roll chart. Steel case. For 105-130V, 60 Hz AC. 12 x 15 x 4 $\frac{1}{2}$ ". Shpg. wt., 20 lbs.

38 E 26526WX Net 89.95

Model 667 as above, but factory wired.

38 E 26534WX Net 139.95

* See Page 11 for Full Credit Details on Easy Pay Plan

EICO Signal Generators - Kit or Factory Wired

MODEL 150 SOLID-STATE SIGNAL TRACER KIT

NEW



KIT 49⁹⁵

WIRED 69⁹⁵

Multi-purpose signal tracer! Provides component substitution of output transformer and speaker. Has independent RF and audio inputs; speaker and calibrated meter output indicators. Ideal for troubleshooting AM, FM and TV receivers as well as hi-fi and PA audio equipment. High frequency RF point contact crystal demodulator probe and direct audio probes are provided. **SPECIFICATIONS:** Output—400 mw. Input for rated output—RF 1 mV, audio 63 mV. Hum—better than 60 db below 400 mw. Meter movement—200 uA. For 105-132VAC, 50/60 Hz. Size: 7½x8½x5" O. Shpg. wt., 6 lbs.
 38 E 27516 Kit Net 49.95
 Model 150 as above but factory wired.
 38 E 27524 No Money Down* Net 69.95

MODEL 147AK DELUXE SIGNAL TRACER KIT



KIT 34⁹⁵

WIRED 49⁹⁵

A deluxe instrument with superb testing facilities, engineered for high sensitivity as well as good audio quality. Features high gain RF and low gain audio channels. Both visual and aural monitors. With shielded RF crystal demodulator, valuable noise locator circuit, built in calibrated wattmeter, substitute test speaker, amplifier and output transformer. Output for VTVM or scope. Triode input circuit for extreme low noise. Hum free operation. Complete with all components and instructions with probes. For 105-125 VAC 50/60 Hz. 8x10x4¾". Shpg. wt., 11 lbs.
 38 E 26617 Kit Net 34.95
 Model 147A. As above, but factory wired.
 38 E 26625 No Money Down* Net 49.95

MODEL 324K RF SIGNAL GENERATOR KIT



KIT 32⁹⁵

WIRED 44⁹⁵

For IF-RF alignment, signal tracing and trouble-shooting of TV, FM, AM sets all on fundamentals; marker generator for alignment of new hi-f and older L-TV IF's. Range: 150 kHz-145 MHz on fundamental; 111-435 MHz on calibrated harmonics — ± 1.5% frequency accuracy. Internal 400 Hz sine-wave modulation variable from 0-50%. Colpitts oscillator. Variable gain external modulator amplifier; Turret-mounted, slug-tuned coil RF output 100,000 microvolts. AF out up to 10 volts. Output impedance is 50 ohms. For 105-125V. AC 50/60 Hz. Size: 8x10x4 Shpg. wt., 10 lbs.
 38 E 26591 Kit Net 32.95
 Model 324. As above, but factory wired
 38 E 26609 No Money Down* Net 44.95

MODEL 379 SOLID-STATE SINE/SQ WAVE GENERATOR

NEW



KIT 54⁹⁵

WIRED 74⁹⁵

• Covers 20 Hz to 2 MHz In 5-Bands
 Simultaneous Sine and Square wave outputs! Frequency Range: Sine Wave — 20 Hz to 2 MHz, Square Wave — 20 Hz to 200 kHz; Output Voltage: Sine Wave — 0-7.5 volts rms into high impedance output, 0-6.5 volts into 600 ohms; Square Wave — 0-10 volts peak-to-peak into high impedance. Accuracy: 3%. For 105-132VAC, 50/60 Hz. 7½x8½x8½". 38 E 27532 Shpg. wt., 9 lbs. Net 54.95
 Model 379 as above but factory wired.
 38 E 27540 No Money Down* Net 74.95

MODEL 377K AUDIO GENERATOR KIT

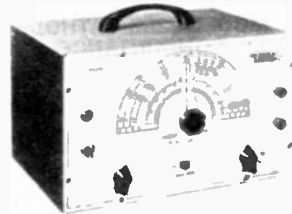

KIT 39⁹⁵

WIRED 54⁹⁵

• Sine Wave: 20-20,000 Hz In 4 Bands
 • Square Wave: 60-50,000 Hz
 Model 377 features R-C (Wein Bridge) oscillator circuit with 1% precision resistors. Includes choke filtering in the power supply. Excellent calibration accuracy, stability and purity of wave-form. Response: ±1.5db, 60-150,000 Hz. Distortion less than 1%. Hum less than 0.4%. Accuracy 3%. For 117VAC, 60 Hz, 50 watts. Size: 7½x11½x7¾". Shpg. wt., 14 lbs.
 38 E 26633 Kit Net 39.95
 Model 377 As above, but factory wired.
 38 E 26641 No Money Down* Net 54.95

MODEL 369K TV-FM SWE MARKED GENERATOR KIT

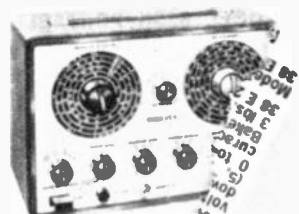

KIT 99⁹⁵

5

• Aligns TV and FM IF's
 Features post injection marker and sweep circuit. Sweep gen. is independent of marker gen. and feeds sweep signal to IF strip being aligned. 5 ranges, 0.5 to 3.5 MHz to 220 MHz. Impedance: 50 ohms. Variable frequency Marker: 4 ranges, 2-225 MHz — 2-75 MHz in Fundamentals, to 225 MHz in Harmonics. Fixed Frequency Marker: 4.5 MHz. crystal included. For 105-125V, 60 Hz AC. Size: 12½x8½x7". Shpg. wt., 16 lbs.
 38 E 26674WX Kit Net 99.95
 Model 369. As above, but factory wired
 38 E 26682WX No Money Down* Net 149.95

MODEL PSI SIGNAL INJECTOR PROBE KIT

Pocket size, cordless, pen type instrument generates and injects a signal covering the audio, IF, and RF spectrum. Contains a solid state oscillator powered by two long-life 1½ volt pen-light cells. Can be coupled into magnetic pickups and circuits without leads. Oscillates at 1000kHz with harmonics to 30MHz. Impedance: 10K ohm. Size: 5½" long x 1½" diameter.
 38 E 27358 Kit. Wt., 3 oz. Net 5.95
 38 E 27342 Factory Wired Net 9.95

MODEL 385 SOLID STATE COLOR BAR GENERATOR KIT



KIT 79⁹⁵

WIRED 109⁹⁵

• 10-Bar Color Display plus Dot and Cross-hatch Pattern

Crystal-controlled, portable unit. Feeds directly into antenna terminals on TV. Produces 10-bar color display plus a well defined dot and crosshatch pattern. Provides individual horizontal and vertical lines for convergence adjustments. A color-coded gun killer can eliminate 1, 2, or 3 colors. Operates on 6 "C" cells. 2½x8½x8. Shpg. wt., 7 lbs.
 38 E 27441 Kit Net 79.95
 38 E 27458 Factory Wired Net 109.95
 99 E 62572 "C" batteries (6 req.) Net .14

EICO Miscellaneous Instruments - Kit or Factory Wired

R&C SUBSTITUTION BOX KITS

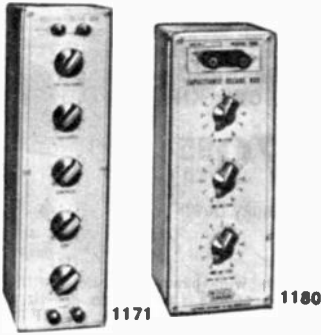

1180K CAPACITANCE DECADE KIT
 Range: 100mmf to 0.111 mf in increments of 100mmf. 3 decade assemblies. Rated 350 VDC continuous, 500 VDC intermittent, 1000 VDC test. Accuracy $\pm 1\%$. 9 x 3 1/2 x 3 1/2" D. Shpg. wt., 3 lbs.
26779 Kit Net 19.95
38 E 26807 As above but wired Net 29.95

1171K RESISTANCE DECADE KIT
 substitute equivalent values of resistance in a circuit. From 0 to 99,999 ohms in 1-m steps in 5 decades. Uses 0.5% accurate resistors. Comparator switch permits instant substitution. 12L x 3 1/2" x 3" D. Less leads. Shpg. wt., 3 lbs.
26773 Kit Net 24.95
1171 Same as above but factory wired
6781 No Money Down* Net 39.95

MODEL 955K IN-CIRCUIT CAPACITOR TESTER KIT

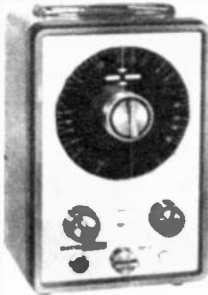

KIT **24⁹⁵**
WIRED **39⁹⁵**

- Test Capacitors In or Out of Circuit
- Electron Ray Tube Indicator Provides Easy Reading
- Tests For Shorts and Opens In or Out of Circuits

Checks for shorts (even in the presence of as little as 1 ohm shunt resistance). Checks for opens; capacitors as small as 15 mmf, in or out of circuit: Wien bridge circuit measures capacitance with $\pm 10\%$ accuracy between 0.1 mf and 50 mf at any point on the 4" lucite dial-product, convertible into dissipation or power factor-indications visible on electron ray tube. Includes fine adjust control. For 105-130 VAC. Size: 8 1/2"H x 5 3/4" x 6" D. Shpg. wt., 4 lbs.
38 E 26814 Kit Net 24.95
 Model 955. Same as above but factory wired and tested.
38 E 26822 No Money Down* Net 39.95

MODEL 950K R-C BRIDGE & RCL COMPARATOR KIT

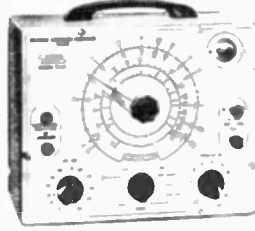

KIT **29⁹⁵**
WIRED **39⁹⁵**

- Comparator Range Allows the Use of Complementary Components as Standards

Combination RC bridge and comparator, a direct reading ratio scale for comparison measurement of capacitance, resistance and inductance with a "standard" complementary component. Measures (in 4 ranges) 0.5 ohms to 500 megohms; 10 mmf to 5000 mfd. Comparator range: .05 to 20. Variable DC polarizing voltage from 0 to 500V tests capacitors for leakage and shorts. "Eye"-tube null indicator. Less leads. For 105-125V. 60 Hz AC. Steel case. 8Hx10Wx4 3/4" D. Shpg. wt., 10 lbs.
38 E 26898 Kit Net 29.95
 Model 950. Same as above but factory wired
38 E 26906 No Money Down* Net 39.95

MODEL 1140 SERIES/PARALLEL RC SUBSTITUTION BOX KIT

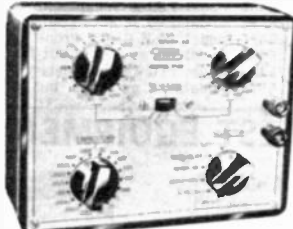

KIT **15⁹⁵**
WIRED **24⁹⁵**

A versatile series parallel RC combination substitution box with switching facilities for selection of any R alone, any C alone, or 1350 combinations of R and C in series or parallel. Resistance values from 15 ohms to 10 megohms; capacitance values from 0.0001 to 0.22 mfd. $\pm 10\%$ accuracy. Open and short circuit positions provided. Can be substituted in circuit to determine values. Convenient 5-way jack binding posts. 6 3/4"Hx5 1/4"Wx2 3/4" D. Shpg. wt., 3 lbs.
38 E 26872 Kit Net 15.95
 Model 1140. Same as above but factory wired and tested.
38 E 26880 Net 24.95

MODEL 944K FLYBACK TRANSFORMER AND YOKE TESTER KIT



KIT **29⁹⁵**
WIRED **39⁹⁵**

Provides a positive check, in just a few seconds, on all types of flybacks and yokes, both in out of the circuit. Operates on extremely sensitive grid-dip principle to show up even one shorted turn. Separate calibration settings for air-core flybacks and yokes to assure accuracy in testing both types. Large, easy-to-read 4 1/2" meter, with three colored scales. Tube complement: one 6K6. 105-125V. AC, 60 Hz. 7"x5"x4" D. Shpg. wt., 6 lbs.
38 E 27011 Kit Net 29.95
 Model 944. Same as above, but factory wired.
38 E 27029 No Money Down* Net 39.95

MODEL 888 SOLID STATE ENGINE ANALYZER KIT



KIT **49⁹⁵**
WIRED **69⁹⁵**

- Large 6" D'Arsonval 2 Color Meter
- Seven professional engine and ignition systems in one. Determine the condition of battery, starter, ignition coil, distributor, voltage regulator, alternator or generator. Performs on 4, 6, or 8 cylinder, 6 or 12 volts, pos. or neg. grounded systems. Self-powered (4 "D" cells not included). SPECIFICATIONS: Dwell 0 to 45° for 8 cyl., 0 to 60° for 6 cyl., 0 to 90° for 4 cyl.; RPM — 0 to 1200 and 0 to 6000 for 4, 6, and 8 cyl.; Voltage — 0 to 3.2 and 0 to 16V. DC; Ohms — 0 to 20K Ω for general continuity and alternator diode testing; Current — 0 to 90 amps. DC. 1 1/2" x 6 x 5". Shpg. wt., 7 lbs.
38 E 27227 Kit Net 49.95
 Model 888 as above but factory wired
38 E 27235 No Money Down* Net 69.95

NEW HI-VOLTAGE PROBE

with Built-in Meter

WIRED ONLY

19⁹⁵

Light, compact! A must for servicemen, engineers and technicians. Measures up to 30 kv. Barriers are provided to isolate high voltage tip from probe handle and meter.

38 E 27557 Wt., 6 oz. Net 19.95

NEW PST-2 SIGNAL TRACER PROBE KIT

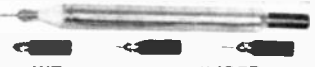

KIT **19⁹⁵**
WIRED **29⁹⁵**

Signal tracer built into a small flashlight size probe. Usable bandwidth: 50 Hz to 200 kHz; to 200 MHz w/demodulator tip supplied. Output: 0.3V, peak-to-peak. Probe and 3-tips supplied. Uses 1—"AA" batt., (not supplied). 6 3/4"Lx 3/4" dia.
38 E 27565 Kit Net 19.95
 Model PST-2 As Above, But Factory Wired.
38 E 27573 Wt., 2 1/2 oz. Net 29.95



Oscilloscopes—Kit and Factory Wired

**DELUXE MODEL 460K
5" WIDE BAND DC SCOPE KIT**

99⁹⁵_{Kit}

No Money Down*



- For Color
- Black & White
- 10 MV RMS/CM Sensitivity
- DC to 4.5 MHz Flat Response
- TV-V and TV-H Sweeps

Excellent Lab precision scope featuring Push-pull direct coupled vertical amplifier with high sensitivity: 25 mv/in. Response flat from DC to 4.5 MHz, useful to 10 MHz, ideal for reproduction of 3.58 MHz color TV sync. burst, 4-step freq.-compensated attenuator in both AC, DC positions. Also internal voltage calibration. Automatic sync. limiter and amplifier. 2X-full screen horizontal positioning. Sweep-freq.: 10 to 100 Hz with external capacitor for lo-freq. sweeps. Preset TV V & H sweep positions (30 and 7875 Hz). Variably lit graphed 5" screen. Very hi-input impedance. Complete with all components and instructions for easy assembly. 13x8 1/2 x 16". For 105-125 VAC. 50-60 Hz. Shpg. wt., 30 lbs.
38 E 26435WX Kit. Net 99.95
38 E Model 460. As above, but factory wired.
38 E 26443WX Net 149.95

**MODEL 435K
WIDEBAND DC
3" SCOPE KIT**

119⁹⁵_{Kit}

No Money Down*



- 18 MV RMS/CM Sensitivity
- Zener Diode Calibration
- DC 4.5 MHz Flat Response

A compact lightweight 3" wideband scope ideal for home color TV service. Push-pull vertical amplifier offers direct or capacitive inputs. Response: flat from DC to 4.5 MHz; sensitivity: 18 mv/cm. Reproduces 3.58 MHz color sync burst easily. Vert. input decade attenuator. Input Impedance: 1 Meg shunted by 35 mmf. Horizontal: flat 1 Hz to 500 kHz. Sensitivity: 0.7 v/cm. Input imp. 4 Meg shunted by 40 mmf. Full screen vert. and horiz. positioning. Sweeps from 10 Hz to 100kHz in 4 ranges plus pre-set TV-V and TV-H Sweep positions. Fast retrace blanking. 5 3/4 W x 8 1/2 H x 12 1/2 D. For 105-125V. 60 Hz AC. Shpg. wt., 17 lbs.
38 E 26377WX Kit. Net 119.95
38 E Model 435 as above, but factory wired.
38 E 26385WX Net 169.95

**MODEL 465
PROFESSIONAL
WIDE BAND
5" SCOPE KIT**

179⁹⁵_{Kit}

No Money Down*



Precision, wide band oscilloscope with frequency response from DC to 8 MHz. V/H amplifier sensitivity of .05 volts P-P/cm. Features: zener diode controlled voltage calibration source; distortionless V and H trace expansion; drift-free V and H positioning; automatic sync limiter and amplifier; full retrace blanking; edge lit calibration grid. Vertical amplifier specs: response from DC to 8 MHz (+1 —5 db); sensitivity, 12 mv/cm rms; input impedance, 1 meg; Horizontal amplifier response from DC to 1 MHz (+1 —3 db); sensitivity, 17 mv/cm rms; input impedance, 1 meg; Sweep ranges: 10-100 Hz. 100-1kHz. 1kHz-10kHz. 10-100kHz. Plus TV-VERT position (30 Hz) and TV-HOR position (7875 Hz). For 117v. AC. 60 Hz. 12 3/4 x 8 1/2 W x 17 1/2 D. Shpg. wt., 30 lbs.

38 E 27425WX Net 17.
38 E Model 465 as above but factory wired.
38 E 27433WX Net 2'

EICO OSCILLOSCOPE ACCESSORY PROBES —

Features: fully shielded rugged terminal board mounting of all parts. Shock-mou floating construction. Probe bodies are color-coded for easy identification. Shpg. wt.,

38 E 26450 Model PSD-K Demodulator Probe Kit	Net 4.
38 E 26468 Model PSD as above but factory wired	Net 6
38 E 26476 Model PD-K Direct Probe Kit	Net "
38 E 26484 Model PD as above, but factory wired	Net 6
38 E 26492 Model PLC-K Low Capacity Probe Kit	Net
38 E 26518 Model PLC as above, but factory wired	Net

EMC TEST EQUIPMENT KITS

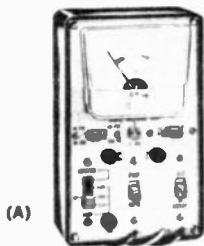

(A)

Kit 14⁵⁰ Wired 21⁵⁰



(B)

Kit 21⁹⁰ Wired 33⁴⁰

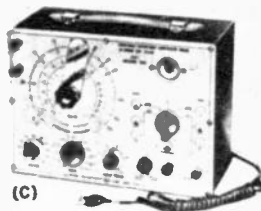

(C)

Kit 28⁴⁵ Wired 45⁹⁵



(D)

Kit 28⁴ Wired 45⁹⁵

[A] MODEL 212 TRANSISTOR ANALYZER KIT. Battery powered, checks all transistors for beta in 3 ranges to 200; leakage on 3-color scale. Tests all transistors in circuit without removing them. Can be used to signal trace AF, IF or RF circuits. Also measures battery voltages on 0-12 volt peak and DC current drain on 0-80 milliampere scale. Checks condition of diodes. Supplied with test leads and instructions. Size: 3 3/4 W x 6 1/4 H x 2" D. Shpg. wt., 2 lbs.
38 E 24018 Model 212 kit Net 14.50
38 E 24026 As above, but factory wired Net 21.50

[B] MODEL 213 TUBE TESTER KIT. Checks all new Compactrons, Nuvistors, Novars and 10 prong tubes in addition to Octals, Locals, Miniatures and 9-prong tubes. Tests for shorts, leakages, intermittents and quality. Quality is indicated directly on 3-color metal dial. Each section of multi-purpose tubes is checked separately. Also tests Magic Eye, Voltage Regulator and Hi-Fi tubes. Supplied complete with high-impact bakelite case and strap, instructions and tube charts in ring bound manual. Size: 8 1/2 x 7 1/2 x 4". Shpg. wt., 5 1/2 lbs.
38 E 24034 Model 213 Kit Net 21.90
38 E 24042 As above, but factory wired Net 33.40

[C] MODEL 801 RESISTANCE COMPARATOR CAPACITANCE & CAPACITY CHECKER KIT. Measures condensers for actual value, leakage, and power factor. Detects in-circuit opens above 50 mmfd, shorts up to 20 mfd, and condensers that are intermittent in operation. Checks capacity values in 4 ranges from 10 mfd to 5000 mfd; resistance in 4 ranges from .5 ohms to 500 megs. Also checks capacitor, inductance or resistance ratio, or transformer windings with a ratio of 20:1 or less. Tests power factor and leakage at rated voltages between 0-500 VDC. Size: 10x7x5"D. Shpg. wt., 7 lbs.
38 E 24059 Model 801 Kit Net 28.45
38 E 24067 Model 801 Wired Net 45.95

[D] MODEL 802 SIGNAL TRACER AND GENERATOR KIT. Combination signal tracer and generator. In the absence of a signal it generates its own signal for audio. IF or RF testing. Incorporates a noise locator circuit for checking noisy components. Provisions are made for using the instrument as a substitute speaker or amplifier. Audio Freq., 400 Hz; IF Freq., 455 kHz (Mod.). Complete with demodulator and audio probes. 10x7x5". Shpg. wt., 8 lbs.
38 E 24075 Model 802 Kit Net 28.45
38 E 24083 Wired Net 45.95

RCA World Famous Test Equipment Kits

MODEL WV-77E (K) VOLTOHMVOM KIT

Kit
38⁰⁰
Wired
52⁰⁰



Easy-to-read 4½" meter, 11 megohm input resistance. 28 ranges include 7 DC voltages: 0-1.5-5-15-50-150-500-1500, 7 AC rms voltages: 0-1.5-5-15-50-150-500-1500, ±5% of full scale accuracy; 7 peak-to-peak AC voltages: 0-4-14-40-140-400-1400-4000 volts; 7 overlapping ohms ranges from 0.2 ohms to 1000 megohms with center-scale values to 10, 100, 1000, 10K, 100K, 1 meg. and 10 megohms. Electronically protected against burnout. For 105-125 v. 50-60 Hz AC. With DC and AC/ohms probes and cables. Shpg. wt., 5½ lbs.

38 E 46029 No Money Down* Net 38.00
WV-77E-E, As above, but factory wired.
38 E 46037 No Money Down* Net 52.00

MODEL WV-38A VOM KIT

Kit
38⁰⁰
Wired
52⁰⁰



Easy-to-read 5¼" meter. Ranges: 8 AC voltage; 0-0.25-1.0-2.5-10-50-250-1000-5000 volts, DC input resistance is 20,000 ohms per volt. 6 AC voltage ranges: 2.5-10-50-250-1000-5000 volts, AC input resistance is 5000 ohms per volt. Resistance from 0-2,000-200,000-20,000,000 ohms in three ranges. DC current has 6 ranges: 50µ-1-10-100-500 milliamperes, and 0-10 amps, with full scale accuracy of ±3%. With leads, less battery. Size: 5¼ x 3¼ x 6¾".

38 E 46045 Shpg. wt., 4 lbs. Net 38.00
Model WV-38A-E As above, but factory wired
38 E 46052 No Money Down* Net 52.00
Model WG-270A—Carrying case for WV-38A
38 E 46060 Shpg. wt., ½ lb. Net 5.25

MODEL WV-98C VOLTOHMVOM KIT

Kit
57⁹⁵
Wired
88⁵⁰

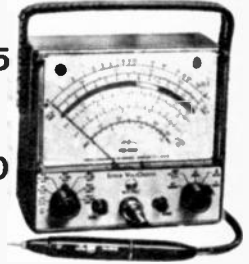

Big 6½" color-coded meter with 200µa movement and accuracy of ±3% on AC and DC. 1% precision multiplier resistors. Meter is burnout proof. Measures p-p voltages up to 4200 volts of sine waves. Range: DC volts, 0-5-15-50-150-500-1500; AC rms volts, 0-1.5-15-50-150-500-1500; Resistance, 0.2 ohms to 1000 ohms to 1000 megohms in 7 ranges. DC input resistance, 11 megohms. Sturdy, single-unit probe with built-in DC/AC/Ohms selector switch. Size: 7W x 6½H x 3¼"D. For 110-130 volts 50/60 Hz. AC. Shpg. wt., 8 lbs.

38 E 46094 No Money Down* Net 57.95
Model WV-98C-E As above, but factory wired.
38 E 46102 No Money Down* Net 88.50

MODEL WR 50B RF SIGNAL GENERATOR KIT

Kit
45⁰⁰
Wired
65⁰⁰

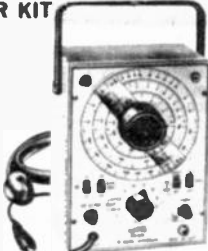

with SWEEP FEATURES

Ideal for aligning and trouble-shooting AM, FM, TV, CB and Ham receivers. Provides tunable output from 85 kHz to 40 MHz in 6 ranges on fundamentals CW or modulated RF. Dial calibration accuracy ±2%. Built-in 400 Hz audio oscillator for internal or external modulation. Front panel crystal socket for oscillator calibration. Shielded outputs. 5¾W x 7¾H x 4¾"D. For 105-130 v., 50/60 Hz AC. Shpg. wt., 7 lbs.

38 E 46326 No Money Down* Net 45.00
WR-50B-W As above but factory wired.
38 E 46318 No Money Down* Net 65.00

NEW! MODEL WG-412-A RC CIRCUIT BOX KIT

Kit
22⁰⁰
Wired
30⁰⁰

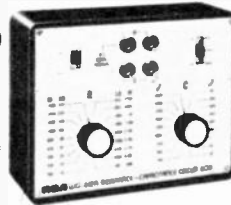

Provides convenient selection of standard resistor and capacitor values... separately, in series, or in parallel RC combinations. Includes 36 one-watt resistors (from 15 ohms to 10 megohms) and 18-600 volt capacitors (from 100 pf to .22 µf). Resistors and capacitors have 10% tolerance. Ideal for component substitution in servicing and circuit design, and for establishing RC circuits for checking impedance, reactance, and frequency characteristics. Includes plug-in test leads with alligator clip connectors. Size: 6¾ x 5¾ x 2¾". Shpg. wt., 2 lbs.

38 E 46466 Kit Net 22.00
WR-412-AW As above, but factory wired.
38 E 46474 No Money Down* Net 30.00

MODEL WO-33A PORTABLE 3" SCOPE KIT

Kit
108⁰⁰
Wired
139⁰⁰

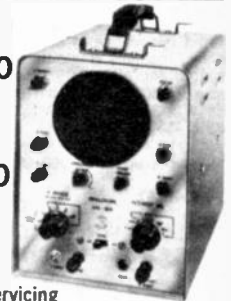

• Ideal For Servicing Color TV, And Audio Equipment.

Easy to build dual band scope kit. Will handle any black-and-white or color-TV servicing job and is also ideal for square wave testing of audio and ultrasonic equipment. Lots of gain and bandwidth. Vertical amplifier has two positions. On wide band position, sensitivity is 100 rms mv/in. and bandwidth within 3 db from 5.5 Hz to 5.5 MHz. On narrow band position, sensitivity is 3 rms mv-in. and bandwidth within 3 db from 20 Hz to 150 kHz. Has external and ± internal sync. Sync range to 4.5 MHz, Sawtooth range from 15 Hz to 75 kHz. Line sweep can be adjusted 160° phase. Vertical circuit input impedance at lo-cap cable input is 10 megohms and 10 picofarads approx. Complete with direct/lo-cap probe and cable, and instruction booklet. Assembly instruction sheet provided with the kit. Power requirement is 50 watt at 105-125 volts, 50/60 Hz. Size: 6½ x 10¼ x 8¾". Shpg. wt., 16 lbs.

38 E 46078WX No Money Down* Net 108.00
WO-33A As above, but factory wired.
38 E 46086WX No Money Down* Net 139.00

MODEL WG-307B TV BIAS SUPPLY KIT

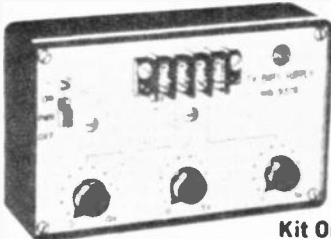

Kit Only

Designed for use in servicing and aligning both color and black and white television sets. Provides three separate DC output voltages, adjustable from 0 to —15 volts minimum for application in RF, IF and AGC bias circuits. Has power transformer. Easy to assemble kit. For 105-125 V, 60 Hz AC. Size: 6¾ x 3¾ x 2". Shpg. wt., 1½ lbs.

38 E 46128 Net 13.50

ACCESSORY PROBES For RCA VTVM And VOM KITS

WG-299E—DC/AC ohm with shielded cable and coax for WV-98C. Shpg. wt., 4 oz.
38 E 46193 Net 9.00

WG-301A—Crystal diode slip-on probe. Use with WG-299E to extend WV-98C VTVM range to 250 MHz. Shpg. wt., 2 oz.
38 E 46219 Net 8.25

WG-289—Hi-volt probe to 59,000 V, for WV-98C and WV-77E (less resistor).
38 E 46235 Shpg. wt., 8 oz. Net 13.50

WG-206—1090 Megohm multiplier. Use with WG-289 for WV-98C and WV-77E.
38 E 46243 Shpg. wt., 2 oz. Net 3.75

WG-325A—RF diode—Extends measurements to 100 MHz for WV-38A. Shpg. wt., 1 lb.
38 E 46250 Net 2.95

WO-91C 5" OSCILLOSCOPE

269⁹⁵ Wired Only

Ideal for servicing B&W or Color TV receivers. Simultaneous P-P measurements and wave shape display. Response: 10 Hz to 4.5 MHz. For 105-125 V 50/60 Hz.
38 E 46292WX Shpg. wt., 35 lbs. Net 269.95

Top Quality Test Instruments by **RCA**

WV500A SOLID STATE BATTERY OPERATED VOLTOHMYST

Only **75⁰⁰**
No Money Down*



- No Zero Shift
- Special 0.5 DC Volt Range
- Constant 11 Megohm Input Resistance

All solid state battery operated completely portable voltmeter that is ideal for service, industrial and lab applications. No warm up time...no zero shift. Seven overlapping resistance ranges measure from 0.2 ohms to 1000 megohms. Eight overlapping DC voltage ranges measure from 0.02 volt to 1500 volts including a special 0.5 DC volt range. Measures AC peak-to-peak voltages of complex waveforms from 0.5 to 4200 volts, and AC(RMS) voltage from 0.1 to 1500 volts. Input impedance of all DC ranges is 11 megohms. Includes single-unit probe with built-in switch for either DC or AC and resistance measurements. With batteries. Size: 6 7/8" x 5 1/4" x 3 1/4" D. Shpg. wt., 5 lbs.

38 E 46359 Net 75.00
WG-411A "SLIP-ON" HIGH VOLTAGE PROBE. Measures up to 50,000 DC volts. Shpg. wt., 1/2 lb.
38 E 46367 Net 13.50

DELUXE WT-501A TRANSISTOR TESTER

Only **66⁷⁵**
No Money Down*

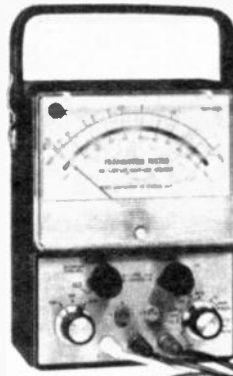

- DC Beta From 1 to 1000
- Collector-to-Base Leakage As Low As 2µa

Completely portable requiring no external power source, tests both low and high power transistors, and has both NPN and PNP sockets. Tests out-of-circuit transistors for d-c beta from 1 to 1000, collector-to-base leakage as low as 2 microamperes, and collector-to-emitter leakage from 20 microamperes to 1 ampere. Special low impedance circuitry assures reliable in-circuit testing. Collector current is adjustable from 20 microamperes to 1 ampere in four ranges. Three color-coded test leads are provided. With two 1.5 volt batteries. Shpg. wt., 4 lbs.
38 E 46342 Net 66.75

New! WG-414A Clip-On Probes, set of 3, for use with WT-501A. Special clip-on connectors and thin flexible shafts for connection to transistor elements on printed circuit boards.
38 E 46441 Net 13.50

WC-506A TRANSISTOR AND DIODE CHECKER

Only **18⁰⁰**
No Money Down*



- Checks NPN And PNP Types
- Tests Out-of-Circuit Transistors
- Large, Easy-To-Read Meter

Compact, battery operated instrument providing quick, simple checks of relative gain and leakage levels of out-of-circuit transistors. Tests NPN and PNP types. Panel switch provides checking high-leakage transistors, such as most germanium power types. Includes a transistor socket, color coded test leads, and a large easy-to-read meter with a single red/green scale. Checks relative front-to-back current ratio of diodes. Powered by two 1.5 volt penlite batteries. Size: 3 3/4" x 6 1/4" x 2". Shpg. wt., 1 lb.
38 E 46409 (WC-506A less bats.) Net 18.00

DELUXE WR-64B COLOR BAR/DOT CROSSHATCH GENERATOR



129⁰⁰
No Money Down*

- Chroma Control to Check Receiver Color Sync-Lock Action
- Crystal Controlled Synchronizing Pulses

Produces dot and crosshatch patterns for adjusting linearity and overscan in both color and black-and-white receivers. Pattern control selects color-bar, dot, or crosshatch with fixed number of dots and lines for ease in checking overscan; Chroma control checks receiver color sync-lock action; crystal-controlled sound carrier for adjustment of receiver fine tuning; crystal-controlled RF oscillator for stable picture carrier, plus crystal-controlled synchronizing pulses. Complete with cables and instructions. Size: 13 1/2" x 10" x 8". For 105-125 VAC., 50/60 Hz. Shpg. wt., 17 lbs.
38 E 46284 WX Net 129.00

NEW! SOLID-STATE REGULATED BENCH POWER SUPPLIES

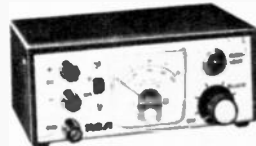

WP-700A
Single Unit
48⁰⁰

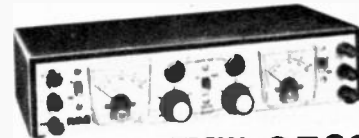

WP-702A
Dual Unit
87⁰⁰

- Negative Feedback Regulator Circuit

These solid-state, voltage regulated, bench-type DC power supplies are for use in circuit design, servicing, industrial and educational applications. WP-700A—Single unit; WP-702A—dual unit with two complete electrically isolated power supply sections. Output voltage for both power units is continuously adjustable from 0-20 volts with a maximum rating of 200 mA. Exceptionally low ripple—.0005 rms volt maximum. Electronic short-circuit protection. Excellent line and load regulation. Input voltage is 105-135 VAC., 50/60 Hz. Size: WP-700A 4 x 6 1/2 x 3; WP-702A 6 x 12 x 3. Wt., 3 lbs. (WP-700A); 5 lbs., (WP-702A).
38 E 46425 Model WP-700A Net 48.00
38 E 46433 Model WP-702A Net 87.00

OTHER OUTSTANDING RCA TEST EQUIPMENT

WR-802A Battery Operated Solid State Color Bar Generator. For portable use. Patterns generated: color bars, dots, crosshatch, vertical lines, horizontal lines, blank raster.
38 E 46391WX Shpg. wt., 5 lbs.. Net 168.00

New! WG-425A AC Adapter. Permits WR-502A to be operated on AC power line.
38 E 46458 Shpg. wt., 6 oz. Net 9.00

WV-120A Power Line Monitor. For 100 to 140V; plugs into wall outlet. Ideal for use in laboratory or production—wherever voltage readings are critical. Accurate RMS readings. Fast meter action reveals "bounces" and fluctuations in line voltage. Accuracy ±2%.
38 E 46185 Shpg. wt., 1 1/2 lbs. Net 18.50

WV-503A Power Line Monitor—Same as above but 200 to 280 V. Wt., 1 1/2 lbs.
38 E 46383 Net 18.50

WR-26A Isotap And Autotransformer Prevents damage to test equipment and units under test. Ideal for use in servicing color TV. Minimizes shock hazard. Operates as high-medium-low isolation transformer or as an auto-transformer for testing at various line voltage settings. Supplies outputs of 105, 110, 115, 120, 125, 130; load ratings have been increased to 400VA Max. continuous operation, and 650VA intermediate operation.
38 E 46417 Shpg. wt. 13 lb. Net 40.00

WA-504A Transistorized Audio Signal Generator. Provides a sine or square wave audio frequency signal for a frequency range from 20 to 20,000 Hz. Produces stable signal with amplitude variation not exceeding 1.5 db. HD of sine wave: less than 0.25%.
38 E 46375 Shpg. wt., 3 1/2 lbs. Net 95.00

Triplett and Sprague Test Instruments

DELUXE TRIPLETT 601 SOLID STATE F.E.T. VOM FOR IC's

only **150⁰⁰**
No Money Down*

- Pushbutton and Battery Operated
- Low Power Ohms for IC Measurements
- 11 Megohm Input On All AC-DC Ranges

With Batteries and Test Probes

Lightweight, portable, battery-operated solid state volt-ohm-milliammeter with pushbutton function switches, and Field Effect Transistorized (FET) circuitry providing high input impedance (11 megohms) on all AC and DC ranges. Low Power Ohms for Integrated Circuit (IC) measurements. A total of 52 range selections can be accomplished using only one selector switch. Model 601 has an accuracy of $\pm 2\%$ of full scale on DC and $\pm 3\%$ on AC. Measures electrical parameters such as DC Volts: 0-1-3-1.3-10-30-100-300 and 1000; AC Volts: 0-0.1-0.3-1-3-1.3-10-30-100-300-1000; Ohms: 1-10-100-1000-10,000-100,000—1 Meg with 10 ohm center scale—both conventional and Low Power; AC-DC current Ranges: 0-10-100-1000-10,000 μ A; DB: -40 to +60. Large 5" meter. Dim: 3 3/4" x 5 1/4" x 6 1/2". Comes complete with (10) AA batteries, test probes and operating instructions. Shpg. wt., 2 1/2 lbs.

38 E 77727

Net 150.00

38 E 77719 Leather Case for Model 601. Wt., 1 lb.

Net 14.70

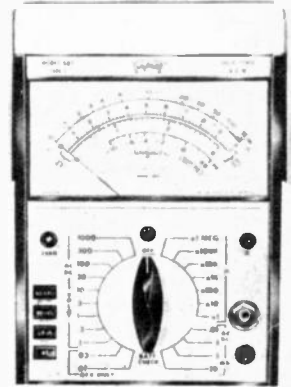

TRIPLETT 630 SERIES VOM's

As low as **61⁰⁰**

- Fused Circuit Prevents Burnouts In Ohmmeter Ranges
- Large Easy-To-Read 5 1/2" Meter
- Single Selector Switch



MODEL 630—5 1/2" meter with spring-backed jewels and 1% precision resistors. Accuracy, 2% on DC, 3% on AC. Single 20-position selector switch. Ranges: DC and AC volts, 0-3-12-60-300-1200-6000 (DC at 20,000 ohms/volt, AC at 5000 ohms/v.); Ohms, 0-1k-10k and 1-2-100 megohms, low reading to .1 ohm. DC current, 0-60 μ A, 0-1-12-120 ma and 0-12 amps. DB, -20 to +77 (600 ohm line at 1 mw); output v., 0-3-12-60-300-1200; jack with condenser in series with AC ranges. Molded, fully insulated case, 3 1/2" x 5 1/2" x 7 1/2". With batteries, leads. Shpg. wt., 5 lbs.

38 E 73049

Net 61.00

MODEL 630A. Same as 630, but with 1/2% resistors and mirror scale. Accuracy, 1 1/2% DC, 3% AC. Shpg. wt., 5 lbs.

38 E 73056

Net 71.00

MODEL 630-NS. Deluxe VOM featuring 200,000 ohms/volts DC. Rugged 5 μ A suspension meter movement has 5 1/2" 2-color mirror scale. Accuracy, 1 1/2% DC, 3% AC. 62 ranges. AC/DC volts to 1200v. DB, -20 to +77 in 10' ranges. Current measurements from 0.1 μ A. With batteries, leads. 3 1/4" x 3 1/2" x 5 1/2". Shpg. wt., 5 lbs.

38 E 73029WX

Net 110.00

ACCESSORIES FOR 630 SERIES VOM

MODEL 639-N. Black cowhide carrying case. Cover flap snaps back allowing full access to meter without removing case. Wt., 2 lbs.

38 E 73171

Net 12.60

No. T-79-127 Replacement leads. Shpg. wt., 1 lb.

38 E 73205

Net 3.20

NEW TRIPLETT HANDSIZE MODEL 310-FET SOLID-STATE VOLT-OHM-MILLIAMMETER

Only **70⁰⁰**
No Money Down*

- 10 Megohm Input Resistance
- 300 mv DC Sensitivity for Transistorized Bias Measurements

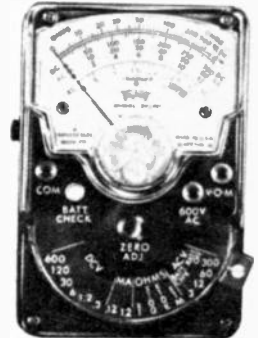

Hand-held, battery operated volt-ohm-milliammeter featuring field-effect transistorized circuitry. 10 megohm input resistance on all DC voltage ranges. High Sensitivity (300 mv fs) allows transistor bias measurements. Features provisions for attaching clamp on AC ammeter adapter (see below). Accuracy of $\pm 3\%$ on DC and $\pm 4\%$ on AC, zero center for null measurements, and a polarity reversing switch. Ranges: DC Volts: 0-0.3-1.2-6-30-120-600; AC Volts: 0-3-12-60-300-600; Resistance: 0-5K-500K-50 megohms; DC Current: 0-0.12-1.2 ma. at 300 mv. Shpg. wt., 1 1/2 lbs.

38 E 72009

Net 70.00

ACCESSORIES FOR 310-FET

MODEL 10 AMMETER ADAPTER. Clamp on type ammeter, plugs into 310-FET. Jaws clamp around single conductor to measure 0-6-12-30-60-120-300 amp AC. Shpg. wt., 3 1/2 lbs.

38 E 73072

Net 20.00

MODEL 379—Leather case. Holds 310 and 10.

38 E 73080 Shpg. wt., 8 oz.

Net 8.00

MODEL 101 LINE SEPARATOR—Divides two conductor cords, increases sensitivity 10X and 20X. For model 10.

38 E 73098 Shpg. wt., 2 lbs.

Net 8.00

MODEL No. 611. Leads adapt model 10 for use with any VOM having 3 volt AC scale at 5000 ohms per volt, such as Triplett 630 series.

38 E 73114 Shpg. wt., 1 lb.

Net 3.20

SPRAGUE MODEL TO-6 TELOHMIKE CAPACITOR ANALYZER

109⁹⁵

No Money Down*

A moderately priced instrument for complete analysis of all types of capacitors, including low-voltage capacitors, at a guaranteed accuracy of $\pm 3\%$ for values to 200 mfd. and $\pm 5\%$ from 200 mfd. up. Capacitance bridge measures capacity in five ranges from 1 mmf to 2000 mfd. with color-keyed pushbutton range selection. Large meter directly indicates insulation resistance up to 50,000 megohms for paper, ceramic and mica capacitors. Wien bridge measures power factor of electrolytic capacitors from 0 to 50% in three ranges. Leakage current of electrolytic capacitors measured directly on meter, with continuously variable test voltage up to 600 volts. Burn-out-proof meter; safety switch. 8 3/4" x 14 3/4" x 6 1/4". For 110-120v 50/60 Hz AC. Shpg. wt., 2 lbs.

38 E 70011WX

Net 109.95

Model TO-6S. Same as TO-6 except for 115-230 VAC/50 Hz.

38 E 70029WX

Net 114.95



- Designed for Versatility, Accuracy, Safety and Convenience
- Tests Low-Voltage Capacitors Used in Transistor Circuits Without Damage

High Accuracy Simpson AC/DC VOMS



As Low As **65⁰⁰**

LOW COST MODEL 260-5 AC/DC VOM

- 20,000 Ohms/VDC, 5000 Ohms/VAC Sensitivity
- Accuracy: $\pm 2\%$ DC, $\pm 3\%$ AC
- 50μ Self-Shielding and shockproof movement

Highly-reliable, low cost VOM famous for rugged dependability and outstanding accuracy. Features DC polarity reversing switch, full wave bridge rectifier for fast easy readings. 20,000 ohms/volt DC sensitivity, 5000 ohms/V. AC. Ranges: DC mv, 0-250; AC and DC volts, 0-2.5-10-50-250-1000-5000; AF output V, 0-2.5-10-50-250; DC μ a, 0-50; DC ma, 0-1-10-100-500; DC amps., 0-10; DB, —20 to +50 in 4 ranges; resistance, 0-20 megs in 3 ranges. Accuracy, DC volts $\pm 2\%$ F.S.; AC volts, $\pm 3\%$ F.S. Housed in bakelite case, $5\frac{1}{4} \times 7 \times 3\frac{1}{4}$ ". With battery and test leads. Shpg. wt., 6 lbs.
38 E 48595 No Money Down* Net 65.00

MODEL 260-5P—Same fine features and ranges as Model 260-5 but equipped with special sensor circuit to prevent burned components, bent pointers, and blown rectifiers. With battery and test leads. Shpg. wt., 6 lbs.
38 E 48470 No Money Down* Net 97.00

MODEL 260-5PRT. Same as above, but with "roll top" safety case. Shpg. wt., 9 lbs.
38 E 48488 No Money Down* Net 103.00

MODEL 270-3—Same as Model 260-5 but with mirror scale, knife edge pointer, self shielded annular meter. Higher accuracy $\pm 1.25\%$ DC, $\pm 3\%$ AC. Dimensions: $5\frac{1}{4} \times 7 \times 3\frac{1}{4}$ ". Shpg. wt., 5 lbs.
38 E 48041 No Money Down* Net 78.00

MODEL 270-3RT—Same as model 270-3 but with roll top case. Shpg. wt., 5 lbs.
38 E 48050 No Money Down* Net 84.00

ADD-A-TESTERS FOR 260 and 270 SERIES AC/DC VOMS

Add unlimited versatility to all Simpson 260 or 270 Series AC/DC VOMS made since 1947 except ROLL TOP models. Turns these VOM'S into 9 different type testers. Shpg. wt., 2 lbs.

STOCK NO.	MODEL	TYPE	NET
38 E 48108	650	Transistor Tester	44.00
38 E 48116	651	DC VTVM	92.00
38 E 48124	652	Temp. Tester	49.00
38 E 48132	653	AC Ammeter	30.00
38 E 48140	654	Audio Wattmeter	34.00
38 E 48181	661	DC Ammeter	33.00

VERSATILE "ADD-A-TESTERS"

Adapter Simply Plugs-in for Complete Unit

Model 313 SOLID STATE VOM

125⁰⁰

No Money Down*

With Test Leads, Isolating Probe, and Operators Manual

- Overload Protected
- Large, Easy-to-Read 7" Scale



Combines VOM convenience with VTVM features. 11 megohm input impedance on DC; 10 megohm input impedance on AC. Operates over 300 hours on a 9-volt transistor radio type battery. Switch checks battery voltage instantly. Built for rugged use with a shockproof, overload protected, self-shielded movement. Frequency and temperature compensated for maximum accuracy. Ranges: DC & AC Volts, 0-0.3, 1, 3, 10, 30, 100, 300, 1000 $\pm 3\%$. DC Current, 0-0.1, 1, 10, 100, 1000 ma. Response: 20 to 100 kHz. ± 0.5 db. Resistance: Rx1, Rx10, Rx100, Rx1K, Rx10K, Rx100K, Rx1M, $\pm 3^\circ$ arc. Size: $7\frac{1}{4} \times 6\frac{3}{4} \times 3\frac{3}{4}$ ". Shpg. wt., 7 lbs.
38 E 48680 No Money Down* Net 125.00

MODEL 312 VTVM

95⁰⁰ No Money Down*

With AC Ohms/DC Probe and Operator's Manual

- Large Easy To Read 7" Scale
- Input Resistance 16 Megohms

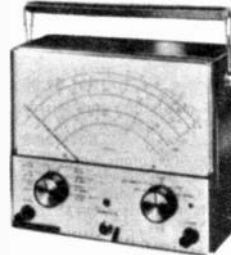

Wide-range VTVM for lab or shop use. Large easy-to-read seven-inch scale designed for accurate testing of today's solid state circuitry. Features 1/2 volt DC range and 16 megohm input resistance for minimum circuit loading. Offers 3% accuracy on AC and DC. Movable handle also serves as a stand for tester. Ranges: DC volts, 0-0.5-1.5-5-15-50-150-500-1500. AC volts, (rms) 0-1.5-15-50-150-500-1500. AC p-p volts, 0-4-14-40-140-400-1400-4000. Frequency response $\pm 3\%$ from 15 Hz to 3 MHz on all AC voltage ranges through 150 volts. Size: $7\frac{1}{4} \times 6\frac{3}{4} \times 3\frac{3}{4}$ ". For 105-125v 50/60 Hz AC. With AC ohms/DC probe. Shpg. wt., 7 lbs.
38 E 48512 No Money Down* Net 95.00

NEW! MODEL 229 AC CURRENT LEAKAGE TESTER

- Measures AC Current As Low As 5μ a

Tests 120 volt AC appliances and electrical equipment for AC current leakage. All ranges protected up to 150 VAC. Ranges: AC current; 0-0.3, 1, 3, 10 mA., AC Voltage; 0-150. Battery Test; Replace-Good. Resolution; 5μ a on 0-0.3 mA range. Accuracy; $\pm 2\%$ at 60 Hz. Input Impedance; 1.5K ohms. Input Resistance; 500K ohms on voltage range. Complete with test leads, batteries, and operator's manual. Size: $5\frac{1}{4} \times 7 \times 3\frac{1}{4}$ ". Shpg. wt., 4 lbs.
38 E 48684 No Money Down* Net 90.00



90⁰⁰

ACCESSORIES for VOM's and VTVM

Stock No.	Model No.	For Model	Description	Wt.	Net
38 E 48066	1818	260 & 270 Series	Leather Case	2	12.00
38 E 48074	7500	Leads	Leads†	1	2.75
38 E 48082	0509	260 & 270 Series	50KV HV Probe	1/2	17.00
38 E 48090	0508	260 & 270 Series	25KV HV Probe	1/2	17.00
38 E 48520	0152	312	RF Probe	1/2	11.75
38 E 48538	0155	312	30KV HV Probe	1/2	17.00
38 E 48678	0577	313	Vinyl Case	1	17.00

†Does not fit roll top Models

†Banana Plugs, Allig. Clips

SIMPSON 92 PAGE BOOK "1001" USES OF THE 260 SERIES VOM. A MUST FOR EVERY STUDENT, TECHNICIAN, AND ENGINEER. WT., 1 LB.
38 E 48611 Net .50

SENCORE Professional Test Instruments

NEW! CG18 PORTABLE COLOR GENERATOR



Only **129⁹⁵** No Money Down*

- 10 RCA Standard Keyed Color Bars
- Interlace Control

Solid state, crystal controlled color generator. Battery operated for maximum portability. Battery operated for maximum portability. Special zener regulated DC power supply for greatest stability and reliability. Uses standard color bars... RCA licensed 10 standard keyed color bars, 10 vertical lines, 14 horizontal lines, crosshatch, and adjustable white dots. Snap tuning for channel 3, 4 and 5 eliminates unnecessary co-channel interference. Front panel timer controls. Interlace control stops dot bounce and pairing of horizontal lines that vary from set to set. Automatic shutoff. Crystal controlled sound carrier: 4.5 MHz for adjusting fine tuning. All steel handy case. Size 9 1/2 x 7 3/4 x 3 3/4". Shpg. wt., 7 lbs. less batteries.

38 E 53249X Net 129.95
"C" Batteries for CG18, 8 required.
99 E 62572 Net ea. .14

DELUXE Model CG141 COLOR GENERATOR



Only **169⁹⁵**

No Money Down*

- Temperature Controlled Circuits
- 2 New Color Patterns

Deluxe, lightweight color generator provides all standard patterns. Temperature control maintains a thermostatically controlled temperature above 80 degrees inside the case. Complete stability to 140°F. Two NEW patterns: A single dot and a single cross that can be centered or moved to any spot on the screen, simplifying both static and dynamic convergence. Snap tuning for channels 2 thru 6. An interlace control to stop dot bounce and form a perfectly round dot. New analyzing features; increased output of composite chroma (± 7 VPP). Sync signals (± 5 VPP) for new TV sets. High quality shock mounted plate glass mirror in lid for convenient set-up and convergence in the home. For 110V., 60 Hz AC. Size: 10x9x3 1/4". Shpg. wt., 9 lbs.

38 E 53181WX Net 169.95

FE14 FIELD EFFECT VOLT-OHM-MILLIAMMETER

• Mirrored Scale

Features all the advantages of a VTVM with the portability of a VOM. Ultra high input impedance, completely protected circuitry, and battery operated. Meter is diode protected and isolated from input. 15 megohm input resistance on DC and 10 megohm input impedance on AC allows accurate voltage measurements with minimum load. Zero center scale of 0.5V., is ideal for checking transistors. DC Volts: 0 to 1, 3, 10, 30, 100, 300 and 1000 full scale. AC Volts: (RMS) 0 to 1, 3, 10, 30, 100, 300 and 1000 full scale; (Peak-to-Peak) 0-2.8, 8.4, 28, 84, 280, 840, and 2800 full scale. Accuracy: DC $\pm 2.5\%$, AC $\pm 4.5\%$. Frequency Response: 10Hz to 10MHz. Ohmmeter: 0-1K, 10K, 100K, 10 meg, 1000 meg, with accuracy of $\pm 3\%$ linear arc. DC current: 0-100 μ a, 1 ma, 10 ma, 1 amp. Size: 7 1/2 x 5 1/4 x 3 3/4". Shpg. wt., 4 lbs.

38 E 53215 Net 69.95

NEW MODEL FE16 FET VOM. Same as above FE14 except accuracy: DC $\pm 1.5\%$; AC $\pm 3\%$. Shpg. wt., 4 lbs.

38 E 53306 Net 84.50

38 E 53223 L39A19 Hi-Volt Probe. Wt., 1/2 lb. Net 9.95



69⁹⁵

NEW! TF151 IN OR OUT OF CIRCUIT TRANSISTOR AND FET TESTER

With Special Reference Book for Testing Transistors and FET's

Tests all transistors and field effect transistors in or out of circuit. Accurate, easily read 6" meter. Tests for AC Beta and out of circuit I_{cho} leakage. Increased current check for high power transistors makes tests more accurate. Special tests for critical RF transistors like GE9's. Also makes the following special tests on FET's: True GM mutual conductance in or out of circuit; I_{gss} leakage checked out of circuit; Special Gate 2 check provided for two gate FET's; Special I_{ds} (Zero Bias) current check provided for matching FET's or for industrial "culling"; Special positive bias test for new enhancement FET's. Included is a special reference book clearly showing all information necessary for testing a transistor or FET and the results to expect. For 115 VAC. Size: 9 1/2 x 7 1/2 x 6". Shpg. wt., 9 lbs.

38 E 53272X Net 129.50



129⁵⁰ No Money Down*

NEW! PS148 DUAL PURPOSE OSCILLOSCOPE/VECTORSCOPE

Precision, wideband 5" oscilloscope with the features of a professional vectorscope. Chroma bandpass and subcarrier alignment with one vector pattern. Minimum loading prevents distorted vector pattern. Impedance of 27 megohms with built-in low capacity probe; 2.7 meg with direct probe. Vertical amplifier response from 10 Hz to 5.2 MHz ± 1 db. Rise time: 0.055 μ sec. High vertical amp. sensitivity of 0.017 v. RMS/inch def. Extended horizontal sweep freq. from 5 Hz to 500 kHz in 5 overlapping ranges. High stability in positive sync. Variable control for locking-in of complex waveforms. External inputs for horizontal sweep and external sync on front panel. Horizontal retrace blanking. Steel case and carrying handle. Size: 11x9x15 1/2". For 115 VAC, 60 Hz.

38 E 53280WX Shpg. wt., 25 lbs. Net 229.50

38 E 53290WX 3963 Demodulator Probe Net 5.75

NEW! SM152 SELF-CONTAINED SOLID STATE SWEEP AND MARKER GENERATOR

Solid state sweep and marker generator with wide, 10" tuning dial. Ultra-flat linear sweep output (from 10 MHz to 920 MHz). 6 bands cover all VHF, UHF, and IF frequencies. Sweep aligns the VHF and UHF tuners, IF and the chroma bandpass. RF sweep output calibrated and variable from 10 μ v to 0.1 v. Ultralinear sweep width calibrated from 0.3 to 15 MHz. Crystal controlled IF markers at 39.75, 41.25, 41.67, 42.17, 42.67, 44.25, 45.75, and 47.25 MHz. Preset chroma outputs of 0-2v. P-P at 3.58 MHz. 3.58 MHz sweep signal at IF frequencies for direct injection into the IF. Crystal controlled markers for: chroma at 3.08, 3.58 and 4.08 MHz; FM IF at 10.7 MHz plus 10.6 and 10.8 MHz bandwidth markers. With all leads, matching pad and detector probes. 13 1/2 x 9 1/2 x 5 1/4".

38 E 53314WX Shpg. wt., 17 lbs. Net 395.00



229⁵⁰



395⁰⁰ No Money Down*

OTHER SENCORE TEST EQUIPMENT

NEW Model TF17 Compact In-Out Transistor FET Tester. Shpg. wt., 7 lbs.

38 E 53256X Net 109.50

NEW Model FE149 Senior Field Effect Meter

38 E 53264X Shpg. wt., 7 lbs. Net 149.50

Model SS137 Sweep Circuit Analyzer.

38 E 53157 Shpg. wt., 12 lbs. Net 94.50

Model TR115 Transistor-Diode Checker.

38 E 53140 Shpg. wt., 3 lbs. Net 29.95

Amprobe, B & K, and Mercury Test Instruments

AMPROBE "SNAP-AROUND" CLAMP-ON AC VOLT AMMETERS WITH ROTARY SCALE

AS LOW AS
24⁵⁰



RS-1-2-3

JUNIORS

Amprobe meters measure AC current and AC voltage without breaking the circuit. To measure current, snap the trigger-operated jaws around single conductor. Meter instantly indicates correct reading. Use furnished safety leads for voltage measurements. Rotary scale shows only scale in use. Accuracy to $\pm 3\%$. Designed for 60 cycle circuits. Have impact-proof cases, unbreakable plastic magnifying meter window, self-shielded meter movement. Complete with carrying case and voltage test leads. Shpg. wt., 2 lbs.

AMPROBE RS-1

Meter measures: AC AMPS: 0-6-15-40-100, AC. Volts 0-150-600. Measures up to $1\frac{1}{4}$ " dia. conductors, to $1\frac{3}{4}$ " x $1\frac{1}{2}$ " bars. $7\frac{1}{2}$ " long, $2\frac{3}{8}$ " wide, $1\frac{1}{2}$ " thick. Scale length $2\frac{1}{4}$ ".

38 E 13011 No Money Down* Net 44.85

AMPROBE RS-2

Same as model RS-1 except has 0-150-300 volts AC range.

38 E 13029 No Money Down* Net 44.85

AMPROBE DELUXE RS-3

Extra versatile meter also includes 0-2000 ohm range, 25 ohms mid-scale. AC Volts ranges 0-150-300-600, AC Amps 0-6-15-40-100-300. Includes case, ohmmeter, battery attachment and volt-meter leads.

38 E 13037 No Money Down* Net 50.50

AMPROBE JUNIORS

Lighter duty, smaller versions of standard Amprobes. Will measure up to $\frac{1}{2}$ " dia. conductors $4\frac{3}{4}$ " long, $1\frac{3}{8}$ " thick, $2\frac{1}{2}$ " wide, $1\frac{1}{8}$ " long scale. Rugged construction with ribbed, non-slip case. For 60 cycle AC. Shpg. wt., 1 lb.

STOCK NO.	MODEL	AC AMPS	AC VOLTS	NET PRICE
38 E 13052	Y25	0-25	0-125-250	24.50
38 E 13094	Y550	0-50	0-150-600	24.50
38 E 13102	Y500	0-100	0-150-600	24.50

Model P1—Carrying Case for Amprobe Juniors. Wt. $\frac{1}{2}$ lb.

38 E 13128 Net 3.25



PORTABLE COLOR GENERATORS FOR TV

Model 1242

99⁹⁵

No Money Down*



Model 1245

134⁹⁵

No Money Down*



DEGAUSSING COIL—Reg. Price 2.49

Only **1^c** With purchase of either Model 1242 or 1245 Color Generator.

MODEL 1242 SOLID STATE COLOR GENERATOR. Produces station quality waveforms for quick easy convergence and color adjustments. High stability over wide temperature ranges. Features dot, cross-hatch, horiz. and vert. lines and color patterns on channels 3 and 4. Over 5000 μ v RF output, built-in gun killer with Miniclipps for easy connection. For 105-125 VAC, 60 Hz. Size: $2\frac{1}{2} \times 4 \times 9\frac{3}{4}$ ".

38 E 17210 Shpg. wt., 3 lbs. Net 99.95

Model 1242 plus Degaussing Coil

38 E 17285M Shpg. wt., 4 lbs. Net 99.96

DELUXE MODEL 1245 SOLID STATE COLOR GENERATOR. Small enough to carry in your tube caddy, it provides actual station-type sync pulse to accurately set the color killer threshold control. Features instant warmup; RF output on channels 3, 4, or 5, without removing cabinet. Provides crystal-controlled rainbow color display, dot pattern, crosshatch, horizontal and vertical lines. Small-step crystal controlled count circuit gives greater reliability and stability of color, dots and lines. Dots are smallest possible with adjustable brightness. Horizontal lines are just one scanning line thick. Includes chroma level control for sync trouble shooting. With RF cable. For 105-125 v., 60 Hz AC. Size: $2\frac{7}{8} \times 8\frac{1}{2} \times 8\frac{3}{8}$ ".

38 E 17160WX No Money Down* Shpg. wt., 4 lbs. Net 134.95

Model 1245 plus Degaussing Coil

38 E 17293WXM Shpg. wt., 5 lbs. Net 134.96

Degaussing Coil alone. Shpg. wt., 1 lb.

99 E 40248 Net 2.49

POPULAR MERCURY TEST INSTRUMENTS—Kit and Factory Wired

MERCURY 1400 IN-CIRCUIT CAPACITOR CHECKER KIT



KIT

29⁹⁵

Wired

39⁹⁵

Provides a special low testing voltage of 2.9 volts AC to prevent damage to even the most delicate transistor type electrolytics. Automatically Indicates shorted or open capacitors. Detects shorted capacitors of all types 'in-circuit' with shunt resistance as low as 6 ohms. Detects open capacitors of all values down to 7 pF with shunt resistance as low as 150 ohms. Indicates value of electrolytics 'in-circuit' from 2 mfd to 450 mfd. All functions indicated on front panel. Dimensions $10\text{W} \times 6\frac{1}{4}\text{H} \times 4\frac{1}{2}\text{D}$.
38 E 37051 Shpg. wt., 8 lbs. Net 29.95
Model 1400 As above but factory wired.
38 E 37010 No Money Down* Net 39.95

MODEL 1101K PORTABLE TUBE TESTER KIT



Kit

49⁹⁵

Wired

69⁹⁵

A fast, accurate, portable tube tester in easy-to-build kit form. Makes dynamic cathode emission tests on Novars, Compactrons, 10-pin types and others. Shorts are detected fast. Tests all sections of multi-section tubes. Has sensitive $3\frac{1}{2}$ " D'Arsonval meter protected against burnout. Sockets are of long lasting construction, includes pin straighteners, CRT cable, and scuff-proof carrying case. $8\frac{1}{2} \times 11\frac{3}{4}$ ". Shpg. wt., 6 lbs.
38 E 37044 No Money Down* Net 49.95
Model 1101, as above but factory wired.
38 E 37093 No Money Down* Net 69.95

DELUXE MODEL 2000 TUBE and TRANSISTOR TESTER



Wired Only

129⁹⁵

No Money Down*

Quickly tests dynamic mutual conductance. Tests all the newest tube types; novistors, 10-pin types, hybrids, compactrons, thyratrons, European types, hi-fi, auto radio, industrial, and voltage regulators. Tubes checked in seconds with easy-to-read chart on attractive 2-tone panel. Tests for shorts, leaks, emission and gas. Also tests transistors, diodes and power transformers. Over 100 megohm sensitivity. Built-in custom pin straighteners. Size: $18\frac{1}{2} \times 10\frac{1}{2} \times 4\frac{3}{4}$ ". Shpg. wt., 16 lbs.

38 E 37077WX No Money Down* Net 129.95

Professional Test Equipment by **B&K**

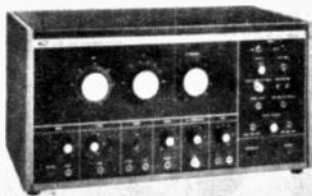

NEW! MODEL 1077 COLOR AND B&W TV ANALYST

379⁹⁵

No Money Down*

- For Checking Every Stage In a Color and B&W Receiver

Designed to simplify and speed servicing of black and white, color, UHF, VHF, tube-type and transistorized receivers. Generates signals for point-to-point signal injection anywhere in a TV receiver. Supplies a complete test pattern by means of a flying spot scanner system. Has RF outputs at all VHF and UHF channels plus IF from 20-48 MHz. Has outputs at 4.5 MHz with 1000 cycle audio for TV sound analyzing as well as outputs for checking horizontal output transformers sync, video, chroma, and sweep sections of a TV receiver. Checks B+ boost and gives high voltage indication. Provides high level keying pulse for testing AGC and color circuitry. Provides keyed rainbow color signals for analyzing color circuitry. Complete with test leads and standard test pattern slide transparencies. For 105-125 VAC, 60 Hz. Size: 17 x 10 1/4 x 10". Shpg. wt., 32 lbs.

38 E 17244WX

Net 379.95



NEW! MODEL 415 SOLID STATE SWEEP/MARKER GENERATOR

349⁹⁵

No Money Down*

- Crystal Controlled RF Output on Channels 4 & 10

Deluxe instrument can completely sweep align the UHF, VHF tuner, IF and the chroma bandpass. Accurate overall alignment can be accomplished by feeding RF output (channel 4 or 10) to antenna terminals of the receiver. True post injection of 11 crystal controlled markers. Can use all of the markers simultaneously or individually. Features Electronic Sweep, and exclusive marker tilt and amplitude. Visual reproduction of alignment curve provides constant reference and minimizes errors. Selectable output impedance of 72 or 300 ohms. 15 kHz filter eliminates need to disable high voltage. Video sweep allows alignment by manufacturers recommended procedure. 2 low impedance bias supplies of ± 0.25 VDC for solid state sets and 1 bias supply of ± 0.50 VDC for vacuum tube sets. Completely solid state with FET's. Size: 17 x 10 1/4 x 10".

13 E 17251WX Shpg. wt., 22 lbs. Net 349.95

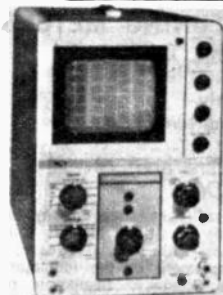

MODEL 1450 "DIAGNOSTIC" OSCILLOSCOPE WITH INTERMITTENT ANALYZER

279⁹⁵

No Money Down*

- Features Automatic Intermittent Signal Tracing Without Your Presence

Features a unique time saving intermittent analyzer that automatically gives and holds a visual indication when an intermittent occurs. You can be out on a service call while this scope is working for you. Easily reproduces 3.58 MHz burst signal in color TV receiver. Has horizontal/vertical push-pull amplification. Response: vertical, ± 3 db. 1 Hz to 4.5 MHz; horizontal, ± 3 db. 1 Hz to 400 kHz. Sensitivity: vertical, 50 mv rms/inch; horizontal, 0.6 volts rms/inch. Sweep: 5 Hz to 500 kHz. Synchronization: automatic, + and - INT., 60 Hz, EXT. 17 1/4 Dx 13 3/8 Hx 8 3/4" W. For 110-120V. 60 Hz AC. Shpg. wt., 27 lbs.

38 E 17238WX

Net 279.95

NEW B&K SERVICING PROBES



Model FP-3 Dyna-Flex 3-Point Probe. Easy one-hand way to check transistors, diodes and components in Printed Circuit Boards. Needle tips are spring loaded for proper contact. Color-coded leads terminate in insulated alligator clips.

38 E 17269 Shpg. wt., 8 oz. Net 12.95

Model HV-30 HI-Volt Probe with Detachable Meter. Direct reading 0-30,000 VDC on separate 1 1/4" meter. Probe length—14 1/2". With case, leads and instruction manual.

38 E 17277 Shpg. wt., 1 1/2 lbs. Net 24.95

OTHER B&K TEST INSTRUMENTS

Model 606 Emission-Type Tube Tester. Checks all standard TV and radio tube types: nuvistors, 10-pin, 12-pin compactrons, voltage regulators, thyratrons, many industrial and European HI-FI tubes. Checks for all shorts, grid emission, leakage, gas, and quality under dynamic load. Compact, sturdy, leatherette covered carrying case. Size: 8 1/2 x 11 x 4 3/4".

38 E 17145 Shpg. wt., 8 lbs. Net 84.95

Model 120 VOM. Accurate 5 1/2" meter offering 61 ranges. 8 AC Volts: 0.1-2-3-12-60-300-600-1200-6000; 9 DC Volts: 0.3-1.2-3-12-60-300-600-1200-6000; DC Current: 0.60-300 μ A, 0.1-2-12-120-600 mA, 0-12 amps. Resistance: 0-200-2K-200K-2 meg-20 meg- Ω to ∞ . Shpg. wt., 4 lbs.

38 E 17194 Net 58.50

Model 970 Transistor Circuit Analyst. In-circuit test of any stage of amplification. Out-of-circuit Beta and leakage current. Power supply has 5 amp output, variable from 1.5 to 15 volts. AM/FM generator outputs: 250 MHz to 2000 MHz AM; 10 MHz to 11.4 MHz AM or FM; 88 to 108 MHz FM. For 105-125 VAC, 50/60 Hz.

38 E 17178WX Shpg. wt., 24 lbs. Net 209.95

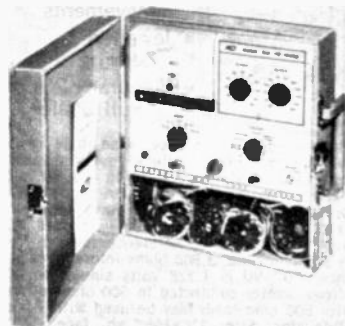

MODEL 465 CRT TESTER REJUVENATOR

94⁹⁵

- For Color or Black and White CRT's
- Rejuvenates Low Emission Picture Tubes

- Repairs CRT While It's In The Set

Valuable time saver! Compact unit checks and rejuvenates virtually all CRT's while still in the TV set. The Model 465 includes many important advances. Features: continuously variable heater voltage control; automatically timed rejuvenation voltage avoids accidental damage to tubes. The voltage to Grid 1 and Grid 2 are also continuously adjustable. Has scuff-free, shock-proof vinyl case, book type tube chart, pilot light and large easy to read meter. 11 1/2 x 10 1/2 x 4 1/2". For: 117 volts 50/60 Hz AC. Wt., 6 lbs., 13 oz.

38 E 17186W No Money Down* Net 94.95

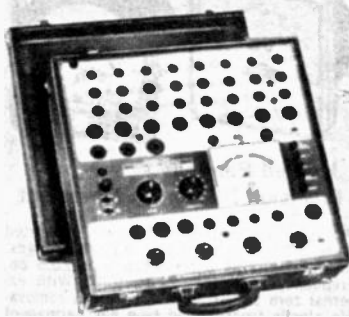

MODEL 707 MUTUAL CONDUCTANCE TUBE TESTER

199⁹⁵

- Tests All New And Old Type Tubes
- Virtually Obsolescent Proof

The deluxe "707" measures true dynamic mutual conductance in seconds. Tests all new type tubes including nuvistors, 10-pin types, 12-pin compactrons, hybrids, European types, voltage regulators, thyratrons etc. and provides for future new sockets. Checks for all shorts, grid emission, leakage and gas. Large 4 1/2" meter with easy-to-read "Replace-Good" scale for quick life tests. Checks each section of multi-grid tubes separately. Lists commonly used tube types on panel with complete listing of cover reference chart. Includes 7, 9, and 10-pin tube straighteners and handsome leatherette-covered carrying case. 11 1/2 x 10 1/2 x 4 1/2" H. Size: 16 1/2 x 15 3/4 x 5 1/2". Shpg. wt., 15 1/2 lbs.

38 E 17152WX No Money Down* Net 199.95

* See Page 11 for Full Credit Details on Easy Pay Plan

Quality Panel Meters

MINIATURE FM & AM TUNING METERS

- Moving Coil Principle
- Highly Sensitive
- Only $\frac{3}{8}$ " Square and 1" Deep



Can be easily installed on any tuner. The remarkable sensitivity enables you to tune in stations with surprising ease. Galvanometer movement of the indicator assures complete accuracy. Insulation resistance between case and terminals: 100 megohms/500 V. Solder lugs are provided at the back. Plastic case. Complete with instruction sheets. Shpg. wt., 4 ozs.

FM TUNING METER

FM TUNING METER. Can be connected between radio detector and AF amplifier. The indicator will rest in the center when station is tuned in. Current sensitivity ± 100 microamps on both sides DC. Internal resistance about 1200 ohms. Imported. **99 E 50262** Net 2.50

AM TUNING METER

AM TUNING METER. Can be connected into the second IF stage of AM radio. Graduated scale with maximum deflection of pointer indicating station being tuned in. Sensitivity 500 μ A. on full scale. Int. resistance about 410 ohms. Imported. **99 E 50254** Net 2.90

LAFAYETTE MINIATURE LEVEL METER

- Highly Sensitive
- Front Panel Area Only $\frac{7}{8}$ Wx $\frac{1}{4}$ "H
- Rubber Cushion Mount



A miniature clear plastic front level meter which will indicate relative audio levels for tape recorders, FM sets or transistorized audio equipment. Actual size of meter is $\frac{7}{8}$ "Dx1Wx $\frac{1}{4}$ "L. Internal resistance—260 ohms. Full scale 500 microamps. Shpg. wt., 1 oz. Imported. **99 E 50361** Net 2.15

ULTRA-MINIATURE TUNING AND BATTERY METER

215

ONLY $\frac{3}{8}$ " IN DIA.
 $\frac{3}{4}$ " IN LENGTH



Ultra-miniature meter can be installed easily in a $\frac{3}{8}$ " diameter hole. Current sensitivity: 500 μ A; $\pm 15\%$ at full scale. Internal resistance: 500 ohms $\pm 10\%$. Imported. Shpg. wt., 3 oz. **99 E 50353** Net 2.15

METER RECTIFIER

only .45



A full wave, economical meter rectifier of exceptionally linear characteristics. Universal electrical replacement for all multi-meters, such as Lafayette's miniature V.O.M.'s. Single screw mount. Long terminals. 5 oz. Imported. **99 E 62077** Net .45

PANEL METERS WITH D'ARSONVAL MOVEMENTS

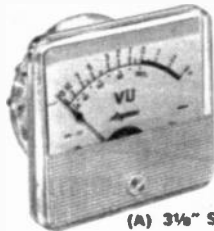

(A) $\frac{3}{8}$ " Square



(B) $\frac{3}{8}$ " Square

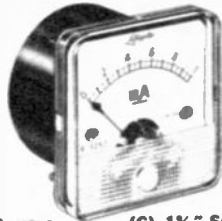

(C) $\frac{1}{4}$ " Square

- Jewelled Bearings

- Accuracy 2% Full Scale

High quality, precision built meters with better than 2% of full scale accuracy. All meters have 4 threaded mounting studs in corners, zero adjust screw and clear plastic fronts except (B) which has black bakelite. Terminal polarity on DC models is identified. (A) standard 3900 ohm "B" scale VU indicator. Includes full wave bridge rectifier, built-in bulb. Ammeters are highly damped, use linear calibrations. Dimensions: (A), (B), — $\frac{3}{8}$ " square, $2\frac{1}{2}$ x $1\frac{1}{2}$ " dial faces, $1\frac{1}{4}$ " overall depth, $1\frac{1}{4}$ " behind panel including terminals. Require $2\frac{1}{2}$ " diameter mounting hole. (C) miniature meters with silvered dials, black pointers — $1\frac{1}{4}$ " square fronts, $1\frac{1}{2}$ " overall front-to-back, with $1\frac{1}{4}$ " behind panel including $\frac{1}{4}$ " terminals. Require $1\frac{1}{2}$ " diameter round hole in panel. $1\frac{1}{4}$ " dial face. Supplied with mounting screws. Imported. Shpg. wt., 1 lb.

STOCK NO.	FIG.	RANGE	EACH	STOCK NO.	FIG.	RANGE	EACH
99 E 50437	A	"V.U. Meter	4.95	99 E 50544	C	0-50 DC Millamp.	2.75
99 E 50429	B	0-50 DC Microamp.	4.75	99 E 50531	C	0-100 DC Millamp.	2.75
99 E 50463	B	0-1 DC Millamp.	3.75	99 E 50494	C	0-50 DC Microamp.	3.25
99 E 50395	B	0-150 AC Volt	3.95	99 E 50601	C	0-10 DC Amp.	2.95
99 E 50528	C	0-1 DC Millamp.	2.95	99 E 50478	C	0-15 DC Volt	2.75
99 E 50536	C	0-5 DC Millamp.	2.75	99 E 50902	C	0-150 AC Volt	2.95

*Standard 3900 ohm "B" scale volume indicator, 0-100% modulation scale, —20 to +3VU illuminated scale.

MINIATURE LAFAYETTE VU METERS

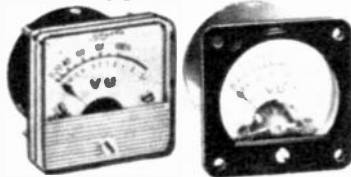

- Jeweled Bearings
- Precision D'Arsonval Movement

Precision VU meters with scale calibrated from —20 to +3 VU and 0-100% Ranges. Impedance: 7.5K ohms. Accuracy: ± 0.5 db. Frequency Response: 25 to 10KC. With external zero adjust. Square type has removable plastic front; round type has permanent glass front. Mount in $\frac{1}{2}$ "D hole. Wt., 8 oz. **99 E 50452** Square Face, $1\frac{1}{4}$ x $1\frac{1}{4}$ " Net 2.90 **99 E 50577** Round Face, $1\frac{1}{4}$ x $1\frac{1}{4}$ " Net 2.90

LAFAYETTE MINIATURE ILLUMINATED VU METER



- D'Arsonval Movements
- Jewelled Bearings
- Accuracy 2% of Full Scale

Illuminated dial for easy, wide-angle readability at all times. Volume level indicator, calibrated in standard —20 to +3 VU and 0-100% ranges. Uses precision carbon film multiplier resistor and full wave rectifier. Damped in accordance with standard VU meter requirements. Reference level 1 mw in 600 ohm line. 3,900 ohms internal resistance. "0" VU is 1.228 volts sine wave AC across meter connected to 600 ohm source with 600 ohm load. May be used with T-pad attenuator. Size: $1\frac{1}{4}$ x $1\frac{1}{2}$ " sq. face, $1\frac{1}{4}$ " overall behind panel. Imported. Shpg. wt., 8 oz. **99 E 50247** Net 3.95

LAFAYETTE EDGE-WISE PANEL METERS



(A)



(B)

VU METER (A)

Has precision D'Arsonval meter with 2% or better full scale accuracy. Calibrated and damped. Upper scale reads —20 to +3VU. Lower scale reads 0-100% modulation. Accurate to ± 0.5 VU from 30-15000 Hz. Size: $3\frac{1}{4}$ Wx $1\frac{1}{4}$ H. Overall depth is $3\frac{1}{2}$ " behind panel including terminals. Has stud-type solder terminals and zero adjustment screw. Shpg. wt., 1 lb. Imported. **99 E 50338** Net 5.95

BALANCE & TUNING METER (B)

Use these precision moving coil DC Ammeter meter movements as stereo balance indicators or as tuning indicators for FM tuners. Pointer at center of the scale indicates zero or null position. Current Sensitivity: ± 100 μ A on both sides. Complete with installation schematics. Clear plastic case. Meter body: $1\frac{1}{4}$ Lx $1\frac{1}{2}$ Wx $\frac{3}{8}$ "D. Depth behind panel 1". **99 E 50346** Shpg. wt., 1 lb. Imported. Net 2.50

Terminal Strips - Poly Rods & Sheets

BEAU BARRIER STRIPS

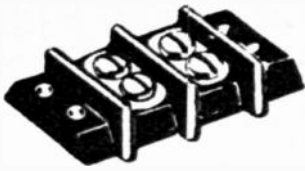

Sturdy closed back Barrier strips moulded in black Bakelite are ideal for permanent installations, as well as breadboard and experimental work. Sturdy barriers between terminal strips insure against accidental shorts. Two mounting holes on each end of strip insure ease of installation. See headings about each series for size specifications. Avg. wt., is 5 oz.

TYPE 19000 — 15 AMP

Leakage path between terminals is 3/8". Base is 7/8" wide x 1 13/32" high.

Stock No.	No. of Contacts	1-49	50-99
33 E 06018	1	.16	.13
33 E 06018	2	.17	.15
33 E 06034	3	.20	.17
33 E 06042	4	.25	.21
33 E 06050	5	.31	.26
33 E 06067	6	.36	.30
33 E 06075	7	.41	.35
33 E 06083	8	.47	.40
33 E 06091	9	.52	.44
33 E 06109	10	.59	.50
33 E 06117	11	.63	.53
33 E 06125	12	.70	.59
33 E 06133	13	.74	.62
33 E 06141	14	.80	.67
33 E 06150	15	.86	.72
33 E 06166	16	.91	.76
33 E 06174	17	.97	.81
33 E 06182	18	1.02	.85
33 E 06190	19	1.07	.90
33 E 06208	20	1.13	.95
33 E 06216	21	1.20	1.00

BAKELITE MOUNTING STRIPS

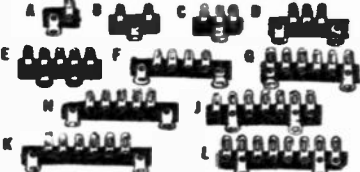

Cadmium plated steel lugs spaced 3/8" on centers. Bakelite strip is 3/8" wide x .062 in. thick. Ideal for supporting and joining electrical components. Type marked "H" have grounding lugs in addition to the number of terminals indicated below. Mount with No. 6 screw. Avg. wt., 1/2 lb. 5 per pkg.

Stock No.	Term.	Fig.	Pk. of 5	20 Pkg. of 5
32 E 12057	1	A	.18	3.25
32 E 12065	2	B	.20	3.70
32 E 12073	2*	C	.20	3.70
32 E 12081	3	D	.28	5.05
32 E 12099	3*	E	.30	5.50
32 E 12107	4	F	.31	5.00
32 E 12115	4*	G	.33	5.95
32 E 12123	5	H	.35	6.40
32 E 12131	5*	J	.36	6.85
32 E 12149	6	K	.39	7.03
32 E 12156	6*	L	.40	7.20

KIT OF 48 SOLDER LUG STRIPS

129



Handy assortment of 48 solder lug terminal strips with 8 of each type from 1 thru 6 lugs. Shpg. wt., 12 oz. Imported. 99 E 61111 Net 1.29

TYPE 19000 — 20 AMP

Leakage path between terminals is 7/10". Base is 1 1/8" wide x 1 1/2" high.

Stock No.	No. of Contacts	1-49	50-99
33 E 06285	1	.19	.16
33 E 06273	2	.20	.17
33 E 06281	3	.26	.22
33 E 06299	4	.34	.28
33 E 06307	5	.41	.34
33 E 06315	6	.47	.39
33 E 06323	7	.55	.46
33 E 06331	8	.62	.52
33 E 06349	9	.68	.57
33 E 06356	10	.76	.64
33 E 06364	11	.82	.69
33 E 06372	12	.89	.74
33 E 06380	13	.96	.80
33 E 06388	14	1.03	.86
33 E 06406	15	1.10	.92
33 E 06414	16	1.18	.99
33 E 06422	17	1.24	1.04
33 E 06430	18	1.31	1.10
33 E 06448	19	1.39	1.16
33 E 06455	20	1.46	1.22

TYPE 22000 — 30 AMP

Leakage path between terminals is 9/10". Base is 1 1/2" wide x 5/8" high.

Stock No.	No. of Contacts	1-49	50-99
33 E 06513	1	.22	.18
33 E 06521	2	.23	.20
33 E 06539	3	.32	.27
33 E 06547	4	.40	.34
33 E 06554	5	.49	.41
33 E 06562	6	.58	.48
33 E 06570	7	.67	.56
33 E 06568	8	.75	.63
33 E 06596	9	.83	.70
33 E 06604	10	.93	.78
33 E 06612	11	1.01	.84
33 E 06620	12	1.10	.92
33 E 06630	13	1.19	.99
33 E 06646	14	1.28	1.07
33 E 06653	15	1.37	1.14

HEAVY DUTY SCREW COLLAR STRIPS



3/8" bakelite, 7/8" wide Nickel Plated Brass Screw Terminals, tinned solder lugs. Avg. shpg. wt., 4 oz.

Stock No.	Term.	1	10	100
32 E 64488	2	.20	.16	.16
32 E 64496	3	.22	.20	.18
32 E 64504	4	.27	.24	.22
32 E 64512	5	.33	.31	.28
32 E 64520	6	.39	.36	.32
32 E 64538	7	.45	.41	.38
32 E 64546	8	.50	.45	.40
32 E 64553	9	.56	.48	.43
32 E 64561	10	.62	.56	.50

TERMINAL STRIPS



High quality bakelite terminal strips. Solder lugs mounted on 3/8" thick insulation. Available with 2 thru 10 solder lugs and screw terminals. Mounting holes for 6-32 screws. Avg. shpg. wt., 4 oz. 5 Per Package.

Stock No.	Term.	Pkg. of 5
32 E 12164	2	.30
32 E 12172	3	.55
32 E 12180	4	.68
32 E 12198	5	.85
32 E 12206	6	.98
32 E 12214	7	1.13
32 E 12222	8	1.20
32 E 12230	9	1.40
32 E 12248	10	1.60

POLYSTYRENE RODS, TUBES AND SHEETS



Feature high dielectric strength, dimensional stability Low loss, arc-resistance, and insulating properties. Moisture proof. Easily sawed, drilled and tapped. Sheets and rods are transparent, tubing satin finish.

POLYSTYRENE SHEETS

Stock No.	Size	Thick	Shpg. WT.	Net Each
13 E 51014	12x12	3/8	8 oz	4.87 3.66
13 E 51022	12x12	3/8	10 oz.	4.70 4.23
13 E 51030	12x12	1/2	12 oz.	5.39 4.85
13 E 51048	12x12	3/4	1 lb.	7.01 6.31
13 E 51055	12x12	1/2	1 1/2 lb.	7.99 7.19
13 E 51063	12x24	3/8	1 lb.	7.64 6.88
13 E 51071	12x24	3/8	1 1/4 lb.	8.97 8.07
13 E 51089	12x24	1/2	1 1/2 lb.	10.29 9.26
13 E 51097	12x24	3/4	2 lbs.	12.09 11.00
13 E 51105	12x24	1/2	3 lbs.	15.34 13.81

1 1/2" POLYSTYRENE RODS

Stock No.	Size	Shpg. WT.	Net Each
13 E 51113	12"x1/2"	2 oz.	.83 .82
13 E 51121	12"x3/8"	3 oz.	.87 .86
13 E 51139	12"x1/2"	5 oz.	.12 .11
13 E 51147	12"x3/8"	6 oz.	.18 .16
13 E 51154	12"x3/8"	6 oz.	.25 .22
13 E 51162	12"x1/2"	6 oz.	.47 .42
13 E 51170	12"x3/8"	8 oz.	.71 .64
13 E 51188	12"x3/8"	8 oz.	.90 .80
13 E 51196	12"x3/8"	8 oz.	1.30 1.23
13 E 51204	12"x1"	8 oz.	1.88 1.67

12" POLYSTYRENE TUBES

Stock No.	O.D.	I.D.	Shpg. WT.	Net Each
13 E 51212	1/2"	3/8"	2 oz.	.10 .09
13 E 51220	3/8"	3/8"	3 oz.	.14 .13
13 E 51238	1/2"	1/2"	3 oz.	.18 .16
13 E 51246	1/2"	3/8"	3 oz.	.25 .22
13 E 51253	3/8"	1/2"	4 oz.	.31 .28
13 E 51261	3/8"	3/8"	5 oz.	.39 .35
13 E 51270	1"	3/8"	6 oz.	.55 .49

POLYSTYRENE CEMENT AND COIL DOPE



Pure polystyrene dissolved in thinner. For coating, doping, sealing coils, and for cementing polystyrene to polystyrene. 2 oz. bottle. Shpg. wt., 4 oz. 13 E 60031 Net .55
THINNER FOR ABOVE, 2 oz. 13 E 60049 Net .59

CRIMPING TOOL AND TERMINALS



A complete crimp tool kit for home, shop. Solderless terminal crimp tool cuts any size wire up to 10 gauge, strips wire easily with clearly marked gauges. Crimps terminals quickly with precision tooled crimping dies. Easy to use with comfortable insulated handles. Complete with plastic box of assorted solderless terminals and connectors. Imported. 13 E 70006 Shpg. wt., 1 lb. Net 2.19

MASONITE BREADBOARD

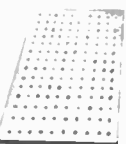

Ideal for Kit Builders
Tempered masonite board with holes spaced 1/2" apart to facilitate mounting of parts. Size 7 7/8" x 11 3/4" x 1/8" thick. Holes 3/4" diam. Shpg. wt., 12 oz. 19 E 17012 Net .25

Printed Circuit Components-Experimenters Items

PERFORATED COPPER-CLAD AND UNCLAD BOARDS

- Ideal for Transistor and Subminiature Circuitry

These sturdy perforated boards are the ideal base for builders, experimenters, and labs to mount miniaturized components. Two types available; either high grade bakelite for wired circuits, or one side copper-clad for "printed" circuitry. Holes are $\frac{1}{16}$ " diameter with $\frac{3}{32}$ " between hole centers. All boards are $\frac{1}{8}$ " thick. For contacts, the flea clips listed on this page are ideal. Avg. shpg. wt., 6 oz.



FLEA CLIPS FOR TRANSISTOR AND SUBMINIATURE CONTACTS

"Flea" clips are specially designed for subminiature work. Fit perfectly in holes in perforated copper-clad and unclad boards with $\frac{1}{16}$ " dia. holes. Made of beryllium copper, silver plated finish. Simply insert wire thru hole for positive grip contact.

PERFORATED CLAD

Stock No.	Net	Each	Lots of	Size
19 E 36012	.35	.30	.24	2 $\frac{1}{2}$ "x3 $\frac{3}{4}$ "
19 E 36020	.64	.52	.47	3 $\frac{1}{2}$ "x6 $\frac{3}{4}$ "
19 E 36038	1.15	.96	.87	7 $\frac{1}{2}$ "x6 $\frac{3}{4}$ "
19 E 36046	1.99	1.58	1.42	10 $\frac{1}{2}$ "x7 $\frac{3}{4}$ "
				18x7 $\frac{3}{4}$ "

PERFORATED UNCLAD

Stock No.	Net	Each	Lots of	No. of Holes	Stock No.	Net	Each	Lots of
19 E 36053	.25	.20	.18	17x12	19 E 36053	.25	.20	.18
19 E 36081	.45	.40	.35	35x19	19 E 36081	.45	.40	.35
19 E 36079	.75	.65	.60	39x35	19 E 36079	.75	.65	.60
19 E 36087	1.20	1.08	.97	56x38	19 E 36087	1.20	1.08	.97
19 E 36095	1.99	1.79	1.65	95x38	19 E 36095	1.99	1.79	1.65

UNPERFORATED COPPER CLAD LAMINATE

Unperforated, finest quality XXXP bakelite and G-10 epoxy glass bases one side copper laminate clad boards for printed circuit work. Avg. shpg. wt., 4 oz.

Stock No.	XXXP Bakelite	Net
19 E 71019	9" x 12"	1.50
19 E 71027	6" x 4 $\frac{1}{2}$ "	.49
19 E 71035	3" x 4 $\frac{1}{2}$ "	.30
19 E 71043	2" x 4 $\frac{1}{2}$ "	.25
19 E 71050	3" x 2 $\frac{1}{4}$ "	.24

Stock No.	Epoxy Glass	Net
19 E 37044	9" x 12"	4.20
19 E 37051	6" x 4 $\frac{1}{2}$ "	1.24
19 E 37089	3" x 4 $\frac{1}{2}$ "	.61
19 E 37077	2" x 4 $\frac{1}{2}$ "	.40
19 E 37085	3" x 2 $\frac{1}{4}$ "	.34

"TECHNIQUES" PRINTED CIRCUIT KITS AND SUPPLIES

- For The Builder—Experimenter—Student—Technician

SCREEN PRINTING KIT NO. 5008

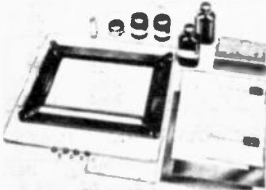

This Screen Printing Kit provides an accurate and rapid means for making larger sample quantities or even short production runs of printed circuits. Frame measures 8"x12". It comes with silk already stretched and is hinge mounted on durable formica covered plywood base. Neoprene squeegee is mounted in sturdy all wood handle. Photo stencil film and all chemicals necessary for making stencils. Complete with screen process etch resistant ink, blockout medium, tape masking, solvent, spare bottle and complete instructions.

19 E 68247 Net 29.95

TECHNICIANS KIT NO. 5003



Contains 8 copper clad single faced and 2 double faced boards from 4 $\frac{1}{2}$ "x6" to 3x2 $\frac{1}{4}$ "; 6 tube sockets; 1 tape resist; 1 liquid resist; eyelets; 1 drill, etching solution and directions. In plastic box size: 9 $\frac{3}{4}$ "x6 $\frac{1}{2}$ "x2". Shpg. wt., 1 lb. 5 oz.

19 E 68064 Net 9.75

EXPERIMENTERS KIT NO. 5002



A good kit to start off learning the technique of etched circuitry. Contains 6 copper clad boards from 4 $\frac{1}{2}$ "x3" to 3x2 $\frac{1}{4}$ "; 3 tube sockets; Dots; 1 pack etchant; 1 tape resist; In eyelet assortment; drill and directions. In plastic box size 5 $\frac{1}{4}$ "x1 $\frac{3}{4}$ "x4".

19 E 68072 Shpg. wt., 8 oz. Net 4.75

PRESENSITIZED COPPER CLAD PANELS

All are $\frac{1}{16}$ " thick copper clad one side. Except #2 sides are XXXP laminate † are G10 epoxy-glass laminate.

Stock No.	Type	Size	Net Ea.
19 E 68031	PXC-F*	6"x9"	2.00
19 E 68049	PXC-B*	6"x4 $\frac{1}{2}$ "	1.00
19 E 68056	PXC-C*	3"x4 $\frac{1}{2}$ "	.75
19 E 68254	PXE-F†	6"x9"	4.00
19 E 68262	PXE-B†	6"x4 $\frac{1}{2}$ "	2.00
19 E 68270	PXE-C†	3"x4 $\frac{1}{2}$ "	1.00
19 E 68445	PXC-FF* ‡	6"x9"	3.00
19 E 68452	PXC-BB* ‡	6"x4 $\frac{1}{2}$ "	1.50
19 E 68460	PXC-CC* ‡	3"x4 $\frac{1}{2}$ "	1.00
19 E 68478	PXE-FF† ‡	6"x9"	5.00
19 E 68486	PXE-BB† ‡	6"x4 $\frac{1}{2}$ "	2.50
19 E 68494	PXE-CC† ‡	3"x4 $\frac{1}{2}$ "	1.25

PROCESSING MATERIALS

Type PXD-8 eight ounce developer Net ea. 1.00

Type PXY-1 one ounce dye Net ea. .75

INDUSTRIAL LABORATORY KIT NO. 5100



Ready to use presensitized copper clad laminate cuts time to make prototype printed circuits. Kit contains 20-pieces single and double clad XXX-P and epoxy fiberglass laminates in assorted convenient sizes, presensitized and uncoated. 20 assorted printed circuit tube and transistor sockets. 2 rolls tape resist strip $\frac{1}{4}$ " and $\frac{1}{8}$ " wide. 200 die-cut tape resist circles $\frac{1}{4}$ " and $\frac{3}{16}$ " diameter. Bottle liquid resist and brush. Ball-point resist pen. Package of printed circuit eyelets and terminals, #51 drill, layout paper, exposure clamp, developing and etching solutions with trays. Full instructions and technical bulletins.

19 E 68015 Shpg. wt., 10 lbs. Net 29.95

PRINTEO CIRCUIT ACCESSORIES

Basic components for the experimenter-designer-lab-limited production-etc. in printed circuit construction. Highest quality materials-indispensable for prototype work.

TAPE RESIST

320' Rolls of Tape Resist (Black) Average Shpg. wt., 2 oz.

Stock No.	Type	Width	Net Ea.
19 E 68122	PRT1	$\frac{1}{16}$ "	.85
19 E 68130	PRT2	$\frac{1}{8}$ "	.75
19 E 68148	PRT3	$\frac{3}{16}$ "	.90
19 E 68155	PRT4	$\frac{1}{2}$ "	.90
19 E 68296	PRT8	$\frac{1}{4}$ "	1.00

RESIST CIRCLES Pkg. of 100 Ea.

19 E 68163	PRD-6	$\frac{3}{16}$ " diam.	.75
19 E 68304	PRD-8	$\frac{1}{4}$ " diam.	.75

TOUCH-UP RESIST

19 E 68171 PRL one ounce jar .50

EYELETS

19 E 68114 PEY12 125 Asst. Eyelets .60

PRINTED CIRCUIT TERMINALS

19 E 68312 PTE10 Pkg. of 10 .40

ECHANTS

19 E 68098 PE16 Pint 1.25
19 E 68106 PE32 Quart 2.25

COPPER CLAD LAMINATE ON EPOXY-GLASS

G-10 Grade Epoxy Glass with copper clad laminate. *Laminated one side. †Both sides laminated. All $\frac{1}{16}$ " thick.

Stock No.	Type	Size	Net Ea.
19 E 68221	PE-A*	9"x12"	6.00
19 E 68239	PE-F*	9"x6"	3.00
19 E 68205	PE-B*	4 $\frac{1}{2}$ "x6"	1.50
19 E 68213	PE-C*	4 $\frac{1}{2}$ "x3"	.75
19 E 68189	PE-D*	4 $\frac{1}{2}$ "x3"	.50
19 E 68197	PE-E*	2 $\frac{1}{4}$ "x3"	.40
19 E 68361	PE-AA†	9"x12"	7.00
19 E 68379	PE-FF†	9"x6"	3.50
19 E 68346	PE-BB†	4 $\frac{1}{2}$ "x6"	1.75
19 E 68353	PE-CC†	4 $\frac{1}{2}$ "x3"	.90
19 E 68320	PE-DD†	4 $\frac{1}{2}$ "x2"	.60
19 E 68338	PE-EE†	2 $\frac{1}{4}$ "x3"	.45

BALL POINT TUBES

Make resist patterns directly on copper clad boards. As easy to use as a ball point pen. Deposits line $\frac{1}{16}$ " wide. No need to "lay-out" colors of resist for color coding of circuiting.

Stock No.	Type	Color	Net ea.
19 E 68395	PRLT	Red	1.25
19 E 68403	PRLT	Black	1.25
19 E 68411	PRLT	Blue	1.25
19 E 68429	PRLT	Green	1.25
19 E 68437	PRLT	Yellow	1.25

VECTOR Boards, Terminals & Kits



VECTOR "PLUGBOARDS" AND RECEPTACLES

Ready-to-wire plugboards ideal for prototypes and short runs. Made of epoxy-paper $\frac{1}{8}$ " thick, meets MIL-P-22324; WE types are epoxy-glass $\frac{1}{8}$ " thick, meets MIL-18177. All boards have .062" holes on alternate intersections of a .1" grid. Eico Varicon contacts attached to board provide terminations. Type 838A is for printed circuits and has etched copper contact strips and etched contacts on .156" centers, .072" wide.

Stock No.	Mfrs. Type	Size	No. Contacts	Net Each		
				1-19	20-99	100-199
19 E 83238	837	3x4½"	12	2.33	2.10	1.98
19 E 83246	837WE	3x4½"	12	2.90	2.32	2.17
19 E 83253	812	4½x6½"	16	2.90	2.60	2.50
19 E 83279	838A	4½x6½"	22	2.81	2.53	2.36
19 E 83303	848WE	4½x6½"	35	6.00	5.40	5.12

RECEPTACLES have solder tabs and mounting holes.

Stock No.	Mfrg. Type	No. Contacts	Used With	Net Each
19 E 83329	R612-1	12	837, 837WE	7.80
19 E 83337	R616-1	16	812	2.24
19 E 83345	R635	35	848WE	4.91
19 E 83352	R644	44	838A	2.62

VECTOR BOARDS FOR INTEGRATED CIRCUITS

"D.I.P." plug-in mounting boards for 14 or 16 lead dual-in-line integrated circuits. Boards are $\frac{1}{8}$ " thick epoxy paper material measuring 4½"x6½" overall with an aluminum frame on 3 sides which fits $\frac{1}{8}$ " card guides. Boards have overall grid of .041" diameter holes spaced on 0.1" centers and an X-Y matrix pattern of .070" etched copper lines running vertically on board and horizontally on board back, except as follows: —2 has etched connector fingers only and no matrix; —3 type has matrix on rear side only. Avg. Shpg. wt., 12 oz.

Stock No.	Mfrs. Type	Desc.	Net Each		
			1-19	20-99	100-199
19 E 83527	3474	4½"x6½" 44 etched contacts, matrix	18.50	9.45	8.82
19 E 83519	3474-2	4½"x6½" 44 etched contacts, no matrix	7.95	7.16	6.68
19 E 83535	3474-3	4½"x6½" 22 etched contacts, matrix back side	8.00	7.27	6.79
19 E 83501	P-139	Line cutter chisel	Net Each 1.50		

VECTOR EXPERIMENTS CHASSIS KITS

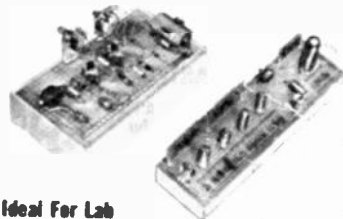

Designed for rapid set-up of experimental tube or transistor circuitry. Each kit contains 1 or more prepunched phenolic boards all $\frac{1}{2}$ " thick, aluminum channels for mounting, an assortment of sockets, push-in terminals types T9.4 and T30N2, spring clips, assorted screws, nuts spacers, metal strap, brackets, installation tool for T30N2 and push-in terminals, 6 sheets of layout paper, plastic parts box and instructions.

Kit No. 20X for tube Circuitry. Includes 1 punched board 4¾x8½" and 8 asstd. tube sockets.

Kit No. 21X for Tube and Transistor Circuitry. Includes 3 boards, 4¾x17", 1¾x1.9", 8½x1.9", 4 transistor sockets, 8 asstd. tube sockets, 14 diode clips and wire.

Kit No. 22X for Transistor Circuitry. Includes 3 boards, 4¾x8½", 1¾x1.9", 8½x1.9", 8 asstd. transistor sockets, 12 diode clips and wire.

Stock No.	Vect. No. Lbs.	Net Each in Lots of		
		1-49	5-199	200-499
19 E 83170	20X 1	6.75	6.00	4.73
19 E 83180	21X 2¼	16.75	15.00	11.73
19 E 83190	22X 1¼	11.50	10.35	8.05

To Speed Your Mail Order — Please Give Your Zip Code Number

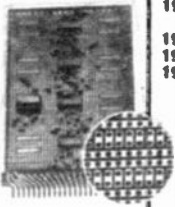

VECTOR ETCHED CIRCUIT KIT

Designed for making low cost etched circuits with the least amount of bother. Circuit can be sketched on grid layout paper provided. Once best circuit is found, Vectoresist can be used to transfer circuit to copper-clad board. Board is then put in bag containing chemical solution and agitated. Circuit takes less than 10 min. to etch. Kit includes two 4½x6½" phenolic boards; one sheet Vectoresist with assorted pad layouts, lines, circles, and connector patterns; etching chemical; grid layout paper; "practice" copper-clad pieces.

19 E 83500 Shpg. wt., 1½ lbs. Net 6.50

VECTOR SOLDERLESS CIRCUIT SET-UP KIT



Provides an easy means of setting-up and testing circuits rapidly without having to solder connections. 1-8½"x17" Vectorbord deck and frame, extra pieces of Vectorbord, brackets, 90-T30N2 Solderless Spring-Clips, Lug-Clips, 100-T9.4 Solderable Terminals, 6-Transistor Sockets, (4 Universal-type, 2 Power-type), 3-Novel 9-pin, 3-Miniature 7-pin and 2-Octal 8-pin tube sockets with mounting wafers. Shpg. wt., 1 lb.

19 E 83204 Model 25X 1-49 ea. Net 21 45
50-199 ea. Net 19.31

VECTOR PREPUNCHED BREADBOARDS

Pre-punched terminal boards for prototypes and production. Ivory epoxy-paper grade EXXXP per mil P-22324. Natural tan phenolic grade XXXP per mil P-31158. Epoxy glass grade G10 per mil P-18177. All $\frac{1}{8}$ " thick except $\frac{3}{16}$ ". Add .093" hole size on .265" spaced centers except $\pm .064$ hole on .2" centers, $\pm .062$ " hole on .141" centers and $\pm .042$ " holes on .1" centers. For use with Vector push-in terminals. Average shpg. wt., 7 oz.

Stock No.	L	X	W	Code	No. of Holes	1-19	20-99	100-199
-----------	---	---	---	------	--------------	------	-------	---------

PHENOLIC BOARDS								
19 E 83071	17"	4.8"			—64x18	1.30	1.17	
19 E 83069	17"	4.8"			+85x23	1.30	1.17	
19 E 83097	19"	8.6"			+(95x43)x2	2.41	2.17	
19 E 83105	19"	8.75"			—72x33	2.33	2.18	
19 E 83113	8.5"	4.8"			—32x18	.67	.70	
19 E 83121	17"	4.8"			—64x18	1.86	1.49	
19 E 83139	8.5"	2.41"			—32x9	.62	.96	
19 E 83147	17x8.51"				64x32	2.06	2.37	
EPOXY PAPER BOARDS								
19 E 83154	17"	4.8"			—85x23	2.14	1.93	
19 E 83162	17"	4.8"			—(85x23)x2	2.14	1.93	
19 E 83584	6.5"	4.5"			—64x144	1.82	1.64	
19 E 83502	17"	4.8"			—169x47	3.54	3.19	
EPOXY GLASS BOARDS								
19 E 83428	17"	4.8"			—64x18	3.87	3.48	
19 E 83436	17"	4.8"			—(85x23)x2	3.96	3.56	
19 E 83576	8.5"	4.8"			—(42x23)x2	1.97	1.77	

PUSH-IN TERMINALS AND INSERTION TOOLS



TYPE T9.4 Terminal, Brass, Tin plated with serrated slots, fits hole size .094".

19 E 83014 Pkg. of 100 1.44

19 E 83402 Pkg. of 1000 10.18

TYPE P122 Insertion tool for T.9.4 terminals.

19 E 83418 Net ea. 1.40

TYPE T28 terminal beryllium copper tin-plated, fits hole size .062".

19 E 83022 Pkg. of 100 1.81

19 E 83306 Pkg. of 1000 11.44

Type T28S. Same as T28 above except silver plated.

19 E 83018 Pkg. of 100 1.72

19 E 83600 Pkg. of 1000 13.51

TYPE P91 Insertion tool for T28 and T28S terms.

19 E 83063 .50

TYPE T30N2 Springclip terminal holds up to six wires without soldering. Nickel plated brass body with nickel plated steel music wire spring fits hole size .094".

19 E 83048 Pkg. of 10 .99

19 E 83030 Pkg. of 100 7.23

19 E 83394 Pkg. of 1000 30.44

TYPE P92A Insertion tool for T30N2 terminals.

19 E 83055 Net ea. 90

VECTORESIST RUB-ON RESIST



Patterns are simply rubbed from VECTORESIST sheet onto copper clad Vectorboard or equivalent and etched with Ferric Chloride or Ammonium Persulfate solution. VECTORESIST contains different line widths, curves, circles, pads and solid areas with standard spaced plug contacts. Sheet size is 9x13". Shpg. wt., ½ lb.

19 E 83212 Net 2.00

19 E 83550 Lines only $\frac{1}{8}$ " to $\frac{1}{4}$ " Net 2.00

Pad layouts, plus base layouts for 3 lead TO-54 and TO-18 Semis.

19 E 83543 Net 2.00

Antenna Coils—Photoconductive & Photoelectric Cells

HIGH-GAIN LOOPSTICK ANTENNA



PHOTO CONDUCTIVE CELLS

Conductivity of these sensitive cells varies with intensity of light. All rated at 20 ma at 200 volts. Wave length 4000 to 8000 angstroms. Resistance at 0 ft. candle is 10 meg for type A, 5 meg for type B. Other chart ratings approx. \pm 50%. Imported.

Stock No.	Fig.	1FC	10FC	100FC	Net
99 E 63208	A	1.5 meg	150,000	25,000	.99
99 E 63216	B	25,000	4,500	700	.99

B3M SELENIUM SOLAR CELL



Ratings (in full sunlight). Output 0.2 to 0.4 volts, $1\frac{1}{2}$ to $2\frac{1}{2}$ milliamperes. Plastic case with adhesive disc. Size: $1\frac{1}{2}$ x $1\frac{1}{2}$ x $\frac{3}{16}$ ". Shpg. wt., 4 oz.

19 E 29033 Net 1.71
In Lots of 10 or more Net ea. 1.52

SIM SILICON SOLAR CELL

Output rating 0.3 to 0.4 volts and 10 to 16 milliamperes in full sunlight. Plastic case with pressure sensitive adhesive disc. Size: $1\frac{1}{2}$ x $1\frac{1}{2}$ x $\frac{3}{16}$ ". Shpg. wt., 4 oz.

19 E 29041 Net 2.20
Lots of 10 or more Net ea. 1.96

RESISTOR PHOTOCELL 89^c



A cadmium sulphide light-activated resistor used to actuate door openers, burglar alarms, relays, light controls, production counters, etc. Resistance varies from 75 ohms at approx. 93 foot-candles to over 10 megohms in total darkness. Maximum volts: 110VAC (peak) 110VDC; maximum dissipation: 2 watt @ 40°C, 1 watt @ 50°C, 0 @ 60°C. Capacity approx. 6pF. $\frac{1}{2}$ " diam. x $\frac{3}{16}$ " thick. Imported. Shpg. wt., 3 oz.

19 E 21014 Net .89

INTERNATIONAL RECTIFIER SELENIUM PHOTOCELL GRAB BAG KIT



Assortment of 8 photocells with varied shapes, sizes and outputs. Some have pig-tail leads mounted; leads supplied for all the cells. Nominal output range $\frac{1}{2}$ - $\frac{1}{2}$ volts; 250 microamps to 5 MA in bright sunlight. Shpg. wt., 8 oz.

19 E 29116 Net 1.98

PHOTO CELL AND SUN BATTERY ASSORTMENT. This interesting special package contains 4 selenium photocells with outputs from $\frac{1}{2}$ to $\frac{1}{2}$ volt and 0.5 ma to 3 ma in bright sunlight. Complete with 24-page instruction and project manual. Shpg. wt., 6 oz.

19 E 29108 Net .99

250 Lafayette Cat. No. 700



PIONEER CDS CELLS

FIG. C (700 Series) FIG. D (900 Series). Hermetically sealed high sensitivity cadmium sulphide cells. Types ending in 01 thru 04 are suggested for use with slowly changing daylight; types ending in 10 thru 13 especially suited for industrial photo-control operations depending on interruption of an incandescent source. Maximum dissipation on 700 series is $\frac{1}{4}$ watt continuous or 1-watt intermittent (1 min. periods); 900 series is $\frac{1}{2}$ watt continuous, 2-watts intermittent. Mean output is photocurrent at 50 V AC and simulated daylight of 1 FC; range varying \pm 33% of mean. Maximum dark current measured at 100V, 5 seconds after 50FC light extinguished. Photosensitive area of 700 series is .1 sq. in; 900 series is .44 sq. in.

DAYLIGHT TYPES

Stock No.	Type No.	Mean Output	Max. Oark Curr.	Max. Oark Volt	Net Ea.
19 E 47027	701	1.5 ma.	25 μ a.	500	1.00
19 E 47035	702	3 ma.	25 μ a.	500	1.00
19 E 47043	703	6 ma.	40 μ a.	350	1.00
19 E 47090	901	1.5 ma.	25 μ a.	1000	1.10
19 E 47068	902	3 ma.	25 μ a.	1000	1.10
19 E 47076	903	6 ma.	40 μ a.	700	1.10
19 E 47084	904	12 ma.	200 μ a.	500	1.10

INCANDESCENT TYPES

Stock No.	Type No.	Nom. Res. Ohms	Min. Res. Ohms	Max. Oark Volt	Net Ea.
19 E 47092	710	1330	4 meg.	500	1.00
19 E 47100	711	670	4 meg.	500	1.00
19 E 47118	712	330	2.5 meg.	350	1.00
19 E 47126	910	1330	4 meg.	1000	1.10
19 E 47134	911	670	4 meg.	1000	1.10
19 E 47142	912	330	2.5 meg.	700	1.10
19 E 47159	913	165	.5 meg.	500	1.10

SELF GENERATING SELENIUM CELLS

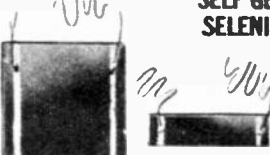

As Low As 59^c

- No external power needed
- Output in sunlight up to 60 MA

Sensitive to a wide spectrum including white, colored or ultra-violet light. All unmounted; complete with leads. Outputs in table below taken at 100 foot candle illumination with 100 ohm load. Shpg. wt., 3 oz. Imported.

Stock No.	Out μ a	Size	Net
99 E 62432	100	$1\frac{1}{2}$ x $\frac{3}{16}$ "	.59
99 E 62440	250	$1\frac{1}{2}$ x $\frac{5}{16}$ "	.69
99 E 62457	350	$1\frac{1}{2}$ x $\frac{7}{16}$ "	.89

B2M SUN BATTERY

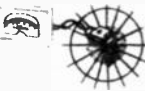

Average sunlight generates 2 ma. current under 100-ohm load. With milliammeter can be used to measure light. In series or series-parallel will drive transistorized equipment. 60 microamps @ 100 foot candles with 55 ohm load. .5 volt in average sunlight, .25 volt at 100 foot candles.

19 E 29017 Net Ea. 1.47 10-Up 1.32



Give high gain across complete AM broadcast band from 540 to 1600 kHz when tuned with standard 365 pF tuning condenser.

A. VARIABLE TYPE. An extremely small yet very powerful replacement antenna with a "Q" of 240-275. Boosts sensitivity and signal to noise ratio. With adjustable ferrite core for maximum peaking efficiency and precise tracking on entire broadcast band. Single, hole snap-mounting, plus bracket. Efficient at any angle. $2\frac{1}{2}$ x $\frac{1}{2}$ ".
32 E 41054 Shpg. wt., 4 oz. Net .59

B. ENERGIZED FERRI-LOOPSTICK. New 5" ferrite rod loopstick antenna with a "Q" of up to 350. Extremely high gain brings in even distant stations not normally received. Adjustable coil with self-locking vinyl collar permits peaking antenna for super sensitive results. $\frac{3}{8}$ x 5". Shpg. wt., 6 oz.
32 E 82019 Net .96

C. 7" SUPER LOOP. Super sensitive ferrite loopstick antenna with a "Q" of up to 425. Excellent for replacement of old style loops. Brings in even hard to get stations. Adjustable for maximum sensitivity over length of 7 in. Complete with mount.
32 E 82027 Shpg. wt., 6 oz. Net 1.35

TRANSISTOR TAPPED VARIABLE ANTENNA COIL



- BOOSTS SIGNAL PICKUP
- SUPER-SELECTIVE!

Specially designed for matching the low input impedance of transistors. Maximum transfer of signal energy from tuning stage when used with 365 to 420 pF variable capacitors, as well as in minimum loading by first transistor stage for sharper tuning and greater selectivity. Highly sensitive with a "Q" of up to 250. With adjustable ferrite core for maximum peaking. Single-hole snap-in mounting, plus bracket. Efficient at all angles. Size: $2\frac{1}{2}$ x $\frac{1}{2}$ " diam.
32 E 41080 Shpg. wt., 4 oz. Net .99

FERRITE ANTENNA KIT

- 3 ANTENNAS FOR TRANSISTOR RADIOS All 3 for 79^c
- HIGH "Q" FOR TOP RECEPTION

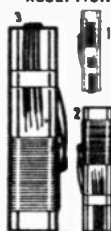

Three sizes of flat ferrite antennas. Each has a high inductance of 480 microhenries. Tapped leads are color coded. Designed to match most AM transistor radios. Matches tuning condenser sect. 167.5—8pF, osc. sect. 75.5—8pF. Sizes: (1) $1\frac{1}{2}$ x $\frac{3}{16}$ x $\frac{1}{16}$ " (2) $2\frac{1}{2}$ x $\frac{3}{16}$ x $\frac{1}{16}$ " (3) $2\frac{3}{4}$ x $\frac{3}{16}$ x $\frac{1}{16}$ ". Imported.
99 E 62275 Wt., 5 oz., Net. 79

KIT OF 3 MINIATURE ADJUSTABLE LOOPSTICKS

89^c

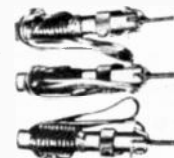

Lafayette's kit of 3 miniature adjustable loopsticks pull in those distant radio stations with amazing ease and clarity. Has set-screw adjusting slug to obtain maximum loudness. May be installed in any position. Complete with instructions. Imported.

99 E 63117 Shpg. wt., 8 oz.—Set of 3 Net .89

Variable Condensers and Accessories

VARIABLE CONDENSERS

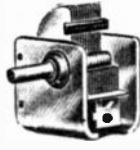
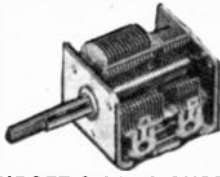
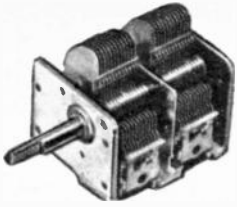

MIDGET 2 GANG SUPER-HET

2 gang. Front section 27 plates with capacity of 10.5 pF to 365 pF; rear section plates with capacity of 7.6 pF to 132 pF individual trimmers on each section. End plates of RF section slotted for easy tracking. 180° rotation. Capacity increases counter clockwise. 1/4" diam. brass shaft, mounted on ball-bearings, extends 1 1/2" from cadmium plated steel frame. Frame size: 1 1/4"Dx1 1/2"Wx1 3/8"H. Standard mounting holes front and rear. Brass contact wiper. For superhet circuits with 455 kHz IF. Shpg. wt., 10 oz.

32 E 11018

Net 1.89

2 GANG TRF

Same construction as above but each gang has 23 plates. Maximum capacity each section 365.7 pF, minimum 10.3 pF. Frame size 2 3/8"Dx1 1/2"Wx1 3/8"H. Shpg. wt., 10 oz.

32 E 11026

Net 1.99

MIDGET 1 GANG TRF

Similar in construction to above but single gang with capacity from 10 to 365 pF. Size 1 3/8"Dx1 3/8"Hx1 3/8"W. Shpg. wt., 5 oz.

32 E 11034

Net 1.29

TRANSISTOR MINIATURE 2 GANG SUPER-HET VARIABLE CONDENSER

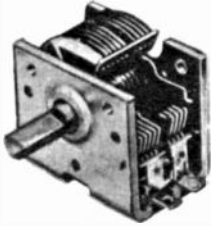

Lightweight—both the frame and plates are aluminum. Smooth ball bearing action over entire 180° rotation. Bakelite stator insulation. Capacity of 11 plate R.F. section is 6.3 to 123.1 pF; 9 plate oscillator section is 5.7 to 78.2 pF. Effective range of trimmers is 15 pF. These add 2 pF to minimum capacity. Capacity increases in counter clockwise direction. Flatted shaft 1/4" diameter by 1 1/4" long. Frame size only 1 3/8"Dx1 3/8"Wx1 1/8"H. Shpg. wt., 5 oz.

32 E 11067

Net 1.39

TINY TUNING CONDENSER—with DIAL

- For Transistor and Miniature Circuits • Only 1" Square, 3/8" Deep • 385 pF • Polyethylene Dielectric



A new "Poly-Vari-Con" model for use in TRF broadcast-band and experimental receivers. Complete with good-looking clear plastic tuning dial with calibrations from 530 to 1600 kHz. Capacity variable from 10 to 365 pF. Knurled dial is 1 1/4" diam.; rotation is 180°. Dial is mounted to condenser shaft by 3/8" diam. chrome-plated threaded retainer. Imported.

99 E 62176 Shpg. wt., 5 oz.

Net .59

HAMMARLUND MINIATURE VARIABLE CONDENSERS



TYPE HF

Single section tuning emp. using "APC" rotor and stator design—ideal for critical high freq. circuits. Isolantite insulation. Air gap is 0.015" nominal.

Stock No.	Mfg's Type	Max. PF	Min. PF	Net
40 E 28817	HF15	17.5	2.8	1.30
40 E 28825	HF35	36.	3.2	1.40
40 E 28833	HF50	42.	3.7	1.60
40 E 28841	HF100	102.	5.3	1.80
40 E 28858	HF140	142.	6.3	1.95

TYPE HFA

Similar to "HF" except very desirable for high frequency low-power applications. Single hole or base mounting. 3/8"x1/4" round shaft. 3/8-32 thread x 3/8"L bushing.

40 E 28411	HFA-15-B+	16	2.8	2.20
40 E 28429	HFA-25-B**	25	3.0	2.30
40 E 28437	HFA-50-B†	50	4.3	2.50
40 E 28445	HFA-100-B††	100	7.5	3.90



TYPE APC

Compact, high quality. Has high leakage resistance and resistant to temperature, moisture, and vibration effects. Straight line capacitance. Hex collar on slotted shaft for rotor and screw-driver adjustment. Air gap is 0.015" nominal. Shpg. wt., 4 oz.

Series APS (Screwdriver Slot)

Stock No.	Mfrs. Type	Max. PF	Min. PF	Net
40 E 28460	APC-25	25	3.0	1.20
40 E 28478	APC-50	50	3.9	1.35
40 E 28486	APC-75	75	4.6	1.45
40 E 28494	APC-100	100	5.5	1.60
40 E 28502	APC-140	140	6.7	1.80

Series APC-B (1/2" Shaft)

40 E 28528	APC-25B	25	3.0	1.30
40 E 28536	APC-50B	50	3.9	1.40
40 E 28544	APC-75B	75	4.6	1.50
40 E 28551	APC-100B	100	5.5	1.70
40 E 28569	APC-140B	140	6.7	1.90



TYPE MAPC

About half the weight and size of the APC, but with the same quality and performance. Excellent for VHF use. Slotted shaft for screwdriver or hex wrench adjust. Nom. air gap 0.0135". Size 3/8"Wx1 3/8"H. Shpg. wt., 4 oz.

Series MAPC (Screwdriver Slot)

Stock No.	Type Mfrs.	Max. pF	Min. pF	Net
40 E 28635	MAPC-15	15	2.3	1.00
40 E 28643	MAPC-25	25	2.6	1.05
40 E 28650	MAPC-35	35	2.9	1.10
40 E 28658	MAPC-50	50	3.2	1.15
40 E 28676	MAPC-75	75	3.9	1.20
40 E 28684	MAPC-100	100	4.5	1.30

Series MAPC-B (1/2" Shaft)

40 E 28692	MAPC-15B	15	2.3	1.00
40 E 28700	MAPC-25B	25	2.6	1.05
40 E 28718	MAPC-35B	35	2.9	1.10
40 E 28726	MAPC-50B	50	3.2	1.15
40 E 28734	MAPC-75B	75	3.9	1.20
40 E 28742	MAPC-100B	100	4.5	1.30



(A)

(B)

COUPLERS AND EXTENDERS

Brass couplings (A) and extenders (B). Diameter of extender or coupling may be equal to, greater than, or less than diameter of shaft extended. Extender shaft length, 3/8"; over-all length 1 1/8". Average shpg. wt., 4 oz. All are couplers except * which are extenders.

Stock No.	Size	Each
32 E 64124	1/4 x 1/4"	.22
32 E 64132	1/4 x 3/8"	.25
32 E 64140	3/8 x 3/8"	.25
32 E 64157*	1/4 x 1/4"	.30
32 E 64165*	3/8 x 1/4"	.30



PANEL BEARING ASSEMBLY

Use with rigid or flexible coupling when mounting. For up to 3/8" panels. Av. shpg. wt. 6 oz.

32 E 64058	3" long, 1/4" shaft	.35
32 E 64066	6" long, 1/4" shaft	.50
32 E 64074	Bearing only	.15

EXTENSION ROOS

For 1/4" dia. extensions. Av. shpg. wt., 4 oz.

32 E 64082	6" Nickel Plated	.35
32 E 64090	6" Fibre	.15
32 E 64108	12" Nickel Plated	.70
32 E 64116	12" Fibre	.30



MICA TRIMMERS AND PADDERS

Base of low-loss ceramic. 1 1/2"x3/4"x3/8" in size. 1 1/2" mtg. ctrs. Capacity ranges derived from 3 turns open to tight setting. Av. shpg. wt., 2 oz.

Stock No.	pF	Each 1-24	Each 25-99
34 E 68386	1.5-15	.36	.32
34 E 68295	2.7-30	.36	.32
34 E 68303	5-.80	.36	.32
34 E 68311	10-.180	.42	.37
34 E 68329	25-.280	.48	.43
34 E 68337	50-.380	.57	.51
34 E 68345	75-.480	.63	.56
34 E 68352	105-.580	.69	.62

DIALS - DIAL CORD - KNOBS

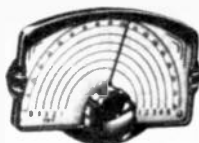
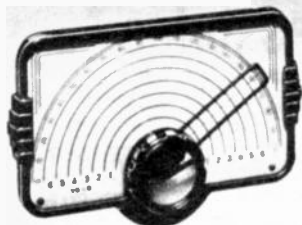

**VERNIER
LOGGING
DIALS**

Precision planetary drive vernier dials with approximately 7 to 1 ratio. Ideal for test equipment, calibration instruments, amateur equipment, etc. 1/4" diam. shaft extending from rear may be easily coupled to another drive shaft. Type A has framed wire hair line, type B has pointer. All with 1 log scale and blank scales. Fluted knob. Imported.

Stock No.	Fig.	Scale width	Log Scale	Blank Scales	Size Overall	Shp. wt.	Net Each
99 E 25660	B	4 1/4"	0-180	5	5x3x1 1/2	13 oz.	2.59
99 E 25678	A	6"	0-200	6	6 7/8x4 1/2x2	1 lb.	2.99
99 E 25686	A	7 1/4"	0-200	6	8 1/2x5 3/4x2 1/4	1 1/2 lbs.	3.95

MATCHED KNOB KITS

- Molded From Hi-Impact Plastic
- Brass Screw and Shaft Insert
- For 1/4" Round or Flat Shaft



KIT OF 5
as low as

69c

Trim distinctive, functionally styled knobs. Finished in an attractive steel gray and molded from tough hi-impact plastic, the knob is of cylinder design with sure-grip fluted sides and an aluminum ring-set in a recessed face. Rugged brass screw and mounting shaft insert will accept 1/4" round or flat shaft. Each kit contains 5 knobs—all same size. Imported. Shpg. wt., 7 oz.

1 7/8" Diam., 7/8" Deep Kit of 5 Net .89
 99 E 61145
 1 3/8" Diam., 1 1/4" Deep Kit of 5 Net .79
 99 E 61152
 1" Diam., 1 1/4" Deep Kit of 5 Net .69
 99 E 61160

Fig. C

PRECISION VERNIER DIALS

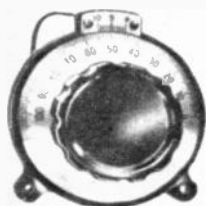

Fig. D

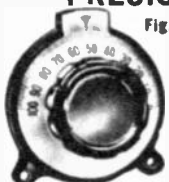

Fig. E



**AS LOW AS
89c**

Precision planetary drive vernier dials with approximately 8 to 1 ratio. Mounts on panel surface and has accurately centered metal inserts for 1/4" shafts. Metal dials are brushed silver finish with deeply etched and black filled engraving to provide maximum legibility even under poor lighting conditions. Reads counter-clockwise 0 to 100 in 180°. Uses tough scratch resistant fluted molded knob and housing for sure grip. Phosphor bronze and brass utilized for internal parts. Imported. Shpg. wt., 8 ozs.

- 99 E 80311 Fig. E 36MM (1 1/2") Diameter Vernier Dial, 1 3/4" from front to back Net .89
 99 E 80303 Fig. D 50MM (2") Diameter Vernier Dial, 1" from front to back Net .99
 99 E 80235 Fig. C 70MM (2 7/8") Diameter Vernier Dial, 1 1/4" from front to back Net 1.39

DIAL CORD



Handy spools of pre-stretched nylon dial cord in sizes that cover almost all replacement needs. Breaking strength med. is 35 lbs., std. 20 lbs., thin 15 lbs. Average shpg. wt., 5 oz.

Type	Dia.	No. 100'	Net	No. 25'	Net
Med.	.040"	32 E 80187	2.60	32 E 80211	.83
St.	.028"	—	—	32 E 80229	.83
Thin	.025"	32 E 80203	2.60	32 E 80237	.83

100 FT. NYLON DIAL CORD

100 ft. spool standard .028" nylon drive cord. Finest quality. Shpg. wt., 8 oz. Net 1.45

METAL KNOB KIT



Set of 3 attractive, tapered aluminum knobs. Set-screw type, fit 1/4" shaft. Polished concave top. 1 3/4" long, diameter tapers from 1 1/4" to 1 1/8". Imported. Net 1.10

COMMUNICATION RECEIVER KNOBS



Molded of Tenite with easy grip knurling. These knobs are 1-7/16" over-all diameter with chrome-plated bevel skirts. Depressed numerals are black enamelled on chrome plate. Designed to fit 1/4" shafts. Numbered 0-10 through an arc of 300° clockwise. Imported. Shpg. wt., 14 oz.

- 99 E 61053 Net ea .34
 Lots of 6 each .28

NATIONAL BALL REDUCTION DRIVE FOR PRECISE TUNING



Efficient drive in ratios of 5:1 and 10:1. Shaft size 1/4"; # female coupling one end, # male shafts both ends.

Stock No.	Type	Reduction	Net Ea.
32 E 51352	NBD1-1 †	5:1	3.89
32 E 51360	NBD1-2 #	5:1	4.37
32 E 51378	NBD2-1 †	10:1	4.48
32 E 51386	NBD2-2 #	10:1	4.94

PROFESSIONAL KNOBS



Add professional appearance to any equipment. Professional black-matte finish with concave top. To fit 1/4" round shaft. All knobs come with set screw. Skirt dimen. 7/8" dia. x 3/8" H. Imported. Shpg. wt., 7 ozs. Net .34

POINTER, BAR AND LEVER KNOBS



Black knobs molded of high quality plastic. All have set screw for 1/4" round or flatted shaft, and white indicator lines. Items marked * have brass insert. Size shown is length. Av. shpg. wt., 3 oz.

Stock No.	Fig.	Size	Net Each		
			1-24	25-99	100-Up
32 E 24110	F	2"	.19	.17	.15
32 E 24128	G	1 1/4"	.11	.09	.08
32 E 24136*	G	1 1/4"	.17	.15	.14
32 E 24144	H	1 1/4"	.13	.11	.10
32 E 24151*	I	1 3/8"	.20	.18	.16
32 E 24169	J	1 3/8"	.12	.11	.10

FLUTED KNOBS



Black fluted knobs, with and without skirt. Made of thermosetting plastic with high gloss finish. All have recessed brass insert and set screw. Mount on 1/4" round or flatted shaft. Shpg. wt., 4 ozs.

Stock No.	Fig.	Diam.	Hght.	Net Each		
				1-24	25-99	100-499
32 E 24060	A	1 1/8"	5/8"	.20	.23	.20
32 E 24078	A	1 3/8"	1 1/8"	.20	.25	.21
32 E 24086	A	1 1/2"	3/4"	.32	.29	.24
32 E 24094	B	1 1/2"	1 1/8"	.85	.59	.53
32 E 24102	B	2 1/4"	3/4"	.72	.65	.58



STANDARD PLASTIC KNOBS

Plastic knobs with knurled bodies for general application. All have molded hole with set screw for mounting 1/4" round or flatted shafts. Fig. P has white indicator lines. Av. shpg. wt., 4 ozs.

Stock No.	Fig.	Diam.	Color	Net Each		
				1-24	89	499
32 E 24177	M	1"	Walnut	.15	.13	.11
32 E 24185	M	1"	Black	.14	.12	.11
32 E 24201	P	1 1/2"	Black	.16	.14	.12
32 E 24219	P	3/4"	Black	.17	.15	.13
32 E 24227	N	3/4"	Maroon	.11	.09	.08

RELAYS — RELAY TOOLS — COUNTERS

SENSITIVE MINIATURE RELAY

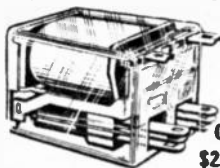

ONLY
\$2.95 ea.

Extremely small, sensitive relay—weighs only 1/2 oz.! Double-pole double-throw, with silver and silver-gold-platinum alloy contacts. Contact handle up to 100 volts at 300 ma. (30 watts). Coil measures 5,300 ohms DC resistance-rated at 4.1 ma, DC pull-in current, 0.95 ma. DC, drop-out. Enclosed in transparent plastic dust cover; Operating time 2-8 milliseconds; release time about 1.5 msecs. Breakdown voltage rating: coil to frame, 500V; contacts to frame 350V. Measures 1 1/4 x 1 1/4 x 7/8". Ideal for model control, photocell relay, carrier-current control and dozens of other miniature applications. Imported. Shpg. wt., 4 oz.
DPDT Miniature DC Relay
99 E 80931

Net 2.95

HAND TALLY REGISTER



2²⁹

- 4 Digit Capacity
- Counts 0-9999
- Single Turn Reset Knob

Registers 0 to 9999. Highly polished chromium plated brass case. Attached finger-ring and compact shape for comfort in holding. Plunger operated for smooth, easy action. Large, clearly read numerals. Knurled reset knob sets register to zero in one turn. Precision accuracy for lab, school and industrial users. Invaluable for inventory control—gate checking—traffic, etc. Small Size, approximately 1 1/4 x 1 3/8". Permits concealed operation. Imported. Wt., 1/2 lb.
99 E 80300

Net 2.20



LITTLE "JEWEL"
REMOTE CONTROL RELAY
1⁹⁵

A natural for remote control receivers, it is highly sensitive, and built to withstand severe crashes. The smallest commercial job available, it weighs less than 1/2 oz. Factory adjusted to pull in at 1.4 MA drop out at 1.2 MA D.C. Single pole, double throw. Used in many R/C receivers. 5,000 ohm coil. Imported.

99 E 60915

Net 1.95

5-DIGIT STROKE-ACTUATED RESET COUNTER



2⁹⁵

Easy-to-mount rugged counter for counting machine operations. One count per stroke. Drilled mounting flange; actuating arm and spring. May be manually or solenoid actuated. Reads up to 99,999; side knob easily resets to zero from any number. Overall size: 2 1/2 x 1 1/2 x 1 3/4". Imported. Wt., 1/2 lb.
99 E 90292

Net 2.95

JONARD RELAY TOOLS POCKET CLEANER-BURNISHERS



Compact penfile for cleaning and burnishing relay contacts. Replaceable steel blades leave no residue. Plastic cap permits working on "live" contacts. Chromed barrel with pocket clip. With 12 blades. Size: 3/8 x 5 1/2". Shpg. wt., 5 oz.

P-4, Penfile with 12 RB-4, 1/4 x 1 1/4" blades.
12 E 22050 Net 3.90

P-6, Penfile with 12 B-6, 3/16 x 1 3/4" blades.
12 E 22066 Net 3.90

RB-4, Replacement blades for P-4, pkg. 25.
12 E 22074 Shpg. wt., 4 oz. Net 3.75

RB-6 Replacement blades for P-6, pkg. 25
12 E 22082 Shpg. wt., 4 oz. Net 3.75

SPRING TENSION GAUGES



Precision gauges for determining tension of relay and other electronic springs. Engraved scale, front and back for indicating horizontally or vertically. Center-to-left or center-to-right reading. 1 1/2 x 5". Shpg. wt., 1/2 lb.
G-10, 0-10 gram gauge in 1 gram steps.
12 E 22108 Net 6.48

G-50, 0-50 gram gauge in 5 gram steps.
12 E 22116 Net 6.48

LAFAYETTE HIGH SENSITIVITY METER RELAY



- Meter Movement
- Closes Circuit at 2 Miles

Extremely sensitive meter type relay. Normally open. Ideal suited for uses with model railroad, photoelectric relay circuit, baby-tenders, remote control toys, remote control boats, fire alarm, and many other practical applications. Precision-built meter movement provides virtually friction-free movement. Contact will close at 2 millamps. Internal resistance 100 ohms. Meter movement rated 5 ma continuous, 10 ma momentary; contacts rated 500 ma continuous, momentary 1 amp at 3v and 250 ma at 6v with resistive load. Sensitivity: 2.5-.6 mw. Internally adjustable. Relay is enclosed entirely and transparent cover permits observation. Solder pins are placed externally for easy connections. SPST. Size: 1 3/4 x 1 3/4 x 1 3/4". Imported. Shpg. wt., 8 oz.
99 E 61996

Net 3.95



5-CHANNEL
RESONANT REED
HOBBY RELAY
8⁵⁰

Frequency tolerance ±1%. Especially adaptable to 5 channel remote control hobby tone receivers and Citizens Band tone signaling receivers. May also be used as high stability, resonant reed oscillator control. Features low tuning error, good temperature stability, low driving requirements. See page 209 for full specifications.

42 E 61012 Net 8.50

MULTI-COUNTER 5-POSITION TALLY REGISTER



AMPERITE THERMOSTATIC DELAY RELAYS

2⁴⁰

Heater-actuated time-delay relays. Operate on AC, DC or pulsating current. Hermetically sealed in glass envelope with optical base. SPST, normally open, closed by heater after delay (in sec.). Heater draws only 2 watts. Contacts rated 3 amp. at 115V AC or 1.0 amp. at 220V AC. Shpg. wt., 4 oz. Size 2 3/4" x 1 1/4" diameter.

Delay Sec.	Normally Open		Normally Closed	
	6.3V AC-DC	115V AC-DC	6.3V AC-DC	115V AC-DC
2	33E35015	33E35148	33E35254	33E35307
5	33E35023	33E35155	33E35262	33E35395
10	33E35031	33E35163	33E35270	33E35403
15	33E35040	33E35171	33E35280	33E35411
20	33E35058	33E35180	33E35290	33E35420
30	33E35064	33E35197	33E35304	33E35437

Any of above Net ea. 2.40

Miniature Relays. Same type delay relays as above, available in miniature size, with delays from 2 to 120 Sec. Contacts rated 2 Amps, at 115 VAC or 1 Amp, at 220 VAC. Has 9 pin miniature base. Size 2 1/2 x 7/8" dia. Shpg. wt., 3 oz.

Delay Sec.	Normally Open		Normally Closed	
	6.3V AC-DC	115V AC-DC	6.3V AC-DC	115V AC-DC
2	33E35404	33E35401	33E35718	33E35025
5	33E35402	33E35619	33E35726	33E35033
10	33E35510	33E35427	33E35734	33E35041
15	33E35528	33E35435	33E35742	33E35050
20	33E35536	33E35443	33E35750	33E35066
30	33E35544	33E35450	33E35767	33E35074

45 33E35551 33E35468 33E35775 33E35082
60 33E35509 33E35676 33E35783 33E35090
75 33E35577 33E35684 33E35791 33E35098
90 33E35585 33E35692 33E35800 33E35916
120 33E35593 33E35700 33E35817 33E35924
Any of above Net ea. 2.40

6-DIGIT ELECTRIC COUNTER

- Registers from 1 to 999,999



12⁹⁵

May be actuated by any switch, relay, etc. Operates in any position. White figures on a black background read up to 999,999. Built-in selenium rectifier. DC operated solenoid, chrome-plated. 6" leads, 110V, AC, 50/60 Hz. Size: 2 1/2 x 2 1/4". Removable front plate: 3 5/8 x 2". Imported. Shpg. wt., 1 1/2 lbs.
99 E 90110 Net 12.95

Potter & Brumfield Relays

SPECIAL PURPOSE RELAYS

LATCHING RELAYS

PC SERIES, Single Coil impulse latching relays for on-off and current reversal switching on alternate pulses. Operates on 30 millisecond pulses to the coil. Gold-plated silver cadmium oxide contacts rated at 7.5 amps. Mtg. Size: $2\frac{3}{32}$ " dia. holes on $2\frac{1}{16}$ " centers. Size: $2\frac{3}{32}$ "x $2\frac{1}{8}$ "x $2\frac{3}{32}$ ". Shpg. wt., 10 oz.



Stock No.	Type	Arrangement	Coil Volts	1-24 Each	25-50 Each	51-99 Each	100-249 Each
30 E 86428	PC11A	DPDT	6VAC	6.20	5.89	5.58	4.34
30 E 86436	PC11A	DPDT	24VAC	6.20	5.89	5.58	4.34
30 E 86444	PC11A	DPDT	120VAC	6.20	5.89	5.58	4.34
30 E 86451	PC11D	DPDT	24VDC	6.00	5.70	5.40	4.20

Stock No.	Type	Arrangement	Coil Volts	1-24 Each	25-50 Each	51-99 Each	100-249 Each
30 E 86469	PC17A	4PDT	24VAC	8.55	8.12	7.70	5.99
30 E 86477	PC17A	4PDT	120VAC	8.55	8.12	7.70	5.99
30 E 86485	PC17D	4PDT	24VDC	8.35	7.93	7.52	5.85

Type KB17AG & KB170G, Latching Relay. Ideal for memory work and overload uses. Both release and trip coils must be for the same voltage. One coil operates relay to set latch and other coil releases it. Operates on momentary impulse to either coil. 4PDT silver contacts rated at 10 amps. Mtg. Size: $2\frac{3}{32}$ " holes on $1\frac{1}{16}$ " centers. Size: $2\frac{3}{32}$ "x $1\frac{1}{4}$ "x $2\frac{3}{32}$ ". Shpg. wt., 10 oz. *60 Hz.



Stock No.	Type	Arrangement	Coil Volts	1-24 Each	25-50 Each	51-99 Each	100-249 Each
30 E 86493	KB17AG	4PDT	120VAC	11.70	11.12	10.53	8.19
30 E 86501	KB17AG	4PDT	24VAC	11.70	11.12	10.53	8.19
30 E 86519	KB17AG	4PDT	6VAC	11.70	11.12	10.53	8.19
30 E 86527	KB170G	4PDT	110VDC	11.95	11.35	10.74	8.37
30 E 86535	KB170G	4PDT	24VDC	10.65	10.12	9.59	7.46
30 E 86543	KB170G	4PDT	6VDC	10.65	10.12	9.59	7.46

RATCHET IMPULSE RELAYS

AP Series. Reliable compact unit requiring on-off or reversing action on alternate operations. Positive ratchet operation at all speeds on impulses as short as 60 ms. Intermittent operation only. Mtg. Size: $1\frac{1}{2}$ " dia. holes on $3\frac{3}{8}$ "x $3\frac{3}{8}$ " triangular centers. Contacts $1/8$ " dia. silver. Rated at 5 amps. Size: $3\frac{3}{8}$ "x $2\frac{3}{8}$ "x $2\frac{3}{8}$ ". Shpg. wt., 9 oz.



Stock No.	Type	Arrangement	Coil Volts	1-24 Each	25-50 Each	51-99 Each	100-999 Each
30 E 86717	AP11A	DPDT	6VAC	9.65	9.17	8.69	6.78
30 E 86725	AP11A	DPDT	12VAC	9.65	9.17	8.69	6.78
30 E 86733	AP11A	DPDT	24VAC	9.65	9.17	8.69	6.78
30 E 86741	AP11A	DPDT	120VAC	9.65	9.17	8.69	6.78
30 E 86758	AP11A	DPDT	240VAC	10.20	9.69	9.18	7.14
30 E 86766	AP11D	DPDT	6VDC	9.65	9.17	8.69	6.76
30 E 86774	AP11D	DPDT	24VDC	9.65	9.17	8.69	6.76
30 E 86808	AP17A	4PDT	120VAC	11.70	11.12	10.53	8.19
30 E 86821	AP17D	4PDT	12VDC	11.70	11.12	10.53	8.19
30 E 86824	AP17D	4PDT	24VDC	11.70	11.12	10.53	8.19

ANTENNA SWITCHING RELAYS

TYPE KT11A AND KT11D. Relay. For switching 300 ohm lines. Glass base for minimum RF loss. DPDT silver contacts rated at 5 amps. Mtg. Size: 1-No. 6-32 stud. Size: $1\frac{1}{8}$ "x $1\frac{1}{8}$ "x $1\frac{3}{8}$ ". Shpg. wt., 2 oz.



Stock No.	Type	Arrangement	Coil Volts	1-24 Each	25-50 Each	51-99 Each	100-249 Each
30 E 86931	KT11A	DPDT	6VAC	4.10	3.90	3.69	2.87
30 E 86949	KT11A	DPDT	120VAC	4.10	3.90	3.69	2.87
30 E 86956	KT11D	DPDT	6VDC	4.10	3.90	3.69	2.87
30 E 86964	KT11D	DPDT	12VDC	4.10	3.90	3.69	2.87

MS MOTOR STARTING RELAYS

For capacitor start, induction-run motors. Arm gap var. to pull-in. AC coils, 60 Hz; 5.9 VA oper. power. Silver contacts; 2 AY are SPST-NC rated $3/4$ HP; 4 AY are SPST-NC-DB rated 3 HP. Mtg. Size: 2 No. $3/32$ " dia. holes on $1\frac{1}{4}$ " centers. Size: $2\frac{1}{2}$ "x $2\frac{1}{2}$ "x $2\frac{3}{8}$ ". 5 oz.



Stock No.	P&B No.	Arrangement	Coil Volts	1-24	25-50	51-99	100-249
30 E 86675	MS2AY	SPST-NC	120	4.00	3.80	3.60	2.80
30 E 86683	MS2AY	SPST-NC	240	4.45	4.23	4.01	3.12
30 E 86691	MS4AY	SPST-NC-DB	120	4.65	4.41	4.16	3.26
30 E 86709	MS4AY	SPST-NC-DB	240	5.10	4.85	4.59	3.57

DUST COVER FOR MS RELAYS. Approx. size: $3\frac{1}{2}$ "x $2\frac{1}{2}$ "x $2\frac{1}{2}$ ".
30 E 85651 Shpg. wt., 1 lb. Net ea. 2.20

Depend on Lafayette for All Your Relay Needs

SOLID STATE TIME DELAY RELAYS

CH SERIES, Knob adjustable DPDT relay with 10A rated contacts. Enclosed in white nylon dust cover with plug-in octal pins. Provide delay on operate, except \uparrow have delay on release. Reset time, 100 milliseconds; Timing accuracy $\pm 10\%$; Repeatability $\pm 2\%$. Polarity reversal protection on D.C. Size: $2\frac{7}{8}$ "x $1\frac{3}{4}$ "x $1\frac{1}{2}$ ". Shpg. wt., 5 oz.



Stock No.	Type	Input Volts	Delay Sec.	1-24 Each	25-50 Each	51-99 Each	100-249 Each
30 E 88622	CHB38-30001	24VAC	1.0-10	19.50	18.52	17.55	15.60
30 E 88630	CHB38-30003	24VAC	1.0-180	19.50	18.52	17.55	15.60
30 E 88648	CHB38-70001	120VAC	1.0-10	19.50	18.52	17.55	15.60
30 E 88655	CHB38-70003	120VAC	1.0-180	19.50	18.52	17.55	15.60
30 E 88663	CHD38-30001	24VDC	1.0-10	18.50	17.57	16.65	14.80
30 E 88671	CHD38-30003	24VDC	1.0-180	18.50	17.57	16.65	14.80
30 E 88689	CHB38-70011 \uparrow	120VAC	1.0-10	23.50	22.32	21.15	18.80
30 E 88697	CHB38-70013 \uparrow	120VAC	1.0-180	23.50	22.32	21.15	18.80
30 E 88705	CHD38-30011 \uparrow	24VDC	1.0-10	21.50	20.42	19.35	17.20
30 E 88713	CHD38-30013 \uparrow	24VDC	1.0-180	21.50	20.42	19.35	17.20

CU SERIES SOLID STATE TIME DELAY RELAYS

Internal DPDT relay with 10A. contacts. Delay on operate only. Types CUA/CUC fixed delay; types CUF/CUH adjustable, using external resistors. Resistances shown in table below indicate max. delay; for lesser delay use intermediate value or potentiometer. Repeatability $\pm 3\%$. Reset time 100ms. Size: $1\frac{1}{4}$ "x $1\frac{1}{2}$ "x $1\frac{1}{2}$ ". Shpg. wt., $3/4$ oz.



Stock No.	Type	Input Volts	Delay Sec.	Resistor Needed	1-24	25-99
30 E 88853	CUA41-70010	120VAC	10	None	13.50	12.82
30 E 88861	CUA41-70120	120VAC	120	None	15.00	14.25
30 E 88879	CUC41-30010	24VDC	10	None	13.50	12.82
30 E 88887	CUC41-30120	24VDC	120	None	15.00	14.25
30 E 88895	CUA41-30010	24VAC	10	None	13.50	12.82
30 E 88903	CUF41-70010	120VAC	1.1-10	200K	14.25	13.54
30 E 88911	CUF41-70120	120VAC	1.1-120	2.4MEG	15.50	14.72
30 E 88929	CUH41-30010	24VDC	1.1-10	160K	14.25	13.54
30 E 88937	CUH41-30120	24VDC	1.1-120	2MEG	15.50	14.72
30 E 88945	CUF41-30010	24VAC	1.1-10	200K	14.25	13.54
30 E 88952	Solder Term. Socket and Retainer for Above				Net .75	
30 E 88960	Printed Circuit Socket for Above				Net .90	

SUB-MINIATURE RELAYS

KM SERIES. Tiny 3-pole relays weighing only 7/8 oz. For multiple switching. Solder lug terminals. Mtg. no. 2-56 tapped core and locating half-punch. Silver contacts, 2 amps. Size: $3/8$ "x $3/8$ "x $1\frac{1}{8}$ ". Shpg. wt., 1 oz.



Stock No.	Type	Arrangement	Coil Volts	1-24 Each	25-50 Each	51-99 Each	100-249 Each
30 E 86840	KM5D	SPDT	6VDC	3.80	3.61	3.42	2.66
30 E 86857	KM5D	SPDT	12VDC	3.80	3.61	3.42	2.66
30 E 86865	KM5D	SPDT	24VDC	3.80	3.61	3.42	2.66
30 E 86873	KM11D	DPDT	6VDC	4.15	4.94	3.74	2.81
30 E 86881	KM11D	DPDT	12VDC	4.15	4.94	3.74	2.81
30 E 86907	KM14D	3PDT	6VDC	4.80	4.56	4.32	3.38
30 E 86915	KM14D	3PDT	12VDC	4.80	4.56	4.32	3.38

STEPPING SWITCH

TYPE SA-1N-12A. Twelve position stepping relay with printed circuit strips to switch currents up to 250 ma. Armature-driven pawl operates a ratchet wheel to drive the movable contacts in steps of 30°. Mtg. Size: two 6-32 holes on $1\frac{1}{4}$ " centers. Size: $2\frac{1}{2}$ "x $2\frac{1}{2}$ "x $1\frac{3}{8}$ ". Shpg. wt., 4 oz.



Stock No.	Type	Coil Volts	1-24 Each	25-50 Each	51-99 Each	100-249 Each
30 E 86972	SA-1N-12A	120VAC	7.35	8.98	6.62	5.15

BU BUZZER

AC operated coil with spring steel armature. Nominal power 4.6VA. Mtg. Size: 6-32 tapped core. Size: $1\frac{1}{2}$ "x $1\frac{1}{2}$ "x $1\frac{1}{8}$ ". Shpg. wt., 3 oz.



Stock No.	Type	Coil Volts	1-24 Each	25-50 Each	51-99 Each	100-249 Each
30 E 86980	BU	6V	1.95	1.85	1.76	1.37
30 E 86998	BU	12V	1.95	1.85	1.76	1.37
30 E 87012	BU	24V	1.95	1.85	1.76	1.37
30 E 87020	BU	120V	1.95	1.85	1.76	1.37

Pilot Light Assemblies

E. F. JOHNSON PILOT LIGHTS

LAFAYETTE PILOT LIGHTS



ONE-INCH ENCLOSED ASSEMBLIES

Attractive, enclosed, candelabra screw base types for 115 V. S6 lamps. Chrome plated threaded jewel permit replacement of lamp from front panel. Mounts in 1" hole; may be used on panels up to 3/8" thick. Binding screw terminals. UL listed. Series 147-1209 have faceted jewel; 2 3/4" behind panel. Series 147-1600 have dome for wide angle visibility; 2 1/4" behind panel. With mounting nut and washer, less lamp. Shpg. wt., 3 oz.

Stock No.	Mfg. No.	Fig.	Jewel	Net ea.
33 E 32467	1209-2	A	Red faceted	2.00
33 E 32475	1209-3	A	Green faceted	2.00
33 E 32483	1209-4	A	Amber faceted	2.00
33 E 32491	1600-2	B	Red dome	1.95
33 E 32509	1600-3	B	Green dome	1.95
33 E 32517	1600-4	B	Amber dome	1.95

ONE-INCH MOUNT ASSEMBLIES

(E) Series 147-802. For 115 V. candelabra screw base bulbs. Semi-enclosed assembly with faceted jewel. Lamp replacement from front or back. Socket portion detaches from panel bushing. 1" mounting hole. Shpg. wt., 5 oz.

Stock No.	Mfg. Type	Color	Net Ea.
33 E 32673	147-802-2	Red	1.00
33 E 32681	147-802-3	Green	1.00
33 E 32699	147-802-4	Amber	1.00

1/2 INCH HORIZONTAL OPEN ASSEMBLIES

(C) For low voltage miniature bayonet (Series 147-403) and screw base (Series 147-400) lamps. 1/2" faceted lens. Easy lamp replacement. 11/16" mounting hole. Solder terminals. Less lamp. Shpg. wt., 2 oz.

Stock No.	Mfg. No.	Socket	Color	Net ea.
33 E 32525	147-403-2	bayonet	Red	.68
33 E 32533	147-403-3	bayonet	Green	.68
33 E 32541	147-403-4	bayonet	Amber	.68
33 E 32558	147-400-2	screw	Red	.65
33 E 32566	147-400-3	screw	Green	.65
33 E 32574	147-400-4	screw	Amber	.65

1/2 INCH VERTICAL OPEN ASSEMBLIES

(D) Space saver for low voltage incandescent bulbs. Series 147-300 for min. screw base; 147-303 for candelabra base; 147-306 for min. bayonet base faceted jewels. Solder terminals. 7/16" mounting hole. Less lamp. Shpg. wt., 2 oz.

147-300 Screw		147-303 Candelabra		147-306 Bayonet		Color
Stock No.	Color	Stock No.	Color	Stock No.	Color	
33 E 32582	Red	33 E 32616	Red	33 E 32640	Red	Red
33 E 32590	Green	33 E 32624	Green	33 E 32657	Green	Green
33 E 32608	Amber	33 E 32632	Amber	33 E 32665	Amber	Amber
Net ea., .40		Net ea., .42		Net ea., .44		



LAFAYETTE SPECIAL NEON ASSEMBLY

For operation on 110 volts AC. Requires 100k resistor in series. When used with 200 v. use 250k resistor in series. AC starting voltage 60v. Servicing life, 5000 to 10,000 operating hours. Chrome finish. Imported. Shpg. wt., 2 oz.

Stock No.	Color	Net ea.	Lots of 10	
			ea.	ea.
99 E 62242	Yellow	.39	.35	
99 E 62259	Amber	.39	.35	
99 E 62267	Red	.39	.35	

LAFAYETTE HOBBYIST PILOT LIGHT ASSEMBLIES

• Ideal for the Builder and Experimenter



For both miniature screw and miniature bayonet lamps. Bulb replaceable from front of panel. Transparent plastic dome, for 180° visibility except when opaque. Front mounting with nickel finish nut and lock-washer. Solder terminals. 5/8" mounting hole. Less lamp. Imported. Shpg. wt., 3 oz.

Screw		Bayonet		Net Ea.	Lots of 10 Ea.
Stock No.	Color	Stock No.	Color		
99 E 63323	Red	99 E 63398	Red	.39	.35
99 E 63331	Clear	99 E 63406	Clear	.39	.35
99 E 63349	Amber	99 E 63414	Amber	.39	.35
99 E 63356	Green	99 E 63422	Green	.39	.35

INDUSTRIAL DEVICES PILOT LIGHTS

PILOT LIGHT ASSEMBLIES WITH SLIDE BASE LAMPS



Bright, highly visible pilot lights utilizing long-lived miniature slide base incandescent lamps rated 5000 hours. Round, light-diffusing screw-in lens permits easy front panel lamp replacement. Stainless steel bezel. Nylon non-strip self-locking fastening nut. Mounts in 1/4" hole. UL listed. Available complete with lamps from 6 to 120 volts. Shpg. wt., 3 oz.



OMNI-GLOW NEON PILOT LIGHTS

For use on instrument panels, etc. Will last in excess of 10-25,000 hours. Built in NE-2H neon glow lamp and current limiting resistor. Mounts in 1/2" hole with speed nut (supplied). Complete with 4 1/2" leads. Operates on 95-125 VAC. Available with rounded, cylindrical or square lens, with chrome bezel. Shpg. wt., 4 oz.

(A) ROUNDED LENS			
34 E 52083 Red lens	34 E 52091 Amber lens		
34 E 52018 Clear lens	34 E 52026 White lens		Net ea. .59
(B) CYLINDRICAL LENS			
34 E 52109 Red lens			
34 E 52117 Amber lens	34 E 52125 White lens		Net ea. .59
(C) SQUARE LENS			
34 E 52133 Red lens			
34 E 52141 Amber lens	34 E 52158 White lens		Net ea. .59
(D) BUTTON TYPE LENS (Mounts in 3/8" hole)			
34 E 52422 Red lens			
34 E 52430 Amber lens	34 E 52448 White lens		Net ea. .59

GLO-DOT NEON PILOT LIGHTS

Especially made for tight spots. Mounts in 5/16" hole with speed nut supplied. High brilliance NE-2H lamp with built-in resistor assures long life. UL and CSA listed. Complete with two 4 1/2" leads. Operates on 95-125VAC. Shpg. wt., 4 oz.

(A) MEDIUM LENS			
34 E 52034 Red lens	34 E 52042 Clear lens		
34 E 52059 Amber lens	34 E 52067 White lens		Net ea. .58
(B) HIGH HAT LENS			
34 E 52168 Red lens			
34 E 52174 Amber lens	34 E 52182 White lens		Net ea. .59

SLIDE BASE LAMPS



STOCK NO.	Lamp NO.	VOLTS	WATTS	END FOOT CANDLE		NET EACH	
				1-9	10-99	100-UP	
34 E 51005	6 PSB	6	.8	800	.51	.44	.42
34 E 51093	12 PSB	12	2.0	2400	.51	.44	.42
34 E 51101	24 PSB	24	1.7	2200	.51	.44	.42
34 E 51119	28 PSB	28	1.1	1900	.51	.44	.42
34 E 51127	48 PSB	48	2.5	1500	.51	.44	.42
34 E 51135	60 PSB	60	3.0	2400	.51	.44	.42
34 E 51143	120 PSB	120	3.0	1600	.51	.44	.42

LINE-O-LITE PILOT LIGHTS

Rectangular pilot light, lamp is high intensity neon, and unit has internal resistor. White nylon housing, chrome plated bezel. Plastic lens size 1/4 x 1 1/2". Mounts in hole 1 1/2 x 1 1/2". With speed nut supplied. Operates on 95-125 VAC. Shpg. wt., 4 oz.

34 E 52190 Red lens		
34 E 52208 Amber lens		
34 E 52455 White lens		Net ea. .65



Relay Accessories — Miniature Pilot Lamps

AC-DC PILOT LAMPS

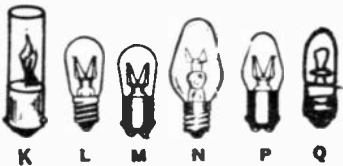

Rated at 115-125V. 1500 hours average use. All are Candelabra Screw base except + are Double Contact Bayonet Candelabra and † is miniature Bayonet. All clear except * is white. Average shpg. wt., 3 oz. each.

Stock No.	Type	Fig.	Watts	Net Ea.	10 Ea.
32 E 66640	3S6	L	3	.37	.33
32 E 66657	636	L	6	.21	.19
32 E 66685	636DC†	M	6	.31	.28
32 E 66673	7C7/C	N	7	.21	.19
32 E 66681	7C7/W*	N	7	.25	.22
32 E 66699	10C7DC†	P	10	.28	.25
32 E 66707	12M†	Q	4	.70	.63
34 E 51077	140MB‡	K	3	.51	.44

PILOT LIGHT SOCKETS

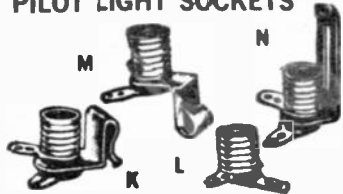

Cadmium plated brackets with tinned brass lugs. Bayonet type with coil spring construction for positive contact. For miniature screw, bayonet, and candelabra base. Avg. shpg. wt., 2 oz.

MINIATURE SCREW TYPE

Stock No.	Type	Fig.	Net Ea.	10	100
32 E 28004	5-01	K			
32 E 28012	5-07	L	.35	2.60	20.00
32 E 28020	5-04	M			
32 E 28038	5-05	N			

MINIATURE BAYONET TYPE

Stock No.	Type	Fig.	Net Ea.	10	100
32 E 28046	7-01	K			
32 E 28053	7-07	L	.40	2.60	20.00
32 E 28061	7-04	M			
32 E 28079	7-05	N			

CANDELABRA TYPE, 115 VOLT

Stock No.	Type	Fig.	Net Ea.	10	100
32 E 28087	6-01	K			
32 E 28095	6-07	L	.39	2.60	20.00
32 E 28103	6-04	M			
32 E 28111	6-05	N			

SOCKETS FOR NEON, ARGON AND PILOT LAMPS



- (P) Clear Receptacle with Edison Socket. 13 E 81276 Shpg. wt., 3 oz. Net .25
- (P) Receptacle with miniature screw socket. 13 E 81284 Shpg. wt., 3 oz. Net .10
- (P) Receptacle with candelabra socket. 13 E 81292 Shpg. wt., 3 oz. Net .19
- (Q) Recessed receptacle with candelabra socket. 13 E 23500 Shpg. wt., 3 oz. Net .56
- (R) Recessed receptacle with double contact bayonet socket. Top mounting. 13 E 34010 Shpg. wt., 3 oz. Net .59
- (S) Double contact bayonet candelabra socket 13 E 34028 Shpg. wt., 3 oz. Net 1.49
- (S) Single contact bayonet candelabra socket 13 E 34036 Shpg. wt., 3 oz. Net 1.39

PILOT LAMPS—FLASHLIGHT BULBS



For radio and T.V. pilot lights, panels, flashlights, toys, appliances, coin machines, etc. Base code: 1- single contact flanged, 2- miniature screw, 4- special, 5- single contact mid-gel, 6- single contact bayonet, 7- double contact bayonet, 8- midgel screw, 9- miniature bayonet, 10- two pin, 11- sub-minioid flanged, 12- 1" tinned leads. Under AMPS, CP means candle-power. †—25,000 hour subminiature lamp, ‡—40,000 hour, *—50,000 hour, —100,000 hour. Shpg. wt., box 10 is 4 oz. 1 lamp, 2 oz.

Stock No.	GE No.	Volt	Amp.	Fig Base	Net Ea.	10 For
32 E 66012	PR-2	2.4	0.50	A	1	.29 1.23
32 E 66020	PR-3	3.6	0.50	A	1	.29 1.23
32 E 66038	PR-4	2.3	0.27	A	1	.20 1.23
32 E 66048	PR-6	2.5	0.30	A	1	.20 1.23
32 E 66053	PR-12	5.95	0.50	A	1	.20 1.23
32 E 66081	PR-13	4.75	0.50	A	1	.20 1.23
32 E 66079	12	6.3	0.15	O	10	.26 1.96
32 E 66087	13	3.7	0.30	H	2	.17 1.05
32 E 66095	14	2.5	0.30	H	2	.17 1.05
32 E 66103	27	4.9	0.30	H	2	.20 1.25
32 E 66111	31	6.2	0.30	H	2	.25 1.53
32 E 66129	40	6.8	0.15	B	2	.15 .86
32 E 66137	41	2.5	0.50	B	2	.26 1.55
32 E 66145	42	3.2	0.35	B	2	.33 1.97
32 E 66152	43	2.5	0.50	C	9	.26 1.58
32 E 66180	44	6.8	0.25	C	9	.15 .86
32 E 66178	45	3.2	0.35	C	9	.22 1.32
32 E 66186	46	6-8	0.25	B	2	.15 .86
32 E 66194	47	6-8	0.15	C	9	.15 .86
32 E 66202	48	2.0	0.06	B	2	.26 1.55
32 E 66210	49	2.0	0.06	C	9	.22 1.32
32 E 66228	50	6-8	1C.P.	H	2	.19 .82
32 E 66236	51	6-8	1C.P.	C	9	.15 .86
32 E 66244	53	14.4	0.12	G	9	.14 .84
32 E 66251	55	6-8	2C.P.	C	9	.15 .86
32 E 66269	57	12-16	2C.P.	C	9	.14 .84
32 E 66277	63	6-8	3C.P.	C	6	.19 1.13
32 E 66285	81	6-8	6C.P.	C	6	.23 1.40
32 E 66283	82	6-8	6C.P.	C	7	.23 1.40
32 E 66448	93	12	15C.P.	F	6	.32 1.90
32 E 66301	112	1.2	0.22	O	2	.17 1.05
32 E 66318	123	1.25	0.30	H	2	.17 1.05
32 E 66327	136	1.3	0.60	H	2	.22 1.39
32 E 66335	222	2.2	0.25	D	2	.17 1.05
32 E 66343	223	2.2	0.25	D	2	.22 1.39
32 E 66350	224	2.15	0.22	E	4	.22 1.39
32 E 66358	233	2.2	0.27	H	2	.22 1.39
32 E 69107	239	6.3	0.36	C	9	.30 1.82
32 E 66378	248	2.5	0.80	H	2	.34 2.11
32 E 66384	313	28	0.17	C	9	.33 1.90
32 E 66382	327	28	0.04	P	5	.71 4.20
32 E 66400	328	6	0.20	P	5	.35 3.29
32 E 66913	330	14	0.08	P	5	.93 5.56
32 E 66921	380*	6.3	0.04	P	5	2.19 12.90

#47 PILOT LAMP 10 for 59c



Most often used pilot light. Replaces pilot in most electronic entertainment equipment. Imported. Shpg. wt., 5 oz.
 99 E 63042 pkg. of 10 .59
 Lots of 5 pks. ea. .53

METER ILLUMINATING PILOT LAMP

For Illuminating Meters Internally
 Used in Lafayette "S" and Modulation panel meters. Operates on 6 volts AC or DC. Can operate on 12 volts with 2 lamps in series. Shpg. wt., 2 oz.
 99 E 62622 Net .34

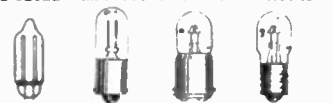

NEON GLOW LAMPS

For 105-125 VAC operation. Screw types have resistor in base for 105-125 v others require external resistor. AC starting voltage shown; DC starting voltage 40% higher. Shpg. wt., 2 oz.

Stock No.	Type	Watts	Start Volt	Base Type	Each	10-Up Each
32 E 66723	A1A	NE-2	1/25	Wire Term.	.10	.08
32 E 66731	A9A	NE-2E	1/10	Wire Term.	.10	.08
32 E 66830	C2A	NE-2H	1/4	Wire Term.	.11	.09
32 E 66749	B5A	NE-17	1/4	D.C. Bay.	.06	.73
32 E 66756	B6A	NE-21	1/4	S.C. Bay.	.90	.71
32 E 69115	A1C	—	1/7	Wire Term.	.13	.10
32 E 69123	A1H	—	1/7	S.C. Midgel	.43	.34
32 E 69131	D2A	—	1/3	Wire Term.	.16	.13
32 E 66798	B7A	NE-45	1/4	Cand. Screw	.81	.53
32 E 66806	B9A	NE-48	1/4	D.C. Bay.	.67	.52
32 E 66814	B1A	NE-51	1/25	S.C. Bay. Min	.20	.16
32 E 66822	B2A	NE-51H	1/4	S.C. Bay. Min	.22	.18
32 E 66871	5AC	NE-68	—	Wire Term.	.40	.32
32 E 66897	5AH	NE-83	—	Wire Term.	.20	.18

CROSS-REFERENCE FOR TUBE TYPES (Cont'd.)

Orig. Type	Replace With	Orig. Type	Replace With	Orig. Type	Replace With	Orig. Type	Replace With	Orig. Type	Replace With	Orig. Type	Replace With
19GT4	19DUP4	21BNP4	21CBP4A	21FLP4	21CBPA	23BX4	23ED4	23FJ4	23ET4	23TP4	23BT4
19GU4	19DUP4	21BSP4	21AMP4B	21FWP4	21FVP4	23BZ4	23CG4	23FL4	23EK4	23U4	23BP4
19P4	19AVP4	21BT4	21CBP4A	21FZ4	21FV4	23CB4	23BQ4	23FMP4	23FP4	23WP4	23FP4A
19Y4	19AVP4	21CEP4	21EMP4	23AC4	23BT4	23CZ4	23AH4	23FV4	23HF4	23X4	23BT4
19Z4	19AVP4	21CMP4	21CBP4A	23AF4	23BT4	23DL4	23EN4	23GP4	23CP4	23Y4	23BT4
20C4	20DP4D	21CUP4	21AMP4B	23AL4	23CQP4	23OQP4	23BK4	23GB4	23FP4	23Z4	23BK4
20X4	20TP4	21CVP4	21CBP4A	23AN4	23BK4	23OSP4	23EN4	23GP4	23FR4	24AD4	24CP4B
20Y4	20SP4	21CWP4	21CBP4A	23AT4	23BK4	23OT4	23OK4	23GE4	23EN4	24AL4	24AH4
21AC4	21AMP4B	21CX4	21DSP4	23AU4	23AH4	23YP4	23ET4	23GT4	23ET4	24AN4	24AE4
21AF4	21Y4A/B	21CZ4	21DE4	23AV4	23CP4	23DZ4	23EQ4	23GWP4	23GJ4	24AV4	24BE4
21AL4	21CBP4A	21DAP4	21DE4	23AW4	23BJ4	23HP4	23EK4	23XG4	23GS4	24DP4	24AE4
21AN4	21CBP4A	21DMP4	21EMP4	23BD4	23BT4	23ES4	23HF4	23HP4	23CP4	24OP4	24CP4B
21AQP4	21AMP4B	21DNP4	21CBP4A	23BH4	23GP4	23EWP4	23EQ4	23HL4	23GQ4	24TP4	24CP4B
21AT4	21CBP4A	21DQ4	21DL4	23BL4	23BK4	23EZ4	23BK4	23HQ4	23HG4	24VP4	24CP4B
21AV4	21AUP4C	21EAP4	21FD4	23BM4	23BT4	23FC4	23GJ4	23HR4	23HW4	24X4	24CP4B
21BA4	21CBP4A	21ED4	21EMP4	23BN4	23CP4	23FD4	23GJ4	23HX4	23HF4	24Y4	24AE4
21BC4	21Y4A/B	21ESP4	21EMP4	23BV4	23BT4	23FE4	23EN4	23KP4	23EN4	24Z4	24AE4
21BD4	21AUP4C	21ET4	21EMP4	23BWP4	23BT4	23FH4	23GJ4	23MP4	23EN4	27AB4	27AD4
										27AG4	27AD4

COLOR PICTURE TUBES

* Indicates may contain used parts, which prior to reuse have been carefully inspected, insuring high quality.

Stock No.	Tube Type	Net Ea.	Dud Value	Stock No.	Tube Type	Net Ea.	Dud Value	Stock No.	Tube Type	Net Ea.	Dud Value
36 E 40356WX	11SP22	66.60	4.25		19GZP22 — USE				25AP22A — USE		
36 E 40485WX	11WF22	90.64	4.25		19GW22/EYP22				25X2P22/25AP22A*		
36 E 40285WX	15L22	96.24	19.25	36 E 40300WX	19HN22	154.40	24.25		25B2P22A — USE		
36 E 40372WX	15NP22	93.16	19.25	36 E 40109WX	21AX22A	81.77	—		25Y2P22/25B2P22A*		
				36 E 40117WX	21CYP22A	74.53	—		25G2P22 — USE		
				36 E 40398WX	21FBP22	72.11	16.75		25X2P22/25AP22A		
				36 E 40406WX	21FJ22	78.95	18.75		25FP22 — USE	25B2P22A	
					21FKP22 — USE	21FJ22			25RP22 — USE	25B2P22A	
				36 E 40299WX	21GF22	96.25	19.25		25S2P22 — USE	25AP22A	
					21GU22 — USE	21FBP22			25UP22	153.00	—
36 E 40483WX	19GV22/	97.31	24.25		21GV22 — USE	21FJ22		36 E 40331WX	25VP22 — USE	25AP22A	
	EXP22			36 E 40489WX	21GW22	189.00	24.25		25WP22 — USE	25AP22A	
36 E 40471WX	19GW22/	105.51	24.25	36 E 40414WX	22P22	122.60	24.25	36 E 40521WX	25X2P22/	93.25	29.25
	EYP22			36 E 40497WX	22KP22	115.73	29.25		25AP22A		
	EYP22			36 E 40505WX	22UP22	168.07	29.25	36 E 40539WX	25Y2P22/	87.77	29.25
	19GX22 — USE			36 E 40422WX	23EG22	162.65	19.25		25B2P22A		
	19GV22/EXP22			36 E 40430WX	25AJ22	181.00	29.25		25Z2P22 — USE	25AP22A	
	19GY22 — USE			36 E 40513WX	25CP22	93.20	29.25				

RCA-GE SPECIAL PURPOSE TUBES RCA-GE

The tubes shown in this listing will be supplied from brand new factory boxed stock manufactured by RCA and GE. Type shown with * is Victoreen Mtc. Quantity users please contact our Industrial

Division (see pg.14.) for quotation on quantities of five or more of any type required. Many types other than shown here are available.

Stock No.	Tube Type	Net Ea.	Stock No.	Tube Type	Net Ea.	Stock No.	Tube Type	Net Ea.	Stock No.	Tube Type	Net Ea.
36 E 41000	0A2	1.35	36 E 41743	6AU6WB	2.70	36 E 42527	2950A	2.05	36 E 43707	6386	8.00
36 E 41024	0A3	1.55	36 E 41768	6BJ6/ECC88	1.90	36 E 42618	5501	6.20	36 E 43723	6417	3.35
36 E 41032	0A4G	1.90	36 E 41818	6SJ7Y	2.15	36 E 42675	5642	3.55	36 E 43806	6550	4.00
36 E 41040	0B2	1.40	36 E 41834	12A6	3.36	36 E 42683	5651A	1.70	36 E 43863	6669/6A5Q	1.05
36 E 41065	0B3	2.35	36 E 41842	12AT7WB	2.55	36 E 42709	5653	5.35	36 E 43871	6677/6CL8	1.65
36 E 41073	0C2	1.50	36 E 41933	6J	1.90	36 E 42808	5666	3.40	36 E 43897	6679/12A7T	1.50
36 E 41081	0C3	1.50	36 E 41990	607	4.20	36 E 42824	5691	8.75	36 E 43905	6680/12A07A	1.25
36 E 41099	0B3	1.45	36 E 42006	611A	7.90	36 E 42857	5696	2.05	36 E 43913	6681/12AX7A	1.25
36 E 41123	1805*	18.59	36 E 42014	612A	7.45	36 E 42931	5626/6AL5W	1.55	36 E 43947	6683	4.25
36 E 41131	1C21	4.15	36 E 42022	613	25.85	36 E 42956	5727	2.90	36 E 43954	6622/E80CC	4.90
36 E 41172	1L4	1.90	36 E 42048	616	4.90	36 E 43012	5751	2.55	36 E 43988	7054	1.55
36 E 41248	1P4G	5.90	36 E 42121	688A	3.80	36 E 43046	5763	2.45	36 E 44062	7056	.95
36 E 41362	2D21	1.30	36 E 42139	688	6.85	36 E 43061	5814A	2.35	36 E 44010	7059	1.50
36 E 41396	2E26	3.95	36 E 42154	684	2.28	36 E 43095	5823	1.75	36 E 44028	7060	1.75
36 E 41438	2X2A	4.20	36 E 42212	922	3.75	36 E 43194	5881	3.50	36 E 44036	7061	1.30
36 E 41446	3A4	1.55	36 E 42238	925	5.95	36 E 43269	5915	1.85		7357 USE 6150W/7357	
36 E 41453	3A5	2.03	36 E 42253	927	7.15	36 E 43277	5963	1.40	36 E 44093	7360	3.75
36 E 41487	3B2B	6.85	36 E 42261	929	3.65	36 E 43293	5965	1.95	36 E 44101	7361	2.40
			36 E 42279	930	5.00	36 E 43327	6012	7.65	36 E 44127	7358	3.50
36 E 41560	3KP1	28.60	36 E 42303	934	7.60	36 E 43426	6080	5.35	36 E 44150	7357	5.28
36 E 41578	3RP1	16.30	36 E 42329	955	7.05	36 E 43442	6082	5.60	36 E 44290	7305	3.85
36 E 41644	5B1A	36.85	36 E 42402	1612	5.80	36 E 43509	6136	2.70	36 E 44218	7984	5.35
36 E 41868	5R4GYB	2.05	36 E 42428	1614	4.95	36 E 43517	6146A	4.30	36 E 44317	9077/7064	1.40
36 E 41877	SUP1	21.10	36 E 42451	1620	7.55	36 E 43525	6146B/6290A	5.15		8290A USE 6146B/6290A	
36 E 41893	6AG7Y	2.80	36 E 42469	1621	3.85	36 E 43590	6201	2.95	36 E 44374	9098	8.05
36 E 41701	6AK6	1.40	36 E 42493	1625	6.30	36 E 43632	6211	2.15	36 E 44382	9096	2.70
36 E 41727	6AS6	3.45	36 E 42501	1629	2.65						
36 E 41735	6A57GA	4.95									

TUBES AND PARTS EXTRACTOR

TUBE PIN STRAIGHTENER

RCA RECEIVING TUBE MANUAL RC26



This handy tube extractor is skillfully constructed of spring steel, nickel plated. Has rubber cushion on the prongs.

A 6" plastic ruler combination tube pin straightener. Accommodates Novar, Nevisitor, and Compactron large 7 pin, 9 pin and 10 pin tubes.

RCA RECEIVING TUBE MANUAL. Contains complete technical data on all current tubes. Features tube theory written for the layman, application information and a circuit section. Tuner, receiver, amplifier, intercom and other circuit diagrams, socket diagrams, tube dimension drawings, resistance-coupled amplifier data, etc., 656 pages. Shpg. wt., 1 1/2 lbs.

31 E 61211 Net .98

13 E 61229 Net .90

10 E 47016 Net 1.75

To Speed Your Mail Order—Please Give Your Zip Code Number

Lafayette Cat. No. 700 267

TRANSISTOR AND HEARING AID BATTERIES

LAFAYETTE Batteries

Lafayette Stock No.	"Eve-ready"	Bur-gess	R.C.A.	Mallory	Volt-age	Wt. Lbs.	Net
32 E 48192 (D)	1050	230	VS336	M13R	1.5	1/4	.19
32 E 47012 (G)	1035	130	VS335	M14R	1.5	3/4	.19
32 E 47020 (AA)	1015	930	VS334	M15R	1.5	3/4	.155
32 E 47038	243	223	VS324	—	4 1/2	1/4	1.36
32 E 48077	216	2U6	VS323	M1604	9.0	3/4	.48
32 E 47046	246	2N6	VS305	M1602	9.0	1/4	1.36
32 E 48986	266	M6	VS322	M1605	9.0	1/2	1.36
32 E 47053	276	D6	VS306	M1603	9.0	1	1.57
32 E 47061	2506	D6P1	VS301	—	9.0	1 1/2	1.92
32 E 47079	239	XX9	VS304	—	13 1/2	1/8	1.36
32 E 47087	2731N	—	VS337	—	4 1/2	3	2.76
32 E 47095	2356N	C6X	VS330	—	9.0	1 1/4	1.64
32 E 47103	2709N	—	VS339	—	9	1/2	1.05
32 E 47129	226	P6	VS300A	M1600	9	3	.88
32 E 48903	333	—	VS332	—	4 1/2	3/8	.68
32 E 48911	222	2MNG	—	—	9	1/4	.65



POPULAR SIZES AT POPULAR PRICES

Popular batteries for portable and transistor sets, flashlights and toys. *For hearing aids and transistor sets. Imported.

Stock No.	Volt-age	Singlv.	Lots of 10 Ea.	Fig-ure	Replaces			Shpg. wt.
					RCA	Bur-gess	Eve-ready	
99 E 60220	9	.34	.29	B	VS300A VS314 VS016 VS084	P6 P6M XX45 U15	226	3 oz.
99 E 60246	67 1/2	1.59	1.43	A	VS016	XX45	467	3 oz.
99 E 60279*	22 1/2	.59	.53	C	VS084	U15	412	3 oz.

INDUSTRIAL BATTERY TYPES

32 E 39019	711	2F4	VS101	1 1/2	3/4	.84
32 E 47137	W356	2F2H	VS136	3	1 3/8	1.92
32 E 47160	750	422	VS134	3	1/8	.79
32 E 47178	703	532	VS346	4 1/2	1/4	1.36
32 E 47186	761T	2370ST	VS130	4 1/2	3/8	1.76
32 E 47202	781	5360	VS028	4 1/2	1/4	1.23
32 E 47228	773	5540	VS029	7 1/2	1/2	1.80
32 E 47236	763	4156	VS102	2 1/2	3/8	1.61
32 E 47244	778	5156SC	VS131	2 1/2	1 1/2	4.16
32 E 47251	W350	230XN	VS114	2 1/2	45	2.69
32 E 47293	762S	5308	VS112	45	3 1/2	3.05

STANDARD FLASHLIGHT BATTERIES



Stock No.	Volt-age	Net	Lots of 10	Fig-ure	RCA	Bur-gess	Eve-ready	Shpg. wt.
99 E 62564	1 1/2(D)	.15	1.20	D	VS036	2	950	4 oz. ea.
99 E 62572	1 1/2(C)	.14	1.20	E	VS035	1	935	3 oz. ea.
99 E 62580	1 1/2(AA)	.10	.69	F	VS034	Z	915	2 oz. ea.

FLASHLIGHT & LANTERN BATTERIES

32 E 48655	912	7	VS074	1 1/2	1/8	.16
32 E 47517(AA)	915	Z	VS034A	1 1/2	3/4	2 for .23
32 E 47509(C)	935	1	VS035A	1 1/2	1/8	2 for .33
32 E 47491(D)	950	2	VS036	1 1/2	1/8	2 for .33
32 E 48663	D-99	—	—	1 1/2	1/8	.19
32 E 48671	735	FAM	VS106	1 1/2	1 1/4	.99
32 E 48689	#6 Ign.	6 Ign.	VS006S	1 1/2	2 3/8	.99
32 E 48697	509	FAM	VS040C	6	1 1/4	.99
32 E 48184	510S	FABP	VS040S	6	1 1/4	.99
32 E 48705	731	TW1	VS317	6	3 1/4	2.15
32 E 48713	706	4F4H	VS103	6	5 3/8	4.01
32 E 48739	716	4F6H	VS140	9	3 1/2	5.53
32 E 48754	904	NE	VS073	1 1/2	1	.095
32 E 48770	510F	FASC	—	6	1 3/4	1.05
32 E 48788	715	4F5H	VS139	7 1/2	8 1/2	4.86
32 E 39069	—	Z46	—	69	3 3/8	2.93

MANGANESE ALKALINE BATTERIES

Up to 10 times longer life. Do not require rest period, operate with same efficiency in continuous or intermittent service.

Stock No.	Eve-ready	Mallory	R.C.A.	Bur-gess	Volt-age	Wt. Oz.	Shpg. No. Per Pkg.	Net
32 E 47475	—	PX-825	—	—	1.5	2.0	4	1.32
32 E 48838	E94	—	—	—	1.5	1.8	1	.52
32 E 48846(O)	E95	MN1300	VS1336	AL2	1.5	4.1	1	.93
32 E 47525(AA)	E91	MN1500	VS1334	AL9	1.5	2.0	2	.79
32 E 48879(C)	E93	MN1400	VS1335	AL1	1.5	2.0	1	.49
32 E 47541	E90	MN9100	VS1073	ALN	1.5	.3	2	.66
32 E 48837	E92	MN2400	VS1074	AL7	1.5	.4	1	.39
32 E 46451	523	MN1306	VS1149	AL133	4.5	2.0	1	1.00
32 E 47426	563	—	VS1563	—	4.5	1.0	1	2.76
32 E 48747	560	—	VS1560	—	7.5	2.0	1	4.62
32 E 47434	564	—	VS1564	—	13.5	5.8	1	9.94
32 E 47533	—	MN1604	VS1323	—	9.0	1.5	1	1.00

KEYSTONE BATTERY HOLDERS

Battery Holders are made of Aluminum Alloy, sturdy construction with insulated, nickel plated Brass eyelets. All multiple holders mount batteries side by side except items marked *mount end to end. Av. shpg. wt., 3 ozs.



Stock No.	Holds	Bur-gess	Eveready	RCA	Mallory	Net Ea.
34 E 50012	1	—	—	—	—	.23
34 E 50020	2	—	—	—	—	.38
34 E 50038	3	7, AL7	912, E92	VS074 VS1074	MN2400	.49
34 E 50046	4	—	—	—	—	.64
34 E 50053	1	—	E9, E12, E133, E502	VS034 VS9	RM12R, TR133R, RM502R, ZM-9 TR233R	.23
34 E 50061	2	2, 9R, Y15	—	—	—	.38
34 E 50079*	2	—	—	—	—	.45
34 E 50087	3	CD6	—	—	—	.49
34 E 50095	4	—	1015E, C450	—	—	.64
34 E 50103	1	—	935, E93	VS035	MN1300	.30
34 E 50111	2	1	—	—	—	.38
34 E 50129*	2	AL2	—	—	—	.45
34 E 50137	1	2, D, 24	950, E95, CH4	VS036 VS1336	—	.30
34 E 50145	2	—	—	—	—	.38
34 E 50152	2	CD10	—	—	—	.46
34 E 50160	1	U15	412	VS084	RM412R	.30

NICKEL CADMIUM BATTERY STANDARD 9-VOLT TRANSISTOR BATTERY

Replaces RCA VS323, Burgess 2U6, Eveready 216, Zenith Z216, Ray-O-Vac 1604, NEDA 1604. Imported.

EXTRA LONG LIFE 9 VOLT BATTERY

As above, but provides more than 50% longer shelf life.

"STORAGE CELL" for TRANSISTOR RADIOS

ONE CHARGEABLE BATTERY OUTLASTS DOZENS OF CONVENTIONAL BATTERIES

- Replaces 2U6, 216, and BL-006P
- Fluid Storage Type
- Plays About 15 Hours on One Charging
- Battery Recharges Overnight
- Complete—Battery Plus Charger

9V Battery complete with charger. Battery 1 7/8x1 1/8"; charger 3 3/4x 1 1/4x7/8" Imported. Shpg. wt., 6 oz. Net ea. .21

BATTERY HOLDER

59c A. Ultra-compact bakelite battery case. Holds 8-1 1/2 volt "Z" penlight cells. 2 3/4" holds. 1 1/8" on centers for mounting. Size: 2 3/4 x 2 3/4 x 1 1/4". Imported. Shpg. wt., 3 oz. Net .59

39c B. Battery holder for 4-1 1/2 volt "Z" penlight cells. Has snap-on battery clip and leads. Size: 1 1/4 x 1 3/8 x 2 1/4". Imported. Shpg. wt., 3 oz. Net .39

Battery Eliminators—Chargers

LAFAYETTE MULTI-PURPOSE BATTERY CHARGER



249

- Recharge All Popular Batteries — Transistor, AA Penlight, C And D Cells ... Up To 3 At One Time!
- Just Plug-In And Use

Designed to charge regular carbon zinc, nickel cadmium and alkaline batteries. Charges up to 3 batteries in a relatively short time for less than a penny. Two compartments automatically adjust to size of battery inserted, plus 2 snaps are provided for 9V., transistor radio batteries. Red light indicates charger is operating. For 110-120 volts 50/60 Hz AC. Imported. Shpg. wt., 1 lb.
99 E 92058

Net 2.49

DYNAMIC HOME BATTERY CHARGER



395

- Recharge Batteries Up to 15 Times
- Battery Tester Included
- "D" - "C" - "AA" and 9V Transistor Sizes

Recharge from one to four batteries at one time. Safety is assured since charger is in operation only when lid is closed. Plugs into standard 110-120 volt. 60 Hz AC outlet. With free battery tester. 34 E 42027 Shpg. wt., 1½ lbs.

Net 3.95

BATTERY CHARGER WITH TWO RECHARGEABLE BATTERIES



SALE! 2⁹⁵
SAVE 2.00

- Recharges Batteries Overnight.
- For Flashlights, Transistor Radios, Toys...
- 2 D Type Batteries Included

Recharges any type D battery overnight. No longer must toys, transistor radios and flashlights be without "live" batteries. White plastic case with 2 rechargeable type D batteries. Replaces VS036, 2, 950 etc. Imported. Shpg. wt., 2 lbs.
99 E 91001 Charger and 2 Batteries

Net 2.95

NICKEL CADMIUM BATTERY CHARGER



- Charges Two or Four Penlight (AA) Batteries At A Time

SALE! 2⁴⁹
SAVE 1.50

Take advantage of the extremely long life of nickel-cadmium batteries. Two or four can be fully charged within sixteen hours. No chance of overcharge. Simple operation from any 117VAC source. Indicator light protects against incorrect insertion of batteries. Size: 2¾x3¾x1".

99 E 91803 Shpg. wt., 1 lb. Imported. ea. 2.49
Batteries for above. 32 E 47400

ea. 1.40

CHART CHARGE NICKEL-CADMIUM BATTERY CHARGER



- Charges 1 to 10 Cells in Series Up to 250 MA

Meets the demands of Nickel-cadmium cells in industrial and hobby use. Continuously variable from 10 to 250 MA to charge 1 to 10 cells in series. Use of isolation transformer eliminates shock hazard. Full wave silicon diode rectification. No meter is required for accurate calibration. Pilot light on-off indicator, UL listed. Cord. 6¼x3¾x2". Shpg. wt., 2 lbs.
34 E 41011

Net 9.95

LAFAYETTE 9-VOLT TRANSISTOR RADIO BATTERY CHARGER AND ELIMINATOR



- Charge Battery, Operate Set On AC, or Both
- Isolation Transformer — Shock-Proof

369

Just plug into any 117-volt AC receptacle and recharge your old 9-volt battery for many hours of extra use; or operate your set indoors without using the battery at all; or you can both charge battery and operate set at the same time. Has 4-position switch for above functions plus off position and pilot light. Size 4Wx1¼xHx 2½"D. Imported. Shpg. wt., 1 lb.
99 E 90219

Net 3.69

AUTOMATIC DRY CELL BATTERY CHARGER



625

- Charge Up To 14 Batteries At A Time
- Uses AC Or DC Power Source
- Will Not Overcharge
- Built-in Battery Tester

Recharges all "D", "C", and 9-volt transistor carbon-zinc, alkaline, mercury, and nickel cadmium batteries. Charging receptacles for 4 "D" cells, 4 "C" cells, 6 "AA" cells and one 9V battery permits recharging up to 14 batteries at one time. Transformer circuitry operates on a demand principle and automatically prevents overcharging. Has built-in battery tester-indicator light. Shock-proof since low voltage charging occurs only when lid is closed. Attractive, decorator styled hi-impact pliable plastic case. For 110-120 volt OC or AC 60 Hz. Size: 7½x4¾x2¾". Shpg. wt., 1¾ lbs.
34 E 25006

Net 6.25

LAFAYETTE HEARING AID BATTERY RECHARGER

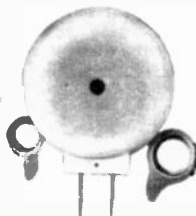

- Recharges Nickel Cadmium Cells Repeatedly To Replace The "675" And "625" Batteries

- Cuts Battery Cost in Half
- Just Insert Rechargeable Cells Into Charger—Plug In And 14 Hours Later They Are Fully Charged

Only 675

Less Batteries

Economical, convenient charger permits replacement of the popular "675" and "625" disposable hearing aid batteries with rechargeable nickel cadmium cells which give up to 15 hours use per charge and 500 charges per cell. Simply insert the nickel cadmium cell into its slide-out compartment and fully recharge in 10-14 hours. Cells cannot be overcharged. Use one cell in the hearing aid while another is being charged, to have power available at all times. Tiny size permits carrying the charger with you. For 110-120 Volt, 60 Hz AC. Less batteries. Imported. Shpg. wt., 3 oz.

99 E 92033 Charger only, less batteries Net 6.75
32 E 47467 Nickel Cadmium Replacement for 675 battery Net 1.05
32 E 47301 Nickel Cadmium Replacement for 625 battery Net .74

CHARGER WITH TWO NICAD® BATTERIES



- Complete with Two Rechargeable Nickel Cadmium "D" Cells

These D-size nicad cells can be recharged hundreds of times, for use in your flashlight, toys, games and other portable appliances. You may buy extra batteries and always have fully charged spares on hand. Charger uses any 115V 60 cycle AC outlet. Size: 4¾x3½x 2". Wt., 2 lbs.
34 E 35013 Complete set Net 7.95
34 E 35021 Extra batteries Net 2.10

795

Semiconductors for Hobbyist and Experimenter

(A) 2-10-WATT POWER TRANSISTORS

Package of 2 PNP 10 Watt germanium power transistors in popular TO-3 case. Similar to 2N155, 2N176, 2N235, 2N351, 2N242, 2N257, 2N268, 2N301A, 2N255, 2N554, 2N555, etc. Shpg. wt., 8 oz.
19 E 15016 Pkg. of 2 Net .89



Pkg. of 2 **89¢**

(B) 4 PNP GERMANIUM TRANSISTORS

Package of 4 PNP General Purpose Type Transistors similar in performance to: 2N107, 2N218, 2N1265, CK722, GT-222, TR722, 2N1191, etc. wt., 6 oz.
19 E 15024 Pkg. of 4 Net .89

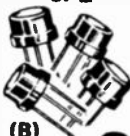

Pkg. of 4 **89¢**

TRANSISTOR MOUNTING KITS

19 E 15313 For TO-3 Type Net .30
19 E 15321 For TO-36 "Door Knob" Type Net .30

(C) 10 GERMANIUM DIODES

Pkg. of 10 germanium diodes that replace 1N34, 1N34A, 1N46, 1N48, 1N51, 1N60, 1N64, 1N64A, 1N87, 1N105, 1N109, 1N147, 1N267, 1N268, 1N295, etc. Shpg. wt., 6 oz.
19 E 15057 Pkg. of 10 Net .79



Pkg. of 10 **79¢**

(D) 2 TOP HAT SILICON RECTIFIERS

750 MIL - 400 PIV
Pkg. of 2 top hat type silicon rectifiers rated at 750 milliamperes, 400 PIV. Shpg. wt., 6 oz.
19 E 42028 Pkg. of 2 Net .89

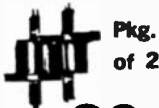

Pkg. of 2 **89¢**

(E) POPULAR POWER TRANSISTORS

MEDIUM POWER TRANSISTORS
Beta=30, BV_{ce}=36 Volts: Shpg. wt., 12 oz. Similar to: 2N155, 2N176, 2N235, 2N242, 2N255, 2N256, 2N301, 2N307, 2N554, AR-5, etc.
19 E 15073 Net ea. .59
In Lots of 100, Each Net .49

HIGH POWER TRANSISTORS
Beta=50; BV_{ce}=36 Volts Min. Shpg. wt., 12 oz. Similar to: 2N157A, 2N176B, 2N257, 2N258A, 2N301A, 2N353, 2N399, etc.
19 E 42051 Net ea. .69
In Lots of 100, Each Net .39



Lots of 100 **49¢**

(F) 2 NPN TRANSISTORS

Package of 2 NPN germanium transistors similar to 2N170 for Audio & RF. Beta 20 minimum. Shpg. wt., 4 oz.
19 E 27029 Pkg. of 2 Net .49



Pkg. of 2 **49¢**

(G) 750 MIL EPOXY SILICON RECTIFIERS

750 mil 400 PIV Epoxy Silicon Rectifier
19 E 50013 Shpg. wt., 2 oz.
Net ea. .37; 10 for 3.49; 100 for 29.95
750 MIL 700 PIV Epoxy Silicon Rectifier
19 E 50021 Net ea. .59 10 for 4.95
100 for 42.50



(G) **37¢**

(H) 40-WATT HIGH POWER TRANSISTOR

Excellent for power supplies, auto replacement, audio output, etc. Similar to 2N173, CTP1504, SFT 266, etc. Bolt mounted.
19 E 15032 Shpg. wt., 8 oz. Net .89



(H) **89¢**

RECTIFIER MOUNTING KITS

19 E 18081 For 3/16" Hex. Base Net .17
10 for 1.39
19 E 15156 For 11/16" Hex. Base Net .27
10 for 2.49
19 E 15164 For 1/4" Hex. Base Net .35
10 for 3.15

(I) 10 SILICON DIODES

Package of 10 silicon diodes. Replaces 1N34, 1N34A, 1N46, 1N48, 1N51, 1N60, 1N87, 1N295, etc. Wt., 4 oz.
19 E 80012 Pkg. of 10 Net .89



Pkg. of 10 **89¢**

(J) PHOTO-MULTIPLIER

POWER TRANSISTOR

PHOTOELECTRIC ELECTRONIC RELAY

- PHOTO ELECTRIC CELL
- POWER TRANSISTOR AMPLIFIER

Complete with Instructions, Data and Diagrams for photo control systems, photo-electronic amplifiers; Relays, Alarms, etc. Shpg. wt., 6 oz.
19 E 15065 Ea. Net 1.79 3 for 4.77



(J) **179**

(K) GENERAL PURPOSE DIODES

Excellent Detector for Transistor and Vacuum Tube Radio Receivers

EQUIVALENT TO: 100 far
1N34 1N34A 1N38A 8.50
1N48 1N56 1N69

19 E 49015 General Purpose Diode Net .10 each; 10 for .90



ONLY **10¢**

GE-509 UNIVERSAL SILICON RECTIFIER

1 amp., 1000 PIV, 60 amp. max. surge.
19 E 28019 Net .79

MOTOROLA HEP PROGRAM FOR HOBBYIST • EXPERIMENTER • PROFESSIONAL



Economical, hobbyist and experimenter oriented semiconductor devices for many varieties of useful and fun-type circuits and projects. (S)=Silicon; (G)=Germanium.

TRANSISTORS	
HEP-2(G), PNP, RF, 750 MHz, 300 mW. 19 E 54247	Net 1.25
HEP-3(G), PNP, 250 MHz, 100 mW. 19 E 54536	Net 1.25
HEP-50(S), NPN, 100 MHz, 300 mW. 19 E 54544	Net .79
HEP-53(S), NPN, RF, 50 MHz, 600 mW. 19 E 54031	Net 1.15
HEP-54(S), NPN, 30 MHz, 310 mW. 19 E 54270	Net 1.00
HEP-55(S), NPN, RF, 200 MHz, 310 mW. 19 E 54280	Net 1.20
HEP-230(G), PNP, Power TO-3, 5 A 90 W. 19 E 54114	Net .89
HEP-231(G), PNP, Power, TO-36, 15 A, 150 W. 19 E 54122	Net 1.69
HEP-254(G), PNP, Gen. Purp. 225 mW. 19 E 54353	Net .89
HEP-310(S), Unijunction 300 mW. 19 E 54171	Net 1.49
HEP-801 Field Effect, Audio, N Channel 19 E 54221	Net 1.59
HEP-802 Field Effect, RF, N Channel 19 E 54361	Net 1.59

INTEGRATED CIRCUITS	
HEP-451 Socket (Pkg. of 2) 10 Pin. 19 E 54239	Net 1.49
HEP-556 MECL 2 input Gate 19 E 54205	Net 1.79
HEP-558 MECL J-K Flip-Flop 19 E 54213	Net 2.39
HEP-572 RTL Dual J-K Flip Flop 19 E 54437	Net 3.90
HEP-580 RTL Dual 2-Input Gate 19 E 54445	Net .95
HEP-581 RTL 4-Input Gate 19 E 54452	Net .95
HEP-582, RTL Dual Buffer 19 E 54460	Net .99
HEP-583, RTL, J-K Flip-Flop 19 E 54470	Net 1.49
HEP-590 Linear Hi-Frequency Amplifier 19 E 54486	Net 3.98
HEP-591 Linear Audio & IF Amplifier 19 E 54494	Net 3.60
HEP-592 Linear Dual (Stereo) Preamp. 19 E 54502	Net 3.25
HEP-593 Linear 1 Watt Power Amplifier 19 E 54510	Net 7.95

HEP PROJECT MANUALS

HEP No. 400—General Hobby/Experimenter Solid State Projects Manual. Fundamentals from interesting projects; i.e.; Panic Button, Deluxe Code Oscillator, Audio Generator, Min-FX Amplifier, Intercom System, Motor Speed Control and Six Meter Converter.
10 E 64013 Net .50
HEP No. 407—Interesting IC theory & applications in such projects as Binary Computer, Organ, Square Wave Generator, Gliditone, Electronic Guitar and Code Oscillator.
10 E 64021 Net 1.00
HEP No. 408—Learn theory and applications of FET's. Interesting projects such as Vibrato, Audio Mixer, Timer, Crystal Oscillator, Pre-amplifier and D.C. Voltmeter.
10 E 64039 Net 1.00

RECTIFIERS

HEP-104 Zeher Diode, 9.1V, 1W, ±10%
19 E 54056 Net 1.20
HEP-151(S), Power, Stud, 50 PIV, 15A
19 E 54551 Net .79
HEP-154(S), Rectifier-Axial Lead, 50 PIV, 1 A
19 E 54379 Net .36
HEP-159(S), Rectifier-Axial Lead, 800 PIV, 1 A
19 E 54072 Net .60
HEP-160(S), Rectifier-Axial 1000 PIV, 1 A
19 E 54569 Net .75
HEP-162(S), Top Hat Rectifier, 200 PIV, 3 A
19 E 54403 Net 1.25
HEP-175 Full Wave Bridge Rectifier, 50 PIV, 1 Amp Single Phase
19 E 54000 Net 1.49
HEP-302 Thyristor (SCR), 200 V, 5 A
19 E 54577 Net 2.69

Hobbyist and Experimenter Semiconductor Specialties



**FOR HOBBYIST
EXPERIMENTER**
WITH APPLICATION SCHEMATICS

GE-X1 Silicon Controlled Rectifier. For plug-in speed control for tools, etc. 117 VAC, 4.7 amps max. 200 PIV.
19 E 27045 Net 2.60

GE-X2A Light Activated Silicon Controlled Rectifier. For "slave" photoflash for flashbulbs, etc. 25 PIV, 1.6 amps max.
19 E 27052 Net 2.80

GE-X3 Silicon Controlled Rectifier. For 12V regulated battery charger. Up to 13 amps and 50 PIV.
19 E 27060 Net 4.00

GE-X4 Silicon Rectifier. For high-low-off control for motor, lamp, heater, etc. 20 amps, 200 PIV.
19 E 27078 Net 1.60

GE-X5 Silicon Controlled Rectifier. For enlarger photo-timer. Also for simple remote controls. 2 amps, 50 PIV.
19 E 27086 Net 2.30

GE-X6 Photocell. For light flasher, or night light control. 250V peak AC or DC. 250 mw max.
19 E 27094 Net 1.40

GE-X7 Reed Switch. For light flasher, and burglar alarm. 15 W max on contacts 500 max. breakdown volts.
19 E 27102 Net .80

C-1 Coil for use with GE-X7.
19 E 27219 Net 1.80

C-2 Coil for use with GE-X7.
19 E 27227 Net 1.80

2R174 Thermistor
19 E 27235 Net 2.20

1D303 Thermistor.
19 E 27243 Net 1.80

C-30B Silicon Rectifier.
19 E 27250 Net 5.85

GE-X8 NPN Transistor. For light flasher, light target, triggered light source. Also for bistable lamp drivers.
19 E 27110 Net .70

GE-X9 Transistor. For light flasher, light target or triggered light source, low frequency switching.
19 E 27128 Net .70

GE-X10 Unijunction Transistor. For high precision tachometer with 12 volt neg. ground. For timing circuits.
19 E 27136 Net 1.35

GE-X11 Zener Diode. For high precision tachometer with 12V neg. grd.
19 E 27144 Net 1.80

GE-X12 Triac. For remote control for lamps and appliances.
19 E 27151 Net 4.50

GE-X13 Diac. For full-wave lamp dimmer, lamp sentinel, and AC motor control.
19 E 27189 Net 1.60

GE-X14 Thyrector. For dual-voltage power supply; 100 watt output.
19 E 27177 Net 1.15

GE-X15 Thermistor. For adjustable temperature alarm to activate bell, buzzer or light. 115-165 degrees F.
19 E 27185 Net 5.50

GE-M100 Transistor. For citizens band receiver and remote control unit (27MHz).
19 E 27281 Net 1.20

GE EXPERIMENTER, HOBBYIST MANUAL



Every engineer, experimenter, hobbyist, student and technician can learn new applications for electronics components with the simple but interesting and useful circuits in this manual. Shpg. wt. 8 oz.
10 E 36078 Net 1.50

EXPERIMENTERS BONANZA!



ONLY
99c

Pkge. of
3 Boards

PRINTED CIRCUIT TRANSISTOR COMPONENT BOARDS

PACKAGE OF 3 BOARDS
... CONTAIN ...

APPROX. 12 TOP BRAND TRANSISTORS
MANY 1% TOLERANCE RESISTORS ...
MANY 5% TOLERANCE RESISTORS ...
GLASS AND MOLDED DIODES ...

plus
TOP QUALITY, PRECISION TOLERANCE
ASSORTED CAPACITORS

Each package contains 3 assorted boards.
Each board approx. 3 3/4 x 2 3/4". Shpg. wt., 8 oz.

19 E 49023 Package of 3 Boards Net .99

EXPERIMENTERS SEMICONDUCTOR KIT

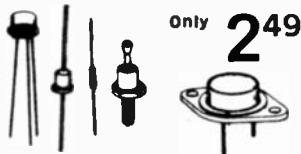

Only **249**

Assortment of 38 Desirable

Semiconductors for Many Useful Purposes.

4 ea.—PNP General Purpose Transistors. 4 ea.—NPN General Purpose Transistors. 2 ea.—Power Transistor—TO-3 case. 4 ea.—Stud Mount Silicon Rectifiers; 2 amp, 200 PIV. 20 ea.—General Purpose Germanium Diodes. 4 ea.—3/4 Watt Zener Diodes (Assorted Voltages). Shpg. wt., 8 oz.
19 E 15347 Net 2.49

EXPERIMENTER'S ADVANCED SEMICONDUCTOR ASSORTMENT

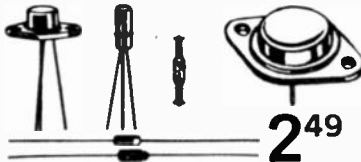

249

50 Assorted Semiconductors
Transistors, Diodes, Zeners, Rectifiers
Excellent assortment consisting of 50 desirable semiconductors for experimenters, hobbyists and for replacement.
Consists of:

5 ea. MADT 50 MHz. HI Frequency Transistors
5 ea. ZENER DIODES—400mw.—Assorted Voltages
2 ea. 3 Ampere DAP Transistors—PNP Germanium TO-5 Case
5 ea. 1N82A HI-Frequency Germanium Diodes
2 ea. SCR .2 Ampere Low Voltage
2 ea. NPN TO-3 Transistors—Silicon Mesa Power
2 ea. PNP TO-3 Transistors—Germanium Power
27 ea. Silicon Rectifiers—400 mw. Over 25 PIV
19 E 15362 Shpg. wt., 8 oz. Net 2.49

SILICON RECTIFIERS

As
Low
As

49c ea.



Top hat lead type silicon rectifiers, for TV, Radio, and power supplies as halfwave, full wave rectifiers and voltage doublers.
Type A: 750 Ma, 400 PIV @ 25°C.
500 Ma, 400 PIV @ 90°C.

19 E 42093 Shpg. wt., 4 oz. Net .59
100 for 48.25

Type B: 750 Ma, 200 PIV @ 25°C.
500 Ma, 200 PIV @ 90°C.

19 E 42101 Shpg. wt., 4 oz. Net .49
100 for 39.50

Type C: 750 Ma, 700 PIV @ 25°C.
500 Ma, 700 PIV @ 90°C.

19 E 50096 Shpg. wt., 4 oz. Net .79
100 for 62.50

TRANSISTOR AND RECTIFIER HEAT SINKS

As Low As

59c



For 1 TO-3 transistor. 22.8 sq. in.†
19 E 15271 Shpg. wt., 8 oz. Net .69

For 1 TO-36 transistor. 27.85 sq. in.†
19 E 15255 Shpg. wt., 8 oz. Net .79

For 3/16" Hex. rectifiers. 16.71 sq. in.†
19 E 15263 Shpg. wt., 8 oz. Net .59

For 1/8" Hex. rectifiers. 22.28 sq. in.†
19 E 15230 Shpg. wt., 8 oz. Net .69

For 1/4" Hex. rectifiers. 27.85 sq. in.†
19 E 15248 Shpg. wt., 8 oz. Net .79

For 2 TO-36 transistors. 70.28 sq. in.†
19 E 15339 Net 1.80

† — Radiating Surface.

STUD-MOUNT SILICON POWER RECTIFIERS



All popular models, 3/16" hexagonal mounting studs. Shpg. wt., 8 oz. per package. Pkgs. of 1, 2 or 4 rectifiers.

2 Ampere Rectifiers

Stock No.	PIV	Pkg. of	Net
19 E 50070	50	4	.49
19 E 50088	100	2	.39
19 E 50054	200	2	.58
19 E 50062	400	2	.97

12 Ampere Rectifiers

Stock No.	PIV	Pkg. of	Net
19 E 50039	50	2	1.19
19 E 50047	100	1	.77
19 E 42077	200	1	1.89
19 E 42085	400	1	1.69

50 Ampere Rectifiers 1 1/2" Hex

Stock No.	PIV	Pkg. of	Net
19 E 15149	50	1	2.49
19 E 15214	100	1	3.25
19 E 15222	200	1	4.25

CODE OSCILLATOR MODULE



98c

- Matchbook Size
- Drives Any PM Speaker

Transistorized code oscillator module ready to connect to your telegraph key, any 1 1/2 to 6 volt battery and any PM speaker. Provides clear tone—ideal for learning Morse code. Simple connecting instructions and schematic included. Shpg. wt., 8 oz.
19 E 15131 Net .98

Experimenter Semiconductor & IC Kits & Circuits

RCA EXPERIMENTER'S KITS

One "basic" and two "add-on" kits contain most necessary components to build the fourteen different circuits shown in the RCA Experimenter's manual. A few additional items such as resistors, condensers, chassis, etc. complete the projects. Circuits include: Lamp Dimmer, motor speed control, electronic timer, time delay, flashers, two battery chargers, model train or racer speed control, heat controls and others.



KD2105 "Basic" kit contains one silicon control rectifier, two transistors and five rectifiers. Shpg. wt., 1 lb.

19 E 43000 Net 9.95
 KD2106 "Add-on" Light Sensor Kit
 19 E 43018 Shpg. wt., 5 oz. Net 2.75
 KD2110 "Add-on" Heat Sensor Kit.
 19 E 43026 Shpg. wt., 4 oz. Net 2.45

COMPUTER CIRCUIT EXPERIMENT KIT



Only
9.95

- With 3-Fairchild μ L 914 IC's
- Boolean Algebra • Truth Tables
- Logic Functions • Flip-Flops
- Binary & Decimal Number Conversions

Ingenious new experiment kit dealing with fundamentals of digital computer circuitry and technology as well as application of integrated circuits in this area. Supplied with all necessary parts including 3 Fairchild μ L914 integrated circuits and comprehensive 18-page kit manual. Manual contains instructions, circuit diagrams, pictorial diagrams, and thorough easy-to-follow discussion of Boolean algebra, lamp driver "truth meter", logic functions and circuitry (AND, OR, NAND, NOR, AND INVERTER), truth tables, adders, number system conversion (decimal to binary and binary to decimal), and three different types of flip-flops and their applications. Shpg. wt., 8 oz.

19 E 53025 Net 9.95

AUDIO CIRCUIT EXPERIMENTERS KIT



Only
9.95

- With Three Fairchild μ L 914 IC's
- Four Printed Circuit Boards, etc.
- 16 Page Instruction & Circuit Manual

Excellent experimenters kit for hobbyists, designers, technicians and students interested in solid state audio circuitry and applications of integrated circuits. Kit comes complete with illustrated instructions and discussion of transistor operation, common emitter class A and B amplifiers, phase splitter, 2 and 4 channel audio mixers, square wave audio signal generator, code practice oscillator, sine wave generator, complete audio amplifier, etc. Shpg. wt., 1 lb.

19 E 53041 Net 9.95

INTEGRATED CIRCUIT EXPERIMENTER KIT



Only
6.95

Excellent kit dealing with theory and applications of revolutionary new Integrated Circuits that offer major advantages over conventional solid state circuitry. Interesting experiments with Gates, Logic Circuits, Flip-Flops, Monostable Multivibrator, Square Wave Generator, Amplifiers, Triggers, Alarms and Counters. Includes 2 Fairchild μ L 914 IC's.

19 E 53017 Shpg. wt., 8 oz. Net 6.95

MOTOROLA HEP IC EXPERIMENTER KIT

Contains 5 popular RTL integrated circuits that will function in many digital and linear applications i.e., one J-K Flip Flop, one Dual Buffer, one 4-input Gate, and two Dual 2-Input Gates, a total of 34 transistors and 48 resistors. Also includes Integrated Circuit Cross Reference Substitution Guide, "Tips on Using IC's," and 8 IC Project Circuits. Shpg. wt., 8 oz.

19 E 54528 Net 3.95

FAIRCHILD INTEGRATED CIRCUITS

• For The Experimenter And Hobbyist

703 LOW POWER RF AMPLIFIER. Contains 3 transistors, 2 diodes and 2 transistors to be used as RF and IF amplifiers, harmonic mixer, oscillator, etc. useful frequencies in excess of 100MHz. Requires 12VDC supply. With 12 page instruction and applications booklet containing 12 circuit diagrams. Shpg. wt., 4 oz.

19 E 25015 Net 1.59

716 LOW POWER AUDIO AMPLIFIER. Contains 11 transistors, 6 diodes and 18 resistors delivering 1/4 watt to 8 ohm speaker or headset. Frequency response 50Hz to 500kHz. Voltage gains of 10, 20, 100, 200 available. Input impedance 10,000 ohms. Requires 18-25V DC supply. With 12 page instruction and applications booklet containing 8 circuit diagrams. Shpg. wt., 4 oz.

19 E 25023 Net 5.95

RCA EXPERIMENTER'S MANUAL

KM-71 RCA silicon controlled-rectifier for experimenters. The first section of this 136 page book covers the theory and operation of solid state electron devices. Section two covers application considerations, construction tips and details, chassis layouts and etc. The final section has eighty-nine pages devoted to circuits for the hobbyist or experimenter. In all twenty-four complete circuits for dozens of control applications are shown. Full construction information is supplied together with schematic and pictorial diagrams. Shpg. wt., 1 b.

10 E 47067 Net .95

RCA EXPERIMENTER'S IC VARIETY PACK

Only
4.40

KD-2117 Kit

Enables the engineer or experienced hobbyist to extend his knowledge of IC's. The pack contains 5 integrated circuits: two KD2114 transistor arrays, one KD-2115 audio amplifiers, and two KD-2116 transistor arrays. Included is a folder giving 12 useful circuits, their schematic diagrams, parts lists, and features. The KD-2114 can be used as a very-wide-bandwidth video amplifier, as an RF amplifier for range between 2 and 100 MHz, an i.f. amplifier with 30 db gain at 1 MHz, or as a class B audio amplifier delivering almost 40 mW. The KD-2115 is a multifunction power amplifier designed for use in portable or fixed communication equipment as well as with a portable PA system, or phonograph amplifier. The KD-2116 is a 4 transistor IC connected to form two independent Darlington pairs for very low noise and a gain bandwidth of over 100 MHz.

19 E 53066 Shpg. wt., 8 oz. Net 4.40

DECIMAL TO BINARY CONVERTER MATRIX KIT



Only
4.95

Invaluable kit for electronic hobbyists, technicians, schools and students interested in digital computer circuitry and technology. Kit includes diodes, pilot lamps, pre-etched printed circuit board and instruction manual. Diode matrix computes the binary number equivalent of the decimal numbers 0 thru 9 and displays binary number on its own pilot lamp readout. Manual contains instructions, circuit and pictorial diagrams and discussion of the binary number system.

19 E 53033 Shpg. wt., 8 oz. Net 4.95

INTEGRATED CIRCUIT SQUARE WAVE AUDIO GENERATOR KIT

Includes: Fairchild μ L914 IC, NPN Silicon Transistor, Printed Circuit Board. Useful kit provides a compact functional audio generator/signal source. Includes manual with discussion of circuit, and supplies diagrams for the use of square wave generator as an amplifier response tester, AF and RF signal injector, continuity tester and a code practice oscillator. Shpg. wt., 8 oz.

19 E 53058 Net 3.95

RCA INTEGRATED CIRCUIT KIT

Integrated Circuit Oscillator and Power Amplifier. All the components needed to enable you to build a 500 mw audio amplifier or a variable-tone audio oscillator. A 20-page manual is included giving complete kit construction details plus integrated circuit information. The IC contains the equivalent of 7 transistors, 11 resistors, and 3 diodes. Shpg. wt., 1 lb.

19 E 43349 RCA KD2112 Net 10.90

RCA "TOP OF THE LINE" UNIVERSAL Replacement Semiconductors

Stock Up On These Top Quality Semiconductors!

REPLACE: More Than 9000 Transistors and Integrated Circuits!
More Than 3200 Rectifiers!

For radio, TV, phonograph, tape recorder, Hi-Fi. Top quality semiconductors intended for replacement of more than 9000 transistors and integrated circuits and more than 3200 selenium and silicon rectifiers used in line and battery operated portable radios, phonographs, tape recorders, TV receivers,

audio frequency amplifiers, automobile radios, etc. SK series have electrical characteristics comparable with, or superior to, devices they replace. See "TOP-OF-THE-LINE" Solid-State Replacement Guide for Complete Replacement Selection!

RCA "TOP-OF-THE-LINE" Solid State Replacement Guide
Select the Semiconductor You Want! only **20¢**

Complete up-to-date listing of over 9000 types of transistors and integrated circuits and over 3200 types of rectifiers cross-referenced against RCA "Top-Of-The-Line" SK series semiconductors. Includes practically all types used in entertainment electronic equipment, including U.S.A. industry-standard EIA types, foreign types, etc. Includes dimensional outlines, terminal diagrams and guide lines on use of SK transistors, silicon rectifiers, and integrated circuits. Shpg. wt., 4 oz. **10 E 47091** Net .20

Stock No.	RCA Type	Net Each	Stock No.	RCA Type	Net Each	Stock No.	RCA Type	Net Each
19 E 43133	SK 3003	.99	19 E 43299	SK 3019	1.47	19 E 43364	SK 3035	5.49
19 E 43141	SK 3004	1.14	19 E 43307	SK 3020	1.32	19 E 43372	SK 3036	5.85
19 E 43158	SK 3005	1.17	19 E 43315	SK 3021	1.95	19 E 43380	SK 3037	11.70
19 E 43166	SK 3006	1.41	19 E 43323	SK 3022	3.96	19 E 43398	SK 3038	1.44
19 E 43174	SK 3007	1.26	19 E 43331	SK 3023	3.96	19 E 43406	SK 3039	1.98
19 E 43182	SK 3008	1.23	19 E 43334	SK 3024	1.98	19 E 43414	SK 3040	2.25
19 E 43190	SK 3009	2.34	19 E 43342	SK 3025	2.70	19 E 43422	SK 3041	2.52
19 E 43208	SK 3010	1.26	19 E 43359	SK 3026	1.80			
19 E 43216	SK 3011	1.62	19 E 43367	SK 3027	3.15			
19 E 43224	SK 3012	4.38	19 E 43375	SK 3028	3.60			
19 E 43232	SK 3013	4.68	19 E 43383	SK 3029	6.30			
19 E 43240	SK 3014	3.15	19 E 43391	SK 3030	.42			
19 E 43257	SK 3015	6.30	19 E 43109	SK 3031	.51			
19 E 43265	SK 3016	.57	19 E 43117	SK 3032	.61			
19 E 43273	SK 3017A	.60	19 E 43125	SK 3033	.81			
19 E 43281	SK 3018	1.35	19 E 43356	SK 3034	4.59			

SILICON RCA ZENER DIODES

Stock No.	Type	Volts	Dissipation	Net
19 E 43448	KD 2501	10V	400mW	.90
19 E 43455	KD 2503	6.2V	1-W	1.00
19 E 43463	KD 2504	9.1V	1-W	1.00
19 E 43471	KD 2505	12V	1-W	1.00



UNIVERSAL REPLACEMENT TRANSISTORS

Meet your repair needs quickly and economically with GE Universal Replacement Transistors! General Electric Universal Replacement Transistors are specifically designed as general replacements for most types of transistors used in radios, TV and other en-

tertainment applications where normal voltages exist. Consult the GE Entertainment Semiconductor Almanac on this page for complete up-to-date Replacement Selection. *Matched pairs.

Stock No.	GE Type	Net Each	Stock No.	GE Type	Net Each
19 E 27268	GE-1	1.20	19 E 27755	GE-15*	7.02
19 E 27276	GE-2	1.02	19 E 27763	GE-16	3.15
19 E 27284	GE-3	1.70	19 E 27771	GE-17	1.42
19 E 27292	GE-4	2.94	19 E 27789	GE-18	1.46
19 E 27300	GE-5	1.68	19 E 27797	GE-19	3.06
19 E 27318	GE-6	1.83	19 E 27805	GE-20	1.10
19 E 27326	GE-7	1.77	19 E 27813	GE-21	1.12
19 E 27334	GE-8	1.29	19 E 27821	GE-22	1.03
19 E 27714	GE-9	1.26	19 E 27839	GE-23	2.52
19 E 27359	GE-10	1.20	19 E 27847	GE-24*	5.04
19 E 27367	GE-11	1.53	19 E 27854	GE-25	7.50
19 E 27722	GE-12	2.34	19 E 28134	GE-26	3.10
16 E 27730	GE-13*	3.56	19 E 27862	GE-FET-1	2.25
19 E 27748	GE-14	3.51			

G-E ENTERTAINMENT SEMICONDUCTORS

Transistors

19 E 27474	2N107	.75
19 E 27482	2N170	1.02
19 E 27490	2N188A	1.83
19 E 27870	2N190	.84
19 E 27888	2N324	.72
19 E 27896	2N404	.54
19 E 27904	2N508	.78
19 E 27912	2N1415	1.02
19 E 27920	2N2160	1.65

CRYSTAL DIODES

19 E 27938	1N34AS	.33
19 E 27946	1N60	.33
19 E 27953	1N82A	.87
19 E 27961	1N82A (lg)	.96
19 E 27979	1N295	.33

ZENER DIODES, 1 WATT; * = 400 Milliwatt

Stock No.	Type	Volts	Net
19 E 28027	GEZD-10-4*	10	.90
19 E 28035	GEZD-3.6	3.6	1.20
19 E 28043	GEZD-5.1	5.1	1.20
19 E 28050	GEZD-5.6	5.6	1.20
19 E 28068	GEZD-6.2	6.2	1.20
19 E 28076	GEZD-9.1	9.1	1.20
19 E 28084	GEZD-12	12	1.20
19 E 28092	GEZD-15	15	1.20
19 E 28100	GEZD-18	18	1.20
19 E 28118	GEZD-20	20	1.20
19 E 28126	GEZD-27	27	1.20

Rectifiers

Stock No.	Type	PIV	MAX Ipc MA	Net
19 E 27987	1N91	100	150	.94
19 E 27995	GE-504A	600	1 Amp	.66
19 E 28019	GE-509	1000	1 Amp	.79

COLOR TV RECTIFIERS

19 E 27417	GEGR-1 Focus Rect.	2.25
19 E 27425	GEGR-2 Boosted Boost	.99
19 E 27433	GEGR-3 Convergence	.86

G-E COLOR TV CRYSTALS

Stock No.	Type	Net
19 E 27375	GE-41 3579.545KC GE only	3.36
19 E 27383	GE-42 3579.545KC other sets	2.28

G-E VAC-U-SEL® DUAL DIODES

Stock No.	Type	Net
19 E 27441	6GC1	.55
19 E 27458	6GD1	.55
19 E 27466	6GX1	.55



ENTERTAINMENT SEMICONDUCTOR ALMANAC

Replace over 11,000 Transistors, Over 5,000 Diodes **25¢**

Complete replacement guide for domestic and imported transistors with recommended G.E. Universal replacements. Also includes guide for replacement of crystal diodes, universal rectifiers, dual-diodes, zener diodes, color rectifiers, 3.5 MHz crystals used in the major popular TV sets and maintenance industrial semiconductors. In addition, includes basic introductory information and specifications on the G.E. Universal replacement and entertainment semiconductors. Shpg. wt., 8 oz. **10 E 36243** Net .25

RCA SOLID-STATE HOBBY CIRCUIT MANUAL

RCA Hobby Circuits Manual



ONLY **1.75**

Features 35 different solid-state circuits provided with full-size drilling templates to simplify circuit board construction. Text sections devoted to the theory of solid-state devices, circuit operation, construction practices and trouble shooting. 224 pages. **10 E 47109** Shpg. wt., 12 oz. Net 1.75

ALLEN BRADLEY - OHMITE - IRC RESISTORS

MOST POPULAR KIT OF 100 RESISTORS 1/2 WATT-10%



ONLY 2⁹⁸

Molded, insulated resistors that meet rigid MIL-R-11E specifications. EIA (RETMA) color coded. Brand new factory-fresh stock with 1 1/2" leads. Mil. equiv. as follows: 1/4 watt RC-07GF; 1/2 watt RC-20CF; 1 watt, RC-32GF; 2 watt, RC-42GF. Body sizes: 1/4 watt 1/4" x .09", 1/2 watt 3/8" x 3/16", 1 watt 1/2" x 1/8", 2 watt 1/2" x 3/16". *Available only in 1/2 watt size—no mil specification.

HOW TO ORDER

Specify Stock Number from the price line, code number and ohmmage from the tolerance chart.

EXAMPLE: For a 1/2 watt, 3900 ohm 10% resistor; order as 52 E 3087, 3900 ohms. For the same resistor with 5% tolerance; order as 52 E 8087, 3900 ohms.

Designed especially for the serviceman. Here is a selection of 100 resistors of the most popular values used in general service work. All brand-new 1/2 watt 10%, full lead length resistors. Color coded. This is no random assortment. You get 3 each: 100, 470, 2200 ohms; 4 each: 1K, 4.7K, 22K, 27K, 33K, 47K, .15 meg, .27 meg, 2.2 meg; 5—10K; 10 each: .1 meg, .47 meg, 1 meg, plus 20 other popular values. Shpg. wt., 1 lb.

32 E 99047 Net 2.98

1/2 & 1 WATT ASSORTMENT 1⁹⁸

A value packed assortment of carbon resistors. Kit of 100 resistors consists of 75 1/2-watt and 25 1-watt resistors. Wide range of resistance value in varied tolerances. All have the standard RMA color code and normal length axial leads. Shpg. wt., 1/2 lb.

32 E 60007 Net 1.98

1 WATT KIT

50 Pieces 1⁹⁸

Selected Values
Contains 2 each of the following selected values: 22 - 39 - 68 - 82 - 330 - 390 - 470 - 750 - 1500 - 2700 - 3000 - 4700 - 7500 - 8200 - 12K - 22K - 68K - 120K - 180K - 200K - 330K - 390K - 560K - 820K - 3.3 Meg.

32 E 80049 Shpg. wt., 12 oz. Net 1.98

1/4 WATT KIT

100 piece kit of 1/4 watt carbon resistors. Assortment of 33 selected values. Body size approx. 1/4" long x 3/16" dia. All +10% tolerance. Shpg. wt., 8 oz.

32 E 60031 Net 1.98

1/10 WATT CARBON FILM RESISTORS

1⁹⁸

100 Piece kit only
A fine selection of 100 miniature 1/10-watt resistors. Especially useful where high resistance to heat, humidity and shock is important. Body size: .28" Long x .08" Dia. Imported. Shpg. wt., 8 oz.

32 E 99039 Net 1.98

OHMITE OHM'S LAW CALCULATOR



Solves Ohm's Law problems with just one setting of the slide. Has parallel resistance computing scales. Covers range from 0.01 ohm to 100 megohms. Current scale in amperes and milliamperes. Handy pocket size 9x3". Shpg. wt., 2 oz.

34 E 63023 Net 2.5

IRC RESIST-O-GUIDE

Pocket size guide, identifies resistance values and color code. Simply dial the colors or resistance values; corresponding data comes up automatically. MIL, EIA, and standard values listed on reverse side.

33 E 45436 Shpg. wt., 1 oz. Net ea. 1.17

10% RESISTORS — SELECT FROM CHART BELOW

STOCK NO.	WATTS	RANGE SEE CHART BELOW	Net Each			Net Each			
			MAY BE ASSORTED			ASST.-MIN. 100 PER VALUE			
			1-4	5-49	50-Up	100-249	250-499	500-999	1M-Up
52 E 1	1/4	10 ohms to 22 meg	.24	.20	.16	.14	.122	.112	.105
52 E 2	1/4	2.7 ohms to 22 meg	.13	.11	.07	.05	.05	.04	.034
52 E 3	1/2	1 ohm to 22 meg	.12	.10	.06	.04	.04	.032	.03
52 E 4	1	2.7 ohms to 22 meg	.18	.15	.09	.06	.055	.050	.045
52 E 5	2	10 ohms to 22 meg	.24	.20	.15	.11	.096	.088	.082

CHART OF AVAILABLE 10% RESISTORS AND ORDERING CODE

Ohms Code	Ohms Code	Ohms Code	Ohms Code	Ohms Code	Ohms Code	Ohms Code	Megs Code
1.0* 001	10 025	120 051	1500 077	18K 103	220K 129	2.2 153	
1.1* 003	12 027	150 053	1800 079	22K 105	270K 131	2.7 155	
1.5* 005	15 029	180 055	2200 081	27K 107	330K 133	3.3 157	
1.8* 007	18 031	220 057	2700 083	33K 109	390K 135	3.9 159	
2.2* 009	22 033	270 059	3300 085	39K 111	470K 137	4.7 161	
2.7 011	27 035	330 061	3900 087	47K 113	560K 139	5.6 163	
3.3 013	33 037	390 063	4700 089	56K 115	680K 141	6.8 165	
3.9 015	39 039	470 065	5600 091	68K 117	820K 143	8.2 167	
4.7 017	47 041	560 067	6800 093	82K 119	Megs Code	10 169	
5.6 019	56 043	680 069	8200 095	100K 121	1.0 145	12 171	
6.8 021	68 045	820 071	10K 097	120K 123	1.2 147	15 173	
8.2 023	82 047	1000 073	12K 099	150K 125	1.5 149	18 175	
	100 049	1200 075	15K 101	180K 127	1.8 151	22 177	

5% RESISTORS — SELECT FROM CHART BELOW

STOCK NO.	WATTS	RANGE SEE CHART BELOW	Net Each			Net Each			
			MAY BE ASSORTED			ASST.-MIN. 100 PER VALUE			
			1-4	5-49	50-Up	100-249	250-499	500-999	1M-Up
52 E 6	1/4	10 ohms to 22 meg	.34	.28	.22	.198	.173	.159	.149
52 E 7	1/4	2.7 ohms to 22 meg	.26	.22	.14	.095	.091	.073	.062
52 E 8	1/2	1 ohm to 22 meg	.24	.20	.12	.075	.073	.065	.056
52 E 9	1	2.7 ohms to 22 meg	.36	.30	.18	.125	.123	.11	.09
53 E 1	2	10 ohms to 22 meg	.48	.40	.24	.19	.185	.175	.16

CHART OF AVAILABLE 5% RESISTORS AND ORDERING CODE

Ohms Code	Ohms Code	Ohms Code	Ohms Code	Ohms Code	Ohms Code	Ohms Code	Megs Code
1.0* 001	11 026	120 051	1300 076	15K 101	180K 127	2.0 152	
1.1* 002	12 027	130 052	1500 077	16K 102	200K 128	2.2 153	
1.2* 003	13 028	150 053	1600 078	18K 103	220K 129	2.4 154	
1.3* 004	15 029	160 054	1800 079	20K 104	240K 130	2.7 155	
1.5* 005	16 030	180 055	2000 080	22K 105	270K 131	3.0 156	
1.6* 006	18 031	200 056	2200 081	24K 106	300K 132	3.3 157	
1.8* 007	20 032	220 057	2400 082	27K 107	330K 133	3.6 158	
2.0* 008	22 033	240 058	2700 083	30K 108	360K 134	3.9 159	
2.2* 009	24 034	270 059	3000 084	33K 109	390K 135	4.3 160	
2.4* 010	27 035	300 060	3300 085	36K 110	430K 136	4.7 161	
2.7 011	30 036	330 061	3600 086	39K 111	470K 137	5.1 162	
3.0 012	33 037	360 062	3900 087	43K 112	510K 138	5.6 163	
3.3 013	36 038	390 063	4300 088	47K 113	560K 139	6.2 164	
3.6 014	39 039	430 064	4700 089	51K 114	620K 140	6.8 165	
3.9 015	43 040	470 065	5100 090	56K 115	680K 141	7.5 166	
4.3 016	47 041	510 066	5600 091	62K 116	750K 142	8.2 167	
4.7 017	51 042	560 067	6200 092	68K 117	820K 143	9.1 168	
5.1 018	56 043	620 068	6800 093	75K 118	910K 144	10 169	
5.6 019	62 044	680 069	7500 094	82K 119	Megs Code	11 170	
6.2 020	68 045	750 070	8200 095	91K 120	1.0 145	12 171	
6.8 021	75 046	820 071	9100 096	100K 121	1.1 146	13 172	
7.5 022	82 047	910 072	10K 097	110K 122	1.2 147	15 173	
8.2 023	91 048	1000 073	11K 098	120K 123	1.3 148	16 174	
9.1 024	100 049	1100 074	12K 099	130K 124	1.5 149	18 175	
10 025	110 050	1200 075	13K 100	150K 125	1.6 150	20 176	
				160K 126	1.8 151	22 177	

Depend on Lafayette For Complete Stocks, Lowest Prices, Fastest Service

Lafayette Cat. No. 700 275

Mallory—IRC Power Resistors



IRC PW-10 POWER RESISTORS



10 Watt wire wound resistors with axial leads. Rectangular ceramic body. 10% tolerance. Body size 1/8" Long x 3/8" square.

MALLORY ADJUSTABLE POWER RESISTORS

Same fine quality and construction as the fixed types, but with an exposed section of winding to provide tapping-off of resistance values from 0 to the max. value of the resistor. All with lug terminals, tolerance $\pm 10\%$, each supplied with 2 mtg. feet and one adjustable clip.

RESISTOR TUBE SIZES AND SHIPPING WEIGHTS

Type	Dia. XL	Shpg. wt., Oz.	Type	Dia. XL	Shpg. wt., Oz.
2AV	3/16"x2"	5	10AV	3/4"x6 1/2"	12
5AV	1/4"x4"	6	20AV	1 1/2"x10 1/2"	16

TYPE 2AV—25 WATT ADJUSTABLE

Stock No.	Ohms	Net Ea.		Stock No.	Ohms	Net Ea.	
		1-9	10-24			1-9	10-24
30 E 43148	1	1.16	.99	30 E 43304	1000	1.16	.89
30 E 43155	3	1.16	.99	30 E 43312	1250	1.19	1.01
30 E 43163	5	1.16	.99	30 E 43320	1500	1.19	1.01
30 E 43171	10	1.16	.99	30 E 43338	2000	1.19	1.01
30 E 43189	15	1.16	.99	30 E 43346	2500	1.19	1.01
30 E 43197	25	1.16	.99	30 E 43353	3000	1.19	1.01
30 E 43205	50	1.16	.99	30 E 43361	3500	1.19	1.01
30 E 43213	75	1.16	.99	30 E 43379	4000	1.19	1.01
30 E 43221	100	1.16	.99	30 E 43387	5000	1.19	1.01
30 E 43239	150	1.16	.99	30 E 43395	6000	1.28	1.09
30 E 43247	200	1.16	.99	30 E 43403	7500	1.28	1.09
30 E 43254	250	1.16	.99	30 E 43411	10K	1.28	1.09
30 E 43262	300	1.16	.99	30 E 43429	12K	1.32	1.12
30 E 43270	400	1.16	.99	30 E 43437	15K	1.32	1.12
30 E 43288	500	1.16	.99	30 E 43445	20K	1.32	1.12
30 E 43296	750	1.16	.99	30 E 43452	25K	1.45	1.23

1-9 Assorted Net ea. .36
100-up Assorted Net ea. .25

MALLORY FIXED POWER RESISTORS



Finest quality wirewounds on ceramic cores with vitreous enamel covering. Give full wattage dissipation. Tolerance $\pm 5\%$ on all values above 10-ohms, other $\pm 10\%$. All types have lug terminals and mounting feet. Lugs and leads are firmly embedded.

RESISTOR TUBE SIZES AND SHIPPING WEIGHTS

Type	Watts	Dia. x L.	Shpg. Wt., Oz.
2.5HJ	25	3/16"x2"	5
5HJ	50	1/4"x4"	6
10HJ	100	3/16"x6 1/2"	10

TYPE 2.5HJ—25 WATT FIXED

Stock No.	Ohms	Net Ea.		Stock No.	Ohms	Net Ea.	
		1-9	10-24			1-9	10-24
30 E 53683	1	.65	.55	30 E 53865	2000	.68	.58
30 E 53691	2	.65	.55	30 E 53873	2500	.68	.58
30 E 53709	3	.65	.55	30 E 53881	3000	.78	.66
30 E 53717	5	.65	.55	30 E 53889	3500	.78	.66
30 E 53725	7.5	.65	.55	30 E 53907	4000	.78	.66
30 E 53733	10	.65	.55	30 E 53915	5000	.78	.66
30 E 53741	15	.65	.55	30 E 53923	6000	.78	.66
30 E 53758	25	.65	.55	30 E 53931	7500	.78	.66
30 E 53766	50	.65	.55	30 E 53949	10K	.78	.66
30 E 53774	75	.65	.55	30 E 53956	12.5K	.81	.69
30 E 53782	100	.65	.55	30 E 53964	15K	.81	.69
30 E 53790	150	.65	.55	30 E 53972	20K	.81	.69
30 E 53808	200	.65	.55	30 E 53980	25K	.81	.69
30 E 53816	250	.65	.55	30 E 53998	30K	.94	.80
30 E 53824	500	.65	.55	30 E 54004	40K	.94	.80
30 E 53832	750	.65	.55	30 E 54012	50K	1.09	.93
30 E 53840	1000	.65	.55	30 E 54020	75K	1.28	1.09
30 E 53857	1500	.65	.55	30 E 54038	100K	1.47	1.25

TYPE 5HJ—50 WATT FIXED

Stock No.	Ohms	Net Ea.		Stock No.	Ohms	Net Ea.	
		1-9	10-24			1-9	10-24
30 E 54046	10	.99	.84	30 E 54160	7500	1.11	.94
30 E 54053	25	.99	.84	30 E 54178	10K	1.11	.94
30 E 54061	50	.99	.84	30 E 54186	12.5K	1.21	1.03
30 E 54079	100	.99	.84	30 E 54194	15K	1.21	1.03
30 E 54087	250	.99	.84	30 E 54202	20K	1.21	1.03
30 E 54095	500	.99	.84	30 E 54210	25K	1.39	1.18
30 E 54103	750	.99	.84	30 E 54228	30K	1.39	1.18
30 E 54111	1000	.99	.84	30 E 54236	40K	1.39	1.18
30 E 54129	1500	1.02	.87	30 E 54244	50K	1.55	1.32
30 E 54137	2000	1.02	.87	30 E 54251	75K	1.77	1.50
30 E 54145	2500	1.02	.87	30 E 54269	100K	1.92	1.63
30 E 54152	5000	1.02	.87				

TYPE 10HJ—100 WATT FIXED

Stock No.	Ohms	Net Ea.		Stock No.	Ohms	Net Ea.	
		1-9	10-24			1-9	10-24
30 E 54509	25	1.38	1.17	30 E 54616	5000	1.44	1.22
30 E 54517	50	1.38	1.17	30 E 54624	7500	1.56	1.33
30 E 54525	100	1.38	1.17	30 E 54632	10K	1.56	1.33
30 E 54533	150	1.38	1.17	30 E 54640	15K	1.69	1.44
30 E 54541	250	1.38	1.17	30 E 54657	20K	1.69	1.44
30 E 54558	500	1.38	1.17	30 E 54665	25K	1.92	1.63
30 E 54566	750	1.38	1.17	30 E 54673	30K	1.92	1.63
30 E 54574	1000	1.38	1.17	30 E 54681	40K	1.92	1.63
30 E 54582	1500	1.44	1.22	30 E 54699	50K	1.99	1.69
30 E 54590	2000	1.44	1.22	30 E 54707	75K	2.20	1.87
30 E 54608	2500	1.44	1.22	30 E 54715	100K	2.46	2.09

TYPE 10AV—100 WATT ADJUSTABLE

Stock No.	Ohms	Net Ea.		Stock No.	Ohms	Net Ea.	
		1-9	10-24			1-9	10-24
30 E 44021	1	1.05	1.66	30 E 44187	2000	2.01	1.71
30 E 44039	2	1.95	1.66	30 E 44195	2500	2.01	1.71
30 E 44047	5	1.95	1.66	30 E 44203	3000	2.01	1.71
30 E 44054	10	1.95	1.66	30 E 44211	4000	2.01	1.71
30 E 44062	25	1.95	1.66	30 E 44229	5000	2.01	1.71
30 E 44070	50	1.95	1.66	30 E 44237	7500	2.13	1.81
30 E 44088	100	1.95	1.66	30 E 44245	10K	2.13	1.81
30 E 44096	150	1.95	1.66	30 E 44252	15K	2.26	1.92
30 E 44104	200	1.95	1.66	30 E 44260	20K	2.26	1.92
30 E 44112	250	1.95	1.66	30 E 44278	25K	2.49	2.12
30 E 44120	300	1.95	1.66	30 E 44286	30K	2.49	2.12
30 E 44138	400	1.95	1.66	30 E 44294	35K	2.49	2.12
30 E 44146	500	1.95	1.66	30 E 44302	40K	2.49	2.12
30 E 44153	750	1.95	1.66	30 E 44310	50K	2.57	2.18
30 E 44161	1000	1.95	1.66	30 E 44328	75K	2.81	2.39
30 E 44179	1500	2.01	1.71	30 E 44336	100K	3.01	2.56

TYPE 20AV—200 WATT ADJUSTABLE

Stock No.	Ohms	Net Ea.		Stock No.	Ohms	Net Ea.	
		1-9	10-24			1-9	10-24
30 E 44344	1	3.19	2.71	30 E 44484	750	3.19	2.71
30 E 44351	2	3.19	2.71	30 E 44492	1000	3.19	2.71
30 E 44369	5	3.19	2.71	30 E 44500	1500	3.26	2.77
30 E 44377	10	3.19	2.71	30 E 44518	2000	3.26	2.77
30 E 44385	25	3.19	2.71	30 E 44526	2500	3.26	2.77
30 E 44393	50	3.19	2.71	30 E 44534	5000	3.26	2.77
30 E 44401	75	3.19	2.71	30 E 44542	10K	3.44	2.92
30 E 44419	100	3.19	2.71	30 E 44559	20K	3.62	3.08
30 E 44427	150	3.19	2.71	30 E 44567	25K	3.81	3.24
30 E 44435	200	3.19	2.71	30 E 44575	30K	3.81	3.24
30 E 44443	250	3.19	2.71	30 E 44583	50K	3.91	3.32
30 E 44450	300	3.19	2.71	30 E 44591	75K	4.09	3.48
30 E 44468	400	3.19	2.71	30 E 44609	100K	4.29	3.65
30 E 44476	500	3.19	2.71				

EXTRA ADJUSTABLE CLIPS

Stock No.	Type	For Use With	Net ea.
30 E 49087	3V	25 and 50 Watt	.18
30 E 49095	4V	100 Watt	.18
30 E 49103	6V	200 Watt	.21

EXTRA MOUNTING FEET

Stock No.	Type	For Use With	Net ea.
30 E 48352	31V	25 and 50 Watt	.06
30 E 48360	32V	100 Watt	.10
30 E 48378	33V	200 Watt	.18

Mueller Clips and Insulators



MINI-GATOR CLIP (A)

*Cad. plated steel, †solid copper. Length 1 1/4", alligator jaws open 3/8". #20 or smaller wire. Avg. shgp. wt., 4 oz. per 100.

Stock No.	No.	Each	Lots 10 Each	Lots of 100 Each	500 up Each
32 E 35009	30*	.07	.05	.043	.041
32 E 35389	30C†	.09	.06	.053	.05

MICRO-GATOR CLIP (J)

Smallest made alligator clip for use on P.C. boards, tiny terminals, and other crowded spots. *Cad. plated steel. †Solid copper. #20 or smaller wire. Avg. shgp. wt., 4 oz. per 100.

Stock No.	No.	Size	Open	Net Each	Lots 10 Each	Lots 100 Each	500 up Each
32 E 35330	34*	1 1/2"	3/32"	.06	.04	.036	.034
32 E 35340	34C†	1 1/2"	3/32"	.08	.05	.046	.043

TEST CLIP WITH MESH TEETH (B)

Pee-Wee clip for general test purposes. Cad. plated steel except *C is solid copper. Avg. shgp. wt., 1/2 oz.

Stock No.	No.	Amp.	Size	Net Each	Lots 10 Each	Lots 100 Each	500 Up Each
32 E 35017	45	5	1 1/2"	.09	.06	.052	.05
32 E 35025	45C*	10	1 1/2"	.14	.11	.092	.087

TWIN CLIPS (G)

Jaws of both ends operate independently. Cad. plated steel 2" long, jaws open 1/2". Shgp. wt., 1 oz.

Stock No.	No.	Each	Lots 10 Each	Lots 100 Each	500 Up Each
32 E 35223	22	.13	.09	.074	.07

FLEXIBLE INSULATORS (H)

Avg. Shgp. wt., 1 oz

Stock No.	Ins. No.	Color	Fits Clip Series	Net Each	Lots 10 Each	Lots 100 Each	Lots 500 Each
32 E 35452	13	Red	11	.81	.57	.49	.46
32 E 35470	13	Black	11	.81	.57	.49	.46
32 E 35488	23	Red	21	.41	.29	.246	.234
32 E 35496	23	Black	21	.41	.29	.246	.234
32 E 35504	26	Red	24A & 25	.23	.16	.130	.131
32 E 35512	26	Black	24A & 25	.23	.16	.130	.131
32 E 35520	29	Red	27	.17	.12	.104	.098
32 E 35538	29	Black	27	.17	.12	.104	.098
32 E 35546	32	Red	30	.05	.03	.029	.027
32 E 35553	32	Black	30	.05	.03	.029	.027
32 E 35561	36	Red	34	.05	.03	.029	.027
32 E 35579	36	Black	34	.05	.03	.029	.027
32 E 35587	47	Red	45	.07	.05	.042	.04
32 E 35595	47	Black	45	.07	.05	.042	.04
32 E 35603	49	Red	48 & 50	.10	.07	.059	.056
32 E 35611	49	Black	48 & 50	.10	.07	.059	.056
32 E 35629	62	Red	60	.06	.04	.033	.031
32 E 35637	62	Black	60	.06	.04	.033	.031
32 E 35645	87	Red	85	.07	.05	.042	.04
32 E 35652	87	Black	85	.07	.05	.042	.04

CROCODILE CLIPS (D)

*Copper, others cad. plated, † Has standard phone tip to one jaw. Avg. shgp. wt., 4 oz. per hundred

Stock No.	No.	Size	Conn.	Each	Lots 10 Each	Lots 100 Each	500 up Each
32 E 35140	85	2 1/2"	Screw	.11	.08	.065	.062
32 E 35157	85C*	2 1/2"	Screw	.21	.15	.127	.121
32 E 35165	85T†	2 1/2"	Tip	.27	.19	.16	.152

ALLIGATOR CLIPS (E)

*Copper, others steel. All fit banana plugs. Avg. shgp. wt., 1 oz.

Stock No.	No.	Size	Open	Conn.	Each	Lots 10 Each	Lots 100 Each	500 up Each
32 E 35173	60	2"	3/8"	Std.	.08	.05	.047	.044
32 E 35181	60S	2"	3/8"	Screw	.09	.06	.054	.051
32 E 35199	60CS*	2"	3/8"	Screw	.14	.10	.082	.078

INSULATED ALLIGATOR CLIPS (F)

*Copper, others cad. plated steel. Size: 2 1/2" - screw connections. Avg. shgp. wt., 1 oz.

Stock No.	No.	Color	Each	Lots 10 Each	Lots 100 Each	500 up Each
32 E 35421	60HS	Red	.13	.09	.076	.072
32 E 35439	60HS	Black	.13	.09	.076	.072
32 E 35447	60CHS*	Red	.17	.12	.101	.096
32 E 35454	60CHS*	Black	.17	.12	.101	.096

BATTERY CLIPS STEEL AND COPPER (B)

*Are solid copper, all others are lead plated. Avg. shgp. wt., 3 oz.

Stock No.	No.	Amp.	Size	Net Each	Lots 10 Each	Lots 100 Each	500 Up Each
32 E 35066	24A	25	2 7/8"	.28	.18	.152	.145
32 E 35074	21A	50	4"	.48	.32	.278	.26
32 E 35082	11A	100	6"	1.27	.89	.76	.72
32 E 35371	25C*	75	3"	.49	.34	.29	.276
32 E 35090	21C*	100	4 1/2"	1.20	.84	.72	.69
32 E 35108	11C*	200	6"	2.34	1.64	1.40	1.33

3 SIDED MESH TEETH CLIPS (B)

All steel cadmium plated except * is solid copper, † has Insulation piercing needle in jaw. Avg. shgp. wt., 1 oz.

Stock No.	No.	Amp.	Size	Each	Lots 10 Each	Lots 100 Each	500 up Each
32 E 35033	480	10	2"	.13	.09	.078	.074
32 E 35041	48C*	20	2"	.20	.14	.119	.113
32 E 35058	50C†	20	2 1/4"	.32	.22	.188	.179
32 E 35116	27	20	2 1/4"	.16	.11	.092	.087
32 E 35124	27C*	40	2 1/4"	.27	.19	.16	.152

FULLY INSULATED ALLIGATOR CLIPS (K)

*Copper, †Cad. plated steel, 2 1/2" long, shgp. wt., 1 oz.

Stock No.	No.	Color	Each	Lots 10 Each	Lots 100 Each	500 up Each
32 E 35660	63†	Red	.19	.13	.11	.105
32 E 35678	63†	Black	.19	.13	.11	.105
32 E 35686	63C*	Red	.22	.15	.13	.124
32 E 35694	63C*	Black	.22	.15	.13	.124

INSULATED ALLIGATOR TEST CLIPS WITH 6 FT. LEAD

Handy for quick connections. Plated brass alligator clip with insulated handles and 6 ft. of No. 22 stranded wire attached. Clip is 1 1/2" overall. Imported. Shgp. wt., 8 oz.
 99 E 62317 Red } 50 for 3.95 10 for .90
 99 E 62325 Black } Singly, each .10

INSULATED ALLIGATOR CLIP

Sturdy nickel-plated brass jaws with plastic insulated thumb rest and insulated barrel. Strong spring with hard bite. Solder lug connection. Overall length 2 1/2". Imported. Shgp. wt., 4 oz. Supplied in Red and Black.
 99 E 62192 Red } Net ea. .09
 99 E 62200 Black } 10 for .79

FAHNESTOCK CLIPS

Brass clips that assure good electrical contact without injury to wire. 3/8" wide except * which are 1/4". Packages of 10. Shgp. wt., 4 oz.

Stock No.	Fig.	Lgth.	Max. Wire	Mtg. Hole	Net P.K.
33 E 71077	B	1"	No. 10	No. 8	.25
32 E 76011	C	1 1/4"	No. 10	No. 8	.32
32 E 64595	A	1 3/4"	No. 10	No. 8	.99
33 E 71028*	B	3/4"	No. 14	No. 6	.20

LAFAYETTE KIT OF 20 INSULATED ALLIGATOR CLIPS

Two kits of insulated alligator clips. Kit A consists of 20 large size clips. Kit B consists of 20 small size clips. All have sturdy nickel-plated jaws with strong spring and hard bite. Each kit contains 10 red and 10 black alligator clips, eared and bagged. Imported. Shgp. wt., 8 oz.
 99 E 62358 Kit B (1 1/2") Net .99
 99 E 62366 Kit A (2 1/2") Net 1.39

MATING ALLIGATOR CLIP AND BANANA PLUG SET

Solder the Banana plugs to your test leads for probing. The sturdy jaw alligator clips firmly mate with the banana jack for clip-on use. Both sets of alligator clips and jacks have red and black plastic insulators. Overall size: Plugs 2", clip 2 3/4", mated 4". Shgp. wt., 4 oz. Imported.
 99 E 62424 2 Alligator Clips and 2 Banana Plugs Net .39

KIT OF 10 JUMPER LEADS

10 handy 14" leads with miniature insulated alligator clips attached to each end. Clips and leads color coded. 5 pairs each a different color. Ideal for serviceman or experimenter. Imported.
 99 E 00572 Shgp. wt., 3 oz. Net .99

Sockets, Connectors, Test Adapters

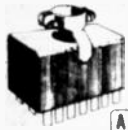

BEAU PLUG CONNECTORS

Beauchaine Series 3300 plugs and sockets are reliable, versatile connectors for chassis or cable use. The cable type have scuff-resistant, insulated backshells made of polypropylene plastic. (UL & CSA listed). Supplied complete with cable clamps. The recessed types have black wrinkle paint

over plated steel shell. All hardware is electroplated. Female contacts are cadmium plated phosphor bronze. Male contacts are cadmium plated brass. Contacts rated voltage 750 V. RMS and a current capacity of 10 amp.

ENCLOSED PLUG WITH CLAMP (FIG. A)

Stock No.	Mfg. No.	No. of Contacts	Net 1-49	Each 50-99
34 E 20015	P-3302 CCT	2	.48	.40
34 E 20023	P-3303 CCT	3	.49	.41
34 E 20031	P-3304 CCT	4	.50	.415
34 E 20049	P-3306 CCT	6	.55	.46
34 E 20056	P-3308 CCT	8	.59	.495
34 E 20064	P-3310 CCT	10	.67	.556
34 E 20072	P-3312 CCT	12	.73	.61
34 E 20080	P-3315 CCT	15	.84	.78
34 E 20088	P-3318 CCT	18	1.10	.915

ENCLOSED SOCKET WITH CLAMP (FIG. B)

Stock No.	Mfg. No.	No. of Contacts	Net 1-49	Each 50-99
34 E 20163	S-3302-CCT	2	.49	.405
34 E 20171	S-3303-CCT	3	.50	.415
34 E 20189	S-3304-CCT	4	.50	.42
34 E 20197	S-3306-CCT	6	.57	.475
34 E 20205	S-3308-CCT	8	.67	.555
34 E 20213	S-3310-CCT	10	.74	.615
34 E 20221	S-3312-CCT	12	.85	.71
34 E 20239	S-3315-CCT	15	1.03	.86
34 E 20247	S-3318-CCT	18	1.20	1.00

SET OF 10 TRANSISTOR SOCKETS



only
98^c

A set of ten universal transistor sockets at a low Lafayette price. Ideal for experimenters, hobbyists and kit builders. For 3-pin transistors in-line or 4-pin types. Includes saddle mounts. Size: 3/4x1/4". 99 E 62614 Shpg. wt., 2 oz. Net .98

ANGLE BRACKET PLUGS (FIG. C)

Stock No.	Mfg. No.	No. of Contacts	Net 1-49	Each 50-99
34 E 20312	P-3302-AB	2	.21	.175
34 E 20320	P-3303-AB	3	.25	.205
34 E 20338	P-3304-AB	4	.25	.21
34 E 20346	P-3306-AB	6	.31	.255
34 E 20353	P-3308-AB	8	.37	.305
34 E 20361	P-3310-AB	10	.41	.345
34 E 20379	P-3312-AB	12	.46	.385
34 E 20387	P-3315-AB	15	.63	.525
34 E 20395	P-3318-AB	18	.78	.65

ANGLE BRACKET SOCKETS (FIG. D)

Stock No.	Mfg. No.	No. of Contacts	Net 1-49	Each 50-99
34 E 20480	S-3302-AB	2	.23	.19
34 E 20478	S-3303-AB	3	.26	.215
34 E 20486	S-3304-AB	4	.26	.22
34 E 20494	S-3306-AB	6	.33	.275
34 E 20502	S-3308-AB	8	.41	.345
34 E 20510	S-3310-AB	10	.49	.41
34 E 20528	S-3312-AB	12	.57	.475
34 E 20536	S-3315-AB	15	.72	.60
34 E 20544	S-3318-AB	18	.87	.725

DEEP BRACKET PLUGS (FIG. E)

Stock No.	Mfg. No.	No. of Contacts	Net 1-49	Each 50-99
34 E 20619	P-3302-DB	2	.52	.435
34 E 20627	P-3303-DB	3	.53	.44
34 E 20635	P-3304-DB	4	.53	.445
34 E 20643	P-3306-DB	6	.60	.50
34 E 20650	P-3308-DB	8	.65	.54
34 E 20676	P-3312-DB	12	.78	.65
34 E 20684	P-3315-DB	15	.93	.775
34 E 20692	P-3318-DB	18	1.15	.955

DEEP BRACKET SOCKETS (FIG. F)

Stock No.	Mfg. No.	No. of Contacts	Net 1-49	Each 50-99
34 E 20767	S-3302-DB	2	.55	.455
34 E 20775	S-3303-DB	3	.56	.465
34 E 20783	S-3304-DB	4	.56	.47
34 E 20791	S-3306-DB	6	.64	.53
34 E 20809	S-3308-DB	8	.71	.595
34 E 20825	S-3312-DB	12	.90	.75
34 E 20833	S-3315-DB	15	1.04	.87
34 E 20841	S-3318-DB	18	1.24	1.035

HORIZONTAL OUTPUT COLOR TEST ADAPTERS



For 6J6, 6K6. Test adapter with No. 3 Pin interrupted allows you to measure and adjust the cathode current of output tubes without removing chassis. Shpg. wt., 8 oz. 33 E 57092 Net 3.75
For 6J56, 6J6. Similar to unit above, but with number 2 pin interrupted. Wt. 8 oz. 33 E 57100 Net 3.95

PICTURE TUBE TEST POINT ADAPTERS FOR COLOR

FOR COLOR TV (A) Test point adapter permits testing of 70° color TV picture tubes in the circuit without removing tube or chassis from set. 33 E 87230 Wt. 9 oz. Net 4.17
Similar to above, but for 90° color tubes. 33 E 87263 Shpg. wt., 8 oz. Net 5.85

FOR BLACK AND WHITE

FOR BLACK & WHITE TV (B) Test socket adapter for black and white CRT's. Except 11D°. Permits in-circuit checks from readily accessible lugs. 33 E 87248 Wt. 4 oz. Net 1.11
110° test adapter for 8 pin TV picture tubes. 33 E 57134 Net 2.55
110° test adapter for 7 pin TV picture tubes. 33 E 57142 Net 2.25

LOW LOSS TRANSISTOR SOCKETS



Transistor sockets with mounting ears for top mounting. 33 E 87271 3 Pin. Net .54
33 E 87289 4 Pin. Net .54

VECTOR CURRENT TEST ADAPTERS



Versatile VECTOR CURRENT TEST ADAPTERS make possible tube circuit current or voltage measurements without cutting leads or making computations. They have two spring test tab elements for each pin. These test tab elements break the circuit when a dual-sided probe is inserted in test position. Probes are gripped by the test tabs and need not be held in position. Current is read at the meter where the two test leads are connected. The same test adapters and probe also permit voltage and wave form readings on any pin position, merely by connecting the leads jointly to the meter. The adapters have mica-filled shell and keyways, and may be used in a horizontal or vertical position.

Stock No.	Mfg. No.	Tube Type	Net Ea.
19 E 83444	T7MC	7 Pin Miniature	2.53
19 E 83451	T8OC	8 Pin Octal	3.19
19 E 83469	T9NC	9 Pin Noval	2.70
19 E 83477	T9RC	9 Pin Noval	3.65
19 E 83485	T12C	12 Pin Compactron	3.85

Dual sided plug-in probe needed for above 19 E 83493 Net Each .79

TRANSISTOR SOCKETS



Miniature transistor sockets of low loss liner filled phenolic. Contacts are of Beryllium copper, gold flashed over silver plate. Fig. A — Ring mount, ring not included, Fig. B — for printed circuit. Pin patterns shown allow for versatile use of 3 or 4 lead transistors.

Stock No.	Fig.	Net
32 E 42195	A	.28
32 E 42211	B	.17
32 E 42260	Ring for Fig. A	.025



Rectangular mica filled transistor sockets. Contacts same specs. as above. Type C are ring mount. (Ring not included). Type E are for printed circuit use.

Stock No.	Fig.	Contacts	Net
32 E 42245	C	3	.10
32 E 42252	C	4	.11
32 E 42161	E	3	.12
32 E 42179	E	4	.12
32 E 42278	D	Ring for Fig. C	.02

INTEGRATED CIRCUIT SOCKETS



For 14 and 16 pin in-line hybrid packages having .100"x.300" grid spacing. For round or flat pins. Phenolic body. Brass electroplated contacts for P.C. version and brass cadmium plated contacts for self-mounting type.

Stock No.	Pins	Body	Net
32 E 65147	14	Self-mtg.	.50
32 E 65154	16	Self-mtg.	.50
32 E 65162	14	P.C.	.50
32 E 65170	16	P.C.	.50

POMONA TEST ADAPTERS



Ideal for in-circuit checking of voltage, resistance, audio and video from above chassis. † for use in sockets having captive shields. Shpg. wt., 6 oz.

Stock No.	Type	Pins	Description	Each
33 E 57019	TVS-7	7	Miniature	1.85
33 E 57027	TVS-8	8	Octal	1.85
33 E 57035	TVS-9	9	Miniature	1.95
33 E 57078	1779	9	Novar	2.25
33 E 57118	2497	9	Magnoval	2.75
33 E 57126	2610	10	Decal	2.55
33 E 57084	1710	10	Miniature	2.25
33 E 57043	TVS-12	12	Compactron	2.55
33 E 57050	1447	17	Miniature	1.95
33 E 57068	1449	19	Miniature	2.15

Amphenol & Eby Tube Sockets



AMPHENOL "MIP" SOCKETS

Molded high dielectric black phenolic, with molded-in plate for 1 1/2" mounting centers. T type is mica-filled, 1 3/4" mounting hole except * 1 1/2" mtg. hole, 1 3/4" mtg. ctrs. # 1 1/2" mtg. hole, † 1 3/4" mtg. hole. ‡ local socket. Avg. shgp. wt., 5 oz.

Stock No.	Mfg. No.	Prongs	1-49	50-249	250-499
32 E 20415	77-MIP-4	4	.19	.16	.13
32 E 20423	77-MIP-5	5	.21	.17	.145
32 E 20431	77-MIP-6	6	.23	.19	.159
32 E 20449	77-MIP-7L #	7L	.28	.23	.194
32 E 20456	77-MIP-7S	7S	.25	.21	.175
32 E 20464	77-MIP-8	8	.21	.18	.15
32 E 20472	77-MIP-8T	8	.25	.21	.178
32 E 20480	88-8*	8	.23	.19	.150
32 E 20498	88-8X†	8	.33	.27	.229
32 E 20506	77-MIP-9	9	.25	.21	.174
32 E 19052	77-MIP-11	11	.29	.24	.20
32 E 20522	77-MIP-12	12	.30	.25	.209
32 E 20530	77-MIP-20‡	20	.67	.56	.489

Type 77-MIP8FK. Octal Socket with live rubber grommets fit into mtg. holes for vibration-free operation. Mounts above or below chassis in 1 1/2" dia. holes on 1 1/2" centers. With hardware. Shgp. wt., 5 oz.

32 E 19029 Net ea. .41
Lots of 50, ea. .34 Lots of 250, ea. .286

AMPHENOL OCTAL SADDLE SOCKET

No. 168-015. Steel mounting plate molded in black bakelite. Uses 1" mounting hole with 1 1/4" centers.

32 E 20931 Net ea. .20
Lots 50 ea. .17 Lots 250 ea. .14

AMPHENOL RELAY SOCKETS

No. 59-106 14 CONTACT (FIG. A) 14 silver plated phosphor bronze contacts with hot tinned tails for easy soldering. Mica-filled phenolic dielectric. Steel saddle, cadmium plated. 1.125" mounting centers. Mounting hole is .750" dia. Shgp. wt., 6 oz.

32 E 21033 Net ea. .45
Lots of 50, ea. .38 250, ea. .318

OCTAL TYPE (FIG. B). Rugged, melamine sockets with high insulation barriers with long creepage paths. Rated 5 amp. 1250V RMS. *Has 4 molded-in threaded inserts for tie points. 103-104 are top mounted, 203-204 are bottom mounted. Shgp. wt., 8 oz.

Stock No.	Mfg. Type	1-24	25-99	100-249	250-499
32 E 19045	146-103	1.50	1.25	1.05	.90
32 E 19912	146-104*	1.91	1.59	1.34	1.15
32 E 19920	146-203	1.50	1.25	1.05	.90
32 E 19938	146-204*	1.81	1.39	1.34	1.15

AMPHENOL "RS" SOCKETS

Removable steel adapter plate with retainer ring allows replacement of most socket types. For mounting ctrs from 1 1/2" to 1 7/8". Molded high dielectric black phenolic. Mounts in 1 3/4" hole. † local socket. Avg. shgp. wt., 5 oz.

Stock No.	Mfg. No.	Prongs	1-49	50-249	250-499
32 E 20540	78-R54	4	.26	.22	.183
32 E 20555	78-R55	5	.28	.23	.196
32 E 20563	78-R56	6	.30	.25	.21
32 E 20371	78-R57S	7S	.32	.27	.225
32 E 20589	78-R58	8	.29	.24	.20
32 E 20597	78-R58L†	8	.40	.34	.282
32 E 20605	78-R59	9	.31	.26	.218
32 E 20613	78-R511	11	.35	.29	.247

AMPHENOL MIN. 7 & 9 PIN SOCKETS



Amphenol sockets for TV, FM, auto radios, etc. 147-series mounts on 3/8" chassis hole with 7/8" mtg. ctrs., 1/4" screw holes. 59-series mounts in 3/4" hole with 1 1/4" mtg. ctrs., .095" rivet holes. # .125" rivet hole. † Black Bakelite. ‡ Mica-filled bakelite. Avg., 5 oz.

BOTTOM MOUNTING TYPE—FIG. (A)

Stock No.	Mfg. No.	No. of Cent.	1-49	50-249	250-499
32 E 20787	147-500‡	7	.31	.26	.218
32 E 20795	147-505‡	7	.31	.26	.216
32 E 20803	59-409‡	9	.35	.29	.245
32 E 20811	59-410‡	9	.36	.30	.253

TOP MOUNTING TYPE—FIG. (B)

Socket with tube shield base to fit shields listed below.

32 E 20829	147-905‡	7	.35	.29	.242
32 E 20837	147-913‡	7	.34	.29	.241
32 E 20845	59-403‡#	9	.51	.43	.359
32 E 20852	59-407‡	9	.41	.35	.291
32 E 20860	59-406‡	9	.40	.34	.283

TUBE SHIELDS—FIG. (C)

For 7-Contact Bases.

32 E 20878	5-401	1 3/8"	.21	.18	.147
32 E 20886	5-402	1 3/4"	.22	.18	.152

For 9-Contact Bases.

32 E 20894	5-405	1 1/2"	.21	.18	.149
32 E 20902	5-408	1 1/4"	.25	.21	.177
32 E 20910	5-409	2 3/4"	.31	.26	.215



AMPHENOL "S" SOCKETS

For new work. Single hole mounting, 1 1/4" dia. Firmly held by tempered steel retainer ring. 9 and 11 prong sockets for Amphenol connectors. Molded high dielectric black phenolic. † mounts in standard 1 1/4" socket hole. Has miniature socket in center. ‡ local socket. Avg. shgp. wt., 5 oz.

Stock No.	Mfg. No.	Prongs	1-49	50-249	250-499
32 E 20688	78-54	4	.18	.15	.128
32 E 20696	78-55	5	.20	.17	.143
32 E 20704	78-56	6	.22	.19	.156
32 E 20712	78-57S	7S	.25	.21	.172
32 E 20720	78-58	8	.21	.18	.147
32 E 20738	78-58L*	8	.32	.27	.228
32 E 20746	78-59	9	.24	.20	.185
32 E 20753	78-S11	11	.28	.23	.194
32 E 20761	78-A7Pt	7	.47	.39	.327
32 E 20779	78-A9Pt	9	.35	.29	.242

AMPHENOL HI VOLTAGE AND TV SOCKETS



(A) Type 59-402. Low-loss bakelite duodecal socket for C.R. tubes. 12 prongs spaced on 1.063" dia., ring. Has removable cap. Shgp. wt., 5 oz.

32 E 20928 Net .93

(B) AMPHENOL 49-SS11L. 11 contact steatite socket for cathode-ray tubes. Has 1 1/4" pin circle. Mounts in 1 1/2" chassis hole. Retainer ring supplied.

32 E 21025 Shgp. wt., 7 oz. Net 1.59

(C) Type 146-101. Melamine, 8 contact octal hi-voltage socket for tubes such as 5U4G, 6L6G, etc. Net .88

EBY TUBE SOCKETS COMPACTRON SOCKET



Mica filled 12 pin tube saddle type socket with four ground lugs. Shgp. wt., 1 1/2 oz.
33 E 87816 Net .30



NOVAR SOCKET

Nine Pin (Novar) Socket with bottom mount saddle plate. Shgp. wt., 4 oz.
33 E 87295 Net ea. .18



NUVISTOR SOCKETS

5 and 7 pin sockets for nuvistor tubes. * are general purpose bakelite. † is mica-filled bakelite. Shgp. wt., 2 oz.
33 E 87198 †5 Pin Net ea. .24
33 E 87206 *7 Pin Net ea. .78

PRINTED CIRCUIT SOCKETS

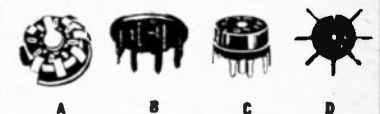

MINIATURE TUBE SOCKET (A). General purpose phenolic socket. Rapid mount. Snap action contacts.

33 E 87024 7 Pin Net .15
33 E 87032 9 Pin Net .18

WAFER SOCKET (B). For rapid assembly. Contacts snap into individual holes.

33 E 87040 7 Pin Net .10
33 E 87057 9 Pin Net .12
33 E 87065 octal Net .27

MOLDED TYPE (C). All molded printed circuit socket. With mounting tabs for individual hole insertion.

33 E 87164 7 Pin Net .12
33 E 87172 9 Pin Net .15

TOP MOUNTING TYPE (D). Molded with tabs for top board mounting.

33 E 87123 7 Pin Net .15
33 E 87131 9 Pin Net .17
33 E 87149 octal Net .42
Avg. shgp. wt., 1 oz.

TV PICTURE TUBE SOCKETS



MOLDEO: New all molded duo-decal socket for std. CRT's. Complete with back plate, contacts, hardware. Less leads.

18 E 27138 Shgp. wt., 6 oz. Net .24

MOLDEO: Duo-decal TV socket with plastic cover. Pins 1, 2, 10, 11 and 12 wired. 18" leads.

18 E 27146 Shgp. wt., 8 oz. Net .90

Same as above wired for electrostatic and magnetic tubes.

18 E 27153 Shgp. wt., 8 oz. Net .96

110° SYLVANIA CRT SOCKET. Wired for easy replacement with 18 inch leads.

18 E 27161 Shgp. wt., 6 oz. Net .90

110° RCA CRT SOCKET. Wired for easy replacement, with 18 inch leads.

18 E 27179 Shgp. wt., 6 oz. Net .89

Color CRT socket, for 70° color tubes, wired with 18" leads.

18 E 27203 Net 3.15

Color CRT socket for 90° color tubes will accept either RCA or Motorola tubes. Wired with 18" leads.

18 E 27195 Net 3.15

Robins and Amphenol Connectors

ROBINS® XLP AND XL CANNON AUDIO AND ELECTRONIC CONNECTORS



Dependable rugged construction. Features push-action Latch-Lock for locking mated fittings together securely. Interchangeable and

mates with Cannon XLR Connectors. Connectors have zinc alloy shell, phenolic insulator, and satin nickel finish. Approx. Shpg. wt. 5 oz.

STRAIGHT CORD PLUGS & SOCKETS

Stock No.	Mfr's. No.	Fig.	Contacts, Type Mount	EACH
33 E 29018	XL-3-11	A	3-Socket	1.40
33 E 29026	XL-4-11	A	4-Socket	1.87
33 E 29034	XL-3-12	B	3-Pin	1.32
33 E 29042	XL-4-12	B	4-Pin	1.75
33 E 29059	XLP-3-11	O	3-Socket	1.50
33 E 29067	XLP-4-11	O	4-Socket	2.04
33 E 29075	XLP-3-12	N	3-Pin	1.44
33 E 29083	XLP-4-12	N	4-Pin	1.92
33 E 29091	XLP-3-15	K	3-Socket 90° Angle	4.12
33 E 29109	XLP-4-15	K	4-Socket 90° Angle	4.35

PANEL AND WALL MOUNT RECEPTACLES

Stock No.	Mfr's. No.	Fig.	Contacts	Type Mount	EACH
33 E 29174	XL-3-13	C	3-Socket	Wall	1.59
33 E 29182	XL-4-13	C	4-Socket	Wall	1.95
33 E 29190	XL-3-14	D	3-Pin	Wall	1.07
33 E 29208	XL-4-14	D	4-Pin	Wall	1.50
33 E 29216	XL-3-13M	E	3-Socket	Panel	1.95
33 E 29224	XL-3-14M	F	3-Pin	Panel	1.65
33 E 29240	XL-3-31	H	3-Socket	Wall	1.77
33 E 29257	XL-4-31	H	4-Socket	Wall	2.05
33 E 29265	XL-3-32	G	3-Pin	Wall	1.15
33 E 29281	XL-3-35	J	3-Socket	Wall, single gang	3.43
33 E 29299	XL-3-36	J	3-Pin	Wall, single gang	3.42
33 E 29307	XL-4-36	J	4-Pin	Wall, single gang	4.20
33 E 29315	XL-3-35-2G	M	3-Socket	Wall, two gang	6.13
33 E 29323	XL-3-36-2G	M	3-Pin	Wall, two gang	6.60
33 E 29331	XL-4-36-2G	M	4-Pin	Wall, two gang	8.40
33 E 29349	XL-34-2G	M	3 & 4 Pin	Wall, two gang	9.40
33 E 29356	XL-34-4G	M	3 & 4 Pin	Wall, four gang	9.42
33 E 29141	XL-3-52	L	3-Pin	Bulkhead Mount	1.53
33 E 29150	XL-4-52	L	4-Pin	Bulkhead Mount	1.86

STAINLESS STEEL WALL PLATE AUDIO OUTLETS

Stock No.	Mfr's. No.	Fig.	Contacts, Type Mount	EACH
33 E 29364	XL-3-25	Q	3-Pin, Wall, Single Gang	3.09
33 E 29372	XL-4-25	Q	4-Pin, Wall, Single Gang	3.40
33 E 29380	XL-3-26	Q	3-Socket, Wall, Single Gang	2.97
33 E 29398	XL-4-26	Q	4-Socket, Wall, Single Gang	3.21
33 E 29406	XL-3-25-2G	R	3-Pin, Wall, Two Gang	4.58
33 E 29414	XL-4-25-2G	R	4-Pin, Wall, Two Gang	5.00
33 E 29422	XL-3-26-2G	R	3-Socket, Wall, Two Gang	4.30
33 E 29430	XL-4-26-2G	R	4-Socket, Wall, Two Gang	4.68

AMPHENOL AC CONNECTORS



U. L. listed. Black phenolic. 61 series rated 110V AC or DC, 160 series 125V. *Mounting plates molded in; # plates mount with retaining ring; mounting plate types require 1 1/2" holes and have 3/8" slotted holes on 1 1/2 to 1 3/4" centers except MIP type needs 1 3/4" hole and has 3/8" holes on 1 1/2" ctrs. † shielded types with 3/8" cable clamp. Δ = shielded types with 3/8" I.D. grommet; 160 series have grounding lug for use if required. Below surface types need 1 1/4" hole and have 3/8" holes on 1 1/4" centers. Shpg. wt., 3 oz.

UNIV. RECEPTACLES (FEMALE) 110V

Stock No.	Mfr. Type	Fig.	1-49	249	499
32 E 20274	61-F1#	A	.44	.37	.31
32 E 20282	61-MIP-61F*	A	.40	.33	.27
32 E 20290	61-F10	B	.56	.47	.396

GROUND RECEPTACLES (FEMALE) 125V

Stock No.	Mfr. Type	Fig.	1-24	99	249
32 E 20308	160-2#	A	.93	.78	.654
32 E 20316	160-4	B	1.88	.90	.75
32 E 20324	160-8†	C	1.06	.88	.74
32 E 20332	160-6Δ	C	.98	.82	.685

STANDARD PLUGS (MALE) 110V

Stock No.	Mfr. Type	Fig.	1-49	249	499
32 E 20340	61-M1#	A	.46	.39	.326
32 E 20357	61-M10	B	.57	.47	.387

GROUND PLUGS (MALE) 125V

Stock No.	Mfr. Type	Fig.	1-24	99	249
32 E 20365	160-3#	A	1.10	.92	.772
32 E 20373	160-5	B	1.25	1.05	.88
32 E 20381	160-9†	C	1.22	1.02	.853
32 E 20399	160-7Δ	C	1.14	.95	.797

STEELE SHELL ONLY (FIG. B)

Lowers "S" sockets, "CP" plugs and series 60, 61 connectors 1 1/4" below the surface. Needs 1 1/4" hole. Cadmium plated.

Stock No.	Mfr. Type	Fig.	1-49	249	499
32 E 21017	61-61	B	.14	.12	.101

AMPHENOL COAXIAL CONNECTORS



Series 83 UHF coaxial connectors for all RF applications. All connectors single contact except * are dual. Connectors mate by 3/64 thrd. couplings. †internal thread. #External thread. Avg. shpg. wt. 6 oz.

Stock No.	Mfr. No.	Fig.	Military Number	Description	Net Each
32 E 19953	83-1AC	—	—	†Cap & Chain	.72 .60 .50
32 E 19961	83-1AP	A	UG-646/U.M.-359,49192	Adapter, Right Angle	1.62 1.33 1.11
32 E 19979	83-1BC	—	—	#Cap & Chain	1.19 .98 .82
32 E 19987	83-1F	C	UG-363/U.PL-274,491049	Adapter, Bulkhead	2.65 2.18 1.83
32 E 19995	83-1H	B	UG-106/U.M.-360,49193	Hood	.45 .37 .31
32 E 20019	83-1HP	B	UG-372/U	Hood	.47 .39 .33
32 E 20027	83-1J	C	PL-258,49191	Adapter, Straight	1.15 .94 .79
32 E 20035	83-1R	D	SO-239,49194	Receptacle	.56 .46 .38
32 E 20043	83-1SP	E	PL-259,49190	Plug	.56 .46 .38
32 E 20050	83-1SPN	E	PL-259A,49195	Plug (Mica-Filled Bake)	1.02 .84 .70
32 E 20068	83-1T	F	M-358,49199	Adapter, Tee	2.95 2.42 2.03
32 E 20076	83-2R	—	SO-265,49196	Receptacle*	4.10 3.36 2.82
32 E 20084	83-21SP	E	UG-358/U	Plug	4.56 3.75 3.14
32 E 20092	83-22AP	A	UG-104/U.PL-293	Adapter, Right Angle*	2.40 1.97 1.65
32 E 20100	83-22F	—	PL-275	Adapter, Strt, Bulk*	3.44 2.82 2.37
32 E 20118	83-22J	C	UG-105/U.PL-285	Adapter, Straight*	2.08 1.71 1.43
32 E 20126	83-22R	—	UG-103/U.SO-264	Receptacle*	1.17 .96 .81
32 E 20134	83-22SP	E	UG-102/U.PL-284	Plug*	1.45 1.19 1.00
32 E 20142	83-22T	F	UG-196/U	Adapter, Tee*	3.40 2.79 2.34
32 E 20159	83-58	A	M-359A,49192A	Adapter, Right Angle	2.08 1.71 1.43
32 E 20167	83-168	—	UG-176/U	Adapter, Reducing	.17 .14 .12
32 E 20175	83-185	—	UG-175/U	Adapter, Reducing	.17 .14 .12
32 E 20183	83-750	E	UG-111/U	Plug	.96 .79 .66
32 E 20191	83-756	E	PL-259A,49195	Plug (Teflon)	1.45 1.19 1.00
32 E 20209	83-765	B	UG-177/U	Hood	1.41 .33 .28
32 E 20217	83-776	E	UG-203/U,49482	Plug	1.53 1.26 1.06
32 E 20225	83-786	B	—	Hood and Gang Nut	.87 .72 .60
32 E 20233	83-798	D	SO-239A	Receptacle	1.30 1.07 .89
32 E 20241	83-821	E	—	Plug*	2.04 1.67 1.41
32 E 20258	83-822	E	PL-259	Plug (Teflon)	.75 .61 .52
32 E 20407	83-850	E	—	Solderless Plug	3.10 2.54 2.14
32 E 20266	83-851	E	—	Solderless Plug	2.23 1.83 1.54

AMPHENOL TYPE BNC CONNECTORS

BMC SERIES. Compact "Quick-Connect-Disconnect" single contact bayonet type locking connectors. All are low voltage and weatherproof. *Rexolite inserts †Teflon inserts.

Stock No.	Mfg. No.	Fig.	Mil. No.	Description	For RG Cable	1-24	25-99	100
32 E 21181	31-003	A	UG 290/U	*Receptacle		.79	.65	.54
32 E 21199	31-203	A	UG 290A/U	*Receptacle		.85	.70	.59
32 E 21207	5575	B	UG625	*Receptacle		.72	.60	.50
32 E 21215	31-236	B	UG625B	*Receptacle		.79	.65	.54
32 E 21223	31-102	B	UG657/U	*Receptacle		1.25	1.03	.87
32 E 21231	31-221	B	UG1094/U	*Receptacle		.70	.58	.49
32 E 21249	31-002	C	UG88/U	†Plug	55U, 58U	.70	.58	.49
32 E 21256	31-202	C	UG88C/U	†Plug	55U, 58U	.75	.61	.52
32 E 21264	31-3202	C	UG88E/U	†Plug	558U, 58CU, 223	.92	.75	.63
32 E 21272	31-012	C	UG260U	*Plug	59U, 62U, 71U	.75	.61	.52



LAFAYETTE Plugs — Jacks

STANDARD LAFAYETTE 2-CONDUCTOR PHONE PLUGS

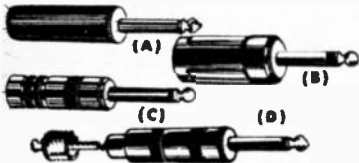

Phone plugs for a wide variety of applications with choice of handle sizes and materials. All sleeves fit standard 1/4" phone jacks. Avg. shpg. wt., 8 oz.

- FIG. A. **SLIM PHONE PLUG** Smooth bakelite handle. Solder terminals with cable clamp. Imported. **99 E 62218** Net .25 ea. — 10 for 2.15
- FIG. B. **BARREL PHONE PLUG** Ribbed plastic barrel handle. Screw terminals. Imported. **99 E 62234** Net .26 ea. — 10 for 2.38
- FIG. C. **SHIELD SLIM PLUG** Ribbed chromed metal handle. Solder terminal with cable clamp. Imported. **99 E 62150** Net .39 ea. — 10 for 3.30
- FIG. D. **PHONE TO PHONO JACK ADAPTER**. Adapts from standard phone plug to RCA type phono plug. Overall length 2 1/2 x 1/2" diameter. Imported. **99 E 62160** Net .39 ea. — 10 for 3.25

STANDARD LAFAYETTE PHONE JACKS FOR 1/4" PLUGS



- FIG. E. **OPEN CIRCUIT JACK** Standard open circuit phone jack, 3/8" bushing, 1/2" long. Camoleto with mounting hardware. Imported. **99 E 62135** Net .23 ea. — 10 for 1.95
- FIG. E. **CLOSED CIRCUIT JACK** Same as above but closed-circuit phone jack. Imported. **99 E 62226** Net .23 ea. — 10 for 1.95
- FIG. F. **EXTENSION CABLE JACK** Fit standard 1/4" phone plug. Screw terminals. Barrel plastic handle matches Barrel plug above. Imported. Shpg. wt., 10 oz. **99 E 62143** Net .28 ea. — 10 for 2.45

PHONO PLUGS AND JACKS



- (A) **Single Prong Shielded Plug**—RCA type, used extensively for mike, phono, etc. Shpg. wt., 4 oz. **99 E 64579** 10 for .35 singly, ea. .04
- (B) **Phone Jack** — Accepts RCA type phono plug. Mounts in rear of panel. Shpg. wt., 4 oz. **99 E 64567** 10 for .50 singly, ea. .06
- (C) **Finger grip plug** — Phono plug with finger grip. Wt., 4 oz. **99 E 78173** 10 for .72 singly, ea. .08
- (D) **Feed Thru** — Accepts male phono plug at both ends. Shpg. wt., 4 oz. **99 E 52012** Ea. .30



FLAT PLUG

Ultra-compact type for use where space is limited. Bakelite body. 1 1/2" dia., 1/4" thick. **99 E 10005** Shpg. wt., 4 oz. Net .66

PHONO PIN JACK SINGLE HOLE MOUNTING



RCA type female input jack. Mounts securely in single 1/4" hole by means of locknut on jack. Screws, nuts and washers unnecessary. Imported. Shpg. wt., 4 oz. **99 E 62341** 10 for 1.70 Singly, ea. .10



ULTRA MINIATURE PLUG & JACK



Plug is 15/16" overall. Jack mounts on panels up to 3/32" thick. Requires 5/32" mtg. hole. Extends-11/32" behind panel. 3 circuit jack can be used open or closed. Shpg. wt., 1 oz. Imported. **99 E 63141** Net .38



SUB-MINIATURE PLUG ADAPTER

Provides Extra Earphone Jack for Transistor Radios

69¢

A sub-miniature combination plug and jack designed for most transistor radios with earphone jacks. Just plug it in and you have 2 jacks for earphones, speakers, etc — can be used in most instruments provided with an earphone jack. Overall size: 2 1/4 x 1 1/16 x 3/4" D. Shpg. wt., 6 oz. Imported. **99 E 63109** Net .60

SUBMINIATURE PHONE PLUG AND JACK



Sub-miniature "phone plug" and jack. Only 1" long x 1/4" diameter, overall. Excellent for transistor and subminiature applications. Plug has removable sleeve. Jack can be mounted on panel up to 1/16" thick. Jack can be used for both open and closed circuits. Imported. 4 oz. **99 E 62101** Plug Net .22

99 E 62119 Jack Net .18

PHONE PLUG TO PHONO JACK ADAPTER



52¢

Brass, nickel-plated adapter. Has standard phone jack on one end to take regular phone plug, and RCA-type phono plug on other end. Has threaded bushing with nut and washer so can be panel mounted if desired. Imported. Shpg. wt., 4 oz. **99 E 62369** Net .52

HEAVY SHIELDED PHONE (A) PLUGS AND JACKS (B)



(A) **Sturdy, heavy brass, nickel-plated phone plugs with screw terminal connections.** Threaded insulated cable outlet may be removed for larger cables to pass through. Body dia. 1/4", overall length 3 1/4". Shpg. wt., 4 oz. Imported. **99 E 62291** Plug Net ea. .50 10 for 5.30

(B) **Matching in-line phone jack, same construction as plug.** Overall length 2". Imported. **99 E 62283** Jack Net ea. .55 10 for 4.95

ALL SHIELDED PHONO PLUG AND JACK



(A) **Removable Shell** for easy soldering of wires. Positive ground convection through unique ground lug reduces hum to a minimum. Extra long handle makes removal from amplifier a snap. Completely shielded in bright nickel plate on brass body and shell. Fits all RCA type jacks. 1 1/4" long. Imported. Shpg. wt., 4 oz. **99 E 62390** Net .22

(B) **Extension Cable Jack** for use with above or any other type phono plug. Imported. Shpg. wt., 4 oz. **99 E 62400** Net .22

3 CONDUCTOR PHONE PLUG & JACK



(A) **3 Conductor Phone Plug**—Black Bakelite Handle. Solder lugs. Open circuit 1/4 shaft. Imported. **99 E 61194** Net .30

(B) **3 Conductor Phone Jack.** Open Circuit. Imported. **99 E 61186** Net .30

MINIATURE 3-CONDUCTOR PLUG AND JACK SET

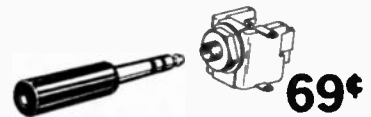

A finely built 3-conductor plug and jack set. Uniquely made so that jack can be used as normally open although one circuit may be used as normally closed. Heavy gauge construction. Plug 1 1/4" overall. Jack mounts in 3/8" hole in panels up to 1/8" thick. Imported. Shpg. wt., 3 oz. **99 E 63261** Net .60

KIT OF 10 PHONO PLUGS

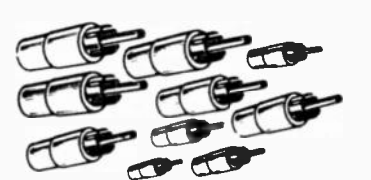

LOW, LOW PRICE 99¢

Kit contains 10 RCA-type phono plugs in assorted colors—Black, Red, Yellow, Blue, and White. Plastic shell with finger grip. Plugs are semi-solderless type—need only spot solder at tip. Fit standard RCA type phono jacks. Imported. Shpg. wt., 2 oz. **99 E 63273** Net .99



DOUBLE PHONO JACK AND PLUG SET

Set consists of two phono male plugs and a dual female socket. Excellent for such dual signal applications as stereo equipment. Sturdy solder contacts are used throughout construction. Shpg. wt., 3 oz. **99 E 63307** Net .23

Plugs — Jacks — Connectors

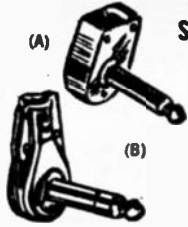

SWITCHCRAFT 3 CONDUCTOR FLAT PHONE PLUGS

1/4" flat phone plugs with removable plastic cap for easy connection of wire leads. Ideal for use where space is limited. Tip rods are 1 1/2" long. All metallic parts are of nickel plated brass. All plugs have screw type terminals except #238 which is solder type. Shpg. wt., 3 oz.

Stock No.	Mfr. No.	Fig.	Color	Net Each
34 E 60391	230	A	Black	.98
34 E 60409	S-230	A	Black	1.23
34 E 60417	235	A	Red	.98
34 E 60425	238	B	Metal	1.02

SWITCHCRAFT "LITTEL PLUGS" AND JACKS

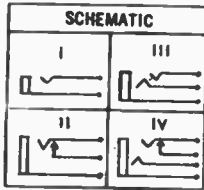
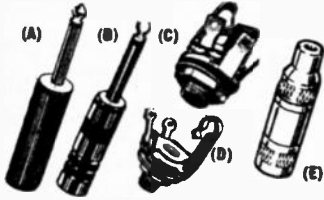

"LITTEL-PLUGS" PHONE PLUGS—Compact quality plugs. Fits standard 3/4" phone jacks except * with .206 diam. sleeve and † with short sleeve for Revere recorders. In plastic handle or with brass nickel plated shells for shielding. Solder terminal has built-in cable clamp. Handle 1 1/4" long, 1/2" diam. Av. shpg. wt., 4 oz.

Stock No.	Type	Fig.	Cond.	Handle	Terminals	Net
34 E 60128	240	A	2	Black	Screw	.94
34 E 60136	245	A	2	Red	Screw	.94
34 E 60144	250	A	2	Black	Solder	.51
34 E 60151	S-250*	A	2	Black	Solder	.94
34 E 60169	255	A	2	Red	Solder	.51
34 E 60177	260	A	3	Black	Screw	.84
34 E 60185	267	A	3	Black	Solder	.75
34 E 60193	280	B	2	Metal	Solder	.72
34 E 60201	S-280*	B	2	Metal	Solder	.72
34 E 60219	R-280†	B	2	Metal	Solder	.93
34 E 60227	297	B	3	Metal	Solder	.93

"LITTEL-JAX" PHONE JACKS (Fig. C) Accept standard 3/4" phone plugs, except * with 210" J.D. sleeve and † mates with 480 Mil type "Littel-Plug." Abbrs.: SCC—single closed ckt; OC—open ckt. 3/4" dia., 1 1/2" overall; 3/8" dia. threaded shank, 3/4" long. Av. shpg. wt., 3 oz.

Stock No.	Type	Schematic	Cond.	CKT.	Jan Type	Net
34 E 60235	11	I	2	OC	—	.30
34 E 60243	C-11	I	2	OC	JJ-034	.45
34 E 60250	S-11*	I	2	OC	—	.33
34 E 60268	12A	II	2	SCC	—	.33
34 E 60278	C-12A	II	2	SCC	JJ-089	.54
34 E 60284	12B	III	3	OC	—	.39
34 E 60292	C-12B†	III	3	OC	JJ-033	.54
34 E 60300	13B	IV	3	SCC	—	.57

"TINI-PLUGS" SUBMINIATURE PHONE PLUGS. 2-conductor phone plugs for use with "Tini-Jax." Only 1 1/4" in length. In plastic or metal shielded handles. Shpg. wt., 2 oz.

Stock No.	Type	Fig.	Handle	Terminals	Net
34 E 60318	740	A	Black	Screw	.54
34 E 60326	745	A	Red	Screw	.54
34 E 60334	750	A	Black	Solder	.51
34 E 60342	755	A	Red	Solder	.51
34 E 60359	770	B	Metal	Screw	.72
34 E 60367	780	B	Metal	Solder	.69

"TINI-JAX" SUBMINIATURE PHONE JACKS (Fig. D) 2-conductor jacks for "Tini-Plugs." Only 3/4" long. Abbrs.: OC—open Ckt.; CC—closed Ckt. Av. shpg. wt., 2 oz.

Stock No.	Type	Schematic	CKT.	Net
34 E 60375	41	I	OC	.30
34 E 60383	42A	II	CC	.33

"TINI-EXTENSION JAX" (Fig. E) An extension or cable jack to mate with "Tini-Plugs." Two conductor with metal housing for ruggedness and electrical shielding. Solder lug terminals. Shpg. wt., 3 oz.

Stock No.	Type	Fig.	Cond.	Terminals	Net
34 E 60480	125	E	2	Solder	.84

SWITCHCRAFT PLUGS AND JACKS

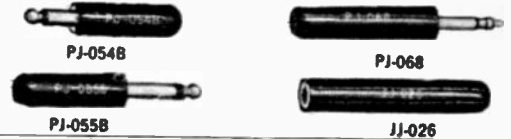

MIL TYPE PLUGS AND EXTENSION JACK

All meet industrial and military requirements. Plugs are made to MIL-P-642A Specs. The extension Jack type 820 meets MIL-J-641A specs. Best quality material and workmanship assure positive internal interlock. Parts will not shift in position. Black elastic handle. Extension Jack fits type 430 "Littel-Plug". All have screw terminals. Av. shpg. wt., 5 oz.

Stock No.	Type	Cond.	S.C. No.	Jan. Type	Net Each
34 E 60086	430	2	PL-55	PJ-054B	.90
34 E 60094	440	2	PL-55	PJ-055B	.90
34 E 60102	480	3	PL-68	PJ-068	2.18
34 E 60110	820	2	JK-26	JJ-026	1.26

SWITCHCRAFT "MICRO PLUGS AND JAX"

(A) A miniaturized 2-conductor plug for use with cables of up to 7/64" O.D. Nylon insulation is used between tip and sleeve. Shpg. wt., 2 oz.
(B) Ultra-miniaturized jack is designed for above plugs. Features solder lugs and positive tip spring grip.

34 E 60433 (A) Black handle (No. 850)	Net	.40
34 E 60441 (A) Red handle (No. 855)	Net	.40
34 E 60490 (A) Natural A1. handle (No. 880)	Net	.40
34 E 60508 (B) Jax (No. TR-2A) Shpg. wt., 2 oz.	Net	.36

SWITCHCRAFT "THICK PANEL JAX"

A long bushing allows mounting in panels of up to 1 1/4" in thickness with a 15/32" diameter hole. Features shielding and solder terminals. No. 151 is 2-conductor and mates with 240, 245, 250, 255, 270, and 280 plugs. No. 152B is 3-conductor and mates with 260, 267, 269, and 297 plugs. Shpg. wt., 2 oz.

Stock No.	Description	Net
34 E 60474	Switchcraft No. 151	.93
34 E 60482	Switchcraft No. 152B	1.02

SWITCHCRAFT STEREO "LITTEL-JAX"

A three conductor jack specially designed for switching out speakers when connecting stereo headphones. Recommended for such stereo applications as record players and multiplex tuners. Dual, normally-closed switch contacts, open both stereo circuits independently when a three conductor plug is inserted. Mounts in single 3/8" diameter hole. Shpg. wt., 3 oz.
34 E 60486 Switchcraft No. 148 Net .72

LAFAYETTE FLAT PHONE PLUG

Two conductor all metal phone plug for standard 3/4" jack, body only 3/8" thick. Shielding crimps to body, center lead to solder terminal. Imported. Shpg. wt., 3 oz.
99 E 62788 Net ea. .39

LAFAYETTE STEREO PHONE JACK

For insertion of standard three conductor plug. Will switch out speakers and allow operation of only headphones or extension speakers. Many uses. Imported. Shpg. wt., 4 oz.
99 E 62739 Net ea. .45

EUROPEAN AUDIO CONNECTORS

Made to European DIN engineering specs. Fully shielded in plastic snap-on shells. Will mate with sockets on Moreloc, Grundig, Telefunken, Uher, etc. Imported.

3 PIN AUDIO PLUG	
34 E 31012 Shpg. wt., 2 oz.	Net .68
5 PIN AUDIO PLUG	
34 E 31020 Shpg. wt., 2 oz.	Net .78

TELEX MINIATURE PHONE PLUG AND JACK

Precision made plugs and jacks. Plug is 1 1/2" long (overall), body is 1/4" diameter, prod is 1/8" Dia. Jack can be mounted on any panel up to 1/8".

32 E 83017 PM-01 Plug	Net .67
TELEX No. JMP-01 Jack (Closed Circuit)	
32 E 83025	Net .42
TELEX No. JMP-02 Jack (Open Circuit)	
32 E 83033	Net .42

Plugs — Jacks — Binding Posts



INSULATED PLUGS

Fig. A. Insulated Tip Plug. Heavy duty. Solder type. 1" handle. 2 1/4" overall.
 32 E 64645 Red Net Ea. .17
 32 E 64652 Black 10 For 1.01

Fig. B. Insulated Solderless Tip Plug. 1" handle, 2" length overall.
 32 E 64660 Red Net Ea. .17
 32 E 64678 Black 10 For 1.01

Fig. C. Insulated Short Tip Plug. Solder type. 1" handle. 1 1/4" overall length.
 32 E 64686 Red Net Ea. .13
 32 E 64694 Black 10 For 1.23

Fig. D. Insulated Banana Plug. Spring type. Internal set screw for soldering. 1" handle. 1 1/4" length overall. Phosphorbronze.
 32 E 64702 Red Net Ea. .25
 32 E 64710 Black 10 For 2.37

Fig. E. Solderless Insulated Banana Plug. Spring type. 1" handle. 1 1/4" overall.
 32 E 64728 Red Net Ea. .20
 32 E 64736 Black 10 For 1.90

Fig. F. Solderless Insulated Banana Plug. Split type. 1" handle. 1 1/4" overall.
 32 E 64744 Red Net Ea. .10
 32 E 64751 Black 10 For 1.71

Fig. G. Insulated Banana Plug. Spring type. 1" handle. 1 3/4" overall. Solder type.
 32 E 64768 Red Net Ea. .20
 32 E 64777 Black 10 For 1.90

Fig. H. Molded Meter Banana Plug.
 32 E 64785 Red Net Ea. .40
 32 E 64793 Black 10 For 3.00

Fig. J. Molded Meter Tip Plug.
 32 E 64801 Red Net Ea. .30
 32 E 64819 Black 10 For 2.85

Fig. K. Molded Spade Lug. 3/4" handle. 1 1/4" length overall.
 32 E 64827 Red Net Ea. .11
 32 E 64835 Black 10 For 1.04

INSULATED JACKS

Fig. L. Phone Tip or Banana Plug. Mounts in 3/8" hole.
 32 E 64843 Red Net Ea. .20
 32 E 64850 Black 10 For 1.90

Fig. M. 5-way Binding Post. Takes phone tips, banana plugs, spade lugs, alligator clip, wire. All insulated type.
 32 E 64868 Red Net Ea. .45
 32 E 64876 Black 10 For 4.27

Fig. N. Nylon All Insulated Tip Jack. 1" overall. Mounts in 3/8" hole.
 32 E 64884 Red Net Ea. .20
 32 E 64892 Black 10 For 1.90

Fig. P. Insulated Tip Jack. 1 1/4" overall length. Mounts in 3/8" hole.
 32 E 64900 Red Net Ea. .15
 32 E 64918 Black 10 For 1.42

Fig. Q. Nylon Insulated Tip Jack. With nylon washer. 1" overall length. Mounts in 3/8" hole.
 32 E 64928 Red Net Ea. .27
 32 E 64934 Black 10 For 2.56

Fig. R. Insulated Banana Jack. 3/4" overall length. Mounts in 3/8" hole.
 32 E 64942 Red Net Ea. .15
 32 E 64950 Black 10 For 1.42

Fig. S. Instrument Banana Jack. 3/4" overall length. Mounts in 3/8" hole.
 32 E 64967 Red Net Ea. .18
 32 E 64975 Black 10 For 1.71

Fig. T. Nylon Insulated Banana Jack. With nylon washer. Overall length 5/8". Mounts in 3/8" hole.
 32 E 64983 Red Net Ea. .25
 32 E 64991 Black 10 For 2.37

METAL JACKS

Fig. U. Metal Tip Jack. Mounts in 1/4" hole.
 32 E 64371 Net ea. .15
 10 for 1.42 100 for 13.50

Fig. V. Metal Banana Jack. Mounts in 1/4" hole.
 32 E 64389 Net ea. .13
 10 for 1.23 100 for 11.70

Fig. W. Metal Banana Jack Mounts in 1/4" hole.
 32 E 64397 Net ea. .12
 10 for 1.23 100 for 10.00

Fig. X. Solderless Phone Tip, Sr. 1 1/4" long.
 32 E 64405 Net ea. .15
 10 for 1.42 100 for 13.50

NON-INSULATED PLUGS

Fig. Y. Solderless Phone Tip, Jr. 1 1/4" long.
 32 E 64413 Net ea. .12
 10 for 1.14 100 for 10.00

Fig. Z. Banana Plug. Spring type. 1 3/4" overall. 6-32x1/2" stud.
 32 E 64421 Net ea. .20
 10 for 1.90 100 for 18.00

Fig. AA. Banana Plug. Spring type. Screw in head. 1 1/2" overall.
 32 E 64439 Net ea. .20
 10 for 1.90 100 for 18.00

Fig. BB. Banana Plug. Spring type. 1 1/4" overall. 6-3/8" stud.
 32 E 64447 Net ea. .20
 10 for 1.90 100 for 18.00

Fig. CC. Banana Plug. Split type. 1 1/4" overall. 6-32x1/2" stud.
 32 E 64454 Net ea. .17
 10 for 1.61 100 for 15.30

AMPHENOL TIP JACKS



Made to MIL specs. Threaded metal bodies mount in 1/4" holes. Handles 1000V peak. Shpg. wt., 1 1/4 oz.

(Fig. B) (Fig. A)

TURRET TERMINAL TYPE (Fig. A) TYPE 350-29175 has silverplated beryllium copper contact. 3/8" long.

Stock No.	Color	1-49	50-249	250-499
32 E 21140	Red	.35	.29	.244
32 E 21157	Black	.35	.29	.244

SILVER TERMINAL TYPE (Fig. B) TYPE 350-29200 has silverplated phosphor bronze contact. 1 1/2" long.

Stock No.	Color	1-49	50-249	250-499
32 E 21185	Red	.41	.34	.285
32 E 21173	Black	.41	.34	.285

LAFAYETTE JUMBO 5-WAY BINDING POST

Accepts phone tip plug, a spade lug, a banana plug, an alligator clip and a strand of wire. Head non-removable from stand. Molded plastic construction. For panels 1/2" to 1/4" thick. Imported.
 99 E 81202 Black Net .25
 99 E 81210 Red Net .25

SMITH DUAL BANANA PLUG



No. 210 moulded polystyrene dual binding post with brass nickel plated plugs on 3/4" centers. Mates with standard binding posts. Polarity indicated on top and side. Wire held by internal set screw. May be stacked. Shpg. wt., 2 oz.
 32 E 85048 Black Net .72
 32 E 85055 Red Net .72

SMITH TEST PRODS

Brass, nickel plated plugs mounted in 4" molded butyrate handles. Shpg. wt., 2 oz.

No. 302 Solderless Test Prod Type
 32 E 65063 Red Net .30
 32 E 65071 Black Net .30

No. 317 Phone Needle Test Prod
 32 E 65089 Red Net .33
 32 E 65097 Black Net .33

SMITH "SPEEDI-MOUNT" JACKS



Unusual dished lockwasher permits fast assembly. Teeth inside jack and panels, prevents pulling out and turning. Mounts in 3/8" hole in panels up to 3/8" thick. Shpg. wt., 1 1/2 oz.

No. 279 Accepts Tip Jacks
 32 E 65105 Red Net .08
 32 E 65113 Black Net .08

No. 398 Accepts Banana Jacks
 32 E 65121 Red Net .08
 32 E 65130 Black Net .08

LAFAYETTE KIT OF 10 5-WAY BINDING POSTS



- For Banana Plug
- For Phone Tip Plug
- For Spade Lug
- For Alligator Clip
- For Strand of Wire

For panels 1/2" to 1/4" thick. Assortment of 10 pieces. 5 Red and 5 Black. Imported. Shpg. wt., 8 oz.
 99 E 82333 Binding Post Kit Net .99

Adjustable Transformers—Rectifiers

STANCOR RECTIFIER TRANSFORMERS

Designed to operate in full-wave center-tapped or bridge type circuits. Each transformer has a tapped primary and a tapped additional

winding permitting a wide range of output voltages. All are 8V mtg type. Primaries are for 117V 50/60 Hz AC operation. Supplied with wiring chart.



Stock No.	Stan.No.	Range of AV Volts	Max. D.C. Resistive	Output Lead Capacitive	Size	Wt.				
						Lbs.	1-9	10-24	25-49	50-99
33 E 82306	RT-201	11.7 to 29.4 11.1 to 28.5	11.2V at 2.0A 23.0V at 1.25A	13.8V at 2.0A 30.0V at 1.25A	3 1/4 x 2 1/4 x 2 1/2	2 1/2	8.51	7.06	7.23	6.81
33 E 82314	RT-202	12.0 to 29.8 12.0 to 29.8	11.1V at 4.0A 24.3V at 2.0A	14.7V at 4.0A 33.0V at 2.0A	3 1/4 x 3 1/4 x 2 1/4	4	10.42	9.38	8.08	8.34
33 E 82322	RT-204	11.7 to 29.2 11.6 to 29.2	12.0V at 8.0A 24.0V at 4.0A	14.5V at 8.0A 32.4V at 4.0A	3 1/4 x 3 3/4 x 3 3/4	6 1/4	15.76	14.18	13.40	12.61
33 E 82330	RT-206	12.0 to 29.7 12.0 to 29.7	11.5V at 12.0A 24.0V at 6.0A	14.4V at 12.0A 32.0V at 6.0A	4 1/4 x 3 1/4 x 3 3/4	9 1/4	20.66	18.59	17.56	16.33

COLOR TV RECTIFIER REPLACEMENTS

*=Silicon, all other selenium

Stock No.	Fig.	Type	Funct.	Replacement for	Net
33 E 59163	A	CTV650*	Focus	General Use.	5.00
33 E 59148	B	80 C*	Volt. Boost	General Use.	.81
33 E 59135	C	F-8*	Volt. Boost	General Use.	.69
33 E 59130	B	60 C*	B+	General Use.	.63
33 E 59106	C	F-6*	B+	General Use.	.51
33 E 59171	G	S-880	Focus	General Use.	1.75
33 E 59189	D	S-879	Volt. Boost	General Use.	1.20
33 E 59213	E	S-855	Convergence	GE M128753, Philco 34-8058, RCA 1470990,	.84
33 E 59221	F	S-420	Convergence	Zenith 212-25	.84
33 E 59197	F	S-798	Convergence	Zenith 212-63	.96
33 E 59205	F	S-781	Convergence	Admiral 93C1-20/21	.84

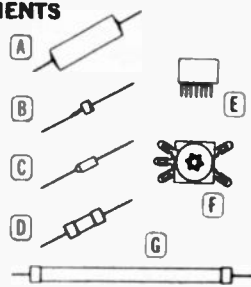

HIGH DENSITY SELENIUM RECTIFIERS

Replacements for radios, TV sets, Hi-Fi etc. 130 VAC input; 380 max. peak inverse volts. All have solder lugs. Avg. shpg. wt., 4 oz.

Stock No.	Ma	Net Each	L/10 Each
33 E 45378	0-75	.50	.53
33 E 45386	75-150	.75	.87
33 E 45394	150-300	1.10	.99
33 E 45410	400-500	1.25	1.12
33 E 45360	500-650	2.00	1.87
33 E 45345	750	1.88	1.67

SARKES TARZIAN SILICON RECTIFIERS

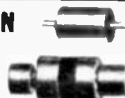

Stock No.	Fig.	Type	Max DC	Max. Input PIV	Net VAC	Net Ea.
33 E 59096	A	F-4	1 amp.	400	130	.51
33 E 59106	A	F-6	1 amp.	600	195	.51
33 E 59056	B	M-500	1 amp.	400	130	.96

HOLDERS FOR TYPE M500

13 E 62045	Single Holder	ea. .16
13 E 62052	Dual Holder	ea. .30

STACO INC. VARIABLE AUTO-TRANSFORMERS



Made of a single-layer winding and high grade toroidal core. Sliding brush taps transformer to permit selection of output voltage. Brush is always in contact with at least

one turn of wire. †Deluxe types have circuit breaker, pilot light, banana jacks, on-off switch and 3 prong plug and receptacle. *Bench types are fused with pilot light & switch.

Stock No.	Mtg.No.	Fig.	Input		Output		Description	Size	Wgt.	Net
			Volts	Hz	Volts	Amps.				
33 E 70343	171	F	120	50/60, 60	0-120, 0-132	1.75	For mounting in panels up to 1/4"	2 1/4" Dia. x 2 1/4" D.	3	11.50
33 E 70335	251	F	120	50/60, 60	0-120, 0-132	2.50	For Mounting in Panels up to 1/2"	2 1/4" Dia. x 3 1/4" D.	3.5	12.00
33 E 70327	371	J	120	50/60, 60	0-120, 0-140	3.75	For Mounting in Panels up to 1/2"	3 3/4" Sq. x 3 1/4" D.	5	17.00
33 E 70319	501	J	120	50/60	0-120, 0-140	5.00	For Mounting in Panels up to 1/2"	4 3/4" x 3 3/4" x 3 3/4" D.	6	18.00
33 E 70301	1010	J	120	50/60	0-120, 0-140	10.00	For Mounting in Panels up to 1/2"	5 3/4" x 5 x 4 1/2" D.	12	23.00
33 E 70293X	1510	B	120	50/60	0-120, 0-140	15.00	For Mounting in Panels up to 1/2"	8 1/4" x 8 x 5 1/4" D.	20	42.00
33 E 70285	1020	J	120	60	0-280	3.5-1.5	For Mounting in Panels up to 1/2"	5 3/4" x 5 x 4 1/2" D.	12	27.00
33 E 70277X	1520	B	120	50/60	0-280	9.5-4.1	For Mounting in Panels up to 1/2"	8 1/4" x 8 x 5 1/4" D.	20	42.00
33 E 70260	2PF171*	G	120	60	0-132	1.75	w/2 Cond., Cord., Plug & Socket	3 7/8" Sq. x 2 1/2"	3.5	22.00
33 E 70251	2PF501*	H	120	50/60	0-120, 0-140	5.0	w/2 Cond., Cord., Plug & Socket	6 1/4" x 5 3/4" x 4 1/2"	9	26.00
33 E 70244	3PN501*	H	120	50/60	0-120, 0-140	5.0	Bench Type w/3 Cond., Cord., Plug & Socket	6 1/4" x 5 3/4" x 4 1/2"	9	28.00
33 E 70236	2PF1010*	C	120	50/60	0-120, 0-140	10.0	w/2 Cond., Cord., Plug & Socket	6 7/8" x 5 x 4 1/4"	12	32.00
33 E 70228	3PN1010*	C	120	50/60	0-120, 0-140	10.0	w/3 Cond., Cord., Plug & Socket	6 7/8" x 5 x 4 1/4"	12	36.00
33 E 70210X	3PN1510*	D	120	50/60	0-140	15.0	w/3 Cond., Cord., Plug & Socket	9 x 6 3/8" x 5 1/4"	22	60.00
33 E 70202W	EJ201V†	E	120	50/60	0-140	2.0 AC/DC	Deluxe Isolated Type w/0-140 V. Meter	7 3/4" x 12 1/4" x 5 7/8"	16	79.00
33 E 70194WX	EJ401V†	A	120	50/60	0-140	4.0 AC/DC	Deluxe Isolated Type w/0-150 V. Meter	9 1/2" x 12 1/4" x 6 3/8"	30	100.00
33 E 70188WX	EJ901V†	A	120	50/60	0-140	9.0 AC/DC	Deluxe Isolated Type w/0-150 V. Meter	11 1/4" x 14 1/4" x 6 3/8"	36	140.00

ACME T8394M VARIABLE VOLTAGE ADJUSTER

300 W. continuous duty variable transformer. Adjusted by rotary tap sw. Used as step up or step down. Voltmeter shows sec. voltage. Pri. 95/100/105/110/115/120/125 volts at 50/60 Hz Sec. out 115 V. 8' cord and plug. Size: 4 3/4 x 4 5/8". Shpg. wt., 9 lbs. **33 E 40615** Net 13.40

PERMA-POWER AUTOMATIC VOLTAGE REGULATOR

Completely automatic voltage control for color TV or appliances rated up to 400 watts. Simple plug-in installation. Automatically shuts off when set or appliance is not in use. Eliminates picture flutter, shrinking, brilliance loss, and other problems caused by line voltage drops. Shpg. wt. 4 lbs. **32 E 40058** Net 14.95
Similar to above—300 watts **32 E 40025** Net 8.25



Chicago-Stancor Transformers

POWER TRANSFORMERS

All primaries 117 V 60 Hz. All 6.3V secondaries are C.T. except * and PC-8414 which has extra 6.3V amp. winding Types with † are for selenium rectifier circuits or tubes such as 6AX5, 6X4, 6X5, etc. All type M mtg. except PC and P are C mtg. Ps is S mtg. PA is A mtg. † Plate V. not center tapped.

Stock No.	Stan No.	Plate		5V Amp	6.3V Amp	Size	Wt. Lbs.	Net Each	
		VCT	MA					1-9	10-24
33 E 80946*	PS-8415	125†	15	—	0.6	2x2½x1¾	¾	3.02	2.72
33 E 80953*	PA-8421	125†	50	—	2.0	2¼x3¾x2½	1½	4.72	4.25
33 E 80981*	PS-8416	250†	25	—	1.0	2½x2¾x1¾	1	4.14	3.73
33 E 80979*	PC-8418	460†	50	—	2.5	3¾x2½x2¾	2¼	7.23	6.51
33 E 80987*	PM-8418	460†	50	—	2.5	2½x2½x3	2¼	6.05	5.45
33 E 81019*	PC-8401	470	40	2.0	2.0	3¾x2½x2½	2¼	8.57	7.71
33 E 81027	PM-8402	480	55	2.0	2.0	2¾x2½x3	2½	8.81	7.93
33 E 81035	PC-8402	480	55	2.0	2.0	3¾x2½x2¾	2½	8.55	7.70
33 E 81050*	PC-8419	480†	70	—	3.0	2½x2½x3	2¾	8.51	7.66
33 E 81076*	PC-8420	520†	90	—	4.0	3½x3¼x2¾	3½	9.31	8.38
33 E 81084	PM-8403	500	70	2.0	2.5	3¾x2½x3	3¼	9.69	8.72
33 E 81118	PC-8404	520	90	2.0	3.0	4½x3½x2¾	4	10.21	9.19
33 E 81134	PC-8405	540	120	3.0	3.5	3½x3½x3½	5	11.32	10.19
33 E 81159	P-6358	600†	65	—	2.7	3½x2½x2½	3	8.45	7.81
33 E 80722	PC-8407	650	55	2.0	2.0	3¾x2½x3½	3¾	8.75	7.88
33 E 80763	PC-8409	700	90	2.0	3.0	3¾x3x3¾	4½	11.73	10.56
33 E 80789	PC-8410	720	120	3.0	3.5	4x3¼x3¾	5½	13.99	12.59
33 E 80805	PC-8411	750	150	3.0	4.5	4¾x3¾x4	6	17.37	15.63
33 E 80821	PC-8412	800	200	3.0	5.0	4¾x4x4	8¾	17.20	15.55
33 E 80839	PC-8414	1200	200	3.0	3.0	4½x3¾x4	8½	20.79	18.71

FILAMENT TRANSFORMERS

All primaries are 117 volt 50-60 Hz AC except † which has a 117/107V.

Stock No.	Stan No.	Volts	Secondary I Amperes	Insul.	Mtg. Type	Shpg. In Lbs.	Net Each	
							1-9	10-24
33 E 80847	P-6133	2.5 CT	5.0	7,500	S	1.5	8.33	5.70
33 E 80854	P-6454†	2.5 CT	10.0	7,500	S	2.5	8.51	5.86
33 E 80880	P-6467	5.0 CT	3.0	2,500	A	1.4	4.40	3.96
33 E 80938	P-6492	5.0 CT	30.0	2,500	C	7.5	16.71	14.59
33 E 80490	P-6465	6.3 CT	.8	1,500	A	0.4	2.74	2.47
33 E 80508	P-6134	6.3 CT	1.2	3,000	A	0.8	2.78	2.48
33 E 80516	P-8190	6.3	1.2	5,000	A	1.0	4.33	3.90
33 E 80540	P-5014	6.3 CT	3.0	2,500	BV	2.0	6.05	5.45
33 E 80557	P-6466	6.3 CT	3.0	2,500	A	1.4	4.40	3.96
33 E 80585	P-6462†	6.3	3.0	7,000	S	2.0	7.84	6.88
33 E 80607	P-4019†	6.3 CT	4.0	2,500	C	2.7	7.77	6.99
33 E 80615	P-3064	6.3 CT	6.0	2,500	BV	2.4	7.18	6.44
33 E 80631	P-6456†	6.3 CT	6.0	2,000	A	2.0	8.23	5.81
33 E 80649	P-6464	6.3 CT	10.0	2,000	C	3.5	8.60	7.74
33 E 80656	P-6308†	6.3 CT	10.0	2,500	BV	3.4	9.97	8.97
33 E 80684	P-6309†	6.3 CT	20.0	2,500	BV	6.7	12.56	11.30
33 E 80672	P-5015	7.5 CT	4.0	2,500	BV	2.7	8.31	7.48
33 E 80680	P-6457†	7.5 CT	21.0	2,000	C	8.0	20.68	18.81
33 E 80688	P-6458†	10.0 CT	5.0	2,000	BV	3.0	8.08	7.27
33 E 81191	P-8130	12.6 CT	2.0	1,500	A	1.4	4.35	3.92
33 E 81209	P-6469	25.2	1.0	1,500	A	1.4	4.14	3.73

INTERCOM AND TRANSCEIVER TRANSFORMERS

A3817 is for citizens band transceivers; A4744 for intercoms voice coil to grid input. Max. watts 58; †10.

Stock No.	Stan No.	Application	Fig.	Pri. Ohms	Sec. Ohms	Size	Lbs.	Net
33 E 82496	A4744	Intercom	VE	4	25,000	1¾x2¾x1½"	¾	3.37
33 E 82520	A80915	General	Q	45-50	3-4/6-8	1¾x2¾x1¾"	1	3.05
33 E 82538	A3817†	Cit. Band	A	5000	6750/4	1¾x1½x2¾"	¾	4.59

DRIVER TRANSFORMERS

All type A mtg. 10,000 ohm primary, single plate to push-pull grids. Use between first audio and push-pull output. Ratio is Pri. to ½ Sec. *

Stock No.	Stan. No.	Max MA Pri. DC	Pri. Ohms	Ratio **	Size	Shpg. Wt.	Net Each
33 E 81217	A-4713	30	10,000	2:1	1¾x2¾x1½	½	3.64
33 E 81225	A-4723	30	10,000	3:1	1¾x2¾x1½	½	3.42

ISOLATION TRANSFORMERS

Electrostatic shields are ground internally to core. All have 1500V insul. † Pri. tapped for 125, 115 and 105V with 115V. Sec. * 117. Pri., tapped sec. with sockets for 105, 115 and 125V. † 117V Pri. to 117V Sec.

Stock No.	Stan. No.	Fig.	Size	Watts	Wt. Lbs.	Net Each
33 E 82405	P-6371†	TE	5¾x4¾x4¼"	175	9	33.41
33 E 82413	P-6410†	K	3¾x2¾x2¾"	50	4	10.25
33 E 82421	P-6415*	KC	5¾x4¼x5¾"	350	17	34.69

CONTROL TRANSFORMERS

Automation-type transformer designed to provide trouble-free performance in high speed automatic equip. Adapted to relays and pilot lamps. Two secondary windings permit series or parallel operation. Primary 115 or 230V 50-60 Hz.

Stock No.	Mfr. No.	Fig.	Secondary		Size	Mtg. Ctr.	Wt. Lbs.	Net Ea.
			Parallel	Series				
33 E 82454	P-6377	J	12V at 4A	24V at 2A	3¼x3¾x2¾"	3½"	2½	6.96
33 E 82462	P-6378	BV	12V at 8A	24V at 4A	3½x2¾x3"	2¼x2¼"	4½	12.67
33 E 82470	P-6379	BV	12V at 16A	24V at 8A	4¼x3¾x3½"	3x2¾"	8	19.81

LAFAYETTE Transformers

TRANSISTOR DRIVER TRANSFORMERS

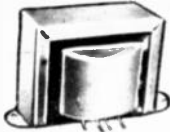

• Truly Miniature—Only $\frac{3}{4} \times \frac{3}{8} \times \frac{3}{8}$ "

OUTPUT TRANSFORMER FOR 3.2 OHM SPEAKERS

Single-ended transformer for driving transistor power-stage. Impedance 10,000 ohms pri., 2000 ohm C.T. sec.: DC res. 500 ohms pri., 50 ohms sec. 1.5 ma. dc unbalanced pri. current. Rated 100 mw. $\frac{3}{4} \times \frac{3}{8} \times \frac{3}{8}$ ". Shpg. wt., 4 oz. Imported.

99 E 61244 Net .89

REPLACEMENT POWER TRANSFORMER



7⁸⁹

Replacement power transformer for many transistorized amplifiers and receivers plus many hobbyist and project applications. Delivers 49 volts at 2.6 amp. and 6.3 volts at 1 amp. continuously. Input 117 volts AC, 60 Hz. Has copper electrostatic shield to minimize hum. With separate core ground. Mounting centers: $3\frac{3}{8} \times 2\frac{3}{4}$ ". Overall size: $4\frac{1}{2} \times 3\frac{3}{8} \times 3\frac{3}{8}$ ". Imported. Wt. $7\frac{1}{2}$ lbs.

99 E 63653 Net 7.89

2 WATT INPUT TRANSFORMER



Rated 2 watts. Frequency response 70 to 20,000 Hz ± 2 db. Primary impedance 100 ohms. Secondary impedance 200 ohms CT. Primary DC resistance 1.8 ohms, secondary 2.7 ohms. Unbalanced primary current, 200 ma DC. Size: $1\frac{1}{4} \times 1\frac{1}{8} \times 1\frac{1}{8}$ ". Wt., 1 lb.

33 E 85796 Net 1.50



Fig. A



Fig. B

50L6 OUTPUT

Fig. B Matches 50L6, 35L6, 25L6, etc. to 3-4 ohm voice coil. Shpg. wt., $\frac{1}{2}$ lb.

33 E 37011 Singly, each 69 Lots of 5, Ea.82

6.3 VOLT FILAMENT TRANSFORMER

Primary 115V. Secondary 6.3V at 1 amp. Shpg. wt., $\frac{3}{4}$ lbs.

33 E 37029 Singly, each 1.39 Lots of 5, Ea. 1.29

UNIVERSAL OUTPUTS

Fig. A. Match any single or push-pull output tubes to any voice coil. Shpg. wt., $\frac{3}{4}$ lbs.

33 E 75037 4 Watt—Singly, each 1.49 In lots of 5, each 1.34

33 E 75045 8 Watt—Singly, each 1.79 In lots of 5, each 1.62

STEP DOWN AUTO TRANSFORMERS

230 to 115V. All supplied with 6' Heavy duty line Cord and built in receptacle.

Stock No.	Wattage	Primary	Secondary	Shpg. WT. lbs.	Singly each	Lots of 5 each
33 E 88014	100	230	115V	5	5.58	5.07
33 E 88022	150	230	115V	5 $\frac{1}{2}$	7.50	6.82
33 E 88030	250	230	115V	8	9.00	8.18
33 E 88048	350	230	115V	9 $\frac{1}{2}$	9.83	8.94
33 E 88055	500	230	115V	14	12.10	11.00
33 E 88063	750	230	115V	19	15.50	14.08
33 E 88071WX	1000	230	115V	25	20.75	18.86
33 E 88089WX	1500	230	115V	31	24.25	22.02

SUBMINIATURE TRANSISTOR AUDIO TRANSFORMERS

ONLY $\frac{1}{2}$ " x $\frac{1}{2}$ " x $\frac{1}{2}$ "

A new series of miniature transformers for transistor and experimental miniature circuits. Ideal for miniature radio receivers, amplifiers, hearing aids, etc. using standard transistors. Incorporate special heat-treated high permeability magnetic cores treated to resist corrosion. Designed for improved frequency response with low distortion. 3" color-coded leads. Average shpg. wt., 4 oz. Imported.

99c

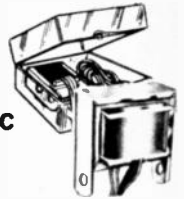

Stock No.	Type No.	Circuit	Impedance Pri. Ohms	Sec. Ohms	O.C. Resistance Pri. Ohms	Sec. Ohms	Net
99 E 61251	TR 97	INPUT	100,000	1000	1000	1000	.99
99 E 61269	TR 98	DRIVER	10,000	2000 C.T.	240	60 C.T.	.99
99 E 61277	TR 99	OUTPUT	500 C.T.	3.2	42 C.T.	0.7	.99
99 E 60345	TR 120	INPUT	200,000	1000	1400	50.5	.99
99 E 61293	TR 116	OUTPUT	500 C.T.	8	50 C.T.	1.7	.99

UNIVERSAL POWER TRANSISTOR OUTPUT TRANSFORMER

- Designed For High Output Transistors
- Used In Auto Radios PA Systems — Intercoms — Etc.

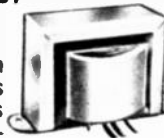

6 WATT OUTPUT TRANSFORMER

Rated 6 watts. Frequency response 70 to 20,000 Hz ± 2 db. Primary impedance 48 ohms center tapped. Secondary, 3.2 ohms; Primary DC resistance 1.1 ohms, secondary 0.3 ohms. Unbalanced primary current 500 ma DC. Size $1\frac{1}{4} \times 1\frac{1}{8} \times 1\frac{1}{8}$ ". Shpg. wt., 1 lb.

33 E 85788 Type AR-503 Net 1.75

24-VOLT FILAMENT TRANSFORMER

1⁷⁹



Primary 117-Volt, secondary 24 Volts at 1 amp. Mounting centers $2\frac{1}{4}$ ". Size $2\frac{1}{4} \times 1\frac{1}{8} \times 1\frac{1}{8}$ ". Imported. Shipping wt., $\frac{1}{2}$ lbs.

99 E 62663 Net 1.79

TRANSISTOR OUTPUT TRANSFORMER

Only $\frac{3}{8} \times \frac{7}{8} \times 1\frac{1}{8}$ ". 2000 ohm primary to 10 ohm voice coil. Matches most transistor outputs. Shpg. wt., 8 oz. Imported.

99 E 61012 Net .89



LINE-TO-VOICE COIL TRANSFORMERS

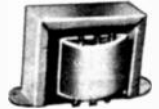

25 VOLT, 16 WATT LINE-TO-VOICE COIL

May be used with either 8 or 16 ohm speakers. 8 ohm speakers have choice of 2, 4, 8 or 16 watt taps. 16 ohm speakers use 2, 4, 8 or 16 watt taps. Imported. Size: $2\frac{3}{4} \times 2\frac{1}{4} \times 2$ ". Shpg. wt., 2 lbs.

99 E 63430 Net ea. 4.29

70.7 VOLT, 10 WATT LINE-TO-VOICE COIL

70 volt line-to-voice coil matching transformer. Primary tapped 10, 5, 2.5, 1.25 and .625 watts. Secondary tapped 5, 8 and 16 ohms. Size: $2 \times 1\frac{1}{2}$ ". Mtg. Centers $2\frac{3}{8}$ ". Imported. Shpg. wt., 1 lb.

99 E 62846 Net 1.49

POWER/ISOLATION TRANSFORMER

- Ideal For Amplifiers, Intercoms and Receivers

1⁹⁵

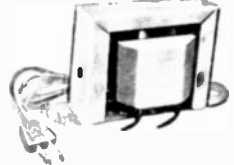

Here is a versatile power transformer that is ideal for experimenters, hobbyists and constructors. Primary 117 volts and secondary 105 volts no-load—82 volts with 150 ma filament load. Literally hundreds of uses for this versatile unit. A 10 page booklet gives pictorial and schematic diagrams for using this transformer in circuits for broadcast receiver phono oscillator, audio amplifier broadcast station, code practice oscillator, capacity operated relay, signal tracer, electronic timer, electronic switch and photocell relay. Minimizes the danger of shock by isolating circuits from the power line. Size: $2\frac{1}{4} \times 2 \times 1\frac{1}{2}$ ". Shpg. wt., 3 lbs.

33 E 75029 Transformer Net 1.95

POWER TRANSFORMER FOR SELENIUM RECTIFIER CIRCUITS

Most popular replacement power transformer for circuits using selenium rectifiers or rectifier tubes such as 6AX5, 6X4, 6X5. Primary is 117V 60 Hz A.C. Plate supply is 125 VAC $\frac{1}{2}$ wave at 15 ma with 6.3V 0.6 amp filament winding. Size: $2 \times 2\frac{3}{8} \times 1\frac{3}{8}$ ". mounting centers 2". Shpg. wt., 1 lb.

33 E 34059 Net 2.25

2²⁵

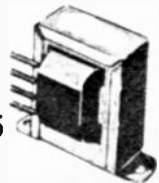

Ohmite Power Controls - Rheostats - Potentiometers

CLU CMU AB pots are rated at 2 watts. Type CMU has 7/8" slotted shaft, CU, CA, CB, CCU have 2" unslotted shaft, CLU has locking type slotted shaft. All 10% tolerance except * are 20%. Avg. shpg. wt., 5 oz

CA CB CU CCU

TYPE CLU MIL RV4L

Locking type with nut and slotted shaft. 1 1/2" dia. All have linear taper.

All have linear taper. 1 1/2" diam. with 7/8" slotted shaft 1/4" in dia.

Stock No.	Ohms	Mfr. No.	Stock No.	Ohms	Mfr. No.
30 E 80017	50	CMU-5001	30 E 80173	35,000	CMU-3531
30 E 80025	100	CMU-1011	30 E 80181	50,000	CMU-5031
30 E 80033	150	CMU-1511	30 E 80189	75,000	CMU-7531
30 E 80041	250	CMU-2511	30 E 80207	.1 Meg.	CMU-1041
30 E 80058	350	CMU-3511	30 E 80215	.15 Meg.	CMU-1541
30 E 80066	500	CMU-5011	30 E 80223	.25 Meg.	CMU-2541
30 E 80074	750	CMU-7511	30 E 80231	.35 Meg.	CMU-3541
30 E 80082	1,000	CMU-1021	30 E 80249	.5 Meg.	CMU-5041
30 E 80090	1,500	CMU-1521	30 E 80256*	.75 Meg.	CMU-7542
30 E 80108	2,500	CMU-2521	30 E 80264*	1.0 Meg.	CMU-1052
30 E 80116	3,500	CMU-3521	30 E 80272*	1.5 Meg.	CMU-1552
30 E 80124	5,000	CMU-5021	30 E 80280*	2.0 Meg.	CMU-2052
30 E 80132	7,500	CMU-7521	30 E 80288*	2.5 Meg.	CMU-2552
30 E 80140	10,000	CMU-1031	30 E 80306*	3.5 Meg.	CMU-3552
30 E 80157	15,000	CMU-1531	30 E 80314*	5.0 Meg.	CMU-5052
30 E 80165	25,000	CMU-2531			

Any of above in lots of 100, Ea. 1.46; Singly, Ea. 1.95

TYPES CU—LINEAR TAPER

2" Round, 1/4" Shaft, 1 1/2" Dia. x 5/8"

Stock No.	Ohms	Mfr. No.	Stock No.	Ohms	Mfr. No.
30 E 80637	50	CU-5001	30 E 80793	35,000	CU-3531
30 E 80645	100	CU-1011	30 E 80801	50,000	CU-5031
30 E 80652	150	CU-1511	30 E 80819	75,000	CU-7531
30 E 80660	250	CU-2511	30 E 80827	.1 Meg	CU-1041
30 E 80678	350	CU-3511	30 E 80835	.15 Meg	CU-1541
30 E 80686	500	CU-5011	30 E 80843	.25 Meg	CU-2541
30 E 80694	750	CU-7511	30 E 80850	.35 Meg	CU-3541
30 E 80702	1000	CU-1021	30 E 80858	.5 Meg	CU-5041
30 E 80710	1500	CU-1521	30 E 80876*	.75 Meg	CU-7542
30 E 80728	2500	CU-2521	30 E 80884*	1 Meg	CU-1052
30 E 80736	3500	CU-3521	30 E 80892*	1.5 Meg	CU-1552
30 E 80744	5000	CU-5021	30 E 80900*	2 Meg	CU-2052
30 E 80751	7500	CU-7521	30 E 80918*	2.5 Meg	CU-2552
30 E 80769	10,000	CU-1031	30 E 80926*	3.5 Meg	CU-3552
30 E 80777	15,000	CU-1531	30 E 80934*	5 Meg	CU-5052
30 E 80785	25,000	CU-2531			

Any of above in lots of 100, Ea. 1.46; Singly Ea. 1.95.

Stock No.	Ohms	Mfr. No.	Stock No.	Ohms	Mfr. No.
30 E 80322	50	CLU-5001	30 E 80498	35,000	CLU-3531
30 E 80330	100	CLU-1011	30 E 80496	50,000	CLU-5031
30 E 80348	150	CLU-1511	30 E 80504	75,000	CLU-7531
30 E 80355	250	CLU-2511	30 E 80512	.1 Meg.	CLU-1041
30 E 80363	350	CLU-3511	30 E 80520	.15 Meg.	CLU-1541
30 E 80371	500	CLU-5011	30 E 80538	.25 Meg.	CLU-2541
30 E 80389	750	CLU-7511	30 E 80546	.35 Meg.	CLU-3541
30 E 80397	1,000	CLU-1021	30 E 80554	.5 Meg.	CLU-5041
30 E 80405	1,500	CLU-1521	30 E 80562	.75 Meg.	CLU-7542
30 E 80413	2,500	CLU-2521	30 E 80570	1.0 Meg.	CLU-1052
30 E 80421	3,500	CLU-3521	30 E 80587*	1.5 Meg.	CLU1552
30 E 80439	5,000	CLU-5021	30 E 80595*	2.0 Meg.	CLU-2052
30 E 80447	7,500	CLU-7521	30 E 80603*	2.5 Meg.	CLU-2552
30 E 80454	10,000	CLU-1031	30 E 80611*	3.5 Meg.	CLU-3552
30 E 80462	15,000	CLU-1531	30 E 80629*	5.0 Meg.	CLU-5052
30 E 80470	25,000	CLU-2531			

Any of above in lots of 100 Ea. 1.90; Singly, Ea. 2.55.

CA and CB-LOGARITHMIC TAPERS

Type CA is clockwise; CB is counterclockwise. 2" Round, 1/4" Shaft, 1 1/2" Dia. x 5/8"

Stock No.	Ohms	Mfr. No.	Stock No.	Ohms	Mfr. No.
30 E 80942	10,000	CB-1031	30 E 80983	250,000	CA-2541
30 E 80959	25,000	CB-2531	30 E 80991	500,000	CA-5041
30 E 80967	50,000	CB-5031	30 E 81015*	1 Meg	CA-1052
30 E 80975	100,000	CA-1041	30 E 81023*	2.5 Meg	CA-2552

Any of above in lots of 100 Ea. 1.90; Singly, Ea. 2.25

TYPE CCU LINEAR TAPER DUALS

Stock No.	Ohms	Mfr. No.	Stock No.	Ohms	Mfr. No.
30 E 81031	10,000	CCU-1031	30 E 81072	250,000	CCU-2541
30 E 81049	25,000	CCU-2531	30 E 81080	500,000	CCU-5041
30 E 81056	50,000	CCU-5031	30 E 81098*	1 Meg.	CCU-1052
30 E 81064	100,000	CCU-1041			

Any of above in lots of 100, Ea. 4.40; Singly, Ea. 5.85

SPST Switch for CMU, CU, CA, CB, CLU

30 E 81106 Net ea. .66



OHMITROL® SOLID STATE POWER CONTROLS

Portable Model

Component Model

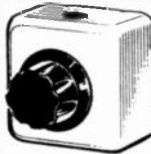

WIREWOUND INDUSTRIAL RHEOSTATS

Vitreous enamel rheostat with copper graphite control brush except * silver-graphite contact brush. Ohmage above 5000 have silicone ceramic coating. Rating indicated are at full setting. Less knob. Avg. shpg. wt., 10 oz.

MODEL E-12 1/2 WATT 7/8" dia. 1/2" deep			MODEL H-25 WATT 1 1/2" dia. 1 1/2" deep			Net Each	
Stock No.	Mfr. No.	Ohms	Stock No.	Mfr. No.	1-4	5-9	
30 E 81114*	0101*	1	30 E 81395	0140*	5.05	4.29	
30 E 81122*	0102*	2	30 E 81403	0141*	5.05	4.29	
30 E 81130	0103	3	30 E 81411	0142*	5.05	4.29	
30 E 81148	0104	6	30 E 81429	0143*	5.05	4.29	
30 E 81155	0105	8	30 E 81437	0144*	5.05	4.29	
30 E 81163	0106	10	30 E 81445	0145*	5.05	4.29	
30 E 81171	0107	15	30 E 81452	0146	4.55	3.87	
30 E 81189	0108	25	30 E 81460	0147	4.55	3.87	
30 E 81197	0109	35	30 E 81478	0148	4.55	3.87	
30 E 81205	0110	50	30 E 81486	0149	4.55	3.87	
30 E 81213	0111	75	30 E 81494	0150	4.55	3.87	
30 E 81221	0112	100	30 E 81510	0151	4.55	3.87	
30 E 81239	0113	125	30 E 81528	0152	4.55	3.87	
30 E 81247	0114	175	30 E 81536	0153	4.55	3.87	
30 E 81254	0115	250	30 E 81544	0154	4.55	3.87	
30 E 81262	0116	350	30 E 81551	0155	4.55	3.87	
30 E 81270	0117	500	30 E 81569	0156	4.55	3.87	
30 E 81288	0118	750	30 E 81577	0157	4.55	3.87	
30 E 81296	0119	1000	30 E 81585	0158	5.05	4.29	
30 E 81304	0120	1500	30 E 81593	0159	5.05	4.29	
30 E 81312	0121	2500	30 E 81601	0160	5.05	4.29	
30 E 81320	0122	3500	30 E 81619	0161	5.35	4.55	
30 E 81338	0123	5000	30 E 81627	0162	5.35	4.55	
30 E 81346	4190	7500	30 E 81635	4200	5.55	4.72	
30 E 81353	4191	10,000	30 E 81643	4201	5.55	4.72	
30 E 81361	4192	12,500	---	---	6.05	5.14	
30 E 81379	4193	15,000	30 E 81650	4202	6.05	5.14	
---	---	20,000	30 E 81668	4203	6.80	5.78	
---	---	25,000	30 E 81676	4204	7.50	6.38	

5151 Knob for Model E Net ea. .30 5150 Knob for Model H Net ea. .30

• Smallest 1 KW & 2 KW Controls Available

OHMITROL solid-state power controls are adaptable to a variety of applications because the built-in trimmer sets the starting point of the control voltage anywhere between 0 and 70 volts for 1KW models; 0-200V on 2KW models. Smooth control from start to full line voltage. On-off line switch at end of control knob rotation. 2-way terminals accept quick-connectors or soldering. Output is RFI filtered. Component models mount with 3/8"—32 bushing on aluminum panel for heat sink. Portable models are self-contained. Sizes: component models 1 3/4" sq. x 1" behind panel; portable models: 4 1/2 x 3 1/4 x 1 1/2". Avg. shpg. wt., 1 to 3 lbs.

COMPONENT MODELS

Stock No.	Ohmite No.	Input	Lead Rating	Output	Trimmer Range	Price
30 E 81858	PCA-1000	120VAC	1KW.8.3A	0-120VAC	0-70V	17.14 15.43
30 E 81866	PCA-1020	240VAC	2KW.8.3A	0-240VAC	0-200V	22.40 20.16
30 E 81874	PCD-1000	120VAC	1KW.8.3A	0-120VDC pulsating	0-70V	31.84 28.66
30 E 81882	PCD-1020	240VAC	2KW.8.3A	0-240VDC pulsating	0-200V	36.70 33.30

PORTABLE MODELS

30 E 81890	PCA-1001	120VAC	1KW.8.3A	0-120VAC	0-70V	25.38 22.82
30 E 81908	PCA-1021	240VAC	2KW.8.3A	0-240VAC	0-200V	32.56 29.30
30 E 81916	PCD-1001	120VAC	1KW.8.3A	0-120VDC pulsating	0-70V	42.56 38.30
30 E 81924	PCD-1021	240VAC	2KW.8.3A	0-240VDC pulsating	0-200V	48.40 43.56

LAFAYETTE-CLAROSTAT & MALLORY Controls



MALLORY T and L-PAD ATTENUATORS L-PADS



CLAROSTAT 4-WATT WIRE-WOUND CONTROLS SERIES 58C-1

Highly stable, smooth operating linear controls. Electrical tolerance $\pm 5\%$ for all ohmages. Rated 4 watts. Shafts are $1\frac{1}{8}''$ L. x $\frac{1}{4}''$ D. Bushing $\frac{3}{8} \times \frac{3}{8}''$ —32. Control diameter $1\frac{1}{2}''$. 1" deep max. Shpg. wt., 4 oz.



For Level Control of low impedance audio circuits. Rated at 15 watts peak audio, 4 watts D.C. Accessories furnished: one bar knob, one dial plate, with matched rotation, one nut, one lock washer. Bushing $\frac{3}{8}''$ —32x $\frac{3}{8}''$, shaft $\frac{1}{4}'' \times 2''$ long. Shpg. wt., 7 oz.

Stock No.	Mfg. No.	Ohms	Stock No.	Mfg. No.	Ohms
33 E 13756	L2	2	33 E 13830	L250	250
33 E 13764	L4	4	33 E 13848	L500	500
33 E 13772	L6	6	33 E 13855	L600	600
33 E 13780	L8	8	33 E 13863	L1000	1K
33 E 13798	L15	15	33 E 13871	L2000	2K
33 E 13806	L50	50	33 E 13889	L3000	3K
33 E 13814	L100	100	33 E 13897	L4000	4K
33 E 13822	L200	200			

Singly Each 2.73
 Quantity Prices (No Assortment)
 Lots of 10, 2.59 Ea. Lots of 25, 2.46 Ea.
 Lots of 50, 2.28 Ea. Lots of 100, 2.05 Ea.

LA-PADS

Same as above with a $\frac{3}{8}''$ —32x1" Bushing. 2 nuts, 2 lock washers. $1\frac{1}{2} \times 1\frac{1}{2}''$ dial plate. Shpg. wt., 8 oz.

Stock No.	Mfg. No.	Ohms	Stock No.	Mfg. No.	Ohms
33 E 13905	L8A	8	33 E 13913	L16A	16

Singly Each 2.05
 Quantity Prices (No Assortment)
 Lots of 10, 2.71 Ea. Lots of 25, 2.57 Ea.
 Lots of 50, 2.37 Ea. Lots of 100, 2.14 Ea.

DUAL L-PADS

Ganged pads for stereo use. Same specifications as single L Pads bushing $\frac{3}{8}''$ —32x1" Shpg. wt., 1 lb.

Stock No.	Mfg. No.	Ohms	Stock No.	Mfg. No.	Ohms
33 E 13921	LL8	8	33 E 13939	LL16	16
			33 E 13947	LL50	50

Singly Each 5.70
 Quantity Prices (No Assortment)
 Lots of 10, 5.42 Ea. Lots of 25, 5.13 Ea.
 Lots of 50, 4.75 Ea. Lots of 100, 4.28 Ea.

T-PADS

Stock No.	Mfg. No.	Ohms	Stock No.	Mfg. No.	Ohms
33 E 13954	T2	2	33 E 14036	T200	200
33 E 13962	T4	4	33 E 14044	T250	250
33 E 13970	T6	6	33 E 14051	T500	500
33 E 13988	T8	8	33 E 14069	T600	600
33 E 13996	T15	15	33 E 14077	T1000	1K
33 E 14010	T50	50	33 E 14085	T2000	2K
33 E 14028	T100	100	33 E 14093	T3000	3K

Singly Each 3.54
 Quantity Prices (No Assortment)
 Lots of 10, 3.38 Ea. Lots of 25, 3.19 Ea.
 Lots of 50, 2.95 Ea. Lots of 100, 2.66 Ea.

REPLACEMENT 5,000 OHM VOLUME CONTROL FOR JAPANESE TRANSISTOR RADIOS



59¢

A volume control with the proper resistance, dimensions and mounting for replacement in thousands of Japanese transistor radios. A 5,000 ohms potentiometer with S.P.S.T. switch. Only $\frac{3}{8}''$ dia., $\frac{1}{2}''$ total depth. Easily installed in printed circuits. Comes with $\frac{1}{4}''$ dia. knob Shog. wt., 2 ozs. Imported
 99 E 60196 Net .59



SUB-MINIATURE VARIABLE RESISTORS

SIZE— $\frac{3}{8}''$ Dia. $\frac{1}{8}''$ Thick
 39c each

Carbon composition potentiometers built for the most compact installations. Ideal for printed circuits. Shpg. wt., 2 oz. Imported
 99 E 61426 1000 ohms, 99 E 61434 5K ohms,
 99 E 61442 10K ohms, 99 E 61459 50K ohms,
 99 E 61487 500K ohms

Any of above Net ea. .39

LAFAYETTE L PADS



L pads for use as "brilliance" controls to vary tweeter level, or as "presence" controls to vary midrange speaker level. Both wire-wound elements are concentrically mounted within one plastic housing. With gold-finished metal escutcheon plate, mtg. screws, and attractive black knob. Size: $1\frac{1}{4}''$ dia., $\frac{7}{8}''$ deep (less shaft), $2\frac{1}{2}''$ deep overall. Imported. Shpg. wt., 6 oz.
 L pad for 8 ohm circuits Net 1.39
 99 E 61343
 L pad for 16 ohm circuits Net 1.39
 99 E 61350

OUTDOOR SPEAKER CONTROLS



8 watt audio potentiometers. Size: $1\frac{1}{4}''$ dia. with $\frac{3}{4}''$ long $\frac{1}{4}''$ dia. shaft. Shpg. wt., 4 ozs.

Stock No.	Mfg. No.	Ohms	Net
33 E 12238	TSa-10	4-ohm-L Pad	1.35
33 E 12246	TSa-35	35	1.35
33 E 12253	TSa-6	6	1.14

LAFAYETTE T PAD



Constant impedance control to adjust speaker volume. With brass satin plate for wall mounting. With all parts and instructions. Impedance: 8 ohms. Imported. Shpg. wt., 10 oz.
 99 E 61360 Net 4.49

LAFAYETTE 1/2 WATT AUDIO TAPER CONTROLS WITH SWITCH

As Low As
 42¢



Popular Universal Replacement Controls

$1\frac{1}{4}''$ dia. control with $\frac{1}{4}''$ dia., $2\frac{1}{2}''$ L. round shaft. Control rated $\frac{1}{2}$ watt audio; switch rated 3 amp.—125V. (AC/DC). Bushing: $\frac{3}{8}''$ —32x $\frac{3}{8}''$. Complete with hardware. Imported. Shpg. wt., 3 oz.
 99 E 63521 1 meg. ea. .49
 Lots of 10 ea. .42
 99 E 63513 $\frac{1}{2}$ meg. ea. .49
 Lots of 10 ea. .42

Mallory Controls

EXPLANATION OF MALLORY TAPERS

Taper No. 1—For audio or antenna shunt circuits.
 Taper No. 2—For Series circuits or cathode voltage controls.
 Taper No. 4—Linear taper for voltage divider circuits.

MALLORY MIDGETROL



Carbon element Midgetrols are rated 1 watt linear or 1/2 watt audio. Size 3/8" dia. with 2 3/4" long x 1/4" dia. round shafts. Shaft can be easily cut to any required length. Supplied with two shafts and knob adaptors for knurled and push-on-knobs, one Patent and instruction sheet. Shpg. wt., 3 oz.

Stock No.	Mfg. No.	Ohms	Tpr.	Stock No.	Mfg. No.	Ohms	Tpr.
33 E 11107	U-1	100	4	33 E 11370	U-36	75K	1
33 E 11115	U-2	500	4	33 E 11388	U-39	100K	4
33 E 11511	U-52R	500	2	33 E 11396	U-40	100K	2
33 E 11123	U-751R	750	2	33 E 11404	U-41	100K	4
33 E 11131	U-3	1K	2	33 E 11412	U-415	125K	4
33 E 11149	U-4	1K	4				
33 E 11156	U-5	1500	2	33 E 11420	U-42	150K	1
33 E 11164	U-5L	1500	4	33 E 11438	U-43	200K	4
33 E 11172	U-6	2K	4	33 E 11446	U-44	250K	1
33 E 11180	U-7	2500	2	33 E 11453	U-45	250K	2
33 E 11198	U-8	3K	4	33 E 11461	U-46	250K	4
33 E 11206	U-9	3K	2	33 E 11479	U-48	500K	4
33 E 11214	U-12	5K	1	33 E 11487	U-50	500K	4
33 E 11222	U-14	5K	4	33 E 11495	U-51	750K	1
33 E 11230	U-18	10K	1	33 E 11503	U-52	1 Meg.	2
33 E 11248	U-19	10K	2				
33 E 11255	U-20	10K	4	33 E 11520	U-53	1 Meg.	1
33 E 11263	U-21	15K	1	33 E 11537	U-54	1 Meg.	4
33 E 11271	U-22	15K	2	33 E 11545	U-155	1.5 Meg.	4
33 E 11289	U-24	20K	1	33 E 11552	U-55	2 Meg.	1
33 E 11297	U-26	20K	4	33 E 11560	U-56	2 Meg.	4
33 E 11305	U-28	25K	2	33 E 11578	U-255	2.5 Meg.	4
33 E 11313	U-28A	25K	4	33 E 11586	U-57	3 Meg.	1
33 E 11321	U-29	25K	4	33 E 11594	U-59	3 Meg.	4
33 E 11339	U-30	30K	4	33 E 11602	U-63	5 Meg.	2
33 E 11347	U-33	50K	1	33 E 11610	U-65	5 Meg.	1
33 E 11354	U-34	50K	2	33 E 11628	U-67	5 Meg.	4
33 E 11362	U-35	50K	4	33 E 11638	U-82	10 Meg.	4

Any of above Singly Ea. 1.02
 QUANTITY PRICES—NO ASSORTMENT
 Lots 25, ea. .92 Lots 50, ea. .85
 Lots 100, ea. .77 Lots 175, ea. .73

SINGLE TAPPED MIDGETROLS

Stock No.	Mfg. No.	Ohms	Tap At	Stock No.	Mfg. No.	Ohms	Tap At
33 E 11644	UT-153	15K	10K	33 E 11743	UT-438	1 Meg.	300K
33 E 11651	UT-415	30K	25K	33 E 11750	UT-443	1 Meg.	450K
33 E 11669	UT-420	250K	50K	33 E 11768	UT-450	2 Meg.	125K
33 E 11677	UT-421	250K	150K	33 E 11776	UT-448	2 Meg.	250K
33 E 11685	UT-425	350K	70K	33 E 11784	UT-454	2 Meg.	400K
33 E 11893	UT-429	500K	50K	33 E 11792	UT-449	2 Meg.	600K
33 E 11701	UT-427	500K	100K	33 E 11800	UT-451	2 Meg.	900K
33 E 11719	UT-430	500K	150K	33 E 11818	UT-457	3 Meg.	900K
33 E 11727	UT-431	500K	225K	33 E 11826	UT-461	3.25 M.	300K
33 E 11735	UT-440	1 Meg.	200K				

Any of above Singly ea. Net 1.26
 QUANTITY PRICES—NO ASSORTMENT
 Lots 25, ea. 1.13 Lots 50, ea. 1.05
 Lots 100, ea. .95 Lots 175, ea. .90

DOUBLE TAPPED MIDGETROLS

Stock No.	Mfg. No.	Overall Resistances	Tap Resistances	
			Tap 1	Tap 2
33 E 11834	UDT-283	500K	100K	200K
33 E 11842	UDT-289	1 Meg.	250K	500K
33 E 11859	UDT-291	1.5 Meg.	225K	500K
33 E 11867	UDT-295	2.25 Meg.	250K	500K
33 E 11875	UDT-296	2.25 Meg.	500K	1 Meg.
33 E 11883	UDT-303	3.3 Meg.	300K	1.5 Meg.

Any of above Singly ea. 1.26
 QUANTITY PRICES—NO ASSORTMENT
 Lots 25, ea. 1.13 Lots 50, ea. 1.05
 Lots 100, ea. .95 Lots 175, ea. .90

SU INSULATED SHAFT MIDGETROLS FOR TV



3/8" dia. carbon controls with 1/4" dia. fixed knurled and slotted phenolic shafts. Shaft protrudes 1/4" beyond bushing. Linear taper. With hex nut. Shpg. wt., 3 oz.

Stock No.	Mfg. No.	Ohms	Stock No.	Mfg. No.	Ohms
33 E 12089	SU-6	1500	33 E 12154	SU-46	250K
33 E 12097	SU-8	3K	33 E 12182	SU-50	500K
33 E 12105	SU-14	5K	33 E 12170	SU-54	1 Meg.
33 E 12113	SU-20	10K	33 E 12188	SU-56	2 Meg.
33 E 12121	SU-29	25K	33 E 12196	SU-56S	2.5 Meg.
33 E 12139	SU-35	50K	33 E 12204	SU-59	3 Meg.
33 E 12147	SU-41	100K	33 E 12212	SU-67	5 Meg.
			33 E 12220	SU-69	7.5 Meg.

Any of the above Singly ea. .93
 QUANTITY PRICES—NO ASSORTMENT
 Lots 25, ea. .84 Lots 50, ea. .78
 Lots 100, ea. .70 Lots 175, ea. .66

ATTACHABLE MIDGETROL SWITCHES



Midgetrol types U, UT and UDT—with dummy terminal + built-in switch/circuit breaker, breaks at 2.5 amps, resets by turning to "off" position. ST types rated 6 amps/125V. DT types rated 3 amps/125V. Shpg. wt., 2 oz.

Stock No.	Mfg. No.	Description	1-24	25-49	50-99	100-174
33 E 11891	US-26	S.P.S.T.	.42	.38	.35	.32
33 E 14804	USB-29	S.P.S.T.†	.98	—	—	—
33 E 11909	US-26T	S.P.S.T.†	.51	.46	.43	.38
33 E 11917	US-27	D.P.S.T.	.51	.46	.43	.38
33 E 11925	US-28	S.P.D.T.	.51	.48	.43	.38



EXTENSION SHAFTS

DS-37

DS-36 Extension Shaft 2 1/4" long x 1/4" dia. For tubular shaft Mid and 2-watt wire-wound controls. Shpg. wt., 2 oz.
 Net .33

DS-37 3/8" diameter shaft. For use with round-shaft Midgetrols to accommodate knobs requiring 3/8" shaft. Shpg. wt., 2 oz.
 Net .33

PUSH-PULL CONTROLS



Carbon element controls with a Push-Pull type SPST switch permanently attached. Switch rated 6 amps/125V. UL listed. Rated 1 watt linear or 1/2 watt audio. Size 3/8" dia. with 2" long x 1/4" dia. shaft. No assortment for quantity prices. Shpg. wt., 4 oz.

Stock No.	Mfg. No.	Ohms	Net Each			
			Taper	1-24	25-49	50-99
33 E 12808	PP-13R	1K	1	1.35	1.22	1.13
33 E 14820	PP-252R	2.5K	1	1.35	1.22	1.13
33 E 14838	PP-253R	25K	1	1.35	1.22	1.13
33 E 14846	PP-15L	100K	4	1.35	1.22	1.13
33 E 12816	PP-15A	100K	1	1.35	1.22	1.13
33 E 12824	PP-25L	200K	4	1.35	1.22	1.13
33 E 12832	PP-254A	250K	1	1.35	1.22	1.13
33 E 12840	PP-55A	500K	1	1.35	1.22	1.13
33 E 12857	PP-55L	500K	4	1.35	1.22	1.13
33 E 12865	PP-16A	1 Meg.	1	1.35	1.22	1.13
33 E 12873	PP-16L	1 Meg.	4	1.35	1.22	1.13
33 E 12881	PP-155L	1.5 Meg.	4	1.35	1.22	1.13
33 E 12899	PP-26A	2 Meg.	1	1.35	1.22	1.13
33 E 14853	PP-36L	3 Meg.	4	1.35	1.22	1.13
33 E 12907	PP-56L	5 Meg.	4	1.35	1.22	1.13

TAPPED TYPES

Stock No.	Ohms	Tapped @	Net Each			
			Taper	1-24	25-49	50-99
33 E 12915	250K	100K-150K	4	1.59	1.43	1.33
33 E 12923	500K	200K	4	1.59	1.43	1.33
33 E 12931	500K	78K-168K	4	1.59	1.43	1.33
33 E 12949	500K	250K	1	1.59	1.43	1.33
33 E 12956	1 Meg.	500K	2	1.59	1.43	1.33
33 E 12964	1 Meg.	100K	1	1.59	1.43	1.33
33 E 12972	1 Meg.	200K	2	1.59	1.43	1.33
33 E 12980	1 Meg.	250K-500K	4	1.59	1.43	1.33
33 E 12998	2 Meg.	500K-1 Meg.	1	1.59	1.43	1.33
33 E 13012	2 Meg.	1 Meg.	4	1.59	1.43	1.33
33 E 13020	3 Meg.	1 Meg.-2 Meg.	4	1.59	1.43	1.33
33 E 13038	4 Meg.	2 Meg.	4	1.59	1.43	1.33

Selected Replacement Capacitors

SPRAGUE 500D MINIATURE METAL-CASE ALUMINUM ELECTROLYTIC CAPACITORS

ECONOMY TUBULAR ELECTROLYTICS

NEW!



- Hermetically Sealed
- With Plastic Sleeves

Reliable, miniature aluminum electrolytic capacitors suitable for miniature electronic circuitry. Excellent replacement for transistorized equipment. Dia. varies from 1/8" to 3/8", lengths vary from 3/4" to 1 1/2". Shpg. wt., 2 oz.

These electrolytic capacitors are specifically designed for service replacement applications. All single electrolytics are hermetically sealed in aluminum cans with outer cardboard insulating sleeves and have solid tinned copper leads. Dual and triple section electrolytics have wax impregnated cardboard tubes with mounting strap, and color coded insulated flexible leads. Avg. shpg. wt., 4 oz.

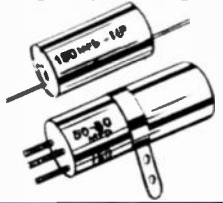

Stock No.	Net Each	Stock No.	Net Each	Stock No.	Mfd.	W.V.	Net Each	Net Each	
	25-49 50-99		1-24 25-49 50-99					In Lots of 10	
6 VOLT									
34 E 85273	1 .39 .29 .23	34 E 85588	1 .39 .29 .23	32 E 01100	10	25	.29	.26	
34 E 85281	2 .39 .29 .23	34 E 85596	2 .38 .27 .21	32 E 01118	25	25	.31	.28	
34 E 85299	3 .39 .29 .23	34 E 85604	5 .42 .30 .24	32 E 01126	20	150	.36	.32	
34 E 85307	5 .39 .29 .23	34 E 85612	6 .39 .29 .23	32 E 01134	40	150	.42	.38	
34 E 85315	10 .42 .30 .24	34 E 85620	10 .42 .30 .24	32 E 01365	150	150	.83	.57	
34 E 85323	15 .42 .30 .24	34 E 85638	15 .42 .32 .25	32 E 01142	8	450	.43	.39	
34 E 85331	20 .39 .29 .23	34 E 85646	25 .45 .33 .26	32 E 01159	20	450	.55	.49	
34 E 85349	25 .42 .32 .25	34 E 85653	35 .48 .36 .28	32 E 01167	40	450	.62	.56	
34 E 85356	100 .48 .36 .28	34 E 85661	50 .51 .37 .29	32 E 01373	80	450	.95	.85	
34 E 85364	150 .51 .37 .29	34 E 85679	75 .54 .40 .31	32 E 01381	100	450	1.04	.94	
34 E 85372	200 .48 .36 .28	34 E 85687	100 .51 .38 .30	Dual Section Tubular Electrolytic					
34 E 85380	250 .51 .37 .29	34 E 85695	150 .54 .41 .32	32 E 01175	20-20	150	.39	.35	
34 E 85398	300 .57 .42 .33	34 E 85703	200 .60 .45 .35	32 E 01183	30-30	150	.41	.37	
34 E 85406	400 .54 .41 .32				32 E 01191	40-40	150	.44	.38
16 VOLT									
34 E 85414	1 .39 .29 .23	34 E 85711	1 .36 .27 .21	32 E 01209	50-30	150	.40	.36	
34 E 85422	2 .39 .29 .23	34 E 85729	2 .42 .30 .24	32 E 01217	50-50	150	.52	.47	
34 E 85430	5 .36 .27 .21	34 E 85737	3 .42 .30 .24	32 E 01399	80-50	150	.59	.53	
34 E 85448	6 .42 .30 .24	34 E 85745	5 .42 .32 .25	32 E 01407	100-50	150	.62	.56	
34 E 85455	8 .42 .30 .24	34 E 85752	10 .45 .34 .27	Triple Section Tubular Electrolytic					
34 E 85463	10 .39 .29 .23	34 E 85760	20 .45 .34 .27	32 E 01415	40-40-20	150	.62	.56	
34 E 85471	15 .42 .32 .25	34 E 85778	35 .48 .36 .28	32 E 01423	50-30-20	150	.64	.58	
34 E 85489	20 .42 .30 .24	34 E 85786	50 .51 .38 .30	32 E 01431	80-40-20	150	.84	.58	
34 E 85497	25 .45 .33 .26	34 E 85794	75 .54 .41 .32	WIDE RANGE ELECTROLYTIC CAPACITOR					
34 E 85505	30 .42 .32 .25	34 E 85802	100 .60 .45 .35	• Replaces A Host of Popular Combinations					
34 E 85513	35 .45 .34 .27								
34 E 85521	50 .45 .33 .26	34 E 85810	2 .48 .36 .28	Compact unit which provides exact electrical replacement for 8 original standard 150 VDC capacitors used principally in printed circuit home radio receivers. 1" dia. x 2 1/2" L. Shpg. wt., 8 oz.					
34 E 85539	75 .45 .34 .27	34 E 85828	4 .51 .38 .29	Replaces all of the following:					
34 E 85547	100 .48 .36 .28	34 E 85836	5 .54 .41 .32	50-30 mfd.	70-30 mfd.	75-30 mfd.	60-40 mfd.		
34 E 85554	150 .51 .37 .29	34 E 85844	10 .60 .45 .35	80-40 mfd.	50-50 mfd.	70-50 mfd.	80-50 mfd.		
34 E 85562	200 .54 .41 .32	34 E 85851	20 .63 .48 .37	33 E 56300				Net 1.18	
34 E 85570	350 .75 .57 .44	34 E 85869	2 .45 .34 .27						

Stock No.	Cap.	Stock No.	Cap.
32 E 01472	5 μF	32 E 01720	250 μF
32 E 01480	6.8 μF	32 E 01738	270 μF
32 E 01498	10 μF	32 E 01746	300 μF
32 E 01506	12 μF	32 E 01753	330 μF
32 E 01514	15 μF	32 E 01761	390 μF
32 E 01522	18 μF	32 E 01779	470 μF
32 E 01530	20 μF	32 E 01787	500 μF
32 E 01548	22 μF	32 E 01795	560 μF
32 E 01556	25 μF	32 E 01803	680 μF
32 E 01563	27 μF	32 E 01811	750 μF
32 E 01571	30 μF	32 E 01829	.001 μF
32 E 01589	33 μF	32 E 01837	.0012 μF
32 E 01597	39 μF	32 E 01845	.0015 μF
32 E 01605	47 μF	32 E 01852	.0018 μF
32 E 01613	50 μF	32 E 01860	.002 μF
32 E 01621	56 μF	32 E 01878	.0022 μF
32 E 01639	68 μF	32 E 01886	.0025 μF
32 E 01647	75 μF	32 E 01894	.0027 μF
32 E 01654	82 μF	32 E 01902	.003 μF
32 E 01662	100 μF	32 E 01910	.0033 μF
32 E 01670	120 μF	32 E 01936	.0047 μF
32 E 01688	150 μF	32 E 01944	.0050 μF
32 E 01696	180 μF	32 E 01951	.0068 μF
32 E 01704	200 μF	32 E 01969	.01 μF
32 E 01712	220 μF		

CERAMIC DISC CAPACITORS



RATED 1000 OCWV

Stock No.	Cap.	Stock No.	Cap.
32 E 01472	5 μF	32 E 01720	250 μF
32 E 01480	6.8 μF	32 E 01738	270 μF
32 E 01498	10 μF	32 E 01746	300 μF
32 E 01506	12 μF	32 E 01753	330 μF
32 E 01514	15 μF	32 E 01761	390 μF
32 E 01522	18 μF	32 E 01779	470 μF
32 E 01530	20 μF	32 E 01787	500 μF
32 E 01548	22 μF	32 E 01795	560 μF
32 E 01556	25 μF	32 E 01803	680 μF
32 E 01563	27 μF	32 E 01811	750 μF
32 E 01571	30 μF	32 E 01829	.001 μF
32 E 01589	33 μF	32 E 01837	.0012 μF
32 E 01597	39 μF	32 E 01845	.0015 μF
32 E 01605	47 μF	32 E 01852	.0018 μF
32 E 01613	50 μF	32 E 01860	.002 μF
32 E 01621	56 μF	32 E 01878	.0022 μF
32 E 01639	68 μF	32 E 01886	.0025 μF
32 E 01647	75 μF	32 E 01894	.0027 μF
32 E 01654	82 μF	32 E 01902	.003 μF
32 E 01662	100 μF	32 E 01910	.0033 μF
32 E 01670	120 μF	32 E 01936	.0047 μF
32 E 01688	150 μF	32 E 01944	.0050 μF
32 E 01696	180 μF	32 E 01951	.0068 μF
32 E 01704	200 μF	32 E 01969	.01 μF
32 E 01712	220 μF		

Assort any of above for quantity price
10 for .90; Singly, each .10.

HIGH CAPACITY DISCS

.015 μF Shpg. wt., 2 oz.	
32 E 09483	10 for 1.26 Singly, ea. .14
.02 μF. Shpg. wt., 2 oz.	
32 E 09491	10 for 1.44 Singly, ea. .16

LAFAYETTE SUBMINIATURE SQUARE CERAMIC CAPACITORS



Shpg. wt., 1 oz.

75 VOLT MICROMINIATURE CERAMIC CAPACITORS

Dependable conservatively rated ceramic capacitors designed for greatest capacitance in the smallest size.

Type	Cap. μF	Size LxWxThick.	Net Each	Lots of 10, Each
33 E 69014	.0005	3/8x1/8x1/16"	.15	.13
33 E 69022	.001	1/2x1/4x1/8"	.15	.13
33 E 69030	.002	3/8x1/4x1/8"	.15	.13
33 E 69048	.005	1/2x1/4x1/8"	.15	.13
33 E 69055	.01	3/4x1/4x1/8"	.22	.19
33 E 69063	.02	1/2x1/4x1/8"	.22	.19
33 E 69071	.05	3/8x1/4x1/8"	.30	.27
33 E 69089	.1	1/2x1/4x1/8"	.50	.45
33 E 69097	.2	3/8x1/4x1/8"	.60	.54

CERAMIC DISC KIT 48 VALUES

98^c



AS LOW AS

99^c

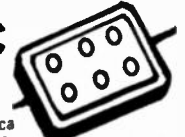

A fine selection of 48 ceramic disc type capacitors. Values included range from .001 mfd to 2 mfd. Voltage ratings range from 50 to 5000 volts DC. Ideal selection for servicemen, builders and experimenters. Shpg. wt., 4 oz.
32 E 60023 Net .98

A kit of popular mica capacitors for servicemen. Contains 50 popular sizes. A handy assortment for any service shop or experiment. Shpg. wt., 2 lbs.
34 E 72016 Net 1.19
Lots of 3 Ea. .99

Cornell-Mallory-Sprague-Aerovox-Electrolytics

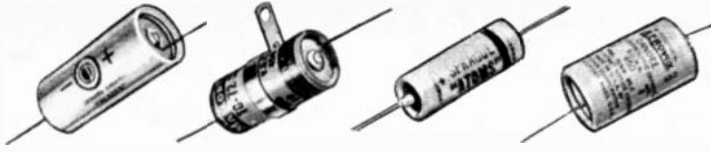

CORNELL BLUE BEAVER

Cornell Dubilier types BBR, BR and BBRD are dry electrolytics in compact aluminum cases. Highest quality for TV general replacement with extra safety for high surge voltages in power supplies. Very low leakage. Operating temperature up to 85°C.

MALLORY TC

Mallory type TC dry electrolytic capacitors are housed in aluminum containers. These compact units are of the highest quality and are ideal for use in TV radio and general replacement in electronic circuitry. Low leakage and built-in safety factors against high voltage surges. Operating temperature up to 85°C.

SPRAGUE "ATOMS"

Sprague types TVA and TV are dry electrolytics in extremely compact metal cases. They are designed to withstand high surge voltages and high ripple currents making them ideal for TV replacements, power supplies, etc. Leakage is very low. Efficient at temperatures up to 85°C.

AEROVOX DANDEE

Aerovox type PRS are dry electrolytic in compact aluminum cases. Dependable replacements for TV and all electronic equipment when a quality unit is required. Feature low leakage high voltage surge protection and operating temperature up to 85°C.

SINGLE SECTION

Stock No.	Cap. MFD.	NET EACH IN LOTS OF		
		W.V.	1-24	25-49
33 E 15082	1000	3	1.05	.82
34 E 84011	50	6	.57	.41
34 E 55102	100	6	.72	.50
34 E 55110	250	6	.81	.64
34 E 55128	500	6	.93	.73
34 E 55136	1000	6	1.14	.89
34 E 75027	1500	6	1.26	.98
34 E 55035	2000	6	1.38	1.08
34 E 75043	100	12	.72	.52
34 E 75050	250	12	.87	.68
34 E 75068	500	12	1.02	.79
34 E 75076	1000	12	1.35	1.05
34 E 55144	100	15	.75	.52
33 E 15090	200	15	.90	.67
34 E 55151	250	15	.93	.74
34 E 55169	500	15	1.05	.83
34 E 55177	1000	15	1.38	1.07
34 E 55185	2000	15	1.92	1.29
34 E 56225	3000	15	2.37	1.82
34 E 56233	4000	15	2.91	2.25
34 E 56241	5000	15	3.15	2.45
34 E 84029	2	25	.34	.39
34 E 84110	5	25	.60	.42
34 E 75084	10	25	.60	.42
34 E 75092	16	25	.60	.43
34 E 55193	20	25	.60	.43
34 E 55201	25	25	.60	.44
34 E 55219	50	25	.66	.47
34 E 55227	100	25	.81	.58
34 E 55235	250	25	1.02	.79
34 E 55243	500	25	1.38	1.07
34 E 56258	1000	25	1.98	1.79
34 E 56265	2000	25	2.91	2.75
33 E 15108	1	50	.34	.39
34 E 75100	2	50	.34	.39
34 E 55250	5	50	.60	.42
34 E 55268	10	50	.60	.42
34 E 75118	20	50	.60	.43
34 E 55276	25	50	.63	.44
34 E 75126	50	50	.72	.52
34 E 55284	100	50	.84	.60
34 E 55292	150	50	.93	.66
34 E 55300	250	50	1.05	.83
34 E 55318	500	50	1.44	1.11
34 E 56274	1000	50	2.32	1.93
34 E 58189	1500	50	3.00	2.26
34 E 58187	2000	50	3.48	2.60
34 E 55326	4	150	.60	.43
33 E 15116	5	150	.60	.43
34 E 55334	8	150	.63	.45
34 E 55342	10	150	.63	.46
34 E 55359	12	150	.66	.47
34 E 55367	16	150	.69	.49
34 E 55375	20	150	.72	.50
34 E 55383	25	150	.75	.53
34 E 55391	30	150	.78	.55

Stock No.	Cap. MFD.	NET EACH IN LOTS OF		
		W.V.	1-24	25-49
34 E 55409	40	150	.81	.58
34 E 55417	50	150	.84	.60
34 E 55425	60	150	.90	.63
34 E 55433	80	150	.96	.69
34 E 55441	100	150	1.05	.75
34 E 55458	150	150	1.14	.82
34 E 75134	200	150	1.32	.93
34 E 75373	300	150	1.68	1.25
33 E 15421*	200	200	1.84	.92
34 E 75381	4	250	.66	.48
33 E 15124	5	250	.69	.49
34 E 75142	8	250	.69	.54
33 E 15132	10	250	.72	.56
34 E 55466	12	250	.75	.57
34 E 55474	16	250	.78	.60
34 E 55482	20	250	.81	.64
34 E 55490	30	250	.87	.68
34 E 55508	40	250	.93	.74
34 E 55516	50	250	1.02	.81
34 E 55524	60	250	1.08	.84
33 E 15439*	140	300	2.05	1.03
34 E 55532	4	350	.63	.49
33 E 15140	5	350	.65	.48
34 E 75159	10	350	.75	.59
34 E 55565	16	350	.84	.63
34 E 55573	20	350	.87	.68
34 E 75167	24	350	.93	.71
34 E 55581	30	350	.99	.77
34 E 55599	40	350	1.05	.80
34 E 55607	50	350	1.11	.87
34 E 75399	60	350	1.17	.91
33 E 15447*	150	400	2.64	1.32
34 E 55615	1	450	.66	.51
34 E 55623	2	450	.66	.52
34 E 55631	4	450	.69	.54
33 E 15157	5	450	.72	.56
34 E 55649	8	450	.75	.60
34 E 55656	10	450	.78	.60
34 E 55672	16	450	.84	.68
34 E 55680	20	450	.93	.73
34 E 55698	30	450	1.02	.80
34 E 55706	40	450	1.08	.83
34 E 75175	50	450	1.26	.98
34 E 55714	60	450	1.41	1.16
34 E 55722	80	450	1.68	1.11
34 E 75183	100	450	1.92	1.69
34 E 55730	4	500	.72	.53
34 E 55748	8	500	.78	.61
34 E 75191	10	500	.81	.64
34 E 55771	20	500	.96	.75
34 E 55789	30	500	1.05	.79
34 E 55797	8	600	1.83	1.37
34 E 55805	10	600	2.19	1.64
34 E 55821	16	600	2.49	1.87
34 E 75209	20	600	2.58	1.93
34 E 55839	8	700	1.74	1.33
34 E 55862	16	700	2.10	1.59

STANDARD BRANDS

Because no one manufacturer offers all sizes, we have made this integrated list. Your order will be filled with one of the 4 famous brands illustrated. We will supply any particular manufacturers brand specified, if available in the size desired. Avg. shpg. wt., 5 ozs.

QUAL SECTION — COMMON NEGATIVE

Stock No.	Cap. MFD.	NET EACH IN LOTS OF		
		W.V.	1-24	25-49
33 E 15165	25-25	25	1.00	.77
34 E 55896	10-10	50	.96	.73
34 E 55904	20-10	150	.93	—
34 E 55912	20-20	150	1.05	.80
34 E 55920	30-20	150	1.02	—
34 E 55938	30-30	150	1.08	.85
34 E 55946	40-20	150	1.14	.84
34 E 55961	40-40	150	1.11	.88
34 E 55979	50-30	150	1.17	.88
34 E 55987	50-50	150	1.26	.93
33 E 15462*	50-50	150	1.30	.85
34 E 84078	80-30	150	1.32	.94
34 E 55995	80-40	150	1.32	.96
34 E 75241	80-50	150	1.41	.99
33 E 15470*	100-50	150	1.56	.78
34 E 56019	100-100	150	1.92	1.32
33 E 15488*	250-50	160	2.18	1.08
33 E 15496*	5-200	200	2.05	1.03
34 E 75290	10-10	250	.98	.75
34 E 56050	20-20	250	1.11	.88
34 E 56084	8-8	450	1.17	.88
34 E 75308	10-10	450	1.23	.92
34 E 56100	16-16	450	1.35	—
34 E 58118	20-20	450	1.50	1.19
34 E 56126	30-30	450	1.95	1.46
34 E 75316	40-20	450	1.77	—

DUAL UNITS — SEPARATE SECTIONS

34 E 56142	15-15	150	1.37	1.14
34 E 56183	40-40	150	1.63	1.36
33 E 15411	70-70	175	2.00	1.68

TRIPLE SECTION

Stock No.	Cap. MFD.	NET EACH IN LOTS OF		
		W.V.	1-24	25-49
34 E 56324	30-25-20	150	1.80	1.36
34 E 56340	40-20-20	150	1.58	1.17
34 E 56357	40-30-20	150	1.86	1.38
34 E 56365	40-40-20	150	1.86	1.40
34 E 75456	50-30-20	150	1.89	1.40
34 E 56381	80-40-20	150	1.98	1.49
33 E 15280	80-50-50	150	2.10	1.78
34 E 56464	50-30-20	150/25	1.86	1.38
33 E 15504*	250-120-50	160/100	2.31	1.16
33 E 15512*	200-250-10	200	3.56	1.78
33 E 15520*	60-60-60	200/200/200	2.93	1.47

QUADRUPLE UNITS

Stock No.	Cap. MFD.	NET EACH IN LOTS OF		
		W.V.	1-24	25-49
33 E 15538*	40-20-20-100	150/25	1.77	.88
34 E 56647	50-50-50-20	150/25	2.07	1.63
33 E 15553*	60-40-40-20	150/25	1.91	.95
33 E 15579*	150-100-20-100	150/25	4.33	2.16
33 E 15587*	10-80-40-40	450/300	2.94	1.47
33 E 15595*	10-40-80-100	450/300/400/50	3.07	1.54

FIVE SECTION

33 E 15611*	40-20-20-20-50	300/50	2.58	1.28
-------------	----------------	--------	------	------

*Cardboard Tubular Wax-Filled Electrolytics

Dipped Mylar - Paper Capacitors And Filters

STANDARD BRAND DIPPED MYLAR-PAPER CAPACITORS

CORNELL-DUBILIER "QUIETONE" FILTERS



SPRAGUE ORANGE DROP



ELMENCO DP



MALLORY PVC

100 WVDC					
Stock No.	CAP. MFD.	NET EACH IN LOTS OF			
		1-24	25-49	50-99	100-249
34 E 67016	.005	.18	.16	.13	.11
34 E 67024	.006	.18	.16	.13	.11
34 E 67032	.0068	.18	.16	.13	.11
34 E 67040	.0075	.18	.16	.13	.11
34 E 67057	.01	.18	.16	.13	.11
34 E 67065	.015	.18	.16	.13	.11
34 E 67073	.02	.18	.16	.13	.11
34 E 67081	.022	.18	.16	.13	.11
34 E 67099	.025	.18	.16	.13	.11
34 E 67107	.03	.18	.16	.13	.11
34 E 67115	.033	.18	.16	.13	.11
34 E 67123	.04	.18	.16	.13	.11
34 E 67131	.047	.21	.19	.15	.13
34 E 67149	.05	.21	.19	.15	.13
34 E 67156	.056	.21	.19	.15	.13
34 E 67164	.068	.21	.19	.15	.13
34 E 67172	.075	.21	.19	.15	.13
34 E 67180	.1	.21	.19	.15	.13
34 E 67198	.15	.24	.22	.18	.15
34 E 67206	.2	.27	.24	.19	.17
34 E 67214	.22	.27	.24	.19	.17
34 E 67222	.25	.30	.27	.22	.18
34 E 67230	.33	.36	.32	.26	.22
34 E 67248	.47	.45	.41	.33	.28
34 E 67255	.5	.45	.41	.33	.28
34 E 67263	.68	.57	.51	.41	.35
34 E 67271	1.0	.72	.65	.52	.44

200 WVDC					
Stock No.	CAP. MFD.	NET EACH IN LOTS OF			
		1-24	25-49	50-99	100-249
34 E 82015	.02	.18	.12	.09	.07
34 E 82023	.022	.18	.12	.09	.07
34 E 82031	.047	.18	.13	.10	.08
34 E 82049	.05	.18	.13	.10	.08
34 E 82056	.1	.21	.15	.11	.09
34 E 82064	.15	.24	.17	.13	.11
34 E 82072	.2	.30	.20	.16	.13
34 E 82080	.22	.30	.20	.16	.13
34 E 82098	.25	.30	.21	.16	.13
34 E 82106	.33	.39	.29	.22	.18
34 E 82114	.47	.45	.33	.26	.21
34 E 82122	.5	.48	.34	.26	.21

400 WVDC					
Stock No.	CAP. MFD.	NET EACH IN LOTS OF			
		1-24	25-49	50-99	100-249
34 E 82130	.01	.15	.10	.08	.06
34 E 82148	.015	.15	.11	.08	.07
34 E 82155	.02	.18	.12	.09	.07
34 E 82163	.022	.18	.12	.09	.07
34 E 82171	.025	.18	.13	.10	.08
34 E 82189	.03	.18	.13	.10	.08
34 E 82197	.033	.18	.13	.10	.08
34 E 82205	.04	.21	.15	.11	.09
34 E 82213	.047	.21	.15	.11	.09
34 E 82221	.05	.21	.15	.12	.09
34 E 82239	.056	.21	.15	.12	.10
34 E 82247	.068	.21	.15	.12	.10
34 E 82254	.075	.24	.17	.13	.11
34 E 82262	.1	.24	.18	.14	.11
34 E 82270	.15	.30	.21	.17	.13
34 E 82288	.2	.36	.26	.20	.16
34 E 82296	.22	.36	.26	.20	.16
34 E 82304	.25	.36	.27	.21	.17
34 E 82312	.27	.38	.32	.26	.22
34 E 82320	.33	.54	.49	.40	.33
34 E 82328	.47	.66	.59	.47	.40
34 E 82336	.5	.72	.65	.52	.44

600 WVDC					
Stock No.	CAP. MFD.	NET EACH IN LOTS OF			
		1-24	25-49	50-99	100-249
34 E 82312	.001	.15	.10	.08	.06
34 E 82320	.0012	.15	.10	.08	.06
34 E 82338	.0015	.15	.10	.08	.06
34 E 82346	.0018	.15	.10	.08	.06
34 E 82353	.002	.15	.10	.08	.07
34 E 82361	.0022	.15	.10	.08	.07
34 E 82379	.0025	.15	.10	.08	.07
34 E 82387	.0027	.15	.10	.08	.07
34 E 82395	.003	.15	.10	.08	.07
34 E 82403	.0033	.15	.10	.08	.07

600 WVDC (Cont.)					
Stock No.	CAP. MFD.	NET EACH IN LOTS OF			
		1-24	25-49	50-99	100-249
34 E 82411	.0039	.15	.10	.08	.07
34 E 82429	.004	.15	.10	.08	.07
34 E 82437	.0047	.15	.10	.08	.07
34 E 82445	.005	.15	.11	.08	.07
34 E 82452	.0056	.15	.11	.08	.07
34 E 82460	.006	.15	.11	.08	.07
34 E 82478	.0068	.15	.11	.08	.07
34 E 82486	.0075	.15	.11	.09	.07
34 E 82494	.008	.15	.11	.09	.07
34 E 82502	.0082	.15	.11	.09	.07
34 E 82510	.01	.15	.11	.09	.07
34 E 82528	.012	.15	.11	.09	.07
34 E 82536	.015	.18	.12	.09	.07
34 E 82544	.02	.18	.12	.10	.08
34 E 82551	.022	.18	.13	.10	.08
34 E 82569	.025	.18	.14	.11	.08
34 E 82577	.027	.18	.14	.11	.08
34 E 82585	.03	.18	.14	.11	.08
34 E 82593	.033	.18	.14	.11	.08
34 E 82601	.035	.21	.14	.11	.09
34 E 82619	.039	.21	.14	.11	.09
34 E 82627	.04	.21	.15	.12	.09
34 E 82635	.047	.21	.15	.12	.09
34 E 82643	.05	.21	.15	.12	.10
34 E 82650	.056	.21	.16	.12	.10
34 E 82668	.06	.27	.18	.14	.11
34 E 82676	.068	.27	.18	.14	.11
34 E 82684	.075	.27	.19	.15	.12
34 E 82692	.082	.27	.19	.15	.12
34 E 82700	.1	.27	.20	.15	.12
34 E 82718	.15	.36	.27	.21	.17
34 E 82726	.2	.45	.33	.26	.21
34 E 82734	.22	.45	.33	.26	.21
34 E 82742	.25	.48	.34	.26	.21
34 E 82751	.33	.48	.36	.28	.22
34 E 82759	.47	.51	.37	.29	.23
34 E 82807	.5	.90	.61	.46	.35

1600 WVDC					
Stock No.	CAP. MFD.	NET EACH IN LOTS OF			
		1-24	25-49	50-99	100-249
34 E 82833	.0005	.48	.35	.28	.22
34 E 82841	.001	.18	.12	.09	.07
34 E 82850	.0015	.18	.13	.10	.08
34 E 82866	.002	.21	.14	.11	.09
34 E 82874	.0022	.21	.14	.11	.09
34 E 82882	.003	.21	.15	.12	.10
34 E 82890	.0033	.21	.15	.12	.10
34 E 82908	.004	.24	.18	.14	.11
34 E 82916	.0047	.24	.18	.14	.11
34 E 82924	.005	.27	.18	.14	.11
34 E 82932	.006	.27	.19	.15	.12
34 E 82940	.0068	.27	.19	.15	.12
34 E 82957	.007	.27	.20	.15	.12
34 E 82965	.0075	.27	.20	.15	.12
34 E 82973	.008	.27	.20	.15	.12
34 E 82981	.01	.30	.20	.16	.13
34 E 82999	.015	.36	.26	.20	.16
34 E 83013	.02	.39	.29	.22	.18
34 E 83021	.022	.42	.30	.23	.19
34 E 83039	.03	.48	.35	.28	.22
34 E 83047	.04	.60	.45	.35	.28
34 E 83054	.05	.69	.51	.39	.32

2000 WVDC					
Stock No.	CAP. MFD.	NET EACH IN LOTS OF			
		1-24	25-49	50-99	100-249
34 E 83260	.001	.24	.17	.13	.11

.001 MFD—400 VOLT SPECIAL



25 for 89¢

QUANTITIES LIMITED

Twenty-five .001 mfd. 400 volt molded plastic capacitors. Shpg. wt., 6 oz.
32 E 01282 Net .89

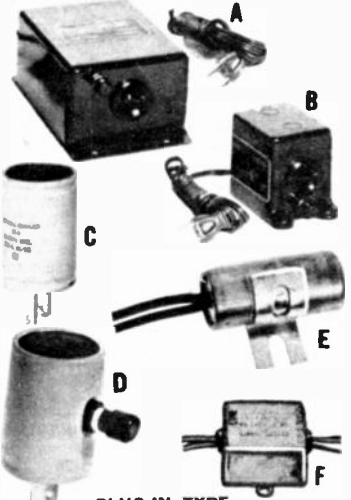

TYPE IF-18. FIG. A. An effective all-wave capacitive-inductive type filter for use with all types of electrical appliances causing severe radio and TV interference, such as air conditioning and ventilating units, machine tools, washing machines, etc. In bakelite case, 6x3 3/4x2 1/2", with line cord and plug, receptacle and ground terminal. Binding post for attachment of ground wire. Rated at 115V AC-DC, 5 amperes.
34 E 50114 Shpg. wt., 5 lbs. Net 7.67

TYPE IF-19. FIG. B. An effective capacitive-inductive type filter, smaller than above, yet having the same degree of attenuation of severe interference. For elimination of interference from food mixers, diathermy machines, electric fans, neon signs, washing machines, business machines, etc. Has line cord, plug, receptacle and terminal for ground connection. Rated 115V AC-DC, 5 amperes. In bakelite case 4x2 1/4x2 3/8".
34 E 50122 Shpg. wt., 3 lbs. Net 7.30

TYPE IF-4. FIG. C. A plastic cylindrical filter for use with small radios and portable TV sets for reduction of low or medium intensity interference caused by small portable electrical appliances such as electric shavers, fans, adding machines, etc. Rated 110V AC-DC, 5 amps. Connects to power line between radio plug and outlet.
34 E 50130 Shpg. wt., 8 oz. Net 1.00

TYPE IF-6. FIG. D. A plastic plug-in cylindrical filter for elimination of moderate interference. Suppresses interference of fluorescent lighting, electric shavers, etc. Connects between power line and appliance or between power line and radio. Has binding post terminal for grounding. Rated 110V AC-DC, 10 amperes. 1 1/8" dia., 2" long.
34 E 50148 Shpg. wt., 8 oz. Net 1.87

WIRED-IN TYPE
TYPE IF-24. FIG. E. FLUORESCENT NOISE FILTER. Dual capacitive type filter for eliminating fluorescent noise. Easily connected by means of flexible leads. In addition has bracket for mounting. For 110V AC-DC. Cylindrical metal case 7/8" dia., 1 7/8" long.
34 E 50163 Shpg. wt., 6 oz. Net 1.14

TYPE IF-34. FIG. F. A capacitive-inductive filter with greater efficiency than that above. Rated 110-220V AC-DC, 2 amperes. Has flexible leads for simple connection, with additional lead for ground. Rectangular metal case 2x2x1 1/4", w/tabs for mounting.
34 E 50171 Shpg. wt., 8 oz. Net 3.12

Lafayette, Meissner, Miller - Coils & Components

LAFAYETTE SUB-MINIATURE TRANSFORMERS ONLY $\frac{3}{16}$ " SQ. AND $\frac{1}{16}$ " HIGH



Net Each
69c

Same as miniature IF transformers to the right except size. Imported.
 99 E 62473 Oscillator Coil Net .69
 99 E 62481 1st IF Net .69
 99 E 62499 2nd IF Net .69
 99 E 63299 3rd IF Net .69

TRANSISTOR OSCILLATOR COIL



Popular broadcast frequency transistor oscillator for replacement purposes as well as for the hobbyist and experimenter. Inductance is 248 μ h and used with a tuning capacitance of 78 mmf. Size: $\frac{1}{2}$ " \times $\frac{1}{2}$ " \times $\frac{3}{16}$ ". Shpg. wt., 4 oz.
 32 E 55406 Meissner 14-9006 Net 5.29

4.5 MHz INTERCARRIER SOUND I.F. COMPONENTS



Fits the popular intercarrier sound TV receivers. Iron core tuning and HI-Q no-drift capacitors are used throughout. Aluminum shields except * Top and bottom tuning. Mounting by G-32 spade bolts. 1469 is used to remove 4.5 MHz signal from output of sound detector or plate of video amp. 1470 may be inserted in any part of circuit to attenuate a 4.5 MHz signal. The discriminator is of the Foster-Seely type. Shpg. wt., 5 oz.

Stock No.	Miller	Item	Net
34 E 88301	1466	Input or Interstage	2.46
34 E 88319	1467	Discriminator	2.70
34 E 88327	1468	Ratio Detector	2.94
34 E 88335	1469*	Sound Pick-Off	1.29
34 E 88343	1470*	Sound Trap	1.29
34 E 88356	1470-A	Sound Trap Shielded	1.62
34 E 88537	1480	Quadrature Coil	1.26
34 E 88545	1481	Quadrature Coil Shielded	1.62

MILLER WIDE RANGE ADJUSTABLE INDUCTORS



For immediate application in many prototype designs where the exact value of the required inductance is not known. Induction measured at 1000 Hz. Dimensions: max. dia. $\frac{3}{16}$ " \times $\frac{1}{4}$ " long. Specifications for tapped are identical to untapped of reference types shown. Column headed "Ratio" refers to the total number of turns on the coil to the number of turns to the tap. Shpg. wt., 6 oz.

Untapped				
Stock No.	Type	L Min.	L Max.	Net
34 E 89846	9001	40 μ h	.240 MH	1.44
34 E 89853	9002	.180 MH	.800 MH	1.62
34 E 89861	9003	.570 MH	2.80 MH	1.95
34 E 89879	9004	2.10 MH	8.00 MH	2.28
34 E 89887	9005	6.00 MH	16.0 MH	2.55
34 E 89895	9006	12.0 MH	40.0 MH	2.97
34 E 89903	9007	30.0 MH	105. MH	3.06
34 E 89911	9008	78.0 MH	240. MH	3.09
34 E 89511	9009	180. MH	750. MH	3.21

Tapped				
Stock No.	Ref. Type	Ratio	Net	
34 E 89929	9011	102/34	1.80	
34 E 89937	9012	204/68	1.95	
34 E 89945	9013	376/128	2.28	
34 E 89952	9014	608/203	2.54	
34 E 89960	9015	1000/333	2.86	
34 E 89978	9016	1480/493	2.97	
34 E 89986	9017	2480/827	3.03	
34 E 89994	9018	3860/1286	3.42	
34 E 89529	9019	6100/2030	3.54	

LAFAYETTE MINIATURE IF TRANSFORMERS AND OSCILLATOR COILS



Slug-tuned printed circuit mounted miniature IF transformers. All have 455 kHz intermediate frequency. Each with schematic and pin contacts. Ideal replacements for Japanese transistor radios. Shpg. wt., 6 oz. Imported.

All Units only $\frac{3}{16}$ " Sq. and $\frac{1}{16}$ " High.
 99 E 63000 Oscillator coil Inductance 270 μ h.
 99 E 63018 1st IF: pri. 70,000 ohms, sec. 1500 ohms.
 99 E 63026 2nd IF: pri. 50,000 ohms, sec. 1000 ohms.
 99 E 63034 3rd IF: pri. 30,000 ohms, sec. 5000 ohms.

Any of above Net ea. .59

**$\frac{3}{4}$ " PERMEABILITY
TUNED I.F. COILS**

Tuned top and bottom, powdered iron cores. Silvered mica condensers, molded plastic bases, etched aluminum cans. $\frac{3}{4}$ " \times $\frac{3}{4}$ " \times 2" With mounting clip and plate. *Spade bolt mtg. with leads. † with diode condenser. Shpg. wt., 4 oz.



Stock No.	Meissner	Type	Function	Net
32 E 55320	16-6758	455 kHz Input	1.89	
32 E 55338	16-6770†	455 kHz Output	2.52	
32 E 55346	16-6752	262 kHz Input	2.21	
32 E 55353	16-6754†	262 kHz Output	2.21	
32 E 55361	16-3487	102 kHz FM Input	2.98	
32 E 55379	16-6678*	455 kHz AC-DC	3.30	

VIDEO PEAKING - FILAMENT CHOKE COILS

Video peaking coils designed to provide proper bandwidth and wave shape for video signals. Wound on plastic forms except shunt type wound over resistor forms. * is filament choke; isolates filament to reduce feedback, stray coupling, etc. $\frac{3}{4}$ " \times $\frac{7}{16}$ " long. Peaking coils $\frac{3}{4}$ " \times $\frac{3}{4}$ " long. Shpg. wt., 2 oz.

Stock No.	Miller	μ h	Shunt	Net
34 E 88558	6175*	0.8	None	.72
34 E 88566	6152	20	None	.72
34 E 88574	6176	36	None	.72
34 E 88582	6172	73	None	.72
34 E 88590	6177	93	None	.72
34 E 88608	6178	120	22K	.72
34 E 88616	6153	120	None	.72
34 E 88624	6179	180	39K	.72
34 E 88632	6180	180	None	.72
34 E 88640	6154	200	None	.72
34 E 88657	6173	250	22K	.72
34 E 88665	6181	250	None	.72
34 E 88673	6155	300	None	.72
34 E 88681	6174	500	None	.72

HORIZONTAL LINEARITY AND WIDTH CONTROLS



Iron core variable inductance coils for linearity and width adjustment. Wound on a bakelite form $\frac{3}{16}$ " in diameter. Mtg. clip fits $\frac{3}{16}$ " hole. 6300's—phenolic form. Avg. shpg. wt., 4 oz.

Stock No.	Miller	Millihenries	Net
34 E 88368	6195	.185-1.000	1.26
34 E 88384	6196-A	.054-.50 Tapped	1.29
34 E 88392	6197	.550-2.300 Tapped	1.29
34 E 88418	6199-A	1.300-4.100 Tapped	1.35
34 E 88426	6199-B	500-1.700	1.32
34 E 88434	6313	5.00-5.0	1.50
34 E 88442	6314	2.0-18	1.50
34 E 88458	6315	4.0-30	1.50
34 E 88475	6317	3.2-9.0 With AGC	1.06
34 E 88483	6318	20-3.0	1.35
34 E 88491	6319	15-60	1.06
34 E 88509	6320	10-3.0 Tapped	1.44
34 E 88517	6321	1.0-5.0 Tapped	1.74
34 E 88525	6322	1.5-10	1.44
34 E 88533	6323	50-5.0 Tapped	1.74
34 E 88541	6324	60-130 Tapped	1.88
34 E 88487	6329	2.2-10 Tapped	1.86
34 E 88495	6330	45-215	2.04

LAFAYETTE 455 kHz UNIVERSAL I.F. TRANSFORMER FOR BROADCAST AND CITIZENS BAND



As Low As

79c



• Only $\frac{3}{16}$ " Square

The most popular replacement I.F. Ideal for experimenters. Exceptionally high gain powdered iron core, compression tuned 455 kHz midget I.F.—only $\frac{3}{16}$ " square by $\frac{1}{16}$ " high. For both input and output circuits. Supplied with mounting clip and adapter plate to replace both midget and larger size cans. Shpg. wt., 4 oz.

32 E 09467 Singly, each .89
Lots of 10 each .79

TINY BROADCAST OSCILLATOR COIL



Utilizes 100 mmfd. Capacity Interwinding. For use with 6SA7, 12SA7, 6BE6, 12BE6, 7Q7, and 14Q7 tubes in receivers having 455 kHz Intermediate Frequency and with effective gang condenser capacities of 108 to 180 mmfd. in unpadded circuits, and 365 to 420 mmfd. in padded circuits. Adjustable iron core permits accurate adjustment for proper tracking and calibration. Its small size of 1" \times $\frac{3}{16}$ " permits its use in the most compact circuits. Shpg. wt., 8 oz.
 32 E 55403 Meissner 14-1073 Net 2.43

ECONOMY ADJUSTABLE R.F. CHOKES



A recently developed nylon molding process makes possible an inexpensive fine of adjustable chokes. They are adjustable from either the top or the bottom, giving you design flexibility. Mounting is achieved by way of a metal clip in a $\frac{3}{16}$ " hole. Dimensions: $\frac{3}{16}$ " \times $\frac{1}{2}$ " long. Shpg. wt., 4 oz.

Stock No.	Miller	Type	Microhenries	Net
34 E 89507	4200	Form only	.84	
34 E 89762	4202	1-2.5	1.11	
34 E 89770	4203	2-5.5	1.14	
34 E 89788	4204	5-12	1.17	
34 E 89796	4205	10-25	1.20	
34 E 89804	4206	20-55	1.29	
34 E 89812	4207	50-140	1.32	
34 E 89820	4208	120-330	1.35	
34 E 89838	4209	310-860	1.38	

JW MILLER 455 kHz IF AMPLIFIER MODULE



• Speeds Construction And Simplifies Wiring

Pre-aligned integrated, 455 kHz intermediate amplifier system consisting of a ceramic filter, transformers, 2 transistors plus diode and associated resistors and capacitors totaling 24 components. Connections for AGC and tuning meter. Gain: 55db; Selectivity: 8 kHz @ 6 db; DC requirement; 2 ma @ 6v. Fully shielded. Size 1.5x.55x.51". Instructions supplied. Types 8901B & 8902B, supersede earlier versions 8901 & 8902. Shown in some project requirements and may be used in their place. A later project requires the new "B" versions and also requires one of the original 8901 matching transformers. Shpg. wt., 4 oz.

8902B Amplifier Module	Net 5.10
34 E 86552	Net 5.10
8901B Matching Input IF Transformer	Net 2.25
34 E 86560	Net 2.25
8903B Combination Offer (1 ea. of above)	Net 6.00
34 E 86578	Net 6.00
8901 - Input IF Transformer	Net 2.25
34 E 86024	Net 2.25

National - Miller Coils and Chokes

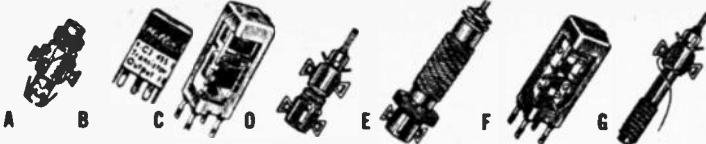

UNSHIELDED MINIATURE TRANSISTOR OSCILLATORS

(Fig. A.) The 34 E 88012 oscillator coil (Revised 5-lug) is designed for use in a converter oscillator circuit. The 34 E 87022 oscillator coil (6-lug) is for use where a separate transistor is used for the oscillator and another transistor for the mixer. I.F. Freq. 455 kHz. Avg. Shpg. wt., 3 oz. Dimensions: $\frac{3}{4}'' \times 1''$ high

Stock No.	Miller	Capacity	Net
34 E 88012	2020	365 mfm.	1.92
34 E 87014	2022	78-100 mfm.	1.92
34 E 87022	2023	365 mfm.	1.92

SUB-MINIATURE TRANSISTOR I.F.'s AND OSCILLATOR

(Fig. B.) Cup core construction permits the use of extremely small shields without adversely affecting transformer operation. A high impedance, tapped primary winding coupled to a low impedance secondary provides optimum energy transfer between stages. Dimensions: $\frac{3}{8}''$ sq. x $\frac{5}{8}''$ high.

Stock No.	Miller	Freq.	Imp.	Item	Net
34 E 88081	9-C1	455kHz	25K	Input	2.76
			600 ohms		
34 E 88131	9-C2	455kHz	25K	Output	2.76
			1000 ohms		
34 E 87030	2021	Oscillator (Tuning)		2.43	
		Cap.	78 pF Max.		

MILLER TRANSISTOR ANTENNAS

STANDARD
Has a fixed inductance of 240 μ h and covers a band of 540-1650 kHz. Large pickup area and high Q. Maximum tuning capacity 365 mfm. Q @ 790 kHz. 450. Shpg. wt., 4 oz. 34 E 88194 Type 2000 Net 2.34

SUB-MINIATURE
Adjustable antenna coil with high Q ferrite cores. Inductance range for 2002 is 40-300 μ h, for 2007, 150-1000 μ h. Freq. range 540-1650 kHz. Q @ 790 kHz for 2002, 250; for 2007, 220. Tuning capacity 2002, 250-450 mfm; 2007, 100-250 mfm. Wt., 4 oz.
34 E 87493 Type 2002 Net 1.65
34 E 88210 Type 2007 Net 2.04

NATIONAL RF CHOKES

Wound on ceramic form except R33, R50 and R60 series on bakelite. All have fungus resistant varnish coat. Type R33 is 2 section, R50 are 3 and 4 section. Types with † mounted on fixed standoff insulator. Types ending in U have removable standoff. Av. Shpg. wt., 2 to 6 oz. † = Millihenries * = Microhenries

Stock No.	Mfr. Type	Fig.	MH \ddagger	Ma	Ohms	NET EACH	
						1-49	50-99
32 E 51014	R-100	A	2.5	115	.44	.57	.54
32 E 51022	R-100	A	5	70	.90	.90	.86
32 E 51030	R-100	A	10	60	1.30	1.12	1.06
32 E 51063	R-100U†	B	10	60	1.30	1.26	1.20
32 E 51105	R-100ST	C	2.5	115	.44	.64	.63
32 E 51121	R-300	A	1	400	11	.57	.54
32 E 51154	R-300ST	C	2.5	375	17	.80	.76
32 E 51162	R-50	D	.	150	15	.42	.40
32 E 51170	R-50	D	1	135	23	.42	.40
32 E 51188	R-50	D	2.5	125	38	.42	.40
32 E 51196	R-50	D	10	115	36	.72	.68
32 E 51212	R-154U	F	1	600	6	2.01	1.91
32 E 51238	R-33	D	1*	850	.06	.36	.34
32 E 51248	R-33	D	11*	350	1.8	.36	.34
32 E 51253	R-33	D	50*	225	3.5	.36	.34
32 E 51261	R-33	D	100*	200	5	.36	.34
32 E 51279	R-33	D	750*	125	16	.36	.34
32 E 51287	R-60	E	2*	1500	.06	.29	.28
32 E 51295	R-40-3.3	G	3.3	125	15.7	.59	.50

MINIATURE I.F. TRANSFORMERS

(Fig. C.) Designed for experimental use and for general replacement in personal radio receivers. Shell core, permeability tuned. Tuning from top and bottom of the shield. Transformers are available for all standard I.F. 12H series for 262 kHz. 12C series for 455 kHz. 1463 thru 1465 for 10.7 MHz and 6203, 6204, 6205 for 4.5 MHz. Dimensions: $\frac{3}{4}'' \times \frac{3}{8}'' \times 2''$ high. * With diodes, filter capacitors. Avg. shpg. wt., 4 oz.

Stock No.	Miller	Item	Net
34 E 87248	12-H1	Input IF	2.01
34 E 87253	12-H2	Output IF	2.01
34 E 87261	12-H6	Output IF	2.07
34 E 87279	12-C1	Input 16 kHz @ 6 db	1.92
34 E 87287	12-C2	Output 21 kHz @ 6 db	1.92
34 E 87295	12-C6	Output IF	1.98
34 E 87329	12C45	Discriminator	3.12
34 E 87337	1463	Input	2.25
34 E 87345	1464	Discriminator	2.61
34 E 87352	1465	Ratio Detector	2.70
34 E 87360	1464-WB	Disc. 900 kHz P/P	2.76
34 E 87378	6203	Input	2.28
34 E 87386	6204	Discriminator	2.61
34 E 87394	6205	Ratio Detector	2.61

UNIVERSAL ADJUSTABLE OSC. COIL

(Fig. D.) Adjustable iron core oscillator coil for general replacement use. RF freq. 500-1800 kHz, IF freq. 100-500 kHz. Dimensions $\frac{3}{4}'' \times 1\frac{1}{2}''$ high. 34 E 87040 Miller Type 71-OSC Net 1.92

FERRITE STRIP

Has an inductance of 240 μ h and is to be used with a condenser having a maximum capacity of 365 mfm. Freq. range 540-1650 kHz. Q @ 790 kHz, 500. Shpg. wt., 4 oz. 34 E 88202 Type 2004 Net 2.31

MINIATURE

Has an inductance of 240 μ h and is designed for use with a standard variable condenser having a maximum capacity of 365 mfm. Freq. range 540-1650 kHz. Q @ 790 kHz, 550. Shpg. wt., 4 oz. 34 E 87485 Type 2001 Net 2.07

HIGH-Q R.F. COILS

(Fig. E.) A complete line of unshielded permeability tuned coils for replacement use or as the front end components in new receiver design. Ranges shown are for use with a 365 mmfd variable tuning condenser. Dimensions: $\frac{3}{4}'' \times 2''$. Avg. shpg. wt., 6 oz.

Stock No.	Miller No.	Use
LONG-WAVE COILS (140-420 kHz)		
34 E 87063	X-5495-A	Antenna Stage
34 E 87071	X-5495-RF	RF Stage
34 E 87089	X-5495-C	Standard Osc. 455 kHz
34 E 87097	X-5496-C	Tapped Osc. 455 kHz
BROADCAST BAND COILS (540-1700 kHz)		
34 E 87105	A-5495-A	Antenna Stage
34 E 87113	A-5495-RF	RF Stage
34 E 87121	A-5495-C	Standard Osc. 455 kHz
34 E 87139	A-5496-C	Tapped Osc. 455 kHz
MEIQUIM WAVE COILS (1.75-5 MHz)		
34 E 87147	B-5495-A	Antenna Stage
34 E 87154	B-5495-RF	RF Stage
34 E 87162	B-5495-C	Standard Osc. 455 kHz
34 E 88188	B-5496-C	Tapped Osc. 455 kHz
SHORT WAVE BROADCAST COILS (9-18 MHz)		
34 E 87519	C-5495-A	Antenna Stage
34 E 87170	C-5495-RF	RF Stage
34 E 87188	C-5495-C	Standard Osc. 455 kHz
34 E 87196	C-5496-C	Tapped Osc. 455 kHz
HIGH FREQUENCY COILS (12-36 MHz)		
34 E 87204	D-5495-A	Antenna Stage
34 E 87212	D-5495-RF	RF Stage
34 E 87220	D-5495-C	Standard Osc. 455 kHz
34 E 87238	D-5496-C	Tapped Osc. 455 kHz
Any of above		Net ea. 2.07

10.7 MHz TRANSISTOR I.F.'s

(Fig. F.) A complete series of IF Transformers specifically designed for operation with transistors. Standard size: $\frac{3}{4}''$ sq. x 2" High. Printed circuit: $\frac{3}{4}''$ sq. x $2\frac{1}{2}''$ high.

STANDARD

Stock No.	Miller No.	Item	Net
34 E 88038	1601	1st IF	2.84
34 E 88048	1602	2nd IF	2.87
34 E 88053	1603	3rd IF	2.87
34 E 88061	1604	Discrim.	2.94
34 E 88087	1606	Ratio Det.	2.94

SUBMINIATURE STYLE

Single tuned I.F.'s and double tuned ratio detector. Size: IF— $\frac{1}{2}''$ sq. x $\frac{5}{8}''$ high—Size: ratio detector— $\frac{3}{8}'' \times \frac{3}{4} \times \frac{1}{2}''$ high.

34 E 88145	2070	1st IF	2.58
34 E 88152	2071	2nd IF	2.58
34 E 88160	2072	3rd IF	2.58
34 E 88178	2073	Ratio Det.	3.08

HIGH-Q FERRITE ANT. COIL

(Fig. G.) Highly efficient broadcast band antenna coil for use in small receivers where no external antenna is desired. High-permeability low loss ferrite tuning core. Freq. range, 540-1700kHz. Supplied with mounting bracket and 18" polyethylene insulated antenna wire. Size: $\frac{3}{8}'' \times 2\frac{1}{4}''$. Wt., 4 oz. 34 E 87055 Miller 6300 Net 1.32

R.F. COIL FORMS

Fine grade quality coil forms. Frequency range of core is 1-20 MHz. Types 20A000-2, 21A000-2, 22A000-2 are constructed of a phenol impregnated tubing which could be certified to MIL-P-798, type PBG. Type 4200-2 is strong nylon. Types 4300-2, 4400-2, 4500-2 are made of silicone-impregnated ceramic. In accordance with JAN 1-10, grade L5. Hardware is included. Shpg. wt., 6 oz.

Stock No.	Type No.	Ola.	Lgth.	Htg. Hole	Net Ea.
34 E 89432	20A000-2	$\frac{1}{4}''$	$\frac{1}{4}''$	$\frac{1}{4}''$	1.05
34 E 89135	21A000-2	$\frac{3}{8}''$	$\frac{1}{4}''$	$\frac{1}{4}''$	1.05
34 E 89457	22A000-2	$\frac{1}{2}''$	$\frac{7}{8}''$	$\frac{1}{4}''$	1.56
34 E 89507	4200-2	.289	$\frac{1}{4}''$	$\frac{5}{16}''$.84
34 E 87725	4300-2	$\frac{3}{16}''$	$\frac{5}{8}''$	$\frac{1}{4}''$	1.23
34 E 89515	4400-2	$\frac{3}{8}''$	$\frac{1}{4}''$	$\frac{1}{4}''$	1.50
34 E 89523	4500-2	$\frac{3}{8}''$	$\frac{3}{8}''$	$\frac{3}{8}''$	1.32

Meissner - Miller Coils & Chokes

MILLER COMMUNICATIONS I.F. TRANSFORMERS

Designed for experimental use in communications equipment where selectivity and stability are important. The 100 kHz I.F. transformer and BFO coil are intended for tube application, while the 455 kHz crystal filter I.F. transformers have taps on the winding to allow for use with both tubes and transistors. The 1800 kHz I.F. transformer offers the best possible "Q" with stability to give a degree of selectivity that compares with lower frequency I.F. transformers. This transformer is for use with tubes only. Type number 1770 is a double tuned I.F. transformer having taps on both Primary and Secondary winding. Dimensions: $\frac{3}{8}$ " by $\frac{3}{4}$ " by 2" high. Average shpg. wt., 5 oz.



MILLER FM STEREO MULTIPLEX INDUCTORS

For use in FM Stereo Multiplex tuners and receivers, both standard and printed circuit. Size: $\frac{3}{8}$ " sq. x $1\frac{1}{8}$ " high. Shpg. wt. 4 oz.

Stock No.	Type	Description	Net
34 E 06404	1709	100 kHz I.F.—2.5 kHz Bandwidth	2.88
34 E 07840	1710	100 kHz I.F.—3 kHz Bandwidth	2.40
34 E 07857	1711	100 kHz B.F.O.	2.22
34 E 07865	1725	455 kHz Crystal Filter I.F. Input	2.52
34 E 07873	1726	455 kHz Crystal Filter I.F. Output	2.22
34 E 07881	1727	455 kHz B.F.O.	2.07
34 E 07889	1730	1800 kHz I.F.—25 kHz Bandwidth	2.88
34 E 07907	1770	455 kHz Double Tuned Transistor I.F.—30K:1K	2.73
34 E 07915	1731	1610 kHz Link Coupling Coil Unshielded	2.40
34 E 06412	1732	1650 kHz I.F. (Citizens Band Transceivers)	2.40
34 E 06420	1733	1650 kHz I.F. Printed Circuit I.F.	2.40
34 E 06438	1740	9 MHz S.S.B. Input Trans.	2.40
34 E 06396	1741	9 MHz S.S.B. Output Trans.	2.40

STANDARD			Net
Stock No.	Type	Description	Net
34 E 08749	1351	Low Pass Filter	2.25
34 E 08756	1352	Band Pass Filter Series Element	2.07
34 E 08764	1353	Band Pass Filter Shunt Element	2.07
34 E 08772	1354	Locked Oscillator 19 kHz	2.94
34 E 08780	1355	Output Transformer 38 kHz	2.76
PRINTED CIRCUIT			Net
34 E 08798	1351-PC	Low Pass Filter	2.25
34 E 08806	1352-PC	Band Pass Filter Series Element	2.07
34 E 08814	1353-PC	Band Pass Filter Shunt Element	2.25
34 E 08822	1354-PC	Locked Oscillator, 19 kHz	2.61
34 E 08830	1355-PC	Output Transformer, 38 kHz	2.61

For use in a newly designed circuit that eliminates the 19 kHz Oscillator and resulting synchronizing problems. In conjunction with an improved low pass filter and detecting system. Improved separation can be achieved.

Stock No.	Type	Description	Net
34 E 07816	1356	19 kHz Output	2.64
34 E 07824	1357	38 kHz Input	2.61
34 E 07832	1358	Low Pass Filter	2.73

RESINITE ADJUSTABLE R.F. COILS



Resinite is a phenolic impregnated tubing which can be certified to MIL-P-79B type PBG. Combines good mechanical and electrical characteristics. Dimensions: $\frac{1}{4}$ " dia. x $1\frac{1}{8}$ " long. Avg. shpg. wt., 4 oz.

MINIATURE ADJUSTABLE R.F. COILS

Stock No.	Miller Type 20A-	Min. μ h $\pm 5\%$	Max. μ h $\pm 10\%$	Net
34 E 09440	107RBI	.088	.120	1.17
34 E 09418	157RBI	.108	.180	1.17
34 E 09424	227RBI	.162	.264	1.17
34 E 09408	477RBI	.356	.564	1.23
34 E 09374	687RBI	.508	.816	1.23
34 E 09362	827RBI	.735	.984	1.23
34 E 09358	106RBI	.885	1.20	1.23
34 E 09366	156RBI	1.08	1.80	1.23
34 E 09333	226RBI	1.62	2.64	1.23
34 E 09341	336RBI	2.38	3.96	1.23
34 E 09325	686RBI	5.08	8.16	1.23
34 E 09291	826RBI	7.35	9.84	1.23
34 E 09275	155RBI	10.8	18.0	1.38
34 E 09283	225RBI	16.2	26.4	1.23
34 E 09259	335RBI	23.8	39.6	1.38
34 E 09218	104RBI	88.5	120.	1.38
34 E 09226	154RBI	108.	180.	1.38
34 E 09176	474RBI	356.	564.	1.38

STANDARD ANTENNA AND R.F. COILS



Designed to cover the broadcast band from 545 to 1580 kHz (190-550 meters) with a 365 mmfd. tuning condenser. High impedance primaries, wound with Litz wire. Shielded coils are in black crackle finish, non magnetic can. $1\frac{1}{8}$ " in diameter, $2\frac{1}{2}$ " high. "unshielded" (shielded. Shpg. wt., 4 oz.

Stock No.	Meissner	Description	Net
32 E 35205	14-1010*	Ant. Coil	2.21
32 E 35213	14-1004†	Ant. Coil	2.21
32 E 35221	14-1011*	RF Coil	1.98
32 E 35239	14-1005†	RF Coil	2.21

PHENOLIC FORM 3-SECTION WINDINGS

Size: $\frac{3}{8}$ " dia. x $\frac{3}{8}$ " long.

Stock No.	Miller	mh	Ohms Max.	ma	Net
34 E 08277	4646	0.24	8.16	125	.75
34 E 08285	4649	0.55	13.2	125	.81
34 E 08283	4652	1.0	19.8	125	.81

FREQUENCY SELECTIVE R.F. CHOKES



Designed for maximum efficiency and highest impedance at specific operating frequencies, this group of R.F. chokes eliminates the designers task of attempting to choose the best coil for a particular application. Designed to cover the major Amateur, Industrial, and Citizens bands.

Stock No.	Miller Type No.	L	Freq MHz	Fig.	Net
34 E 09697	RFC-14	84 μ h	7-20	1	1.29
34 E 09705	RFC-21	38.5 μ h	15-30	1	1.02
34 E 09713	RFC-28	24 μ h	25-40	2	1.14
34 E 09721	RFC-50	8.2 μ h	30-90	2	.99
34 E 09739	RFC-144	1.72 μ h	75-180	2	.89
34 E 09747	RFC-220	.82 μ h	160-340	2	.89
34 E 09754	RFC-420	.22 μ h	325-500	2	.84

FERRITE CORE R.F. CHOKES



A new series of R.F. Chokes taking advantage of the high permeability of ferrite cores. These chokes combine high inductance and low D.C. resistance. Size: $\frac{1}{4}$ " diameter x $\frac{7}{8}$ " long. $1\frac{1}{2}$ " axial leads.

Stock No.	Miller Type	mh	Ohms Max.	MA.	Net
34 E 07923	6302	2.5	9	160	1.05
34 E 07931	6304	5	14	160	1.23
34 E 07949	6306	10	31	100	1.35
34 E 07956	6308	25	82	65	1.35
34 E 07964	6310	50	127	65	1.62

COILMASTER DELUXE ACCURATE COIL WINDER



Latest redesigned model gives even greater accuracy than ever to meet modern requirements. Easy-to-use set winds honeycomb, spiderweb and solenoid coils of various widths and diameters—equal in appearance to a factory job. Also suitable for winding chokes, transformers and filter inductors. Indicator counts number of turns on coil. Uses #22 to #40 wire. Supplied with accessories including wood spools, metal pegholders and extension for making long solenoid coils. Instructions included, but less coil form and pegs. Shpg. wt., 6 lbs. Net 8.25

MILLER ADJUSTABLE CERAMIC FORMS AND R.F. COILS

Permeability tuned coils wound on silicone impregnated ceramic forms. Hardware necessary for assembly is supplied.



STANDARD ADJUSTABLE CERAMIC FORM AND R.F. COILS

Dimensions (form): $\frac{3}{8}$ " diameter x $1\frac{1}{8}$ " long.

Stock No.	Type	Microhenries	Net
34 E 09515	4400	Form Only	1.50
34 E 07535	4404	1.6-3.1	2.01
34 E 07543	4405	3.3-6.5	2.04
34 E 07580	4406	7.3-14	2.10
34 E 07568	4407	16-29	2.16
34 E 07576	4408	33-66	2.28
34 E 07584	4409	74-124	2.34
34 E 07592	4410	138-238	2.37
34 E 07600	4411	270-451	2.40
34 E 07618	4412	495-760	2.43
34 E 07626	4413	825-1300	2.46
34 E 07634	4414	1400-2000	2.46

MINIATURE R.F. COIL AND FORM

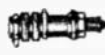

Dimensions (form): $\frac{1}{4}$ " diameter x $\frac{7}{8}$ " long.

Stock No.	Miller	Microhenries	Net
34 E 09523	4500	Form Only	1.32
34 E 07859	4501	.44-.76	1.80
34 E 07867	4502	1.1-1.5	1.80
34 E 07875	4503	1.7-2.7	1.80
34 E 07863	4504	3.1-4.8	1.80
34 E 07891	4505	5.5-8.6	1.80
34 E 07709	4511	66-114	2.10
34 E 07717	4512	120-190	2.13

SUBMINIATURE ADJUSTABLE R.F. COILS



These compact adjustable coils offer a minimum two-to-one inductance range with relatively small changes in Q. The tuning adjustment is accessible from either the top or bottom of the coil assembly. Magnetic and electrostatic shielding. Printed circuit terminals. Size: $\frac{1}{2}$ " sq. x $\frac{3}{8}$ " high. Avg. shpg. wt., 4 oz.

Stock No.	Miller Type	L Min.	L Max.	C(pf)	Typical Dist.	Net
34 E 09572	9054	28.0 μ h	60.0 μ h	11.0	2.10	
34 E 09598	9056	120.0 μ h	280.0 μ h	9.0	2.10	
34 E 09614	9058	650.0 μ h	1.3Mh	8.0	2.16	
34 E 09622	9059	1.3Mh	3.0Mh	16.0	2.16	
34 E 09630	9060	3.0Mh	10.0Mh	7.0	2.37	
34 E 09648	9061	8.0Mh	20.0Mh	7.0	2.37	
34 E 09655	9062	15.0Mh	40.0Mh	7.0	2.37	
34 E 09663	9063	20.0Mh	60.0Mh	10.0	2.46	

Cutler Hammer Switches

AC - DC TOGGLE SWITCHES LIGHT DUTY — 3 to 6 AMPS

For use on small motor-driven tools and appliances where a sturdy switch is required. Long life and high arc resistant. $\frac{1}{8}$ dia. threaded stem. Length of stem $\frac{1}{32}$ except $\frac{1}{16}$ and $\frac{1}{4}$. All have solder lug terminals except # 6" wire leads. 3 screw terminals. All 3 amps at 250V except \dagger 1 amp. U.L. listed. Avg. shpg. wt., 3 oz.

Stock No.	Mfr's. Type	Con- tacts	Fig.	Amps			Net Each
				125V	1-24	25-49 50†	
34 E 33026	8280-K-14*	SPST	A	3	.68	.64	.53
34 E 33034	8280-K15†	SPST	A	3	.68	.64	.53
34 E 33042	8280-K16	SPST	A	3	.68	.64	.53
34 E 33059	8282-K13†	SPDT	C	3	.84	.81	.68
34 E 33087	8282-K14†	SPDT	G	3	.84	.81	.68
34 E 33075	8282-K12†	SPDT	G	3	.88	.81	.68
34 E 33083	8284-K14†	2 Cir. C	G	3	.90	.85	.71
34 E 33091	8290-K15†	SPST	B	3	.82	.77	.65
34 E 33100	8290-K16†	SPST	B	3	.82	.77	.65
34 E 33117	8295-K7†	SPST	C	3	.82	.77	.65
34 E 33125	8295-K8†	SPST	C	3	.82	.77	.65
34 E 33133	8360-K6*	DPST	G	3	1.22	1.18	.97
34 E 33141	8360-K7	DPST	G	3	1.22	1.18	.97
34 E 33186	8363-K6*	DPDT	E	3	1.41	1.33	1.11
34 E 33174	8363-K7	DPDT	E	3	1.41	1.33	1.11
34 E 33182	8363-K8†	DPDT	E	3	1.41	1.33	1.11
34 E 33200	8370-K7	DPST	G	6	1.32	1.24	1.04
34 E 33224	8372-K7†	DPST	D	6	1.60	1.52	1.27
34 E 33232	8373-K7	DPDT	E	6	1.51	1.43	1.19
34 E 33257	8375-K7†	DPDT	D	6	1.85	1.84	1.53
34 E 33285	8381-K7†	SPST	A	6	.78	.74	.62
34 E 33273	8381-K8	SPST	A	6	.78	.74	.62
34 E 33281	8391-K7†	SPST	B	6	.92	.87	.73
34 E 33290	8391-K8†	SPST	B	6	.92	.87	.73
34 E 33307	8396-K7†	SPST	C	6	.92	.87	.73
34 E 33315	8396-K8†	SPST	C	6	.92	.87	.73

STANDARD DUTY — 8 to 16 AMPS

Quick make, quick break contact mechanism eliminates pitting caused by high arcing. These long life switches are primarily designed for use on small motors and similar equipment. All in bakelite case with screw terminals. $\frac{1}{8}$ threaded stem x $\frac{1}{32}$ long except \dagger $\frac{1}{16}$ stem length. U.L. listed. All 8 amp at 250V and 16 amp at 125V, except \dagger 15 amps at 250V. Avg. shpg. wt., 3 oz.

Stock No.	Mfr's. Type	Con- tacts	Fig.	Amps			Net Each
				125V	1-24	25-49 50†	
34 E 33323	7320-K2†	DPST	H	16	1.37	1.29	1.08
34 E 33943	7320-K3	DPST	H	16	1.37	1.29	1.08
34 E 33331	7321-K2†	SPST	H	16	1.46	1.39	1.16
34 E 33950	7321-K3	SPST	H	16	1.46	1.39	1.16
34 E 33348	8680-K1†	DPDT	H	5	4.17	3.85	3.21

SPST MIDGET SWITCH

Type 8097-K3. Bat handle $\frac{1}{8}$ " from end of threaded stem. 3 Amps at 125V AC. .75 at 250V DC. Screw terminals. Threaded stem dia. $\frac{1}{8}$ ". stem length $\frac{1}{32}$ ". Shpg. wt., 2 oz.

Stock No.	Mfr's. Type	Fig.	Amps			Net Each
			125V	1-24	25-49 50†	
34 E 33018	M		.57		.54	.45

ON-OFF PLATE FOR TOGGLES

34 E 33935		Net Ea.	1-8	.06
			10-99	.05

"ROCKETTE" SWITCHES

Modern design, dependable, with nylon rocker-type actuator. Fast connect .250" terminals except # have screw terminals 6-32 tapped mtr. holes on $\frac{1}{4}$ " ctrs. Requires $\frac{1}{4}$ " x $\frac{1}{8}$ " hole. U.L. and CSA listed.

Stock No.	Mfg. Type	Ampere's		Con- tacts	Fig.	Amps			Net Each
		125V	250V			1-24	25-49	50†	
34 E 34164	8134K2IA1M52	6	3	SPST		.83	.80	.50	
34 E 34172	8134K2OIA1M52	6	3	SPDT		.71	.68	.50	
34 E 34149	8132K2IE6M52	6	3	DPST		.94	.88	.74	
34 E 34156	8132K2OE6M52	6	3	DPDT		.97	.81	.85	
34 E 34123	8144K2IA1M52	15	10	SPST		.71	.59	.47	
34 E 34131	8144K2IA1M50†	15	10	SPST		.75	.63	.50	
34 E 34107	8144K2OIA1M52	15	10	SPDT		.82	.77	.65	
34 E 34115	8142K2IE6M52	15	10	DPST		1.13	1.04	.87	
34 E 34081	8142K2IE6M50†	15	10	DPST		1.28	1.06	.85	
34 E 34099	8142K2OE6M52	15	10	DPDT		1.28	1.06	.85	



AC TOGGLE SWITCHES LIGHT DUTY — 6 AMPS

For use in radios, appliances and other equipment which use snap action mechanism. All rated 6 amps at 125V and 3 amps at 250V. * Center-off position. Threaded stems are $\frac{1}{8}$ " in. dia., stem length $\frac{1}{32}$ ". U.L. listed. Avg. shpg. wt., 3 oz. † indicates screw terminals. ‡ indicates solder terminals.

Stock No.	Mfr's. Type	Con- tacts	Fig.	Amps			Net Each
				1-24	25-49	50†	
34 E 33490	7580-K4*	SPST	K	.71	.68	.57	
34 E 33448	7580-K6†	SPST	K	.81	.58	.49	
34 E 33455	7581-K4*	SPDT	K	.82	.77	.65	
34 E 33463	7581-K6†	SPDT	K	.86	.83	.53	
34 E 33505	7582-K4†	DPST	K	.82	.77	.65	
34 E 33513	7582-K6†	SPDT	K	.86	.83	.53	
34 E 33521	7590-K4†	DPST	F	1.10	1.03	.86	
34 E 33530	7590-K6†	DPST	F	.89	.84	.70	
34 E 33547	7591-K4*	DPDT	F	1.30	1.22	1.02	
34 E 33554	7591-K6†	DPDT	F	1.00	.94	.78	
34 E 33582	7592-K4†	DPDT	F	1.30	1.22	1.02	
34 E 33570	7592-K6†	DPDT	F	1.00	.94	.78	

STANDARD DUTY — 10 to 15 AMPS

Slow make, slow break mechanism. All have 15/32 diameter threaded stem. 15/32 long except \dagger 11/32 long, and * center off, all rated 10 amps at 250 V AC and 15 amps at 125V AC. U.L. listed. Avg. shpg. wt., 3 oz. † indicates screw terminal, ‡ indicates solder terminals.

Stock No.	Mfr's. Type	Con- tacts	Fig.	Amps			Net Each
				1-24	25-49	50†	
34 E 33588	7500-K13†	SPST	K	.82	.77	.65	
34 E 33596	7500-K14†	SPST	K	.82	.77	.65	
34 E 33604	7501-K12†	SPST	K	.71	.68	.57	
34 E 33612	7501-K13†	SPST	K	.71	.68	.57	
34 E 33620	7502-K12†	SPDT	K	.97	.91	.76	
34 E 33638	7502-K13†	SPDT	K	.97	.91	.76	
34 E 33653	7503-K13†	SPDT	K	.82	.77	.65	
34 E 33661	7504-K3†	SPDT	K	.97	.91	.76	
34 E 33678	7504-K4†	SPDT	K	.97	.91	.76	
34 E 33695	7505-K4†	SPDT	K	.82	.77	.65	
34 E 33703	7560-K5†	DPST	F	.82	.77	.65	
34 E 33729	7561-K4†	DPST	F	1.10	1.03	.86	
34 E 33745	7562-K4†	DPDT	F	1.59	1.51	1.28	
34 E 33752	7562-K5†	DPDT	F	1.59	1.51	1.26	
34 E 33760	7563-K4†	DPDT	F	1.30	1.22	1.02	
34 E 33778	7583-K5†	DPDT	F	1.30	1.22	1.02	
34 E 33786	7584-K6†	DPDT	F	1.59	1.51	1.26	
34 E 33802	7565-K5†	DPDT	F	1.30	1.22	1.02	
34 E 33810	7565-K6†	DPDT	F	1.30	1.22	1.02	
34 E 33844	7610-K2†	3PST	L	2.49	2.35	1.96	
34 E 33851	7611-K2†	3PST	L	2.14	2.01	1.68	
34 E 33877	7613-K2†	3PDT	L	2.62	2.48	2.07	
34 E 33893	7615-K2†	3PDT	L	2.62	2.48	2.07	

HEAVY DUTY — 15 to 20 AMPS

Switches contain heavy parts, larger clearances and higher ratings. Handle large motors and heavier loads. Longer life on lighter loads. All Bakelite bodies, screw terminals and quick make and break contacts. $\frac{1}{8}$ threaded stem $\frac{1}{32}$ long except * $\frac{1}{16}$ stem. U.L. listed. All 10 amps at 250V except † 20 amps. Shpg. wt., 3 oz.

Stock No.	Mfr's. Type	Con- tacts	Fig.	Amps			Net Each
				125V	1-24	25-49 50†	
34 E 33356	7360-K7*	DPST	H	20	2.37	2.23	1.86
34 E 33364	7360-K8	DPST	H	20	2.37	2.23	1.86
34 E 33372	7361-K5	SPST	H	20	2.47	2.33	1.94
34 E 33388	7402-K3†	DPST	H	20	3.18	2.99	2.50
34 E 33406	7402-K4†	DPST	H	20	3.18	2.99	2.50
34 E 33422	8690-K2	DPDT	H	15	4.95	4.66	3.89

LAFAYETTE SUBMINIATURE SWITCHES

TOGGLE SWITCH Industrial quality, subminiature, D.P.D.T., AC toggle switch. Rated at 10 amps, 125 volts A.C. Life tested through 100,000 cycles. Contact resistance, 0.01 ohms. Insulation resistance 100 meg-ohms at 500 V.A.C. Maximum breakdown voltage 1000 V.A.C. Body size $1/2 \times 1/2 \times 1/16$ ". Bushing $1/4 \times 5/16$ ". Handle $3/8$ ". L. Behind panel depth, including lugs, $3/4$ ". Includes slip-on insulator for handle, mounting hardware and "on-off" plate. Shpg. wt., 2 ozs.
 99 E 81624 imported. Net ea. 1.49
 Lots of 100 ea. 1.19 Lots of 10 ea. 1.35
SUBMINIATURE MOMENTARY PUSH-BUTTON SWITCH (Fig. B) All dimensions and specifications exactly the same as above except momentary push button action. Imported.
 99 E 81830. Net ea. 1.89
 Lots of 100 ea. 1.35 Lots of 10 ea. 1.52

Switches—Toggle, Push-Button, Slide & Telephone

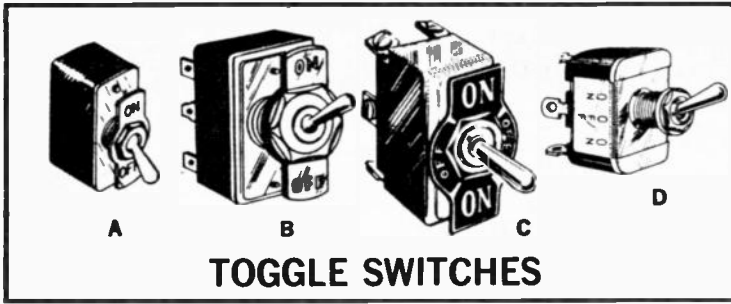

TOGGLE SWITCHES

(A) SPST BAT HANDLE

Rated 3 amps—125V. Body size 1½x3/4x1/2" behind panel. Bushing 7/16" diam. 7/16" long. Bat handle 1/2" long. Shpg. wt., 3 oz. Imported.
 99 E 61509 Net ea. .28
 In lots of 10, ea. .25

(B) HEAVY DUTY 6 AMP DPDT

Rated 250V at 3 Amps or 125V at 6 amps. Switch body 1½ x 3/4 x 7/8" behind panel including terminals. Bushings 15/32" Dia. 7/16" long. Bat handle 1/2" long. Shpg. wt., 3 oz. Imported.
 99 E 61517 Net ea. .39
 In lots of 10, ea. .35

(C) 6 AMP. DPDT CENTER OFF

Rated 6 amps, 125 V.A.C. 1½x3/4x1" behind panel including screw terminals. Bushing 7/16 x 7/16". 5/8" bat handle. Shpg. wt., 3 oz. Imported.
 99 E 61483 Net ea. .49
 In lots of 10, ea. .45

(D) 10 AMP. SPDT CENTER OFF

Rated 10 amps at 125V. Silvered lugs for low loss connections. Body size 1½x9/16x 5/8" depth behind panel. Bushings 3/8" Dia., 7/16" long. Bat handle 1/2" long. Shpg. wt., 3 oz. Imported.
 99 E 61558 Net ea. .39
 Lots of 10, ea. .35

DELAY ACTION SWITCHES FOR HOME AND CAR

- Keeps light on for 60 seconds after turning off switch
- FOR YOUR SAFETY**



For the car. Keeps car lights on for 60 seconds while you walk to house then turns them off automatically. Easy to install in any 6 or 12 volt car. 3/4 x 1½" diam.
 34 E 46010 (Fig. B) Shpg. wt., 6 oz. Net 2.39

For the home. Install in regular wall outlet. Keeps outside lights on for 60 seconds while you go to car. Rated 10 amps 125V.
 34 E 38058 (Fig. A) Shpg. wt., 5 oz. Net 2.39

SLIDE SWITCHES AT LOW PRICES



Compact slide switches in cadmium steel housings. All rated 3 amp at 125 volts AC. 1½" mounting centers. Shpg. wt., 3 oz.

Stock No.	Circuit	Each	Lots 10 Lots 100	
			Each	Each
34 E 37035	SPST	.14	.12	.10
34 E 37043	SPDT	.15	.13	.11
34 E 39114	DPST	.19	.17	.14
34 E 39122	DPDT	.20	.18	.15

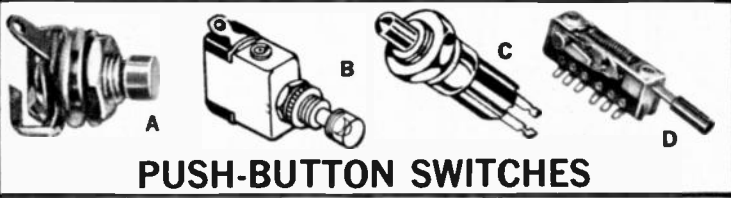

PUSH-BUTTON SWITCHES

(A) MINIATURE MOMENTARY

Momentary contact push-button switch ideal for all miniaturized applications. Single pole two circuit push-to-make type. Beryllium copper leaf contacts. Overall diameter 1/2", overall depth 11/16", protrudes 3/8" behind panel. Bushing 1/4" dia., 3/16" long. Supplied with washer and mounting nut. Shpg. wt., 3 oz. Imported.
 99 E 62184 Miniature Push-Button Switch .19
 In Lots of 10, ea. .17

(B) ILLUMINATED P.B. SWITCH

A compact illuminated switch which will indicate mode of operation at a glance. Button lights in "N" position takes no more space than conventional switches. Lamp is built into push handle. SPST Type. Current capacity, 10 Amps at 125VAC, 6A at 250V AC; insulation resistance, 100 meg ohms or more at 500V DC. Solder terminals. Single-hole mtg. Mount in 13/64 hole, 1½" behind panel. Shpg. wt., 4 oz. Imported.
 99 E 61921 Net 1.75

(C) SUB-MINIATURE MOMENTARY

Momentary contact push button switch. SPST, non-snap action. Rated 115V AC at 100 ma. Overall dimensions 3/8x3/4"L. Bushing 1/4" long. Shpg. wt., 1 oz. Imported.
 99 E 61590 Net ea. .23
 5 For .99

(D) MINIATURE 4 PDT SPRING RETURN

Push button switch, ideal for ham or citizens band. Rated at 800 milliamp for 100V AC. Ideal for transistor application. Heavy duty spring. Two circuit operation. Measures 1½x 5/16x1/2" plus 1/2" plunger. Shpg. wt., 3 oz. Imported.
 99 E 61756 Net ea. .49

3PDT AC-DC SLIDE SWITCH

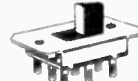

29¢

3 PDT AC-DC Slide Switch: Rated at 500 microamps at 100V. Solder lug terminals. Measures 3/4"Wx1¾"Lx7/8"D. Overall including 5/16" trigger. Mounting centers 1½". Shpg. wt., 3 oz. Imported.
 99 E 61665 Net ea. .29
 In lots of 10, ea. .25

ULTRAMINIATURE SPDT SLIDE SWITCH



29¢

Exceptionally shallow design—only 1/8" deep for panel mounting. Contact resistance: 1/20 ohm or less; insul. res., 20 megohms at 500V DC, max. AC current 0.5 amps. Withstands 600V AC. Size: 5/8x1/8x5/16". Size of switch body, mounting ears add 1/2" to overall length. Mfg. centers 1". Shpg. wt., 2 oz. Imported.
 99 E 61897 Net .29

RUGGED TELEPHONE TYPE 4PDT LEVER SWITCH

CHROME PLATED CAM



69¢

Telephone Type 4 PDT. Lever switch: 3 position lever action switch of non induction construction. Has 4 sets of SPDT contacts—Has 3 locking positions—Heavy insulated rollers. Panel mount, 15/16" mounting centers. Size: 2½" long behind panel, 5/8Wx1¾"H. Shpg. wt., 3 oz. Imported.
 99 E 61491 Net ea. .89
 In lots of 10, ea. .83

MINIATURE DPDT SLIDE SWITCH



29¢

Perfect for ultra-small switch applications. Rated current capacity, 3 amps at 125 volts. Can withstand up to 1000V AC. Solder lug terminals. Measures 15/16L x 1/4W x 3/8"D. Mounting centers: 13/16". Shpg. wt., 1 oz. Imported.
 99 E 61863 Net .29

4PDT MINIATURE SLIDE SWITCH



Panel mount. Current capacity 500 ma at 100V AC. Contact resistance 1/2 ohm at 500 volts. Measures 1½x5/16Wx9/16"D. Mounting center 1½". Shpg. wt., 3 oz. Imported.
 99 E 61764 Net ea. .59
 In lots of 10, ea. .55

DUAL-SPEAKER FADER CONTROL



Controls the volume of both front and rear speakers. Gradually reduces volume on one speaker while increasing volume on the other. Control comes completely mounted on black and silver metal plate with ivory pointer knob plus attached wiring for connections to both speakers. With mtg. hardware and instructions.
 99 E 85078 Shpg. wt., 8 oz. Net .64

Switches for Industry and Experimenters

MAGNETIC PROXIMITY SWITCH



- Magnet Switch—Circuit Closes When Magnet Approaches Switch
- Activating Magnet Supplied
- Hermetically Sealed

An ingenious little device that has untold uses in the home—in a burglar alarm system, electric trains, "magic tricks," and many more. As the magnet approaches the switch, the circuit closes. Hermetically sealed; precious metal contacts; 1 milli-second actuation. 15 watts resistive max. up to 1 amp to 250 volts. Size: 2 3/8" with leads. 34 E 44015 Shpg. wt., 3 oz. Net 1.74

MIDGET-BAKELITE KNIFE SWITCHES

As Low As

19^c

Complete switches mounted on black bakelite base with insulated knob handle of black bakelite. Plated brass contacts provide positive low-resistance connection. Imported.

SPDT KNIFE SWITCH

Overall size 1 1/2 x 2 3/8". Shpg. wt., 6 oz. 99 E 61925 Net .19 ea.—10 for 1.69

DPDT KNIFE SWITCH

Overall size 1 3/4 x 2 3/8". Shpg. wt., 4 oz. 99 E 61533 Net .25 ea.—10 for 2.25

ILLUMINATED "SEE-SAW" SWITCH

99^c

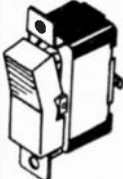

SPST. Flip action, rocker arm type, rated at 125V AC, 10 amp. Illuminated. Mounts flush in panels up to 1/8" thick. Requires mounting hole 1 1/4 x 5/8". Mtg. centers 1 1/2". Shpg. wt., 2 oz. Imported. 99 E 62598

Net ea. .99
Lots of 10 ea. .89

RUGGED LEVER SWITCH FOR AUDIO AND INTERCOMS

99^c

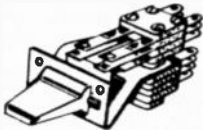

4PDT Audio Lever Switch: Has 2 dual sets of single pole, double throw contacts. One set is momentary contact-spring return, (press-to-talk), in the reverse position of the lever (dictate), the second set of contacts remain in the positive position until released. Panel mounting, mtg. centers 1" apart. Size 2 1/4" long behind panel. 1 3/8" W x 1" H. Imported. Shpg. wt., 3 oz. 99 E 61562

Net ea. .99

3-WAY SPEAKER SWITCH



Gives choice of front speaker alone, rear speaker alone, or both together. Comes completely assembled on black and silver metal plate with ivory knob and cable for connection to both speakers. With hardware and simple instructions. Imported. 99 E 65086 Shpg. wt., 1/2 lb. Net 4.9

HEAVY DUTY LOCK SWITCH



- For Burglar Alarm Systems
- Hidden Auto Disconnect

Heavy duty bakelite construction insures minimum internal resistance and greater current carrying capacity. Extra heavy contacts. Terminals set for simple installation—well recessed to prevent shorting. Installs in any hole from 3/4" to 1 1/4" in dia., in any panel up to 3/4" thick. Two terminal single throw. Key can be removed in both "on" and "off" position. Prevents tampering with automotive equipment. Activates alarm systems—only key can shut off. Suitable for marine equipment. With 2 keys. Wt., 8 ozs. 33 E 64015 Net 1.29

MASTER DISCONNECT SWITCH



- Disconnects Battery & Generator Circuits With A Single Switch

With a flip of a single lever protect cars, boats against fires resulting from shorts, battery run down due to appliances unknowingly left on, theft by ignition "jumping" (when mounted in concealed position). Perfect for cars, boats, heavy equipment. All steel construction, operates on ball bearings for quick, easy operation and rapid reset. Fits 6 or 12 volts. Shpg. wt., 1 lb. 11 E 67012 Net 6.75

DPDT "SEE-SAW" SWITCH

49^c



Flip action, rocker arm type equipment switch. Mounts flush in panel up to 1/8" thick. Requires rectangular mounting hole 1/2 x 1 1/4" long. Mtg. centers 1 3/8". Rated 4 amps at 125V AC. Imported. 99 E 61574 Shpg. wt., 2 oz. Net ea. .49

Lots of 10 ea. .45

4 POLE-3 POSITION

39^c



Four pole rotary selector switch, 3 positions per pole. Useful in hi-fi preamps and stereo applications. Spring loaded, positive detent action. Shorting type. Over-all diameter 1 1/4". Depth behind panel, including lugs, 3/4". Bushing 3/8 x 3/8" 1/4" knurled shaft, 1 1/4" long. Shpg. wt., 3 ozs. Imported. 99 E 61586 Net .39 Lots of 10. ea. .35

3-WAY PUSH-BUTTON SWITCH



Just push a button to select either front speaker alone, rear speaker alone or both together. Comes completely assembled on black & silver metal plate with cable, hardware and simple instructions. Imported. Shpg. wt., 1/2 lb. 99 E 65102 Lots of 3, ea. .75 singly, ea. .89

HART AND HEGEMAN MOMENTARY PUSH BUTTON SWITCHES



Metal base push switches with laminated phenolic sections, slotted sleeve 15/32 diam., 7/16" long. All have solder lug terminal, and plain tops except "P". Those shown as red and black are supplied with detachable insulated stem coverings. Complete with mounting ring and nut. Rated 1 A. 125 VAC. Shpg. wt., 3 oz.

Stock No.	Insulator	Mfg. No.	Net Each		
			1-24	25-50	50-99
2 CIRCUIT—ONE N.O., ONE N.C.					
34 E 34503	—	3392E	.94	.88	.74
34 E 34511	Red	3392A	1.17	1.10	.92
34 E 34529	Black	3392A	1.17	1.10	.92

Identical to the above switches except slotted sleeve is 15/32" by 9/16" long. Shpg. wt., 3 oz.

2 CIRCUIT—ONE N.O., ONE N.C.					
34 E 34537	—	3392	.94	.88	.74
34 E 34545	Red	3392AE	1.17	1.10	.92
34 E 34552	Black	3392AE	1.17	1.10	.92

NORMALLY CLOSED—SPST					
34 E 34560	—	3391	.73	.68	.57
34 E 34578	Red	3391GJ	.96	.90	.75
34 E 34586	Black	3391GJ	.96	.90	.75

NORMALLY OPEN—SPST					
34 E 34594	—	3391E	.73	.68	.57
34 E 34602	Red	3391GL	.96	.90	.75
34 E 34610	Black	3391GL	.96	.90	.75

Type 3391-194 Snap-On Insulator Buttons for any of the above switches. Wt. 1 oz. 34 E 34628 Red Net ea. .22 34 E 34636 Black Net ea. .22

SWITCHCRAFT TINI-SWITCH

Subminiature push-button switch for use in limited space applications. Specially useful in miniaturized-transistor devices, microphones, intercoms or wherever an extra small switch is desired. One-piece plastic shaft available in red or black. Suitable for low level circuits only. NO=normally open. NC=normally closed. Threaded 1/4" bushing. 11/16" long, requires 3/8" behind panel. Shpg. wt., 3 oz.



Black Type

Stock No.	Mfg. No.	Contacts	Net Ea. in Lots of		
			1-24	25-50	50-99
34 E 60011	961	SPST-NO	.57	.53	.48
34 E 60029	962	SPST-NC	.57	.53	.48
34 E 60037	963	SPOT	.66	.61	.55

Red Type

34 E 60045	951	SPST-NO	.57	.53	.48
34 E 60052	952	SPST-NC	.57	.53	.48
34 E 60080	953	SPOT	.66	.61	.55

MINIATURE ROTARY SWITCH

3 GIANG 9 POLE 3 POSITION

79^c ea.

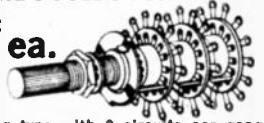

Non-shorting type with 3 circuits per gang or section. Rated current capacity is 50 ma at 100 VAC. Insulation resistance 100 megohms at 500 VDC. Contact resistance without load is 1/100 ohm at 6 VDC. Perfect for transistor applications. Mounting depth is 1 1/2". Imported. Shpg. wt., 4 oz. 99 E 61715 Net 7.99

MALLORY Switches and Dial Plates



CERAMIC SELECTOR SWITCHES

Ideal for RF circuits. All non-shorting. Ceramic insulation, silver plated contacts. $\frac{1}{2}$ " spacing between gangs except 1" on 3 gang. Voltage breakdown 500V AC or DC. Max. non-breaking resistive load is 10 amps. 1" mtg. radius. Notched shaft $2\frac{1}{2} \times \frac{1}{4}$ " diameter with $\frac{3}{8} \times \frac{3}{8}$ " bushing. Adjustable stop. Type with * have added "OFF" position preceding others. With knob, nut and lock washer. Shpg. wt., 8 oz.

SINGLE GANG

Stock No.	Mfg. No.	Poles Pos.		1-4 Each	5-9 Each
		Per Gang	Per Pole		
30 E 40573	172C	1	11	2.64	2.20
30 E 40581	173C*	2	5	2.64	2.20
30 E 40599	174C*	3	3	2.64	2.20

TWO GANG

Stock No.	Mfg. No.	Poles Pos.		1-4 Each	5-9 Each
		Per Gang	Per Pole		
30 E 40607	176C	1	11	3.77	3.15
30 E 40615	177C*	2	5	3.77	3.15
30 E 40623	178C*	3	3	3.77	3.15

THREE GANG

Stock No.	Mfg. No.	Poles Pos.		1-4 Each	5-9 Each
		Per Gang	Per Pole		
30 E 40631	180C	1	11	4.80	4.00
30 E 40649	181C*	2	5	4.80	4.00



DECADE SWITCHES

Type 153L capacitor switch and 154L resistor switch for simple construction of decade boxes (up to 10 positions). Phenolic insulation. The number of positions is adjustable for use as a single decade or with more switches as a multiple decade. Requires only 4 capacitors or resistors for full decade operation. Depth behind panel is 1". Lateral space 2". Voltage breakdown rating 500V DC or AC. Shaft 2" long x $\frac{1}{4}$ " diameter. With knob and hardware. Shpg. wt., 8 oz.

Stock No.	Type	1.4 Each	5.9 Each
30 E 41266	153L	3.00	2.50
30 E 41274	154L	3.27	2.72

Type 389 Dial Plate for above 1
30 E 40839 Net .12

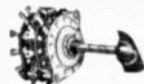

MULTIGANG ROTARY SWITCHES

Phenolic wafers. $\frac{1}{2}$ " spacing between gangs except 3 and 4 gang is 1". Indexing is 30°. Have 1 fixed and 1 adjustable stop. Voltage breakdown 1000V AC or DC. Contacting members silver coated 2" notched shaft requires $\frac{1}{2}$ " mtg. hole. Types with * have additional off position with all circuits open. With bar knob, nut and lock washer. Avg. shpg. wt., 8 oz.

Stock No.	Non-Shorting Mfg. No.	Gang	Pos. Poles	Total Pole	Pos.
					1-4 Each
30 E 40417	1311L	1	1	11	2.33
30 E 40425	1315L*	1	2	5	2.33
30 E 40433	1313L*	1	3	3	2.33
30 E 40441	1312L*	1	4	2	2.33
30 E 40458	1321L	2	2	11	2.87
30 E 40466	1325L*	2	4	5	2.87
30 E 40474	1323L*	2	6	3	2.87
30 E 40482	1322L*	2	8	2	2.87
30 E 40490	1331L	3	3	11	3.60
30 E 40508	1335L*	3	6	5	3.60
30 E 42686	1333L*	3	9	3	3.60
30 E 42694	1332L*	3	12	2	3.60
30 E 40516	1341L	4	4	11	4.24
30 E 40524	1345L*	4	8	5	4.24
30 E 42660	1343L	4	12	3	4.24
30 E 42678	1342L*	4	16	2	4.24
30 E 40532	1351L	5	5	11	4.57
30 E 40540	1356L*	5	10	5	5.04
30 E 40557	1361L	6	6	11	5.37
30 E 40565	1366L*	6	12	5	6.14



MINIATURE PUSH-BUTTON SWITCHES

Non-locking type, contact made only when depressed. Silver contacts, cadmium plated frame. Mount in $\frac{3}{16}$ " hole on up to $\frac{1}{4}$ " panels. Mtg. radius $1\frac{1}{4}$ ". Mtg. depth $\frac{3}{16}$ " min to $\frac{7}{16}$ " max. Circuit codes: M=make, B=break, MBB =make before break. Voltage breakdown 500 V DC. With hardware. Shpg. wt., 3 oz.

Stock No.	Mfg. No.	Circuit	Net Ea.
30 E 41118	1011	SPST-M	.77
30 E 41126	1012	SPST-B	.77
30 E 41134	1013	SPDT	.87
30 E 41142	1014	DPST-M2	.97
30 E 41159	1015	DPST-B2	.97
30 E 41167	1016	DPDT	1.17
30 E 41175	1017	DP-M2B1	1.17
30 E 41183	1018	DPDT-MBB	1.60



MINIATURE LEVER SWITCHES

Phenolic type all are single section type. Contact rating is 350 MA at 500 volts RMS resistive load. 30° indexing. Mtg. holes $1\frac{5}{8}$ " apart. * are positive action and spring return. † are spring return. Supplied with lever knob. Shpg. wt., 3 oz.

SHORTING TYPES

Stock No.	Mfr. No.	Cir. Pos.	1-4	5-9	10-24
			Pos. Ea.	Ea.	Ea.
30 E 41472	6M1213	2	3	1.26	1.05 .95
30 E 41498	6M1213U*	2	3	1.26	1.05 .95
30 E 41506	6M1412S†	4	2	1.44	1.20 1.08

NON SHORTING TYPES

Stock No.	Mfr. No.	Cir. Pos.	1-4	5-9	10-24
			Pos. Ea.	Ea.	Ea.
30 E 41514	6M2213	2	3	1.26	1.05 .95
30 E 41522	6M2213S†	2	3	1.26	1.05 .95
30 E 41530	6M2213U*	2	3	1.26	1.05 .95
30 E 41548	6M2412S†	4	2	1.44	1.20 1.08



LEVER ACTION SWITCHES

Positive action, phenolic sections. 6000 series have mtg. brackets with round holes $1\frac{3}{8}$ " apart; 5000 series have elongated holes in bracket with $2\frac{3}{8}$ " centers. Voltage rating 500 VAC-DC. Max. nonbreaking current resistive load, 6 amp. at 6 VAC. 20° indexing with knob and hardware. Shpg. wt., 4 oz.

Stock No.	Mfg. No.	Poles Pos.		1-4 Each	5-9 Each
		Per Gang	Per Pole		
30 E 41209	5124	2	4	1.54	1.28
30 E 41217	6142	4	2	1.33	1.11
30 E 41225	6143	4	3	1.33	1.11

Non-Shorting

Stock No.	Mfg. No.	1-4	5-9		
30 E 41233	5224	2	4	1.54	1.28
30 E 41241	6242	4	2	1.33	1.11
30 E 41258	6243	4	3	1.33	1.11

UNIVERSAL MOUNTING BRACKET

"L" shape. For rear support of switches. Shpg. wt., 2 oz.

30 E 41100	Type RB254	Net. .05
------------	------------	----------



24 POSITION TAP SWITCH

Single circuit 24 positions, continuous rotation with no stops. 15° spacing between positions. Non-shorting. 2" notched shaft. $\frac{3}{8} \times \frac{3}{8}$ " bushing. 2 phenolic sections. Voltage breakdown 1000V AC-DC. With knob, hardware and dial plate. Shpg. wt., 6 oz.

30 E 41191 Mfg. No. 13124L

Net ea. 3.07

DIAL PLATES

Silver markings on black background. Use 30° spacing plates for all Mallory 1200 L and 1300 L series switches and for 1 $\frac{1}{4}$ " base. 3100 J and 3200 J series. 20° spacing for 1 $\frac{1}{8}$ " base switches in latter series. 1 $\frac{1}{8}$ " diam. $\frac{1}{8}$ " hole. Shpg. wt., 2 oz.

20° Spacing		30° Spacing		20° Spacing		30° Spacing	
Stock No.	Stock No.	Marking	Stock No.	Stock No.	Marking	Stock No.	Marking
—	30 E 40664	1 to 2	30 E 40961	30 E 40771	Off 1 to 3	—	—
—	30 E 40672	1 to 3	30 E 40979	30 E 40789	Off 1 to 4	—	—
—	30 E 40680	1 to 4	30 E 40987	30 E 40797	Off 1 to 5	—	—
30 E 40870	30 E 40698	1 to 5	30 E 40995	30 E 40805	Off 1 to 6	—	—
30 E 40888	30 E 40705	1 to 6	30 E 41019	30 E 40813	Off 1 to 7	—	—
30 E 40896	30 E 40714	1 to 7	30 E 41027	30 E 40821	Off 1 to 8	—	—
30 E 40904	30 E 40722	1 to 8	30 E 41035	30 E 40829	Off 1 to 9	—	—
30 E 40912	30 E 40730	1 to 9	30 E 41068	30 E 40847	Off 1 to 10	—	—
30 E 40920	30 E 40748	1 to 10	30 E 41076	—	Off 1 to 11	—	—
30 E 40938	30 E 40755	1 to 11	30 E 41043	—	Off 1 to 14	—	—
—	30 E 40763	1 to 12	30 E 41092	—	Off 1 to 16	—	—
30 E 40953	—	1 to 17	—	—	—	—	—

ANY OF ABOVE NET EACH .12



PHENOLIC MINIATURE ROTARY SWITCHES

Stators and rotors use Richardson T725 grade phenolic. Has common contact on same side as the switching contacts. Commercial equivalent to MIL-S-3786. Breakdown voltage between contacts, and contacts and frames is 1700 V R.M.S., 60 cycles. Contact rating is 350 MA at 500 volts R.M.S. resistive load. Shaft is 2" long by $\frac{1}{4}$ " dia. with $\frac{1}{2}$ " spacing between wafers. Wafers are $1\frac{1}{4}$ " dia. and 30° indexing. Over-all dia. $1\frac{1}{8}$ ". Supplied with knob, adjustable stop, lock washer and nut. Shpg. wt., 3 oz.

Stock No.	Non-Shorting Mfr. No.	Cir. Per Sec.	Sec.	Pos.	1-4	5-9
					Ea.	Ea.
30 E 41720	4M21111	1	1	11	1.80	1.50
30 E 41738	4M2215	2	1	5	1.80	1.50
30 E 41746	4M21211	1	2	11	2.58	2.15
30 E 41753	4M2313	3	1	3	1.80	1.50
30 E 41761	4M21311	1	3	11	3.24	2.70
30 E 41779	4M2412	4	1	2	1.80	1.50
30 E 41787	4M2225	2	2	5	2.58	2.15
30 E 41795	4M21411	1	4	11	3.81	3.18
30 E 41803	4M21511	1	5	11	4.47	3.73
30 E 41811	4M2323	3	2	3	2.58	2.15
30 E 41829	4M2235	2	3	5	3.24	2.70
30 E 41837	4M21611	1	6	11	5.04	4.20
30 E 41845	4M2422	4	2	2	2.58	2.15
30 E 41852	4M2245	2	4	5	3.81	3.18
30 E 41860	4M2255	2	5	5	4.47	3.73
30 E 41866	4M2265	2	6	5	5.04	4.20



Rotary and Foot Switches

MALLORY SINGLE GANG ROTARY SWITCHES

Single gang, phenolic wafer, 1 1/4" diameter and 30° indexing except * are 1 1/8" and have 20° indexing and adjustable stop. Voltage breakdown 300 V AC or DC. 2" notched shaft with 3/8" threaded bushing, 3/8" long. With bar knob, nut and lockwasher. Shpg. wt., 4 oz.

Shorting Type		Non-Shorting		Posi- Poles	tions	1-4 Each	5-9 Each	10-24 Each	25-49 Each	50-95 Each
Stock No.	Mfg. No.	Stock No.	Mfg. No.							
30 E 40011	3115J	30 E 40138	3215J	1	5	1.13	.94	.86	.81	.76
30 E 40020	3112J	30 E 40144	32112J	1	12	1.13	.94	.86	.81	.76
30 E 40037	3122J	30 E 40151	3222J	2	2	1.13	.94	.86	.81	.76
30 E 40045	3123J	30 E 40189	3223J	2	3	1.13	.94	.86	.81	.76
30 E 40052	3126J	30 E 40177	3226J	2	6	1.13	.94	.86	.81	.76
30 E 40060	3134J	30 E 40185	3234J	3	4	1.17	.98	.88	.83	.78
30 E 40078	3142J	30 E 40193	3242J	4	2	1.17	.98	.88	.83	.78
30 E 40086	3143J	30 E 40201	3243J	4	3	1.95	.98	.88	.83	.78
30 E 40094	31117J*	30 E 40219	32117J*	1	17	1.79	1.45	1.30	1.23	1.16
30 E 40102	3129J*	30 E 40227	3229J*	2	9	1.79	1.45	1.30	1.23	1.16
30 E 40110	3136J*	30 E 40235	3236J*	3	6	1.83	1.53	1.39	1.31	1.22
30 E 40120	3136J*	30 E 40243	3236J*	6	3	1.83	1.53	1.39	1.31	1.22



ALL PURPOSE SWITCHES

Single section phenolic type 2" long by 1/4" dia. shaft with 3/8" bushing. Supplied with knob lockwasher and nut except 1 uses knurled shaft, no knob furnished. *Spring return feature. S HAS AC Line Switch. Shpg. wt., 3 oz.

SHORTING TYPES					
Stock No.	Mallory No.	Cir.	Pos.	1-4 Each	5-9 Each
30 E 49194	4M1114DS	1	4	1.00	1.50
30 E 49202	5M1112	1	2	1.00	.90
30 E 49210	5M1113	1	3	1.00	.90
30 E 49226	5M1113K†	1	3	.75	.63
30 E 49236	5M1213	2	3	1.00	.90

NON-SHORTING TYPES					
Stock No.	Mallory No.	Cir.	Pos.	1-4 Each	5-9 Each
30 E 49244	4M2412S*	4	2	1.44	1.20
30 E 49251	5M2213*	2	3	1.00	.90

TAPESWITCH MATS—STRIPS AND ALARMS

Tapeswitch mats and strips close an electrical circuit. They may be used to activate annunciators in stores, offices, etc.; used to control automatic door openers in food and department stores; can be used to turn on lights, ring bells, actuate electric counters, etc. Perfect for alarm systems in homes, stores and industry.

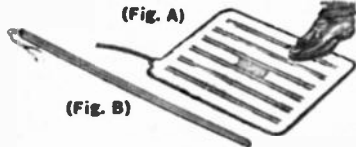

Tapeswitch Flexible Switch Mats (Fig. A). Less than 5 lbs. pressure activates these mats. Although rated and tested at 1 amp., 117VAC for floor switching, 24-volts or less is recommended. Only 3/32" thick; water-resistant durable covering. Shpg. wt.: 17 x 23" mat, 1 lb.; 6 x 23" mat, 6 oz. 17 x 23" Mat with 6' Cord.

33 E 66010 Net ea. 12.00
6 x 23" Stair Tread Mat with 10' Lead.
33 E 66020 Net ea. 4.90

Tapeswitch Ribbon Switches (Fig. B). These "Press at any point" switches can be activated with only 12 oz. of finger pressure. Normally open, momentary contact type with 4' leads. Moisture-proof chrome yellow vinyl cover. Only 9/16" thick. Rated 1 amp., 117 VAC or 28 VDC. Shpg. wt.: 2' length, 4 oz.; 5' length, 7 oz.

33 E 66036 2' length Net ea. 3.20
33 E 66044 5' length Net ea. 5.84

CUT TO LENGTH SWITCHING RUNNER

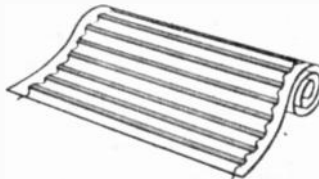

5-ft. long x 30" wide x 1/8" thick and can be cut to any length. 5 lbs. nominal foot pressure. Solder or twist connections easily made. Excellent extended area signaling for concealed indoor alarms and controls. Switching elements on 2 1/2" centers are wired in parallel and covered in a polyethylene envelope. For indoor use only. Install under rug, rubber runner, mat or tile. Wt., 1 1/2 lbs. 33 E 66077 Net 13.40



100-WATT FOOTSWITCH

"Tapeswitch"—Long-life foot-switch, rated at 100 watts. Uses Conترفlex in molded flat pad 2" x 5" x 1/4" thick. Complete with 6' U.L. listed lead. Sealed, weather-proof. Momentary, normally-open contacts. Non-tiring, user can stand on it, jump on it. Can be taped or cemented to floor. Wt., 12 oz. 33 E 66069 Net 3.04

CHIME ANNUNCIATOR KIT



22⁹⁵

- Announces Visitors
- Guards Against Theft

TS-1 Annunciator Kit—Complete entrance signal system for stores, homes, offices, shops, etc. Kit contains CVP 1723 (17" x 23") switch mat, dual-note chime, plug-in transformer, 24/2 lead wire 25-ft. long, hardware, and installation instructions. Easy to install. 117VAC. Shpg. wt., 4 lbs.

33 E 66051 Net 22.95

LINEMASTER FOOT SWITCHES

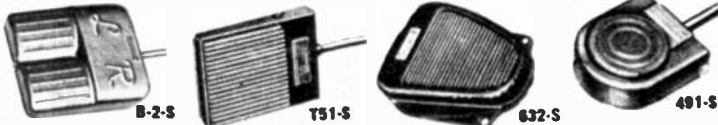

Model B-2-S "Executive". Two momentary SPDT switches side by side. Interlock prevents both circuits from being operated at same time. Both sides normally off when not in use. 15 amps, 125 VAC. 4 1/2" x 4 1/4". Shpg. wt., 14 oz.

34 E 36006 Net ea. 7.50
Model T51-S "Treadlite". Compact, rugged. SPDT momentary contacts rated 7 amps at 125-250v. AC, 1/2 H.P. at 115v. AC. Rubber tread and skid-proof base 3 1/2" x 2 1/4" x 1".

34 E 36011 Wt. 7 oz. Net ea. 2.75
Model T51-SC—Same with a six ft. cord and two prong series plug. Shpg. wt., 1 lb.

34 E 36029 Net ea. 4.00
Model T-51-SC3—Same as above but with 3 conductor cord and 3 prong grounded series plug. Shpg. wt., 1 1/2 lb.

34 E 36076 Net ea. 5.80

Model 632-S "Clipper". Momentary contact with SPDT, rated at 20 amps 125-250v. AC, 1 HP 115-230v. AC. Cast iron housing, skid-proof base pad, black wrinkle finish. Size 4 1/2" x 3 1/2" x 1 1/2". Shpg. wt., 2 1/4 lbs.

34 E 36052 Net ea. 6.25
Model 632-D. Same as 632-S but maintains contact until again actuated.

34 E 36060 Wt. 2 1/4 lbs. Net ea. 11.00
Model 491-S "Compact"—SPDT momentary contacts rated 10 amps 125v. AC, 1/2 HP at 115v. AC. Steel housing, black wrinkle finish, skid-proof base. 2 1/2" x 2 1/2" x 1". Wt., 7 oz.

34 E 36037 Net ea. 3.25
Model 491-SC. Same with six foot cord and two prong plug. Shpg. wt., 7 oz.

34 E 36045 Net ea. 5.00

LAFAYETTE FOOT SWITCH



Only 2²⁵
Keeps Your Hands Free!

Ideal treadle switch for bench tools etc. SPST momentary contact rated at 10 amps. 125v. AC. Steel housing, grey crackle finish. Skidproof base, 6 ft., series wired cord. 2 1/2" x 2 1/2" x 1". Shpg. wt., 1 lb. Imported.

99 E 60707 Net 2.25

Antenna Wire - Guy Wire - Speaker and Zip Cord



SHIELDED "CONCO-FOAM"

- All Channel Color TV and FM Cable
- Assures excellent VHF, UHF, COLOR and B/W T.V. and FM reception in crowded areas where reception is critical. Mylar-aluminum shielding provides strong and clean signals, eliminating electrical noise and ghost signals, 22 gauge, solid copperweld conductors, foam insulation, mylar-aluminum foil shield, stranded tin copper down wire, black polyethylene outer jacket. Spade terminals included. 3 lbs. per 100 ft. Only in lengths listed below.
- | | | |
|------------|--------------|----------|
| 32 E 31867 | 50 ft. coil | Net 4.39 |
| 32 E 31875 | 75 ft. coil | Net 5.99 |
| 32 E 31883 | 100 ft. coil | Net 7.89 |



FOAM-TV TWIN LEAD

- For UHF-VHF and Color TV
- A flat 300-ohm twin lead with the conductors totally encased in and surrounded by polyethylene foam with an outer black polyethylene jacket. Has high resistance to ultraviolet rays, oil, fumes, moisture, salt air and abrasion. 20-gauge stranded copper conductors. Available only in lengths listed below. Shpg. wt. 2 1/4 lbs. per 100 ft.
- | | | |
|------------|---------------|-----------|
| 32 E 36031 | 50-ft. Coil | Net 2.00 |
| 32 E 36049 | 100-ft. Coil | Net 3.79 |
| 32 E 36015 | 500-ft. Coil | Net 16.99 |
| 32 E 36023 | 1000-ft. Coil | Net 33.50 |



LIFELINE COPPERWELD TWIN LEAD

- Guaranteed for Life of Your Antenna
- Guarantee: If this deluxe 300 ohm line fails to last the life of your antenna we will replace it at no charge. 20 Gauge Copperweld (copper clad steel) conductors with finest brown polyethylene insulation. Chemically protected against deterioration. Special "waste free" dispenser package. Shpg. wt. 3 1/8 lbs. Per 100 ft.
- | | | |
|------------|-----------------|-----------|
| 32 E 36163 | 100 ft. package | Net 2.49 |
| 32 E 36480 | 1000 ft. | Net 23.30 |

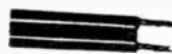

300 OHM TWIN LEAD

BROWN. High quality, low-loss lead-in for all TV and FM installations. 55 mil polyethylene dielectric—22 gauge copper leads. Only in lengths listed below. Shpg. wt., 2 lbs. per 100 ft.

- | | | |
|------------|----------------|-----------|
| 32 E 89121 | 100 ft. coil | Net 1.40 |
| 32 E 89139 | 500 ft. coil | Net 6.85 |
| 32 E 89147 | 1,000 ft. coil | Net 12.81 |
- CLEAR. Same as above but clear for a better blend with the base boards.
- | | | |
|------------|-----------------|-----------|
| 32 E 89154 | 100 ft. spool | Net 1.68 |
| 32 E 89162 | 500 ft. spool | Net 7.51 |
| 32 E 89170 | 1,000 ft. spool | Net 14.11 |

HEAVY DUTY

300 ohm brown twin lead with 80 mil thick polyethylene insulation and 20 gauge copper conductors. Shpg. wt., 2 lbs. per 100 ft.

- | | | |
|------------|----------------|-----------|
| 32 E 89188 | 100 ft. coil | Net 1.74 |
| 32 E 36452 | 1,000 ft. coil | Net 15.54 |



ROTATOR CABLES

4 CONDUCTOR FLAT. Flexible stranded No. 20 copper encased in tough plastic insulation. Shpg. wt., 3 lbs. per 100' coil.

- | | | |
|------------|--------------|----------|
| 32 E 89105 | 100 ft. coil | Net 3.10 |
|------------|--------------|----------|

4 CONDUCTOR ROUND HEAVY DUTY. Belden 8489. All 18 gauge stranded flexible conductors, plastic insulated and jacketed. 6 lbs.

- | | | |
|------------|--------------|----------|
| 32 E 17106 | 100 ft. coil | Net 7.15 |
|------------|--------------|----------|

5 CONDUCTOR FLAT. Same construction as 4-cond. flat. Shpg. wt., 4 lbs.

- | | | |
|------------|-------------|----------|
| 32 E 36312 | per 100 ft. | Net 3.89 |
|------------|-------------|----------|

8 CONDUCTOR ROUND. Belden 8488, No. 22 stranded copper conductors. Vinyl insulated, vinyl jacket. In 100 ft. coils only.

- | | | |
|------------|--------------|----------|
| 32 E 14863 | 100 ft. coil | Net 5.70 |
|------------|--------------|----------|

8 CONDUCTOR ROUND HEAVY DUTY. Belden 8448. Similar to above but 2 conductors are 18 gauge.

- | | | |
|------------|--------------|----------|
| 32 E 14574 | 100 ft. coil | Net 8.55 |
|------------|--------------|----------|



ANTENNA WIRE

Finest grade high tensile strength copper for all antenna requirements. Avg. shpg. wt., 1 lb. Only in lengths listed below.

- | | | |
|------------|-------------------------|----------|
| 32 E 36189 | 75 ft. 7/22 bare | Net 2.18 |
| 32 E 36197 | 100 ft. 7/22 bare | Net 2.84 |
| 32 E 36221 | 75 ft. 7/26 bare | Net 1.03 |
| 32 E 36239 | 100 ft. 7/26 bare | Net 1.29 |
| 32 E 30091 | 100 ft. 12 solid enamel | Net 4.30 |
| 32 E 30109 | 100 ft. 14 solid enamel | Net 3.00 |

COPPERWELD. Copper outside conductor bonded to steel core. For ham antennas, commercial installations, non-stretch, hard drawn high conductivity copperweld wire.

- | | | |
|------------|------------------|----------|
| 32 E 36247 | 75 ft. 12 solid | Net 2.95 |
| 32 E 36254 | 100 ft. 12 solid | Net 3.92 |
| 32 E 36262 | 75 ft. 14 solid | Net 2.39 |
| 32 E 36270 | 100 ft. 14 solid | Net 3.65 |

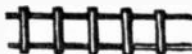

UHF-VHF OPEN LINE

300 OHM. Attenuation averages only 1.9 db over entire UHF band. No. 18 copperweld wire—pure polyethylene separators spaced at 6". Spaced only 1/2" between conductors. Shpg. wt., 2 1/2 lbs. per 100'. Available only in lengths listed below.

- | | | |
|------------|---------------|-----------|
| 32 E 36106 | 100 ft. coil | Net 3.41 |
| 32 E 36114 | 250 ft. coil | Net 8.10 |
| 32 E 36122 | 500 ft. spool | Net 15.78 |

450 OHM. Similar to above. 1" spacing between conductors.

- | | | |
|------------|---------------|-----------|
| 32 E 36130 | 100 ft. coil | Net 3.41 |
| 32 E 36148 | 250 ft. spool | Net 8.10 |
| 32 E 36155 | 500 ft. spool | Net 15.78 |

FIBERGLASS GUY WIRE

• Revolutionizes Ham and TV Antenna Systems • Non-Metallic Guy Line



A non-inductive, non-conducting, non-absorbing guy line for minimum loss. Provides 1000 pounds tensile strength. Eliminates unwanted radiation losses. Completely isolates the antenna system. Will not rot, shrink, stretch, or sag. Only in lengths listed below. Shpg. wt., 2 1/2 lbs. Per 100' spool.

- | | | |
|------------|---------|-----------|
| 32 E 45016 | 100 ft. | Net 5.19 |
| 32 E 45024 | 600 ft. | Net 29.95 |

STEEL GUY WIRE

Six strands of No. 20 high tensile strength galvanized steel wire.

- | | | |
|------------|------------------------------|------|
| 33 E 31014 | 50 ft. roll. Wt., 1 1/2 lbs. | 45 |
| 33 E 31022 | 100 ft. roll. Wt., 2 lbs. | 69 |
| 33 E 31030 | 500 ft. roll. Wt., 12 lbs. | 3.25 |

VINYL COVERED GUY WIRE

6 strands of No. 20-gauge high tensile strength galvanized wire. Weatherproof, non-stretch, long lasting. Ideal for TV guy wire, clothesline, and numerous garden uses. Translucent aqua green color.

- | | | |
|------------|-------------------------------|------|
| 32 E 36494 | 50 ft. roll. Wt., 1 1/2 lbs. | 1.05 |
| 32 E 36502 | 100 ft. roll. Wt., 2 1/2 lbs. | 1.98 |
| 32 E 36510 | 250 ft. roll. Wt., 6 1/2 lbs. | 4.82 |

ALUMINUM GUY WIRE

7-18 gauge stranded wires. Breaking strength 500 lbs. Shpg. wt., 2 lbs.

- | | | |
|------------|--------------|------|
| 34 E 48275 | 100 ft. roll | 2.49 |
|------------|--------------|------|

ALUMINUM GROUND WIRE

- No. 8 gauge solid conductor.
- | | | |
|------------|-------------------------------|------|
| 33 E 31048 | 50 ft. coil. Wt., 1 1/2 lbs. | 85 |
| 33 E 31055 | 100 ft. coil. Wt., 2 1/2 lbs. | 1.89 |
| 33 E 31063 | 500 ft. coil. Wt., 13 lbs. | 7.95 |



SET OF 2 STEREO CABLES

Set of 2—15 ft. speaker cables, each with spade lugs on all ends. Clear plastic covered polarized conductors, 24 gauge copper conductors. Shpg. wt., 1 lb.

- | | | |
|------------|---------|---------|
| 32 E 36488 | Per Set | Net .99 |
|------------|---------|---------|

ZIP-CORD MINIATURE PARALLEL CABLE

Multi purpose miniature zip cord. 2 conductor, 24 gauge stranded. Extremely flexible for Hi-Fi installations, auto speakers, low voltage control, etc. Available in white, brown, gray, clear.

- | | | |
|---------------------------------------|---------------|----------|
| Average shpg. wt., 2 lbs. per 100 ft. | | |
| 32 E 89238 | 25 ft. white | Net .47 |
| 32 E 89246 | 25 ft. brown | Net .47 |
| 32 E 89253 | 25 ft. gray | Net .47 |
| 32 E 89261 | 25 ft. clear | Net .47 |
| 32 E 89279 | 50 ft. white | Net .77 |
| 32 E 89287 | 50 ft. brown | Net .77 |
| 32 E 89285 | 50 ft. gray | Net .77 |
| 32 E 89303 | 50 ft. clear | Net .77 |
| 32 E 89311 | 100 ft. white | Net 1.22 |
| 32 E 89329 | 100 ft. brown | Net 1.22 |
| 32 E 89337 | 100 ft. gray | Net 1.22 |
| 32 E 89345 | 100 ft. clear | Net 1.22 |



SPEAKER-LAMP CORD

U.L. listed 2 conductor zipcord for lamps, speaker leads, etc. All No. 18 Gauge except * is 16 Gauge. Shpg. wt., 4 lbs. per 100 ft. Only in lengths shown below.

RUBBER INSULATION POSJ

- | | | |
|------------|------------|----------|
| 32 E 31727 | Black 25' | Net 1.40 |
| 32 E 31719 | Brown 25' | Net 1.40 |
| 32 E 31735 | Black 100' | Net 4.00 |
| 32 E 30505 | Brown 100' | Net 4.00 |
| 32 E 30513 | Brown 250' | Net 9.50 |

PLASTIC INSULATION POT

- | | | |
|------------|-------------|----------|
| 32 E 31743 | Black 25' | Net 1.40 |
| 32 E 31750 | *Black 25' | Net 2.50 |
| 32 E 31768 | Brown 25' | Net 1.40 |
| 32 E 31776 | *Brown 25' | Net 2.50 |
| 32 E 31784 | Gray 25' | Net 1.40 |
| 32 E 31792 | *White 25' | Net 1.40 |
| 32 E 31800 | Black 100' | Net 3.66 |
| 32 E 31818 | *Black 100' | Net 6.75 |
| 32 E 30026 | Brown 100' | Net 3.66 |
| 32 E 31826 | *Brown 100' | Net 6.75 |
| 32 E 31834 | Gray 100' | Net 3.66 |
| 32 E 31842 | *White 100' | Net 3.66 |
| 32 E 30497 | Brown 250' | Net 8.85 |



INDIVIDUALLY SHIELDED ZIP CORD

Two conductors No. 24 (7 x 32) individually shielded in spiral wrap. Gray plastic jacket over each conductor. Ideally suited for audio, hi-fi, stereo and laboratory use. Shpg. wt., 1 lb. per 25'.

- | | | |
|------------|-----------|----------|
| 32 E 31893 | 25' spool | Net 2.90 |
| 32 E 31701 | 50' spool | Net 3.33 |



Coaxial and Special-Purpose Cable



RG LOW-LOSS COAXIAL CABLES

Excellent for RF, amateur and citizens band applications. All branded with standard type numbers and meet requirements of RG cables on qualified products list of U.S. Government. O.D.: RG-8/U, RG-11/U, RG-11A/U .405"; RG-58/U, RG-58A/U .195"; RG-59/U .242. MMF/FT.:

RG-8/U 29.5; RG-11/U 20.5; RG-11A/U 20.5; RG-58/U 28.5; RG-58A/U 29.5. RG-59/U 21. Available only in lengths listed below. Average shpg. wt., per 100 ft., 12 lbs.

RG Type	Imp. Ohms	50 Ft. Length		100 Ft. Length		250 Ft. Lengths		500 Ft. Lengths	
		Stock No.	Net	Stock No.	Net	Stock No.	Net	Stock No.	Net
RG-8/U	52	32 E 17090	7.75	32 E 30315	14.40	32 E 17090	30.90	32 E 30323WX	57.75
RG-11/U	75			32 E 30349	12.45	32 E 17114	29.40	32 E 30358WX	49.95
RG-11A/U	75			32 E 30166	13.50			32 E 30216WX	57.75
RG-58/U	53.5	32 E 17122	2.91	32 E 30364	5.10	32 E 17130	11.05	32 E 30372WX	18.85
RG-58A/U	50	32 E 17148	3.23	32 E 30224	6.08			32 E 30232WX	22.15
RG-59/U	73	32 E 17155	3.35	32 E 30390	5.97	32 E 17163	13.50	32 E 30406WX	20.85

LOW LOSS POLYFOAM COAX

These polyfoam coaxial cables have basically similar constructional and physical specifications as the standard cables bearing the same RG number. Lower attenuation and capacitance result in signal strength increases up to 35%. 75 ohm cables are for TV and FM use while 50 ohm cables are ideal for amateur radio and CB. Available only in lengths listed.

RG-11/U 75 ohm coax feeder with non-peaking attenuation characteristics. Ideal for distribution lead-in.

32 E 31214 100 ft. coil Net 15.30

RG-59/U 72 ohm coax cable for improved FM and TV reception. Minimizes noise, ghosts and color smears. Recommended for color TV.

32 E 31248 100 ft. coil Net 8.50

RG 8/U. 50 ohm impedance cable with minimum signal loss and stray radiation for increased antenna system efficiency.

32 E 30463 100 ft. coil Net 14.85

RG-58/U. 53.5 ohm impedance cable with low loss and increased operation range for use in CB and amateur radio.

32 E 31180 100 ft. coil Net 5.90

RUBBER JACKETED SERVICE CORDS

U.L. listed, rubber sheathed service cord. Each stranded copper conductor has color coded rubber insulation, cotton wrapped with tough outer rubber jacket. Ideal for electronics equipment, household appliances, garden and power tools. 3V for light appliances; S1 for medium appliances and S for heavy duty equipment. Rated 300 volts maximum except S#14 and S#10 rated 600 volts. Available only in lengths shown below. Average shpg. wt., per 100 ft., 6 lbs.



U.L. Type	No. Strs.	Cond.	O.D.	Amps	25 Ft. Spool		50 Ft. Spool		100 Ft. Spool	
					Stock No.	Net	Stock No.	Net	Stock No.	Net
SV	18	2	.250"	5	32 E 30992	1.58	32 E 31008	2.95	32 E 31016	5.67
S1	18	2	.340"	7	32 E 31024	2.52	32 E 31032	4.57	32 E 31040	8.43
S1	18	3	.345"	7	32 E 31057	2.92	32 E 31065	5.12	32 E 31073	9.84
S1	16	3	.375"	7	32 E 31081	3.69	32 E 31099	7.09	32 E 31107	13.55
S	14	3	.500"	15	32 E 31115	6.77	32 E 31123	12.92	32 E 31131	25.05
S	10	3	.690"	25	32 E 31149	12.13	32 E 31156	22.45	32 E 31164	42.92

STEREO PHONO PICKUP WIRE

Extremely flexible, lightweight wire for all stereo cartridges and tone arms. No. 32 stranded 2, 3 and 4 conductor twisted miniature color coded cables. Low hum and noise pickup for best stereo performance. Shpg. wt., 10 ft., 4 oz.; 25 ft., 7 oz.

UNSHIELDED WIRE

Cond.	10 Ft. Spool		25 Ft. Spool	
	Stock No.	Net	Stock No.	Net
2	32 E 31263	.51	32 E 31271	.89
3	32 E 31289	.59	32 E 31297	1.38
4	32 E 31305	.75	32 E 31313	1.88

SHIELDED WIRE

*Individually shielded conductors

2	32 E 31321	.79	32 E 31339	1.38
3	32 E 31347	.89	32 E 31354	1.55
4	32 E 31362	1.20	32 E 31370	2.08
2*	32 E 31388	.95	32 E 31396	1.90

BELL WIRE

No. 18 solid, 2 conductor twisted pair. Plastic insulated. Shpg. wt., 3 lbs. per 100'.
32 E 36288 100 ft. coil Net 2.31
32 E 36296 500 ft. coil Net 16.25

BELDEN COPPER BRAID

Flexible tinned copper braiding. Size is oval I.D. except * is flat width. Shpg. wt., per 50 ft., is 2 lbs.

Size ID"	10 Ft. Spool	50 Ft. Special
	Stock No.	Stock No.
5/32	32 E 14301	32 E 14360
3/16	32 E 14319	32 E 14376
5/16	32 E 14327	32 E 14384
1/2	32 E 14335	32 E 14392
5/8	32 E 14343	32 E 14400
19/32"	32 E 14390	32 E 14418

THERMOPLASTIC HOOK-UP WIRE



Convenient spools of plastic insulated wire. Shpg. wt., 25'—1/2 lb.; 100'—3 lb.

Stock No. Description Net

32 E 31891	#20 Solid—25 ft. Red	.46
32 E 31909	#20 Solid—25 ft. Black	.46
32 E 31917	#20 Solid—25 ft. Blue	.46
32 E 31925	#20 Solid—25 ft. Green	.46
32 E 31933	#20 Solid—100 ft. Red	1.05
32 E 31941	#20 Solid—100 ft. Black	1.05
32 E 31950	#20 Solid—100 ft. Blue	1.05
32 E 31966	#20 Solid—100 ft. Green	1.05
32 E 31974	#22 Solid—25 ft. Red	.46
32 E 31982	#22 Solid—25 ft. Black	.46
32 E 31990	#22 Solid—25 ft. Blue	.46
32 E 31998	#22 Solid—25 ft. Green	.46
32 E 31974	#22 Solid—25 ft. Red	.46
32 E 31982	#22 Solid—25 ft. Black	.46
32 E 31990	#22 Solid—25 ft. Blue	.46
32 E 31998	#22 Solid—25 ft. Green	.46
32 E 32360	#22 Solid—100 ft. Red	1.03
32 E 32378	#22 Solid—100 ft. Black	1.03
32 E 32386	#22 Solid—100 ft. Blue	1.03
32 E 32394	#22 Solid—100 ft. Green	1.03
32 E 32402	#20 Stranded—25 ft. Red	.53
32 E 32410	#20 Stranded—25 ft. Black	.53
32 E 32428	#20 Stranded—25 ft. Blue	.53
32 E 32436	#20 Stranded—25 ft. Green	.53
32 E 32444	#20 Stranded—100 ft. Red	1.20
32 E 32451	#20 Stranded—100 ft. Black	1.20
32 E 32469	#20 Stranded—100 ft. Blue	1.20
32 E 32477	#22 Stranded—100 ft. Green	1.20
32 E 32485	#22 Stranded—25 ft. Red	.46
32 E 32493	#22 Stranded—25 ft. Black	.46
32 E 32519	#22 Stranded—25 ft. Blue	.46
32 E 32527	#22 Stranded—25 ft. Green	.46
32 E 32535	#22 Stranded—100 ft. Red	1.05
32 E 32543	#22 Stranded—100 ft. Black	1.05
32 E 32550	#22 Stranded—100 ft. Blue	1.05
32 E 32558	#22 Stranded—100 ft. Green	1.05

BARE NICKEL CHROMIUM WIRE



For electrical heating appliances and devices whose operating temperatures do not exceed 1850°F. Ideal for compact resistance required of heavy duty rheostats and controls. 1/4 lb. spools. Shpg. wt., 6 oz.

Stk. No.	Size	Net	Stk. No.	Size	Net
32 E 31404	14	1.67	32 E 31479	28	3.14
32 E 31412	16	1.76	32 E 31487	30	3.44
32 E 31420	18	1.85	32 E 31495	32	3.78
32 E 31438	20	1.95	32 E 31503	34	4.50
32 E 31446	22	2.13	32 E 31511	36	5.45
32 E 31453	24	2.45	32 E 31529	38	8.88
32 E 31461	26	2.70	32 E 31537	40	10.86

MAGNET WIRE

Finest quality. Available in plain enamel or heavy FORMVAR insulation. See FORMVAR listing for approx. footage per lb.



PLAIN ENAMELED

B&S Size	1/4 Lb. Spool	1/2 Lb. Spool
	Stk. No.	Stk. No.
14	32 E 31578	32 E 31586
16	32 E 30588	32 E 30596
18	32 E 30604	32 E 30612
20	32 E 30620	32 E 30638
22	32 E 30646	32 E 30653
24	32 E 30661	32 E 30679
26	32 E 30687	32 E 30695
28	32 E 30703	32 E 30711
30	32 E 30729	32 E 30737
32	32 E 30745	32 E 30752
34	32 E 30760	32 E 30776
36	32 E 30786	32 E 30794
38	32 E 30802	32 E 30810
40	32 E 31594	32 E 31602

HEAVY FORMVAR IN 1 LB. SPOOLS

Stock No.	B&S Size	Feet	Net
32 E 30828	14	78	1.54
32 E 30836	16	124	1.59
32 E 30844	18	198	1.83
32 E 30851	20	313	1.79
32 E 30869	22	501	1.79
32 E 30877	24	798	1.91
32 E 30885	26	1200	2.04
32 E 30893	28	1999	2.24
32 E 30901	30	3200	2.52
32 E 30919	32	4900	2.77
32 E 30927	34	7950	3.04
32 E 30935	36	12,800	3.39
32 E 30943	38	20,000	4.08
32 E 30950	40	31,700	5.89

INTERCOM WIRE



2-conductor Twisted; Flexible, tinned copper with plastic insulation over each conductor. Shpg. wt., 2 lbs. per 100 ft. Available only in lengths listed below.

32 E 30521	100 ft. coil	Net 1.14
32 E 30539	250 ft. spool	Net 2.36
3 conductor twisted. Same construction as above. Shpg. wt., 3 lbs. per 100 ft.		
32 E 30547	100 ft. coil	Net 1.54
32 E 30554	250 ft. spool	Net 3.25
3 conductor twisted. Same construction as above but with outer plastic jacket overall. Shpg. wt., 3 lbs. per 100 ft.		
32 E 30562	100 ft. coil	Net 3.85
32 E 30570	250 ft. spool	Net 8.80

Belden Wire For Microphones-Intercom-P.A. Sound



SINGLE CONDUCTOR HIGH IMPEDANCE MIKE CABLE

Shielded single conductor cables. No. 25 tinned stranded wire; 3x33 copper and 4x33 copper-weld tinned, cellulose yarn braid, polyethylene insulated, tinned copper braid shield, chrome-vinyl jacket. Type 8410 has rubber insulation and black rubber jacket. Available only in lengths listed below.

Beld. No.	Out. Diam.	Wt. 100'	15 Ft. Spool		25 Ft. Spool		50 Ft. Spool		100 Ft. Spool	
			Stock No.	Net	Stock No.	Net	Stock No.	Net	Stock No.	Net
8411	.144"	2 lb.	32 E 13071	1.05	32 E 13089	1.47	32 E 13097	2.34	32 E 13105	4.45
8401	.200"	3 lb.	32 E 13113	1.31	32 E 13121	1.73	32 E 13139	3.06	32 E 13147	5.85
8410	.245"	4 lb.			32 E 13162	3.15	32 E 13170	5.55	32 E 13188	10.35



2-CONDUCTOR LOW-IMPEDANCE MINIATURE AND STD. MIKE CABLES

All cables shielded. Miniature types 8420 and 8413 both No. 24 stranded tinned. 8420 has polyethylene insulation and chrome vinyl jacket, 8413 rubber insulation and black rubber jacket. Stranded types: 8422 is 22 stranded tinned, poly insulation and chrome vinyl jacket; 8412 No. 20 stranded tinned, rubber insulation and black rubber jacket; 8402 same as 8412 but brown hypalon jacket; 8428 is heavy duty No. 18 stranded tinned, black Neoprene jacket for studio use. Available only in length listed below.

Beld. No.	Out. Diam.	Wt. 100'	15 Ft. Spool		25 Ft. Spool		50 Ft. Spool		100 Ft. Spool	
			Stock No.	Net	Stock No.	Net	Stock No.	Net	Stock No.	Net
8420	.185"	2½ lb.	32 E 13196	1.86	32 E 13204	2.78	32 E 13212	4.20	32 E 13220	7.95
8413	.190"	2½ lb.	32 E 13238	2.10	32 E 13246	3.15	32 E 13253	5.95	32 E 13261	10.95
8422	.231"	4 lb.	32 E 13279	1.65	32 E 13287	2.51	32 E 13295	4.65	32 E 13303	8.20
8412	.268"	5 lb.			32 E 13329	3.23	32 E 13337	6.10	32 E 13345	11.40
8402	.268"	6 lb.							32 E 13399	12.75
8428	.295"	6¾ lb.							32 E 13386	15.75



SHIELDED CABLES FOR PA AND INTERCOM

2 CONDUCTOR-TWISTED PAIR-SHIELDED CABLES

All have stranded tinned copper conductors except No. 8739 is solid. Each conductor has vinyl insulation except * has polyethylene. Shielding: types marked * have aluminum-polyester shield with stranded tinned ground wire; types marked # have tinned copper braided shield; types marked Δ have tinned copper spiral wrapped shield. All have overall chrome vinyl jacket except # have no outer jacket over shield. Available only in lengths listed below.

Beld. No.	Gauge	O.D."	Lbs. 100 Ft.	100 Ft. Spool		250 Ft. Spool		500 Ft. Spool	
				Stock No.	Net	Stock No.	Net	Stock No.	Net
8739Δ	22	.160	2½	32 E 13519	4.15			32 E 15407	17.70
8737Δ	22	.170	2½	32 E 13527	4.45	32 E 15415	9.30	32 E 15423	19.50
8759Δ	20	.195	3	32 E 13535	5.35			32 E 15431	22.35
8790Δ	18	.231	4	32 E 13543	6.60	32 E 15449	14.25	32 E 15456	28.50
8780Δ	16	.266	5	32 E 13550	8.25			32 E 15464	38.75
8761*	22	.167	2					32 E 15472	18.95
8762*	20	.196	3	32 E 13576	5.05	32 E 15480	10.45	32 E 15488	20.85
8760*	18	.222	3			32 E 15506	12.85	32 E 15514	25.05
8758#	20	.165	2	32 E 13600	5.10			32 E 15522	20.85
8789#	18	.204	3					32 E 15530	30.75
8779#	16	.225	4					32 E 15548	39.40



2-CONDUCTOR-TWISTED PAIR-UNSHIELDED

All have tinned stranded copper conductors except * are solid copper. Types with † have chrome vinyl jacket overall, others without jacket. All conductors have vinyl insulation. Available only in lengths listed below.

Beld. No.	Gauge	O.D."	Lbs. 100 Ft.	100 Ft. Spool		500 Ft. Spool	
				Stock No.	Net	Stock No.	Net
8481	22*	.112	1	32 E 13717	2.07	32 E 15555	6.85
8482	19*	.130	1½	32 E 13630	2.63	32 E 15563	9.75
8460	18	.175	2	32 E 13725	3.75	32 E 15571	14.85
8470†	16	.195	2½			32 E 15580	19.90
8740†	22*	.150	2	32 E 13741	2.55	32 E 15597	9.15
8461†	18†	.226	3	32 E 13766	4.75	32 E 15605	19.50
8471†	16	.256	4			32 E 15613	24.60

SHIELDED SOUND-PA-INTERCOM CABLE



BELDEN 8208, 2 conductor No. 18 tinned stranded copper, twisted pair, rubber insulated, braided tinned copper shield, chrome vinyl jacket overall O.D. .255". Shpg. wt., 100', 4 lbs.
 BELDEN 8735, 3 conductor No. 22 tinned stranded copper vinyl insulated, cabled, tinned copper braid shield chrome vinyl jacket overall. O.D. .199". Shpg. wt., 100', 3 lbs.

Available only in lengths listed below.

Belden No.	15 Ft. Spool		50 Ft. Spool		100 Ft. Spool		500 Ft. Spool	
	Stock No.	Net	Stock No.	Net	Stock No.	Net	Stock No.	Net
8208					32 E 13808	8.55	32 E 15621	38.10
8735	32 E 13885	1.35	32 E 13873	3.55	32 E 13881	6.15	32 E 15639	28.55

3-CONDUCTOR CABLES FOR PA AND INTERCOM



SHIELDED CABLES

All have 3 conductors. Type 8771 has cabled No. 22 stranded tinned copper conductors with polyethylene insulation, aluminum-polyester shield, stranded tinned copper No. 22 ground drain wire and overall chrome vinyl jacket. O.D. is .175". Type 8772 is identical except has No. 20 conductors and ground wire, O.D. is .280". Type 8776 is same but with No. 18 conductors and No. 20 ground wire, O.D. is .286". Type 8781 is same but with 18 gauge conductors, vinyl insulation, tinned copper wrapped shield and no ground wire, O.D. is .236". Available only in lengths listed below.

Stock No.	Beld. No.	Gauge	Feet	Lbs.	Net
32 E 15654	8771	22	500	11	20.85
32 E 15662	8772	20	500	16	28.25
32 E 15670	8770	18	500	22	32.50
32 E 15688	8791	18	100	6	8.20
32 E 15696	8791	18	500	24	38.45

UNSHIELDED CABLES

All are 3-conductor solid #19 copper, vinyl insulated and cabled. 8487 has chrome vinyl outer jacket. 8483 has no jacket. Shpg. wt., 2½ lbs. per 100 ft.

Stock No.	Beld. No.	O.D.	Feet	Lbs.	Net
32 E 15712	8483	.132	100	3	3.45
32 E 15720	8483	.132	500	13.90	



SPECIAL INTERCOM AND P.A. CABLES

BELDEN 8734, 3 conductor No. 22 stranded tinned copper with vinyl insulation. 1 conductor with tinned copper braid shield, 2 unshielded, cabled with overall chrome vinyl jacket. O.D. .194". Shpg. wt., per 100', 3 lbs. Available only in lengths listed below.

32 E 13972	100 ft. spool	Net 5.40
32 E 15738	500 ft. spool	Net 22.80

BELDEN 8763, 3 conductors No. 20 stranded tinned copper with polyethylene insulation. 2 conductors with aluminum-Mylar wrapped shield, 1 unshielded. Also has No. 20 stranded, tinned copper ground wire. Chrome vinyl jacket overall, O.D. .210". Shpg. wt., per 100', 3½ lbs. Available only in lengths listed below.

32 E 15746	500 ft. spool	Net 25.80
------------	---------------	-----------

BELDEN 8732, 4 conductors No. 22 stranded tinned copper with polyethylene insulation. 2 conductors with tinned copper braid shield, 2 unshielded. Chrome vinyl jacket overall. Oval shape O.D. .188" x .296". Shpg. wt., 100', 3½ lbs. Available only in lengths listed below.

32 E 13998	100 ft. spool	Net 6.90
32 E 15753	500 ft. spool	Net 29.25

SHIELDED PHONO PICKUP CABLE

BELDEN TYPE 8431, Extremely limp and flexible. No. 24 stranded (16x36) tinned copper, rubber covered, tinned copper braid shield, brown cotton braid jacket. Only in lengths listed below. Shpg. wt., 100 ft., 1 lb.

32 E 14020	15 ft. coil	Net each 1.11
32 E 14038	25 ft. coil	Net each 1.48
32 E 14046	100 ft. coil	Net each 4.85

BELDEN PHONO PICKUP CABLE

BELDEN 8430, Flexible, #32 stranded twisted pair. Coded red and black. Small diameter. Shpg. wt., 4 oz.

32 E 14053	25 ft.	Net .92
------------	--------	---------

Belden TV, Intercom and P. A. Wire

COILED MICROPHONE AND TELEPHONE CORDS

Have insulated cadmium bronze conductors except * has 5 strands tinned copperweld and 16 strands tinned copper. Microphone cables have black neoprene jacket except # has gray vinyl; telephone cables, black vinyl jacket. Type 8499 and 8605 shielded; type 8497, 1 shielded and 2 unshielded conductors, all others unshielded. Telephone cables have spade terminals and strain relief. Shpg. wt., 1/2 lb.

Stock No.	Belden No.	Cond.	Type	Extends		Net
				From	To	
32 E 14236	8415*	4	Mic	1 1/2"	6'	1.50
32 E 15064	8497*	3	Mic	1 1/2"	6'	1.56
32 E 15092	8499	1	Mic	7 1/2"	4'	1.05
32 E 17395	8605 #	1	Mic	21 1/2"	12"	1.55
32 E 15100	8494	4	Tel	10"	4 1/2"	1.80
32 E 15118	8495	3	Tel	10"	4 1/2"	1.41

TINNED BUS BAR WIRE

Solid tinned copper bus-bar wire. Especially for use where high current conductor is needed as in power plants, ground wire, switchboards and point to point wiring. Made in accordance with government specification QQ-W-343. Comes only in standard spools of 100 and 1000 feet, except 8011 available in 100 ft. spool only.

Belden No.	AWG	O.D.	100 Ft. Spool Stock No.	Oz.	Net	1000 Ft. Spool Stock No.	Lbs.	Net
8025	30	.010	32 E 15126	2	.75	32 E 15134	1/4	3.15
8024	28	.012	32 E 15142	2	.75	32 E 15159	1/2	3.45
8023	26	.016	32 E 15167	3	.80	32 E 15175	1	3.75
8022	24	.020	32 E 15183	4	.81	32 E 15191	1 1/4	4.26
8021	22	.025	32 E 15209	5	.84	32 E 15217	2	5.10
8020	20	.032	32 E 15225	6	1.01	32 E 15233	3 1/2	7.95
8019	18	.040	32 E 15241	8	1.32	32 E 15258	5 1/2	10.05
8013	16	.050	32 E 15266	14	1.89	32 E 15274	8 1/2	18.15
8012	14	.064	32 E 15282	24	2.82	32 E 15290	13	24.00
8011	12	.080	32 E 15308	40	4.28			

BELDEN TEST PROD WIRE

Extremely flexible, limp rubber covered hi-voltage lead. No. 18 stranded, tinned, cotton wrap. 8899 for 5000 working volts. 8898 for 10,000 working volts. In red or black. Shpg. wt., 100 ft., 2 lbs.

Belden No.	10 Ft. Stk. No.	Net	25 Ft. Stk. No.	Net	100 Ft. Stk. No.	Net
8899 Red	32 E 17239	.83	32 E 17254	1.31	32 E 17270	4.20
8899 Blk	32 E 17247	.83	32 E 17262	1.31	32 E 17288	4.20
8898 Red	32 E 17296	1.17	32 E 17312	2.18	32 E 17338	5.70
8898 Blk	32 E 17304	1.17	32 E 17320	2.18	32 E 17346	5.70

MINIATURE TEST PROD WIRE

Belden 8890. Similar to above, but with No. 24 stranded wire. For 1000 working volts. Available only in 25 and 100 ft. spools. Available red or black. Shpg. wt., 100 ft., 1/2 lb.
 32 E 17353 25 ft. Red 32 E 17361 25 ft. Black Net 1.01
 32 E 17379 100 ft. Red 32 E 17387 100 ft. Black Net 2.52

VINYL COVERED MULTIPLE PAIRED CABLE

For balanced line intercom system and telephone wiring. Unshielded #22 solid tinned copper conductors, vinyl insulated, cabled in pairs, chrome vinyl outer jacket. Available only in lengths listed below.

Belden No.	O.D.	Lbs.	100 Ft. Spool Stock No.	Net	250 Ft. Spool Stock No.	Net
8740	2	1.50	32 E 13741	2.55	32 E 15779	9.45
8741	4	2.01	32 E 15787	4.30	32 E 15795	9.95
8742	6	2.40	32 E 15803	5.65	32 E 15811	12.75
8743	12	3.05	32 E 15829	9.00	32 E 15837	20.85
8744	18	3.54	32 E 15845	12.90	32 E 15852	30.15
8754	26	4.09	32 E 15860	18.00	32 E 15878	43.50
8745	30	4.20	32 E 15886	22.15	32 E 15894	51.15

VINYL COVERED MULTIPLE UNPAIRED CABLE

All conductors unshielded stranded tinned copper except * include two No. 18 conductors. Each conductor vinyl insulated cabled. Chrome vinyl jacket overall. Available only in sizes listed below.

Belden No.	O.D.	Lbs.	100 Ft. Spool Stock No.	Net	25 Ft. Spool Stock No.	Net	100 Ft. Spool Stock No.	Net	250 Ft. Spool Stock No.	Net
8443	3	.150	2		32 E 14244	1.20	32 E 14525	3.30	32 E 15902	6.65
8444	4	.168	2 1/4		32 E 14251	1.49	32 E 14533	4.50	32 E 15910	9.30
8445	5	.180	2 1/2		32 E 14269	1.68	32 E 14541	5.18	32 E 15928	11.30
8446*	6	.222	4	32 E 14277	1.70		32 E 14558	7.75	32 E 15936	17.05
8447*	7	.246	5				32 E 14566	8.70	32 E 15944	19.30
8448*	8	.251	5	32 E 14285	1.86		32 E 14574	9.30	32 E 15951	21.10
8449*	9	.261	5	32 E 14293	2.06		32 E 14582	10.05	32 E 15969	23.10
8456	10	.260	5 1/4				32 E 14988	10.20		
8457	12	.260	5 1/2				32 E 14970	10.95		
8458	15	.320	8				32 E 14947	18.75		
8459	25	.370	11 1/2				32 E 14954	28.50		

BELDEN DUOFOIL 75 OHM COAX

Belden 8228. Low loss 100% shielded, 75 ohm, 100% sweep tested coaxial cable for 82 channel VHF/UHF color or black and white TV reception. No. 18 solid bare copper conductor with low loss polyethylene insulation. Shielding is polyester film with aluminum lamination on both surfaces. Has 4 No. 28 solid tinned copper-weld drain wires spirally wrapped. Overall PVC black all weather jacket is only .242"OD. Only in lengths listed below.

32 E 17411	100' Shpg. wt.,	4 lbs.	Net 6.30
32 E 17403	500' Shpg. wt.,	16 lbs.	Net 20.70

BELDEN 8290 SHIELDED PERMOHM 300 OHM COLOR TV LEAD-IN



Designed for 82 channel color TV reception, 8290 Permohm combines the strong signal strength of twin-line with the clean signal of shielded cable. Shielded to eliminate ignition and other interference caused by line pick-up weatherproof. Shpg. wt., 5 lbs. per 100 ft. Available only in lengths listed below.

32 E 15357	50 ft.	Net 5.95	32 E 15373	100 ft.	Net 10.15
32 E 15365	75 ft.	Net 8.05	32 E 15977	500 ft.	Net 47.90

BELDEN 300 OHM TWIN LEAD



Type 8225. Fig. A, for TV and FM antennas. Low loss polyethylene insulation. Stranded No. 20 (7x28). Shpg. wt., 100 ft, 2 lbs.

32 E 14061	(50 ft.)	1.22	32 E 14079	(75 ft.)	1.59
32 E 14087	(100 ft.)	2.00	32 E 15985	(250 ft.)	4.94

Type 8235. Fig. B. Low loss 300 ohm line for UHF or VHF TV antennas and for amateur transmitting and receiving—Twin lead rated 1KW(RF). Resists oxidation and sun; made with 100% virgin polyethylene web. 18 gauge (7x26) stranded.

32 E 14103	(100 ft.)	5.05
------------	-----------	------

Type 8230. Fig. A. "Weldohm" copper coated steel wire. Polyethylene insulation. Almost twice as strong as plain copper. Perfect for long runs. Stranded No. 20 (7x28). Shpg. wt., 100 ft, 2 lbs.

32 E 14129	(50 ft.)	1.34	32 E 14137	(75 ft.)	1.77
32 E 14145	(100 ft.)	2.22	32 E 15993	(250 ft.)	5.50

Type 8285. Fig. C. Encapsulated in low loss cellular polyethylene. Delivers a strong signal on all channels VHF or UHF. A must for color TV. 2 Conductor #22 (7x30) stranded copper weld conductors. Shpg. wt., 4 lbs. per 100 ft.

32 E 14160	(50 ft.)	2.85	32 E 14178	(75 ft.)	3.85
32 E 14186	(100 ft.)	4.90	32 E 17015	(250 ft.)	11.65

Type 8275. Fig. D. UHF-VHF lead, ideal for color and black and white TV. 7x28 copper weld conductors, polyethylene jacket with inert gas filled unicellular polyethylene core. Shpg. wt., 4 lbs. per 100 ft.

32 E 15043	(50 ft.)	2.70	32 E 15050	(75 ft.)	3.80
32 E 15068	(100 ft.)	4.85	32 E 17023	(250 ft.)	11.05

UNSHIELDED 2 CONDUCTOR TWISTED PAIR SPEAKER AND INTERCOM CABLE



Belden 8295. 2 conductor No. 20 stranded tinned copper, vinyl insulated, cabled with overall chrome vinyl jacket. O.D., .190" Shpg. wt., 100', 2 lbs. Lengths available only in sizes listed below.

32 E 14202	100 ft. spool	Net 3.30
32 E 17056	500 ft. spool	Net 12.40



BELDEN CATHODE RAY TUBE CABLE

Belden 8066 CRT cables with No. 18 stranded tinned copper polyethylene insulation. Reduces corona. Long life construction. Vinyl jacket, O.D. .208. Working voltage 40KV. Only in lengths listed below.

Shpg. wt. 3 lbs.	100 ft.	
32 E 17084	25 ft. spool	Net 2.00
32 E 17072	100 ft. spool	Net 5.70

BELDEN 8817 LITZ WIRE

Copper Celanamel insulated nylon wrap. 5x44 stranded O.D. .008". For rewinding RF coils, antenna primaries, etc. 100' spool. Shpg. wt., 4 oz.

32 E 14855	100 ft. spool	Net .71
------------	---------------	---------

Wire - Antenna Kits - Insulators

MIL-W76B PLASTIC HOOK-UP WIRE



Tinned copper conductor. Vinyl insulation. Nominal wall thickness .017". Rated 1000 volts. Resistant to acids, alkalis, oil, flame, moisture, and fungus. Shpg. wt., 100'—1 1/4 lbs. 1000'—7 lbs.

STRANOEO WIRE

Stock No. White	Stock No. Black	Stock No. Red	TYPE MW-	Cond Size	Length Ft.	Net
32 E 33228	32 E 33236	32 E 33244	C24(7)u	24	100	1.37
32 E 33251	32 E 33269	32 E 33277	C24(7)u	24	1000	8.85
32 E 33285	32 E 33293	32 E 33301	C22(7)u	22	100	1.50
32 E 33319	32 E 33327	32 E 33335	C22(7)u	22	1000	10.35
32 E 33343	32 E 33350	32 E 33358	C20(10)u	20	100	1.73
32 E 33376	32 E 33384	32 E 33392	C20(10)u	20	1000	11.70
32 E 33400	32 E 33418	32 E 33426	C18(16)u	18	100	2.18
32 E 33434	32 E 33442	32 E 33459	C18(16)u	18	1000	16.15
32 E 33467	32 E 33475	32 E 33483	C16(26)u	16	100	2.88
32 E 33491	32 E 33509	32 E 33517	C16(26)u	16	1000	22.50
32 E 33525	32 E 33533	32 E 33541	C14(41)u	14	100	4.05
32 E 33558	32 E 33566	32 E 33574	C14(41)u	14	1000	34.95
32 E 33582	32 E 33590	32 E 33608	C12(65)u	12	100	6.00
32 E 33616	32 E 33624	32 E 33632	C12(65)u	12	1000	49.20

SOLID WIRE

32 E 33640	32 E 33657	32 E 33665	C22(1)u	22	100	1.26
32 E 33673	32 E 33681	32 E 33699	C22(1)u	22	1000	8.10
32 E 33707	32 E 33715	32 E 33723	C20(1)u	20	100	1.50
32 E 33731	32 E 33749	32 E 33756	C20(1)u	20	1000	10.05
32 E 33764	32 E 33772	32 E 33780	C18(1)u	18	100	1.92
32 E 33798	32 E 33806	32 E 33814	C18(1)u	18	1000	13.75
32 E 33822	32 E 33830	32 E 33848	C16(1)u	16	100	2.40
32 E 33855	32 E 33863	32 E 33871	C16(1)u	16	1000	19.35



Fig. A. Brown glazed porcelain. Shpg. wt., 2 oz.

32 E 30083 lots of 10 ea. .08

Fig. B. Johnson 136-32. 1 1/2" Long. Dry glazed porcelain. Shpg. wt., 2 oz.

32 E 32459 Net ea. .16

ANTENNA STRAIN INSULATORS

E. F. JOHNSON INSULATORS



THRU PANEL INSULATORS. Compression mounted by means of a stud. Flat mounting surfaces with cushion washer. Hardware: *10-32, †1/4"-20, ‡6-32. First 3 types are steatite, others porcelain. Average shpg. wt., 10 oz.

Stock No.	Mfrs. Type 135-	Fig.	Top Ht.	PNL Hole	Net Each 1-49	50-99	100-499
33 E 32012	40	A*	1 1/4"	3/16"	.48	.44	.40
33 E 32038	42	A*	7/8"	1/8"	.44	.41	.37
33 E 32053	44	A†	5/8"	3/8"	.33	.30	.28
33 E 32061	45	B*	1 1/8"	1/2"	.64	.59	.54
33 E 32095	47	A‡	4 1/2"	3/8"	2.50	2.30	2.10
33 E 32103	48	B*	2"	1/8"	1.00	.92	.84

STAND OFF INSULATORS. Type 65, 65-2, 66 are ribbed and have drain and etched aluminum bases. Type 66 and 67 have smooth surfaces and drawn bases †—hardware-banana jack and a solder lug mounted on top of the insulator * similar to fig. E, but with square base. Avg. wt., 1 lb.

STEATITE

Stock No.	Mfrs. Type 135-	Fig.	Body Ht.	Hard-ware	Net Each 1-49	50-99	100-499
33 E 32178	20	C	1 1/2"	10-32	.36	.33	.30
33 E 32186	20-2	D	1 1/2"	†	.40	.37	.34
33 E 32194	22	C	1"	8-32	.22	.20	.19
33 E 32202	22-2	D	1"	†	.30	.28	.25
33 E 32210	24	C	3/8"	6-32	.18	.17	.15

PORCELAIN

33 E 32228	60	E*	4 1/2"	1/4-20	1.20	1.10	1.01
33 E 32236	62	E* <td>2 3/4"</td> <td>1/4-20</td> <td>.68</td> <td>.63</td> <td>.57</td>	2 3/4"	1/4-20	.68	.63	.57
33 E 32244	65	E	1 3/8"	10-32	.35	.32	.30
33 E 32251	65-2	E	1 3/8"	†	.40	.37	.34
33 E 32269	66	F	2 3/4"	1/4-20	.85	.78	.71
33 E 32285	67	F	4 1/2"	1/4-20	1.20	1.12	1.01
33 E 32293	68	E* <td>2"</td> <td>10-32</td> <td>.56</td> <td>.52</td> <td>.47</td>	2"	10-32	.56	.52	.47

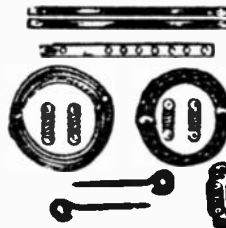

UNIVERSAL 3-WAY ANTENNA SYSTEM 4 89

• Makes Any Of 3 Marconi And Doublet Systems

Uniquely designed set of parts for construction of any of 3 types of short and long wave antennas. All parts supplied for either a doublet, double doublet, or inverted L antenna system. Contains 100 ft. bare aerial wire, 50 ft. twisted insulated transmission line, 4 insulators, 2 screw eyes, doublet lightning arrestor, window lead-in strip, ground clamp and complete instructions. Shpg. wt., 4 lbs. 32 E 31859 Net 4.89

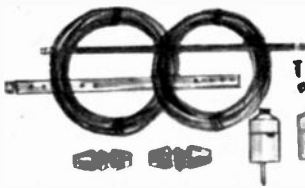

ANTENNA KIT

1 59

Ideal for small crystal, diode and transistor broadcast and short-wave sets. 50 ft. 7 x 26 bare copper aerial wire, 25 ft. rubber covered lead-in wire, 10-in. window lead-in strip, 2 antenna and 2 stand-off insulators. Simple printed instructions. Shpg. wt., 2 lbs. 32 E 30984 Net 1.50



HOOK-UP WIRE ASSORTMENTS

Various colors, gauges and insulation.

KIT OF SIX 25-FOOT COILS

Convenient kit of six 25' coils.

Shpg. wt., 1 lb.

32 E 79007 Net per kit .90

KIT OF FIVE 100-FOOT COILS

Shpg. wt., 4 lbs.

32 E 79015 Net per kit 2.39

LEAD IN BUSHINGS AND INSULATORS



Insulated bushings ideal for use in transmitter and antenna installations. Type 50, 52, and 55 are steatite, supplied with cushion washers and hardware. Type 54 is porcelain less all hardware except cushion washer. Maximum diameter; Type 50 3/4", Type 52 1 3/4", Type 54 3 1/2", and Type 55 3/4". Avg. shpg. wt., 8 oz.

Stock No.	Mfrs. Type 135-	Fig.	Top Ht.	PNL Hole	Net Each 1-49	50-99	100-499
33 E 32319	50	M	1/2"	15/32"	.42	.39	.34
33 E 32335	52	M	1 1/8"	1 1/2"	.89	.82	.75
33 E 32350	54	J	4"	2 1/4"	1.30	1.19	1.10
33 E 32368	55	L	1/4"	1 5/8"	.33	.30	.28

Fig. N. ANTENNA STRAIN INSULATORS. Porcelain, heavily glazed, nickel-plated brass hardware. Type 107 and 112 are 1" diameter; type 104 is 5/8" square with 400 lbs. breaking strength.

Stock No.	Mfrs. Type 136-	Size	Shpg. Wt.	Net Each 1-49	50-99	100-499
33 E 32376	104	4x5 1/2" sq.	4 oz.	.30	.28	.26
33 E 32384	107	7x1" sq.	10 oz.	1.35	1.19	1.13
33 E 32392	112	12x1" dia.	1 1/4 lb.	1.95	1.79	1.64

Fig. O. STEATITE CONE INSULATORS. Complete with 2 machine screws, washers, and a cork cushion washer. Avg. shpg. wt., 2 oz.

Stock No.	Mfrs. Type 135-	Ht.	Width	Net Each 1-49	50-99	100-499
33 E 32129	500	5/8"	5/8"	.23	.21	.19
33 E 32137	501	1"	3/4"	.34	.31	.29
33 E 32145	502	1 1/2"	1"	.54	.50	.46

Fig. P. FEEDER SPREADERS. Silicone impregnated. 3/8x1/2" cross section. Avg. shpg. wt., 3 oz.

Stock No.	Mfrs. Type	Length	1-49	Net Each 50-99	100-499
33 E 32400	136-122	2"	.18	.17	.15
33 E 32418	136-124	4"	.28	.26	—
33 E 32426	136-126	6"	.45	.42	—

Experimenter Boxes — Electrical Accessories

PLASTIC CASES FOR MINIATURE ELECTRIC GEAR



Clean, polystyrene cases. Ideal for miniature assemblies. All have ball type hinged covers except ¹, which have removable covers. Avg. shpg. wt., 6 oz.

Stock No.	Size LxWxH"	Net
13 E 38011	1 3/4 x 2 3/4 x 1"	.12
13 E 38029	2 7/8 x 1 3/4 x 1"	.14
13 E 38037	2 7/8 x 2 x 1"	.18
13 E 38045	3 3/8 x 2 3/4 x 1"	.19
13 E 38052 [*]	4 3/8 x 2 3/4 x 5/8"	.21
14 E 44015	7 1/2 x 5 1/2 x 1 1/2"	.80
14 E 68069	4 3/4 x 2 5/8 x 1"	.90
14 E 44017	4 3/8 x 3 3/4 x 1 1/4"	.92
14 E 44025	5 x 5 4/4 x 1 3/4"	.97
14 E 44033	5 3/4 x 3 1/2 x 1 3/4"	.90
14 E 44023	3 7/8 x 3 3/8 x 1 1/4"	.28

BAKELITE UTILITY CASE WITH ALUMINUM PANEL

As Low As **59c**



Ideal for housing small electronic devices.

Sturdy bakelite box features smooth rounded corners and recessed brass inserts for screw mounting of aluminum panel. Complete with hardware. Imported.

Stock No.	Size	Net ea.
99 E 80772	3 1/4" x 2 1/2" x 1 1/4"	.59
99 E 80780	4" x 2 1/2" x 1 1/4"	.60
99 E 80756	5 1/8" x 2 1/2" x 1 1/4"	.78
99 E 82721	6 3/4" x 3 3/4" x 1 1/4"	1.09
99 E 80764	7 3/4" x 4 1/4" x 2 3/8"	1.49

MINI-COOL BOXES

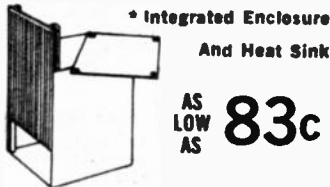

* Integrated Enclosure
And Heat Sink

AS LOW AS **83c**

Made of aircraft alloy aluminum, drills and machines beautifully. Patented lock-joint corners tighten under stress. Six flat parts assemble easily with screwdriver; 2 finned sides have .100" max. wall for use as heat sink; 2 plain sides have .040" wall. Strong and rigid, will withstand 2-tons. Easily mounted above or below chassis. Avg. Shpg. wt., 2 lbs.

Stock No.	L X W X H	Net
19 E 22004	2" x 2.8" x 2"	.83
19 E 22012	3" x 2.8" x 2"	1.03
19 E 22020	4 1/2" x 2.8" x 2"	1.33
19 E 22038	6" x 2.8" x 2"	1.63

PLAIN TYPES

Identical to above but with all sides plain, none finned.

19 E 22046	2" x 2.8" x 2.6"	.86
19 E 22053	3" x 2.8" x 2.6"	1.06
19 E 22061	4 1/2" x 2.8" x 2.6"	1.26
19 E 22079	6" x 2.8" x 2.6"	1.63

BUILDER'S PANEL KIT

Ideal set of 5 panels for the experimenter. Consists of 1 plain black bakelite panel, 3 perforated boards with holes on 1/2" centers, and 1 aluminum panel with perforated circular pattern for speaker outlet. All panels are sized and have mounting holes to fit 99-62721 case at left. Shpg. wt., 2 lbs.



99 E 83380 Net 1.30

FLEXI-CAB UNIQUE CUSTOM CABINETS



Fast, Easy, Push-Together, Stay Together Assembly

Now you can give your projects that exclusive decor look with designer styled Flexi-Cab vinyl clad steel cabinets. Type ^{*} finished in simulated black leather, Type [†] in simulated walnut. Front panels are brass finished. All sides link together with mar-resistant plastic bindings. All kits supplied with package of 40 pressure sensitive function identifying labels. Average shpg. wt., 2 lbs.

Stock No.	Size	Net ea.
19 E 22508 [*]	3x4x4"	2.90
19 E 22517 [†]	3x4x6"	3.79
19 E 22525 [*]	3x4x6"	3.79
19 E 22533 [†]	3x6x9"	4.49
19 E 22841 [*]	3x6x9"	4.49

BAKELITE CASES BAKELITE PANELS

Ideal for building test equipment and small electronic devices. All black bakelite with rounded corners and recessed threaded inserts for mounting panels. Walls 1/8". Panels are 3/8" thick. Avg. shpg. wt., 11 oz.



Stock No.	Size	Net Each	5-Up
19 E 20018	6 1/4 x 3 3/4 x 2"	.65	.58
19 E 37010	Panel for above	.45	.41
19 E 20024	6 3/4 x 5 1/4 x 2 1/4"	.84	.76
19 E 37028	Panel for above	.60	.54
19 E 20032	8 3/4 x 7 3/8 x 2"	1.59	1.43
19 E 37030	Panel for above	.75	.68

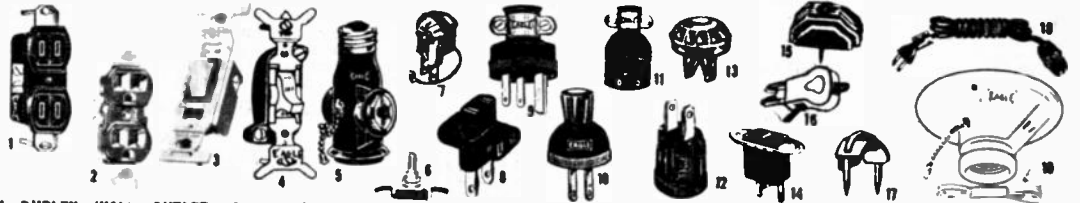

1. DUPLEX WALL OUTLET. 2-pc. bakelite body. Will take up to #10 wire. Totally enclosed heavy duty contacts. UL listed. 13 E 81052 Ea. .20; 10 for 3.34

2. E-Z WIRE PARALLEL GROUND DUPLEX WALL OUTLET. Breakoff terminals for 2 separate 3-wire circuits. Easily wired by pressure terminals or screws. UL listed. 15 amps; 125 V. 13 E 81183 Ea. .45; 10 for 3.99

3. E-Z WIRE QUIET SWITCH. Ultra-quiet action switch — no clicking noise. Has screw, and E-Z wire pressure terminals. 15 amps; 120V. UL listed. 13 E 81201 Ea. .40; 10 for 4.50

4. SILENT MERCURY SWITCH. Absolutely soundless. Must be mounted in upright position. With mtg. screws and plaster board ears. 15 amps., 125V. Ivory. Shpg. wt., 4 oz. 13 E 81328 Net 1.00

5. BAKELITE PULL CHAIN CURRENT TAP. Pull chain controls lamp, two side taps are always on. Lamp outlet 250W, Side Taps 660W 125V. UL listed. 13 E 81235 Net .45

6. BAKELITE CURRENT TAP. Similar to above less pull chain. UL listed. 13 E 81045 Net .32

6. CANOPY ROTARY SWITCH. Bakelite knob, single pole. Very shallow. Wire leads. Rated 3 amp. at 125V. U.L. Listed. 13 E 81128 Net .32

CANOPY PULL SWITCH. Similar to above with pull chain on/off. 13 E 81334 Net .46

7. PARALLEL GROUND ADAPTER. Adapts 3 wire tools and appliances to 2 wire AC outlets. 15A., 125V. 3/4" ground lead and lug. With cord clamp. U.L. Listed. 13 E 81151 Net .24 10 for 2.15

8. RUBBER CUBE TAP. 3 outlets. Unbreakable one piece soft rubber construction. 13 E 81102 U.L. Listed Net .32

9. PARALLEL GROUND RUBBER PLUG. With cord clamp. U ground Dia. 1 1/2". 15 amps; 125V. U.L. Listed. 13 E 81219 Net .55

10. FLEXIBLE RUBBER HANDLE PLUG. Can be used for heavy duty work. 15A. 125V. 13 E 81078 U.L. Listed Ea. .11; 10 for .99

11. RUBBER CORD CONNECTOR. With pull handle for extension cords. 1 1/4" diameter. With cord clamp. 2 wire. U.L. Listed. 13 E 81144 Net .44

11. PARALLEL GROUND RUBBER CONNECTOR. For extension cord 1 1/2" diameter, with cord clamp. 3 wire. U.L. Listed. 13 E 81342 Net 1.00

12. BAKELITE EDISON SOCKET ADAPTER. Adapts standard parallel outlet to take standard bulb with Edison base. 660W, 125V. 13 E 81227 U.L. Listed. Net .21

13. BAKELITE PLUG. Sturdy prongs. U.L. List. 13 E 81037 Ea. .60; 10 for .72

14. CHASSIS AC RECEPTACLE. Mounts from top or bottom. Mtg. centers 1 1/2". U.L. Listed. 15A. 125VAC/DC. Solder terminals. 13 E 09048 Net .17

15. 3-WAY SURFACE OUTLET. Brown Pin Type terminals, wood screw. U.L. Listed. 13 E 81060 Ea. .24; 10 for 1.18

16. JIFFY PUSH PULL PLUG. Attaches in 5 seconds without any tools. Spring prongs. Brown. U.L. Listed. 13 E 81136 Ea. .13; 10 for 1.15

17. INSULATED STAPLES. No. 5. 1/4" x 3/8". 13 E 81084—Package of 100 Net .35

18. CUBE TAP EXTENSION. Trio tap, 9 ft. rubber cord. AC plug. Brown. U.L. Listed. 13 E 81110 Net .85

19. 4" PORCELAIN PULL RECEPTACLE WITH OUTLET. Also usable at 3 3/4" size. Easily wired by pressure terminals or screws. Lamp-holder 250W, outlet 15A., 125V. With mtg. screws, cord. 13 E 81359 Net .80

To Speed Your Mail Order—Please Give Your Zip Code Number

Premier Metal-Barber-Colman Motors

ALUMINUM CHASSIS

Chassis are of one piece construction with gussets spot-welded to the bottom flanges for additional strength. Made of No. 18 gauge (0.40) aluminum except # are No. 14 gauge (.064) in natural aluminum finish. Bottom plates have holes to match chassis and have 4 pressed dimples. No. 18 gauge (.040) in natural aluminum finish. Avg. shpg. wt. 2 lbs.

CHASSIS



BOTTOM PLATES

Stock No.	Size Inches	Lbs.	Net Ea.		Stock No.	Size Inches	Lbs.	Net Ea.	
			1-49	50-99				1-49	50-99
12 E 81906	4x6x1½	¼	1.50	1.35	12 E 82870	1.00	.90		
12 E 81914	4x6x2	¼	1.60	1.44	12 E 82870	1.00	.90		
12 E 81922	4x6x3	¼	1.85	1.66	12 E 82870	1.00	.90		
12 E 81930	4x8x2	¾	1.75	1.57	12 E 82888	1.10	.99		
12 E 81948	4x17x3	1	3.15	2.83	12 E 82896	1.15	1.03		
12 E 81955	5x7x2	¼	1.65	1.48	12 E 82904	1.00	.90		
12 E 81963	5x7x3	¼	1.90	1.71	12 E 82904	1.00	.90		
12 E 81971	5x10x3	¾	2.10	1.99	12 E 82912	1.00	.90		
12 E 81989	5x13x3	¾	2.40	2.18	12 E 82920	1.15	1.03		
12 E 81987	5½x9½x1½	½	1.85	1.48	12 E 82938	1.00	.90		
12 E 82011	6x14x3	1	3.15	2.83	12 E 82946	1.50	1.35		
12 E 82029	6x17x3	1	3.50	3.15	12 E 82953	1.50	1.35		
12 E 82037	7x7x2	½	1.90	1.71	12 E 82961	1.00	.90		
12 E 82045	7x9x2	½	2.00	1.80	12 E 82967	1.00	.90		
12 E 82052	7x11x2	¾	2.15	1.93	12 E 82987	1.15	1.03		
12 E 82060	7x11x3	¾	2.65	2.38	12 E 82987	1.15	1.03		
12 E 82078	7x12x3	¾	2.85	2.38	12 E 82995	1.35	1.21		
12 E 82086	7x13x2	¾	2.25	2.02	12 E 83019	1.40	1.26		
12 E 82094	7x15x3	1	3.60	3.24	12 E 83027	1.50	1.35		
12 E 82102	7x17x3	1½	3.65	3.28	12 E 83035	1.60	1.44		

CHASSIS

BOTTOM PLATES

Stock No.	Size Inches	Lbs.	Net Ea.		Stock No.	Size Inches	Lbs.	Net Ea.	
			1-49	50-99				1-49	50-99
12 E 82110	8x10x2½	1	2.65	2.38	12 E 83043	1.25	1.12		
12 E 82128	8x12x3	1	3.10	2.79	12 E 83050	1.50	1.35		
12 E 82136	8x17x2	1½	3.50	3.15	12 E 83068	1.75	1.57		
12 E 82144	8x17x3	1¼	3.85	3.48	12 E 83068	1.75	1.57		
12 E 82151	8½x15x3	1¼	3.75	3.37	12 E 83076	2.15	1.93		
12 E 82169	10x12x3	1¼	3.65	3.28	12 E 83084	1.65	1.48		
12 E 82177	10x14x3	1¼	3.90	3.51	12 E 83092	1.75	1.57		
12 E 82185	10x17x2	1¼	3.85	3.48	12 E 83100	1.90	1.71		
12 E 82193	10x17x3†	1¾	4.35	3.91	12 E 83100	1.90	1.71		
12 E 82201	10x17x4†	2	5.85	5.26	12 E 83100	1.90	1.71		
12 E 82219	10x23x3†	2½	6.60	5.94	12 E 83118	2.90	2.61		
12 E 82227	11x17x2†	1¾	4.50	4.05	12 E 83126	2.00	1.80		
12 E 82235	11x17x3†	2	4.50	4.72	12 E 83126	2.00	1.80		
12 E 82243	12x17x2†	1¾	4.65	4.18	12 E 83134	2.40	2.16		
12 E 82250	12x17x3†	2¼	5.50	4.95	12 E 83134	2.40	2.16		
12 E 82268	12x17x4†	2¾	6.35	5.71	12 E 83134	2.40	2.16		
12 E 82276	13x17x2†	1¾	4.75	4.27	12 E 83142	2.85	2.38		
12 E 82284	13x17x3†	2¼	5.65	5.08	12 E 83142	2.85	2.38		
12 E 82292	13x17x4†	2½	6.90	6.21	12 E 83142	2.85	2.38		
12 E 82300	17x17x4†	3	11.80	10.44	12 E 83159	3.25	2.92		

TABLE TYPE RELAY RACKS

Rigidly constructed of #16 gauge steel finished in gray hammertone. Base constructed of one piece, similar to a chassis. Panel mounted holes are tapped for 10-32 machine screws. Shipped knocked down.

Stock No.	Mfr. Type	HxWxD"	Space	Lbs.	Net
12 E 85923WX	TR-2119	25x21x12"	21x19"	17	11.65
12 E 85972WX	TR-2819	32x21x12"	28x19"	20	14.15

TELEPHONE TYPE RELAY RACKS

Open type racks constructed of #12 gauge steel finished in gray hammertone. Vertical members and top crossbrace are included together. Panel mounting holes are tapped for 10-32 machine screws. Racks shipped knocked down with all necessary bolts for easy assembly. Base punched to accommodate type CA-4 casters.

Stock No.	Mfr. Type	HxWxD"	Panel Space	Lbs.	Net
12 E 85999WX	RR-800	39½x20x18¾"	36¾x19"	40	23.80
12 E 85907WX	RR-801	74¼x20x20¾"	71¾x19"	55	28.30
12 E 85915WX	RR-802	79½x20x20¾"	77 x19"	60	32.80

STANDARD AMPLIFIER FOUNDATIONS

Consists of regular chassis with ruggedly constructed metal covers. Top cover has perforations, rounded corners; 6" high; 1-pc chassis with corners spot-welded; Gray Hammertone Finish.

Stock No.	Type	Chassis BxWxD		Net		
		Lbs.	1-24	25-49	50-99	
12 E 85303	AF-510	5x10x3	9	7.70	6.93	6.24
12 E 85311	AF-615	6x14x3	10	8.55	7.69	6.92
12 E 85329	AF-1017	10x17x3	13	10.75	9.67	8.70
12 E 85337	AF-1317	13x17x3	15	12.10	10.89	9.80

ALUMINUM PANELS

Aluminum panels, type MAP, bright aluminum protected both sides by peelable masking paper. Type ARP painted gray hammertone both sides. 19" wide, ¼" thick.

"MAP" Masked Aluminum					"ARP" Gray Hammertone				
Stock No.	Type	Each	Hgt.	Lbs.	Stock No.	Type	Each	Lbs.	Net
12 E 85469	119	1.25	1¾"	½	12 E 86822				119 1.40
12 E 85477	319	1.90	3½"	1	12 E 86830				319 1.90
12 E 85485	519	2.80	5¼"	1½	12 E 86848				519 2.65
12 E 85493	719	3.10	7"	2	12 E 86856				719 3.25
12 E 85501	819	3.75	8¾"	2½	12 E 86863				819 3.75
12 E 85519	1019	4.70	10½"	3	12 E 86871				1019 4.75
12 E 85527	1219	5.35	12¼"	3½	12 E 86889				1219 5.80
12 E 85535	1419	6.15	14"	4	12 E 86897				1419 6.35
12 E 85543	1519	6.90	15¾"	4	12 E 86905				1519 7.10
12 E 85550	1719	7.70	17½"	4½	12 E 86913				1719 7.75
12 E 85568	1919	8.50	19¼"	5	12 E 86921				1919 8.50
12 E 85576	2119	9.25	21"	6	12 E 86939				2119 9.40

SLOPING PANEL UTILITY BOXES



Steel and aluminum sloping panel cabinets with round top corners and sloping front. For installations that require opening in rear of box. No. 20 gauge steel—Black Wrinkle finish. No. 18 gauge (.040) aluminum—natural aluminum finish. 4½"Hx4¼"D.

BLACK WRINKLE

Stock No.	WIDTH	TYPE	LBS	NET	
				1-49	50-99
12 E 86650	4¾"	SPC-1200	¾	1.85	1.66
12 E 86668	5¾"	SPC-1201	1	2.00	1.80
12 E 86676	6¾"	SPC-1202	1	2.15	1.93
12 E 86684	7¾"	SPC-1203	1½	2.35	2.11

ALUMINUM

12 E 86692	4¾"	ASPC-1200	½	2.35	2.11
12 E 86700	5¾"	ASPC-1201	½	2.50	2.25
12 E 86718	6¾"	ASPC-1202	¾	2.65	2.38
12 E 86726	7¾"	ASPC-1203	¾	2.85	2.58

BARBER-COLMAN SHADED-POLE UNIDIRECTIONAL MOTORS



Shaded-pole AC induction motors for driving cooling fans, appliances, displays, vending machines, pumps, movie projectors. Simple, dependable construction—no brushes, contacts, capacitors. All motors rated for continuous duty when operated at room ambients below 100°F.; CW rotation viewed facing the drive hub

or shaft. Porous bronze alignable bearings used on all unidirectional motors. 115 volt, 60 cycle field coils with Class A insulation and molded phenolic bobbins. Long life lubrication. Mounts with two #10-32 tapped studs on rear of motor. Table below indicates full load characteristics. Shpg. wt., 1½ lbs.

Stock No.	Mfr's. Type	Torque lb.-in.	Speed RPM	Max. HP	Input Amps	Approximate Dimensions in.	Net Each	
							1-9	10-24
32 E 16017*	AYAA707-118	.025	1900	.0007	.13	2¼x2¼x1½	6.75	5.00
32 E 16025	DYAB569-110	.045	2400	.0017	.15	2¾x2¼x1½	6.50	5.82
32 E 16033	DYAF761-110	.10	2800	.0045	.27	2¼x2¾x1½	6.85	5.90
32 E 16041	KYAF764-110	.045	2400	.0017	.15	2¾x2¼x1½	9.25	8.05
32 E 16058*	OYA767-118	.20	2900	.009	.39	2¼x2¾x2¼	19.20	16.65



COOLING FANS

Fans listed to the right may be used with above motors for cooling electronic tubes, projection lamps, and in deodorizers, heaters required air delivery against a low static head. Aluminum blades and zinc plated steel hubs. Blows air forward when mounted with hub towards the motor. *Free air delivery measured 12 inches from front of fan. Fan dia.: Type 303=3"; 403=4"; 502-1=5". Hub dia.: 303=1/8"; 403=1/8"; 502-1=5/32". Avg. shpg. wt., 2 oz.

Stock No.	Mfr's. Type	CFM*	Fan Motor	Net Each	
				1-9	10-24
32 E 16116	AYFA 303	75	AYAA707-110	2.02	1.90
32 E 16124	AYFA 403	190	DYAB569-110	2.39	2.25
32 E 16132	AYFA 502-1	300	DYAF761-110	2.86	2.55



Premier Metal Products

METAL UTILITY CABINETS

Have two removable sides for easy accessibility. Have flanged edges and spot-welded corners. No. 20 ga. steel finished in Black Wrinkle; No. 16 ga. (.051) aluminum in natural aluminum finish. Avg. shpg. wt. of steel cabinets 3 lbs., aluminum 1 1/2 lbs. Type No. is prefixed by "C" for steel and AC for aluminum.



COMPACT CABINETS



Body made of 20 gauge steel with .064 aluminum front panel. Top four corners are rounded. Sides are perforated for ventilation. Top handle is recessed. Panel fits into 1/2" recess. Two inch opening in rear for leads. Welded construction. Base has rubber feet. Body finished in dark grey metallic enamel panel in light grey metallic enamel. With hardware for assembly. Ideal for instrumentation. ACH series chassis are on next page.

Stock No.	Size DxWxH"	Use Chassis	Wt. Net lbs. Ea.
12 E 84355	8x6 1/8x8	5x7x2	4 11.00
12 E 84363	8x8 1/8x8	7x7x2	5 12.05
12 E 84371	8x10 1/8x8	7x9x2	6 12.85
12 E 84389	12x8 1/8x9	7x11x2	7 14.00
12 E 84397	18x11 1/8x11	10x17x3	10 16.95
12 E 84405	18x14 1/8x12	13x17x3	11 19.25

MINIATURE ALUMINUM OPEN-END CHASSIS



Ideal for small amplifiers, oscillators, and miniature assemblies. Made of 18 gauge (.040) aluminum, natural finish. Avg. shpg. wt. 1/2 lb.

Stock No.	Size DxWxH"	ACH Type	NET 1-24	NET 25-49
12 E 83183	2 3/4 x 2 3/4 x 1 1/4	1350	.55	.49
12 E 83191	1 3/4 x 3 1/2 x 1	1351	.55	.49
12 E 83209	3 1/4 x 4 1/2 x 2	1352	.65	.58
12 E 83217	2 3/4 x 4 1/2 x 1	1353	.65	.58
12 E 83225	3 3/4 x 4 1/2 x 1 1/2	1354	.65	.58
12 E 83233	3 3/4 x 4 1/2 x 1 1/4	1355	.75	.67
12 E 83241	5 3/4 x 4 1/2 x 1 1/2	1356	.80	.72
12 E 83258	4x3 1/2 x 1	1357	.65	.58
12 E 83266	4x4 1/2 x 1	1358	.75	.67
12 E 83274	4x5 1/2 x 1	1359	.75	.67
12 E 83282	4x6 1/2 x 1	1360	.80	.72

UNIVERSAL METER CASES



A meter case that can accommodate either a 2" or 3" meter. Center hole for 2" meter increases to 3" meter hole by simply removing a knock-out. 4 3/4 x 4 1/2 x 4 1/4". Supplied with two 1/2" dia. knockouts for feed through insulators or Volume Controls. Type SPC-23 #20 gauge steel—Black Wrinkle Finish. Type ASPC-23 #18 gauge (.040) Aluminum—Natural Finish. Average shpg. wt. 3/4 lb.

Stock No.	Type	1-49	50-99
12 E 83187	SPC-23	1.85	1.48
12 E 83175	ASPC-23	2.15	1.93

CASTERS FOR RACKS AND CABINETS

Made of Plaskite non-marking composition wheel with Ball Bearing Swivel Plate. Packed one set of 4 in box with screws for assembly.



Stock No.	Mfr. No.	Wheel Diam.	Net Per Set of 4
12 E 83373	CA-4	2"	4.90
12 E 83381	CA-5	3"	11.80

BLACK WRINKLE STEEL

Mfr. Type	Stock No.	Net Each 1-49	50-99	Size HxWxD"
C-442	12 E 83399	1.60	1.44	4x4x2
C-453	12 E 83407	1.65	1.48	4x5x3
C-564	12 E 83415	1.85	1.66	5x6x4
C-596	12 E 83423	2.85	2.56	5x9x6
C-666	12 E 83431	2.50	2.25	6x6x6
C-695	12 E 83449	2.90	2.61	6x9x5
C-754	12 E 83456	2.40	2.16	7x5x4
C-8101	12 E 83464	5.15	4.63	8x10x10
C-1276	12 E 83472	4.00	3.60	12x7x6 15x9x7

NATURAL ALUMINUM

Mfr. Type	Stock No.	Net Each 1-49	50-99
AC-442	12 E 83480	1.65	1.48
AC-453	12 E 83498	1.75	1.57
AC-564	12 E 83506	2.00	1.80
AC-596	12 E 83514	3.40	3.06
AC-666	12 E 83522	2.65	2.38
AC-695	12 E 83530	3.25	2.92
AC-1276	12 E 83548	4.65	4.18
AC-1597	12 E 83555	6.40	5.78

STREAMLINED CABINETS

The perfect cabinets for electronic devices not requiring excessive depths. Has hinged top front vertical rounded corners and a removable front panel. Slides and back of cabinet are louvered for ample ventilation. Back has opening for leads. Constructed of #20 gauge steel. Finished in gray hammerstone.



Stock No.	Mfr. Type	HxWxD"	Panel Size	Lbs.	Use Chassis	Net Each	
						1-24	25-49
12 E 85782	HTC-200	8x10x8	8x8	6	7x7x2	7.15	6.43
12 E 85790	HTC-201	8x12x8	8x10	6 1/2	7x9x2	7.65	6.07
12 E 85808	HTC-202	8x16x8	8x14	11	7x13x2	8.65	7.78
12 E 85816	HTC-203	9x17x11	9x15	6 1/2	10x14x3	16.25	14.62
12 E 85824	HTC-204	12x20x12	12x18	13 1/2	10x17x3	18.25	16.42
12 E 85832	HTC-205	8x14x8	8x12	7 1/4	7x11x2	18.15	7.33

SLOPING PANEL CABINETS

These handy cabinets have rounded top corners and a removable front panel. Back of cabinet is perforated and has opening for leads. Constructed of #20 gauge steel. Finished in gray hammerstone.



Stock No.	Mfr. Type	Size HxWxD"	Use Chassis"	Lbs.	Net	
					1-24	25-49 50-99
12 E 85840	SFC-500	8x8x8	7x7x2	6	5.45	4.90 4.41
12 E 85857	SFC-501	8x10x8	7x9x2	7	6.10	5.49 4.94
12 E 85865	SFC-502	8x14x8	7x13x2	8	5.50	5.85 5.26
12 E 85873	SFC-503	9x18x8	7x17x3	10	9.35	8.41 7.57
12 E 85881	SFC-504	12x18x12	10x17x3	14	11.95	10.75 9.67

ALUMINUM MINIBOXES

Two piece case made of #16 gauge (.051) aluminum. Each section forms 3 sides. Flanges assure proper shielding. Available in variety of sizes for popular electronic devices and construction projects. Available in natural finish or grey hammerstone.

NATURAL ALUMINUM

Stock No.	AMC Type	Net		Size—LxWxH"	Lbs.	PMC		Net	
		1-49	99			1-49	99		
12 E 83870	1000	.75	.67	2 3/4 x 2 1/2 x 1 1/2	1/4	12 E 83845	1000	.90	.81
12 E 83688	1001	.85	.76	3 1/4 x 2 1/2 x 1 1/2	1/4	12 E 83852	1001	1.00	.90
12 E 83696	1002	.85	.76	4x2 1/2 x 1 1/2	1/4	12 E 83860	1002	1.00	.90
12 E 83704	1003	1.00	.90	4x2 1/4 x 2 1/4	3/8	12 E 83878	1003	1.15	1.03
12 E 83712	1004	1.10	.99	5x2 1/4 x 2 1/4	3/8	12 E 83886	1004	1.25	1.12
12 E 83720	1005	1.25	1.12	5x4x3	1/2	12 E 83894	1005	1.40	1.26
12 E 83738	1006	1.15	1.03	5 1/4 x 3x2 1/2	1/2	12 E 83902	1006	1.35	1.21
12 E 83746	1007	1.50	1.35	6x5x4	1	12 E 83910	1007	1.75	1.57
12 E 83753	1008	1.65	1.40	7x5x3	3/4	12 E 83928	1008	1.90	1.71
12 E 83761	1009	2.50	2.25	8x6x3 1/2	1 1/4	12 E 83936	1009	2.75	2.47
12 E 83779	1010	3.10	2.79	10x6x3 1/2	1 1/2	12 E 83944	1010	3.35	3.01
12 E 83787	1011	3.40	3.06	12x7x4	1 3/4	12 E 83951	1011	3.85	3.48
12 E 83795	1012	4.10	3.69	17x5x4	2	12 E 83969	1012	4.60	4.14
12 E 83803	1013	1.25	1.12	10x2 1/2 x 1 1/2	1/2	12 E 83977	1013	1.40	1.26
12 E 83811	1014	1.65	1.48	12x2 1/2 x 2 1/4	3/4	12 E 83985	1014	1.90	1.71
12 E 83829	1015	1.10	.99	4x2x2 3/4	3/4	12 E 83993	1015	1.25	1.12
12 E 83837	1016	1.10	.99	4 1/4 x 2 1/4 x 1 1/2	3/4	12 E 84017	1016	1.25	1.12

GREY HAMMERTONE

SLOPING COMPACT CABINETS

Two piece unit made of #20 cold rolled steel. Front, bottom and back form one "U" shaped unit which screws to one piece cover and sides. Top and sides of units extend beyond the front panel area and slope toward the bottom of the panel. Choice of two-tone grey enameled finish, black outer shell with blue insert or black with gold insert.



Stock No.	Mfr. No.	Wheel Diam.	Net Per Set of 4	Two-Tone Grey		Blue-Black		Gold-Black	
				Stock No.	Net	Stock No.	Net	Stock No.	Net
6x10x7"				12 E 85831	6.90	12 E 84413	7.50	12 E 84454	7.50
7x12x8"				12 E 85949	7.55	12 E 84421	8.20	12 E 84462	8.20
3x8x5"				12 E 85956	3.90	12 E 84439	4.30	12 E 84470	4.30
5x5x5"				12 E 85964	4.20	12 E 84447	4.70	12 E 84488	4.70

Littelfuse Safety Devices

TYPE 3AG STANDARD FUSES

Series 312000. Quick acting for low time-lag applications such as amplifiers—auto radios. U.L. listed. $1\frac{1}{4} \times \frac{1}{4}$ " diam. All rated 250 volt except 8 amp is 125V. 5 fuses per pkg. Shpg. wt., 6 oz.

Stock No.	Amps	Per 20 Pkgs.		Stock No.	Amps	Per 20 Pkgs.	
		Pkg.	Per Pkg.			Pkg.	Per Pkg.
13 E 10010	1/100	2.25	1.88	13 E 10135	1		
13 E 10020	1/2	1.98	1.65	13 E 12503	1 1/4		
13 E 10036	3/4	.87	.73	13 E 10143	1 1/2	.39	.33
13 E 10044	1/2			13 E 12511	1-6/10		
13 E 10051	.15	13 E 10150	2				
13 E 10069	.175			13 E 12529	2 1/2	.48	.40
13 E 10077	3/4	13 E 10168	3				
13 E 10085	1/4			13 E 10176	4	.69	.58
13 E 10093	3/10	13 E 10184	5				
13 E 10101	3/4	13 E 10192	6				
13 E 10119	1/2			13 E 12537	7	.69	.58
13 E 10127	3/4	13 E 10200	8				

3AG STANDARD PIGTAIL FUSES

Series 318000. Designed for use in TV receivers and other applications where absolute economy in space is necessary. Rated at 250V. UL listed through 3 amps. $1\frac{1}{4} \times \frac{1}{4}$ " diam. pigtails $1\frac{1}{2}$ " #20 tinned copper wire. 5 fuses per pkg. Shpg. wt., 6 oz.

Stock No.	Amps	Per 20 Pkgs.		Stock No.	Amps	Per 20 Pkgs.	
		Pkg.	Per Pkg.			Pkg.	Per Pkg.
13 E 11489	3/4	1.50	1.25	13 E 11547	1 1/2	.69	.58
13 E 11497	1/4	1.14	.95	13 E 11554	2		
13 E 11505	1/4	.87	.73	13 E 11562	3	.72	.60
13 E 11513	3/4			13 E 11570	4		
13 E 11521	3/4			13 E 11580	5	.69	.58
13 E 11539	1	13 E 11596	6				
				13 E 12545	7	.87	.73
				13 E 12552	8		

LIMITED CURRENT FUSES

Series 332000. Exact TV replacements. Fuses match holders for specific size ranges. Rated 250 volt through 6 amps and 125 volt above 7 amps. 5 fuses per pkg. Shpg. wt., 6 oz.

Stock No.	Amps	Per 20 Pkgs.		Stock No.	Amps	Per 20 Pkgs.	
		Pkg.	Per Pkg.			Pkg.	Per Pkg.
13 E 10020	1/2	1.89	1.58	13 E 10952	1 3/4	.45	.38
13 E 10036	3/4	1.23	1.03	13 E 10960	2		
13 E 10044	1/2	.90	.75	13 E 10978	2 1/2	.51	.43
13 E 10053	3/4			13 E 10986	3		
13 E 10061	1/4			13 E 10994	3 1/2	.78	.65
13 E 10079	3/10	13 E 11016	4				
13 E 10087	4/10	.72	.60	13 E 11026	5		
13 E 10095	3/4			13 E 11034	6		
13 E 10099	1/2			13 E 11042	7	.45	.38
13 E 10011	3/4	13 E 11050	8				
13 E 10029	1			13 E 11067	10		
13 E 10037	1 1/4						
13 E 10045	1 1/2						

SLOW BLOW LIMITED CURRENT FUSES

Series 333000. Exact TV replacement. Fuse matched to fuseholder. All rated 125 volts except 6 1/4 and 7 amp rated 32 volt. 5 fuses per pkg. Shpg. wt., 6 oz.

Stock No.	Amps	Per 20 Pkgs.		Stock No.	Amps	Per 20 Pkgs.	
		Pkg.	Per Pkg.			Pkg.	Per Pkg.
13 E 11075	1/100	1.68	1.40	13 E 11208	1	1.23	1.03
13 E 11083	1/2			13 E 11216	1 1/4		
13 E 11091	3/4	.87	.73	13 E 11224	1-6/10	1.14	.95
13 E 11109	1/10			13 E 11232	1 3/4		
13 E 11117	.15			13 E 11240	2	.69	.58
13 E 11125	2/10	13 E 11257	2 1/2				
13 E 11133	1/4	13 E 11265	2-8/10				
13 E 11141	3/10	1.23	1.03	13 E 11273	3-2/10	.78	.65
13 E 11158	4/10			13 E 11281	3 1/2		
13 E 11166	1/2			13 E 11299	4	.69	.58
13 E 11174	6/10	13 E 11307	5				
13 E 11182	3/4			13 E 11315	6 1/4	.78	.65
13 E 11190	8/10	13 E 11323	7				

AUTO FUSE ASSORTMENT



Universal auto fuse assortment easily stored in glove compartment for emergency use. Fuses for radio, heater, lights, cigar lighter, air conditioner, windshield wipers, etc. packed in plastic case, 10 fuses. Assorted value. Shpg. wt., 2 ozs.

13 E 11745 Net .94
Universal auto fuse retainer. Holds fuses with spring loaded action. Just attach wires into circuit and load with a fuse.
13 E 11752 Shpg. wt., 2 ozs. Net .42

TYPE 3AG SLOW BLOW FUSES

Series 313000 High time-lag to withstand heavy surges, blows quickly on shorts. Units through 5 amps are rated 125 volts and are UL listed, above 5 amp rated 32 volt. 5 fuses per pkg. $1\frac{1}{4} \times \frac{1}{4}$ " diam. Shpg. wt., 6 oz.

Stock No.	Amps	Per 20 Pkgs.		Stock No.	Amps	Per 20 Pkgs.	
		Pkg.	Per Pkg.			Pkg.	Per Pkg.
13 E 10216	1/100	1.68	1.48	13 E 10390	1	1.23	1.03
13 E 10208	1/2			13 E 12588	1-2/10		
13 E 10234	1/4	.87	.73	13 E 10408	1 1/4	1.14	.95
13 E 10242	1/10			13 E 10418	1 1/2		
13 E 10250	1/4			13 E 10424	1-6/10	.90	.75
13 E 10267	.15	13 E 10432	2				
13 E 10275	.175			13 E 10440	2 1/2	1.14	.95
13 E 10283	3/4	13 E 12576	2-8/10				
13 E 10309	1/4			13 E 10457	3	.69	.58
13 E 10291	2/10	13 E 10465	3.2				
13 E 10317	3/10	1.23	1.03	13 E 10473	4	.90	.75
13 E 10325	3/4			13 E 10481	5		
13 E 10333	4/10			13 E 10499	6 1/4		
13 E 10341	1/2			13 E 10507	7	.78	.65
13 E 10358	6/10	13 E 10515	8				
13 E 10366	7/10			13 E 10523	10	.93	.78
13 E 10374	3/4	13 E 10531	15				
13 E 10382	8/10			13 E 10549	20	.69	.58
		13 E 10556	25				
		13 E 10564	30				

3AG SLOW BLOW PIGTAIL FUSES

Series 315000. Widely used in TV receivers. Designed to withstand heavy surges and instantaneous peaks yet quick acting under short circuit. All rated 125 Volt. UL listed through 3.2 amp. $1\frac{1}{4} \times \frac{1}{4}$ " diam. pigtails $1\frac{1}{2}$ " #20 tinned copper wire. 5 fuses per pkg. Shpg. wt., 6 oz.

Stock No.	Amps	Per 20 Pkgs.		Stock No.	Amps	Per 20 Pkgs.	
		Pkg.	Per Pkg.			Pkg.	Per Pkg.
13 E 10572	1/100	2.10	1.75	13 E 10705	3/4	1.50	1.25
13 E 10580	1/2			13 E 10713	8/10		
13 E 10598	3/4	1.50	1.25	13 E 10721	1	1.41	1.18
13 E 10606	1/10			13 E 10739	1 1/4		
13 E 10614	.15			13 E 10747	1 1/2	1.23	1.03
13 E 10622	3/4	13 E 10754	1-6/10				
13 E 10630	2/10			13 E 10762	2	.78	.65
13 E 10648	1/4	13 E 10770	2 1/2				
13 E 10655	3/10			13 E 10788	3	1.23	1.03
13 E 10663	3/4	13 E 10796	3.2				
13 E 10671	4/10			13 E 10804	4	.69	.58
13 E 10689	1/2	13 E 10812	5				
13 E 10697	6/10						

TYPE 8AG INSTRUMENT FUSES

Series 3261000. Designed for high-speed action to protect delicate electrical equipment. All rated at 250 volts, except 5 amp rated 32 volt. 5 fuses per pkg. $1 \times \frac{1}{4}$ " diam. Shpg. wt., 6 oz.

Stock No.	Amps	Per 20 Pkgs.		Stock No.	Amps	Per 20 Pkgs.	
		Pkg.	Per Pkg.			Pkg.	Per Pkg.
13 E 11331	1/500	6.00	5.00	13 E 11414	1/2	.57	.48
13 E 11349	1/200	2.52	2.10	13 E 11422	3/4		
13 E 11356	1/100	2.25	1.88	13 E 11430	1	.39	.33
13 E 11364	1/32	1.98	1.65	13 E 11448	1 1/2		
13 E 11372	1/16	1.23	1.03	13 E 11456	2	.69	.58
13 E 11380	1/8	.67	.73	13 E 11463	3		
13 E 11398	1/4	.57	.48	13 E 12586	4	.78	.65
13 E 11406	3/8			13 E 11471	5		

TYPE 3AB FUSES

Series 314000. Steatite enclosed, ARC-Quenching Powder filled fuses. Will not shatter against quick shorts. Medium time lag, types through 15 Amp. UL listed. All 250 Volt except 30 amps 125 volt. $1\frac{1}{4} \times \frac{1}{4}$ " Dia. 5 fuses per pkg. Shpg. wt., 6 oz.

Stock No.	Amps	Per 20 Pkgs.		Stock No.	Amps	Per 20 Pkgs.	
		Pkg.	Per Pkg.			Pkg.	Per Pkg.
13 E 11604	1	.78	.65	13 E 11653	10	.69	.58
13 E 11612	2			13 E 11661	12		
13 E 11620	3			13 E 11678	15	.75	.63
13 E 11638	5	13 E 11687	20				
13 E 11646	8	.69	.58	13 E 12594	25	.93	.78
				13 E 11695	30		

PLUG FUSES

UL listed. Wt., 6 oz. PER BOX OF 5



13 E 11703—10 amperes
13 E 11711—15 amperes
13 E 11729—20 amperes
13 E 11737—30 amperes

39¢

Fuses and Fuse Holders

SUBMINIATURE PICOFUSES

Series 275000. For computer, micro-electronic and aerospace circuits of 125V., or less, where short-circuit currents as high as 300 amps may occur. Ceramic body. Only 7/32" long x 5/64" dia. Axial tin coated copper leads. 5 fuses per pkg. Shpg. wt., 2 oz.

Stock No.	Per 20 Pkgs.		Stock No.	Per 20 Pkgs.	
	Amps.	Per Pkg.		Amps.	Per Pkg.
13 E 12396	1/8	2.13 1.78	13 E 12453	1 1/2	1.06 1.55
13 E 12404	1/4		13 E 12461	2	
13 E 12412	3/8		13 E 12479	3	
13 E 12420	1/2	13 E 12487	4		
13 E 12438	3/4		13 E 12495	5	
13 E 12446	1				

LITTELFUSE EUROPEAN EQUIPMENT FUSES

Used in Hickok instruments, tape recorders, Radios, Hi-Fi equipment and Hickok test equipment, 5x20 mm. Rated at 250V. 5 fuses per pkg. Shpg. wt., 6 oz.

Stock No.	Amps.	Per Pkg.	Per 20 Pkgs.	Stock No.	Amps.	Per Pkg.	Per 20 Pkgs.
13 E 12107	1/2	1.32	.88	13 E 12198	1 1/2	1.05	.88
Type F 212 Series Standard Fuse							
13 E 12115	1/8	1.68	.88	13 E 12206	1 1/4	1.05	.88
13 E 12123	1/4	1.32	1.10	13 E 12214	2	1.38	1.15
13 E 12131	1/2			13 E 12222	4		
13 E 12149	8/10			13 E 12230	6		
Type T 213 Series Slow Blow Fuse							
13 E 12156	1	1.05	.88	13 E 12248	2	1.38	1.15
13 E 12164	1/4	1.38	1.15	13 E 12255	4		
13 E 12172	1/2						
13 E 12180	1						

LITTELFUSE 32 VOLT AUTO FUSES

307000 Series Medium acting fuses designed for auto use. Sizes to S.A.E. specifications, length according to current to guard against over fusing. For Buss specify SFE all 1/4" Diam. 5 fuses per pkg. Shpg. wt., 6 oz.

Stock No.	Amps.	Per Pkg.	20 Pkgs. Per Pkg.
13 E 12263	4	.28	.24
13 E 12271	6		
13 E 12289	7.5	.28	.24
13 E 12297	9		
13 E 12305	14	.25	.21
13 E 12313	20		
13 E 12321	30	.28	.24

BUSS FOREIGN CAR FUSES

Replacement glass fuses for porcelain body fuses used in Volkswagen, Mercedes-Benz, Opel, Porsche, Saab, Volvo, Renault ('64 & later), Fiat and others. All 1/4" dia. x 31/32 except *1/4" dia. x 21/32. 5 fuses per pkg. Shpg. wt., 6 oz.

Stock No.	Amps.	Per Pkg.	Stock No.	Amps.	Per Pkg.
13 E 62102	8	.30	13 E 62136	25	.30
13 E 62110	15		13 E 62144*	25	.40
13 E 62128	16				

SNAP-ON FUSE HOLDER

For fast replacement of pigtail fuses. One side of dual holder clips on to blown fuse. New fuse fits into other side.

13 E 12308 wt., 4 oz. Each .20 10 for 1.75



PHOSPHOR BRONZE FUSE CLIPS

Bright nickel plate with fuse stop ears. 10 clips per package. Shpg. wt., 4 oz.

Stock No.	Littl fuse #	For Fuses Types	Net Per	Pkg. of 10
			1-9	10-up
13 E 12339	101001	Standard Hi-Voltage	.28	.24
13 E 12347	103001	SFE, 3AG, 3AB, 8AG	.47	.39
13 E 12354	105001	4AG, 4AB	.57	.47
13 E 12362	107001	N.E.C.—30 Fuses	.72	.60
13 E 12370	109001	N.E.C.—30 Fuses	2.76	2.30

BUSS FUSETRON DUAL-ELEMENT PLUG FUSES

Contains both a thermal cutout and fuse to withstand heavy starting surge currents yet protect on dangerous overloads or short circuits. For 125V. Four fuses per pkg. Shpg. wt., 5 oz. per pkg.

Stock No.	Buss #	Rating Amp.	Per Pkg.	Stock No.	Buss #	Rating Amp.	Per Pkg.
13 E 62060	T-20	20	.40	13 E 62086	T-25	25	.40
13 E 62078	T-15	15		13 E 62084	T-30	30	

To Speed Your Mail Order—Please Give Your Zip Code Number

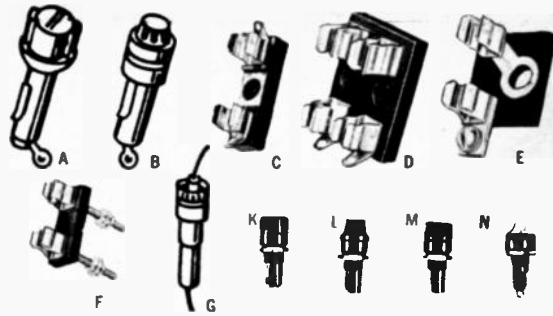

LITTELFUSE MOUNTINGS AND EXTRACTOR POSTS

Mounts and fuse holders for every application. *Includes fuse. Avg. shpg. wt., 3 oz.

Stock No.	Fig.	For Fuses	Description	Net Ea.
13 E 11760	A	3AG, 3AB	Panel mount, screw slot	
13 E 11778	B	3AG, 3AB	Panel mount, finger knob	.57
13 E 11786	A	8AG	Panel mount, screw slot	
13 E 11810	C	8AG	Single fuse, lug terminal	.20
13 E 11828	C	3AG, 3AB	Single fuse screw terminal	.38
31 E 11844	D	8AG	Double fuse, lug terminal	.38
13 E 11851	E	8AG	Meter-back mtg.	.37
13 E 11869	F	8AG	Below panel mtg.	.55
13 E 11877	F	3AG, 3AB	Below panel mtg.	.57
13 E 11885	G*	SFE(9A)	Auto inline fuse retainer	.42
13 E 11893	G*	SFE(14A)	Auto inline fuse retainer	.42
13 E 11901	G*	SFE(20A)	Auto inline fuse retainer	.42

MINIATURE 3AG FUSE EXTRACTOR POSTS

Shortest 3AG fuse posts. Test Post hole in knobs. UL listed. Body and knob meet MIL-P-14F type CFG. Rated at 15 amps, 250 volts. Fig. K has straight bottom terminals, behind panel length 1 1/2". Fig. L, M has right angle bottom terminal behind panel length 1 1/4". Fig. L has knurled knobs. Fig K, M has fluted knobs. Shpg. wt., 3 oz.

Stock No.	Mfg. No.	Fig.	1-99	NET EACH	500 Up
13 E 11927	342014	K	.42	.35	.28
13 E 11935	342022	L	.48	.40	.32
13 E 11943	342004	M			

3AG INDICATING FUSE POSTS

Series 344000. Fuse holder with foolproof neon indicator that lights when the fuse blows. Mounts in 5/8" Diameter "D" hole with an overall length of 2 3/8" including the inserted fuse. Comes in models for voltages between 2 1/2 and 250 volts with a maximum current rating of 20 amps.

Stock No.	Fig.	Mfr. No.	Volts	Net Each		
				1-99	100-499	500 Up
13 E 11950	N	344006	2.5-7			
13 E 11968	N	344012	7-16	2.80	2.33	1.87
13 E 11976	N	344024	16-32			
13 E 11984	N	344125	90-125	1.71	1.42	1.14
13 E 11992	N	344250	200-250			

BUSS FUSE MOUNTINGS



Convenient methods for mounting fuses on equipment, radio, TV, instruments, etc. Fuses easily replaced. Shpg. wt., 6 oz.

Stock No.	Buss #	For	Net Ea.	Stock No.	Buss #	For	Net Ea.
13 E 62003	HPC	5AG	.64	13 E 62037	HJM	8AG	.41
13 E 62011	HCM	4AG	.58	13 E 62045	4405	3AG	.19
13 E 62029	HKP	3AG	.41	13 E 62052	4408	3AG	.35

As Low As \$19⁹⁹ DUAL FUSE HOLDER WITH CLEAR PLASTIC COVER

LOTS OF 10

Dual fuse holder for popular 3AG, 3AB, and 8AG fuses with durable, clear plastic, protective cover. Rated 250 volts 3 amps. Has right angle bottom solder terminals. Imported.

99 E 63372 Shpg. wt., 4 oz. Net Each .24
Lots of 10, Net Each .19

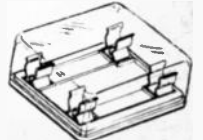

Intermatic

Time Controls - Clock Timer

Intermatic TIME-ALL



Finger-tip control plus angled face for easy access and viewing. All controls on top for easy operation. Attractive, walnut grain panel with champagne white case goes with any decor. Wake up with music, TV, or even fresh coffee; start air-conditioners before you arrive home; baby's bottle is ready on time. Can also be used to defrost refrigerator, turn lights on or off. Does not have to be reset each night. Easy-to-read AM and PM dial for full 24 hour period. Can be controlled manually. Plug-in receptacle for equipment to be controlled. With color coded ON and OFF trippers. Minimum "ON" time: 15 min. Maximum "OFF" time: 23 hr. 45 min. Capacity: 1875 Watts. For 125VAC, 60 Hz. Complete with 5 ft. cord, plug and instructions. Size: 3 3/4 x 4 1/2 x 3 1/2". UL listed and CSA approved. Shpg. wt., 2 lbs.
13 E 27584 Net 9.70

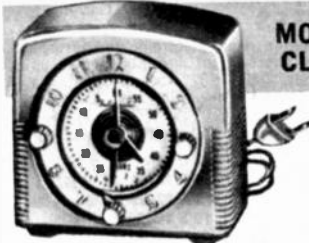

MODEL A401-4
CLOCK TIMER

8⁹⁶

Not only tells time, but turns appliances both on and off automatically for periods of 15 minutes to 5 1/2 hours. Cooks dinner while you're away, wakes you to music, controls electric fans, heaters, radios, TV sets, etc. No installation problem—just plug it in and set. Capacity 1875 watts. Special alloy "T." Plaskon case 4 3/4 x 4 1/2 x 2 1/4" D. 6 ft. cord. For 110V 60 Hz. U/L Listed. Shpg. wt., 3 lbs.
13 E 27170 Net 8.96

• Turn Lights and Appliances On and Off Automatically

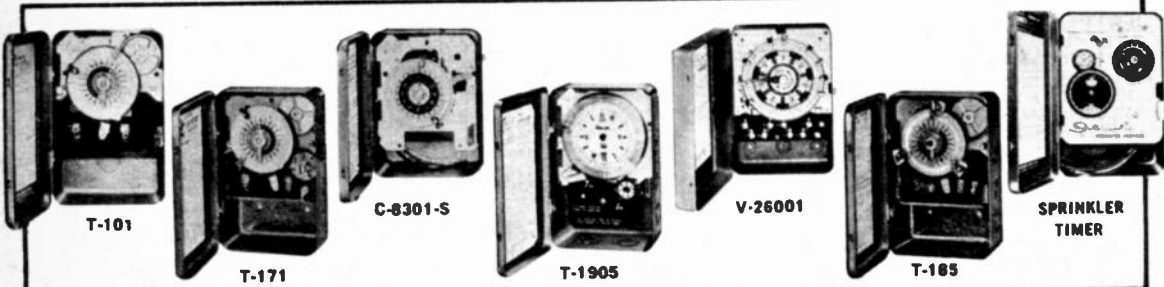

TYPE T101 TIME SWITCH

Turns equipment "on" and "off" once in 24 hours, or from 1-12 "on" and "off" operations a day can be obtained by use of extra trippers—can be added without removing dial. Min. on or off time 1 hr., max. 23 hours. Can be turned on or off manually with reset SPST switch rated at 40 amps. 4375 watt capacity. Mounting holes and knockouts. Gray steel case. UL Listed. Operates on 110 volt 60 Hz AC. 7 3/4 x 5 1/2 x 3" D. Shpg. wt., 4 lbs.
13 E 27022 Net 9.72

TYPE T103. Same as above, but with DPST switch.
13 E 27600 Net 11.02

TYPE P101. Similar to T101 except but with 6 ft. cord set and receptacle. Capacity 1250 watts. Shpg. wt., 4 lbs.
13 E 27345 Net 11.02

TYPE P101-300. Same as P101 but with 3-wire cord set and receptacle. Recommended for Air Conditioners.
13 E 27295 Net ea. 11.67

TYPE T171

"SKIPPER" TIME SWITCH

Automatically turns equipment on or off skips operations on any selected days. Ideal where offices or factories are closed on Saturdays, Sundays or Holidays. Turns "on and off" once every 24 hours with single set of trippers supplied, but up to 11 on and off operations can be had by adding extra trippers below. With 3 skipping screws; more can be added. 1 cut out tripper advances day dial automatically. Min. on or off time 1 hour, maximum 23 hours. Cap. 4000 watts. 7 3/4 x 5 x 3". U/L Listed. Shpg. wt., 4 lbs. For 110-120V 60 Hz AC. SPST — Skips "ON" Operation.
13 E 27063 Net 12.97

Type T175 — SPDT. Opens one circuit and closes another. Skips either "ON" or "OFF" operation.
13 E 27071 Net 14.27

Type P171 — Portable Plug-in version of Type T171. Capacity 1250 watts (contacts 10 amps). Shpg. wt., 6 lbs.
13 E 27088 Net 14.27

TYPE C-8301-S CYCLER TIMER

Up to 12 sets of ON-OFF trippers provide repeated operations. ON operations may range from 10 sec. to 11 min., 10 sec.; OFF from 50 sec. to 11 min., 50 sec. Dial makes complete revolution every 12 minutes. Ideal for ventilating fans, pumps, process timings, etc. SPST, rated at 15 amp. For 110-125V, 60 Hz AC. U/L Listed. Case 6 1/2 x 5 x 3" with 2 comb knockouts on bottom.
13 E 27188 Shpg. wt., 2 1/2 lbs. Net 11.67
EXTRA SET ON-OFF TRIPPERS FOR C-8301-S
13 E 27196 Shpg. wt., 2 oz. Net .72

PROGRAM TIMERS

1-96 OPERATIONS EVERY 24 HOURS

TYPE T-1905. Designed for applications requiring many ON-OFF operations. Can be set for as many as 48 ON and 48 OFF operations during any 24-hour period. Minimum "ON" or "OFF" period is 15 minutes; maximum is 23 hours 45 minutes. Ideal for control of heating, air-conditioning, ventilating, etc. Has SPDT switch. Contacts rated to handle 20 amps at 125 volts. For 105-125 V; 60 Hz AC, U/L Listed. 7 3/4 x 5 x 3". Shpg. wt., 4 lbs.
13 E 27139 Net 21.09

TYPE T1975. Same as T1905 above, but has "Skipper" feature for omitting operations on selected days. Shpg. wt., 4 lbs.
13 E 27360 Net ea. 24.34

TYPE P1971. Portable Plug-in version of Type 1975. Contacts rated 10 amps at 125 volts — 60 Hz AC. Shpg. wt., 6 lbs.
13 E 27147 Net 26.29

7 DAY PROGRAM TIMER

Provides a different program each day of the week, with up to 4 on-off operations per day. 3-hour minimum between operations. 4PST rated 20 amps. per pole. 110-125V 60 Hz AC. Steel case, 10 7/8 x 7 3/8 x 3 3/8". Grey finish. 1/2" .34" knockouts. 7 sets of trippers. U/L Listed. Shpg. wt., 6 1/4 lbs.
13 E 27337 Type V26001 Net ea. 22.39
TYPE V26003. As above, but 4P: 2N0-2NC. Rated 40 amps. per pole.
13 E 27345 Net ea. 22.39
Set ON-OFF (1 ea.) trippers for either above.
13 E 27352 Net .50

TYPE T185 TIME SWITCH

For applications where multiple "on-off" cycles of 5 to 60 minutes are required in a 24 hr. period. A minute selector on each specially designed tripper sets the number of minutes, (5 to 60), the "on-off" cycle will operate. Up to 12 combinations can be used at the same time. Minimum interval between start of each cycle, 1 1/4 hrs. rated 40 amps, 4375 watts, 125 volts, AC. 7 3/4 x 5 x 3". With 3 trippers (for 2 "on-off" Hz). For 110-125 volts, 60 Hz AC. U/L Listed. Shpg. wt., 4 lbs.
13 E 27048 Net 13.82

Extra Trippers for above. One Tripper for each additional "on-off" Hz. Wt., 4 oz.
13 E 27055 Net 1.49

"SKIPPER" 3 CIRCUIT SPRINKLER TIMER

THE INTERMATIC lawn sprinkling system time controls permit completely automatic pre-programmed watering of up to 3 zones. A 24 hour time dial can be set to initiate sprinkling any time during the day while skipper wheels serve to eliminate watering on selected days. Time durations per area are adjustable from 5 to 60 minutes. May be manually operated. Rated at 120 volts. 60 Hz, 5 amps. Gray hammertone case measuring 7 3/4 x 5 x 3". U/L Listed. Shpg. wt., 3 lbs.
TYPE LS-7041 14 DAY SKIPPER
13 E 27592 Net 17.52

SWITCH ACCESSORIES

TRIPPERS—Set of ON-OFF units (one for each) for all models except T185, C8301S, T1905, P1971, T1975 and Sprinkler Timer. Shpg. wt., 2 oz.
13 E 27097 per set Net .50

COMB. ON-CUTOFF TRIPPER. For "Skipper" types only.
13 E 27105 Shpg. wt., 2 oz. Net .50

SKIPPING SCREW. For "Skipper" types only.
13 E 27113 Shpg. wt., 2 oz. Net .08

LAFAYETTE Techni-Timer

- Makes Any Appliance Completely Automatic
- No Special Wiring—Just Plug In
- Handles Loads Up To 1875 Watts
- Turns Lights And Appliances On and Off
- Can Be Set To Skip-A-Day • 1 Year Guarantee

ONLY
7⁹⁵

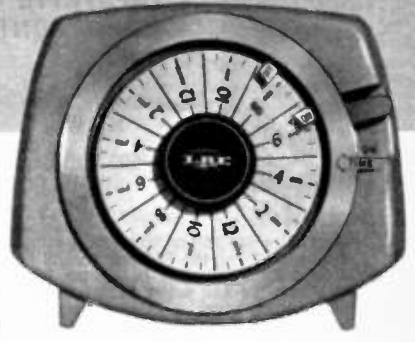

The Lafayette Techni-Timer makes practically everything electrical automatic. Turns radios on and off. Does not have to be reset each night. Defrosts refrigerator, controls roaster, electric blanket, fans, coffee-makers, phonographs, etc. Turns your home lights on and off automatically while you're away. Repeats cycle every 24 hours—no need to reset. Minimum ON time 15 minutes, maximum ON time, 23-hours. Minimum OFF time 1-hour, max. OFF time, 23-hours 45 minutes. Easy-to read- 24-hour dial. Can be set to skip-a-

day operation and, controlled manually without automatic reset. Attractive design. For shelf, table or wall mounting. With 6 ft. cord, plug and receptacle for equipment to be controlled. Highest quality—we will repair any defect due to material or workmanship within 1 year without charge. Simply ship timer to Lafayette prepaid. 5Wx4Hx2½"D. For 110V 60 Hz AC. Shpg. wt., 2 lbs. UL/CSA listed.
13 E 01407 Net ea. 7.95

Intermatic
IN-WALL TIME-ALL®
9⁵⁰

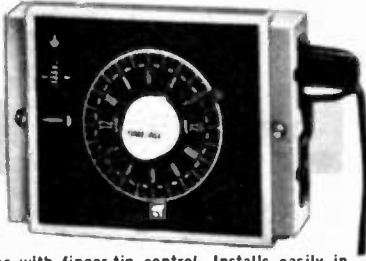

- Fits into Existing Outlet Box

Smartly styled wall timer with finger-tip control. Installs easily in standard, single outlet wall box. Automatically controls air conditioners, lamps, radios, coffee makers, and any other plug-in appliance. Resets automatically. 1 timed AC outlet and 1 AC outlet completely independent of timer. May also be used manually. Minimum "ON" time: 15 min. Maximum "OFF" time: 23 hr. 45 min. Capacity: 15 amps. 125 volts, 60 Hz. Compact, only 1¼" above wall. Pearl white housing.
13 E 27576 Shpg. wt., 2 lbs. Net 9.50

WESTCLOX 24 HOUR CLOCK AND SWITCH TIMER
9⁹⁵



- Turns Lights, Appliances On and Off

Beautiful electric clock/timer makes any appliance completely automatic while serving as a timepiece, complete with a sweep second hand. Just plug the appliance into the timer and plug the timer into the wall outlet for instant operation. Will repeat one on-off cycle per day without resetting or may be manually switched. Unlimited applications! Handsomely styled wood tone case with gold color spun aluminum dial. Handles appliances up to 1800 watts (15 amperes). For 117 VAC. UL Listed. Shpg. wt., 1¼ lbs.
13 E 56500 Net 9.95

RHODES MARK-TIME SWITCHES

A TIMED EXTENSION CORD

- For Hi-Fi TV, Fan And Other Small Appliances

A 3-way combination for every home—an automatic time switch, extension cord, convenient outlet. Timing range up to 4 hours. Easy to operate—plug it into any wall outlet, connect one, two or three devices to be controlled, and turn the knob to the time period desired. At the end of time period, the electricity is turned off automatically. 6-foot cord. 10 amp. capacity. Shpg. wt., 1 lb.
13 E 85012 Net 5.95

B FOR WALL BOX INSTALLATION

A dependable and versatile time switch to automatically turn off attic fans, porch and garage lights, window lights, heating units, etc. at any preset time. Has special HOLD feature: turn of knob cuts out timing mechanism and allows unit to be used as a regular toggle switch. Capacity 20 amps, 125 volts AC. Satin-chrome dial 4½H x 3"W; switch 2½H x 1¾W x 1¼D". Fits any standard rectangular wall box. Shpg. wt., 1 lb.
MODEL 90024—time range up to 1 hour
13 E 85020 Net 5.63
MODEL 90015—12 hours. Shpg. wt., 1 lb.
13 E 85038 Net 5.63

C PHOTOGRAPHIC TIME SWITCH

It's easy to control accurate timing on photographic developers, enlargers, and photo copy equipment by plugging them into the convenience outlet on this inexpensive unit. Adjustable stop makes repeated settings—even in total darkness—easy and foolproof. Times up to 60 seconds, then automatically shuts off current. May also be used as "on-off" switch when timing is unnecessary. Rated 10 amps—125 volts—A.C. UL and CSA listed. Shpg. wt., 1 lb.
13 E 85046 Model 78174 Net 7.46

D BUILT-IN INDUSTRIAL TIME SWITCH

Easily panel mounted or installed in a 4" octagon switch box using the adapter plate. May be used in conjunction with thermostats to time control zone heated areas. Versatile SPDT construction permits switch to be wired for either "on" or "off" tyoe operation. Rated at 20 amps. 125V/240V AC. UL and CSA listed. 1 lb.
13 E 85079 15 min. Net 6.38
13 E 85087 30 min. Net 6.38
13 E 85103 60 min. Net 6.38
ADAPTER FOR 4" Octagon Switch Box
13 E 85095 Net 3.38

E 2-SPEED PRECISION TIMER

- For Precise 1 Second To 1 Hour Timing In The Home, Office and Laboratory

Indispensable for timing precise, short operations such as boiling eggs, pressure cooking, heat and sun lamp treatment, home permanents, photo developing and printing, long distance calls, etc. Times up to 6 minutes in seconds and up to 1 hour in minutes. Exclusive 2-speed feature permits instant timing speed change by flick of a lever. A bell sounds at end of timing period. Smartly styled in white with dial face a rich copper tone. 4 x 2½". Shpg. wt., 1½ lbs.
13 E 85053 Model 2130 Net 5.21

F UTILITY HOUSEHOLD TIMER

This reliable, low-priced timer in a neat durable white plastic case has innumerable household timing uses, i.e., cooking, baking, home permanents, games, remembering appointments, TV and radio programs, etc. Times any interval up to one hour accurately and gives resonant bell signal at end of period. 3½ x 3 x 1½". Shpg. wt., ¾ lb.
13 E 85061 Model 29001 Net 2.36

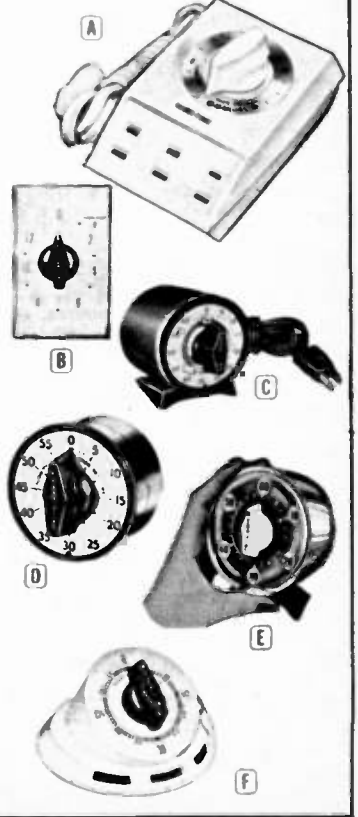

Automatic Timers and Circuit Breakers



LAFAYETTE TV TIMER CONTROL

- Simple to Use—Just Plug In
 - 500 Watt Capacity with 15' Cord
- Only **4.50**

Now you can fall asleep while TV is still on! No need to wake up and turn it off . . . the TV Timer Control turns off your TV set automatically. Simply plug the TV into the Timer Control, and the Timer Control into the wall outlet. Then turn the dial to choose the automatic "turn-off" time . . . from 5 minutes to one hour. The 500-watt capacity makes it ideal for use with most other household appliances—radio, hi-fi, tape recorder, lamp, patio light, electric blanket, heating pad, hair dryer, etc. With 15' cord, imported. Shpg. wt., ½ lb. **99 E 80798** . . . Net 4.50



Automatic Portable Interval Timer

Only **7.95**

- Control Operating Time of Household Appliances
- Time Range: 0-60 Minutes
- Minimum Setting: 1 Minute

MODEL PT-301 Easy-to-use—just plug timer into outlet, connect appliance and set the large easy-to-read dial to the desired operating time. Appliance begins operation immediately and stops at pre-set time. White case with walnut trim. For 120 volts 60 Hz. AC only, 1875 watts max. UL listed. Size: 5W x 4H x 3"D.

13 E 27535 Shpg. wt., 2 lbs. Net 7.95
MODEL PT-304 Similar to above but 0-24 hours. Minimum setting ½ hour.
13 E 27543 Shpg. wt., 2 lbs. Net 7.95

5-HOUR "RINGER TIMER"

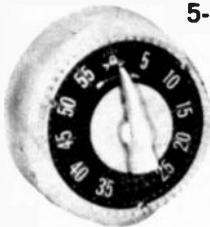

5.25

- Portable "Alarm Type" Timer
- Rings From 1 Minute to 5 Hours

An indispensable aid for your everyday timing needs—cooking, photography, phone calls, etc. Loud long-ringing bell signals the end of the preset time period. Has an easy-to-read, crystal covered black dial with bold white numerals, gold hour dividers, and a red dial window to show the hours from 1 to 5. Housed in an attractively styled high-impact white plastic case. From England. Shpg. wt., 1 lb. **13 E 13501** Net 5.25

PARAGON® TIMITE® MINIATURE 24-HOUR FOR HANDY MOUNTING



MODEL 101 compact time control ideal for window displays, night lights, yard lights, etc. Provides one on-off operation per day with minimum setting of two hours. Has manual trip lever. 24-hour dial is divided into 30 minute segments for easy, accurate setting. Fits over a U.S. standard single gang handy box. Size: 4½"Hx2¾"Wx3¾"D. Capacity: 15 amp. non-ind., 1800W, 1 HP. 12 amps., full load. For 120V., 60 Hz. UL and CSA Listed. **13 E 17510** Shpg. wt., 1½ lbs. Net \$0.95



PARAGON TI-MITE TIMER

- Protect Your Home With Automatic Lighting
- 5.95**

Neat and cordless. Plugs directly into electrical receptacle. Turns lights ON at a preselected time and OFF 5 hours later for a lived-in look. Repeats cycle every 24 hours. Controls up to 300 watts. Grey and black 3¾"x2¾"x2". Shpg. wt., 1 lb. **13 E 17589** Net 5.95

FLUSH MOUNTED INTERVAL TIMERS



- Fits Single Standard Outlet Box

This manually pre-set silent synchronous motor driven interval timer can be used for attic and exhaust fans, yard lights, and other applications. Flush-mounted, fits U.S. single standard outlet box. Ivory molded wall plate, gold finished dial plate with black numerals, gold knob. 4¼x2¾x1¾". Shpg. wt., ¾ lbs.

Stock No.	Model	Range	Net
13 E 17520	FA51	0-20 Hour	6.95
13 E 17536	FF15	0-15 Minute	6.95
13 E 17544	FF51	0-60 Minute	6.95

SWISS POCKET TIMER

- Set It and Forget It
- Buzzes at Any Pre-Set Time up to 120 Minutes



Avoid parking tickets, late appointments, etc. Also use as a timer on phone calls, cooking, photography, etc. The 120-minute dial is marked in 5 minute intervals. To operate, just set the dial to the time wanted and the buzzer will sound off when the pre-selected time has elapsed. With handy key chain. Shpg. wt. 1/4 lb. **13 E 31115L** Net 4.95

INTERMATIC TIMING MOTOR

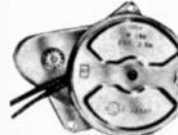

Self-starting synchronous motor with lifetime lubrication. Geared to 4 clockwise revolutions per hour. Will retain constant speed even under line voltage variations of 25%. Torque load 5 oz. in. maximum. Shaft ¼"x¾" dia. For 110-120 volt 60 Hz AC. Shpg. wt., 9 oz. **13 E 27246** Intermatic W-160 Net 3.30

MINI BREAKER



As Low As **1.29**

- UL Listed—Not A Fuse—A True Circuit Breaker
- Don't Replace—Just Reset

Complete circuit protection—fits in standard Edison base fuse receptacle! Time delay for starting surges. Never needs replacing—just reset! Shpg. wt., 2 oz.

Stock No.	Amps	Net Each
12 E 70016	5	1.49
12 E 70024	10	1.39
12 E 70032	15	1.39
12 E 70040	20	1.39
12 E 70057	30	1.39

MALLORY RESET CIRCUIT BREAKERS

- Just Reset
- Not A Fuse—A True Circuit Breaker

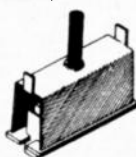

Exact replacement circuit breakers for television and industrial applications. Button must be pressed to reset. Tripping mechanism is temperature compensating for constant protection. Normal tripping time is 10 seconds or less. All values above 3.1 amps have special heavy-duty contacts to withstand heavy surge currents. Twist tab mounting lugs. Adapter for bushing mount listed below.

Stock No.	Mfrs. Type	Break Curr. Amps	Oper. Curr. Amps	Surge Curr. Amps	Net Each
33 E 14806	CBT050	0.5	0.325	2	.81
33 E 14814	CBT075	0.75	0.49	3	.81
33 E 14822	CBT100	1.0	0.65	5	.81
33 E 14830	CBT150	1.5	0.975	12	.81
33 E 14848	CBT175	1.75	1.14	12	.81
33 E 14855	CBT200	2.0	1.3	12	.81
33 E 14863	CBT225	2.25	1.46	12	.81
33 E 14871	CBT250	2.5	1.63	12	.81
33 E 14889	CBT275	2.75	1.79	12	.81
33 E 14897	CBT300	3.0	1.95	12	.81
33 E 14705	CBT310	3.1	2.1	25	.88
33 E 14713	CBT325	3.25	2.11	25	.88
33 E 14721	CBT350	3.5	2.2	25	.88
33 E 14739	CBT375	3.75	2.44	25	.88
33 E 14747	CBT400	4.0	2.6	25	.88
33 E 14754	CBT450	4.5	2.92	25	.88
33 E 14762	CBT500	5.0	3.25	25	.88
33 E 14770	CBT600	6.0	3.9	25	.88
33 E 14788	CBT700	7.0	4.14	25	.88

Type CBB adapter for bushing mount. Bushing ¾"-32x¼" with nut.
33 E 14796 Net .18

Electronic Burglar, Warning Systems

LAFAYETTE PHOTO ELECTRONIC RELAY SYSTEM

Includes Photo Cell Receiver Plus Electronically Operated Relay Plus Exciter Lamp ——— Efficient 2-Unit, 3-Element Design

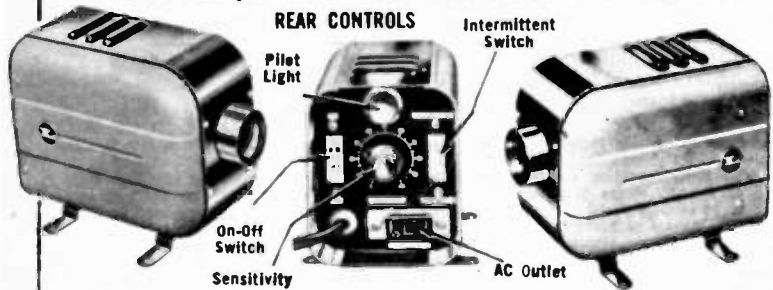

- Complete—Ready to Operate—NOT A KIT!
- Operates Bells, Buzzers and Counters
- The Perfect "Guard" for Homes, Stores and Industry
- Removable Infra-Red Filter For "Invisible-Light" Operation

18⁹⁵ A SET

The Lafayette Photo-Electronic Relay is your key to an inexpensive indoor warning or counting system. Consisting of a rugged exciter and relay unit and operating on 110-120V AC, it can be connected to signal persons entering a room, counting people or merchandise or function as an effective alarm system to warn of intruders. Effective up to 48 feet (without filter, 18 to 20 feet with filter, relay unit has a convenient variable sensitivity control and switch for intermittent alarm operation. Exciter has removable infrared filter. Mounts easily across area to be supervised. Metal case. Size: 4¼Hx3Wx4½"D. Imported.

99 E 90821 Shpg. wt., 6 lbs.	Net 18.95
99 E 902766 Volt 20 Watt Replacement Bulb	Net .39 ea.
ACCESSORIES FOR ABOVE	
99 E 90235 Electric Bell, 110V AC. Shpg. wt., 2 oz.	Net 1.99
99 E 90243 Electric Buzzer, 110V AC. Shpg. wt., 10 oz.	Net 1.79
99 E 901106-Digit Electric Counter. Shpg. wt., 1½ lbs.	Net 12.95

MALLORY SONALERT ELECTRONIC AUDIBLE SIGNAL DEVICE

Solid-state circuitry, no mechanical wear—no arching—no RF noise. Small size, lightweight, and low current drain allow them to be used in most circuits where warning devices are needed. Type SC628P has pulsating tone. Extensively used in fault alarms in computers, fire signals, instruments, appliances, and communications as well as telephone signals and protection equipment. Application possibilities are limitless. Size: all 1¼" dia. x .781" long, except † are 1.38" long. Installed weight: all 1¼ oz. except † are 2 oz. All Models manufactured with silicone transistors, allowing operating temperature of -40° to +185° F. Shpg. wt., 6 oz.



Stock No.	Type No.	Operating Voltage	Freq. Hz	Intensity DB	Current MA.	Net Each	
						1-24	25-49
12 E 74018	SC628	6-28DC DC	2800	68-80	3-14	5.50	5.40
12 E 74026	SC628H	6-28DC	4500	68-80	3-14	6.35	6.25
12 E 74034††	SC628P	6-28DC	2800	68-80	3-14	9.95	9.75
12 E 74042††	SC628A	6-28AC/DC	2800	68-80	3-14	8.75	8.60
12 E 74067††	SC110	110 AC	2800	80	14	8.75	8.60

WORNER MODEL 4000 ELECTRONIC "WATCHMAN"

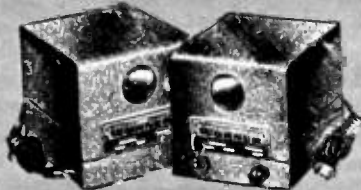

Economical indoor alarm system. Consists of exciter lamp unit and matching electronic relay, in attractive hammered-rod cases. Exciter unit has 2 prefocused f6 lenses for maximum light dispersion, infra-red filter to furnish invisible beam. Relay unit has toggle switch choice of momentary or continuous alarm operation, outside light rejector, sensitivity control. Built-in 6V. A.C. power supply permits use of external electrical alarms. Ranges: white light 50', invisible light 35'. Size each unit 5x5x5½". For 110-120 V. 50-60 cycle AC. Total shpg. wt., 14 lbs.

12 E 88042 No Money Down* Net 96.30

WORNER ELECTRONIC RECEPTIONIST

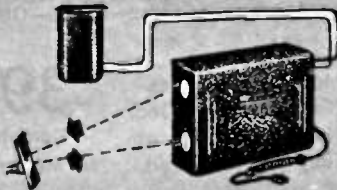

56²⁵

No Money Down*

MODEL 81 ANNOUNCER. Consists of "Photo-electric" unit, chime and mirror. Chime rings when light beam is intercepted. Unit has exciter lamp which projects beam across passage, and photocell which receives reflected beam from mirror; may be placed up to 10' from mirror. 8¼x6½x2¾". For 110-120 V. 50-60 cycle AC. Shpg. wt., 9 lbs.

12 E 88018 Net 56.25

BURGLAR LOCKALARM

3⁹⁵



For Doors



- Requires No Wiring

Burglar-resistant Sentinal Burglar Lock-alarm; automatically locks when unauthorized forced entry is attempted, plus emits a piercing sound capable of awaking the entire household. Inconspicuously mounts on doors, and windows in minutes with only a screwdriver. No wiring necessary, uses a single penlite AA 1½ volt battery. Complete with mounting hardware, horn, and latch mechanism. Shpg. wt., ½ lb.

14 E 63504 Net 3.95
99 E 62580 Battery for above Net .10

CHIME ANNUNCIATOR KIT



19⁹⁵

- Announces Visitors
- Guards Against Theft

Signals entrance into office, store or shop by ringing chime. Includes concealable mat 18x24x¾" thick, 2-note chime, transformer, wire and instructions. Shpg. wt., 4 lbs.

33 E 64051 Net 19.95

WORNER MODEL 5150 ELECTRONIC BURGLAR ALARM

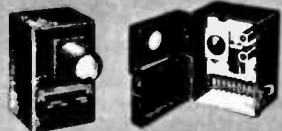

Indoor detection system. Infra-red beam operates amplifier up to 150 ft. Removable red filter. Both units have on-off switch. Amplifier relay unit features sensitivity control, extraneous light shielding and lock. Only keyholder can turn off alarm or reset trap. Steel cases. Light source 4½x4¼x7"; amplifier 5¼x7x5¼" with split door, hinged bottom. For 110/120V 50-60 Hz. Shpg. wt., 14 lbs.

12 E 88059WX No Money Down* Net 153.57
60-1130 REPLACEMENT BULB 6 V., 32 CP., 2000 hours. For models 61, 4000, and S150.
12 E 88026 Shpg. wt., 5 oz. Net .66
EXTRA CHIME for Models 61 and 4000 and any other 6 VAC power source. Serves as an excellent warning device.
12 E 88034 Shpg. wt., 2 lbs. Net 6.75

Alarms - Save Money - Save Lives

SELF CONTAINED FIRE ALARM

3⁹⁵

- Can Be Heard 1/2 Mile Away
- For Home—Office—Warehouse—Farm—Store



Sensitive, precision unit set to howl with a continuous, unmistakable blast of sound the moment air temperature reaches 135°. Operates on two standard flashlight batteries. So inexpensive you can install one in every room plus basement, attic, and garage. Batteries should be replaced approximately once a year. A touch of the test switch on the bottom of case will assure you that unit is in proper operating order. Completely self-contained independent of electrical house current. Size: 2 3/4 x 5 1/2 x 1 1/2". Shpg. wt., 1 lb.

14 E 39504 (Less Batteries) Net 3.95
 99 E 62564 Batt (2 Req'd) Net ea. .15

GULTON FIRE ALARM

9⁹⁵

- Always Fully Charged
- Extra Loud Alarm Horn
- Always on Guard



Built-in 117 VAC charging circuit keeps internal batteries up to full power. Assures top notch performance at all times. Never needs replacement batteries. Works even in the event of a power failure. Loud continuous alarm sounds when room temperature reaches danger level (126°-140°). Convenient test button allows periodic checking of unit. Attractive alarm affords you a maximum of safety and protection when strategically placed throughout your home. Shpg. wt., 1 1/2 lbs.

14 E 14507 Net 9.95

FIRE ALARM

5⁹⁵

- Always On Guard—No Batteries—No AC Plug
- Tiny and Powerful Only 2" x 2 1/4"



Sensitive fire alarm requires no batteries or electricity, no wind-up springs. Powered by its own self-contained hermetically sealed electronic energizer. Loud piercing siren sounds off for 2 hours or more. No maintenance—requires replacement only after activated by fire. Special sensor tip will trigger alarm when temperature reaches 135° F. Guards homes, offices, boats, trailers, etc. Easily installed on walls, doors, or ceilings. Tiny, powerful alarm protects your life, family, and property. Decorative design with ivory finish. Shpg. wt., 1/2 lb.

14 E 17500 Net 5.95

HOME FIRE ALARM

29⁹⁵

- Loud—Clear Alarm
- Complete Signal Unit—6 Detectors



Sensitive thermostatic detectors—located in every potential fire area—react to heat instantly. The alarm alerts you and your family before flames spread. The system does not depend on house current for operation. Long life, heavy duty battery will last at least one year. System is readily checked by means of a heat button. The push button kept within easy reach of bed, serves as an intruder alarm. Provision is made in the signal unit for attaching another alarm (6 volt bell, buzzer or horn) for outside or remote locations. The signal unit is completely enclosed in a chrome plated steel housing. Measuring only 4 1/2 x 5 1/2 x 3 1/2" overall—can be located in any convenient area. Detectors, only 2" in diameter, are unobtrusive and cover areas up to 400 sq. ft. System includes signal unit with 2 horns and provision for a 3rd, 6 thermostatic detector switches (five 135°, one 200°) 150 ft. of 18 gauge twisted pair control wire, test button, 2 boxes of staples, battery and instruction book. Shpg. wt., 8 lbs.

14 E 82017 Net 29.95
 14 E 82025 135° Detector Switches. Shpg. wt., 3 ozs. Net ea. 1.95
 14 E 82033 200° Detector Switches. Shpg. wt., 3 ozs. Net ea. 1.95
 14 E 81019 Test Button. Shpg. wt., 3 ozs. Net .35
 18 Gauge, twisted pair control wire. Shpg. wt., 3 lbs. per 100 ft.
 32 E 36288 100 ft. Net 2.31
 32 E 36296 500 ft. Net 10.25
 32 E 48697 Replacement battery, Eveready 509. Shpg. wt., 1 1/4 lbs. Net .99

ALERT BURGLAR ALARM SYSTEM

PROTECTION FOR **39⁹⁵** No Money Down*

Yourself,
 Family,
 Property
 PROTECT AGAINST
 Intruders,
 Thieves,
 Vandals



Alert system consists of transistorized warning system, 750 feet of hair thin wire, 12 contact switches for doors and windows, mounting pins. Extra switches and wire are available to expand the system to cover as many areas as desired. Warning stickers included to notify potential intruders your property is protected. Once this alarm is set your key is needed to stop its operation. Built-in delay operation allows enough time to set the alarm and secure the premises before the system goes into operation. Battery operated unit is independent from AC power interruption. Protect orchards, boats, camp sites, etc.—use it anywhere. Set of lantern batteries last approximately one year under normal use. Light and horn operate for more than twelve hours unless unit is turned off. Less batteries. Shpg. wt., 8 lbs.

14 E 13012 Net 39.95
 14 E 13020 Pkg. of 6 Extra Switches Net 1.50
 14 E 13038 Extra spool of wire (750 feet) Net 1.50
 32 E 48697 Batteries (Two Required) Net ea. .99
 BY-PASS SWITCH LOCK KIT. Permits cut-off of one doorway so that you may gain access to protected area without setting off the alarm. Complete with instructions.
 14 E 13046 Shpg. wt., 6 oz. Net 6.50

DOOR BURGLAR ALARM

For: Apartment—Store—Home—Office

- Fits All Doors
- Mounts In Minutes
- No Lock Hole In Door
- No Wiring Necessary
- Fully Transistorized

39⁹⁵

Complete
 No Money Down*

Fully transistorized, battery operated burglar alarm for the home, apartment, store, and office. Universal mounting fits any door. Pushbutton control is provided for manual alarm to signal for aid at any time, another control has been included to permit you to open the door from the inside without setting off the alarm. Upon closing the door alarm is automatically reset. Slide switch control can be set for instant, or 20 second delay before alarm sounds. Key operated switch controls on/off and reset functions. Mounts instantly, no wiring required. Constructed of heavy-gauge, anodized aluminum with neutral sand colored finish. Comes complete with battery and mounting hardware Size: 4 1/2 x 8 x 3". Shpg. wt., 2 lbs.

14 E 13509 Net 39.95

ON-GUARD



EMERSON-RITTENHOUSE INTRUSION AND FIRE SECURITY SYSTEMS

DELUXE INTRUSION/FIRE SECURITY SYSTEM

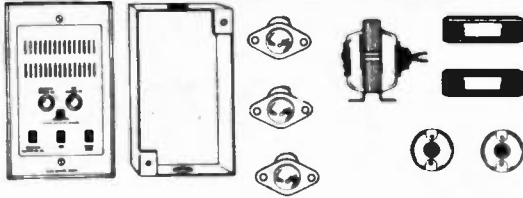

Professional intrusion protection . . .
fire protection . . . smoke protection.

74⁹⁵

No money down*

A complete package of protection utilizing advanced electronic circuitry. Detects an intruder and sounds the alarm at the trip of the sensitive detectors. Surprises the intruder with an alarm that can't be silenced by closing window or door. Alarm sounds off until manually reset at the control panel. Also safeguards you against fire and smoke! Protects your life and property 24 hours a day. When you're asleep, smoke is a lethal threat—the system will arouse you . . . give you advance warning. Can be used with any Emerson-Rittenhouse Home Radio/Intercom and our optional accessory indoor and outdoor alarms. Features distinctive warning signals . . . continuous for fire and smoke; pulsed for intrusion. Gold anodized control panel with both "intrusion on" and "fire system on" panel lights. "Intruder system on/off" switch, "test" switch, and "alarm reset" switch. Gives special broken wire warning signal. Panel measures only 5 1/8" by 7 7/8" overall. Operates on "stand-by" battery (optional) power (automatic switch-over). Includes deluxe control panel with wall box; two 135°F heat detectors; three flush mounting door/window security switches; two manual alarm pushbuttons; and one power transformer. Does not include smoke/heat detectors, indoor or outdoor alarm (select from optional accessories). Shpg. wt., 6 lbs.

13 E 83603 Net 74.95

Optional Battery For Above

Net each 2.15

32 E 48705 (2 required)

STANDARD INTRUSION SECURITY SYSTEM

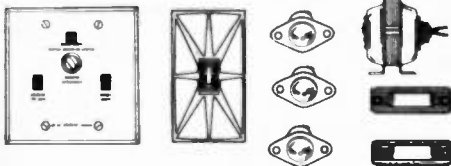

44⁹⁵

No money down*

A complete package for intruder protection only. Has most of the basic features of deluxe system but does not include fire and smoke protection. Features gold anodized control panel with "system activated" light; "system on-off" switch; and "alarm reset" switch. Panel measures only 4 3/8" x 4 3/8" and mounts in a standard 2-gang electrical box. Control panel may be concealed in closet, etc. Complete package includes security control panel, indoor alarm horn, three flush mounting door/window security switches, two manual alarm pushbuttons, and power transformer. Shpg. wt., 6 lbs.

13 E 83504 Net 44.95

ACCESSORIES FOR SECURITY SYSTEMS

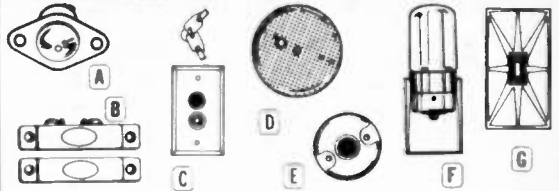

A—DOOR/WINDOW SECURITY SWITCHES. For flush mounting in door and window frames. Need not be mortised, fits 3/4" hole.

13 E 83520 Shpg. wt., 4 oz. Net 1.99

B—MAGNETIC DOOR/WINDOW SECURITY SWITCHES. For use where surface mounting is necessary. Dimension: 2 1/2" H x 1 1/2" x 3/8" (two units).

13 E 83538 Shpg. wt., 4 oz. Net 3.29

C—OUTSIDE KEY-LOCK CONTROL. Permits protection while owner is away from home. Indicator light illuminates to confirm system is activated. Mounts on standard single-gang box. Tamperproof . . . alarm sounds if intruder removes panel. Stainless steel finish. Dimensions: 4 1/2" H x 2 3/4" W.

13 E 83546 Shpg. wt., 1 lb. Net 19.95

5-Conductor Cable for above control.

13 E 83553 120-ft. Shpg. wt., 2 lbs. Net 6.49

D—SMOKE/HEAT DETECTOR. Monitors both smoke and temperature in living areas. Actuates fire alarm to give advanced warning. Provides warning before smoke reaches dangerous level. Ideal for hallway to sleeping area. Installation at head of stairs or ceiling mounting in rooms. For use with deluxe intrusion/fire system. Surface mounted. 5 7/8" diameter x 2 1/4" deep. Off white finish.

13 E 83561 Shpg. wt., 2 lbs. Net 79.95

E—HEAT/FIRE DETECTORS: Detectors automatically actuate fire alarm system when temperature in area monitored reaches danger level. Designed for mounting on ceiling in center of room. One detector covers 20' x 20' room area . . . additional detectors should be used in larger areas. For use with intrusion/fire system. Surface mounted. 1 5/8" diameter. 135°F for living areas.

14 E 82025 Shpg. wt., 4 oz. Net 1.95

E—HEAT/FIRE DETECTORS 200°F for attic and furnace areas.

14 E 82033 Net 1.95

F—OUTSIDE BEACON ALARM HORN. Provides warning light and alarm horn in one integral unit. Designed for installation outside of home, under eave or in an area which can be seen by neighbors or passers-by. Tapered red cylindrical lens. For use with all Emerson Security Systems. Back plate dimensions: 4 1/2" x 6 1/4". Mounts on single-gang 3 1/4" or 4" outlet box. Extends from wall 4 3/4". Brushed aluminum.

13 E 83579 Shpg. wt., 7 1/2 lbs. Net 19.95

G—INDOOR ALARM HORN. Installs in central location in home. Emits loud warning signal in the event of intrusion or fire. Surface mounted. Finish: off white. 4" x 2" x 7".

18 E 83587 Shpg. wt., 5 lbs. Net 5.95

G—INDOOR ELECTRONIC ALARM HORN. For use with any Emerson-Rittenhouse Home Radio/Intercom System. Emits same warning signal as the non-electronic indoor alarm horn. Pipes signal to intercom system for distribution to all "listening" speakers. May be used with all Emerson Security Systems. Off white finish, 4" x 2" x 7".

13 E 83595 Shpg. wt., 5 lbs. Net 13.95

WIRE FOR ABOVE ALARM SYSTEMS

18 Gauge Single Conductor Wire For Window and Door Switches.

13 E 83512 200 Ft. Roll. Shpg. wt., 2 lbs. Net 3.95

18 Gauge 2-Conductor Wire For Smoke/Heat Detector, Heat/Fire Detector, Indoor Alarm Horn, Beacon Alarm Horn, and Alarm Push Button.

32 E 36288 100 Ft. Coll. Shpg. wt., 3 lbs. Net 2.31

32 E 36296 500 Ft. Coll. Shpg. wt., 15 lbs. Net 10.25

Euphonic

ULTRASONIC INTRUSION ALARM

Protects Your Home or Business
Against Thieves, Prowlers, Vandals

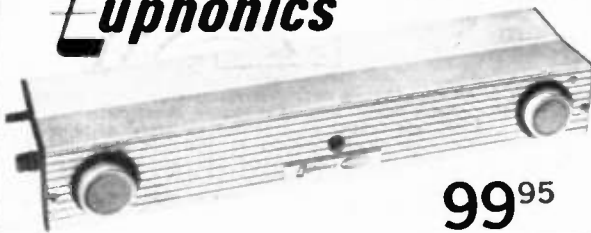

99⁹⁵

No Money Down*

- Easy Plug in Installation
- No Wiring
- No Cables
- Invisible Ultrasonic Beam Covers An Entire Room
- Turns on Lamps—Rings Bell

Versatile alarm principle recognized as dependable by banks, jewelry stores, and other high security industrial/military areas is now available for home and small business use. Operates with invisible, inaudible ultrasonic waves that saturate an elliptical area of up to 24 ft. in front of unit. Automatically detects interruption of beam and operates lights or bell. No special switches or concealed wiring is necessary . . . sets up in minutes. Unit automatically arms itself after you leave protected area and operates in your choice of six modes. Complete flexibility ranges from self operated reset after one minute through continuous operation until manually reset. Circuitry provides for immediate lights on and bell after 20 seconds in one mode. This is a safety feature to permit you or your family to enter alarm area. For 115 VAC, 60 Hz.

12 E 87036 Shpg. wt., 9 lbs. Net 99.95

MODEL B-3 3 1/2" Bell For Above. Shpg. wt., 2 lbs.

12 E 87044 Net 4.95

MODEL B-6 Deluxe 6" Bell For Above. Shpg. wt., 4 lbs.

12 E 87051 Net 19.95

High Intensity Lamps

LAFAYETTE 5-WAY HIGH INTENSITY LAMP



- Hi-Lo-Off Selector Switch
- Adjustable Telescoping Arm

5⁹⁵



Spot Light T.V. Light Night Light Wall Light

Beautifully designed, transformer powered telescoping Hi-Intensity lamp featuring HIGH and LOW switch. Telescopes from 3½" to 11½". May be used as a desk and wall light, spot and TV lamp. Use as a night light when closed. Shade swivels 360° with an arc of 180°. Shade and base are richly finished in black. Uses #93 bulb, supplied. Overall height 13". 117V, 60 Hz. Imported. 99 E 91985 Shpg. wt., 2½ lbs. Net 5.95

DIAL-A-LITE HIGH INTENSITY LAMP By



- Dials Any Degree of Light



13⁹⁵

Now you can vary your light continuously from a soft glow that is dimmer than a night light to a brilliant, glare-free, white light equivalent to 150 watts of illumination. Slide switch turns light on or off without disturbing dial setting. Telescoping arm extends to 15"; shade swivels 360°. The lamp can be hung on a wall by using keyhole slot on base. Unit folds down to only 3¼x9¼". Sand finish. For 120v, 60 Hz, AC. Uses GE No. 1129 bulb (included). 117V, 60 Hz. Shpg. wt., 1½ lbs. 13 E 81318 Net 13.95

"NIGHT-WATCH" HIGH INTENSITY LAMP



Only 8⁹⁵

- Hi-Lo-Off Selector Switch
- Rosewood Inlay on Shade and Base



Richly styled high intensity lamp with rosewood inlay on both base and shade. Tip-proof base is of high impact polypropylene which cannot crack, chip, or mar. May be used as a night light in "lo" position when shade is rested on base. Chrome plated steel folding arm directs light in any direction. Equal to 150-watts of illumination with G.E. 1141 bulb supplied. Charcoal finished sides. U. L. listed. 117V, 60 Hz. Imported. 12 E 17504 Shpg wt., 3 lbs. Net 8.95

HIGH INTENSITY DESK LAMP



Only 14⁹⁵



- Spring Control Keeps Perfect Balance
- Swings—Swivels—Stretches
- 24" Arm Reach—Air-Cooled Shade

Directs light where it's needed. A gentle tap glides the light to any position and holds it. Specially designed shade stays cool. 117 volt, long-life 40S11N bulb. Smartly designed base is weighted for stability. U.L. listed. Charcoal color. 117V, 60 Hz. 12 E 69547 Shpg. wt., 8 lbs. Net 14.95

HI-LOW HIGH INTENSITY LAMP



3⁹⁵

- Hi-Lo-Off Selector Switch
- Rugged Construction

Ideal for desk or wall mounting. Lamp shade turns in any direction, giving an ample uniform, non-glare beam of light. Sturdy hinged arm extends to 14 inches, folds flat against a hi-impact base. Hi-Lo-Off switch plus 6 ft. cord. Gold finish lamp shade and arms; ivory base. Uses #93 bulb, supplied. 117 volts, 60 Hz. 12 E 25507 Net 3.95

FLUORESCENT DESK LAMPS

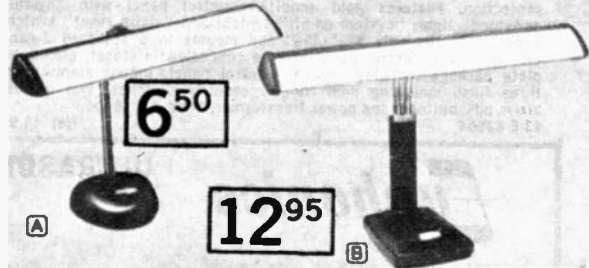

6⁵⁰

12⁹⁵

Fig. A. An attractive all metal fluorescent lamp with combination solid/gooseneck support finished in chrome. Brown metal base with push button light control... perfect for study, office or den. Translucent white plastic diffuser for maximum light dispersal. Includes 14-watt, 15", cool fluorescent bulb. Streamline design complements any room decor, 14 inches high by 5 inches wide. Provides illumination anywhere on your work or reading surface. 117V, 60 Hz. Imported. Shpg. wt., 4½ lbs. 12 E 16027 Net 6.50

Fig. B. Attractive, all metal desk lamp with two 15-watt fluorescent bulbs for maximum light. Contemporary design matches any decor. Dual, polished chrome goosenecks and black finish base. 18½" metal shade with plastic light diffuser for high light dispersion and reduced eye fatigue. Great for students, office work, or reading. Pushbutton starter and off switch on base. Height: 17" With two bulbs. 117V, 60 Hz. 12 E 16043 Shpg. wt., 6 lbs. Net 12.95

REPLACEMENT HIGH INTENSITY BULBS

Popular replacement bulbs for most high intensity lamps. Avg. shpg. wt., 3 oz.

Stock No.	Type No.	Qty.	Net
12 E 75502	93	2	.55
12 E 75528	1133	2	.65
12 E 75536	40S11N	1	.65
12 E 75544	1073	2	.65
32 E 66715	1156	1	.47
32 E 66475	1129	1	.33
32 E 69149	1141	2	.65

Luxo Home-Office-Shop Lamps



A DELUXE INCANDESCENT LAMP

Model LB-1A. Designed for use wherever work areas must be well illuminated. Non-friction, spring-balanced design permits easy positioning, and keeps lamp permanently in place. Can be raised or lowered, swivels 360°, and has 45" reach. Dual-shade construction reduces heat and maintains new lamp performance. Easily clamps to edge of table or desk. Dove gray finish. Accepts standard bulb. U.L. listed. Less bulb.
 12 E 6954W Shpg. wt., 5½ lbs. Net 17.50

B DELUXE COMBINATION INCANDESCENT and FLOURESCENT

Model LC-1A. Ideal for use in any office or home where maximum lighting efficiency is necessary. Separate switches independently control each light. Spring-controlled, counter balanced arms "finger-touch" "stay put" positioning; can be raised or lowered, rotates 360°, extends 45". "C" clamp mtg. bracket. Handsome dove gray finish. U.L. listed. Less bulbs.
 12 E 69562W Shpg. wt., 8 lbs. Net 24.95
 12 E 75015 22 watt, cool white fluorescent lamp Net 3.34

C DELUXE FLOURESCENT MAGNIFIER LAMP

Model LFM-1A. Designed for assembly and inspection of miniature parts, reading numbers and fine print. Spring balanced design; the lightest touch guides the light to any fixed position users hands are left completely free. 5" magnifier; 360° swivel; reaches 25 to 45". Constructed with precision ground lens and die cast aluminum shade. Dove gray. "C" clamp mtg. U.L. listed.
 12 E 69570W Less Bulb. Shpg. wt., 9 lbs. Net 33.95
 12 E 75015 22 watt, cool white fluorescent lamp Net 3.34

D DELUXE FLOURESCENT DESK LAMP

Model FL-1A Dual-light fluorescent desk lamp with uniquely designed shade and inner reflector to produce maximum, non-glare lighting. Spring-balanced extension arms permit smooth, easy adjustment. Has two button starter switch, and top quality ballast for quiet operation. 45" reach, 360° sweep. Includes "C" clamp mtg. bracket. Beautiful desert tan. UL listed.
 12 E 69580W Less bulbs. Shpg. wt., 9½ lbs. Net 24.95
 12 E 10020 15 watt, cool white lamp. (2-required) Net ea. 1.15

FLOURESCENT MAGNIFYING LAMP

As Low As **21⁹⁵**



● 5" Diameter Lens
 Designed for precision work, features a 5" diameter magnifying glass with a powerful 13" focus, surrounded by a 22 watt shadow-free fluorescent tube. A custom-engineered arm permits complete directional mobility —special adjustment knobs insure the proper tension and steadiness for any desired position. 45" arm reach. Ideal for assembly, laboratory, quality control and other detail work. In kit or assembled form. Shpg. wt., 8 lbs.
 12 E 69521W Kit, less lamp Net 21.95
 12 E 69530W Assembled less lamp Net 25.95
 T9, 22-watt, cool white lamp
 12 E 75015 Net ea. 3.34

ALL PURPOSE LAMP

17⁹⁵



● Universal Joints
 ● Light at Any Angle
 ● Extends to 36"
 Ideal for factory benches, tables and drafting boards. Two bolts clamp base securely to any surface up to 3" thick. Spring-controlled swivel joints and double arm action give you light in any desired position. Arm extends 36". Uses two T8, 15-W lamps. For 110-125V., 60 cycles AC. Bronze finish.
 12 E 10012W Less lamps. Shpg. wt., 10 lbs. Net 17.95
 12 E 10020 T8, 15-watt, cool white lamp Net ea. 1.15

FLOURESCENT MAGNIFYING LAMP

18⁹⁵



● Flexible Gooseneck
 ● 5" Lens with 13" Focus
 The perfect lamp for the hobbyist who needs plenty of light and magnification for close precision work. The flexible, goose-neck arm adjusts and holds the lamp in the position you want. Five inch diameter magnifying glass; overall length about 2½ feet. Sturdy, clamp-mount base. Uses 22-watt circline fluorescent lamp.
 Less Lamp. Shpg. wt., 6 lbs. Net 16.95
 12 E 10046
 T9, 22-watt, cool white lamp Net 3.34
 12 E 75015

STUDY-LYTE CLAMP ON LAMP

As Low As **11⁵⁰**



● Spring Control
 ● Extends to 45"
 Perfect illumination where you need it—moves up, down, sideways at your lightest touch, and stays exactly where you put it. From a central position, the 45" arm reach can swing to illuminate any area on a desk or table, six feet long and four feet wide. Sleek all-metal construction with versatile 3" throat edge clamp. Uses standard bulb (not included). Available in easy-to-assemble kit form or completely assembled.
 12 E 69503W Kit. Shpg. wt., 5 lbs. Net 11.50
 12 E 69513W Assembled Net 13.50

LAFAYETTE CLAMP-TYPE "DRAFTING LAMP"

7⁹⁵

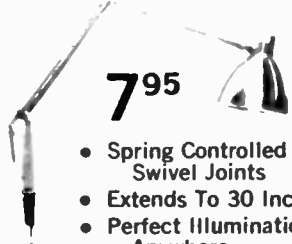

● Spring Controlled Swivel Joints
 ● Extends To 30 Inches
 ● Perfect Illumination Anywhere
 A deluxe lamp from Lafayette for perfect illumination wherever you require it. Ideal for benches, tables, and drafting boards. Clamps securely to any surface up to 3" thick. Spring controlled swivel joints and double arm action moves light in any direction. Arm extends to 30". Neutral color. For 110-125V., 60 cycles AC, less bulb. Imported.
 Shpg. wt., 9 lbs. Net 7.95
 99 E 90771

LAFAYETTE Wireless Remote Control

Only **14⁹⁵** For Lamps, T.V., Hi-Fi, Household Appliances



- Turns Lights and Appliances On and Off From Anywhere In Your Home—By Remote Control!
- Simply Plug In and Operate!
- A Lafayette Exclusive!

Now you may turn on or off any electrical device from anywhere in your home or shop. The Lafayette wireless remote control requires no additional wires. Simply plug in your transmitter wherever you choose in the house, and the appliance, TV, hi-fi system or lights that are plugged in to the receiver will be turned off or on by pressing the button on the transmitter. Perfect for viewing TV or listening to hi-fi in bed. When you get sleepy press the switch and turn everything off. Safe! Simple remote switch of lights, lamps, radios, TV and appliances. Transmitter and Receiver operate on ordinary house current, receiver accepts any 105 to 120 volt device up to 300 watts. Imported. Shpg. wt., 1/2 lb.
99 E 91183 Complete Transmitter & Receiving Unit Net 14.95
99 E 91787 Extra Transmitter Net 5.95

WIRELESS REMOTE CONTROL SWITCH



Teleswitch



Only **17⁹⁵**

- Turn On and Off Lamps, Hi-Fi, TV, And Radios From Chair or Bed
- From Car To Open and Close Garage Door

Telewand
 "Microsonic Beam" switches On/Off any appliance in the home. A touch of the button on the wireless transmitter switches TV, hi-fi, lamps, radios, fans or other electrical devices On/Off up to 40 feet away. Consists of a Teleswitch (miniature receiver), and a Telewand (miniature transmitter). Installs in seconds... just plug the AC cord from the appliance you wish to control into the Teleswitch socket, then plug the AC cord from the Teleswitch into any 110-120V., 60 Hz AC wall outlet. For use with up to 7.5 Amps. 860 Watts. Telewand operates on 9V battery. Shpg. wt., 1 1/2 lbs.

12 E 87610 Net 17.95
90 E 88212 Battery for above. Net .21
 Ext. Telewand for above less battery.
12 E 87628 Shpg. wt., 1/2 lb. Net 4.95

AUTOMATIC PHOTO-ELECTRIC LIGHT CONTROL



Only **3⁹⁵**

- Automatic Light Switch
- Turns Lights On At Sunset Off At Sunrise

Automatically turns lights on at dusk and off at dawn. Helps to prevent burglary, vandalism, and accidents. Just attach to lamp cord and plug into wall socket for automatic light control. Responsive only to daylight... car lights, flashlights, or lightning will not operate unit. For 117 V AC, 300 Watts. UL Listed. Shpg. wt., 1 lb.

12 E 87619 Net 3.95

AUTOMATIC OUTDOOR LAMPLIGHTER CONTROL



3⁹⁵

- Turns Lights On At Dusk/Off At Dawn Automatically
- Easily Screws Into Fixture Socket

Helps prevent burglary... vandalism... accident by turning on all your outdoor lights at home, store, office, factory, signs, etc. It's cordless. Screws into any standard or floodlight socket. Compact, requires only 2 1/4" of additional clearance in fixture. Weather resistant. 300 watts. U.L. listed. Shpg. wt., 1 lb.

12 E 28301 Net 3.95

LAFAYETTE 1000 WATT PHOTO-ELECTRIC LIGHT CONTROL

- Turns Lights On At Sunset Off At Sunrise
- Automatic Light Switch



Only **6⁹⁵**

Automatically switches on house, office, or store lights at sunset and off at sunrise. Great for vacation time, or daily use. No need to come home to a dark house at night. Helps keep burglars away. No special wiring necessary—just plug into wall socket and plug lamp into jack. 1000 watt capability permits use of several standard lights—will brilliantly light an entire house. Brass finish illuminator measures only 3" in diameter. Supplied with a 6 ft. cord. Wt. 1 lb.

12 E 01020 Net 6.95

PHOTO-ELECTRIC LIGHT CONTROL

- Easily Installs In Light Fixtures—Post Lanterns—Etc.
- 5⁹⁵**



Now! Electronically protect your home in minutes... photo electronic "Lamp Litter" automatically turns lights On at dusk, Off at dawn. Easily installs in driveway post lanterns; yard lights around swimming pools, patios, and gardens; or, in expose mounted knockout type switch boxes. Built-in time delay prevents accidental switching from auto headlamps or flashing lights. UL component listed for 120 volts 800 watts maximum. Size: 1Hx1Wx2 1/4"D. Shpg. wt., 1/2 lb.

13 E 64504 Net 5.95

Lamps—Electrical Accessories

UNDER-CABINET FLUORESCENT LAMP

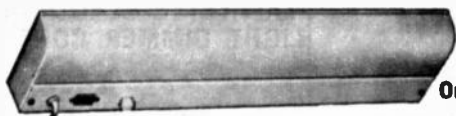

Only
4⁹⁵

- Complete with Bulb
- Convenient AC Outlet

Ideal for shop or kitchen work counters. Can be mounted on the wall or under a shelf. Has white plastic diffuser, pushbutton switch, convenience outlet, cord and plug. With 15-watt bulb. White enamel finish. Size: 18 1/4 x 3 3/4 x 1 1/4" H. Shpg. wt., 3 lbs.

12 E 16050 Net 4.95
12 E 10020 Replacement Bulb. Shpg. wt., 6 oz. Net 1.15

160 CFM BLOWER— OPERATES ON 115 VOLT

- 1500 RPM-160 Cubic Feet Per Minute
- 4 3/4" Diameter Intake
- 3" x 3 3/4" Output
- Complete With Fixed Mounting Studs

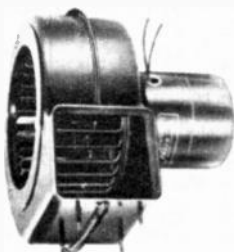

ONLY **8⁹⁵**

Heavy Duty centrifugal blower usable in many applications—air distribution in confined areas, exhaust fumes and gas, etc. Suitable for ventilation equipment in home, marine, and commercial use. Provides efficient quiet operation. 10" A.C. leads for 115VAC. 60 Hz .64 Amp. Shpg. wt., 8 lbs.

12 E 54036 **8.95**

FLUORESCENT LIGHT with SHELF

- Choice of White or Walnut with Bulb

Luxury, indirect lighting combined with handy shelf space. Holds up to 85 lbs. safely. Shelf is a full 7" deep and 18" wide. Ribbed anti-glare diffuser. Push-button switch. AC outlet. Has cord and plug. 15-watt bulb and easy-mount hardware. Imported. Shpg. wt., 5 lbs.

12 E 68048W White finish Less Accessories Shown Net 8.50
12 E 68055W Walnut finish Less Accessories Shown Net 8.50

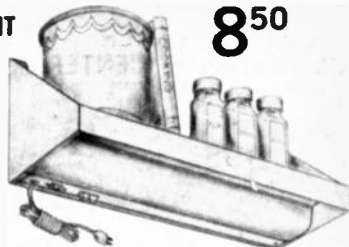

8⁵⁰

PROGRESS CEILING or WALL FAN

Only **9⁹⁵**

- Ideal for Bathroom, Utility or Recreation Room
- Attractive Aluminum Grille



Utility ventilating fan of compact design. Fits in "problem" areas such as shallow ceilings and partitions. Quiet operation with a big 6", four blade fan with 60 cfm capacity. Vents to standard 3" round duct, built-in plaster frame and outlet box. Has removable aluminum grille and automatic back-draft damper. Fits between 2"x4" studding. Size: 4x7 3/4 x 9". Shpg. wt., 6 1/2 lbs. UL listed.

12 E 75551 Net 9.95

CHIME ACCESSORIES



(A) **POLISHED BRASS LIGHTED PUSH BUTTON.** Surface mount, equipped with miniature electric bulb. No special wiring required. 12 E 48525 For 6 to 16V. Wt., 4 oz. Net 1.40

(B) **"COLONIAL" LIGHTED PUSH BUTTON.** Solid polished cast brass with lighted push button center. No special wiring required. 12 E 48533 Wt. 1 lb. Net 1.99

(C) **"QUICK MOUNT" SIGNAL TRANSFORMER** for bells, buzzers, chimes. Thermal Switch prevents overload. Rated 16v., 10-W. 12 E 48541 UL listed. Wt., 4 oz. Net 2.95

VINYL PLASTIC ELECTRICAL TAPE

59^c



- UL Listed
- 60 Ft. x 3/4"
- .008 in. Thick
- 10,900 V. Breakdown

First quality, pressure sensitive polyvinyl chloride tape. Extremely high dielectric strength of 10,900V breakdown. Insulation resistance of one million megohms. Over 150% elongation at break. Excellent resistance against acids, alkalis, oils, salt water, etc. Tensile strength of 15 lbs. per in. High conformability. Forms tight, smooth protective wrap. Imported. Shpg. wt., 4 oz. **99 E 80152 Net .59**

LARGE PLASTIC TAPE KIT:

10 rolls of vinyl plastic tape. Each roll 33 ft. by 3/4". 1 ea. of Red, white, sky blue, blue, grey, yellow, brown, green, black and orange. Shpg. wt., 1 1/2 lbs. **99 E 80301 Net 2.89**

"THE COSMOPOLITAN" ELECTRIC DOOR CHIME

6⁹⁵

- Ivory—Gold Leaf Trim
- Gold Resonating Tubes

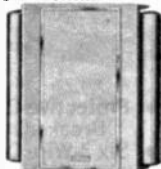

A universal design for all areas of the home. With handsome gold resonating side tubes. Soft Ivory plastic cover with gold leaf trim. Two-notes front door, one-note rear door. Installation instructions included. 7 1/2 H x 7 W x 2 3/4 D. Shpg., wt., 2 lbs. 12 E 48517 Net 6.95

LAFAYETTE ELECTRIC BELL

1⁹⁹

- Chrome-Plated Bell

Ideal as a fire alarm, burglar alarm warning bell. Gives a clear, loud ring to overcome high level background noise. Gleaming chrome-plated bell on a sturdy plastic base. 110 volts: AC. Overall size, 4 1/4" across and 2 1/4" deep. Imported. Shpg. wt., 1 lb. **99 E 90235 Net 1.99**



LAFAYETTE ELECTRIC BUZZER

1⁷⁹

Extra loud buzzer in a metal housing set on heavy plastic base. Six inch leads. Red metallic finish. For 110V AC. Overall: 3 3/4" L x 2 3/4" W x 2" H. Imported. Shpg. wt., 10 oz. **99 E 90243 Net 1.79**

"THE WELCOME" ELECTRIC DOOR CHIME

Provincial White with Gold Leaf Trim
4⁵⁰



Contemporary design, blends well with any decor. Rich resonant tones: two-notes front door, one-note rear. Provincial white case, brushed brass plate and gold leaf trim. Installation instructions included. 4 3/4 H x 7 1/2 W x 2 3/4 D. Shpg. wt. 1 1/2 lbs. 12 E 48509 Net 4.50

DEARBORN CIRCUIT GUARD



- A Must for Maintenance Men, Homeowners, Trailer Users, etc.

Detects faults instantly. Checks proper wiring of 3-wire outlets. Prevents dangerous shocks from the beginning, at your wall outlet. Indispensable for safe operation of appliances, power tools and office machines. Easily used by homeowners, service men and electricians, no meters necessary. Detects whether or not proper ground and AC polarity are available. Just plug into outlet, coded lights tell exactly what circuit condition is present: circuit OK, improper ground, improper neutral, reversed polarity, reversed ground and power, and power off. 12 E 73002 Shpg. wt., 1/2 lb. Net 5.95

Electronic Dimmers—Electrical Accessories

FUSED POWER CONVENIENCE CENTER

Only **3⁹⁵**

- Mounts Anywhere—Bench, Walls, Floor,
- 6 Fused Outlets Anywhere



Lafayette's power control center adds six, fused convenient outlets anywhere you choose. Designed to mount on walls, floor, benches, counter tops or for portable use. On/Off rocker switches and panel mounted On/Off indicator light. Built-in fused holder with replaceable 15 amp. fuse. Heavy duty 8-foot line cord. For 120 volts AC, 1500 watts, 15 amps. With Fuse. Imported.
99 E 92090 Shpg. wt., 1 lb. Net **3.95**
Pkg. of 5 fuses for above
13 E 11679 Net **.75**

DELUXE 6-STATION ELECTRIC OUTLET CONTROL CENTER

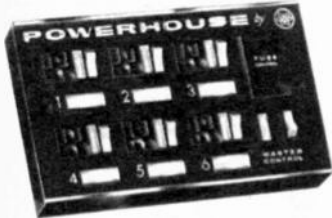

- 7 Individual Finger-Touch Rocker Power Switches
- 7 Individual "Signal-Glo" On/Off Indicator Lights

Provides six isolated, fused three prong "U" type grounded outlets. Convenient for home workshops, counter tops, etc. Mounts on wall, bench, floor, or remains portable. Each outlet utilizes a switch and indicator light. Built-in fuse compartment gives complete equipment protection. Entire fuse panel pulls out for easy, safe fuse changing. Rating: 15 amperes @ 100-120 volts AC/DC (1800 Watts). 6 ft. 3 cond. heavy-duty cord. Size: 10Lx6Wx1 1/4"D.
14 E 21106 Shpg. wt., 3 lbs. Net **14.50**
13 E 11679 Pkg. of 5 Fuses Net **.75**

3 WAY POWER CONTROL



2⁹⁵

- Individually Switched Outlets With Indicator Lights

Switchable power outlet box for wall or bench mounting. Three individually controlled outlets, each with its own indicator light. Measures 4x2 1/2x1 1/4". Equipped with 3 polarized receptacles, 3 toggle switches, 3 indicator lights, 6 ft. line cord. Rated 5 amps at 125 volts AC/DC. Imported. Shpg. wt., 1 lb.
99 E 80079 Net **2.95**

ELECTRIC OUTLET CONTROL CENTER



- For Use in Home, Office, Industry
- Mount on Bench or Walls, or Keep Portable

5⁴⁹

If you need extra outlets, you need this Electric Outlet Control Center. Has six individual outlets with its own built-in fuse box. Finger-touch control on-off rocker switch with jeweled on-off indicator panel light. Heavy duty line cord for use in the home, office and industry too. Complete with mounting screws for permanent installation on wall or bench, or use it as a portable control center. For 110/120 V AC/DC, 1500 watts, 15 amps. Less fuse. Imported. Shpg. wt., 1 lb.
14 E 21031 Net **5.49**
13 E 11711 Box of 5 15-amp fuses Net **.39**

POWER CONTROL OUTLET BOX



- Protective Circuit Breaker
- Six 3-Wire Outlets

Only **7⁹⁵**

Designed to safely and conveniently deliver power to appliances, tools, lights, office equipment, etc. Easily mounted on wall, bench, floor, or kept portable. Six 3-wire "U" type grounded outlets controlled by one switch. Built-in circuit breaker protects equipment. Pilot light indicates when power is on. Rugged steel case. Rating: 100-120 V AC/DC @ 15 amperes. Size: 13 1/2 x 2 1/4 x 2".
12 E 19508 Shpg. wt., 2 1/4 lbs. Net **7.95**



TAP-LITE SWITCH

- With Wall Plate
- Screwless Terminals

Clear wall plate permits using any color of material to match or contrast with any wall color. Connects in less time than wall switches. A feather-light touch actuates the switch. Tap—it's on, Tap—it's off. Free color inserts with each switch—can be used as is—painted—or used as a pattern. Fits standard electrical boxes. Rated 15 amps., 120-220V AC. UL Listed. Shpg. wt., 6 oz.
12 E 40019 Single Pole Net **1.99**
12 E 40027 3-Way Net **2.39**
12 E 40035 Single Pole—2 gang Net **3.95**

AC LINE CORD



6-ft., fine-quality, zip cord is an ideal replacement for worn line cords in lamps, radios, small appliances, etc. Sturdy plug at one end; other end stripped and tinned.
12 E 39011 Shpg. wt., 5 oz. Net each **.29**

LAFAYETTE ELECTRONIC LIGHT DIMMER CONTROL

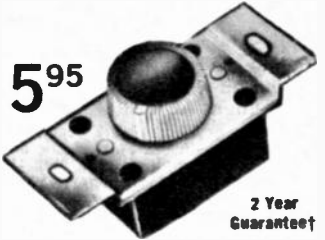

5⁹⁵

2 Year Guarantee

- Full Range—Total Darkness To Maximum Brightness
- 600 Watts Capacity

Enjoy modern lighting in any room in your home or office. Soft light for TV viewing, bright light for reading or working. Easy to use, dimming is continuous from off to full illumination. Push on or off at any light level. Fits into standard single gang wall box without rewiring. Ivory plastic knob has brass finish insert. For 120 volts. 60 cycles AC. Operates incandescent lamps to 600 watt capacity. Highest quality — we will repair any defect due to material or workmanship within 2 years without charge. Simply ship to Lafayette prepaid. Shpg. wt., 1 lb.
12 E 01011 Net **5.95**

PORTABLE LAMP DIMMER



8⁹⁵

- Use With Any Incandescent Lamp
- Dial From Total Darkness To Full Brightness
- 350-Watt Capacity

Dial the exact intensity of light desired. Create a light mood in any room in your home. Full-wave feature allows continuous dimming of any light load up to 350-watts. Efficient electronic circuit saves you money — pay only for the light you use. With cord and special plug/receptacle. For 120 VAC. Gold Color.
13 E 27568 Shpg. wt., 1 lb. Net **8.95**

LAMP DIMMER



4⁹⁵

- Easily Screws Into Standard Lamp Socket
- Full Range—Total Darkness to Full Brightness

Solid-state lamp dimmer designed to fit into a standard lamp socket. Eliminates special wiring. Provides variable brightness to enhance your furnishings, set a mood, TV viewing, nursery, etc. Turning lower section of dimmer selects light level from darkness to full bright. Lower intensity levels increase bulb life and reduce electricity cost. For 1 or 3-way bulbs up to 250 watts.
12 E 16506 Shpg. wt., 1/2 lb. Net **4.95**

Lamps — Electrical Accessories



GIANT PATIO LAMP

The lamp of 100 uses. Perfect for patio, garden, photography, attic, workshop, and window display. 10" all aluminum tarnish proof reflector mounted in double swivel clamp on base. 6' rubber covered cord and rubber plug. Shpg. wt., 2 lbs.

12 E 20011 Net 2.90

TV SERVICE LITE

1.95

Keep your hands free. Spring clamp with rubber covered ends attaches anywhere in TV cabinet. 4 1/4" highly polished aluminum reflector uses standard 25 watt bulb. Complete with 6 ft. cord and plug, less bulb. Shpg. wt., 1 1/2 lbs.

18 E 17014 Net 1.95



EXTENSION FLUORESCENT WALL LAMP



10.95

- Scissors Type Extension
- Complete with Wall Bracket and Hardware

A smartly styled wall-lamp for use in the den, office, shop, even the living room. Wall bracket swivels 180° horizontally and the arm extends to 24"—enough light in any direction over a large area. Arm closed is 15". Adjustable shade. Arm, wall mounting brackets and screws are brass-plated. Uses a 22-watt Circline fluorescent tube. UL Listed. Shpg. wt., 4 lbs.

12 E 10061 Less Lamp Net 10.95
19, 22-watt, Cool White lamp, wt. 6 oz.
12 E 75015 Net 3.34

REMOTE CONTROL

- For TV, Hi-Fi, Lamps, etc.

1.39



Turn any 110 volt appliance on and off without getting up from your chair or bed. Control your TV, radio, hi-fi, lamp, fan, appliance, movie projector, tape recorder, phonograph, etc. Nothing to connect—just plug it in. Easy fingertip control with handy in-out push switch. Long 10-foot cord makes it ideal for TV viewing when you're confined to bed. Imported. Capacity—250 watts. Shpg. wt., 1/2 lb.

99 E 80699 Net 1.39

TAP-A-LINE

As Low As **1.75**



A must for use in areas having a limited number of outlets. Permits the use of as many as 8 different appliances at one time. Easy to install or use unmounted. Rated at 1000 watts. Ivory colored tough plastic 12" long by 1" square. Four foot heavy cord and plug. Shpg. wt., 1 1/2 lbs.

12 E 47014 Net 1.75

Same as above but 2 feet long. Net 2.70
12 E 47022 Net 2.70

WEATHERPROOF DUPLEX PLATE

For outdoor AC outlets and switches. Individual "snap" covers. Lock in open position—"snap" shut—seal tight. Rust proof brass plate with aluminum finish, rubber gasket and stainless steel hinge springs. Wt., 8 oz.

13 E 81177 Net 1.48



CONVERTIBLE GROUND PLUG

.89

Convertible plug fits all wall outlets—2 or 3-hole. Grounding blade is locked firmly in place until intentionally deflected by depressing the blade-latch button. For use on all hand held tools and appliances. U.L. listed.

12 E 45018 Net .89



INDOOR-OUTDOOR EXTENSION CORDS

- 2-Wire and 3-Wire, 16 Gauge
- Molded Connectors



Use indoors and out, with power tools, refrigerators, mowers, fans, etc. All are 16-gauge, 3 cond. cords have 3 prong plug. * 2-conductor † 3-conductor.

Stock No.	Feet	Amp.	Shpg. Wt.	Net
12 E 25010*	25 ft.	7 amp.	2 lbs.	1.70
12 E 15011*	50 ft.	5 amp.	3 lbs.	2.99
12 E 34020*	100 ft.	5 amp.	3 lbs.	5.50
12 E 34030†	25 ft.	10 amp.	1 1/2 lbs.	2.89
12 E 25020†	50 ft.	7 amp.	2 1/4 lbs.	4.79
12 E 34040†	100 ft.	5 amp.	3 1/2 lbs.	7.95

TROUBLE LAMPS

as low as

1.59

- 2 Side Outlets
- Heavy Rubber Construction



Heavy-duty vinyl plastic insulation; all copper wire. Flip-Lok cage eliminates removal for re-lamp. Uses standard lamp. Heavy rubber handle with 2 side tool-tap outlets, on/off switch. Shpg. wt., 2 lbs.

12 E 78013 50-ft. Lamp Net 2.29
12 E 78526 25-ft. Lamp Net 1.59

TOUCH-A-MATIC NITE-LITE

- 3,000 Hour Bulb



Goes on and off at a touch. Vertical design hugs the wall. Shade rotates 360° for any desired light. All bakelite construction. With 3000-hr. bulb. 3 1/2" long. Shpg. wt., 4 oz.

13 E 81243 Net .59

CORD STRAIN RELIEFS

Package of 5 rubber cord strain reliefs prevents all standard line cords from pulling loose. Fits 3/8" holes for permanent or temporary installations. Imported. Shpg. wt., 1 oz.

99 E 62747 Net .29



CORDOMATIC HANDY LIGHT

As Low As

7.95

- Retracts automatically



Provides light and power up to 20 feet from installation. Swivels 180° when wall mounted—360° when ceiling mounted. Detaches easily to change location. Simply hang it up and plug it in. Eliminates the inconvenience and hazards of tangled cords. U.L. listed.

13 E 83025 Shpg. wt., 5 lbs. Net 7.95
3-Wire Lite. As above but with 3-wire cord and plug. Net 9.95
13 E 83041 Net 9.95

CORDOMATIC PORTABLE OUTLET REEL

7.95

- 3-Way Electric Outlet
- Safe, Automatic Electric Service Wherever Needed



Now you can have portable electric power wherever you need it in the home, and outside the house too. Just plug in the cord and carry the portable outlet reel where you want to use it. Cord pulls out to any desired length up to 15 feet... locks into position... automatically retracts when the reel is not in use. 3-way outlet operates several appliances at once. Case: 6 1/2" dia.; 1 3/4" thick. 10 amps. Shpg. wt., 3 lbs.

13 E 83033 Net 7.95

FLUORESCENT TROUBLE LIGHT

5.95

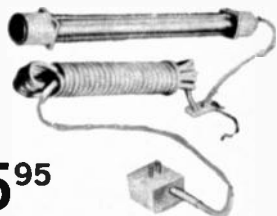

The ideal trouble light with 20 feet of cord. All plastic construction with tight fit end caps—shock proof and water proof. Cool burning without glare or shadow. Butyrate burn shield; fluorescent bulb.

12 E 44500 Shpg. wt., 2 lbs. Net 5.95

Flashlights-Lanterns-Fire Extinguishers

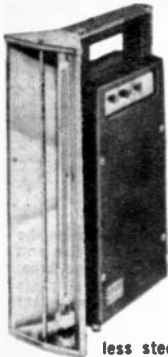

BURGESS SAFARI LITE FLUORESCENT LIGHT SAFE—BRIGHT—

- AC or Battery Operation
- Hi-Lo Switch

18³¹

Efficient battery powered light weighs only a compact 9 lbs. yet delivers plenty of bright light for use in tents, trailers, boats, patios, etc. Especially useful during emergencies. Two light levels are provided for brilliant or low intensity illumination. Operates on batteries for only pennies per hour. Built-in 110 volt circuit permits use with standard AC current. Attractive polystyrene case and handle complemented with gleaming stain-

less steel trim. Size: 12 $\frac{3}{4}$ Hx4 Wx7 $\frac{3}{4}$ " D. With batteries.

13 E 80567 Shpg. wt., 11 lbs. Net 18.31

Extra batteries for above (2 required). Wt. ea., 1 $\frac{1}{2}$ lbs.

32 E 39068 Net each 2.93

12 E 10079 F8T5CW Replacement Bulb Net 1.55



GULTON RECHARGEABLE SPORTSTER LANTERN

14⁹⁵

- Sealed Beam Light

Never buy batteries again with this smartly styled, rechargeable sportsmen's lantern. Sealed beam light provides a bright 7000 candlepower. Its long distance beam is ideal for hunting, camping, boating (it floats!) or any other outdoor ac-

tivities. Features an adjustable handle that locks in any position. Handsomely finished in navy blue with silver trim. Sportmen's Lantern operates on 4 permanent nickel cadmium batteries with 110 VAC charging built right in. Size: 3 $\frac{3}{4}$ x7x5 $\frac{1}{4}$ ". Shpg. wt., 2 lbs. 14 E 14523 Net 14.95

DELUXE RECHARGEABLE FLASHLIGHT

Slim, handsomely styled, flashlight with strong spotlight beam. Never needs batteries Works on two long-lasting nickel cadmium power cells. Just remove cap and plug into any 110V AC wall outlet for a few hours. Smartly sized, tapered body fits in purse, travel bag or brief case. Length 5 $\frac{1}{2}$ "; lens diameter 2 $\frac{1}{4}$ ". Shpg. wt., 1 lb.

12 E 84043 Net 6.50

32 E 66038 PR-4 Repl. Bulb Net .20

RECHARGEABLE FLASHLIGHT

Never needs batteries—ready for use. Recharge in standard home 110V AC outlet. Utilizes long lasting nickel cadmium power cells. Handsome shock resistant plastic case includes magnifying lens for brilliant light. Easily fits pocket or purse, handy and comfortable to hold. Size: 5 $\frac{1}{4}$ Lx2"W. Shpg. wt., 1 lb.

12 E 84027 Net 4.50

32 E 66343 223 Repl. Bulb Net .22

"SUPER POWER" SEALED BEAM SEARCHLIGHT

- For Campers, Truckers, Hunters

Deluxe, all purpose searchlight with long range GE 4546 sealed beam. Penetrates heavy fog and the darkest nights. Operates on 4 "D" batteries. Chrome finish. Shpg. wt., 1 $\frac{1}{2}$ lbs.

12 E 84084 Net 3.95

Batteries for above. (4 required.)

99 E 62584 Net ea. .15

DELUXE POWERHEAD LANTERN WITH EVEREADY BATTERY

Extra large power beam from big 4 $\frac{3}{4}$ " head. For motorists, home owners, blinkers, campers. 6-position warning blinker arm telescopes into contour handle. Separate switches; gleaming chrome, sturdy steel construction. With bulbs and #731 Eveready battery. Shpg. wt., 6 lbs.

12 E 84050 Net 5.95

GULTON "STANDBY" LIGHT

Plugs into any ordinary AC outlet. When electricity fails the "standby" goes on illuminating its area with a powerful beam. Eliminates many problems encountered because of sudden darkness. Powered by rechargeable nickel-cadmium batteries. "Standby" incorporates its own built-in recharger. Always ready for emergencies. You never buy batteries again. May be used as an extra powerful flashlight when and where you need it. Shpg. wt., 1 $\frac{1}{2}$ lbs.

14 E 14515 Net 9.95

Turner "TRAILBLAZER" LANTERN

10⁹⁵

With Tank

- Safe—Economic—Portable—Instant Light
- Equivalent To 125 Watt Electric Bulb

Model LP-4 instant, economical portable lantern is designed with the camper or outdoorsman in mind. Provides adjustable light from a low glow to an intensive brite level equivalent to a 125 watt electric bulb. Exclusive air adjustment control assures perfect operation—up to fifteen hours of light on one tank of propane fuel! Safe no pumping, priming, and no dangerous liquid fuels. Beautiful enamel shade dispenses light in a complete 360 degree circle through a crystal clear globe, 18 inches high. Complete with Tank.

13 E 26537 Shpg. wt., 6 lbs. Net 10.95

Deluxe Trailblazer Lantern similar to above. Features 2-mantle construction that provides light intensity equivalent to 250 watt electric bulb.

13 E 26545 Shpg. wt., 7 lbs. Net 14.95

13 E 26560 Extra Mantles (pkg. of 2) Net .39

13 E 26511 Extra Propane Fuel Tank. Shpg. wt., 2 $\frac{1}{2}$ lbs. Net 1.19

2 $\frac{1}{4}$ LB. DRY CHEMICAL FIRE EXTINGUISHER

7⁹⁵

- Rated 6 B:C Coast Guard, ICC, Marine Testing Institute and UL Listed

Extinguishes flammable liquids, grease and electrical fires. Powerful 2 $\frac{1}{4}$ lb. pressurized extinguisher meets marine and other requirements. Easy one-hand operation. Built-in pressure indicator can be read at a glance. Non-toxic dry-chemical won't injure fabrics, etc. Tamper-proof lock. Meets Coast Guard and ICC specifications. UL listed. Rated 6 B:C. Corrosion resistant construction. 14Hx3" diam. Shpg. wt., 5 $\frac{1}{2}$ lbs.

13 E 45040 Net 7.95

DISPOSABLE RECHARGE CYLINDER: Recharges extinguisher in minutes. Shpg. wt., 4 lbs.

13 E 45057 Net 4.95

JET ACTION HYDRO-PUMP FIRE EXTINGUISHER

2⁹⁵

- For Auto, Home, Boat
- With Wall Bracket

Extinguishes oil and grease fires, chemical fires electrical fires, wood, paper, and plastic fires. Chemically smothers fires in seconds that water cannot control. Just aim and pump. Put a unit wherever a fire is likely to start. Keep one ready in your kitchen, basement, bedrooms, and car. Complete with "Quick-Disengage" wall mounting bracket and hardware. Imported. Shpg. wt., 2 lbs.

14 E 21064 Net 2.95



ARC Welding Outfits

WITH CONTINUOUS MANUAL DUTY CYCLE

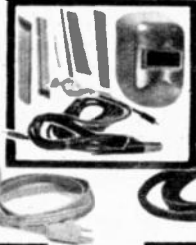

Complete
80 AMP
Outfit
No Money Down* **71⁹⁵**

Complete
125 AMP
Outfit
No Money Down* **109⁹⁵**

80 AMP ARC WELDING OUTFIT

- Continuous Manual Duty Cycle
- 9 Heat Ranges, 20-80 Amps.

Model 80A hardworking portable welder. Industrial type. Built for continuous welding on a wide variety of jobs for maintenance men, plumbers, steam-fitters. Repair-money-saver for farm, home, garage, shop. Dual coil construction. Primary amps. 29. Power factor. 80%. Arc volts, 25. Welded metal cabinet 9 $\frac{1}{4}$ x12 $\frac{1}{2}$ x9 $\frac{1}{4}$ " Complete with

HEAVY-DUTY 125 AMP ARC WELDING OUTFIT

Model 125A above, but super-industrial type for fast production and maintenance, featuring 16 instant heat stages ranging from

- Handles $\frac{1}{16}$ " to $\frac{1}{8}$ " Rods on

Work up to $\frac{1}{4}$ " thick

head shield, ground, power and welding cables, assorted electrodes, electrode holder, 3-prong plug, ground clamp and easy instructions. Plugs into a 115-volt line fused for 30 amps 50/60 Hz AC. Shpg. wt., 39 lbs.

13 E 20514WX Net 71.95
20 to 125 amps; handles $\frac{1}{16}$ " to $\frac{3}{32}$ " rods on metal up to $\frac{1}{2}$ " thick. Shpg. wt., 82 lbs.
13 E 20522WX Net 109.95

CARBON ARC TORCH

Increases versatility of any arc welder. AC or DC. Welds, solders, cuts, etc., all metals. Handles up to $\frac{1}{4}$ " carbons; use in heat ranges up to 125 amps. Two 5 ft. cables, lugs, four $\frac{1}{4}$ " cored carbons. Shpg. wt., 2 $\frac{1}{2}$ lbs.

13 E 20530 Net 9.95

DYNAMIC MARK 35

PORTABLE ELECTRIC ARC WELDER

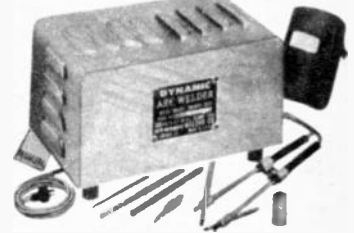

No Home Workshop Should Be Without One

Complete Ready To Use **19⁹⁵**

- Weld-Brize-Solder-Cut
- Produces 11,000° Heat Operation on 110 Volt Line

Practical, dependable unit that produces professional welding—Save time, money by making your own repairs. Cuts and welds up $\frac{1}{4}$ " metals with $\frac{1}{16}$ " welding rods and $\frac{1}{4}$ " carbon. Completely portable. Simple instructions explain how to make spot repairs. Weld-braze-solder-cut on most metals. Ideal for use around home-shop-farm-even repair auto bodies. Includes welding and carbon rods, Protective mask, holders, 10 ft. H.D. cables, ground clamp, brazing rods, flux, solder and instruction manual. For 115VAC or DC. Fused for 30 amps. Shpg. wt., 6 lbs.
13 E 20548 Net 19.95

KESTER SOLDER AND FLUX



Uniform compound of 40% tin and 60% lead with evenly distributed and free-flowing flux.

Kester "44" Resin Core Solder

14 E 32012 $\frac{1}{16}$ " Dia.—1 oz. Box Net .24
14 E 32020 $\frac{3}{32}$ " Dia.—1 lb. Sp. Net 1.69
14 E 32038 $\frac{1}{8}$ " Dia.—5 lb. Sp. Net 7.99
14 E 32046 $\frac{1}{4}$ " Dia.—1 lb. Sp. Net 1.69
14 E 32053 $\frac{1}{4}$ " Dia.—5 lb. Sp. Net 7.99

Acid Core

14 E 32061 $\frac{1}{16}$ " Dia.—1 $\frac{1}{2}$ oz. Box Net .24
14 E 32079 $\frac{1}{16}$ " Dia.—1 lb. Sp. Net 1.69
14 E 32087 $\frac{1}{8}$ " Dia.—5 lb. Sp. Net 7.99

KESTER RESIN-FIVE SOLDER

Very active resin core flux. Non-corrosive and non-conductive. Easily solders zinc, brass, nickel plate and ferrous metals. 50% tin and 50% lead.

14 E 32095 $\frac{3}{32}$ " Dia.—1 lb. Sp. Net 1.99
14 E 32103 $\frac{1}{8}$ " Dia.—5 lb. Sp. Net 9.75
14 E 32111 $\frac{1}{4}$ " Dia.—1 lb. Sp. Net 1.99
14 E 32129 $\frac{1}{4}$ " Dia.—5 lb. Sp. Net 9.95

KESTER PASTE FLUX

14 E 32137 2 oz. can Net .15

"SAL-MET" FLUX

1.09 • Non-corrosive

A non-corrosive flux that will solder all metals cleanly and permanently—copper to aluminum; aluminum to aluminum, copper to steel, etc. No special treatment of metal required. Packed in 1 oz. tubes.
14 E 49016 Net 1.09

ERSIN MULTICORE SOLDER

5-core construction assures constant maximum flux. Fast melting, non-corrosive, non-sticky, non-toxic. 2-lb. packs in foam and skin wrap for utmost protection, non-oxidation.



40% TIN, 60% LEAD #16 GAUGE
14 E 35015 1 lb. spool Net 2.67
14 E 35023 7 lb. spool Net 18.41

60% TIN, 40% LEAD #16 GAUGE
14 E 35031 1 lb. spool Net 3.34
14 E 35049 7 lb. spool Net 23.52

60% TIN, 40% LEAD #16 GAUGE
14 E 35056 1 lb. spool Net 3.40
14 E 35064 7 lb. spool Net 23.50

DISPENSER PAKS: In flameproof aluminum tubes. 60% Tin, 40% Lead,
14 E 35072 18 gauge, 14 Ft. Net .69
14 E 35080 Extra Thin 22 Gauge, 21 Ft. Net .69

BEAU-TECH SOLDERING AIDS

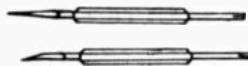

Hard-chrome plated tips to shed solder with both ends insulated from one another. Spade end for scraping joints, connections or reaming out lug holes. Shpg. wt., 4 oz.

Stock No. Net ea.
14 E 24019 Printed Circuit-Straight Tip89
14 E 24027 Printed Circuit-Angled Tip89
14 E 24035 Printed Circuit-Scrapper Tip89
14 E 24043 Straight Tip89
14 E 24050 Angled Tip99

SPYRALINE SOLDER



• 60% TIN — 40% LEAD

11 ft. of high quality, $\frac{1}{16}$ " 60/40 activated resin core solder in handy dispenser. Container is non-flammable—affords insulation when working on a "hot" circuit. Eliminates waste—pull out only what you need. Keeps solder clean and unspooled. Shpg. wt., $\frac{1}{2}$ lb.
14 E 39058 Singly, Ea. .59
Pkg. of 3 1.62

SPYRALINE PRINTED CIRCUIT TOUCH UP SOLDER designed for a fast bond without overheating. Melting range of 240°-320°F; for low wattage soldering iron. Safe for silver, ceramics and transistors. Shpg. wt., $\frac{1}{2}$ lb.
14 E 39066 Net ea. .79 Pkg. of 3 2.16

PRINT-KOTE SOLDER. Non-corrosive flux with low melting solder combined with pure silver. 2 oz. coil. Shpg. wt., 4 oz.
13 E 60098 GC-9131 Net .84

CHEMALLOY FLUXLESS ALUMINUM SOLDER

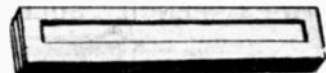

•No Flux Needed—Easy To Use

New, improved, fluxless aluminum solder will solder, braze, or weld aluminum, zinc, potmetals, copper, brass, galvanized metals, aluminumized—copperized—tinned surfaces. Solders and "fills" die cast parts.
14 E 34018 4 oz. Bar, 500° Net .89
14 E 34034 1 lb. Bulk, 500° Net 1.99



Dual-Heat Soldering Guns-Irons



As Low As **5.30**
100/140 WATTS



As Low As **7.30**
145/210 WATTS

A 100/140 WATT "EXPERT" SOLDERING KIT

- Includes Gun, 3 Tips, Wrench, Flux Brush, Aid Tool, Solder, Sturdy Carry Case Plus Instructions
- Prefocused Spot-Light Illuminates Work
- Dual Heat Gun—UL Listed

MODEL 8200-PK. Just the thing for the novice or professional. Compact design and built-in prefocused spotlight eliminates maneuvering difficulties. Break-proof plastic utility case can be used to hold other parts or tools. Weller Expert Soldering Kit features the 8200 gun with exclusive tip Grip which assures constant heat. Dual heat feature gives choice of 100 or 140 watts under the pull of the trigger. Accessories include 3 durable soldering tips, tip changing wrench, nylon flux brush, soldering aid to facilitate difficult connections and all purpose solder. All the items you need for first-class solder connections are packed in a high impact plastic case. UL listed.

13 E 39150 Shpg. wt., 3 3/4 lbs. Net ea. 7.45
Lots of 3 Net ea. 6.60

B 100/140 WATT DUAL-HEAT GUN

Model 8200. Dual heat solder gun only, featured in above kit. Includes tip, instruction book. 120VAC 60 Hz. UL listed.

13 E 39142 Shpg. wt., 2 1/2 lbs. Net ea. 5.95
Lots of 3 Net ea. 5.30

TEMPMATIC® TEMPERATURE CONTROLLED SOLDERING TOOL

- For Light and Heavy Soldering

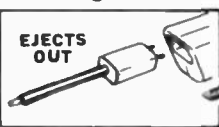

Only **9.75**



Effectively combines the features of temperature controlled operation with the ease and convenience of a lightweight, pistol-shaped soldering gun. Quick heating powerhead makes over 30,000 connections. Controlled maximum temperature assures delicate component protection. Convenient ejection button permits changing powerheads in seconds without tools. Long-life premium plated tips vastly extend tip life. With stainless steel, long reach barrel for difficult locations. For 117 volts AC.

Model ET-7A Tool with 3/8" Chisel-Point 700°F Powerhead Net 9.75
13 E 39571 Shpg. wt., 1 lb.

Model ET-6B Tool with 1/2" Conical-Point 600°F Powerhead Net 9.75
13 E 39589 Shpg. wt., 1 lb.

W-PS "PENCIL" SOLDERING IRON



Low-cost, lightweight soldering iron designed for miniature soldering, kit building and production work. 25 watts, extremely efficient, ruggedly constructed. Impact-resistant handle remains cool. For 110-120 volts, 60 Hz. AC. Complete with tip and 2-wire power cord. See additional tips under replacement tip listing. Shpg. wt., 4 oz.

Stock No.	Mfg. No.	Description	1-11	12+
13 E 39415	WPS	Iron, 1/8" tip and cord	3.90	3.45

C 240/325 WATT HEAVY DUTY SOLDERING KIT

MODEL D-550 PK. A Professional Heavy Duty soldering Kit featuring the dual-heat 240/325 watt Weller gun. Everything needed for hundreds of applications in Hobbies, Shopwork, Household repairs. Case can be used as tool kit lunch box or tackle box. Kit contains D-550 Solder gun. All purpose solder, Cutting Tip, Soldering Tip, Smoothing Tip, Tip Changing Wrench and Instruction Booklet. Replacement and accessory tips are available at low cost to fit special applications. Entire kit is enclosed in a high impact plastic case with carrying handle. UL listed. Shpg. wt., 5 lbs.

13 E 39183 Net ea. 10.45
Lots of 3 Net ea. 9.30

Model D-550 240/325-Watt Heavy Duty Soldering Gun. UL listed. Shpg. wt., 3 3/4 lbs.

13 E 39175 Net ea. 8.95
Lots of 3 Net ea. 7.95

D 145/210 WATT PROFESSIONAL SOLDERING GUN

MODEL D-440. New High Wattage. Guns—these latest professional Model Soldering guns have everything! Increased wattage—dual spoolites—rugged plastic case—featherweight balance. Come equipped with cord, plug and one tip. For 110-120 volts, 60 Hz, AC. Model D-440, Dual-heat type. 145/210 watts. UL listed. Shpg. wt., 3 lbs.

13 E 39167 Net ea. 8.25
Lots of 3 Net ea. 7.30

WELLER REPLACEMENT TIPS & PARTS

Stock No.	Type	Description	Avg. shpg. wt., 3 oz.	Net
13 E 39191	7300	Copper Tip, pkg. of 2, for 8, S-107, D-207		.35
13 E 39209	8125	Plated Tip, pkg. of 2, for 8200, 8100B		.35
13 E 39217	8125M	Tip Nuts with Tip for 8200, 8100B		.35
13 E 39225	7135	Copper Tip, pkg. of 2, S-400, D-440, 8100		.35
13 E 39233	7135M	Tip Nuts with Tip for S-400, D-440, 8100		.35
13 E 39241	7250	Copper Tip, pkg. of 2, S-500, D-550, 8250A		.35
13 E 39258	7250M	Tip Nuts, Tip, S-500, D-550, 8250A		.35
13 E 39274	6110	Cutting Tip for D-440, 8100, 8200, 8100B		.35
13 E 39282	6120	Smoothing Tip for D-440, 8100, 88200		.35
13 E 39290	6130	Cutting Tip for D-550, 8250A		.35
13 E 39308	6140	Smoothing Tip for D-550, 8250A		.35
13 E 39316	7323	Switch for all Single-Heat Models		.90
13 E 39324	7324	Switch for all Dual-Heat Models		.90
13 E 39423	ST-1	3/4" Screwdriver Tip For WPS		.75
13 E 39431	ST-2	3/2" Screwdriver Tip For WPS		.75
13 E 39449	ST-3	1/8" Screwdriver Tip For WPS		.75
13 E 39530	ST-4	3/4" Screwdriver Tip For WPS		.75

SOLDERING IRON KIT

- Develops 750° Tip Temperature

Model SP-23-K perfect iron for hobbyist and professional. Pencil tips permit accurate soldering of connections or joints. Kit contains: 25 watt iron; 5 ft. 60/40 Rosin core solder; 3 pre-tinned plated copper tips; solder aid tool and instructions.

13 T 3945 Shpg. wt., 1 lb. Net 3.35

Model SP-23 25 Watt Soldering Pencil. 13 T 3948 Shpg. wt., 1/2 lb. Net 2.25

Cone shape tips for SP-23 Iron.

13 E 39548 (pk. of 2) Net .53

"MARKSMAN" 40 WATT SOLDERING IRON. Lightweight—compact. Suitable for hobby, electronic and industrial use. Weighs only 2 oz., with 1/4" diameter plated copper tip.

13 E 39555 Net 2.99

13 E 89583 (pkg. of 2) Replacement chisel for above Net .90

"Automatic" Soldering Guns by

WEN



As Low As
5³⁵

25/200 WATT SOLDERING KIT

- Features Automatic Thermal Regulation (ATR)

Model 222K5. Complete soldering kit for household and model work. Kit contains Hot Rod 222 gun with ATR, two interchangeable tips for light (up to 100 watts) and medium (100-200 watts) soldering, a handy plastic cutting accessory, plus a flat iron for sealing plastic bags, ironing out dents, etc. Complete with roll of solder and rugged carrying case. UL listed. Shpg. wt. 4 lbs.

13 E 65352 Net ea. 8.95 Lot of 3 8.04 ea.

Model 222 "Hot Rod" gun alone with medium duty 100-200 watt tip. UL listed. Shpg. wt., 2½ lbs.

13 E 65345 Net ea. 5.95 Lot of 3 5.35 ea.



As Low As
9⁴⁶

25/450 WATT HEAVY-DUTY SOLDERING KIT

- Features Automatic Thermal Regulation

Model 450K4. Complete soldering kit designed to handle every soldering job from the most delicate printed circuit, to rugged sheet metal work. Kit contains Model 450 25/450 watt gun that automatically regulates heat to suit the job and three interchangeable tips for 25 to 450 watts of heat power. Complete with solder and convenient carrying-case. UL listed. Shpg. wt., 4½ lbs.

13 E 65360 Net ea. 11.95 Lot of 3 10.75 ea.

Model 450 Heavy duty gun alone with extra heavy duty 200-450 watt tip. UL listed. Shpg. wt., 3 lbs.

13 E 65196 Net ea. 10.46 Lot of 3 9.46 ea.

WEN REPLACEMENT TIPS

Stock No.	Type	Description	Net
13 E 65220	45F7	25-100w Tip for 222,450	.90
13 E 65230	45M7	100-200w Tip for 222,450	.90
13 E 65246	45A7	200-450w Tip for 450	.90
13 E 65204	75A7	Std. Tip for 75	.75
13 E 65212	75B7	Fine Tip for 75	.75
13 E 65295	19B4	Repl Tip for 100	.39
13 E 65253	45S7	Plastic Cutter Attachment for 222 and 450	.45
13 E 65261	45P57	Flat Iron Attachment for 222 and 450	.45

LIGHTWEIGHT SOLDERING PISTOL



As Low As **3⁵⁹**

- Instant Heat—Fast Cooling
- Spotlight Focuses on Work
- Trigger On/Off Switch

WEN 75. A finely balanced soldering pistol for delicate and heavy jobs. Draws only enough current necessary with ATR—50w surge and 30w operating produces 100w heat. Transformer voltage is low for cool handling. 120V AC. UL listed. Shpg. wt., 1¼ lbs.

13 E 65279 Net 4.07
Lots of 3 each Net 3.59

LAFAYETTE SOLDERING GUN

1⁹⁹



- Easy-To-Handle Pistol Grip
- Ideal for Printed Circuits and Miniature Work

Comfortable, contoured grip offers long periods of use without strain. 30-watt ventilated element is just right for working on printed circuits and miniature electronic equipment. Designed for extra long life and dependable service. Easily replaceable tip. Imported. 115 VAC. Shpg. wt., 1 lb.

99 E 80814 Net 1.99

99 E 80285 Replacement Tip. Shpg. wt., 2 oz. Net .26

LAFAYETTE 30-WATT SOLDERING PENCIL



- Lightweight—A Mere 2 oz.
- Perfectly Balanced—No Fatigue!
- Exceptionally Cool Running!

1⁵⁹

Designed specifically for industrial use. Maximum wattage in the lightest-smallest-coolest 30-watt iron available. Nine inches long—weighing a mere 2 oz. less the cord—for reaching easily into "parts-packed" chassis. Especially suited for precision electronic wiring. Element of high quality nichrome wire, precision wound on a "double" mica base. Highly stable heating characteristics assure long life and safety in use on precision circuitry. Replaceable screw-in, nickel-plated copper tip. 110-120v AC/DC. Imported. Shpg. wt., 8 oz.

99 E 80277 Net 1.59

99 E 80285 Replacement Tip Net .26

ORYX-TELVAC MINIATURE SOLDERING IRON

- World's Lightest—Only 1/4 ounce!
- Only 6" Long!
- Incomparable for Transistor

Heats in 30 seconds—long life—low voltage element. Prevents damage to small assemblies—pin point heat concentration. Sturdy—no ceramic or mica formers. Operates from any 6 volt source—including dry cells, wet cells, filament or step down transformers. Shpg. wt., 4 oz.

Stock No.	Type	Watts	Tip	1-11	12 or More
13 E 78017	6	6	Fixed	5.95	5.35
13 E 78025	6A	6	B	5.95	5.35
13 E 78033	9-6	8.3	A, B	5.95	5.35
13 E 78041	11-6*	10	D, E	7.45	6.70
13 E 78058	12-6	12	C	5.95	5.35
13 E 78066	18-6	18	F	7.95	7.15
13 E 78074	25-12†	25	G, H	8.45	7.60

*Develops 1000°F uses 12-Volt

REPLACEMENT TIPS

Nickel*. Others are nickel plated copper.

Stock No.	Type	Size	For Model	Net
13 E 78082	A	5/32"	9-6	.54
13 E 78090	B	3/32"	6A, 9-6	.54
13 E 78108	C	3/16"	12-6	.54
13 E 78116	D*	5/32"	11-6	1.80
13 E 78124	E*	3/32"	11-6	1.80
13 E 78132	F	3/16"	18-6	1.25
13 E 78140	G*	3/16"	25-12	1.85
13 E 78157	H	1/4"	25-12	2.35

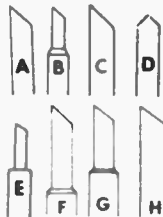

ORYX TRANSFORMERS

13 E 78165 Type 54203 6-Volt Net 5.50
13 E 78173 Type 5420 12-Volt Net 6.45



Standard Line Soldering Tools



1.87 777 CLEAN-ROOM SOLDERING HANDLE

- Fatigue-free, Pastel Colored
- Convection Cooled Polypropylene Grip

777 pencil-type irons sport a cool-to-hold grip! Spring sockets accept a wide range of thread-in elements, tips and tipleets, give you the right tip and the right temperature. For exacting work on miniature, sub-miniature and printed circuits. Full length insulated cord, UL listed, 5" long, Shpg. wt., 4 oz.

Stock No.	Net ea.		
	1-9	10-49	50 and up
13 E 21968	1.87	1.53	1.40

776 SOLDERING HANDLE

Similar to 777, with standard red handle and cork grip. Durable, economical. 5" long. Shpg. wt., 4 oz.

Stock No.	Net ea.		
	1-9	10-49	50 and up
13 E 21397	1.65	1.36	1.24

HEATING UNITS



For 777 and 776 Handles

For use interchangeably with any tipleet except * for 800 and † for 100 series only. Iron base, silver plated. Av. shpg. wt., 2 oz. For 115V, AC-DC.

No. Stock	Type	Description	Fig.	Net Each		
				1-9	10-50	50-99 up
13E21405	4045*	Super Hi-Heat 850° 47½ W	1	3.17	2.60	2.38
13E21413	4035	Super Hi-Heat 850° 47½ W	1	3.17	2.60	2.38
13E21421	4037†	High-Speed 900° 47½ W	2	3.17	2.60	2.38
13E21439	1235	Hi-Heat 750° 37½ W	1	1.92	1.58	1.44
13E21447	535	Standard 650° 23½ W	1	1.52	1.25	1.14
13E21454	1237†	Hi-Speed 900° 37½ W	2	2.13	1.75	1.60

7070 TECHNICIANS SOLDERING KIT



- Interchangeable Tips & Heating Units
- Complete with 777 Handle, 37½W Heating Unit, 3 Tips, Solder

4.88

Worthy soldering package for electronic assembly and service. Features #777 pastel handle with "Clean-Cool" grip, #1237 heating unit, 3 interchangeable thread-on-copper tips, and a spool of 60/40 rosin core solder. UL listed. Shpg. wt., 1 lb.
13 E 21900 1-5, Net each 4.88
6-up 4.48

TIPLEETS and MINI-TIPS



Thread-in and thread-on soldering tips. Made of super tough copper alloy. The PL series is iron clad and silver plated. Others are unplated. The 100 series Mini-Tips, ¾Lx¼" O.D., are used with 1237 and 4037 units only. The 300 series tipleets, 1Lx½" O.D., are used with heating units 535, 1235, 4035 and with the Princess soldering irons. The 800 series Tipleets, ¾" O.D. for high heat transfer, are used with the 4045 unit. 833 and 834 1¾" L, 823 and 824 are 1" L. Av. shpg. wt., 2 oz.

Stock No.	Model	Fig.	Type	Net Each		
				1-10	10-50	50-99 up
13 E 21629	PL 111	A	Pencil	.80	.66	.60
13 E 21637	PL 113	B	Chisel	.80	.66	.60
13 E 21645	PL 331	C	Pencil	.60	.49	.45
13 E 21652	PL 332	D	Offset	.60	.49	.45
13 E 21660	PL 333	E	Chisel	.60	.49	.45
13 E 21678	PL 338	F	Needle	.60	.49	.45
13 E 21686	PL 340	G	Micro	.60	.49	.45
13 E 21694	PL 823	H	Pyramid	.70	.58	.53
13 E 21702	PL 824	E	Chisel	.70	.58	.53
13 E 21710	PL 833	E	Chisel	1.00	.82	.75
13 E 21728	PL 834	D	Offset	1.00	.82	.75
13 E 21736	111	A	Pencil	.40	.33	.30
13 E 21744	113	B	Chisel	.40	.33	.30
13 E 21751	331	C	Pencil	.25	.21	.19
13 E 21769	332	D	Offset	.25	.21	.19
13 E 21777	333	E	Chisel	.25	.21	.19
13 E 21785	823	H	Pyramid	.30	.25	.23
13 E 21793	824	E	Chisel	.30	.25	.23

ELEMENT UNITS with TIPS

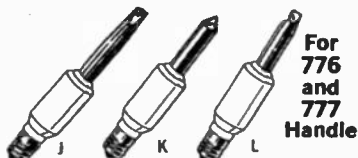

For 776 and 777 Handle

4000 Series, Super Hi-Heat. 900°-1000°F tip temperature, 47½ watts for heavy duty use. Tellurium copper base, plated with iron and pure silver. For 115V, AC-DC. Av. Shpg. wt., 5 oz.

Stock No.	Type	Descrip.	Fig.	Net Each		
				1-9	10-50	50-99 up
13 E 21462	4033	¼" Chisel J	3.17	2.60	2.38	
13 E 21470	4036	Pyramid K	3.17	2.60	2.38	
13 E 21488	4039	¾" Chisel L	3.17	2.60	2.38	

1200 Series, Hi-Heat. 750°-800°F tip temperature. 37½ watts for medium duty use. Silver-plated solid Armo pure iron. *Copper tip. For 115V, AC-DC. Av. shpg. wt., 3 oz.

Stock No.	Type	Descrip.	Fig.	Net Each		
				1-9	10-50	50-99 up
13 E 21496	1233*	¼" Chisel J	1.92	1.58	1.44	
13 E 21504	1236	Pyramid K	1.92	1.58	1.44	
13 E 21512	1239	¾" Chisel L	1.92	1.58	1.44	

800 Series, Standard. 650°-750°F tip temperature. 23½ watts for general purpose use. Tellurium copper tip. For 115V, AC-DC. Av. shpg. wt., 3 oz.

Stock No.	Type	Descrip.	Fig.	Net Each		
				1-9	10-50	50-99 up
13 E 21520	533	¼" Chisel J	1.52	1.25	1.14	
13 E 21538	536	Pyramid K	1.52	1.25	1.14	
13 E 21546	539	¾" Chisel L	1.52	1.25	1.14	

Ungar

Only 9.95

SOLID STATE SOLDERING GUN



- Hi-Lo Switch, Instant Selection of 500° or 900° F

Solid state soldering gun with easy-to-set dual heat control for fast 500° or 900° heat at the flick of a switch. No changing elements necessary. Designed for solid state kit construction, servicing and the professional. No bulky, heavy transformers to cause fatigue and get in the way. Electrically isolated tip for safe, damage-free soldering of IC's and FET's. With 3 different tips. For 117 VAC. Grounded cord set. UL listed. Shpg. wt., 1 lb.

Stock No.	Description	Net ea.		
		1-3	4-11	12-up
13 E 20829	Replacement Tip (long chisel)	9.95	8.95	7.95
13 E 20837	Replacement Tip (short chisel)			Net .40
13 E 20845	Replacement Tip (pyramid)			Net .40
13 E 20852	Replacement Tip (short chisel)			Net .40

MINI-TORCH BLOW TORCH AND SOLDERING KIT

- Pencil Size With Pinpoint Flame-Solder-Brazes
- Kit Includes 2 Chargers

Complete Kit

3.95

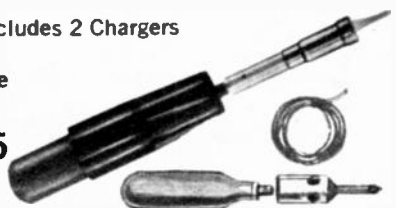

An extremely useful and highly efficient miniature blow torch. A high heat, 3500°F, pin point flame delivers instant power. Unit is less than 7" long from tip to end. Charged by a butane cartridge which gives 30 minutes of continuous service. May be turned on or off at any time. Economical throw-away cartridges can be stored indefinitely. Entire unit weighs approximately 4 oz. A true portable high heat torch. Ideal for repairs on wiring—radio—TV installations—appliances—pipes and plumbing. Wonderful for making putty soft and workable. Supplied complete with 2 chargers, soldering tip and coil of rosin core solder. Shpg. wt., 1 lb.

13 E 45016		Net 3.95
13 E 45073	Extra chargers, Pkg. of 4	Net 1.19

Imperial Line Interchangeable Soldering Components by Ungar

IMPERIAL 6010 40-WATT SOLDERING KIT



- High Quality Components
- Includes: Handle, Cord, Heat Cartridge, and 3 Tips

Slim designed "Perma-Cool" handle uses a heat-sink and a double cushion of air to keep handle cool. Handy octagonal shape prevents rolling. Perfectly balanced for easy finger tip control. Package includes 40-watt heat cartridge that delivers up to 950°F tip temperature. UL listed. Shpg. wt., 1 lb.

13 E 21991 1-5 8-11 12-up
Net ea. 7.55 7.20 6.73



"PERMA-COOL" HANDLES #6100

Three cool pastel colors; virtually indestructible finely ribbed handles. Die-cast aluminum heat sink built in. UL listed. 0.8" O.D. at grip; 4.7" lgth. Wt. 1 oz.

Stock No.	Color	1-9 ea.	10-99 ea.	100-up ea.
13 E 21025	Ivory	1.52	1.26	1.20
13 E 21033	Beige	1.52	1.26	1.20

SOLDERING IRON HOLDER For Ungar & Imperial Line

- Protects the operator
- Protects the iron



Protects operator against "hot tip" burns; protects iron against breakage. Attaches easily to top or underside of bench, or to wall. Angle adjusts to your convenience. Shpg. wt., 8 oz.

Stock No.	1-9	10-49	50 up
13 E 21157 #6800 For Imperial Line			
13 E 21165 #9000 For Standard Line			
Net	1.9	1.49	50 up
Each	1.95	1.75	1.59

SLIP-ON POWER CORD SETS



- With Plug

Instantly adapts iron to any 2 or 3 wire outlets. Wire is 6' long, 18 ga, 65 strands copper. Shpg. wt., 4 oz.

*With Standard 2-Wire Plug; †Parallel 3 Conductor Ground Plug.

Stock No.	Mfg. Type	Wire Color	1-9	10-99	100-up
13 E 20811 6103 3†			3.88	2.74	2.51
13 E 21116 6102 2* Beige			2.22	1.86	1.71
13 E 21132 6102 2* Ivory			2.22	1.86	1.71

HEAT CARTRIDGES

Reduced watt density; stainless steel, sealed cartridge, interchangeable; threaded. UL listed—7½" length. .363" dia. 1.1 oz.—Color coded.

Stock No.	Mfrs. No.	Watts	1-9	10-99	100-Up
13 E 21058	6200	40	4.12	3.46	3.17
13 E 21066	6201	30	4.12	3.46	3.17
13 E 21074	6202	25	4.12	3.46	3.17
13 E 21389	6203	60	4.73	3.97	3.63
13 E 20761	6207	100	6.31	5.30	4.97

Stock No.	Mfrs. No.	Watts	1-9	10-99	100-up
13 E 20779 (1-9)			1.29	1.08	.99

INTERCHANGEABLE THREAD ON MINI-TIPS AND MICRO-TIPS

Interchangeable with Imperial line handles only. For 25, 30, 40, or 60-watt models. Tips have a max. pt. diameter of .05". †Tellurium Copper; §Iron Clad 25K gold plated; *can be bent to make offset.

Ungar Stock No.	Ungar No.	Shape	Size In. O.D.xL.	Net Each	Ungar Stock No.	Ungar No.	Shape	Size In. O.D.xL.	Net Each
13 E 21173	6304	§Micro-chisel*	3/64 x 1/2	1.06 .89	13 E 21264	6331	§Screwdriver	1/8 x 3/4	1.06 .89
13 E 21181	6305	§Micro-spade*	3/64 x 1/2	1.06 .89	13 E 21272	6333	§Needle	1/8 x 3/4	1.06 .89
13 E 21199	6312	†Pencil	1/8 x 3/4	.48 .40	13 E 21280	6338	§Spade	1/8 x 3/4	1.06 .89
13 E 21207	6313	§Pencil	1/8 x 3/4	1.06 .89	13 E 21298	6368	§Long taper chisel	3/16 x 3/4	1.25 1.05 .96
13 E 21215	6316	§Offset pencil	1/8 x 3/4	1.06 .89	13 E 21306	6372	§Screwdriver	3/16 x 3/4	1.25 1.05 .96
13 E 21223	6318	†Long taper chisel	1/8 x 3/4	.48 .40	13 E 21314	6390	§Screwdriver	3/16 x 1½	1.29 1.08 .99
13 E 21231	6319	§Long taper chisel	1/8 x 3/4	1.06 .89	13 E 21322	6424	§Long taper chisel	1/4 x 3/4	1.29 1.08 .99
13 E 21249	6324	†Long taper pyramid	1/8 x 3/4	.48 .40	13 E 21330	6474	§Long taper chisel	3/8 x 3/4	1.48 1.24 1.13
13 E 21256	6325	†Long taper pyramid	1/8 x 3/4	1.06 .89					

PRINCESS DE-SOLDERETTE



For Removal of Microminiature Components... Ideal for I.C. Chip Re-Work and Repair. Fast... Safe... Efficient.

MODEL 6992. 18 watt Heat Capsule melts solder fast. Vacuum tip rated at 5.5 oz. per sq. in. draws melted solder from board for easy removal of microminiature components. "Ungarized" white coating inside and outside of collector prevents molten solder from sticking. Stainless steel tip with .033 aperture prevents clogging.

Stock No.	1-9	10-49	50 up
13 E 21918	14.67	13.16	11.93

HOT-VAC DE-SOLDERING TOOL

- De-solders, Cleans Printed Circuits
- One-hand Operation



Hot-Vac Melts, Removes Solder. Vacuum action lifts solder from board for easy removal of components. Special tip coating prevents solder from sticking. Handle stays cool. Wt., 1 lb.

Stock No.	1-5	6-11	12-Up
13 E 21850	12.09	9.93	9.05
13 E 21959	Replacement tip for above. Net 1.08		

UNGAR KLEEN TIP #400

Effective for removing oxidation and cleaning soldering tips. Clean tips last twice as long! With phenolic tray, two specially processed sponges and bracket for attaching to work bench. Shpg. wt., 6 oz.

Stock No.	Net
13 E 21819	1.13
13 E 21975	.45

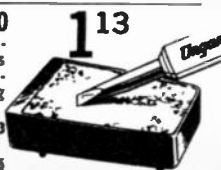

PRINCESS MINIATURE SOLDERING IRON KITS

- Featherweight only 3 oz.
- Operates on 120 Volts AC/DC
- Complete with 10 Watt Capsule, 3 Copper Tips

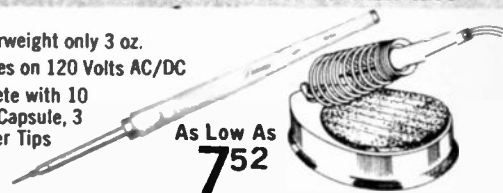

Model 6975 Pencil light, high heat iron for critical miniature soldering. Provides flexibility in tip shapes. Heat capsules and soldering nibs thread into turquoise handle with fingertip ease. Shpg. wt., 6 oz.

Stock No.	1-9	10-49	50-up
13 E 21876	7.52	6.75	6.12

PRINCESS SOLDERING STATION, Model 6900. Same as kit above but with deluxe soldering iron holder equipped with sponge. 1 lb.

Stock No.	1-9	10-49	50-up
13 E 21884	10.66	9.56	8.87

Replacement sponge for Model 6900. 13 E 20795 Net .49

HEAT CAPSULES

For use with Princess miniature soldering irons. Heat ranges from 400°F (6 watts) to 1000°F (18 watts). Shpg. wt., 1 oz.

Stock No.	Model	Tip Temperature	Watts	1-9	10-49	50-up
13 E 21926	6906	400°F to 450°F	6	3.75	3.37	3.05
13 E 21934	6910	550°F to 650°F	10	3.75	3.37	3.05
13 E 21892	6915	700°F to 800°F	15	3.75	3.37	3.05
13 E 21942	6918	900°F to 1000°F	18	3.75	3.37	3.05

REPLACEMENT TIPS

See Facing Page For Listing Under Tiplets And Minitips. #PL-300 And 300 Series Will Fit Princess Heat Capsules.

G.C. and WALDOM Radio & TV Hardware

ANY PACKAGE
59^c

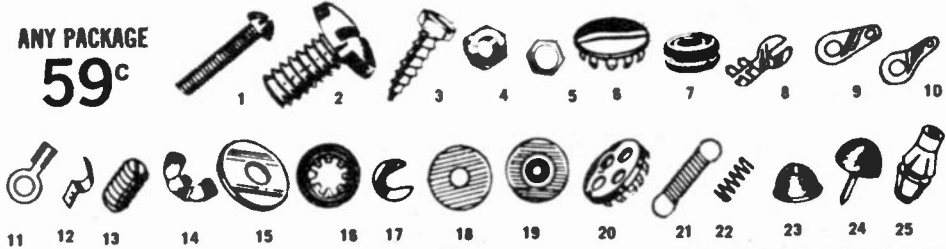

Size Stock No. Qty. Size Stock No. Qty.

Fig. 1—ROUND HEAD STEEL MACHINE SCREWS, NICKEL PLATED

2-56 x 1/4	13 E 43524	60	6-32 x 1/2	13 E 43599	45
2-56 x 1/2	13 E 43532	60	6-32 x 3/4	13 E 43607	45
2-56 x 3/4	13 E 43540	60	8-32 x 1/4	13 E 43615	45
4-36 x 1/4	13 E 43557	60	8-32 x 1/2	13 E 43623	35
4-36 x 1/2	13 E 43565	50	8-32 x 1	13 E 43631	30
4-36 x 3/4	13 E 43573	50	10-32 x 1/2	13 E 43649	30
6-32 x 1/4	13 E 43581	50	10-32 x 1	13 E 43658	25

Fig. 2—BINDER HEAD STEEL MACHINE SCREWS, NICKEL PLATED

4-40 x 1/4	13 E 43664	50	6-32 x 1/2	13 E 43706	45
4-40 x 1/2	13 E 43672	50	8-32 x 1/2	13 E 43714	35
6-32 x 1/4	13 E 43680	50	10-32 x 1/2	13 E 43722	30
6-32 x 3/8	13 E 43698	50			

Fig. 3—SELF TAPPING SHEET METAL SCREWS, NICKEL PLATED

Assorted	13 E 43730	30	6 x 1/2	13 E 43763	35
4 x 1/2	13 E 43748	50	8 x 1/2	13 E 43771	30
6 x 1/4	13 E 43755	45	10 x 3/8	13 E 43789	20

Fig. 4—HEX NUTS, NICKEL PLATED

Assorted	13 E 43797	40	6-32 x 1/4	13 E 43839	60
2-56 x 3/16	13 E 43805	60	8-32 x 5/16	13 E 43847	50
4-36 x 1/4	13 E 43813	60	10-32 x 3/8	13 E 43854	45
4-40 x 1/4	13 E 43821	60			

Fig. 5—MOUNTING NUTS, NICKEL PLATED

Vol. Con.	13 E 43862	20	Toggle Sw.	13 E 43870	15
-----------	------------	----	------------	------------	----

Fig. 6—HOLE PLUGS, NICKEL PLATED

Assorted	13 E 43888	10	1/2"	13 E 43904	8
3/8"	13 E 43896	12			

Fig. 7—VINYL GROMMETS

1/8"	13 E 43912	25	3/8"	13 E 43953	15
3/16"	13 E 43920	20	1/2"	13 E 43961	10
1/4"	13 E 43938	18	5/8"	13 E 43979	4
5/16"	13 E 43946	15			

FIG. 8-11—SOLDER LUGS—HOT TIN DIPPED

Size Hole	Fig.	Stock No.	Qty.	Size Hole	Fig.	Stock No.	Qty.
#6	8	13 E 43987	45	#8	10	13 E 43441	45
#8	8	13 E 43995	45	#6	11	13 E 43458	45
#6	9	13 E 43417	45	#8	11	13 E 43486	45
#8	9	13 E 43425	45	#10	11	13 E 43474	45
#6	10	13 E 43433	45				

FIG. 12—CABLE CLAMPS, CADMIUM PLATED

Size	Fig.	Stock No.	Qty.
1/8"-3/8"	12	13-43482	30
3/8"-1/4"	12	13-43490	25

Fig. 13—KNOB SET SCREWS

Assorted	13 E 42518	20
----------	------------	----

Fig. 14—WING NUTS, NICKEL PLATED

Assorted	13 E 42526	15
----------	------------	----

Fig. 15—METAL WASHERS, NICKEL PLATED

Assorted	13 E 42534	100
----------	------------	-----

Fig. 16—LOCKWASHERS, NICKEL PLATED

#4	13 E 42542	90
#6	13 E 42559	90
#8	13 E 42567	80
#10	13 E 42575	80

Fig. 17—"C" WASHERS

Assorted	13 E 42583	35
----------	------------	----

Fig. 18—FLAT FIBRE WASHERS

Assorted	13 E 42591	50
----------	------------	----

Fig. 19—EXTRUDED FIBRE WASHERS

Assorted	13 E 42609	40
----------	------------	----

Fig. 20—VENT HOLE PLUG

1"	13 E 42617	6
----	------------	---

Fig. 21—TENSION SPRINGS

Asstd. L.G.	13 E 42625	15
Asstd. S.M.	13 E 42633	15

Fig. 22—COMPRESSION SPRINGS

Asstd. L.G.	13 E 42641	20
Asstd. S.M.	13 E 42650	20

Fig. 23—RUBBER FEET

Assorted	13 E 42666	10
3/8" O.D.	13 E 42674	10
5/8" O.D.	13 E 42682	10

Fig. 24—RUBBER TACK BUMPERS

5/8" O.D.	13 E 42716	10
-----------	------------	----

Fig. 25—CORD STRAIN RELIEF

For Post	13 E 42724	7
----------	------------	---



**WALDOM
HARDWARE
KITS**

1⁵⁹

SELF-TAPPING SHEET METAL KIT

Contains balanced assortment of plated self-tapping, slotted hex head sheet metal screws in sizes: #4 x 3/8", #6 x 3/4", #8 x 1/2", #8 x 3/4", #8 x 1/4" + #8 x 3/8", #8 x 1/2", and #8 x 3/8". Total of 165 pieces in handy compartmented plastic box with hinged cover. **13 E 73190 Shpg. wt., 1 lb. Net 1.59**

MACHINE SCREWS, NUTS AND SHEET METAL SCREW KIT
Packet as above. Contains round-head steel plated machine screws in sizes: 4-40 x 1/2, 6/32 x 3/4, 6/32 x 3/4, 8/32 x 1/2, sheet metal screws, #6 x 1/2 and assortment of nuts. Total of 265 pieces. Shpg. wt., 1 lb. **13 E 73208 Net 1.59**

BINDER HEAD ASST.
Same as above but machine screws have binder heads. **13 E 73216 Net 1.59**

WOOD SCREW KIT
In same handy box. Contains assortment of 131 round head and flat head plated wood screws in 8 sizes for #4, 6 and 8 holes. **13 E 73224 Shpg. wt., 1 lb. Net 1.59**

DUPONT NYLON NUT KIT



• Fits Over 250
Combinations of
Thread Sizes

• Self Tapping! Self Locking

A selection of 21 tough DuPont nylon nuts for hundreds of uses in the home or shop. Fits sizes from 1/4" to 3/8" diameter. Left hand, right hand, wood screws. Self tapping, self locking. **12 E 28014 Shpg. wt., 3 oz. Net 1.00**

MASTER NYLON NUT KIT
Mechanic's assortment of over 70 nylon nuts described above. Covered, compartmented plastic case. **12 E 28022 Shpg. wt., 6 oz. Net 2.15**

**FLEXIBLE NECK
INSPECTION LIGHT**



For use in any position. Perfect for hard to see areas in servicing TV's, Hi-Fi's, Auto and household appliances. Battery powered, with flexible chrome-plated neck and high intensity light beam, that puts the light where you want it. Durable plastic case with handy metal loop for hanging. Uses 2 "C" cells. Complete with extra bulb. Imported. Shpg. wt., 1 lb. **13 E 27501 Net 3.19**

**TRANSPARENT
UTILITY BOXES**



As Low As
50^c

Clear plastic boxes ideal for storing screws, nuts, bolts and hundreds of other small parts. With hinged cover, built-in partitions.

Stock No.	Dimensions	Com. part.	wt.	Ea.
14 E 66044	8 1/2" x 4 1/2" x 1 1/2"	12	7 oz.	.50
14 E 66051	10 1/2" x 5 1/2" x 2"	18	17 oz.	1.19

**ADJUSTABLE
BOXES**

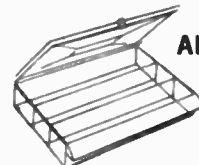

75^c

"See thru" plastic. Full width compartments are adjustable—9 dividers are supplied with each box. Curved "roll-out" type compartments allow fingertips to roll small items out with ease. Boxes can be stacked. Size: 1 1/2" x 8 3/4" x 5 3/4". Available in two types. Shpg. wt., 1/2 lb.
13 E 76227 6 compartments Net .75
13 E 76235 3 compartments Net .75

Waldom Solderless Terminals and Connectors

Highest quality terminals made of pure copper, electroplated. Insulated types have permanently attached rigid vinyl sleeves. Crimp on rapidly and make positive, uniformly reliable connections. Column headed "Type"; ST is Spade Tongue; HT is

Hook Tongue; FS is Flanged Spade; RT is Ring Tongue; B is Butt Connector (length of non-insulated $\frac{1}{8}$ " insulated $\frac{1}{16}$ "); QDM is Quick Disconnect Male; QDF is Quick Disconnect Female; NI is Nylon Insulated Closed End Connector.

Type	Fig.	Wire Range	Stud Size	NON-INSULATED TYPES						INSULATED TYPES					
				Qty.	Stock No.	Net	Qty.	Stock No.	Net	Qty.	Stock No.	Net	Qty.	Stock No.	Net
ST	A	22-18	4-6	45	13 E 73604	1.09	100	13 E 73232	2.27	20	13 E 73794	1.09	100	13 E 73471	4.47
ST	A	22-18	8	45	13 E 73612	1.09	100	13 E 73240	2.27	20	13 E 73802	1.09	100	13 E 73489	4.47
ST	A	22-18	10	45	13 E 73620	1.09	100	13 E 73257	2.27	20	13 E 73810	1.09	100	13 E 73497	4.47
ST	A	16-14	4-6	45	13 E 73638*	1.09	100	13 E 73265	2.27	20	13 E 73828†	1.09	100	13 E 73505	4.47
ST	A	16-14	8	45	13 E 73646	1.09	100	13 E 73273	2.27	20	13 E 73836	1.09	100	13 E 73513	4.47
ST	A	16-14	10	45	13 E 73653*	1.09	100	13 E 73281	2.27	20	13 E 73844†	1.09	100	13 E 73521	4.47
HT	B	22-18	4-6	45	13 E 73661*	1.09	100	13 E 73299	2.27	20	13 E 73851	1.09	100	13 E 73539	4.47
FS	C	22-18	4-6	45	13 E 73679*	1.09	100	13 E 73307	2.27	20	13 E 73869†	1.09	100	13 E 73547	4.47
FS	C	16-14	4-6	45	13 E 73687	1.09	100	13 E 73315	2.27	20	13 E 73877	1.09	100	13 E 73554	4.47
RT	D	22-18	4-6	45	13 E 73695*	1.09	100	13 E 73323	2.27	20	13 E 73885†	1.09	100	13 E 73562	4.47
RT	D	22-18	8	45	13 E 73703	1.09	100	13 E 73037	2.27	20	13 E 73893	1.09	100	13 E 73570	4.47
RT	D	22-18	10	45	13 E 73711*	1.09	100	13 E 73331	2.27	20	13 E 73901†	1.09	100	13 E 73577	4.47
RT	D	16-14	4-6	45	13 E 73729*	1.09	100	13 E 73349	2.27	20	13 E 73919†	1.09	100	13 E 73584	4.47
RT	D	16-14	8-10	45	13 E 73737*	1.09	100	13 E 73356	2.27	20	13 E 73927†	1.09	100	13 E 73592	4.47
RT	D	12-10	8-10	3	13 E 73745*	1.09	100	13 E 43045	3.30	17	13 E 73935†	1.09	100	13 E 43060	5.79
B	E	22-18		45	13 E 73752*	1.09	100	13 E 73364	2.50	18	13 E 73943†	1.09	100	13 E 73372	5.28
B	E	16-14		45	13 E 73760	1.09	100	13 E 73380	2.50	18	13 E 73950	1.09	100	13 E 73380	5.28
QDM	F	18-14	1/4" Male	45	13 E 73778*	1.09	100	13 E 73406	2.60	19	13 E 73968†	1.09	100	13 E 73422	4.80
QDF	F	18-14	1/4" Female	45	13 E 73786*	1.09	100	13 E 73414	2.60	19	13 E 73976†	1.09	100	13 E 73430	4.80
NI	G	22-14	O.D. 5/16", I.D. 1/4", Lgth. 39/64"							27	13 E 73984†	1.09	100	13 E 73448	3.89
NI	G	16-10	O.D. 7/16", I.D. 3/8", Lgth. 23/32"							15	13 E 73992	1.09	100	13 E 73455	5.68



Fig. A Fig. B Fig. C



Fig. D Fig. E Fig. G



Fig. F Male Fig. F Female

SOLDERLESS TERMINALS, CONNECTOR ASSORTMENT WITH CRIMPING TOOLS

215 Non-insulated Types indicated by asterisk (*) above, plus Universal Crimping Tool. In handy compartmented plastic box. 13 E 43011 Shpg. wt., 4 lbs. Net 9.85

138 Insulated Types indicated by (†) above, plus Universal Crimping Tool. In handy compartmented plastic box with hinged cover. 13 E 43029 Shpg. wt., 3 lbs. Net 12.05



VACO CRIMPING TOOL with BOLT CUTTER

- Crimps Insulated & Non-Insulated Terminals
- Slices 6 Bolt Sizes



Handy, fast tool for all electrical connections. No soldering needed. Cuts and strips wire 22 to 10 gauge. Wire cutter at tip for close work. Crimps both insulated and non-insulated terminals. Bolt slicer accommodates 6 sizes of bolts, 4-40, 5-40, 6-32, 8-32, 10-32 and 10-24. Black oxide finish for beauty and durability. Insulated handles. 13 E 77001 Shpg. wt., 1 lb. Net 4.95

CRIMPING TOOL AND TERMINALS

- Wire Cutter, Wire Stripper
- Includes Assortment of Terminals

A complete crimp tool kit for home, shop. Solderless terminal crimp tool cuts any size wire up to 10 gauge, strips wire easily with clearly marked gauges. Crimps terminals quickly with precision tooled crimping dyes. Easy to use with comfortable insulated handles. Complete with plastic box of assorted solderless terminals and connectors. Imported. 13 E 70006 Shpg. wt., 1 lb. Net 2.19

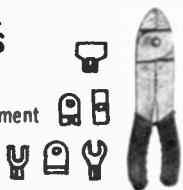

WIRE BENDING JIG

Handi-Bender forms wire sizes up to 1/4" dia. Steel slots and steel bending pins make basic bends such as eyes, angles, curves, circles, and for straightening wire. Makes dozens of useful and decorative articles. Complete instructions included. 14 E 70103 Shpg. wt., 1/2 lb. Net .99

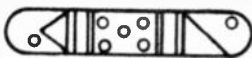

KRYLON CRYSTAL CLEAR ACRYLIC SPRAY

1.39 EA



Dry in minutes, goes on clear—stays clear, tough, pliable, lasting. Prevents deterioration and moisture breakdown of insulation. Preserves and protects. 1 Pint Can.

13 E 14673 Net 1.39 Lots of 3 1.29

ECCOBOND 26

- Sticks Anything to Anything



Handiest bonding agent ever for the lab bench or production line. Repairs tools, hardware, furniture, boats. Features permanent adhesion to metals, plastics, paper, ceramics, etc. Cures in four hours at room temperature—in minutes at 150 F. Can be sanded or worked—takes paint readily. White color. Mixes easily. Shpg. wt., 8 ozs. 14 E 51053 Net 1.95

TWIN-WELD EPOXY ADHESIVE CONTACT NEEDLE INJECTOR



Engineered for permanent adhesive use for metal, wood, glass, ceramics, concrete, hard rubber, fiberglass, brick and many other materials. Quick, easy repairs. Can be molded to any shape. Use as a coating or filler—as a gasket—as caulking—as a dielectric. No solvents. Non-toxic, non-alkaligenic. Shpg. wt., 1 lb. 14 E 73016 Net 1.49

- Attach Anything to Anything

Made on the hypodermic principle to inject cleaners and oils into shafts, controls and tight places. Supplied with a 2-oz. bottle. Shpg. wt., 5 oz. 13 E 60924 Net .48

TRANSISTOR Z5 SILICONE GREASE WITH INJECTOR

Easily dispenses compound to hard to reach areas when replacing transistors. Injector made of polyethylene plastic with neoprene plunger. 13 E 61096 Wt. 10 oz. Net 2.39



CHEMICALS As Low As 55c

Pjebond Cement. Sticks anything to anything. Dries rapidly—waterproof—very high strength. Shpg. wt., 5 oz. 13 E 60973 2 ozs. Net .60
Red-X Corona Dope. Prevents corona shorts in Hi-Voltage circuits. Flexible—fast drying. 13 E 60981 2 ozs. Shpg. wt., 5 oz. Net .70
Electronic Contact Cleaner. New red cleaner—made with Lube—Rex. Fast drying—universal contact cleaner. Shpg. wt., 5 oz. 13 E 61013 2 ozs. Net .60
Liquid Non-Slip. Penetrating—fast drying. Prolongs life of cables and belts. Prevents slipping. Shpg. wt., 5 oz. 13 E 61021 2 ozs. Net .55
Pheno-Lubricant. Special lubricant for phonos. Will not thin out. Clings to metal surface. 2 oz. tube. Shpg. wt., 5 oz. 13 E 61039 Net .50
Pheno Non-Slip. Prevents slippage on turntables, changers, tape recorders, etc. 13 E 61054 Shpg. wt., 1 lb. Net .96
Service Cement. For repairing speakers and general radio work. Vibration-proof, waterproof—fast drying. 13 E 61062 2 ozs. Shpg. wt., 5 oz. Net .59



G.C. Alignment Tools And Service Aids

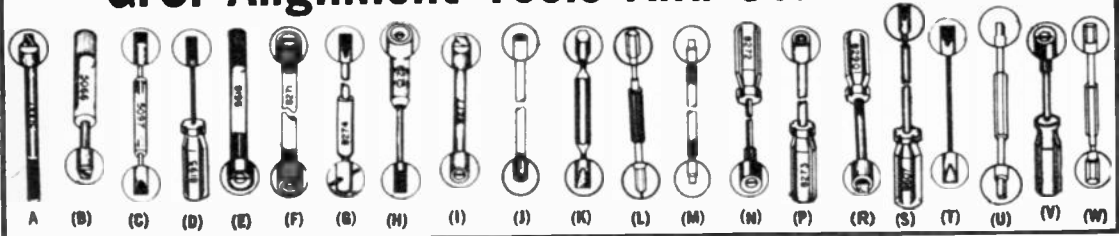

Average Shipping Weight of all below: 8 Ozs.

Stock No.	TYPE	FIG.	DESCRIPTION	Net	Stock No.	TYPE	FIG.	DESCRIPTION	Net
13 E 60502	5000	A	Metal Tip Alignment Screwdriver	.46	13 E 60635	9087	M	Slug Tuner Adjusting Tool	.75
13 E 60510	5066	B	Short Alignment Screwdriver	.40	13 E 60650	8272	N	TV I.F. Osc Tool (RCA, G-E, Admiral)	1.20
13 E 60528	5097	C	K-Tran Alignment Tool	.78	13 E 60668	8273	P	TV All-Purpose Aligner, recessed blade	.99
13 E 60536	8195	D	Channel Tuning Tool with 1/8" blade	.78	13 E 60676	8290	R	Universal Screwdriver Aligner	.70
13 E 60544	8196	E	Short Recessed Blade for TV & FM	.48	13 E 60700	8987	S	X-57 Slim Line Screwdriver 7"	.69
13 E 60551	8271	F	Stackpole Stud-Type core aligner	.66	13 E 60718	8988	S	X-57 Slim Line Screwdriver 12"	.99
13 E 60569	8274	G	TV Long Aligner (Admiral, Zenith, RCA)	.99	13 E 60726	8728A	T	7" Delrin Screwdriver	.47
13 E 60577	8275	H	TV Zenith Universal Aligner	.52	13 E 60734	8728	T	12" Long Delrin Screwdriver	.58
13 E 60593	8277	I	TV "Shorty" All-Purpose Duplex Aligner	.57	13 E 60742	9440	U	Transistor I.F. core alignment tool	.63
13 E 60601	8278	J	TV Tuning Wand	.60	13 E 60759	9298	V	Recessed Driver with 1/8" Blade	.48
13 E 60619	8282	K	Zenith TV Wrench & Aligner	.37	13 E 60767	9091	W	5" .125 Hex Double End Iron Core Tool	.48
13 E 60627	8606	L	Zenith Nylon Hex Wrench	.48					

REPAIR CRADLE

5⁴⁵



G.C. "Quick-Rig" makes radio repair work quick and easy. Complete 360° rotation permits you to lock the chassis at the best working angle, clamps chassis securely and eliminates make shift setups. All metal, sturdy construction. Adjustable width for different sizes of turntables, etc. Shpg. wt., 5 lbs.

13 E 60890 Net 5.45

24" PICK-UP TOOL



Has mechanical fingers that will pick-up and hold screws, nuts, and bolts. Just press button to open, release button to close. Flexible shaft. Shpg. wt., 4 oz.

13 E 55551 Net .79

LOCKING FORCEPS

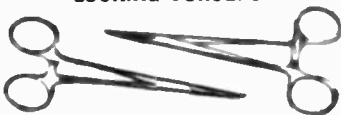

All stainless steel 5 1/2" long. They have unusual holding qualities necessary in many servicing situations. Shpg. wt., 1 1/2 lbs.

14 E 23011 Straight Nose Net 2.69
14 E 23029 Curved Nose Net 2.69

G.C. SERVICE TWEEZERS



Made of polished nickel-plated spring steel. Shpg. wt., 4 oz.

Self-Closing Type. 6 1/2" long, with blunt points.
13 E 60850 (A) Net .99
Heavy-Duty Type. 6 1/2" long, with slide lock and blunt points.
13 E 60866 (B) Net 1.10
Precision Type. 4 1/2" L. Pointed.
13 E 60874 (C) Net .75
All 3 above in leatherette case.
13 E 60882 Net 2.84

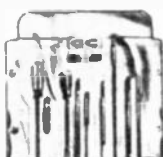

Contains 9 essential tools in roll-type case. One each of above tools, fig: C-D-E-F-G-H-I-K-R.

13 E 60817 Shpg. wt., 8 oz. Net 6.26

STANDARD T.V. ALIGNMENT TOOL KIT

6²⁶

COLOR T.V. ALIGNMENT TOOL KIT

Five different alignment tools for all standard adjustments in color TV. Made of natural Delrin® for extra durability. Includes "Extend-It" which makes each tool a long reach aligner. Each tool is color coded for easy identification. Packed in vinyl pocket saver.

13 E 61203 Shpg. wt., 6 oz. Net 2.49

ILLUMINATED MIRROR

Battery powered, inspecting tool with insulated shaft. Locking switch for on-off and one-hand operation. With bulb but less batteries. 12 1/4" long. Shpg. wt., 1 lb.

13 E 60825 Net 2.02
Batteries for above. (2 Required.)
99 E 62580 Net. ea. .10

INSPECTION MIRROR

Made of metal shaft with 1" dia. glass mirror and plastic handle. Length 7 3/8". Shpg. wt., 5 oz.

13 E 60148 Net .42

X-ACTO SOLDERING AID KIT

- Hard Chrome Plated Steel



Contains five tools and a universal, double-chuck handle—all in an always handy, see-through carrying case. Individual tools can be quickly replaced as needed. All tools are made of hard chrome-plated steel, to which solder will not adhere. The hex-shaped, double-chuck handle is rugged and comfortable to use. Shpg. wt., 1/2 lb.

13 E 74148 Net 2.69

TEL-A-TURN ALIGNMENT TOOLS



Automatically counts the turns right or left, just insert the tool in screw head, or slug, line up calibrator sleeve, rotate tool, read the number of turns on calibrator. Made of polyester fiberglass with clear calibration sleeve. Shpg. wt., 2 oz. IF Aligner. One end fits a #4 stud, the other end fits a #6 stud.

13 E 60775 Tel-a-Turn Tool Net 1.05

An alignment tool with standard metal tip at one end. Other end 7/8".

13 E 60783 Tel-a-Turn Tool Net 1.05

A double-ended Hex aligner that turns both top and bottom slugs. One end has 100° hex, other is .125" hex.

13 E 60791 Tel-a-Turn Tool Net 1.05

UNIVERSAL ALIGNMENT TOOL KIT

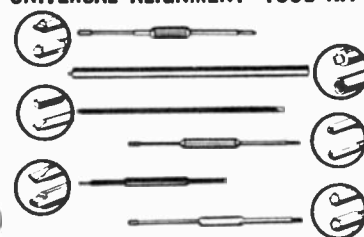

A handy, all-purpose kit in a convenient vinyl pouch. Kit contains 6 basic essential tools from 4 1/4" to 7" L, with 12 serviceable sides that will service the majority of TV sets. FM, AM, CB, HAM instruments, etc. Shpg. wt., 1 lb.

12 E 30028 Net 1.95

5 PIECE HEAT SINK KIT



1²⁹

- Use as a Third Hand

Set of 5 spring loaded aluminum heat sinks to protect components while soldering. Includes 1 1/2" and 2 1/2" straight and bent jaws, and one 2 1/2" with magnetic base for use as a third "hand."

14 E 15017 Shpg. wt., 6 oz. Net 1.29

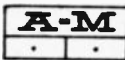

Akro-Mils Parts Cabinets



(A)



(B)



(C)

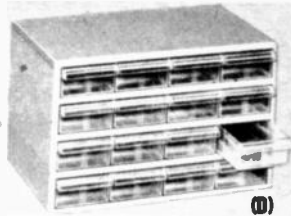

(D)

Complete labeling kit included with each cabinet . . . all models set-up with welded steel frame, ready to use ALL "MODULAR," CABINETS CAN BE STACKED—ADDED TO—CHANGED—ARRANGED—REARRANGED

Charcoal Gray Hammertone Finish

(D) MODEL 17-416, 16 long wide drawers.

(A) MODEL 17-136, 36 compact drawers:

Drawer size: 1 1/4"Hx2 3/4"Wx5 7/8"D.
Cabinet size: 17 1/2"Wx6Dx11 1/4"H. Cabinet, "See-Thru" drawers, dividers, and index labels. Shpg. wt., 13 lbs.
13 E 76102W Net 13.49

Drawer size: 2Hx4Wx11"D.
Cabinet size: 17 1/2"Wx11Dx10 1/4"H. Cabinet, "See-Thru" drawers, dividers and index labels. Shpg. wt., 17 lbs.
13 E 76126W Net 19.99
MODEL 18-416. Above but with unbreakable opaque drawers.
13 E 76052W Net 19.99

(B) MODEL 17-024, 24 deep compact drawers.

Drawer size: 2Hx2 3/4"Wx5 3/4"D.
Cabinet size: 17 1/2"Wx6Dx10 1/4"H. Cabinet, "See-Thru" drawers, dividers, and index labels. Shpg. wt., 11 lbs.
13 E 76110W Net 13.49

MODEL 17-715, 15 long deep drawers.
Drawer size: 3 1/2"Hx3 3/4"Wx11"D.
Cabinet size: 17 1/2"Wx11Dx10 1/2"H. Cabinet, "See-Thru" drawers, dividers, and index labels. Shpg. wt., 17 lbs.
13 E 76060W Not illustrated Net 19.99
MODEL 18-715. Above but with unbreakable opaque drawers.
13 E 76078W Not illustrated Net 19.99

(C) MODEL 17-320, 20 long drawers.

Drawer size: 2Hx3Wx11"D.
Cabinet size: 17 1/2"Wx6Dx10 1/4"H. Cabinet, "See-Thru" drawers, dividers, and index labels. Shpg. wt., 18 lbs.
13 E 76037W Net 19.99
MODEL 18-320. Above, but with unbreakable opaque drawers.
13 E 76045W Net 19.99

MODEL 17-909, 9 long deep wide drawers.
Drawer size: 3 1/2"Hx5 1/4"Wx11"D.
Cabinet size: 17 1/2"Wx11Dx10 1/2"H. Cabinet, "See-Thru" drawers, dividers, and index labels. Shpg. wt., 16 lbs.
13 E 76086W Not illustrated Net 19.99
MODEL 18-909. Above but with unbreakable opaque drawers.
13 E 76094W Not illustrated Net 19.99

PORTABLE 15 DRAWER STORAGE ORGANIZER

350

• All Steel Frame
Ideal storage unit for hobbyist or handyman. All steel unitized frame 10"x8"x6". Compact yet holds many items in easy to locate fashion in 15 "see-thru" drawers. 2 3/4"x1 1/4"x5 3/4". Unbreakable tote handle. Metallic blue baked enamel finish. With drawer dividers and labels. Shpg. wt., 3 1/2 lbs.
13 E 76250 Net 3.50

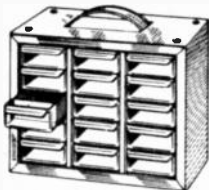

18 DRAWER STEEL UTILITY CABINET

565

• Compact Drawers
Model 11-118. Steel frame cabinet 10"W x 9"H x 6"D. See-thru drawers 5 3/4" x 2 3/4" x 1 1/4". Adjustable dividers permit compartment variation. Stack or hang from wall. Shpg. wt., 4 3/4 lbs.
13 E 76169 Net 4.30
24 Drawer Model 11-124. Similar to above—9"x6"x13" Shpg. wt., 6 1/2 lbs.
13 E 76177 Net 5.65

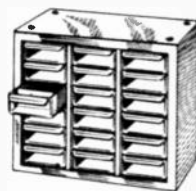

PORTABLE LOCKING CABINET

565

Model 11-463 For secure storage of medicines, tools, small easily lost parts. Chip-proof welded steel frame provides for safe storage and transport. Locking steel door prevents theft and spilling. Key-hole slots for hanging. 12 drawers 1 1/4"x2 3/4"x5 3/4" 1 jumbo drawer 2 1/2"x8 3/4". Overall size 10"x9"x6". With carrying handle. Adjustable dividers and labels. Shpg. wt., 5 3/4 lbs.
13 E 76219 Net 5.65

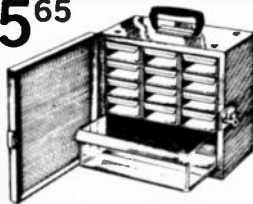

16 DRAWER STEEL UTILITY CABINET

565

• Deep Drawers
Model 11-266. Charcoal hammertone welded steel heavy duty 9"Hx13"Wx 6"D frame with 16 extra deep 2 3/4"x 2"x5 3/4" "see-thru" drawers. Baked enamel finish cannot chip or peel. Can be stacked for more compact arrangement. Adjustable dividers and labels included. Suitable anywhere from office desk to workbench. Shpg. wt., 6 1/2 lbs.
13 E 76193 Net 5.65

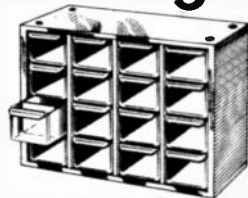

48 DRAWER PARTS CABINET

• Heavy Gauge Welded Steel Frame 995

Extra large cabinet 21 1/2"Hx12 1/2"W x 6 1/4"D. holds hundreds of items. Modular construction permits arrangement in single or multiple units, on walls, workbenches, shelves, or shop floors. Rigid steel frame and full metal shelf support any load in drawers. Plastic feet prevent scratches when standing, and secure multiple stacking. Inside drawer size: 1 3/4"x2 1/2"x5 3/4". Crystal-clear drawers. Feature safety stop and safe-grip-handle comes with 1 divider per drawer and index cards. Baked enamel finish. Imported. Shpg. wt., 14 lbs.
13 E 77506WX Net 9.95

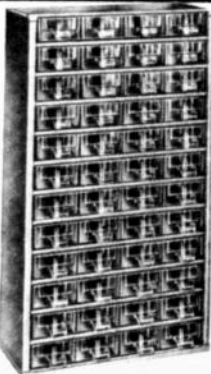

30 DRAWER PARTS CABINET

• FOR: Home—Office—Shop Only 549

Clear plastic drawers 2 3/8" x 1 1/4" x 5 3/4"D., each with removable dividers; safety stops to prevent accidental spilling. Cabinet tilts when carried; back punched for hanging. Bottom and top mate for solid stacking. Metal sides and back with contrasting high impact plastic top and bottom. Comes with labels, dividers and handle. 17H x 9 3/4W x 6 1/4"D. Shpg. wt., 8 1/2 lbs.
13 E 54505W Net 5.49

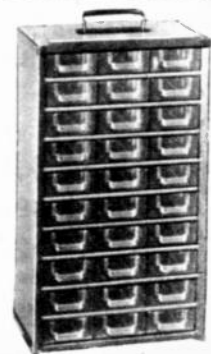

Hobby—Tool Kits

DREMEL MOTO-TOOL KITS

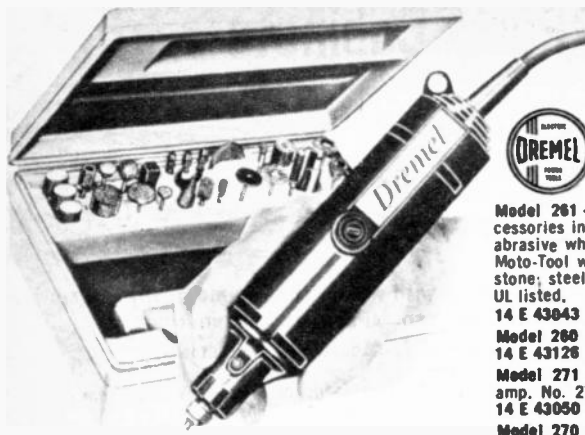

- Grinds—Polishes—Engraves—Sands—Drills
- Precision High-Speed Steel Cutters and Wheel Points

Model 261 — Kit. Rugged, compact machine shop with an assortment of fine accessories in a molded polyethylene case, 30,000 rpm for peak performance with small abrasive wheel points and both high-speed and carbide cutters. Kit contains: No. 260 Moto-Tool with $\frac{1}{32}$ ", $\frac{3}{32}$ ", $\frac{1}{16}$ ", $\frac{1}{8}$ " collets; 4 emery wheel points; 8 cutters; dressing stone; steel saw; 4 brushes; $\frac{1}{2}$ " drum sander, and mandrels. 117 VAC, .5 amp motor. UL listed.

14 E 43043 Shpg. wt., 4 lbs. Net 27.95

Model 260 Moto-Tool only —
14 E 43126 Shpg. wt., $1\frac{1}{4}$ lbs. Net 21.95

Model 271 — Heavy Duty Moto-Tool Kit. Similar to above but with heavy duty .8 amp. No. 270 Moto-Tool.
14 E 43050 Shpg. wt., 4 lbs. Net 32.95

Model 270 Heavy-Duty Moto-Tool only—
14 E 43134 Shpg. wt., $1\frac{1}{2}$ lbs. Net 26.95

DREMEL DELUXE MULTI-PURPOSE MOTO-SHOP

44⁹⁵

No Money Down*

- 5 Basic Powertools In One Compact Unit
- Jig Saw—Disc Sander—Bench Grinder—Buffing Wheel—Flexible Shaft
- Powered By Ball-Bearing 3450 RPM Rotary Motor

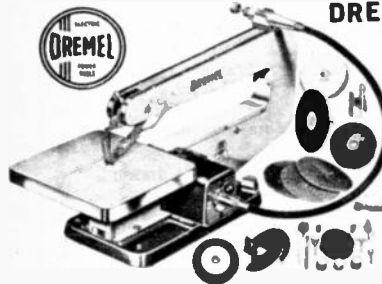

Model 572 Lightweight, compact portable multi-purpose workshop with 15" jig saw. Flexible accessory shaft attaches directly to power takeoff from motor for drilling, grinding, routing, sharpening, deburring and carving; has oilless bronze bearing, instant action wrenchless chuck, and neoprene cover. Accessories include: 3-sanding discs, grinding wheel, cloth buffing wheel, wire brush wheel, wheel guard, mounting bracket, 12-piece set, and 4-saw blades. U.L. Listed. 117V, 60 Hz AC. Shpg. wt. 18 lbs.

14 E 43068W Net 44.95

MICRO MINIATURE WORKSHOP



- Grinds — Sands
- Drills
- Polish — Carve — etc.
- Heavy-Duty .75 Amp Tool

Ultra modern Micro power tool handles all jobs that ordinary power tools can't. This miniature workshop is a must for hobbyists, handy men and industrial plants that require fine finishing work. Incorporates outstanding features that include: slide-snap "on-off"

switch, STA-COOL plastic housing with large air vents for cooler operation, instant-action wrenchless Chuck, powerful 115 volt universal motor, convenient hanger hook. Kit comes complete with: 1 — motor tool, 1 — $\frac{3}{32}$ " collet, 1 — $\frac{1}{8}$ " collet, 1 — 2-prong adaptor, 1 — rotary file, 6 — sanding discs, 3 — cut-off discs, 2 — mounted stones, 2 — bristle brushes, 1 — dressing stone, cotton buff, felt wheel and $\frac{1}{8}$ " and $\frac{3}{32}$ " drill. Rugged heavy-duty case.

13 E 53507 Shpg. wt., 4 lbs. Net 24.95

DREMEL ACCESSORIES

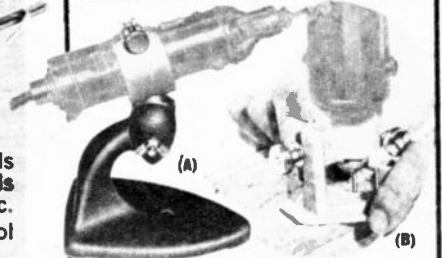

(A) **Model 223 Universal Stand.** Leaves both hands free for holding the work. Adjusts to hold Moto-Tool at any angle. Quick action clamp for receiving and releasing Moto-Tool. Heavy cast iron base.

14 E 43062 Shpg. wt., 3 lbs. Net 6.95

Adapter For Model 223 Universal Stand. For Use With 260 Moto-Tool.

14 E 43100 Net 1.25

(B) **Model 224 Shaping Table** can be mounted vertically on Moto-Tool when used with Universal Stand. Or, when inverted, it provides accurate control for routing and depth grinding. Table can be raised or lowered to regulate depth of cut.

14 E 43118 Shpg. wt., $\frac{1}{2}$ lb. Net 3.95

8-PC. BRUSH AND STONE SET



8-assorted pieces mounted on $\frac{1}{8}$ " or $\frac{3}{32}$ " shanks. Consists of 3 mounted grinding stones, 2 bristle brushes, 2 wire wheels, and 1 steel bun. Ideal for hobby tools. In handy plastic box. Shpg. wt. 8 oz.

13 E 50024 Net 1.95

VARIABLE SPEED FOOT CONTROL



3²⁹

- Speed Variable from 0 to Max. Speed of Motor

Regulate the speed of the motor in your sewing machine, hobby tool, etc. Handles up to 110 watts. 10-ft. cord with 2-way outlet—for motor and light. 1 amp.

12 E 54010 Shpg. wt. $1\frac{1}{2}$ lbs. Net 3.29

12-PC. ROTARY STEEL CUTTER SET



Selected assortment of 12 steel burrs of different shapes. Tempered tool steel for use on metal, plastic or wood. $\frac{1}{8}$ " and $\frac{3}{32}$ " shanks, in handy plastic box. Ideal for hobby tools. Shpg. wt. 8 oz.

13 E 50032 Net 1.95

6-PC. MOUNTED STONE SET



1²⁹

Six assorted grinding stones and wheels. Set of mounted grinding points, stones, and wheels. Mounted on $\frac{1}{8}$ " and $\frac{3}{32}$ " shafts. An ideal accessory for the hobby tools. Shpg. wt. 8 oz.

13 E 50616 Net 1.29

UNIMAT

The ALL-PURPOSE 5-in-1
METAL-MACHINING WORKSHOP

Miniature Machine Shop

Only **139⁵⁰** No Money Down*

- Precision Metal-Working Lathe
- 11-Speed Ball-Bearing Spindle, Accurate to 1/2 Thousandths
- Converts to Vertical Mill or Drill in Seconds
- Turn, Mill, Bore, Saw, Buff, Sand, Polish, Grind—Steel, Aluminum, Brass, Plastic or Wood
- Ideal for R&D Labs, Model Shops, Electronic and Home Workshops

SPECIFICATIONS: Complete 5-in-1 machine shop small enough to use on a radio serviceman's bench. Designed as a multi-functional power tool. Converts from horizontal lathe to vertical drill press. The changeover causes no wear or loss of accuracy in precision fit parts. The motor-headstock detaches for use as a portable hand drill, power grinder or buffer. Extra attachments available include a very accurate circular saw, saber and jig saw, flexible shaft, lathe bed power feed, threading attachment, precision collets and cutting tools. Belt drive provides 11 speeds ranging from 900 to 7,200 RPM. Motor can also be controlled by rheostat foot switch or SCR power supply.

Includes 1/10 HP Brush Type fan cooled motor, drill press arm, column and hand lever, face plate, lathe dog, grindstone arbor, tool post, 2 dead centers, 1/4" Jacobs chuck and key. Allen wrench roughing tool bit, and a spindle return spring. 17 1/2 x 10 1/2 x 5 3/4" wood chest. 40-page manual. For 115V AC/DC operation. Imported. Shpg. wt., 30 lbs.

14 E 10141WX

Net 139.50

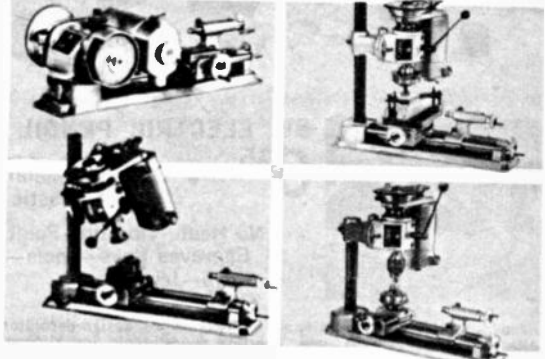
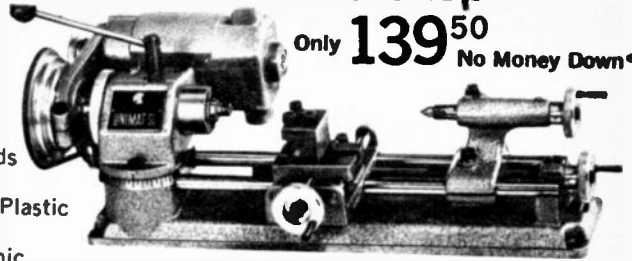

UNIMAT ATTACHMENTS AND ACCESSORIES

Model DB-1001 3 jaw universal lathe chuck with reversing jaws, key and back plate. Shpg. wt., 1 lb.

14 E 10133

Net 24.95

Model DB-1210 Milling Table: 5" x 3" with clamps. Shpg. wt., 3 lbs.

14 E 10026

Net 12.50

Model DB-1010 Machine Vise: jaws open 1 1/4". Mounts cross slide or mill table. Shpg. wt., 1 1/2 lbs.

14 E 10034

Net 9.50

Model DB-2820: Set of 6 Lathe Tool Bits.

14 E 10059

Net 10.90

Model DB-2860 Tool Kit: 2 tool bits, 4 drills, 2 grind wheels, 2 milling cutters, center drill and countersink bits, 2 chisels, boxed.

14 E 10042 Shpg. wt., 1 1/2 lbs.

Net 16.95

Model DB-1290 Power Feed Attach: 1:50 reduction, feeds .0008" per revolution. Shpg. wt., 7 lbs.

14 E 10067

Net 24.95

Model DB-1002 4-Jaw Independent Chuck; capacity 2 1/4".

14 E 10075

Net 23.90

Model DB-1080 Jig Saw Attach. Cuts to center of 16" circle. 12 blades incl. Shpg. wt., 6 1/2 lbs.

14 E 10117

Net 19.90

x-acto

CORDLESS POWER DRILL SET

4⁹⁵

- Drills Wood, Metal, Plastics
- Grinds, Drills, Carves
- Polishes

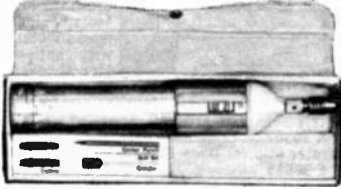

Model 378. Powerful, versatile, efficient. Polish-deburr-carve-grind-drill, with new ease! Complete with center punch, grinder, drill bit and 3 precision collets. Drills plastic, wood, light metal. In handy styro foam holder. Embossed case. Less batteries.

13 E 74248 Shpg. wt., 3/4 lbs.

Net 4.95

99 E 02572 "C" Batteries for above; 2 req.

Net ea. .14

KNIFE AND TOOL SET

• Precision Knives

Model 84 knife and tool set. Contains handles #1 (5/16 x 5" aluminum) for light work; #2 (7/16 x 5" alum.) for med. work; #5 (13/16 x 4 3/4" plastic) for heavy work. Plus 4 assorted routers, 2 different punches, plane, 1" sander, spoke shave, balsa stripper, 11 assorted blades and 4 assorted gouges. A complete wood carving workshop. In wood case with clear plastic cover. Shpg. wt., 2 1/2 lbs.

13 E 74230

Net 11.25

Replacement blades that fit all X-ACTD tools. Avg. shpg. wt., 2 oz.

No. 11 for fine angle cutting: deep cuts, narrow spots.

13 E 74073 #11, pkg. of 5 Net .54

No. 24 for close corner cuts: templates, mats, trimming.

13 E 74123 #24, pkg. of 5 Net .54

SMALL BLADES



x-acto

HOBBY DEN TOOL CABINET

Only **26⁵⁰**

- Assorted Hobby Tools In Fitted Cabinet

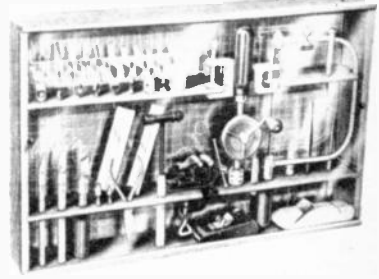

Model 89. Wooden cabinet with sliding see-thru cover. Stores, protects a full assortment of hobby tools. Back has silhouette of each tool for easy replacement. Set includes: 6-extra blades; 6-assorted gouges; 4- assorted routers; 2-punches; 3-knives (with blades); 1-hobbycraft saw (with extra blade); 2-screw drivers; 2-"C" clamps; 1-tweezer; 1-sander; 3-tweezer clamps; 1-hand drill; 1-file; 1-planer; 1-hammer (with extra heads); 1-bench vise; 1-pair pliers; 1-drill bit; 2-screw driver bits; 2-razor saw blades; 2-chucks; and a "Project Handbook and Tool Guide". Size 13 1/4 x 21 1/4 x 3". Shpg. wt., 9 lbs.

13 E 74263

Net 26.50

KNIFE CHEST

Model 82. Handy knife chest. Perfect for model building, photo retouching, shaping templates, cutting insulation, or cutting gaskets. Contains handles #1 for light cutting, #2 for medium work and #5 for heavy cutting plus 11 assorted blades including trimming, double edged and fine cutting.

Complete with wood case. Shpg. wt., 3/4 lb.

13 E 74184

Net 4.50

4⁵⁰



* See Page 11 for Full Credit Details on Easy Pay Plan



Sabre-Lathe Multi-Purpose Shop Tool

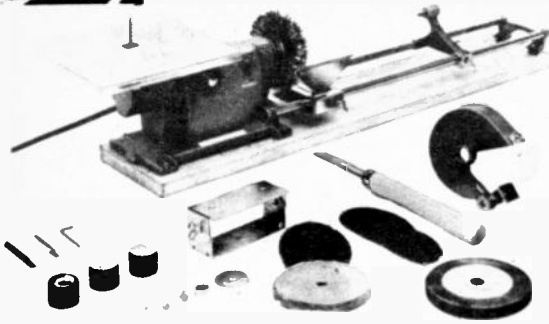

ONLY
29⁹⁵

It's a . . .

- Wood Turning Lathe
- Sabre Jig Saw
- Bench Grinder
- Disc or Drum Sander
- Buffing or Polishing
- Horizontal Drill

A home shop tool that will excite the interest of every home craftsman! Powerful, 3-speed motor provides plenty of drive for every operation...unit changes for any purpose in just seconds. Complete with wood turning chisel, sanding discs, sanding drum discs, 3 sabre saw blades, 45° adjustable sanding table. Entire unit is mounted on wooden base for easy portability and stability. Lathe has 18" bed, 4" throat, can be used for spindle or face plate turning. 115 volt, approximately 1/3 h.p. motor, AC only. Output speeds 3,700, 3,300 and 3,100 rpm. With illustrated instruction booklet. Mounted on 32" x 6" board. Shpg. wt., 16 lbs.

13 E 36502W

Net 29.95



BVI ELECTRIC PENCIL

6⁹⁵

- Writes On Metal—Wood—Plastic
- No Heat—Vibrating Point Engraves Keys—Tools—Toys—Jewelry

Handy, useful... mark, identify and engrave names, design decorator effects on luggage tags, toys, sporting goods, tools and kitchenware. Automatic with built-in mercury switch. You pick it up—it turns on. Put it down and it turns off. Easy as a pencil. Marks won't erase, smear or rub off. Tough hardened steel point vibrates 7200 strokes a minute. Lightweight. 7 x 3 x 2". 110 VAC, 50/60 Hz motor. Shpg. wt., 5 lbs.

13 E 80542

Net 6.95

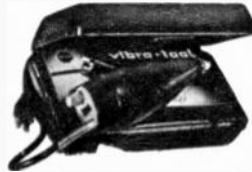

BURGESS VIBRO-TOOL KIT

- Versatile Multi-purpose Tool
- Files—Saws—Cleans—De-burrs—Engraves
- Complete With 6 Accessories

Performs many operations on nearly any kind of material with its accessories. Features motor control switch plus dial setting for engraving depth. Heavy-duty 2-speed motor delivers 3600 and 7200 strokes per minute. Rugged nylon

14⁹⁵

housing. Molded plastic case with accessory storage area. Complete with accessories: Carbide tipped engraving point, knife blade, saw blade, half round chisel 1/2 inch tool, hammer and abrasive point. Shpg. wt., 1 1/2 lbs.

13 E 80534

Net 14.95

DREMEL

ELECTRIC ENGRAVER

11⁹⁵ Writes Like A Pencil
Calibrated Stroke Adjustment



Model 290 heavy duty engraver provides a fast permanent method of marking all types of materials. High speed reciprocating motor delivers 7,200 strokes a minute with a calibrated adjustment that regulates the depth of engraving from fine lines to deep marks. Engrave steel, brass, aluminum, copper, silver, plastic, ceramic,

glass, pewter. Identify dies and molds, shop and garden tools, production parts, sporting goods, camera equipment, jewelry, etc. Minimize inventory mixups, theft, and loss. Complete with solid carbide engraving point and storage case. Shpg. wt., 1 1/2 lbs.

14 E 43142

Net 11.95



ETCH-O-MATIC MARKING KIT

19⁹⁵

- Write or Type on Stencil
- Etch Into Metal in Seconds

Electrically etches lettering, marks or drawings into metal surfaces including tools, equipment and toys. Permanently marks metal surfaces up to .002" deep with optional adapter clip. Special stencil covers 7/8x1 3/4" and makes 100-

300 marks. Takes only 3-10 sec. each. Kit marks up to 2000 items. Complete with special stencils, electrolyte and electric cord. Completely safe. For 110 VAC. Shpg. wt., 1 lb

12 E 30507

Net 19.95

Adapter Clip for Deep Etching
12 E 30515

Net 2.95

GRASS EDGER-TRIMMER

Only **17⁵⁰**



DELUXE SHRUB AND HEDGE TRIMMER

- Powerful 3 AMP 4500 RPM with Rugged Reduction Gears
- Easily Adjustable Trimming Height
- Die Cast Aluminum Housing

Lightweight Edger-Trimmer easily trims close-up to trees, foundations, and fences. Turning handle converts unit into a powerful edger. Features 6" tempered spring steel blade, diecast aluminum housing, side grip, finger tip push button switch on handle, fully adjustable trimming height, and oiled-for-life bronze bearings. Requires 115 volt 50/60 Hz 3 amp. AC motor. Shpg. wt., 9 1/2 lbs. UL listed.

13 E 36544W

Net 17.50

Turns on side for use as edger

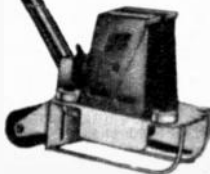

- Double Edge 16" Blade
- "Roll-Bar" For All Angle Use

The fast labor saving way to trim hedges, shrubs and bushes. Deluxe "Roll-Bar" handle allows maximum comfort and safety—adjusts for any angle cut. 2-cutting edges, each with 16-teeth—cuts 15" swath in either direction. 16" blade cuts at 1850 strokes per minute. Die-cast aluminum housing with bright finish and enamel finish roll-bar. Fingertip On/Off switch. Hardened spring steel teeth are self-sharpening. 2.6 amp, 115 volt, 50/60 Hz AC motor. UL listed. Shpg. wt., 6 lbs.

13 E 36536 WX

Net 19.95

Popular Power Tools



Black & Decker



A 18⁹⁵

A RAM TWD-WAY ELECTRIC SANDER

- Orbital or Straight Line
- Positive Slide Switch
- 3/8" Stroke Orbital or Straight

Model R-120. Heavy-duty electric sander with 3/4" orbital or straight line stroke. Features 3.5 amp, universal series wound motor. Heavy-duty ball bearing and self-lubricating sleeve bearings. Pad size: 3 3/4 x 7 1/8"; sandpaper size: 3 3/4 x 9". Assorted grit paper included. Industrial mirror finish, 6 ft. 3-cond cord. For 115 V. 60 Hz. AC-DC. UL listed. Shpg. wt., 6 lbs.
13 E 71020 **Net 18.95**

C DELUXE DUAL ACTION FINISHING SANDER

- Lever Control for Straight Line or Orbital Sanding

- Polished Aluminum Housing

Model U-240. Professional results in cabinet, auto or boat repair and finishing. Over 25 sq. in. of sanding area. Heavy duty 1/6 HP motor with 4000 strokes per min. for smooth, fast material removal. Improved, burn-out protected motor. Ruggedly constructed and comfortable one or two hand control. Allows flush sanding on 3 sides; can be used in any position. Paper easily changed. For 115 VAC. Shpg. wt., 7 1/2 lbs.
12 E 68606 **Net 24.88**

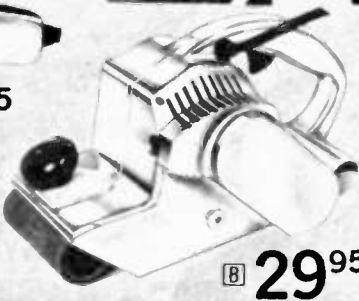

B 29⁹⁵

B HEAVY DUTY 4" BELT SANDER

- Powerful 7.5 Amp Motor

Model 72510: A powerful belt sander for every sanding job. Rugged gear drive moves 1500 surface feet per minute. Unique snap-lock on front roller for easy belt changing, vacuum cleaner hook-up provided for dust pick-up. Die cast aluminum housing, locking trigger switch. Uses standard 4x21 3/4" belt. AC motor with life-time lubricated bearings. 3-cond. cord. For 115 V 60 Hz AC. UL listed.
13 E 36601 Shpg. wt., 13 lbs. **Net 29.95**

Sanding Belts For Above
13 E 36619 40 Grit, Coarse **Net .79**
13 E 36627 60 Grit, Medium **Net .79**
13 E 36635 80 Grit, Fine **Net .79**

D 2-SPEED SANDER POLISHER

- Powerful 1/2 H.P. Motor
- Burnout-Proof Armature
- Sands Metal and Plastics

Model 940: Combines two handy tools—a sander operating at 3400 RPM and an efficient polisher at 1800 RPM. As a sander, you get the right combination of high speed and oversize sanding discs. Has perfect balance . . . auxiliary grip handle for right or left hand use. Tool rest. Extra large wool polishing bonnet permits working around and over edges. UL and CSA Listed. For 117 VAC. Shpg. wt., 8 1/2 lbs.
13 E 65180 No Money Down* **Net 34.97**



C 24⁸⁸



D 34⁹⁷

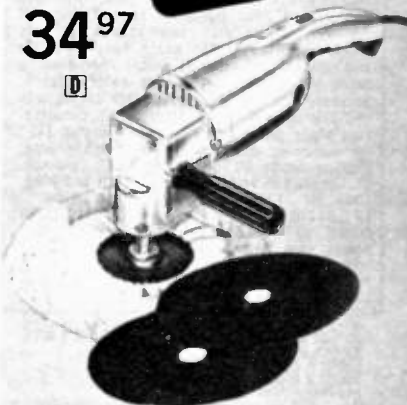

DREMEL ELECTRIC SCROLL SAW



10⁹⁵

- Cuts Intricate Scroll Work
- No Sanding Required

Easily cuts intricate scroll work . . . saws wood up to 3/4" thick, asphalt, rubber and plastic floor or wall tiles, aluminum and light metals. Thin, fast cutting blade saws so smoothly, no sanding is required. High-speed reciprocating motor produces 7,200 strokes per minute. Unique 4-way blade holder permits cutting in any direction. For 115 VAC Shpg. wt., 3 lbs.
14 E 43027 **Net 10.95**
Pkg. of 10 replacement blades for above
14 E 43035 Shpg. wt., 3 oz. **Net .59**

RAM "INDUSTRIAL" 6" BENCH GRINDER



31⁵⁰

- Precision Balance
- 6" Wheels: 1-Coarse, 1-Fine

Model R-600. Precision bench grinder for fast, accurate grinding and sharpening. Useful in any workshop. Powerful 6.4 amp. motor for tough jobs. Reaches full, 3300 RPM in seconds. Sealed, heavy duty bronze bearings. With adjustable tool rests for varying grinding angle and plexiglass eye shields for safety. Has 11" clearance between wheel centers for long work. 3-cond. power cord. For 115 VAC, 60 Hz. Shpg. wt., 24 lbs.
13 E 71327WX **Net 31.50**

ARCO QUIK-SANO VERTICAL PORTABLE SANDER POLISHER

- Sands, Grinds, Polishes, Sharpens: Metal, Steel, Wood, Plastics
- Portable
- For Any 1/4-1/3 H.P. Motor; With 1/2" Shaft

Safe, Versatile, Sharpens everything — from razors to plow — shares. Belt falls harmlessly to bench if it snaps. 19" high. With 1" x 42" abrasive belt, 50 grit. Shpg. wt., 11 lbs.
12 E 18502 Less Motor **Net 19.95**
12 E 18510 50 Grit, Heavy **Net .69**
12 E 18528 120 Grit, Medium **Net .69**
12 E 18536 270 Grit, Fine **Net .69**



19⁹⁵

* See Page 11 for Full Credit Details on Easy Pay Plan

SKIL
POWER TOOLS



7 1/4" BUILDERS' SAW

29⁸⁸

- 1 1/2 HP Burnout Protected Motor
- 5200 RPM No Load Speed 10 Amp Motor
- UL Listed

Model 574 Tackle the "big" jobs, with this dependable 7 1/4" builders' saw. Reinforced die-cast housing that really stands up. Cuts 2x4's with ease, at 45° angle. Easy set bevel and depth adjustments. Safe non-binding blade guard with vari-torque safety clutch. Sawdust ejector keeps your work clean, lets you see what you are doing. 7 1/4" combination blade and blade wrench. Powerful 1 1/2" HP motor is designed to be trouble free. Cutting depth: 90° 2 3/4", 45° 1 7/8", 10 amps. UL listed. 115 volts AC, 3 wire cord and plug. Shpg. wt., 12 1/2 lbs. See rip fence below.

13 E 69263 Net 29.88
Model 537 Deluxe 7 1/4" double insulated power saw. Similar to above with convenient 2-prong plug. Shpg. wt., 10 lbs.
13 E 69388 No Money Down* Net 42.88
13 E 69123 Rip Fence Net 1.79

RAM GO 7 1/4" "INDUSTRIAL" POWER SAW

- Powerful 1 1/2 HP 10 Amp. Motor
- With Auxiliary Handle and Rip Guide



24⁹⁵

Dependable power saw provides reserve power to cut thru 2x4's with ease. Powerful 10 amp., 5400 RPM motor. Cuts up to 2 1/4" vertically and 2 1/2" at 45°. Balanced for one hand operation with auxiliary grip for difficult cutting tasks. Features heavy-duty bronze bearings, removable rip guide, floating blade guard, and easily set depth and angle adjustments. With mirror finish. Combination blade included. For 115 VAC, 60 Hz, 3-cond. power cord. UL listed. Shpg. wt., 12 lbs.
13 E 71335 Net 24.95

HEAVY-DUTY 7 1/2" POWER SAW

Powered By
GENERAL ELECTRIC MOTOR

- Develops 2 1/2 HP • 12 Amp Motor
- With Rip Fence • Mirror Finish



34⁹⁵

Built to handle the toughest cutting jobs. Rugged 2 1/2 HP, 5000 RPM G.E. motor and big 7 1/2" chrome-nickel steel combination blade will cut thru 2x4's at a full 45°. Balanced design provides effortless control. Ball bearing slip clutch eliminates kickbacks. With auxiliary handle, spring-back blade guard and adjustable rip guide. Easily set angle and depth adjustment. Shock-proof handle and trigger. 3-cond. power cord. For 115 VAC, 25-60 Hz. Mirror finish. UL listed. Shpg. wt., 14 lbs.
14 E 48117 No Money Down* Net 34.95

HEAVY-DUTY 10" POWER CHAIN SAW

- 2 HP—10 Amps • With Oregon "Omark" Chain and Bar

A powerful, top quality chain saw designed for professional or industrial use. This rugged, multi-purpose tool will also do dozens of jobs for the home craftsman, carpenter, contractor, or on the farm. Positive chain adjustment eliminates slack. Chain travels at 2650 feet p/minute for fast, true cuts up to 10 inches deep. Cool running quiet helical cut gears in a sealed grease chamber. Self lubricating bearings. Beautifully balanced weighs only 12 lbs. 10 Amp 2 HP motor. UL and CSA listed. Wt., 14 lbs.
14 E 48042W Net 59.95

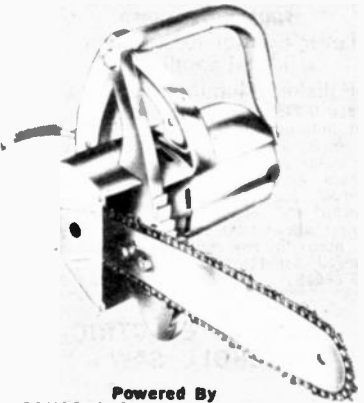

Powered By
GENERAL ELECTRIC MOTOR

59⁹⁵

No Money Down*

RAM GO 1/4 H.P. ROUTER

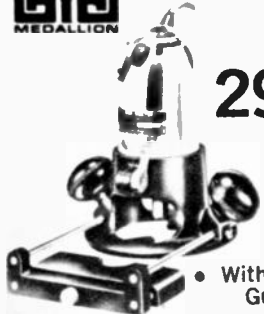

29⁹⁵

- With Cutting Guide

Model R60: For hobbyists, home repairmen. Easy-to-make smooth cuts with or against the grain for fine inlaying, cabinetry, corncing. Does beading, grooving, routing, fluting, cove-cutting, dove tailing. Features threading base with positive lever-locking depth of cut adjustment; veneer cutting guide and wrench included. 1/4" chuck uses standard router bits. Height 8". For 115V., 60 Hz AC. 20,000 RPM cutting speed. UL Listed. Shpg. wt., 5 lbs.
13 E 71087 Net 29.95

4-Pc. Router Bit Set. Includes 1/4" & 1/2" straight bits, 1/4" core bit, and 3/8" "V" groove bit. Shpg. wt., 1 lb.
13 E 71137 Net 9.95



ELECTRIC PLANER

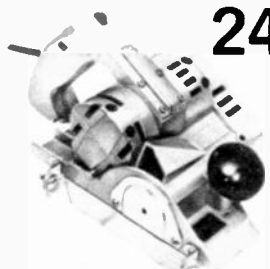

24⁹⁵

- Adjustable Guide Permits Planning At Any Desired Angle

Does a professional job of planing! Easily adjustable planing depths of 1/2" and 3/4". 2 hardened steel, adjustable cutting blades may be removed for sharpening, adjustable fence and angle guide may be removed for planing flush into corner. Burn-out protection. Motor develops 3/8 hp. (industrial rating). Spindle speed 14,000 rpm with double race ball bearings. Die-cast aluminum housing. With 3-cond. cord. For 115V 50/60 Hz AC.
13 E 36585 Shpg. wt., 7 lbs. Net 24.95

ELECTRIC CIRCULAR SAW BLADES

Fast cutting, long lasting, edge holding, rust-resistant! Select the correct blade for the job. For use with 7"-7 1/2" electric saws with 5/8" round arbor hole. Shpg. wt., 1/2 lb. **Combination Blade:** For cross-cut and rip work.
13 E 71053 Net 1.69
Planer Blade: Hollow-ground for very smooth cutting, cross-cut, rip, mitre.
13 E 71079 Net 3.89
Flooring Blade: For repairing floors, and cutting where nails are encountered.
13 E 71061 Net 1.99
Plywood Blade: Fine-tooth for smooth, splinter-free cutting of plywood.
13 E 71319 Net 2.39



fury

SABRE SAW

11⁹⁵



- 1/4 HP Motor • With Rip Guide

MODEL F-8: A rugged, multi-purpose sabre saw. Can be used as a rip, crosscut, jig saw, hack saw, band, coping, keyhole and scroll saw. Easily cuts 2 x 4's, plywood plastic, composition board, aluminum and a host of other materials. Powerful 3 amp. 1/4 H.P. motor with a built-in cooling system, produces 3500 1/4" long strokes per minute. Adjustable base, rip guide and mitre gauge. Bevel cuts from 0° to 45°. "On/Off" slide-switch. With 3-assorted blades. For 115V., 60 Hz AC/DC. UL listed. Mirror finish.

13 E 71160 Shpg. wt., 4 lbs. Net 11.95
Wood Cutting Blades, Pkg. of 6
13 E 71170 Net 1.69
Metal Cutting Blades, pkg. of 3
13 E 71160 Net 1.25



2-SPEED ALL-SAW



35⁹⁵

- Heavy-Duty 1/2 HP Motor

Model 908: "Souped-up" heavy duty-fast cutting — 1/2 HP saw for every kind of sawing. Cuts metals up to 1/2". Cuts pipe and thin-wall up to 2". Cuts curves, circles, and straight lines. Cuts 2x4's, 4x4's and 6x6's. Makes its own starting holes. Motor fan blows air stream over work to keep the guide free of sawdust. Complete with 7 blades designed for all sorts of regular and special cutting. Powerful 6 amp 110 VAC motor. 3400 1" SPM. UL listed.

- 13 E 65014 Shpg. wt., 9 lbs. Net 35.95
SAW TABLE FOR WEN "908" & "909D". Heavy duty table for straight, circle, curve, bevel, and angle cuts. Size: 18 x 18 x 8 1/2".
13 E 65055 Shpg. wt., 14 lbs. Net 11.50
EXTRA BLADES FOR WEN Models "908" — "909D" — "921". Pkg. of 3. Shpg. wt., 8 oz.
#91 7 1/2" — Very fast rough cuts.
13 E 65063 Net 1.39
#92 3 1/2" — Fast rough cuts
13 E 65071 Net 1.19
#93 2 3/4" — Medium cuts,
13 E 65089 Net .95
#94 2 1/2" — Fine scroll cuts
13 E 65097 Net .95
#96 3 3/4" — High-speed steel.
13 E 65113 Net 1.39
#97 3 3/4" — High-speed, extra fine.
13 E 65121 Net 1.39
#900. One each of above blades plus knife blade. Pkg. of 7.
13 E 65139 Net 2.55

HEAVY-DUTY VARIABLE SPEED SABRE-JIG SAW

Powered By

GENERAL ELECTRIC MOTOR

- "Dial Control" Any Speed From 0-4800 S.P.M.
- Cuts Thru 6x6 Lumber

Electronic dial variable speed control lets you use this one tool for any cutting job. Cuts through 6" logs, 6 x 6" lumber, metal pipe, masonite—practically any material. Makes its own starting hole. Low speed for steel and plastics, medium for non-ferrous metals, high for rip or cross-cut. Bevel cuts to 45°. Features a 5 amp. 1/2 HP General Electric motor. With 6' 3-cond. cord, 5 assorted blades and rip gauge. For 115 VAC, 25-60 Hz. UL listed. Shpg. wt., 4 1/2 lbs.

- 14 E 48059 Net 27.95
Heavy-Duty Sabre Jig-Saw. Similar to above less variable dial speed control. 3.5 amp. motor. Shpg. wt., 4 1/4 lbs.
14 E 48067 Net 20.95

27⁹⁵



HEAVY-DUTY VARIABLE SPEED JIG SAW

- Powerful 1/2 H.P. 4-Amp. Motor
- Exactly The Right Speed Under Your Thumb
- Rips Through 6" Logs

Model 521—Take on a variety of cutting jobs more efficiently. Pressure sensitive, thumb operated speed control automatically varies torque and speed as you cut... no wasting of time pre-setting speeds. Low speed for metal; high speed for wood; intermediate speeds for plastic, masonite, plaster board, rubber, etc. 1/2 H.P. motor drives blade from 0 to 2800 1" strokes per minute. Also has calibrated 8" adjustable rip guide. Includes 7-blades for every cutting job; 3-wire 6' cord with adapter. 115 VAC. UL/CSA listed. Shpg. wt., 4 lbs.

- 13 E 65386 See Blades Below. Net 25.95

25⁹⁵



"INDUSTRIAL" SABRE SAW

- Rugged 3.2 Amp. Motor
- With Rip Guide

Model R-146 Professional sabre saw with 2 1/2" capacity in wood. Easily controlled cutting action for straight or curved cuts at any angle up to 45° either side. 1/2" length of stroke at 3500 SPM for extra smooth, fast cutting. Universal 3.2 amp. motor provides plenty of cutting power. Self-lubricating bronze bearings. With removable rip guide. Includes one wood, one metal and scroll saw. 3-cond. power cord. For 115 VAC, 60 Hz. UL listed. Shpg. wt., 7 lbs.

13 E 71343 Net 22.50
See listing under RAM "Fury" sabre saw for additional blades.

22⁵⁰

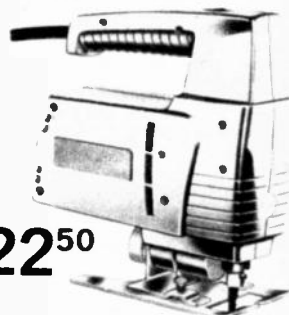

ROTO BLADE SPEED SAW

Power Steer The Blade With Just A Twist Of The Knob

- 2" Capacity in Wood
- Cuts Intricate Scrolls and Curves

Model 911 Roto-Blade sabre saw cuts in any direction without turning the saw itself. Permits the most intricate cuts with the twist of a knob. Does the job easier and faster. Power steering blade revolves a full 360° and can be locked at any angle desired. Cuts metal, plywood, composition materials and plastic with equal ease. Base tilts up to 45° right or left. 3/8" stroke and 3400 SPM for smooth cutting. With one scroll and one coarse cutting blade. Powerful 3.1 Amp. Therm-O-Weld 115 volt, 50-60 Hz AC-DC motor. 3-cond. power cord. UL listed and CSA approved. Shpg. wt., 6 lbs.

13 E 61500 No Money Down* Net 37.95

37⁹⁵





HUSKY 3/8" DRILL 10⁹⁵

- 3 AMP UL Listed
- Auxiliary Left or Right Handle
- Double Reduction Gears

A rugged, powerful 3/8" drill for tough drilling jobs around the house and shop. Features double reduction gears for maximum torque. No load speed 1000 rpm. Capacity 3/8" in steel, 1" in wood. Ball thrust bearing takes the full drilling load. Welded commutator leads prevent motor burnout. Geared key chuck, 3-conductor power cord. Bright finish. For 120 VAC, 50-60 Hz.

13 E 36551 Shpg. wt., 4 lbs. Net 10.95



1/4" DRILL

- 2.5-Amp UL Listed Motor
- Jacobs Geared Chuck & Key
- Multiple Thrust Bearings

Model F-11 popular drill for all-around home and hobby use. 1/4" geared chuck drill rated at full 2.5 amps. UL listed. 1/4" capacity in steel, 1/2" in hardwood. 1200 RPM speed under full load; 2000 RPM no-load speed. Precision anti-friction bearings. Automatic trigger switch. Specially designed gear train for maximum torque transfer. For 115 volts. AC/DC. Shpg. wt., 3 lbs.

13 E 71012 Net 8.95

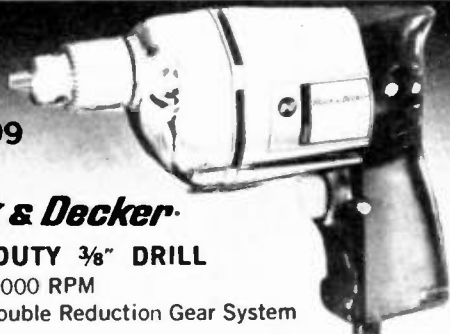

14⁹⁹

Black & Decker

HEAVY-DUTY 3/8" DRILL

- 1/2 HP 1000 RPM
- Uses Double Reduction Gear System

Model U-124 Heavy duty capacity 3/8" drill incorporates a double reduction gear that permits a wide range of drilling needs. Perfect for grinding, buffing, mixing and all types of heavy and light drilling chores. Heavy duty UL listed 2.3 amp motor and precision gears combine to give maximum torque at all drilling speeds. "Cyclocac" handle provides positive grip at all times. Jacobs geared chuck and key for quick change of bits. Handy trigger switch, with locking button, permits use in awkward places. 3 wire cord plug. Uses 115V AC. Shpg. wt., 5 lbs.

12 E 68507 Net 14.99

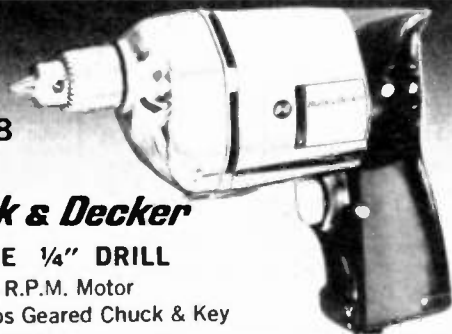

11⁸⁸

Black & Decker

DELUXE 1/4" DRILL

- 2250 R.P.M. Motor
- Jacobs Geared Chuck & Key

Model U-100 Just the thing for the hobbyist, home workshop or general use in the home. Ideal for use on wood, metal, masonry. Drills, sands, polishes, buffs, grinds, and even mixes paint. Can be used with attachments to make circular saw, jig saw or finishing sander. 1.9 amp. motor has precision oilite bearings for long life. Rugged 2250 rpm motor provides adequate power for most any job, big or small. Sure grip handle eliminates wrist strain. 3 wire cord and plug for safe use anywhere. UL listed, operates on 115V AC. Shpg. wt., 4 1/2 lbs.

12 E 68515 Net 11.88



Thor 29⁹⁵

3/8" VARIABLE SPEED DOUBLE INSULATED COMPACT DRILL

- Solid-State Magnetic Motor—Diode Circuitry
- Double-Reduction Gears

A power drill that is so light, rugged and powerful... so comfortable! Revolutionary fast-back design features balanced power and lightweight materials. Weighs only 1 1/4 lbs.! Ingenious use of polycarbonate housing makes this drill virtually indestructible and is double insulated for safety. Unique magnetic motor offers variable speeds from 0-1200 r.p.m. 4-diode circuitry is solid-state, full wave rectifier with highly efficient energy transfer. Additional quality features include life-time lubricated spherical bearings, and industrial quality commutator, 18-blade wind tunnel fan, double reduction gears, plus induction-hardened armature pinion. For 117VAC., 60 Hz. 13 E 53242 Shpg. wt., 3 lbs. Net 29.95

346 Lafayette Cat. No. 700

HEAVY-DUTY 4-SPEED 1/2" REVERSIBLE DRILL



- 6 Amp 1/2 HP Burnout-Proof Motor
- Double Reduction Gears for Super Torque

Model 950 is designed for the big jobs! a rugged heavy duty 1/2" drill where greater power is required. Simple, easy to use two-lever control for electronic gear reduction and speed changes for precise and accurate drilling of any type of material. Reversing on all 4-speeds permits you to back out from extremely dense materials. Welded armature. Double reduction gears deliver hi-torque for heavy jobs. Trigger switch locks in place for extended operation. Precision Jacobs geared chuck and key. Polished die-cast aluminum housing. 120 V. AC/DC with 3 wire cord. UL and CSA listed. Size: 11x8 1/2x3 1/2". Shpg. wt., 9 lbs. 13 E 65337 Net 35.95

35⁹⁵
No Money Down*

* See Page 11 for Full Credit Details on Easy Pay Plan

SKIL REVERSING

DRIVE-R-DRILLS with Adjustable Trigger Speed Control

- Pre-set the Maximum Speed You Desire Forward or Reverse
- Lock Drill at Any Speed
- Burn-out Protected Motor

As Low
As
31⁸⁸

Now! with adjustable locking variable speed control which can be locked at any speed either in forward or reverse. Unique, all-purpose drills which can tackle most any drilling job with precision and accuracy. Just squeeze the trigger for any drilling speed from 0 to maximum rpm plus reverse speed! Using a driver bit or socket you can drive or remove screws and nuts quickly and easily without accessories. Taps holes in metal too! Has powerful burnout protected motor, high torque helical gears and geared key chuck. Locking button for sustained operation. Lightweight aluminum housing. With 6 ft. 3-wire cord and plug. For 115 v., 60 cycles AC. UL listed.

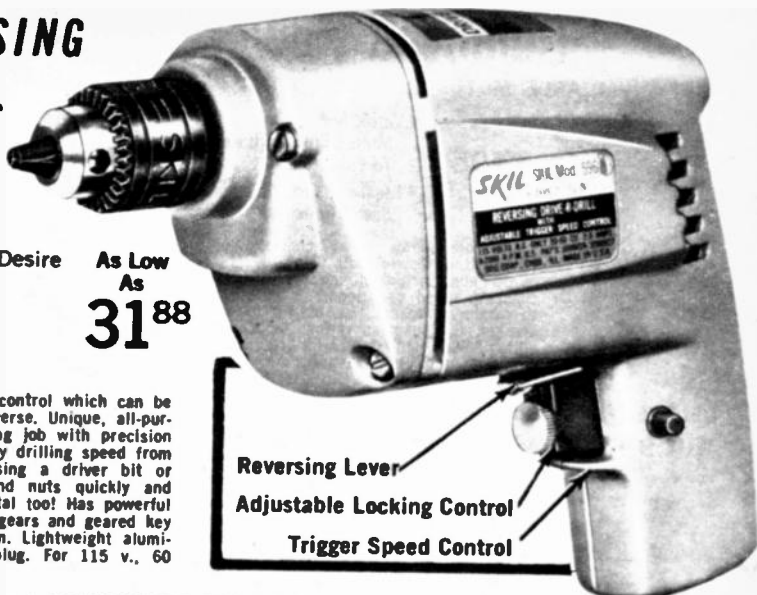

Reversing Lever
Adjustable Locking Control
Trigger Speed Control

1/4" ADJUSTABLE DRIVE-R-DRILL

Model 586 rated at 2.5 amps, 0-2000 rpm Forward/Reverse. Standard home workshop size chuck. Capacity 1/4" in steel, 1/2" in wood. Shpg. wt., 4 lbs.

13 E 69313 No Money Down* Net 31.00

3/8" ADJUSTABLE DRIVE-R-DRILL

Model 597 drill has extra capacity chuck; 0-750 rpm, forward/reverse 3-amp motor. Double reduction gears. Capacity: 3/8" in steel, 3/4" in wood. Removable handle. Shpg. wt., 4 1/2 lbs.

13 E 69321 No Money Down* Net 36.00

1/2" ADJUSTABLE DRIVE-R-DRILL

Model 598 Heavy-duty-deluxe 3 amp 0-500 rpm forward/reverse, no load speed. Heavy-duty double-reduction gears multithrust bearings. Capacity: 1/2" in steel, 1 1/4" in wood. Removable handle. Shpg. wt., 5 lbs.

13 E 69339 No Money Down* Net 39.00



50 Piece Power Workshop

WITH 3/8" VARIABLE TRIGGER SPEED CONTROL DRILL



Complete
Kit
Only
29⁹⁵

Powerful! Efficient! Flexible! Rugged 3/8" variable speed power drill with 3/4 HP 3 Amp universal motor is capable of performing most any job around workshop and home. Squeeze the trigger for any speed you desire from 0 to 1,000 RPM. Complete assortment of attachments includes: Jacobs geared chuck and key, tilting top saw attachment, crosscut and rip saw blade, horizontal bench stand, lampwool polishing bonnet, 13 pc. drill kit, rubber backing pad, steel paint mixer, grinding wheel, 6 pc. adapter set, steel saw table with protractor and mounting post, drill press with mounting post and stand, and 15 pc. sanding disc set (5 fine, 5 med., 5 coarse). Drill features multiple thrust bearings and locking button on handle for constant speed without holding trigger. Bright mirror finish with pistol grip handle for easy handling. With instruction book. Drill UL listed. For 115 volts AC, 60 Hz. Shpg. wt., 12 lbs.

13 E 71293W Net 29.95
13 E 71244 Orill Only. Shpg. wt., 3 1/2 lbs. Net 15.95

7 PIECE SOCKET SET

- Fits All Electric
Screwdriver Drills

1⁵⁹

Drills 1/4" hex shank fits all power screwdrivers and drills. Fits directly into chuck for driving and removing bolts and nuts. Set contains socket adapter and 6 sockets — 3/16", 1/8", 1/4", 3/8", 1/2", 5/8".

14 E 79054 Shpg. wt., 1/2 lb. Net 1.59

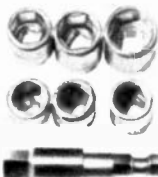

6-PC. SCREWDRIVER BIT SET **2⁹⁹**

- Fits All Electric Screwdriver
And Variable Speed Drills

Versatile set provides a variety of bits and finders to speed-up assembly and service work. For slotted and Phillips head screws. Kit includes 3-slotted bits and finders for screw sizes 6-8, 8-10, & 10-12; 3-Phillips bits No.'s 1, 2, & 3. All have 1/4" Hex shank. Shpg. wt., 1/2 lb.

14 E 79047 Net 2.99



* See Page 11 for Full Credit Details on Easy Pay Plan

Lafayette Cat. No. 700 347

Selected Power Tool Accessories

"JIFFY" VARIABLE MOTOR SPEED CONTROL



8⁹⁵

- Varies Speed on AC-DC Motors From 0 RPM To Full Speed
- Ideal For Electric Drills, Saws, Polishers

Dependable motor speed control ideal for workshop power tools using universal AC-DC and series DC motors. Assures constant speed variation from zero rpm to maximum speed. Has built-in circuit breaker, 5 amps load rating. Input: 120 volts 50-60 Hz AC. 3-wire receptacle and line cord. 3x2½x1¼"D. 13 E 27006 Wt. 1 lb. Net 8.95

UNIVERSAL DRILL PRESS STAND



11⁹⁵

- Adjustable Depth Stop
- Spring Return Tension
- Adjustable Cradle
- Adjustable Depth Gauge Dial

Drill stand can be used with any 1/4" or 3/8" drill or 1/2" compact. Converts hand drill to powerful lever operated drill press. Rack and pinion gear feed and spring return mechanism plus depth adjustment. Base drilled for bench or truck mounting. 2¼" stroke, 5 to 1 leverage. Shpg. wt., 8 lbs. 13 E 71350 Net 11.95

DELUXE VARIABLE MOTOR SPEED CONTROL

11⁹⁵

- Varies Speed on AC-DC Motors from 0 to Full RPM
- Up to 8-Amps
- 3-Position Switch: Variable — OFF — Full Speed

Perfect for all workshop power tools and home appliances. Use with drills to start holes, saws to extend blade life, polishing at low speeds etc. 3-position switch. Variable, OFF and Full permits maximum speed control, with Universal (AC-DC) or DC motors rated to 8 amps. Has automatic breaker surge protection. Input 120V AC only, 3 wire line cord. Black aluminum case, 4½x2½x1¼"D. 13 E 27014 Shpg. wt., 1 lb. Net 11.95



"ARCO-SAW" ATTACHMENT with "DADO-ARBOR" To Cut Any Groove

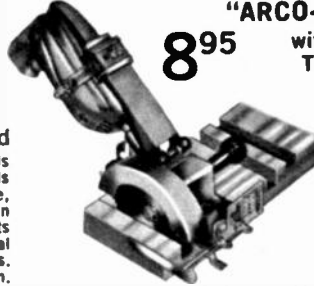

8⁹⁵

Attaches to any ¼ and ¾" drill in seconds! "Dado-Arbor" swivels sawblade to cut grooves up to ½Wx1"D., in one cut; "Dado-Arbor" is easily removed for straight or angle cuts . . . cuts 2x4's in one cut with 5" blade. Graduated depth and bevel gages allow cuts up to 1¾"D; bevels to 45°. Has adjustable rip gage and visual guide, self-lubricating lifetime bearings, strong safety-bracket and clamp. Fully assembled with instructions.

14 E 14275 Shpg. wt., 3 lbs. Net 8.95
14 E 14283 5" Hycarbon Combination Blade Net 1.49

VARIABLE MOTOR SPEED CONTROL

- Up To 10 Amps
- Can Be Used As Lamp Dimmer

Controls speeds of all workbench power tools and home appliances, 0 rpm to full rpm. Permits variety of uses for power tools and appliances. Built-in circuit breaker.



12⁹⁵

er. Portable, useful anywhere in the house. Works on AC-DC motors, DC motors or with AC only motors except capacitor start or split phase types 10 amps, Input—for 120 VAC, with 3-wire receptacle and line cord. 13 E 53515 Shpg. wt., 1 lb. Net 12.95

"JIG SAW" ATTACHMENT



3⁷⁵

- Fits Any Electric Drill

Fits all electric drills as easily as a standard bit! Ideal for cutting plumbing, and holes for switchboxes . . . works without boring a starting hole. Does work of jig, keyhole, coping, rip, band and hacksaw. Cuts straight lines, intricate patterns and circles in wood, plastics, and metals; cuts 2x4's. Air blower keeps cutting line free of sawdust. Complete with blade, instructions. Shpg. wt., 1½ lbs.

14 E 14259 Net 3.75
Pkg. of 6 blades (2-coarse, 2-medium, 2-fine). Shpg. wt., 2 oz. Net 1.49
14 E 14267

FLEXIBLE SHAFT ATTACHMENT



Operates off any fixed or portable power drill; enables you to drill at any angle anywhere. Capacity up to 1/4" size drills; 36" overall length, with chuck. Operates on speeds up to 6000 rpm. Imported. Wt., 1 lb. 13 E 56112 Net 2.49
32 E 64124 Coupler to use with motor below. Net .22

HOBBY MOTOR



5⁹⁹

For motorizing hobby tools, dental and jewelers lathes, sewing machines. 1/15 h.p. motor—5000 RPM full load and 15,000 RPM no load speed. CCW rotation facing shaft end. Steel housing—3½" long, less shaft, x 2¼"H x 2¼"W. Two tapped 10-32 mounting holes on 2¼" centers, 1/4" shaft, 3/4" long. Fan cooled, permanent oilite bearings, and external brush openings. 12" cord lead. For 117V AC or DC. 19 E 24109 Shpg. wt., 1½ lbs. Net 5.99

5-PC. ROTARY FILE SET



For electric drill, drill press, flexible shaft. Milled from solid tool steel, hardened and tempered. Cuts steel and other metals, wood, plastic, wallboard, etc. For hole enlarging, routing, shaping, finishing. With ¼" shank. Shpg. wt., ½ lb. 13 E 50180 Net 3.49

4⁹⁵

- Fits Any Electric Drill

PLANER ATTACHMENT

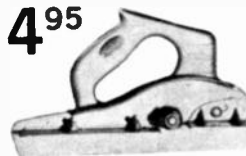

A professional tool with hardened and ground carbon alloy steel cutter. Perfect balance and comfortable handle for easy use. Instant, positive depth adjustment and 1¾" wide cut. Diagonal shearing action planes easily with or across grain. For 1/4" or 3/8" drill. Shpg. wt., 2 lbs.

14 E 62530 Net 4.95

4⁹⁵

SANDER ATTACHMENT



Sand in minutes! For use with all 1/4" or 3/8" drills. Orbital action, ball bearing construction. Complete with three standard size no-load, jewel-hard abrasive sandpaper sheets in coarse, medium and fine grit. Top handle for easy handling.

14 E 62522 Wt., 1½ lbs. Net 4.95

HEDGE TRIMMER ATTACHMENT

- Lock Into Place With Ease

5⁹⁵



Converts any 1/4" drill into an easily handled hedge trimmer. Cuts, trims and shapes hedges and shrubbery. Extra long 14" blade of hardened tool steel. Keen edges for fast shearing action. Steel drive gear—permanently lubricated. Long, comfortable handle. Locks in any of 10 different positions. Light weight-compact. Shpg. wt. 3 lbs. 13 E 50156 Net 5.95

Selected Accessories For Power Drills

SCREWDRIVER RESTORER

5⁹⁵



- Refinish Phillips, Yankee, Sets, Chisels, Punches

At last! An attachment to grind Phillips or regular (Yankee) screw drivers to their original shape. Chuck in any drill. Will grind all Phillips drivers up to 3/16" and all Yankee type drivers up to 1/2" as easily as sharpening a pencil. Use for chisels, punches too. Shpg. wt., 1 lb.

13 E 29513

Net 5.95

4-PC. RADIUS & BEVEL CUTTER SET



Use with any electric drill, drill press, etc. Set consists of adjustable bevel-cutter (cuts 45 bevels from 1/32" to 5/16"). Radius cutters—3 sizes for 1/8", 3/16", 1/4" cuts. Dual guides assure accurate cuts. Cuts wood, plastics, soft metals. Tool steel fully hardened and tempered.

14 E 14309

Net 4.75

ADJUSTABLE BEVEL CUTTER



Fits any electric drill. Makes fast, clean 45° corner bevels. Adjusts from 1/32" to 5/16" wide. Cuts wood, plastics and soft metal. Made of hardened, tempered manganese alloy tool steel. Shpg. wt., 2 oz.

14 E 14168

Net 1.49

3 PC. CORNER FINISHING CUTTER SET

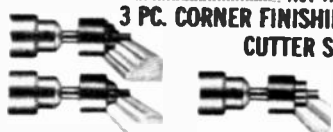

Use with any electric drill, drill press, etc. Consists of fancy cove-cutter, Roman ogee-cutter and rabbit-cutter for cutting 3/16" contours. Dual guides assure accurate cuts in wood, plastic, soft metals. Made of fully hardened and tempered steel. Shpg. wt., 1/2 lb.

14 E 14333

Net 2.95

3 PC. CORNER FINISHING CUTTER SET



Consists of beading-cutter, cove-cutter and ogee-cutter for cutting 3/16" contours. Dual guides assure accurate cuts in wood, plastics, or soft metals. Made of fully hardened and tempered steel. Shpg. wt., 1/2 lb.

14 E 14341

Net 2.95

ADJUSTABLE 82° COUNTERSINK

Adjusts to exact depth with automatic stop... single flute, chatter-free design assures round, clean cuts. Tempered and hardened manganese tool steel construction. Countersinks in steel, wood, plastic. 1/4" shank. Shpg. wt., 4 oz.

14 E 14143

Net 1.19



ARCO SCREW & NUT DRIVER DRILL ATTACHMENT

4⁴⁹

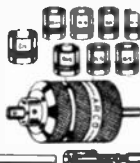

- Complete 11 Piece Screw and Nut Driver

For rapid fastening of both screws (slotted and Phillips) and nuts (hex and square head). Has non-slip industrial type clutch for fast easy driving. Bit holder prevents screw head slippage. Includes flat bits and bit holders for #6-14 slotted screws, #2 Phillips head bit, 6 hex socket wrenches (1/4", 3/8", 3/8", 7/8", 1/2"), and socket wrench holder with half lock. Shpg. wt., 1 1/2 lbs.

14 E 14218

Net 4.49

7-BLADE DEEP HOLE SAW

1¹⁹

- Cuts holes in 2 x 4's



Fits any electric drill or drill press. Cylindrical saw blades cut holes from 1" to 2 1/2" in diameter in any stock up to 2". Hole sizes are 1", 1 1/4", 1 1/2", 1 3/4", 2", 2 1/4", 2 1/2". Cut wood, plastic, metal, sheetrock, wall-board, masonite, formica, etc. Has guide bit and automatic slug ejector. Imported.

13 E 55262 Shpg. wt., 1 1/2 lbs.

Net 1.19

3-PC. ROTARY RASP SET

3¹⁹

- Shape, Cut, Form, Mill

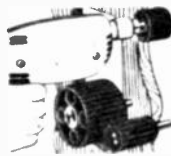

3-rotary rasp drums: 3/4" dia, 1 1/4" dia., 1 7/8" dia.; length of each drum 1 1/2". Ideal for beveling, planing, paint removing, sanding. Cuts wood, plastic, etc. Made of hardened and tempered steel.

14 E 14291 Shpg. wt., 1/2 lb.

Net 3.19

1/2" CHUCK FOR 1/4" DRILLS

99c



- Add 1/2" Capacity to 1/4" Drill

Converts 1/4" electric drill to 1/2" capacity. Properly machined to insure correct balance. May also be used on standard 1/2x24 motor arbor or shaft. Imported. Shpg. wt., 1 lb.

13 E 55270

Net .99

RIGHT ANGLE DRIVE

3⁷⁵



Close coupled—right angle attachment for working in confined spaces. 2 to 1 gear ratio permits halving or doubling drill speed. High speed for drilling and sanding—slow speed for polishing—large hole drilling—masonry drilling, etc. Fits 3/4" chuck or may be screwed directly to drill spindle. Includes 3/8-24 male and female adapters— and 3/4" plain shaft adapter. Shpg. wt., 1 lb.

14 E 38039

Net 3.75

REVERSE-A-DRIVE SPEED REDUCER SCREWDRIVER



As Low As

3⁷⁵

- Includes 2 Bits and 1/4" Socket Adapter

Model W-350 speed reducer can be fitted to any electric drill or drill press quickly and easily. Forward speed reduction of 11 to 1, and reverse of 4 to 1 develops high torque. Ideal for nut running, and heavy duty screw-driving. Easy stop-start action with hand clutch control. Accessories include yankee type—1/4" slotted bit with finder—#2 Phillips bit-adapter. Shpg. wt., 1 lb.

14 E 79021

Net 5.25

Model W-300L. Heavy Duty Industrial Type. Similar to above. Accessories include 5/16" slotted and Phillips bits and 1/4" socket adapter. Unit is adaptable for direct drive from drill. Makes your present chuck free to be used on other end of model W-300L for drilling and tapping.

14 E 79013

Net 7.49

Model W-400 speed reducer similar to above but less reversing feature. Ends tedious driving of screws and nuts. Can be fitted to any electric drill quickly and easily. 11 to 1 speed reduction through the use of a planetary gear system. Easy stop-start action with hand clutch control. Includes slotted bit with finder, #2 Phillips and 1/4" socket adapter. Shpg. wt., 1 lb.

14 E 79039

Net 3.75

DRILL SAW BIT

4^{9c}



An extremely versatile tool. Cuts circles, ovals, squares, into wood, plastic, bakelite. Will withstand years of rough, continuous use. Imported.

14 E 61102 Shpg. wt., 4 oz.

Net .49

ARCO DRILL STAND

- Fits All 3/4" or 3/8" Electric Drills



1²⁹

Attaches to workbench. Is ideal for buffing, sanding, grinding. Fits all electric drills. 3 oz.

14 E 14200

Net 1.29

1/4" & 3/8" JACOBS TYPE DRILL CHUCKS

As Low As

3³⁹



Made in U.S.A.

- Key Included

Comparable to Jacobs 1B Key type geared tooth chuck. Capacity 0-1/4", thread 3/8 x 24". Ruggedly constructed. Polished finish. Used as standard equipment on most electric drills. Made to rigid specifications. Wt. 1 lb.

For 1/4" Drills—Capacity 0-1/4". Thread 3/8 x 24"

14 E 15504

Net 3.39

For 3/8" Drills—Capacity 1/16"-3/8". Thread 3/8 x 24".

14 E 15512

Net 4.69

Adapter to attach above chucks to power drills with female spindles.

14 E 15520

Net .29

Popular Power Drill Accessories

14 Pc. HIGH SPEED DRILL SET with CENTER PUNCH



Century
SINCE 1940

9 95

- 13 Sizes 1/16"-1/2" Plus Center Punch
- Hang on Pegboard—Mount on Wall or Stand on Workbench

Made in U.S.A.

Top quality, high speed drill set contains sizes 1/16, 1/8, 3/32, 1/4, 5/16, 3/8, 7/16, 1/2, 5/8, 3/4, 7/8, 1, 1 1/8, 1 1/4, 1 1/2 and 1 3/4". 3/8, 1/2 and 5/8" with 1/4" shanks. Also contains center punch for accurate placement of drill. Convenient, high impact plastic case stands on workbench or mounts easily on wall or pegboard. Has built-in shelf for holding pencils or additional drill bits, chuck keys, etc. Shpg. wt., 1 lb.

13 E 10112 Net 9.95

Century
13 PC. HIGH SPEED DRILL SET WITH CENTER PUNCH
Made in U. S. A.
5 50 • 12 Sizes: 1/16" - 1/4"

Precision ground high speed drills and center punch placed in unbreakable flexible plastic case which opens and closes like a book! Drill Sizes: 1/16"-1/4". Handy center punch assures exact position of drill bit.

13 E 10500 Shpg. wt., 10 oz. Net 5.50

HIGH SPEED TWIST DRILL SET



B High quality, high speed tool steel "hot twisted" for perfect-uniformity, "isotherm" heat treated for remarkable toughness. These twist drills keep cutting much longer than conventional drills. Made in Italy.

A 10-PIECE HIGH SPEED DRILL SET 1/16" to 1/4"
In Plastic Indexed Case. Shpg. wt., 6 oz.

12 E 47501 Net 3.19

B 11-PIECE HIGH SPEED DRILL SET 1/8" to 3/8"
11 drills, plastic unbreakable case. With straight shanks. Designed for use with 3/8" drills. Shpg. wt., 10 oz.

12 E 47519 Net 5.95

DOUBLE POWER GRINDER



5 95

Equipped with double tool rests — will accommodate 4" or 5" grindstone. Nylon bearings require little or no lubrication, and have outstanding abrasion resistant characteristics. Furnished complete with one coarse, one fine grinding wheel. Shpg. wt., 10 lbs.

14 E 78043 Net 5.95

SANDING AND POLISHING KIT



1 79

Use with any standard drill. Includes 5" rubber backing disc, 7 assorted-grain sanding discs, 6" lambs wool polishing bonnet. For shop, auto work, hobby, etc.

14 E 36013 Shpg. wt., 1 lb. Net 1.79

LAWN MOWER SHARPENER

- Sharpens All Rotary Mowers



Quickly and easily sharpens any flat blade—rotaries, hoes, scythes, etc. 1/4" shank fits any electric drill. Reversible grinding wheel. Wt., 1/2 lb.

14 E 14226 Net .99

KNIFE & SCISSOR SHARPENER



Converts any electric drill or bench motor to a knife or scissors sharpening machine. Consists of rugged, specially designed grindstone with 1/4" shank arbor attached. Shpg. wt., 1/2 lb.

14 E 14234 Net .99

TOOL STEEL TAPERED REAMER

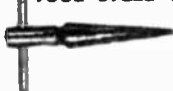

89c

Enlarges holes to 1/2". Tapers down to 1/8" point. Fits any 3/8" drill chuck. Machined edges. Overall length 4 3/4". Length of "T" handle 4". Imported. Shpg. wt., 1/2 lb.

14 E 61029 Net .89

29-PIECE CHROME VANADIUM DRILL SET AS LOW AS

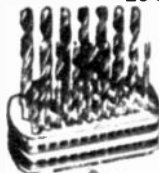

8 50

Precision ground chrome vanadium twist drills with indexed stand. Blue temper quality. Sizes 1/16" to 1/2" by 64th. Imported. Shpg. wt., 4 lbs.

13 E 55767 Net 8.50

29 PIECE SET WITH TURNED DOWN SHANKS. Same as above, but with shanks turned down to 1/4".

13 E 55775 Net 9.50

13-PC. TWIST DRILL SET

89c

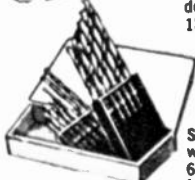

Set of 13 full length twist drills, complete with metal index. Sizes: 1/16" to 1/4" by 64ths. Household quality. Imported.

14 E 81151 Shpg. wt., 8 oz. Net .89

COMPASS CIRCLE CUTTER

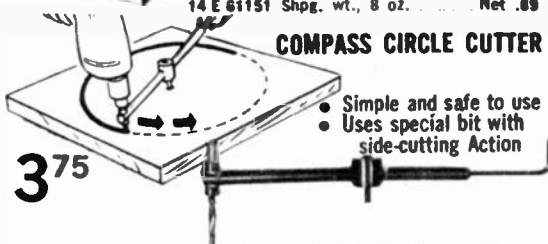

- Simple and safe to use
- Uses special bit with side-cutting Action

3 75

Simple and safe to use, makes perfect circles in wood in seconds. Use with any electric drill to cut speaker holes, vents, pipes, ceiling lights, etc. Can also be used to make discs, rings and fancy shapes. Cuts circles 1 1/2" to 12" in diameter. Has special bit for smooth side cutting. Shpg. wt., 1 lb.

12 E 41009 Net 3.75

HEAVY-DUTY INDUSTRIAL COMPASS CUTTER. As above except cuts up to 18 inch circular holes in fiberglass, 2" wood plank, sheet metal, 1/4" aluminum and laminated plastics. Special router bit has drill point allowing you to bore center and radius hole. Shpg. wt. 1 1/2" lbs.

12 E 41017 Net 7.95

TWIST DRILL SHARPENER

- Sharpens Drills from 1/16" to 1/2"



Fits any 1/4" or larger electric drill. 3" aluminum oxide grinding wheel. Sharpens any bit up to 1 1/2" dia. Also has adjustable tool rest for sharpening chisels, knives, scissiors, etc.

14 E 14093 Shpg. wt., 1 1/2 lbs. Net 1.69

WHIZZ-DISC



ALL PURPOSE CUTTING AND SANDING DISC

- Will Cut or Shape Anything

STEEL
Only
2 95

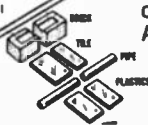

Cuts through the thickest materials — steel, brick, plastics. Super-hard silicon carbide particles embedded in tough resilient fabric form a shatter-proof, safe-to-use disc. No teeth to catch work and bind or kickback. Also removes paint, rust, shapes stone, metal, wood and plastic. Can be used on hand drill for close quarters. Complete with instructions, 7" Whizz Disc, 5" backing pad, 1/4" arbor and flange washers. Shpg. wt., 1 lb.

14 E 14350 Net 2.95

WHIZZ-DISC for Portable & Bench Saws, 7" dia.

14 E 14366 3/4" bore Net 1.95

14 E 14374 1/2" bore Net 1.95

You Can Depend On Lafayette For Quality Tools—Low Prices

Vacuum Cleaners... Staple Guns



HIPPO POWERFUL VACUUM CLEANER

Only
29⁹⁵

his

hers

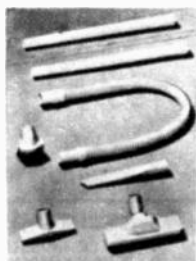
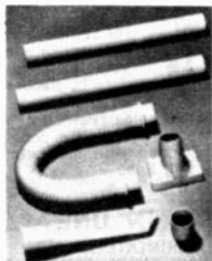

- Perfect for Around the Home, In the Garden . . . Any- place Where a Quick Cleaning, Portable Vac is Needed

Powerful, portable vacuum for general household cleaning with the "HERS" model or use in the garage or garden with the "HIS" model. Unbreakable Lexan housing. Only 15" long and 7" dia. Weighs 6½ lbs. With 18 ft. cord and shoulder strap. 1 HP motor. UL and CSA listed. Both models with 2½" to 1¼" adapter for use of standard vacuum accessories. Shpg. wt., 8 lbs.

"HERS" Hippo equipped with 3' hose, 9" crevice tool, 2¼" round dusting brush, 5" upholstery nozzle, 9" floor nozzle with brush and 2-pc. 40" extension wand—all 1¼" diameter. **13 E 35637W** Net **29.95**

"HIS" Hippo equipped with 3' hose, 14" crevice tool, 6" rectangular nozzle with brush, hose coupling and 2-pc. 40" extension wand—all 2½" dia. **13 E 35629W** Net **29.95**

Disposable Paper Bags for Hippo. Pkg. of 5. **13 E 35645** Net **.99**

SHOP-VAC® ALL PURPOSE VACUUM CLEANERS

- Heavy Steel Drum—Excellent for the Home, Garage, Patio, School or Workshop

- Powerful 1 HP Motor, 6 ft. 2½" Dia. Hose



AS LOW AS
24⁹⁵

Deluxe Shop-Vac 10 Gallon Vacuum Cleaner outfit. Can be used for rough cleaning nearly anywhere. Excellent for picking up pebbles, wood chips, sawdust and other debris. Also attaches to woodworking machines for chip and sawdust removal. Reversible air flow—use it as a blower too. Perfect for winter oil burner cleaning. Complete with two-way 4-wheel dolly, 6 ft. 2½" dia. hose, 6" nozzle, 2½" to 1¼" adapter, 2-pc. 45" extension wand, right angle elbow, cloth filter bag and pkg. of 5 paper filters. UL listed. Shpg. wt., 29 lbs. **13 E 35652WX** No Money Down* Net **34.95**

5 Gallon Shop-Vac Vacuum Cleaner: includes 6 ft. 2½" dia. hose, 6" nozzle, 2½" to 1¼" adapter, cloth and paper filter. UL listed. Shpg. wt., 17 lbs. **13 E 35660W** Net **24.95**

ACCESSORIES FOR ABOVE

- Two-Way 4-Wheel Dolly. For 5 gallon cleaner. **13 E 35678W** Shpg. wt., 2 lbs. Net **5.49**
- 13 E 35512W** 45" Extension Handle. Wt. 2 lbs. Net **3.95**
- 13 E 35686** Large Crevice Nozzle. Wt. 1 lb. Net **2.95**
- 14" Floor Nozzle with Brush:** For floors, stairs, etc. Net **4.95**
- 13 E 35694** Shpg. wt., ½ lb. Net **4.95**
- Paper Filter Bags: For extra dirty jobs, slips over cloth bag. **13 E 35561** Pkg. of 5. Shpg. wt., ½ lb. Net **.99**
- 13 E 35579** Replacement Cloth Bag. Wt., 4 oz. Net **1.39**



MULTI-PURPOSE GUN TACKER KIT

Only
13⁵⁰

- Includes: Gun, Case—Wiring, Screening, And Window Shade Attachments—Staple Lifter

Professional staple gun with a powerful action that drives 6 heavy duty staple sizes, 1/4", 5/16", 3/8", 1/2", 9/16" and Cellitile®—especially designed for ceiling tile. Kit contains: staple gun; multi-staple pak of 2000 1/4", and 1000 ea. 3/8", 1/2" and Cellitile® staples, and attachments. **13 E 57508** Shpg. wt., 5½ lbs. Net **13.50**

STAPLES FOR THE MODEL T-50 GUN

Quantity 5000, avg. shpg. wt., 1 lb.

Stock No.	Size	Net
13 E 57524	¾"	2.29
13 E 57532	½"	2.69
13 E 57540	¼" (Cellitile®)	3.15
13 E 57537†	Multi-Paks	2.50

†Assortment—2000 ¼" 1000 ea. ¾", ½" & Cellitile®.

Swingline®

HEAVY DUTY STAPLE GUN

- Built-In Staple Extractor
 - Easy Loading of 5 Staple Sizes
- Model 800 drives 5 sizes of staples. Snap open load. Exclusive power dot and tandem springing deliver super power. Loading takes only a moment. Built in extractor. Accepts 1/4" to 9/16" staples including special loktile staples for firm holding of ceiling tiles. **13 E 58128** Shpg. wt., 1½ lbs. Net **8.95**

Stock No.	Leg Length	Shpg. wt.
13 E 58134	1/4"	7 oz. .42
13 E 58142	¾"	7 oz. .45
13 E 58150	3/8"	7 oz. .45
13 E 58167	1/2"	7 oz. .53
13 E 58175	¾"	7 oz. .58
13 E 58183†	¾"	7 oz. .65

†Special Loktile Staples

(B) CABLE TACKER

- Fast-action
 - Reaches Into Tight Places
- Model 300 Swingline fast-action staple gun for fastening low voltage electric and telephone wire, cable, rods, barbed wire, etc. Fires arched crown staples, 1/4"x3/8". Narrow width permits reaching into tight places. **13 E 58092** Shpg. wt., 3 lbs. Net **11.50**
- 13 E 58100** Shpg. wt., 8 oz. Net **.99**

STAPLE GUNS

MODEL 800

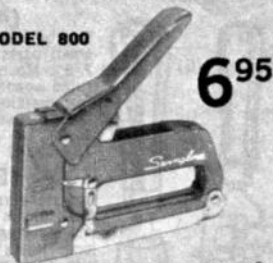

6⁹⁵

MODEL 300



11⁵⁰

Buy Now! Pay Later . . . Use Lafayette's Easy Pay Plan. No Money Down.

Vises For Workshop And Industry



PORTABLE VACUUM VISE

WITH 2 JAWS, 1½" AND 2¼"

5⁹⁵

No clamps, no screws! Vacuum power holds vise securely on any non-porous surface. Use it on formica, linoleum, metal, porcelain or any painted smooth finish surface. Anvil back, 2 jaws. 1½" and 2¼" open to 2¼ inches. 360° rotation swivelhead. Easy to use vacuum action and jaw controls. For hobbyist, repairman. Imported.

13 E 55916 Shpg. wt., 4½ lbs. Net 5.95

HEAVY DUTY 4" SWIVEL BASE MACHINIST VISE

7⁹⁵

This favorite machinist vise swivels full 280° Width of Jaw: 4". Geared bolt and base plate give positive lock against slippage. Removable hardened pipe jaws open to 4¾"; plated screw bar. Steel handle balls forged from handle stock. Precision machined malleable iron castings. Self-lubricating graphite bronze bearing. Imported. Shpg. wt., 16 lbs.

13 E 55990 Net 7.95

HEAVY-DUTY 8" MODEL. Similar to above: Width of Jaws: 6" opens to 6¼".

13 E 58120WX Shpg. wt., 24 lbs. Net 12.95

HEAVY DUTY 18" BENDING AND FORMING BRAKE

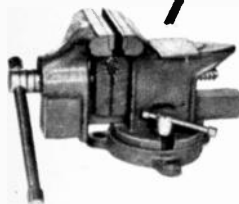

- Handles Up To 18" Width In Up To 16 Gauge Thickness

- For Experimenters—Servicemen—Shops
- Clean Smooth Bends
- Forms Up To 90°

9⁹⁵

Unique design permits forming chassis, boxes, covers, trays, etc. by means of 1" deep slots in brake-bar which allow corners to fold in. Provides flange edges up to 1" high. Easy to adjust for thickness, accuracy, angle of bend. Rugged construction offers a life time of service. Shpg. wt., 17 lbs.

99 E 80640WX

Net 9.95

3" MITRE CORNER CLAMP



ONLY

1¹⁹

Portable clamp fully exposes both sides of the joint — allows you to put fastenings wherever you wish. Handy for clamping, cutting, gluing, nailing, etc. Sturdy die-cast aluminum. Chrome plated T-slide bars. Imported. Shpg. wt., 3/4 lbs.

14 E 70111

Net 1.19

(A) HAND VISE

The only practical way to grip and hold small parts. 1¼" die cast jaws open to 7/8". Mounted on a 4" comfortable ferruled wooden handle. Holds work for drilling, marking, filing, sawing, etc. Endless uses in handiwork. Imported. Shpg. wt., 1 lb.

13 E 55346

Net .79

(B) PIN VISE

Has standard 1/4" chucks with 3 hardened jaws. Chuck opening from 0" to 1/4". Set on "easy-grip" ferruled wood handle 4" long. Holds small drills, reamers, screw bits, files, etc. A "natural" for the hobbyist and craftsman. Imported.

14 E 61201 Shpg. wt., ½ lb. Net .79

ADEL HAND "NIBBLING" TOOL

4¹⁵

- Cuts any shape or opening by

Easily operated hand "Nibbler" cuts any shape hole in sheet steel—aluminum—copper—or plastic. Metal remains flat and straight after cutting. Does not add strain or distortion to edges. Cuts holes in preformed sheet metal without distorting original form. Cuts in all directions. Any design—angle—radius. Follows scribe lines easily. Best possible tool for cutting template and model parts. Shpg. wt., 8 ozs.

14 E 12055

Net 4.15

14 E 12063 Replacement punch for above

Net 2.12

3" MACHINIST VISE SWIVEL-BASE

4⁷⁵



3" MACHINIST VISE SWIVEL-BASE
A sturdy, reliable, swivel base vise for tool room, home or shop jobs. Three inch jaws; 3" opening. Swivel base permits 360° degree revolution. Locks in any position. Anvil back. Well made of malleable iron castings. Hardened tool steel jaw faces. Ideal for carpentry, sanding, sawing, tool sharpening, carving. Complete with fixed pipe jaws. Imported. Shpg. wt., 10 lbs.

13 E 55908

Net 4.75

WILTON

ELECTRONIC VISE WITH POSITIONER



14⁹⁵

For small sub-assemblies and intricate electronic work including printed circuits. Rubber protected jaws are 2¼"W with a 6¼" opening. PowArm positioner offers superior positive lock and fast on-off action with horizontal handle. Shpg. wt., 3 lbs.

14 E 80029

Net 14.95

4 TOOLS IN ONE

FOR INDUSTRIALS, EXPERIMENTERS, REPAIR SHOPS, MODEL WORKERS, SCHOOL SHOPS, HOME WORK SHOPS



- Punches • Shears • Rivets • Forms

An ideal tool for plant, shop or home use. Used extensively in industrial plants on small jobs. Handles stock up to 1" wide to 16 gauge. Punches clean, sharp, smooth, burr-free holes—up to 1" from edge—¼", ⅜" and ½" round. Forms bend up to 90° in rod or bar stock. Cleanly shears metals up to 1" wide, 16 gauge, without distortion. Rivets easily with any type solid or hollow rivet. Rivets up to a maximum combined thickness of ¾". Shpg. wt., 5 lbs.

14 E 11016

Net 9.95

EXTRA PUNCH SETS

Avg. shpg. wt., 4 oz.

14 E 11024 Hex—¾", ⅞" and 1¼" Net 2.49

14 E 11032 Square—½" and ⅝" Net 1.69

14 E 11040 Rectangular—½" x ⅜" and ⅞" x ¼" Net 1.89

REMINGTON 10" TUNGSTEN CARBIDE ROD SAW



1⁶⁹

- Cuts Like A Diamond
- Fits Any Hacksaw Frame

Solves 'impossible' cutting problems fast! Cuts materials that an ordinary hacksaw can't cut; ceramic tile, glass, masonry materials, tough plastics, welds, steel alloys... virtually anything hard or tough. Cuts curves and angles in any direction. No teeth to blunt, break, set or sharpen. Fits common hacksaw frame. Shpg. wt., 4 oz.

13 E 38508

Net 1.69

13 E 56047 Heavy Duty Hacksaw Frame

Net 1.59

PATTERN MAKER AND CONTOUR GAUGE

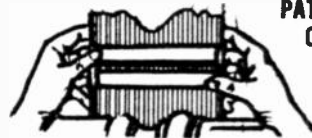

ONLY 1⁴⁹

Match and Outline Any Irregular Shape
For home, shop and industry. Simplifies measurement and copying of irregular shapes. Easy to use, just press the gauge's steel teeth against any irregular surface to exactly match and hold the shape taken. Uses include: measuring pillar contour, fitting floor tile, carpeting, wood moldings, fitting linoleum, 6" long.

14 E 52051 Shpg. wt., ½ lb.

Net 1.49

PRECISION OILER



89^c

Instrument for precision oiling. Spout is only .003" dia. Made of stainless steel and butyrate. Filled with clear, non-staining machine oil. Can be refilled. Hypo action prevents messy, harmful overoiling. Shpg. wt., 4 oz.

14 E 83106

Net .89

Precision Metal Working Tools

LAFAYETTE CHASSIS PUNCH SET

- Easy-smooth holes in sheet metal
- 5 Sizes: 1/2", 3/8", 3/4", 1", 1 1/4"

5⁹⁵



Five most often needed round hole punches. Easily cuts smooth accurate holes for sockets, plugs, controls, panel lights, switches, terminals, and most radio parts. Drive with any wrench or with included T-handle. Punch sizes included are 1/2", 3/8", 3/4", 1", 1 1/4". Complete with punches, dies, T drive handle, tapered reamer, fitted case, and instructions. Shpg. wt., 2 1/2 lbs. Imported. **99 E 80244** Net **5.95**

DELUXE 40-PIECE TAP AND DIE SET

- National Coarse & Fine Thread

9⁹⁵



40-pc. set for mechanics, machinists, engineers. One tap and die in each of following: 4-36, 12-24, 3/8-16, 3/8-24, 6-32, 1/4-20, 1/4-20, 1/2-20, 8/32, 1/4-28, 3/8-14, 1/2-13, 10-32, 3/8-18, 3/8-24, 1/2-Pipe Tap; plus long handle adjustable tap wrench, "T" handle tap wrench, die handle, screwdriver, screw pitch gauge. Hinged metal box with moulded rubber inlay tray. Imported. **13 E 95882** Shpg. wt., 6 3/4 lbs. Net **9.95**

20-PIECE TAP AND DIE SET

- National Coarse Sizes

3⁹⁵



Twenty of the most often needed taps and dies. Sizes popularly used in radio, hobby, home, shop and light industry. Contains one tap and one die in each of the following sizes: 6-32, 8-32, 10-24, 12-24, 1/4-20, 3/8-16, 3/8-24, 1/2-14, and 1/2-13. Includes die stock and adjustable tap wrench. Entire set contained in a fitted metal case. Imported. Shpg. wt., 4 lbs. **13 E 95108** Net **3.95**

12 NEEDLE FILES

- Swiss Pattern

All files are double cut for sharper, faster cutting. For hobbyist, jewelers, watchmakers, etc. All over the world. Consists of 12 assorted flat, oval, round, triangular and edge files to fit every need. Imported. Shpg. wt., 1/2 lb. **14 E 64336** Net **2.99**



HANDY WARDING FILE SET

99^c

- 5 Individual Files

Perfect for shop-home-hobby work. Kit consists of flat, half round, triangular, square, round and taper files. All with individual hard plastic handles. Sturdy plastic pocket case included. Imported. Shpg. wt., 1/2 lb. **13 E 55122** Net **.99**



5-PC. ASSORTED FILE SET

1⁵⁹

Five files selected for utility and durability. Good quality — three standard shapes — two triangular. Sizes 6" to 12". Shpg. wt., 2 lbs. **13 E 55080** Net **1.59**



DIRECT READING CALIPER

READ SIZE HERE



Measure round, flat, or irregular shapes up to 4" thick. Direct readings on 0-4" scale calibrated in 32nds. Measure up to 3" from the edge of a part. Knurled thumb-screw locks the caliper at midscale position for use as a gauge. Shpg. wt., 1 lb. **14 E 29018** Net **1.95**

VERNIER SLIDING CALIPER

1¹⁹



Sharp pointed projection for accurate dividing, scribing, etc. Lock nut insures against errors caused by sliding gauge. Rule graduated in 16th and 32nds plus 5" depth gauge. Precision-made. Imported. Shpg. wt., 1 lb. **14 E 61128** Net **1.19**

5-PC. SCREW EXTRACTOR SET

79^c

Chrome vanadium set. Removes broken and mutilated screws—bolts—studs, even 1/8" and 1/4" pipe. Simply drill damaged screw—twist extractor in—and back screw out. With plastic pouch. Imported. Shpg. wt., 1 lb. **13 E 95452** Net **.79**

GREENLEE CHASSIS PUNCHES



TYPE 730



TYPE 731



TYPE 732

Cut holes in metals up to 16 gauge thick with the turn of an ordinary wrench. No sawing, reaming or filing. TYPE 730, Round Holes, AVG. Shpg. wt., 1 1/2 lbs. ea.

Stock No.	Size	Net ea.	Stock No.	Size	Net ea.
13 E 29010	1/2"	2.85	13 E 29267	1 1/4"	3.35
13 E 29020	3/8"	2.85	13 E 29432	1 3/8"	4.15
13 E 29036	5/8"	2.85	13 E 29275	1 3/8"	4.15
13 E 29044	1 1/8"	2.85	13 E 29283	1 1/2"	4.55
13 E 29051	3/4"	2.85	13 E 29291	1 3/8"	5.50
13 E 29069	1 1/8"	2.85	13 E 29309	1 3/4"	6.30
13 E 29077	7/8"	2.85	13 E 29317	1 7/8"	7.80
13 E 29085	1 1/8"	3.20	13 E 29325	2"	8.35
13 E 29093	1"	3.20	13 E 29333	2 1/4"	9.00
13 E 29101	1 1/8"	3.35	13 E 29341	2 1/4"	9.30
13 E 29119	1 1/4"	3.35	13 E 29358	2 1/2"	15.10
13 E 29127	1 1/2"	3.35	13 E 29366	2 3/4"	21.00
13 E 29135	1 3/4"	3.35	13 E 29382	3"	29.80

TYPE 731, Square Holes, Avg. Shpg. wt., 2 lbs. TYPE 732, Keysted Sockets, Avg. Shpg. wt., 1 1/2 lbs.

Stock No.	Size	Net ea.	Stock No.	Size	Net ea.
13 E 29143	1/2"	6.90	13 E 29176	1 1/4"	6.40
13 E 29150	3/8"	6.80	13 E 29184	1 3/8"	6.70
13 E 29168	3/4"	7.50	13 E 29192	1 1/2"	7.20
13 E 29390	7/8"	8.68	13 E 29416	1 3/4"	8.50
13 E 29408	1"	9.10	13 E 29424	1 3/4"	9.40

Replacement cap screws for 730, round hole, punches above. Shpg. wt., 4 ozs.

13 E 29200	For 1/2", 3/8", 3/4"	Net .30
13 E 29218	For 1/4" through 7/8"	Net .30
13 E 29226	For 1" through 1 1/2"	Net .35
13 E 29234	For 1 1/4" through 1 3/4"	Net .55
13 E 29242	For 1 7/8" through 2 1/2"	Net .85
13 E 29259	For 2 3/4" and 3"	Net 3.50

12 NEEDLE FILES

- Swiss Pattern

All files are double cut for sharper, faster cutting. For hobbyist, jewelers, watchmakers, etc. All over the world. Consists of 12 assorted flat, oval, round, triangular and edge files to fit every need. Imported. Shpg. wt., 1/2 lb. **14 E 64336** Net **2.99**



HANDY WARDING FILE SET

99^c

- 5 Individual Files

Perfect for shop-home-hobby work. Kit consists of flat, half round, triangular, square, round and taper files. All with individual hard plastic handles. Sturdy plastic pocket case included. Imported. Shpg. wt., 1/2 lb. **13 E 55122** Net **.99**



5-PC. ASSORTED FILE SET

1⁵⁹

Five files selected for utility and durability. Good quality — three standard shapes — two triangular. Sizes 6" to 12". Shpg. wt., 2 lbs. **13 E 55080** Net **1.59**



DIRECT READING CALIPER

READ SIZE HERE



Measure round, flat, or irregular shapes up to 4" thick. Direct readings on 0-4" scale calibrated in 32nds. Measure up to 3" from the edge of a part. Knurled thumb-screw locks the caliper at midscale position for use as a gauge. Shpg. wt., 1 lb. **14 E 29018** Net **1.95**

VERNIER SLIDING CALIPER

1¹⁹



Sharp pointed projection for accurate dividing, scribing, etc. Lock nut insures against errors caused by sliding gauge. Rule graduated in 16th and 32nds plus 5" depth gauge. Precision-made. Imported. Shpg. wt., 1 lb. **14 E 61128** Net **1.19**

5-PC. SCREW EXTRACTOR SET

79^c

Chrome vanadium set. Removes broken and mutilated screws—bolts—studs, even 1/8" and 1/4" pipe. Simply drill damaged screw—twist extractor in—and back screw out. With plastic pouch. Imported. Shpg. wt., 1 lb. **13 E 95452** Net **.79**

POCKET MAGNET

An Alnico magnet useful for inspection of hardware to sort steel from brass, as a retriever of small parts. Highly efficient. Size 1 1/2 x 1/2 x 1/4" D. 1/4" between poles. With plated keeper. Shpg. wt., 3 oz. **14 E 33036** Imported from England. Net **.99**



POWER MAGNET

Made of Alcomax—a material with 12 times the magnetic energy of tungsten steel. Designed for efficient performance—weight ratio—will lift up to 50 times its own weight. Horseshoe shape with plated keeper. Ideal for such applications as magnetic clutch, work holding, etc. Size 1 1/2 x 1 1/2 x 1 3/4" W. Distance between poles is 7/8". Imported from England. **14 E 33028** Shpg. wt., 1/2 lb. Net **2.95**

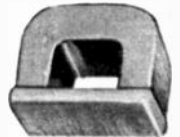

BUTTON MAGNETS

A special "Alnico" button carefully designed to produce a highly efficient magnetic field. Attachable to any non-ferrous material by non-magnetic screws. Ideal for use most everywhere as magnetic fasteners. Supplied with plated keeper. Imported from England. Avg. shpg. wt., 3 oz.



STOCK NO.	HEIGHT	MTG. DIA.	NOLE DIA.	NET EA.
14 E 33093	3/8"	1/2"	1 1/8"	.66
14 E 33101	1/2"	3/8"	3/4"	.80
14 E 33119	3/4"	1"	3/4"	.90

High Quality Pliers—Cutters for Electronics

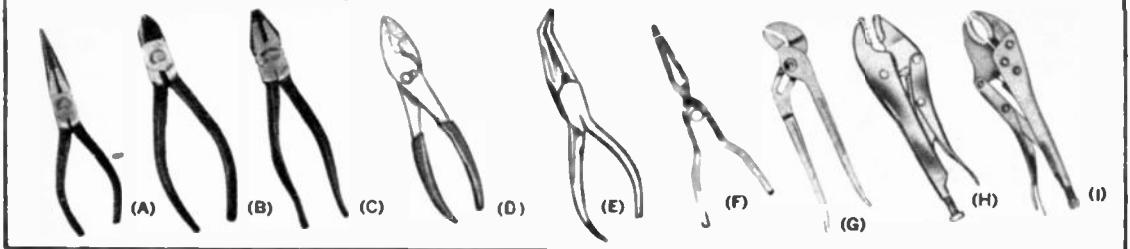

(A) **6 1/4" LONG NOSE PLIERS.** Durable drop forged steel pliers with hardened and tempered side cutting edges. Insulated handles for protection and comfort. Thin nose reaches into any space. Completely polished and lacquered finish to prevent rusting. Imported. Shpg. wt., 10 oz.
13 E 55783 Net 1.29

(B) **6 1/4" DIAGONAL CUTTING PLIERS.** Fully drop forged steel construction. Hardened and tempered cutting edges... thin nose for hard to reach places. Shockproof handles are insulated for comfort and protection. Rust-proof finish is completely polished and lacquered. Imported. Shpg. wt., 10 oz.
13 E 55791 Net 1.29

(C) **7" LINESMAN'S CUTTING PLIERS.** Large, strong holding grip. Rugged drop forged construction... tempered steel edges. Comfort design handles are shock insulated. Nose and handles protected by polished and lacquered finish—prevents rusting. Imported. Shpg. wt., 1 lb.
13 E 55809 Net 1.59

(D) **8" SLIP JOINT PLIERS.** Rugged, efficient... adjust to a variety of positions, reach into any area. Strong gripping head with insulated cushion-grip handles. Long-lasting drop forged steel with attractive and protective chrome plated finish. Imported. Shpg. wt., 10 oz.
13 E 55817 Net .99

(E) **6 1/2" CURVE NOSE PLIERS.** Versatile long-nose pliers bent 45° at midpoint of jaws. Forged from special heat treated, alloy steel and chrome plated to resist rust. Hand honed side cutters. Insulated grips. Shpg. wt., 10 oz.
13 E 55205 Net 1.19

(F) **LIGHT WEIGHT LONG NOSE PLIER.** Ideal for all types of delicate work and for reaching into hard-to-get-at places. Spring closing—holds wires, nuts, screws, etc. Handy for mechanics, assemblers, hobbyists. 8 3/4" long, with soft plastic colored handles. Shpg. wt., 4 oz.
14 E 26014 Net 1.19

(G) **9 1/2" HEAVY DUTY WATER PUMP PLIERS.** Drop forged arc joint slip-groove for big leverage on work you can't get with other gripping tools. Fully chromed and polished plier offers maximum leverage and strength. 5 adjustments. 1" parallel opening. Deep milled jaws made of chrome vanadium steel. Imported. Shpg. wt., 1 lb.
14 E 55211 Net 1.59

(H) **10" LOCKING PLI-WRENCH.** Super power locking combination pliers, wrench, clamp and vise. Exerts over 1,000 lbs. of pressure. Heat treated, drop forged jaws. Machine milled teeth. Chrome plated. Imported. Shpg. wt., 1 lb.
14 E 55229 Net .99

(I) **10" PLI-GRIP WRENCH WITH QUICK RELEASE.** Made of high quality chrome molybdenum steel. All purpose drop-forged steel jaw for flat, round, or hex work. Quick fingertip release lever permits convenient one hand operation. Has spring tension adjustment and bright plated finish. Imported. 13 E 55099 Shpg. wt., 1 1/4 lbs. Net 1.99

KRAEUTER "INDUSTRIAL" PLIERS

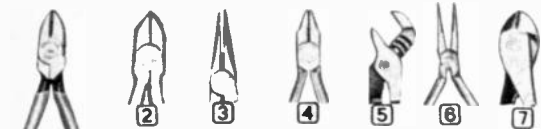

• All With Cushion Grip Handles

Fine quality—hammer-forged from high grade tool steel. Individually fitted, tempered and adjusted. Fully polished heads. Rust-resistant cushion grip handles.

Stock No.	Type	Fig.	Description	Net
13 E 28012	35015	1	5" Diagonal Cutters	2.79
13 E 28020	35016	1	6" Diagonal Cutters	3.19
13 E 28038	37015	2	5" Needle Point Diagonals	3.29
13 E 28046	36616	3	6" Needle Nose with Cutter	3.29
13 E 28061	38306	4	6 1/2" Side Cutters	3.75
13 E 28079	27510	5	10" Joint Pliers	2.99
13 E 28202	36535	6	5" Radio & Ignition Long Nose Cutting Pliers (Cross-Coil Springs)	3.75
13 E 28095	36107	7	7" Heavy Duty Diag.	3.19

CHAN NEL LOCK LITTLE CHAMP PRECISION PLIERS

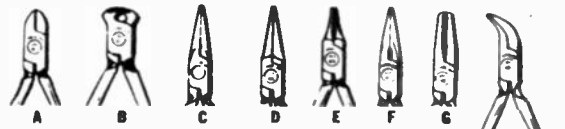

• Top Quality Precision Pliers

Fine quality small pliers, ruggedly designed for bench work that requires delicate handling. Drop forged from high grade steel. Precision made and polished to jewelers finish with plastic cushion grip handles. Avg. shpg. wt., 5 ozs.

Stock No.	Type	Fig.	Description	Net
13 E 30059	41-G	A	4 1/4" Diagonal Cutter	2.99
13 E 30067	42-G	B	4" End Cutter Nipper	2.99
13 E 30075	43-G	C	4 3/4" Needle Nose	2.59
13 E 30083	44-G	D	4 3/4" Flat Nose	2.59
13 E 30091	45-G	E	4 1/2" Round Nose	2.69
13 E 30109	47-G	F	4 3/4" Needle Nose Cutter	2.99
13 E 30117	48-G	G	4 3/4" Transverse End Cutter	2.99
13 E 30125	49-G	H	4 1/2" Curved Needle Nose	2.99

WIRE STRIPPER AND CUTTER



Only **1.19**

• Self Opening

For any size wire, stranded or solid. Adjustable arm for varying wire size. Made of hardened tool steel finely ground cutting edges. Built-in spring holds cutter open. Has ring-latch to hold blades in closed position. Shpg. wt., 4 oz.
14 E 16502 Net 1.19

STRIP-ER-CLIP



1.49

• Adjusts Instantly to Correct Wire Size

A precision tool with an exclusive safeguard that prevents damage to wires. Eight stop gauge adjusts instantly to the correct wire size. For all wires between 12 and 26 gauge. Comfortable insulated grip. Specialty ground cutting edge. Shpg. wt., 1/2 lb.
13 E 61195 Net 1.49

CHAN NEL LOCK ELECTRONIC PLIERS

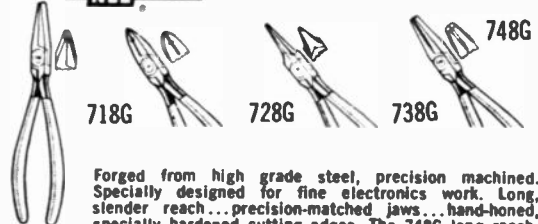

Forged from high grade steel, precision machined. Specially designed for fine electronics work. Long, slender reach... precision-matched jaws... hand-honed, specially hardened cutting edges. The 748G long reach, end cutters are fine enough to cut a human hair—rugged enough to cut 12 gauge copper wire. The 738G long reach, round nose will pick up a human hair with its precision machined parts. The 728G-long reach diagonal cutters have a patented wire stripper that really works. The 718G-long reach, flat nose has a bulldog grip with watchmakers precision. Length 8". Av. shpg. wt., 8 ozs.

13 E 30018	748G end cutter with plastic grips	Net 2.99
13 E 30026	738G round nose with plastic grips	Net 2.99
13 E 30034	728G diagonals with plastic grips	Net 3.19
13 E 30042	718G flat nose with plastic grips	Net 2.99

Professional Screwdrivers-Nutdrivers

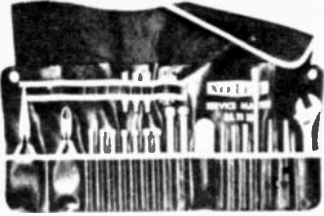

(A)

(A) SERVICE MASTER TOOL KIT

- Versatile — 23 Piece Set — Quick-Change Tools
- Durable, Roll-Up Vinyl Canvas Case

Model 99SM—Valuable kit has: pliers—6" long nose and 5" diagonal; 6" adjustable wrench; 9 regular nutdrivers 3/16" through 1/2"; 3 stubby nutdrivers, 1/4", 5/16" and 3/8"; Phillips screwdriver; 2 slotted screwdrivers, 3/16" and 1/4"; 2 reamers; extension. Shpg. wt., 2 3/4 lbs.
13 E 48438 Net 26.85



(B)

(B) "TRAY BIEN" NUT DRIVER SET

- Solid Shaft 7 Color Coded Nut Drivers
- Carrying Case for Bench Caddy or Wall Mounting

Model 127TB molded plastic bench tray has fold away stand. Holds tools securely yet permits easy removal. Hex sizes 3/16", 7/32", 1/4", 9/32", 5/16", 11/32", 3/8".
13 E 48489 Shpg. wt., 1 1/2 lbs. Net 6.60



(C)

(C) NUT DRIVER SCREWDRIVER SET

- 14 Piece Nut and Screwdriver Set
- Durable Plastic Roll Kit

Model 99PR—Thirteen interchangeable nut drivers and screwdrivers. Nine nutdrivers, 3/16, 7/32, 1/4, 9/32, 5/16, 11/32, 3/8, 7/16, 1/2". Slotted screwdriver 3/16" and 1/4". Phillips screwdrivers (#1 and #2). Handle. Roll up kit. Shpg. wt. 2 lbs.
13 E 48212 Net 9.42



(D)

(D) "TRAY BIEN" NUT DRIVER SET

- Hollow Shaft—7 Color Coded Nut Drivers
- Carrying Case for Bench, Caddy or Wall Mounting

Model 147TB contains 7 hollow shaft color coded nut drivers. (Hex sizes 1/4", 9/32", 5/16", 11/32", 3/8", 7/16", 1/2".) Housed in attractive "snap lock" case for secure holding and easy removal.
13 E 48477 Shpg. wt., 2 lbs. Net 8.70

COMPACT DOUBLE DUTY TOOL SETS

(E) PS-120 COMPACT NUTDRIVER SET—10 nutdrivers, 3/32" pocket-size. Piggy-back "torque amplifier" handle slips over pocket tool handles, gives grip and power of standard drivers. See-thru plastic case, slimmed to fit your pocket; stands on flat base. 3/8, 1/4, 5/16, 3/8, 1/2, 5/8, 3/4, 7/8, 1, 1 1/8, 1 1/4, 1 1/2, 1 3/4, 2. Shpg. wt., 1 lb.
13 E 48822 Net 5.85

(F) PS 7 DOUBLE DUTY TOOL SET—Saves bench space. Gives grip, reach and power of standard drivers with remarkable "torque amplifier" handle. Set includes: (all 3/4") 2 color coded nutdrivers, 1/4" and 3/8"; 2 slot tip screwdrivers, 2 Phillips screwdrivers, #0 and #1. Slim, pocket-fitting see-thru plastic case.
13 E 48220 Shpg. wt., 1/2 lb. Net 4.13

(G) PS 88 SCREWDRIVER SET—Compact, for bench and pocket. Set has 5 slot tip screwdrivers: 3/8, 1/2, 5/8, 3/4, 1; 3 Phillips screwdrivers: #0, #1, #2. All 3/4" pocket size plus 1x3/4" hollow handle. See thru plastic case, stand-up base. Shpg. wt., 12 oz.
13 E 48444 Net 4.20

(H) 99PS-90 SET OF SCREWDRIVERS-NUTDRIVERS—Contains seven nutdrivers: 3/8, 1/2, 5/8, 3/4, 1, 1 1/8, and 3/4"; two slotted screwdrivers: #1 and #2 Phillips screwdrivers; an extension blade (adds 4" reach to single end blades); regular handle 1 1/2x4 1/4". Easy to work with in space-saving, convenient see-thru plastic case with flat base that stands up on work bench. Shpg. wt., 1 lb.
13 E 48451 Net 8.93

(E)

(F)

(G)

(H)

VINYL PLASTIC ELECTRICAL TAPE

59¢



- UL Listed
- 60 Ft. x 3/4"
- .008 in. Thick
- 10,900 V. Breakdown

First quality, pressure sensitive polyvinyl chloride tape. Extremely high dielectric strength of 10,900V breakdown. Insulation resistance of one million megohms. Over 150% elongation at break. Excellent resistance against acids, alkalis, oils, salt, water, etc. Tensile strength of 15 lbs. per in. High conformability. Forms tight, smooth protective wrap. Imported. Shpg. wt., 4 oz.
99 E 00152 Net .59

LARGE PLASTIC TAPE KIT:

10 rolls of vinyl plastic tape. Each roll 33 ft. by 3/4". 1 ea. of Red, white, sky blue, blue grey, yellow, brown, green, black and orange.
99 E 00301 Shpg. wt., 1 1/2 lbs. Net 2.89

HIGH QUALITY CHROME VANADIUM SHAFTS—U.L. HANDLES



ROUND BLADE SCREWDRIVERS

Stock No.	Type #	Shaft Size	Overall	Net
13 E 48248	R144	4" x 1/4"	8"	.93
13 E 48253	R146	6" x 1/4"	10"	1.02
13 E 48261	R148	8" x 1/4"	12"	1.06
13 E 48279	R182	2" x 1/8"	2 1/2"	.39
13 E 48287	R183	3" x 1/8"	5"	.39
13 E 48295	R184	4" x 1/8"	6 1/2"	.45
13 E 48311	R188	8" x 1/8"	10 1/2"	.60
SET-SCREW TYPE—with pocket clip				
13 E 48320	R184 1/2	4" x 1/8"	6"	.42
13 E 48337	R3323	3" x 3/32"	5"	.39
PHILLIPS SCREWDRIVERS—alloy steel				
13 E 48345	X101	3" #1 pt.	6 1/2"	.78
13 E 48352	X102	4" #2 pt.	7 3/4"	.96
13 E 48360	X103	6" #3 pt.	10"	1.35
13 E 48378	X108	6" #1 pt.	10"	.90

HOLLOW SHAFT NUT DRIVERS

Stock No.	Type #	Shaft Size	Overall	Net
13 E 48485	HS-6	3/16"	6 1/4"	.88
13 E 48489	HS-7	7/32"	6 1/4"	.99
13 E 48113	HS-8	1/4"	7"	.99
13 E 48901	HS-9	9/32"	7"	.99
13 E 48121	HS-10	5/16"	7"	.99
13 E 48139	HS-11	11/32"	7"	.99
13 E 48147	HS-12	3/8"	7"	.99
13 E 48519	HS-13	13/32"	7 1/4"	1.14
13 E 48154	HS-14	7/16"	7 1/4"	1.14
13 E 48327	HS-15	15/32"	7 1/4"	1.14
13 E 48162	HS-16	1/2"	7 1/4"	1.14
13 E 48170	HS-18	9/16"	7 1/4"	1.20
13 E 48188	HS-20	5/8"	7 3/4"	1.35
13 E 48535	HS-22	11/16"	7 3/4"	1.95
13 E 48543	HS-24	3/4"	7 3/4"	1.95

Shpg. wt., 6 oz.

Extremely handy tool for assembling and disassembling. It's a 1/4 and 3/8" nut driver, a no. 1 Phillips screwdriver, and a 3/8" slotted screwdriver. Shpg. wt., 8 oz.
13 E 48238 Net 1.85

4-WAY POCKET TOOL



Selected Tools For The Hobbyist



Moody®
MINIATURE
TOOL KITS
AS LOW AS
1.29

MASTER TOOL SET

Model SC-5 Screwdriver and Awl Set. Five interchangeable blades insert into chuck. Blades are .100", .080", .070", .055" and 1 awl. For repairing radios, cameras, electric razors, etc. With plastic case. 14 E 27012 Shpg. wt., 8 oz. Net 1.29

Model SH-2 Screw Holding Screwdriver Set. Solid locking chuck takes either the 2 1/2" or the 1 3/4" length blades. All four parts contained in a plastic case. 14 E 27020 Shpg. wt., 4 oz. Net 1.29

Model OE-5 Offset Open End Wrench Set. Five, tiny offset open end wrenches. All interchangeable use one handle. Tough, heat treated steel. Easily remove or attach the tiny nuts used in sub-miniature electronic work, hobby, aeronautical, automotive, etc. Sizes are: 5/64, 3/32, 7/64, 1/8, 5/32. 14 E 27030 Shpg. wt., 8 oz. Net 1.89

Model BW-5 Socket Wrench Set. Five interchangeable tiny hex socket wrenches. Hold tiny nuts for #00, #0 and #1 thread. Fits hex nuts 5/64, 3/32, 7/64, 1/8 and 5/32". Magnetized to hold those tiny ones firmly. Complete with dust proof, stand up case. Wt., 6 ozs. 14 E 27046 Net 2.95

Model SW-5. Same as above less magnetic handle. 14 E 27061 Net 2.89

Model PA-5 Phillips Driver and Allen Wrench Set. Chuck-type knurled aluminum handle accommodates #0 and #1 Phillips drivers and #4, #6, #8 Allen wrenches. Handle has torque lever for quick tightening. Handle plus 5 tools. 14 E 27053 Shpg. wt., 7 ozs. Net 1.89

Model TS-5 Tap Set. Has 5 heat treated steel taps ideal for cutting tiny inside threads on small items, knurled chuck type handle has torque hole for firm leverage. Tap sizes, 0-80, 1-72, 2-56, 3-48, 4-40. 14 E 27079 Shpg. wt., 7 oz. Net 4.95

Model #70 Tap Drill set for cutting small holes which have to be tapped, 5 precision drills made of heat treated steel. Drill sizes: 3/64", #20, #53, #47, #43. 14 E 27087 Shpg. wt., 6 oz. Net 2.69

MOODY MASTER TOOL SET

Model MMK-6 compact, six tool sets for the hobbyist, jewelry and electronic trades. Contains models SC-5, PA-5, SW-5, OE-5, TS-5, and #70 listed above. Complete with leatherette carry case. 14 E 27095 Shpg. wt., 1 1/2 lbs. Net 15.95



(A) POP RIVETOOL KIT

A professional tool which joins virtually anything, metal to metal, plastic to wood, fabric to fabric. Easy to operate, just insert rivet into tool, place in pre-drilled hole and squeeze—you have a strong rivet joint. "Pop" rivets are strong, neat and permanent. Ideal for hobbyists, electronics, household and auto repairs. Kit includes riveter, and supply of rivets of various sizes. Uses 1/8" rivets. Shpg. wt., 2 lbs. 13 E 54018 Net 2.75

(B) DUAL RIVETOOL KIT

Contains the new "Pop" rivet tool with two interchangeable nosepieces to set 1/8" steel and aluminum and 3/16" aluminum "Pop" rivets. Includes 1/8" and 3/16" rivets in assorted lengths, backup plates, plus new threaded "Pop" rivets. Shpg. wt., 3 1/2 lbs. 13 E 54083 Net 4.49

RIVETS FOR ABOVE KITS

1/8" Rivets Steel			
Stock No.	Qty.	Work Thickness	Net
13 E 54026	25	1/8"	.44
13 E 54034	20	1/4"	.44
13 E 54042	15	1/2"	.44

3/16" Rivets Aluminum			
Stock No.	Qty.	Work Thickness	Net
13 E 54091	15	1/8"	.44
13 E 54109	12	1/2"	.44
13 E 54117	10	3/8"	.44

Back-Up (Reinforcing) Plates			
Stock No.	Qty.	Rivet Size	Net
13 E 54059	40	1/8"	.44
13 E 54125	30	3/16"	.44

PROFESSIONAL 6-PC PRECISION SCREWDRIVER SET

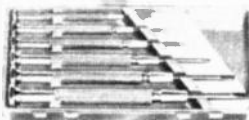

• **Hardened, Tempered, Rustproof Blades**
Perfect for the hobbyist, jewelry and electronic trades. This precision 6 piece screwdriver set has sizes from #1 to #6, width of blades 0.8-3.8MM. All have knurled handles with swivel heads. Chrome plated brass handles with diameter of 3.5-8.0MM. Blades are hardened, tempered and rustproof for rugged use. Complete with handy plastic indexed case with hinged cover. Imported. 13 E 56039 Shpg. wt., 1/2 lb. Net 1.99

SELF-ADJUSTING SOCKET WRENCH



• **Adjusts Automatically from 1/4 to 7/16"**

Now one tool replaces many socket wrenches! Simply press this wrench on any bolt or nut from 1/4" to 7/16" in size and it automatically selects the right socket to fit, no other adjustments needed. High tensile strength sockets minimize slippage, provide high torque. Accommodates bolt extensions up to 1 1/4" long. Chrome plated steel housing, insulated handle. Length 6". Shpg. wt., 1/2 lb. 14 E 22500 Net 2.95

6 PIECE HOLLOW SHAFT NUT DRIVER SET



• **Heavy-Duty Plastic Handle**
• **Made in U.S.A.**

2.49

Heavy duty nut drivers with plastic handle. Hollow blade permits tightening of nut over long screws...slim-line styling reaches anywhere. Blade features rust proof finish. Sizes: 3/16, 1/4, 5/16, 11/32, 3/8 and 7/16". Each nut driver is 5 1/2" long. Made in U.S.A. Shpg. wt., 1 lb. 13 E 55833 Net 2.49

6 PC. "LOCKGRIP" SCREWDRIVER SET

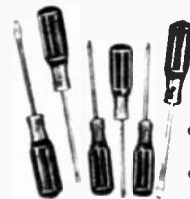

2.39

• **Slip-proof Vinyl grip**
• **Magnetized Nickel-Plated Steel**

6 pc. set includes 1 ea. of 4x3/4", 6x3/4", 4x1/4" and 6x1/4" cabinet and mechanics type screwdrivers and 1 ea. 3x3/4", and 4x1/4" Phillips-type. Shpg. wt., 1 1/2 lb. 13 E 63019 Net 2.39

25-PC. TOOL SET



Set consists of 1 plastic screwdriver handle with aluminum chuck; 4 screwdriver blades (1/4x1/4", 3/8x3/8", 1/2x5/8" flat drivers and one No. 1 Phillips blade); 8 open and box end wrenches (1/2", 5/8", 3/4", 7/8", 1", 1 1/4", 1 1/2", 1 3/4"); 2-way flat ratchet handle; 2-way flexible shaft extension; 2-way 1/4" extension bar; 8 steel sockets (3/16, 1/8, 1/4, 5/16, 3/8, 1/2, 5/8, 3/4, 7/8, 1"). All in a convenient roll pouch with pocket for each tool. Imported. 13 E 55330 Wt., 1 1/2 lbs. Net 1.95

Swingline inc. ELECTRIC GLUE GUN



• **Automatic Feed Trigger**
• **Finger Tip Control Thermostat**

ONLY 6.95

Features exclusive automatic feed trigger and finger tip thermostat control, handy "on-off" switch plus contoured handle. You get 60 second bonding for wood, tile, leather, fabrics, metals, masonry; or caulking. Thermostat control has three heat ranges for "idling," "normal operation" and "extra flow." "Open/Close" nozzle control valve wrench included. Rated 70 watts at 120V., AC/DC. UL listed. Size: 6 3/4 x 4 1/2". Made of black, heat-resistant phenolics. 13 E 58217 Shpg. wt., 1 1/2 lbs. Net 6.95
Pkg. of 8 Hot Melt Glue Sticks 13 E 58225 Net .49
Pkg. of 8 Hot Melt Caulk 13 E 58223 Net .49

The Right Tools at the Right Price

POW-O-MATIC STEEL TAPE

- Push Button
- 3/4 In. x 12 Ft.

2²⁹



Power push-button 12' yellow steel measuring tape. Easy to read, red and black. Ft. and inch markings. 1/4" and 1/8" graduations, with zip belt clip. 14 E 16036 Shpg. wt., 1/2 lb. Net 2.29



18-PC. HEX KEY WRENCH SET

69^c

9 short arm wrenches from .050" through 1/4", and 9 long arm wrenches 3/4" through 3/8". Quality tool steel. Bright plated—in plastic roll up kit. Imported. 14 E 76019 Shpg. wt., 1 1/2 lbs. Net .69

12" LAZY SUSAN BEARING

2⁹⁹



Handy in making and assembling turntables and rotating fixtures, 140 steel ball bearings insure maximum stability for large items such as TV's, tables, etc. 6 3/4" inside dia. center opening. 20 E 44030 Shpg. wt., 2 lbs. Net 2.99

COMBINATION SQUARE & SCRIBER

99^c



Many uses—tri and mitre square, depth gauge, marking gauge, level, scriber. Graduated 8ths and 16ths on one side, 16ths and 32nds on other. 12" blade. Shpg. wt., 1 lb. 14 E 61136 Net .99

"LEVEL-UP" UNIVERSAL SURFACE LEVELER

89^c



Level anything. Simply center the bubble in the ring. The "Level-Up" may be mounted on a larger base for spanning large areas. Imported. Shpg. wt., 4 ozs. 99 E 00370 Net .89

LEATHER TOOL HOLSTER

1⁴⁹



Heavy, pliable, top grain leather. Stitched and riveted. 5 pockets and tape sling. Practical, rugged tool carrier. Overall size 8 1/2 x 10". Imported. Shpg. wt., 1 lb. 14 E 61193 Net 1.49

9 1/2" METAL SHEARS

1⁹⁹



Straight cutting snips with drop forged steel blades. Lock keeps self-opening handle in closed position. Tough plastic grips on handles. 9 1/2" long. Imported. Shpg. wt., 12 oz. 13 E 55957 Net 1.99

CLAW HAMMER WITH FIBERGLASS HANDLE

2⁷⁵



Drop Forged 16 oz. hammer with head permanently wedged by special plastic bonding process. Polished and perfectly balanced head. 13 E 56096 Shpg. wt., 2 lbs. Net 2.75

TUBING CUTTER

99^c



A quality cutter for copper, brass, or aluminum tubing. Up to 1" capacity. Alloy steel cutting wheel; slide-lock reamer. Ideal for light plumbing, etc. Imported. Shpg. wt., 8 oz. 13 E 55403 Net .99

SAFETY EYE GUARD

99^c



Made in USA. Meets Fed. Spec. for impact and piercing. Optically clear plastic. Non-fogging. Well ventilated. Undistorted vision. Fits any size corrective eyeglasses. Shpg. wt., 4 ozs. 13 E 55353 Net .99

FILTER MASK

99^c



Multi-purpose filter mask comes complete with 3 latex and 3 gauze filters. Protects nose and throat from dust during sanding, boat scraping, grinding and plant or garden spraying. Pliable mask molds to all facial contours. All filters are replaceable. Shpg. wt., 6 oz. 13 E 55061 Net .99

REVOLVING LEATHER PUNCH

1²⁹



Has 6 standard punching tubes. Made of long-lasting tempered steel. Imported. 14 E 61144 Shpg. wt., 12 ozs. Net 1.29

WORK BENCH MAGNIFIER

99^c



Handy 3" diameter magnifying glass with a flexible shaft and an attractive metal base. Ideal for hobbyists or students. Imported. Shpg. wt., 1/2 lb. 13 E 55073 Net .99

SELF LOCKING HASP-LOC

2⁷⁵



Self contained; no need to purchase a separate padlock. No keys required to lock; keys used for opening only. Heavy duty and rust proof. Size 4 1/2" with 2 keys. 13 E 75054 Shpg. wt., 1 lb. Net 2.75

MULTI-DRIVE SCREWDRIVER

1²⁹



All-purpose screwdriver with 5 interchangeable bits, "He-Man's" sized grip. 5 popular bits: #1 Phillips, #2 Phillips, 1/4" Yankee blade, 3/8" Yankee blade and awl. Chrome plated. Imported. 13 E 55025 Shpg. wt., 1 lb. Net 1.29

FLARING TOOL

1⁵⁹



Made of high grade chrome plated tool steel. Malleable clamp. Rapid opening hinge for swivel cone yoke. Sizes: 3/16", 1/4", 5/16", 3/8", 1/2" and 5/8" O.D. Shpg. wt., 2 1/2 lbs. 13 E 55395 Net 1.59

AUTOMATIC CENTER PUNCH

2⁹⁹



Speedy, automatic, and adjustable—a single-hand operated punch gives light or heavy impressions with just the turn of a screw. Spring pressure adjusts from 5-30 lbs. Imported from England. Shpg. wt., 8 oz. 14 E 32200 Net 2.99

RETRACTABLE UTILITY KNIFE WITH 5 BLADES



Die-cast handle with industrial finish. Retractable blade—non slip grip. 14 E 16064L Shpg. wt., 8 oz. Net .99
5 additional all-purpose knife blades. 14 E 16072L Shpg. wt., 4 oz. Net .35

ELECTRIC-MATE POCKET KNIFE

For handymen and electricians. Two-blade knife with safety lock. Features a knife, wire scraper and screwdriver. Non slip handle. Overall size; 3 1/2". With belt loop. 14 E 16510 Net 1.39



CAMPER'S "KOMBO-KNIFE"

1⁷⁹



11 steel blades, spoon, fork, 3 1/2" saw, 3 1/2" knife, pruning knife, scissors, can opener, bottle opener, corkscrew, screwdriver, file, scraper. Leather sheath. Imported. 13 E 55064 Shpg. wt., 1 lb. Net 1.79

SECURITY TRAVEL LOCK

2⁷⁵



For salesmen, and travelers whenever a portable lock is needed. Fits doors, cabinets without permanent installations or tools. Stainless bar and chrome finish. 14 E 44512 Shpg. wt., 1 lb. Net 2.75

High Quality Drop-Forged Steel Socket Sets



• CHROME PLATED **5⁵⁰**
17 PIECE 1/4" DRIVE SOCKET SET

Heavily chrome plated socket set. Contains 6 Pt. socket; 3/16", 7/32", 1/4", 9/32", 5/16", 11/32", 3/8", 7/16", 1/2", 11/16", 3/4", 1". Plus: 2" extension, 6" extension, 5 1/4" flex handle, 4 1/2" crossbar, 5 1/2" reversible ratchet. Each set packed in heavy gauge lacquered metal box. Imported. Shpg. wt., 2 lbs.

13 E 55643 Net 5.50

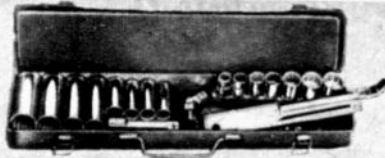

• CHROME PLATED **13⁹⁵**
21 PIECE 3/8" DRIVE SOCKET SET

Precision quality socket set. Contains: 12 Pt. socket sizes: 3/8", 7/16", 1/2", 9/16", 5/8", 11/16", 3/4", 12 Pt. deep socket sizes: 3/8", 7/16", 1/2", 9/16", 5/8", 11/16", 3/4", 1". Plus: 3" extension, 9" flex handle, 6" crossbar, universal joint, 8" reversible ratchet. Packed in heavy gauge red lacquered metal box with handle. Imported. Shpg. wt., 5 lbs.

13 E 55650 Net 13.95

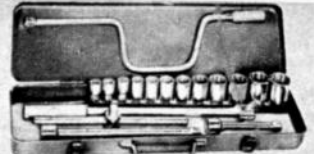

• CHROME PLATED **16⁹⁵**
19 PIECE 1/2" DRIVE SOCKET SET

Quality steel precision socket set. Contains: 12 Pt. socket sizes: 1/2", 9/16", 5/8", 11/16", 3/4", 1", 1 1/16", 1 1/8". Plus: 5" and 10" extension, 15" flex handle, sliding T-bar, 17" speeder handle, 10" reversible ratchet. Packed in heavy red lacquered metal box with handle. Imported. Shpg. wt., 15 lbs.

13 E 55635 Shpg. wt., 15 lbs. Net 16.95

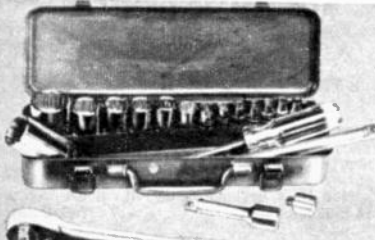

• CHROME PLATED **9⁹⁵**
21 PIECE 1/4" AND 3/8"

Contains: 1/4" drive, 6 Pt. socket sizes: 3/16", 7/32", 1/4", 9/32", 5/16", 11/32", 3/8", 7/16", 1/2", 11/16", 3/4", 1". Plus: 3/8" drive, 8" reversible ratchet, spinner handle, 3" extension, 6" extension, 3/8" Drive: 12 Pt. socket sizes: 9/16", 5/8", 13/16" spark plug socket (with neoprene insert), adaptor; 3/8" to 1/4" drive. In metal box. Imported. Shpg. wt., 4 lbs.

13 E 55585 Net 9.95



• CHROME PLATED **7⁹⁵**
11 PIECE 3/8" DRIVE METRIC SET

Handy socket set for foreign car and motorcycle mechanic. Includes 7 mm. socket sizes — 9, 10, 11, 12, 14, 17 and 19 mm; 3" extension; 7 1/2" reversible ratchet; and 3/8" spark plug socket (with neoprene insert). In heavy gauge, red lacquered metal storage box with molded inlay. Imported. Shpg. wt., 3 lbs.

13 E 56054 Net 7.95

REVERSIBLE RATCHETS

As Low As

2⁹⁵



Professional Quality. Highly chrome plated. Imported. Shpg. wt., 1/4 lb.
 13 E 55601 3/4" drive; 8" length Net 2.95
 13 E 55593 1/2" drive; 10" length Net 3.39

13/16" SPARK PLUG SETS

only

99^c



A professional quality spark plug socket of chrome plated drop forged steel with neoprene insert. 3/8" drive; shpg. wt., 1/4 lb.
 13 E 55619 Net .99
 1/2" drive; shpg. wt., 1/4 lb.
 13 E 55627 Net .99

PROFESSIONAL TORQUE WRENCHES



As Low As

9⁹⁵

Chrome plated 1/2" drive square with accurate pointer indicating torque applied in either direction in ft./lbs. Scale exceeds federal specifications. GGG-W-00686A. Type 1, Class 1, Style A. Overall length 19 1/2". Scale graduated in 5 ft./lb. steps. Complete with booklet, tips on torque. 0-100 ft./lb. Popular model for auto work. For normal auto maintenance. Shpg. wt., 1 1/2 lbs.

13 E 01415 Net 9.95
 0-150 ft./lb. unit for larger displacement engines, trucks, etc.
 13 E 01423 Shpg. wt., 2 1/2 lbs. Net 11.95

ADJUSTABLE END WRENCHES



AS LOW AS

1³⁹

Fully Drop Forged

Adjusts jaws with a flick of your thumb... oversized knurl speeds opening and closing. Entire wrench is made of drop forged steel and fully polished. Thin head gets into tight places easily. Extra long for better leverage.

Stock No.	Size	Max. Jaw Open.	Shpg. Wt.	Net
13 E 55668	6"	3/4"	8 oz.	1.39
13 E 55676	8"	1"	11 oz.	1.99
13 E 55684	10"	1 1/4"	1 1/2 lb.	2.49
13 E 55692	12"	1 3/4"	2 lbs.	3.19



5-PIECE DOUBLE END WRENCH SETS

1⁹⁹

- Drop Forged Alloy Steel
- Mirror Finish
- High Quality



5-Piece Open-End Wrench Set. Made of fine drop forged alloy steel. Both openings and body of wrench have a mirror finish. Sizes: 5/16" x 11/32", 3/8" x 7/16", 1/2" x 9/16", 9/32" x 11/16", 5/8" x 3/4". Complete with metal clip. Shpg. wt., 1 lb.

13 E 55866 Fig. A Net 1.99

5-Piece Open-End Metric Wrench Set. Same quality as above. Sizes 8mm thru 17mm. Shpg. wt., 1 lb.

13 E 56146 Fig. A Net 2.75

5-Piece Combination Set. Open-end and box end openings in same wrench. Same quality as above. Ends offset. Size 3/8", 7/16", 1/2", 9/16" and 5/8", 11/16" and 3/4". Shpg. wt., 1 lb.

13 E 55874 Fig. B Net 1.99

3-PIECE BOX END WRENCH SET

1⁶⁹

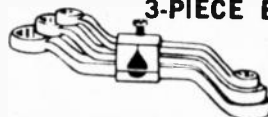

- Professional Quality

Top quality drop forged alloy steel. Mirror finish. Sizes: 3/8" x 7/16", 1/2" x 9/16", and 5/8" x 11/16". All are short pattern, 45° offset. With metal retaining clip. Shpg. wt., 1 lb.

13 E 56153 Net 1.69

Tools and Tool Boxes

MECHANICS' FOUR TRAY CANTILEVER TOOL BOX

HEAVY DUTY 10 DRAWER MACHINIST'S CHESTS



- Electrically Welded Heavy Duty Steel
- Ten Felt-Lined Drawers
- Pin-Tumbler Chest Lock



AS LOW AS **31⁵⁰**

Heavy gauge steel chest with 10 felt lined drawers for storage and protection of tools. Rugged construction with integral full length hinges, and full suspension drawer slides for full extension of each drawer. Removable front panel locks when cover is closed and stores below drawers in a fitted compartment when open. Overall size: 8 1/2" x 17 1/2" x 20". Tilt in top 8 1/2" x 4" x 20". 6 drawers 7 1/2" x 1" x 8 3/8". Others 7 1/2" x 2" x 8 3/8". 7 1/2" x 1 1/2" x 18 1/4", 7 1/2" x 2 3/8" x 18 1/4", 7 1/2" x 3" x 18 1/4". Shpg. wt., 40 lbs.

• Full Size Storage Compartment PLUS **9⁹⁵**
Four Easy-Glide Cantilever Trays

Professional quality tool box... stores, protects precision tools. Ideal for machinists, electronics and automotive repairmen. Double cover swings out fully exposing four easy-glide cantilever trays for easy access to each compartment. Bottom compartment is completely exposed and large enough to store most bulky tools. Entire box is made of prime quality, extra-heavy gauge steel. Also has two heavy-duty round handles running along the entire length of the box and padlock eyes for locking. Handsome baked blue enamel finish. Over-all size: 17" L x 8" W x 8 1/4" H. Shpg. wt., 13 lbs.

13 E 56104W Net 9.95

HIP-ROOF TOOL BOX

With Lift-Out Tray



Long lasting, electrically welded heavy gauge steel construction with full-length hinge. Perfect for the homeowner, mechanic, or handyman. Plated handle will not break or pull out. Lift-out tray for smaller tools. Large storage area for bigger tools, 19Lx7Wx7 1/4"D. Shpg. wt., 6 bs.

13 E 42500W Net 3.95

STEEL TOOL AND UTILITY BOX

13 1/2" long tool box. Cantilever tray with four compartments. Room enough for soldering iron, pliers, screw drivers, wrenches, etc. Pushbutton catch with hasp for lock. Full grip handle. Baked enamel finish in glossy green. 13 1/2" L x 6 1/2" W x 5" D. Shpg. wt., 3 lbs.



14 E 04067 Net 2.19

Turner BLOW-TORCH KIT

Model LP-99 Everything the home handyman needs to sweat fittings, solder and bend metal. All brass torch with improved pencil point burner assembly, heavy duty burner tip for larger flame, chisel point solder tip, brass flame spread, spark lighter and tank of fuel. Durable steel chest. UL listed. 6 x 10 1/4 x 3". Wt., 4 1/2 lbs.



13 E 26503 Net 6.99

Super capacity fuel tank. Fits all standard propane torches, stoves, lanterns, etc. Shpg. wt., 2 1/2 lbs.

13 E 26511 Net 1.29

MINIATURE IMPROVED HOIST

• Completely Assembled

Simple, reliable hoist enables you to lift as much as 2000 lbs, yet, weighs only 1 1/2 lbs! Ideal for hunters to hoist heavy game for cleaning, or boat owners to mount outboard engines with ease; can also be used to stretch a chain link fence. Has rust resistant cadmium plated housings, heavy duty welded ring, double grip safety hooks, nylon rollers, and locking device to eliminate slack. Includes high tensile-strength 65' nylon rope for long life. Shpg. wt., 2 lbs.



13 E 19060 Net 4.95

3 DRAWER TOOL CHEST

Only **12⁹⁵**

An all purpose ruggedly constructed 3 drawer carrying type chest. Drawers have full suspension slides. Drawers may be locked in place even if cover is closed. Features electrically welded heavy gauge steel and baked enamel silicone treated finish. Dimensions: Box — 8 1/2" Dx 10 1/4" H x 20" long; 3 drawers — 7 1/2" Dx 1 1/2" H x 18 1/4" L. Shpg. wt., 18 lbs.

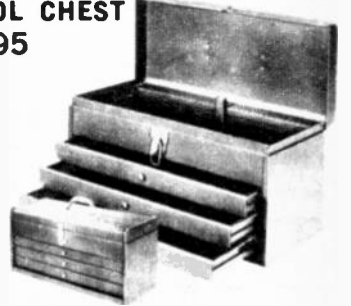

13 E 19508W Net 12.95

SELF ADJUSTING AUTOMATIC WRENCH



AS LOW AS **1⁴⁹**

Fully drop forged steel. Slim design lets you work easily in hard to reach spots. Designed with an easy action floating head. Highly chrome plated, rust-resistant finish. Imported.

Stock No.	Size	Max. Jaw Open.	Shpg. Wt.	Net
13 E 56013	6"	1"	1/2 lb.	1.49
13 E 55841	8"	1 1/2"	10 oz.	1.75
13 E 55858	10"	2"	1 lb.	2.49
13 E 56021	12"	2 1/2"	1 1/4 lb.	3.19

11 PIECE COMBINATION WRENCH SET

- Full Professional Size
- Handy Vinyl Roll-Up Kit

8⁹⁵

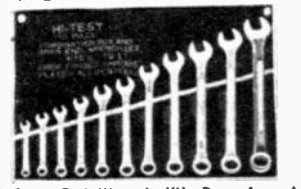

11 Piece Combination Box and Open End Wrench Kit. Drop forged alloy steel with bright chrome plated finish. Sizes: 3/8", 7/16", 1/2", 9/16", 5/8", 11/16", 3/4", 13/16", 7/8", 15/16", and 1". Length of wrenches 6" to 13" long. Shpg. wt., 6 lbs.

13 E 56138 Net 8.95

Work Benches — Shelves — Cabinets

DEXION SLOTTED ERECT ANGLE STEEL UNITS



- Workshop
- Garage
- Playroom
- Basement
- Attic
- Office

STANDARD DUTY easy to custom build the equipment you need in steel. Hundreds of uses in the workshop, garage, attic, playroom, basement and office. All you do is measure, cut and bolt together using only a hacksaw and wrench. Made of strong cold-rolled gray-enameled steel. Corner plates provide added structural strength and rigidity—eliminate need for crossbracing. Angles are conveniently marked-off for measuring. 40 ft. outfit consists of 8 5-ft. lengths of 1"x1"x.040" angle steel, 12 corner plates and 50 nuts and bolts. 12 E 77060WX Shpg. wt., 11 lbs. Net 9.75

- HEAVY DUTY ANGLE STEEL** 39 ft. outfit consists of six 6½ ft. lengths of 1¼ x 1¼ x .064" plus 50 nuts and bolts, 12 corner plates. Shpg. wt., 18 lbs. Net 11.75
- 12 E 77078WX Plastic feet accessories for 1" x 1" units, pkg. of 4. Shpg. wt., 6 oz. Net .45
- 12 E 77086 Plastic feet for 1¼ x 1¼" units, pkg. of 4. Shpg. wt., 6 oz. Net .45
- 12 E 77094 Extra nuts and bolts, pkg. of 25 Net .75
- 12 E 77102 Corner Plates. Pkg. of 6 Net .59
- 12 E 77110

STEEL STORAGE UNITS

- Braced on Back & Sides
 - Heavy Angle Posts
- As Low As **5.95**

For stores, offices, garages, basements, pantries, closets—just what you need to solve your storage problems, you'll find dozens of uses for these rugged racks. Available in two sizes to fit virtually anywhere—30W x 12D x 60"H with 4 shelves, or 36W x 12D x 72"H with 5 shelves. Corner post and all edges are rounded and snag-proof with back and side braces providing added strength and rigidity. Charcoal tone finish. Shipped unassembled with protective floor guards and all necessary hardware for fast easy assembly.

- 4-Shelf Unit Size: 12 x 30 x 60". Net 5.95
- 13 E 23070W Shpg. wt., 20 lbs.
- 5-Shelf Unit Size: 12 x 36 x 72". Net 8.49
- 13 E 23088WX Shpg. wt., 28 lbs.
- Extra Shelves For Above
- 12 x 30" Shelf. Shpg. wt., 2 lbs. Net 1.59
- 12 E 23093W
- 12 x 36" Shelf. Shpg. wt., 2¼ lbs. Net 1.89
- 12 E 23101W



DELUXE STEEL SHELVES

- Combines Strength and Beauty
- Unlimited Arrangements For All Storage Needs

6 shelf units ideal for offices, garages, stores—anyplace where both strength and beauty dictate your storage needs. Completely new design eliminates unsightly bolt holes and gives a clean modern appearance. New principle of post and shelf attachment provides extra rigidity and does away with unattractive crisscross bracing. Units have split posts to permit assembly at full or half height in unlimited arrangements to meet every storage and space requirement. Baked enamel yellow shelves, Walnut wood grain posts. 72"H x 36"W.

13 E 18534WX 12" deep, wt. 27 lbs. Net 10.95

13 E 18542WX 18" deep, wt. 38 lbs. Net 12.95

Doublewidth 12-Shelf Unit

Overall 72" Wide x 72" High supplied with 12-shelves 36" Long x 12 Deep. Shpg wt., 50 lbs. 13 E 18559WX Net 19.95

360 Lafayette Cat. No. 700

Depend on Lafayette For Complete Stocks, Lowest Prices, Fastest Service

STEEL FRAME WORK BENCH

Includes Tool Rack, Peg Board Back Panel and Bottom Shelf



17.95

A new all-steel frame work bench that is the ultimate in convenience and serviceability. The rigid, all steel frame is the core of this complete workshop that will last for years. Features a big 24x48" work top of special, heavy-duty, compressed, high-impact board to withstand the roughest use. Matching bottom shelf offers handy storage space. Convenient tool rack with peg board back panel. Base on each leg gives extra support and can be bolted down if desired. Easy-to-assemble. 34½" high. (Tools not included). Shpg. wt., 60 lbs. 13 E 35041WX Net 17.95

ALL-PURPOSE BENCH FRAME

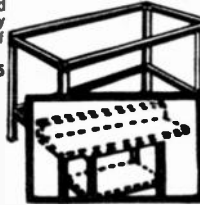

It's easy to make a bench for every purpose—in the garage, store, house, laundry room, playroom, etc. Heavy gauge steel, completely pre-drilled, ready-to-assemble—just add the top. For larger benches, combine 2 or more. Overall: 22½x47½x34" high. Shpg. wt., 19 lbs. 13 E 35017W Net 5.50

- TOOL RACK.** Prepunched to fit frame. 46"L. 4½"H. 13 E 35025W Shpg. wt., 2 lbs. Net 1.99
- CASTERS** For easy moving. Sets of 4. 13 E 35033 Shpg. wt., 1 lb. Net 1.40

"ADD-A-DRAWER"



In only seconds you get a permanent drawer under any flat surface—table, bench, cabinet, shelf, desk, etc. Completely assembled—comes with 2 brackets and 4 screws for easy installation. All-steel drawer with handy knob. Gray—can be repainted any color of your choice. Drawer size: 12 x 12 x 3½". Shpg. wt., 4 lbs. 13 E 35023 Net 3.95

HOBBY CRAFT "PEGBOARD" CABINET

7.95

- Sturdy Steel Construction

- With Pegboard Back and 20 Clear Plastic Drawers

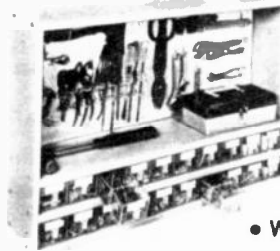

Storage cabinet for home, shop, office, or garage. Large 13 x 30" pegboard back stores hand tools, small power tools, etc. 20 clear plastic drawers for small parts storage; drawers (2¾"W x 2"H x 6"L) can be divided and labeled. 20 dividers and labels are included. Size: 30W x 19½H x 6½"D. Shpg. wt., 13 lbs. 13 E 49513W (Tools not included) Net 7.95

TOOL-MATE

- 4 Dust-Free Drawers

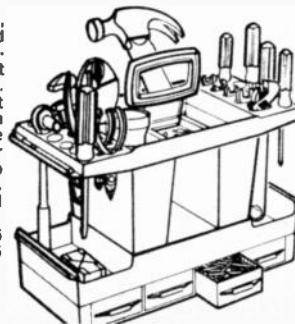

The perfect portable tool organizer for the handyman or hobbyist... a workshop at your fingertips! Tool-mate keeps hand tools and small parts handy and organized. 39 different tool slots; jumbo storage wells for large tools; and dust-free drawers for small parts. Everything is stored in an up-right, easy-to-use, easy-to-find position. Minutes to assemble... no tools needed. Size: 11½"W x 14L x 7"W. Shpg. wt., 2 lbs. 13 E 78243W Net 3.49

Sprayers for Handyman-Professional-Hobbyist

SPRAYIT 720 PROFESSIONAL TYPE SPRAY UNIT

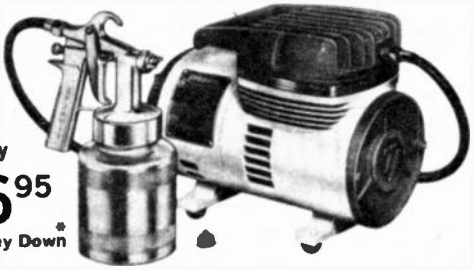

Only
66⁹⁵
No Money Down*

- Heavy Duty 1/3 H.P. Integrally Designed Motor
- For Home, Commercial, Farm and Professional Use

Here's a real workhorse! Completely integrated, high capacity spray outfit is ideal for all your painting needs—big or small—at home, on the farm, or in the shop. Has its own 1/3 H.P. integrally designed motor, and built-in oilless diaphragm compressor that delivers a big 2.5 C at 35 P.S.I. Compressor bearings are permanently lubricated for long trouble free service. The lightweight aluminum spray gun with aluminum quart cup has a fully adjustable spray pattern for added flexibility. Safe and easy to use—has a safety valve at 40 P.S.I. for built-in protection. With 8' electrical cord, 15' rubber air hose. For 12 V, 60 cycle AC. Shpg. wt., 29 lbs.

14 E 84088WX Net 66.95

See Listing For Additional Sprayit Accessories.

SPRAYIT

PRESSURE FLOW PAINT ROLLER KIT

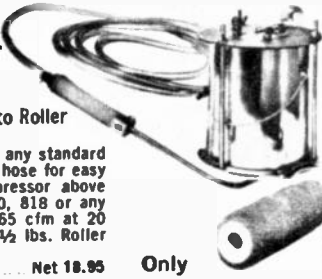

- No Dip—No Drip— Feed Paint Directly From Can to Roller

Saves time and steps. Bolts to any standard 1 gallon can. Has 15 ft. supply hose for easy reach. Use with Sprayit compressor above and models 254, 400, 600, 720, 818 or any compressor with range from .65 cfm at 20 psi to 3 cfm at 40 psi. Wt., 6 1/2 lbs. Roller wt., 1/2 lb.

- 14 E 84096 Net 18.95
- 3/4" Hi-Pile Roller for rough surfaces. 14 E 84104 Net 3.29
- 3/8" Pile Roller for smooth surfaces. 14 E 84112 Net 2.50

HOBBY & TOUCH-UP AIR BRUSH

Only **5⁹⁵**

Complete with:
Air Brush, 5 ft. Vinyl Hose, Air Valve, Mixing Jar, Instruction Folder and Plastic Case



Ideal for making patterns, designs; especially where a soft edge is needed for blending such as on chipped furniture and refrigerators, or touching-up rust spots on cars. Colors can be used mixed or straight. Adjustable for fine or heavy spray. Air-brush and valve assembly made of high impact deirin with metal control and paint tip. All materials resist solvents and paint chemicals. Complete with Aerosol Power Pack, Mixing Jar and Case.

13 E 45511 Shpg. wt., 1 1/2 lbs. Net 5.95
Replacement Aerosol Power. Pack. Shpg. wt., 1 lb. 13 E 45529 Net 1.40

AERO/MATCH SPRAY BRUSH

2⁷⁵

Spray with your own paint, you can match anything — even multi-colors. The 15 oz. power unit outlasts about three aerosol paint cans. Non-toxic, non-inflammable, pressurized gas. Easy-to-use, easy-to-clean. Not affected by paint solvents. Can spray any liquid paint, etc. Shpg. wt., 1 1/2 lbs.

- 14 E 50105 Net 2.75
- 14 E 50113 Replacement Power Unit Net 1.35



SPRAYIT 600-8 HEAVY DUTY HANDYMAN SPRAYER



Only
35⁹⁵
No Money Down*

- Integral Compressor-Motor
- Sprays Oils, Paints, Stains, Insecticides, Liquid Wax

All-purpose spray unit that gives professional results from the start. Provides uniform adjustable pattern from "dime" size to a fan 10" wide. Precision made with sealed ball bearings, never needs oiling. Easy-to-use 2-finger trigger gun. Air delivery: 1.5-2 CFM at 15-20 lbs. Complete with 6 ft. cord and plug, 8-ft. air hose, spray gun. Comes with internal-mix fan spray nozzle—1 pint capacity aluminum cup. For 115 v. 60 Hz AC. Shpg. wt., 11 lbs.

14 E 84146 Net 35.95

See Listing Below For Additional Accessories

SPRAYIT ACCESSORIES

- MULTI-COLOR KITS: For best results in spraying multi-color paints. 14 E 84021 Shpg. wt., 8 oz. Net 2.39
- AIR TOOLS KIT: For inflation and dusting. Includes chuck for all tires—footballs, basketballs, toys, air mattresses "dusting" attachment. 14 E 84039 Shpg. wt., 4 oz. Net 2.10
- QUART SPUN ALUMINUM CUP: Fits all of above spray guns. 14 E 84120 Shpg. wt., 8 oz. Net 2.40

SPRAY-ALL

ELECTRIC SPRAYER

- 5 Position Nozzle Adjustment
- Sprays Undiluted Solutions of S.A.E. 10 Weight Or Less



All purpose electric spray-all for use in garden, home, office or shop. Use it to paint boats, cars, fences, furniture, cabinets and household appliances. Use it around the lawn and garden. Spray insecticides in the home for mothproofing clothing. Spray-all comes in red polypropylene housing with unbreakable graduated 28 oz. jar plus genuine sapphire jeweled nozzle and 5 position control switch for adjustment to any job.

only
8⁹⁵

12 E 43500 Shpg. wt., 2 1/4 lbs. Net 8.95

"HOPPY" SPLIT-IMAGE TRANSIT

Only
7²⁹

- Plate Glass Mirrors

Amazingly accurate instrument that will indicate level and measure a minimum of 1/8" rise or fall at 25'.

Makes present day bubble and string type levels obsolete. It not only indicates level but shows exactly how much correction is needed. One man can perform any leveling or incline measuring job quickly, easily, and accurately. Makes any complicated measuring/leveling job simple. Use it for patio layout, bricklaying, flooring, surveying, terracing, fencing, plumbing, shelving, guttering, drainage, irrigation, indispensable as a leveling and grading tool for model railway pike. Shpg. wt., 2 lbs.

- 14 E 18011 Net 7.29
- 14 E 18029 case—Shpg. wt., 1 1/2 lbs. Net 3.95

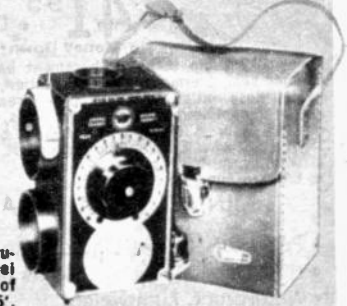

* See Page 11 for Full Credit Details on Easy Pay Plan

PORTABLE POWER GENERATOR WITH PERMANENT MAGNET ALTERNATOR

- Produces 115 Volts AC
- 3 H.P. Lauson Engine
- Choice of 500 Watt, 1000 Watt or 1250 Watt Models —Continuous Duty



as low as **139⁹⁵**

No Money Down*

A compact, portable electric power plant for on-the-spot electricity anytime, anywhere. Features a permanent magnet alternator that gives you more power and trouble-free operation — no brushes, armature windings, belts, slip rings or commutators. Dependable Lauson 3 H.P., 4 cycle engine gives easy-to-start, long-life service hour after hour. 1½

qt. capacity fuel-tank. Standard equipment includes: visual fuel gauge, visual oil level indicator, Duplex receptacle, rubber shock absorbing feet, recoil starter and carrying handle. Portable. Compact. 115 VAC.

Stock No.	Continuous Outy	Shpg. wt.	Net
13 E 49042WX	500 Watts	48 lbs.	139.95
13 E 49018WX	1000 Watts	63 lbs.	194.95
13 E 49026WX	1250 Watts	79 lbs.	209.95

SUBMERSIBLE POW-R-PAK PUMPS

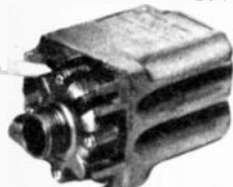

- Corrosion Resistant
- Hermetically Sealed Motor
- For Circulating And Dispensing Water

All-new Pow-R-Pak trouble free pumps for underwater use. Circulates and dispenses water and mild acid solutions for fountains,

beverage dispensers, aquariums, photo developing, air conditioning, etc. Permalubed. Corrosion resistant stainless steel and plastic unit. Overload protection, threaded inlet and outlet. Outlet: E-200 has 1/4" std. pipe thread, E-400, 700 has 3/8" std. pipe thread. Comes with 6 ft. cord. For 110 Volts, 60 Hz. AC. Average size: 2½x4x4".

Stock No.	Model	Gals. per Hr. At			Max. Ht.	Amps.	Shpg. wt. Lbs.	Net
		1 Ft.	3 Ft.	6 Ft.				
13 E 89048	E-200	220	155	80	7'	.40	2¾	12.95
13 E 89055	E-400	400	320	220	11'	.91	3¼	17.50
13 E 89063	E-700	700	540	430	13'	1.9	4¼	29.95

1300 GPH SUBMERSIBLE PUMP

- Standard Hose Connection Outlet
- Operates at Depths up to 40 ft.
- Double Epoxy Coating—Will not Corrode

41⁹⁵

No Money Down*

Heavy-duty sump pump or basement baller. Has long life carbon ceramic seal, thermo-overload protection, and leaf strainer. Standard garden hose outlet. 3/4" std. pipe thread inlet. Ideal for many underwater applications, such as in pools, fountains, etc. Pumps gallons per hour: 1300 @ 2 ft., 1030 @ 5 ft., 810 @ 10 ft., 600 @ 15 ft., 300 @ 25 ft. Shut off @ 40 ft. 4.5 amps load. 4¾Hx7"D. 110V 60 cy. AC. With cord. 13 E 89030 Shpg. wt., 9 lbs. Net 41.95

MINIATURE PUMP AND MOTOR

- Powerful—Raises Liquid up to 12 Feet
- High Capacity—1 ½ Gallons per Minute
- Waterproof, Lightweight Construction
- Industrial Quality

3⁹⁸



A motorized, miniature pump for the hobbyist and "Do-it-Yourselfer." Pumps liquids from container to container at the rate of up to 1½ gallons per minute and raises liquids up to 12 feet. Ideal for fountains, water house plants, aquariums, science projects, waterfalls, etc. Pumps water, chemicals, viscous liquids. Requires just 3 to 12 volts DC. Shpg. wt., 1 lbs. 13 E 19037 Net 3.98

TINY TIGER "HUSH TONE" PORTABLE GENERATOR

99⁹⁵

No Money Down*



1 HP MOTOR

- Economical Gas Driven Motor
- 115 A.C. 350 Watts Electric Power 12V D.C. 12 Amps.
- Only 12 lbs.
- Automatic Overload Relief—for Tools, Appliances, Boats
- 12V D.C. for Battery Charging

Model 67—Lightweight, rugged metal construction! Features a 1 hp, 2 cycle Ohlsson & Rice air cooled engine with a high capacity magneto ignition. 6 pint, premixed (24 parts gas—1 part oil) fuel capacity allows operation at full power (6,300 rpm) for 2½ hours. Also features built-in quietness with a larger "Hush Tone" spark arrester muffler. Dual voltage, direct drive Tiny Tiger generator produces up to 350 watts of 115V., AC, and 12 amps of 12V. DC simultaneously for charging auto batteries or starting cars, boats and trucks. Constant voltage within 110-120 volts with an automatic overload relief system. Light enough to carry anywhere (14 lbs.)... small enough to carry in one hand (8½"H x 8½"W x 10¼"L.) Shpg. wt., 15 lbs. 12 E 35522 Net 99.95

HANDY CARRYING CASE

12 E 35514 Shpg. wt., 5 lbs.

Net 9.95

WATERFALL KIT



Only

15⁹⁵

Enhancing waterfall of cascading water constantly recirculated by electric pump. Gallons per hour delivery: 180 @ 1 ft., 140 @ 3 ft.; 100 @ 5 ft.; shut off @ 10 ft. Outlet ¾"; inlet 1/2" pipe O.D. Load; amps. .65; watts 43. No concrete needed; complete with instructions. Kit consists of pump, 8-ft. plastic hose, 7 ft. sealing poly, pump filter. Shpg. wt., 4 lbs. 13 E 89022

Net 15.95

WATER FLOW METER

4⁹⁵

- Automatic Shut-Off For Any Sprinkler
- Non-Corroding
- Up To 750 Gallons Per Setting



Set it, then forget it. The automatic water meter does the rest, shutting-off automatically when sprinkling is completed. Set dial for the degree of sprinkling needed up to 750 gallons. Quickly attached to any standard faucet or sprinkler. Non-corroding heavy duty zinc construction gives years of dependable service. Size: 8x7x3". 12 E 78001 Shpg. wt., 2 lbs. Net 4.95

DELUXE ELECTRONIC INSECT KILLER

Easy To Use... Just Plug-in

- Ideal For Patios
- No Chemicals
- No Sprays
- No Fumes

As Low As **6⁹⁵**



Safe, automatic insect control system with ACTINIC-LITE™ electronic exterminator. Eliminates flying insects such as beetles, gnats, mosquitoes, moths, bees, and flies without the use of insecticides; does not require refills, produce disagreeable odors or harmful fumes. Works continuously anywhere... in or out-of-doors; on porch, patio, around barbecue pit, in the garden. Simple and easy to use... just plug-into any 110 volt AC outlet within 15' to 30' of area to be protected and enjoy the comfort of insect-free living. Engineered to provide years of trouble-free performance and service. Attractive white and green finish. Complete with suspension ring, line cord and plug. Size: 7Hx3¾" Dia. Imported. Shpg. wt., 1 lb. 14 E 21072 Net 6.95

Economy Electronic Insect Killer. Similar to above. Black Finish.

14 E 21080 Shpg. wt., 1 lb. Net 6.95

14 E 21098 Replacement bulb for above insect killers. Net 1.59

* See Page 11 for Full Credit Details on Easy Pay Plan

Perma-Power Liftmaster^{T.M.} Garage Door Openers

Transmitter
Receiver
Motor Control

119⁹⁵
No Money Down*

ECONOMY GARAGE DOOR OPENER

• 1/4 HP Motor—For Doors Up To 16 Ft.
Solid-state garage door opener. No need to get in and out of car in bad weather. Eliminate the physical strain of manual opening and closing. Easily and quickly installed on existing door. Adapts to single or double; sectional or 1-piece; wood, metal, or fiberglass door. Up to 175 lbs. of pulling force; enough to handle most garage doors. Needs only 1½" Headroom between door and ceiling. Garage light is turned on when door is opened; remains on two minutes after door is closed for you to leave garage in safety. Wall mounted receiver with pushbutton for instant stopping, opening or closing door from the inside. Door automatically stops when it hits an object. Streamlined motor housing provides protection against dust and moisture. For 117 VAC, 60 Hz. UL listed. Shpg. wt., 55 lbs.
13 E 82126WXZ Net 119.95
See Listing of Accessories Below



No Need To Get Out Of Car Door Opens Automatically

- With Exclusive "Velvet Glide"
- Gear-Head Chain Drive
- Opens—Closes—Securely Locks Garage Door
- Automatically Controls Garage Door and Lights from Inside Your Car
- Fully Transistorized Transmitter and Receiver with Private Pulse-Tone Coding
- Operates 1-Piece or Sectional Doors

Transmitter
Receiver
Motor Control

149⁹⁵
No Money Down*

DELUXE HEAVY DUTY GARAGE DOOR OPENER

• 1/3 HP Motor—For Doors Up To 22 Ft.
Deluxe, Perma-Power garage door operating system. Easily handles any residential, track guided garage door; metal, fiberglass or wood doors up to 22 ft. wide and 8 ft. high. Only your pulse-tone signal sender can open the door. Gear-head chain drive motor exerts 200 lbs. of push-pull force. Needs only 1½" of headroom space between high arc of door and ceiling. Fully automatic. Built-in light goes on as soon as door starts to open and stays on for approximately two minutes after door closes. If door hits obstruction, it stops automatically. Safety clutch prevents damage. When started again, it will reverse itself. Sender can be carried in pocket, kept in glove compartment, clipped to sun visor or mounted under dash. Motor operates on 117 VAC, 60 Hz. UL listed. Shpg. wt., 65 lbs.
13 E 82118WXZ Net 149.95
See Listing of Accessories Below

ABOVE GARAGE DOOR OPENERS SHIPPED F.O.B. CHICAGO, ILLINOIS. NO C.O.O. SHIPPING CHARGES ARE COLLECTED ON DELIVERY. SEND FULL REMITTANCE OR USE LAFAYETTE'S EASY PAY PLAN.

ACCESSORIES

- Extra transmitter for second car. 13 E 82076 Shpg. wt., 1 lb. Net 19.50
Switch with 2 keys for outdoor location. 13 E 82043 Shpg. wt., ¼ lb. Net 4.50
Outside quick release lock. Used to open door from outside when electricity fails. Shpg. wt., ¼ lb. Net 4.95
13 E 82134 Net 4.95

RADIO CONTROLS FOR ANY DOOR OPENER

- Transistorized Pulse-Tone Coding Receiver and Transmitter
- Up-date or Convert Any Electronically Operated Garage Door Opener to Operate from Your Car

52⁹⁵

No Money Down*

System consists of two units, a transistorized radio Pulse-Tone signal sender and receiver. Operates any electrically controlled door opener up to 100 feet away. Pulse-Tone modulation circuitry gives you complete

security; only your personal, pocket size Pulse-Tone signal sender can trigger the receiver. Installs in minutes. Shpg. wt., 7 lbs.

13 E 82100 Net 52.95

Radio Control for Any Door Opener

Receiver
Transmitter

LUBRI-LIFT

• Dry Spray
Silicone Lubricant
Specially formulated for garage door openers and other moving hardware. Will not collect dust or grease. Won't get sticky or gummy from age or temperature changes. 16 oz. spray can. Shpg. wt., 1½ lbs.
13 E 82142 Net 2.50



CRANKCASE DRAIN PLUG

- Repairs stripped or leaking oil-pan Drains

Oil pan drain plug stops leaks due to stripped or leaking threads. Takes temperatures from minus 70 to +260°F. Resists acid, sludge, water, and gasoline. Shpg. wt., 6 oz.
11 E 36506 Net 1.49



- ### PLASTIC "JERRY CAN"
- Reversible, Self-storage Spout



Lightweight, unbreakable. Improved spout for easy pouring. Has an air vent for free pouring. Built-in carrying handle. One gallon size. Shpg. wt., ¾ lbs.
11 E 38015 Net .99
Three gallon size. Shpg. wt., 1½ lbs.
11 E 38023 Net 1.59
Five gallon size. Shpg. wt., 2½ lbs.
11 E 38031 Net 2.59

10 FT. NYLON TOW CABLE



3⁷⁵

The perfect cable for towing ANYTHING UP TO 5,000 LBS. Constructed of heavy-duty, 1" wide, DuPont Nylon webbing that stretches 25% to take up shocks for smooth, safe towing. Oil, grease and water resistant too! Dual, self-aligning clip attaches to any bumper. Shpg. wt., 3 lbs.
11 E 24023 Net 3.75

AUTOMATIC SIPHON

- Outboards
- Power Mowers

Automatic—safe—simple pump for transfer of gasoline or any liquid. Pump-type siphon works without putting tube to mouth. Just squeeze the bulb to start the flow. Transparent inserts permit view of liquid flowing. Use for any gas engine equipment. Shpg. wt., 8 oz.
13 E 19029 Net 1.29



ACME TIRE PRESSURE GAUGE



1⁵⁹

Accurate mechanic-quality pencil-type gauge. Triple chrome plated finish. 4-sided nylon indicator bar calibrated from 8-40 lbs. in one lb. units. Spring lip holds gauge in pocket. Built-in deflator tip.
11 E 30509 Shpg. wt., 4 oz. Net 1.59

Battery Chargers And Booster Chargers



**LAFAYETTE
BOOSTER CHARGER**

- 50 Amp. Battery Boost Power
- 10 Amp. Battery Charger
- For 6, 8 or 12 Volts

Only 26⁹⁵

Starts cars fast in the coldest weather with automatic 50 amp. boost. Perfect for 6, 8, or 12 volt batteries used in trucks, cars, boats, tractors and other vehicles. Operates as a booster and as a 10 amp. charger. Features include: color coded meter indicates battery condition, charging and booster rate, and correct polarity. Full wave charging circuit, triple density selenium rectifiers, isolated and fully impregnated transformer, and an auto-reset circuit breaker; heavy duty 8' input cord, and heavy duty 6' cables with soldered clamps for full output; acid resistant front panel and baked enamel back and sides. All internal components are plated for protection against corrosion, UL listed. Size: 8Hx5¾Wx6"D.

11 E 01062 Shpg. wt., 13 lbs.

Net 26.95

HY-CHARGE® 2-IN-1 BATTERY CHARGER



- For 6 & 12 Volts
- Automatic Circuit Breakers

4⁹⁵

The Hy-charge battery charger keeps all 6 and 12 volt batteries fully charged for peak performance even at 40° below freezing. Full 1 amp. "safe"

charge rate prevents flacking and plate buckling—Has automatic circuit breakers to prevent overloading. Easy to use—plug the line cord into any 110V outlet, connect the two terminals to battery. Can't overcharge—automatically tapers off. With handle and wall bracket. Size: 5x3½x3". Shpg. wt., 3½ lbs.

11 E 76023

Net 4.95

SCHAUER 6-AMP BATTERY CHARGER



- For 6 & 12 Volts
- Built-in Meter
- Automatic Circuit Breaker

12⁵⁰

Model B-6612 charges both 6 and 12 volt batteries at a 6-amp rate. Will recharge the average battery in from 3 to 7 hours. Charger is equipped with an automatic circuit breaker for overload protection. Selector switch changes operation from one voltage to another, and an accurate numeral dial ammeter shows the exact rate of charge. Case is of rugged steel. Complete with battery cables 117 VAC., 60 Hz. UL Listed. 9¾x6x6½".

11 E 55183 Shpg. wt., 9 lbs.

Net 12.50

SURE-FIRE 8-AMP AUTOMATIC BATTERY CHARGER WITH 6-HOUR TIMER



- For 6 & 12 Volts
- Colored Meter—Automatic 6-Hour Timer
- Trickle Charge

22⁹⁵

Automatic timer can be set from 5-min. to 6-hrs. After timer shuts-off, charger automatically into a trickle charge cycle which keeps battery fully charged. Uses selenium rectifiers and features automatic circuit breakers. Color meter shows rate of charge. With 6' power cord, 50-amp clips attached to battery cables. 117 VAC. 10x6½x7½". UL Listed. Shpg. Wt., 15 lbs.

11 E 76072

Net 22.95



SURE-FIRE BOOSTER CHARGER

- 100-Amp. Battery Boost Power 6, 8 or 12-Volts,
- 10 Amp. Battery Charger
- Trickle Charger

As Low As **36⁹⁵** No Money Down*

Model WS-100-10. Get that extra "punch" needed to get your battery started in cold weather!

Provides 100 amp. booster power, 10 amp. and trickle charging for 6, 8 or 12-volt batteries. Ammeter indicates changing current. Features full wave rectifiers, heavy-duty transformers and an automatic reset circuit breaker. Push-button control panel with reverse polarity indicator light is enclosed in a rugged steel case with a baked wrinkle finish. Steel carrying handle also stores the heavy-duty input cord. U.L. Listed. Size: 12x7x9". Shpg. wt., 20 lbs.

11 E 76098

Net 36.95

Model WS-200-20 similar to above but with extra heavy-duty 200 amp. boost power, 20 amp. charger with trickle charge. For 6, 8 or 12 volts. Size: 12x9x9". Shpg. wt., 30 lbs.

11 E 76106WX No Money Down*

Net 49.95

SURE-FIRE 3-AMP BATTERY CHARGER

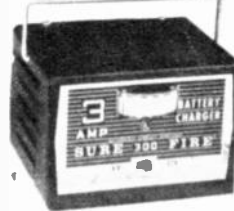

8⁵⁰

- For Both 6 & 12 Volts
- Built-in Meter
- Automatic Reset Breaker

Full 3-amp battery-charger for quick starts in all weather. Edge view colored meter shows actual

rate of charge and indicates battery condition. Reset circuit breaker gives automatic overload protection. Has 6 and 12 volt selector switch. Delivers tapering charge. Vented steel case; may be wall mounted. 6 ft. battery leads with 50 amp clips. Size: 6 x 4½ x 5¾". For 105-125 Volt. 60 Hz AC. UL Listed.

11 E 76049 Shpg. wt., 5 lbs.

Net 8.50

SCHAUER

10-AMP BATTERY CHARGER



- For 6 & 12 Volts
- With Meter
- Automatic Circuit Breaker

16⁵⁰

Model C-6612. Heavy-duty 10-amp charger for 6 or 12 volt battery, which will bring the battery to full charge in 2 to 6 hours or less. Equipped with an automatic circuit breaker for overload protection. Selector switch for changing voltage. Accurate ammeter shows rate of charge entering battery. Rugged steel case with gold colored finish and two-tone brushed aluminum. Complete with cables. 117 VAC, 60 Hz. Shpg. wt., 12 lbs.

11 E 55191

Net 16.50



terado TRAV-ELECTRIC 74¹⁹

Self-Contained Power Supply with Battery and Automatic Recharger

- Delivers 117 Volts 60 Hz A.C. At 125 Watts Continuous
- 3 to 4 hours of Portable T.V. Operation on One Charge

Hundreds of uses: Operates TV's, power tools, barbecue motors, lights, hedge clippers, or appliances using 117V., 60 Hz AC. Has self-contained 30 amp. rechargeable wet storage battery. Frequency stable within ½ cycle with load changes. Plugs into AC outlet, or, car cigarette lighter to recharge battery. Has automatic overcharge protection. Meter shows charge rate and hours of anticipated output. Size: 12x5½x8". Shpg. wt., 36 lbs.

11 E 63161WX No Money Down*

Net 74.19

terado - C-D- TRIPP LITE Inverters

AS LOW AS
39⁸⁷

- Transistorized
- 110 Volt AC Electricity From Your 12 Volt Battery



Compact and convenient power inverters. Converts 12VDC to 110V 60 cycles AC. †Features frequency regulation $\pm 1/2$ cycle with changing input load and voltage. Ideal for tape recorders. ‡With remote control.

Stock No.	Mfr. No.	Watts Cont.	Watts Interm.	Size	Shpg. Wt. Lbs.	Net
11 E 63013	50170	125	150	10 $\frac{1}{4}$ x 6 x 6	9 $\frac{1}{2}$	39.87
11 E 63153	50205	140	175	10 $\frac{1}{4}$ x 6 x 6	9 $\frac{1}{2}$	46.94
11 E 63195	50129	275	300	6 x 6 x 12 $\frac{1}{2}$	20	78.15
11 E 63203	50128	450	500	6 x 6 x 12 $\frac{1}{2}$	20	97.17
11 E 63237WX†	50201	150	175	10 $\frac{1}{4}$ x 6 x 6	20	100.51
11 E 63245WX†	50200	175	200	10 $\frac{1}{4}$ x 6 x 6	21	114.53
11 E 63252WX‡	50191	275	300	10 $\frac{1}{4}$ x 6 x 6	30	158.40

TERADO "HASH-FREE" DC-to-AC INVERTERS



- 110 Volt Home Electricity Anywhere

Vibrator type inverters. All have automatic frequency control. Convert 6 or 12 volts DC to 110 volts, 60 cycle AC. Frequency regulation $\pm 1/2$ with changing input load and voltage. Filtered, ideal for use with tape recorders. Converters are equipped with cigarette lighter plugs or for direct connection to battery in case of larger voltage units. †Less handle—with mounting bracket. ‡Remote control has variable AC output switch signal light.

Stock No.	Mfr. No.	DC Input	Watts Cont.	Watts Interm.	Size	Wt. Lbs.	Fig.	Net
11 E 63054	50115	6	35	40	2 $\frac{1}{2}$ x2 $\frac{1}{2}$ x4 $\frac{1}{2}$ "	3	A	18.47
11 E 63062	50116	12	40	50	2 $\frac{1}{2}$ x2 $\frac{1}{2}$ x4 $\frac{1}{2}$ "	3	A	18.47
11 E 63070	50126	6	60	75	4x5x6"	8	C	38.47
11 E 63088	50127	12	75	100	4x5x6"	8	C	38.47
11 E 63096†	50137	6	75	100	4x5x6"	9 $\frac{1}{2}$	C	53.90
11 E 63104†	50138	12	100	125	4x5x6"	9 $\frac{1}{2}$	C	53.90
11 E 63120‡	50153	12	175	200	5x5x11"	22	B	84.07

TERADO "DYNAMO" DC TO AC INVERTER

Operate any small radio in any 12 volt car, truck, boat or trailer. No installation—just plug into cigar lighter. Operate electric shaver or any electric appliance up to 25 watts. With generator condenser and ignition noise suppressor. Size: 2 x 2 x 3 $\frac{1}{4}$ ".
11 E 63179 Shpg. wt., 2 lbs. Net 13.00



TRAV-ELECTRIC "AUTO-SHAVER"

Operates all electric shavers. Plugs into cigarette lighter. Polyethylene non-breakable case. Size: 3 $\frac{3}{4}$ "W x 2 $\frac{1}{4}$ "D x 4 $\frac{1}{4}$ "H. 6 volt 10-15 watts, 12 volts 15-20 watts. Shpg. wt., 2 lbs.
11 E 63039 6 Volt Net 11.85
11 E 63047 12 Volt Net 11.85

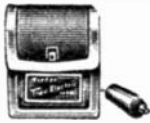

CORNELL DUBILIER DC TO AC INVERTER

Only **42⁹⁵** No Money Down*

- Delivers 125 Watts Continuously
- Features "Hash Free" Filtering For Interference-Free Reception



Ideal for cars, boats, house trailers, campers, etc., as a source of AC power independent of power lines. Converts 12 volts DC to 110-120 volts AC at 60 Hz. Designed primarily for television receivers, tape recorders, phonographs and other frequency sensitive devices. Specifications: Input: 12 volts @ 12 amperes (full load); Output: 120 watts continuous, 140 watts intermittent; RF Filtering: both input and output; Size: 8 $\frac{3}{4}$ "x7 $\frac{1}{2}$ "x3 $\frac{3}{4}$ "H. Shpg. wt., 16 lbs.
11 E 16256W Net 42.95

Model MK-3544-4 Mounting Kit—Heavy flanged plate for bulkhead or floor mounting. Includes hardware and instructions.
11 E 16264 Shpg. wt., 2 lbs. Net 3.60

TRIPP LITE 150-WATT TRANSISTORIZED INVERTER

- Delivers 150 Watts Continuously
- Provides Household Current Anywhere
- Fused to Protect Battery

34⁹⁵

NO MONEY DOWN

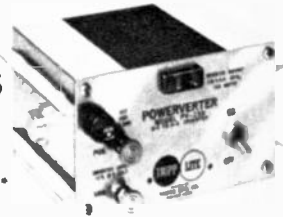

Model PV-150

A low-cost transistorized inverter which changes 12-volt DC to 115-volt 60 Hz AC. Delivers 150-watts continuously; 175-watts intermittently for shavers, recorders, radios, TV and many other appliances. Has on-off switch and replaceable fuse. Rugged construction. Size: 5 x 5 x 3 $\frac{1}{2}$ ". Shpg. wt., 5 $\frac{1}{2}$ lbs.
11 E 89505 Net 34.95

100 WATT TRANSISTORIZED INVERTER

29⁹⁵

- Converts 12 Volt DC to 115 Volt AC
- Delivers 100 Watts Continuously
- Plugs In to Lighter

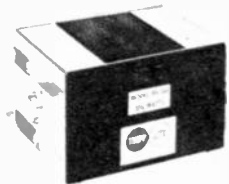

Model PV-100. Designed to give instant AC power where fast emergency service is needed. Lightweight, low-cost inverter converts 12 volts DC to 115V., 60 cycles AC; delivers 100 watts continuously. Specifically engineered to power televisions, and tape recorders in cars, boats, planes, or mobile homes. Incorporates 2-power switching transistors. Complete with cigarette lighter plug, and standard AC outlet. Size: 4 $\frac{1}{2}$ x 4 $\frac{1}{2}$ x 3". Shpg. wt., 5 lbs.
11 E 89547 Net 29.95

TRIPP LITE ALL SOLID STATE POWERVERTERS



Model PV-200-B Model PV-450-B

- Combination Power Inverters and Battery Chargers
- Model PV-200-B—200-WATT INVERTER, 6 AMP BATTERY CHARGER.** Converts 12-volt DC to 115-volt 60 cycle AC, delivers 200 watts continuously, 250 watts intermittently. 4 power transistor circuitry for oover boost. Battery charger is rated 6 amp, has automatic control which tapers current down to prevent overcharging. Size: 3 $\frac{1}{2}$ x 5 x 5" Shpg. wt., 5 $\frac{1}{2}$ lbs. Net 49.95
11 E 89513 No Money Down*
- Model PV-450-B—450 WATT INVERTER, 10 AMP BATTERY CHARGER.** Rugged, heavy-duty inverter with 450-watt continuous output, 500 watt intermittent. 10 power transistors; hash-free TV, AM-FM reception. Battery charger rated 10 amp, ampere meter for both inverter and battery charger use. Pilot light warns against overloading. Built-in rack handles. Size: 5 $\frac{1}{2}$ "x9 $\frac{1}{2}$ "x10". Shpg. wt., 14 lbs. Net 99.50
11 E 89534 No Money Down*

TRANSISTORIZED BATTERY INVERTER-CHARGER

- Combination 300 Watt Power Inverter and 20 Amp. Battery Charger

Only **59⁹⁵** No Money Down*



Inverter is rated at 300 watts continuous, and 400 watts intermittent output. Ideal for radios, TV, ham gear, electronic test equipment, hi-fi and stereo components, vacuum cleaners, electric shavers, etc. Fully rated battery charger has three charging rates; 20, 10, and 3 amperes. Unit features: metered inverter input and output; metered charger output; fully transistorized circuitry with fused overload protection; high efficiency heat sink; pushbutton control panel, and a vented steel case with carrying handle. Comes complete with 6' AC power cord and 8' battery cables with clips. Overall size: 12x7x9". UL listed. Shpg. wt., 23 lbs.
11 E 76114WX Net 59.95

LAFAYETTE Automotive Test Equipment

6½" DWELL
TACHOMETER

3½" DWELL TACHOMETER

28⁹⁵

- Tunes up Electronically, Any Car Ever Made
- Three Dwell Scales
- Giant 6½" Easy-to-Read Scale
- Use to Adjust Carburetors
- Use to Adjust Points

Made in U.S.A.



16⁹⁵

- Tune Up Electronically Any Car Ever Made
- 3½" Double Jeweled D'Arsonval Meter
- For 4, 6 or 8 Cylinder Engines
- For 6 or 12 Volt Systems
- Point Resistance Check

Made in U.S.A.



A complete ready-to-use Dwell Meter and Tachometer which will operate on any car ever made. Tests cam dwell angle and engine RPM on 4, 6 or 8 cylinder cars, 6 or 12 volt right on the engine. Giant 6½ easy-to-read meter makes it simple for anyone to adjust points and carburetors to insure maximum gas economy and quiet engine running. RPM readings are also essential to properly service automatic transmissions. Three dwell angle scales are provided: 0 to 45 degrees, 0-60 degrees, and 0 to 90 degrees. This instrument is suitable for dwell angle adjustment on all foreign and domestic cars. Dual range tachometer 0 to 1000 rpm for precise carburetor adjustments. 0 to 5000 rpm, suitable for making all other tests at high engine speeds. Complete with instruction manual. Shpg. wt., 4 lbs.

11 E 01013W

Net 28.95

Electronically tune your car! This Dwell-Tachometer permits setting the carburetor for maximum efficiency, gas economy and greater power; indicates the correct point gap setting electrically (even if the points are pitted or corroded); permits setting points with the distributor cap off and engine cranking, and permits setting points on "Window" distributors with engine running. It also locates defective spark plugs; permits correct engine RPM setting for automatic transmission adjustments, throttle linkage and idle adjustment. RPM scale: 0-3000; 8-cylinder dwell: 5-45°; 6 cylinder dwell: 20°-60°. 4 cylinder reading obtained by doubling 8 cylinder scale reading. Two-color scale. Small and compact—measures only 6¼x3¾x2". Complete with instruction manual. Shpg. wt., 2 lbs.

11 E 01054

Net 16.95

PROFESSIONAL DC-POWER TIMING LIGHT



- Ultra-Brite Xenon Strobe Tube

Chrome finished DC-power timing light. The ultimate in a mechanic's light. Ultra-brilliant blue white Xenon strobe tube light for day or night use. Insures maximum light. Rugged case; designed for operator to reach inaccessible timing marks. Simple replacement of xenon bulb. For 6 and 12 volt battery. On/Off Switch. Shpg. wt., 2 lbs.

11 E 42405 Net 22.95

PROFESSIONAL AC-POWER TIMING LIGHT

Deluxe 110 volt AC power timing light. Uses ultra-brilliant white xenon strobe tube. For day or night use. Plugs into any 110 volt AC line, insures maximum light regardless of condition of vehicles battery. Rugged black case with power cord and On/Off switch. Shpg. wt., 1½ lbs.

11 E 42397

Net 12.95



TUNE UP KIT

10⁹⁵

- Tunes Engine For Maximum Efficiency
- For Accurate Ignition Timing of Any Engine

A complete kit to tune up the important systems of your car, truck or marine engine. Permits maximum efficiency for more economical operation. Kit includes compression tester, vacuum fuel pump tester and deluxe timing light with remote starter switch. Compression tester locates valve, ring, piston and cylinder troubles. Big 2½" dial is calibrated 0-300 lbs. pressure. Vacuum and fuel pump tester checks pressure and suction of fuel pump and vacuum system. 2½" dial calibrated in 0-30 inches and 0-3 lbs. Comes with rubber tubing for easy connections. Brilliant prefocused timing light features remote starting switch. For 6, 12 or 24 volt systems.

11 E 42090 Shpg. wt., 5 lbs.

Net 10.95

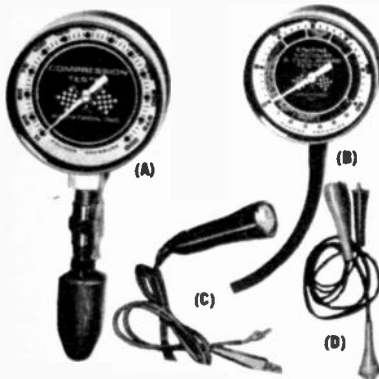

(A) COMPRESSION TESTER shows worn or defective rings, pistons and cylinders. Easy-to-read 2½" dial, calibrated from 0-300 lbs. Has offset stem and rubber nose cone to fit all spark plug holes.

11 E 42074 Shpg. wt., 12 oz. Net 2.99

(B) VACUUM and FUEL PUMP TESTER indicates worn or faulty parts in fuel pump or vacuum system. Easy to read 2½" dial matches dial on compression tester, calibrated from 0-30 inches vacuum and 0-7 lbs. for pressure. Aids in setting timing, adjusting carburetor or tuning motor.

11 E 42066 Shpg. wt., 12 oz. Net 3.19

(C) STANDARD TIMING LIGHT gives brilliant light for precision setting of ignition timing. With oil-and-gas resistant leads.

11 E 17050 Shpg. wt., 1 lb. Net 2.99

(D) REMOTE STARTER SWITCH permits operation of starter and turning over of engine from outside of car when adjusting points, valves, testing compression, etc.

11 E 17027 Shpg. wt., ½ lb. Net 2.39



5⁹⁵

TIMING LIGHT WITH REMOTE STARTER

Deluxe neon prefocusing light. Cranks engine from the outside—checks points, bearings and tappets. The remote starter is also useful in testing the fuel pump, generator, compression and electrical system. For 6, 12 or 24 volt systems. Shpg. wt., 1½ lbs.

11 E 42002

Net 5.95

COMPLETE SOLID-STATE ENGINE ANALYZER

For All Electrical Systems 6, 12, 24 or 32 Volt
—Regular, Transistorized or Magneto Ignition,
8, 6 or 4 Cylinder 4 or 2 Cycle Engines.

ONLY
49⁹⁵

- Large 6" D'Arsonval Double Jeweled Meter
- Do-It-Yourself Instruction Book

No Money Down*



Solid-State Engine Analyzer Will Test:

- Dwell or Cam Angle
- Measure Engine Speed
- Adjust Carburetors
- Adjust Points
- Check Condensers
- Check Coil Resistance
- Measure Carbon Suppressor Spark Plug Cables
- Check Batteries
- Test Alternators, Generators & Regulators
- Check Shorts & Opens in Wiring
- Checks All Lamps, Fuses, Relays & Switches
- Check Diodes

Performs "FIFTEEN" authoritative tests under actual operating conditions! Tests output voltages in three separate ranges: 0-3.2, 0-16, 0-32 VDC. Determines the condition of batteries, battery cables, spark plug wires, coil wire, solenoids and starter motors. Permits precise setting of distributor points (cam-dwell angle) and test centrifugal advance mechanism on three scales: 0-45° for 8-cylinder, 0-60° for 6-cylinder, and 0-90° for 4 cylinder. RPM scales allow precise setting of carburetor air/fuel mixture and engine RPM in four separate scales: 8 or 6-cylinder (low) 0-1,200, (high) 0-6000; 4-cylinder (low) 0-2400, (high) 0-12,000. Measures amps from -5 to +90. Resistance scale from 0-100,000 ohms. High voltage coil and spark test scale from 0-30,000 volts. Operates on single "D" cell battery. Complete simple operating instructions allows anyone to use this instrument to its full capabilities. Detailed information supplied by make and model. Rugged steel case finished in baked enamel. Rear storage compartment holds 5½' leads, clamps, plug jacks and connectors. Size: 12x6½x6". Shpg. wt., 10 lbs.

11 E 24502 Net 49.95
99 E 62564 Battery For Above Net 1.15

BATTERY CELL TESTER

Accurately test batteries in or out of car. Locates weak cells quickly and indicates battery condition at a glance. Special alloy shunt between adjustable legs places 200 amperes (equivalent to average breakdown voltage of battery) load on battery during test. Rugged, modern molded grip design with large 3-color dial that reads: Bad, Weak and Good. Complete with instructions. Shpg. wt., 1½ lbs.



11 E 17076 Net 4.95

PRECISION IGNITION POINT SETTING TOOL KIT

Set points without finding high spot on cam or removing distributor. Even does dual points in one operation. Includes 5-micro-precision rings with feeler gauges, adapters, and tool for hex-wrench GM points. List of popular cars displayed inside cover of box. Shpg. wt., 8 oz.



11 E 31507 Net 4.95

ALL-ELECTRONIC MOTOROLA ALTERNATOR SYSTEM

As Low As **54⁹⁵**

- All-Transistor Voltage Regulator and 7-Diode Alternator
- Extends Battery Life
- Guaranteed For 3 Years (or 30,000 Miles)*



Low cost solution to the heavy demands made by your car on its electrical system. Unlike D.C. generators, it supplies a charge at idle speeds and keeps the battery at a uniform high level of charge. The all-transistor voltage regulator has no contact points to stick or burn. Fits all domestic cars with 12-volt, negative ground electrical systems. The complete system includes: Alternator with standard-size pulley; all-transistor regulator (with all connecting wires); universal mounting bracket; instructions for installation.

11 E 75017 35-Amp. (wt. 12 lbs.) Net 54.95

11 E 75025 40-Amp. (wt., 13 lbs.) Net 57.95

11 E 75033 55-Amp. (wt., 15 lbs.) Net 61.50

Manufacturer's guarantee covers repair or replacement of parts proven defective in normal use within 3 years or 30,000 miles (whichever occurs first).

AUTOMATIC DIRECT-READING TACH-N-DWELL

29⁹⁵



- Tune-Up Electronically Any Car Ever Made
- Dual Meter Lets You Read Engine Speed & Dwell Angle Simultaneously

Now! In seconds detect problems in the primary ignition circuit that cause slow starting, rough idling, excessive gasoline consumption, poor acceleration and sluggish high speed passing. Makes simultaneous tests of dwell and RPM; lets you perform professional electronic tune-ups on both 2 and 4 cycle engines. Operates on 6, 12 or 24 volt systems. Front panel features two (one for Dwell; one for RPM) large 4½" double jeweled D'Arsonval meters with color-coded meter faces for easy, accurate readings—three tach ranges, plus three dwell ranges provide all the necessary ranges for virtually every engine. Self-contained solid-state circuitry eliminates adjustment and burn-out. Complete with carrying handle, color-coded test leads. Housed in sturdy steel cabinet with baked enamel finish. Size: 12¾ x 6¼ x 4¾".

11 E 24510 Shpg. wt., 5 lbs. Net 29.95

DIXON ENGINE ANALYZER

- Tests: Engine RPM—15⁹⁵
Ignition Points—
Cam Dwell—Alternator
Regulator—
Carburetion

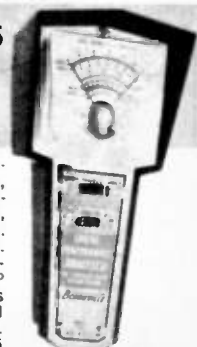

Versatile, compact hand-held tester combines three vital instruments: Tachometer, dwell meter and voltage meter. Allows accurate checks on condition of ignition points, alternator, generator, cables and connection. Reads engine RPM and cam dwell angle. Scales: 0-1200 RPM (8-cyl.), 0-1600 RPM (6-cyl.); 0-2 and 0-20 volts; 0-45° and 0-60° dwell and points resistance indicator. Works on 4, 6 or 8 cyl., neg. or pos. ground. Dual switch permits testing from one connection.

11 E 21524 Shpg. wt., 2 lbs. Net 15.95

* See Page 11 for Full Credit Details on Easy Pay Plan

Lafayette Cat. No. 700 367

Capacitive Discharge Ignition System

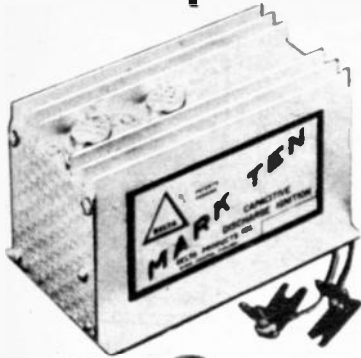

39⁹⁵ With Silicon Controlled Rectifier

No Money Down* • Quick, Easy Installation • Constant Spark to 10,000 RPM
Down* • Extremely Low Input Power—Less Load On The Engine

Combines all the advantages of capacitive discharge with those of solid state circuitry. Patented circuitry eliminates point bounce problems and positively fires plugs regardless of point condition. Fast rise time spark prevents fouling from three to ten times. Point contacts last indefinitely. Eliminates mis-firing, reduces oil contaminants, prolongs engine life. Provides smoother and more efficient operation at all speeds; constant spark up to 10,000 RPM; with dramatically improved acceleration and economy. Provides faster, easier starting in all weather. Reliability and performance proven

on thousands of military, commercial and private vehicles from Alaska to Cape Town. Unit operates with all commercial and original equipment tachometers. Installs immediately with two simple connections to the existing coil, leaving the standard system intact. No temperature limitations—mounts anywhere. Requires only a very small amount of input power—reduces load on engine and electrical load. For 12 volt negative ground system only. Shpg. wt., 2½ lbs.

11 E 84506

Net 39.95

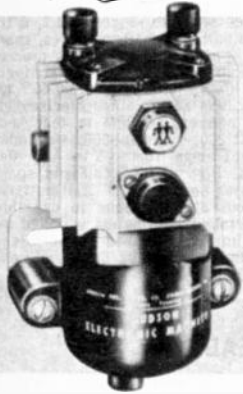

ELECTRONIC MAGNETO IGNITION SYSTEM

- Quick, Easy Installation • Silicon Transistor System
- Reduces Fuel Consumption

39⁹⁵

No Money Down*

Positively improves performance! Like a mechanical magneto used on racing cars, the electronic magneto provides a minimum of 30,000 volts with the fastest rise time of any system available. Like having a permanent tune-up; doubles plug and point life, gives 2 to 6 miles more per gallon, allows instant starts in sub-zero weather... even with heavy carbon deposits and fouled plugs, helps your engine to develop its highest potential horsepower under any conditions. Operates on 6 or 12 volt systems; single or dual point. Will not interfere with operation of radio, electronic or ignition test equipment. Uses a silicon transistor... is fully protected by zener diodes. Completely sealed against water and corrosion. Simple installation by transferring wires from present coil to the magneto and connecting an additional wire to ground and you're ready to go! Size: 7½ x 3½". Shpg. wt., 3½ lbs.
11 E 35508 No Money Down* Net 39.95

MOTOROLA CAPACITOR DISCHARGE IGNITION SYSTEM

Only 56⁹⁵

No Money Down*

- With Silicon Controlled Rectifier
- Extends Point And Plug Life
- Quick Easy Installation



A complete ignition modernizing kit giving your car the added efficiency and economy of electronic switching. Operates by a simple connection to the existing coil and distributor breaker point. For any number of cylinders. The "CDI 12" features a capacitor discharge current and higher constant voltages for maximum combustion and improved miles per gallon. The heavy-duty mounting unit is epoxy coated for moisture and dust-proofing. Fully sup-

ported for excellent radio reception. Installation is simplified by damage proof circuit protected from reverse polarity or open secondary leads. Shorter, more powerful sparks at plugs increase combustion, reduce plug wear, increase engine life many times. Overall increase in performance, acceleration and gas mileage. Designed for cars with 12-volt negative ground systems. Shpg. wt., 3 lbs.
11 E 75068 Net 56.95

LECTRA-SCOPE ENGINE ANALYZER



4⁵⁰

- Tests Ignition & Engine Performance

Shows what's going on in any 6 or 8 cylinder engine. Individual lights for each plug... glows with each spark. Steady glow all o.k.; weak flickering light shows dirty contacts, wasted gas; bright light shows heavy engine load, dragging brakes. Installation instructions. Shpg. wt., 1 lb.

11 E 78502 8 Cylinders Net 4.50
11 E 78510 6 Cylinders Net 4.30

DELUXE 270° OIL PRESSURE GAUGE/AMMETER



9⁹⁵

- Gauges Tilt In Any Direction
- Internal Lighting—Lights The Gauges
- Separate Black and Walnut Panel Inlays Supplied

Attractive two in one oil-ampere gauge console. Large, illuminated 2" dials tilt in any direction. 270° full swing oil pressure gauge with precision geared brass bourdon tube movement detects trouble before it occurs... not after. Reads pressure accurately 0-80 lbs. psi. Sender units has a universal ¼ PT connector. Ammeter gives accurate current readings for all generator or alternator equipped cars. Shows rate of charge or discharge from 60-0-60 amperes. Shpg. wt., 1½ lbs.
11 E 42439 Net 9.95

DELUXE 270° OIL/WATER GAUGES/AMMETER



17⁹⁵

Custom panel of three illuminated 2" gauges that tilt in any direction. 270° full swing oil pressure gauge with precision geared brass bourdon tube movement reads accurately from 0-80 lbs. psi. Ammeter gives accurate charging rate of both generator and alternator systems from 60-0-60 amps. 270° full swing mechanical water temperature gauge also features a precision geared brass bourdon tube movement. Reads 100°-220° F. Complete with 72" capillary tube and adapter. Shpg. wt., 2 lbs.
11 E 42447 Net 17.95

"CUSTOM RALLY STYLED" Auto Gauges



15⁹⁵

SOLID-STATE ELECTRONIC TACHOMETER

- Heavy Chrome Die Cast Case
- Shift Set Needle
- 0-8,000 RPM • 6 or 12 Volts

An attractive 3 1/4" illuminated black and white face tachometer with precision 0-8000 RPM scale and adjustable shift indicator. Factory calibrated solid-state circuitry and durable, vibration-proof chrome zinc die cast construction assure steady, accurate readings throughout the entire range. Can be used with transistor ignition systems. Has 360° universal mount 1 1/2" slim line case for easy dash mounting on compacts or on steering wheel column. Comes complete with installation kit. For 6 and 12 volt positive or negative ground. Shpg. wt., 2 lbs. 11 E 42330 For 8 Cylinders Net 15.95 11 E 42348 For 6 Cylinders Net 15.95



21⁹⁵

3 1/4" TRANSISTORIZED TACHOMETER

- For 4, 6, or 8 Cylinder — 0-8,000 RPM
- Deluxe Chrome Die Cast Case
- Convenient Shift Set Needle

Rugged, precision engineered Tach features low power drain transistor circuitry, black and white illuminated dial face, and handsomely styled 3" long vibration-proof chrome die-cast housing. Tach also boasts a built-in shift set needle, adjustable steering column ring, and 360° universal mount. Will operate with transistor or regular ignition systems, 6 or 12 volt positive or negative ground. Easily mounted on or under dash, on console, or on steering column. Reliable indication permits better use of engine power—2 must for the demanding driver. Shpg. wt., 2 1/2 lbs. 11 E 42413 Net 21.95

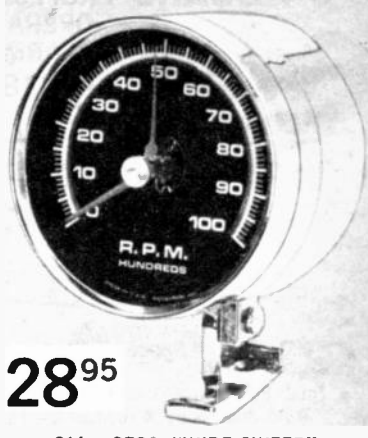

28⁹⁵

3 1/4" 270° "WIDE-SWEEP" TRANSISTORIZED TACH

- Precision 0-10,000 RPM Scale for 6 or 8 Cylinder

Our finest tachometer features a wide sweep 3 1/4" illuminated black and white scale, precision D'Arsonval movement calibrated to 2% accuracy, and a shift set needle with 270° swing. Equal divisions between graduated markings for pin-point accuracy over the entire range. This handsomely styled instrument is virtually unaffected by vibration. Has deluxe 3" long chromed zinc die cast housing and 360° universal mounting for dash, console, or steering column mounting. For transistor or regular ignition systems at 6 or 12 volt positive or negative ground. Shpg. wt., 2 1/2 lbs. 11 E 42363 Net 28.95

GAS SAVER VACUUM GAUGE

Only
12⁹⁵

- Automatically Shows Miles Per Gallon
- Chrome Die Cast Case



DELUXE 3 1/4" TWIN VACUUM GAUGE. Automatically shows miles per gallon. Saves up to 40% of your gasoline dollars by showing you how to drive for the best economy or power. Checks your engine constantly by measuring its manifold pressure on a clear, four color illuminated dial. With 360° universal mounting, zinc die cast case, T-connector, 6 ft. vacuum tubing, steering column mount ring and instructions. Fits any car. 11 E 42058 Shpg. wt., 2 1/2 lbs. Net 12.95

(A) AMMETER & OIL PRESSURE GAUGES

The ammeter calibrated in a 60-0-60 scale. Exact oil pressure from 0 to 80 lbs. is indicated. Easily installs in any 6 or 12 volt car without drilling. 1 3/4" diam. black dial faces with calibrations in white. Size 5 1/2 x 2 7/8 x 2 1/8". Supplied with 6 and 12 volt bulbs and wire, all necessary fittings plus full instructions. Imported. Shpg. Wt., 1 1/2 lbs. 99 E 85011 Net 4.95 11 E 80041 T Fitting Net .49

(B) WATER TEMPERATURE GAUGE

Heavy-duty vapor tension thermometer which indicates from 100 to 220 degrees fahrenheit on a 2" diameter dial. Has 72" of armored capillary tubing with 1/2" male pipe thread adapter. Includes mounting bracket, 6/12-volt illuminating kit, hardware and instructions. Imported. Shpg. wt., 2 lbs. 99 E 85060 Net 3.95

DELUXE 3 1/4" GAUGE AMMETER WATER-OIL PRESSURE

As
Low
As
15⁹⁵

- All Electric—No Tubing

End guess work and space problems with this beautiful three-in-one gauge. Illuminated dial face gives accurate individual readings of oil pressure, amperage, and water temperature. Amp. gauge reads —60 to +60, oil pressure registers 0 to 80 lbs., and water temperature is indicated from 100° to 220°. Fits all 12 volt negative or positive ground alternator or generator electrical systems. Handy 360° universal mount and durable chrome zinc die cast case. Supplied with wire, adjustable mounting ring, and senders. 11 E 42033 Shpg. wt., 2 1/2 lbs. Net 19.95

OIL AND AMMETER GAUGE—Similar to above, less water temp. gauge. 11 E 42041 Shpg. wt., 2 lbs. Net 15.95

LAFAYETTE ILLUMINATED AUTO GAUGES

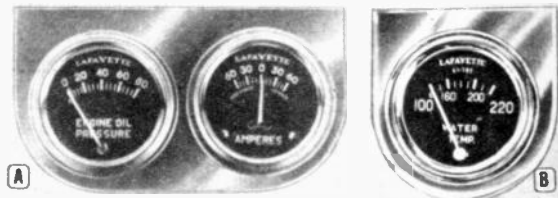

Automotive Theft Protection Devices

ON-GUARD PROFESSIONAL SIREN-OPERATED BURGLAR ALARM

27⁸⁸

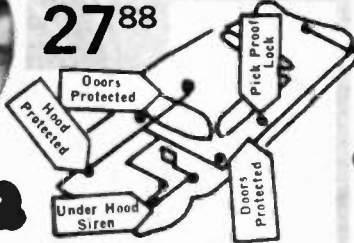

- Loud, Police-type Siren Gives 3-Way Protection—All Doors, Trunk and Hood • Complete—Easy To Install
- Pick-Proof On-Off Key Lock Mounts on Outside of Auto

Get 24-hour protection on your car, station wagon or truck with this complete burglar alarm system. The sharp penetration sound of the police-type siren will scare thieves away. The siren blasts off when anyone opens a door, the hood or trunk. The alarm can be shut off only with the alarm key. Complete system includes deluxe spun-aluminum siren with trumpet, 4 door switches, hood switch, trunk switch, 2 brackets, electrical lock with 2 keys, wire, mounting hardware, instructions and 2 warning decals. For 12-volt cars only. 11 E 62015 Shpg. wt., 3 lbs. Net 27.88

ON-GUARD HORN BURGLAR ALARM



As Low As

6⁸⁸

- Sounds Car Horn When Entry Is Forced
- Protection For All Doors, Trunk, and Hood
- Pick-Proof ON/OFF Key Lock Mounts on Outside of Auto

Protect your car, wagon, truck 24 hours a day. Easy to install auto alarm system activates when anyone opens a door, the trunk, or hood. When an entry point is opened a shrill sound of the vehicle horn will be heard. The alarm will not be silenced by closing the point of entry. Can be shut off only with the alarm key. System includes six alarm activator switches, lock, 2 keys, 2 relay switch unit, wire, mounting hardware, and simple instructions. Shpg. wt., 2 lbs. 11 E 62023 Net 6.88

PULSATING HORN BURGLAR ALARM

Similar to above except when an entry point is opened, a "Vibrating Shrill Beeping" pulsating sound of the vehicle horn will be heard. 11 E 62031 Net 9.88

ON-GUARD WHEEL LOCKS

6⁹⁵

Set of 4

Extra heavy chrome-plated wheel locks. Protects costly custom "Mag" and standard wheels against theft. Wheel locks look like regular lug nuts but can only be removed with key. Set consists of 4 locks—one lock per wheel.

FITS THE FOLLOWING CARS

Chev. 46-69 Chevy II 62-69 Buick 64-69
Camaro 67 Corvair 60-69 Firebird 64-69
Chevelle 64-69 Corvette 53-69 GTO 64-68
Olds F-85 64-69 Tempest 64-69
For Standard Wheels, Set Of 4 With 2 Keys.
11 E 62049 Shpg. wt., 1 lb. Net 6.95
For "Mag" Wheels, Set Of 4 With 2 Keys.
11 E 62056 Shpg. wt., 1 lb. Net 6.95

370 Lafayette Cat. No. 700

AUTO BURGLAR ALARM

Only
19⁹⁵



- Loud Siren Gives Fool Proof Protection To Doors, Trunk, and Hood
- Pick-Proof Key Lock Mounts on Outside of Auto

A heavy-duty siren with large 4 1/2" rotor constructed of DuPont Delrin for loud piercing sound output with less current drain. System helps prevent break-in, pilferage, damage, and inconvenience. Activator switches protect all access openings including trunk and hood. Can be wired to sound when emergency brake is released. Automatically flashes interior light on when alarm sounds. Instantly discloses violation and remains on until manually reset by pick proof lock switch. Great for cars, wagons, trailers, trucks, and vans. Supplied with relay switch unit, six alarm activator switches, wire, terminals, screws, in-line fuse, and pick-proof key lock with two keys.

11 E 89034 Shpg. wt., 5 lbs.

Net 19.95

CAR HOOKLOCK ANTI-THEFT DEVICE

Only
9⁹⁵

- Locks Steering Wheel and Pedal
- No Wiring—No Fitting

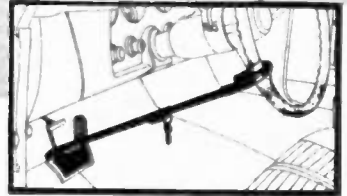

Car anti-theft device that makes your car theft-proof in seconds! Requires no wiring or special fittings. Fully adjustable steel rod with an individualized key lock attaches to the steering wheel and brake pedal making it impossible to drive your car away. 360 degree swivel top permits universal mounting for all makes and models of cars. Comes complete in hammered bronze finish. Shpg. wt., 3 1/2 lbs.

11 E 26507

Net 9.95

SECRET AUTO-IGNITION GUARD

2³⁹



- Stops Car Theft
- Only You Can Start Your Car
- Fits Every 6 and 12 Volt Car and Truck

With just a turn of a knob, the auto ignition guard will stop any car thief. Even master keys and "jumping methods" will not start your car—only you can start it. Hooks up in minutes; fits 6 and 12 volt cars and trucks. Shpg. wt. 1/2 lb.

11 E 13117

Net 2.39

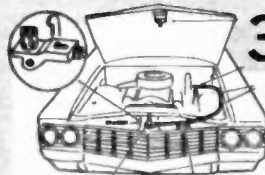

3²⁹

- Prevents Theft of Battery and Engine Parts

AUTO HOOD LOCK KIT

Hood can only be opened from inside of car. Protects battery, generator, distributor, etc. Complete with all parts for installation. Fits following cars:

61 Buick	67-68 Chevelle	64-65 Mustang
64 Cadillac	63-65 Comet	68 Olds
68 Camaro	63-67 Ford	63-68 Tempest
61-68 Chev.	63-65 Falcon	62-66 Rambler (not Classic)
67-68 Chevy II	64-67 Mercury	64 T-Bird

and other cars with striker bolt in hood
11 E 53014 Shpg. wt., 1 lb. Net 3.29

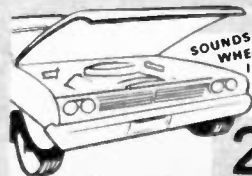

HOOD ALARM

Fits any Car, Truck, or Station Wagon

Protects such vital parts as battery generator, carburetor, or ignition system. Horn sounds to indicate hood has been raised . . . frightens away thieves or vandals. Fits any car, truck, or station wagon. Automatic shut-off switch permits under hood servicing. Easy installation. Shpg. wt., 1/2 lb.

2²⁹

11 E 43023

Net 2.29

To Speed Your Mail Order — Please Give Your Zip Code Number

Custom Horns-For Your Car

MUSTANG HORN

- Whinnies like a Wild Mustang

9⁹⁵

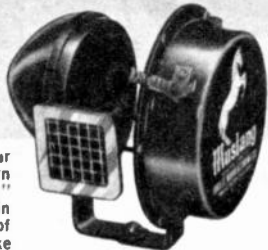

You've seen a mustang—now hear a mustang! Compact size horn "whinnies like a wild mustang" when you press the horn button in the car. Adds a new dimension of life to your Mustang or other make automobile. Conveniently mounts anywhere under the hood. Fits any car. Complete with horn button control, wire, and all necessary mounting hardware. Black enamel finish with chrome plated grill. Dimensions: 5" x 5½" x 6". Shpg. wt., 4 lbs.

11 E 44526 For 12 volt Net 9.95

CONTINENTAL HORN

12⁹⁵

- With European Sound

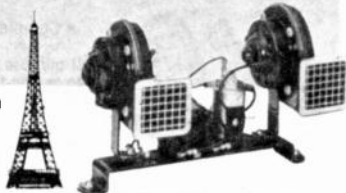

Swing with the sounds of the continent! Twin continental electric horn automatically alternates from high to low notes like European police horns. Clear, crisp tones are sure to attract the attention of pedestrians and other motorists. Different from other horns, consists of a high note unit and a low note unit mounted on a single sturdy frame. Mounts under the hood of virtually any car, in any available space. Complete with horn button control, wire, mounting hardware, and complete installation instructions. Black enamel finish with bright chrome grill. For 12 volt. Dimensions: 3½" x 5½" x 9". Shpg. wt., 6½ lbs.

11 E 44500 Net 12.95

BEEP-BEEP HORN

DISTINCTIVE TONE

Only 5⁹⁵

Go mod! Newest sound sensation! Distinctive BEEP-BEEP sound awakens the daydreamer, gets immediate attention from the slow pokes . . . just two quick taps on the horn and you're way out. Powerful 4" x 5½" x 6½"H horn is easily installed in any car. Complete with mounting hardware and horn button control. Finished in 2-tone black and red enamel. For 12 V.

11 E 44534 Shpg. wt., 2¼ lbs. Net 5.95



King of the Road TRIPLE TONE ELECTRIC AUTO HORN

13⁹⁵

- 3 Horn Assembly

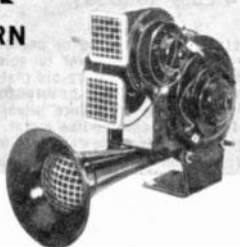

Get rid of your old horn—be a King of the Road. Blow the loudest, richest, most melodious horn around. Custom quality three horn assembly gives you a distinctive, attention getting sound. Complete with horn button, wire, and mounting bracket. Dimensions 5½" x 8 x 10¾" L. Black enamel finish. For 12 volt systems.

11 E 44542 Shpg. wt., 5 lbs. Net 13.95

AM-000-GAH!



HORN
10⁹⁵

- Chrome Plated Bell
- With Horn Button

A real joy for the sports car enthusiast. An authentic motor driven horn approved as an exact reproduction in sound and appearance by members of antique car, hot rod, and horseless carriage clubs the world over. Chrome plated bell with black wrinkle painted housing. With horn button, wire, bracket and instructions. Shpg. wt., 1 lb.

11 E 30012 6-volt Net 10.95
11 E 30020 12-volt Net 10.95

For Compacts and Sports Cars Net 10.95
11 E 30079 12-volt Net 10.95
11 E 30083 6-volt Net 10.95

"FIAMM" ELECTRO COMPRESSOR AIR HORNS

- Chrome Plated Brass Trumpet
- Range of ½ Mile
- Loud—Clear—Continental Tone

As Low As
15⁹⁵



Model 32. Custom quality chromed trumpets with loud clear, piercing, continental tone. Range up to ½ mile. Ideal for use on trucks, sports cars, emergency vehicles, buses, boats, etc. Compressor pumps air to trumpets instantly when horn is pressed—there's no waiting for pressure to build up. Supplied with Town and Country Selector Switch which enables use of original horns for city driving. Complete with: 2 horns (7" & 9"), compressor, fittings, horn relay, 11 E 82500 Shpg. wt., 6 lbs. Net 19.95

Model 22. Same as above but trumpets are enameled die-cast metal. 11 E 82518 Net 15.95

"FIAMM" 5-TRUMPET MUSICAL HORN

Musical horn that plays the award winning "Col. Bogey March" from "The Bridge Over The River Kwai." Five trumpets made of sturdy enameled die-cast metal. Range one mile. A special cycle switch allowing 2 of the louder trumpets to sound simultaneously and a Town and Country selector switch permitting you to use your original horn, as well as the original horn button. Includes fittings, hose, relay and compressor. For 12V only. From Italy. Largest horn 14". 11 E 82526 No Money Down.* Shpg. wt., 12 lbs. Net 59.95

"DING-DONG" BELL from BERMUDA



5⁹⁵

- Easily Installed
- Just Step On It

"Ding-Dong" carriage bell, bringing with it the charm and color of romantic Bermuda. Engineered for musical clarity, people will thrill to its beautiful resonant tone. The Bermuda bell is precision constructed, rust proof, and polished to a glistening finish. Built to outlast the life of your car. Minutes to install. 5½" diameter.

11 E 10501 Shpg. wt., 2 lbs. Net 5.95

* See Page 11 for Full Credit Details on Easy Pay Plan

Automotive Accessories & Specialties

29⁹⁵

DRIVER ALERT

- Gives Advance Warning
- Miniature and Completely Transistorized
- Complete With Long Life Mercury Batteries
- Clips Easily on Sunvisor



• Warns of Traffic Zones!



- Rugged Printed Circuit

Miniature electronic detector gives an audible warning whenever it intercepts a radar beam. Dual-Band circuit detects all commonly used police radar speed meters and traffic control devices, both vertically and horizontally polarized, to promote safer driving. Miniaturized and completely transistorized. Top quality components; printed wiring; 8 transistors; two 1,000 hour mercury cell, self-testing batteries (equivalent to 35,000 miles of driving at 35 M.P.H.) Magnesium case eliminates radio, TV and other interference. Weighs

only 13 ozs., measures 3 3/8" x 2 1/4" x 3 1/4" D; clips to sunvisor. Complete with batteries, sunvisor clip. Instructions included. Shpg. wt., 1 1/2 lbs.

11 E 42017

Net 29.95

This item not intended for resale in States where its use is forbidden in motor vehicles by public regulation.

25-FT. 12 VOLT TROUBLE LAMP

DELUXE 4-WAY EMERGENCY FLASHER

3⁹⁵



- Built-in Heavy-duty Flasher and Fuse
- All 4 Directionals Blink On and Off
- Flashing Pilot Light With Audible Click

Simply pull out the switch and all 4 directionals start blinking, along with pilot light in switch. Completely separate heavy-duty system cannot overload or damage car's existing light system. Unbreakable mounting bracket for mounting through or under dash. Easy to install; self-insulating connectors. Instructions included. 11 E 02039 Shpg. wt., 1 lb.

Net 3.95



- Complete With 50 Watt Bulb

An all purpose emergency light for shop, garage or "on-the-road" use. 12-volt light taps directly from battery of cars, trucks or boats. Color coded alligator clips, yellow cord. Complete with bright 50 watt bulb. Shpg. wt., 2 1/2 lbs.

12 E 44518

Net 2.89

12 E 44524 Replacement bulb Net .45

LITE BUZZER



- Reminds You To Turn Off Your Lights When You Park Your Car
- Saves Battery and Service Charges

LAFAYETTE 4-LITE WARNING SWITCH KIT

- Fits All 6V and 12V Cars



1³⁹

Just flip the emergency warning switch and all four directional signals on your car flash on and off setting up a safety zone around your car. Ideal for use during emergency road stops. Pilot light that flashes when unit is on. Complete with installation instructions. Imported. Shpg. wt., 1 lb.

99 E 05144 Net 1.39



Sounds off with an audible noise when you turn off your ignition without turning off your lights. Saves your battery, service charge. Clips to fuse panel with 2 alligator clips and one thumb screw. Easy to install. Mounts under dash. Shpg. wt., 1/2 lb.

11 E 50010

Net 2.89

SPARK PLUG AND 6 AND 12 VOLT TESTER

1⁴⁹



- With Retractable Test Probe Needle And Alligator Clip

For testing 6 and 12 volt wiring systems on cars boats, trailers, or any low volt system. Test spark plugs, check fuses, find faulty sockets, shorts, broken wires. Quick easy visual test. Neon flash tells the story. Shpg. wt., 4 oz.

11 E 31515

Net 1.49

SEQUENTIAL SIGNAL FLASHER



For 2-Bulb Tailight



For 3-Bulb Tailight

As Low As 10⁹⁵



- Convert Your Turn Signals To A Moving Line of Light

Convert your car's two or three lamp rear turn signals so that they flash on in sequence, creating the effect of a moving line of light pointing the way you intend to turn. Rugged and reliable both right and left signal circuits are complete in one compact unit. A safety innovation. Easy-to-install... all wiring done at signal lamps. Shpg. wt., 1/2 lb. For 12 volt negative ground only.

11 E 34501 For 2-Bulb Tailight Net 10.95

11 E 34519 For 3-Bulb Tailight Net 14.95

BACK-ALERT



3⁶⁹

Clear, audible alarm, prevents back-up accidents by alerting pedestrians as well as other motorists when vehicle is placed in reverse gear. Quick clip terminal attaches to back-up light wire without cutting, splicing or taping. Mounts on trunk lid or rear panel with 2 self-tapping screws. Rust-proof brass with chrome finish. Includes wire and all hardware. 12 Volts only. Shpg. wt., 1 lb.

11 E 11509 Net 3.69

ELECTRO PLATING KITS

- Replate Worn Chrome, Silver, Gold, or Plate New Items
- Easy to Use

As Low As 6⁷⁵



Retouch worn, rusted or peeled areas of chrome, silver or gold plated articles. Restore old plating to its original beauty by electroplating with pure silver, 24K gold or chrome-like metal. Plate new articles with equal safety and ease. Kits come complete with battery case, plating brush, holder, wire and clip, plating solution and directions. Less batteries. Chrome Plating Kit: covers approx. 12-20 sq.' Use 4 AA cells. 11 E 25509 Shpg. wt., 2 lbs. Net 0.49

Silver Plating Kit: covers approx. 2 sq.' Use 2 AA cells. 11 E 25525 Shpg. wt., 1 lb. Net 0.75

Gold Plating Kit: covers approx. 1 sq.' Use 2 AA cells. 11 E 25533 Shpg. wt., 1 lb. Net 13.50

Refills for above. Material to do as much as in original kit.

11 E 25517 For Worn Chrome Kit, Shpg. wt., 1 1/2 lbs. Net 3.98

11 E 25541 For Silver Kit, Shpg. wt., 1 lb. Net 3.75

11 E 25558 For Gold Kit, Shpg. wt., 1 lb. Net 0.49

99 E 62580 Batteries for above Net .70

Popular Accessories for Your Car

DELUXE SLIP-ON HEADREST

8⁹⁵

- Fits All Cars
- Original Equipment Type
- Adjusts Automatically Up Down Forward or Back

Equip your car with safety and comfort feature found on all 1969 models. This sturdy headrest uses original equipment styling and materials. Just clamp on seat; adjusts up, down, forward or back automatically. Fits all cars, even bucket seats. Heavy steel strut, vinyl covered, molded foam filled headrest. Shpg. wt., 2 lbs.

11 E 65547 Black Net 8.95
11 E 65554 Blue Net 8.95

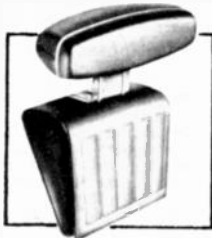

AUTO VACUUM CLEANER

4⁹⁵

- Plugs Directly Into 12 Volt Cigarette Lighter Outlet
- Easy-to-Handle—Stores Conveniently in Trunk

Portable and powerful! Cleans upholstery, carpeting, ash trays, under moldings—top handle for easy handling. Sucks up dust, dirt and lint into a removable container. Designed to give trouble-free service. Complete with 13 foot cord, On/Off switch and two attachments—a utility pick-up and a long nozzle to reach hard to get at places. Power source: 12V., DC. Imported. Shpg. wt., 2 lbs.

11 E 33503 Net 4.95



SLIP-ON HEADREST

4⁹⁵

- Installs Easily—No Tools Required

4-way adjustable headrest is easily custom fitted to give relaxed, tireless comfort, protection against whiplash. Tempered spring steel construction allows a perfect fit with virtually any seat. Face of headrest section is curved in channel quilted roll and pleat for a heightened look of luxury. Rugged leather grained vinyl cover. Comes fully assembled. Shpg. wt., 3½ lbs.

11 E 65521 Black Net 4.95
11 E 65539 Blue Net 4.95



Bon Aire SUPER POWER AUTO VACUUM CLEANER

8⁹⁵

Made in U.S.A.



- Super Power Suction
- Plugs Into Cigarette Lighter Socket

A smart portable accessory for every car owner. Super power suction cleans in seconds. Specially designed nozzle gives easy access to hard to get at places such as under seats, ash trays, and in crevices. Its lightweight, and durable rust and dent proof construction make this fine unit ideal for boats, planes, trailers, and tents also. Easy to handle and well balanced. Operates off standard 12V DC car battery. Plugs right into the cigarette lighter socket. Size: 17" long x 4" wide. Shpg. wt., 2½ lbs.

11 E 22506 Net 8.95

PRIMETTA "FOGGLES"

FOR SAFER DRIVING:

- AT NIGHT
- IN RAIN
- IN FOG
- IN SNOW



Scientifically designed to protect eye from glare of headlights, street lights, etc. without materially reducing vision. Filter lens exclude all ultraviolet rays. Ideal for driving at night, in rain, fog and snow. For 20-20 vision. With case. Shpg. wt., 6 oz.

11 E 32018 Net 2.35
Clip-on "Foggles," — use on existing glasses. 11 E 32026 Net 1.95

AIRWAY COMPASSES

- No Holes to Drill • No Wiring

Universal mounting bracket with pressure sensitive base for dash or windshield. Aviation-type geared regulators, unife magnets. Built-in battery light on illuminated models. Dial calibrated each 15 degrees. Black and chrome. Shpg. wt., 1 lb.

11 E 65018 Illuminated Net 2.49



DELUXE AIRWAY UNIVERSAL COMPASS

- Complete with Adhesive Plate for Windshield Mounting

4⁹⁵

Precision instrument features fingertip regulators with 8 gears and special magnets to provide added accuracy and quick compensation. Design allows up to 30° tilt. Calibrated in 5 degree intervals. Universal bracket mounts in any position on all craft and vehicles. Rigid crystal clear plastic with gleaming chrome and black finish. Illuminated. Shpg. wt., 1 lb.

11 E 65059 Net 4.95



AUTO/MARINE BATTERY CLOCK

- Attractive Case—Chrome Bezel—Sweep Second Hand

10⁹⁵

OPERATES UP TO 1 YEAR ON SINGLE "C" CELL

A smartly designed and ruggedly constructed battery-operated clock designed for use in the car and cabin cruiser. Use it as a desk clock or take it with you on trips. Chrome bezel, with bright easy-to-read white face, has black markings and features a second pacing sweep hand. Employs a unique fiber mesh fastening arrangement on its base. Can be positioned on any metal, wood, plastic surface, including padded dashboards and yet is readily removable. Light in weight, only 13 ounces, this attractively styled conversation piece is mounted in a sturdy 3¼ x 3½ x 2½" gray plastic case. Wt., 1 lb.

11 E 17506 Net 10.95
99 E 62572 Battery for above Net .14

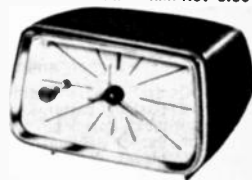

MAGNA-CLOCK With ALARM

- Attractive Walnut Woodgrain Finish

30 hour springwind alarm clock with powerful magnet in base. Attach to car dash board (has special adapter plate for attachment to padded dash). Ideal also for home or office. Luminous hands and dial. Overall size: 2¾" x 3".

11 E 22100 Shpg. wt., 1 lb. Net 6.95
Similar to above except Black Finish 11 E 22118 Net 6.25



MAP MEASURER & COMPASS

Just trace along route on map and multiply miles — per inch factor by reading on dial. Reads directly in inches up to 39". Built-in magnetic compass has cardinal and secondary points—full 360° markings in tenths. Accurate and dependable. Complete with leather sheath. Imported. Shpg. wt., 8 oz.

13 E 41015 Net 1.49



RADIO TRANSVERTER

Now you can avoid the expense of buying a car radio with this radio transverter. Simple to operate—remove 9-volt battery from your transistor radio, connect contacts from transverter to battery contacts in the radio, and then plug into the cigarette lighter. Shpg. wt., 6 oz.

11 E 48014 For 12-volt Cars Net 1.59



Auto Warning Signal Lamps—Defrosters



DELUXE REVOLVING BEACON

- 6.49** • Plugs Into Cigarette Lighter Outlet
• Rotates Like a Lighthouse Beacon

A red warning light that rotates 360 degrees and flashes in all directions. Suction mount holds the beacon firmly in place. Signals for help for miles around; creates a safety zone during a traffic emergency:

For use on autos, boats, trucks, docks, etc. For 12 volt use; complete with cigarette lighter adapter plug. Shpg. wt., 2 lbs.

11 E 13042 Net **6.40**
BLUE TURRET LENS. Converts Revolving Beacon for use by emergency vehicles, volunteer fire depts., CD units, etc. Shpg. wt., 1 lb.
11 E 13059 Net **.95**



3.95 "THE ROTATOR"

- Revolving Safety Beacon

Giant size amber turret lens flashes and rotates full 360°. Bright enough to signal help for miles around. Creates a safety zone while changing a flat or during a traffic emergency. For use on autos, boats, trucks, docks, etc. Big suction cup base will mount on any smooth surface. Giant size amber turret lens, brilliant chrome finish. Uses 3 "D" batteries. (Not included.) Shpg. wt., 1½ lbs.

11 E 14503 Net **3.95**

Batteries for above. Net ea. **.15**
99 E 62384 Net ea. **.15**

RAPID-FIRE™ FLASHER



- Signals and Warns For Miles Around

Automatic traffic hazard protection. Five lights create hundreds of different flashing patterns. Brilliantly signals help. Can be used in car without unlocking doors—great for women traveling late at night. Rubber suction cup mounts and 15 ft. cord permits fast easy attachment. Plugs into cigarette lighter. For 6 or 12 volt use. Imported. Shpg. wt., 1½ lbs.

11 E 13125 Net **4.95**

32 E 60156 Repl. Bulb Net **.33**

WINDSHIELD DE-ICER

- Heavy Duty—Just Heat and Scrape **Only 9.95**



Heavy duty, fast acting de-icer with high capacity blower. Clears up iced windows long before your car's own heating system has a chance to take effect. No more frozen windshields to block or distort vision. Heavy gauge, 16 ft. cord is long enough to reach all windows. Plugs into cigarette lighter. Break-resistant, cycloc housing. With mounting bracket and in-line fuse. Shpg. wt., 3½ lbs.

11 E 22514 Net **9.95**

INFRA-RED WINDSHIELD DEFROSTER



- Plugs into Cigarette Lighter **2.79**

Quickly melt away mist, ice, and snow. You no longer have to wait for car to warm up before cleaning windshield—just plug it into your cigarette lighter, and start defrosting immediately. Complete with 12 foot cable for reaching back windshield. Two suction cups make mounting fast and easy. Length: 15". Shpg. wt., 1 lb.

11 E 13075 Net **2.79**



HELLA QUARTZ-IODINE FOG AND DRIVING LAMPS

- 260,000 Candle Power
• Die-cast, Slim-Line Body

High power, long life lamp gives life saving illumination in poor weather, makes night driving safer and less tiring. Wide angle, sharp cut-off fog lamp beam penetrates heavy fog. Driving lamp has concentrated, narrow beam for reaching far ahead of normal high beams. Chrome plated body. Sealed lens and reflector keeps out dirt and moisture. Fully adjustable mounting bracket. 5¾" diameter, 2½" deep. Shpg. wt., 2 lbs.

11 E 26515 Fog Lamp, yellow Net **11.95**

11 E 26523 Driving Lamp, clear Net **11.95**

11 E 26531 Replacement Bulb Net **4.75**

Accessory Switch with 10 Ft. Cable. **11 E 26549** Shpg. wt., 4 oz. Net **.89**



11.95

PATHFINDER DELUXE PLUG-IN SPOTLIGHT



4.95

- 12 Volt GE Sealed Beam
• 10-Foot Cord with Plug
• All Chrome, Zinc Cast Housing

Plug-in portable spotlight is a real "life-saver" in emergencies—provides dependable, instant, powerful light for safety in every night-driving need. Finger-grip handle permits easy direction of light beam. Flexible 10-foot cord; GE sealed beam; convenient hang-up hook; rich chrome plate on die-cast metal. Fits most cigarette lighter sockets.

11 E 16250 Shpg. wt., 2 lbs. Net **4.95**

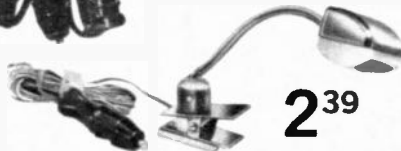

2.39

ALL PURPOSE CAR LIGHT

- Clamp On and Magnetic Base

Ideal auxiliary car light for use in writing or reading in cars at night. Magnetic base and clamp, plus 8½ ft. cord permits use as trouble light in and around the car. 6" chrome flexible shaft adjusts to any position. Magnetic or clamp on base permits temporary or permanent installation. Features switch at base and 8½ ft. cord with plug to fit any cigarette lighter. Imported.

99 E 95201 Shpg. wt., 1 lb. Net **2.39**



WARNING SIGNAL REFLECTOR

2.39

- Magnetic Base
• Large 4" Two-Faced Parabolic Reflector



Double faced 4" reflector signals traffic from both directions. Provides life saving illumination for emergency stops. Powerful magnets in base attach to any metal surface, or use adapter plate to stand on ground. Can be held and used as hand signal. Shpg. wt., 1 lb.

11 E 99508 Net **2.39**

CAR DEFROSTER GUN AND SCRAPER



2.99

Made of hi-impact red plastic with 10 foot cord and plug. 200 watt heat capacity gun plugs into cigarette lighter. For 12 volt cars only. Imported. Shpg. wt., 1 lb.

11 E 14024 Net **2.99**

CHILTON'S AUTO MANUALS



CHILTON'S 1969 AUTO REPAIR MANUAL — A completely revised manual for every American car since 1961. 3000 pictures, 1400 pages. Helps pin-point trouble and correct it. **10 E 28010** Shpg. wt., 11 lbs. Net **8.50**

"DO-IT-YOURSELF" Auto Accessories

CUSTOM SIDE LIGHTS

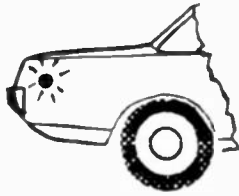

Two For
2⁹⁵



- Conforms To New Car Safety Standards

Newly designed, custom side marker lights that keep pace with 1969 model cars by conforming to the new automotive safety code. Small button style design will enhance your cars appearance by day, prevent accidents by night . . . your cars visibility improves attracting attention of drivers coming from either side. Easy to mount and install into car's electrical System. . . . Complete with hardware and instructions. Chrome finish. . . .

11 E 27505 Set of 2 Amber for front. Wt., ½ lb. Net 2.95
11 E 27513 Set of 2 Red for rear. Wt., ½ lb. Net 2.95



AUTO SIDE REFLECTORS



Style trim reflectors for night-time safety. Easily applied, self-adhesive, permanent acrylic auto side reflectors attracts the attention of drivers coming from either side. Classic styling with stainless steel frame harmonizes with every car. Shpg. wt., 4 oz.

11 E 23504 Amber for front Net 1.89
11 E 23512 Red for rear Net 1.89

WIDE ANGLE INTERIOR MIRROR

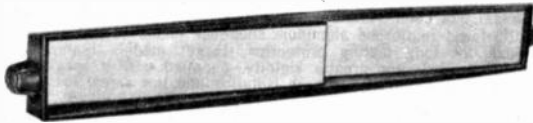

6⁹⁵ • Full View Clears Blind Spots
• Easy to Install

Wide angle interior mirror gives you a full rear view of all on-coming traffic, both in the rear and on the sides. Eliminates the blind spot on the side of your car, prevents accidents. Eliminates glare and distortion. Does not interfere with forward vision. Fully adjustable. 2 angled non-glare mirrors side by side, set in non corrosive plastic housing. Easily installs in most cars. All fittings included. Length 24". Shpg. wt., 2 lbs.

11 E 11517 Net 6.95

SNOWMASTER EMERGENCY TIRE CLEATS

They're cleats — not chains — and that makes the difference. These heat treated, hardened steel cleats bite into ice and snow like tank treads — they dig deep, grip firmly, won't slip like chains. Quickly installed on most cars and light trucks with slotted rims. Each cleat is 1" Wx1 ¼" Lx ½" D. Shpg. wt. 2 lbs. 11 E 28503 Set of 2 Net 2.75

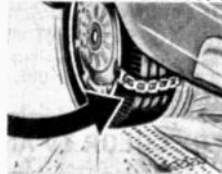

BATTERY BOOSTER CABLES

Standard equipment for starting stalled cars, charging batteries, etc. Made with heavy duty, flexible rubber-covered cable. Rugged copper-clad positive action grips identified by Black and Red heavy vinyl covered handles. Shpg. wt., 3 lbs.

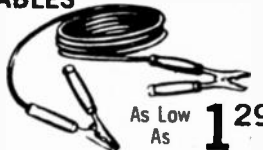

11 E 29014 8 ft. long, set of 2
11 E 29022 12 ft. long, set of 2
11 E 29030 12 ft. long, 6 gauge copper cable
11 E 29055 Set of Battery Booster Cable Clips (Red & Black) Net .59

CIGARETTE LIGHTER PLUG

Run any 6 and 12 volt accessory from cigarette lighter receptacle of your car—battery chargers, shavers, CB radios, trouble lights, etc. Also use to replace defective plugs. Imported. Shpg. wt., 8 oz.

99 E 85136 Net .49



49^c

ELECTRONIC CRUISE CONTROL

EASY
TO
INSTALL

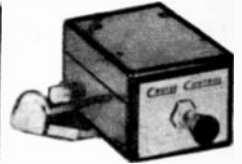

Only
19⁹⁵

- Maintains Any Selected Highway Speed
- Does Not Affect Braking or Instant Acceleration
- Helps Adhere To Posted Speed Limits
- Sets Fast Idle for Quick Cold-Weather Warm-Up

An Electronic Cruise Control which enables you to drive at a constant speed by automatically holding the throttle steady. Eliminates the need to keep a foot glued on accelerator on long trips. Once you reach desired speed, simply pull out knob and the Cruise Control will automatically hold that speed. Allows instant acceleration for passing but takes over again when the foot is taken off the gas pedal. Ceases to function the moment the brake is depressed and completely disengages in the event of any malfunction. Designed to fit all cars and trucks. Shpg. wt., 1 ½ lbs.

11 E 59011 Net 19.95

DEFROSTER/DEFOGGER KIT FOR REAR WINDOW

Only
16⁹⁵



- Enjoy The Convenience and Safety of Clear Rear Vision
- Adjustable Louvers Direct Air Where Needed

Rear window defrosting kit with giant defrosting capacity — 50 cu. feet of warm air per minute quickly defrosts and defogs rear window regardless of weather. Unit is easily installed in trunk; does not interfere with spare tire or luggage space. Adjustable louvers to direct flow of air are recessed; will not interfere with vision or rear deck space. Dash switch controls defroster operation. Improves heating and air conditioning operation of car by increasing air circulation. Kit includes heavy duty motor, defroster hoses, adjustable louvers, switch, wiring, templates, and installation instructions. Fits all cars, (except station wagons, convertibles, and rear engine cars) for 12 volt electrical system. Shpg. wt., 5 lbs.

11 E 12507 Net 16.95

WINDOW DEFROSTING FAN

- For Front or Rear Window
- Harmless 6" Rubber Blades
- Plugs into Cigarette Lighter



A practical automotive accessory which keeps windshield free from frost or fog while you drive. High speed 3,000 rpm motor controlled from drivers seat by 2-speed switch. Complete with cord; universal swivel joint on sturdy base. 2 ½ lbs.

11 E 34022 For 12 volt cars Net 9.95

SPARK PLUG CABLE KITS

As Low As

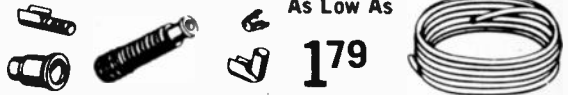

179

- Auto and Marine — 4, 6, and 8 Cylinder Engines

Eliminates auto and marine starting problems in any weather. Keeps moisture out—eliminates high-voltage leakage! 8 cylinder set: 27 ½" DUPONT HYPALON® COVERED copper ignition wire, 8 angle spark plug terminals, 8 straight spark plug terminals, 8 spark plug protectors, 10 distributor wire terminals, 9 distributor nipples and 1 ignition coil nipple. Shpg. wt., 2 lbs.

11 E 49517 Net 2.29

4 & 6 CYLINDER SET. 20' ignition wire, 8 distributor wire terminals, 7 distributor nipples, 6 angle and 6 straight spark plug terminals, 6 spark plug protectors and 1 ignition coil nipple. Shpg. wt., 2 lbs. 11 E 49525 Net 1.79



LVL-UV Log-Periodic Antennas

FOR VHF-UHF-FM/STEREO

COLOR
Approved

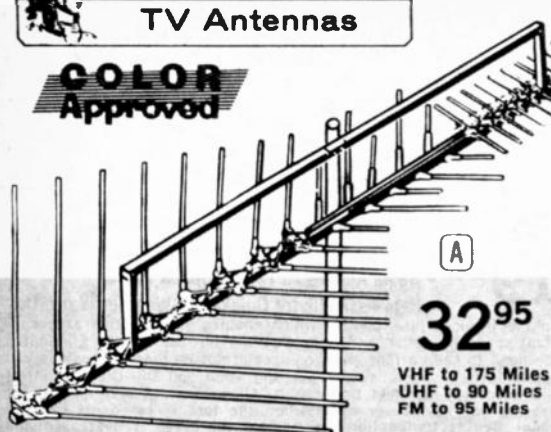

(A)

32⁹⁵

VHF to 175 Miles
UHF to 90 Miles
FM to 95 Miles

3 ANTENNAS IN 1

UHF-VHF-FM CHANNELS 2-83



Complete with VHF-UHF-FM Signal Splitter

NO EXTRA CHARGE!

- For Color or Black-White Pictures Plus FM
- One Down Lead for All 3 Signals
- Powerful Log Periodic Design
- High Front-to-Back Ratio—High Gain
- Goldenized Finish For Long Lasting Protection
- More Picture Power On Channels 2 To 83

Super color improved antennas of famous log periodic design. Now you can easily install one antenna instead of three to obtain superb reception on VHF channels 2-13, UHF channels 14-83 and the FM band with one down lead. Ends unsightly roof clutter while providing strong, clear signals to improve the performance of any TV or FM set. For color TV and stereo FM. All antennas are preassembled with dowel reinforced aluminum snap-lock elements and goldenized finish for long lasting protection. Larger models feature boom brace supports for greater rigidity. Supplied with a specially designed 3-way splitter for good isolation and low signal loss.

(A) 28 ELEMENT "EXTREME FRINGE" ANTENNA

Range in miles up to: VHF to 175, UHF to 90, FM to 95. 28 Elements 13 for VHF/FM, 15 for UHF. Has 1" square 15 ft. boom with twin brace boom supports. Shpg. wt., 15 lbs.
18 E 01802WX No Money Down* Net 32.95

(B) 18 ELEMENT "FRINGE" ANTENNA

Range in miles up to: VHF to 125, UHF to 65, FM to 70. 18 elements 7 for VHF/FM, 11 for UHF. Has 1" square 10'1" boom.
18 E 01828WX Shpg. wt., 9 lbs. Net 20.95

(C) 12 ELEMENT "SUBURBAN" ANTENNA

Range in miles up to: VHF to 85, UHF to 50, FM to 55. 12 elements, 5 for VHF/FM, 7 for UHF. Has 1" square 4'8" boom. Shpg. wt., 7 lbs.
18 E 01836WX Net 14.95

(D) 10 ELEMENT "METROPOLITAN" ANTENNA

Range in miles up to: VHF to 60, UHF to 30, FM to 35. 10 elements, 3 for VHF/FM, 7 for UHF. Has 1" square 30" boom. Shpg. wt. 5 lbs.
18 E 01844WX Net 10.95

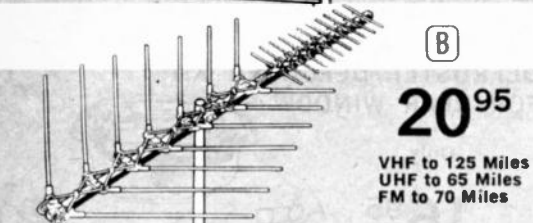

(B)

20⁹⁵

VHF to 125 Miles
UHF to 65 Miles
FM to 70 Miles

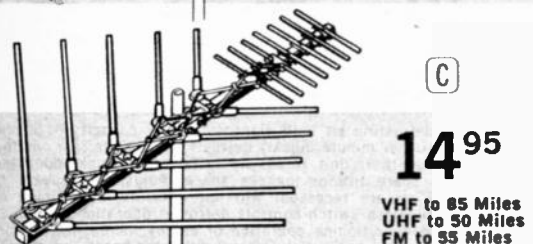

(C)

14⁹⁵

VHF to 85 Miles
UHF to 50 Miles
FM to 55 Miles

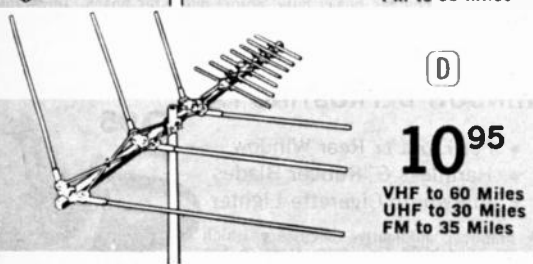

(D)

10⁹⁵

VHF to 60 Miles
UHF to 30 Miles
FM to 35 Miles

COLOR
Approved

LAFAYETTE "TECHNI-POWER" COLOR TV ANTENNAS

35 ELEMENT
VHF to 150 MILES
UHF to 90 MILES
FM to 75 MILES

29⁹⁵

23 ELEMENT
VHF to 100 MILES
UHF to 60 MILES
FM to 60 MILES

17⁹⁵

FOR VHF-UHF-FM/STEREO CHANNEL 2 TO 83

- Complete With VHF-UHF-FM Signal Splitter
- One Down Lead For All Three Signals
- For Color or Black and White Plus FM

Powerful combination VHF, UHF TV and FM-FM/Stereo antennas for near or deep fringe reception. The corner reflector yagi combination brings in uniform gain on VHF-UHF plus FM. The corner reflector doubles as a reflector system on UHF and as a director system on VHF. Built of high tensile strength aluminum with a gleaming goldenized finish for lasting protection. Factory pre-assembled for simple installation. Includes 3-way signal splitter for good isolation and low loss.

35 ELEMENT "DEEP FRINGE" ANTENNA
Boom length, 120 inches. Shpg. wt., 18 lbs.
18 E 02107WX Net 29.95

23 ELEMENT "NEAR FRINGE" ANTENNA
Boom length, 81 inches. Shpg. wt., 12 lbs.
18 E 02115WX Net 17.95

TWIN-BOOM VHF-UHF-FM/Stereo Log-Periodic Antennas



3 ANTENNAS IN 1

Complete with VHF-UHF-FM Splitter
NO EXTRA CHARGE

- Delivers Powerful 82 Channel TV Performance
- Finest For Color or Black/White Pictures Plus FM
- One Down Lead

<p>15 ELEMENT</p> <p>18⁹⁵</p> <p>VHF to 100 Miles UHF to 60 Miles FM to 65 Miles</p>	<p>24 ELEMENT</p> <p>28⁹⁵</p> <p>VHF—To 150 Miles UHF—To 80 Miles FM —To 85 Miles</p>	<p>39 ELEMENT</p> <p>43⁹⁵</p> <p>VHF—To 200 Miles UHF—To 100 Miles FM To 110 Miles</p>
--	---	--

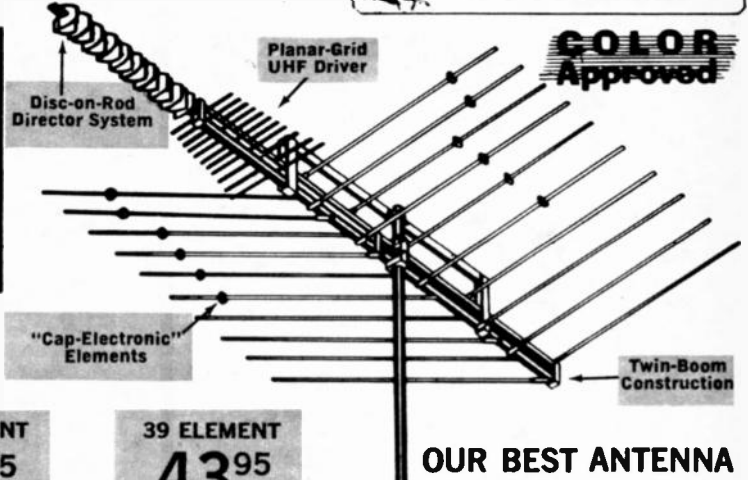

OUR BEST ANTENNA

Lafayette deluxe all-purpose twin boom three-in-one antennas for VHF, UHF, FM/STEREO. New frequency independent design permits all elements to work together on both low and high bands for maximum front-to-back ratio and high db gain. Extra long up to 110" reinforced aluminum VHF dipoles with wide band "cap-electronic" elements operate on both fundamental and harmonic modes. The result is an increased number of working elements producing maximum gain and directivity to bring sharpness and color brilliance to your screen. Disc-on-Rod director system reinforces performance of planar-grid UHF driver on low end of UHF band. It's log-periodic dipoles step-up gain, flatten response, and narrows beamwidth, on channels 14 to 83. Improved impedance match obtained by unique twin boom construction which combines mechanical rigidity with superior electrical performance. Utilizes single 300-ohm downlead. Rugged quality construction boasts 1" twin booms, heavy duty insulators, rust resistant hardware and lasting goldenized finish. Supplied complete with splitter to separate VHF, UHF, and FM signals.

39 ELEMENT "ULTRA-FRINGE" ANTENNA
Range in miles up to: VHF to 200, UHF to 100, FM to 110 — Has heavy-duty 1" square 14" 8" "twin-boom" and boom brace support. Shpg. wt., 18 lbs.
18 E 02081WX Net 43.95

24 ELEMENT "DEEP-FRINGE" ANTENNA
Range in miles up to: VHF to 150, UHF to 80, FM to 85 — Has heavy-duty 1" square 10" "Twin-Boom."
18 E 02073WX Shpg. wt., 12 lbs. Net 28.95

15 ELEMENT "NEAR FRINGE" ANTENNA
Range in miles up to: VHF to 100 UHF to 60, FM to 65 — Has heavy duty 1" square 6'6" "Twin Boom."
18 E 02123WX Shpg. wt., 10 lbs. Net 18.95

LVL-LOG-PERIODIC ANTENNAS FOR VHF AND FM STEREO

LAFAYETTE "HIGH POWER" "VECTOR-LOG"™ SWEPT-ELEMENT ANTENNAS DESIGNED FOR VHF-TV CHANNELS(2-13) AND FOR DYNAMIC FM

- Intensifies Color or Black-White Pictures . . . Plus FM
- Excellent Front-to-Back Ratio . . . High db Gain
- Sharp-Narrow Directivity and Selectivity
- Flat TV Color Response — Plus FM Signal
- Protective Goldenized Finish

Lafayette's powerful, revolutionary LVL — designed specifically for (VHF) true-to-life color reception plus black and white. Also reaches out to pull in static-free FM and stereo FM signals. Five models to choose from for ideal performance. Offers such exceptional quality features as: Heavy aluminum reinforced insulator cups—heavy duty insulators—special back-up brackets and square boom! Triple thick combination sleeved elements assure great ruggedness. Double contact drive line and air-insulated spacers provide maximum signal delivery to set. Less mast and twin lead.* With boom brace support.

Stock No.	Range	Elements	Boom Length	Shpg. Wt.	Net
18 E 01851WX	up to 75 miles	5	4' 8"	5 lbs.	8.95
18 E 01869WX	up to 100 miles	7	6'11"	7 lbs.	12.95
18 E 01877WX	up to 140 miles	10	9' 5"	10 lbs.	17.95
18 E 01885WX	up to 175 miles	15*	12' 5"	13 lbs.	23.95
18 E 01893WX	up to 200 miles	18*	14' 4"	16 lbs.	28.95

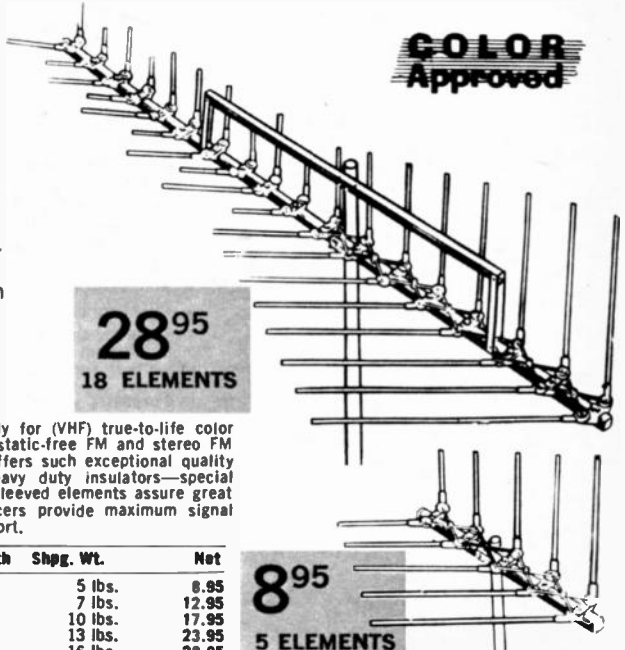

LAFAYETTE "Fringe Area" Antenna Outfits

• 20-40 FT. MAST • WITH OR WITHOUT FAMOUS ALLIANCE ROTATOR • FINEST COMPONENTS

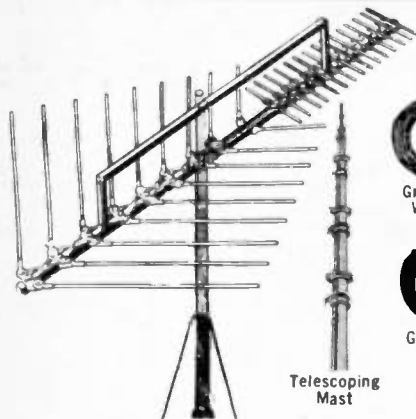

KIT A

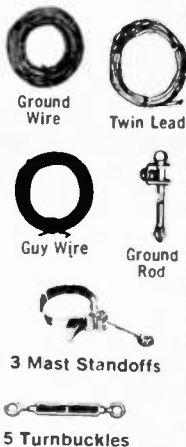

Telescoping Mast

KIT B

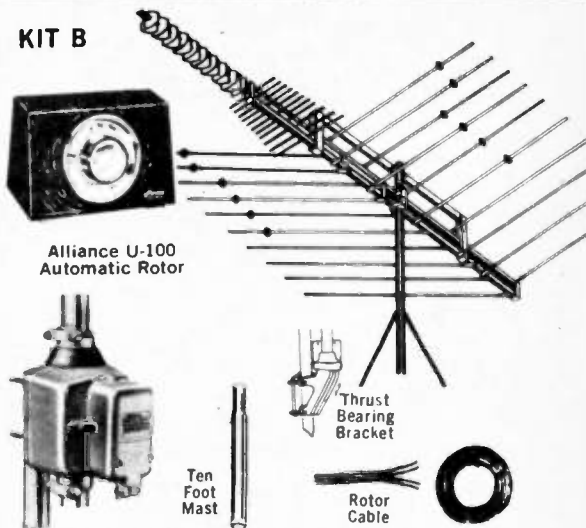

SAVE WHEN YOU BUY COMPLETE ANTENNA OUTFIT

Nothing else to buy. Available with or without automatic rotor. Buying a kit gives you substantial savings over the total catalog price of individual components if purchased separately.

INSTALLATION ACCESSORIES

Deluxe Antenna Outfits feature Lafayette "Deep-Fringe" Log-Periodic Antennas. (See pages 376 and 377 for listing of antennas). Chosen by experts to meet the most demanding reception problems—each kit contains pre-selected high-gain antenna, telescoping mast of heavy gauge galvanized steel, plus all components in kit "A" which includes a universal base mount, lightning arrester, 50' ground wire, 3-7½" mast standoffs, 5-3½" wood screw standoffs, 5-guy hooks, 5-turnbuckle, ground rod, 200' guy wire supplied with 20' outfits; 500' supplied with 40' outfits. 100' twin lead supplied with all outfits except 82 channel VHF-UHF-FM outfits get 100' of tubular twin lead. Optional Automatic Rotor package (Kit "B") includes—Alliance U-100 Automatic Rotor, thrust bearing, additional 10' antenna mast, 100' of rotor cable. With instructions for top quality installation. Kits shipped express only.

"ULTRA-FRINGE" VHF-UHF-FM ANTENNA OUTFITS

Stock No.	Antenna	Mast	Kit	Wt.	Net
18 E 90276WXM	18 E 02081WX	20 Ft	A	44 lbs.	53.95
18 E 90284WXM	See Page	20 Ft	A&B	68 lbs.	94.95
18 E 90292WXM	377	40 Ft	A	74 lbs.	63.50
18 E 90300WXM	377	40 Ft	A&B	91 lbs.	103.95

"DEEP FRINGE" VHF-UHF-FM ANTENNA OUTFITS

18 E 90318WXM	18 E 02073WX	20 Ft	A	38 lbs.	40.95
18 E 90326WXM	See Page	20 Ft	A&B	62 lbs.	82.50
18 E 90334WXM	377	40 Ft	A	68 lbs.	49.95
18 E 90342WXM	377	40 Ft	A&B	85 lbs.	91.95

"EXTREME-FRINGE" VHF-UHF-FM ANTENNA OUTFITS

18 E 90193WXM	18 E 01802WX	20 Ft	A	42 lbs.	44.95
18 E 90201WXM	See Page	20 Ft	A&B	66 lbs.	84.95
18 E 90219WXM	376	40 Ft	A	72 lbs.	53.50
18 E 90227WXM	377	40 Ft	A&B	89 lbs.	94.25

"ULTRA-FRINGE" VHF-FM ANTENNA OUTFITS

18 E 90235WXM	18 E 01893WX	20 Ft	A	42 lbs.	38.95
18 E 90243WXM	See Page	20 Ft	A&B	66 lbs.	79.95
18 E 90250WXM	377	40 Ft	A	72 lbs.	48.00
18 E 90268WXM	377	40 Ft	A&B	89 lbs.	89.95

PRIME AREA VHF TV ANTENNAS

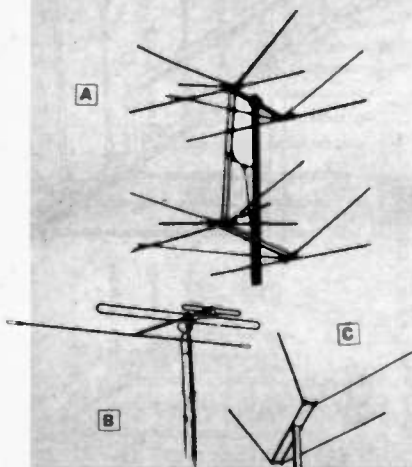

A 20 ELEMENT STACKED CONICAL TV ANTENNA

- Range To 40 Miles
- All Aluminum—Goldenized Finish

All elements snap open and lock in without tools. Efficient conical design for all reception areas. Two complex bays with Q bars, less mast. Shpg. wt., 8 lbs.
18 E 01059WX Net 6.50

B INLINE FOLDED DIPOLE ANTENNA

Efficient folded dipole design. Broad band, uni-directional response. Perfect impedance match results in reduced stray reflections and ghosts. All aluminum goldenized finish, less mast. Shpg. wt. 4 lbs.
18 E 01075W Net 3.95

C VEE-BEAM ANTENNA

Provides excellent gain. Sharply directional pick-up pattern gives steady clear pictures. Easy to install. All aluminum goldenized finish. Less mast. Shpg. wt., 4 lbs.
18 E 01364W Net 2.99

CONICAL WINDOW ANTENNA

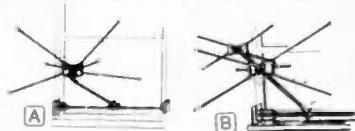

- More Antenna for Less Space
- All Aluminum Construction

A VHF MODEL

Contains 4 full-sized elements plus 2 high frequency dipoles. Ideal for apartment building, hotels, etc., or wherever roof-top installations are impractical but necessary for the greater gain which is provided by a good outdoor antenna. Complete with all mounting hardware, less 300 ohm twin lead. Base spans up to 44". Shpg. wt., 3 lbs.
18 E 01380W Net 5.50

B VHF/UHF MODEL

Same as VHF model plus 8 element UHF section.
18 E 01646W Net 8.50
18 E 01398 Extension bar to 60" Net 1.59
18 E 01406 Extension bar to 72" Net 1.95

Super Color 'Tenna

FOR VHF - UHF AND FM/STEREO
COMPLETE WITH VHF/UHF/FM SIGNAL SPLITTER

- For Color and Black and White
- Protected Goldenized Finish
- Completely Pre-Assembled Snap Open Design
- Easy To Install, Just One Down Lead

26 Element super color antenna with high gain providing fringe area reception on all VHF/UHF/FM channels. High front-to-back ratio minimizes co-channel interference. Rugged aluminum harness, with rust-proof clips deliver maximum signal to set. Includes VHF/UHF/FM signal splitter. Requires only one down-lead. Range: 26 element, up to 140 miles VHF, 90 miles FM, 60 miles UHF. Boom length 105" with aluminum boom support.

18 E 01630WX Shpg. wt., 8½ lb. Net 22.95

18 ELEMENT super color antenna. Same as above except range up to 100 miles VHF, 75 miles FM, 50 miles UHF. Boom length 85" less boom support.

18 E 01620WX Shpg. wt., 6½ lbs. Net 17.95

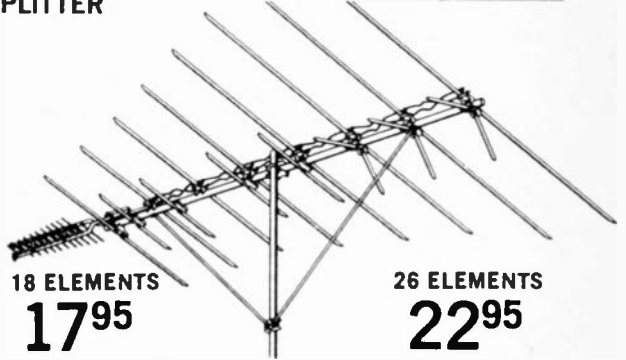

18 ELEMENTS

17⁹⁵

26 ELEMENTS

22⁹⁵

FAMOUS COLOR 'TENNA

14⁹⁵

- For VHF-FM Reception
- Range: Up To 125 Miles
- For Color and Black-White

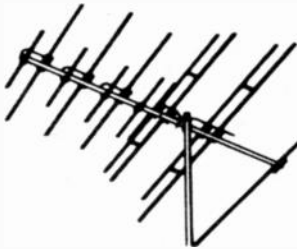

Twelve twin-driven elements work with carefully tuned, phased and spaced directors and reflectors to extend flat high gain response across entire VHF band. Cuts out ghosts and unwanted signals. Rugged reinforced aluminum elements and brackets stand up under most severe wind and ice loading. 100% pre-assembled for easy installation. Less mast, lead in. Shpg. wt., 7 lbs.

18 E 01018WX Net 14.95

"Star Fire"™ COLOR ANTENNA

- For VHF-UHF-FM Reception
- With VHF-UHF Signal Splitter
- Range Up To: VHF—60 Miles UHF—35 Miles FM —30 Miles

9⁹⁵

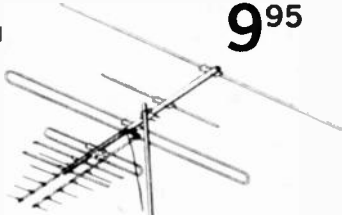

Eleven element high gain antenna provides VHF-UHF & FM reception with one downlead. Separate folded dipoles on low and high bands assure greatest power with constant 300 ohm impedance match. Sturdily constructed 68" boom. Completely pre-assembled—just snap open to install. Goldenized finish resists corrosion.

18 E 01976WX Shpg. wt., 5 lbs. Net 9.95

"PRIME AREA" VHF-UHF-FM ANTENNA

Only 5⁹⁵

- 8 Elements
- Range Up To 30 Miles
- Complete with VHF-UHF Resistor Splitter

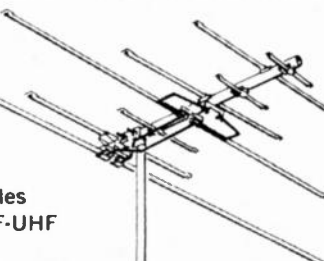

Receives sharp, clear pictures on all VHF, UHF Television channels plus FM/stereo. Features sturdy all-aluminum construction, dual high band directors, single downlead, snap-open assembly, and goldenized finish. Supplied complete with UHF-VHF resistive splitter.

18 E 02065W Shpg. wt., 4 lbs. Net 5.95

SUPER COLOR 'TENNA FOR VHF-FM STEREO

19⁹⁵

- For Deep Fringe Reception
- Range Up To: 175 Miles
- For Color & Black and White

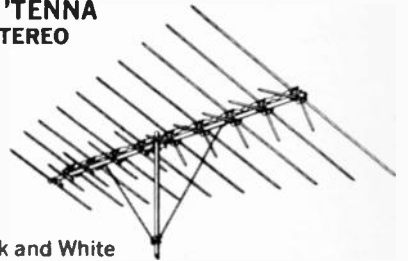

Deluxe, high gain 19 element antenna delivers crisp, clean pictures in remote areas. In-line design provides high front to back ratio to minimize adjacent channel interference. Completely preassembled—snap open design. Heavy duty aluminum elements. Goldenized finish for weather and corrosion resistance. Boom length 110". With boom brace support.

18 E 02099WX Shpg. wt., 9 lbs. Net 19.95

MAXIMUM PERFORMANCE FRINGE ANTENNA

12⁹⁵

- For VHF-FM Reception
- Range To: 100 Miles
- 21 Active Elements
- Goldenized

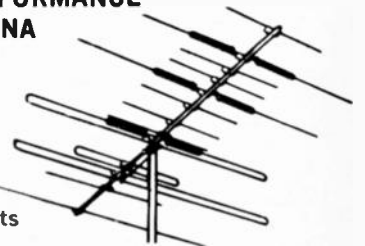

Field proven design for fringe reception. Goldenized finish to combat corrosion. Compound yagi array to "suck-in" signals where other designs fail. "Tension-lok" hardware. Heavy wall tubing throughout. Snap-open design. Fiberglass-Insulators. Less Mast. Shpg. wt., 8½ lbs.

18 E 01042WX Net 12.95

POWER BEAM VHF ANTENNA

7⁹⁵

- For VHF-FM Reception
- Range To 60 Miles
- Goldenized Finish

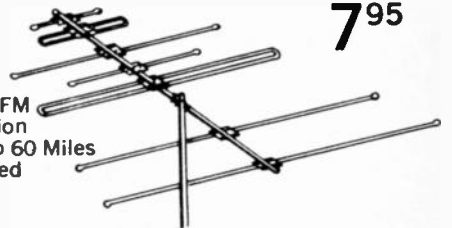

The ideal metropolitan and suburban VHF TV antenna. Broad-band, sharply directive. Full length elements, all aluminum construction, famous in-line design. 300-ohm impedance match reduces stray reflections and ghosts. Fiberglass insulators for maximum strength and weather protection. Less mount and lead-in. Shpg. wt., 6 lbs.

18 E 01026WX Net 7.95

JFD

LPV-VU COLOR LOG PERIODIC ANTENNAS

FOR CHANNELS 2-83 AND FM STEREO

3 ANTENNAS IN 1

VHF/UHF/FM

As Low As 15²⁷

Complete 3 Way
VHF/UHF/FM Splitter
with Every Antenna

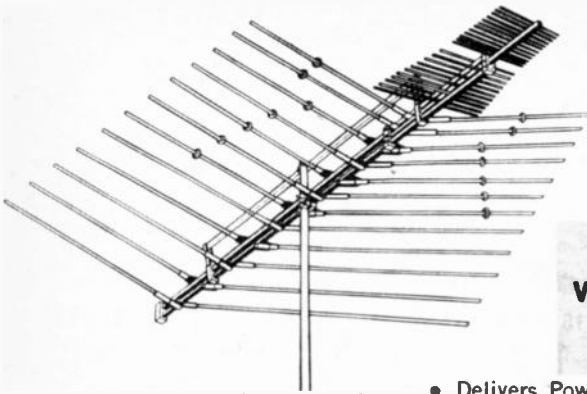

One powerful antenna for all your color, or black/white TV, and FM stereo needs! Combines acclaimed frequency independent log periodic design with new capacitor-coupled dipoles to develop unmatched picture power on channels 2-83 for brilliant color, black/white—plus FM stereo. Log periodic design with "Cap-Electronic" dipoles gives maximum gain and directivity. Dipoles work on higher mode for higher gain, narrower beamwidths, and higher front-to-back ratios. The higher mode of operation achieves better gain on channel 7 to 13 and UHF channels 14 to 83. FM signals are fully separated. Simplified installation; with a single antenna you cover the entire VHF-UHF TV range, plus the FM band, with a single down lead. Models LPV-VU-120 thru LPV-VU-180 reinforced with U-boom. Protective gold anodized aluminum construction.

- Delivers Powerful 82-Channel TV Performance—COLOR or Black/White and FM/Stereo
- Features Space-Age Frequency Independent Log Periodic Design
- Only One Downlead Into Your Home
- VHF/UHF-FM Signal Splitter Included
- Utilizes Capacitor-Coupled "Cap-Electronic" Dipoles for Extra High Gain

Stock No.	Model No.	Active Elements	Max. Range in Miles			Boom Length	Shpg. wt. lbs.	Net
			VHF	UHF	FM			
18 E 38234WX	LPV-VU180	35	150	90	60	206"	20	51.14
18 E 38242WX	LPV-VU150	30	125	80	50	176"	18	43.84
18 E 38259WX	LPV-VU120	26	110	70	50	157"	15	38.51
18 E 38267WX	LPV-VU90	21	90	60	40	113"	12	29.21
18 E 38770WX	LPV-VU60	14	70	40	30	98"	10	21.44
18 E 38929WX	LPV-VU40	11	50	30	25	68"	8	17.08
18 E 38937WX	LPV-VU30	9	40	30	20	47"	6	15.27

JFD

LPV-TV COLOR LOG PERIODIC VHF/FM ANTENNAS FOR CHANNELS 2-13 AND FM STEREO

- Cap-Electronic Dipoles Assure Fine Performance On All VHF Channels
- Based On Patented Space-age, Log Periodic Design

Pulls in extra true color and sharp black/white pictures—plus tru-fidelity FM through patented frequency-independent, log periodic design with cap-electronic dipoles. Maximum gain and directivity on all VHF channels and especially channels 7-13. High S/N ratio eliminates snow. Ghost and interference rejected by sharp directivity, narrow beamwidth and high f/b ratio. "Flip-Quick" construction for quick easy assembly. Models LPV-TV100 thru LPV-TV190 reinforced by powerful U-boom. All models gold anodized for protection against weather and corrosion.

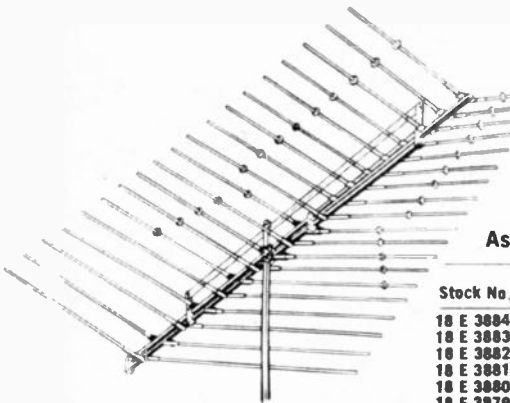

As Low As 13⁶⁶

Stock No.	Model No.	Active Elements	Range in Miles	Boom Length	Shpg. wt.	Net
18 E 38846WX	LPV-TV190	19	VHF up to 200	205"	23 lbs.	55.30
18 E 38838WX	LPV-TV160	16	VHF up to 175	176"	19 lbs.	42.62
18 E 38820WX	LPV-TV130	13	VHF up to 150	143"	15 lbs.	35.50
18 E 38812WX	LPV-TV100	10	VHF up to 125	112 3/4"	13 lbs.	29.30
18 E 38804WX	LPV-TV80	8	VHF up to 100	81"	8 lbs.	22.53
18 E 38796WX	LPV-TV60	6	VHF up to 75	70 3/4"	7 lbs.	16.94
18 E 38952WX	LPV-TV50	5	VHF up to 60	56"	6 lbs.	13.68

JFD

LPL-FM LOG PERIODIC FM/STEREO ANTENNAS

- Up To 41% More Gain Than Conventional FM Yagis
- Uniform Gain Across Entire FM Band
- Directional Sensitivity for Highest Interference Rejection

Log periodic array of L-dipoles pull in superior gain—provides extra high signal strength for FM and FM Stereo-multiplex tuner circuits. Offers maximum rejection of reflected or multipath signals that cause stereo distortion. Elements provide a backfire radiation for superior f/b ratio. Frequency independent wideband response permits unvarying gain across the entire FM band. Low VSWR transfers maximum signal from the antenna to the set. Easy to assemble. Gold anodized construction protects against weather and corrosion.

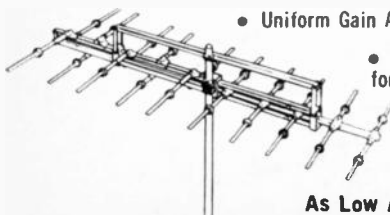

As Low As 12⁵⁷

Stock No.	Model	Elements	Range in Miles	Shpg. wt. lbs.	Net
18 E 38275WX	LPL-FM10A	10	to 175	11	31.47
18 E 38283WX	LPL-FM8A	8	to 150	10	25.52
18 E 38291WX	LPL-FM6A	6	to 125	8	18.87
18 E 38309WX	LPL-FM4A	4	to 75	6	12.57

Super Colortron Antennas by *Winegard*

COLOR
Approved

NEW "COLOR-WEDGE" FOR SUPER POWER COLOR CH 2-83 AND FM STEREO

Complete With VHF/UHF
Signal Splitter

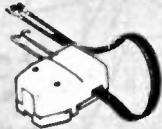

- Delivers Superb Color Fidelity and Perfect Black and White
- Exclusive Built-In Cartridge Housing
- Optional Solid State Preamplifier Loads Instantly Into Housing
- Single Download Into House
- Gold Anodized Throughout
- Super Rugged Truss Construction

Winegard Color-Wedge high gain, 82 channel antennas provide superb color fidelity, perfect black and white pictures and excellent FM stereo reception even in deep fringe areas. Extremely high front-to-back ratio and sharp directivity insure ghost-free reception. Narrow vertical reception lobe prevents antenna from picking up such interferences as airplane flutter, ignition noise, and harmonic radiations from citizens band or amateur transmitters. Antennas feature perfect, no-loss coupling between VHF and UHF sections and precise impedance match to down-lead terminals for excellent signal transfer to TV set. Wedge design of VHF elements provide maximum VHF capture area for increased gain . . . up to 50% shorter than most all-channel antennas with comparable gain. Antenna is gold anodized and performance is not affected by moisture. Super-rugged truss construction holds elements in perfect alignment and withstands the most severe weather conditions. Completely pre-assembled, easy to install. For extra power, use Super Colortron Cartridge Amplifier. See listing below.



Exclusive! Built-in
Cartridge Housing

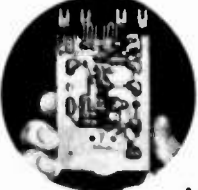
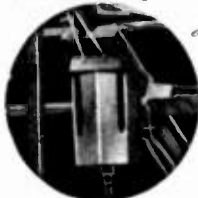

Optional
Solid State
Preamplifiers
Load Instantly
Into Housing

As Low As
36⁶³
No Money Down*

Model
CW-1000

Model
CW-96

Stock No.	Model No.	Elements	Max. Range in Miles			Boom Length	Shpg. Wt.	Net
			VHF	UHF	FM			
18 E 60782WX	CW-1000	56	275	125	220	135"	28	65.95
18 E 60840WX	CW-98	38	235	110	175	114"	18	47.85
18 E 60857WX	CW-96	27	175	90	125	77"	14	36.63

Solid State Amplifier For Above Antennas See Listing Below

HIGH GAIN 82-CHANNEL SUPER COLORTRON ANTENNAS FOR VHF-UHF-FM

Extremely high uniform gain for VHF-UHF-FM reception. Three models with pin-point directivity. High front-to-back ratio for sharp, clear color and black and white reception. Exclusive impedance correlators allow each model to be much more compact for easier installation and less wind resistance. Features vertical resonant UHF reflectors for very high UHF gain. FM control elements allow user to peak antenna for extra long distance FM and FM stereo. Exclusive built-in cartridge housing holds 300 ohm terminal board (included) for weather-tight down-lead connection. For extra power, use Super Colortron Cartridge amplifier listed below.

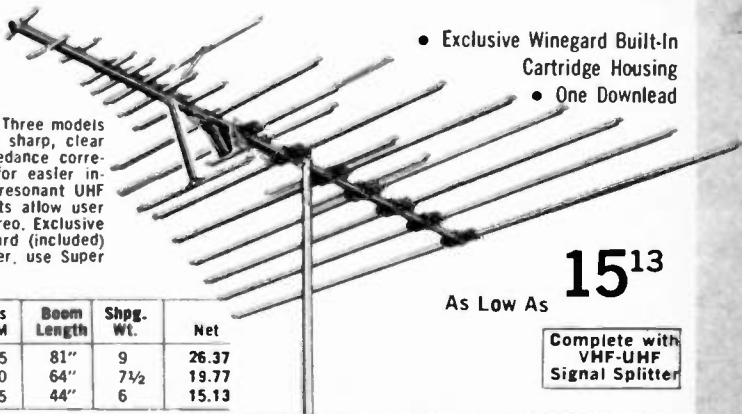

- Exclusive Winegard Built-In Cartridge Housing
- One Download

As Low As **15¹³**

Stock No.	Model No.	Elements	Max. Range in Miles			Boom Length	Shpg. Wt.	Net
			VHF	UHF	FM			
18 E 60618WX	SC-81	23	135	80	85	81"	9	26.37
18 E 60626WX	SC-80	18	100	65	70	64"	7½	19.77
18 E 60634WX	SC-79	13	80	50	55	44"	6	15.13

Complete with
VHF-UHF
Signal Splitter

SOLID STATE CARTRIDGE AMPLIFIER FOR ALL SUPER-COLORTRON ANTENNAS ABOVE

- Amplifies VHF-UHF & FM Signal
- Signal Booster Extends Reception Range, Strengthens Weak Channels and Lets You Operate Several Sets At The Same Time

Model AC-823B Adds greater range to your Super-Colortron antenna with this solid state cartridge amplifier. Printed circuit design with long-life overlay silicon transistors, adds big signal boost right at point of reception. Helps pull in weak distant channels and delivers strong clean signals to TV set for crisp, clear, snow-free color and black and white. Slides perfectly into Super-Colortron cartridge housing on antenna. Includes connector and power supply that mounts on back of TV set. For 300 ohm lines. For 117 VAC, 60 Hz. Shpg. wt., 2 lbs. **18 E 60659** Nea 28.05

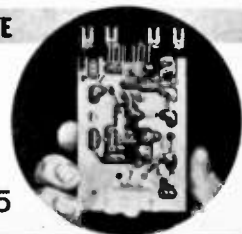

Only
28⁰⁵

* See Page 11 for Full Credit Details on Easy Pay Plan

Rembrandt Electronic Rotating TV Antennas

"RIVIERA" UHF-VHF-FM ALL-DIRECTION DOUBLE STACKED COLOR ANTENNA



21⁹⁵

No Money Down *

Both Models Include 12 Position Selector Switch with a Built-in VHF-UHF Separator.



- Range up to 125 miles VHF, 50 miles UHF, 60 miles FM
- Receives channel 2-83 from all directions without a rotor
- All aluminum flip-out assembly

Perfect for application where color TV or FM multiplex signals are extremely weak due to distance from transmitting antenna and to other receiving conditions. Here is an antenna with only one transmission line for all VHF-UHF-FM stations in all directions without the use of a motorized rotor. The 12-position selector switch with new built-in UHF-VHF Signal Separator conveniently connected at the set electronically rotates the antenna beam pattern instantly without physically moving the antenna. Superb gain on channels 2-83. Insures best reception in any direction. 16½" doweled aluminum elements are 60 inches long. Complete with switch, 45" stacking bars and 2-7/8" angle type mast insulators for Polymicalene line listed below. Shpg. wt., 10 lbs.

See listing below for Low-Loss Lead in Wire.

18 E 12346WX Less Mast

Net 21.95

"U-Install-It" kit: Includes Riviera antenna, chimney mount, two five ft. masts, 100 ft. of Polymicalene 4-conductor lead-in wire, 8 stand off insulators and complete instructions. Shpg. wt., 16 lbs.

18 E 12353WX No Money Down*

Net 34.95

"SQUARE WAVE" UHF-VHF-FM STEREO ALL-DIRECTION COLOR ANTENNA

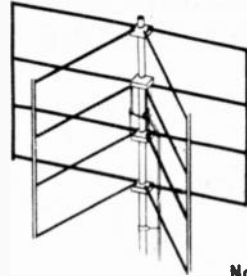

36⁹⁵

No Money Down*

- Range Up To 170 Miles VHF, 100 Miles UHF, 100 Miles FM
- Powerful 4 Bay Fringe Antenna
- Uses Only One Down Lead

The 16 element Rembrandt Square Wave VHF/UHF/FM antenna with "special adjustable angle heads" makes it possible to adjust the UHF and VHF polar direction receiving patterns to insure best reception in any location. Brings in stations from different directions, strengthens weak channels, and helps clear-up ghosts and snow. The 12-position selector switch, with new built-in UHF-VHF signal separator conveniently connected at the set, insures even stronger reception by electronically rotating the antenna beam pattern instantly without physically moving the antenna. Ideal for application where color TV or FM multiplex signals are extremely weak due to distance from transmitting antenna. The 4 special color locking stabilizers eliminate color breathing and fading (due to antenna) and provide for clear sharp color. 16 x 60" gold permalized elements mounted in heavy-duty 10-position insulator blocks, to eliminate antenna drift, are adjustable for best reception pattern. Stainless steel screws and non-ferrous wing nuts for longer life. Complete with 12 position selector switch. Shpg. wt., 12 lbs.

See listing below for Low-Loss Lead in Wire.

18 E 12361WX No Money Down*

Net 36.95

TV GHOST ELIMINATOR

5⁹⁵



- Improves Color Reception
- Receives From All Directions
- Filters Out Interference
- No Installation Problem

Electrically rotates the polar-receiving pattern of your existing antenna and phases the ground wave picked up by the electrical

wiring system with the sky wave picked up by the antenna. Improves any existing antenna; indoor, outdoor, master or built-in. Boosts pick-up power of any antenna—old or new. Just a flick of the selector control tunes out ghosts—filters out interference—tunes in those "hard-to-get" problem channels. Automatically amplifies TV signal strength for "snow" free, brighter, clearer pictures. Works on every channel—in any location—with any antenna—for any TV set. No installation problem—simply attach to antenna terminals in back of TV set—and plug into 117V AC/DC socket. UL Listed. Shpg. wt., 2 lbs.

18 E 12064

In lots of 6 ea.

Net 5.95

Net 5.00

TV COLOR COMPUTER

Only **12⁹⁵**

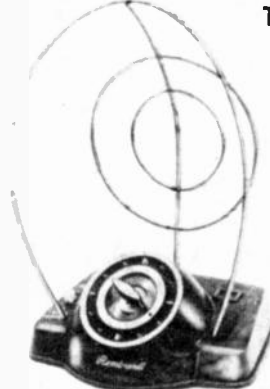

- Instantly Improves The Performance of Any Roof Antenna

"TV Color Computer"—assures you of clearer, sharper, brighter color as well as black and white picture reception on all VHF-UHF channels from your present room antenna! Simply by setting a dial, the "Color Computer" electronically compensates for weather and atmospheric changes which affect TV signals plus corrects signal mismatching between antenna and TV set. Automatically simplifies color tuning and potentially eliminates annoying ghosts and shadows strengthening picture color, contrast and brightness simultaneously. Easily installed. Attractive styling in walnut or mahogany blends with any room decor. Shpg. wt., 1½ lbs.

18 E 12395 Walnut

18 E 12403 Mahogany

Net 12.95

Net 12.95

VHF-UHF SEPARATOR and GHOST ELIMINATOR

- Attenuating Control—No Loss
- No Mismatch

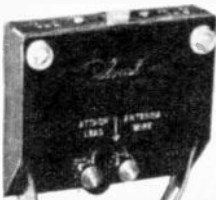

Separate UHF and VHF signals at set while it helps eliminate ghost and picture tear due to overloading in strong signal areas. Built-in attenuating control eliminates poor sync., multiple images, buzz, beats in picture, etc. Slide switch to VHF or UHF depending on channel selected. To help eliminate a VHF ghost, throw switch to UHF and vice versa. Connects to back of set. Shpg. wt., ½ lb.

18 E 12387

Net 3.95

THE "RIVIERA" And "SQUARE WAVE" ANTENNAS MUST BE USED WITH THE LOW LOSS LEAD IN WIRE LISTED BELOW

Special 4 conductors, matched impedance transmission line. Low loss, mica-filled Polymicalene copper conductors.

32 E 10010W 50 ft. length Net 5.00

32 E 10028W 75 ft. length Net 7.50

32 E 10036W 100 ft. length Net 9.95

REMBRANDT SELECTOR SWITCH

- With Built-in VHF-UHF Signal Splitter

12-Position Switch with knob to select proper antenna elements for best reception from any direction. Replacement for all "Riviera", "Atlas", and "Square Wave" antennas. Shpg. wt., 2 lbs.

18 E 12379

Net 8.75

FM Antennas for Superior Performance

"DOUBLE-DRIVEN" 5 ELEMENT FM ANTENNA

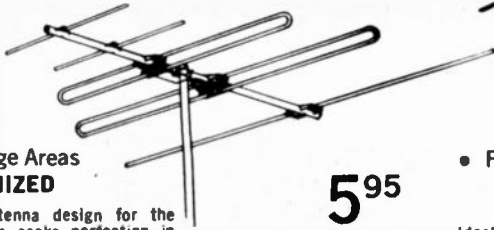

- For Fringe Areas
- GOLDENIZED**

5⁹⁵

High gain antenna design for the audiophile who seeks perfection in FM reception. Extra elements on this antenna serve to pull in stations where others fail. Trouble free operation even under severe weather conditions. The fully automatic snap-lock brackets insure easy, rapid and secure installation. Shpg. wt., 3 lbs.

18 E 01487WX Net 5.95

"DOUBLE-DRIVEN" 10 ELEMENT FM ANTENNA

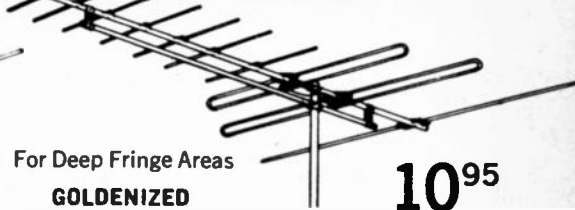

- For Deep Fringe Areas
- GOLDENIZED**

10⁹⁵

Ideally suited to Multiplex FM reception. This 10-element double-driven, yagi array has the necessary added gain, sensitivity and directivity to compensate for the lack of signal strength. All-aluminum goldenized construction. Fiberglass insulators. Torsion lock hardware sure-lock mast clamp. Shpg. wt., 7 lbs.

18 E 01281WX Net 10.95

FM ANTENNA KIT

- Attaches To Existing TV Mast
- All Directional
- 40 Mile Range



4⁹⁵

Provides excellent gain for areas up to 40 miles from the station. Gold alodized aluminum. Complete with 50 ft. of 300-ohm twin lead, mast standoff, screw eye standoffs, mast mount.

18 E 01323W Shpg. wt., 5 lbs. Net 4.95

FM ANTENNA ONLY. Shpg. wt., 3 lbs. Net 3.29

18 E 01331W Net 3.29

FM ANTENNA

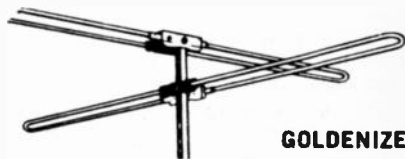

GOLDENIZED

All direction reception—no rotators needed. Double mast mount—rugged, rigid parallel mounting. For use on all masts. Goldenized finish. Shpg. wt., 3 lbs.

18 E 01307W Net 4.50

HIGH GAIN BROAD BAND FM ANTENNAS

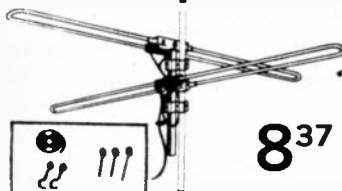

8³⁷

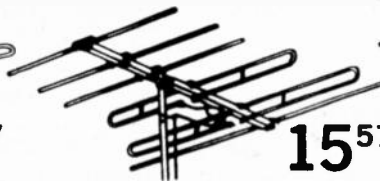

15⁵⁷

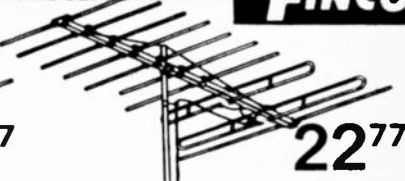

22⁷⁷



ALL DIRECTION FMT-A KIT

- Receives Stations from All Directions
- Gold Corodized

Model FMT-A Mounts on present T.V. mast. An All Direction FM Antenna designed for reception over the entire FM band. Two folded dipoles are matched with a special quarter wave phasing stub for optimum gain and "all direction" radiation pickup pattern. Kit supplied with 50 ft. of 300 ohm twin lead, two mast stand-off insulators, 3 Wood screw-eye stand-off insulators.

18 E 30280W Shpg. wt., 3 1/2 lbs. Net 8.37

FM STEREO MODEL FM-4G

- Range Up to 125 Miles
- Gold Corodized

Receive clear, strong signals with this 6 element FM antenna. Geometrically designed to provide 9.6 db gain with twin driven element and impedance control stubs. Extra wide spacing of the six elements results in high front to back ratio (22.5). Square boom for rigid support with locking brackets for no-tilt elements. Preassembled Shpg. wt., 6 1/2 lbs.

18 E 30249WX Net 15.57

FM STEREO MODEL FM-5

- Range Up to 175 Miles
- Gold Corodized
- Braced—10 Ft. Square Boom

10 Element deluxe FM antenna using twin drive elements with impedance control "T" match stubs. Db gain of 9.6 for maximum reception throughout 88-108 MHz band. Patented fidelity phasing provides 27.1 front to back ratio with 1.25 SWR. Corrosion resistant with gold finish. Sturdy saddle mounting of elements and "box girder" snap out, self aligning brackets are pre-assembled for easy installation. Shpg. wt. 9 lbs.

18 E 30231WX Net 22.77



WINDOW MOUNTED FM ANTENNA

- Ideal For Apartments, Buildings, etc.

Only

9⁹⁵

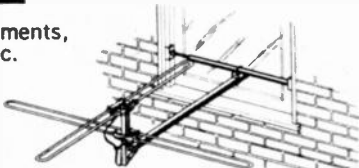

Model FM-WT. The ideal answer to FM/FM Stereo reception problems in apartment buildings, etc., wherever a rooftop antenna is impractical but an outside antenna is needed for improved reception. The antenna is FINCO's famous omnidirectional FMT, ingeniously mounted on a highly adaptable window mount. Mounting can be either horizontal or vertical. The sturdy extendable window frame mount will fit any window up to 42 inches wide. Shpg. wt., 4 lbs.

18 E 30452W Net 9.95

FM STEREO-PLEX ANTENNA

- Receives up to 50 Miles In Any Direction
- Goldenized

8⁹⁵

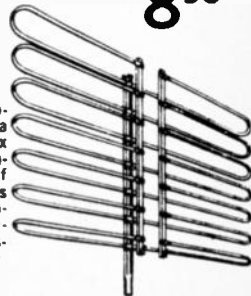

Model FM-88 Seven-Element Stereo-Plex FM antenna is the first antenna designed specifically for Multiplex Stereo FM. An omni-directional antenna with triple the power of crossed dipoles . . . and four times the power of "S" shaped FM antennas. All aluminum construction. Receives from any direction at distances up to 50 miles from the station. Shpg. wt., 4 lbs.

18 E 24028W Net 8.95

Add Channels 14-83 To Your 12 Channel TV Set

BLONDER-TONGUE UHF CONVERTER

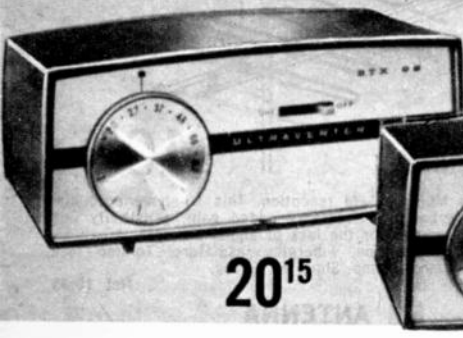

20¹⁵

BLONDER-TONGUE UHF CONVERTER/AMPLIFIER

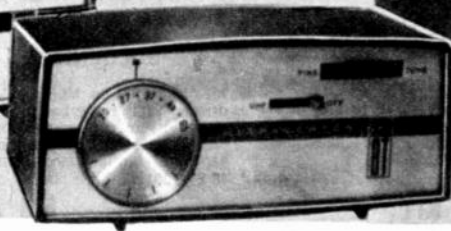

30⁹⁰

FINCO UHF CONVERTER



14⁹⁵

- All Channel-All Transistor
- Ideal for Good Signal Areas
- Drift Free! Distortion Free!

Model BTX-998 Keep abreast with the new look in TV programming. If your present television has been dated by modern UHF reception, modernize your TV and allow for future expansion. Adds all UHF channels (14-83) to your TV set. Ideal for prime signal areas up to 20 miles from the station, and in many areas can perform well using only an indoor antenna. Low noise, solid state circuit meets critical needs of good color TV reception. Rugged, reliable patented tuner. Fine vernier illuminated dial for easy tuning. Spliceless, stripless terminals. Complete with UHF loop antenna, connecting cable. For 110-120 V, 60 Hz., AC. UL Listed. Shpg. wt., 2 lbs. **18 E 18301** Net 20.15

- All Channel--All Transistor
- Amplifies Signal 3 Times
- Illuminated Dial for Tuning

Model BTX-11A If you live anywhere within the range of a UHF station you can enjoy additional educational and regular programming. This attractive converter adds all UHF channels (14-83) to your present TV, anywhere within the range of a UHF station. Features a new dual speed 100 to 1 fine vernier and illuminated dial for easy tuning; double tuned UHF input circuits and shielded oscillator section for interference-free reception. AC convenience outlet. Complete with UHF loop antenna, connecting cable. Reliable patented tuner; spliceless, stripless terminals. For 110-120V, 60 Hz AC. UL Listed. Shpg. wt., 2 lbs. **18 E 18319** Net 30.90

- All-Transistor and All Channel for Strong Signal Area

Model U-VERT 100 economy UHF converter provides clear, all-channel reception in metropolitan areas where you receive a strong television signal. Adds all the UHF channels (14-83) to your present TV set. Unit is housed in a sturdy, plastic, streamlined cabinet that looks like expensive furniture ... will actually enhance the appearance of any room as it sits on top of the TV set. Easy to install—all you need is a screwdriver and a few minutes of your time; extremely simple to operate. Meets all FCC specifications. Overall cabinet size 8x5x 3 1/4". Operates with 110-120 volts, 60 Hz., AC. Underwriters Laboratories Listed. **18 E 30314** Shpg. wt., 2 1/4 lbs. Net 14.95

Rembrandt

COLOR CHAMPION UHF/VHF ANTENNA



19⁹⁵

- Features Color Tuning Loops and Power Boosters
- VHF-UHF Network Switch

Get clearer, sharper pictures on all VHF/UHF channels 2 thru 83, in color and black and white, plus FM stereo. Combined action of color tuning loops, power boosters, and 5 section 46" solid brass elements give superb reception. 12 position picture correction control clears up ghosts, snow and color fading in most difficult areas. Separate VHF/UHF isolation network switch allows consistent true color levels and sharper color register. Attractive styling with walnut finish. Range up to 30 miles. Shpg. wt., 5 lbs. **18 E 12411** Net 19.95

Winegard

COAXIAL VHF/UHF COLOR ANTENNA

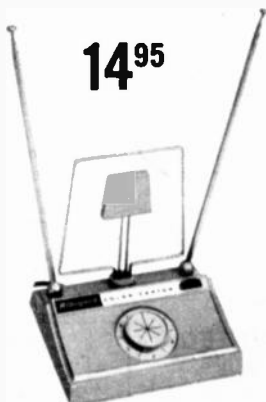

14⁹⁵

- Shielded Coaxial Color Cable
- VHF/UHF Signal Filter
- Isolation Network Switch

Model CR-200 82 channel VHF-UHF-FM indoor TV antenna for finest color and black and white reception. 12 position fine tuning control provides sharp, bright pictures. Features full length 45" telescoping and rotating chrome VHF dipoles set in heavy duty ball joint sockets. Stainless steel rotating UHF dipoles are tuned and tested to pick up maximum signals for all UHF channels. Handsome low profile slim-line antenna housings are made of durable hi-impact styron. Easy to install, takes only seconds to connect to TV set. **18 E 60865** Shpg. wt., 4 lbs. Net 14.95

Gavin MONITOR 1000

VHF-UHF COLOR ANTENNA

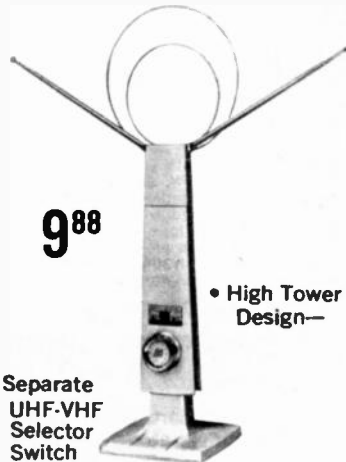

9⁸⁸

- High Tower Design—
- Separate UHF-VHF Selector Switch

Deluxe indoor antenna featuring superb color reception with the unique rotating scanner. Simple to adjust antenna position without moving base. Four section chrome plated arms and a full power, double UHF loop. The separate UHF/VHF selector switch brings in maximum signal on channels 2-13 and 14-83. Two transmission lines for each range insures maximum transfer. 12-position switch tunes UHF as well as VHF. Clears ghosts and eliminates interference. Beautiful styling complements any room decor. wt., 3 lbs. **18 E 16008** Walnut Net 9.88 **18 E 16016** Sand-wood Net 9.88

Rembrandt

Color VHF/UHF Indoor Antennas

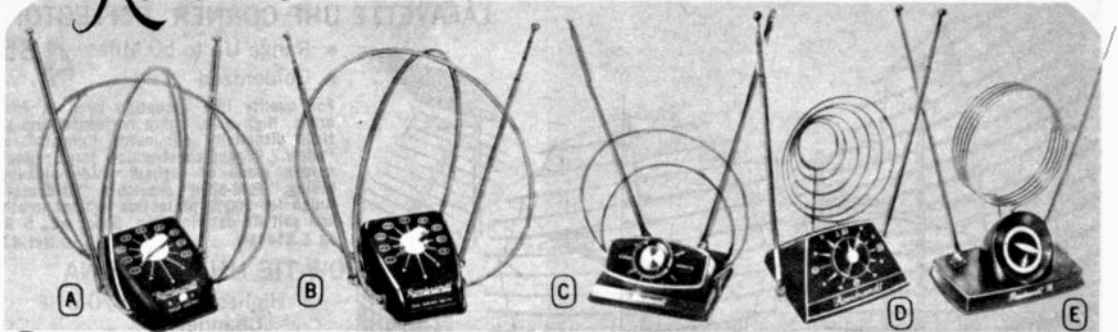

A "COLOR KING" VHF/UHF ANTENNA

- Clear, Sharp Color/B&W Pictures
- Special Color Phasing Loops and Color Filter Control

Deluxe indoor antenna for color and black and white reception on all VHF and UHF channels. Perfect pictures insured by color phasing loops and color filter coupled with 46" solid brass telescoping arms. 12 position picture correction control with silver plated contacts to clear up annoying "ghosts" and "snow" even in the most difficult reception areas. Separate VHF and UHF transmission lines provides low-loss matched impedance. Attractive styling in walnut or mahogany. Shpg. wt., 4 lbs.

18 E 12221 Walnut Net 12.95
18 E 12239 Mahogany Net 12.95

B "DELUXE" VHF/UHF ANTENNA

- For Channels 2-83
- For Color, Black and White TV

Indoor TV antenna with 46" telescoping arms coupled with adjustable radar loops for extra efficient operation in difficult reception areas. 12-position dual control to reject ghosts and orient antenna to direction of strongest signal. Solid brass tip balls on telescoping arms eliminate signal losses and static discharge interference. Radar loop principle makes possible clearer and sharper pictures on all channels. Matched impedance with separate leads for VHF and UHF. Attractive, durable plastic base. Shpg. wt., 4 lbs.

18 E 12072 Mahogany Net 9.95
18 E 12080 Walnut Net 9.95

C "POWER-KING" VHF/UHF ANTENNA

A new TV antenna for all channels VHF/UHF 2 thru 83, plus color, black and white, and FM stereo. Features unique concentric rings and long 39" solid brass telescoping arms for clear, sharp pictures. 12-position station direction control helps clear up ghosts and snow in difficult areas. New streamline styling. Includes separate leads for VHF and UHF. Available in mahogany and walnut. Shpg. wt., 3 lbs.

18 E 12148 Mahogany Net 4.98
18 E 12155 Walnut Net 4.98

D "RADAR COIL" VHF/UHF ANTENNA

A powerful indoor antenna utilizing 46" long solid brass 4 section telescoping arms to provide efficient reception, 12-position switch helps eliminate ghosts and snow. A real beauty to grace any decor. Includes separate leads for VHF and UHF. Available in mahogany, and walnut. Shpg. wt., 3 lbs.

18 E 12114 Mahogany Net 6.95
18 E 12122 Walnut Net 6.95

E FM STEREO/MULTIPLEX ANTENNA

- Reduces Drift, Hum and Noise

The Model FM1000 features 1/4-wave 4-section precision arms; 3/4-wave induction coil; 12-position station direction control and a special noise filtering circuit for extremely effective performance. Weak stations are strengthened and reflected signals and background noise are blocked out. Low silhouette slim-line styling. Shpg. wt., 3 lbs.

18 E 12171 Mahogany Net 6.95
18 E 12197 Walnut Net 6.95



Folds Out of Sight

BACK OF SET VHF-UHF TV ANTENNA

- Rotates - Adjusts Up and Down

4.95

Monitor 100 UV. Universal replacement for all TV sets—portable or consoles. Modern adhesive sticks securely to wood, metal, or plastic. Mounts in seconds. Fold-away, 4-section chromed dipoles disappear behind set when not in use. Excellent for UHF, VHF, or FM. Separate UHF and VHF leads. Shpg. wt., 2 lbs.

18 E 16032 Sandalwood Net 4.95

UNIVERSAL PORTABLE TV REPLACEMENT ANTENNA RODS

Exact replacement telescoping antenna rods for all indoor TV antennas. Easily replaces existing 4, 5 or 6 section broken or bent antenna rods. Heavy gauge—chrome finished. Easily installed with a screwdriver. Shpg. wt., 1/2 lb.

18 E 54009 4 section 38" long Net 1.10
18 E 54017 5 section 38" long Net 1.39
18 E 54025 6 section 40" long Net 1.69

FM TWIN LINE ANTENNA

Folded dipole type for indoor use. Six foot lead-in with spade lugs. Install behind cabinet, under rug, or any concealed place. Imported.

99 E 40287 Shpg. wt., 1 1/2 lbs. Net .99

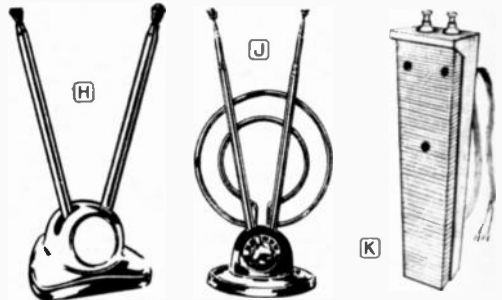

H 4-SECTION DIPOLE ANTENNA

Tip proof base. 4-section aluminum dipoles adjust for best picture on all VHF channels and FM. Handsome mahogany base. Tip-proof felt padded base design safeguards TV cabinet. Complete with 300-ohm twin line. Shpg. wt., 2 lbs.

18 E 38408 Net 1.39

J ASTRO-JET SWITCH-TYPE ANTENNA

- Maximum VHF/UHF/FM Performance

Dual direction-finding loops pull in stronger signals on UHF spectrum. 4-section, 38 inch, telescoping dipoles provide VHF reception. Multi-position channel-selector switch rejects ghosts, interference. Separate leads for VHF and UHF. Cushioned, tip-proof mahogany base. Shpg., wt., 2 lbs.

18 E 38853 Net 3.69
Similar to above for VHF/FM only. Net 2.79
18 E 38390

K UNIVERSAL BEHIND-SET TV ANTENNA

For portable and console TV's. Excellent replacement. 5-section, highly polished dipoles extend to 38" and have a 360° swivel. Collapses behind set. With mounting screws.

18 E 71011 Shpg. wt., 1 lb. Net 1.99

UHF TV Antennas for Channels 14-83

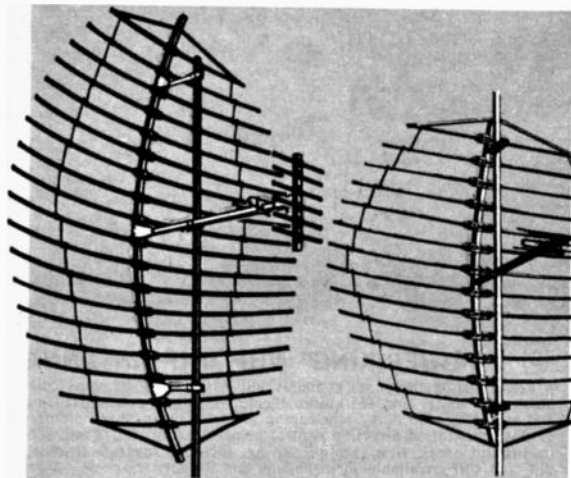

7-Ft. Diameter **29⁹⁵**

5-Ft. Diameter **16⁹⁵**

LAFAYETTE PARABOLIC UHF ANTENNA

Ultimate In Directivity — Rugged Construction
Sharp Pictures Even In Fringe Areas

7-FT. DEEP FRINGE PARABOLIC ANTENNA

Range Up To 150 Miles

Advanced 7 ft. diameter antenna utilizes a parabolic design to achieve the highest performance characteristics attainable. Multiple element construction has extremely high front-to-back ratio with narrow beam width to help eliminate ghost reflections—especially in fringe areas. All aluminum thick-wall assembly is fitted with vibration dampers for quiet high wind operation. For channels 14 to 83. Impedance: 300 ohms. Shpg. wt., 13½ lbs.

18 E 01927WX Net 29.95

5-FT. PARABOLIC UHF ANTENNA

Range Up To 110 Miles

A 5 foot parabolic antenna which utilizes a signal drive broadband driver unit. The high front-to-back ratio eliminates the necessity of reflectors which shadow the center of the field. Signals reaching any part of the parabola are concentrated on the driver mounted at the exact focal point. This selective design provides up to 18.6 db gain. Back of reflector acts as a shield to reduce unwanted and reflected signals. Preassembled for easy installation. Small diameter, rugged elements with vibration dampers limit ice loading. All aluminum with protective Gold Corodized finish. Shpg. wt., 6½ lbs.

18 E 01901W Net 16.95

LAFAYETTE UHF CORNER REFLECTOR

- Range Up to 50 Miles **4³⁵**
- Goldenized



For quality UHF reception even in fringe areas. High gain, sharp horizontal and vertical directivity eliminates "ghosts" and "snow." Rugged construction, large reflector screen made of highest grade aluminum tubing. "Fold-open" assembly. "Goldenized" finish for 100% protection against weather and salt-air deterioration. Shpg. wt., 5 lbs.

18 E 01448W Net 4.35

4-BAY BOW-TIE UHF ANTENNA

- Highest Gain on 70 UHF Channels
- Completely Preassembled
- Excellent Directivity
- Flat Response Across Each Channel
- Range Up To 50 Miles

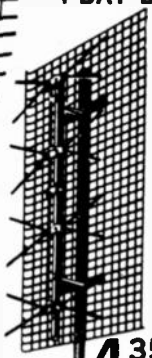

Four bay, UHF bowtie antenna. Exceptionally high (12db) gain—relatively flat across the entire spectrum... Fully factory assembled. Quickest and easiest to install. High efficiency screen grid reflector boosts front to back ratio. Unique "cross-over" phasing bars—open V elements, Rugged—rigid—corrosion resistant construction. Wt., 5 lbs.

18 E 01422WX Net 4.35

UHF "TRANSLATOR" 4-BAY ANTENNA

Four bay bow-tie and screen reflector. Specially designed for re-peter transmitter reception. Tuned to the UHF translator frequencies. Average 16db gain on channels 70-83. Complete pre-assembled. Shpg. wt., 5 lbs.

18 E 01430WX Net 4.35

BLONDER-TONGUE "GOLDEN DART" UHF ANTENNA

- Range Up to 50 Miles **4⁶⁹**



No matter what UHF channels serve your area—from 14 to 83—the Dart delivers a sharp, clean pattern on every channel. Utilizes the logarithmic—periodic

principle which is the modern approach to UHF TV antenna design. Maintains an excellent front-to-back ratio (more than 20 db). An extremely low VSWR prevents ghosts and smears. Completely pre-assembled, nothing to snap out, no screws to tighten. Rugged, unitized welded construction. Shpg. wt., 2 lbs.

18 E 18012 Net 4.69

JFO ULTRA-VISTA UHF INDOOR ANTENNA

- Log-Periodic Design **Only 4⁹⁵**



A log periodic UHF indoor antenna—with electronically tuned brass-plated trapezoid dipoles. Frequency-independent design pulls in extremely strong signal on all channels 14 to 83. Sharp unidirectional beamwidth removes snow, rejects ghosts and interference. Unusually low VSWR, 300-ohm twin lead. Tip resistant, rubber cushioned stand. Shpg. wt., 3 lbs.

18 E 38606 Net 4.95

JERROLD PARA-PRO 27 ELEMENT UHF ANTENNA

- Add On To Present VHF Antenna—No Antenna Coupler Required
- Range Up To 75 Miles



Low silhouette, high-gain periodic design requiring little space and offering a minimum of wind resistance. Has 11 driven elements plus 16 parasitic directors for perfect, sharp corner reception across entire UHF band. Comes assembled with all hardware for quick, easy mounting to existing mast. Shpg. wt., 4 lbs.

18 E 36113W Net 6.95

ATTACHABLE UHF-TV ANTENNA LOOP

- Fits all Television Sets **1¹⁹**

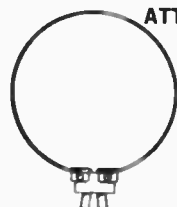

UHF indoor antenna has omni-directional pick-up for stronger signal reception. Simple to install, universal mounting lugs will fit twin lead terminals on any UHF converter or TV set. Shpg. wt., 4 oz.

18 E 38754 Net 1.19

UHF INDOOR ANTENNA

- Attractive "Bow Tie" Design **3⁷⁵**



Decorator designed to blend perfectly with any interior. Black "bow ties" are sharply set off by the attractive golden grid. Provides excellent UHF reception; minimizes snow and ghosts; attaches to back of any TV set; uses 300-ohm lead-in wire. Shpg. wt., 2 lbs.

18 E 63240 Net 3.75

Color TV-FM Boosters



COLOR-AMP TRANSISTORIZED VHF-UHF-FM ANTENNA BOOSTER

FOR CHANNEL 2-83

Only

17⁹⁵

COLOR Approved
Made in U.S.A.

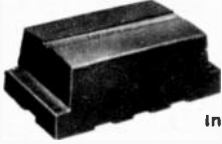

Indoor Power Supply



Mast Mounted Unit

- Gain 20 db VHF-FM — 10 db UHF — Uses Low Noise 2-Transistor Solid-State Circuit
- Use With Any Outdoor TV or FM Antenna — AC Isolation Transformer — No-Shock Hazard

Enjoy vivid color and crisp black and white pictures; instantly improve your FM reception. 2-transistor solid-state mast-mounted pre-amplifier overcomes downlead losses and rejects interference, matching your roof antenna to your TV or FM set under all atmospheric and weather conditions. Gives 20 db boost to UHF and FM; 10 db to VHF. Designed for moderate to fringe area signals. Weatherproof outdoor housing mounts easily on any antenna boom or mast. Complete with 117 VAC indoor power supply and hardware. Has single 300-ohm input and output thru "no-strip" screw terminals. Shpg. wt., 2 lbs. **Net 17.95**

COLOR-BOOST TRANSISTORIZED VHF-FM ANTENNA BOOSTER

FOR CHANNEL 2-13

Only

12⁵⁰

COLOR Approved
Made in U.S.A.

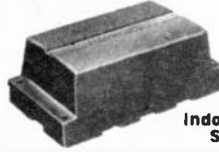

Indoor Power Supply



Mast Mounted Unit

- Gain +14.6 db — Supplies TV set Up To 5 Times More Signal
- Low Noise High Gain Transistorized Circuit — Use With Any VHF (Ch. 2-13) Or FM Antenna

Solid-state antenna preamplifier for superb fringe area reception. Gives sharp color and clean black and white pictures without snow and interference plus provides a healthy boost to FM. Features exclusive lightning protection circuit, highest quality components, and latest RF circuit techniques. Weatherproof outdoor housing has handy five-way mounting bracket and "no-strip" screw terminals. Separate power supply plugs into any 117 VAC, 60 Hz outlet. AC isolation transformer in the power supply eliminates shock hazard. Has single 300 ohm input and output. Shpg. wt., 2 lbs. **Net 12.50**

TRANSISTORIZED 4-SET VHF-TV/FM BOOSTER

- Amplifies Signals for Top Reception on Up to 4 Sets
- Easy to Connect and Economical to Operate

If your antenna isn't putting in signals of sufficient strength then this Lafayette Booster Amplifier is just what you need. Screw-on terminals make wire connections easy, no cutting is necessary. Transistor circuit runs cool, draws little current. Signal strength is boosted 3 to 5 times. Will operate up to 4 TV and or FM sets on the same antenna. Input impedance is matched to antenna impedance. Needs no adjustment. Isolated outputs insure maximum set separation. Can be mounted in any convenient location where adequate ventilation is provided. Size 4 3/4" x 1 1/4" x 3 1/2" D. For 117 volts, 60 Hz AC. Imported. Shpg. wt., 1 lb **99 E 40115** **Net 14.95**

14⁹⁵

COLOR Approved

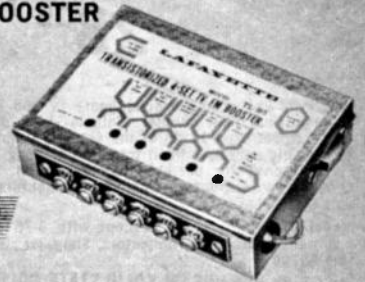

FINCO

INDOOR 2-SET FM SIGNAL BOOSTER



- High Gain 20db
- Ideal For Stereo And Monaural FM

Only **16⁶⁵**

Model 65-7, high gain, 20 db (nominal), low noise transistorized FM amplifier, designed to reject any strong signals outside the FM band to improve reception of weak FM signals in deep or medium fringe areas, even where strong local signals are present. Shock hazard is eliminated through the use of an isolation transformer. 300-ohm input and unique output board will drive 1 or 2, 300-ohm sets. Compact, and easily mounted on set, baseboard, or wherever desirable. Complete unit measures: 1 3/4" x 4 x 1 1/2". **18 E 30421** Shpg. wt., 1 1/2 lbs. **Net 16.65**

INDOOR VHF-UHF-FM COLOR AMPLIFIER



25⁵⁰

- Intensifies Color
- Clears Up "Ghost", "Snow", And Interference
- 4—300 ohm Outputs

Model PC-4382CD VHF/UHF/FM Director 3 Transistor Amplifier. Improves performance of any VHF/UHF/FM combination antenna using one downlead. Broadband design. 300 ohm input splits to four 300 ohm outputs with 6.5 db gain per output. Network completely isolates each output and prevents interaction. Ultralow noise silicon "Noverload" transistor circuitry. Improves color reception. Easily mounts in any position on any surface. For 110-120 VAC, 60 Hz. Size: 5 x 3 1/2 x 1 3/4". Shpg. wt., 2 lbs. **18 E 39166** **Net 25.50**

Model PC-4312CD Similar to above except for VHF — Ch. 2-13 and FM, 8 db gain per output. **18 E 39174** **Net 18.00**

JFD

MAST MOUNTED VHF-UHF-FM COLOR AMPLIFIER



Indoor Power Supply



Mast Mounted Unit

35²⁵

Model SP-2382CD VHF/UHF/FM Mast Mounted 3 Transistor Amplifier. 12 db gain on VHF and FM, 14 db gain on UHF. Clears up ghosts, snow and interference. For color, black and white and FM reception. 300 ohm input with two 300 ohm outputs. Weather and lightning protected amplifier unit mounts on mast for high signal to noise ratio. Compact power supply with built-in splitter mounts near set. Needs only one downlead from VHF/UHF/FM antenna. For 110-120 VAC, 60 Hz. Shpg. wt., 2 lbs. **18 E 39158** No Money Down* **Net 35.25**

Model SP-2300CD Similar to above except for VHF — Ch. 2-13 and FM only; 4 db gain single output, 8.5 db gain at each of 2 outputs. **13 E 39183** **Net 28.50**

TV-FM Boosters by Winegard

VHF-UHF-FM SOLID STATE BOOSTER-COUPLER

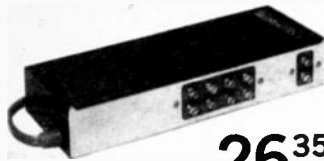

26³⁵

- 4-300 Ohm Outputs
- Perfect For Ch. 2-83 and FM Home System
- Excellent For Color Because Of Uniform Gain

Model BC-382 highly efficient TV-FM signal amplifier with overlay silicon transistors and printed circuitry. Delivers full gain on all 82 channels (5 db for VHF, 4.5 for UHF), enough to operate 1, 2, 3, or 4 sets. 15 db isolation between outputs. Low noise (6.2 db avg., VHF, 11.7 db avg., UHF), cuts snow even in deep fringe areas. Uses existing 300-ohm downlead to the input and has 4-300 ohm outputs with "no-strip" connections. In enamel steel case with connectors and instructions. 117 VAC. Shpg. wt. .3 lbs.

18 E 60733 Net 26.35

Model BC-702. Similar to above except for 75 ohms; avg., gain 6.5 db per output.

18 E 60741 Net 29.65

SOLID STATE VHF-FM 4-SET BOOSTER-COUPLER



23⁰⁵

- +7.1db Gain To Each Of 4-300 Ohm Outputs
- Recommended For Color and Black and White—
- Improves FM Reception
- 75 and 300-ohm Inputs

Model BC-234 makes a good home TV and FM system amplifier, or an amplified 4-set coupler. Gain is +7.1 db at each of the 4-300 ohm outputs or +14 db at the single 75 ohm output. Uses temperature stable overlay silicon transistors—long life, low cost operation. Flat response for perfect color reception. No interaction between sets. All metal housing. Includes connectors. 117VAC.

18 E 60750 Shpg. wt., 3 lbs. Net 23.05

Model BC-274 As above, except with 4-75 ohm outputs. Avg., gain 4 db per output. With connectors. Shpg. wt., 3 lbs.

18 E 60766 Net 26.37

+25 db VHF-UHF-FM SOLIO-STATE COLOR SYSTEM AMPLIFIER



39⁵⁵

- Will Drive 10 TV/FM Units
- Use In Motels, Apartments, Hospitals, Homes

Model DA-825A. 75-ohm, 82-channel high quality color and black and white amplifier with 25 db gain. Rugged transistor circuitry features silicon transistors in a unique grounded emitter circuit for excellent stability, sensitivity, and ultra-low noise figure (5.1 db VHF, 7 db UHF). Provides 35 db mV per channel UHF output with 4-channel input operating at 60% maximum input level, ideal for home and commercial MATV systems with up to 10 line tap offs. May be used with a single 82 channel antenna or separate VHF-UHF antennas. Has separate inputs for VHF and UHF. Model CS-775 separator-joiner recommended for separating VHF-UHF signal from a single downlead of a 82 channel antenna. Compactly designed in a vented cabinet unit. Complete with coaxial connectors, hardware and built-in 117VAC power supply. Shpg. wt., 3 lbs.

18 E 60709 No Money Down* Net 39.55

Model CS-775 Separator-Joiner to attach single downlead to separate UHF-VHF inputs of DA-825A above. Shpg. wt., 1 lb.

18 E 60824 Net 5.25

SUGGESTED DISTRIBUTION SYSTEM FOR ABOVE

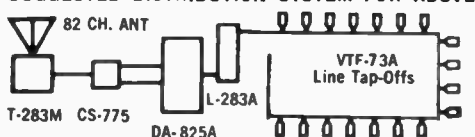

82 CHANNEL 2-TRANSISTOR VHF-UHF-FM SOLID-STATE AMPLIFIER



19⁹⁵

Mast Mounted Unit



Indoor Power Supply

- 20db Gain On VHF-FM
- 10db Gain On UHF
- For Color and Black and White
- Use With Any VHF-UHF-FM Antenna

Model RD-830 Twin-transistor antenna preamplifier gives big signal boost to any 82 channel antenna for beautiful color and black and white reception. No extra wires needed; connects to existing downlead. High signal input assures snow-free reception of weak and distant stations. AC isolation transformer—no shock hazard. Protected against lightning, static discharges, or power line surges. Built-in hi-pass filter. Has single 300 ohm input and output. With AC power supply, mtg. hardware. 117 VAC. 60 Hz. Shpg. wt., 2 lbs.

18 E 60873 Net 19.95

Model RD-870 Same as above but 75-ohm output.

18 E 60881 Net 19.95

VHF-UHF-FM SOLID-STATE 2 SET BOOSTER-COUPLER



13¹⁵

- Doubles Input Signal
- Perfect For Color and Black and White
- High Isolation Between Sets

Model BC-830. Boosts signals on all channels 2 thru 83, plus FM; operates two TV sets or TV and FM set from single 300 ohm antenna downlead. Unique lightning protected circuit overcomes loss of splitting signals. Average gain of 5.25 db to each output, provides a healthy boost for snow-free pictures. High input level prevents overload in mixed signal areas. 300 ohm input and output thru handy "no strip" screw terminals. Operates on 117VAC., 60 Hz. Shpg. wt., 1 lb.

18 E 60717 Net 13.15

Model BC-890. Similar to above, except with 2-75 ohm outputs. Average gain 4.5 db to each output. Shpg. wt., 1 lb.

18 E 60725 Net 14.20

FM SUPERCHARGER



11⁸⁸

- Transistorized
- Gives You 8 Times More FM Signal
- Ideal for Stereo and Monaural FM
- Easy to Install

Model FM-340. Greatly improves FM and FM stereo reception. Transistorized booster-amplifier adds +17 db gain (8 times more signal) to incoming signal. Ideal for fringe and deep fringe areas. 300 ohm input and output. Bandpass: 88-108 MHz. Operates on 110-120 VAC 60 Hz.

18 E 60442 Shpg. wt., 1 lb. Net 11.88

ACCESSORIES FOR DISTRIBUTION SYSTEM

Model VTF-73A—Flush mounting 82 channel variable line tap. Matches 75 ohm input to 300 ohm output. Fits standard wall box-with plug.

18 E 60774 Shpg. wt., 6 oz. Net 3.28

Bakelite Wall Box—Knockouts top and bottom—standard size.

18 E 70013 Shpg. wt., 6 oz. Net .79

Model T-283M—Mast mounted 82 channel. Matching Transformer matches 300 ohm antenna to 75 ohm coaxial cable, with connector.

18 E 60816 Shpg. wt., 6 oz. Net 3.25

Model CS-775—75 ohm separator-joiner designed to separate or mix together VHF and UHF TV signals on coaxial lines—with 3 connectors.

18 E 60824 Shpg. wt., 1/2 lb. Net 5.25

Model L-283A—82 channel (VHF-UHF-FM) Solid-State line amplifier increases number of outlets (line tap-offs) you can run in a system. Powered by trunk line from DA-825A amplifier, with connectors.

18 E 60899 Shpg. wt., 10 oz. Net 29.36

Model CS-285—Behind set VHF-UHF signal splitter.

18 E 60584 Shpg. wt., 6 oz. Net 1.98

Model CS-175—Behind set VHF-UHF signal splitter and 75-300 ohm matching transformer.

18 E 60675 Shpg. wt., 6 oz. Net 3.28

Model T-203—75-300 ohm back of set matching transformer.

18 E 60204 Shpg. wt., 6 oz. Net 2.15

BLONDER TONGUE

TV and FM Boosters

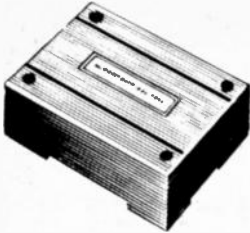

4-SET TV-FM AMPLIFIER/COUPLER

As Low As **13⁴⁰**

- Silicon Transistors
- Feeds Up To 4-Sets

Indoor, solid state, 4-output, 300 ohm VHF/FM indoor powered splitter for VHF channels 2-13 plus FM. Single transistor low noise, more powerful silicon circuitry. Can be used to supply up to 4 TV sets. Excellent isolation between outputs prevents interaction between sets, 300 ohm balanced input and output impedance. All terminals equipped with stripless screws. Size: 3 x 4 1/8 x 1 1/8". For 110-120VAC, 60 Hz.

18 E 18350 Shpg. wt., 1 lb. Net 13.40

Similar to above except for use with 75 ohm coaxial cable. Provides 5db (typical) gain at each output.

18 E 18368 Net 17.90

MAST-MOUNTING VHF-UHF-FM AMPLIFIER



35²⁵ • 2-Transistor Circuit
No Money Down* • Approved For Color—Built-in FM Filter

Weatherproof all-channel (2-83) amplifier and remote power supply. Silicon transistors provide peak performance in any location. Will not overload if there are strong local stations. Dual amplification increases signal up to 5 times. Has separate 300 ohm UHF and VHF inputs and outputs. Provides signal for up to 4 sets. Comes complete with power supply and mounting hardware. 2 1/4 x 5 x 3 7/8"; Power supply, 4 7/8 x 3 1/8 x 1 3/8".

Power Supply 117 VAC.
18 E 18095

Net 35.25

MAST-MOUNTING 2-TRANSISTOR VHF/FM AMPLIFIER

Solid state, mast-mounted home TV amplifier with remote power supply. 2-transistor circuit brings in distant and local stations with sparkling clarity and no overloading. Built-in 2 set coupler. Provides 17 db gain. Hardware provided. 117VAC. Size amplifier: 2 1/4 x 5 x 3 7/8"; Power supply, 4 7/8 x 3 1/8 x 3 3/8". Similar appearance to above. Shpg. wt., 1 1/2 lbs.

18 E 18103

Net 25.17

MAST-MOUNTED 2-TRANSISTOR UHF AMPLIFIER

- Triples Signal Strength
- Silicon Transistor Circuit

Offers maximum S/N ratio to give snow-free pictures, even in difficult fringe areas. Will not overload strong signals. High db gain offers top performance on channels 14-83. Operates on existing twin-lead antenna wire. Remote power supply works on 117 VAC, 60 Hz. Mounting hardware supplied. Dim.: (ea. unit) 3 x 4 1/8 x 1 1/8".

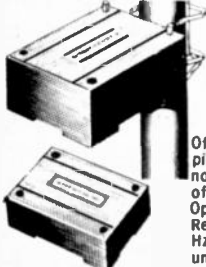

Power Supply 18 E 18137 Shpg. wt., 1 1/4 lbs. Net 29.65

AMECO NUVISTOR FM PREAMPLIFIER

22⁹⁵

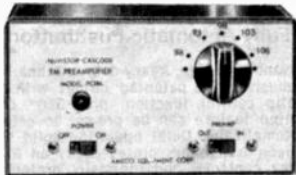

Nuvistor Cascode FM Preamplifier is the ideal solution for weak, fading, and noisy FM reception. Extremely easy to install and operate; just connect between your existing FM antenna and tuner or receiver with 300 ohm twin-lead wire. Contains its own power supply and ON/OFF indicator light and may be placed anywhere near the FM tuner. Once desired station is tuned on FM tuner, the control is also tuned to that station for optimum reception. Greatly helps to eliminate fading and background noise especially inherent in weak FM multiplex signals. Features two 6DS4 nuvistors in cascode circuit. Size 5 3/4" W x 3 H x 3 3/8" D. Power requirements 120 VAC, 60 Hz. Shpg. wt., 3 lbs. 21 E 20012 Net 22.95

4-SET TV-FM TRANSISTOR AMPLIFIER

Only **16⁷⁵**

- For Color and Black and White
- For Up To 4-TV Or FM Sets



Indoor 300 ohm amplifier for channels 2-13 plus FM transistor—4 output amplifier can supply up to 8 or more TV sets with couplers. Gain: VHF 8 db. Maximum signal to noise ratio for clear strong pictures. Excellent isolation between outputs prevents interaction between sets. Ideal for use in home and small 300 ohm systems. Stripless screw terminals, with self-contained power supply. 8 1/4 x 3 1/4 x 1 3/8". For 110-120 VAC, 60 Hz.

18 E 18335 Shpg. wt., 1 lb. Net 16.75

4-SET VHF-UHF-FM AMPLIFIER

Similar to above except for channels 2-83 plus FM, 3-transistor silicon circuitry provides excellent gain across entire band. Gain: VHF, 8 db; UHF, 6 db. 110-120 VAC, 60 Hz.

18 E 18343 No Money Down* Net 41.42

MAST-MOUNTED HIGH GAIN TV/FM AMPLIFIER

42⁸⁵

No Money Down*

- 28db Minimum on VHF/FM
- Solid-State
- For Deep-Fringe



Deluxe two-piece mast mounted amplifier for use in the most difficult reception areas. One of the most powerful units available for the home. May be used in small hotels, appliance stores, etc. Will drive up to 50 sets in a properly designed distribution system. May be used as a preamplifier for an HAB or other distribution amplifier. Power is duplexed onto lead connecting amplifier and its remote power supply. (Power supply is included with unit). Mast mounted amplifier has 300 ohm input and 75 ohm output. Specs: 28db minimum gain on all VHF and FM frequencies. Remote Amplifier/Power supply mounts anywhere—indoors. Single 75-ohm input and output. Supplied with coaxial connectors. Size: Mast Mounted Unit—5 x 3 x 3; Indoor Amplifier/Power Supply—8 x 3 x 2. For 117 volts AC, 60 Hz. Shpg. wt., 3 lbs.

18 E 18376 Net 42.85

VHF MASTER TV/FM SYSTEM AMPLIFIER

46⁷⁵

No Money Down*

- Serves Up to 50 TV Sets
- For Homes, TV Showrooms, Schools and Motels
- High Gain



Model HAB, low-noise broadband amplifier for use in larger home systems, motels, appliance stores. High and low band gains are independently variable, providing compensation for different signal strengths and increased system losses at higher frequencies. Will drive up to 50 sets in a properly designed distribution system. Dual impedance 75 and 300 ohm input and output. Gain controls adjust output to desired level. 25 db minimum gain on all VHF/FM frequencies. Bandpass of 54-108 MHz and 174-216 MHz. Gain control range: 15 db, ch. 2-13 and FM; 15 db, ch. 7-13. Noise figure: ch. 2-6, 4 db; 7-13, 6 db; FM, 4 db (typical). Max. output (at full gain, across 75 ohms): 0.9V total low band; 0.6V high band, for 1% crossmodulation. 105-120VAC, 60 Hz

18 E 18087 Shpg. wt., 5 lbs. Net 46.75

INDOOR 8-SET VHF AMPLIFIER

68⁸⁵

- 22db Output Isolation
- Built-in Splitter
- 75 Or 300 Ohm

Model DA-8B, has built-in splitter with 8 fully isolated outputs. Minimum high gain of 10 db from antenna to each output. Choice of 75 or 300 ohm connections at input and outputs. Adjustable gain control adjusts output to desired level. Gain control range: 20 db. Uses all triode circuitry. For 105-120 VAC, 60 Hz 9 x 5 x 5 1/2. Illustration similar to above. Shpg. wt., 6 lbs.

18 E 18277 No Money Down* Net 68.85



Alliance Tenna-Rotor® Systems

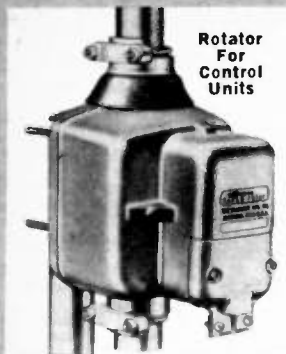

Rotor For Control Units

35⁹⁷
No Money Down*



28⁷⁸

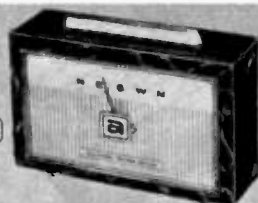

24⁰³

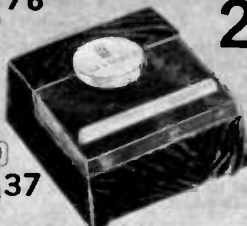

19³⁷



2⁹⁷

- Factory Lubricated for Life
- Reinforced Housing for All Weather Protection
- External Hardware Stainless Steel or Corrosion Resistant Materials

- Will Handle the Largest Color TV Antenna in Winds In Excess of 90 M.P.H. Rotation Speed 1 R.P.M.
- Magnetic Brake for Instant Stops with No Drift
- Full 360° Rotation

A Model C-225 Automatic Rotor System with Transistorized Control Box. If an individual can lift and install his antenna, this Tenna-Rotor will support it, hold it, and rotate it. Accepts masts to 1 3/8" O.D. Guy wire accesses provide secure installation. Has patented offset feed thru design for greater strength to weight ratio. Control Case is completely transistorized featuring a patented phase-sensing bridge circuit designed from scientific laboratory test equipment. Completely silent operation and accurate repeatability. Size: Rotor 7 3/4 x 4 1/2 x 8". Control Case 6 1/2 x 4 1/4 x 5". 115 V. 60 Hz AC, 80 watts. Uses 5 Cond. Cable. Shpg. wt., 12 lbs.
18 E 14011W Net **35.97**

C Model T-45 Manual Rotor System. Slight pressure on the control bar rotates antenna through its full 360° cycle and stops at any point by releasing the bar. New patented 5-wire circuit provides a precision system that is unaffected by motor current, cable length and line voltage variations. Improved electrical system with expanded meter scale, assures pin-point accuracy and easy-to-read antenna direction indication. 115 V, 60 Hz at 70 Watts. Size: Rotor 7 3/4 x 4 1/2 x 8". Control Case 6 1/2 x 4 1/4 x 2 1/2". Uses 5 Cond. Cable.
18 E 14029W Shpg. wt., 12 lbs. Net **24.03**

B Model U-100 Automatic Rotor System. If an individual can lift and install his antenna, this Tenna-Rotor will support it, hold it, and rotate it. Accepts masts to 1 3/8" O.D. Guy wire accesses provide secure installation. Control Box fully automatic, just set control knob and antenna rotates to desired position and stops automatically. Indicator shows position of antenna. Has positive mechanical stop at the end of rotation. Sizes: Rotor 7 3/4 x 4 1/2 x 8". Control Case 7 x 4 1/2 x 4". 115 V, 60 Hz AC at 65 watts. Uses 4 Cond. Cable. Shpg. wt., 12 lbs.
18 E 14037W Net **28.78**

D Model K-22 Manual Rotor System. Economy model—provides instant fingertip control of rotation. Push on end of bar and antenna turns clockwise. Push down on other end and antenna turns counter-clockwise. Automatic signal light indicates when limit of travel in either direction has been reached. Size: Rotor 7 3/4 x 4 1/2 x 8". Case 5 x 5 x 4". 115 V, 60 Hz, AC at 50 watts. Uses 4 Cond. Cable.
18 E 14045W Shpg. wt., 12 lbs. Net **19.37**

E Thrust Bearing Bracket. Increases stress capacity of antenna rotators up to 300 lbs. and is recommended for stacking antennas. Withstands winds up to 90 MPH. Prevents buckling and bending. Shpg. wt., 3 lbs.
18 E 14052 Net **2.97**

CORNELL DUBILIER ROTORS

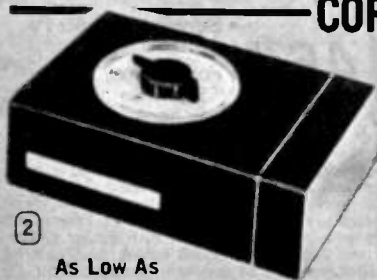

2

As Low As
34⁹⁵
No Money Down*

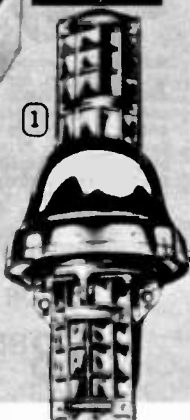

1

AR-22R AUTOMATIC ROTOR SYSTEM (units 1 & 2)

Heavy duty rotor will handle antennas up to 150 lbs. Developed from years of experience in the amateur radio field. Completely weather-proof and life lubricated. Simple automatic operation. Set the edge-lit dial at the desired position and the rotor will automatically rotate to this position and firmly brake in place. Reversible clamps will accommodate masts from 7/8" to 2" O.D. Control unit is marked in compass points. Housed in attractive Black Vinyl steel clad cabinet, dial edge illuminated. Complete with rotor, control unit and instructions. Uses 4 wire cable. For 110/120 Volt, 50-60 Hz A.C. Wt. 14 lbs.
42 E 86076WX No Money Down* Net **34.95**

AR-33 SOLID STATE AUTOROTOR™ (units 1 & 3)

- Fully Automatic Pushbutton Antenna Rotor

Advanced design, heavy-duty antenna rotor. Control unit; features an exclusive CDE patented circuit with five station pushbutton automatic control function, plus 360° compass dial operation; push-button feature can be pre-set to select any five antenna positions automatically. Quiet operating solid state circuitry includes rugged silicon transistors protected by an RF bypass provision, heavy-duty relay contacts, and thermally protected transformer. Unit controls the famous CDE heavy-duty "Bell" rotor. Uses five conductor cable. For 110/120V., 50/60 Hz AC. Shpg. wt., 16 lbs.
42 E 86100WX No Money Down* Net **49.95**

CABLES FOR ALLIANCE AND CDE ROTATORS

4 Conductor flat cable. Shpg. wt., 3 lbs. per 100 ft.
32 E 89105 per 100 ft. Net **3.10**

5 Conductor Cable. Shpg. wt., 4 lbs. per 100 ft.
32 E 36312 per 100 ft. Net **3.89**

TV Degaussers, Tuner Cleaners, Antenna Switches

LAFAYETTE COLOR TV TUNER CLEANER - LUBRICANT

- For Color and Black and White
- With Spray-Aid Needle

Non-flammable, non-toxic, easy to use. Can be applied without removing chassis from the cabinet. Will not harm plastics or electrical insulation or detune the tuner. Excellent for both color and black and white sets. 6 oz. spray can.

18 E 01904 Shpg. wt., 8 oz. Net .99
16 oz. economy size spray can with spray-aid needle. Shpg. wt., 1 1/2 lbs. Net 1.99
18 E 02158



LAFAYETTE 7" COLOR TV PURIFIER

- For Sharp and Clear Color Reception

Sharpens color reception through demagnetization of the picture tube. Simply turn on the set, plug in the purifier, and with switch depressed rotate unit in front of the TV screen. Use regularly to keep your color reception sharp and clear. Convenient clip for hanging on back of set when not in use. Imported. For 110-120 VAC, 60 Hz.
99 E 40248 Shpg. wt., 1 lb. Net 2.49



WALSCO 7" COLOR TV PURIFIER

- Portable Tube Kaddy Size
- For In-The-Home Servicing
- Color TV Degaussing Coil

Improve the quality of color TV with this portable 7" DEGAUSSER. Easily demagnetizes tube shield and accessories to eliminate stray colors and purify the picture. Momentary push button switch simplifies operation. You don't need to be a technician to use this little marvel. U.L. listed. For 110-120 VAC, 60 Hz. Shpg. wt., 1 lb.
18 E 04022 Net 5.95



PROFESSIONAL DEGAUSSING COIL

- For Color TV Receivers
- Large 13" Diameter Coil

Well suited for the serviceman or set owner. Heavy-duty degaussing coil demagnetizes and removes stray magnetic flux from color TV chassis and picture tube to achieve color purity. Contains momentary switch to de-energize coil without pulling plug. With 9 ft. cord. For 110-120 VAC, 60Hz.
18 E 04055 Shpg. wt., 2 1/2 lbs. Net 19.95



LAFAYETTE ANTENNA SELECTOR SWITCH

- Up To 3 Antennas on One Set
- Up To 3 Sets on One Antenna

Lafayette low-loss switch for easy change from one antenna to another. Allows up to 3 antennas for one set with 300 ohm lead. Also permits one antenna for 3 sets. Housed in attractive plastic case. For VHF/UHF or FM. Shpg. wt., 1/2 lb.
99 E 40263 Net 1.49



VIDAIRE SIGNAL ATTENUATOR

May be used with all TV sets troubled with excessive signal. Eliminates poor sync., multiple images, buzz, beats in picture, etc., when caused by signal overloading. Produces 1000 to 1 change in signal reaching set. Reduces most cross-modulation effects. Adjustable for all signal areas. Simple to mount—simple to install. Shpg. wt., 8 oz.
18 E 80012 Net 3.49



VIDAIRE COLOR GHOST ELIMINATOR

- Adjustable for All Picture Conditions
- Reduce Color Fringing
- Reduce Multiple Images

Get true color reception with this color ghost eliminator. Reduces or eliminates multiple images (ghosts) in a picture. Reduce the effects of intermitting caused by strong signals of radio and TV transmitters in nearby areas. L-pad attenuator keeps constant 300-ohm impedance. Adjustable for all channels.
18 E 00020 Shpg. wt., 1 lb. Net 4.50



BAKELITE KNIFE SWITCH

10 for 225

Excellent for TV antenna switching. Heavy metal parts mounted on bakelite base. Double pole, double throw. Shpg. wt., 4 oz.
99 E 81533 Net Ea. .25
10 for 2.25



INJECTORAL TUNER CLEANER-LUBRICANT

- With Injector Needle
- For Color—Black and White

Super 100. Fast drying, will not harm plastics or electrical insulation. Non-toxic, non-flammable. Can be sprayed on without removing chassis from cabinet. Contains "anti-static" agent. Will not cause drift or detune tuners.

3 oz. spray can. With plastic injector needle. 18 E 34043 Shpg. wt., 1/2 lb. Net .99
6 oz. spray can. With steel injector needle. 18 E 34050 Shpg. wt., 1 lb. Net 2.10
16 oz. spray can with steel injector needle. 18 E 34068 Net 2.99



"No Noise" VOLUME CONTROL & CONTACT CLEANER

- Cleans and Lubricates
- Will Not Harm Plastics

For color and black and white TV, radios, volume controls, band switches, pushbutton assemblies, relays, and electrical contacts. Restores, lubricates, protects, and cleans. Non-toxic and non-flammable. Prevents gumming. Does not change capacities. 6 oz. spray can with 5" extender (needle). Shpg. wt., 10 oz.
18 E 43010 Net 1.99



CHEMTRONICS "FROST AID"

- With Pin-Point Spray Needle

Pinpoints bad capacitors and transistors, oxidized joints by cooling components. Leaves no residue. With spray needle for hard to reach places. Non-flammable. 8 oz. spray can. Shpg. wt., 1 lb.
18 E 52011 Net 1.39



50 PIECE TV KNOB KIT

Selection contains 50 assorted TV knobs including such types as channel selector, fine tuning, volume, etc. Useful and attractive. Many with gold lettering or gold inserts. Shpg. wt., 3 lbs.
32 E 99021 Net 1.95



STANDARD KOLLSMAN "ARBO" PRESET TUNERS

15⁹⁵

- Replacements for over 1500 Different Models

Latest advances in tuner design result in maximum performance, with outstanding frequency stability and precise tuning. With 13 position detents. IF Video: 45.75 MHz. IF Sound: 41.25 MHz. B+: 125 — 145 VDC. Antenna input: 300Ω balanced to ground. With mounting brackets. Shpg. wt., 3 lbs.



Stock No.	Model No.	Heater	Net
18 E 20109	SBR-250	6.3V	15.95
18 E 20117	SBR5-252	600ma	15.95
18 E 20125	SBR4S-251	450ma	15.95



2-SET VHF-UHF-FM COUPLER

1 49

- Up To 2 TV or FM Sets From One Antenna
- Low Signal Loss

Couples 2 TV or FM sets from a single TV/FM Antenna. Low insertion loss and high isolation between sets. Ideal for color or black and white installations. Easy to install, no-strip 300-ohm input and output terminals and mounting hardware, when used with 82 channel (VHF-UHF) TV sets. 99-40339 signal splitter required (see this page). Imported. Shpg. wt., 1 lb. 99 E 40313

Net 1.49

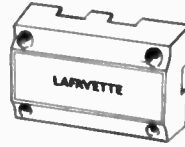

4-SET VHF-UHF-FM COUPLER

1 99

- Up To 4 TV or FM Sets From One Antenna
- Low Signal Loss

Couples up to 4 TV or FM sets from a single TV/FM antenna. Excellent design gives high isolation between sets and low insertion loss. For color and black & white. Easy to install, no-strip 300-ohm input and output terminals, and mounting hardware, when used with 82 channel (VHF-UHF) TV sets. 99-40339 signal splitter required (see this page). Imported. Shpg. wt., 1/2 lb. 99 E 40321

Net 1.99

3-SET VHF TV/FM COUPLER



- Up to 3 TV or FM Sets On One Antenna

1 69

Highly efficient 3 set coupler. For coupling 2 or 3 TV or FM sets to one VHF or FM antenna of any type. No interaction—less than 6.0 db insertion loss. 40 to 50 db rejection ratio. Imported. Shpg. wt. 1 lb. 99 E 40107

Net 1.69

INDOOR VHF-UHF SIGNAL SPLITTER



1 49

- Separate VHF And UHF Signal From A 82 Channel Single Line Installation

Back of set, VHF-UHF signal splitter. Adapts a single all-channel 300-ohm twinlead to a 82 channel TV set with separate VHF and UHF 300-ohm input terminals. Low insertion loss and high isolation between VHF and UHF bands insures sharp pictures on color and black & white. No-strip input terminals—includes pre-attached VHF-UHF leads. Imported. Shpg. wt., 1/2 lb. 99 E 40339

Net 1.49

1 79 2-ANTENNA COUPLER (VHF-UHF)

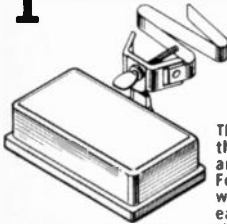

- Weatherproof Plastic Case
- Mounts on Mast
- Combines Separate UHF and VHF Antennas Into Single Line

This efficient UHF/VHF coupler combines the signal from the separate UHF and VHF antennas into a single transmission line. Features maximum signal transference with extremely low insertion loss. Mounts easily on mast. Sturdy, weatherproof plastic case with metal clamp. Imported.

99 E 40164 Shpg. wt., 1/2 lb.

Net 1.79

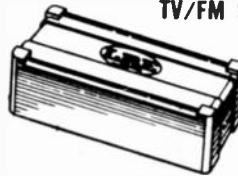

TV/FM SPLITTER-COUPLER

- Splits TV and FM Signals From VHF TV Antenna
- Low Signal Loss

2 95

Splits TV and FM signals with minimum loss to either signal from a single VHF-TV antenna. Also combines separate TV and FM antennas into single down lead line. Prevents interference; gives complete isolation between sets. For indoor or outdoor mounting. Imported. Shpg. wt., 1/2 lb. 99 E 40222

Net 2.95

2-SET VHF-TV/FM COUPLER

59c



Use one antenna for two sets. Compact electronic set coupler assures performance of two TV sets on one installation. Easy to connect. Imported. Shpg. wt., 1 lb. 99 E 40040

Net .59

JFD HIGH PASS FILTER

3 09 • For Outdoor—Indoor Use

Model HP50. Hi-pass wavetrap that eliminates ham, citizens' band, police, fire, marine interference. Low phrase shift ideal for color TV indoor or outdoor mounting. No-Strip terminals eliminate wire-stripping, splicing or cutting. Low insertion loss—300 ohm impedance. Shpg. wt., 1/2 lb. 18 E 30200

Net 3.09

SUPEREX CLEAR PIX



1 19

- 27 MHz Citizens Band Interference Filter

Clear Pix by-passes most sources of TV interference before they have a chance to enter your receiver. Picture and sound enter stripped of common types of man-made interference. Designed for maximum interference elimination at 27 MHz (citizens band). Requires just a screwdriver to install. 18 E 51088 Shpg. wt., 6 oz. Net 1.19

392 Lafayette Cat. No. 700

LAFAYETTE HIGH PASS FILTER

2 29



A high pass filter for use at the antenna terminals of a TV set to block interfering signals from radio amateurs, police and taxicab transmitters, paging systems, X-ray machines, passing automobile ignition noise, etc. Attenuation more than 25 db at 47 MHz. Only .5 db insertion loss. Imported. 99 E 40214 Shpg. wt., 8 oz. Net 2.29

LAFAYETTE LO-PASS LINE FILTER

2 69

- Dual Ferrite Core Coils

Exceptionally efficient line noise eliminator. Utilizing dual ferrite core coils, heavily wound. Eliminates line noises caused by motors, industrial RF, neons, appliances, etc. Particularly useful on TV and FM sets, radios, tuners, record players. Automatic attenuation of unwanted disturbances. For 110-125 VAC., 60 Hz; 350 watts max. Imported. Shpg. wt., 1 1/4 lbs. 99 E 40057

Net 2.69

LAFAYETTE TV FILTERIZER

2 95

- Eliminates Most Television Interference

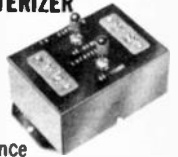

Easily adjusted to remove any antenna-fed interference causing picture distortion: FM, diathermy, SW, ignition, amateur/CB, adjacent channel, etc. Does not attenuate signal. Actually tunes out unwanted signal. Matches any antenna. Metal case finished in black enamel. Easily installed. Size 4 x 2 3/4 x 1 1/2". Imported. Shpg. wt., 7 oz. 99 E 40172

Net 2.95

FINCO FM BAND PASS FILTER



MODEL 3007. Eliminates interference from citizen band, amateur operators, electric motors, aircraft, fluorescent lamps and auto ignition. Provides up to 40 db attenuation of all interfering signals outside the FM band. Less than 1 db insertion loss in 88 to 108 MHz band. Recommended to be mounted at FM radio set for maximum effectiveness but may be mounted anywhere in line for less serious applications. 18 E 30165 Shpg. wt., 8 oz. Net 4.38

Depend on Lafayette For Complete Stocks, Lowest Prices, Fastest Service



TV-FM SPLITTERS - COUPLERS - COMBINERS

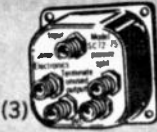
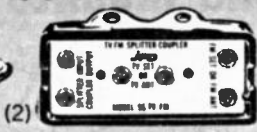
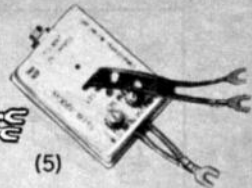

• Low Insertion Loss • True Color Fidelity—Sharp Black/White—True Fidelity FM • No-Strip Terminals

3 2-SET VHF/UHF/FM COUPLER

Model SC42 Couples 2 TV or FM sets from one TV or FM antenna. Low insertion loss and high inter-set isolation makes this unit ideal for use on COLOR or BLACK & WHITE installations. No-strip terminals provided for quick connections, 300-ohms input and output. Supplied with wood screws for indoor use and insta-mount adhesive. When used with 82-channel (VHF-UHF) TV set either Model SS-21 or SS-83 signal splitter required at your set.
18 E 38135 Shpg. wt., 1 lb. Net 2.40

(2) 3-SET VHF/UHF/TV COUPLER

Model SC-67 Similar to above except couples up to 3 TV or FM sets from one TV or FM antenna.
18 E 38143 Shpg. wt., 1 lb. Net 2.97

2) 4-SET VHF/UHF/FM COUPLER

Model SC72 similar to above except couples up to 4 TV or FM sets from one TV or FM antenna. Shpg. wt., 1 lb.
18 E 38150 Net 3.30

(1 & 2) 2-ANTENNA COUPLER (VHF/UHF)

Model SC20 combines separate VHF and UHF antennas so that only one 300-ohm downlead is needed. High insulation for crisp clear color. No-strip terminals. Mast mounting hardware supplied.
18 E 38127 Shpg. wt., 1 lb. Net 2.85

4 INDOOR VHF/UHF SIGNAL/SPLITTER

Model SS21 splits VHF/UHF signal from all-channel 300-ohm single downlead into separate VHF-UHF outputs. For feeding into 82-channel TV set with separate VHF-UHF antenna input terminals. High and low pass filter networks insure sharp, clear pictures—Color or black/white. No interaction because UHF and VHF lines are completely isolated from each other. No-Strip terminals. Includes wire lead. Mounts quickly with insta-mount adhesive.
18 E 39083 Shpg. wt., 1 lb. Net 2.40

(4) INDOOR VHF/UHF/FM SIGNAL SPLITTER

Model SS83 similar to above except splits VHF/UHF/FM signal into separate VHF/UHF and FM outputs. Shpg. wt., 1 lb.
18 E 39091 Net 2.97

(5) VHF/UHF SPLITTER 75-300 OHM MATCHING TRANSFORMER

Model MT-36 2-way 75 to 300-ohm matching transformer. Plus splits VHF/UHF signal from all-channel, single 75 ohm downlead into separate VHF/UHF outputs. For feeding into 82-channel TV set with separate VHF-UHF antenna input terminals. With coaxial cable fitting.
18 E 39133 Shpg. wt., 1/2 lb. Net 2.97

(5) VHF/UHF/FM SPLITTER 75-300 OHM MATCHING TRANSFORMER

Model MT-58 similar to above except splits VHF/UHF/FM signal into VHF/UHF and FM outputs. Shpg. wt., 1/2 lb.
18 E 39190 Net 4.17

2-WAY VHF/UHF/FM 75 OHM LINE SPLITTER (3) Model SC42-75 splits one 75-ohm VHF/UHF/FM line into two 75-ohm outputs. Also combines two 75-ohm lines into one line. 3 mating plugs supplied.
18 E 39109 Shpg. wt., 1 lb. Net 6.50

4-WAY VHF/UHF/FM 75 OHM LINE SPLITTER (3) Model SC72-75 splits one 75-ohm VHF/UHF/FM line into four 75-ohm lines. Excellent for use in home or master antenna TV system. May be combined with an (SC42-75) to provide any number of lines. 5 mating plugs supplied.
18 E 39117 Shpg. wt., 1 lb. Net 8.70

(1 & 2) TV/FM SPLITTER-COUPLER FM FILTER

Model S5TV/FM splits FM signal from TV/FM signal to FM set—and TV signal to TV set. Ideal for stereo—prevents interference. Can also be used as FM bandpass which will admit clean FM signals only through to the FM tuner. Can also combine TV and FM antennas into a single system. Eliminates all TV, amateur and citizens band signal pickup by antenna or transmission line. 300-ohm impedance. With hardware.
18 E 39125 Shpg. wt., 1 lb. Net 3.57

JFO VHF-UHF-FM COAXIAL CABLE MATCHING TRANSFORMER KIT

- 75-300 Ohm Impedance Match
- Includes Outdoor and Indoor Units
- Ideal for COLOR TV

Model MT-51 Complete kit of matching transformers for installing TV & FM antennas. For use with noise-free 75-ohm coax cable. Weather-proof outdoor transformer matches any 300-ohm antenna to 75-ohm coaxial cable. Indoor transformer at set matches the 75-ohm coax to the 300-ohm TV or FM set. Includes coaxial cable fittings. Shpg. wt., 1/2 lb.
18 E 38895 Net 4.20



Indoor Unit

MATCHING TRANSFORMER KIT WITH VHF-UHF-FM SPLITTER

Model MT-59 similar to above except indoor unit has separate VHF/UHF and FM outputs. For feeding into 82-channel TV set with separate VHF-UHF antenna input terminals plus FM set. With fittings. Shpg. wt., 1/2 lb.
18 E 39141 Net 6.29



Outdoor Unit

BLONDER-TONGUE INDOOR VHF-UHF CABLEMATCH

- 75-Ohm Coax to 300-Ohm Impedance

Model 4564 cablematch VHF/UHF indoor matching transformer, especially suited for matching TV set inputs to a coax distribution system. Match 75-ohm coaxial cable to 300-ohm input. Connectors: Two spade lugs (300 ohms) and a solderless Type F plug supplied. For RG-59 type cable. Shpg. wt., 6 oz.
18 E 18384 Net 1.95



COAXIAL SHIELDED CABLE KITS

High quality 75-ohm RG-59U low loss coaxial cable, with connector on each end. Shpg. wt., 2 lbs.

- 18 E 58075 50' with connectors Net 4.50
- 18 E 58083 75' with connectors Net 5.75
- 18 E 58091 100' with connectors Net 6.95



BLONDER-TONGUE 2-SET VHF-VHF-FM COUPLER

- Excellent Isolation
- No Strip Terminals

Model A-102U/V. Couples 2 TV or FM sets from one TV/FM Antenna. Low loss design and excellent isolation between sets prevents interaction. No strip terminals for use with 300-ohm line. When used with 82-channel TV set, with separate VHF-UHF antenna input terminals. Behind set signal splitter required (see 99-40339 facing page). Sturdy, non-breakable case. Shpg. wt., 1/2 lb.
18 E 18327 Net 2.20



LAFAYETTE INDOOR/OUTDOOR VHF-UHF-FM 75-300 MATCHING TRANSFORMER

- Rugged Weather-Proof Housing with Weather Boot
- Ideal for Color TV

82-channel VHF-UHF matching transformer efficiently matches 300-ohm antenna or TV set to 75-ohm coaxial cable. Weatherproof unit has leads which attach directly to either antenna terminals on set. With connector. Shpg. wt., 1/2 lb. Imported.
99 E 40347 Net 1.89



LAFAYETTE OUTDOOR VHF-FM 300-75 OHM MATCHING TRANSFORMER

- With Coaxial Fitting
- Ideal for Color

Coaxial cable matching transformer for installing VHF-TV and FM antennas. For use with noise-free 75-ohm coax cable. Matches 300-ohm antenna to 75-ohm coax. With mounting bracket and fitting. Imported.
99 E 40271 Shpg. wt., 1/2 lb. Net 1.69



LAFAYETTE INDOOR VHF-FM 75-300 OHM MATCHING TRANSFORMER

- With Coaxial Fitting

Indoor matching transformer especially suited for matching VHF-FM 75-ohm coaxial cable to 300-ohm TV set antenna input terminals. Two spade lug leads and fitting. Shpg. wt., 1/2 lb. Imported.
99 E 40269 Net 1.39

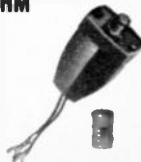

South River

**HEAVY-DUTY
SUPER MOUNT
795**

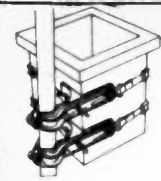

A super-heavy pair of chimney mounts made of cast aluminum alloy. Extra strong and durable. Will withstand the most severe weather conditions. Two 12 ft. stainless steel $\frac{3}{4}$ " straps and stainless steel seals. Six aluminum corner brackets to protect chimney bricks. The most ideal and permanent installation for those who want quality and durability. Will hold masts up to 2" O.D.

18 E 56012 Shpg. wt., 5 lbs. Net 7.95
Same as above with 18' straps. Net 8.79
18 E 56277

**HEAVY-DUTY 1-PIECE CHIMNEY
550 MOUNT**

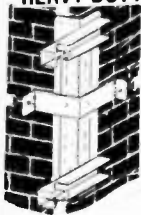

Completely preassembled chimney mount. One piece construction saves installation time. Extra heavy $12' \times \frac{3}{4}$ " strap, eye bolts and seals are stainless steel for extra strength and durability. With corner brackets to protect chimney. Heavy duty, embossed, 12 gauge main bracket is hot-dip galvanized. Takes masts up to $1\frac{1}{2}$ " O.D. Shpg. wt., 5 lbs.

18 E 63331 Net 5.50

**RATCHET TYPE
CHIMNEY MOUNT
419**

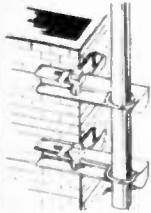

Fastens easily with an ordinary wrench. Two 12' heavy-duty stainless steel straps assembled at one end. Two heavy-gauge brackets per set with serrated U-bolts.

Easily assembled. Rainbow gold color rust-proof finish. Accepts masts up to $1\frac{1}{2}$ " O.D. Shpg. wt., 2 1/2 lbs.

18 E 63315 Net 4.19
Same as above but with two 18' straps. Net 5.19
18 E 63323 Shpg. wt., 3 lbs.

**CHIMNEY MOUNT
319**

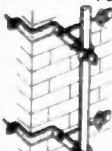

An ideal chimney mount for life-long satisfactory service under the most severe conditions. "Z" type heavy gauge aluminum brackets. Complete mounting kit of two 12' stainless steel $\frac{3}{4}$ " straps and stainless steel seals. Rugged, corrosion resistant mount accommodates masts up to $1\frac{1}{2}$ " O.D. Perfect for TV and FM antenna systems.

18 E 65062 Shpg. wt., 3 lbs. Net 3.19

**CHIMNEY MOUNT
249**

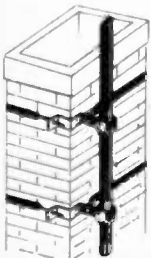

"Z-MOUNT" design provides simple installation and sturdy support. Hot-dipped galvanized coat for protection. Takes up to $1\frac{1}{2}$ " O.D. masts. With 2-10 ft. stainless steel $\frac{3}{4}$ " straps and seals. Shpg. wt., 3 lbs.

18 E 01653 Net 2.49

TV Antenna Mounts-Towers

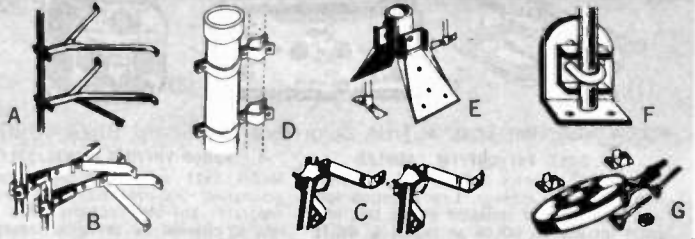

(A) 12" WALL MOUNT. Completely constructed of steel, using extra heavy gauge steel tubing which will not bind. Protected against corrosion by the ALCOTE finish. Special "sure grip" U-bolts. Holds mast up to $1\frac{1}{2}$ " O.D. tripod leg for one section. (Set of 2.)
18 E 63059 Shpg. wt., 3 lbs. Net 2.69

ADJUSTABLE 18" WALL MOUNT
18 E 63067 (Set of 2) Net 5.59

(B) 6" SNAP-IN ALUMINUM WALL BRACKET. Heavy gauge aluminum. Carriage bolts throughout. Full thread hex head lag screws. Masts just "snap-in" for easy handling. Tripod legs. (Set of 2.) Shpg. wt., 3 lbs.
18 E 65013 Net 1.99

(C) 4" STAINLESS STEEL WALL BRACKET. All stainless steel construction for extremely long life. Provides 4" clearance from wall. With special shaped U-bolt to hold masts up to $1\frac{1}{2}$ " O.D. (Set of 2.) Shpg. wt., 2 lbs.
18 E 01968 Net 1.99

(D) 4" WALL BRACKET. Securely grips all masts from 1" to $1\frac{1}{2}$ " O.D. Made of rust resistant steel. With hardware. (Set of 2.)
18 E 01661 Shpg. wt., 2 lbs. Net .79

(E) 4" SNAP-IN VENT PIPE MOUNT. Snap in feature eliminates holding of mast while applying hardware. Single front locking carriage bolt for easy one hand tightening. Heavy gauge aluminum. (Set of 2.)
18 E 65070 Shpg. wt., 2 lbs. Net 1.79

(F) PEAK ROOF MOUNT. A heavy gauge steel peak roof mount. Heavily plated to resist corrosion. Will accommodate masts up to $1\frac{1}{2}$ " in diameter. Fully adjustable, can be easily rotated. Complete with all necessary hardware. Shpg. wt., 5 lbs.
18 E 63083 Net 1.59

(G) ALL-ANGLE MOUNT. Permits setting of $\frac{1}{2}$ " to $1\frac{1}{4}$ " masts at most suitable angle for maximum reception. Rust-resistant steel. With mounting hardware. Shpg. wt., 3 oz.
18 E 01992 Net .59

(H) STAINLESS STEEL STRAP KIT. Replacement kit. Consists of 2 12 ft. $\frac{3}{4}$ " stainless steel straps, stainless steel seals, triangular eyebolts, lockwashers, hexnuts. Puts an end to rust and corrosion. Shpg. wt., 2 lbs.
18 E 63091 Net ea. 1.79

South River **ANTENNA MOUNTS**

UNIVERSAL TRI-MOUNT ROOF TOWER

- Mounts at any Angle — Flat Roof — Peak Roof

Completely preassembled, easier faster installation. Mounts on flat, peaked, sloped or eaved roofs. No guying required. 18 ga. $5' \times 1\frac{1}{4}$ " steel mast and heavy hot-dip galvanized steel tubing. Includes annular threaded roof nails and roof sealing patches for a secure installation. Shpg. wt., 5 lbs.
18 E 56335WX Net 4.95

UNDER-EAVE MOUNT



- For Modern Overhanging Eaves

Permits mounting antenna to the underside of over-hanging eave. Can also be used as a sturdy self supporting flat roof mount. Heavy gauge steel and Hot-Dip galvanized for maximum corrosion resistance. One piece mounting of welded construction with a heavy gauge embossed steel diagonal support. Complete with installation hardware.
18 E 56038 Shpg. wt., 6 lbs. Net 4.95

BANTAM TV TOWERS

- No Guy Wires Needed
- One Man Installation
- Fit Any Roof

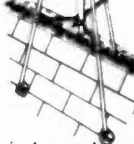

As
Low
As **5.49**

Bantam TV towers designed for convenient mounting on any peak or flat roof-tops. Eliminates cumbersome guy wires. Antenna tower is self supporting. Hot-Dip galvanized $\frac{3}{4}$ " steel tubing insures strength and corrosion-proof service. Hardened screw nails for strong and rigid fastenings. Adjustable feet. Completely pre-assembled with hardware and watertight roof seals. Less mast.

For 7' tower. Use with $1\frac{1}{4}$ " O.D. x 5' mast. 18 E 56046W wt., 5 1/2 lbs. Net 5.49
For 13' installation. Use with $1\frac{1}{4}$ " O.D. x 10' mast. 18 E 56053WX Shpg. wt., 7 lbs. Net 7.75

HEAVY-DUTY ROOF TOWERS

Hot-dipped galvanized $1\frac{1}{4}$ " steel tubing. Recommended for color TV installations when heavy multi-element antennas are used. Accommodates masts up to $1\frac{1}{2}$ " O.D. Complete with all hardware and watertight roof seals.
For 6' tower. Use with 5' mast. 18 E 56285W Shpg. wt., 7 lbs. Net 5.49
For 12' tower. Use with 10' mast. 18 E 56293WX Shpg. wt., 12 lbs. Net 8.75

UNIVERSAL ALL-POSITION MOUNT

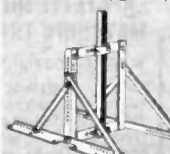

A strong self-supporting mount which adjusts to any position on peak, slope, flat, corner, or sidewall of building. Positive locking braces eliminate need for guy wires in most installations. Two plane adjustment for true vertical alignment of mast. Made of heavy gauge hot dipped galvanized steel.
Standard model for masts up to $1\frac{1}{2}$ " O.D. 18 E 56319 Shpg. wt., 6 lbs. Net 3.95
Large model for masts up to $2\frac{1}{2}$ " O.D. 18 E 56327 Shpg. wt., 6 1/2 lbs. Net 4.49

TV Antenna—Towers—Masts—Accessories

SPAULDING "STRATO TOWERS" "EP SERIES" INSTALL ON GROUND OR ROOF



High quality beaded channel construction. All riveted, no welds to rust. Rugged, zinc plated steel. More strength—less wind resistance at tower top. Top sections accept any rotator. All sections factory assembled. Each tower consists of one or more 8' sections plus an 8' mast, base plate, house bracket and mast kit assembly. Free standing installations require guying every 16'. Roof mount, and guy stations are extra.

Stock No.	Type	Hgt.	Sect.	Weight	Net
18 E 73025XZ	EP-2	22'	2	51 lbs.	33.70
18 E 73033XZ	EP-3	30'	3	71 lbs.	44.45
18 E 73041XZ	EP-4	38'	4	90 lbs.	53.65
18 E 73058XZ	EP-5	46'	5	109 lbs.	62.85
18 E 73074XZ	EPR-1	Roof Mount Base		2 lbs.	4.70
18 E 73082XZ	GS-12	Guy Station		3½ lbs.	3.95

"XCB SERIES"—CYLINDER BASE

NO CONCRETE REQUIRED

Extreme high strength, self-supporting towers. Self-aligning hinge base for quick easy installation. Can be assembled on the ground and hinged up or built vertically, section upon section. All riveted 100% galvanized steel construction prevents rust. With 4 ft. base, hinged feet, 8' mast, mast kit 8' tower sections.

Stock No.	Type	Hgt.	Sect.	Weight	Net
18 E 73090XZ	X28CB	23'	2	89 lbs.	53.65
18 E 73108XZ	X36CB	31'	3	120 lbs.	66.45
18 E 73116XZ	X44CB	39'	4	155 lbs.	84.80
18 E 73124XZ	X52CB	47'	5	184 lbs.	107.00
18 E 73132XZ	X60CB	55'	6	272 lbs.	132.45

*Height includes antenna mast. Shipped F.O.B. Frankfurt, Ind. No C.O.D. Send full remittance or use LAFAYETTE'S Easy Pay Plan. Shipping charges collected on delivery.

"XCB"
TOWERS

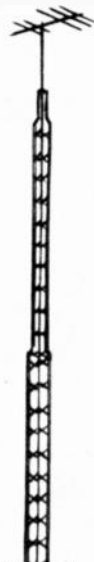

"EP"
TOWERS

TELESCOPING TV MASTS

Heavy duty telescoping masts. Ideal for any TV antenna array. Hotdip zinc galvanizing inside and outside provides unusual ruggedness and impenetrable corrosion resistance. Designed for easy installation and assembly. Husky bolts lock sections automatically. No slipping, no twisting. Precision fitting assures lasting service. 18 and 20 gauge walls. Supplied complete with all guy rings, clamps and necessary hardware. Total 5 10-ft. sections for height up to 50 ft.: 0.0. #1 (1¼"), #2 (1½"), #3 (1¾"), #4 (2"), #5 (2¼"). Shipped express only.

50-FT. MAST—Consists of all 5 sections listed above: Nos. 1, 2, 3, 4 and 5. Height 50 feet. Shpg. wt., 39 lbs.
18 E 56095WX Net 16.95

40-FT. MAST—Consists of 4 sections. Nos. 1, 2, 3 and 4. Height 40 feet. Shpg. wt., 28 lbs.
18 E 56103WX Net 12.95

30-FT. MAST—Consists of 3 sections. Nos. 1, 2 and 3. Height 30 feet. Shpg. wt., 21 lbs.
18 E 56111WX Net 8.95

20-FT. MAST—Consists of 2 sections: Nos. 1 and 2. Height 20 feet. Shpg. wt., 14 lbs.
18 E 56129WX Net 5.95

ALL ANGLE MOUNT

Swivel base mounts on any surface—flat, slant, peak or wall. Heavy gauge weather-proofed steel. Takes any mast up to 2¼" O.D. Complete with hardware.



18 E 56186 Net 1.39

¾" PLATED GROUND RODS



For use where pipe ground is not available. Heavy steel yoke for head, 4 ft.
18 E 72159W Shpg. wt., 1½ lbs.69

ALUMINUM ANTENNA MASTS

- Gold Alodized



This Golden Alodized aluminum mast will outlast any antenna. Made of a tough 19 gauge extra strong, drawn aluminum alloy. Two or more masts may be telescoped together. 1¼" O.D.

18 E 38176W5', wt. 1½ lbs. Net 1.29
18 E 56145WX10', wt. 2½ lbs. Net 2.39

ALUMINUM MASTS. 19 gauge-heavy wall-high tensile strength. Rust and corrosion proof. Swaged for stacking. 1¼" O.D.

18 E 38184W 5', wt. 1½ lbs. Net 1.09
18 E 38192WX 10', wt. 2½ lbs. Net 2.09

SUPER HEAVY-DUTY ALUMINUM MAST

Made of high strength aluminum alloy. Recommended for use with rotors and large antenna installations. Length 10, ft. 1¼" O.D. Wall thickness full ¼". Shpg. wt., 5 lbs.

18 E 56202WX Net 6.95
18 E 56268WX 10', 1½" O.D. Net 7.69

GOLD KOTE STEEL MAST

- Gold Colored to Match Most Antennas

Corrosion resistant steel mast sections made to fit all antennas. Made of rigid steel tubing with rugged high tensile strength. Highly protective gold colored baked enamel finish for lasting beauty and endurance. "Jam Fit" construction. 1¼" O.D.

Stock No.	Hgt.	Gauge	Wt., Lbs.	Net
18 E 63257W	5'	20	2½	.89
18 E 63265WX	10'	20	5	1.39
18 E 63273W	5'	16	4	1.39
18 E 63281WX	10'	16	8	2.49

INSULATED NAILS

Single head wiring nails excellent for fastening 300 Ohm twin lead antenna wire to woodwork, baseboard, etc. Does not affect signal. #14x¾" brown. Shpg. wt., 4 oz.

18 E 02032 Box of 50 Net .59



STEEL GUY WIRE

Six strands of No. 20 high tensile strength galvanized steel wire.

33 E 31014 50 ft. roll, Wt., 1½ lbs.45
33 E 31022 100 ft. roll, Wt., 2 lbs.69
33 E 31030 500 ft. roll, Wt., 12 lbs. 3.25



VINYL COVERED GUY WIRE

6 strands of No. 20-gauge high tensile strength galvanized wire. Weatherproof, non-stretch, long lasting. Ideal for TV guy wire, clothesline, and numerous garden uses. Translucent aqua green color.

32 E 36494 50 ft. roll, Wt., 1½ lbs. 1.05
32 E 36502 100 ft. roll, Wt., 2½ lbs. 1.98
32 E 36510 250 ft. roll, Wt., 6½ lbs. 4.82

ALUMINUM GUY WIRE

7-18 gauge stranded wires. Breaking strength 500 lbs.

34 E 46275 100 ft. roll, Wt., 2 lbs. 2.49
33 E 31048 50 ft. coil, Wt., 1½ lbs.85
33 E 31055 100 ft. coil, Wt., 2½ lbs. 1.69
33 E 31063 500 ft. coil, Wt., 13 lbs. 7.95

ALUMINUM GROUND WIRE

7-18 gauge stranded wires. Breaking strength 500 lbs.

33 E 31048 50 ft. coil, Wt., 1½ lbs.85
33 E 31055 100 ft. coil, Wt., 2½ lbs. 1.69
33 E 31063 500 ft. coil, Wt., 13 lbs. 7.95

STEEL TURNBUCKLES



(A) Takes up guy-wire slack. Rustproof galvanized steel. Size 7½" open, 5½" closed. Shpg. wt., 8 oz.

18 E 7217518
18 E 63299 Box of 10 1.82

(B) Hook and eye type used where quick removal is required. Shpg. wt., 8 oz.

18 E 7218318
18 E 63307 Box of 10 1.62

DOUBLE HEAD INSULATED NAILS

Same as nails on left, but with double head. Recommended for all tubular and shielded 300 Ohm twin lead. #3x¾" brown. Shpg. wt., 4 oz.

18 E 02040 Box of 50 Net .69



ANTENNA INSTALLATION KITS

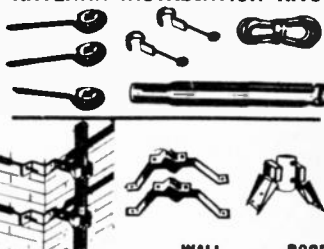

CHIMNEY MOUNT WALL MOUNT ROOF MOUNT

Chimney Mount Kit includes "Z" type chimney mounts with stainless steel straps. Wall Mount Kit includes set of 2-7" galvanized wall brackets.

Roof Mount Kit includes galvanized roof mount, 1 guy ring, clamp and 50-ft. of galvanized steel guy wire.

Each of the above kits also includes 2-5' galvanized steel masts, 3-3½" screw standoffs, 2-mast standoffs. Kits for use with VHF-UHF-FM antennas, supplied with 100 ft. foam twin lead cable; kits for use with VHF-FM antennas, supplied with 100 ft. twin-lead cable; Avg. shpg. wt., 10 lbs.

FOR VHF-UHF-FM ANTENNAS

Stock No.	Description	Net
18 E 16040WX	Chimney Mount Kit	6.95
18 E 16057WX	Wall Mount Kit	6.50
18 E 16065WX	Roof Mount Kit	6.95

FOR VHF-FM ANTENNAS

Stock No.	Description	Net
18 E 18073WX	Chimney Mount Kit	6.50
18 E 18081WX	Wall Mount Kit	5.50
18 E 18099WX	Roof Mount Kit	5.95

X at End of Stock No. Indicates Truck or Express Shipment

Installation Accessories

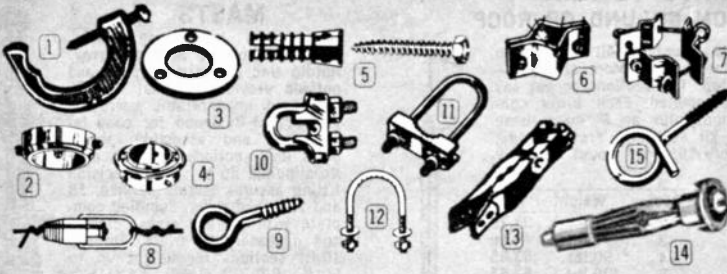

- (1) "GRIP" GROUND CLAMP. Makes vise-like grip on pipe. Sharp pointed screw makes perfect contact. Shpg. wt., 4 oz.
18 E 82018 Net .16
- (2) COLLAR. Universally adapted to masts up to 1 3/8". Hardened cone points. Permits mast orientation when using guy wires. Shpg. wt., 2 oz.
18 E 56061 Net .42
- (3) FLOATING GUY RING. Free-floating. Will not bind. Retains guy wire securely. Galvanized steel. Shpg. wt., 5 ozs.
18 E 63182 For 1 1/4" mast. Pkg. of 225
18 E 63190 For 1 1/2" mast. Pkg. of 225
- (4) GUY WIRE RING & COLLAR. Cast aluminum floating guy wire ring and collar permits complete orientation of the mast. Will fit masts up to 1 3/8". Shpg. wt., 1 lb.
18 E 81051 1.59
 Same as above but will take masts up to 1 3/4".
18 E 56079 1.69
- (5) MOUNTING ACCESSORIES. Lag screw expansion shield. 100% rust proof. Shpg. wt., for 10, 2 oz.
18 E 83032 Net .12 ea. 10 for 1.00
 Lag bolts, 1/4" diam. shank 1 1/2" long.
18 E 81069 Net .05 ea. 10 for .40
- (6) MAST GUY CLAMP. Has 6 guying points. A handy thing to keep in the tool kit. Will accommodate masts up to one and one-half inches in dia. Shpg. wt., 1/2 lb.
18 E 6321624
- (7) 3-WAY GUY WIRE CLAMP. Fits masts up to 2 1/4" diameter. Features 3 eye bolts for guy wire attachment. Made of heavy gauge steel. Shpg. wt., 3 oz.
18 E 6320839

- (8) BALL-TYPE GUY WIRE TIGHTENER. Simply draw guy wire through the "grip-tite"; loop wire back, and twist once. Provides easy method for adjusting and tightening guy wire. Cast zinc housing. Shpg. wt., 4 oz.
18 E 01935 Net .79
- (9) CLOSED EYE BOLT. For anchoring guy wires. Size: 1/4 x 5". Shpg. wt., 10 oz. for 5.
18 E 63224 Net ea. .08
- (10) CABLE CLAMP. Strong aluminum alloy body construction with plated steel U-bolt. Fits cables up to 3/16" dia. Provides solderless and spliceless cable-loop termination. Shpg. wt., 4 oz. pkg. of 2.
18 E 67126 Net per pkg. .35
- (11) MAST CLAMP. Notched retaining clamp holds 2 masts firmly in sturdy U-bolts, Galvanized steel. Wt., 3 oz.
18 E 01950 Net .29
- (12) U BOLTS. Made of galvanized steel. Supplied with nuts and washers in place. Shpg. wt., 4 oz.
18 E 02024 2 pieces per pkg. Pkg. .25
- (13) QUICK CLIP. For speedy, simple attachment of antenna lead-in to TV set. Can't short out. Shpg. wt., 2 oz.
18 E 02057 Pkg. of 2 Ea. .35
- (14) HOLLOW WALL SCREW ANCHORS. 2 1/2" long, 3/8" body, 7/8" sleeve. With 10-24 screw. Shpg. wt., 6 oz.
18 E 53019 Net .14
 10 for 1.20
- (15) GUY WIRE HOOK EYE. Strong and permanent anchoring. Made of galvanized steel. Av. shpg. wt., 4 oz.
18 E 02016 5 pieces per pkg. Pkg. .34

South River LIGHTNING



PROTECTION KIT
 • Complete!
 Nothing
 Else To Buy
379

Do-it-yourself kit to minimize lightning strikes to your antenna. Directs and discharges excess to ground. Kit contains: 50 ft. heavy-duty electrical conductor type, aluminum ground wire, coppered-steel ground rod and clamp. U.L. listed lightning arrester, 6 ground wire nail fasteners, ground wire warning tag and complete detailed instruction sheet. Shpg. wt., 4 lbs.
18 E 56194 Net 3.70

JFD LIGHTNING ARRESTERS

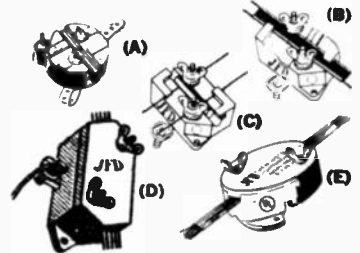

(A) ECONOMY VHF/UHF ARRESTER

Model AT-131S saw-tooth washers grip transmission line securely without stripping or cutting wire. Designed for flat, tubular, oval or open types. Constructed of low-loss material that assures less capacity and inductance, resulting in less loading on UHF. With mounting screw and steel strap. UL listed. Shpg. wt., 10 oz.
18 E 38010 Net .89

(B) "LITTLE GIANT" VHF-UHF ARRESTER

Model AT-105 No wire stripping or spreading of the line necessary. For flat, round, oval or open twin lead. Small size permits easy inside or outside mounting. Complete with ground lug and screws for wall or window sill mounting. Special high dielectric plastic construction does not vary line impedance, insures maximum signal transfer. UL listed. Shpg. wt., 9 oz.
18 E 38028 Net .99

(C) DELUXE VHF-UHF ARRESTER

Model AT-110 Fits all flat, round, oval, or open twin lead. Exclusive strain relief lips—mounts on mast, wall or window sill. Discharges antenna and lead-in static. Nickel plated brass hardware never corrodes. UL listed. Shpg. wt., 9 oz.
18 E 38044 Screw type Net 1.40
 AT-110S with stainless steel mounting strap for pipe mounting.
18 E 38051 Net 1.75

(D) 4 WIRE ROTATOR ARRESTER with STRAP

Model AT-104S Chisel point contact eliminates stripping, tightening wing nut completes installation. For 4-wire rotator lead-in. Low-loss polystyrene case. UL listed. Shpg. wt., 1/2 lb.
18 E 38069 Singly Net 2.09

(E) 5 WIRE ROTOR ARRESTER

Model AT-106 Protects 5-wire cables for automatic antenna rotators from lightning and static discharge. Easy to install in line, just slip lead into place. With hardware for wall or window mount. UL listed. Shpg. wt., 1/2 lb.
18 E 38903 Net 2.59
18 E 38911 For pipe mounting Net 2.95



UNIVERSAL STANDOFF INSULATORS

Latest polyethylene insert will accommodate twin-lead, open line, hollow and tubular lines, round lines, oval lines double lines, etc.

- (1) SCREW-EYE STANDOFF. First choice for fast secure anchoring. Shpg. wt., 10 oz.
18 E 01679 3 1/2" 4 pieces per pkg. PKG. .23
18 E 01687 5" 4 pieces per pkg. PKG. .28
18 E 01695 7 1/2" 4 pieces per pkg. PKG. .36
 Stainless steel screw-eye standoff 3 1/2".
18 E 01703 4 pieces per pkg. PKG. .49
- (2) DRIVE-IN STANDOFF. Made of galvanized steel. Av. shpg. wt., 3 oz.
18 E 01711 3 1/2" 2 pieces per pkg. PKG. .23
- (3) ADJUSTABLE STRAP-TYPE STANDOFF. Fits any size mast. Av. shpg. wt., 6 oz.
18 E 01729 7 1/2" 2 pieces per pkg. PKG. .39
18 E 01737 3 1/2" 2 pieces per pkg. PKG. .29
- (4) "CLIP-ON" STANDOFF. Attach to mast instantly—"Click" and they're on 3 1/2" long. Av. shpg. wt., 6 oz. For 1 1/4" mast.
18 E 01745 2 pieces per pkg. PKG. .28

- (5) SUPER NAIL INSULATOR. Takes flat twin-lead or coaxial cables. Easily drives in brick, mortar, wood and even most concrete. Secure connection. 3 3/8" long. Shpg. wt., 4 oz.
18 E 01752 2 pieces per pkg. PKG. .28
- (6) COLOR VHF/UHF SCREW-EYE STANDOFF. For all UHF/VHF lines. 3 pcs. per pkg. 5 1/2" long. Shpg. wt., 4 oz.
18 E 01760 PKG. .45
- (7) OPEN LINE STANDOFF. Designed especially for use with open line transmission wire installations. Ideal for use as anchor point, spacer, etc. Polystyrene block and galvanized steel hardware. 5 1/2" nail type. Shpg. wt., 6 oz.
18 E 58067 5 pieces per pkg. PKG. .72
- (8) STANO-OFF SUPPORT. Break resistant plastic—adhesive base. Attaches firmly to aluminum, brick, concrete—all surfaces. Use with any machine or wood screw-eye. Shpg. wt., 2 oz.
18 E 37012 Net ea. .19 4 for .68
- (9) COLOR INSULATORS. Converts most existing standoffs for color. Pkg. of 6, wt., 4 oz.
18 E 01778 PKG. .23

TV-FM Installation Accessories

NOISE FILTER

99¢

- Stop Radio & TV Noises



Eliminate radio and TV noise caused by household appliances, oil burners, motors, neon signs, etc. Just plug filter in any wall outlet and TV or radio into filter and enjoy noise-free entertainment, or plug noise producing appliance into filter and eliminate noise throughout house. Shpg. wt., 1/2 lb.

18 E 19010 Net .99

AUTOMATIC ELECTRONIC TV SOUND STABILIZER

395



- Suppresses Blaring Sound Of Most Commercials

This remarkable device maintains the sound level in any TV set, automatically compensating for the increase in volume when a commercial is aired. Lights glow to show when the Equalizer is working. Only 2 wires to connect. Shpg. wt., 8 oz.

18 E 44018 Net 3.95

MOSLEY UNIVERSAL ROOF-THRU/WALL THRU



Weatherproof entrance accessory for all types of antenna and rotor lead-in line. Mounts on any sloped roof or on the wall of any non-brick structure with hardware included. Insect-proof housing molded of black cyclac for break-resistant strength. Easy to install with built on flange and rubber gasket. No roof cement needed. Shpg. wt., 8 oz.

18 E 42070 Net 1.12

UNIVERSAL BUSHING



Fits all types or coaxial or twin-lead wires. Fits walls up to 1 1/2" thick. Requires 3/4" hole. Shpg. wt., 1 lb.

18 E 72019 Net ea. .95

TWIN LEAD SPLICE

Speeds splicing without need for twisting or soldering. Shpg. wt., 2 oz.

18 E 70096 Net .17

SOLDERLESS TWIN-LEAD CONNECTORS



Plug fits transmission line socket below. Shpg. wt., 2 oz.

99 E 40073 Net ea. .24

Solderless socket for above.

Shpg. wt., 2 oz.

99 E 40081 Net ea. .24



AC-TV RECEPTACLE AND WALL PLATE

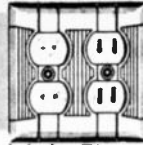

Duplex AC receptacle and duplex TV receptacle on one 2 gang wall plate. Puts both outlets in one location. Use with standard wall box. Ivory only. Shpg. wt., 6 ozs.

18 E 70062 Net 1.49

Molded 2 contact plug for 300 ohm lead.

18 E 70130 Net .19

4 wire rotor combination plates. Similar to above except includes 4 conductor rotor outlet in place of one 2-wire outlet.

18 E 70039 Shpg. wt., 6 oz. Net 1.85

Molded 4 contact plug for rotor lead.

18 E 70054 Net .39

5 wire rotor combination plate. Similar to above except includes 5 conductor rotor outlet in place of one 2-wire outlet.

18 E 70161 Shpg. wt., 6 oz. Net 1.79

18 E 70179 5 con. plug. for rot. lead. Net .49

BAKELITE WALL BOX



Necessary for terminating TV lines in old or new work. Knockouts top and bottom. Sturdy construction with steel ears. Black standard size. U.L. Listed. Shpg. wt., 6 ozs.

18 E 70013 Net .79

"OPEN-HOLE" WALL BRACKET



Permits attaching any wall plate to wall openings without the use of a wall box in up to 3/4" wall board or plaster. Shpg. wt., 4 ozs.

18 E 70021 Net .42

UNIVERSAL TV-FM PLUG & SOCKET

35¢



Compact low loss—300 ohm plug and socket. Surface mounting socket—low loss polystyrene plug. Solderless screw terminals. Imported. Shpg. wt., 2 oz.

99 E 40065 Plug & Socket Net .35



3 For .99

SURFACE OUTLET AND PLUG



- Complete With Solderless Plug

Surface mounting outlet and plug for TV-FM and loudspeakers. A neat baseboard mounted outlet with plug. Fits 300-ohm twin lead or speaker wire. Nickel plated brass hardware with set screw connectors. Unbreakable ivory plastic, with mounting screws. Shpg. wt., 6 oz.

18 E 57259 Net .89

ANTENNA CONNECTOR

For quick solderless connection of lead-in to TV antenna terminal. Fits 99-40081 socket. Low-loss polystyrene and non-ferrous metal. Standard 1/2" spacing. Shpg. wt., 2 oz.

18 E 4201230

Solderless socket for above.

99 E 40081 Net .24

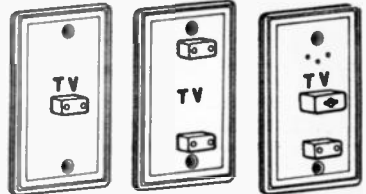

(1) (2) (3)

LAFAYETTE TV/FM WALL PLATES

- Fits Standard Outlet Box
- Complete with Plugs and Mounting Bracket

SINGLE TV/FM WALL PLATE

(1) Single TV/FM wall plate which can be used to neatly custom install an antenna system. Plug is polarized and designed to accept a 300-ohm twin lead line. Ivory finish.

99 E 40131 Shpg. wt., 1/4 lb. Net .49

DUPLEX TV/FM WALL PLATE

(2) A dual TV/FM wall plate designed to supply two signal sources. Can be used for two different TV antennas each oriented in a different direction or a TV and FM antenna. Plugs are slotted for 300-ohm twin lead. Ivory finish.

99 E 40149 Shpg. wt., 1/4 lb. Net .79

TV-FM ROTOR WALL PLATE

(3) Wall plate has 5-wire outlet for 4 or 5-conductor rotor leads and 2 twin-lead outlets. Flexible design allows easy installation. Includes 1 plug for TV twin lead and 1 plug for rotor cable. Ivory finish. Wt., 1/2 lbs.

99 E 40305 Net .99

MOSLEY WALL-PLATE FOR HEAVY-DUTY TWIN LEAD

- Complete With Plug, Wall Bracket, Hardware
- Excellent For All 300-Ohm Shielded Cable and Tubular Cable



For TV installation where heavy-duty twin-lead cable is used—shielded or unshielded. Low loss socket with solderless plug for easy installation, may be mounted with wall mounting bracket or in standard outlet box. With polarized plug and wall mounting bracket. Shpg. wt., 5 oz.

18 E 42020 Net 1.67

TV-FM COAXIAL WALL PLATES

- For 75 Ohm Antenna Installation

Ivory coaxial outlets, flush mounting especially designed for superior color and black/white reception, provides a constant impedance match with 72 ohm RG 59U coaxial cable. Complete with all connector, plug, mounting brackets. Fit all standard wall outlet boxes. Shpg. wt., 1/2 lb.

Stock No.	Description	Net
18 E 42087	1 TV-FM Coax Outlet	2.64
18 E 42095	1 TV-FM Coax Outlet With 4 or 5-wire rotor	3.63

MOSLEY SHIELDED TWIN-LEAD SPLICER

- Permits Splicing of Shielded 300-Ohm Twin-Lead



No need for twisting or soldering.

18 E 42061 Shpg. wt., 4 oz. Net .90

Picture Tube Brighteners — Service Aids

TV TUBE RESTORER

- 120 Different Combinations
- Corrects Open Cathode — Heaters to Cathode Short — Open Control Grid Control Grid to Cathode Short — Low Emission

One simple unit provides the cure for most ailing picture tubes. Latest model features slide switches—not pin plugs as older units do. Rugged, well made socket—compact, single unit design. Works on electrostatic or electromagnetic focusing tubes, in series or parallel circuits. Includes instructions. For Duodecal Base Shpg. wt., 1 lb. 4 ozs. **18 E 46047 FIG. (A)** Net 3.98

UNIVERSAL 110° CRT REJUVENATOR

A single heavy-duty unit which performs four ways. A simple adjustment adapts it for either series or parallel wired filaments and it can be used on electromagnetic or electrostatic focus tubes. Shpg. wt., 1 lb. For Sylvania Type 110° Tubes. **18 E 46013 FIG. (C)** Net 1.95
For RCA Type 110° Tubes. **18 E 46021 FIG. (B)** Net 1.95

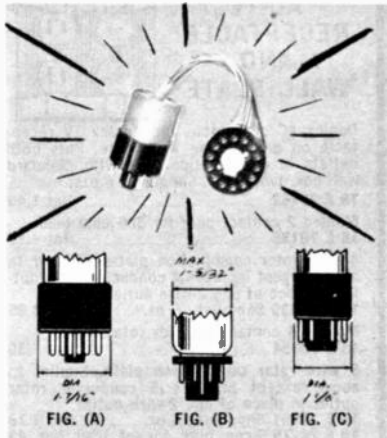

TV TUBE "BRITENER"

You simply attach two plugs as directed on the instructions. For magnetic tubes and PARALLEL CIRCUITS only. Renews brightness contrast. For Duodecal Base. Wt., 8 oz. **18 E 46039 FIG. (A)** Net .79

UNIVERSAL TV TUBE "BRITENER"

Restores brightness to dim TV picture tubes. Operates on all types—magnetic or electrostatic—and in all circuits—parallel or series. For Duodecal Base. Shpg. wt., 10 oz.

18 E 46005 FIG. (A)

Net 1.49

COLOR PICTURE TUBE BRIGHTENER

- Boost Fading Color Picture Tubes
- No Wiring Necessary—Plugs Right In

Bring out the lost sharpness and detail of fading color picture tubes. Electron emission is increased by boosting the filament voltage, thereby returning full contrast and color quality to the set. Plugs in between picture tube and socket. No wiring or switching is necessary. For round tubes (12 pin base). **18 E 46070** Net 4.95

For rectangular tubes (12 pin base). **18 E 46088 Shpg. wt., 1 lb.** Net 5.49

ACME T8394M VARIABLE VOLTAGE ADJUSTER

300 W. continuous duty variable transformer. Adjusted by rotary tap sw. Used as step up or step down. Voltmeter shows sec. voltage. Pri. 95/100/105/110/120/125 volts at 50/60 Hz. Sec. out 115 V. 8' cord and plug. Size: 4¼x4x5". Shpg. wt., 9 lbs. **33 E 40015** Net 13.40

AUTOMATIC TV VOLTAGE REGULATOR

AS LOW AS

825

- Compensates For Low Line Voltage

For color or black and white TV. Returns full height and width of TV picture affected by low line voltage. Boosts 110-volts automatically when line is below 110 volts. Increases set sensitivity. Reduces low line hazards. Simple plug-in installation. Turns on and off with the TV set. Shpg. wt., 4 lbs. Perma-Power model D-210, 400 watts. **32 E 40058** Net 14.95
Perma-Power model D-200, 300 watts. **32 E 40025** Net 8.25

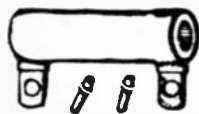

FUSIBLE RESISTORS

Replacements for Motorola, Crosley, Emerson, Raytheon, Philco, Hoffman, Hallicrafters, Tru-tone, Sears, Montgomery Ward, Sentinel, Arvin and many others. Shpg. wt., 5 oz.

18 E 77026—Kit of 4. 5.6 Ohms Net .59
18 E 77034—Kit of 4. 7.5 Ohms .59
18 E 79030—Kit of 4. 4.7 Ohms Each Kit
Assorted Kit, 1 each of above values plus one 9.0 ohm and one 22 ohm. **18 E 79048** Net .69

COLOR-CODED TV FUSES

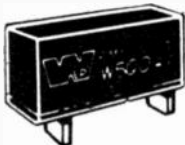

- Plug-in Type

45^c

Exact replacement fuses used in many TV sets, such as, RCA, Zenith, Emerson, Olympic, etc. When ordering, order same color as that removed from TV set. Shpg. wt., 4 oz.

Stock No.	Color	Stock No.	Color
18 E 31015	Red	18 E 31114	White
18 E 31023	Blue	18 E 31064	Grey
18 E 31031	Pink	18 E 31072	Yellow
18 E 31049	Black	18 E 31080	Maroon
18 E 31056	Lt. Green	18 E 31122	Dk. Green

Net each .45

TUBE GUARD



- Stop Voltage Surge
- Adds Life To TV-Radio and Hi-Fi Tubes

The "Tube Guard" will pay for itself many times over by greatly reducing costly vacuum tube replacements. The Tube Guard checks surge of current, reduces filament damages and increases tube life. Just plug "Tube Guard" into outlet, and appliance into it. 300 watts. UL listed. Shpg. wt., 8 oz. **18 E 31098** Net 1.49

600 WATT TUBE GUARD

Recommended for protection of color TV receivers. U.L. listed. **18 E 31106** Net 1.75

HORIZONTAL BAR GENERATOR



Provides Horizontal Lines On Any T.V. Set—Quick—Accurate Alignment

Simplifies precise setting of yoke. Makes possible accurate positioning of focus coil or magnet. Quick adjustment of vertical linearity, height and centering. Plugs onto picture tube. Shpg. wt., 8 oz. **18 E 27013** Net 1.50

TV SERVICE EXTENSION HARNESS KIT



Makes possible testing sets with picture tube electrically connected in circuit, but removed from chassis. Reduced danger of contact with high voltage terminals and tube breakage. Consists of anode extension harness, yoke extension harness, tube socket extension harness and sturdy plastic carrying case. CRT extension is for both electrostatic and electromagnetic tubes. Shpg. wt., 1 lb. **18 E 27088** Net 4.80

Color Extension Harness Kit. Similar to above but designed for color TV. Shpg. wt., 1½ lbs. **18 E 27211** Net 10.50

TV LINE CORD



- Interlocking Type

Replacement cord for RCA, Philco, GE, Admiral, and others. It has regular molded plug on one end and special rubber plug on the other to fit TV sets. UL listed. A very handy thing to have in your service kit or on the workbench. 6 ft. brown cord. Shpg. wt., ½ lb. **18 E 41014** Net .32

Same as above but with polarized terminals at both ends. **18 E 74015 Shpg. wt., ½ lb.** Net .36

"CHEATER" EXTENSION



A 6 ft. extension for RCA, Philco, G.E., Admiral and other interlock type sets. Handy for service kit and work bench. **18 E 49041 Shpg. wt., 10 oz.** Net .39

INTERLOCK TV LINE SOCKET



Conventional male interlock socket. Standard type used on all television receivers. Heavily plated contact pins. ¼" mounting centers. Shpg. wt., 6 oz. **18 E 27187** Net .16

Books About IC's—Transistors—Tubes

TRANSISTOR CIRCUITS



By Rufus P. Turner
OVER 150 PRACTICAL **295**
CIRCUITS

SOME OF THE HIGHLIGHTS
• Audio Amplifiers • RF
and IF Amplifiers • Radio
Receivers • Triggers and
Switches • Control Devices
• Test Instruments • Mis-
cellaneous Circuits.

GERNSBACK No. 63. Takes transistors out of the lab and puts them on the work bench. Over 150 practical circuits for amplifiers, oscillators, power supplies, amateur equipment and other units. All were designed by experts—some by the author himself. All were tested in the author's laboratory—and all of them work! No watering down with transistor testing or theoretical explanation circuits! Shpg. wt., 5 oz.

10 E 41011 Net 2.95

SEMICONDUCTOR HANDBOOK (Sams 20620). A modern, complete sourcebook for industrial semiconductor data in one comprehensive, heavily illustrated volume. Covers a wide variety of the latest circuitry applications including grown-junction, alloyed-junction, drift MADT, mesa, planar and epitaxial mesa types. 288 pages. Shpg. wt., 12 oz.

10 E 23936 Net 8.75

TRANSISTOR PROJECTS Gernsback No. 89. The best practical transistorized projects for building many types of radios, test equipment and other electronic gear, selected from Radio-Electronics magazine. Each one debugged and tested. 160 pages. Shpg. wt., 6 oz.

10 E 41045 Net 2.95

BASIC THEORY AND APPLICATION OF TRANSISTORS. DOVER. Prepared by U. S. Army. Requires only minimal knowledge of physics and theory of electron tubes. Covers crystal semi-conductors, function of transistors, applications and construction; structure of matter, characteristics of crystals, PN junctions, amplifier fundamentals, parameters and transistor analysis. 272 pages. 6 1/2 x 9 1/4".

10 E 31202 Shpg. wt., 10 oz. Net 1.75

UNDERSTANDING AND USING UNIJUNCTION TRANSISTORS (Sams 20720) by Stu Hoberman. Details the construction, operation, characteristics and applications of the unijunction transistor (UJT). Includes timing, triggering and sensing circuits, oscillators, power-controlling devices, counters, and computer memory systems. 96 pages. Shpg. wt., 8 oz.

10 E 23944 Net 2.50

101 QUESTIONS AND ANSWERS ABOUT INTEGRATED CIRCUITS (Sams 20634) by Leo G. Sands. Answers the most frequently asked questions about integrated circuits. Explains how these circuits are formed, where they are used, and what circuit actions they accomplish. 128 pages.

10 E 23951 Shpg. wt., 8 oz. Net 2.95

SOLID STATE POWER SUPPLIES AND CONVERTERS. (Sams 20310) by Allan Lytel. A complete guide to building advanced solid-state power supplies for longer life and smaller size. 112 pages. Shpg. wt., 9 oz.

10 E 23241 Net 2.95

TRANSISTOR IGNITION SYSTEMS HANDBOOK. By Brice Ward. This is the first book of its kind, providing a comprehensive understanding of newly developed automobile transistor ignition systems. Begins with ignition system requirements and discusses transistor system components and their functions. Explains practical systems in detail. Presents general installation procedures, troubleshooting and testing techniques, including check charts and other supplementary information. 176 pgs. 5 1/2 x 8 1/2". Sams (20298).

10 E 22797 Shpg. wt., 10 oz. Net 3.75

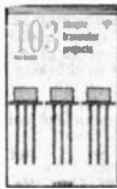

103 SIMPLE TRANSISTORS PROJECTS

By Thomas S. Kneitel. 103 fascinating experiments of transistors and semiconductor circuits. Gives detailed explanations of steps that may not be familiar to some experimenters. Every circuit experiment consists of description of the purpose of circuit schematic diagram, and complete parts list. Partial list of experiments: A 2-meter transmitter hunt beacon. Microphone booster, Audio/amplifier/oscillator, Light controlled relay, 128 pgs. 5 1/2 x 8 1/2". Rider No. 0313.

10 E 10024 Shpg. wt., 6 oz. Net 2.95

FUNDAMENTALS OF INTEGRATED CIRCUITS Hayden (5695) by L. Storm. A complete guide to integrated circuits—their theory, manufacture, and application. Presents basic approaches to IC electronics and practical circuit design. Discusses thin-film, monolithic and hybrid IC circuits, layout, and packaging principles. 208 pages, 7 x 10". Clothbound. Shpg. wt., 1 lb. 2 oz.

10 E 12509 Net 8.95

FET CIRCUITS Sams (20505) by Rufus P. Turner. Explains the principles of construction and operation of field effect transistors. Stresses the application of FET's in practical amplifier, oscillator, receiver, control, and test instrument circuitry. 160 pages. Shpg. wt., 10 oz.

10 E 23662 Net 3.95

TRANSISTOR SUBSTITUTION HANDBOOK. 9th Edition. (No. 20705) by Howard Sams Engineering Staff. Fully updated—Lists thousands of direct substitutions for all types of transistors—U.S. and foreign, home entertainment, industrial, military. Manufacturers' recommendations for substitutes of general-purpose types also included. 144 pages.

10 E 21104 Shpg. wt., 9 oz. Net 1.95

TRANSISTOR SPECIFICATIONS MANUAL 4th Edition. (Sams 20707). Contains the electrical and physical parameters for virtually all of the transistors now in use. Provides physical data, dimensions and other information required to install the unit; identifies leads and terminals for each transistor. 288 pages.

10 E 22524 Shpg. wt., 1 lb. Net 3.50

TRANSISTOR THEORY & CIRCUITS MADE SIMPLE. AMECO. This book explains the theory of transistor actions in a simple straightforward manner. Explains how transistors operate in amplifiers, oscillators and other electronic circuits. Transistors are analyzed and explained. Many practical transistor circuits are given. The book is for servicemen, amateurs, experimenters and engineers. 128 pages. 6 x 9".

10 E 57108 Shpg. wt., 7 oz. Net 1.75

BOOKS ABOUT TUBES

RCA RECEIVING TUBE MANUAL RC-26. Contains complete technical data on all current tubes. Features tube theory written for the layman, application information and a circuit section. Tuner, receiver, amplifier, intercom and other circuit diagrams, socket diagrams, tube dimension drawings, resistance-coupled amplifier data, tube curves, etc. 656 pages.

10 E 47018 Shpg. wt., 1 lb. 5 oz. Net 1.75

RCA RADIOTRON DESIGNERS HANDBOOK. 4th Ed. A comprehensive reference book for design and application of radio receivers and audio amplifier circuitry. 1000 illustrations and cross-reference index on 7000 items. 1500 pages, 5 1/2" x 8 1/4".

10 E 47028 Shpg. wt., 5 lbs. Net 7.00

Lafayette Publication

Revised Second Edition



TRANSISTORIZED MINIATURE AMPLIFIER AND TUNER APPLICATIONS by Rufus P. Turner. Over 60 challenging and interesting applications, many original. Illustrated 96 pages. Shpg. wt., 6 oz.

10 E 01049 Net 1.50

For Complete Details see Page 218

RCA LINEAR INTEGRATED CIRCUIT FUNDAMENTALS

(IC-41) Provides an understanding of basic principles involved in design and application of linear integrated circuits. Covers general considerations, differential and operational amplifiers, transfer characteristics, equivalent circuit models, frequency response, phase compensation and circuit applications for communications, TV, radio, instrumentation, telemetry, data-processing and control. 350 pages. Shpg. wt., 1 lb.

10 E 47075 Net 2.00

GE TRANSISTOR MANUAL (7th edition). Expanded "Reader's List" of basic reference works on transistor theory and application; new chapter explaining transistor reliability, expanded and up-dated comparison charts, outline drawings, over 1200 JEDEC types. New experimenter's chapter with 17 circuits for building; expanded hi-fi chapters; expanded radio receiver chapter; and a complete explanation on how to interpret a spec sheet. 660 pages.

10 E 36201 Shpg. wt., 1 1/4 lb. Net 2.00

GE SCR MANUAL. Complete data on silicon-controlled rectifiers. Includes SCR basic theory, ratings and applications. Covers regulating circuits and controls, test circuits, light-actuated devices, trigger and turn-off circuits. New information and applications for triacs and thyristors illustrated. 530 pages. Soft-bound. Shpg. wt., 1 1/2 lbs.

10 E 36235 Net 3.00

RCA TRANSISTOR, THYRISTOR AND DIODE MANUAL (SC-14). A comprehensive manual covering basic technology, operating principles, characteristics and ratings, applications and testing data for more than 900 semiconductor devices. 656 pages. Shpg. wt., 14 oz.

10 E 47042 Net 2.50

RCA TUNNEL DIODES (T0-30). Written specifically for circuit engineers. Describes tunnel-diode theory for switching and microwave applications. A valuable guide on the use of the tunnel diode. Easy-to-understand text; well-illustrated; covers theory, applications, as well as performance data. 5 1/2 x 8 1/4". 160 pages. Wt., 9 oz.

10 E 47059 Net 1.50

RCA SILICON POWER CIRCUITS MANUAL (SP-51.) Provides information for a broad range of power circuits using silicon transistors, rectifiers, thyristors and triacs. Discusses applications for rectification, filtering, power conversion and regulation, and control in both RF power and low frequency amplifiers. 448 pages. Shpg. wt., 1 lb.

10 E 47083 Net 2.00

ABC'S OF VARACTORS Sams (20508) by Rufus P. Turner. Introduction to varactors, special semiconductors acting as voltage-variable capacitance. Explains basic theory, typical circuits, and practical micro-wave applications, as well as other use in receivers, transmitters and amplifiers. 112 pages.

10 E 23589 Shpg. wt., 8 oz. Net 2.75

Color TV Publications

SAMS COLOR TV BOOKS

COLOR TV TRAINING MANUAL. (20472). 2nd Edition. Comprehensive manual to train the technician in servicing Color TV. Describes science of color, requirements and make-up of composite color signal, servicing procedures. Outlines use of color test equipment. Illus. 224 pgs., 8½"x11". Shpg. wt., 1 lb., 5 oz.
10 E 21286 Net 6.85

SYMFACIT GUIDE TO COLOR-TV SERVICING (20710) by-PF Reporter Editorial Staff. A quick guide to better and faster color-TV servicing using observation and correct analysis of the picture on the screen to reveal which section of the set is faulty. Symptom analysis, waveform, voltage and component analysis for every trouble situation. 128 pages.
10 E 23069 Shpg. wt., 10 oz. Net 3.95

TRANSISTOR COLOR TV SERVICING GUIDE (20683) by Robert G. Middleton. Fills a definite need for servicing literature. Functionally divided according to sections in the transistor color-TV receiver and further subdivided according to symptoms. 8½"x11", 112 pages.
10 E 23977 Shpg. wt., 11 oz. Net 4.50

COLOR TV SERVICING GUIDE (20358) by Robert G. Middleton. Follows the same picture-tube-and-trouble symptom format so successful in black and white TV servicing guides, showing how to apply fast troubleshooting procedures based on analysis of symptoms. Includes many full-color picture tube photos illustrating various operating troubles with concise explanations of probable causes and diagnosing procedures. 8½"x11", 112 pages. Shpg. wt., 12 oz.
10 E 23150 Net 4.25

USING SCOPES IN COLOR TV (20718) by Robert G. Middleton. Concentrates on chroma-circuit waveform analysis and interpretation of special patterns such as vectorgrams. Describes the uses of a scope in checking band-pass amplifiers, matrixing circuitry, chroma demodulators etc. and the problems which arise during successful servicing of color TV sets. 160 pages.
10 E 23965 Shpg. wt., 12 oz. Net 3.95

COLOR TV SERVICING MADE EASY. No. VOL. 1 (20135) by Wayne Lemons and Carl Babcock. Practical, service and set-up procedures explained. Covers all major color receivers from 1957 to 1964. Contains authoritative information on troubleshooting, adjustments providing the benefit of experience gained through actual service work on thousands of receivers. 192 pgs. 5½"x8½".
10 E 21302 Shpg. wt., 10 oz. Net 3.95

COLOR TV SERVICING MADE EASY VOL. 2 (20523) Brings you up-to-date on new color circuitry and developments since Volume 1. 228 pp.
10 E 23605 Shpg. wt., 12 oz. Net 4.95

KNOW YOUR COLOR-TV TEST EQUIPMENT (20256) by Robert Middleton. Written for TV technicians, this book explains the instrument function and circuit action in simple terms. Shows how to service, maintain and calibrate this equipment for continuing reliable performance. Numerous troubleshooting approaches given in detail. Gives much useful setup information. Illustrations, diagrams. 160 pages. 5½"x8½". Shpg. wt., 9 ozs.
10 E 22486 Net 3.50

SELECTED PUBLISHERS

PRACTICAL COLOR TV SERVICING TECHNIQUES. (GL/TAB No. 438) by R. L. Goodman. Shows simplified methods of servicing old and new color receivers, from antenna terminals to CRT. Includes portable and solid state TV, with full color illustrations, case histories and service instrument techniques. 297 pages.
10 E 41599 Shpg. wt., 1 lb., 2 oz. Net 4.95

COLOR TV REPAIR (Gernsback No. 123) by 10 Servicing Experts. A staff of 10 top technicians tells how to fix color TV receivers. Each trouble symptom is described in detail, and the perfect solution provided. Includes tips on how to pinpoint the defective color section quickly and describes unexpected causes of TV color failure. 100 pages, softbound. Shpg. wt., 7 oz.
10 E 41532 Net 2.95

A NEW WAY TO SERVICE COLOR TV (Gernsback No. 136) by Carl Babcock. The serviceman author emphasizes the practical aspects of trouble-shooting and repairing the difficult-to-fix color TV sets, steering clear of the complex theory. The principal approach is visual examination, from which interpretations and localizing of the trouble to a particular circuit or area follow. A few measurements and further tests, pinpoint the trouble to definite components. 192 pages.
10 E 41581 Shpg. wt., 12 oz. Net 3.25

ON THE COLOR TV SERVICE BENCH (G/L TAB No. 489) by Jay F. Shane. Common sense service bench approaches for solving color TV trouble-shooting problems. Clear explanations of essentials evolved from numerous case histories. 192 pages.
10 E 41672 Shpg. wt., 9 oz. Net 4.95

CITIZENS BAND & 2-WAY RADIO BOOKS

99 WAYS TO IMPROVE YOUR CB RADIO

by Len Buckwalter



(Sams 20515) Tells how to operate, service and maintain CB equipment in top condition and get most use from it. Gives 99 down-to-earth highly useful hints that will prove invaluable to anyone interested in CB activity. 128 pp.
10 E 23597 Shpg. wt., 9 oz. Net 2.95

CITIZENS BAND RADIO HANDBOOK (3rd Ed. Sams 20569). By David E. Hicks. Completely revised and updated. Discusses the various types of equipment, how to choose to fit your specific needs, and your licenses. Covers CB equipment, circuits, antennas, fixed and mobile installations, maintenance, repairs, measurements, and operating procedures. 192 pages. 5½"x8½".
10 E 23613 Shpg. wt., 8 oz. Net 4.25

ABC'S OF CITIZENS BAND RADIO Sams (20019). By Len Buckwalter. Explains the functions, operation, regulations, and setup and operating procedures. The book explains how to obtain an FCC license and how to efficiently set up and operate CB radio equipment. 96 pages. 5½"x8½". Shpg. wt., 6 oz.
10 E 23266 Net 2.50

CB RADIO ANTENNA 2nd Ed. Sams (20567). By David E. Hicks. Thoroughly explains selection, installation, operation and servicing CB antennas for those who wish to buy or improve the performance of their CB gear. 144 pages.
10 E 23621 Shpg. wt., 8 oz. Net 3.50

CB RADIO CONSTRUCTION PROJECTS Sams (20099). By Len Buckwalter. Complete step-by-step details for building inexpensive CB devices, accessories and test instruments to help CB operators get full efficiency from equipment. Field-tested, do not conflict with FCC Regulations. 112 pages.
10 E 23233 Shpg. wt., 9 oz. Net 2.95

UHF BUSINESS RADIO HANDBOOK



by Leo G. Sands
(Sams 20088). Covers all aspects of Business Radio Service and UHF Radio communications systems. Describes its purpose, types of equipment, operation, UHF mobile and fixed stations, relay stations, antenna systems, servicing and FCC regulations. Complete guide in this fast growing field. 192 pages. Shpg. wt., 10 oz.
10 E 23175 Net 3.95

WALKIE-TALKIE HANDBOOK by Leo G. Sands (Sams 20572). Describes the various types of walkie-talkies and how they work. An excellent guide for the selection and various applications of walkie-talkies. Covers accessories, specifications, maintenance and licensing requirements. 176 pgs. 5½"x8½".
10 E 23654 Shpg. wt., 8 oz. Net 3.95

CB RADIO SERVICING GUIDE 2nd Edition Sams (20722). By Leo G. Sands. A practical "how-to" guide for locating all types of CB troubles. Gives detailed procedures for tuning up, testing, and trouble-shooting. Explains FCC regulations. Covers both single and multichannel receivers and transmitters. Step-by-step analyses of transmitter circuits. Trouble-shooting procedures aimed at rapid solutions. 160 pages. 5½"x8½".
10 E 22094 Shpg. wt., 9 oz. Net 3.95

TWO WAY MOBILE RADIO MAINTENANCE Sams (20479). By Jack Barr, 2nd Edition. A valuable guide to planning, installing and maintaining all types of 2-way mobile radio systems. An extremely practical field servicing handbook. 256 pages. Shpg. wt., 10 oz.
10 E 23191 Net 4.95

ELIMINATING ENGINE INTERFERENCE Sams (20184). By John O. Lenk. Explains the "why" of engine interference with CB, amateur and Marine communications and the solution to this serious problem by noise-suppression, shielding and modifying equipment. 112 pages. Shpg. wt., 6 oz.
10 E 23217 Net 2.75

PRACTICAL CB RADIO SERVICING



by Freeland and Sands (Hayden/Rider 0777). A useful, well-organized and complete practical guide for servicing CB and two-way radio equipment. Covers operational checks, measurements, noise and interference and trouble-shooting receiver and transmitter. 192 pages.
10 E 12772 Shpg. wt., 10 oz. Net 4.75

MOBILE AND MARINE STATION LICENSE MANUAL by Leo G. Sands, Sams (20295) Reference Manual for the numerous radio services included in the mobile and marine category. Contains many data tables. Interpretations of FCC Regulations, eligibility requirements for obtaining licenses and frequency allocations. 320 pages.
10 E 23183 Shpg. wt., 1 lb. Net 7.50

CB RADIO OPERATORS GUIDE (GL/Tab No. 498) by Robert M. Brown. A virtual CBer's bible — everything you need to know to get into CB and get most out of your installation, includes buying base and mobile station equipment, installation, antennas, improvements, trouble-shooting, emergency assistance, etc. 192 pages. Shpg. wt., 9 oz. Softbound.
10 E 41680 Net 3.95

101 EASY CB PROJECTS (Sams 20663) by Robert M. Brown. A collection of simple, inexpensive yet practical CB radio equipment and accessories. Each easy-to-build device is a useful addition to any CB radio operator's gear. Complete description, parts list, and instructions for each construction project. 128 pages.
10 E 23993 Shpg. wt., 6 oz. Net 3.25

ANTENNAS FOR CITIZENS RADIO SERVICE (Radio Publications) Features build-it-yourself antennas for the Citizens Radio Service with easy-to-follow construction information for efficient low-cost antennas. Shpg. wt., 4 oz.
10 E 50020 Net 1.50

Books About Amateur Radio



AMERICAN RADIO RELAY LEAGUE BOOKS

RADIO AMATEUR'S HANDBOOK. Latest edition used all over the world by both hams and professionals. Packed with theory and practical design, information on station equipment, audio and RF circuits, HF, VHF, and UHF, phone and C.W., receivers, transmitters, antennas, mobile equipment etc. 6½x9½". 10 E 89010 Shpg. wt., 2 lbs. 3 oz. Net 4.00

A COURSE IN RADIO FUNDAMENTALS. A study guide keyed to the Amateur's Handbook. Describes numerous experiments for easy understanding. Complete with questions and answers after each chapter. 103 pages. 10 E 89051 Shpg. wt., 6 oz. Net 1.00

MOBILE MANUAL FOR AMATEURS. Contains articles selected from QST magazine. Covers all aspects of mobile operation, including converters, receivers, transmitters, power supplies and antennas. 272 pages, illustrated. Shpg. wt., 14 oz. 10 E 89028 Net 2.50

ANTENNA BOOK. Gives antenna and transmission line theory, plus instructions for building amateur antennas for all bands from 160 meters up into the UHF regions. 330 pages. Shpg. wt., 1 lb. 10 E 89036 Net 2.50

RADIO AMATEUR'S VHF MANUAL. A thorough treatment of VHF with authentic VHF history. Covers receiving and transmitting principles, techniques and construction; antenna and feed system design; microwaves; test equipment; interference; VHF hints and kinks. Emphasis is on tried and tested equipment and practice. 6½x9½". 360 pages. 10 E 89184 Shpg. wt., 1 lb. 3 oz. Net 2.50

THE RADIO AMATEUR'S OPERATING MANUAL. A ready reference source and guide to standard good operating practices. Ideal for the amateur who wishes to learn or brush up on operating procedures, and who wishes information on all facets of amateur operating. Shpg. wt., 9 oz. 10 E 89200 Net 1.00

LIGHTNING CALCULATOR TYPE A. Solves AC circuit problems: frequency, inductance and capacitance. Shpg. wt., 2 oz. 10 E 89168 Net 1.50

LIGHTNING CALCULATOR TYPE B. Problem-solving aid for voltages, currents, power. 10 E 89176 Shpg. wt., 2 oz. Net 1.50

RADIO AMATEUR CALLBOOKS

RADIO AMATEUR CALL BOOK—UNITED STATES SECTION. Lists all (over 280,000) licensed amateurs in the United States, possessions and personnel in foreign countries with their call letters and addresses. Published quarterly. Latest edition will be shipped. 9x12". 10 E 50095 Shpg. wt., 2 lbs. 6 oz. Net 6.95

FOREIGN RADIO AMATEUR CALL BOOK. Covers all countries outside of 50 United States. Over 133,000 calls. Published quarterly. Latest edition will be shipped. 10 E 50103 Shpg. wt., 1 lb. 7 oz. Net 4.95

RADIO AMATEUR DX GUIDE. The guide manual for DX enthusiasts. Features a listing of foreign prefixes, great circle maps, section map, time conversion charts, contest and field day log, world-wide postal information, great circle bearing tables and other information invaluable to the amateur. 10 E 50137 Shpg. wt., 10 oz. Net 2.00

UNDERSTANDING AMATEUR RADIO. Written for the beginner. Simply explains the elementary principles of electronic and radio circuits, transmitters, receivers and antennas. A must in setting up and operating the amateur station. 6½x9½". 320 pages. Shpg. wt., 15 oz. 10 E 89192 Net 2.50

HOW TO BECOME A RADIO AMATEUR
10 E 89077 Shpg. wt., 7 oz. Net 1.00

RADIO AMATEUR LICENSE MANUAL
10 E 89085 Shpg. wt., 6 oz. Net 1.00

LEARNING THE RADIO-TELEGRAPH CODE
10 E 89093 Shpg. wt., 3 oz. Net .50

OPERATING AN AMATEUR RADIO STATION
10 E 89101 Shpg. wt., 3 oz. Net .25

GATEWAY TO AMATEUR RADIO. A set of all 4 of the above books. 10 E 89119 Shpg. wt., 1 lb. Net 2.50

HINTS AND KINKS. Dozens of time-saving tips on construction, operation and repair of amateur equipment. Describes "the easy way" of accomplishing the difficult. 10 E 89044 Shpg. wt., 7 oz. Net 1.00

SINGLE SIDEBAND FOR THE RADIO AMATEUR. A selection of the best SSB articles appearing in QST magazine. Thoroughly discusses the theory and practical methods of this popular new development. Shows how to build the needed equipment. 253 pages. 10 E 89069 Shpg. wt., 13 oz. Net 2.50

AMATEUR RADIO MAP OF THE WORLD Made especially for amateur radio, this map shows distances, call prefixes for different countries and other required information. 30x40". 10 E 89127 Shpg. wt., 15 oz. Net 2.00

AMATEUR STATION LOG BOOK. Convenient amateur radio log book, with list of Q signals. Spiral bound. Shpg. wt., 7 oz. 10 E 89135 Net .50

MINILOG. Miniature log book, especially handy for mobile or portable operation. 10 E 89143 Shpg. wt., 3 oz. Net .30

OFFICIAL RADIOGRAM FORMS. 70 blank message forms for traffic handling. 10 E 89150 Shpg. wt., 5 oz. Net .35

EDITORS AND ENGINEERS

RADIO HANDBOOK (No. 167). 17th Edition. Tells how to design, build and operate the latest types of amateur transmitters, receivers and associated gear. Provides extensive simplified theory on almost every phase of radio practice, specifically written for the amateur, technician and engineer. Broadest reference coverage, up-to-date original data. 6½x9½" 848 pages. Hardbound. Shpg. wt., 3 lbs. 10 E 24017 Net 12.95

AMATEUR RADIO INCENTIVE LICENSING STUDY GUIDE (EE-050) by Robert M. Brown and Tom Kneitel. Contains multiple-choice questions that are as close to FCC examinations as possible, followed by formal study guides. Also includes the full text of the incentive licensing rule changes. 160 pages. 10 E 24041 Shpg. wt., 10 oz. Net 2.75

AMECO BOOKS

ADVANCED CLASS RADIO AMATEUR LICENSE GUIDE (No. 16-01). A study guide for the Advanced class ham license. Contains questions and answers pertaining to the subject matter required for this license. Also includes an FCC-type multiple choice practice exam. 6 x 9". 48 pages. Shpg. wt., 3 oz. 10 E 57132 Net .50

EXTRA CLASS RADIO AMATEUR LICENSE GUIDE (No. 17-01). Helps prepare for the Extra Class ham license. Presents questions and answers grouped according to the subject matter for easy study. FCC type multiple choice practice exam. 6x9", 48 pages. Shpg. wt., 5 oz. 10 E 57140 Net .75

RADIO AMATEUR QUESTION AND ANSWER LICENSE GUIDE (No. 5-01). Helps prepare for Novice, Technician, or General class exams. F.C.C. questions with easy to understand answers. Includes 2 typical F.C.C. exams. 6 x 9". 32 pages. Shpg. wt., 3 oz. 10 E 57033 Net .50

AMATEUR RADIO THEORY COURSE (No. 102-01). Complete home study theory course covering Novice, Technician, conditional and general classes. Almost 400 typical F.C.C. questions to help prepare for exams. 6 x 8½". 300 pages. Shpg. wt., 10 oz. 10 E 57041 Net 3.95

COMMERCIAL OPERATOR'S Q & A LICENSE GUIDE. These books cover the exam material for F.C.C. licenses. Includes questions and simplified answers and a sample F.C.C. type examination.

ELEMENTS 1, 2 & 9 (No. 8-01). Covers third class radio-telegraph and radio-telephone exam. 48 pages. Shpg. wt., 3 oz. 10 E 57066 Net .75

ELEMENT 3 (No. 9-01) This element plus elements 1 and 2 above. Covers the 2nd Class Radio Telephone License. 160 pages. 10 E 57116 Shpg. wt., 7 oz. Net 1.95

ELEMENT 4 (No. 10-01) This element plus elements 1, 2, and 3 above. Covers the 1st Class Radio-Telephone License. 80 pages. 10 E 57124 Shpg. wt., 6 oz. Net 1.25

RADIO PUBLICATIONS

CUBICAL QUAD ANTENNAS. By William I. Orr. Handbook of quad assembly and data. X-Q high gain. 7 MC and 50 MC quads. Trigamma 3 band single feed. Gains, front/back, patterns. Simplified and improved construction. 10 E 50030 Shpg. wt., 2 oz. Net 3.95

BEAM ANTENNA HANDBOOK. By William I. Orr. Covers the construction, installation, and evaluation of rotary beam antennas. New, simplified designs using easily obtainable materials are given. Full dimensional charts are given for the 6, 10, 11, 15, 20 and 40 meter bands! All you need to know about beams! 128 pages. Shpg. wt., 6 oz. 10 E 50079 Net 3.95

BETTER SHORTWAVE RECEPTION. By William I. Orr. Covers the exciting field of shortwave radio for the SWL and the radio amateur. The mysteries of shortwave transmission and reception explained in simple language. Jam-packed with data and such useful information as "do-it-yourself" radio projects, DX tuning hints, international broadcasting, etc. 139 pages. Shpg. wt., 6 oz. 10 E 50061 Net 3.25

Hayden/Rider Publications

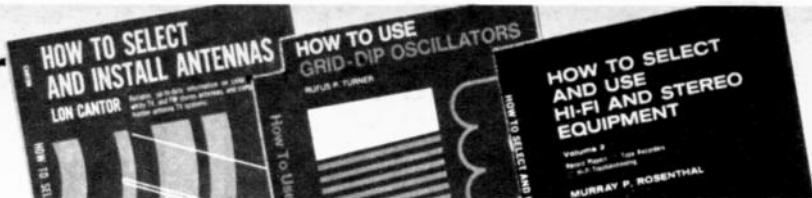

TELEVISION AND SERVICING

HOW TO SELECT AND INSTALL ANTENNAS (No. 0786) by Lon Cantor. A unique guide covering all aspects of antenna selection and installation for color, and black and white TV, FM stereo, UHF, VHF, or complete master TV systems — mechanical as well as electronic. Includes special consideration of local, fringe and near fringe area problems. 112 pages. Shpg. wt., 9 oz.
10 E 12038 Net 3.95

1969 TUBE CADDY-TUBE SUBSTITUTION GUIDE (0800) by H. A. Middleton. Eight comprehensive sections listing over 14,400 direct substitutions, including the latest tubes. Covers foreign picture tubes on the American TV market. This years edition of the Tube Caddy is bigger and easier to use. 128 pages. 4 1/4 x 5 7/8". Shpg. wt., 5 oz.
10 E 11915 Net 1.49

ADVANCED SERVICING TECHNIQUES. A practical authoritative EIA approved advanced servicing course emphasizing systematic, industry approved troubleshooting procedures utilizing the latest test instruments.

Vol. 1 (No. 0363) by Zbar and Drne. Covers all phases of color and black and white TV servicing. 8 1/2 x 11". 298 pages. Clothbound.
10 E 11782 Shpg. wt., 1 1/2 lbs. Net 8.95

Vol. 2 (No. 0364) by Neely et al. Covers home audio equipment—stereo hi-fi, changers, recorders, intercoms, etc. 8 1/2 x 11". 192 pages. Clothbound.
10 E 11790 Shpg. wt., 1 1/4 lb. Net 6.95

BOOKS ON AUDIO, HI-FI, FM

HI-FI LOUDSPEAKERS AND ENCLOSURES (No. 0721). 2nd Edition by Abraham Cohen. This classic in hi-fi literature, completely covers this subject. Answers all questions about loudspeakers and enclosures; design, construction of crossover network; etc. Discusses the room as part of the acoustic circuit and the ramifications of stereo practices. 216 pgs.
10 E 12582 Shpg. wt, 10 oz. Net 5.95

HOW TO SELECT AND USE HI-FI AND STEREO EQUIPMENT by Murray P. Rosenthal. All aspects of high fidelity are comprehensively covered in these 2 volumes. Vol. 1 (No. 0340) Spells out the Criteria and pitfalls when selecting new equipment. Fully covers loudspeakers and enclosures, receivers, tuners, amplifiers and headphones. 128 pages.
10 E 12046 Shpg. wt., 9 oz. Net 3.25

Vol. 2 (No. 0341) Presents full details on record players and tape recorders including operation, and maintenance. Discusses records, tapes, tone arms and styl. Features a section on hi-fi troubleshooting. 112 pages.
10 E 12053 Shpg. wt., 9 oz. Net 3.25

PRACTICAL PA GUIDEBOOK (No. 0778). By Norman Crowhurst. Covers the entire field of public address systems. Shows how to properly install, operate and service. All aspects of the subject, from the initial survey to the selection of appropriate equipment, are detailed. Treats microphones, loudspeakers and their placement. 128 pgs. Shpg. wt., 10 oz.
10 E 12590 Net 3.95

UNDERSTANDING ELECTRONIC ORGANS (No. 0750) by Thomas Jaski. This guide covers the basics of organ operation and theory used in organ construction. Circuits—their necessity and effects—are discussed in detail, as well as the mechanical details of organ consoles such as keys, pedal, stops etc. Also includes tone generators, special effects, accessories and repairs. 224 pages.
10 E 12061 Shpg. wt., 12 oz. Net 4.95

FUNDAMENTALS OF TELEVISION (No. 0391). By Walter H. Buchsbaum. Provides a complete and modern course in television theory, operation, and servicing. Emphasis is placed on understanding essential working principles; mathematics is held to an absolute minimum. The key circuits are explained with practical troubleshooting procedures. 291 pages. 6x9". Softbound. Shpg. wt., 1 1/2 lbs.
10 E 11808 Net 4.95

TV TROUBLE SHOOTING AND REPAIR (No. 0296—2nd ed.). By Robert G. Middleton. Newly revised and updated edition. Bridges the gap between "theory" and "hardware" treatment to cope with the real problems in repairing TV malfunctions. Each chapter is complete within itself. 216 pages, 5 1/2 x 8 1/2".
10 E 10214 Shpg. wt., 11 ozs. Net 4.75

HOW TO TROUBLESHOOT A TV RECEIVER (No. 0152, 2nd Ed.). By J. Richard Johnson. Step-by-step guide tells where to start and how to continue in trouble-shooting all TV receivers. Discusses tools, equipment and accessories, preliminary observations and checks, use of test patterns and cross-hatch patterns, tubes, controls, sound troubles, etc. Soft cover, 5 1/2 x 8 1/2", 128 pages.
10 E 10198 Shpg. wt., 6 oz. Net 3.75

HOW TO USE SIGNAL GENERATORS IN RADIO/TV/HI-FI SERVICING (No. 0767). Tests for antenna systems, AM, "M and TV receivers and high fidelity amplifiers. 127 pages.
10 E 11949 Shpg. wt., 10 oz. Net 3.25

BASIC TELEVISION by Dr. A. Schwur, Ph.D., D. Ed. A "picture book" course in the fundamentals of TV written in non-technical language so that anyone having a knowledge of radio can master TV in easy to learn, simplified steps. Teaches everything about TV theory and circuitry with a minimum of mathematics. 450 original illustrations, which make each idea completely understandable, are a feature of this series. The course is broken down into 5 volumes and systematically covers every portion of the subject. Vols. 1-5 Complete Set—(No. 0082).
10 E 10396 Shpg. wt., 2 lbs. 1 oz. Net 16.25

TAPE RECORDING BOOKS

HOW TO SELECT AND USE YOUR TAPE RECORDER (No. 7535). By David Mark. A general introduction to the tape recorder, with non-technical explanation of its theory and operation. Surveys benefits and applications, presents criteria for purchasing, and serves as a guide for use and maintenance. Revised 2nd edition, 5 1/2 x 8 1/2". Softbound, 126 pages. Shpg. wt., 7 oz.
10 E 11824 Net 3.50

HOW TO SERVICE TAPE RECORDERS (No. 573). By C. A. Tuthill. Presents in a balanced manner, an introduction to magnetic recording, an analysis of the operation of the mechanical and electronic systems of many modern tape recorders, and detailed directions for maintenance and trouble-shooting. Revised to incorporate the newest machines. 5 3/4 x 8 1/2" Softbound, 165 pages.
10 E 11832 Shpg. wt., 8 oz. Net 3.95

GETTING THE MOST OUT OF YOUR TAPE RECORDER (No. 0251). By Herman Burstein. Explains in non-technical language how to get maximum enjoyment from a tape recorder. Tells how tape heads operate and shows how a tape recorder can be added to an audio system; discusses microphones, record level indicators, or varieties. In soft cover, 5 1/2 x 8 1/2", 176 pages.
10 E 11295 Shpg. wt., 9 oz. Net 4.25

RADIO-THEORY And REPAIR

RADIO TROUBLESHOOTING GUIDEBOOK (No. 0149). Vol. 1. By Rider & Johnson. Covers fundamental principles of radio receiver operation, written on an elementary level. Special section on trouble diagnosis, recognition of faults and their repair. Every type of AM and FM receiver is discussed. Soft cover, 5 1/2 x 8 1/2", 160 pages. Illustrated.
10 E 10537 Shpg. wt., 8 oz. Net 3.75

REPAIRING TRANSISTOR RADIOS (No. 0270). By S. Libes. New methods and procedures developed for the repair of transistor radios. Deals with basic transistor theory, transistorized circuitry designs, superhet radio receiver principles. Servicing sections include procedures, check points, charts, test equipment, etc. Soft cover, 168 pages. 5 1/2 x 8 1/2". Shpg. wt., 10 oz.
10 E 10545 Net 3.75

HOW TO READ SCHEMATIC DIAGRAMS (No. 0200). By David Mark. Covering the symbols and abbreviations used in schematic diagrams related to the electronics field, this book starts with individual components and carries through to complete receivers and similar equipment. Components and circuits are identified and explained. Soft cover, 160 pages. 5 1/2 x 8 1/2", illustrated. Shpg. wt., 9 oz.
10 E 11394 Net 3.50

FUNDAMENTALS OF RADIO. By Murray P. Rosenthal. A complete course in radio theory from electricity and electromagnetism to antennas and receivers. Includes sections on radio mathematics, troubleshooting instruments and electronic techniques. Paper Bound (No. 0733).
10 E 12558 Shpg. wt., 1 1/4 lbs. Net 4.95

BASIC RADIO REPAIR (No. 0417). By Marvin Tepper. In two comprehensive volumes, the radio technician or hobbyist will find a sensible up-to-date approach to servicing both receivers and transmitters. General servicing procedures are outlined and applied to the practical techniques for repairing superheterodyne, portable, automobile and FM receivers. Transistor receivers are treated in 4 full chapters. The remainder of the book is devoted to servicing transmitters including FM and SS8. 212 pages. 6x9".
10 E 10438 Cloth bound Net 6.70

BASIC RADIO (No. 0081) by Marvin Tepper. An exhaustive coverage of the fundamentals and circuitry of radio communications. Over 750 specially prepared illustrations, conceived and selected for their ability to make the idea at hand readily understandable, provide the "picture-book" approach to the subject matter. Six major sections thoroughly cover: DC electricity, AC electricity, electron tube circuits, AM and FM receivers, transistors and transmitters. 800 pages. Clothbound. Shpg. wt., 4 lbs.
10 E 10511 Net 14.85

TRANSISTOR BOOKS

TRANSISTOR BASICS: A SHORT COURSE by George C. Stanley, Jr. (No. 5819). Provides a fast way to gain a practical understanding of transistors. An excellent introduction to transistor principles, circuit analysis, applications and troubleshooting techniques. Simplified approach will enable the reader to determine desired circuit values with an accuracy adequate to almost any practical situation. 102 pages. 5 9/8 x 8 1/4". Softbound. Shpg. wt., 9 oz.
10 E 11964 Net 2.95

Hayden/Rider Publications

TEST EQUIPMENT BOOKS

IT'S EASY TO USE ELECTRONIC TEST EQUIPMENT (No. 0308). By Kevin and Gilmoro. Describes and explains various basic electrical and electronic test instruments and outlines the various techniques for using these instruments. Emphasis is on practical application with more than 100-illustrations. 192 pages. 5½ x 8½".
10 E 11121 Shpg. wt., 8 oz. Net 4.55

HOW TO USE METERS (No. 0144). By John F. Rider. Explains use of panel meters, VOMs, and VTVMs when servicing radio and TV receivers, amplifiers, power supplies, and amateur transmitters. Shows what, how and where to use various meters. Discusses measurements and applications in different circuits. Illustrated. Soft cover, 144 pages.
10 E 11063 Shpg. wt., 8 oz. Net 4.35

PRACTICAL OSCILLOSCOPE HANDBOOK (No. 0475). By R. Turner. (2 vol.). Vol. I introduces the oscilloscope and explains the applications of interest to technicians, radio operators, etc. Volume II explains applications for technicians in science and industry. Shpg. wt., 12 oz. Softbound.
10 E 11097 Net 6.90

OBTAINING & INTERPRETING TEST SCOPE TRACES (No. 0148). By John F. Rider. Explains screen traces seen on test scopes in understandable, non-mathematical language. Contains over 800 scope traces in sinusoidal group — square, rectangular, trapezoidal, sawtoothed, differentiated and integrated waveforms. Gives examples with explanations. Shows how to connect and operate scope. Soft cover, 5½ x 8½". 190 pages.
10 E 11055 Shpg. wt., 10 oz. Net 3.00

HOW TO USE GRID-DIP OSCILLATORS (No. 0790) Revised 2nd Edition by Rufus P. Turner. Discusses construction and use of GDO's showing versatility of applications in checking L-C circuits, resonant frequencies of antennas, as a variable signal source for trouble-shooting, adjusting and aligning of radio, TV and transmitters. Evaluates commercial units, both assembled and in kit form. 128 pages. Shpg. wt., 9 oz.
10 E 12079 Net 2.95

BOOKS ABOUT COMPUTERS

HOW TO BUILD A WORKING DIGITAL COMPUTER (No. 0748). By Alcessor, Phillips and Weik. Features a unique approach to explaining how and why computers work. Detailed construction techniques for building an inexpensive working computer, with all component specifications and step-by-step assembly instructions. Complete theory explanations precedes construction. Includes programming explanation and solution of actual problems. 176 pages. Soft-bound.
10 E 11006 Shpg. wt., 14 oz. Net 3.95

BASICS OF DIGITAL COMPUTER PROGRAMMING (No. 0405). By John S. Murphy. This text provides a solid grounding in the use of procedure language for programming as well as a firm understanding of computer's applications to business. 150 pgs. 6x9".
10 E 11022 paper bound. Wt. 7 oz. Net 3.75

CB BOOKS

CBer's HOW-TO-BOOK (No. 0718) by Leo G. Sands. A complete guide for selecting, installing, operating, testing, repairing and modifying CB equipment. Includes information on mobile unit and base station features, walkie-talkies and phone patches. A fully illustrated all-points guide with tables for all CB Codes and Channels. 128 pages. Shpg. wt., 9 oz.
10 E 12007 Net 3.50

HAM BOOKS

RADIO OPERATOR'S LICENSE Q & A MANUAL (No. 0771). Seventh edition by Milton Kaufman. This seventh edition of the popular license preparative manual has been completely updated in accordance with the latest FCC examination requirements for any radio-telephone operator's license. Contains elements I, II, III, IV, VII and IX. Questions and answers for elements III and IV completely revised; all other elements have been updated. 576 pages. 5½ x 8¼". Cloth-bound. Shpg. wt., 2½ lbs.
10 E 11980 Net 8.95

GETTING STARTED IN AMATEUR RADIO (No. 0708). By Julius and Jack Berens. Newly revised, this text tells how to quickly learn Morse Code, gives the fundamentals of electronic theory, lists the current FCC laws and regulations, and fully prepares you, through thorough study questions and sample examinations, for either the Novice or General-Class License tests. 160 pages. 5½ x 8½".
10 E 11261 Shpg. wt., 10 oz. Net 3.75

BUILDING THE AMATEUR RADIO STATION (No. 0709). By Julius and Jack Berens. Recently brought up to date, this book explains the electronic components required to build your station, shows how to follow schematic and wiring diagrams, and completely details the Novice and General class stations (receiver, transmitter, and antenna) you can build. 136 pages.
10 E 11253 Shpg. wt., 7 oz. Net 3.45

INDUSTRIAL ELECTRONICS

INDUSTRIAL CONTROL CIRCUITS (No. 0202). By Sidney Platt. This book looks at Industrial control circuits through the eyes of the beginner. Circuits governing the initiation, processing, and finishing stages of industrial electronic equipment are explained in a comprehensive manner. Specific industrial applications are described to illustrate the problems of industrial control. There are chapters on electronic relay control timing circuits, photoelectric control, power controls, etc. Soft cover, 200 pages, 5½ x 8½", illustrated.
10 E 10602 Shpg. wt., 12 oz. Net 4.35

BASIC SYNCHROS & SERVOMECHANISMS. By Van Valkenburg, Neoger, Neville, Inc. Profusely illustrated 2-volume set used by the U.S. NAVY. Specially prepared text explains and makes picture-clear basic principles of synchros and servomechanisms, including typical applications. 2 soft cover volumes. 270 pgs. 6x9". (No. 0057)
10 E 10677 Shpg. wt., 1 lb. Net 7.00

BASIC PRINCIPLES AND APPLICATIONS OF RELAYS (No. 0434). By Harvey Pollack. A comprehensive discussion of relay construction, operation and application at the technician level. 5½ x 8½". 112 pages.
10 E 10636 Shpg. wt., 7 oz. Net 3.50

POWER SUPPLIES FOR ELECTRONIC EQUIPMENT (No. 0735) by Leo G. Sands. A clear and concise guide to power supplies in electronic equipment and devices. Covers theory, applications, stability, use, maintenance and purchase. 196 pages.
10 E 11998 Shpg. wt., 10 oz. Net 4.25

USING THE SLIDE RULE IN ELECTRONIC TECHNOLOGY by Charles Alvarez is written for electronic students, both beginners and advanced. It can also serve as auxiliary text in math theory. All scales are discussed separately with detailed examples, graded in difficulty to develop speed and accuracy in use of the slide rule. 120 pp. 5½x8½" paperback.
10 E 11626 Shpg. wt., 8 oz. Net 2.95



THE ELECTRONIC INVASION

by Robert M. Brown



A Detailed Technical Explanation of Electronic Bugging and Debugging (No. 0779) Discusses the secret techniques, devices, circuits, users and suppliers of bugs and anti-bugs. Covers all ramifications of electronic snooping, including miniature microphones and amplifiers, receivers, beepers, speech scramblers, techniques and circuitry. Includes a buyers directory and a section on eavesdropping and the law. 176 pages. 5½ x 8¼".
10 E 11972 Shpg. wt., 10 oz. Net 3.95

BASIC TECHNICAL BOOKS

HAYOEN 1-7 SERIES. Comprehensive 7 section courses in the fundamentals of electricity and electronics using modern scientific concepts and teaching methods. One concept to a page, with appropriate color illustrations. Summary - review and questions. Harry Mleaf, Editor. Clothbound. Shpg. wt., 4 lbs.



ELECTRICITY ONE-SEVEN (No. 5551). Thoroughly covers: Producing Electricity; DC circuits; AC circuits; LCR circuits; test equipment; power sources; and electric motors. 976 pages and index.
10 E 12601 Net 12.76

ELECTRONICS ONE-SEVEN (No. 5560). Thorough coverage of: Electronic signals; electronic building blocks; electron tubes; semiconductor devices; power supplies and amplifiers; oscillators, modulators, demodulators and discriminators; auxiliary circuits and antennas. 992 pages and index.
10 E 12764 Net 14.96

BASIC ELECTRICITY (No. 0039). By Van Valkenburg, Neoger, Neville, Inc. Famous illustrated training course used by the Navy. Each page has at least one picture and explains one idea. Covers AC and DC components and circuits, AC and DC motors and machinery. Clothbound 6 x 9". Total 624 pgs.
10 E 11306 Shpg. wt., 2 lb. 7 oz. Net 12.75

BASIC ELECTRONICS-EXPANDED COURSE. By Van Valkenburg, Neoger & Neville, Inc. (No. 0049). Famous illustrated standard Course covering vacuum tube diodes, power supplies, oscillators, amplifiers, detectors, receivers and transmitters plus semiconductors, transistors, and FM. Used by the Navy to train technicians. 666 pages. Clothbound.
10 E 10669 Shpg. wt., 3 lbs. Net 14.85

TRANSISTOR IGNITION SYSTEMS (No. 0700) by Marvin Tepper. Complete descriptions of the transistorized ignition systems, used in newer model cars. Includes operation, servicing, and installation information; trouble-shooting charts. 136 pgs. Shpg. wt., 10 oz.
10 E 11733 Net 3.49

HOW TO SOLVE PROBLEMS IN ELECTRICITY AND ELECTRONICS (No. 0302). By Henry Jacobowitz. Covers simple problems in DC circuits and progresses through more complex problems in AC electricity, tubes and transistors. All problems with solutions worked out. 152 pgs.
10 E 10594 Shpg. wt., 9 oz. Net 3.95

HOW TO SCORE HIGH ON THE SCHOLASTIC APTITUDE TEST (No. 0304). By Albert Gomula. Treats questions of the type used in Scholastic Aptitude tests covering English and Mathematics. Contains practice exercises and answers. 224 pages, 8½ x 11", illus.
10 E 11030 Shpg. wt., 1 lb., 5 oz. Net 2.59

Howard W. Sams Books

BOOKS ON TV & RADIO — THEORY AND SERVICING



SAMS PHOTOFAC FOLDERS

PHOTOFAC FOLDER. Covers almost all post war radio and TV sets, record changers, and hi-fi equipment, etc. In addition to schematics, each folder contains pictures of chassis indicating parts location, parts lists, aligning procedures and troubleshooting tips. All folder sets are in stock. Use the free index listed below to determine the folder set you require. Folder sets 1 through 200 are special orders, and will be shipped postpaid directly from publisher to you. When ordering, remit in full and specify stock number 60EY and the folder set number desired. When ordering Photofact Folders No. 201 through 500, specify stock number 61E and the folder set number desired. When ordering Photofact Folders 501 and above, specify stock No. 62E and the folder set number desired. Shpg. wt., each folder set, 8 oz.

STOCK NO.	PHOTOFAC NOS.	EACH
60EY	1-200	3.50*
61E	201-500	3.00
62E	501 and higher	2.75

*Shipped Postpaid

FREE ANNUAL INDEX. Helps you find the Sams Folder Set that contain the Information you desire. Lists sets by make and model. Shpg. wt., 2 oz.
10 E 21229 FREE

BINDER FOR FOLDER SETS. This attractive, durable, black leatherette binder holds 10 folders. Hardboard. Size, 9½ x 11½ x 6".
10 E 21237 Shpg. wt., 4 lbs. Net 6.00

REFERENCE DATA FOR RADIO ENGINEERS. New 5th Edition. This updated data book is a reference library in one fact-laden volume prepared under the direction of the IIT staff. 50% of the text is new material not covered in previous editions. It includes tables, formulas, standards, circuit information, charts, nomographs and diagrams. A truly time saving tool for the engineer, technician and student. Will be shipped postpaid directly from publisher to you. Over 1100 pages, 1350 illustrations.
10 E 23928Y Net 20.00

HOBBY BOOKS

ELECTRIC GUITAR AMPLIFIER HANDBOOK (2nd Edition). (No. 20894) by Jack Barr. Practical information for the musician and serviceman interested in musical amplification systems. Provides specific service information for commercial instruments, schematics and detailed drawings of typical circuits. Describes faulty components, grid bias, voltages and wave forms in simple language. 160 pages. Shpg. wt., 8 oz.
10 E 22854 Net 3.95

TV SERVICING MADE EASY (No. 20385) by Wayne Lemons. Clearly explains, in serviceman's language, how to solve the tougher types of TV troubles. Based on actual experiences and case histories. Shows how to trouble-shoot, analyze and repair problems. 160 pgs. 5½ x 8½". Shpg. wt., 9 oz.
10 E 22888 Net 3.95

TV TUBE SYMPTOMS AND TROUBLES (Sams 20478) by Robert G. Middleton. Second edition. A picture book of TV troubles caused by defective tubes. A handy 10-page TV tube trouble chart tells which tubes to replace to correct specific troubles. Tube caused defects are clearly explained and depicted in photos. Illustrated. 96 pages, 5½ x 8½". Shpg. wt., 6 oz.
10 E 23262 Net 2.50

TRANSISTOR-TV SERVICING GUIDE. (2nd Edition). (No. 20696) by Robert G. Middleton. Provides full information on latest circuitry and new test procedures. Lists symptoms encountered in each stage of receiver, and step-by-step procedures for analyzing and isolating each picture and/or sound defect. 128 pages, 8½ x 11". Shpg. wt., 12 oz.
10 E 24086 Net 4.50

TV SERVICING GUIDE (SAMS 20361) Trouble shooting procedures based on analysis of symptoms with picture tube photos with possible causes for each symptom. 132 pages. 8½ x 11".
10 E 21401 Shpg. wt., 1 lb., 2 oz. Net 3.25

CLOSED-CIRCUIT TELEVISION HANDBOOK (No. 20726) by Leon Wertman. Gives comprehensive detailed information in an easy-to-understand, up-to-date presentation. Suited for those who plan to use, install and service CCTV. Covers the subject from simple 400 single-camera system to the most exotic systems. 288 pgs. Shpg. wt., 1 lb.
10 E 22425 Net 5.95

TUBE SUBSTITUTION HANDBOOK (No. 20700) by Sams Staff. Completely up-dated with over 12,000 substitutions for receiving and picture tubes. Instructions on how to make correct substitutions and how to cross reference for additional substitutions. 96 pgs. Shpg. wt., 6 oz.
10 E 23365 Net 1.75

FM—FROM ANTENNA TO AUDIO (No. 20723) by Leonard Feldman. Presents a complete picture of FM reception and equipment from basic principles to latest developments. Details each section of the FM receiver including measurements and alignment procedures. 160 pages. Shpg. wt., 10 oz.
10 E 24074 Net 3.95

HOW TO BUILD SPEAKER ENCLOSURES (No. 20520) by Badmaleff and Davis. A thorough and comprehensive book providing practical and theoretical information on constructing high quality speaker enclosures. Contains many detailed drawings and instructions for building various enclosures, including testing techniques. Discusses drivers, horns and crossover networks. 144 pages.
10 E 23902 Shpg. wt., 9 oz. Net 3.50

HI-FI STEREO HANDBOOK (3rd Edition). (SAMS 20583) Covers fidelity and distortion, amplifiers and pre-amplifiers, loudspeakers, baffles and enclosures, program source equipment, and system design. 288 pages, 5½ x 8½".
10 E 23357 Shpg. wt., 12 oz. Net 5.50

TROUBLESHOOTING AUDIO EQUIPMENT (No. 20525) by Mammie Horowitz. Stage-by-stage analysis of audio amplifiers and preamps, both vacuum tube and transistor. Covers pickups, microphones, phase inverters and drivers, tone controls, equalization, tape recorders and stereo systems. 160 pages. Shpg. wt., 9 oz.
10 E 23308 Net 3.95

HOW TO READ SCHEMATIC DIAGRAMS (2nd Ed.). (SAMS 20588) Explains the purpose and meaning of various types of electronic equipment diagrams. Pictures and describes the different symbols used to schematically represent electronic and house wiring components. Tells how to interpret diagrams and follow signal paths. 160 pages. Shpg. wt., 3 oz.
10 E 23381 Net 3.50

TRANSISTOR RADIO SERVICING MADE EASY. No. 20442 by Wayne Lemons. Written to provide the kind of help needed to repair transistor radios. Completely avoiding theory. He guides you in learning repair techniques that will help you repair practically any transistor radio trouble in minutes. 144 pgs. 5½ x 8½". Shpg. wt., 9 oz.
10 E 21344 Net 3.50

PRACTICAL TRANSISTOR SERVICING. (SAMS 20314) A guidebook to servicing all types of transistorized and all transistor equipment. Tells how the transistor works, circuit components and their functions, isolating trouble to a stage, normal transistor voltages, defective voltages and their meanings, servicing auto radios, and troubleshooting. 192 pages. 5½ x 8½". Shpg. wt., 10 oz.
10 E 21351 Net 4.25

RADIO SERVICE TRAINING MANUAL by Edward Rice. Helps speed up the location of troubles in the complete field of radio receivers, including tube and transistor types of auto, home and personal sets. "Programmed" troubleshooting charts show how to quickly isolate any type of trouble to a specific component. Hi-Fi amplifiers and stereo systems are also included. 288 pgs. Softbound (20343). Shpg. wt., 14 oz.
10 E 22409 Net 5.50

Hardbound (No. 20342). Shpg. wt., 1 lb.
10 E 22417 Net 7.50

ELECTRONIC SERVICING FOR THE BEGINNER. (SAMS 20090). A practical method to learn basic trouble-shooting methods for radio, TV, hi-fi and stereo, home-made and ham gear, etc. Learn by building equipment and then testing it. 160 pages. Shpg. wt., 4 oz.
10 E 21450 Net 3.95

HI-FI AND TAPE RECORDING

101 QUESTIONS AND ANSWERS ABOUT AUTO TAPE UNITS (20671) by Lee G. Sands. Easy-to-understand presentation of tape cartridge and cassette player installation, operation, circuitry, maintenance and troubleshooting procedures. Deals with tape cartridges and cassettes. 72 pages. Shpg. wt., 8 oz.
10 E 24082 Net 1.75

101 EASY AUDIO PROJECTS (No. 20600) by Robert M. Brown and Tom Kneitel. Contains complete discussion and instructions for building simple, useful and inexpensive audio projects. Includes intercoms, wireless microphones, AM and FM tuners, telephone amplifiers, PA, reverbs, etc., with detailed schematic and parts list for each project. 168 pages. Shpg. wt., 10 oz.
10 E 23010 Net 3.50

ABC'S OF TAPE RECORDINGS (2nd Ed.). (SAMS 20395) by Norman H. Crewhurst. Tells how tape recorders work, how to choose a recorder best suited to your needs and how to use tape recorder for fun as well as business. 96 pages. 5½ x 8½". Shpg. wt., 6 oz.
10 E 22821 Net 2.50

TAPE RECORDERS—HOW THEY WORK. 2nd Ed. (No. 20445) Covers drive motors, volume indicators, bias oscillators, equalization circuits, amplifiers, and magnetic heads. Discusses frequency response, tape overload, bias settings and other subjects. 224 pages, 5½ x 8½". Illustrated. Revised.
10 E 23340 Shpg. wt., 12 oz. Net 4.50

Howard W. Sams Publications

TEST EQUIPMENT

- 101 WAYS SERIES TO USE YOUR TEST EQUIPMENT.** By Robert Middleton. Invaluable for all users of test equipment. Each volume contains data on hookup connections required, equipment needed, test procedures, and evaluation of results. All 5½x8½". Illus.
- 101 Ways to Use Your Sweep Generator. 160 pages. Shpg. wt., 6 oz. Net 3.50
- 10 E 22136 (20511) Net 3.50
- 101 Ways to Use Your Oscilloscope. 192 pages Shpg. wt., 6 oz. Net 3.50
- 10 E 22144 (20416) Net 3.50
- 101 Ways to Use Your VOM and VTVM. 144 pages. Shpg. wt., 6 oz. Net 3.50
- 10 E 22151 (20510) Net 3.50
- 101 Ways to Use Your Signal Generator. 144 pages. Shpg. wt., 6 oz. Net 3.50
- 10 E 23522 (20548) Net 3.50
- TROUBLESHOOTING WITH THE OSCILLOSCOPE.** 2nd Ed. (20350) by Robert G. Middleton. Permits you to view and analyze instantaneous electronic circuit actions. Applications in troubleshooting are actually unlimited. 192 pages. Net 4.50
- 10 E 23555 Shpg. wt., 6 oz. Net 4.50

TRANSISTORS

TRANSISTOR FUNDAMENTALS by Training & Retraining, Inc. A four volume carefully planned, programmed course in semiconductor theory and circuitry. Progress self-checked by the reader via summary questions and tests.

- Vol. 1. Basic Semiconductor and Circuit Principles. 240 pages. Net 4.50
- 10 E 24090 Shpg. wt., 12 oz. Net 4.50
- Vol. 2. Basic Transistor Circuits. 200 pages. Net 4.50
- 10 E 24108 Shpg. wt., 11 oz. Net 4.50
- Vol. 3. Electronic Equipment Circuits. 192 pages. Net 4.50
- 10 E 24116 Shpg. wt., 10 oz. Net 4.50
- Vol. 4. Digital and Special Circuits. 208 pages. Net 4.50
- 10 E 24124 Shpg. wt., 11 oz. Net 4.50
- All four volumes in slipcase. Net 15.95
- 10 E 24132 Shpg. wt., 3 lbs. 4 oz. Net 15.95
- TRANSISTOR FUNDAMENTALS WORKBOOK.** Practical applications of theory fundamentals above. 264 pages. Net 4.50
- 10 E 24140 Shpg. wt., 4 oz. Net 4.50
- 101 QUESTIONS & ANSWERS ABOUT TRANSISTORS** (20517) by Leo G. Sands. Answers the most frequently asked question about transistors and their applications. Covers characteristics, types, functions, testing with schematics, graphs and photos to illustrate the answer. 112 pages. Net 2.95
- 10 E 23571 Shpg. wt., 8 oz. Net 2.95
- 49 EASY TRANSISTOR PROJECTS** (No. 20617) by Robert M. Brown and Tom Kneitel. Provides complete, easy-to-understand instructions for building simple projects, such as radios, intercom systems, light relay controls, timers, test equipment, etc. Complete diagrams and parts lists. 64 pages. Net 1.75
- 10 E 23829 Shpg. wt., 5 oz. Net 1.75
- TRANSISTOR ETCHED-CIRCUIT PROJECTS** (No. 20390) by James Kyle. Explains 30 fascinating etched-circuit construction projects for hobbyists, experiments and students. Includes unique easy-to-use removable negatives with detailed instructions for their use. Describes how to design and photo-etch your own project. 160 pages. Shpg. wt., 8 oz. Net 3.50
- 10 E 22862 Net 3.50
- SMALL ENGINES SERVICE MANUAL** (No. 20357, 8th Edition). Contains information you need to service virtually any small engine in operation today. Enables you to service lawn mowers, garden tractors, karts, scooters, cycles, etc. 320 pages. Net 4.95
- 10 E 21484 Shpg. wt., 1 lb., 10 oz. Net 4.95
- INVENTORS IDEA BOOK** (No. 20232) by L. George Lawrence. Contains over 175 suggestions about specific needs of industry and technology awaiting the attention of an inspired inventor. Ideal for the experimenter, technician, engineer or student. 128 pages. Net 2.75
- 10 E 22870 Shpg. wt., 7 oz. Net 2.75

ELECTRONICS

- MODERN DICTIONARY OF ELECTRONICS** 3rd Ed. (No. 20600). By Rudolf F. Graf. Revised. Includes more than 16,500 definitions applicable to electronics, special Pronunciation Guide, terminology expressed in Greek alphabet symbols, and electronic symbols and abbreviations. 608 pages, 6x9". Hardbound. Net 9.95
- 10 E 23870 Shpg. wt., 1 lb. Net 9.95
- ELECTRONICS IN OCEANOGRAPHY** (No. 20507). By George Lawrence. Provides a comprehensive description of electronics systems for gathering and interpreting oceanographic data. Includes measurements of temperature, light, salinity magnetism, pressure, gravity, navigation, ranging, marine animals, and submarines for oceanography. 288 pages. Shpg. wt., 14 oz. Net 5.50
- 10 E 23415 Net 5.50
- UNDERSTANDING ELECTRONIC CIRCUITS** (No. 20484). By F. J. Waters. Explains the basic electronic circuits used in most electronics equipment in simple terms. Illustrated; very little technical jargon or math. 160 pgs. Shpg. wt., 8 oz. Net 3.95
- 10 E 22367 Net 3.95
- HANDBOOK OF ELECTRONIC TABLES AND FORMULAS** (No. 20848). (3rd edition.) Revised, up-dated and expanded. A one-step reference for all charts, tables, formulas, laws, symbols and standards. Full-color fold-out pages show assignments for the entire frequency spectrum. 232 pages. Hardbound. Shpg. wt., 10 oz. Net 5.50
- 10 E 23886 Net 5.50
- ELECTRONIC GAMES AND TOYS YOU CAN BUILD.** By Len Buckwalter. Step-by-step instructions show you how to build 15 fascinating electronic games and toys. 128 pages. Shpg. wt., 3 oz. Net 2.95
- 10 E 22399 SAMS 20183 Net 2.95
- ELECTRONICS EXPERIMENTS & PROJECTS** (No. 20194). By Len Buckwalter. Makes learning the principles of electronics easy. Projects include a low-power communications system, alarm detection device, weather station and electronic computer. All easily assembled from inexpensive parts. 128 pages. 5½x8½". Shpg. wt., 6 oz. Net 2.95
- 10 E 21510 Net 2.95
- ABC'S OF LASERS AND MASERS** (No. 20262). By Allen Lytal. Explains how these special semiconductors are used in micro-wave and light frequency radiation application. Provides an understanding of Laser theory and its significance. 5½x8½". 128 pgs. Net 2.95
- 10 E 23001 Shpg. wt., 6 oz. Net 2.95
- ABC'S OF CAPACITORS** (No. 20097) by William F. Mullin. Tells what capacitors are and how they are constructed. Explains capacitor operating principles, their uses and methods of testing them. 96 pages. Shpg. wt., 7 oz. Net 2.50
- 10 E 23860 Net 2.50
- ELECTRONIC ORGANS** (No. 20188). Pertinent specifications, schematics, and servicing information on representative organs. 272 pages. 5½x8½". Shpg. wt., 13 oz. Net 5.75
- 10 E 21526 Net 5.75
- ABC'S OF ELECTRONIC ORGANS** (2nd edition) (No. 20551). By Norman Crowhurst. Explains fundamental principles of electronic organs, including theory and operation. Includes chapter on maintenance and troubleshooting. 128 pages. 5½x8½". Shpg. wt., 10 oz. Net 2.95
- 10 E 23431 Net 2.95
- BRIDGES AND OTHER NULL DEVICES** (No. 20564). By Rufus P. Turner. Explains the basic theory of bridge circuits, bridges, and bridge resembling devices. Covers resistance, capacitance, inductance, combination and r-f type bridges. Numerous actual use of these circuits are included. 144 pages. Shpg. wt., 10 oz. Net 3.50
- 10 E 23399 Net 3.50
- ELECTRICAL MOTOR CONTROLS & CIRCUITS** (No. 20163). By David Fuchs and Stephen Garstag. A complete handbook for installers and maintenance technicians covering automatic and semiautomatic control circuits, starting, speed reduction, reversal, pilot devices, protection, and control circuit design. Illustrated. 288 pgs., 5½x8½". Net 5.75
- 10 E 21872 Shpg. wt., 14 oz. Net 5.75

COMPUTER BOOKS

- ENCYCLOPEDIA OF ELECTRONIC COMPUTER BASICS.** Comprehensive up-to-date 6-volume study of electronic computers. Written to be understood by any reader with some background in basic electronics. Encompasses the complete technology of computers and data processing. Covers installation, maintenance and troubleshooting. Illustrated. 5½x8½". Shpg. wt., 12 oz. Vol. 1-6 Complete set of 6 volumes (No. 20134). Shpg. wt., 4¼ lb. Net 27.00
- 10 E 21666 Net 27.00
- COMPUTER CIRCUIT PROJECTS YOU CAN BUILD** (No. 20084). By Leo Boschen. Details construction of 13 basic computer-circuit projects explaining theory and applications. Gives working knowledge of fundamental computer circuitry. 144 pgs. Net 3.25
- 10 E 21674 Shpg. wt., 8 oz. Net 3.25
- ABC'S OF COMPUTERS** (No. 20012). A basic introduction to computers. Explains what they are, how they operate, and what they can be expected to do. 144 pages. Net 2.95
- 10 E 23027 Shpg. wt., 8 oz. Net 2.95
- ABC'S OF COMPUTER PROGRAMMING** (No. 20123). A full introduction to the principles and applications of digital computer programming — from simple sub-programs to intricate assembly and compiler programs. 5½x8½". 128 pgs. Shpg. wt., 6 oz. Net 2.95
- 10 E 21690 Net 2.95
- COMPUTER DICTIONARY** (No. 20102). By Charles Sippel. Essential reference defining over 5000 terms and concepts of computer technology. Includes sources for computer equipment, personal training, factual discussions and listings of information on electronic data processing. 336 pages, 6x9 softbound. Shpg. wt., 1 lb. Net 5.50
- 10 E 23274 Net 5.50
- ## AMATEUR RADIO
- SHORT-WAVE LISTENER'S GUIDE** (20695) 3rd Edition by H. C. Woodruff. All the important and available information on International Broadcast Stations useful to the SWL. 96 pages. Shpg. wt., 5 oz. Net 2.25
- 10 E 22490 Net 2.25
- BUILDING YOUR AMATEUR RADIO NOVICE STATION** (20050) by Howard S. Pyle W7OE. Tells how to build inexpensive transmitters, receivers, and accessories. Full-size templates provided with simplified construction details. Equipment also serves well in General Class. 128 pages. Shpg. wt., 9 oz. Net 3.75
- 10 E 23506 Net 3.75
- FIRST-CLASS RADIOTELEPHONE LICENSE HANDBOOK** (20086) by Edward M. Noll. Completely revised and updated. Contains questions and answers based on revised FCC element 4, needed to qualify for a 1st class license. Also provides essential knowledge required by communications engineer. 400 pages. Shpg. wt., 1 lb. Net 5.75
- 10 E 23090 Net 5.75
- SECOND-CLASS RADIOTELEPHONE LICENSE HANDBOOK** (20316) by Edward M. Noll. New 3rd edition. Complete study course for elements I, II, and III of latest FCC exams. Prepares you for license needed for communications and 2-way radio work. 336 pages. Shpg. wt., 14 oz. Net 5.75
- 10 E 23068 Net 5.75
- ABC'S OF SHORT-WAVE LISTENING** (20554) by Len Buckwalter 2nd Ed. Introduction to the exciting world of short-wave radio. Covers international, amateur, police, emergency, aircraft, ships-at-sea, and even orbiting satellite communications. Discusses receivers and antennas. 96 pages. Shpg. wt., 7 oz. Net 2.50
- 10 E 23514 Net 2.50
- ABC'S OF ELECTRIC MOTORS AND GENERATORS** (No. 20186). By Allen Lytel. A basic introduction. Explains how they operate. Both AC and DC motors and generators are covered. 128 pages. 5½x8½". Net 2.95
- 10 E 21492 Shpg. wt., 6 oz. Net 2.95

G.L./Tab & Supreme Publications

HOW TO USE YOUR VOM-VTVM AND OSCILLOSCOPE (No. 438) by Martin Clifford.

A guide for the everyday application of the most frequently used test instruments and how to get more reliable test results in less time. 192 pages. Shpg. wt., 9 oz.
10 E 41607 Net 3.95



RADIO-CONTROL MANUAL (No. 135) by E. Z. Safford, Jr.

Completely Revised. Principles of radio-control planes, boats, and cars; from super simple to super sophisticated. Circuits (tube and transistor) you can build and use. 192 pages. Shpg. wt., 10 oz.
10 E 41615 Net 3.95



HOW TO TEST...ALMOST EVERYTHING ELECTRONIC (No. 132), by Jack Darr.

Practically every testing technique for almost every kind of electronic equipment. Hundreds of illustrations make text crystal clear. Soft-bound. 160 pages. Shpg. wt., 7 oz.
10 E 41557 Net 2.95



TEST EQUIPMENT BOOKS

THE OSCILLOSCOPE (No. 498) Revised 3rd Edition by George Zwick. An updated, enlarged analysis of the scope and how to use it in all fields of electronics. Discusses scope components, measurement, alignment waveforms, triggered sweep, electronic switches, practical experiments, commercial scopes and numerous useful applications. 256 pages. Softbound. Shpg. wt., 10 oz.
10 E 41698 Net 4.95

AUDIO AND HIGH FIDELITY

AUDIO SYSTEMS HANDBOOK (No. 494) by Norman H. Crewhurst. A down-to-earth technical approach to the whole audio system. Covers amplifiers, equalizers, mixers, filters, distribution systems, program sources, reverberation, hi-fi home systems, public address, speaker systems, acoustics and more. 192 pages. Soft-bound. Wt., 9 oz.
10 E 41714 Net 4.95

BOOKS ON ELECTRONICS

ELECTRONICS DATA HANDBOOK (No. 118) by M. Clifford. The most used and needed formulas and data in electronics in logical, orderly fashion for quick reference. 160 pages. Shpg. wt., 5 oz.
10 E 41433 Net 2.95

HOBBY BOOKS

ELECTRONICS HOBBYISTS' HANDBOOK (No. 89) by Rufus P. Turner. Over 100 circuits for planning, designing and building your own electronic projects. Complete Parts list for each project. 160 pages. 114 illustrations.
10 E 41052 Shpg. wt., 6 oz. Net 2.95

BOOKS ABOUT TRANSISTORS

ELECTRONIC DESIGNERS HANDBOOK (No. 220) by T. K. Hemingway. A practical guide to transistor circuit design. In depth analysis of specific circuits independent of parameter variations and ambient temperature changes. Details problems, design and testing of prototypes. 296 pgs. Shpg. wt., 1 lb. 2 oz. Paperbound.
10 E 41623 Net 4.95

DESIGNING AND BUILDING HI-FI FURNITURE (No. 79) by Jeff Markell. Design principles, woodworking techniques, finishing, types of woods, application of design to different types of audio equipment. 224 pages.
10 E 41151 Shpg. wt., 11 oz. Net 4.95

RADIO-CONTROL HANDBOOK-REVISED (No. 83) by H. G. McEntee. An up-to-date version of the handbook which has become the standard in the field. New ideas for remote control of model boats, planes and cars by radio. Information on servos and actuators as well as receivers and transmitters. 304 pages. Shpg. wt., 1/2 lb. 160 pages.
10 E 41425 Net 4.95

SEMICONDUCTORS FROM A TO Z (No. 493) by Phillip Dahlen. Everything you need know about everything in semiconductors. Includes basic diodes and transistors, FET's, integrated circuits, photo devices, varicaps, SCR and zener diodes and much more. Explains operation, circuitry and applications in modern semiconductor technology. 256 pages. Soft bound.
10 E 41708 Shpg. wt., 12 oz. Net 4.95

MAINTAINING HI-FI EQUIPMENT (No. 58) by Joseph P. Marshall. Servicing guide and troubleshooting handbook. 13 chapters cover diagnosis, distortion, bass and treble faults, pickups, turntables, tuners, etc. 224 pages.
10 E 41177 Shpg. wt., 5 oz. Net 4.95

SERVICING RECORD CHANGERS (No. 59) Discusses every functional assembly as a unit so that even beginner can learn quickly. Illustrates intricate mechanisms. 224 pages.
10 E 41375 Shpg. wt., 11 oz. Net 4.95

MODEL RADIO CONTROL (No. 74) by Edward L. Safford, Jr. Covers coders, decoders, transmitters, receivers, control systems, troubleshooting, etc.—from theory to practical hints. Tells how to build successful models. Illustrated. 192 pages.
10 E 41227 Shpg. wt., 1/2 lb. Net 3.95

SUPREME PUBLICATIONS

TELEVISION SERVICING MANUALS

For faster, easier TV repairs. Factory data on practically all sets. Complete circuits, all needed alignment facts, wiring board views, waveforms, voltages, production changes, and double-page schematics. Size: 8 1/2 x 11". Shpg. wt., 1 1/2 lb.

No.	Vol.	Year	Pages	Net
10 E 51580	TV-28	1969	192	4.00
10 E 51564	TV-27	1968	192	4.00
10 E 51549	TV-26	1967	192	4.00
10 E 51531	TV-25	1966	192	3.00
10 E 51481	TV-24	1965†	192	3.00
10 E 51499	TV-23	1965*	192	3.00
10 E 51010	TV-22	1964	192	3.00
10 E 51028	TV-21	1963	192	3.00
10 E 51036	TV-20	1962†	192	3.00
10 E 51044	TV-19	1962*	192	3.00
10 E 51051	TV-18	1961	192	3.00
10 E 51069	TV-17	1960	192	3.00
10 E 51077	TV-16	1959†	192	3.00
10 E 51085	TV-15	1959*	192	3.00
10 E 51093	TV-14	1958	192	3.00
10 E 51101	TV-13	1957†	192	3.00
10 E 51135	TV-10	1955†	192	3.00
10 E 51143	TV-9	1955*	192	3.00
10 E 51150	TV-8	1954	192	3.00
10 E 51184	TV-5	1951	192	3.00

*Early †Additional

MASTER INDEX For Supreme TV and Radio.
10 E 51192 Shpg. wt., 3 oz. Free

PRACTICAL RADIO AND ELECTRONICS COURSE. Complete home study course of 53 lessons for the beginner. Covers every topic of radio, electronics, with lessons on test equipment, FM, radio, and an introduction to TV, etc. 3-in-1 volume includes all lessons, test questions. 8 1/2 x 11" x 216 pages.
10 E 51457 Shpg. wt., 1 lb. 12 oz. Net 3.95

TELEVISION SERVICING COURSES. Covers everything in TV. Easy-to-follow well illustrated lessons on circuits, picture faults, shorts, UHF, alignment, antenna data and test equipment. Complete training in TV servicing. Profusely illustrated. 8 1/2 x 11".
10 E 51210 Shpg. wt., 1 1/2 lb. Net 3.00

RADIO DIAGRAM MANUALS

Simplify repairing. Cover home radios, stereo, combinations, transistor portables, FM, auto sets. Large schematics, all needed alignment facts, printed boards, voltages, dial stringing, hints. 8 1/2 x 11". Shpg. wt., 1 1/2 lb.

No.	Vol.	Year	Pages	Net
10 E 51556	26	1966	192	2.50
10 E 51507	25	1965	192	2.50
10 E 51226	24	1964	192	2.50
10 E 51234	23	1963	192	2.50
10 E 51242	22	1962	160	2.50
10 E 51259	21	1961	192	2.50
10 E 51267	20	1960	192	2.50
10 E 51275	19	1959	192	2.50
10 E 51283	18	1958	192	2.50
10 E 51291	17	1957	192	2.50
10 E 51309	16	1956	192	2.50
10 E 51317	15	1955	128	2.50
10 E 51325	14	1954	192	2.50
10 E 51333	13	1953	168	2.50
10 E 51341	12	1952	192	2.50
10 E 51358	11	1951	192	2.50
10 E 51366	10	1950	192	2.50
10 E 51374	9	1949	160	2.50
10 E 51382	8	1948	192	2.50
10 E 51390	7	1947	192	2.00
10 E 51408	6	1946	192	2.50
10 E 51416	5	1942	192	2.50
10 E 51424	4	1941	192	2.50
10 E 51432	3	1940	208	2.50
10 E 51440	1	1926-1938	240	2.50

AUTO RADIO DIAGRAMS MANUAL (No. AU-1). Covers all 1964-65 auto sets. Provides schematics, alignment facts, complete service information. 8 1/2 x 11". 128 pages. Shpg. wt., 10 E 51515 Shpg. wt., 1 lb. Net 2.50

RADIO SERVICING BY COMPARISON. Introduces a remarkably simplified technique of radio repairing—the comparison method. Voltohmmeter is only equipment needed—point-to-point circuit, cross-reference locates faults instantly. Applicable to any radio, old or new. 1000 service hints. Includes 26 large circuit diagrams. 48 pages. 8 1/2 x 11".
10 E 51200 Shpg. wt., 6 oz. Net 1.50

ADVANCED RADIO CONTROL (No. 122). Provides advanced techniques for the radio control enthusiast. A step-up from the previous basic R/C books. 192 pages.
10 E 41466 Shpg. wt., 6 oz. Net 4.95

LEARN ELECTRONICS BY BUILDING (No. 112). By John Schroeder. Learn electronics by building the units yourself. Start with basic theory; finish by constructing amplifiers and receivers. An easy, practical approach for beginners of all ages.
10 E 41201 Shpg. wt., 9 oz. Net 4.95

RADIO AND T.V.—THEORY AND SERVICING BOOKS

BASIC RADIO COURSE (No. 104). By John T. Frye. Everything—Ohms Laws, capacitance, tubes, transistors and how they work in a receiver—practical servicing techniques—discussed in a light-hearted style that makes what's being taught stick. 224 pages.
10 E 41342 Shpg. wt., 10 oz. Net 4.95

RADIO REPAIR (No. 78). By G. Warren Heath. Symptoms, troubles and repair techniques. Covers latest transistor sets, printed circuit repair, modular receivers, use of test instruments. 224 pages. Shpg. wt., 11 oz.
10 E 41359 Net 3.95

RADIO TV REPAIR (No. 80). Handy, practical service manual which lists hundreds of "tough-dog" troubles alphabetically, many cross-referenced. Will help you cut down troubleshooting time. 224 pages. Illustrated.
10 E 41334 Shpg. wt., 11 oz. Net 3.95

SERVICING THE SOLID-STATE CHASSIS (No. 495) by Homer Davidson. Explains the techniques of solid-state trouble-shooting all popular home entertainment equipment. Covers transistorized TV, small portable and AC-DC radios, AM-FM multiband receivers, auto radio and cartridge tape players, stereo amplifiers and portable tape recorders. 224 pages. Softbound. Shpg. wt., 9 oz.
10 E 41730 Net 4.95

Books On Science & Technology — Language Records



BASIC ELECTRICITY. Prepared by the U.S. Navy as a training course text. Provides a thorough coverage of the basic theory of electricity and its applications. Excellent for classroom use or for homestudy. 448 pgs. Shpg. wt., 1 lb., 12 oz. **10 E 31301** Net 3.00

BASIC ELECTRONICS. Originally prepared by the U.S. Navy as a training course. Covers every important aspect of applied electronics, clearly illustrating important concepts, apparatus and techniques. 459 pages. **10 E 31319** Shpg. wt., 1 lb., 12 oz. Net 2.95

TEACH YOURSELF SERIES

This Famous Series Published by the English University Press Is An Ideal, Thorough, Yet Inexpensive Course in the Basic Branches of Mathematics and Mechanics. Clothbound.

TEACH YOURSELF ALGEBRA by P. Abbott. A complete basic course in the most widely used branch of mathematics. Material simply presented with over 1200 problems (answers in the appendix) included to aid the student. All important areas of algebra are covered, with only an understanding of arithmetic necessary to master the techniques presented. Table of logarithms. 307 pages. 4 1/4 x 7". Clothbound. **10 E 31079** Shpg. wt., 10 oz. Net 2.00

TEACH YOURSELF GEOMETRY by P. Abbott is an excellent text both for a beginner and a refresher course in geometry. Divided into two parts, the first deals with the basic geometrical truths. The second presents the formal proofs of the geometrical propositions. Other areas treated are: parallel straight lines, theorem of Pythagoras, solid geometry, prisms, and much more. 334 pages. 4 1/4 x 7" Clothbound. **10 E 31129** Shpg. wt., 10. oz. Net 2.00

TEACH YOURSELF TRIGONOMETRY by P. Abbott. Requiring only a knowledge of high school algebra this course provides the essential of trig as applied to physics, navigation, surveying, and engineering. Over 465 problems with answers to aid the student progress. 204 pages. 4 1/4 x 7". Clothbound. **10 E 31087** Shpg. wt., 7 oz. Net 2.00

TEACH YOURSELF ELECTRONIC COMPUTERS by F. L. Westwater. Covers every aspect of digital computers in a lucid, interesting manner. Explains how a digital computer works and what it can do. Prepared specifically for laymen and beginning science and engineering students. Illustrated. 151 pages. **10 E 31327** Shpg. wt., 7 oz. Net 2.00

TEACH YOURSELF ELECTRICITY by C. W. Wilman. Current, resistance, voltage, ohm's law, chemical effects of current, circuits, motors, inductance, capacitance, transformers, converters, measuring instruments, etc. Over 250 problems. Illustrated. 184 pages. **10 E 31103** Shpg. wt., 8 oz. Net 2.00

TEACH YOURSELF CALCULUS by P. Abbott puts calculus within the reach of anyone with an elementary knowledge of algebra and geometry. Presents simplified and shortened proofs to eliminate possible pitfalls for the beginning student. Tables of circular measures and hyperbolic functions. 380 pages. **10 E 31095** Shpg. wt., 11 oz. Net 2.00

TEACH YOURSELF THE SLIDE RULE by Burns Snodgrass is a comprehensive course book enabling you to perform fast and accurate calculations with the slide rule. Full instruction covering A, B, C, D, LL, L, S, T, and other special purpose scales. 20 illustrations. 80 problems. 207 pp. 4 1/4 x 7". **10 E 31137** Shpg. wt., 6 oz. Net 2.00

INTRODUCTION TO ELECTRONICS. A U.S. Navy training manual in the fundamentals of electronics. Profusely illustrated with nearly 150 charts, diagrams, photographs, schematics, drawings, etc. 145 pages. Shpg. wt., 11 oz. **10 E 31285** Net 1.25

HOBBY



The Scientific American Book of Projects for the AMATEUR SCIENTIST by C. L. Strong. A magnificent volume of meaningful experiments in major areas of science, astronomy, biology, natural sciences, earth sciences, nuclear physics, mathematics, electronics, etc. Measuring metabolism in animals; studying hummingbirds; an electric seismograph; simple magnetic-resonance spectrometer; amateur rocketry; homemade interferometer. 256 illustrations. 608 pages. **10 E 75159** Shpg. wt., 4 lb. 9 oz. Net 6.95

AUDEL BOOKS

QUESTIONS AND ANSWERS FOR ELECTRICIANS EXAMINATIONS (No. 60049). A comprehensive guide to preparing for the various electricians license examinations. Contains the required theoretical information and a thorough understanding of the definitions, specifications and regulations of the National Electrical Code. 288 pages. Shpg. wt., 12 oz. **10 E 24504** Net 3.95

HOME REFRIGERATION AND AIR CONDITIONING (No. 60139). All the necessary data on modern units, systems, machines and refrigerants. Covers principles, operation and servicing procedures. 576 pages. **10 E 24512** Shpg. wt., 3 3/4 lbs. Net 6.95

ELECTRIC MOTORS (No. 60150). Covers construction, hookups, control, maintenance and trouble-shooting of all types of electric motors. A thorough guide to all considerations of the subject. 432 pages. **10 E 24520** Shpg. wt., 1 1/4 lbs. Net 5.95

WIRING DIAGRAMS FOR LIGHT AND POWER (No. 60020). Explains in simple terms the wiring methods for practically all fields of electricity. Includes hundreds of self-explanatory diagrams. 320 pages. **10 E 24538** Shpg. wt., 1 1/4 lbs. Net 4.00

HOME APPLIANCE SERVICING (No. 60016). Covers all aspects of every kind of home appliance and how to make electrical repairs. Includes vacuum cleaners, washing machines, dryers, irons, toasters, blenders, dishwashers, broilers, coffeemakers, fans, refrigerators, air-conditioners, ranges, and much more. Profusely illustrated. 608 pages. **10 E 24546** Shpg. wt., 1 3/4 lbs. Net 6.95

OIL BURNERS (No. 60151) Revised 2nd Edition. Fully covers the theory of construction, installation, operation, testing, servicing and repair of all oil burner equipment. Includes combustion, ignition systems, electrical wiring and control diagrams. 295 pages. Shpg. wt., 1 1/2 lbs. **10 E 24553** Net 4.95

PRACTICAL ELECTRICITY (No. 60161) Revised 2nd Edition. Comprehensive coverage of electric theory, circuits, house wiring, lighting, heating, intercommunication and alarm installations. A practical, profusely illustrated quick ready reference. 486 pages. Shpg. wt., 2 lbs. **10 E 24561** Net 5.95

ADDITIONAL BOOKS FOR THE ENGINEER, PHYSICIST AND STUDENT

- TREATISE ON ELECTRICITY & MAGNETISM** by James Clark Maxwell
10 E 31038 Vol. I Electronics and Electrokinematics, 530 pages 3.00
10 E 31046 Vol. II Magnetism and Electromagnetism, 530 pages 3.00
APPLIED OPTICS AND OPTICAL DESIGN by A. E. Conrady
10 E 31053 Vol. I Optical Theory and Simple Systems, 518 pages 4.00
10 E 31061 Vol. II Optical Design and Advanced Systems, 323 pages 3.50
10 E 31111 THE EVOLUTION OF SCIENTIFIC THOUGHT FROM NEWTON TO EINSTEIN by A. D'Abro, 482 pages 2.75
10 E 31160 INTRODUCTION TO FOURNIER METHODS AND THE LEPLACE TRANSFORM. 785 pages 2.50
10 E 31178 THE PRINCIPLE OF RELATIVITY. A. EINSTEIN. 224 pages 2.00
10 E 31186 THE ELECTROMAGNETIC FIELD 2.25
10 E 31194 HIGHER MATHEMATICS FOR STUDENTS OF CHEMISTRY AND PHYSICS by J. W. Mellor, 641 pages 3.50
10 E 31210 CALCULUS REFRESHER FOR TECHNICAL MEN. A. Albert Klaf, 431 pages 2.25
10 E 31228 ADVANCED CALCULUS. E. B. Wilson, 566 pages 3.00
10 E 31269 SPACE AND TIME by Emil Borel, 243 pages 2.00

LISTEN & LEARN

LANGUAGE RECORD COURSE



3-12" LP RECORDS PER COURSE

5.95

Learn a language as it is actually spoken, for travel and study, for use in restaurants, shopping, sightseeing etc. Features dual language recording — first in English sentence, then its foreign equivalent. Each set contains 3 high-fidelity 33 1/3 LP records for 1 1/2 hours playing time plus convenient manual with full record text and phonetic transcription. Shpg. wt., 3 lbs.

- 24 E 20016 French 24 E 20065 Japanese
 24 E 20024 Spanish 24 E 20073 Mod. Greek
 24 E 20032 German 24 E 20081 Portuguese
 24 E 20040 Russian 24 E 20099 Mod. Hebrew
 24 E 20057 Italian

Net ea. 5.95

SHORTWAVE LISTENING

WORLD RADIO TV HANDBOOK 1969. Contains details on every short-wave and TV station throughout the world. Each station identified by call, frequency, station personnel, address, power, programs and language, license fee, identification signals and network affiliation. 340 pgs. Imported. Shpg. wt., 1 lb., 3 oz.

10 E 12012 Net 5.95

RCA PUBLICATIONS

RCA SOLID-STATE HOBBY CIRCUIT MANUAL HM-90. Features 35 different solid state circuits provided with full size drilling templates to simplify circuit board construction. Text sections devoted to the theory of solid state devices, circuit operation, construction practices, and trouble shooting. 224 pages. Shpg. wt., 12 oz. **10 E 47117** Net 1.75

Drafting & Drawing Supplies

L&E DRAFTING SETS



7⁹⁵

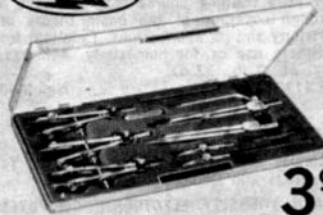

3⁹⁵



3⁹⁵

TECHNICAL DRAFTING SET

- Center Wheel Adjustment
- Professional Quality
- Made in W/Germany of Nickel Plated Brass

Contains 6 $\frac{1}{8}$ " self-centering compass, one leg knuckle joint with divider, pencil, pen parts and lengthening bar; 6 $\frac{1}{8}$ " self-centering divider; spring bow divided 4 $\frac{1}{8}$ ", center wheel adjustment with interchangeable needle points; spring bow pencil and spring bow pen, both 4 $\frac{1}{8}$ " with center wheel adjustment and interchangeable needle point; two 5 $\frac{3}{8}$ " ruling pens; extra handle for pen and pencil parts; adjustment tool; lead case and leads; and spare parts kit, all in velvet lined snap closing case. Shpg. wt., 1 $\frac{1}{2}$ lbs. 99 E 70039 7.95

UTILITY DRAFTING SET

- Side Wheel Adjustment
- Made in W/Germany of Nickel Plated Brass
- Professional Quality

Made in Germany of hard rolled, nickel plated brass. All instruments are nested in a fitted, velvet lined case. Contains three side wheel 3 $\frac{3}{4}$ " bow instruments—one a divider, one a pencil and one a pen. All have reversible needle point. 5 $\frac{1}{4}$ " compass with pen and pencil parts—and lengthening bar. 5 $\frac{1}{4}$ " divider with straightening device. 5" ruling pen. Extra handle for use with pen and pencil parts. Capsule with extra leads. Perfect for school, labs, industrials. Shpg. wt., 1 lb. 99 E 71649 Net 3.95

PROFESSIONAL GIANT BOW

- 6" Size with Center Wheel Adjustment
- Finely Balanced—Professional Type
- Made in W/Germany of Nickel Plated Brass

Professional quality utility set in a fitted, velvet lined case. Made in Western Germany of nickel plated brass. 6" giant bow has preferred center wheel adjustment. Makes circles from 1/8" to over 10" in diameter. Set includes 6" giant bow, interchangeable pen and pencil parts, extra needle for using bow as divider, handle for use with pen and pencil parts, lead, lead box and repair parts. Shpg. wt., 1 lb. 99 E 70633 Net 3.95

draftette PORTABLE DRAFTING MACHINE

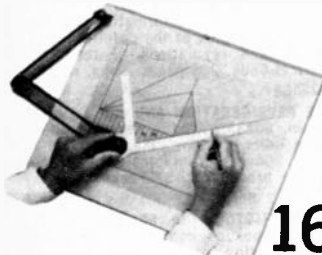

16⁹⁵

• Precision Instrument

Model 9-B—sketch draft, design, draw diagrams and schematics like a professional. A new DRAFTETTE which gives you all the advantages of a T-square, triangle and protractor in a compact, easy to operate portable drafting machine. Constructed of anodized aluminum, features tubular arms, 360° protractor, one-piece 6"x9" scale calibrated in 16ths-1/8-1/4. Mounted on a 16"x21" drawing board, completely assembled ready to use. Shpg. wt., 5 lbs. 15 E 74011 Net 16.95

draftette PORTABLE DRAFTING MACHINE

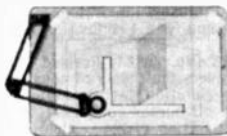

8⁹⁵

- Mounted on 11 x 17" Hardwood Board

Model #117 portable drafting machine with interchangeable one-piece aluminum 4 x 6" scale, calibrated in 16th, 1/4 and 1/8 or 10/50ths (eng.) and Metric. Full 360° protractor. Precision all-aluminum construction gives you a rugged and accurate machine. Ideal for schematics, layouts, etc. 15 E 74060 Shpg. wt., 4 lbs. Net 8.95

draftette SKETCH KIT

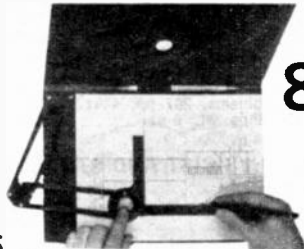

8⁹⁵

Model #68 portable drafting drawing machine permanently mounted in a Vinyl binder (self-locking). Can be used for sketching, designing, drawing, and drafting. Great for traveling. Contains a precision portable drafting instrument with a 4 x 6" scale, 360° protractor, pad of 50 sheets, drawing-tracing paper 8 $\frac{1}{2}$ x 11", pencil, all in one compact binder. Does not require tape or tacks to hold paper in place for use. Binder 9 $\frac{1}{2}$ x13x1". Shpg. wt., 2 lbs. 15 E 74029 Net 8.95

Model #300 Professional Sketch Kit. Similar to above, uses 8 $\frac{1}{2}$ x 14" drawing paper and is mounted in binder 14 $\frac{1}{4}$ x 10 $\frac{1}{4}$ x 1". Shpg. wt., 3 lbs. 15 E 74086 Net 10.95

PORTABLE DRAWING KIT



2⁹⁵

- Can Be Carried or Stored

A folding portfolio conveniently carried or stored. Includes a 12-inch T-square, a 180° protractor, a 6-inch French curve, a 4-inch 45/90° and a 4-inch 30/60°, a 50-sheet drawing pad and drawing pencil. Plastic portfolio is 9x13 $\frac{1}{2}$ x1 $\frac{1}{2}$ ". Tools housed in separate pockets. Shpg. wt., 3 lbs. 15 E 14330 Net 2.95

SUPER DRAWING KIT

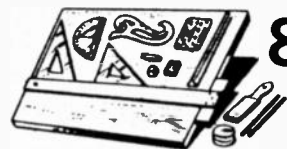

8⁹⁵

Contains all the necessary equipment for drafting, mechanical drawing, designing. Sturdy accurate components. Includes—18x24" drawing board, 24" T square, 10" 30°/60° triangle, 8" 45° triangle, french curve, 12" triangular rule, 6" 180° protractor, 4 pencils, pencil pointer, erasing shield, thumb tacks, and art gum. 15 E 57016 Shpg. wt., 10 lbs. Net 8.95

HARD MAPLE PANTOGRAPH

For Enlarging, Reducing, Reproducing

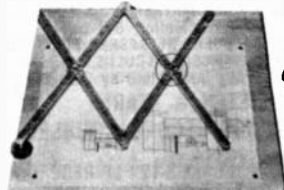

4⁹⁵

- "Quick-Change" Feature Allows Setting to Any Ratio

A 21" adjustable pantograph with 21 different ratios from 1 $\frac{1}{8}$ to 8. Enlarges, reduces or reproduces drawings, etc. Most rapid, accurate means of reducing or enlarging to scale. Lacquered highly finished bars are 21" long and 3/4" wide. Heavy ball bearing standard. Chrome plated hardware, ratio thumb screws and nuts. Complete with lead, accessories and detailed instructions. Shpg. wt., 2 lbs. 15 E 56026 Net 4.95

31" PANTOGRAPH

Similar to above except 31" long, with 32 ratios. Complete with accessories and instructions. 15 E 56067 Net 6.95

Drafting & Drawing Supplies

DATAK

INSTANT LETTERING KITS

As Low As **2⁵⁰**

Sharply defined 1/8" high, Gothic typeface, letters, numerals, and most often used electronic terms. Transfer easily and cleanly onto any smooth, dry surface—paper, metal, plastic, wood, or glass. Not a decal, goes on instantly without water or tapes. Leaves no background haze or film. Looks like it was printed on! Hundreds of characters on 3 x 5" sheets in each set. Shpg. wt., 6 oz.



Stock No.	Mfg. No.	No. of Sheets	Kit Includes	Color	Net
32 E 75047	9581	24	Letters, words Numerals	Black	4.95
32 E 70554	9591	24	Letters, Words Numerals	White	4.95
32 E 75060	9601	12	Alphabets Only	Black	2.50
32 E 75096	9611	12	Alphabets Only	White	2.50
32 E 75104	9621	12	Numerals Only	Black	2.50
32 E 75112	9631	12	Numerals Only	White	2.50

METER AND DIAL MARKING KIT

Contains 12 5" x 7" sheets—4 different sheets in 3 colors, black, white and red. Sheets have switch patterns, arcs, graduation lines, letters and numerals etc. for marking rotary and standard switches and dials, etc.

32 E 75013 per package Net 4.95

DATAKOAT PROTECTIVE COATINGS. Maximum protection for instant lettering.

32 E 75062 Protective Coating Kit Net .99

32 E 75070 Protective Coating Kit (16 oz. spray can) Net 2.95

BOOKBINDERS OUTFIT

8⁹⁵



Bookbinding is not only a satisfying hobby, but a practical one. Better paperbacks may be rebound into permanent hard covered books. This kit contains 3 yds. Linmaster material, printed endpapers, binders board, tools and all the other material required to completely rebound approximately 12-books. Complete instructions. Shpg. wt., 10 lbs.

13 E 35611 Net 8.95

FAMOUS ARTISTS OIL PAINTING SET

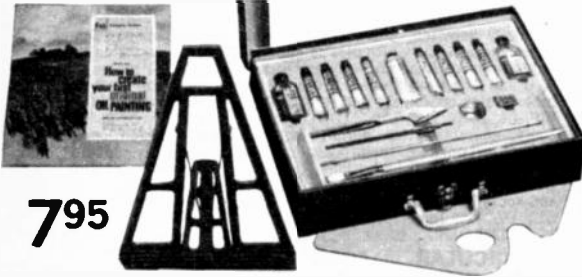

Introduction to painting by Norman Rockwell. Four famous artists show how they would paint the same scene. Step by step instructions in full color lead beginner from first line to finished painting. Woodgrained, hinged cardboard case with metal latch and handle contains 8 tubes oil colors, permalba white, palette, brushes, canvas panel and canvas sheets, easel etc. Shpg. wt., 7 lbs.

15 E 59020 Net 7.95

20 CAMEL HAIR BRUSHES

69^c



Imported camel hair brushes. Sizes #1 through #5. Each brush is 6 1/2" long with different color handles. Excellent for cleaning tuners and precision parts. Perfect for water color, cabinet touch-up, and sign lettering. Shpg. wt., 8 oz.

15 E 78509 Net .69

ELECTRONIC DRAFTING TEMPLATE



ELECTRONIC TEMPLATE. Exceptionally accurate! Made to J.I.C. standards. All elements of electronic and CR tubes are provided for—plus tube bases for 7, 8 and 9 prong tubes. Includes: transistors, diodes, rectifiers, plugs, etc. Covers all symbols. Size: 7x5". Thickness: .030". Shpg. wt., 4 ozs.

15 E 43018 Net 2.19

FRENCH CURVE SET



Made of crystal clear plastic .090" thick. Set consists of eight French curves. Excellent for perspective, three dimensional drawing and general applications. Wt., 1/2 lb.

15 E 14256 Net 2.95

TACIRO

TACROGRAPH SET

• Complete with Three Nibs



A top quality drawing pen for all lettering and drawing work. Uses both India and drawing inks. Precision point for constant flow lines. Slim, easy to hold pen comes with 3 color coded nibs. Fine (Size 0, Grey nib), Light Medium (Size 1 Yellow nib), Very Broad (Size 3, Blue nib). Ideal for your every artistic and mechanical need. Shpg. wt., 8 oz.

15 E 80026 Net 4.95

TACIRO

TACROGRAPH SET

9⁷⁵ Complete with (7) Nibs



Professional, quality Tacrograph pen set. Uses both drawing and India inks, 7-precision crafted points. With rubber sleeve for easy removal of nib. In attractive velveteen lined leatherette pigskin case. Nibs: White-00-very fine; grey-0-fine; yellow-1-light med.; beige-2-heavy med.; green-2 1/2-broad; blue-3-very broad; red-4-extra broad. Shpg. wt., 1 lb.

15 E 80034 Net 9.75

LETTERING GUIDE SET



Made of transparent plastic. Use with either sharp pencil or ink. Each has complete alphabet, numbers and commonly used signs. Set consists of six guides. Sizes 1/8, 3/16, 1/4, 5/16, 3/8, and 1/2". Shpg. wt., 1/2 lb.

15 E 14322 Complete Set Net 4.95

LETTERING PEN

Reservoir type drawing pen. Designed for use with lettering guides from 1/8" to 1/2". Shpg. wt., 3 oz.

15 E 14074 Net 1.49

JON GNAGY'S TV MASTER ART STUDIO

featuring the MATCHSTICK MANNIKIN



Only **4⁹⁵**

This 14" x 20" box is jammed full of art materials and instructions. Includes 5 separate instruction books: The 64-page "Learn to Draw" book with over 200 illustrations to make it easy for beginning artists of all ages; 48-page full color "Learn to Draw Landscapes"; 48-page in color "Learn to Draw Human Figures" and two 16-page full color books on "How to Paint in Watercolors and Pastels." Includes the flexible 3-dimensional "Matchstick Mannikin" to be used as a model for drawing figures in action, two 8 color watercolor palettes in trays, 24-colored pastels, brushes, paints, sketching paper and other materials. Shpg. wt., 4 lbs.

15 E 59012 Net 4.95

Engine Divided Slide Rules

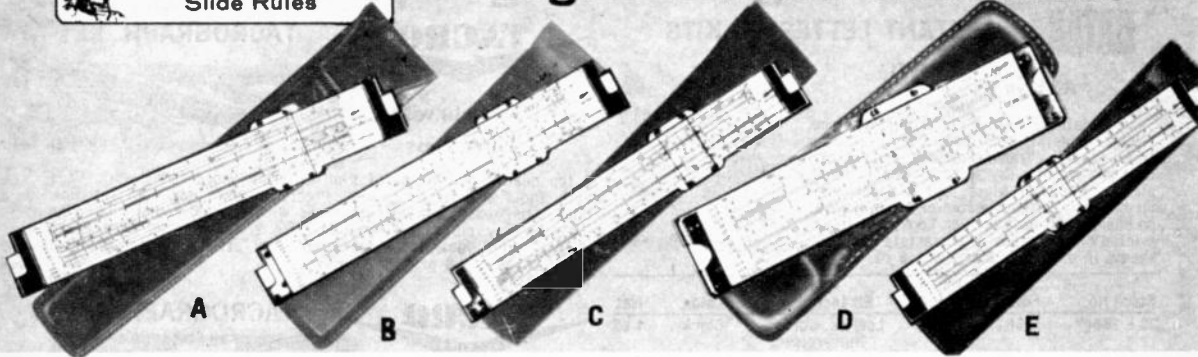

(A) 13¼" VECTORLOG® SLIDE RULE

For Communications Engineers and Physicists

• Laminated Bamboo Construction • P, P', and Q Scales • For Direct Vector Addition • Hyperbolic Sine and Tangent Scales. Two Sine Scales—One Marked in Degrees. One Marked in Radians • 5 Log Log Scales Plus a Voltage DB Scale • Complete with Belt Carrying Loop and Leather Case • With 10" Scale

The Lafayette VECTORLOG Slide Rule provides a new concept in scientific calculation, incorporating scales and arrangement designed for quick-easy-manipulation. Twenty-seven (27) scales incorporate the many problems encountered in Electrical Engineering and Physics. The unique P, P', and Q scales allow direct right angle vector addition. No longer are several settings required to obtain right angle vector sums—these scales work in the same manner as the C and D for multiplication. The two Hyperbolic Sine and one Hyperbolic Tangent Scale, the voltage db scale, and the five Log Log scales, provide maximum coverage of these dynamic fields. VECTORLOG is the result of extensive tests for ease of manipulation. Several of these features are: C and D scales on both the front and back of the rule; Sine scales in both degrees and radians, removing the necessity of bothersome conversion of units; a problem-tested location of scales; and adjusted screws to allow variable tension on the slide. Scales include: (FRONT) Tr-1, Tr-2, P, P', Q, ST, S-1, S-O, C, D, LL01, LL02, LL03, LL1'; (REAR) Sh-1, Sh-2, DF, A, B, C, D, Cl, CF, Th, C, D, LL3, LL2, db. With instruction book, leather carrying case, and belt carrying loop. Imported. Shpg. wt., 1½ lbs.

99 E 71020

Net 16.95

(B) 13¾" DELUXE LOG LOG DUPLI DECIMAL TRIGONOMETRIC SLIDE RULE

- With 11" Scale • 25 Scales with 8 Log Log Scales
- Extended Range Avoids "Going Off Scale"
- Extra P Scale Simplifies Computations • Two Color Scales

A log log dupli decimal trigonometric slide rule contains 25 scales including 8 Log Log Scales. Troublesome end-for-end resetting is eliminated by extensions of C and D scales. Twin set of Log Log scales run from 1.001 to 100,000 and .999 to .00001, enlarging the scale by one scale length each compared with ordinary log log slide rules. Extra features include P scale which enables direct "readout" of cosine value. Scales include LL01, LL02, LL03, DF, CF, C1F, C1, C, D, LL3, LL2, LL1, LL00, L, K, A, B, S, ST, T, C, D, DI, P, and LLO. With instruction book, saddle leather case. Imported. Shpg. wt., 1½ lbs.

99 E 70539

Net 15.95

USING THE SLIDE RULE IN ELECTRONIC TECHNOLOGY. For detailed description of this book see page 403.

10 E 11628 Shpg. wt., 8 oz.

Net 2.95

5" POCKET SLIDE RULE



- Extremely Accurate
- Has Standard S, L and T Scales

Convenient pocket sized slide rule of specially selected and treated bamboo. Will not warp, shrink or lengthen under varying atmospheric conditions. A, B, C1, C, D and K scales engraved on white plastic surface. Reverse side of slide has standard S, L, and T scales. The upper beveled edge of the rule is graduated in mm to 13 cm. Other edge is divided into 5 inches by 32nds. Only 5¼" long over all. Carried easily in any pocket. Shpg. wt., 8 oz. Imported.

99 E 70302

Net 3.95

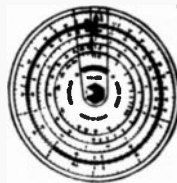

A versatile calculating instrument specially constructed with special chemical resistant, ¼" thick, plastic, it will not shrink or expand under varying climatic conditions. 12 scales to solve problems involving multiplication, division, proportions, squares, cubes, and all trigonometric functions. Special scales allow direct conversions of angles from radians to degrees. Ideal for quick calculations. With leatherette case.

99 E 71276 Wt., 4 oz. Imported.

Net 2.80

(C) 12½" DECIMADYNE™ SLIDE RULE

A Dynamic Reactance Slide Rule

- With 10" Scale
- Automatic π Multiplication on DF Scale
- Continuous Resonant Frequency Scale
- Direct Power Factor Read-out
- Simplifies and Speeds Up RLC Calculations

Specially designed to speed up calculations for radio and electrical communication engineering, for decibel, inductive reactance, capacitive reactance, resonant frequency, surge impedance, etc. Feature scales include: DB—for computation of electric communication circuit; DF and CF—same as D and C scales, except that they are "folded" at π ; XC—for computation of capacitive reactance; XL—for computation of inductive reactance; F₁ and F₂—for calculating resonant frequency. The 17 scales are: DB, DF, CF, C1F, C1, C, D, A, XC, XL, K, Kl, S, T, F₂, F₁, DI. With instruction book, leather carrying case, belt carrying loop. Imported. Shpg. wt., 1 lb.

99 E 71284

Net 13.95

(D) DECIMALOG™ 6½" LOG LOG DUPLI DECIMAL TRIGONOMETRIC SLIDE RULE

- P Scale (Pythagorean) permits direct "readout" of Cosine Values
- 24 Scales including 8 Log Log Scales • With 5" Scale

A pocket version of our 13¾" Log Log Dupli Decimal Trigonometric slide rule. Contains all the scales of the 13¾" rule except the "ST" scale. Two color scales—positioned for each in use and rapid calculations. "C" and "D" scales on both sides of the rule, "P" scale for direct, cursor line reading of cosines of angles. Scales—front face: LL1, LL2, LL3, DF, CF, C1F, C1, C, D, LL3, LL2, LL1. Back face: LLO, L, K, A, B, S, T, C, D, DI, LLO. Engine divided rule of laminated, non-hygroscopic bamboo. Complete with instruction book and leather case with pocket clip. Imported. Shpg. wt., 8 oz.

99 E 70997

Net 7.95

(E) 12½" LOG LOG DUPLI TRIG SLIDE RULE

- With 10" Scale

Specially selected, laminated, non-hygroscopic bamboo. Scales machine engraved on white plastic in permanently accurate calibrations. Adjusting screws permit varying tension on slide. 21 scales including C, D and CI on both sides. LLO and LLOO scales refer to B scale. All other scales coordinate and refer to D scale. Scales are L, LL1, DF, CF, C1F, C1, C, D, LL3, LL2, LLOO, A, B, K, C1, C, D, S, ST and T. Scale characteristics permit multiplication, division, proportion, inverse proportion, reciprocals, cotangents, squares, square roots, cubes, cube roots, logarithms, tangents, sines, PI factor multiplication and division, powers and roots of numbers less than 1, powers and roots of numbers greater than 1, logarithms to base "e." Shpg. wt., 1½ lbs. Imported.

99 E 70310

Net 11.95

4" CIRCULAR ARCHITECTS-ENGINEERS SLIDE RULE

ARCHITECTS-ENGINEERS RULES

249

289

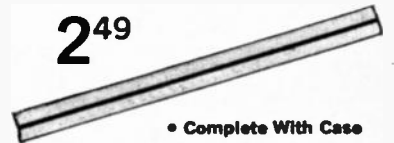

- Complete With Case

TRIANGULAR SCALE: 12" professional triangular architect scale with colored grooves engine divided. All plastic will not warp or chip. Divided as follows: 3/32, 1/8, 3/16, 1/4, 3/8, 1/2, 3/4, 1, 1½, 3" to the ft.—Complete with hard plastic case. Wt., 8 ozs.

15 E 58042 Architect's Scale

Net 2.49

DELUXE ENGINEER'S TRIANGULAR SCALE: Similar to above, divided as follows: 20, 30, 40, 50 and 60 parts to the inch. Shpg. wt., 8 ozs.

15 E 58089

Net 2.49

Selected Popular Specialties

LAFAYETTE BINOCULAR MAGNIFIER

- Leaves Hands Free
- Reduces Eyestrain
- With 3 Lenses

Only
8⁹⁵

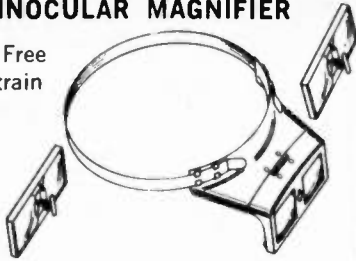

Ideal for technicians, inspectors and hobbyists. Precision ground and polished lenses for very close work without eyestrain. Headband adjusts to any head size. Lenses can be changed with pushbutton ease for three magnifying powers. Flip up viewer may be worn over eyeglasses. Supplied complete with 3 lenses—2X, for 9" working distance; 2.5X for 5½" working distance and 3X for 4½" working distance. Imported. Shpg. wt., 1 lb.
99 E 72068 Net 8.95

LAFAYETTE OPTICAL MICROMETER

- Pocket sized Comparator
- Direct measurements to .005"
- Measures Diameters - Radii - Angles
- Linear scale in inches

High quality optical micrometer using a triplet lens system of approximately 7 power. Triplet system affords a wide flat field of view. Extremely accurate reticle of etched glass. Unaffected by changes in temperature and humidity—impervious to oil, solvents and scratches. 0.5 inch linear scale calibrated to .005 inch. 10 mm scale calibrated to .2 mm. Hole diameters from ¼" to ¾" and from .005 to .05". Thickness scales from ¼" to ½". Radii from ⅛" to ¾" and angles from 0 to 90°. Measures instantly—without adjustments. Accurate to edge of 1" field. Adjustable focus. Reticle removable for use as highpower magnifier. Infinite uses in lab and industry. Complete with leather case. Imported Shpg. wt., 6 oz.
99 E 70757L Net 7.95

Only
7⁹⁵



RUBBER TYPE SET

An easy to use printing kit that comes complete with 14-point (¼") rubber type, 22 numerals, over 100 capital letters, punctuation marks, ink pad and tweezers. Print anything from one to four lines long. Special "base-lock" type for perfect alignment. Neat, clean, and clear results. Many printing uses in the home or business. Instructions included. Shpg. wt., 1½ lbs.
15 E 60010 Net 2.99

Extra set of (1/5") rubber type. 22 numerals, over 100 capital letters, punctuation marks.
15 E 60002 Net 2.25

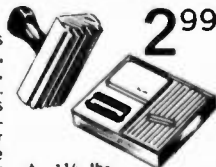

GIANT ILLUMINATED MAGNIFIER

- Ideal For:
Map Readers
Collectors
Hobbyists
- 3.5x Magnification

2⁷⁵

Powerful 3.5x illuminated magnifier... excellent for coin collectors, naturalists and proofreaders. Has giant 3½" view diameter plus 1½" view plate scaled in millimeters and inches. Two "C" batteries and flashlight bulb provide extremely bright field of vision. Gleaming chrome and ivory colored hood. Imported.
12 E 64076 Shpg. wt., 1 lb. Net 2.75
99 E 62572 "C" battery (2-req.). Net ea. .14



FRACTION ADDING MACHINE

Continuous adding or subtracting of fractions, decimal equivalents, or mixed fractions and decimals. Answers shown instantly. Invaluable for the shop and technical school, office, factory, machinists, designers, draftsmen, and engineers. Made of satin-finished aluminum—only one moving part—numbers and lines etched and filled for years of trouble-free service. Complete with plastic case and instructions. Shpg. wt., ½ lb.
13 E 17015 Net 2.99



MAGNA SIGHT-MASTER 3-D BINOCULAR MAGNIFIER

- Leaves Hands Free
- Reduces Eyestrain
- 3-Dimensional
- Can be Worn With or Without Glasses

As Low
As **4⁹⁵**



A precision optical instrument enabling anyone to do very close work and see it clearly in 3 dimensions. Adjusts to any head size comfortably. No moving parts to replace. Ideal for hobbyists, repairmen, inspectors and technicians. Available in 4 sizes. Imported. Shpg. wt., ¾ lb.

15 E 20055 1.75X, 14" Working Distance Net 4.95
15 E 20063 2.25X, 10" Working Distance Net 4.95
15 E 20071 2.75X, 8" Working Distance Net 5.49
15 E 20069 3.5X, 4" Working Distance Net 5.99

"HEAD LIGHTS" T.M.

- Ideal Illumination—Leaves Your Hands Free

4⁵⁰



Illumination device leaves hands free for work... especially useful in poorly lighted areas. Features brilliant dual lights mounted on eyeglass frames. Ideal for home, workshop, office, etc. Can be used with regular glasses. A boon for stamp collectors, artists, watch repairers. Also permits reading in bed without disturbing others. Power supplied by a convenient battery pack. Accepts two standard "C" cells.

15 E 37505 Net 4.50
99 E 62572 "C" Batteries (2 required) Net ea. .14

MICRO-VIEW MAGNIFIER

- 2X to 9X Variable Power
- Engraved Metric and Inch Scales
- Folding - Portable - Compact
- Highly Corrected Lens Systems

A portable, compact magnifier ideal for thousands of uses—coins, maps, stamps, rocks, gems, material, engraving, etc. Adjusts for near, far or normal sight from 2 to 9 power magnification. Two engraved measurement gauges. Black enamel finish—folds to a compact 1.6" x 1.7" x 8". Imported. Shpg. wt., 6 oz.
99 E 71672 Net 1.99



PROJECT-A-SCOPE

- Projects Giant Pictures in Color or Black and White
- Films or Negatives Not Needed

Handsome projector molded of heat and abuse resistant, hi-impact plastic for long life. Casts sharp, giant-size enlargements on any white wall or screen in brilliant color or black and white. Simple to operate. Can be used by students, artists, lecturers and demonstrators. Children can project comics or story books to amuse themselves and their friends. Uses ordinary household bulbs. U/L listed. 110 volts, AC-DC. Shpg. wt., 2 lbs.
15 E 50011 Net 5.95



PEN-SCOPE

- 8 Power Telescope
- 30 Power Microscope

1⁹⁸

The 8 power telescope with adjustable sliding focus barrel that extends to over 8 inches, collapses to 5½" and fits easily in pocket. Barrel slips off to convert to a 30 power microscope. Nickel-plated metal case with pocket clip. Dia. only 5/16". Imported.
99 E 71987L Shpg. wt., 8 oz. Net 1.98



Ladies' And Men's Watches



WATCHES SHOWN ACTUAL SIZE

A SELF WINDING 17 JEWEL DAY AND DATE CALENDAR WATCH

Just set it and forget it! Deluxe Swiss watch is self winding, and automatically changes the day and the date. Precision made 17 jewel movement is water resistant, antimagnetic, and features an unbreakable mainspring. Case is a handsomely styled gold tone with a stainless steel back and a matching expansion band. Easy-to-read dial features the date in red and the day of the week in black, raised gilt numerals on an attractive white dial face and a sweep second hand. Shpg. wt., 8 oz. 13 E 31289L Net 34.95

B 17 JEWEL WRIST ALARM WATCH

Elegantly styled, Swiss made wrist alarm serves as an automatic reminder anytime—anyplace. Dependable 17 jewel movement is water resistant, antimagnetic and features an unbreakable mainspring and radium dial. Case is gold tone with stainless back or all stainless steel. Both with genuine lizard band. Dial has raised gilt numerals on a white face with a sweep second hand. Shpg. wt., 8 oz. No Money Down* Stainless Steel Case 13 E 31149L Net 34.95 Gold Tone Case 13 E 31156L Net 34.95

C 17 JEWEL DOUBLE-BUTTON CHRONOGRAPH WATCH

Precision made 17 jewel Swiss chronograph is ideally suited for accurate elapsed timing of sporting events, scientific experiments, etc. Features a tachometer for measuring speed, a telemeter for measuring the distance of sound and a stop watch with a 30 minute register and a sweep second hand. Accurate, dependable movement features an unbreakable mainspring. Water resistant, dustproof and antimagnetic. Bright chrome case with a stainless steel back, raised numerals, and a genuine leather strap. No Money Down* 13 E 31131L Wt., 8 oz. Net 34.95

D DAY AND DATE CALENDAR WATCH

Tell the time, day, or date at a glance with this elegantly styled Swiss made calendar watch. Precision movement is antimagnetic. Watch features an unbreakable mainspring, water resistant high polish gold tone case, handsome white dial face with raised gilt numerals, easy to read red day—black date, and a sweep second hand. 13 E 31305L Wt., 8 oz. Net 10.95 Lady's Day/Date Calendar Similar to above but Lady's model. Ideal as a matching set with the men's watch. 13 E 31313L Net 10.95

New! DIGITAL CALENDAR WRIST WATCH

- Gives You The Hour, Minute And Date At A Glance
- Sweep Second Hand

Hour
Minutes
Date

Only **14⁹⁵**

- Swiss Precision Crafted

Digital read-out watch shows hour and minute and date in large, easy-to-read red and blue numerals. Great for anyone who must account for time at a glance... pilots, rally drivers, etc. Ideal for the visually handicapped. Striking dial features sweep second hand and incorporates an automatic calendar which digitally indicates the day of the month. Precision anti-magnetic Swiss movement has unbreakable mainspring. Beautiful gold tone color florentine finish with genuine lizard strap. Imported. 13 E 31329L Shpg. wt., 8 oz. Net 14.95



WATCHES SHOWN ACTUAL SIZE

E MEN'S CALENDAR WATCH

Precision made calendar watch has large date window. Date changes automatically every 24 hours. Dial features distinctive raised gilt numerals and a sweep second hand. Swiss movement is anti-magnetic with unbreakable main spring. Smartly finished in a gold tone color case and comfortable matching metal expansion band. Shpg. wt., 8 oz. 13 E 31370L Net 7.50

F ELEGANT 17 JEWEL LADIES' WATCH

Detailed 17 jewel watch has the look of elegance every woman desires. Finished in a shining high polish gold tone color with comfortable matching tapered bracelet that encircles the wrist with glamor. Precision Swiss crafted antimagnetic movement has unbreakable mainspring. Beautiful ivory colored dial face with raised gilt numerals exhibits legibility and exquisite taste. Wt., 8 oz. 13 E 31321L Net 26.50

G FREE FORM LADIES' PENDANT WATCH

Exquisite free form pendant watch is boldly beautiful on sweaters or silks. Gleaming gold tone finished case comes complete with an attractive complementary chain. Precision movement is a product of fine quality Swiss craftsmanship. Antimagnetic plus unbreakable mainspring. Features an elegant white dial face with raised gilt "dots" for an added touch of luxury. Shpg. wt., 8 oz. 13 E 31347L Net 9.95

**DELUXE
SPORTSMAN'S WATCH
WITH WORLD TIMER**

An Automatic Underwater Watch That Indicates Elapsed Diving Time

Tells Time In 26 World Wide Cities

Only **17⁹⁵**

- Swiss Precision Crafted
- Automatic Day-N-Date Calendar
- Stainless Steel Band

Designed for the active sportsman! Tell the time, day and the date at a glance. Revolving bezel lets you know the time in 26 cities around the world, and also operates as a 60 min. elapsed timer. Features a telemeter scale, a sweep second hand and luminous hands and dial markers. Rugged, precision timepiece is water-resistant, anti-magnetic and has an unbreakable mainspring. Hermetically sealed pressurized case provides protection to 5 atmospheres. Case is finished in bright chrome with a stainless steel back and a matching stainless steel band. Shpg. wt., 8 oz.

13 E 31271L Net 17.95

**SPORTSMAN'S
CALENDAR WATCH
SWISS PRECISION CRAFTED**

An Automatic Underwater Watch That Indicates Elapsed Diving Time.

As Low As **11⁹⁵**

- Also Available In Lady's Model
- Pressurized Water-Resistant Case
- Automatic Daily Calendar
- Parking Meter Time
- Luminous Marker and Hands

Handsome wristwatch especially designed for the sportsman who is apt to get his watch wet—fishermen, hunters, or skin divers. Hermetically sealed pressurized case provides maximum protection to 5 atmospheres. Movable outer bezel permits easy timing of events, parking meter time, or elapsed submerged time. Swiss crafted anti-magnetic movement features automatic daily calendar, unbreakable mainspring, and sweep second hand. Luminous hour markers and hands for high visibility. Polished chrome case, stainless steel back, and comfortable waterproof strap. Imported. Shpg. wt., 8 oz.

13 E 31180L Men's Net 11.95
Ladies Model—Similar to above
13 E 31263L Net 12.95
Same as above men's watch but with 17 jewel movement.
13 E 31198L Net 21.95



PRECISION-SWISS STOP WATCHES



As Low As **10⁵⁰**



As Low As **11⁵⁰**



- Accurate Jeweled Movements
- Anti-Magnetic Hair Spring
- Unbreakable Main Spring

A 1/10 SECOND TIMER

Designed for close timing. Large hand registers 1/10 of a second, up to 30 seconds; small hand reads minutes, up to 15. Start, stop, and continue from crown; instant zero, 7 jewel movement. Chromium plated case. Shpg. wt., 8 oz. Imported.

13 E 31032L Net 11.95
Same as 13 E 31032 (above) except 1 jewel.
13 E 31024L Net 10.50

B 1/5 SECOND TIMER

- Ideal for Sports

Second hand registers 1/5 of a second and completes turn in 60 seconds. Small hand indicates up to 30 minutes. Side slide starts and stops hands. Fast resetting dependable 7-jewel movement. Shpg. wt., 8 oz. Imported.

13 E 31040L Net 11.95
Same as 13 E 31040 (above) except 1 jewel.
13 E 31057L Net 10.50

C TRACK TIMER 1/10 SECOND

Excellent for athletics. The second hand indicates tenths of a second and seconds, and completes one turn in 10 seconds. The small hand registers up to 10 minutes. Start, stop, and reset by successive depressions of the crown. 7-jewel movement. Shpg. wt., 8 oz. Imported.

13 E 31065L Net 15.95
Same as 13 E 31065 (above) except 1 jewel.
13 E 31073L Net 11.50

D DECIMAL TIMER

Ideal for industrial time-studies. Easy-to-read outer dial divided in 1/100 of a minute registering up to one minute. Inner dial graduated in minutes and registers up to 30 minutes. Push button, for timing out, brings both hands back to zero. Pressures on the crown will consecutively start, stop and again start the timer. Dependable 7-jewel movement. Swiss made. Shpg. wt., 8 oz.

13 E 31016L Net 11.95

PEDOMETER

- Leather Strap Attaches To Ankle
- Range 0-24 Miles
- Ideal For Hikers, etc.

Do you walk a lot? Want to know how far? This easy to use pedometer is the answer. A precision instrument, no larger than a wrist-watch, accurately registers up to 24 miles. Easily reset. Complete with ankle strap and instructions. Weighs 2 1/2 oz. Made in West Germany. Shpg. wt., 8 oz.

13 E 51008L Net 4.75



4⁷⁵

PEDOMETER

- Range 0-25 Miles
- Ideal For Hikers, etc.
- Clips To Belt

Fine quality pedometer accurately registers distance you have walked in quarter mile increments from 0 to 25 miles. Large easy to read dial. This precision instrument comes with clip for wearing on belt. Easily set, simple to use. A must for those who want to know their distance traveled. Shpg. wt., 8 oz.

13 E 31123L Net 6.49



6⁴⁹

To Speed Your Mail Order—Please Give Your Zip Code Number



(A)



(B)

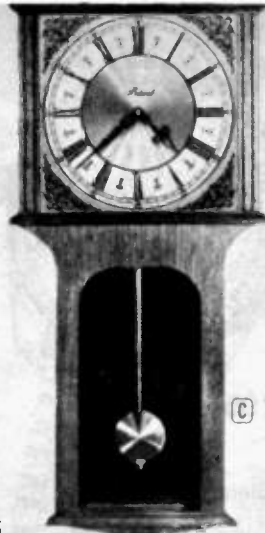

(C)



(D)

CORDLESS ELECTRIC PENDULUM CLOCKS

(A) AMERICAN TRADITIONAL PENDULUM CLOCK

Charming replica of an old favorite expertly reproduced in Timewood and carefully accented in walnut tones. Mottled parchment dial is in striking contrast to the large Roman Numerals. The graceful motion of its swinging pendulum completes the authenticity of this ageless favorite. Runs up to one year on a single "D" cell. Size: 14"Hx9"W x 2"D. Shpg. wt., 3 lbs.

13 E 30547W Net 16.95
99 E 62564 Battery for above Net .15

(B) TEMPUS PENDULUM CLOCK

Tempus . . . A timely novel recreated into a precision timepiece. Soft leather simulated material is expertly crafted and meticulously embossed to emphasize its distinctive and realistic book design. Ornate hands and bold Roman Numerals complement the graceful swinging pendulum. Operates up to one year on a single "D" cell. Size: 13 3/4"H (with pendulum) x 7 1/2"W. Shpg. wt., 2 lbs.

13 E 30554W Avocado Green Finish Net 16.95
13 E 30562W Black Levant Finish Net 16.95
99 E 62564 Battery for Above Net .15

(C) GRANDFATHER PENDULUM CLOCK

Warm walnut American styling for a charming blend of accuracy and handsome traditional design. Beautifully accented handsome spun gold and ivory dial with smoked antique Federal mirror complements the graceful motion of the golden swinging pendulum. Carved walnut veneer trim is crowned with an eagle to complete this elegant timepiece. Runs up to one year on a single "D" cell. Size: 25H x 11"W.

13 E 30521W Shpg. wt., 5 lbs. Net 29.95
99 E 62564 Battery for above Net .15

(D) SPINDLE PENDULUM CLOCK

A replica of the Federal Era — this handsome timepiece is designed of walnut finished maple. Its delicately turned spindles and bold pediment casing frame the spun gold dial. Gracefully swinging pendulum seems to float in space against an avocado and gold woven richly textured tapestry background. A handsome timepiece of superb craftsmanship that stands or hangs. Runs up to one year on a single "D" cell. Size: 22" high x 12" wide. Shpg. wt., 5 lbs.

13 E 30570W Net 29.95
99 E 62564 Battery for above Net .15

TV LAMP CLOCK

10⁹⁵



Ideal for use on a TV cabinet, in the kitchen or baby's room. Provides soft illumination and precise time. Attractive sturdy plastic case, with gold trim. Size: 4x7x3 3/8". Deep. Shpg. wt., 3 1/2 lbs. UL listed, 110V. 60 cycles.

14 E 60013 Walnut Net 10.95
14 E 60021 White Net 10.95

24-HOUR ELECTRIC WORLD CLOCK



- Adjustable for Various Time Zones
- South Polar Projection

Self starting, accurate electric clock. Tells world-wide and local time. Calibrated in hours — 1 to 24, minutes and seconds — 1 to 60. Black dial with white graduations. 8" overall diameter. Chrome plated case. UL listed. 110V. 60 Hz. AC.

13 E 26024 Shpg. wt., 1 1/2 lbs. Net 9.95

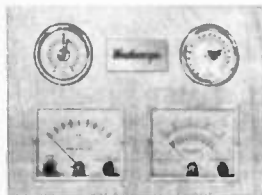

WEATHERSCOPE WEATHER STATION

- Outdoor Thermometer — Barometer — Wind Speed Indicator

WEATHERSCOPE WEATHER STATION

Complete weather information center including wind speed and direction, barometric pressure and maximum-minimum outdoor temperature. Handsome 17" x 12". Walnut panel with brass bezels ready for wall mounting. Includes wind speed and direction roof unit with 60' of lead-in wire for outdoor mounting. 40' of capillary tubing for thermometer. With battery and instructions. Shpg. wt., 16 lbs.

13 E 74503W No Money Down* Net 199.95

WINDSCOPE® WIND SPEED AND DIRECTION INDICATOR

Tells wind speed or direction by 2-position knob. Self contained, no outside power source needed. Easy to install and maintain. Outdoor parts corrosion-resistant. Attractive mahogany-finished indoor indicating unit 6 1/2"x5". Boxed with battery, 60 feet of lead-in wire and instructions. Shpg. wt., 9 lbs. (Not illustrated)

13 E 74511W No Money Down* Net 89.95

Taylor

WEATHER HAWK RECORDING THERMOMETER OR BAROMETER

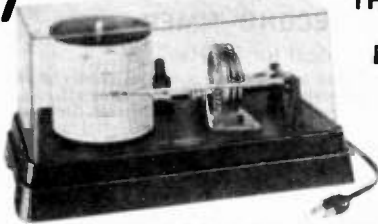

Only **49⁹⁵**

WEATHER-HAWK RECORDING THERMOMETER

Records outdoor temperatures on 7-day chart, 110 volt, 60 cycle. Range minus 40° to +120° F. Eight feet capillary tubing. Black plastic base with clear cover. 13"x7". Boxed, with 13 charts, ink and instructions. Shpg. wt., 6 lbs.

13 E 74529W No Money Down* Net 49.95

WEATHER-HAWK RECORDING BAROMETER

Records barometric pressure changes on 7-day chart, range 29-31 inches. Uni/Mag movement for maximum pen motion, 110 volt 60 cycle. For altitudes 0-10,000 feet. With 13 charts, ink and instructions. Shpg. wt., 5 lbs.

13 E 74537W No Money Down* Net 49.95

Weather Instruments for Year-Round Comfort

A HOME WEATHER STATION

Three accurate dial-type instruments report barometric pressure, temperature, and humidity. Finely etched precision calibrated aluminum dials for easy reading. Heavy metallized finish has the warm glow of polished brass. Mounted on wood-grained panel 15½x5¾". For horizontal or vertical mounting.
13 E 40017 Shpg. wt., 2 lbs. Net 9.95

B EXECUTIVE DESK WEATHER CONSOLE

Luxurious desk weather station features three distinctively styled spun gold dials with red twin arrow indicating needles. Accurately reports temperature, barometric pressure, and humidity. Antique white outer case has rich wood grained background with polished gold bezels. Size: 11¾x3½".
13 E 16090 Shpg. wt., 3 lbs. Net 11.50

C DELUXE WEATHER STATION

Strikingly handsome collection of three fine instruments skillfully crafted into a central weather reporting station. Utilizes a precise and sharply calibrated thermometer, barometer, and humidity meter. Each instrument reflects the warm glow of polished brass. Richly grained lustrous panel. 20" tall case may be vertically or horizontally mounted.
13 E 40023 Shpg. wt., 5 lbs. Net 14.95

D INDOOR OUTDOOR THERMOMETER AND HUMIDITY METER

Richly appointed precise instrument reports indoor as well as outdoor temperature plus indoor humidity. Richly grained 14" tall case enhanced by deep luster finish. Metal scale and dials. Supplied with 48" outdoor cable and humidity guide.
13 E 40033 Shpg. wt., 2 lbs. Net 9.95

E DECORATIVE WALL HUMIDITY INDICATOR

Rich gold bezel on a handsome wood grain panel. Precision indicator needle accurately pinpoints the percent of humidity as well as "dry, moderate, or humid" weather comfort zones.
13 E 16066 Shpg. wt., ¾ lb. Net 2.95

F DECORATIVE WALL THERMOMETER

Smartly styled double thermometer featuring large, easy-to-read fahrenheit and centigrade temperature scales. Has bright spun gold bezel on a decorative wood grain wall panel.
13 E 16074 Shpg. wt., ¾ lb. Net 2.95

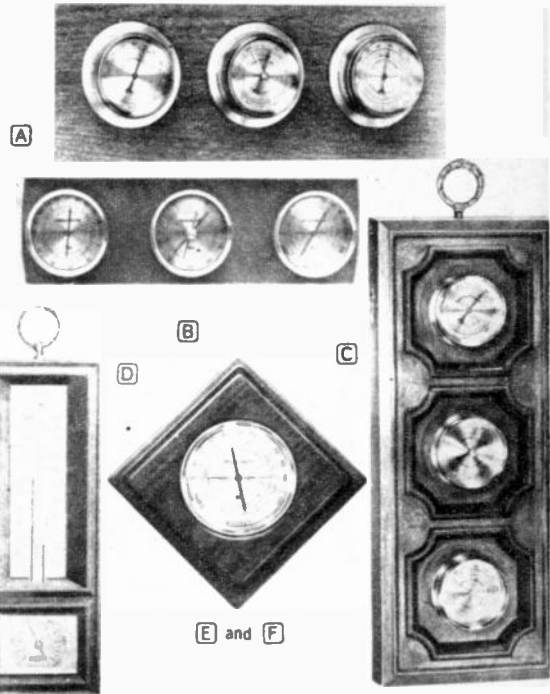

RAIN GAUGE

- Keep Record of Total Rainfall

Precision rain gauge designed to give accurate rainfall records. Unique "chisel" shape permits recording of minute quantities. Easily operated cumulative rainfall indicator. Scale graduated up to 5½ inches. Scale in black numerals. With instructions for mounting and use, to obtain weather-station accuracy to 1/10th of an inch. Overall length 10¾", width 2½". Shpg. wt., 8 oz.



13 E 16017 Net 1.59



WIND SPEED INDICATOR

24⁹⁵

- For All Sportsmen, Yacht Clubs
Gun Clubs, Fishing and
Hunting Camps
- Great For Pilots

Wind velocity registered by liquid filled tube. Calibrated in both MPH and Beaufort Scale. No calculations, reads just like a thermometer. Vane-type external fittings must be mounted on outside elevated point.

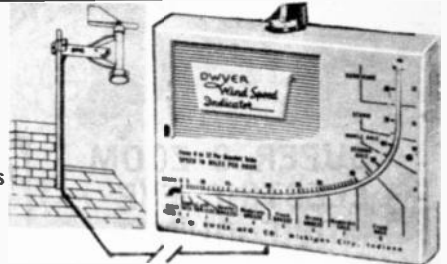

Attractive gray indicator features jet black calibrations. Supplied with 50 ft. tubing to connect outer unit to gauge. Gauge Size: 7¾x5½x1".
13 E 62508 Shpg. wt., 3 lbs. Net 24.95

MAXIMUM-MINIMUM THERMOMETER



- READ: Present, High, Low Temp.

For weather enthusiasts-gardeners-farmers, etc. Gives three readings at a glance—maximum, minimum and present temperatures. Self-registering—no knobs—magnets—or push buttons needed for reset. Magnifying lens case for ease of reading. Maintains automatic check on temperature variations. Makes you the local weather expert. Shpg. wt., 1 lb.

13 E 16033 Net 5.65

REMOTE READING THERMOMETER. Same as above but with remote "sensor" for comfortable indoor reading of outdoor temperature. Includes mounting bracket and instructions.

13 E 16041 Net 7.50

IN-OUTDOOR THERMOMETER

Shows inside and outside temperature from the comfort of your room. Inside location ideal for quick easy reading. Single scale for instant comparison. Modern plastic case. 8x2½" L. 48" long copper capillary tube and bulb. Large numerals for easy reading. No moving parts to become worn.

13 E 16025 Shpg. wt., 1 lb. Net 2.95

POCKET THERMOMETER



Ideal for the laboratory, factory, etc. Mercury type—total immersion. White scale with black numerals. Sub-divided by 2° F. Polished nickel-plated case; tube length 5½". Shpg. wt., 4 oz.

15 E 48015 Range: -30° to 120°F Net 2.79

15 E 48023 Range: 0° to 220°F Net 2.79

"SLIDE RULE" HUMIDICATOR

- Slide Rule Readings
- No Computing
- No Conversion
- Ease and accuracy

Fastest and easiest method of determining relative humidity. With the cursor (slide) set on the temperature, the relating humidity is read directly off the humidity graph. The "humidicator" graph is calibrated in increments of 2%. Both thermometers are calibrated in increments of 2° from 20°F to 120°F. Background colors chosen for easily readability. Overall size, including cistern is 13½x3¾". Mounted on mahogany board with provisions for hanging. Imported.

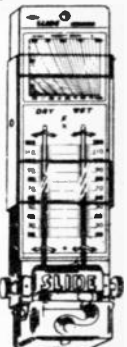

99 E 90060 Shpg. wt., 1 lb. Net 3.29



Camera Only
74⁹⁵
 SAVE When You Buy
 Complete Outfit
154⁹⁵ No Money
 Down*

DELUXE SUPER 8 REFLEX AUTO POWER ZOOM MOVIE CAMERA

- Thru-The-Lens CdS Electric Eye
- 3.5 To 1 Power Zoom
- Two-Speed Operation
- Fast f/1.8 Lens

Take sharper, better exposed movies with this deluxe super 8 power zoom reflex camera. Features a thru-the-lens CdS electric eye that automatically controls the lens opening according to light conditions and drop-in, instant cartridge loading. Shoots 50 ft. with a single cartridge. Meter system automatically adjusts for film speeds from 10-400 ASA. Electric film drive motor does away with bothersome hand winding. Offers a choice of two filming speeds: 18 and 24 fps. Super fast f/1.8 Cinetor 3.5 to 1 zoom lens may be manually or automatically operated. Warning signal shows in viewfinder under insufficient light conditions. Exceptional features include automatic resetting footage counter, built-in type "A" filter, battery tester, focusing eyepiece, full range film speed, safety lock, light bar receptacle, cable release socket, pistol grip, and die-cast aluminum body with hinged doors. Focuses from 6 ft. to inf. Imported. Shpg. wt., 4 lbs.

15 E 78079L Net 74.95
 15 E 16103 Camera Case for Above Net 3.95
 99 E 62580 Batteries for Above (4 req.) Net ea. .10

COMPLETE POWER ZOOM MOVIE CAMERA OUTFIT

Everything you need for movie making and showing fun. Matched components consists of Power Zoom Super 8 f:1.8 camera—fully automatic 500W brilliance projector with F/1.5 Zoom Lens, automatic Reel-to-Reel threading thru gate, single knob control for Forward, Reverse, Still and Automatic Rapid Rewind. 400 ft. capacity. Projector includes self contained case—outfit also includes: 1-camera case; 1-roll Kodachrome film with free processing; extra 400 ft. reel and can; Mr. "Magoo" cartoon; 1-30x40 inch folding tripod screen; 4-batteries for camera; 1 Light Bar, 2 Bulbs. Shpg. wt., 23 lbs.

15 E 90173WXM Net 154.95
 Auto Zoom Projector Only
 Full feature, forward, still and reverse. Shpg. wt., 16 lbs.
 15 E 78087WX Net 74.95

SUPER 8 ZOOM ELECTRIC EYE MOVIE OUTFIT

- Super 8 Loads Instantly
- Drop-In Cartridge-Shoot 50 Ft.
- No Winding-Electric Film Drive
- Automatic Reel-to-Reel Threading Projector
- Includes Camera, Projector, Case, Screen, Movie Light and Film

Complete Zoom
 Movie Outfit
 Only
99⁹⁵
 No Money Down*

Complete home movie making outfit. Includes super 8 zoom movie camera with sharp f/1.8 color-corrected 2 to 1 zoom ratio. Advanced, extremely accurate CdS electric eye exposure system sets the lens automatically for continuous, perfect exposures. No need to fumble with extra controls and miss the once-in-a-lifetime shot. Movie camera also features a built-in pistol grip, battery powered electric film drive, viewfinder with over/under exposure warning signal, footage indicator, tripod socket, built-in A filter, cartridge loading with auto door lock and a sturdy die-cast aluminum body. With 4 long-life alkaline batteries. Super 8 movie projector features convenient automatic reel-to-reel threading and automatic rapid rewind. Fast, coated f/1.4 lens and 500 watt bulb provide a bright, sharp screen image. Capacity is a full 400 ft. Projector has an adjustable framing control, built-in elevation adjustment, focus control, trimmer, automatic tension, clearing brush, and a high pressure fan cooling system, 110-120 VAC, 60 Hz. UL listed. With spare 400 ft. cap. reel. Self-contained case with carrying handle. Outfit also includes double light bar and 2 bulbs, Kodak super 8 film cartridge, carry-all camera case and 22 x 32" table top projection screen. Shpg. wt., 23 lbs.

15 E 90199WXM Net 99.95
 15 E 78152WX Camera only. Shpg. wt., 2 1/2 lbs. Net 49.95
 15 E 78061WX Projector only. Shpg. wt., 15 lbs. Net 49.95



Deluxe Super 8 Movie Cameras



**YASHICA
SUPER 8-60E
6-1 POWER
ZOOM**

Only
169⁹⁵
No Money
Down*

- 8-48mm f/1.8 Automatic Zoom Lens
- Motorized—3-Speeds
- With Ultra-Modern Servomatic CdS Thru-the-Lens Exposure Control
- Reflex Viewing

Deluxe electric drive Super 60 Electronic reflex camera with fast electric f/1.8 lens zooms from 8 to 48 mm. Automatic CdS thru-the-lens exposure system and micro-split focusing. Super 8 drop-in cartridge loading, no threading. Shoot 50 ft. without rewinding. Other features include film type indicator window, parallax free reflex viewing, shutter trigger with continuous run button, spotlight and backlight lighting control, automatic film ASA speed selector, insufficient light indicator, remote control, single frame, adjustable eyepiece, and cable release sockets, 85A filter, battery checker, footage counter, and movie light slot. ASA Speeds: 25-400. Film Speeds: 12, 18, 24 fps. Imported. Shpg. wt., 3 lbs.
15 E 36408L Net 169.95

YASHICA SUPER 8—40E

Similar to above but with Yashinon f/1.8, 4:1 power zoom from 9 to 36 mm. Imported. Shpg. wt., 3 lbs.
15 E 36424L Net 139.95
99 E 62580 Batteries for above (4 required) Net ea. .10

**BAUER C 1 M SUPER 8
4-1 POWER ZOOM
CAMERA**



Only
129⁹⁵
No Money
Down*

- 9 to 36mm f/1.8 Schneider Varigon Power Zoom Lens
- Fully-Automatic Behind-the-Lens Electric Eye
- 18, 24 fps and Single Frame

Bauer Super-8 movie camera with fast f/1.8, 4:1 power zoom lens. Sensitive, fully automatic behind-the-lens electric eye for perfect exposures. f/stop locking arrangement provides exposure control under extreme lighting conditions. Shoots single frame, 18, and 24 fps. Electric drive ad zoom powered by 3 penlite cells. A full 50 ft. of film without threading or rewinding with Super 8 instant cartridge loading. Reflex focusing and viewing with built-in f/stop indicator and battery control. Other features include: auto-resetting footage counter, built-in "A" filter, film-type indicator window, adjustable eyepiece, and movie light mounting slot. Focuses from 5 ft. to infinity. Imported from W. Germany. Shpg. wt., 3 lbs.
15 E 37216L Net 129.95

BAUER C2M SUPER 8 MOVIE CAMERA

As above but with 8-40 mm Schneider Varigon f/1.8, 5:1 power zoom lens. Shoots 12, 18, 24 and single frame, plus incorporates fading control. Manual override on exposure control. Focuses from 3 ft. to infinity. Operates on 4 penlite cells. Shpg. wt., 3 lbs.
15 E 37208L Net 209.95
99 E 62580 Batteries for above (4 required) Net ea. .10



**VICEROY SUPER 8
5-1 POWER ZOOM**

Only
89⁹⁵
No Money Down*

- 5 to 1 Power Zoom
- Fully Automatic Thru-the-Lens CdS Electric Eye
- Thru-the-Lens Reflex Viewing
- Standard and Slow Motion

Fully automatic super-8 movie camera. Accurate, thru-the-lens CdS electric eye automatically gives proper exposures under varied light conditions. Features 5 to 1 (8-40 mm) power zoom, thru-the-lens viewing and focusing, and a high or low light warning signal. Instant 50 ft. cartridge loading, no threading required. Sharp, f/1.8 focusing zoom lens for high quality pictures. Focuses down to 5 ft. Two filming speeds: 18 fps for standard and 32 fps for very slow motion special effects. Custom designed, leather padded grip for comfortable, non-tiring use. With built-in battery checker and adjustable eyepiece. Lightweight body of strong cast aluminum. Includes lens hood. Imported. Shpg. wt., 4 lbs.
15 E 78160L Net 89.95
99 E 62580 Batteries for above (4 required) Net ea. .10

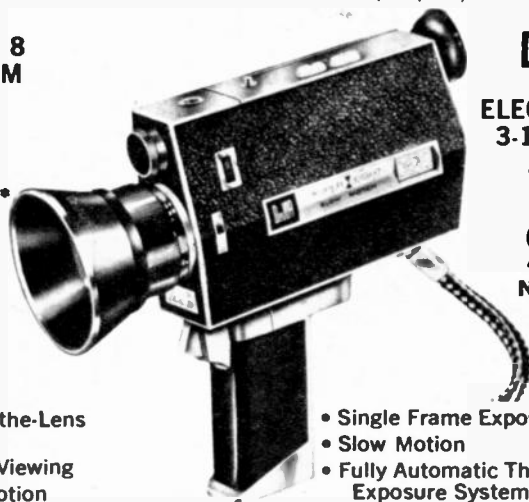

DeUR'

**ELECTRA 300
3-1 POWER
ZOOM**

Only
99⁹⁵
No Money
Down*

- Single Frame Exposure
- Slow Motion
- Fully Automatic Thru-the-Lens Exposure System

Super 8 reflex automatic movie camera with f/1.8, 10.5-32 mm power zoom. Sensitive CdS thru-the-lens meter assures correct exposures for proper colors. Reflex thru-the-lens viewing and focusing for accurate framing and sharp pictures. Features convenient fade-in, fade-out control and single frame exposure. Simple, drop-in cartridge loading. 50 ft. of shooting. Switch on trigger selects slow motion for slowing down fast action or standard speed for normal shooting. f/stop and over/under exposure signal is clearly visible thru view-finder. Also includes battery indicator, footage indicator, built-in type A filter, lens hood and eyepiece hood, and carrying strap. Rugged die-cast aluminum housing. Imported.
15 E 52124L Shpg. wt., 6 lbs. Net 99.95
99 E 62580 Batteries for above (4 required) Net ea. .10

* See Page 11 for Full Credit Details on Easy Pay Plan

Super 8 MM and Standard 8 MM Movie Projectors



**DUAL PROJECTOR
FOR BOTH SUPER
AND STANDARD 8**

84⁹⁵



- 400 Feet Reel Capacity
- Instant Switch From Standard To Super 8MM Film

Model 588 Super or regular 8 mm movies . . . take your choice, the Anscovision 588 projector shows them both with brilliant, crisp projection. Ideal for the amateur photographer with a new super 8mm camera and a library of family history on regular 8 mm film. Sharp f/1.5 zoom lens permits flexibility in separation of screen and projector. Finger tip controls select rapid rewind, reverse, still, or rapid forward operation. Has convenient elevation control and room light coordinator outlet. Accepts reels up to 400 feet. Other quality features include 500 watt brilliance, automatic film threading and self-contained carrying case. For 110 volts 50/60 Hz. AC. Shpg. wt., 13 lbs.

15 E 78129W No Money Down* Net 84.95

DeJUR

**DUAL PROJECTOR
FOR BOTH SUPER
AND STANDARD 8**

69⁹⁵

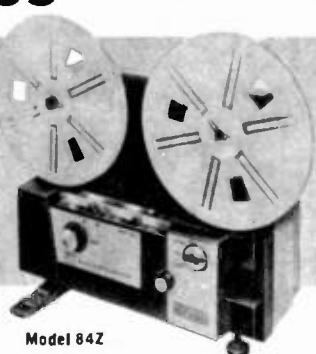

Model 84Z

- A Movie Projector That Thinks It's A Slide Projector
- With Self Contained Case

Enjoy stopping movie film to examine a particular scene but afraid to burn the film? Worry no more . . . DeJUR's Eldorado 84-Z projector is designed to be run for long, extended periods in a 100% illuminated "still" position. Provides the safety of a slide projector with full brilliance viewing. Handles both standard and super 8 MM film. You can even splice the two together and run them on the same reel. Sharp f/1.5 zoom lens assures full screen viewing under most room conditions. Other features include long-life Quartz Halogen lamp, automatic reel to reel threading, fast rewind, life-time lubrication, and self-enclosed carrying case. For 117 volts 60 Hz. AC. Shpg. wt., 14 lbs.

15 E 52132WX No Money Down* Net 69.95

**VICEROY 801
SUPER 8 AUTOMATIC
MOVIE PROJECTOR**

49⁹⁵

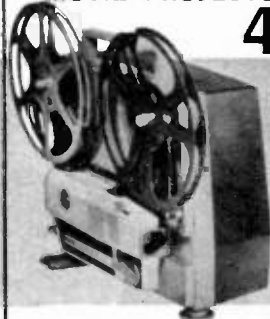

- Automatic Reel to Reel Threading
- f/1.4 Lens, 500-Watt Brilliance
- Automatic Rapid Rewind

Beautifully styled super 8 MM projector combines 500-watt brilliance and a fast f/1.4 color coated lens for vivid screen viewing. Automatic film threading design features an Adjusto-Matic film control for proper feed of film onto take-up reel. High pressure fan assures quiet, trouble-free, cool operation. Accepts film reels with up to 400 ft. capacity. Has automatic rapid re-wind and adjustable framing control. Includes built-in elevation adjustment, focus control, trimmer, automatic tension, clearing brush, and 6 ft. UL listed power cord. Mounted in a handsome self-contained carrying case with handle. Supplied with 400 ft. empty reel. For 117 volts 60 Hz. AC. Shpg. wt., 15 lbs.

15 E 78061WX No Money Down* Net 49.95

BELL & HOWELL

**DELUXE DUAL PROJECTOR
FOR BOTH SUPER AND
STANDARD 8 FILMS**

Model 466Z

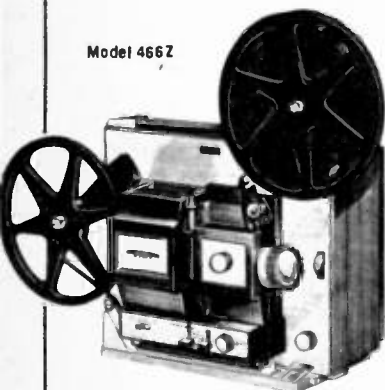

169⁹⁵

No Money Down*

- Variable Speed
- Reverse Operation
- Rugged Die-Cast Case

Projects super or regular 8 MM film with fully automatic reel to reel threading and variable film speed control. Brilliant f/1.2/19-32 MM Filmovara zoom lens assures crisp full screen viewing without the bother of setting up that "special" projector to screen spacing. Incorporates spindle adapters for super 8 reels, dial focusing, framing dial, tilt control, reverse and rapid rewind, film cutter for both super and standard 8 film, auto-load 400 ft. reel, and cord storage compartment. Motor fan cooling switch permits after show cooling for fast safe operation. Rugged die-cast construction. Self contained carrying case. For 117 volts 60 Hz. AC. 15 E 65084WX Shpg. wt., 20 lbs.

Net 169.95

BAUER

**T-4 DUAL PROJECTOR
FOR SUPER AND
STANDARD 8 FILMS**

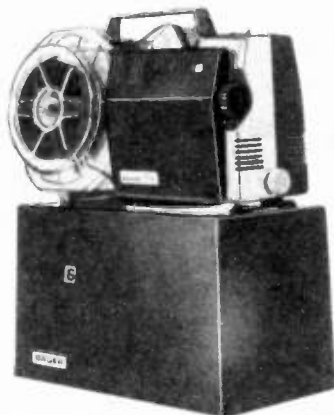

Only
99⁹⁵

No Money Down*

- Instant Switch From Standard To Super 8
- 2-Speeds (Normal-Slow Motion)

Small, light, and very easy to use, this automatic projector accepts both super and standard 8 MM movie films. Reel to reel threading is fully automatic. True beam bulb combines with ISCO Varlo f/1.4/18-30 MM zoom lens to provide brilliant full screen viewing. Projector automatically shuts itself off at end of reel. Rewinding is as easy as pushing a button . . . no cumbersome attaching of film end to reel. Speed can be changed from regular 18 fps. to half regular speed for slow motion studies. Accepts up to 400 ft. capacity reels. High speed rewind operation. Self-contained carrying case. For 117 volts 60 Hz. AC. Shpg. wt., 11 lbs.

15 E 37257WX

Net 99.95

Movie Editors And Accessories

ATLAS-WARNER DUAL 8 EDITOR



For Both
Standard
and Super 8

24⁹⁵

- Over 17 Sq. In. Viewing Screen
- Die-cast Construction

Large screen editor with over 17 sq. in. of viewing area. Film slips in place in seconds; notches in exact frame that is being viewed. Takes reels up to 400 ft. Smooth and rapid rewind operates without scratching film. Adjustment knob for critical focusing. Foldaway arms for convenient storage. Die cast construction, with dry splicer and splicing tape. Size: 9½ x 7 x 6½". UL listed. 15 E 04093 Shpg. wt., 7½ lbs. Net 24.95

For Super 8 only, similar to above. Net 20.95

baia MARK II REVIEWER-EDITOR



13⁹⁵

- Single Sprocket Drive • 3¼"x2¼" Viewing Screen

Compact Super 8 mm viewer with prismatic shutter magnifies picture more than 300 times. Features slip-in film loading that eliminates threading. Uses single sprocket drive to assure no skipping or film wear. Features automatic framing and focusing, fold-away butt type one step splicer, folding 400-ft. capacity rewinds, and a convenient frame marker. Complete with a supply of Mylar splice tape and Uniflex Splicer. Shpg. wt., 4 lbs.

15 E 36374 For super 8 mm Net 13.95

Same as above but for standard 8 mm. Net 13.95

SUPER 8 SEALED-BEAM MOVIE LIGHT

5⁹⁵

- Head Tilts for Bounce Lighting



Compact, powerful 650 watt tungsten sealed beam lamp will provide sparkling, bright indoor movies. Features top mounting and switch on power cord. Will fit all new super 8mm cameras plus all standard 8mm cameras with tripod socket on top, with 6½ ft. cord and exposure guide. UL listed. 15 E 04089 Shpg. wt., 3½ lbs. Net 5.95

DELUXE 650 WATT QUARTZ MOVIE LIGHT

- Head Tilts for Bounce Lighting
- For All Super-8 Cameras



Shoot brilliant movies indoors. Long life, quartz-bromine movie light for maximum output. Small, all metal unbreakable housing with built-in on/off switch. UL listed. With 6½ ft. cord. Shpg. wt., 1 lb. 15 E 68005 Net 9.95

DELUXE ZOOM MOVIE CASE

- Adjustable Shoulder Strap
- Nickel Plated Hardware,

6⁹⁵



Holds substantially any super 8 camera with attached hand grip. Made of exquisite black vinyl material, firm core and fully lined, with French stitching. Ample space also provided for camera accessories; film, lens filters. Size: 11 x 10¼ x 3¾. Shpg. wt., 2 lbs. 15 E 16053 Net 6.95

SPORTPOD

- Use It Anywhere
- 3-Section—Extends to 58"

The Sportpod is a 3-section leg with tripod screw on top, protected with a removable cap. Offers rigid camera support with least possible weight and bulk. Supplied with suspension strap. Total extended length is 58"; telescopes to 21½". Sections measure 7½" ¾" and ¾" in diameter. Shpg. wt., 1½ lbs. 15 E 36010 Net 4.29

4²⁹



DUAL-8 FILM SPICER

Universal splicer for Super 8 and Regular 8 film. "S" shaped cutting blade prevents film flexing or pop-out during projection. With small supply of splicing tape.



15 E 36457 Net 1.99
Mylar Splicing Tape (36 splices)
15 E 66025 For Standard 8 Net .59
15 E 66058 For Super 8 Net .59

SUPER-8 MOVIE VIEWER

See your home movies the moment you receive them. Easily portable unit can be taken anywhere in the home or when visiting friends. Built-in illumination. Has optical type shutter. Film is advanced or reversed easily, even single frames can be viewed. Lightweight, high impact plastic housing. Shpg. wt., 1 lb. 15 E 34544 Net 0.95



TITLE LETTER SET

4⁴⁹



Title your slides or 8 or 16 mm movies with 3-D letters. Set contains 119, ¾"H letters, characters, and symbols. Make animated titles easily and simply. Self-stick back lets you mount them anywhere. Letters are clear and crisp for easy legibility. Blue color. 15 E 36440 Shpg. wt., 1½ lbs. Net 4.40

AUTO-THREAD REEL AND CAN

A fully automatic self-threading take up reel. Designed for all standard projectors. Quality constructed with a precision die-cast hub and sturdy flanges. 400' capacity. Shpg. wt., 14 oz. 15 E 41051 Net .79
15 E 41077 200' Capacity Net .59
For Super 8
Reel and Can. 400' Capacity. 15 E 41069 Net .79
15 E 41085 200' Capacity Net .59



DELUXE LENTICULAR SCREEN

- Automatic Lever-Type Handle Permits Smooth Easy Adjustment

10⁹⁵



Specialty-designed, optically-correct lenticular screen is free of glare, sheen and hot spots. Amazing sharpness and color rendition. Durable vinyl fabric resists fire and fungus. Sturdy, secure tripod legs. Screen is 40 x 40". Shpg. wt., 12 lbs. 15 E 50052W Wt. 12 lbs. Net 10.95
Same as above. Extra Large 50" x 50" Super Screen—Ideal for New Super 8 Movies. Shpg. wt., 14 lbs. 15 E 50219W Net 16.25

GLASS BEADED SCREEN
Fine grain glass beading for extra brilliance excellent viewing. Heavy-duty folding tripod adjustable to various heights. Large 30" x 40" size. 15 E 50037W Wt. 10 lbs. Net 6.95
TABLE TOP SCREEN
22 x 30" Lenticular. Shpg. wt., 2 lbs. 15 E 07021W Net 2.95



YASHICA **89⁹⁵** No Money
LYNX-5000E with case Down*

- Unique Electronic Integrated Circuit CdS Exposure System
- Combination Range and Viewfinder—Exposure Signal In Viewfinder

Modern easy to use camera with cds exposure system that uses "space-age" electronic circuitry for accurate exposure every time. "Over" or "under" signal appears in the viewfinder indicating which way to adjust the speed or aperture. Lamp turns off when correct exposure is set. Other features include shutter speeds from 1-1/1000th plus B, convenient speed aperture coupling, M & X synch., automatic parallax correction, rangefinder focusing, self-timer, single stroke film advance with double exposure prevention, auto-reset film counter, rapid rewind and an accessory shoe. ASA range is 10 to 800. Includes 45mm f/1.8 color corrected lens, case and strap. Imported. Shpg. wt., 3 lbs.

15 E 36465L Net 89.95



KONICA
AUTO S2 35MM

- Fully Automatic, Match Needle or Manual Option—CdS Meter
- Rangefinder-Viewfinder Featuring Parallax and Field Compensation

84⁹⁵ with case
 No Money Down*

Just set the shutter and shoot with this fully automatic 35 mm camera. Features a cds electric eye built into the lens for accurate exposure even when using filters. Shutter automatically locks under extreme lighting conditions. Uses Insta-Grip-Loading for quick, easy film loading. Other features include rangefinder focusing with automatic parallax correction and field compensation, short stroke film advance, shutter speeds from 1-1/500th and B, M & X synch., self-timer, and an auto-reset film counter. Can be used automatically, semi-automatically or manually. Includes a fast 45 mm f/1.8 lens with a built-in collapsible lens shade, case and strap. Imported. Shpg. wt., 3 lbs.

15 E 76065L Net 84.95



As Low As
49⁹⁵
 with case
 No Money Down*

VICEROY 35 MM RANGEFINDER CAMERAS

- CdS Electric Eye • Fast 45 MM F/1.8 Lens
- Aperture Readings Are Visible In The Viewfinder

Model 503. Just focus and shoot! Perfect exposure is assured by the fully automatic cross coupled CdS exposure meter. Camera functions automatically with a manual override. Features shutter speeds from 1-1/500th and B, flash synch. at all speeds, self-timer, ASA to 400, combination range/viewfinder with parallax correction marks, f-stop and warning signal appear in finder, rapid film advance, and an auto-reset film counter. Includes 45 mm f/1.8 5-element lens case and strap. Imported.

15 E 78178L Shpg. wt., 3 lbs. Net 59.95

Model 504. Similar to above but with 40mm f/2.8 lens. ASA to 500. 1/30-1/500 sec. Shpg. wt., 3 lbs.

15 E 78186L Net 49.95



AIREQUIPT
REMOTE CONTROL
SLIDE PROJECTOR
59⁹⁵

No Money Down*

- Includes Remote Control for Forward/Reverse and Micro Focus

- 500 Watt Lamp
- 4" 3-Element Color Correct Lens
- Complete With Circular Magazine For 100 Slides

Model 135. Fully remote controlled projector with a sharp 4" lens and a 500 watt lamp for brilliant screen viewing. Features a highly efficient blower for cool, quiet operation, slide preheat to insure immediate focus, thermo-cut-off to prevent overheating, panel focus control, elevation control, 3-way on/off switch, and a smartly designed self-contained unbreakable case.

15 E 36473W Shpg. wt., 10 lbs. Net 59.95

MODEL 125 SLIDE PROJECTOR

Similar to above except no remote control. Control panel focusing. With 100 slide circular magazine. Shpg. wt., 10 lbs.

15 E 36531W Net 44.95

15 E 36481 100 Slide Circular Magazine Shpg. wt., 1 lb. Net 2.79

15 E 36499 36 Slide Metal Magazine Shpg. wt., 1/2 lb. Net 1.99



KEYSTONE TARGETRONIC®
RANGEFINDER AUTO-FOCUS
SLIDE PROJECTOR

Only
79⁹⁵

No Money Down*

- Targetronic® Electronic Auto-focusing

- Remote Control
- With Circular Magazine for 100 Slides

Auto-focusing slide projector with built-in rangefinder. Unique system focuses slide before it flashes on the screen, automatically. Focusing remains perfect from the first slide thru the last. Brilliant, 4" color-corrected lens and 500 watt bulb for maximum illumination. Quiet turbine blower keeps projector cool. Remote or panel control of forward and reverse operations. Free-running support system assures fool-proof tray loading and easy access to any slide. Accepts many popular straight and rotary trays and stack loaders. With elevation adjustment. Sturdy die-cast base and tray tunnel. Self-contained case and carrying handle. With 100 slide circular tray. For 115 VAC. UL listed.

15 E 84135W Shpg. wt., 13 lbs. Net 79.95

15 E 84143 100-Slide Circular Magazine. Shpg. wt., 1 lb. Net 2.79

15 E 84150 40-Slide Straight Magazine. Shpg. wt., 1/2 lb. Net 1.29



MIRANDA "SENSOREX" 35 MM SLR

- Behind-The-Lens CdS Meter
- Variable Delay Self-Timer

199⁹⁵
with case
No Money Down*

Fully automated SLR camera utilizes cross-coupled behind-the-lens CdS meter (ASA range 25-1600 and EV 3-18) and ultrasharp Auto Miranda lens. Illumination is measured with the lens wide open and exposure is set by adjusting f-stop and/or shutter speeds. Multi-spill-grid resolves into perfect clarity when pin point focus is achieved. Features interchangeable lens mount, built-in self timer, instant return mirror, interchangeable viewfinder, and rapid advance geared 150° cocking lever. Complete with built-in variable delay self-timer. Includes case and strap. Specifications: 50mm f/1.8 lens. Speeds: B, 1-1/1000th sec. FP & X Synch. Imported.

15 E 37117L Shpg. wt., 3 lbs. Net 199.95
 "SENSOREX" 35 MM f/1.4. As above with super fast lens. Net 249.95
 15 E 37240L No Money Down*



MIRANDA "SENSOMAT" 35MM SLR

- Shutter Speeds to 1/1000th
- Thru-The-Lens CdS Meter
- Sharp 50 MM F/1.8 Lens

159⁹⁵
with case
No Money Down*

"Sensomat" is a truly versatile 35 mm SLR featuring a thru-the-lens CdS metering system with a narrow angle of acceptance for easier, more perfect picture taking. Match needle in the viewfinder can be centered for proper exposure by rotating the diaphragm and/or the shutter speed dial. ASA range: 25-1600. Other features include fully interchangeable finder and lens systems, shutter speeds of 1-1/1000th plus B, FP & X synch., automatic reset film counter with a magnifying lens, and a front and top shutter release for greater convenience. Focus from 17". Camera includes 50 mm f/1.8 auto lens, case and strap. Imported. Shpg. wt., 3 lbs.

15 E 37224L Net 159.95
 "SENSOMAT" 35 MM f/1.4. As above but with fast lens. Net 199.95
 15 E 37232L No Money Down*

Minolta SR-T 101 35MM SLR

219⁹⁵
with case

No Money Down*

- Cross Coupled CdS Thru-The-Lens Exposure System
- F/1.7 55 MM Lens



A quality SLR featuring Minolta's "contrast light compensator" thru-the-lens CdS metering system. Exposure "match-needles" in viewfinder respond to change in aperture and/or shutter speeds. Exposure readings not affected by light entering viewfinder. Shutter speed scale visible in viewfinder. Readings are taken with lens wide open. ASA range is 6-6400. Features an instant return mirror; a focal plane shutter with speeds from 1-1/1000th plus B; FP&X synch.; auto-reset frame counter; self-timer, mirror lock, depth of field preview, and built-in accessory shoe. Includes a 55 mm f/1.7 lens, case and strap. Imported. Shpg. wt., 4 lbs.

15 E 34551L Net 219.95

YASHICA TL ELECTRO-X 35MM SLR

199⁹⁵
with case

No Money Down*

- Electronic Thru-the-Lens IC Exposure Readout System
- Electrically Operated Metal FP Shutter



Advanced SLR camera features rugged integrated circuitry which controls the CdS thru-the-lens exposure system. Electronic readout signals over or under exposure in the viewfinder and is coupled to the aperture and the shutter. Switch sets diaphragm for manual operation. Quiet, Copal Square metal shutter is electrically operated; gives precise speeds continuously from 2 sec. to 1/1000 sec. plus B. System functions perfectly even in hot or cold conditions. Takes average reading at stopped-down aperture. Full focusing screen. With automatic FP-X sync selector, hot shoe for flash, self-timer, battery checker, and mirror lock. Sharp f/1.7, 50 mm lens. ASA 25-800. Imported.

15 E 36556L Shpg. wt., 4 lbs. Net 199.95

SAWYER'S PROJECTOR/VIEWER

Only
29⁹⁵

- It's a Slide Projector
- It's a Viewer



Dual purpose, portable projector/viewer. Flip the lever, it's a slide projector; flip the lever, it's a viewer. Large, convenient knob focuses both viewer and projector. Large 30" x 30" picture. No slide repositioning necessary when changing from projector to viewer. 100-watt illumination for a bright image even in normal room light. Operates on 115 VAC. Precision construction throughout. Holds up to 40 slides. Viewer has 3 1/2 x 3 1/2" viewing area.

15 E 66082W Shpg. wt., 6 lbs. Net 29.95

Kowa

"SET"
35MM SLR
89⁹⁵

with case

No Money Down*



Kowa "SET" fully coupled behind-the-lens CdS exposure meter system measures illumination with the lens at full aperture. Match-needles, visible in the viewfinder. ASA range is 10-800. Finder uses a microprism dot in the center for more accurate focusing, and a Fresnel collar for a bright edge-to-edge view. Features an easy loading system, leaf shutter with speeds from 1-1/500th and B, rapid advance lever, autoreset film counter, self-timer, and a 50 mm f/1.8 lens. M or X synch. Imported. Shpg. wt., 2 lbs.

15 E 63048L Net 89.95

Kowa "SET-R". Similar to above plus full lens interchangeability with Kowa lens system. Shpg. wt., 2 lbs.

15 E 63055L No Money Down* Net 109.95

* See Page 11 for Full Credit Details on Easy Pay Plan

Lafayette Cat. No. 700 421

Photo Flash, Strobes and Viewers

LAFAYETTE TRANSISTORIZED ELECTRONIC STROBE FLASH



14⁹⁵

- Lightweight & compact
- Fully Transistorized
- Operates On 4 Economical "AA" Cell Batteries

Now you can have a high-powered transistorized electronic flash that operates from standard AC house current or 4 economical "AA" cell batteries. Compact and feather-weight—no power pack is required. Flash duration is 1/2000th of a second for "stop-action" pictures. Recycling time: 6 to 8 seconds; color temperature; balanced for all daylight B&W and color films. Guide number dial for F stop on back. Mounts either vertically or horizontally. Fits any camera shoe. Complete with AC cord, camera cord and batteries. Imported. Shpg. wt., 2 lbs.

99 E 71847 Net 14.95
32 E 48861 Alkaline batteries for above (4 req.) Net ea. .39

ULTRABLITZ CORNET "100" ELECTRONIC FLASH

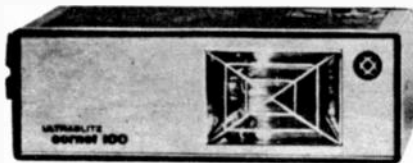

19⁹⁵

- Operates on Batteries or AC
- Fully Transistorized
- Re-cycling Time 5-12 Seconds
- With AC Cord

Featuring compact design and quality transistorized circuitry. Uses two "C" type batteries or AC. Solid state circuit for low battery drain and constant high intensity output. F-stop computer, retractable pc cord and "hot center contact" for cameras and "hot shoe." Guide No's: Kodachrome II (ASA 25) 44; (ASA 64) 63; Tri-X (ASA 400) 176. Color temp: 5600° K. Angle of illumination: Vertical; 50°, Horizontal; 58° Ready light indicator. Imported. Shpg. wt., 2 1/2 lbs.

15 E 37158 Net 19.95
32 E 48879 Alkaline Batteries for above (2 req.) Net ea. .49

HI-BEAM ELECTRONIC STROBE FLASH



- With Built-in Rechargeable Nickel Cadmium Batteries and Charger

Only 26⁹⁵

Compact, powerful flash no larger than a cigarette pack and weighing only 8 1/2 oz. gives you light where and when you need it. Guide No. 40 for ASA 25 films. 1/3000-sec. flash duration. It operates from either 110v

or 220v AC with built-in cord or its self-contained rechargeable nickel cadmium batteries. Shoot every 10 seconds with up to 60 flashes per charge. Reflector coverage is 55°; color temperature is balanced for all daylight and B & W color films. Size 3 7/8 x 2 3/8 x 1 3/8". Imported. Shpg. wt., 1 lb.

13 E 36395 Net 26.95

ULTRABLITZ BAUER E-160 ELECTRONIC FLASH

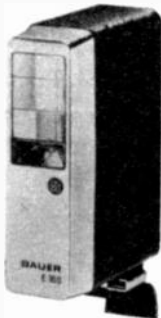

Only 47⁹⁵

No Money Down*

- With Built-in Rechargeable Nickel Cadmium Batteries
- Compact—Only 1 1/4"Wx3 1/2"Hx2 7/8"D
- Includes Recharger

Very compact, lightweight strobe adds only 8 1/2 oz. to your camera. Packs the power of larger, heavier units. Provides 1250 BCPS with a Kodachrome II (ASA 25) guide No. of 45. Does not interfere with camera controls or ease of operation. Operates on nickel cadmium battery which provides up to 45 flashes per charge or with AC adapter. Recycles in 6 sec. on AC or 8-10 sec. with ni-cad battery. Beam coverage is suitable for use with wide angle lenses (73° horizontal x 53° vertical). Convenient hot shoe mounting or interchangeable 9" PC sync cord. Complete with AC adapter/recharger, 9" sync cord and built-in nickel cadmium battery. Imported. Shpg. wt., 2 lbs.

15 E 37273L Net 47.95

BC II FLASH GUN

3⁵⁰

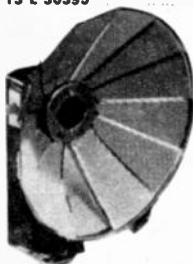

Efficient fan type reflector folds for easy carrying and stowage. Dual socket accepts both M2 and No. 5 flashbulbs plus A-G1 series with adapter supplied. Features include coiled cord with PC tip, test light circuit, shoe mount and guide number dial. Supplied with case.

15 E 66066 Shpg. wt., 1 lb. Net 3.50
32 E 47558 Battery for above Net 1.17

LAFAYETTE FLASH CUBE GUN

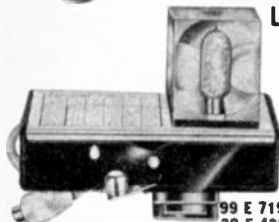

Now any camera can use the new flash-cubes! Simple trigger mechanism revolves the cubes with automated convenience. BC type unit for low battery drain. Compact unit takes one 15 volt battery. Push button battery tester. Easy to read ASA exposure table. 7 1/2" Sync-cord with PC Connector fits most cameras. Imported. Shpg. wt., 1/2 lb.

99 E 71995 Net 1.99
32 E 48358 15 Volt Battery (1 req.) Net 1.00

REMOTE SHUTTER RELEASE



Designed to permit the camera to be used from distances up to 20 feet from the photographer. Simplifies nature shots. Excellent for candid shots of children. Has a professional rubber bulb.

15 E 49021 Net 4.95

35MM SLIDE SORTER

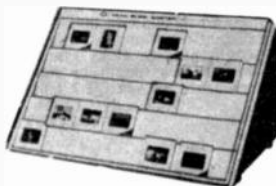

The illuminated 11"x15" inspection screen is large enough to see a whole tray full of slides (35) at one time. Folds flat in a jiffy for compact storage, built-in illumination with on-off switch, 6 ft. line cord; can be used with 110 or 120 volts, AC or DC. Size: 15x8 1/2 x 8 1/2". Shpg. wt., 3 lbs.

15 E 38188 Net 2.95

SAWYER'S PANA-VUE VIEWERS

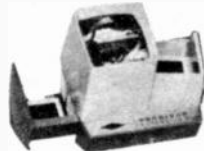

PANA-VUE AUTOMATIC R

Brilliant viewer boasts over 7 square inches of viewing area. Up to 36 slides easily changed with built-in "push-pull" lever. Accepts stacks of 2 x 2 slides of any type intermixed. Powered by 2 "D" cells (supplied). Great for hand or table top use. Shpg. wt., 3 lbs.

15 E 66074 Net 6.95

PANA-VUE 1R

Provides bright viewing of all 2 x 2 slides including super size. Convenient design efficiently serves as a hand or tabletop viewer. 4X magnification brings out slide highlights and detail. Operates on 2 "C" cells (supplied). Shpg. wt., 2 lbs.

15 E 66090 Net 4.59

LAFAYETTE CdS EXPOSURE METER

• Professional Quality Ultra Sensitive—Measures Moonlight, Candlelight, Bouncelight

19⁹⁵

NOT A KIT
Completely
Wired

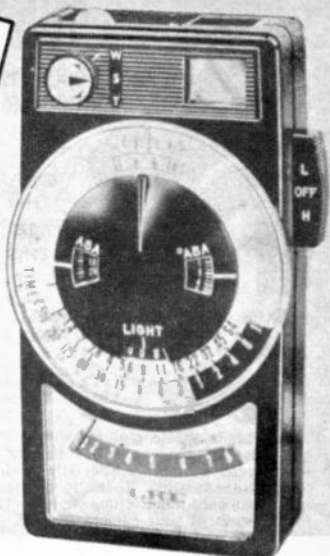

Now you can achieve correctly exposed photographs from the light of a single candle with this versatile, low cost Lafayette meter. Ultra-sensitive CdS photocell meter utilizes dual light ranges to accurately measure light intensity including extremely low light levels for night or available light photography. Operates comfortably with one hand. A single slide switch controls light range and automatically moves the proper scale into position for easier readings. Measures reflected and incident light with built-in hemispheric diffuser. The meter can be adjusted with a click stop switch to three angles of light acceptance: 15° telephoto, 45° standard and 75° wide angle matching your readings to the camera lens and scene being photographed. Reflex viewfinder with frame markers provide precise area readings for 15° and 45°. Has battery test and "off" position to prolong battery life. External zero adjustment and two mercury batteries (included) assure accuracy over long continuous use. Cushioned jewel mechanism and high impact case, 4 1/2 x 2 1/2 x 1 3/8" D. Imported. Shpg. wt., 13 oz.

99 E 71979L Net 19.95
15 E 16095 Hard leather eveready case strap. Wt., 6 oz. Net 3.95

SPECIFICATIONS

Sensitivity: Low Range, 0.44 to 110 footcandles; High Range, 110 to 28,000 footcandles. ASA Film Speed Range: 6 to 12,000 (1° to 12°). Diaphragm Stops: f/0.5 to f/64. Shutter Speeds: 1/4000 second to 30 minutes. Movie Scale: 4 to 128 frames per second. EL-VS Scale: -12 to +22. Acceptance Angle: 15° Tele, 45° Std.; 75° Wide Angle. Color Response: 5,600 Angstroms (peak). Photocell Type: Cadmium Sulphide. Batteries: 2 Mercury.

DROP FRONT "PRO" BAGS



AS
LOW
AS
11⁵⁰

The perfect accessory bag for professionals or camera bugs. Heavy duty bags will hold movie, reflex, 35mm and press cameras, flash guns, bulbs, meters and a host of other items. Constructed of durable vinyl material, with red corduroy lining and non-jam zipper. Leather loops, hand strap and front key lock.

PRO 13 Size: 13 x 10 x 6". Shpg. wt., 3 lbs.
15 E 16079 Net 11.50
PRO 16 Size: 16 x 7 x 9 1/2". Wt., 3 1/2 lbs.
15 E 16087 Net 14.95

DELUXE GADGET BAG



6⁹⁵

Fine quality gadget bag of scuff and water-resistant vinyl, with a heavy duty wrap-around zipper. Red corduroy lined interior adjusts for various pieces of photographic equipment. Features a front leather pocket—8 x 5 x 1 1/2". Includes shoulder strap and durable, polished hardware. Overall size: 10 x 5 x 8". Shpg. wt., 2 1/2 lbs.
15 E 16129 Net 6.95

CLAMP TRIPOD



An indispensable photographic accessory. Combines in one small unit, a clamp, tilt top, and table top tripod. Legs stored in shaft. Will clamp to trees, pipes, light stand, car, window, etc. Supplied complete with zipper case. Shpg. wt., 1 lb.
15 E 39022 Net 6.50

DELUXE ELEVATOR TRIPOD

11⁹⁵

- 4-Sections Extend to 60"
- Durable Lightweight Aluminum

Deluxe, lightweight tripod features many conveniences that make it ideal for use with both movie and still cameras. 4-section aluminum legs and double-rise center post extends to 60"; closes to 16". Panhead tilts for vertical shooting. Set screw thumb lock holds center post firmly in place. Legs have nylon leg locks with bushings, and non-slip rubber tips. Constructed of durable aluminum throughout. Color: Blue with high chrome base. Shpg. wt., 3 lbs.
15 E 87013 Net 11.95



ELEVATOR TRIPOD



Tri-Tilt Head Velvet Smooth Panning

For any small camera—35mm, reflex or movie. Compact and lightweight... folds to 16", extends to 47" plus 7" with geared center elevator. Single action tilt/pan and 180° swing over for vertical and horizontal format pictures. Positive lock, folding crank. Chrome plated brass legs. Weighs 31 Oz. Imported. Shpg. wt., 2 1/2 lbs.
99 E 70294 Net 6.95

SOLIGOR "UF" DUAL RANGE CdS EXPOSURE METER

10⁹⁵

- Includes Zipper Case, Neck Strap, and Battery
- ASA Speeds From 6 to 6400



Sensitive dual range CdS exposure meter in a ultra modern, streamline body designed for single hand operation and easy carrying. CdS electric eye circuitry assures correct readings from moonlight to dazzling, brilliant sunlight. High-Low light ranges permit accurate easy calibration. Large computer dial clearly indicates correct exposure possibilities. Accepts film speeds from ASA 6 to 6400, diaphragm stops from f/1 to f/32, and shutter speeds from 30 seconds to 1/2000th of a second. EV scale: -4 to +20. Cine: 8-32 fps. Din: 9-39. On/off switch conserves battery. Shpg. wt., 1/2 lb.
15 E 37265L Net 10.95

"35" CLIP-ON EXPOSURE METER

4⁵⁰

- ASA Scale 10 to 1000
- Weighs 1 Oz.

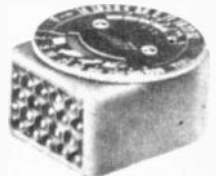

Exceptionally convenient exposure meter. Clips right on camera—quick easy reading. Gives better, more accurate exposed pictures with a minimum of effort. Speeds 1/1000 to 1 second. Lens aperture f:1.4 to f:22. Mounts on camera or may be hand held. Complete with leather case and instructions. Imported. Shpg. wt., 1/2 lb.
99 E 70344 Net 4.50

Telephoto and Close-Up Lenses

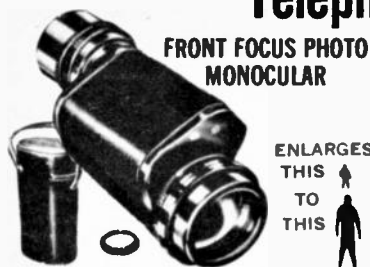

FRONT FOCUS PHOTO MONOCULAR

ENLARGES THIS TO THIS

MAKES YOUR CAMERA TELEPHOTO—Brings Distant Objects From 6 to 8 Times Nearer



9⁹⁵

Take super-telephoto pictures with your single lens or twin-lens reflex camera. The front focus system is specially made for on-camera operation. There is no need to miss those once-in-a-lifetime shots. Increases focal length of your camera lens 6X or 8X depending on model selected (i.e. 50mm lens plus 8X monocular equals 400mm telephoto). Rugged, lightweight construction—weight only 7½ ounces; is only 5 inches long. Includes converter supplied to fit any series 6 adapter ring. With leather case. Imported. Wt., 1 lb.
 99 E 70724 6 x 30 mm Net 9.95
 99 E 70740 8 x 30 mm Net 9.95



VARI-CLOSE-UP LENS FOR SLR CAMERAS

19⁹⁵

- Sharp Focus From 3 Feet to 1 Inch Without Distortion

Variable magnification (+1 to +10 diopters), close-up lens for use on normal and medium telephoto lenses. Can be used with any single lens reflex, focusing camera either still or movie. Attaches easily to front of lens with series VII adapter ring. Does not interfere with automatic diaphragm and does not interfere with built-in meter systems of most cameras. No exposure compensation needed. Shpg. wt., 1/2 lb.
 15 E 36523 Net 19.95

LENS SET FOR POLAROID CAMERAS

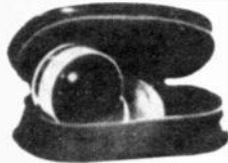

As Low As **17⁵⁰**

- Wide Angle & Telephoto Lens
- View Finder

An ideal companion to the Polaroid Camera. Telephoto lens increases the focal length of the lens and results in a 3 times magnification. Wide Angle lens provides a 75% increase of subject area. Each lens has a "conversion band scale." Supplied with slip-on ring adapter, ring, view finder and case with shoulder strap. Imported. Wt. 2 lbs. For Polaroid Models 100, 101, 103, 230, 240, 250, 340, 350, 360.
 15 E 49237 Net 29.95

For Models 104, 210 and 220. Net 25.50
 15 E 49302
 For New Color Pack II Net 27.50
 15 E 49567
 For "Big Swinger" Net 18.95
 15 E 49344
 For Model 20 "Swinger" Net 17.50
 15 E 49310

SOLIGOR LENSES FOR TELEPHOTO OR WIDE-ANGLE SHOTS

As Low As **24⁹⁵**



Interchangeable lenses designed for use with single lens reflex cameras. Each lens is hard coated and fully color corrected. Shipped Prepaid Direct From Factory. No C.O.D. Send full remittance or use Lafayette's Easy Pay Plan.*

AUTOMATIC LENSES

High quality, fully automatic lenses for many SLR cameras including Canon FL; Minolta SR series, SRT 101; Miranda F, FV, G, Senomat; Nikon; Pentax. Manual diaphragm control when desired. Full lens versatility for your SLR camera. Specify make and model of camera.

Stock No.	Auto Lens	Net
15 E 37281Z	28mm f/2.8	64.95
15 E 37299Z	135mm f/2.8	59.95
15 E 37307Z	200mm f/3.5	79.95
15 E 37315Z	300mm f/5.5	99.95
15 E 37323Z	90-230mm Zoom	139.95

PRESET LENSES

Low cost preset lenses for limited budgets. Compact, precision optics for most SLR cameras. Full range of focal lengths from wide angle to long telephotos to make previously "impossible" shots a reality. Specify make and model of camera.

Stock No.	Preset Lenses	Net
15 E 37331Z	28mm f/2.8	49.95
15 E 37349Z	35mm f/3.5	24.95
15 E 37356Z	85mm f/1.5	89.95
15 E 37364Z	135mm f/3.5	29.95
15 E 37372Z	180mm f/3.5	39.95
15 E 37380Z	250mm f/4.5	74.95

AUXILIARY LENSES Add Telephoto And Wide Angle To Your Camera

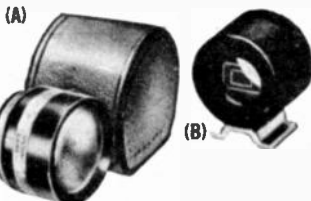

- Telephoto—Twice As Close!
- Wide Angle—75% More

9⁹⁵

Telephoto shots—wide angle shots of extreme close ups. Easy as 1-2-3 with the new auxiliary lenses. Each lens is hard coated for maximum light transmission. Prefocused and color corrected. No increase in exposure setting is necessary. Bring your subject twice as close with Telephoto—add with any color or black and white film. 75% more area with the Wide-Angle. Use Auxiliaries and close-ups mount by means of series 6 or 7 adapter ring. Imported. Shpg. wt., of each auxiliary lens approx. 6 ozs.

AUX. TELEPHOTO LENS (A)	
15 E 49252 (Series 6)	Net 9.95
15 E 49278 (Series 7)	Net 13.50
AUX. WIDE ANGLE LENS (A)	
15 E 49260 (Series 6)	Net 9.95
15 E 49286 (Series 7)	Net 13.50
VIEW FINDER FOR TELEPHOTO AND W-A LENS (B)	
15 E 49294	Net 4.95

POLAROID® CLOSE-UP KIT



Lets you photograph small objects as close as 9 inches to the lens, record flowers, stamps, coins, etc. Kit includes a close-up lens and a view/focus adapter that is easily clipped onto the viewfinder. Can be used with the following Polaroid Color Pack cameras 340; 240; 230; 135; 103; 102; 101; 100. Shpg. wt., 1/2 lb.
 15 E 30120 Net 9.95

WIDE ANGLE AND TELEPHOTO LENSES for KODAK INSTAMATIC CAMERAS



5⁴⁹

Increase your cameras' versatility with a wide angle or telephoto lens. No adjustments necessary. Just slip on the lens and shoot. The telephoto increases the focal length and results in a magnification of about 2 times the image size as compared with the normal lens. The wide-angle lens decreases the focal length and results in an increased subject area of about 75%. Each lens includes a built-in viewfinder. Shpg. wt., 1/2 lb.

For Instamatic Models—
 104, 154, 100, 150, 124R, 174R Hawkeye 50. Net 5.49
 15 E 49351 Wide Angle Lens
 15 E 49369 Telephoto Lens Net 5.49

For Instamatic Models—304, 404, 300, 400
 15 E 49377 Wide Angle Lens Net 5.49
 15 E 49385 Telephoto Lens Net 5.49

Complete Lens Set of Wide Angle, Telephoto, Viewfinder with Case.

(Not Illustrated)
 For Instamatic Models—S-10, S-20
 15 E 49393 Shpg. wt., 1 lb. Net 16.95
 For Instamatic Models—314, 414
 15 E 49575 Shpg. wt., 1 lb. Net 16.95
 For Instamatic Models—714, 814
 15 E 49583 Shpg. wt., 1 lb. Net 16.95
 For Instamatic Models—704, 804, 700, 800
 15 E 49401 Shpg. wt., 1 lb. Net 16.95

CLOSE-UP ATTACHMENT FOR KODAK INSTAMATIC CAMERAS



1⁹⁵

Add to the versatility of your Instamatic camera with this handy close-up attachment. Slips easily onto the front of the lens. For use with all black and white, and color films. Shpg. wt., 4 oz.
 For Instamatic 100, 150, 104, 124R, 154, 174R Net 19.95
 15 E 36507
 For Instamatic 300, 350, 304, 354. Net 19.95
 15 E 36515

Selected Photo Accessories - Film

2 x 2 SLIDE FILE

179

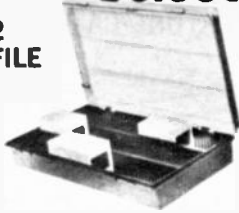

Portable file for 35mm, Instamatic slides—holds 300 2 x 2 cardboard slides or 150 aluminum, metal or glass mounts. Index card and permanent, molded-in numbering system permit you to instantly find your slide. Made of rugged high impact polystyrene. Shpg. wt., 2 lbs.
15 E 50227 Net 1.79

G.E. OR SYLVANIA PROJECTION LAMPS



AS LOW 1.99 AS

Exact replacement projection lamps for most movie and slide projectors. We will fill your order with either G.E. or Sylvania depending on stock availability. *Lafayette imports. Shpg. wt., 6 oz.

Stock No.	ASI Code	Watts	Net Ea.
15 E 36564	CLS	300	3.59
15 E 36572	CYC	300	3.59
15 E 36580	CZA/CZB	500	5.29
99 E 71227	CZX/DAB*	500	1.99
15 E 36598	DAK	500	4.89
15 E 36606	DCA	150	5.29
15 E 36614	DCH/DFP	150	4.99
15 E 36622	DOB	500	5.29
15 E 36630	DEF	150	6.29
15 E 36648	DEK	500	5.49
15 E 36655	DFA	150	5.49
15 E 36663	DFC/DFN	150	4.99
15 E 36671	DFG	150	4.99
15 E 36689	DJL	150	5.49
15 E 36697	DLS	150	5.79
99 E 71219	EDK*	500	1.99

PHOTO ALBUM

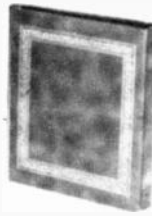

Convenient album will save hours in mounting your favorite snapshots. Easy action expandable 3-ring binder holds photos perfectly flat and safe without the use of paste, glue or corners. Handsome, gold embossed simulated leather cover. Fillers hold approximately 72 3 1/2" sq. prints. Shpg. wt., 1 lb.
15 E 83004 Net 2.79
Pkg. of (6) 2 sided fillers holds 72 3 1/2" sq. prints.
15 E 83012 Net 1.89

SELF-TIMER FOR POLAROID CAMERAS

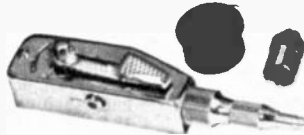

Self-Timer lets you put yourself in the picture. Can be preset from 5 to 15 seconds. Shutter will snap automatically.
FOR ALL COLOR PACK CAMERAS
15 E 49484 Shpg. wt., 1/2 lb. Net 4.49
FOR BIG SWINGER
15 E 49482 Shpg. wt., 1/2 lb. Net 4.49

LAFAYETTE AG CUBE ADAPTER

Now you can make your own flash cube by simply inserting 4 AG type bulbs into this sturdy reusable adapter. Will fit any camera with a flash cube socket. Imported. Shpg. wt., 3 oz.
99 E 72076 Net Ea. .99



PHOTO COPIER FOR POLAROID CAMERAS

As Low As 4.95



Want copies of your Polaroid snapshots? Make them yourself on the spot in as little as 15 seconds using your present Polaroid. It's easy! Imported. Shpg. wt., 2 lbs.

FOR MOST POLAROID COLOR PACK CAMERAS
15 E 49500 Net 7.49
FOR POLAROID COLOR PACK II CAMERA
15 E 49559 Net 7.49
FOR POLAROID SWINGER 20
15 E 49518 Net 4.95
FOR BIG SWINGER
15 E 49526 Net 7.49

DEVELOPMENT TIMER FOR POLAROID

5.95



• 10 to 120 Seconds
Development Timer avoids wasting expensive color film through improper development. Now you don't have to count to develop your Polaroid film. Get top notch pictures everytime. Can be set for up to 120 seconds in 10 second intervals. For All Color Pack cameras. Bell rings when time is up. Imported. Shpg. wt., 1/2 lb.
15 E 49534 Net 5.95

300 DYNACHROME COLOR FILM WITH PROCESSING

- Beats the High Cost of Color Film
- Same Fine Pictures
- Processing Included Direct To Your Home



Dynachrome film is the newer, faster color film now in demand. Same reversal type, same natural colors, same superb quality. Only the price is different—it's almost like getting the processing free. And the low price includes processing direct to your home. Av. Shpg. wt., 6 oz.

COLOR SLIDE FILM

15 E 18182L	35mm, 20 Exp. Daylight ASA 64	Net 2.59
15 E 18190L	35mm, 36 Exp. Daylight ASA 64	Net 3.74
15 E 18174C	126, 20 Exp. Daylight ASA 64	Net 2.59

COLOR MOVIE FILM

15 E 18083L	8mm, 25 ft. Double Roll Daylight ASA 25	Net 2.79
15 E 18091L	8mm, 25 ft. Double Roll Indoor ASA 40	Net 2.79
15 E 18166L	Super 8mm 50 ft. Cartridge Indoor/Outdoor ASA 40	Net 3.49

WESTINGHOUSE FLASHBULBS



BUY IN QUANTITY AND SAVE

Stock No.	Lamp Type	Pkg. Quan.	Per Pkg.	In Lets of 3 ea.
15 E 47256	AG-1B	12	1.55	1.39
15 E 47223	AG-3B	12	1.59	1.45
15 E 47280	M3	12	1.59	1.45
15 E 47306	5	12	1.69	1.49
15 E 47314	5B	12	1.69	1.49



• Pre-Tested To Insure Every Shot
Shpg. wt., 6 oz.

FLASHCUBES



For use with new instant load flashcube cameras, 4 flash pictures without changing bulbs. Package of 3 cubes, takes 12 snapshots.
15 E 26328L Shpg. wt., 6 oz. Net 1.49

KODAK FILM with PROCESSING INCLUDED

• Slides Returned Mounted, Ready for Viewing or Showing! • Convenient, direct-mail "mailers" in every roll • A full number of Prints guaranteed for Kodacolor and black and white

After the complete roll has been filmed, put it into the mailer, drop into a mailbox and in a few days your finished films are delivered postpaid to your door. You get 3 1/2" square or 3 1/2 x 5" giant prints with Kodacolor and Black and White (except CX-135 which is 2 1/2 x 3 1/2"). Should you get less than the full number of prints or printable negatives per roll you will receive coupons for additional FREE prints. DO NOT MAIL FILM TO LAFAYETTE RADIO.

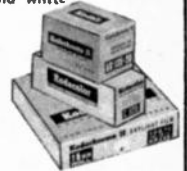

Av. Shpg. wt., 6 oz.

KODACHROME STANDARD 8MM MOVIE FILM-TYPE II

ASA Index 25 Daylight—40 "A" Indoor

Stock No.	Film Size	Description	Net
15 E 47033L	K459	8mm, 25 ft. Double roll, Daylight	3.35
15 E 47041L	KA459	8mm, 25 ft. Double roll. "A" Indoor	3.35

KODAPAK KODACHROME MOVIE FILM FOR SUPER 8MM

15 E 47058L	KA-464	Super 8mm 50-ft. Cartridge, Indoor/Outdoor	Net 3.75
-------------	--------	--	----------

KODACHROME 35MM, TYPE II AND X FOR COLOR SLIDES

Type II ASA Index 25 Type X ASA Index 64

15 E 47068L	K135-20	35mm, Type II, 20 Exp.	2.85
15 E 47074L	K135-36	35mm, Type II, 36 Exp.	4.19
15 E 47062L	KX 135-20	35mm, Type X, 20 Exp.	2.85
15 E 47090L	KX 135-36	35mm, Type X, 36 Exp.	4.19
15 E 47106L	KX 126	Instamatic Cartridge, 20 Exp.	2.85

FOR COLOR SNAPSHOTS

15 E 47118L	CX-127	127 Indoor/outdoor, 12 Exp.	3.45
15 E 47124L	CX-120	120 Indoor/outdoor, 12 Exp.	3.45
15 E 47132L	CX-620	620 Indoor/outdoor, 12 Exp.	3.45
15 E 47140L	CX-126	Instamatic cartridge, 12 Exp.	3.59
15 E 47157L	CX-135	35mm Indoor/Outdoor, 20 Exp.	4.49

Minolta



ONLY
31⁹⁵ EACH
No Money Down*

"16 II" SUBMINIATURE CAMERA

An extremely easy-to-operate, palm-size camera. Sliding camera in and out of built-in case advances film, cocks, shutter, counts exposure and prevents double exposure—all automatically. 6 shutter speeds from 1/30 to 1/500 sec. plus "B". Takes B & W pictures, color prints or color slides that fit any 35mm projector. Direct viewfinder shows picture exactly as it will appear on film. Lens opening from f/2.8 to f/16. With Case. Imported. Shpg. wt., 1 lb.
15 E 34163L Net 31.95

MINOLTA 16 II Accessories. AV. Shpg. wt., 8 oz.	
15 E 34213 Duo Fit Flash Gun	Net 6.49
15 E 34221 Bracket for Flash and Tripod Mtg.	Net 1.95
15 E 34239 Aux. Lens Set—2 closeup, 1 distance, 1 Y filter	Net 4.49
15 E 34247 Color Filter Set—1 ea. 1A, 80A, 81B	Net 4.49

FILM FOR "16 II"—All are 20-exposure magazines Shpg. wt., 3 oz.	
15 E 34171L Kodak Plus-X	Net .99
15 E 34197L Kodachrome II	Net 1.29
15 E 34189L Kodak Double-X	Net .99
15 E 34502L Ektacolor Negative (color prints)	Net 1.40

MINI-"16" COLOR SLIDE PROJECTOR

Compact, lightweight projector to match Minolta and other 16 mm sub-miniature cameras. Sharp 40 mm Rokkor F/2.5 lens. Includes deluxe vinyl carrying case, standard slide carrier and 75 watt projector lamp. For 110-120 volts AC-DC. Imported.
15 E 34353 Shpg. wt., 3½ lbs. Net 31.95

Revere 3M

FLASH CUBE 126 CAMERA



Only
17⁹⁹

- 3 Focus Settings
- 3 Lens Settings
- Uses Kodak 126 Cartridge Film

Revere Model 1034 is a quick loading cartridge camera with automatic flashcube rotation. Features 3 focus settings for more precise focusing and detailed pictures or slides. Has 3 lens settings for varied light conditions. Other fine features include a sharp double element glass f/8 43 mm color corrected lens, precision optical viewfinder, double exposure safeguard, and tripod socket. Camera finished in attractive leatherette with chrome trim. Wrist strap.
15 E 18208L Shpg. wt., 3 lbs. Net 17.99
32 E 46964 Batteries. Pkg. of 4 Net 2.48

YASHICA MAT 124 TLR CAMERA

- Coupled CdS Exposure Meter **99⁹⁵**
- 12 or 24 Exposures No Money Down*

Versatile twin lens reflex camera offers superior quality pictures. Enlargements retain sharpness and good contrast. CdS meter coupled to aperture for easy operation. Accurate thru-the-lens viewing and focusing. Shutter speeds from 1 to 1/500 sec. plus B. M-X sync, self-timer and shutter lock. 12 pictures with 120 film, 24 pictures with 220 film; Sharp 80mm f/3.5 taking lens stops down to f/32 and focuses from 3 ft. to infinity. Viewing lens is f/2.8 for a bright image. Waist-level viewfinder with built-in hood. ASA 25-400. Imported.
15 E 36549L Shpg. wt., 5 lbs. Net 99.95



YASHICA atoron

ULTRAMINIATURE CAMERA KIT



COMPLETE WITH CASE, FILTERS, FLASHGUN, CHAIN STRAP, AND BUILT-IN MATCH-NEEDLE EXPOSURE METER. Only **84⁹⁵**

Ultraminiature, lightweight camera accepts Minox-type film cartridges. Features drop-in loading—no film threading—no double exposures—no rewinding. Advanced, programmed shutter with speeds from 1/45 to 1/250 sec. plus bulb. Matchneedle exposure system with ASA range from 25-400. Yashinon f/2.8, 18 mm lens gives detailed black and white, color prints and color slides. Bright, optical viewfinder can be used even in dimly lit surroundings. Parallax correction frame, visible in viewfinder, allows accurate framing when shooting closeup. Camera has built-in UV and V2 filters. Includes camera and case, additional ND4X and 80B filters, cordless AG flashgun, and chain strap. Imported. Shpg. wt., 1½ lbs.
15 E 36259L No Money Down* Net 84.95

PRELOADED CARTRIDGE FILM FOR ATORON Av. Shpg. wt., 2 oz.	
15 E 36267L Two, 36 exposure ASA 125 B & W.	Net 1.98
15 E 36275L Two, 36 exposure XT-Pan ASA 25 B & W.	Net 1.98
15 E 36283L Two, 36 exposure Kodachrome II Slides.	Net 3.29
15 E 36291L Two, 36 exposure Ektacolor S Prints.	Net 2.59
32 E 47541 Batteries for above. Pkg. of 2.	Net .66

YASHICA EZ-PKG INSTANT-LOAD ELECTRONIC CAMERA



- Automatic CdS Electric Eye
- Sharp f/2.8 Lens

Only
49⁹⁵
No Money Down*

New type electronic shutter system combines with cartridge load features to provide automated operation. Perfect for the average snap-shooting family. Fast 37 mm f/2.8 four element lens with internal CdS exposure sensor. Exceptional features include 3 transistor exposure control, flashcube socket, 3 position focusing system, and black grain with brushed aluminum finish. Bright frame viewfinder shows parallax correction and signals if light is insufficient. If internal computer chooses slow speed camera signals that tripod should be used. Speed: 1/300-2 sec. ASA: 50-160.
15 E 36416L Shpg. wt., 2 lbs. Net 49.95

KODAK INSTAMATIC CAMERA COLOR OUTFIT



As Low As **18⁵⁰**

- Accepts Flashcube—Rotates it Automatically

Model A124R Outfit. Simple-to-operate Kodak Instamatic 124R camera with Lumenized f/11 factory focused lens for good quality pictures. Quick, lever film advance and shutter which automatically adjusts for outdoor or flash shooting eliminates confusion and gets perfect pictures every time. Outfit contains camera with wrist strap, Kodacolor-X film cartridge, flashcube, alkaline batteries and instruction book. Shpg. wt., 4 lbs.
15 E 26359L Net 18.50

Model A174R Outfit. Features Kodak 174R camera with spring operated film advance for up to 12 pictures in 12 sec. Automatically advances film after each exposure. f/11 Lumenized lens is pre-focused from 4 ft. to infinity. Inserting flashcube automatically adjusts shutter speed for flash operation. Outfit includes camera with wrist strap, Kodacolor-X film cartridge, flashcube, alkaline batteries and instruction book. Shpg. wt., 6 lbs.
15 E 26367L Net 26.95

Tapewriter — Embossing Tools

DYMO MARK VI LABEL MAKER KIT EMBOSSSES BOTH 3/8" AND 1/4" TAPE

- You Get - Tool - 2 Wheels For Large and Small Characters - Case and 5-12' Rolls of Tape
- Convenient Tape Cut-off Lever

6⁸⁸
Tool Only

Low-Cost tapewriter kit for home, office, store or workshop. Makes raised-letter labels that are self-adhesive, permanent and waterproof. Set dial to letter, number, or symbol and squeeze the handle. When label is completed, squeeze trigger to snip off tape. Kit includes: High-impact plastic embossing tool, two wheels, three 3/8" and two 1/4" rolls of tape plus carrying case. Shpg. wt., 1 1/2 lbs.

14 E 41404 Net 9.88

MODEL M6 Tool only. Complete with 3/8" character wheel and 144" roll of Tape.

14 E 41492 Shpg. wt., 1 lb. Net 6.88



NEW DYMO SLIMLINE TAPEWRITERS

- Flat Easy To Store Design
- Lightweight But Extremely Rugged

16⁹⁵

Slimline Tapewriters® are a mere 1" thick and styled in attractive brushed chrome and Cyclocac® plastic.

MODEL 1450-01 1/4" & 3/8" SLIMLINE TAPEWRITER KIT featuring the 1450 tapewriter, one horizontal 1/7" wheel (with A-Z 0-9 &—/¢ + \$, % # #), one horizontal 3/8" wheel (with A-Z 0-9 ./-/\$), one vertical 1/4" wheel (with A-Z 0-9 → ← ↑ ↓ /aco&-) plus one magazine each of 3/8" black and 1/4" red tape. Supplied in molded carrying case. Shpg. wt., 2 lbs.

14 E 41542 Net 16.95

MODEL 1450 TAPEWRITER Only with 3/8" horizontal wheel and 144" roll of 3/8" tape. Shpg. wt., 1 lb.

14 E 41559 Net 12.95

MODEL 1470-01 1/2" SLIMLINE TAPEWRITER KIT featuring the 1470 Tapewriter, one horizontal 1/4" wheel (with A-Z 0-9 ./-), one horizontal 3/8" wheel (with A-Z 0-9 ./-/\$), one vertical 1/4" wheel (with A-Z 0-9 → ← ↑ ↓ /aco&-) plus one magazine each of black and red 1/2" tape. Molded carrying case. Shpg. wt., 2 lbs.

14 E 41567 Net 18.95

MODEL 1470 TAPEWRITER Only with 1/4" horizontal wheel and 144" 1/2" tape. Shpg. wt., 1 lb.

14 E 41575 Net 14.95

1/4" or 3/8" LABELMAKERS

- Handy Tape Cut-Off

Home labelmaker embosses raised characters on vinyl tape. Just dial the letters, numbers, or symbols and squeeze the handle. Has pull tab cut-off and rugged plastic body. Size: 6 1/2" x 6". Choice of model with 1/4" or 3/8" wheel. Shpg. wt., 2 lbs.

14 E 41534 3/8" Model Net 2.88

14 E 41013 1/4" Model Net 2.88



2⁸⁸

DYMO EMBOSSING TAPES

1/4 INCH
Each contains 144" of 1/4" glossy vinyl tape with adhesive backing. Shpg. wt., 1/4 lb.

Net ea. .89

Stock No. Lots of 3 .75 ea.

14 E 41021 Blue	14 E 41062 Brown
14 E 41039 Green	14 E 41070 Black
14 E 41047 Red	14 E 41302 Orange
14 E 41054 Clear	14 E 41310 Yellow
14 E 41518 Wal. Grain	14 E 41328 Gold

3/8 INCH
Contains 144" of 3/8" dirt/moisture resistant vinyl tape with adhesive backing. Shpg. wt., 1/4 lb.

Net ea. .89

Stock No. Lots of 3 .85 ea.

14 E 41112 Brown	14 E 41153 Blue
14 E 41120 Black	14 E 41161 Green
14 E 41138 Red	14 E 41278 Orange
14 E 41146 Clear	14 E 41286 Yellow
14 E 41526 Wal. Grain	14 E 41294 Gold

1/2 INCH
Contains 144" or 1/2" glossy vinyl tape with adhesive backing. Shpg. wt., 1/4 lb.

Net ea. 1.29

Stock No. Lots of 3 1.15

14 E 41187 Black	14 E 41229 Green
14 E 41195 Yellow	14 E 41237 Brown
14 E 41203 Red	14 E 41245 Gold
14 E 41211 Blue	14 E 41252 Clear

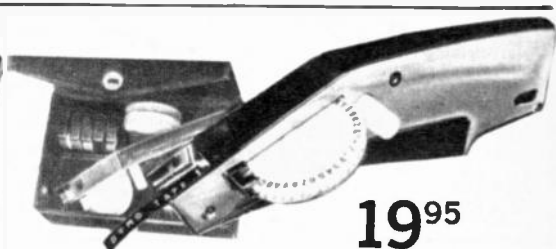

19⁹⁵

DELUXE 1/4" & 3/8" TAPEWRITER KIT

- With 3 Wheels — 3/2" Giant Letters 3/8" Standard Characters
- And Vertical Direction Wheel
- Chrome-Plated—with 10 Rolls of Tape and Case

MODEL M-10 Changes tape size internally, by simple up or down movement of selector pin. Features wide letter spacing, and regular. Rapid change embossing wheels for any application. Complete with custom-fitted carry case, tapewriter, giant letter and standard-letter embossing wheels, 5 magazines of 3/8" tape, 5 magazines of 1/4" vinyl tapes in assorted colors.

14 E 41443 Shpg. wt., 2 lbs. Net 19.95

MODEL M-10 TAPEWRITER. With 2 wheels: 144" roll of tape.

14 E 41419 Shpg. wt., 1 lb. Net 14.95

MODEL M-14 1/4" & 3/8" TAPEWRITER

Similar to Model M-10 Tapewriter Above except with durable all metal construction. Includes 3/2" optimum size lettering wheel and 144" roll of tape.

14 E 41401 Shpg. wt., 2 lbs. Net 9.95

3/8" LABELMAKER

- With 144" Roll of Tape
- Special Vertical Wheel Included



4⁵⁰

For embossing raised white letters on 3/8" vinyl tape. Designed for easy operation. Perfect for making label anywhere in the home. Comes with automatic pull-tab, tape cut-off, special-use 44 character vertical wheel and 42 character horizontal wheel. With 144" roll of 3/8 inch tape. Made of high impact Cyclocac plastic. Size: 5Lx2 3/4 Wx5 3/4 D. Shpg. wt., 1 1/2 lbs.

14 E 41500 Net 4.50

SMITH-CORONA

"FIGUREMATIC" Portable Electric Adding Machine

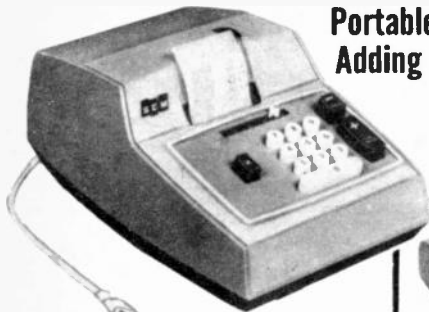

72⁹⁵

No Money Down*



- Totals 8 columns to \$999,999.99

A fast-figuring electric portable that adds, subtracts and multiplies. Full-featured construction with 10 keys. Add-Subtotal, Subtract-Total, and Repeat. "Clear" and digital indicator are combined. Lists 7 columns of figures. New, easy-load ribbon cartridge gives thousands of extra prints. Easy to carry—the cord tucks in, stylish dust cover snaps on, built-in retractable carrying handle comes out, and away it goes. Ideal for everyone who figures—at work, home, in-between. Overall 7x9x13". For 110-115 volts, 60 Hz, AC. Shpg. wt., 10½ lbs.

15 E 40079W

Adding tape for above 2½" wide.

15 E 40061

Net 72.95

Net ea. .39

Bohn COMPACT

ELECTRIC ADDING MACHINE

With Direct
Credit Balance

Only

89⁹⁵

No Money Down*



- Larger Capacity:
Totals 11 Columns
Up To \$999,999,999.99

Model 10/11 for home or office use enters 10, totals 11 columns. Instant response from a short stroke 10-key keyboard. Fully automatic operation—addition, subtraction, multiplication, total, subtotal and true credit balance. Clearly marked single-use function keys. Raised PLUS bar makes "sure target". "Ezy-Lock" multiplication key simplifies and speeds up all repeat operations. 2-color ribbon. All steel frame and steel mechanism for years of dependable service. Two-tone high impact styrene housing.

15 E 55002W Shpg. wt., 16 lbs.

Contour-fitted Statesman Carry Case with zipper and handles.

15 E 55010

Net 89.95

Net 6.95

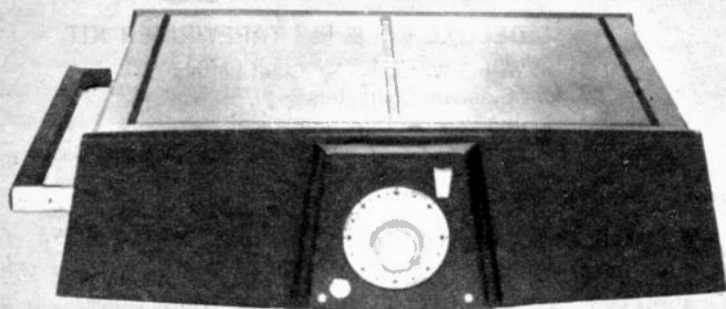

COPYMATE[®] DRY COPIER

Only

29⁹⁵

- Completely Dry
- Easy To Use

- Does Not Use Messy Chemicals
— Inks-Powders-Sprays
- Makes Crisp Black-On-White Copies
- Copy Letters-Photographs
— Even Pages Bound In Books

Easy to use dry copier for home and office. Anyone can make permanent, black-on-white copies of documents, recipes etc. in less than one minute, regardless of color or thickness up to size 8x10. No messy chemicals, inks, powders or sprays; uses two ordinary 150 watt frosted bulbs and "Copymate" paper. Features a built-in automatic timer that determines proper exposure, and also indicates when copies are ready. Handsome brown and gold case with built-in carrying handle. For 110-120 VAC, 60 Hz. UL listed. Size: 22¼x17¼x6¼". Shpg. wt., 9 lbs.

15 E 48019W

"Copymate" Paper. 33 sheets per pkg. Shpg. wt., 1½ lbs.

15 E 48027

Net 29.95

Net 2.99



AUTOMATIC ELECTRIC PENCIL SHARPENER

13⁹⁵

- Automatic
Stopper When
Pencil Is
Sharpened
- Heavy Duty
Electric Motor

Model 660—Ideal for student, artist, draftsman, business firms . . . gives a needle point instantly. Unit even sharpens charcoal and pastel pencils. Sensitive micro switch automatically stops motor when pencil is sharpened. Carefully machined precision ground cutters last indefinitely. Easy cleaning with convenient push out receptacle drawer. Safe for even a child to use. Sturdy die cast metal with heavy duty 115 volt AC motor. UL Listed. Imported.

15 E 17051 Shpg. wt., 3½ lbs.

Net 13.95

ELECTRIX[®] THE EXECUTIVE PERSONAL FAN

Only

9⁹⁵

- Powerful—Compact
Whisper Quiet
- Use Anyplace You Relax

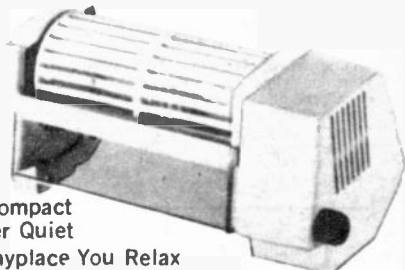

Cools like fans several times in size. Set it on a desk, alongside your bed, or in the kitchen . . . wherever a breath of fresh air is needed without blowing up a storm, or disturbing papers. The Executive is so whisper quiet and efficient you can use it any place you relax or work. Durable, high impact Cylolac[®] base adjusts to direct a concentrated, cooling, even stream of air. Beautiful off-white/walnut finish. For 117 VAC, 60 Hz. Size: 8Wx4Hx4"D.

15 E 51019 Shpg. wt., 2 lbs.

Net 9.95

SMITH-CORONA

Coronet Electric™ Typewriters

CORONET ELECTRICTM 134⁹⁵	CORONET ELECTRICTM 12 TM 149⁹⁵	CORONET AUTOMATIC™ ELECTRIC 164⁹⁵
--	--	---

Type Easier Electrically with this Coronet Electric typewriter. Makes up to 10 carbons...repeats dots, dashes, spacing, the letter X and underlines. Full-sized 88 character keyboard features Impression control dial and touch selector. Amazing accelerator action gives faster type-bar actions for a snappier touch. Includes effort saving page gage, quick set margins, exclusive forward-glide top deck, push-variable line spacing. Pica characters. Strong steel frame. Trimline luggage type carrying case. U.L. listed. 110-120 Volts AC. Shpg. wt., 26 lbs.

15 E 40038WX Tan, No Money Down* Net 134.95
 15 E 40046WX Mist Blue, No Money Down* Net 134.95

CORONET ELECTRIC 12

Similar to above with versatile 12" carriage. Shpg. wt., 29 lbs.
 15 E 40111WX Mist Blue, No Money Down* Net 149.95
 15 E 40129WX Tan, No Money Down* Net 149.95

CORONET AUTOMATIC ELECTRIC Similar to above with 10" push-button power return carriage. Shpg. wt., 26 lbs.
 15 E 40137WX Mist Blue, No Money Down* Net 164.95
 15 E 40145WX Tan, No Money Down* Net 164.95

SMITH-CORONA SUPER STERLING



- Quick-Set Visible Margins
- Luggage-Style Carrying Case

89⁹⁵
 No Money Down*

Top quality portable with office-size 88-character pica type keyboard. Features: full length tabulator key sets and clears; personal touch pressure selector; quick-set visible margins, sets margins at the flick of a finger; page gauge shows space remaining on page; push variable line spacing; ribbon color selector with stencil position; easily cleaned platen; forward glide top deck for easy access to type bars and ribbon. With attractive, luggage-type vinyl-clad steel carrying case. Star-mist blue finish. Shpg. wt., 23 lbs.
 15 E 40152WX Net 89.95



Pica characters

- With Luggage Type Carrying Case

ROYAL



PORTABLE ALL-ELECTRIC

- With Electric Carriage Return
- Luggage-Style Carrying Case

144⁹⁵
 No Money Down*

Portable, all-electric typewriter with modern styling and office electric features in a compact size. Space bar with automatic repeat forward spacing. Repeats periods, letter "X", dashes and underlines. Automatic repeat key. Full width tab bar preset for convenience. Full 88-character keyboard with pica type. Paper bail with carriage scales. Wide carriage accepts standard business envelopes. Touch-set margin controls. Ribbon color selector and stencil position. Line space selector with half spacing. Variable impression control. Beige color. With detachable 8 ft. cord and impact resistant carrying case. Imported. Shpg. wt., 27 lbs.
 15 E 31011WX Net 144.95

ROYAL



ROYAL SPRIT™

54⁹⁵
 No Money Down*

- Tabulator, Pre-Set for Convenience

Deluxe portable has features that make quick work of every typing job. Features pre-set tabulator, touch-set margins, wide carriage, calibrated paper bail, automatic and manual ribbon reverse, ribbon color selector and stencil cutter, dual shift keys for minimum pressure, full-size 88-character pica type keyboard and a touch pressure regulator. With handsome high-impact console carrying case. Blue and gray finish. Imported. Shpg. wt., 12 lbs.
 15 E 31029W Net 54.95



ROYAL MERCURY™

44⁹⁵

- Two-Color Ribbon
- All-Metal Construction with Case No Money Down*

Portable typewriter with full-size 88-character pica type keyboard, carriage which takes standard business envelopes, two-color ribbon and stencil cutter, calibrated bail and touch-set margin controls. Dual shift keys for minimum pressure and a regulator for heavy or light touch. With automatic and manual ribbon reverse. Weighs only 10 lbs. with case. Gray finish. With high-impact console carrying case. Imported. Shpg. wt., 12 lbs.
 15 E 31037W Net 44.95

* See Page 11 for Full Credit Details on Easy Pay Plan

MINI-BIKES

- Easily Transported — Ideal for Teens, Hunters, Campers, Fishermen, Farmers, and Ranchers
- Factory Assembled

COMANCHE II 5 H.P. DELUXE TRAIL BIKE†

- Runs Up To 27 MPH
- Large 18" Knobby Tires
- Overall Length 58" — Rugged 116 Lbs.

Rugged 5 HP engine drives the Comanche thru the toughest woods and trails. Large 18" knobby tires, coil spring front suspension, oversize polyfoam seat and tough welded twin-beam frame even out the roughest terrain. Rear mounted 1½ gal. gas tank keeps you out all day without refueling. Aircraft-type disc brake for fast, constant stopping. Heavy duty all steel clutch and 14.5:1 reduction climbs steep hills easily. 7½" ground clearance avoids hang-ups. Sealed ball bearings for maximum life. Convenient motorcycle throttle and hand brake lever. With kickstand, chromed steel clutch guard, and forestry approved muffler. Bonded enamel finish. 58" overall length. Shpg. wt., 126 lbs.

13 E 68539WXZ See note below. No Money Down* Net 209.95

"CABALLERO" DELUXE 3½ HP MINI-BIKE†

- Runs up to 28 MPH

4-cycle Tecumseh engine for high torque and speed. Comfortable ride with full front and rear suspension, oversize polyfoam seat, large 12½" knobby pneumatic tires with steel rims, tough aircraft-type disc brakes and convenient motorcycle throttle and brake lever. All-steel automatic clutch and chrome clutch guard. 5½" road clearance. Attractive full length fenders and bonded enamel finish. With kickstand and 2 qt. gas tank. 48½" overall. Weighs only 79 lbs. Shpg. wt., 89 lbs.

13 E 68513WXZ See note below. No money down* Net 156.95

"CORSAIR" 3½ HP MINI-BIKE†

Similar to "CABALLERO." With coil spring front suspension only and without fenders. Weighs 75 lbs. Shpg. wt., 85 lbs.

13 E 68521WXZ See note below. No money down* Net 134.95

**ALL MINI BIKES SHIPPED F.O.B. DUMONT, N.J.
NO C.O.D. SHIPPING CHARGES COLLECTED ON DELIVERY
SEND FULL REMITTANCE OR USE LAFAYETTE'S EASY PAY PLAN***



AS LOW AS **134⁹⁵**

No Money Down*

**Fun For
The Whole
Family**

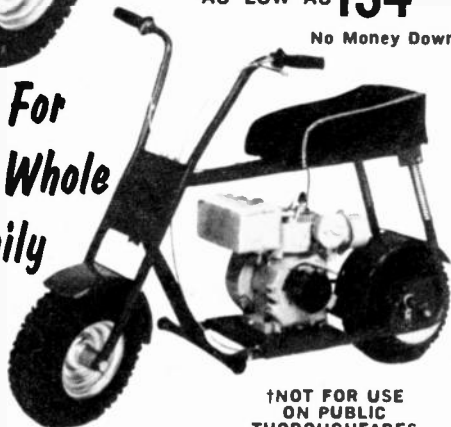

†NOT FOR USE
ON PUBLIC
THOROUGHFARES



99⁹⁵

FRIDGETTE

5.5 CU. FT.

COMPACT REFRIGERATOR

The perfect small refrigerator for apartment, home or office. Walnut grain laminate plastic top and front, coppertone sides and chrome trim. 5.5 cu. ft. (including full size across-top freezer). Deluxe features: 2 removeable adjustable chrome shelves; 1 heavy duty glass shelf; full size, across-the-top freezer; large see-thru vegetable crisper, 3 in-door storage racks plus egg holder; 8-pos. thermostat; magnetic door catch, hermetically sealed compressor unit, 2-tone interior and interior light. Imported. 34Hx 20Wx23D. Operates on 110 VAC. 60 Hz. 13 E 32790WX7 Wt., 115 lbs. Net 119.95

Similar to above, laminated top only, standard interior, white finish. Shpg. wt., 115 lbs. 13 E 32808WXZ No Money Down* Net 99.95

2.2 and 5.5 Cu. Ft. Models Shipped FOB Newark, N. J. No C.O.D. Send Full Remittance Or Use LAFAYETTE'S EASY PAY PLAN*. Shipping Charges Collected On Delivery.

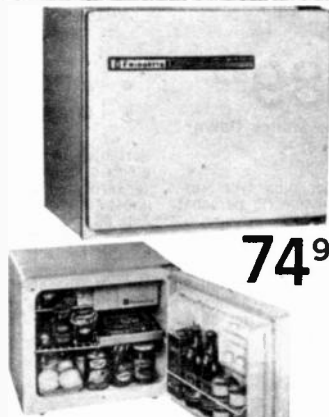

74⁹⁵

FRIDGETTE

2.2 CU. FT.

COMPACT REFRIGERATOR

Compact refrigerator holds 2.2 cu. ft. (including freezer). Ideal for small apartments, campers, or boats. Freezer accommodates 2 ice cube trays. Features in-door storage rack and egg holder; 2 removeable adjustable shelves; hermetically sealed compressor unit; and 7-position thermostat and magnetic door catch. White finish. Operates on 110 VAC, 60 Hz. Imported. Size: 18Hx 19½Wx18"D. Shpg. wt., 65 lbs.

13 E 32766WXZ Net 74.95

Similar to above in coppertone finish.

13 E 32774WXZ Net 79.95

14" walnut legs for both of above (4).

13 E 32782Z Shpg. wt., 2 lbs. Net 3.99

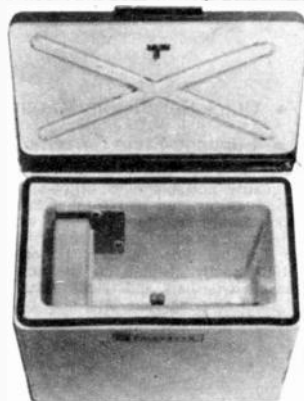

FRIDGETTE

**COMPACT PORTABLE
REFRIGERATOR**

49⁹⁵ • Works On Both —
110 Volts AC and
12 Volts DC

Lightweight, .4 cubic foot portable refrigerator perfect for use in autos, trailers, boats, or on picnics. Interior measures 12Lx 6Wx10" deep and features a high impact PVC plastic liner. Plugs Into cigarette lighter or AC outlet. Stores all types of food with the convenience of a home refrigerator. Ice tray and cover keeps premade icecubes cold. Quiet operating absorption system, no disturbing compressors or motors. Fits almost anywhere. Outside dimensions are 14¾Wx 12½Dx13"H. All metal construction. With all power cords. Shpg. wt., 25 lbs. 13 E 32758WX No Money Down* Net 49.95

A
Acoustic Padding 139
ADAPTERS
AC 94
Audio 137, 282
Crystal Holder 461
Jack & Plug 282
Microphone 137
Phono 137, 282, 283
Test-Point 278
Tube Socket 278, 279
"V" 137
Adding Machines 428
Adhesives 247, 337
Alarms 321-323, 469, 370
Alignment Tools 338
Alkaline Batteries 268, 269
Alternator System, Automotive 367

AMATEUR EQUIPMENT
Amplifiers 455, 456
Antennas 464, 465
Clocks 463
Code Practice 272, 462, 463
Converters 465
Crystals 461
Headphones 206-208, 460
Interference Filters 392, 460
Keys 462
Lowpass Filters 461
Microphones 157, 159, 160

Phone Patch 460
Preamplifiers 465
Receivers 457, 458, 494, 495
Relay (Ant.) 460
RF Power Meters 460
"S" Meters 460
SWR Bridges 460
Transceivers 455, 456, 458, 459

Transmitters 459
Kits 459
VFD's 459
AMMETERS
240, 246, 242, 245, 369

AMPLIFIERS
Amateur 455, 456
Broadcast Kit 213
Guitar 199-201
Hi-Fi 10, 15-19, 26-29, 32, 36-40, 64
Kits, Hi-Fi 37-40, 212
Modules 218, 220
P.A. 140-145
Phono 212, 220
Telephone 165
Anchors (Bolts) 396
Annunciators 307, 321

ANTENNAS
Amateur 464, 465
Auto Radio 173
Citizens Band 470, 471, 472, 473, 474, 475
Direction Finding 472
Ferrite 250
F.M. 376-383, 385
Marine 451
Radio Control 211
Shortwave 453
TV, Indoor 382, 384-386
TV, Outdoor 376-382
VHF Communications 449
Antennas 449

ANTENNA ACCESSORIES
Boosters 381, 387-389
Coaxial Cable 393, 470, 471
Coils 250, 300-302, 461
Connectors 173, 397, 467
Couplers 388, 392, 393
Distribution Units 388, 389
Ground Clamps 396
Ground Rods 395
Guy Rings 396
Guy Wire 308, 395
Installation Kits 395, 396, 470

Insulators 396, 397
Lightning Arrestor 396
Masts 395
Matching Coil 393
Mounts 394-396, 472
Outlets 473
Rotors 390, 473
Splitters 392, 393, 465
Switches 391
Towers 395
TV Filters 392
Twin-Line 308, 311
Wire 308
Artists Materials 408, 409
Attenuators, TV 391
Audio Generators 228, 234
Kits 234
Audio Mixers 150

AUTO SUPPLIES
Accessories 107, 171-177, 363, 366-375
Alternator System 307
Antennas 173
Fuses 316, 317
Radios 174, 175, 177-179
Speakers 171, 172, 177
Suppressors 173
Test Equipment 366-369, 372
Ignition Systems 368
Vibrators 173

B
Baffles, Speaker 149, 171
Banjo 194
Barometer 415
Barrier Strips 247
Bases, Record Changer 73, 179

BATTERIES
Booster Cables 268, 269
Chargers 270, 364, 365, 468
Clips 269, 277
Eliminators 230, 231, 270, 468
Holders 269
Photo-Flash 268
Rechargeable 269
Tester 232, 246
Bench Frame 360
Bias Supply 230, 231, 238
Binding Posts 284
Binoculars 411, 437
Blow Torch 334, 359
Boards, Printed Circuit 248, 249
Bongos 205
Bookbinder Duffit 409

BOOKS
Amateur 401, 403, 405
Audio & Hi-Fi 402, 404-406
Binder 404
Citizens Band 400, 403
Experimenters 219, 272-274, 399, 404-407
General Science 407
Music 205
Printed Circuit 218, 399
Recording 404
Servicing 399, 400, 402-406
Transistor 402-406

Boosters
TV & FM 381, 387-389
Boxes, Plastic 313, 336
Breadboard, Masopite 247-249
Bridges
Capacitance & Resistance 229, 235, 237, 239, 242
Standing Wave 460
Brushes 117, 409
Bug Killer 362
Burglar Alarms 321-323, 370
Bushings 312

C
CABINETS
Accessories 139
Finishing Kits 139
Hi-Fi 67
Metal 313-315, 339
Parts 339
Racks 314
Record 67
Repair Kit 139
Speaker 53, 65
Utility 339

CABLES (See Wire & Cables)
Calipers 353
Cam-Dwell Tester 366, 367
Cameras
Accessories 419, 423, 424, 425
Kits 426
Lenses 424
Movie 416, 417
Rangefinder 420, 426
SLR 420
Subminiature 426
Tripods 419, 423
Twin Lens Reflex 426

CAPACITORS
Assorted 294
Ceramic 294, 298, 299
Checker 229
Electrolytic 294, 295, 298
High Voltage 299
Mica 294, 297
Mylar 296
Padder & Trimmer 251, 298, 296, 297
Paper Substitution Boxes 229, 235, 237, 239
Testers 239, 242
Kit 242
Transmitting Variable 251

CARTRIDGES
Crystal-Ceramic 128-130
Magnetic 126, 127
Microphone 157, 159, 106, 113, 115, 120
Tape 315
Casters 315
Chassis, Metal 313-315
Punch 353
Repair Cradle 338, 352
Chargers, Battery 270, 364, 365
Chimes 307, 321, 327
Chokes, Filter 287
RF 300-302
Circle Cutter 350
Circuit Breakers 320

CITIZENS BAND
Equipment 466-493, 495
Antennas 470-475
Crystals 476
Microphones 157, 159, 160
Parts 467
Pocket Pager 477
Preamplifier 468, 469
Selective Caller 480
Systems 478, 479
Test Equipment 466, 469
Transceivers 481, 486-495
Walkie-Talkie 481-485
Clamps 472
Cleaners 118, 134, 135, 391, 443
Ultra Sonic Vacuum 350

CLIPS
Magnetic 353
Clocks 223, 373, 414, 463
Clock Radio 190, 191
Code Equipment 462, 463
COILS
Antenna 250, 300-302, 461
Dope 247
Miniature 300-302
Multiplex Stereo 302
Oscillator 300-302, 467
Radio & TV 300-302

Transmitting 300-302, 461
Coil Form 301
Coil Winder 302
Color Bar Generator 228, 237, 238, 241, 242
Color Organ 41, 202, 219
Color TV Sets 169

COMMUNICATIONS RECEIVER
212, 452-454, 494
Compass 373
Compression Tester 366
Computer Kits 214

CONDENSERS (See Capacitors)
CONNECTORS
Antenna 173, 280, 397, 467
Cable 278, 280-283
Microphone 46, 280-283
RF 280
Solderless 337
Contact Cleaner 391
Containers 313, 363
Continuity Tester 227, 229, 230, 232

CONTROLS (See Potentiometers)
CONVERTERS
Amateur 465
Auto Radio 175, 177
Mobile, Marine 451
Police-Aircraft 449
Power 468
UHF 449
Copier 425, 428

CORDS
Line 308-309
Power 309
Zip 308
Counters 253
Counter-Sinks 349
Crimping Tools 247
Crossovers 57, 59

CRYSTALS
Calibrator 461
CB, Amateur, and VHF 209, 476
Color TV 274
Frequency Std. 461
Sockets 461
Current Checker 240
Cutters, Wire 354
Tubing 357
Cutting Needles 134

D
Decade, Boxes 235
Defroster, Auto 374
Degaussing Coil 391

DEMAGNETIZER
Head 115, 116, 118, 139
Tape 115-118, 139
Depth Indicator 450

DIALS
Cords 252
Plates 252, 306
Vernier 252

DIODES
Zener 271, 272, 272, 274
Direction Finders 450, 451
Door Chime 307, 321, 327
Door Viewer 170
Drafting 408, 409
Equipment 360
Drawer Slides 139

DRILLS
346, 347

Accessories 347-350
Bits 349, 350
Sharpener 350
Stands 349
Drum Duffit 197
Dwell Meter 366, 367

E
EARPHONES
206-208

EASY PAY PLAN
11

Electrical Accessories 313, 327-329
Electrolytic Capacitors 294, 295, 298
Electronic Flash 422
Enclosure Finishing Kit 139
Enclosures, Speaker 51, 53, 65
Engine Analyzer 367
Engraving Tool 340, 342
Equipment Cabinet (Hi-Fi) 67
Escapements, R/C 211
Experimenter's Kits 214-223, 248
Exposure Meters 423
Extension Cords 313, 328, 329
Extension Rods 251
Eye Guard 357

F
Fahnestock Clips 277
Fans, Cooling 134, 314, 327, 428
Field Strength Meter 466
Files 350, 352
Film 425

FILTERS
Auto Ignition 468
Interference 296, 392, 451, 461, 468
Rumble 134
Finishing and Repair Kits 139
Fire, Alarms 321, 323
Extinguishers 330
Fire/Police Receivers 182-185, 444-448
Flaring Tool 357
Flash Bulbs & Guns 422, 425
Flashlights 330
Flux, Soldering 331

FM
Antennas 376-383, 385
Boosters 388, 389
Communications Receivers 444-448, 495
Splitters, Couplers 388
Receivers 33, 34, 40, 106
Tuners 37, 39, 40, 106

FM-AM
Radios 174, 175, 183-191
Receivers 2-8, 20-25, 30-35, 37, 106, 183-187, 496
Tuners 9, 37
Forming Tool 337
Fuses 316, 317, 320, 398
Mountings 317
Fusible Resistors 398



LAFAYETTE

GENERAL INDEX

G
 Garage Door Opener 363
 Garden Tools 342, 348-350
 Gauges 352, 366-369
 Stylus Pressure 135
 Generator, Signal 228, 236, 237, 238, 241, 243
 AC Power 362, 451
 Geology Equipment 221, 222
 Glue Gun 356
 Grilles, Speaker 139, 172
 Grinders 343, 350
 Grommets 336
 Ground Rods 395
 Guarantee 436
 Guitars 192-196

H
 Hammers 357
 Hardware
 Radio-TV 336, 337
 Heads, Recording 122
 Headphones 123-125, 206-208
 Accessories 125, 206-208
 Headphone Cushions 207
 Head Rest, Auto 373
 Hearing Aids 206
 Heat Sinks 338

HIGH FIDELITY
 Accessories 125, 130, 131, 134, 135, 138, 139
 Amplifiers 10, 15-19, 26, 29, 32, 36-39
 Amplifier Kits 38, 39
 Cabinets 67
 Cartridges
 Phono 126-130
 Tape 120
 Changers 68, 70-74
 Color Organ 41, 202, 219
 Connection
 Cables 137
 Crossover
 Networks 59
 Enclosures, Speaker 51, 53, 65
 Headphones 123-125, 208
 Outdoor
 Speakers 58, 148
 Phonographs 78-81
 Preamplifiers 33, 38, 39
 Preamp Kits 38, 39
 Receivers, FM 33, 34, 40
 FM-AM 2-8, 20-25, 30, 31, 33, 34, 37, 110, 496
 Reverberation
 Units 32, 64, 176, 177, 202
 Speaker Crossover
 Kits 57, 59
 Speakers & Speaker
 Systems 36, 42-64, 66
 Stereo Compacts 2, 3, 35, 37, 80-84, 188
 Systems 18-31, 35, 37, 75, 76, 82, 84
 Tape Decks 90, 91, 98, 100, 111
 Tape Players 99, 110, 111
 Tape Recorders 85-88, 92-94, 97-99, 102
 Test Record 139
 Tone Arms 127, 131
 Tuners 9, 33, 36-40
 Tuner Kits 37-39
 Turntables 69-74
 Hoist, Miniature 359
 Horn, Auto 371

HOW TO ORDER 436

I
 IF Transformers 300-302, 467
 Insect Kit 362
 Inspection
 Light 336, 411
 Mirror 338
 Insulation, Acoustic 139
 Insulators 277, 312
 Stand-off 312, 396
 Integrated Circuits 271, 273

INTERCOMS
 Cable 161-165, 170
 Speakers 310, 311
 Wireless 171
 Interference filters 392, 468
 Inverter 354, 355
 Intrusion Alarms 321-323

JACKS
 Banana 284
 Phone 137, 282-284
 Phono 137, 282-283
 Tip 284
 Jig Saw 340, 342, 343, 345, 348

KEYS, Code Practice 462

KITS
 Amplifier 37-40, 212, 220
 Antenna 312
 Antenna
 Installation 395, 396, 440
 Audio
 Generator 234, 235
 Battery Tester 232
 Bias Supply 237
 Black Light 215
 Bookbinder 409
 Bridge, RC 235
 Broadcast Amplifier 213
 Broadcast Radio 213
 Cabinet 67
 Capacitor Checker 242
 Capacitor Substitution
 Box 235, 237
 Clock 223
 Code Practice
 Oscillator 220
 Computer 214, 273
 Converter 217, 220
 Enclosure 367
 Engine Analyzer 214-223, 248
 Experiment 223, 248
 Flyback and Yoke
 Tester 225
 Insect 362
 Keyer 463
 Lettering 409
 Mineral 221
 Oscilloscope 236, 237
 Photocell Relay 213
 Power Supply 220
 Preamplifier 38, 39
 Printed Circuit 220, 248, 249
 Probes 236
 R-C Substitution
 Box 235
 Receiver 37, 212, 217
 Short Wave Receiver 212, 213, 217
 Signal Generator 236, 237
 Signal Tracer 236
 Speaker Enclosure 65
 Speaker System 57, 66
 Tape Editing 115, 116, 119
 Tape Maintenance 115-117
 Teknikits 221, 439

TEST EQUIPMENT
 (See Item Wanted)

Transistor Diode
 Checker 233, 242
 Treasure Finder 220
 Tube Tester 233, 236, 242
 Tuners 37-40
 VOM 233, 237
 VTVM 233, 237
 Wireless Broadcast
 Amplifier 220
 Yoke Tester 225
 Knives 341, 357
 Knobs 252, 391

L
 L-Pads 138, 291
 Lazy Susan Bearing 357
 Label Maker 427
 Labeling Tape 427
 Lamp Cords 308

LAMPS
 Adjustable 327, 329
 Auto 372
 Fluorescent 324, 325, 327, 329
 Fixtures 327, 329
 High Intensity
 Inspection 324, 325, 337, 411
 Movie
 Neon 258, 259
 Outdoor 329, 330
 Panel 258, 259, 467
 Pilot 258, 259
 Portable Beacon
 Projection 330
 Replacement 258, 259
 Stroboscopic 115, 117, 135
 Ultra Violet 443
 Lantern 330
 Lathe 341, 342
 Lettering Kits 409
 Levels 357
 Leveling Kit, Phono
 Lighting Arrestors 396

LINE CORDS
 Appliance 308, 309, 328, 329
 TV 398
 Line Voltage Tester 230, 232, 242
 Locks 357
 Lubricants 135, 363, 391
 Lugs 377

M
 Magnets 353
 Magnifiers 41, 357
 Marine
 Equipment 147, 180, 450
 Masts, TV 395
 Megaphone, Power 140, 222, 451
 Melodicas 205
 Memory Card File 214
 Mercury Batteries 268

METERS
 Elapsed Time 245
 Exposure 423
 Field Strength 460
 Flow (Water) 362
 Frequency 245
 Panel 244-246
 Power Line 230, 238, 242, 246
 RF "S" 460
 "S" 466
 Stereo Balance
 Tuning 244
 VU 134
 Wattmeter 240
 Metronome 205
 Microammeter 245

MICROPHONES
 152-160, 280, 281
 Accessories 151, 157
 Cable 159, 160, 281
 Cable 137, 159, 467
 Cartridges 155, 157, 159
 Connectors 280, 281
 Contact 154
 Mixers 150

Stands & Booms 151, 159, 160
Transformers 159, 160

MICROSCOPES
 170, 411, 438-440
 Accessories 439, 441
 Illuminator 439
 Stylus
 Inspection 134, 135
 Milliammeter 245, 246
 Minibikes 430
 Mixers 150
 Modules, Solid-State 212, 216, 217, 272
 Monitors, Aircraft 183, 184, 444-448

MOTORS 314, 348
 Phono 131
 Speed Control 340, 348
 Movie Cameras 414, 416, 417, 419
 Editor 419
 Lamps 419
 Projector 414, 418
 Screen 419
 Outfits 414, 416
 Viewer 419
 Musical Instruments 192-198, 202, 205
 Accessories 156, 197, 199-203, 204, 219
 Microphones 154

N
 Needles 127, 130, 132, 133
 Needles, Cutting 134
 Neon Lamps 259
 Sockets 259
 Networks, Crossover
 (See Crossovers)
 Nibbling Tool 352
 Nickel Cadmium
 Batteries 268, 269
 Noise
 Suppressors 173, 296, 468
 Novatorn 221
 Nut Drivers 355, 356
 Nuvistor Tube Socket 279

O
 OHM's Law Calculator 275
 Oiler 116, 352
 Organs 198
OSCILLOSCOPES
 Kits 236, 237, 241, 243, 236, 237
 Oscillator Coils 467
 Outlets, AC 313, 328, 329

P
 Panels, Rack 314, 315
 Pantograph 408
 Pedometer 413
 Pencil Sharpener 428
 Pens 409

PHONO EQUIPMENT
 Amplifiers 131, 212
 Bases 68, 73, 139
 Cables 137
 Cartridges 126, 128-130
 Changers 68-73
 Covers 135
 Levels 135
 Motors 131
 Mounting Boards 118
 Needles 130, 132, 133
 Oscillator 131
 Preamplifier 131
 Plugs & Jacks 137
 Spindles-Spiders 130, 135

Systems 80-84
 Tone Arms 131
 Turntable 131
 Phonographs 77-81
 Photocells 250
 Photo Electric Equipment
 Kits 213
 Switch 326
 Photographic Equipment
 416-426

PICTURE TUBES
 Brighteners 266, 267
 Extension Harness 278, 279
 Restorers 243, 398
 Sockets 278, 279
 Pilot Lights 258, 259, 467
 Planers 344, 350
 Plastic Cases 313, 336
 Plating Kits 372
 Pliers 354

PLUGS
 AC 313
 Banana 277
 Cable 137, 278, 280-283
 Phone 137, 282-283
 Phono 137, 282-283
 Pocket Pager
 Police/Fire Receiver 182-185

Polystyrene Rods 247
 Sheets 247
 Tubes 247
 Posts, Binding 284
 Potentiometers 290-293
 Power Controls 290
 Power Plants 262, 451
 Power Supplies 219, 230, 231, 238

PREAMPLIFIERS
 Amateur & CB 468, 469
 Hi-Fi 38, 39
 Kits 38, 39

PRINTED CIRCUITS
 218-220, 248, 249, 272, 273, 278, 279
 Boards 248, 249
 Connectors 248, 249
 Sockets 248, 249
 Kits 248, 249
 Probes 230, 236-238, 240, 243
 Projectors
 Movie 416
 Opaque 411
 Slide 420, 421

PUBLIC ADDRESS
 Accessories 149-160, 171
 Amplifiers 140-145
 Baffles 148
 Megaphones 140, 222, 451
 Microphones 152-160
 Mixer-Preamps 150
 Pocket Pager 477
 Speakers 146-149
 Systems 140-145
 Pumps
 Submersible 362
 Siphon 363
 Punches 357
 Chassis 353

R
RACKS
 Steel 314
 Radar Detector 372

RADIO CONTROL EQUIPMENT
 Airplane 209
 Cars 209
 Garage Door Opener 363

Systems and Accessories 209-211

RADIOS
(Also See Receivers)
Automobile 174, 175, 177
Kits 180, 185, 187, 447
Marine 106, 178-187, 447
Portable 32, 180, 188-191
Table 450-451
Radio-Telephone 415
Rain Gauge 350
Reamers 183-187, 496

RECEIVERS
Aircraft 183, 448
Communications 212, 452-454, 458, 495
Fire/Police 182-185, 444-448
FM 33
FM-AM 2-8, 20-25, 30, 35, 37, 106, 183-187, 496
VHF Communications 183, 444-448, 495

RECORDS
Adaptors 130
Albums 77, 135
Blanks 134
Cabinets 67
Care Accessories 134, 135
Changers 68-73
Code Practice 463
Foreign Language 407
Guitar Instruction 205
Racks 134
Test 139

RECORDERS, TAPE
85-88, 99-103, 112
Recording Tapes 113, 119-121

RECTIFIERS
Meter 244
Rectifier Mounting Kits 271, 272
Selenium 271, 274, 285
Silicon 271, 272, 274, 285
Reels, 8 mm 419
Tape 117, 120
Refractometer, Sugar 437
Refrigerators 430

RELAYS
209, 253-257, 460
Cleaning Tools 253
Remote Control Equipment (See Radio Control)
Remote Control (Switches) 326
Remote TV/Radio Earphone Adapters 206

RESISTORS
275, 276
Adjustable 276
Assortment 275
Color Code Guide 275
Fusible 398
Power 276
Substitution Box 229, 235, 237
Reverberation Equip. 32, 64, 176, 177, 202
Rheostats 290
Riflescope 442
Rivets 356
Rotors, Antenna 405, 473
Router 345, 390
Rules 357, 410

S

Sanders 343, 348, 350
Saws 342-345, 348-350, 352
Blades 343-345, 348-350
Science Specialties 221, 223
Screwdrivers 355-357
Security Equipment 321-323, 370
Servos, RC 209-211

SemiConductors 271-274
Shaft Coupling 251
Shelves 139, 360
Brackets 139
Shears 357

SHIPPING INSTRUCTIONS

435
Shortwave Receivers 174, 178, 184-187, 190
Signal Generators 118, 228, 234, 236-238, 241
Kits 234
Signal Tracers 230, 235-237
Siphon 395, 405

SLIDE
Projector 420, 421
Rules 410
Staining Kit 439
Viewer 421, 422

SOCKETS
Cable 278
Crystal 461
Pilot Light 259
Printed Circuit Relay 256
Transistor 278
Tube 278, 279
Socket Wrenches 356, 358
Solar Cells 250

SOLDERING EQUIPMENT
Accessories 332-334
Guns & Irons 332-334
Solder 331
Aids 331, 338

SPEAKERS
Auto 107, 171, 172, 177
Ceiling & Wall 148, 149
Coaxial 54, 57, 59
Hi-Fi 51-54, 56, 57, 59, 63
Extension 148
Musical Instruments 204
Outdoors 58, 146-148
P.A. 146-149
Pillow 206, 208
Replacement 171
Systems 42-64
Systems, Kits 57, 66
Trumpets 147
Tweeters 55, 57, 59
Woofers 55, 57, 59

SPEAKER ACCESSORIES
Acoustic Padding 139
Bases 60
Cable 308, 309
Controls 59, 138
Crossovers 57, 59
Enclosures 51, 53, 65
Grille, Auto Speaker 172
Grille Cloth 139
L-Pads 138, 291
Stands and Bases 60
Switches 138, 172
T-Pads 138, 291
Spectroscope 443
Spotting Scopes 442
Sprayer, Paint 361
Standoff Insulators 396
Stands, Microphone 151, 159, 160
Staple, Gun 351
Staples 351

STEREO EQUIPMENT (See Hi Fidelity)

Strobe Lights 41
Styli 127, 130, 132, 133
Brush 117, 134, 135
Microscopes 134, 135
Pressure Gauges 135
Store Addresses 12, 13
Submersible Pump 362

SWITCHES
Antenna 257, 391, 461
Automatic Light 321, 326
Coaxial 461

Delayed Action 304
Dimmer (Light) 328
Foot 307
Intercom 304-306
Knife 305, 391
Lever 305, 306
Lock 305
Mercury 313
Microphone 281
Momentary 303-306
Photoelectric 321, 326
Potentiometer 291
Proximity 305
Push-Button 303-306, 327
Remote Control 326, 329, 340
Rocker 303, 305
Rotary 305-307
Slide 304
Speaker 138, 172, 305
Starter Remote 366
Stepping 257
Time 318-320
Toggle 303, 304
Wall 328
Whistle 326
Switch Plates 306

T

T-Pads 291
Tachometer 366, 367, 369

TAPE
Alignment 119
Cartridges 106, 113, 120
Demagnetizer 107, 114-118, 139
Editing Kit 115, 116, 119

Electrical 327, 355
Labels 115-117
Leader & Timing 116, 118, 120
Prerecorded 105, 113
Recording 119, 120
Reels 117, 119
Sensing 116
Splicer 106, 115, 116, 118, 120
Test 115

TAPE RECORDING EQUIPMENT

Accessories 106, 107, 114-119, 122
Auto, Portable Player 95, 96, 102-104, 106, 109, 114
Decks 90, 91, 98, 100, 111
Home Player 99, 110, 111
Heads 110, 122
Recorders 85-88, 92-94, 97-99, 102
Stereo Tape Head Conversion Kits 122
Taps & Dies 353, 356
Telephones 116, 222
Amplifier 165, 222
Answering Equipment 167
Extension Cord 166
Intercom 164-166
Pickup 117, 118
Recorder 167
Telescopes 170, 441, 442
Accessories 441

TELEVISION

Alignment Tools 338
Antennas 376-386
Antenna Couplers 388, 392, 393
Attenuators 391
Black & White Boosters 381, 387-389
Cheater Cord 398
Clock 463
Close Circuit Camera 170
Color Set 169
Controls 290-293
Degausser 391
Distribution Units 388, 389



Extension Speakers 148
Harness Kits 398
I.F. Coils 300-302
Knobs 391
Masts 395
Matching Transformer 393
Picture Tubes 266-267
Picture Tube Brightener 398
Picture Tube Tester/Rejuvenator 233, 243
Receivers 168, 169
Remote Control 326
Rotors 465, 473
Sound Stabilizer 397
Splitter 392, 393
Towers 395
Tuner 391
Twin Line 308, 311
Voltage Regulator 285, 398
UHF Converters 384
Templates 409
Terminals 248, 249
Terminal Strips 247

TUBES
Adapters 278, 279
Brighteners 233
Caddy 265
Cooling Fan 134, 314
Manuals 267
Pin Straighteners 267
Pullers 267
Saver 398
Shields 279
Sockets 278, 279
Testers 226, 227, 233, 236, 242, 243
Kits 233, 236, 242

TUNERS
Auto 177
AM 106
FM Hi-Fi 39, 40, 106
FM Kits 37, 39
FM-AM, Hi-Fi 9, 36
TV, Front End 391
Tuning Dials 252

TEST EQUIPMENT (See Item Wanted)
Test Leads 229, 277, 284
Tester Battery 232
Tube 226, 227, 233, 236, 242
Thermometers 417
Timers 135, 318-320, 425
Timing Light 366
Tone Arms 127, 131

TURNABLES
69-74
TVI Filters 468
TV Sets 168, 169
Tweeters 57, 59
Tweezers 338
Typewriters 429

U

UHF Converters 384
Ultra-Sonic Cleaners 443
Ultra Violet Light 443

V

Vacuum Cleaner 351
Vacuum Gauge 366, 369
Variable Voltage Transformers 285
VFO's 472
Vibrators 173, 468
Vises 352
Voltage Regulators 285, 398
Voltmeters 241, 242, 245, 246

VOLUME CONTROLS
138, 290-293
Accessories 292-293

VOM'S
224, 225, 232, 237-239, 240
Kits 232, 237
VTVM 226, 232, 237, 240
Kits 232, 237
VU Meters 134

W

Wall Plates 329
Walkie-Talkie 481-485
Accessories 484, 485
Watches 412, 413
Waterfall Kit 362
Wattmeter 240
Weather Instruments 221, 414
Welders 331
Wire Bending Jig 337



WIRE & CABLE

Antenna	173, 308, 312
Appliance	308-309
Coaxial	309-311, 393, 470, 471
Extension Cords	313, 328, 329
Hook-Up	312
Ignition	375
Intercom	310, 311
Line	308-309
Litz	311

Magnet	309
Microphone	137, 159, 310, 311
Phono	137, 309, 310
Rotor	308
Shielding	309
Speaker	308, 310, 311
Telephone	166, 309, 311
Test Prod	311
Twin Line	308, 311
Wire Strippers	354

Wireless Broadcaster Kit	220
Wireless Intercom	162
Woofers	57, 59
Work Benches	360
Wrenches	357-359
Y	
Yoke Checkers	225
Z	
Zener Diodes	272, 274

INDEX TO MANUFACTURERS

A	
Acme	284, 398
Acoustic Research	39, 60
ADC	127
Adel	352
Aerovox	295, 297, 298
Airequipt	420
Aiwa	98, 112
Akro-Mils	339
Alert	322
Allen-Bradley	275
Alliance	390
Altec Lansing	63, 204
Ameco	389, 457, 459, 461-463, 467, 468
Amperite	253
Ampex	97, 98, 100, 104
Amphenol	256, 279, 280, 281, 284
Amprobe	230, 242
Antenna Specialists	474
Arco Tool	343, 348
Argonne	288
ARRL Books	401
Arrow	351
Astatic	128-130, 151
Atlas Sound	147, 151, 204
Atlas Warner	419
Audel	407
Audio Devices	134
Automatic Radio	104, 108, 109, 114
B	
B&K	242, 243
B&W	461
Baia	419
Barber-Colman	314
Bauer	417
Beauchaine	247, 278
Belden	309-311
Bell & Howell	418
Benjamin/Miracord	74
Black & Decker	343, 346
Blaupunkt	178
Blonder-Tongue	384, 386, 389, 393
Bogen	150, 163
Bohn	428
Brother	428
BSR	130
Burgess	268, 330, 342
Bushnell	437
Buss	317
BVI	342
C	
C. F. Cannon	207
Cannon Electric	280
Centralab	298, 299
Century	350
Channellock	354
Chemalloy	331
Chicago-Stancor	284, 286, 287
Citizen-Ship	210, 211
Clarex	250
Clarostat	291
Clevite-Brush	207

Concord	102
Cordomatic	329
Cornell-Dubilier	296, 365, 390, 465, 473
Craig	96, 99, 102, 111
Criterion	42-50
Crown	167
Cushcraft	464, 465, 473
Cutler Hammer	303
D	
Data	409
Dearborn	327
Dejor	417
Delta	368
Dexion	360
Dixon	367
Dow Key	461
Drake, R. L.	457-459, 461
Dremel	340, 342, 343
Dual	69
DuPont	336
Dymo	427
Dynachrome	425
Dynaco	38, 39, 64
Dynamic	331
E	
Eagle	324
EBY	279
Eico	40, 41, 220, 231-236, 463, 475
Electra	447
Electro-Voice	59, 128, 129, 146, 147, 160
Elenex	473
Elmenco	296
EMC	236
Emerson-Rittenhouse	163, 323
Emico	230, 246
Empire	63, 64, 126, 127
Ersin	321
Estey	198
Euphonics	323
Eveready	268
F	
Fairchild	273
Fedtro	320, 362
Fiamm	371
Finco	383, 387, 392
Fisher	30-32
G	
Garrard	70-73
Gavin	384, 385
General Cement	336, 338
General Electric	130, 261-267, 271, 272, 274, 399
Gernsback	399, 400
Gilbert	223
G.L./Tab	406
Grado	127
Greenlee	353
Gulton	322, 330
H	
Hallicrafters	457
Hammarlund	251, 457

Harman-Kardon	63, 75
Hart & Hegeman	305
Hayden-Rider	402, 403
Hirshline	360
Hitachi	178
Hohner	205
Hy-Charge	364
Hy-Gain	464, 475
I	
IMC	134
Industrial Devices	258
Injectoral	391
Intermatic	318-320
Int'l Rectifier	250, 275, 276
IRC	275
J	
JBT	245
JFD	380, 386, 387, 392, 393, 396
Jerrold	386
Johnson, E. F.	257, 312, 461, 473
Jonard	253
Judson	368
K	
Kester	321
Keystone	269, 420
Kidde	330
Kinector	227
Kingston	230
KLH	61, 76
Kodak	425, 426
Konica	420
Koss	124, 125
Kowa	421
Kræuter	354
Krylon	337
L	
Lear Jet	109, 111, 114
Lectrotech	230
Littelfuse	316, 317
Linemaster	307
Lowell	149
Luxo	325
M	
Magnus	198
Mallory	173, 268, 276, 291-293, 306, 307, 320, 321
Marantz	323
McGraw Edison	342-344, 346
Meissner	300, 302
Mercury	242
Miller, J.W.	300-302
Minolta	421, 426
Miranda	421
Misco	148
Moody	356
Mosley	464, 473
Motorola	267, 268, 271, 273
Mueller	277
Mullard	265

N	
National	252, 301
New-Tronics	465
Nordmende	178
Norelco	96, 98, 99, 103, 215
Nortronics	122
Nova-Tech	447, 451
O	
Ohmite	275, 290
On-Guard	370
Oryx-Telvac	333
P	
Panasonic	97, 99, 101, 111, 168, 169, 178
Paragon	320
Perma Power	284, 363
Pickering	126
Pomona	278
Porter	223
Potter and Brumfield	254-257
Precision	228
Premier	314, 315
R	
Ram	343-347
Ranger	109
Raytheon	215
RCA	237, 238, 261-268, 273, 274, 399, 407
Rectilinear	63
Regency	448
Rembrandt	382, 384, 385
Remington	223
Renwal	352
Revere	426
Rhodes	319
Rider	463
Roberts	101
Robins	115-117, 135, 280
Royal	429
S	
Sams Publications	400, 404, 405
Sangamo	297
Sarkes-Tarzian	285
Sawyers	421
Schauer	364
Scotch	36, 120
Scott, H.H.	34, 35, 37
Secore	241
Sennheiser	124
Seth Thomas	205
Shakespeare	451
Sharp	178
Shop-Vac	351
Shure	127, 150, 157
Shure-Fire	364
Shurite	246
Simpson	240
Skil	344, 347
Smith, H.H.	284
Smith-Corona	428, 429

Soligor	423, 424
Sonar	450, 451
Sonotone	130
Sony	96-102, 104, 112
South River	394, 396
Spaulding	395
Sprague	239, 294-296, 298
Spray-It	361
Spyraline	331
Staco, Inc.	284
Standard Kollsman	391
Superox	125, 206, 392
Supreme	406
Swan	458, 459
Swingline	351, 356
Switchcraft	137, 281, 283, 305
T	
Tacro	409
Taylor	414
Teac	100
Techniques	248
Telex	208, 283
Tenna	108
Terado	364, 365
Testor	209
Thor	345, 346
Trindl	321
Triplett	239, 245
Tripp-Lite	365
Turner	157, 320, 359
U	
Ultrablitz	422
Ungar	334, 335
Unimat	341
United Audio	69
University	59, 147
Utah	64, 131, 146, 172, 204
V	
Vaco	337
Vector	249, 278
Vibroplex	462
Viceroy	417, 420
Viking	112
W	
Waldom	336, 337
Walsco	391
Weller	332
Wen	333, 343, 345, 346
Westlock	319
Westinghouse	425, 447
Wharfedale	62
Winegard	381, 384, 388
Wollensak	102
Worner	321
X	
X-Acto	338, 341
Xcelite	354
Y	
Yashica	417, 420, 421, 426

You Can Depend On **LAFAYETTE...**

...for Your Complete Satisfaction

When you buy from Lafayette, you buy with confidence. Lafayette's pledge to you, of "Satisfaction Guaranteed or Money Refunded," is your assurance that we mean what we say. For 49 years we have kept this pledge to you . . . and shall continue to do so in the future.

LAFAYETTE AAA GUARANTY

LAFAYETTE HIGH FIDELITY SPEAKERS = 5 YEARS
LAFAYETTE HIGH FIDELITY RECEIVERS = 2 YEARS
LAFAYETTE HIGH FIDELITY TUNERS = 2 YEARS
LAFAYETTE HIGH FIDELITY AMPLIFIERS = 2 YEARS

All Lafayette high fidelity components identified as covered by Lafayette's AAA guaranty are guaranteed to be free of defects in material or workmanship from the date of sale for the time period shown above. During that period we will repair (or at our option replace) them without charge for either material or labor. Material must be returned prepaid to us for our inspection. This guaranty does not apply to items which have been subjected to misuse, abuse, alteration, repair without our authorization or used in violation of operating instructions, nor to normal wear and tear. The speaker guaranty does not cover external parts such as cabinets, grille cloth etc. Serial number must not be defaced. Guaranty is not transferrable.

OTHER GUARANTEES

All merchandise not covered either by the special guarantees on this page or by other specific guarantees in the catalog are covered by a 90 day repair or replacement guarantee (at our option) against defects in material or workmanship.

LAFAYETTE AAM GUARANTY

This guaranty covers Lafayette items so indicated in our catalog which contain several integrated sections in a single unit such as compacts and integrated entertainment centers. The time period for each section is as follows:

SPEAKERS	5 YRS.
RECEIVER OR TUNER SECTION	2 YRS.
AMPLIFIER SECTION	2 YRS.
RECORDER SECTION	3 MOS.
CHANGER SECTION	3 MOS.

The terms and conditions of this guaranty are otherwise identical to the AAA Guaranty.

SATISFACTION GUARANTEED

If for any reason you are not satisfied with your purchase, return it to us within 30 days after we ship it, in the original factory carton and we will exchange it or return your money (less transportation charges). Merchandise returned must be in good condition and not soldered or abused—no holes drilled or changes made in any other way. This policy does not apply to kits, nor to pre-recorded tape, records, books or merchandise not regularly stocked that has been ordered especially for you.

HOW TO RETURN MERCHANDISE

(Merchandise Returned Must be in New Condition)

We want you to be completely satisfied with every item you purchased from us. If there is an irregularity in your shipment and you find it necessary to return an item to us, follow these instructions:

- 1) PARCEL POST SHIPMENTS** Place all order papers, invoices, correspondence and your instructions in an envelope inside your package.
- 2)** On the outside of your package, mark "First Class Mail Enclosed" (directly below the postage) and add an additional 6c postage. **Do not send the letter separately;** it will delay our speedy adjustment handling.
- 3)** Pack the merchandise securely and send to:
**Customer's Service Dept.,
 LAFAYETTE RADIO ELECTRONICS,
 111 Jericho Turnpike,
 Syosset, L.I., N.Y. 11791**



- 4)** For your protection, report damaged receipts to your postman and enclose his report with your papers.

BY EXPRESS OR TRUCK

If your shipment is received damaged, obtain a report from your express agent or trucker, and mail to us. Wait until you receive our instructions on how to return.

(NOTE—Merchandise not regularly stocked that has been ordered for you is NOT returnable for refund or exchange).

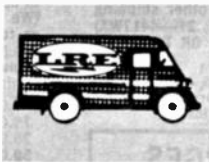

IF IT IS NECESSARY TO WRITE US:

Before writing, please compare papers or invoices with merchandise received. You will find explanations on your order papers about how your order has been handled. Sometimes merchandise arrives before or after order papers. Please wait until you have both before writing. If you write, be sure to include all papers concerning the order. Please give names of items, catalog numbers, quantity, color, price, and any special information you think necessary. The more details you give us, the more quickly your adjustment will be made. On Easy Payment orders, be sure to include your EP account number on package and correspondence.

Fast Direct Air Shipping Service To West Coast

The Following Area will now receive speedy air shipping service: **LOS ANGELES.**

No more than 4 day door to door delivery via United Parcel Service to California, Washington and Oregon.

Parcels utilizing this rapid service must weigh no more than 50 pounds and measure up to 108 inches in combined length and girth. This system applies if the service or rates are to your benefit.

SHIPMENTS OUTSIDE OF THE UNITED STATES

We ship all over the free world. Allow up to 60 days for delivery. Write to our International Sales Division for details (See page 6).

Make Lafayette Your One Dependable Source for Everything in Electronics

SHIPPING AND DELIVERY INFORMATION

PARCEL POST SHIPMENT

HOW TO ESTIMATE PARCEL POST CHARGES



WEIGHT 1 Lb. & Not Exceeding	Local	1st & 2nd Zone up to 150 mi.	3rd Zone 150 to 300 mi.	4th Zone 300 to 600 mi.	5th Zone 600 to 1000 mi.	6th Zone 1000 to 1400 mi.	7th Zone 1400 to 1800 mi.	8th Zone Over 1800 mi.
2	\$0.50	\$0.60	\$0.60	\$0.65	\$0.70	\$0.80	\$0.85	\$0.90
3	.50	.65	.70	.75	.85	.95	1.05	1.15
4	.55	.70	.75	.85	.95	1.10	1.20	1.35
5	.55	.75	.80	.90	1.05	1.25	1.40	1.60
6	.55	.80	.90	1.00	1.15	1.40	1.55	1.75
7	.60	.90	.95	1.10	1.30	1.50	1.75	1.95
8	.60	.95	1.00	1.15	1.40	1.65	1.90	2.15
9	.65	1.00	1.05	1.25	1.50	1.80	2.05	2.35
10	.65	1.05	1.15	1.35	1.65	1.90	2.25	2.55
11	.65	1.10	1.20	1.40	1.75	2.00	2.40	2.75
12	.70	1.15	1.25	1.50	1.85	2.15	2.55	2.90
13	.70	1.20	1.35	1.55	1.95	2.25	2.70	3.10
14	.75	1.25	1.40	1.65	2.05	2.40	2.85	3.25
15	.75	1.30	1.45	1.75	2.15	2.50	3.00	3.45
16	.75	1.35	1.55	1.80	2.25	2.60	3.15	3.60
17	.80	1.40	1.60	1.90	2.35	2.75	3.30	3.80
18	.80	1.45	1.65	1.95	2.45	2.85	3.45	4.00
19	.85	1.50	1.75	2.05	2.55	2.95	3.60	4.15
20	.85	1.55	1.80	2.10	2.65	3.10	3.75	4.35
For Each Extra Lb.	Add 5c	Add 5c	Add 5c	Add 5c	Add 10c	Add 10c	Add 15c	Add 15c

Up to 16 oz., all zones allow 6¢ for first 2 oz., 2¢ for each additional oz. Find the weight of your merchandise in the extreme left-hand column of the chart at left. Pay the amount listed for Parcel Post shipment to your zone. A fraction of a pound is charged as a full lb. For example, if the weight is 6 lbs. and 1 oz. to Zone 3, postage would be for 7 lbs. (95c). Over 40 lbs. shpd. truck or exp. See below.

AIR PARCEL POST SHIPMENTS

We will ship your order via Air Parcel Post upon your request. Rates are given in the table, below. Size and weight limits: 70 lbs. and 100 in. (length plus girth).

7c per ounce, up to 8 ounces									
ZONES 1, 2 & 3 4 5 6 7 8									
1st LB.	.80	.80	.80	.80	.80	.80	.80	.80	
For Each	Add	Add	Add	Add	Add	Add	Add	Add	
Extra Lb.	48c	50c	56c	64c	72c	80c	80c	80c	
U.S. Territories, Possessions and APO & FPO Addresses, 80c per lb.									
MINIMUM ORDER CHARGE									
ORDERS UNDER \$5.00								\$5.00	
PARCEL POST								\$5.00 to 15.00	20¢
HANDLING								15.01 to 50.00	30¢
CHARGE								50.01 to 100.00	40¢
								100.01 to 150.00	50¢
								151.00 and up	60¢

USE YOUR ZIP CODE TO FIND YOUR PARCEL POST ZONE

This zone chart lists the first three digits (prefix) of the ZIP Codes of the sectional center facility of address. To determine the zone distance to a particular post office, ascertain the ZIP Code of the post office to which the parcel is addressed. The first three digits of that ZIP Code are included in this chart, and to the right thereof of the.

Zip Code Prefixes	Zone	Zip Code Prefixes	Zone	Zip Code Prefixes	Zone	Zip Code Prefixes	Zone	Zip Code Prefixes	Zone	Zip Code Prefixes	Zone		
006-009	7	080-086	2	178-199	2	339	6	469	5	577	7	756-762	6
010-013	2	087-098	1			350-364	5	470	4	580-585	6	763-770	7
	3			200-218	3	365-366	6	471-472	5	586-593	7	773	6
015-018	2	100-116	1	219	2	367-374	5	473	4	594-599	8	774-775	7
019	3	117-118	1	220-238	3	376	4	474-479	5			776-777	6
020-024	2	119-127	2	239-253	4	377-385	5	480-489	4	600-639	5	778-797	7
025-026	3	128-136	3	254	3	387	6	490-491	5	640-648	6	798-799	8
027-029	2	137-139	2	255-266	4	388-389	5	492	4	650-652	5		
030-033	3	140-149	3	267	3	390-392	6	493-499	5	653	6	800-812	7
034	2	150-154	4	268-288	4	393	5			654-655	5	813	8
035-043	3	155	3	289	5	394-396	6	500-503	6	656-676	6	814	7
044	4	156	4	290-293	4	397	5	504	5	677-679	7	815	8
045	3	157-159	3	294	5			505	6	680-692	6	816-828	7
046-049	4	160-161	4	295-297	4	400-402	5	506-507	5	693	7	829-874	8
050-051	3	162-163	3	298-299	5	403-406	4	508-516	6			875-877	7
052-053	2	164-165	4			407-409	5	520-539	5	700-722	6	878-880	8
054-059	3	166-169	3	300-324	5	410-418	4	540	6	723-724	5	881-884	7
060-067	2	170-171	2	325	6	420-427	5	541-549	5	725-738	6	890-898	8
068-077	1	172-174	3	326-329	5	430-458	4	550-554	6	739	7		
078	2	175-176	2	330-334	6	460-466	5	556-559	5	740-754	6		
079	1	177	3	335-338	5	467-468	4	560-576	6	755	6	900-999	8

ABOUT C.O.D. ORDERS

If you order C.O.D., the post office collects a handling charge, plus a money order fee, in addition to the regular parcel post charge. (We cannot accept C.O.D.'s for APO's, FPO's or for special-order merchandise). The extra C.O.D. fees are:

Amount of Order	Money Order Fee	COD Fee
Minimum Order \$5.00		
\$ 0.01 to 10.00	25c	70c
10.01 to 25.00	25c	80c
25.01 to 50.00	35c	90c
50.01 to 100.00	35c	1.00
100.01 to 200.00	40c	1.10

UNITED PARCEL DELIVERY

If your area is serviced by UPS and the service or rates are to your benefit, we will route your order via United Parcel Service. This fast, economical service is available from New York to most of the eastern states for parcels up to 50 lbs. and 108 inches in length and girth.



LAFAYETTE

APPROXIMATE REA EXPRESS CHARGES

Weight	100 Miles	150 Miles	300 Miles	500 Miles	1000 Miles	2000 Miles	2400 Miles
20 lbs.	5.50	5.65	5.75	6.10	6.80	8.15	8.80
30 lbs.	5.85	6.05	6.25	6.80	7.80	10.00	10.95
40 lbs.	6.20	6.50	6.70	7.45	8.80	11.85	13.15
50 lbs.	6.60	6.90	7.20	8.15	9.85	13.70	15.30
60 lbs.	6.95	7.35	7.70	8.80	10.85	15.55	17.45
70 lbs.	7.35	7.75	8.20	9.50	11.90	17.40	19.60
80 lbs.	7.70	8.15	8.65	10.15	12.90	19.25	21.80
90 lbs.	8.05	8.60	9.15	10.80	13.90	21.10	23.95
100 lbs.	8.40	9.00	9.60	11.40	14.85	22.75	25.90

LAFAYETTE TRU-ZOOM™

Wide Angle • Not a "Vari-Power"



44⁹⁵ No Money
Down*

One Control Zooms both barrels!

- 7X to 12X—or any Power in Between
- Center Focus—Right Eye Adjust—Plus Single Synchronous Zoom Control!

Sensational Zoom action holds even fast-moving subjects in perfect view. Sight in any subject at 7-power—then Zoom up to 12-power (or any power in between) for closeup viewing. Full 40mm, objective lenses, hard coated achromats. Field of view is 323 feet at 1000 yds., at 7 power (6°), 289 feet at 1000 yds. at 12 power (5.5°). Prisms clamped in shock-resistant mounts. Lightweight alloy frame and body. Sealed against dust and moisture. Includes push-lined, hard case and straps. Imported. Shpg. wt., 5 lbs.
99 E 71006 Net 44.95

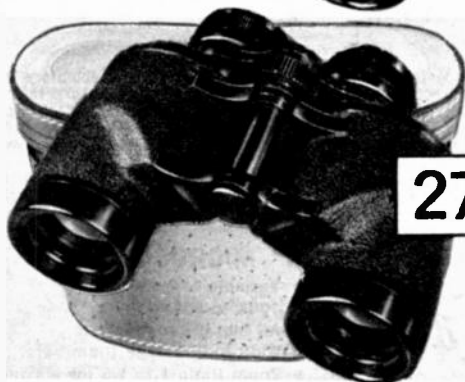

27⁹⁵



As Low As
16⁹⁵

EXTRA WIDE-ANGLE BINOCULARS

- Doubles The Field Of Ordinary Binoculars
- 580 Ft. Field Of View at 1000 Yards
- Oversize Oculars • Exceptional Quality

A multi-purpose, precise 7x35mm binocular that is particularly adept for field studies. Wide-angle hard coated prisms permit brilliant and close-up details of sporting events, without sacrificing the image, as is the case with regular narrow angle binoculars. Field of view at 1000 yards is 580 feet! Center focus and right eye adjustment insure perfect focus. All optics are sealed against moisture and are properly collimated and aligned. Hard lined case for protective storage when not in use. Complete with neck strap. Imported. Shpg. wt., 4 lbs.
99 E 70195 Net 27.95

BINOCULAR MOUNTING CLAMP

Tripod adapter fits all binoculars by clamping around center post. Binocular can be stored in case with mount attached. Fits onto any standard camera tripod. Especially adapted for high powered binoculars. Imported. Shpg. wt., 4 oz.
15 E 42059 Net 2.29

VERSATILE BINOCULARS

Precise design—quality material—and expert workmanship. All lenses are hard coated—prisms clamped in lightweight alloy frame and body—sealed against dust and moisture—properly collimated and aligned. All are center focus with adjustable right eyepiece. Hard lined case and neckstraps included.

7x35 POPULAR, VERSATILE, ALL PURPOSE BINOCULARS. For the sportsmen—hunter—bird watcher—vacationer. High luminosity. Compact design. Imported. Shpg. wt., 3 lbs.
99 E 70187 Net 16.95

7x50 NAVY STYLE NIGHT GLASSES. Favored for marine use. The choice of professionals because of exceptionally high light gathering power. Superior image brightness. Imported. Shpg. wt., 3½ lbs.
99 E 70161 Net 21.95

20x50 KING OF THE LONG RANGE. Hunters, mountain climbers, plane spotters, forest rangers—any long distance viewing and observation requirement. Imported. Shpg. wt., 4½ lbs.
99 E 70203 Net 27.95

MAGNI-BOOSTER

Converts Binoculars Into High-Powered Scope

- Magnifies Binocular power 2½ Times (7 Power becomes 17½ Power!)

Instantly converts standard binoculars into a high-powered all-purpose spotting scope with crystal clear magnification! Performs the function of usually bulky telescopes. Increases the power of your binoculars 2½ times making it possible to spot details which cannot be seen with the binoculars alone. Ideal for slipping onto your binoculars when spotting game, checking target hits, or other uses where critical viewing is necessary. Easily slips off for standard binocular viewing. Fits over front lens of binocular with appropriate locking adapter (see below). Focuses with binocular controls or with its own focusing ring. Shpg. wt., 1 lb.
15 E 42018 Net 14.95

MOUNTING ADAPTERS

Stock No.	For Binocular Objective Rim Dia.	Net
15 E 42026	1¾" to 2" O.D.	2.49
15 E 42034	2" to 2½" O.D.	2.49
15 E 42042	2½" to 2¾" O.D.	2.49

* See Page 11 for Full Credit Details on Easy Pay Plan

Bushnell

INSTA-FOCUS 7x35 Wide Angle Binocular



39⁹⁵



"Focus So Fast—You'll Think It's Automatic!"

- With Hard Lined Case

Superb performance, both optically and mechanically. Focus fast and accurately with finger. Perfect for baseball, football, racing, nature study, and travel. When the action is fast, there's no time to adjust the focus as in standard binoculars. Exclusive "INSTA-FOCUS" changes focus so rapidly it's almost automatic. Reduces eye fatigue to a minimum. Wide field of coverage (578 feet at 1000 yds.). Blue coated lenses provide protection against reflected glare of water, sand, snow, and haze. With hard lined case. Shpg. wt., 4 lb.
15 E 11013 Net 39.95

LAFAYETTE

Microscopes

900X "ZOOM" STUDENT LABORATORY

Complete Outfit
For Only **19⁹⁵**

- Zoom from 100 to 900 Power
- All Metal Construction
- All Dissecting and Mounting Materials
- Prepared and Blank Slides
- Includes AC/DC Substage Illuminator



For BEGINNERS & INTERMEDIATE STUDENTS

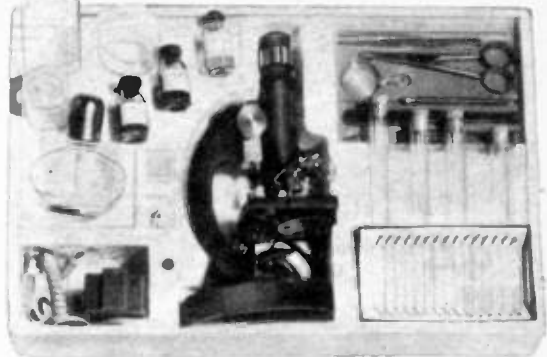

A complete microscope laboratory for the student and enthusiast. Provides all necessary material to explore the interesting field of microscopic research. The 900X microscope offers various combinations of magnification from 100X to 900X with four objective lenses (10X, 20X, 40X, 60X). Combined with the fine ocular which "zooms" from 10X to 15X, the scope provides clear, sharp images. Tube movement governed by adjustable downstop with a locking screw...prevents costly slide breakage. The 900X features an optical condenser, plano mirror and built-in 3-volt light using the

AC adapter included, or 2 penlight batteries. Laboratory includes a dissecting kit with hand lens, blunt-end scissor, scalpel and probe; glassware (test tubes, specimen bottles, alcohol burners). There are several prepared slides, blank slides, cover glasses, mounting balsam, Methylene Blue and Rhodamine stains. Imported. Shpg. wt., 7 lbs.

99 E 71953 Complete Microscope Outfit	Net 19.95
99 E 71060 Replacement bulb	Net .15
99 E 62580 Battery (2 required)	Net ea. .10

80X TO 1200X ZOOM MICROSCOPE SET

24⁹⁵



- 80X-1200X Magnification
- Variable Zoom Eyepiece
- 3-Way Substage Mirror
- Complete Set of Dissecting Instruments
- 4 Achromatic Objective Lenses
- All Metal Construction

Constantly variable magnification of 80, 100, 160, 200, 400, 600, 800 and 1230 times. Zoom eyepiece for less specimen adjustment and controlled detail magnification. Excellent dual knob coarse and fine focus control. Stage includes optical condenser and aperture diaphragm. Spring loaded rack prevents damaging objective. Substage illuminator-mirror combination for direct, incandescent, or reflected illumination. Includes 2 prepared slides, 4 blank slides, spatula, scalpel, probe, scissors, tweezers, and magnifying glass. Wooden case with carrying handle. Illuminator operates on penlight cells or house current, by means of a transformer. Less batteries. Imported. Shpg. wt., 6 lbs.

99 E 71409 Zoom Microscope	Net 24.95
99 E 71060 Replacement Bulb	Net .15
99 E 62580 Battery (2 required)	Net ea. .10
TRANSFORMER—Permits use of house current for illumination of zoom microscope.	
99 E 71102 Shpg. wt., 8 oz.	Net 1.80

900X "ZOOM" MICROSCOPE SET

14⁹⁵



- Variable Magnification
- 100X to 900X
- All Metal Construction
- Built-in Substage Illuminator
- Zoom Ratio 1 to 1.5 for Maximum Resolution
- 4 Coated Objectives

Ideal for student or hobbyist. Features advanced zoom type micro-optics. Zoom action permits smooth, vibration-free, variable magnification without disturbing stage or specimen. Four hard coated objectives set in a revolving "click stop" turret give magnifications of 100X, 150X, 200X, 300X, 450X, 600X, and 900X. Zoom action permits choosing multiple magnifications without changing eyepiece or objective. The eyepiece zooms smoothly from 10X to 15X. Illuminator operates with batteries or house current, by means of transformer listed below. Round hole disc diaphragm controls illumination. Includes instructions, sample slides, 6 piece dissecting kit and wooden carrying case. Less batteries. Imported. Shpg. wt., 5 lbs.

99 E 71391 900X Microscope	Net 14.95
99 E 71060 Replacement bulb	Net .15
99 E 62580 Battery (2 required)	Net ea. .10
TRANSFORMER—Permits use of house current for illumination of zoom microscope.	
99 E 71102 Shpg. wt., 8 oz.	Net 1.80

600X MICROSCOPE SET

6⁹⁵



- With Sub-Stage Light
- 75X - 300X - 600X
- Triple Revolving Turret

For the student—hobbyists—or budding scientist! Features built-in sub-stage light and three achromatic objective lenses giving magnification of 75X, 300X and 600X. Complete with 3-glass slides, 5-piece dissecting set and hardwood cabinet. All metal, shpg. wt., 4½ lbs.
15 E 64020 Net 6.95
99 E 62580 Battery (2-req'd.) Net ea. .10

70X TO 200X MINI ZOOM MICROSCOPE

Only **4⁹⁵**

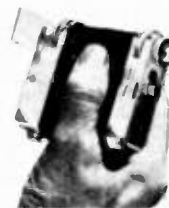

- Comes Complete With Case and Built-in Light

Excellent for close inspection of samples. Small size makes it handy anywhere...in the home, factory, or even out in the field. Variable zoom eyepiece is adjustable from 70 to 200 times magnification. Built-in illuminator incorporates a self-contained battery compartment. "Camera type" design features handy snap-in stage. Complete with vinyl case, glass slides and reflex plate. Imported.

Size: 3¼"H x 2¾"W x 7⁄8"D

99 E 72100 Shpg. wt., ½ lb.	Net 4.95
Battery for Above (2 Required)	
99 E 62580	Net ea. .10

Microscopes and Accessories



PORTABLE FIELD MICROSCOPE

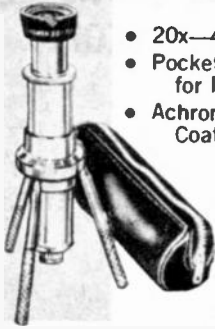

- 20x—40x—80x
- Pocket Size—
for Field or Lab
- Achromatic—
Coated Lenses

5⁹⁵

Unparalleled for "rockhounds" prospectors, coin and stamp collectors, students and hobbyists. Indispensable for examination of gross and opaque subjects. Highly polished, finely machined chromium plated brass tubes, mount and tripod legs. Draw tube permits focusing on objects from flat surface to 1 3/4" high. Ideal for inspecting large specimens, small parts, surfaces of large places. Size collapsed is only 4 3/4", fully extended 6 1/2" less tripod. Includes soft leather case and tripod legs. Imported. Shpg. wt., 1 lb. 99 E 70013 Net 5.95

DELUXE 1200X RESEARCHER MICROSCOPE SET

- 25X to 1200X in 12 Ranges
- Full Range Fine Focus Adjustment
- Integral Mechanical Stage
- Rotating Diaphragm
- All Metal Construction

Closely parallels the "Society" grade microscope. Four Huygenian eyepieces: 5X, 10X, 15X P20X combine with four achromatic objectives: 5X, 10X, 40X, 60X to yield 12 combinations: 25X, 50X, 75X, 100X, 150X, 200X, 300X, 400X, 600X, 800X, 900X, 1200X. Dual knob rack and pinion coarse focusing with tension adjustment for slow motion. Micro-motion fine focusing adjustment. Spring loaded to prevent objective from driving through slide. 85mm x 85mm stage can be moved in any direction, with slide, by 2 knurled screws while looking through the eyepiece. Sub-stage has rotating, 5-position diaphragm and 35mm plano/concave reflecting mirror. Stable horseshoe base. Complete with set of 5 basic dissecting instruments, 10 slides, pack of cover slips, tube of mounting fluid. All in a dovetailed wooden carrying case with handle and four rubber feet. Imported. Shpg. wt., 10 lbs. 99 E 70419 44.95

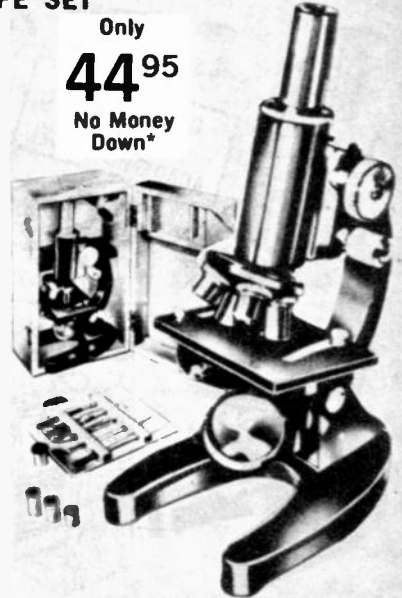

Only
44⁹⁵
No Money
Down*

LAFAYETTE® MICROLITE

- Use with any Microscope
- Furnishes Bright, Even Light

2⁹⁵



Provides a bright, evenly lighted field of view. Lamp may be raised or lowered to any desired height on its 4 1/2" stanchion. Inclination and elevation joint permit swinging through 360° in both horizontal and vertical plane. Fully adjustable for transparent or opaque specimens, direct or indirect illumination. Invaluable where oblique light is necessary. Operates on 110-120 volts AC/DC. Self-contained switch, cord and plug. Lamp body is 5 1/2" long, stand is 5 1/2" high. Imported. Shpg. wt., 1 lb. 99 E 70245 Net 2.95

99 E 70245
99 E 71110 Replacement Bulb

MICROSCOPE MECHANICAL STAGE

- With Graduated Scale
- Vernier to 1/10th mm
- Attaches to Any Square Microscope Stage

7⁹⁵

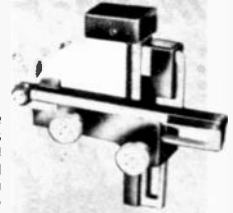

Attaches to any square microscope stage 70 mm x 80 mm or larger. Accommodates slides up to 75 mm x 50 mm. Both lateral and front-to-back movement by rack and pinion. Adjustment scales are graduated in single millimeters with verniers reading to 1/10th mm. Essential accessory for all high magnification examination. Permits relocating any portion of a slide or charting the entire slide. Spring clip automatically accommodates slides of varying dimensions. Imported. Shpg. wt., 12 ozs. 99 E 70872 Net 7.95

MICRO-SLIDE TEKNIKIT



As Low As
89^c



Carefully prepared slides of universal interest. Cleaned, dissected, embalmed, stained, mounted and covered. Professional size. Set includes 12 prepared slides and slotted, covered box. Imported. Shpg. wt., 8 oz.

- | | |
|----------------------------------|----------|
| 99 E 70047 Parts of Insects | Net 1.39 |
| 99 E 70054 Spiders | Net 1.69 |
| 99 E 70062 Tiny Creatures | Net 1.59 |
| 99 E 70070 Sea Life | Net 1.59 |
| 99 E 70088 Structure of Blood | Net 1.15 |
| 99 E 70096 Life Cycle of Insects | Net 1.39 |
| 99 E 70104 Bacteria | Net 1.59 |
| 99 E 70112 Plankton | Net 1.39 |
| 99 E 70120 Micro-Animals | Net 1.29 |
| 99 E 70138 Micro-Organisms | Net 1.29 |
| 99 E 70146 Substance of Cells | Net .89 |
| †Set of 6 slides | |

A HUNTING WITH THE MICROSCOPE. How to prepare and study cultures—set up a microscope zoo and garden—grow micro organism—perform micro surgery. Illustrated with photographs and drawings. Net .99
10 E 60029

D MICRO-POLARIZING KIT. A simple, inexpensive accessory to change any microscope into a polarizing microscope. The set consists of an Analyzer and a Polarizer. The Analyzer will fit any microscope eyepiece. The Polarizer can be placed on or under the stage or between the condenser lens and the stage. The polarizer is indexed for polarizer axis. Supplied complete with instructions and fitted, dust-proof case. Imported. Shpg. wt., 6 ozs. Net .99
99 E 71367

B HOW TO DISSECT. Tips on dissecting the digestive, reproductive, nervous, circulatory and structural systems of the earthworm, crayfish, grasshopper, starfish, squid, shark, frog, gladiolus, perch, lobster, octopus, snail, moths, barnacles, etc. Special projects: behavior of earthworms, food and oxygen in space ships, regeneration, micro-dissection, camouflage, etc. 128 pages. 82 photos. Net 1.25
10 E 60011

C SLIDE PREPARATION KIT. 30 glass slides, 3"x1", in a fitted, sturdy, cardboard container. Slotted guides hold slides upright for easy indexing. Includes slide covers and vial of mounting fluid. Imported. Shpg. wt., 1 lb. Net 1.59
99 E 70815

E DISSECTING AND SLIDE MOUNTING SET. All the necessary implements for dissecting, staining and mounting micro-subjects on slides: Seven dissecting instruments; 5 well slides, 20 blank slides; 50 cover glasses; 50 blank labels, blue stain; mounting fluid. All in a fitted wooden case. Imported. Net 4.95
15 E 42059 Shpg. wt., 1 1/2 lbs.



The "Micro-Standard Mark II" 1500X SOCIETY STANDARD MICROSCOPE



**CLINICAL AND
ADVANCED
ACADEMIC MODEL**

99⁹⁵
No Money
Down*

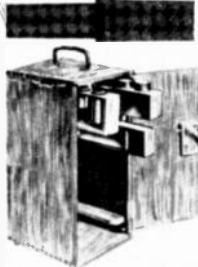

- 25X to 1500X in 12 RANGES
- 4 ACHROMATIC OBJECTIVES IN ROTATING TURRET
- VARIABLE SUBSTAGE CONDENSER WITH IRIS DIAPHRAGM
- STANDARD SOCIETY OPTICS, BOTH OBJECTIVES AND EYEPIECES
- RIGID QUALITY CONTROL STANDARDS
- PAR FOCAL WITHIN 0.1mm

An unusually fine optical instrument designed especially for precision viewing requiring high magnification with an oil immersion lens. The outstanding features of great range and engineered versatility, optimum clarity and great magnification are usually found in microscopes costing much more.

OPTICAL SPECIFICATIONS: Three Huygenian eyepieces—5x, 10x, 15x, Four achromatic objectives—5x, 10x, 40x, 100x (oil immersion). FOCAL LENGTH: 170 mm. Monocular. FOCUSING: Coarse focus with adjustable tension. Fine focus vernier adjustment. Par-Focal within 1/2 rotation of fine focus control (0.1 mm.). Spring loaded safety device prevents objective going through slide. STAGE: Square stage: 95 mm x 95 mm. Integral mechanical stage, adjustable in any direction. Stage clips. SUBSTAGE: Focusing condenser with variable iris, diaphragm. 41 mm plano/concave mirror. Tilting Base. Black and chrome finish. Overall 12" high, 6 1/2" deep, 4 1/2" wide. Includes fitted wood cabinet with lock and key, 3 slides, bottle of cedar oil. Imported. Shpg. wt., 1 1/2 lbs.
99 E 71342WX

Net 99.95

Micro-Plex —Binocular-Monocular Research Microscope

- 20X to 2000X • Interchangeable Binocular/Monocular Tubes
- Vernier calibrated mechanical stage • Eight paired eyepieces
- Quadruple revolving nosepiece



319⁹⁵
No Money Down*

An outstanding instrument with features of construction and design that will, without reservation, be appreciated by competent experts.

OPTICAL SPECIFICATIONS: Four achromatic, coated objectives 4X/0.15 n.a., 10X/0.25 n.a., 40X/0.65 n.a., oil immersion 100X/1.25 n.a. Eight paired eyepieces. Two each 5X Huygenian, 10X Huygenian, 15X peri-planatic, 20X Kellner. Oust proof quadruple revolving nosepiece.

FIELD SIZE: Field is 4.7 to 2.0mm for the 20X to 80X range, 1.88mm—0.8mm for 50X—200X, 4.7mm—2.0mm for 200X—800X, 1.88mm—0.8mm for 500X—2000X. Taken at 170mm focal length.

BODY: Interchangeable Binocular tube inclined 45°, graduated interpupillary adjustment, left eyepiece adjusts for refractive difference between eyes. Monocular is extendable, graduated from 140 mm to 190mm. Parfocal at 170mm.

STAGE: Square stage 125mm x 130mm. Mechanical stage with 30 mm x 70mm range of movement with vernier accuracy to 0.1mm. Slides of practically every shape and size, including petri dishes, can be used.

FOCUSING: Coarse focus by means of coaxial rack and pinion drive on dovetail slide. Fine focus by coaxial micrometer slow motion Meyer's type adjust. Graduated 1 division equals .002mm (2 micron intervals).

SUBSTAGE: Rack and pinion drive. Double lens bright field condenser (interchangeable) 1.2 n.a. iris diaphragm. Filter holder, stop against over-wind, 50mm plano-concave mirror. Satin black enamel finish. Chrome trim. 13 1/4 x 8 1/2 x 5 1/4" overall. Net weight 34 lbs. Includes fitted cabinet of fine grained oak with lock and key, 5cc of cedar oil, spring clips, spanner, blue filter. Imported. Shpg. wt., 42 lbs.
99 E 70401WX

Net 319.95

Medica II —Medical-Bacteriological Microscope

- Standard Society Size
- 20X to 1500X
- Vernier Calibrated Mechanical Stage
- Extendable Monocular Tube
- Par-focal at 170mm Tube Length

189⁹⁵
No Money Down*



Outstanding design—features unexcelled optically and mechanically—and priced far below any equivalent instrument.

OPTICAL SPECIFICATIONS: Four coated achromatic objectives. 4X/0.10 n.a., 10X/0.25 n.a., 40X/0.65 n.a., oil immersion 100X/1.25 n.a. Three eyepieces, 5X Huygenian, 10X Huygenian, and 15X peri-planatic.

BODY: Extendable, monocular tube. Graduated from 155 mm to 200 mm. Parfocal at 170 mm.

STAGE: Square stage 120mm x 125mm. Graduated mechanical stage with 50mm x 80mm range. Vernier accurate to 0.1 mm.

FOCUSING: Coarse focus by means of rack and pinion drive or dovetail slide. Fine focus by coaxial, lever type, micro-motion. Full 16 revolutions for 3mm travel. Spring loaded safety device prevents driving through subject. Focusing tension adjustable.

SUBSTAGE: Ring type, rack and pinion drive. Double lens bright field condenser (interchangeable) 1.2 n.a., iris diaphragm, filter holder, stop against over-wind, 50mm planoconvex mirror. 12 1/2 x 8 1/2 x 5 1/4" overall. Net weight 21 lbs. Includes fitted cabinet, 5cc of cedar oil, spanner, spring clips, blue filter. Imported. Shpg. wt., 29 lbs.
99 E 70393WX

Net 189.95

Arcturus

ARCTURUS 4 1/2" D. EQUATORIAL REFLECTOR

- 450X with Barlow Lens

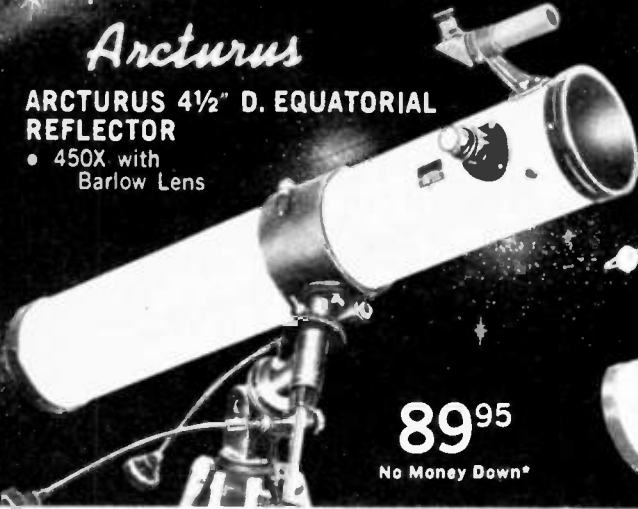

89⁹⁵

No Money Down*

- Eyepieces and Barlow Lens For 450X, 300X, 225X, 150X, 90X and 45X • 900mm Focal Length • Micromotion Controls For Horizontal, Polar, Declination • 4 1/2" (114mm) F/8 Spherical Aluminized Quartz Mirror • Barlow Lens Included

4 1/2" spherical, aluminized quartz mirror gives wide, flat field of view and outstanding color definition. Three coated eyepieces provide magnifications of 45X, 150X, 225X; (with Barlow lens 90X, 300X and 450X). Fast resolving power of 1.5 seconds and 900mm focal length permits detailed viewing up to twelfth magnitude. 5X24mm right-angle, prismatic finder scope with cross hairs easily locates objects to be viewed. Micro-motion controls and equatorial mount with hour and declination circles provides complete control for tracking. Heavy-duty hardwood tripod with accessory tray adjusts from 33 to 60". Complete with lenses, Sun glass, Moon glass, Barlow lens. Scope size: 4 1/2" Dia., 36" long. Imported. Shpg. wt., 32 lbs.

99 E 72183WX

Net 89.95

LAFAYETTE Telescopes

Meteor 4" Reflector

- 264X with Optional Barlow Lens



29⁹⁵

- Eyepieces for 132 and 64 X
- 4" (100 mm) f/11
- Aluminized First Surface Secondary Mirror

A fine, compact professionally designed 4" reflecting telescope with carefully aluminized optics for exceptionally low light loss. Primary mirror is aluminized and quartz overlaid. Highly achromatic optical system features very low chromatic aberration. Adjustable wooden 48" tripod with tray brace and convenient optical sight permit easy field use on uneven surfaces. Rack and pinion drive assures smooth focusing. Lightweight aluminum body has white baked enameloid finish: Specs.: Mirror Dia.: 4"(100mm). Focal Length: 800 mm. Eyepieces: 25 and 12.5 mm Huygenian. Resolving Power: 1.4 seconds. Supplied with stand, sun filter and two eyepieces. Imported.

99 E 72126WX Shpg. wt., 10 lbs.

Net 29.95

99 E 70542

Barlow lens for double power. Wt., 8 oz. Net 3.95

2X BARLOW LENS



3⁹⁵

Provides greater eye relief even on short focal length eyepieces. Sharpens definition and reduces image deterioration by permitting use of lowpower eyepieces to achieve high magnification. This also provides for greater illumination and a wider field. Accepts eyepieces of 24.5-mm (.97") O.D. and fits draw tubes of that size. Imported.

99 E 70542 Shpg. wt., 1 lb. Net 3.95

LAFAYETTE TELE-CAM ADAPTER

- Adapts Most Cameras to Your Reflector or Refractor Telescope For Permanent Records of Your Observations

Make permanent visual records of your astronomical observations, wildlife sightings etc. This easy to use adapter matches most cameras to virtually any reflector, refractor, or fixed lens telescope. Accurate, motion-free alignment assures you the finest pictures possible from your equipment. May be used with interchangeable or fixed lens cameras. With complete instructions. Imported. Shpg. wt., 1 lb.

99 E 71946

Net 6.95

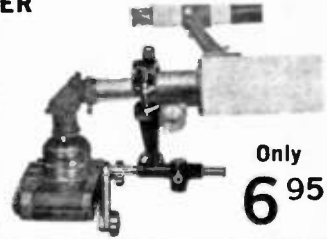

Only 6⁹⁵

DELUXE MICROSCOPE ACCESSORIES



12⁹⁵

- Sections to 10 Microns (0.00039 inch)
- Micro-Pitch Screw Drive

Essential tool for free hand sectioning of biological specimens. Equally suitable for the serious hobbyist and student as well as lab applications where the accuracy of a hand operated feed is sufficient. The micro-fine pitch screw feed is graduated in 10 micron intervals. The dense, composition stage is absolutely flat, 75 mm in diameter, "Straight razor" type micrometer knife of surgical quality steel. Ground and tempered to take and hold a keen cutting edge. Supplied with microtome knife, pitch and compartmented wooden storage cabinet. Imported. Shpg. wt., 2 lbs.

15 E 21012

Net 12.95

MICRO-STANDARD



19⁹⁵

- Locates Any Spot On A Slide, "On The Nose"
- Smooth Action—Horizontal And Vertical
- Foolproof Co-ordinate System

Graduated mechanical stage attaches to any "Society" size microscope stage such as Medica, Micro-Plex and Micro-Standard. Adjustable holder takes any slide up to 90 mm x 50 mm. Essential for methodical examinations such as is required under an oil immersion lens or in blood counting. Locates and relocates portion of the slide quickly and easily. Vertical movement by rack and pinion — horizontal movement by worm gear. Machine engineered scales, graduated in single millimeters with vernier reading to 1/10th mm. All slides can be chartered by means of the co-ordinates of these scales. Spring clip automatically fits the slide into proper position. Imported. Shpg. wt., 1 lb.

99 E 70385L

Net 19.95

"MICRO'DAPTER"™

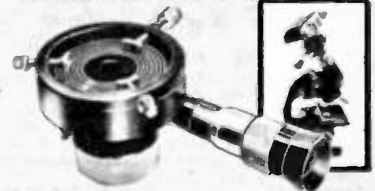

- Micro-photography!
- Astro-photography!
- Use Any Camera/ Microscope or Camera/Telescope Setup

14⁹⁵

Permits the use of any camera — even movie cameras — with practically all microscopes and telescopes. No need to remove the camera lens. Cross hairs are super-imposed on the image for centering. The image is automatically in focus for the camera when viewed in focus through the MICRO'DAPTER. Accessory sleeves permit the MICRO'DAPTER to be used with other than Society size microscopes. The MICRO'DAPTER may be used with any telescope by attaching to eyepieces of 29 mm (1 1/8") maximum diameter. Imported. Shpg. wt., 1 1/2 lbs.

99 E 70007

Net 14.95

* See Page 11 for Full Credit Details on Easy Pay Plan

Spotting — Rifle — Sport Scopes

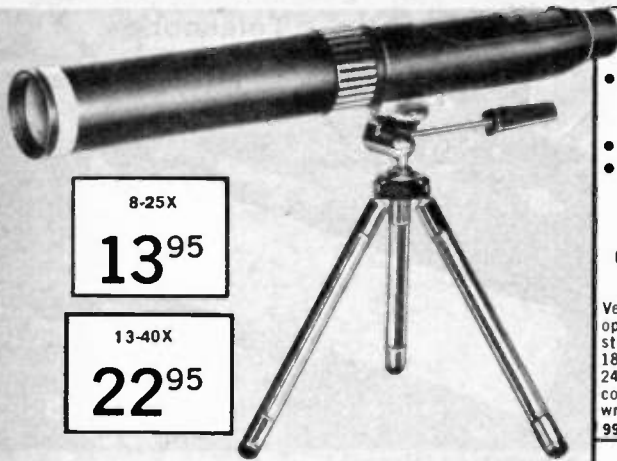

8-25X
13⁹⁵

13-40X
22⁹⁵

LAFAYETTE 8-25X 30-mm ZOOM SPOTTING SCOPE

- Zoom Any Power From 8X to 25X
- Quick Focusing With Table Top Tripod

An outstanding variable power spotting scope that is ideal for any "spotting" need in field or general use... shooters, bird watchers, etc. Features 30mm coated lens for brilliant viewing. Fingertip controls for quick zooming and focusing. Has a built-in camera tripod socket. Includes a table-top tripod with rubber-tipped legs that prevent scratching of furniture. Compact, lightweight and portable... Ideal for taking it everywhere you go. Complete with black, zippered carrying case with convenient belt loop. Overall length of scope is 12". Imported. Shpg. wt., 3 lbs.

99 E 71920

Net 13.95

DELUXE 13-40X 40-mm ZOOM SPOTTING SCOPE

- Zoom From 13x to 40x Power
- 40 mm Objective

Same unique design as above but with extra power and larger 40-mm objective. With tripod less case. Overall Length 16".

99 E 72191 Shpg. wt., 4 1/4 lbs.

Net 22.95

15-30X ZOOM SPOTTING SCOPE



39⁹⁵
No Money Down*

- Full Size 50mm Objective

Any power from 15X to 30X! Ideal for any "Spotting" Need. Pan-head, elevator tripod mount included. Perfect all round scope. Powerful, small lightweight, brilliant viewing. Minimum focusing distance 82 ft. All aluminum and chromed brass. Imported.

Shpg. wt., 5 lbs.

99 E 71011

Net 39.95

30X, 60mm SPOTTING SCOPE



16⁹⁵

- With Case Tripod

The perfect companion for shooting, hunting and nature fans. Field of view is 85 feet at 1000 yds.! High relative brilliance due to 60mm objective lens. All optics are coated. Equipped with a 11 1/2" tripod and zippered leather carrying case. Minimum focusing distance 60 ft. Imported.

Shpg. wt., 3 lbs.

99 E 70153

Net 16.95

LAFAYETTE 8x24 MINI-SCOPE

- Includes 6x Super Wide-Angle (11°) Objective
- Fits in Palm of Hand
- Use as Close-up Magnifying Glasses



Only **12⁹⁵**



Versatile, precision pocket telescope provides powerful 8-power optics, yet slips into your pocket. Ideal for travel, hiking or nature study. For a larger field, quick-change to the 6x extra-wide view 18mm lens. Pulls in the action at football, hockey, and shows. 24mm coated lens provides 435 ft. viewing area at 1000 yds., 18mm coated lens gives 575 ft. viewing area. With soft zippered case, wrist strap. Imported. Shpg. wt., 1 lb.

99 E 72159

Net 12.95

THEATER AND SPORTS GLASSES

- Worn Like A Pair Of Ordinary Glasses
- Weighs Less Than 3 oz. With Case



Only **7⁹⁵**

Handsome, lightweight, binocular quality sport glasses for viewing indoor or outdoor events! Designed to be worn like ordinary eyeglasses, each optic individually focuses to match personal viewing requirements; can also be worn by people who require prescription glasses. High resolution, distortion-free lenses magnify 2.8 times. Soft rubber eye shields on each eyepiece cushions glasses against wearers face for maximum comfort without eye strain, and prevents glare and reflections from extraneous light. Complete with black carrying case and neck chain.

99 E 72175L Shpg. wt., 10 oz.

Net 7.95

10X30mm TELESCOPE with TRIPOD



7⁹⁵

- Full 10 Power
- Portable-Compact- Lightweight

A 10 power, 30mm internal (front) focus telescope that is compact, lightweight and portable—ideal for taking it everywhere you go. Features coated achromatic lenses. Has built-in camera tripod socket. Sturdy tripod supplied with rubber-tipped legs. Minimum focusing distance 14 ft.

Shpg. wt., 2 lbs.

99 E 70716

Net 7.95

3-7X 20MM ZOOM RIFLE SCOPE

10⁹⁵



- Cross Hair Reticule
- Hard Coated Lens
- Internal Windage And Elevation

Now, a zoom rifle scope especially designed for .22's. Hard coated lenses feature finest quality optics with constant brilliant sharp sighting through full power range. Field of view: 30 ft. at 100 yds. @ 3 power, 16.8 ft. at 100 yds. @ 7 power. Fine cross hair reticule pinpoint target. Easy, fast installation with all .22's that have grooved receivers. Internal windage and elevation adjustments for positive "zero-in." Eyepiece diameter: 1". Tube diameter 3/4". All parts and components are precision built and weather resistant. Eye relief is 2 to 3". Imported. Shpg. wt., 1 lb.

15 E 64012

Net 10.95

4X RIFLESCOPE

6⁴⁹



- Internal Adjustments
- Light weight—only 6 1/2 ozs.
- Cross Hair Reticule
- Hard Coated Lenses

Popular, all-around scope for the small game hunter. Bright field, approx. 30 feet at 100 yards. Eye relief distance from 3 1/2 to 4 1/2 inches. Eyepiece diameter, 1" tube diameter 3/4". Hard coated, achromatic lenses reduce glare. Internal windage and elevation adjustments for positive "zero-in." Fine, cross hair reticule pinpoint target. Featherweight, weather-resistant, precision built. Easy, fast installation with all .22's with grooved receivers, some air rifles. Imported. Shpg. wt., 1 lb.

99 E 71607

Net 6.49

Lab and Field Research Equipment

SUGAR REFRACTOMETER



- A Modified Abbe Design—Reads Percentage of Sugar in Solution
- Completely Portable—Fits in Pocket
- Accuracy $\pm 0.2\%$ for Low Range Instruments— $\pm 0.5\%$ for High Range

An accurate hand sugar refractometer. Designed for accurate measurements of the percentage of sucrose or dissolved solids in solution. Particularly suited to the sugar industry. Permits accurate measurements, in the field, of sugar percentage in fruits and vegetables. Equally suitable for use in the "juice" industry, in canning plant lab, candy, chocolate and jelly industries, soft drink plants, breweries, agricultural as well as in other phases of chemistry and clinical pathology. Simple in operation—no moving parts except the focusing eyepiece. Completely color corrected optical train, perfectly clear field. Range of 0-32%, reads directly to 0.2%, easily estimated reading to 0.1%. Accuracy $\pm 0.2\%$. Includes adjusting screw driver, temperature correcting tables, leather carrying case and straps. Imported. Shpg. wt., 1 1/2 lbs.

99 E 70180L No Money Down* Net 39.95

DIRECT VISION SPECTROSCOPE



- Focussable Field

A simple accurate instrument for the spectroscopic analysis of emission spectra from light sources, vaporized chemical salts, solids, liquids and the Solar Spectrum. Convenient for experimental and student use. A broad dispersion field of high intensity is obtained from several dispersing prisms of matched glass, while a high grade optical system yields good resolution, sufficient to separate 5769.6Å* from 5790.6Å* in the spectrum of a fluorescent lamp. The slit is preset and can be focused sharply by means of an eye piece draw-tube, assuring easy viewing and establishment of Fraunhofer lines of the Solar spectrum or bright lines of the emission spectra. Metal parts are made of chrome-plated, corrosion-proof brass. Supplied in fitted case. Imported. Shpg. wt., 9 oz.

99 E 70773L Net 21.75

ULTRA-VIOLET HAND LAMP



An economical, compact, self-contained source of both short wave and long wave ultra-violet light of medium intensity. For lab, home and field use where high intensity is not required. Operates from either AC house current or batteries. Easily carried—weighs only 1 lb., 14 ozs. Portability extends its uses. Typical applications: fluorescence demonstrations, mineral determination, prospecting. Special circuit has been designed for high efficiency, low drain operation. Tubes are easily replaced. Separate, extra large filters for short wave and long wave and switch for independent operation of each source. Includes 6 identified mineral samples and a 12-page book which describes some of the many uses of ultra-violet radiation. Comes complete ready for use—for 110-120 volts 50/60 cps. AC. Less batteries (2-45V "B" batteries required for portable use). Battery adapter case optional. Size: 5 1/2 x 2 x 8 1/2". Shpg. wt., 4 lbs.

15 E 45045 Net 34.95

Battery Adapter Case with adjustable shoulder strap. Shpg. wt., 2 lbs.
15 E 45052 Net 7.75
45-Volt "B" Battery (2 required for battery operation). Shpg. wt. 3 oz.
32 E 40101 Net ea. 2.97

U/V FLUORESCENCE ACCESSORY SET

Contains 16 different items including: invisible water paint (4 colors), invisible tracer powder, invisible writing ink, phosphorogram, UV transmitting and absorbing clear plastic, invisible dye, 10 yds, fluorescent elastic cord. 48-page "Story of Black Light" book of experiments. (Not Illustrated). Shpg. wt., 1 1/2 lbs.

15 E 45060 Net 7.95

* See Page 11 for Full Credit Details on Easy Pay Plan



A



B

40 WATT ULTRASONIC CLEANER

A Model LP-1HD. Completely self-contained easy-to-handle ultrasonic cleaner capable of serving a variety of cleaning applications. Automatic 5-minute time switch turns unit off when cleaning cycle is finished. Control dial for Low and High Power Operation. Stainless Steel worktop and sides protect unit against spills and splashes. One-Pint Stainless Steel cleaning tank cannot be marred or harmed by any normal cleaning agent or solvent, warm or cold. Ideal for removing grease, tar, wax, sulphides, fluxes, and fingerprints from components, miniature mechanisms and a variety of other precision parts. Generator Freq: 90 KHz., RF input power: 40 watts. Uses no tubes or transistors. Dimensions 9 1/2 x 5 x 4 3/4". See listing below for solvents. Shpg. wt., 6 lbs.

15 E 23028 No Money Down* Net 69.95

20-WATT HOME ULTRASONIC CLEANER

B Model LP-2. A low cost ultrasonic cleaner that has most of the advantages of larger models. A convenient 3 1/4" diameter x 1 1/2" deep round Pyrex Beaker with standoffs may be filled, emptied and objects rinsed without moving the basic cabinet. The cleaning liquid is cavitated at an ultrasonic frequency of 90 kHz (nominal). With automatic overheat cutoff. Uses no tubes, transistors or complicated electronic circuitry. Entire cleaner is housed in an attractive metal and stainless steel cabinet measuring 6" x 4" x 4". See listing below for solvents. Operates on 110 volts 60 Hz AC. Shpg. wt., 6 lbs.

15 E 23034 No Money Down* Net 39.95

ULTRASONIC CLEANER

As
Low as
99⁹⁵
No Money
Down*

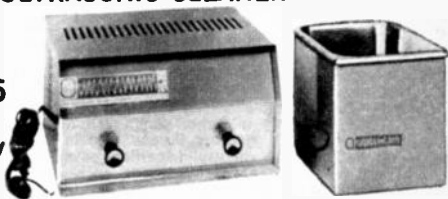

- Employs an Advanced Cleaning Process
- High Capacity—1/2-Gallon Tank
80-watt Average Output Generator

A new standard of time-saving, immaculate cleaning. A special transducer located in the solvent tank is excited by an ultrasonic generator (at 90,000cps). It sets the solvent in agitation, producing microscopic bubbles (cavitation) which disintegrate dirt particles. Soil can be removed from the finest crevices without damage to delicate parts. Ultrasonic Cleaner consists of a 80-watt pulse generator and a 1/2-gallon cleaning tank. Tank constructed of stainless steel with 4A grade polish. Specifications: Input 110-117V, 50/60 cycles; Output 90 kc—80 watts, avg., 320 watts peak. Generator size: 12L x 9 3/4W x 7"H. Tank size: 6 1/4L x 7W x 6 1/2"H. Complete with 4' connecting cable and 1-year free service guarantee. Exterior of Tank and generator finished in baked enamel gray. See listing below for solvents. Shpg. wt., 26 lbs.

15 E 85017WX Net 149.95

30-WATT ULTRASONIC CLEANER

For cleaning small manufactured parts — electrical contacts, contact lenses, dentures, bearings, jewelry, etc. Generator output 30 watts average, 120 watts peak. Inside tank dimensions: 3 3/8 x 3 3/8 x 3" deep, 1-pint capacity. Shpg. wt., 24 lbs.

15 E 85025WX No Money Down* Net 99.95

120-WATT ULTRASONIC CLEANER

• 1 1/2 Gallon Tank
An extra high capacity cleaner widely used in electronics, automotive and other precision instrument fields. Valuable in all areas of applied medicine. Polished stainless steel tank size (inside): 12 3/4 x 7 x 8 1/2" high. Generator output: 90 KHz @ 120 watts average. 480 watts peak. 32-page manual. Shpg. wt., 37 lbs.

15 E 85033WX No Money Down* Net 249.95

Ultrasonic Cleaning Chemicals. Shpg. wt., 9 lbs. per gal.

15 E 85041 Ammoniated Detergent, 1 gal. Net 5.50

15 E 85058 Detergent Concentrate, 1 gal. Net 5.00

15 E 85066 Zero Residue Fast Dry Solvent, 1 gal. Net 5.50



LAFAYETTE

VHF Monitor Receivers

MONITOR

STATE, COUNTY AND MUNICIPAL POLICE—FIRE DEPARTMENT—
CIVIL DEFENSE—RAILROADS—TRUCKING—HIGHWAY MAINTEN-
ANCE—FORESTRY—AVIATION—CONSERVATION—PETROLEUM AND
INDUSTRIAL ACTIVITIES.

POLICE AND FIRE DUAL BAND SOLID STATE FM RECEIVER



- + 17 TRANSISTORS
- + 10 DIODES
- + 2 THERMISTORS

For: Super Sensitivity
and Selectivity

Model PF-175 Only **99⁹⁵** No Money
Down*

**CRYSTAL CONTROL PLUS
TUNEABLE RECEPTION**

2 Receivers In 1!

2 Bands:

30-50 MHz + 152-174 MHz

Listen to U.S. Weather Forecasts and Disaster Warnings!

An advanced FM receiver that is outstanding in performance and features. Covers two VHF communications bands with super-sensitivity—fully tuneable or can be crystal controlled for reception on a single frequency in either band. Also tunes to 162.55 MHz and 163.275 MHz U.S. Weather Bureau reports and disaster alarms in many parts of the country. Superheterodyne circuit includes tuned RF and mixer stages. Four IF stages, each using an advanced space-age Integrated Circuit (IC). 100% solid state design offers top reliability too! "Instant-on" transistor circuit permits immediate response to emergencies! Built-in universal power supply assures continuous monitoring under any conditions—the unit also operates from a 12VDC battery supply for field use or as an emergency portable if AC power fails. Front panel controls include a 4-position selector for choice of Xtal or Tuneable reception on either of the two VHF bands. Variable squelch control lets you silence the re-

ceiver during no-signal conditions to reduce monitoring fatigue. Also equipped with illuminated slide-rule dial, plus handy on-off volume control. Has a handsomely styled vinyl-clad steel cabinet in a simulated walnut wood-grain finish, and equipped with built-in 4" front-mounted speaker and external phone jack. Size: 13¼W x 7½D x 6"H. Imported. Shpg. wt., 17 lbs.
99 E 25892WX Model PF-175 (less Crystals) Net 99.95
CRYSTALS—Specify Exact Operating Frequency. Subject to up to 4 weeks delivery.
40 E 82079Z 30-50 MHz Net 5.95
40 E 82087Z 152-174 MHz Net 5.95
Ground Plane Antennas. Shpg. wt. 2 lbs.
40 E 01178W 30-50 MHz Net 8.95
40 E 01160W 130-174 MHz Net 7.50
40 E 13017W Window antenna for 30-50MHz. Wt. 3 lbs. Net 7.95

POLICE AND FIRE SINGLE BAND SOLID STATE FM RECEIVERS



- + 13 TRANSISTORS
- + 9 DIODES
- + 2 THERMISTORS

Model PF-30
30-50 MHz

Model PF-60
152-174 MHz

Only **79⁹⁵**
No Money Down*



Crystal Control Plus Tuneable Reception

- 4 IC's Plus 12 Transistors for PF 30
- Crystal Control Plus Tuneable Reception
- 117 VAC and 12 VDC Operation
- Tape Recorder Output Jack

Same super-sensitive solid-state FM receivers as Model PF-175 except that these are single band models covering the high or low bands. Advanced IC's included in the IF stages, plus tuned RF and Mixer stages. Also feature same rugged design for trouble-free operation and have universal power supply for either normal 117 VAC operation or 12 VDC battery operation for field use or during emergencies. Model PF-60 can tune to 162.55 MHz and 163.275 MHz U.S. Weather Bureau reports and disaster alarms in many parts of the country. Controls: Variable Squelch, On-Off Volume, Tuning and Selector (Tune-Xtal), Less Crystal. Size: 13¼W x 7½D x 6"H.

Imported. Shpg. wt., 16½ lbs.
99 E 25900WX Model PF-60 152-174 MHz Net 79.95
99 E 25918WX Model PF-30 30-50 MHz Net 79.95
CRYSTALS—Specify Exact Operating Frequency 4 weeks delivery.
40 E 82087Z 152-174 MHz Net 5.95
40 E 82079Z 30-50 MHz Net 5.95
40 E 01160W Ground Plane Antenna for 130-174 MHz. 2 lbs. Net 7.50
40 E 13017W Window Antenna for 30-50 MHz. Wt. 3 lbs. Net 7.95
40 E 01178W Ground Plane Antenna for 30-50 MHz. 2 lbs. Net 8.95

MONITOR

Business Service
Taxicabs
Railroads
Auto Emergencies

Police Department
Fire Department
Special Emergency
Local Government



LAFAYETTE
VHF Monitor
Receivers

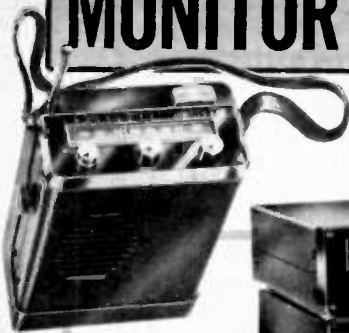

Portable



Base Station



Model PB-50 30-50 MHz
Model PB-150 152-174 MHz

Only **69⁹⁵**
No Money Down*



*Listen To U.S. Weather Forecasts
and Disaster Warnings!†*

POLICE AND FIRE SOLID STATE MOBILE MONITOR RECEIVERS

★ Tunable Plus One Crystal Position

★ 4 IC's Plus 13 Transistor†

Thrill to urgent police broadcasts, hear the excitement of fire squads in action! PB-150 tunes to 162.55 MHz and 163.275 MHz. U.S. Weather Bureau weather reports and disaster alarms in many parts of the country. You have a choice of two wide range models, tuneable from either 30 to 50 MHz or 152 to 174 MHz. Each has provision for one crystal controlled frequency. The highly sensitive front end features .7μv for the PB-50 and less than 1μv for the PB-150. The selective "I.F." features four integrated circuits in the IF section. Weak distant stations can be heard clearly, while outside noise and interference are drastically reduced. The efficient 2.8 watt audio section terminates in a big 3 x 5" PM speaker, providing for clean, clear sound reproduction. Only 2 3/4" high, the units are ideal for car, truck or boat and are easily mounted under virtually any dash board or control panel (Mounting brackets are included). Power may be supplied by any standard 12 volt negative ground battery or by the HB-502B 117 VAC base station power supply listed. Its 13 transistor + 4 IC's (PB-150) † and 12 Transistor + 4 IC's (PB-50) solid state circuitry features extremely low current drain. Three controls complement the stylish front panel: Volume/Squelch, X'tal/Tune, and

Tuning. Antenna Impedance: 50-75 ohms. Size 2 3/4 Hx6 1/4 Wx8" D. Imported. Shpg. wt., 7 lbs.
99 E 25934WX Model PB-50 (30-50 MHz) Net 69.95
Crystal for PB-50. Specify exact operating frequency.
40 E 82079Z 3-4 weeks delivery Net 5.95
99 E 25926WX Model PB-150 (152-174 MHz) Net 69.95
Crystal for PB-150. Specify exact operating frequency.
40 E 82087Z 3-4 weeks delivery Net 5.95
Model HB-502B AC Power Supply and Nicad Battery Charger. Net 16.95
99 E 32088W Shpg. wt., 5 lbs.
Model HB-506 Portable DC Power Pack with shoulder strap. Net 19.95
99 E 31544 Less Batteries. Shpg. wt., 2 lbs. Net 19.95
32 E 48879 "C" Alkaline HB-506 Battery (8 req.) Net ea. .49
32 E 48887 "C" Nicad Chargeable Alternate Batt.(10 req.) Net ea. 4.06
Mobile Antennas For PB Monitors
40 E 01137W 130-174 MHz Shpg. wt., 1 lb. Net 5.95
40 E 01145W 30-36 MHz. Shpg. wt., 2 lbs. Net 11.95
40 E 01152W 36-42 MHz. Shpg. wt., 2 lbs. Net 11.95
40 E 01129W 42-50 MHz. Shpg. wt., 2 lbs. Net 11.95

NEW! MINIATURE AC PLUS DC POLICE AND FIRE MONITOR RECEIVER

Model Micro P-100 (148-174 MHz)

- Tuneable (148-174 MHz) Plus 2 Crystal Positions
- 1 FET Plus 14 Transistors Plus 9 Diodes
- Self Contained 117 Volt AC and 12 Volt DC Supply

Only 1 3/4" High

99⁹⁵

*Hear U.S. Weather
Bureau Forecasts
on 162.55 MHz†*

No Money Down*

Delivery November 15, 1969

Hear exciting "live" details concerning activities and emergencies in your area. Listen in on Police, Fire, Ambulance, and other public service radio communications. Continuously monitor the U.S. Weather Bureau forecasts and disaster Warnings. Hear all this and more on Lafayette's Micro P-100 miniature solid state monitor receiver. It's compact size (1 3/4 Hx4 1/4 Wx7 3/4" D) permits convenient mobile and base operation. Exceptional features include tuneable (148-174 MHz) plus 2 crystal receive positions, better than 1μv sensitivity for 20 db S/N, 3 ceramic IF filters for exceptional selectivity, variable squelch, built-in fused AC and DC power supplies, 2 watt audio output, SO-239 antenna jack, and space age styling with attractive illuminated dial. Supplied with AC and DC cables plus mobile mounting/base station stand bracket. For 117 VAC 60 Hz. or 12 VDC (Negative Ground). Easy portable operation with optional battery operated portable power pack. Imported.

99 E 26122 Shpg. wt., 5 lbs. Net 99.95
HB509A Portable Battery Pack with Shoulder Strap
99 E 32260 Less Battery. Shpg. wt., 2 lbs. Net 19.95
32 E 48879 Alkaline Batteries for HB-509A (8 req.) Net ea. .49
40 E 82087Z Crystal for 148-174 MHz (Specify Frequency) Net 5.95
† More Than 1 Crystal Used, They Must Be Within 1 MHz of Each Other
† Consult your local weather bureau concerning reception in your area.

* See Page 11 for Full Credit Details on Easy Pay Plan



Mobile: For Car, Truck, Boat, etc.



Base: For Home, Office, etc.

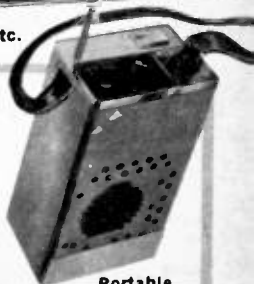

Portable

LAFAYETTE Police and Fire Professional Solid State FM Mobile Receivers

Only
99⁹⁵

No Money Down*

ONLY 2" HIGH!



6-CHANNEL CRYSTAL CONTROLLED

MONITOR:

Public Safety
Fire
Police
Local Gov't
Special Emergency
Highway Maintenance
Forestry Conservation
U.S. Weather
& Disaster Warnings

Model HA-39 39MHz - 40MHz	Model HA-42 42MHz - 43MHz	Model HA-45 45MHz - 46MHz	Model HA-46 46MHz - 47MHz	Model HA-153 153MHz - 155MHz	Model HA-155 155MHz - 157MHz	Model HA-159 159MHz - 164MHz
-------------------------------------	-------------------------------------	-------------------------------------	-------------------------------------	--	--	--

- 19 Transistors, 6 Diodes (HA-153 Thru HA-159)
- 18 Transistors, 6 Diodes (HA-39 Thru HA-46)
- Double Conversion Superheterodyne Receiver
- Very Low Battery Drain • Variable Squelch
- Sensitivity: 0.7 μ V For 20db Quieting
- Instantaneous Operation—No Warm-up
- 12 Volts DC (Neg. or Pos. Ground) or 117 Volts AC with Optional Solid-State Power Supply

This superbly engineered, solid state, crystal controlled FM receiver enables superior, accurate monitoring of Fire, Police, Local Government, Special Emergency, etc. Its superior solid state circuitry permits instantaneous operation—no loss of precious time due to warmup...permits immediate response to emergencies! The compact, miniature size makes it ideal for car, truck and boat, as well as for home and office with the optional solid state matching AC power supply. Six crystal-controlled channel capability permits operation on up to 6 frequencies with highly accurate optional crystals. Features an exceptionally sensitive double conversion superheterodyne circuit with 0.7 μ v sensitivity for 20 db quieting. Designed and built for reliable, trouble-free performance, the receiver uses rugged, heat resistant Silicon Mesa transistors in all critical areas (oscillator, RF and IF). Very low current on 12 volts DC permits continuous monitoring in mobile operation for long periods of time...even with the motor switched off! Complete with built-in 3 x 5" speaker and mobile mounting bracket. Size: 6W x 8D x 2"H. Imported. Shpg. wt., 6 $\frac{1}{2}$ lbs.

Model HA-39: For 39 to 40 MHz Operation.	
99 E 26023WX Less Crystals	Net 99.95
40 E 82046Y† Crystal for HA-39	Net 6.95
Model HA-42: For 42 to 43 MHz Operation.	
99 E 26031WX Less Crystals	Net 99.95
40 E 82053Y† Crystal for HA-42	Net 6.95
Model HA-45: For 45 to 46 MHz Operation.	
99 E 26049WX Less Crystals	Net 99.95
40 E 82061Y† Crystal for HA-45	Net 6.95
Model HA-46: For 46 to 47 MHz Operation.	
99 E 25084WX Less Crystals	Net 99.95
40 E 82012Y† Crystal for HA-46	Net 6.95
Model HA-153: For 153 to 155 MHz Operation.	
99 E 25060WX Less Crystals	Net 99.95
40 E 82020Y† Crystal for HA-153	Net 6.95
Model HA-155: For 155 to 157 MHz Operation.	
99 E 25076WX Less Crystals	Net 99.95
40 E 82038Y† Crystal for HA-155	Net 6.95
Model HA-159: For 159 to 164 MHz. Also monitors U.S. Weather Reports and Disaster Warnings in many parts of the country.	
99 E 26090WX Less Crystals	Net 99.95
40 E 82095Y† Crystal for HA-159	Net 6.95
†Specify Exact Operating Frequency. Must Be Ordered Specially 3 to 4 Weeks Delivery. Crystal Tolerance \pm 0.0015%. Wt. 4 oz.	
HB-302B: 117V AC Sturdy attractive matching power supply for base station operation. 6W x 7$\frac{1}{2}$D x 2$\frac{3}{4}$"H. Imported.	
99 E 32088W Shpg. wt., 5 lbs.	Net 16.95

ECONOMY MONITOR SYSTEMS WITH "PB" and "PF" POLICE AND FIRE RECEIVERS

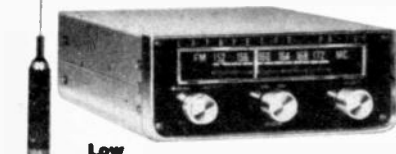

Low Band Antenna
MOBILE STATIONS



High Band Antenna

- PB-150 Monitor Receiver (152-174 MHz)
- High Band Mobile Antenna, Roof or Trunk Mount, Complete with Cable

40 E 90189WXM Shpg. wt., 11 lbs. Net 73.95

- PB-50 Monitor Receiver (30-50 MHz)
- Low Band Mobile "Rapid-Grip" Trunk Lid Mount Antenna (30-36 MHz)
- 20 Ft. Coaxial Cable Assembly

40 E 90197WXM Shpg. wt., 13 lbs. Net 81.95

Same as 40 E 90197WXM except with 36-42 MHz antenna.

40 E 90205WXM Net 81.95

Same as 40 E 90205WXM except with 42-50 MHz antenna. Shpg. wt., 13 lbs.

40 E 90213WXM Net 81.95

Package Price

73⁹⁵

No Money Down*

Save 1.95

from individual catalog prices

Package Price

81⁹⁵

No Money Down*

Save 2.90

from individual catalog prices



Ground Plane

BASE STATION With Outdoor Antenna

- PF-60 High Band Receiver (152-174 MHz)
- High Band Ground Plane Antenna
- 50 Ft. RG-8/U Low Loss Coaxial Cable

40 E 90403WXM Shpg. wt., 26 lbs. Net 92.95

- PF-30 Low Band Receiver (30-50 MHz)
- Low Band Ground Plane Antenna
- 50 Ft. RG-8/U Low Loss Coaxial Cable

40 E 90411WXM Shpg. wt., 26 lbs. Net 93.95

- PF-175 Dual Band Monitor Receiver
- Low Band Ground Plane Antenna
- High Band Ground Plane Antenna
- 2 ea. 50 ft. RG-8/U Coaxial Cable

40 E 90445WXM Wt., 35 lbs. Net 127.95

SAVE 5.45 from individual catalog prices.

Package Price

92⁹⁵

No Money Down*

Save 3.00

from individual catalog prices

Package Price

93⁹⁵

No Money Down*

Save 3.45

from individual catalog prices

VHF and UHF Police and Fire Monitor Receivers

LAFAYETTE HAND-HELD FM VHF POLICE and FIRE RECEIVERS

2 MODELS: 146-175 MHz
27- 50 MHz

YOUR CHOICE
17⁹⁵ each

- All Solid State—10 Transistors
- Superheterodyne Receiver

Only an alert and informed citizen can keep up with the electrifying happenings of our everyday life. Two superb Lafayette FM/VHF receivers bring you live coverage of your city or town's daily drama on either 146-175 MHz or 27-50 MHz police and fire bands. 146-175 MHz receiver tunes to 162.55 and 163.275 MHz U.S. Weather Bureau weather reports and disaster alarms in many parts of the country. Has a built-in 2½" speaker plus an external earphone jack for convenient private listening. Rugged construction and sleek styling combine to give a clean professional type appearance. Operates on 4 penlight batteries (included with set). This ultra-compact unit also features a built-in swivel telescoping antenna and provision for an external antenna. With carrying strap. Size: 6 x 2 x 1½". Imported.

99 E 35313L 146-175 MHz FM VHF Receiver, Wt. 2 lbs. Net 17.95
99 E 35339L 27-50 MHz FM VHF Receiver, Wt. 2 lbs. Net 17.95

ACCESSORIES FOR HAND-HELD FM VHF RECEIVERS

Stock No.	Description	Shpg. Wt.	Net Ea.
99 E 35362	117 VAC Adapter.	10 oz.	3.95
99 E 62580	Extra "AA" Batteries (4 required)	1 oz.	.10
40 E 79018	Earphone for Private Listening	5 oz.	.59
99 E 30264	Replacement Antenna	6 oz.	.99



- ★ Pocket Size
- ★ Tuneable

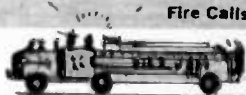

Fire Calls



Police Calls

NOVA-TECH "ACTION II" 5 BAND SOLID STATE AM-FM/VHF POLICE MARINE RADIO with RADIO DIRECTION FINDER

5 Bands

Police: 30-50 MHz
Marine: 1.5-4.5 MHz
Police: 150-175 MHz
Beacon: 200-400 kHz
AM: 550-1600 kHz

129⁹⁵
with batteries,
earphones,
AC adapter,
case

Deluxe 5 Band Portable Receiver with Radio Direction Finder. Tunes in FM police frequencies (both high and low band). Also covers entire regular marine band, new VHF marine band, special weather broadcasts (up to 200 mile radius around reporting station), navigation beacons, shortwave, 75 meter "ham" band, and your favorite AM music, news and sports programs. Features squelch control, three telescoping antennas, rotating loop antenna, 180° left-right bearing scale, null meter, DF level control, calibrated optical sights on rotating antennas for taking visual bearings, pushbutton dial light, earphone jack, 117VAC adapter cord which plugs into house current. Sensitive 14-transistor circuit for superb sensitivity and selectivity. Includes instruction manual with Morse code guide. Dim. 9½x5½x2½". Imported. Shpg. wt., 6 lbs.

40 E 38022WX No Money Down* Net 129.95

99 E 62580 Extra "AA" batteries (4 required) Net ea. .10



NEW ELECTRA "BEARCAT" 8-CHANNEL CRYSTAL-CONTROLLED BATTERY/AC VHF-UHF POLICE MONITORS with ELECTRONIC SCANNING

- For 117 VAC or Mobile 12 VDC Negative Ground

CHOOSE FROM THREE MODELS

Deluxe 12 Volt mobile and fixed AC monitor radios automatically scan up to 8 crystal controlled channels. Ideal for Police, Fire, and Public Services. Manual channel switching if desired... or any single channel may be locked in. 8 Pilot lamps to read out active channel. Controls: variable squelch, volume/on-off switch, Scan/Manual switch, channel selector, 1uv. input sensitivity for 20db quieting. Reliable solid state circuitry with IC's and FET's for instant-on operation. For 115VAC or 12 Volt DC negative ground systems. Complete with indoor telescopic antenna, mobile mounting bracket, antenna plug, and 2 power cords. Size: 9 x 4 x 6½". Shpg. wt., 4 lbs.

40 E 17000 X Model BCL 30-50 MHz Net 139.95
40 E 17034 X Model BCH 150-174 MHz Net 139.95
40 E 17018 X Model BCU 450-470 MHz Net 149.95

CRYSTALS FOR ELECTRA BEARCAT MONITORS

For each crystal ordered, you will receive a separate crystal certificate card. Send filled out card to manufacturer. Manufacturer sends crystal within 30 days. Note: for models BCH and BCU: the scanning range between channel 1 and channel 8 is limited to 10 MHz spread. For Model BCL-scanning range is limited to 7 MHz.
40 E 17026Z Net 5.00



As Low As

139⁹⁵

with mobile
mount...
Less Crystals

3 Crystal-Controlled Models:

30- 50 MHz FM-VHF Band
150-174 MHz FM-VHF Band
450-470 MHz UHF-FM Band

* See Page 11 for Full Credit Details on Easy Pay Plan

Regency Special Purpose FM-VHF Receivers

FOR: State, County and Municipal Police—Fire Departments—Civil Defense—Trucking—Railroads—Aircraft—Highway Maintenance—Forestry Conservation—Petroleum and Industrial Activities.

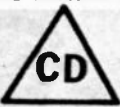

MOBILE FM-VHF RECEIVERS



No Money Down* **150⁰⁰** ea.

- M-40; Tunable 30-50 MHz
- M-160; Tunable 152-174 MHz

These high quality tunable mobile receivers cover the entire FM communications band with excellent sensitivity. 10 tube circuit features a fully tuned RF amplifier, dual conversion, and two stages of limiting followed by the discriminator. Power output is 8 watts, built-in 4" speaker. For 12 VDC 3.9 amperes. Housed in attractive cabinet, only 4½ x 6½ x 8¾". Shpg. wt., 10 lbs.
 MODEL M-40 Mobile FM receiver for 30-50 MHz band. Sensitivity 2µv for 20 db quieting. 40 E 60018WX Net 150.00
 MODEL M-160 Mobile FM receiver for 152-174 MHz band. Sensitivity 2µv for 20 db quieting. 40 E 60034WX Net 150.00

TUNABLE FIXED FM-VHF RECEIVERS

- MR-10D Tunable 152-174 MHz • MR 33D Tunable 30-50 MHz



Only **84⁹⁵** ea.

Extra sensitive FM receivers for police and fire departments, Civil Defense, and industry use. Ideal for any type of fixed or portable application. 3-gang tuning condenser. Sensitivity of 4 µv or less for full 20 db quieting. Adjustable squelch eliminates noise between transmissions. Built-in 5" speaker, 8 watt output, illuminated slide-rule dial for night operation. Two-tone metal cabinet 11¼ x 7½ x 6½". For 105-125 volts 60 Hz AC only. U.L. listed. Shug. wt., 11 lbs.
 MODEL MR-10D 152-174MHz 40 E 60216WX No Money Down Net 84.95
 MODEL MR-33D 30-50 MHz 40 E 60224WX No Money Down Net 84.95

REGENCY "ON-CALL" CRYSTAL-CONTROLLED TRANSISTORIZED FM-VHF RECEIVERS



As Low As **115⁰⁰**
 No Money Down*

- Emergency Receivers to Alert Police and Firemen
- For 30 to 50 MHz; 150 to 175MHz
- 3 Way ON-CALL Power Supply permits Operation on 117VAC, 12VDC, or optional internal Battery Pack
- Single channel or 6 Channel Crystal Controlled Models

The "ON-CALL" Transistorized Emergency Receivers combine the reliability of transistors and a 1 µv sensitivity for a strong, clear signal with minimum distortion and background noise. Optional internal battery pack is automatically activated in case of power failure. Includes Squelch control. Audio output 1.5 watts. 21 transistors—9 diodes. Cabinet—blue vinyl—laminated steel. Size 11Wx4¼Hx7½"D. Shpg. wt., 8 lbs.—Each unit comes with one crystal.†

CHOOSE FROM FOUR BASIC MODELS

MODEL TML-1† Single channel crystal control for 30-50MHz.	Net 115.00
40 E 66247XZ	
MODEL TMH-1† Single channel crystal control for 150-175MHz.	Net 115.00
40 E 66254XZ	
MODEL TML-2† Six channel crystal control for 30-50MHz.	Net 130.00
40 E 66221XZ	
MODEL TMH-2† Six channel crystal control for 150-175MHz.	Net 130.00
40 E 66239XZ	

AR-136 AM-VHF AIRCRAFT MONITOR RECEIVER

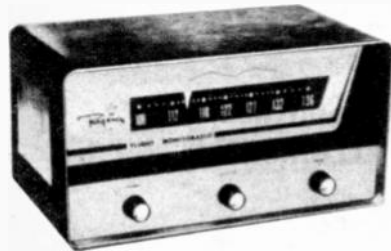

99⁹⁵ No Money Down*

- Electronic Squelch
- Nuvistor RF Amplifier
- Frequency Range 108-136MHz

A deluxe 9-tube "Flight Monitoradio" for use in the home, office, by pilots, flight schools and clubs. Includes all ILS, radar approach, UNICOM, Omnisrange (VOR), control tower, private, commercial and military air craft communications. VHF frequency range 108 to 136 MHz. Sensitivity 1µV. Features nuvistor RF stage, fully tuned 2nd rf stage, built-in 5" speaker, noise squelch, tone and volume controls and illuminated slide rule dial. Blue vinyl laminated steel cabinet. Size: 12¼W x 6¼H x 6¾"D. For 105-125V 60 Hz AC. Shpg. wt., 16 lbs.
 40 E 60158WX Net 99.95

Accessories for "ON-CALL" Receivers

Emergency tone alarm kit. Optional feature of great value in alerting volunteer fireman, off-duty policemen, emergency squads, or private ambulance crews.
 SPECIFY TRANSMITTING ALARM AUDIO FREQUENCY: 313.0, 349.0, 389.0 or 433.7.
 40 E 66320Z Shpg. wt., 3½ lbs. Net 40.50
 Extra crystals—please specify exact frequency.
 40 E 66189Z Shpg. wt., 2 oz. Net 6.95
 DC Power Cord enables receiver to be operated from any 12VDC power source with a negative ground. Net 2.95
 40 E 66197 Shpg. wt., 6 oz. Net 2.95
 Emergency Battery Pack. Will switch circuit automatically to 12VDC if the 117VAC power fails. Net 20.35
 40 E 66205 Shpg. wt., 1 lb. Net 20.35
 Carry Handle and Mobile Mtg. Bracket
 40 E 66213 Shpg. wt., 8 oz. Net 5.35

†ALL MODELS ARE ORDERED SPECIAL AND ARE SUBJECT TO 6 WEEKS DELIVERY. SHIPPED COLLECT FROM INDIANAPOLIS. NO COD ORDERS.

LAFAYETTE VHF Antennas—VHF Receivers & Converters

DELUXE LAFAYETTE MOBILE FM VHF ANTENNAS

HIGH BAND MOBILE ANTENNA

Only **5⁹⁵** With 12" Cable

- For 130-174MHz
- For 450-470MHz

Mobile roof or trunk mount for 130-174MHz or 450-470 MHz operation. Terminates in 3/8" bolt. Whip has set screw-type adapter for easy tuning. Comes with 12" RG-58U cable and PL259 connector pre soldered to the antenna. Length 21½". Shpg. wt., 1 lb.

40 E 0113W Net 5.95

LOW BAND MOBILE ANTENNAS

11⁹⁵ ea.

- For 30-50MHz
- Features "Rapid-Grip" Trunk-Lid Mount

3 deluxe new base loaded FM-VHF mobile antennas to choose from—30-36MHz, 36-42MHz, 42-50MHz. All 3 antennas include "Rapid-grip" trunk lid mounts for simple and easy installation. No holes to drill. Provides ideal omni-directional signal pattern. Consists of weatherproof phasing transformer, stainless steel whip and cadmium plated "rapid-grip" mount. Overall length 43". Wt. 2 lbs.

40 E 0114SW 30-36MHz Net 11.95
40 E 01152W 36-42MHz Net 11.95
40 E 01128W 42-50 MHz Net 11.95

20' Coaxial Cable Assembly for above antennas. Terminate with PL-259 on one end and universal lugs on other end.

42 E 70021 Net 2.95

LOW-BAND 30-50 MHz WINDOW MOUNT ANTENNA

- Perfect for Apartment Applications

Especially designed for apartment installation where other outdoor antennas can not be used. May be cut to resonate at any desired frequency from 30 to 50MHz. To receive signals below 30MHz, simply leave antenna at maximum length. Comes with angle mount bracket for ledge mounting. Shpg. wt., 3 lbs.

40 E 13017W Net 7.95

LAFAYETTE DUAL BAND FM-VHF INDOOR MONITOR ANTENNA

Only **8⁹⁵**

- For 30-50MHz 130-174MHz

Dual band indoor antenna enables you to operate your VHF FM communications receiver without having to put up an outdoor antenna. Consists of 2 section stainless steel whip with center loaded coils for 30-50MHz and 130-174MHz. Ideal for use with Lafayette Models PF175, PF60, PF30 FM VHF receivers. Overall length 48". Lug-type connector. Imported.

99 E 26106 Wt., 2 lbs. Net 8.95

LAFAYETTE MONITOR FM-VHF GROUND PLANE ANTENNAS

As Low As

7⁵⁰

Model LR-145 High Band Monitor

For 130-174 MHz and 450-470 MHz. Light-weight, omni-directional vertical ground plane antenna. 4 Radials are of stainless steel construction. Radiator is of chrome plated brass and highly corrosion resistant. Coaxial fitting on antenna base directly accepts the standard PL-259 coaxial plug. U-bolts are provided to accept up to 1½" diameter masts. Shpg. wt., 2 lbs.

40 E 01160W Net 7.50

Model LR-40 Low Band Monitor

For 25-30 MHz. Omni-Directional vertical ground plane antenna. 3-solid aluminum radials, cadmium plated steel mounting brackets, Lug-Type connector. U-Bolt supplied to accept up to 1½" masts. Tuning Chart supplied. Shpg. wt., 2 lbs.

40 E 01178W Net 8.95

LAFAYETTE "RANGE-BOOST"™ 2 BAND FM VHF GROUND PLANE COMMUNICATIONS ANTENNA

Only **19⁹⁵**

- For 30-50MHz, 130-174MHz
- Boost your FM Receiving Range

An exceptionally efficient ground plane antenna for operation between 30 to 50MHz and 130 to 174 MHz (on the high band, maximum antenna cable length to receiver should be 50 ft. for best efficiency). Comprised of 4 easily assembled drooping elements tuned to 30 MHz and a vertical radiator with a matching transformer and a low and high band collinear collector. Ideal for use with Lafayette FM communications receivers. Constructed of heavy-duty aluminum alloy rods and stainless steel tip section. Antenna comes complete with mounting bracket for 1" pipe or 1¼" tubing. Shpg. wt., 6 lbs.

40 E 01053WX Net 19.95

NEW DELUXE SOLID STATE FM-VHF MONITOR TUNERS WITH SQUELCH

only **44⁹⁵** No Money ea. Down*



- For High And Low Band Police, Fire, Aircraft
- Plugs Into Your Regular AM Car Radio
- Tuneable And Crystal Control
- Self-Contained Battery Power Supply or Can Operate off 12 Volt Negative Ground Car Battery

Tuneable converter that enables your regular car AM radio to receive Police and Fire frequencies. Drift free monitoring with FET transistor oscillator. 3 gang tuning capacitor. Completely tuneable or crystal controlled operation. Built in squelch. Comes complete with 24" special low capacity coax cable with Motorola plugs on each end of the cable ready to plug into your auto radio. 2½"x3½"x4½". Operates on 9V battery or off 12V negative ground car battery. Shpg. wt., 2 lbs.

STOCK NO. TUNES NET
40 E 20079 Police 150-164 MHz 44.95
40 E 20053 Police 33-48 MHz 44.95

ACCESSORIES FOR TUNERS
99 E 60212 9 Volt battery Net .21

Crystals for Tuners—specify exact frequency, allow 3 weeks for delivery
40 E 20061Z Net 5.10

SOLID-STATE MINI POCKET AM-VHF AIRCRAFT RECEIVER

only **9⁹⁵**

"Mini" Solid State aircraft radio receiver. Pocket size, covers standard aircraft band 108-136 MHz. Listen to aircraft in flight, or airport towers from up to 10 miles away. Features variable tuning. 4½" whip antenna, and earphone. Includes 2 Mallory MS76 batteries. Imported.
40 E 21002L Shpg. wt., 1/2 lb. Net 9.95
Package of 6 extra batteries 32 E 46949 Shpg. wt., 1/2 lb. Net 1.80



Quality Sonar Marine Electronic Equipment

**MODEL 75AW TRANSISTORIZED
75-WATT MARINE RADIO TELEPHONE**



299⁹⁵

No Money Down*

- Features Tuned RF Amplifier For All 6-Channels
- Power Supply Has 80% Efficiency for Low Battery Drain

Equipped with crystal for 162.55 MHz To pick up U.S. Weather Bureau Forecast

Meets FCC requirements for commercial boats having six or more passengers for hire. Powerful 75-watt transmitter has a tuned RF amplifier for all 6 marine channels. Advanced 10 transistor, 3 tube, 10 diode circuit. Receiver features low battery drain (3/10 ampere), gated noise limiter, silicon transistors, broadcast band coverage, adjustable squelch, and front mounted hi-fi oval speaker. Transmitter utilizes power saver "stand-by" switch, front panel tuning and RF output indicator, high level class "B" modulation, and speech limiter. Non-magnetic all aluminum construction treated against the effects of salt water and fungus. Power requirements: 12 volts DC. Size: 13½x10½x6¼"H. Supplied with universal mounting bracket and push-to-talk mike, 3-pair of matched crystals for 2182 kHz coast guard, 2638 kHz, and 2738 kHz Ship-to-shore. Also includes 162.55 MHz crystal so VHF weather reports can be received instantly from U.S. Weather Bureau Stations at all times. Shpg. wt., 17 lbs. 40 E 43287WX Model 75AW Net 299.95

Model 115W Same as above but with 115 watt input. Shpg. wt., 18 lbs. 40 E 43295WX No Money Down* Net 379.95

ACCESSORIES FOR SONAR MARINE RADIO TELEPHONES

Model AN16—Deluxe 18 Ft. Heavy-Duty Fiberglass Antenna with heavy-duty chrome lay down mount. Shpg. wt., 11 lbs. 40 E 43220WX No Money Down* Net 80.00

**NEW FM-1802 VHF-FM TRANSISTORIZED
25-WATT MARINE RADIO TELEPHONE**



595⁰⁰

- Freq. Coverage: 156-162 MHz
- Complete with Microphone and 5 Crystals

Provides maximum legal power. Features helical resonators, IC limiters, crystal filter, fade lock squelch, dual RF stages, and instant switching to 1 watt level. Freq: 156-162.5 MHz. Comes with crystals for: receive and transmit for safety and call, receive and transmit for ship to ship, and receive for weather—162.55 MHz. Antenna Input 50 ohms. Voltage: 13.8 VDC (negative ground). Size: 11W x 12D x 4" H. Wt., 13 lbs. 40 E 43311WX No Money Down* Net 595.00

Crystals (Pair Per Channel) Specify frequency. Allow 3 weeks for delivery. 40 E 43329Z Net 20.00 per pair

MODEL D120B DEPTH INDICATOR

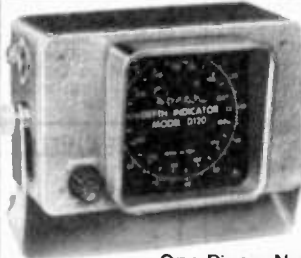

only

139⁵⁰

No Money Down*

- Reads Up To 250 Feet
- 360°, 4" Scale With 1-Foot Calibrations

- One-Piece, Non-Magnetic Construction

Highly sensitive, extremely accurate depth indicator for bulkhead mounting. Measures from 1 to 250 feet. Easily installed—even while boat is in water. For 12 VDC. Size: 11¼Wx7½Hx7½"D. Complete with transducer, gimbal and fairing block. Shpg. wt., 10 lbs. 40 E 43121WX Net 139.50

MODEL D10 TRANSISTORIZED DEPTH INDICATOR

MODEL DC-380 COMBINATION CHART AND FLASHER DEPTH RECORDER

MODEL DF-1301 TRANSISTORIZED DIRECTION FINDER



114⁹⁵

No Money Down*

Complete with transducer and gimbal.

- Range: 1 to 60 feet
- Soundings: 40-per-second

Lightweight and rugged one-piece transistorized depth indicator for shallow water navigation and fish location. Features an optically designed non-glare dial with 1-foot calibrations to 60 feet, adjustable magnetic key and governor control that protects against deviation in indication due to boat's voltage variation. Constructed in a non-magnetic, special aluminum cabinet treated against salt spray and fungus effects. 200 kHz operating frequency. For operation on 12 volts DC Negative Ground only. Current drain on 12 volts is a low 1/4 ampere. Shpg. wt., 3½ lbs. 40 E 43303WX Net 114.95

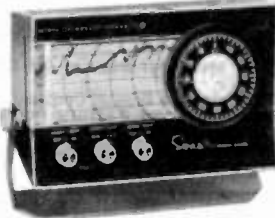

239⁹⁵

No Money Down*

A highly sensitive depth recorder which both records your voyage as you sail and provides an instant flashing indication for safe navigation. The unit can serve as a reliable navigational guide in unfamiliar channels and to help find schools of fish and underwater wrecks. Illuminated two color chart is calibrated from 0 to 120, 120 to 240 ft. Has 4"x6" viewing area. 360° flasher dial indicates 0 to 480 ft. Takes 5 soundings per second. Only 5 amps. current drain. Size: 10¾Wx6¾Hx6¾"D. For 12 VDC positive or negative ground. Shpg. wt., 15 lbs. 40 E 43236WX Net 239.95

Complete With Transducer, Gimbal, Fairing Block



249⁵⁰

No Money Down*

Equipped with crystal for 162.55 MHz To pick up U.S. Weather Bureau Forecast

Features left/right meter indication of boat heading. 3 bands: Beacon (180 kHz to 420 kHz); Standard Broadcast (525 kHz to 1650 kHz); Marine (1600 to 3500 kHz) plus Consolan reception. Also features crystal for 162.55 MHz. enabling listener to hear U.S. Weather Bureau VHF forecasts. Sensing system provides true null bearings ±1°. Includes, ANL, antenna, speaker, compass rose, and amplified meter for greater sensitivity. With battery. Size: 13¾L x 10½D x 8"H. Shpg. wt., 14 lbs. 40 E 43279WX Net 249.50

Selected Marine Radios, Antennas, and Accessories

"SHIPMATE" MOBILE MARINE RADIO CONVERTER

19⁹⁵

- Receive Marine Broadcasts On Your AM Car Radio
- Tuning Range 2000-3000kHz
- For Coast Guard, Marine Telephone, Ship-to-Ship Broadcast, WWV (weather), Ship-to-Shore Conversions



Now you can listen to marine broadcasts on your car radio. A flick of the switch and your auto radio becomes a powerful, long-range marine receiver. Switch back and it plays the normal broadcast band. All-transistor circuitry uses only 1/2000 of an amp from built-in battery; virtually the battery's entire shelf life. Converter selects any frequency between 2000 KHz and 3000 KHz. Operates with either 6V or 12V automobile ignition system. Comes complete with mounting hardware, 24" antenna cable and 9v battery. Size: 4½x2½x1½".

40 E 32017 Shpg. wt., 1½ lbs. Net 19.95
 "Weathermate" Mobile Marine And Weather Band Converter: All the features of above plus continuous marine weather reception. Includes crystal-controlled VHF converter for 162.55 MHz. Also tunes 2-3 MHz. 4½ x 2½ x 1½". Shpg. wt., 1½ lbs.
 40 E 32025 No Money Down* Net 39.95

NOVA TECH "NOVA" 3" SOLID STATE 3 BAND MARINE RADIO DIRECTION FINDER

BANDS

Marine 1.7-5 MHz
 Beacon 200-400 kHz
 AM 550-1600 kHz

Only
 99⁹⁵



With Earphone and Batteries

A precision 3-band radio direction finder designed for the boat owner as well as the marine enthusiast. Tunes low frequency navigation beacon and weather bands; marine and shortwave plus standard AM broadcast bands. Also tunes WWV to provide accurate time ticks for celestial navigation. Circuit consists of eleven transistors, tuned RF, 3-gang tuning condenser, heavy-duty speaker, built in BFO (for Consolan reception), rotary antenna and null meter. Operates on 4 inexpensive "AA" batteries. Size: 9"x3"x6". Shpg. wt., 3 lbs.

40 E 38030WX No Money Down* Net 99.95
 99 E 62580 Extra "AA" batteries for above (4 required) Net ea. .10

DELUXE LAFAYETTE PISTOL-GRIP POWER MEGAPHONE



29⁹⁵

- Weighs only 4½ lbs.

Lightweight, powerful megaphone provides high sound volume output. Uses 4 size 0 flashlight batteries and has a patented non-linear current-limiting device to give maximum possible battery life. Reflexed air column in the horn serves to concentrate and direct the amplified sound and throw it for a considerable distance. Rubber rimmed horn is of lightweight spun aluminum. Microphone is built into the base of the horn. Unit measures 12½" long; mouth diameter is 8¼". Imported. Shpg. wt., 6 lbs.

99 E 45049W Power Megaphone Net 29.95
 "D" cell Battery for above (4 required).
 99 E 62564 Shpg. wt., 1 oz. Net ea. .15

"HUSH-TONE" TINY TIGER PORTABLE GENERATOR

99⁹⁵

No
 Money
 Down*



Miniature,
 Powerful,
 Portable
 Emergency Generator

Model 67 "Hush-Tone"—Features a 1 hp, 2 cycle Ohlsson & Rice air cooled engine with a high capacity magneto ignition. 3½ pint, premixed (10 parts gas—1 part oil) fuel capacity allows operation at full power (6300 rpm) for 2½ hours. Dual voltage, direct drive generator produces up to 350 watts of 115V., AC, and 12 amps. of 12V., DC simultaneously. Constant voltage within 110-120 volts with an automatic overload relief system. Light enough to carry anywhere (12 lbs.). Small enough to carry in one hand (8½"H x 8¼"W x 10¼"L). Shpg. wt. 16 lbs.
 12 E 35522 Net 99.95

NEW! MARINE BAND TUNEABLE ALTERNATOR FILTERS



- for 2-3 MHz.

TM-68 Heavy Duty Alternator Filter: Rated at 68 amps for use with extra heavy duty alternators. Meets the need for an efficient method of eliminating alternator noise in communication receivers on the 2-3 MHz Marine Band. Internal Trimmer on filter can be set to the exact frequency necessary to attenuate the unwanted noise. Wt., 2 lbs.
 42 E 44034 Net 8.95
 TM-49 Alternator Filter: Same as above but rated at 49 amps continuous. Wt., 2 lbs.
 42 E 44042 Net 7.95

SONAR MODEL HA-1 SOLID-STATE 2-WAY 30-WATT HAILER



- Complete with Control Unit, Mike, Trumpet, and 25 Ft. Cable

Sonar hailer features powerful 16 watt amplifier (30 watts Peak) for long distance operation. Especially designed to serve as a boat to boat, boat to dock, boat to swimmer or skier communicator, as a 2-way boat intercom, and for electronic listening or hailing with independent volume controls. Can also be used as extra loud electronic manual or automatic fog horn. Gimbal mounting bracket. Meets Coast Guard requirements for class 1, 2, 3 and international communications standards. 6¾ x 2½ x 5".
 40 E 43246WX No Money Down* Net 125.00
 Intercom Remote Speaker For Above
 40 E 43261 Wt., 2 lbs. Net 12.95

NEW SHAKESPEARE WONDERSHAFT FIBERGLASS 2-3 MHz MARINE BAND ANTENNAS

207B

As Low As
 55⁰⁰

208B



210

Engineered to withstand the most rugged marine environment—all fittings are chrome-plated brass—the loading coil and radiating conductor are completely encapsulated within white fiberglass to insure continuing high performance. For use with any radiotelephone between 2-3 MHz. Compatible with sideband frequencies. Resonant frequency of antennas: 2920 kHz. Does not require separate costly insulator.

Model 207B 18' 2 section antenna. Excellent for medium-sized craft. Use 210 mounting hardware. Length of base section 9 ft. Length of tip section 9 ft. Base fitting threads: 1"-14, female, diameter of mast section: 1½".
 40 E 27009WX No Money Down* Net 55.00

Model 208B 23' 2 section antenna. For optimum performance on medium and large craft. Use 210 mounting hardware. Length of base section, 14 ft., length of tip section, 9 ft. Base fitting threads: 1"-14 female, diameter of mast section 1½".
 40 E 27017WX No Money Down* Net 65.00
 210 Mounting Hardware—consists of laydown mouter and upper bracket.
 40 E 27025W Net 19.95

The World At Your Finger Tips!

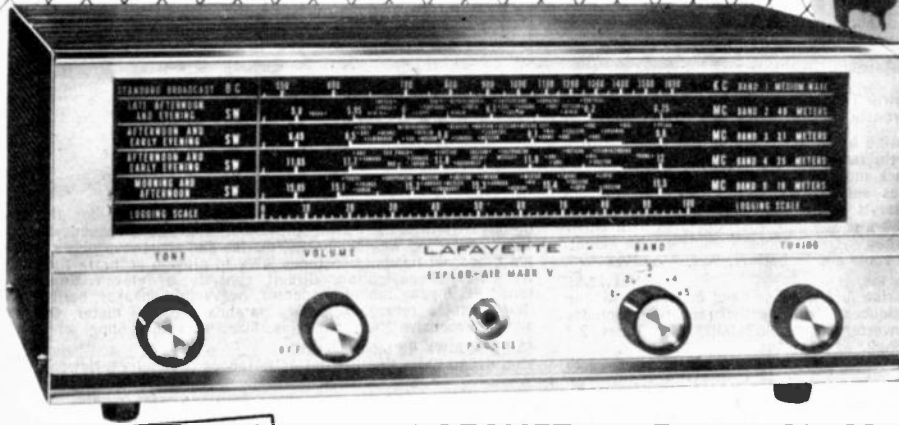

BRING HISTORY MAKING NEWS INTO YOUR HOME... FROM THE FAMOUS CAPITALS OF THE WORLD!

LAFAYETTE Explor-Air Mark V Shortwave + AM Broadcast Receiver

Only **49⁹⁵**
No Money Down*

5 BANDS

Broadcast + 4 Exciting International Shortwave Bands

- 550 to 1600 kHz • 9.45 to 9.8 MHz
- 5.9 to 6.25 MHz • 11.45 to 12 MHz
- 15.05 to 15.5 MHz

SUPERHETERODYNE— Not Super-Regenerative!

NOT A KIT— COMPLETELY WIRED

Listen to world-wide exciting current events right in your own home... hear the actual broadcasts from the major news centers around the world in English and foreign languages; BBC London, Radio Moscow and many others. The Explor-Air Mark V receiver is refined in its ability to bring in stations loud and clear and features simplicity of operation. In addition to the standard AM broadcast frequencies, the receiver is designed to tune the popular international shortwave broadcast bands on 49, 31, 25 and 19 meters (each band occupies a select portion of the full shortwave spectrum) through the use of individual tuned circuits for each of the five bands. For greater ease of tuning on congested bands each shortwave band has been extended to cover the entire width of the 0 to 100 logging scale.

Operating features on the receiver include a self-contained 4" dynamic speaker, built-in loopstick antenna, large illuminated slide-rule dial calibrated in frequency and indicating place names, a front panel headphone jack for optional silent listening, controls for Volume Off/On, Tone and Band Selection, plus rear panel connection for external shortwave antenna. **SPECIFICATIONS:** Full coverage on 5-bands; AM Broadcast (0.55 to 1.6 MHz), and International Shortwave on 49 Meter (5.9 to 6.25MHz), 31 Meter (9.45 to 9.8MHz), 25 Meter (11.45 to 12 MHz) and on 19 Meter (15.05 to 15.5MHz). Receiver is AC transformer powered with efficient superheterodyne circuitry. Complete with beautiful walnut grained metal cabinet. For 105-125V., 50/60 Hz AC. Size: 14Wx8Dx6"H. Imported. Shpg. wt., 11 lbs. **99 E 25850WX** **49.95**

ECONOMY SHORT-WAVE PACKAGES WITH EXPLOR-AIR MARK V

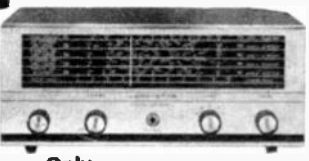
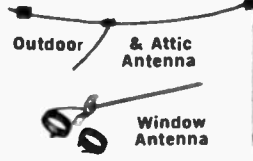

Explor-Air Mark V plus Shortwave Window Antenna **Only 56⁹⁵ SAVE 2.95** From individual catalog prices. Net 56.95

40 E 90148WXM Shpg. wt., 14 lbs. No Money Down*

Explor-Air Mark V plus Shortwave Outdoor and Attic Antenna **Only 53⁹⁵ SAVE 2.95** From individual catalog prices. Net 53.95

40 E 90122WXM Shpg. wt., 13 lbs. No Money Down*

HY-GAIN SW-9 SHORTWAVE WINDOW ANTENNA



Only 99⁵

Includes Universal Window Mounting Bracket

The ideal shortwave antenna for window installations, where roof-top antennas are impractical or cannot be used. Provides broadband performance comparable with other larger installations. Consists of one 9 foot aluminum tubular element with a universal mounting bracket and feedline. Simple to install. Answers the problems of apartment dwelling SWL's. Shpg. wt., 3 lbs. **40 E 31183WX** Net 99.50

HY-GAIN SW-6 SHORTWAVE ANTENNA

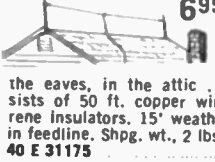

69⁵

A completely assembled antenna, ready to install. Scientifically tuned for 1.8 to 30 MHz coverage. Can be installed on any existing structure: pole-to-pole, pole-to-tree, garage-to-house, under the eaves, in the attic... all provide excellent reception. Consists of 50 ft. copper wire attached at both ends to low-loss styrene insulators. 15' weather-proof rope on each insulator, plus lead-in feedline. Shpg. wt., 2 lbs. **40 E 31175** Net 6.95

* See Page 11 for Full Credit Details on Easy Pay Plan

H E A R . . .

Sensational, Live, History Making World Events . . .

Superb Hi-Fi FM Musical Programs . . .

Weather, Marine and AM Broadcasts . . .

RIGHT IN THE COMFORT OF YOUR HOME



**LAFAYETTE 7-Band Professional AM-FM Hi-Fi,
Shortwave and Weather Receiver Explor-Air Mark VI**

7 BANDS	Hi-Fi FM-AM Broadcast — Shortwave — Weather and Marine Bands			
	1 Weather/Marine	150-400kHz	5 Shortwave	9.45-9.85MHz
	2 AM Broadcast	550-1600kHz	6 Shortwave	11.85-12.05MHz
	3 FM Broadcast	88-108MHz	7 Shortwave	15.05-15.55MHz
	4 Shortwave	5.9-6.25MHz		

Our Low,
Low Price
79⁹⁵
No Money Down*

- ★ Thrill To Live Broadcasts of World-Shaking Events!
- ★ Relax With The Magnificent Sound of FM Hi-Fi Music!
- ★ Hear Latest Weather & Marine Reports!
- ★ Enjoy Popular AM Local News, Sports, etc.

Hear exciting international news on this specialized international coverage receiver from: Prague, Berne, Berlin, BBC, London, Havana, Vatican, Moscow, Rio, Canada, Japan, Bucharest, Mexico, France, Athens, etc.

The Lafayette Explor-Air Mark VI is a professionally designed FM, AM, Shortwave and Weather receiver with such advanced features as individually tuned circuits for each band, automatic volume control, 455kHz ceramic filter for superior selectivity, tuned RF stage for outstanding sensitivity, and a 'Shock-free' high voltage transformer-operated power supply. Seven full dial bands offer extra-wide station separation; illuminated wide-view slide rule dial is labeled with clearly visible names of primary cities and countries. The back panel has terminals for external AM and FM antennas; tape recorder out-

- 17 Transistors, 6 Diodes, 2 Thermistors
- Attractive Front Panel with Large Illuminated Slide-Rule Dial
- Illuminated Jewel Band Indicators
- Private Listening Headphone Jack
- Built-in FM and AM Antennas
- Tape Record Output Jack
- 105-125VAC/50-60 Hz; 24VDC

put jack; 8-ohm extension speaker jack; speaker fuse and 24 volt DC input connection. Attractive styling includes brushed aluminum trim and control panel, and oiled walnut wood sides. **SPECIFICATIONS:** two built-in 4" PM speakers. **FM Sensitivity:** 2µV or less. **Cross Modulation:** 70 db. **Oe-emphasis:** 75 microseconds. **Distortion:** 1% or better @ 20 µV. **Image Ratio:** 45 db. **Antenna Impedance:** 300 ohms. **AM: Suppression @ 10V** 35 db. **Shortwave:** as low as 2 µV sensitivity. **Size:** 14 3/4" x 6 1/2" x 9 7/8" D. Imported. Shpg. wt., 17 lbs. **99 E 26015WX** Net 79.95

SAVE ON THESE ECONOMY EXPLOR-AIR MARK VI SYSTEMS!

Only **82⁹⁵**
No Money Down*
SAVE 3.95 From Individual Catalog Prices!

Explor-Air Mark VI
Shortwave Outdoor and
Attic Antenna
Shpg. wt., 19 lbs.
40 E 90163WXM

Net 82.95

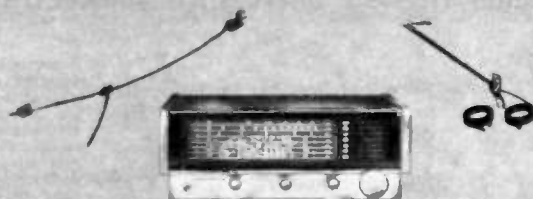

Only **85⁹⁵**
No Money Down*
SAVE 3.95 From Individual Catalog Prices!

Explor-Air Mark VI
Shortwave Window
Antenna
Shpg. wt., 20 lbs.
40 E 90171WXM

Net 85.95

* See Page 11 for Full Credit Details on Easy Pay Plan



5 Band AM/CW/SSB Solid-State Amateur And SW Receiver



Only
99⁹⁵
No Money Down*

**2 Field Effect Transistors +
10 Transistors +
8 Diodes**

HA-600T

5 BANDS: Shortwave - Amateur - AM Broadcast - Weather & Marine Bands

- BAND A**
150 kHz to 400 kHz
- BAND B**
550 kHz to 1600 kHz
- BAND C**
1.6 MHz to 4.8 MHz
- BAND D**
4.8 MHz to 14.6 MHz
- BAND E**
10.5 MHz to 30 MHz

PRODUCT DETECTOR FOR SSB/CW

- 10 Transistors, 2 FET's, 7 Diodes, and 1 Zener Diode
- Mechanical Filter for Exceptional Selectivity
- Huge Edge-Illuminated Slide Rule Dial with "S" Meter
- 117-Volts AC and 12-Volts DC Negative Ground Operation
- Full 24½ Inches of Bandsread On 10-80 Meter Bands
- Automatic Series Gate Noise Limiter With AVC on AM

The HA-600T general coverage receiver combines the latest solid state electronics with sleek, modern appearance to achieve a superb blend of performance and style. Advanced circuitry utilizes two Field Effect Transistors in the front end RF stages to assure high sensitivity with lowest noise factor. 10 high performance transistors and 8 diodes compliment the FET's to provide sharp response with exceptional stability. Series-Gate noise limiter and automatic volume control circuitry provide efficient noise and audio blasting suppression on AM. Built-in variable BFO permits clear reception of code and single sideband signals. 455 kHz mechanical filter assures superior selectivity. Receiver's operation is virtually undisturbed by harmonics or noise from antenna to speaker. Rear panel accessory socket provides convenient connection for audio output, 12 VDC, ground and AVC line, along with receiver muting connections. Huge fly-wheel operated slide rule dial has easy-to-read illuminated main tuning, logging, and bandsread scales. Electrical bandsread features wide calibration for easier tuning of crowded ham bands. Operates from 117 VAC 60 Hz or 12 VDC (negative ground only) perfect for emergency use! Imported. Shpg. wt., 18 lbs.
99 E 25959WX Net 99.95
Matching 3 x 5-inch speaker in handsome cabinet.
40 E 09056 Net 8.95

turbed by harmonics or noise from antenna to speaker. Rear panel accessory socket provides convenient connection for audio output, 12 VDC, ground and AVC line, along with receiver muting connections. Huge fly-wheel operated slide rule dial has easy-to-read illuminated main tuning, logging, and bandsread scales. Electrical bandsread features wide calibration for easier tuning of crowded ham bands. Operates from 117 VAC 60 Hz or 12 VDC (negative ground only) perfect for emergency use! Imported. Shpg. wt., 18 lbs.
99 E 25959WX Net 99.95
Matching 3 x 5-inch speaker in handsome cabinet.
40 E 09056 Net 8.95

SPECIFICATIONS

Sensitivity: 1µv at 10 db signal to noise ratio. Selectivity: ± 6 kHz at 60 db down, ± 2 kHz at 6 db down. Intermediate Frequency: 455 kHz. BFO Frequency: 455 kHz ± 2.5 kHz. Antenna Impedance: 50-400 ohms. Audio Power Output: 3-watts at 4 ohms. Speaker Impedance: 4, 8, and 500 ohms. Headphone Impedance: 8 ohms. Receiving Modes: AM-CW-SSB. Power Requirements: 105-120 Volts 60 Hz (17 watts max.) 12 Volts DC (650 ma. max.). Size: 15W x 9¼D x 8¼"H.



Model HE-48B MATCHING AMATEUR SPEAKER

ONLY
8⁹⁵

- Excellent Speaker for Lafayette or Other Receivers Which Require External Speaker
- Large 3 x 5 Inch Permanent Magnet Speaker

A quality 3x5-inch permanent magnet speaker designed into a handsomely styled cabinet with attractive finish. Provides clean, crisp, and clear audio response—even during single sideband reception. Made for Lafayette or other manufacturer's receivers which need external speaker provisions. Voice coil impedance: 8 ohms. Size: 7½Hx3½Wx5¼"D. Shpg. wt., 4 lbs.
40 E 09056 Net 8.95

Made in U.S.A.

HE-48B

6-METER SOLID-STATE MOBILE TRANSCEIVER

With Built-in V F O



PORTABLE



BASE



HA-750

MOBILE

- 5-Watts DC Input—
- 18-Transistors, 8-Diodes, 2-Zener Diodes
- Tuneable Receiver, Xtal/VFO Transmitter
- ± 200 KHz Vernier Receiver Tuning
- Sensitivity Less Than $1\mu\text{V}$ for 10db S/N

Only
119⁹⁵

No Money Down*

Years of engineering research in 2-way communications brings you a major breakthrough in size, performance, and pricing of 6-meter 2-way gear . . . the HA-750. Fully transistorized 50-52 MHz circuitry features selectable single knob VFO receiver/transmitter tuning with vernier offset or crystal controlled transmitter with tunable receiver operation. Fine features include illuminated "S"/"PRF" meter, spot switch, series gate automatic noise limiting, built-in 3 x 5" speaker, and relay switching. 5-watt transmitter draws less than 1 ampere on full transmit. May be used as a 2.5 watt public address amplifier with external speaker. Supplied complete with DC power cable, mobile mounting bracket, and plug-in PTT dynamic microphone. Size: 2 $\frac{3}{8}$ "Hx6 $\frac{1}{4}$ "Wx8"D. Imported. Shpg. wt., 5 $\frac{1}{2}$ lbs. **99 E 26056WX** For Negative Gnd. Only Net 119.95

MODEL HB-502B Charger/AC Power Supply for 117 Volts AC operation. Charges nicad batteries used in portable power pack. **99 E 32088W** Shpg. wt., 5 lbs. Net 16.95

MODEL HB-506 PORTABLE DC POWER PACK Attaches to HA-750 for convenient portable operation. Less Batteries. **99 E 31544** Shpg. wt., 2 lbs. Net 19.95

"C" Dry Cell for HB-506 Power Pak (8 required) **99 E 62572** Net ea. .14 Lots of 10 Net 1.20

32 E 48879 Alternate "C" Alkaline Cell (8 required) Net ea. .48

DELUXE DYNAMIC DESK MICROPHONE with PTT and "Lock" Switch. **99 E 46088** Shpg. wt., 1 $\frac{1}{2}$ lbs. Net 11.95

50MHZ. CRYSTALS FOR HA-750 Special order—4 weeks delivery. **40 E 57014Y** Specify exact operating frequency Net 4.95

LAFAYETTE 6-METER "RAPID-GRIP" MOBILE ANTENNA. Wt., 2 lbs. **40 E 01095** Less Cable Assembly Net 11.95

42 E 70021 20 Ft. RG-58/U Mobile Cable Assembly Net 2.95

100-WATT MOBILE LINEAR AMPLIFIER Model HA-250

SMALL... COMPACT ONLY 2 INCHES HIGH!

Convert Flea Power To Real Power!

- Covers 20-54 MHz . . . 6, 10, 11 and 15 Meters (Not Permitted on 11 Meters Class D (CB) Operation in U.S.A.)
- No External Switching Required
- Will Work On Any Signal of 1 to 10 Watts — AM, FM, SSB or DSB, and CW
- Completely Self-Contained 12 Volt Power Supply



79⁹⁵

No Money Down*

Boost flea power to real high power for extended range and better readability. Provides up to 100 watts PEP (50 Watts DC) input into a 50 ohm load (with 8 watts RF drive). Unique RF sensing circuit automatically switches in linear when transmitter is activated. Absolutely no external switching is necessary. Built-in relay directly connects antenna to input SO-239 coaxial socket when receiving. No internal connections are required to your existing equipment. Simply insert the unit in series with your transmitter (or transceiver) and antenna and you're on the air with a real punch. Circuitry is broadbanded so only one tune-up is usually necessary on any band. Illuminated front panel meter indicates relative RF strength of linear's output signal when linear is on, or exciter's relative RF signal strength when linear is off. Self-contained power

supply utilizes a high efficiency toroid power transformer. Ruggedly designed chassis with oversized heat sinks assures sturdy and cool operation. Supplied with comprehensive manual, fused DC power cables and mounting bracket. Size: 7"D x 9"W x 2"H. Made in U.S.A. Shpg. wt., 3 $\frac{1}{2}$ lbs. 12 Volt DC Negative Ground Only. **40 E 01061WX** Net 79.95

SPECIFICATIONS: Frequency Coverage: 20-54 MHz. Plate Power Input: 50 Watts (100 Watts PEP). Minimum RF Drive: 1 Watt. Maximum RF Drive: 10 Watts. Input Impedance: 50 Ohms. Output Impedance: 40-600 Ohms (50 Ohms Nominal). Amplification Modes: AM, FM, SSB or DSB, CW. Power Requirement: 11.5-14.5 Volts DC (Neg. Ground only).

* See Page 11 for Full Credit Details on Easy Pay Plan

Lafayette Cat. No. 700 455

6 and 10 Meter Amateur Transceivers



**COMPLETELY WIRED
BUILT-IN VFO**

129⁹⁵

No Money Down*

**Model HA-460
50-52 MHz.**

**Model HA-410
28-29.7 MHz.**

- Dual Conversion with Crystal Controlled 2nd Converter
- Built-in Low Pass Television Interference Filter
- 20-Watt DC Input—2E26 Final
- Built-in Solid State 12 V.D.C. and 117 V.A.C. Power Supplies
- Tuned Nuvistor Front End

Exciting 400 series transceivers feature a powerful plate modulated 20 watt DC input transmitter and stable VFO with its own frequency control knob. Tune up is fast and efficient with broad-banded driver and multiplier stages. Shielded low pass filter minimizes TVI problems. Dual conversion receiver utilizes a crystal controlled 2nd converter. Nuvistor RF amplifier's sensitivity is less than 1 μ V. for 10 db signal to noise ratio. Selectivity at 8 kHz is 35 db. Effective automatic noise limiter eliminates most types of QRM. Other features include spotting switch, use of standard 7 and 8 MHz crystals with front panel crystal socket; illuminated meter that reads S units on receive and RELATIVE RF output on transmit; plug-in encapsulated dust free relay switching; front panel earphone jack; push-pull audio amplifier; and rugged push-to-talk ceramic mike with coiled cord and plug. Going mobile? The 400's come with both 117 V.A.C. and 12 V.D.C. (positive or negative ground) built-in solid state power supplies. Supplied with AC + DC power cords, mike and mobile mounting bracket. Size: 12 $\frac{1}{2}$ "x5 $\frac{1}{2}$ "x3 $\frac{3}{4}$ "D. Imported. Shipping weight, 22 pounds.

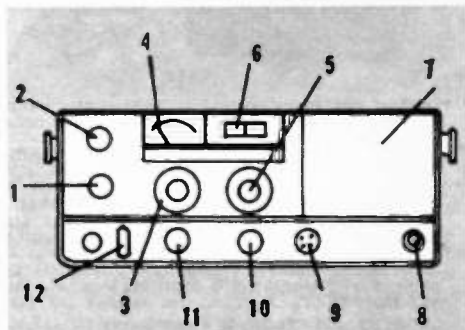

FRONT PANEL FEATURES

- 1 Air Variable Antenna Load Control
- 2 Air Variable Plate Tuning Control
- 3 Calibrated VFO Frequency Control
- 4 Illuminated "S" and RF Output Meter
- 5 Calibrated Receiver Frequency Control
- 6 Transmitter Frequency Spotting Switch
- 7 Front Panel Communications Speaker
- 8 Front Panel Standard Earphone Jack
- 9 Positive Contact PTT Microphone Socket
- 10 Volume Control
- 11 Crystal-VFO Operation Mode Selector
- 12 Front Panel Crystal Socket

- Lafayette Model HA-460—6 Meter Amateur Transceiver for 50.0-52.0 MHz.
99 E 25793WX Net 129.95
- Crystals for HA-460. Specify Fundamental Frequency (divide operating frequency by 6). Will supply to nearest 5 kHz.
40 E 54037Z Specify Frequency Net 2.95
- Lafayette Model HA-410—10 Meter Amateur Transceiver for 28.0-29.7 MHz.
99 E 25751WX Net 129.95
- Crystals for HA-410. Specify fundamental frequency (divide operating frequency by 4). Will supply to nearest 5 kHz.
40 E 54029Z Specify frequency Net 2.95
- Lafayette 6-Meter "Rapid-Grip" Mobile Trunk Antenna. Less Cable. Shpg. wt., 2 lbs.
40 E 01095 Net 11.95
- 20 Ft. RG-58/U Cable Assembly. Net 2.95
42 E 70021

120 WATT 2-METER MOBILE LINEAR AMPLIFIER



Model HA-260

Made in U.S.A.

- 120 Watts (PEP)
- Works with any AM, FM and CW Exciter with 1 or more watts output
- No External Switching
- Covers 144 to 148 MHz

Only **99⁹⁵**
No Money Down*

A completely self contained VHF linear amplifier designed specifically for mobile use. Efficient RF amplification stage utilizes a special purpose mobile application Amperey DX296/8637 twin triode. RF sampling relay automatically switches linear in the instant the exciter is energized. No external switching, wiring, or muting circuits are necessary. Antenna is automatically connected directly to input socket in off or standby modes. Front panel controls permit full flexibility of tuning and power level selection. Illuminated relative RF power output meter simplifies linear and exciter tuning. Built in power supply features high efficiency transistor and toroid transformer circuitry. Oversized heat sinks assure cool operation. Output impedance 50 ohms. Supplied with manual, fused DC power cable, and mounting bracket. 12 Volt DC Negative Ground Only. Size: 11 $\frac{1}{2}$ "x8 $\frac{1}{2}$ "x2 $\frac{5}{8}$ "H. Shpg. wt., 7 lbs.
40 E 01087WX Net 99.95

Top Quality Amateur Band Receivers

Drake Model R-4B Triple Conversion Receiver

- Solid State Linear Permeability Tuned VFO
- Noise Blanker on CW, SSB, AM
- Crystal Lattice Filter

430⁰⁰

Improved version of Model R-4A. Triple conversion with exceptional features. Covers 80, 40, 20, and 15 meters completely, and 28.5-29 MHz. Segment of 10 meters with crystals furnished. Ten accessory crystal sockets for any ten additional 500 KHz. ranges from 1.5-30 KHz. with the exception of 5.0-6.0 MHz. Selectivity v control with 4 bandwidths: .4 KHz., 1.2 KHz., 2.4 KHz., and 4.8 KHz. Pass band tuning permits SB selection without returning and adjustment. Noise blanker, notch filter, 100KHz crystal calibrator. Crystal lattice filter 1st IF. Crystal oscillator and low frequency VFO outputs are pre-mixed. Receives SSB, AM, CW and RTTY with full RF gain. Product detector for SSB/CW—diode detector for AM. Transceive capability: transceives with T-4XB "Reciter" or T-4X Transmitter. S-meter. Less speaker. 60 watts. 120/240VAC, 50/60 Hertz. 5½H x 10¾W x 11¼"D. Shpg. wt., 18 lbs.

40 E 65306WX No Money Down*

Net 430.00

Model MS-4 Matching Speaker for R-4B. Wt., 8 lbs.

40 E 65041



Drake 2C SSB/AM/CW Receiver



229⁹⁵

- Solid State AVC
- Product Detector For SSB/CW
- 3 Bandwidths of Selectivity

Covers the 80, 40, 20, and 15 meter ham bands plus 28.5 to 29.0 mHz of 10 meters with crystal furnished. Also tunes any 500 kHz range between 3.0 and 30 MHz with accessory crystal. Features include: USB/LSB, CW, AM, RTTY with full RF gain; solid state AVC with fast attack and slow release for SSB, or, fast release for high break-in CW; solid state audio with 1.8 watts output; selectivity control provides bandwidth choice of .4, 2.4, and 4.8 kHz. Set has 50 kHz selectable-passband filter and accurate S-meter. Rear panel jacks for antenna, loudspeaker, external muting and sidetone. Size: 11¾Wx6½Hx9¾"D. Shpg. wt., 15 lbs.

40 E 65280WX No Money Down* Net 229.95

Model 2-CS Matching Speaker for 2-C.

40 E 65298W Shpg. wt., 6 lbs. Net 19.95

NEW Hammarlund HQ-200 General Coverage Receiver



249⁹⁵

Continuously tunable from 540 kHz to 3 MHz with five bands. Electrical bandwidth calibrated for all amateur bands from 80 thru 10 meters. Eight tubes plus 5 diodes. Zener regulated and temperature compensated high frequency oscillator. Selectivity continuously variable from 12 kHz (AM) to 2.9 kHz (SSB) and 100 Hz (CW). Q multiplier operates independently of BFO. BFO variable ±2 kHz. Other features include antenna trimmer, AVC, series noise limiter, product detector, and "S" meter. Sensitivity: better than 0.5 µv. for CW and SSB. Audio output: 2.5 watts (EIA). Power requirements: 117/230 volts AC 50/60 Hz. Sizes: 16½Wx8Hx9½"D. 40 E 28924WX Shpg. wt., 22 lbs. Net 249.95

Model S-101 Speaker for HQ-200

40 E 28932W Net 19.95

Hammarlund HQ-180AC Triple Conversion Receiver



519⁹⁵

- SSB, AM, CW Reception
- Built-in 24 Hour Clock Timer
- General Coverage 540-30 MHz

Triple conversion, general coverage receiver for SSB, AM, and CW reception. Calibrated bandspread on the 80, 40, 20, 15 and 10 meter amateur bands plus a ±3KHz vernier. Full dial coverage from 540KHz to 30MHz. Slot filter, selectable sideband, tuned I.F. and separate linear detector. Sensitivity: .7 µv on SSB/CW for 10:1 SN ratio. Built-in 100KHz crystal calibrator. Fast attack and adjustable decay AVC. Adjustable selectivity (1-2-3 KHz on upper and lower sidebands). Adjustable series-type noise limiter for positive and negative clipping. Built-in 24 hour clock time. 17 tubes and silicon diode power supply. For 115/230V, 50/60 Hz AC. Size: 19x10½x13". Shpg. wt., 45 lbs.

40 E 28148WX No Money Down* Net 519.95

Model S200 Speaker for HQ-180AC

40 E 28304 Shpg. wt., 10 lbs. Net 24.95

NEW Hallicrafters SX-133 General Coverage Receiver



249⁹⁵

Deluxe four band superhet receiver tunes 535 kHz to 31.5 MHz. Covers foreign and domestic short-wave broadcasts, amateurs, aircraft and marine plus standard AM. Receives code (CW), voice (AM), and single sideband (SSB), selectable upper or lower. Calibrated electrical bandspread on the 80, 40, 20, 15, 10 meter amateur bands, citizens band and the 49, 31, 25, and 19 meter shortwave bands. Fine features include selective crystal filter, calibrated BFO, product detector, antenna trimmer, "S" meter, effective noise limiter, and crystal calibrator. For 117 VAC 50/60 Hz. Size: 18¾Wx8Hx9¾"D. Shpg. wt., 35 lbs.

40 E 25656WX No Money Down* Net 249.95

Model R-50 Matching Speaker. Wt., 8 lbs.

40 E 25441 Net 19.95

Hammarlund HQ-215 Solid State Amateur Band Receiver



529⁵⁰

- 80 thru 10 Meters
- Selectable USB, LSB, CW, or AM
- Selectable Filters

Frequency Coverage: 80-15 meters, 28.5-28.7 MHz, plus provisions for 13 optional 200 kHz segments from 3.4 to 30.2 MHz. 26 Transistor, 13 diode, 2 zener diode circuitry features selectable AGC, variable BFO, series noise limiter, rejection tuning, less than 100 Hz./Hour drift, and transceive operating provisions. Sensitivity: Better than 0.5 µv. for 10 db signal to noise ratio. Selectable Filters: 2.1 kHz. provided, plug-in space for two optional filters. Power Requirements: 117/234 volts 50/60 Hz. or 12 to 15 volts DC negative ground only. Size: 6.8Hx15.8Wx 14"D. Shpg. wt., 21 lbs.

40 E 28908WX No Money Down* Net 529.50

Model S215 Speaker for HQ-215

40 E 28916WX Shpg. wt., 10 lbs. Net 24.95

NEW Ameco R-5A 5-Band General Coverage Receiver



99⁹⁵

Fine receiver for the short wave listener and ham. Covers .54 to 54 MHz. in five bands. Includes all amateur bands from 160 to 6 meters including the 27 MHz. Citizens Band and 2-way Monitor frequencies from 30-50 MHz. Fully transistorized with built-in power supply—no warm up necessary. Features 2 IF stages for high selectivity, 6" slide rule dial, electrical bandspread, noise limiter, BFO for CW reception, headphone jack for private listening, and jack for external Q multiplier. Controls: main tuning, bandspread, volume, BFO tuning, band switching, RF gain plus switches for power, ANL and AM/CW. Vinyl covered metal cabinet. Size: 12x6x9". For 117 Volts AC. Shpg. wt., 12 lbs.

40 E 10542WX No Money Down* Net 99.95

* See Page 11 for Full Credit Details on Easy Pay Plan

Deluxe Amateur SSB Transceivers and SWL Receivers

**NEW SWAN 260 "Cygnets" 5-BAND 260 WATT
COMPLETELY SELF CONTAINED SSB TRANSCEIVER**



435⁰⁰
with Mike

No Money Down*

- Built-In AC and DC Power Supplies and speaker

The Cygnets features full frequency coverage of the 10, 15, 20, 40, and 80 meter bands with a power input rating of 260 watts P.E.P. in the single sideband mode, and 180 watts CW input. Crystal lattice filter at 5500 kHz is used in both transmit and receive modes and provides excellent selectivity with a 2.7 kHz bandwidth at 6 db down. Receiver sensitivity is better than 1/2 microvolt — great for pulling in those DX signals. Temperature compensated on all bands. Solid state oscillator circuitry with zener diode regulation permits wide variation in supply line voltage without frequency shift. Unwanted sideband suppression is —45 db, carrier suppression is —60 db, and distortion products are down approximately 30 db. Supplied complete with all power cords and carrying handle; thus making it one of the most versatile and portable sets on the market. Dimensions: 13Wx5 1/2 Hx11"D. Shpg. wt., 25 lbs. For 117 VAC, 60 Hz and 12 VDC.

40 E 70173WX

Net 435.00

**DELUXE SWAN 500C 5-BAND
SSB TRANSCEIVER**



565⁰⁰

No Money Down*

- 520 Watts SSB Input
- 360 Watts CW Input
- 125 Watts AM Input
- Crystal Lattice Filter

Deluxe 5-band SSB transceiver for fixed, mobile, or portable operation. Using a pair of 6LQ6 tetrodes the final amplifier operates with increased efficiency and power output on all bands. The 500C is conservatively rated at 520 watts P.E.P. on sideband; 360 watts CW input and 125 watts AM. Full 5 band frequency coverage: 3.5-4.0 MHz, 7.0-7.5 MHz, 13.85-14.35 MHz, 21-21.5 MHz, 28-29.7 MHz. Features: Selectable upper and lower sideband, 100 KHz crystal calibrator, automatic noise limiter, increased VFO stability, crystal lattice filter, advanced product detector circuit plus new AGC system, provision for internal speaker. Sensitivity is better than .5 μ v. The precision tuning mechanism is very smooth and provides easy tuning. Rejection better than 100 db. Built-in accessory socket for external VFO. 16x15 1/4x8 1/4". Shpg. wt., 22 lbs.

40 E 70140WX

Net 565.00

ACCESSORIES FOR SWAN 500C

40 E 70090WX 177Kc AC Power Supply and Speaker, 11 lbs. Net 105.00
40 E 70066WX 14-117 12VDC Power Supply, Wt., 8 lbs. Net 130.00
40 E 70074 VX-11 Plug-in Vox Adapter, Shpg. wt., 5 lbs. Net 35.00

DRAKE MODEL TR-4 SSB/AM/CW TRANSCEIVER

599⁹⁵

No Money Down*

- Full Frequency Coverage 10-80 Meters
- Automatic TR Switching on CW
- CW Side Tone Oscillator
- Vox or PTT on SSB or AM

Deluxe SSB/AM/CW transceiver with VOX and PTT on SSB and AM, automatic transmit/receive switching on CW. Ideal for mobile or portable work. Sensitivity less than 1/2 microvolt for 10 db S/N. Features: Selectivity 2.1 kHz at 6 db, 7.5 kHz at 60 db; Ranges 3.5-4 MHz, 7.0-7.6 MHz, 13.9-14.5 MHz, 21-21.6 MHz, 28-28.6 MHz, 28.5-29.1 MHz, 29.1-29.7 MHz; Transistorized permeability tuned oscillator which tunes 4.9-5 MHz. Less than 100 Hz drift after warmup; input power 300w PEP (SSB) 260w AM or CW; 20 tubes 6 diodes and built-in 100 kHz xtal calibrator. Size: 10 3/4 Wx5 1/2 Hx14 3/8"D. Shpg. wt., 13 1/2 lbs.

40 E 65215WX Model TR-4

Net 599.95

ACCESSORIES FOR DRAKE TR-4

40 E 65041 MS-4 Matching Speaker for TR-4, wt. 5 1/2 lbs. Net 19.95
40 E 65249WX AC-4 AC Power Supply for TR-4, 19 lbs. Net 99.95
40 E 65397WX DC-4 DC Power Supply for TR-4, 10 lbs. Net 125.00

DELUXE DRAKE SW4A DUAL CONVERSION SHORTWAVE BROADCAST RECEIVER



299⁰⁰

No Money Down*

- Crystal Lattice Filter
- Crystal Controlled HF Oscillator
- Ultra Precision Tuning Dial Accuracy

Improved version of Model SW-4. Superb AM reception of international shortwave broadcasts. Coverage of frequencies: 6.0-6.5 MHz, 9.5-10.0 MHz, 11.5-12.0 MHz, 15.0-15.5 MHz, 17.5-18.0 MHz, 21.5-22.0 MHz, and 25.5-26.0 MHz with crystals supplied. Three accessory crystal sockets are provided for coverage of any three additional 500 KHz ranges between 1.5 and 30 MHz, except 5.0-6.0 MHz. Precision tuning with excellent stability crystal lattice filter, push pull output, S-Meter for signal strength indication. Preselector gives superb sensitivity by peaking antenna and RF stages. Amplified AVC. Impedance: 4 ohms. 120/140 VAC, 50/60 Hz. 5 1/2 Hx10 3/4 Wx11 1/8"D. Shpg. wt., 18 lbs.

40 E 65330WX

Net 299.00

40 E 65041 MS Matching Speaker for SW-4, 5 1/2 lbs. Net 19.95

Direct Frequency Dialing

Amateur Transmitters and 6-Meter Transceivers

DRAKE
2-NT CW TRANSMITTER



149⁰⁰ No Money Down*

- 100 Watts Input Power
- Automatic Transmit Switching
- Built-in Power Supply

Works all amateur bands 80 thru 10 meters crystal or VFO controlled. Features automatic transmit switching and antenna change over relay. Simplified tuning is provided by broadband, low level stages and fixed loading; PA Plate tuning only! Additional features include: Automatic receiver muting; built-in CW sidetone with adjustable level; low pass filter prevents TVI; spotting function; RF indicator light and built-in power supply. In standby position transmitter can be used as a code practice oscillator. Plate meter is red-lined for Novice power. Delay control varies from full "break-in" to 4 seconds. Also has 2-front panel crystal sockets; rear panel mute, external switch, VFO and key jacks. For 120V., 50-60 Hz AC. Size: 9 $\frac{7}{8}$ "x6 $\frac{1}{2}$ "x6 $\frac{1}{2}$ " D. Shpg. wt., 14 lbs. **40 E 65272WX** Net 149.00

DRAKE
T-4XB SSB/CW/AM TRANSMITTER



449⁰⁰ No Money Down*

- 200 Watts PEP Input
- 5 Bands SSB, CW, AM and RTTY
- 2 Crystal Lattice Filters
- Solid State Linear Permeability Tuned VFO

Improved version of model T-4X. Covers 160-10 Meters. Permeability tuned solid-state VFO has a calibration accuracy of better than 1 KHz. Rated at 200 watts PEP on SSB, 180 watts PEP on AM, and 180 watts CW. AM controlled carrier modulation is compatible with SSB linear amplifiers. Two crystal lattice filters for sideband selection. Plate/current relative output meter. Automatic transmit-receive switching on CW delivers true break-in to 60 wpm. VOX or PTT on SSB and AM. AGC operates on SSB to prevent flat topping due to overdrive. Size: 5 $\frac{1}{2}$ " H x 11 $\frac{1}{2}$ " D x 10 $\frac{3}{4}$ " W. Less power supply. Shpg. 18 lbs. **40 E 65322WX** Net 449.00

AC-4 117VAC Power Supply for T-4XB
40 E 65249WX Net 99.95

AMECO
2 AND 6 METER TRANSMITTER



Only
159⁹⁵ No Money Down*

- Frequency Coverage: 50-54 MHz, and 144-148 MHz.
- Power Input: 75 Watts, AM
- Meter Reads Final Cathode Current, Final Grid Current and PF Output
- Built-in Solid State Power Supply

A complete 75 watt phone and CW Transmitter with a built-in power supply and modulator. Only the final has to be tuned when you QSY. Crystal controlled or can be used with a VFO. Crystals used are the 8 MHz. type. Power input to the final is 75 watts on CW and 75 watts peak on AM phone. Tube lineup: 6GK6-osc, tripler; 6GK6 doubler, 7688 tripler (on 2 meters); 79E4 final; 12AX7 and 6GK6 modulator. Size: 11 $\frac{1}{2}$ " x 9 $\frac{1}{2}$ " x 6". Shpg. wt., 36 lbs. **40 E 10351WX** Net 159.95

NEW AMATEUR 6 METER TRANSCEIVERS

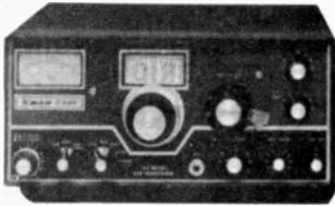

NEW SWAN 250C 6 METER SSB-CW-AM TRANSCEIVER

- 240 Watts P.E.P. in SSB
- Crystal Lattice Filter

Provides complete six meter band coverage from 50 to 54 MHz. Famous Swan vernier tuning covers 500 kHz segments of band. Accurate calibration is assured by built-in 250 kHz crystal calibrator and 5 kHz increment dial. Two cascade 6CW4 nuvistors provide a receive noise figure of better than 3 db. Selectivity is 2.8 kHz at -6db. Crystal lattice frequency: 10.9 MHz. Receiver operates both on AM and SSB. Fully selectable upper or lower sideband. Power Rating: 240 watts P.E.P. input for SSB, 180 watts CW input, and 75 watts AM input. Uses two 6146B finals. Distortion products —30db. Carrier suppression: —50db. Unwanted sideband: —40db. Meter monitors "S" units, P.A. cathode current, and relative output. Wide range Pi-Network antenna matching. Accessory socket for noise silencer. Size: 5 $\frac{1}{2}$ " H x 13" W x 11" D. Shpg. wt., 18 lbs. **40 E 70181WX** No Money Down* Net 450.00
Model 117XC AC Power Supply
40 E 70090WX Shpg. wt., 11 lbs. Net 105.00
Model 14-117 12VDC Power Supply
40 E 70066WX Shpg. wt., 8 lbs. Net 130.00



NEW DRAKE TR-6 6 METER SSB-CW-AM TRANSCEIVER

- 300 Watts P.E.P. in SSB
- Built-in PTT, VOX, Anti Vox, 100 kHz. Calibrator

Covers 49.4 to 54.0 MHz—full six meter band plus MARS—with accessory crystals (49.9-51.0 MHz. crystals supplied). Ultra-stable permeable tuned oscillator tunes 600 kHz ranges with 1 kHz readability. Front panel switch selects Four IF bandwidths: 2.4 kHz upper sideband, 2.4 kHz lower sideband, 6.0 kHz AM, and 0.3 kHz CW. Function switch selects product or envelope detector as well as built-in AM screen modulator. Receiver utilizes F.E.T. front end. Switchable AGC for fast or slow recovery. Power input: 300 watts PEP, SSB, CW. Uses popular 6JB6 finals. Dual meters monitor automatic Level Control, S-Units, plate current, and relative RF output. Extra input and output jacks for converters and/or outboard receivers. Sizes: 5 $\frac{1}{2}$ " H x 10 $\frac{3}{4}$ " W x 16 $\frac{1}{2}$ " D. Shpg. wt., 13 lbs. **40 E 65405WX** No Money Down* Net 599.95
Model AC-4 AC Power Supply
40 E 65249WX Shpg. wt., 19 lbs. Net 99.95
Model DC-4 DC Power Supply
40 E 65397WX Shpg. wt. 10 lbs. Net 125.00
Model MS-4 Matching Speaker
40 E 65041WX Shpg. wt. 5 $\frac{1}{2}$ lbs. Net 19.95

AMECO MODEL AC-1T AMATEUR TRANSMITTER KIT

Only
24⁹⁵



- Ideal for Novice
- Self Contained

The ideal unit for beginner or novice. Contains transformer powered AC power supply. Uses a Pi-network output. Has full 15-watt input on 40 and 80 meters. Easy to build and operate. Complete with punched chassis, all parts, tubes (6V6 and 6X5) and instructions. Shpg. wt., 8 lbs. Complete with 1 coil kit.
40 E 10096 Transmitter Kit Net 24.95
40 E 10104 CK1 extra coil kit Net 1.10

AMECO MODEL 621 VFO

Only
69⁹⁵
No Money Down*



Versatile VFO for operation on 50, 144 and 220 MHz. Can be used with the AMECO T-62 or with any transmitter using 8 MC crystals. High stability. No chirp with keying. Warmup time is very short as both oscillators use transistors. Size: 6x5x7 $\frac{1}{2}$ ". Shpg. wt. 6 lbs. **40 E 10443** Net 69.95

Add These Deluxe Accessories To Your Ham Station

LAFAYETTE SWR AND FIELD STRENGTH METER



ONLY
9⁹⁵

- Measures SWR, Relative Forward And Reflected Power to 1 KW
- Reads Field Strength

A handy 2-in-1 meter for use in the amateur radio station to check transmitters for SWR measurements. Can be left continuously in the circuit for monitoring transmitter outputs, SWR: 1:1 to 3:1; Accuracy ± 5 db, 2 to 30 MHz; Impedance: 52 Ohms; Antenna: 5-section, collapsible. Comparative RF field strengths can be easily determined with this fine meter. Sensitive 100 microammeter movement with easy to read 2-color dial. Impedance matches 52 Ohm coaxial lines. Attractive grey hammertone aluminum case. Size: $1\frac{3}{4}$ "x $5\frac{1}{2}$ "x $2\frac{1}{4}$ "D. Imported. Shpg. wt., 1 lb. **40 E 25371** Net 9.95

DOW KEY DK-60 SERIES COAXIAL RELAYS

As Low As
20⁸⁰



Heavy-duty SPOT coaxial relays rated 1 KW. Impedance. 50 ohms. Life over 1,000,000 operations. VSWR, less than 1.15:1 from 0 to 500 MHz. Features patented automatic receiver-protecting connector for positive isolation of RF from receiver: Greater than 100 db isolation between receiver and transmitter lines from 0 to 500 MHz/ With UHF coaxial connectors. Size: $2\frac{3}{4}$ "x $3\frac{3}{4}$ "x $1\frac{1}{8}$ ". Shpg. wt., 9 oz.

Stock No.	Type	Coil Volts	Net Ea.
40 E 52015	DK-60-G2C	115VAC	20.80
40 E 52023	DK-60-G2C	12VDC	21.80

SUPEREX AMATEUR HEADPHONE



Only
24⁴⁵

Made specially for the Ham and short wave listener. Comfortable, removable and replaceable vinyl foam ear cushions make long hours at the rig a pleasure. Dual impedance, 600 and 4-16 ohms, can be changed at plug. **40 E 85015** Shpg. wt., $2\frac{1}{2}$ lbs. Net 24.45

EICO 710 GRID DIP METER

Kit
34⁹⁵
Wired
59⁹⁵
No Money Down*



Extremely stable grid dip meter with a frequency range of 400 kHz to 250 MHz. Covers AM and FM broadcast bands, low and high band mobile radios, CB, and all ham bands through VHF. Use to tune transmitters, trim antenna to proper length, locate parasitic oscillations, measure circuit resonance, determine capacitance, "Q" values, and inductance. In addition, can also be used as a transmitter monitor and a wavemeter. Uses eight precision, plug-in coils, 0-500 μ a meter, and a rotating drum scale. Operates on 115 VAC, 60 Hz. Size: $2\frac{1}{4}$ "x $2\frac{1}{4}$ "x $6\frac{7}{8}$ ". Shpg. wt., 3 lbs.

Model 710 Kit Net 34.95
40 E 74258
Model 710 Factory wired and tested. Net 59.95
40 E 74266

R.L. DRAKE W-4 RF WATTMETER



Only
49⁵⁰
No Money Down*

- Frequency Coverage: 2-30 MHz.

Reads forward and reflected power directly in watts (VSWR from nomogram). Two scales in each direction, 200 and 2000-watts full scale. Calibration accuracy: $\pm 5\%$ of reading $+2$ watts on 200 watt scale; $\pm 5\%$ of reading $+20$ watts on 2000-watt scale. Size: $5\frac{1}{2}$ "x $3\frac{3}{4}$ "x $4\frac{1}{2}$ "D. Shpg. wt., 4 lbs. **40 E 65371** Net 49.50

NEW DRAKE WV-4 RF WATTMETER. Same as above but for coverage from 20-200 MHz. Power Capability: 1000 Watts full scale. Shpg. wt., 4 lbs. **40 E 65413** Net 73.50

HY-GAIN "On The Air" SIGN



8⁹⁵

Dramatic red on black "On The Air" indicator face mounted in gray high impact plastic case. Mounts atop gear on wall brackets. Internally illuminated. Bulb and 6 ft. cord included. Attaches to antenna change-over relay or transmitter control relay. Size: 4x8 in. oval. **40 E 31167** Shpg. wt. 1 lb. Net 8.95

E. F. JOHNSON PHONE PATCH



25⁰⁰

A compact automatic hybrid-transformer type patch which accepts PTT, manual, or VOX keying. Separate receiver and transmitter input gain controls provide flexible operation without over drive. Effectively shielded and RF by-passed to virtually eliminate RF feedback into the phone line. Switches audio from speaker to telephone headset for undistorted, hum-free response. Adjustable "line null" control. Size: $2\frac{1}{2}$ "x $6\frac{1}{2}$ "x $2\frac{1}{2}$ "D. Shpg. wt., 3 lbs. **40 E 46231** Model 250-46 Patch Net 25.00

B & W 6 METER FILTERS



As Low As
15⁹⁵

MODEL 423 designed to reduce TVI. Spurious harmonics above 62 MHz attenuated at least 50 db. Uses 2 SO-239 connectors. Freq. range: 30-54 MHz; Power rating: 100 watts max.; Impedance 52 ohms (reversible). Size: $5\frac{1}{2}$ "x $1\frac{3}{4}$ ". Shpg. wt., 1.5 lbs. **40 E 16275** B&W 423 Net 15.95
B&W 427. 6 meter low pass filter designed for freq. range of 30-54 MHz. Power rating: 1 KW max. 2 SO-239 connectors. 52 ohm impedance. $11\frac{1}{2}$ "x $2\frac{1}{2}$ ". Shpg. wt., $2\frac{1}{2}$ lbs. **40 E 16077** B&W 427 Net 25.75

AMECO "SWB" STANDING WAVE BRIDGE



Only
10⁹⁵

Inductive bridge that is continually left in the line. Reads SWR's from 1.8 kHz to 225 MHz. Handles 1000W. Has negligible insertion loss. Contains two SO-239 UHF connectors. Size $2\frac{1}{4}$ "x $1\frac{3}{4}$ "x $4\frac{1}{2}$ ". **40 E 10419** Shpg. wt., 2 lbs. Net 10.95

AMECO "BIU" BRIDGE INDICATOR UNIT



Only
16⁹⁵

A sensitive 100 microamp $2\frac{1}{4}$ " square D'Arsonval Meter that reads in SWR, percentage power and percentage voltage (three scales). Switching provides for reading of any one of two bridges. Size: $2\frac{3}{4}$ "x $5\frac{1}{2}$ "x $3\frac{1}{2}$ "D. Shpg. wt., 2 lbs. **40 E 10427** Net 16.95

Improve Your Amateur Station Performance

(A) **B&W 550A Coaxial Antenna Switch**—Instantly selects any one of five transmitters, antennas, exciters, receivers or transceivers using 52 or 75 ohm line. 2P-5 Pos. Rated 1 KW. Shpg. wt., 2 lbs.

40 E 16028 Net 11.15
 40 E 16036—Knob for 550A wt., 2 oz. Net 1.35
 40 E 16044—Dial plate for 550A wt., 2 oz. Net .75
 40 E 16051—B&W 550A-2 SP-2Pos.coax switch wt., 2 oz. Net 10.20

(B) **B&W 425 Low Pass Filter**—usable with transmitters to 1-KW. Completely self contained—eliminates TVI. 85db attenuation. For 52 ohm coax. Shpg. wt., 6 lbs.

40 E 16085 Net 22.50
 40 E 16093—as above but for 75 ohm coax. Net 22.50

(C) **Drake TV-1000LP Low Pass Filter**—handles 1 KW 1D to 160 meters. 200 watts on 6 meters. Shpg. wt., 2 lbs.

40 E 65140 Net 16.95
 40 E 65132—Drake TV100LP. handles 100w, 80-10M, 20w-6M Net 5.95

(D) **Ameco HP-45-High Pass Filter**—For attenuation of 40db at 14 MHz and 20db at 28 MHz, 300 ohms. Shpg. wt., 3 oz.

40 E 10054 Net 1.35

(E) **Johnson 250-23-3 "Matchbox" Antenna Coupler**—For 80, 40, 20, 15 and 10 meters. Matches balanced lines 25 to 1500 ohms and unbalanced lines 25 to 3000. Reads SWR. TR relay 750w PEP with directional coupler. Shpg. wt., 11 lbs.

40 E 46062—No Money Down* Net 94.95

(F) **Johnson 250-39 TR Switch**—Provides instantaneous high efficiency electronic antenna switching. Rated at 4KW. Instant break-in on SSB, DSB, CW, and AM. Shpg. wt., 5 lbs.

40 E 46181 Net 29.95

(G) **W2AU BROAD BAND BALUNS**—A transmitting and receiving balun with built in lightning arrester. Properly balances all coax fed antenna systems. Handles 1KW AM/CW, 2KW PEP. Completely weather-proof. withstands 650 lbs. of antenna tension.

BALUN 1:1 model matches 50 or 75 ohm unbalanced to 50 or 75 ohm balanced load. Shpg. wt., 6½ oz.

40 E 47023 Net 12.95
 BALUN 11:1 model matches 50 or 75 ohm unbalanced coax line to 200 or 300 ohm balanced load. Shpg. wt., 6½ oz.

40 E 47031 Net 12.95

(H) **NEW Solderless PL-259 Low-Loss Coaxial Connectors.**—Two types — Fits either RG58/U or RG59/U cable. Quick, easy connections. No fuses, no boiler, no adapter, no soldering required.

42 E 89106 Solderless PL259 for RG58/U Cables. Net ea. 1.25
 42 E 89114 Solderless PL259 for RG59/U Cable. Net ea. 1.25

AMATEUR AND SPECIAL PURPOSE CRYSTALS



As Low As

295

AMATEUR CRYSTALS

Most popular with hams. Acid-etched quartz. Stainless steel electrodes. Pin size: .093" spaced .486". Tolerance \pm 500 hertz at designated frequency. Will supply within 5KHz. Specify frequency desired when ordering. Av. shpg. wt., 2 oz. (ALLOW 3 WEEKS FOR DELIVERY.)

40 E 54011Z 3500-4000kHz Net 2.95

40 E 54029Z 7000-7425kHz Net 2.95

40 E 54037Z 8-8.2MHz, 8.33-8.9MHz Net 2.95

SPECIAL APPLICATION CRYSTALS

For Oscillators with low crystal currents.

Type H-173. HC-6/U. Pin. Dia. .050". Pin Spacing .486"—Specify Frequency. ALLOW 30 DAYS FOR DELIVERY.

21-40 MHz Supplied within \pm .005%. Net 4.95

40 E 22010Z Net 4.95

40-54 MHz Supplied within \pm .005%. Net 5.95

40 E 22026Z Net 5.95

54-74 MHz Supplied within \pm .005%. Net 6.95

40 E 22059Z Net 6.95

TV and Marker Crystal. Calibrated \pm .005%.

Type H-173 (HC-6U) Pin Dia. .050" Spacing .486" for 1000 KHz. Net 7.95

40 E 22034L Net 7.95

MOSLEY CRYSTAL HOLOER ADAPTORS

Mosley 5-75 adapts ½" spaced holder to ¾" spacing. Shpg. wt., 2 ozs.

40 E 58046 Net .50

Mosley 75-5 adapts ¾" spaced holder to socket with ½" spacing to octal socket. Shpg. wt., 2 ozs.

40 E 58053 Net .50

40 E 58053 Net .50

40 E 58053 Net .50

40 E 58053 Net .50

40 E 58053 Net .50

40 E 58053 Net .50

40 E 58053 Net .50

40 E 58053 Net .50

B&W 550A Coaxial Switch



(A) 11¹⁵

B&W 425 Low Pass Filter



(B) 22⁵⁰

Drake TV-1000LP Low Pass Filter



(C) 16⁹⁵

Ameco HP45 High Pass Filter



(D) 1³⁵

Johnson 250-23-3 Matchbox



(E) No Money Down*

Johnson 250-39 TR Switch



(F) 29⁹⁵

W2AU BROAD BAND BALUNS



(G) 12⁹⁵

Solderless PL-259 Connectors



(H) only 1²⁵ ea.

B&W MINIDUCTORS

Highly efficient miniature coils offering extremely low losses and real space-saving economy. Ideal for compact circuits. Air wound, polystyrene insulation. Easily cut to size. All are 2" long except miniductors with 1" diameter are 3" long. Shpg. wt., 6 oz.

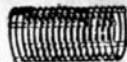

STOCK NO.	TYPE	TURNS PER IN.	DIA.	NET
40 E 16107	3001	4	½"	.60
40 E 16143	3005	4	¾"	.60
40 E 16184	3009	4	¾"	.72
40 E 16226	3013	4	1"	.78
40 E 16127	3003	16	½"	.78
40 E 16168	3007	16	¾"	.78
40 E 16200	3011	16	¾"	.96
40 E 16242	3015	16	1"	1.02

STOCK NO.	TYPE	TURNS PER IN.	DIA.	NET
40 E 16119	3002	8	½"	.66
40 E 16150	3006	8	¾"	.66
40 E 16192	3010	8	¾"	.86
40 E 16234	3014	8	1"	.86
40 E 16135	3004	32	½"	.84
40 E 16176	3008	32	¾"	.84
40 E 16218	3012	32	¾"	1.14
40 E 16259	3016	32	1"	1.14

24⁵⁰



DRAKE SCC-1 CRYSTAL CALIBRATOR

Crystal controlled 100 kHz FET oscillator. Uses two integrated circuits to produce 50

kHz calibration points. Requires no tuning, band switching, or plug-in coils. Maximum stability attained through the use of zener regulation. Has provision for both local and remote on/off switch. 50 kHz to 432 MHz frequency range. Requires 15 to 18 VDC, 40 ma. Reverse polarity protection. Size: 3¾" x 2¼". 40 E 65309 Shpg. wt., 1 lb. Net 24.50

CRYSTAL SOCKETS

These Steatite insulated sockets will strongly hold the crystal contacts. Can be used for chassis or for panel mounting. The bushing will project through a round hole in panel. Av. shpg. wt., 2 oz.

Stock No.	Type	Pin	Spacing	Each
40 E 37123	CS-8	.125"	.750"	.36
40 E 37131	CS-6	.095"	.486"	.36
40 E 37149	CS-5	.125"	.500"	.36
42 E 09011	CS-7	.050"	.486"	.36

RF COAXIAL CONNECTORS

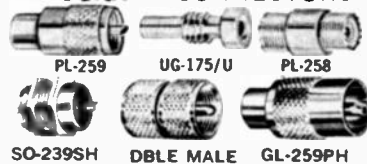

PL-259 UG-175/U PL-258
 SO-239SH DBLE MALE GL-259PH

42 E 69031 PL-259 Connector .49

42 E 69049 UG-175/U Reducer —Adapts PL-259 to RG-58/U Diameter. .16

42 E 69056 PL-258 Junction Adapter —Accepts PL-259 on both ends for cable extension .49

42 E 69064 — UHF Double Male—.99 Free turning nuts

42 E 69072 SO-239SH Single hole chasis mount .49

42 E 69080 GL-259PH PL-259—for quick .79 on—off application without threading.

LAFAYETTE Amateur Keys and Oscillators

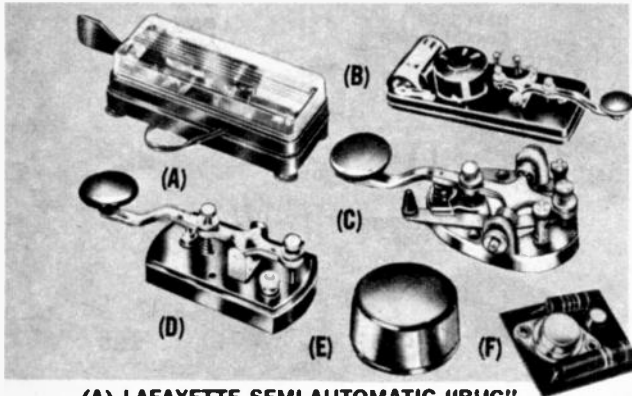

(A) LAFAYETTE SEMI-AUTOMATIC "BUG"

A quality "Bug" designed for clear, easy sending and wide range of speed. 7 adjustments for speed and comfort. Precision-tooled, anti-rust nickel-plated brass and stainless steel operating parts. Speed adjustable 10 wpm to as high as desired. 1/8" silver contacts; weight scale for reproducible speed settings. 6 $\frac{7}{8}$ "L x 3W x 2 $\frac{1}{4}$ "H, exclusive of knobs and feet. Imported. Shpg. wt., 3 $\frac{1}{2}$ lbs. 99 E 25520 Net 10.95

(B) LAFAYETTE CODE PRACTICE SET

Ideal for the beginning amateur and code practice groups. Key has adjustable spring tension, and adjustable contact clearance. High frequency buzzer has frequency, and tension adjustment with lock nuts to assure constant frequency. There is provision for insertion of head set by means of binding posts with knurled tightening screws. For individual, group or remote listening. Uses Lafayette 1 $\frac{1}{2}$ Volt battery. Base 6 $\frac{3}{4}$ "L x 2 $\frac{3}{4}$ "W x 1 $\frac{3}{8}$ "D, overall length 8 $\frac{1}{2}$ ". Imported.

99 E 25538 Shpg. wt., 2 lbs. (less battery) Net 1.79
 99 E 62564 "D" Cell battery for above Net .15
 99 E 25504 Stethoscope Headset Net 1.39

(C) LAFAYETTE "BRASS-POUNDER'S" KEY

A precision-made key designed for hard usage. Spring tension and contact clearance adjustments; 3/16" silver contacts; adjustable ball-bearing pivots; Circuit closing switch. Base 3 x 2"; overall size 5 x 2 $\frac{3}{8}$ x 1 $\frac{1}{4}$ ". Imported. Shpg. wt., 1 $\frac{1}{2}$ lbs. 99 E 25553 Net 2.29

(D) LAFAYETTE BEGINNER'S KEY

Economical key for beginning amateurs. Solid, heavily chrome and nickel plated metal parts, molded phenolic base. Adjustable spring tension, adjustable metal parts and adjustable contact clearance. 2 mounting holes in base. Base 3 $\frac{3}{4}$ "L x 1 $\frac{1}{4}$ "W. Overall length 5"; height 1 $\frac{3}{8}$ ". Imported. Shpg. wt., 12 oz. 99 E 25546 Net .79

(E) HIGH FREQUENCY CODE PRACTICE BUZZER

Adjustable frequency buzzer ideal for individual or group code practice. Perfect code item for the ham shack. Black molded phenolic housing. Works with 1 $\frac{1}{2}$ volt battery. Screw adjustment for changing tone. 1 $\frac{7}{8}$ " diam. x 1 $\frac{1}{4}$ " high. Imported. Shpg. wt., 6 oz. 99 E 25561 Net .79

(F) MINIATURE CODE OSCILLATOR MODULE

Transistorized. Ready to connect to your telegraph key, any 1 $\frac{1}{2}$ to 6 volt battery and any PM speaker—ideal for learning Morse code or developing speed in receiving or sending—volume may be increased by using higher voltage battery up to 6 volts. Simple connecting instructions and schematic included. Shpg. wt., 8 oz. 19 E 15131 Net .96

LAFAYETTE CODE PRACTICE OSCILLATOR



7⁹⁵

3-WAY OPERATION:

- Light Indicator
- Variable Pitch Tone
- Light-Tone Combined

A terrific aid for the beginning Morse Code learner to experienced hams who wish to improve their code speed. Completely self-contained, it can be carried wherever you go. Efficient built-in speaker provides loud, clear signal. Excellent for group practice sessions. Variable pitch control gives pleasing tone by changing frequency. For private use, without disturbing others, you have a choice of earphone tone operation, flashing light or both together. Uses low drain battery-operated transistor oscillator. Specifications: Tone frequency range: Approx. 500 to 2000 Hz variable Controls: Pitch, Tone, Light and Light/Tone. Terminals: Key, Earphone. Batteries: Includes 2 "C" cells. Case: Hi-impact bakelite. Size: 6 $\frac{1}{4}$ "H x 3 $\frac{3}{4}$ "W x 2"D. Imported.

99 E 25603 Shpg. wt., 1 $\frac{1}{4}$ lbs. Net 7.95
 99 E 62572 Extra "C" cells for above, 2 required Net ea. .14
 Lightweight Crystal Headset for above. Imported.
 99 E 25504 Shpg. wt., 5 oz. Net 1.39

AMECO CODE PRACTICE OSCILLATOR

- Variable Tone Control



15⁹⁵

Code practice oscillator for 110 volts AC or DC. Produces pure steady tone with built-in 4-inch speaker. Can take a large number of headphones or keys. Oscillator is easily converted to a CW or phone monitor making it ideal for group as well as individual use. With tubes. Shpg. wt., 3 lbs. 40 E 10070 Net 15.95

VIBROPLEX SEMI-AUTOMATIC KEYS



Super Deluxe "Presentation." Patented jewel movement and Super-speed control. Polished chromium precision machined parts mounted on a 24K gold-plated base top with colorful red switch knob, finger and thumb piece. Jeweled movement reduces friction, maintains smoother, easier operation. Shpg. wt., 5 lbs. 40 E 88084. No Money Down* Net 43.95

"Champion". Low priced Vibroplex with same high standards of high quality for clear, speedy and easy sending. Ideal for amateur or professional radio operators. Chromium finished top parts with grey crystal base. Single lever with 2 pairs of contact points. Shpg. wt., 4 lbs. 40 E 88019 Net 21.95

"Original". Acclaimed by veteran operators for its extremely smooth, clear, rapid, effortless and accurate operation. A rugged, well built, expertly engineered machine for all classes of transmitting work. Large contact points. Die cut dot contact. Chrome-plated mechanism. Cast-iron base. Shpg. wt., 5 lbs. 40 E 88027 Net 27.50

Deluxe "Original". As above but jeweled bearings, chrome-plated base. Shpg. wt., 5 lbs. 40 E 88035 No Money Down* Net 32.95

CORD AND WEDGE for above. Specify model of key. Shpg. wt., 8 oz. 40 E 88050 Net 2.75

Vibro-Keyer. An efficient keying mechanism for an electronic transmitting unit. Same large size contacts and frame as Deluxe Vibroplex. Easy operating trunion lever. Size: 3 $\frac{1}{2}$ "x4 $\frac{1}{2}$ ". Shpg. wt., 3 lbs. 40 E 88068 Net 20.95

LAFAYETTE SOLID STATE WIRELESS CODE PRACTICE OSCILLATOR SET



Makes learning code as easy as possible. Ideal for students, hobbyists or aspiring amateurs. Portable, battery operated. Just place oscillator antenna next to any AM radio... turn radio on and you're ready to practice or improve your code speed. Includes hand key and 9-volt battery. Transistorized oscillator features low battery drain. Size: 3 $\frac{1}{4}$ "Wx2Dx1"H. Key: 4 $\frac{3}{4}$ "Lx1 $\frac{1}{4}$ "W. Imported. Shpg. wt., 2 lbs. 99 E 28080 Net 3.95
 99 E 60212 Extra 9 volt battery. Net .21

Only 3⁹⁵

Code Courses and Keyers for the Amateur

EICO MODEL 717 ELECTRONIC KEYSER KIT

KIT

59⁹⁵

WIRED

89⁹⁵

No Money Down*



- Accurately Keys Any CW Transmitter with Perfect Machine-Like Morse Code
- Aural and Front Panel Lamp Monitoring
- 4 Overlapping Switch-selected Ranges

Fully automatic electronic keyer which may also be used as a code practice oscillator. Provides clean-cut, accurately timed dots and dashes, proportioned from 3 to 75 WPM in 4 overlapping switch-selected ranges. Easily attaches to any CW transmitter. Features big 3x5" speaker, separate volume and tone controls, and vernier control on all speed ranges. Dot/space ratio-1:1. Dash/dot ratio 3:1. 5 1/2 x 8 x 8 1/4". Shpg. wt., 9 lbs.

40 E 74191 Kit Net 59.95
40 E 74209 Factory Wired Net 89.95

12 LESSON RECORD CODE COURSE

• 12 Lessons On A 12" LP Record



3⁵⁰

Learn Morse Code the modern practical way. Supplied with 12 lessons on a non-breakable high quality 33 1/3 rpm long playing record, recorded with code sound to provide further aid. Perfect for home studying. Speed progresses steadily from 3 to 16 1/2 rpm. Complete with sturdy record album and instruction manual. Shpg. wt., 1 1/2 lbs.

40 E 89017 Net 3.50

RIDER "SOUND & SIGHT" RECORD CODE COURSES



• Learn Code With Easy Sight and Sound Method

AS LOW AS 9.75

0079 NOVICE COURSE—0 to 8 WPM includes 3 LP records, 47 identification cards, and 38 page instruction book. Shpg. wt., 2 lbs.

40 E 53013 Net 9.75

0484 ADVANCED COURSE—9-20 WPM 3 LP records, instruction booklet. Shpg. wt., 2 lbs.

40 E 53023 Net 9.75

AMECO RECORD CODE COURSES

Includes New Extra Class, Supplementary General, and Supplementary Extra Courses



AS LOW AS 3.95

Fast, accurate method for learning code. JUNIOR COURSE: one 33 1/3 RPM LP; from start to 7 1/2 WPM. ADVANCED: one 33 1/3 LP; 8 1/2 to 18 WPM. SENIOR: two 33 1/3 RPM LP's from start to 18 WPM. EXTRA CLASS COURSE: one 33 1/3 RPM LP; 13 to 22 WPM. SUPPLEMENTARY GENERAL CLASS COURSE: concentrated study from 12 to 15 WPM; one 33 1/3 RPM LP. SUPPLEMENTARY EXTRA CLASS COURSE: concentrated study from 19 to 24 WPM; one 33 1/3 RPM LP. Courses include 32 page manual with FCC-type exams.

Stock No.	Course	Speed	Wt.	Net
40 E 13050	Junior	33 1/3 RPM	1 Lb.	3.95
40 E 13074	Senior	33 1/3 RPM	2 Lb.	7.50
40 E 13090	Advanced	33 1/3 RPM	1 Lb.	3.95
40 E 10518	Extra Class	33 1/3 RPM	1 Lb.	3.95
40 E 10526	Supplementary general	33 1/3 RPM	1 Lb.	3.95
40 E 10534	Supplementary Extra	33 1/3 RPM	1 Lb.	3.95

TAPE CODE—LEARN CODE ON A TAPE RECORDER



AS LOW AS 5⁵⁰

Prerecorded magnetic tapes containing a complete course in the International Morse Code. The tapes are 7", 1200 ft. pre-recorded at 3 3/4 ips and can be played

on any standard tape recorder. Playing time 2 hours per tape. Shpg. wt., 1 1/2 lbs.

NOVICE Basic Instructions & code 4-8 WPM. Net 6.50

40 E 49011 ADVANCED Code at 9-18 WPM. Net 5.50

40 E 49029 New EXTRA Code instruction at 22-31 WPM. Net 5.50

40 E 49037

DELUXE CLOCKS FOR YOUR HAM STATION

24-HOUR ELECTRIC WORLD CLOCK

- 8" Overall diameter
- Adjustable for Various Time Zones
- South Polar Projection

9⁹⁵

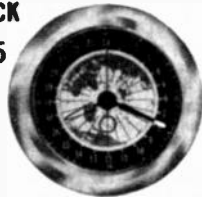

Self starting, accurate electric clock. Tells world-wide and local time. Calibrated in hours—1 to 24, minutes and seconds—1 to 60. Black dial with white graduations. Chrome plated case. U.L. Listed. 110-120 v. 60 Hz AC. Shpg. wt., 1 1/2 lbs. 13 E 26024 Net 9.95

DELUXE 24 HOUR ELECTRIC WORLD CLOCK

- Large 12" Clock Face
- Red Sweep Second Hand

Finely constructed, accurate 24 hour electric wall clock. Has 12" white dial face with black numerals and hands. Gray case is 13 1/4" overall diameter. UL listed electric movement. Shpg. wt., 5 lbs. 13 E 26578 Net 19.95

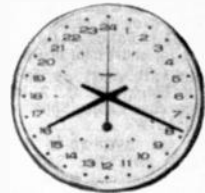

24 HOUR TYMETER CLOCK

Only 15⁰⁰

Numeral type, 24 hour station clock. Self starting electric. Dome shaped full vision window. UL listed motor and cord. For 110V-60 Hz AC. 4x4x7 3/4". Shpg. wt., 4 lbs. 40 E 91021 Net 15.00



24 HOUR CALL-IDENT TYMETER CLOCK

- 10 Minute Repeat Timer

22⁵⁰



24-hour direct reading dial shows minutes and hours. 10-minute repeat timer buzzes warning to sign your call letters. Timer independently switched. Self-starting electric. For finish plastic case. Size: 7 3/4 x 4 x 4" D. 110-120V, 60 Hz AC. Walnut 40 E 91013 Shpg. wt., 5 lbs. Net 22.50

WORLD TIME ILLUMINATED ELECTRIC WORLD CLOCK

Only 59⁹⁵

- Oiled Walnut Frame
- Instantly Indicates Correct Standard Time at 70 Key Points



Modern, international electric wall time clock, showing the local time in 70 major cities throughout the world—automatically eliminates the need for international time conversion charts. Enlarged, vivid time indicators are adjustable, permitting precise setting for standard and daylight saving time. Set in handsome walnut frame 15Hx22Wx5"D. Illuminated. Powered by a heavy duty 115V., 60 Hz AC clock motor. Shpg. wt., 5 lbs. 40 E 30011WX Net 59.95

* See Page 11 for Full Credit Details on Easy Pay Plan

Lafayette Cat. No. 700 463

Selected Fixed Amateur Antennas

LAFAYETTE ALL-BAND VERTICAL TUNEABLE 10 TO 80 METERS ANTENNA



Only **14⁹⁵** • Omni-Directional, Vertically Polarized
• Irridite Treated To Mil Specs

Our best buy multi-band antenna. Can be tuned to any amateur band 10 through 80 meters by a single adjustment. Has amazing efficiency for DX or local contacts. Ground or roof top or tower installation. Can survive winds in excess of 50 mph. Overall height 18'; knocks down to only 5'. Uses 3½" diameter air wound coil as matching inductor. All steel parts irridite treated to Mil Specs. Impedance 52 ohms. Maximum power 1000 watts AM or CW—2 KW PEP. Omni-directional; vertically polarized.
40 E 01048WX Shpg. wt., 5 lbs. ... Net 14.95

CUSHCRAFT "TRIK STIK" ANTENNA

6⁹⁵



- For Amateur, SWL, TV, FM, Business Radio, CB, VHF Low and High band monitor, Aircraft Reception

Universal antenna designed for vertical or horizontal mounting. All aluminum construction. Supplied with U-bolt, bracket, and hardware for mounting on a mast or tower. Can also be mounted to a building using nails or screws. 2-54" element sections, 2-51" element inserts, 23" support boom. Complete instructions for frequency settings.
40 E 19189W Shpg. wt., 2 lbs. ... Net 6.95

HY-GAIN 18 AVQ 10 THRU 80 METER VERTICAL TRAPPED ANTENNA

- Individually Tuned Hy-Q Trap For Each Band
- Easily Installed Using Minimum Space

Ruggedly constructed of heavy gauge, taper-swaged aluminum, the 18 AVQ can be easily installed for all-band operation. Delivers outstanding omni-directional performance on each band. Uses 4 separately tuned "Hy-Q" air dielectric traps. Traps are factory pre-tuned to provide peaked performance. Low angle of radiation assures uncompromised results for short haul or DX communications.

Mounts with mast up to 1½" diameter. Overall height 32 ft. 2 in. For use with 52 ohm coax cable. Shpg. wt., 15½ lbs.
40 E 31191WX ... Net 67.50

67⁵⁰

No Money Down*

MODEL 14 AVQ 10-40 METER VERTICAL TRAPPED ANTENNA. Self-supporting multi-band trap vertical for 10 thru 40 meters. Solid State Traps. Roof or ground mounted. Low angle DX radiation pattern. SWR less than 2:1. Only 21' high. Shpg. wt., 10 lbs.
40 E 31043WX No Money Down* ... Net 39.95

ROOF MOUNTING KIT for 14 AVQ includes 5' mast, roof mount, ground plane radial wires, insulators and all necessary hardware.
40 E 31050WX Shpg. wt., 9 lbs. ... Net 16.95

HY-GAIN MULTIBAND TRAP DOUBLET

- Slim Hi-Q Traps
- Heavy Duty End and Center Insulators



Feature Slim Line Solid State Traps. Heavy duty end and center insulators. Copper clad stranded steel wire elements. SWR less than 2:1 at resonance on every band. Install horizontally or as inverted V. 1 kw P.E.P. or 500 watts AM.

Stock No.	Model	Frequency	Length	Shpg. Wt.	Net
40 E 31068WX	2BDQ	40 & 80 Meters	110'6"	2 lbs.	32.50
40 E 31092WX	5BDQ	10, 15, 20, 40 & 80 Meters	111'6"	5 lbs.	48.50

Center Insulator for Multiband Doublet
40 E 31217

Net 4.95

DELUXE MOSELY TA SERIES BEAM ANTENNAS FOR 10, 15, 20 METERS

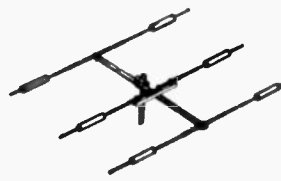

Deluxe Model TA 33. 3-element beam providing up to 8 db gain on the 10, 15 and 20 meter bands. Trap design provides broadband performance and stability—beam easily handles a full kilowatt of AM signal. 25 db front-to-back ratio, SWR 1.1/1, or less, at resonance. Beam length 14 ft., element length 28 ft. Shpg. wt., 53 lbs.
40 E 58020WX No Money Down* ... Net 133.10

Model TA-33 "Junior," similar to above, but only 300 watts AM. Boom length 12 ft., Element length 26'8". Shpg. wt., 28 lbs.

40 E 58038WX No Money Down* ... Net \$2.75

Deluxe Model TA36 6 Element Beam. Automatic band switching through high impedance parallel resonant trap circuits. Handles 1000 watts AM/CW or 2000 watts PEP. SWR 1.5/1 or better. Beam length 29 ft., boom length 24 ft. Shpg. wt., 71 lbs.
40 E 58079WX No Money Down* ... Net 167.85

MOSELY MODEL MCQ-3B 2 ELEMENT CUBICAL QUAD FOR 10, 15, 20 METERS

105⁰⁰

- Square Shape, Aluminum Casting Spreader, Gamma Matching, Boom Mast clamp.

Designed and engineered for superior DX. Outstanding features: square shape, aluminum casting spreader mount, 52-ohm single feed line, gamma matching, boom-to-mast clamp, aluminum wire rated at 1 KW AM and 2 KW SSB, VSR 1.5/1. Boom length 8 ft., spreader length 12' 8", element length 17 ft. Shpg. wt., 40 lbs.
40 E 58007WX No Money Down* ... Net 105.00

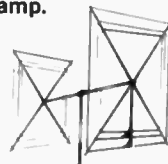

CUSHCRAFT BEAM ANTENNAS FOR 2, 6 AND 10 METERS

Model A50-5 5-Element, 6 Meter Beam. Deluxe rugged, full size, constructed of ¾" 0.049 wall aluminum tubing. Boom is 0.058 wall drawn aluminum. Driven element is "Reddi" matched for direct coax feed. Light enough for any heavy duty TV rotator. Turning radius—7'6"; Forward Gain—9.5 db; F/B ratio—29 db. Comes with all parts marked for quick, neat assembly and center band operation. Shpg. wt., 15 lbs.

40 E 19121W ... Net 29.50

Model A50-3 3-Element 6-Meter Beam. 7.5 db forward gain, 6 foot boom. Shpg. wt., 8 lbs.
40 E 19238W ... Net 18.95

MODEL A-1447 7 ELEMENT 2-METER BEAM. Full size. Aluminum tubing. Beam length, 98". Forward gain 11 db F/B ratio 26 db. Shpg. wt., 6 lbs.

40 E 19139W ... Net 12.95

Model A-144-11, 11-Element 2-Meter Beam. Boom length 144". Forward Gain 13 db F/B ratio 28 db. Shpg. wt., 9 lbs.
40 E 19147W ... Net 16.95



NEW DELUXE HY-GAIN MONOBAND BEAMS

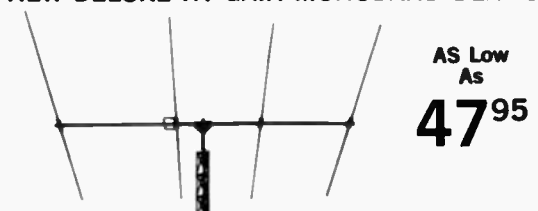

AS Low As **47⁹⁵**

Taper swaged, slotted tubing, tiltable cast aluminum boom to mast clamp and heavy gauge, machine formed element-to-boom brackets. High strength aluminum tubing with irridited hardware. Power rated to 2KW PEP.

Stock No.	Model	Band	Elements	Gain	DB	Longest Element	Boom Size	Wt. Lbs.	Net
40 E 31233WX	1038A	10M	3	8	17'	8' x 2"	12	47.95	
40 E 31241WX	1538A	15M	3	8.5	23'	12' x 2"	20	59.95	
40 E 31258WX	2038A	20M	3	8	35'	16' x 2"	35	104.95	
40 E 31266WX	2048A	20M	4	9.2	36½'	26' x 2"	50	134.95	
40 E 31274WX	4028A	40M	2	5.2	43'	16' x 2"	40	142.95	

Mobile Amateur Antennas And Rotors

DELUXE LAFAYETTE "RAPID-GRIP" MOBILE ANTENNAS FOR 2 AND 6 METERS

NEW-TRONICS "HUSTLER" MOBILE ANTENNAS FOR 10-15-20-40-75 METERS



As Low As **9⁹⁵**

- "Rapid-Grip" Mount Provides Permanent Antenna Installation In Seconds Without Drilling Holes

6 Meter Mobile Antenna with "Rapid Mount"

Features waterproof base loading phasing transformer, 43" stainless steel whip with adapter for extra fine tuning, and a cadmium plated trunk-clip "Rapid-Grip" mount with water resistant body seal. Offers ideal omnidirectional signal pattern. Mounts on lip of trunk without drilling holes. Shpg. wt., 2 lbs. Less coaxial cable. **40 E 01095 Net 11.95**



2 Meter Mobile Antenna with "Rapid Mount"

Features rust-resistant cadmium plated "Rapid-Grip" Mount base and stainless steel whip approximately 19 inches long. Whip has set-screw for easy field tuning. Mounts on lip of trunk without drilling holes. Offers ideal omnidirectional signal pattern. Complete with 16 ft. of RG 58/U cable and PL-259 plug. Shpg. wt., 1 1/2 lbs. **40 E 01103 Net 9.95**

2 AND 6 METER MOBILE AND FIXED SQUALO'S

Cush Craft

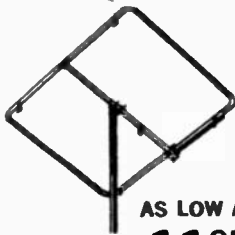

AS LOW AS **11⁹⁵**

Ideal for "net" control, monitoring, or general ham coverage. The "Squalo" is a Full half-wave, horizontally polarized, omnidirectional antenna. Low Q for broad-band coverage and direct 52 ohm "Reddi" Match feed. SWR 1.5 to 1 or less. Full 360° pattern without deep nulls. Models ASQ-2 & ASQ-6 are packed with rubber suction cups for car top mounting and a horizontal support for mast or tower mounting.



- Fold Over Swivel Mast
- Power Rating Up To 300 Watts SSB

An outstanding antenna assembly permitting multi-band mobile operation with exceptional results. Buy only one mast and select the resonators for the bands you operate. No need for matching devices, use any feed line length of 52-ohm cable. Each of the five resonators has a coil specially designed for maximum radiation for a particular band. Center frequency tuning is by means of an adjustable stainless steel rod in the resonator assembly. The 54-inch fold-over, heat treated, 1/2" aluminum mast permits instantaneous interchange of resonators for the desired band. SWR is less than 2 to 1 for any center frequency within each band. Power Rating: AM input 75 watts; SSB input up to 300 watts PEP. Mast has 3/8"-24 base stud to fit all standard mounts.

Stock No.	Model No.	Description	Wt.	Net
40 E 55010WX	MO-1	54" Mast Fender Mount	2 lbs.	10.75
40 E 55026WX	MO-2	54" Mast Bumper Mount	2 lbs.	10.95
40 E 55034	RM-10	10 Meter Resonator	10 oz.	7.95
40 E 55042	RM-15	15 Meter Resonator	1 lb.	8.95
40 E 55050	RM-20	20 Meter Resonator	1 lb.	9.95
40 E 55067	RM-40	40 Meter Resonator	1 1/2 lbs.	11.95
40 E 55075	RM-75	75 Meter Resonator	2 lbs.	13.95

DELUXE CORNELL-DUBILIER HEAVY-DUTY ANTENNA ROTORS

As Low As **69⁹⁵** No Money Down*

- Heavy Duty Construction
- Indicator Calibrated in Compass Points



MODEL TR-44 ANTENNA ROTOR—For single bay amateur antenna application. Big in performance and durability. Rotor contains 48 heavy duty bearings in two 6 1/2" ball races, 450 in-lbs average torque. Indicator is calibrated in compass points and 3° increments. Double stage switch allows meter reading while motor is off. For mast or pipe to 2 1/4" O.D. For 110-120V, 50-60 Hz. Less cable. Shpg. wt., 18 lbs. **40 E 03020WX No Money Down* Net 69.95**

HAM-M ANTENNA ROTOR—World famous extra heavy duty rotor. Meets all amateur radio applications. Supports antennas up to 1000 lbs. Uses same compass indicator unit as the TR-44, calibrated in 3° increments. Heavy duty stainless steel gears and pinions, solenoid brake release. For 110-120VAC, 50-60 Hz. **40 E 03010WX Shpg. wt., 27 lbs. No Money Down* Net 129.95**
100' roll of 8 conductor rotor cable for TR-44, HAM-M **32 E 14574 Net 0.95**

STOCK NO.	MODEL NO.	DESCRIPTION	SHPG. WT.	NET PRICE
40 E 19055W	ASQ-2	2 Meter 10" square	2 lbs.	11.95
40 E 19063W	ASQ-6	6 Meter 30" square	4 lbs.	15.95

AMECO AMATEUR CONVERTERS AND PREAMPS FOR RECEIVERS AND TRANSCEIVERS

PV NUVISTOR VHF PREAMPLIFIERS

As low as **14⁹⁵**



Designed for either 50, 144 or 220 MHz, a Model PV Nuvistor-preamplifier can be used ahead of a receiver or converter to improve the gain and noise figure considerably. Unit employs a completely neutralized 6CW4 Nuvistor, for a gain of over 20 db and a noise figure of 2.5 db at 50 MHz, 3.0 db at 144 MHz, and 4.0 db at 220 MHz. Completely wired and tested, requires 100-150 VDC at 8 ma and 6.3 volts at .13 amps, AC or DC. Only 2 1/2 x 3 1/2 x 7". Shpg. wt., 2 lbs.

- 40 E 10195 PV-50, for 50 MHz Net 14.95
- 40 E 10203 PV-144, for 144 MHz Net 15.50
- 40 E 10211 PV-220, for 220 MHz Net 17.95
- 42 E 09015 PV-27, for 27 MHz Net 12.95

Model PCL-P ALL BAND NUVISTOR PRE-AMP (6-160 METERS) FOR RECEIVERS

34⁹⁵ No Money Down*

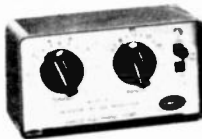

- Continuous Tuning

Model PCL improves receiver reception. Covers 6 through 160 meter amateur bands continuously. Uses 2 6DS4 Nuvistors in a cascode circuit for greater receiver gain and extremely low noise figure of 1.8 to 3.5 db. Also improves image and spurious rejection. Controls: 4-position range switch (1.8 to 54 MHz); Antenna Tuning Control, and 3 position switch for On, off and standby. Built-in 117 VAC power supply. Size: 5 1/2 x 3 3/4 x 3" D. **40 E 10369 Net 34.95**

Model PT—same as PCL-P but for transceivers. **40 E 10484 Shpg. wt., 4 lbs. Net 59.95**

MODEL CB-6 6 METER CONVERTER

Kit **21⁹⁵**
Wired **35⁹⁵**



Utilizes a 6UB8 mixer-oscillator, a 6ES8 cascode RF amplifier and specially designed transformers. High sensitivity. Noise figure—better than 4 db. IF rejection—over 100 db. Housed in 2 piece satin finished copper chassis. WILL NOT BECOME OBSOLETE, since the IF output can be easily changed to match any receiver. Size: 4 x 2 1/2 x 5". Comes less power supply. Complete with tubes, crystal for 14.18 MHz IF output and instructions. Shpg. wt., 1 lb.

- 40 E 10270 CB-6K Kit Net 21.95
- 40 E 10206 CB-6W above, wired Net 35.95
- Model CB-2 Meter Converter—same as above but for 2 meters. Shpg. wt., 1 lb.
- 40 E 10310 CB-2K Kit Net 24.95
- 40 E 10320 CB-2W Wired Net 39.95

Improve Your Amateur And CB Operating Effectiveness With LAFAYETTE Meters and Testers

SWR Bridge and RF Power Meter

Deluxe Solid State Field Strength Meter

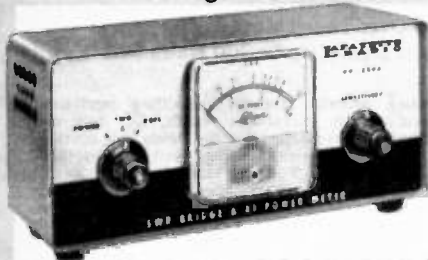

22⁹⁵

- Measures Standing-Wave-Ratio in a Transmission Line
- Measures Up To 15 Watt Output Into a Built-In Dummy Load
- VSWR Measurement From 1:1 to 10:1 and Reflected Power to 1 KW

Highly accurate SWR and direct power readings up to 50 MHz. The unit may be permanently inserted in the transmission line for SWR and relative power monitoring. For 52 or 75 ohm lines. Insertion loss is negligible. Meter has 50 μ a movement; calibrated directly in watts from 0.15 and in SWR from 1 to 10 IF (reads infinity at full scale) . . . Housed in an attractive grey metal cabinet, 3 $\frac{1}{4}$ x 7 $\frac{1}{4}$ x 2 $\frac{3}{8}$ ". Sits on 4 rubber feet. Imported. Shpg. wt., 2 lbs.
99 E 25082 Net 22.95



- Permits Easy Tune-Up For Maximum Transmitter Output
- Earphone Jack to Monitor Audio
- Tuned Input From 3 to 55 MHz
- 200 μ a Meter Movement
- 20" Telescoping Antenna

15⁹⁵

Covers 3MHz to 55 MHz in 3 bands. Ideal for use with ham, Citizens Band or other transmitters within this frequency range. Enables user to tune his transmitter and antenna for maximum RF output. 200 μ a meter is calibrated from 0 to 10. Earphone jack provided. Front panel controls: gain on-off switch, tuning, and band selector switch. Battery powered—can be operated anywhere. With 20" telescoping antenna and battery. 4 $\frac{1}{2}$ " H x 4 $\frac{3}{8}$ " D x 4 $\frac{1}{8}$ " W. Imported.
99 E 25108 Shpg. wt., 2 lbs. Net 15.95
99 E 25157 High output crystal earpiece for above. Net 1.09
99 E 62560 Replacement battery for above Net .10

Radio Field Indicator



7⁹⁵

- Continuously Measures Transmitter RF Output
- Requires No Electricity, Batteries, or Transmitter Connection
- Powerful Magnet on Bottom Plate for Mounting on Dashboard or Other Metal Surfaces

Checks performance of your marine, mobile or fixed transmitter. Features a 200 μ a meter movement with variable sensitivity control. Earphones can be plugged in for an aural check of output. Antenna extends from 3 $\frac{1}{4}$ " to 10 $\frac{3}{4}$ ". Powerful magnet allows easy mounting. Use anywhere . . . requires no electricity or batteries. Dimensions: (less antenna) 3 $\frac{1}{8}$ " W x 2 $\frac{1}{4}$ " H x 2"D. Imported.
99 E 25090 Shpg. wt., 7 oz. Net 7.95
99 E 25157 High output crystal earpiece for above Net 1.09

Deluxe Wave-Meter



9⁹⁵

- Instant Readings of Transmitter RF Output
- Requires No Batteries or Connections to Transmitter
- Compact, Portable, and Accurate

A miniature wavemeter for checking transmitter output. Determines relative strength of fundamental frequency and any harmonic or parasitic radiation. Complete and self-contained, requires no power. Telescoping antenna is included. Tunes 1.6 to 150 MHz in four calibrated bands. Only 3 $\frac{1}{8}$ " W x 2 $\frac{1}{8}$ " H x 1 $\frac{1}{2}$ " D. Antenna is 10 $\frac{3}{4}$ " extended. 3 $\frac{1}{4}$ " telescoped, is fitted with a screw plug and is removable. Imported. Shpg. wt., 8 oz.
99 E 25116 Net 9.95

Miniature Illuminated "S" Meter



2⁹⁵

- Indicates Strength of Received Signal
- Jeweled Bearings
- Accuracy 2% of Full Scale
- High Quality D'Arsonval Movement
- Clear Plastic Front

Durable wrap-around plastic front panel provides wide-angle readability. Zero adjustment screw on front panel; jeweled bearing movement. Calibrated in "S" units from 0.9 with the scale terminating in +10 and +30 calibrations. Additional full scale calibrations of 0-5 and 0-10 in linear scale divisions. Silvered dials; black numerals and pointers. Illuminating lamp for either 6 or 12 volt operation. 1 $\frac{5}{8}$ " dial face; 1 $\frac{1}{4}$ " overall behind panel. Supplied with mounting screws. Imported. Shpg. wt., 8 oz.
99 E 25132 Net 2.95

Deluxe "S" Meter



8⁹⁵

- Signal Strength Meter Using VTVM Principles
- Magnetic Feet For Mobile Dashboard Mounting
- Sensitivity and Zero Adjust Controls

Designed for use with any superheterodyne receiver employing AVC. Meter is calibrated in "S" units from 1 to 9, and in db up to 30db over S9. Partial peak clipping is provided for noise limiting. Simple installation—B+, filament and ground. It is adaptable to either 6 or 12-volt equipment, and to receivers using 150 ma or 300 ma series string filament systems. Requires 150-200 VDC for B+. Complete with 12AU7 and installation instructions. Imported.
99 E 25124 Shpg. wt., 2 lbs. Net 6.95

Miniature Illuminated Modulation "S" Meter



2⁹⁵

- Combination "S" Meter, % Modulation Meter and RF Power Output Meter
- Accurate D'Arsonval Movement
- Jewel Bearings

Highly accurate. Features wide viewing angle and 3-color scale. Front panel zero adjustment. Calibrated scales (1 MA full scale), 0 to 100% modulation, "S" units 0-9, also +10 and +30. Linear full scale markings of 0 to 5. Dimensions: dial face, 1 $\frac{5}{8}$ "; depth 1 $\frac{1}{4}$ " overall. Supplied with 4 mounting screws and lugs. For 6 or 12 volts. Dust resistant case. Imported. Shpg. wt., 8 oz.
99 E 25074 Net 2.95

Full-Size Illuminated "S" Meter

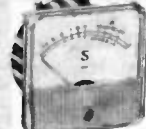

4⁹⁵

- Indicates Strength of Receiver Signal
- 2 Jewel Movement
- Clear Plastic Front
- Calibrated to S9 +40 db

A quality "S" meter (basic 1 ma, 2 jewel movement) designed to replace many "S" meters used in communications receivers. Clear plastic front measures 2 $\frac{3}{8}$ " square and meter fits standard 2 $\frac{1}{8}$ " round hole. Perfect for the experimenter and amateur. Complete with mounting screws, instructions for installation and use. For 6 volt or 12 volt operation. Zero adjustment control on front panel. Imported. Shpg. wt., 1 lb.
99 E 25140 Net 4.95

Lafayette CB Replacement — Experimenter Parts

12 VOLT DC POWER CABLE

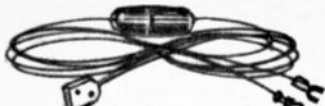

Consists of one hot red lead and one black ground lead. One end of assembly terminates in a rugged 3 contact female plug, ready for mating with chassis power socket. The opposite end terminates in lugs for solid connections to the battery point and ground. Midway in the line is a durable plastic holder containing a protective fuse. Features well soldered connections, strong wire. Overall length approximately 6 feet long. For HB-500, A, HB-555, HB-525, A, B, C, HB-625, HB-23, Telsat 150, Telsat 50, HA-750, PB-50, PB-150, HA-39, 42, 45, 46, 153, 155, HA-159, 99 E 31106 Imported. Wt., 8 oz. Net 2.50

DC POWER CHASSIS JACK



Mounts on chassis rear and accepts plug of 12 volt DC power cable 99 E 31106 above. Used in HB-500, A, HB-525, A, B, C, HB-625, HB-23, HA-525, A, B, C, HA-750, PB-150, PB-50, HA-39, 42, 45, 46, 153, 155, 159, Telsat 150 and Telsat 50. Imported. 99 E 63638 Shpg. wt., 4 oz. Net .89

CABLE ASSEMBLIES



FOR COMSTAT 23, 25, 25A, 25B, COMSTAT 23 MKV, MK VI.

AC Cable Assembly. 5 3/4 ft. of durable cable terminating in dual prong power plug on one end and in 8-prong octal socket on other. Shpg. wt., 8 oz. 99 E 31817W Imported Net 1.95

DC Cable Assembly. 4 1/2 ft. fused DC cable tinned on one end and terminating in octal socket on other. Shpg. wt., 8 oz. 99 E 31825 Imported Net 2.50

AC CABLE ASSEMBLIES For HE-20, A, B, C; HE-43, A, B, C; HE-45, A, B; HE-50, A, HB-333. Shpg. wt., 1 lb. 32 E 09327 Net 1.95

AUTOMOBILE CIGARETTE LIGHTER CABLE

Connect the two free leads of this power cable to your equipment power input, plug into car cigarette lighter outlet and that's all there is to it. Fused for safety by fuse in bayonet type fuse holder wired into cable. 3 ft. long. For HE-20 Series, HE-43 Series, HE-45 Series, HE-50 Series etc. Shpg. wt., 6 oz. Observe equipment polarity. 32 E 09301 Net 2.50

Same as above but for HB-200, HB-111 and HB-222 etc., observe equipment polarity. 32 E 09319 Net 2.50

MOBILE MOUNTING BRACKETS

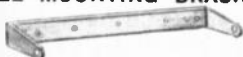

Complete with top mounting holes, and with adjustable side mounting holes for knurled screws. Used in Lafayette HB-525, A, B, C, HB-625, HA-750, PB-50 and PB-150, Telsat 50, Telsat 150. 6 1/4 x 2 x 3/4". Imported. 99 E 63588 Shpg. wt., 8 oz. Net 1.49

Same as above but for Lafayette HB-555, HB-23, HA-39, 42, 45, 46, 153, 155, HA-159. 6 1/4 x 2 1/4 x 3/4". Imported. 99 E 63596 Shpg. wt., 8 oz. Net 1.49

27MC WALKIE-TALKIE TELESCOPING ANTENNA

Attractive and highly efficient 12 section chrome plated brass telescoping antenna for "walkie talkie" transceivers. Measures 52" fully extended and 5 1/2" retracted. Has #8-32 threaded stud and nut at bottom for easy mounting, and soldering lug for electrical connection. Shpg. wt., 10 oz. 99 E 30082 Net 1.95



LAFAYETTE MINIATURE MICROPHONE CONNECTORS

(A) Microphone Plug for CB and Amateur Microphones. Precision engineered and sturdily constructed. Plug takes any 4 conductor (or 3 conductor with shield), coiled cord or straight cable. Features threaded retaining ring for positive locking, integral cable retaining clamp, and polarizing keyway. Size: 1 1/4" L x 1/2" D. Used with microphone in Comstat 23, Comstat 25, 25A, 25B, HB-444, HB-444/25, HB-444/25A, Comstat 19. Imported. 99 E 62630 Shpg. wt., 8 oz. Net 1.29



(B) Microphone Chassis Socket on equipment chassis or panel and mates with 99-62630 plug. Size: 3/4" x 5/8" dia. Requires 5/8" mounting hole. Used in Comstat 23, Comstat 25A, 25B, HB-444 / 25, HB-444/25A. Comstat 19. Imported. Wt., 8 oz. 99 E 62648 Net .89



MICROPHONE PLUG

Attractive, sturdy plug used with HB-555, HB-600, HB-600A, HA-650, HE-20D, HB-525, A, B, C, HB-625, HE-20T, HB-23, HA-750, and Telsat 23, Telsat 150 and Telsat 50 microphones. Four male prongs on one end with retaining cable clamp on the other end. Sturdy molded plastic body with plated metal housing. Size: 5/8" OD x 1 1/2" overall. Imported. Shpg. wt., 4 oz. 99 E 62838 Net .99



MICROPHONE CHASSIS SOCKET

Mounts on chassis rear of equipment. Accepts and mates with microphone plug 99 E 62838 above. Used in HB-555, HB-600, A, HA-650, HE-20D, HB-525, A, B and C, HB-625, HE-20T, HB-23, HA-750, Telsat 23, Telsat 50, and Telsat 150. Imported. 99 E 63646 Shpg. wt., 4 oz. Net .99



ILLUMINATING PILOT LAMPS

S Meter Illuminating Lamp. Operates on 6 volts AC or DC. Used in Lafayette Comstat 23, Comstat 25, Comstat 25A, 25B, HB-444 and HB-444/25A. Imported. Shpg. wt., 2 oz. 99 E 62622 Net .29



Channel Selector Dial Indicator Lamp. Used in Lafayette HB-500, HB-525, A, B, C, HB-625, HB-600, HE-20D, HE-20T, HA-39, 42, 45, 46, 153, 155, HA-159, HA-750, Telsat 150, Telsat 50, PB-50, PB-150. Imported. 99 E 63612 Shpg. wt., 2 oz. Net .29

KNURLED SCREW

For mounting mobile bracket onto Lafayette HB-525, A, B, C, HB-555, HB-625, HB-23, HA-750, Telsat 50, Telsat 150, PB-50 and PB-150. Imported. Shpg. wt., 4 oz. 99 E 63604 Net .45



For Lafayette Comstat 23, Comstat 25, Comstat 25A, 25B, HB-444/25. Shpg. wt., 4 oz. 99 E 31833 Net .45

MODULATION & AUDIO OUTPUT TRANSFORMER

Used in H-29-B, Subminiature 3/4 x 3/4 x 3/4" H. Center-tapped primary; 2 secondary windings. Impedance: primary — 500 ohms C.T., secondary — 8 ohms and 3K ohms. With schematic. Shpg. wt., 8 oz. 99 E 61327 Imported. Net .89



OUTPUT AND MODULATION TRANSFORMERS

Used in any circuit using a 6AQ5 tube as a modulator output and requiring 3.2 ohm secondary for PM speaker, as in Lafayette HE-20A, B & C, HE-43A, B & C. 2 1/2 x 1 1/4 W x 1 3/8" H. With application instructions. Shpg. wt., 1 1/4 lbs. 32 E 09053 Net 2.95



RECEIVER OSCILLATOR COIL

Compact, slug-tuned receiver oscillator coil. Slug tuned to give resultant IF frequency of 455kHz. Has tapped primary, plus secondary windings. 3/8" diam. x 3/4" L. Avg. Q=80. Imported. 99 E 62028 Shpg. wt., 4 oz. Net .59



1st IF TRANSFORMER

Subminiature IF transformer. 455-kHz IF. Slug-tuned 3/4" sq. x 3/4" High. Primary 70,000 ohms, secondary 15000 ohms. Shpg. wt., 6 oz. 99 E 62481. Imported. Net .69



2nd IF TRANSFORMER

Subminiature slug tuned 455 kHz transformer. Impedance: 50,000 ohm primary, 1,000 ohm secondary. 3/4" sq. x 3/4" H. Shpg. wt., 6 oz. 99 E 62499 Imported. Net .69



3rd IF TRANSFORMER

Precision-built, subminiature 455-kHz IF transformer. Slug-tuned. Primary 30,000 ohms; secondary 5,000 ohms. 3/4" sq. x 3/4" H. Shpg. wt., 6 oz. Imported. 99 E 63299 Net .69



HEAVY DUTY CB MICROPHONE CABLE



- Retractable
- 3 Conductors Plus Shield

A durable coiled cord, retractable microphone cable with 3 insulated conductors, one of which is shielded. Extends to 5 feet and retracts to 10 inches. Is used with Lafayette HB-500, A, 525, A,B,C, HB-625, HB-600, HE-20D, HE-20T, HA-750, HB-23, Telsat 23, Telsat 50, Telsat 150. Imported. 99 E 63620 Shpg. wt., 8 oz. Net 1.95

1650 KHZ INTERMEDIATE FREQUENCY TRANSFORMERS

For use in any citizens band receiver utilizing 1650kHz IF Frequency. 1 7/8 x 3/4 x 3/4". Complete with schematic. Used in HE-20 Series, HE-43 Series, HB-111 Series, and HB-200 Series. 32 E 09137 Wt., 8 oz. Net 1.89



Improve Your Citizen Band Performance

LAFAYETTE CB LOW PASS FILTER



SALE

6⁹⁵

WAS 7.95
1969 Cat. 690

- Avoid TV Set Interference
- 50db Attenuation of Radiated Spurious and Undesirable Signals!
- Simple Installation

Designed to effectively reduce TVI which may be emanating from your CB transmitter. This professional quality filter attenuates radiated spurious and other undesirable harmonic signals higher than 50 MHz approximately 50 db or more; Minimizes interference with your own or your neighbor's TV set. Simple to install with two built-in SO-239 connectors. Just place unit between transmitter and antenna. Impedance is 50-75 ohms and connections may be reversed for same impedance match. Max. power rating is 100 watts. Very well constructed with spot-welded case and finished in dark metallic grey. Size: 5x2x1 3/4". Shpg. wt., 1 1/2 lbs. 42 E 01232 Net 6.95

LAFAYETTE AUTO-MARINE ENGINE NOISE SUPPRESSOR KIT

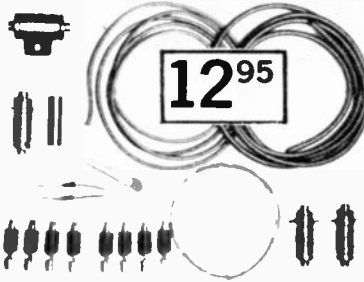

- A Must for Mobile CB and Ham Operators
- 13 Components Plus Shielded Cable, Bonding Strap and All Mounting Hardware

Easily installed kit will effectively suppress noise and interference created by the operation of electrical equipment in your car or boat such as spark plugs, circuit breakers, coils, generators, regulators, or distributor assemblies. Consists of 8-spark plug suppressors; 1-distributor suppressor; 12-ft. shielded cable; 18-inch bonding strap, 1/4"-wide, 4-coaxial capacitors. All necessary hardware and complete instructions for installation are included. Shpg. wt., 2 lbs. 42 E 09052 Net 12.95

GENERATOR NOISE FILTER

- Freq. Range 3-30 MHz
- Simple to Install • Adjustable



2²⁹
99 E 60188 Shpg. wt., 1 lb. Net 2.29

Enables quiet receiver operation for Citizens Band, Amateur and Industrial frequencies. Standard frequency range 3-30 MHz. Maximum current 25 amps. Imported.

VOLTAGE REGULATOR FILTER

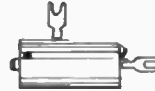

- Will Operate on 6-12-24 & 32 Volt Systems at all Frequencies

Eliminates noises in communication receivers caused by points in voltage regulator. Not voltage or frequency critical—no tuning required. Wt., 8 oz. 42 E 89013

Net 2.95

ALTERNATOR NOISE FILTER



3²⁹

A highly effective filter for alternator equipped automobiles. Attenuates alternator noise by 50 db. Can operate up to 32 volts DC. Results in quiet mobile receiver operation. Shpg. wt., 8 oz. 42 E 49009

Net 3.29

LAFAYETTE QUIAT-COM™ SOLID STATE VIBRATOR

- No Vibrator Hash Noise
- Much Longer Vibrator Life
- No Mechanical Noise
- More Efficient, Cooler Operation

Exceptionally efficient replacement for CB vibrators, as well as for vibrators used in Amateur and communications equipment rated up to 85-watt consumption. Available in POSITIVE Model and in NEGATIVE Model. For 12 Volt operation only. Shpg. wt., 1 lb. **Quiat-Com Positive Model** Replaces vibrators with Pin 1 Positive. 42 E 01216 Positive Quiat-Com Net 6.95 **Quiat-Com Negative Model** Replaces vibrators with Pin 1 Negative. 42 E 01224 Negative Quiat-Com Net 6.95

TUNEABLE ALTERNATOR FILTER



- Handles Up To 52 Amps.
- 22-60 MHz Range

Designed for ultimate in mobile alternator noise suppression. Can also be used with Amateur and Business Band mobile rigs. Tunes 22-60 MHz. Adjustable frequency trimmer rating 52 amps continuous. Shpg. wt., 2 1/2 lbs. 42 E 44026

6⁹⁵

Net 6.95

LAFAYETTE 6 TO 12-VOLT SOLID-STATE DC CONVERTER

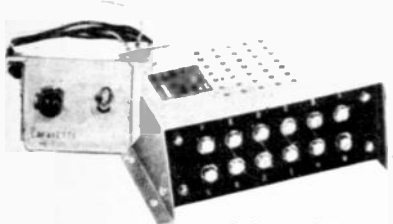

19⁹⁵

- 1 Amp. Output

Great news for CB'ers with 6 VDC negative, or positive ground battery systems. Now you can install a mobile communications system using your present 6 VDC system. Operate your Lafayette HB-500, A, B, HB-600, A, B, HB-525, A, B, C, HB-625, HE-20T, Teisat 23, HB-23 and any other Solid State CB transceiver drawing less than 1-Amp during transmission. This unit will fit neatly under the dashboard, or on the firewall. Attractive miniature remote control panel with on-off switch and pilot light indicator. Size 5 1/4" x 4 1/4" x 2 1/4". Imported. 99 E 30843 Shpg. wt., 4 1/2 lbs. Net 19.95

DELUXE LAFAYETTE NICKEL CADMIUM BATTERY CHARGER AND ELIMINATOR



13⁹⁵

- Charges at a Rate of 40 ma. per hour
- Permits 117 Volt AC Base Station Walkie Talkie Operation
- Includes Plug-in Battery Holder for Charging 10 "Z" Cells

Consists of a deluxe battery eliminator which permits 117VAC base station operation of 12 volt walkie talkies rated up to and including 2 watts input. Also includes plug-in battery holder for charging 10 "Z" size nickel cadmium batteries. Charges at a rate of 40ma per hour. Imported. Shpg. wt., 4 lbs. 99 E 31361M Net 13.95

AMECO CB TRANSCEIVER RF PREAMPLIFIER



No Money Down* 59⁹⁵

- FET Transistor Amplifier
- Improve Receiver Sensitivity
- Connects to CB Transceiver No Modification Required

Model "PCB" solid-state preamplifier improves sensitivity, increases gain of receiver section of transceiver over 20 db. Improves signal-to-noise ratio. Automatic switching bypasses preamplifier when transmitting. Built-in gain control increases immunity to front-end overload. "ON THE AIR" sign automatically lights when transmitting. Power switch controls entire station. Allows convenient connection of auxiliary receiver. Size: 7 1/2" x 3 1/4" x 4 1/2". Shpg. wt., 3 lbs. 42 E 69090 Net 59.95

LAFAYETTE—Headquarters for CB Accessories & Equipment

LAFAYETTE CB Nuvistor Preamplifier

10⁹⁵

Made in U.S.A.



- Designed Especially for the CB Band
- Improve Receiver Gain, Noise Figure, Spurious Signal Rejection and Image Rejection

Can be added to virtually any CB transceiver to improve gain and noise figure. Covers a frequency range of 26.96 to 27.225 MHz and employs a nuvistor tube in a neutralized circuit. Tuned circuitry is employed for both the grid and plate. Gain is 20 db and noise figure of 2.0 db at 27MHz. Power requirements are 6.3 volts at 135 ma. and 100-250 volts DC at 8 ma. Only 2 1/2 x 3 1/2 x 1 1/2". 42 E 01273 Shpg. wt., 2 lbs. Net 10.95

Mobile Burglar Alarm For CB Transceivers

4⁹⁵

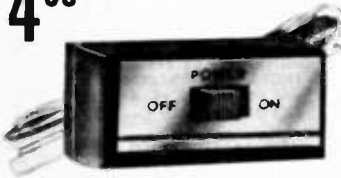

- Prevent Theft of Your Transceiver
- Solid State Integrated Circuit
- For 12 V. Neg or Pos Ground

Protect your CB equipment. Burglar alarm connects to your horn and CB Transceiver. Horn automatically blows when someone tries to steal your CB unit. Two-way switch permits you to remove your transceiver without sounding alarm. Features reliable, solid-state IC circuitry. Complete with instructions, wire and mounting hardware. 42 E 71011 Shpg. wt., 3 oz. Net 4.95

NEW Mini CB Phone Patch

13⁹⁵



Talk anywhere in the world from your car or truck. Simple installation allows your telephone to be connected to your CB communications system. For use with 3-16 ohm speakers and high impedance microphone inputs. Transmit gain control to compensate for varying line levels. On-off switch disconnects patch when not in use. Dimensions: 3 3/4 x 2 1/4 x 2 1/4". Shpg. wt., 2 lbs. 42 E 12007 Net 13.95

LAFAYETTE CB Transceiver Tester

- Measures
- RF Power Output
 - % Modulation
 - Relative Field Strength
 - Crystal Activity
 - SWR

- Generates
- Crystal Controlled RF Signal
 - 1 kHz Audio Signal
 - Modulated Audio Signal

- Provides
- In-Circuit Instant Connection to Antenna Without Removing Cables From Transmitter

- Permits
- Aural Monitoring of Local Transmitters
 - Visual Transmitter Monitoring with Oscilloscope

Features sensitive d'Arsonval meter, front panel jacks for aural and visual monitoring, audio generator output and RF signal generator output; ceramic jacks for standard miniature crystal sockets. Controls include Function Selector, Antenna Selector, Generator Selector, Modulation Calibrate Switch, Modulation Calibrate Control and Meter Adjust Control. Sturdy professional type SO-239 sockets accept standard PL-259 connectors. Sturdy attractive molded case with brushed aluminum front panel. 7 7/8 x 5 3/8 x 2 7/8". Includes 9V battery; 30" telescoping antenna. Shpg. wt., 4 lbs. 42 E 01265 No Money Down* Net 42.95



42⁹⁵

Made in U.S.A.

CB and Ham SWR Mini-Bridge

13²⁵

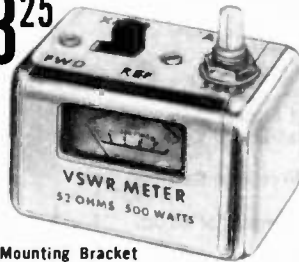

- With Mounting Bracket
- Handles A Full 500-Watts Average Power
 - Ideal For Inline Mobile Applications
- Only 2 3/4" long by 1 1/2" high by 1 3/4" wide, yet will handle a full 500-watts average power with negligible insertion loss. Gives stable meter readings of SWR plus an additional scale shows relative output power. Designed for 52-ohm impedance lines. Supplied with universal mounting bracket for inline applications. Shpg. wt., 8 oz. 42 E 21040 Net 13.25

CB Output Power Sensor

9⁹⁵



- Reads Output Power and Converts Volts To Watts†
- Output power sensor and dummy load! Easy-to-use and very accurate. Helps trouble shoot transmitter and antenna by reading output power and converting volts to watts (when used with a VOM rated at 10K, 20K or 100K ohms/volt. Voltage to watts conversion table on the sensor will show output in watts. Dummy load: non-inductive 52-ohms. Shpg. wt., 6 oz. 42 E 21057 Net 9.95

CB Antenna Match

9⁹⁵



- 1.1:1 VSWR
- Gives a perfect antenna/transmission line match of 1.1:1 VSWR for full power. Requires no special tools for installation. Simply insert the CB MATCHER between the transmitter and antenna lead-in. Adjustable tuning knobs permit precise matching under various operating conditions. 42 E 21032 Shpg. wt., 6 oz. Net 9.95

Antenna Coaxial Switch

5⁹⁵



- 2-Position
 - Rated At 1 KW AM, 2 KW PEP SSB
- CBer's and Hams can stop reaching behind their rigs, wasting time and missing calls switching antenna leads. With this quality coaxial switch—just turn the knob and instantly change from one antenna to another. Size: 2 1/2 x 1 1/4". Shpg. wt., 1 lb. 42 E 21024 Net 5.95

* See Page 11 for Full Credit Details on Easy Pay Plan

LAFAYETTE Base Station Citizens Band Antennas

NEW! LAFAYETTE "SUPER QUAD" CB FIXED ANTENNA

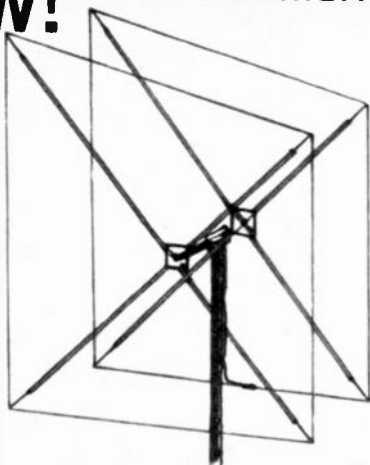

Only **44⁹⁵**
No Money Down*

Made in U.S.A.

- 30 db Front-To-Back Ratio
- 7.5 db True Forward Gain

"Maximum focus" design featuring large reflector element produces 7.5 db true forward gain—reduces interference drastically with 30db front-to-back ratio. Can be operated vertical or horizontal. Split-wire matching eliminates loading stubs. Rain, snow, and ice cannot detune the quad. Precision matching provides optimum VSWR at center, 1.3:1 or better at band edges. Sturdy, seamless aluminum tubing throughout. Dipoles are steel-core copper-clad cable. Fool-proof assembly—prealigned. Accepts masts up to 1½" pipe or 2" tubing. Less coaxial cable. Shpg. wt., 15 lbs.
42 E 01580W Net 44.95

LAFAYETTE "RANGE-BOOST/11"™ END FED 1/2-WAVE CB ANTENNA

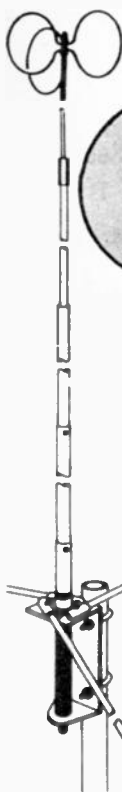

Static Clover Leaf

- Heavy Duty Mounting Bracket
- Static Clover Leaf Ball Design Reduces Receiver Noise
- 3.75 db True Omni-Directional Gain
- VSWR—1.17-1
- Signal to Noise Improvement of 6-20db

The "Range Boost/11" 1/2-wave CB base station antenna is one of the most popular of Lafayette's famous line of high performance CB antennas. Specially designed anti-static cloverleaf ball drastically reduces receiver noise by continuous dissipation of static discharge. Offers a 3.75 db true omni-directional gain. Tremendous signal to noise ratio improvement of 6-20 db giving you very clean reception. VSWR is 1.17-1. Includes a phasing transformer, rubber covered for moisture resistance. Vertical radiator consists of 3 seamless aluminum tube sections topped by a solid aluminum 108" top section. 3 54" radials provide proper transmission line decoupling. New heavy duty mounting bracket. Direct ground lightning protection. 50 ohm, 17'6" over-all length. Accepts up to 1½" masts PL-259 cable connector. Shpg. wt. Less mast and coax, 6 lb.
42 E 01448W Net 19.95

DELUXE HEAVY DUTY LAFAYETTE 4 ELEMENT GROUND PLANE ANTENNA

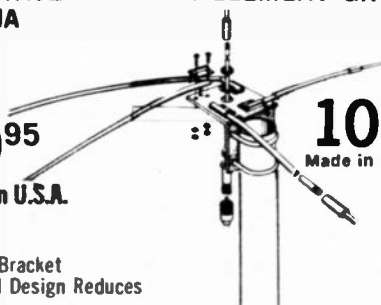

10⁹⁵

Made in U.S.A.

- The Ideal Antenna For Your CB Base Station
- High Efficiency Ground Plane Antenna
- All Aluminum Construction
- Accepts PL-259 Connector

Solid aluminum 108" heat-treated radials and radiator. Elements supplied in two 54" lengths joined by threaded coupling nuts. Radial droop for 50 ohm match. Accepts 1½" tubing, RG-58/U cable and PL-259 connector. Less mast and coax. Shpg. wt. 4 lbs.
42 E 01582W Net 10.95

LAFAYETTE'S 3-ELEMENT VERTICAL BEAM CB ANTENNA



17⁹⁵

MADE IN U.S.A.

- Multiplies Power 8 Times
- Completely Precision Tuned and Ready to Assemble and Install
- Steel Parts Irridite Treated to MIL Specs

An exceptionally high gain, directional antenna system for Citizen's Band communications. It develops a forward gain of 8 db. Front-to-back ratio is 25 db; front-to-side, 40 db. 50 ohm feedline match for maximum efficiency. Comes with bracket for vertical or horizontal mounting. The 1¼" O.D. aluminum boom is 8 feet long. ¾" to ¼" D.D. aluminum elements are approximately 16½ ft. long. All steel hardware is irridite treated to MIL specs. Accepts up to 1½" mast. Completely factory pretuned. Furnished with simple mounting instructions. Less mast and coax cable. Shpg. wt., 7 lbs.
42 E 01133WX Net 17.95

POLYFOAM COAX CABLE ASSEMBLY FOR BASE STATIONS



8⁵⁰

Complete transmission line packages designed for better CB operating efficiency. The polyfoam dielectric insures low line loss important in getting the most from your base station. Ready to use. PL-259 connectors on both ends.

Stock No.	Type	Length	WT.	Net
42 E 09102	RG8/U-50 ohms	50 ft.	7 lbs.	8.50
42 E 09110	RG8/U-50 ohms	100 ft.	11 lbs.	14.95

UNIVERSAL ANTENNA MOUNTING KIT AND LIGHTNING PROTECTOR



Deluxe mounting kit for base station consists of: Blitzbug Lightning Arrestor, 50 ft. ground wire, angle base and roof mount—works on any surface—takes masts up to 2¼" D.D. 50' of steel guy wire, 3 steel turnbuckles, 3 way guy wire clamps, package of 3 open eye bolts. (Kit comes less mast.) Shpg. wt., 6 lbs.
42 E 01307M Net 6.99
10 ft. 16 gauge Gold Kote steel mast—1¼" D.D. Shpg. wt., 8 lb.
18 E 63201WX Net 2.49

LAFAYETTE Mobile Citizens Band Antennas

LAFAYETTE STAINLESS STEEL CB MOBILE ANTENNA

- 102" Stainless Steel Whip For Optimum 11-Meter Performance
- Heavy-Duty Cadmium Plated Stainless Steel Spring
- Aluminum Swivel Ball Jointed Mount Base

Only

6⁹⁵

Made in U.S.A.

Aluminum swivel mount base designed to be mounted on any surface. Plated steel spring holds rod in properly adjusted position and prevents rod damage from shocks and blows. Stainless steel whip for resiliency and strength. Less cable. Has lug terminals for 42 E 70021 cable assembly. Shpg. wt., 4 lbs.

42 E 01554WX Net 6.95



DELUXE LAFAYETTE HEAVY-DUTY MOBILE CB-AM ANTENNA

- One Antenna Does the Job of Two
- Low Loss Cables
- All Connections Under Dash

7⁹⁵

Deluxe Cowl mounted antenna doubles for Citizens Band and broadcast reception. Eliminates two antennas on your car. Sturdy construction with heavy chrome plate, 46" long collapsing to 31". Fits the 7/8" to 1 1/4" space left by auto antenna. Includes automatic dividing harness, 1' cable to AM set, 2' cable to CB rig and 5' cable with PL-259 plug to antenna. Small divider unit fits under dash. Imported. Shpg. wt., 4 lbs.

99 E 30603W Net 7.95



LAFAYETTE CENTER-LOADED MOBILE CB GUTTER CLAMP ANTENNA

- Easily Snaps on Rain Gutter of automobile
- Offers Outstanding 11 Meter Performance
- Portable—Easily Removable When Not In Use—Prevents Theft or Damage



6⁹⁵

Portable center-loaded CB antenna is ideal for the CB'er. Easily removable when not in use—prevents theft or damage. Gutter clamp snaps on rain gutter of automobile. Heavy spring assures positive grip. Clamp is heavily plated to resist corrosion. Only 20 inches in length—outstanding 11 meter performance. SWR 1:1. Furnished with 12' of RG58/U cable with PL-259 connector. Imported. Shpg. wt., 3 lbs.

99 E 31882 Net 6.95



LAFAYETTE BASE LOADED TRUNK MOUNTED MOBILE ANTENNA

- No Visible Holes in Car
- Trunk Groove Mount
- Installs in Seconds
- Phasing Transformer Completely Weatherproof
- 39" Stainless Steel Whip

ONLY **9⁹⁹**

MADE IN U.S.A.

Exciting mobile antenna from Lafayette permits the CB'er to mount his antenna without any visible holes on his car. Special trunk groove mount requires just two tiny 7/32" holes in groove of car trunk lid. Antenna holds securely and is adjustable to all cars. Features base loaded, weatherproof phasing transformer (only 4" high, 1" diameter) and a 39" stainless steel whip. Complete with all mounting hardware, simple mounting instructions. Less cable. Shpg. wt., 5 lbs.

42 E 01455 Shpg. wt., 5 lbs. Net 9.99



LAFAYETTE BASE LOADED "AUTO-TOP" CITIZEN BAND ANTENNA

- Automobile rooftop application effects ideal Omnidirectional signal patterns
- Mounts neatly from outside vehicle in 3/4" hole
- Base loaded Phasing Transformer completely weatherproof
- 39" Stainless Steel whip

Only **7⁹⁹**

Made in U.S.A.

The Lafayette Base Loaded "Auto-Top" Citizens-Band antenna offers the CB'er the ideal omni-directional signal pattern with very low signal to noise. This quality antenna consists of an inconspicuous base loaded, neutral gray weatherproof phasing transformer (only 4" high, and 1" in diameter), a 39" stainless steel whip, and all mounting hardware including complete and simple mounting instruction sheets. Antenna mounts in 3/4" hole. Comes less cable. Shpg. wt. 2 lbs.

42 E 01208W Net 7.99



LAFAYETTE "RAPID-GRIP" MOUNT BASE LOADED MOBILE CB ANTENNA

- "Rapid-Grip" Mount Provides Permanent Antenna Installation In Seconds Without Drilling Holes



Only **11⁹⁵**

MADE IN U.S.A.

"Rapid-Grip" mobile antenna is especially suitable for trunk mounts. No holes to drill. Slips over trunk lip. Cable is completely hidden. Neat, trim, professional appearance. Offers ideal omni-directional signal pattern. Water resistant body seal. 39" Stainless Steel whip. Base loaded phasing transformer completely weather proof. Overall length 43". Less cable. Has lug terminals for 42 E 70021 cable assembly. Wt., 3 lbs.

42 E 01521 Net 11.95



LAFAYETTE CB BUMPER MOUNT ANTENNA WITH STAINLESS STEEL STRAP

- Cadmium Plated Bumper Mount with Plated Steel Strap
- 102" Stainless Steel Whip
- Heavy-Duty Cadmium Plated Steel Spring

Only

9⁹⁵

Made in U.S.A.

An outstanding Lafayette CB antenna featuring a full-size 102" stainless steel whip and a fully adjustable steel plated mount with a steel plated strap which was specially designed to fit most cars. Heavy duty plated steel spring is built for extremely rugged mobile use. Less cable. Shpg. wt., 3 lbs.

42 E 01596WX Net 9.95



20 FT. COAXIAL CABLE ASSEMBLIES

(A) • FOR MOBILE APPLICATION (B)



These cable assemblies are necessary for connection between Citizens Band Transceiver and Antenna.

TYPE A—Consists of 20 ft. RG-58/U cable with PL-259 plus UG-175/U on both ends. Required for Ground Plane and Coaxial and Mobile Antennas terminating in a coaxial jack. Shpg. wt., 8 oz. 42 E 70013 Type A; 20 ft. length Net 3.25

TYPE B—Same as Type A except one end is terminated with PL-259 plus UG-175/U and other end with universal ring type terminal lugs for mobile antennas. Shpg. wt., 8 oz. RECOMMENDED FOR USE WITH LAFAYETTE ALL STAINLESS STEEL MOBILE ANTENNA ABOVE. 42 E 70021 Type B; 20 ft. length Net 2.85

CB Walkie-Talkie and Mobile Antennas & Mounts

**NEW DELUXE UNIVERSAL
BASE LOADED CB
WALKIE-TALKIE ANTENNA**

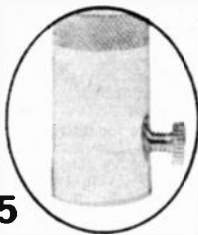

1⁹⁵

- Replaces Broken Or Existing Recessed Antenna
- Instantly Attaches Without Tools

Universal base loaded CB walkie-talkie antenna. Only 16" in length. Replaces broken or existing recessed antenna. Instantly attaches without tools. Can be tuned to compensate for antenna length. Made of non-corrosive materials. Operates equal to long telescoping antennas. **99 E 32187 Wt., 1 1/2 lbs. Net 1.95**

**LAFAYETTE CENTER-LOADED
CB WHIP ANTENNA**

3⁹⁵

- For Base Station or Portable Use
- Adjustable Whip Stub

Sturdy, attractive, portable chrome plated center-loaded whip antenna. Terminates in a PL-259 connector. Adjustable whip is 11 1/4" in length. Also provided is an additional whip stub, 12 1/4" total length. Center loading coil is completely weather-proof. Imported. Shpg. wt., 1 lb. **99 E 31890 Net 3.95**

**CB SIGNAL-HUNTER
DIRECTION-FINDING ANTENNA**

Only **12⁹⁵**



- Track Down CB Interference
- Locate Stations in Distress
- Plugs Into Your CB Set

Tracks down sources of CB interference, TVI, stranded motorists, boats in distress, unknown transmitters, etc. Mounts with suction cup and bracket. Tunes quickly with knob on loop. Indications are made on receiver's S-meter and volume output as loop is rotated. Can be used for transmitting over short distances. 8 ft. cable permits mounting on either side of the car. 50 ohms impedance. Complete with PL-259 connector and RG-58/U cable. Shpg. wt., 4 1/2 lbs. **42 E 21016W Net 12.95**

**LAFAYETTE MOBILE AM TO CB
ANTENNA CONVERTER**

6⁹⁵

- 1 Antenna Now Does the Job of 2 Antennas
- Converts Any AM Automobile Antenna to a Highly Efficient Combination CB and AM Antenna

Specially designed Lafayette AM to CB antenna converter consisting of a weather-proof loading coil with a universal mount and adjustable matching 7/4" stub. Covers entire 27 MHz Citizens Band. Easily attaches to your existing AM automobile antenna. Includes dividing harness which couples your new combination AM and CB antenna directly to your Citizens Band Transceiver and AM auto radio. Imported. **99 E 31163 Shpg. wt., 2 lbs. Net 6.95**

**ANTENNA SPECIALISTS
ANTENNA MOUNTS**



(A) Model M-191, Double Chain Bumper Mount. Cadmium plated. Accepts 3/8"-24 thread of spring or whip. **42 E 10183 Shpg. wt., 2 lbs. Net 9.20**

(B) Model M-147 Stainless Steel Bumper Strap Mount. No holes to drill—easily adjusted. **42 E 10399 Shpg. wt., 4 lbs. Net 12.00**

(C) Model M-4—whip hold-down clip. **42 E 10191 Shpg. wt., 1/2 lb. Net .85**

(D) Model M-161 Quick Grip Mount. Standard trunk-lid mount accepts all 3/8" snap-in-type antennas. No holes to drill. Water resistant body seal. **42 E 10472 Shpg. wt., 1 lb. Net 7.50**

LAFAYETTE CENTER-LOADED FIBER-GLASS CB COWL MOUNT ANTENNA

Only **7⁵⁰**

- With 5' of Cable
- Easily Mounts On Cowl or Rear Deck

Only 38" high but performs like 102" antennas. Designed for cowl mounting, provides an excellent radiation pattern. Substitutes for conventional 1/4 wave whips as well as base-loaded antennas in the 27 MHz band. The four foot whip eliminates the possibility of striking overhead objects. Specially designed rocker support assures 8-point grounding and permits mounting up to 35° angle on fender, cowl or rear deck—Fits any 15/16" to 1/4" mounting hole. Complete with 5 ft. of RC-58/U cable. Shpg. wt., 3 lbs. **42 E 01125W Net 7.50**

**UNIVERSAL LAFAYETTE MOBILE
CB ANTENNA ACCESSORIES**

CHROME PLATED SWIVEL BALL MOUNT BASE. Can be mounted vertically or horizontally. With lug terminals. Imported. Shpg. wt., 3 lbs. **99 E 30306 Net 1.95**

HEAVY DUTY CHROME PLATED STAINLESS STEEL SPRING. Provide maximum support for long whips and heavy centerloaded whips. Imported. **99 E 30363 Wt. 2 lbs. Net 2.79**

CHROME PLATED BUMPER MOUNT WITH STAINLESS STEEL STRAP. Completely adjustable for vertical mounting on most types of automobile bumpers. Highly reliable and durable. Eliminates need of cumbersome link type chain mounts. Imported. Shpg. wt., 1 1/2 lbs. **99 E 30355 Net 3.95**

LAFAYETTE Citizens Band Walkie-Talkie Antenna Replacement Guide

- Fits All Lafayette and Many famous name Walkie-Talkies

Designed for the various Lafayette "Walkie-Talkie" portable CB Transceivers indicated. Will also fit many of the other "Walkie-Talkie" units manufactured by companies other than Lafayette. Check the specs of the antennas listed on the chart below for the antenna best suited to your present "Walkie-Talkie" All measurements are in inches. Imported. Average shpg. wt., 1 lb.

Antenna Stock No.	Diam. of Base	Collapsed Length	Extended Length	For LAFAYETTE Walkie-Talkie Model	Net Ea.
99 E 30082	12 1/2	6	52 3/4	HE-29, HE-29B	1.95
99 E 30413	11 7/16	5 3/4	51	HE-29C	1.95
99 E 31114	11 13/32	5 7/8	51 1/4	HE-29D	1.95
99 E 30371	11 1/2	6 1/4	54 1/2	HA-60, HA-61, HE-86, HE-88, HA-100, 100A, 100B	1.95
99 E 30389	9 7/16	7 1/4	52 3/4	HE-25, HE-88, HA-711	1.95
99 E 30397	11 7/16	5 3/4	50	HE-66, HE-82, HE-83	1.95
99 E 30405	9 3/8	5 7/8	43 1/4	HA-70, HA-70A	.98
99 E 31122	8 5/16	5 3/8	36 1/2	HA-70B, HA-70C	.98
99 E 31130	11 3/8	4 5/8	38	HA-130, HA-130A	1.49
99 E 31148	6 1/4	6	30	GT-3	.98
99 E 30173	10 7/16	7	58	HA-150	1.95
99 E 30074	11 7/16	7 1/4	62 3/4	HA-300, HA-300A	2.25
99 E 31155	11 7/16	7	58	HA-99, HA-303	2.25
99 E 31387	11 7/16	7	58	HA-300B	2.25
99 E 32021	8 5/16	7 1/4	49 1/4	HA-132	1.95
99 E 32039	9 3/8	7 3/8	55	HA-73A	1.95
99 E 32047	11 3/8	6	49	HA-73, HA-305, HE-210A, HA-62	1.95
99 E 32054	10 3/8	7	55	Dyna-com 2, 2A, 3 and 3A	2.95
99 E 32062	10 3/8	8 3/4	67 1/2	Dyna-com 5 and 6, HB-506	3.95

CB Base Station Antennas, Rotors and Accessories

LAFAYETTE LOW COST 1/4 WAVE GROUND PLANE ANTENNA

Only **7⁹⁵**

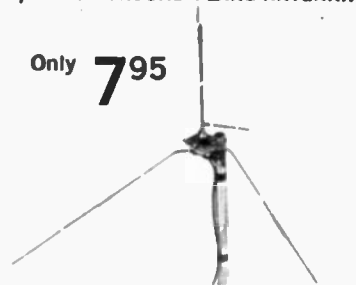

Sturdy trouble-free base-station ground plane antenna for CB. High quality solid aluminum elements, cadmium plated steel mounting bracket, 360° polar pattern provides complete coverage. Overall height, 108"; impedance, 50 ohms nominal; SWR: 1.5/1 or better. Takes solder lug connectors. 42 E 01547W Shpg. wt., 5 lbs. Net 7.95

LAFAYETTE "DUMMY" ANTENNA LOAD FOR CB TRANSCEIVERS

1⁵⁹



A 52 ohm non-inductive load for testing and tuning-up Citizens Band transmitters up to 5 watts. Built into PL259 coaxial plug. Shpg. 42 E 09029 wt., 1 lb. Net 1.59

CORNELL DUBILIER AR-22R AUTOMATIC ROTOR FOR CB ANTENNAS



34⁹⁵ No Money Down*

- Fingertip Control
- Control Unit Shows Direction of Rotation

Heavy-duty rotor unit will handle antennas up to 150 lbs. Simply set the control unit pointer to the desired direction, and the antenna will automatically rotate to this position and stop. Perfect for TV, Ham or Citizen Band applications. Rotor unit employs 12 heavy duty ball bearings in two 6½" races. Reversible clamps on rotor will take masts from ¾" to 2". O.D. control unit is marked in compass points. N.S.E.W. NW, NE, SW, and SE. Housed in attractive black vinyl steel cabinet. For 110-120 volts, 50-60 Hz AC. Uses 4-conductor rotor cable.

42 E 86078WX Shpg. wt., 14 lbs. Net 34.95
Model AR-33 Solid State Pushbutton Automatic Rotor. Same as AR-22R but with deluxe pushbutton control unit that enables you to pre-set the antenna to any 5-positions. Uses 5-conductor rotor cable. 42 E 86100WX 49.95
100 ft. coils of rotor cable. 32 E 89105 4 Cond. Shpg. wt., 3 lbs. 3.10
32 E 36312 5 Cond. Shpg. wt., 4 lbs. 3.09

MOSLEY WEATHER-GUARD ANTENNA COAT

Fast drying, clear coating compound protects against corrosive action of salt, water, moisture, and ultraviolet radiation. Will not discolor antenna. Applies easily with a brush. Shpg. wt. 1 lb. 42 E 51112 Net 1.24



ELENEX "TIGER TAIL" PORTABLE BASE STATION ANTENNA

Only **29³⁵**

with 12' coaxial cable

- Built-In Power Meter
- Ideal For Office Building, Apartments And Emergency Use

High intensity, low angle, stainless steel ¼ wave whip with tunable center loading Ferrite core coil and built-in reflected power meter. Designed to permit quick installation for portable or semi-portable requirements. Conveniently located tuning knob easily tunes coil for best antenna resonance on all CB channels in virtually any surroundings. Built-in matching coil assures perfect match of antenna to transmission line. Adjustable, heavy gauge aluminum mounting bracket mounts to windows, door frames, boats, trailers, etc. Antenna base and meter case constructed of rugged aluminum. Complete with 12' coaxial cable and connector. Overall length: 51". Shpg. wt., 3½ lbs. 42 E 43010W Net 29.35



AVANTI "ASTRO PLANE" BASE STATION ANTENNA

29⁹⁵

- Packs Maximum Signal Strength At Most Efficient Position
- Full Omni-directional Signal

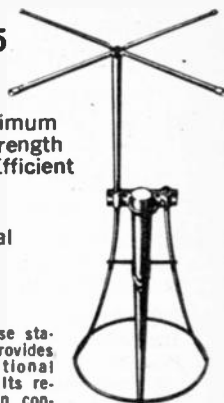

"Astro-Plane" base station antenna provides full omni-directional communications. Its revolutionary design concentrates signal power on top for maximum, efficient operation. Heavy duty aluminum construction with corrosion resistant fittings, including solderless coax connector, assure a long, trouble free life. Double bracing withstands 120 mph winds. Impedance: 50 ohms; SWR: less than 1.4/1; power gain: 4 db; length: 12". Can be mounted on a single mast up to 1½". Shpg. wt., 4 lbs. 42 E 34019W Net 29.95

CUSHCRAFT "RINGO" 1/2 WAVE VERTICAL CB FIXED ANTENNA

Only **18⁹⁵**

- 3.75 db gain
- Covers All 23 Channels with 1:1 SWR

A new Citizen Band vertical antenna with power ring tuning for amazing full circle gain. Power ring gives a perfect match between antenna and feed cable to utilize all available transmitter power. Construction is all .049 wall aluminum tubing with solid hold telescope clamps and phenolic base insulator. Designed for 52 ohm direct coaxial feed. Overall height: 17'10". Direct DC ground to eliminate static discharge noise and lightning hazard. Shpg. wt., 10 lbs. 42 E 20026WX Net 18.95

MOSLEY FLUSH MOUNT COAX TERMINATING OUTLETS



Designed for CB, Amateur Band and all business band radios. Termination for antenna coax and rotor cables in a flush wall outlet. Attractive molded ivory plastic does away with unsightly straggling leads. Easy to install, makes positive connection. Shpg. wt., 6 oz.

Stock No.	Fig.	Mosley No.	Type of outlet	Net
			Not	
42 E 51034	III.	C-1PK Single SO-239		3.00
42 E 51062	A	C-2PK Double SD-239		4.90
42 E 51070	B	CR-4PK Single SO-239		
		4 wire rotor socket		3.91
42 E 51088	C	CR-8PK Single SO-239		
		8 wire rotor socket		5.20

LAFAYETTE LIGHTNING PROTECTOR

3⁹⁵



Designed to fit any standard coaxial cable. Employs the spark gap principle to eliminate static build up on coaxial cables. Provides a constant drain off, reducing chances of a direct lightning strike and in many cases eliminating noise problems. Constructed of ¾" D.D. brass by 2¼" long. Employs one PL-259 plug and one DKCB connector. 42 E 20018 Wt., 1 lb. Net 3.95

E. F. JOHNSON ANTENNA METER AND CB MATCHBOX

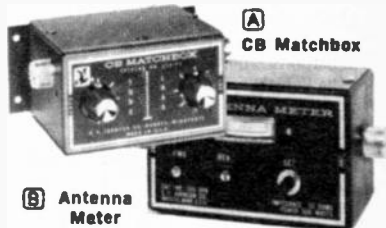

(B) Antenna Meter

Deluxe antenna instruments for correcting & measuring mobile or base station CB antenna systems. Units connect between CB transceiver and antenna transmission line.

(A) Model 250-49 CB Matchbox. Compact self-contained antenna matching unit enables maximum energy transfer to antenna system. Simple adjustment of "Tune" and "Load" controls correct SWR up to 5:1 to give almost perfect 1:1:1 antenna match. Requires no external power source. Size: 4½x4x2¾". Shpg. wt., 3 lbs. 42 E 39141 Net 15.95

(B) Model 250-849 Antenna Meter. Direct reading antenna meter measures SWR up to 10:1. No external power needed. Size: 4½x4x2¾". Shpg. wt., 3 lbs. 42 E 39133 Net 14.95

Antenna Specialists Citizen Band Antennas



Base Station Antennas

"SUPER MAGNUM" MODEL M-117 1/2-WAVE CB BASE STATION ANTENNA

SALE 29⁹⁵

was 32.95
1969 Catalog 690

- Stati-Lite Ball for Additional Dissipation of Static Electricity
- Hi"Q" Phasing Transformer Provides Resonance over entire CB Band



Rigid aluminum vertical radiator provides minimum improvement in signal-to-noise of 6 db, a 3.75 db of true gain as compared to a flat ground plane antenna. Top mounted orbital ball drastically reduces static discharge noise. Full 1/2 wavelength 108" radials offer maximum RF coupling... low radiation angle intensifies signal coupling. Includes powerful phasing transformer and mounting hardware to take up to 1 1/2" masts. Treated against corrosion. Easy to install. Shpg. wt., 10 lbs.
42 E 10019W No Money Down* ... Net 29.95

MC-227 "MIGHTY MAGNUM" 1/2 WAVE OMNI-DIRECTIONAL CB BASE STATION ANTENNA

36⁹⁵

- Power-Tip Radials Lower Radiation Angle
- Phasing Coil Optimizes Impedance Match—VSWR Less Than 1.4:1
- "Stati-Lite Diamond" Reduces Receiver Noise



Ruggedly constructed, omni-directional, base station antenna with 4 db gain. Increases radiated power to 13-watts. "Power-Tip" radials lower radiation angle and increase range. "Stati-Lite Diamond" reduces receiver noise. Phasing coil optimizes impedance match—VSWR less than 1.4:1. Completely waterproof transformer jacket. Four electrically shortened radials (only 60" long) permit easy installation and decreases wind resistance. Overall height: 16' 7". Takes masts up to 1 1/2" O.D. Parcel Post Shippable. Wt., 10 lbs.
42 E 10563W No Money Down* ... Net 36.95

MR-119 "SUPER SCANNER" ELECTRONIC ROTATABLE CB FIXED ANTENNA

79⁹⁵

- Electronically Scans A Full 360°
- Omni-Position for Locating Other Stations
- Includes Separate Scan Control Unit

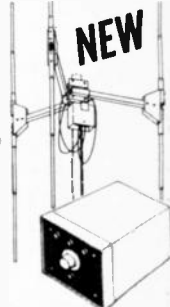

Multi-element directional antenna system electronically rotatable for a full 360° in three 120° steps plus an OMNI-POSITION for quickly locating CB stations, particularly mobile. This is accomplished by use of the "Scanner's" separate electronic Scan Control unit. Compact array of 3 sector-phased 17 1/2" vertical elements extend less than 3 feet from the mounting boom. Resists over 100 mph winds. 7.75 db directional gain, —23 db front-to-back ratio. Requires 4-cond. rotor cable. Takes masts from 1 1/2" to 2". Shpg. wt., 17 lbs.
42 E 10571WX No Money Down* ... Net 79.95
100 ft. coil of 4-cond. rotor cable. 32 E 89105 ... Net 3.10

Mobile Antennas

M-180 ADJUSTABLE GUTTER CLAMP MOBILE ANTENNA

17⁹⁵
With 12'
Coaxial Cable

- Clamps On In Seconds and Adjusts To 5-Positions From Inside The Vehicle

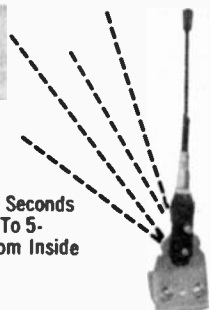

Easily snaps on rain gutter of car! Swing-away base design permits instant lowering while seated in the car. Heavy duty, chrome plated mount has spring loaded position adjustment for 0°, 45° or 90° mounting on either side of vehicle. Sleek black fiberglass center loaded whip is professionally designed for heavy-duty operation. Has all the things a CB'er would want in a mobile antenna: Ruggedness, reliability and high performance. Shpg. wt., 5 lbs.
42 E 10522W ... Net 17.95

"QUICK-GRIP" MOBILE ANTENNAS

18⁹⁵
Each
With 16'
Coaxial Cable

- "Quick-Grip" Trunk Mount—No Holes to Drill—Simple Installation, Mounted in Seconds.



(A) Model M175. Base Loaded Antenna with attractive gray jacket and chrome end fittings. Stainless steel whip. Whip adapter provides 1 1/4" adjustment for extra fine tuning. "Quick-Grip" mount. Solderless lead connection with PL-259 at set end of 16 foot coaxial cable. Shpg. wt., 1 lb.
42 E 10498W ... Net 18.95

(B) Model M-177. Just 20" long. Includes center loading coil, stainless steel spring and beautiful black phenolic base. Quick-grip mount. Solderless lead connection with PL-259 at set end of 16' coaxial cable.
42 E 10514W Shpg. wt., 1 lb. Net 18.95

M-168 MOBILE "GRIP-STICK" MAGNETIC ANTENNA

16⁹⁵
With 16'
Coaxial Cable

- Ideally Suited for Temporary Emergency, or Permanent Mounting
- No "Installation" Involved

No "Installation" involved. Merely place it on the vehicle-center of the rooftop, or back deck, run cable thru window or trunk (under seats) to CB radio. Stainless steel whip, anodized aluminum base, black phenolic insulator, and grey center loading coil. VSWR under 1.5:1. With 16 ft. coaxial cable and PL-259 connector. Shpg. wt., 1 1/2 lbs.
42 E 10480W ... Net 16.95



M-178 "STICK-SHIFT" MOBILE MAGNET ANTENNA

16⁹⁵ With 16'
Coaxial Cable

For temporary or permanent mobile applications. Powerful magnet feature lets user shift position of antenna or change from one vehicle to another. Triple chrome plated metal base. Fine tuning adjustment, VSWR 1.5:1 or better, 38" stainless steel whip with 16 ft. RG-58/U cable termination in PL 259 connector. Shpg. wt., 2 lbs.
42 E 10530W ... Net 16.95



MODEL M-20 CB WINDOW MOUNTING ANTENNA

For apartment installation where other outdoor antennas can not be used. Jointed, 9 ft. aluminum radiator is supported by adjustable heavy-duty cadmium bracket. Will accept either twin or coaxial feed line. As with all antennas, performance will improve with height above ground. Shpg. wt., 2 lbs.
42 E 10092W ... Net 9.60



M-90 96" FIBERGLASS WHIP MOBILE ANTENNA

A 96" white fiberglass CB whip antenna designed for use only on the 27-MHz band. Mounting adapter consists of chrome plated brass ferrule with 3/8" 24 male thread to fit standard base or spring. Wt., 1 lb.
42 E 10217WX ... Net 9.35
MODEL M-3B 102" WHIP. Similar to M-90 except stainless steel construction. Shpg. wt., 1 lb.
42 E 10225WX ... Net 4.90



Quality Hy-Gain Base Station and Mobile Antennas

"HELLCAT" MOBILE ANTENNAS

MODEL CLR/II BASE STATION ANTENNA

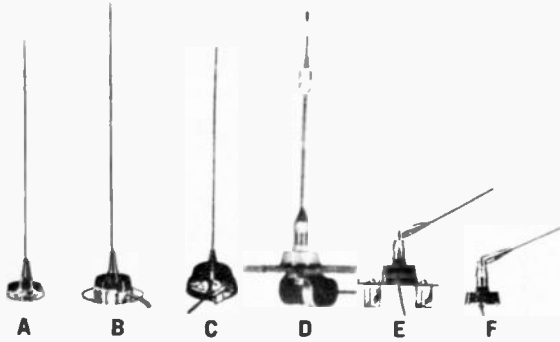

As Low As **14⁹⁵**

- A** "HELLCAT 2" ROOF TOP MOUNT ANTENNA. Base loaded, and almost impervious to damage. The extremely short, strong, lightweight stainless steel tip rod provides a very flexible capability to withstand garages and low hanging obstacles. Only 23 inches high. Complete with 22' of coax and connector. 42 E 35184W Shpg. wt., 2 lbs. Net 14.95
- B** "HELLCAT 3" MAGNET ANTENNA. Magnetically mounted in an instant and requires no holes or tools. You'll talk loud and clear with a low SWR on all 23-channels. Complete with 16' of coax and connector. Overall height is 34 1/2". 42 E 35172W Shpg. wt., 3 1/2 lbs. Net 16.95
- C** "HELLCAT 4" TRUNK MOUNT ANTENNA. Mounts easily and quickly on the lip of your trunk lid. Is base loaded with an etched copper coil, giving a very low SWR on all 23 channels. With 22' coax and connector. Overall height 47". 42 E 35180W Shpg. wt., 3 1/2 lbs. Net 19.95
- D** "HELLCAT 9" MARINE ANTENNA. Gives optimum performance mounted on fiberglass or wooden boat. Does not require a ground plane. Operates as a 1/2 wave antenna and provides a very high radiation efficiency compared to other 1/4 wave antennas. Mounts with a single 3/4" hole. With tuning unit, 22' coax and connector. Overall height 58 1/2". 42 E 35198W Shpg. wt., 4 lbs. Net 26.95
- E** "HELLCAT 6" CAMPER AND TRAILER ANTENNA. Installs quickly and easily on all types of campers and house trailers. Mounting bracket is complete with low profile base and chrome plated brass automatic fold-over, providing necessary mechanical protection. With 22' coax and connector. Overall height 47". 42 E 35206W Shpg. wt., 3 1/2 lbs. Net 22.95
- F** "HELLCAT 7" THE FOLD-OVER ROOFTOP ANTENNA. Tension loaded base provides rigid support at all time, yet folds when struck by an obstacle or when the vehicle is garaged. Complete with 22' coax and connector. Shpg. wt., 3 lbs. 42 E 35214W Net 19.95

32⁹⁵ • Electrically Extended
5/8" Wave Length Radiator
• Delivers 8 DB Circuit Gain

Deluxe collinear ground plane antenna. Rugged base mounting assembly insures survival in winds up to 100 MPH. Maximum (20 ft.) Radiator develops greatest possible gain. 3.4 db in measured field strength intensity plus improvement in signal/noise ratio resulting from vertical element being at DC ground. Total circuit gain in excess of 8 db. DC ground feature protects antenna and equipment from lightning damage. Element material top quality aluminum tubing 1 1/4" to 3/8". All seamless tubing. Mount on mast 1" to 1 1/2". SWR less than 1.2:1. Fed with 52 ohm coax. Shpg. wt., 10 lbs. 42 E 35016WX No Money Down* Net 32.95

PH-1 CO-PHASER makes possible the simple installation of a phased array of two CLR/11 antennas. Adds 4.5 db gain and doubles the effective radiating power. Shpg. wt., 4 lbs. 42 E 35024 Net 14.95

NEW! "LONG JOHN" 5 ELEMENT ROTATABLE BEAM

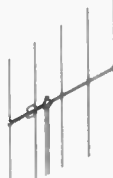

46.5 watts of talk power! 9.3 db gain, feed point 52 ohms. Features heavy wall aluminum elements and Hy-Gain's super strength taper swaged tubing. Longest element 18', boom length 18', turning radius 9'. Rotates with heavy-duty TV rotator. Shpg. wt., 19 lbs. 42 E 35230WX No Money Down* Net 54.95
Cornell Dubilier AR-22R Rotor for above. 42 E 86076WX Shpg. wt., 14 lbs. Net 34.95

SUPER DUO BEAM SDB6 BASE STATION CB ANTENNA

• Provides Power Multiplication Of 13 Times Your Transceiver Power

79⁹⁵

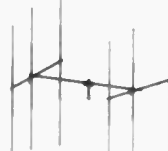

6-element twin driven rotatable beam antenna concentrates your entire signal in a single narrow beam... and directs it with pinpoint accuracy. Extra heavy-duty wall tubing in 3 sections, plus heavy duty boom-to-mast clamp with tiltable feature for easy installation. 12 ft. booms and 14 ft. cross booms. Forward gain is in excess of 12 db, and front-to-back ratio is 15 db. SWR is 1.5/1 or better. Impedance is 50 ohms. Beam can be rotated with any heavy duty TV rotator. Supplied complete with phasing harness and all mounting hardware. Shpg. wt., 36 lbs. 42 E 35156WX No Money Down* Net 79.95

NEW! BIG GUN

4 ELEMENT CB QUAD

Only

149⁵⁰

No Money Down*

- 14.2 db Gain
- Power Multiplication Factor 26.3

4-element, selectable polarity, extended aperture quad. Features extra long 20', 2" diameter boom plus optimum spacing of elements. Gives 26.3 times the power of your CB rig. 3-position polarity switch lets you receive omnidirectional; transmit either vertical or horizontal, 49° at the 1/2 power points. Front-to-back ratio: 38.7 db. SWR: 1.24/1. Feed line: 52 ohms. With super-strength tiltable mast clamp. 42 E 35222WX Shpg. wt., 52 lbs. Net 149.50

Lafayette Cat. No. 700 475

EICO 715 "TRANS/MATCH" HAM/CB TRANSCEIVER TEST SET

Kit **39⁹⁵**

Factory Wired **59⁹⁵**

No Money Down*



The self-powered "TRANS/MATCH" is a professional test set that's designed for complete checking of both ham and CB equipment. Reliable, compact, portable, quick and easy to use, it enables you to obtain maximum results from your ham or CB transceiver or transmitter. Measure R.F. power to 50 watts and Standing Wave Ratio (Forward & Reflected power). Features a direct reading field strength meter sensitive to 100 microamps for accurate readings. Specifications: SWR: 1-30, True RF Power Range; 10 watts and 50 watts. Modulation percentage; 0-100%, headphone jack output. Relative field strength; 1-10. Scuff resistant vinyl finish case, extruded aluminum polished panel. Size: 4 7/8" x 8 1/4" x 3 1/2". Shpg. wt., 5 lbs. 40 E 74233 715 KIT Net 39.95
40 E 74241 715 WIRED Net 59.95

* See Page 11 for Full Credit Details on Easy Pay Plan



Lafayette...Headquarters for CB Crystals



A complete listing of transmitting and receiving crystals for the most popular CB Transceivers and Walkie-Talkies on the market today. These crystals are available for any channel from 1 to 23. Extremely accurate "3rd overtone" crystals are precision made and meet F.C.C. tolerance requirements of .005% *No crystal required in receiver circuit of these transceivers. Shpg. wt., 3 oz.

2²⁵
each

HOW TO ORDER CRYSTALS

Add two (2) digits representing the desired channel to the appropriate stock number listed below, i.e., the correct stock number for Lafayette Model HB-115 transmit crystal for channel 1 is 46 E 1801, likewise for channel 23 is 46 E 1823.

LAFAYETTE CB EQUIPMENT

Model	Stock Numbers Transmit Receive	Model	Stock Numbers Transmit Receive	Model	Stock Numbers Transmit Receive	Model	Stock Numbers Transmit Receive
HB-115, A	46E18 *	HE-20T, HA-150	46E15 46E12	HA-450	46E15 46E10	Comstat 19	46E61 46E82
HE-15, A, B	46E18 *	HE-43, A, B, C, HE-90	46E18 46E19	HB-500, A	46E15 46E16		
HE-20, A, B, C	46E18 46E19	HB-111	46E61 46E19	HB-555	46E15 46E13		
HE-20 D	46E11 46E12	HB-200	46E61 46E19	Comstat 9 Kit	46E61 46E17		

LAFAYETTE "WALKIE-TALKIE" CB TRANSCEIVERS

Model	Stock Numbers Transmit Receive	Model	Stock Numbers Transmit Receive	Model	Stock Numbers Transmit Receive	Model	Stock Numbers Transmit Receive
HE-29, A, B	46E18 46E42	HA-73, A, HE-75	46E15 46E12	HA-135, 711, A	46E15 46E12	Dyna-Com, 2, a, 3	46E14 46E10
HE-29C, D; GT-50, A	46E15 46E12	HA-85, A; HA-99	46E15 46E12	HE-210, A, HA-295	46E15 46E12	Dyna-Com 3a	46E11 46E10
HA-60, A; HA-62, A	46E15 46E12	HE-88, HE-100, A, B	46E15 46E12	HA-300, A, B	46E11 46E12	Dyna-Com5, 5a, 6, 12	46E15 46E10
HE-66; HE-82	46E18 46E42	HA-130A, HA-132	46E15 46E12	HA-303, HA-305	46E15 46E12		

POPULAR CB CRYSTALS FOR STANDARD BRAND TRANSCEIVERS

Mfr. Model	Stock Numbers Transmit Receive	Mfr. Model	Stock Numbers Transmit Receive	Mfr. Model	Stock Numbers Transmit Receive	Mfr. Model	Stock Numbers Transmit Receive
Airline (Wards) TRR4		Echo 880	46E18	Messenger 300	46E29 46E45	"Companion I	46E57 46E59
GT1-498, -499	46E28 46E56	"Commander"	46E20 46E21	Per. Messenger	46E28 46E56	and II"	46E57 46E59
62-426, -427	46E29 46E21	Eico 740, 742	46E20 46E21	Messenger 100	46E29 46E21	"Companion III	46E29 46E21
-428, -429, -568	46E20 46E21	760, 760A,	46E26 *	Kaar TR326A, TR327,		and IV"	46E29 46E21
-569, -574, -575	46E20 46E21	761, 762	46E26 *	TR330, TR33, B	46E61 46E50	"Escort I"	46E57 46E59
62-526, -527,	46E11 46E55	770, 771,	46E26 46E22	TI190	46E18 46E50	and IV"	46E57 46E59
-552, -553	46E11 46E55	772, 777	46E26 46E22	Knight Kit 240B	46E20 *	"Sentry I"	46E57 46E59
62-522, -523,	46E27 46E37	Sentinel 12	46E18 46E22	C11	46E18 *	"Sentry II"	46E29 46E21
62-524, -525, -560	46E27 46E37	Fanon Masco FCB-3A,		C100	46E28 *	Jenny, J. C. "Pencrest 10",	
62-541, -561	46E25 46E52	FCB-4A, -6, -12,	46E29 46E21	C555	46E28 46E56	Model 8121	46E28 46E38
Allstate (Sears) 6450,		-13	46E29 46E21	KN2500, KN2550	46E18 46E19	Philmore CTIW, TC-1,	
6452, 6458	46E20 46E21	FCB-55, -90, -91	46E29 46E21	KN2580, KN2585	46E18 46E19	TC-5, TC-11,	46E18 *
6455, 6462, 6465, 46E11	46E21 46E21	DCL-11, DCL-92	46E29 46E21	KN2520,	46E29 46E51	TC-612	46E18 *
6469, 6471	46E11 46E21	DCB-50, RCB-10	46E29 46E21	KN2522, L-2540,	46E29 46E51	TC-90, TC-95	46E18 46E42
6491	46E11 46E55	L-1000, L-2000	46E29 46E21	L-2541, L-2542	46E29 46E51	TC-95D, TC-99	46E20 46E21
6550	46E27 46E37	FCB-5A, 9A, -11	46E20 46E21	A-2543, A-2544,	46E29 46E51	Polycom 2, PC11, 11G,	
6552	46E25 46E52	FCB-99A,	46E20 46E21	A-2545,	46E29 46E51	12G, PCB2, N,	46E30 46E40
6556	46E29 46E21	RT-101	46E18 46E42	KN2590	46E61 46E23	Pro, PCN-4,	46E30 46E40
6558, 7551	46E29 46E45	General Radio Tel.		KG4000	46E28 46E38	PCN-8, PCN-12	46E30 46E40
7550	46E27 46E43	MC1, MC2,	46E18 46E42	Safari II, III, IV	46E29 46E51	Poly Pup T-7A	46E25 46E51
AMD AMD9,		MC3, Echo 9,	46E18 46E42	Lincoln L2000A,		Poly Compact	46E25 46E63
AMD15-020	46E20 46E21	MC4, MC5	46E61 46E42	L2700A	46E18 *	RCA Mark VII,	46E27 46E37
Amphenol C-60, C-75,		MC6, EM5, EM6	46E61 46E42	L2542	46E20 46E21	Mark VIII, IX	46E44 46E37
725, 750	46E25 46E33	VS2, VS3, VS4	46E61 46E46	Lloyd's 6A-01, 7A-08,		Mark X	46E25 46E60
510B	46E25 46E34	VS5, VS6, VS7	46E61 46E46	7A-11B, 7A-15,	46E20 46E21	Personal Com.	46E20 46E21
600, 625, 650, 675	46E25 46E45	Globe X-90	46E20 46E21	8A-22F, WT122	46E20 46E21	CBR-1A5, 300	46E20 46E21
Apelco AR-9	46E48 46E42	CB-100	46E18 46E36	603B, 715,	46E20 46E21	Realistic CBK-1, TR-1,	
Arkey SQ9, SQ9W	46E18 46E23	CB-100A	46E18 46E42	811, 901	46E20 46E21	TR-2, TR-3,	46E18 46E42
Automatic Radio		Gonset G11, G12,		Magnavox WT-101	46E20 46E21	Pocketphone,	46E18 46E42
Com-Rad II,	46E11 46E21	G14, G15	46E49 46E19	Mark Products		TRC-X20,	46E18 46E42
MCR 6450,	46E11 46E21	Hallcrafters CB2,		"Cobra 5"	46E29 46E51	94L594	46E18 46E42
TRR6448,	46E11 46E21	CB3, CB3A, CB5,	46E27 46E37	CB280	46E25 46E51	TRC-27A	46E18 46E42
MCE6510	46E11 46E21	CB5A, CB7, CB9,	46E27 46E37	"Charger",	46E25 46E51	TRC-5	46E61 46E43
8endix CB-6, CB-12	46E49 46E19	CB4	46E27 46E43	CB281	46E25 46E51	TRC-6	46E61 46E42
MM-8	46E61 46E50	CB6	46E28 46E56	"Mustang 65",	46E31 46E23	TRC-12	46E25 46E51
Browning S-9, T2700		CB11	46E20 46E21	"Pacer I"	46E31 46E23	TRC-14, TRC-15	46E25 46E51
"Compact"	46E18 *	CB12, CB19, CB21	46E25 46E52	"Mustang II"	46E31 46E23	TRC-44	46E20 46E21
"Eagle" S-23	46E28 *	CB15	46E29 46E21	"Space Station"	46E31 46E23	Regency CBM-27	46E18 *
23/8	46E28 *	CB20 "Reactor"	46E25 46E47	"Colt-23"	46E53 *	"Bronco"	46E25 46E51
Burstein-Applebee		Hallmark		"Pacer II"	46E53 46E51	"Charger"	46E25 46E51
BA-8	46E61 46E23	Duo-Com	46E18 *	"Starfire"	46E18 46E23	"Colt 23"	46E53 *
BA-22	46E18 *	212, 512, 1250X	46E18 46E42	"7110	46E61 46E43	Ross RE-014, RE-011,	
Channel Master		Hammarlund HQ105TR,		Econoline"	46E61 46E43	11TR, RE334,	46E20 46E21
6427	46E11 46E45	105TRC, 105STRS,	46E18 *	Midland 13-103	46E28 *	100 Pager	46E28 46E38
6428	46E11 46E21	CB205	46E18 *	13-105, 13-106,	46E29 46E21	200	46E28 *
6552, 6553, 6554	46E20 46E21	CB5, CB6	46E61 46E19	13-108, 13-110,	46E20 46E21	300	46E20 46E51
Cliffone CD5, CD6,		CB212, CB214	46E27 46E43	13-111, 13-120,	46E20 46E21	Sonar "D"	46E18 46E42
CD7, CD11, 99	46E26 46E35	Health CB2, GW10, 11,		13-124, 2910	46E20 46E21	"G"	46E31 46E41
Clarleon 15-020,		12, 22, 32, 34,	46E28 46E23	13-132, 13-133,	46E20 46E21	"H"	46E48 46E41
15-030, 15-050,	46E20 46E21	42, MW30,	46E28 46E23	13-143, 13-150,	46E20 46E21	T-2	46E20 46E55
15-200	46E20 46E21	MW33, MW34	46E28 46E23	13-755, 13-775,	46E20 46E21	Com CBP	46E18 46E42
15-040	46E28 46E56	G14, GW21,	46E28 46E38	13-125	46E28 46E56	Sony CB-106,	
15-400, 15-410	46E11 46E55	GW52, GRS-65A	46E28 46E38	13-160	46E18 46E19	CB-901	46E28 46E56
Courier TR-5, TR-6	46E25 46E21	GW30, WG31	46E28 *	Olson Spotter 1,		Spiegel T3B, 322,	
12	46E18 46E42	Intermark C11	46E18 46E42	2, 3, RA-530	46E18 *	X328	46E25 46E47
AGS-200	46E18 46E19	"Cipher 1000"	46E20 46E21	8	46E25 46E51	X855T, W888	46E18 46E42
Daystrom DM-277,		International Exec.		S-9, RA-638	46E28 46E56	R1408M	46E20 46E21
278, 348	46E18 46E23	CTZ-50, CTZ-5A2	46E61 46E39	RA-396, RA-442,	46E18 46E19	V889	46E25 46E52
GRS-65	46E28 46E38	CT7-5B2	46E61 46E39	RA-443	46E18 46E19	Truetone 190, 4101	
Demco T-110A,		10	46E61 *	RA-446	46E20 46E21	TRE512, 1200,	46E18 46E42
"Satellite" CB-1A	46E31 *	50, 100, 100A,	46E61 46E39	RA-482, RA-521	46E18 46E42	1250, DX4100,	46E18 46E42
"Chalet"	46E20 46E21	100C, 100D	46E61 46E39	717	46E61 46E23	Utica MC27, TC27,	
"Ravelle"	46E31 46E41	Iwata CT-1000		Pace I, II, 100,		T&CII, 91-00	46E18 46E36
RE-0117	46E20 46E21	WT-5000	46E20 46E21	200, 2300	46E29 46E60	Webster WT-2, 550,	
"Democophone"	46E20 46E21	Johnson Messenger I,		Panasonic RJ4	46E28 46E56	565, 575	46E25 46E47
DeWald TR-800,		Messenger II,	46E27 46E43	RJ6	46E20 46E21	World Radio Labs	
TR-910	46E18 *	Messenger III,	46E29 46E45	Pearce Simpson		ECKB, "DX'er"	46E18 *
TR-1000,	46E18 46E19			CBD-5	46E54 46E59	SM-100	46E25 46E21
R-1050, F-1050	46E18 46E19					"Champion 77"	46E18 46E42
						"Hustler"	46E48 46E23

LAFAYETTE Industrial Pocket Pager

**REACH YOUR MAN ON THE MOVE
INSTANTLY, QUIETLY, PRIVATELY!**

EXCELLENT for: Factories, Hospitals, Warehouses, Farms, Research Compounds, Department Stores, Sports, etc.

CONTACT: Doctors, Nurses, Plant Engineers, Supervisors, Maintenance Men, Security Personnel, Department Heads, and other Key Personnel.

- Up to 230 Vital People At Your Fingertips!
- Save Busy Switchboard Time and Money!
- Minimize Disturbing Non-Private Paging!

Lafayette's Industrial Selective Pocket Pager introduces a new concept in realistic, economical local communications with vital personnel normally on the move. By inserting or clipping the Pocket Pager into your shirt pocket you can easily be reached by your superior who operates a Lafayette solid state 27 MHz transceiver to which is connected a Lafayette selective Encoder-Decoder. With the Priva-Com IIIA Encoder-Decoder up to 23 different people can be called vocally with a private message. With the Lafayette Priva-Com 10 selective calling Encoder-Decoder up to 230 different people can be contacted privately. The selection of the transceiver channel corresponding to the frequency of the individual you wish to call, followed by the activation of the call button on the Priva-Com unit breaks the Pager's silence with an audible tone and permits the message to be heard through the Pager. Activation of the reset switch returns the Pager to silent standby. This amazing little Pager features an 18-transistor, 5-diode superheterodyne circuit with RF stage for 0.7 μ v. sensitivity, mechanical filter for superior selectivity, an internal ferrite bar antenna, an earphone/external speaker jack, etc. It is supplied complete with channel 6 crystal, plus 2 dummy filters required for operational check prior to actual use. It requires the insertion of any 2 of the optional tuning fork filters listed below. The Pager uses one 5.4-volt mercury battery or one 5-volt nickel cadmium rechargeable battery (batteries are optional). Size: 5 1/2"H x 2 3/4"W x 1 1/4"D. Shpg. wt., 1 lb. Less Tuning Filters and Battery.

99 E 35602L Net 69.95

Alternate Receive Crystal. For any CB channel from 1 to 23. (specify channel)..... Net 2.25

46 E 10 Net 2.25

†See Page 476 on How to Order Crystals.

5.4 Volt Mercury Battery (1 required) Net 3.44

32 E 46741 Pkg. of 2 Net 3.44

Alternate 5-Volt Nicad Rechargeable Battery.

32 E 67010 Net 16.95

99 E 35610 Nicad Battery Charger. Shpg. wt., 2 lbs. Net 19.95

40 E 79018 Earphone for Pager Net .59



**Sensational
Low Price** **69⁹⁵**
No Money Down*

OPTIONAL ACCESSORIES

Frequency Tuning Fork Filters. (Any Two Listed Below)
99 E 35529 817.5Hz Net 19.95
99 E 35537 862.5Hz Net 19.95
99 E 35545 922.5Hz Net Ea. 4.95
99 E 35552 967.5Hz Net Ea. 4.95

LAFAYETTE RECOMMENDED INDUSTRIAL PAGER SYSTEMS



12 CHANNEL PAGING SYSTEM

- Lafayette Model HE-20T 27 MHz Transceiver
- Lafayette Priva-Com IIIA Encoder-Decoder
- 1/2 Wave Indoor Antenna with cable and connector
- Lafayette Industrial Pocket Pager

Recommended for systems requiring private communication with up to 12 different individuals or with any number of people using up to 12 different channel frequencies. The Pager channel frequencies are pre-determined by the frequencies of the crystals in the HE-20T which is supplied initially with crystals for channel 9. Eleven additional pairs of crystals are required for 12 channel operation. Crystal frequency in each pager must match the associated HE-20T channel. Complete system; Shpg. wt., 22 lbs. 42 E 91530WXM No Money Down* Net 219.95
See Page 476 for additional crystals for HE-20T.



23 CHANNEL PAGING SYSTEM

- Lafayette Model HB-600 27-MHz Transceiver
- Lafayette Priva-Com IIIA Encoder-Decoder
- 1/2 Wave Indoor Antenna with Cable and Connector
- Lafayette Industrial Pocket Pager

Recommended for systems requiring private communication with up to 23 different individuals, or with any number of people using up to 23 different channels. The HB-600 is supplied complete with all crystals required for the 23 different channels. The crystal frequency of each pager must match the transceiver's channel it is supposed to receive. Mt., 19 lbs. 42 E 91548WXM No Money Down* Net 349.95

Same system as above except with Lafayette Priva-Com 10 instead of Priva-Com 111A. Permits transmission of private messages to up to 230 different individuals and to many times that number with semi-private messages. No additional crystals are required. Shpg. wt., 25 lbs. 42 E 91555WXM No Money Down* Net 399.95

* See Page 11 for Full Credit Details on Easy Pay Plan

LAFAYETTE Economy CB 2-Way Radio Systems

LAFAYETTE COMSTAT 23 MK VI 23 CHANNEL 2-WAY RADIO SYSTEMS



Ground Plane

SAVE \$6.45

From Individual Catalog Prices

Only **112⁹⁵**

No Money Down*



SAVE \$6.80

From Individual Catalog Prices

Only **119⁹⁵**

No Money Down*



Body Mount



Cable

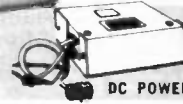

DC POWER SUPPLY



Cable

Base Systems

Consists of: Lafayette Comstat 23 Mark VI 23 channel crystal-controlled CB transceiver; a heavy duty Ground Plane Antenna, and 50' of RG-8/U low-loss cable assembly. 42 E 91563WXM Wt., 27 lbs. Net 112.95

Same system as above except with "Range Boost II" deluxe 1/2 wave end-fed antenna instead of ground plane antenna. 42 E 91571WXM Wt., 29 lbs. Net 121.95

Mobile Systems

Consists of: Lafayette Comstat 23 Mark VI 23 channel crystal-controlled CB transceiver; 12 volt DC Power Supply; stainless steel Body Mount Antenna; Mobile Mounting Bracket; 20' Cable Assembly. Wt., 27 lbs. 42 E 91589WXM Net 119.95

Same system as above except with Bumper Mount Antenna. Shpg. wt., 26 lbs. 42 E 91597WXM Net 122.95



Range Boost II



Bumper Mount

LAFAYETTE COMSTAT 25B 23 CHANNEL 2-WAY RADIO SYSTEMS

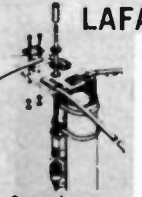

Ground Plane

SAVE \$7.45

From Individual Catalog Prices

Only **151⁹⁵**

No Money Down*



SAVE \$7.90

From Individual Catalog Prices

Only **141⁹⁵**

No Money Down*



Body Mount

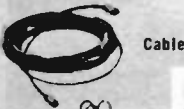

Cable



Cable

Base Systems

Consists of: Lafayette Comstat 25B 23 channel crystal-controlled CB transceiver; heavy duty Ground Plane Antenna; and 50' RG-8/U cable assembly. Shpg. wt., 27 lbs. 42 E 91605WXM Net 151.95

Same system as above except with "Range Boost II" high gain 1/2 wave length base station antenna. Shpg. wt., 26 lbs. 42 E 91035WXM Net 160.95

Mobile Systems

Consists of: Lafayette Comstat 25B 23 channel crystal-controlled CB transceiver; stainless steel Body Mount Antenna; 20' RG-58/U coaxial cable assembly. Shpg. wt., 21 lbs. 42 E 91613WXM Net 141.95

Same system as above except with bumper mount instead of body mount antenna. 42 E 91621WXM Wt., 21 lbs. Net 144.95



Range Boost II



Bumper Mount

Model HE-20T ECONOMY 2-WAY RADIO SYSTEMS

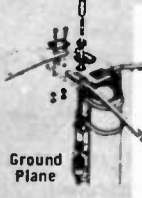

Ground Plane

SAVE \$4.45

From Individual Catalog Prices

Only **104⁹⁵**

No Money Down*



SAVE \$3.90

From Individual Catalog Prices

Only **95⁹⁵**

No Money Down*



Body Mount



Cable



Cable

Base Systems

Consists of: Lafayette Model HE-20T 23 channel tuneable plus 12 channel crystal-controlled base and mobile solid-state CB transceiver; heavy duty Ground Plane Antenna; 50' RG-8/U low loss cable assy. 42 E 91639WXM Shpg. wt., 25 lbs. Net 104.95

Same system as above except with "Range Boost II" deluxe 1/2 wave end-fed antenna. 42 E 91647WXM Shpg. wt., 27 lbs. Net 113.95

Mobile Systems

Consists of: Lafayette HE-20T 23 channel tuneable plus 12 channel crystal-controlled base and mobile solid-state CB transceiver; stainless steel Body Mount Antenna; and 20' RG-58/U coaxial cable assembly. 42 E 91654WXM Shpg. wt., 19 lbs. Net 95.95

Same as above except with Bumper Mount instead of body mount antenna. 42 E 91662WXM Shpg. wt., 18 lbs. Net 98.95

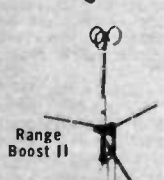

Range Boost II



Bumper Mount

LAFAYETTE Economy CB 2-Way Radio Systems

MODEL HB-23 2-WAY SYSTEMS

SAVE \$4.90

From Individual Catalog Prices

Only **104⁹⁵**

No Money Down*

SAVE \$6.40

From Individual Catalog Prices

Only **129⁹⁵**

No Money Down*

Body Mount



Ground Plane



Cable



Cable



HB-23

HB-502B

Mobile Systems

Consists of: Lafayette Model HB-23 Solid-State CB Transceiver with 23 channel crystal control capability; stainless steel Body Mount Antenna; and 20' RG-58/U Cable Assembly. Shpg. wt., 12 lbs. 42 E 91670WXM Net 104.95

Same as above except with Bumper Mount instead of Body Mount Antenna. Wt., 11 lbs. 42 E 91688WXM Net 107.95

Base Systems

Consists of: Lafayette Model HB-23 Solid-State CB Transceiver with 23 channel. Crystal control capability; HB-502B AC Power Supply; heavy duty Ground Plane Antenna; 50' RG-8/U Cable Assembly. Wt., 25 lbs 42 E 91696WXM Net 129.95

Same as above except with "Range Boost II" deluxe 1/2 wave end-fed antenna. Wt., 27 lbs. 42 E 91704WXM Net 138.95

Bumper Mount



Range Boost II

MODEL HB-525C 23 CHANNEL 2-WAY RADIO SYSTEMS

SAVE \$7.90

From Individual Catalog Prices

Only **151⁹⁵**

No Money Down*

SAVE \$9.40

From Individual Catalog Prices

Only **176⁹⁵**

No Money Down*

Body Mount



Ground Plane



Cable



Cable



HB-525C

HB-502B

Mobile Systems

Consists of: Lafayette Model HB-525C 23 Channel Solid-State CB Transceiver; stainless steel Body Mount Antenna; 20' RG-58/U Coaxial Cable Assembly. Shpg. wt., 12 lbs. 42 E 91712WXM Net 151.95

Same system as above except with Bumper Mount instead of Body Mount Antenna. 42 E 91720WXM Wt., 11 lbs. Net 154.95

Base Systems

Consists of: Lafayette Model HB-525C 23 Channel Solid-State CB Transceiver; HB-502B AC Power Supply; heavy-duty Ground Plane Antenna; 50' RG-8/U Low Loss Cable Assembly Shpg. wt., 26 lbs. 42 E 91738WXM Net 176.95

Same as above except with "Range Boost II" deluxe 1/2 wave end-fed antenna. Wt., 28 lbs. 42 E 91746WXM Net 185.95

Bumper Mount

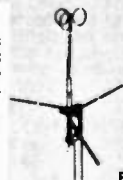

Range Boost II

MODEL HB-625 23 CHANNEL 2-WAY RADIO SYSTEMS

SAVE \$9.90

From Individual Catalog Prices

Only **189⁹⁵**

No Money Down*

SAVE \$11.40

From Individual Catalog Prices

Only **214⁹⁵**

No Money Down*

Body Mount

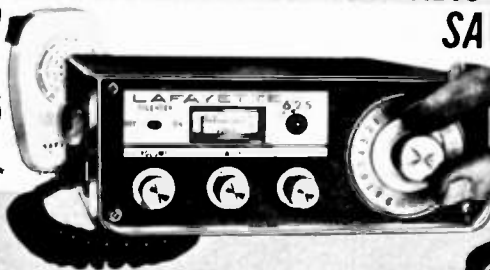

Ground Plane



Cable



Cable



HB-625

HB-502B

Mobile Systems

Consists of: Lafayette HB-625 23 Channel Solid-State CB Transceiver with integrated Circuit Ignition Noise Silencer; stainless steel Body Mount Antenna; 20' RG-58/U Coaxial Cable Assembly. Shpg. wt., 12 lbs. 42 E 91753WXM Net 189.95

Same system as above except with Bumper Mount instead of Body Mount Antenna. 42 E 91761WXM Wt., 11 lbs. Net 192.95

Base Systems

Consists of: Lafayette HB-625 23 Channel Solid-State CB Transceiver with IC Ignition Noise Silencer; HB-502B AC Power Supply; heavy duty Ground Plane Antenna; 50' RG-8/U Low Loss Cable Assembly. Wt., 26 lbs. 42 E 91779WXM Net 214.95

Same system as above except with "Range Boost II" deluxe 1/2 wave end-fed antenna. 42 E 91787WXM Wt., 28 lbs. Net 223.95

Bumper Mount



Range Boost II

* See Page 11 for Full Credit Details on Easy Pay Plan

LAFAYETTE Priva-Com® Encoder-Decoders

SAVE MONEY—SAVE TIME—BOOST EFFICIENCY

PRIVA-COM® 10 SOLID STATE BASE STATION SELECTIVE ENCODER-DECODER

- Push-button Selection of Any one of 10 Dual-Tone Frequencies
- Indicator Lamps Signal and Identify Incoming Calls
- External Speaker/Horn Switch and Terminals
- Dual Tone Minimizes False Triggering On Stray Signals
- Compatible With Priva-Com III, IIIA and IV

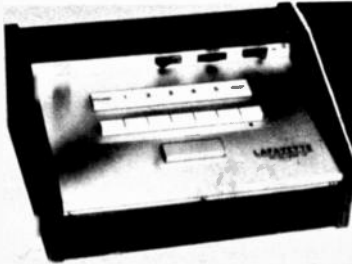

SALE 99⁹⁵
NOW ONLY

SAVE 30.00

- Mates directly With HB-555, HB-525A,B,C, HB-600, HB-625, HE-20T, HB-23, Telsat 23, Telsat 50, and Telsat 150.

23 Transistors, 13 Diodes, 6 Thermistors and 5 Tuning Fork Filters

Expertly designed solid state circuitry features push-button selection and communications with any one of 10 mobile stations at any one time, or with any assorted quantity of remote stations using up to 10 different dual tone frequencies. The remote mobile remains quiet until the call signal from the Priva-Com 10 activates the receiver. When the remote or mobile station initiates a call to the base station, the Priva-Com 10 indicator lamps signal and identify the call.

With a remote speaker or horn connected to the external speaker/horn terminals an audible signal can be heard with the incoming call. Attractively styled with brushed aluminum panel and oiled walnut wood case. For 115 volt AC 50/50 Hz operation. Size: 10 1/2" W x 7 7/8" D x 3 3/4" H. Shpg. wt., 6 lbs. Imported.

99 E 31619W No Money Down* Net 99.95

PRIVA-COM® IIIA SOLID STATE ENCODER-DECODER

- 9 Transistors plus 2 Diodes
- Dual Tone Minimizes Stray Signal Interference

Mates Directly with Lafayette HB-555, HB-525A, HB-525B, HB-525C, HB-600, HE-20T, HB-625, HB-23, Telsat 23, Telsat 150, Telsat 50

- Compatible with Lafayette Priva-Com III, IV and Priva-Com 10



For Lafayette 12 Volt Solid State CB Transceivers

Only **34⁹⁵**
No Money Down*

*Real Tiny: 1 1/4" H x 3 3/4" W x 6 1/4" D.

Using a new ingeniously designed ceramic and resonant tuning fork circuitry instead of conventional reed relays, the diminutive Priva-Com IIIA is exceptionally adaptable for reliable mobile as well as fixed station performance. Its dual tone signal minimizes the possibility of the transceiver speaker being turned on by stray ignition and power line signals. The Priva-Com IIIA mutes the receiver. When its call switch is activated, either at base or mobile stations, the CB receiver is activated and the indicator light goes on. This light

stays on until manually reset. The Priva-Com IIIA features simple-to-operate push-button switches for Standby, Normal, Call and Reset; a Volume Control; Indicator Light; and a sturdy mobile bracket for mounting under dash, under transceiver, etc. Supplied with 2 plug-in selective ceramic and resonant tuning fork filters, one for 817.5 Hz, and one for 997.5 Hz tone frequencies. Size: 1 1/4" H x 3 3/4" W x 6 1/4" D. Imported. Shpg. wt., 3 lbs.

99 E 31585 No Money Down* Net 34.95

LAFAYETTE PRIVA-COM® IIIA PLUG-IN TUNING FORK SELECTIVE FILTERS

Choice of any two different frequencies listed below for those wishing to vary their Priva-Com IIIA frequencies. Shpg. wt., 4 oz.

99 E 35529 For 817.5 Hz
99 E 35537 For 862.5 Hz

99 E 35545 For 922.5 Hz
99 E 35552 For 967.5 Hz

99 E 35560 For 997.5 Hz
Each Net 4.95

PRIVA-COM® IV PRIVATE TONE CALLER

Same as Priva-Com IIIA except for use with Lafayette Comstat 25A and Comstat 25B. Compatible with Priva-Com IIIA and Priva-Com 10.

Shpg. wt., 3 lbs.

99 E 31239 No Money Down* Net 34.95

TUNING FORK FILTERS FOR PRIVA-COM® IV

To vary your Priva-Com frequencies. Select any two frequencies below not already supplied. Shpg. wt., 4 oz.

99 E 31189 For 817.5 Hz
99 E 31197 For 862.5 Hz

99 E 31205 For 922.5 Hz
99 E 31213 For 967.5 Hz

99 E 31221 For 997.5 Hz
Each Net 4.95

PRIVA-COM® V PRIVATE ENCODER-DECODER

- 10 Dual-Tone Frequency Capability
- Incoming Call Indicator Light
- Operates Horn or External Alarm
- Mates Directly with Lafayette Comstat 25, 25A, 25B, and Lafayette Tube Type CB Transceivers with Built-in Priva-Com Socket.
- Compatible with 42 E 91522M Below



For Lafayette Tube-Type CB Transceivers

Only **29⁹⁵**
No Money Down*

This highly dependable encoder-decoder mutes the CB receiver until a Priva-Com dual tone signal is received. Upon receipt of this signal the incoming call indicator light goes on, the horn or external alarm, if connected to the Priva-Com, is operated and the receiver

speaker is activated for audible communications. Both base stations or mobiles can initiate calls. Is not compatible with Priva-Com IIIA, IV or 10. Size: 4 1/4" x 2 1/4" x 5 3/4". Shpg. wt., 3 lbs.

42 E 01497 For Tube Transceivers Net 29.95

PRIVA-COM V FOR SOLID STATE CB TRANSCEIVERS

Same as above plus adapter which permits direct mating and efficient performance of Priva-Com V with Lafayette 525C, HB-600,

HE-20T, HB-625, HB-23, Telsat 23, Telsat 150 and Telsat 50.
42 E 91522M For Solid State Transceivers wt., 4 lbs Net 34.95

WALKIE TALKIES

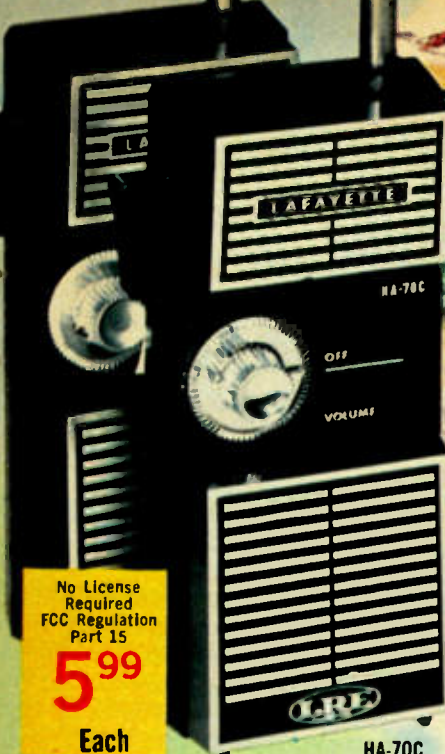

No License Required
FCC Regulation
Part 15
5⁹⁹
Each

HA-70C

(A) "ASTRO COMMANDER"

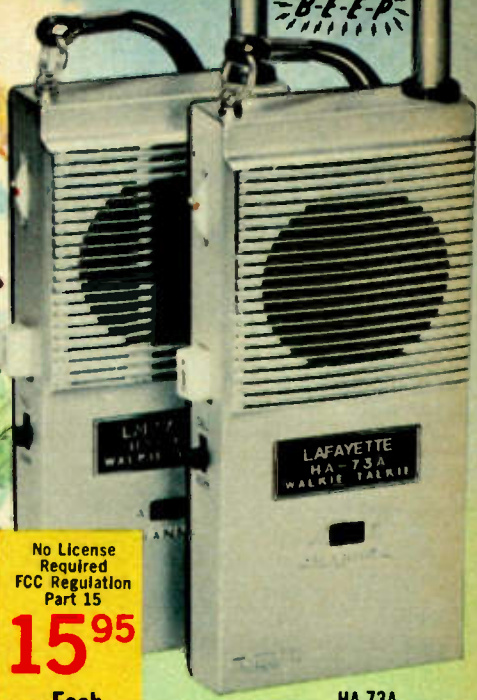

No License Required
FCC Regulation
Part 15
15⁹⁵
Each

HA-73A

(B) 2 CHANNEL 7-TRANSISTOR SUPERHET WITH CALL ALERT

SOLID STATE CB TRANSCEIVER/AM RADIO BASE STATION

29⁹⁵ with mike, headphone, and batteries
(No FCC License Required)



- Tuneable On All 23 Citizen Band Channels
- Crystal Control Transmit Up To 1 Mile on Channel 9
- Built-in Quality AM Radio • Built-in Practice Code Key

Excitement for every member of the family. Actually a 100 milliwatt CB base station transceiver, quality AM radio and practice code oscillator in a compact, attractive, professional styled cabinet. CB transceiver section has tuneable superheterodyne receive for all 23 channels, and is crystal-controlled to transmit on channel 9. Built-in telescoping antenna. Specifications: Max. Audio Output: 200MW; RF Power Input: 100 MW; AM Radio tunes 54 to 1600 kHz. Operates on 6 "D" type batteries. Includes microphone, headphone, and batteries. Imported. Size: 12½x5¼x6" D. Shpg. wt., 5 lbs.
17 E 78331W Net 29.95
99 E 62564 Extra "D" Batteries Net ea. .15

Lafayette Your Headquarters For Citizens Band Equipment

Walkie Talkies by Lafayette

PIONEER & LEADER IN 2-WAY CB RADIOS

(A) "ASTRO COMMANDER" CB WALKIE TALKIE HA-70C

- Not a Kit—Completely Wired
- Interstage Transformer for More Sound

Compact 3-transistor walkie-talkie features a sensitive superregenerative receiver for minimum noise pick-up when voice signal is being received. Crystal controlled transmitter provides range up to 1/4 mile. Has push-to-talk button, off-on volume control, and efficient speaker/mike. Supplied with telescoping antenna, crystal, battery, and plastic carrying case. Size: 5½ x 2½ x 1¾". Imported. Shpg. wt., 1 lb.
99 E 30801L HA-70C Net ea. 5.99

99 E 60212 Replacement Battery Net .21
Optional 9-Volt Lead-Acid Rechargeable Battery Plus Charger. Imported. Shpg. wt., 6 oz.
99 E 90169 Net 2.69

(B) 2 CHANNEL 7-TRANSISTOR SUPERHET
CB WALKIE TALKIE HA-73A

- Powerful Push-Pull Audio • Built-in Call Alert
- Battery Eliminator Jack

New power boost reflex circuit utilizes 7 transistors to achieve higher sensitivity for extended range. 2-channel operation permits greater flexibility. Call alert system sends or receives a pleasant alerting tone for convenient calling. Also features Battery Eliminator Jack for 117 Volts AC operation with optional battery eliminator. Case features beautiful die-cast chrome high-lighted front panel. Supplied with carrying strap, telescoping antenna, battery, and plug-in crystals for channel 9. Size: 5½x1¼x2¾". Imported.
99 E 31452L HA-73A. Shpg. wt., 3 lbs. Net ea. 15.95
46 E 15 Extra Transmit Crystal (Specify Channel*) Net 2.25
46 E 12 Extra Receive Crystal (Specify Channel*) Net 2.25
*See Page 476 on "How To Order Crystals".

99 E 60212 Replacement Battery Net .21
99 E 30124 AC Battery Eliminator Net 2.95
Optional 9-Volt Lead-Acid Rechargeable Battery Plus Charger. 99 E 90169 Imported. Shpg. wt., 6 oz. Net 2.69

Another LAFAYETTE 2-WAY RADIO FIRST! Never Before!



FCC
Type
Accepted

5 WATTS
HAND-HELD POWER

PLUS

12 CHANNELS
SWITCHABLE
CRYSTAL CONTROLLED

DYNA-COM 12

Only **99⁹⁵**
Less Batteries
With Leather
Shoulder Strap

No Money Down*

- ★ 12 Switchable Crystal Controlled Transmit and Receive Channel Positions
- ★ 5-Watts FCC Maximum Permitted Input Power —In The Palm of Your Hand!
- ★ 14 Transistors, 6 Diodes, 1 Posistor
- ★ Superheterodyne Receiver plus PF stage with 0.7 μ v Sensitivity
- ★ Automatic Compressor Range Boost for Consistently High Talk Power
- ★ Use it in your Car with Optional Cigarette Lighter Plug-In Adapter
- ★ Public Address External Speaker Jack with PA Switch

- Mechanical Filter for Superior Selectivity
- Variable Squelch plus Automatic Noise Limiter for Minimum Noise
- Battery Condition and Automatic Relative RF Power Output Indicator
- External Antenna Jack Permits Use with Base Station and Mobile Antennas
- Provision for External Battery Pack, Mobile Battery and Battery Charger/Eliminator
- Push-pull Audio/Modulator Circuit for More Powerful Speech Transmission and High Quality Reception.
- TVI Trap to Minimize Television Interference

SEE PAGE 485 FOR ALL DYNA-COM ACCESSORIES

*See Page 11 for Full Details on Easy Pay Plan

From CB's Number 1!



NEVER BEFORE!

5 PLUS 12

Another 5 watt 2-way radio first by Lafayette, the Dyna-Com 12 pioneers the walkie talkie feature of 12 switchable crystal controlled transmit and receive channel positions for extra utility and flexibility. In addition to its superb engineering resulting in excellent sensitivity, selectivity, adjacent channel rejection, and RF protection, the Dyna-Com 12 incorporates all the features you would ever expect to find in a high power hand-held walkie talkie. Meets the highest requirements for portable or mobile 2-way communications. Its full-time automatic compressor "Range Boost" modulation circuit delivers consistently high talk power for greater effective range. In addition, the Dyna-Com 12 features built-in PA facilities, automatic series gate noise limiter, RF Power/Battery Condition meter, and variable squelch. The removable battery pack makes it simple to charge the ni-cad batteries on or off the walkie-talkie. The Dyna-Com 12 may be connected

to your auto, boat, or tractor 12 volt battery and to external antenna for efficient mobile communications. It can also be used on 110 volt 60 Hz AC with the optional battery eliminator/charger, and with a base station antenna for reliable base station communications. Features a professionally designed attractive die-cast case with shoulder carrying strap and crystals for channel 10 less batteries. Size: 3 1/4 x 10 1/2 x 2 1/8" D. Imported. Shpg. wt., 5 lbs.
99 E 32013L Net **99.95**

46 E 15 Extra Transmit Crystal (Specify Channel)† Net **2.25**
46 E 10 Extra Receive Crystal (Specify Channel)† Net **2.25**
99 E 25413 Earphone for Dyna-Com 12 Net **1.29**
99 E 32104YL Dyna-Com 12 Modified for 26.620 MHz Net **109.95**
99 E 32112YL Dyna-Com 12 Modified for 27.575 MHz Net **109.95**

† See Page 476 on How To Order Crystals.

DYNA-COM OPTIONAL ACCESSORIES†

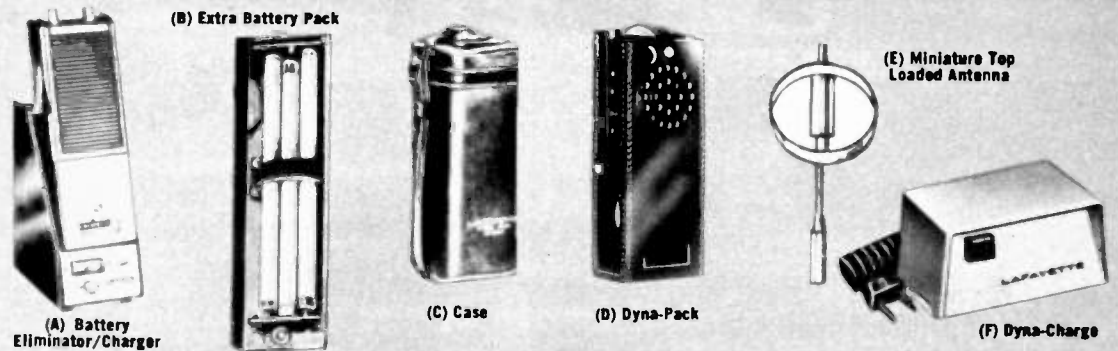

(A) Battery Eliminator/Charger. Plugs into 117 VAC outlet to permit base station operation. Charges up to 12 nickel cadmium batteries internally and externally in Dyna-Com 5, 5a, 6, and 12; charges batteries of Dyna-Com 2, 2a, 3 and 3a in holder externally with adapter (supplied). Negative ground only. Has fused AC line. Size: 7 3/8" H x 5 5/8" D (at bottom) x 3 1/4" W. Imported. Shpg. wt., 5 lbs.
99 E 31478 Net **22.95**

(B) Extra Battery Pack for Dyna-Com 5, 5a, 6 and 12. Extra removable back of walkie-talkie plus battery holder. Enables charging of complete battery pack outside of walkie talkie while another pack is in use. Imported. Shpg. wt., 2 lbs.
99 E 32203 Net **8.95**
Nicad Rechargeable Batteries for Pack
32 E 47400 12 required Net ea. **1.40**

Mobile Cigarette Lighter Cable Assembly permits operation of Dyna-Com from car 12 volt DC cigarette lighter. Shpg. wt., 6 oz.
99 E 46054 Net **2.95**

(C) Cases: Genuine Top Grain Leather. Shpg. wt., 12 oz.
42 E 28011 For Dyna-Com 2a, 3a Net **4.95**
42 E 28029 For Dyna-Com 5, 5a Net **5.95**
42 E 28045 For Dyna-Com 6, 12 Net **5.95**

(D) Dyna-Pack External Battery Pack with 10 "D" batteries. Plugs Into Dynacom's to assure reserve power when required in the field. Imported. 3 x 3 1/4 x 7 1/2". Shpg. wt., 4 lbs.
99 E 31015 Net **5.95**

Extra 10-cell Battery Holder for Dyna-Pack
99 E 31312 Net **1.95**

Antenna Adapter Cable. Connects PL-259 plug of external antennas to Dyna-Com's antenna Jack. Shpg. wt., 6 oz.
42 E 06201 Net **2.95**

Nicad Rechargeable Batteries. 12 required for Dyna-Com 5, 5a, 6 and 12; 10 for Dyna-Com 2, 2a, 3 and 3a. Shpg. wt., 1 oz.
32 E 47400 Net ea. **1.40**

Alternate Heavy-Duty Alkaline Batteries. 12 required for Dyna-Com 5, 5a, 6 and 12; 10 for Dyna-Com 2, 2a, 3 and 3a. Shpg. wt., 2 oz.
32 E 47525 Pkg. of 2 **.79**

(E) Miniature Top Loaded Antenna. Highly efficient coil loaded 18" antenna which mounts on top of collapsed telescopic antenna. Imported. Shpg. wt., 1 lb.
99 E 31437 Net **4.50**

(F) Dyna-Charge. Charges from 8 to 15 nicad "Z" size cells. Plugs directly into Dyna-Com 5, 5a, 6 and 12 charge jacks and into Jack of Extra Back Battery Pack. Charge batteries of Dyna-Com 2, 2a, 3 and 3a externally in holder with use of adapter (Supplied). Size: 3 1/4 x 2 3/4 x 2". Imported. Shpg. wt., 2 lbs.
99 E 31007 Net **8.95**

† Applicable to Dyna-Com 2, 2a, 3, 3a, 5, 5a, 6 and 12 unless otherwise Specified.

LAFAYETTE Model HE-20T 5-Watt Solid-State Citizen Band 2-Way Radio

- 12 Channel Crystal Controlled Transmit and Receive
- 23 Channel Tuneable Receive
- 455kHz Mechanical Filter
- 117 VAC and 12 VDC Negative or Positive Battery Ground
- Also a PA Amplifier with External Speaker

With RF Overload Protection (Pat. Pend.)

Nowest addition to the popular HE 20 series of CB transceivers. This 12 transistor, 10 diode Solid State transceiver is ideal for fixed and mobile communications. Solid-state circuitry features low battery drain and provides instant operation; full 5-watt transmitter input with efficient push-pull audio modulator; and an extra-sensitive superhetrodyne receiver with sensitivity of .7 μ V for 10db signal-to-noise ratio. Fine selectivity and adjacent channel rejection is obtained through a 455 kHz mechanical filter. Receiver also incorporates automatic floating series-gate noise limiter and variable squelch control resulting in virtually no background noise between calls. Other features: dust-free transmit-receive relay, earphone jack for headphones or external extension speaker for CB/PA application, illuminated "3" and relative power output meter, mobile mounting bracket and front panel mounted 4" speaker. Also features Priva-Com private tone caller socket. Complete with fused DC line cord for negative ground battery, push-to-talk mike and set of crystals for channel 9. Includes FCC license application form 505. Size 8 $\frac{1}{4}$ "W x 4 $\frac{1}{4}$ "H x 11 $\frac{3}{8}$ "D. Imported. Shpg. wt., 13 $\frac{1}{2}$ lbs. 99 E 3088 4WX

Net \$9.95

OPTIONAL ACCESSORIES

- | | |
|--|-----------|
| 99 E 31084 Positive ground fused 12 VDC cord | Net 1.50 |
| 46 E 15 Extra transmit crystal (specify channel)† | Net 2.25 |
| 46 E 12 Extra receive crystal (specify channel)† | Net 2.25 |
| 99 E 31031WXY HE-20T Modified for 27.575 MHz (GOV'T) operation | Net 99.95 |
| 99 E 31023WXY HE-20T Modified for 26.62 MHz (C.A.P.) operation | Net 99.95 |
- † See Page 476 for "How To Order Crystals."



For Base Station and Mobile Operation

Only **89⁹⁵**
No Money Down*

FCC
Type
Accepted

LAFAYETTE Comstat 19 5-Watt 2-Way Radio



- 9 Crystal Controlled Transmit and Receive Channels
- Convenient Front Panel Crystal Socket
- Modulation Monitor
- Phone Jack for Private Listening or External Speaker
- Pi Network Antenna Matching
- Convenient Variable Squelch Control
- Sensitive 23 Channel Tuneable Receiver

Advanced electronic circuitry utilizes 7 tubes and 3 diodes to achieve 13 stages of dynamic performance. Sensitive superhetrodyne receiver permits reception of weak distant stations even in problem areas. Effective series gate limiter minimizes ignition and other noise pick-up. Receiver can be manually tuned or crystal controlled. Variable squelch control permits quiet automatic stand-by operation. Powerful audio stage delivers up to 100% AM plate modulation for real talk power. Monitor allows visual indication of modulation. Built-in 117VAC power supply. Front panel receive and transmit crystal sockets plus 8 sets of internal crystal sockets. Front panel phone jack for private listening or external speaker. Receiver sensitivity: 1 μ V @ 10 db signal to noise ratio. Output impedance, 50 ohms. Supplied complete with push to talk ceramic microphone with coiled cord and positive lock plug, bracket for mobile or shelf mounting. 117 VAC power cord, and a pair of crystals for channel 11. Size: 12 $\frac{1}{4}$ "Wx8 $\frac{1}{4}$ "Dx 5 $\frac{1}{8}$ "H. Shpg. wt., 15 lbs.

99 E 30678WX	Net 59.95
46 E 61 Extra Transmit Crystal (Specify Channel)†	Net 2.25
46 E 62 Extra Receiver Crystal (Specify Channel)†	Net 2.25

HA-19 POWER SUPPLY Adapts Comstat 19 for 12 volt mobile operation negative or positive battery. Size 6Wx4Hx4 $\frac{1}{2}$ "D. 42 E 47045W Shpg. wt., 4 lbs. Net 13.95

† See Page 476 for "How To Order Crystals."

NOW ONLY

59⁹⁵

No Money Down*

D.O.T. APPROVED IN CANADA

486 Lafayette Cat. No. 700

* See Page 11 for Full Credit Details on Easy Pay Plan



FCC Type Accepted Part 91
CANADIAN D.O.T. APPROVED

†Choice Of One:
27.235, 27.245,
27.255, 27.265,
27.275 MHz.
Separate Licenses
Required for CB
and Business Radio

Only
219⁹⁵
No Money Down*

LAFAYETTE
C. B. Commander

HB-600 Solid State 2-Way Radio

5 Stage RF Ignition Noise Siler!
With RF Overload Protection!

23 Crystal Controlled CB Channels...All Crystals Supplied!

PLUS Choice From 5 Business Band Frequencies†

The "CB Commander" offers every feature you'll ever want in a 2-way CB radio — PLUS provision for Business Band† operation! You get 23 crystal-controlled CB channels plus 2 extra channels — lets you choose from 5 Business Band† frequencies — 27.235, 27.245, 27.255, 27.265, or 27.275 MHz. Range Boost circuit increases average modulation and lets your voice cut through noise to reach further! A dual conversion receiver provides high sensitivity — pulls in even the weak signals! A unique 5-stage RF Ignition Noise Siler (Pat. Pend.) provides excellent ignition noise reduction, literally "chops out" ignition noise — even really weak signals become perfectly intelligible under severe ignition noise conditions — you learn what quiet operation really means! Other top features include a mechanical filter for razor-sharp selectivity, Delta tuning, Variable Squelch, effective Automatic Noise Limiter, Push-Pull audio, plus provision for Public Address operation with external speaker. Built-in solid-state AC and DC power supply permits low drain operation on 117V AC or 12V DC (Neg. or Pos. Gnd.). Supplied with push-to-talk dynamic microphone with coiled cord, AC and DC power cables, "quick-release" mounting bracket and hardware, microphone bracket. Dimensions: 4³/₄" high, 11¹/₂" wide, 8" deep. Shpg. wt., 11 lbs. †Limited to 19 channels in Canada from 27.00 MHz to 27.230 MHz. Imported.

BUSINESS BAND CRYSTALS†

The same crystal has both transmit and receive functions. Only one crystal required for each frequency listed below.

42 E 42558	27.235 MHz	Net 3.95
42 E 42566	27.245 MHz	Net 3.95
42 E 42574	27.255 MHz	Net 3.95
42 E 42582	27.265 MHz	Net 3.95
42 E 42590	27.275 MHz	Net 3.95

- **RANGE BOOST.** For greater "talk-power."
- **SQUELCH/PA.** "Quiets" the receiver between calls — adjustable to suit operating conditions. Full counter-clockwise for PA operation.
- **PHONE JACK.** For headphones or speaker.
- **NOISE LIMITER.** Provides choice of noise reduction circuits—(A) Audio Noise Limiter, (B) Audio Noise Limiter plus RF Noise Siler.

- Unique RF Noise Siler (Pat. Pend.)
- 21 Transistors, 13 Diodes—Draws 1 ampere Maximum On Full Transmit!
- Mechanical Filter for Ultra Selectivity and Adjacent Channel Rejection
- Ultra-Stable Circuit Uses A Separate Crystal for Each Transmit/Receive Channel—All CB Crystals Supplied!
- Plug-in Dependable Sealed Relay Switching
- 0.5 μv Dual Conversion Receiver with 3-Crystal "Delta" Fine Tuning
- Pi-Network Output With Low Pass Filter
- Plug-in Facilities for Lafayette Selective Call Unit
- Operates As a PA Amplifier with External PA Speaker
- Built-in Solid State 117 Volt AC and 12 Volt DC Power Supply

99 E 30710WX Net 219.95
487 Lafayette Cat. No. 700

* See Page 11 for Full Credit Details on Easy Pay Plan

488

Deluxe HB-625 Solid State Mobile 2-Way Radio with CB's First IC Ignition Noise Reducer

Only **189⁹⁵** No Money Down*

3  +3 Stage

RF  ☆

FCC Type Accepted

- Selective Dual Conversion Superhet Receiver
- 3-Position Delta Tune for Accurate Tuning
- Mechanical Filter for Superior Selectivity
- Front Panel Transmit Mode Indicator Light
- Range Boost™. Circuitry for Added Talk Power
- Built-in Public Address Amplifier Facilities
- Accepts Priva-Com® Plug-in Private Tone Caller
- 12-Volt Portable or Mobile DC Operation



18 Transistors + 3 I.C.'s + 11 Diodes With RF Overload Protection (Pat. Pend.)

23-Crystal Controlled Channels . . . ALL CRYSTALS SUPPLIED

The HB-625 incorporates a highly selective 455 kHz mechanical filter to virtually eliminate adjacent channel splatter. It utilizes a 3-stage RF noise silencer including a 10-transistor, 8-diode integrated circuit to keep ignition noise interference from getting into the receiver's audio without cutting the incoming signal strength. Range Boost audio system uses revolutionary new IC microcircuits for increased effective talk power. Variable squelch and standard ANL combine with noise silencer to provide quiet, pleasurable reception. Other quality features include built-in public address amplifier facilities with rear panel jack for hi-fi tuner or tape recorder input. Operates instantaneously from 12-volts DC positive or negative ground with low battery drain or on 117 volts AC with optional power supply. Supplied with mounting bracket, power cord, PTT dynamic micro-

phone with coiled cord, and FCC Form 505 CB License Application. Size: 2 3/8" H x 6 1/4" W x 8" D. Imported. Shpg. wt., 7 lbs.

99 E 31486WX Net 189.95

Model HB-502B AC Power Supply for base station operation and Nicad Battery Charger.

99 E 32088W Shpg. wt., 5 lbs. Net 16.95

Model HB-506 Portable DC Power Pack. Attaches to HB-625 to permit portable DC operation. Includes battery pack (less batteries), telescopic antenna, and shoulder strap. Shpg. wt., 2 lbs.

99 E 31544W Net 19.95

Batteries For HB-506 Portable Pack. "C" Alkaline (8-required).

32 E 48879 Shpg. wt., 2 oz. ea. Net ea. .49

☆ **UNIQUE 3-STAGE RF**



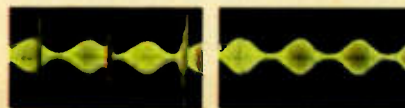

Super quiet 3 stage RF Noise Silencer utilizes a revolutionary 10 transistor 7 diode integrated circuit. Unlike other simple ignition noise reducing circuits which operate in the audio stage to merely limit the noise, the RF noise silencer employs a receiver circuit to actually silence the receiver for the brief duration of each noise impulse—eliminates it before it even reaches the audio stages! You get spectacular reduction of ignition noise without distortion, audible holes or volume reduction. Just listen and you'll know what really quiet reception is!

* See Page 11 for Full Credit Details on Easy Pay Plan

Telsat™ 23 Deluxe Solid State 2-Way Radio



23 Crystal Controlled Channels...

ALL CRYSTALS SUPPLIED



1 IC, 18 Transistors, 10 Diodes

ONLY **159⁹⁵**
No Money Down*

Operates On 117 Volts AC Or 12 Volts DC
With RF Overload Protection (Pat. Pend.)

FCC TYPE ACCEPTED

Deluxe External Features

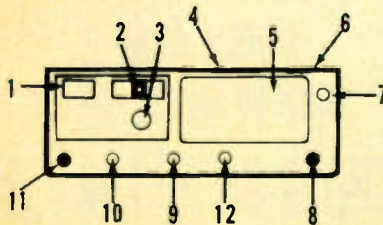

- | | |
|--------------------------------|-----------------------------|
| 1. Automatic "S"/Prf Meter | 7. Transmitter RF Indicator |
| 2. Channel Selector Dial | 8. PTT Microphone Socket |
| 3. Channel Selector | 9. Variable Squelch Control |
| 4. Auxiliary Input Jack (rear) | 10. Volume/Off-on Control |
| 5. Large PM Speaker | 11. Phone/External |
| 6. Priva-Com Socket (rear) | 12. Delta Fine Tune |

- Double Conversion Superhet Receiver
- Mechanical Filter Plus IC For Super Selectivity
- Excellent Sensitivity of Less Than 1 μ v.
- Range Boost Circuitry For Added Talk Power
- Accepts Priva-Com Plug-in Private Tone Caller
- Full Public Address Amplifier Provisions

- Illuminated Automatic S/Prf Meter
- Variable Squelch Plus Noise Limiting
- Automatic Transmit Indicator Light
- 3-Position ± 1.4 kHz Crystal Delta Fine Tune
- Pi-Network For Optimum RF Output
- TVI Trap Minimizes TV Interference

An exciting feature packed deluxe 23 channel 2-way radio ready to serve as either a 117 volt AC base or 12 volt DC mobile station. Entire design is geared toward communications reliability. Use of revolutionary space age integrated circuitry assures greater sensitivity and selectivity with high efficiency and low power drain. Full 23 channel crystal controlled transmit and receive operation—all crystals supplied. Receiver's superior selectivity is attained by using carefully tuned IF stages coupled with a hand crafted mechanical filter. Delta tune permits copy of "off channel" stations. Full legal power transmitter uses Range Boost modulation for far greater talk power. Front panel light indicates presence of RF energy at antenna socket. Illuminated S/Prf meter reads signal

strength on receive and RF output on transmit. Built-in public address provisions include audio input for tape recorder, tuner, etc. and tape output jack for recording. Accepts Lafayette Priva-Com plug-in private tone caller. Supplied with PTT dynamic microphone, mobile mounting bracket, DC cable, and FCC License Form 505. Size: 4 $\frac{1}{2}$ "H x 11 $\frac{1}{2}$ "W x 8"D. Imported. Shpg. wt., 11 lbs. 99 E 31577WX Net 159.95

Dynamic Desk Stand Push-To-Talk Mike Shpg. wt., 1 $\frac{1}{2}$ lbs. 99 E 46088 Net 11.95

DC Cable for positive ground vehicles. Shpg. wt., 8 oz. 99 E 31064 Net 1.30

CB's HOTTEST SELLER

REAL COOL

LAFAYETTE HB-525C

**Solid-State Mobile
2-Way Radio**

Only **149⁹⁵**

No Money Down*

23 Crystal Controlled Channels

ALL CRYSTALS SUPPLIED

Accepts Priva-Com® Plug-In Private Tone Caller

WITH RF OVERLOAD PROTECTION (Pat. Pend.)

With
REVOLUTIONARY NEW



ONLY 2 3/8" HIGH

FCC Type Accepted/Canadian O.O.T. Approved†

- 1-IC, 18-Transistors, 9-Diodes, 1-Thermistor
- Dual Conversion For High Selectivity
- Variable Squelch Plus Series Gate Automatic Noise Limiting
- Pi-Network for Optimum RF Output
- Mechanical 455 kHz Filter
- Automatic S/Prf Illuminated Meter

- 3-Position Crystal Delta Tune
- Transmit Mode Indicator Light
- Range Boost™ Circuitry for Added Talk Power
- P.A. Amplifier with Addition of External Speaker
- Auxiliary Audio Input Jack
- 12 Volt DC Operation (Neg. or Pos. Ground)

Lafayette's most advanced model of the famous HB-525 series of CB transceivers. Now with all the great features plus new revolutionary Integrated Circuit. Crystal controlled synthesizer provides 23 channel transmit and receive operation... all crystals supplied. Dual conversion receiver incorporates 455 kHz mechanical filter and Integrated Circuit for high selectivity, superior adjacent channel rejection, and extra long life. Variable squelch quiets receiver when no signal is being received. 3-position crystal delta tune permits easy copy of off-frequency stations. Powerful 5 watt transmitter features range boost modulation circuit for greater effective range. Illuminated S/Prf meter indicates signal strength on receive and RF output in transmit. Full public address provisions include audio input jack for tape recorder, tuner, etc. Supplied with PTT dynamic mike, mobile mounting bracket, DC cable, and FCC license Form 505. Size: 2 3/8x6 1/4x8"D. Imported.
99 E 31569WX Shpg. wt., 7 lbs. Net 149.95

MODEL HB-502B AC POWER SUPPLY/CHARGER
For base station operation of HB-525C; also charges HB-506 batteries.
99 E 32088W Shpg. wt., 5 lbs. Net 16.95

MODEL HB-506 PORTABLE DC POWER PACK
attaches to HB-525C for convenient portable operation. Shpg. wt., 2 lbs.
99 E 31544W Less Batteries Net 18.95

"C" Dry Cell (8 req.) for HB-506
99 E 62572 ea. .14; 10 for 1.20
"C"-Alkaline, Alternate HB-506 Battery (8 req.)
32 E 48879 Net ea. .49
"C" Nicad, Alternate HB-506 Battery (10 req.)
32 E 48887 Net ea. 4.06

99 E 46088 CB Dynamic Desk Mike Net 11.95
†D.O.T. Permits Legal Operation On 19 Channels
Only in 27.00 MHz Thru 27.30 MHz Range.



Portable

Desk Mike

Base Station

* See Page 11 for Full Credit Details on Easy Pay Plan

Lafayette COMSTAT 25B

FCC Type Accepted

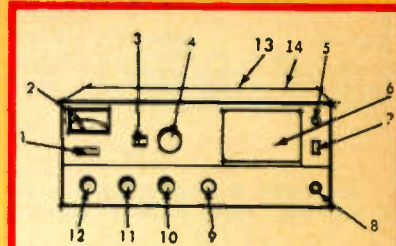

FEATURES

1. Range Boost Switch
2. Illuminated "S"/"PRF" Meter
3. Illuminated Channel Indicator
4. Single-Knob Channel Selector
5. Modulation Indicator Light
6. Front Panel PM Speaker
7. CB/Public Address Switch
8. Headphone/External Speaker Jack
9. Positive-Lock Mike Connector
10. 2.5 kHz Fine Tuning Vernier
11. Volume Control/Power Switch
12. Adjustable Squelch Control with Standby Switch for Low Drain Instant Operation
13. Wired-In Priva-Com Socket (Rear)
14. T.V. Interference Trap (Rear)

Famous 23 Channel CB Best Seller...

NOW with BRAND NEW *Space-Age Styling!*

With Standby Switch for Low Current Instantaneous Operation

Only
139⁹⁵

No Money Down*

★ Accepts Priva-Com® Private Call Unit

- 17 Tube Performance with 11 Tubes, 2 Transistors and 11 Diodes
- Built-in 117 VAC, 12 VDC Solid-State Power Supply
- Dual Conversion Receiver Features 8/10 μ V Sensitivity
- Range Boost Circuitry for Added Talk Power
- Pi-Network and Low Pass Filter for Maximum Power Output
- Vari-tilt Mounting Bracket

Lafayette's outstanding 23 channel crystal-controlled tube-type CB transceiver now sports a brand new professional look! The pace-setting Lafayette Comstat 25B, with its high performance circuitry for excellent mobile and base station operation, features a handsome midnight-black and contrasting brushed aluminum front panel with complementary multi-colored illuminated "S-PRF" meter and attractive control knobs. A 2.5 kHz total spread fine tuning vernier facilitates accurate reception. Highly selective circuits greatly suppress adjacent channel interference (-45db). Variable squelch quiets receiver between calls. Crystal frequency synthesizer enables operation on all 23 CB channels with crystals supplied. No extra crystals are necessary! Built-in dual purpose power supply al-

lows 12-VDC mobile and 115-VAC base station operation. Front panel switch converts transceiver to a handy 4.5 watt public address amplifier. A convenient front panel jack for headphones or external extension speakers for CB/PA is provided. Comstat 25B also features push-to-talk relay switching and plug-in ceramic microphone with coiled cord. Rear socket is prewired to accept Lafayette Priva-Com selective call unit. Complete with vari-tilt mounting bracket which facilitates both easy mounting and optimum positioning of set as well as serving as an adjustable table top base. With FCC License Application Form 505. Size: 12WX 8½Dx5" H. Imported. Shpg. wt., 16 lbs.

CRYSTALS SUPPLIED FOR ALL 23 CHANNELS!

99 E 32146WX

Net 139.95

* See Page 11 for Full Credit Details on Easy Pay Plan



A LAFAYETTE

STAR CB VALUE

23 Channel Crystal Controlled Two-Way Radio

Only

99⁹⁵

No Money Down*

FCC TYPE ACCEPTED

LAFAYETTE Comstat 23 Mark VI ... Designed for High Performance... ALL CRYSTALS SUPPLIED

Lafayette offers a truly great CB value, the Comstat 23 Mark VI deluxe 5-watt CB transceiver with 23 crystal-controlled channels at an amazingly low price. Crystal synthesizer circuit includes all crystals necessary for active coverage of all 23 CB channels. Each channel is clearly identified on the illuminated channel selector dial. Features a sensitive and selective dual conversion superheterodyne receiver. Sensitivity is 0.8 μ v; selectivity is -6 db ± 3 kHz; image rejection is -75 db. Variable squelch control for quieting receiver during "no signal" conditions; full-time automatic noise limiter; and a tape recorder output jack on the rear panel. Audio output is 4-watts into a built-in 3 1/2 in. speaker. RF output is coupled through a highly effective pi network and low pass filter for maximum energy transfer to the antenna with low harmonic radiation. Matches antennas from 50-75 ohms. Range Boost circuitry is incorporated for greater average talk power. Includes standby switch for low current drain and instant operation. With facilities for PA and external speaker or phones of 4-8 ohm impedance. For operation on 105-120 volts AC, 50/60 Hz or operates mobile with the use of the optional 12 volt power supply. Size: 12Wx8 1/2 Dx5" H. Imported. Shpg. wt., 20 lbs.
99 E 32237WX Net 99.95

- 14 Tube Performance with 9 Tubes, and 10 Diodes
- Dual Conversion Receiver Features 8/10 μ v Sensitivity
- Pi-Network and Low Pass Filter for Maximum Power Output
- Internal Range Boost Circuitry for Greater Average Talk Power
- Built-in 117 VAC Power Supply, Operates Mobile with Optional 12 VDC Power Supply
- Variable Squelch Control with Standby Switch for Low Drain Instant Operation

FEATURES

1. Illuminated "S"/"PRF" Meter
2. Illuminated Channel Indicator
3. Single Knob Channel Selector
4. Large Front Panel PM Speaker
5. Tape Record Output Jack (Rear)
6. Transmit Modulation Indicator Light
7. CB/Public Address Switch
8. Headphone/External Speaker Jack
9. Variable Squelch Control with Standby Switch for Low Drain Instant Operation
10. Volume/Power ON-OFF Control
11. Positive-Lock Microphone Socket

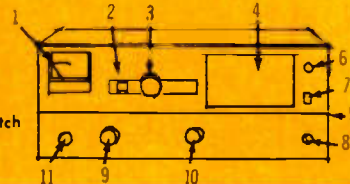

OPTIONAL ACCESSORIES

MA-19 DC Power Supply. Permits 12 volt mobile operation with negative or positive battery ground. 6Wx4Hx 4 1/2"D. Shpg. wt., 4 lbs.
42 E 47045W Net 13.95

Mobile Mounting Bracket facilitates under-dash mobile mounting. Imported. Shpg. wt., 2 lbs.
99 E 31874 Net 2.95

23 Crystal Controlled CB Channels

LAFAYETTE

Two-Way Radio

With Revolutionary New

ELECTRONIC
MIRACLE
OF THE
SPACE AGE



INTEGRATED
CIRCUIT

ONLY **99⁹⁵** FOR OPERATION
ON CHANNELS
9, 13 AND 19
No Money Down*

Add 2 More Channels With Each
Additional Plug-in Crystal

ONLY **124⁹⁵** FULL 23 CHANNEL
OPERATION
No Money Down*



With RF
Overload Protection

PAT. PENDING



LAFAYETTE
HB-23

FCC Type Accepted
Canadian D.O.T. Approved

- ★ 15-Transistors, 8-Diodes, Plus I.C.
- ★ Full 5-Watt FCC Maximum Input Power
- ★ 455 kHz Mechanical Filter In IF Stage
- ★ Dual Conversion Superheterodyne Receiver

NEVER BEFORE ...

**A CB Transceiver With Such
Economical Versatility!**

- Large 5 x 3 Inch Speaker
- Accepts Priva-Com® Private Tone Caller
- Variable Squelch Plus Automatic Noise Limiting
- Portable Operation With Optional Pack
- 12 Volts DC Negative or Positive Ground
- 117 Volts AC With Optional AC Power Supply

Solid-state ultra compact crystal synthesis CB transceiver incorporates 15 transistors and one integrated circuit stage to achieve superior sensitivity, greatly increased dependability, and lower current drain. Synthesis type frequency control section utilizes a maximum of sixteen crystals for full 23 channel operation. Permits economical addition of 2 channels with each plug-in crystal listed below. Carefully tuned 455 kHz mechanical filter assures razor sharp selectivity with excellent adjacent channel rejection. Dual conversion receiver features 0.7 μ v sensitivity, ANL, variable squelch, and push-pull audio amplifier. Transmitter provides full 5 watt legal limit input. Illuminated front panel meter monitors "S" units on receiver and PRF output during transmit. PA Speaker/Earphone jack for silent listening or public address operation. Wired to accept Privacom plug-in private tone caller. For 12 VDC negative or positive ground. 117 VAC and portable operation achieved with accessories listed below. Complete with dynamic push-to-talk microphone, power cable, mounting bracket, fixed crystal for channels 9, 13, and 19, and FCC application Form 505. Size 5 3/4" W x 7 7/8" D x 2 1/4" H. Imported. Shpg. wt., 6 1/4 lbs.

99 E 31494WX Net 99.95

Package of 10 Plug-in Crystals. Converts HB-23 from 3 channels to full 23 channel operation. 99 E 31742 Shpg. wt., 1 lb. Net 25.00

HB-502B Solid State 117VAC Power Supply/Charger. Enables operation of HB-23 as a table top 117 VAC base station, also charges nickel cadmium batteries used in the HB-507 pack. 99 E 32686W Net 16.95

99 E 46088 Base Station Dynamic Desk Microphone Net 11.95

Model HB-507 Portable Battery Pack. Adapts HB-23 for convenient portable operation with shoulder strap. Less "C" batteries. 99 E 31551 Shpg. wt., 2 lbs. Net 19.95

32 E 48879 "C" Alkaline Battery for HB-507 (8 required) Net ea. .49

32 E 48887 Alternate Nickel Cadmium Battery (10 required) Net ea. 4.06

OPTIONAL INDIVIDUAL PLUG-IN CRYSTALS: Each Crystal Adds 2 Operating Channels. Inserts Into Specified Crystal Sockets.

99 E 31635 Channels 1 and 5; For Socket A 99 E 31692 Channels 11 and 15; For Socket G

99 E 31643 Channels 2 and 6; For Socket B 99 E 31700 Channels 12 and 16; For Socket H

99 E 31650 Channels 3 and 7; For Socket C 99 E 31718 Channels 17 and 21; For Socket I

99 E 31668 Channels 4 and 8; For Socket D 99 E 31726 Channels 18 and 22; For Socket J

99 E 31684 Channels 10 and 14; For Socket F 99 E 31734 Channels 20 and 23; For Socket L

Any One of Above Crystals Net each 3.45

HB-23



Desk Mike HB-502B

HB-23 Base Station

HB-507



HB-23

Portable HB-23 With HB-507
Power Pack

* See Page 11 for Full Credit Details on Easy Pay Plan

Lafayette Cat. No. 700 493

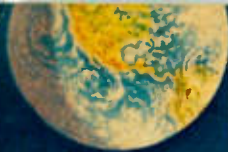

NEW

Model HA-800

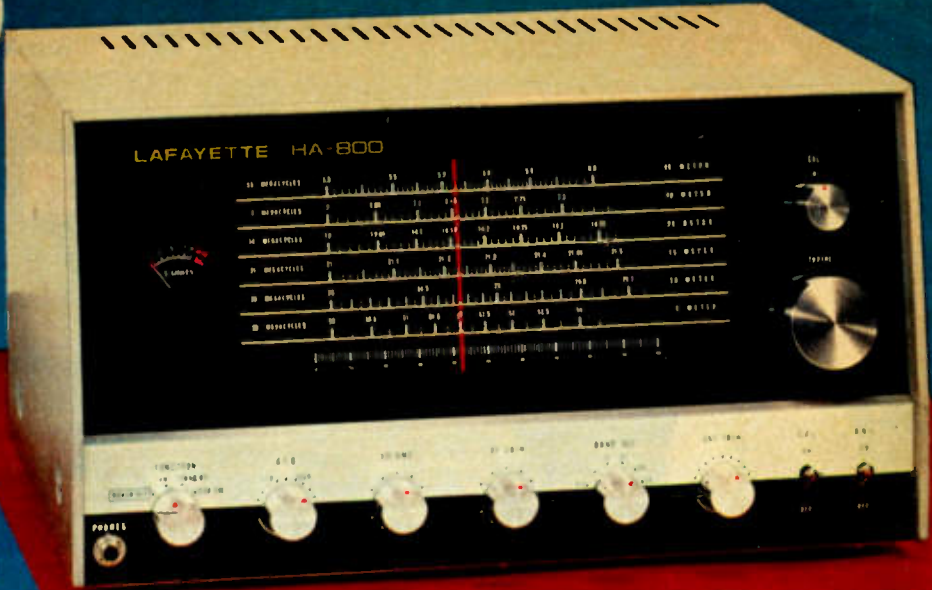

6 through 80 meter

SSB/AM/CW SOLID STATE AMATEUR RECEIVER

SIX AMATEUR BANDS INCLUDING 6 METERS

80 METERS 3.5-4.0 MHz	40 METERS 7.0-7.3 MHz	20 METERS 14.0-14.35 MHz	15 METERS 21.0-21.45 MHz	10 METERS 28.0-29.7 MHz	6 METERS 50.0-54.0 MHz
---------------------------------	---------------------------------	------------------------------------	------------------------------------	-----------------------------------	----------------------------------

3 FET's + 7 DIODES
+ 14 TRANSISTORS

ONLY 149⁹⁵

No Money Down*

- ★ Product Detector for SSB/CW
- ★ Built-in 100 kHz Crystal Calibrator
- ★ Operates on 117 VAC or 12 VDC

Two Mechanical IF Filters Assure High Selectivity And Sharp Bandwidth

Field Effect Transistors Virtually Eliminate RF Overload

Constant Voltage Regulated Zener Power Supply

Solid State Circuitry Delivers Reliable, Cool, and Superior Performance

Easy-to-Read Illuminated And Calibrated "S" Meter

100 kHz Crystal Calibrator For Precise "Zero Beating"

- Dual Conversion On All Bands
- Two 455 kHz Mechanical Filters For Sharp Selectivity
- FET's For Automatic Radio Frequency Overload Protection
- Zener Voltage Regulated Power Supply

- Series Gate Automatic Noise Limiting
- External Receiver Muting Rear Panel Connection
- Illuminated Calibrated "S" Meter
- Huge Edge-Illuminated Slide Rule Dial

New Lafayette Model HA-800 receiver covers the 80 through 6 meter amateur bands with outstanding reception of CW, AM, and SSB signals. Dual conversion circuitry utilizes 3 FET's and 14 transistors + 7 diodes for cool, reliable performance. Tuned RF and 1st mixer stages combine with an FET to provide maximum sensitivity with high front end selectivity and an excellent signal-to-noise ratio. Intermediate frequency circuits feature two selective mechanical filters. Product detector and BFO assure crisp CW and clear SSB. Built-in 100 kHz. calibrator provides accurate frequency pre-selection

(supplied less crystal). Power supply utilizes a constant voltage zener stage. Rear panel accessory socket provides convenient connection for audio output, 12 volts DC, ground, and receiver muting. Front panel earphone and rear panel tape output jacks. Operates from 117 VAC 50/60 Hz. or 12 volts DC. Imported. Shpg. wt., 18 lbs.
 99 E 25942WX \$8 Monthly* Net 149.95
 Model HE-488 3 x 5" Matching 8 ohm Speaker Net 8.95
 40 E 09056 Shpg. wt., 4 lbs. Net 3.95
 100 KHz. Calibrator Crystal for HA-600 Receiver 40 E 09015L Net 3.95

SPECIFICATIONS

Controls: Function Switch (Power Off, AM, Stand-By, SSB-CW), BFO (Variable LSB-USB), Volume, RF Gain, Band Selector (3.5, 7, 14, 21, 28, 50 MHz), Antenna trim, Tuning, Calibration (tuning), Calibration (on-off), Automatic Noise Limiter, Battery Saver Pilot Light Switch (rear panel); Sensitivity: Better than 1µv. on 80, 40, 20 meters, .5µv. on 15, 10 meters and 2.5µv. on 6 meters; Selectivity: -6db. at ±2kHz, -60db. at ±6kHz. Intermediate Frequen-

cies: 1st IF 2.608 MHz, 2nd IF 455kHz; BFO Frequency: 455kHz ±2.5 kHz; Image Rejection: Better than -40db. Audio Output: Impedance 8 and 500 ohms, Power 1 watt; Antenna Input Impedance: 50 ohms; Power Requirements 105-120 Volts 50/60 Hz AC, 12 volts DC (Negative Ground); Power Consumption: AC 8.5 watts, DC 6.8 watts; Size: 15W x 9 3/4" x 8 1/4" H.

break through

Monitor 150-174 MHz
or 30-50 MHz and
Communicate on 23
CB Channels



FCC
TYPE
ACCEPTED

**NEVER
BEFORE**

A CITIZENS BAND 2-WAY RADIO *Plus* A POLICE and FIRE MONITOR RECEIVER

1—Integrated Circuit + 1-FET + 25-Transistors + 9-Diodes

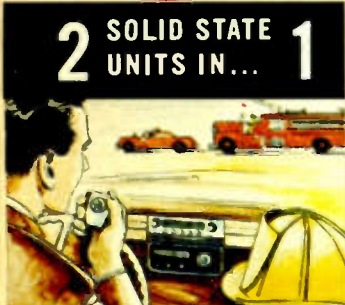

**2 SOLID STATE
UNITS IN... 1**

- CB TWO-WAY RADIO**
- 5-Watt FCC Max. Rating
 - Dual Conversion • 0.7 μ V Sensitivity
 - 23 Crystal Controlled Channels... All Crystals Supplied!
 - Socket For Priva-Com - Quiet Standby

**TELSAT 150
CB Plus
150-174 MHz**

**TELSAT 50
CB Plus
30-50 MHz**

ONLY 199⁹⁵ ea. No Money Down*

VHF FM MONITOR RECEIVER

- Tuneable Receive Plus 2 Crystal Positions
- Monitors 150 thru 174 MHz or 30 thru 50 MHz
- Manual Tuning Plus Two Switchable Crystal Positions for Optional Crystals†
- Less Than 1 μ V Sensitivity

Telsat 150 Receives Weather Reports‡

- 117 VAC With Optional Power Supply
- Ideal Size For Car and Home
- 12 VDC Neg. Ground

**FOR
VOLUNTEER FIREMEN,
AUXILIARY POLICE, Etc.**

This exciting Lafayette Innovation in the field of communications permits you to become an alert and informed citizen in your community! Now you can monitor the police and/or fire frequencies and immediately communicate with your family and with members of your volunteer fire or auxiliary police squad. The Lafayette Telsat 150 and Telsat 50 are unique compact combinations of a 5-watt 23 channel solid state CB transceiver (all crystals supplied) and a VHF police/fire or industrial monitor receiver. These units are expertly engineered for outstanding CB and VHF performance in a car, truck, and boat, as well as in an office or home (with optional AC power supply). Complete with mobile mounting bracket and FCC license application form 505. Less crystals. Size: 2½H x 6½W x 8"L. Imported. Shpg. wt., 8 lbs.
Telsat 150 (150-174 MHz) Net 199.95
99 E 32153WX

Telsat 50 (30-50 MHz)
99 E 32179WX Net 199.95
Model NB-502B Matching AC Power Supply for operation in the home or in the office.
99 E 32088W Shpg. wt., 5 lbs. Net 16.95
Monitoring Crystals. Specify exact monitoring frequency. Special order, 3-4 weeks delivery.
‡Note: If more than 1 optional crystal is used, the crystals must be within 1 MHz of each other.
40 E 82087Z For 150-174 MHz Net 5.95
40 E 82079Z For 30-50 MHz Net 5.95
VHF Monitoring Antennas For Telsat 150 (150-174 MHz)
Roof or Trunk Mount Mobile Antenna
40 E 01137W Shpg. wt., 1 lb. Net 5.95
Base Station Antenna
40 E 01160W Shpg. wt., 2 lbs. Net 7.50
42 E 09102 50' Base Antenna Cable Net 8.50
Telsat 50 uses CB Antenna for VHF & CB.
Note: For CB Antennas see pages 470-475.



†Consult local weather bureau about reception on 162.55 and 163.275 MHz.

*See Page 11 for Full Credit Details on Easy Pay Plan

NEW Lafayette 50 Watt Solid-State AM/FM Stereo Receiver



Amazing
LOW PRICE
ONLY

129⁹⁵ with
CASH

No Money Down*

FULL 2 YR.

GUARANTEE †

COMPARE the Features! COMPARE the Price!

33 Transistors, 25 Diodes, 2 Thermistors

SPECIFICATIONS

TUNER SECTION
 FM: 4 Gang Tuning Condenser; Tuning Range: 88-108 MHz; I/F Sensitivity: 2.5µV; S/N Ratio: -60 db; Distortion: 0.7% at 100% Mod; Spurious Rejection: 70 db; Capture Ratio: 5 db; Stereo MPX: Separation: 35 db at 400 Hz; Selectivity: 40 db; Antenna Impedance: 300-Ohm Balanced; AM: 3 Gang Tuning Condenser; Tuning Range: 535-1605 kHz; Image Rejection: 50 db.

AMPLIFIER SECTION
 Power Output: 50 Watts +1 db, 40 Watts IIF; Power Bandwidth: 35-30,000 Hz; Frequency Response: 20-20,000 Hz ±1.5 db; Harmonic Distortion: 0.1% at 1 Watt; Hum/Noise: Aux. -75 db; Max. Phono: -60 db; Ceramic Phono: -55 db; Input Sensitivity: Max. Phono: 2.3mV; Ceramic Phono: 80 mV; Aux.: 250mV; Output Impedance: 4-16 ohm speaker (main and remote). 8 ohm headphones.

- 50-Watts ±1db Stereo Amplifier
- 4-Gang FM Tuning Condenser for Extra Sensitivity
- Illuminated Signal Strength Meter

An outstanding hi-fi value, the Lafayette LR-100 features deluxe decorator-designed styling plus full-range, full-fidelity sound from thrilling stereo or mono FM broadcasts, AM broadcasts, as well as phono or tape. A full complement of front panel tone controls (Bass, Treble, Volume/Balance) and push-button switches (Loudness, Stereo/Mono, High Filter) enable the LR-100 to be tailored to the acoustical characteristics of any room, and to match the sound characteristics of virtually any phono cartridge, tape player or speaker system—performance features normally included only on much more expensive hi-fi components. Excellent sensitivity, selectivity, and capture ratio are inherent in the technologically advanced and long-life circuitry of the LR-100. You will be delighted with the clear

- Built-In FM plus Flexible-Mount AM Antenna
- Front and Rear Panel Tape Output Jacks
- Front Panel Stereo Headphone Jack
- High Frequency Filter

reception of the weak as well as the stronger stations! The amplifier section has power to spare . . . 50 watts will drive main and remote stereo speakers, and will easily fill any room with clean, wall-to-wall sound. Some additional fine features of the LR-100 are: automatic stereo switching; signal-strength tuning meter for more accurate tuning; MPX filter; FM stereo indicator light; front and rear panel tape outputs for easier tape recording; stereo headphone output for enjoyable private listening; fused speaker outputs; distinctively styled front panel and attractive simulated walnut grain vinyl-clad metal case. Size: 14½Wx4½Hx10½"D. For 117 VAC 50/60 Hz. Imported. Shpg. wt., 21 lbs.
 99 E 02214WX Net 129.95

†See Page 435 for AAA Guarantee Details

*See Page 11 for Full Credit Details on Easy Pay Plan



4-gang FM Tuning Condenser in extra sensitive FM Front End plus durable, long-life semi-conductors provide outstanding sensitivity and selectivity.

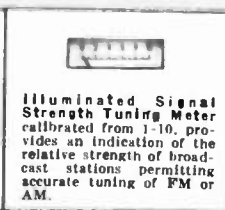

Illuminated Signal Strength Tuning Meter calibrated from 1-10, provides an indication of the relative strength of broadcast stations permitting accurate tuning of FM or AM.



FM Stereo Light Indicator works in conjunction with automatic FM Stereo Switching Circuit. Indicating when receiver has been tuned to stereo station and receiver has switched to FM Stereo operation.



Speaker Mode Switch works sound to main or remote speakers separately, or to both simultaneously, plus a headphone only position for private listening.