



RADIO & TV SETS
See Pages 92-97



BOATS —
MARINE
GEAR
See Pages
26-27



1966 Spring Catalog

No. 663

LAFAYETTE

RADIO ELECTRONICS



MUSICAL INSTRUMENTS
See Pages 49-53



MOTOR
BIKES —
See Page 33

AUTO
ACCESSORIES
See Pages
28-32



C.B. EQUIPMENT
See Pages 2-15

MAIL ORDER DIVISION
111 JERICHO TURNPIKE,
SYOSSET, L. I., N. Y. 11791
See Center Insert for Store Addresses

SHOP FROM THE
BIG
1966 LAFAYETTE CATALOG

For largest selection, see
the 512-page 1966
Lafayette Catalog.



NO MONEY DOWN
with Lafayette's Easy-Pay Plan.
See CATALOG FLAP

Open a

Lafayette

Credit
Account
TODAY

NO MONEY DOWN

Up To 2 Years To Pay
LOW MONTHLY PAYMENTS

2 EASY PAY CREDIT PLANS

To suit your individual needs

EXTENDED PLAN*

TAKE UP TO
2 Years To Pay

BUDGET PLAN*

LOW
Credit Service Charge

*Pay balance in 30 days, save entire service charge.

Start Now To Take **FULL ADVANTAGE**
LAFAYETTE'S Easy Pay Plans

- No down payment.
- Take up to 2 years to pay.
- One low Monthly Payment buys all your electronic and hi-fi requirements.
- No hidden charges. Small service charge included in fixed monthly payment.
- Add-On any time you like. No money down and usually no change in monthly payment.
- Choose the plan that suits you best—Budget or Extended.

**No need to wait to enjoy anything
you need from LAFAYETTE**

HERE IS HOW YOU MULTIPLY YOUR SHOPPING DOLLAR UP TO 20 TIMES

Monthly Payments FOR ONLY	\$5	6	7	8	9	10	11	15	17	19	22	23	24
YOU CAN BUY UP TO	\$100	110	130	160	180	200	220	300	340	400	440	460	500

See Easy Pay Schedule on back of Order Blank

SALE!

LAFAYETTE Quality Citizens Band "Walkie Talkie" At Low, Low Price Our Walkie Talkies Feature Plug-In Crystals



A Our Lowest Price Ever!

5.99

each



C 9.50 each

When You Buy Two or More



D 12.45 each

When You Buy Two Or More



NEW 10 Trans with Range

23

When You Buy Two or More



B 2 Channel 300mw

NEW!

27.95

each

When You Buy Two or More



A LAFAYETTE HA-70B "SPACE COMMANDER" CB "WALKIE-TALKIE"

- Not a Kit—Completely Wired
- Crystal Transmit
- Sensitive Superregenerative Circuit
- Interstage Driver Transformers . . . More Audio, Huskier Modulation

Excellent for countless exciting short range applications up to ¼ mile. This compact Lafayette Walkie-Talkie is a 3-transistor transmitter with crystal control on transmit and with efficient super-regenerative receiver—has minimum external ignition noise pickup when voice signal is being received. Has Push-to-Talk button, on-off switch and efficient speaker that is also used as microphone. Complete with built-in telescopic antenna, transmit crystal, 9-volt battery and plastic carrying case. Size: 5½x2½x1¾". Imported. Shpg. wt., 1 lb.

99 A 3062L Model HA-70B	Net ea. 5.99
99 A 6021 Replacement Battery	Net .21

*Does not have Plug-In Crystals

B NEW LAFAYETTE HA-99 2-CHANNEL 300 MW 9-TRANSISTOR SUPER-POWER WALKIE TALKIE

- Two Switchable Channels • 300 Milliwatts Power
- Range Boost for Greater Effective Range
- 12 Volt Battery Supply For Reserve Power

Beautifully styled walkie talkie features 300 milliwatts input and built-in Range Boost circuitry increasing effective range. Two switchable channels give multiple channel versatility at the flip of a switch. Ideal for reliable low cost communication. Other features include 9 transistor, 3 diode, 2 thermistor circuit and sensitive superhet receiver with push-pull audio and modulator. 12-volt battery supply provides plenty of power from 8 economical penlight cells or any external 12V DC source. Supplied with pair of crystals for channel 10, batteries, leather carrying case and telescoping antenna. Handsome black and silver metal case. 2¾Wx7½Hx1½"D. Imported. Shpg. wt., 2¾ lbs.

99 A 3072L	Net ea. 28.95
Two or More	Net ea. 27.95

C LAFAYETTE GT-3 "ARMY COMMANDER" WALKIE TALKIE

- Completely Wired—Not a Kit
- Lightweight—Less Than 10 Ounces
- Ideal for Camping, Cycling, Hunting, Fishing, Home, etc.

The Lafayette GT-3 is an authentic 2-way radio similar in appearance and design to the "walkie talkies" used by our armed forces for dependable communications. This 3-transistor receiver has crystal control on transmit with a super-regenerative receiver—gives range up to ¼ mile. Quick and easy to operate—just pull up the telescopic whip antenna, slide the power on-off switch up, press the push-to-talk button and you're ready for action. Has separate ear cup and mouthpiece for convenient 1-hand operation. Complete with antenna, crystal, 9-volt battery, and carrying strap. Overall Size 9x2½x2½". Imported. Shpg. wt., 1 lb.

99 A 3058L Model GT-3	Net ea. 9.91
Two or More	ea. 9.51
99 A 6021 Extra Battery	ea. .21

*Does not have Plug-In Crystals

D LAFAYETTE HA-130 5-TRANSISTOR SUPERHET CB "WALKIE TALKIE"

Superheterodyne — Not Superregenerative
Ideal for Sports, Camping, Farm, Home and Industry

5 transistor, 2 diode circuit employs crystal-controlled superheterodyne receiver for clear, crisp reception and 100 milliwatt transmitter using plug-in, easy-to-change crystals. Simple to operate—only a push-to-talk switch and on/off volume control. Collapsible 34-inch antenna. Housed in durable black and silver simulated leatherette plastic case. Supplied with channel 10 transmit and receive plug-in crystals, earphone jack for private listening and 9 volt battery.

99 A 3053L	Net ea. 12.95
Two or More	Net ea. 12.45
99 A 6021 9 Volt Battery	Net .21

..A Snap to Operate On All CB Channels

NEW 13 Transistors
with Range Boost
37⁴⁵
When You Buy
Two or More

SALE! **44²⁵**
SAVE
\$5.00
Two or More
No Money
Down
\$5 Monthly

SALE!
SAVE 10.00
58⁹⁵
Two or More



SALE!

[E] NEW! LAFAYETTE HE-29D 10 TRANSISTOR CB WALKIE-TALKIE WITH RANGE BOOST™

- Built-in Range-Boost™ for Greater Range
- Transmits and Receives up to 2 Miles
- Leather Case with Shoulder Strap

Complete portable 2-way communications for everyone, everywhere: hunting, fishing, boating, etc.; at work in construction, warehouses, offices and farms. Weighs only 16 ounces and easily slips into your pocket. Powerful transmitter with built-in Range Boost circuitry gives greater effective range. In professionally designed black and brushed aluminum metal case. Supplied with leather carrying case, shoulder strap, earphone, antenna, 6 penlight batteries and a pair of crystals for channel 10. 6⁷/₈x2³/₄x1³/₈". Shpg. wt., 2¹/₂ lbs. Imported.

99 A 3066L Net ea. 24.95
Two or More Net ea. 23.95
99 A 6258 Replacement Batteries (6 required) Net ea. .095
AC POWER PACK 117VAC. Replaces batteries in HE-29D.
99 A 3012 Shpg. wt., 2 lbs. Net 6.95

[F] NEW! LAFAYETTE Model HE-100B 13-TRANSISTOR CB "WALKIE-TALKIE" with Range Boost™ For Greater Range

- Variable Squelch and Automatic Noise Limiting
- AVC, Push-Pull Audio Output

Easy to use... carry it anywhere for sports or business. Efficient superhet receiver has automatic noise limiting and variable squelch to reduce background noise and Range Boost circuitry for greater effective signal range. Handy controls include push-to-talk switch, volume, and variable squelch. Power is supplied by 8 small penlight batteries or optional 117 volt AC power pack. Lightweight unit is housed in a rugged hi-impact plastic case. Supplied with leather case, earphone, 44-inch telescopic antenna, batteries, and crystals for channel 10. Size: 3Wx2³/₄Dx9"H. Imported. Shpg. wt., 2 lbs.

99 A 3046L \$5 monthly Net 37.95
Two or More Net Each 37.45
99 A 3024 AC POWER PACK 117 volt AC. Shpg. wt., 1 lb. Net 7.45

[G] LAFAYETTE HE-75 1-WATT 13 TRANSISTOR CB WALKIE-TALKIE with Squelch

- Uses Powerful Silicon Transistors in Output Stage
- Crystal Controlled Receive and Transmit
- Automatic Noise Limiter, Squelch, AVC

Push-to-talk transmitter delivers a clean signal even at extreme ranges. Sensitive superhet receiver features push-pull audio output for superior voice communications. Other outstanding features include: effective automatic noise limiter, variable squelch and AVC. Local/Distance switch prevents overload distortion at close range. Has interchangeable plug-in battery compartment for penlight cells or optional rechargeable nickel cadmium battery. With whip antenna, earphone, leather carrying case, batteries and pair of crystals † for channel 13. 3x8x2"D. Imported. Shpg. wt., 2 lbs.

99 A 3016L Net 44.95
Two or More Ea. 44.25
Rechargeable nickel cadmium battery in sealed compartment.
99 A 3018 Net 14.50
CANADIAN APPROVED HE-75 (D.O.T. App. oval No. 169361071)
99 A 3004L Net 44.95
Two or More Ea. 44.25

[H] LAFAYETTE Model HA-135 2-CHANNEL 1.35 WATT 12 TRANSISTOR CB WALKIE-TALKIE

- 2 Crystal Controlled Receive and Transmit Channels
- Push-Pull Modulator and Audio Output
- Automatic Noise Limiter, Variable Squelch, AVC

A truly dependable performer for the demanding requirements of business, industry, campers, hunters and fishermen. Offers two separate crystal controlled channels with a 1.35 watt input. Develops almost a full watt output! Sensitive superhet receiver provides sharp selectivity and includes push-pull audio output and modulator for high intelligibility; variable squelch; RF output and battery condition indicator; automatic noise limiter; external antenna jack and battery eliminator socket. Housed in rugged metal case with handsome die-cast front panel. 3³/₄Wx9¹/₂Hx1¹/₄"D. Uses 8 economical penlight cells. With leather carrying case, earphone, 52" telescoping whip antenna and pair of crystals † for channel 10. Shpg. wt., 3¹/₂ lbs. Imported.

99 A 3035L \$5 Monthly Net 59.95
Two or more \$5 Monthly Ea. 58.95

†42 A 4204C Extra Transmit Crystal, Specify Channel Net 2.25
†42 A 4203C Extra Receive Crystal, Specify Channel Net 2.25

LAFAYETTE Model HA-450 2.5 Watt 6-Channel Crystal-Control Solid State Portable And Mobile CB Transceiver

- 6-Channel Crystal Control Transmit & Receive
- Powerful 2.5 Watt Input
- 12 Transistors, 4 Diodes
- External Plug-in Push-to-Talk Dynamic Microphone
- "S" and Battery Meter, ANL, and Variable Squelch
- Supplied with Pair of Channel 9 Crystals
- Operates with 8 "D" Batteries Supplied
- Complete with Leather Carrying Case, Antenna, and Mobile Mounting Brackets

SALE!
NOW ONLY
109⁹⁵
SAVE 10.00



Here is Lafayette's versatile super walkie-talkie designed to set a new trend in CB 2-way radio. Use it as a powerful walkie-talkie with its self-contained "D" size batteries, or simply detach battery pack and switch to external antenna for ultra-compact under dash mobile installation. HA-450 has the added optional feature of using 8 rechargeable nickel cadmium "D" batteries for long-life portable operation. 6-channel selector with illuminated dial allows you to transmit and receive on six different CB channels. All-transistor circuit (8 Silicon, 4 Germanium) utilizes Automatic Noise Limiter and Adjustable Squelch for quiet, communications. Motorola-type antenna jack for external antenna, with mobile/built-in telescopic whip antenna switch, mobile mounting bracket and cable make

mobile installations quick and easy. Operate at 12 volt DC positive or negative ground from portable or mobile (car, boat, etc.) batteries. Size: with battery pack, 10 3/8 x 6 D x 2 3/4" H. Mobile, 10 1/2 x 4 1/2 x 2 3/4" H. Shpg. wt., 8 lbs. Imported.

99 A 3063L \$6.50 Monthly Net 109.95

Replacement Batteries

99 A 6256 "D" Cells (8 required)	Net Each	.13
32 A 4884 Heavy duty "D" Alkaline Batteries (8 req'd)	Net Ea.	.49
42 A 0907C Extra Transmit Crystal (Specify Channel)	Net	2.25
42 A 0135C Extra Receive Crystal (Specify Channel)	Net	2.25
42 A 3206 Adapter PL259 Plug to Motorola Plug	Net	.54

LAFAYETTE MODEL HA-300 A 2-WATT, 2-CHANNEL CB "WALKIE-TALKIE"

A compact Hand-Held 2-Way Radio With All These Features

- Powerful 2 Watts • 2-Channel Operation • 13 Transistors, 2 Diodes • Fully Crystal-Controlled • Self-Contained Rechargeable Batteries • Plug-in Battery Charger • Provision for External Antenna • Lightweight—Weighs Less than 2 1/2 lbs.

Full 2 watts RF input—offers up to 10 mile range over favorable terrain. 2-channel operation. Receiver employs a superheterodyne circuit with 1 RF and 2 IF stages for high sensitivity, push-pull audio for high output and undistorted sound plus a variable squelch control. Automatic gain control circuit maintains uniform sound level. Automatic Noise Limiting circuit reduces ignition and other electrical noise. Uses rugged silicon transistors in output circuit for greater reliability. 10-section, chrome-plated telescopic antenna plus receptacle for external antenna with plug-in crystals for channels 10 and 15.

8 3/4 x 3 1/2 x 2". Black metal case with chrome trim and silvered grill. Imported. Shpg. wt., 4 1/2 lbs.

99 A 3069L \$5 Monthly Net 84.95

Extra Transmit Crystal. Specify Channel	Net	2.25
42 A 4204C	Net	2.25
Extra Receive Crystal. Specify Channel	Net	2.25
42 A 4205C	Net	2.25
Replacement NiCad Battery (2 req.)	Net Each	10.75
99 A 3070	Net Each	10.75

SALE!
NOW ONLY
84⁹⁵ Each
SAVE 15.00

PRICE INCLUDES

- 2 Nickel Cadmium Batteries
- Plug-in 117V 50/60 Cycle Battery Charger
- Earphone
- Crystals for 2 Channels
- Leather Case with Strap



LAFAYETTE MODEL HA-150 2-CHANNEL 1-WATT ALL-TRANSISTOR PORTABLE CB TRANSCEIVER

- Meter for Indicating Battery Strength & Modulation Level
- An External Push-to-Talk Dynamic Microphone for Greater Effective Range
- Complete with 2-Pair Plug-In Transmit/Receive Crystals
- 13-Transistor 5-Diode Circuit
- Push-Button Operated
- Self-Contained Batteries or Powered by External 12-Volt DC Supply
- Lightweight — Weighs only 4 lbs.

Full 1-watt RF input...up to 6-mile range...quick-release battery compartment. 4 convenient push buttons give you complete control. It can be carried, or used on a desk, table, car or boat. Receiver has high 1mv. sensitivity, push-pull audio, and large 3-inch speaker for clear, full-tone reproduction. Complete with channel 10 and 15 plug-in crystals (2 transmit, 2 receive), batteries, push-to-talk dynamic microphone, leather carrying case, earphone. Dimensions: 9 1/2 x 2 1/4 x 5 1/2" D Imported. Shpg. wt., 7 lbs.

99 A 3014L \$5 Monthly	Net	69.95
Two or More	Net ea.	68.95
99 A 6257 1.5-volt "C" cell (8 required)	Net ea.	.13
42 A 4204C Extra transmit Crystal. Specify Channel	Net	2.25
42 A 4205C Extra Receive Crystal. Specify Channel	Net	2.25
42 A 3206 Ext. Antenna Socket Adaptors PL-259 to HA-150	Net	.54

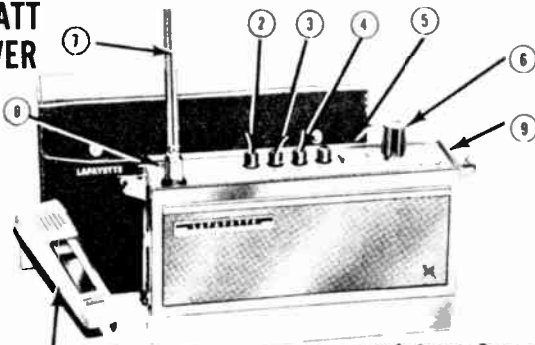

SALE! 68⁹⁵ Each 2 or More
NOW ONLY

1. PLUG-IN PUSH-TO-TALK DYNAMIC MICROPHONE
2. CHANNEL SELECTOR
3. SQUELCH
4. AUTOMATIC NOISE LIMITER
5. MODULATION-BATTERY INDICATOR SWITCH/METER
6. POWER ON-OFF/VOLUME
7. TELESCOPING WHIP ANTENNA
8. EXTERNAL BATTERY SOCKET
9. EARPHONE CACKET

LAFAYETTE Model HB-555 Mobile-Ade 5-WATT Solid-State Mobile CB Transceiver

only 2 1/8" High

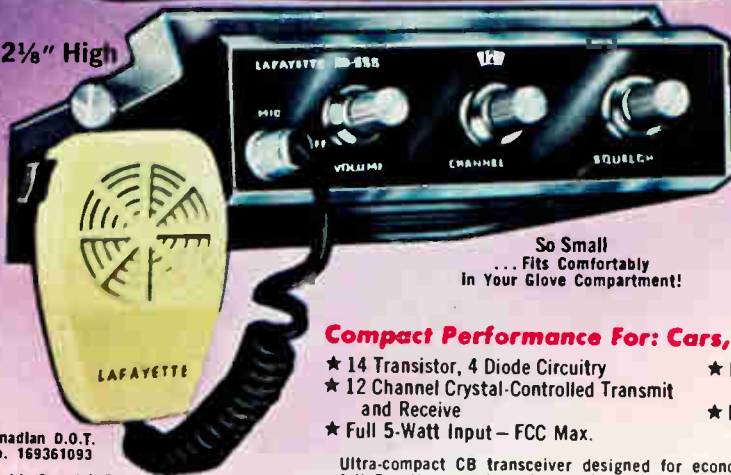

Only **99⁹⁵**

No Money Down

Business

FOR: Personal Use

Emergency H.E.L.P.

So Small
... Fits Comfortably
In Your Glove Compartment!

Compact Performance For: Cars, Trucks, Boats, Taxis, etc.

- ★ 14 Transistor, 4 Diode Circuitry
- ★ 12 Channel Crystal-Controlled Transmit and Receive
- ★ Full 5-Watt Input - FCC Max.
- ★ Double Conversion Superhet with 455 KC Mechanical Filter
- ★ Push-Pull Audio Amplifier-Modulator

Canadian D.O.T.
No. 169361093

- Variable Squelch Control Plus Automatic Series Gate Floating Noise Limiter
- Large Self-Contained 3 x 5 Inch Speaker
- Push-To-Talk Plug-In Microphone
- For 12 Volts DC Negative or Positive Ground or 117 Volts AC with Optional AC Power Supply
- Supplied with Pair of Channel 9 Crystals for CB and Emergency Mobile Aid through H.E.L.P.

Ultra-compact CB transceiver designed for economical and rugged operation. MOBIL-ADE's full 5-watt transmitter input with highly efficient push-pull audio modulation gives you a husky signal to punch through crowded CB channels. Razor sharp selectivity and fine adjacent channel rejection is achieved by the 455 KC mechanical filter. An excellent choice for both business and personal applications. Sensitivity: .7 μ v. for 10 db signal to noise ratio. Unit has socket for direct use with Lafayette PRIVA-COM II selective call unit. Supplied with microphone, sturdy mobile mounting bracket, power cable, and a pair of channel 9 crystals. Size: 5 3/4" W x 7 1/8" D x 2 1/8" H. Shpg. wt., 7 lbs. Imported.

99 A 3049WX 12 Volt DC 55 monthly	Net 99.95
42 A 0907C Additional Transmit Crystal (Specify Channel)	Net 2.25
42 A 0137C Additional Receive Crystal (Specify Channel)	Net 2.25
SOLID-STATE AC POWER SUPPLY for 117 Volt AC base station use.	
99 A 3028W Model HB-501 Shpg. wt., 10 lbs. Imported	Net 16.95

LAFAYETTE HE-20d Citizens Band Transceiver

FAMOUS CB FAVORITE...NOW ALL-TRANSISTOR PLUS 2 POWER TUBES



THE HE-20d AT AN
AMAZINGLY LOW PRICE

89⁹⁵

No Money Down

- Powerful Tube Transmitter for Maximum FCC Output
- Built-in 115 VAC and 12 VDC Solid-State Power Supplies
- Complete with Channel 9 Transmit and Receive Crystals
- Professional Styling, Attractive Aluminum Knobs
- Jack for Public Address Speaker or for Private Listening Earphone

- ★ 10 Transistors, 2 Tubes, 10 Diodes
- ★ 12 Position Crystal-Controlled Transmit and Receive—23 Channel Tuneable Receiver
- ★ All Transistor Superhet Receiver with .5 μ v Sensitivity
- ★ Mechanical Filter for Superior Selectivity
- ★ 100 Milliwatt and 5 Watt Operation

PLUS

- Illuminated "S" and Relative RF Power Meter
- Illuminated 23-channel Tuning Dial
- Variable Squelch Plus Automatic Series Gate Noise Limiting for Minimum Mobile and Interstation Noise
- Push-to-talk Dynamic Microphone for Enclosed Relay Switching
- Pi-Network Output Matches 30 to 100 Ohm Antennas

Lafayette's outstanding addition to the famous HE-20 series of fine performing CB transceivers. Special two-way power switch permits normal 5 watt or 100 milliwatt operation. Spotting switch permits channel tuning with pin-point accuracy. Supplied with mounting bracket, push-to-talk dynamic microphone, AC and DC power cords plus a set of crystals for channel 9. Size: 12 3/4" W x 5 H x 7 1/2" D. For 115 V.A.C. and 12 V.D.C. Shpg. wt., 14 lbs. Imported.

99 A 3052WX \$5 monthly	
42 A 0136C Transmit Crystal (specify channel)	Net 89.95
42 A 0137C Receive Crystal (specify channel)	Net 2.25
Civil Aeronautics Patrol Crystals (26.62 Mc)	Net 2.25
42 A 0136C Transmit Crystal, Specify 26.62 Mc	Net 2.25
42 A 0137C Receive Crystal, Specify 26.62 Mc	Net 2.25

LAFAYETTE HB-115A Push-To-Talk CB Transceiver

Now With Switch For 5 Watt and 100 Milliwatt Operation

SALE! SAVE 5.00
NOW ONLY **49⁹⁵**

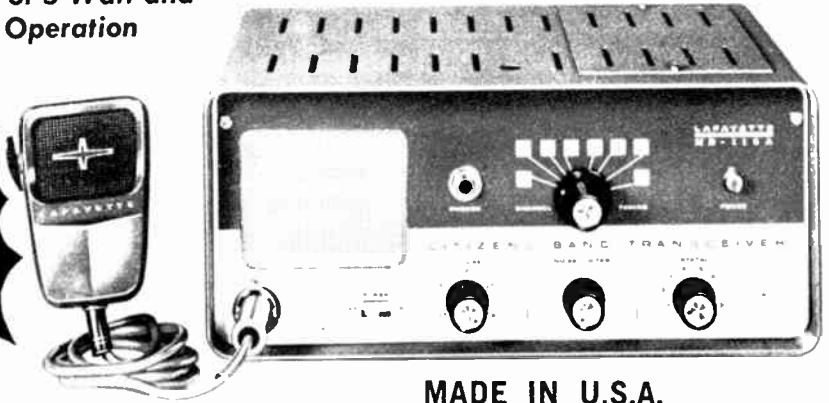

MADE IN U.S.A.

- 12 Tube Functions, Plus 1 Diode, Plus 2 Silicon Rectifiers
- 8 Crystal-Controlled Transmitting Positions
- Tunable Superheterodyne Receiver Over All 23 Channels
- Push-to-Talk Plug-In Ceramic Microphone
- Pi-Network for Maximum Power Output
- Full-Wave Variable Noise Limiter

The HB-115A features 8 crystal-controlled transmitting channels operating at the maximum legal input power of 5 fully modulated watts as well as a lower power level of 100 milliwatts; a pi-network output which matches 30-100 ohm antennas for maximum output; and an RF stage in transmit and receive sections. The superheterodyne receiver is tunable on all 23 channels with over 2 watts audio output, has Automatic Volume Control and a very effective fullwave variable Noise Limiter. Features a front panel speaker/earphone jack for an extra external speaker or for an earphone or headset for quiet listening; and a separate on-off power switch for trouble-free operation.

Power receptacle in rear for 115-volt AC line cord and 6 or 12 volt

external mobile power supply. Supplied complete with Channel 14 transmitting crystal, efficient push-to-talk ceramic microphone, and mounting brackets. 6 or 12-volt power supply optional (see below). Size: 11½Wx5Hx6¾"D. Shpg. wt., 13 lbs.

- | | |
|--|--------------|
| 42 A 0101WX \$5 Monthly | 49.95 |
| POWER SUPPLY: Adapts HB-115A for mobile operation. Complete with cable and mounting flanges. Size: 6Wx4Hx4¼"D. Shpg. wt., 4 lbs. | |
| 42 A 0102W For 12 Volts | Net 11.50 |
| 42 A 0103W For 6 Volts | Net 11.50 |
| TRANSMITTING CRYSTALS: For any of the 23 channels. | |
| 42 A 4201C Specify channel or frequency | Net 2.25 |

LAFAYETTE HB-200 Dual Conversion Deluxe CB Transceiver

- Dual Conversion for Exceptional Selectivity and Gain
- 9 Tubes plus 3 Silicon Diodes plus 2 Crystal Diodes for 17 Tube Performance
- 8 Crystal Receive Positions plus 8 Crystal Transmit Positions plus 23-Channel Tunable Receive
- Spotting Switch for Exact Frequency Location on Tunable Receive
- Wired to Accept "PRIVA-COM™" Selective Call Unit
- Super Sensitivity—1-Microvolt or less
- Built-in 117-Volt AC Power Supply with 12-Volt DC Mobile Transistorized Power Supply
- Dual Cascade Series Gate Noise Limiter
- 13 MC Transmit Crystal for Extra Stability

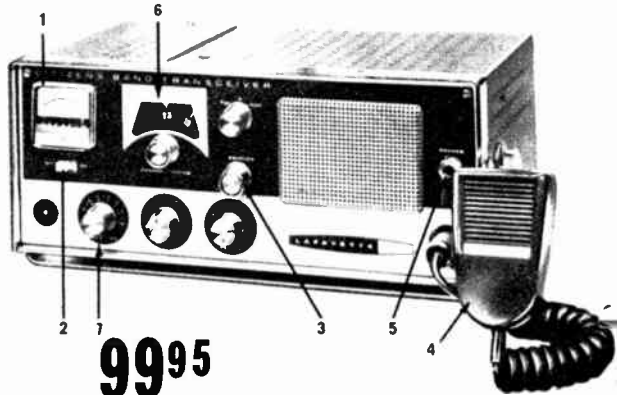

99⁹⁵

No Money Down
\$5 monthly

MADE IN U.S.A.

Now With Switch For 5 Watt and 100 Milliwatt Operation

The excellent selectivity and gain of its dual conversion receiver makes the Lafayette HB-200 a natural for efficient fixed and mobile communications over distances of up to 20 miles or more, depending on the terrain and the height of the antenna. It incorporates a Pi-network for matching the output to 30-100 ohm antennas for maximum signal output; input socket on rear of chassis for silent communications between calls when used with Lafayette PRIVA-COM™ selective call unit. Complete with bracket handle, efficient Push-to-Talk Ceramic Microphone, pair of transmit and receive crystals for channel 14 plus crystal for dual conversion, and built-in 117-volt AC Power Supply with 12 volt DC Mobile Transistorized Power Supply. Size: 12x5x8½"D. Shpg. wt., 15 lbs.

- | | |
|--|-----------|
| 42 A 0118WX | Net 99.95 |
| 42 A 4701C 13 MC Transmit Crystal (Specify Channel) | Net 2.25 |
| 42 A 4202C Receive Crystal (Specify Channel) | Net 2.25 |
| Direct Plug-in Antenna for Short Distances. Shpg. wt., 1 lb. | |
| 99 A 3015 | Net 3.95 |

- 1 Illuminated Meter Indicates "S" Readings, Relative Power Output, and Modulation
- 2 Spotting Switch Pinpoints Tuneable Receiver Frequency
- 3 Adjustable Squelch
- 4 Relay Switching Push-to-Talk Ceramic Microphone
- 5 Phone Jack for Quiet Listening
- 6 Illuminated Dial
- 7 Channel Selector Switch

See Page 11 for Complete Base Station (Home, Office, etc.) and Mobile Systems with Models HB-200 and HB-115A.



- FEATURES**
1. Range Boost Switch
 2. Illuminated S/R/F Meter
 3. Single-Knob Channel Selector
 4. Modulation Indicator Light
 5. CB/Public Address Switch
 6. Headphone/External Speaker Jack
 7. Positive-Lock Mike Connector
 8. 2.5 KC Fine Tuning Vernier
 9. Volume Control-Power Switch
 10. Adjustable Squelch Control with Standby Switch for Low Drain Instantaneous Operation
 11. PTT Ceramic Microphone

LAFAYETTE Comstat™ 25 25-Channel Crystal Controlled Range Boost™ CB Transceiver

23 CB plus 2 Emergency H.E.L.P.* Channels-All Crystals Supplied! Obsoletes All 23 Channel Crystal Control CB Transceivers!

139⁹⁵

- 15 Tube Performance with 10 Tubes, 2 Transistors and 9 Diodes
- Built-in 117 VAC, 12 VDC Solid-State Power Supply
- Dual Conversion Receiver Features 8/10 μ v Sensitivity
- Final Utilizes Pi-Network and Low Pass Filter for Maximum Power Output
- 5-Watt/100-Milliwatt Selector Switch (Rear)

Exclusive Range Boost circuit greatly increases the average talk power. Fine tuning vernier control with 2.5 KC total bandspread simplifies precise zeroing-in on frequency. Highly selective circuits greatly suppress adjacent channel interference (-45 db) and a variable squelch effectively quiets the receiver between calls. Switchable power level allows operation at 100 milliwatts for transmission over short distances. Illuminated front panel meter indicates relative RF output in transmit position and doubles as an S-meter during reception. Front panel switch converts transceiver to a

handy 4.5 watt public address amplifier. Comstat 25 features push-to-talk relay switching and a plug-in ceramic microphone with coiled cord. Rear socket is pre-wired to accept Lafayette PRIVA-COM selective call unit. Supplied with vari-tilt mounting bracket. Size: 12Wx8½Dx5"H. Shpg. wt., 16 lbs. 99 A 3065WX Shpg. wt., 16 lbs. \$7.50 monthly Net 139.95

* Automobile Mfg. Association H.E.L.P. Application Pending Before Federal Communications Commission.

- FEATURES**
1. Channel Selector. 25 Positions; 23 for CB and 2 for Choice of Licensed Business Band Frequency.
 2. Illuminated "S" and RF Power Meter.
 3. Jack for Headphone or Speaker.
 4. Squelch/PA. Quiets Receiver between Calls. Counterclockwise for PA.
 5. Triple-crystal Delta Fine Tune.
 6. Noise Limiter Selects A) Audio Noise Limiter plus RF Noise Silencer, B) Audio Noise Limiter plus RF Noise Silencer.
 7. Dynamic PTT Microphone for Plug-in sealed Relay Switching.
 8. Range Boost for More "Talk Power"
 9. Speaker 5x3" PM Type.



S9 Magazine 1965
"At the least, the HB-600 is a major breakthrough in CB communications..."

* FCC Type Accepted

LAFAYETTE Model HB-600 Solid State "CB Commander" 28 Channel Crystal Controlled Range Boost™ Transceiver

23 CB Channels Plus Choice From 5 Business Band* Channels

219⁹⁵

- Unique RF Noise Silencer (Pat. Pend.)
- 21 Transistors, 13 Diodes—Draws 1 Ampere Maximum on Full Transmit!
- Mechanical Filter for Ultra Selectivity and Adjacent Channel Rejection
- Ultra-Stable Circuit—27 CB Crystals Supplied!—No More to Buy!
- Dual Conversion Receiver with 3-Crystal Delta Tuning
- Pi-Network Output with Low Pass Filter
- Plug-in Facilities for Selective Call Unit
- Solid State AC DC Power Supplies
- "Quick-release" Mobile Mounting Bracket

The "CB Commander" offers every feature you'll ever want in a 3-way CB transceiver—PLUS provision for Business Band* operation. Its 2 extra crystal positions let you choose from 5 Business Band frequencies—27.235, 27.245, 27.255, 27.265 or 27.275MC. Business Band* operation permits increased antenna height—gives you greater range and coverage—and less crowding! Range Boost circuit increases average modulation and lets your voice cut through noise to reach farther. A dual conversion receiver provides high sensitivity—pulls in even the weak signals. RF Noise Silencer (PAT. Pend.) provides spectacular ignition noise reduction. Also

features built-in solid state AC and DC power supply for low drain operation on 117 VAC or 12 VDC (Neg. or Pos. Gnd.). Dimensions: 4¾" high, 11 13/16" wide, 8" deep. Shpg. wt., 11 lbs. Imported. 99 A 3071WX Net 219.95

Business Band Crystals.* Specify one of the following frequencies for which you have received Business Radio License—27.235, 27.245, 27.255, 27.265, or 27.275 Mc. \pm .001% 42 A 0132C Only 1 Crystal Required Net ea. 4.95

NEW! LAFAYETTE Model HB-444/25 Deluxe 25-Channel Crystal Controlled Range Boost 5 Watt CB Transceiver

23 CB plus 2 Emergency H.E.L.P.* Channels-All Crystals Supplied!

Obsoletes All 23 Channel Crystal Control CB Transceivers!



Features

- 1 Illuminated "S" and RF Power Meter
 - 2 Variable Noise Limiter/Off
 - 3 Variable Squelch
 - 4 Triple Crystal Delta Tune
 - 5 CB/P.A. Volume Control and Switch
 - 6 "Range Boost™"
 - 7 Phone and External Speaker Jack
 - 8 Illuminated Function Indicator Strip
 - 9 Channel Selector
 - 10 Illuminated Channel Indicator
 - 11 100 MW Switch
 - 12 Selective Call Socket Accepts PRIVA-COM™ for Silence Between Calls
- * Automobile Mfr's. Association's Mobile Emergency H.E.L.P. Application Pending Before F.C.C.

**13 TUBES
8 DIODES**

179⁹⁵

NO MONEY DOWN

Advanced Full Wave
"Range Boost™"
Circuit

- Dual Conversion Receiver with 3/10 μ v Sensitivity.
- 17 Tube Performance with 13 Tubes (2 Nuvistors) and 8 Diodes
- Low Noise Nuvistor "Front End"
- 13 Crystal Frequency Synthesized Circuit Provides 23 Crystal-Controlled Transmit & Receive CB Channels Plus 2 For H.E.L.P.—No Extra Crystals to Buy!
- Triple Crystal Delta Tuning Offers \pm 2.5 KC Fine Tuning on Receive
- Built-in Solid State 117 VAC & 12 VDC Power Supplies
- Deluxe Metal Cased PTT Ceramic Microphone
- Extruded Front Panel with Illuminated Function Indicator Strip
- 5 Watt—100 Milliwatt Switch

Features complete crystal control transmit and receive facilities on all 23 CB channels and on two pending mobile emergency frequencies—requires NO extra crystals! The famous "Range Boost" circuit increases modulation percentage to cut through crowded channels. 5-watt/100-milliwatt switch enables you to reduce power instantly! Great for Mobile and Base operation. The HB-444/25 contains a built-in solid state power supply for both 12 VDC and 117 VAC operation. Rear socket accepts the Lafayette PRIVA-COM™ selective calling unit. With its fully ventilated metal case, graceful front panel, aluminum knobs, illuminated "S"/RF Power meter, and function indicator panel strip, the HB-444/25 is the perfect CB unit for the home, car, office, boat or truck! A specially designed "Vari-Tilt" mounting bracket, crystals, PTT microphone, and two power cables are included. Size: 12Wx8½Dx5"H. Shpg. wt., 20 lbs. Imported.

99 A 3064WX \$9 Monthly Net 179.95

LAFAYETTE Model HB-500A Solid-State 5 Watt Dual Conversion Citizens Band Transceiver

SMALL — QUIET — POWERFUL



ONLY **109⁹⁵**

NO MONEY DOWN

- 12 Crystal Transmit and Receive Positions
- 23 Channel Tunable Receiver with Spotting Switch for Pinpointing Channel
- Dual Conversion with 5/10 μ v Sensitivity
- Mechanical Filter for Razor Sharp Selectivity and Adjacent Channel Rejection
- 15 Transistors, 4 Diodes, plus 1 Thermistor
- "S" Meter and 5x3" Front-mounted Speaker
- Dependable Sealed Relay Switching
- Panel-controlled Variable Squelch
- \pm .003% Crystals Exceed FCC Spec.

Canadian D.D.T. Approval
No. 169361086

In addition to the outstanding features above, this fine solid state CB transceiver has a powerful push-pull circuit that supplies up to 2.7 watts of audio into a big 5x3" front-mounted speaker. A powerful 3-stage transmitter offers full modulation capability—you can lower your voice to a whisper and still hit 100% modulation! 9 rugged heat-resistant silicon mesa transistors in critical areas assure dependable, failure-free operation. Other features include ear-phone jack and illuminated channel dials. Supplied complete with special easy-mount mobile bracket with exclusive "quick-release" feature, push-to-talk dynamic microphone and .003% tolerance transmit and receive crystals for channel 9. For operation on 12V DC negative or positive ground with DC cable supplied. Size: 3Hx11½Wx 6¼"D. Shpg. wt., 12 lbs.

Model HB-500A \$7.50 Monthly
99 A 3050WX Net 109.95

Receive crystal (specify channel) \pm .003%
42 A 0908C Net 2.25

Transmit crystal (specify channel) \pm .003%
42 A 0142C Net 2.25

HB-500A C.A.P. CRYSTALS (26.620 mc)
Transmit Specify Ch. 10
42 A 4205C Net 2.25
42 A 0142 Receive Crystal Net 2.25

Model HB-501 Solid State AC Power supply
for HB-500 for fixed station operation (at home, business, office). Size: 11½x6¼x 2½". Shpg. wt., 10 lbs.
99 A 3028W Net 16.95

QUALITY
MECHANICAL
FILTER

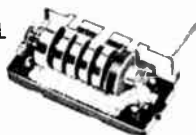

Advanced circuit features include a costly mechanical filter that provides razor-sharp selectivity . . . virtually eliminates interference from stations on adjacent channels—a quality exclusive feature not generally found in other CB units!

LAFAYETTE Comstat 9™ 5-Watt Citizens Band Transceiver Kit

- 9-Crystal-Controlled Transmit and Receive Channels
- Front Panel Transmit and Receive Crystal Socket
- 23-Channel Tuneable Receiver
- High-Efficiency 7-Tube Circuit
- 5-Watt or 100-Milliwatt Operation
- 115 VAC and 12 VDC Power Supply
- Pi-Network Antenna Matching

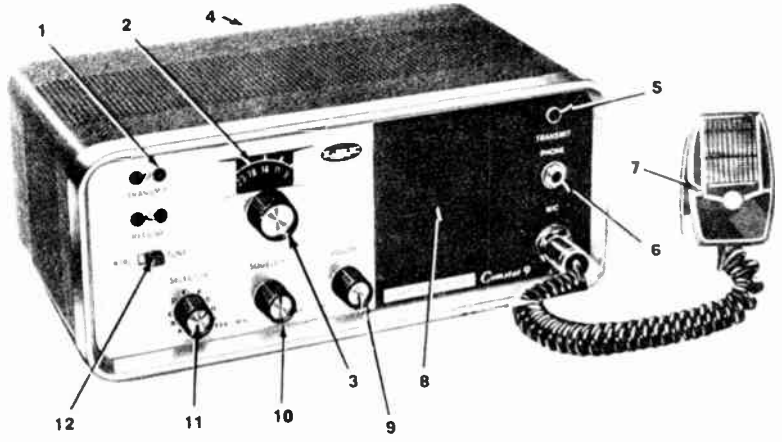

59⁹⁵
NO MONEY DOWN

FOR 5-WATT AND 100-MILLIWATT OPERATION

Purchase this carefully engineered kit and save yourself dollars by wiring it yourself. Efficient 7-tube circuitry, top quality parts, plus Lafayette's famous easy-to-follow directions combine to give you unexcelled construction satisfaction as well as a CB transceiver with excellent performance. Incorporates 9 crystal controlled receive and transmit channels with an integrated tuneable 23-Channel receiver section for exceptional operating flexibility. Sensitive superheterodyne receiver features effective series floating gate noise limiter and a tuned RF amplifier for high gain and low noise reception. Sensitivity 1 μ v for 10 db. S/N ratio. Selectivity: -21 db at 8 KC. Adjacent Channel Rejection: -31 db. Adjustable squelch circuit insures quiet stand-by operation. Transmitter provides full 5-watt input with up to 100% plate modulation. Front panel light indicates modulation. Short range operation for use as intercom, at CB jamborees, etc. is facilitated by a 100 milliwatt switch. Output impedance: 50 ohms. Ceramic microphone features plug-in push-to-talk operation and coiled cord. External crystal sockets mounted on front panel for added flexibility. Built-in power supply operates on 117 VAC or 12 volts DC.

Kit comes complete with parts, wire, solder, easy-to-follow manual, microphone, and sturdy attractive metal cabinet. Less crystals and vibrator. 12Wx4 $\frac{1}{2}$ Hx7 $\frac{3}{8}$ "D. Shpg. wt., 20 lbs.

42 A 0915WX \$5 monthly	Net 59.95
42 A 4701C Transmit Crystal Specify Channel	Net 2.25
42 A 0914C Receive Crystal Specify Channel	Net 2.25
OPTIONAL DC ACCESSORIES	
42 A 0916 Mobile Mounting Bracket	Net 1.50
42 A 0917 DC Cable Assembly for 12V DC	Net 1.50
32 A 5603 Standard 12v. Vibrator	Net 1.89

or	
QUIAT-COM (TM) Solid-State Vibrator	
42 A 0121 Shpg. wt., 1 lb.	Net 5.95

Features

1. Front Panel Crystal Sockets
2. Illuminated Vernier Tuning Dial
3. Tuneable Receive Dial Control
4. 5-Watt or 100 Milliwatt Switch (Rear)
5. Modulation Indicator
6. Phone Plug for Earphone Listening
7. Plug-In Push-to-Talk Ceramic Mike
8. Front Panel Speaker
9. Volume Control/Power Switch
10. Variable Squelch
11. 9-Channel Crystal Transmit-Receive Selector Switch
12. Xtal-Tune Receiver Mode Switch

MONEY-SAVING CB PACKAGES WITH COMSTAT 9 KIT

Base Station Package

	74⁵⁰	Lafayette Comstat 9 CB Transceiver Kit	59.95
		Lafayette Heavy Duty Ground Plane Antenna	11.95
	SAVE 3.90	50 Ft. RG-8/U Low Loss Poly-foam Coaxial Cable Assembly	6.50
From Individual Catalog Prices		TOTAL	78.40
42 A 9042WXM Shpg. wt., 31 lbs.		Net 74.50	



Mobile Station Package

	64⁹⁵	Lafayette Comstat 9 CB Transceiver Kit	59.95
		Stainless Steel CB Body Mount Antenna	6.95
	SAVE 4.10	20 Ft. RG-58/U Coaxial Cable Assembly	2.15
From Individual Catalog Prices		TOTAL	69.05
42 A 9040WXM Shpg. wt., 25 lbs.		Net 64.95	

LAFAYETTE HA-85A 6-TRANSISTOR SUPERHETERODYNE CITIZENS BAND "WALKIE TALKIE"

- 6 Transistors Plus 2 Diodes
- Transmits and Receives up to 1 Mile
- Leather Case with Shoulder Strap

ONLY 16⁵⁰ each
When You Buy Two or More

Small enough to slip into your pocket. In attractive metal case with leather carrying case and shoulder strap. Complete with earphone in addition to built-in speaker, telescoping antenna, 6 penlight batteries and a pair of crystals for channel 10. Size: 6 $\frac{1}{2}$ x2 $\frac{3}{4}$ x1 $\frac{3}{8}$ " Imported. Shpg. wt., 2 $\frac{1}{2}$ lbs.

99 A 3061L Model HA-85A	Net 16.88
Two or More	Net Ea. 16.50
42 A 4204C Transmit Crystal, Specify Channel	Net 2.25
42 A 4205C Receive Crystal, Specify Channel	Net 2.25
99 A 3012 AC Power Supply. Wt. 2 lbs.	Net 6.95
99 A 6258 "Z" Batteries, 6 required.	Net .095

Plug-in Transmit and Receive Crystals . . . Simple Operation on Any of CB Channels.



Buy Now! Pay Later . . . Use Lafayette's Easy Pay Plan. No Money Down

LAFAYETTE Money-Saving CB Packages

LAFAYETTE MODEL HB-555 SOLID STATE CB MOBILE SYSTEMS



Save 4.10
from Individual Catalog Prices

Package Price
104⁹⁵
No Money Down

ALTERNATES

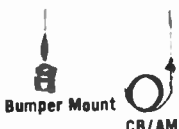

Model HB-555 Solid State CB Transceiver	99.95
All Stainless Steel Body-Mount Whip Antenna	6.95
20 Ft. RG-58/U Coaxial Cable Assembly	2.15
TOTAL	109.05

42 A 9022WXM Shpg. wt., 12 lbs. Net 104.95
Alternate HB-555 Mobile Systems

Same as 42 A 9022WXM except with double chain bumper mount antenna with stainless steel whip instead of body-mount antenna.
42 A 9023WXM Shpg. wt., 15 lbs. Net 112.95
Same as 42 A 9022WXM except with CB/AM 46" telescoping chrome plated cowl mount antenna for both car AM broadcast radio and CB transceiver instead of body-mount whip antenna and coaxial cable assembly.
42 A 9024WXM Shpg. wt., 11 lbs. Net 105.80

LAFAYETTE MODEL HB-600 SOLID STATE CB SYSTEMS

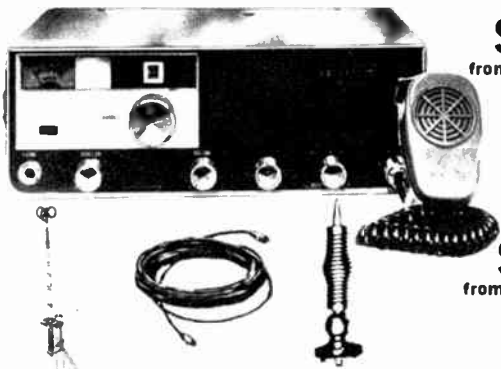

Save 12.45
from Individual Catalog Prices

Package Price
233⁹⁵
No Money Down

Save 11.10
from Individual Catalog Prices

Package Price
217⁹⁵

Base Station System

LAFAYETTE HB-600 28 Channel Solid State Range Boost™ Transceiver	219.95
Lafayette 'Range Boost'™ 1/2 Wave Antenna	19.95
50 Ft. RG-8/U Low-Loss Polyfoam Coaxial Cable Assembly	6.50
TOTAL	246.40

42 A 9044WXM Shpg. wt., 28 lbs. Net 233.95
Same as above with 100 Ft. RG-8/U cable assembly
42 A 9045WXM Shpg. wt., 32 lbs. Net 238.40

Mobile Station System

LAFAYETTE Model HB-600 Solid State CB Transceiver	219.95
LAFAYETTE All-Stainless Steel Body Mount Antenna	6.95
20 Ft. RG-58/U Coaxial Cable Assembly	2.15
TOTAL	229.05

42 A 9046WXM Shpg. wt., 16 lbs. Net 217.95

LAFAYETTE MODEL HE-20D FIXED AND MOBILE CB SYSTEMS

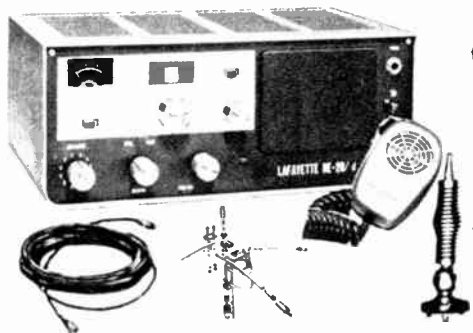

Save 5.45
from Individual Catalog Prices

Package Price
102⁹⁵

Save 5.10
from Individual Catalog Prices

Package Price
93⁹⁵

Base Station System

LAFAYETTE Model HE-20D CB Transceiver	89.95
Heavy-Duty Ground Plane Antenna	11.95
50 Ft. RG-8/U Low-Loss Polyfoam Coaxial Cable Assembly	6.50
TOTAL	108.40

42 A 9028WXM Shpg. wt., 25 lbs. Net 102.95

Mobile Station System

LAFAYETTE Model HE-20D CB Transceiver	89.95
All Stainless Steel Body Mount Antenna	6.95
20 Ft. RG-58/U Coaxial Cable Assembly	2.15
TOTAL	99.05

42 A 9029WXM Shpg. wt., 19 lbs. Net 93.95

LAFAYETTE MODEL HB-500A SOLID STATE CB SYSTEMS

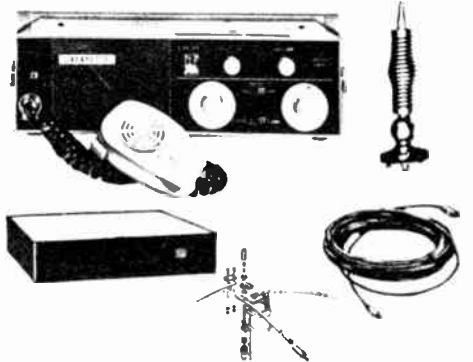

Save 6.10
from Individual Catalog Prices

Package Price
112⁹⁵
No Money Down

Save 7.40
from Individual Catalog Prices

Package Price
137⁹⁵

Mobile Station System

LAFAYETTE Model HB-500A Solid State C.B. Transceiver	109.95
All Stainless Steel Body Mount Antenna	6.95
20 Ft. RG-58/U Coaxial Cable Assembly	2.15
TOTAL	119.05

42 A 9047WXM Shpg. wt., 17 lbs. Net 112.95

Base Station System

Model HB-500A Solid State CB Transceiver	109.95
Model HB-501 Solid State AC Power Supply	16.95
50 Ft. RG-8/U Low-Loss Polyfoam Coaxial Cable Assembly	6.50
Heavy-Duty Ground Plane Antenna	11.95
TOTAL	145.35

42 A 9048WXM Shpg. wt., 33 lbs. Net 137.95

LAFAYETTE Money-Saving CB Packages

LAFAYETTE COMSTAT™ 25 CITIZENS BAND SYSTEMS

Base Station System

Lafayette Comstat™ 25 25 Channel Crystal Controlled CB Transceiver	139.95
Heavy-Duty Ground Plane Antenna	11.95
50 Ft. RG-8/U Low-Loss Polyfoam Coaxial Cable Assembly	6.50
TOTAL	158.40
42 A 9051WXM Shpg. wt., 27 lbs. Net	149.95

Mobile Station System

Lafayette Comstat™ 25 25 Channel Crystal-Controlled CB Transceiver	139.95
All Stainless-Steel Body Mount Antenna	6.95
20 Ft. RG-58/U Coaxial Cable Assembly	2.15
TOTAL	149.05
42 A 9052 WXM Shpg. wt., 21 lbs. Net	141.50

SAVE 8.45

from Individual Catalog Prices

Package Price

149⁹⁵

No Money Down

SAVE 7.55

from Individual Catalog Prices

Package Price

141⁵⁰

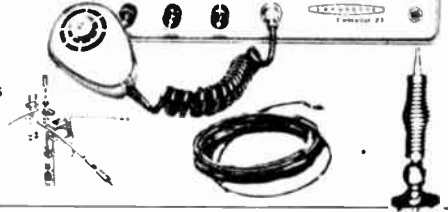

LAFAYETTE MODEL HB-444/25 CITIZENS BAND SYSTEMS

Base Station System

Lafayette HB-444/25 25 Channel Crystal-Controlled CB Transceiver	179.95
Heavy-Duty Ground Plane Antenna	11.95
50 Ft. RG-8/U Low Loss Polyfoam Coaxial Cable Assembly	6.50
TOTAL	198.40
42 A 9049WXM Shpg. wt., 31 lbs. Net	187.95

Mobile Station System

Lafayette HB-444/25 25 Channel Crystal-Controlled CB Transceiver	179.95
Stainless-Steel Body Mount Antenna	6.95
20 Ft. RG-58/U Coaxial Cable Assembly	2.15
TOTAL	189.05
42 A 9050WXM Shpg. wt., 25 lbs. Net	181.95

SAVE 10.45

from Individual Catalog Prices

Package Price

187⁹⁵

No Money Down

SAVE 7.10

from Individual Catalog Prices

Package Price

181⁹⁵

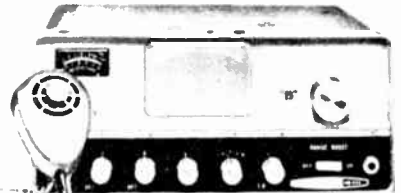

LAFAYETTE MODEL HB-200 CITIZENS BAND SYSTEMS

Base Station System

Lafayette Model HB-200 CB Transceiver	99.95
Heavy-Duty Ground Plane Antenna	11.95
50 Ft. RG-8/U Low-Loss Polyfoam Coaxial Cable Assembly	6.50
TOTAL	118.40
42 A 9036WXM Shpg. wt., 26 lbs. Net	112.50

Mobile Station System

Lafayette Model HB-200 CB Transceiver	99.95
All Stainless Steel Body Mount Antenna	6.95
20 Ft. RG-58/U Coaxial Cable assembly	2.15
TOTAL	109.05
42 A 9037WXM Shpg. wt., 19 lbs. Net	103.50

SAVE 5.90

from Individual Catalog Prices

Package Price

112⁵⁰

No Money Down

SAVE 5.55

from Individual Catalog Prices

Package Price

103⁵⁰

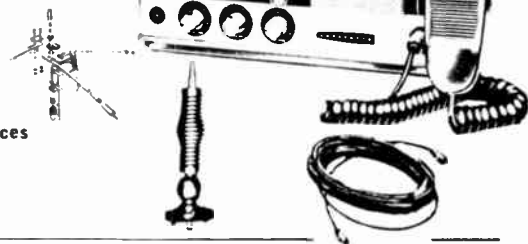

LAFAYETTE MODEL HB-115A CITIZENS BAND SYSTEMS

Base Station System

Lafayette Model HB-115A CB Transceiver	49.95
Heavy-Duty Ground Plane Antenna	11.95
50 Ft. RG-8/U Low-Loss Polyfoam Coaxial Cable Assembly	6.50
TOTAL	68.40
42 A 9038WXM Shpg. wt., 24 lbs. Net	64.50

Mobile Station System

Lafayette Model HB-115A CB Transceiver	49.95
Stainless Steel Body Mount Antenna	6.95
20 Ft. RG-58/U Coaxial Cable Assembly	2.15
12-Volt DC Power Supply	11.50
TOTAL	70.55
42 A 9039WXM Shpg. wt., 22 lbs. Net	66.50

SAVE 3.90

from Individual Catalog Prices

Package Price

64⁵⁰

No Money Down

SAVE 4.05

from Individual Catalog Prices

Package Price

66⁵⁰

No Money Down

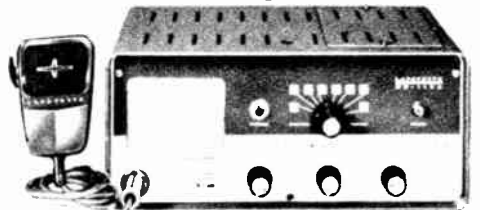

LAFAYETTE PRIVA-COM® II Selective Caller

FOR 12 VOLT SOLID STATE TRANSCEIVERS

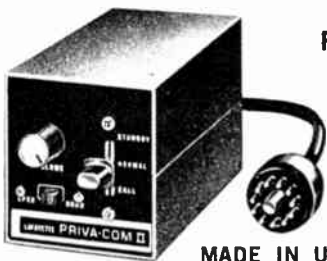

MADE IN USA

- Choice of 10 Dual Frequency Codes
- For Quiet, Private Communications
- Operates Horn or Other External Device for 1 Second When Transceiver is Unattended
- Fully Compatible With All LAFAYETTE PRIVA-COM Selective Callers

32⁵⁰

2 for
62.50

Plugs Directly into LAFAYETTE HB-600 and HB-555.
Plugs Directly into LAFAYETTE HB-500 and Other 12 Volt Transistorized Transceivers after Installation of Priva-Com Conversion Kit.

PRIVA-COM II CONVERSION KIT

Converts HB-500 and all 12 volt transistorized transceivers not equipped with a PRIVA-COM socket for direct plug-in use with PRIVA-COM II. Consists of socket, color coded wire, hardware and installation instructions. Shpg. wt., 8 oz.
42 A 0133 Net 1.50

The Lafayette PRIVA-COM II is designed for use with any 12 volt push-to-talk transistorized transceiver. The PRIVA COM II mutes the speaker. When the PRIVA-COM II call switch is activated, at either base or mobile, the transmitted dual tone is received by the other PRIVA-COM. The speaker is automatically activated and locked "on". If the receiving unit's switch is in the HORN position, a horn or other auxiliary signal device will be activated for one second. Both base and mobile units can initiate calls at any time and can revert to normal operation instantly by placing the call switch in the NORMAL position. The PRIVA-COM II is fully compatible with the LAFAYETTE HA-200 and HA-100 PRIVA-COM units. Complete with mounting bracket and instructions. Size 2 3/4" x 3 3/4" x 5 1/2" D. Shpg. wt., 3 1/2 lbs.

Net 32.50
2 for 62.50

LAFAYETTE PRIVA-COM SELECTIVE CALLER

32⁵⁰

- For Quiet Private Communications
- Outstanding Performer with Lafayette HB-444/25, Comstat™, 23/25, HE-20, A, B, C, HE-90, HB-111, HB-222, HB-333, HB-200 & HB-400 as well as with any Push-to-Talk Tube Type CB Transceiver
- Compatible with Lafayette HA-100 and Priva-Com II

Same as PRIVA-COM II except used only with tube type transceivers. Features, in addition, an indicator light which lights up when signal is received. This light remains on until manually reset. Cable terminates in plug which mates with Lafayette CB Transceiver. Complete with mounting bracket and instructions. Size 3 3/4" x 3 3/4" x 5 1/2" D. Shpg. wt., 3 1/2 lbs.

42 A 0110 \$5 Monthly Net 32.50
2 for 62.50

* Not recommended for Solid State Transceivers nor those with carbon microphones less preamplifiers.



MADE IN USA

LAFAYETTE CB TRANSCEIVER TESTER



37⁹⁵

MADE IN U.S.A.

- Measures
 - RF Power Output • Relative Field Strength
 - SWR • % Modulation • Crystal Activity
- Generates
 - Crystal Controlled RF Signal
 - Modulated Audio Signal • 1 KC Audio Signal
- Permits
 - Aural Monitoring of Local Transmitters
 - Visual Transmitter Monitoring with 'scope
- Provides
 - In-Circuit Instant Connection to Antenna Without Removing Cables From Transmitter

Sensitive D'Arsonval Meter

Features front panel jacks for aural and visual monitoring, audio generator output and RF signal generator output; ceramic jacks for standard miniature crystal sockets. Controls include Function Selector, Antenna Selector, Generator Selector, Modulation Calibrate Switch, Modulation Calibrate Control and Meter Adjust Control. Sturdy professional type SO-239 sockets accept standard PL-259 connectors. Sturdy attractive molded case with brushed aluminum front panel. 7 7/8" x 5 3/8" x 2 7/8". Shpg. wt., 4 lbs. Includes 9V battery; 30" telescoping antenna.
42 A 0126 \$5 Monthly Net 37.95

LAFAYETTE AUTHENTIC MECHANICAL FILTER



19⁹⁵

- Super Selectivity
- 60 db Attenuation of Unwanted Signals
- Complete Adjacent Channel Rejection
- For 455KC IF Tube Circuits

EXCELLENT FOR: Citizens Band Transceivers; Amateur: AM, CW, SSB Receivers; Short-wave and Standard Broadcast.

Update your present receiver to cope with today's crowded bands. Pick up distant stations formerly masked by strong signals. The Mechanical Filter provides a steep-skirted, flat top, ideal band pass response. At 2.5 Kc on either side of the center frequency, the filter provides 60 db attenuation. The complete filter network consists of a mechanical filter and 2 coupling transformers. Easily installed between mixer and 1st I.F. stages. Specifications: Center Frequency, 455 kc; 6db bandwidth 2 kc; 60 db bandwidth 6 kc; Input/Output Impedance 10K ohms; Insertion Loss, 1.5-3 db. Size: 2 3/4" x 5" x 8 1/2" D (overall). Imported. Shpg. wt., 8 oz.
99 A 0123 Net 19.95

LAFAYETTE HA-115 AUDIO COMPRESSOR AMPLIFIER FOR CITIZENS BAND TRANSCEIVERS



25⁹⁵

Made in U.S.A.

- For 6 volt, 12 volt or 117 volt Base and Mobile Transceivers,
- Illuminated Meter Directly Reads Modulation Percentage
- Printed Circuitry, Advanced Design
- Works with all Popular CB Units

The audio compressor instantly and automatically increases the "talking power" by increasing the average modulation of CB transmitters. This, however, is accomplished without the side effects of over modulation. Final power input remains within the legal 5-watt limit (as per FCC decree) but effective talk power is increased many times. Requires very little power for operation hence existing power supplies may be utilized. Comes complete with operating and installation instruction. Size: 3 1/2" x 3 7/8" x 5" D. Shpg. wt., 2 lbs.
*Except HB-222 and solid-state (transistor) CB transceivers.
42 A 0117 Net 25.95

Deluxe LAFAYETTE Citizens Band Accessories

LAFAYETTE CB NUVISTOR PREAMPLIFIER

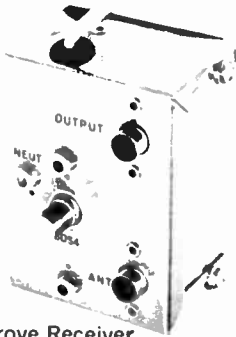

- Improve Receiver Gain, Noise Figure, Spurious Signal Rejection & Image Rejection

9⁹⁵

Made In U.S.A.

Can be added to virtually any CB transceiver to improve gain and noise figure. Covers a frequency range of 26.96 to 27.225MC and employs a nuvistor tube in a neutralized circuit. Tuned circuitry is employed for both the grid and plate. Gain is 20 db with noise figure of 2.0 db at 27 MC. Power requirements are 6.3 volts at 135 ma. and 100-250 volts DC at 8 ma. Only 2½x3½x1½". Shpg. wt., 2 lbs.
42 A 0127

Net 9.95

LAFAYETTE CB LOW PASS FILTER



- Avoid TV Set Interference
- 50db Attenuation of Radiated Spurious and Undesirable Signals!
- Simple Installation

5⁹⁵

MADE IN U.S.A.

Designed to effectively reduce TVI which may be radiated from your CB transmitter. This professional quality filter attenuates radiated spurious and other undesirable harmonic signals higher than 50 MC approximately 50 db or more; Minimizes interference with your own or your neighbor's TV set. Simple to install with two built-in SO-239 connectors. Just place unit between transmitter and antenna. Impedance is 50-75 ohms and connections may be reversed for same impedance match. Max. power rating is 100 watts. Very well constructed with spot-welded case and finished in dark metallic grey. Size: 5x2x1¾". Shpg. wt., 1½ lbs.
42 A 0123

Net 5.95

LAFAYETTE QUIAT-COM™ SOLID STATE VIBRATOR

TRANSISTORIZED 12 VOLT CB REPLACEMENT VIBRATOR

- No Vibrator Hash Noise
- Much Longer Vibrator Life
- No Mechanical Noise
- More Efficient, Cooler Operation
- Uses Top Grade Transistors from Famous Manufacturer... NO Surplus Transistors!



ONLY **5⁹⁵**

Exceptionally efficient replacement for CB vibrators, as well as for vibrators used in Amateur and communications equipment rated up to 85-watt consumption. Available in POSITIVE Model and in NEGATIVE Model. For 12 Volt operation only. Shpg. wt., 1 lb.

QUIAT-Com Positive Model

Replaces vibrators with Pin 1 Positive.
42 A 0121 Positive Quiat-Com Net 5.95

QUIAT-Com Negative Model

Replaces vibrators with Pin 1 Negative.
42 A 0122 Negative Quiat-Com Net 5.95

TOP QUALITY CB MICROPHONES

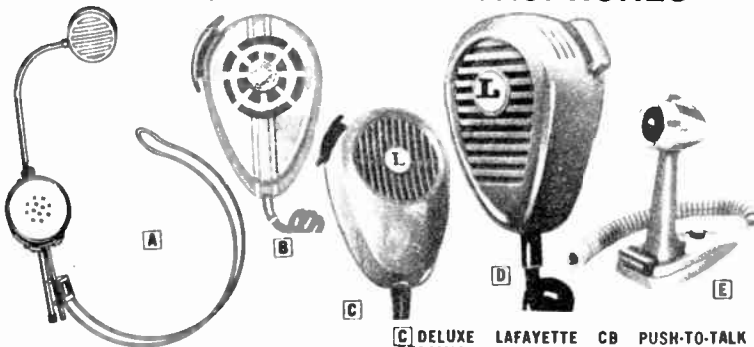

[A] LAFAYETTE BOOM MIKE. Perfect answer to your CB and Ham mobile needs. For use with VOX or foot switch for transmit-receive changeover. Lightweight and comfortable. 8 ohm earphone has cushion for comfort and outside noise suppression. Crystal mike for high output and full modulation. Boom and headband adjusts to individual preference. Smartly styled mike head mounted on swivel for maximum pick up. Finished in chrome and two tone plastic. Complete with 5 ft., 4 conductor cable. Shpg. wt., 1 lb. Imported.
99 A 2565

Net 3.98

[B] LAFAYETTE CB ALL METAL CERAMIC MIKE. Adopted as the standard microphone for the LAFAYETTE HB-444 CB Transceiver. Durable metal case fits snugly in the palm of the hand; resists tough mobile operating conditions. The 3-conductor plus shield coiled cord is permanently attached to the microphone for minimum wear. Wired for electronic switching. Has built-in hang-up button for easy mobile mounting. Complete with instruction for conversion to relay switching. Imported. Shpg. wt., 1 lb.
99 A 4562

Net 6.95

[C] DELUXE LAFAYETTE CB PUSH-TO-TALK CERAMIC MIKE. Standard mike for Lafayette HB-400. Lightweight, rugged, dark grey case shaped for comfortable operation. High output. The 3-conductor plus shield coiled cord is firmly connected to the mike for extra long wear. Wired for electronic switching. Complete with instructions for conversion to relay switching. Imported. Shpg. wt., 8 oz.

99 A 2533

Net 4.95

[D] NOISE CANCELLING CB MIKE. A high output (-48db) low noise cardioid pattern PTT ceramic mike. Rugged high impact cyclac dark grey case with 3 conductors (one conductor shielded). Frequency Response 300-3000 cps. With hangup clip. Less plug. Shpg. wt., 1 lb.

44 A 4501

Net 3.77

[E] TURNER MODEL "+2" TRANSISTORIZED CB MIKE. Increase signal strength and range! Frequency response of 300-3500 cps. Push-to-talk bar with locking switch permits normal PTT operation or VOX. Relay or Electronic switching! 3 conductor, 1 shield blue coiled cord. Output impedance 5000 ohms. Battery included. Shpg. wt., 4 lbs.
44 A 7016

Net 29.11

Replacement 9-volt battery
99 A 6021

Net .21

LAFAYETTE AUTO-MARINE ENGINE NOISE SUPPRESSOR KIT

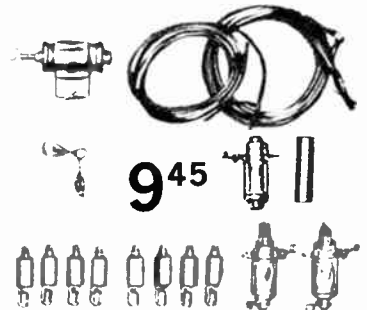

9⁴⁵

- A Must For Mobile CB and Ham Operators
- 14 Components Plus Hook-up Wire

This easily installed kit will effectively suppress ignition, generator and voltage regulator noise. Consists of 8 spark plug suppressors; 1 distributor suppressor, 1 voltage regulator suppressor; 4 coaxial capacitors; shielded cable and braid for wiring filter system. All necessary hardware and instructions for installation are included. Shpg. wt., 2 lbs.

42 A 0905

Net 9.45

ALTERNATOR NOISE FILTER



4⁴⁹

- For CB, Amateur & Commercial Mobile Communications

A highly effective filter for alternator equipped automobiles. Attenuates alternator noise by 50 db. Can operate up to 32 volts DC. Results in quiet mobile receiver operation. Shpg. wt., 8 oz.

42 A 4900

Net 4.49

Deluxe LAFAYETTE Citizens Band Antennas

BASE STATION

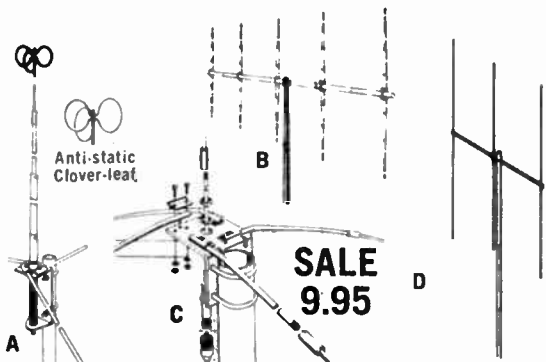

(A) LAFAYETTE "RANGE-BOOST"™ END FED 1/2-WAVE CB ANTENNA
The Range-Boost's specially designed anti-static clover-leaf ball drastically reduces receiver noise by continuous dissipation of static discharge. Offers a 3.75 db true omni-directional gain. Tremendous signal-to-noise ratio improvement of 6-20 db offers very clean reception. VSWR is 1.17:1. Includes a phasing transformer, rubber covered for moisture resistance. Vertical radiator consists of 3 seamless aluminum tube sections topped by a solid aluminum 108" top section. 3 54" radials provide proper transmission line decoupling. Direct ground lightning protection. 50 ohm. 17'6" over-all length. Accepts up to 1 1/2" masts and PL-259 cable connector. Less mast and coax Shpg. wt., 10 lbs. Made in U.S.A.
42 A 0111WX Net 19.95

(B) FAMOUS LAFAYETTE "STARFIRE V"™ DELUXE 5-ELEMENT CB VERTICAL BEAM ANTENNA. One of the most powerful CB antennas ever offered by Lafayette! Tremendous 10 db forward gain multiplies your effective radiated power by as much as 10 times. Front-to-back ratio 25 db. V.S.W.R. under 1.5:1. Gamma matched to 52 ohm coax-transmission lines. All aluminum construction for greater weather resistance. Boom length 17 ft. Reflector element (highest 18 1/2 feet. Mounts on masts up to 2" in diameter. Turning radius 8'6". Vertical wind load 125 lbs. STARFIRE "V" is furnished with complete mounting instructions. Less mast and coax cable. Shpg. wt., 15 lbs. Made in U.S.A.
42 A 0114WX \$5 Monthly Net 37.95

(C) LAFAYETTE DELUXE HEAVY-DUTY GROUND PLANE ANTENNA. High efficiency ground plane antenna constructed of four solid aluminum 108" heat treated radials and one radiator. Elements supplied in two 54" lengths joined by threaded coupling nuts. Accepts 1 1/4" tubing, RG-58U 50 ohm coaxial cable and PL-259 coaxial connector. Less mast and coax. Imported. Shpg. wt., 4 lbs.
99 A 3031W SALE 9.95

(D) LAFAYETTE'S "STAR-FIRE"™ 3-ELEMENT VERTICAL BEAM CB ANTENNA. An exceptionally high gain, directional antenna which develops a forward gain of 8 db. Front-to-back ratio is 25 db; front-to-side, 40 db. 50 ohm feedline match for maximum efficiency. Comes with bracket for vertical or horizontal mounting. 1 1/4" O.D. aluminum boom is 8 feet long. 5/8" to 7/16" O.D. aluminum elements are approximately 16 1/2 ft. long. All steel hardware is irridite treated to MIL specs. Accepts up to 1 1/2" mast. Completely factory pretuned, and furnished with instructions. Made in U.S.A. Less mast and coax cable. Shpg. wt., 11 lbs.
42 A 0113WX Net 16.95

POLYFOAM COAX CABLE ASSEMBLIES

• PL-259 Connectors on Both Ends

Stock No.	Type	Length	Wt.	Net
42 A 0910	RG8/U-50 ohms	50 ft.	7 lbs.	6.50
42 A 0911	RG8/U-50 ohms	100 ft.	11 lbs.	10.95

UNIVERSAL ANTENNA MOUNTING KIT AND LIGHTNING PROTECTOR



Deluxe mounting kit for base station consists of: Blitzbug Lightning Arrester, 50 ft. ground wire, angle base and roof mount—works on any surface—takes masts up to 2 1/4" O.D., 50' roll of steel guy wire, 3 steel turnbuckles, 3 way guy wire clamps, package of 3 open eye bolts (Kit comes less mast.) Shpg. wt., 6 lbs.
42 A 0130M Net 5.99
18 A 5617WX—10' steel mast—16 gauge, wt., 8 lbs. Net 2.10

MOBILE

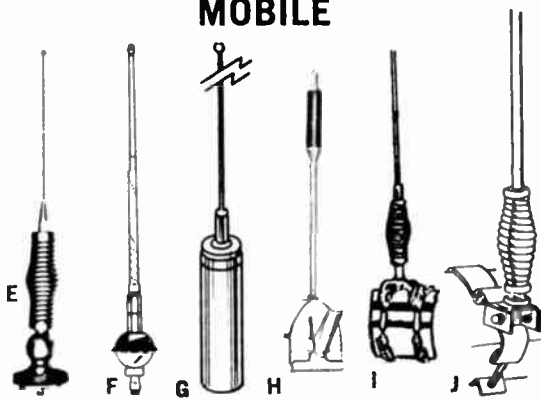

(E) FAMOUS LAFAYETTE ALL STAINLESS STEEL CB MOBILE ANTENNA
Full quarter wave 102-inch stainless steel whip, heavy-duty chrome plated stainless steel spring and swivel ball jointed base designed for mounting on any surface. Base has lug terminals for 42 A 7002 cable assembly. Perfect for rear deck mobile mounting. Less cable. Imported. Shpg. wt., 4 lbs.
99 A 3034WX Net 6.95

(F) LAFAYETTE CENTER-LOADED FIBERGLASS CB COWL MOUNT ANTENNA. Only 48" high but performs like 102" antennas. Four foot whip eliminates the possibility of striking overhead objects and black plastic whip covering protects against shorting. Specially designed rocker support assures 8-point grounding and permits up to 35° mounting angle on fender, cowl, or rear deck—fits any 1 1/4" to 1 1/2" mounting hole. Complete with 5' RG-58/U cable. Shpg. wt., 3 lbs. Made in U.S.A.
42 A 0112W Net 6.95

(G) LAFAYETTE BASE LOADED "AUTO-TOP" CITIZEN BAND ANTENNA. The Lafayette Base Loaded "Auto-Top" Citizens-Band antenna offers the CB'er the ideal omni-directional signal pattern with very low signal to noise. This quality antenna consists of an inconspicuous base loaded, neutral gray weatherproof phasing transformer (only 4" high, and 1" in diameter), a 39" stainless steel whip, and all mounting hardware including complete and simple mounting instruction sheets. Antenna mounts in 3/4" hole. Comes less cable. Shpg. wt., 2 lbs. Made in U.S.A.
42 A 0120 Net 7.99

(H) LAFAYETTE CENTER-LOADED MOBILE CB GUTTER CLAMP ANTENNA. This portable CB Center-loaded antenna is ideal for the CB'er. Easily removable when not in use—prevents theft or damage. Gutter clamp snaps on rain gutter of automobile. Heavy spring assures positive grip. Clamp is heavily plated to resist corrosion. Only 20 inches long—outstanding 11 meter performance. SWR 1:1. Furnished with 12 ft. of RG-58U cable with PL-259 connector. Shpg. wt., 3 lbs. Made in U.S.A.
42 A 0125 Net 10.88

(I) LAFAYETTE "PROFESSIONAL" DOUBLE CHAIN BUMPER MOUNT CB ANTENNA. Complete heavy duty double-chain bumper mount assembly. No holes to drill; assembles in minutes. Consists of professional heavy-duty double-chain bumper mount with "Z" shaped links, cadmium plated shock absorbing springs that can bend through 90° without damage. 102" stainless steel whip with removable plated steel adapter and whip hold-down gutter clip. Built for long, satisfactory service and performance. Less cable. Fits all cars. Made in U.S.A.
42 A 0119WX Shpg. wt., 8 lbs. Net 14.95

(J) LAFAYETTE CB BUMPER MOUNT ANTENNA WITH STAINLESS STEEL STRAP. Features a full one-quarter wavelength 102" stainless steel whip and a fully adjustable chrome plated mount with a specially designed stainless steel strap to fit most cars. No loading coil—maximum efficiency! Heavy-duty chrome plated steel spring is built for extremely rugged mobile use. Imported. Shpg. wt., 3 lbs.
99 A 3032WX Net 8.95

COAXIAL CABLE ASSEMBLIES FOR MOBILE ANTENNA APPLICATIONS



TYPE A—Consists of 20 ft. RG-58/U cable with PL-259 plus UG-175/U on both ends. Required for Ground Plane, Coaxial and Mobile Antennas terminating in a coaxial plug. Shpg. wt., 8 oz.
42 A 7001 Net 2.49
TYPE B—Same as Type A except one end is terminated with PL-259 plus UG-175/U and other end with universal ring type terminal lugs for mobile antennas. Shpg. wt. 8 oz.
42 A 7002 Net 2.15

Improve Your CB Performance

LAFAYETTE HEAVY-DUTY MOBILE CB-AM ANTENNA

SALE

Only **7.95**

was 9.95

Deluxe cowl mounted antenna doubles as CB antenna and AM broadcast antenna. Eliminates an extra antenna on your car. 46" long, antenna collapses to 31" and fits in the 7/8" to 1 3/4" auto antenna mounting hole. Includes automatic dividing harness, AM radio cable, transceiver cable and antenna cable with PL-259 connector. Small divider unit fits under dash with all connections cables low loss. Imported. Shpg.

hidden. All wt., 4 lbs. 99 A 3060W

Net 7.95

DELUXE UNIVERSAL MOBILE CB ANTENNA MOUNTS



(A) Chrome Plated Swivel Ball Jointed Mount Base. Chrome plated swivel ball mount base with lug terminals. Can be mounted vertically or horizontally on any surface. Imported. Shpg. wt., 3 lbs.

99 A 3030 Net 1.95



(B) Heavy Duty Chrome Plated Stainless Steel Spring. Heavy duty chrome plated stainless steel spring provides maximum support for long whips and heavy center loaded whips. Imported. Shpg. wt., 2 lbs.

99 A 3036 Net 2.79



(C) Chrome Plated Bumper Mount with Stainless Steel Strap. Chrome plated mount and stainless steel strap which is completely adjustable for vertical mounting on most types of automobile bumpers. Eliminates need of cumbersome link type chain mounts. Imported. Shpg. wt., 1 1/2 lbs.

99 A 3035 Net 3.95

ANTENNA SPECIALISTS "COLORGUARD" CB MOBILE ANTENNAS

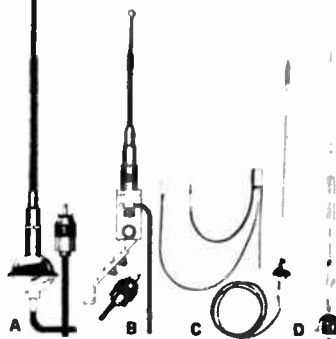

Each COLORGUARD antenna incorporates a prominent element of INTERNATIONAL ORANGE—a highly visibility fluorescent color accepted by military and civilian authorities the world over as a standard emergency color. With a COLORGUARD your vehicle is instantly recognized as one equipped with emergency communications equipment.

A. M-140 Cowl/Fender Mounting Fiberglass Antenna Swivel mount. Only 48". With 5 ft. RG-58/U cable and PL-259 connector. Mounts in 7/8" hole.

42 A 1034W Shpg. wt., 2 lbs. Net 9.46

B. M-142 Trunk Mount Fiberglass Antenna Requires only two 3/8" holes in trunk lid. 48" high. With 15 ft. RG-58/U cable and PL-259 Connector.

42 A 1035W Shpg. wt., 4 lbs. Net 10.83

C. M-143 CB-AM Cowl Mount Antenna Operates AM broadcast receiver and CB unit from one antenna. Mounts in 7/8" hole. 46" high. With CB-AM dividing harness and all cables. 42 A 1036W Shpg. wt., 3 lbs. Net 16.46

D. M-145 18" Foot Mount Fiberglass Antenna 3/4" snap-in mounting. With 16 ft. RG-58/U cable and PL-259 connector.

42 A 1037 Shpg. wt., 2 lbs. Net 11.61

BLITZ BUG LIGHTNING PROTECTOR

Only **3.95**



Designed to fit any standard coaxial cable, the "Blitz Bug" employs the spark gap principle to eliminate static build up on coaxial cables. Provides a constant drain off, reducing chances of a direct lightning strike and in many cases eliminating noise problems. Constructed of 3/4" O.D. brass by 2 1/4" long. Employs one PL-259 plug and one DKCB connector (takes PL-259 plug).

42 A 2001 Shpg. wt., 1 lb. Net 3.95

CB SIGNAL-HUNTER DIRECTION FINDING ANTENNA

ONLY

9.95



- Track Down CB Interference
- Locate Stations in Distress
- Plug Into Your CB Set

Tracks down sources of CB interference, TVI, stranded motorists, boats in distress, unknown transmitters, etc. Mounts with suction cup and bracket. Tunes quickly with knob on loop. Indications are made on receiver's S-meter and volume output as loop is rotated. Can be used for transmitting over short distances. 8 ft. cable permits mounting on either side of the car. 50 ohms impedance. Complete with PL-259 connector and RG-58/U cable. Shpg. wt., 4 1/2 lbs.

42 A 2101W Net 9.95

MOSLEY FLUSH MOUNT COAX TERMINATING OUTLETS



- Positive, Trouble Free Connection
- Complements any Room Decor

Designed for CB, Amateur Band and all business band radios. Termination for antenna coax and rotor cables in a flush wall outlet. Attractive molded ivory plastic does away with unsightly straggling leads. Easy to install, makes positive connection. Shpg. wt. 6 oz.

Stock No.	Mosley No.	Type of outlet	Net
42 A 5105	C-1PK	Single 83-1R	2.11
42 A 5106	C-2PK	Double 83-1R	3.78
42 A 5107	CR-4PK	Single 83-1R, 4 wire rotor socket	3.13
42 A 5108	CR-8PK	Double 83-1R, 8 wire rotor socket	3.73

CORNELL-DUBILIER MODEL AR-22R AUTOMATIC ROTOR FOR CB ANTENNAS

- Fingertip Control
- Control Unit Shows Direction of Rotation

32.83

Deluxe heavy-duty rotor unit will handle antennas up to 150 lbs. Simply set the control unit pointer to the desired direction, and the antenna will automatically rotate to this position and stop. Perfect for TV, Ham or Citizen Band application. Rotor unit employs 12 heavy duty ball bearings in two 6 1/2" races. Reversible clamps on rotor will take masts from 7/8" to 2". O.D. Control unit is marked in compass points, N.S.E.W. NW, NE, SW, and SE. Housed in attractive brown plastic cabinet with rubber feet. For 110-120 volts, 50-60 cps AC. Requires 4 conductor cable. Shpg. wt., 14 lbs.

42 A 8607WX \$5 monthly Net 32.83

4 conductor cable for AR-22R Net 2.50

32 A 8910 100' coil Net .03

32 A 8911 less than 100' per ft. Net .03

LAFAYETTE CB TO AM ANTENNA COUPLER

- Everything Needed to Put CB and AM on One Antenna

5.95

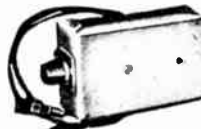

Specially designed network permits any Citizen's band mobile antenna to be used also for broadcast reception. No switching necessary. With SO-239 antenna receptacle, 2 ft. lead with coaxial auto plug for broadcast radio connection and 2 ft. lead with PL-259 coaxial plug for transceiver connection. Shpg. wt., 1 1/4 lb.

42 A 0903 Net 5.95



LAFAYETTE 6-Meter Solid-State Transceiver

COMPLETELY PORTABLE AND MOBILE — TAKE IT WITH YOU EVERYWHERE!



119⁹⁵

NO MONEY DOWN
Only \$6.50 Monthly

Model HA-650
PORTABLE

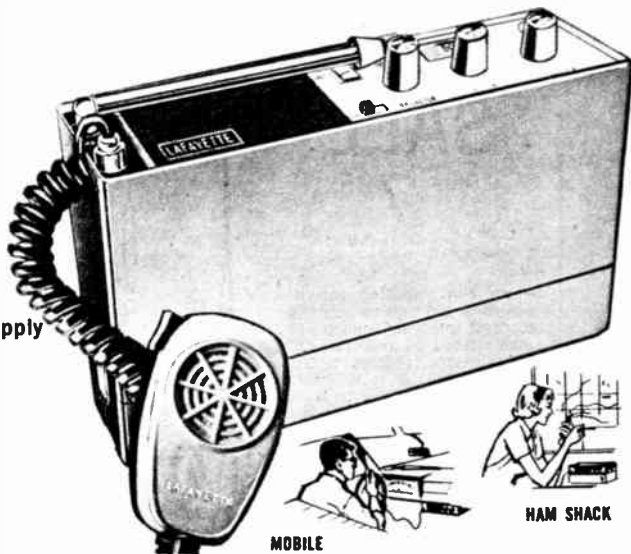

- 2.5 Watts Input Using Built-In Battery Supply
- RF Output Efficiency Better Than 50%
- 6 Crystal-Controlled Transmit Positions
- Tuneable Superheterodyne Receiver
- Optional Power Supply Allows Fixed Station Operation Using 115 VAC
- Complete with Leather Carrying Case, Shoulder Strap and Batteries

New! An extraordinary value from Lafayette's communications engineers. Excellent for portable and emergency use—Great for field days! All solid-state craftsmanship delivers more than 50% efficiency into the antenna. Push-pull modulated 2.5-watts input final assures consistently high modulation level for greater talk power. Oscillator features 6 crystal positions and uses standard 8 mc fundamental crystals. Convenient spotting switch allows zeroing transmit frequency on tuneable 8-stage receiver. Receiver sensitivity 1.2 μ v. for 10 db quieting. Built-in series gate noise limiter allows quiet operation even in noisy locations. Zener diode power supply circuitry used as voltage regulator in RF and mixer stages. Relay transmit-receive switching actuated by efficient plug-in push-to-talk dynamic microphone. Tunes popular low section of 6 meters (50 to 52 MC). Fixed station operation facilitated by external antenna connector and use of optional HB-501 115 VAC power supply.

Supplied complete with leather carrying case, telescopic whip antenna, shoulder strap, and 10 "D" cells. Dimensions: 9½Wx5½Hx2¼"D. Less crystal. Shpg. wt., 8 lbs.

99 A 2570WX \$6.50 monthly Net 119.95

REPLACEMENT BATTERIES

99 A 6256 "D" Cells (10 req.) Net ea. .13
Lots of 10 Net Each .125
"D" Size Heavy Duty Alkaline Battery 32 A 4884 Net ea. .49

MODEL HB-501 SOLID-STATE AC POWER SUPPLY. Allows use of HA-650 on 115 VAC for convenient fixed station use. Shpg. wt., 10 lbs.

99 A 3028W Net 16.95
8 MC Fundamental Crystal (Specify frequency—Supplied \pm 5KC)
40 A 5403C Net 2.89

ADAPTER CABLE ASSEMBLY

4 Ft. RG-58/U cable assembly. Adapts Motorola type external antenna connector of HA-650 for input to SO-239 jack of external antenna, Linear Amplifier, etc.
40 A 0904 Net 1.69

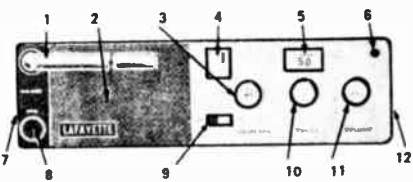

1. Telescopic Whip Antenna
2. Efficient Front Mounted Speaker
3. Volume Control With OFF-ON Switch
4. Easy-To-Read S-Meter
5. Calibrated Receiver Dial
6. Standard Earphone Jack
7. External Antenna Connector
8. Dynamic Push-To-Talk Microphone Socket
9. Convenient Spotting Switch
10. Tuneable Receiver Control
11. Transmit Frequency Switch
12. Sturdy All-Metal Case

LAFAYETTE 100-Watt PEP Mobile Linear Amplifier

Small . . . Compact—Only 2" High

CONVERT FLEA POWER TO REAL POWER!

Now, Lafayette offers a completely self contained, 12-volt DC mobile linear amplifier for use with all low-power rigs having output of 1 watt or more. Provides up to 100 watts PEP output into a 50 ohm load (matches 40-600 ohm impedances depending on power of input signal). Operates on 6, 10, 11, and 15 meter bands. Absolutely no switching required. When transmitter is turned on, a special RF sampling circuit switches the linear's B+ voltage thus energizing the linear instantaneously. Solid state power supply requires 1 amp. idling, 8 amp. full input. Small, compact size permits easy installation under-dash or in your trunk. Broad-banded so all you do is tune it to a desired band and forget it. No internal connections are required to your existing equipment. Simply insert the unit in series with your transmitter and you are "on the air" with a real "punch"! May be used with any signal. Incorporates a handy tuning meter for pin-point accuracy. Ruggedly designed chassis with over-sized heat sinks for cool transistor operation. Size: 7"x9"x2". Shpg. wt., 3½ lbs.
40 A 0106WX 12-Volt DC Negative Ground Net 79.95



79⁹⁵ **NO MONEY DOWN**
\$5 MONTHLY

Model HA-250

- Covers 20-54 MC . . . 6, 10, 11 and 15 Meters (Not Permitted on 11 Meters Class D (CB) Operation in U.S.A.)
- No External Switching Required
- Will Work On Any Signal of 1 Watt or More—AM, FM, SSB or DSB, CW
- Completely Self-Contained for 12 Volt Operation

SAVE! • 6 METER SPECIAL • SAVE!

LAFAYETTE 6 Meter Power Package

Lafayette Model HA-650 6-Meter Solid State Portable and Mobile Transceiver, plus Lafayette 100 Watt PEP Mobile Linear Amplifier, plus 4 Ft. Interconnecting Cable Assembly.

40 A 9011WXM Shpg. wt., 14 lbs. Net 194.95

16 Lafayette Cat. No. 663

Complete Package

Only 194.95

SAVE 6.90 from individual catalog prices

Citizens Band Equipment Is Available on Easy Pay Plan—No Money Down

New! LAFAYETTE 6 and 10 Meter Amateur Transceivers Model HA-460 for 50-52 mc. Model HA-410 for 28-29.7 mc.

20 Watts D.C. Input—2E26 RF Amplifier
Built-in VFO—Nuvistor Front End

Only **149⁹⁵**

- Built-in Low Pass Television Interference Filter
- Effective Silicon Controlled Rectifier Noise Limiter
- Dual Conversion with Crystal Controlled 2nd Converter
- Metal-Cased Ceramic PTT Microphone with Coiled Cord
- Built-in Solid State 12 V.D.C. and 117 V.A.C. Power Supplies



The 6 and 10 meter amateur bands are hotter than ever with band openings and exciting DX contacts occurring more frequently. Extended radio propagation due to increased sunspot activity is on the way and Lafayette is ready and waiting for the challenge. We call them our 400 communication series. You'll refer to them as the most amazing units on the market packed with plenty of extras like transformer coupled plate modulation.

The powerful 20 watt DC RF plate input power transmitter with time proven 2E26 final features a built-in stable VFO with its own frequency control knob. Tune up is fast and efficient with driver and multiplier automatically tuning with VFO. A shielded television interference filter stage minimizes TV problems. Spotting switch permits quick "zero beat" break in. Receiver is dual conversion with a crystal controlled 2nd converter. Nuvistor RF amplifier's sensitivity is less than 1 μ v. for 10 db. S to N. Selectivity is 35 db at 8 KC. SCR controlled noise limiter effectively eliminates most types of QRN. Other great features include use of standard 7 and 8 mc. Crystals with front panel crystal socket; illuminated meter that

reads S units on receive and RELATIVE RF output on transmit; plug-in encapsulated dust free relay switching; front panel ear-phone jack; push-pull audio amplifier; and rugged all metal push-to-talk ceramic mike with coiled cord and plug. Going mobile? The 400's come with both 117 V.A.C. and 12 V.D.C. (positive or negative ground) built-in solid state power supplies. Supplied with AC+DC power cords, mike and mobile mounting bracket. Size: 12 $\frac{1}{2}$ "x5 $\frac{1}{2}$ "x3 $\frac{3}{4}$ " D. Shpg. wt., 22 lbs.

Lafayette Model HA-460 — 6 Meter Amateur Transceiver for 50.0-52.0 MC. \$8 monthly. Delivery May 1, 1966.

99 A 2579WX Net 149.95
Crystals for HA-460 Specify Fundamental Frequency (divide operating frequency by 6). Will supply to nearest 5 KC.

40 A 5403C Specify Frequency Net 2.89
Lafayette Model HA-410 — 10 Meter Amateur Transceiver for 28.0-29.7 MC. \$8 Monthly. Delivery May 1, 1966.

99 A 2575WX Net 149.95
Crystals for HA-410 Specify fundamental frequency (divide operating frequency by 4). Will supply to nearest 5 KC.
40 A 5402C Specify frequency Net 2.89

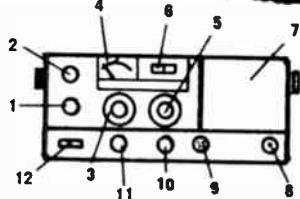

Front Panel Features

1. Air Variable Antenna Load Control
2. Air Variable Plate Tuning Control
3. Calibrated VFO Frequency Control
4. Illuminated "S" and RF Output Meter
5. Calibrated Receiver Frequency Control
6. Transmitter Frequency Spotting Switch
7. Front Panel Communications Speaker
8. Front Panel Standard Earphone Jack
9. Positive Contact PTT Microphone Socket
10. Volume Control with Off-On Switch
11. Crystal-VFO Operation Mode Selector
12. Front Panel Crystal Socket

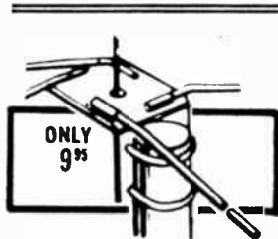

LAFAYETTE 6-METER GROUND PLANE ANTENNA

- The ideal Antenna for Your 6-Meter Base Station or Solid Aluminum Radials $\frac{5}{8}$ " Diameter, 58" Long
- Accepts PL-259 Connector

An outstanding deluxe 6 meter base station antenna covering the 50-54 MC Band, Solid aluminum radial and radiator with $\frac{5}{8}$ " diameter—radials are 58" long—radiator is 55 $\frac{1}{2}$ " long. Radials have a 45° droop. Accepts 1 $\frac{1}{4}$ " tubing. RG-58/U cable and PL-259 Connector. Shpg. wt., 4 lbs.

- 48 A 0101W** Net 9.95
10 METER GROUND PLANE ANTENNA
Same as above except 108" radials supplied in two 54" lengths joined by threaded coupling nuts. Shpg. wt., 4 lbs.
89 A 3031W Net 11.95

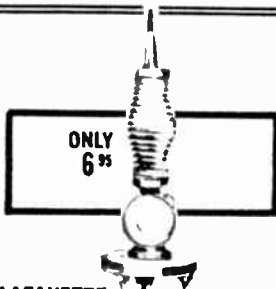

LAFAYETTE ALL STAINLESS STEEL 6-METER MOBILE ANTENNA

- 58 in. Stainless Steel Whip For Optimum 6-Meter Performance
- Heavy-Duty Chrome Plated Stainless Steel Spring and Swivel Ball Jointed Mount Base.

Chrome swivel ball mount base designed to be mounted on any surface. Stainless steel spring holds rod in properly adjusted position and prevents rod damage from shocks and blows. Stainless steel whip for maximum resiliency and strength. Imported. Shpg. wt., 4 lbs.

- 99 A 2535WX** Net 6.95
Same as above but for 10 meters.
98 A 3034WX Net 6.95

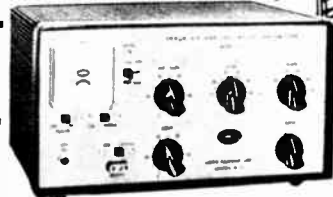

AMECO MODEL TX-62 TRANSMITTER AND FINCO MODEL A-62 ANTENNA 2 AND 6 METER PACKAGE

169⁹⁵

- Frequency Coverage 50-54 MC and 144-148 MC
- Power Input: 75 Watts CW, 75 Watts Peak on Phone
- Meter Reads Final Cathode Current, Final Grid Current, and RF Output
- Built-in Modulator and Solid State Power Supply

A deluxe economy package for the amateur including the famous Ameco TX-62 2 & 6 meter transmitter and Finco A-62 2 & 6 meter antenna. Broad banded transmitter features easy tuning, full modulation, and fast band switching. 8 mc. crystal or external VFO frequency control. Tube lineup: 6GK6, osc., tripler; 6GK6 doubler; 7688 tripler (2 meters); 12AX7 speech amp.; 6GK6 modulator; 7984 final. Size: 11 $\frac{1}{2}$ "x9 $\frac{1}{2}$ "x6". The Finco A-62 antenna features heavy duty aluminum construction, 6 ft. 11 in. turning radius, and use of one transmission line for both 2 and 6 meters. Ameco TX-62 and Finco A-62. Shpg. wt., 48 lbs.

- 40 A 1043WX** Net 169.95
40 A 1035WX TX-62 Transmitter only. Shpg. wt., 36 lbs. Net 146.95
40 A 6301WX A-62 Antenna only. Shpg. wt., 11 lbs. Net 33.34

Amateur Equipment Is Available on Easy Pay Plan—No Money Down

Lafayette Cat. No. 663 17

LAFAYETTE 8-Tube AM/CW/SSB Amateur Communications Receiver Model HA-230



NEW "ALWAYS ON" FILAMENT VOLTAGE IN MIXER AND OSCILLATOR STAGES FOR FREQUENCY STABILITY!

MODEL HA-230
WIRED

MODEL KT-340
KIT

Only
69⁹⁵

Only
62⁹⁵

No Money Down
\$5 Monthly

No Money Down
\$5 Monthly

4 BANDS:

- 550-1600 Kc
- 1.6-4.8 Mc
- 4.8-14.5 Mc
- 10.5-30 Mc

- 8 Tube Superhet Circuit
- 1 RF + 2 IF Stages for High Gain Reception
- Built-in Q-Multiplier for Crowded Phone Operation
- Effective Automatic Noise Limiter
- Built-in Edgewise S-Meter
- Calibrated Electrical Bandsread on Amateur Bands 80 through 10 Meters

Outstanding bandsread, selectivity with built-in Q multiplier, and sensitivity combine to make the HA-230 one of the "hottest" general coverage receivers we have ever offered. Illuminated slide rule dial, bandsread with markings every 5 KC on 80 and 40 meters, every 20 KC on 20 and 15 meters, and every 50 KC on 10 meters, plus an edgewise S-meter combine to make this receiver Q-5 on the crowded amateur bands. Built-in BFO can be used to separate CW stations by means of the pitch control. Effective Q multiplier adds excellent selectivity. Front panel controls: Function Switch, Audio Gain, Selectivity (Q-Multiplier), Frequency (BFO), Band Selector, IF Gain, Antenna Trimmer, AVC-MVC Switch, ANL Switch, Main Tuning, Bandsread Tuning, and Headphone Jack.

Receiver sensitivity: 1.0 microvolts for 10 db signal-to-noise ratio. Selectivity: —60 db at 10 KC, 6 db at 0.8 KC with Q-Multiplier. IF Frequency: 455 KC. Speaker: External PM type (not supplied), 4 or 8 Ω impedance. Audio output: 1.5 watts. Tubes: 3-6BA6, 2-6BE6, 1-6AV8, 1-6AV6, 1-6AQ5, and 1-5Y3. Size: 7Hx15Wx10"D. For 105 to 120 volts, 60 cycle AC. 50 watts. Imported. Shpg. wt., 25 lbs.

99 A 2522WX Net 69.95

99 A 2569 Model HE-48A Matching 3x5" Speaker, 4 lbs. Net 7.95

KT-340 SEMI-KIT This receiver is also available in kit form with all major components and front end premounted and precalibrated. Minor components are easily installed. Imported.

99 A 2521WX Model KT-340 Semi-Kit Net 62.95

Deluxe LAFAYETTE Model HA-225 SSB/CW/AM 14-Tube Amateur Communications Receiver



NEW "ALWAYS ON" FILAMENT VOLTAGE IN MIXER AND OSCILLATOR STAGES FOR FREQUENCY STABILITY!

Only
119⁹⁵

No Money Down
\$6.50 Monthly

Dual Conversion On 6 Meters

5 BANDS:

- 150-400 Kc
- 1.6-4.8 Mc
- 4.8-14.5 Mc
- 10.5-30 Mc
- 48-54 Mc

- 14-Tube Superheterodyne Circuit
- Extra RF Stage and Mixer/Osc. for Dual Conversion on 6 Meters
- New Product Detector Circuit for Improved SSB Reception
- Crystal Calibrator for Checking Receiver Calibration Markings

The HA-225 features full amateur band coverage of 80 through 6 meters plus the marine beacon band. Calibrated electrical bandsread on amateur bands 80 thru 10 meters (6 meters is tuned with main tuning controls). Dual conversion on 6 meters provides average of 50 db image rejection. Other features include antenna trimmer for optimum performance on all bands, built-in edgewise "S" meter, special recording jack in rear permits easy connection to tape recorder. remote control socket on the back allows simultaneous control of HA-225 with a transmitter. Sensitivity: .5 Microvolt for 10 db s/n ratio. Selectivity: variable from 60 db to 93 db in Q-Multiplier operation with ±10 KC detuning. Front Panel Controls: AF Gain, RF Gain, 5-Position Function Switch, BFO Frequency, Band Selector, Q-Multiplier Selectivity, Q-Multiplier Frequency, Band

Spread Tuning, Main Tuning, Antenna Trimmer, Power On-Off Switch, MVC-AVC Switch, Rec-Send Switch and Headphone jack, IF—455 KC. Audio Output —1.5 Watts. Output impedance—8 and 500 ohms (speaker not supplied). Tubes: 4-6AQ5, 3-6BA6, 2-6BE6, 1-6BL8, 1-6AL5, 1-6AQ5, 1-0A2 plus 6CA4 rectifier. Size: 17Wx74Hx10"D. Imported Shpg. wt., 28 lbs. Model HA-225. Less Calibrator Crystal

99 A 2523WX \$6.50 Monthly Net 119.95

Optional Calibrator Crystal, 100KC, Type HC/13U 40 A 0901L Net 3.95

Model HE-48A Matching 3x5" Speaker Shpg. wt., 4 lbs. Net 7.95

99 A 2569 Net 7.95

LAFAYETTE 10-80 Meter SSB/AM/CW Amateur Receiver

5 HAM BANDS
PLUS WWV

3.5—4.0Mc 21.0—21.5Mc
7.0—7.5Mc 28.0—29.7Mc
14.0—14.5Mc WWV at 15Mc

Only
139⁹⁵

No Money Down



Model HA-350

HA-94
Speaker Mate
(Optional)

- Mechanical Filter for Exceptional Selectivity
- 12 Tubes Dual Conversion • Automatic Noise Limiter
- Product Detector for Selectable Upper and Lower Sideband Reception
- Complete with Crystals for 80, 40, 20, 15 and 10 Meters
- 100 KC Crystal Calibrator and Crystal BFO
- "S" Meter—Calibrated in "S" Units 1-9 and to +40 db

Lafayette's newest and most advanced communications receiver. Dual conversion circuitry features an image and IF rejection of more than 40 db. A product detector, providing selectable upper or lower sideband, solves the problems in SSB reception. Tuneable preselector circuit gives sensitivity of less than 1 microvolt for 10 db signal-to-noise ratio. Selectivity: Bandwidth of 2 KC at 6 db down and 6 KC at 60 db down using mechanical filter. Front panel 100 KC crystal calibrator reset control used in conjunction with the 15 MC WWV station assures accurate calibration. CHECK THESE SPECIFICATIONS! Audio output: 1-watt maximum. Speaker impedance: 8; 500 ohms (speaker not supplied). Front panel controls: Preselector; Cal—On/off; Band Selector; Receive/Send; Tuning Cal Reset; Function—Off/AM/SSB1-CW/SSB2; RF gain; AF Gain; ANL; Phone jack. Tube

MECHANICAL FILTER

Ultra-sharp selectivity is achieved by means of a true mechanical bandpass filter in the 455 Kc IF section. The filter consists of three sections—an input transducer, 6 non-corrosive nickel alloy resonators and an output transducer.

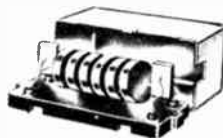

complement: 6BZ6—RF amp.; 6BL8—Xtal controlled 1st mixer; 6BE6—2nd mixer; 6BA6—VFO; 6BA6—1M amp.; 6BA6—IF amp.; 6AL5—AVC rectifier and AM noise limiter; 6AQ8—product detector and crystal calibrator; 6AV6—1st audio amplifier; 6AQ5 audio output; 6BA6—BFO; 0B2—regulator, Silicon Full Wave rectifier. Size: 15Wx7½Hx10"D. For 115V 50/60 cps AC. Imported. Shpg. wt., 25 lbs. Less Calibrator Crystal.

99 A 2524WX \$8 Monthly
100KC Calibrator Crystal for HA-350.

Net 139.95

40 A 0901L

Net 3.95

MODEL HA-94. Speaker mate for HA-350. 8-inch heavy-duty 8 ohm speaker in matching cabinet. Size: 7½Wx5¼Dx7¾"H.
99 A 2571 Shpg. wt., 5½ lbs.

Net 12.95

7-TUBE SWL BROADCAST RECEIVER MODEL HA-63

4 BANDS

• 550-1600 Kc • 4.8-14.5 Mc
• 1.6-4.8 Mc • 10.5-30 Mc

- Superhet Circuit plus RF Amplifier Stage
- 1.5 Microvolt Sensitivity
- 3-Section Tuning Capacitor with Electrical Bandspread
- Antenna Trimmer for Optimum Performance on All Bands
- Front Panel AVC-MVC Selector, ANL and BFO
- Jack for Headphones or External Speaker
- AC Transformer Operated
- Big Slide Rule Dial • Illuminated "S" Meter

Provides full fingertip coverage of AM broadcast, marine and aeronautical bands, civil defense, WWV, amateur and foreign frequencies. The BFO permits (CW) code reception too. 4 bands cover: 1.6-4.8MC; 4.8-14.5MC; 10.5-31MC and 0.55-1.6MC AM band. Full electrical bandspread on all frequencies with 0-100 logging scale and built in "S" meter assures you of accurate tuning. Big slide rule dial is easy to read. Other features are switchable AVC/MVC to reduce blasting or fading; automatic noise limiter (ANL) for maximum noise rejection; and an antenna trimmer control which assures optimum reception on all bands. All controls are conveniently located on front panel. Headphone jack for private listening. An external PM type speaker is required (not supplied). Impedance 4-8 ohms. Beautifully styled in modern steel cabinet. Tubes: (2) 6BA6, (2) 6BE6, (2) 6AV6, (1) 6AR5

SALE!
SAVE 10.00
NOW ONLY
49⁹⁵



Electrical Bandspread on the 80, 40, 20, 15 and 10 Meter Bands.

plus selenium rectifier. Audio output: 1.5 watts. Sensitivity: 1.5µv. AC transformer operated. 117 volts 50/60 cycles AC. Size: 13Wx7½Hx10"D. Imported. Shpg. wt., 19 lbs.

99 A 2534WX HA-63 Alone
99 A 2569 HE-48A Speaker for HA-63

Net 49.95
Net 7.95

LAFAYETTE "BEAT BANDER" EXTERNAL BFO

Only **6⁹⁵**



Designed for any receiver that does not have its own BFO. Enables simultaneous use of BFO and receiver's "Q" multiplier. Connects easily to antenna circuit. Frequency range: 3.5 to 4 MC on fundamentals. Harmonics: 7-8 MC, 14-16 MC, 21-24 MC, and 28-32 MC. Stable, reliable transistor circuitry. With coax cable and 9-volt battery. 4½x3½x3". Imported. Shpg. wt., 1½ lbs.
99 U 2502 Net 6.95

NEW! RECEIVER SPEAKER MATE MODEL HE-48A

ONLY **7⁹⁵**

Matching 3x5" speaker in handsomely styled cabinet for HA-230, KT-340, HA-63, and HA-225. Gives clean audio response, 8 ohm impedance. Size: 7½Hx3½Wx5¼"D overall. Imported. Shpg. wt., 4 lbs.
99 A 2569 Net 7.95



Quality Amateur Station Accessories

LAFAYETTE CODE PRACTICE OSCILLATOR



7⁹⁵

3-WAY OPERATION:

- Light Indicator
- Variable Pitch Tone
- Light-Tone Combined

A Terrific aid for the beginning Morse Code learner or experienced hams who wish to improve their code speed. Completely self-contained. Efficient built-in speaker provides loud, clear signal. Excellent for group practice sessions. Variable pitch control gives pleasing tone by changing frequency. For private use, without disturbing others, you have a choice of earphone tone operation, flashing light or both together. Uses low drain battery-operated transistor oscillator. Specifications: Tone frequency range: Approx. 500 to 2000 cps, variable. Controls: Pitch, Tone, Light and Light/Tone. Terminals: Key, Earphone. Batteries: Includes 2 "C" cells. Case: Hi-Impact bakelite. Size: 6¼x3¾x2"D. Imported. Shpg. wt., 1¼ lbs. **99 A 2560** Net **7.95**

Extra "C" Cells for Above (2 req.). **99 A 6257** Net ea. **.13**

Crystal Headset for Above **99 A 2550** Shpg. wt., 5 oz. Net **1.39**

WATERS 359 COMPREAMP



- Increases Speech Power Output of a Transmitter Up to 4 Times

A two-stage solid state amplifier/limiter which connects between the microphone and transmitter input without any wiring change. Front panel provisions for switching the Compreamp in and out for adjustment of the compression level. Completely self-contained and battery powered. Impedance, input 100K, output 50K. Operating Voltage levels, input .005V to .020V, output .060V. 10 db gain. Shpg. wt., 4 lbs. **40 A 8405** Net **27.95**

99 A 6021 9-volt battery for above Net **.21**

CUSHCRAFT TRIK STIK UNIVERSAL ANTENNA

Only **6⁹⁵**

Universal antenna designed for vertical or horizontal mounting. Can be used for 27 Mc. Citizens Band, Low and High Band Business Radio, 10, 6, and 2 Meters, Police, Fire, Civil Defense, Aircraft, Shortwave and FM reception. Complete instructions are supplied with measurements for frequency settings. Shpg. wt., 5 lbs. **40 A 1918W** Net **6.95**

20 Lafayette Cat. No. 663

B&W 550A Coaxial Switch



(A) Drake TV-1000LP Low Pass Filter



(C) Lafayette SWR and Field Strength Meter



(E) Lafayette SWR Bridge and RF Power Meter

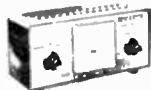

(G) Lafayette Brass Pounders Key



(I)

B&W 425 Low Pass Filter



(B) Ameco HP45 High Pass Filter



(D) Lafayette Radio Field Strength Indicator



(F) Lafayette Grid Dip Meter



(H) Superex Amateur Headphones



(J)

(A) B&W 550A Coaxial Antenna Switch—Instantly selects any one of five transmitters, antennas, exciters, receivers or transceivers using 52 or 75 ohm line. 2P-5 Pos. Rated 1 KW.

40 A 1602—Shpg. wt., 2 lbs. Net **8.25**
40 A 1603—Knob for 550A Net **1.02**
40 A 1604—Dial plate for 550A Net **.75**

(B) B&W 425 Low Pass Filter—usable with transmitters to 1-KW. Completely self-contained—eliminates TVI. 85db attenuation. For 52 ohm coax. Shpg. wt., 6 lbs. **40 A 1608** Net **17.64**

(C) Drake TV-1000LP Low Pass Filter—handles 1-KW 10 to 160 meters. 200 watts on 6 meters. Shpg. wt., 2 lbs. **40 A 6514** Net **16.61**

(D) Ameco HP-45-High Pass Filter—For attenuation of 40 db at 14 MC and 20db at 28MC. 300 ohms. Shpg. wt., 3 oz. **40 A 1005** Net **.93**

(E) Lafayette SWR and Field Strength Meter—Measures SWR (1:1 to 3:1), relative forward and reflected power to 1 KW, reads field strength. Impedance 52 ohms. With coax fittings. **99 A 2537** Wt., 1 lb. Net **9.77**

(F) Lafayette Radio Field Indicator—Continuously indicates transmitter output. Features 200 µa. meter with variable sensitivity control. **99 A 2509** Wt., 7 oz. Net **6.75**

(G) Lafayette SWR Bridge and RF power Meter—Measures up to 15 watt output. Highly accurate SWR indications (1:1 to 1:10). For up to 50 Mc. For 52 and 75 ohm. **99 A 2508** Wt., 2 lbs. Net **19.95**

(H) Lafayette Nuvistor Grid Dip Meter—Covers 1.7 to 180 Mc. in 6 bands. Complete with plug-in coils. **99 A 2503** Wt., 2 lbs. Net **19.95**

(I) Lafayette Brass Pounders Key—Features spring tension, silver contacts, and adjustable ball bearing pivots. **99 A 2555** Wt., 1½ lbs. Net **1.95**

(J) Superex Amateur Headphones—Comfortable dual impedance design (600 and 4-16 ohms). **40 A 8501** Wt., 2 lbs. Net **24.95**

LAFAYETTE ALL-BAND VERTICAL TUNEABLE 10 TO 80 METERS ANTENNA

- 10 To 80 Meters
- For Fixed Operation
- Omni-Directional, Vertically Polarized
- Irridite Treated To Mil Specs

14⁹⁵ Made in U.S.A.

LOW, LOW PRICE

Our best buy multi-band antenna. Can be tuned to any amateur band 10 through 80 meters by a single adjustment. Has amazing efficiency for DX or local contacts. Ground or roof top or tower installation. Can survive winds in excess of 50 mph. Overall height 18'; knocks down to only 5'. Uses 3½" diameter air wound coil as matching inductor. All steel parts irridite treated to Mil Specs. Impedance 52 ohms. Maximum power 1000 watts AM or CW—2 KW PEP. Omni-directional; vertically polarized. Shpg. wt., 5 lbs. **40 A 0104WX** Net **14.95**



LAFAYETTE "RANGE-BOOST"™ FM DUAL BAND COMMUNICATIONS ANTENNA

19⁹⁵

- 4 Element Ground Plane Antenna For 30-50 MC and 130-174 MC
- Boost Your FM Receiving Range

An exceptionally efficient ground plane antenna for operation between 30 to 50 MC and 130 to 174 MC. Comprised of 4 easily assembled drooping elements tuned to 30 MC and a vertical radiator with a matching transformer and a low and high band colinear collector. Ideal for use with Lafayette FM communications receivers. Constructed of heavy-duty aluminum alloy rods and stainless steel tip section. Antenna comes complete with mounting bracket for 1" pipe or 1¼" tubing. Shpg. wt., 6 lbs. **40 A 0105WX** Net **19.95**

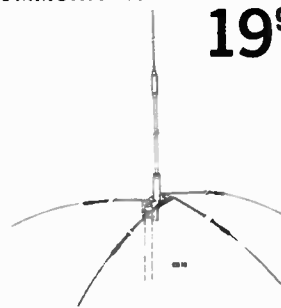

Make Lafayette Your One Dependable Source for Everything in Electronics

Deluxe LAFAYETTE VHF Communications Receivers

MONITOR CALLS FROM STATE, COUNTY AND MUNICIPAL POLICE — FIRE DEPARTMENT — CIVIL DEFENSE — RAILROADS — TRUCKING — HIGHWAY MAINTENANCE — FORESTRY AVIATION — CONSERVATION — PETROLEUM AND INDUSTRIAL ACTIVITIES

LAFAYETTE Model HA-520 Dual Band FM Receiver

DUAL BAND: 30-50 Mc. and 152-174 Mc.

- Variable Squelch
- Solid State Power Supply
- 10 Tubes
- Nuvistor RF Amplifier (152-174 Mc)
- Built-in 4" PM Speaker
- Front Panel Phone Jack
- Illuminated Slide Rule Dial
- Attractive Green Metal Cabinet

ONLY
89⁹⁵



TWO RECEIVERS IN ONE
MONITOR CALLS FROM: POLICE AND FIRE DEPARTMENTS, COMMERCIAL, INDUSTRIAL AND PUBLIC SAFETY ACTIVITIES.

The HA-520 provides outstanding performance on the 2 VHF FM communication bands with a sensitivity of 3 μ V for 20 db quieting. The HA-520 pulls in calls from miles away. Adjustable squelch control silences receiver during periods of no signal — reduces monitoring fatigue. With a squelch circuit the receiver "jumps to life" when a signal comes on the frequency. Excellent for volunteer firemen to monitor calls. Uses ten tubes plus a full-wave silicon diode transformer operated power supply. Power requirements: 117 volts, 50/60 cps AC, 47 watts. Dimensions: 11 $\frac{1}{2}$ "x5 $\frac{1}{2}$ "x7 $\frac{3}{4}$ "D. Shpg. wt. 11 lbs.
99 A 2572WX \$5 Monthly Net 89.95

LAFAYETTE FM EMERGENCY RADIOS

LAFAYETTE HA-55A AIRCRAFT RECEIVER

Model HA-50A 30-50 MC
Model HA-52A 152-174 MC



Only **59⁹⁵** each

- Nuvistor Front End*
- 3 IF Stages, Fully Tuned RF Circuit

Two deluxe FM communications receivers for the office, field or home. Excellent sensitivity of 4 μ V or less for 20 db quieting and built-in adjustable squelch for dependable all-day monitoring of emergency, commercial or industrial communications. Both units feature 3 IF stages and fully tuned RF stage. Model HA-52A incorporates 6CW4 nuvistor "front-end". A built-in 4" speaker gives clear voice reproduction... and as a special feature a front panel phone jack may be used for private listening. Large, easy-to-read slide rule dial is illuminated for night operation. Housed in attractive blue-grey metal cabinet... makes a handsome addition to any home or office. Power requirements: 117 volts AC at 50/60 cps. Size: 11 $\frac{1}{2}$ "x5 $\frac{1}{4}$ "x7 $\frac{3}{8}$ ". Imported. Shpg. wt., 14 lbs. *Model HA-52A Only.
99 A 2561WX Model HA-50A 30-50 mc \$5 monthly Net 59.95
99 A 2562WX Model HA-52A 152-174 mc Net 59.95

Only
59⁹⁵

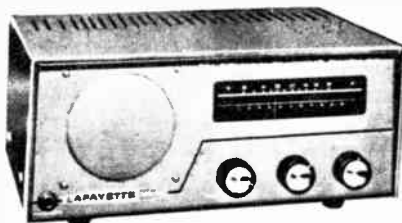

- For 108-136 Mc. Operation

Listen To Aviation Control Towers and Aircraft

Monitor the exciting frequencies of aircraft communications! Multi-purpose tubes give 11 tube performance. Two RF stages including a 6CW4 nuvistor really pulls in the stations. A variable squelch adjustable from front panel facilitates absolute quieting. A built-in 4" speaker provides excellent voice reproduction, and a front panel phone jack makes private listening possible. Large, easy-to-read slide rule dial is illuminated for night operation. Attractive blue-grey metal cabinet. For 117 volts AC at 50/60 cps. Size 11 $\frac{1}{2}$ "x5 $\frac{1}{4}$ "x7 $\frac{3}{8}$ ". Imported. Shpg. wt., 14 lbs.
99 A 2563WX Model HA-55A 108-136 mc \$5 monthly Net 59.95

SPECIAL BONUS — Save On Receiver-Antenna Packages

MODEL HA-520 PACKAGE



Save **9⁹⁵**

Model HA-520 dual band FM receiver plus "Range Boost" ground plane antenna. Shpg. wt., 19 lbs.
40 A 9010WXM Net 99.95
Antenna only. Wt., 6 lbs.
40 A 0105WX Net 19.95

MODEL HA-50A PACKAGE



Save **7.34**

Model HA-50A 30-50 Mc. FM emergency radio plus window and ledge mount antenna. Shpg. wt., 17 lbs.
40 A 9008WXM Net 59.98
Antenna only. Wt., 3 lbs.
40 A 1301W Net 7.35

MODEL HA-52A PACKAGE



Save **6.21**

Model HA-52A 152-174 Mc. FM emergency radio plus high band ground plane antenna. Shpg. wt., 16 lbs.
40 A 9009WXM Net 59.96
Antenna only. Wt., 2 lbs.
40 A 1302W Net 6.22

MODEL HA-55A PACKAGE



Save **6.21**

Model HA-55A 108-136 Mc. aircraft receiver plus high band ground plane antenna. Shpg. wt., 16 lbs.
99 A 2577WXM Net 59.96
Antenna only. Wt., 2 lbs.
40 A 1302W Net 6.22

Tune in on World Wide Shortwave Broadcasts



SALE
SAVE 10.00
NOW 39⁹⁵
WAS 49.95

MODEL HA-226
4-BANDS

• 550-1600 Kc • 1.3-4.3 Mc • 4.3-12 Mc • 11-30 Mc

FAMOUS LAFAYETTE MODEL HA-226 4-BAND SHORTWAVE BROADCAST RECEIVER

- Easy Tune Slide Rule Dial
- Sensitive Superheterodyne Circuit
- Illuminated S-Meter
- Large 4" Speaker

Hear marine, aeronautical, foreign shortwave stations and the popular 10 through 80 meter amateur bands plus your favorite AM broadcast station. Covers frequencies from 550 KC to 30 MC in four band-switched ranges. Has 0-100 logging scale for instant station location. AVC reduces fading and blasting. Built-in 4-inch speaker provides lots of room filling volume. Illuminated S-meter shows signal strength and correct tuning for best reception. Convenient front panel head-

phone jack automatically disconnects speaker when optional headphones are used. AC transformer operated. Built-in BFO circuit allows crisp CW listening. Front Panel Controls: Off/On Volume, Band Selector, Main Tuning, & CW/Phone Switch. All metal case has handsome light blue finish. Size 10¹/₂"Wx6Hx8"D. For 110-120 volts, 50-60 cycles AC. Imported. Shpg. wt., 12 lbs.
 99 A 2520WX HA226 Net 39.95

FAMOUS LAFAYETTE AND **EICO** TEST EQUIPMENT



14⁹⁵

LAFAYETTE CIRCUIT CAPACITOR CHECKER

- Checks Capacitors in Circuit
- Magic Eye Indicator
- Wide Range 10 MMF to 2000 MMF

Allows you to check most capacitors from 10 mmf to 2000 mmf for open or shorted conditions without unsoldering. Just connect the test leads across the component you wish to test, press the switch and note the eye tube's face for an open or short condition. Checks coupling, by-pass, filter and blocking capacitors. Accurate readings are made in seconds—an important factor in today's complex electronic equipment. It also indicates capacitor leakage. Tests for opens on capacitors of 10 mmf. or more; for shorts up to 2,000 MF. Shunted by not less than 10 ohms. Complete with test leads and instructions. For 117 VAC. Size: 7¹/₂"Wx5Hx4¹/₂"D. Shpg. wt., 5 lbs. Imported.
 99 A 5022 Net 14.95



29⁹⁵

LAFAYETTE RF SIGNAL GENERATOR

- Six Bands: 120 KC to 260 MC
- Dual Output RF Terminals
- Separate Variable Audio Output

A stable, wide range signal generator engineered to fill the need for an accurate low cost service instrument. Full frequency range: 6 Fundamental bands—120-320 Kc 320-1000 Kc. 1-3.5 Mc, 3.2-11 Mc, 11-38 Mc, 36-130 MC. One harmonic band 120-260 Mc. Frequency Accuracy: ±2%. Audio Output: to 8 volts. Large 4¹/₂" Etched Circular Dial (Vernier tuned) High-Low RF Output Terminals. Tube Complement: 12BH7A, 6AR5, Selenium Rectifier. Power Requirements: 105-125VAC 50/60 Cps., 12 Watts. Attractive gray wrinkle steel case with leather carrying handle. Complete with test leads. Size: 7Hx10¹/₂Wx5³/₄"D. Imported. Shpg. wt., 9 lbs.
 99 A 5015 Net 29.95



Kit 89⁹⁵
Wired 129⁹⁵

EICO MODEL 460K 5" WIDE BAND SCOPE-KIT

Excellent Lab' precision scope featuring Push-pull direct coupled vertical amplifier with high sensitivity: 25 mv/n. Response flat from DC to 4.5 MC, useful to 10 MC, ideal for reproduction of 3.58 MC color TV sync. burst. 4-step freq.-compensated attenuator in both AC, DC positions. Also Internal voltage calibration. Automatic sync. limiter and amplifier. 2X-full screen horizontal positioning. Sweep-freq.: 10 to 100K cps with external capacitor for lo-freq. sweeps. Preset TV V & H sweep positions (30 and 7875 cps). Variably lit graphed 5" screen. Very hi-input impedance. Complete with all components and instructions for easy assembly. 13x8¹/₂x16". For 105-125 VAC, 50-60 cycles. Shpg. wt., 30 lbs.
 38 A 2643WX Model 460 Kit Net 89.95
 Model 460. As above, but factory wired.
 38 A 2644WX \$7 Monthly Net 129.95

Quality Test Equipment for Every Use

LAFAYETTE 20,000 OHMS-PER-VOLT VOM with GIANT 6" METER

- 20,000 Ohms-per-volt DC
- 1% Multiplier Resistors
- DC Volts From 0-5000V in 8 Ranges
- AC Volts From 0-5000V in 6 Ranges

26⁹⁵



A precision VOM for accurate measurement of voltage, current, resistance and decibels. Gives you accuracy comparable to bench type units, with the added feature of complete portability. Expanded 6" meter scale in red and black. 50-microamp meter sensitivity provides 20,000 ohms per-volt input resistance on DC and 5,000 ohms per-volt on AC—Wide-range frequency response measures 10 to 100,000 cycles within ± 0.5 db. A single 1.5V battery in the ohm-meter circuit prevents burnout to low current drain devices. SPECIFICATIONS: SENSITIVITY: 20,000 ohm/volt DC, 5000 ohms/volt AC. RANGE: AC: 0-5000 volts (in 6 ranges): 2.5, 10, 50, 250, 1000, 5000V; DC: 0-5000 volts (in 8 ranges): 0.25, 1, 2.5, 10, 50, 250, 1000, 5000V. DC Current, 0-10 amps. OHMMETER: 0-20 megohms (in 3 ranges): 0-2K, 200K, 20M. DECIBELS: -20 to +50 db. ACCURACY: DC: $\pm 3\%$ Full Scale. AC: $\pm 4\%$ Full Scale. RESISTANCE: $\pm 3\%$ Full Scale. Heavy gauge steel case with high impact plastic panel. Includes test leads, batteries and leather carrying handle. Size $6\frac{1}{4} \times 7\frac{1}{4} \times 3\frac{1}{8}$ " D. Imported. Shpg. wt., $4\frac{1}{2}$ lbs.

99 A 5013

Net 26.95

LAFAYETTE TUBE TESTER

For HOME, SHOP BENCH or LABORATORY

- Checks Compactrons, Nuvistors, T-9 Types 7-pin Miniatures, Octals, Lock-ins and 9-pin Miniatures
- Fast-Setting Slide Switches Covering All Elements of 12-Pin Compactron Tubes
- Accurately Checks Over 1800 Different Tubes
- Tests for Cathode Emission, Leakage and Shorts plus Filament Continuity.

A modern, dependable tube checker designed for fast, accurate testing—the ideal low-cost tube tester for any radio-TV serviceman, experimenter, technician. Tests most of the tube types employed in Radio, Hi-Fi, Monochrome, and Color TV, including the 12-pin compactrons, nuvistors, T-9s, 7, and 9-pin miniatures—actually tests over 1800 different tubes! A special alligator clip lead is furnished to test tubes with top caps. Slide switches connect the various tube elements to their respective test circuits. 3-position tube slide switch for checking shorted elements, cathode emission and filament continuity. A leakage indicator light indicates an interelement short or leakage. Large easy-to-read meter calibrated 0-100 has a red-green "Replace-Good" scale, plus a special scale for checking diodes. A handy slide out metal tray contains tube charts which facilitate rapid selection of test settings. Metal case is attractively finished in cream and steel gray. Completely portable—weighs only 6 lbs. and measures $8\frac{1}{2} \times 9\frac{3}{4} \times 2\frac{1}{2}$ " H. Supplied with carrying case. For 105-125 volts, 60 cycle AC. Imported. Shpg. wt., 7 lbs.

99 A 5011 Tube Checker

Net 19.95

DELUXE TUBE TESTER IN CARRYING CASE. SAME AS OUR TUBE TESTER ABOVE, BUT HOUSED IN A PORTABLE WOOD CASE WITH GREY VIVID TRIM. IMPORTED.

99 A 5012

Net 21.95

LAFAYETTE TRANSISTOR ANALYZER KIT

6-IN-1 TESTER

- In-Circuit and Out-Of-Circuit Transistor Checker (Including Power Types)
- Diode and Rectifier Checker
- Signal Generator
- Battery Tester
- Voltmeter
- Milliammeter

Lafayette's 6-in-1 Transistor Analyzer is a tester capable of testing transistors of all types including power types. The in-circuit test provides an actual performance check. Externally the transistor is checked for leakage on a multi-colored scale and for beta gain in 3 ranges up to 200. Makes trouble shooting transistor radios easy by supplying a 5kc test signal with harmonics for checking the RF, IF, and AF circuits. This signal can also be coupled to an oscilloscope for a visual circuit function test. Also checks the condition of diodes and rectifiers. Features a voltmeter for testing transistor radio batteries. This analyzer can check current drain up to 80 ma. Complete with test leads and step-by-step illustrated instructions. Black case and anodized aluminum front panel. $6\frac{1}{2} \times 5\frac{1}{2} \times 2\frac{3}{8}$ ". Shpg. wt., $3\frac{1}{2}$ lbs.

19 A 0901

Net 13.50

Extra $1\frac{1}{2}$ volt Battery (2 required)

32 A 4801

Net ea. .13

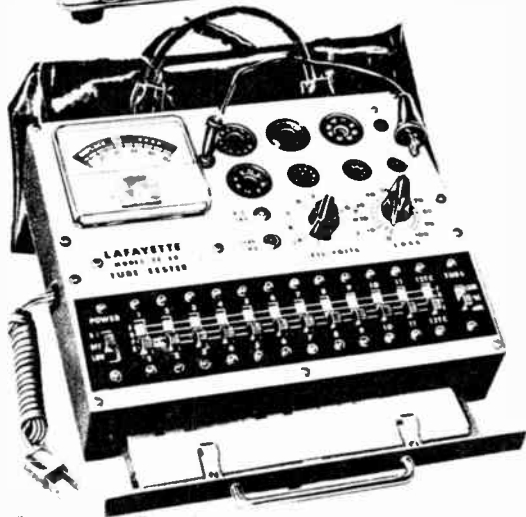

19⁹⁵

Tests for Cathode Emission, Leakage and Shorts plus Filament Continuity.



MADE IN U.S.A.

13⁵⁰

Top Quality LAFAYETTE Test Instruments



Not a Kit — Completely
Wired and Tested

MADE IN U.S.A.
26⁹⁵

LAFAYETTE VTVM with GIANT 6 1/2" METER

- Accurately Measures AC Peak-to-Peak Voltage, AC RMS Voltage, and Resistance without Additional Probes or Accessories
- Wideband RMS Measurements on any Waveform from 30 cps to Over 5 MC
- Direct Reading DB Scale

A high quality, accurate VTVM employing a giant 6 1/2" easy reading 400µA meter. 11 megohm input resistance. AC RMS voltages may be read directly up to 1500 volts and resistance from 0 to 1,000 megohms in 5 overlapping ranges. Has zero-center scale for alignment of FM and TV detector circuits. Push-pull amplifier electrically isolates the meter movement — meter is virtually impossible to burn out. Precision 1% multiplier resistors. SPECIFICATIONS: DC VOLT-METER RANGES: 0 to 3, 30, 150, 300, 1500 volts. Input resistance: 11 megohms (1 megohm in probe) on all ranges. A.C. VOLT-METER RMS RANGES: 0 to 3, 30, 150, 300, 1500 volts. PEAK-TO-PEAK RANGES: 0 to 8, 80, 400, 800 volts. DECIBEL RANGES: —10 to +5, +6 to +25, +26 to +45 db. Response: 30 cps to above 5 Mc. OHM-METER RANGES: 0 to 1000 megohms in 5 overlapping ranges. ZERO CENTER VOLT-METER RANGES: 0-1.5, 15, 75, 150, 750 volts. Complete with 1 1/2 V battery, instructions, and 3 probes: Common, AC volts/ohms and DC volts probe. Size 7 1/2x6 1/2x5 1/2". For 110-120 V 60 cycle AC. Shpg. wt., 7 lbs.

38 A 0101W Net 26.95
38 A 0103 Accessory RF Probe 1 lb. Net 3.95
38 A 0106 H.V. Probe, Extends range to 30,000 V. 1 lb. Net 5.85
38 A 1501 Leather Case for VTVM. 1 lb. Net 2.95

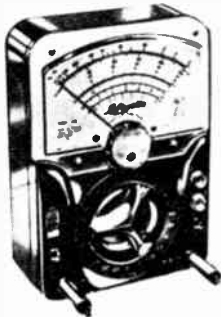

LAFAYETTE 30,000 OHMS PER VOLT MULTITESTER

16⁸⁸

FACTORY WIRED AND TESTED

- 30,000 Ohms Per Volt DC, 15,000 Ohms per Volt AC
- 1% Precision Resistors
- Unique "Buzzer" for Fast Short Tests
- 27 Meter Ranges on 2-Color Scale

A deluxe portable VOM with a high order of accuracy. Provides wide voltage, current, resistance and db ranges clearly visible on a large 4" meter with 2-color calibrations. Sensitive 33 microamp meter provides full scale readings down to 1/4 volt on DC and 0.05 milliamps. Ranges: DC volts 0-25, 1, 2.5, 10, 25, 100, 250, 500, 1000; AC volts 0-2.5, 10, 25, 100, 250, 500, 1000. DC Current: 0-0.05, 5, 50, 500 ma; 0-12 amps. Ohmmeter: 0-60K, 6Meg, 60 Meg. Db's: —20 to +56 db. Controls: Range Switch, Ohms Adjust. Audio output jack with DC blocking capacitor. With leads, batteries. 4 1/2"Wx6 1/2"Hx 2 1/4"D. Imported. Shpg. wt., 2 lbs.

99 A 5004 Net 16.88
38 A 0108 Pigskin Carrying Case for above Net 1.95

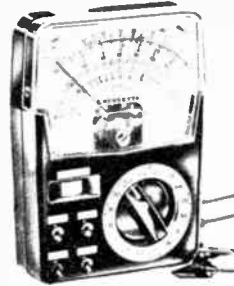

LAFAYETTE 20,000 OHMS PER VOLT MULTITESTER

- 20,000 Ohms/Volt DC, 10,000 Ohms/Volt AC
- 1% Precision Resistors
- Easy-To-Read 3" Meter

9⁹⁵

Factory Wired

Easy visibility is provided by the large 3" meter with two large color scales. 40 µA, D'Arsonval meter movement permits a high input resistance on all ranges. Rugged high impact plastic case. Sensitivity: 20,000 ohm/volt DC, 10,000 ohm/volt AC. Range (DC Volts): 0-3, 30, 60, 300, 600, 3,000V; AC Volts: 0-6, 60, 120, 1200V. DC Current: 0-60 µA, 0-12, 0-300 ma. Resistance: 0-60K, 0-6 megohms. Decibels: —30 to +63 db. Audio output jack. Supplied with test leads and 1 1/2V battery for resistance measurements. Size: 3 1/4 x 4 1/2 x 1". Imported. Shpg. wt., 1 lb.

99 A 5008 Net 9.95
Pigskin Carrying Case for above Net 1.95
38 A 0107 Net 1.95

LAFAYETTE SIGNAL GENERATOR AND TRACER



SALE! 23⁹⁵

Not A Kit
Factory Wired
And Tested

- Two Test Instruments in One
- Built-in Audio Circuit

Made in U.S.A.

The Signal Generator serves as a full service instrument—the Signal Tracer follows any signal generated by a broadcasting station or injected by the Signal Generator section. Features 5 frequency ranges and an attenuator switch to control both the R.F. signal and the 400 cycle audio tone. RANGES: 250-850 KC, 850-3000 KC, 3-11 MC, 11-45 MC, 35-120 MC, 400 cps audio signal. Modulation slide switch, and power switch, signal output jack, AF input jack, 2 preamp output jacks, 4 1/2" Alnico V speaker. 3 tubes plus selenium rectifier, and 2 Probes. Dimension: 7 1/2x9 1/2x5 3/4". Shpg. wt., 9 lbs.

38 A 0102W Net 23.95



LAFAYETTE Pocket AC-DC VOM

4⁹⁵ FACTORY WIRED

- Extremely Compact, Weighs 5 Ozs., Measures Only 3 7/8x2 1/8x1"
- 1,000 Ohms Per Volt Sensitivity
- Reads: 0-1000 Volts AC-DC, 0-100K Ohms, 0-150 MA

The Lafayette pocket multitester features small physical size, and a wide selection of useful ranges. Can be used for trouble-shooting any type of electronic circuits or electrical appliances such as irons, lamps, radios, television, hi-fi equipment, etc. 1000 ohms per volt sensitivity and 1% precision resistor components assure accurate, precise readings. Operation is extremely easy, no switching or fidgeting required. Ranges Volts: 0-15-150-1000 AC and DC. Ohms: 0-100K; MA: 0-150. The VOM comes completely wired and tested, and is enclosed in durable plastic case. All accessories including battery are rubber insulated. Color coded flexible test leads are supplied. Shpg. wt., 1 lb. Imported.

99 A 5010 AC-DC POCKET VOM Net 4.95
99 A 5061 Pigskin Carrying Case for above Net 1.75

LAFAYETTE Automatic Timers... Stop Watches

TV TIMER CONTROL

4⁹⁵

- Turns Off TV Automatically While You Sleep
- Simple to Use—Just Plug In
- 500 Watt Capacity

Now you can fall asleep while TV is still on! No need to wake up and turn it off... the new TV Timer Control turns off your TV set automatically. Simply plug the TV into the Timer Control, and the Timer Control into the wall outlet. Then turn the dial to choose the automatic "turn-off" time... from 10 minutes to one hour. The 500-watt capacity makes it ideal for use with most other household appliances—radio, hi-fi, tape recorder, lamp, patio light, electric blanket, heating pad, hair dryer, etc. Imported. Shpg. wt., 1 lb.

13 A 2850

Net 4.95



TIMED EXTENSION CORD

A 3-way combination for every home — an automatic time switch, extension cord, convenient outlet, 0-4 hour time cycle. Easy to operate—plug it into any wall outlet, connect one, two or three devices to be controlled, and turn the knob to the time period desired. At the end of this time period, the electricity is turned off automatically. 6-foot cord. Shpg. wt., 1 lb.

13 A 8501

Net 5.11

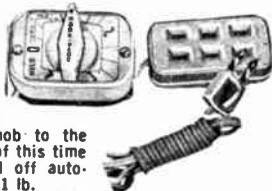

TELECHRON TIMER SWITCH

- Radio—TV—Appliance Timer
- 60 Minute Sleep Switch

Automatically turns on radios—TV sets—etc.—at any preset time within 12 hour period. "Sleep-Switch" allows up to one hour "on". Built in signal alarm. Gold finish dial—3½" square bezel. 1¾" deep. SPST rated 15 amps at 115 volts, 1650 watt load capacity. For 110-120V. 60 cy. AC only. Shpg. wt., 2 lbs.

13 A 4409

Net 5.40



1/10 SECOND STOP WATCH

Designed for close timing. Large hand registers 1/10 of a second, up to 30 seconds; small hand reads minutes, up to 15. Start, stop, and continue from crown; instant zero. 7 jewel movement. Chromium plated case. Shpg. wt., 8 oz. Imported.

13 A 3103L

Net 9.95

Same as 13 A 3103L (above) except 1 jewel.

13 A 3102L

Net 8.40



1/5 SECOND STOP WATCH

Second hand registers 1/5 of a second and completes turn in 60 seconds. Small hand indicates up to 30 minutes. Side slide starts and stops hands. Fast resetting dependable 7-jewel movement. Shpg. wt., 8 oz. Imported.

13 A 3104L

Net 9.95

Same as 13 A 3104L (above) except 1 jewel.

13 A 3105L

Net 8.40



PEDOMETER

- Range 0-25 Miles
- Ideal for Hikers, Salesmen, Efficiency Experts, etc.

4⁹⁵

Fine quality pedometer accurately registers distance you have walked in quarter mile increments from 0 to 25 miles. Large easy to read dial. This precision instrument comes with clip for wearing on belt. Easily set, simple to use. A must for those who want to know their distance traveled. Shpg. wt., 8 oz.

13 A 3112L

Net 4.95

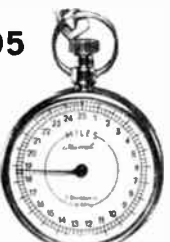

LAFAYETTE® TECHNI-TIMER™.

New Low 7⁹⁵

Price WAS 8.50

- Makes Any Appliance Completely Automatic
- No Special Wiring—Just Plug In
- Handles Loads Up To 1875 Watts
- Turns Lights And Appliances On and Off
- 1 Year Guarantee



The Lafayette Techni-Timer makes practically everything electrical automatic. Turns radios on and off. Does not have to be reset each night. Defrosts refrigerator, controls roaster, electric blanket, fans, coffee-makers, phonographs, etc. Turns your home lights on and off automatically while you're away. Repeats cycle every 24 hours—no need to reset. Minimum ON time 15 minutes, maximum ON time, 23-hours. Minimum OFF time 1-hour, max. OFF time, 23-hours 45 minutes. Easy-to-read 24-hour dial. Can be controlled manually without automatic reset. Attractive design. For shelf, table or wall mounting. With 6 ft. cord, plug and receptacle for equipment to be controlled. Highest quality—we will repair any defect due to material or workmanship within 1 year without charge. Simply ship timer to Lafayette prepaid. 5Wx4Hx2½"D. For 110V 60 cycles AC. Shpg. wt., 2 lbs. UL/CSA approved.

13 A 0140

Net ea. 7.95



PARAGON TIMITE® MINIATURE 24-HOUR FOR HANDY BOX MOUNTING

A compact time control ideal for window displays, night lights, yard lights, etc. Provides one on-off operation per day with minimum setting of two hours. Has manual trip lever. 24-hour dial is divided into 30 minute segments for easy, accurate setting. Fits over a U.S. standard single gang handy box. Size: 4½Hx2¾Wx3¼"D. Capacity: 15 amp. non-ind., 1800W. 1 HP. 12 amps., full load. For 120 v., 60 cycles. UL and CSA approved. 13 A 1751 Shpg. wt., 1½ lbs.

13 A 1751

Net 7.77



INTERMATIC TYPE T101 TIME SWITCH

Turns equipment "on" and "off" once in 24 hours, or from 1-12 "on" and "off" operations a day can be obtained by use of extra trippers — can be added without removing dial. Min. on or off time 1 hr., max. 23 hours. Can be turned on or off manually with reset SPST switch rated at 40 amps. 4375 watt capacity. Mounting holes and knockouts. Gray steel case. UL approved. Operates on 110 volt 60 cycle AC. 7¾Lx5Wx 3"D. Shpg. wt., 4 lbs.

13 A 2702

Net 8.42



"SKIPPER" 3 CIRCUIT SPRINKLER TIMERS

Intermatic lawn sprinkling system time controls permit completely automatic pre-programmed watering of up to 3 zones. A 24 hour time dial can initiate sprinkling any time during the day while skipper wheels eliminates watering on selected days. Time durations per area adjustable from 5 to 60 minutes. May be manually operated. Rated at 120 volts, 60 cycle, 5 amps, Gray hammer-tone case 7¾x5x3". Shpg. wt., 3 lbs.

13 A 2725 7 day

Net 15.56

13 A 2726 12 day

Net 15.56



SWISS POCKET TIMER

Avoid parking tickets, late appointments, etc. Use as timer on phone calls, cooking, etc. 120-minute dial is marked in 5 minute intervals. To operate, just set dial to time wanted and buzzer will sound off when pre-selected time has elapsed. With handy key chain. Shpg. wt. 1/4 lb.

13 A 3111L

Net 3.95



Top Quality Marine Electronic Equipment

HARTMAN 30-WATT MARINE RADIO TELEPHONES

"HURRICANE 30" 30 WATT MARINE RADIO TELEPHONE

- Includes • Mike
- 2 Crystals

The "Hurricane 30" features maximum transistorization for minimum power drain. Full 30 watts input assures reliable communications at all times. And you get four channels—two ship-to-ship channels, one emergency coast guard, one Marine Telephone Operator, plus standard broadcast reception. Neat front panel has performance meter for achieving best power setting, plus Automatic Noise limiter, Lifetime Melamine woodgrain cabinet is completely moisture-fungus proof. Includes carbon push-to-talk microphone, built-in 6" speaker, and 2 crystals for 2182 kc, and 2138 kc. For 12 volt operation. 8 1/2 x 13 1/2 x 4 1/4" H. Shpg. wt., 19 lbs. 40 A 7203WX Net 199.50

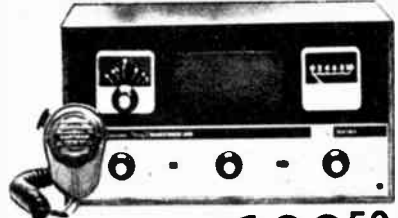

As Low As **199⁵⁰**

- 30 Watts Input
- 4 Channels Plus Broadcast
- 30-mile Range Ship-to-Ship
- 50-mile Range Ship-to-Shore

DELUXE HURRICANE 30 MARINE RADIO TELEPHONE PACKAGE

- Includes
- Antenna • Mike
- 4 Crystals • Wiring Harness

Deluxe quality precision radiotelephone. Same specifications as Hurricane "30" at left but includes everything necessary for installation: Deluxe center-loaded whip antenna with stand-off bracket and chrome-plated brass swivel-based lay-down hardware, wire harness for power and antenna leads, 4 crystals: 2182 kc, 2638 kc, 2738 kc, and Marine Telephone Operator crystal. (Specify area for Marine Operator); mike, mounting hardware. Choice of woodgrain lifetime melamine cabinet to match the interior of your boat. For 12 v. operation. Shpg. wt., 25 lbs. 40 A 7204 WXY \$15 Monthly Net 299.00

HARTMAN MC-62 SOLID STATE SHIP-TO-AUTO CONVERTER

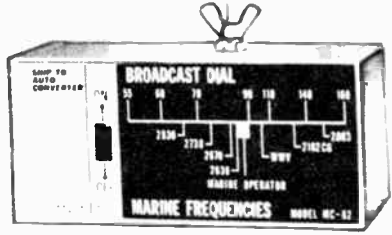

ONLY **19⁹⁵**

- For Coast Guard, Marine Telephone, Ship-To-Ship Broadcasts, WWV (weather), and Ship-To-Shore Conversations

Now you can listen to marine broadcasts on your car radio. A flick of the switch and your auto radio becomes a powerful, long-range marine receiver. Switch back and it plays the normal broadcast band. All-transistor circuitry uses only 1/2000 of an amp from built-in battery; virtually the battery's entire shelf life. Converter selects any frequency between 2000 KC and 3000 KC. Operates with either 6V or 12V automobile ignition system. Shpg. wt., 2 lbs. 40 A 7202 Net 19.95

NEW! NOVA TECH PILOT II SOLID STATE 4 BAND RADIO DIRECTION FINDER



BANDS

UHF	108-136MC
Marine	1.5-4.5MC
Beacon	200-400KC
AM	550-1600KC

129⁹⁵

No Money Down

4 band radio receiver picks up the entire marine and aircraft bands, weather reports, and standard AM. Features: rotating loop for sharp nulls and accurate bearings, 180° left-right bearing scale, null meter, DF level control, calibrated optical sights, push button dial light, 4 antennas, 2 external headphone jacks, 12 transistors. Complete with AC adapter, batteries, mounting bracket, and earphone. Size: 9 1/2 x 5 1/2 x 2 1/2". Imported. Shpg. wt., 5 lbs. 40 A 3801WX \$7 monthly Net 129.95
99 A 6258 Batteries for above (4 required) Net ea. .095

Sonar D-120B DEPTH INDICATOR



139⁵⁰

No Money Down

- Reads Up To 250 Feet
- 360°, 4" Scale With 1-Foot Calibrations
- One-Piece, Non-Magnetic Construction

Highly sensitive, extremely accurate depth indicator for bulkhead mounting. Measures from 1 to 250 feet. Easily installed—even while boat is in water. For 12 VDC. Size: 11 1/4 x 7 1/2 x 7 1/2" D. Complete with transducer, gimbal and fairing block. Shpg. wt., 10 lbs. 40 A 4312WX \$7.50 Monthly Net 139.50

DELUXE MARINE COMMUNICATION CENTER



ONLY **179⁹⁵**

A MUST FOR EVERY BOAT OWNER

- CONSISTS OF • Solid State Amplifier • Rugged 12" Aluminum Speaker on 360° Swivel Base • Remote Cabin Intercom • 3-Way Dynamic Mike • Auxiliary Radio-Phono Input Accessory

Precision engineered and designed as a multi-purpose marine Communication center. This system performs long range hailing; automatic fog signaling; complete marine public address communicating; U.S. Coast Guard distress signaling; long range electronic listening. The communications center also serves as a boat horn; multi-purpose alarm system; shipboard two-way intercom system; controlled fog horn; marine radio auxiliary input; ship-to-ship and ship-to-shore hailer; and "Mayday" emergency signaler. Solid state circuitry. Completely weatherized. For both 6 and 12 volt operation. Includes all mounting hardware. Imported. Shpg. wt., 22 lbs. 40 A 3901WX \$9 monthly Net 179.95



Hummingbird 74⁹⁵

- Row It!
- Sail It!
- Outboard!

Tough, lightweight family boat molded of expanded polystyrene. Unsinkable, it safely supports up to four adults. Has two wide, comfortable transverse seats plus a roomy insulated storage compartment which doubles as an extra seat. Maintenance free solid one piece construction is unaffected by salt water. Weighing only 48 lbs. it can be easily transported on car roof—requires no docking facilities. Can be used with outboard motor up to 3.5 HP (below), oars, or optional sail kit. Length: 9 ft. 3 in. 52"

beam. Blue & white hull. Shpg. wt., 100 lbs. Ship F.O.B. Scranton, Pa. No C.O.D. Shpg. charges collected on delivery.
13 A 2151WXY Less oars, oarlocks Net 74.95

SAIL KIT. Includes: aluminum mast and mast extension spar (13'9" high); alum. boom 7' long; 40-sq. ft. nylon sail, dagger board, wood rudder, tiller. Rigging and Sailing instruction book. See Shpg. information for boat. Shpg. wt., 20 lbs.
13 A 2152WXY\$5 monthly..... Net 49.95

OUTBOARD MOTORS BY **ESKA**

SKIPPER 300 3-HP
• Runs 1½ Hours on 2 Pints of Gas • Ideal for Slow Trolling • Easy to Carry—Weight 27 lbs. **69⁹⁵**

Lightweight, easy to carry and stow. Precision built, will run 1½ hours on only two pints of gas! Runs as little as 1 to 2 mph. Full 360° pivot. Automatic rewind starter. Front and back carrying handles. Aluminum propeller. Shpg. wt., 30 lbs.
12 A 3102WX \$5 monthly Net 69.95

GOLDEN JET 500 5-HP
• Compact • Lightweight • Powerful • Ideal for Trolling **89⁹⁵**

5 H.P. only 30 pounds with balanced front and rear handle for easy carrying and short 40 inches fits in any car trunk. Precision quiet air cooled engine throttles down for slow trolling. Full 360° pivot. Automatic rewind starter. Submersible parts salt resistant aluminum. 4½" Pitch Semi-Weedless propeller. Built-in Tank holds 3½ Pints Fuel. Shpg. wt., 38 lbs.
12 A 3103WXY \$5 monthly Net 89.95

NEW! GOLDEN JET 700 7-HP
• 7 HP Only 40 Inches Tall • Easy to Stow in Car or Boat • Weighs 33 lbs. • Air Cooled Engine Doesn't Freezeup **119⁹⁵**

Lightweight and compact with lots of power for small boat fishing. Economical for all day running. Precision air cooled motor has automatic spark control for smooth slow trolling and fast speed. Corrosion resistant for fresh and salt water operation. Automatic rewind starter. ¾ pint integral tank. Water muffled exhaust. Shpg. wt. 41 lbs.
12 A 3106WXY \$5 monthly Net 119.95

AUXILIARY FUEL TANK
Capacity 3½ gal. With hose and connections.
12 A 3105Y Wt. 3 lbs. Net 13.95

All motors shipped F.O.B. Dubuque, Iowa, No C.O.D. Shpg. charges collected on delivery.

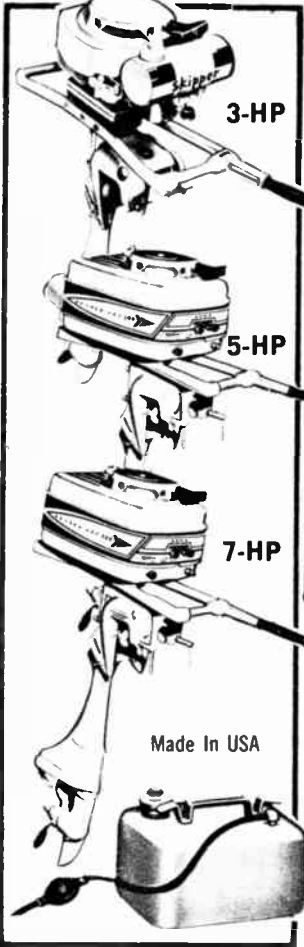

MARINE DISTRESS SIGNAL KIT

350 • For Day or Night Use

Can be stored on your boat indefinitely, always ready for emergency use. Waterproof package kit contains (3) 10-shot signals, (2) 10-minute flares, (1) sea whistle, (1) fluorescent dye marker, (1) package waterproof matches and (2) launching handles. Shpg. wt., 2 lbs.
12 A 5302 Net 3.50

3-STEP ALUMINUM FLOATING LADDER

649 • Universal Hook Fits 7" to 11" Gunwales

Heavy duty tubular aluminum boat ladder with sealed air that keeps ladder afloat if it drops overboard accidentally. Standoff legs adjust to fit contour of hull, prevents slap. Universal hook is vinyl-sleeved to prevent marring or scratching rail, sure grip. Fits gunwales 7" to 11", 36½" long. Shpg. wt., 4 lbs.
12 A 5303 Net 6.49

ALL-PLASTIC BILGE PUMP

399 • Non-Corrosive • Self-Priming • Floats • Pumps 10 Gallons Per Minute

Constructed of durable rustproof, polyethylene. It Floats. Double-action valve maintains a steady water flow—pumps 10 gallons per minute. 25½"L. 18" extra spout for deeper hulls. Shpg. wt., 1 lb.
12 A 5301 Net 3.99

LAFAYETTE Automotive Test Equipment

LAFAYETTE DWELL TACHOMETER

Completely Wired
Not A Kit

28⁵⁰

- Tunes up Electronically, Any Car Ever Made
- Three Dwell Scales
- Giant 6½" Easy-to-Read Scale
- Use to Adjust Carburetors
- Use to Adjust Points



A complete ready-to-use Dwell Meter and Tacnometer which will operate on any car ever made. Tests cam Dwell angle and engine RPM on 4, 6 or 8 cylinder cars, 6 or 12 volt right on the engine. Giant 6½ easy-to-read meter makes it simple for anyone to adjust points and carburetors to insure maximum gas economy and quiet engine running. RPM readings are also essential to properly service automatic transmissions. Three dwell angle scales are provided: 0 to 45 degrees, 0-60 degrees, and 0 to 90 degrees. This instrument is suitable for dwell angle adjustment on all foreign and domestic cars. Dual range tachometer 0 to 1000 rpm for precise carburetor adjustments. 0 to 5000 rpm, suitable for making all other tests at high engine speeds. Shpg. wt., 4 lbs.

11 A 0101 Net 28.50

NEW! DWELL TACHOMETER

16⁹⁵

- Tune Up Electronically Any Car Ever Made
- 3½" Double Jeweled D'Arsonval Meter
- For 4, 6, or 8 Cylinder Engines
- For 6 or 12 Volt Systems
- For 2 or 4 Cycle Engines
- Burnout Proof
- Bakelite Case
- Point Resistance Check
- Made in USA

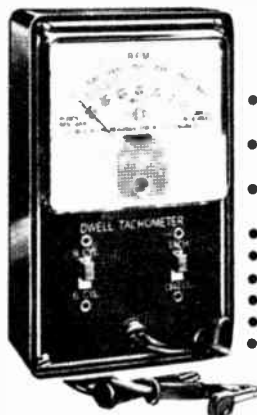

Electronically tune your car! This Dwell-Tachometer permits setting the carburetor for maximum efficiency, gas economy and greater power; indicates the correct point gap setting electrically (even if the points are pitted or corroded); permits setting points with the distributor cap off and engine cranking, and permits setting points on "Window" distributors with engine running. It also locates defective spark plugs; permits correct engine RPM setting for automatic transmission adjustments, throttle linkage and idle adjustment. RPM scale: 0-3000; 8-cylinder dwell: 5-45°; 6 cylinder dwell: 20-40°. 4 cylinder readings obtained by doubling 8 cylinder scale reading. Two-color scale. Small and compact—measures only 6¼x3¾x2". Shpg. wt., 2 lbs.

11 A 0105 Net 16.95

AUTOMOTIVE TESTING EQUIPMENT

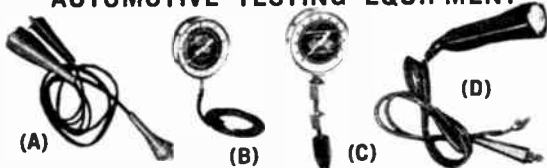

(A) REMOTE STARTER SWITCH

Eliminates the need of a second man when making compression, fuel pump, generator, starter, and electrical tests. Permits the mechanic to crank the engine from any position. Shpg. wt., ½ lb.

11 A 1702 Net 1.90

(B) VACUUM & FUEL PUMP TESTER

Accurately checks pressure and suction of fuel pump and vacuum system. 2½" dial, easy to read. A precision instrument calibrated from 0-30 inches for vacuum and from 0-7 lbs. for pressure. Color coded dial indicates when repair is necessary. Heavy duty case, complete with tubing.

11 A 4206 Shpg. wt., 12 oz. Net 2.89

(C) COMPRESSION TESTER

Finds trouble in valves, rings, pistons, cylinders. Offset stem allows easy access to usually hard to reach back cylinders. Big 2½" dial calibrated from 0-300 lbs. pressure. Fits all spark plugs.

11 A 4207 Shpg. wt., 12 oz. Net 2.89

(D) STANDARD TIMING LIGHT

For adjustment and setting of ignition timing under actual operating conditions. Shpg. wt., 1 lb.

11 A 1705 Net 2.69

ION-X ELECTRONICALLY IONIZES GASOLINE BOOST POWER!

7⁹⁵

- Changes Electron Balance of Fuel
- No Carbon Build-up
- More Horse Power From Your Engine
- Increased Gas Mileage

Remarkable component which changes molecular structure of gasoline before it enters the carburetor. Assures more power, less carbon build up from greater combustion intensity. More closely added air fuel mixture. Easy to install. Shpg. wt., 1 lb. Imported.

11 A 1505 Net 7.95



DELUXE 4-WAY EMERGENCY FLASHER

3⁸⁸

Was
~~4.49~~

- Built-in Heavy-duty Flasher and Fuse
- All 4 Directionals Blink On and Off
- Flashing Pilot Light with Audible Click



Simply pull out the switch and all 4 directionals start blinking, along with pilot light in switch. Completely separate heavy-duty system cannot overload or damage car's existing light system. Unbreakable mounting bracket for mounting through or under dash. Easy to install; self-insulating connectors. Instructions included.

11 A 8203 Shpg. wt., 1 lb. Net 3.88

LAFAYETTE ILLUMINATED AMMETER & OIL PRESSURE GAUGES

4⁹⁹

- Complete with Cable and all Standard Fittings
- Attractive Chrome Panel

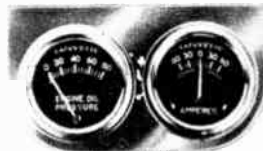

Keep a constant check on the condition and performance of your car's electrical and oil pressure systems. The ammeter calibrated in a 60-0-60 scale measures the actual rate of current flow . . . helps prevent generators from burning out and overcharging or discharging the battery. Exact oil pressure from 0 to 80 lbs. is indicated. Easily installs in any 6 or 12 volt car below the dash, without drilling or can be mounted right in the dash. Both meters are mounted in an attractive chrome panel. Easy to read meters feature 1¾" diam. black dial faces with calibrations in white. Size: 5¼Wx2½Rx2¼"D. Supplied with 6 and 12 volt bulbs and wire, all necessary fittings plus full instructions.

99 A 8501 Imported. Shpg. Wt., 1½ lbs. Net 4.99

11 A 8004 T Fitting Net .49

Automotive Gauges for Improved Performance

(A) OIL - AMP - WATER GAUGE

- All Electric - No Tubing

End guesswork and space problems with this beautiful three-in one gauge. Gives accurate, individual readings of oil pressure, amperage and water temperature. Fits all cars, generator or alternator systems. Amp. gauge reads -60 to +60; oil pressure registers 0 to 80 lbs.; water temperature indicates 100° to 220°. With necessary wire, adjustable mounting ring, senders. Shpg. wt., 2½ lbs.

11 A 4203 Net 19.95

(B) OIL AND AMMETER GAUGE

- All Electric - No Tubing

Compact two-in-one gauge gives accurate readings of oil pressure and amperage. No need for guesswork when only red warning lights are used. Multi-color indicator scales as above. With electric oil sender, adjustable ring for mounting on steering column and all necessary wire. Shpg. wt., 2 lbs.

11 A 4204 Net 14.95

(C) TRANSISTORIZED TACHOMETER

- Regular or Transistor Ignition • 4-6-8 Cylinder, 6 or 12 Volt

Here is the modern electronic guide to make your driving more efficient and more fun. Illuminated 3" dial face and electro magnetic meter movement, accurately measures engine speed from 0 to 8000 RPM. Helps reduce gas, oil bills, prevents over speeding and eliminates costly repairs due to improper engine operation. Factory calibrated, no adjustments required. Separate sending unit is a transistorized magnetic amplifier for constant accuracy; easy installation. Universal mounting with clamp. Shpg. wt., 2 lbs.

11 A 4202 Net 19.95

(D) GAS SAVER - VACUUM GAUGE

- Automatically Shows Miles Per Gallon

Stop gas waste! Handsome chrome plated Gas Saver gauge shows you exactly how to drive for the best economy or power. Works all seasons of the year and during all types of traffic conditions. Meter reads actual miles per gallon. Also checks your engine constantly by measuring its manifold pressure on the clear four color dial. Complete with 6 ft. vacuum line tubing, T connector, steering column mounting ring and instruction. Shpg. wt., 2½ lbs.

11 A 4205 Net 12.88



(A)

Only

19⁹⁵



(B)

Only

14⁹⁵

- Big 3 Inch Illuminated Dial Faces
- Heavy Chrome Die Cast Case
- 12 Volt Negative Or Positive Ground
- 360 Degree Mounting Adjustment



(C)

Only

19⁹⁵

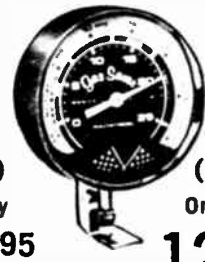

(D)

Only

12⁸⁸

CAPACITIVE DISCHARGE IGNITION SYSTEM WITH SILICON CONTROLLED RECTIFIER

- Quick, Easy Installation
- Constant Spark to 10,000 RPM
- Extremely Low Input Power—Less Load On The Engine
- Silicon Controlled Rectifier

Combines all the advantages of capacitive discharge with those of solid state circuitry. Patented circuitry eliminates point bounce problems and positively fires plugs regardless of point condition. Fast rise time spark prevents fouling from three to ten times. Point contacts last indefinitely. Elimination of mis-firing, reduces oil contaminants, prolonging engine life. Provides smoother and more efficient operation at all speeds; constant spark up to 10,000 RPM; with dramatically improved acceleration and economy. Provides faster, easier starting in all weather. Reliability and performance proven on thousands of military, commercial and private vehicles from Alaska to Cape Town. Unit operates with all commercial and original equipment tachometers. Installs immediately with two simple connections to the existing coil, leaving the standard system intact. No temperature limitations—mounts anywhere. Requires only a very small amount of input power—reduces load on engine and electrical load. For 12 volt negative ground system only. Shpg. wt., 2½ lbs.

11 A 8450 \$5 Monthly Net 39.95



39⁹⁵ No Money Down

AH-000-GAH! HORN

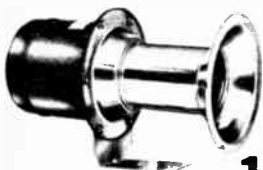

- Chrome Plated Bell

10²⁹

A real joy for the sports car enthusiast. An authentic motor driven horn approved as an exact reproduction in sound and appearance by members of antique car, hot rod, and horseless carriage clubs the world over. Chrome plated bell with black wrinkle painted housing.

11 A 3001 6-volt Net 10.29

11 A 3002 12-volt Net 10.29

PROFESSIONAL SIREN-OPERATED BURGLAR ALARM

For Cars, Station Wagons, Trucks

- Loud, Police-type Siren Gives 3-Way Protection—All Doors, Trunk and Hood
- Pick-Proof On-Off Key Lock Mounts on Outside of Auto
- Complete—Easy To Install



Get 24-hour protection on your car, station wagon or truck with this complete burglar alarm system. The sharp penetration sound of the police-type siren will scare thieves away. The siren blasts off when anyone opens a door, the hood or trunk. The alarm can be shut off only with the alarm key. Complete system includes siren with trumpet, 4 door switches, hood switch, trunk switch, 2 brackets, electrical lock with 2 keys, wire, mounting hardware, instructions and 2 warning decals. For 12-volt cars only. Shpg. wt., 3 lbs.

11 A 6201 Net 27.95

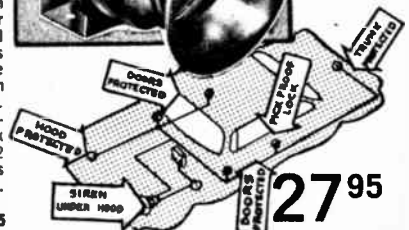

27⁹⁵

To Speed Your Mail Order - Please Give Your Zip Code Number

Lafayette Cat. No. 663 29



RADAR SENTRY*

- Gives Advance Warning Within 1/2 Mile Range
- Miniature and Completely Transistorized

29⁹⁵

Warns of Radar Traffic Zones

Miniature electronic detector warns you of radar traffic zones up to 1/2 mile away. Dual-Band circuit detects all commonly used police radar speed meters and traffic control devices to promote safer driving. Miniaturized and completely transistorized. Top quality components; printed wiring; 8 transistors; two 1,000 hour mercury cell, self-testing batteries (equivalent to 35,000 miles of driving at 35 M.P.H.) Magnesium case eliminates radio, TV and other interference. Weighs only 13 ozs., measures 3 3/8" x 2 1/4" x 3 3/4" D; clips to sunvisor. Complete with batteries, sunvisor clip. Instructions included.

11 A 4201 Shpg. wt., 1 1/2 lbs. Net 29.95

*This item not intended for resale in States where its use is forbidden in motor vehicles by public regulation.



CUSTOM-FIT HEADREST

6⁹⁵ • Makes Any Car Seat a Contour Chair!

Now you can make your car seat really comfortable with this advanced design headrest. Helps prevent whiplash too. Dorsal cantilever design keeps headrest snug against back of neck and head. Locks to seat automatically. 3 Knobs, finely calibrated gives 4-way adjustment to custom fit any individual, chair or car seat. Full 5" vertical adjustment; 4" forward and back. Looks like original equipment. Made of soft vinyl plastic with molded wing rests. Shpg. wt., 2 lbs.

11 A 1201 Black only Net 6.95

AIRWAY COMPASSES

- No Holes to Drill
- No Wiring



Universal mounting bracket with pressure sensitive base for dash or windshield. With aviation-type geared regulators, conifer magnets. Built-in battery light on illuminated models. Dial calibrated each 15 degrees. Black and chrome. Shpg. wt., 1 lb.

11 A 6501 Illuminated Net 2.25

NAVIGATIONAL DIAL CALIBRATED EACH 5 DEGREES
11 A 6502 Non-Illuminated Net 3.19
11 A 6503 Illuminated Net 3.79

MAP MEASURER & COMPASS

Just trace along route on map and multiply miles — per inch factor by reading on dial. Also reads directly in inches up to 39". Built-in magnetic compass has cardinal and secondary points — full 360° markings in tenths. Accurate and dependable. Complete with leather sheath. Shpg. wt., 8 oz. Imported.

13 A 4101 Net 1.59



CAR MAP LIGHT

249

- For Map or General Illumination

A portable lamp which can be plugged into any 12-volt cigarette lighter receptacle. Has 5 3/4 inch gooseneck making completely adjustable to any position you desire. Throws a concentrated beam of light without annoying glare to driver. Lamphed is only 2 7/8" L. Ideal for reading road maps, light ash tray or ignition switch. Has convenient on-off switch, bulb, wt., 1/2 lb. Imported.

99 A 8517 Net 2.49



PLUG-IN AUTO POLISHER

11⁸⁸

- Plugs Into Cigarette Lighter
- Genuine Lamb's Wool Buffer

Get a lustrous auto shine with a minimum effort. Auto polisher plugs into any 12-volt cigarette lighter. 18-foot vinyl cord lets you reach every part of the car. Includes lamb's wool buffer, polishing disc. Brass gears for long life. Easy-grip, contoured handle prevents weariness. Shpg. wt., 4 lbs.

11 A 6250 Net 11.88

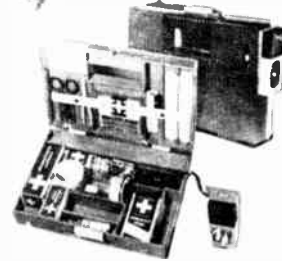

FIRST AID KIT

- Complete with Flashlight and Safety Blinker

A first-aid kit with a portable flashing red warning light and white utility light. Blue/white molded plastic carrying case has cotton, ammonia inhalant, box of band aids, 2 tongue depressors, adhesive tape, tweezers, gauze bandage, drinking cup, 3x3 and 4x4 gauze pads, blade holder, first-aid book, scissors, list of contents, antiseptic/burn ointment. Lights operate on "D" batteries (not incl.).

11 A 8201 Shpg. wt., 3 lbs. Net 4.50
99 A 6256 Batteries for above (4 Req.) Net 13.95

NEW! PATHFINDER OELUXE PLUG-IN SPOTLIGHT

- With GE Sealed Beam
- 10-Foot Cord • All Chrome

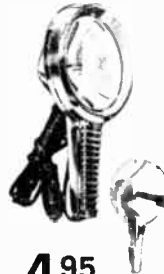

4⁹⁵

Plug-in portable spotlight is a real "life-saver" in emergencies—provides dependable, instant, powerful light for safety in every night-driving need. Finger-grip handle permits easy direction of light beam. Flexible 10-foot cord; GE sealed beam; convenient hang-up hook; rich chrome plate on die-cast metal. Fits all cigarette lighter sockets. Stows away in glove compartment.

11 A 1625 Shpr. wt., 2 lbs. Net 4.95

WINDOW DEFROSTING FAN

- Harmless 6" Rubber Blades
- Plugs in Cigarette Lighter



A practical automotive accessory which keeps windshield free from frost or fog while you drive. High speed 3,000 rpm motor controlled from drivers seat by 2-speed switch. Complete with cord; universal swivel joint on sturdy base. 2 1/2 lbs.

11 A 3401 For 6 volt cars Net 7.95
11 A 3402 For 12 volt cars Net 7.95

19⁹⁵

ELECTRONIC CRUISE CONTROL

- Maintains Any Selected Highway Speed
- Does Not Affect Braking or Instant Acceleration
- Helps Adhere To Posted Speed Limits
- Sets Fast Idle for Quick Cold-Weather Warm-Up

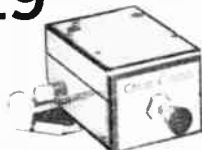

New Electronic Cruise Control enables you to drive at a constant speed by automatically holding the throttle steady. Eliminates the need to keep foot glued to accelerator on long trips. Once you reach desired speed, simply pull out knob and Cruise Control will automatically hold that speed. Allows instant acceleration for passing but takes over again when the foot is taken off the gas pedal. Ceases to function the moment the brake is depressed and completely disengages in the event of any malfunction. Designed to fit all cars and trucks. Shpg. wt., 1 1/2 lbs.

11 A 5901 Net 19.95

EASY TO INSTALL

NEW!

NEW! INTERPOL "2-TOOTER" ELECTRONIC HORN CONVERTER

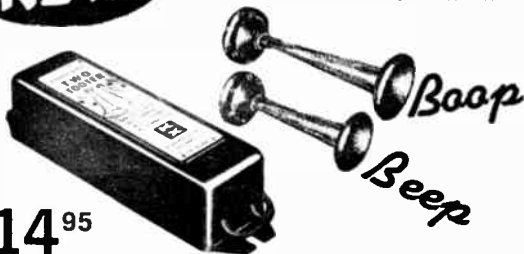

14⁹⁵

- Makes Any Auto Horn A French-Type Dual Horn
- Variable "Tooting" Speed Control Inside Car
- Easy to Connect in Minutes

The most exciting horn since the "ooooo-ga!" The Interpol 2-Tooter converts the paired sound of your car's two horns, playing the high and low notes in rhythmic alternation. The amazing result is a dual-note horn with a saucy "Continental" flair. Inside control permits the driver to vary the repeat speed for a friendly salute or an urgent warning. Compact, transistorized, solid-state unit mounts under the hood, connects in minutes. Fits 6 or 12-volt systems. Size: 6½x1¾x1¼". Shpg. wt., 2 lbs. 11A 1525 Net 14.95

NEW!

AUTO-TIME STEERING WHEEL CLOCK



- Fits All Cars
- 36-Hour Jeweled Swiss Movement
- Luminous Hands for Night Driving

12⁹⁵

Add a stylish custom look, plus an outstanding time piece, to your car's interior. With Auto-Time, the steering wheel clock, steering wheels lose their drab appearance forever as your car's interior gains a new luster. The 36-hour jeweled Swiss movement is shock-proof and anti-magnetic... you get perfect time all the time. With luminous hands for night driving, Auto-Time's bold face and sweeping second hand are easy to see. Easy to install, fits all cars from Volkswagens to Cadillacs. Shpg. wt., 1 lb. 11A 19 25 Net 12.95

LAFAYETTE 4-LITE EMERGENCY WARNING SWITCH KIT

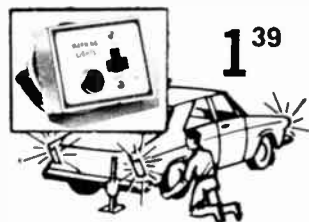

1³⁹

- Fits All 6V and 12V Cars

Just flip the emergency warning switch and all four directional signals on your car flash on and off setting up a safety zone around your car. Ideal for use during emergency road stops. Under-dash switch has built-in pilot light that flashes when unit is on. Complete with installation instructions. Shpg. wt., 1 lb. Imported 99 A 8514 Net 1.39

ROTATING "LIGHTHOUSE" BEACON

- Rotates Full 360°
- Giant Suction Cup Mount
- Battery Operated
- 14 Inches High

2⁹⁹

Red warning light rotates and flashes 360 degrees like a lighthouse beacon. Bright enough to signal help for miles around. Creates a safety zone while changing a flat tire or during a traffic emergency. For use on autos, boats, trucks, docks, etc. Suction cup will mount on any smooth surface. Handy hooks for easy carrying or hanging up. Powered by three flashlight batteries. Shpg. wt., 2 lbs. Imported. 99 A 8516 Net 2.99 Batteries for above (3 required) 99 A 8256 Net ea. .13 Blue Turret Lens—Convert above beacon for emergency use 99-A 8518 Net .49



ROTATING BEACON

- Rotates Full 360°
- Visible For Miles

3⁹⁹

Ideal warning light to maintain roadside safety. Flashes full 360 degrees constantly rotating to warn oncoming vehicles when you are stalled or off the road. Alerts emergency authorities to your difficulty quickly... can be seen for miles around. With convenient plug and 16 ft. cord which fits cigarette lighter receptacle. Big rubber suction cup base permits mounting light on roof, hood, truck, dash or any smooth surface on your car or boat. Compact, easy to store. Overall height, 6 inches. For 12-volt systems. Shpg. wt., 2 lbs. Imported. 99 A 8515 Net 3.99 Blue Turret Lens—Convert above beacon for emergency use 99-A 8518 Net .49



LAFAYETTE ELECTRONIC TRANSISTORIZED IGNITION SYSTEM

6/12-Volt Negative Ground System

12⁹⁵

- Increases Engine Economy — Pays For Itself
- Greatly Extends Point, Spark Plug and Condenser Life
- Last For The Life Of Your Car
- Heavy Duty Coil 400:1 Ratio
- Easily Installed

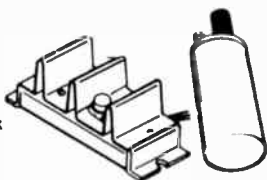

Heavy-duty deluxe transistorized ignition system. Higher firing reliability reduces aging effects in the engine. Condenser is eliminated thereby making the routine replacement of this part unnecessary. More reliable winter starting—battery stays charged. Better coil reliability: heavy-duty coil is designed to run cooler. Gas mileage stays high; timing stays adjusted between check-ups. Installation is accomplished without modifying the engine or vehicle wiring—your conventional ignition system easily restored when you trade your car in. Complete system includes heavy duty 15 amp transistor amplifier with wiring harness, coil resistor and low inductance coil with mounting bracket. Specially designed amplifier chassis gives max. heat dissipation. Shpg. wt., 3½ lbs. 11 A 0102 6/12-Volt Neg. Gnd. Net 12.95

LAFAYETTE 2-TRANSISTOR ELECTRONIC IGNITION SYSTEM



19⁹⁵

- Full Power at High RPM
- Eliminates Point Pitting and Condenser
- Easier Starting Especially in Winter
- Includes Relay For High Current Switching

Takes the needless burden of high current off of your points and deliver a constant high power spark even at speeds exceeding 10,000 RPM. Modern 2-transistor circuit switches and controls the coil primary circuit through a combination amplifier-electronic switch action. Reduces point current to a low value and with proper use extends their life to the life of the car. Carries 100% primary current to over 20,000 RPM. Special low-inductance coil delivers constant full voltage at all speeds. Spark plugs last longer due to complete burning of fuel. Condenser replacement and problems are eliminated. Transistors are removable and unit is serviceable! System includes double insulated coil, epoxy potted amplifier, ballast, and relay. Shpg. wt., 5 lbs.

11 A 0103 For Negative Ground Systems Net 19.95
POINT INSULATION KIT: Adapts transistor ign. kits to permit use with positive ground systems. Shpg. wt., 3 oz. Net 2.50
11 A 0104 Net 2.50

Battery Chargers, Inverters and Accessories

COLD-START BOOSTER-CHARGER

Our First Combination Battery Charger and Booster.

- 50 Amp Booster (6 volt)
- 25 Amp Booster (12 volt)
- 10 Amp Charger (6/12 v)

25⁹⁵

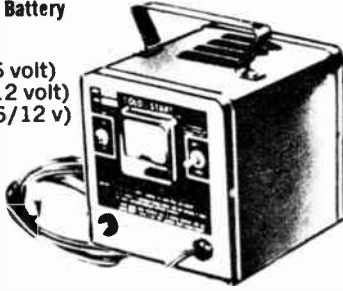

Perfect for starting 6V, 8V, 12V cars. Works as a booster—as a charger. Supplied with heavy copper cables; thermal switch prevents overheating; works up to 200-ft. away from AC power source. Power output; 12V Boost, 25 amps maximum; 6V Boost, 50 amps max.; 6/12V Charge, 10 amps tapering to 5 amps max.; Power Input: 5 amps max. at 117V AC, 60 cycles. Shpg. wt., 9½ lbs. 11 A 4001 Net 25.95

3-AMP. BATTERY CHARGER WITH BUILT-IN METER FOR BOTH 6 AND 12 VOLT BATTERIES

Edge view colored meter shows actual rate of charge and indicates battery condition. Reset circuit breaker gives automatic overload protection. Has 6 and 12 volt selector switch. Delivers tapering charge. Vented steel case; may be wall mounted. 6 ft. battery leads with 50 amp. clips. Size: 6x4½x5¾". For operation from 105-125 Volt, 50-60 cycle A.C. Shpg. wt., 5 lbs. 11 A 7604 Net 8.25

8²⁵ U L Approved



3 DRAWER TOOL CHEST

- Electrically Welded Heavy Gauge Steel
- Durable Baked Enamel Silicone Treated Finish

As Low As **9⁶⁹**

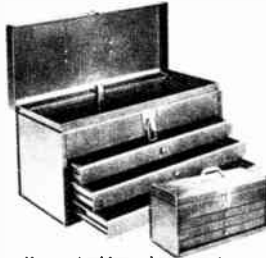

All purpose ruggedly constructed 3 drawer carrying type chest. All drawers have full suspension slides, easily removable for cleaning. Carrying handle on top. Exclusive rear-locking mechanism allows locking drawers in place even after cover is closed. Dimensions: Box—8½dx10¼hx20" long; 3 Drawers—7½dx1½hx18¼"L. Shpg. wt., 18 lbs. 13 A 1950 Net 10.49

2 DRAWER TOOL CHEST. Same as above except has 2 drawers. 8½dx10¼hx20"L. Shpg. wt., 16 lbs. 13 A 1951 Net 9.69

BUMPER JACK

4⁹⁵

- Lifts Cars Weighing Up To 5000 lbs.
- Stable 3 Legged Design



Provides strong stable support. Eliminates the complicated procedures with most single leg jacks. Engineered to grip bumper and simultaneously hold it from three ground supports. Triple leg design permits use on a hill or on soft shoulders. Protects you and your car. Universal design virtually fits all cars. 3-inch wide bumper hook rides on a main channel constructed of heavy steel. Utilizes quality ball bearings and acme threaded screw. Insures easy cranking. Designed to lift most cars on the road weighing 5000 lbs. or less. This 3 legged jack with chains between legs belongs in every car. Lifts up to 28½ inches. Shpg. wt., 15 lbs. 11 A 5228W Net 4.95

125 WATT TRANSISTORIZED INVERTER

- For Any Equipment Requiring From 10 to 125 Watts
- Charge Indicator Gives "Low Charge" Warning
- Fused to Protect Battery



29⁹⁵

A heavy-duty inverter for safe, dependable portable power. Converts your car's 12 v dc from cigarette lighter socket, to 117v, 60 cycles AC to operate electric shavers, recorders, radios, TV and many more. On-off switch and pilot light indicates that inverter is delivering AC power, and that battery has ample charge. 6¼Wx3½Hx6¼"D. 11 A 2101 Shpg. wt., 8 lbs. Net 29.95

CORNELL DUBILIER MODEL 12TV12 DC TO AC INVERTER

- Ideal for Automotive, Marine, House Trailers, Campers, etc., as a Source of AC Power Independent of Power Lines



NO MONEY DOWN **33⁸⁸**

The Model cycles 12TV12 converts 12 volt DC to 110-120 volt AC at 60

Designed primarily for television receivers, tape recorders, phonographs and other frequency sensitive devices.

SPECIFICATIONS

Input: 12 volts @ 12 amperes (full load); Output 120 watts continuous, 140 watts intermittent; RF filtering on both input and output. 8¾Lx7½Wx3¾"H. Wt., 13¾ lbs. Shpg. wt., 16 lbs. 11 A 1825W Net 33.88

Model MK-3544-5 Mounting Kit for 12TV12—Provides safe, secure mounting to bulkhead, wall, or floor. Supplied with all necessary mounting hardware. Shpg. wt., 2 lbs. 11 A 1826 Net 3.60

TERADO "DYNAMO" DC TO AC INVERTER

Convert Your Table Model Radio to a Car or Boat Radio

Operate any small radio in any 12 volt car, truck, boat or trailer. No installation—just plug into cigar lighter. Needs no outside antenna—table radio will operate on their own built-in antenna. Will also operate your electric shaver or any electric appliance up to 20 watts. Complete with generator condenser and ignition noise suppressor. Measures only 2x2x3¾". Shpg. wt., 2 lbs. 11 A 8317 Net 6.75



UNBREAKABLE PLASTIC "JERRY CAN"

- For Gas, Water, Juice, Oil — Car, Boat, Barbecue, Lawn Mower
- Will Not Rust, Corrode, Break or Shatter
- Reversible, Self-storage Spout

As Low As **99¢**



Light weight, unbreakable plastic can ideal for carrying any liquid, for any use. Improved spout for easy pouring, reverses for self storage. Air vent for free pouring. Chemically inert, not affected by oil, acid, etc. Won't dent or break. Built-in carrying handle. 1-gallon size fits in refrigerator.

One gallon size. Shpg. wt., 1½ lbs. 11 A 3801 Net .99
Three gallon size. Shpg. wt., 2 lbs. 11 A 3802 Net 1.79
Five gallon size. Shpg. wt., 3½ lbs. 11 A 3803 Net 2.99

FAMOUS MAKE - MOTOR BIKES

by World's Largest Manufacturer of Motor Bikes in France

No Money
Down

139⁹⁵

Go... Up to 225 MPG
Go... At Speeds Up to
34 MPH
Go... With 50cc Engine

For town and country use. Fun to ride and economical too. Takes hills easily, and gets a fantastic 225 mpg! Features include: sturdy pressed steel body; 12V alternator, automatic clutch, pedal starter, hub rear brake, headlight, luggage rack, saddle seat, stop and tail lights, tool kit and kick stand. 3.5 hp engine uses regular gas. Wheel: 2.00x23, color tan. Shpg. wt., 91 lbs. Shipping—See Special Note below.
11 A 7951WXY \$7.50 monthly Net 139.95
Windshield for above bike. Tinted blue.
11 A 7954WXY Shpg. wt., 6 lbs Net 14.95



Go... At Speeds Up To
45 MPH
Get... Up To 200 MPG

209⁹⁵

No Money Down

There's lots of go and action in this 4.2 HP beauty. Get up to 200 miles per gallon at speeds to 45 mph. Easy to ride... automatic clutch and transmission—no shifting. Smooth riding too with sturdy pressed steel frame, double coil hydraulic front and rear suspension system and comfortable double seat. Has auto-type internal expanding brake on both front and rear wheels. Accessories inc.: built-in headlight, stoplight, taillight, electric horn, speedometer, license bracket, tool kit, whitewall tires and kickstand. Blue and chrome body. Wheel: 2.25x18. Shipping See Special Note below.
11 A 7952WXY \$11.00 monthly Shpg. wt., 130 lbs. Net 209.95
11 A 7954WXY Windshield for above. Blue tint. 6 lbs. Net 14.95



Go... At Speeds Up to
50 MPH
With "BIG" 50cc Engine
Get... Up To 200 MPG

269⁹⁵

No Money Down

For the young at heart, big cycle performance with scooter economy. Comfortable for two, you can zoom up to 50 mph with powerful 4.4 hp 50cc motor and no shift automatic clutch and transmission. Hydraulic front and rear suspension for smoother ride. Auto-type internal expanding front and rear brakes. Accessories include: tool kit, powerful headlight, stop and tail lights, electric horn, suspended footrest, lock-type pedals, kickstand, speedometer, license bracket and whitewall tires. Wheel: 2.25x18". Chrome and black finish. Shipping. See Special Note below.
11 A 7953WXY \$13.50 monthly Shpg. wt., 143 lbs. Net 269.95
11 A 7954WXY Windshield for above. Blue tint. 6 lbs. Net 14.95



SHIPPING INSTRUCTIONS

SHIPPED F.O.B. HOUSTON, TEXAS • NO C.O.D.
SHPG. CHARGES COLLECTED ON DELIVERY.

NOTE: MANY STATES ISSUE SCOOTER DRIVER'S LICENSE; OTHERS DRIVER'S LICENSE. CHECK LOCAL LAWS BEFORE ORDERING.

CYCLE GUARD

Glow rod and form fitting riding gloves. Looks like real antenna. Be safe—be seen in fluorescent international orange.
11 A 7851 Shpg. wt., 3 lbs. Net 4.95



Buy Now! Pay Later... Use Lafayette's Easy Pay Plan. No Money Down

Lafayette Cat. No. 663 33

LAFAYETTE TRANSISTORIZED AUTOMOBILE REVERBERATION SOUND SYSTEM

FROM LAFAYETTE... AUTO REVERBERATION
A 3rd DIMENSION IN SOUND

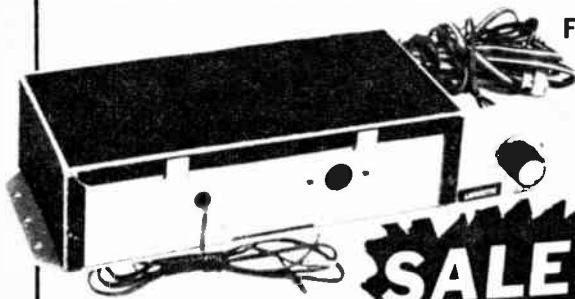

Made in U.S.A.

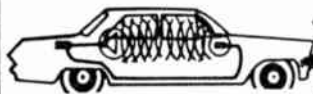

SALE!

Our Lowest
Price Ever

19⁹⁵
was
21.95

The Lafayette Transistorized Automobile Reverberation sound system consists of the transistorized amplifier chassis with the reverberation unit, under dash control plate with on-off switch, fader control, and interconnecting cables. Includes simple instructions for connecting the reverb unit to your regular under dash auto speaker, and to a separate rear seat speaker (if your auto does not have a rear seat speaker, see Lafayette's listing of rear speakers on page 35). Reverberation is an entirely different approach to sound reproduction. Normal sound reproduction from a single source has a flat, one dimensional effect; with proper sound delay through "REVERBERATION," tones are created with a truly third dimension for concert hall originality. Mounts conveniently in the trunk of your car. For all 12-volt negative ground AM or FM auto radios. Dim.: 10½x4x6". Shpg. wt., 3 lbs.
17 A 0105 Net 19.95

SOLID STATE AUTOMOBILE RADIOS

WARRANTY FULL 2 YEAR WARRANTY ON ALL PARTS AND LABOR. GUARANTEE COVERS FREE EXCHANGE OR REPAIR OF ANY COMPONENT PROVEN DEFECTIVE IN NORMAL USE.

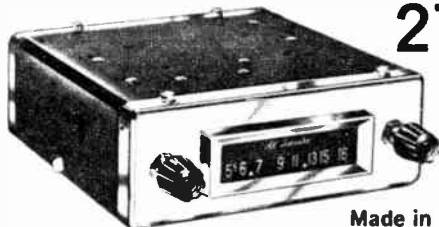

Made in U.S.A.

27⁹⁵

UNIVERSAL AM MANUAL RADIO

- For 12-volt Negative Ground

Quality AM radio that utilizes "solid state" construction in a super-heterodyne circuit for trouble-free operation. 5 transistors and 2 diodes. Large easy to read illuminated dial. Finger-tip control to adjust tone as you desire. Features an electronic automatic volume control to keep signals strong and steady. Unit is exclusively hand wired for ruggedness. Conveniently fits under-dash. Available for 12-volt negative ground installation. Neutral gray-tan baked enamel finish. Overall size: 5½Dx6½Wx2"H. Shpg. wt., 4½ lbs.
17 A 7404 Net 27.95

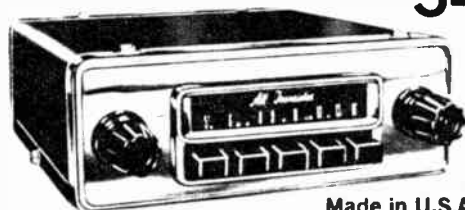

Made in U.S.A.

34⁹⁵

UNIVERSAL AM PUSHBUTTON RADIO

- For 12-volt Negative Ground

All-transistor push-button AM radio fits all cars requiring 12 volt, negative ground installation. Handwired superheterodyne circuit employs 5 transistors and 2 diodes for outstanding reception. Automatic volume control keeps signals strong and steady. 5x7" built-in speaker. Radio mounts neatly under dash. Gray-tan baked enamel finish. Overall size: 5½Dx6½Wx2"H. Shpg. wt., 6 lbs.
17 A 7406 \$5.00 monthly Net 34.95

DELUXE VOLKSWAGEN PUSH-BUTTON AUTO RADIO with VW ANTENNA

- Designed Especially for VW's
- 5 Quick-Set Push Buttons
- 5 Watts Superb Audio Power
- 5" External Speaker

Rich, radiant chrome and elegant appointments blend beautifully with the car's interior. Features all-transistor circuit of advanced design which gives a full 5 watts of superb audio power. Automatic volume control provides constant, even, comfort-level listening. Continuously variable tone control. Five quick-set push buttons permit finger-tip station tuning. Seven tuned circuits, including RF stage, give maximum sensitivity. Installed in minutes. Includes a free antenna which is designed for the Volkswagen. Shpg. wt., 7½ lbs.
17 A 7408 \$5.00 monthly Net 39.95

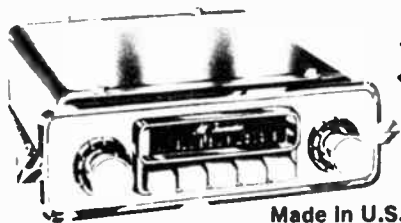

Made In U.S.A.

39⁹⁵

DELUXE PUSHBUTTON AM-FM RADIO

- For 12 Volt Negative-Positive Ground

Full transistorized AM-FM auto radio with Hi-Fi features. 11 transistors, 8 diodes, 2 thermistors. Push-pull Hi-Fi output. AFC for FM drift-free performance. High sensitivity for long distance reception on both AM and FM. Four I.F. stages on F.M. for maximum noise limiting. Continuously variable tone control. Large 6x9" external speaker. Radio mounts neatly under dash. Overall size: 6½W x2¾Hx6¾"D. Shpg. wt., 6 lbs. Imported.
17 A 7412 \$5.00 monthly Net 69.95

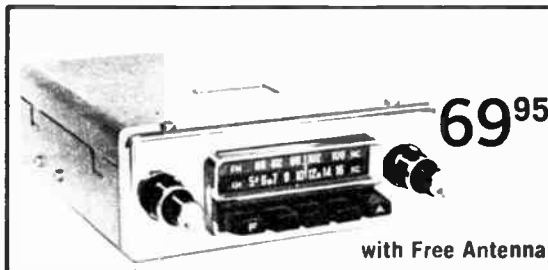

with Free Antenna

69⁹⁵

CUSTOM MOUNTING TRIM KITS for in-dash installation of above radios, in most automobiles.* Specify type of radio, model and year of car. Allow 3 to 4 weeks for delivery.
17 A 7413Y Net 4.95

* Most compact cars will accept only under-dash installation.

NEW!

LEAR JET 8 Track Stereo Car Tape Players

RCA 8 TRACK STEREO TAPE CARTRIDGES FOR LEAR JET, FORD, MOTOROLA, CHRYSLER 8-TRACK STEREO TAPE PLAYERS



FROM
4⁹⁵

- Many Moods of Harry Belafonte
28 A 1102—Shpg. wt., 5 oz. Net 6.95
- Music From Mary Poppins
28 A 1203—Shpg. wt., 5 oz. Net 4.95
- Lovely And Alive—Lena Horne
28 A 1151—Shpg. wt., 5 oz. Net 6.95
- Elvis Presley "Gold Records"
28 A 1179—Shpg. wt., 5 oz. Net 6.95
- Pink Panther—Henry Mancini
28 A 1166—Shpg. wt., 5 oz. Net 6.95
- Beethoven Sym. No. 5 Reiner
28 A 1250—Shpg. wt., 5 oz. Net 6.95
- Tchaikovsky Sym. No. 4 Monteux
28 A 1247—Shpg. wt., 5 oz. Net 6.95
- Bizet Carmen—Price—Von Karajan
28 A 1262—Shpg. wt., 5 oz. Net 6.95
- Gaite Parisienne—Boston Pops
28 A 1224—Shpg. wt., 5 oz. Net 6.95
- Sound of Music—Julie Andrews
28 A 1214—Shpg. wt., 5 oz. Net 7.95

Write for Lafayette's complete selection of RCA 8-Track Stereo Cartridges

"Stereo 8" Player
Less Radio

124⁹⁵

No Money Down

"Stereo 8" Player
with AM Radio

149⁹⁵

No Money Down

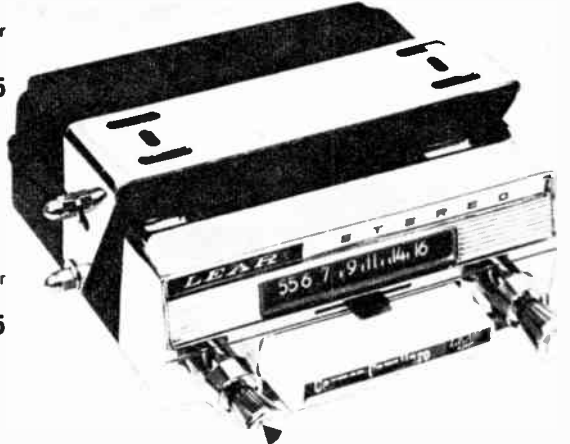

THRILL TO STEREO AS YOU DRIVE--ENVELOPE YOURSELF in the BRILLIANCE and "PRESENCE" of FULL TONAL STEREO SEPARATION

Lear Jet solid state Stereo "8" Car Tape Players feature 8 track playback. 8 Tracks give you twice the music! You get up to 1 hour 20 minutes of stereo music; up to 2 hours and 40 minutes of monaural music. Available with and without AM radio. Outstanding features: automatic endless play of entire cartridge, tape speed 3 3/4 IPS, push-button program selector, front loading of cartridge, easy installation with adjustable mounting bracket. Power output: 4 watts per channel rms. Overall Dim. 8"Wx7 1/4"Dx2 3/4"H. For 12 VOLTS NEGATIVE GROUND.

- Stereo 8 Mobile Player Less Radio. Shpg. wt., 8 lbs.
17 A 1800WX ... \$7 monthly ... Net 124.95
- Stereo 8 Mobile Player with Radio. Deluxe radio includes double tuned IF coils and RF stage for outstanding sensitivity and selectivity. Shpg. wt., 11 lbs.
17 A 1801WX ... \$8 monthly ... Net 149.95
- Speaker Kit for above Players—includes 4 wide range speakers with grills and all connecting cables. Shpg. wt., 4 lbs.
17 A 1802W ... Net 15.00

NEW! GLOBETRAVELER JR. 5 BAND SOLID STATE AUTO/PORTABLE

- 5" x 7" Speaker, Illuminated Dial

109⁹⁵

5 Bands, 2 watts of audio output, tuning indicator, large 5"x7" wide range speaker make the Globetraveler Jr. the ideal and versatile set for car travel and home. SW bands from 16-41 meters and band spread on 49 meter band. FM has AFC. 5 wave-band selector keys, battery test meter, telescopic coil and ferrite antennas. Operates on 5 "D" cells (not supplied) or with car battery. 11 1/2"x8"x3 3/4". Shpg. wt., 8 lbs. Imported.
17 A 7204XL ... Net 109.95

Car Mounting Bracket with lock and key. Permits set to play thru all car batteries, 6 or 12 volt—reverse polarity. Shpg. wt., 4 lbs.
17 A 7205 ... Net 19.95

99 A 6256 "D" Type Batteries for above. (5 req.) ... Net ea. .13

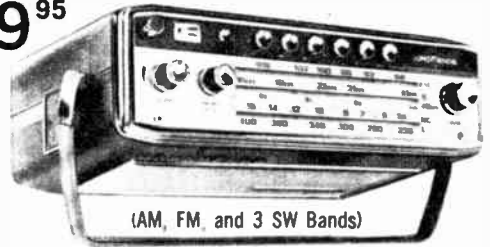

(AM, FM, and 3 SW Bands)

REAR SPEAKER KITS FOR AUTO RADIOS DELUXE UNDER-DASH SOLID STATE CAR REVERBERATION SOUND SYSTEM



Complete kits for adding second speaker in rear of your car. Switch-controlled kits include a P.M. speaker, 3-position selector switch for cutting in front, rear, or both speakers; dial plate with mounting bracket, knob and hardware; chrome grille, wire and wiring instructions. Kits for transistorized auto radios have speakers with multi-impedance voice coils to match 40, 20, 8-10 ohms or less; work with all sets. Simple to install. Shpg. wt., 4 lbs.



21⁹⁵
was
23.95

SALE!

- For 12-Volt Negative Ground Installation
- Convenient Under Dash Mounting
- Complete With Rear Seat Speaker and Grill, Cable and Installation Instructions.

A completely transistorized reverberation unit giving your car radio system the concert hall sound. The beautifully styled unit, quickly and easily mounts under the dash at various angles. Speaker is the only component mounted in rear of the car. Fader command control adjusts from under dash unit. Operates on the principle of compensating for absence of reflected waves in the car. With second speaker sound waves are acoustically mixed for a brilliant rich new sound. Size: 9Wx1 1/4"Hx 4"D, with front plate. Shpg. wt., 4 1/4 lbs.
17 A 7414 ... Net 21.95

STOCK NO.	SPEAKER	CONTROL	RADIO TYPE	GRILLE	NET
32 A 2209	5x7	Switch	Tube	Chrome	2.98
32 A 2207	6x9	Switch	Tube	Chrome	3.45
32 A 2208	6x9*	Switch	Tube	Chrome	4.65
32 A 2210	6x9	Fader	Tube	Chrome	3.89
32 A 2211	6x9*	Fader	Tube	Chrome	4.89
32 A 2202	6x9	Fader	Trans.	Chrome	4.69
32 A 2203	6"	Fader	Trans.	None†	3.39

† This kit for installation in autos with recess between seats in rear. No grille supplied.
* Deluxe speaker with 2.15 oz. magnet.

LAFAYETTE Public Address Amplifiers & Systems

LAFAYETTE GUARANTEE

If you are not satisfied with your Lafayette Sound System you may return it at once for full refund less only transportation charges. 1 YR. AMPLIFIER GUARANTEE. All parts guaranteed against defects

in material and workmanship for 1 year. Ship defective part to us prepaid for prompt replacement.

LAFAYETTE 22-WATT P.A. AMPLIFIER MODEL PA-622



An outstanding 22-Watt P.A. amplifier for medium sized area: up to 6000 sq. ft. Inverse feedback circuitry assures low hum and distortion for exceptionally clean, pure sound. Extremely good frequency response — 30-20,000 cps ± 2 db — make this an ideal unit not only for paging, but for background music, etc. Front panel controls: mike, and two auxiliary inputs (phono, tuner, recorder); master tone control, and on-off switch. Outputs are provided for 4, 8, and 16 ohms, 25 and 70.7 volts, complete with Amphenol 75MCF mike connector and phono plug for auxiliary input. Metallic green cabinet, green and natural aluminum front panel. For 110-120 volts, 50-60 cps AC. Size: 12 $\frac{3}{4}$ x8 $\frac{1}{4}$ x5 $\frac{1}{16}$ ". Shpg. wt., 25 lbs.

44 A 0125WX \$5 Monthly Net 41.95
44 A 0119 Net 16.95

LAFAYETTE 22-WATT PORTABLE P.A. SYSTEMS



As Low as
67⁹⁵
No Money Down

- Lafayette PA-622 22-Watt P.A. Amplifier
- Heavy Duty 12" P.A. Speaker
- Carrying Case for Amplifier, Speaker(s), Microphone and Cables
- Lafayette 99-4515 High Impedance Slim Crystal Microphone with 7' Cable, Connector, Removable Stand Adapter, Lavalier Cord and On-Off Switch
- 35' Speaker Cable

Above public address system, shpg. wt., 55 lbs.
44 A 9052WXM \$5 Monthly Net 67.95

Same as above except with Electro-Voice 727SR crystal microphone with ON-OFF Switch, detachable desk stand, 5' cable and floor stand couples, instead of 99-4515 microphone. Net 73.95

44 A 9051WXM \$5 Monthly Net 73.95

Same as 44 A 9052WXM except with 2 heavy duty 12" 15-watt speakers. Shpg. wt., 60 lbs. Net 73.95

44 A 9054WXM \$5 Monthly Net 73.95

Same as 44 A 9051WXM except with 2-12" heavy duty 15 watt PA speakers. Shpg. wt., 60 lbs. Net 79.95

44 A 9053WXM \$5 Monthly Net 79.95

22-WATT PERMANENT INDOOR SYSTEMS

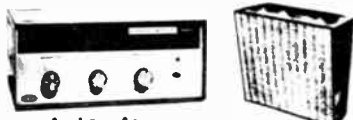

As Low As
52⁹⁵
No Money Down



- Heavy Duty 12" Speaker

Includes powerful 22-watt P.A. amplifier; Rugged, specially designed hi-power 12" P.A. speaker. Polished walnut wooden wall baffle; Electro-Voice 727SR crystal microphone with on-off switch, complete with detachable desk stand for desk, table-top or hand held use; 35' speaker cable and mike connector. For 110-130 Volts, 50-60 cps AC. Shpg. wt., 47 lbs.

44 A 9048WXM Net 58.95

Same as above except with Lafayette 99-4515 slim crystal mike with on-off switch, lavalier cord and bracket, complete with 7' cable and connector and removable swivel-type stand adaptor instead of E-V 727SR microphone. Net 52.95

44 A 9049WXM Net 52.95

Additional 12" 15 watt P.A. speaker and walnut wood baffle. Shpg. wt., 12 lbs. Net 9.95

44 A 9050WXM Net 9.95

LAFAYETTE "TINY MITE" SOLID-STATE 12 WATT MOBILE PA AMPLIFIER

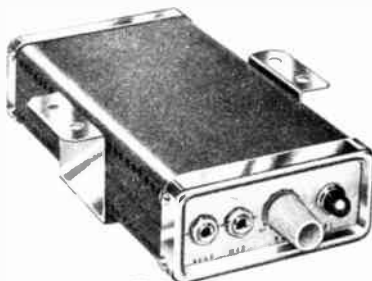

- Real Tiny — Only 1 $\frac{3}{8}$ "Hx3 $\frac{3}{8}$ "Dx5 $\frac{1}{8}$ "W
- All Solid State — No Warmup!
- For 12 Volts DC, Negative or Positive Ground

ONLY **29⁹⁵**

Ideal for mobile PA applications, the "Tiny Mite" fits into practically all cars and trucks and features two inputs (100K and 600 ohms) for use with dynamic, crystal, or magnetic microphones; phono pickup; tape recorder or AM radio. Output impedance: 8 or 16 ohms. Low current consumption: draws maximum of 1.6 ampere from vehicle's battery. Fused for overload protection. Complete with microphone plug, battery and speaker cables, and under-dash mobile mounting bracket. Imported.

99 A 4574 Shpg. wt., 2 lbs. Net 29.95

LAFAYETTE Solid State 12 Watt Mobile PA System

Lafayette Solid State 12 Watt Mobile PA Amplifier Net 29.95

2 Lafayette Horn PA Speakers Net 15.90

Lafayette Push-to-Talk Dynamic PA Microphone Net 3.95

TOTAL 49.80

Above Lafayette mobile PA system consists of Lafayette's new 12 watt solid state miniature mobile PA amplifier, 2 weather-proof 8 watt P.A. trumpet speakers with 90° dispersion and low impedance matching dynamic push-to-talk microphone. Shpg. wt., 7 lbs.

44 A 9068WXM \$5 Monthly Net 46.95

System Price

46⁹⁵

SAVE 2.85

From Individual Catalog Prices.

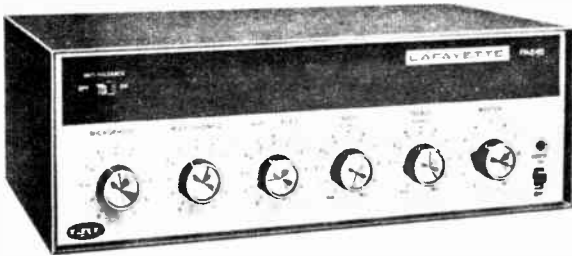

LAFAYETTE MODEL PA-645 45-WATT P.A. Amplifier

An outstanding P.A. amplifier that incorporates a low frequency filter which acts as an anti-feedback network and trumpet protector. Two handy outputs are provided; one at 25 volts and the other at 70.7 volts. Separate bass and treble controls. Master gain control eliminates chance errors when making volume adjustments. Outputs: 4, 8, and 16 ohms. Comes complete with Amphenol 75MCF connector and phone plug. Handsomely styled metallic green case with aluminum and green front panel. For 115V, 50/60 cps AC. 15 1/4 x 10 1/4 x 5 1/4". 44 A 0130WX \$5 monthly. Shpg. wt., 30 lbs. Net 54.95
44 A 0119 Phonotop for above. Shpg. wt., 8 lbs. Net 16.95

PA-645 SPECIFICATIONS

POWER OUTPUT: 45 watts RMS (90 watts peak)
FREQUENCY RESPONSE: ±2 db, 30 to 20,000 cps.
INPUTS: 2—Microphone; 2—Auxiliary (high gain phono, tuner, or tape recorder)
CONTROLS: 2—Microphone; 1—Auxiliary fader; 1—Bass, 1—Treble; 1—Master gain, 1—Anti-Feedback; 1—On-Off
OUTPUTS: 4, 8, 16 ohms; 25 and 70.7 volts
TUBES: 2—12AX7; 1—6AV6; 2—6L6GC; 1—5AR4/GZ-34
POWER CONSUMPTION: 110 watts at 120 VAC

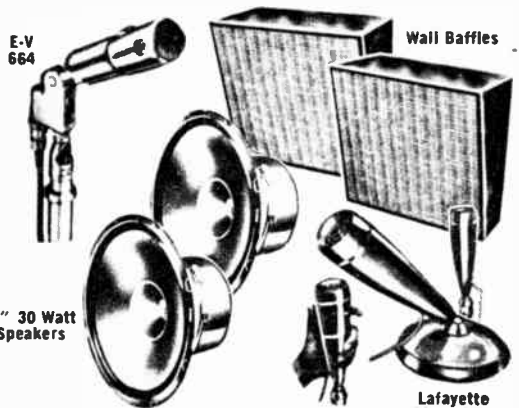

45-WATT INDOOR PA SYSTEMS

As Low As

99⁹⁵

- Lafayette 45-Watt Popular PA Amplifier
- 2-12" Special Heavy Duty 30-Watt PA Speakers, Each with 1 1/4 lb. Ceramic Magnet and 20-14,000 CPS Range
- 2 Sturdy Attractive Walnut Wall Baffles for Speakers
- Choice of Deluxe Dynamic Mikes
- 2-35' lengths of Speaker Cable

Above system with Lafayette 99 — 4501 versatile dynamic microphone with 250 and 50,000 ohm dual impedance and desk stand. Can also be hand-held or used with standard floor stand. Shpg. wt., 60 lbs. For 110-130 volts, 50/60 cycle AC.
44 A 9063WXM \$5 monthly Net 99.95
Same as above except with Electro-Voice Model 664 dynamic cardioid microphone instead of Lafayette 99 — 4501.
44 A 9064WXM \$7 monthly Net 128.95

**ELECTRO-VOICE
664 DELUXE
CARDIOID
DYNAMIC MIKE**

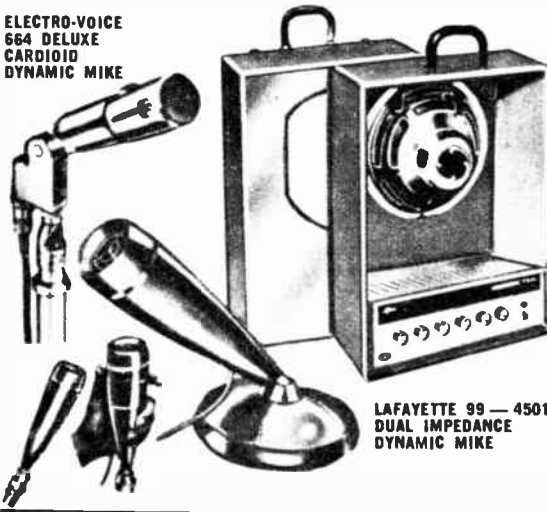

LAFAYETTE 99 — 4501
DUAL IMPEDANCE
DYNAMIC MIKE

45-Watt Portable P.A. Systems With Dual Speakers

112⁵⁰

As little As
\$6 Monthly

- For the Majority of Sound System Applications
- School Auditoriums, Churches, Theaters, Dance Halls, Studios, Lecture Halls.

45-WATT PORTABLE SYSTEM COMPONENTS

Lafayette Popular PA-645 Versatile 45-Watt P.A. Amplifier
2 Each 30-Watt Heavy Duty 12" P.A. Speakers with 1 1/4 lb. ceramic magnet.
Lafayette 99 — 4501 All-Purpose Dynamic Dual Impedance Microphone for desk stand, floor stand, or hand held use, with removable ball-joint desk stand, floor stand adapter and 8' cable.
Attractive Sturdy Carrying Case For Amplifier Speakers And Accessories serves as efficient baffle for speakers.
2 35' Speaker Cables.
44 A 9065WXM Complete system. Shpg. wt., 80 lbs. Net 112.50
Same 45-Watt P.A. System as above except with Electrovoice Model 664 cardioid dynamic microphone with on-off switch and 18' cable for high feedback problem areas, instead of Lafayette 99 — 4501 dynamic microphone. Shpg. wt., 81 lbs.
44 A 9066WXM Net 139.95

45-WATT OUTDOOR SYSTEMS

• Lafayette Popular, Versatile 45 Watt PA Amplifier
• Choice of Deluxe Dynamic Microphones • Three E-V 844A 30-Watt Weatherproof Speakers • For Airports, Loading platforms, Railroad Stations, Country Clubs, etc. • For up to 100,000 Square Ft. Area

As Low As

119⁹⁵

Above system with Lafayette 99 — 4501 deluxe dynamic 250 & 50,000 ohm dual impedance microphone with desk stand. Microphone can be hand-held or used with standard floor stand. Includes microphone connector. Shpg. wt., 59 lbs.
44 A 9059WXM \$6.50 monthly Net 119.95
Same system as above except with Electro-Voice 664 deluxe dynamic cardioid mike instead of Lafayette microphone.
44 A 9060WXM \$8 monthly Net 146.95
Same system as 44 — 9059WXM except with 2 Electro-Voice 848 Wide-Range 30-Watt CP Component Diffraction Projectors instead of 3 E-V 844A's. Shpg. wt., 67 lbs.
44 A 9061WXM \$9 monthly Net 165.95
Same as 44 — 9061WXM except with E-V 664 dynamic cardioid mike instead of Lafayette 99 — 4501 microphone.
44 A 9062WXM \$10 monthly Net 192.95

LAFAYETTE PA-645
45-WATT AMPLIFIER

ELECTRO-VOICE 848CDP
30-WATT PROJECTORS

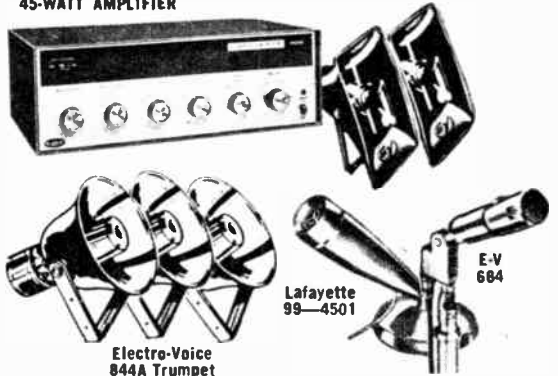

Electro-Voice
844A Trumpet

Lafayette
99—4501

E-V
664



LAFAYETTE MODEL PA-675 75-WATT P.A. AMPLIFIER

Provides a full 75 watts of clear audio signal power (150 watts on peaks). Controls: separate bass and treble, master gain, separate mixer and inputs for 2 separate microphones, common mixer for both auxiliary inputs that control phono tuner or recorder. Switchable anti-feedback network attenuates lowest frequencies to minimize feedback and prevent speaker burnout. Response: 30-20,000 cps \pm 2 db. Inputs: 2 auxiliary (phono, tuner, or tape), 2 microphone. Output: 8 and 16 ohms. 70.7 and 25 volt constant voltage outputs for a constant level sound system. Comes complete with 75 MCIF mike connector and 1 phono plug. Rugged case is of a light metallic green with aluminum and green front panel. Tubes: 1-12AX7A; 6AV6, 2-6CA7; 5AS4A, 5Y3GT. Size: 5 $\frac{1}{4}$ x10 $\frac{1}{4}$ x5 $\frac{1}{4}$ ".
44 A 0135WX \$5 monthly. Shpg. wt., 39 lbs. Net 82.95
44 A 0119 Phonotop for above. Shpg. wt., 8 lbs. Net 16.95

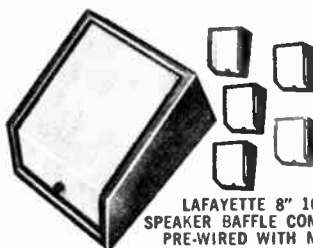

LAFAYETTE 8" 10-WATT
SPEAKER BAFFLE COMBINATIONS
PRE-WIRED WITH MATCHING
TRANSFORMER & VOLUME CONTROL



CHOICE OF
MICROPHONES
LAFAYETTE
99-4521
DYNAMIC
MIKE

E-V 641
DYNAMIC
MIKE
ON EV-428
TOUCH-TO-
TALK
STAND

75-WATT INDOOR PAGING SYSTEMS

COMPLETE SYSTEM AS LOW AS

159⁹⁵

Lafayette PA-675 75-Watt P.A. Amplifier; 6 ea. Lafayette 8" Speaker-Baffle Combinations With 70 Volt Line Tapped For 10, 5, 2.5, 1.25 And .625 Watts Per Speaker; And Electro-Voice 641 Dynamic Microphone With 428 Touch-to-Talk Stand With DPDT Switch and 18' Cable. Shpg. wt., 95 lbs.

44 A 9039WX Net 184.95

Same as above except with Lafayette 99-4521 "Dyna-Slim" hi-output dynamic microphone with On-Off switch, stand adapter and plug-in cable instead of EV microphone and stand.

44 A 9040WX Shpg. wt., 95 lbs. Net 159.95

Additional Speaker Baffle Units. Shpg. wt., 7 lbs.

99 A 4552W Net ea. 14.95

75-WATT HI-POWER

OUTDOOR P.A. SYSTEMS

COMPLETE SYSTEM AS LOW AS

164⁹⁵

A truly hi-power outdoor P.A. system for up to 200,000 square feet of coverage. Consists of: Lafayette PA-675 75-watt PA amplifier, 3 University PH trumpets with 3 Lafayette 99-4507 driver units and Lafayette 99-4521 high impedance dynamic microphone with stand adapter, talk switch and 7' cable & plug. Shpg. wt., 100 lbs.

44 A 9055WXM \$9 monthly Net 164.95

Same as above except with Electro Voice 641 dynamic microphone with 18' cable and E-V 428 "touch-to-talk" desk stand with a DPDT switch instead of 99-4521 microphone. Shpg. wt., 100 lbs.

44 A 9056WXM \$10 monthly Net 185.95

Same as 44 A 9055WXM except with 3 E-V 848 CDP projectors with 30-watt drivers instead of University PH trumpets. Shpg. wt., 100 lbs.

44 A 9057WXM \$10 monthly Net 195.75

Same as 44 A 9057WXM except with E-V 641 dynamic microphone plus E-V 428 desk stand. Shpg. wt., 100 lbs.

44 A 9058WXM \$11 monthly Net 216.95

ELECTRO-VOICE 848COP 30-WATT PROJECTORS

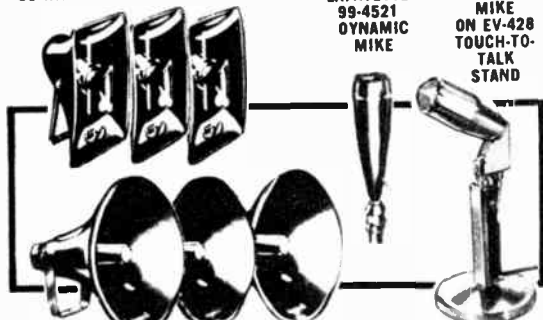

LAFAYETTE
99-4521
DYNAMIC
MIKE

E-V 641
DYNAMIC
MIKE
ON EV-428
TOUCH-TO-
TALK
STAND

UNIVERSITY PH TRUMPETS AND LAFAYETTE PA-57 DRIVERS

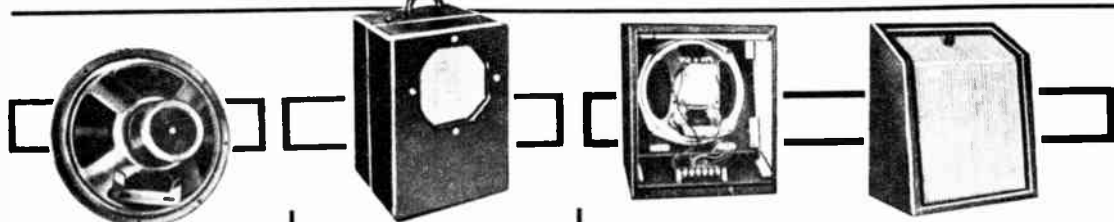

FAMOUS LAFAYETTE PA SPEAKERS

- 12"—Full 15 Watts of Power
- 8"—Full 10 Watts of Power
- Thinline Styling

12" MODEL—Ideal for use singly for medium power systems or in multiples for higher power. Rugged mechanical construction, dust-proofed and rust-resistant. 8 ohm voice coil. 3" deep. Has 10 oz. ceramic magnet. Shpg. wt., 5 lbs.
44 A 0102 Net 5.98

8" MODEL—Rated at 10 watts, with 4.8 oz. ceramic magnet, 8 ohm voice coil 2 $\frac{7}{8}$ " deep. Shpg. wt., 3 lbs.
44 A 0103 Net 3.95

LAFAYETTE PORTABLE PA CASE

- 2 Baffles In One Case
- Room For Two 12" Speakers

A sturdily constructed case for amplifier, two 12" speakers, microphone and cable. Made of heavy plywood with reinforced metal corners. In addition to room for two 12" speakers, there is ample space for any amplifier and phono top measuring up to 17 $\frac{1}{2}$ " wide x 12" deep x 12" high. Includes blocks to prevent smaller amplifiers from shifting while being carried and carrying handle. Shpg. wt., 22 lbs.
44 A 0121WX Net 19.95

LAFAYETTE 8" 10-WATT PRE-WIRED SPEAKER-BAFFLE COMBINATION

14⁹⁵

- For Public Address, Paging, Music Distribution Use
- Built In 70-Volt Line Matching Transformer with Taps for 10, 5, 2.5, 1.25 and .625 Watts
- Built-In Individual Volume Controls
- Only A Screwdriver Needed to Connect Speaker Lines

An 8-ohm speaker baffle combination for any type of indoor sound system. Perfect for schools, stores, offices, churches. Each unit is completely pre-wired. The heavy-duty 8" speaker with 4.64 oz. Alnico V Magnet rated at 10 watts, is installed in the acoustically-designed plywood baffle; the matching transformer is mounted directly on the sturdy warp-free speaker frame. Each speaker has its own volume control for setting volume levels, as desired at each speaker location—extremely important in most school, department store, etc., paging or music distribution system installations. Size is 11Wx9 $\frac{1}{2}$ Hx6 $\frac{1}{2}$ "D. Shpg. wt., 7 lbs. Imported.
99 A 4552W Speaker Baffle Combination Net 14.95

PA Outdoor Speakers and Megaphones

LAFAYETTE MINIATURE HORN PAGING SPEAKER

- Mounts Easily
- 90° Dispersion
- Weatherproof

7⁹⁵



An excellent general purpose paging speaker of amazingly compact size. Ideal for portable PA systems, patios, etc. Long throw projection of 90° dispersion offers maximum speech intelligibility in high noise areas. Compact size enables it to be mounted anywhere in almost any position. Frequency response 400-12,000 CPS. Impedance 8 ohms. Power handling capacity 5 watts, 8 watts maximum. Complete with mounting bracket, 2-conductor cable. Horn diameter 5 1/8". Depth 4 3/4". Imported. Shpg. wt., 1 1/2 lbs. **99 A 4508** Net **7.95**

LAFAYETTE 25-WATT DRIVER UNIT FITS ALL TRUMPETS and PROJECTORS

9⁹⁵

Hermetically sealed weatherproof driver unit. Delivers 25 watts of power. Will fit any trumpet or projector of your choice without modification. The widerange frequency response of 120-7,100 cps assures excellent reproduction of music and speech. 16 Ohm impedance. Size: 4" Diameter, 3 3/4" depth. Imported. Shpg. wt., 3 3/4 lbs. **99 A 4507** Net **9.95**

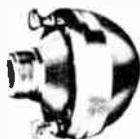

OUTDOOR WEATHER-PROOF SPEAKER

5⁶⁹

- Frequency Response: 100 to 10,000 CPS
- Compact—3 3/4"Wx3 3/4"Hx2 1/2"D
- Enclosed in a Cadmium Plated 20-Gauge Steel Case
- Specifically Designed Plastic Impregnated Cloth Speaker Cone



Compact, Weatherproof, Dustproof. Will withstand Immersion in boiling water, and is impervious to salt spray. Equipped with key slot mounting hole plus a mounting cutout to accept a volume control: on-off or push-to-talk switch. Voltage: withstands up to 100 volts RMS. Temperature Extremes: from -80°F to 160°F. 8 ohm impedance. Shpg. wt., 5 lbs. **44 A 5201** Net **5.69**

FOURJAY-OUTDOOR PATIO SPEAKERS



MUSIC HORN



PATIO PAIR



THE PATIO PAIR

The Patio Pair consists of a separate loudspeaker baffle with weatherproof speaker, and a separate patio lamp. Identical in styling in green and white fiberglass with pipe fitting for 1" pipe. Speaker provides even dispersion of sound. Accepts up to 100-watt bulb.

Model S-DF1 8 WG Speaker Baffle. Includes 10-watt, 8" weatherproof speaker with 40-11,000 cycle range, 8-ohm voice coil. **44 A 2801** Shpg. wt., 6 lbs. Net **17.05**

Model LMP 60/100WG attractive Patio Lamp less bulb. **44 A 2802** Shpg., 4 lbs. Not Illustrated Net **10.05**

OUTDOOR MUSIC HORN

Extend your hi-fi music system to your lawn, patio or backyard. Also ideal for schools, clubs and churches. Completely weatherproof. Uses 8" dual cone speaker. Produces rich, wide-range sound. Response: 50-12,000 cps. Dispersion 120°. Housed in high-impact case with heavy-duty steel mounting bracket. Size: 14x10 1/4". Shpg. wt., 9 lbs. **44 A 2804** Net **24.45**

LAFAYETTE 10-Watt TRANSISTORIZED SHOULDER MEGAPHONE

- One Self-Contained Unit
- Lightweight—7 lbs. With Battery
- Can be Shoulder Held
- 10 Watt Transistor Amplifier

59⁹⁵

No Money Down

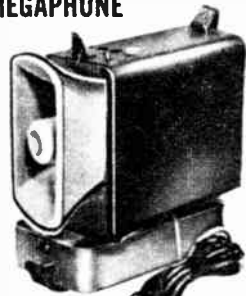

A powerful, portable, completely flexible megaphone suited to all field operations. Amplifier, battery and speaker are housed in one case. May be slung from shoulder, surface mounted or used with speaker extended up to 15 ft. from case. Hand-held microphone with detachable, retractable cord. All controls on top of case for convenience. 3 inputs—2 for crystal or dynamic microphones, 1 for radio or tape recorder. All 3 inputs may be "mixed" simultaneously. Jack for additional external speaker. Powered by 6 "D" flashlight cells or an external 9 or 12V battery. Complete with carrying case, mike with case, carrying strap, 2 input plugs and battery, 10 watts max. output. Inputs (1) 50 K ohms, (2) 150 K ohms, (3) 4 ohms. Speaker size: 7 1/4"x4x7 3/4" overall. Case size: 17 1/2"x4 1/2"x8 1/16". Imported. Shpg. wt. 11 1/2 lbs. **99 A 4506** \$5 Monthly Net **59.95**

DELUXE LAFAYETTE PISTOL-GRIP POWER MEGAPHONE

29⁹⁵

- Weighs only 4 1/4 lbs. complete with batteries
- Ideal for lifeguards, coaches, construction gangs, sporting events—plus hundreds of other applications!



A lightweight megaphone notable for its extreme economy in battery power despite its high sound volume output. Uses 4 size D flashlight batteries and has a patented non-linear current-limiting device to give maximum possible battery life. The reflexed air column in the horn plus its special shape serve to concentrate and direct the amplified sound and throw it for a considerable distance! The rubber-rimmed horn is of lightweight spun aluminum and construction is extremely sturdy throughout. Microphone is built into the base of the horn. Unit measures 12 1/2" long; mouth diameter is 8 1/4". Imported. Shpg. wt., 6 lbs. **99 A 4505** Power Megaphone Net **29.95**

BATTERIES FOR ABOVE—"D" cell Battery for above (4 required.) Shpg. wt., 1 oz. ea. **99 A 6256** Net ea. **.13**

OUTDOOR 8" PATIO SPEAKER

- WEATHER PROOF—WATERPROOF
- CLEAR Hi-Fi Sound
- Mounts anywhere—Indoors or Out
- Use Two for Stereo

9⁹⁵



The perfect outdoor hi-fi speaker to let you enjoy records and music while relaxing outdoors on your patio; in your yard; at your bar-b-que. Handsome enough for recreation rooms and dens. Completely wired, ready to install to the radio, phono or intercom system. Unaffected by dampness, humidity, rain or snow; the metal baffle finished in golden-bronze enamel. 3.16 oz. Alnico V magnet. 8 ohm impedance. L pad for perfect matching. Peak power 8-10 watts. Size: 10 1/2"x11 5/4". Shpg. wt., 5 lbs. **44 A 3305** Net **9.95**

Similar to above but with 8" coaxial speaker with built-in tweeter and electronic crossover. For extended range coverage of 70-12,000 cps. Shpg. wt., 7 lbs. **44 A 3306** Net **11.50**

LAFAYETTE Popular Quality Microphones

LAFAYETTE STUDIO CRYSTAL MICROPHONE



4⁹⁵

- Dual Crystal Cartridges
- All Directional
- High Output

Here is a microphone with a 360° pick-up, and the added power and sensitivity of two individually shock mounted and phased crystal cartridges. This arrangement assures you of maximum pickup from all sides. Swivel mounted to give fuller flexibility. Case is chrome plated. Standard 5/8"-27 thread. Overall size 7Hx 3"W complete with 4 ft. cable. Shpg. wt., 2 lbs. Imported.

99 A 4511 Net 4.95

LAFAYETTE DUAL IMPEDANCE SLIM DYNAMIC MICROPHONE



11⁹⁵

- 600 & 50,000 Ohm Impedance Selected By Simple Rotation of Plug
- Ruggedly Constructed
- On-Off Switch

Beautiful, professional-looking dynamic with solidly-cast, tapered, slim case with satin-chrome finish. Heavy duty slide-type on-off switch. Built-in transformer supplies dual unbalanced impedances—low Z is 600 ohms, high Z is 50,000 Ohms. Swivel mount fits all standard 5/8"-27 threaded stands. Blast filter eliminates unpleasant "pops" with voice use. Omnidirectional when used vertically—cardioid pattern when tilted. Complete with 5 ft. plug-in cable. Shpg. wt., 2 1/2 lbs. Imported.

99 A 4523 Net 11.95

LAFAYETTE DUAL IMPEDANCE OMNI-DIRECTIONAL DYNAMIC MIKE

11⁹⁵



- Designed Specifically for High Quality PA Applications
- Omni-directional Pattern at all Frequencies

A superb dual impedance, omni-directional Dynamic microphone. Designed for high quality PA applications. Superior anti-feedback properties. Allows close talking without boom or bass accentuation. Features pop-proof wire mesh grille. Special filter minimizes wind effect. Attractive chrome plated frame of modern design.

Equipped with on-off switch. Freq. Response 100-10,000 cps. Sensitivity: 30 K at -60 db. Mylar diaphragm for "pop" and "blast" proofing. Dual impedance: may be shifted from high impedance to 250 ohm low impedance by means of a cable connection. Shpg. wt., 2 lbs. Imported.

99 A 4546 Net 11.95

LAFAYETTE DYNAMIC P.A. MICROPHONE with Switch



3⁹⁵

- 300-2500 cps Frequency response
- Push-to-Talk Switch
- Ideal for Solid State P.A. Amplifiers

The perfect companion microphone to the "Tiny Mite" mobile PA amplifier. Features a high impact styrol case, hang-up clip and flexible single conductor shielded cable. Omnidirectional pattern mike has output impedance of 300 ohms and output level of -73 db at 1000 cps. Frequency Response: 300-2500 cps. Grey and black case, with push-to-talk switch. Imported. Shpg. wt., 1 lb.

99 A 4577 Net 3.95

3 WAY SLIM CRYSTAL MICROPHONE

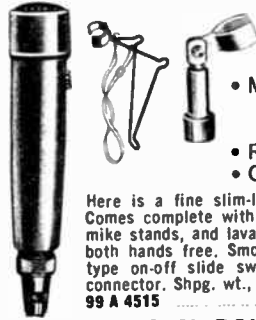

3⁹⁵

- May be hand-held, stand mounted or suspended by lavalier cord!
- RESPONSE 60-10,000 CPS
- On-Off Switch

Here is a fine slim-line design, only 4 5/8"x1 1/8" diam. Comes complete with swivel adapter to fit all standard mike stands, and lavalier cord and bracket which leaves both hands free. Smooth wide range response. Locking type on-off slide switch. Detachable 7 ft. cable and connector. Shpg. wt., 2 lbs.

99 A 4515 Net 3.95

LAFAYETTE GENERAL PURPOSE DYNAMIC MICROPHONE



10⁹⁵

- A Hi-Fidelity Omnidirectional Microphone For Recording, Radio Broadcasting, and PA Applications

A high quality omni-directional dynamic microphone at such an unusually low price. Beautifully styled in a chrome-plated diecast frame that is equipped with an on-off switch. Specifically designed for recording, radio broadcasting, and public address applications. Features a "pop-proof" and "blast-proof" mylar diaphragm, and superior anti-feedback properties. Frequency response 100-10,000 cps. Sensitivity: 30K at -60 db, 600 ohms at -70 db.

99 A 4545 Shpg. wt. 2 lbs. Imported. Net 10.95

LAFAYETTE TRANSISTORIZED STEREO MIKE MIXER



- Transistorized - No Warm-up
- Compact and Durable
- Matches High Impedance Microphones
- Up to 4 Input Channels

Now a stereo version of the popular LAFAYETTE mono mixer. Combines up to four microphones professionally into one stereo output. Each mike control independent of the other, permits fading of one input while increasing others. Controls high impedance microphones, recorders, phonographs or tuners. Output jack fits standard circuit phone pin plugs (RCA). Inputs are standard 2-circuit phone plugs. Requires single 9 volt battery (not supplied). Size: 6Wx2 1/4"Hx3 1/2"D.

99 A 4563 Shpg. wt., 1 1/4 lbs. Imported. Net 9.95

99 A 6021 Battery for above Net .21

LAFAYETTE TRANSISTORIZED MIKE MIXER



4⁸⁵

- Up to 4 Channels
- Matches High Impedance Microphones
- Modern Solid State Design

Mixer controls high impedance signals from mikes, phonos, recorders or tuners. Standard 2-circuit phone inputs, standard RCA phone plug output. 9 volt battery. Imported.

99 A 4535 Shpg. wt., 1 1/4 lbs. Net 4.85

99 A 6021 Battery for above Net .21

Lafayette Miniature Microphone Connectors



(A) Microphone Plug for CB and Amateur Microphones. Precision engineered and sturdily constructed. Plug takes any 4 conductor (or 3 conductor with shield), coiled cord or straight cable. Features threaded retaining ring for positive locking, integral cable retaining clamp, and polarizing keyway. Size: 1 1/4"x1 1/2" Dia. Shpg. wt., 8 oz.

99 A 6263 Net .99



(B) Microphone Chassis Socket. Mounts on equipment chassis or panel and mates with 99 A 6263 plug. Size: 3/4"x9/16" Dia. Requires 5/8" mounting hole. Shpg. wt., 8 oz.

99 A 6264 Net .89

Selected Electronic Specialties

KINEMATIX "IMP II" FM WIRELESS MIKES

As Low As **39⁹⁵**

- Transmits Clearly Up To 200 Ft.
- Can Be Used With Any 88-108 Mc FM Tuner, FM Radio, FM Portable, FM Auto Radio
- Compact—Fits Into Shirt Pocket

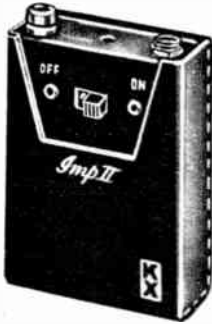

FCC Type-Approval
Number: WM 101

A transistorized FM transmitter and microphone, so small it can be concealed in shirt pocket or cigarette box, yet transmits up to 200 feet with perfect clarity to any 88-108 MC FM receiver. Ideal for PA systems, security and surveillance work, babysitter, survey work and many other applications requiring remote sound pick-up without bothersome wires. Comes complete with leather case and built-in super-sensitive pin-head mike. Also has input for any low impedance (1000 ohms) mike. Tunable between 88-108 MC, frequency response 30-20,000 cps. Size: 3x1½x2¾". Requires 1 battery (listed below). Shpg. wt. 1 lb.

44 A 4301L Model IMP11/M-222... Net 49.95
Model IMP11-221, less built-in mike
44 A 4302 L... Net 39.95
Battery for above units. Shpg. wt., 1 oz.
33 A 1428... Net 1.05

LAFAYETTE EXTENSION SPEAKER AND BAFFLE



Only
5⁴⁴

For desk or shelf use or can be hung neatly on the walls of extra rooms, patio, lobbies, waiting rooms or anywhere you wish to direct voice or music. Wide range speaker offers fine sound reproduction. Complete with volume control and 22 ft. of wire. Impedance 8 ohms; Imported. Shpg. wt., 3½ lbs.
99 A 0121... Net 5.44

LAFAYETTE HI-FI SLIM BAFFLE SPEAKER

Only **5⁹⁵**



- 6" Speaker, 12 oz. Magnet
- Only 2½" Deep

The perfect speaker to furnish music or paging throughout your home, office or factory, this unique ceiling and wall baffle speaker offers fine audio reproduction. Two are perfect for stereo. Voice coil is 1" Diam. Frequency Response: 90-9,000 cps. Impedance: 8 ohms. Overall size including metal baffle is 9½". Requires 6½" wall cutout. Imported. Shpg. wt., 3 lbs.
99 A 4505... Net 5.95

ELECTROVOICE SONOCASTER OUTDOOR HI-FI SPEAKER SYSTEM

Sale **16⁹⁵**

was 22.05

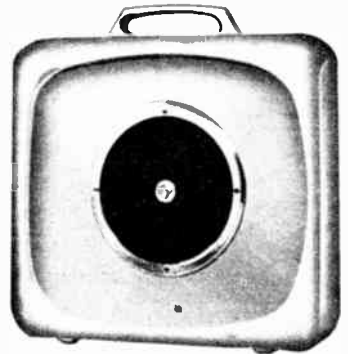

Lightweight, rugged and weatherproof. Special radax coaxial 8" speaker provides amazingly wide range response, 70-13,000 cps. Ideal for use with existing stereo system, improves performance of any portable radio, record player, recorder, etc. Plastic molded housing. Accessory hangup bracket included. Molded in handle. 8 ohms. 30 watts peak. 16¾Hx17Wx5¾"D. Shpg. wt., 8 lbs.
21 A 3030... Net 16.95

CONCORD CLOSED CIRCUIT TV CAMERA

Only
299⁹⁵

- For Security—For Surveillance—For Sales Promotion
- Output Signal: RF Over 30 mV Video: 1.4V P-P
- Use with any Home TV Set or Commercial Monitor

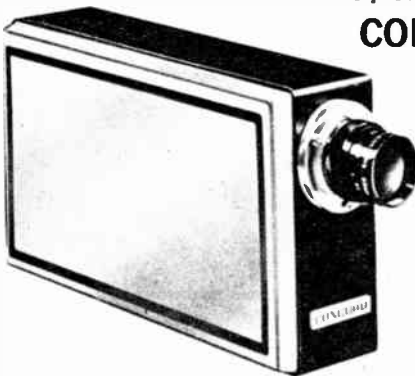

ELEVATOR



SUPERMARKET



BANK

Just hook the Concord Automatic TV camera to the antenna input of any home TV set, commercial monitor or the 12" portable below and you open up a world of unlimited uses for business, industry and the home. A closed circuit TV system is particularly useful in surveillance, sales training, teaching, in-store promotion, watching the family swimming pool, baby's room, or the front door at home. Its special lens system which automatically adjusts for any light intensity, its low cost solid state design, compact size, and simplicity of operation make it a practical and useful tool for unattended operation everywhere. Turn it on and forget it — just watch the receiver! Specifications: video output RF over 30 mV, video: 1.4V-P-P. Video Bandwidth: 5 MC; RF Carrier Frequency: TV channel 5-6; Output impedance: 75 ohms; Camera Tube: Vidicon 7735A; Lens: F1.8 C

mount (will accept other lenses) Power Supply: 117 volts, 60 cps AC, 11 watts; Dimensions: 8½x2½x4½", excluding lens. With 16 foot cable assembly and 10 foot AC line cord. Wt. 15 lbs.
17 A 3701WX \$15 Monthly... Net 299.95

Closed Circuit TV Package. Save 4.95 From Individual Catalog Price. MTC-12 Camera plus 12" Portable UHF-VHF TV Set. Complete with 16 ft. cable and matching transformer for simple inter-connection between camera and TV set
17 A 9003WXM Shpg. wt., 38 lbs.... Net 374.95

12" Portable UHF-VHF TV Set, only. Shpg. wt., 23 lbs.
17 A 3017WX... Net 79.95

Make Lafayette Your One Dependable Source for Everything in Electronics

Lafayette Cat. No. 663 41

LAFAYETTE 6 Station Intercom Systems

IN ATTRACTIVE HAND RUBBED OILED WALNUT CABINETS.

MPR
REMOTE

9⁹⁵
ea.

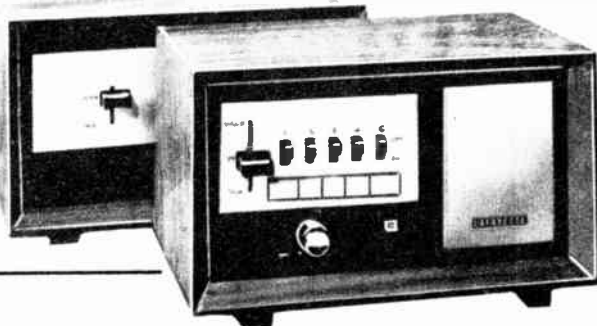

MPI-6
MASTER

22⁹⁵
ea.

MASTER TO MASTER HOOKUP

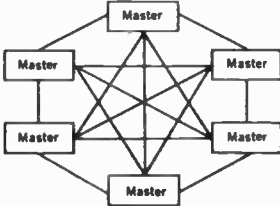

All-Master Intercom System incorporates up to six separate master stations enabling 3 private conversations or a 6-station conference to be held. Utilizes a three-position switch for listening, momentary talking, or Stand By; and a five-station selector-call switch.

MASTER TO REMOTE HOOKUP

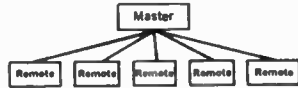

Master-to-Remote Intercom System enables master station to communicate with up to five remotes either separately or in a six-station conference. Master's 5-station selector-call switch permits private or non-private conversations. Calls may be originated by remote stations as well as master.

Lafayette's Multi-Purpose 6-Station Intercom Systems in attractive oiled walnut cabinets offer a wide range of applications for home or office use. May be hooked-up in All-Master installation containing up to six separate master stations or Master-Remote system containing one master station and up to five remotes. Master unit has 5-station selector control, three-way talk-listen-standby switch, and volume control. Remote unit has Talk-Listen switch. Wiring instructions: For Master-to-Remote system, each remote is connected to the master by a 3-conductor unshielded cable. For Master-to-Master installations, each unit is intercon-

needed by an unshielded cable containing one more conductor than the total number of master units in the system. For 115V 60 cps AC. Dim: Master and Remote: 6Hx9 1/2 Wx5 7/8" D. Imported. 99 A 4565 MODEL MPI-6 6-Station Master wt., 8 lbs. Net ea. 22.95 99 A 4566 MODEL MPR Remote for above wt., 6 lbs. Net ea. 9.95

CABLE FOR ABOVE SYSTEMS

Beiden 8443. 100 Ft. 3-conductor unshielded cable 32 A 1452 Shpg. wt., 2 lbs. Net 2.65
Beiden 8447. 100 Ft. 7-conductor unshielded cable 32 A 1496 Shpg. wt., 4 1/4 lbs. Net 6.56

DELUXE LAFAYETTE ULTRA SELECTIVE 10 STATION HIGH SPEED TELEPHONE INTERCOM SYSTEM



24⁹⁵
Per Phone

12⁹⁵
Power Supply



- 100% Privacy—Up to 5 Simultaneous Conversations
- Immediate Operation—No Dialing
- Selective Ring—Selective Talk
- Battery or AC Operated

Completely private 10 station ultra-selective intercom system. Unit is styled like regular telephone, complete with coiled cord and junction box. Its functional design permits positioning on desk or hanging from the wall. No need to waste time dialing, simply set pointer to desired station, push ring button and speak. Interruptions or listening in by other stations is impossible. Handles up to 5 simultaneous conversations. Conference calls are available by one station calling another until all are on the line. Frees your regular telephone lines for outside calls. Power for all units in the system is obtained from a central location, either from a battery source or the AC power adapter listed below. Low power consumption on either AC or DC: 100ma calling, 25ma talking. Finished in black plastic.

99 A 4560 10 Station Lafayette phone. Imported. Shpg. wt., 3 3/4 lbs. Net ea. 24.95
99 A 4561 AC Power Supply for system Net 12.95
32 A 4868 1 1/2 V Battery for DC operation—6 required Net ea. .84

WIRING INSTRUCTIONS

The total number of unshielded conductors common to each phone is 2 more than the total number of phones in the system.
32 A 1490K Beiden 8456, 10 cond. unshielded Net per ft. .075
32 A 1491K Beiden 8457, 12 cond. unshielded Net per ft. .08

NEW! LAFAYETTE 2-STATION SOLID STATE INTERCOM SYSTEM



9⁹⁵

1 station
Solid-state miniature 2-station Intercom. Operates from one inexpensive 9-volt battery. System consists of one master and one remote with 66 feet of lightweight cable. Plug at each end speeds up connection—no tools needed! Master unit has power on/off/volume control and listen-talk switch—you can listen or talk to the master without operating any buttons. Master and remote can call each other even when master is switched off. Housed in a high impact plastic case with cable and 9-volt battery. Dimensions: 3Wx1 3/4 Hx4" D. Imported. Shpg. wt., 1 1/2 lbs.
99 A 4578 2-Station Transistorized Net 9.95

99 A 6021 Extra 9-volt battery Net .21
AC power supply and battery charger for above, Shpg. wt., 2 lbs.
33 A 7702 Net 2.99

LAFAYETTE 4-Station Solid-State Intercom System

- Instant Communications—No Warm up, Heat or Hum
- 4-Way Selector Switch—3 Remote Stations
- Remote Tone Call
- 2-Wire Distribution System
- Battery Powered

Deluxe solid state 4-station intercom system that combines smart styling, and portability with high quality performance. All interstation calling is accomplished with one 4-way selector switch. Push-button listen-call switch on all units. Call signal operates even when master switch is "off". Simple coded interruption of buzzer signal lets master operator know which remote is calling. Cool, efficient solid state master unit runs on a single, economical 9-volt battery. With selector switch in "wait" position battery life is further extended. Master unit has its own volume control with "on-off" switch. Easy hook-up is facilitated by inclusion of three 60 foot lengths of 2-conductor wire with jacks at each end. Just plug in and talk. Additional wire is available at extra cost. See below. Complete set consists of, master control unit, 3-remote units, 9-volt battery and wire. Size: Master: 4½xw3½"D; Remotes: 2Wx4"D. Imported. Shpg. wt., 2½ lbs.

99 A 4555 Complete 4-station System Net 19.95
 99 A 6021 Replacement 9-volt Battery (1 Req.) Net .21
 32 A 3052 Additional wire, 100 Ft. Coil Net .94



19⁹⁵

Complete System Includes:
 1 Master Control Unit
 3 Remote units
 3—60 Ft. lengths of hook-up wire
 1—9 volt battery

Deluxe LAFAYETTE Wireless Intercom System

- Operates from any 117V AC DC Outlet
- No Wires to Connect
- Ideal for Home or Office
- Add as Many Extra Stations as Desired



ONLY
27⁵⁰
 2 Stations

Lafayette offers a high quality 2-station wireless location Intercom. Handsomely styled, these units offer quality performance for home or business use. Each unit features a 3-position bar-control lever: Dictate (for use as "baby sitter," lengthy talking), Talk (has spring return to Listen position), and Listen. No wires to connect—simply plug into any 117V AC/DC outlet. Front panel volume control and pilot light; adjustable squelch control at rear reduces interference during quiet periods. Dependable 3" speaker. Add as many remotes as needed. Imported Shpg. wt., 10 lbs.

99 A 4547M 2-Station System Net 27.50
 Extra Station. Shpg. wt., 5 lbs. Imported.
 99 A 4544 Net 14.25

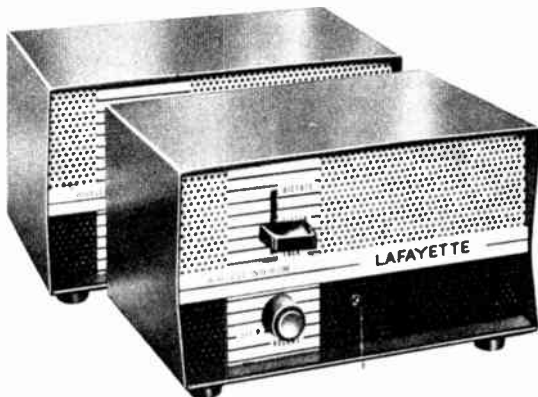

Deluxe LAFAYETTE 2 Channel Solid-State Wireless Intercom

- No Wires to Connect—just plug into AC outlet
- Each unit a "Master"—use as many as needed
- Squelch Circuit for noise-free operation

The latest in wireless intercoms—small, compact and fully transistorized. Each unit is a "master"—you can use 2, 3, 4, or as many units as required. No wires to connect—just plug each unit into a regular AC outlet. 5 transistors, 3 diodes, 1 silicon rectifier and 1 thermistor assure clear, powerful output. Units draw so little electrical current, you can leave them on all day! Perfect anywhere in the home—can even be used between adjacent homes or buildings on the same electric company power line transformer. Two channels (160 & 200 KC) for maximum flexibility. Ideal when 2 pairs are used—each pair can be used for simultaneous but independent communication using separate channels, or for communication between all units using the same channel. Controls; Volume/on-off. Press-to-talk bar with "lock-talk" feature, and channel selector (A-B). Circuit includes Squelch for noise-free operation. Transformer power supply and pilot light. Ivory high-impact plastic case 5x6¼x3". For 117V, 60 cycles AC. Imported. Shpg. wt., 4 lbs.

99 A 4556 2 Station Wireless Intercom System Net 39.95
 Additional Intercom Stations. Shpg. wt., 2 lbs.
 99 A 4557 Net ea. 21.95



ONLY
39⁹⁵
 2 Stations

Telephones for Intercoms and Private Phone Systems

SOLID STATE TELEPHONE AMPLIFIER

- Several People Can Listen in on Conversation Simultaneously

Our Lowest Price Ever!

6⁸⁸

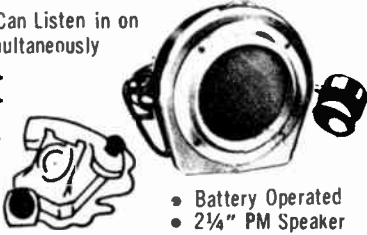

- Battery Operated
- 2 1/4" PM Speaker

An efficient battery operated telephone amplifier can be applied to and used with any type of telephone. Amplifies incoming voice and projects it through a 2 1/4" PM speaker. Suction cup on pickup coil attaches easily to telephone and makes permanent installation unnecessary. Volume control (with on-off switch) permits adjustment of volume to appropriate level for up to several people to listen in on conversation at the same time. Powered by 9-volt battery (supplied). Size: 3 3/8"Wx3 5/8"Hx2 3/8"D. Shpg. wt., 1 lb. Imported.

99 A 9085 Net 6.88
99 A 6021 Replacement 9V Battery Net .21

DIAL PHONE

Have your own Private Intercom

6⁹⁵



- For Intercoms, Extensions Private Systems

Popular modern dial phone. Can be used to make complete private systems. Equipment taken from service, reconditioned and ready to work. Simple 3-wire hook-up. Complete with handset, dial bell, induction coil and connecting cable. General appearance may vary slightly from catalog illustration. Shpg. wt., 8 lbs.

44 A 1801 Net 6.95

30 FT. TELEPHONE EXTENSION CORD

- Ideal Extension Cord for Use With Phones Listed on This Page

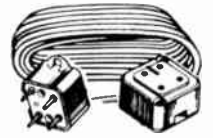

SALE 2⁴⁹

Add flexibility to your telephone intercom. Now be able to move your telephone intercom from room to room. 30 feet of telephone extension cord with standard 4-pin plug and jack. Color-coded cord to match screw terminals on plug and socket. Imported. Shpg. wt., 1 lb.

99 A 4539 Net 2.49

DELUXE LAFAYETTE EASY-PHONE TELEPHONE AMPLIFIER

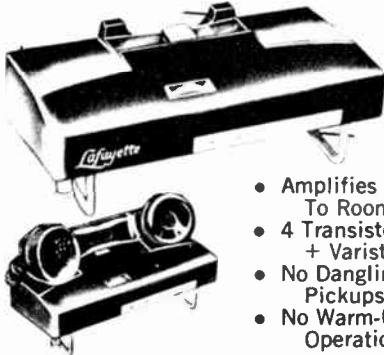

14⁹⁵

- Amplifies Telephone To Room Volume
- 4 Transistors + Varistor
- No Dangling Wires Or Pickups To Connect
- No Warm-Up, Instant Operation

The Easy-Phone amplifier is ideal for group conversation with one telephone in the room. Easy to operate: simply place the telephone on the amplifier, adjust the volume and everyone can listen, leaving both hands free for writing or typing. The Easy-Phone is a 4-transistor battery powered amplifier and inductive pick-up, in an attractive plastic case. Features: 3" speaker, volume control; on/off switch activated by telephone's weight sturdy chrome plated runners. 8 1/4"L x 3 1/8"W x 2 3/8"H. Supplied with miniature plug and jack for recorder input. Imported. Shpg. wt., 3 lbs.

99 A 9020 With batteries Net 14.95
99 A 6258 Extra Penlite Battery Net .095

THE "PRIVATE EAR"

- Telephone Detector
- No Wires Connected to Phone
- No Special Receiver Rest

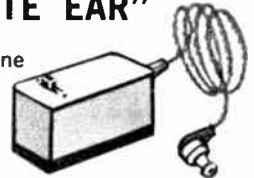

9⁹⁵

Now a pickup amplifier operating independently of your telephone. No wires connected, nothing put under the receiver. Simply place the unit next to your telephone for clear reception. Operates on its own battery power. Some practical uses are: an extension receiver, increases reception in noisy areas and for the hard of hearing, for defective use, and listening on extensions without lifting receiver. Ideal for all telephones except some push button models. Imported. Shpg. wt., 8 oz.

99 A 9096 Net 9.95
99 A 6021 Extra Battery for above Net .21

AUTHENTIC DANISH AND FRENCH ANTIQUE TELEPHONES

- Not Reproductions
- Ideal For Antique Lovers
- Add Elegant Continental Charm To Your Decor
- For Private Phone Systems, Extensions or Intercoms

Add continental charm to your home with one of these authentic Danish and French antique telephones. Not a reproduction. These imported phones have been rebuilt like new to include modern transmitting and receiving elements, and are ready to work. Complete with handset, dial, bell, induction coil, and 4 ft. cord with 4-pin telephone plug.

(A) Danish Antique Phone—Black with nickel handset. Net 34.95
44 A 4401W Shpg. wt., 15 lbs.
(B) Classic French Cradle Phone—Baked enamel. Completely rebuilt in Denmark. Shpg. wt., 10 lbs. Net 44.95
44 A 1601W
(C) Antique Danish Wall Phone—A real collectors item. Mahogany finish. Net 44.95
44 A 1602WX Shpg. wt., 25 lbs.

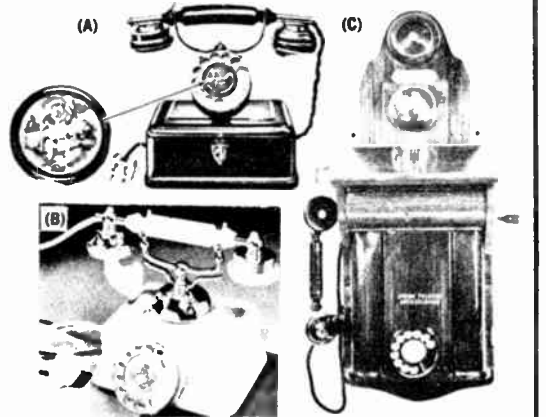

Outstanding LAFAYETTE Hi-Fi Amplifier Kits

LAFAYETTE MODEL KT-630 30-WATT STEREO AMPLIFIER KIT

Enjoy exciting, wide-range stereo reproduction anywhere in your home or office. The KT-630 features built-in equalized preamplifiers, DC on the filaments in the preamp stage to minimize hum and noise, and 4 pairs of stereo inputs—magnetic and ceramic cartridge, tuner, and auxiliary. An attractively styled brushed aluminum gold anodized extruded front panel with matching gold knobs complements the superior electrical specifications. For 110 to 125 Volts, 50-60 cycles AC; Size 12 $\frac{1}{2}$ "Wx11 $\frac{1}{2}$ "Dx5 $\frac{1}{4}$ "H, overall. Less cabinet. Shpg. wt., 15 lbs.

21 A 0930WX \$5 monthly Net 39.95

Brown metal case for KT-630. Shpg. wt., 4 lbs.

21 A 0931W Net 3.95

SPECIFICATIONS

Input Jacks: Magnetic phono, Ceramic phono, Auxiliary, and Tuner; AC Convenience outlet on rear; Rated Power Output: 12 $\frac{1}{2}$ watts RMS per channel; 15 watts per/ch IHF; Sensitivity: Phono (magnetic): 2 mv; Phono (ceramic) 70 mv; Tuner and Aux. 65 volt; Frequency Response: 20-60,000 cps. \pm 1.5 db at 1 watt; Harmonic Distortion: 1% at 12 $\frac{1}{2}$ watts RMS per channel; Hum and Noise: Aux. and Tuner —72 db below rated output, Phono —50 db below rated output; Output Impedance: 4, 8, 16 ohms; Tube Complement: 2 —ECC83/12AX7, 4 —ECL82/6BM8, 1 —EZ81/6CA4.

LAFAYETTE MODEL KT-645 45-WATT STEREO AMPLIFIER KIT

Forty-five watts of beautiful stereo for only a few evenings of pleasurable, interesting, and educational kit building! And the KT-645 is so flexible—it offers virtually every control needed in the modern stereo system. Features instant selection of any one of 3 program sources, dual preamps for low level phono inputs—RIAA equalized for flat response, handy front panel Speaker Phase/AC off switch for proper phase selection without disconnecting speaker cables, concentric volume control for independent or simultaneous level adjustment of both channels, and front panel stereo headphone jack. Attractive brushed aluminum gold anodized extruded front panel with matching gold knobs. Size: 14 $\frac{1}{2}$ "Wx12 $\frac{3}{4}$ "Dx5 $\frac{1}{4}$ "H, overall. Less cabinet. Shpg. wt., 24 lbs.

21 A 0945WX \$5 monthly Net 59.95

Brown metal case for KT-645

21 A 0946W Net 3.95

SPECIFICATIONS

Rated Power Output: IHFM 45 watts, 22 $\frac{1}{2}$ watts per channel; Inputs: Aux, Tuner, Ceramic Phono, Magnetic Phono, and Tape out; Sensitivity: Phono (magnetic): 3 mv. for rated output per channel, high level inputs: .4v. for rated output per channel. Frequency Response: 10-25,000 \pm 1/2 db at 1 watt; Harmonic Distortion: Less than .15% at normal listening level at 1 KC; IM Distortion: Less than .3%; Hum and Noise, high level inputs: 70 db below rated output per channel, Phono —50 db below rated output per channel; Output Impedance: 8 and 16 ohms; Tube Complement: 4-EL84, 2-7199, 3-12AX7, 2 silicon diodes; Power Requirements: 180 watts, 110-125 V, 50-60 cycle AC.

LAFAYETTE MODEL KT-615 15-WATT MONAURAL HI-FI KIT

KT-615 offers versatility and flexibility. Three separate inputs for a fully integrated hi-fi system. Separate bass and treble controls provide full tonal quality. Push-pull ECL82 output stage for clean, wide response. Hum Balance control for minimum hum and noise. 4, 8, and 16 ohm output. Less case listed below. Size 11 $\frac{1}{2}$ "Wx7 $\frac{1}{2}$ "Dx4 $\frac{1}{2}$ "H. Shpg. wt., 9 lbs.

19 A 0912 KT-615 less case Net 19.95

Attractive Gray Case for KT-615

19 A 0913 Shpg. wt., 2 lbs. Net 3.95

SPECIFICATIONS

Power Output: 15 Watts IHFM, 12.5 watts RMS; Frequency Response: 15-60,000 cps \pm 2 db at 1 watt (average listening level), 35-25,000 cps \pm 2 db at full 15 watt output; Harmonic Distortion: 1.1% at full output; Hum and Noise: Phono —45 db. Aux/Tuner —75 db; Input Sensitivity: Aux/Tuner .5 volt, Mag Phono 1.5 mv, Ceramic 25 mv; Tubes: 2—ECL82/6BM8, EZ81/6CA4, ECC83/12AX7.

ASSURANCE OF COMPONENT QUALITY ONE YEAR PARTS GUARANTEE

All Components in this unit are conservatively engineered to operate well within their performance capabilities. As assurance of this quality, Lafayette will replace any parts, including tubes, which fail to perform properly due to defects of material or workmanship.



Made in U.S.A.

39⁹⁵
Less Cabinet

FRONT PANEL CONTROLS

- | | |
|---------------------------------|--|
| 1 Selector: Aux, Tuner, Phono | 6 Right Amplifier Mode Selector Slide Switch |
| 2 Bass Control | 7 Left Amplifier Mode Selector Slide Switch |
| 3 Treble and AC Off Control | 8 AC Indicator Light |
| 4 Concentric L/R Volume-Balance | |
| 5 Loudness On/Off Slide Switch | |



59⁹⁵
Less Case

Made in U.S.A.

FRONT PANEL CONTROLS

- | | |
|---------------------------------|-------------------------------|
| 1 Selector: Aux, Tuner, Phono | 7 Loudness Switch |
| 2 Concentric L/R Bass | 8 Right Amplifier Mode Switch |
| 3 Concentric L/R Treble | 9 Left Amplifier Mode Switch |
| 4 Concentric L/R Volume-Balance | 10 AC Indicator Light |
| 5 AC Off/Speaker Phase | |
| 6 Stereo Phone Jack | |



Made in U.S.A.

Shown in Optional Case

- Easy-to-Build—All Parts, Wire, Solder, and Instructions Included.
- Inputs for Magnetic or Ceramic Phono, AM/FM Tuner, and Auxiliary Equipment
- Attractive Two-Tone Gray Panel with Silver Trim

19⁹⁵

MONEY BACK GUARANTEE

Your Lafayette Kit when properly wired must meet our specifications or you may return it for FULL REFUND of the purchase price

LAFAYETTE "EXPLOR-AIR"™ 4-BAND RECEIVER KIT



- 4 Bands for Total Coverage
- Covers 10, 15, 20, 40, 80, 160 Meter Amateur Bands
- Tunes International Broadcast, Citizens Band, Maritime, Aeronautical and WWV Time Signals
- Complete Band Switching from Front Panel
- Bandspread Tuning
- Built-in 4" Speaker

TUNE IN
THE WORLD!



22⁹⁵

MADE IN U.S.A.

Lafayette's sensational shortwave receiver kit is a complete shortwave and standard broadcast set which covers the entire region from 550 kilocycles to 30 megacycles. Four whole bands of fascinating programming. Perfect for language students and shortwave listeners.

Only a regenerative circuit can offer such amazing performance and yet be so simple to build. Building this fine kit is an absolute pleasure—it's so well designed you can't go wrong. Kit includes all the parts you need, and the detailed step-by-step instruction book with its giant pictorial drawings shows you just how to put them together. One front panel knob does all the bandswitching, immediately taking you from band to band. All coils are prewound for

greater accuracy. Complete 4 band coverage of broadcast stations, international broadcast bands, amateur, maritime, and WWV time signals. Big 4" speaker and sensitive circuit with 50C5 output stage and 12A7 regenerative detector and amplifier stages give you all the volume you want. Phone jack for privacy automatically disconnects speaker. All controls are on the front panel: On-Off Volume, Main Tuning, Band Spread, Bandswitch, Antenna Tuning, and Regeneration. 110 volt 50-60 cycle AC-DC power supply. Size: 10x7x5".

19 A 0905 (Less Cabinet) wt., 5 lbs. Net 22.95
Leatherette covered Wooden Cabinet for above. 1 lb. Net 2.85
19 A 0906 Net 2.85

LAFAYETTE KT-92 5-WATT PUSH-PULL AMPLIFIER KIT

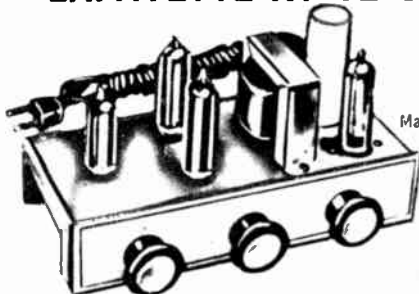

Made in U.S.A.

10⁹⁵

- Push-Pull Audio Output Stage—Inverse Feedback Circuit
- Separate Volume, Bass & Treble Controls
- AC or DC Operation

Here in kit form is an AC-DC hi-fi amplifier that presents deluxe features despite its amazingly low price. The separate bass and treble controls permit adjustment of both low and high frequency response and balance. Works equally well with both crystal or ceramic cartridges. Tube line-up consists of a 12AX7 amplifier and phase inverter, a pair of 35C5's in push-pull, having a power-packed low-distortion output plus a 35W4 rectifier. The circuit utilizes an inverse feedback loop to reduce the level of hum and distortion. Kit is complete containing all essential parts, tubes and detailed instruction manual showing pictorial and schematic diagrams. Shpg. wt., 4 lbs.

19 A 0101 Net 10.95

CITIZEN-SHIP ANALOG R/C PROPORTIONAL SYSTEM



- Dual Simultaneous with Trim Controls, Plus Trimmable Motor
- Tone Modulated for Noise Rejection

199⁹⁵ No Money Down



Consists of:

Model APT Transmitter — High output from center loaded antenna. Low battery drain. Size: 2 3/4 x 5 5/8 x 6 7/8". Weighs 2 3/4 lbs. with batteries.

Model APR Receiver — Extremely sensitive, eliminated dead spots. Size: 1 1/8 x 1 3/4 x 2 1/8". Weighs 3 3/4 oz.

2 Model APC Proportional Servos — Closed loop feedback servos to be used on control surfaces. All nylon drive train for quiet, efficient operation. Temperature compensated by thermistor. Size: 2 5/8 x 1 3/8 x 1". Weighs 2 3/4 oz.

1 Model APM Trimmable Servo — For motor control.

1 Printed Circuit Wiring Board — Complete with switch and 5 plugs and sockets. Interconnects servos, receiver and batteries. System Shpg. wt., 5 lbs.

42 A 1915WX 27.145 Mc; Less batteries—\$10 monthly Net 199.95

42 A 1916 Model APC Servo Net 27.95

BATTERIES REQUIRED

32 A 4705 For APT (1 req.) Net 1.26

32 A 4736 For APR. Nicad battery (4 req.) ea. Net .91

32 A 4738 For servos. Nicad battery (4 req.) ea. Net 1.54

Alternate Dry Batteries

99 A 6258 For APR plus Servos (8 req.) ea. Net .095

LAFAYETTE PRECISION-LAPPED R/C ENGINES

- Precision Lapped For Peak Performance

MODEL 55RC

- Excellent Starting, Running and Idling Characteristics

29⁹⁵

OTHER MODELS FROM 8.95



Sturdily constructed engines specifically designed for R/C use. Throttle precision engineered for smooth, steady power from idle to maximum rpm. Plated piston for long engine-life and quick break-in. Machined connecting rod, balanced crankshaft for vibration-free smooth running. Complete with glow plug, needle valve and instructions. Imported.

Model 55RC a reliable engine to power the large RC craft. Double ball bearing. 1/4" dia. crankshaft. Coupled exhaust and intake throttle. Throttle take-off on either side. Bore .932; Stroke .826; Displacement .564; Compression 8:1; wt. 12 oz.
99 A 9111 Shpg. wt., 1 1/2 lbs. Net 29.95

Model 45RC. Same as Model 55RC with Bore .849; Stroke .827; Displacement .469; Compression 8:1; wt., 12 1/2 oz.
99 A 9110 Shpg. wt., 1 1/2 lbs. Net 24.95

Model 15RC. Bore .594; Stroke .547; Displacement .151; Compression 7:1; wt., 4 1/2 oz. 3/8" dia. crankshaft.
99 A 9109 Shpg. wt. 1 lb. Net 10.95

Model 09RC. Same as Model 15RC with Bore .50; Stroke .484; Displacement .096; wt., 3 1/4 oz.
99 A 9108 Shpg. wt., 1 lb. Net 8.95

LAFAYETTE R/C Equipment and Accessories

LAFAYETTE SOLID STATE R/C TONE TRANSMITTER

29⁹⁵



- Extended Range Circuitry
- Center Loaded Antenna

Three transistor crystal controlled audio tone transmitter operates on 27 megacycles with single 9 volt battery. Features 11-section collapsible center loaded antenna and variable output tuning. Built-in meter monitors battery current. Microswitch transmitting key actuates 100% modulated 550 cycle tone with 3/8 mile range when used with 99 A 9106 R/C receiver shown below. Black anodized aluminum case. 5 1/2 x 3 3/8 x 1 1/8". Shpg. wt., 2 lbs. Imported.

99 A 9105

Net 29.95

LAFAYETTE SOLID STATE R/C TONE TRANSMITTER

14⁹⁵

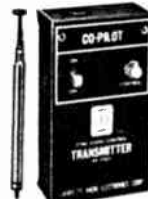

Crystal controlled 3 transistor R/C transmitter operates on a single 9 volt battery providing a 100% modulated 550 cycle tone. Perfect for the novice! Only 4 3/4 x 2 3/4 x 1 3/8". Contains pushbutton switch, 6-section antenna (3'9" extended) and pre-wired plug. Black aluminum anodized case easily snaps apart for transmitter adjustment. Shpg. wt., 1 lb. Imported.

99 A 9103

Net 14.95

LAFAYETTE SOLID STATE SUPER-REGENERATIVE R/C RECEIVER

17⁹⁵



Operated with other units or as a companion to the 99 R 9105 transmitter above this 4 transistor receiver receives audio tones between 400 and 1000 cycles. Sensitive relay allows use of all types of escapements or single channel servos. Operates on single 9 volt battery. Lightweight (less than 2 oz.); compact (1 1/4 x 2 1/4 x 1 1/4"). Black anodized case with prewired plug. Complete with battery connector, switch, tuning wand and easy-to-follow instructions. Shpg. wt., 1 lb. Imported.

99 A 9106

Net 17.95

LAFAYETTE SOLID STATE SUPER-REGENERATIVE R/C RECEIVER

14⁹⁵



Extremely lightweight, this 27 mc. 4 transistor receiver weighs less than 2 oz. yet will receive a 550 cycle tone up to 1/2 mile using the 99 R 9103 transmitter above. Relay start current is 12 mA. resets at 10 mA. Operates from single 9 volt battery. Housed in black anodized aluminum case with pre-wired plug. 2'1 1/2" antenna required. Supplied with miniature phone jack, slide switch and battery connector. Shpg. wt., 1 lb. Imported.

99 A 9104

Net 14.95

R/C CENTER LOADING COIL ANTENNA



High efficiency, center loaded, 11-section telescoping antenna collapses to 8 1/2" and extends to 54". High Q chrome-plated brass antenna transfers maximum power for distant remote control. Shpg. wt. 1 lb.

99 A 9098 Imported

Net 2.99

COMPOUND R/C ESCAPEMENT



One pulse, right turn; two pulses, left turn. Three closes circuit for supplementary control. Rudder returns to neutral when transmitter keying button is released. With ratchet governor. Uses 1 1/2 volt battery. 1 1/2 oz. Size: 2 3/8 x 2 1/4 x 1 3/8" overall. Shpg. wt., 6 oz. Imported.

99 A 9036

Net 3.45

MULTI-PURPOSE ELECTRO SERVO MECHANISM

4⁹⁵



Operates with any single channel R/C receiver and transmitter. Requires 3 volts. Provides for steering and automatic return to neutral. Single pulse operation. Only 2 1/2 x 2 x 1 3/8" overall. Includes instructions and linkage to extend actuator arm. Shpg. wt., 8 oz. Imported

99 A 9033

Net 4.95

R/C GLOW PLUGS



For R/C model engines. Platinum alloy coil element withstands the terrific heat of the hottest fuels. 3/8" hex head fits standard nut wrench. Shpg. wt., 4 oz. Imported.

Glow plug for large wingspan contest planes. 99 A 9113 Net 1.25

Glow plug for small wingspan speed planes. 99 A 9112 Net .65

5-CHANNEL RESONANT REED HOBBY RELAY

7⁹⁵

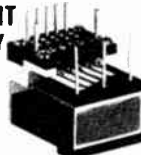

TUNED TO 266.0 CPS, 280.8 CPS, 313.0 CPS, 349.0 CPS, 389.0 CPS

Frequency tolerance ±1%. Especially adaptable to 5 channel remote control hobby tone receivers and Citizens Band tone signalling receivers. Can also be used as high stability, resonant reed oscillator control. Features low tuning error, good temperature stability, and low driving requirements. Reed response approx. 75 milliseconds; contact rating 100-ma at 48 VDC, 15 ma at 100 VDC, 1 ma at 150 VDC. Drive power varies from 1 milliwatt at 100 cps to 50 milliwatts at 800 cps. Weight 1 oz. 1 3/4 x 1 3/8 x 1 1/4". Mounts by two 6/32" tapped holes on back and bottom. 600 ohm DC resistance. Shpg. wt., 8 oz. 42 A 1908 Net 7.95

CITIZEN-SHIP MODEL TCB CAM ACTION SERVO

21⁷⁵



- Gives Variable Ratio
- Ideal For Contest Work

For use up to 140°F. Operates directly from any standard reed bank. Features a variable push and pull ratio for slow start, smooth flying, and fast finish for quick recovery. Perfect for aileron and elevator. Weighs 3 oz. Uses 6 volts (4 penlight cells). Shpg. wt., 1 lb.

42 A 1909 Less Batteries Net 21.75

1 1/2 Volt Batteries (4 req.)

32 A 4002 Net ea. .13

MODEL TLB TRANSISTORIZED LINEAR ACTION SERVO Same as Model TCB except true linear motion-rack and pinion gearing. Ideal for motor and trim. Shpg. wt., 1 lb.

42 A 1914 Less Batteries Net 21.75

1 1/2 Volt Batteries (4 req.)

32 A 4002 Net ea. .13

LITTLE "JEWEL" REMOTE CONTROL RELAY

- The Mighty Mite of the R/C Field
- Weighs less than 1/2 oz.!
- Size: 3/4"H, 1/2"W, 1 1/8"L



A natural for remote control receivers, it is highly sensitive, and built to withstand severe crashes. The smallest commercial job available, it weighs less than 1/2 oz. Factory adjusted to pull in at 1.4 MA drop out at 1.2 MA D.C. Single pole, double throw. Used in outstanding R/C receivers. 5,000 ohm coil. Imported

99 A 6091

Net 1.95

R/C ESCAPEMENT



A sturdy 2 arm self neutralizing escapement. Converts electrical impulses from remote control receiver to mechanical motion. Four 90° rotations—two by armature activation, two by neutralization. Has ratchet governor. Weighs only 7/8 oz. Size: 1 3/8 x 2"W overall. Shpg. wt., 5 oz. Imported

99 A 9034

Net 1.95

27.255 CRYSTAL .005% TOLERANCE!

2²⁵



Designed for use in R/C model planes, boats, cars, etc., as well as on channel 23 of class "D" Citizens Band Equipment. Type HC-6/U holder; Pin spacing .493; Pin dia .050". 42 A 4206 Net 2.25

42 A 0901 Crystal Socket for above Net .20

R/C MINIATURE CONNECTOR

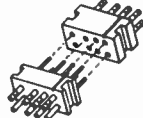

Miniature 8-pin plug & jack weighs only 1/4 oz. & measures 1 x 3/4". Many useful R/C applications! Imported.

99 A 9091

Net 99

Easy To Build Educational Kits

LAFAYETTE 20-IN-1 TRANSISTOR EXPERIMENTERS KIT

Fun To Build — Educational — and all 20 projects result in a useful working instrument!

PROJECTS YOU BUILD **16⁹⁵**

1. TRANSISTOR TESTER
2. VOICE ACTUATED ALARM
3. PHOTO TIMER
4. AUDIO AMPLIFIER
5. CRYSTAL SET
6. SOLAR RADIO
7. RAIN ALARM
8. TIMER
9. ONE TRANSISTOR RECEIVER
10. CODE PRACTICE OSCILLATOR
11. METROPHONE
12. TWO TRANSISTOR RECEIVER
13. ELECTRONIC RELAY
14. HOME BROADCASTER
15. PHOTO ELECTRIC RELAY
16. BURGLAR ALARM
17. WIRELESS TRANSMITTER
18. REGENERATIVE RECEIVER
19. CITIZENS BAND MONITOR
20. AUDIO OSCILLATOR

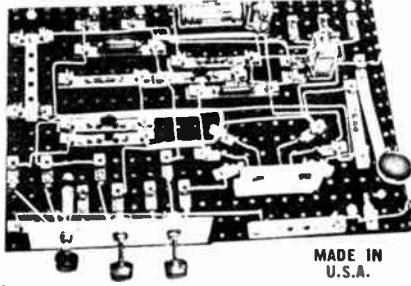

Excellent for beginners as well as advanced experimenters, this kit enables you to build and learn about 20 interesting and useful transistor circuits. By utilizing "Breadboard" construction, each project can be simply wired and traced. After building the basic circuit, any of the 20 projects can be built by simply inserting a few preassembled component blocks and interconnecting leads between them. A soldering iron is only required for the basic wiring and not for subsequent projects. All wiring is covered in a step-by-step manner by the instruction manual. Each of the 20 projects is clearly presented with step-by-step instructions, large easy-to-read pictorial wiring diagrams, schematic diagrams, and an explanation of the circuit behavior. The kit is complete with perforated mounting board, 2-transistors, 1-diode, earphone, and all other parts required for construction. The detailed 28-page instruction manual contains a wealth of information about each project. Less batteries.

- | | |
|---|-----------|
| 19 A 0902 Complete. Shpg. wt., 6 lbs. | Net 16.95 |
| 99 A 6258 Z Cell Battery for Kit projects | Net .095 |
| 32 A 4723 2 1/2 Volt Battery for Kit projects | Net 1.61 |

SHORTWAVE AND SUPERHET BROADCAST RADIO KIT

17⁹⁵

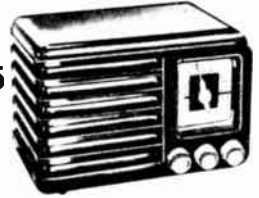

2 bands cover both standard broadcast 540-1700 KC and shortwave 5.8-18 MC which includes international broadcast, 40 and 20-meter ham bands and some of the aeronautical and marine bands. Superheterodyne circuit has high gain IF's, built-in broadcast band loop antenna. Comes complete with walnut cabinet, 4" PM speaker, tubes (12SA7, 12SK7, 12SQ7, 50L6 plus 35Z5 rectifier) and all parts. Easy to follow step-by-step instructions. Shortwave band requires external antenna (not supplied). Size 9 3/8" x 6 1/2" x 4 1/2". For 110V AC or DC. Shpg. wt., 6 lbs.

19 A 4001 Net 17.95

LAFAYETTE WIRELESS BROADCASTER/AMPLIFIER KIT

Treat yourself and your family to hours of fun with this Lafayette Kit. Make your own radio programs, announcements, etc., through AM radios anywhere in the house, without wires or extra gadgets. Designed for easy construction by youngsters or adults, it combines in one compact unit a powerful 3-tube wireless broadcaster and an audio amplifier. Clearly written instruction manual makes it a cinch to build. Operates on any frequency between 900 and 1600 kilocycles on your radio dial. It will accept any crystal or magnetic microphone. In addition, it may be used directly as a phono or microphone amplifier. No external preamp is required. Simple slide switch permits either form of operation. Just connect it to a PM speaker (4-16 ohms). Conforms to FCC regulations and is designed to provide high quality voice or record broadcasts. No license or permit is necessary. Complete with crystal clear instruction manual. Less Mike. For 105-125V AC or DC. Attractively styled metal cabinet. Size 4Hx8Wx4 3/8"D. Shpg. wt., 3 lbs.

19 A 0903 Net 12.95

Same as above, but factory wired & tested

19 A 0908 Net 14.95

Crystal microphone for above, Desk or hand held. 5 ft. cable.

Shpg. wt., 1 lb. Imported.

99 A 4543 Net 1.95

ONLY
12⁹⁵

Made in U.S.A.



Use it either as a

Wireless Broadcaster or AM Audio Amplifier!

- CLEAN, MODERN STYLING • POWERFUL SIGNAL
- WORKS WITH ALL CRYSTAL AND MAGNETIC MIKES AND PHONO CARTRIDGES
- PLAYS THROUGH ALL AM RADIOS

LAFAYETTE SUPER-SENSITIVE PHOTOCELL ELECTRONIC RELAY KIT

- WITH CLAIREX CADMIUM SULPHIDE PHOTOCELL
- ADJUSTABLE SUPER SENSITIVITY—WORKS WITH JUST A FLASHLIGHT AT 250 FEET!
- NEEDS NO SPECIAL HIGH-INTENSITY LIGHTS
- INSTANTANEOUS OR SUSTAINED OPERATION ON THE FLIP OF A SWITCH!

Ideal for sustained operation required for burglar alarms, door buzzers and for instantaneous on-off operation required

for counters, packaging, door opening, motor activation plus countless industrial applications. Switch converts unit from instantaneous "on-off" to sustained "on" operation. "RESET" switch opens the external circuit and turns off the alarm. The unit operates on 110 volts AC and incorporates the efficient 5823 cold cathode tube. A simple change in wiring (in instructions), as well as convenient input terminals, enables you to supply the external circuit with any desired voltage. Relay contacts rated at 3 amps permitting up to 300 watts external load on 110 Volts AC. Complete with all parts, photocell, tube chassis, silkscreened metal cabinet and easy-to-follow illustrated instructions. Size: 3x4x5". Shpg. wt., 3 lbs.

19 A 0904 Complete Kit Net 12.95

ACCESSORIES FOR ABOVE

- | | |
|--|----------|
| 99 A 9023 Electric Bell, 110V AC imported. Shpg. wt., 2 oz. | Net 1.75 |
| 99 A 9024 Electric Buzzer, 110V AC imported. Shpg. wt., 10 oz. | Net 1.45 |
| 99 A 9011 6-Digit Electric Counter imported. Shpg. wt., 1 1/2 lbs. | Net 9.95 |



12⁹⁵

Made in U.S.A.

LAFAYETTE LIGHT SOURCE KIT For Electronic Relay Kit

7⁵⁰



MADE IN U.S.A.

Used to actuate electronic relay. Unlike units using sealed beam, this light source is carefully designed to throw a narrow beam of light so relatively small objects and people will "break" the beam. Unit includes red filter to make beam practically invisible. Range: white light—70', red 5'. With instructions. Size—6Lx5Hx4"W

19 A 0911 Shpg. wt., 5 lbs. Net 7.50

LAFAYETTE Musical Instruments & Accessories

LAFAYETTE ELECTRIC METRONOME

Only **14⁹⁵**

- Flashing Baton
- Battery Operated



A smart, modern electronic metronome that uses transistors and is battery operated. Contains no motors or gears, has no tubes to replace, and does not have to be plugged in. Starts operation at the turn of a dial. Features a bright neon light which flashes in synchronization with an audible beat. Dial also provides for suitable tempo (40-208). Draws so little current that battery lasts almost indefinitely. 6" high and 7" wide at base. Imported. Shpg. wt., 2 lbs. **99 A 9063** Net 14.95

DRUM COMBO OUTFIT

119⁹⁵
\$6.00 Monthly

14 x 20" single-tension bass drum with permanent-type tom-tom and cymbal holders. 14 x 5 1/2" snare drum with separate tension flanged hoop, metal snare, professional throw-off. 12 x 8" tom-tom with separate tension, flanged hoops. 12" cymbal, drum pedal with adjustable beater and springs, disappearing spurs, snare-drum stand, holder for tom-tom sticks. Metal parts are highly nickel plated. Bright sparkle finish. Imported. Shpg. wt. 45 lbs.



13 A 8701WX Net 119.95

DELUXE 4-PIECE DRUM OUTFIT. Professional 4-piece set including: 5 1/2 x 14" snare drum, 22" bass drum, 9 x 13" tom tom and 16 x 16" floor tom tom—all separate tension, plastic heads. Shpg. wt., 55 lbs. **13 A 8745WX** Net 199.95

SETH TOMAS KEYWOUND METRONOME

Only **11⁵⁰**

The original Seth Thomas metronome, from America's first and only manufacturer of keywound metronomes. A useful aid in music and dancing instruction, or wherever beat timing is important. Adjustable pendulum permits selection of beat tempo from 40 to 208 beats per minute. Selected hardwood case finished in walnut. Height 8 3/8". Base 4 1/2". Shpg. wt., 1 1/2 lbs.

13 A 4450 Net 11.50

13 A 4452 Above but mahogany finish Net 11.50

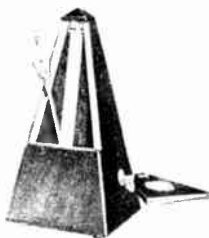

SNARE DRUM

Complete with Stand, 10" Cymbal Brushes, Sticks **34⁹⁵**
No Money Down



An exciting snare drum at a low Lafayette price. 14x5 1/2" separate tension snare drum with metal snares, tone modulator, heavy duty throw-off, flanged hoops, rolled rims, nickel plated hardware. Bright sparkle finish. Complete with norwood metal stand, 10" cymbal, sticks, brushes, instruction book. Shpg. wt., 15 lbs. Imported. **13 A 8705WX** \$5 Monthly Net 34.95

MUSICAL CONTACT MICROPHONE

1⁹⁵
Deluxe Microphone

2⁴⁹
With Volume Control

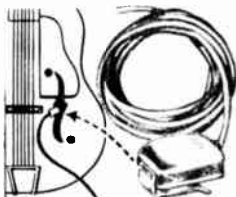

- Easily Attaches to All String Instruments

This high quality contact microphone is ideal for amplification of single stringed instruments such as guitars, banjos, mandolins, cellos, ukuleles, etc. Provides rich, natural reproduction of the actual tone with sufficient amplification to be heard in a large hall. The clamp bar on the mike slides directly under the sounding board cutout to give a secure fit. Comes equipped with 8 ft. cable for connection to public address amplifiers, tape recorders or radios. Frequency response 40-9,000 cps. High impedance. Size: 1 1/2 L x 15/16 W x 5/16" D. Imported. Shpg. wt., 12 ozs.

99 A 4575 Net 1.95

Same musical contact microphone as above except with volume control. Shpg. wt., 12 oz.

99 A 4576 Net 2.49

GUITAR STRINGS • LEATHER STRAP



A



B



C

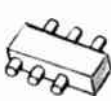

(A) Guitar String Set, Set of 6 strings. Silver plated copper wire wound. Shpg. wt., 2 oz. **13 A 8746** Net 1.50

(A) Nylon Classic Guitar Strings, Set of 6 strings. Shpg. wt., 2 oz. **13 A 8747** Net 1.50

(A) Flat Wound Hi-Fi Strings for electric guitars. High Quality. Shpg. wt., 2 oz. **13 A 8748** Net 3.75

(B) Adjustable Foam Padded Guitar Neck Strap. Shpg. wt., 4 oz. **13 A 2250** Net 1.49

(C) Guitar Pitch Pipe. Shpg. wt., 4 oz. **13 A 2251** Net 1.39

METHOD FOR GUITAR by JOE FAVA

A contemporary approach towards comprehensive mastery of the guitar written in a clear concise manner by a professional. The strings are learned in order of their difficulty with musical arrangements for study. Profusely illustrated.

13 A 8706 Book I (1st position) 40 pages Net 1.49

13 A 8707 Book II (2nd position) 40 pages Net 1.49

13 A 8708 Book III (High positions) 48 pgs. Net 1.98



HOW TO PLAY THE GUITAR

Famous "Music Minus One" Records!

The easy way to learn all the chords and rhythms on your guitar. Has vocal accompaniment; ballad styles; folk, country and western; rhythm and blues; shuffle beats. Features guitar demonstration and text by George Barnes, spoken commentary by Bob Mersey. Shpg. wt., 1 lb. **24 A 4506** Net 3.50



LAFAYETTE® Electric Guitars and Amplifiers

Our Most Popular Best Selling Guitars



A "Value" Electric Guitar

32⁹⁵

B Dual Pickup Solid Body

44⁹⁵

C "Capri" Electric Guitar

59⁹⁵

G 10-Watt Tremolo Amplifier

54⁹⁵

F 5-Watt Amplifier

29⁹⁵



D Deluxe 4 Pickup

SALE
79⁹⁵ **SAVE**
10.00

E Deluxe Triple Pickup

69⁹⁵



H 25-Watt Tremolo Amplifier

89⁹⁵



Electric Guitars—Amplifiers and Combinations

A "VALUE" ELECTRIC GUITAR

- Magnetic Pick-up • Individual Adjusting Screws • Individual Tone and Volume Controls.

The perfect instrument for the budget-minded musician be he beginner or advanced. Features double cut-away solid body construction for that true "twangy" electric guitar sound and rugged dependability. Other features are a sensitive magnetic pick-up with individual adjusting screws, individual tone and volume controls, 20 frets with 6 marked positions. Comes complete with connecting cord with standard plugs on each end. Deep mahogany color with sunburst.

99 A 9022WX \$5 Monthly Imported. Shpg. wt., 12 lbs. Net 32.95

CARRYING CASE ONLY. Shpg. wt., 3 lbs.

13 A 8712WX Net 8.95

5-WATT GUITAR AMPLIFIER OUTFIT. Includes 99 A 9022WX guitar,

99 A 9101WX amplifier, and 13 A 8712WX case. Shpg. wt., 35 lbs.

13 A 9015WXM \$5 Monthly Net 62.95

B SOLID DOUBLE CUTAWAY—DUAL PICKUP ELECTRIC GUITAR with Tremolo Tailpiece

- 2 Adjustable Pickups • Individual Tone Controls • Individual Volume Controls • Individual Rocker Switches • Solid Mahogany Body—3 Piece Laminated Neck.

Elegant double cutaway design features tremolo tailpiece and detachable steel reinforced warp-proof neck. Solid Mahogany Gleaming hand rubbed finish body. Rosewood fingerboard with 8 white inlaid markers and 20 frets. 2 microphone pickups each adjustable for tone and volume balance. Separate tone and volume controls. Sensitive pickups have individual adjustment screws for each string. Chrome plated guard plate. Highly polished shaded mahogany finish. 39Lx 12Wx11¼"D. Less case. Imported. Shpg. wt., 10 lbs.

99 A 9060WX \$5 Monthly Net 44.95

Carrying case.

13 A 8715WX Shpg. wt., 3 lbs. Net 8.95

5-WATT GUITAR—AMPLIFIER OUTFIT. Includes 99 A 9060WX Guitar,

99 A 9101WX amplifier and 13 A 8715WX case. Shpg. wt., 35 lbs.

13 A 9016WXM \$5 Monthly Net 74.95

C "CAPRI" DOUBLE CUTAWAY SOLID BODY ELECTRIC GUITAR

- 2 Powerful Adjustable Pickups • 7 Controls for Maximum Versatility • "Hi-Response" Tremolo Tailpiece.

Designed for brilliant tone and styled for a professional look and feel. Genuine mahogany body with contour cut back. Rosewood fingerboard has 20 frets, celluloid binding, and seven inlaid pearl position markers. Laminated neck with steel reinforcing rod. Adjustable dual magnetic pickups. Adjustable compensating roller bridge. "Hi-response" tremolo unit. Supergloss metallic finish. Deep sparkle pick-guard. Dual volume controls, tone control, and individual switches including rhythm/solo switch. 39" Long, 12" Wide, 1¼" Deep, 25" scale. Cool "mint green" and metallic teal-blue finish—hand rubbed to a super gloss. Imported. Shpg. wt., 15 lbs.

99 A 9107WX \$5 Monthly Net 59.95

13 A 8715WX Carry Case Net 8.95

GUITAR AMPLIFIER OUTFIT. Includes 99 A 9107WX guitar, 13 A 0134

10-watt tremolo amp., 12 A 6701 foot switch, and 13 A 8715WX case.

13 A 9022WXM \$6.50 Monthly Shpg. wt., 55 lbs. Net 114.95

F 5-WATT MUSICAL INSTRUMENT AMPLIFIER

A dynamically designed 5-watt straight AC musical instrument amplifier. Top mounted controls and panel for "easy reach" operation. Separate volume and tone controls. Full size high-quality speaker. Speaker cone is specially treated for full brilliance of tone and long trouble-free life. AC isolation achieved through a rugged power transformer. Sturdy wood cabinet covered in beautiful black leatherette. Inputs are provided for two instruments. Pilot light operates with on-off switch. Uses no-slip rubber feet and useful carrying handle. Size: 11Hx13Wx6¼"D. For 117 volts 50/60 cycles AC.

99 A 8101W Imported. Shpg. wt., 11 lbs. Net 29.95

G 10-WATT MUSICAL INSTRUMENT AMPLIFIER WITH TREMOLO

- Big 12" Jensen Speaker • 4 Instrument Inputs

A deluxe 10-watt tremolo amplifier with big 12" specialty designed speaker by Jensen. Provision for three instrument inputs. Jack provided for tremolo foot switch. Handy carrying handle. Controls: volume, tremolo speed, tone. AC chassis utilizing 4-tube circuitry. Handsome brushed aluminum top mounted control panel for "easy reach." Heavy ¾" wood cabinet covered in luxurious black vinyl. On-off switch activates pilot light. Size: 15½Hx16½Wx10"D. For 117 volts 50/60 cycles AC. Shpg. wt., 20 lbs.

13 A 0134WX \$5 Monthly Net 54.95

Foot switch required to activate tremolo control. Shpg. wt., 1½ lbs.

12 A 6701 Net 2.99

D 4 PICKUP DOUBLE CUTAWAY SOLID BODY ELECTRIC GUITAR

- Custom Crafted—Brilliant Tone—Elegant Styling • 6 Self-Cancelling Push Button Selector Switches • Slim, Rounded Fast Action Neck • Ten Deluxe Inlaid Position Markers • Four Fully Adjustable Matched and Balanced Pickups • "Hi-Response" True Vibrato Tailpiece • Separate Volume and Tone Controls.

Designed for the professional musician. Combines all the most wanted features in one outstanding instrument. Carefully contoured and beveled double cutaway design. Fast, slim, rounded neck with ten inlaid position markers. Neck reinforced with adjustable steel rod. Six self-cancelling push button selector switches for instantaneous tone changes. Automatic selection of correct pickup combinations. "Hi-Response," positive action tremolo tailpiece. Separate master tone and volume controls. Heavy-duty precision machined heads. Triple chrome plated hardware. Deep rosewood fingerboard with 21 close spaced frets. Fully adjustable pickups—carefully matched and balanced for perfect performance. Size overall: 42" long, 13¼" wide, 1½" deep. Less case. Imported. Shpg. wt., 6 lbs.

99 A 9117WX Net 79.95

13 A 8749WX Sturdy Case for Above Net 8.95

Guitar Amplifier Outfit: Includes 99 A 9117WX Guitar, 13 A 0133WX

25-Watt Tremolo Amplifier, 12 A 6701 Foot Switch and 13 A 8749WX

Case. Shpg. wt., 70 lbs.

13 A 9023WXM Net 174.95

E DELUXE TRIPLE PICKUP DOUBLE CUTAWAY ELECTRIC GUITAR

- Slim Fast Action Neck • Lightweight Contoured and Beveled Body • Super Silent "Soft-Touch" Switches • True Vibrato Tailpiece • Separate Volume and Tone Controls • Adjustable Steel Reinforcing Rods.

Handcrafted, functional solid mahogany body design. Professional quality throughout. Individually adjustable triple pickups for chord and solo playing. Even hard chords are easier with the slim, fast action neck with close spaced frets. Gleaming, hand rubbed solid mahogany body. Rosewood fingerboard with white inlaid position markers. Scratch resistant pick guard plate. "Hi-response" tremolo unit for "Hawaiian" effects. Precision made machined heads. Fully adjustable bridge. Triple chrome plated hardware. Full range tone and volume controls plus separate switches for rhythm, solo, and "take-off." 39" long, 12" wide, 1¼" deep. Less case. Imported. Shpg. wt., 10 lbs.

99 A 9116WX \$5 Monthly Net 69.95

Sturdy Case for Above. Shpg. wt., 5 lbs.

13 A 8715WX Net 8.95

25-WATT GUITAR AMPLIFIER OUTFIT. Includes 99 A 9116WX guitar,

13 A 0133WX 25 watt tremolo amplifier, 12 A 6701 foot switch, and

13 A 8715WX case. Shpg. wt., 65 lbs.

13 A 9025WXM \$8 Monthly Net 154.95

H LAFAYETTE 25-WATT MUSICAL INSTRUMENT AMPLIFIER WITH TREMOLO

- Jack for External Tremolo Control
- 4 Instrument Inputs • Two Channel Amplifier
- Big 12" Jensen Speaker with Large 14.7 oz. Ceramic Magnet

You get faithful reproduction of every note and tone played with minimum hum for clear, undistorted sound. The built-in heavy duty speaker by Jensen, featuring a 14.7 oz. ceramic magnet, was specially designed for use in musical instrument amplifiers. Couple this with 25 big watts and you will have truly "big tone" performance. Dynamic AC chassis utilizing 6-tube circuit offers outstanding versatility. Two-channel amplifier has 2 volume and 2 tone controls—one for each channel. Features a remote control foot switch jack for colorful tremolo operation, plus 2 tremolo controls—speed and intensity, for utmost flexibility. Other outstanding features include: on-off-standby switch; pilot light; top-mounted fuse; rugged carrying handle; magnificent brushed aluminum top-mounted control panel. Rugged wood case covered in shimmering black vinyl. Size: 17½Hx21Wx10½"D. For 117 volts 50/60 cycles AC. Shpg. wt., 30 lbs.

13 A 0133WX \$5 Monthly Net 89.95

Foot switch required to activate tremolo control.

12 A 6701 Shpg. wt., 1½ lbs. Net 2.99

LAFAYETTE® Electric, Spanish and Western Guitars



A Professional Cutaway Electric Guitar

59⁹⁵



B Electric Bass

74⁹⁵



C The "Big Beat"

59⁹⁵



E Jumbo Western

SALE
34⁹⁵
was 45.95



F Baritone Ukulele

15⁹⁵



G 7 Piece "Economy" Outfit

21⁹⁵



D

Classic Spanish Guitar

24⁹⁵

(A) LAFAYETTE PROFESSIONAL CUTAWAY ELECTRIC GUITAR

- Tremolo Tailpiece
- Auditorium Size—42½"×17½"
- Dual Adjustable Pickups
- Five Controls—including Solo/Rhythm Switch
- Laminated Arched Top and Back

Grand auditorium size—true professional design—engineered for professional performance. Laminated maple neck with oval rosewood fingerboard. Six large inlaid position markers and nickel silver frets. White, pin-striped celluloid binding on top and back edges. Nickel plated hardware, de luxe machine heads, two sensitive pickups with individually adjustable pole pieces. Permits full range of individual emphasis and overall balanced response. Five controls permit choice of units, vary tone and volume, select between bridge pick-up for solo and forward pick-up for rhythm work. Arched laminated top and back in a shaded walnut finish with golden sunburst. Size 42½×17½×3½". Less case, Shpg. wt., 18 lbs. Imported. 99 A 9121WX \$5 Monthly Net 59.95

GUITAR-AMPLIFIER COMBINATION

Consists of 99 A 9121WX guitar, 13-1030WX 25-watt tremolo amplifier and 12-6701 foot switch. Shpg. wt., 50 lbs. 13 A 9026WX Net 134.95

(B) ELECTRIC BASS

- Beautiful Hand-Rubbed Finish
- Completely Self-Contained

Contour-cut solid body and 30-piece adjustable steel reinforced neck. Rosewood finger board with 20 frets. Finger board is bound with celluloid. Heavy-duty pick-up with individual tuning peg for each string. Separate tone and volume controls plus input jack. 45" long by 12¾" wide. Beautiful, polished hand-rubbed finish. Shpg. wt., 15 lbs. Imported. 12 A 6702WX \$5 monthly Net 74.95

2 PICK-UP ELECTRIC BASS. Similar to above but with 2 magnetic pick-ups. Shpg. wt., 16 lbs. 12 A 6704WX \$5 monthly Net 84.95

Case for above. Shpg. wt., 4 lbs. 12 A 6703WX Net 9.95

(C) THE "BIG BEAT" Built-in Completely Transistorized Amplifier and Speaker!

- Double Cut Away Solid Mahogany Body
- 3 Piece Laminated Neck with Adjustable Truss Rods
- Rosewood Fingerboard With 10 Position Markers
- Individual Machines With White Markers
- Precision Fretted-Uniform "FEEL"

An exceptionally fine guitar with a "Show-Stopper" finish, PLUS a built-in specially designed and engineered miniature transistorized amplifier and speaker! Auditorium size, 40¼×13½". The self-contained amplifier affords perfect portability with the tone range and volume of "stationary" amplifier units. May also be used with any external guitar amplifier. With external jack and cord. Imported. Shpg. wt., 15 lbs. 99 A 8087WX \$5 monthly 59.95

Batteries for above (2 required). 99 A 6021 Net ea. .21

(D) CLASSIC SPANISH GUITAR

- Steel Reinforced Neck
- Mirror-Bright Violin Finish on Sides and Back

Enjoy the warmth of the rich vibrant tone that only a true classic guitar can inspire. Crafted with a fan-braced top of selected white spruce; back, sides and neck of exquisite mahogany brought to a gleaming violin finish. Ebony fingerboard with 18 frets and inlaid position markers on side for easier fingering. White button engraved machines; three piece laminated neck. Overall size 39×14". Shpg. wt., 11 lbs. Imported. 99 A 9086WX Net 24.95

Case for above. Shpg. wt., 5 lbs. 13 A 8741WX Net 8.95

(E) JUMBO COUNTRY & WESTERN STYLE FOLK GUITAR

SALE! 34⁹⁵
was 45.95
Cat. 660

- Extra-wide Body for Deep, Rich Sound
- Beautiful Spruce Top
- Get Big Sound At A Small Price

For western, country and hootenanny fun. Genuine dark, mahogany back and sides; white spruce top. Hardwood 1¾" neck. Top and back edges bound with heavy white celluloid. Celluloid bound rosewood fingerboard inlaid with eight pearl position dots. Guard plate, pin bridge; steel reinforced neck. 41"×16". 13 A 8734WX Shpg. wt., 11 lbs. Net 34.95

Carrying case. Shpg. wt., 3½ lbs. 13 A 8735W Net 8.95

(F) BARITONE UKULELE

- Excellent Tonal Quality
- Beautiful Polished Finish
- Great for Both Beginner and Expert

This baritone ukulele features highly polished sides, back and neck—it's a real eye catcher! Top edge is finely bound with white celluloid. Inlaid pearl position markers aid finger location. Strings are carefully gauged true-tone nylon. The sound hole is bound with black and white celluloid and is decorated with inlaid purfling. White patent pegs and a white bone nut add the finishing touches. Gives the warmth of tone and ease of response to satisfy any player. Shpg. wt., 4 lbs. Imported. 13 A 8730WX Net 15.95

(G) 7 PIECE "ECONOMY OUTFIT"

- Everything You Need Including A Beginner's Record Course To Start You Off Right

7-piece special guitar outfit with beginner's record course. You get: guitar, guitar bag, record course, 3 guitar picks, extra set of strings, neck cord. Guitar has hardwood body with shaded sunburst finish and steel reinforced neck. White striping around top edge and sound hole. Imported. Complete Outfit. Shpg. wt., 9 lbs. 13 A 8723WX Net 21.95

Guitar Only. Shpg. wt., 7 lbs. 13 A 8724WX Net 16.95

NEW! AMPLIVOX ALL-TRANSISTOR 8 WATT SPEAKER-AMPLIFIER

39⁹⁵

- 3 Instruments Inputs
- Molded Royale Case



Baronet S-808 8-watt all transistor audio amplifier. Features 6x9 Hi-Fi speaker with cabinet coupled bass driver for full instrument range. Three instrument inputs allows use with bass as well as standard guitar or accordion. No warmup necessary; ready to use instantly. Separate volume and tone controls. Acoustical case of handsome molded Royale for durability. For 117 VAC. Size: 10x14x5". Shpg. wt., 8 lbs. 13-8225WX Net 39.95

ALL-TRANSISTOR SPKR/AMP WITH TREMOLO. Same as above plus tremolo—separate tremolo speed and strength controls. Shpg. wt., 9 lbs. 13-8226WX Net 49.95

5-WATT SPEAKER-AMPLIFIER WITH TREMOLO

39⁹⁵

No Money Down

- UL Approved
- Front-Mounted Controls



A complete 5-watt amplifier with exciting tremolo control. Hi-Fi speaker for powerful sound without distortion. One speed and one strength control for tremolo. Has 3 tubes plus rectifier, 2 instrument inputs, 1 foot switch input, tone control, volume and tremolo controls. Fully approved by U.I. Case is covered with silver and tan tweed Keratol. Slanted front panel covered with matching grille cloth. Tastefully designed control panel in black and gold, with large black and gold knobs. Shpg. wt., 18 lbs. 13 A 8719WX Net 39.95

Foot switch to control tremolo for above. Shpg. wt., ½ lb. 12 A 6701 Net 2.99

GUITAR AMPLIFIER AND HIGH FIDELITY PHONOGRAPH

69⁹⁵

No Money Down

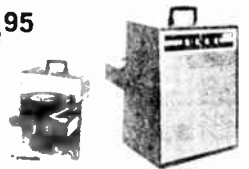

- Controls Provided To Mix Guitar, Mike, And Records
- 10 Watts of Audio Output

A handsome amplifier-phonograph capable of delivering 10 watts of audio power. Has separate controls and input circuitry for both phonograph and guitar which provides smooth blending of both sound sources. Matched permanent magnet speaker for maximum tonal range. Lock-cornered veneer cabinet covered with washable, scuff-resistant proxylon impregnated cloth. Record changer plays records at 16, 33, 45 and 78 RPM. Records of the same speed may be intermixed. Shpg. wt., 25 lbs. 13 A 8744WX Net 69.95

LAFAYETTE Model LR-800 70-Watt AM-FM Stereo Receiver



24 TUBES, 9 DIODES
with case

179⁹⁵

\$9 Monthly
No Money Down

- Tuned Nuvistor "Front-end" with 1.5 μ v Sensitivity
- FM "Stereo Search" Circuitry—Signals Presence of Stereo Broadcasts
- Complete Preamplifier Control Facilities — 70-watt Amplifier
- Front Panel Stereo Headphone Jack
- Bar-Type Tuning Indicator for AM and FM

The deluxe Model LR-800 contains on one compact chassis all the electronics necessary for a superb complete home music system. Just add speakers to enjoy the magnificent fidelity of FM, FM Stereo or high quality standard AM broadcast. Addition of a phono or tape transport completes your high fidelity system. Features: Extremely sensitive 'Nuvistor' front end pulls in FM stations free of noise and spurious signal interference. Amazing "Stereo Search" circuit pin-points stereo stations quickly and positively with a tone signal heard through your loudspeakers. Bar-type electron-ray tuning indicator and large easy-to-read slide rule dial, with flywheel tuning action make tuning FM or AM a pleasure. Variable AFC controls "locks-in" stations.

Powerful 70-watt stereo amplifier reproduces all program material with clean sound even with inefficient speaker systems. The audio control center features separate friction-lock bass and treble controls for each channel, balance control, rumble and FM noise filter; loudness switch and front panel stereo headphone jack/speaker "off" switch for private listening. Tape monitor lets you evaluate recorded material as you tape it. Separate

Mode selector permits choice of Left channel, Right channel, Stereo, Mix and Reverse. Input selector controls access to AM, FM, FM stereo tuner, Phono, Tape and Auxiliary program sources. Gold anodized extruded aluminum panel and contrasting case go well with any decor. 17Wx5 7/8Hx14"D. For 117V 50/60 cycles AC. Shpg. wt., 40 lbs. Imported.
99 A 0005WX \$9 monthly Net 179.95

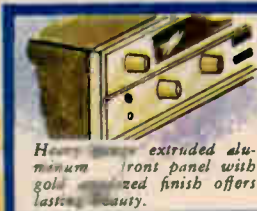

Heavy-duty extruded aluminum front panel with gold-colored finish offers lasting beauty.

ON OFF

STEREO SEARCHER

"Stereo-Search" Circuitry — Provides audible tone signal for positive identification—best separation.

TUNING



Bar-type tuning indicator makes tuning for lowest distortion easy on both AM and FM.

PHONO

TAPE HO

AUX

Three Light-Indicators. Colored light system indicates exact setting of Mode selector switch at a glance.

SPECIFICATIONS

Tuner Section—FM Sensitivity: 1.5 μ v for 20 db quieting. MPX Separation: 37 db @ 400 cps, Frequency Response: FM Mono—20-20,000 cps \pm 1db, FM Stereo 50-15,000 cps \pm 1db. Harmonic Distortion: Less than 0.5% @ 1KC. Amplifier Section—Power Output: 35 watts per channel Music Power, Hum and Noise: 55 db low level, 80 db high level. Harmonic Distortion: 1% at full output. Output Impedances: 8 & 16 ohms, switch selected. Equalization: RIAA (Mag), NAB (tape Head). Tubes: 24 inclu. EM-84 tuning eye, 9 diodes, 1 selenium rectifier. 2 AC receptacles, 1 switched.

LAFAYETTE 70-Watt Stereo Systems with LR-800 FM-AM Receiver



LR-800 Stereo Receiver

CHOICE OF CARTRIDGE



Garrard Model 50



Criterion 20

SAVE \$71.35

From Individual Catalog Prices
SYSTEM PRICE

229⁹⁵

Lafayette Model LR-800 70-Watt AM-FM Stereo Receiver	179.95
Garrard Model 50 4 Speed Record Changer	44.50
Pickering V-15/AT-2 Diamond Needle Cartridge*	19.95
Wood Base for Record Changer (Oiled Walnut)	3.95
2 Lafayette Criterion 20 2-Way Ducted Port Speaker Systems (Oiled Walnut)	52.95
Total	301.30

Above stereo system with choice* of Pickering V-15/AT-2, Shure M7/N21D, or Empire 888 diamond needle cartridge, and all necessary cables and instructions. Shpg. wt., 71 lbs.
21 A 9089CWXM Net 229.95

Alternate 70-Watt Stereo System

Same as above system except with Lafayette "Criterion 100A" deluxe 2-way ducted port shelf and floor speaker systems (oiled walnut) instead of "Criterion 20" speaker systems. Shpg. wt., 86 lbs.

SAVE \$71.75 from individual catalog prices.

21 A 9095CWXM Net 266.50

LAFAYETTE Model LR-400 30-Watt AM-FM Stereo Receiver

16 TUBES, 6 DIODES

Only

149⁹⁵

No Money Down



- Sensitive Nuvistor Front End
- 16 Tubes plus 9 Diodes
- 30-Watt Fully Integrated Stereo Amplifier
- Tone Stereo "Searcher" For Locating Stereo Stations Easily and Positively
- FM Stereo Noise Filter
- Front Panel Stereo Headphone Jack
- Bar-Type "Magic-Eye" For Precise Tuning
- Complete Stereo Controls

Make the LR-400 the heart of your stereo system. Combines on one compact chassis a sensitive stereo FM-AM tuner, a powerful 30-watt stereo amplifier and complete control facilities for extraordinary performance. Highly sensitive nuvistor control provides an additional RF stage to a wide-band tuner circuit to bring in fringe signals with ease. The tuner also utilizes Lafayette's famous stereo "Search" circuit which takes the guesswork out of finding FM stereo stations. During tuning for stereo, a continuous tone is heard through your loudspeakers when a stereo station is on the air. Switchable filter reduces hiss and background noise during reception of weak stereo signals. A superb 30-watt stereo push-pull amplifier brings out the rich sound present in FM and modern stereo records. Annoying Hum and noise are virtually reduced to the vanishing point. A complete complement of operating controls provide optimum flexibility. As added conveniences, a front panel stereo headphone jack and speaker on-off switch for your private listening pleasure, and phono and aux., indicator lights are provided. Controls include: Variable AFC, Tuning, Power on/off, Concentric friction lock Volume, Base and Treble; Selector (AM, FM Stereo Search, Stereo FM, Phono Aux.); Mode Switch (Left, Right, Mix, Stereo, Rev.) and switches for loudness and MPX Noise Filter. Rear panel controls are: Impedance selector switch, speaker phone switch and hum balance. AC Convenience receptacle. Handsome tilted gold anodized extruded aluminum panel for easier view and contrasting case harmonize with any decor. 175/8x5 7/8x13 3/4"D. For 117V, 50/60 cycles AC. Imported. 99 A 0004WX ... \$8 Monthly ... Shpg. wt., 36 lbs. ... Net 149.95



Heavy-Gauge Extruded Aluminum Front Panel With Gold Anodized Finish Offers Lasting Beauty



Stereo "Search" Circuit Pinpoints Stereo Broadcasts By Tone Signal



Electronic Bar-Type Tuning Indicator

SPECIFICATIONS

TUNER: FM 88-108MC, AM 550-1600KC; SENSITIVITY: 2 1/2 UV For 20 db S/N ratio; FM SEPARATION: 25 db @ 400 cps; FREQUENCY RESPONSE: 20-20,000 cps ± 2 db. AFC, MPX, Noise Filter. AMPLIFIER: Output: 15 watts per channel (music Power); TONE CONTROLS ± 10 db boost & cut; EQUALIZATION: RIAA, HUM & NOISE: Mag. Phono—55 db; Aux. —68 db. INPUTS: 4 Pair, SPEAKER IMPEDANCE: 8-16 ohms. TUBES: 16 Tubes, 9 diodes, plus EM84 Tuning eye.

LAFAYETTE 30-Watt Stereo Systems with LR-400 FM-AM Receiver

SAVE \$61.35

From Individual Catalog Prices

SYSTEM PRICE 209⁹⁵

Lafayette Model LR-400 30-Watt FM-AM Stereo Receiver	149.95
Garrard Model 50 4-Speed Record Changer	44.50
Pickering V-15/AT-2 Diamond Needle Cartridge*	19.95
Wood Base for Record Changer (Oiled Walnut)	3.95
2 Lafayette "Criterion 20" 2-Way Ducted Port Shelf	
Speaker System Finished in Oiled Walnut	52.95
TOTAL	271.30

Complete system as above with all necessary cables, instructions, and your choice* of Pickering V-15/AT-2, Shure M7/N21D, or Empire 888 diamond needle cartridge. Shpg. wt., 67 lbs. 21 A 9091CWXM \$11.00 monthly ... Net 209.95

30-Watt Alternate Stereo System
Same system as above with 2 "Criterion 100A" deluxe 2-way ducted port speaker systems instead of "Criterion 20" systems. Shpg. wt., 111 lbs.

SAVE \$64.30 from individual catalog prices. 21 A 9094CWXM \$12.50 monthly ... Net 245.95

CHOICE OF CARTRIDGE

Pickering V15/AT 2	Empire 888	Shure M7/N21D
--------------------	------------	---------------

LR-400 Stereo Receiver

Garrard Model 50

Two Lafayette Criterion 20

LAFAYETTE 15-Watt Matched Stereo Phono System Featuring Model LR-300 AM-FM Stereo Receiver



Lafayette Model LR-300 15-Watt AM-FM Stereo Tuner-Amplifier 119.95
 Garrard Model 50 4-Speed Record Changer 44.50
 Pickering V-15/AT-2 Diamond Needle Cartridge* 19.95
 Wood Base for Record Changer (Oiled Walnut).... 3.95
 2 Lafayette "Criterion 20" 2-Way Ducted Port Shelf Speaker Systems (Oiled Walnut) 52.95
TOTAL 241.30

SAVE 51³⁵
 From Individual Catalog Price

SYSTEM PRICE 189⁹⁵
 No Money Down

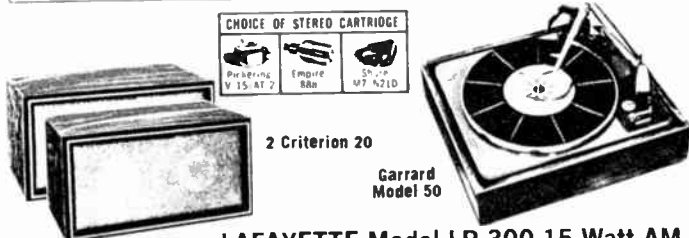

Above stereo system with your *choice of Pickering V-15/AT-2, Shure M7/N21D, Empire 888 diamond needle cartridge, and with all necessary cables and instructions. Shpg. wt., 60 lbs.
21 A 9088 CWXM \$10.00 Monthly Net 189.95

LAFAYETTE Model LR-300 15-Watt AM-FM Stereo Receiver

The LR-300 combines an AM, FM, and FM Stereo tuner, 15-watt stereo amplifier and all necessary control features to provide a complete stereo ensemble. Add only speakers! Features "Stereo Search", AFC, MPX filter, built-in AM antenna, tuning eye, AC receptacle, and illuminated slide rule dial with flywheel tuning. Also includes front panel stereo headphone jack, 8-16 ohm impedance selector and 6-position selector switch. Specifications: TUNER FM Sensitivity: 3 μ v for 20 db S/N ratio—Frequency Response: FM, 20-20,000 cps \pm 2 db; FM Stereo, 50-15,000 cps \pm 2 db—Harmonic Distortion: FM, less than

1% @ 400 cps; FM Stereo, less than 2% @ 400 cps—FM Stereo Separation: 25 db @ 400 cps. AMPLIFIER Power Output: 7 1/2 watts music power per channel—Hum and Noise: 55 db down for low level input, 75 db down for high level input—Output Impedance: 8 & 16 ohms switched—Gold extruded aluminum panel and contrasting case. For 117 volts, 50/60 cycle AC. Size: 16 3/4" W x 12 1/2" D x 5 7/8" H overall. Shpg. wt., 29 lbs. imported.
99 A 0003WX \$7 monthly Net 119.95

NEW! LAFAYETTE Model LRE-80 80-Watt Solid State Stereo Amplifier

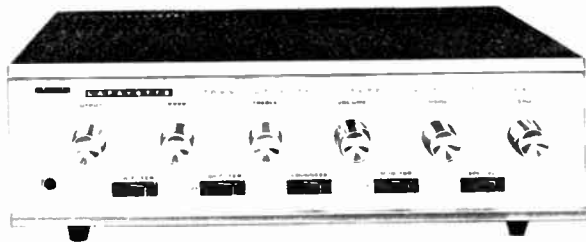

ONLY 119⁹⁵
 No Money Down

- Advanced 29 Semiconductor Circuit
- Direct Coupled Output Matches 4, 8 or 16-Ohm Speakers
- Tape Monitor Facilities For Expert Taping
- Deluxe Solid Extruded Aluminum Front Panel

80-WATT MATCHED STEREO SYSTEM WITH MODEL LRE-80



SAVE 28³⁶
 from Individual Catalog Prices.

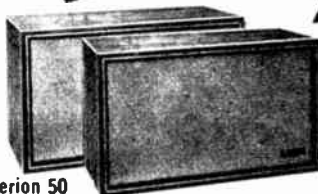

SYSTEM PRICE 199⁹⁵
 No Money Down

Superb 80-watt solid state Stereo amplifier combines excellent musical reproduction with handsome low-silhouette styling. Advanced 29 semiconductor circuit features instant operation, without hum, noise or microphonics; power to drive any stereo speaker system to its full capacity; and special electronic short-circuit protection. Full complement of inputs and controls include: Bass, Treble, dual Volume, 5-position Mode, 5-position Input, 4-position Output including Power/Off, Speaker Phase and Headphone Switch. Rocker switches for: Low Filter; High Filter; Loudness; Tape Monitor. Special (for Tape Head or Phono Input); Stereo Headphone jack. Also stereo inputs for tuner, tape recorder, plus Aux. 1 and 2. Two AC convenience outlets, 1 switched. Specifications: Power Output: 80 watts IHF. Response: \pm 1 db, 22-24,000 cps. Harmonic Distortion: less than 1%. Handsome extruded aluminum gold panel. With case. Size: 13 1/4" W x 4 1/2" H x 10" D. For 110-120 volts, 60 cycles AC. Imported. Shpg. wt., 20 lbs.
99 A 0147WX \$6.50 Monthly Net 119.95

Complete matched stereo system consisting of Lafayette Model LRE-80 80-watt transistorized stereo amplifier; Garrard Model 50 4-speed record changer; walnut finished wood base for changer; choice of Pickering V-15/AT-2, Shure M7/N21D, or Empire 888 diamond needle cartridge; and 2 Lafayette "Criterion 50" ducted port 2-way shelf and floor speaker systems (oiled walnut finish).
21 A 9689CWXM Shpg. wt., 70 lbs. Net 199.95

NEW! LAFAYETTE Model LA-350A 70-Watt Stereo Amplifier

99⁹⁵

No Money Down

- Six Pairs of Stereo Inputs For All Sources
- Handsome Extruded Aluminum Front Panel
- DC On Preamp Filaments For Minimum Hum
- Tape Monitor Switch
- Stereo Headphone Jack on Front Panel
- Separate Channel Tone Controls

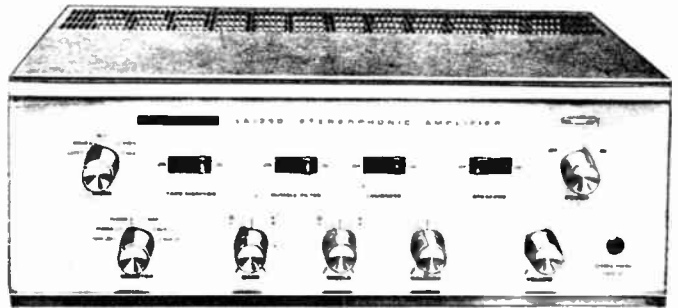

Packed with power, features, and handsome styling! Included among its 11 front panel controls are a six-position program selector for tape head, Phono, Tuner and Auxiliary; mode switch; bass and treble controls, balance control; volume control; tape monitor switch; rumble filter; and headphone jack. Two AC convenience outlets on rear apron. Aluminum front panel and knobs with contrasting case fit in any decor. Size: 14¹/₂Wx5¹/₄Hx10¹/₂H. For 117V 60 cycle AC. SPECIFICATIONS Power Output: 35 watts per channel IHFM; Frequency Response: 15-30,000 cps \pm 1 db at normal listening level; Harmonic Distortion: less than 1%; Outputs: 8 and 16 ohm, dual tape outputs. Tubes: 9. Imported. Shpg. wt., 30 lbs. 99 A 0130WX \$5 Monthly Net 99.95

LAFAYETTE 70-WATT STEREO SYSTEMS

Lafayette Model LA-350A 70-Watt Stereo Amplifier	Net 99.95
Garrard Model 50 4-Speed Record Changer	Net 44.50
Pickering V-15/AT-2 Diamond Needle Cartridge*	Net 19.95
Wood Base for Record Changer (Oiled Walnut)	Net 3.95
2 Lafayette "Criterion 50" 2-Way Ducted Port Bookshelf and Floor Speaker System (Oiled Walnut)	Net 59.90
TOTAL	228.25

Above stereo system with *choice of Pickering V-15/AT-2, Shure M7/ND12, or Empire 888 diamond needle cartridge; plus all necessary cables and instructions. Shpg. wt., 101 lbs. 21 A 9098WX Net 189.95

Same stereo system as above except with 2 Lafayette "Criterion 200A" deluxe 3-way bookshelf and floor speaker systems (oiled walnut) instead of 2 "Criterion 50" speaker systems. Shpg. wt., 115 lbs. 21 A 9099WX Net 263.95

YOU SAVE 44.34 from individual catalog prices.

CHOICE OF STEREO CARTRIDGE		
Pickering V-15/AT-2	Empire 888	Shure M7/ND12



Garrard Model 50

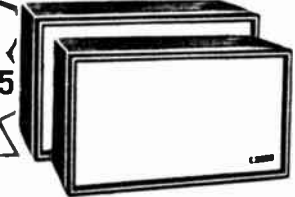

2 Criterion 50

SAVE 38.30

From Individual Catalog Prices!

SYSTEM PRICE 189⁹⁵

NO MONEY DOWN

LAFAYETTE LA-340A 40-Watt Solid Stereo Amplifier

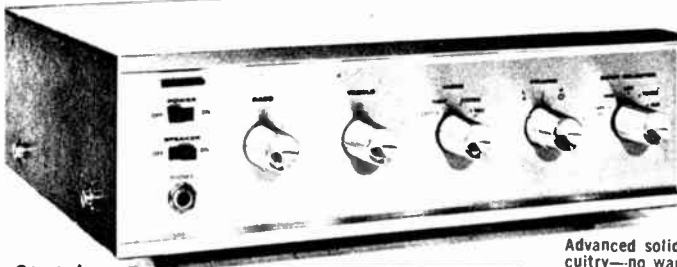

Garrard Model 50

CHOICE OF STEREO CARTRIDGE		
Pickering V-15/AT-2	Empire 888	Shure M7/ND12

79⁹⁵

NO MONEY DOWN

- Complete Stereophonic Control Facilities
- Compact Size
- Cool Running, Reliable Transistor Circuitry
- 20-20,000 cycles \pm 1 db
- Freedom From Hum and Noise
- Instantaneous Warmup

Advanced solid state design offers the advantages of space age circuitry—no warmup . . . cool operation . . . low noise and distortion plus wide frequency response. Features five input pairs to accommodate every mono or stereophonic program source . . . turntable, FM stereo tuner, tape recorder etc. Has front panel stereo headphone jack and dual concentric volume controls. A special circuit protects output transistors if speaker line is shorted. A special circuit \pm 1db, 30-20,000 cps. Harmonic Distortion: 1%. Hum and Noise: \pm 70 db. For 4, 8, 16 ohm speakers. Handsome gold extruded aluminum panel and knobs, metal case included. Size: 11³/₄Wx3³/₄Hx10¹/₂D. For 117V 50/60 cps AC. Imported. Shpg. wt., 10 lbs. 99 A 0011WX \$5 Monthly Net 79.95

40-Watt Solid State Bookshelf Stereo System

Lafayette Model LA-340A 40-Watt Solid State Stereo Amplifier	Net 79.95
Garrard Model 50 4-Speed Record Changer	Net 44.50
Pickering V-15/AT-2 Diamond Needle Cartridge*	Net 19.95
Wood Base for Record Changer (Oiled Walnut)	Net 3.95
2-Lafayette "Criterion 50" Ducted Port 2-Way Bookshelf Speaker Systems (Oiled Walnut)	Net 59.90
TOTAL	208.25

Complete 40-watt solid state stereo system as above with your *choice of Pickering V-15/AT-2, Shure M7/ND12 or Empire 888 diamond needle cartridge plus all necessary cables and instructions. Shpg. wt., 53 lbs. 21 A 9083CWXM \$9.00 Monthly Net 173.95



2 Criterion 50

SAVE 34.30

From Individual Catalog Prices!

SYSTEM PRICE 173⁹⁵

NO MONEY DOWN

LAFAYETTE 30-Watt Stereo System with Model LA-224A Stereo Amplifier

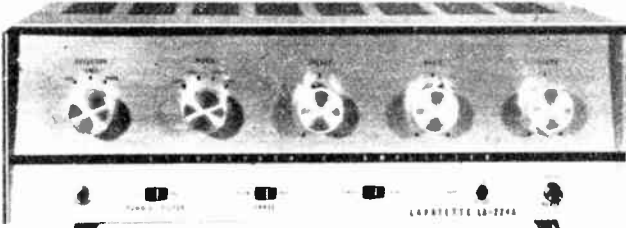

SAVE 41³⁵ from individual catalog prices

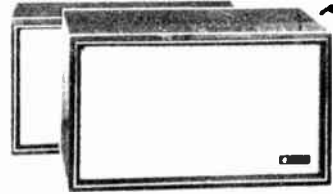

2 Lafayette "Criterion 20"

CHOICE OF STEREO CARTRIDGE



Garrard Model 50

LAFAYETTE Model LA-224A 30-Watt Stereo Amplifier

A Brilliant Stereo Performer... low distortion, wide response, high output with all the control facilities for a first class stereo system! Features concentric bass and treble controls; volume controls for each channel; mode switch; input selector switch for magnetic, crystal or ceramic cartridge, tuner and tape or auxiliary inputs; rumble filter; phase switch and headphone jack. Beautifully styled in a low silhouette enclosure with ivory and gold front panel with matching knobs. Size: 14¹/₂Wx10¹/₂Dx5¹/₄"H. For 115V 60 cycle AC. SPECIFICATIONS: Power Output: 15 watts per channel; Frequency Response: 25-25,000 cps ± 1.5 db at rated output; Distortion: 25% at 1 watt (1 KC); Hum & Noise—75 db Below Rated Output; Outputs: Dual 8 and 16 ohm, dual tape outputs; Tubes: 10. Imported. Shpg. wt., 20 lbs. 99 A 0026WX \$5 Monthly Net 59.95

30-WATT STEREO SYSTEM

LAFAYETTE Model LA-224A 30-Watt Stereo Amplifier	59.95
Garrard Model 50 4-Speed Record Changer	44.50
Pickering V-15/AT-2 Diamond Needle Cartridge*	19.95
Wood Base for Record Changer (Oiled Walnut)	3.95
2-Lafayette "Criterion 20" Ducted Port 2-Way Bookshelf and Floor Speaker Systems (Oiled Walnut)	52.95
TOTAL	181.30

SYSTEM PRICE
139⁹⁵
No Money Down

Above 30-watt stereo system with *choice of Pickering V-15/AT-2, Shure M7/N21D or Empire 888 diamond needle cartridge plus all necessary cables and instructions. Shpg. wt., 5 lbs. 21 A 9084CWXM \$7.50 monthly Net 139.95

LAFAYETTE 50-Watt Stereo Systems with Model LA-248 50-Watt Solid-State Stereo Amplifier

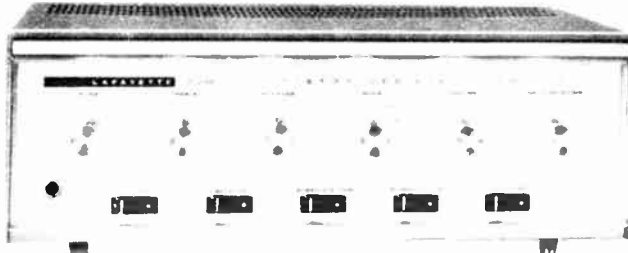

SAVE 36³⁵ from individual catalog prices

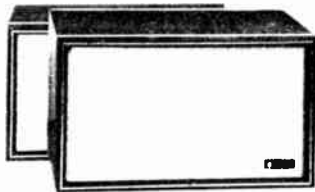

2 Lafayette "Criterion 20"

CHOICE OF STEREO CARTRIDGE



Garrard Model 50

LAFAYETTE Model LA-248 50-Watt Solid-State Stereo Amplifier 19 TRANSISTORS, 5 SILICON DIODES

The LA-248 combines a deluxe all-transistor stereo preamplifier and dual channel 50-watt power amplifier on one compact chassis. Features front panel stereo headphone receptacle, scratch and rumble filters, separate on-off power switch, bass and treble controls for each channel, 4-position mode switch, volume, balance and 5-position input selector switch (tape head, mag. phono, cer. phono, Tuner, Aux.). Frequency response: ± 1 db, 20-20,000 cps. Harmonic Distortion: 1%, Hum and Noise: Tuner, -74 db; mag. phono, -54 db. For 4, 8 or 16 ohm speakers. Brown textured metal case, gold anodized extruded aluminum panel and knobs. For 105-125V 50/60 cycles AC. Size: 13¹/₂Wx4¹/₂Hx10³/₄"D. Imported. 99 A 0025WX Shpg. wt., 18 lbs. Net 99.95

50-WATT SOLID STATE STEREO SYSTEM

Lafayette LA-248 50-Watt Solid State Stereo Amplifier	99.95
Garrard Model 50 4-Speed Record Changer	44.50
Pickering V-15/AT-2 Diamond Needle Cartridge*	19.95
Base for Record Changer (Oiled Walnut)	3.95
2-Lafayette "Criterion 20" 2-Way Ducted Port Bookshelf and Floor Speaker System (Oiled Walnut)	52.95
TOTAL	221.30

SYSTEM PRICE
184⁹⁵
No Money Down

Above solid state stereo system with *choice of Pickering V-15/AT-2, Shure M7/N21D or Empire 888 diamond needle cartridge and with all necessary cables and instructions. Shpg. wt., 49 lbs. 21 A 9086CWXM \$10 monthly Net 184.95 Same system as above with 2 Lafayette Criterion 100A instead of Criterion 20 speaker systems. Shpg. wt., 93 lbs. 21 A 9097CWXM \$11 monthly Net 218.95 You save \$39.30 from individual prices!

LAFAYETTE 10-Watt Stereo Amplifier Model LA-214



Lafayette Model AC-33 with Base

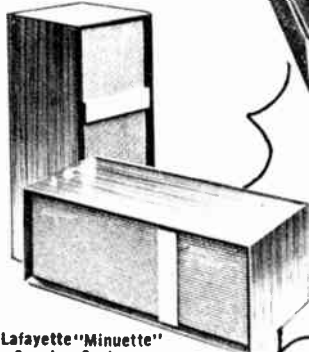

Lafayette "Minnette" Speaker Systems

Only
39⁹⁵

- 5 Watts of Power Each Channel
- Frequency Response 50 to 20,000 cps ± 1 db
- Front Panel Stereo Phone Jack
- Dual Concentric Bass and Treble Controls
- Rumble Filter
- Inputs for Ceramic and Crystal Phono, Tuner, High Level Tape
- Beautifully Styled

The Lafayette model LA-214 is a complete amplifier/preamplifier that will reproduce such program sources as stereo or monophonic record changers, tuners, and stereo tape player. Controls, in addition to above are: Power/on; Volume, Mode selector (4 positions); 3-position program selector; speaker phase switch and Speaker/Phone switch. Also included are a hum adjust and AC convenience outlet. Fused for maximum component protection. Impedance 8 or 16 ohms. Power output: 5 watts music power each stereo channel or 10 watts if used monophonically. For 105-125 volts 50/60 cycles AC only. Size: 12 $\frac{1}{2}$ "W x 5Hx7 $\frac{3}{4}$ "D (with legs). Imported. Shpg. wt., 15 lbs.

99 A 0023W \$5 Monthly Net 39.95

SAVE 6.67
from Individual
Catalog Prices!
SYSTEM PRICE 89⁵⁰
No Money Down

LAFAYETTE 10-WATT MATCHED STEREO SYSTEM

Lafayette Model LA-214 10-Watt Stereo Amplifier	39.95
Lafayette Model AC-33 4-Speed Record Changer	
With Turnover Stereo Cartridge and LP Diamond Stylus	25.77
Wood Base For Changer (Oiled Walnut)	3.95
2 Lafayette "Minnette" Hi Fi Speaker Systems (Oiled Walnut)	26.50
TOTAL	96.17

Above 10-Watt Stereo System complete with necessary cables, connectors, and instructions. Shpg. wt., 40 lbs.
21 A 9065WXM \$5 Monthly Net 89.50

LAFAYETTE 15-Watt Hi-Fi Amplifier Model LA-218



Garrard Model 50

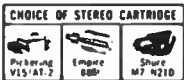

Only
44⁹⁵

- Hum & Noise 75 db Below Rated Output
- Power Output 15-Watts
- Sensitivity: 3 mv. Magnetic Phono
- 5 Input Selections
- Frequency Response: 30-20,000 cps ± 1.5 db At Normal Listening Level

The Lafayette LA-218 can be easily integrated into a fully equipped hi-fi system utilizing the 5 input selections. Its high input sensitivity permits either magnetic or ceramic cartridges to be used for full power output. Operates with AM, FM or tape deck sources. A loudness control compensates for the loss of low frequencies when listening at low levels. Has scratch filter to reduce noise of dusty or damaged records and headphone jack for private listening. Individual bass and treble controls. Response ± 1.5 db, 30-20,000 cps. Harmonic Distortion, less than 1% at rated output. Hum and Noise: 75 db down. Output Impedance: 8 and 16 ohms. Tape output. Beautifully styled in low silhouette enclosure. Size: 12 $\frac{3}{4}$ "Wx5 $\frac{1}{4}$ "Hx8 $\frac{1}{4}$ "D. Imported. Shpg. wt., 18 lbs.

99 A 0043WX \$5 Monthly Net 44.95

SAVE 27.80
from Individual
Catalog Prices!
SYSTEM PRICE 115⁵⁰
No Money Down

15-WATT CRITERION BOOKSHELF HI-FI SYSTEM

Lafayette Model LA-218 15-Watt Hi-Fi Amplifier	44.95
Garrard Model 50 4-Speed Record Changer	44.50
Pickering V-15/AT-2 Diamond Needle Cartridge*	19.95
Wood Base for Changer (Oiled Walnut)	3.95
Lafayette "Criterion 50" 2-Speaker, 2-Way Ducted— Port Bookshelf Speaker System (Oiled Walnut)	29.95
TOTAL	143.30

Above system with *choice of Pickering V-15/AT-2, Shure M7/N21D, or Empire 888 diamond needle cartridge, plus necessary cable and instructions. Shpg. wt., 48 lbs.

21 A 9069CWXM \$6.50 monthly Net 115.50



"Criterion 50"

LAFAYETTE AM-FM, FM, and FM Stereo Tuners

Two 3-Gang Tuning Condensers with Added Tuned RF Stage for Superb Sensitivity and Selectivity

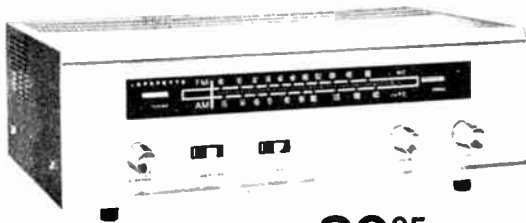

89⁹⁵

NO MONEY DOWN
\$5 MONTHLY

3-Gang Tuning Condenser with Tuned RF Stage for Excellent Sensitivity and Selectivity



74⁹⁵

ONLY
NO MONEY DOWN
\$5 MONTHLY

Transformer Power Supply

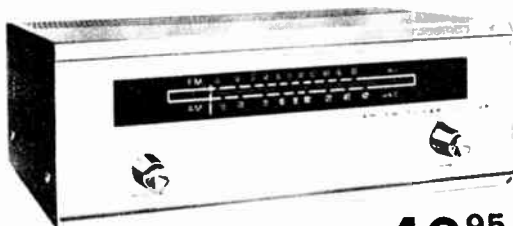

Only **49⁹⁵**

NO MONEY DOWN
\$5 MONTHLY

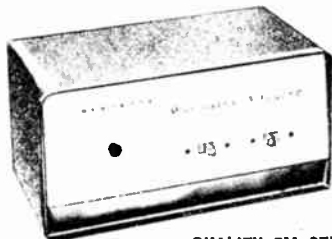

19⁵⁰

MADE IN
U.S.A.

QUALITY FM STEREO MULTIPLEX
AT MINIMUM COST

LAFAYETTE AM/FM STEREO TUNER MODEL LT-325A

- Features New Audible Tone Stereo Search System
- Stereo Noise Filter Switch
- 20 Tube Performance — 12 Tubes, Rectifier, Tuning Eye, plus 9 Diodes
- Automatic Stereo Mode Indicator, Tuning Eye
- AFC, Dual Limiters and Wide-Band Ratio Detector

Simplicity, Flexibility, and Superb Styling carefully integrated into one AM/FM FM Stereo Tuner! Some of its many features include "Stereo Search", an audible signal to identify stereo stations, plate follower output circuit and grounded grid low noise front end. Also features AVC, wide-band ratio detector and built-in AM antenna. Beautiful extruded aluminum front panel with matching knobs and contrasting metal case. Size 14 $\frac{3}{4}$ "x4 $\frac{7}{8}$ "x9 $\frac{1}{2}$ "D. SPECIFICATIONS Frequency Response: 15-15,000 cps \pm 1 lb; FM Stereo Separation: greater than 38 db @ 400 cps; Harmonic Distortion: less than 1% @ 400 cps; FM Tuner Sensitivity: 2 μ v for 20 db S/N. Tubes: 10. Imported. Shpg. wt., 17 $\frac{1}{2}$ lbs. 99 A 0133WX \$5 Monthly Net 89.95

LAFAYETTE FM STEREO TUNER MODEL LT-250

- Built-in FM Multiplex with 38 DB Stereo Separation
- Stereo Mode Indicator, Tuning Eye, Stereo Search
- Frequency Response, 20-20,000 Cycles
- Low Silhouette Styling

Remarkable, quality performance and styling that will delight both eye and ear! Features positive multiplex station identity, low noise front end, tuning eye, flywheel tuning, and stereo dimension control. Stereo Channel Separation: 38 db at 400 cps; Distortion: less than 1%; Tubes: 12 plus 8 diodes. Extruded aluminum front panel with matching knobs and metal case complement its fine electrical specifications. Size: 12 $\frac{3}{4}$ "x4 $\frac{7}{8}$ "x9 $\frac{1}{2}$ "D. For 117V 50/60 cps AC. Imported. Shpg. wt., 13 lbs. 99 A 0002WX \$5 Monthly Net 74.95

NEW! LAFAYETTE AM/FM TUNER MODEL LT-100B

- AFC Defeat for Tuning Weaker Stations
- FM Multiplex Output Jack
- 10 Tube Performance — 7 Tubes (3 Dual Purpose)
- FM Ratio Detector Plus Limiter
- Grounded Grid RF Stage
- AFC for Tuning Simplicity — Locks in Stations

Features a powerful grounded grid RF stage, FM Multiplex output jack, flywheel tuning, large illuminated slide rule dial, built-in AM ferrite loop antenna and 4-position selector switch. FM SPECIFICATIONS Sensitivity: 3 μ v; Frequency Response: 20-20,000 cps \pm 1 db; Harmonic Distortion: less than 1% at 400 cps. Low silhouette metal enclosure with brown finish contrasts with the gold anodized extruded aluminum front panel. Size: 12 $\frac{3}{4}$ "x4 $\frac{7}{8}$ "x9 $\frac{1}{2}$ "D. For 110-125V 50/60 cps AC. Imported. Shpg. wt., 15 lbs. 99 A 0134WX \$5 Monthly Net 49.95

LAFAYETTE MULTIPLEX ADAPTER KIT MODEL KT-220

- 30db Separation at 400 Cycles
- Self-Powered
- Ideal for Lafayette Tuners Equipped with MPX Output Jacks

Enjoy thrilling FM Stereo from any Lafayette FM tuner or any other quality wide-band FM or AM-FM tuner. Self powered, the KT-220 easily connects to the built-in multiplex jack on your tuner and special instructions are provided for connection to tuners without multiplex jacks. Preamplified coils require minimum adjustment. Provides 30 db separation at 400 cps with less than 1% distortion. Beige front panel with ivory trim and brown cabinet. Size: 8 $\frac{1}{2}$ "x4 $\frac{3}{8}$ "x4 $\frac{3}{8}$ "H. For 110-125V 50/60 cps AC. Shpg. wt., 4 lbs. 19 A 0907 Net 19.50

HURRY! WHILE THEY LAST



Spectacular Low Prices on FM Stereo Receivers

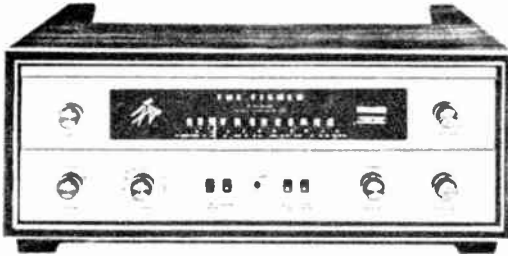

FISHER Model 400 65-Watt
FM Stereophonic Receiver

Only **199⁹⁵**

Everything you need for superb stereo entertainment in one compact and attractive unit. Includes a highly sensitive FM stereo multiplex receiver utilizing 4 wideband IF stages. Stereo beam instantly shows when stereo multiplex is being broadcast. **CONTROLS:** Tone, Balance, Loudness Compensation, Sharp Cutoff High Frequency Filter, and Separate Bass and Treble for Each Channel.

Specifications: (FM) Sensitivity: 1.8 μ v IHFM USABLE; Signal to Noise Ratio: 70 db (100% Modulation); Harmonic Distortion: 0.5% (Audio); Music Power: (IHFM), 65 Watts; Frequency Response: 25-25,000 cps \pm 1 db; Hum and Noise: -80 db (at rated output); For 105-120 Volts, 50/60 cps AC. Size 17 $\frac{1}{2}$ Wx5 $\frac{3}{4}$ Hx13"D. Shpg. wt., 33 lbs.

21 A 3612WX Less cabinet. \$10.00 Monthly Net 199.95
Custom Oiled Walnut Wood Cabinet For Model 400. Shpg. wt. 8 lbs.
21 A 3615W Net 22.45

Fisher 400 FM Stereo Music System

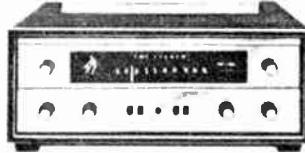

PICKERING V15/AT-2

FISHER 400 less case

Complete System
Only

249⁹⁵

SAVE 71³⁵
From Individual
Component Catalog
Prices

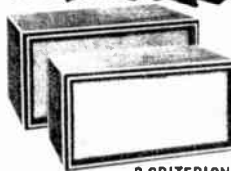

2 CRITERION 20



GARRARD MODEL 50

Now you can buy a Fisher 400 System for only \$249.95. Complete system includes: Fisher Model 400 FM stereo receiver, less case, Garrard Model 50 4-speed automatic changer with walnut wood base, Pickering V15/AT-2 stereo cartridge with diamond needle, and 2 Lafayette Criterion 20 2-way speaker systems with hand rubbed oiled walnut finish. Nothing else to buy. All connecting cables included. Shpg. wt., 66 lbs.
21 A 3660WXM \$12.50 monthly Net 249.95

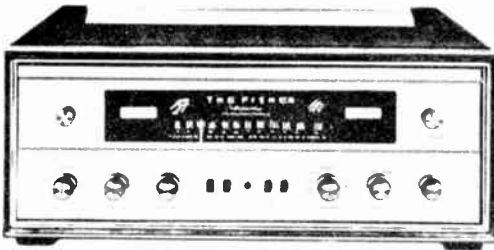

Deluxe **FISHER** 500C 75 Watt
FM Stereophonic Receiver

Only **249⁹⁵**

A combination FM stereo tuner and dual 75-watt amplifier featuring the exclusive "Stereo Beacon" which instantly signals the presence of FM stereo. Has Golden Synchrode front end for greater sensitivity and image rejection. Four IF stages and three Limiters are used. **Controls:** 4-Position Speaker Selector; Separate Bass and Treble controls for each channel; Balance; 7-Position Input Selector; Loudness Contour; Volume and AC On-Off; Tuning; Earphone Jack. **SPECIFICATIONS:** (FM) Sensitivity: 1.8 μ v IHFM usable; Frequency Response: 25-25,000 cps \pm 1.5 db; Hum and Noise: -80 db (at rated output); For 105-120 volts, 50/60 cps AC. Size 17 $\frac{1}{2}$ Wx5 $\frac{3}{4}$ Hx13 $\frac{1}{2}$ "D.
21 A 3613WX Less Cabinet. Shpg. wt., 39 lbs. Net 249.95
Custom Oiled Walnut Wood Cabinet For Model 500-C. Shpg. wt., 8 lbs.
21 A 3615W Net 22.45

Fisher 500C FM Hi-Fi Music System

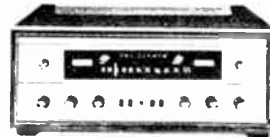

EMPIRE 888

FISHER 500C less case

Complete System Only

299⁹⁵

SAVE 71³⁵
From Individual
Component Catalog
Prices



2 CRITERION 20



GARRARD MODEL 50

Deluxe stereo system includes: World Famous Fisher 500C 75 watt FM stereo receiver less case, Garrard Model 50 4-speed automatic record changer with oiled walnut wood base, Empire 888 stereo cartridge with diamond needle, and 2 Lafayette Criterion 20 2-way speaker systems with hand rubbed oiled walnut finish. All connecting cables included. Shpg. wt., 72 lbs.
21 A 3661WXM \$15 monthly Net 299.95

Save Up To 61.35 On Famous Stereo Systems

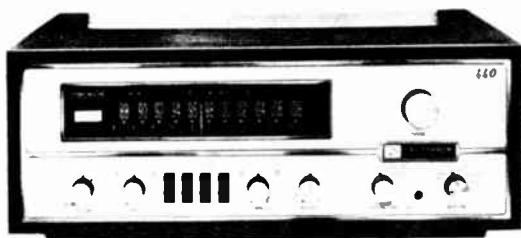

FISHER Model 440T Solid State 70 Watt FM Stereo Receiver

Only
280⁰⁷
No Money Down

The model 440-T combines...on one compact chassis...a superb solid state FM-Stereo tuner, a versatile low-noise solid state Stereo preamplifier-control unit, and a powerful 70 watt IHF solid state silicon amplifier. Controls: dual-concentric volume control, friction-lock bass and treble controls, balance control, tuning control; 5-position selector switch, 5-position Mode/Monitor switch; loudness, muting, main/remote speakers, and high filter switches. Specifications: Music power rating (IHF Standard @ 4 ohms: 70 watts IHF. Harmonic distortion: 0.8%. Frequency response: 22-22,000 cps \pm 1.5 db. Hum and noise: -80 db. Stereo separation: 50 db all modes. Tuner usable sensitivity (IHF Standard): 2.0 μ v. Power requirements: 105-120 volts, 50/60 cps AC. Shpg. wt., 25 lbs.
21 A 3688WX \$15 Monthly Net 280.07
Custom oiled walnut wood cabinet for 440-T. Shpg. wt., 8 lbs: Net 22.45
21 A 3642W

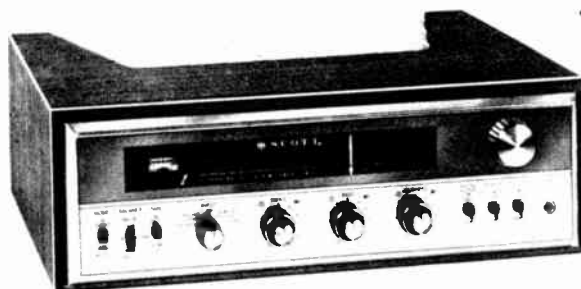

SCOTT Model 342 Solid State 65 Watt FM Stereo Receiver

SALE! 239⁹⁵ No Money Down
was 254.95

The Scott model 342 combines a superb solid state FM tuner with a powerful 65 watt IHF solid state amplifier on one handsome chassis. Features wide-range transformerless output. Controls: Balance, dual loudness, separate bass and treble controls, Tuning, stereo/mono Mode switch; Tape Monitor; Noise filter, Speaker On/Off; front panel stereo headphone output and automatic stereo switching. Specifications: Music power rating (IHF Standard @ 4 ohms, 65 watts. Harmonic distortion: 0.8%. Frequency response: \pm 1 db, 18-25,000 cps. Hum and Noise: -80 db. Stereo separation: 35 db. Tuner usable sensitivity: 2.5 μ v. Cross modulation rejection, 85 db. Capture ratio, 6 db. Power requirements: 105-120 volts, 60 cycles, AC. Size in case: 15 1/4 Wx5 1/4 Hx13 3/4 D. Shpg. wt., 17 lbs.
21 A 6070WX \$11.50 monthly Net 239.95
Custom oiled walnut wood cabinet for 342. Shpg. wt., 5 lbs. Net 22.50
21 A 6024W

Fisher 440T FM Stereo Hi-Fi Music System



EMPIRE 888

SAVE 58⁸⁷
From Individual
Component
Catalog
Prices

Complete System Only
349⁵⁰
No Money Down

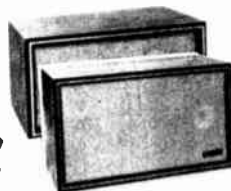

2 CRITERION 50



GARRARD 50

Deluxe stereophonic FM phono system includes: Fisher 440T 70-watt solid state FM stereo receiver less case, Garrard Model 50 4-speed automatic record changer with oiled walnut wood base, Empire 888 stereo cartridge with diamond needle, and 2 Lafayette Criterion 50 2-way speaker systems with hand rubbed oiled walnut finish. Nothing else to buy. All connecting cables included. Shpg. wt., 88 lbs.
21 A 3696WXM \$19 monthly Net 349.50

SCOTT 342 FM Stereo Hi Fi Music System

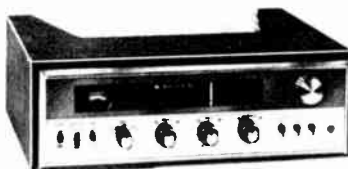

Pickering
V15/AT-2

SAVE 61³⁵
From Individual
Component Catalog
Prices

Complete System Only
299⁹⁵
No Money Down



2 Lafayette
Criterion "20"



Garrard Model 50

Treat yourself and your family to this exciting stereo home music system featuring the Scott 342 65-watt Solid State FM Stereo Receiver. System includes: Scott 342 less case, Garrard Model 50 4-speed automatic record changer with oiled walnut wood base, Pickering V15/AT2; with .7 mil diamond needle and a pair of Lafayette Criterion "20" 2-way speaker systems in rich hand-rubbed oiled walnut finish. Nothing else to buy... all connecting cables are included. Shpg. wt., 50 lbs.
21 A 6075WXM \$15 monthly Net 299.95

SAVE UP TO 23% on LAFAYETTE Speaker Systems

5 Year Guarantee

A Lafayette quality product that is guaranteed against defects in material and workmanship for 5 years. If this unit fails to operate due to such defects, simply return it prepaid with your original sales slip or order. Lafayette will repair it without charge including return transportation.

LAFAYETTE ELIPTOFLEX ENCLOSURE

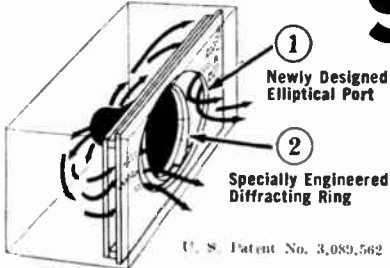

The patented "Eliptoflex" utilizes a unique elliptical port which broadens frequency response and provides better transient response. A specially engineered diffracting ring eliminates cancellation effects between front and rear radiation. "Eliptoflex" achieves a degree of natural smoothness, low distortion and robust bass hitherto found only in large quality, or expensive low efficiency speaker systems. Efficient design does not require high wattage amplification. Beautifully finished on 4 sides. Dimensions: 14Hx23 $\frac{1}{4}$ Wx13 $\frac{1}{4}$ "D.

LAFAYETTE ELIPTOFLEX® SPEAKER SYSTEM

SALE!
SAVE UP TO
15⁰⁰

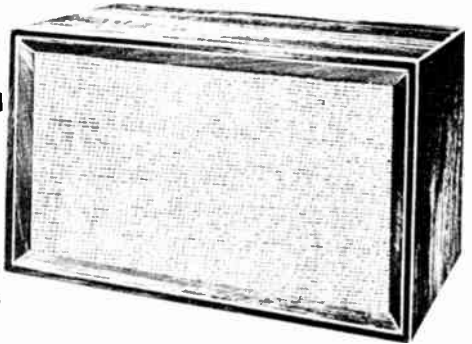

ELIPTOFLEX WITH DELUXE LAFAYETTE SPEAKERS

21 A 0115WX With SK-58 Mahogany	46 lbs.	Was 69.95	Sale 54.95
21 A 0116WX With SK-58 Walnut	46 lbs.	Was 69.95	Sale 54.95
21 A 0112WX With SK-58 Oiled Walnut	46 lbs.	Was 69.95	Sale 59.95
21 A 0117WX With SK-58 Unfin. Birch	46 lbs.	Was 64.95	Sale 49.95
21 A 0118WX With SK-180 Mahogany	44 lbs.	Was 71.95	Sale 57.95
21 A 0119WX With SK-180 Walnut	44 lbs.	Was 71.95	Sale 57.95
21 A 0120WX With SK-180 Oiled Walnut	44 lbs.	Was 71.95	Sale 62.95
21 A 0114WX With SK-180 Unfin. Birch	44 lbs.	Was 66.95	Sale 52.95

ELIPTOFLEX ENCLOSURE ALONE

20 A 0127WX Mahogany	35 lbs.	Net 41.95
20 A 0128WX Walnut	35 lbs.	Net 41.95
20 A 0129WX Oiled Walnut	35 lbs.	Net 41.95
20 A 0130WX Unfin. Birch	35 lbs.	Net 34.95

SUPERB LAFAYETTE CUSTOM HI-FI SPEAKERS

A WIDELY ACCLAIMED LAFAYETTE® SK-58® 12" COAXIAL SPEAKER. Exclusive 12" coaxial speaker featuring heavy, high flux density TSK-5 magnets for high efficiency; $\frac{3}{4}$ " wide sheepskin cone-edge suspension and special composition fibre cone material treated for ultra-linear, distortion-free response. Coaxially-mounted 3" cone-type tweeter has a bell shaped mounting for maximum dispersion of high frequencies without back radiation. Overall wide range response 30-15,000 cps. Smooth built-in crossover network at 3,000 cps. Power handling capacity 20 watts continuous sine wave, 35 watts peak program material. Magnet weight, 1 $\frac{1}{4}$ lbs. Complete with "brilliance" level control. Impedance 8 ohms. Imported. Shpg. wt., 11 lbs.

99 A 0019W

Net 29.95

B FAMOUS LAFAYETTE SK-180 10" 3-WAY TRIHELIX® SPEAKER. Fresh engineering concepts have resulted in a single 10-inch speaker designed expressly for use in book-shelf size enclosures. The "Trihelix" is in effect a complete three-way high-fidelity speaker system with three mechanically and electronically independent speakers mounted within a single 10-inch frame. Although they are individual units the 2-inch tweeter and 5-inch midrange speakers have been especially designed to complement the woofer. An adjustable brilliance control permits matching of sound to room acoustics. Overall Response 30 to 18,000 cps \pm 3 db. Free Air Resonance 35-55 cps. Impedance 16 ohms. Power Rating: 20 watts. Crossover: 1500 & 5000 cps. Overall Depth: 7". Imported. Shpg. wt., 8 lbs.

99 A 0020W \$5 Monthly

Net 32.95

20 A 0109W Adapter Board to fit SK-180 to 12" cutout

Net .99

A Model SK-58
12" Coaxial Speaker

29⁹⁵



B Model SK-180
10" 3-Way
Trihelix Speaker

32⁹⁵

No Money
Down

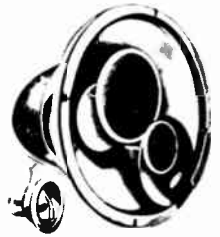

NEW! GARRARD MODEL SP-20 4-SPEED MANUAL RECORD PLAYER

- Full Size Weighted Turntable
- Automatic Return of Arm To Rest, and Shut off After Play

An excellent, compact, 4-speed manual record player for basic music systems and quality audio visual applications. Plays 16 $\frac{2}{3}$, 33 $\frac{1}{3}$, 45, and 78 RPM. Features full size weighted turntable, specially designed Garrard Motor, semi-counter balanced Tone arm with adjustable stylus pressure, interchangeable plug in head, automatic return of tone arm to rest and shut-off after play. Size: 14 $\frac{3}{8}$ Lx 12 $\frac{1}{2}$ Wx3 $\frac{1}{2}$ " above and 2 $\frac{1}{8}$ " below motor board. Imported from England. (Less base) For 110-130V, 60 CPS. Shpg. wt., 9 lbs.

21 A 3752W SP-20. \$5 Monthly Net 37.50
21 A 3753WM SP-20 with P/AT-1 Net 37.51
21 A 3754WM SP-20 with V15ATE Net 44.95

SP-20 Alone **37⁵⁰**
\$5 Monthly

SP-20 with
Picking
P/AT-1 Stereo
Cartridge **37⁵¹**
\$5 Monthly

SP-20 with
Picking
V15/ATE
Elliptical
Cartridge **44⁹⁵**
\$5 Monthly



Deluxe Performing LAFAYETTE

5 Year Guarantee

A Lafayette quality product that is guaranteed against defects in material and workmanship for 5 years. If this unit fails to operate due to such defects, simply return it prepaid with your original sales slip or order. Lafayette will repair it without charge including return transportation.

LAFAYETTE "Criterion 20" THE "MINIATURIZED" SPEAKER SYSTEM!

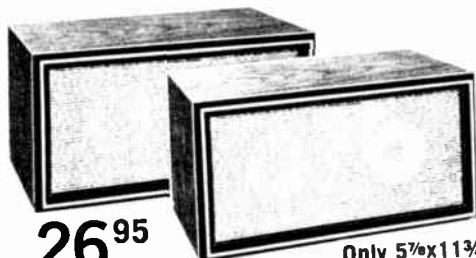

26⁹⁵
2 for 52.95

Only 5 7/8" x 11 3/4" x 7 1/8"

- 20 Watt Power Handling Capacity

Hardly bigger than a table radio, yet offers astonishing high fidelity reproduction! The rich, deep-down bass must be heard to be believed—gives you excitingly real sound—fits anywhere . . . on a bookshelf . . . table . . . even on a wall! Comes finished on all four sides in a rich, hand-rubbed oiled walnut veneer, tastefully framed in an ebony and gold picture frame molding with white gold acoustic grille material. A 4-inch woofer equipped with a large magnet and voice coil provides high efficiency and power capability. A 6 db per octave L-C crossover network transfers power to a newly developed mid-range/high frequency unit which provides brilliant highs. Power Rating: 20 watts program material. Frequency Response: 45 to 20,000 cps. Crossover Frequency: 2800 cps. Nominal Impedance: 8 ohms. Imported. Shpg. wt., 8 lbs.

99 A 0142WX Criterion 20 Net 26.95

LAFAYETTE "Criterion 50" TRUE 2-WAY BOOKSHELF SYSTEM

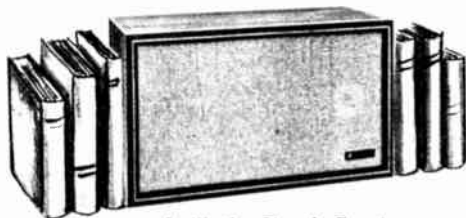

29⁹⁵

- 8" Woofer Plus 4" Tweeter
- Highly Efficient—Perfect for Low Power Amplifiers
- Handles 20 Watts

A true 2-way bookshelf-type speaker system that offers impressive hi-fi sound, yet measures only 19Wx8 3/8Dx10 3/4"H. Contains two separate speakers — you get an 8-inch woofer and a 4-inch tweeter to provide realistic wide-range reproduction. An acoustically "tuned" enclosure, fully lined, assures smooth, resonant-free sound output with extended bass response. The enclosure is finished on all four sides in a rich, hand-rubbed oiled walnut veneer and tastefully framed in an ebony and gold picture frame molding with white and gold acoustic grill material. Truly, an outstanding buy at this low price. For use with low-power stereo amplifiers — but rated at 20 watts program material for use with larger amplifiers. Designed for vertical or horizontal placement. Overall response: 35-18,000 cycles. 3000 cps electrical crossover. Nominal impedance: 8 ohms. Shpg. wt., 28 lbs. Imported.

99 A 0128WX Criterion 50 Net 29.95

LAFAYETTE ULTRA-COMPLIANCE 2-WAY SPEAKER SYSTEMS

VERY SMALL IN SPACE—LESS THAN 1 CU. FT.

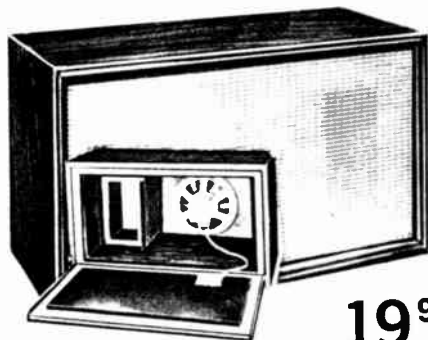

19⁹⁵

- Frequency Response 40-16,000 cps
- Especially Designed Vented, Tuned Duct Type Enclosures
- Unique Mechanical 2-Way Speaker with Heavy Magnet

Ultra-Compliance 2-Way Systems featuring a unique dual cone speaker with heavy magnet structure employed in a specially designed tuned ducted port enclosure. Both tweeter and woofer "float" on flexible, corrugated edges, with the outer edge of the tweeter cone attached to the mid-section of the woofer. This results in a mechanical crossover so that both cones operate in phase at low frequencies, but only the tweeter cone radiates high frequencies. The same type of wide-range frequency response, as found in true coaxial or multiple speaker systems is achieved in these unique "Ultra-Compliance" Speaker Systems. Frequency response is 40-16,000 cps—Impedance: 8-16 ohms. Available in mahogany or oiled walnut. Finished on four sides. Dimensions 10 3/8Hx13 7/8Lx8 7/8"D. Imported. Shpg. wt., 15 lbs.

99 A 0122WX Model SK-124A Mahogany Net 19.95

Set of Two Speaker Systems \$5 Monthly Net 38.90

99 A 0118WX Model SK-123A Oiled Walnut Net 19.95

Set of Two Speaker Systems \$5 Monthly Net 38.90

LAFAYETTE "Criterion 100A" DELUXE 2-SPEAKER 2-WAY SYSTEM

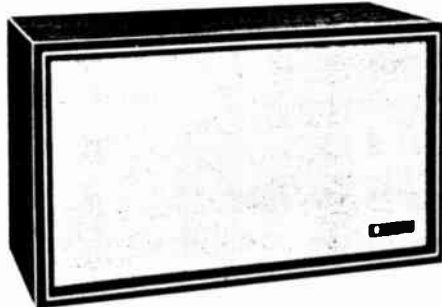

44⁹⁵

- Powerful Handling Capacity—30 Watts
- Powerful 10" Woofer with 1 lb. Magnet Plus 4" Tweeter
- "Tuned" Enclosed with Tube-Type Ducted Port
- High Frequency Brilliance Control
- Overall Response 30-19,000 Cycles

No Money Down

An unusually compact speaker system that delivers really "big" sound. Enclosure is a bass-reflex design using a ducted port of the tube type to provide proper acoustic "tuning." The tube provides a special path for the low frequency sound waves radiated from the rear of the woofer so that they emerge "in-step" with those radiated from the front and thus provides substantially greater bass sound power from the system. Solid wood construction, plus the use of sound absorbent material ensures an extremely rigid enclosure, free of undesirable resonances. A powerful 10-inch woofer provides reproduction of the low frequencies. A 4-inch cone-type tweeter provides reproduction of the mid-range and high frequencies (to beyond audibility) and is of the closed back type to prevent interaction with the 10-inch woofer. Smooth transition is achieved by means of electrical crossover at 2800 cycles. Features high frequency brilliance, control at rear of cabinet. Dimensions are 21 1/2Wx11 3/4Hx 10 1/2"D. Overall frequency response: 30-19,000 cycles; nominal impedance: 8 ohms; power handling capacity: 30 watts program material. Shpg. wt., 30 lbs. Imported. Oiled walnut finish on 4 sides. 99 A 0148WX \$5 Monthly Net 44.95

Hi-Fidelity Speaker Systems

5 Year Guarantee

A Lafayette quality product that is guaranteed against defects in material and workmanship for 5 years. If this unit fails to operate due to such defects, simply return it prepaid with your original sales slip or order. Lafayette will repair it without charge including return transportation.

LAFAYETTE "decor-ette V"™ SLIM 5-SPEAKER 3-WAY SYSTEM



Model SK300

- Four Specially Engineered 6½-inch Low Resonance Speakers—One 2½-inch Cone Type Tweeter Designed to Achieve Optimum Performance in a Thin Type Audio-panel Enclosure Only 4¼ Inches Thick
- Frequency Response 50-18,000 cps
- Power Handling Capacity: 25 Watts

39⁹⁵ 2 for **78.50**

A dazzling 5-speaker system—magnificently styled and offered in an ultra-slim enclosure only 4¼" deep. Four 6½" low resonance woofers assure rich deep-down bass. A 2½" cone-type tweeter provides sparkling reproduction of the mid-range and highs. Overall response of this system is 50-18,000 cps. Enclosure is finished in a rich hand rubbed oiled walnut veneer with matching picture frame molding. System may be used for floor mounting, bookshelf, or even wall mounting. Supplied complete with matching legs. Dimensions: 21¾Hx17¾Wx4¼"D. Power handling capacity: 25 watts program material. Nominal impedance: 8 ohms. Imported. Shpg. wt., 17 lbs.

99 A 0008WX \$5 Monthly Net 39.95
2 for 78.50

EXCITING LAFAYETTE "Criterion XL-360" MULTI-DIMENSIONAL 5-SPEAKER SYSTEM



- Full 360° Sound Dispersion of All Frequencies
- Sit Anywhere . . . Hear Everything
- Glorious, True-to-life Sound
- Four 6x3" Mid Range Speakers with Ultra-high Frequency Metallic Cone Tweeter
- One 8" High Compliance Woofer
- Slim Upright Design Offers Elegant Styling
- Power Handling Capacity—20 Watts

54⁹⁵

No Money Down

Enjoy the thrilling experience of multi-dimensional, "all-around" sound with the Criterion XL-360. This remarkable system offers full 360-degree sound dispersion over its entire range—from 32 cycles all the way up to 20,000 cycles. The XL-360 delivers deep, powerful bass . . . clear, natural mid-range . . . smooth, unexaggerated highs. With two of these systems, stereo comes through with dramatic realism . . . virtually surrounds you with glorious, living sound-in-any-room and with almost any arrangement! SPECIFICATIONS Max. Freq. Range: 32-20,000 cycles; Power Handling Capacity: 20 watts; Nominal Impedance: 8 ohms; Crossover: Electrical at 3000-Mechanical at 8000. Genuine walnut veneer with rich oiled finish. Dimensions: 32½Hx11½Dx11½" W. Shpg. wt., 30 lbs. Imported.

99 A 0124WX \$5 Monthly Net 54.95

LAFAYETTE SK-270 "decor-ette II"™ SLIM 5-SPEAKER 3-WAY SYSTEM

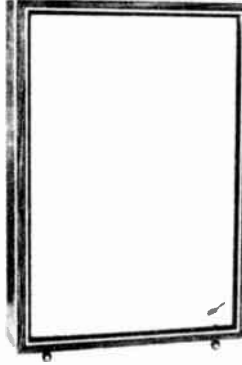

- Two 8" Woofers with ½-lb. Magnets and Rigid-flex Floating Piston Hyperbolic Cones
- One 6" Mid-Range Driver
- One 6" Direct Radiator Dome-Type HF Tweeter
- One 3½" Cone-Type Tweeter
- Power Handling Capacity, Continuous 30 Watts

59⁹⁵

Designed by Lafayette engineers—built by the foremost English hi-fi speaker manufacturer to Lafayette's rigid specifications. The "decor-ette II" is a 5-speaker 3-way system utilizing the latest advanced acoustic designs. Two 8" woofers with ½ lb. magnets provide maximum distortionless bass from 500 cycles down to 40 cycles. A 6" mid-range open back driver provides uniform response from 500 to 7500 cycles. 3½" cone-type tweeter disperses the mid-highs smoothly from 1000 to 10,000 cycles. A 3" direct radiator dome-type tweeter offers smooth high frequency response from 2500 cycles to beyond the audible limits and adds overall brilliance to the system. RC electrical crossover frequency is 5000 cps. Instantaneous peak load power: 60 watts. Impedance: 8 ohms. Size: 25Hx17Lx4¾"W. Shpg. wt., 24 lbs. Imported.

21 A 0106WX \$5 Monthly Net 59.95

DELUXE LAFAYETTE "Criterion 200A" 3-Speaker 3-WAY SYSTEM

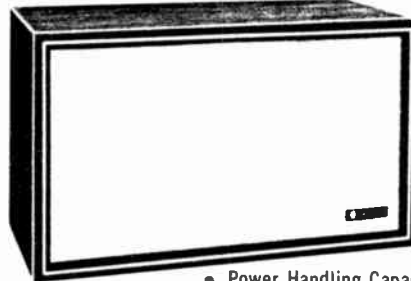

- Power Handling Capacity—40 Watts
- 12" Woofer With 1 LB Magnet
- 3" Dome-Type "Super" Tweeter
- 8" Closed Back Midrange Unit
- Response 25-25,000 cps
- "Tuned" Enclosure with Tube-Type Ducted Port
- 2 Controls—Brilliance, Presence

69⁹⁵

No Money Down

One of our finest speaker systems—manufactured to rigid specifications and designed to provide full, wide-range response . . . from a low 25 cycles all the way up to 25,000 cycles! The Criterion 200 employs 3 separate speakers to provide performance that will satisfy even the more critical listener. 12" woofer with a 1 lb. magnet and 2½" diameter voice coil provides deep, solid bass . . . reproduces low-frequency instruments with thrilling realism! A superb 8" mid-range speaker and a back-loaded 3" metallic dome-type "Super" tweeter provide flawless reproduction of the mid-range and high frequencies. Features high frequency brilliance control and mid-range presence control at rear of cabinet. Enclosure is finished on all four sides in a rich, hand-rubbed oiled walnut veneer, attractively framed in an ebony and gold picture-frame molding with white and gold acoustic material. Dimensions 24Wx14Hx12"D. Overall Frequency Response: 25 to 25,000 cps. Crossover Frequencies: 700 and 5,000 cps. Impedance: 8 ohms. Power Handling: 40 watts program material. Imported. Shpg. wt., 35 lbs.

99 A 0149WX \$5 Monthly

Net 69.95

Hi-Fi Speakers Are Available on Easy Pay Plan—No Money Down

Top Quality Speakers and Enclosure Kits

**LAFAYETTE
MODEL SK-500 3-WAY
12" HI-FI SPEAKER**

37⁹⁵

No Money Down



- Magnet Weight—1¾ lbs.
- Power Handling Capacity—30 Watts

12" 3-way Hi Fi speaker which makes possible bass response with an almost unbelievable low distortion of less than 1% at power levels of from 1 watt to 30 watts. Custom designed in England to Lafayette's rigid specifications. Features pneumatic air suspension woofer, precisely balanced mid-range radiator, and a wide-dispersion "dome lens" compression type multicellular axially mounted radial treble horn. Frequency response: 25 to 20,000 cps. Voice coil diameter: Woofer, 1¾"; Tweeter, 1". Built-in crossover at 2000 to 5000 cycles. High frequency L-pad control is provided with attractive escutcheon and knob. Impedance 8-16 ohms. Overall depth 6½". Made in England. Shpg. wt., 18 lbs.
21 A 0140WX \$5 Monthly Net 37.95

**DELUXE LAFAYETTE
MODEL SK-215 3-WAY
15" HI-FI SPEAKER**

64⁵⁰

No Money Down



- Massive 5 lb. Magnet

Our finest hi-fi speaker custom built in England to Lafayette's rigid specifications. Features huge 15" free-edged woofer, axially mounted midrange radiator and precision pressure-driven horn loaded tweeter with aluminum diaphragm and 1" coil, built-in 12db/octave crossover network, level control, massive 5 lb. ceramic magnet and 3" main voice coil all combined to produce superb, full fidelity sound. Frequency response: 20-20,000 cps; cone resonance, 25 cps. Magnetic flux density: over 250,000 Maxwells. Cross-overs: mechanical, 2000 and electrical, 5000 cps. Power capacity: 50 watts (80 peak). Impedance, 16 Ohms. Dimensions: 15¼" diameter, 6½" overall depth. Imported. Shpg. wt., 30 lbs.
21 A 0130WX \$5 monthly Net 64.50

**DELUXE LAFAYETTE
MODEL SK-216 3-WAY
12" HI-FI SPEAKER**

54⁵⁰

No Money Down



- Massive 5 lb. Magnet

An exceptional 12" speaker precision made in England to Lafayette's rigid specifications. Advanced 3-way design features a super-efficient 5 lb. ceramic magnet and 3" main voice coil. 12" high compliance woofer, mid-range radiator and precision pressure-driven horn-loaded compression tweeter are axially mounted to achieve a smooth, 20-20,000 cps response of utmost clarity. Other highlights include: 35 cps cone resonance; flux density of over 250,000 Maxwells; 1" aluminum tweeter voice coil. Crossovers: mechanical, 2000 cps, electrical, 5000 cps—12 db/octave. Level control. 50 watts. Impedance: 16 ohms. Dia., 12¼". Depth, 5½". Shpg. wt., 25 lbs.
21 A 0129WX \$5 monthly Net 54.50

LAFAYETTE UNIVERSAL HI-FI BASS REFLEX ENCLOSURE KITS

Ideal for Use with Above Speakers

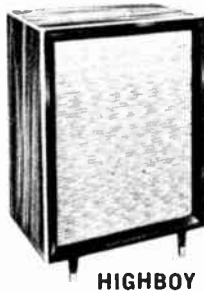

HIGHBOY

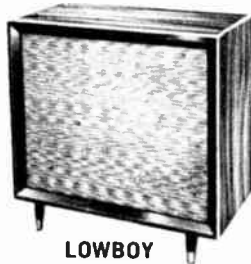

LOWBOY

29⁹⁵



- Easy to Assemble • 3/4" White Birch • Precision-Cut — Fits Together Smoothly • Ideal for Single Wide Range, 2-way or 3-way Speaker Systems • High or Lowboy Style

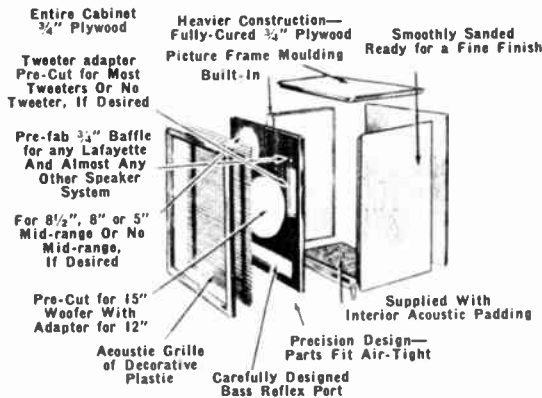

All pieces of these carefully-designed, bass-reflex, high-fidelity speaker enclosures are accurately pre-cut of ¾" plywood to precision-fit snugly together and eliminate all spurious resonances. Surface is of white birch veneer. Front panels feature picture frame moulding and plastic acoustic grilles to blend with any finish and room decor. Tapered offset legs are protected by gleaming brass ferrules. Lined with acoustic material that prevents reverberation and cabinet resonance. Cutouts are provided for a 15" speaker plus adapter for 12", 8½" or 8" midrange, plus adapter for 5" and a blank-wood block if no midrange speaker is used; cutout with adapter boards for 2 sizes of rectangular and 3 sizes of round compression horn tweeters plus a blank block if no tweeter is used. Kits are supplied unfinished, smoothly sanded and ready for finishing. Lowboy-style cabinet dimensions are (less legs) 27¼"Wx23½"Hx 16¼"D; legs are 7" high. Highboy has the same dimensions with height and width interchanged. Complete instructions, all parts, hardware, and grille are included. Shpg. wt., 54 lbs.
Unfinished Highboy Enclosure Kit.

- 20 A 0121WX Net 29.95
- Unfinished Lowboy Enclosure Kit
- 20 A 0122WX Net 29.95
- Lafayette Professional Walnut Stain Finishing Kit. Includes brush, filler stain, sealer, solvent and sandpaper plus easy to follow instructions. Shpg. wt., 6 lbs.
- 13 A 1803 Net 3.50

Our Best Selling Stereo Headphones

DELUXE LAFAYETTE F-770 STEREO-PHONES

17⁹⁵



- Private Listening
- No Space Problem
- Stereo and Monaural
- Soft Foam Rubber Ear Pads
- Exceptionally Fine Quality
- Frequency Response 25 to 15,000 Cycles
- Actually 2 High Fidelity Dynamic Speakers

The Lafayette F-770 combines broad frequency response and faithful reproduction with a comfort-oriented design to make listening with them a real pleasure. The Stereophones are actually two 2½" high fidelity dynamic speakers with a frequency response range of 25 to 15,000 cycles. Perfect for stereo and monaural operation, the headphones are rated at 1/2 watt maximum input; impedance, 8 ohms per phone. The soft foam rubber ear pads provide extremely comfortable listening, help to keep out noise and maintain an excellent bass response. Imported. Shpg. wt., 2 lbs.

99 A 0034

Net 17.95

FAMOUS LAFAYETTE F-767 STEREO HEADPHONES

Widely Acclaimed Headphones For The Hi-Fi Enthusiast

11⁸⁸



- Air-Cushioned Headband
- Soft Foam Rubber Ear Cushions for Maximum Comfort and Bass Response
- High Sensitivity

The F-767 headband is covered with an air-filled vinyl bag which serves as a gentle air cushion. Soft foam rubber ear pads keep out external noise, provide maximum bass response. Sensitivity is very high. Frequency response: 30-15,000 cycles. Impedance, 8 ohms per phone. Supplied with cylindrical overload control box for connection of the headphones to equipment that does not have stereo headphone jacks. May also be attached to two separate 2-conductor phone plugs. Complete with attached stereo phone plug, overload junction box and instructions. Imported. Shpg. wt., 2½ lbs.

99 A 0035

Net 11.88

25 FT. UNIVERSAL STEREO HEADPHONE EXTENSION CORD

Listen to stereo through your favorite stereo headphone anywhere in the room. Flexible 3-conductor cable, grey vinyl jacket, 25 ft. in length. With ¼" 3-circuit plug on one end and a 3-circuit jack on the other end. Imported. Shpg. wt., 1 lb.



99 A 0116

Net 2.29

LAFAYETTE "Stereo-Trol" For Stereo Headphone Listening

- Enjoy Natural, Realistic, Full Dimensional Stereo with Headphones

Accurately controls stereo separation of channels by permitting you to mix both channels to individual preference. Eliminates the "Hole-In-The Middle Effect." Offers full dimensional stereo. Ideal for use with all low impedance headphones. Requires 10 watts per channel. 4 controls for volume, balance, channel selector, mode (mono, stereo, full dimensional stereo). Oiled walnut cabinet. Size: 4½Hx11Wx3¼O. Imported.

99 A 0141

Net 24.95

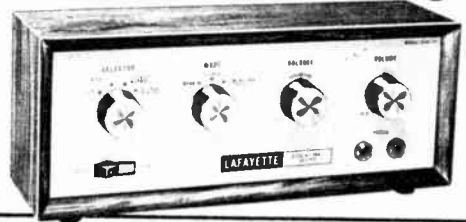

SPECIALLY DESIGNED LAFAYETTE SPEAKERS FOR COMPACT SYSTEMS

(A) LAFAYETTE 2½" TWEETER Remarkable compact tweeter handles 2 watts input music power. Frequency response of 1,200 to 20,000 cycles. Magnet weighs 1.3 oz. Impedance: 8 ohms. Imported. Shpg. wt., 1¼ lbs.

99 A 0145

Net 1.99

(B) LAFAYETTE 3" TWEETER Fresh sounding foam-mounted cone tweeter delivers 1,200 to 20,000 cps. frequency response. Resonant frequency: 1,200 cps. Power handling capability 8 watts peak. Impedance: 8 ohms. Imported. Shpg. wt., 1 lb.

99 A 0156

Net 2.95

(C) LAFAYETTE 4½" WOOFER Resonant frequency: 80 cycles. Handles up to 8 watts music power. Frequency response: 80 to 12,000 cps. Magnet weighs 8.6 oz. Rugged steel frame construction. Impedance: 8 ohms. Imported. Shpg. wt., 3 lbs.

99 A 0144

Net 4.95

(D) DELUXE LAFAYETTE 5" WOOFER Superb bass response is achieved through careful matching of large 1½ pound magnet, 1" voice coil, and specially treated cloth surrounded cone. Frequency response: 40 to 12,000 cps. Resonant frequency: 40 cps. Will handle 15 watt peak power. Imported. Shpg. wt., 5 lbs.

99 A 0155

Net 9.95

(E) LAFAYETTE 5" FULL RANGE HI-FI SPEAKER Outstanding 50 to 18,000 cps. audio reproduction. Resonant frequency: 52 cps. Magnet weighs 3.6 oz. Power capacity 8 watts (16 peak). Impedance: 8 ohms. Dia. 5½", Depth 3¼". Imported. Shpg. wt., 3 lbs.

99 A 0151

Net 5.95

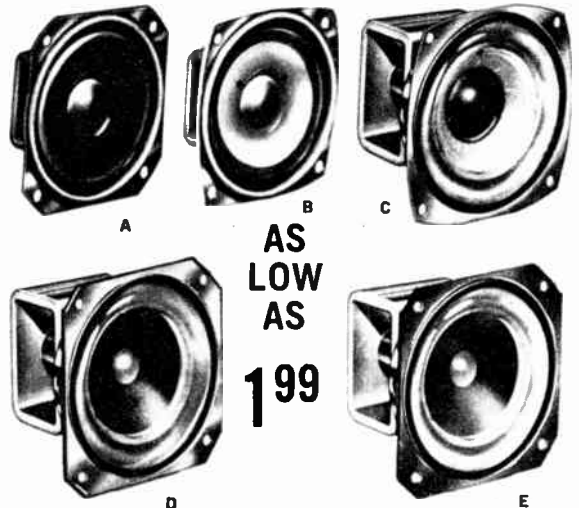

AS
LOW
AS
1.99

Garrard LAB 80 and A70 Turntables with Pickering Elliptical Stereo Cartridge

Our Lowest Prices Ever

**NEW PICKERING
V15/ATE ELLIPTICAL
STEREO CARTRIDGE**



ONLY 34⁵⁰

Deluxe stereo cartridge with a true bi-radial .0009 x .0004 diamond elliptical stylus especially designed for tone arms that track at 1 to 4 grams. Vertical tracking angle, 15°. Wt.. 3 oz.
21 A 5362L \$5 monthly Net 34.50

**NOW
FOR ONLY**

**New Pickering V15/ATE
Elliptical stereo cartridge
with the purchase of the
Garrard Lab 80 or A70
Automatic Turntables**



**LAB 80
ONLY 99⁵⁰**

**LAB 80
With V15/ATE 99⁵¹**

**A70
ONLY 84⁵⁰**

**A70
With V15/ATE 84⁵¹**

LAB 80 AUTOMATIC TURNTABLE Precision automatic transcription turntable for professional reproduction of 33 $\frac{1}{3}$ and 45 rpm LP records only. Dynamically balanced tone arm is of low resonant afrormosia wood. Tracking force adjustable with audible/visual guide. Features integral cueing device, automatic shut off, heavy 12" balanced cast non-magnetic turntable, and advanced Garrard Lab series 4-pole shaded motor. Stereo wired. For 110-130V —17x14 $\frac{1}{4}$ " less base. Shpg. wt., 22 lbs. Imported from England.
21 A 3705WX —LAB 80 less cartridge Net 99.50
21 A 3750WXM —LAB 80 with V15/ATE Ellip. cart. Net 99.51

A70 AUTOMATIC TURNTABLE features a completely dynamically balanced tone arm with built-in bias compensator enabling the arm to track even the lightest and most compliant cartridges accurately, without distortion. Other outstanding features include: double shielded Lab Series 4-pole shaded motor, full-sized heavy balanced cast "sandwich" turntable. Stereo wired. Size: 16 $\frac{3}{4}$ x14 $\frac{1}{4}$ ". For 110-130V, 60 cycles AC. Less base. Shpg. wt., 20 lbs. Imported from England.
21 A 3706WX —A70 less Cartridge Net 84.50
21 A 3751WXM A70 with V15/ATE Ellip. cart. Net 84.51

**UP-DATE YOUR HI-FI SYSTEM WITH ONE OF THESE FINE PREMIUM
HI-FI STEREO CARTRIDGES COMPLETE WITH DIAMOND NEEDLE**



☆ EMPIRE ☆ PICKERING
☆ GRADO ☆ ORTOFON

Pickering V15/AT-2
21 A 5355L 19.95 Empire 888
21 A 3418L 19.95

Pickering V15/AM-1
21 A 5316L 21.95 Empire 888P
21 A 3436L 21.95

Ortofon SPU/T
21 A 3208L 50.00 Empire 888PE
21 A 3419L 32.95

New Grado "B"
21 A 4107L 19.75 New Grado "BE" Elliptical
21 A 4108L 32.50



☆ SHURE

1176 M-3D
21 A 6201L

1795 M7/N21-D
21 A 6206L

2195 M-44-5
21 A 6215L

1995 M-44-7
21 A 6216L

3550 M-55E*
21 A 6221L

*Elliptical Diamond Stylus

Famous Garrard Automatic Turntables

1¢

More for Choice of Below
Group A Cartridges With Purchase of
Garrard AT60 or 50



Pickering
V15/AT-2

Empire 888

Shure M7/N21D

TYPE AT60 AUTOMATIC TURNTABLE

The AT60 combines turntable performance with record changer convenience. Plays all 4-speeds: 16 $\frac{2}{3}$; 33 $\frac{1}{3}$; 45 and 78 rpm. Automatic intermix operation when desired. Features a heavy cast, oversized turntable . . . dynamically balanced and non-magnetic. The tone arm is the tubular, counterweight adjusted, dynamically balanced design with built-in stylus pressure gauge legible from the top. Stereo wired. Size: 15 $\frac{3}{8}$ Lx13 $\frac{1}{8}$ "D. For 110-130V, 60 cycles AC. Less base. Shpg. wt., 13 lbs. Imported from England.

21 A 3707WX	—AT60 less Cartridge	Net 59.50
21 A 3736WXM	—AT60 with Pickering V15/AT-2 Cart.	Net 59.51
21 A 3737WXM	—AT60 with Empire 888 Cartridge	Net 59.51
21 A 3723WXM	—AT60 with Shure M7/N21D Cart.	Net 59.51
AT60 with Pickering V15/ATE Ellip. cart.		Net 64.50

MODEL 50 AUTOMATIC TURNTABLE

Quality in the Garrard tradition at a modest price. Oversized turntable and handsome mat styling, counter-weighted cast aluminum tone arm with finger-touch stylus pressure adjustment. Convenient plug-in head, 4-pole shaded motor provides 4 accurate speeds: 16 $\frac{2}{3}$, 33 $\frac{1}{3}$, 45 and 78 rpm. Smooth changer mechanism offers automatic intermix operation. Size: 14 $\frac{1}{4}$ Lx12 $\frac{1}{2}$ "D. Stereo wired. Less base. For 110-130 volts, 60 cycles AC. Shpg. wt., 11 lbs. Imported from England.

21 A 3708W	Model 50 less Cartridge	Net 44.50
21 A 3738WXM	Model 50 with Pickering V15/AT-2 Cart.	Net 44.51
21 A 3739WXM	Model 50 with Empire 888 Cartridge	Net 44.51
21 A 3726WXM	Model 50 with Shure M7/N21D Cart.	Net 44.51
Model 50 with Pickering V15/ATE Ellip. Cart.		Net 49.50

5⁰⁰

More for Pickering V15/ATE Elliptical
Cartridge With Purchase of Garrard AT60
or 50



AT60
Only **59⁵⁰**

AT60
with choice of
group A cartridge

59⁵¹

AT60
with Elliptical
V15/ATE

64⁵⁰



MODEL 50
Only

44⁵⁰

MODEL 50
with choice of
group A cartridge

44⁵¹

MODEL 50
with Elliptical
V15/ATE

49⁵⁰



ACCESSORIES FOR GARRARD RECORD CHANGERS

(A) LAFAYETTE RECESSED WOOD BASES

OILED WALNUT—Shpg. wt., 6 lbs.	
24 A 1203W For LAB 80	Net 3.95
24 A 1201W For A70	Net 3.95
24 A 1205W For AT60, 50, SP30	Net 3.95
MAHOGANY—Shpg. wt., 6 lbs.	
24 A 1204W For LAB 80	Net 3.95
24 A 1202W For A70	Net 3.95
24 A 1206W For AT60, 50, SP30	Net 3.95

(B) 45 RPM SPINDLES—Shpg. wt. 10 oz.

21 A 3709 For LAB 80	Net 3.80
21 A 3710 For A70	Net 3.80
21 A 3711 For AT60, 50, SP30	Net 3.80

(C) PLASTIC OUST COVERS—Wt. 1 $\frac{1}{2}$ lbs.

21 A 3733 For A70, LAB 80	Net 4.95
21 A 3734 For AT60, 50, SP30	Net 4.95



Low Priced, Top Quality LAFAYETTE 4-Speed Automatic Changers

MODEL AC-33

SALE!

25⁷⁷

Less Base

Was 26.95



Complete with .7 Mil Diamond Needle

Made In U.S.A.

Deluxe Lafayette Model AC-33 features a balanced heavy-duty 4-pole motor and a heavy 11" turntable platter. Plays 16 $\frac{2}{3}$, 33 $\frac{1}{3}$, 45 and 78 RPM records — both stereo and monaural — either automatically or manually. Intermixes up to twelve 10" and 12" records of the same speed. Will stack up to fourteen 7" 45 RPM records. Two controls: on-off reject switch, and 4-speed selector automatic shut-off after last record has been played. Slim-type aluminum tubular tone arm comes equipped with Euphonics turnover stereo cartridge with .7 mil diamond stylus for microgroove records. Size: 13 $\frac{1}{2}$ x12x7 $\frac{1}{2}$ ". 4 $\frac{1}{2}$ " below and 5 $\frac{1}{2}$ " above mounting board. Shpg. wt., 12 lbs.

21 A 0136W Deluxe-AC-33 less base	Net 25.77
24 A 0221W Recessed oiled walnut base for AC-33	Net 3.95
21 A 0105 45 RPM spindle for AC-33	Net 1.65

MODEL AC-10

Only

17⁵⁰

Less Base

Made In U.S.A.



Lafayette AC-10 offers outstanding performance at a low, low price. Plays both stereophonic and monaural records. Balanced featherweight tone arm with Flip-type Ronette ceramic stereo cartridge. Heavy precision turntable. Plays 16 $\frac{2}{3}$, 33 $\frac{1}{3}$, 45 and 78 RPM records. Intermixes 10" & 12" records of the same speed. Single knob speed/function control. Automatic 3-way shutoff after last record. 117VAC, 60 cycles. Only 13 $\frac{1}{2}$ x12x7 $\frac{1}{2}$ ". 3" below and 5 $\frac{1}{2}$ " above mounting board. Brown & gold finish. Shpg. wt., 12 lbs.

21 A 0135W Model AC-10 less base	Net 17.50
24 A 0221W Recessed Oiled Walnut Base for AC-10	Net 3.95
21 A 0105 45 RPM Spindle for AC-10	Net 1.65

Hi-Fi Components Are Available on Easy Pay Plan—No Money Down

Lafayette Cat. No. 663 69

LAFAYETTE Receiving Tubes

THE QUALITY LINE
WITH THE

2 YEAR GUARANTEE

Lafayette tubes are made in the U.S.A. to rigid quality standards which assure you of efficient performance and long-life. We will replace without charge any tube which, due to defects in material or workmanship, fails in normal use within 2 years from date of purchase. Simply bring or return the tube postpaid to the store from which you purchased it along with your original sales-slip or order.



MADE
IN
U.S.A.



MADE
IN
U.S.A.

ASSORTMENT PRIVILEGE: TUBES MAY BE ASSORTED FOR QUANTITY PRICE

Tube Type	Net 1-9	Each 10-49	Asst. 50-Up	Tube Type	Net 1-9	Each 10-49	Asst. 50-Up	Tube Type	Net 1-9	Each 10-49	Asst. 50-Up	Tube Type	Net 1-9	Each 10-49	Asst. 50-Up
024	1.08	.96	.86	6AUGA	.88	.78	.70	6CU8	2.03	1.80	1.62	8AW8A	1.58	1.40	1.26
1G3GT/				6AUBA	1.98	1.76	1.58	6CW4	1.98	1.76	1.58	8CG7	1.06	.94	.85
1B3GT	1.24	1.10	.99	6AV5GA	2.12	1.88	1.69	6CX8	1.92	1.70	1.53	8FQ7	1.06	.94	.85
1K3/J3	1.24	1.10	.99	6AV6	.72	.64	.58	6CY5	1.56	1.38	1.24	10DE7	1.44	1.28	1.15
1R5	1.44	1.28	1.15	6AW8A	1.58	1.40	1.26	6CY7	1.38	1.22	1.10	12AD6	1.17	1.04	.94
1U4	1.38	1.22	1.10	6AX3	1.15	1.02	.92	6DA4A	1.38	1.22	1.10	12AT6	.79	.70	.63
1U5	1.20	1.06	.95	6AX4GTB	1.13	1.00	.90	6DE4	1.38	1.22	1.10	12AT7	1.29	1.14	1.03
1V2	.99	.88	.79	6AY3	1.31	1.16	1.04	6OE6	1.08	.96	.86	12AU6	.90	.80	.72
1X2B	1.31	1.16	1.04	6BA6	.86	.76	.68	6OE7	1.51	1.34	1.21	12AU7A	1.06	.94	.85
2AF4	1.74	1.54	1.39	6BA8A	1.80	1.60	1.44	6OK6	1.02	.90	.81	12AV5GA	2.03	1.80	1.62
2B4A	1.24	1.10	.99	6BC5	1.02	.90	.81	6DN7	1.51	1.34	1.21	12AV6	.72	.64	.58
2CY5	1.38	1.22	1.10	6BC8	1.69	1.50	1.35	6DQ5	3.54	3.14	2.83	12AV7	1.53	1.36	1.22
3A3	1.44	1.28	1.15	6BE6	.95	.84	.76	6DQ6B	1.76	1.56	1.40	12AX4GTB	1.15	1.02	.92
3BC5	1.11	.98	.88	6BGGGA	2.77	2.46	2.21	6DR7	1.85	1.64	1.48	12AX7A	1.08	.96	.86
3BN6	1.62	1.44	1.30	6BH6	1.24	1.10	.99	6DT6A	.93	.82	.74	12AZ7A	1.29	1.14	1.03
3BZ6	.97	.86	.77	6BH8	1.80	1.60	1.44	6DW4	1.58	1.40	1.26	12BA4	1.38	1.22	1.10
3CB6	.97	.86	.77	6BJ6	1.24	1.10	.99	6EA7	2.34	2.08	1.87	12BA6	.72	.64	.58
3CY5	1.69	1.50	1.35	6BK4	3.40	3.02	2.72	6EA8	1.35	1.20	1.08	12BE6	.75	.66	.59
3DC4	1.85	1.64	1.48	6BK7B	1.60	1.42	1.28	6EB8	1.98	1.76	1.58	12BH7A	1.31	1.16	1.04
3V4	1.17	1.04	.94	6BL7GTA	1.98	1.76	1.58	6EJ7	1.60	1.42	1.28	12BL6	1.29	1.14	1.03
4BQ7A	1.87	1.66	1.49	6BL8	1.69	1.50	1.35	6EM5	1.44	1.28	1.15	12BY7A	1.38	1.22	1.10
4BZ6	.95	.84	.76	6BN4A	1.53	1.36	1.22	6EM7	2.16	1.92	1.73	12C5/			
5AM8	1.83	1.62	1.46	6BN6	1.35	1.20	1.08	6ER5	1.60	1.42	1.28	12CU5	1.24	1.10	.99
5AQ5	1.08	.96	.86	6BN8	1.42	1.26	1.13	6EW6	1.04	.92	.83	12CA5	1.26	1.12	1.01
5AT8	1.71	1.52	1.37	6BQ5/EL84	1.02	.90	.81	6FH5	1.42	1.26	1.13	12DQ6B	1.80	1.60	1.44
5BR8	1.89	1.68	1.51	6BQG6TB/				6FQ7	1.06	.94	.85	12SA7	1.98	1.76	1.58
5CG8	1.42	1.26	1.13	6CU6	1.85	1.64	1.48	6GH8A	1.35	1.20	1.08	12SK7	1.80	1.60	1.44
5CL8A	1.74	1.54	1.39	6BQ7A	1.69	1.50	1.35	6GK5	1.74	1.54	1.39	12SN7GTA	1.15	1.02	.92
5T8	1.89	1.68	1.51	6BR8A	1.74	1.54	1.39	6J5	1.67	1.48	1.33	12SQ7	1.69	1.50	1.35
5U4GB	.88	.78	.70	6BS8	1.69	1.50	1.35	6JA6	1.20	1.06	.95	17AX4GTA	1.38	1.22	1.10
5U8	1.40	1.24	1.12	6BU8	1.53	1.36	1.22	6JEG	3.83	3.40	3.06	17D4	1.38	1.22	1.10
5Y3GT	.72	.64	.58	6BZ6	.95	.84	.76	6K6GT	1.11	.98	.88	17OQ6B	1.78	1.58	1.42
6AB4	1.11	.98	.88	6BZ7	1.69	1.50	1.35	6L6GC	2.01	1.78	1.60	17J2B	1.60	1.42	1.28
6AF3	1.40	1.24	1.12	6C4	.79	.70	.63	6S4A	1.06	.94	.85	19AU4GTA	1.60	1.42	1.28
6AF4A	1.69	1.50	1.35	6CB6A	.95	.84	.76	6S7	1.87	1.66	1.49	22DE4	1.53	1.36	1.22
6AG5	1.29	1.14	1.03	6CD6GA	2.48	2.20	1.98	6SK7	1.92	1.70	1.53	25BQ6GTB/			
6AH4GT	1.47	1.30	1.17	6CF6	1.24	1.10	.99	6SL7GT	1.51	1.34	1.21	25CU6	1.98	1.76	1.58
6AM6	1.98	1.76	1.58	6CG7	1.06	.94	.85	6SN7GTB	1.11	.98	.88	25CD6GB	2.59	2.30	2.07
6AK5	2.03	1.80	1.62	6CGLA	1.35	1.20	1.08	6T8A	1.44	1.28	1.15	25ON6	2.68	2.38	2.14
6AL5	.79	.70	.63	6CL6	1.71	1.52	1.37	6U8A	1.40	1.24	1.12	25LG6T	1.22	1.08	.97
6AM8A	1.47	1.30	1.17	6CL8A	1.69	1.50	1.35	6V6GTA	.93	.82	.74	35C5	.90	.80	.72
6AN8A	1.69	1.50	1.35	6CM7	1.24	1.10	.99	6W4GTA	1.04	.92	.83	35L6GT	1.11	.98	.88
6AQ5A	.90	.80	.72	6CN8	1.80	1.60	1.44	6W6GT	1.22	1.08	.97	35W4	.48	.42	.38
6AS5	1.24	1.10	.99	6CO8	1.49	1.32	1.19	6X4	.72	.64	.58	35Z5GT	.88	.78	.70
6AS8	1.80	1.60	1.44	6CS6	1.11	.98	.88	6X5GT	.95	.84	.76	50C5	.90	.80	.72
6AT6	.93	.82	.74	6CS7	1.26	1.12	1.01	6X8A	1.49	1.32	1.19	50EH5	.97	.86	.77
6AT8A	1.80	1.60	1.44	6CU5	1.22	1.08	.97	7AU7	1.11	.98	.88	50L6GT	1.15	1.02	.92
6AU4GTA	1.53	1.36	1.22												



LAFAYETTE BATTERIES

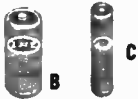

POPULAR 1.5 VOLT
FLASHLIGHT
BATTERIES

Stock No.	Voltage	Fig-ure	RCA	Bur-gess	Eve-ready	Shpg. Wt.	Each	Lets 10 Ea.
99 A 6258 1 1/2 (D)	A	VS036	2	950	4 oz.	.13	.125	
99 A 6257 1 1/2 (C)	B	VS035	1	935	3 oz.	.13	.125	
99 A 6258 1 1/2 (AA)	C	VS034	Z	915	2 oz.	.095	.09	

As little
as
20¢

9-VOLT TRANSISTOR RADIO BATTERY

Replaces RCA VS323, Burgess 2U6, Eveready 216, Zenith Z216, Ray-O-VAC 1604, NEDA 1604. Shpg. wt., 2 oz. Imported.

ea. in lots of 10 99 A 6021 Net ea. .21
Net ea., Lots 10 .20



9-VOLT "STORAGE CELL" FOR TRANSISTOR RADIOS!



- Replaces 2U6, BL-006P and BA-2
- Battery Recharges Overnight
- Battery Can Be Used Over and Over Again

9V Battery complete with charger. Battery 1 7/8x1 1/8"; charger 3 3/4x 1 1/4x7/8". Imported.

99 A 9016 Battery and Charger. Shpg. wt., 6 oz. Net 2.89
99 A 6026 Battery Replacement for above Net 1.29

HOBBY IGNITION BATTERY

59¢

- Protected Terminals
- Perfect For Glow Plugs

Specially designed for engines using glow plugs. Terminals are fully protected by plastic caps to prevent accidental short circuiting. 1 1/2 volts. Imported. Shpg. wt., 1 lb.

99 A 6235 Net .59



LAFAYETTE Budget-Priced TV Picture Tubes

FULL ONE-YEAR GUARANTEE



Net price "with Dud" based on your prepaid shipment or delivery of old picture tube (Dud). Returned tubes must be intact, under vacuum and without scratches. Green glass duds not accepted. When ordering give stock number and type. Every Lafayette picture tube is top quality-made of entirely new materials except the glass, which is tested and inspected to meet new-glass standards. † Indicates aluminized screens. ‡ Indicates metal tubes Δ indicates bonded face. When no price appears under column headed "NET LESS DUD," tube is available only with return of your old tube.

Tubes which fail in normal use within one year will be replaced upon receipt of your returned tube. You pay only transportation.

AVERAGE SHIPPING WEIGHTS: 10" Tubes, 14 lbs.; 12" - 17 lbs.; 14" - 14 lbs.; 16" - 22 lbs.; 17" - 24 lbs.; 19" - 26 lbs.; 20" - 30 lbs.; 21" - 35 lbs.; 24" - 44 lbs.

Stock No.	Type No.	Net Less		Net With		Stock No.	Type No.	Net Less		Net With	
		Dud	Oud	Oud	Oud			Oud	Oud		
36 A 0106X	108PA 10BP4A	—	9.33	36 A 0164X	21FLP4 CBP4A*	14.45	10.95	36 A 0165X	21FP4C*	16.45	14.95
36 A 0107X	12KP4A*	—	11.75	36 A 0166X	21MP4†	26.50	21.50	36 A 0167X	21WP4	15.00	14.00
36 A 0108X	12LP4A*	—	10.95	36 A 0178X	21WP4/WP4A*	18.00	17.00	36 A 0168X	21XP4A*	17.50	16.50
36 A 0109X	14AJ4A*	—	17.25	36 A 0170X	21YP4A/21YP4B*	16.25	12.25	36 A 0171X	21ZP4B*	16.25	12.25
36 A 0111X	14BP4/CP4	17.50	14.50	36 A 0179X	23BK4P* Δ	30.50	28.50	36 A 0180X	23BT4P* Δ	30.50	28.50
36 A 0113X	14HP4	Use 14QP4A	—	36 A 0181X	23CP4/BNP4* Δ	30.50	28.50	36 A 0182X	23EP4* Δ	30.50	28.50
36 A 0114X	14QP4A*	—	15.00	36 A 0183X	23JP4* Δ	30.50	28.50	36 A 0184X	23KP4/FP4*	26.50	20.50
36 A 0115X	14RP4A	Use 14WPA	—	36 A 0172X	24AHP4/ALP4*	30.50	23.50	36 A 0173X	24ALP4	Use 24AHP4/ALP4	—
36 A 0119X	16GP4†	17.00	16.00	36 A 0174X	24ANP4	Use 24DP4A/AEP4	—	36 A 0175X	24AUP4*	28.75	21.75
36 A 0121X	16KP4A/RP4A*	—	12.95	36 A 0176X	24CP4A*	28.00	19.00	36 A 0177X	24DP4A/AEP4*	26.75	19.75
36 A 0123X	16WP4	—	16.50	36 A 0178X	24EP4*	26.75	19.75				
36 A 0124X	17AVP4A/BJP4*	18.50	15.50								
36 A 0126X	17BP4B*	14.75	13.75								
36 A 0129X	17BWP4*	21.50	16.50								
36 A 0131X	17CDP4*	22.95	17.95								
36 A 0132X	17CFP4*	18.90	15.90								
36 A 0133X	17CP4†	19.45	17.95								
36 A 0134X	17DAP4*	24.50	19.50								
36 A 0135X	17DSP4*	19.50	14.50								
36 A 0136X	17DXP4/ZP4*	21.95	16.95								
36 A 0137X	17GP4	21.45	19.95								
36 A 0138X	17HP4/RP4	12.00	11.00								
36 A 0139X	17HP4B/RP4C*	14.95	13.95								
36 A 0140X	17LP4/VP4	13.95	12.95								
36 A 0141X	17LP4A/VP4B*	16.95	15.95								
36 A 0142X	17QP4	13.50	12.50								
36 A 0143X	17QP4A/B*	15.95	14.95								
36 A 0144X	19AFP4*	28.75	25.75								
36 A 0176X	19AJ4A*	22.50	17.50								
36 A 0145X	19AP4A/B†	19.95	18.95								
36 A 0146X	19AVP4*	22.50	17.50								
36 A 0147X	19AXP4*	22.50	17.50								
36 A 0149X	20CP4B DP4B*	—	14.50								
36 A 0151X	20HP4D*	—	11.95								
36 A 0152X	21ACP4A/AMP4A*	14.45	10.95								
36 A 0154X	21AP4†	23.75	18.75								
36 A 0155X	21AUP4/AVP4	14.75	12.75								
36 A 0163X	21AUP4A/AVP4B*	16.95	15.95								
36 A 0158X	21AWP4A*	16.95	14.95								
36 A 0161X	21AYP4	Use 21XP4A	—								
36 A 0162X	21CQP4*	20.95	15.95								
36 A 0165X	21DEP4A*	20.95	15.95								
36 A 0177X	21DLP4/DQP4*	21.00	17.50								
36 A 0163X	21EP4B*	15.45	13.95								

PICTURE TUBE CROSS REFERENCE

For picture tubes not listed alphabetically above, check this cross reference for tube type required.

Type No.	Use
16KP4/RP4, 16QP4, 16RP4, 16TP4, 16UP4, 16XP4	16KP4A/RP4A
17AP4, 17BP4C/D, 17JP4	17BP4B
17ATP4A/BJP4, 17BJP4, 17CBP4, 17CLP4	17AVP4A/BJP4
17BRP4, 17BZP4, 17CAP4, 17CKP4, 17CWP4, 17DKP4/DLP4, 17DTP4	17OSP4
19ARP4, 19AUP4	19AFP4
19AGP4, 19AZP4, 19BVP4, 19XP4	19AVP4
21ACP4, 21AMP4, 21AMP4A/B	21ACP4A/AMP4A
21AQP4/A, 21BSP4, 21CUP4	21YP4A/21YP4B
21AFP4, 21BCP4	21FLP4/CBP4A
21ALP4/A/B, 21ALP4A/FLP4, 21ANP4/A, 21ATP4/A/B, 21BAP4, 21BNP4, 21BTP4, 21CBP4A/B, 21CMP4, 21CVP4, 21CWP4, 21DNP4	21EP4A
21CEP4, 21CZP4, 21DAP4, 21DFP4	23TP4
23AFP4, 23XP4, 23YP4	23BK4P
23ANP4, 23ATP4, 23BLP4	23KP4/FP4
23MP4, 23WP4	24CP4A
24ADP4, 24CP4B, 24QP4, 24TP4, 24VP4/A, 24XP4	24EP4A/AEP4
24AEP4, 24ANP4, 24DP4, 24YP4, 24ZP4	

BATTERY CHARGER WITH TWO RECHARGEABLE BATTERIES

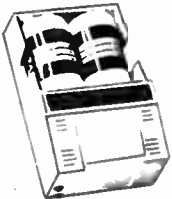

5⁹⁵

Recharges Batteries Overnight. For Flashlights, Transistor Radios, Toys, . . . 2 2-Volt D Type Batteries Included

Recharges any type D battery overnight! No longer must toys, transistor radios and flashlights be without "live" batteries. White plastic case with 2 rechargeable 2 volt type D batteries. Replaces VS036, 2, 950 etc. Shpg. wt., 2 lbs. Imported.

99 A 9100 Charger and 2 Batteries Net 5.95
99 A 6265 Rechargeable Battery Net 1.25

BATTERY CHARGER



A deluxe dry cell battery charger that will charge 1½ volt D, C, AA and popular 9-volt size transistor radio batteries. Also carbon, zinc-alkaline and nickel-cadmium batteries of the same sizes. Double latch switches for utmost safety and reliability. Special pockets for each size battery. Red light indicates proper charging.

33 A 5401 Shpg. wt., 2½ lbs. Net 3.99

LAFAYETTE 9-VOLT TRANSISTOR RADIO BATTERY CHARGER AND ELIMINATOR



- Charge Battery, Operate Set On AC, or Both
- Isolated Transformer — Shock-Proof

3⁴⁵

Just plug into any 117-volt AC receptacle and recharge your old 9-volt battery for many hours of extra use; or operate your set indoors without using the battery at all; or you can both charge battery and operate set at the same time. Has 4-position switch for above functions plus off position and pilot light. Size: 4Wx1½Hx2½"D. Imported.

99 A 9021 Shpg. wt., 1 lb. Net 3.45

BATTERY CHARGER AND ELIMINATOR

The dry cell battery recharger and eliminator will replenish your supply of flashlight batteries. Recharges "C," "D" and "Z" cell batteries in 2 to 4 hours—keeps battery-operated toys always on the go. It's a battery eliminator too—simply plug into any 110V AC outlet. Delivers 4 to 6 V. DC for "recharge" or "eliminate." Shpg. wt., 1½ lbs.

33 A 7701 Net 4.95



LAFAYETTE'S Revolutionary Color LVL*

SALE!

Save Up To
\$4.00

COLOR
Approved

OUR NEW "HIGH POWER" ALL-CHANNEL (2-13) *LAFAYETTE "VECTOR-LOG"® SWEEP-ELEMENT ANTENNA DESIGNED FOR VHF-TV AND FOR DYNAMIC FM

As Low As **849**

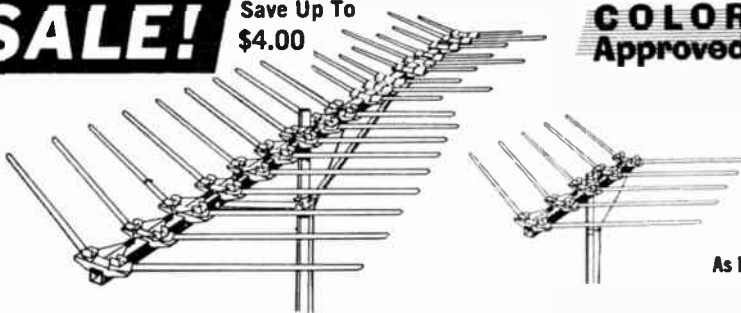

- The finest For Color or Black-White Pictures... Plus FM
- Excellent Front-to-Back Ratio... High dB Gain
- Sharp-Narrow Gain Pattern and Selectivity
- Flat TV Color Response—Plus Stereo, Mono FM Signal
- Protective Goldenized Finish

The revolutionary LVL*... five models to choose from for ideal performance. Offers such exceptional quality features as: Heavy aluminum reinforced insulator cups—heavy duty aluminum rivets—special back-up brackets and square booms! Triple thick combination sleeved elements assure great ruggedness—double contact drive line—and air-insulated spacers provide maximum signal delivery to set. Less mast and twin lead.

Stock No.	Range	Elements	Shpg. wt.	Net
18 A 0159WX	75 miles	5	5 lbs.	8.49
18 A 0160WX	100 miles	7	7 lbs.	11.95
18 A 0157WX	125 miles	10	10 lbs.	17.49
18 A 0159WX	150 miles	15	13 lbs.	23.49
18 A 0161WX	175 miles	18	16 lbs.	26.99

FAMOUS COLOR 'TENNA

UP TO 125 MILES OF POWER FRINGE RECEPTION

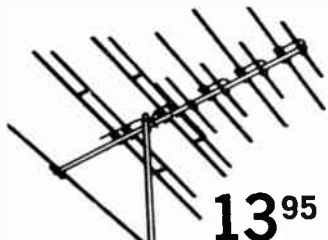

1395

- Engineered for Superior Color & Black and White Reception
- High Gain on All VHF Channels

Twin-driven elements work with carefully tuned, phased and spaced directors and reflectors to extend flat high gain response across entire VHF band. Cuts out ghosts and unwanted signals. Rugged reinforced aluminum elements and brackets stand up under most severe wind and ice loading. 100% pre-assembled for easy installation. Less mast, lead-in. Shpg. wt., 7 lbs.

18 A 0101WX

Net 13.95

POWER BEAM VHF ANTENNA

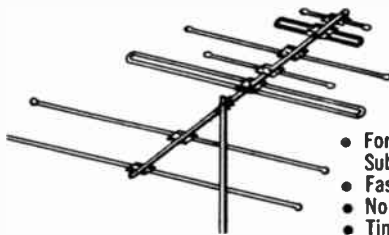

764

- For Local And Suburban Reception
- Fast Installation
- No Loose Parts
- Time Proven Design
- Goldenized

The ideal metropolitan and suburban VHF TV antenna. Broad-band, sharply directive. Full length elements, all aluminum construction, famous in-line design. 300-ohm impedance match reduces stray reflections and ghosts. Fiberglass insulators for maximum strength and weather protection. Less mount and lead-in. Shpg. wt., 6 lbs.

18 A 0102WX

Net 7.64

FAMOUS COLOR 'TENNA

UP TO 150 MILES OF EXTRA POWER FRINGE RECEPTION

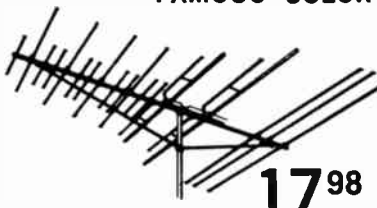

1798

- In-line Twin-Driver, Yagi Design
- Deep Fringe Gain on All VHF Channels
- Completely Pre-assembled

Delivers the extra picture power needed for crisp, clear pictures in remote areas. In-line twin driven yagi design provides more gain and higher front-to-back ratio. Result: More TV stations, more picture power. Factory preassembled for snap-out assembly. Reinforced gold anodized aluminum construction. Less mast and twin lead. Shpg. wt., 10 lbs.

18 A 0103WX

Net 17.98

MAXIMUM PERFORMANCE FRINGE ANTENNA

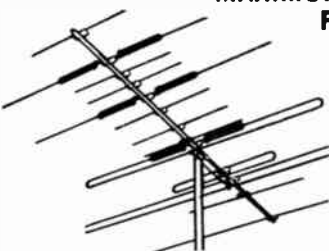

1188

- Range to 100 Miles
- 21 Active Elements
 - Snap Open Design
 - Fiberglass Insulators
 - Compound Yagi Array

GOLDENIZED

Field proven design for fringe reception. Gold anodized to combat corrosion. Compound yagi array intercepts signals where other designs fail. "Tension-lok" hardware. Heavy wall tubing throughout. Less Mast. Shpg. wt., 8½ lbs.

18 A 0104WX

Net 11.88

Select A Complete Antenna Installation Kit From Listing Below

"U-INSTALL-IT" KITS

All the items for simple installation. Your choice of an all angle roof mount or chimney mount—lightning arrester—75 feet of 300 ohm twin lead—screw eyes—mast stand offs and 5 ft. 1¼ O.D. steel mast. Shpg. wt., 9 lbs.

18 A 0118W	With Roof Mount	Net 3.25
18 A 0106W	With Roof Mount and 10 ft. Mast	Net 3.49
18 A 0119W	With Chimney Mount	Net 3.89
18 A 0127W	With Chimney Mount and 10 ft. Mast	Net 4.25
18 A 0120WM	With Alum. Wall Brackets	Net 3.99
18 A 0121WM	With Alum. Wall Brackets and 10 ft. Mast	Net 4.25

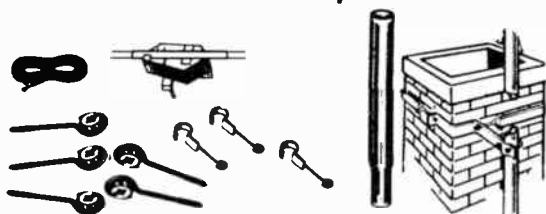

LAFAYETTE Super Color 'Tenna

**COLOR
Approved**



REVOLUTIONARY PERMA-GRIP MAST CLAMPS

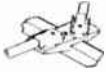

MASSIVE ELEMENT BRACKETS



RUGGED MAXIMUM TRANSFER INSULATORS



PROTECTED LEAD WIRE TERMINALS

As Low As

9⁹⁵

- Goldenized Finish
- 1" Square Boom
- Completely Preassembled
- High Gain For Clear, Sharp Color Pictures

Truly a deluxe antenna for Color and Black and White TV reception as well as FM and FM Multiplex. Good impedance match gives maximum transfer of signal and minimum noise pickup. Narrow polar pick-up pattern minimizes ghosts and interference. Perfect alignment is maintained by double locks on the elements. Easy mounting with "Gator Grip" mast clamp and preassembled, flip open elements. Protected lead wire terminals. Also features: high front-to-back ratio flat response. "Goldenized" finish for long life and better performance. Less mast and twin lead.

Stock No.	Range	Elements	Shpg. wt.	Net
18 A 0156WX	75 miles	8	8 lbs.	9.95
18 A 0155WX	100 miles	12	9 lbs.	13.39
18 A 0154WX	125 miles	16	12 lbs.	19.95
18 A 0153WX	150 miles	22	14 lbs.	24.50
18 A 0152WX	175 miles	31	17 lbs.	32.50

"TECNI-POWER" DEEP FRINGE ANTENNA



- 22 Active Elements
- Range To 140 Miles

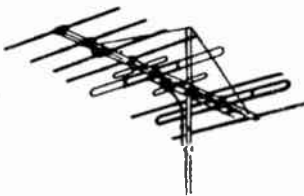

GOLDENIZED

TV antenna obtains maximum front-to-back ratio without sacrifice of gain on either low or high band! 18 active elements on high band and 4 on low band. Multiple reflectors and directors, combined with the colinear elements sharply increase the directivity. Broadbanded for all VHF Channels 2 through 13. All aluminum screws and nuts to eliminate rusting at vital contacts; tagged connection points; "molded-in" lead line connection screw, and lifetime high impact polystyrene insulators and end caps to prevent whistle and icing. Shpg. wt., 9½ lbs.

18 A 0117WX Goldenized Net 17.95

LAFAYETTE TRANSISTORIZED 4-SET TV/FM BOOSTER

14⁹⁸

- Amplifies Signals for Reception on Up to 4 Sets
- Easy to Connect and Economical to Operate
- Can Be Mounted in any Location, in any Position

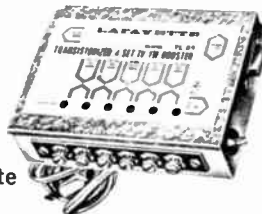

If your antenna isn't pulling in signals of sufficient strength then this Lafayette Booster Amplifier is just what you need. Screw-on terminals make wire connections easy, no cutting is necessary. Transistor circuit runs cool, draws little current. Signal strength is boosted 3 to 5 times. Will operate up to 4 TV and or FM sets on the same antenna. Input impedance is matched to antenna impedance. Needs no adjustment. Isolated outputs insure maximum set separation. Can be mounted in any convenient location where adequate ventilation is provided. Size 4¾Wx1¼Hx3½"D. For 117 volts, 60 cps AC. Shpg. wt., 1 lb. Imported

99 A 4011 Net 14.98

20 ELEMENT STACKED SNAP OPEN CONICAL ANTENNA

- All Aluminum
- No Loose Parts
- Fastest Installations

5⁹⁵

GOLDENIZED

All elements snap open and lock in without tools. Efficient conical design for all reception areas. Two complete bays with Q bars, less mast. Shpg. wt., 8 lbs.

18 A 0105WX Singly, ea. 5.95

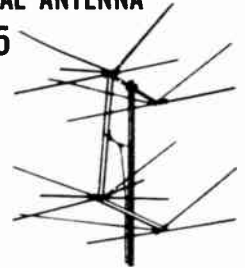

LAFAYETTE COLOR-AMP TRANSISTORIZED TV/FM ANTENNA BOOSTER

**COLOR
Approved**

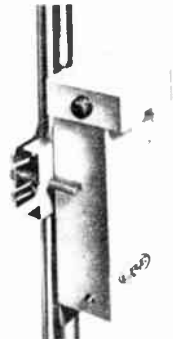

24⁹⁵

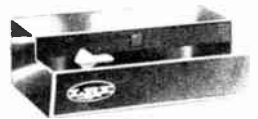

- Gain 20db/Up
- Built-in 2-Set Coupler
- Uses Low Noise, High Gain Solid-State Circuit
- Use With Any Outdoor TV or FM Antenna
- AC Isolation Transformer—No Shock Hazard

Improve the performance of any new or existing outdoor TV/FM antenna. Efficient solid-state design utilizes reliable silicon transistors for more than 20 db gain across the entire band. Compact, lightweight construction permits mast mounting for maximum transfer of energy. Metal case is weatherproof with built-in lightning-protected circuit and high-pass filter which rejects CB and other interference. Separate power supply plugs into any 110-volt house outlet. . . . No batteries required. Consumes less power than an electric clock. Handles up to 2 TV or FM receivers. Uses standard 300 ohm twinline. Imported. Shpg. wt., 2 lbs. Complete with instructions.

99 A 4018 Net 24.95

All Channel Electronic Rotating TV Antennas

ALL CHANNEL'S "RIVIERA" POWERFUL ULTRA-FRinge VHF-FM ANTENNA

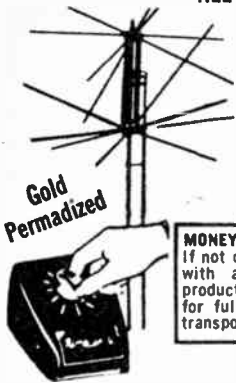

19⁸⁵

MONEY BACK GUARANTEE
If not completely satisfied with any ALL CHANNEL product, return at once for full refund, less only transportation charges.

- Guaranteed 200 Mile VHF Reception or Your Money Back
- Broadband VHF and FM, motorless all direction reception
- Receives channel 2-13 from all directions without a rotor
- All aluminum flip-out assembly

Field tests reception on VHF of up to 200 miles has made possible this unprecedented guarantee. This most powerful ultrafringe antenna may be used for receiving TV channels 2-13 and the FM broadcast frequencies. Perfect for application where color TV or FM multiplex signals are extremely weak due to distance from transmitting antenna and to other receiving conditions. Here is an antenna with only one transmission line for all VHF and FM stations in all directions within a 200 mile radius without the use of a motorized rotor. The nine position selector switch conveniently connected at the set electronically rotates the antenna beam pattern instantly without physically moving the antenna. Superb gain on channels 2-6 comparable to stacked 10-element single channel yagis. 16" doweled aluminum elements are 60 inches long. Complete with switch, coupler, 45" stacking bars and 2-7½" angle type mast insulators for Polymalene line listed below. Shpg. wt., 10 lbs.

18 A 1201WX Less Mast Net 19.85
"U-Install-It" kit: Includes Riviera antenna, chimney mount, two five ft. masts, 100 ft. of Polymalene 4-conductor lead-in wire, 8 stand off insulators and complete instructions.
18 A 1202WX Shpg. wt., 16 lbs. Net 27.32

THE RIVIERA MUST BE USED WITH THE LOW LOSS LEAD IN WIRE LISTED BELOW

Special 4 conductors, matched impedance transmission line. Low loss, mica-filled Polymalene copperweld conductors.

32 A 1001W 50 ft. length Net 5.00
32 A 1002W 75 ft. length Net 7.50
32 A 1003W 100 ft. length Net 8.90

ALL CHANNEL COMPONENT PARTS

18 A 1204 12-Position Switch Net ea. 5.93
18 A 1205 Stacking Harness Net ea. 2.87

LAFAYETTE COLOR TV/FM COUPLER

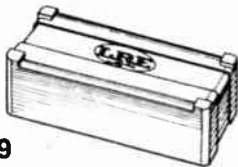

1⁴⁹

- Low Signal Loss
- For Two Set Operation

Ideal for operating two TV and/or FM receivers from a single antenna. Has low loss and high isolation between sets. Easy to connect with one antenna downlead. Supplied with indoor/outdoor universal mounting hardware. Imported. Shpg. wt., ½ lb.
99 A 4019 Net 1.49

LAFAYETTE 4-SET COLOR TV/FM COUPLER



2²⁹

- For Up To 4 TV/FM Sets
- Mounts On Set, Wall or Baseboard

For operation of up to four TV and/or FM sets with a single broadband antenna connection. Gives complete isolation between sets. Low forward loss makes it ideal for use with color TV and FM stereo sets. Imported. Shpg. wt., ½ lb.
99 A 4020 Net 2.29

LAFAYETTE TV/FM SPLITTER - COUPLER

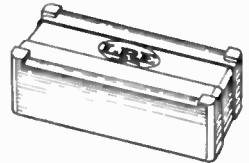

2⁹⁵

- Splits TV and FM Signals From All-Band TV Antenna
- Low Signal Loss

Splits TV and FM signals with minimum loss to either signal from a single broadband antenna. Also combines separate TV and FM antennas into one line. Gives complete isolation between sets. For indoor or outdoor mounting. Imported.
99 A 4201 Shpg. wt., ½ lb. Net 2.95

ALLIANCE TENNA-ROTORS

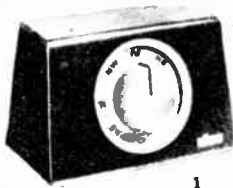

1

- Restyled, Redesigned for Faster, Smoother, Efficient Operation
- Magnetic Brake Provides Instantaneous Stop
- Full 360° Rotation—1 RPM
- Factory Lubricated for Life
- Reinforced Zinc Die Cast Housing
- All Weather Protection

Model U100 (1 & 2)—Fully automatic just set control knob and antenna rotates to desired position and stops automatically. Indicator shows position of antenna. Has positive mechanical stop at the end of rotation. Size: Rotator 7¾x5¼x8". Control Case 7x4½x4" 110V, 60 cps AC at 65 watts. Uses 4 cond. cable.
18 A 1403W Shpg. wt., 12 lbs. Net 28.20

Model T-45 (2 & 3)—Slight pressure on the control bar rotates antenna through its full 360° cycle and stops at any point by releasing the bar. 5-wire bridge type circuit provides a precision system that is unaffected by motor current, cable length and line voltage variations. Factory lubricated for life. Completely moisture sealed. Uses 5-conductor cable.

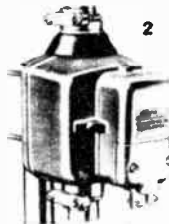

2



3



4

18 A 1402 Shpg. wt., 12 lbs. Net 23.55
TBB THRUST BEARING BRACKET increases stress capacity to 300 lbs. Wt., 3 lbs.
18 A 1405 Net 2.91
4 Conductor flat cable, Shpg. wt., 3 lbs. per 100 ft. Net 2.50
32 A 8910 per 100 ft. Net .20
32 A 8911K less than 100 ft. per ft. Net .03
over 100 ft. per ft. Net .25

5 Conductor Cable, Shpg. wt., 4 lbs. per 100 ft. Net 2.97
32 A 3631 per 100 ft. Net .20
32 A 3630K less than 100 ft. per ft. Net .04
over 100 ft. per ft. Net .29

UHF Converters—Antennas—Accessories

FINCO U-VERT 200 UHF CONVERTER

- Electronic Circuit for Local and Suburban Reception
- Illuminated Dial for Easy Tuning
- Convenient AC Outlet

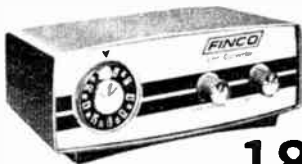

18⁵⁷

A deluxe, all transistor converter featuring a powerful electronic circuit that makes it ideal for use in local as well as suburban areas. Exclusive ultra-clear fine tuning dial, plus an illuminated channel-tuning dial, ensures easy channel selection. Handsomely styled, durable plastic cabinet looks "just right" on top of the TV cabinet. Easy to install with just a screwdriver. Uses sensitive circuit to provide low noise and picture-perfect reception. AC convenience outlet. Overall size 8x5x3 1/4". Meets all FCC requirements. For 110-120 volts, 60 cps, AC. Shpg. wt., 2 1/4 lbs.

18 A 3032

Net 18.57



BLONDER TONGUE BTX-11A UHF CONVERTER/AMPLIFIER

28⁹⁵

- Amplifies Signal 3 Times
- Illuminated Dial

for Precise Channel Tuning

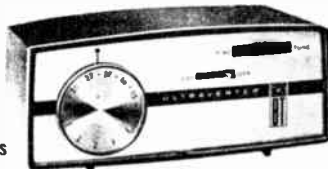

Adds all UHF channels (14-83) to your TV set anywhere within the range of a UHF station. Features a new dual speed 100 to 1 fine vernier and illuminated dial for easy tuning; double tuned UHF input circuits and shielded oscillator section for interference-free reception. AC convenience outlet. Rugged, reliable patented tuner; spliceless, stripless terminals. For 110-120 volts, 60 cps, AC. Shpg. wt., 2 lbs.

18 A 1831

Net 28.95

ECONOMY UHF ANTENNA

- Highest Gain on 70 UHF Channels
- Completely Preamsembled
- Excellent Directivity

4⁵⁰

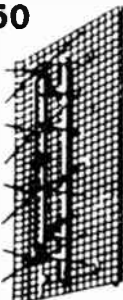

Four bay, UHF bowtie antenna. Exceptionally high (12db) gain — relatively flat across the entire spectrum... Fully factory assembled. Quickest and easiest to install. High efficiency screen grid reflector boosts front to back ratio. Unique "cross-over" phasing bars — open V elements. Rugged — rigid — corrosion resistant construction. Shpg. wt., 5 lbs.

18 A 0142WX

Net 4.50

UHF "TRANSLATOR" 4-BAY ANTENNA

Four bay bow-tie and screen reflector — tuned to the UHF translator frequencies. Average 16db gain on channels 70-83. Completely preassembled.

18 A 0143WX Shpg. wt., 5 lbs.

Net 4.50

POWRSOPE UHF ANTENNA

Powerful UHF Fringe Antenna

- Positive Big Screen Ghost Rejection
- 18 db Gain at Translator Frequencies
- 13 db Gain over UHF Spectrum
- Quick, Strong Installation

12⁹⁹



True Parabolic Focal Design

The most powerful UHF fringe antenna — proven by performance in the toughest fringe and translator UHF areas. Unique parabolic design exceeds the capture area of 12 and 16 bay car's whisker type arrays. Single dipole provides maximum signal without phasing harness. All metal construction reduces signal loss due to weather deterioration. Pre-assembled screen and dipole are installed in minutes for maximum performance and reliability. Shpg. wt., 10 lbs.

18 A 2401WX

Net 12.99

AC-TV RECEPTACLE AND WALL PLATE

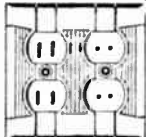

Duplex AC receptacle and duplex TV receptacle on one 2 gang wall plate. Puts both outlets in one location. Use with standard wall box. Ivory only. Shpg. wt., 6 ozs.

18 A 7006

Net 1.39

Molded 2 contact plug for 300 ohm lead.

18 A 7013

Net .18

Rotor combination plates. Similar to above except includes 4 conductor rotor outlet in place of one 2-wire outlet. Shpg. wt., 6 oz.

18 A 7003

Net 1.61

Molded 4 contact plug for rotator lead.

18 A 7005

Net .34

LAFAYETTE UHF/VHF ANTENNA COUPLER

Only 1⁹⁹

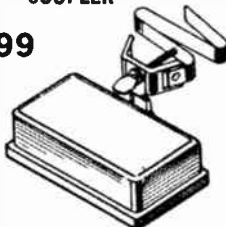

- Weatherproof Plastic Case
- Mounts on Mast
- Combines UHF and VHF Antennas Into Single Line

This efficient UHF/VHF coupler combines the signal from the separate UHF and VHF antennas into a single transmission line. Features maximum signal transference with extremely low insertion loss. Mounts easily on mast. Sturdy, weatherproof plastic case with metal clamp. Imported. Shpg. wt., 1/2 lb.

99 A 4016

Net 1.99

ECONOMY 300-ohm TWIN LEAD



100 FT.

99¢

High quality — heavy gauge — all purpose twin lead. Perfect FM/TV transmission line. Polyethylene insulation. Shpg. wt., 2 lbs.

32 A 8912

Net .99

LAFAYETTE TV/FM WALL PLATES

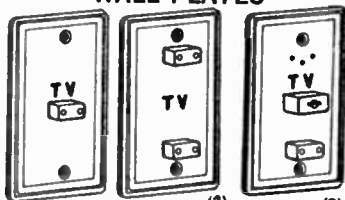

- Fits Standard Outlet Box
- Complete with Plugs and Mounting Bracket

SINGLE TV/FM WALL PLATE

(1) Single TV/FM wall plate which can be used to neatly custom install an antenna system. Plug is polarized and designed to accept a 300-ohm twin lead line. Ivory finish. 99 A 4013 Shpg. wt., 1/4 lb. Net .69

DUPLEX TV/FM WALL PLATE

(2) A dual TV/FM wall plate designed to supply two signal sources. Can be used for two different TV antennas each oriented in a different direction or a TV and FM antenna. Plugs are slotted for 300-ohm twin lead. Ivory finish. Imported.

99 A 4014 Shpg. wt., 1/4 lb. Net .99

TV-FM ROTOR WALL PLATE

(3) Combines two polarized dual conductor plugs with a four conductor polarized rotor receptacle. Flexible design allows easy installation. Screw type sturdy terminals are solderless. All plugs are slotted to accept standard rotor and twin line cables. Ivory finish. Imported.

99 A 4015 Shpg. wt., 1/2 lb. Net 1.19

FOAM TV TWIN LEAD

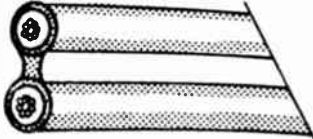

- For UHF-VHF and Color TV

A flat 300-ohm twin lead with each conductor encased in polyethylene foam with an outer black polyethylene jacket. Has high resistance to ultra-violet rays, oil, fumes, moisture, salt air and abrasion. 20-gauge stranded copper conductors. Available only in lengths listed below. Shpg. wt., 2 1/2 lbs. per 100 ft.

32 A 3603 50-ft. Coil Net 1.75

32 A 3604 100-ft. Coil Net 3.25

LAFAYETTE "MULTIPLEX 10 EXTENDED RANGE FM ANTENNA"

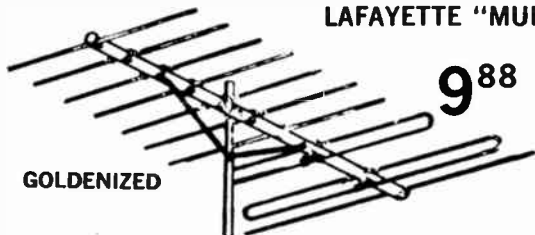

9⁸⁸

GOLDENIZED

- 10-Element Yagi Array
- All-Aluminum Construction
- Fibreglas Insulators

Ideally suited to Multiplex FM reception. This 10-element, double-driven, yagi array has the necessary added gain, sensitivity of signal strength. All-aluminum gold anodized construction. Fibreglas insulators. Torsion lock hardware. Sure-lock mast clamp. Shpg. wt., 7 lbs. **18 A 0126WX** Net **9.88**

LAFAYETTE ULTRA-LITE FM ANTENNA

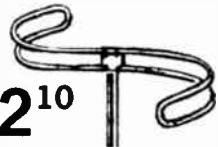

2¹⁰

- Solid Rod Elements
- Perfect for Indoor Concealed Installations

Here is the FM antenna you have been waiting for. Designed for either outdoor mast or indoor closet/attic installation. Easy to install — no holes to drill. Provides excellent gain for areas up to 35 miles from station. Perfect for multiplex reception. Brings in all stations clearly. Gold corodized finish for weather and corrosion protection. Strong, yet lightweight design. Shpg. wt., 1 lb.

18 A 0134

Net **2.10**

FM Antenna Kit

Same as above, but with kit containing 50 ft., 300 ohm line, 3-3/4" Stand-off; 1-7/8" stand-off and 1 mast wrap around stand-off. Shpg. wt., 3 lbs.

18 A 0135

Net **3.23**

FM STEREO-PLEX ANTENNA

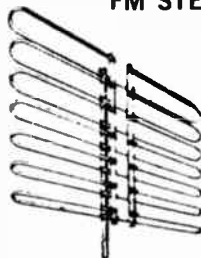

8²⁵

The Model FM-88 Seven-Element Stereo-Plex FM antenna is the first antenna designed specifically for Multiplex Stereo FM. An omni-directional antenna with triple the power of crossed dipoles . . . and four times the power of "S" shaped FM antennas. All aluminum construction. Receives from any direction at distances up to 40 miles from the station. Shpg. wt., 4 lbs. **18 A 2400W** Net **8.25**

NO RUST BARGAIN MOUNT



1⁹⁸

The ideal chimney mount for life-long satisfactory service under the most severe conditions. Heavy gauge aluminum brackets. Two 12 ft. stainless steel straps and stainless steel seals. Shpg. wt., 4 lbs.

18 A 6505

Net Each **1.98**

HEAVY-DUTY SUPER MOUNT

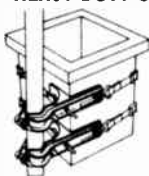

5²⁹

Each Lots of 3

A super-heavy pair of chimney mounts made of cast aluminum alloy. Extra strong and durable.

Will withstand the most severe weather conditions. Two 12 ft. stainless steel straps and stainless steel seals. Six aluminum corner brackets to protect chimney bricks. The most ideal and permanent installation for those who want quality and durability. Will hold masts up to 2" O.D. Shpg. wt., 5 lbs.

18 A 5601

Each **5.88**

Lots of 3, Each **5.29**

GC SPRAY KLEEN



97¢

Now get to those hard to reach places with this electronic contact-control cleaner. No need to dismantle chassis or components for cleaning. A must for every serviceman. Lubricates and cleans all contacts, controls, relays, switches and other moving components in one easy, efficient and fast operation. Simply apply and operate the mechanism several times. Will eliminate radio and TV noise due to dust, dirt and corrosion on electrical contacts.

6 oz. can. Shpg. wt., 12 oz.

18 A 8403

Net **3.97**

12 oz. can. Shpg. wt., 1 1/2 lbs.

18 A 8404

Net **1.90**

ANTENNA MASTS

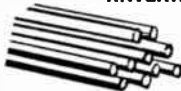

- Gold Anodized
- Lightweight
- Strong and corrosion proof

This Golden Anodized aluminum mast will outlast any antenna. Made of a tough, extra strong, drawn aluminum alloy. Two or more masts may be telescoped together.

18 A 3817W 5' wt. 1 1/2 lbs. Net **1.25**

18 A 5614WX 10' wt. 2 1/2 lbs. Net **2.39**

ALUMINUM MASTS. 19 gauge-heavy wall-high tensile strength. Rust and corrosion proof. Swaged for stacking.

18 A 3818W 5 ft. Wt. 1 1/2 lbs. .89

18 A 3819WX 10 ft. Wt. 2 1/2 lbs. 1.69

10 ft. Mast shipped via express only.

STEEL MASTS. New corrosion-resistant 5 ft. steel mast made to fit all antennas. One end is tapered. "Jam Fit" construction with locking key. 1 1/4" O.D.

18 A 5615W 5 ft. Wt., 2 1/2 lbs. .75

18 A 5616WX 10 ft. Wt., 4 1/2 lbs. .39

18 A 5617WX 10 ft., 16 gauge Wt., 8 lbs. 2.10

TELESCOPING TV MASTS



Heavy-duty telescoping masts, ideal for an TV antenna array. Hotdip zinc galvanizing inside and outside provides unusual ruggedness and impervious corrosion resistance. Designed for easy installation and assembly. Husky bolts lock sections automatically. No slipping, no twisting. Precision fitting assures lasting service. 18 and 20 gauge walls. Supplied complete with all guy rings, clamps and necessary hardware. Total 5 10-ft. sections for height up to 50 ft.; O.D.: #1 (1 1/4"), #2 (1 1/2"), #3 (1 3/8"), #4 (2"), #5 (2 1/4"). Shipping express only.

50-FT. MAST—Consists of all 5 sections listed above: Nos. 1, 2, 3, 4, and 5. Height 50 feet. Shpg. wt., 39 lbs.

18 A 5609WX Net **14.49**

40-FT. MAST. Consists of 4 sections: Nos. 1, 2, 3 and 4. Height 40 feet. Shpg. wt., 28 lbs.

18 A 5610WX Net **10.49**

30-FT. MAST. Consists of 3 section. Nos. 1, 2 and 3. Height 30 feet. Shpg. wt., 21 lbs.

18 A 5611WX Net **7.75**

20-FT. MAST. Consists of 2 sections. Nos. 1 and 2. Height 20 feet. Shpg. wt., 14 lbs.

18 A 5612WX Net **4.79**

ALL ANGLE BASE and ROOF MOUNT. Takes any mast up to 2 1/4" O.D. With hardware. Wt., 2 lbs.

18 A 5618 Net **3.99**



TV FILTERIZER

2⁹⁵

- Eliminates Most Television Interference

Easily adjusted to remove any antenna-fed interference causing picture distortion: FM, diathermy, SW, ignition, amateur/CB, adjacent channel, etc. Does not attenuate signal. Actually tunes out unwanted signal. Matches any antenna. Metal case finished in black enamel. Easily installed. Size: 4x2 1/4x1 1/2". Imported. Shpg. wt., 7 oz.

99 A 4017

Net **2.95**

TV INTERFERENCE FILTER

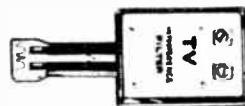

99¢

- K-Type High Pass Filter
- Attenuation From 0 to 54 MC
- No Soldering—Attaches in Seconds

Suppresses interference caused by amateur radio transmitters, small motors, auto ignition, and medical electronic equipment. Enjoy fine clear TV reception. Connection requires only a screw-driver. Shpg. wt., 1/2 lb.

99 A 4012

Net **.99**

LO-PASS LINE FILTER

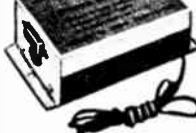

2⁴⁹

- Dual Ferrite Core Coils

Exceptionally efficient line noise eliminator. Utilizing dual ferrite core coils, heavily wound. Eliminates line noises caused by motors, industrial RF, neons, appliances, etc. Particularly useful on TV and FM sets, radios, tuners, record players. Automatic attenuation of unwanted disturbances. Imported. Shpg. wt., 1 1/4 lbs.

99 A 4005

Net **2.49**

NEW! LAFAYETTE 8-25X 30mm ZOOM SPOTTING SCOPE

13⁹⁵

- Any Power from 8X to 25X
- Quick, Fingertip Focusing
- Table-Top Tripod Included

An outstanding varipower spotting scope that is ideal for any "spotting" need in field or general use... shooters, bird watchers, etc. Features 30mm coated lens for brilliant viewing. Fingertip controls for quick zooming and focusing. Has a built-in camera tripod socket. Includes a table-top tripod with rubber-tipped legs that prevent scratching of furniture. Compact, lightweight and portable... ideal for taking it everywhere you go. Complete with black, zippered carrying case with convenient belt loop. Overall length of scope is 12". Imported. Shpg. wt., 3 lbs. **99 A 7192** Net 13.95



NEW! LAFAYETTE 20X 40mm SPOTTING SCOPE

19⁹⁵

- Portable, Compact Lightweight
- Coated Prismatic Lens
- Quality, Precision Workmanship

Extremely attractive spotting scope with 40mm coated lens. A complete assortment of accessories makes it ideal for use everywhere by everyone. Complete with black, zippered carrying case with belt loop, elevator table tripod with rubber-tipped legs, tripod adapter, pistol grip with convenient wrist strap, car window adapter. Overall length of scope, 10 1/2". Imported. Shpg. wt., 3 lbs. **99 A 7193** Net 19.95



• LAFAYETTE BINOCULARS AND SCOPE •



- All Lenses Are Coated!
- Sealed Against Dust & Moisture

Precise design, quality material and expert workmanship. All center focus; adjustable right eye-piece. Leather case, neckstraps included. Imported.

- 7x35 Popular, versatile, all-purpose binoculars. **99 A 7018** Shpg. wt., 3 lbs. Net 19.95
- 7x50 Navy style night glasses. Favored for marine use. **99 A 7016** Shpg. wt., 3 1/2 lbs. Net 24.95
- 20x50 King of the long range. **99 A 7020** Shpg. wt., 4 1/2 lbs. Net 29.95



- Wide angle view
- Fully adjustable

A multi-purpose 7x35 mm binocular which is especially useful in field studies. Wide angle view allows brilliant and close-up views of sporting events without cutting the image as regular narrow angle binoculars do. Field of view at 1000 yards. is 525 feet! Center focus and right eye adjustment insures perfect focus. All optics are coated. Lined leather case provides protection when not in use. Imported. **99 A 7019** Net 29.95



TRU-ZOOM™

- Not a "Vari-Power," One Control Zooms both barrels!
- Center Focus, Adjustable Right Eyepiece, plus Single Synchronous Zoom Control!

Sight in subject at 7 power—then Zoom up to 12 power (or any four in between) for closeup viewing power. 40 mm objective lenses are hard coated achromats. Field of view is 290 feet at 1000 yards at 12 power (5.5°). Prisms in shock-resistant mounts. Lightweight alloy frame and body. Includes lined hard leather case and straps. Shpg. wt., 5 lbs. Imported. **99 A 7108** \$5 Monthly Net 44.95

"THE BIG EAR"

12⁹⁵

- Big 18" Reflector Disk

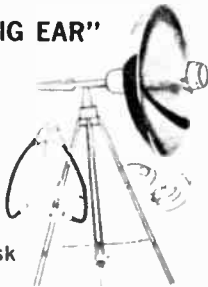

Powerful new transistorized listening device. Not just a toy—works on the same principle as the fabulous Missile Tracking Antennas. Pick up sounds too distant for you to hear. Complete with sturdy tripod and stethoscope-type earphones. Uses one 9V Battery (not supplied). Shpg. wt., 5 lbs. **13 A 2510W** Net 12.95

- 99 A 6021** 9V Battery for above Net .21

MAGNA-SIGHTER® 3-D BINOCULAR MAGNIFIER

- Leaves Hands Free
- Reduces Eyestrain
- 3-Dimensional!

7⁸⁸



A precision optical instrument enabling anyone to do very close work and see it clearly in 3 dimensions. Adjusts to any head size comfortably. No moving parts to replace. Ideal for hobbyists, repairmen, inspectors and technicians. Available in 4 sizes. Shpg. wt., 3/4 lb.

- 15 A 2001** 1.75X, 14" Working Distance Net 7.88
- 15 A 2002** 2.25X, 10" Working Distance Net 7.88
- 15 A 2003** 2.75X, 8" Working Distance Net 7.88
- 15 A 2004** 3.5X, 4" Working Distance Net 9.38

4X RIFLESCOPE



- Lightweight—only 6 1/2 ozs.
 - Hard Coated Lenses
 - Internal Adjustments
 - Cross Hair Reticule
- 5⁸⁸**

Popular, all-around scope for the small game hunter. Bright field, approx. 30 feet at 100 yards. Eye relief distance from 3 1/2 to 4 1/2 inches. Eyepiece diameter, 1" tube diameter 3/4". Hard coated, achromatic lenses reduce glare. Internal windage and elevation adjustments for positive "zero-in." Fine, cross hair reticule pinpoints target. Featherweight, weather-resistant, precision built. Easy, fast installation with all .22's with grooved receivers, some air rifles. Imported. Shpg. wt., 1 lb. **99 A 7160** Net 5.88

Lafayette Lamps... Electrical Accessories

LAFAYETTE HIGH INTENSITY LAMP

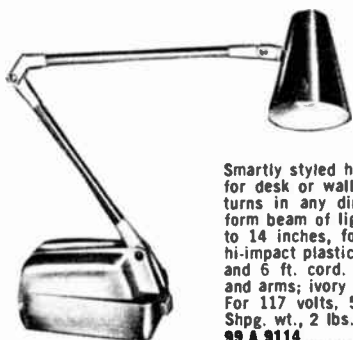

ONLY
4⁹⁵

Smartly styled high intensity lamp ideal for desk or wall mounting. Lamp shade turns in any direction throwing a uniform beam of light. Hinged arm extends to 14 inches, folds flat against rugged hi-impact plastic base. Has on-off switch and 6 ft. cord. Gold finish lamp shade and arms; ivory base. Uses No. 93 lamp. For 117 volts, 50/60 cycles. Imported. Shpg. wt., 2 lbs.
99 A 9114 Net 4.95

LAFAYETTE CLAMP-TYPE "DRAFTING LAMP"



7⁹⁹

- Spring Controlled Swivel Joints
- Extends To 30 Inches
- Perfect Illumination Anywhere

A deluxe lamp from Lafayette for perfect illumination wherever you require it. Ideal for benches, tables, and drafting boards. Clamps securely to any surface up to 3" thick. Spring controlled swivel joints and double arm action moves light in any direction. Protects your eyes. Arm extends to 30". Comes in neutral color to blend with any decor. For 110-125V, 60 cycles AC. Comes less bulb. Imported. Shpg. wt., 9 lbs.
99 A 9077 Net 7.99

LLOYD'S 5-WAY LIGHT

- High Intensity Lamp
- High-Low Intensity Switch



WALL LAMP



SPOT LIGHT



NIGHT LIGHT



TV LAMP

12⁹⁵

A unique high-intensity lamp efficiently suiting a variety of purposes. May be used as a desk and wall light, night light, spot, and TV lamp. Features two stylish cylinders with chrome arm and wall bracket—practical as well as attractive. Reflector rotates full 180° for maximum high intensity illumination wherever required. Comes complete with bulb. Shpg. wt., 2 lbs.
12 A 4550 Net 12.95

ALL PURPOSE LAMP



14³⁸

Ideal for factory benches, tables and drafting boards. Two bolts clamp base securely to any surface up to 3" thick. Spring-controlled swivel joints and double arm action give you light in any desired position. Arm extends 36". Uses two T8, 15-W lamps. For 110-125V., 60 cycles AC. Bronze finish. Less lamps. Shpg. wt., 10 lbs.

T8, 15-watt, cool white lamp Net 14.38
12 A 1002 Net ea. .92

NEW LAFAYETTE UNDER CABINET LAMP

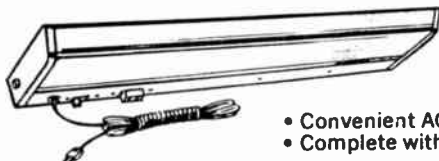

As Low As
4⁹⁵

- Convenient AC Outlet
- Complete with Bulb

An extremely functional lamp, ideal for glare-free light over kitchen or shop work counters. Shallow design, only 1 1/4" deep. Complete with fluorescent lamp, built-in AC outlet, 7-foot line cord. White. Imported. Shpg. wt., 4 lbs.

99 A 9119 15-Watt Lamp; 18 1/2" long Net 5.95
12 A 1002 15-Watt Replacement Bulb Net .92
99 A 9120 8-Watt Lamp; 12 1/2" long Net 4.95
12 A 1007 8-Watt Replacement Bulb Net 1.39

LAFAYETTE LUMEN-AIRE

- Universal All-Angle Fixtures
- Indoor-Outdoor Use

Weather-proof flood or sealed-beam spotlight fixture for permanent or portable locations. Lumen-Aire comes complete with reflector and all hardware (less bulb). Shpg. wt., 1 1/2 lbs.

Lumen-Aire Flood-light
99 A 9094 Imported Net 9.95
150W floodlight bulb Net 1.25
12 A 1102
Spot-Light Lumen-Aire
99 A 9095 Net 5.95
150W Spot light bulb Net 2.15
12 A 1103 Net 2.15



5⁹⁵

LAFAYETTE AUTOMATIC PHOTO-ELECTRIC 'LUMINATOR

ONLY
4⁹⁵

- Automatic Light Switch
- Lights on at sunset—off at sunrise



Photo-electronic, light-sensitive switch turns lights on and off at dusk and dawn. You need never come home to a darkened house. Just plug it in for protection from prowlers—illuminate outdoor areas—any place you require automatic illumination. Measures only 3 3/4"-2 1/2"-2 1/4". Use on 117-volt AC only. Maximum 300 watts lamp load. Instruction included. Shpg. wt., 1 lb. Imported.
99 A 9084 Net 4.95

NEW! LAFAYETTE 'LUMINATOR SR.

Automatic Light Control Handles up to 1000 Watts



5⁹⁵

- Turns Lights On and Off Automatically
- For Permanent or Mobile Installation
- Never Needs Setting

A light-sensitive photo-electric switch that turns your lights on and off automatically at dusk and dawn. Has a capacity of 1000 watts so you can control several fixtures if you desire. Color-coded 6-foot 3-wire cord can be permanently connected to a fixture or wire it to the plug listed below for mobile or temporary installations. Water-proof construction makes it ideal for outdoor use. Housed in clear plastic case measuring 4x2x2". For 105-130V, 50-60 cps. Shpg. wt., 1 lb.
99 A 9115 Net 5.95
Plug for adapting 'Luminator Sr. to mobile use.
12 A 5050 Net .35

New! Intermatic Malibu Outdoor Lighting System

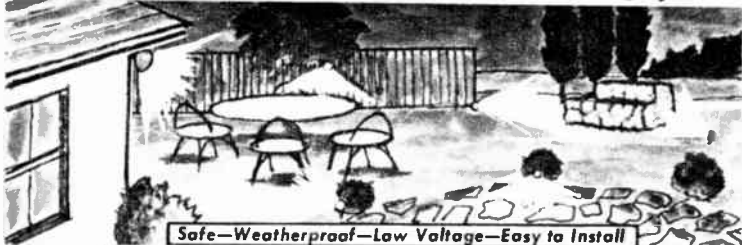

Safe—Weatherproof—Low Voltage—Easy to Install

Now decorate your home with light. Provide safe, economical illumination for walks, steps, driveway, garden, etc. Heavy-duty transformer reduces 110 volt AC to harmless 12-volt current which powers the lights. Easy to install . . . just spread the cable and attach the lights anywhere—on ground, on walls, in trees. Any lamp may be easily moved to another location on the cable, or reposition the complete system in minutes. All components are weatherproof; heavy-duty low-voltage cable is plastic coated for outdoor protection and re-seals itself when the lamp pins are removed. Sealed beam type lamps used throughout. Optional timer provides completely automatic on/off operation. Complete system includes lights, 50' wire with 3-light set or 100' wire with 6-light set, mounting stakes, wall brackets, assorted color lens coverings, transformer. Shpg. wts.: 3-lt. set, 21 lbs., with timer 23 lbs.; 6-lt. set, 27 lbs., with timer 29 lbs.

13 A 2738 3-Light Set	Net 37.95
13 A 2739 3-Lt. Set with Timer	Net 47.95
13 A 2740 6-Light Set	Net 57.95
13 A 2741 6-Lt. Set with Timer	Net 67.95

Additional Lamp Housing. Complete with seal beam unit, ground stake, wall bracket, clear lens. Shpg. wt., 3 lbs.	
13 A 2743	Net 5.95



as low as
37⁹⁵

Additional 50' Low Voltage Cable.	
13 A 2742 Shpg. wt., 2 lbs.	Net 5.95
Set of 3 Lenses	Net per pkg., 1.25
13 A 2744 Clear	
13 A 2745 Red	13 A 2748 Blue
13 A 2747 Green	13 A 2746 Yellow

YARD 'N PATIO LIGHTER

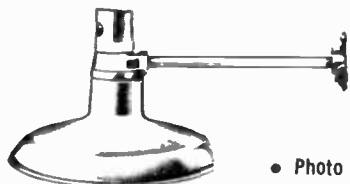

- Photo Electric Controlled

18⁷⁵

A complete photoelectric lamp system, to provide automatic lighting when you want it in your yard or patio. Control unit is completely weather protected. External switch leg provides instantaneous control of other lights up to 650 watts combined. Includes: Std. 1/2" aluminum pipe 13" long, mounting bracket and photo control. Overall length 22" (with reflector). 14" wide (with reflector). For 105-130V 50/60 cycles AC.

13 A 2728 Shpg. wt., 4 lbs.	Net 18.75
-----------------------------	-----------

SWITCH OPERATED LAMPHOLDER AND OUTLET BOX

- Portable, Unbreakable, Weatherproof
- Provides Light and Current where Needed

6⁹⁵

Weatherproof power source with a built-in lampholder. Designed to provide power and illumination outdoors. Fills the need for garden and patio lighting. Built-in AC receptacle can supply power to electric tools, barbecues, etc. With control switch. All plastic unbreakable construction insures no metal corrosion. Has individual "stay-open" hinged switch/outlet covers. Attached stake allows easy installation. Complete with 20' of #18 three wire cord. Shpg. wt., 2 1/2 lbs.

12 A 4800	Net 6.95
-----------	----------



ELECTRIC OUTLET CONTROL CENTER

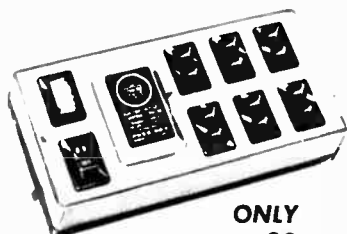

ONLY 4⁹⁹

- Adds 6 Extra Outlets Wherever Needed
- For Use in Home, Office, Industry
- Mount on Bench or Wall, or Keep Portable

If you need extra outlets, you need this Electric Outlet Control Center. Has six individual outlets with its own built-in fuse box. Finger-touch control on-off rocker switch with jeweled on-off indicator panel light. Heavy duty line cord for use in the home, office and industry too. Complete with mounting screws for permanent installation on wall or bench, or use it as a portable control center. For 110/120 V AC/DC, 1500 watts, 15 amps. Less fuse. Shpg. wt., 1 lb. Imported.

14 A 2103	Net 4.99
13 A 1170 Box of 5 10-amp fuses	Net .28
13 A 1171 Box of 5 15-amp fuses	Net .28

3 WAY POWER CONTROL

ONLY 2⁴⁹



- Individually Switched Outlets With Indicator Lights

Switchable power outlet box for wall or bench mounting. Three individually controlled outlets, each with its own indicator light. Measures 4x2 1/2 x 1 3/8". Equipped with 3 polarized receptacles, 3 toggle switches, 3 indicator lights, 6 ft. line cord. Rated 5 amps at 125 volts AC/DC. Shpg. wt., 1 lb. Imported.

99 A 8007	Net 2.49
-----------	----------

INDOOR-OUTDOOR EXTENSION CORDS

- 2-Wire and 3-Wire, 16 Gauge
- Molded Connectors



Use indoors and out, with power tools, refrigerators, mowers, fans, etc. All are 16-gauge, 3 cond. cords have 3 prong plug. * 2-conductor † 3-conductor.

Stock No.	Feet	Amp.	Shpg. Wt.	Net
12 A 2501*	25 ft.	7 amp.	2 lbs.	1.59
12 A 1501*	50 ft.	5 amp.	3 lbs.	2.75
12 A 3402*	100 ft.	5 amp.	3 lbs.	4.95
12 A 3403†	25 ft.	10 amp.	1 1/2 lbs.	2.29
12 A 2502†	50 ft.	7 amp.	2 1/4 lbs.	3.75
12 A 3404†	100 ft.	5 amp.	3 1/2 lbs.	6.99

LAFAYETTE ELECTRONIC LIGHT DIMMER CONTROL

- Full Range Total Darkness To Maximum Brightness
- Replaces Ordinary Wall Switch

7⁹⁵



Enjoy modern lighting in any room in your home or office. Soft light for TV viewing, bright light for reading or working. Easy to use, dimming is continuous from off to full illumination. Push on or off at any light level. Fits into standard single gang wall box without rewiring. Ivory plastic knob has brass finish insert. For 120 volts, 60 cycles AC. Operates incandescent lamps to 600 watt capacity. Shpg. wt., 1 lb.

12 A 0101	Net 7.95
-----------	----------

FLUORESCENT TROUBLE LIGHT

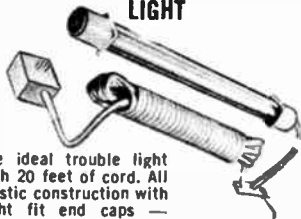

The ideal trouble light with 20 feet of cord. All plastic construction with tight fit end caps — shock proof and water proof. Cool burning without glare or shadow. Butyrate bulb shield; fluorescent bulb. Shpg. wt., 2 lbs.

12 A 4450	Net 5.99
12 A 1007 Replacement Bulb	Net 1.39

OUR LOWEST PRICE EVER

On SKIL

VARIABLE SPEED DRILLS

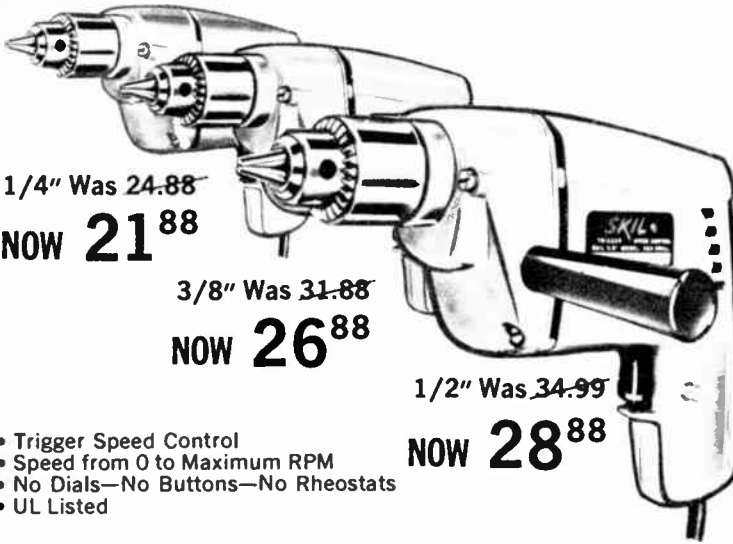

1/4" Was 24.88
NOW **21⁸⁸**

3/8" Was 31.88
NOW **26⁸⁸**

1/2" Was 34.99
NOW **28⁸⁸**

- Trigger Speed Control
- Speed from 0 to Maximum RPM
- No Dials—No Buttons—No Rheostats
- UL Listed

MODEL 501TSC 1/4" DRILL

Absolute speed control at your fingertips. Make holes in steel without centerpunching. "Super Burnout Protected Motor" rated at 2.5 amps. 0-2,000 rpm no load. Equipped with helical gears, geared chuck and key. Capacity: 1/4" dia. in steel, 1/2" dia. in wood. Aluminum housing, 3-wire cord and 3-prong plug. For 110-120 v., 60 cycles AC. Wt., 4 lbs.
13 A 6901 Net 21.88

MODEL 569TSC 3/8" DRILL

Heavy duty drill has extra capacity chuck; powerful, burnout protected motor. Trigger speed control, 0-1,000 rpm. 3-amp motor. Double reduction gears. Capacity: 3/8" in steel, 3/4" in wood. Aluminum housing with removable handle. For 110-120 v., 60 cycles AC. Shpg. wt., 5 lbs.
13 A 6917 Net 26.88

DELUXE MODEL 545TSC 1/2" DRILL

Compact, yet powerful enough to handle heavier jobs. 3-amp. burnout protected motor; 0-750 rpm no-load speed with trigger control. Heavy-duty double-reduction gears, multi-thrust bearings. Capacity: 1/2" in steel, 1 1/4" in wood. Aluminum housing; removable handle. For 110-120 v., 60 cycles AC. Wt., 5 lbs.
13 A 6919 Net 28.88



HUSKY 3/8" DRILL

9⁹⁵

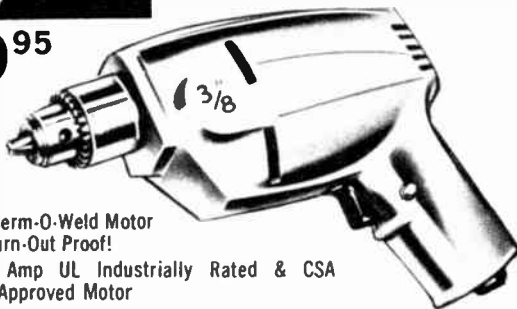

- Therm-O-Weld Motor
- Burn-Out Proof!
- 3 Amp UL Industrially Rated & CSA Approved Motor

A handy, value packed tool that will delight the home craftsman and do-it-yourselfer. Fully industrially rated by UL and CSA approved. Capacity: steel—3/8"; hard wood—3/4". Universal series wound Therm-O-Weld motor features burn-out proof construction. AC momentary contact switch with locking pin. Special alloy self-oiling bronze bearings. Complete with 6-ft. 3-wire UL approved lead cord. For 115V, 25-60 cps AC. Specially designed case for balance and ease of operation. Shpg. wt., 5 1/2 lbs.
13 A 5318 Net 9.95



1/4" DRILL—OUR TOP DRILL VALUE

7⁹⁵



- 2-Amp UL Approved Motor
- Jacobs Geared Chuck and Key
- Multiple Thrust Ball Bearings

Lafayette's top drill value, 1/4" geared chuck drill rated at a full 2.0 amps. UL approved. 1/4" capacity in steel, 1/2" in hardwood. 1200 RPM speed under full load; 2000 RPM no load speed. Precision anti-friction bearings. Automatic trigger switch. Specially designed gear train for maximum torque transfer. Mirror finish. Overall length 8". For 115 volts. AC/DC. Shpg. wt., 3 lbs.
13 A 7101 Net 7.95

Model F-12S. Same as above but with 2-speed selection. Pressure on trigger switch determines speed. Shpg. wt., 3 lbs.
13 A 7120 Net 10.95



4-SPEED 1/2" REVERSIBLE DRILL



32⁸⁸

NO MONEY DOWN

- Multiple Speeds from 340 to 2400 RPM
- Powerful 6 Amp., 1/2 HP Burnout-Proof Motor
- Double Reduction Gears for Super Torque
- UL Industrially Rated

Model 950—A versatile, heavy duty 1/2" drill to handle big jobs—where great power is required. Quick, easy two-lever control of electronic and gear reduction speed changes permit efficient use of drill for any type of material or size of hole. All 4 speeds are reversible too with extra safety double switch. 6 amp. 1/2 horsepower motor, 120V AC/DC. 6 ft. 3-wire cord. UL and CSA approved. Size 11x8 1/2 x 3 1/2" (LHW). Die Cast aluminum housing, balanced for continuous operation. Shpg. wt., 9 lbs.
13 A 6533 \$5 monthly Net 32.88

UNIVERSAL DRILL PRESS STAND



- Adjustable Depth Stop
- Spring Return Tension
- Adjustable Cradle
- Adjustable Depth Gauge Dial

10⁴⁴

Can be used for any 1/4" pistol grip electric drill. Features rack and pinion gear feed, and adjustable depth stage. 15 to 1 leverage. Drill press head is clamped in rigid position. 2 1/4" stroke. Square base is providing with slots for drill bit and for bolting work to base. Other features include spring return tension, fast hand-action, head clamps and adjustable depth gauge dial. Shpg. wt., 6 lbs.
14 A 3604 Net 10.44

New SKIL 1/4" Drive-R-Drill

WITH REVERSING TRIGGER SPEED CONTROL

- Operates Both Forward and Reverse By Trigger Finger Pressure
- Burnout Protected Motor
- Lightweight Aluminum Housing

24⁸⁸



EXCLUSIVE TRIGGER SPEED CONTROL
0-2,000 RPM Forward
0-2,000 RPM Reverse

Unique, all-purpose drill which can tackle most any drilling job with precision and accuracy. Just squeeze the trigger for any drilling speed from 0 to maximum 2,000 rpm plus reverse speed! Using a driver bit or socket you can drive or remove screws and nuts quickly and easily without accessories. Taps holes in metal too! Has powerful 2.5 amp. burnout protected motor, high torque helical gears and geared key chuck. Capacity: 1/4" diameter in steel and 1/2" in wood. Locking button for sustained operation. Lightweight aluminum housing, 9" long. With 6 ft. 3-wire cord and plug. For 115 v., 60 cycles AC. U.L. listed. Less Bit, Shpg. wt., 4 lbs. 13 A 6927 Net 24.88

WEN 2-SPEED 7" SANDER-POLISHER

- Powerful 1/2 H.P. Motor
- Burnout-Proof Armature

32⁹⁹



Model 940: Combines two handy tools — a sander operating at 3400 RPM and an efficient polisher at 1800 RPM. As a sander, you get the right combination of high speed and oversize sanding discs. Has perfect balance . . . auxiliary grip handle for right or left hand use. Extra large wool polishing bonnet permits working around and over edges. UL and CSA approved. For 110-120 v., 60 cycles AC. Shpg. wt., 8 1/2 lbs. 13 A 6518 Net 32.99

THOR COMPACT 1/4" ELECTRIC DRILL

34⁵⁰

NO MONEY DOWN

- Shock-Proof Gearing
- Full Wave Diode System
- Life-Time Stator
- Weighs Just 27 Ounces (Less Cord)

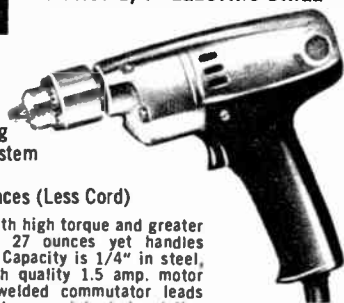

Model E-110. Compact with high torque and greater efficiency. Weighs only 27 ounces yet handles rugged "big drill" jobs. Capacity is 1/4" in steel, 1/2" in hard wood. High quality 1.5 amp. motor will not burn out — welded commutator leads and new high temperature resistant insulation permanently protects the armature. No wire windings in stator, guaranteed for life! 1200 rpm, no load; full load 900 rpm. Uses full wave diode system for constant service and industrial use; shock-proof gearing and splined armature shaft, with 8 ft. 3-wire cord. U.L., CSA listed. Overall length, 6 1/4". Shpg. wt., 2 lbs. For 117 v., 25-60 cycles AC. 13 A 5316 \$5 Monthly Net 34.50

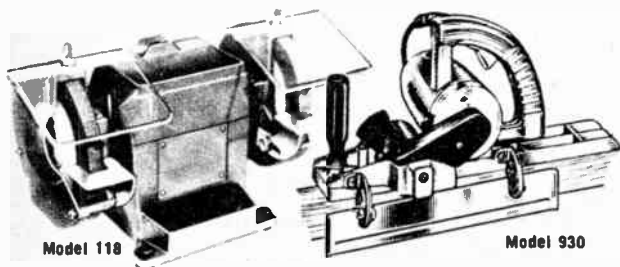

Model 118

Model 930

THOR 4 1/2" BENCH GRINDER

- 1/4 H.P. Motor
- Two Grinding Wheels

Model 118. Ideal for light to medium-duty work. 2.5 amp motor has no load speed of 3450 rpm. Features heavy-duty steel wheel guards; protective eye shields; adjustable tool rests; built-in front water cooling tray; castin tool parts tray. Two 4 1/2 x 4 1/2" wheels (one 40-grit, one 70-grit). 6-ft. 3-wire cord. U.L. Industrial rated and CSA approved. For 115V 60 cycle AC. Shpg. wt., 11 lbs. 13 A 5312 Net 16.95

WEN ELECTRIC HAND PLANE

- 1/2 H.P. Burnout-Proof Motor
- Industrially Rated

Model 930: Air cooled cog belt drive; heavy-duty oilite bearings; separately adjustable twin cutters; welded burnout-proof armature; finger control trigger switch. Cutter speed 14,500 R.P.M. Mitre guide plate angle adjusts up to 45°. Guide plate is removable for surface planing. Cutting width 2 1/4"; depth adjustable to 1/16". Polished aluminum housing with air stream chip ejector. Shoe length 16". 3-wire 8-ft. cord. For 110-120v, 60 cycles AC. U.L., CSA rated. Shpg. wt., 9 lbs. 13 A 6503 \$5 Monthly Net each 32.99



29⁹⁵

- Integral Compressor-Motor
- Sprays Oils, Paints, Stains Insecticides, Liquid Wax

NEW SPRAYIT 600-6 PROFESSIONAL-TYPE SPRAY UNIT

All-purpose spray unit that gives professional results from the start. Provides uniform adjustable pattern from "dime" size to a fan 10" wide. Precision made with sealed ball bearings, never needs oiling. Easy-to-use 2-finger trigger gun. Air delivery: 1.5-2 CFM at 15-20 lbs. Complete with 6 ft. cord and plug, 8-ft. air hose, spray gun and Viscosimeter which takes the guess-work out of mixing for best spray results. For 115 v, 60 cy. AC. Shpg. wt., 11 lbs. 14 A 8405 Net 29.95

MULTI-COLOR KITS: For best results in spraying multi-color paints. 14 A 8402 Shpg. wt., 4 oz. Net 2.10

AIR TOOLS KIT: For inflation and dusting. Includes chuck for all tires—footballs, basketballs, toys, air mattresses "dusting" attachment. 14 A 8403 Shpg. wt., 4 oz. Net 1.70

SKIL MODEL 574 7 1/4" HEAVY-DUTY POWER SAW

- Powerful 1 1/2 HP Motor
- Safety Slip Clutch
- U.L. And C.S.A. Approved



29⁸⁸



MODEL F-7 7" POWER SAW

- Universal 1 1/2 H.P. Motor
- Heavy Duty 3 Conductor Cord
- UL and CSA Approved

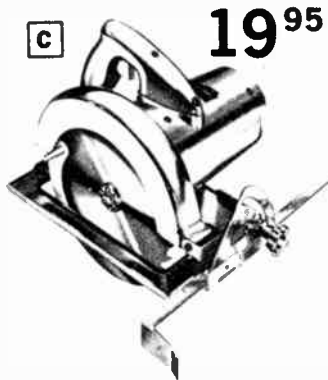

19⁹⁵

HEAVY DUTY SABRE SAW

- Powered with G.E. Motor
- Cuts 6" Lumber at 90°

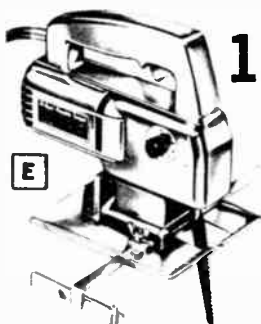

19⁴⁹

(A) 7 1/4" HEAVY-DUTY POWER SAW. 10 amp. motor develops over 1 1/2-hp... lots of power for big jobs. Full size 7 1/4" saw has adjustable depth and bevel controls to cut up to 2 3/4" at 90°; 1 7/8" at 45°. Features: safety-slip vari-torque clutch, dual exhaust sawdust ejector, bind-free blade guard and machined housings for accurate bearing alignment. No-load speed, 5200 rpm. With hard tooth combination blade, wrench, 3 conductor cord, plug. Burnout proof universal motor. For 110-120 v. AC. UL, CSA listed. Shpg. wt., 12 lbs.

13 A 6926 Net 29.88
13 A 6912 Rip Fence Net 1.95
Shpg. wt., 4 oz.
13 A 6911 Saw Carrying Case Net 11.95
Shpg. wt., 12 lbs.

(B) SABRE SAW. Cuts 2x4's, plywood, plastic, composition board, aluminum and a host of other materials. Has many uses—rip, cross-cut, jig saw, hack saw, band, coping, key-hole and scroll saws. 115v, AC/DC. 1/4 H.P. universal motor operates at 3500 strokes per minute. Length of stroke is 11/16". Built-in cooling system. Long-life on-off slideswitch. Adjustable base, rip guide and mitre gauge. Cuts on angles from zero to 45°. Bright, mirror finish. With 3 assorted blades. 2.4 amps. Shpg. wt., 4 lbs.

13 A 7116 Net 12.77

(C) Model F-7, 7" POWER SAW. A powerful 8 amp. motor provides plenty of reserve power to zip through straight or angle cuts. Cuts vertically to 2 1/4" at 90° to 2" at 45°. Features self-lubricating bronze bearings, floating blade guard, safety retracting handle, combination rip and cross-cut blade and 3-wire cord and plug. No load speed, 5000 rpm. Motor is a universal 1 1/2 hp AC-DC 115 volts. UL Approved. With safety slip clutch. Bright mirror finish. Shpg. wt., 15 lbs.

13 A 7103 Net 19.95

(D) Model R-120, 2-WAY ELECTRIC SANDER. With 3/16" stroke in orbital or straight line. 2.4 amp. universal series wound motor. Heavy-duty ball bearing and self-lubricating sleeve bearings. Pad size: 3 1/2"x7 1/8"; sandpaper size: 3 1/2"x9". Industrial mirror finish. 6-ft. UL approved cord. 115V, 60 cycles, AC-DC. Shpg. wt., 5 lbs.

13 A 7102 Net 16.95

(E) HEAVY DUTY SABRE SAW. Capable of handling dozens of cutting jobs. Use as rip, cross-cut, coping or keyhole saw. Powerful, precision 3.5 amp motor. Cuts up to 6" in woods! Also cuts plastics, metals and most other materials. Extra large adjustable base enables accurate bevel cuts up to 45° angle. Sawdust blower removes sawdust as you cut. Makes its own starting hole. 4800 strokes per minute. Complete with 5 blade assortment and 3 wire 6 ft. rubber covered cord. For 115 V; 60 cycles AC-DC. Shpg. wt., 4 1/4 lbs. UL and CSA approved.

14 A 4806 Net 19.49

HEAVY-DUTY VARIABLE SPEED SABRE SAW. Same as above, but with electronically variable speed control lets you select maximum cutting power for every job. Shpg. wt., 4 1/2 lbs.

14 A 4805 Net 25.95

(F) Model 509, 'SOUPEO UP' SABRE SAW. Super-long blade easily cuts through 6x6" lumber. Cuts 4x4" at a 45° angle! Power enough to cut steel plate up to 1/2" thick; iron pipe up to 2" in diameter. 1/2-hp 6 amp motor, oilite bearings and heavy duty roller and gears. Saw tilts 45°. Finger control trigger-switch. Saw dust blower. Includes seven blades for cutting wood, steel, hardboard, sheet metal, pipe, leather, rubber, formica, etc. With rip guide and circle cutter guide. 8 ft. 3 cond. cord and adapter. 110v. AC/DC. UL. and C.S.A. listed. 8 1/2x7Wx7 1/2"H. Shpg. wt., 8 1/4 lbs.

13 A 6501 Net 29.97

9T2 Saw Table—Makes the "909" a Bench Saw. Heavy duty, rugged table for straight cuts, circle, curve, bevel and angle cuts. 18x18x18 1/2". Shpg. wt., 14 lbs.

13 A 6505 Net 11.21



MODEL F-8 SABRE SAW

- Complete with Mitre Gauge, Rip Guide, Assorted Blades

12⁷⁷

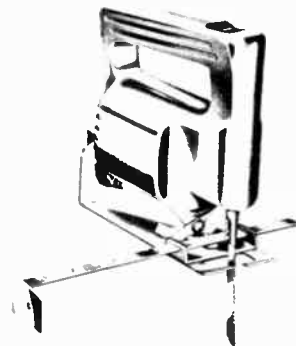

MODEL R-120 2-WAY ELECTRIC SANDER

- Orbital or Straight Line
- Positive Slide Switch

16⁹⁵

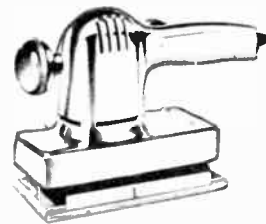

MODEL 509 'SOUPEO UP' SABRE SAW

29⁹⁷

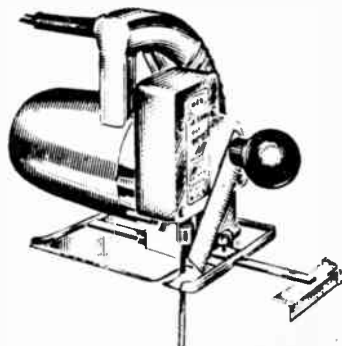

NEW! THERMOGRIP HOT-MELT GLUE GUN

60 Second Bonding

- Neat
- Clean
- Easy

5⁹⁵



Electric glue gun hot-melts sticks of solid glue which are inserted in rear of gun. Glue is fed from gun by pressing thumb on glue stick as tool is moved along surface. Pieces are then just pressed together. Takes only 60 seconds for a permanent, waterproof bond. Perfect for bonding wood, pottery, leather, metal, fabric and many other materials. Bond is slightly flexible allowing some "give". Ideal for caulking boats, installing tile, repairing furniture. 115V, AC-DC. Shpg. wt., 1 lb.

- 13 A 5413 Net 5.95
 13 A 5414 Pkg. of 7 glue sticks Net ea. .49
 13 A 5415 Pkg. of 7 sealer sticks Net ea. .49



LABEL MAKERS

AS LOW AS

4⁹⁹

MODEL M-4

- With 144" Roll of Tape
- Embosses 42-5 Characters on 1/4" and 3/8" Tape
- Permanent, Self-Sticking Raised Letters

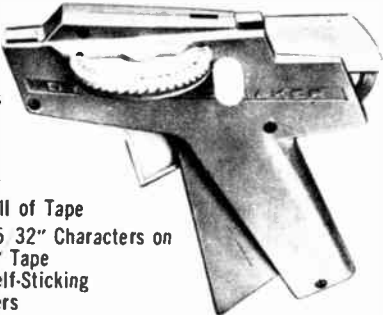

MODEL M-38D 1/4" & 3/8" TAPE WRITERS

Built of heavy plastic. Embossing wheel has 42 characters. Just dial the letters and squeeze the handle. Complete with 144" roll of tape. Uses 1/4" and 3/8" tape. See listing below for additional tape.

- 14 A 4143 Shpg. wt., 2 lbs. Net 6.88

MODEL M-4 1/4" TAPE WRITER

Embossing wheel has 44 characters. Complete with 144" roll of 1/4" embossing tape. See below for additional tapes. Shpg. wt., 2 lbs.

- 14 A 4101 Net 4.99

EMBOSSING TAPES

1/4 INCH

Each contains 144" Shpg. wt., 1/4 lb. Net ea., .89 in lots of three, .79 each

Stock No.	Stock No.	Stock No.
14 A 4102 Blue	14 A 4105 Clear	14 A 4106 Brown
14 A 4103 Green	14 A 4131 Yellow	14 A 4107 Black
14 A 4104 Red	14 A 4132 Gold	14 A 4130 Orange

3/8 INCH

Contains 144" Shpg. wt., 1/4 lb. Net ea., .99 in lots of three, .89 each

Stock No.	Stock No.	Stock No.
14 A 4111 Brown	14 A 4114 Clear	14 A 4115 Blue
14 A 4112 Black	14 A 4128 Yellow	14 A 4116 Green
14 A 4113 Red	14 A 4129 Gold	14 A 4127 Orange

CHASSIS PUNCH SET

- Easy-Smooth Holes in Sheet Metal
- 5 Sizes: 1/2", 5/8", 3/4", 1", 1 1/8"

Five most often needed round hole punches. Easily cuts smooth accurate holes for sockets, plugs, controls, panel lights, switches, terminals, and most radio parts. Drive with any wrench or with included T-handle. Punch sizes included are 1/2", 5/8", 3/4", 1", 1 1/8". Complete with punches, dies, T drive handle, tapered reamer, fitted case, and instructions. Shpg. wt., 2 1/2 lbs. Imported.

- 99 A 8024 Net 5.49



ARC WELDING OUTFIT



- Continuous Manual Duty Cycle
 - 9 Heat Ranges
- 65⁹⁵

Practical low cost welder ideal for plumbers, steamfitters, and maintenance men. Excellent for the home, garage, farm and shop too! Saves time and money in repairs and maintenance! Portable—carry it right to the job. 9 heat ranges from 20 to 80 amperes. Dual coil construction. Handles 1/16 to 3/32" rods on work up to 1/4". Arc voltage: 25 volts; Input Current: 29 amperes. Power Factor: 80%. Welded steel cabinet finished in attractive baked grey heat resistant enamel. Complete with head shield, ground, power and welding cables, electrode holder, assorted electrodes, ground clamp and instructions. For 115 volts, 3-wire, 50/60 cps AC. Dimensions: 9 1/2 x 12 1/2 x 9 1/4. Shpg. wt., 39 lbs.

- 13 A 2051WX Net 65.95

POP RIVET TOOL KIT

3³⁹



A professional tool which joins virtually anything, metal to metal, plastic to wood, fabric to fabric. Easy to operate, just insert rivet into tool, place in pre-drilled hole and squeeze gun and you have a strong rivet joint. KLIK rivets are strong, neat and permanent. Ideal for Hobbyists, Electronics, Household and Auto repairs. Kit includes Riveter, supply of rivets of various sizes. Extra rivets available at low cost.

- 13 A 5401 Shpg. wt., 2 lbs. Net 3.39
 13 A 5402 25 Rivets for Work up to 1/8" Thick Net .44
 13 A 5403 20 Rivets for Work up to 1/4" Thick Net .44
 13 A 5404 15 Rivets for Work up to 1/2" Thick Net .44
 13 A 5405 40 Back-up (Reinforcing) Plates Net .44

WELLER 8200PK 'EXPERT' SOLDERING KIT

6⁴⁹

Features the 8200 constant heat gun with handy prefocused spotlight. Gives choice of 100 or 140-watts with the pull of the trigger. Accessories include 3 durable soldering tips, tip changing wrench, nylon flux brush, soldering aid and all purpose solder. In hi-impact plastic case. Shpg. wt., 3 3/4 lbs.

- 13 A 3915 Net 6.49



VARIABLE MOTOR SPEED CONTROL

- Varies Speed on AC-DC Motors From 0 RPM To Full Speed
- Ideal For Electric Drills, Saws, Polishers

8⁹⁵

Dependable motor speed control ideal for workshop power tools using universal AC-DC and series DC motors. Assures constant speed variation from zero rpm to maximum speed. Has built-in circuit breaker. 7.5 amps no-load rating. Input: 120 volts 50-60 cycles AC. 3-wire receptacle and cord.

- 13 A 2700 Shpg. wt., 1 lb. Net 8.95



CRAFTOOL**SHOP-VAC®****ALL-PURPOSE VACUUM CLEANER****29⁹⁵****ACCESSORY KIT**

- Excellent for the Home, Garage, Yard, Shed or Shop
- 5 Gallon Capacity Steel Drum
- 6 Ft. 2½" Diameter Hose
- 1 H. P. Motor

Can be used for rough cleaning nearly anywhere! Excellent for picking up pebbles, wood chips, sawdust and other debris. Also attaches to woodworking machines for chip & sawdust removal. Reversible air flow—use it as a blower too! Perfect for winter oil burner cleaning! Shpg. wt., 17 lbs. UL Approved.

13 A 3552W Net **29.95**
13 A 3553W Caster Set, 2 lbs. Net **4.29**
13 A 3551 45" Extension Handle, 3½ lbs. Net **3.95**

ACCESSORY KIT: Includes 1 14" floor nozzle with brush, 30" extension handle, and adapter which permits use with ordinary vacuum hose and accessories. Shpg. wt., 5½ lbs.

13 A 3550W Net **9.95**

STEEL STORAGE UNITS

As Low As

5⁹⁵

For stores, offices, garages, basements, pantries, closets—just what you need to solve your storage problems, you'll find dozens of uses for these rugged racks. Available in two sizes to fit virtually anywhere—30Wx12Dx60"H with 4 shelves, or 36Wx12Dx72"H with 5 shelves. Corner post and all edges are rounded and snag-proof with back and side braces providing added strength and rigidity. Gray enamel finish. Shipped unassembled with all necessary hardware for fast easy assembly. Size: 12x30x60". Shpg. wt., 25 lbs.

13 A 2301WX Net **5.95**
 Size: 12x36x72". Shpg. wt., 33 lbs.

13 A 2302WX Net **6.89**

Extra Shelves for above
13 A 2303 12"x30" shpg. wt.,
 2 lbs. Net ea. **1.25**

13 A 2304 12"x36" shpg. wt.,
 2¼ lbs. Net ea. **1.35**

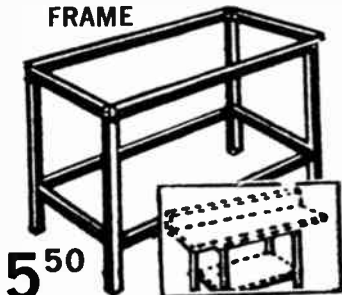
ALL-PURPOSE BENCH FRAME**5⁵⁰**

It's easy to make a bench for every purpose—in the garage, store, house, laundry room, playroom, etc. Heavy-gauge steel, completely pre-drilled, ready-to-assemble—just add the top. For larger benches, combine 2 or more. Overall: 22½x47½x34" high. Shpg. wt., 19 lbs.

13 A 3501W Net **5.50**

TOOL RACK, Prepunched to fit frame.
 46"L, 4½" H.

13 A 3502 Shpg. wt., 2 lbs. Net **1.95**

CASTERS For easy moving. Sets of 4.

13 A 3503 Shpg. wt., 1 lb. Net **1.35**

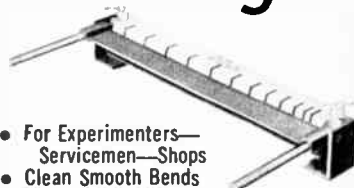
18" BENDING AND FORMING BRAKE**9⁹⁵**

- For Experimenters—Servicemen—Shops
- Clean Smooth Bends
- Forms Up To 90°
- Handles Up To 18" Width In Up To 16 Gauge Thickness

Unique design permits forming chassis, boxes, covers, trays, etc. by means of 1" deep slots in brake-bar which allow corners to fold in. Provides flange edges up to 1" high. Easy to adjust for thickness, accuracy, angle of bend. Rugged construction offers a life time of service. Shpg. wt., 14 lbs.

99 A 8064 Net **9.95**

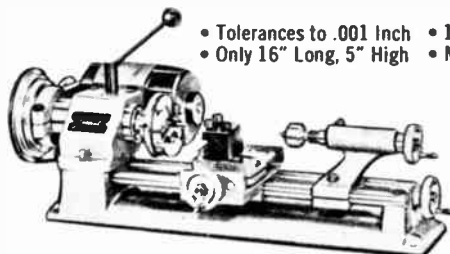
UNIMAT MINIATURE MACHINE SHOP

- Tolerances to .001 Inch
- Only 16" Long, 5" High
- 11 Spindle Speeds
- Metal-working Lathe, Drill Press, Grinder, Milling Machine, Hand Drill, Polisher.

ONLY
139⁵⁰
No Money Down

SPECIFICATIONS: Complete 10-in-one machine shop small enough to use on a radio serviceman's bench. Designed as a multi-functional power tool. Converts from horizontal lathe to vertical drill press. The changeover causes no wear or loss of accuracy in precision fit parts. The motor-headstock detaches for use as a portable hand drill, power grinder or buffer. Extra attachments available include a very accurate circular saw, saber and jig saw, flexible shaft, lathe bed power feed, threading attachment, precision collets and cutting tools. Belt drive provides 11 speeds ranging from 900 to 7,200 RPM. Motor can also be controlled by rheostat foot switch or SCR power supply.

Includes 1/10 HP Brush Type fan cooled motor, drill press arm, column and hand lever, face plate, lathe dog, grindstone arbor, tool post, 2 dead centers, 3 jaw universal lathe chuck with reversing jaws, 1/4" Jacobs chuck and key, Allen wrench roughing tool bit, and a spindle return spring. 17½x10½x5½" wood chest. 40-page manual. For 115V AC/DC operation. Imported. Shpg. wt., 30 lbs.

14 A 1001WX \$7.50 Monthly Net **139.50**

ATTACHMENTS & ACCESSORIES

Model DB 1210 Milling Table, Steel, 5x3" with 2 sets of clamps.

14 A 1002 Shpg. wt., 3 lbs. Net **10.50**

Model DB 1010 Clamping Vise, Reach of jaws: 1¼" Mounts on cross slide on Milling table.

14 A 1003 Shpg. wt., 1½ lbs. Net **7.95**

Model DB 1130 Tool Kit, Consists of: 2 tool bits, 4 drill bits, grindstone w/cup, single-end cutting key seat cutter, counter sink bit, center drill bit and 2 wood chisels. In box.

14 A 1004 Shpg. wt., 1½ lbs. Net **15.50**

Model DB 1100 set of 6 tool bits.

14 A 1005 Shpg. wt., 1 lb. Net **9.50**

Model DB 1290 Power Feed Attachment, 1:50 reduction, feed rate of .0008" per revolution.

14 A 1006 Shpg. wt., 7 lbs. Net **19.95**

Model DB 1001a 4-Jaw Independent Lathe Chuck, Capacity 2¼".

14 A 1007 Shpg. wt., 1¼ lbs. Net **22.50**

2½" Circular Saw Attachment, 6x8" table, rip fence, blade guard, and arbor. Max depth of cut ½"

Model DB 1240 Saw, Shpg. wt., 2½ lbs. Net **14.95**

14 A 1012

Model DB 1241 Blade (wood), Shpg. wt., 3 oz. Net **1.50**

14 A 1009

Model DB 1242 Blade (metal), Shpg. wt., 3 oz. Net **2.25**

14 A 1010

Model DB 1070 Jig Saw Attachment, Cuts to center of 16" circle. With 12 assorted blades.

14 A 1011 Shpg. wt., 6½ lbs. Net **19.50**

RAM *fury* ¼-H.P. ELECTRIC HEDGE TRIMMER



SALE 18⁸⁸

- Tempered Steel Blade
- Adjustable Handle For Easy Cutting

A lightweight yet ruggedly built hedge trimmer that's easy to hold and use. 14-inch beveled blade of tempered steel. . . Trims shrubs and hedges at 1800 cutting strokes per minute. 115-Volt AC Universal air-cooled motor. Top handle adjusts 180° for easy cutting. Convenient on-off slide switch. Complete with 3-conductor 18" stub cord. Overall length is 23½". Shpg. wt., 4 lbs.

13 A 7115 Net 10.88

"SHOP KING" HEDGE TRIMMER

5⁴⁹



- 14" BLADE

Converts any ¼" drill into an easily handled hedge trimmer. Cuts, trims and shapes hedges and shrubbery. Extra long 14" blade of hardened tool steel. Keen edges for fast shearing action. Steel drive gear—permanently lubricated. Long, comfortable handle. Locks in any of 10 different positions. Light weight-compact. Shpg. wt., 3 lbs.

13 A 5015 Net 5.49

10-INCH ELECTRIC 1¾ h.p. CHAIN SAW

POWERED WITH G.E. MOTOR



54⁹⁵ \$5 Monthly

A powerful, top-quality portable chain saw designed for professional or industrial use. This rugged, multi-purpose tool will also do dozens of jobs for the home craftsman, carpenter, contractor or on the farm. Positive chain adjustment eliminates slack. Chain travels at 1300 feet per minute for fast, true cuts up to 10 inches deep. Cool-running quiet helical cut gears in a sealed grease chamber. Self lubricating bearings. Beautifully balanced, weighs only 12 lbs. Motor develops 1¾ hp., 8.0 amps. 115V. 25-60 cy., AC/DC. 3-wire, 6-ft. cord. Shpg. wt., 14 lbs.

14 A 4804 Net 54.95

"STOR-ALL" LAWN LOCKER

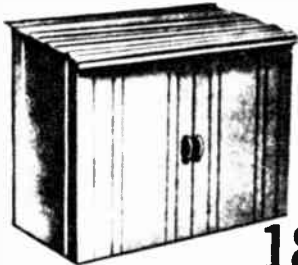

18⁹⁵

- For Toys, Lawn & Pool Equipment, etc.

Sturdy steel construction, steel floor. Roof folds back for easy access, doors have spring latch. 24 cu. ft. of storage space. Finished in gloss green. Overall 4'Wx2'Dx3'H. With instructions for easy assembly. Shpg. wt., 60 lbs.

13 A 8807WX Net 18.95

WONDER-WORKING "GARDEN GENIE SPRAYER"

Now Everyone Can Have A "Green Thumb"

5⁹⁵

- ★ Does Most Everything But Mow the Lawn
- ★ Effective, Handy Garden Servant
- ★ You Walk—Garden Genie Does the Work



Makes spraying lawns and gardens as simple as turning on the water. Combines versatility and efficiency with simplicity and ease — you just walk and the Garden Genie does the work. It can fertilize the lawn, flowers, shrubs and trees quickly and safely. It pre-mixes plant food solutions and covers a wide area. Also used for safe, easy and effective control of destructive insects and plant diseases. The sprayer works in front of you, keeping unpleasant insecticide spray away from you; sprayer also tilts back and gets those garden pests up in bushes and trees. A single jugful gives 60 gallons of solution—plant food or insecticide. Features fingertip control for switching from wide-angle high-pitched spray for fertilizing and pest control, to powerful, ground-sweeping jet for cleaning walks, driveway, patio, even the family car. Lightweight, sturdily constructed, on wheels for easy maneuverability. Shpg. wt., 9 lbs.

12 A 6702W Net 5.95

ELECTRA-SPRAY

- Foolproof Spray Painting
- Includes New Viscometer



7⁴⁶

Sprays every kind of sprayable paint or liquid —adjustable, jeweled nozzle provides fine, medium or coarse spray. Completely rust-proof construction. Brass and stainless steel parts. High impact plastic housing. 22 ounce interchangeable mason-type jar. Electro-magnetic motor never needs oiling or adjustment. Comfortable pistol grip handle with self-releasing trigger switch. The new VISCOMETER insures perfect paint consistency—regardless of brand—every time. Complete with 8 ft. heavy duty cord, 22 ounce jar, viscometer, wrench and instructions. For 115 V.A.C. only. Shpg. wt., 5 lbs.

13 A 3712 Net 7.46

SUBMERSIBLE PUMP

- Will Not Corrode or Rust
- Hermetically Sealed Motor
- For Circulating and Dispensing Water



12⁷⁵

It's the all-new Delron aluminum pump for underwater use. Guaranteed not to corrode or rust; hermetically sealed motor. Circulates and dispenses water and mild acid solutions for use in fountains, beverage dispensers, aquariums, photo developing, air conditioning, etc. Gallons per hour delivery: 240 @ 1 ft.; 180 @ 3 ft.; 125 @ 5 ft.; shut off @ 12 ft. Outlet ¾"; inlet ½" pipe O.D.; height 4½"; depth 4¼". 6 ft. safety cord. 115 V, 60 cy, AC, 49 watts load; .67 amps load. Shpg. wt., ¾ lbs.

13 A 8901 Net 12.75

NEW WATER FLOW METER

- Automatic Shut-off For Any Sprinkler
- Non-Corroding
- Up to 750 Gallons per Setting

3⁹⁵



Set it, then forget it. The automatic water meter does the rest, shutting-off automatically when sprinkling is completed. Set dial for the degree of sprinkling needed up to 750 gallons. Quickly attached to any standard faucet or sprinkler. Operates under low or high pressure and compensates for variations in pressure. Non-corroding heavy duty zinc construction gives years of dependable service. Size: 8x7x3". Shpg. wt., 2 lbs.

12 A 7800 Net 3.95

WATERFALL KIT



Enchanting waterfall of cascading water constantly recirculated by electric pump. Gallons per hour delivery: 180 @ 1 ft., 140 @ 3 ft.; 100 @ 5 ft.; shut off @ 10 ft. Outlet ¾"; inlet ½" pipe O. D. Load: amps .65; watts 43. No concrete needed; complete with instructions. Kit consists of pump, 8-ft. plastic hose, 7-ft. sealing poly, pump filter. Shpg. wt., 4 lbs.

13 A 8902 Net 15.88

Smith Corona Typewriters - Adding Machine



109⁹⁵

\$6 monthly
No Money Down

134⁹⁵

\$7.50 monthly
No Money Down

SALE!
67⁹⁵

Save \$600

GALAXIE® II TYPEWRITER

Offers all of the most wanted features. Natural arc action provides effortless typing. Vital moving parts are protected with exclusive jeweled escapement which maintains factory-new precision. Exclusive page gage tells how far you are from the bottom of the page. Changeable type accepts up to 40 optional snap-on characters. 88 character keyboard features key set tabulation, quick set margin, single, double, and triple spacing. All steel frame construction. Beautiful Trimline carrying case. Shpg. wt., 23 lbs.
15 A 4001WX Pica-Charcoal Grey Net 109.95
15 A 4002WX Pica-Metallic Blue Net 109.95

CORONET ELECTRIC

This Smith Corona electric makes up to 10 clear carbons . . . repeats dots, dashes, spacing, the letter X, and underlines. Full sized 88 character keyboard features impression control dial and touch selector. Amazing accelerator action gives faster type bar action for a snappier, livelier touch. Packed with such effort saving features as the page gage and quick set margins. Equipped with exclusive forward-glide top deck. Strong steel frame construction. Perfect for every member of the family. Trimline carrying case. Shpg. wt., 26 lbs.
15 A 4003WX Pica-Metallic Gray Net 134.95
15 A 4004WX Pica-Star Mist Blue Net 134.95

"FIGUREMATIC"

ADDING MACHINE

- Totals up to \$999,999.99

A fast-figuring electric portable that adds, subtracts and multiplies. Full-featured construction with 10 keys. Add-Subtotal. Subtract-Total, and Repeat. "Clear" and digital indicator are combined. Lists 7 columns of figures. Easy to carry—the cord tucks in, stylish dust cover snaps on, built-in retractable carrying handle comes out and away it goes. Overall 7x9x13". For 110-115 volts, 60 cycles, AC. Shpg. wt., 10½ lbs.
15 A 1704WX \$5 Monthly Net 67.95

BROTHER PORTABLE TYPEWRITERS



42⁹⁵

No Money Down



Luggage Style
Carrying Case

57⁹⁵

No Money Down



73⁹⁵

No Money Down

PORTABLE TYPEWRITER

Features an 88-character keyboard — 4 more characters than most standard typewriters (I, +, =, 1); Red/Black ribbon, stencil position; 1-, 1½-, and 2-line spacing, and an erasure table. Also includes line-lock mechanism, easy margin setting, jam release key, synchronized measuring scale, card holder, and a touch selector. Popular pica type. All steel. With case. 6¾x14½x15". Shpg. wt., 15 lbs. Imported.

15 A 1701WX \$5 Monthly Net 42.95

DELUXE PORTABLE TYPEWRITER

Deluxe features include an 88-character keyboard, convenient "touch" adjustment, automatic pushbutton tabulator, and a variable line spacer. 1, 1½ and 2 line spacing; Red/Black ribbon; stencil position. Hand-set margins, paper bale scale, jam release key, synchronized measuring scale and card holder provide additional typing comforts. Pica type. Dimensions: 16x18x8". With carrying case. Imported. Shpg. wt., 19 lbs.

15 A 1702WX \$5 Monthly Net 57.95

HOME/OFFICE TYPEWRITER

Deluxe features include jam release key, synchronized measuring scale, card holder, convenient touch adjustment. Variable line spacer, and extra wide paper capacity. Also features an automatic and manual ribbon reverse, line finder, line drawing aperture, paper meter, segment shift and automatic pushbutton tabulator. With case. 88 characters pica type. Dimensions: 16¾x18x7¾". Imported. Shpg. wt., 23 lbs.

15 A 1703WX \$5 Monthly Net 73.95



Slide Rules — Drafting Equipment

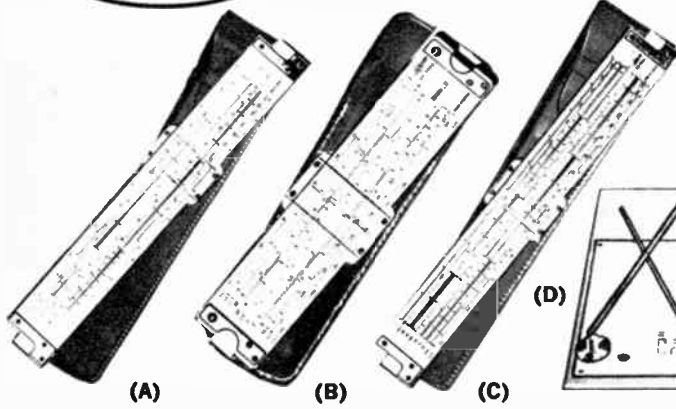

(A) LAFAYETTE VECTØRLOG • 12" SLIDE RULE

- Laminated Bamboo Construction
- P, P', and Q Scales—For Direct Vector Addition
- Hyperbolic Sine and Tangent Scales
- Two Sine Scales
- 5 Log Log Scales Plus a Voltage DB Scale

The Lafayette VECTØRLOG Slide Rule provides a new concept in scientific calculation. Twenty-seven (27) scales incorporate the many problems encountered in Electrical Engineering and Physics. The unique P, P', and Q scales allow direct right angle vector addition. No longer are several settings required to obtain right angle vector sums—these scales work in the same manner as the C and D for multiplication. The two Hyperbolic Sine and one Hyperbolic Tangent Scale, the voltage db scale, and the five Log Log scales, provide maximum coverage of these dynamic fields. Several of these features are: C and D scales on both the front and back of the rule; Sine scales in both degrees and radians, removing the necessity of both—some conversion of units: A problem-tested location of scales; and adjustment screws to allow variable tension on the slide. Scales include: (FRONT) TR-1, TR-2, P', P. Q. ST, S-1, S-0, C, D, LL01, LL02, LL03, LL1'; (REAR) Sh-1, Sh-2, DF, A, B, C, CF, Th, C, D, LL3, LL2, db. With instruction book, leather carrying case, and belt carrying loop. Imported. Shpg. wt., 1½ lbs.

99 A 7102 Net 16.88

(B) DECIMA-LOG™ DELUXE 5" LOG LOG DUPLI DECIMAL TRIGONOMETRIC SLIDE RULE

- P Scales (Pythagorean) permits direct "readout" of Cosine Values
- 24 Scales including 8 Log Scales

A pocket version of our 10" Log Log Dupli Decimal Trigonometric slide rule. Contains all the scales of the 10" rule except the "ST" scale. Two color scales—positioned for ease in use and rapid calculations. "C" and "D" scales on both sides of the rule, "P" scale for direct, cursor line reading of cosines of angles. Scales—front face: LL1, LL2, LL3, DF, CF, C1, C, D, LL3, LL2, LL1. Back face: LLO, L, K, A, B, S, T, C, D, DI, LLO. Engine divided rule of laminated, non-hygroscopic bamboo. Complete with instruction book and leather case with pocket clip. Imported. Shpg. wt., 8 oz.

99 A 7099 Net 8.88

TACROGRAPH SET

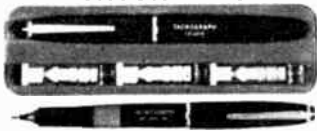

- Complete with Three Nibs

A top quality drawing pen for all lettering and drawing work. Uses both India and drawing inks. Precision point for constant flow lines. Slim, easy to hold pen comes with 3 color coded nibs. Fine (Size 0, Grey nib). Light Medium (Size 1 Yellow nib). Very Broad (Size 3, Blue nib). Ideal for your every artistic and mechanical need. Shpg. wt., 8 oz.

15 A 8002 Net 4.48

AUTOMATIC ELECTRIC PENCIL SHARPENER

- Fully Automatic Electric Operation
- Clog-Proof Sealed Motor
- Ball Bearings Never Need Oiling

Ideal for student, artist, draftsman, business firm. Gives a needle sharp point instantly . . . even sharpens charcoal and pastel pencils. Automatic indicator lights when pencil is sharpened. Specially tempered steel cutters last indefinitely. Non-slip suction cups hold firmly to most any surface. Sealed motor, with ball bearings, never needs oiling. Large, clear receptacle is easily removed for cleaning. Simple and safe for even a child to use. Size: 5x3¼x4¾". 115V, AC. UL listed. Imported. Shpg. wt., 3 lbs.

15 A 3201 Net 9.95

(E)

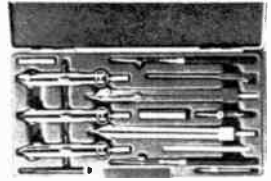

(F)

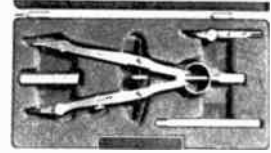

(C) 10" LOG LOG DUPLI TRIG SLIDE RULE

Specially selected, laminated, non-hygroscopic bamboo. Scales machine engraved on white plastic in permanently accurate calibrations. Adjusting screws permit varying tension on slide. 21 scales including C, D and CI on both sides. LLO and LLO0 scales refer to B scale. All other scales coordinate and refer to D scale. Scales are L, LL1, DF, CF, C1F, C1, C, D, LL3, LL2, LLO, A, B, K, C1, C, D, S, ST and T. Scale characteristics permit multiplication, division, proportion, inverse proportion, reciprocals, cotangents, squares, square roots, cubes, cube roots, logarithms, tangents, sines, PI factor multiplication and division, powers and roots of numbers less than 1, powers and roots of numbers greater than 1, logarithms to base "e". Shpg. wt., 1½ lbs. Imported.

99 A 7031

Net 10.45

(D) HARD MAPLE PANTOGRAPH

A 21" adjustable pantograph with 21 different ratios from 1½ to 8. Enlarges, reduces or reproduces drawings, etc. Most rapid, accurate means of reducing or enlarging to scale. Lacquered highly finished bars are 21" long and 3/4" wide. Heavy ball bearing standard. Chrome plated hardware, ratio thumb screws and nuts. Complete with lead, accessories and detailed instructions. Shpg. wt., 2 lbs.

15 A 5802

Net 3.99

(E) TECHNICAL DRAFTING SET

Contains 6½" self-centering compass, one leg knuckle joint with divider, pencil, pen parts and lengthening bar; 6½" self-centering divider; spring bow divider 4½", center wheel adjustment with interchangeable needle points; spring bow pencil and spring bow pen, both 4½" with center wheel adjustment and interchangeable needle point; two 5¾" ruling pens; extra handle for pen and pencil parts; adjustment tool; lead case and leads; and spare parts kit, all in velvet lined snap closing case. Imp. W. Germany.

99 A 7003

Shpg. wt., 1½ lbs. 6.85

(F) PROFESSIONAL GIANT BOW

Professional quality utility set in a fitted, velvet lined case. Made in Western Germany of nickel plated brass. 6" giant bow has preferred center wheel adjustment. Makes circles from ¼" to over 10" in diameter. Set includes 6" giant bow, interchangeable pen and pencil parts, extra needle for using bow as divider, handle for use with pen and pencil parts, lead, lead box and repair parts. Shpg. wt., 1 lb. Imported.

99 A 7083

Net 3.50

9 95

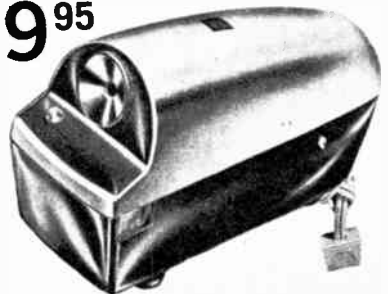



OUR LOWEST PRICE EVER

SALE 11⁹⁵
Save 4.00 was 15.95

"BUDGET PRICED" MOVIE CAMERA

- Fast f/1.9 4-Element Lens
- Electric Drive—No Winding
- Enclosed Optical Viewfinder
- No Focusing Necessary

A truly modern, versatile and inexpensive movie camera. Fast f/1.9 4-element lens captures all the exciting action in brilliant color or black and white. Fixed focus lens never needs adjustment because of a change in the distance between camera and subject. Electric motor drive with built-in standard "C" batteries eliminates bothersome hand winding. Just aim and shoot—even beginners get perfect movies every time. Automatic reset footage meter is easily readable. Variable, click stop lens aperture opens from f/16 to f/1.9. "Drop-in" spool loading is easy and economical. Comes with wrist strap. Exposure guide on side of case. Imported. Shpg. wt., 4 lbs.

99 A 7180L Net 11.95

ACCESSORIES FOR MOVIE CAMERA

- 99 A 6257 Batteries (2 req.) Net each .95
- 15 A 1601 Carrying Case Net 2.95
- 15 A 3408 Pistol Grip Handle Net 1.89



ARGUS SUPER

8mm AUTOMATIC ELECTRIC EYE

Enjoy the simplicity and convenience of an all-electric movie camera plus extra bright, extra sharp pictures at a budget price. Easy, instant cartridge loading eliminates threading and fumbling. Fully automatic electric eye sets lens openings for proper exposures. Electric film drive eliminates winding forever. Argus Cinepar f/1.8 fixed-focus lens never needs adjusting. Sturdy and lightweight die-cast aluminum construction. Less batteries. Shpg. wt., 3 lbs. Imported.

- 15 A 8206L Model 810B \$5 monthly Net 49.95
- 99 A 6258 Batteries (4 Req.) Net ea. .95
- 15 A 8207 Folding Pistol Grip Net 7.95

MINOLTA AUTOPAK 8 K5 SUPER 8 MOVIE CAMERA

- Ultra-Sharp Rokkor f/1.8 Zoom Lens
- Exclusive "Total Control" Viewfinder

A deluxe, fully automatic zoom movie camera for use with easy loading Super-8 film cartridges. Sensitive behind-the-lens CdS electric eye gives correct exposure... automatically compensates for zooming, filters or changes in film and motor speed. "Total Control" viewfinder provides instant checking of aperture, film load, film remaining, plus through-the-lens viewing and focusing. Sharp f/1.8 Rokkor lens zooms from 9.5mm wide angle to 30mm telephoto. Also features: 3-speed electric motor drive (12, 18, 24 fps), battery check, single frame, remote control, built-in type A filter, safety lock, continuous run and built-in handgrip, wrist strap. Imported.

- 15 A 3624L \$8 monthly Shpg. wt., 3 lbs. Net 149.95
- 15 A 1602 Deluxe Zoom Movie Case. Wt., 2 lbs. Net 6.95
- 99 A 6258 Batteries (4 required) Ea. Net .95

DELUXE SUPER 8 POWER ZOOM REFLEX MOVIE CAMERA

- f/1.8 Focusing Zoom Lens
- All Electric Drive • CdS Electric Eye

A fine super 8 mm zoom movie camera packed with outstanding features. Instant cartridge loading eliminates threading problems. Runs 50 feet in one direction without reversing. 8.5 mm to 35 mm focal length f/1.8 to f/22 zoom lens allows focusing from 4 feet to infinity. Compensated CdS lens opening assures fine results. Reflex viewing gives parallax-free viewing and shows f/stops and filter position. Features include slow motion speed, electric drive with battery checker and remote cord socket, and electric zoom. Shpg. wt., 3 lbs.

- 15 A 8209L Model 8148 \$7 monthly Net 129.50
- 15 A 8207L Folding Pistol Grip For Above Camera Net 7.95
- 99 A 6258 Batteries for above (4 req.) Net ea. .95

SUPER 8mm ZOOM MOVIE CAMERA WITH PISTOL GRIP

- Fast f/1.8 Reflex Zoom lens
- Fully Automatic Electric Eye

A completely automatic camera which has a host of features. This sleek, compact Yashica Super 8-25 features instant loading, fully automatic exposure, electric film drive and the brilliant Yashinon f/1.8 reflex zoom lens with a 2½ to 1 ratio — 12 to 30mm. Incorporates an exposure warning system in the viewfinder, which indicates over- or under-exposure, as well as the lens opening. Exposure is automatically set by the cartridge for ASA 25 and 40. Other features include a battery check—adjustable eyepiece, footage counter, 18 fps speed and single frame, cable release socket and molded plastic grip with attached wrist strap for comfortable shooting. Less batteries. Shpg. wt., 3 lbs. Imported.

- 15 A 3622L Model Super 25 \$5 monthly Net 89.95
- 99 A 6258 Batteries for above (4 req.) Net .95

Minolta

149⁹⁵

With Grip
No Money Down

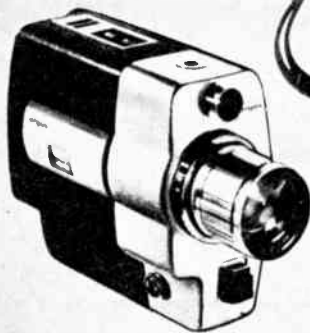

argus
129⁵⁰
No Money Down



YASHICA

89⁹⁵

No Money Down

**(A) De Jur "DUO-VISTA" DELUXE
8 mm ZOOM MOVIE PROJECTOR**

• Built-In Viewing Screen

Professional quality, flickerless 8 mm movie projector features built-in viewing screen (or regular projection), automatic reel to reel threading, sharp f/1.2 zoom lens, multiple speed control (forward-reverse), instant slow motion, room light control, film trimmer and positive chain and gear drive. Shpg. wt., 20 lbs.
 15 A 5202WX \$5 monthly. Was 124.95 Net 99.95
 De Jur ELDORADO II movie projector. As above but for Super-8mm film size. Shpg. wt., 20 lbs.
 15 A 5204WX \$7.50 monthly Net 139.95

**(B) BELL & HOWELL AUTO LOAD
SUPER 8 mm PROJECTOR**

Sharp 1" f/1.6 lens enhances all home movies. Brilliant illumination system allows enlarged viewing without light fall off. Design gives you finger-tip control of framing, tilt, and direction. Features automatic loop setter, still picture control, touch threading, and motor cooling switch. Rugged construction has built-in film cutter. Complete with 400-ft. reel. Shpg. wt., 20 lbs.
 15 A 6501WX Model 356 \$5 monthly Net 79.95
 Same as above but with f/1.6 Filmovara Zoom Lens, automatic reel to reel threading, dial focusing, and cord and storage door.
 15 A 6502WX Model 357Z \$5 monthly Net 99.95

(C) "HOLIDAY" 8mm PROJECTOR

• Full 500-watt Lamp • Coated f/1.6 Lens

MODEL 3000. Swing out gate for fast loading, rapid rewind, quick-tilt, and separate blower and lamp switches are among the many convenience features. All aluminum die cast construction utilizes oilite bearings and high intensity turbo cooling. 400-ft. reel capacity. Shpg. wt., 10 lbs.
 15 A 8204WX \$5 monthly Net 34.95

(D) REVIEWER - EDITOR

• Single Sprocket Drive • 3x2 1/4" Viewing Screen

Compact Super 8 mm viewer with prismatic shutter magnifies picture more than 300 times. Features slip-in film loading that eliminates threading. Uses single sprocket drive to assure no skipping or film wear. Features automatic framing and focusing, fold-away butt type one step splicer, folding 400-ft. capacity rewinds, and a convenient frame marker. Complete with a supply of Mylar splice tape. Shpg. wt., 4 lbs.
 15 A 6603 For super 8 mm Net 14.95
 Same as above but for standard 8 mm. Net 14.95
 15 A 3620 Shpg. wt., 4 lbs. Net 14.95

Minolta



29⁹⁵ each

MINOLTA "16 II" SUBMINIATURE CAMERA. An extremely easy-to-operate, palm-size camera that you can carry with you always. No need to miss those once-in-a-lifetime shots. Sliding camera in and out of built-in case advances film, cocks shutter, counts exposure and prevents double exposure—all automatically. 6 shutter speeds from 1/30 to 1/500 sec. plus B. Click-stop settings. Internally synchronized for electronic flash and bulb. Takes regular black and white pictures or color slides that fit any 35 mm projector. Direct viewfinder shows picture exactly as it will appear on film. Lens opening from f/2.8 to f/16. Click-stop settings. Complete with case. Imported. Shpg. wt., 1 lb.
 15 A 3416L Net 29.95

MINOLTA "16" II Accessories. Avg. Shpg. wt., 6 oz.
 15 A 3421 Baby BC Flash with Capacitor and Case Net 4.95
 15 A 3422 Bracket for Flash and Tripod Mtg. Net 1.95
 15 A 3423 Aux. Lens Set—2 closeup, 1 distance, 1 Y filter Net 3.95
 15 A 3424 Color Filter Set—1 ea. 1A, 80A, 81B Net 3.95
FILM FOR "16 11" 20-exposure magazines. Shpg. wt., 3 oz.
 15 A 3417L Kodak Panatomic X Net .98
 15 A 3419L Kodachrome II Net 1.25
 15 A 3418L Kodak Tri-X Net .98

MINI-"16" COLOR SLIDE PROJECTOR. Compact, lightweight projector to match Minolta and other 16 mm Sub-miniature cameras. Sharp 40 mm Rokker F/2.5 lens. Includes carrying case, standard slide carrier and 75 watt projector lamp. For 110-120 volts AC-DC. Imported.
 15 A 3435 Shpg. wt., 3 1/2 lbs. Net 29.95

PRICE BUSTING SALE!

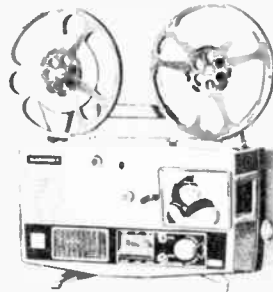

(A) 99⁹⁵

No Money Down

(B) 79⁹⁵

No Money Down

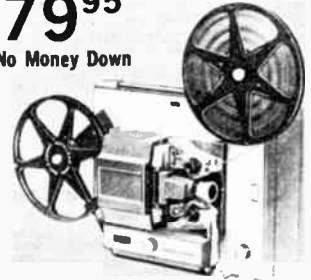

(C) 34⁹⁵

No Money Down

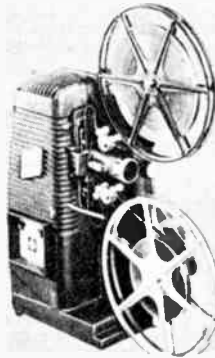

(D) 14⁹⁵

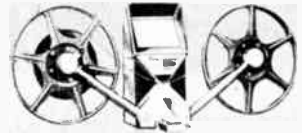

(A)



(B)

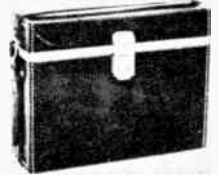

(C)

(A) DIAL-A-BOUNCE MOVIE LIGHT

A versatile lamp that is a must for indoor movie making. Features long life sealed super flood lamp. Calibrated knob on handle adjusts lamp to desired angle up or down for indirect bounce or direct lighting. Camera bracket mounts left or right for convenience. UL and CSA approved. Shpg. wt., 4 lbs.
 15 A 2801 Net 7.49

(B) SUPER 8MM MOVIE LIGHT

Compact, powerful 650 watt tungsten sealed beam lamp will provide sparkling, bright indoor movies. Features top mounting and switch on power cord. Will fit all new super 8mm cameras plus all standard 8mm cameras with tripod socket on top, with 6 1/2 ft. cord and exposure guide. Shpg. wt. 3 1/2 lbs.
 15 A 8406 Net 6.49

(C) DELUXE ZOOM MOVIE CASE

Takes all 8mm zoom movie cameras (including those with pistol grip attached) plus supply of extra film. Covered with attractive black vinyl, reinforced with aluminum trim. Has handy "Presto" lock. Overall Size: 10 1/2 x 9 x 3 1/2" D. Shpg. wt., 1 1/2 lbs.
 15 A 1602 Net 6.95

SALE

On Miranda SLR 35MM Cameras



SAVE 15⁰⁰
OFF OUR REGULAR
LOW PRICES

Model "F"
139⁹⁵
with case

Model "FM"
159⁹⁵
with case



A deluxe 35 mm single lens reflex camera which features a sharp, fast f/1.9 lens internally coupled and interchangeable with every other lens in the extensive Miranda system, plus lens of most other 35's. Pentaprism is interchangeable too with other types of finders and the brilliant viewfinder brings out details even in the dimmest light. Shutter speed ranges from 1/1000 to 1 sec. Multigrad center pot permits precise focusing to as close as 17". The "F" also has instant return mirror, depth-of-field preview button, single-action rapid advance lever and many other features. Complete with case. Shpg. wt., 3 lbs. Imported.
15 A 3704L \$7.50 monthly Net 139.95

A fully-automatic professional quality camera! Pentaprism viewfinder gives a large, sharp preview of your picture without parallax. Fast, needle sharp focusing is assured with ground glass split range finder even under adverse lighting conditions. Range finder may be used with all lens types, even wide angle and telephoto. Hard coated lens on interchangeable lens mount focuses at 17 inches. CdS exposure meter built into pentaprism housing. Eleven speed focal plane shutter to 1/1000 sec. Automatic exposure counter. Lever type film advance. Complete with case. Shpg. wt., 3 lbs. Imported.
15 A 3707L \$8 monthly Net 159.95

TARON AUTO SE
Automatic Rangefinder Camera

LYNX-5000 35mm

500-WATT SLIDE PROJECTOR

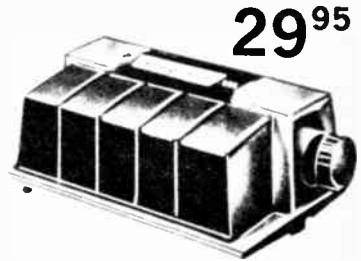
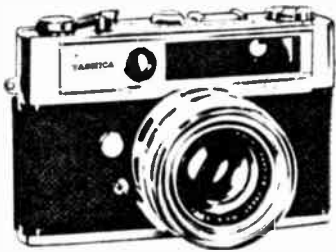

44⁹⁵
With Case

- All-in-one Finder
- Sharp, Super-fast f/1.8 lens
- Two-Stage CdS Meter

75⁹⁵
With Case

- Automatic Slide Changer
- Color Corrected 4" f/3.5 lens
- Holds up to 40 Slides
- 500-Watt

Set the ASA scale to match the film in use, select a shutter speed, rotate the aperture ring to align two red marks and shoot! F-stop indicator at top of the viewfinder field; light-meter includes warning signal for over or under exposure. Specifications: f2.8 Taronar lens (f 400mm); Shutter Speeds: B, 1/30, 1/50, 1/125, 1/250; X— contact; Single stroke, self-cocking, 120° lever winder with automatic stop; Selenium Circle Eye EE Photometer; ASA 10-400 with case. Shpg. wt., 3 lbs. Imported.
15 A 7203L \$5 monthly Net 44.95

Set the needle in the finder and SHOOT! The LYNX-5000 combines an easy-to-operate match needle CdS exposure meter with a super-speed f/1.8 lens and a high speed (up to 1/1000 sec.) shutter. Features a split-image focus rangefinder, sensitive two-stage CdS meter with on-off switch and ASA range 10-800. Viewfinder lets you set perfect exposure without removing eye from finder as you compose and focus. Shpg. wt., 3 lbs. With case. Imported.
15 A 3613L \$5 monthly Net 75.95

Designed and engineered for simplicity of operation, ease of maintenance, and long life. 4" color corrected, hard coated f/3.5 lens. Sharp, brilliant pictures assured by 500-watt lamp. No slide trays required. Project any 35mm, Bantam, 127, or Instamatic slides. Loads up to 36 slides. Different size slides can be loaded together. Unit is completely self contained and requires no tools for a bulb change. Uses standard projection lamp. Compact 5¾Hx14Lx8½"W. For 105-120 volt 50/60 cycle operation. Shpg. wt., 7½ lbs.
15 A 8401 Net 29.95

LAFAYETTE TRANSISTORIZED ELECTRONIC STROBE FLASH

LAFAYETTE Cds EXPOSURE METER



SALE! 15⁹⁵
was 17.95

- Lightweight & Compact
- Fully Transistorized
- Operates On 4 Economical "Z" Cell Batteries



SALE!
9⁹⁵
was 12.88

- Super Sensitive Cds Meter
- Push-Button Battery Test Circuit
- ASA 6 to 12,000

Now you can have a high-powered transistorized electronic flash that operates from standard AC house current or 4 economical "Z" cell batteries. Compact and feather-weight — no power pack is required. Flash duration of 1/2000 second for fast pictures. Recycling time: 6 to 8 seconds; color temperature: 5800° Kelvin. Guide number dial for F stop on back. Mounts either vertically or horizontally. Fits any camera shoe. Complete with AC cord, camera cord, and batteries. Size: 4¾Wx3½Dx1½"H. Imported.
99 A 7184 Shpg. wt., 2 lbs. Net 15.95
99 A 6258 Extra batteries for above 4 req. Net .95

An extremely sensitive Cadmium Sulfide exposure meter. Perfect for all types of photography either indoors or outdoors. Perfect for all high or low level lighting. May be held in the hand, around the neck, or attached to camera. Film sensitivity scale: ASA 6 to 12,000. Exposure time scale 8 sec. to 1/1000 sec. Lens aperture f/1 to f/32. Light value scale (EV): LV4 to 17. Movie scale 8 to 64. Measures reflected or incident light. Complete with mercury battery, leather carrying case and carrying/neck cord.
99 A 7186 Shpg. wt., 1 lb. Net 9.95

Instamatic Camera Outfits by Kodak

KODAK INSTAMATIC 104 OUTFIT. Automatically gives four brilliant flashes without bulb handling. Photoflash bulbs are enclosed in a revolutionary "flashcube." Pre-sets shutter speed for correct exposure. No dials to adjust. Film loads instantly. Take sharp color or black and white slides or snapshots. Outfit includes camera, wrist strap, flashcube, batteries, and film cartridge. Shpg. wt., 5 lbs. **15 A 2630L Instamatic 104** Net 15.95
 Package of 3 Four-shot Flashcubes Net ea. 1.79
 15 A 2632 Shpg. wt., 3 oz.

KODAK INSTAMATIC 154 OUTFIT. The complete foto outfit for the casual photographer who desires quality results. Features new "flashcube" for instant load photoflash shooting. Cube contains four bulbs with reflectors. Eliminates ejecting hot bulbs. Spring wound automatic advance, instant 10-thread loading, and automatic flash exposure setting are among the other features of this versatile camera. Complete with wrist strap, film cartridge, flashcube batteries. Shpg. wt., 6 lbs. Net 21.95
 15 A 2631L Instamatic 154 Net 21.95
 Package of 3 Four-shot Flashcubes Net ea. 1.79
 15 A 2632 Shpg. wt., 3 oz.

FRONT PHOTO FOCUS MONOCULAR

MAKES YOUR CAMERA TELEPHOTO
 —Bring Distant Object from 6 to 8 Times Nearer

ENLARGES THIS **AS LOW AS 10⁹⁵**
TO THIS

Take super-telephoto pictures with your single lens or twin-lens reflex camera. The front focus system is specially made for on-camera operation. There is no need to miss those once-in-a-lifetime shots. Increases focal length of your camera lens 6X, 7X or 8X depending on model selected (i.e. 50mm lens plus 8X monocular equals 400mm telephoto). Rugged, lightweight construction — weight only 7½ ounces; is only 5 inches long. Includes series V1 adapter ring and leather case. Shpg. wt., 1 lb. imported. Net 10.95
 99 A 7072 6x30 mm Net 10.95
 99 A 7073 7x35 mm Net 12.95
 99 A 7074 8x30 mm Net 12.95

KODAK FILM with PROCESSING INCLUDED

• Slides Returned Mounted, Ready for Viewing or Showing! • Convenient, direct-mail "mailers" in every roll • A full number of Prints guaranteed for Kodacolor and black and white.

After the complete roll has been filmed, put it into the mailer, drop into a mailbox and in a few days your finished films are delivered postpaid to your door. You get 3½" square or 3½x5" giant prints with Kodacolor and Black and White (except CX-135 which is 2½x3½"). Should you get less than the full number of prints or printable negatives per roll, you will receive coupons for additional FREE prints. DO NOT MAIL FILM TO LAFAYETTE RADIO.



KODACHROME MOVIE FILM-TYPE II

ASA Index 25 Daylight—40 "A" Indoor

Stock No.	Film Size	Description	Net
15 A 4703L	KR459	8mm, 25 ft. Double roll, Daylight	3.25
15 A 4704L	KRA459	8mm, 25 ft. Double roll, "A" Indoor	3.25

KODAPAK MOVIE FILM FOR SUPER 8

15 A 4705L	KA-464	Super 8mm 50-ft. Cartridge, Indoor/Outdoor	Net 3.75
------------	--------	--	----------

KODACHROME 35MM, TYPE II AND X

Type II ASA index 25 Type X ASA index 64

15 A 4706L	KR135-20	35mm, Type II, 20 Exp.	2.80
15 A 4707L	KR-135-3	35mm, Type II, 36 Exp.	4.25
15 A 4708L	KX135-20	35mm, Type X, 20 Exp.	2.80
15 A 4709L	KX135-36	35mm, Type X, 36 Exp.	4.25
15 A 4710L	KX126	Instamatic Cartridge, 20 Exp.	2.80

KODACOLOR-COLOR SNAPSHOTS

15 A 4711L	CX-127	127 indoor/outdoor, 12 Exp.	3.15
15 A 4712L	CX-120	120 indoor/outdoor, 12 Exp.	3.15
15 A 4713L	CX-620	620 indoor/outdoor, 12 Exp.	3.15
15 A 4714L	CX-126	Instamatic cartridge, 12 Exp.	3.25
15 A 4715L	CX-135	35mm Indoor/Outdoor, 20 Exp.	3.99

KODAK BLACK & WHITE ROLL FILM

15 A 4716L	VP-126	Instamatic Cartridge	12 Exp.	1.59
15 A 4717L	VP-127	127 Verichrome Pan	12 Exp.	1.39
15 A 4718L	VP-120	120 Verichrome Pan	12 Exp.	1.39
15 A 4719L	VP-620	620 Verichrome Pan	12 Exp.	1.39
15 A 4720L	PX135-20	35mm, Plus X	20 Exp.	2.39
15 A 4721L	PX135-36	35mm, Plus X	36 Exp.	3.50

KODAK INSTAMATIC

104 OUTFIT
15⁹⁵



KODAK INSTAMATIC 154 OUTFIT

21⁹⁵

AG "REPEATER" BC FLASH

3⁹⁵

- Holds & Fires 6 Flash Bulbs Without Reloading

Holds six AG-1 flash bulbs for rapid successive firing. Weighs only 6½ oz. Maximum light output assured by a precisely designed 2" reflector and fresnel lens combination. Indicator shows number of bulbs left. Built-in exposure calculator, test light, flash shield. Bulbs and battery load easily from front. Fits any camera with standard accessory shoe. Replaceable standard cord with PC fitting. Uses long lasting 22.5v BC battery. Less battery. Imported. Shpg. wt., 8 oz. Net 3.95
 99 A 7170 Net .59
 99 A 6208 22.5v Battery for above



LAFAYETTE BOUNCE BC FLASH

3⁹⁹

- For Straight or Bounce Flash
- Compact, with Vinyl Case

A versatile bounce BC flash gun with many outstanding features. Swivels for intermediate to full bounce light. Reflector completely folds for easy carrying. Positive shoe lock. Accepts AG-1, M2, M3, M5, 5 & 25 bulbs. Used bulbs are disposed of by a spring action bulb ejector. Bright neon circuit testlight indicates that circuit is fully energized and ready to "shoot." Completely retractable PC cord. Useful exposure indicator dial. Complete with vinyl case. Less Battery. Shpg. wt., 1 lb. imported. Net 3.99
 99 A 7187 Net .59
 99 A 6027 Battery for above

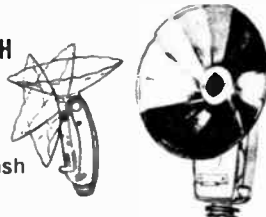

DROPFRONT PRO BAG

PRO-11. Zippered for easy access. Styled for easy hand or over-the-shoulder carrying. Removable, adjustable straps. Chrome plated snaplock, feet and hardware. Handsome, heavy back simulated cowhide with leather and corduroy lining. Front tripod carrying straps. Measures 11" long x 6¼" wide x 8¾" high. Shpg. wt., 3 lbs. Imported. Net 9.95
 15 A 3412 Net 9.95



PRO-13 Same as above except measures 13x7x9½". Net 11.95
 15 A 3413 Shpg. wt., 3 lbs. Net 11.95
 SUPER-PRO 16, Same as above but measures 16x7¾x11". Net 15.95
 15 A 4924 Shpg. wt., 4 lbs. Net 15.95

LENS SET FOR POLAROID 100, 101, 103

- Wide Angle and Telephoto Lens
- View Finder for Accurate Composition

An ideal companion to the Polaroid Camera. Telephoto lens increases the focal length of the lens and results in a 3 times magnification. Wide Angle lens provides a 75% increase of subject area. Each lens has a "conversion band scale." Supplied with slip-on ring adapter, special electric-type bracket for viewfinder and flash, filter retaining ring, view finder and genuine leather case with shoulder strap. Shpg. wt., 2 lbs. Imported. Net 32.50
 15 A 4923 Net 32.50



Deluxe Portable TV Sets At Low Lafayette Prices

**NEW! PANASONIC VHF/UHF
12-INCH* PORTABLE TV**



- Tunes Channels 2 Thru 83
- Front Mounted Speaker
- 110° Aluminized Picture Tube

79⁹⁵

Get sharp, magnificently clear TV pictures on a full 75 square inch screen. Full-range front mounted speaker in acoustically matched cabinet gives added listening pleasure. Has 10,000 volts of picture power and 2-stage frame-grid IF amplifier for greater sharpness even in remote signal areas. "Set and forget" VHF tuner and solid state dual speed UHF tuner for fast, accurate all channel reception. Weighs only 19 lbs. Built-in 39½" VHF telescopic whip antenna, handy carrying handle. Grey cabinet, 16¼Wx12Hx10¾"D. For 117V, 60 cycles AC. Imported. Shpg. wt., 23 lbs. Net 79.95

* Overall diagonal measurement

**NEW! PANASONIC 12-INCH* SOLID STATE
AC or BATTERY OPERATED VHF/UHF TV**

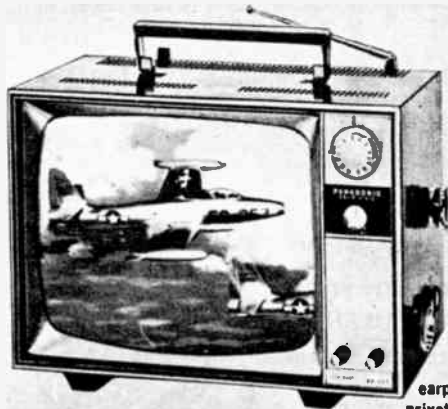

with
earphone for
private listening

- Built-in Automatic Timer
- Covers Channels 2 Thru 83
- 30 Transistors and 15 Diodes

139⁹⁵

Truly portable TV with big 12" screen and sophisticated solid state circuitry. Provides brilliant, clear pictures both indoors and out on all 83 channels. Front mounted 2x6" oval speaker. Operates from AC house current, optional DC Battery pack and charger. Built-in timer can be set for up to a full hour and set turns itself off—automatically. Other features include aluminized picture tube, power transformer, earphone and Built-in VHF/UHF antennas. 13¼Wx10¼Hx10¼"D. Imported. For 117V, 60 cycles AC. Shpg. wt., 23 lbs. Net 139.95

17 A 3018WX \$7.50 Monthly Net 139.95
Battery Pack and Charger for above TV set. Net 39.95
17 A 3019W Net 39.95

* Overall diagonal measurement

**4½-INCH* SOLID STATE BATTERY
OPERATED VHF-UHF PORTABLE TV**



Price Includes:

Charger, Batteries, Earphone
& Carrying Case.

- Goes Anywhere - Fits Everywhere
- Covers Channel 2 Thru 83
- Earphone For Private Listening

SALE!
119⁹⁵
WAS
129.95

A miniature marvel. Receives bright, clear, "photo-like" pictures from VHF and all UHF channels both indoors and outdoors. Features powerful solid state circuitry with AGC and AFC for stable pictures. 3-way operation: standard AC, rechargeable batteries or 12 VDC for auto or boat connection with optional power cord (below). With AC charger, dual telescopic antennas, front mounted speaker, 3 rechargeable batteries, earphone and carrying case. (Overall diagonal measurement). Size: 8½Wx4¾Hx8¾"D. Imported. Shpg. wt., 15 lbs. Net 119.95
17 A 1706WX \$7 monthly Net 119.95
17 A 1707 DC Power Card for above. Shpg. wt., 1 lb. Net 3.95
32 A 4742 Replacement batteries, 3 required Net 2.76

**9-INCH* SOLID STATE BATTERY
OPERATED VHF-UHF PORTABLE TV**



- Great For Home—Car—Boat
- Lightweight, Solid State Design
- Covers Channels 2 Thru 83

SALE!
99⁹⁵
SAVE!
22.55
WAS
122.50

Compact, completely transistorized 9" portable TV set. Keyed AGC noise limiter and AFC circuits provide high picture stability even in fringe areas. Uses AC power or portable power pack (optional) or any 12V DC battery in a car or boat (with optional power cord). With 82-channel tuner; 3x5" front speaker; 9¾Hx9¼Wx8¼"D. *Overall Diagonal Measurement. Imported. Net 99.95
17 A 1708WX Shpg. wt., 14¾ lbs. Net 99.95

Portable Power Pack. Includes battery, battery charger, carrying case. Net 24.95
17 A 1709 Shpg. wt., 9 lbs. Net 24.95
17 A 1707 DC Power Card for above. Shpg. wt., 1 lb. Net 3.95
32 A 4743 Replacement Rechargeable Battery. 6 lbs. Net 9.94

Specialty Radios for Every Occasion

AM CLOCK RADIO

OUR LOWEST PRICE
EVER FOR A CLOCK RADIO **13⁹⁵**

Beautifully styled AM clock radio in a high impact white plastic cabinet with silver trim at Lafayette's lowest price ever for a clock radio. Wake up to the pleasant sound of music every morning. Features deluxe Westclox automatic clock, large front mounted speaker for excellent sound quality, 5 tubes, 2 IF stages and built-in antenna. Size: 9 $\frac{3}{4}$ "Lx5 $\frac{1}{4}$ "Hx3 $\frac{3}{4}$ "D. For 117 VAC-60 cycles AC. Shpg. wt., 6 lbs.

17 A 1101 Net 13.95

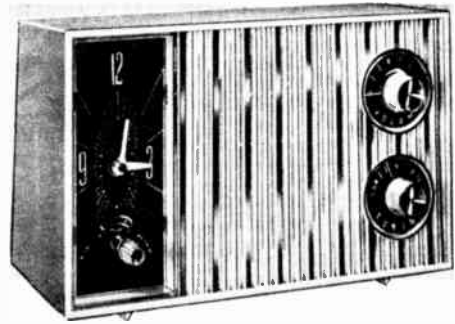

NEW PANASONIC R-1010 SOLID STATE "RADAR-MATIC" AM PORTABLE

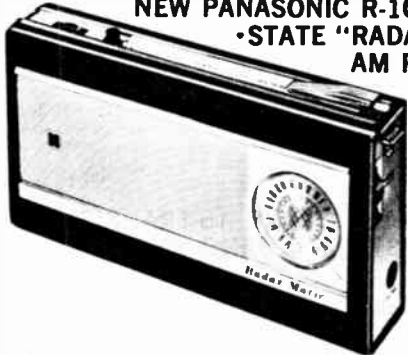

- Solid State Circuitry with Electro-Mechanical Automatic Tuning

29⁹⁵

Automatically tunes in every station with the touch of a bar. Manual tuning also. 10 transistor, 3 diode circuitry provides brilliant reception. 3 $\frac{1}{2}$ " speaker, gives full balanced sound. Automatic volume control. 2 position sensitivity switch. With batteries. Imported. Dim.: 7 $\frac{7}{8}$ x4 $\frac{1}{4}$ x1 $\frac{7}{8}$ ". 17 A 3014L Shpg. wt., 2 $\frac{1}{2}$ lbs. Net 29.95

99 A 6258 Extra Batteries (4 required) Net .095

Radar-Matic FM-AM Portable: Same as above except with FM band. With batteries.

17 A 3011L Shpg. wt., 3 lbs. \$5 Monthly Net 69.95

99 A 6257 Extra Replacement Batteries (4 req.) Net ea. .13

DELUXE SOLID STATE MICRO RADIO

11⁹⁵

Includes Leather Strap Earphone and Batteries

- Sub-Miniature Components Provide Top Performance in a Palm Size Radio
- Full Well Balanced Tones

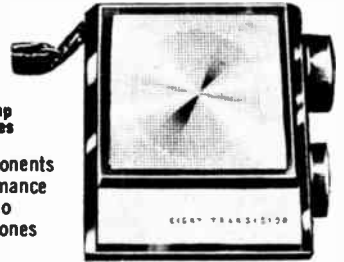

The MICRO radio uses subminiature components and 8 transistors to give big radio performance in a remarkably small unit. Carry it along with you wherever you go. A special 1 $\frac{1}{2}$ " high efficiency dynamic speaker magnificently reproduces all your favorite stations. Accurate pin-point tuning makes it easy to pull in stations. Automatic Volume Control does away with fading, and 2 thermistors compensate for wide temperature variations. The AGC transistor stage compensates for directional fade-out when radio is repositioned. Earphone included for private listening and extra battery life. Operates on one 9 volt battery. Includes leather strap, earphone and battery. Imported. Shpg. wt., 1 lb.

17 A 6909L Net 11.95
99 A 6021 Extra battery for above Net .21

NEW SOLID STATE BATTERY OPERATED PORTABLE AM RADIO/PHONO



ONLY
26⁹⁵



A great all-around performer — indoors and out. Listen to your favorite records wherever you go—school dorm, patio, or beach plus AM broadcasts. Lightweight. Features a powerful 6-transistor radio and 4" speaker for full, rich tone. Three speed turntable has constant speed motor and starts automatically when tone arm is lifted. Weighs less than 4 lbs. Coral and Ivory plastic case, 8 wide, 11" long and 3 $\frac{1}{2}$ " deep. With batteries; synthetic sapphire needle. Imported. Shpg. wt., 6 lbs.

24 A 4603 Net 26.95

Replacement "C" Type Batteries for above. 6 required.

99 A 6257 Net ea. .13

NEW PANASONIC RF-1006M SOLID STATE 3 BAND AM/FM/MB AUTO/PORTABLE

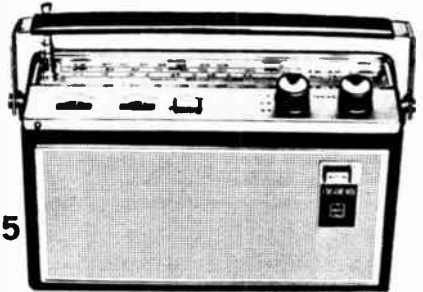

ONLY
54⁹⁵

Easy-to-Install 3-Band Car Radio—Slides Out For Take-It-With-You Listening Pleasure On Beach, Boat!

Truly versatile 10-transistor portable mounts in your car. Receives AM, FM with AFC and Marine Band (1.6-4.5 Mc) for boating enthusiasts. Plugs into car battery with below optional car bracket. Has telescopic antenna big 5" speaker, tone control, earphone jack and phono jack for crystal or ceramic cartridge. With batteries. 9 $\frac{1}{4}$ "Wx2 $\frac{5}{8}$ "Hx5 $\frac{3}{4}$ "D. Imported. Shpg. wt., 5 lbs.

17 A 3015L \$5 Monthly Net 54.95

Universal Mounting Bracket with Lock for Auto-Use (6 or 12 volts—reverse polarity)

17 A 3016 Net 12.95

99 A 6257 Extra Batteries. 4 required Net ea. .13

Deluxe Portables . . . Priced Just Right

9-TRANSISTOR 3-BAND AM/SW/MB PORTABLE

16⁹⁵

- Includes Batteries and Earphones



Enjoy exciting shortwave broadcasts along with entertaining standard AM reception. Carefully designed tuning circuit covers 540-1600kc, 1.6-4.0mc, and 4-12mc in three ranges. Super sensitive ferrite-core and 12 section whip antenna draw in distant signals and feed them into a 9-transistor, 2-Diode, 1-Thermistor high performance circuit. Delivers clear audio reproduction. Solid-state construction allows use of four penlite cells. Smart black leatherette covered cabinet has a gleaming silver front grill. Complete with batteries and earphone. Imported. Shpg. wt., 5 lbs.

17 A 7904L Net 16.95
99 A 6250 Extra 2 cells for above; 4 required Net .095 ea.

3 BAND 11 TRANSISTOR AM/FM/SW PORTABLE RADIO

24⁹⁵

With Earphone & Batteries



Handsomely designed 3 band solid state portable radio utilizes 11 transistors, 4 diodes, and 1 thermistor for sensitive performance. Convenient multi-band operation tunes the 88-108mc. FM band, 540-1600 kc. standard broadcast band, and 4-10 mc. shortwave band. Enjoy exciting international shortwave broadcasts in addition to regular domestic radio service. Features a built-in ferrite bar and telescoping whip antenna. Complete with batteries and earphone for personal listening. Imported. Shpg. wt., 2 lbs.

17 A 6914L Net 24.95
99 A 6250 Extra batteries for above (4 req.) Net each .095

TOP QUALITY FULL SIZE 8 TRANSISTOR AC/BATTERY RADIO

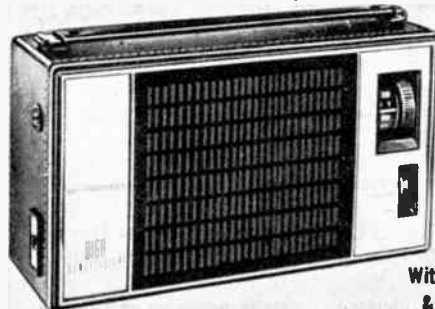

17⁹⁵

With Earphone & Batteries

Larger than standard pocket sized portables to insure mellow full size tonal quality. Sensitive 8 transistor superheterodyne circuit features a 3 gang condenser and tuned RF stage. Operates up to 500 hours on 4 economical flashlight batteries. Built-in AC adapter circuit permits operation directly from 115 VAC. Self storing AC cord. Housed in a beautiful ebony leatherette covered cabinet and handle, with earphone and batteries. Size: 8 3/4x3x5 1/4". Imported. Shpg. wt., 5 lbs.

17 A 7906L Net 17.95
Extra Batteries for Above (4 Required)
99 A 6257 Net ea. .13

A DELUXE FULL SIZE LAFAYETTE CRITERION® I SOLID STATE FM-AM PORTABLE RADIO

- 11 Powerful Transistors, 6 Diodes, 1 Thermistor
- Large 4" Speaker Offers Life-Like Hi-Fidelity Sound Reproduction
- AFC Locks-in FM Stations

Enjoy the remarkably static-free tone of FM and the great variety of AM stations which this superb low-cost portable has to offer. This deluxe full-size "set", (9x6 1/2x3 1/2"D), features one RF and 3 IF stages to give you real pulling power of stations both near and far. Big 4" speaker delivers full tone high fidelity sound. AFC circuit makes drift virtually non-existent. Geared tuning with large circular tuning dial pinpoints FM and AM stations easily. Built-in carrying handle is recessed to hold 33" telescoping FM antenna. Spacious interior contains 7" ferrite antenna for powerful AM reception and 4-cell battery compartment. Economical home use is possible with optional 6-volt power supply which connects to 110-120 volt AC house line. Luxurious break-resistant black plastic case with satin chrome grille. Complete with earphone and batteries. Shpg. wt., 3 1/2 lbs. Imported.

99 A 3515L Net 24.95
Plug-in AC Adapter for "Criterion I"
99 A 3516 Net 3.95
Extra "C" cell batteries, 4 req.
99 A 6257 Net ea. .13

B ROYAL DELUXE 15-TRANSISTOR SOLID STATE 4 BAND PORTABLE

- Tunes AM, FM, SW and Marine Band
- Beautiful Styling, Trimmed in Walnut Veneer Finish

Buy now and get special bonus of 1 year supply of 12 batteries, plug-in AC adapter, and earphone.

Tunes the standard broadcast band-50-1600 Kc; marine band-1.7-4.7 mc.; shortwave band 5-12 mc., and FM band 88-108 mc. Features 15 transistors, 6 diodes, and 1 thermistor. Advanced circuitry includes an FM Automatic Frequency Control, powerful push-pull audio output circuit, and separate tone control. Telescopic antenna "brings in" distant stations. AC adapter permits operation on 117 VAC without the use of batteries. Case is trimmed in elegant walnut veneer finish. Complete with 12 batteries, AC adapter, and earphone. Size 10x8x3". Imported. Shpg. wt., 6 lbs.

17 A 6912L \$5 Monthly Net 49.95

C LAFAYETTE "MIGHTY-12" 12 TRANSISTOR POCKET RADIO

- With AC Jack
- Powerful Superheterodyne Circuit

Attractively designed, precision made powerful 12 transistor pocket radio. Superheterodyne circuitry and a ferrite antenna pull in AM stations clearly. With the AC adapter you save your battery by using 110V AC in your home. Outstanding tone quality from push-pull audio output circuit and 2 1/4" speaker. Automatic volume control circuit minimizes annoying fading and sudden blasts of volume. Black plastic and leather carrying case. Handy thumbwheel controls for volume and tuning and easy-view dial permits trouble free operation. Earphone included for private listening, also AC power jack. Operates on one 9 volt battery. Imported. Shpg. wt., 3/4 lb.

17 A 4202L Net 7.95
17 A 3101 AC adapter for above radio Net 3.95
99 A 6021 Extra 9V battery for above radio Net .21

D NEW 9 TRANSISTOR AM/FM POCKET PORTABLE RADIO

Now, own a sensitive AM/FM Pocket Portable for less than \$13.00. Utilizes 9-transistors, 4-diodes and 1 thermistor for powerful performance on both the standard broadcast and FM bands. Features geared vernier tuning for easier, more precise station selection, ferrite antenna for AM and fold-a-way telescopic antenna for FM. Enjoy it everywhere you go. Push-pull output for clear, full tone. Low drain circuit operates on single 9-volt battery. Measures 4 3/8x3x1 3/8"D. Housed in beautiful black and silver plastic case, includes private-listening earphone, battery and carrying strap. Imported. Shpg. wt., 1 lb.

17 A 7601L Net 12.95
99 A 6021 Extra 9-volt battery. Imported. Net .21

**A LAFAYETTE'S FINEST
AM-FM PORTABLE**

Engineered to the Highest
Electronic Standards

24⁹⁵

*Complete with Earphone
and Batteries*

Powerful Circuitry Offers Extremely
High Sensitivity and Selectivity

OPTIONAL AC ADAPTER



3⁹⁵



**B ROYAL DELUXE
15 TRANSISTOR SOLID STATE
4 BAND PORTABLE**

- Tunes AM, FM, SW and Marine Band

Plus this Special Bonus

- 1 Year Supply of 12 Batteries
- AC Adapter for Plug-in Play
- Earphone for Private Listening



ALL FOR **49⁹⁵**

No Money Down



**C LAFAYETTE "MIGHTY-12"
12 TRANSISTOR RADIO**

7⁹⁵



Complete with AC Jack,
Earphone, Carrying Case & Batteries

**D 9 TRANSISTOR AM/FM
POCKET PORTABLE RADIO**

ONLY
12⁹⁵



Complete with
Carrying Strap, Earphone, Telescopic Antenna & Battery

Buy Now! Pay Later . . . Use Lafayette's Easy Pay Plan. No Money Down

Lafayette Cat. No. 663 95

Our Finest Performing Table Radios

NEW! SOLID STATE 15 TRANSISTOR AC AND BATTERY OPERATED AM-FM RADIO



Features Deluxe Top Grain
Cowhide Cabinet with
Diecast Front Panel.

- Operates on 117V AC.
or 4 "D" Cell Batteries

39⁹⁵

with batteries,
earphone, 117V AC line cord

A powerful, versatile, 15 Transistor AM-FM radio that will play anywhere. Operates on 117V AC house current or 4 "D" cell batteries. Large 4" speaker offers brilliant sound reproduction. Features AFC lock which prevents drift on FM; AGC on AM prevents volume fade, rotary tone control, ferrite core AM and dual telescopic FM antennas. 15 transistors, 4 diodes, and 1 thermistor circuit. Deluxe top grain cowhide cabinet with diecast front panel 10 $\frac{3}{4}$ "x6 $\frac{1}{2}$ "x2 $\frac{3}{4}$ ". Imported. Shpg. wt., 6 lbs.

17 A 7907L

99 A 6256 Replacement "D" cell batteries—4 req.

Net 39.95

Net .13 ea.

OUR FINEST SOLID STATE FM-AM CLOCK RADIO

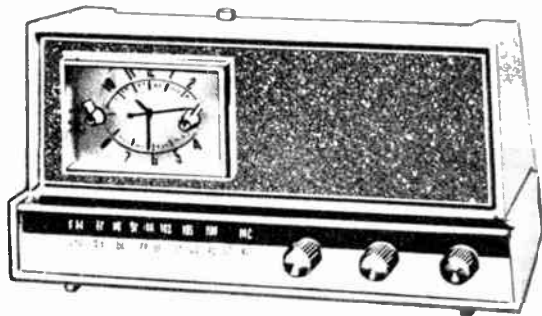

- Automatic Telechron Clock
- Lighted Clock Face, Snooze Alarm
- Deluxe Solid State Circuitry
- Rich Hi-Fi Tone, AFC

49⁹⁵

NO MONEY DOWN

The perfect FM-AM clock radio. You will be thrilled with its beauty, rich Hi-Fi tonal quality and amazing power. Has 9 transistors, 1.1 watt output, 2-step tone control and Automatic Frequency Control (AFC) which locks in FM Stations for clear reception, virtually drift-free. Includes standard AM reception and a large 4" PM speaker. Automatic Telechron clock with snooze alarm lets you wake up to beautiful music and then catch another "40 winks" of sleep. Beautifully styled antique white molded plastic cabinet with silver trim around the clock. Lighted clock face. FM antenna built into line cord. Size 6 $\frac{1}{2}$ x13x15"D. For 110-120 Volts 6 AC. Imported. Shpg. wt., 8 lbs. 17 A 3008 \$5 Monthly

Net 49.95

96 Lafayette Cat. No. 663

A DELUXE NEW AM-FM STEREPHONIC CONSOLE TABLE RADIO

Now you can listen to full dimensional FM stereo as well as AM with this beautiful console table radio. Full rich high-fidelity sound is achieved through a pair of "pull-away" speaker cabinets each containing a 6 $\frac{1}{2}$ " bass-midrange speaker and a 2 $\frac{1}{2}$ " tweeter. Speakers cabinets may be easily detached to locate them more conveniently anywhere in a room for more stereo separation. Other deluxe features: AFC to prevent drift on FM, FM stereo indicator shows when stereo signal is received, slide rule dial with logging scale, function indicator lamps for AM and FM. 4 Controls—tone, balance, volume and selector. 12 tubes. Cabinet is made of high impact plastic with walnut wood grain finish. Cabinet 17 $\frac{3}{4}$ "x9 $\frac{1}{2}$ "x10". Speakers 8 $\frac{3}{4}$ x3 $\frac{3}{4}$ x8 $\frac{1}{2}$ ". Cabinet is mounted on walnut wood pedestal. Imported. For 110-120V, 60 cycles AC.

17 A 7801WX \$5 Monthly

69.95

3 Band FM/AM SW Radio. Same size deluxe console type table radio but less FM stereo feature. Includes 3.5 to 9 MC shortwave band. Imported. Shpg. wt., 22 lbs.

17 A 7809WX \$5 Monthly

49.95

B FM/AM/SW TWIN SPEAKER TABLE RADIO

Now you can own a 2 foot long radio which will be a conversation piece in your home. Enjoy static-free FM, AM and exciting shortwave broadcasts. Features 2 6x4" speakers, AFC for drift-free FM reception, variable tone control for bass and treble adjustments and giant dual tuning dial with logging scale. Built-in AM antenna and jack for external speaker. Colored pilot lamps indicate band in use. Ebony finished plastic cabinet. Size: 24 $\frac{1}{2}$ Wx6 $\frac{1}{4}$ Hx5"D. For 110-120 V 50/60 cps AC. Imported. Shpg. wt., 9 lbs.

17 A 7805WX \$5 Monthly

Net 31.95

C NEW TWIN SPEAKER AM-FM TABLE RADIO

Elegantly styled AM-FM Table Radio at Lafayette's low, low, price Features automatic frequency control to prevent drift on FM stations. Twin 4" dynamic speakers provide room filling high fidelity sound. 6 tubes plus 3 diodes superheterodyne circuit provide excellent reception on AM and FM bands. 3 controls, slide rule dial, 1 watt audio output. 17"x6 $\frac{1}{2}$ "x5" For 110-120V 60 cycles, AC. Shpg. wt., 9 lbs. Imported.

17 A 7811W

Net 29.95

D SOLID STATE FM/AM CLOCK RADIO

SALE SAVE 7.00
WAS 44.95 **NOW 37⁹⁵**

A handsome solid state clock radio with AFC drift-free FM reception and 2 speakers for rich hi-fi tone! Completely automatic clock with alarm wakes you in the morning to your favorite station. Convenient sleep switch shuts radio off at any preset time (up to 1 hour). Housed in a beautiful walnut wood grained plastic cabinet. Size: only 11 $\frac{1}{4}$ x3x4 $\frac{1}{2}$ ". Shpg. wt., 7 lbs.

17 A 7806 \$5 Monthly

Net 37.95

E NEW DECORATOR STYLED FM-AM TABLE RADIO

A masterpiece of design and engineering. Unique vertical shape, slender depth, surrounded by magnificent rosewood cabinet. This styling is matched by powerful solid state circuitry of 9 transistors, 5 diodes and 5 rectifiers. Two speaker sound system (6 $\frac{1}{2}$ " and 2 $\frac{1}{2}$ ") provide full rich sound. Other exciting features include giant vertical slide rule dial with lighted dial pointer and satellite indicator for easy pinpoint tuning; automatic frequency control for stable FM reception and continuous tone control. Size: 11 $\frac{5}{8}$ Wx14 $\frac{1}{2}$ Hx5 $\frac{1}{2}$ "D. For 110-120 volts, 60 cycles AC. Imported. Shpg. wt., 12 lbs.

17 A 3013WX \$5 Monthly

Net 59.95

F SOLID STATE FM/AM TABLE RADIO IN WALNUT WOOD CABINET

A handsomely styled solid state FM-AM table radio that will enhance the decor of any room. Powerful superheterodyne circuit gives excellent selectivity with high sensitivity. 16 semiconductor design provides extra power for pulling in hard to get stations. FM section features built-in AFC to prevent annoying station drift. Larger 3x5 inch speaker gives rich, clean sound reproduction. Geared vernier slide rule dial. Beautiful full size oiled walnut wood cabinet. Offers instantaneous operation. Operates on 117 volts 60 cycles AC. Radio measures 10x5 $\frac{1}{2}$ x3 $\frac{1}{2}$ ". Shpg. wt., 4 lbs.

17 A 7905

Net 27.95

Depend on Lafayette for Complete Stocks, Lowest Prices, Fastest Service



A DELUXE NEW AM-FM STEREPHONIC CONSOLE TABLE RADIO **69⁹⁵**



B 3 BAND FM/AM/SW
TWIN SPEAKER
TABLE RADIO

31⁹⁵

The Longest Radio We Have Ever Offered

C NEW TWIN SPEAKER
AM-FM TABLE RADIO

29⁹⁵



E NEW DECORATOR STYLED
AM-FM TABLE RADIO

59⁹⁵



D BEAUTIFUL ALL-TRANSISTOR
FM/AM CLOCK RADIO

SALE
37⁹⁵



F SOLID STATE FM/AM TABLE RADIO
IN WALNUT WOOD CABINET

27⁹⁵

Our Finest Solid-State Phonographs

LAFAYETTE BATTERY OPERATED 45 RPM PORTABLE PHONO



- Compact, Light Weight, Portable
- Plays All 45 RPM Records
- Travels With You Anywhere

A compact portable record player perfect for picnics, beaches or anywhere you go. Faithfully reproduces the sound of all your popular 45 RPM records. Completely transistorized circuitry — no warm up necessary. Operates on 2 size "C" and one 9 volt battery with low current drain. Controls: on-off gear release, speed adjustment (allows for speed difference with various records). Rugged two tone plastic case and cover comes with hand strap for portability. 2½ inch speaker gives natural tone for excellent performance wherever you are. Imported, less batteries.

99 A 1033 Shpg. wt., 2 lbs. Net 9.95

BATTERIES FOR 45 RPM PHONO

99 A 6257 "C" Type—2 required Net .13
99 A 6021 9 Volt—1 required Net .21

LAFAYETTE L-10 SOLID STATE 4-SPEED PORTABLE PHONOGRAPH



19.95

- Plays — 33⅓, 45, 16⅔, & 78 RPM
- Instantaneous ON
- Built-in 45 RPM Adapter Disc

Plays monaural records of all speeds . . . 33⅓, 45, 16⅔ and 78 RPM . . . all sizes 12", 7", 10". PM type speaker is set in front grille for full-tone sound dispersion. 2 controls—on/off Vol., tone. Manual turntable has foam rubber mat. Tone arm is equipped with Vaco dual turnover cartridge with 2 synthetic sapphire needles. Attractive two tone brown and white washable Pyroxylin coated fabric. Dim: 12¼"X10"X5" high. 110-120V. 60 cycles. AC UL Approved. Shpg. wt., 9 lbs.

24 A 0212 Net 19.95

98 Lafayette Cat. No. 663

A FAMOUS LAFAYETTE "PRO-50" SOLID STATE COMPACT STEREO HI-FI PHONO SYSTEM

- Magnificent Decorator Styled Matched Components Constructed of Genuine Walnut Wood With Beautiful Oiled Walnut Finish
- 20 Watt Solid State Stereo Amplifier

Lafayette's designers and audio engineers have created an exciting solid state stereophonic high fidelity phonograph system. Offers rich, brilliant sound reproduction. The control center consists of a powerful 20 watt (P-P) solid state stereo amplifier with 5 controls: Loudness, Balance, Bass and Treble—and Selector switch for phono, Tuner-Tape. Deluxe Garrard 4-speed automatic changer plays 7", 10" and 12" records. Intermixes different size records of the same speed. Features automatic shut off dynamically balanced tone arm, shock mounted motor and 11" precision cushioned turntable.

- Each Matched Speaker System has an 8" Woofer and 3½" Tweeter
- Equipped with input jacks for FM/FM Stereo Tuner and Tape

Equipped with a wide range turnover stereo cartridge with diamond stylus for LP and stereo records and a synthetic sapphire stylus for standard 78 RPM records. Two matched speaker systems each contain a large 8" woofer with a 9 oz. ceramic magnet and a 3½" tweeter. Control center has 2 external speaker jacks. Phonograph and matching speaker systems are housed in oiled walnut wood cabinets. Dim: Phonograph control center: 21Lx13Wx37⅞"H. Speaker enclosure: 13Lx4½Dx15½"H. For 110V 60c AC. UL App. With 45 RPM spindle. 24 A 0216WX Shpg. wt., 40 lbs. Net 129.95

B DELUXE LAFAYETTE MODEL LS30 SOLID STATE STEREO HI-FI PHONOGRAPH

- Solid State Circuitry—10 Watt Stereo Amplifier
- GARRARD 4 Speed Automatic Intermix Changer
- 4 Speakers—2 8" Woofers, 2 3½" Tweeters Offer Exquisite Tone
- 4 Controls—Loudness, Balance, Bass, Treble

Solid-state circuitry offers "instant-on" and exquisite sound reproduction. Each detachable wing contains one 8" heavy duty woofer and one 3½" tweeter plus a built in 7" extension cord for wall-to-wall full dimensional sound. Garrard 4 speed automatic intermix changer will handle all sizes and all speeds of both stereo and mono records. Intermixes different size records of the same speed. Automatic shut off. Turn-over stereo

cartridge is equipped with a diamond stylus for LP and stereo records. Beautiful all wood case with silver grey and black scuff resistant Pyroxylin coated material. For 110v 60c AC. Dim: 17¾Hx24½Wx10"D UL approved. Shpg. wt., 45 lbs.

24 A 0215WX \$5.00 Monthly Net 89.95

45 RPM Adapter for above Net 3.80
24 A 0217

C LAFAYETTE MODEL LS-25 SOLID STATE DECORATOR STYLED PORTABLE STEREO PHONO

- Garrard 4-Speed Automatic Intermix Changer
- Two 6" Extended Range Detachable Speakers Offer Full Dimensional Stereo Sound ■ Diamond Needle

The Lafayette Model LS-25 Solid State Stereo Phonograph features beautiful functional styling—each unit perfectly style-matched, assembling into one compact unit for ease of portability. The Garrard 4 speed automatic intermix record changer handles all size records and will intermix different size records of the same speed. Features automatic shut-off after the last record. Tone arm is equipped with a VACO crystal stereo turnover cartridge with diamond needle for LP and stereo records and synthetic sapphire for 78 RPM records. Powerful Solid State Stereo amplifier offers exciting stereo

realism—3 audio control functions. Separate full range compensated loudness and balance controls plus a tone control. Each detachable speaker wing contains one 6" extended range speaker offering sparkling full dimensional sound—Wood case is covered with pyroxylin-coated silver and black scuff-resistant material. For 110-120 volt, 60 cycle AC. Dim: 22Lx13¾Hx8¾"D. Shpg. wt., 25 lbs. UL Approved.

24 A 0214WX \$5 monthly Net 69.95

45 RPM Spindle for above phono Net 3.80
24 A 0217

D PORTABLE LAFAYETTE MODEL LS-20 SOLID STATE STEREOPHONIC PHONOGRAPH

- Famous BSR 4-Speed Automatic Intermix Record Changer
- Complete With Vaco Stereo Turnover Cartridge with Diamond Microgroove Needle
- Solid State Stereo Amplifier Offers Instantaneous "ON"

The handsome low priced — top quality Lafayette Model LS-20 Solid State Stereo phonograph has been engineered and styled for complete portability—it goes anywhere — fits everywhere. Beautiful wood cabinet comes with scuff-resistant, washable, Pyroxylin material in pastel blue and white with exquisite blue tweed speaker grilles. Features Famous BSR 4 speed automatic intermix record changer. Plays all speeds — intermixes different size records of the same speed — has automatic shut-off after last record has been played. Precision built solid state stereo amplifier features 3 con-

trols: loudness left channel, loudness right channel, and tone. 2 separate heavy duty speakers in each speaker wing department offer extremely natural, full-bodied sound reproduction. Includes Vaco Stereo Turnover cartridge with diamond needle for LP and stereo records, and synthetic sapphire-stylus for standard 78 RPM records. Dim: 21¼"X13"X7¾"D. For 110-120 Volt 60 cycle AC. Shpg. wt., 27 lbs. UL Approved.

24 A 0213WX \$5 monthly Net 54.95

45 RPM Spindle for above phono Net 1.49
24 A 0220

Buy Now! Pay Later . . . Use Lafayette's Easy Pay Plan. No Money Down

A FAMOUS LAFAYETTE
 "PRO 50" COMPACT STEREO
 HI-FI PHONOGRAPH SYSTEM

129⁹⁵

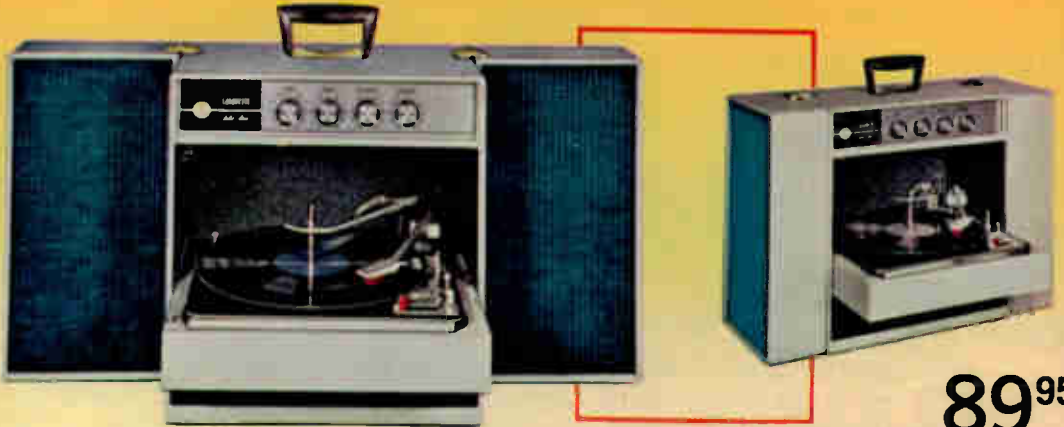

89⁹⁵

B DELUXE LAFAYETTE MODEL LS30 STEREO PHONOGRAPH

Models Pro 50, LS30, LS25
 and LS20 are equipped
 with diamond LP needles.
 U.L. Approved.

Made in
 U.S.A.



69⁹⁵

C MODEL LS25 STEREO PHONOGRAPH

PERFECTLY STYLED AND MATCHED IN DECORATOR CASE FOR EASE
 AND PORTABILITY — SOLID STATE CIRCUITRY — INSTANT "ON"

Phonographs Are Available on Easy Pay Plan—No Money Down



54⁹⁵

D LAFAYETTE MODEL LS20
 STEREO PHONOGRAPH

ENGINEERED AND STYLED FOR COMPLETE PORT-
 ABILITY—GOES ANYWHERE—FITS EVERYWHERE

Lafayette Cat. No. 663 99

Famous Name Stereo "Compact" Phonos

NEW! FISHER MODEL 85-8 35-WATT SOLID STATE STEREO MUSIC CENTER

249⁵⁰



Complete 35-watt quality high fidelity system in oiled walnut wood cabinetry at moderate cost. Compact — occupies very little space. Features 35-watt solid state stereo control amplifier, Garrard 4-speed Automatic Turntable with automatic shut-off, Pickering magnetic cartridge with diamond needle, front-panel headphone jack, Input for stereo tape recorder and stereo tuner. Includes 2 separate matched speaker systems each containing one 8" woofer, and one 2 1/2" tweeter. Size: AMPLIFIER/CHANGER Section: 16 5/8" W x 4 1/4" H x 13 7/8" D, Speaker System: 17" W x 10" H x 8 3/4" D for 110-120V 50/60 cps. Shpg. wt., 61 lbs.

24 A 5603WX \$12.50 Monthly **Net 249.50**
 New Model 85-10 — Same as 85-8 except with 2 deluxe matching speaker Systems each containing one 10" woofer and one 2 1/2" tweeter. Dim. of Speaker Systems: 22 1/2" W x 12 3/4" H x 10 1/2" D. Shpg. wt., 67 lbs.
 24 A 5604WX \$15 Monthly **Net 299.50**
 Model PC-1 Plastic Plexiglass Cover for 85-8 and 85-10. **Net 14.95**
 24 A 5605W

NEW! FISHER MODEL 95-8 35-WATT SOLID STATE FM STEREO MUSIC CENTER

349⁹⁵



Professional caliber compact stereo system containing all of the facilities of a complete radio-phonograph. Features a solid state 35-watt stereo amplifier, a stereo FM tuner housed in an attractive oiled walnut case, 2 separate matched speaker systems with oiled walnut finish each containing an 8" woofer and one 2 1/2" tweeter, and a Garrard 4-speed automatic record changer with Pickering magnetic diamond needle cartridge. FM Stereo Tuner has exclusive "stereo beacon" which automatically signals when a stereo broadcast is being received. Includes front panel headphone jack, inputs for stereo Tape recorder, illuminated dial scale and tuning meter. Size: Main Section: 20 3/4" W x 4 1/4" H x 15 7/8" D, Speaker Systems 17" W x 10" H x 8 3/4" D. For 110-120V 50/60 cps. Shpg. wt., 67 lbs.

24 A 5606WX \$19 Monthly **Net 349.95**
 New Model 95-10 Same as 95-8 but with 2 deluxe matching speaker systems each containing one 10" woofer and one 2 1/4" tweeter. Dim. of Speaker System: 22 1/2" W x 12 3/4" H x 10 1/2" D. Shpg. wt., 72 lbs.
 24 A 5607WX \$19 Monthly **Net 399.56**
 Model PC-1 Plastic Plexiglass Cover for 95-8 and 95-10 **Net 14.95**
 24 A 5605W

HARMAN-KARDON SC-440 SOLID STATE AM-FM STEREO MUSIC SYSTEM

379⁰⁰

IN BEAUTIFUL OILED WALNUT WOOD CABINET



Capture the pure and spacious sound of stereo with this fine matched component stereo music system housed in beautiful oiled walnut cabinets. Powerful 80-watt AM-FM stereo receiver features bass, treble, and balance controls; contour and speaker switches; stereo tape output and front panel stereo headphone jack. Tuner has D'Arsonval tuning meter; automatic stereo indicator light and built-in FM-AM antenna. The Garrard AT-60 automatic turntable features automatic shut-off and a high compliance stereo magnetic cartridge. Each speaker cabinet as a 10" long-excursion woofer and a 3 1/2" curvilinear tweeter to provide full rich sound. SPECIFICATIONS: EIA music power output: 80 watts. Frequency response: ± 1 db, 15-25,000 cps. Harmonic distortion: less than 1%. FM sensitivity: 2.9 μV IHF. Multiplex separation: 30 db. Dimensions: Receiver/Turntable module, 18 1/4" W x 16 1/4" D x 5" H. Speaker systems, each 22 7/8" H x 13 5/8" x 10 1/2" D. For 110-120 volts, 60 cps AC.

21 A 4265WX \$19 Monthly. Shpg. wt., 100 lbs. **Net 379.00**
 Plastic Dust Cover for Model SC-440. Wt., 2 lbs. **Net 19.95**
 21 A 4257W

EMI/SCOPE MODEL 201 SOLID-STATE COMPACT STEREO PHONO

199⁵⁰

No Money Down



A professional quality, compact stereo component system. Features a solid state pre-amp/amplifier with 36 watts IHF power output; four specially engineered EMI speakers (one 5" woofer and one 3 3/8" tweeter in each enclosure) and a Garrard 4-speed record changer with a Pickering V15 stereo magnetic cartridge and retractible diamond stylus. A unique feature of the Model 201 is its comprehensive top-mounted control panel with inputs for 2 electric guitars, (making it a powerful guitar amplifier); 2 high impedance microphone inputs, (permitting mixing, paging or recording); stereo inputs for tuner or tape recorder for playback; stereo outputs for tape recording and a stereo headphone receptacle for private listening. Controls include: a speaker selector switch for operation of two additional remote speakers, bass, treble, loudness and stereo balance controls. Frequency response: 20-20,000 cps. Handsome vinyl charcoal-brown carrying case has gold and silver trim. Size: (Changer/Amplifier), 17 3/4" W x 13 1/4" D x 7 1/2" H. Speakers: 13 1/4" W x 4 3/4" D x 17 3/4" H. For 110-120 volts, 60 cycles AC. Shpg. wt., 41 lbs.

24 A 8601WX \$10 Monthly **Net 199.50**

Phono Amplifiers; Preamps & Accessories

Trutest® STEREO/8 AMPLIFIER



Compact Low
Silhouette Styling!

17⁹⁵

- Separate Stereo Volume-Balance Controls
- Variable Tone Control With On-Off Switch
- Front-Panel Phono-Tuner Switch for Selection of Phono or Tuner
- Selector Switch for Monaural or Stereo Operation

Ideal for that low cost stereo system you are planning for your living room, den, bedroom or business. Excellent for converting your present monaural console or portable to stereo. Controls include separate Left Channel and Right Channel Volume-Balance Controls, Stereo/Monaural Mode switch, Variable Tone control with On-Off switch, Phono/Tuner Selector switch; 4 jacks in rear for stereo tuners and stereo crystal or ceramic phono cartridges; 2 pair of 4-ohm output terminals accept most speakers. Tubes and components mounted horizontally for compactness. Complete with case. Tube complement: 1-12AX7, 2-35C5, and 1-35W4. Size: 7 $\frac{1}{8}$ "Wx2 $\frac{1}{4}$ "Hx5 $\frac{1}{2}$ "D. Imported. Shpg. wt., 6 lbs.

99 A 0047 Net 17.95

Trutest® STEREO/5 AMPLIFIER

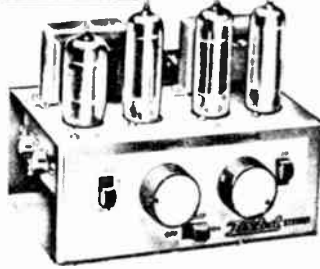

10⁹⁵
Fully Wired

- For Both Stereo and Monaural
- Individual Stereo Volume-Balance Controls

A stereo amplifier priced to fit everyone's purse. This rugged, precision made dual channel stereo amplifier will amaze you with its fine quality . . . Ideal for that low cost stereo system you're planning for your home or business. Perfect for converting your present console or portable to stereo. Controls include separate left channel and right channel volume controls, stereo-monaural mode switch, tone control switch and on-off switch. Provision for crystal or ceramic cartridge. 4-ohm output terminals accept most speakers. Tube complement: 2-35C5, 1-35W4 and 1-12AX4. Size: 4 $\frac{1}{2}$ "Hx5 $\frac{1}{2}$ "Wx4 $\frac{1}{2}$ "D. 115 volt 60 cycles. Shpg. wt., 5 lbs. Imported.

99 A 0046 Net 10.95

COMPLETE STEREO PHONO SYSTEMS



Trutest Stereo/8



Diamond
Stylus

Lafayette Model AC-33
Changer (Base Optional)

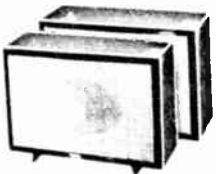

2 Lafayette SK-109

SALE!
AS LOW AS
47⁹⁵

Stereo/5 (Alternate)



Complete system consists of Trutest Stereo/8 Stereo Amplifier, Lafayette Model AC-33 Automatic 4-speed Record Changer with an 11" turntable, wide range stereo turnover cartridge with .7 mil diamond stylus, and 2 Lafayette SK-109 Miniature Speaker Systems in attractive mahogany veneer finish. Above system supplied complete with 25' speaker cable for each speaker, less changer base. Shpg. wt., 26 lbs.

99 A 9906WXM \$5 Monthly Net 54.70

Same system as above except with Stereo/5 stereophonic amplifier instead of Stereo/8 amplifier. Shpg. wt., 26 lbs.

99 A 9907WXM \$5 Monthly Net 47.95

24 A 0221W Recessed oiled walnut changer base Net 3.95

24 A 0222W Recessed mahogany changer base Net 3.95

THREE TUBE AC-DC PHONO AMPLIFIER

- Output Transformer
- Variable Tone Control



Equipped with a variable tone control and volume control with off position. Delivers up to 2 watts output to 3 ohm speaker. Uses 3 tubes: 35W4, 50C5, 12AV6. Input impedance: 150 K ohms. Features top mounted output transformer. Less tubes. Size: 5 $\frac{1}{2}$ "x2 $\frac{1}{4}$ "x4". Imported. Shpg. wt., 2 lbs.

99 A 0153 Net 3.95

36 A 9001M Kit of 3 tubes Net 1.63

LAFAYETTE STEREO PHONO PREAMP

9⁹⁵

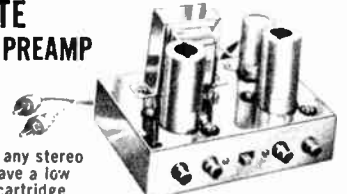

A self powered stereo preamplifier for use with any stereo amplifier that does not have a low level input for magnetic cartridge, tape head, or microphone. Response: ± 2 db 30-20,000 cps. Gain (Phonograph): 40 db, 5 mv input for 1 volt output. Gain (Microphone): 60 db, 1 mv input for 1 volt output. Output impedance: 100,000 ohms. Preamp has Phono-Tape Equalization Switch, 4 input jacks, 2 16-inch output leads with RCA phono plugs. Easily mounted on amplifier chassis. Power supply: 105-125 VAC. 50/60 cps. 8 watts. Size: 5 $\frac{3}{8}$ "x3 $\frac{3}{8}$ "x4 $\frac{1}{8}$ ". Polished chrome chassis. Less 2 12AX7 tubes. Shpg. wt., 3 $\frac{1}{2}$ lbs. Imported

99 A 0139 Net 9.95

12AX7 Tube for above (2 required) Net ea. 1.20

LAFAYETTE MONAURAL PHONO PREAMP

Same as stereo preamp above except with 2 input jacks and 1 output lead. Size: 3 $\frac{3}{8}$ "x3 $\frac{3}{8}$ "x4 $\frac{1}{8}$ ". Less 12AX7 tube. Imported. Shpg. wt., 3 $\frac{1}{2}$ lbs.

99 A 0138 Net 5.95

12AX7 tube for above Net 1.20

ROTRON WHISPER FAN

- Super Silent, Compact
- Reduces Service Costs
- Ideal For Cooling Hi-Fi Equipment

14⁸⁵



The ideal fan for cooling hi-fi equipment. Extremely quiet, introduces no distortion, yet it moves 60 cubic feet of cool air per minute. Lets your equipment last up to 40% longer! Compact in design, easily installed in any position. Airflow is reversible. Advanced heavy system: slow speed, and prelubrication will provide years of maintenance-free operation. For 115VAC, 60 cps, 7 watts. Size: 1 $\frac{1}{2}$ " deep and 4 $\frac{1}{4}$ " square. Shpg. wt., 1 lb.

24 A 7501 Net 14.85

4 TUBE AC/DC STEREO PHONO AMPLIFIER

- 2 Output Transformers
- Separate Tone Controls



Powerful yet compact stereo amplifier produces up to 2 watts per channel. Uses 4 tubes: 2 12AV6 2 50C5. Selenium rectifier power supply. Output impedance: 3 ohms. Separate volume controls for each channel. Size: 6 $\frac{1}{8}$ "x2 $\frac{1}{4}$ "x4". Less tubes. Imported. Shpg. wt., 3 lbs.

99 A 0154 Net 6.50

36 A 9002 M Kit of 4 tubes Net 2.60

LAFAYETTE RECORDING TAPES

LAFAYETTE'S FAMOUS MONEY-BACK GUARANTEE
YOU BE THE JUDGE!

Lafayette's tape is made by outstanding nationally known manufacturers. It is first quality, splice free, red oxide coated, with full frequency response, uniform output and no "drop-outs." Resistant to moisture, heat, cold and abrasion.

We guarantee absolute satisfaction or your money back. If for any reason you are dissatisfied, return the tape at once and we will refund your money less only transportation charges. You are the sole judge.



LAFAYETTE ACETATE RECORDING TAPE

Acetate base magnetic recording tape with uniform standard red oxide coating provides wide range high fidelity response over the audio spectrum. Features noise free reproduction, low abrasion and uniform output. In 1 mil and 1 1/2 mil thickness.

Stock No.	Feet	Reel	Mils	Wt. Lbs.	Net Per Reel		
					1-4	5-24	25 Up
28 A 0102	600	5"	1 1/2	1/2	.99	.90	.85
28 A 0103	900	5"	1	3/4	1.20	1.10	.99
28 A 0101	1200	7"	1 1/2	1	1.59	1.49	1.35
28 A 0104	1800	7"	1	1 1/4	1.98	1.88	1.79

LAFAYETTE MYLAR RECORDING TAPE

Mylar base is especially strong, durable and break resistant, and is virtually impervious to heat, cold or humidity. All in clear plastic reels, individually boxed.

Stock No.	Feet	Reel	Mils	Wt. Lbs.	Net Per Reel		
					1-4	5-24	25 Up
28 A 0105	1200	5"	1/2	3/4	1.75	1.58	1.42
28 A 0106	1800	7"	1	1 1/4	2.49	2.25	2.13
28 A 0107	2400	7"	1 1/2	1 1/4	3.10	2.79	2.51

LAFAYETTE TENSILIZED MYLAR TAPES

These tapes are of the same high quality as the standard acetate and mylar Lafayette tapes with the added advantages of the tensilized mylar base. Super-strong mylar is prestretched and is highly resistant to breakage, moisture, heat, cold, and humidity. Highly polished, splice-free, quiet, non-abrasive finish. Smooth output throughout the entire audio spectrum. Tensilized mylar gives you the most permanent type of base and is therefore ideal for your most treasured recordings. All are 1/2 mil, thus permitting the maximum amount of footage per reel. Individually boxed - in self-mailing box.

STOCK NO.	FEET	REEL SIZE	WT. LBS.	NET PER REEL		
				1-4	5-24	25-UP
28 A 0109	300+	3"	1/2	.69	.63	.59
28 A 0110	600	3 1/4"	1/2	1.00	.90	.80
28 A 0111	1200	5"	1/2	2.25	2.03	1.83
28 A 0108	2400	7"	1/2	3.69	3.39	3.05

LAFAYETTE BULK TAPE ERASER AND DEMAGNETIZERS

PROFESSIONAL MODEL

- Completely Erases Tape
- Two Erasing Coils
- Erases up to 1" Tapes
- Erases 1/4" Tapes in One Operation—No Reversing
- For 3", 5", 7" or 10 1/2" Reels

12⁵⁰ Standard Model

18⁹⁵ Professional Model

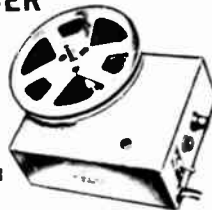

A carefully designed and precisely manufactured tape "degausser" for complete erasing of tapes. Just place the tape reel on spindle of demagnetizer, slowly rotate 2 or 3 turns, take off, and that's all. Reduce tape hiss to the level of new "virgin" tape. Two completely separate coils are used for doubly-effective erasures, even of large, 10 1/2" reels. Will erase 1" wide tape. An extra powerful unit for heavy-duty use—draws over 9 amperes. Can be used to demagnetize tape, magnetically stripped film, plus tools and watches. Has a heavy, custom finished case, a rugged non-magnetic top, heavy duty on-off switch and power cord. Has built-in fuse. Pilot light prevents accidentally leaving it turned on. Size 6 1/4 x 7 7/8 x 3 1/2". 105-125V, 60 cycle. Shpg. wt., 14 lbs. Imported.

99 A 1516 Professional Model Net **18.95**

STANDARD MODEL

Similar to professional model for all size reels but handles only standard size 1/4" tapes or smaller and reel must be turned over once. Has separate spindle positions for 10 1/2" and 3, 5, and 7" reels; non-magnetic bakelite plate for reel rest. One powerful coil consumes 5 amps. Metal case 7 1/4 x 4 3/4 x 3 1/2". Shpg. wt., 9 lbs. Imported.

99 A 1518 Net **12.50**

LAFAYETTE TAPE HEAD DEMAGNETIZERS DELUXE MODEL WITH 3 REMOVABLE POLE PIECES



Has 3 complete sets of removable pole pieces: straight, 45° and 90° for quick easy use with any tape head. Removes magnetism that accumulates in every tape head insuring optimum signal-to-noise ratio. For 110 Volt 60 cycle. Shpg. wt., 1 lb.

24 A 0901 Net **3.95**

1200 FT. LEADER TAPE ON 7 INCH REEL



- For Indexing and Cueing

Lafayette brings you this jumbo reel of leader tape at a tremendous savings over the cost of leader tape customarily available in 100 ft. quantities. 1 1/2 mil white mylar tape. 1200 ft. x 1 1/4" wide on 7" clear plastic reusable reel. Individually boxed. Shpg. wt., 1 lb.

28 A 7701 Net **2.79**

1200 FT. 1 1/2 MIL MYLAR BASE RECORDING TAPE



AS LOW AS

79^c

Lots of 25

Lafayette brings you this 1 1/2 mil mylar base quality recording tape at an unbelievable low price. This 1 1/2 mil mylar tape features the exceptional strength and resistance to heat, cold, humidity and abrasion that are characteristic of mylar. 7" reel. Shpg. wt., 1 lb.

28 A 0113 Each Net **.99**
Lots of 5, ea. **.89** . . . Lots of 25, ea. **.79**

HIGH IMPEDANCE DYNAMIC MIKE FOR HOME RECORDING

3⁷⁵



- Ideal Mike for Home Recording Use
- Frequency Response: 60-10,000 CPS

An outstanding Lafayette Microphone for home use. Frequency Response: 60-10,000 CPS ± 10db. Output Level: -57db @ 1000 CPS. Impedance: 50,000 ohms. Complete with 6 1/2 shielded cable with plug. Size 1 5/8 x 2 1/4 x 7/8"D. Shpg. wt., 8 oz. Imported.

99 A 4553 Net ea. **3.75**

TELEPHONE PICKUP FOR RECORDING TELEPHONE CONVERSATIONS



1⁴⁹

Induction telephone pick-up for cradle or upright phones. Picks up conversations without wire tapping or special circuitry. Simply place phone base on pickup and connect leads to high impedance input of an audio amplifier or directly to a tape recorder. Shpg. wt., 8 oz. Imported.

99 A 1034 Net **1.49**

Magnificent Performing Solid State Tape Recorders

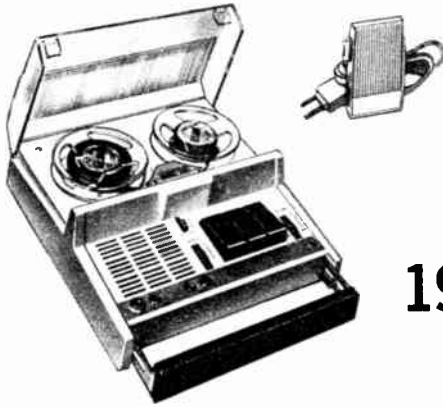

Complete with Remote Control Mike, Earphone, Batteries, 3" Reel of Tape, and Take-up Reel.

19⁹⁵

5 TRANSISTOR BATTERY OPERATED PUSHBUTTON TAPE RECORDER

- 24 Minutes Recording Time
- For Student, Businessman, Housewife . . .

Neat, sturdy, compact and very functional solid state tape recorder excellent for the student, businessman, housewife or just for family fun! For the student—record important facts in class. For the businessman—record calls made and sales. For the housewife—record your shopping list as the cabinets go bare. Push button operated with a record interlock switch. Features remote control mike, earphone jack, and AC adapter jack for the optional AC adapter listed below. Variable speed control compensates for weak batteries. Accepts 3" reels. Retractable handle disappears into case. Complete with earphone and battery. Imported. Shpg. wt., 3½ lbs.

27 A 4701	Net 19.95
27 A 4702 Optional AC Adapter	Net 4.95
99 A 6257 Replacement "C" battery 2 req.	Net ea. .13
99 A 6051 Replacement 9V battery 1 req.	Net ea. .21

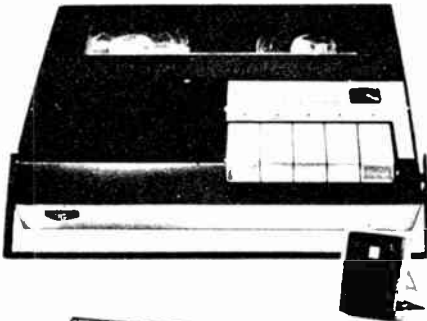

Complete with Mike, 3" Reel of Tape, Patch Cord, Earphone, and Batteries.

39⁹⁵

SOLID STATE BATTERY OPERATED PUSH-BUTTON RECORDER

Capstan driven, 2-speed, push-button, solid state, remote control, battery operated tape recorder provides superb recording and clear playback anywhere! 2 speeds — 3¾ and 1⅞ ips. Features VU meter. Uses 3" reels for up to 1 hour recording time. Fast forward and rewind speeds are also featured. Frequency Response: 100-7000 cps at 3¾ ips. Operates on 4 "C" batteries. Size: only 10¼x2½x7¾"D. Imported. Shpg. wt., 1½ lbs.

27 A 0101L \$5 Monthly	Net 39.95
99 A 6257 Extra "C" Batteries	Net ea. .13
21 A 0107 AC Adapter	Net 6.95



VOICE-ACTIVATED MIKE FOR ABOVE RECORDER. SOUND STARTS YOUR RECORDER. ABSENCE OF SOUND STOPS YOUR RECORDER. IMPORTED. SHPG. WT., 2 LBS.

27 A 0104 Net 19.95



Complete with Mike, 3" Take-up Reel, Reel of Tape, and Batteries.

54⁹⁵

SOLID STATE AC AND BATTERY POWERED PORTABLE RECORDER

Capstan driven, completely transistorized, tape recorder operates on both AC and batteries. Batteries switch in when AC power fails. 2 Speeds: 3¾ and 1⅞ ips. Single lever operation. 3½" dynamic PM speaker. Features battery condition meter and up to 1 hour recording time with 3" tapes. Outputs for earphone and external speaker. Frequency Response: 100-7000 cps @ 3¾ ips. Size: only 9¾x3x8½"D. UL approved. Imported. Shpg. wt., 6 lbs.

27 A 0102L \$5 Monthly	Net 54.95
99 A 6257 Extra "C" batteries (6 req.)	Net ea. .13



VOICE ACTIVATED MIKE FOR ABOVE RECORDER. SOUND STARTS YOUR RECORDER. ABSENCE OF SOUND STOPS YOUR RECORDER. IMPORTED. SHPG. WT., 2 LBS.

27 A 0104 Net 19.95



Complete with 2 Microphones, earphone, 5" reel of tape, take-up reel, batteries, AC cord.

89⁹⁵

No Money Down

NEW SOLID STATE AND BATTERY POWERED PORTABLE STEREO RECORDER

- Record or Play Stereo Anywhere—Even Outdoors
- Two Speeds—1⅞, 3¾ IPS, Capstan Drive
- Pushbutton Controls Plus Record Level Meter
- Plays Pre-Recorded Tapes

Record and playback 4-track stereo with this amazingly compact all solid-state machine. With battery operation you can take it with you while traveling, use it on a boat, at parties, meetings or at the beach. NAB equalization permits playback of pre-recorded tapes. Built-in converter for household 117V, 60 cycle AC operation. Capstan belt drive keeps speed constant. Plays up to 2 hrs. at 1⅞ ips with 1.5 mil 600 ft. tape, to 1 hr. at 3¾ ips. Takes 5" reels. Features two speakers for wide stereo separation, fast pushbutton control, tone control switch and record level meter. Has extension speaker jacks. Rugged carrying case. 15¼x11½x3½". Imported.

27 A 1011WX \$5 monthly	Shpg. wt., 14 lbs.	Net 89.95
99 A 6256 Replacement "D" batteries, 4 req.		Ea. Net .13

Tape Recorders Are Available on Easy Pay Plan—No Money Down

Lafayette Cat. No. 663 103

Deluxe Selection of Tape Recorders—From 98.75

NORELCO MODEL 150 SOLID STATE CARRY-CORDER



98⁷⁵

No Money Down

CAR-MOUNT

24.95

Carry it everywhere . . . ideal for students, salesmen, busy executives. Records voice and music on 2 tracks at 1 7/8 ips. 300 ft. triple-play tape cartridge provides up to 1 hour play/record time. Uses 5 "C" size flashlight cells. Recording level/battery life meter. Complete with remote control mike, patch cord, vinyl carrying case, 4 tape cartridges and separate microphone pouch. Size 7 3/4x4 1/2x2 1/4". Imported. Shpg. wt., 4 lbs.
 27 A 4804XL Model 150—\$6.50 monthly Net 98.75
 99 A 6257 "C" Type Battery, 5 required Net ea. .13

UNIVERSAL CAR-MOUNT FOR CARRY-CORDER. Easy to hook-up—Does not use car battery. Mounts under dash. Enables self-contained carry-corder to be played thru car radio. You can easily remove Carry-Corder and take it with you wherever you go. 11 1/2x3Dx 5 1/2"W. Imported. Wt., 3 lbs.
 27 A 4815L Net 24.95

WOLLENSAK-3M MODEL 5250 4 TRACK STEREO RECORDER



189⁹⁵

No Money Down

- 4 Track Record/Playback
- 4 Speeds—Sound On Sound

4 Speed transistorized stereo tape recorder—7 1/2, 3 3/4, 1 7/8 and 1/4 ips. Featuring 2 self centered speakers, two VU meters and tone-volume controls, 4 number digital counter, automatic shut-off, pause control. Also monitor operation, reel locks, automatic tape lifters and head demagnetization. At 7 1/2 ips 40-17,000 cps response, 48 db S/N; at 3 3/4, 40-10,000 cps response and 45 db S/N. Output—3w EIA, 5w peak per channel. With 7" reel of tape. 16x10x7". Shpg. wt., 25 lbs.
 27 A 5017WX \$10.00 monthly. Net 189.95

DELUXE SONY SUPERSCOPE MODEL 260 SOLID STATE STERECORDER

- Built-in Radial Sound Projection Speakers
- Solid State 30 Watt Music Power Amplifier
- 4 Track Stereo/Monophonic Record-Playback

229⁹⁵

No Money Down

Enjoy breathtaking sound at modest cost. Completely self-contained, the 260 features 4-track stereophonic and mono record/playback; solid state stereo preamplifier and power amplifier with 10-watts music power per channel, two built-in 4"x8" high compliance elliptical speakers; automatic end of reel shut-off; two professional VU meters for accurate record level; automatic tape lifters to prevent head wear during fast forward and fast rewind; pause control and tape counter for precise editing; separate bass and treble tone controls; smooth balanced capstan rim-drive—no belts and FM stereo inputs to record multiplex "off the air." Operates vertically or horizontally. SPECIFICATIONS: 7 1/2 and 3 3/4 ips. ± 3 db, 50-15,000 cps. S/N: 50 db. Flutter & Wow: under 0.19% @ 7 1/2 ips. For 117 V, 60 cycles AC. 2 1/8x7 3/4x15 1/2"D. Imported.
 27 A 6010WX \$11.50 monthly. Shpg. wt., 39 lbs. Net 229.95



With 2 Dynamic Mikes

DELUXE CONCORD MODEL 350 AUTOMATIC SOLID STATE RECORDER

- Tape Reverses Automatically and Instantly at End of Reel
- Operates on 6 "D" Type Flashlight Batteries
- Takes up to 5" Reels

Completely automatic monaural two-speed tape recorder with voice controlled operation—just speak into the microphone and recorder starts . . . saves valuable tape. Recorder may also be operated manually by positive-action push-buttons. Features a digital tape counter, variable tone control, cue button for editing and VU Meter/Battery Level indicator. Accepts reels up to 5", and will record up to 6 hours at 1 7/8 ips. SPECIFICATIONS: Frequency Response: 50-10,000 cps; Speeds: 1 7/8 and 3 3/4 ips; Transistors: 9; Speaker: 3"x6". Complete with remote dynamic microphone, earphone, empty reel, sensing tape and patch cord. Operates on 6 "D" cell batteries (not included) or on 117 volts AC with optional AC adapter below. Wt., 12 lbs. imp.
 27 A 3514WX \$8 Monthly Net 149.50
 99 A 6256 "D" Type Batteries (6 req.) Net ea. .13
 27 A 3515 AC Adapter. Shpg. wt., 1 lb. Net 18.95



149⁵⁰

No Money Down

A Portable Battery Operated Tape Recorder with Automatic Reverse, Voice Operation, and Pushbutton Control.

LAFAYETTE Model RK-650 Professional 4-Track Stereo Record & Playback Tape Deck

Complete With Solid State
Stereo Record And
Stereo Playback Preamps

**ONLY 99⁹⁵ NO MONEY
DOWN**

- Pushbutton Motor Controls
- Automatic Cut-off Switch
- Separate Record/Play and Erase Heads
- Smooth, 4-Pole Capacitor Start Motor
- Plays 2/4 Track Stereo, 2/4 & Full Mono
- Records 4-Track Stereo or Mono from FM, AM, FM Multiplex, Radio or Phono Sources; Live from Microphones
- Records Sound-with-Sound
- Individual Volume Controls
- 2 Level Indicator Meters
- Self-Holding Pause Control

Tape transport and electronic components are integrated into one lightweight unit, for use in either a portable carrying case or a handsome built-in home installation. Ultra quiet 4-pole heavy duty, low slip capacitor-start motor and belt-drive for double flutter filtering. Automatic tape and machine stop at end of the tape or during a break in the tape. The Pause control assists in making "pro" recordings by stopping the tape momentarily for editing. Separate channel recording permits sound-with-sound. Clear FM multiplex recording is assured by high (80 KC) bias operation: All tape transport and electronic controls are located on the top panel for easy access. For 117V, 60 cycles AC. Tape Deck is complete with transistor playback preamps, 4 connecting cables and empty reel. Shpg. wt., 20 lbs. Less Case and Microphones. Imported. Size: 15 1/2" x 6 1/4" x 11 1/8" D.

99 A 1502WX \$5 Monthly	Net 99.95
Model RK-650 with deluxe carrying case	Net 114.95
99 A 1503WX \$6.50 Monthly	Net 6.95
Oiled Walnut wood base for RK-650	Net 17.95
24 A 0209W	
Carrying Case for Model RK-650	
99 A 1505W	
Dynamic Microphone for RK-650	Net ea. 4.75
99 A 4502	2 for 8.95

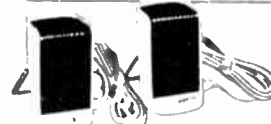

Optional Dynamic
Microphones



RK-650 on
Oiled Walnut Base



RK-650 in Deluxe
Carrying Case

SPECIFICATIONS:

Frequency Response, Record/Playback: 40-18,000 cps at 7 1/2"; 40-12,000 cps at 3 3/4" ips. 4 transistors, 4 tubes: 1 full-wave bridge rectifier. Audio Output: 8 volts per channel. Signal-to-Noise Ratio: -45 db. Interchannel Separation: 45 db or better, Wow & Flutter: 0.2% at 7 1/2" ips. 0.25% at 3 3/4" ips. Bias & Erase: 80KC; Rewind Time: Less than 4 minutes for

1200 ft. of tape. Speed Accuracy: 98%; Controls: Power/Speed; Individual Volume and Master Volume; separate channel Record buttons with safety Interlock, selfholding pause lever; Rewind, Play, Fast Forward Stop Button. Input Selector Switch (Mike, Radio, Mix) Counter: 3 digit; 2 Record Level Meters; Outputs: 2 audio, 2 monitor; Inputs: 4.

DELUXE SOLID STATE 4 TRACK STEREO RECORDER

**ONLY
179⁹⁵**

NO MONEY DOWN

COMPLETE WITH:

- 2 Dynamic Mikes
- 7" Reel of Tape
- Empty 7" Reel, Splicing Tape
- 2 Radio Patch Cords
- 2 Line Cords
- And 2 Extra Plugs

- 4 Track Stereo—Record and Playback
- Vertical or Horizontal Operation

Outstanding stereo recording and playback facilities with this top quality solid-state tape recorder. Among the many features are: pause control, monitoring, built in 4x6" PM speakers, separate volume and tone controls for each channel and 2 VU meters. In addition sound on sound operation, automatic shut-off and a digital index counter are included. Plays up to 12 hours mono, 6 hours stereo with 7" reels. Jacks for mikes, auxiliary inputs and external speakers. Speeds: 7 1/2 and 3 3/4". Wow and flutter less than .25% at 7 1/2". Frequency response 60-15,000 cps at 7 1/2" ips. 60-10,000 cps at 3 3/4". Power output, 2 watt per channel. Oim: 13 3/4" x 16 1/2" x 8". Imported. For 110-120V 60c AC. Shpg. wt., 30 lbs.

27 A 0106WX \$9 Monthly Net 179.95

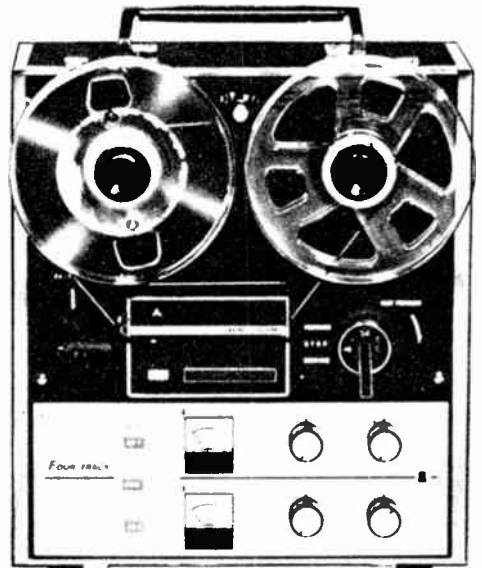

Tape Recorders Are Available on Easy Pay Plan—No Money Down

A Deluxe LAFAYETTE Model RK-675 4-Track Stereo Pushbutton Tape Recorder

FEATURES SOLID STATE STEREO RECORD AND PLAYBACK PREAMPLIFIERS

SALE!
139⁹⁵
WAS 159.95

- Records 4-Track Stereo, 4-Track Monaural
- Plays 4 and 2-Track Stereo and 4-Track Monaural
- 6 Pushbutton Controls • Sound-with-Sound
- Automatic Shut-off of Tape Transport
- Wide Frequency Response for "Life-Like" Reproduction
- Heavy Duty 4-Pole Capacitor Start Motor

An extraordinary self-contained portable tape recorder with professional quality features. Records and plays back 4-track stereo and monophonic tapes at 2 speeds, 7½ and 3¾ ips. Records from any source—radios, FM tuners, Hi-Fi stereo amplifiers or "live" from the quality dynamic microphones supplied. Makes sound-with-sound tapes . . . accompany yourself in a duet or add your voice to prerecorded music. The rugged tape mechanism features a heavy duty 4-pole capacitor-start motor. Gives smooth tape run, low flutter and wow. Automatic shut-off of entire transport at end of tape . . . disengages controls to neutral position . . . prevents tape spillage. Easy-to-use push-buttons

provide positive control of tape motion. Has separate interlocking record buttons. Magnificent tone is assured with 2 big 6x4" full tone speakers and side flaps for better stereo separation. Other features include digital tape counter, pause control for editing, 2 record level meters, and individual channel volume controls. Complete with luxurious simulated leather case, 2 dynamic microphones, cables and take-up reel for 105-125V 60 cycles AC. Size: 16¼W x 7H x 2¼"D. Shpg. wt., 35 lbs. Imported.

Model RK-675. \$7.50 Monthly.
99 A 1504WX Net 139.95
7" Reel of Lafayette Recording Tape
28 A 0101 Net 1.59

SPECIFICATIONS:

Frequency Response. Record/Playback: 40-18,000 cps @ 7½ ips; 40-12,000 cps @ 3¾ ips. Amplifiers: 4 transistors, 6 tubes; 1 full-wave bridge rectifier. Audio Output: 3-watts per channel. Signal-to-Noise Ratio: —45 db. Interchannel Separation: 45 db or better; Wow & Flutter: 0.2% @ 7½ ips, 0.25% @ 3¾ ips. Bias & Erase: 80KC; Rewind Time: Less than 4 minutes for 1200 ft. of tape. Speed Accuracy: 98%. Controls: Power/Speed Selector; Individual Volume for each channel; Variable Tone Control; Separate Channel Record buttons with safety interlock. Self-holding pause lever; Rewind, Play, Fast Forward and stop buttons, Input Selector Switch (Mike, Radio, Mix), Output selector switch (Mono, Stereo, Mute), Counter: 3 digit; 2 Record Level Meters; Outputs: (4) 2 audio, 2 monitor; Inputs: (4) 2 Mike, 2 Phono/tuner.

B NEW! LAFAYETTE MODEL RK-142A PORTABLE TAPE RECORDER

59⁹⁵

No Money Down

- With Recording Level Indicator
- ½-Track Doubles Play and Record Time
- Two Speeds—3¾ or 7½ ips
- Takes up to 7" Reels
- 4x6" Speaker for Fine Tonal Reproduction
- Provision for External Speaker
- New Pause Control for Editing

Perfect for home, school or office. At home, the RK-142A proves ideal for parties or recording your favorite musical performance. Handy fool-proof operation has been provided by a specially designed lever-type record switch which completely eliminates the chance of accidental erasure. Pause control for editing and instant switch speed selection. At 3¾ ips, the RK-142A provides more than 4 hours recording on long play ½ mil 2400 ft. tape reel. A special 4x6-inch heavy duty permanent magnet speaker furnishes an exceptionally fine tonal quality.

Record level indicator facilitates record by showing you when the volume control is correctly set. Jacks provided for microphone, phono and extension speaker (special alligator clip cord is supplied). Complete with sensitive dynamic microphone. Finished in attractive scuff-resistant material. Dimensions: 11¼x9¾x7¼". For 117 volts, 60 cycles AC. Shpg. wt., 22 lbs. Imported. Model RK-142A Deluxe Tape Recorder.

99 A 1524WX Net 59.95
7" Reel of Lafayette Recording Tape.
28 A 0101 Net 1.59

SPECIFICATIONS

TAPE SPEED: 7.5 and 3.75 ips. S/N RATIO: —42 db or better at 7.5 ips tape speed. REWIND TIME: 3 min. for 7" reel. FAST TAKE-UP TIME: 3 min. for 7" reel. RESPONSE: Record playback response essentially flat with tone at max. treble. WOW/FLUTTER: 0.2% or better at 7.5 ips; 0.3% at 3.75 ips. POWER OUTPUT: 2 watts. CONTROLS: on/off-tone; volume, record interlock button, speed selector, motor shift control with pause feature.

C The Widely Acclaimed LAFAYETTE RK-137A Tape Recorder

89⁹⁵

No Money Down

- Two Speeds—3¾ & 7½ ips
- Pause Lever Provides Instant Stop for Editing
- VU Meter Recording Level Indicator
- Electronic Track Selector Switch
- Heavy-Duty 6x4" PM Speaker
- Separate Erase and Record Heads

The RK-137A Tape Recorder contains a fine, quality constructed, smooth performing tape mechanism. Engineered to provide virtually every wanted tape recorder feature, the RK-137A performs brilliantly, with facilities for 4-track monaural record/playback and 4-track stereo playback *(when used with a second channel containing a tape head input such as found in a component Hi-Fi system). Controls are completely functional and are designed and arranged to make the RK-137A a genuine pleasure to use. Features include: a rugged, easy to use shift lever for fast rewind, fast forward, play and record functions; a special push-button safety record switch assures against accidental erasure of tapes; velvet-smooth volume and on-off tone controls; a pause lever instantly stops tape in motion, especially useful for editing; track switch provides fast, depend-

able electronic switching between tape tracks 1-4 and 3-2. In addition a VU recording level meter has been incorporated to indicate correct volume setting for recording. Speeds are adjustable from 3¾ to 7½ inches per second by means of a simple capstan adjustment. From a standard 7" 1200 ft. reel the RK-137A provides over 2 hours monaural record/playback time at 7½ ips and over 4 hours at 3¾ ips. Jacks are furnished for microphone input. High impedance Radio-Phono Input, Extension Speaker Output, Monitor Output and Stereo Head Output for playback of 2nd stereo channel. Supplied complete with dynamic microphone, shielded patch cords, and empty 7 inch reel. Imported. Shpg. wt., 22 lbs. For 117 volts, 60 cycles AC.

99 A 1511WX Model RK-137A Net 89.95
7" reel of Lafayette Recording Tape
28 A 0101 Net 1.59

FEATURING

4 TRACK STEREO PLAYBACK*
4 TRACK MONAURAL
RECORD-PLAYBACK

SPECIFICATIONS

Response: 40-15,000 cps at 7½ ips. 40-9000 cps at 3¾ ips. S/M Ratio: 40 db. Wow/Flutter: less than 0.3%. Channel Separation: 46 db. Inputs: Radio, Mic. Outputs: Stereo Tape Head, External Spkr., Monitor. Amplifier: Single Channel. Tube-type preamp and power amp. Tape Heads: 4-Track Stereo record/playback and erase heads.

COMPLETE WITH
CARRYING CASE, 2
DYNAMIC MICROPHONES,
OUTPUT CABLES AND
EMPTY 7" TAPE REEL



A DELUXE LAFAYETTE
MODEL RK-675 STEREO
PUSHBUTTON TAPE RECORDER

SALE! 139⁹⁵
WAS 159.95

**THE JOYOUS SOUND
OF MUSIC FROM A
LAFAYETTE RECORDER**



B DELUXE NEW! LAFAYETTE
MODEL RK-142A
PORTABLE TAPE RECORDER

59⁹⁵
No Money Down

COMPLETE WITH
DYNAMIC MICROPHONE,
SHIELDED CONNECTING
CABLE WITH CLIP
LEADS AND EMPTY
7" REEL.
Takes Tracks up to 7 Inches



COMPLETE WITH
SHIELDED PATCH CORDS,
MICROPHONE AND EMPTY
7" REEL LIGHTWEIGHT
CARRYING CASE

C WIDELY ACCLAIMED
LAFAYETTE RK-137A
TAPE RECORDER

89⁹⁵
No Money Down

LAFAYETTE
RADIO
ELECTRONICS
 111 JERICHO TURNPIKE
 SYOSSET, L.I., N.Y. 11791

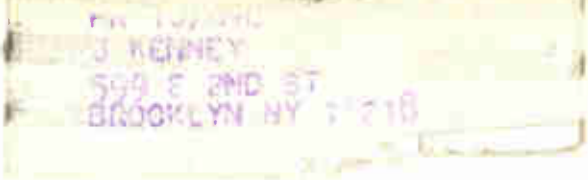

BULK RATE
 U.S. Postage
PAID
 LOUISVILLE
 KENTUCKY
 Permit No. 599

POSTMASTER
 IF UNDELIVERABLE DO NOT RETURN

4 5-6

New! LAFAYETTE Model LR-880T 70 Watt Solid State AM-FM Stereo Receiver



- Uses 66 Semiconductors for Extreme Reliability
- Space Age Printed Circuit Modules
- FM "Stereo Search" Circuitry for Fast Stereocast Identification
- Sensitive Wide-Band FM Tuner With Virtually No Cross Modulation—4 IF Stages
- Transformerless Output Circuit for Minimum Distortion
- Powerful 70-Watt Amplifier with Electronic Short Circuit Protection
- Stereo Headphone Jack and Tape Monitor

The LR-880T, Lafayette's exciting solid-state Hi-Fi receiver sets a new standard of performance at a remarkably low price. Space-age circuitry gives you 70-watts of instantaneous music power at 8 ohms without the use of distortion producing output transformers. The equally superb solid-state tuner section features the famous "stereo search" circuit to audibly signal the presence of FM stereo broadcasts, 4 FM IF stages, excellent selectivity, stereo separation and rejection of SCA storecast interference. Large easy-to-read slide rule dial has precision signal-strength "tuning" meter for accurate station tuning with smooth flywheel action. Also receives exemplary AM too. Colored lights on dial face show at a glance your external program source (Phono, Tape Head, Aux.). The beautiful gold anodized extruded aluminum

panel features a full set of easy-to-operate controls. These include: Power On/Off Tuning; Volume; Balance, dual concentric Bass and Treble; 5-position Mode switch; and 6-position Input Selector switch. Positive action, more reliable rocker switches are used for Loudness; Speaker/Headphone; Stereo Multiplex Noise Filter; Tape Monitor and Stereo Search. Convenient front panel stereo headphone jack. Stereo inputs are provided for tape head, magnetic, crystal or ceramic phono cartridges and auxiliary (high level) sources. Has built-in ferrite bar AM antenna, terminals for 300-ohm FM twinline. Fused, well-regulated power supply. Size: 17¾x 5½x14"D. Includes case. For 110-120 volts, 60 cycles AC. Imported. Shpg. wt., 28 lbs.

99 A 0152WX \$11 Monthly Net 219.95

ONLY
219⁹⁵

with case
 No Money Down

LR-880T SPECIFICATIONS

Power Output: 70 watts IHF, 35 watts per channel. Response: ±1 db 20-20,000 cps at rated output. Harmonic Distortion: less than 1%. Hum & Noise: High level, 72 db below rated output; Low Level, 60 db below. IHF FM Sensitivity: 2 μV for 30 db. Stereo Separation: 35 db. Cross Modulation Rejection: 95 db. Universal Speaker Outputs: (4, 8, 16) ohms. SCA Rejection: More than 50 db. Semiconductors: 40 transistors, 8 silicon diodes, 17 germanium diodes, 1 Zener diode, 2 AC receptacles, 1 switched.

LAFAYETTE 70-Watt Stereo System with Model LR-880T AM-FM Stereo Receiver

LAFAYETTE Model LR-880T 70-Watt Solid State AM-FM Stereo Receiver	219.95
Garrard Model 50 4-Speed Record Changer	44.50
Pickering V-15/AT-2 Diamond Needle Cartridge*	19.95
Wood Base for Record Changer (Oiled Walnut)	3.95
2 LAFAYETTE "Criterion 100A" Deluxe 2-Way, Ducted Port Shelf or Floor Speaker Systems (Oiled Walnut)	89.90
TOTAL	378.25

SYSTEM PRICE

295⁰⁰

Above stereo system with *choice of Pickering V-15/AT-2, Shure M7/N21D, or Empire 888 Cartridge, plus necessary cables and instructions. Shpg. wt., 110 lbs.
 21 A 9098WXM \$15 Monthly Net 295.00

SAVE \$83.25
 from Individual Catalog Prices

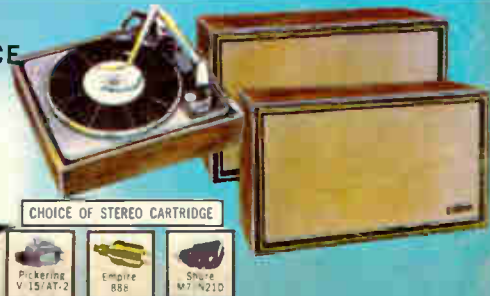

CHOICE OF STEREO CARTRIDGE

Pickering V-15/AT-2	Empire 888	Shure M7/N21D
---------------------	------------	---------------